

# Earths Forbidden Secrets

Part One

## Searching for The Past



# MAXWELL IGAN

*Lovingly dedicated to:*

*my son Daniel,  
my mother Pauline  
and  
my father Bill.*

# Earths Forbidden History

Part One

## Searching for the Past

By

Maxwell Igan

# Authors Note



The main goal of this book is to provide information to people, much of it that is sometimes quite well hidden. It is my sincere hope that everyone who reads this work will be inspired to question things; and to search out these, and other new truths and discoveries for themselves.

When I first started this book, it was my desire to cover a really huge variety of topics and put a vast amount of 'hard to get' information all in one epic work. However, after several months of work the word 'epic' began to take on a new meaning for me and the sheer volume and intertwining nature of the text became far too cumbersome to be deemed in any way manageable in a single book and, though the information herein is still quite vast, I was forced to remove several chapters of work.

Due to the detailed nature of the topics I sacrificed in this 'slicing process,' it is more than likely that each sliced chapter will now be further divided into smaller portions before then being expanded upon into a number of separate volumes to be released at later dates.

The principle source of the Biblical quotations in this book is the original Hebrew version of the Old Testament from the 1992 Jerusalem Bible. This is because when all is said and done, all other version of the texts are simply the translations and interpretations of various individuals and ultimately it is what is written in the original Hebrew version that really counts. All English biblical quotes are taken from the King James Version. A full bibliography of other sources is also provided at the close of the book.

I do not ask or expect anyone to blindly believe what is written within the pages of this book without investigating all the evidence for themselves, and in fact I very much *urge you to do so*.

In the meantime however, I hope you find this book informative and enjoyable and I thank you in advance for taking this time to read it.

Remember, the truth is always out there somewhere, and sometimes, right in front of us too, if we would only notice.

- Max Igan

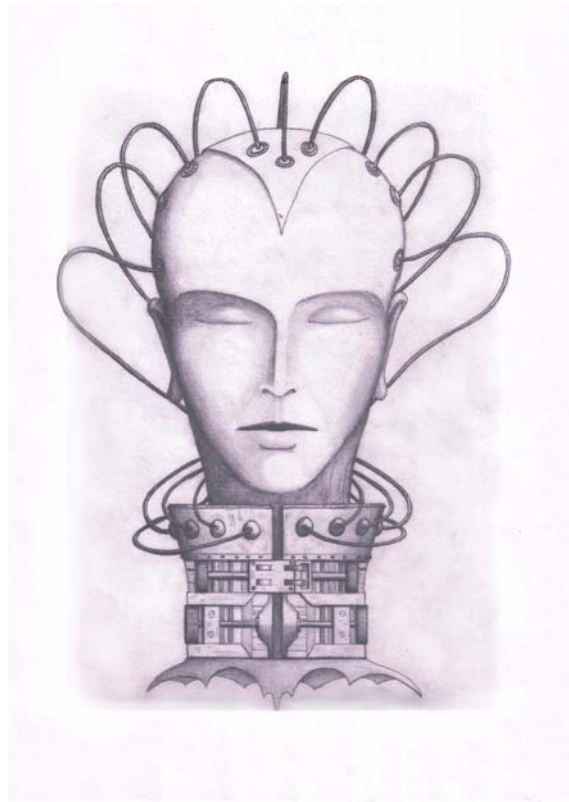

“If you are thinking 1 year ahead, plant seeds  
If you are thinking 10 years ahead, plant a tree  
If you are thinking 100 years ahead, educate the people.”

- Chinese Emperor Kuan Tsu, 5<sup>th</sup> century BC

# Earths Forbidden History

## Part I

### Searching for the Past

#### Table of Contents

1. Enigma & Conspiracy
2. Riddles from the Past
  - The Piri Reis Map of 1513
  - The Orontius Fineus Map of 1531
  - The Bauche Map of 1737
  - The Franco Rosselli Map of 1508
  - The Mercater Map of 1538
  - The Egyptian Pyramid
  - Aztec Earplugs?
  - The Lost Necklace
  - The Mysterious Metal Vase
  - The Puma Punka Stone
  - The Nasca Lines
  - The Ica Stones
  - Ancient Nanotechnology
  - A 500,000 year old Spark Plug
  - Stone Age Modern Hand Tools
  - A Fossilized Human Handprint
  - An Ancient Calculator?
  - Baalbeck
  - An Iron Pot in Coal
  - Evidence of Advanced Medical Knowledge
  - A Petrified Human Skull
  - Ancient Electricity
  - An Ancient X-Ray Machine
  - A Fossilized Human Shoeprint
  - The Dropa Stones
  - A Fossilized Human Finger
  - A Brass Bell in Coal
  - The Rhodesian Man
  - A Pillar of much too Pure Iron
  - 2.8 Billion year old Metal Spheres
  - The Crystal Skulls
  - The Nampa Image
  - The Dogon
  - The Giant Stone Balls of Costa Rica
  - The Lanzhou Stone
  - The Colorado Pavement
  - The Kentucky Pavement
  - A Fruit that really shouldn't exist
  - Loose Ends

3. Of Lost Explorers and Ancient Mysteries

A Lost Frontier  
Fawcett's Tale  
Impossible Buildings  
Softening Stone with Plant Extracts

4. A Valley of Kings

The Giza Valley Complex  
The Great Pyramid  
The Sphinx  
Investigations of the Facts  
The Date or not the Date?  
Stone Synthesis according to the Ancients  
Modern Techniques for Synthesizing Limestone

5. The Death of a God

The Broken God  
A Dragon Whips its Tail  
Strange Connections

Part Two:

Investigation

6. The Lost Lands

A Sunken World  
The Golden Empire  
Possible Physical Evidence  
Great Southern Land  
Tracing the Outline

7. The Case for Ancient Flight

The Story of Icarus and Daedalus  
Babylon  
China  
India  
Egypt  
Columbia  
The Amazing Vymanika-Shastra

8. The Remapping of Prehistory

Fact vs. Fiction?  
Door Number Three  
Wings in the Night  
The Dragons of St. George  
Gradualism vs. Cataclysm  
The Flipping of the Mill

9. The Tale of the Sumerians

The Art of Translation  
In the Real Beginning  
The Epic of Creation  
Tales of Gods and Men  
After the Deluge  
The Downfall of Kings

10. The Maya

The Story of the Maya  
The Luck of Cortez  
Quetzalcoatl

Part Three:

Analysis

11. Creation Connections

Connecting the Dots  
Manco Capac & The Golden Wand  
The Lost Mines of the Gods

12. The Signs of War

The Evidence for Ancient Advanced Weaponry  
Castles of Glass  
The Radioactive Skeletons of India  
The Shattered Desert  
Tektites  
The Harpoon of Horus  
The Mysterious Sinai

13. The Grand Deception

The Cover Up in Motion  
A Mosaic of History  
The Politics of Control  
Of Hobbits, Dinosaurs & Alphabets

14. Forgotten Codes

The Great Puzzle  
Science and Religion  
Divine Codes

15. Afterthoughts

A God of Science & Numbers  
Our Newest Neighbor  
A New Doctrine



Part Four:  
Appendices

*Appendix 1.*  
A History in Myth

*Appendix 2.*  
The Enuma Elish

*Appendix 3.*  
The Mayan Calendar

*Appendix 4.*  
The Hopi Blue Star Prophecy

Sources

List of Plates



# Prologue



It has been often said that it is only by gaining a true understanding of the Earth's past that we can ever hope to find the vital key to understanding its future and in turn, our own. Such notions have always caused mankind to ponder himself, our planet, the stars, the universe, and beyond, but much of this thought invariably returns to thoughts of the past and the nature of God.

Mankind has always wondered such things and ever since the dawn of our recorded history there have been countless stories and legends to tempt the matter further: Myths from the depths of time that hint of other, far more Ancient civilizations, like ours in the 21<sup>st</sup> century or even better, that once dwelt in mysterious lands, some of which have long since disappeared beneath the oceans. In many of these ancient stories we read tantalizing and bizarre accounts of strange and unknown technologies, tales of ancient gods, flying craft and ancient foes waging great wars against each other, wars that were fought with fantastic and devastating weapons.

Over the years a great number of scholars have attempted to dispel these tales as rumors and fanciful myths yet still the stories have persisted and in a strangely unnerving re-enforcement of them, we find, dotted across our planet, the remains of immensely ancient and enigmatic structures of unknown origin and even more bizarre things.

Archeologists and explorers have uncovered amazing pyramids, megalithic stone cities and magnificent structures of intricate difficulty. Many of these structures are built in ways that are utterly unknown to us and even still defy our current levels of technical expertise.

How did they get there? Who built them and what was their purpose?

Do they all share a common link and if so, what is it?

Strange and incongruous artifacts built by amazing and unknown technology that irrefutably dismantle the Academic presentation of our history have also been found in places where they simply have no place being, and there are curious stone Stele's and cave paintings also depicting seemingly impossible scenes from our far distant past.

So many of these types of things have now been recovered, from such a variety of locations, that they can no longer be simply classed as unusual artifacts and dismissed as 'curious'.

In recent years there has been a veritable storm of writers, almost reaching saturation point, warning of dire times to come, Global War, Massive Earth changes, Armageddon, the fulfillment of dark prophecies and a doom that has been long foretold that will soon descend upon our world. Let's face it, it has always been easy to sell Doomsday; it has been done ever since man has lived within organized communities and there is always someone who is willing to listen. But is there any tangible evidence for these claims and in what form does it take?

In recent years, startling new discoveries have been made and fresh evidence has been unearthed that may help us to answer many of these and other, even more profound riddles and perhaps shed the light that has been sorely needed to illuminate many other theories. Evidence

that may now at last force us to re-adjust our mindset and radically rethink the way we have viewed the earth, our history and ultimately, our future. The information is as important to mankind as it is urgent but, in an almost unfathomable act of irresponsibility, it is still for the most part, being ignored by Governments and Academics, all over the world.

The arguments and conclusions contained in this work are the accumulated result of over 25 years of investigation and personal research. Many of the arguments presented here are not new, but new discoveries however small, can at times reveal a new importance and add a new and significant relevance to old theories. Plus in order to see the larger picture, the many smaller pieces of the puzzle must first be put into order.

One of the purposes of this work is to demonstrate that there is in fact, an abundant amount of evidence, much of it in full view, that proves beyond any shadow of doubt that there was indeed an advanced civilization that existed on this planet in ancient times, the traces of which can be found every where. There are even tantalizing hints of even more, something that they may have left behind for us to help us to decipher the celestial information they deemed so important.

This book will demonstrate that all mythologies and many recent discoveries in virtually all fields of science now present irrefutable evidence to us that our history is simply not what we're being led to believe; and not only that, but "the Powers that Be" know full well of this startling information but quite obviously refuse to allow the knowledge to become public.

This work intends to present undeniable proof of a history that the public at large has been forbidden to see. We will then examine the implications its existence holds for our past, our present, and our future – Indeed, for us all.

Ninety percent of all wars that have been fought in the last 2000 years have been waged over religion and yet all religions ultimately stem from the same source. It has been said that if all of mankind were truly educated in the singular source of all religions and in the true nature of our world and mans relation to it, there could never possibly be wars fought over doctrines described in books. The Ancients, we shall see, had no religion, as such, but instead had what could be described as a deeper knowledge of reality, a science and religion that were both integrally combined into a way of life.

Education is mankind's greatest natural resource. Only through total education can mankind truly ensure a balanced and harmonious future, and in a world such as ours, education should be free and mandatory. With proper and open education everything else falls into place.

The scholastic institutions we have established for ourselves are in fact highly detrimental to the pursuit of true learning and the current distribution of selected knowledge based on the economic ability of the individual can ultimately only lead to a break down of our society such as we are even now beginning to witness on our streets. Yet even with this, education is always one of the lowest expenditures in the budgets of any given Nation.

Education and knowledge should not be the property of an elitist club greedily hoarding its wealth, but a free and open establishment designed for the benefit and progress of the whole of mankind.



Part One

# Evidence

“Those who do not remember the past are condemned to repeat it”

- George Santayana

## Chapter One

# Enigma & Conspiracy

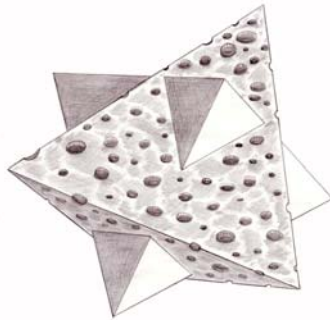

“To see the future you must look backwards” - the book of Isaiah

The beginnings, both of earth and of man, are a complete mystery.

The theories concerning our beginnings that we have been presented with, by both Academics, who talk of evolution and gradualism; and by Theologians who claim creation, are each fraught with a myriad of inconsistencies and contradictions. In reality, the true histories of both man and of our planet are still an enormous riddle. It would seem that all anthropological, archeological and now even genetic evidence says that modern man simply does not belong here.

The question was posed by scholar Zechariah Sitchin in this manner: *“If life indeed began through a series of spontaneous and random chemical events as evolution and science has so far surmised then why is it that all life on Earth stems from a single source and not from a myriad of different sources that were each arrived at by chance? And most importantly why does life on Earth contain so few of the chemical elements that can be found in abundance on the Earth yet so many others that are in fact, celestial elements, and rare to our planet? Could it be possible that the seed of life did not actually evolve on the Earth but in fact came here from somewhere else?”*

We have, in some ways, gained some insight into the very first stages of our Solar System and our home planet. How it was first formed from the gases, elements and primordial stuff of the universe, gradually cooling into a solid sphere and how the elements then reacted and combined until somehow at last, the spark of life was born; but from then on, it becomes a little hazy.

Embracing evolution, scholars have taught us that all life on earth first came from the sea, gradually finding limbs and crawling its way onto land where it slowly evolved to form new creatures, and eventually birds, animals and all other life. We are taught that in ancient times, well before the dawn of man, strange prehistoric beasts of huge proportions ruled the earth, enormous cold blooded reptilian creatures, which we have named Dinosaur, meaning: "Terrible Lizard." It is believed they first appeared around 193 million years ago and reigned supreme until most were wiped out some 65 million years ago in the shattering impact of a meteorite or comet fragment in the vicinity of the Gulf of Mexico. The event caused mass extinctions among many species by covering the entire globe with a cloud of dust and debris plunging the planet into a nuclear winter and a devastating ice age. But, almost miraculously, small pockets of the prehistoric creatures somehow withstood the ravages of cold, survived the ice age and continued to evolve. Then there is a kind a 'grey area' during which the first man evolved from apes and began life in caves some 2 to 3 million years ago. During that time primitive man is said to have evolved from primates through to Australopithecus, Homo-Habilis; Homo-Erectus; then Neanderthal species, which eventually declined to be replaced by Cro-Magnon a species that was very similar to modern man that seemed to appear apparently from nowhere. Then eventually Cro-Magnon was itself replaced when the first species of Homo-Sapiens was born about 250,000 years ago. Homo-Sapiens-Sapiens or modern man is said to have first appeared about 40,000 years ago, at which point it's not considered to be too 'grey' anymore and we're told that mans history then becomes a relatively straightforward affair: Over time, man ceased dwelling in caves, learned to become hunters and gatherers, formed villages to live within organized communities and slowly progressed to civilization about 6,000 years ago, eventually learning to sail and travel, and finally culminating in our current civilization and advanced level of technology.

We are therefore, in the 21<sup>st</sup> century, at the very cutting edge and peak of mans technological achievement so far. Never before in the history of our species has man had such wonders at his fingertips as those we have created for ourselves in the brief moment in time that is the 150 odd years since the industrial revolution of the 1800's – apparently.

All scientific investigation into our past up to this point has been designed to fit within this orderly paradigm. But due to these restrictions, and even with all of the significant advances in technology we may have made in the past 150 years, we have made very little progress in solving the puzzles presented to us by the earths past.

The reality is that our distant history is still an enormous riddle. We only know what we do from the gradual piecing together of the many enigmatic and confusing traces that have so far been recovered from around the world, but our true knowledge of ancient history still remains confusing, unknown, or fragmented at best.

All we really have are various creation myths and theories. And it must be clearly understood here that in the case of archeology and even evolution, theories are really no more than ideas and possibilities; one person putting forth what they see as a rational scenario based on the various information or artifacts they have personally been able gather and study. A hypothesis or *possibility* based on available evidence. These theories are then put forth to the Academic community for peer review and when the evidence that led to the conclusions has been tested and assessed and criticized and re-assessed and re-criticized and the idea has been deemed agreeable by all parties, an overall assumption of fact is born. This "fact" can then be used as a basis, or 'rule of thumb,' for further studies; that is, until someone else comes along and disproves it by discovering and proving a new 'fact'. That is how peer review works.

For example: the theory encompassing the entire history of mans ascension that was just described for you on the second page was surmised from scientists studying a total collection of a mere 200 hundred bone fragments, which was the entire amount that had been excavated and recovered from around the world at the time. And the theory has never really been subject to any serious revision or academic challenge.

The entire theory is also based on the assumption that Darwin was correct...

But what if the basic supposition that was used as the ‘rule of thumb’ in many of these cases was erroneous to begin with?

What if it didn’t happen that way at all?

What if our history did not actually run as has so far been believed?

Surely if it could in any way, shown to be possible that mans history and indeed the entire Earths history ran in a completely different way to what has been currently theorized, *and taught as fact*, then shouldn’t that be investigated too? Shouldn’t all avenues be exhausted before being dismissed, until the whole and real truth is found?

Isn’t that true investigative science?

Well, yes it is, but the trouble unfortunately, is that modern science contains a certain amount of Politics and well, people just simply hate having their theories proved wrong. In fact it’s always been that way. As history recalls to us, the great scientist Copernicus wasn’t even game to release his theory on planetary rotation until he was on his death bed and it was his very last day of life; and just look at what happened to Galileo. Even Newton, as admired and respected as he was, never announced his involvement in Alchemy and his search for the hidden codes of creation he believed were locked within the words of the Bible until death, for fear of being tried for heresy. In that respect, it appears that things haven’t really changed a great deal.

If the truth be known, and in stark contrast to the currently accepted view of history we are presented with by Academia, there are certain, and quite numerous, telltale signs on our planet and in our solar system at large that suggest a very different course of events than the orthodox tenet, and there are also other more esoteric signs that can be found around the world, evidence that has been left by our ancestors clearly suggesting that they possessed a very extensive and extraordinarily detailed knowledge of these events and of the behavior and workings of our planet and solar system. There is also evidence that they based entire cultures on these celestial events and believed them to be moments of incredible significance for mankind and for the earth. And there are also tantalizing hints of a long forgotten method to decipher these earthly and celestial signs, if we could but find a way to read and understand them.

I understand of course that most people who disagree with the theories of Charles Darwin are almost automatically labeled as ‘creationists’ but I assure you that this is by no means the case.

In all reality, after even a cursory investigation, biblical creation stories are far too contradictory to make any real sense. Also, in the case of the biblical tale, the really disturbing part is that the story is not actually original to the bible as has been claimed but is in fact, as has now been adequately proven, a borrowed, greatly edited version of a much earlier, more complete account.

By way of comparison, the orthodox accounts and theories of evolution and mans past history that we have been given by Academia, (*and that are now presented to us, virtually as concrete facts,*) are also patchy and problematic at best, while some can even appear quite fanciful.

The real problem with both theories being, that they simply cannot account for a great many details and, in many cases, are both vastly contrary to quite solid evidence.

But cunningly, when such evidence is found, if it appears to, in some way, prove our history to be different to what is taught; it is hurriedly dismissed, ignored, hidden, thrown into a dark basement locker or somehow, mysteriously ‘lost.’ In the past many such acts of intellectual vandalism were often committed in the name of various religions in an effort to maintain supremacy. Such things are probably to be expected by religious organizations as most are essentially insecure in their foundations and need constant reinforcement, but when we find these deeds also being committed within the scientific community it becomes far more sinister and disturbing. In an institution of learning such an attitude can only be described as detrimental to the true pursuit of knowledge and extraordinarily unscientific – at best. And have you ever noticed how many Scholars that do actually come forth with a different theory about our past, and seriously attempt to discover and debate the real truths, often have their efforts constantly thwarted and are invariably ridiculed and ostracized? And not just by Academia either, many are quite often terribly vilified through legal, social, and media channels as well. It seems incredulous

how much trouble and effort is actually gone to in order to stifle their information and perpetuate what appears to be, an enormous myth that is being currently presented to us as historical fact.

The real truth of the matter is that almost every continent on earth can lay claim to some strange or unusual relic from the past that cannot easily be explained by either Academics or Theologians. Many scholars have attempted to explain away or quietly dismiss such enigmas off handedly but there are simply too many that have been found and even more that continue to be unearthed that just cannot be explained away.

Where then, did all these things come from?

Do we need to know? Are they all nothing more than a collection of interesting and unexplained “oddities” from a past that is largely unimportant to our future lives, or is there actually something of benefit, or even great importance, that we can learn from them?

Was there a real reason for the people of old to have gone to such a ridiculous amount of effort to create the many intricately detailed works of such amazing precision that have been recovered, or to build such incredible structures? Could there be some message contained within the structures of these Ancient Places that we may be missing? If these ancient structures were really designed purely as Temples then it certainly seems that these people went to an awful lot of trouble to build them and to make sure we would notice their work. Or could it be that many of them were perhaps something other than merely temples or fortresses?

When examining some of these structures it seems inconceivable, almost incomprehensible the people who lived in our distant past could possibly have ever created such enormously impressive stone monuments and delicately tooled items, but somehow, they are there – and we’re not just talking about a couple of odd items here either, there are absolutely hundreds of them in all shapes, sizes and forms. Ancient Monuments, Sunken ruins, Incredible Pyramids, strange and ‘out of place’ artifacts of a scientific or mechanical nature, and even odder things, in almost all countries, right across the entire expanse our globe.

Thankfully, in recent years a number of very reputable scientists, mathematicians and archeologists have begun to realize that things are quite simply not what they have seemed and are beginning to explore some of the more radical possibilities of mans beginnings that evidence has suggested. In this time several new fields of study have also opened up within the science community. Undoubtedly one of the most intriguing of these fields must surely be the study of ‘Ooparts’ or ‘Out-Of-Place-Artifacts’ though often the study of these Ooparts can present a good deal more questions than it can answers.

Before the study of Ooparts was recognized as a genuine (*though still highly criticized*) field of study, such items were usually considered merely as curio’s or archeological oddities. An out of sight, out of mind approach was invariably adopted towards any such artifacts and they were quickly locked away or, in acts of gross irresponsibility, dumped at sea before anyone noticed, so as not to rock ‘the archeological, anthropological or historical boat’, so to speak. Many such artifacts are rumored to have been dumped off the coast of America by the Smithsonian Institute – after all, who wants to re-write all those history books? Such out of place artifacts were usually deemed ‘painful’ or ‘time wasting’ because they invariable provide evidence that is contrary to the orthodox tenet we are presented with, and they raise far too many questions for the closed minded. They can be the most intriguing questions too. All of these artifacts ultimately question our past as they simply *don’t belong* where they were found and definitely don’t fit in with in with what we “*know*” to be mans history. Yet here they are, right before our eyes. For example:

How could ancient Jewelry bear evidence of electroplating?

How could a stone slab and set of earplugs from the Aztec era bear the signs of being machine cut at a time when there were supposed to be no machines?

How can there be ancient maps that accurately show the Antarctic coast and continent, free from ice, hundreds of years before it was even discovered?

How could a lump of coal have a delicate gold chain trapped inside?



How can there be numerous signs on earth that suggest ancient atomic or nuclear warfare?  
How can ancient Indian texts contain scores of pages of complicated flight manuals?  
How can 'modern human' fossils exist?  
How could people in ancient times have moved 800 ton blocks of stone?  
How could the Mayans have built those gap free Megalithic Fortresses?  
How could a 500,000 year fossil encrusted geode contain a spark plug within it?  
How can there be a computer code or algorithm encoded into the text of the Bible?  
And that's just a few of the examples. There are literally dozens more.

In the ensuing investigations of such enigmatic riddles and artifacts there have been many amazing, and sometimes downright outrageous, statements made by people in numerous publications throughout the world; so many in fact, that it becomes difficult to distinguish truth from fiction. Theories have been put forth concerning vast armies of slaves, teams of craftsmen devoting their entire lives to the completion of one small object, Master stone masons, Alien Intervention, Beings from other dimensions, Time Travelers, 'Gods' from other planets.

All have been suggested as possible explanations, and the list goes on.

At this point you may be asking, 'But why should we really care anyway? What's all the fuss about? The past is just the past - isn't it?'

Well, interestingly enough, such may not always be the case, because the past may also be a good indication of the future and, (*notwithstanding the fact that it would just be awfully nice to actually know the truth,*) there are many scholars who believe that there are certain routine events that occur on Earth that concern both mankind and the planet we live on significantly. Many believe them to be events that are, in fact, a normal part of our solar system's rotational mechanism and that they happen in regular and predictable orbital cycles.

There also is real evidence to suggest that the people of Earth's ancient past possessed some very detailed information concerning these events. Many of them based *their entire cultures, sciences and religions* on them! And there are also other more esoteric signs: Enigmatic references and hints of a hidden book or code with which we may be able to unlock these mysteries of our past and future.

At face value, it seems significant that those people who inhabited our far distant past quite obviously considered a detailed understanding these celestial events to be far more noteworthy and important than any other religious knowledge, science, or indeed, *anything else at all!* In fact, they considered the information to be *so* important, that they appear to have based their entire civilizations upon it.

The question is why?

Why such an extraordinary preoccupation with astronomy and the Zodiac? What for? What kind of information could they glean from such a constant and accurate scrutiny of the heavens that they deemed so important that it would account for the meticulous degree of perfection insisted on in aligning their structures? How on earth did they acquire such extraordinarily sophisticated knowledge to begin with? Who or where could they have possibly acquired such information *from*? Much of it is data that would probably be extremely useful to us today and yet we have only learned a fraction of it and we are still searching through ancient myths and modern sciences trying to fully comprehend that which we have so far managed to gather.

Most people think of the zodiac as names for nice patterns in the sky or a report they read in a daily newspaper but the Zodiac is actually an incredibly complex celestial mechanism. It must be clearly understood just the ancient knowledge of its existence is astounding because even a basic understanding of the phenomenon of precession of the zodiac requires some very advanced scientific know how to obtain. It does not happen from someone merely observing the stars, even if they were to spend their entire life doing so, and yet we ourselves obtained our knowledge of precession and the cycles of the zodiac from the ancients, not through discovering it of our own accord.

*Even when the earth was still believed to be flat, man had knowledge of the zodiac and precession of the equinoxes.* Precession is the result of a slow axial wobble the earth maintains as it travels around the sun so how could that possibly be?

This fact alone presents substantial evidence that our history may not be really what it seems. And if our history really is substantially different to what has been presented to us - and may truly hold significant information in regard to our future as the evidence seems to suggest, then why is the *real* information being withheld from the general public?

It is one of the intentions of this book to examine many of these subjects and the urgent significance it holds for us all. But be warned, to properly answer to these questions, we have to be prepared to assimilate a vast amount of data and to look outside of the orderly academic framework we have been given of our history.

We must also be prepared for the moment, to objectively look outside of any currently prevailing religious belief system we may embrace and attempt to examine *all* of the evidence with an *open mind* before blindly believing any doctrine.

Please understand at this point that it is not my desire to attack any religion or creed during the course of this book, nor do I wish to diminish anyone's personal religious beliefs, my sole intention is the presentation of facts and an examination of the implications that are presented to us through a rational assimilation of *evidence*. For those of you who are religious, I ask to remember before dismissing any of this evidence offhandedly that Jesus himself said: "The Truth shall set you Free!"

If any person reading this belongs to a religious organization that rests on a foundation so frail that it cannot be faced by the facts and hard evidences that will be presented during the course of this work then I would suggest that it may be prudent for them to examine their surroundings and consider the sad possibility that their faith may have been misplaced. Especially those poor unfortunates belonging to the new wave of unbelievably misguided radical Islamic groups who somehow mistakenly believe they are doing 'the will of Allah' while in fact twisting the words of their own faith beyond recognition and blowing themselves and others up in the unfathomably deranged belief that mass murder leads to paradise and they will be '*gwine up t' hebben*' if they kill those who embrace a different belief system. But then most such individuals are usually banned or prevented from reading anything that may interfere with their doctrine anyway.

Radical religious extremism seems to have been in our world since the onset of religion, either from one side or the other. Of course back in the 15<sup>th</sup> century it was Christian suicide bombers like Guy Fawkes trying to blow up London and not those who embrace Islam, but the same extremist misinterpretation of doctrines was evident even then.

In any serious attempt at discovering the real truths to our past differences of Religious opinion should be set aside and there is no piece of information that should be left out. Not anything. No ruin, artifact, doctrine, myth, legend, fossil, Oopart or otherwise, should be considered too small or insignificant to be included in the puzzle and examined for its relevance. For without all the evidence, discovering any real answers to our past without contradictions would not be possible and be no more than another fanciful theory.

But the thing is, my intrepid reader, when you really get involved in the topic and look at what data actually does exist – much of it in the form of hard physical evidence, that completely and utterly dissolves both our Academic and Theological views of history – you see it re-enforced by a myriad of ancient texts; then you witness the extraordinary lengths that some Governments and both the Academic and Religious communities at large are willing to go to, just to keep the information out of the public eye, it becomes very hard to keep the word "conspiracy" from springing to mind. And you can forget the media.

Naturally, I'm well aware that whenever anyone mentions the word conspiracy these days, especially when referring to the science or archeological community, they are walking on very thin ice and toying with their own credibility. The modern world tends to be very skeptical about

conspiracies unless we're talking about Al Qaeda, or perhaps some other terrorist splinter cell either real or invented, and the scientific community considers itself to be reasonably impregnable behind the walls of Academia it has created for itself and they simply hate people who attempt to tunnel in underneath and undermine their Doctorates..

We have been deeply conditioned to immediately associate the word 'conspiracy' with the word 'theory' yet if one is to analyze the nature of what a conspiracy really is it suddenly becomes easy to see a number of them happening all around us, almost every day.

All a conspiracy actually consists of is two or more people, maybe even a committee, deciding to do something in order to achieve a mutually desirable outcome for themselves – and not really telling anyone else about it. One person just needs to say “Hey if I do this and you do that, then this should happen and we'll be better off!” and Bang! You have a conspiracy. Just look at insider trading, there's a nice little conspiracy for you.

A conspiracy can take many forms, some more complex than others. Look at price fixing; and what do you think our World Leaders are doing when they're meeting behind closed doors? Socializing? Playing darts over a couple of beers and talking about the garden? No of course they're not. They're planning moves for the future - 'negotiating'; saying, 'If you do this, I'll do that'. Well gee, sounds like - (*you've got it*) a 'conspiracy.' Even in tandem if you want get finicky about it because they are doing it all behind closed doors – our Publicly elected 'Leaders of the Public' have privately 'conspired' to discuss things that concern the public *out* of public earshot. They've '*conspired to further conspire*' if you like. You know how it goes...

Lets be realistic about it, criminals are charged with conspiracy regularly, in fact two persons with criminal records need only converse with each other to be charged with conspiracy. Yet when someone mentions the word conspiracy in regards to the government or especially the Academia Community there is invariably a huge media storm whipped up around them and they are publicly ridiculed.

So are we then to assume that no one but criminals or terrorists ever plan things together in private in order to achieve an outcome that is mutually favorable for them? I mean in reality, isn't that what politics is actually all about? That's why parliaments have closed sessions: to plan things, '*to conspire*' so they all know what the next move will be, entire economies can either flourish or flounder from the outcome of such meetings, its called politics, if done on a corporate level we call it insider trading and you go to jail. It's a bit obvious really but in actual fact, in the *real* world, conspiracies happen virtually all the time.

Blatant double standards constantly flown in full public view while being cunningly denied can always be a fascinating topic but, when used by powerful governments who don't even bother to disguise them any more, they can also become a little scary too. Don't get me wrong, I don't like to think the worst of anyone, but looking at it logically and realistically; what, after all, was the blatant invasion of Afghanistan and Iraq by the 'Coalition of the willing' (*or was that a coalition of the economically coerced?*) if not a conspiracy to deceive the peoples of at least three nations, if not the world.

Of course, when initiating any such mass deception, the best way is to prevent any *real* conspiracy from being exposed is to create an unending air of ridicule around anyone making the claims purporting to it. This is because if you can make the person look stupid enough in public – whether they are or not, even by dropping snide little comments here and there at the correct moments, then other people won't want to listen to what the person is saying either – even if its very important and concerns them greatly. You get the 'Ooh but some people say...' syndrome; it sort of goes like this:

*“Some people say the theory is stupid! ...What, you believe it? You're kidding! But wait... you're not stupid too are you?”* ...it's a tried and true formula.

No-one wants to feel that they might be thought of as stupid or weird, now do they? Politicians and media tend to use this method frequently, while the Fox (*Fix*) news network seems to have refined it down to an art form. They do it to promote the party line but just always seem to

neglect to mention who these ‘Some People’ actually are. Of course, due to cunning media portrayals, to make an actual conspiracy appear virtually non-existent to the public, you just have to put the word ‘theory’ in the same sentence or even just publicly call it a conspiracy *claim* and the public subconscious will automatically associate it with the word ‘theory’ and view the person making the claim as a ‘conspiracy theorist’ then everyone will start thinking of The “X-Files”, “UFO’s” and the “lunatic fringe” and it will all go away. Planting this type of seed in some ones mind is perfect for eliminating free and independent thought. As was once pointed out in an enormously witty and typically humorous article by the extraordinarily prolific composer Frank Zappa:

Many people, when faced with something that may require serious thought or opinion, or perhaps may require them to think outside of what is the ‘accepted norm’ seem to willingly lower their socio-intellectual profile and undergo this strange kind of, “self-inflicted, home-made, mental nose job” – almost everyday, in order to maintain their status as ‘One of the Guys.’ As he pointed out: Many modern people treat intelligence as some kind of hideous deformity and in order to “cosmeticize” it, they willingly lower their perceived IQ level in order to be able to converse about insignificant drivel with their peers. Let’s face it, it’s no good to appear too intelligent because no-one wants to ‘hang around’ with someone who is smarter or possibly more informed than they are, now do they, this is simply not ‘fun.’

Perhaps you remember the story of the Emperors New Clothes by Hans Christian Anderson?

The tale relates how the King had employed an expensive and gifted tailor for the task of making his new outfit. The Kings ego was enormous and he paid the tailor a vast amount of gold to make him a suit that would be the most splendid in all the land yet when the clothes were finished the King was *positive that he actually had none on!* The cunning tailor assured King that the clothes were in fact, woven from enchanted thread that could only be seen by those possessed of great intelligence, but to the very stupid, he said, the fabric would be invisible.

All the members of his court at once assured the King that the fabrics he had donned were the finest ever and his new clothes were absolutely superb and magnificent, indeed the most splendid and dazzling they had ever seen. So then the King turned to them and said he was very pleased they were not all stupid and, not wishing to himself appear stupid to the members of his court, he walked about the kingdom naked and had a parade to show the town his new attire.

The entire town cheered and praised the Emperors new clothes and all discussed the splendor of the magnificent garments and the quality of the stitching among them selves until one young peasant boy who knew nothing of ego dared to ask: Why is the king naked?

And it was true. The king was in fact no more than a naked fool surrounded by bigger fools who had all been controlled by their own egos.

Well, in a scenario almost reminiscent of a scene from Anderson’s story, there is now enough real evidence to totally disprove the history we have been asked to believe, much of it is right out in plain view and yet it is still being ignored and in some cases flatly denied by mainstream academia. Those people who do try to investigate these things and bring to public attention, issues that may sometimes go against the “norm,” are ridiculed, usually by someone with a Degree who invariably uses their position of assumed knowledge as a means to completely disregard and discredit what is often quite significant research or substantial facts. No apposing evidence is ever presented by the academic quarter and the poor researcher is then usually subjected to a series of vilifying personal attacks designed to shift attention away from the actual evidence they were trying to present in the first place. If they then attempt to protest and return to the actual issue, they are generally harassed, banned from archeological sites and made the brunt of endless bad media coverage until they finally just shut up and go away. The whole issue is then closed, hushed up and forgotten as quickly as possible, hopefully to never again see the light of day. It’s a sad, but unfortunately, very common occurrence these days to see an archeologist,

anthropologists or Academic 'heavy weight' who has been backed into a corner by indisputable evidence, suddenly start brandishing their degree and launch into a series of scathing personal attacks against their opposition, simply because they can come up with no valid scientific rebuttals to dispute the hard cold facts they have been presented with.

Unfortunately when so many debates surrounding these issues are continuously and repeatedly conducted in such a predictable and completely unscientific manner, after a while it becomes difficult to think imaginatively enough to see it as anything else *but* a conspiracy.

In all reality, *any* reasonable theories need to be fully evaluated. All the world leading archeological teams need to combine their resources, *all* the available information needs to be accessed and viewed together as a whole; *all* of the monuments need to be examined "en masse" and *all* the existing ancient texts from *all* countries need to be studied together as one, though due to the worlds populations constant religious and racial bickering such a thing may never actually occur.

Many of these ancient tales have always been viewed exclusively as myth and fantasy, but when these ancient 'myths' are corroborated by each other and by physical evidence and when such inexplicable evidence is in turn found to be adequately explained by the myths then it stands to logic and reason that perhaps a more detailed scrutiny may perhaps be in order.

Could some of these ancient texts and scriptures actually contain complex scientific information, hidden within the narrative in the form of code or numerology as Newton and many others have believed?

Is there a coming 'Armageddon'?

Are we to expect a devastating global war?

Could a global catastrophe, a celestial 'event' or polar reversal such as is alluded to so often be what we are being warned of in ancient texts and myths?

Is that what the monuments and astronomical alignments are trying to tell us?

Do they tell us to watch for certain astronomical or celestial signs that warn of impending disaster?

There have been many authors who have theorized that it is indeed so. In fact, it has recently been discovered that there is a computer code or algorithm running through the entire Hebrew Bible that has been now confirmed to be real by many of the worlds leading mathematicians. The author who released his study of the code believes it tells us of a coming World War. The code appears to speak of or predict all major world events past, present and future and simply has no right being there unless someone put it there purposely, and that someone must either have been a time traveler who knew of all the events that would ever befall the world, or lived for literally thousands of years, or possibly even something else, some intelligence vastly more significant.

Does this mean that God is real? Could it be that time is cyclic as some have surmised? It says in the bible that the end days will be as the first days, and implies as much in many other texts and legends. But have both have these periods already come gone before?

Is man destined to repeat again, things that have befallen in the past?

It is the intention of this work to explore many of these questions in an effort to provide a deeper understanding of our past, our future, ourselves and the perilous situation we now find ourselves in.

The journey towards our future begins with an understanding of our past and so I would first now like to present to you, a collect of rather intriguing artifacts, just so you can first see what kind 'ooparts' actually have been found around our planet that might suggest to us that perhaps a wider investigation of our true past may be sorely needed by the Powers that Be. There is a myriad of these rather unusual discoveries that have been made, some recently, some many years ago and all of these artifacts represent discoveries that need to be included as pieces of the puzzle if we are ever to gain any coherent picture of our past

So hold on folks because when you really start looking into some of these intriguing discoveries and begin to grasp a true understanding of their real significance and where they all may actually come from, the conclusions can be quite astounding.



# Riddles from the Past

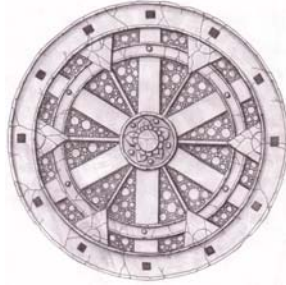

It all started for me when I was a young child and I saw a picture of the Great Pyramid. I was told right then that no-one really knew how it was done and in that moment I was hooked on our mysterious past.

From that moment, all interest in comic books was gone and for hours I would pore over my mother's encyclopedias. I couldn't understand much of the text, but the pictures of Dinosaurs and ancient and mysterious megalithic structures absorbed me totally.

Where do they come from I wondered? Does mankind really have an unknown history that has been lost or forgotten? Could there really have been an advanced civilization in far ancient times, *before* our recorded history? The questions and debates on the issue have raged for years. When asked, most scholars will tell you that it's a nice idea, but fanciful at best and there is really no hard evidence to show that such a civilization ever really existed. However, many others will argue that there is actually a significant body of evidence that *does* exist that simply cannot be explained away. So what are the realities? What kind of evidence are we talking about? Just a bunch of weird cave paintings and esoteric theories by strange people, or is there something more tangible?

To be perfectly honest about it, anthropological evidence, however convincing, is always circumstantial, while legends and myths without evidence are questionable at best and naturally open to individual interpretation, so we must look for further corroboration. When we do, we find that there is in fact, a large and ever growing body of hard physical evidence that goes a long way towards disproving what we have been led to believe. This evidence tells us that either the history we are taught of the earths is wrong, or the history we are taught of mankind's development is wrong – or both.

The reality of this is fast becoming far too great to deny and still more evidence to re-enforce the conclusion is being found ever more frequently. So the obvious conclusion that we're faced with here is that the academic community is either completely stupid (*which is doubtful,*) or quite simply not telling us the truth! Maybe they're just waiting for the right moment...

But before we try and find where the answers to our puzzle may lie, let's investigate what kind of body of evidence for an Ancient civilization of advanced technology actually does exist, in what form it takes and whether we are presented with anything that truly cannot be explained. And as you will see, the evidence that our entire history is wrong is indeed quite vast and comes in a great variety of forms. But to start with we can examine some of the tantalizing Ooparts

mentioned in the previous chapter – and, according to our orthodox history, these objects really are extremely Out-Of-Place!

A word must also be said here on the methods used to date many of these artifacts. In objects that contain organic material, the Radio-carbon dating method was used. While other inorganic objects were dated by dating the rock strata they were found in and other standard geological methods. Both these dating techniques are subject to variation depending on past events that may have occurred at the sites being dated and this will be discussed later but for now, consider some of these enigmas:

### **The Piri Reis Map of 1513**

In 1929 there was an amazing map discovered in the Imperial Archives at Constantinople that had been sitting, virtually unexamined, for years. The map (*Fig.1*), which had been drawn in 1513 by a Turkish Admiral named Piri Reis, showed North America, South America, Greenland and Antarctica. However what is so perplexing about this map is that Antarctica had not been discovered in 1513. Antarctica was not located until 1820 and America had only been discovered in 1492, a mere 21 years prior to the map's creation and yet it is mapped quite accurately.

Remarkably, the map also depicts several land masses bearing their correct longitudes even though longitude itself was not discovered until the late 1700's either.

Reis had been a famous Turkish Admiral of the 16<sup>th</sup> Century. He had a passion for maps, He loved cartography and was a highly experienced and respected mariner. In his day, he was considered to be an expert on all Mediterranean Lands and Coastlines and also held high in the favors of the Turkish court. Such a noble status enabled him to enjoy privileged access to the Imperial Library at Constantinople and he spent much of his spare time there. In his notes Reis said that he had based his map on several much older maps he had seen at the library, including



*Fig.1*

one that Columbus is reported to have viewed prior to his voyage to the Americas. The map in question was said to have been captured from the Spaniards in a naval engagement and later



given to the admiral by a Spanish prisoner who had apparently sailed on three of Columbus's New World voyages! Many scholars have indeed suspected that Columbus was in possession of a map and already knew of the existence of America before embarking on his famous 'voyage of discovery'. Reis also wrote a well known Turkish book on sailing called '*Kitabı Bahriye*' in which he gives detailed and accurate descriptions of the coastlines, harbors, bays, currents, shallows and straits of the Mediterranean and Aegean Seas. He was beheaded by the Turkish Court in 1554 or 1555 for reasons now unknown.

In case you can't see it, That's the top piece of Africa on the top right of the map and the tip of south America reaching out to it from the left side of the map, running up through the gulf of Mexico and up to Nth. America. The tip of Antarctica can be seen sticking up on the bottom right. Another interesting point to this map is the strange layout of the South American continent which looks sort of stretched out of shape. However, viewing the sphere of earth from space accurately produces this type of view. Funny that...

### **The Orontius Finaeus Map of 1531**

The Orontius Finaeus map (*fig.2*) was found in 1960 by Charles Hapgood and it too, apparently shows the continent of Antarctica along with the accurate outlines of Antarctic rivers that are now covered by thick glaciers. The map was found in the Library of Congress in Washington DC where it had been sitting unstudied for a great many years. In the map the continent and coastline is shown to be ice free and, like the Piri Reis map, it too shows an accurate depiction of the Ross Sea which today is totally hidden beneath a floating ice shelf several hundred meters thick.

Studies of actual core samples taken from the Antarctic ice shelf have also clearly revealed numerous layers of strata in the ice showing that the area has indeed gone through several periods of dramatic environmental change. Some sedimentary deposits that were found in the samples were from sea water that had flowed into the area and were even actually datable. The tests show that the sediments were deposited sometime around 4000 years ago which indicates that the Ross Sea would have had to have been flowing and free from ice at the time for the deposits to have occurred.



Fig.2

### **The Bauche Map of 1737**

Phillip Bauche was a French geographer of the 18<sup>th</sup> century who also drew a map that clearly shows Antarctica except that Bauche's map shows Antarctica two separate land masses, with detailed shorelines (*fig.3*). For many years the map was generally considered to be wrong because when Antarctica was discovered it actually looked nothing what Bauche had drawn.

Then in 1958 a seismic survey of Antarctica was carried out which surprisingly showed that Antarctica was indeed two archipelago islands covered by a thick layer of ice that made it appear as only one land mass and not only that, but that the general topography of the lands beneath the ice matches the drawings on the Bauche map in every detail. So how on earth this can be in any way possible? This map means that Bauche was in possession of a correct map showing Antarctica 100 years before it was discovered and not only that, but *without* any ice on it.

Antarctica has not been in an ice free condition for a minimum of *at least* 10,000 years and many scientists believe that the period of time to be more like several million years.



Fig.3

### **The Franco Rosselli map of 1508.**

Franco Rosselli was a renowned Florentine cartographer of the 15th century who created a relatively small but richly illustrated copperplate engraving, hand colored on Vellum, measuring just 6 x 11 inches (*fig.4*). The piece is now kept in the National Maritime Museum in Greenwich.

At the time Rosselli created the map, cartography was still a relatively new and experimental art which makes the revelations in his world map even more amazing. The map's depiction of Antarctica is a work of great accuracy and even names the area quite specifically as Antarticus.



Fig.4

The details on the Rosselli map are extremely well painted and as with the previous maps, geographical features such as the Ross Sea and Wilkes Land are particularly easy to identify on it.

Again, what is so perplexing about this extraordinary map is the year it was painted in 1508. According to our history this is a full *three and a half centuries* before Antarctica was discovered. And yet here again we have Antarctica depicted accurately on a 15th century Florentine map.

### **The Mercator Map of 1538**

And even yet another intriguing map is one drawn in 1538 by Mercator, another highly respected cartographer who lived in the 16<sup>th</sup> century. His works are quite famous and you can still buy a Mercator atlas in shops today. Mercator was known to periodically update his works and produce a new, more definitive world atlas as more shores became charted and more accurate charts become available to him. In doing such an update, his 1538 world map (*fig.5*) was replaced by a new one in 1569. However we now know that not only was his 1538 map far more accurate than the latter one but what proved to be even more amazing was that it also contained correct measurements of longitude.

To put all this mention of longitude into some sort of perspective for you: Longitude is the distance in degrees east or west of the Prime Meridian. Due to the Earth's rotation, it is far harder to calculate longitude than it is latitude, which can be measured by using the stars or the sun for observation. To calculate Longitude, requires an equation of 'distance = speed x time' and, most importantly, an accurate clock. Discovering longitude was once described as "greatest of all naval problems" and in the 1700's an actual Board of Longitude was set up in England to solve the issue. In 1714, Sir Isaac Newton appeared before the board and explained that the real problem was that "a watch required for such accuracy has not yet been invented". The Queen then offered a prize of 20,000 pounds to any man who might build such a device and finally, in 1761, a man by the name of Harrison claimed the prize and put forth his prototype chronometer which then "ushered in a new era of sea travel" for the world.

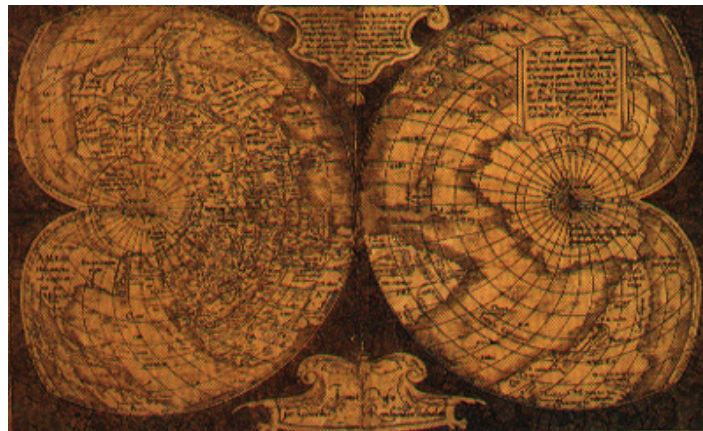

Fig.5

During the 19<sup>th</sup> century maps then began being updated with the correct degrees of longitude. However Mercator's map of 1538 was marked with correct longitude a full 223 years before it was discovered. Where was he able to gain that information from? It is obvious that Mercator himself had no real knowledge of longitude at the time and must have borrowed or been given the information from another source because he then updated his subsequent maps incorrectly with what was considered to be more recent and therefore, supposedly more reliable information.

These maps constitute some extremely significant evidence indeed, for if ancient man had never circumnavigated the globe or possessed any knowledge of longitude then how can any of these maps exist?

### *The Egyptian Pyramid*

In any list of strange and unusual artifacts one of the first things that comes to mind is, of course, the Great Pyramid in Egypt. The Pyramid has been the source of endless theories, ideas, rumors and speculation. Amazing powers have even been attributed to it.

Though many theories have been put forward as to how the pyramid was built, under scrutiny, none presented so far have proved able to be adequate. It has been theorized to have been built to serve as everything from a tomb, to an initiation chamber, to a cosmic beacon, to a giant water pump and many other things besides. Endless books have been written on it and endless theories argued. Indeed the entire Giza Valley Complex is quite remarkable and there are many mysteries surrounding the entire Necropolis; its uses and construction.

The Complex is in fact, *so* remarkable, that an entire chapter is dedicated to it later in this work. (See chapter 4 – *A Valley of Kings*).

### *Aztec Earplugs?*

The Aztec Culture, as with many other past cultures of the Mesoamerican region had a love for Obsidian. It was used mainly for objects of a sacrificial or ritualistic nature and is a reasonably common find at many South American sites. In case you're unfamiliar with it, Obsidian is a very brittle, black volcanic glass and is quite difficult to carve or work with.

However, sometime during the past an 'unknown Aztec craftsman' is believed to have made these wonderful and rather unusual little items (*fig.6*) which are thought to be earplugs. Yes that right, earplugs, and we are asked to believe that they were made by using the typical Aztec tools of the time, such as bamboo drills, stone chisels and fine sand as an abrasive agent.

This can only be seen as an incredibly unfathomable conclusion, because these items are polished to a constant thickness of *less than one millimeter* throughout, they are perfectly circular, completely symmetrical and are both *exactly* the same size.

Now just think about that for a moment and remember that we're talking about *earplugs* here. These things really are, very small, as I'm sure you will realize if you consider the size of an actual ear canal, plus they have been made to an incredible degree of precision from *obsidian*.

Just notice the accuracy of the small flanges protruding from the ends of the items. It is very difficult to imagine someone making these from brittle Obsidian by using primitive hand tools.



*Fig.6*

However the most fascinating and interesting thing about these artifacts is that under close scrutiny the unmistakable signs of machining are actually quite clearly visible on the surfaces making the idea that they were hand made even more difficult to deal with.

### *The Mysterious Metal Vase*

In June, 1851, 'Scientific American' reprinted a report that had first appeared in the Boston Transcript about a metallic vase that had been discovered by miners (*fig.7*). The vase was found in two parts among rubble that had been dynamited out of solid sedimentary rock in Dorchester, Mass. The strange thing though, is that it came from about 15 feet below the surface and was deeply embedded *inside* the rock. This indicates it had been there for an extremely long time.

The bell-shaped vase measures 4-1/2 inches high and 6-1/2 inches at its base and consists of a zinc and silver alloy while the sides are decorated with designs of flowers and bouquet arrangements, all inlaid with pure silver. The rock out of which the vase came from came is estimated at about 100,000 years old.

How did this vase come to be solidly embedded within 15 feet of solid sedimentary rock?



Fig.7

### *The Lost Necklace*

It is a known fact that coal is formed over thousands of years from fallen timber that has been charred and undergone immense pressure for many years beneath many tons of earth. A lump of coal therefore, by the simple nature of its own creation, is very ancient stuff. There is quite literally, no such thing as 'new coal'. Yet one morning in June of 1891, a Mrs. S. W. Culp, of Morrisonville, Illinois was fragmenting coal into smaller pieces for her kitchen stove when she noticed that one of the lumps she had broken apart had a chain necklace stuck in it. The chain measured about 10 inches long and was later found to be made of eight-carat gold. Unfortunately no photograph exists of the necklace and its whereabouts is presently unknown, however, the actual event is quite well documented.

As accounted by 'the Morrisonville Times' of June 11, 1891, investigators concluded that the chain, which was described as being "of antique and quaint workmanship" had not simply been accidentally dropped in with the coal by a worker, since an examination of the item clearly displayed some hard fragments of the coal that still clung on to the links of the chain, while the part of the coal that had broken apart also still bore the distinct impression of where the chain had been encased in it. The reporter of the day described it in this way:

*"Mrs. Culp thought the chain had been dropped accidentally in the coal, but as she undertook to lift the chain up, the idea of its having been recently dropped was shown to be fallacious, for as the lump of coal broke, it separated almost in the middle, and the circular position of the chain placed the two ends near to each other; and as the lumps separated, the middle of the chain became loosened while each end remained fastened to the coal....."*

How did a finely wrought gold chain come to be firmly encased in a lump of coal, an object that's very existence requires it to be many thousands of years old?

Obviously the chain wasn't lost too recently.

### **The Puma Punka Stones**

There is a most interesting thing that can be found in the Puma Punka Complex near Tiahuanaco. At the ancient site, standing upright in a courtyard, there can be found a tall flat stone that has a striking feature on it. The entire complex is actually quite remarkable, featuring a huge doorway complete with lintels that has been cut from a single stone and many other odd shapes that appear to have been machined including this one (*fig.8*).

The remarkable thing about this ancient slab is that it has a perfect cut or groove approximately 1cm wide running down its entire length while inside the groove there is a set of equidistant holes that appear to have been drilled into it.

The site is only a few hundred meters from the famous site of Tiahuanaco but the stone slab and many other enigmatic features of the site are so hard to explain and pose so many difficult questions that the entire site is virtually hushed up by the entire archeological community and almost never mentioned to tourists.

The consistent accuracy of the groove and the holes within it cannot possibly have been achieved with any known types of hand tools. It would appear that the only satisfactory explanation is that it was done by a machine or possibly – by molding?



*Fig.8*

### The Nasca Lines

In continuing our display of 'oogarts' mention must of course be given to the enormous motifs, spirals and geometric shapes that appear on the Nasca Plains in Peru. There really are few places on earth more baffling or shrouded in mystery. The actual Nazca civilization was one that had flourished in the area from between 200 B.C. and 600 A.D. but no one really knows the true origins or meaning of the enormous and very mysterious Nazca Lines.

The lines appear etched into a vast plateau, 37 miles long and 15 miles wide called Pampa Colorado that sits high in the mountains of the Nasca region of Peru. The lines were probably first brought to the wider attention of the world by Eric Von Daniken in his book "*The Chariots of the Gods.*" The etchings are of truly monumental proportions with the plain containing literally thousands of criss-crossing, zigzagging, spiraling and parallel lines covering virtually the entire plateau. The lines have been made by simply removing the hard rocky surface of the plain and exposing the lighter soil beneath. They range in average width from 6 inches to over 6 feet and run in absolutely every direction across the plain. Some of the lines are over 6 miles long and yet they still run unbroken over plains, hills and valleys and always remain perfectly straight and true. The motifs they depict include bird, animal and human forms, astronomical symbols and interestingly, even one section that seems to look exactly like an enormous long runway (fig.9).

The truly gigantic size of these glyphs that are depicted at Nazca also means that none of them at all are visible to a person standing on the ground and only a person viewing them from the air can see that they actually form shapes and pictures.



Fig.9



Fig.10



Fig.11



Fig.12

The Nazca lines were only discovered accidentally when a plane flew over the site in the mid 20th century and the surprised pilot suddenly noticed them from the air. From the vantage point of the sky however, there can be clearly seen the huge shapes of a monkey (*fig.10*), a Hummingbird (*fig.11*) and one that really does look like an astronaut (*fig.12*). And that's just a few. There are many, many more, covering virtually the entire plateau (*fig.13*).

The enormous size of these pictograms really and truly cannot be understated and it is widely believed that the design blueprint for the Nasca site could only properly have been realized from the air. How else would the artist ever know if the design was correct? It also seems strange that anyone would go to all the trouble of covering a mountain plateau in huge pictograms that no-one (*who couldn't fly*) would ever possibly be able to view in the first place, there is simply no apparent point to such an exercise.

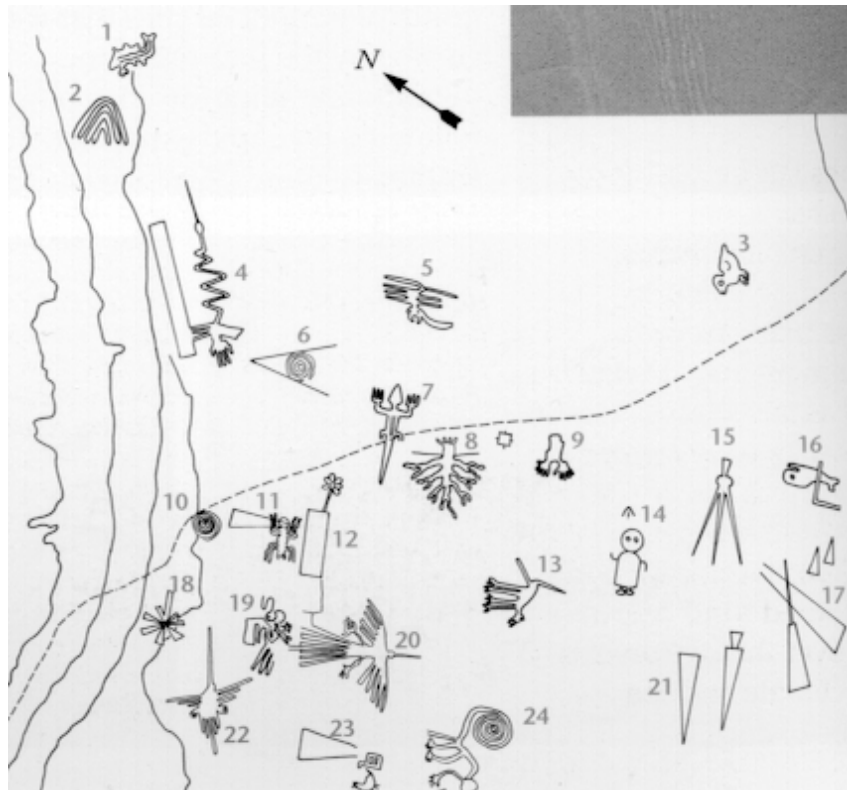

Fig.13

### *The Ica Stones*

Undoubtedly another one of the greatest enigmas of the archeological world surrounds a collection of some 15,000 artifacts that were found in Peru in 1960. Similar in many ways to the Nazca lines, I refer to a collection of glyphs carved onto stones that collectively form a veritable 'rock library' now known as the Ica Stones. The unusual scenes depicted in detailed carvings on the stones appear to be from the Pre-Columbian era and the sheer volume of them is astonishing.

But there is also a rather intriguing story that surrounds these enigmatic carved stones.

The stones were supposedly found in a cave by a native farmer at a place called Ica, about 300 klm from Lima. The farmer claimed to have found piles of them in various caves and gorges in the area, some scattered about the ground and some slightly buried beneath the surface. At first the farmer had only a few bags of carved stones but then later returned with literally thousands of the artifacts and for some time made a comfortable living for himself selling the stones to tourists at a market stall.



Before long the farmer had become something of a local celebrity and word of his find began to circle in the Archeological community and many experts began to descend on the area to investigate the validity of the stones, Naturally the sudden attention quickly aroused the interest of the Peruvian Government who, fearing Peru would become another Egypt and soon be overrun with diggers and robbers, promptly arrested the farmer to investigate his claims for themselves.

It is unclear what was said to the farmer during his confinement but upon his release he suddenly stated *in writing* that the entire collection of stones was a hoax and that he had carved the stones himself in order to trick the tourists and make some easy money. He had just never realized it would get so out of hand.

But there's much more to the story than that.

In 1966 the town's local physician Dr. Javier Cabrera received one of the stones from a native as a birthday present. The Doctor, who had heard of the farmer's novelties, noticed that the stone certainly *looked* ancient but what had really intrigued him was the fact that it appeared to accurately depict a type of prehistoric fish (*fig.14*). The actual farmer in question was wholly uneducated, unable even to read. So how then, puzzled the Doctor, could such a man possibly possess enough knowledge of paleontology to be able to produce an accurate and anatomically correct carving of an extinct sea creature?



Fig.14

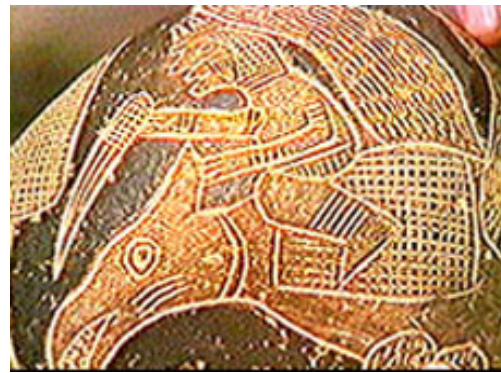

Fig.15

Now, somewhat interested, Dr. Cabrera began to visit the farmer and soon became the main recipient of the carved stones, of which it appeared the farmer had a virtually endless supply. The Doctor then began to create a kind of stone library which he organized by subject matter; the subjects including the races of man, ancient animals, lost continents and global catastrophes. He questioned the farmer many times about the source of the stones but the farmer, still in fear of being arrested again and jailed for life, remained evasive and persisted with his story that he had carved the stones himself. (It must also be understood here that removing or selling ancient artifacts carries a heavy penalty under international law, a fact which could help to explain the farmers' sudden change of attitude when he was arrested).

The farmer produced more of the stones for sale every week and after purchasing a few thousand of them Dr. Cabrera began to feel as though he had indeed fallen prey to the farmer and that the man had actually created the thousands of carved stones himself. So he then began pressing the man on the method he had used to carve them but again the man continued to remain evasive and kept refusing to discuss even the method he had used to carve them with the doctor.

Eventually Dr. Cabrera reasoned that logically, because of the enormous volume of stones in the collection, if the farmer had indeed carved all the stones himself he would have to have carved the first stone when he was 2 years old and then carved one stone every day for *over 40 years* in order to produce the total library! It didn't take much to reason that quite obviously such a thing was not possible so Dr. Cabrera then set out to find out the answers about the Ica Stones based on a study of the many designs depicted on them.

The carved stones come in a huge variety of sizes: there are some that will fit in the palm of your hand, others about as large as a medium sized dog and all sizes in between. Every stone depicts an image etched into the surface of the rock in continuous lines, not scratched on by repeated lines. Geologically, they are a form of andesite, a very hard volcanic rock that varies in color from grey to black and is quite difficult to etch using hand tools. (*Andesite comes in various forms – coal is also a type of andesite*)

Notably the etched sections on the rocks reveal a different color than the original patina that appears on the outer surface of the stone and yet the etched grooves also reveals signs of this patina indicating that the etching was done a very long time ago. However patina can also be faked and so one of the stones was also sent for testing to laboratories in Germany who have since authenticated both the patina and the incisions of the etchings as being extremely ancient.

To briefly explain the dating of carved stone: Radio carbon dating, commonly used on such things as pottery or clay figurines, cannot be used on rock because rocks contain no organic material, however the surface of rock has a ‘varnish’ coating covering it which is the result of bacteria and other minute organisms that adhere to it over time. Old rock will have a coating of this thick black varnish which is known as ‘Patina’ on its surface. A good strong patina takes thousands of years to darken, discolor and eventually form a solid coating on each stone. Etching the surface of the stones naturally removes this layer of varnish. On the Ica stones however, this layer of patina can also be found within the etched grooves which indicates that the etching was done an extremely long time ago. At least long enough for the varnish to build up again.

Many of the scenes depicted on the Ica stones are quite astounding (*fig.16*) and seem well beyond the knowledge of an uneducated farmer from a small Peruvian village.



Fig.16

There are stones showing genetic codes, and the prolongation of life, some that show blood vessels being reconnected via re-absorption tubes. One stone depicts a cesarean section while using acupuncture as a form of anesthetic. There are many stones that clearly depict people riding on dinosaurs (*fig.17*) and on flying reptiles (*fig.15*).

There are stones depicting natives wearing tall crowns and long robes similar to the Incas in appearance while performing medical procedures on patients (*fig.18*). Some even depicting heart and brain transplants. Others show men, using telescopes to view an approaching comet (*fig.19*).

There is a series of four stones that show the four hemispheres of the earth and studies have now shown that all of them are reasonably accurate except that one shows an extra continent that is no longer there (*fig.20*).

It's interesting that lost continents are such a constant theme of so many ancient myths isn't it?

Another very interesting stone shows a rather accurate depiction of some of the lines found on the Nasca Plains (*fig.21*) even though the lines can only really be viewed from the air. It is difficult to believe such an accurate carving could have been done by a village farmer.

Dr. Cabrera soon reasonably concluded that it simply was not possible that the farmer had carved all the artifacts on his own, he simply did not have the time, the skills needed, or the scientific and botanical knowledge required to create the stones. After some time and after purchasing about 11,000 of the stones, the Doctor became a trusted friend of the farmer.

He eventually learned that the man was only released from prison once he had agreed to present a signed confession stating that he was cheating the tourists. He had agreed to say that the stones did not come from the hills but that he had actually carved them himself. It was either that or go to prison for the remainder of his life for selling stolen antiquities.



Fig.17



Fig.18

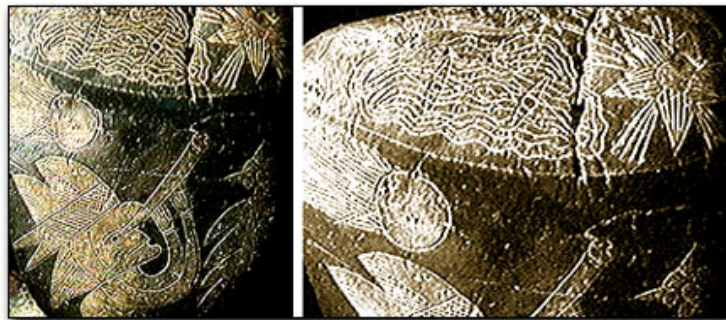

Fig.19



Fig.20



Fig.21

Dr. Cabrera continued his research in an effort to interpret the maps depicted on several stones even working with numerous geologists to obtain their expertise. Several of the stones had maps on them showing what looked like the world, only in a somewhat weird configuration. Some of the angles and land masses looked vaguely familiar, but the majority of the continents were badly warped into strange shapes making identification difficult. However after further study Geologists have now confirmed that based on current computer projections, the shapes indicated on the rocks are indeed accurate for the planet Earth, as it was – about 13 million years ago, that is, pre-stone age. Some of the carved stones even accurately show ancient star charts.

And again, the poses enormous questions, for how could anyone without very recent scientific knowledge accurately know how the skies looked from the earth and how the earth looked from the skies at around 13,000,000 years ago? Let alone an uneducated farmer in Peru - in 1960.

Some local farmers, lured by the fame of the stones, have now taken to creating and selling forgeries to unsuspecting tourists and so stones that have recently appeared from the area are highly questionable. However, there is no denying the authenticity of the original stones. Who actually created them will probably always remain an unsolved mystery but the graphic detail and unquestionable accuracy of the 15,000 artifacts truly poses one of the greatest enigmas and most alluring mysteries of South America.

### **Ancient Nanotechnology?**

Here are some very inexplicable little items. These most intriguing artifacts were made between 1991 and 1993 by a group of men prospecting for gold on the Narada River, which is located on the eastern side of the Ural Mountains in Russia. In a far cry from gold, what the prospectors found were some highly unusual and mostly spiral-shaped objects (*fig.22*), the smallest of them measuring a miniscule 1/10,000<sup>th</sup> of an inch!

At first glance the objects appeared to be similar to tiny shells or crustaceans only analysis proved them to be something quite different. Laboratory tests subsequently revealed that these most unusual objects are actually composed of an alloy of copper and the rare metals tungsten and molybdenum, though what on earth they are, what they may have been used for or who made them is an utter mystery.

Further tests have calculated these objects to be between 20,000 and 318,000 years old!

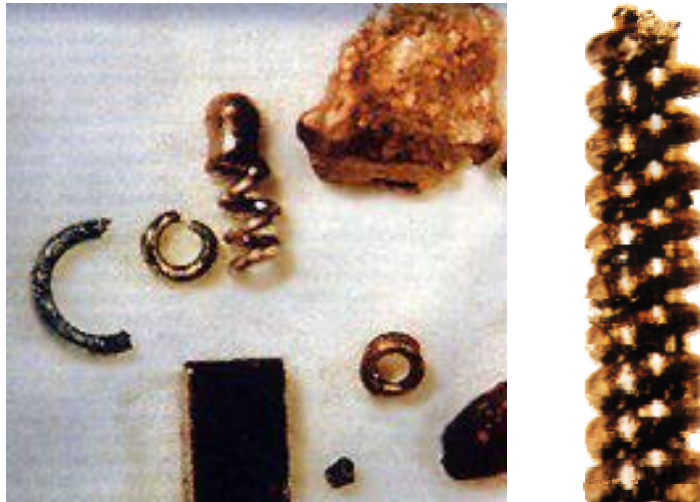

Fig.22

### **A 500,000 year old Spark Plug**

In another equally bizarre find in 1961, the owners of a gift shop in Olancho, California retrieved what appeared to be a normal fossil-encrusted geode while fossicking in the Coso

Mountains. Much to their surprise however, when they later cut the geode in half with a diamond saw, instead of a collection of crystals as one would expect, they found an obviously artificial object inside it.

The encased object had a metal core surrounded by layers of a ceramic-like material and a hexagonal (now petrified) wooden sleeve (fig.23). To the surprise of all, when X-rayed, the object appeared to very closely resemble a modern day spark plug or some other electronic component (fig.24), showing far too many striking similarities to be just casually dismissed (fig 25).

The obvious problem here is that it was found encased inside a fossil encrusted geode that was an estimated to be around 500,000 years old!

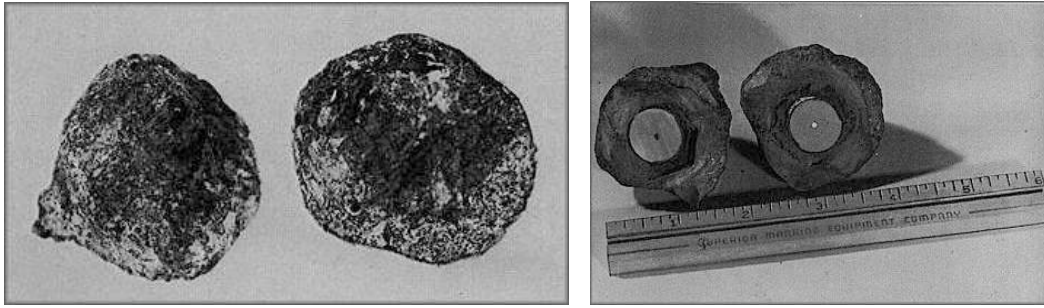
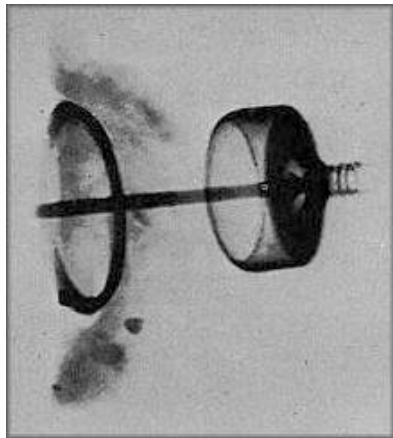

Fig.23

The last known person to be in possession of the intriguing Coso artifact was one of the original people who discovered it a Mr. Wallace Lane. Lane kept the object at home with him but flatly refused to display it to anyone during his later years. It is thought that Wallace Lane has since died and the current location of the artifact unfortunately remains unknown.



*(The artifact)*

Fig.24

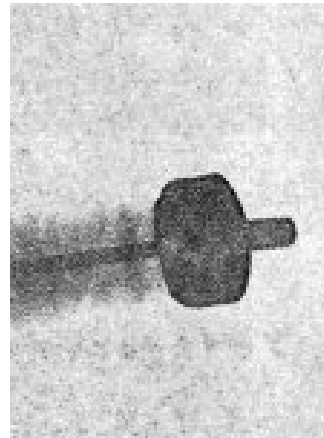

*(a champion spark plug)*

Fig.25

### **Stone Age 'Modern' Hand Tools**

Do you realize how long it takes for an object to fossilize? We are told that the process literally takes *millions* of years. Consider then that a group of workers quarrying limestone in 1786 came across an amazing artifact in an underground sand bed about 50 feet below ground level. In the layer of sand they found the stumps of stone pillars and fragments of half-worked rock and after digging a little further, they discovered coins, petrified wooden hammers handles, and pieces of other petrified wooden hand tools. The sand in which the discovery was made was lies beneath a layer of limestone that has been dated to be at least 300 million years old and still more recent discoveries of petrified tools have occurred since then:

There was a hammer handle found inside a 100 million year old rock near London, England (*fig.26*). This find was particularly unique in fact because though the exterior of the handle was petrified, the interior was discovered to contain an amount of porous coal. Now this is very significant and quite remarkable because there is no scientific way to account for such a thing happening. To explain: The process of petrification occurs when timber or other organic objects are buried in silt; when this occurs, silicates impregnate the material and dissolve it, slowly replacing the oxygen and hydrogen which begins the process of silification which eventually



Fig.26

leads to petrification. Coal on the other hand, is formed by charred timber being greatly compressed under tons of earth. The two processes could not be more different, yet in this case each process must have occurred virtually simultaneously or in extremely short succession. As for Science? Scientists are unable to produce petrified timber containing porous coal through any modern methods. This also completely negates any possibility of the item being a hoax.

### ***A Fossilized Human Hand Print***

We also have the amazing and thoroughly 'impossible' discovery of a completely fossilized handprint which corresponds perfectly to an actual human hand which was found in Limestone at Glen Rose (*fig.27*). The fossil shows a considerable amount of detail, even the print of the thumb nail. Do you really realize how long it takes for something to fossilize?

This fossil quite simply should not exist because the limestone in which this hand print was found has been designated to be from the Middle Cretaceous period which places it at around 110 *million* years old.



Fig.27

### *An Ancient Calculator?*

Further evidence of ancient machining can be observed in the mysterious ‘*Antikythira Device*,’ an artifact that was found at the site of an ancient shipwreck just off the Greek island of Antikythira. The artifact is manufactured from bronze and consists of a series of interlocking cogs and wheels and although heavily corroded, is quite unique and very extraordinary (*fig.28*). When it was first discovered experts thought it was possibly some type of navigational instrument, but a more detailed investigation revealed it to be something vastly more complex.

Radiograph and X-ray examination revealed the existence of a differential turntable comprising of over 30 interlocking geared cogs set at various different planes fixed within the device testifying to an extremely high degree of craftsmanship and a clockmakers attention to detail. It is quite obviously a precision instrument of enormous complexity. But what exactly is it?

The instrument bears inscriptions, unfortunately heavily corroded by sea water, that seem to refer to zodiac positions with a great deal of accuracy which, apart from its perfection in manufacture, is something that then also involves a considerable amount of astronomical expertise. It also has certain similarities with some known astronomical instruments and is thought to possibly be an advanced type of ‘*astrolabe*’, a celestial calendar and navigational device used for determining and exhibiting the year round positions of stars and planets.

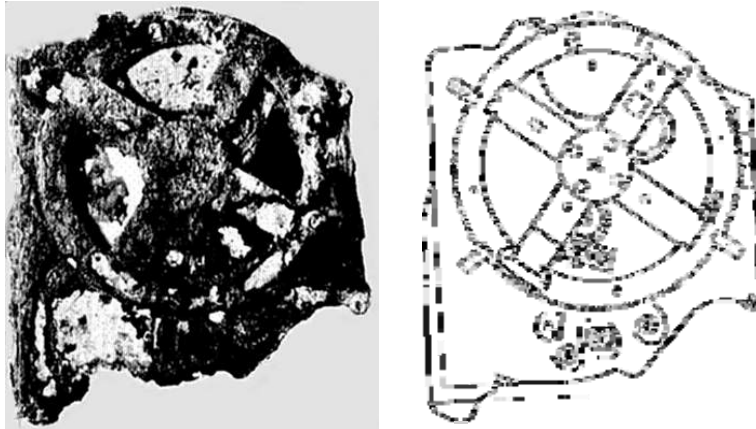

Fig.28a

Adding even further to the puzzle, the wreck, from which the device was salvaged, dates back to nearly one hundred BC and it has been previously thought that such refined craftsmanship was completely unknown until the mid 16th century. No other artifact that comes anywhere near this degree of sophistication has ever been recovered from another wreck either before or since. Even Astrolabes that have been recovered from vessels that sank millennia later look simplistic by comparison as this diagram shows (*fig.28b*).

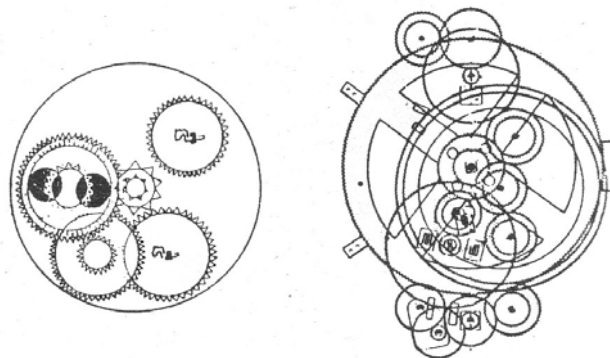

Fig.28b

The Antikythira Device is very much a puzzle in itself but another very intriguing part of the puzzle is this: For this kind of precision machined instrument to even exist, it means that there must also have been an equally sophisticated machine on which it was made, yet we have no record of such a machine ever existing and no hint of any such capability has ever been found, so who made it – and how?

### **Baalbeck**

Still many other, even more wondrous things were achieved in times long past.

In eastern Lebanon lies a city called Baalbeck that can truly lay claim to some of the most spectacular ruins on earth: The ruins of the Temple of Jupiter (*fig.29*).

Now in attempting to identify the true origin of the constructions at Baalbeck we are told by Academics that in 27 BC, the Roman emperor Augustus supposedly came to the rather unfathomable decision to build what is absolutely and irrefutably the grandest, mightiest and most lavish temple built in of all antiquity and to do so in what is quite literally, the middle of nowhere.

The ruins at Baalbeck are absolutely massive with its huge courtyard constructed on a wide platform that is still retained by three huge walls. These retaining walls contain twenty-seven limestone blocks, larger in size than those that can be found anywhere else in the world. Each of the blocks in these walls weighs in excess of 300 metric tons, however there are three blocks in the wall that, weigh in at over 800 tons each. This trio of blocks has gained world-renowned and are collectively known as the "Trilithon" (*fig.30*).

The Temple of Jupiter really is one of the most impressive ancient Temples in the world. It measures 88x48 meters and stands on a platform or podium reached via a wide stairway that can also only be described as truly monumental. The actual Podium rises a full 13 meters above the surrounding terrain (*fig.31*). The Trillithon in the retaining walls are three of the four largest stone blocks ever hewn.



Fig.29

Now if we really think about all this and consider events within the officially accepted academic framework that we are given of history, the site chosen for the Temple of Jupiter makes no real sense at all and we can find no apparent or obvious rhyme or reasons Augustus may have had for selecting the site at Baalbeck for such an elaborate temple.



In Roman times, Baalbek was (apparently) just a small city on a trading route to Damascus. It held no special religious or cultural significance for Rome, other than being in the centre of a coveted burial region that was favored by local tribes. It also seems completely out of character for the undeniably selfish Rome to have gone to all the trouble of creating such lavish and extravagant architecture in Lebanon - and at a place like Baalbek that is located so far from Rome. The Romans were, after all, an enormously and undeniably greedy empire and were in the very process of *stealing* historic treasures from other countries, such as the obelisks from Egypt, at the very same time the Temple of Jupiter was under construction.

It makes much more sense to surmise that Baalbek may have had something else the Romans wanted from the site. Possibly something no other place, not even Rome, could offer them. It could even be the reason why so many people wished to be buried there. But we are told by Academics that no, the temple is definitely and indisputably of Roman origin.



Fig.30 (man in back corner)

There are however, serious problems with this claim. Investigation into the blocks in the retaining wall of the Baalbek temple site very clearly shows them to be far more eroded than the bona fide Roman ruins of the Temple of Jupiter and the two other Roman temples that can also found on the site. Now since the stone of the retaining wall is of the same type as the Temple, it is reasonable and logical to assume that the heavily eroded blocks are naturally, much older.

It is then also logical to surmise that the Roman temple was in fact, an augmentation to a much older pre-existing platform and this of course would also help to explain why on earth such a remote site was chosen for the temple – because it offered Augustus a ready made, pre-existing platform on which to construct it.

The issue really is quite simple and straight forward and it's difficult to understand why the idea that construction of the platform and retaining wall could have taken place earlier than the Temple is scoffed at by the mainstream Archeological Community. The substantial amount of erosion visible on the large blocks of the retaining wall quite adequately qualifies as material proof of their far greater age than the actual ruins of the Temple of Jupiter. It's reasonably apparent that if quite substantial geological evidence significantly apposes the theory then the theory is obviously incorrect!

But there is a problem with this for academics, because this of course would have to mean that when the Romans had constructed the Temple of Jupiter, they had done so on a platform that had been previously constructed by a far more ancient party who at this stage remains unknown and they certainly don't want to bring up that "Ancient Civilization" thing again.

A notable point in this issue is that the Roman Empire was well known to have been quite an egotistical regime and yet we find no claim to building the incredible retaining wall anywhere in Roman records. There still exists, actual texts that record Roman transport capabilities during the reign of many Roman Emperors, including Augustus. These records clearly show that the load limit for the transportation of big blocks elsewhere in the Roman empire at the time was just a little over 300 metric tons and that was achieved only with the greatest amount of difficulty. The highly celebrated transportation of the 323 ton Laterano Obelisk to Rome, for example, was an enormously difficult and dangerous task that spanned the reign of three emperors. And yet we find that transportation of the massive 800 ton blocks at Baalbeck for the Temple of Jupiter is not mentioned in Roman records anywhere at all. This fact also raises immediate questions.

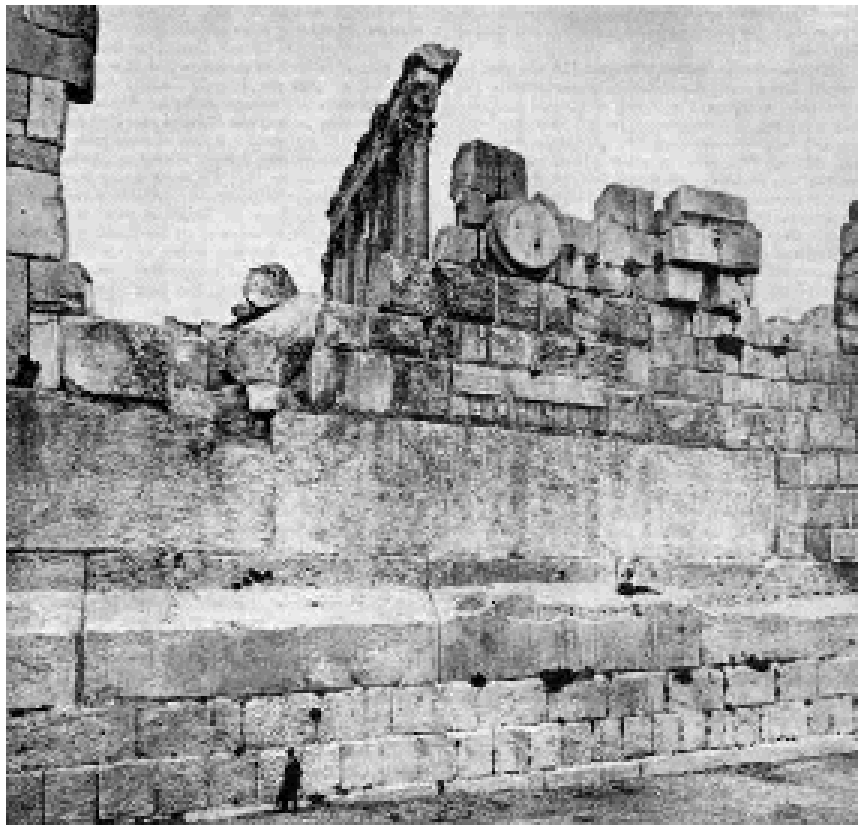

Fig.31 (man in foreground)

It is also very worth noting that by the reign of Augustus, the Romans also knew about, and very often used, concrete. The Coliseum still standing in Rome today is a good example of a classic Roman concrete structure. It has simply never been in Roman style to build with megalithic blocks. In fact such megalithic architecture appears no where else at all in the entire Roman Empire. It is also significant that Ptolemy conferred the title of Heliopolis upon Baalbek. For him to have given the place that particular title, it stands to reason that Baalbeck had to have been an ancient holy place and must have already had some notable architecture or some significant connection to the other Heliopolis (Sun City), also part of Ptolemy's domain in Egypt.

And there's still a further clue: In 636 AD the Temple of Jupiter was taken over by the Arabs who turned it into a fortress, also doing some further construction of their own. This means that the blocks used in the Arab sections of Baalbeck were laid about 650 years *after* the blocks of the

Roman Temple. So consider this conundrum: If the large blocks of the retaining wall were Roman, then the newer Arab blocks would mark the erosion of the older Roman blocks as they were after the first six or seven-hundred years since they were laid. Right? So how then, can the erosion of the large blocks in the retaining wall be so much greater than the erosion of both the old blocks of the Roman Temple and the newer blocks of the Arab ruins, in the subsequent 1500 years since the Arab section was constructed?

According to local legend, Baalbek had supposedly been a religious centre devoted to Baal in Phoenician times and local Arab legends actually place the cyclopean blocks of the retaining wall back to the time of Cain and Abel. Other tales tell that the platform was built by the Gods of old.

Near the southern entrance of Baalbeck is a quarry where the stones used in the temples and retaining walls were cut. No traces of any ancient road can be found between the quarry and the Temple which also raises questions on how the enormous 800 ton quarried monoliths were ever even transported to the site.

This lack of any road can only mean either one of two things: Either the blocks of the retaining wall were transported so far back in antiquity that all trace of the road has long since disappeared, or: a road was never required for the task of transporting them. In fact a road would have been of little use anyway due to the sheer weight of the blocks. The foundations of any road strong enough to be used for such a task would have to have been truly immense and if such a road had ever existed some trace of it would undoubtedly still remain today. So how were they moved?

Another huge stone block known as the "Stone of the Pregnant Woman" (*fig.32*) still now lies in the ancient quarry where it was cut in antiquity. It measures 21.5m x 4.8m x 4.2meters in size, weighs an estimated 1,000 tons and is the largest hewn stone to be found anywhere in the world.



Fig.32

There is no contractor or crane in the world that is capable of moving these hewn blocks from the quarry to the temple site. Such a task is still well beyond any of our current transportation capabilities. In fact I will quite happily donate the entire proceeds from the sale of this book to anyone who can move this stone from the quarry to the Baalbeck Temple podium.

### *An Iron Pot in Coal*

In 1912, two employees who were shoveling coal in the Municipal Electric Plant in Thomas, Oklahoma, broke apart a larger chunk for the furnaces when, to the surprise of both men, an iron pot fell of the chunk (*fig.33*). Several experts subsequently examined the iron pot and it was

declared to be genuine. The imprint of the pot could also still be clearly seen in the broken chunks of coal that had encased it.

According to Robert O. Fay of the Oklahoma Geological Survey, the Wilburton mine coal in which the pot was found is about 312 million years old.



Fig.33

### **Evidence of Advanced Medical Knowledge**

Apart from enigmatic works in stone there are also telltale signs of extremely advanced surgical procedures that were performed in days long past. These come in the form of numerous skulls from the Neolithic age that appear to have been trepanned. Trepanning involves inserting plates into a patient's skull. It's a delicate and quite advanced medical procedure. Richard Mooney explains the process in his book 'Colony Earth' in this way:

*"Trepanning today is an operation in which a section of bone in the skull is removed, either to ease pressure caused by a tumor or blood clot, or to remove splinters of bone caused by a skull fracture, and the cavity closed by a plate. The operation is hardly minor and requires great skill and care to perform. It is difficult to believe that Neolithic man - if he was, as has been thought, extremely primitive - could have carried out such operations with the crudest techniques, a flint knife, and no anesthetics or notions of hygiene."*

Evidence shows that the survivors of this ancient cranial treatment also went on to live for years afterwards, this is very remarkable considering that up until quite recent times, patients undergoing any type of trepanning had a very high mortality rate due to infection, blood poisoning and the other obvious complications involved with cranial surgery. Still more evidence of ancient trepanning also comes to us from the former Soviet Union where examination of several skulls unearthed at Ishtikunuy near Lake Sevan in Armenia, indicate a similar highly developed technique of cranial surgery employed over 4000 years ago! One patient had obviously suffered a serious head injury and the prehistoric surgeon had neatly plugged the fracture by using a carefully shaped wedge that had been delicately crafted from animal bone. The skull showed obvious signs that the patient's bone tissue had then grown over and enveloped the plug which adequately indicates that the person had survived the operation and lived for quite some time afterwards.

Another similar skull was found revealing that one woman had been operated upon to remove an inch wide object that had smashed through her skull, penetrating directly into the brain but the surgeon had cut around the object to remove the splinters and again closed the wound using a

section of crafted animal bone. Such an operation would have been incredibly complex and would also have undoubtedly involved brain surgery and yet the growth of the bone over the wound again shows that this patient of prehistoric times was then able to live on for many years afterwards.

### **A Petrified Human Skull**

Another completely baffling artifact was unearthed in the form of a petrified human cranium with the eye sockets broken that was found along with other human bones and soft organs in Pennsylvania and again in an Anthracite vein (*fig.34*). According to official geological estimates, the structures of Anthracite are a *minimum of 300 million years old* which means that this man existed on earth in the Carboniferous period or possibly even earlier.



Fig.34

### **Ancient Electricity**

There is compelling evidence of an ancient electrical supply that was used as much as we use the electric current today. On a low voltage scale: several clay pots have been excavated in Iraq that appeared to have been soldered with a lead/tin alloy, topped with copper discs and sealed with bitumen (*fig.35*). The device is in fact, basically a laden jar; when a mixture of copper sulphate and acetic acid (citrus juice or vinegar) was added to these excavated pots they produced around 2 volts of electricity. Over the years many more of these electric cells have been discovered in other places throughout the Old Persian Empire and also in Egypt indicating that the use of them was widely and quite commonly practiced. Electroplating is a technique that was previously thought to be only recently discovered however such small voltage is perfect for electroplating objects and may help to explain the discovery of pieces of electroplated gold jewelry found at sites in Egypt.

On the higher voltage scale: Scholars have often wondered how such intricate paintings were done in many Egyptian tombs and yet there are no signs of soot on the ceilings of any of them. Soot would indicate the use of a candle, lamp or some kind of flame to provide light for the artist. Many have surmised that a series of linking mirrors may have been used to bring in light from the

outside. There are however, some very interesting paintings on the walls of a tomb at Abydos in Egypt that appear to show people holding large filament devices (like big light bulbs) that are

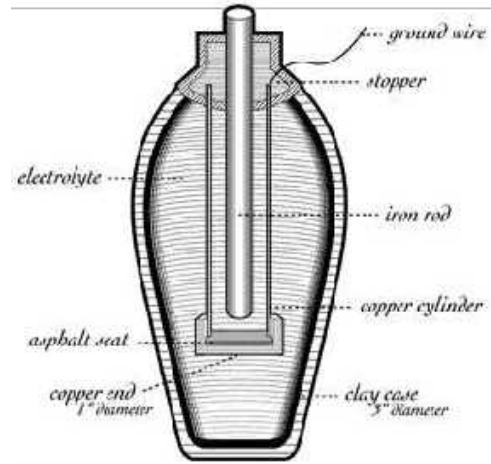

Fig.35

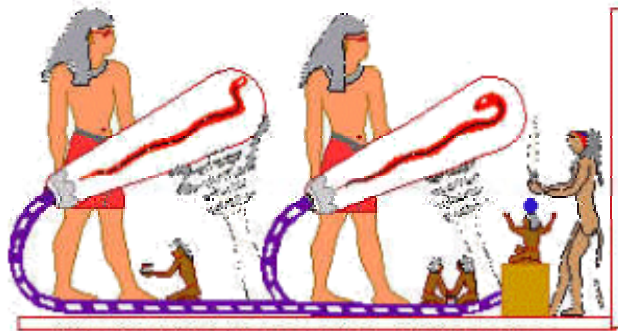
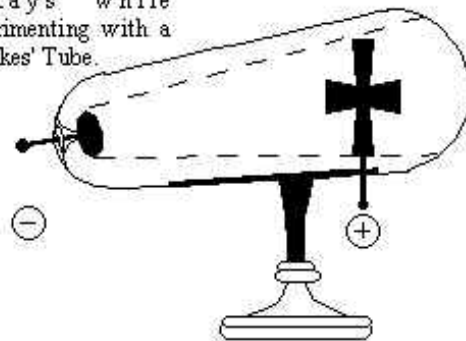

Fig.36

resting on stands and attached to some kind of power supply box by a cable while other people are working nearby with hand tools (fig.36). These filament devices also look very similar to a device known as 'Crooke's Tube' (fig.37) which is an early cathode ray tube. X-Rays were actually discovered while conducting experiments with a Crooke's Tube.

Röntgen discovered X-Rays while experimenting with a Crookes' Tube.



Accelerated electrons fly past the anode and form a shadow on the wall of the tube.

Fig.37

### ***An Ancient X-ray Machine***

There is also a quite remarkable rock painting that can be found in the caves of Toro Muerto in Peru that closely resembles a figure with raised arms holding what appears to be an X-ray plate of the thorax. I have been unable to obtain a photograph of the painting but apparently the ribs, chest cavity and a central column resembling the spine are all clearly visible on the plate the figure is holding. Now what on earth could that be doing there?

### ***A Fossilized Human Shoe Print***

A most amazing artifact was discovered in Antelope Springs, Utah by William J. Meister in June of 1968. Meister split open a two-inch-thick slab of rock with his hammer and the rock fell open "like a book," revealing a shoeprint of a human on one side with trilobites right in the print itself (*fig.38*). This artifact is extremely significant because this is not a footprint, no, no, no, it's a



Fig.38

*shoeprint!* The other half of the rock slab in turn, showed an almost perfect mold of the print and fossils. The shoeprint is 10 1/4 inches long and 3 1/2 inches wide; the heel is indented slightly like the sole of a modern shoe and seems to have crushed a living trilobite. The obvious problem the artifact creates is that trilobites lived between 300 and 600 million years ago yet here is evidence that a person wearing a shoe once crushed one beneath his heel. The heel of the fossil print even displays fine stitching similar to that found on a modern leather shoe. Go figure...

### ***The Dropa Stones***

There are very few artifacts more mystifying than the Dropa stones. The tale of the stones is quite an amazing story and some time should be given for a reasonable account.

I just love this story.

Our tale begins in 1938 high in the BayanKara-Ula Mountains on the border between China and Tibet. A group of archeologists, led by a Professor Chi Pu Tei, were exploring a series of interlinked caves when, much to their surprise, they came upon a collection of neatly arranged graves within the cave system. The graves contained within them a number of somewhat unusual skeletal remains and the scientists at first surmised that they had discovered a new species of ape. However, since it is unreasonable to conclude that apes buried each other it was deduced that the skeletons could only be of an unusual and possibly hitherto unknown race of human beings. The

remains were quite unique in that they were only around 5 feet in height, had unnaturally spindly bodies and quite large and 'overdeveloped' heads (fig.39).

While the archeological team was studying the skeletons, one of the men also accidentally stumbled across a large, round stone disk that lay half buried in the dust on the floor of the cave. The disc had a hole in the center and a fine, spiral groove radiated to the rim and looked ridiculously like a kind of 'Stone Age Gramophone record'. (fig.40). Closer inspection, however, showed that the spiraling groove was, in fact, a continuous line of tiny and very closely written characters that had been somehow meticulously inscribed on to the surface of the disc. The object, it appeared was indeed a record of sorts, though not of the gramophone variety. On the walls of the caves themselves archeologists also discovered crude pictures of the rising Sun, the Moon, the Earth and some unidentifiable stars all joined together by lines of pea-sized dots. The discs and the cave drawings have both been dated at around 12,000 years old.



Fig.39



Fig.40

In all, 716 such discs were eventually found and retrieved from within the cave system; all have been dated as being between 10,000 and 12,000 years old. Each stone disk is precisely 9 inches (22.7 cm) in diameter and 3/4 inch (2 cm) thick, each disk has a perfectly circular 2 cm hole in the exact center and each bears an inscription in the form of strange carved hieroglyphics.

For 20 years after their discovery, all attempts to translate them having failed, the discs sat in the Peking museum mostly forgotten. Finally in 1963 another Chinese Professor, Dr. Tsum Um Nui was finally able to break the code and set about deciphering the discs. And it's here that the story becomes even more intriguing. Initially, the Professor's conclusions on the meaning of the discs was considered so shattering that his transcriptions were suppressed and he was forbidden to publish his findings by the Peking Academy of Pre History. However two years later in 1965, Dr. Nui and four of his colleagues at last received permission to release his transcription.

The story it told was astounding, to say the least for the discs told the tale of a spaceship, perhaps like a probe or scout ship, from a distant planet that crash-landed in the Himalaya Mountains region thousands of years ago. They tell how the surviving occupants of the spacecraft, *'the Dropa'*, had taken refuge in the caves of the mountains but despite their peaceful intentions, they had been misunderstood by members of the local Ham tribe who were occupying



neighboring caves. The ham tribe distrusted them and hunted down the survivors and killed some of them.

According to Dr. Tsum Um Nui, one of the first lines of the hieroglyphs reads: "The Dropas came down from the clouds in their aircraft. Our men, women and children hid in the caves ten times before sunrise. When at last they understood the sign language of the Dropas, they realized that the newcomers had peaceful intentions". Another section mentions that the Ham Tribe eventually became the friends of the Dropa and even expressed regret that their spaceship had crash-landed in such remote and inaccessible mountains and that there had been no way of building a new one to enable the Dropa to return to their own planet.

However, in those 27 years since the discovery of the first disc, archeologists and anthropologists had also learned a good deal more about the isolated Bayan-Kara-Ula region and much of the information seemed to corroborate the bizarre story recorded on the discs. Local legends, still surviving in the area, also speak of small, gaunt, yellow faced men who 'came from the clouds, long, long ago'. These legends tell of men who had huge, bulging heads and puny bodies and were considered to be so ugly and repellent that they were hunted down by local tribesmen on horseback and many were killed. The description of the 'invaders' is also remarkably close to the skeletons originally discovered in the caves in 1938 by Professor Chi Pu Tei.

Most interestingly, the cave systems of the BayanKara-Ula Mountain area are still inhabited today by two semi-troglodyte tribes known as the Hams and the Dropas. The Dropa tribesmen are themselves, extremely odd in appearance, being somewhat frail and stunted and averaging only about five feet in height. They are neither typically Chinese nor Tibetan and anthropologists readily admit: "*Their racial back-ground really is a mystery.*" Are the Dropa the descendants of the people mentioned in the discs? Do these strange discs actually record a disastrous space mission by alien astronauts 12,000 years ago? Nearly all the leading theorists believe so. We may never know for sure but the message contained in the discs is extremely fascinating none the less.

#### **A Fossilized Human Finger**

Another similar artifact that simply just should not exist is this fossilized human finger. The fossil, known simply as "DM93-083" dates from the Cretaceous Period or about 100 to 110 million years ago (*fig.41*). X-Rays of the specimen have also shown some less dense areas within the finger revealing the presence of marrow within the bone, shown in the slide by the darker areas.

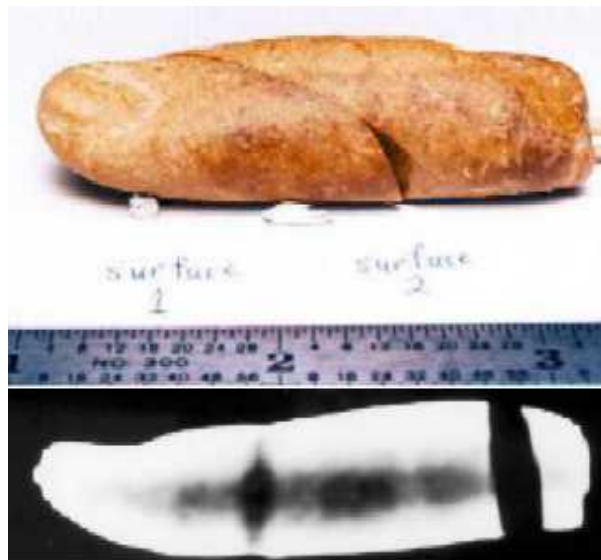

Fig.41

### **A Brass Bell In Coal**

In a discovery in 1944 that by now is almost becoming common place, a man called Newton Anderson found this quaint brass bell inside a lump of coal that was mined near his house in West Virginia (*fig.42*). Newton dropped the lump and it broke revealing the bell encased inside. The bell underwent rigorous testing and was extensively analyzed at the University of Oklahoma and found to contain known metals but mixed together in an unusual blend and quite different from any modern alloys.

Numerous other such discoveries in coal have even been recorded, including the delicate gold chain mentioned previously and a cast iron pot that was also found inside a coal seam.

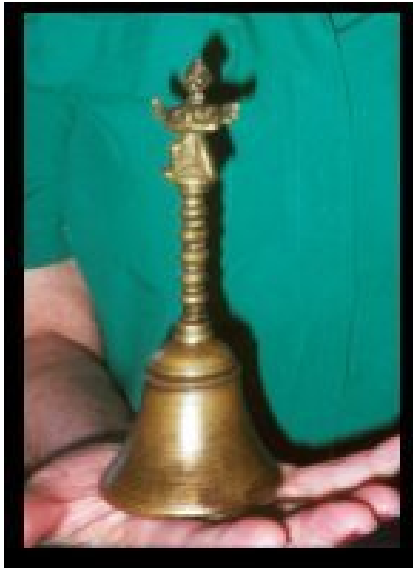

Fig.42



Fig.43

### **The Rhodesian Man**

In 1921 a Neanderthal skull was discovered 60 feet below ground in Rhodesia that produced a strange mystery. Upon examination it appeared that the skull had been pierced by a high velocity projectile similar to a bullet in the left temple area (*fig.43*). Tests have shown that the injury must have indeed occurred at the moment of death and not from a stray bullet years afterwards.

This means that whoever fired the fatal bullet must have done it thousands of years ago.

According to author, Rene Noorbergen: "A German forensic authority from Berlin has positively stated that the cranial damage to Rhodesian man's skull could not have been caused by anything but a bullet." The rounded entry point of the wound also testifies to the great speed at which the projectile would have had to have been traveling.

### **A Pillar of much too Pure Iron**

In Delhi India there is an Iron Pillar that has completely defied metallurgists by remaining absolutely rust free for the last 1600 years, ever since its discovery by the west (*fig.45*). It's unclear for how long the pillar has actually been standing for (*in fact there is more than one of these in India*) but the problem lies in the fact that such rust free iron, of the type that is found in these pillars is unheard of in our modern technology.

These iron pillars are in fact a metallurgist nightmare, or dream, depending on your mindset, but one truly interesting thing is the fact that the only other place completely rust free iron has been located, is in rock samples that were brought back from the moon during the Apollo missions!

So where 'on earth', did the iron used to make these pillars in India come from in ancient times? Some people have theories on where such pillars are from – save that thought.



Fig.45

### **2.8 Billion year Old Metal Spheres**

In a most bizarre series of finds that are still ongoing, for the past 60 years or so, miners in Africa have been finding literally hundreds of metal spheres, some from quite deep underground. And at least one of them, possibly more, has three parallel grooves running around its circumference (*fig.44*). The spheres seem to come in two types: one is of a solid bluish metal and has white flecks in it and the others are hollow with a kind of spongy centre. The curator of the museum of Klerksdorp in South Africa, where many of the spheres are housed, a Mr. Roelf Marx describes them this way: "The spheres are a complete mystery. They look man-made, yet at the time in Earth's history when they came to rest in this rock no intelligent life existed. They're nothing like I have ever seen before"

Roelf Marx also wrote a further letter dated September 12, 1984 that contains more information on the spheres. In it he wrote: "There is nothing scientific published about the globes, but the facts are: They are found in pyrophyllite, which is mined near the little town of Ottosdal in the Western Transvaal. This pyrophyllite ( $Al_2Si_4O_{10}(OH)_2$ ) is a quite soft secondary mineral with a count of only 3 on the Mohs' scale and was formed by sedimentation about 2.8 billion years ago. On the other hand the globes, which have a fibrous structure on the inside with a shell around it, are very hard and cannot be scratched, even by steel." (*The Mohs' scale of hardness was devised and is named after Friedrich Mohs, who chose ten minerals as reference points for comparative hardness, with talc the softest and diamond the hardest.*)

However, as if the mere existence of these metal spheres is not enough there is still another amazing property of the artifacts that captured the attention of a Mr. John Hund of Petersburg about fifteen years ago. While playing with one of the objects on the flat surface of a table one

day, Hund apparently noticed that the sphere seemed to be particularly well balanced so he decided to take it to the California Space Institute at the University of California for testing to determine just exactly how well balanced it actually was. What the results of the tests surprisingly showed, was that the sphere was in fact balanced perfectly and exactly.

The balance of the sphere was in fact, *so* exact, that it exceeded the limits of any of the space institutes current measuring technology – and these are the people who make gyrocompasses for NASA! Not too badly balanced at all really...



Fig.44

The sedimentary rock in which most of these spheres were found is located well below the surface in deep underground mines and is estimated to be a staggering 2.8 *Billion* years old.

### *The Crystal Skulls*

Perhaps it's because they are fashioned in the shape of human skulls or maybe it's due to the hint of some dark and mysterious curse, whatever the reason may be; there are few artifacts that have generated more interest than the crystal skulls.

There have actually been several crystal skulls of quite incredible workmanship found in various places around the world though perhaps the most widely celebrated and also the most mysterious of these is the Mitchell-Hedges Skull which has also been known as 'the skull of doom' (*figs.46a & 46b*). There are at least three very good reasons for this. Firstly, the skull is very similar in form and size to an actual human skull, even featuring a fitted and removable jawbone while most other known crystal skulls are of a more stylized or avant-garde appearance, quite often with unrealistic features and teeth that are simply etched onto the surface of the crystal. Secondly, it is as yet, unknown how the Mitchell-Hedges skull was constructed. From a scientific and technical perspective, it appears to be an utterly impossible object that has been made to a ridiculous degree of perfection by an unknown technique, which today's most talented sculptors and engineers are still unable to duplicate, even by modern methods and quite simply should not exist. Thirdly: It is a complete mystery as to where the skull actually comes from.

The discovery of the skull is still a controversial matter and one that has been brought into question many times. The story goes like this: A British explorer by the name of F. A. Michael Mitchell-Hedges, embarked on several expeditions with the aim of searching for evidence of the lost civilization of Atlantis. He claims that his step-daughter Anna unearthed the skull in 1927 during such an expedition that he had led into the ancient Mayan ruins of Lubaantun, in Belize (*then called British Honduras*). According to Mitchell-Hedges, Anna (*then 17 years old*) was searching inside a structure that was believed to have once been a temple, when she found the cranium of the crystal skull inside. At the time of the discovery, the skull was lacking its jawbone which was itself found three months later, about 25 feet away from where the cranium had been

found. Mitchell-Hedges says that he felt the object held some special significance and claims that he didn't want to take the skull away from the site where it had been found and had offered it to the local priests but that the Mayans had then given the skull back to him as a gift upon his departure - a dubious tale at best.

Michael Mitchell-Hedges was born in 1882 and died in 1959. He was known by his friends as a "charming rogue." At one stage of his career he was even known as "the British Baron Von Munchausen." He was an explorer, an author, a gambler and a soldier with Pancho Villa during the Mexican Revolution. He was undoubtedly a very colorful and quite 'roguish' character, the rather impressive initials that he had next to his name actually resulted from him having joined the London Zoological Society and enabled him to enter the zoo on Sundays. Although I think that he may have actually founded the society to begin with.



Fig. 46a

Many people found Mitchell-Hedges story to be 'questionable' at the time and evidence now shows that his tale of the skull's discovery was probably entirely fabricated. There are no known photographs of the skull among those that were taken during any of his Lubaatun expeditions, and there is no record of Mitchell-Hedges ever displaying or even acknowledging any existence of the skull any time prior to 1943. It is also interesting that when he took the skull on a trip to South Africa in 1947, Mitchell-Hedges himself made this cryptic remark about the skull: "*We took with us the sinister Skull of Doom of which much has been written. How it came into my possession I have reason for not revealing.*" Yet the story he had always maintained was that it was found by his step-daughter, so why would he have reason for not revealing how he came by the object?

Many believe that the skull was placed there for the young girl to find but if Mitchell-Hedges did indeed put the skull in the temple for Anna to find in 1927 and just never let on about until 1943, then where did he actually get it from prior to 1927?

There are several other theories on how Mitchell-Hedges came to be in possession of the skull and a number of books have been written on the subject. One theory suggests that the skull is actually a 12,000 year old artifact that has been handed down from an Ancient civilization through the Knights Templar and eventually coming into the custodianship of the Inner Circle of the Masons Lodge. Mitchell-Hedges was, in fact, an Inner Circle Mason and may have “acquired” it through the lodge or possibly from a Lodge gambling debt. Another theory is that it may have been looted from a pyramid on one of his Mexican expeditions, which is why he may not have wanted to reveal how he came by it. Another more fascinating theory holds that the Knights Templar had been in possession of it for centuries but had previously moved the skull to Lubaatun many years before to prevent it from falling into the hands of the Vatican and that Mitchell-Hedges had been purposely sent to the site by the Freemasons to retrieve the artifact.



Fig.46b

In a somewhat less romantic series of events however, it is believed that in reality Mitchell-Hedges purchased the skull in 1943 at an auction at Sotheby’s Auction House in London. This has now been reasonably verified by documents found at the British Museum which had in fact bid against Mitchell-Hedges for the crystal artifact at the same sale. The Sotheby’s records show that the artifact was actually purchased by Mitchell-Hedges from one Sidney Burney but the Museum could only go as high as 340 pounds. Burney then sold the skull to Mitchell-Hedges for 400 British pounds. So now the question now becomes: Who was Sidney Burney and how on earth did the skull come to be in *his* possession?

Unfortunately no other records remain of anyone called Sidney Burney. The enigmatic skull remains in the possession of Anna Mitchell-Hedges who, even after all these years, continues to maintain that she discovered the skull, even though the Sotheby’s auction has been verified and there is considerable reason to question that she was ever present at the Lubaatun expedition at all. If there is any truth in the tale at all and she was present on the expedition, then there is little

doubt that Mitchell –Hedges actually placed the skull in the temple for her to find. Anna still often displays the skull on frequent ‘final’ tours and she now lives in Canada.

The Mitchell-Hedges skull is made of clear quartz crystal. Both cranium and mandible are perfectly proportioned and are believed to have been fashioned from the same solid piece of crystal. It weighs 11.7 pounds and is about five inches high, five inches wide, and seven inches long. Except for some very slight anomalies in the temples and cheekbones, it is an anatomically perfect replica of a human skull. Because of its small size and other characteristics, it is thought to bear a closer resemblance to a female skull than a males’, which has led many to refer to the Mitchell-Hedges skull as a "she."

In 1970, the Mitchell-Hedges family loaned the skull to the Hewlett-Packard Laboratories in Santa Clara, California for extensive study. HP is a computer equipment manufacturer and a leading facility for crystal research. The studies were conducted by an Art restorer named Frank Dorland who oversaw the testing procedures and the HP examinations yielded some quite remarkable results. Researchers discovered that the skull had actually been cleverly carved against the natural axis of the crystal. To explain: The axis or orientation of a crystal's molecular symmetry is an important aspect of crystal cutting and is something that is always taken into account by modern crystal sculptors, because if they carve against the natural axis the piece will usually shatter. This is true even when using lasers and other high-tech cutting methods and yet this skull is cut *against* the natural axis. Then, to exacerbate the issue of the object even further, the HP tests could find no trace of microscopic scratches on the surface of the crystal either. Such microscopic signs would be a welcome indication that it had been carved with metal instruments or other tools.



Fig.47

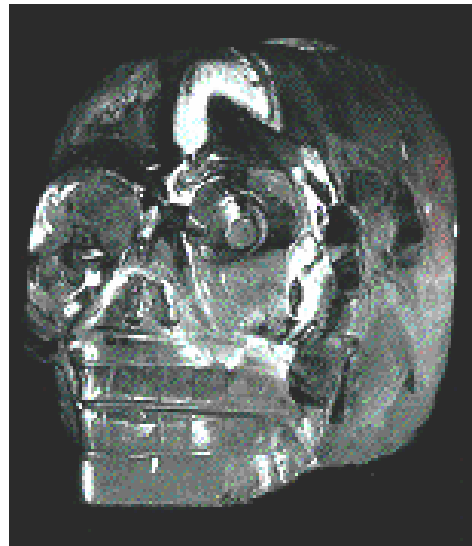

Fig.48

Finally, after a series of exhaustive tests and microscopic examinations, Dorland's best possible hypothesis for the skull's construction was that it had been roughly hewn out using something like diamonds and then the detail and clean up work would have been very meticulously done using a gentle solution of silicon sand and water. But assuming that it could really have been done that way at all, which is the only possible way that anyone can think of, the entire somewhat exhausting job would have then required the combined and devoted services of an extremely gifted group of sculptures, working in shifts and required a labor of *continuous man-hours* totaling about 300 years to complete. Under these circumstances, experts believe that successfully crafting a shape as complex as the Mitchell-Hedges skull by hand is quite frankly, impossible; as one HP researcher is said to have remarked, "The damned thing just simply shouldn't exist!"

The mysteries of the skull, however, do not end there. The skull has been fashioned in such a way that the zygomatic arches (*the bone arches that extend along the sides and front of the cranium*) are accurately separated from the skull piece, and act as light pipes, using the principles of optics, to channel light from the base of the skull to the eye sockets, the eye sockets are miniature concave lenses that transfer light either from the 'bone arches' or from a source below into the upper cranium. While in the interior of the skull is a ribbon prism and small light tunnels which greatly magnifies and brightens objects that are held beneath the skull.

Strange powers and manifestations have also been attributed to the Mitchell-Hedges skull. During his years of testing the skull at Hewlett-Packard, Frank Dorland says it sometimes displayed strange characteristics. Dorland says that often the eyes would flicker as though alive and still other observers have reported strange odors and sounds emanating from the object. It has been known to give off sensations of heat and cold to those who touch it, even though the actual crystal has always remained at a constant physical temperature of 70 degrees F under all conditions, and has also produced sensations of thirst and sometimes of taste in some instances. Dorland and other also took strange photographs of the skull in which object could be seen within it such as strange flying discs and mountain temples. The skull has also many times been reported to emanate a glowing aura. Other observers have reported that occasionally the skull will change color. Sometimes the frontal cranium may become cloudy up while at other times it remains perfectly clear, sometimes it will start off cloudy and then clear right up as if the space within the skull had 'disappeared into an empty void.' Over a period of 5 to 6 minutes, a dark spot often begins forming on the right side and slowly spreads until it has blackened the entire skull, then recedes and disappears as mysteriously as it came.



Fig.49

Still others, including Mitchell-Hedges himself have said the skull holds a curse and for this reason it is also sometimes known as the "Skull of Doom." Mitchell-Hedges is known to have referred to the skull as "the embodiment of evil" and said that "some people who have laughed cynically at the skull have died while others have become stricken and seriously ill." It is doubtful any such curse actually exists, at least not one that will kill as is believed to be the case with the infamous "Hope Diamond", in fact, it maybe quite the opposite. Mitchell-Hedges was in



possession of the skull for over 30 years with no harmful effects and during that time he actually survived eight bullet wounds and three knife attacks before dying at the age of 77 in June 1959.

One other interesting theory about the skull was put forth by Nick Nocerino in the book *'Mystery of the Crystal Skulls Revealed'* holds that the crystal skulls "record vibrations in the form of images of events that have occurred around them. In this way they seem to work as video cameras of sorts, recording holographic scenes." The authors believe the Mitchell-Hedges skull is part of a set and that there are actually 13 such skulls that exist and the rest are still kept in a chamber beneath Potala Palace in Tibet. The general opinion of the book is that the skulls are actually of extra terrestrial origin.

Unfortunately, none of this brings us any closer to solving the mystery of the mysterious object for the questions still remain: *Where* did it originally come from? And, *Who* made it?

The Mitchell-Hedges skull is not the only crystal skull to have been found. There two other skulls quite similar to it though not nearly as remarkable. These are known as the British Crystal Skull (*fig.47*) and the Paris Crystal Skull (*fig.48*). Both artifacts are said to have been bought by mercenaries in Mexico in the 1890s, possibly even as part of the same purchase. The British and Paris skulls are extremely similar in size and shape, in fact so much so, that some have speculated that one skull was used as a model to produce the other. Both skulls are made of clear but cloudy crystal and are not nearly as finely sculpted as the Mitchell-Hedges skull; The features are only superficially etched into the surface and appear somewhat incomplete. The British Crystal Skull is on display at London's Museum of Mankind while the Paris Crystal Skull is kept at the Trocadero Museum in Paris.



Fig.50



Fig.51

Further examples of primitively sculpted skulls are a couple called the Mayan Crystal Skull and the Amethyst Skull (*fig.49*). They were discovered in the early 1900s in Guatemala and Mexico, respectively, and were brought to the U.S. by a Mayan priest. The Amethyst Skull is made of purple quartz and the Mayan skull is clear, but the two are otherwise very alike. Like the Mitchell-Hedges skull, both of them were studied at Hewlett-Packard, and they too were found to be inexplicably cut against the axis of the crystal.

However, the only other known crystal skull that comes close to resembling the Mitchell-Hedges skull is one called the Rose Quartz Crystal Skull (*fig.50*), which was reported as being found near the border of Honduras and Guatemala. It is not clear in color and is slightly larger than the Mitchell-Hedges, but boasts a comparable level of craftsmanship, including a removable

lower jaw. And as is also the case with the Mitchell-Hedges Skull, many have attributed strange and psychic properties to the Rose Quartz Skull.

The history of the Amethyst skull is unclear; it was reportedly part of a collection of crystal skulls that were in the possession of the Mexican President Diaz from 1876-1910, but there are also reports that the skull was discovered in the Oaxaca area (Mexico) and was handed down from generation to generation through an order of Mayan Priests. It now believed to reside in San Jose, California with a group of businessmen who have apparently offered it for sale.

Regardless of any earthly or unearthly properties the crystal skulls may or may not possess, the question still remains: where did they come from? There are countless theories on the subject some suggest that they are the creation of some higher intelligence. Others believe they were created by extraterrestrials or a legacy left behind from beings that lived in Atlantis or Lemuria. Where ever they come from and whatever their purpose, there can be no doubt that in the intriguing realm of ancient artifacts, there are few antiquities that are as thought provoking or have brought more controversy and debate as these carved crystal skulls.

The Museum of Man, in London also contains a crystal skull of indeterminate origin that was purchased by them at the turn of the last century from an antiquity dealer in New York. The Man Museum skull is called the Aztec Skull (*fig.51*). It is interesting to note that the museum no longer keeps it on display, though it can be viewed by request. This is because several museum personnel as well as many visitors have claimed that the skull moves on its own within the glass case in which it is enclosed.

### **The Nampa Image**

During the drilling of a well in Nampa Idaho in 1889 a tiny figurine made of baked-clay was brought up in amongst the debris churned out by the huge drill bit. The object is a one inch long figure of a man with one leg broken off at the knee, possibly from coming into contact with the drill bit. The possibility of the object being a hoax is extremely doubtful as it was extracted from a depth of about 300 feet making the possibility of someone planting it there highly unlikely. Today the controversial little object remains the property of Charles F Adams and is still displayed in a glass case at Boise's Park Museum in Boston. Scientists still cannot agree whether the object is a genuine relic or merely a unique little 'odddity.'

Similar finds have been made in other drilling operations. In 1852 a well driller in Whiteside County Illinois retrieved a copper ring and another copper device shaped like a boat hook from 120 feet below the surface and in 1971 a drill bit brought up a bronze coin from a depth of 114 feet just outside Chillicothe Illinois.

### **The Dogon**

The Dogon (*fig.52*) are an African tribe located mainly in the Bandiagara and Douentza districts of Mali, West Africa. The tribes population (about 300,000) being most heavily concentrated along a 200 kilometre stretch of escarpment called the Cliffs of Bandiagara. In which they have managed to use to fashion some spectacular dwellings for themselves (*fig.53*).

In the early 20<sup>th</sup> Century two French anthropologists named Marcel Griaule and Germain Dieterlen spent a good deal of time living with the Dogon in order to study their ways. In 1930, after they had been living with the tribe for some 15 years, four Dogon Priests decided that it was time to take the Frenchmen into their confidence and invited the men to share in the tribes most important and secret tradition. The tale was the secret Dogon creation myths about their sacred star which they named as *Po-Tolo*. The star to which they were referring is Sirius which located some 8.6 light years from earth. Sirius is also the brightest star in the night sky.

The Dogon told the Anthropologists that Sirius was the home of the Gods who had made them who they are. They told them that Sirius is the smallest and heaviest thing there is and that it was white in color. They said that it had a companion star, invisible to the human eye but that it

moves around Sirius in an elliptical orbit that took 50 years. They said Sirius was incredibly heavy and that it rotated on its axis and they further describe it as having a circle of reddish rays around it that is 'like a spot spreading but staying still'. Dogon oral traditions also quite adamantly state that they have known for thousands of years that Jupiter had moons and Saturn had rings around it.



Fig.52

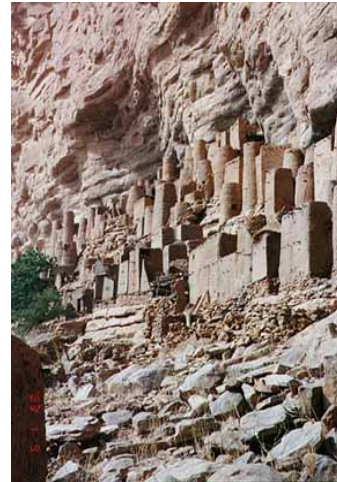

Fig.53.

Initially the men did not see the astronomical importance of what they had been told by the tribe and only offhandedly published the story in an obscure Anthropological journal. However sometime later the information was noticed by several astronomers and deemed worthy of a further, more detailed investigation.

What they discovered was that the Dogon had in fact, accurately described the three principal properties of a white dwarf star: small, heavy and white and had also stated that Sirius is a binary star, both of which we now know the Sirius system to be (*fig.54*). They are also absolutely correct in their knowledge of its companions' rotation as Sirius-B orbits Sirius-A every 49.9 to 50 years.

Their description of reddish rays is also quite remarkable as this space telescope photograph reveals (*fig.55*) and perfectly describes the DNA type pattern that is made by the elliptical orbit of the two stars rotating around each other as they travel through the sky (*fig.56*).



Fig.54



Fig.55

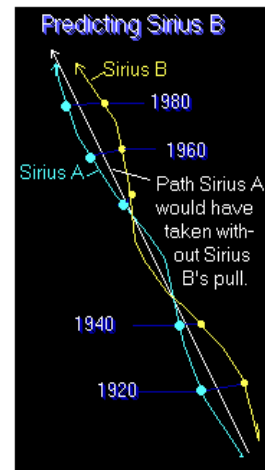

Fig.56

The Dogon people also use an extremely unorthodox calendar that is based on a 50 year cycle. This cycle is uniquely unusual because it does not follow any cycles coinciding with any

movements of our earth, moon or sun but instead is based wholly on the rotational movements of Sirius B. In fact the entire Dogon Culture is based around the 50 year cycle of Sirius B.

The Dogon People of pre 1930 had no telescopes or real written language. How is it they were able to accurately describe things we still only possessed a very limited knowledge of? Where did they get their information? The Dogon repeatedly say that they were taught these things many, many years ago by their Gods who visited them from their home planet which orbits Sirius B. The Dogon also describe them as being amphibious creatures.

### **The Giant Stone Balls of Costa Rica**

Yet such proof may have already been long ago provided by an amazing discovery was made in the 1930's by workmen who were clearing land for a banana plantation.

While burning and hacking away the jungle the workmen literally stumbled across scores of stone balls that had somehow been shaped and placed in the forest. Many of these balls are perfectly spherical and vary greatly in size (*fig.57*) ranging from the size of a tennis ball to around 8 feet in diameter and weighing up to around 16 tons and are great distances from each other with not apparent design to their positioning. Though these spherical stones are quite obviously not a natural occurrence, who may have made them and placed them at their locations or why remains a complete mystery. Some have theorized that the area was once a huge scale map of the Solar system but unfortunately too many of the stones have now been moved from their original locations to know whether this may have been the case.

These spheres are also cut to perfection and are incredibly smooth. Cutting a large stone into an absolutely perfect sphere is an extremely difficult undertaking and the methods that may have been used to achieve such flawless results is also totally baffling.



**Fig.57**

### *The Lanzhou Stone*

A truly amazing object has recently come to light in the form of an uncommon stone with a threaded metal bar inside it that was recently found by a Mr Zhilin Wang in China near to the Marzong Mountain region on the borders of the Gansu and Xijiang provinces.

The mysterious stone is pear shaped, about 6 x 8 cm, extremely hard and weighs 466 grams. Incredibly the rock is of a type that is totally unknown suggesting that it may in fact be a meteorite. However it is not only due to its unknown make up that the item has attracted enormous attention from many geologists and collectors around the world but also because of the startling artifact it contains within it.

As reported in the '*Lanzhou Morning News*' on June 26, 2002:

"More than 10 geologists and global physicists from the National Land Resources Bureau of Gansu Province, Colored Metal Survey Bureau of Gansu Province, the Institute of Geology and Minerals Research of China Academy, Lanzhou Branch, and the School of Resources and Environment of Lanzhou College gathered to study the origin of this mysterious stone.

"After a discussion about its possibility of being man-made and the possible reasons for its formation, the scientists unanimously labeled the stone as one of the most valuable in China and in the world for collection, research and Archeological studies.



Fig.58

"During the discussion, the scientists proposed many hypotheses about the formation of this stone, but found all incredible. The screw-threaded metal bar is tightly enclosed in the black lithical material. Neither the bar's entrance to the stone nor the exposed bar tip appear to be man-made. Moreover, the screw thread width remains consistent from the thick end to the thin end, instead of varying due to the growth of organisms. One of the hypotheses says that this stone could be a relic from a prehistoric civilization, since a civilization equivalent to ours is thought to have existed on earth before our current one. Another theory is that it could be a stony meteorite and it could have brought the information of an extraterrestrial civilization.

At the end of the conference, all scientists agreed that further research is needed to address questions such as how the stone was formed and whether the "metal bar" is truly metal, before the "visitor-from-outer-space" mystery can be solved."

What this stone and the threaded object is still remains any bodies guess at the moment but if it is indeed a meteorite, then it has provided us with unquestionable prove that we are not alone.

### **The Colorado Pavement**

Sometime people really do find things right in their own back yard. In 1936 a man named Tom Kenny was digging a vegetable cellar on his property in Plateau Valley on the Western slopes of the Rocky Mountains in Colorado when his progress was suddenly halted when his pick struck a slab of stone at a depth of about 10 feet. Further digging revealed a smooth and level pavement made of 5 inch square, handmade tiles that had been laid with mortar. Analysis of the mortar also revealed it to be of a different chemical composition to anything that can be found locally, further adding to the mystery.

Scientists cannot fathom the mystery of the pavement and can only agree that it is between 20,000 and 80,000 years old. The problem again is that the pavement was found in the same geological era as the 3 toed the Miocene horse which reputedly roamed the area from around 6 to 30 million years ago. Oops! The pavement still exists on the Kenny property today.

### **The Kentucky Pavement**

In another discovery extraordinary similar to the pavement discovered on Tom Kenny's property in Colorado was made by workmen digging at Blue Springs Kentucky. At first the men discovered the bones a mastodon at a depth of around 12 feet, however after further digging, 3 feet *deeper* they uncovered a broad stone pavement of totally unknown origin that was constructed of large, neatly cut stone slabs resembling a road of some kind.

Who could have paved a road through the Rocky Mountains so long ago that it now lies 15 feet below the ground?

### **A Fruit that Really should not Exist**

I've included this last little tid-bit in the riddles section simply because I think it's interesting and just because it may give you something to think about in your everyday life, something that really is most strange.

Most people are completely unaware of this fact but there is a fruit that is eaten by millions of people all around the world everyday that is quite remarkable and in all reality, simply shouldn't exist. I'm talking of course, about the banana. Bananas are actually the most mysterious fruit in the world because bananas have no seeds and what makes this even more mysterious is the fact that they are found in almost every country in the world.

Now that may not sound so odd at first but let me fully explain this enigma to you:

Firstly, banana plants are not trees; they are actually a perennial herb. The trunk of the plant is really nothing more than the plants outer leaves. The real stem of the plant doesn't actually become visible until it pushes out through the top to produce the large purple flower that will eventually develop into the fruit. Then, having finished its perennial reproductive cycle, the plant dies. The problem here, is that in the reproductive cycle of the banana, seeds are completely absent from the mature fruit! A new 'seedling' (*known as a 'sucker'*) can only ever be generated from a piece of the plants rootstock and yet bananas are found in almost most every place on earth, even on quite remote and isolated islands.

How in the world did they all get there?

The seeds certainly weren't carried across the oceans by prevailing winds. To fully appreciate this anomaly first consider that the only other seedless plants that exist anywhere in the world are things like seedless grapes, naval oranges and the many genetically modified varieties of commercial vegetables that can now be purchased, the point is, any other seedless plants that exist, anywhere in the world, are all that way because they have *genetically modified!*

And yet here we have the humble banana, which is also the only food in existence that contains exactly the correct requirements of vitamins and minerals for mans metabolism completely. It is the only food that man can live on healthily, by itself, with complete nutrition, it is found all over the world and yet we have no knowledge of how it could possibly have come into being. It seems

highly improbable that the worldwide distribution of a seedless fruit that is perfectly tailored for sustaining man would have just somehow 'happened.'

It is extremely unlikely for such a plant to have ever been produced by nature all on its own and many people believe that somehow, somewhere, sometime, someone in our far distant past genetically engineered bananas into the widely dispersed and remarkably nutritious plant that we find everywhere in such abundance to day.

These people cite that bananas are living daily proof of an ancient culture that spanned the entire globe in remote pre-history. Botanists also now tentatively agree that the spread of the banana plant appears to have radiated outward from the Pacific region.

The Banana plant incidentally, is not actually a fruit or a vegetable, but it *does* reach a height of around 30 feet at maturity which makes it the Worlds largest herb and the tallest plant in existence that does not have a woody trunk.

### **Loose Ends**

The amount of objects similar to the ones we have just discussed that have actually been found on our planet is staggering, is continually growing and as you can see, many of these artifacts are absolutely unexplainable and absolutely do not fit in any way within our currently accepted framework of history at all. In fact, many of them go so far as to disprove our current theories on the past completely. How is it that scholar's can ask us to accept the theories they have offered us as 'fact' yet in order for us to do so, they ask that we ignore the abundant physical evidence that is right before our eyes? Could it be because the hard evidence completely undermines the very theory they are asking us to believe?

There are many other strange and Out-Of-Place Artifacts (Ooparts) that have been found that are not included in this list and many unconfirmed stories of others. For the purposes of this work I have preferred to deal only with anomalies I have been able to substantially confirm. There are many other reports, though perhaps not quite as compelling because many could have been either forged or misinterpreted but some are interesting to say the least:

**A Gold thread stuck in Rock:** In 1844 The London Times reported that workmen quarrying stone near the River Tweed in Scotland unearthed a piece of gold thread embedded in the rock eight feet below ground level.

**A Much Too Old Screw:** A two-inch metal screw was apparently discovered in a piece of feldspar unearthed in 1865, from the Abbey Mine in Treasure City, Nevada. The screw had long since oxidized and disappeared, but the impression of its form, particularly the slotted head and shape of the thread, could still be clearly seen within the feldspar. The piece of Feldspar that contained the screw has been calculated to be around 21 million years in age.

**A Very old Nail:** In 1851 and as reported in the Illinois Springfield Republican, A man named Hiram de Witt had found a fist-sized chunk of auriferous quartz while on a trip to California. When de Witt accidentally dropped the rock and it cracked apart a cut-iron nail was found inside. The quartz was about 1 million years old.

**Bones Found in Rock:** A man by the name of Ed Conrad, reportedly discovered some impossibly old human bones, trapped in rock in Pennsylvania. The remains had been fossilized and were trapped within solid shale. The bones appear to be human, but the rock in which they were found is between 280 and 300 million years old.

**Grand Canyon Mummies:** In 1931, a Dr. F. Bruce Russell is reported to have found strange underground tunnels in the Death Valley area of the Canyon. Russell claimed to have discovered winding tunnels containing artifacts that appeared to be a combination of Egyptian and American Indian cultures. He said that he had found mummified remains that were over eight feet tall at the site. Russell returned with a group of men but was unable to locate the entrance again. No one has ever rediscovered the mysterious tunnels Russell claims to have found.

**Strange Skeletons:** In 1888, seven skeletons were reportedly found in a burial mound just outside Clearwater Minnesota. All of the skeletons were anatomically correct except for the skulls

which had double rows of teeth in both the upper and lower jaws. The foreheads were also unusually low and sloping, with prominent brows. All had been buried in a sitting position, facing the lake.

**The Salzburg Cube:** In 1885 a strange steel cube was found embedded inside a block of coal. The edges were sharp and straight and later tests confirmed that the object most definitely to be artificially manufactured. The device showed every sign of being machine made and appeared to even possibly be a small part of a much larger instrument.

We have no real idea how many other enigmatic artifacts and items of tremendous significance have simply been labeled “error” and tucked away in a basement drawer in a museum somewhere, never again to see the light of day and we must then pause to question how such a thing could ever be allowed to happen?

Just one of these anomalies should give one reason to pause, but when the sheer volume and unpublicized nature of them becomes apparent it gives cause for alarm. And there are dozens and dozens of such anomalies that can be found all over the world. I could fill an entire volume with such finds and have merely scratched the surface with this list. There are certainly enough of them to challenge the disciplines of traditional science but, because they don't fit with the conventional theories and in some instances may even disprove them, these anomalies and exceptions to the academic rule are almost always rejected out of hand. Such an attitude can only be described as a most un-scientific mindset. If theories are never to be challenged, if no one in science is ever willing to be proved wrong, if mankind ever becomes egotistical enough to claim that we now already know all there is to know and have discovered all there is to discover, then sadly, we have no science, no future and have lost sight of ourselves.

But the real point here is that these artifacts cannot simply be dismissed as ‘curio’s’ and thrown by the wayside because they don’t fit within the academic framework of history.

They exist! That is simple fact! So if accepting the fact that these artifacts actually exist is contrary to our current idea of history, then what are we to do? They exist, and when all is said and done it’s as simple as that.

Our view of history is quite obviously wrong and instead of perpetuating an idea we know to be totally erroneous we should be attempting to discover the real truths.

Isn’t that what intelligent and rational people are supposed to do? Isn’t that how mankind should progress towards the future?

It’s pretty obvious just by these artifacts alone that there’s definitely something going on here that we’re not being told about.

When one considers the significance of these artifacts, their implications to disprove what we know as history and the unwillingness of academia to present them for scrutiny or in many cases even acknowledge their existence, is ‘conspiracy’ too strong a word?

So not being able to thus rely on our numerous and trusted institutions to keep us informed, we are therefore forced to seek out the truth in these matters for ourselves but hold on folks because when you attempt to investigate the true nature of these artifacts as many others have attempted to do before us, it can seem for a while that the going just gets weirder.





## Chapter Three

# Of Lost Explorers & Ancient Mysteries



### *A Lost Frontier*

Our journey now moves to the vast areas of rainforest nestled in the northern reaches of South America. The jungles of the Andes are an environment that can be likened to no where else on earth and high in the jagged mountains in areas such as the Matto Grosso region of Brazil (*fig.59a*,) the jungle is some of the most dense and unforgiving in the world (*fig.59b*.)

The great explorer Percy Fawcett had called the area “The Roof of the World” and he was right. High in the heavily wooded mountains, even still, there are no towns, roads or known inhabitations of any kind as far as can be seen, just a continuous undulating blanket of dense green jungle, broken occasionally by jagged mountain peaks crumbling skyward and snaking rivers that team with piranha and huge crocodilian. The thick jungle in between them is populated by countless species of insect, enormous spiders, monkeys and other more terrifying predators: Black Panthers and giant anacondas, the largest and most feared snakes in the world. It is a place where the moist forest air itself is alive with all manner of hidden and still yet unknown compounds. Primitive tribes still live in these remote areas and it’s possible that some areas may yet be inhabited by other tribes that are even still unknown.

When the intrepid Fawcett had gone missing in the area in 1925, every major metropolitan newspaper in the entire world had announced: “The disappearance of the expedition organized by Colonel Percy Harrison Fawcett in the mysterious region of Matto Grosso, in the heart of Brazil in search of ‘THE LOST CITY!’”

Colonel Fawcett was certainly not the first to venture into the wilds of the South American Jungles, nor the last. He is however, if not one of the most famous, undoubtedly the most daring and his story is almost certainly one of the most intriguing. The diaries of Percy Fawcett have inspired many a Hollywood Movie pertaining to ‘Lost Worlds’ and mysterious jungle treasures.

### Fawcett's' Tale

Colonel Percy Fawcett (*fig.60*) had been a retired official of the British Army, a veteran fighter of the Boar Wars in India during the late 1800's, an explorer of outstanding reputation and considered by his peers to be an expert bushman in any class of forests or other rugged terrains. In 1906 he was requested by the British government to survey the borders between the countries of Bolivia and Brazil.

At the time both the Brazilian and Bolivian Governments had wanted their borders properly defined once and for all in order to quell the constantly erupting border disputes they were experiencing, disputes they were afraid would soon lead to open war between their two countries. Of course, and in true political fashion, neither country had trusted the other to do the job fairly so eventually both countries agreed that only a neutral party could suffice for the task. The Royal Geographic Society of Britain had then recommended Fawcett for the job. Fawcett had agreed and traveling by canoe and foot over roughly an 18 month period in 1906-07, he surveyed and mapped the borders of the two countries using a compass and a sexton, a staggering feat given the conditions he faced and the terrain he covered.

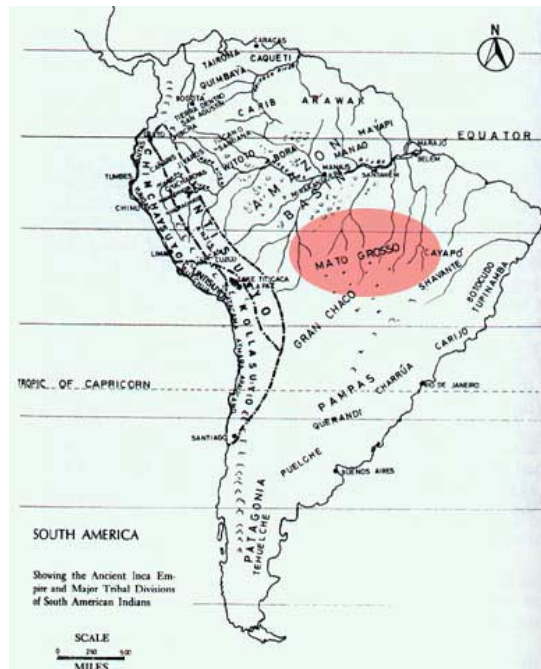

Fig.59a

During the four year period from 1908 to 1912 he had then continued further, also successfully surveying the boundary of Paraguay and the border between Peru and Brazil. Then Fawcett's mind began to turn toward the undertaking of various explorations in the region. Finally, when embarking upon a new expedition from a place deep in the Brazilian Jungle that he had named "Dead Horse Camp", he wrote his last letter to his wife on May 29<sup>th</sup> 1925.

In the letter he said this to her:

*"Our route will be from Dead Horse Camp, 11° 43' south and 54° 35' west, where my horse died in 1921, roughly northeast to the Xingu, visiting on the way an ancient stone tower which is the terror of the surrounding Indians, as at night it is lighted from door and windows. If we do not return, I desire not that you organize any rescue game... It is too dangerous. For if I, with all my experience, fail, then not much hope is left in the triumph of others and I would not encourage such an attempt. That is one of the reasons of why I do not say exactly where we go... one thing is doubtless: the answer to this enigma and perhaps to the prehistoric world... it will be found when*

*these old cities have been located and are open to scientific research. BECAUSE the CITIES EXIST... of THAT I AM CERTAIN..... You need have no fear of failure."*

And those were the last words that anyone ever heard from him.



Fig.59b

Fawcett entrusted the letter to one of three assistants who had helped the expedition thus far having told them that he no longer required their services. He had commented that a smaller group would look less like an invasion to the Indians and therefore be less likely to be attacked, an attitude that had in fact, always been his policy. He said to his assistants that the route was carefully planned. He then disappeared into the Jungle, taking with him, his eldest son Jack and another man, who was a close friend of Jack's. None of them were ever seen or heard of again.

Fawcett had been 58 years old at the time.

Despite his wishes, several rescue missions were actually undertaken in an effort to discover what had become of Fawcett, some fraught with disaster and all without success. There were also several, reported sightings by various persons of a man matching Fawcett's description, though none of these reports were ever confirmed. Rumors still abound concerning his disappearance. Some have said they saw him living with a native tribe attending his son who had become too ill to travel; some claim to have seen him wandering lost and crazed in the Jungle, still searching; one claimed that he had been captured by headhunters and that he had even seen a shrunken head resembling Fawcett. It has even been speculated that he actually found his lost city of gold but that it was still inhabited and he was never allowed to leave.

The diaries of Percy Fawcett were later published in a highly informative book entitled "*Exploration Fawcett*," later re-released as "*Lost Cities, Lost Trails*." I highly recommend reading these factual accounts of one of the truly great explorers if the book can still be found. To this day, no one has yet fully explored the Matto Grosso region of Peru and it still remains an area shrouded in Legend and Mystery (*fig.61*).

The intriguing story of Colonel Fawcett and his search for the Lost Cities he was so sure existed is one that could fill many books on its own. It began with a tantalizing tale Fawcett had heard regarding a man named Diego Alvarez.

Alvarez had been a Portuguese mariner who had apparently reached South American shores a few years after the discovery of the American continent after being shipwrecked. He had struggled ashore in Peru and then began a life filled with everything you would find in a good

adventure story. The tale he tells is one of survival in the savage jungles, capture by cannibals, bold escapes and daring adventures in fabulously rich gold and silver mines fiercely guarded by hostile Indians deep in the thick jungles. Alvarez named the place as '*The Lost Mines of Muribeca*'.



Fig.60

Fawcett is reported to have found an old document in Rio de Janeiro, dated 1753, that spoke of Alvarez and tells of how another man, of seemingly unknown origin, whom Fawcett names only as Francisco Raposo, - "I must identify him by some name" had at that time decided to make an attempt to find the rich mines Alvarez had spoken of, only according to Raposo, he had discovered no such mines. Instead after climbing a narrow pass up a difficult mountain he and his men had found, hidden deep in the Amazon: "at their feet, about four miles away, a huge city."

Raposo said this ancient and now uninhabited city was located in an area known as the '*Serra do Roncador*' (*Snorer or Bluster's Mountain*) near the Rio Xingu, in northeast Brazil. Raposo described the City as being very large and showing evidence of once being inhabited by a "highly civilized people." He mentioned a city square, many cyclopean ruins, buildings still partially roofed with stone slabs, stone archways, columns, and statues. Many of Raposo's description are quite detailed and also sound strikingly familiar to other Mayan ruins that have since been located that he could have obviously known nothing about in 1753 giving a great deal of credibility to the story and also going a long way re-enforce Fawcett's tale of his still yet to be rediscovered '*Lost City*'. A city Fawcett referred to only as "Z."

Sometime later Fawcett himself also came to own a most unusual stone idol bearing some curious inscriptions in an unknown language that have still yet to be translated. He said the idol generated an electric current that traveled up the arm of the person who was holding it. He eventually came to believe that this idol was connected to the lost cities he sought, cities he also firmly believed to somehow have a connection to the legendary land of Atlantis. He describes the idol in his book:

*"I have in my possession an image about ten inches high, carved from a piece of black basalt. It represents a figure with a plaque on its chest inscribed with a number of characters, and about*

its ankle a band similarly inscribed. It was given to me by Sir H. Rider Haggard, who obtained it from Brazil and I firmly believe that it came from one of these lost cities.

“There is a peculiar property in this stone image to be felt by all who hold it their hands. It is though an electric current were flowing up ones arm, and so strong is it that some people have been forced to lay it down. Why this should be I don’t know. Experts at the British Museum were unable to tell me anything about the idols origin.”

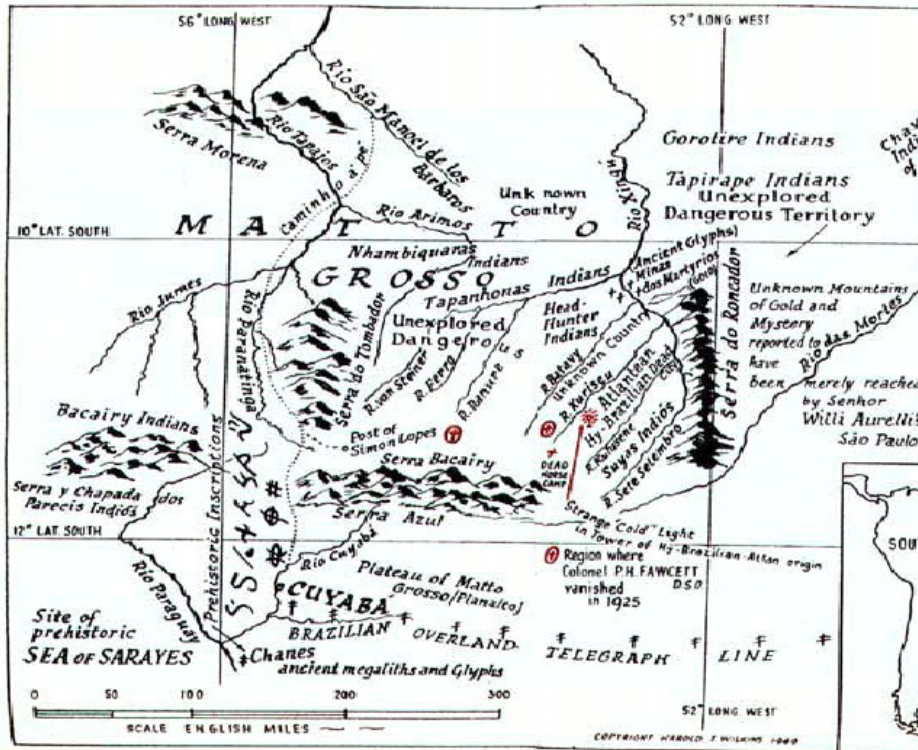

Fig.61

The black basalt image Fawcett spoke of is still a source of wonder and debate (fig.62). As of yet both the writing that appears on the plaque the character is holding and the writing on the ankle bands has not been deciphered (fig.63).

I would be more than happy to hear from anyone who may be familiar with this language or has found anything similar in another location.

In the course of his extensive and very well documented explorations Fawcett discovered many other strange and unusual things. On one of his South American journeys he lived among an tribe of white Indians known as the ‘Tapuyas,’ describing them as follows: “The Tapuya tribe are as fair as the English and they have hands and feet that are small and delicate.” His book also tells of another Amazonian tribe who were red haired and also fair skinned.

On one expedition local Indians told him of a cave filled with markings or petroglyphs in an unknown language that exist at Villa Rica and he heard many stories about lost cities deep in the jungles. One tale in particular, a story recorded in manuscript form by Jesuit missionaries in the 1700’s, told that in the jungles of Cuyaba, Brazil, somewhere in the Matto Grosso region, there are apparently strange bright lights that shed no heat, which the Indians say, have burned continually and quite unattended for many generations and still burn today in the ruins of now uninhabited and long dead cities. Fawcett claims to have also once seen these lights from distance himself. It is rumored by some that just such an eternal, cold light energy has also been found in ancient Roman and Egyptian tombs and in areas of Tibet and India though I am unable to confirm

these rumors. The production of such an eternal cold light source is beyond our current level of technology and still remains a puzzle to modern science.



Fig.62



Fig.63

Colonel Fawcett had first heard these strange stories some time after he had accepted his first survey contract. Until he had known of them, his South American expeditions were completely oriented toward civil and engineering work though even while performing his daily tasks he continued to nurture a keen interest in the forest. During his surveys he also made copious amounts of notes containing detailed observations about everything he saw, especially the ways of the white settlers, the Indians of the forest, and the forest wildlife all of which are recorded in detail in his book. However after Fawcett became familiar with the story of Francisco Raposo his attentions and interests began to shift away from just pure engineering and more toward ventures of exploration and discovery.

In one place in his diaries he records a remarkable conversation with another explorer concerning an unusual forest bird that nests in perfect round holes in rock cliffs. The man had actually spent 25 years living in the forests with the local natives and he had this to say:

*"They make the holes themselves. I've seen how they do it, many a time. I've watched, I have, and seen the birds come to the cliff with leaves of some sort in their beaks, and cling to the rock like woodpeckers to a tree while they rubbed the leaves in a circular motion over the surface. Then they would fly off, and come back with more leaves, and carry on with the rubbing process. After three or four repetitions they dropped the leaves and started pecking at the place with their sharp beaks, and—here's the marvelous part—they would soon open out a round hole in the stone..."*

*"Do you mean to say that the bird's beak can penetrate solid rock?"*

*"...No, I don't think the bird can get through solid rock. I believe, as everyone who has watched them believes, that those birds know of a leaf with juice that can soften up rock till it's like wet clay."*

*"The man continued with a personal story about his nephew. He had walked through the thick bush to a nearby camp to retrieve his horse, which had gone lame and had been left there temporarily. He noticed, when he arrived, that his New Mexican spurs had been eaten away almost completely. The owner of the camp asked him if he had walked through a certain plant about a foot high, with dark reddish leaves. The young man said he had walked through a wide area that was completely covered with such plants.*

*"That's it!' they said, 'That's what's eaten your spurs away! That's the stuff the Incas used for shaping stones. The juice will soften rock up till it's like paste. You must show me where you found the plants.' But when they retraced the young man's steps they were unable to locate them."*

There is also an interesting footnote to Fawcett's story about these birds that lends further credence to the tale. A man who had been a member of the Yale Peruvian Expedition that discovered Machu Pichu in 1911 wrote this strange story in his notes:

*"Some years ago, when I was working in the mining camp at Cerro de Pasco (a place 14,000 feet up in the Andes of Central Peru), I went out one Sunday with some other Gringos to visit some old Inca or Pre-Inca graves—to see if we could find anything worth while. We took our grub with us, and, of course, a few bottles of pisco and beer, and a peon—a cholo—to help us dig. Well, we had our lunch when we got to the burial place, and afterwards started to open up some graves that seemed to be untouched. We worked hard, and knocked off every now and then for a drink. I don't drink myself, but the others did, especially one chap who poured too much pisco into himself and was inclined to be noisy. When we knocked off, all we had found was an earthenware jar of about a quart capacity, and with liquid inside it.*

*"I bet its chicha!" said the noisy one. "Let's try it and see what sort of stuff the Incas drank!"*

*"Probably poison us if we do." observed another.*

*"Tell you what, then—let's try in on the peon!"*

*"They dug the seal and stopper out of the jar's mouth, sniffed at the contents and called the peon over to them.*

*"Take a drink of this chicha," ordered the drunk. The peon took the jar, hesitated, and then with an expression of fear spreading over his face thrust it into the drunk's hands and backed away.*

*"No, no, señor," he murmured. "Not that. That's not chicha!" He turned and made off.*

*"The drunk put the jar down on a flat-topped rock and set off in pursuit. "Come on, boys—catch him!" he yelled. They caught the wretched man, dragged him back, and ordered him to drink the contents of the jar. The peon struggled madly, his eyes popping. There was a bit of a scrimmage, and the jar was knocked over and broken, its contents forming a puddle on top of the rock. Then the peon broke free and took to his heels.*

*"Everyone laughed. It was a huge joke. But the exercise had made them thirsty and they went over to the sack where the beer- bottles lay.*

*"About ten minutes later I bent over the rock and casually examined the pool of spilled liquid. It was no longer liquid; the whole patch where it had been, and the rock under it, were as soft as wet cement! It was as though the stone had melted, like wax under the influence of heat."*

The head of the Machu Pichu expedition Hiram Bingham also tells a similar tale that was related to him by natives of how the edges of great stones would be rubbed with the juices of a certain plant which would render them like clay to and create a perfect joint.

The possibility of such a plant existing is not at all unreasonable. There are still a myriad of undiscovered species in the Amazon basin. Unfortunately though, due to the rapid rate of deforestation that is occurring there, we may fast be running out of time to find it. Bingham himself never put much faith in the story as he could never conceive of how such enormous stones would have been lifted in the first place for such rubbing of the edges to have taken place, let alone placed it into its position in the wall. Local legends have always insisted the task was done by giants and Bingham himself surmised that such could only be the case

### *Impossible Buildings*

The ability to soften stone would certainly go a long way in explaining the unique stonework found in the Mayan structures and before you laugh the thought off as ludicrous, consider that many of the fortresses actually bear some very unusual markings that could easily be explained by tooling the surface while it was still soft. It should also be realized that many of the stones used in these structures are truly immense, some as tall as three meters and virtually impossible to maneuver into place using any of our our current expertise. And not to forget that some of the stones, like this famous one at Cuzco (*fig.64*), have up to twelve perfectly fitting angles, and that is just the ones that are visible on the face. Beneath the face, the back and side sections are also perfect, In fact, *so perfect* that a razor blade cannot fit between the joints and it is the same over



Fig.64

the entirety of the wall on *every block of stone!* Consider that fact when looking at the wall at Sacsayhuaman (*fig.65*). Apart from it resembling a wall made of grey ‘play dough’ from a distance, such precision is, as yet, impossible using any kind of cutting tool and even if it were possible to cut the stones with such precision, how on earth would they have then been maneuvered into place? Presumably, if they were hewn and then placed in the walls, the process would also have been repeated many times over for *each block* for fine adjustments to be made to the angles in order to reach the absolute precision obtained in every block. Such a method is not only implausible but is nothing short of impossible and so it stands to reason that the obvious and somewhat disturbing explanation is that the joining edges, quite simply, were not cut in any conventional sense. It is known that the stones were in fact quarried and transported to the site for the quarries they came from have been located. But how were they worked to such perfection and then transported to the site which is located 13,000 feet (*Four Kilometers*) above sea level and how were the joints perfected? When one looks at these Mayan structures they certainly do have the appearance of a wall that is made of clay that has solidified. Again, take the wall at Sacsayhuaman (*fig.65*); it seems enormously strange, and also highly unlikely, for the builders to have gone to such incredible trouble to make sure the stones fitted together with what is an absolutely ridiculous degree of perfection, while using the most difficult shapes imaginable, only then to leave the visible face of the wall virtually covered with a myriad of imperfections that makes them look rough and unfinished.





Fig.65

To be honest, that is an interesting enough point in itself. But what does an even closer examination of some of these imperfections on the walls produce?



Fig.66

There is a section of a great wall at Ollantaytambo, Peru (*fig.66*) has some highly unusual and very tell tale markings on it. Notice the flat section near the top of the stone marked on the right and the long scrape marks on the stone marked on the left? These marks simply don't look as if they have been purposely carved onto the walls in any way at all. Another section of the Sacsayhuaman wall (*fig.67*) that bears a number of strange scrape marks and dents on its surface that look very much like tool marks. Interestingly, if you prod a lump of soft clay or cement with the end of a stick and let it dry, you can create marks and dents that look just like these.

The stonework at Ollantaytambo is nothing less than spectacular and not by using all our advanced laser and computer systems combined nor by gathering all the technology we could

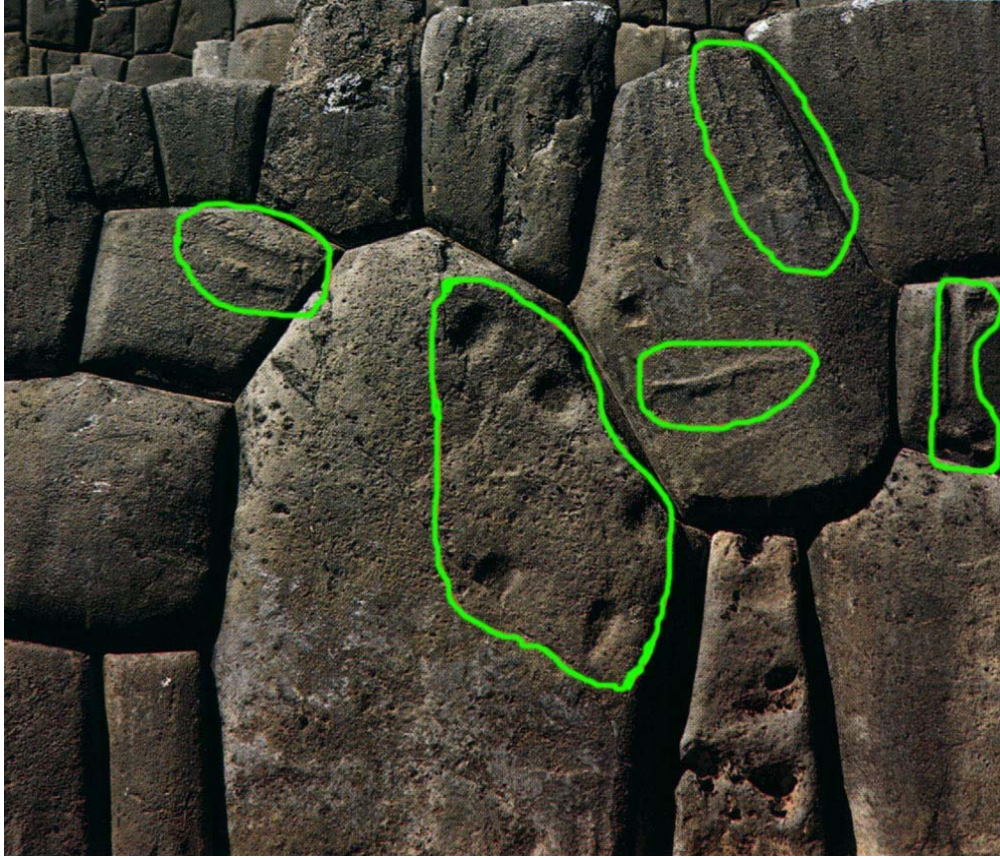

Fig.67

muster, could we begin to come even close to achieving what has been done in the construction of these Jungle megaliths of ancient times. Softening the stones seems to be the only logical explanation of how these walls were built. It's the only thing that can adequately explain the precision fit of the stones which would then naturally settle snugly together under their own weight easily creating a perfect and gapless joint.

On another section of the walls at Ollantaytambo we can notice the small plugs protruding from the bottom of each small filling stone between the larger ones such as you might see used to provide stability in concrete form work? (*fig.69*). It is commonly believed that the protrusions found on the stones in these walls were used to hang gold plating or for tying ropes to for handling. Unfortunately for both of these theories, the protrusions are of completely insufficient size or shape and are too randomly placed to be effective for either of those uses.

They could however, be formed by making marks in the support structure. And interestingly, when working with a substance of such great weight, such protrusions would in fact, *actually be necessary* to prevent any uncontrolled movement of the heavy and wet material on the outer face of the wall while it solidified.

No-one has adequately explained how the people of ancient times built these structures, or even why on earth they would have thought it necessary to go to so much trouble. All we know is that they did, because the structures are there and still defying our analysis. Archeological and documented evidence suggests the actual builders of these incredible megalithic fortresses may in fact date back to a period far before the Mayans inhabited the area to when the dominant race was the Olmecs. There is also further evidence to suggest that the actual purpose of these structures may have been vastly more profound than simply temples or fortresses. This will be discussed further in a later chapter.

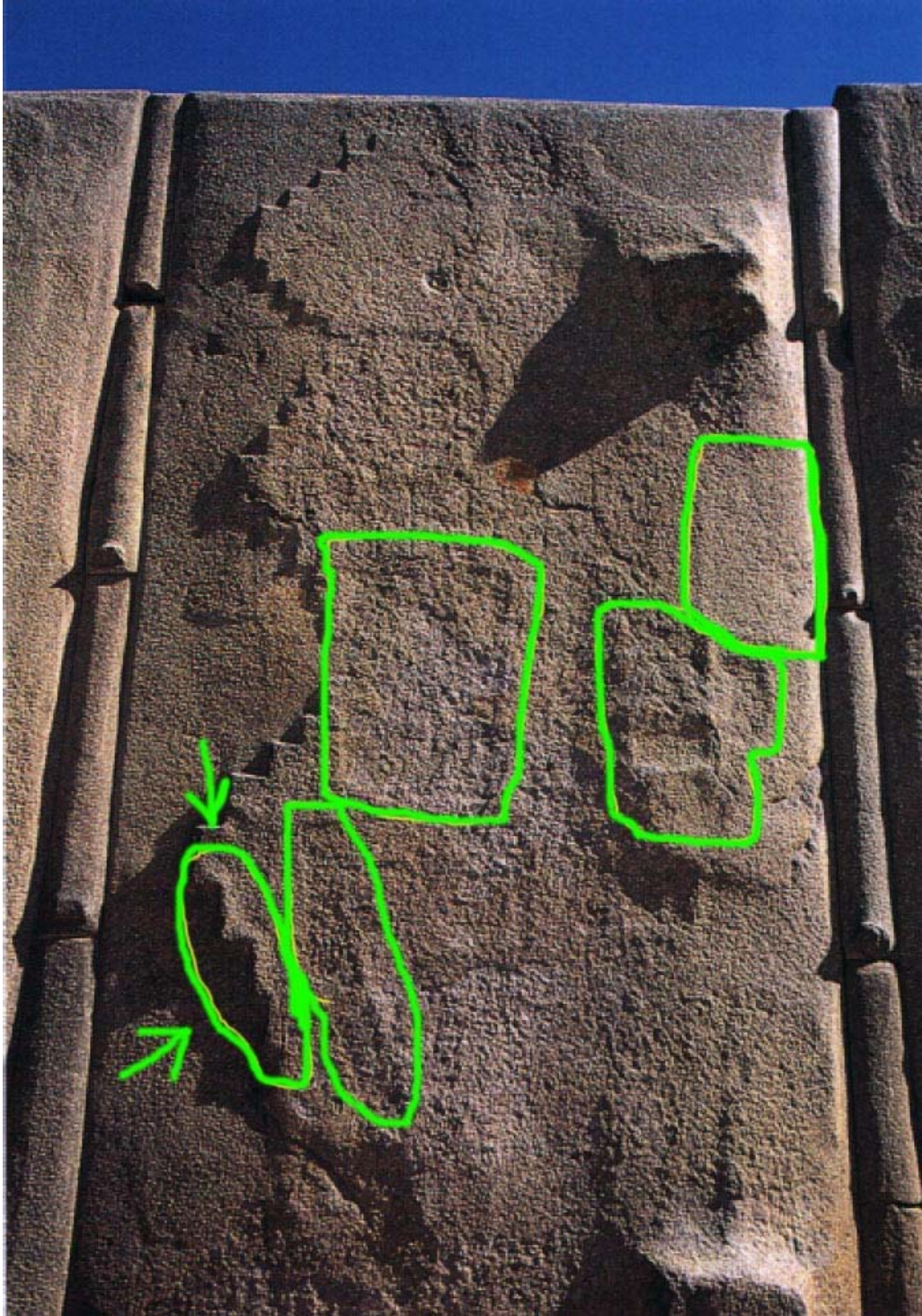

Fig.68

*This is a particularly enigmatic stone from the Ollantaytambo wall (fig.68): Although the surface of the stone is quite rough and could very well have been hewn, it is very difficult to explain the zigzagging pattern on the face of the stone. While it is true that the 'stairway' pattern is a motif common to many Mayan structures, notice how the bottom section of the lower zigzag appears to have protruded slightly and sagged a little. It seems quite unlikely and somewhat unreasonable to think that something like this would have been purposely carved onto the surface of the wall? Other sections look as if they have been slapped with blocks or prodded with the end of sticks while the material was still soft and just look at the narrow 'filler' stones between the large slabs.*

It is obvious that the ancients actually did know of a way to soften stone. It seems to be the only thing that fits. How else could it have been done?



Fig.69

Local legends repeatedly maintain that the walls were erected by giants, gods who raised the stones in a single night. Legends also tell of how the edges of the stones would be rubbed with the juice of a special plant which would soften the stone like clay and thus perfect the joint.

To think that simply because we have not yet located the small crimson plant Fawcett spoke of in the myriad of unknown species that have yet to be discovered in the Amazon jungle certainly does not mean that such a plant does not exist. To rule something out completely because it has been found yet would be nothing short of foolhardy, with such an attitude we would never have discovered electricity, that's a given.

One of the more unfortunate things in the dilemma though, is that time is fast running out. We may now never find any such plant. Not now that the main Amazon basin has been ruined by American oil interests and the remaining forests are still being destroyed at the rate of at least 3 football fields a day. It's almost like they're *trying* to make sure all evidence of such a thing is destroyed. But then, one should never attribute an action to malice when it can be adequately explained by stupidity. Though, when one is considering the actions, motives and attitudes of modern governments, unfortunately it's usually the former. Such a plant may have already become a victim of industry, lost forever in the technological crunch.

But then, thanks to a remarkable man, we may not need to find it...

Recent discoveries and work by a Dr Joseph Davidovits of the Geopolymer Institute have produced some remarkable insights into the processes the ancients may well have used to construct these amazing fortresses.

### **Softening Stone with Plant Extracts**

Amazingly, a recent ethnological discovery has actually shown that some witch-doctors of the HUANKA tradition remarkably, use no tools in the making of small stone objects, but in fact still use a chemical solution *made from plant extracts* to actually soften the stone material!

According to Dr. Davidovits, in a paper that was written by Dr. Davidovits, A. Bonnett and A.M. Marriote and presented at the 21st International Symposium for Archaeometry at Brookhaven National Laboratory in New York, USA in 1981:

*“The starting stone material (silicate or silico-aluminate) is dissolved by the organic extracts, and the viscous slurry is then poured into a mould where it hardens. This technique, when mastered, allows a sort of cement to be made by dissolving rocks; statues which could have been made by the technique of the pre-incan HUANKA, by dissolution followed by geopolymeric agglomeration, are found to contain Ca-oxalate in the stone.”*

The trio then proposed the hypothesis that the large stones in found in the Mayan Fortresses and monuments were in reality, artificial and had in fact been agglomerated with a binder after certain rocks had been slowly disaggregated, an idea that fits very well with what the walls look like and also happens to be in total agreement with local legends and traditions such as those that were told to Fawcett.

The group then even went on to present to the meeting some actual samples of stone that had dissolved and re-aggregated themselves to prove it!

*“We present here the first results on plant extracts on the dissolution or dis-aggregation of calcium carbonate containing rocks (Bio-tooling action). The feasibility of chemically working calcium carbonate with various carboxylic acids found in plants (acetic, oxalic and citric acid) has been studied. Maximum bio-tooling action is obtained with a solution containing:*

*Vinegar (1 M) (acetic acid)*

*Oxalic acid (0.9 M)*

*Citric acid (0.78 M)*

*The great surprise was actually to discover very ancient references to their use since Neolithic times for working materials which are very hard but easily attacked by acids, such as chalk. Thus, a bas-relief from the tomb of Mera, at SAQQARAH (VI dynasty, 3Millenium B.C., Egypt) shows the hollowing out of "Egyptian alabaster" (CaCO<sub>3</sub>) vases by a liquid contained in a water skin or bladder. An experiment of interest was to compare the "bio-tooling" technique with the shaping of a hole using a steel tool and the quartz sand technique recommended by pre-historians. The hole resulting from sand abrasion has rough walls, whereas bio-tooling gives a smooth finish.”*

The work by Dr. Davidovits is nothing short of brilliant and also very refreshing. It's also interesting to note how quickly the problem was solved once the right approach to dealing with it had been adapted.

There is now very little doubt about how the Ancients actually built these incredible structures and indeed, softened or perhaps melting the stone has always really been the only possible explanation. The ancient Mayans were indeed quite capable of producing very large quantities of the acids that were used by Dr Davidovits in his experiments from many plants that were quite common to the region in the distant past.

Plants such as: Fruits, Potatoes, Maize, Rhubarb, Rumex, Agave Americana, Opuntia, Ficus Indica and Garlic to name a few.

It is highly feasible that the stones were quarried, then broken or crushed to manageable sizes for transportation to the locations and re-aggregated on site while being cast back into the megalithic slabs we now see, after all, since we have seen that they certainly had and knew about the means to do it, it somehow seems absurd to think they would not have made use of the knowledge.

Once again, the simplest and most likely explanation is usually correct.

But all of this knowledge still does not answer the fundamental questions: Who actually built them and Why?



# A Valley of Kings

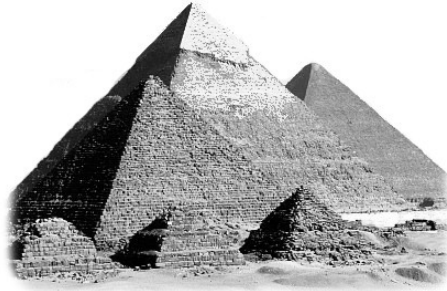

The ruins found the Jungles of South America are spectacular enough but there are few places in the world that have captured the collective mind of mankind more than the Necropolis at Giza in Egypt (*fig.70*). For years many furious debates have raged concerning the construction of the complex especially Great Pyramid and many people have proposed numerous different ideas on the methods that were employed in the task. Theories have been put forward concerning huge stone blocks rolled into place on logs via great earthen ramps. Elaborate Pulley Systems. Massive stones transported from far off quarries by river barges. Counter-weights. Sand traps. Armies of slaves doomed to generations of pulling and lifting - and many other theories. Alien help has been suggested and even Levitation.

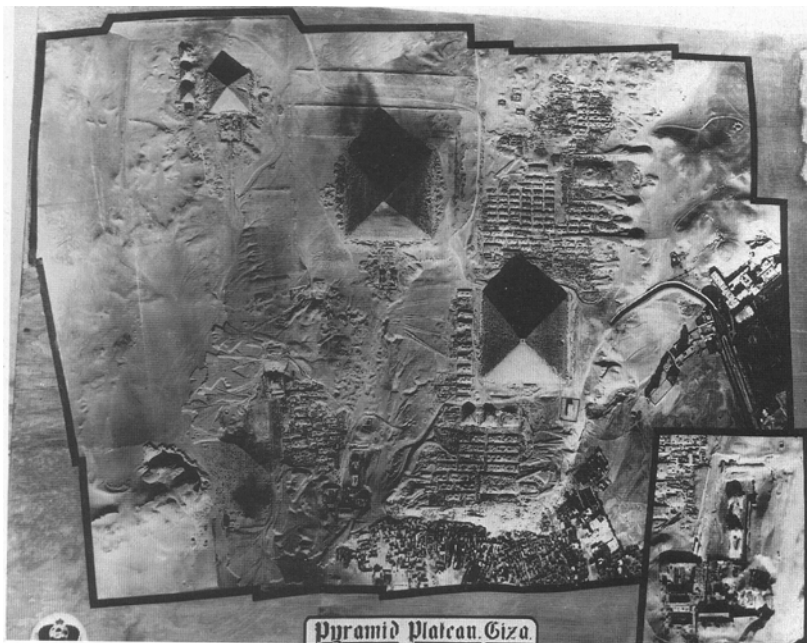

Fig.70

But for all the myriad of ways that have been suggested, every one can be found to contain flaws and none can yet provide an adequate explanation that accounts for all the variables.

There are many ancient stele and paintings that exist depicting almost every conceivable aspect of everyday ancient Egyptian life but have you ever considered that not one exists that depicts the building of the pyramids or of people ever even man-handling massive stone blocks?

Ultimately no-one really seems to know who it was done by or how it was done – not yet.

### **The Great Pyramid**

The Great Pyramid is the largest and most controversial of the three large Giza Pyramids. It stands at one side of the three. It's not the one in the middle with the limestone casing still intact near its summit as many erroneously believe but is in fact the pyramid behind that one, the one that has been completely stripped of its limestone casing and is missing the cap stone (*The missing cap stone is an intriguing mystery all on its own*). But before we continue, some facts about the Great Pyramid must be taken into account, if only to answer the question: Why all the debate? So please first consider these rather interesting points:

The Great Pyramid (*fig.71*) is about as high as a 40 story building and contains an estimated 23 million blocks of rectangular limestone, each weighing an average of 2.5 tons (*though the exact number is still an issue for contention and recent x-rays have revealed there actually may be as little a half that amount*). The blocks are fitted together so precisely that a thin knife blade cannot be inserted between any of them. In its finished state it was covered with smooth limestone casing



Fig.71

stones which created a surface that weathered to harden and become smoother and shinier with age causing the pyramid to reflect the Sun and shine brightly from a distance. Napoleon described it as shining like a diamond on the distant horizon. It is said that in those days it was actually visible from Palestine. Its sides rise up from the ground at a uniform 51 degrees and it is almost perfectly square and level. So great is its accuracy that no other structure that has been built, either before or since, is comparable to it. Even those buildings constructed recently using modern laser methods cannot equal the accuracy of this single ancient stone structure. The method employed to square and level the base prior to commencing its construction is also a total mystery because, to make matters even more difficult, a large hump of bedrock exists near the

center of the base of the Pyramid which actually protrudes into the mass of the pyramid itself (fig.72).

This hump of protruding bedrock is nowhere near level which means that a standard 4, 5, 6 method of squaring the base could not have been used, and yet the first layer of blocks have been laid directly *and fitted perfectly* onto this bedrock base to create a perfectly level second layer. The Great Pyramid is accurately aligned to True North, not Magnetic North (*which would have been a lot easier*) more accurately than any other existing structure built either before or since. Creating various equations using its measurements produce results that give us the distance from the Earth to the Sun, The distance from the Earth to the Moon, The diameter of the Earth, The Radius of the Earth at the equator, The length of the solar, sidereal and anomalistic years and the mathematical formula of *Pi*, thousands of years before it was discovered - just to name a few.

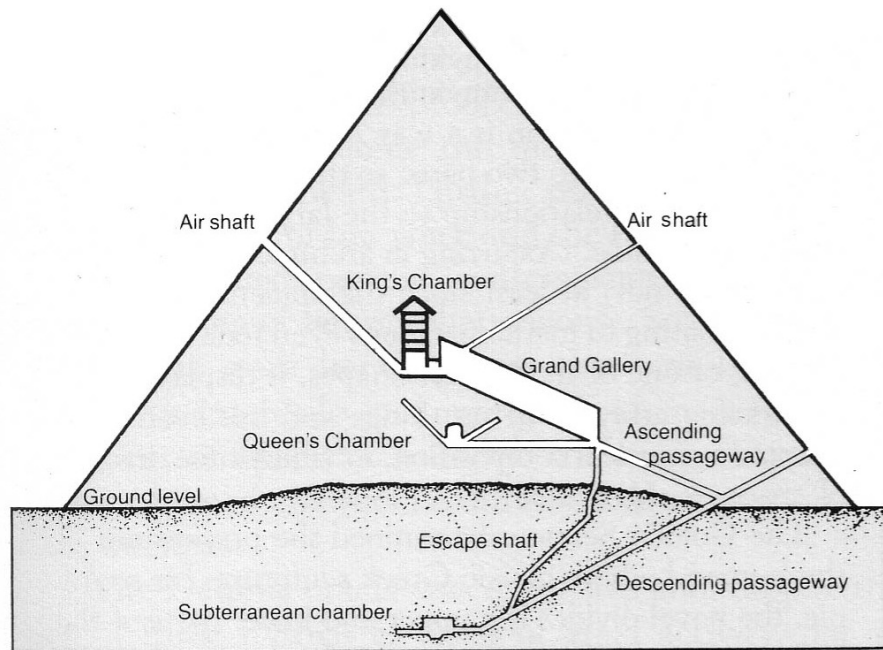

Fig.72

If it is indeed a tomb as we are told then the Great Pyramid has also somehow been constructed in the most difficult way imaginable, even to the extent that it would appear the builders were looking for the hardest way possible to build a structure. The building and layout of the stone blocks is indeed so remarkable with the blocks fitted together to such a degree of precision and in such an unusual fashion that even the most sophisticated, scientifically minded construction teams have not been able to replicate it (*even a scientific team who tried using Laser cut Styrofoam and glue*). It contains so much stone that it could swallow within its structure, all of Saint Paul's Cathedral, Westminster Abbey in London, Saint Peter's in Rome, and the Cathedrals of Florence and Milan without even bulging at the sides.

The sides of the Great Pyramid are not flat. There is actually a slight indentation that runs up the middle of each side starting in a flat triangular section in the middle of each side (fig.73). These indentations were not noticed until the mid 20<sup>th</sup> century when an aerial photograph was taken of the pyramid. These new points have provided scholars with new points of reference for various measurements but they also raise some more intriguing questions.

Remember, the Great Pyramid used to be covered with a polished limestone casing that was flat and smooth, completely obscuring these indentations. So why on earth were they put there in the first place? And then, after completing such a feat of perfect construction, why then cover them up with casing stones? What on earth was the point to such an exercise? However, because



the indents are there, we can now measure from one corner to the other ie: A – B, we can measure across the bend to all points ie: A – D – E – B and we can measure from one corner to the top of the flat triangle to the other corner ie: A – C – B.

Please note that all measurements are done in pyramid inches and sacred cubits. A pyramid inch is .0011 larger than a standard inch while one sacred cubit is 25 pyramid inches. This method of measurement is only found at Giza, the U.S.A and Stonehenge and is the same method of measurement that is used and described in the bible for such things as the two arks.

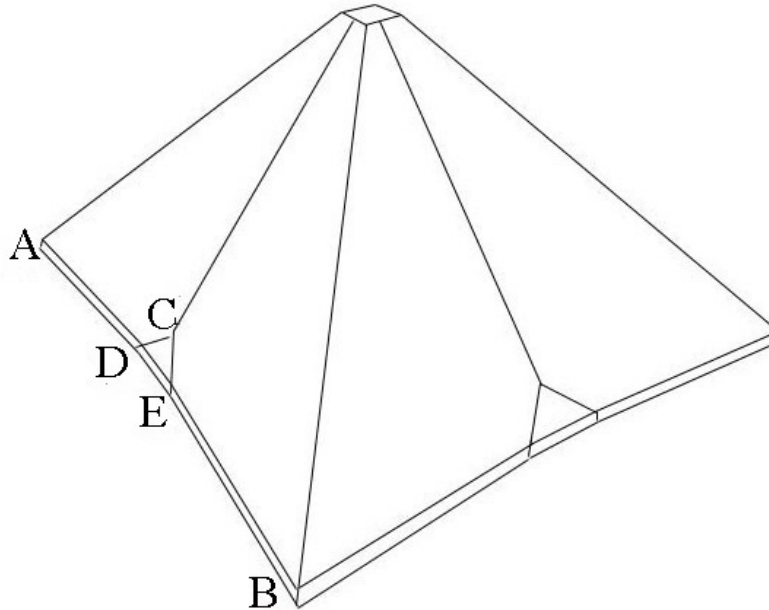

Fig.73

Interestingly, the distance between points A – B is 365.242 sacred cubits, the exact length of the solar year. The distance across the indentation between points A – D – E – B is 365.256 cubits, the exact length of the sidereal year. The distance between points A – C – B is 365.259 the exact time it takes from earth to return to its perihelion, the anomalistic year.

When a circle is made by using the arc created by the indentation, the circumference of the circle is the same as the circumference of the earth at the equator.

And yet the casing stone were flat! Why were these incredibly accurate measurements purposely contained in the stonework beneath them?

In the 'King Chamber' is a hollowed out stone block rising from the stone of the chamber floor that appears to have been fashioned by an as yet unknown means that we are told was where the sarcophagus would have lay. Because of the placement of the stone blocks, passage ways and hollow spaces above the chamber the room is extremely resonant, causing the entire pyramid to ring like an enormous bell when this hollow stone block is struck.

What purpose does all this serve? Coincidence?

Still an impossible feat of engineering by today's standards, the Great Pyramid just stands there elegantly and defiantly before us, an absolute marvel of construction and mathematics, a complete mystery and a true wonder, by any measure.

So how did it all get there? Who built it? How was it done and why was it built at all? Why on earth go to so much trouble and use such a bizarre and difficult design? And why incorporate so much mathematic, scientific and astronomical information into its measurements?

The Great Pyramid is commonly believed to be the work of the Pharaoh Khufu also known as Cheops. Construction of the Pyramid is said to have taken place during the reign of Khufu about

4500 years BP at around 2500 BC while the Sphinx is thought to have been constructed at a later date, presumably within Khufu's son Khafre's life time. Therefore the Pyramid is presumed to be slightly older than the Sphinx. We are told that the smaller pyramid of three found at the Giza complex was built by the Pharaoh Menkara.

These are the mostly accepted theories and indeed are widely taught as fact by Egyptologists and in schools throughout the world.

Some of the main reasons given for coming to these conclusions and believing that the timeline of 2500 BC is correct are as follows:

There exists in the Giza valley near to the Great Pyramid, a Stele that mentions the name of Khufu. The Pyramid is said to be the final rest resting place for Khufu, though no remains have ever been reported to have been found inside. There is also an inscription within the Pyramid itself, located on a wall in a small ante chamber in a roof section above the Kings Chamber appearing in a manner similar to graffiti which also bears the name Khufu.

There was a Mummy retrieved from the smaller pyramid in 1837 that was reported to be the remains of Menkara that is also widely believed to validate the theories.

But there are serious problems with this reasoning.

### *The Sphinx*

The Sphinx (*fig.74*), located in the Giza complex close to the Great Pyramid, is perhaps the most controversial structure in all Egypt. It is carved directly out of the surrounding stone of the plateau and many large blocks have been excavated around it to clear the area. The removed blocks were later used to build the Sphinx Temple that sits nearby. The Sphinx raises a number of interesting questions that beg for explanations but for the purpose of this work the only questions we really need to answers are: Who really built it? And; when was it done?

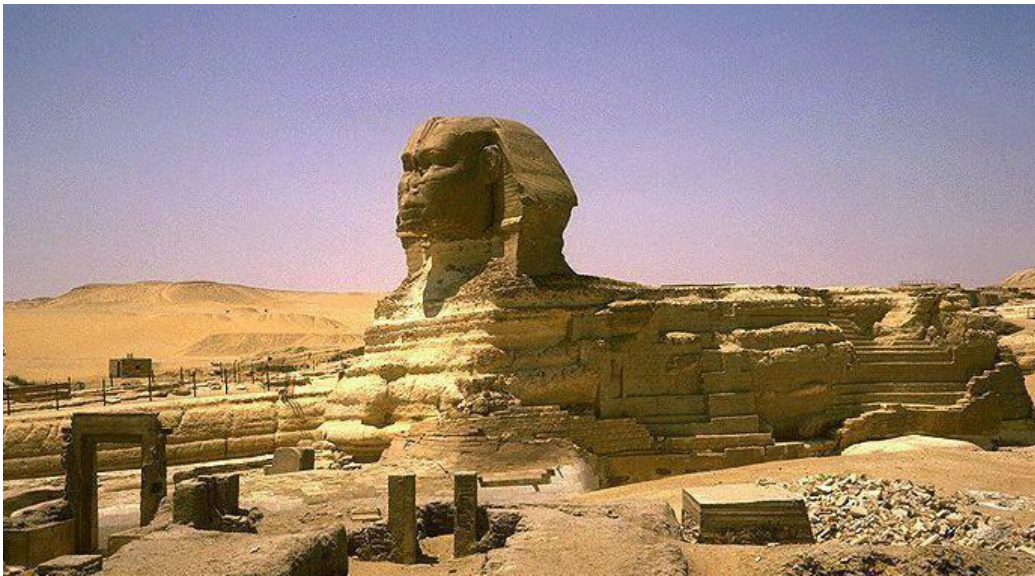

Fig.74

The Sphinx is believed by Academics to have been built by Khafre who was a son of Khufu and to have been constructed around 2450 BC. This is because in between the paws of the Sphinx there is a stele that bears the inscription 'Khaf'. The theory is also said to be corroborated by several statues of Khafre that were found in the temple next to the sphinx and mainly because one of the statues was in the form of a sphinx. It is also said by many scholars that verification of who built the Sphinx is quite simple as the face depicted on the Statue is clearly that of Khafre and that this can be verified by a simple examination of the many statues, busts and carvings of Khafre that still exist today. But there are also serious and very obvious flaws with this theory.

### *Investigations of the Facts*

Although both these theories are still presented to us as fact, the evidence we have been presented with to validate them both is flimsy and circumstantial at best. In reality, the theory that Khufu and Khafre were responsible for the monuments and that they were built as elaborate tombs has long been disproved. There is an abundant amount of new evidence to suggest otherwise and it is now well known by many scholars that the Pharaohs of Egypt were in fact, not the builders of the Giza complex.

In truth, and contrary to common public belief, nothing has ever actually been found in any of them to confirm or even seriously suggest the pyramids were ever tombs in the first place.

When examining the Sphinx we should take into account that the ancient Egyptians went to great pains to produce accurate depictions of their rulers and this can be seen in the various surviving statues we have of them. Many of these statues are quite detailed, even capturing facial expressions and the genuine non-symmetry and subtle variations between one side of the face and the other. It therefore seems safe to assume that they would have also strived for a certain degree of accuracy when building statues.

Using today's face recognition techniques and computer technology several stark contrasts between the Sphinx and the face we know as Khafre become very apparent. But any layman can just apply basic geometry to compare the angles of the Sphinx to those of Khafre (*fig.75*).

Such comparison clearly shows that the profile of the Sphinx differs totally to that of Khafre. The angles and general shape of the profile is all wrong. At just a glance at the Sphinx, the cheeks are too prominent; the jawbone the wrong shape, the brow too pronounced and the ears too high.



Fig.75

This can then be confirmed further by observing the number of glaring differences that also become apparent when using the same simple geometry to compare the facial angles in the front views of the two faces (*fig.76*). As we can see, the jaw is too wide, the mouth is wrong, the eyes are the wrong shape and the ears... ah yes those ears.

It suffices to say: the two statues simply don't look anything like each other. I mean, sure there's one head with two eyes, two ears, one mouth, the remnants of a nose and the same standard Egyptian head dress but that's where the similarities end. (*The nose is thought to have been blown off by Napoleon's forces, though this is also heavily debated.*)



Fig.76

Then there is the stele bearing the name 'Khaf' standing between the paws of the Sphinx itself (fig.77). This granite stele was erected to commemorate restoration work that was done on the monument by King Thutmose IV sometime between 1425 and 1417 BC. That this single syllable of 'Khaf' that appears on the stele should give Egyptologists reason to believe Khafre was the builder is somewhat bizarre because the very same stele also describes the entire Giza Necropolis as being a 'Splendid Place of the First Time' which of course associates the whole complex a far earlier epoch in Egypt's history.

There is also another stele at Giza called '*the Inventory Stele*' which mentions Khufu building a temple and also mentions the Great Pyramid as being next to the Sphinx, which also indicates that both the sphinx and the pyramid were already there before Khufu's time.

Naturally, Egyptologists have branded the Inventory stele as a forgery because it is contrary to the orthodox theory, though they neglect to indicate who they think may have forged a 4500 year old stone stele or why. This same extraordinary approach has been seen with other stele as well, as in the case of the king list in which the bottom half of the list is said and has been proven to be genuine but the top half is said to be either a 'forgery' or 'mythology' or 'mistaken.'

One of the main anchor points for the theory that Khufu was the builder the Great pyramid lies with an inscription bearing his name that was found in a small antechamber within the pyramid that had long been sealed. This inscription was seized upon as proof but has always been highly suspect and has been now confirmed as a forgery yet it is still used to validate the theory. The story of the inscription goes like this:

In 1837 a man by the name of Colonel Howard Vyse and two companions claimed to have found the remains of the Pharaoh Menkara inside the smaller Giza Pyramid thus proving at last who built it. However the real fact of the matter is that the mummy was a fraud, consisting of a 2000 year old coffin and some bones from the Christian era which had been assembled into a fraudulent 'discovery.' This fact is widely known by scholars and cannot be disputed by anyone yet it is almost never publicized. The fact that the inscription found inside the antechamber of the great pyramid was also found by Colonel Vyse in the same year should immediately give one pause, and yet we find that this fact is absolutely *never* publicized. Why?

The forgery of the inscription has actually now been positively confirmed by the great-grandson of a man *who witnessed the actual event!* The suspect nature of the inscription was mentioned by the Sumerian scholar Zechariah Sitchin in his book '*The Stairway to Heaven*'. A

reader of the book then wrote to Sitchin confirming the forgery which he reported on in a later book entitled *'The Wars of Gods and Men'* in which he says:

*"At the end of 1983, a reader of that book came forward to provide us with family records showing that his Great-Grandfather, a master mason named Humphries Brewer, who was engaged by Vyse to help use gunpowder to blast his way inside the pyramid, was an eyewitness to the forgery and, having objected to the deed, was expelled from the site and forced to leave Egypt altogether!"*



Fig.77

It is therefore somewhat strange that still in 2006 any book on the Giza complex you may pick up released by mainstream Academia still states that the smaller Giza pyramid was built by the Pharaoh Menkara even though the fraud was exposed almost immediately is widely known about.

It is interesting that smooth sided square based pyramids were never part of ancient Sumerian construction yet Sitchin also offers us pictorial evidence in the form of 6000 year old Mesopotamian Clay Tablets clearly depicting a smooth sided square based Pyramid during construction (*fig.78a*) and celebrations after its completion (*fig.78b*) and one clearly depicting the serpent symbol of the Sumerian God Enki (*fig.78c*) presenting us with further proof that the monuments were known to the ancient Sumerians of 6000 years ago and of their far greater antiquity than is currently theorized. There is also documented evidence in 6000 year old Sumerian texts which mention the construction of an abode called the EN.KUR which translates as 'House that like a Mountain Is' and describes how the structure was eventually abandoned due to a conflict and had its cap-stone removed. These texts also mention the hurried hacking of an emergency shaft to rescue someone imprisoned inside the EN.KUR by huge sliding stones, which adequately explains three enigmas of the Great pyramid all in the one text!

Clearly, if the pyramid was not known to the ancient Sumerians as we are told then they could not possibly be in possession of such accurate information that is also so unique to the structure.



Fig.78a



Fig.78b

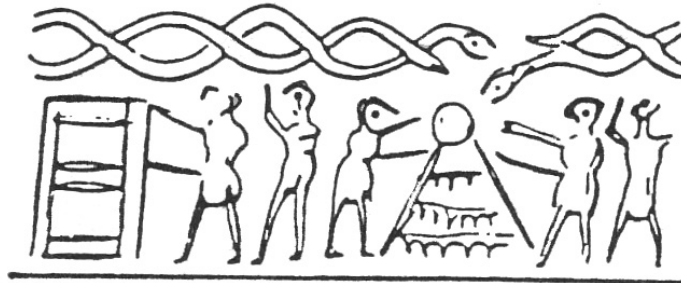

Fig.78c

In the extremely well researched book *'The Keeper of Genesis'* released in 1996, the authors John Hancock and Robert Bauval present strong evidence to support the theory that the sphinx was not built in the image of Khafre. In the book, Hancock and Bauval even go so far as to employ the services of a forensic scientist who specializes in face recognition to compare the two faces. His comparison shows undeniable discrepancies between the two and also punches some more serious holes in the 'Sphinx is Khafre' theory. The two authors also present a very solid case in regards to dating the entire complex by examining the work of John Anthony West which raises serious geological questions about the entire Giza complex. In West's excellent book *"The Serpent in the Sky"* he also questions the alignments of the monuments, suggesting that these alignments were in no way incidental but rather, they held very significant and easily confirmable astronomical implications.

This is an issue that was also raised in Robert Bauval's book *'The Orion Mystery.'* But in *'The Keeper of Genesis'*, and against a torrent of opposition from the academics, the authors of also put forth another bold theory that not only is the face on the Sphinx not that of Khafre, but based

on overwhelming geological evidence, the Sphinx is in fact, much older than even the Great Pyramid.

### *The Date or not the Date?*

The work done by West and Schoch and the claims made by Hancock and Bauval in *the Keeper of Genesis* at once produced a veritable storm of criticism from the Academic community.

The notion that someone who held no Doctorate or degree would dare to present such an absurd theory infuriated them. They flatly proclaimed the authors to be wrong and refused to speculate any further on the possibility that the sphinx was not Khafre. They bluntly dismissed the idea of the sphinx being older than the great pyramid as ridiculous and I believe, also banned the entire party from further access into the Giza complex to conduct any more investigations.

It is an interesting thing that any investigative team that tries to present a different theory on the Giza complex to that which is put forth by the general academic community is subsequently banned from further access to the site by the Society of Egyptology. It doesn't sound like they feel very secure in their convictions and really don't want people messing around with the 'facts'.

Science is supposed involve conclusions that are reached through the rational investigation of *all* of the theories and *all* of the evidence, not conclusions arrived at through the blind assumption of one theory as fact. No theory should ever be placed in a position where it is no longer open for debate, especially one so loosely based on circumstantial evidence and pertaining to a site of such significance that is still so full of mystery. But, unfortunately, in blatant disregard for the true advancement of genuine scientific research, the Society of Egyptology is quite adamant about banning anyone with a new theory that doesn't quite fit with their own. It seems that they are quite intent on keeping the real truth about the Giza complex very tightly under wraps indeed.

It's very difficult to understand how this type of attitude and behavior could be construed as an intelligent or scientific approach to solving the issue in any way and the reasons they may have for doing this will be discussed later. But for now, the relevant authorities simply say: the debate is closed because we already know, and can prove, who built them! This is of course a statement of either pure stupidity or blatant deception because as we have already shown, it is an assumption based on very thin circumstantial evidence. If the truth be known, there is a far greater amount of much more conclusive evidence to dispute not only the theory, but that actually *proves* that Khufu and Khafre were in fact, not the builders.

The problem that the authorities faced with is this: if Khufu and Khafre did not build them then who did? No one can show who it actually may have been. The authorities also refuse to consider that it may have been constructed long before 2500 BC because if it was, then history is presented with a rather large gap of time between the civilization that built the complex and the civilization it has been attributed too, it is a large gap in history that cannot be readily explained without admitting our history is wrong and that an advanced civilization existed in antiquity.

That is something they wish to avoid at all cost.

It is also a matter of some sensitivity for Egypt. At present they are able to say, "Look what our ancestors did! They built the greatest wonder on earth." It is a matter of immense pride for them and understandable why they may not wish to concede that it is not strictly true, that Egypt in fact inherited the complex from a civilization that wasn't actually theirs. But despite what Academia says about the Giza complex, overwhelming evidence exists to dispute the time frame we have been given for its construction.

The Sphinx is very heavily eroded with horizontal grooves, punctuated by deep vertical fissures. Egypt's top archeologist Dr. Zahi Hawass adamantly states that this massive amount of erosion was caused by desert winds.

Now quite frankly, wind erosion is an extraordinarily strange claim to make, just in considering the history of the monument. The statue was actually buried in the sand for most of its life. It was uncovered sometime between 1417 and 1425 BC by King Thutmose IV but was soon covered again by the desert sands. It was still buried up to its neck when Napoleon arrived in 1798 and

remained so until it was partially cleared again in 1817 (fig.79) and still more in 1858 and 1885 (fig.80). But it was not fully exposed until 1926. So there really wasn't a great deal of time for all of this wind erosion to have occurred. But even with it being covered for so long, according to estimates based the figures Dr. Hawass has provided for the rate of this erosion, if it were indeed a fact, then the Sphinx should be all but gone by now, or wafer thin at the very least. There is also the disturbing fact that the deep vertical fissures are quite clearly the results of water erosion caused by prolonged exposure to precipitation. Naturally, any of these telltale fissures that appear on the actual monument are being hurriedly covered by new 'restoration' work that is being carried out (Fig.81). But even with this new work, there can be no doubt whatsoever that the erosion seen on the monument was in fact, caused by water.

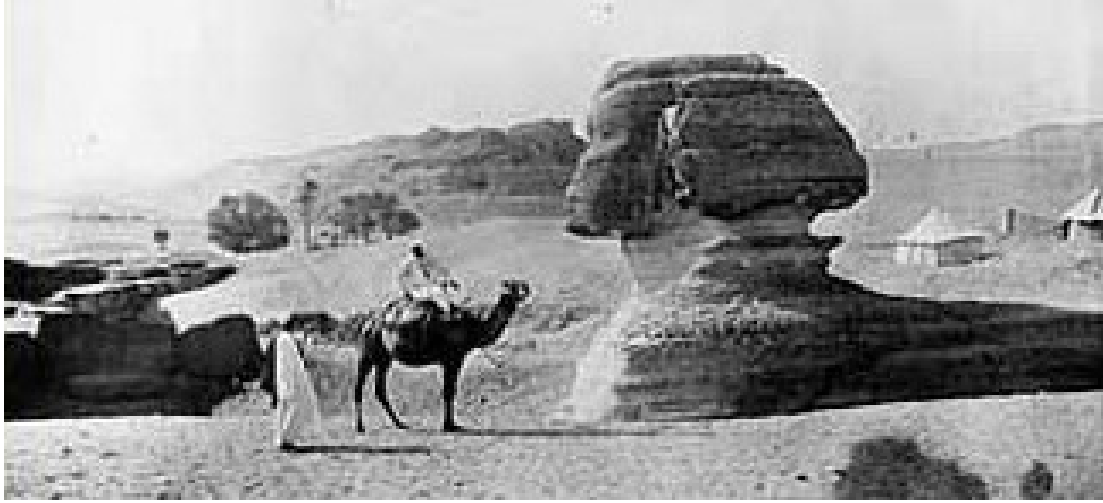

Fig.79

Hancock and Bauval sum it up nicely in *'The Keeper of Genesis'*:

*"The weathering patterns, which have been studied by geologists from Boston University, have been identified as having been caused by prolonged exposure to heavy rains. In 2500 BC when Egyptologists presume that the sphinx was built, Egypt was as bone dry as it is today. Between 15000 and 7000 BC, however, the science of palaeo-climatology indicates that Egypt several times passed through periods of wet climate which could have caused weathering patterns such as these.*

*"The trench surrounding the Great Sphinx which was created at the same time that the sphinx was carved, very clearly indicates the rolling scalloped 'coves' and very deep vertical fissures characteristic of precipitation-induced weathering in limestone (fig.82).*

*"The sciences of geology and palaeo-climatology alone, however, can only demonstrate that the sphinx and its enclosure are much older than previously thought. Archeo-astronomical analysis provides a far more accurate tool for dating the sphinx"*

The work done by West and Schoch clearly demonstrates beyond any doubt that the massive amount of erosion visible on the Sphinx was indeed caused by water.

The somewhat controversial issue of the Sphinx bearing signs of water erosion was actually first raised by a French Egyptologist named Schwaller de Lubizc who's theory was considered to be much too contentious at the time and was also hurriedly dismissed.

The Academic community chooses to completely disregard this indisputable evidence of water erosion because it poses an enormous problem for them. It's universally agreed that Egypt has been subject to severe flooding in the past but geological studies of the area show that the last time there were any rains or floods in Egypt, of a magnitude to cause the type of erosion that can be found on the sphinx, was between 7,000 and 15,000 years ago and that just doesn't help their cause at all because it actually proves their theory to be irrefutably erroneous.





Fig.80

Now just think about all that for a moment. These types of standard geological tests are used to date the last flood in the area and hundreds of other sites around the world and the results are accepted. Yet when *exactly the same tests* are used and they irrefutably prove the erosion on the Sphinx and its enclosure was very clearly created by water, but the results are dismissed and the entire debate on the issue is not mentioned to the public.

Did you see that? In the blink of an eye and a quick bit of 'scientific sleight of hand', one set of standard geological tests is to be accepted while another set of identical test is to be disregarded. Simply because it's not an issue when the last torrential rains occurred in Egypt, but it *is* an issue to say the Sphinx may have been there at the time because if it was there it would prove them wrong, *so they simply disallow the test*. And if someone does one behind their back, well then the test is disregarded and if they complain, it's back to the doctorate waving and personal attacks as the last line of defense.

And let's face it folks, it's really the only defense they have.

The fact that no such erosion is visible anywhere on the pyramids is also a serious issue for contention because that means that the Sphinx may have even been there *before* the Great Pyramid, in fact *well before it*. This is also an arena that Egyptologists view as very dangerous ground and flatly refuse to enter in to. Any attempt to raise the issue invariably produces a wave of scathing and usually very personal and unscientific attacks punctuated by numerous brandishing of degrees. Of course one must remember that the pyramids were all encased with smooth, weathered and much hardened limestone and that this may well have served for protection of the 3 monuments during any great rains or floods thus preventing any visible signs of water erosion while the Sphinx would have been left exposed to any damaging flood waters

However, according to West and others, the entire Giza complex can be accurately dated by simply studying the astronomical alignments of the various monuments.

The reason astronomy can so easily be used for this task is because astronomy, ritual and reincarnation were such very important parts of the Egyptian belief system and many believe the basis of the entire Ancient Egyptian culture. The Egyptians believed heavily in the duality

between heaven and earth and they considered the kingdom of the god Osiris to be a very specific place in the heavens. This duality and the nature of the Duat itself are very well explained in a book entitled *'Initiation'* by Elizabeth Hiach. In the book Hiach aptly explains the Egyptian reincarnation beliefs which included the various levels of discipline that must be attained in order to reach the 'ship/house/place/planet of millions of years'. Hiach believes that the pyramid featured very significantly in this process and that the Kings Chamber was actually an initiation chamber. She says that the initiate who had attained high enough level of enlightenment could lie in the actual sarcophagus and be able to 'meditate' through all of their incarnations without the need of living them enabling them to then reach their final incarnation with the Gods who reside within the Duat.



Fig.81

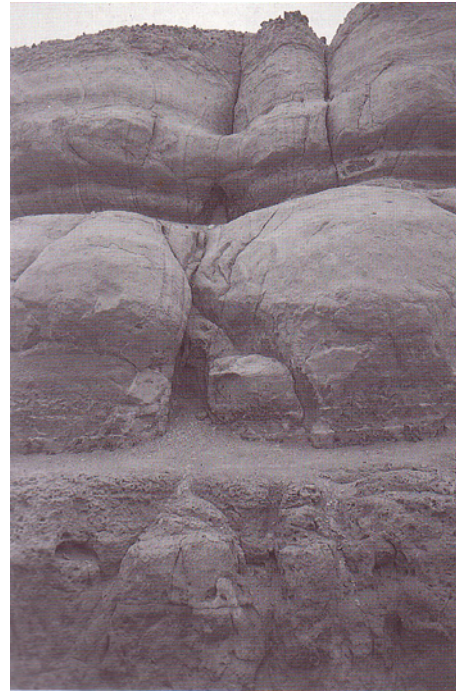

Fig.82

Hiach claims that the shape of the pyramid and the unusual placement of the blocks within the ceiling of the Kings Chamber are designed in such a way that certain cosmic energies are channeled through the stonework and concentrated at one end of the sarcophagus. The centre of this concentrated energy lies precisely where a person's pineal gland would be if they were laying in the enclosure. *(The pineal gland lies at the front centre section of the brain between the frontal lobes, kind of between and behind the eyes, and seems to serve no real biological function. The gland is also known as 'the third eye,' in eastern cultures and is believed to be our highest spiritual receptor when awakened. It is also often referred to as 'the impaired eye'.)*

Such a theory is not entirely without interest as unusual concentrations of energies within the Kings Chamber have actually been reported by various people and it is quite strange for the roof of the Chamber to have been constructed in such a fashion (*fig.83*) as it serves no purpose in regards to strengthening the structure and seems like it would have been an awful lot of trouble to build. *(The cavities were hidden within the structure until they were found during excavation in search of treasures.)*

It is thought that the ancient Egyptians believed the Duat to be a place where man could live in immortality with the Gods and that the soul of a man could reach this place through knowledge and ritual. Many believe that they also believed that the Duat was a specific place in the sky, namely the stars of Sirius and Orion's belt. Hancock and Bauval believe the Giza structures were

built as an Earthly representation of the Duat and placed in a way that would intentionally mirror the duat on the earth at the time of construction.



Fig.83

As is known to us and was also known to the ancient Egyptians, due to axial wobble, the earth experiences a gradual movement of the stars across the skies. This gradual movement is called 'the precession of the equinoxes' and is what gives us the changing signs of the zodiac.

This precession can be calculated by marking the slow rotation of the stars against the vernal equinox. It takes 2160 years for one house of the zodiac to move completely past the vernal point. An entire precession through all the signs of the zodiac takes 29,920 years to complete. Hancock and Bauval used a computer model to simulate this axial wobble and determine exactly when the Giza complex would represent an accurate depiction of the duat of earth. In *the Keeper of Genesis* they had this to say:

*"What is required in order to achieve the ideal ground-sky arrangement, is somehow to 'rotate' the heavens in an anti-clockwise direction... The vast engine of the earth's axial wobble offers us a mechanism by which this can be done: we need only instruct our computer to track the precessionally induced movements of the stars backwards in time."*

*"As it does so, millennium by millennium, we observe that the orientation of Orion's belt at culmination is slowly rotating anti-clockwise and thus approaching ever closer to our desired meridian to meridian match. It is not until 10,000 BC however – 8000 years before the 'Pyramid Age' that the perfect correlation is finally achieved with the Nile mirroring the Milky Way and the three Pyramids and the three belt identically disposed to the same meridian"*

It is only in this epoch that we can find a perfect ground to sky correlation and it is also the only time when the sphinx would have gazed at his own celestial counterpart of Leo as it rose on the vernal point. Hancock and Bauval go on to say:

*"There is a feature of this 10,500 BC correlation which suggests strongly that coincidence is not involved. The pattern that is frozen into monumental architecture in the form of the pyramids marks a very significant moment in the 25,920 year procession cycle of the three stars of Orion's belt – one that is unlikely to have been selected at random by the Pyramid builders... The question reduces to this: is it a coincidence, that the Giza necropolis as it has reached us today out of the darkness of antiquity, is still dominated by a huge equinoctial lion statue at the east of its horizon and by three gigantic pyramids disposed about its meridian in the distinctive manner of the three stars of Orion's belt in 10,500 BC?"*

*"And is it also coincidence that the monuments in this amazing astronomical theme park manage to work together – almost as though geared, like the cogs-wheels of a clock – to tell the same time?"*

When this information was coupled with the West and Schoch water erosion evidence, the picture was complete for them. But when West and Schoch completed testing their theory and first excitedly announced the results of their investigations to the world, the outcry was almost deafening and the barrage of criticism overwhelming. Egypt's top Archeologist Dr. Zahi Hawass

and another renowned Egyptologist Dr. Mark Lehner, who is considered the world foremost authority on the Sphinx were quick to launch scathing personal attacks on the pair and publicly discredited the theory as much as possible. Dr. Lehner even went so far as to accuse West and Schoch of being “ignorant and insensitive”.

Now just think about that for a moment – science, insensitive? It is a somewhat unusual remark to come from a scientist don't you think? His sole intent was to remove the issue from the scientific arena and place it on a more personal playing field. As usual in many such cases it was a public display of a most unscientific attitude that completely failed to address any of the evidence that was being presented. The whole affair was similar to a school boy who had a drawing criticized by one of his peers rather than a scientist debating evidence, for heavens sake... “insensitive”? Get some sort of a scientific grip!

These personal attacks we are now seeing so frequently are actually a highly political strategy that has recently been adopted by Academia and are fast becoming the standard final move. The method is often employed by cunning Politicians when losing an argument. If an issue becomes too obvious to argue against, the best tactic is to discredit anyone who dares to call ‘that which is accepted’ into question thereby shifting attention away from the actual issue and turning it into a more personalized attack against the presenter. It's the ‘Emperor's New Clothes Syndrome’

In the case of the Giza complex, rather than having to argue a case they are aware they could not possibly win, Hawass and Lehner again simply invoked the demeanor of ‘untouchable authority’ that is presumed by their positions in the academic hierarchy. It should be mentioned here that Anthony West himself actually holds no credentials, being a self-taught archeologist and so is not part of the “club” so to speak. Though even with this being the case, his research on the Sphinx was nothing short of excellent and his findings were backed up by a considerable amount of scientific, geological and astronomical data. (*It probably should also be pointed out that Albert Einstein was just a patent clerk when he destroyed many of Newton's theories – back then, intelligence was intelligence. Things are not quite that simple now.*)

Shortly after the theory was put forth, the American Association for the Advancement of Science invited a debate on the issue, but only Lehner and Schoch were allowed to participate while West, who held most of the evidence, was not, due to his lack of credentials. As was discussed in chapter one, this is another method the Academic community constantly employs to keep credible new information and theories out of the public information loop:

Academia decrees that only people with Degrees and Doctorates are permitted to practice science and they have two very important and quite simple filters in place to ensure that independent research is suppressed: One; Credentials; and Two; Peer Review; because no matter what your evidence or theories are, nothing gets past peer review, **but** you cannot receive peer review without first having credentials **but** of course in order to get credentials you need to tow the party line and embrace the accepted theories or you simply won't get your degree in the first place. So what do you do? Remember Catch 22? It's actually quite brilliant in its simplicity – in some scary way.

Again this is a ridiculous and extraordinarily unscientific approach to science because science is something that anyone can study and learn. All that is needed is for one to possess a keen and analytical mind. A person does not need a degree to educate oneself or record facts, or to conduct experiments, observe their outcomes and think about them in a critical way. In a truly free and open society where the pursuit of true knowledge is nurtured, science, by its very basic fabric, needs to be part of the free democratic process and all theories examined. Science was never designed to be an ‘elitist club’ presided over by closed minds. Such behavior is truly irresponsible and can only ever serve as a hindrance to legitimate research and the genuine pursuit of real truths. Science cannot properly function as an Authoritarian Regime.

The thing is that the entire debate over the real age of the pyramids and the Sphinx could very easily be put to rest once and for all if the Egyptologists really wanted to settle the dispute. They

simply need to hire a team of independent and impartial investigators to either prove or disprove the theory once and for all.

Why hasn't this been done? And why are they so against anyone doing it?

The answer is so blatantly obvious that the question doesn't really need asking. It's because they know their theory is *totally wrong!* And they know that any *real* study into the site will prove this and then our whole theory of history will come crashing down. That is why they go to such extraordinary lengths to prevent anyone from conducting tests that they *know* will prove them wrong. And don't let's forget that it's the theories of Dr. Hawass and Dr. Lehner that are being threatened here and it is *they* who are the ones who virtually control all Egyptology.

Imagine their embarrassment if it could be publicly demonstrated that they were both incorrect in their theories? And not only that but it would seem they are also quite aware of the facts but still continually go to extraordinary lengths to keep the real truth hidden from public view.

I think it's high time the world asked them to present the evidence that proves them correct and demonstrate to us how it outweighs the far more abundant evidence that proves them wrong because so far, their theories have never been independently and publicly scrutinized. The good Doctors have simply brandished their credentials and their arguments have been taken at face value and simply accepted without the need for them to present any corroborating proof. This type of approach to science is unacceptable and can in no way be construed as serious research.

The fact of the matter is that the entire Giza complex is a complete mystery and probably still remains so simply because Egyptologists will not open it up to serious research. The time frame Academia has provided for construction of the monuments makes no sense at all. The pyramids were an incredible architectural achievement and yet the quality of all subsequent constructions in the area steadily declined. Don't builders usually improve with experience? Why then does the opposite apply in Egypt? The simple truth is that the site was not built by them. John Anthony actually summed the whole thing up very eloquently in his book *'Serpent in the Sky'*:

*"Every aspect of Egyptian knowledge seems to have been complete at the very beginning. The sciences, artistic and architectural techniques and the hieroglyphic system show virtually no signs of a period of development; indeed, many of the achievements of the earliest dynasties were never surpassed, or even equaled later on. This astonishing fact is readily admitted by orthodox Egyptologists but the magnitude of the mystery it poses is skillfully understated, while its many implications go unquestioned. How does a civilization spring, full blown into being? Look at the 1905 automobile and compare it to a modern one. There is no mistaking the process of 'development,' but in Egypt there are no parallels. Everything is right there at the beginning. The answer to the mystery is of course obvious, but because it is repellent to the prevailing cast of modern thinking, it is seldom seriously considered. Egyptian civilization was not a 'development' but a legacy."*

Academics like Dr. Lehner dispute the age of the pyramids or Sphinx as being circa 10,500 BC because they simply say that Man had no civilization at that period of our history and maybe they're right. But what if it was not the civilization of man who constructed them? What if they were actually constructed by those who all the ancient tales tell us they were? What if they were built by the ancient rulers who were thought of as Gods?

In fact the actual builders and true function of the great pyramid may be far more controversial and amazing than anyone could have imagined and this will be discussed later in this book but for now the discussion will turn to how it may well have been done.

### **Stone Synthesis According to the Ancients**

Egyptologists have long claimed that no ancient records exist that describe how the Pyramids were built yet at around the age of 17, I became aware of another, very curious, Stele that is engraved on a stone on the island of Sehel, near Elephantine, north of Aswan in Egypt (*fig.84*). For some strange reason this Stele, known as *'the Famine Stele'*, has never been deemed worthy of serious research by scholars and is merely considered to be an interesting oddity by the Society

of Egyptology. Yet after even a cursory investigation of the artifact one cannot help but question the unfathomable reasoning behind this conclusion.

The Famine Stele actually describes an ancient method for manufacturing limestone. It names the aggregates needed for the raw material and the plant extracts that are required to then bond the mixture of aggregates together. Could the pyramids have actually been cast instead of built by teams of men maneuvering hewn blocks?

Now correct me if I'm wrong, but surely the fact that such a Stele even exists at all should give scholars a reason to at least examine the methods described in the ancient text to see if there is any validity to them. Indeed, I believe the Famine Stele needs to be made the subject of some very serious and rigorous research before being so readily dismissed. The simple fact that people of ancient times bothered to right this text down (*carved in stone so it would last a very long time*) coupled with the fact that the Stele describes such a thing as manufacturing stone should give cause for even the most mentally obtuse to consider it worthy of some serious investigation.



Fig.84

The Famine Stele was discovered in 1889 by C.E. Wilbour and was subsequently deciphered by various scholars: first Brugsch in 1891, then Pleyte in 1891, Morgan in 1894, Sethe in 1901 and finally by Barguet in 1953. The hieroglyphic text was then examined and the previous translations were all compared with each other. Unfortunately the Stele is slightly incomplete and somewhat damaged with a section that has been broken off near the top but we can still glean enough information from what does exist to kind of 'fill in the blanks.'

One third of the Stele deals with the building of monuments involving three of the most renowned characters of ancient Egypt: the Pharaoh Zoser, the Scribe Imhotep and the God Khnum. The remainder of the Stele speaks of various aggregates and plant extracts to be used in the process of manufacturing stone, possibly even for the monuments mentioned.

The text contained in this unique artifact has almost exclusively been considered to be interesting but fanciful and has been dismissed as a topic of no real use to any serious investigator of Egyptian antiquities. Yet in studying the Stele an intriguing question emerges: What would happen if we actually tried it and did what they described? Could the stone of the Pyramids have actually been mixed and poured into place at the site using plant extracts and aggregates available

in Egypt? And also, would such aggregates and extracts have been available at the location at the time of their construction?

The answer to both these questions is very a resounding: Yes, they could have, quite easily!

So surely if one can follow the methods described in the famine stele text and in doing, create a mixture that will solidify into a stone of comparable texture and composition to the stone used in the Pyramids, then is it not conceivable that it is most likely the method that was used in their construction. Indeed, it is the only really possible way it could have been done.

The true answer as to how the monuments were constructed may have suddenly become quite blatantly obvious. Indeed, it would appear that the builders even wrote it down for us.

The question is: Why is this Stele still being ignored by Egyptology?

### **Modern Techniques for Synthesizing Limestone**

Then at last, someone came to the fore with a radical new theory in the now familiar form of Prof. Joseph Davidovits of the Geopolymer Institute, who also proposed the plant extract theory in the Mayan process and again, all credit must be given to the man. Ten Points!

Prof Davidovits wrote a fascinating report in 1998 in which he proposed the idea that the pyramids were indeed constructed using aggregated limestone rather than by manipulating quarried blocks. His theory was then finally published in 1999 in a book entitled: "*The Pyramids: an enigma solved*".

In the book he put forth the very sound, though academically radical theory that outcrops of relatively soft limestone could simply have been quarried and easily disaggregated with water and then the muddy limestone sludge (*including the fossil-shells*) mixed with lime and some kind of tecto-alumino-silicate forming material such as kaolin clay, silt, or the Egyptian salt 'Natron' which is a basic sodium carbonate. The limestone mud could then easily have been carried up by the bucketful and then poured, packed or rammed into formwork molds made of wood, stone, clay or brick that had been erected on the pyramid sides. The re-agglomerated limestone, thus bonded by basic geochemical reaction into a substance known as geopolymer cement, would then have hardened into resistant Limestone blocks as it dried actually solidifying into a substance a great deal harder and stronger than the original starting material.

Critics of this theory argue that Davidovits has never proved that Giza limestone really is geopolymer (*and of course this is impossible to do because neither he nor anyone else is ever permitted to remove any material for testing*) and they firmly state that the fact that the limestone blocks at Giza contain intact fossil remains substantially proves that they can not be manufactured stone or geopolymers but are in fact hewn blocks of natural limestone.

Interestingly, no-one specifies exactly why they think that intact fossil shells in the pyramid blocks prove that they are not manufactured blocks as even the most fundamental knowledge of Davidovits cast-stone theory clearly suggests that it was the Giza quarries themselves (*where else?*) that provided the limestone rubble for the aggregates of the pyramid blocks. Such intact fossils actually exist in abundance in the limestone of the Giza quarries.

Since that time, scientists at the Geopolymer Institute have successfully managed to manufacture and cast re-agglomerated limestone. Because it is (*of course*) prohibited to remove any material from the site of the actual pyramid for testing, for the purpose of the test the scientists selected a soft material containing a high percentage of fossilized shells from a quarry in France to ensure the geological material used in the experiment was very similar to that which is found in the quarries of the Giza plateau in Egypt. The purpose of the test was to demonstrate that this type of soft limestone material is indeed perfect for re-agglomeration. The scientists then disaggregated the material with water, they then mixed the muddy limestone and its fossil shells with kaolin clay and a basic geopolymeric binder. The limestone mud was then packed into a pyramid shaped mould. The re-agglomerated limestone they created, bonded by geochemical reaction, then hardened into a resistant geopolymer limestone block (*fig.85,86*) that turned out to be a great deal harder than the original starting material exactly as they had predicted it would.

It was very notable that the whole process had the effect of strengthening the softer stone thereby making it more resistant to such things as weather, pollution, acid rain, temperature



Fig. 85





Fig.86

variations and all those things that will generally just mess up your megalithic monument.

Because the Institute was not authorized to sample original materials from the Giza plateau quarries (*naturally*), they were not able to use the exact formula described in the ancient Egyptian text. The French limestone that was used in the test is very similar but unlike the Giza limestone, had no reactive clay in it and the team was forced to add some. Nevertheless, the final result was extremely close to the constituency of that which is found in Egypt both chemically and geologically. According to Davidovits, with the Egyptian formula, the result is also slightly different because it requires bigger blocks for a better cohesion and is not particularly suitable for smaller items. However even with the slight change of formula due to differences in the materials, these ground-breaking tests have clearly demonstrated that the process is quite possible and the only real key to the complete success of the procedure is in using the appropriate raw materials to begin with.

During a Television special filmed in 1991 called 'This Old Pyramid', Prof. Davidovits had the opportunity to demonstrate his cutting-edge theory and in the process, to also demonstrate a unique property of the Giza limestone that further supports the idea. In the presentation a chunk of limestone taken from the nearby Giza quarry was very easily disaggregated in water within 24 hours, leaving the clay and the other constituents gently separated from each other.

This demonstration showed that the existing fossils in the limestone would naturally remain intact as it would not have even been necessary to crush the stone during the manufacturing process as unlike other limestone, material from the Giza quarry simply breaks down in water all on its own.

As I mentioned before all credit must be given to Prof. Joseph Davidovits of the Geopolymer Institute for his groundbreaking study into this process and I highly recommend reading his work on the subject.

This certainly may go a good deal in helping explain how these ancient masses of stone may have been constructed but again we are still left with the question:

By whom were they made and for what purpose?



## Chapter Five

# The Death of a God



As was stated at the start of this work, in attempting to gain a complete picture of our past and find the key to our future all pieces of the puzzle must be examined, no matter how small or obscure they may seem to be.

In keeping with that view we must now pause for a brief moment and turn our eyes to our nearest celestial neighbor, the planet known to the ancient Sumerians as Lahmu and to the Greeks as the celestial God of War. The planet we now call Mars.

### **The Broken God**

In an amazing demonstration of Yale taught intelligence George Walker Bush made following statement on August 11<sup>th</sup> 1994: *“Mars is essentially in the same orbit as the Earth. Mars is somewhat the same distance from the Sun, which is very important. We have seen pictures where there are canals, we believe, and water. If there is water, that means there is oxygen. If oxygen that means we can breathe”*

In actual fact Mars today, is a barren wasteland. It is an inhospitable windswept rock with a poisonous butterscotch colored atmosphere of mostly CO<sub>2</sub> and Methane stretched thinly over a dusty reddish landscape. The question is how could it be so inhospitable when the Earth its neighbor is just the opposite?

Some may not know this but our enigmatic celestial neighbor does have a slight atmosphere (*not breathable*) and a north polar ice cap that scientists have proven to be frozen CO<sub>2</sub> and water. Yes that right, water. Pure, drinkable, life giving H<sub>2</sub>O exists on Mars, frozen at its North Pole (*fig.87a*) quite a lot too as can be seen in this 3d image (*fig.87b*). Get yourself a telescope it's quite easy to see. Mars has a south polar ice cap too but that is said to be all frozen CO<sub>2</sub> and there are further indications of a certain amount of moisture existing in the atmosphere as the North Polar Ice Cap undergoes some quite drastic seasonal changes (*fig.87c*).

Mars also bears some dramatic evidence of former ocean beds, vast river systems and a period of catastrophic global flooding. Of course the planet is barren, dry and windswept now but the evidence still remains. Everywhere across the surface we can still observe the signs of rivers, lakes and even islands. In fact all the telltale signs of water erosion are still very easy to see on the planets surface today (*fig.88*).

Of course what this all means is that Mars must have once had a greenhouse atmosphere similar to that of the Earth, probably more CO<sub>2</sub> than anything else and unlikely to have ever been breathable but an atmosphere that was still much warmer than what it is today nonetheless. Otherwise the water would have always remained frozen at the poles and we would not see all the evidence of erosion that is still visible on the surface.

The question is thus raised: It is quite obvious that Mars once had an atmosphere of sorts and a great deal of water on its surface, so where did it all go? Why is Mars now so desolate? Sometime in the past it appears that the planet somehow lost its ability to retain its warmth and lost all of its



Fig.87a

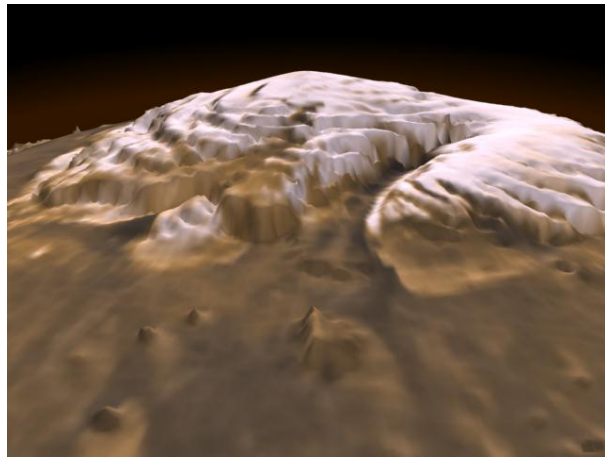

Fig.87b



Fig.87c

atmosphere. In the process it also lost all of its abundant water and oceans which either disappeared into space or seeped underground to lie locked and frozen beneath the surface.

What could have happened?

The answer to this question may well lie in the visible geology of the planet because there is every indication that Mars recently suffered an enormous catastrophe on quite a global scale which caused enough damage for it to physically lose its atmosphere and a good deal more

besides. Of course, when I say recently I mean sometime in the last few thousand to few hundred thousand to few million years, which, in astronomical terms, is really just the other day.

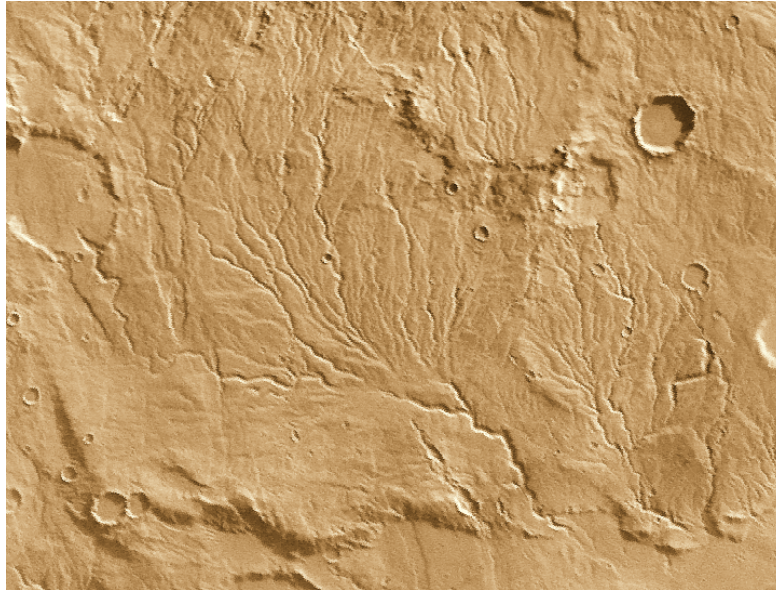

Fig.88

### **The Dragon Whip's its Tail**

A most interesting and very unusual feature that is quite unique to Mars is that the top section of the planet is divided from the bottom section by an enormous jagged and uneven cliff that stretches around the entire planet. There are no breaks in this cliff; it goes *all the way around!*

The top section of the globe is sparsely cratered lowlands and the bottom is heavily cratered highlands. This provides us with an instant clue. These highland and lowland sections of the planet are large enough to be described as each taking up an entire hemisphere of the planets surface but are not at all defined by the hemispheres of the globe with the unbroken cliff that separates the two, running around the planet at roughly 35 degrees to its axis. Get the picture?

It's kind of like looking at an orange with the top half of the peel roughly torn off while the skin still remains covering the bottom half. This of course gives us every indication that a reasonably large chunk of the planets crust is somehow missing from the top half of the planet.

This distinguishing separating feature on the Martian surface is known by scientists as the 'Line of Dichotomy' (*fig.89*).

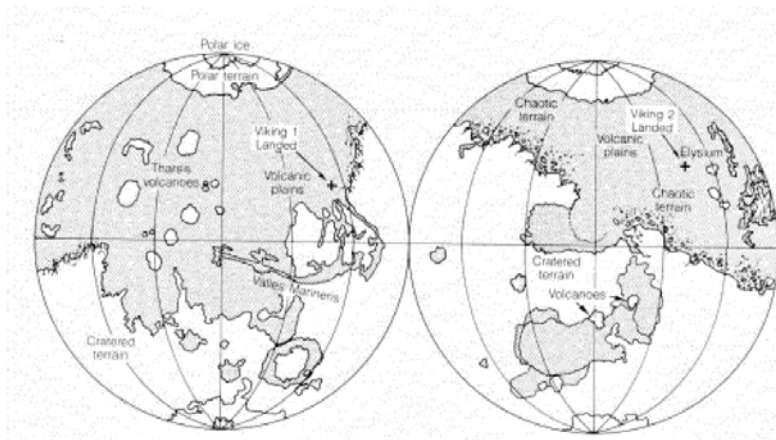

Fig.89

Mars is significantly smaller than earth (*fig.90*) and yet boasts surface features that are massive, literally dwarfing those found on earth or indeed on any other planet in our solar system. Apart from its missing water and this line of dichotomy being the largest single cliff in the solar system (*an average of 3 klms high – and just think about that for a second*), Mars also boasts the largest Canyon, the largest volcanoes and the largest crater in our solar system. The sheer size of these surface features seems out of all proportion on our smaller neighbor. Not bad for one little planet.



Fig.90

When I say these volcanoes are large I mean *really huge*. The largest of the three, known as Olympus Mons is the largest volcano in the solar system (*fig.91*). It is more than 372.84 miles (*600 km*) across, towers 16.8 miles (*27 km*) above the surrounding plain and has a caldera of over 50 miles (*80 km*) wide! Noticeably all three of these huge volcanoes are located on the top section of the planet while near its equator is the largest canyon imaginable. Known as Valles Marinares, this gigantic rift on the surface of Mars makes the Grand Canyon look like a furrow (*fig.92*).



Fig.91

Some of the slopes and cliffs look quite gentle and scalable in this mosaic of the Candor Chasma area in Valles Marineris looking from north to south (*fig. 92b made from images from both the Viking Orbiters*), but it must be understood that this trench is a whopping *five to seven km deep* split in the Martian surface, an enormous rip, stretching to a gaping 200 km across. At over 5000 km long it would stretch across the entire continent of Australia. Then on the other side of the planet nearer the bottom, in fact almost directly opposite the area where we find the three huge volcanoes, is a huge impact crater and all the signs that a very large object at one time slammed into Mars with such enormous speed and energy that penetrated deep into the planet.

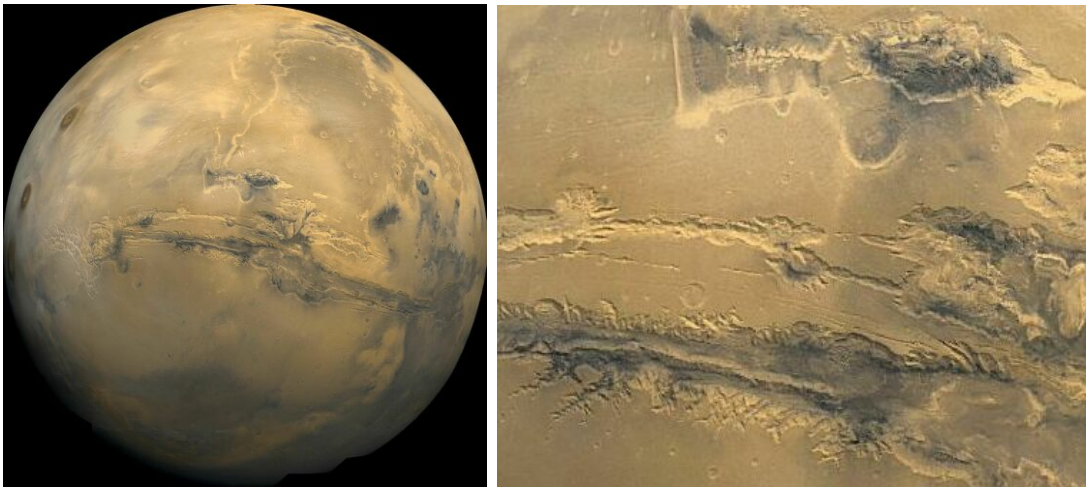

Fig.92



Fig 92b

Do you see where this all leads?

There is significant evidence that Mars recently suffered the impact of an asteroid or comet fragment. An impact so great and so devastating that the object in question punched deep into the planets lower hemisphere and so doing blew all the crust of the top hemisphere from the force of the blow. The impact had totally devastating results and may well have caused the planet to bulge and split its surface and three huge gaping ‘blisters’ to appear opposite to the impact site to release the sudden pressure and catastrophic energy from the blow that was delivered to it.

In a book by Graham Hancock, Robert Bauval and John Grisham that was published in 1998 on the subject entitled "*The Mars Mystery*" the authors also proposed exactly that scenario and presented some quite viable evidence to support their claim. Of particular interest is the fact that there is an ancient Sumerian tale which mentions the Earth, the Moon and Mars all suffering calamities at around the same time due to the close passage of a celestial body about 11,500 years ago. Could it be possible that Mars was devastated on that occasion? Could it even possibly have been as recently as that?

### *Strange Connections*

There are other strange legends of Mars too. One of particular interest is related by the Zulu tribe of Africa. An ancient Zulu legend has it that the tribe arrived here many years ago in 'celestial boats' because their planet was about to be attacked by an 'invader' of some kind. What or who this invader may have been is not entirely clear, however the legend says that the Zulus placed all of their women and children in 'boats' and sent them to their nearest neighbor, namely the Earth. Certainly it's an interesting legend for an African tribe to have.

There are certain Pyramids in Mexico that seem to clearly depict the Martian Calendar, a somewhat unusual coincidence if coincidence it be because the calendar is very accurate.

There also exist legends from ancient Sumer which talk of 'Gods' traveling to and from the planet which the Sumerians knew as Lahmu! And there is the enigmatic and very mysterious Cydonia region which many believe to contain pyramids and other structures.

We also have the contentious issue of the cubit. The biblical cubit is widely accepted to have been 523.5 to 524 mm (20.61 to 20.63 in) in length, and was subdivided into 7 palms of 4 digits, giving a 28 part measure in total. The cubit is a bizarre unit of measure to exist on Earth. We can see where feet and inches come from, as unnatural a length as it may be it works for us because we all have them, but then again why was the foot divided into 12 parts and not 10 or 15? We have 10 fingers and 10 toes divided into groups of five digits after all. Twelve is not a natural number for mankind to adopt so why is it that things were always divided into twelve portions? Why do we have a dozen of something?

The meter is of course quite a natural unit of measure for the Earth. Everything comes out even. The earth itself can be measured in meters perfectly. It is a surprise then to see that Mars can be measured in perfectly in cubits. The cubits works on Mars the same way a meter works on earth. The relative length of measure in relation to the size of the sphere is the same. As unnatural as it seems to us in relation to the Earth, the cubit is the perfect length to use if we lived on Mars so what on Earth is it doing here, *on* Earth, and how or why did any one who lived on Earth ever come up with such a bizarre unit of measure in the first place – and so long ago?

As irrelevant as it may seem to you at this moment, just retain the information contained in this chapter as food for thought in the back of your mind for now as we move on.



Part Two

# Investigation

“Information is not knowledge; knowledge is not wisdom; wisdom is not truth; truth is not beauty.”

- Frank Zappa



## Chapter Six

# The Lost Lands

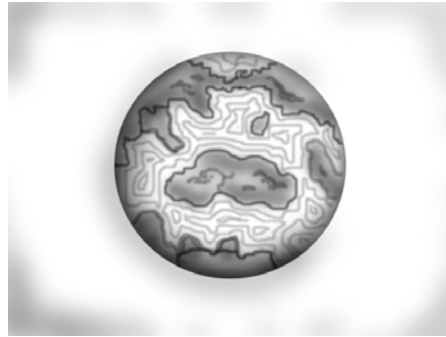

As we now return to earth and consider what catastrophic celestial events may have actually happened in the distant past, another nagging question and ground that many scholars loathe to tread inevitably arises. I speak of course of the dreaded “A Word” – Atlantis. It has been the goal of many expeditions, the source of endless debate, countless books and a myriad of theories.

The legend of Atlantis is one that has persisted for longer and captured the imagination of more people than perhaps any than any other tale in our history. There have been countless expeditions, archeological digs and underwater excursions made in the hope of finding some trace of the elusive sunken land that many believe *must* exist but we are told that so far, few real clues to its reality have been found. There have been many under water ruins found, like those in the Mediterranean which is literally full of ruins, plus traces have been found off the shores of Indonesia and other places but scholars have argued that none so far have seemed to be in the correct location to be Atlantis – judging from what information we have to go on.

However there have been various other discoveries that don’t seem to come to public attention. There have been reports of structures and even pyramids that have been found underwater and still more reports that others have been glimpsed beneath the waves on clear days by seasoned fishermen and pilots.

### **A Sunken World**

Our primary source of information and first real glimpse of Atlantis comes from Plato in his two ancient works ‘*Timaeus*’ and ‘*Critius*’. These two dialogues offer us a rich glimpse into the workings, government and infra structure of Atlantis from the perspective of Plato. There are many people believe that these are the only two sources of the tale but such a belief could not be further from the actual truth. There are numerous mentions of the island-continent by other Grecian scholars who were not adding to or embellishing Plato’s original account but were in fact corroborating it and there are other things that lend credence to Plato’s accounts as well.

One significant contributing clue is Plato’s mention of ‘the Pillars of Heracles’ (*also known as Hercules*) which were apparently two pillars of gold inscribed with ancient teachings in the form of hieroglyphs. Consider also, these other ancient references from a number of sources:

1. Such pillars are mentioned in works by a commenter of Plato’s writings called Proclus. Proclus mentioned that the traveler Crantor visited ‘*Sais*’ in Egypt as Solon had also done,

- 300 years before him and that during these visits both men had been shown a golden pillar inscribed with hieroglyphics just as had been described by Plato.
2. Another Greek historian named Herodotus is reported to have actually seen “two pillars, one of pure gold, the other of emerald which shone with such brilliancy at night...” *while visiting a temple of Heracles at ‘Tyre’ (also known as Phoenicia)*. It was actually not uncommon for the Phoenicians to erect such ‘Pillars of Heracles’ in almost all the places they colonized as they did at Gibraltar for example. The Phoenicians record that such pillars were erected to commemorate the first founding of Atlantis by Atlas and Heracles.
  3. The Egyptian historian Manetho, also mentions the existence of two pillars and tells us that before the great flood the Egyptian deity Thoth inscribed them with hieroglyphs containing all of the ancient wisdom so it would not be lost in the deluge that was soon to come.
  4. Other historians have reported that Alexander the Great inspected many such large pillars of gold bearing unusual hieroglyphic markings in the lands of Northern India. These histories mention that Alexander traveled beyond the ‘Pillars of Hercules and Dionysus’. This is quite a significant statement because Dionysus is in fact, a divine representation of Atlas – his Heavenly counterpart so to speak. So here we have a European conqueror reportedly finding Atlantian Pillars *and* a reference to Heracles and Atlas in Northern India. Some people have also said that such pillars were constructed to mark the outer borders of the Atlantian territories. Interesting.
  5. A Jewish historian called Josephus who lived around the time of Christ also made mention of either Seth or Thoth inscribing some pillars with ancient knowledge: “*in order that wisdom and astronomical knowledge should not perish in the cataclysm, (?th) made two pillars, one of stone and one of brick in which he inscribed this knowledge for posterity, said pillars still existing in the land of ‘Siriad’ to this day*”
  6. The Mayans also have creation legends which talk of a lost and mysterious continent that they call ‘Aztlán’. They say this land was the place from whence they first came but it was destroyed in terrible volcanic upheavals and later sank beneath the seas and their ancestors were forced to set out in canoes and catamarans to look for new lands. There was even a quite famous frieze that was removed from the Mayan city of Tikal actually depicting the event (*fig.93*). The stone frieze was displayed in the Berlin museum but was unfortunately destroyed during the Allied bombing of Berlin in 1945.
  7. The Indian traditional texts of the Ramayana and the Mahabharata make constant references to the land of ‘Atala’, a ‘paradise’ that sank beneath the sea. In these texts the Rama Empire is recorded to have fought Great wars against the people of Atala with both nations using powerful and devastating weapons.
  8. Many ancient maps such as those mentioned in the second chapter show a group of islands in the Atlantic Ocean. Mostly just labeled as ‘the Atlantic Islands’. There are usually seven of them shown on most ancient maps. Today there are only two main islands in the area: Cuba and the Dominican Republic, however many ancient maps show three or four more, as on King Henry’s Map of 1500 (*fig.94*) and the Benincasa Map of 1482 (*fig.95*). Some see this as a reference to a sunken civilization, however it must be taken into account that some islands have been known to come and go.

These are just some other references to Atlantis that come from places that were not necessarily associated with Plato, and there are many tales of Ancient Cataclysms if one wants to delve a little deeper. One remarkable thing about all the tales of Atlantis, and the same is true for most references found in ancient text that indicate they may be referring to a sunken civilization, is that all the event timelines match up very closely. This becomes especially noticeable with it happens with events recorded by civilizations who apparently had no contact with each other. We will investigate this a little later but for the moment we will briefly revisit the actual legend itself.



Fig.93

### ***The Golden Empire***

Plato tells us that Atlantis was an Island-continent consisting of seven separate land masses that was located in the area that is now the Atlantic Ocean and that it was founded around about 11,000 years ago. He describes Atlantis as a land that was abundant in a variety of natural resources and whose people prospered greatly due to this natural wealth. It was known to be a great center of trade and commerce in the Ancient World, a powerful nation that controlled many sea routes and also held sway over other territories it controlled in Africa and Europe.

We are told that the God '*Poseidon*' took to himself, a mortal wife whose name was '*Cleito*' and he made Atlantis his domain. Poseidon loved Cleito deeply and on a hill, in the middle of the central island of Atlantis, Poseidon constructed a dwelling for himself and his wife and then built seven moats around the house in ever larger circles, to protect her. Cleito gave birth to five sets of twin boys who were to become the first rulers of Atlantis. Poseidon divided Atlantis among his ten sons and control of the hill and the surrounding lands was given to his eldest son '*Atlas*'. Atlas built a temple on the central hill to honor his father and inside he erected an enormous golden statue of Poseidon standing astride great chariot drawn by magnificent winged horses that dominated the central hall. It was here that the High council and governing body of Atlantis would meet to discuss and decide policies, pass laws, make judgments and pay tribute to the great Poseidon. A great canal, to be used for the purposes of travel and trade was dug from the central hill and ran south through the rings of land and water for 5.5 miles eventually arriving at the sea.

The city of Atlantis itself was very densely populated and sat just outside of the central ring of moats covering a circular area of 11 square miles. The majority of the Atlantian population was said to have lived within the actual city itself. Plato describes it as being a beautiful city with walls that were clad with gold, silver, bronze, tin and an unknown metal named by Plato as orichalch. Just beyond the city, surrounded by another great canal, lay a vast fertile plain 330 miles long and 110 miles wide where food crops were grown. So fertile was the ground and so temperate the climate, that two harvests were made each year, one harvest nurtured by the winter

rains and the other fed with water collected from the mountains and streams in the great canal. To add to the bi-yearly harvests the land was also rich in fruit, nuts and herbs. To the north of the plain were tall mountains and all the land about was covered in rivers, lakes and rich meadows all peppered with farms and villages. There was abundant animal life to be found on Atlantis too and even elephants could be found there.

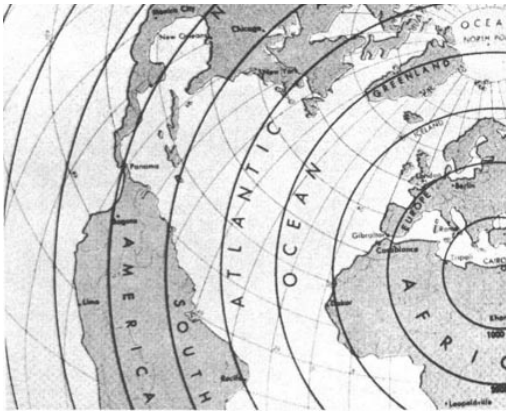

Fig.94

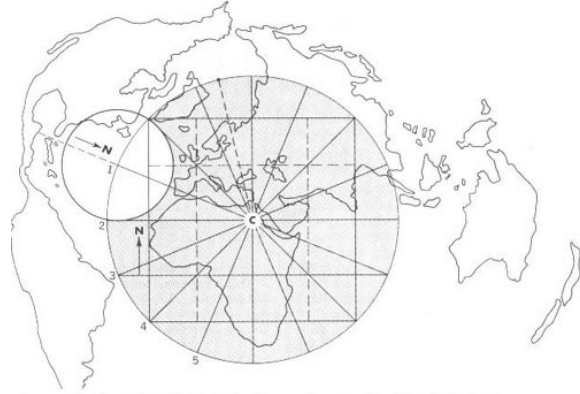

Fig.95

The Atlantian Empire thrived in such a fashion for many years but slowly their technology and greed overcame them and they became egotistical and ever more warlike, always craving still more power and lands.

Plato affirms this attitude in his dialogue in which he says that the once noble people of Atlantis became corrupted by greed and a lust for power and when the great God Zeus looked down from the heavens and saw the corruption and immorality of the Atlantians he called a meeting and summoned all the other gods to council to decide the Empire's fate. Then, when all was decided he cast down a great destruction on Atlantis and in a huge violent cataclysm the entire continent sank beneath the waters, never to be seen again. According to Greek tradition, when the seven islands of Atlantis sank they were turned into the constellation of the Pleiades because they preferred death rather than dishonor at the hands of their persecutor Orion who still hunts them across the skies.

There are histories that exist in ancient Indian texts that tell of a great war between the Rama Empire and an Empire they name as Atala, which they refer to as an 'Island Paradise'. This war, say the texts, was ultimately responsible for the disappearance of both civilizations.

Plato tells us that the destruction of Atlantis was about 9,000 before the time of Solon, and we know from history that Solon is supposed to have visited Egypt in 600 BC. So if we add that 600 to the last 2000 years we arrive at an estimated date of 11,600 BP (*Before Present*) or about 9,600 BC, that the destruction of Atlantis is said have occurred. We will return and investigate this date a little later in this book.

### **Possible Physical Evidence**

So if there really was a sunken continent; that supposedly supported an advanced civilization; that once existed in the Atlantic, wouldn't there be some trace of it left?

In actual fact, there are over 30 separate sets of ruins that have been found in various locations on the bottom of the Atlantic since 1956. These include remains off the coast of Bimini in the Bahamas, the Canary Islands, Cuba, Andros Island, Cadiz and Cay Sal in Spain, near Florida, and off the coast of Morocco.

One of the most famous discoveries concerning Atlantis would undoubtedly be what has become known as the 'Bimini Road' or 'Wall' discovered in the early 1960's off the coast of Bimini Island by Dr. Manson Valentine (*fig.96*). The road consists of hundreds of huge square

flat megalithic stones laid out like a long road on the ocean floor. The paved underwater road is located about 20 miles off the Bimini coast and despite claims to the contrary, this enigmatic stone road still remains totally unexplained. It's also notable that in 1975 a team of about 20 researchers including, archeologists, a marine biologist, a cartographer and a geologist conducted a diving expedition to investigate the Bimini road. The team retrieved some artifacts from the site for further analysis and their results showed that the materials used to build it were not to be found any where in that part of the world.

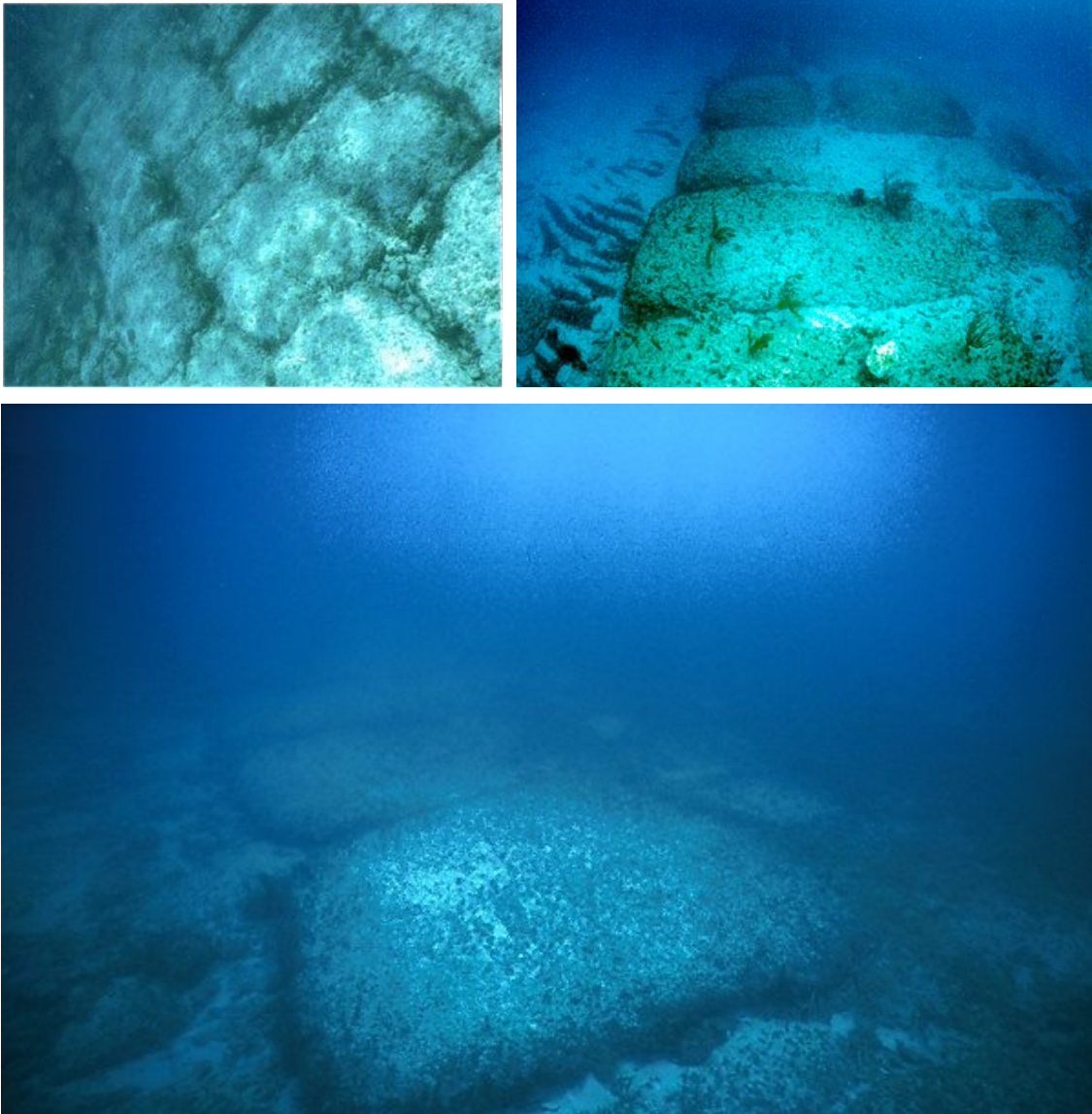

Fig.96

In 1977 another amazing discovery was reportedly made on the Atlantic Ocean floor near Cay Sal in Spain by Arl Marshall. Marshall claimed to have seen a 650 foot pyramid that emitted a mysterious light. He described it as being surrounded by “*sparkling white water that turned to deep green*” that was “*a shocking contrast to the dark black waters at that depth*”. Fortunately, Marshall also had the foresight to photograph the event.

In 1970 a Dr. Ray Brown was diving on the sea bed off the Bahamas accompanied by 4 others when he reportedly discovered paved roads, rectangular buildings, Domes, strange unidentified metallic objects that looked like instruments of some kind and a statue holding a strange crystal

with miniature pyramids inside it. The crystal and metallic objects were then taken to Florida University for testing where they discovered that the crystal actually amplified energy that was passed through it. The crystal was then photographed from several angles using a Kirlian camera which is a special high and low frequency camera that can record images beyond our field of vision. The Kirlian photographs clearly revealed an 'eye' within the crystal that was not visible to the naked eye. The scientists at the university decided that the crystal was truly unique and had been made by a method that was unknown to them.

An incredible discovery was also made by the crew of a salvage ship out of Spain called the 'Talia' and the find was reported by its captain, Reyes Miraga. During their dives Capt. Miraga and his crew video taped literally miles of buildings, pillared temples, pyramids and statues. There were wide curved boulevards with smaller streets branching off like the spokes of a wheel, looking very close to Plato's description of the actual City of Atlantis. Another sunken city remarkably like Miraga's was discovered off Spain by Dr. Maxine Asher who photographed the ruins and also retrieved an urn from the site.

In 1958 Dr. William Bell apparently discovered and photographed a structure at the bottom of the Atlantic. What Bell claims to have found was a 6 foot spire atop two gear-like bases with a peculiar light emanating from the bottom of the shaft.

In the 1970's the foundations of a structure measuring 75 feet by 100 feet was found on the ocean floor off the coast of Andros Island. Several pilots have reported seeing mysterious domed structures beneath the water in the Florida straits on days when the ocean has been clear and underwater ruins have been located off the coast of Morocco while even more ruins, these bearing the signs of having been destroyed by lava and similar in many ways to some Aztec and Mayan ruins, were discovered by a Soviet Exploration team at Ampere Seamount in the Atlantic in 1978.

Similar ruins were also found off Cadiz in Spain and ruins carved with unusual symbols were also reportedly found on the sea bed off the Canary Islands in 1981 by a P. Cappellano.

It is unknown what civilization these many ruins that have been found beneath our oceans actually belong to; whether it was a land called Atlantis or whether the name Atlantis is any more than pure invention. One thing that *is* certain however is that, beyond any shadow of doubt, there was indeed once a civilization that existed on this planet which was most utterly destroyed by a major event that was something very sudden and very catastrophic.

What could such an event have been?

### **The Legend of Lemuria**

The idea that there may have been a civilization even more ancient than Atlantis that was the motherland of human kind is also one that has endured in mans collective consciousness for many years, and a thought that is at once both compelling and tantalizing.

Such is the tale of Lemuria, a land and culture that is said to have existed in the vicinity of the Pacific and Indian Oceans. It is possible that if it existed, Lemuria was indeed the civilization that predated the legendary Rama and Atlantian civilizations and would have been the stuff of Atlantian legends as Atlantis is of ours. Though it has never been proven that there ever was a body of land in the Pacific region, there are several land masses in the Pacific that are said to be the remains of a once great continent. These include Fiji, New Zealand, Australia, Hawaii, Easter Island, the Philippines and Indonesia. Actual sunken ruins have also been found in several regions in the Pacific, notably, off the Hawaiian Islands of Maui and Oahu, off the islands of Japan and close to the Indonesian coastline, but do they have anything to do with Lemuria? Studies into some of these ruins were actually carried out by a United Nations diplomat named Farida Iskoviev, who researched the Maui ruins in 1972 and subsequently concluded that they were most definitely genuine and also extremely ancient.

As strange as it may seem to you at first, the chances of a continent simply disappearing does not seem so far outside the realms of possibility due to recently discovered knowledge of the relationships between tectonic movements and magma flows that has given us valuable insights

into just what our planet is capable of. But before we examine this further, let's take a closer look at the actual legend of Lemuria and find out exactly what we are being asked to believe.

### **Great Southern Land**

According to legend, Lemuria was a civilization that began on great continent in the Pacific region sometime between 200,000 and 78,000 years ago (*though others have pushed the date back further and estimate it to be 150 million*). Lemuria is a recently adapted name and the actual name of the continent is believed to have been 'Mukulia' or 'Mu.' The Australian Aborigines speak of the land in their "dreamtime" legends and call it 'Gondwana Land' The Lemurian civilization is said to have lasted for a staggering 52,000 years until it was destroyed during massive earthquakes and subsidence caused by a cataclysmic Polar shift that is believed to have occurred about 26,000 years ago. The continent is said to have existed in the area that is now the Pacific and Indian Oceans. Its boundaries can be now seen as the Pacific Tectonic Plate and was about 5000 miles long and about 3,000 miles wide, tropical and home to a population that reached around 60- 65 million. Explorer, James Churchward placed the continent between Africa and South America in his theoretical map (*fig.97*).

It also is said by many to be the original earthly home of the pantheon of ancient Egyptian Gods of which Ra was the head, or perhaps the place Ra disappeared to in his times of exile. Though there are many others who believe Lemuria existed at time in Earth's history that predated the time of Ra and Osiris.

Legend tells us that though Lemuria never reached the level of technology that other ancient civilizations (*such as Atlantis or the Rama Empire*) were said to have reached, it was able to obtain certain achievements in fields such as construction. The Lemurian civilization was very adept at building monuments and it was they who first discovered how to build earth-quake proof megalithic structures. But it is said that it was in the science of government that they most excelled and where their greatest achievements lay.

We are told that the Lemurians considered their greatest resource and key to the success of their empire to be education. There was only one government and everyone spoke one language. Everyone was thoroughly educated in the ways of nature and the universe and given a trade which resulted in great prosperity for the land and the people. Education was compulsory until age 21 for the entire population and was a requirement for entering 'citizen school'. Citizen training then lasted for a further 7 years and at age 28 people were able to legally become 'Citizens of the Empire'.

The Lemurians apparently knew of the impending destruction about to befall their continent and they set out to colonize other areas. After the final demise of the continent it is said they settled in two main areas and divided into two distinct cultures: Those that favored the ways of science colonized an Island-Continent in the Atlantic which was to grow into the Empire of Atlantis, while those that favored the ways of spirituality colonized the area that is now India and began the Rama Empire. It is said that the Governing body or 'Elders' of Lemuria were all members a society known as 'the thirteenth school'. Legend has it that when the elders became aware of the doom that was approaching their land they moved the thirteenth school to a then uninhabited plateau in Central Asia which was later to become Tibet, where they established a library and another new school which they named 'The Great White Brotherhood'.

The actual continent is supposed to have been destroyed in the earths far distant past during a cataclysm that was brought about by a polar shift. The land mass of the continent is said to have been so immense that it encompassed all of Australia, New Zealand, Indonesia, the Philippines, all of Oceania, most of western north America and everything in between and when the continent sank, the massive subsidence it created in its wake formed the Pacific basin, an event which had the effect of lowering the world's oceans significantly when water rushed in to fill the newly made hollow. It was during this event that other, lower land masses were uncovered as the waters receded and the continental land mass that was to become Atlantis became fully exposed.

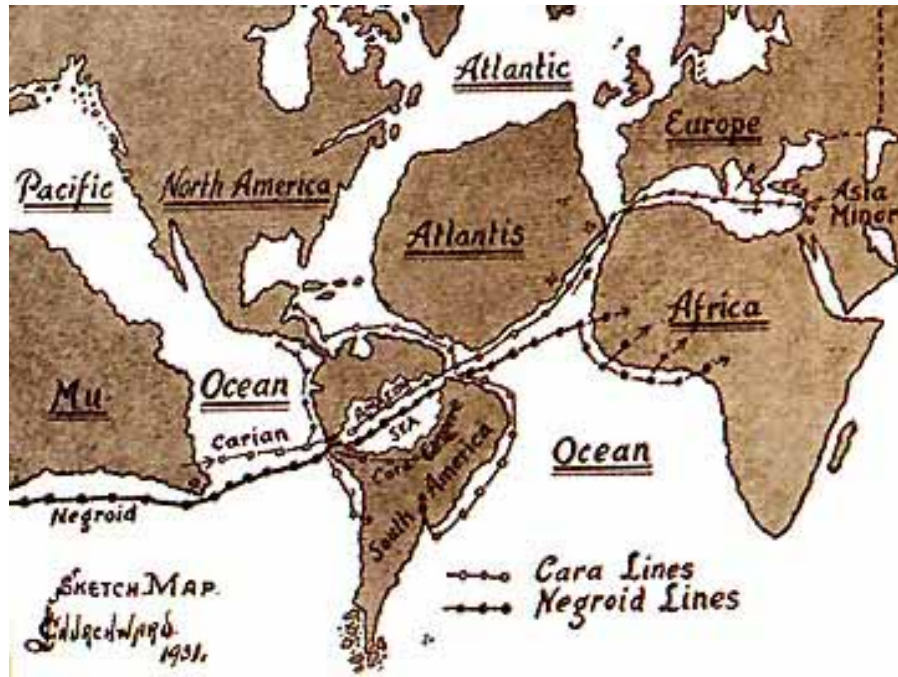

Fig.97

### Those Who Tell

The idea of a sunken civilization in the Pacific area was first proposed by the explorer James Churchward in the late 19<sup>th</sup> century. Churchward claimed that, through studying ancient texts, he had discovered the signs of an advanced civilization in our distant past that existed on a long lost continent that had sunk below the Pacific Ocean about 60,000 years ago after a cataclysmic earthquake. He then set about publishing his findings in a series of 5 books collectively known as the 'Legend of Mu'. At the time Churchward had been working with a French Doctor called Auguste Le Plongeon who believed he had managed to decipher some ancient Mayan texts. However there are many who believe that Le Plongeon's translations were grossly inaccurate and that because Churchward, though a notable explorer, had never discovered anything of great importance, he had fabricated his lost continent out of desperation. Comparisons of geological finds containing many striking similarities between fossil and sedimentary strata found both in India and Africa that were made in the 1800's at first, tended to support Churchward's theory, but as scientists gained a better understanding of plate tectonics, opposition to his sunken continent theory increased ever more dramatically.

Since that time however, there have been other discoveries that lend a little more weight to the idea. A German Naturalist by the name of Ernst Heinrich Haeckel also reasoned that Lemuria could explain the absence any fossil remain of early man reasoning that any remains would now be lost: "If man originated on a sunken continent in the Indian Ocean, all the fossils of the 'missing link' are now under the sea." Many others reason that a great continent once existing in the pacific could also account for the wide distribution of large flightless birds that only exist in the southern hemisphere such as the Australian emu, the ostrich and once the dodo. The distribution of Lemur's has also been attributed to Lemuria.

Charles Hapgood published a book entitled 'Maps of the Ancient Sea Kings' which expanded on Churchwards theory. Later author and 'Maverick Archeologist', David Hatcher-Childress, examined Hapgood's theory in detail in his book 'Lost Cities of Ancient Lemuria the Pacific' and did well to substantiate much of his work..



Some information that is presented to us about the lost continent is highly dubious and needs to be approached with a certain amount of caution. Many writings exist on Lemuria, the people, the communities, their way of life and so forth. Many writings claim the Lemurians were a telepathic race and other, even more fanciful things. Unfortunately we only have the vaguest of hints to such a place ever even existing, let alone what kind of people they may have been and books that go as far as discussing the ways of the Lemurian people are purely speculation as no texts, hieroglyphic or otherwise have ever been found to exist that deal with such topics.

One of the most well known of these more 'esoteric' sources would undoubtedly be the works of Madame Blavatsky, a 'seer' of the late 1800's. In her book "*The Secret Doctrine*" Madame Blavatsky claimed to have learned of Lemuria in '*The Book of Dzyan*' which she alleged was shown to her by the Mahatmas. Some of Madame Blavatsky's claims were pretty outrageous, she said that some Lemurians had four arms, used telepathy as their main form of communication, that some had an eye in the back of their head that provided them with psychic vision and other such spurious claims. Blavatsky also wrote heavily on the underground world of Agartha and the secret Thule Society (*of which Adolf Hitler was a member*)

Notably Blavatsky herself denounced her own claims shortly before her death in 1891, however, not to be deterred by her own rebuttals of her work, shortly afterwards a man by the name of Scott Elliot picked up where Blavatsky had left off and published a disheveled, over written and rather ponderous book entitled '*The Story of Atlantis and the Lost Lemuria*'. Elliot's work seems to be wholly fantastical and in his book he describes Lemurians as being 12 to 15 feet tall with flat faces except for a muzzle protruding from the center and even the very earliest Lemurians as being a race of 'egg laying hermaphrodites' at one point!

The myths and traditions of ancient India contain some references to both Lemuria and Atlantis. The Rig Veda for example speaks of "the three continents that were", one was home to a race called the Danavas. A land called Rutas was said to be an immense continent far to the east of India and home to a race of sun-worshippers, but Rutas was said to have been destroyed by a volcanic upheaval and sunk beneath the ocean. Fragments of the continent remained as Indonesia and the Pacific islands, and a few survivors reached India, where they became the ancient learned race known as the Brahmans. The same type of story also appears in the Mayan creation myths, namely in a tale called the 'Popol Vuh,' and there are also paintings depicting the event (*fig.98*).

Some of the works that exist referring to Lemuria are quite ponderous and esoteric and require a great deal of intellectual 'sifting' and it is not the intention of this work to explore them in full, just to alert the reader to their existence. Should you however wish to explore these tales in detail for yourselves a full bibliography is provided at the close of this book.

### **Tracing the Outline**

Many scientists and archeologists state that the topography in the Pacific and Indian Ocean area does not reveal anything that looks like a sunken land mass however there are theories as to why this could be.

In the late 1800's Charles Hapgood put forth a theory that had some merit that went something like this: Due to geological upheavals and just through normal environmental activity, vast amounts of vegetable and animal matter constantly fall to the ground and are buried beneath the earth and as this rotting matter composts underground it produces methane and other gasses. These gasses form into underground pockets and, through constant tectonic movements, eventually join together to form super pockets of underground gas. Since the gas is constantly



Fig.98

being replenished by composting matter and gas is lighter than earth, over great periods of time these gas pockets gradually work themselves closer and closer to the surface. Hapgood theorized that such a super-pocket had possibly existed under the Lemurian continent and had burst open during a past seismic event virtually swallowing the continent whole and then the ocean floor had simply closed back over the fault and filled with sludge and debris eventually burying all trace. Of course, his critics had a field day with such a theory saying that the concept was absurd, pointing out that vegetable matter rots too close to the surface of the earth and the idea that there could possibly exist, vast gas deposits, beneath the earth was totally and utterly preposterous.

It wasn't until the latter half of the 20<sup>th</sup> century that Natural Gas was discovered in vast deposits beneath the earth, much to the embarrassment of Hapgood's critics. But could such super-pockets as Hapgood describes actually exist?

Knowing what we now know, the idea is not at all unreasonable. But what evidence exists of a place such as Lemuria?

Recently, some amazing sunken ruins that many believe can be attributed to the lost continent have actually been found by divers off the coast of Japan (*fig.99*). Some of these ruins are quite spectacular and include Terraces, hexagonal post holes, columns, roads and other megalithic structures (*fig.100*). For some reason these ruins have not been featured or even reported by any western media at the time of writing this in 2006. I can however confirm for you that they were

located in 60 – 100 feet of water off the coast of Okinawa, Japan in 1995. The terraces are quite massive, by normal standards. And another site was discovered soon after just off the southern end of the island of Yonaguni, the southernmost island of Japan.



Fig.99

The Yonaguni location is quite an extensive site, with five irregular terraced sections resembling ceremonial platforms. There have so far been eight of these anomalous, underwater sites found in the vicinity of Japan to date. Kimura firmly believes the ruins to be man made and the traces of an unknown civilization, perhaps from the Asian mainland. One site includes the ruins of a building about 240 feet long (*fig.101*) Two of Japan's leading researchers, Kihachiro Aratake, and Prof. Masaaki Kimura, a marine geologist with the University of the Ryukyus in Okinawa, have spent several years studying eight sites in all, especially Yonaguni, which was found by Aratake also in 1995.

In an article in 'Ancient American', the writer Frank Josef had this to say about the find:

“One of the greatest discoveries in the history of archaeology was made last summer, off Japan. There, spread over an amazing 311 miles on the ocean floor, are the well-preserved remains of an ancient city, or at the very least, a number of closely related sites.

“In the waters around Okinawa and beyond to the small island of Yonaguni, divers located eight separate locations beginning in March 1995. That first sighting was equivocal - a provocative, squared structure, so encrusted with coral that its manmade identity was uncertain. Then, as recently as the summer of 1996, a sports diver accidentally discovered a huge, angular platform about 40 feet below the surface, off the southwestern shore of Okinawa. The feature's artificial provenance was beyond question. Widening their search, teams of more divers found another, different monument nearby – then another and another... They discovered long streets, grand boulevards, majestic staircases, magnificent archways, enormous blocks of perfectly cut and fitted stone - all harmoniously welded together in a linear architecture unlike anything they had ever seen before.

“In the following weeks and months, Japan's archaeological community joined the feeding-frenzy of discovery. Trained professionals formed a healthy alliance with the enthusiasts who first

made the find. In a progressive spirit of mutual respect and working alliance, academics and amateurs joined forces to set an example of cooperation for the rest of the world. Their common cause soon bore rich fruit. In September, not far from the shore of the island of Yonaguni, more than 300 airline miles south from Okinawa, they found a gigantic, pyramidal structure in 100 feet of water. In what appeared to be a ceremonial center of broad promenades and flanking pylons, the gargantuan building measures 240 feet long.



Fig.100

“Exceptionally clear sub-surface clarity, with 100 foot visibility a common factor, allowed for thorough photographic documentation, both still photography and video. These images provided the basis of Japan’s leading headlines for more than a year. Yet, not a word about the Okinawa discovery reached the US public, until the magazine, “Ancient American” broke the news last spring. Since that scoop, only the CNN network televised a report about Japan’s underwater city.

“Nothing about it has been mentioned in any of the nation’s other archaeology publications, not even in any of our daily newspapers. One would imagine that such a mind-boggling find would be the most exciting piece of news an archaeologist could possibly hope to learn. Even so, outside of the “Ancient American” and CNN’s single report, the pall of silence covering all the facts about Okinawa’s structures screens them from view more effectively than their location at the bottom of the sea. Why? How can this appalling neglect persist in the face of a discovery of such unparalleled magnitude? At the risk of accusations of paranoia, one might conclude that a real conspiracy of managed information dominates America’s well-springs of public knowledge.”

The site was also visited in 1998 by a team of American divers who were skeptical at first but became more interested when they discovered some intriguing holes in the rock platforms.

A few possible scenarios have been suggested in respect to dating these sites. One possibility is that they may have been submerged when sea levels rose as the continental ice sheets melted at the end of the last Ice Age. Another one is that because Japan sits on the edge of the Pacific 'Ring of Fire', tectonic activity might have caused some type of massive land subsidence and this is not at all unlikely. Teruaki Ishii, who is a professor of geology at Tokyo University, suggests a date contemporaneous with the ancient civilizations of Mesopotamia and the Indus Valley for the ruins, putting them at about 8,000 B.C. while others have suggested an age of around 12,000 BP.

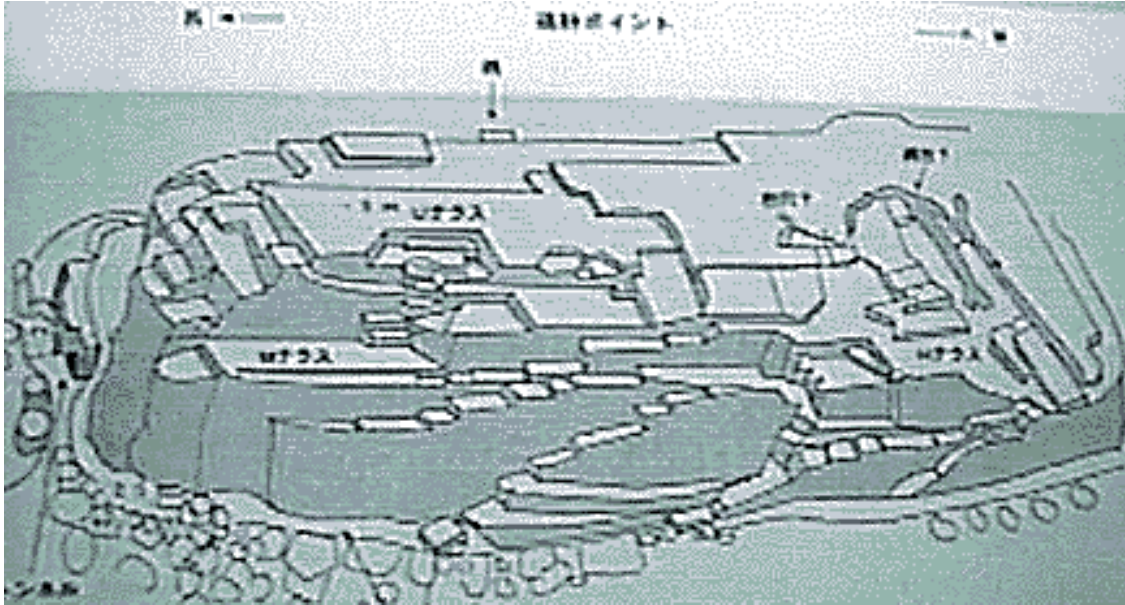

Fig.101

There is every indication that more than one ancient civilization may well have existed on the earth and indeed, every possibility that a civilization preceding even the one which we know as Atlantis may well have even existed.

As you read further you will see why this is not a wholly unlikely or impossible scenario.



# The Case for Ancient Flight

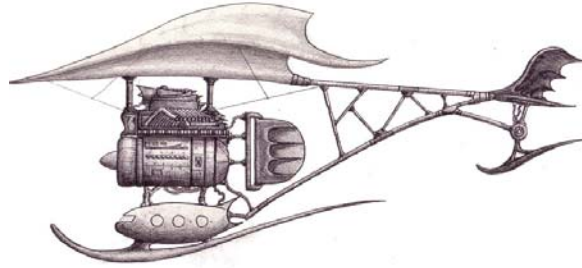

The acceptance of the existence of an ancient civilization is fast becoming an issue that is no longer open for debate as the evidence of its existence and technological achievements at least in the fields of masonry and building, is quite apparent. Furthering this, the question has also often been asked whether these people of Ancient times were able to travel through the skies in aircraft like we do today and before you scoff at the notion of this I ask you to first consider a few things.

The first thing to consider is that there are actually a good deal of passages in past records and ancient texts that do in fact mention flight and the machines that were used for it and also consider that there is enough of this written evidence existing in vastly different cultures to suggest that sometime in our distant past, an age of aviation did indeed occur – and at a much earlier time in our history than we ever could have thought possible.

A consistent and ever growing bulk of this documentary evidence quite openly states that the secrets of powered flight were very well known to many nations at a time that is now well before our recorded history. These reports are not limited either and can be found in the ancient records, Religious Texts, Mythology and artifacts from wide variety of cultures. There is an ancient Indian book called the Vimaanika-Shastra for example, which contains passages that read more like flight manuals than religious texts, even going into great detail to explain the various metals that should be used in the construction of the craft, where they could be located and how to smelt them. Other passages describe the many controls and functions for the craft and detailed techniques used for maneuvering the machines in different types of weather and wind strengths. Even the clothing to be worn by the pilots is described in detail.

Local legends of the Greeks, Columbians and Egyptians also speak of flying craft, even the Polynesian Islands in the South Pacific have legends that talk of a fair skinned people who once arrived from the west aboard "shining boats" that flew above the sea. Other islands of the Pacific also have extremely similar legends of flying canoes that brought people from far off places.

The true history of flight may actually encompass far more and be a great deal longer and broader we ever could have even imagined in our wildest dreams.

### *The Story of Icarus and Daedalus.*

One of the earliest stories of flight is undoubtedly the epic Greek tale of Icarus and Daedalus by the Roman poet Ovid. As with many other stories concerning the fantastic deeds of the Gods, the ancient Roman tale is seen almost exclusively in terms of an adventurous and colorful myth. However, a closer look at this ancient poem can reveal a good deal more to us.

In the story recounted by Ovid in his work '*Metamorphoses*' Ovid describes Daedalus as a being a highly skilled and talented architect who was the actual designer of the infamous 'Cretan Maze,' the enormous circular underground maze that was built at the request of King Minos to trap and imprison the legendary Minotaur.

When his labors were done and the maze was complete Daedalus became restless and longed for his homeland again but he knew that the tyrant King Minos would block his return and that the way by sea would surely be closed to him. So instead of sailing he decided to build himself a flying machine. *"The king may block my way by land or across the ocean, but the sky, surely, is open, and that is how we shall go."* According to Ovid's epic, he then: *"set his mind to sciences never explored before, and altered the laws of nature."*

Ovid tells us that eventually Daedalus constructed two flying craft, one for himself and the other one for his son Icarus. In his account Ovid does not state whether the craft were powered in any way or had perhaps been some kind of glider, possibly even a type of hang-glider, but it is reasonable to assume that such a craft would have to have been powered in some way in order Daedalus to feel confident he would be able to transverse an ocean. Ovid does however tell us that before their departure Daedalus went to great pains to ensure his son Icarus was well instructed on all the rudiments of flight and the capabilities of his craft and even then, kept a watchful eye over him once they were in the air.

Ovid tells that the sight of these two flying machines also created a considerable amount of excitement among spectators on the ground who happened to witness the event: *"Some fisherman, perhaps plying with his quivering rod, some shepherd leaning on his staff, or a peasant bent over his plough handle caught sight of them as they flew past and stood stock still in astonishment, believing that these creatures who could fly through the air must be gods."*

The two craft headed out from Crete across the Aegean Sea. But the poem tells us that for Icarus the wonder of flying was an incredibly exhilarating experience and he became so exited by the thrill of it that he eventually flew out of earshot of his father and soon forgot all about his instructions. Icarus soared ever further skywards until the wax his father had used to bind the wings of his craft together began to melt from the heat of the sun. His craft soon fell to pieces and he fell and was *"swallowed up in the deep blue waters, which are now called after him"*.

Today the legend of Icarus and Daedalus is viewed entirely as an interesting poetic myth. Yet it could easily be factual testimony of an event that may have really occurred in the history of early aviation. This is hinted at because, by way of comparison, it is quite an unusual story in that it is not a magical exploit like the many other ancient myths. It is in fact, quite an 'earthly' tale containing within the narrative some very conceivable and quite plausible human accomplishments. There is also the fact that Daedalus is described as a master architect who was already known to have constructed great things such as the maze. This also makes it entirely plausible that such a man may well have conceived of a way to fashion some type of aircraft considering that today, practically anyone with two brain cells working in unison can assemble a hang-glider from a car boot. Plus there is the fact that Daedalus was so concerned for the safety of his son and realized there were limitations to the capabilities of the craft and seemed to be very aware of its shortcomings. This is very different to the exploits described in other mythological tales. All of these points lend credence to the ancient tale and its possible authenticity as a factual account of early aviation.

## Babylon

Possibly the very earliest existing record to mention aviation, even preceding many Indian texts, is an ancient set of Babylonian laws named the 'Halkatha.' The Halkartha contains but a single passage which unmistakably reads: *"To operate a flying machine is a great privilege. Knowledge of flying is most ancient, a gift of the gods of old for saving lives."*

Another similar Babylonian text called the "Epic of Etana," which is thought to be derived from an earlier Sumerian tale, contains references to the magical flight of Etana on the back of a huge eagle. Throughout the story as Etana is continually taken ever higher, there are numerous and remarkably accurate descriptions of the view that unfolds below. The thing is that the tale reads like a genuine account of someone who very familiar with flying. It is difficult to conceive of how the author could have imagined the details that are mentioned throughout the narrative. There are detailed descriptions of a 'patchwork of color', mentions of atmospheric haze and accurate description of geographical features that it would be very hard for someone to describe unless they had actually experienced flight. So who could have made and recorded these types of accurate observations in an ancient text that was written somewhere prior to 2400 BC?"

In his book '*Secrets of the Lost Races*', Rene Noorbergen made the following remark about the tale: *"Whatever the vehicle of ascent may have been, the 'Epic of Etana' certainly supplies us with a very accurate description of the Earth's surface from various altitudes - descriptions which were not verified in our own era until the high altitude aerial flights of the 1950s, and the first space shots of the 1960s"*.

In the same book Noorbergen also mentions a 5000 year old Chaldean manuscript called '*the Sifr'ala*' which is believed to actually contain a detailed account of how to build an aircraft. The passage was found by a somewhat surprise archeologist while deciphering the text who was amazed to find passages on the subject of flight and mentions of things such as: *"vibrating spheres, graphite rods and copper coils,"* and contain comments on *"wind resistance, gliding and stability"*. Unfortunately many key lines of the text are missing, making any attempt at learning the complete method for reconstructing the craft now virtually impossible.

Aint it just always the way?

## China

China is perhaps the most mysterious of the ancient developed civilizations anywhere on earth. Though, this mystery is mainly because the occasional Chinese ruler had decided that history should start with them, and subsequently set about erasing any records preceding their reign. Fortunately some ancient texts still managed to survive these ravages though nothing from extreme antiquity and among them are numerous references to experimental aircraft. Some of these texts have been dated as being written sometime prior to 2000 BC.

One such text mentions that the Emperor Cheng Tang ordered the construction of a flying machine in 1766 B.C. The report tells us that the craft was then subsequently destroyed for fear of anyone else discovering the secret of flight. The same text states that much later, in the 3rd century B.C. a Chinese poet called Chu Yun made a detailed aerial survey of the Gobi desert. In these passages Chu Yun even lavishes enormous praise to the fine construction of his craft and speaks of the great durability it displayed during several wild desert wind and sand storms that he encountered during his flight.

## India

More than most countries, India is a place that has a particularly rich and detailed tradition of ancient flying machines throughout their history and mythologies. There are numerous stanzas in the '*Ramayana*.' Many mentions of such machines are also made in the epic wars that are described in the '*Mahabharata*.' and some extraordinarily lengthy passages referring them in another ancient book called the '*Vymaanika-Shaastra*.'



There is another ancient collection of sacred Hindu books called the ‘*Samaranga Sutradhara*’ that contain at least 200 passages concerning almost every conceivable aspect of flying and the amazing descriptions in the narrative abundantly demonstrate that the authors of the work had a very detailed knowledge of aviation, mechanics and equipment that comes very close to what we know today. Author and self-taught Archeologist, David Hatcher-Childress has written some excellent books discussing these texts and I highly recommend anyone with an interest in the topic to obtain and read them. (See: ‘sources’ at the close of this book.) These texts call the ancient flying machines ‘*Vimana*’s.

They describe the craft as having "*carefully welded joints*", and as being powered "*by controlled fire from the iron containers*" that were like "*the roar of a lion*" that would set the *Vimana* in motion so that "*the traveler sitting inside the Vimana may travel in the air, to such a distance as to look like a pearl in the sky*" This description sounds remarkably like modern jet powered planes, even very adequately describing the noise that they make. One chapter describes a complicated process for smelting and refining mica telling us that the process: "*will yield a metal shining like a precious stone, very light, unbreakable, unburnable and indestructible.*"

In fact the entire *Vyamaanika-Shaastra* reads more like a flight school manual than mythology! It’s hard to imagine any reason for including such things in religious texts, for they tell no story, convey no message and have no moral or meaning. They only serve to describe the technical details of flying craft and their related topics.

As an example, both in the *Vyamaanika-Shaastra* and in a book called ‘*the Yantra Sarvasva*,’ *Vimana* are described as being of 3 classes: Those that travel from place to place. Those that travel from country to country. And those that travel from planet to planet. The texts are also greatly concerned with military *vimana* recording them as having special requirements which they state quite categorically. According to these ancient texts, such military craft needed to be:

- \* Impregnable, unbreakable, non-combustible and indestructible.
- \* Capable of coming to a dead stop in the blink of an eye.
- \* Invisible to enemies
- \* Able to listen to the conversations and sounds in hostile *Vimanas*
- \* Able to see and record things, persons, incidents and situations inside hostile *Vimanas*.
- \* Able to know the directions and movements of other *Vimama* in the area at all times.
- \* Capable of rendering the crew of a hostile *Vimana* into a state of suspended animation, mental stupor or complete unconscious.
- \* Capable of destruction
- \* Manned by pilots and travelers who can easily adapt themselves to the climates and environments through which they moved.
- \* Temperature regulated inside
- \* Constructed of light, heat absorbent metals.
- \* Equipped with mechanisms to enlarge or reduce images and enhance or diminish sounds.

Now not to completely ignore the fact that what has just been described to us sounds like some sort of cross between a Stealth Fighter and a UFO, it seems safe to assume from these texts that the ancient Indians actually had some pretty advanced knowledge about certain technologies.

There is very little doubt that many of these tales are quite authentic. Many of them come from the great Indian Epics themselves and there are quite literally hundreds of them and still many more (*in fact probably most of them*) that haven’t yet been translated from their original Sanskrit

Apart from the myriad of ancient texts and legends dealing with the subject ancient flight there is also certain physical evidence to support the claim of its reality in bygone days.

Of course, we’re not talking about actual ancient flying machines as none have ever been located nor, I imagine ever will be, but there are some other somewhat intriguing artifacts that *have* been found.

### Egypt

A small artifact that was discovered in a tomb near Saqqara in 1898 and labeled simply as ‘bird object’ is quite interesting. It was found *again*, years later, in a basement storage area of the Cairo Museum of Antiquities. For many years the artifact, catalogued simply as item number 6347, RM 22A, (*fig.102*) had lay in a small box, almost forgotten and was considered to be small and mostly insignificant. But the intriguing thing is that the artifact is actually a tiny wooden aeroplane.

It was not until 1969 that an archaeologist by the name of Dr Kalil Messiha noticed the extraordinary resemblance of the object to modern delta winged aircraft and decided the item was worth further investigation. A research committee was immediately formed and the findings were so impressive that the object was put on immediate display in the museum.

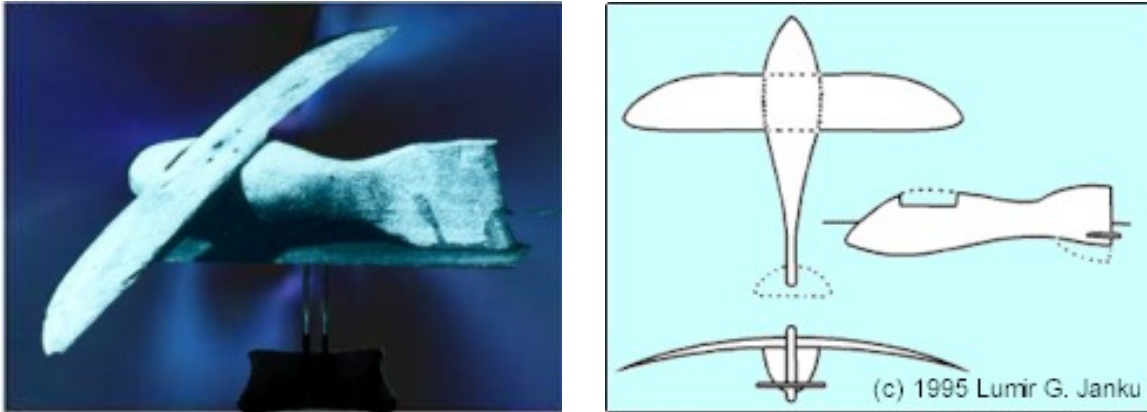

Fig.102

Aerodynamic experts later testified that in their opinion, the model was remarkably airworthy “*indicating knowledge of principles of aircraft design which had taken European and American designers a century of airfoil experimental work to discover.*” Some experts noted definite similarities between the model and the recent NASA developments in oblique-winged aircraft like the space shuttle design.

Numerous such artifacts have now been discovered, all showing knowledge of advanced aerodynamics, and in a temple in Abydos in Egypt, there are hieroglyphics near the ceiling that look very much like modern aircraft in profile. The glyphs closely resemble a helicopter, an airplane and some kind of hovercraft or flying disc (*fig.103*).

### Colombia

Another miniature flying machine now simply known as the ‘*Gold Jet*’ (*fig.104*) was also discovered in Columbia in South America. The tiny gold object is considered to be well over a thousand years old and looks very much like a modern plane or space shuttle. It is thought to come from a pre-Incan culture, possibly the Toltecs or Olmecs, and measures just two inches long. The artifact has attracted considerable attention due to its extraordinary resemblance to a modern fighter plane. According to one test pilot a Mr. Jack A. Ullrich: The shape of the wings and the tapering of the fuselage also suggests the original aircraft it was modeled from was probably jet powered and capable of supersonic speeds!

Critics say that the object could just as easily represent a bird or flying fish and this could very well be a possibility. However it’s notable that the object also depicts a triangular upright tail-fin which has no equivalent in the animal kingdom and provides a strong indication that it is actually a depiction of a flying machine.

Interestingly, the miniature model even has an insignia on the tail fin such as can be found on today’s modern fighter planes. This has been likened by scholars to the second letter in Hebrew alphabet – the letter beth. It has been speculated that the artifact may not have originated in

Colombia and could even have been Phoenician, possibly imported from somewhere in the Middle East. There are at least six other very similar artifacts that have been discovered from other locations in South America such as Venezuela, Peru and Costa Rica.

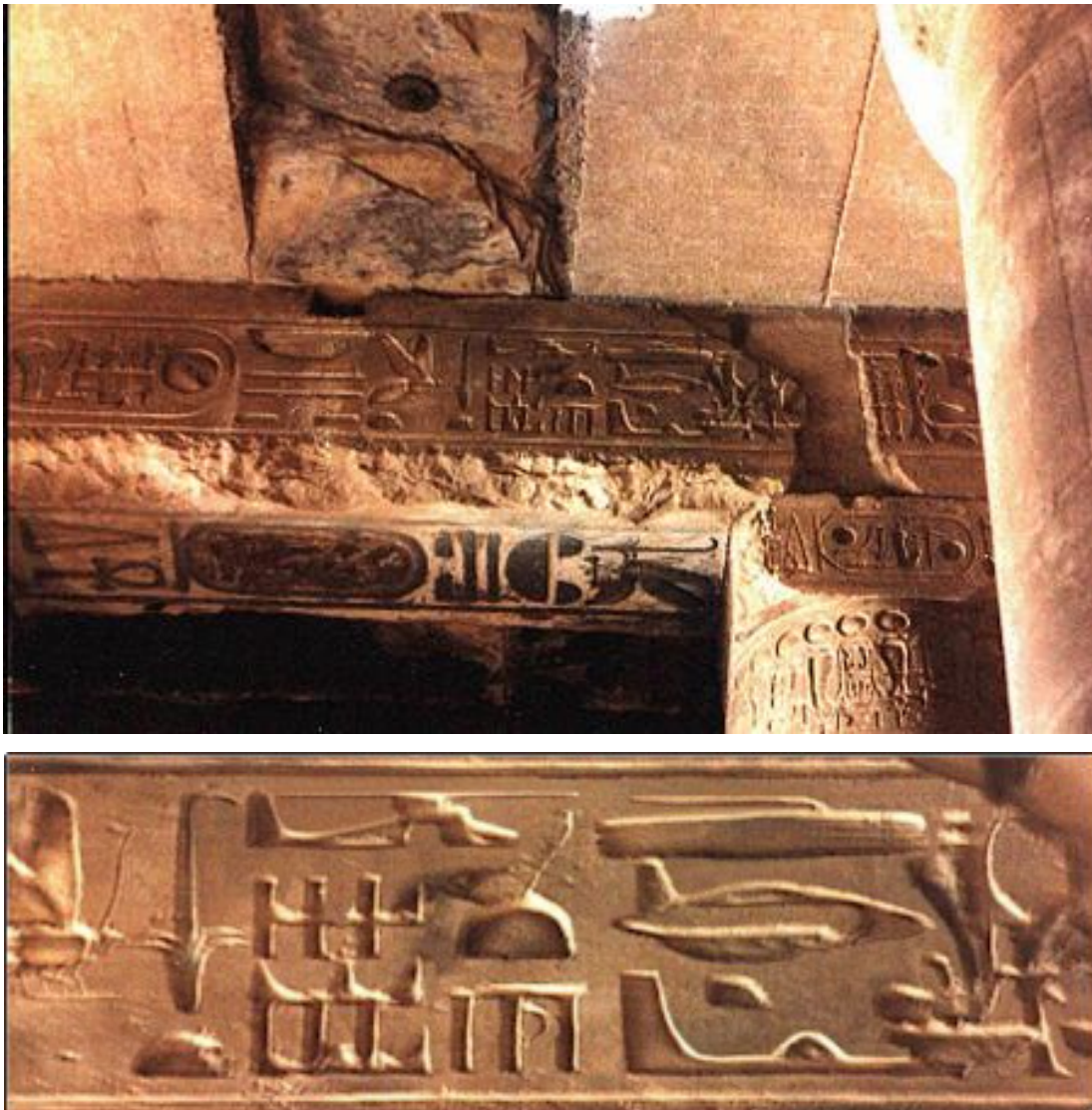

Fig.103

There is also a huge body of evidence in the form of ancient texts even apart from the many Indian epics, all suggesting that flight was a reality long before our modern world and it is highly unlikely that races from different parts of the earth could invent tales that are so strikingly similar in both content and time frame or that sculptures and artists of our ancient past could randomly produce works of such aerodynamic accuracy without first hand knowledge on the subject. There is also the vast markings in the desert of the Nasca Plains in Peru discussed in chapter two that only be properly viewed from the air to be considered. If no one was capable of flight then why construct them? And how could the artist have ever designed the layout in the first place?

Written records taken from ancient oral traditions in Nepal also mention powered flight, these records say that the real secrets of flight were not known to all people but only to a select few called the 'Yavanas', who were thought to be a light-skinned people of the eastern Mediterranean region, most probably from Greece. This is quite interesting because Greece is actually the country that provides us with one of the best known accounts of the perils that were associated

with early aviation in the tale of Icarus and Daedalus. And apart from that, if you stop to consider the motivations behind record keeping, why on earth would the scribes in Nepal go to all the trouble of acknowledging their lack of expertise on the subject of flight unless someone else was already around doing it better than they could? For them to just casually mention it in amongst the rest of their history makes no sense at all: “Oh and by the way, we can’t fly...” That would be the same as our current historians bothering to record the fact that man is still incapable of turning into a tree during the 21<sup>st</sup> century. The simple fact of it being mentioned at all gives one immediate cause for thought, and in particular because it’s mentioned in fashion that would suggest a *non*-proficiency in the skill in comparison to others, Most traditional texts deal with the accomplishments of a civilization, not with its shortcomings.



Fig.104

### **The Amazing Vymanika-Shastra**

As previously mentioned, the Vymanika-Shastra is a remarkable work from ancient India. It is said to be a Religious text but if so, then it is one that seems to contain no religious or moral significance at all. There are of course the standard praises and recognition of the greatness of the gods that regularly punctuates the work, but no real story as such. The work serves only to offer mankind the benefits of aeronautics. Unfortunately the copies of this book that have survived from antiquity are incomplete making any complete rendering of the narrative now impossible though we do have a reasonable amount to go on.

The descriptions in the texts are quite technical in places and highly detailed throughout. I was going to attempt to present a summary of the work in this section however the subject matter is extremely vast and the lack of any ‘storyline’ make summarisation of the book impossible. I will though present for you here, a list of some of the various topics that are covered in just the first chapter of the book, to give you an understanding of the peculiar nature of this remarkable text.

The book opens with this statement:

“I make obeisance to the Divine Being, who is visible on the crest of the Vedas, who is the fountain of eternal bliss, and whose abode is reached by Vimaanas.

“Having studied the Shastraas propounded by previous men of science to the best of my ability, for the benefit of mankind, I shall deal with the science of Aeronautics, which is the essence of the Vedas, which will be a source of joy and benefit to humanity, which will facilitate comfortable

travel in the sky from world to world, in eight chapters, consisting of 100 topics, in 500 sutras.”

### *Synopsis of Chapter One*

Sutra one describes for us the nature of a Vimaana;

“Owing to similarity of speed with birds, it is named Vimaana.”

“The Vimaana is a vehicle which flies in the sky with speed comparable with birds”.

“That which can fly in the sky with speed equal to that of birds is called Vimaana.”

“That which can speed on earth, on water, through air, by its own power, like a bird, is a “Vimaana.”

“That which can fly through air from one place to another is a Vimaana”

“That which can fly through air from one country to another country, from one island to another island, and from one world to another world, is a “Vimaana”.”

Having thus defined for us what the word Vimaana means, in sutra two, the author proceeds to describe its details to us:

The texts say that a vimaana pilot should acquaint himself thoroughly with 32 secrets of the workings of the Vimaana before attempting to use the craft. Such things as the technical details of the craft; special maneuvers and abilities it could perform, how to handle the vehicle in battle situations and deal with hostile Vimaanas, are all described in detail in this sutra.

In sutra three, we are told of five types of atmospheric regions and the different aerial routes that a pilot needs to familiarize himself with:

“...the regions of the sky are five... In these 5 atmospheric regions, there are 5,19,800 air ways traversed by Vimanas of the Seven Lokas or worlds, known as Bhooloka, Bhuvraloka, Suvarloka, Maholoka, Janoloka, Tapoloka and Satyaloka. Rekha has 7,03,00,800 air routes, Mandala has 20,08,00,200 air routes, Kakshya has 2,09,00,300 air routes, Shakti has 10,01,300 air routes, and Kendra has 30,08,200 air routes.”

Sutra Four deals with the dangers of ‘whirlpools’:

“Aavartaas or aerial whirlpools are innumerable in the above regions. Of them the whirlpools in the routes of Vimanas are five. In the Rekhapathha there occurs “Shaktyaavarta” or whirlpool of energy. In Mandala-pathha there occurs the whirlpool of winds. In Kakshyaa-pathha there occurs Kiranaavarta or whirlpool from solar rays. In Shakti-pathha there occurs shytyaavarta or whirlpool of cold-currents. And in Kendra-pathha there occurs gharshanaavartha or whirl-pool by collision. Such whirlpools are destructive of Vimanas, and have to be guarded against.

“The pilot should know these five sources of danger, and learn to steer clear of them to safety.”

Sutra Five Deals with the various structural parts of the Vimaana:

We are told that a Vimaana consists of 31 main parts

“Just as the human body, if it is complete in all its limbs, is best able to accomplish things, the Vimana, if it is complete in all its parts, will be capable of functioning efficiently”

Sutra Six deals with the clothing required by the pilot:

“The clothing should be different for different seasons.”

A great amount of detail is given on the methods for fashioning specific apparel the pilots were required to wear for health, safety and psychological reasons:

“With this material, fashioning the apparel and clothes of the pilots handsomely... It will ward off evils, promote fitness of body and health of mind, and improve their strength, energy, and competence.”

Sutra Seven deals with which foods the pilot should consume at different times of the year:  
“Food according to Seasons.”

Section Eight tells of the food types required:  
“The three Varieties ward off seasonal evil effects”

Sutra Nine informs us of strict meal times for the pilots:  
“That at set times”

The times for taking meals are prescribed as follows: Family men should take food twice a day, or once a day. Ascetics should take food once a day. Others can take food four times a day. Air pilots should take food 5 times a day. And yogis may take as many times as they like.

Sutra Ten deals with vitamin supplements that may also be used:

We are told that if the food-stuffs prescribed above are not available for use during flights, then essence extracts made by cooking certain foods with admixture of spices may be dried and ‘food balls’ made from them should be supplied to the pilots for consumption during flights.

“There are 5 kinds of food that are nutritious and wholesome; cooked rice or grain, gruel, cooked flour, baked flat bread, and preparations made out of essence-extracts from food materials. The last named are superior to all the others”.

Sutra Eleven continues the theme of food supplements:

“Or essence of fruits, roots, and bulbs.”

We are told that that preparations made from edible roots, potato and other bulbous vegetables, and from fruits are also suitable for use as food-balls.

Sutra Twelve continues the Supplement theme, this time speaking of herbal supplements:

“Like roots, bulbs and fruits, grasses, shrubs and herbs, provide good food for men. Six kinds of doorva grass, 6 kinds of munja hemp, 6 kinds of darbha or long grass, 6 kinds of shoundeera, and 6 kinds of Ashwakarna or sal, or mimordica charantia, Shatamoolee of 3 kinds, Kaaruvellie; Chandravellee, Madhuvellie, Varchulee, Makutee vellee, sugandhaa, and sooryavellee may be made to yield good food, nutritious and bracing.”

Sutra Thirteen Deals with the various metals and alloys used in the construction of Vimaanans:

The book tells us that: “There are 3 kinds of metals... By mixing them, 16 kinds of heat-absorbing metals are produced.

“Metals which are light, and are suitable for producing vimaanans are 16. They are heat absorbing, and should be used in the manufacture...”

“...16 metals formed by mixing root metals and are non-heat-conductors and are useful for Vimanans.”

The texts also suggest a significant geological knowledge by the author. It also mentions extensive mining operations to recover the metals required for the craft and speaks of where they may be located:

“In the 7<sup>th</sup> layer of the earth, in the third mine therein, metals of the Soma series are found. They are of 38 kinds. Among them there are three from which heat resisting metals are to be extracted. In the 3<sup>rd</sup> section of the 7<sup>th</sup> layer of the earth, Metals possessed of 5 special qualities, are called “root-metals”.

“There are 3000 metal bearing layers within the earth. Of them 1300 layers contain the better quality. In the 7<sup>th</sup> layer metals are of 27 types. The 3<sup>rd</sup> type of metals are of five-fold qualities, and are known as root metals.”

Sutra Fourteen speaks of the methods for purifying the Metal ores for use in the manufacture of various alloys:

The texts speak of the different plant extracts and concentrated juices that were applied to ores in various ways to produce different types of lightweight metals. This section explains the processes involved for some of them.

\*

The above descriptions are merely a summary of the first chapter of the Vimaanika-Shastra. There are still seven more that continue along this same theme with extraordinary detail. I could go on but I think you get the point.

The topics dealt with in this ancient Indian book are extraordinary, and it's virtually the same wherever you go in the world; if you look for them, it seems that all countries have ancient legends and long standing traditions of pre-historic flight.

Whatever the other truths of our history are, the reality is that ancient knowledge of flying machines was a world-wide phenomenon. To many people, the existence of texts such as these coupled with the wide spread nature and enormous bulk of the other evidences previously mentioned constitutes proof enough that the only possible conclusion that can be reached from it all is that thousands of years ago some form of Ancient civilization that possessed the knowledge of aviation actually did exist and that flight was quite well known about by many cultures.

Others have said: But if such is indeed the case and ancient man knew of flight then where are the remains of their ancient flying machines? There has been no remains of any such craft that have ever been found at archaeological sites; if they ever had existed surely we should have found some trace of them by now. The answer to that is simple.

If there was an ancient civilization that was destroyed in either a devastating war or in a natural cataclysm, all trace of them would in fact, be gone by now. Every piece of metal, every nut and bolt would be rusted to dust and every piece of concrete decayed. Not one trace would remain. Unless it was a massive monument of stone or an item that had been covered by earth or rock and preserved by time.

No, only objects such as the megalithic structures we still find, or perhaps a depiction of the event painted on a stele by one of the few survivors, or objects like the 'ooparts' mentioned in the second chapter would have survived for us to find, which indeed they have.

That's how it will always be; and if our civilization was wiped out today and another grew up over many thousands of years from the fragmented and scattered pockets of survivors. What would be left on the earth of our civilization 20,000, 50,000 or 100,000 or even a million years from now to show the people of that time that we were ever here?

The answer of course, is nothing.

Nothing would remain of us or our civilization except legends and possibly some small artifacts that had escaped and remained buried somehow; perhaps a fossilized footprint or a painting one of the survivors had drawn on the wall of a cave he'd found to shelter in for the winter. And then as the survivors grew into a civilization and again became as modern man, imagine their mirth at the laughable notion that men may have flown or even walked across the earth in a time that is 100,000 or 200,000 years before their civilization.

"But why have we found none of these "ancient' flying machines?" They would ask.



## Chapter Eight

# The Remapping of Prehistory



“People call them Pterodactyls;  
But that is because they are ashamed  
To call them flying dragons, after Denying  
So long that flying dragons could exist.”

- Charles Kingsley (from 'the Water Babies')

### **Fact vs. Fiction**

Apart from all of the records concerning ancient flight that exist there is still more startling evidence to dispute our accepted historical event chronology and even very significant evidence that dramatically disputes Darwin's theory of evolution – to the extent of punching some quite serious holes in it. In truth, even the epoch of 65 million years ago that is presumed for the extinction of the dinosaurs is highly disputable and can, in no way, be seen as an absolute fact.

If one looks at modern history, the release of Darwin's "*Origin of the Species*" offering scholars his theory of evolution and natural selection, actually came along at just the right moment for the Academic world. Such a theory was sorely needed by the flailing science community of the day as ammunition against those with a 'Creationist' mindset, but although much of the dogma involved in the Creationist version of events is grossly unrealistic, unfortunately for scientists, Darwin's theory of evolution is also every bit as dogmatic and just as full of loose ends itself.

Of course, and quite despite this fact, any scientist worth their degree will continue to stand by the theory and tell you that somehow and in some way, evolution is the true key and is ultimately at the very heart of all forms of life. To be honest, it's hard to even get Creationists to the serious



debating table because they simply refuse to concede in the many fatal flaws in their argument such as the literal concept of the 'six days of creation.'

Naturally in regards to this, many creationists argue that it all lies with the literal interpretation of the verse, because it does not say that God had actually *created* the Day and the night at the time he was creating everything else, and they say that the Day and the night didn't come until later. Creationists then theorize that there is actually nowhere in the text that a normal '24 hour day' is implied, and they argue that each of the six days could actually have been as long as He needed it to be in order to get the job done.

Trying to explain to them, the absurdities of this paradoxical argument can sometimes be futile. For instance, if there were no 'days' as such at the time, then how could the task have been completed in six of them? And if it really was achieved in what were actually 6 indeterminate lengths of time, then why say six of them? Why not just say 'an indeterminate length of time?' The point is; why on earth use days as a reference if there were no actual days to begin with?

The theory really is too flawed to even warrant serious discussion. If one were to merely take the Biblical story of Genesis at face value, the entire tale is in such opposition the laws of the universe, that faith must rise significantly superior to intelligence for a sane person to actually believe it. Yet despite all of this the biblical creation tales do indeed contain an element of truth hidden within the narrative and so we need to look for a deeper meaning to the biblical reference of 6 days.

It is now universally agreed by scholars that the story of creation as related in Genesis is not truly unique to the Christian Bible and original to Genesis as we have been told by the Christian Authorities, but is in fact a borrowed and condensed form of the Babylonian Enuma Elish. It is now also universally agreed that the earlier Babylonian tale has itself been adapted from an even earlier Sumerian account. This can be clearly seen when one approaches all three books as historical rather than religious texts.

In considering all of this, it's possible that the true message within the Christian bible is more likely to reside within the hidden algorithmic code recently discovered within its narrative than in the actual biblical stories themselves. Therefore the answers to the biblical riddles must lie purely within the pages of the original Hebrew version as all other versions are far too greatly changed from the original form to serve any real useful purpose other than for some possible historical references.

When arguing against the creationists, the fact that Darwin's theory is in fact missing one of its key cornerstones and also has serious flaws, has never been seen as an issue for academia, at least not in regards to teaching the theory as fact. But if the truth be known, even Darwin realised that it was only a hypothesis and the data that was available to him did not provide absolute evidence that his theory was correct. The absence of "transitional species" both living and from the fossil record has also always been a matter of contention because such records are sorely needed to prove that evolution is a fact and that over vast periods of time, species do in fact slowly transform into other higher species. Yet here we are over 150 years after evolution was first theorized, after literally thousands of excavations, and there are still no transitional species apparent anywhere in the fossil record.

Creationists naturally seize on this information as proof of their own convictions but in truth, an enormous amount of evidence that actually apposes *both* theories has now been found and as repellent as the idea may seem to some, there is even much that suggests the very real possibility that 'outside intervention' may have played a key role. Though as we have seen, such annoying little artefacts are usually spirited away and quietly locked up before anyone notices. But as we have stated repeatedly and as anyone with a brain knows, if rules must be bent and evidence dismissed in order to make a theory work, then quite obviously the theory is wrong!

To most people, it makes perfect sense, but not to Academics and in complete disregard of the vast amounts of contrary evidence, for the last 150 or so years, scientists have continued to tread the path of evolution. Towards this end, every possible bone fragment has been examined and re-

examined countless times still with no success at obtaining any kind of clearer picture or any real answers at all.

After such a lengthy period of time you would think that any normal person or profession would have possibly explored some other avenues, but not Academia, they continue forward up what is looking more and more like a blind alley, convinced that sooner or later someone in the science community will uncover the 'missing link' they so desperately need to prove Darwin correct. They feel justified in these continued and invariably fruitless quests, insisting that not enough time has yet passed since the theory was conceived for them to find the evidence they need in such an inadequate and as yet incomplete fossil record.

Yet if the truth be known it is extremely unlikely that any such transitional species will ever be found. Why? Because though evolution is, in some ways, undoubtedly correct, quite simply not enough time has yet passed on the earth for anything as complicated as modern man to have yet evolved. Recent studies in Human DNA also undeniably prove that, on a cellular level, it is not in fact genetically possible that man ever did evolve from apes.

No scientist would probably ever tell you any of this unless forced to debate the issue with you on paper, but the differences in the two species are simply much too vast for evolution from primates to modern man to have ever been possible in the time since the arrival of primates on the earth, or even since the time of Australopithecus.

In fact, according to the sciences of biology and genetics, such a transition is actually quite inconceivable. Consider also that between the arrival of Australopithecus and the appearance of Neanderthal a period of about 2,900,000 years passed and yet there was no real advancement in all of that time, and we can see this because the tools that we have discovered of the two species remain virtually identical. Then about 35,000 years ago modern man suddenly arrived on the scene. Where did he come from so quickly? How is it possible?

Put quite simply, it's not – not without help.

### **Door Number Three**

It must be difficult to be a scientist who is forced to remain within set parameters while knowing full well that within these parameters, a surprising number of species that exist on earth including man, quite simply have no business actually being here at all.

In order to help deal with this dilemma, when new theories are presented within Academia, the new information is assessed, discussed, criticised, moulded, remoulded and even remoulded yet again if necessary until the new data can be fitted comfortably into the current paradigm in any particular field, be it archaeology, palaeontology, biology – whatever. As we have previously discussed, this process is necessary in order to make the information conform as closely as possible to every leading, and obviously concerned, scientist's current way of thinking. To present a theory in any other way within Academia is simply inviting immediate rejection under a barrage of scathing criticism. This authoritarian system of excruciating "peer review" has always been an effective way of keeping independent thinkers among the orthodox science community out of the public information loop.

However, in spite of this vast 'information filtering system' that is in place, it is becoming increasingly clear that Darwin's theory will soon become as obsolete as the notion that the earth is flat and the stars revolve around us despite the constant attempts by academia to keep the flailing theory's nose above the fast rising waters of contrary evidence.

Author Lloyd Pye wrote an extremely informative and very well researched book on this topic that I highly recommend reading entitled '*Human Origins*' where he aptly demonstrates the enormous difference between Primates and Humans. Naturally the work received some scathing criticism from the science community despite its meticulous research and abundant evidence.

Such constant attacks are becoming tiresome these days but can also be useful in some ways, because knowing how intent Academia at large is in suppressing information, you usually find

such criticism from them a good reason to read, what is more often than not, a highly informative paper. Otherwise it wouldn't have ruffled so many academic feathers. But the fact that there are fatal flaws in Darwin's theory is now evident and much to their annoyance, it has even been scientifically proven by Academia itself due to recent, quite major advancements that have been made in various fields, such as the discovery, mapping and study of DNA. The information is also quite well known within science community itself, though they just seem to make a point not to actually inform the public. The information emerged as yet another somewhat rude shock for science, about 1980 and further confounded the devotees of Darwinian thinking.

You see, Palaeontologists, through the study of bones, had discovered that, (*if it actually happened,*) the split in the evolutionary chain when primates evolved into man must have occurred sometime between 5 million and 8 million years ago. Then, armed with this information a group of Geneticists in 1980 decided to attempt to narrow that date down to discover a more accurate timeline. The Geneticists believed that this wide bracket of 3 million years could be narrowed dramatically by charting mutations in DNA and so they began gathering DNA samples from around the world to use in their subsequent experiments.

A controversy then erupted when the results for these tests came in and the information was deemed so shocking that the tests were run again, in fact several times over because what they showed was that genetically, man was in fact, no more than 200,000 years old. Naturally the roar of protests from Anthropologists was unprecedented.

However, subsequent testing has now proved beyond any doubt that the geneticists were absolutely correct, and there are other things too. Lloyd Pye covers these topics quite extensively in '*Human Origins*' and again, I highly recommend reading it.

For example a popular statistic that is presented to us to back up evolution is the fact that the DNA of humans differs from chimpanzee DNA by as little as 1% and from gorillas by only 2%. This makes it appear to those who are uneducated in the science of genetics, that evolution is quite obviously correct and humans and primates are virtually cousins. However, what they never seem to mention is that the human DNA tree has three billion base pairs and so 1% of this is in fact, *30 million base pairs*. Now, 30 million base pairs is, in reality, a tremendous amount of difference between the two species by any measure. And of course with Gorillas, that would be 60 million base pairs.

Primates also suffer from very few genetic disorders apart from perhaps Albinism, which is a gene common in a variety of animals groups, including humans. By way of comparison, humans have over 4,000 genetic disorders; several that will most definitely kill absolutely every victim!

So, are we asked to believe that these disorders manifested in our evolution to a 'higher and more improved species'?

One of the most undeniable and obvious differences of all between the species can also be found in the fact that primates have 48 chromosomes yet humans, who are considered to be vastly superior to them in the evolutionary chain have only 46 chromosomes! So, how in the world could we just lose two full chromosomes in this 'evolutionary improvement process' we are supposed to have undergone? Two full chromosomes is an awful lot of DNA to just disappear! Primates are also much stronger than humans, in fact on a pound for pound ratio, about 5 to ten times stronger, even small monkeys. If we really evolved from primates then apart from losing chromosomes, how did we also become so puny and weak compared to our 'ancestors' in this 'improvement process'?

When analysed, nothing about evolution makes any logical sense at all really.

The list goes on: Human bones are far lighter than any primate bones or Neanderthal or any other so called 'ancestral' species; and more. It was explained well in a recent article by Lloyd Pye explains in which he made the following observations:

*"Skin:* Human skin is not well adapted to the amount of sunlight striking Earth. It can be modified to survive extended exposure by greatly increasing melanin (its dark pigment) at its

surface, which only the Negro and Aborigine races have achieved. All others must cover themselves with clothing or frequent shade or both, or sicken from radiation poisoning.

*“Body Hair:* Primates need not worry about direct exposure to sunlight because they are covered from head to toe in a distinctive pattern of long body-hair. Because they are quadrupeds (move on all fours), the thickest hair is on their back, the thinnest on the chest and abdomen. Humans have lost the all-over pelt, and we have completely switched our area of thickness to the chest and abdomen while wearing the thin part on our back.

*“Fat:* Humans have ten times as many fat cells attached to the underside of their skin as primates. If a primate is wounded by a gash or tear in the skin, when the bleeding stops the wound's edges lie flat near each other and can quickly close the wound by a process called "contracture". In humans, the fat layer is so thick that it pushes up through wounds and makes contracture difficult if not impossible. Also, contrary to the propaganda to try to explain this oddity, the fat under human skin does not compensate for the body hair we have lost. Only in water is its insulating capacity useful; in air, it is minimal at best.

*“Head Hair:* All primates have head hair that grows to a certain length and then stops. Human head hair grows to such lengths that it could be dangerous in a primitive situation. Thus, we have been forced to cut our head hair since we became a species, which may account for some of the sharp flakes of stones that are considered primitive hominid "tools".

*“Fingernails and Toenails:* All primates have fingernails and toenails that grow to a certain length and then stop, never needing paring. Human fingernails and toenails have always needed paring. Again, maybe those stone "tools" were not only for butchering animals.

*“Skull:* The human skull is nothing like the primate skull. There is hardly any fair morphological comparison to be made, apart from the general parts being the same. Their design and assembly are so radically different as to make attempts at comparison useless.

*“Brains:* The comparison here is even more radical because human brains are so vastly different. (To say "improved" or "superior" is unfair and not germane, because primate brains work perfectly well for what primates have to do to live and reproduce.)

*“Locomotion:* The comparison here is easily as wide as the comparison of brains and skulls. Humans are bipedal; primates are quadrupeds. That says more than enough.

*“Speech:* Human throats are completely redesigned relative to primate throats. The larynx has dropped to a much lower position, so humans can break typical primate sounds into the tiny pieces of sound (by modulation) that have come to be human speech.

*“Sex:* Primate Females have oestrous cycles and are sexually receptive only at special times. Human females have no oestrous cycle in the primate sense and are continually receptive to sex.”

In regard to the origin of man there has only ever been a choice between door number one and door number two but recently, door number three has been unveiled for even though both Creationists and Darwinists have strong teams of supporters, the vast amount of overwhelming evidence against both the theories can no longer be ignored. It's no good trying to surround the issue with an air of *'the emperors new clothes'* syndrome because it just can't work for ever.

Maybe it's because Academia deems the world at large is not ready for the real information, but whatever is behind the motivation, the truth cannot be suppressed for ever and in a stroke a bad luck for both sides of the Orthodox coin, and at this stage the evidence for creation by outside intervention that lies behind door number three, by far outweighs the evidence of creation by any other means.

### *Wings in the Night*

Apart from the fact that it's extremely doubtful if not impossible that we ever 'evolved' from primates, have you ever considered the very real possibility that the entire timeframe we have been given for the events that have occurred on the Earth may in fact be completely wrong? For example there is significant evidence suggesting that the Dinosaurs may not have actually died out 65 million years ago at, but may have in fact survived until much more recently?

As ridiculous as the idea may seem to you at first; incredibly, evidence suggests that the theory is not without substance and should not be too lightly dismissed without first receiving some serious consideration. A considerable amount of unusual and strangely persistent legends abound concerning strange flying beasts for example; there are quite literally hundreds of such reports, many of them, from some quite populated parts of the world and from very respectable people. There are also strange rock carvings and paintings around the world as well as artifacts that depict such creatures. One quite fascinating story describing such a winged creature appeared in an interesting book by a British Anthropologist called Frank H Mellard entitled '*In Witch-Bound Africa*' first published in 1923.

Frank Mellard was the Chief Magistrate for the Kasempa district of Northern Rhodesia from 1911 until 1922 and also a respected scholar and explorer. In one section of his book he describes a tribe of natives known as the '*Kaonde*' who live in the Jiundu swamps in North-West Zambia reporting that the tribe lived in fear of a terrifying winged monster that inhabited the depths of a nearby section of swamp. The natives called the beast a '*Kongomato*' which means '*the overwheeler of boats*' and they describe the creature as not being so much like a bird, but rather more like a huge lizard but with large membranous wings that spanned around 4 to 7 feet, similar looking to those of a bat. They say it has no plumage and leathery skin, reddish in colour. The natives told Mellard that they believed it has a beak that also contained teeth but readily admitted that no-one had actually seen it close enough to be really sure and lived to tell any tales about it. Mellard tried to convince any of the natives to take him to the swamp where the Kongomato was located but could not get one of them to take him there for any money or prize and he firmly believed that the natives were quite genuinely terrified of the area it was said to live, particularly after nightfall. Eventually he obtained some books that contained pictures of some Pterodactyls to show the tribe and claims that every single native unhesitatingly pointed at the picture and nodded, firmly stating that this was their kongomato.

Mellard said that for his part in the tale, he believed the natives and wrote that he was convinced the creature had somehow survived the passage of time, at least until recently, adding that the swamps of Northern Zambia would indeed make an ideal habitat for such a creature.

There are a number of other explorers who have lent corroboration to Mellard's strange tale of flying beasts from Zambia too.

Quite an interesting comment is made by A. Blayney Percival in a similar book to that of Mellard's entitled '*A Game Warden on Safari*' that was published in 1928. When writing of a conversation he had with some local natives in Kenya, Blayney remarks: "... *the Kitui Wakumba tell of a huge flying beast which comes down from Mount Kenya by night; they only see it against the sky, but they have seen its tracks; more, they have shown these to a white man, who told me about them, saying, he could make nothing of the spoor, which betrayed two feet and an, apparently, heavy tail.*"

And another tale containing a striking number of similarities to Mellard's story were also recounted in '*A Game Warden Takes Stock*' by Colonel C.R.S. Pittman published in 1942: "*When in Northern Rhodesia I heard of a mythical beast which intrigued me considerably. It was said to haunt formerly, and perhaps still to haunt, a dense, swampy forest region in the neighbourhood of the Angola and Congo borders. To look upon it is death. But the most amazing feature of this mystery beast is its suggested identity with a creature bat-bird-like in form on a gigantic scale strangely reminiscent of the prehistoric pterodactyl. From whence does the primitive African derive such a fanciful idea?*"

Again in a later book entitled *'Old Fourlegs- The Story of the Coelocanth'* published in 1956, J.L.B. Smith a South African Professor writes: *"The Descendents of a missionary who had lived near Mount Kilimanjaro wrote from Germany giving a good deal of information about flying dragons they believed to still live in those parts. The family had apparently heard of them from the natives and one man had actually seen such a creature at night. I did not and do not dispute at least the possibility that some such creature may still exist."*

In a book entitled *'Searching for Hidden Animals'* by Roy Mackal there is a report about one of the zoologists who was on the team examining the Coelocanth called Dr. Courtenay-Latimer, who also investigated the sighting of a large 'flying lizard' in Namibia. Apparently a boy resting under a tree was awoken by the crashing sound of a huge reptilian looking beast rushing down from a mountain slope behind him. The boy tells of sheep scattering in all directions to escape the creature which landed on the ground in a huge cloud of dust. The boy says that the creature made a dreadful amount of noise and gave off an odour similar to 'burned brass' and he passed out from the fright of the incident. The Police were called and the incident investigated by them and the by local farmers, some of whom actually said they had seen the creature and witnessed it slip into a crevice in the mountain side. The Police then gathered some dynamite and set a charge in the crevice in the hope of killing or sealing the beast inside. After the charge was detonated, several members of the party reported to have heard a low moaning coming from the rubble for a short period and then silence.

I would be most interested to know where the location of the actual crevice is in Namibia to see if anyone has attempted to clear away the rubble from the blast by now to see what may actually lie buried beneath.

Africa is not the only place where similar sightings have been reported. There was even a news report that appeared in the *'Illustrated London News'* way back on February 9<sup>th</sup> in 1856 concerning an utterly amazing event that reportedly occurred in France. The tale was recounted in *'Lost Cities of North and Central America'* by David Hatcher Childress, in which he describes: *"...a story of a tunnel being cut to unite St. Dizier and Nancy railways in France, from the 'Press Graylouse' news service, which describe how, when a rock was blasted open. A creature exactly like a pterodactyl with a wingspan of about ten feet and 'livid black' emerged from the rock, walking with the aid of its wings, emerged into light and expired after uttering a hoarse cry. Naturalists reportedly identified the creature as a pterodactyl and the rock strata as being millions of years old."*

Even America has its fair share of similar tales. As a point of interest, the largest pteranodon skeleton ever found was retrieved in fossil form, from Big Bend National Park in North America. The creature sported a wingspan of an impressive 51 feet making it the largest flying reptile remains ever found. A number of Pterodon remains have been retrieved from the Big Bend area so we know they inhabited the area once and another interesting fact is that almost every Indian tribe in continental America, both north and South all have tribal legends of flying monsters.

According Hatcher-Childress in *'Lost Cities...'* many have stories of: *"...a gigantic flying monster so large that, 'it darkened the sun.'*

*"The Haida natives of Queen Charlotte Islands of British Columbia believe that some Thunderbirds were so large that they could literally pick up small whales from the sea. Much of their art and woodcarving depicts such a capture by a Thunderbird. Some South American Indians believed that the bird was constantly at war with the powers living beneath the sea, particularly a horned serpent and that it tore up large trees in search of giant grubs which were its favourite food. The clapping of these giants' wings created thunder, so they were known as 'Thunderbirds'..."*

David Hatcher-Childress also says that carving of one of these birds can be seen on the bluff, facing the Mississippi at near Alto Illinois in his book *"Lost Cities of the Americas"*.

There was an intriguing tale by John Keel that appeared in the March 1991 edition of *'Fate'* magazine. The incident was first reported in the *'Tombstone, Arizona Epitaph'* in April of 1880.

The story goes that two prospectors returning to Tombstone actually shot and killed either a Pterodactyl or a Pterodon, even retrieving the carcass and returning with it to the town. Keel reports that the beast was nailed to a barn wall and a photograph taken with six prospectors standing beneath it with their arms outstretched and fingers touching. The creature is said to have had a wingspan of about 36 feet. Keel also claims to have seen the photograph himself and says that at least 20 other people who claim to have also seen it have written to him about it but unfortunately no-one seems to know where it maybe located now. Apparently there were two photographs at a place called Hamersley Fork, one of which is said to have burnt in a house fire, while the other was reported to have been 'taken away by strangers.' It's is debatable whether this event actually occurred or whether the photograph actually exists, but it's and intriguing tale none the less. I have searched high and low for a copy of the photograph and have had no luck as yet, but I'll keep you posted...

However not all sightings of flying creatures are from events that were reported so long ago, in fact there are some very unusual instances that have happened quite recently.

As documented again by Hatcher-Childress in '*Lost Cities...*' There was an extremely bizarre series of events involving a number of different people that occurred in 1975 and 1976 in the town of Raymondville, Texas.

Firstly, on December 24<sup>th</sup> in 1975 a man, by the name of Joe Suarez, woke up to find his tethered goat had been ripped to shreds and partial devoured yet strangely, no tracks could be found that led either led to or from the carcass. What had killed the animal was a total mystery to the man. Local police were called but could also find no trace of tracks or footprints to identify the unknown assailant. Then, 21 days later, at 10.30 in the evening, on January 14<sup>th</sup> 1976, and in the same town a young man called Armando Grimaldo was sitting with his Mother in their backyard when he was suddenly attacked viciously by a 'strange winged creature.' Armando apparently told the Raymondville press that as he walked around to the far side of the house, he felt something with big claws grab him from behind and that he looked back to see what it was then began running for his life, claiming it to be the most scared he has ever been. Armando kept running to reach the cover of his Mothers house, stumbling and sprawling as the beast kept clutching at his clothes and trying to get hold of him as he ran. Unable to reach the house, he was forced to dive under a low bush to escape the creature, his clothes now all but torn to shreds. The beast hovered about the bush a little and then flew off panting as if tired from the exertion.

Eventually the boy collapsed through the door of his Mothers house and onto the floor, his clothes torn and bloodied muttering 'bird' over and over again in Spanish. He was taken to hospital and treated for minor wounds and shock before being later released. Armando Grimaldo describes his attacker as being about 6 feet tall, blackish-brown leathery skin, a wingspan of 10 to 12 feet and large red eyes. (*I don't suppose there's much use trying to identikit that one huh?*)

A short time later, on that very same night, on the outskirts of the nearby town of Brownsville, which is also on the Rio Grande, a creature exactly matching its description crashed into the side of a mobile-home owned by a Mr. Alverico Guajardo. He quickly went outside to investigate the incident and noticed a large creature of some kind on the ground next to his wall. So he got inside his station-wagon and flicked on his headlights for a better look. Guajardo described what as saw as looking like 'a creature from hell.' The beast was apparently startled by the lights because, according to Guajardo, as soon as his headlights struck the creature it rose up from the ground turning to glare at him with huge red eyes and began making 'a horrible sounding noise in its throat.'" He reports that the creature then continued regarding him menacingly for 2 or 3 minutes with its wings drawn up and 'wrapped around its shoulders' before slowly backing out of the light and disappearing into the night. He says that the beast was truly terrifying and at the time, he was almost paralysed with fear at the sight of it.

In January of 1976, another bizarre incident was reported by two sisters named Deany and Libby Ford who saw what they described as a "Huge and strange, big black bird" at a pond just outside of Brownsville, Texas. The sisters say that the creature was as tall as they were and had a

face like a bat. When they were later shown a book containing pictures of prehistoric animals both sisters identified the creature they had seen as being a Pterodon.

The next month on February 26<sup>th</sup> 1976, the San Antonio 'Light' reported that 2 days previously on February 24<sup>th</sup>, three local school teachers had seen an enormous 'black bird' while driving to work. The three said the creature had leathery wings with a span of about 15 to 20 feet. They observed it swooping in low over several cars commenting that as it did so it appeared to glide more than fly. The three say that it was large enough, at and times low enough, for its shadow to cover the entire road. Another similar creature was also seen at the same time by the group, only further off in the distance that seemed to be circling a herd of cattle. Upon their arrival at the school where they worked the group immediately began looking through encyclopaedias for the creature and also identified the beast they had observed as a Pterodon.

Then yet another event occurred on September 14<sup>th</sup> 1982, when, at 3.55 am in the morning, a Mr. James Thompson, who was an ambulance technician from Harlington, saw what appeared to be a huge 'bird-like object' fly over highway 100 at a height of around 150 feet. Thompson says that at first he thought it was a large model plane and expected it to land on the road until he noticed it flap its wings. In the night sky the creature seemed to have a black or greyish colour and looked to be covered with hide rather than plumage.

These are just some sightings that have been reported. There have been quite a number of other sightings of similar creatures in many other places around the world as well, places as diverse as Africa, North and South America, Sumatra and even in France, England and New Zealand.

Could it actually be possible that some of these creatures somehow managed to survive, deep in the swamps or high in the peaks of some of the more remote and inaccessible regions even until the 20<sup>th</sup> Century? In actuality, there is absolutely no conclusive evidence at all, to prove that the chronology of 65 million years is in any way correct for the extinction of the species and further evidence that even suggests that the event may have in fact occurred a good deal more recently than any Palaeontologist who values his doctorate would ever care to admit.

### *The Dragons of St. George*

There is an tantalizing footnote to all this talk and rumour of Prehistoric flying creatures and just ponder this fact for a moment: The first dinosaur ever discovered was an Ornithopod called the *Iguanodon*, which was found in England in the early 1800s. As a point of interest the specimen that was recovered was more than twice the height of a person and belonged to a group of medium-sized plant eaters that walked on two legs and used its long tail for balance, but that's beside the point. The real point is: The species was until that time, completely unheard of. The actual Dinosaur genus was not even named until 1824 yet many people who lived in our distant past seemed to have possessed a substantial amount of knowledge in regards to these creatures.

For example, in an incredible discovery in 1928, just northwest of Tucson, Arizona a man called Charles Manier, came across an ancient lime kiln, apparently of Roman design, which came as quite a shock in Tucson. When it was opened it was found to contain an assortment of ancient Roman artefacts made in the most part, from lead. In all more than 30 items were finally recovered from the site, These included spears, swords, daggers, batons and even a 62 pound cross. All of the objects were encrusted with a substance known as 'caliche' which is a hard crusty type of material that 'grows' with age similar to a terracotta tile, this growth is due to a chemical reaction that occurs when metals are exposed to desert soil and water. The thick caliche displayed on these artefacts also aptly testified to the extreme age of the items.

Controversy still rages over the authenticity of the artefacts as no one had ever imagined there had been a roman settlement in North America in ancient times and many find the idea extremely difficult to accept. The actual find was quite surprising enough, but archaeologists received yet a further shock when they examined the motifs displayed on the artefacts themselves. Some displayed both Hebrew and Latin symbols while one broadsword bore a most unusual engraving that looks remarkably like a brontosaurus! (*fig.105*)



It seems hard to imagine that some ancient engraver just came up with an accurate motif of an extinct creature unless he had actually seen one. It also seems incongruous to imagine that someone who wished to fake a geological discovery would carve a brontosaurus on a sword blade as it would naturally cause too much speculation.

In a similar find, there is a portrayal of a pterosaur-like creature that appears on an ancient Saxon shield from the Hoo burial site in Sutton. The shield depicts a creature with wings folded back along its scaly sides and on its handle is a long beak full of teeth, a crest, and there is an unmistakable tail protruding from the wing tips (*fig.106*). From all reports a flying reptile known as the 'Widfloga' (*far-ranging flyer*) was quite well known to the Saxons. The shield is still displayed at the British Museum in London.

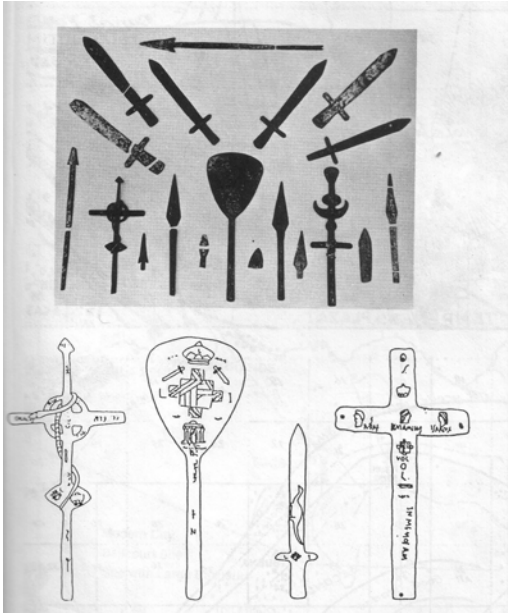

Fig.105

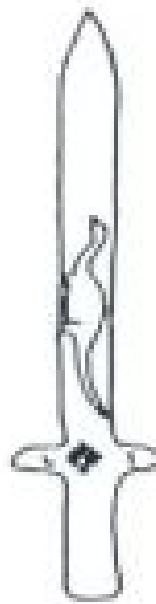

Fig.106

There is also a Mesopotamian cylinder seal dated at 3300 BC that seems to quite accurately depict an unusually shaped dinosaur known as an Apatosaurus.

An Apatosaurus was a type of Sauropod, a group of dinosaurs with quite an unusual body shape. The picture on the right is a modern artist's impression of an Apatosaurus based on a recovered skeleton, while the image on the left is the Mesopotamian cylinder seal. (*fig.107*).

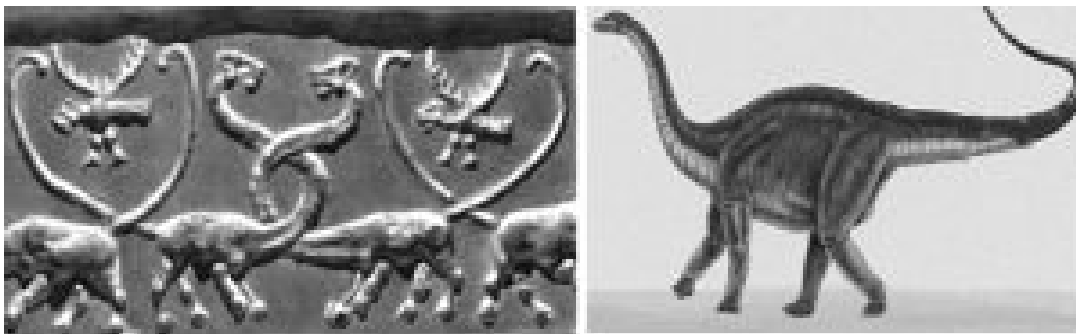

Fig.107

There are a great many striking similarities between the two depictions with the Mesopotamian cylinder showing some quite stunning realism. The creature may even have sported a large crest such as depicted on the seal. Such information cannot be established from the skeletal remains that are available to us. No fossils or skeletons of the creature were ever found until quite

recently. So the question is what, I wonder, did the ancient artist use as a model that enabled him to accurately depict such a convincing looking Saurapod?

Moving along, there is every indication that such a plesiosaur-like creature may have once inhabited an area in Queensland, Australia and been known to the local Aborigines.

Both aboriginal peoples around the Lake Galilee area and other tribes located farther to the north tell stories of a long-necked animal with a large body and flippers. The Elders of the Kuku Yalanji aboriginal tribe of North Queensland, Australia, apparently have stories of a creature called a 'Yarru,' which they say once dwelt in rain forest water holes. There is actually a cave painting that depicts a creature with features that are strikingly similar to a plesiosaur. The unique X-Ray art of the Australian Aboriginals is also applied to the painting quite accurately and depicts the animal's intestinal tract, possibly indicating that these creatures may have once even have been hunted for food (*fig.108*)

. An urn from Caria, in Asia Minor (Turkey), estimated to be from 530 BC, depicts what appears to be a Mosasaurus along with several other well known sea creatures (*fig.109*). The animal behind the dinosaur is a seal, while an octopus is below it along with what appears to be a dolphin. The thick jaws, big teeth, large eyes, and positioning of the fins on the creature in the painting match a Mosasaurus skeleton very closely. There were some slight variations in the species and some Mosasaurus were indeed known to have a narrow crest located behind the eye that may well have had a fin attached to it as depicted on the Carian urn.



Fig.108



Fig.109

Numerous pieces of art depicting long-tailed, long-necked creatures with a head crest were produced by the ancient Sumatrans. Some of these animals strongly resemble the Hadrosaur. One picture depicts a creature which is being hunted by ancient people that bears a striking resemblance to a Corythosaurus (*fig.110*).



Fig.110

Next we find a tomb in Carlisle Cathedral in the U.K. where Richard Bell, the Bishop of Carlisle was buried in 1496. The tomb is inlaid with brass, depicting various types of animals in decorative engravings upon it. Although the tomb is worn by the innumerable feet that have walked across it since the Middle Ages, one particular engraving is quite unmistakably a

dinosaur. It's just casually there in amongst the other everyday images of birds, a dog, an eel, etc. a beautiful representation of two Brontosaurus looking creatures (*fig.111*).

And the list goes on: There were reports of a 'flying serpent' matching the description of a Pterosaur living in Egypt that persisted through to the 1600's. There are the depictions on the Ica stones discussed earlier in chapter 2 (*fig.112*), depictions in Egyptian Tombs (*fig.113*). We find a slate palette from Hierakonpolis showing the triumph of King Nar-mer over what appear to be Pterosaurs, (*fig.114*) ancient rock art by North American Indians (*fig.115*), a cave painting of Brontosaurus like creature in the Gorozomzi Hills, 25 miles from Salisbury England; in the Mayan city of Tajin in Vera Cruz, there are rock carvings of what appears to be a Pterodon. And still the list goes on and on.



Fig.111



Fig.112

The same question persists: How on earth could these ancient drawings of anatomically correct dinosaurs come to be all over the world unless the artists who drew them were not in some way familiar with the creatures?



Fig.113



Fig.114

In another remarkable find in 1945, (*one of my favorites*), an archeologist called Waldemar Julsrud came across copious amounts of clay figurines which lay buried at the foot of El Toro Mountain, located in an area near the outskirts of Acambaro, Mexico. In all, over 33,000 of the small ceramic figurines were eventually found in the area and all were identified to have come from a Pre-classical Culture known as the Chupicuaro (*believed to have existed in the locality from around 800 BC to 200 AD.*) The authenticity of this find has often been questioned by Academics though because, lo and behold, the collection also includes anatomically correct dinosaurs (*fig.116*).

The discovery was considered very controversial so, in 1954, the Mexican government sent a team of respected archeologists to investigate the site which they then announced to be authentic.

The next year in 1955, Professor of Anthropology at UNH Charles Hapgood, (*the same man who discovered the remarkable Bauche Map in the US Congressional Library discussed in chapter 2*) conducted quite an elaborate investigation on the figurines which included extensive radiometric dating and thermo-luminescent testing, done by the University of Pennsylvania. Then much later in 1990, an investigation was also conducted by another archeologist by the name of Neal Steedy who works for the Mexican government and who also testified to the authenticity of the Artifacts.

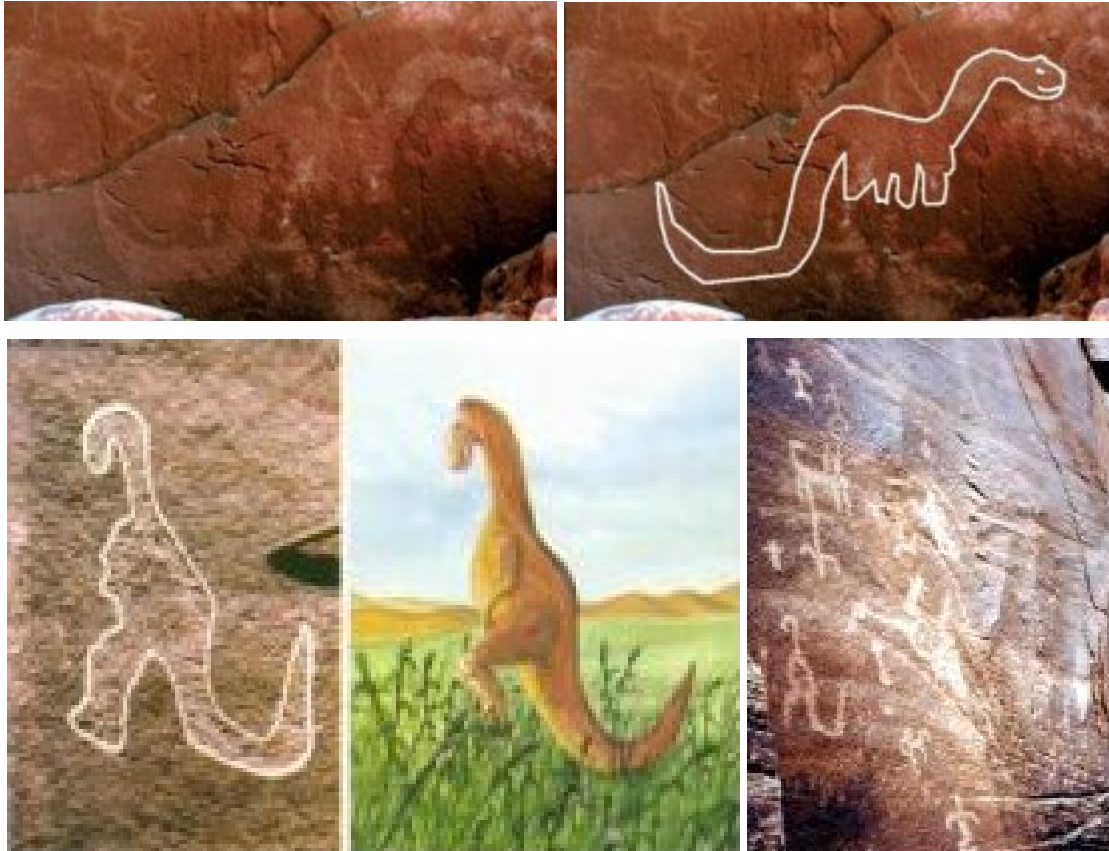

Fig.115

Because Julsrud's work has amply survived these numerous tests and investigations, even to the extent of the Mexican government once imprisoning two individuals for selling these artifacts on the black market, it is safe to take these ceramic figures at face value.

The most notable point about the small models is that not only are the dinosaurs depicted in the models anatomically correct, but they also appear in very agile and active poses, fitting well with known scientific evidence. This strongly suggests the possibility of the sculptor having actually observed the creatures first hand. It is also notable that, similar to the sketches we have seen on the Ica Stones, some Sauropod's are also shown with a distinctive looking spinal frill. Fossil remains do not reveal to us if these creatures had such a feature but it's interesting that two vastly different cultures would imagine the same type of feature on the same type of unusual looking beast. It is much more reasonable to assume that the two cultures had, at some time, both seen the same type of creature.

Other remains found at the site included an extinct ice-age horse, the skeleton of a woolly mammoth, and a number of ancient human skulls further validating the antiquity of the site.



Fig. 116

As one last point of interest in this matter: As recently as December of 1691, a dragon was still believed to be living in an area of wetlands near Rome. The creature was said to have lived in a cave and supposedly terrorized the local population quite regularly. It was reported to have been eventually killed by locals and a sketch of the skeleton has survived in the possession of a man named Ingegniero Cornelio Meyer (*fig.117*). The most remarkable thing about the animal depicted in the sketch is that it appears to be a Pterosaur known as the 'Scaphognathus' (*actually, the Rhamphorhynchoid Pterosaur known as Scaphognathus crassirostris, if you feel like being technical about it.*)



Fig.117

According to experts on such matters, of which I am most certainly not one: *“The creature clearly displays a head crest complete with a dual piece of skin attached to it which is characteristic of the species, five digits are visible on each foot and are anatomically correct for the Scaphognathus Pterosaur inasmuch as each digit is of the proper length, the first one appearing slightly shorter and offset to the rest. The femur is correctly displayed as a single bone and the twin lower leg bones (the tibia and fibula), are also quite visible. A small wing claw can be seen on the far wing where it curves forward, and the wings themselves are depicted membranous and are correctly positioned forward of the legs on the vertebrae which also matches existing fossil records.”*

Some scholars have theorized that the accuracy of the depiction in this sketch suggests that it may in fact, be a drawing of a fossil or possibly a faked composite, though the latter is extremely doubtful as it is far too accurate to be a composite or fabrication. And the visible skin in the drawing further suggests that was not in fact modeled from a fossil as it also depicts quite accurate wing features plus ears and an accurately drawn head crest.

The Scaphognathus depicted in his sketch really does look extraordinarily like the classic interpretation of a Medieval Dragon so familiar in the tales of Knights such as Saint George who was said to have slain a dragon and rescued the town.

Could many of these tales be actually based in truth? Could such people as St. George have actually been killers of various Pterosaurs and creatures like the Scaphognathus in the past? There is a reasonable amount of evidence to suggest that it was a very real possibility.

But how could dinosaurs have actually survived that long, for all those millions of years? And how could we possibly be so far off the mark with our chronology you ask?

Well it really depends on how you look at things because, though only one real possibility is taught as fact by Academia, there are actually two quite different schools of thought on the forces that shape our world the true causes and nature of dramatic geological changes.

### **Gradualism vs. Cataclysm**

The question whether dramatic or earth changing geological change happen slowly over enormously long periods of time are actually more sudden events is one that is still hotly debated.

Essentially: Are landscapes changed gradually through layers of sedimentary deposits that slowly cover ancient sites with the dust of ages or are civilizations suddenly swallowed and landscapes quickly alerted through sudden and violent cataclysmic upheavals?

We know gradual change is in many ways a reality because we have witnessed it. However we know that cataclysmic upheaval is a reality as well because we have witnessed that too. It could very well prove to be the case that the earth has been shaped by both of these two forces and that both schools of thought are in some way correct.

For example: We have seen recent ruins being slowly covered by the dusts of time and we have witnessed Mount Saint Helens displace an entire hillside and churn up 200 feet of new mountain in a single day. It's obvious that some catastrophe caused the mass extinction of the Dinosaurs and we have learned from Levy-Shoemaker Nine that comets really do hit planets. So we know cataclysms are quite possible. But do they happen on a global scale?

Do they happen in regular cycles?

There is strong evidence of cataclysmic geological changes happening on the earth quite frequently. This can be shown simply by the fact that fossils exist. Fossils can only be formed when sudden changes occur and creatures are quickly covered by silt. This can only happen either through volcanic eruptions in wet locations, tsunamis, earthquakes or other such violent means. A creature that just lies down on the ground and dies naturally will never form into a fossil.

As is also the case when dating many non-organic artifacts, the date of 65 million years ago that is given for the extinction of the dinosaurs is only arrived at through examination of the sedimentary layers in which the fossils were found. Geologists assume that these many layers of sediment are deposited gradually over millions of years. But what if many layers were deposited in close succession through a series of cataclysmic events?

It is very obvious that the landscapes that once existed on earth have gone through some incredibly dramatic changes even during the time of man but what if vast amounts of sedimentary layers in which many of these fossils have been located were deposited, not over millions of years but over thousands?

What if it doesn't actually take millions of years to create a fossil, but just several thousand? I mean how does anyone really know for sure? It's not as if anyone has ever exactly made one to

find out is it? A person can't exactly press their hand into clay and then say "Well I'll just come back and check on its progress once every million years so" now can they?

Perhaps fossils are formed in as little as 200,000 years or even 20,000 years, who really knows for sure. Even fossils themselves are enigmatic things. Fossils, in many ways, prove cataclysmic change to be a reality simply because they exist. As we have already noted, if living creatures just lay down and die, they do not just fossilize, they need to be covered with silt. Think about that for a moment. Silt is a wet sandy material. So how did the fossils found in arid inland areas come to be covered with silt and pressed under many layers of sedimentary deposits?

To try and put it all into some kind of perspective, we can see that the 'Ooparts' discussed in chapter two are enigmatic certainly, but the timeframe we have been given for some of them seems totally incongruous. The metal spheres found in Africa for example, are estimated to be *2.8 Billion years old!* This seems all out of proportion for *any* ancient civilization and the existence of the spheres at such great depths seems to suggest it more likely that vast sedimentary layers were deposited quickly, over thousands of years, not millions. But this all creates something of a dilemma.

To stop and analyze the situation we now find ourselves in:

Firstly: We are told that Dinosaurs became extinct around 65,000,000 years ago.

Secondly: the science of genetics proves beyond doubt that modern man is genetically no older than 200,000 years.

Thirdly: if we examine all the evidence presented in the previous sections, we can prove man actually existed contemporaneously with Dinosaurs. We can also adequately corroborate this statement by examining existing fossil records such as the shoeprint shown in fig. 38.

If we examine this evidence and view the entire picture from a logical perspective, we are thus left with only two possibilities: (a): civilized men who wore stitched leather shoes lived between 65 – 600 million years ago, (*doubtful*); or (b): Dinosaurs still roamed the planet until quite recently and contemporaneously with men who wore shoes with stitched soles (*highly probable according to available evidence*).

Left really with only one plausible conclusion, we can then logically surmise that if 65 million years ago is all wrong for the mass extinction of the Dinosaurs then obviously, the estimated time taken for layers of sedimentary deposits is also completely wrong. Fossil records show us this.

Therefore, if man is no older than 200,000 years as genetic evidence proves *and* he existed contemporaneously with dinosaurs as fossil records prove, then the only conclusion we are left with is that not only is our estimated orthodox chronology out, but it's out by a whopping 64,800,000 years!

As repellent as this conclusion may be for some people, when combined and really looked at, the fossil, geological, Anthropological and Genetic evidence *all* say that it is indeed so!

The only other possibility comes from the quantum world – time travel.

### **The Flipping of the Mill**

So how might such cataclysms occur? The theories of Celestial impacts and Polar reversals have always been a popular belief. But again, what are the realities?

We know from the geological evidence still visible on Mars and from comet Levy-Shoemaker Nine that impacts are an absolute fact, but is it really possible for the Earth to turn over on its axis? It is a question that has been argued and debated for many years. But what are the actual facts?

The phenomenon of reversed polarity or Magnetic Polar Reversal, where north becomes south and vice versa is actually now a well established scientific fact. Through geological studies we have been able to determine the original magnetic orientation of certain ore based rocks and rock formations and what changes have occurred to them in the past. These studies have shown that

over the course of the Earth's lifetime reversals in magnetic polarity have actually happened quite often and seemed to have occurred on some kind of regular basis, in fact almost too often for comfort. Why this gives us some cause for alarm is the fact that the next polar reversal is actually now long overdue.

There are two types of polar reversals. Magnetic reversal and Geographic reversal, the former is reversal of the planets magnetic poles while the latter is a full geographical flip of the Earth on its axis. It is uncertain whether both events occur in tandem but it is believed by many experts that the two are intrinsically linked in some way.

A Magnetic Polar Reversal would be a relatively benign event when compared to a Geological Polar Reversal even though it would still be likely to cause some seismic activity, unusual tidal movements, some major disruptions among bird, aquatic and animal navigation and certainly massive microwave, electronic communication and electrical malfunctions. It is also universally agreed that a magnetic polar reversal would also result in a further lessening of the protective magnetic and ozone fields that encapsulate the planet and allow harmful solar radiation to temporarily penetrate down to the Earth's surface. Geological evidence indicates that the last reversal of the magnetic poles occurred sometime around three quarters of a million years ago. Scientists agree that, since there is no evidence of any mass extinction's at that time, the effects on life must have been relatively small.

By way of comparison, a full Geographic Polar Reversal, involving the poles of the planet physically changing places would be a much different proposition to a magnetic reversal. A full polar reversal would be an event over which we have absolutely no control whatsoever and it would be totally catastrophic, capable of quickly destroying all life on Earth.

Some scholars believe that full polar reversals are a catastrophic, but unfortunately routine event that is a normal part of our planet's rotational mechanism and that they in actual fact, happen in regular orbital cycles.

There are reports in the bible of a day of sunlight that was two days long and accompanied by dramatic events that apparently occurred in the distant past and surprisingly we also find confirmation of such an occurrence from the other side of the world in South America where we find reports of a day that was night in which the sun never rose. Obviously the sun and moon would have remained where they were and the event would have to have been the result of some type of retardation in the Earth's rotational mechanism and possibly even a celestial flip.

In his work '*Critius*' The ancient Greek philosopher Plato also hints at Polar reversal when he says: "*At periods the universe has its present circular motion, and at other periods it revolves in the reverse direction... Of all the changes which take place in the heavens this reversal is the greatest and most complete.*" But Plato also gave warning that during such reversal periods: "*There is at that time great destruction of animals in general*"

It is not fully understood what the exact mechanics behind polar reversals are exactly, though it is speculated that a slip in the lithosphere due to the weight of ice build up at the South Pole could account for it. It is however, widely accepted and agreed that reversals tend to happen when there is a wide divergence between the magnetic and geographic poles (*as is presently the case*). Another possibility is that the Earth is grossly unbalanced. That is the greatest area of landmass is immediately opposite the greatest body of Ocean and since the relative weights between land and water are disproportionate, one side of the planet is much heavier than the other making its rotational forces act a little like an unbalanced washing machine. This theory also gives rise to the possibility that some force of influence, possibly a largish meteor impact or the close passage of another celestial body could literally flip the planet over on its axis.

It has also been speculated that Polar reversal actually involves a fluid like layer of the earth known as the lithosphere. If the theory is correct then the link between Magnetic and Geographic reversal may possibly be more apparent.

It is known that vast streams of magma constantly flow beneath the Earth's crust. Much of it rises from deep within the earth through the movement of tectonic plates but a good deal of it is



also produced from the heat build up of pressure and movement in the region where the earths crust meets the second layer. This second layer is called the mantle and it is much harder than the crust. Due to rotation, axial wobble and the sheer weight of pressure the crust is in a state of constant movement and is always rubbing against the mantle. This rubbing produces heat and more magma which then creates a thin layer of 'sludge' between the crust and mantle and it has been theorized that it is this thin layer of fluid-like sludge known as the lithosphere that occasionally allows the crust to simply slip around the outside of the mantle. Just imagine a baked potato wrapped in aluminum foil with the potato as the mantle and the foil as the crust, it is easy to slip the foil around to the other side of the potato without changing the orientation of the actual potato. In this type of scenario the actual planetary axis would not shift geographically but the crust would reorient itself in relation to the mantle with catastrophic results. This would cause drastic geographic and magnetic changes on the surface. You can imagine what kind of earthquakes would occur on a planetary scale if the entire crust slipped around the mantle. It has been predicted that in such a slip of the lithosphere most of the water on the planet would temporarily relocate to the poles before spreading out around the globe again. The wall of water produced in such an event would be well beyond anything that could be categorized as a 'wave'.

In such an event the continent that is now located at the South Pole for example, could theoretically move to different location and a new continent could literally take its place to begin its own private ice age just as Antarctica is doing now.

Is such a slipping of the lithosphere possible? Yes unfortunately it is.

The earth is flying through space, and when I say flying, I mean *really flying* folks. I mean we are really stepping out, pedal to the metal. The Earths rotational speed is about 1,000 miles per hour and while we're spinning like some huge top we're also racing not stop around the sun. Earth travels along its orbital plane at around 66,600 miles per hour (*18.5 miles per second*). I know it all seems nice and casual and peaceful while you just sit around on the surface reading or whatever but folks we are really on the move. Earths axis is of course tilted to the perpendicular at about 23.5 degrees which gives us our four seasons, but while we're spinning at this angle we are also wobbling slightly on this 23.5 degree axis. This slight discrepancy to the vertical obliquity of the elliptic is an excursion of about 2.4 degrees in either direction from our true axis. The full cycle of one wobble from 24.5 degrees to 22.1 degrees takes around 13,000 years to complete in each direction giving us a round total of 26,000 from point A and back to point A and providing us with the 26,000 year procession of the zodiac. You get all that? It seems solid on the surface but it's not really a totally stable rotation

One major factor contributing to a lithosphere slip could be the enormous and ever increasing weight of the south polar ice cap. The Antarctic ice cap grows by an estimated 10,000,000 cubic meters of ice a day just through normal condensation, dew and snow fall which generates an incredible amount of added weight to the ice cap daily. When such weight is combined with axial wobble and a layer of fluid like sludge between the crust and the mantle a sudden slip of the lithosphere becomes a very real possibility and it would only take something like a celestial event to serve as the catalyst to trigger it off.

A similar effect to that which creates the fluid layer found in the lithosphere can be seen on a smaller scale in the south polar ice cap itself. The enormous weight of the ice resting on the continent beneath it subjects the surface of the continent to a huge amount of pressure. Pressure creates heat and when that is combined with tectonic movement the result is a thin layer of sludge lying between the ice cap and the continent and one that is in a constant state of movement. Given this fact, there is even the distinct likely hood that the entire south polar ice cap could even just slip off the continent it's resting on and into the ocean causing massive floods and Tsunamis world wide. The great flood of Noah in the bible was said to have come from the south. The ancient deluge spoken of in the Sumerian tales was reported to have come from the south. In fact it's the same in virtually all of the ancient myths that deal with or mention the flood in any detail at all.

There is an abundant wealth of evidence to suggest that the people of the ancient world understood the cycle of rotational events surrounding Polar Reversal far better than we do today and took the event quite seriously. It is no surprise that they considered the information to be extremely important. They understood that as one day gives way to the next and one year to the next, so does one age give way to the next and they understood very well that when these changes occur there are periods of great disruption and turbulence that can be incredibly destructive to life on earth. And they have stressed repeatedly through their monuments and texts that this destructive cycle is repeated again and again and is a routine element of the planet we live on.

All of the texts, all of the monuments and all legends from all cultures that refer to such an occurrence hint at the same message: The event always occurs close to a change in the Zodiac.

We are currently in the 'no time' between Pisces and Aquarius. The work in done in '*Hamlets Mill*' by Giorgio De Santillana & Hertha Von Dechend and a basic understanding of celestial mechanics aptly shows that due to our current orbital position in the vastness of the milky way, the possibilities of something like this occurring very soon are extremely possible.

Through studying ancient texts, geological evidence and by modern scientific methods we can be absolutely certain that Polar Reversals have definitely occurred quite often in the past and we are able to irrefutably predict that another Polar Reversal of some type will indeed occur again in the future and that it is in fact, only a matter of time. Unfortunately there is absolutely nothing we can do to prevent such an event and when it does happen it has the potential to be either a huge inconvenience or a catastrophe of epic proportions with few survivors. Which ever it will be we can only hope that such an event does not occur for as long as possible.



# The Tale of the Sumerians



I would like now to relate to you a story.

It's quite an epic tale but I feel that time should be given to relate the account in full and afford to it the attention and detail it deserves, though it will of course be highly summarized. I feel this story can provide some important pieces of our puzzle. It's a remarkable tale and well worth telling to say the least.

A brief rundown of how this translation was arrived at is in order and so I will provide some basic information for you though rest assured, the translation has been meticulously researched by its author and I am quite sure his interpretations are correct. If you would like to explore the tale further, and I highly recommend that you do so, a full bibliography is provided in the sources section at the end of this book.

## *The Art of Translation*

Our story does not even begin until the mid 1800's because it was then that archeologists first discovered the remains of the ancient civilization of Sumer. The subsequent wealth of hitherto unknown records meticulously documented on, not hundreds or thousands, but *tens of thousands* of clay tablets uncovered by archeologists that were compiled by the scribes of this ancient culture has since astounded Archeologists, Theologians and scholars alike.

The Ancient civilization of Sumer existed in the area of the Persian Gulf that was once known as Mesopotamia (*now southern Iraq*). The Sumerian writings are perhaps the oldest record of an actual civilization that we have any real knowledge of and, through clay tablets, cylinder seals and stele, the Sumerians have provided us with a graphic and richly detailed version of mans early histories including the story of creation, both of the earth and of man.

The texts also tell us of fierce and devastating wars fought over the possession and control of the Earths resources that ultimately led to the utter destruction of the Sumerian civilization.

Many of these ancient texts are written in complex metaphor. In this respect the Sumerians were no exception and the texts can still be interpreted in this manner to reveal fantastic and epic stories of no apparent, or obscure mythological, meaning. However a new insight into the real method of translating them has now opened up an entire new meaning so that now, in complete

contrast to the Christian or even the Babylonian creation myths which still remain full of constant symbolism, vagueness and metaphor, the earlier Sumerian version of the story can be viewed as an almost scientific account of a series of well documented events that happened in a very specific timeline.

It has now been universally agreed by both scholars and Theologians alike that the biblical story of creation does indeed have its basis in the Babylonian 'Enuma Elish' which itself is undoubtedly an abbreviated versions of the much earlier Sumerian texts. This can be easily confirmed as a great many parallels that can be seen in the Sumerian account when it's compared to the Babylonian and Christian creation stories. It appears obvious that both of the latter accounts were heavily influenced by the much longer and more detailed Sumerian story.

The Sumerian account of the creation of the earth and the rise of man, as controversial as it may be, is strangely enough, the only tale that adequately provides a scientific explanation that is plausible for not just the earth and mankind, but for many other puzzling aspects of our solar system too. I'd say that's quite a reasonable achievement for 6000 year old cunifrom and hieroglyphic texts carved into tablets and Stele's (*fig.118*).

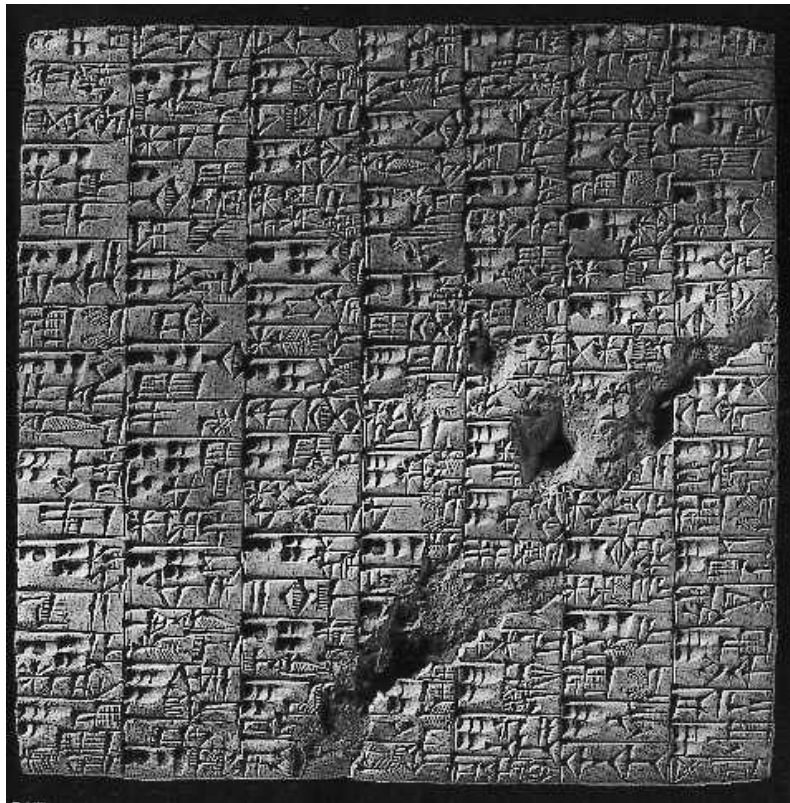

Fig.118

A vividly detailed interpretation of these Sumerian texts was done by the brilliant, though controversial scholar and archeologist, Zechariah Sitchin who then published his findings in a Masterwork he aptly named '*The Earth Chronicles*'. The astounding work consists of a series of 6 books of detailed translations and interpretations to date.

Sitchin is a respected archeologist who worked for several decades on Sumerian translations and archeological sites. His books are intelligently presented, meticulously researched, highly informative and extremely well documented works, containing details on almost every aspect of the texts and I highly recommend reading them.

It dawned on Sitchin that since the Babylonian tale has its roots in the Sumerian account it, a better understanding of the texts may be achieved if one was to interpret the Babylonian

cosmology of the tale as actually being Sumerian. Using this new approach, and in a labor of over 50 years Sitchin, has since painstakingly pieced the story together from fragments of Sumerian, Babylonian, Akkadian, Assyrian, Hittite, Canaanite, Egyptian and Hebrew sources into a most remarkable and scientific account of our real beginnings.

The story that Sitchin found emerging from these tablets was so controversial, the implications so explosive for mankind that many people have found it extremely difficult to take the story at face value. Yet every single anomaly we are faced with about our Earth, our Solar System, and ourselves is mentioned and explained in these 6000 year Sumerian accounts. The enormous bulk of evidence he also presents to support his conclusions is literally, quite overwhelming.

Coincidence?

The thing I love the most about Sitchin's books, as ponderous as they may sometimes become due to the sheer volume of information and research they contain, is just that – the meticulous and detailed research the reader is presented with to support the conclusions that are reached.

Sitchin will inform you that something is so, in a short passage. But nothing is taken at face value and the explanation as to *why* it is so may run into many pages of detailed research and cross referencing. And this fact is also why Sitchin's conclusions are so credible, because of his meticulous attention to detail.

Have you ever noticed that when ever anyone releases a book that contains radical ideas that disagree with mainstream academia, there is always a veritable storm of writers and scholars who strive to prove them wrong and point out the holes in their various theories? Just look at the berating that Erich Von Daniken received for the ridiculous lack of research in his book '*the Chariots of the Gods*'. Von Daniken was actually thought provoking, but his lack of research and disregard for facts really was appalling.

One very notable point about Zechariah Sitchin's works however, is that, as controversial as they are, since his first book was published in 1975, no-one has yet come forth with a valid argument to disprove his interpretations of the texts or his conclusions. While there are many who disagree with his interpretations, as much as they *may* find the story hard to swallow, no-one has been able to dispute the events the Sumerians describe. In regards to this, Sitchin himself has always stated that the story of creation he has presented in *the Earth Chronicles* is not his, it's the story as it was related by the Sumerians and if anyone has a problem with the tale then their arguments should be directed at the Sumerians and not at him. All he has done is present us with what he believes to be an accurate translation of the texts. As I previously mentioned, these translations represent a personal labor to Sitchin of over 50 years.

Much of the earlier Sumerian Tale can still be gleaned from studying the Christian story of Genesis in particular the Hebrew version but of course much of the translation is open to interpretation and it is mainly in this respect that the tales differ, though the earlier Sumerian version is undoubtedly more complete. In his book '*the 12<sup>th</sup> Planet*' Sitchin aptly points out translational errors. For example: The Christian story tells us that

*"In the beginning, God created the Heaven and the Earth".*

But if we look at it in the Hebrew what is actually written is:

*"In the beginning God created the **Rakia** and the Earth".*

Sitchin points out that the Hebrew word Rakia also has several possible translations depending on its context and one of those translations is 'firmament.' Therefore in the Christian tale, the word Rakia has been translated as 'firmament' and is interpreted as 'heaven.'

As in the Sumerian story, in the Babylonian tale, via an awful lot of metaphor, we are informed as to the order of birth of all the planets but in respect to the earth, we are told that it was the god '*Marduk*' who slew the 'haughty dragon' Tiamat and did the creating. Marduk was a supreme God of ancient Babylon so in many ways the statement is virtually identical to what is said in the Christian Bible if you want to take it that way. However in the Sumerian version of events we are basically told that it was the 'Celestial Lord' Nibiru who created the Rakia and the Earth.

Now Nibiru, is thought to be an specific Sumerian god so again it can mean the same thing as what we started with. But here's the thing, to the ancient Sumerians, Nibiru is also known to have been used as a reference to a celestial body – a planet, and they are quite specific about this. As has been noted by Sitchin, another translation of the Hebrew word Rakia is “hammered bracelet” and that is also quite significant. It all lies in the personal interpretation of the Hebrew texts you see. So with a more open and honest approach to the translations, the Christian story of:

*‘In the beginning God created the Heaven and the Earth’*

Very easily translates to reveal the earlier Babylonian and Sumerian versions of: *Marduk/Nibiru created the Hammered Bracelet and the Earth*”. And the Sumerian texts are quite specific about how these events transpired.

The Hammered Bracelet referred to in the Sumerian texts is of course a very adequate and quite accurate description of the Asteroid belt in our solar system that lies in between the orbits of Mars and Jupiter. So in reality, we find that the ‘hammered bracelet’ translation is actually far more in context with our known solar system than that of ‘heaven.’

It is also quite significant that Bodes Law shows that there should in fact be another planet existing in our solar system at the location of the asteroid belt. There is every sign to suggest there once was but instead, all we find there now is an enormous collection of rocks, debris and cosmic rubble stretching out in a vast ring around the sun (*like a ‘hammered bracelet’*). Bodes Law also heavily suggests that there should be at least one more planet in our solar system. Such a planet was positively confirmed in late 2005.

From their texts, it would appear that the Sumerians were in possession of quite a significant amount of scientific and astronomical knowledge and knew of all these things.

For example: Uranus was unknown until 1781 and Neptune until 1846. In modern astronomy we didn't even know our solar system had as many as 9 planets orbiting the Sun until 1936 when Pluto was discovered. It had been previously thought that there were only 8 and yet the Sumerians already knew of the existence of all of these planets 6000 years ago including our newly discovered member which now makes 10 even as Bodes Law suggested, though the Sumerian texts say that there are actually 12 planets, not 10 or even 11 (*fig.119*).

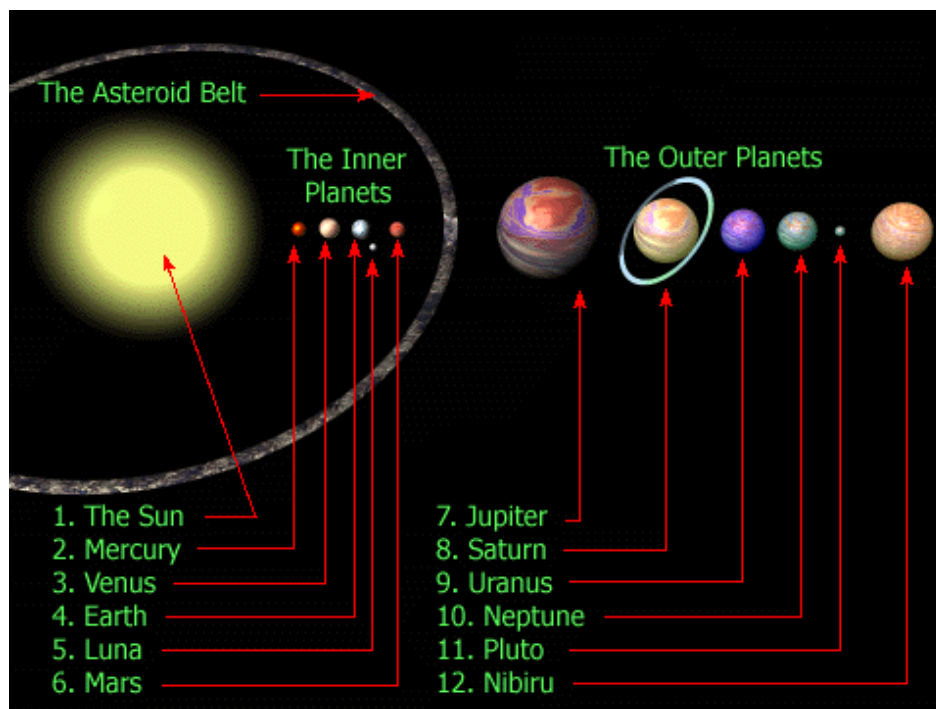

Fig.119 (Not to Scale)

As the diagram shows the reasons for this discrepancy are firstly, because they considered the Sun to be a rightfully included member of the Solar System and secondly, because they believe our moon actually has a considerable history of its own. Many scientists and scholars have surmised that our moon is too big to be called a real satellite and have debated whether the Earth and the Moon should really be classed as a double planetary system. The Sumerian believed it to be so and their name for the celestial body we know as the moon was '*Luna*'

The other planet that also exists in our solar system, the one that we have only now discovered, they name as '*Nibiru, the planet of the crossing.*' The Sumerians say that Nibiru is a large planet, possibly comparable in size to Saturn or Uranus and that it has an extremely vast elliptical orbit and that it takes 3600 of our years to complete just one orbit around our Sun. They also say that Nibiru is the dwelling place of the '*Anunnaki,*' their Gods.

Numerous mentions of the Anunnaki are made in various religious texts including the Christian Bible in which they are often referred to as the '*Elohim*' and the '*Nephilim*' or sometimes in more recent versions of the bible merely as 'giants.'

In their texts the Sumerians repeatedly state that time flows differently on Nibiru than how it flows on earth. They stress the point that the flow of time on any given planet is directly related to the time it takes that planet to orbit its parent star, in this case, the Sun. This means for example, that since it takes 12 earth years for Jupiter to orbit the Sun, a man living on Jupiter for one orbit, would only physically age on year as apposed to someone on standing on earth who would age 12 years in the same period of Earth time. It therefore stands to reason that a person who lived on a planet that takes 3,600 earth years to orbit the Sun would also only age one year during that orbital timeframe. Such discrepancies in time are actually proven in part by Einstein's Special theory of Relativity and it is well known how time flows slower for astronauts when they are away from earths rotational pull for example. Einstein even speculated that time was a type of 'fabric' that the planets 'roll' across similar to a ball rolling across a strip of linen.

The Sumerians inform us that one year on planet Nibiru was called a shar and was equivalent in time to 3,600 Earth years. They also say that the average Anunnaki lifespan was around about 120 shars which equates to 120 times 3600 or 432,000 earth years. According to the Sumerian King List a period of 120 shars passed from the time the Anunnaki first arrived on Earth until the time of the Great Flood. This is extremely significant as 432,000 is a number that also features very highly in numerous other mythologies as well.

Now before you start dismissing all this offhand, I again stress to you and ask you to remember that as far-fetched and bizarre as all that may sound to you, that this is not a fantasy tale contrived by myself or by Zechariah Sitchin, but is in fact gleaned from translations of 6000 year old Sumerian clay tablets. And as we progress you will see that the Sumerian account really is the most plausible explanation of creation that exists. It is also worth noting that the Sumerian record of events is the only account that provides totally a plausible series of events that adequately explains every single puzzle we are faced with about the rest of our solar system too. The fact they knew of all of the planets in our solar system, even their correct relative sizes, rotational movements and eccentricities, details that take advanced scientific knowledge to discover, plus of the existence of the asteroid belt also raises the question: If their story is untrue then how on earth were they able to acquire such accurate and detailed knowledge?

Let's face it, how in the world were these ancient peoples ever even able to calculate precession of the equinoxes? Mere knowledge of its existence requires some very advanced scientific know-how. For now just consider the fact that it takes 72 years for the vernal point to move through just one degree of the elliptic – would **you** notice a 1 degree change in the location of the stars in 72 years? ...No, I didn't think so.

The Sumerians called such a one degree shift in the heavens a "Celestial Portion."

The Sumerian story of creation begins at a far earlier time than the Christian version though the two stories do eventually overlap. The Sumerian version however, begins with the actual creation

of the solar system. The second stage of creation then proceeds with an enormous cosmic collision.

According to the tale a huge 'rogue' planet named as Nibiru that was not originally part of our planetary system became drawn into the gravitational pull of our outer planets and eventually the Sun and began an enormously vast, elliptical and permanent orbit. The texts say that Nibiru's orbit is in fact, so eccentric and elliptical that during its perihelion it crosses the paths of all the other planets except the inner most four, making its closest pass precisely where we now find the asteroid belt (*fig. 120*). They also tell us that the orbit of this 'rogue planet' was contrary to the paths of the other planets of the system causing it to travel around the Sun in the opposite direction to them. It was during its entry to our solar system and on the second subsequent orbit, while making close orbital passes of the inner planets that two enormous celestial disasters occurred.

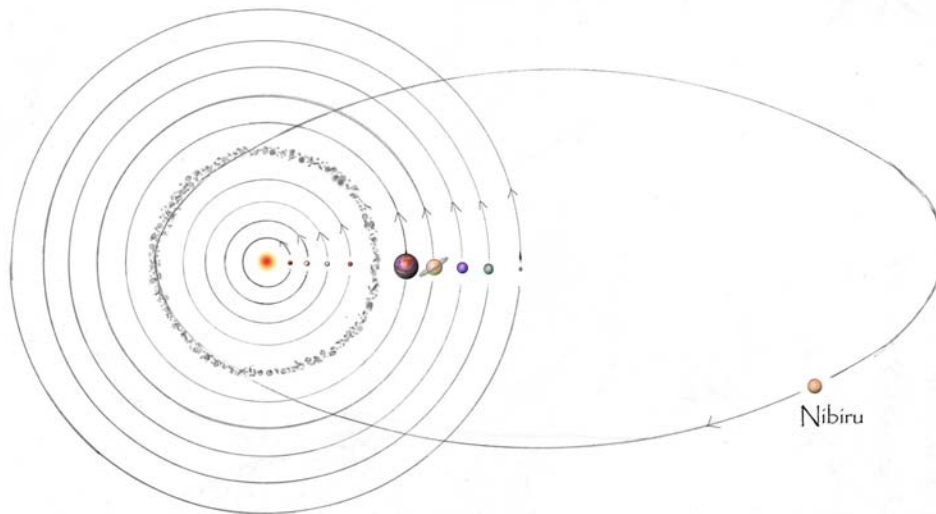

**Fig.120** (*not to scale*)

And as you read this account I am about to relate to you, as bizarre as it sounds, I ask you to consider deeply what you know of science and astronomy and also of mythology and biblical tales and again remember that the following tale is not from someone's imagination but is in fact an accurate (*though paraphrased*) translation compiled from an account of our beginnings that was written by the Sumerians 6000 years ago and saved on tens of thousands of clay tablets that have been found in Mesopotamia in the last 150 years, the information their fragments and pieces contain collected, painstakingly reassembled and meticulously researched by Zechariah Sitchin, the world leading authority on Sumerian texts.

Now with all of the above in mind, according to the 6000 year old Sumerian account, the actual creation of the Solar System, including the creation of Hammered Bracelet and the Earth, and ultimately of man, the calendar, civilization and pretty well the whole shebang went like this:

### **In the Beginning**

Far, far back, in the depths of time, Apsu (*our Sun*) was originally born with two companions, one was Mummu (*the planet Mercury*) and the other a watery planet called 'Tiamat' or even as 'Beautiful Tiamat – the Mother of All' (*some cryptic references to Tiamat are actually even made in Biblical texts on occasion, where it is referred to as Tehom or Tehom-Raba - 'Great Tiamat'*). The next planets to come were Lahamu (*Venus*) and Lahmu (*Mars*) then, before the first two had even yet formed properly, came Anshar (*Saturn*), Kishar (*Jupiter*), An (*Uranus*) and Antu



(*Neptune*), while a smaller planetoid the Sumerians called 'Gaga' (*Pluto*) was in turn born from Saturn and orbited the ringed planet as its satellite.

According to the texts, at this early time the Earth, as such, had not yet come into being while all of the existing planets still had erratic and unstable orbits and wandered this way and that, all greatly affected by each others gravitational pulls.

How many years, things remained in this state is not mentioned in the tale but we are told that the next thing to occur, and still many, many eons ago, was a 'celestial invasion'. A large planet the texts name as '*Nibiru*' was thrown from its own orbit far out in space and entered in to our still unstable solar system. It was an event that would eventually prove to be a stabilizing factor for our system but also one that wrought great havoc among the planets that already orbited our Sun for as it entered it was also traveling in the opposing direction to the other planets.

The Rogue Planet Nibiru was first attracted into our Solar System by the gravitational pull of Neptune. Upon its initial entry, the planet was apparently still quite unstable and plastic because its passage past Neptune caused it to bulge dramatically from one side in the direction of the planet. Neptune's gravitational pull also affected its trajectory causing it to curve in towards the center of our solar system. The next planet it was to pass was Uranus and in doing so it caused great distress to the planet, upsetting it immensely. The planet '*bowed to greet him*' (*we can see through our own studies that unlike any other planets, Uranus is in fact, on its side, while its magnetic field remains vertical. This anomaly is here mentioned and explained by Sumerian texts*). Nibiru's passage by the planet must have indeed been close because four great chunks were also torn from Nibiru creating four satellites that orbited about it wildly. The texts name these four satellites as the four winds: North wind, South wind, East wind and West wind. The largest of these new satellites was said to be the North wind. Then Nibiru approached Saturn, passing so close that it actually touched the planets rings, whereby its course was bent even further inwards by the huge gravitational pull of the giant and was now locked on course towards the inner planets.

As it passed by first Saturn and then Jupiter the approaching Nibiru had a major influence on the inner planets, causing massive volcanic activity and very erratic orbital behavior. The massive gravitational force of the approaching Nibiru caused huge chunks to be wrenched from Tiamat until the planet had 11 satellites revolving around it. One of them called 'Kingu' continued to attract debris and grow until it had grown to the size of a small planet. Then, pulled by the gravity of the approaching invader, Kingu left its orbit around Tiamat and began to assume the orbital characteristics of a planet in its own right, though it still remained close to Tiamat.

Nibiru continued relentlessly on its course, on its way tearing Saturn's moon, Gaga from the planets grip. During these close passes three more moons were also wrenched from the body of Saturn, the texts name them as Evil Wind, Whirl Wind and Matchless Wind.

Nibiru was now surrounded by seven wildly orbiting satellites as the planet then began its approach towards Tiamat.

As the two planets drew near to each other Tiamat became inexorably drawn by the gravity of the huge invader and there were massive electrical discharges that began arcing between to two planets which caused great damage to Tiamat. But then something occurred, perhaps the electrical arcing provide an 'electro-magnetic cushion' of some kind that repelled the two bodies, but for whatever the reason, Nibiru course became erratic and it did not collide with Tiamat, however, one of its satellites did. The satellite called Evil Wind plowed straight into Tiamat, cracking and splitting the planet in two as massive electrical discharges from Nibiru entered deep into Tiamats core completely extinguishing its life. This is illustrated well by Sitchins own diagrams (*fig.121*). Then Nibiru, now inexorably locked into orbit, left the inner planets to begin its vast elliptical journey around our sun and it was on its second orbit through our solar system that a further disaster struck.

And, hard as it may be to grasp at first, it is here that the Christian story of Genesis begins and parallels the Sumerian tale

### The Epic of Creation

According to the texts, on its second orbit Nibiru itself collided with Tiamat's lower half and delivered the truly fatal blow. The already damaged planet was no match for the enormous bulk of the invader which hit one colossal piece of the already cracked Tiamat square on, pulverizing it completely. The remaining half of Tiamat was struck by the orbiting North Wind, Nibiru's largest moon, shunting the remainder of the broken sphere further towards the Sun and into a new orbit taking its large satellite Kingu with it (fig.122). Kingu, now lifeless from the encounter, shrunk in size and cooled to a desolate battered wasteland. The force of the blow was so great that the other ten moons of Tiamat were also shattered, the debris sent flying off on vast elliptical orbits of their own, though following Nibiru's path, now in the opposite direction of the other planets of the system (an event which explains not only their existence, but also the incredibly vast and retrograde orbits of the comets in our solar system).

Gaga the former moon of Saturn, confused by Nibiru's influence, began its life as a small planetoid we now call Pluto and continued off on its own eccentric orbit, which now marked the elliptical line that Nibiru had created with its entrance to our solar system. (Modern scientists have also theorized that Pluto may once have been a moon of Saturn, in fact its orbital path still overlaps that of Saturn's today).

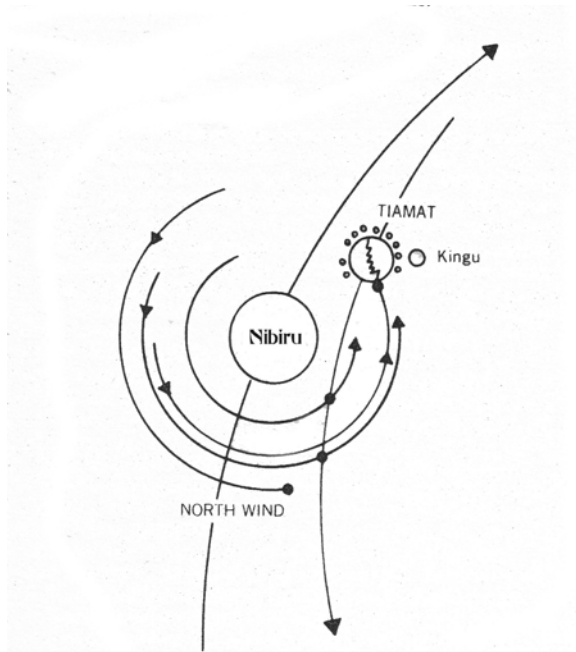

Fig.121

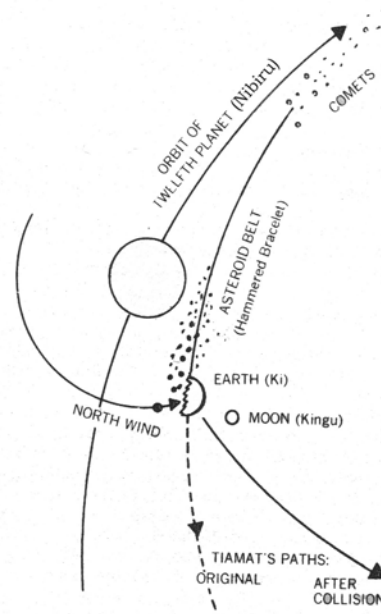

Fig.122

The waters that were left on the broken sphere that was once the beautiful Tiamat spread out over the remaining chunk of the planet which, now shunted a little closer to the sun, began its new orbit as the Earth, while the remaining debris from the collision that floated in space spread slowly out to form the hammered out band that is now the asteroid belt. The Sumerians say the evidence of this cosmic event is still visible on the earth and that is why all the land mass is on one side of the planet and, if you removed the oceans from earth, it would not appear as a true sphere like the other planets, but rather slightly 'scooped out' where the Pacific basin lies, because it never formed completely back into a proper sphere shape. They say the Pacific basin is the scar that still remains from the wound the planet once bore. This event apparently also gave the Earth its axial wobble, "The stars, their images, as the stars of the Zodiac, he fixed." It was during this cosmic collision that the 'Seed of Life' was also transferred to the Earth from Nibiru.

Nibiru, through the fixed orbital path it had acquired, was now destined to always return to the site of the celestial collision and cross the path of the asteroid belt where Tiamat had once orbited. For this reason the planet is called “Nibiru – the Planet of the Crossing’.

And so it was that “The Celestial Lord created the Hammered Bracelet and the Earth”

Again the texts do not mention how long things stayed in this fashion. They do however most definitely say that intelligent life first appeared on Nibiru long before it was ever to be found on earth, Where this life came from or how it evolved is not told, just that it was there

But eons later, all was not well on Nibiru, for because of the vastness of its new orbit and the great distances the planet traveled from the Sun, the inhabitants of the planet, the Anunnaki, were suffering and facing a slow but inevitable extinction due to a steady erosion of their planets atmosphere. It had started when a hole had appeared in the protective ozone layer that surrounded the planet. Nibiru usually remained at a reasonably constant temperature throughout its vast orbit due to a thick greenhouse atmosphere that was continuously replenished by constant volcanic activity. But that activity had now slowed down endangering life on the Planet.

It was decided to create “Weapons of Terror” to reawaken the volcanoes but even after the blinding explosions from them had been directed at the sleeping mountains they still refused to release their volcanic clouds and the atmosphere continued to erode. It was then discovered by scientists that the problem could be alleviated by suspending fine particles of gold dust in the upper atmosphere to create a curtain of charged particles which would protect and shield them during the planets vast orbital peregrinations away from the sun.

Gold was a substance that was very rare on Nibiru but the Anunnaki knew that gold existed in abundance within the Hammered Bracelet and so a dangerous mission was organized to retrieve the substance from the chunks of blasted rock within the asteroid belt.

The mission was a total failure and many brave heroes were crushed by the giant boulders in a dangerous quest that was attempted to gain a quantity of the precious metal from the asteroids and rescue their planet. Not hero one returned from the quest.

According to the texts, it was about 455,000 BC that due to a failure of the ruler of Nibiru to fix the deteriorating environment, a rebellion erupted. The ruler, ‘Alalu’ was deposed by his half-brother ‘Anu’ who wrested the kingship from Alalu in a naked wrestling contest.

In fear for his safety after his defeat, Alalu fled Nibiru, escaping in a Celestial Boat and after a journey fraught with dangers, reached the inner planets and became the first emissary of the Anunnaki that arrived on Earth. His initial arrival was very shaky, not knowing whether the atmosphere was breathable, or if he would be better landing on land or water, he hesitated and his chariot was snared by the Earths gravity: “Its spread wings became aglow, Earths atmosphere was like an oven...” Eventually he crash landed safely in the Sinai region.

He soon discovered that the precious and much needed gold could be found here. Alalu sent word to Nibiru of his find but it wasn’t until about 5000 years later that a further group of 50 Anunnaki (*the biblical Elohim*) led by one of Anu’s sons named ‘Ea’ arrived to investigate.

When Ea (*meaning ‘Lord of Water’*) first arrived on Earth, the texts tell us that he and his party were also extremely unsure of the landing so, after locking onto Alalu’s beacon, they splashed their craft down in the waters of the Persian Gulf. When they arrived on the shore they were wearing “Fish Suits” and because they were still unsure of the atmosphere each had also donned an “Eagle Mask.”

Ea quickly established the first Anunnaki settlement of ‘Eridu’ in the area that was once Mesopotamia, with the objective of extracting gold from the waters of the Gulf.

Though little gold was extracted from the ocean waters, operations went well quite under Ea’s control for some time but eventually gold production in the Gulf region began to falter and slow so Ea’s father Anu decided to visit Earth to investigate the problem, bringing with him his other son, Ea’s half brother named ‘Enlil’ who, though younger than Ea was of purer blood and so the

rightful heir. This was later to prove a bitter source of rivalry between the descendents of the two half brothers.

During Anu's visit it was decided to increase the gold mining operations so Anu and the two half-brothers drew lots for control of the coveted Persian Gulf operation. After the draw it was decided that Anu was to remain ruling on Nibiru, Enlil was placed in charge of the Gulf facility while Ea was sent to a new southern land called the Abzu to commence mining operations in a new location (*The Abzu is often referred to in mythology as 'the Underworld' or as 'Hades' in biblical references but which in fact was, according to the texts, a settlement in Southern Africa*). Ea was also given a new title: "Enki" – 'Lord Earth' signified by the symbol of the Serpent and basically meaning, one who has great knowledge of the secrets of the earth, literally, "He Who Solves Secrets" or "He Who Knows Metals"

Enki's younger half-brother Enlil, the legal heir of Anu, was made the true ruler of Earth and placed in control of the operations at Eridu and received the title 'Lord of the Command'.

It is mentioned in the texts that on this particular occasion, before Anu's visit was concluded and he departed from Earth to return to Nibiru, he was again challenged by Alalu who declared Anu to be a usurper. Again they removed their attire and wrestled, oiled and naked and again Anu won the match but so distraught was Alalu that when the fight had ended and Anu had been declared the rightful victor, he set upon his half-brother and 'bit his manhood off' and swallowed it, injuring Anu greatly but also sealing his own fate.

With the phallus of Anu burning in his stomach horribly, slowly poisoning him he was brought before the Seven-Who-Judge and by them was banished to die alone on Lahmu (*Mars*), though to this end he was accompanied by one faithful servant called Anzu, (*possibly himself a grandson of Alalu's*) who wished to provide the once Nibirian King a fitting burial and in so doing have his own deeds remembered for all time.

During that time the climate on Earth began to mellow into something more comfortable for the Anunnaki and more arrived on Earth to help obtain the much needed gold. One of the new arrivals was Enki's half-sister 'Ninmah' who was also a medical officer and geneticist. While on the journey from Nibiru to Earth Ninmah stopped on Lahmu to see what had become of Alalu and Anzu. The texts describe Lahmu as having ice caps at both poles and as being of 'reddish hue' with lakes and water fit to drink but lacking in sufficient atmosphere for breathing without the aid of the 'Eagle Masks'. Alalu was long dead but Ninmah was able to revive Anzu who told her he had placed Alalu's body in a cave beneath a great mountain that arose beside a lake nearby.

Sumerian tablets tell us that when the party left Lahmu they used weapons of power to carve the great mountain beneath which Alalu was buried into his image.. The texts say that the image was of his face "looking skyward towards Nibiru and Earth, whose gold he discovered" and that they carved the monument of Alalu wearing the 'Eagle-Mask' but with his face uncovered.

The Sumerian texts have here quite accurately described Mars including its polar ice cap which, science has shown, is indeed frozen water and have mentioned the existence of the bizarre and very enigmatic 'face on Mars'. The question is: How on Earth could they possibly know about any of that?

Soon, with the arrival of a party of 300 more Anunnaki, the gold mining operations on earth were running smoothly again. The gold bearing ores were being steadily shipped from Africa (*the Abzu*) to the Gulf to be refined, then sent up to a way station that had been established on Lahmu near to the tomb of Alalu. From there refined gold was shipped to Nibiru in bulk via spacecraft that would periodically arrive. Texts inform us that the Anunnaki that were in command of the way station were named the 'Igigi' (*later to become the biblical Nephilim*) and that by this time the Anunnaki had also set up a total of seven vital operations centers in the Persian Gulf region to deal with the mammoth task of coordinating the procedures and exporting the refined ores. These control settlements included a spaceport at 'SIP.PAR', a control center at 'NIP.PUR', a medical center at 'E.DIN' and a Metallurgical center at 'SHUR.AP.PAK'.

During this time, and with the help of the Igigi, Alalu's grandson Anzu attempted to seize control of the Earth operations and a short war broke out. However Enlil's son Ninurta quickly squashed the disturbance and disposed of the troublesome grandson.

### *Tales of Gods and Men*

Eventually a mutiny arose among the Anunnaki in Africa who were endlessly laboring in the mining operations under Enki's control. The Anunnaki were tired of their years of toil in the mines and after a conference, it was decided by Enki to enlist the help of his half-sister Ninmah the geneticist and create a worker race to relieve some of the burden of the Anunnaki.

Enki was himself a great scientist, and he and Ninmah used elements of the Anunnaki (DNA), mixed with the elements of animals to experiment in the task. Initially, a variety of animals were used in the tests and some odd looking creatures were produced. It was believed that creatures such as horses would produce strong workers but after a few Anunnaki-horse hybrids and other even stranger creatures were developed, the idea of breeding creatures of pure burden was abandoned. Enki said he knew of a small race that lived in the forests of the Abzu that would be perfect for the task and Ninmah eventually succeeded in creating a primitive worker race by mixing the essence of the Anunnaki (DNA) with DNA taken from this lesser primate species. Eventually success was achieved and soon many of the new workers began to take over the toils of the African mining operation. (*The procedures she used and the methods of birth etc were recorded in quite a detailed manner in some of these texts*). Ninmah named the new race she had created the 'Adamu'. A most interesting detail of the Sumerian account is the mention that all the genetic experiments were at first conducted in crystal dishes without success. It was not until Enki surmised that perhaps not enough of the actual elements of Earth itself were present in the experiments and suggested the use of a clay dish for the process, which would possibly leech some traces of those elements into the mixture through its use, that success was obtained.

*"And the Lord fashioned man from the clay of the ground"*

Even after the race had been created though, it soon became apparent that many more would be required to ease the toil of the Anunnaki workers and so soon Enki again sought the services of his half-sister and her genetic prowess. Ninmah conducted further tests, began more genetic manipulation and soon Enki's son Ningishzidda succeeded in giving the new Adamu race the desire and ability to procreate by adding two more two more pieces to the Human DNA strand. He added 'the leaves of knowing to their tree of life'.

The Sumerians describe this 'Human Tree of Life' as resembling two intertwined serpents, the texts tell us that the human tree at that time only had 22 'leaves' and that Ninmah added two more. Such an account very accurately describes the 24 chain double helix strand found in human DNA. Again, how on earth would the ancient Sumerians know that do you suppose?

When Enlil discovered the Adamu could now procreate he was furious with Enki and demanded how much more his brother would grant to his new 'pet race' without consent and how long it would be before he further altered their Life Tree to include to long life span of the Anunnaki. His brother and sister replied that they would never add the two extra leaves required for longevity. But Enlil was not appeased and he forced the Adamu to leave the Edin facilities where they had been housed and fend for themselves in the wilds, though many were still required to work for the Anunnaki as was their purpose.

Even cast out of the Edin by Enlil, the Adamu began to multiply greatly before very long and soon both brothers had an abundant supply of the new Adamu workers both for the mines in the Abzu and for the many tasks in the centers in Mesopotamia. Things then went along steadily for a time until the Earth descended into a Glacial period at around 200,000 BC during which time most of the Anannaki returned to Nibiru for the duration.

The Adamu race and other species on Earth regressed during this glacial period which lasted until around 100,000 BC when the Earth at last began to warm again and it was during this time

that the Anunnaki returned to Earth again. But during the 100,000 years that Anunnaki had been away the descendents of the Adamu had not been idle. The race had multiplied greatly during the ice age and had evolved into a species that had become fair to behold though at this time food was also becoming scarce due to the recent ice age and proliferation of mankind.

The Anunnaki were also becoming tired of the sameness of their diet.

It was sometime around this period that Lord Enki was apparently taken by two young Adamu maidens he saw bathing by a river and made love to both that afternoon leaving a servant, sworn to secrecy, to watch over them to then inform him if the maidens fell pregnant and gave birth. Soon he was informed that such births had indeed taken place, one male and one female and so Enki had the children brought to his house and to the amazement of all the two children were capable of speech. This was the first time speech had been seen in the Adamu.

Enki named the two children Adapa (*the biblical Adam*) and Ti-Amat after the great cosmic mother (*the biblical Eve*.)

According to Sumerian texts Adapa and Ti-Amat eventually had two sons: Abael and Ka-in. In delight that intelligent man had now 'miraculously' come into being the Anunnaki had grains and sheep brought from Nibiru and the two sons were taught in their ways. Abael was taught as a shepherd and in the ways of animals by one of Enki's sons named Marduk. Ka-in was trained in the skills of farming and the nature of soils and minerals by a son of Enlil called Ninurta. However when the first lambs were born and the first crop was harvested and the two sons brought them before Enki he was greatly hungry for fresh meat and so showed a great deal more joy at the prospect of fresh meat than of bread. Ka-in felt dejected and soon Abael began belittling his brother and boasting that Enki favored him more and so the tension grew.

Due to a dispute over water one day Ka-in killed his brother Abael with a rock and so was brought before The-Seven-Who-Judge and condemned to death for his crime. Enki then revealed his transgressions with the maidens stating that Adapa was in fact, his son and so too was Ka-in his descendant. He explained to all that the speech of Adapa was in fact no miracle but done in hope of making modern man so food could be supplied, The council then overturned Ka-in's death sentence to one of banishment and said that Ka-in must be given a mark so that he and his descendants would be recognized and not killed by mistake. Ningishzidda then genetically altered Ka-in's essence and he was sent to wander in a distant country.

Things went along quite steadily for long while. Adapa and Ti-Amat had another son called Sati (*the biblical Seth*) and eventually, a further 30 sons and 30 daughters and mankind continued to proliferate.

Soon, for one excuse or another, many of the Igigi (*the biblical Nephilim*) came to earth and many took the daughters of the new race (*the descendents of Adapa*) to be their brides. But the Anunnaki were larger and more powerful than the Adamu women and many of them died in childbirth. (*These events are also mentioned outright the Christian story of Genesis*).

Enlil viewed the unions made between Anunnaki and the descendents of Adapa as distasteful thinking it degrading of his people to breed with a lesser race and began to form a dislike for mankind, but he allowed the practice to continue none the less. The children of many of these unions between Anunnaki became people of renown. These were the Godly offspring and Hero's of the many ancient legends.

Then suddenly at around 75,000 BC the Earth descended into another Ice Age, far more severe than the previous one. During this time the Anunnaki retreated again and a great many of the Adamu race were wiped out. The texts do not mention what triggered either of these two ice ages, just the fact that they both occurred. We are told that during this second glacial period various regressive species of Adamu roamed the earth but by its conclusion the dominant race on Earth were the descendents of Adapa – Homo-Sapiens-Sapiens.

One text mentions that sometime during this period Nibiru's passage through the asteroid belt with one of Tiamat's former moons (*now a comet*) following behind it apparently loosened many

huge boulders which cause meteor storms on the earth, the moon and mars. According to the personal account of Enki himself, the moon was apparently struck by the comet itself as it passed.

When the Anunnaki returned to Earth, they again found pockets of man who had survived the Ice age. Enki and Ninmah were so overjoyed at finding survivors and so impressed by the hardiness of their new race that they both agreed that the time had come to elevate those humans who were of Anunnaki parentage to the position of Rulers in Shuruppak, the great medical center of Ninmah. The decision by his brother and sister to do this enraged Enlil beyond belief and secretly he began to plot the demise of the race of man for he had also become tired with all the noise and disturbance that was being created by man and had, more than once, imposed severe noise restriction on them. For a great number of years he employed various methods to dispose of mankind who by now had multiplied immensely and were creating noise, mess and general chaos. He allowed the proliferation of waves of pestilence and disease, plagues of insects, droughts, great fires and for general mayhem to be the lot for mankind as punishments for their transgressions but still the race held on.

Then, at around 13,000 BC Enlil saw his opportunity to be rid of man once and for all.

You see, the Anunnaki had noticed a strange groaning and seismic rumblings that emanated from the "Great Whiteland" in the south (*Antarctica*) with every passage of Nibiru and had set up sensitive equipment at the southernmost tip of the Abzu (*Africa*) to monitor such activity. Enlil knew that Nibiru would soon be making another close passage past the Earth and his readings had shown that with the gravitational pull of the huge celestial body in such close proximity to the Earth, a slip of the Antarctic Ice Cap was imminent. The event would generate an enormous global tsunami and world wide flooding. He knew that it would be imperative for the Anunnaki to leave Earth during such an event or they would surely perish in the deluge.

Enlil then held a meeting with Enki, Ninmah and the other Anunnaki and informed them of the approaching calamity but made them swear to secrecy and to withhold information about the impending disaster from men so the race would be obliterated in the Flood. But Enki was distraught and could not bear to keep to the oath, so great was his love for the race he had created with his half-sister and civilized man that had sprung from the line of Adapa. So one night after a vision he devised a plan and the next day he went to visit one of his Human sons in secret. The man was named 'Ziusudra' (*the biblical 'Noah' also know as 'Utnapishtim' or as 'Atra-hasis' in some tales.*)

Not looking at Ziusudra but instead pretending to speak to a reed hut and so holding true to his vow, Enki told the hut about the doom that was about to befall the Earth and left instruction on a tablet for the building of a great submersible vessel that would 'roll and tumble' in which a man and his companions could safely ride out a great deluge that was soon to come from the south and engulf all civilization. Enki emphasized haste in the task and said to gather inside the craft, his family and all the domestic creatures that he could. He then provided Ziusudra with a navigator named 'Ninagal' who was another of his sons. Enki then instructed him that he should look to the west for a sign that the deluge was imminent and it would be then time to board the vessel and seal it tightly. He said not to inform anyone of the doom that was to befall mankind but instead to say to his countrymen that he had won the displeasure of Lord Enlil and was now to move to the Abzu to serve Lord Enki and those who wished to travel with him he would take.

We are told that Enki and Ninmah were also sorrowful that all the creatures of the world, including those that they had brought from Nibiru would also perish in the flood and so they conceived a plan to extract the 'essence' (DNA) from as many as they could so they could repopulate the earth with them after the deluge. The precious seeds of all the animals they could find were collected in pairs, one male and one female then stored in a box and delivered to Ninagal by messenger for him to also hold safety within Ziusudra's vessel.

Then, sometime around circa 11,000 BC, came the deluge.

At the first signs of the event the Anunnaki immediately launched their ships from the spaceport at Sippar to the west of Ziusudra's position with his submersible vessel.

When Ninagal saw launch of so many ships he saw the sign that Enki had told him would come from the west, for the Anunnaki were now departing, so Ziuzudra hurriedly boarded the vessel and sealed himself inside to await deluge, taking with him his family, those who had wished from the start to sail with him to the Abzu, his navigator and what creatures he could gather to him.

Then came a massive deluge of ocean from the south that engulfed the globe

The ships of the Anunnaki escaped the flood and sat in orbit as they watched the devastation from the heavens as the waters swept across the Earth. Ninmah wept openly at the destruction and Enki also grieved greatly. And there they waited until the torrents subsided.

### *After the Deluge*

Soon after the flood waters subsided the Anunnaki returned to Earth. When Enlil found that there were humans who had survived the deluge and he learned of his brother Enki's deception, he was furious and wanted to kill the survivors on the spot but his brother and sister begged him to see reason. They pleaded with Enlil, saying that the race of man had many admirable qualities and should be given a chance to prove its worth and that soon he too would grow to love them.

Finally, after Enki had related to his brother the divine vision that had caused him to conceive the plan for mankind's salvation Enlil agreed to spare the survivors and allow them to live with his blessing. Enlil himself granted man the use of seeds and farming implements while Enki taught Ziusudra and his sons the domestication of animals. Thus for many years, mankind lived and prospered in peace with the Anunnaki.

Though a great destruction had been wrought upon the earth, a wonder had also been revealed: When the waters had subsided and Enki surveyed the Earth in his "Whirlwind", described in the texts as a "Black Sky-bird," he found that the waters of the deluge had also uncovered vast amounts of the urgently needed gold in a new land across the sea.. Vast quantities had been found strewn all about as nuggets and much could be obtained without even the need for mining and so settlements were soon established to collect the gold and ship it back to the Persian gulf for transportation back to Nibiru.

Lahmu had also been finally devastated by the most recent passage of Nibiru and had now lost what little atmosphere it did had and its remaining water had dissipated with what remained now locked and frozen at its poles.

Enlil then divided the lands and allotted the descendants of Ziusudra three regions to control. During this period Enlil's son 'Ninurta' built mighty dams in the mountains and drained the waters from Mesopotamia, making the whole area habitable again and Enki set about reclaiming still more lands in the Nile Valley. The Anunnaki kept control of the Sinai Peninsula area and re-established their former spaceport only this time they set up their control center on Mt. Moriah (*the site that was later to become Jerusalem*) as the former sites all now lay beneath meters of dried mud and soil. All but one: The massive stone blocks that had been used to construct the landing platform at Sippar had withstood the waters and still remained and so the old platform was also incorporated into the new facilities.

Enki had six sons. The most notable of these were one named 'Marduk' (*the Egyptian God 'Ra'*), one named 'Nergal', one named 'Ningishzidda' (*the Egyptian God 'Thoth'*), and one named 'Dummuzi'. Marduk had earlier been in charge of the Igigi manning the way station on Lahmu before the deluge and had taught Abael in the ways of animal husbandry.

Enki, himself a great scientist, taught much of his knowledge to all of his sons, but of them all, the wisest and most adept by far was Ningishzidda.

For a time Lordship of the Nile region was given to Marduk who through various wives and concubines, also had sons. Of them all, the three that mostly concern our tale were named Satu (*the Egyptian God 'Seth'*), Asar (*the Egyptian God 'Osiris'*) and another son called Nabu.

While still retaining lordship, Marduk then divided control of the Egyptian territories between his sons Satu and Asar.



During this period when the Anunnaki were establishing the new facilities in the gulf they needed a twin peaked mountain for the new landing corridor where there were only flat plains and so they are reported to have built an artificial mountain at the location and then filled it with sensitive equipment and powerful crystal arrays. The place was also built to function as a landing beacon emitting a powerful beam skyward from its summit. The location they are said to have done this was in “The Land of the Two Narrows” (*the Nile Valley*).

The beacon functioned primarily to triangulate landings at the new spaceport. It was called the E.KUR “House Which like a Mountain Is.” The texts tell us that first a smaller scale model was constructed and then the two large peaks that were required for the landing corridor were made. They tell us that the main structure had a crystal stone that on its summit that beamed its force skyward. The Beam emanating from the capstone was itself powered by crystal stones arranged inside within a long gallery. All was controlled by ‘the Pulsing Stone’ which was mounted in an enclosure within the main chamber. The power and force of this crystal array was then magnified by special hollow chambers between it and the capstone. The entrance to the Ekur was said to be by means of a secret ‘swivel-stone.’ Cuneiform and pictorial texts found on ancient Sumerian clay tablets indicate that both the design and construction of the Ekur was accomplished by Enki’s son Ningishzidda (*Thoth*.) The Sumerian account also tells us that to mark the occasion of his great accomplishment, a lion shaped monument bearing the face of Ningishzidda and looking along the 30<sup>th</sup> parallel directly toward the landing facility in the Persian Gulf was erected.

The texts say the shape of a lion was chosen so all who live in future times would know that the task was achieved in the age of the lion (*circa 10.500 BC*).

The two brothers Asar and Satu wed two sisters called Asta and Nebat. Asar wed Asta (*the Egyptian Goddess ‘Isis’*) and spent much of his time in the Abzu with his father and was granted succession by Marduk. But Satu, through coaxing from his wife Nebat, also coveted the throne killed his brother Asar, cut off his phallus and cast him into the waters in a coffin. Satu then assumed rule of all Egypt.

Asta retrieved the body of her husband Asar and with the aid of Enki, Ninmah and Ningishzidda became impregnated with Asar’s seed. She then bore a child named Horon (*the Egyptian god ‘Horus’*) who was the son of Asar and long trained to avenge his father’s death.

Satu was attacked by Horon and eventually defeated by Horon’s ‘divine weapon’ in the aerial battle that ensued. The device was said to be a powerful missile known as ‘the weapon of thirty’ known in Egyptian texts as the Harpoon of Horus. Satu was then brought before the council by Horon, however he soon escaped and seized control of the Sinai Peninsula and Canaan.

The descendents of Enlil were enraged that a rebellious descendent of Enki was now in control of all the Mesopotamian spaceport facilities and Enlil’s son Ninurta launched a war to regain control of the Peninsula during which Satu was again forced to flee, then making his last stand inside the Ekur itself. There he was able to stay indefinitely, impregnable.

About 30 years later, tired of the fighting Ninmah convened a peace conference. The descendents of Enlil were thereby victorious and soon disposed of the murderous Satu and Ninurta himself removed the ‘Pulsing Stone’ from the main chamber and all the navigational equipment and weaponry from the Ekur. Then he himself cast down its crystal capstone so it could never again be used as a weapon.

Rightful division of the Earth and proper boundaries was then re-established and, much to the rising anger of Marduk, during the proceedings new rulers were decided upon.

Following the disturbance created by Satu, control of Egypt was thereby transferred from the house of Marduk to the house of Ningishzidda and the construction of a new, substitute ‘Beacon City’ was begun at ‘Annu’ (*Heliopolis, the biblical On*) Marduk was given charge of the new city and on its tower he placed the Ben-Ben – the conical upper section of his ‘Celestial Boat’.

Outposts were then established at the gateways to space facility to prevent unauthorized access, one of these outposts was the city of Jericho. For her role in the proceedings Ninmah was given

the new title of ‘Ninhursag’ – ‘Peacemaker.’ Sometime during this time security of the new spaceport facility at Sippar was allotted to the hero of the deluge, Ziusudra himself.

The period of peace continued for many years and during the time the Anunnaki granted various technological advances to mankind. The Anunnaki ruled the earth fairly though still retaining the status of “Demigods.’ But eventually man was granted kingship on Earth while Enlil’s son Ninurta sat as ‘over-ruler’, the first urban civilization was established in Sumer (*first region*) and the calendar was begun at Nippur in 3760 BC. The capital of the new civilization was called ‘Kish’ and the Anunnaki also re-established their ‘Golden Cities’ at Eridu and Nippur.

Then about 100 years later, the great Anu arrived back on Earth for a celebratory pageant and a new temple was built in his honor at ‘Uruk’ (*also known as Erech*). Anu was pleased with the temple and relegated it as the new dwelling of his beloved grand-daughter ‘Inanna’ (*also known as Ishtar*).

As joyous as this occasion was it we are informed here by the texts that it was disturbing to Anu at just how much the short sun cycles of the earth had been affecting the Anunnaki who had remained on Earth for extended periods. He was especially upset by the appearance of his two sons and daughter who had been here the longest of all. Now, despite their extended life spans, the three had aged greatly, and appeared much older than their father.

Eventually, after Anu’s departure the position of ‘over-ruler’ in Sumer was transferred to a descendent of Enlil named ‘Nannar’ (*also known as ‘Sin’*). *The land in question in fact still bears his name today ‘Sins Land’ – Sinai*).

Marduk however, had other ideas and after rallying support among Igigi and men he declared himself to be commander of a new ‘Gateway to the Gods’ and commenced the construction of a city and great tower at “Babili” to serve as a new spaceport at the site. The rebellion was soon squashed by the ‘Enlilites’ and the new spaceport was totally destroyed in the infamous Tower of Babel incident mentioned in the Bible. Marduk, now confused and further dejected, his planned coup squashed, then returned to Egypt where he immediately deposed his brother Ningishzidda and again seized control of Egypt. Ningishzidda fled the battle in time, but due to a subsequent scheme by Marduk to discredit and also depose the rights of his younger brother Dummuzi (*who happened to be betrothed to Anu’s favorite grand-daughter Inanna*) his younger brother was killed by accident.

Fearful of the indirect hand he had played in the death of his younger brother Dummuzi, Marduk fled to hide in the now abandoned Ekur, locking himself within its central chamber by lowering three key stones but he was tried for his crimes in his absence by a group assembled outside. Instead of death, the court imprisoned Marduk alive inside the Ekur at Inanna’s request and great blocking stones were released within the structure sealing it completely. However Marduk’s sentence was overturned and he was rescued before he starved to death in a daring plan devised by Ningishzidda that involved using the original building plans of the Ekur and hacking and blasting a twisting way through an emergency shaft.

Upon his release Marduk again disappeared into exile and became known as Amen, the unseen god. Inanna never forgave Marduk for his hand in Dummuzi’s death and it would ultimately prove to be a source of endless tensions and devastating ruin.

The rule of Egypt was somewhat disorderly and chaotic for the next 350 years until finally order was re-established with the installation of the first Pharaoh in Memphis and it was then that civilization came to the second region. At that time the kingship in Sumer was transferred from Kish to Uruk and Inanna was given control of this third region. (*It was about this time that the Indus Valley civilization also began.*) Eventually the line of Kingship began to deteriorate, the royal capital began to shift about again and Enlil soon began to once more lose patience with the multitudes of noisy and unruly humans.

It was then that Inanna/Ishtar fell in love with ‘Sharru-kin’ (*also called ‘Jargon’*) they were married in a great ceremony and a new capital was established called ‘Agate’. This was the

beginning the fourth region and the birth of the Akadian Empire. About 60 years later, after coaxing from Inanna and with the aim of ruling all four regions, Sharru.kin removed sacred soil from Babylon to take to Agate. Marduk, who had been hiding in Babili, was incensed by the action and the old dispute between Marduk and Inanna soon began to flare up again. Eventually Marduk's brother Nergal traveled from South Africa to Babili and persuaded Marduk to leave Mesopotamia for fear of further wrath from Anu.

Sometime during this period, due to the escalating conflicts Enlil and Enki held council with each other and decided to establish a second more secret spaceport in the new lands from whence the gold was being extracted. They decided that the facility would be known only to a few so that the vital gold shipments to Nibiru could continue what ever occurred in Mesopotamia. And so a city was built beside a lake high in the mountains and an ore refining facility was established.

Here Ningishzidda had found other humans, the descendants of Ka-in, who had also survived the deluge by sheltering on high mountain peaks. Ningishzidda then taught these survivors mining and the in the crafting of certain metals.

Very significantly, we are told that the event began with the presentation of tools at a special ceremony that is said to have taken place on a remote island that lies on a lake found high in the mountains of the New Land, the land where the Gold was found.

Soon Inanna's son 'Naram-sin' ascended to the throne and, spurned on by his mother, who had become increasing more warlike since her encounters with Marduk, he seized control of the Sinai Peninsula and invaded Egypt. Within 35 years Inanna had usurped power over all Mesopotamia and Naram-sin was defying the over-rule of Ninurta at Nippur. However, they had not counted on the anger of Anu and the other great Anunnaki leaders who responded angrily by totally obliterating the city of Agate. Before long all of Sumer and Akadia were occupied by foreign troops loyal to Enlil and Ninurta, but Inanna escaped and fled. To stem any further uprisings the Anunnaki then reinstated themselves as over-rulers of the Earth and began establishing and dividing territories of control.

Soon a new city called 'Lagash' was built in Mesopotamia and Sumer began a new age of Prosperity under enlightened rulers, its civilization reaching new heights and in 2193 BC a man called 'Terah' was born into the Royal family in Nippur.

Thirteen years later Egypt again became divided. Those followers who were loyal to the house of Marduk, retained rule of Upper Egypt, while those apposed to Marduk, retained the throne of Lower Egypt. Enlil and Ninurta were increasingly absent during this time and Inanna made many unsuccessful attempts to regain rule of Uruk.

But soon, the conflicts began to escalate until the earth was plunged into all out war.

### **The Downfall of Kings**

By around 2200 BC various settlements and territories had been established and with them, various disputes had broken out amongst the Anunnaki.

In 2123 BC Terah had a son named 'Ibrium' (*the biblical Abraham*) and 10 years later Enlil handed control of the lands of 'Shem' to Nannar and a capital was established for the new empire at 'Ur'. Overall control of Sumer was given to 'Ur-Nammu' who then ascended the throne and was named Protector of Nippur. But in 2096 BC, Ur-Nammu was killed in battle. The people of Ur greatly mourned his loss and saw it as a betrayal by Anu and Enlil. 'Shugli' was next to ascend the throne of Ur and at first he worked greatly to strengthen the old ties with the house of Anu but eventually he was to fall under the charms of Inanna and became her lover. Soon Shugli exchanged the city of 'Larsa' to the Elamites in exchange for foreign military services and a new unrest swept across the lands.

Princes, loyal to Marduk marched northward from Thebes led by Marduk's son Mentuhotep-1 who was also gaining further supporters of his father's cause in Western Asia as he marched. Nannar ordered Shugli to send his Elamite troops in to suppress the uprisings and unrest in the

Canaan Empire and the Elamites pushed forward eventually reaching as far as the gateway to the Sinai Peninsula and the Anunnaki spaceport but in 2048 BC Shugli was also to die in the battle.

Marduk then moved to the land of the Hittites and Ibruum was sent to Canaan with elite troops to serve in a position of a peace keeper. The next year 'Amar-sin' (*the biblical 'Amraphel'*) ascended the throne of Ur while Ibruum went to Egypt where he stayed for 5 years before returning to Canaan with further troops.

Before long Amar-sin was under the beguiling influence of Inanna who guided him in forming a 'Coalition of Eastern Kings.' Amar-sin then launched a military incursion to gain control of the Sinai but the Coalition forces, led by an Elamite called 'Khedor-la'omer' were blocked by Abraham at the entrance to the spaceport. Then 3 years later Ama-sin was replaced as king by 'Shu-sin' however it was already clear that the Empire was beginning to disintegrate. Nine years later Shu-sin was also replaced by 'Ibbi-sin' but by this time many of the western provinces were becoming increasingly loyal to Marduk.

Marduk had not been idle in his absence and had been working in secret, gathering support for his cause for many years and by 2024 BC he reasoned that he was finally in a position to regain the control he felt he so deserved. Gathering all his followers and loyal supporters he marched on Sumer and took up the throne at Babylon, declaring himself as supreme ruler over earth and endowing upon himself the new title of "Ra". Enki begged his son to rethink his actions but Ra/Marduk then removed Nibiru's name from the creation epic (*Enuma Elish*) to be replaced by his own as the ultimate creator of all. He created a new 10 month calendar, taught his followers to follow the cycles of the Sun and declared himself to be "the Lord of All". He also had the image of his brother Thoth removed from the sphinx and replaced it with that of his slain son Asar. But he went too far when he declared his sons to be worthy of the life spans provided by a trip to the "Place of Everlasting Years" and partaking of the food and drink of Nibiru and then declared the Sinai Peninsula Spaceport to be the 'Duat', the gateway to heaven for all those loyal to him.

Elsewhere across the region, the fighting had spread across to central Mesopotamia and Ra's forces led by his son Nabu were quickly gaining the upper hand. But when the fighting finally reached as far as Nippur and the 'Holiest of Holies' was defiled in the Temple there it began to become too much for Enlil who demanded punishment for Ra and Nabu.

Enki desperately opposed the punishment and pleaded for clemency for his son Ra but another of Enki's sons, and Ra's own brother Nergal, agreed that this time Ra had gone too far and sided with his uncle Enlil. Anu hesitated in his decision, but when Ra's son Nabu began rallying his Canaanite followers in preparation to capture and control the spaceport and it became clear that all would soon be lost, Anu approved the use of the "Weapons of Terror".

Attacks were then launched by Nergal and Ninurta during which the spaceport and all the errant Canaanite cities were utterly decimated. But it had also been decreed that only those cities that were designated should be obliterated and the people at large must be spared.

The weapons they used numbered seven and Nergal and Ninurta were carefully instructed in their use. Enlil stressed to Ninurta that Ibruum/Abraham must be spared the destruction and that his line must survive at all cost. In the texts the Seven Weapons of Terror were given names by Nergal. The first he called *The One Without Rival*; the second: *The Blazing Flame*; the third was: *The One Who With Terror Crumbles*; the fourth: *The Mountain Melter*; fifth was: *Wind That The Rim Of The World Seeks*; the sixth weapon: *The One Who Above And Below No One Spares*; and the seventh weapon was filled with "Monstrous Venom" and named: *Vaporizer Of Living Things*.

Then at a sign from Enlil, Nergal and Ninurta unleashed the terrible power of the mighty weapons upon the targets they had chosen which were destroyed utterly in the ensuing blasts. However the Anunnaki themselves were unaware of the extent of the destruction they were about to unleash upon the world or of the long term consequences of their actions. Their main objective had been to quell the fighting once and for all but within one year a poisonous and radioactive cloud from the attacks had spread across all of Sumer, and Egypt killing thousands. The water

over all of Mesopotamia became contaminated; the animal life in the area died out and the soil became barren and lifeless.

Soon the once great civilization of Sumer lay broken and decimated, never to rise again.

The stronghold Ra had constructed at Babili survived the destruction. Enlil then relinquished dominion of the lands of the first region to Ra and continued the gold operations in the new lands.

And so ends the story of the Sumerians.

It is not stated in the text why the Anunnaki never returned to rebuild their civilization nor if they ever planned to return again. It would in some ways seem that they just preferred to wash their hands of the whole affair and simply leave man to his own devices.

But then things may not always be what they seem at first glance

Now, notwithstanding the fact that what has just been related to us sounds something like “Science Fiction meets Genesis vs. the Sun God”, this ancient Sumerian tale seems to be an awfully detailed account of planetary and genetic creation and massive wars that contains a striking number of recognizable biblical references and an extraordinary amount recently discovered scientific information – for a tale written on clay tablets from a civilization of around 6000 years ago! From people who weren’t supposed to know about the Giza Valley Complex in Egypt or about things like the 24 strand DNA ‘tree’ with its serpentine shape, or about genetic engineering, space travel, weapons of mass destruction, radiation fallout, the asteroid belt, advanced astronomy, the mysterious ‘Face on Mars’ or the fact that sea water contains the worlds largest gold deposits (*if we only knew how to extract it*). – Wouldn’t you agree?

And again I ask you to remember, and I cannot stress this point enough, that this remarkable story did not spring from some science fiction writer’s pen; but from clay tablets written by the ancient Sumerians of 6000 years ago.

As a point of interest, have you ever noticed that the modern medical symbol of two serpents intertwined around a dagger is an accurate depiction of DNA? The same symbol has been used since ancient times and yet DNA has only recently been discovered. The pure fact that such a symbol was chosen indicates that the information was likely once known but somehow forgotten since the intertwined symbol was adopted. The use of that particular design by the medical profession still today is far too great a coincidence to be lightly dismissed. Even the choice of the serpent is suggestive of Enki. Why use a serpent, why not use a vine?

There is a great deal more to the Sumerian story but a full account of the tale would fill this entire book.

Please understand that the story as it has just been presented to you is in a paraphrased and condensed form taken from translations of 6000 year old Sumerian tablets as presented to us by Zechariah Sitchin. I highly recommend reading Sitchin’s books ‘the Earth Chronicles’ for a far more detailed and comprehensive version.

I find it to be quite remarkable that the Sumerian texts mention the construction of a huge landing beacon in the Nile valley on such an old text. The beacon, named the EN.KUR which means “House that like a Mountain Is” in the Sumerian account is, I believe, the first mention of any construction in the Nile valley that appears in any histories.

As the texts abundantly show, the story of Adam being created from the clay of the ground as well as Adam and Eve’s expulsion from Eden after their encounter with the serpent and the discovery of sex, also has its roots in a Sumerian story dealing with a confrontation between Enlil and Enki that erupted when Enki gave the Adamu race the ability to procreate. This sexual ability is why the race was removed from the Edin facility. There have not been any Sumerian text found of the actual moment of expulsion as yet but a picture that has survived is interesting. It shows the confrontation between the “Lord God” (*Enlil depicted on the right*) and the “Serpent God” (*Enki depicted on the left*) and the offering of the forbidden fruit from the tree of life (*fig.123*).

As Sitchin points out, what makes this depiction particularly interesting is: "...it writes out, in archaic Sumerian" (as the star and triangle symbol resembling ↓) "the Gods epithet/name, the 'star' spells 'God' and the triangular symbol reads BUR, BURU, or BUZUR – all terms that make the epithet/name mean "God who Solves Secrets", "God of the Deep Mines", and variations thereof. The bible (in the original Hebrew) calls the God who tempted Eve 'Nachash' which has been translated as "Serpent" but the literal translation of Nachash also means 'He Who Solves Secrets' and 'He Who Knows Metals.' The connections are clear. This depiction is actually of particular interest because it shows the Serpent God with his hands and feet in tethers, suggesting that Enki may even have been arrested after his unauthorized deed.



Fig.123

*"In his anger, Enlil ordered the expulsion of the Adam – the Homo sapiens Earthling - from the E.Din ('The Abode of the Righteous Ones')"*

As previously mentioned one of Enki's epithets was "He Who Solves Secrets" thereby further identifying him as the biblical Nachash (*The Serpent*)

Sitchin also did well in verifying many of the Sumerian locations mentioned in the texts (*fig.124*). For example: He reasoned that if both the pre and post-diluvial flight paths were actually at 45 degrees to the 30<sup>th</sup> parallel, that if certain landmarks that the texts suggested really were the points that were used to triangulate the landings and that if seven vital control centres lay *along* the flight path as the texts also suggested, then locating them and the actual landing pad at Sippar, should be a reasonably straight forward and logical affair.

Sitchin indeed succeeded in locating all of the sites for the seven centres along the pre-diluvial flight path as his own diagrams show (*fig.125*) and then also located all the facilities along the post-diluvial flight path (*fig.126*) and lo and behold, at the exact point of the triangle where the Post-Diluvial Spaceport is said to have been, we find the ruins of Baalbeck with its huge cyclopean stone platform of ancient and completely unknown origin that local legends tell us was 'built by the Gods'

The evidence Sitchin has also provided to substantiate the claims made by the Sumerian texts is substantial to point of being overwhelming and I have little doubt that the events the Sumerians describe, and the scenario Sitchin purports, (*proves in this authors opinion*) will one day be accepted as solid fact.

And there is also the 6000 year old Sumerian account of the death of Alalu on Lahmu (*Mars*) to consider. We are told of him being placed in a cave beneath a mountain and of the Anunnaki carving the mountain into the likeness of his face wearing an 'Eagle Mask' (*Space Helmet*) gazing skyward. Could that be the real explanation of the enigmatic 'Face on Mars'? The unusual surface feature in the Cydonia region, though heavily eroded, certainly does not look natural in any way at all either in the first Viking Satellite photograph (*Fig.127*) or in the more recent ones

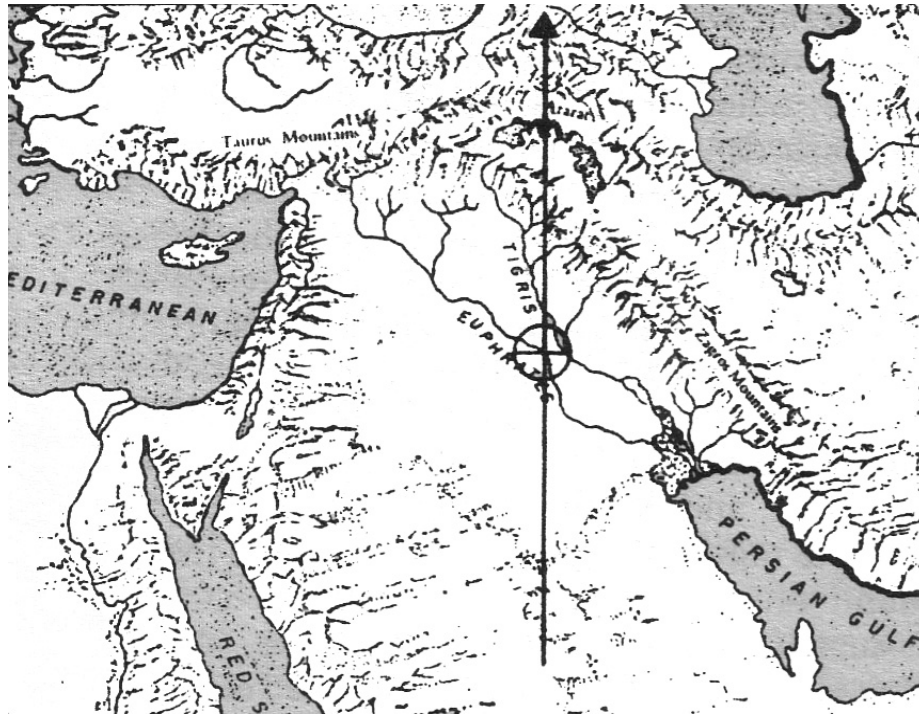

Fig.124

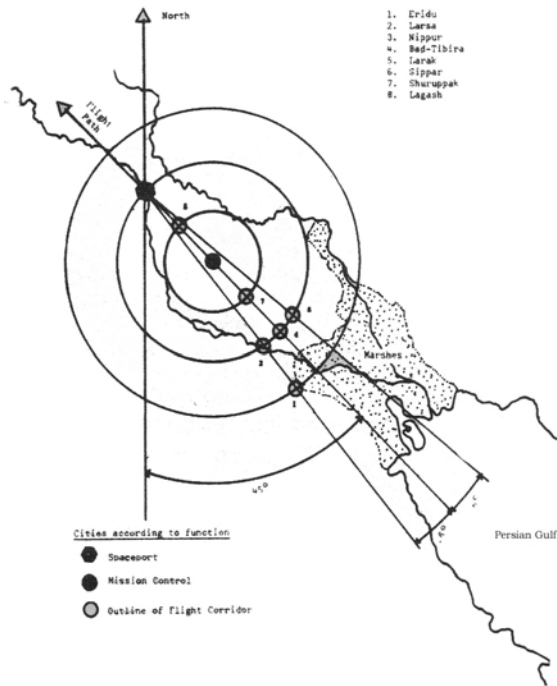

Fig.125

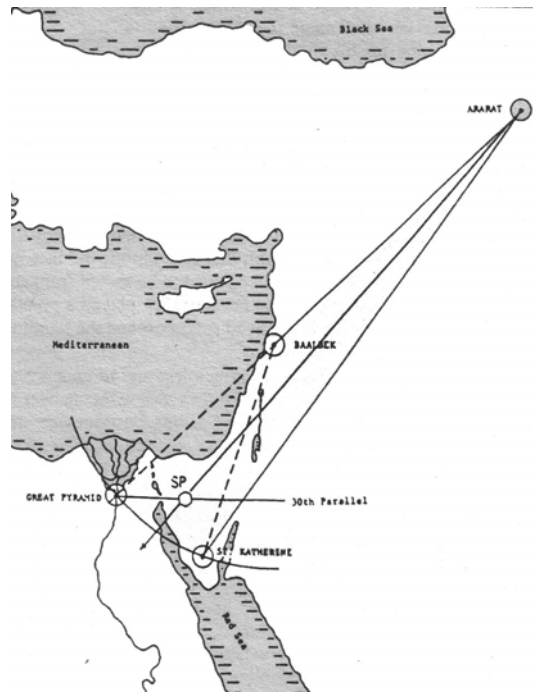

Fig.126

taken by the Mars Global Surveyor (*fig.128*). Especially strange is the perfectly edged 'helmet'.  
 And the 'way station' that is said to have existed in the vicinity, could this explain the strange pyramidal shapes nearby that look like purposely laid out structures? (*fig.129*) Maybe not, but the fact that the ancient Sumerians seemed to know of and mention such features is interesting none the less.

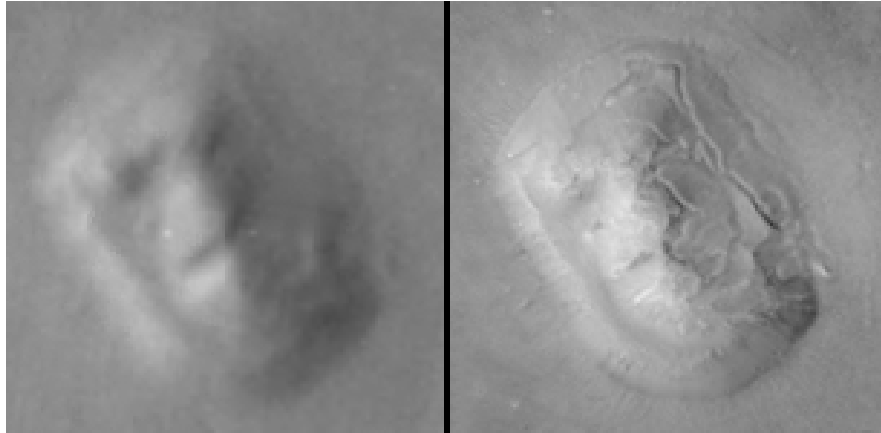

Fig.127

Fig.128



Fig.129

And there is another surprising little artifact of some interest, again presented to us by Sitchin: This comes in the form of an ancient coin that has survived from Byblos, a city that lies on the Mediterranean coast of Lebanon in the Mesopotamian area (*the biblical city of Gebal*).

The coin (*fig.130*) depicts the Temple of Ishtar which was originally the “Landing Place” constructed in the Cedar Mountains for Anu’s visit. In this ancient rendition of the temple we are shown a Grand Temple with a large courtyard behind it. In the courtyard we see a platform that looks as though it has been reinforced by cross-members. The courtyard area has a large wall around it forming an enclosure that can be reached a wide staircase and a large conical shaped object sits on the re-enforced platform dominating the engraving.

In all honesty, the depiction on the coin really does look very remarkably like a rocket ship sitting on a launch pad. Does this engraving show us the ruins that still remain at Baalbeck? (*Figs. 29, 30 & 31*) Is this coin an actual depiction of the huge cyclopean platform, reached by that monumental staircase - as it used to once be? Certainly it if it needed to be robust enough for a launch pad as the texts suggest, it would certainly help account as to why it was built as a 13 metre high, 88 x48 metre wide platform using *300 ton blocks* and why it may have been



necessary to incorporate those *800 ton blocks* into the retaining wall. Yes, I think it would make sense to do that.



Fig.130

The claims made by Sitchin in his translations of the ancient Sumerian texts are remarkable to say the least and the fact that these same stories were edited and condensed to produce the Christian tale of Genesis may come as a real shock to many of those of a religious nature yet as we can see the connections are obvious.

But could this tale be true?

Can the story they tell of ancient gods from another, planetary body with a vast elliptical orbit in any way be verified? The tale describes a race called the Anunnaki and says that their quest on this planet was the attainment of gold to protect the eroding atmosphere on their own planet.

Could it be true?

In an attempt to find answers to these questions we must first look to another enigmatic culture.



## Chapter Ten

# The Maya



### *The Story of the Maya*

The mysterious Mayan civilization existed in South America from sometime before 500B.C. evolving through the Olmecs, the Toltecs, the Mayans and the Aztecs, who held power over the lands until the arrival of the Spanish. A complete run down of the History of the Maya is not required for the purposes of this work however a brief history is in order.

Like that of ancient Egypt, the civilization of the Mayans is one that seems to have sprung 'full blown' into existence. There is no period of development, suddenly it was just 'there!' Though unfortunately there exists now only very little information at all about the actual Civilization due to the brutal irresponsible acts committed by the Spanish Conquistadors under the callous leadership of Hernando Cortez in their invasion, destruction and vandalism of the Empire in 1519 A.D. In their Ego and greed, the Spanish invaders sought to thoroughly loot the whole country, kill or enslave the entire population and systematically destroy every trace of the culture in the name of Spain, the Roman Catholic Church and of course, gold.

But just stop and think about that for a minute –

Why gold?

Gold has always been considered a prize throughout our entire history. It is but a soft yellow metal of little practical use, yet it has always been considered worthy of invasion, war or even murder to obtain. Few substances on earth can arouse more lust or greed in the hearts of men.

Why?

Why was gold, a metal for which there was no real use for in the ancient past, ever considered to be so valuable? It is soft and can be polished. Its great stuff for making pretty trinkets from but it is virtually useless in regards to any practical application. It's much too soft to be used for items that would have been considered of value in the past such, as weapons or armor, or for use in building or industry or really for anything but decoration. Of course it has unique electrical properties but would people in ancient have known or needed that?

How and why could gold have ever served any useful purpose to have been deemed so valuable and sought after in such remote and ancient times?

The Aztecs used no form of money or metal tools yet when the Spanish arrived they were astounded and amazed by the beauty and sheer volume of treasures the Indians possessed. When they arrived at Cuzco they found a city that was quite literally covered with gold, even the

buildings. The complex contained a garden where the plants, birds, insects and even a fountain were all fashioned from pure gold in intricate detail. The main temple had a courtyard in which there stood a field of maize of which every stalk was fashioned from silver and the ears of corn from pure gold. The yard contained an amazing 180,000 square feet of golden and silver corn!

Every year, gold was brought by his subjects and paid in tribute to the king but none was ever allowed to leave Cuzco, under pain of death. There in Cuzco it was held in storage for the gods to whom the people believed it actually belonged and who would one day return to claim it. Many of the buildings in Cuzco were also draped with decorated gold sheeting fashioned into elaborate plaques and fixed to the walls by silver nails. The nails that were removed from one Temple alone in Cuzco, weighed in excess of 13,000 ounces of silver.

During the subsequent looting of the civilization by the Spanish, in what can only be described as one of the greatest acts of cultural vandalism in our history, over a period of about 10 years upwards of 11,000,000 ounces of golden artifacts were melted down and sent to Spain as gold bullion. Between 1519 and 1749 some 300,000,000 ounces of gold were pillaged and removed from the country.

Yet despite all of this vast wealth of precious metal the civilizations of South America used no currency and remained completely unaware of the concept of money. And though master goldsmiths, they also possessed no knowledge of metal tools.

So, without metal tools, how did they produce megalithic structures? How were they able to obtain such vast quantities of gold if they were unable to mine it? And why have there been found the traces of ancient mines in the region? If they were not mined by the Indians then by whom were they made? What were the enigmatic sites of Cuzco and Tiahuanaco on the shores of Lake Titicaca used with their myriad of underground tunnel systems used for? Why were they built in such an inaccessible region?

The answers to these questions still puzzle many scholars and the actual recorded accounts that have survived are extremely limited. South American civilization was totally decimated within ten years of the Spanish landing, except for possibly one or two strongholds the Spanish did not manage to find and much of the Mayan history and culture was recorded on the elaborate gold plaques and Stele that were stolen and removed by the Spanish who melted most of what they found into ingots for shipment back to Spain.

Many papyrus scrolls had also once existed but the Religious culture of the South American Indians was so different and so bizarre with its strange, sometimes even Christian beliefs and conflicted with the Roman Catholic Church in so many ways that the very existence of the texts and even the Mayan language itself was considered to be an abomination and the first Archbishop of Mexico is claimed to have burned tens of thousands of such scrolls in the 1500's.

To the Catholic Spanish, the beliefs of the Natives appeared as some horrible travesty of Christianity because the Mayan religious system did actually contain many elements that can be found in Christianity but by the time of the Aztec rule, many new rites involving other much more barbarous practices had also been introduced and the two opposing belief systems had become intertwined. The Spanish were also convinced that the Megalithic structures of the civilization had undoubtedly been built by demons and there were some priests who even believed the Devil himself had created the entire culture and religious system in a heinous mockery of Christianity that assured the pagan souls of the Natives would be more effectively damned to an eternity in hell. Due to this attitude, apart from a few Temple inscriptions, today only four Mayan books remain. These were saved and smuggled away by an honest priest who could see the historical significance of the culture and the evil that had been wrought on the Natives by his people in the name of his church.

These four books are called: the Dresden Codex, The Paris Codex, the Madrid Codex and the Grolier Codex.

So how was it, that Cortez and his men were able to destroy the Mayan Empire so completely and so effectively? It happened so quickly that it would almost seem that they had 'God on their

side,' and in a way it could be said that they did, because in a simple case of mistaken identity, the Aztecs opened their doors and welcomed the murderous Spaniard invaders right into their midst as honored guests and even held a mighty banquet in honor of their arrival.

The arrival of the Spanish Conquistadors was perceived to be a great and long-awaited day by the Aztecs and many people came to the banquet to greet and honor the visitors. But when the Spanish arrived at the Aztec city and saw the riches that adorned it the cunning Conquistadors placed armed guards on all the doors of the banquet hall and slaughtered the entire gathering of unarmed Natives with sword, axe and musket and then brutally looted the city showing no mercy to the inhabitants. One of the most brutal and merciless was a commander named Francisco Pizarro who became almost obsessed with finding a mythical city of gold that the Spanish called 'El Dorado' – City of the Golden man. *(There are some fascinating and details tales regarding this 'Golden King' but their inclusion in this book is unnecessary for this story.)*

The story of the Spanish conquests is quite detailed and very tragic but to put it all in a greatly simplified nutshell, eventually through a series of ignoble events the Spanish succeeded in taking the Aztec king Montezuma as hostage and demanded no less than a room full of gold to secure the king's release *(a very large room, actually more like a small hall)*. The people complied with their demands, but when the Spanish saw how easily the ransom was raised they demanded more and again his subjects brought the gold for the invaders. But no matter how much gold the people brought to secure the release of their king, the Spanish kept their king imprisoned and continued demanding more; in fact so much, that they earned the nickname "the gold-eaters" from the Natives who felt certain the Spanish must use the yellow metal for food, so great was their need for it.

When it became obvious to them that the Spanish would never free their king, so great was their lust for more gold, the Aztecs gathered all their remaining treasures and hid them away from the Spanish in a secret place where it still remains, hidden and still undiscovered to this day.

Montezuma was eventually beheaded by the Conquistadors even after the ransom was paid many times over and it is likely that it was never Cortez's intention to release him.

But why did the poor Aztecs welcome the ruthless and gold hungry Spanish so freely and openly into their midst and then comply so readily to their ruthless demands?

It's because the very day that Cortez arrived on their shores, it was a very significant date in a very significant year and in reality they were actually already expecting a long anticipated visit from someone else.

### **The Luck of Cortez**

The ancient legends of the South Americas talk of a visitor that had once come to their shores. The exact date of the arrival of this mysterious stranger has been heavily debated, many scholars believe it to have most likely been sometime after 500 BC, but there is other evidence to suggest it may even have been a great deal earlier than that. The visitor is described as a man "bearded and fair-skinned" who dressed in flowing garments marked all over with crosses.

The legends call him 'Quetzalcoatl' and describe him as a God of learning and life; a great leader and teacher of infinite wisdom. One legend has it that Quetzalcoatl came to their shores on a "Raft of Feathered Serpents" that was drawn by clouds and later disappeared on such a raft, saying to them upon his departure that he would return one day to reclaim his throne and depose his enemies. The name Quetzalcoatl itself translates as "Plumed Serpent".

Quetzalcoatl is said to have shown them how to plant corn and grow crops, *(something which greatly changed their quality of life)*. They say he taught them writing and the Calendar; it was Quetzalcoatl, say the Mayans, who taught them to build and it was he who constructed their wondrous megalithic structures. He is described by them as "the author of all activities that are beneficial to man", a person of great wisdom who lived by a strict moral code, forsaking all intoxicating or carnal pleasures.

The reasons for his departure are unclear. One legend tells that one day Quetzalcoatl was tricked into acts of lewdness by a rival who had disguised an intoxicating potion as medicine and convinced him to drink plenty of the draught. When he awoke the next day to find what he had done he was greatly shamed by his actions and left the Mayan shores, but vowed to one day return and reclaim his kingship. Another legend holds that he was needed elsewhere and sailed away northward and there are others giving various reasons as to why he left.

For whatever the reason, Quetzalcoatl eventually left South America but upon his departure he said to the Mayans that he would return to their shores one day and told them to look for his arrival on the day of 'nine wind' (*April 22<sup>nd</sup>*) in the year of the Reed. A reed year occurs once every 52 years in the Mayan Calendar. Most legends say that when Quetzalcoatl left on his raft of feathered serpents he sailed back to his home, a land that lay to the north while his followers shot flaming arrows into the air to mark their way as he left, leaving *fiery cross-like patterns* in the sky. Some stories say that he flashed into the heavens to become the morning star.

When Cortez arrived on those same shores in 1519 it was in the year of the reed, and not only that but it was April 22<sup>nd</sup>, the very day that Quetzalcoatl was predicted to return. On that most fateful of days Montezuma's scouts had hastily run to deliver news to him that sentries along their eastern coast had seen floating Palaces propelled by billowing white clouds arriving at their shores in the morning mists. The clouds had large *fire red crosses* on them and flames erupted from the bellies of the palaces followed by the sounds of roaring thunder. They told the king that when the palaces had at last come to land all kinds of strange creatures had emerged from their bellies: Some half man and half metal, others with six legs and two heads, some with strange sticks that poured out fire and death and with them were huge and savage beasts that foamed at the mouth. Yet all these creatures paid homage to one figure that stood in the center, a man all clad in metal, *bearded and fair-skinned*. It could only be Quetzalcoatl!

For the Mayans had never seen sailing ships, cannons, guns and men in armor or on horseback before. (*To the Mayans, a man on a horse may well appear at first to be a creature with six legs & two heads, one that foamed at the mouth*). They believed that such amazing things could only possibly mean the return of their great teacher and leader and they were very anxious not to offend him and welcome him in a manner befitting such a great one. Montezuma himself was quite apprehensive about the return of Quetzalcoatl because when he had left, he had sworn to take vengeance on those who had betrayed him and since his departure the Mayans had turned from his teachings somewhat and begun barbaric practices and even human sacrifices were now commonplace. Montezuma knew that Quetzalcoatl would be greatly angered by such activity and expected him to exact retribution.

When Cortez arrived the Mayans hastily presented him with the crown of Quetzalcoatl which was a huge plumed and golden headdress and they bowed before him. The decorative headdress was immediately sent back to Spain and can still be found today in the Spanish Museum.

Had it not been the 22<sup>nd</sup> of April on a Reed Year perhaps more precautions would have been taken in approaching the strangers, but the Mayans were unwilling to appear rude to a God.

Never could the poor Maya have been more sadly mistaken, to their peril, ruin and death.

### **Quetzalcoatl**

So who exactly was Quetzalcoatl, this ancient and most mysterious of benefactors? Numerous legends tell us that a person called Manco Capac was the legendary founder of the South American civilization. The event is said to have begun with a ceremony on Lake Titicaca and the presentation by Quetzalcoatl/Viracocha of a golden wand to Manco Capac with who was then told to go forth and found the civilization. This legend indicates that Quetzalcoatl did not just arrive and improve the Mayan civilization; he was there at its inception. In fact this legend even suggests that the entire thing was probably Quetzalcoatl's idea in the first place!

There has always been a great deal of confusion as to the actual identity of this enigmatic teacher of the Mayans and much argument over who Quetzalcoatl really was or even whether he was a real figure at all. However it is reasonable to assume that he was indeed an actual character because of the detailed descriptions of him that were preserved in Mayan traditions. It's unlikely that the Mayans would have fabricated a pale skinned, bearded god of western appearance if they had not actually once seen a person fitting that description as it is completely contrary to the appearance of the dark skinned and beardless Mayans.

There also exists a stele depicting Quetzalcoatl. The relief clearly depicts a bearded person of western appearance (*fig.131*). There is also a character of extremely similar features that is described in many other South American cultures. All of these characters are pale skinned and bearded, all dress in long flowing, robe-like garments and all are said to have appeared suddenly, imparted great knowledge and wisdom on the civilizations they visited and then departed. In all instances the man was said to be traveling north when he departed and all of these legends associate the figure with 'feathered serpents' in some way.

This same character has been known as: Quetzalcoatl in Cholula; Votan in Chiapas; Wixpepecha in Oaxaca; Viracocha in Peru; Bochica in Columbia; Zamma and Kukulcan in Yucatan; Sume and Paye-Tome in Brazil and Gucumatz in Guatemala. The similarities in the stories from all of these places give weight to the very real possibility that such a person did actually once exist.

One early and very well researched article that contained some quite well reasoned insights into Quetzalcoatl was written by a man named Dominick Daly. The article was first published in a November issue of '*American Antiquarian*' in 1880 and later reprinted in '*The Unexplained*' by William Corliss and again in '*Lost Cities of North and Central America*,' a very informative book by David Hatcher-Childress. In the article Daly had this to say:

"The Mexicans had preserved a minute and apparently an accurate description of the personal appearance and habits of Quetzalcoatl. He was a white man, advanced in years and tall in stature. His forehead was broad; He had a large black beard and black hair. He is described as dressing in a long garment, over which there was a mantle marked with crosses. This is a description which was preserved for centuries in the traditions of a people who had no intercourse with or knowledge of Europe, who had never seen a white man, and who were themselves dark skinned, with but few scanty hairs on the skin to represent a beard.

"It is therefore difficult to suppose that this curiously accurate portraiture of Quetzalcoatl as an early European Ecclesiastic was a mere invention in all its parts – a mere fable which happened to hit on every particular characteristic of such an individual. Nor is it easier to understand why the early Mexicans would have been at pains to invent a messiah so different to themselves and with such peculiar attributes. Yet despite of destructive wars, revolutions and invasions – in spite of the breaking up and dispersal of tribes and nations, the traditions of Quetzalcoatl and the account of his personal peculiarities survived among the people until the days of the Spanish Invasion.

"... Enough remained of the teachings of Quetzalcoatl to impress the Spaniards of the sixteenth century with the belief that he must have been a native of Europe. They found that many of the religious beliefs of the Mexicans bore an unaccountable resemblance to those of Christians. The Spanish ecclesiastics in particular were astounded by what they saw and knew not what to make of it. Some of them supposed that St. Thomas 'the apostle of India' had been in the country and imparted a knowledge of Christianity to the people; others with pious horror and in mental bewilderment declared that the Evil One himself had set up a travesty of the Religion of Christ for the more effectual damning of the souls of the pagan Mexicans.

"The religion of the Mexicans as the Spanish found it was in truth an amazing and most unnatural combination of what appeared to be Christian beliefs and Christian virtues and morality with the bloody rites and idolatrous practices of pagan barbarians. The mystery was soon explained to the Spaniards by the Mexicans themselves. The milder part of the Mexican religion was that which Quetzalcoatl had taught them. He had taught it to the Toltecs, a people who had

ruled Mexico some centuries before the arrival of the Spaniards. The Aztecs were in possession of power when the Spaniards came and it was they who introduced that part of the Mexican Religion which was in such strong contrast to the religion established by Quetzalcoatl.



Fig.131

“...The Mexicans believed in a universal deluge, from which only one family (that of Coxcox) escaped. Nevertheless and inconsistently enough with this they also spoke of a race of wicked giants, who had survived the flood and built a pyramid in order to reach the clouds; but the gods frustrated their designs and rained fire down upon it..

“...Whether due to teachings or to accidental coincidence, it is certain the Mexicans held many points of belief in common with the Christians. They believed in the trinity, the incarnation and apparently the redemption.”

So who was this mysterious teacher? There are many who have speculated that he was indeed an early Christian missionary and some who have even dared to suggest that it may have even been Christ during one of his journeys, such people have pointed to the similarities in the phonetic rendering of the two names Quetzal Coatl – Jesus Christ.

According to most records, Jesus traveled extensively in the years prior to his ministry, visiting, among other places, Egypt, Tibet and India to study with the yogi's. It has even quite often been speculated that he did not in fact die cross and continued his travels after the resurrection. Such an idea was explored in Robert Bauval's excellent book *'The Holy Blood & The Holy Grail'* and more recently in *'The DaVinci Code.'*

As repellent as the idea may be to some people, it does actually have some merit when one considers the events surrounding the crucifixion as they have been presented to us.

In *'Lost Cities of North and Central America,'* David Hatcher-Childress made some striking observations. He comments:

“The crucifixion of Jesus was a curious event. ...a case can be made that he was not meant to die on the cross. It was customary in Roman times to break the legs and arms of persons who had died on the cross (usually by starvation or by suffocation from the ribcage pressing down on the lungs). It was also customary for all prisoners to be taken down from their crosses just prior to the Sabbath, which starts on Friday at dusk. Jesus was nailed to the cross in the early afternoon of a Friday and taken down just before dusk, having been crucified for as little as 4 or 5 hours, during which time he ‘gave up the ghost.’

“It is rather remarkable that a person with the vitality and yogic powers as Jesus would die within a few hours on a cross when most criminals took several days to die. Persons are crucified every year in such diverse places as the Philippines and Mexico in commemoration of the event, all of them coming through quite safely. Crucifixion does not kill a person in four hours.

“It seems more possible that Jesus, who had undoubtedly studied certain forms of yoga, was able to go into an altered state of consciousness, a deep mental state, where he would appear dead to any person, including a doctor.

“Such states are not uncommon and are generally known as catalepsy and even today, yogi’s, in the Himalayas and elsewhere, are still performing such feats.

“The crucifixion of Jesus is a remarkable affair and fraught with interesting contradictions and interpretations. It is worth noting that when Jesus said on the cross ‘My God, my God, what hast thou forsaken me?’ he was drawing attention to the 22<sup>nd</sup> psalm. At that time, it was common for scholars to refer to a whole verse by quoting the first line, as everyone knew the Old Testament by heart. The 22<sup>nd</sup> psalm, written by King David goes on to say in the 16<sup>th</sup> verse:

“ ‘a company of evildoers encircles me; they have pierced my hands and feet – I can count all my bones – they stare and gloat over me; they divide my garments among them, and for my raiment they cast lots. But thou, Lord, be not far off...’

“Therefore it would appear that Jesus was not in despair, but was instead drawing attention to the 22<sup>nd</sup> psalm as a prophecy of the terrible wrong that was being committed against him. Taken down from the cross at dusk, Jesus appeared to be dead. His mother Mary and Joseph of Arimathea, stood by to claim the body which was ‘not pulverized’ (i.e. Had its bones broken) as was the Roman tradition. Instead, they wrapped the body in a shroud after they had covered it with aloe sap, known for its natural healing qualities. Jesus had been pierced in the side by a spear, and was bleeding, which is rather suspicious, since a dead person does not bleed after his heart has stopped.

“The possibility that Jesus survived the crucifixion seems a credible one. In fact, what is incredible, is that someone with the vitality and personal power of Jesus would have died on the cross in such a short time. More likely, he could have lasted many days, probably outliving common criminals.”

So with all this being the case, what actually did happen to Jesus after the crucifixion? Many claim there is evidence to suggest that Quetzalcoatl may well have been Jesus. Others have speculated that it may also have been the Irish saint, St. Brendan or that possibly the two were traveling together as Quetzalcoatl did not travel alone but did in fact have an ‘entourage’ of sorts. There are also rock carvings and stele that exists depicting a South American man wearing an earring sporting a Christian ‘Star of David’ symbol (*fig.132*). Could this be a coincidence or could it be something more?.

In a further deepening of the mystery there is still other evidence to suggest that Quetzalcoatl may well have had an Egyptian connection.

In ‘*The Fingerprints of the Gods*’ the author Graham Hancock suggested the figure was the Egyptian deity Osiris, who was also reported to have made many peregrinations in order to impart what wisdom he could on other less fortunate races. This is quite interesting because there have



often been rumors in south American tales that Quetzalcoatl never returned as promised because he was in fact brutally killed by his brother and in the stories we find pertaining to Osiris we find that he is reported to have traveled widely doing the very things that Quetzalcoatl is said to have done only upon his return to Egypt (*which also lies in a northerly direction from the Mayan cities*) he was killed and dismembered by his jealous brother Seth.

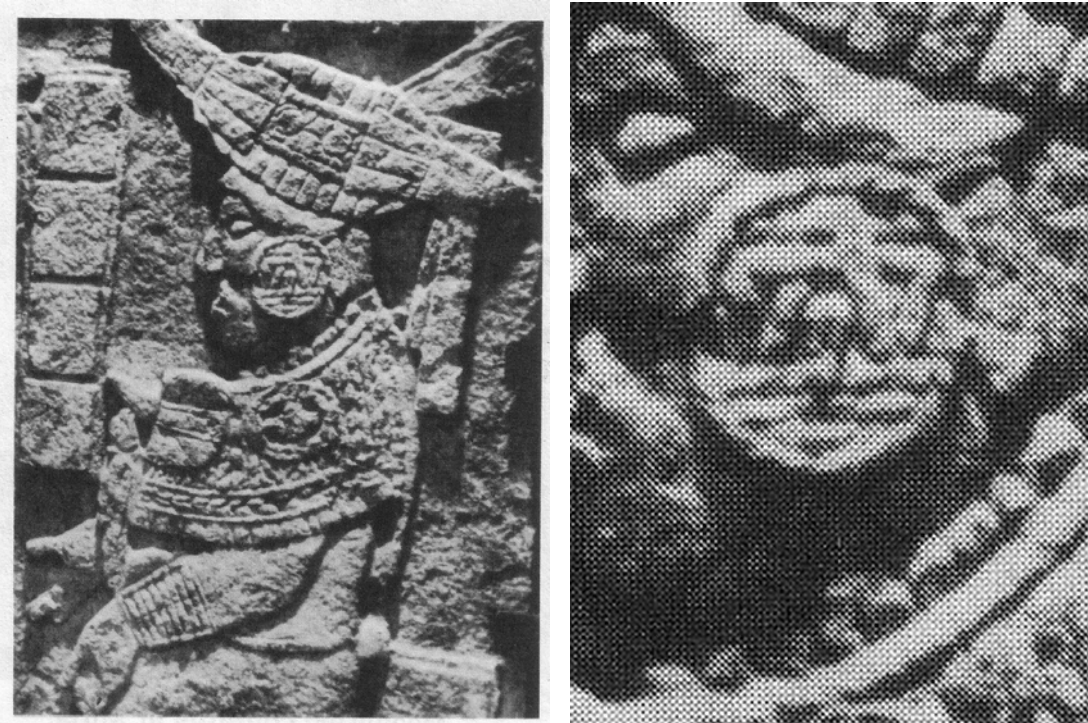

Fig.132

This information is all very interesting but it does not give any concrete clues as to who Quetzalcoatl actually was or any clues as to the real identity of Manco Capac. But what are we to make of the South American race themselves? In fact, what about all the tribal races of the Americas – Where did they originate? Where else in the world can be found a race of darker skinned beardless humans?

Lack of facial hair is a genetic trait that is completely unique to the races of the Americas and this fact in itself can provide us with an important clue to these questions

If we now return to biblical accounts, we are told in Genesis that following the death of Abel, God placed a mark on Cain so that he and his descendents would always be known from other races. This mark of Cain has always been colorfully depicted by institutions such as Hollywood as being in the nature of a tattoo on his forehead.

Such an idea is of course extremely unlikely as any type of physical mark would never have sufficed to also deal with his descendents. It is therefore much more reasonable to assume that if such a mark was indeed placed upon a man *and his descendents* then it would have to have been a genetic mark that would therefore have been passed on to his descendents via his genes.

Such a mark could well be the inability to grow facial hair.

It is quite noteworthy that despite of the numerous genetic differences between the Caucasian, Negroid, Mongoloid and Oriental races the only people to be found anywhere in the world that lack facial hair are the tribes of the Americas.

The bible informs us that Cain was given a mark by God and then cast out to 'wander in distant lands'. We are also informed that when Cain left he built a new city, which also indicates that he took people with him when he left. This in turn suggests that the biblical creation of Adam was

not referring to the creation of just one man and one woman but in fact to the creation of the race of Adam, the creation of *the* Adam, the Adamu, the race we are told of in Sumerian texts.

It is this author's opinion, and the opinion of many others, that the tribes of the Americas are indeed the descendents of the biblical Cain – the ten lost tribes of Israel spoken of in biblical texts and that after the deluge of circa 11,500 BC, it was one of Cain's surviving descendents who became the enigmatic Manco Capac.

I am also of the opinion that Quetzalcoatl was in reality, none other than the actual Egyptian deity known to us as Thoth, the God of Science and numbers, also known as Hermes in Greek and as the Sumerian God Ningishzidda, brother of Ra/Marduk and son of the great god of science known in Sumer as Enki, in Egypt as Ptah, and in Biblical tales as the Serpent.

And in fact, as we shall see, the Egyptian and Sumerian connections to the ancient civilizations of South America can be readily proven.



Part Three

# Analysis

“When the going gets weird,  
The weird turn Pro.”

- Hunter S. Thompson

# Creation Connections

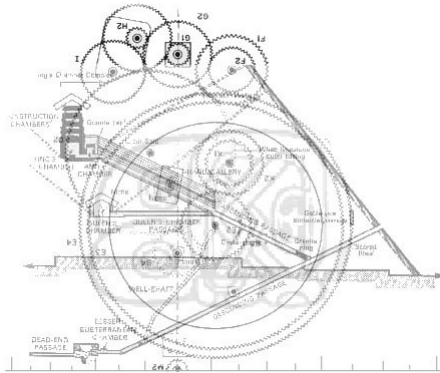

As has been repeatedly said throughout this work, scholars now agree that both the biblical and Babylonian accounts of creation are borrowed from Sumerian tales and as we have seen, it is also undeniable that traces of the Sumerian story can still be found within the general narrative of the bible. As we have previously noted, it all lies in the translation. The example of Hebrew word ‘Rakia’ easily translates to both ‘firmament’ interpreted by Christians as Heaven, and ‘Hammered Bracelet’ which adequately describes the asteroid belt.

These translational errors can also be seen in the biblical account of the creation of Eve from a rib of Adam. As aptly demonstrated by Sitchin: In the original Sumerian account Eve (*Ti-Amat*) is created from the *ti* of Adam. *Ti* can be translated as both ‘rib’ and as ‘life’. So in fact the Biblical account may well be a play on words and the correct translation may actually be that Eve was created from the *life* of Adam, essentially his “essence” which also fits nicely with the Sumerian account and strongly hints at genetic engineering and the manipulation of DNA. ‘Nachash’ has been translated as serpent and interpreted as a snake by Christians yet we have seen that it also means ‘He who solves Secrets’ and “He who knows Metals’ and was in fact an Epithet of the Sumerian God Enki.

We have also seen Sitchin's claim that the tale of the serpent, the tree of life and the expulsion from Eden were known about in Sumer is also undeniable as it is documented and depicted on cylinder seals as shown in fig.105. Even the name Eden can be seen as an obvious reference to the Anunnaki medical center in Mesopotamia mentioned in Sumerian texts which was called the E.DIN. And again it is there in the biblical account of Adam which can be seen as an obvious derivation of the Sumerian account of the Adamu created by Ninmah through genetic manipulation and even inclusion of clay in the successful result. The number of ‘coincidences’ are just too great to ignore. The Sumerians also claim that the Earth and the Hammered Heaven was created by a Celestial body with a vast elongated orbit.

Sitchin believes that the civilization of South America was in fact the civilization that was said to have been established in the ‘third region’ by those based in the Persian Gulf – the Gods, with Sumer being the first region, Egypt the second region, while the fourth region, the Sinai Peninsula, was ‘retained by the Gods’.

According to his calculations, the deity known as Thoth, (*also known as Ningishzidda and Hermes*) ruled Egypt for a time until he was deposed by his brother Ra, (*also known as Marduk*).

This event is said to have occurred in 3115 B.C. significantly, just two years before the Mayan Calendar was started in 3113 B.C. If the Sumerian account is true then it is quite reasonable to assume that upon fleeing his brother Ra in Egypt the most logical place for him to have first gone to seek refuge was the abode of his father who had already set up a substantial operations center in the Abzu which has now been identified as Southern Africa. It is quite possible that then gathered supplies, assembled a group of followers and made his way to South America to become known as Quetzalcoatl, the feathered serpent. It's also reasonable to assume that if such an event occurred then we should find traces of it – which indeed we do.

One tantalizing hint of this is the remarkable fact that the Mayan calendar was started on 3113 B.C. which coincides very closely with the date that Thoth is reported to have fled Egypt, in fact just two years later. This makes it highly likely that the Mayan Calendar and long count were also begun by the Great Master of science and Mathematics Thoth. Further weight is added to this claim by the fact that Ancient Sumerian, Akkadian and Egyptian texts all indicate that it was also he who began the first Sumerian calendar in Nippur. Under scrutiny the Mayan Calendar can also be seen to have many similarities to the calendar of Nippur. Too many to be mere coincidence.

There is also the fact that the original builders of many of the most ancient sites attributed to the Mayan culture were in fact the mysterious Olmecs and it is now obvious the Olmecs were of African descent. This is made abundantly clear by depictions on ancient Olmec Stele. Many of these depict animals that are totally unknown in South America, such as elephants and giraffes, plus the ethnicity of the race can easily be ascertained from the bizarre and very enigmatic Olmec Heads that have been found scattered through the South American jungle (*fig.134*) simply by comparing the features to those of a normal African Male (*fig.133*).



Fig.133



Fig.134

Of particular interest however, are the tales pertaining to the legendary father of the South American civilization, Manco Capac who stories tell us was presented with a golden wand by Viracocha or Quetzalcoatl (*who were most likely one and the same*) with which to found the civilization in a ceremony on the island of the Sun on Lake Titicaca high in the Andes.

### **Manco Capac & The Golden Wand**

There are a number of different variations on the tale of Manco Capac but the gist of the story is that Manco Capac was a south American survivor of the deluge. Far back in time on an island on Lake Titicaca, he was given a golden object by the Gods and told to go forth from there and find a place where the object would 'sink into the ground' and in that place he was to found a new city and a new civilization. The place that he founded was Cuzco.

The elaborate ceremony involved the presentation of a golden wand to Manco Capac from Viracocha /Quetzalcoatl. The wand Manco Capac was given then enabled him to found the great

civilizations of the Andes. It has also been adequately confirmed by scholars that the Andean civilization did indeed sprout from Lake Titicaca and Cuzco.

This enigmatic wand object given to Manco Capac, an object which enabled him to found a city, has always been depicted as resembling a short pole with an offset triangular head. Judging from all the existing depictions of this wand, it is now agreed by most scholars that it was in fact an object greatly resembling an axe or mattock. So it then seems highly likely that the ceremony actually involved the presentation of tools and the knowledge of how to use them. Certainly such a gift would have been much more beneficial in the founding of a city than any type of wand that comes to mind. Many of the illustrations we are shown of Manco Capac also re-enforce this conclusion (*fig.135*). A great deal of significance is placed on this presentation of *tools* in the legend and the fact that it was tools that were being presented on the celebrated occasion also strongly suggests that Quetzalcoatl had another agenda other than merely the founding of a city.



Fig.135

Quetzalcoatl telling Manco Capac to found a city at a place where his axe or mattock would “sink into the ground” also suggests a need to find a place to dig. Manco Capac may have well been told to find a suitable place to build a city in a location conducive to the commencement of mining or tunneling operations.

The Sumerian account translated by Sitchin has led him to believe that the entire Cuzco and Tiahuanaco facilities were set up as sophisticated ore refining facilities involved mainly with the collection and shipment of gold to Nibiru and the refining manufacture and distribution of bronze due to ongoing troubles that had been manifesting in Mesopotamia at the time. Surprisingly, there is a substantial amount of evidence to re-enforce this conclusion.

Quite noticeably, many stones at the site do actually still have traces of ‘H’ shaped bronze ‘clamps’ that were used in places to keep the blocks in place by fitting into special  $\perp$  shaped cutouts in the blocks themselves (*fig.136*). At yet we are repeatedly told by academics that the only metal the Indians used was gold and that they used no metal tools. So how then did the bronze clamps found in Mayan ruins come into being? Clamps that have been found in Mayan ruins are incidentally, exactly the same as those that have been found in Mesopotamia, even

containing the same amounts of copper, again strongly suggesting a connection between two cultures.

In his book *‘The Lost Realms’* Sitchin also points to the fact that beneath Tiahuanaco are a series of complicated tunnels and sluice sections lined with smoothed Mica obviously made for channeling waters that would have been ideal for the refining and separation of minerals and trace elements from various ores. Sitchin goes into a great deal of detail and presents some dramatic evidence to support his hypothesis of these mining operations but it is not the purpose of this work to present to you the abundant wealth of supporting evidence that is presented in his books but merely to alert you of the validity of his research. I highly recommend reading his books.

The evidence he presents to support his conclusions is amply proven in his book *‘The Lost Realms’* but a presentation of some of the more obvious facts may be in order.

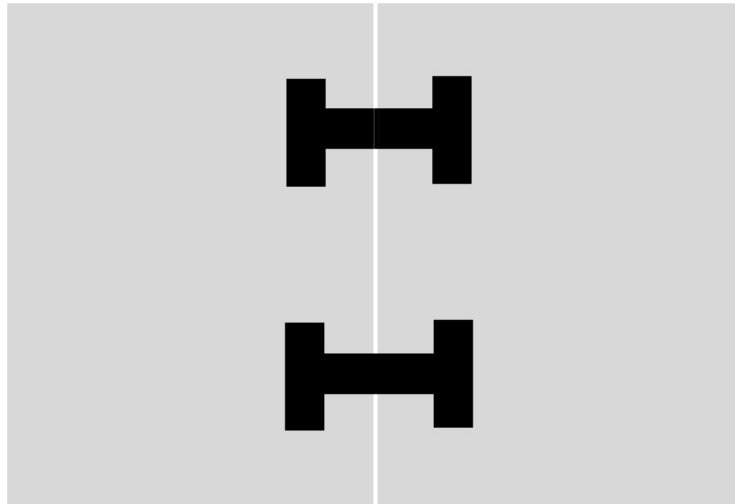

Fig.136

### **Connecting the Dots**

Returning first to the possibility that the tribes of the Americas are indeed the lost tribes of Israel and the descendents of the biblical Cain we can consider this verse from Genesis:

And Cain went away from the presence of Yahweh  
And dwelt in the land of Nod, east of Eden,  
And Cain knew his wife and she bore him Enoch  
And he built a city  
And called the city by his sons name, Enoch

The Aztec capital was called Tenochtitlan, literally meaning ‘City of Tenoch’. The city is thought by many to have been built by a leader who named it after himself but they fail to further take into account that the Aztecs used to refer to themselves as *‘Tenochas’* meaning the descendents of Tenoch. For this reason many others consider Tenoch to have been a founding father of some kind in the far distant past. When one considers the Aztec custom of prefixing many of their people and place names with the letter T, it is not unreasonable to suggest that Tenoch may have actually been the Biblical Enoch the actual son of Cain.

To investigate the possibility of this we only need to examine the myths and cosmology of the South American legend to see if any relationships can be found.

The oldest civilization we have any real records of is the culture of Sumer and the fact that the people of Ancient Sumer had advanced astronomical knowledge is certain. Now we find that the people who inhabited the ancient and enigmatic civilizations of South America possessed exactly the same knowledge exactly as it was known in Sumer. This fact is also certain and can be readily

proven. Such unique calendar systems for example prove that they had contact with and retained tales from the civilization that existed in ancient Sumer. For example as with the calendar started in Sumer, the Mayan calendar has 52 weeks and there is also the sacred cycle of 52 year. The sacred number of Thoth was also 52 and there is a legend of a special 'game of 52' that Thoth would play.

The ancient Sumerians had knowledge of all the planets of our solar system, even the one whose presence has only just been confirmed in late 2005. They even knew the positions and relative sizes of them as depictions of them on cylinder seals and clay tablets clearly show and these claims can be readily confirmed by simply studying the Sumerian seals. Very notably the Sumerians always depicted Earth by the number 7.

Consider for a moment a depiction of our solar system. In modern times the planets are always depicted in a straight line counting from the sun outwards as shown previously in fig.103, but what if one was draw them in their relative sizes but in a circular fashion going around the sun with an arrow pointing in the direction of their orbits. With our knowledge up to this point and our newly discovered planetary body not yet included, would the drawing not look something like this? (fig.137) So, armed with knowledge of the new body that indeed does exist in our solar system, now compare it to this rendition of an ancient Sumerian depiction found on a cylinder seal (based on Sitchins own illustrations) (fig.138).

As the diagrams show, the only real discrepancy is in the Sumerian placement of Pluto which is shown between Saturn and Uranus, however if one considers that Pluto used to once be a satellite of Saturn and that it now has an elliptical orbit that overlaps that of Saturn then the placement of it in the Sumerian diagram is easily explained. The extra planet depicted on the Sumerian seal is placed noticeably more distant that the other planets also indicating an elongated orbit similar to that of Pluto and is shown to be quite a large planetary body.

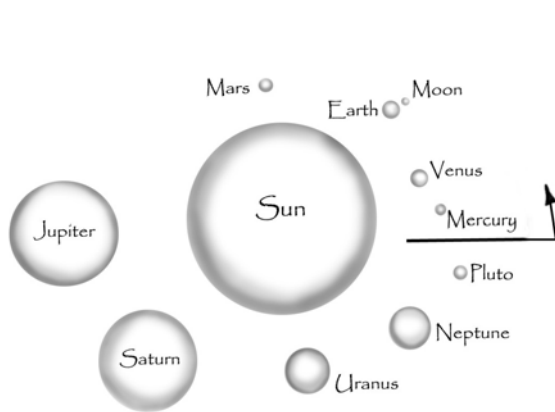

Fig.137

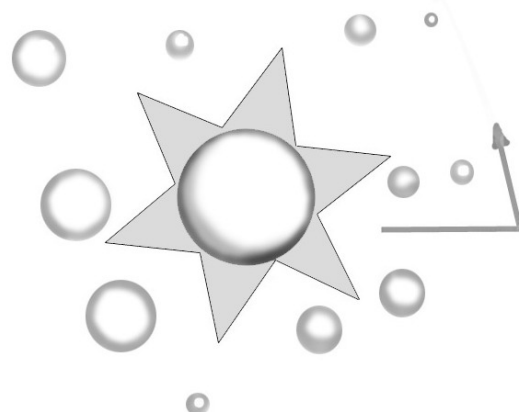

Fig.138

Since evidence has shown the people of ancient Sumer have achieved a substantial degree of scientific accuracy with every other claim they have made, including the relative sizes of the planets (as can be seen in the diagram), it is quite reasonable to assume that they may well be accurate in their depiction of the relative size of our newly found solar member too.

Modern scholars always refer to the Earth as the third planet as we number our solar system from the Sun outwards. However the legends told by the Sumerians and Mesoamericans repeatedly state that their knowledge of astronomy came from their Gods and the Sumerians inform us that their Gods reside on the newly found member of our solar system that they name as Nibiru, the planet of the crossing. Sitchin notes that for those who live on Nibiru the solar system was counted from the outer planets inwards and so Earth was always referred to as the seventh planet and was thus depicted by the Sumerians by the number 7, seven dots or sometimes a seven pointed star, Venus was shown with 8 points, Mars with 6 points, Jupiter with 5 etc.



This number is very significant because we also find it in Mayan culture used in a similar celestial reference. Again, it seems highly unlikely that two such vastly different cultures would come up with such similar references by themselves without having some type of contact.

It may not now surprise some to know that even the very same story of creation was also well known to the civilizations that existed in South America.

Again, it is very unlikely for such a thing to have happened by chance.

Knowledge of the creation story by the Mayans has been explained by some as being no real surprise as the Christian influences in Mayan culture were obvious, but new evidence shows that it's much more likely the Mayan creation story actually had its roots, not in the Christian tale but in fact in the much earlier tale of the event – as it was first related – in Sumer. This opinion can be further re-enforced by an actual personal account written by Don Juan de Santa Cruz Pachacuti-Yumqui Salcamayhua (*sometimes referred to as Santa Cruz and sometimes as Salcamayhua*) who was the son of a Spanish nobleman and an Inca Princess.

The story contains information that has somehow been ignored by many scholars who continue to claim that the Mayans only ever worshiped the Sun, but certainly may have had some kind of early Christian connections. Yet if it is indeed true that the Mayan culture is actually a legacy from the original civilization of the Olmecs, then it should be taken into account that the Olmecs existed long *before* Christianity. Even the most conservative scholars date the civilization to around 500BC, so, how then, would such a Christian connection have come about?

It was due to the Spanish discovery of the greatly revered Sun-Stone made from pure gold that many scholars have always assumed the Maya to have worshiped the Sun God. However when the Spanish looted the Aztec empire, unbeknownst to them, certain artifacts had been removed and replaced with others, and one of these artifacts was the Sun Stone. What the Spanish found was certainly spectacular enough: a disc depicting the Mayan Calendar in intricate detail, made from pure gold that measured 72 inches in diameter and was as thick as 3 coins but in reality, it was simply that – a golden calendar showing the sacred cycles and the zodiac, the divine information that had been given to them by the Gods, but it was not the item that had originally taken pride of place on the temple wall.

Yes the Sun was revered by certain rulers, yes the Sunstone held the central position in the temple when the Spanish arrived and yes it was made from pure gold, but then, in Cuzco, practically everything that was hanging anywhere was made from pure gold.

In the account written by Salcamayhua which is entitled '*Relacion*' (*translated into English by Clemens Markham*), he states that it was the very first king of the Inca dynasty who decorated the temple wall and it was he who ordered the making of a "*flat plate of gold which signified that there was a creator of Heaven and Earth.*" Salcamayhua illustrated his dialogue with a large diagram showing the layout of the wall that held the golden plate and other items as it had originally been. His drawing is incredibly significant because, lo and behold, it shows that the original item that took pride of place on the wall was not a round Sun-Stone but was in fact *oval* in shape.

According to Salcamayhua's book, the ovoid plaque was later replaced with the round Sun-Stone when a certain ruler had later declared the Sun to be supreme over all Gods. Then the Sun-Stone was later removed by a subsequent ruler who abhorred the worship of idols and ordered his people not to pay homage to the Sun and the Moon, but instead to return to the ways of old and revere the celestial body, the true creator, as represented by the ovoid plaque. It was also this emperor who ordered that images be placed around the golden plate.

In this first hand account it is very significant that by his referring to the golden oval plaque as a representation of the 'creator of all' Salcamayhua has made it abundantly clear that he did not mean the Sun. This can be easily ascertained as the images of both the Sun and the Moon were also depicted on either side of the oval plate.

But why was the creator of all represented as a plain oval plaque?

Sitchin purports that the oval relates to the Sumerian story of the earth's creation and that the temple wall is in fact a depiction of the solar system and the creation of man and it may surprise you to know that all evidence suggests that he is absolutely correct.

In the sketch done by Salcamayhua, also reproduced by Sitchin and which I have again reproduced for you here (*fig.139*), we are shown the Temple Altar (*at the bottom*) while just above it are other elements of the Earth: we can see the first man and woman, Lake Titicaca where legend holds that Manco Capac received his golden wand from the Gods, the Winged Serpent and the tree of life are all visible. We see night and day represented by stars on one side and clouds on the other and the Earth is also clearly displayed and noticeably depicted by 7 stars beneath it. The image also shows water retreating from the mountains while the entire globe is surmounted by a rainbow, strongly suggesting the retreat of the global deluge. In the upper section we see 4 planets beneath the oval plate and five above it signifying the 4 inner planets and the 5 outer planets separated by the vast elliptical path of Nibiru. In this Mayan temple we therefore see the entire cosmology of the Earth exactly as it was perceived by the Sumerians.

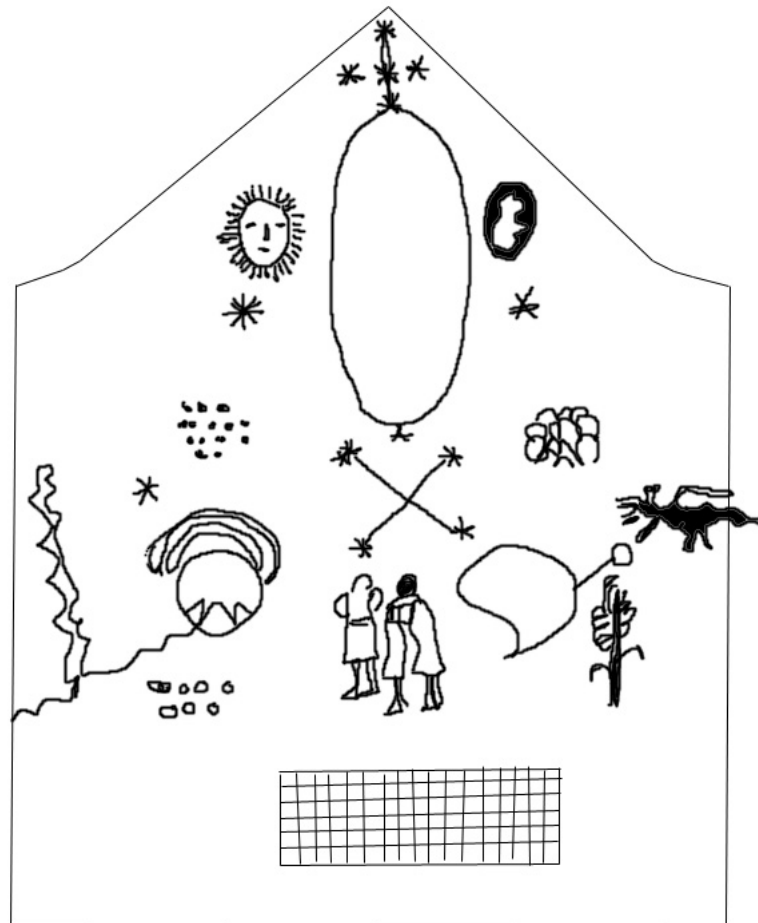

Fig.139

And there are other clues to this Sumerian connection in South America. In Ancient Sumerian depictions of Ninmah showing the creation of the Adamu race we see the sign of Ninmah and her role in the birth proceedings signified by the Sumerian symbol for the Umbilical cutter (*fig.140*) as in here, in a Sumerian depiction (*my rendition*) of the event (*fig.141*) with Ninmah (*identified by the tree*) opposite Enki. A representation of the planet Nibiru can also be seen as the winged

disc. In Egyptian depictions of the female deity Hathor we again find the Umbilical Cutter and Hathor has also been clearly identified as being the Sumerian Goddess Ninmah.

Would it now surprise you to know that there is a remarkable stele from the Mayan culture known as Izapa Stele number 5, a cast of which is shown here (*fig.142*) that amply confirms the Sumerian and Egyptian connections.



Fig.140



Fig.141

In the depiction we see the tree of life and there is an older bearded god of large stature relating the story of creation to a Mayan Native of smaller stature seated opposite him while between them we again see the same Sumerian representation of the Umbilical Cutter (*shown in the detail - fig.143*). Interestingly the two central figures in the stele are shown as having the faces and hands of Elephants which is an animal that is totally unknown to South America and which also re-enforces the notions of an African connection to the Olmecs as previously stated. At the bottom of the Stele we clearly see some smooth sided pyramids beside a flowing river like those found at Giza beside the Nile. Smooth sided pyramids are not found anywhere in South American construction.



Fig.142

The similarity between these depictions is undeniable and the remarkable scene this stele depicts, which includes information relative to Sumer and Giza really should not be under-stated or lightly dismissed. It is absolutely inconceivable to think that two such legends could coexist, even utilizing similar tools, in two separate places that supposedly never had contact with each other. Obviously such contact did take place but it happened so long ago that the only records we have of the event have been pieced together from fragments of texts and stele; and from mythology and legends.



Fig.143

### ***The Lost Mines of the Gods***

The claim by Sitchin that the area of Lake Titicaca was set up as a major metallurgy center is quite an extraordinary piece of detective work and the supporting evidence is astounding. Again the conclusion that the entire complex was set up as part of a major control center to deal with matters of travel and supply is further hinted at by the depiction on the Mayan stele of the figure bearing the 'Star of David' symbol on his ear-ring in fig 133.

The Star of David symbol is extraordinarily similar to an earlier Sumerian emblem (*fig.144*) which is quite likely the original precursor to the Jewish symbol. The Sumerian symbol, which signifies a 'Supreme Place of the Four Regions', has also been found at many ancient trade centers in the Persian Gulf area such as the ancient Sumerian city of Ur.Shulim, (*the modern Jerusalem,*) at Uruk (*the Biblical Erech*) and at other places that are all thought to have been vital control centers of the Sumerians that dealt with matters of travel and supplies. Plus there further evidence to support the conclusion that the site was indeed used for the refining of metals.

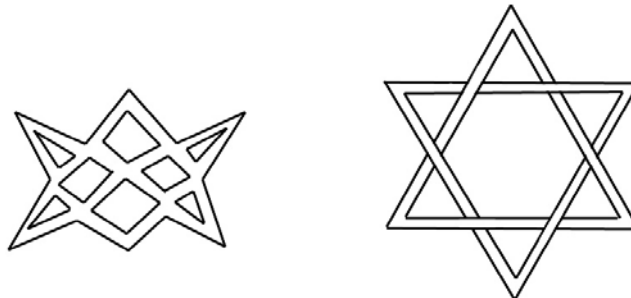

Fig.144

The mountain on which Tiahuanaco (*fig.145*) is situated is itself also extremely rich in tin bearing ores. Tin of course is not a naturally accessible metal like gold and must be smelted and extracted by various chemical processes and then mixed with a required percentage of copper to produce bronze, it's not just a straightforward and simple procedure. The ancient bronze clamps that are still evident on many stone slabs are intriguing because only minimal supplies of copper with which they could have been made are available anywhere near the location of Cuzco. In startling contrast to this lack of a local copper source, many of the river rocks on the shore of Lake Titicaca, especially near the remains of ancient docks and port facilities at Puma Punka, are stained a deep bluish green.

What causes rocks to turn a bluish green?

The only thing that can cause such a reaction is prolonged exposure to copper – end of list. It's similar to the way rocks rich in iron turn red as the iron oxidizes with the water, rocks rich in copper turn a bluish green. Yet the rocks at Lake Titicaca contain no copper! It therefore stands to reason that there was once a good deal of copper *brought* into Cuzco via the Puma Punka port facility. Then of course we need to ask why would all this copper have been brought in if not to mix with the abundant source of tin that already existed there in order to make bronze? It would certainly seem more reasonable than taking the ore bearing tin to the source of the copper. The manufacture of bronze at the site is further confirmed from the presence of the bronze clamps.



Fig.145

When considering this shoreline of greenish rocks on Lake Titicaca high in the Andes (*fig.146*) and the possibilities of an ancient metallurgy facility founded by the Gods and the descendents of Cain, there are also some comments made in an enigmatic passage in the Bible to consider in which such distant and remote mines and even the forgotten descendents of Cain seem to be suggested. The passage occurs when Job is talking to Yahweh complaining about all of the trials and tribulations heaped upon him and Yahweh says to Job:

Surely, there is a source for silver  
A place where gold is refined  
Where copper is obtained from ores  
And iron is smelted out of stones  
To darkness He puts an end  
The usefulness he researches  
Of stones in depths and obscurity

He breaches the brook away from Habitation  
 Where the forgotten and strange men move about  
 There is a land from which the ingots come  
 Whose underground is upheaved as with fire  
 A place where the blue-green stones are  
 That has the ores of gold  
 Even a vulture knows not the way thereto  
 And a falcons eye has not discerned it

There He set His hand to the granite  
 He overturned the mountains at their roots  
 He cut galleries through the rocks  
 And all that his precious eyes had seen  
 He dammed up the sources of the streams  
 And that which is hidden He brought to light



Fig.146

These Biblical verses coupled with ancient Sumerian texts, significant geological evidence, local legends and the substantial genetic differences to be found in the races native to the Americas provides a strong case that the South American civilization was indeed established by the lost tribes of Israel and possibly even the son of Cain himself.



## Chapter Twelve

# The Signs of War



Many religious texts and mythologies from numerous cultures repeatedly speak of devastating wars that were fought by the Gods in our distant past. Such events are also mentioned in the recently discovered Sumerian accounts. So it may not now surprise you to learn that certain puzzling geological evidence supports this hypothesis and does suggest that sometime in its far distant past, several parts of earth indeed experienced the scalding effects of great heat similar to the temperatures that are reached during an atomic or thermonuclear blast. There are many, such as David Hatcher-Childress, who have claimed this as evidence of an ancient war that was fought with Nuclear and perhaps other even more advanced weaponry.

The evidence to support and substantiate such a radical theory and yes even the Sumerian account of events is actually startlingly abundant and quite compelling.

### *The Evidence for Ancient Advanced Warfare*

First let us consider the following notable comments that were included in an article that appeared in the New York tribune on February 16<sup>th</sup> of 1947:

“When the first atomic bomb exploded in New Mexico, the desert sand turned to *fused green glass*. This fact, according to the magazine Free World, has given certain archaeologists a turn. They have been digging in the ancient Euphrates Valley and have uncovered a layer of agrarian culture 8,000 years old, and a layer of herdsman culture much older, and a still older caveman culture. Recently, they reached another layer, a layer of *fused green glass*.”

By studying the results of atomic tests it is now a well established fact that the detonation of an atomic device on or above a desert will produce a sufficient amount of heat to melt and fuse the silicone in the sand and transform the surface of the ground into a sheer sheet of greenish glass in proximity to where the blast occurred. So the question is, could such sheets of glass that have been found in deserts and deep in archaeological digs be real testimony that such events occurred in ancient times?

The idea is not entirely lacking in evidence. Such ancient sheets of glass are a reality and a known geological fact. A large number such discoveries have been quite well documented. This is not to say that all desert glasses are mysterious, scientists and meteorologists know that desert glass can be quite naturally formed when lightning strikes the desert for example, sometimes fusing the sand it strikes. The geological oddities sometimes recovered that are created by these strikes are called *fulgurites*. But lightning strikes invariably create fulgurites in distinctive root-

like patterns that appear as unusual glass globules and 'splashes' that spread out in bizarre branching and tubular forms. A desert lightning strike can never, ever create a flat sheet of fused sand under even the most abnormal of conditions.

As reported in the book *Mysteries of Time and Space* by Brad Steiger and Ron Calais, one of the very first engineers to graduate from the Massachusetts Institute of Technology was a man by the name of Albion W. Hart. Upon his graduation Hart was immediately assigned an engineering project in the interior of Africa, only in order to access the site, he and his men were required to travel to a quite remote and almost inaccessible region that lay across a vast expanse of desert.

There was an article written on Hart's life by Margarethe Casson that appeared in the magazine *Rocks and Minerals* (no. 396, 1972), that mentions this occasion. In the article she writes: "At the time he was puzzled and quite unable to explain a large expanse of greenish glass which covered the sands as far as he could see. ... Later on, during his life he passed by the White Sands area after the first atomic explosion there, and he recognized the same type of silica fusion which he had seen fifty years earlier in the African desert."

According to the very ancient Indian epics of the 'Ramayana' and the 'Mahabharata', fantastic and extremely devastating battles were fought in the distant past using plasma powered aircraft, chemical warfare, and particle beam, plasma and atomic weapons just as such weapons of mass destruction were used for war in the 20th century with horrific and deadly results.

*Now hold on a minute there! You're saying, Ancient Nuclear weapons, Plasma weapons, Particle Weapons, are such things even remotely possible?*

Sadly we know from first hand experience that atomic energy is quite possible but how conceivable is the development of even more advanced weaponry?

There are actually some distinct possibilities. The ancient and mysterious Greek fire for example, was a substance that was said to be very powerful and also 'quite indistinguishable', even underwater. The substance was described as a 'chemical fireball' and was reportedly used at least as far back as the 5th century BC. Unfortunately the formula for Greek fire was lost and has never been re-discovered since.

The plasma gun is even now, a reality and has already been developed experimentally for peaceful purposes (*of course*). A group of Ukrainian scientists from the Geotechnical Mechanics Institute have already experimentally drilled tunnels in iron ore mines by using a device called a Plasmatron. The Plasmatron is a plasma gun which delivers a gas jet at a temperature of 6,000°C. The actual 'plasma' in this case, is an electrified gas. The Plasmatron literally melts the stone in front of it collecting the molten rock and machine coating the tunnel walls behind it as it progresses. The result is a perfectly round tunnel coated with a thick layer of smooth glass.

Electrified gases are also featured substantially in the 'Vymanika-Shaastra,' the ancient book from India discussed earlier that describes vast amounts of technical information and the various techniques used in maintaining and piloting an ancient type of Indian flying craft known as a Vimana. The text also talks of using the liquid metal mercury as fuel for the craft. Interestingly enough, electrified mercury could very easily be used as plasma and with excellent results. There is an excellent book on the topics discussed in the Vymanika- Shaastra that was released by David Hatcher-Childress called '*the Anti Gravity Handbook*.'

Further possibilities on the weapons and methods used for waging ancient war are discussed at length by Robin Collins in the book '*Ancient Astronauts: A Time Reversal?*' Collins discusses the very real possibility of weapons such as fusion devices and in the book he informs us that the fusion torch has been a further development of the plasma jet. Collins also says that "In 1970 a theory to develop a fusion torch was presented at the New York aerospace science meeting by Drs Bernard J. Eastlund and William C. Cough. The basic idea is to generate a heat of at least fifty million degrees Celsius which could be contained and controlled. That is to say, the energy released from the device could be used for many peaceful applications with zero radioactive waste products to avoid contaminating the environment and zero production of radioactive



elements such as plutonium, which is a product of nuclear reaction and is the deadliest substance known to man.”

We know that it's entirely possible because thermonuclear fusion is known to occur both naturally in stellar processes, and unnaturally in things like (*man made*) atomic explosions.

According to Collins: “it has been calculated that the fusion of a deuterium nucleus (a heavy hydrogen isotope which can be easily extracted from sea water) with another deuterium nucleus, or with tritium (another isotope of hydrogen) or perhaps with helium, could be used for the device. The resulting fusion torch made from such a combination would be an ionised plasma jet which would vaporise absolutely anything and everything that the jet was directed at. That's if it was used for military purposes, while for peaceful applications, one example of a use of the torch could be to reclaim valuable basic elements from junk metals.

“In 1974 the University of Texas scientists announced that they had actually developed the first experimental fusion torch which gave a heat output of ninety-three degrees Celsius. This is five times the previous hottest temperature obtained for a contained gas and is twice the minimum heat that is needed for fusion, but the temperature was only maintained for one fifty-millionth of a second instead of the one full second which would be required for the reaction.”

While further investigating the possibility of still other types of advanced weaponry, Collins also happens to mention the following:

“Soviet scientists have discussed and proposed at the United Nations a ban on developing new warfare ideas such as creating holes or "windows" in the ozone layer to bombard specific areas of the Earth with increased natural ultra-violet radiation, which would kill all life-forms and turn the land into barren desert.

“Other ideas discussed at the meeting were the use of "infrasound" to demolish ships by creating acoustic fields on the sea, and hurling a huge chunk of rock into the sea with a cheap atomic device. The resultant tidal wave could demolish the coastal fringe of a country. Other tidal waves could be created by detonating nuclear devices at the frozen poles. Controlled floods, hurricanes, earthquakes and droughts directed towards specific targets and cities are other possibilities.

“Finally, and although not a new method of warfare, incendiary weapons are now being developed to the point where "chemical fireballs" will be produced which radiated thermal energy similar to that of an atomic bomb.”

There is also the very real possibility of building weapons that incorporate radio waves to incapacitate enemies or even crumble structures. If properly contained and controlled, such microwave devices would prove to be a highly effective form of weaponry and interesting are also described in detail in ancient Indian texts.

As you can see, there are a great many new weapons that are actually on the drawing board right now and even as you read this book, more new ideas are being devised. So we know these types of sciences are possible.

The question is. Has it happened before?

### *Castles of Glass*

As exhibit A: Evidence of the very real possibility of such events in our distant past can be seen in the existence of a large number of enigmatic, highly vitrified ruins that can be found in many parts of the world. The scattered nature of these ruins, including areas of Scotland, France, Turkey and the Middle East and the vitrified stones they contain is something that just cannot be easily explained. According to author David Hatcher-Childress, there are at least 60 such vitrified forts that exist just throughout Scotland alone! Among the most well-known of these Scottish ruins are Tap o'Noth, Dunnideer, Craig Phadraig (near Inverness), Abernathy (near Perth), Dun Lagaidh (in Ross), Cromarty, Arka-Unskel, Eilean na Goar, Bute-Dunagoil on the Sound of Bute off Arran Island and the Cauadale hill-fort in Argyll, West Scotland.

Perhaps the best example of them is said to be Tap o'Noth, which is near the village of Rhynie in North-eastern Scotland. The ruins are of a massive fort was built high on the summit of the Tap o'Noth mountain at a height of 1,859 feet. At first glance it appears that the walls of the fortress are made of a blackened, cindery rubble, but on a closer examination becomes strikingly evident that they are actually made of melted and fused together rocks!

What were once individual stone blocks within the walls are now black, and glassy masses that have been fused together by a heat that was in places, so intense that the remains of actual molten rivulets of rock that once ran down the walls like melting wax can still be seen quite clearly.

One early theory proposed was that the forts are located on the remains of ancient volcanoes and that the people used molten stone being ejected from the eruptions to build their settlements. I'm not sure whose brainwave the idea actually was, but it seems somewhat fanciful at best.

That theory however, was soon replaced with the notion that the vitrification was in fact, done on purpose, in order to strengthen the walls. This theory purported that the builders had perhaps designed the forts in that fashion, surmising that fires had been lit so as to temper the stone in order to produce walls strong enough to resist both the invading armies and possibly the dampness of the local climate. It's an interesting theory to say the least, but one that has a number of serious problems. Firstly, there is no indication that such vitrification does actually strengthen the walls in any way at all and secondly, there is every indication that the fire in fact weakens them substantially. In many cases, the walls of the fortresses seem to have almost totally collapsed because of the fires. Also, since the walls of many Scottish forts are only partially vitrified, it does not seem to have been done purposely as walls that have only been partially completed would hardly have been considered to have been an effective fortification.

It must be appreciated that some of these ruins are massive too, indicating that they were once occupied by extremely large forces. In one section of the book '*Mysterious Britain*' the authors Janet and Collin Bord discuss the vastness of the ruins of 'Maiden Castle' in Scotland which gives a good indication of the enormous size of some of these ancient fortresses:

"It covers an area of 120 acres, with an average width of 1,500 feet and length of 3,000 feet. The inner circumference is about 11.2 miles round, and it has been estimated...that it would require 250,000 men to defend it! It is hard, therefore, to believe that this construction was intended to be a defensive position."

Numerous vitrified remains can also be found in the western United States. One such site was discovered in Death Valley by the American explorer Captain Ives William Walker in 1850. Walker apparently discovered a city about a mile long with the lines of the streets and the positions of the buildings still visible. At the centre of the site was a huge rock, between 20 to 30 feet high, with the remains of an enormous structure atop it. The southern side of both the rock and the building was melted and vitrified. Walker assumed that a volcano had been responsible for this phenomenon, but there is no volcano in the area. In addition, tectonic heat could not possibly have caused such visible liquification on the surface of the rock.

More vitrified ruins can also be found in France, Turkey, India and some areas of the Middle East. Some of the ancient ziggurats of Iran and Iraq also contain vitrified material. Some of the vitrification on these ruins is thought by some archaeologists to have been caused by the very ancient and very mysterious Greek fire.

The vitrified remains of the ziggurat at Birs Nimrod (Borsippa), south of Hillah that were once thought to be the Tower of Babel, are also crowned by a large mass of vitrified stone brickwork and actual baked clay bricks that have all been fused together by some type of truly intense heat.

### **The Shattered Desert**

As exhibit B we present one of the strangest and more unusual mysteries of ancient Egypt in the form of the great glass sheets that were discovered in the Libyan Desert by Patrick Clayton, a surveyor for the Egyptian Geological Survey. Clayton was driving among the dunes what is a

virtually uninhabited area of the 'Great Sand Sea' near the Saad Plateau in Libya, just north of the south western corner of Egypt when he was startled by the sound of his tyres crunching loudly on something in the sand. When he alighted from his vehicle to investigate the sound it turned out that he was driving on what appeared to be large pieces of the most beautifully clear, yellowy-greenish glass.

It was soon discovered that this stuff wasn't just any ordinary old yellow glass either, but that it was in fact, an ultra-pure type of glass consisting of a staggering, 98 per cent pure silica. It has also been realised that Clayton wasn't the first person to come across this field of glass and that various 'prehistoric' hunters and nomads had obviously also found the now-famous Libyan Desert Glass (LDG) before him. The same glass had been used to make knives, various sharp-edged tools and other objects that had been found in the past. It has been reported that a carved scarab of LDG was even found in Tutankhamen's tomb (*fig 147*), which clearly indicates that the glass was also sometimes used for jewellery and had obviously been there for an extremely long time. The Glass had in fact often been seen before through its use in some artefacts but the actual location of source had been hitherto unknown until discovered by Clayton in 1932.

An article by Giles Wright that appeared in the British science magazine *New Scientist* (July 10, 1999) entitled "The Riddle of the Sands", states that LDG (*fig.148*) is the purest natural silica glass ever found and that there is easily in excess of a thousand tonnes of this ultra pure glass lying strewn across hundreds of square kilometres of bleak uninhabited desert in Libya. Some of the chunks have been reported to weigh as large as 26 kilograms, but most LDG is found in smaller, angular pieces looking more like weathered glass shards from a gigantic broken yellow bottle. So where on earth did all this stuff just come from? How in the world did it get there?

According to the article, LDG, pure as it is, does contain some defects: tiny bubbles, white wisps and inky black swirls. The whitish streaks consist of refractory minerals such as cristobalite but the black ink-like swirls are mainly iridium, an extraterrestrial element that is commonly associated with some type of an impact such as a meteorite or comet.

The generally accepted theory is that the glass was most likely created by the searing, sand-melting impact of some kind of a cosmic projectile though no-one is quite sure what.



Fig.147

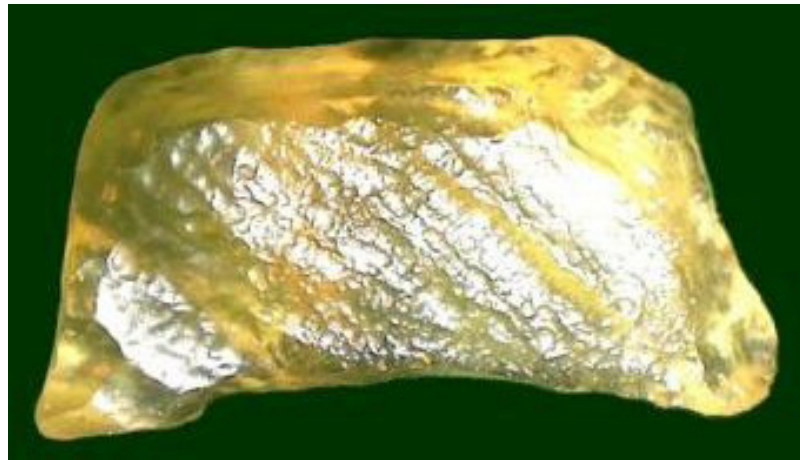

Fig.148

But again, there are some serious problems with this theory. For example: Where did such an immense *amount* of glass shards come from? And how did they get so widely dispersed? There is also the perplexing fact that there is no evidence of any kind of any impact crater whatsoever anywhere in the vicinity, either on the surface of the desert or detected by microwave probes that have been made beneath the ground by ground penetrating satellite radar.

Furthermore, LDG is incredibly free of impurities, in fact far more so than any other known type of glass and actually appears to be much *too* pure to have really been the result of something as destructive as a meteor or comet collision, both of which are very catastrophic and extremely

'messy' events when viewed from a geological perspective. The general vicinity around other known impact craters, such as the ones at Wabar in Saudi Arabia and at Henbury in central Australia for example, are positively littered all about with all manner of debris: chunks of exploded rock, bits of iron, traces of Iridium and other known types of fragmented meteorite material. No such debris can be found anywhere in the vicinity of the Libyan Desert Glass sites though some slight traces of Iridium are indeed found within the glass itself. And just to make matters even more perplexing, LDG is actually concentrated in two areas of the Libyan Desert and not just one. One area is large and oval-shaped while the other is more like a strange circular ring of about six kilometres wide that is about 21 kilometres in diameter. It lies in the desert like a huge glass, six kilometre wide race track while the wide circular centre of the ring remains totally devoid of the glass. Now what do you suppose would cause something like that to appear in the middle of a vast desert? It really doesn't seem like it could be a natural occurrence in any way shape or form.

Another theory is that there may have been a *soft* projectile impact. That is, an earthbound meteorite of perhaps 30 metres in diameter that may have detonated prior to actually impacting with the earth's surface, say at about 10 kilometres or so above the desert, thereby creating a searing blast of hot air that melted the sand beneath it. Just such a soft-impact is theorized to have possibly occurred in the famous 1908 'Tunguska Event' in Siberia.

*(The Tunguska event, like the LDG, still remains a complete mystery).*

Yet another theory holds that perhaps a comet passed close to the earth and scorched the desert sands with the friction of its passing or perhaps a meteorite glanced off the desert surface, leaving a glassy crust and only a slight crater that was soon filled in by the sands. But the problem with both these theories is that there are *two* known areas of LDG. Are we to suppose that there were in fact, two of the cosmic projectiles that were travelling in tandem? And even so, how would it be possible for a projectile to melt the outside of the ring but then still leave the centre field completely intact and undamaged?

There is an interesting article that appeared in a British journal called *Nature* (no. 170) in 1952 entitled "*Dating the Libyan Desert Silica-Glass*" In it the author, Kenneth Oakley said:

"Pieces of natural silica-glass up to 16 lb in weight occur scattered sparsely in an oval area, measuring 130 km north to south and 53 km from east to west, in the Sand Sea of the Libyan Desert. This remarkable material, which is almost pure (97 per cent silica), relatively light (sp. gin. 2.21), clear and yellowish-green in colour, has the qualities of a gemstone. It was discovered by the Egyptian Survey Expedition under Mr P.A. Clayton in 1932, and was thoroughly investigated by Dr L.J. Spencer, who joined a special expedition of the Survey for this purpose in 1934.

"The pieces are found in sand-free corridors between north-south dune ridges, about 100 m high and 2&5 km apart. These corridors or "streets" have a rubbly surface, rather like that of a "speedway" track, formed by angular gravel and red loamy weathering debris overlying Nubian sandstone. The pieces of glass lie on this surface or partly embedded in it. Only a few small fragments were found below the surface, and none deeper than about one metre

"While undoubtedly natural, the origin of the Libyan silica-glass is uncertain. In its constitution it resembles the tektites of supposed cosmic origin, but these are much smaller. Tektites are usually black, although one variety found in Bohemia and Moravia and known as moldavite is clear deep-green. The Libyan silica-glass has also been compared with the glass formed by the fusion of sand in the heat generated by the fall of a great meteorite

"Reporting the findings of his expedition, Dr Spencer said that he had not been able to trace the Libyan glass to any source; no fragments of meteorites or indications of meteorite craters could be found in the area of its distribution. He said: 'It seemed easier to assume that it had simply fallen from the sky.'

"It would be of considerable interest if the time of origin or arrival of the silica-glass in the Sand Sea could be determined geologically or archaeologically. Its restriction to the surface or

top layer of a superficial deposit suggests that it is not of great antiquity from the geological point of view. On the other hand, it has clearly been there since prehistoric times.”

Or could it be entirely more plausible to assume that the vitrified desert is actually the result of a war fought sometime in the ancient past using atomic, fusion or plasma weapons? The idea gathers even more weight as we begin to examine further evidence.

### **The Radioactive Skeletons of India**

Exhibit C can be seen in a totally baffling discovery that was made by a soviet archeological team investigating the ancient sites of Harappa and Mohenjo-Daro in India. When the scientists had excavated far enough to reach the street level of the Mohenjo-Daro complex (*fig.149*) they were surprised to discover a great number of skeletons lying unburied in the streets of the town and sprawled out as though they had suddenly be caught in some great disaster. Not unlike those caught in the eruption of Mt. Vesuvius that were found at Pompei, many of the Harappa and Mohenjo-Daro skeletons were of people holding hands or walking down the street. It appears that many of them had just been going about their daily business at the time of death (*fig.150*).

Evidence shows that the settlements of Harappa and Mohenjo-Daro were wiped out entirely. The walls of Mohenjo-Daro also bear signs of vitrification and since there is no evidence of any volcanic activity in the area or any signs of an impact crater the question again arises:

To what can we attribute this type of mass death and vitrification of stone?



Fig.149

The skeletons at these sites are estimated to be thousands of years old, even by traditional archeological dating standards and what initially puzzled scientists was that firstly; the remains showed no obvious signs of trauma or violence that could be attributed as a cause of death and secondly; if the bodies had just been left lying in the streets, then why were they in such good condition? Why hadn't they been devoured, or at least mutilated by wild animals? How could it be that these bodies had just been left here; alone and completely untouched long enough to be covered by the dusts of time?

However, further investigation revealed an even more startling discovery: The Harappa and Mohenjo-Daro skeletons are also among the most radioactive remains ever found, revealing radiation levels equal to those that have been recorded in corpses that were recovered from Hiroshima and Nagasaki. At one particular site the Soviet scientists recorded radiation levels from one corpse that were over 50 times greater than normal. Again, a nuclear or atomic war in ancient times would adequately account for such high radiation levels.

A word must also be said on the estimated age of these skeletons: While it's true that the remains have been Radiocarbon dated to around 2500 BC, it must be remembered that Carbon dating requires measuring the amounts of residual radiation levels that are left in any organic



Fig.150

object. However, when a radioactive event like an atomic explosion has occurred in the vicinity of the site, the remains that are found there will contain significant amounts of radiation due the event and thus appear to be significantly younger than they actually are. If the ruins and radioactive skeletons found at Harappa and Mohenjo-Daro were indeed the result of such an event in ancient times then the true age of the site may be anyone's guess.

### **Tektites**

An enigmatic exhibit D is the large areas of desert that have been found strewn with mysterious globules of glass known as 'tektites' (fig.151) Tektites are occasionally discussed in geological literature though not very often as they tend to pose more questions than answers. They are blobs of "hardened glass" and one possibility is that they come from meteorite impacts in most instances, but evidence shows that in the majority of cases there is no nearby impact crater plus there is also the problem that many tektites contain traces of non-earthly elements.

Another possibility is that tektites have a terrestrial explanation only that theory is almost never explored as involves ancient war and the use of atomic or other weapons capable of melting sand.

The debate on tektites was summed up quite well in an article entitled "The Tektite Problem", by John O'Keefe, published in *Scientific American* in August of 1978:

"If tektites are terrestrial, it means that some process exists by which soil or common rocks can be converted in an instant into homogeneous, water-free, bubble-free glass and be propelled thousands of miles above the atmosphere. If tektites come from the Moon, it seems to follow that there is at least one powerful volcano somewhere on the Moon that has erupted at least as recently as 750,000 years ago. Neither possibility is easy to accept. Yet one of them must be accepted, and I believe it is feasible to pick the more reasonable one by rejecting the more unlikely.

"The key to solving the tektite problem is an insistence on a physically reasonable hypothesis and a resolute refusal to be impressed by mere numerical coincidences such as the similarity of terrestrial sediments to tektite material. I believe that the lunar volcanism hypothesis is the only one physically possible, and that we have to accept it. If it leads to unexpected but not impossible

conclusions, that is precisely its utility. To cite just one example of the utility, the lunar origin of tektites strongly supports the idea that the Moon was formed by fission of the Earth.



Fig.151

“Tektites are indeed much more like terrestrial rocks than one would expect of a chance assemblage. If tektites come from a lunar magma, then deep inside the Moon there must be material that is very much like the mantle of the Earth--more like the mantle than it is like the shallower parts of the Moon from which the lunar surface basalts have originated. If the Moon was formed by fission of the Earth, the object that became the Moon would have been heated intensely and from the outside, and would have lost most of its original mass and in particular the more volatile elements. The lavas constituting most of the Moon's present surface were erupted early in the Moon's history, when its heat was concentrated in the shallow depleted zone quite near the surface. During the recent periods represented by tektite falls, the sources of lunar

volcanism have necessarily been much deeper, so that any volcanoes responsible for tektites have drawn on the lunar material that suffered least during the period of ablation and is therefore most like unaltered terrestrial mantle material.

“Ironically, that would explain why tektites are in some ways more like terrestrial rocks than they are like the rocks of the lunar surface.”

There is of course one other explanation for the existence of Tektites and that is that they serve as strong evidence of nuclear events in our distant past. As much as the theory disagrees with the accepted academic version of history, the evidence is just far too compelling to simply ignore without adequate investigation.

### *The Harpoon of Horus*

Exhibit E is further documentary and pictorial evidence in the form of ancient texts that describe a fierce war that raged between the two Egyptian deities, Horus and Seth.

As mentioned by Sitchin in *The Wars of Gods & Men*, temple inscriptions at Edfu in Egypt report that, during his battles with Osiris, Horus launched into the air in a ‘Nar,’ (a ‘fiery pillar.’) these vehicles are described as being elongated, cylindrical and equipped with short fins near the rear. The bulkhead is said to have contained two ‘eyes’ which constantly changed colour from blue to red to black to blue. The vehicle produced vapours and trails from its rear and emitted rays from the front. They even drew a picture of it for us (fig.152)

Funny how the ancient depiction of a Nar (fiery pillar) seems to look just like some kind of rocket...

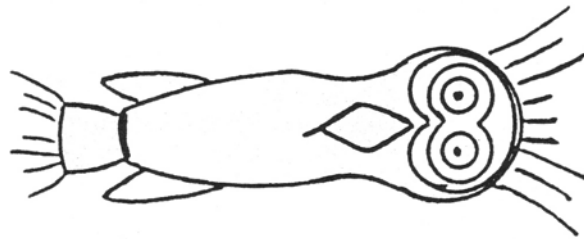

Fig.152

During the battle Horus was hit by a ‘bolt of light’ from the flying vehicle of Seth while he himself flew about in the ‘Winged Disc of Ra.’ Horus is then reported to have struck Seth with a ‘harpoon’ which the texts describe as ‘a weapon of thirty.’ There is picture that exists from Edfu depicting the ‘Harpoon of Horus’ which strongly suggests that the device was perhaps a Multiple Warhead Missile consisting of a large warhead that broke open to reveal two smaller multiple warheads inside (fig.154) The nickname ‘weapon

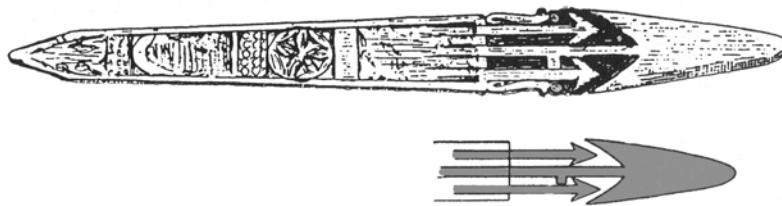

Fig.153

of thirty’ the device received suggests that each inner warhead possibly contained 15 smaller devices. Perhaps by sheer coincidence, a very similar device is a modern Naval Multiple Warhead Missile that is currently manufactured by Mc Donnell & Douglas which also happens to be called a harpoon.



### *The Mysterious Sinai*

Exhibit F is a huge and very mysterious plain that can be found in the Sinai desert. The tales of creation, ancient wars and great annihilation by sophisticated weapons told by the Ancient Sumerians talk of a great destruction that was wrought upon an ancient space port that is said to have existed in the vicinity that was utterly destroyed by advanced weaponry. If such an event really occurred surely some trace of such devastation would still be found; and indeed such can still be seen in the area presently known as the 'Israeli Militarized Zone' of the Sinai peninsula.

The area contains a vast triangular plain that consists of normal coloured sands but appears black from a distance because the ground is literally covered with scorched and blackened rocks. The extent of the contrasts on this plain that continues to baffle scientists was not fully realised until satellite pictures were taken of the area (*fig.154*) which only succeeded in adding to the puzzle.



Fig.154

Sumerian texts tell us that this plain was the location of the Ancient Spaceport, the Edin and the 5 other 'vital control centres' that were completely obliterated in the final conflicts of the Anunnaki by "Seven Weapons of Terror" and it is here that we find a huge blackened scar on the planets surface that can be likened to no where else on Earth.

Now what do you suppose would cause that?



## Chapter Thirteen

# The Grand Deception

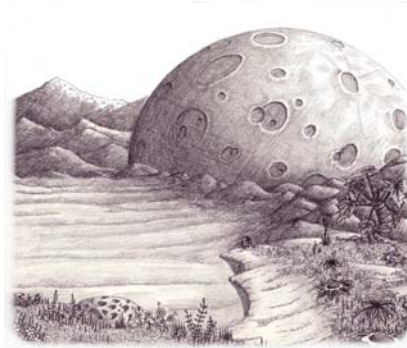

“Facts are Stupid Things...”

- former US President, Ronald Regan

We have discussed ancient texts and we have seen an abundance of evidence to support them, and still we have only really scratched the surface. Some of the conclusions have staggering implications for mankind and yet the information is being disregarded. Is there indeed a ‘Global Conspiracy’ in place to keep this information out of the public eye? Such things are invariably denied but before we continue on our quest we will put the puzzle aside for a brief moment to discuss this phenomenon.

Naturally, and as I previously stated, I’m well aware that when ever anyone mentions the word conspiracy in our modern and supposedly free society, especially in regard to the Government, or the Scientific or Academic communities they are sure to attract a storm of criticism. They are of course, always at the ready to discredit anyone suggesting such an idea and create a media circus around them to distract any attention away from the actual point they’re trying to make. In these cases it is always a good rule of thumb to be wary of anyone who relies on invoking their academic credentials to support their case because it invariably means that they have no valid arguments of their own to present to the table so they can only resort to waving credentials and launching personal attacks in such a way that it allows them to ignore the actual evidence that is being presented. Of course the media is only too happy to back them up and publicize the ‘tasty bits’ too if need be. As briefly discussed in the first chapter, conspiracies actually do happen quite often and in the case of our history, the evidence of an entirely different course of events is now simply far too overwhelming to just be dismissed. The irony of it all is that most of it is right out in plain view. The good news is that the participants in the conspiracy to keep the facts suppressed are quite obvious and their overall plan and daily tactics become predictable and

transparent once you have acquired the necessary skills to spot them, though it's not always easy to penetrate the smokescreen of propaganda and disinformation to get to the real agenda hidden beneath. However the bad news is that the conspiracy is Global and there are some very big players involved who have worked very hard to get the current academic mindset deeply ingrained in our psyche. Of course the Persian Gulf region has been kept a war zone for so long now that it's kind of hard to get in there to do much more investigation. Perhaps after they have bombed all trace of any ancient ruins out of existence they will let people back in to investigate.

In the meantime our governments seem to work very hard to provide as many distractions in people's daily lives as they can. This is because if you can keep the population living on the edge all the time they end up so caught up with the rigors of daily modern life, getting to work, paying the bills, looking out for the kids, worrying about the economy, the college fund, the groceries, the neighbors, terrorists, God, taxes, fine print, the environment and keeping up with the Jones, they don't really notice or even often care about looking at the bigger picture to see what's going on all around them, let alone in what may have happened in the past.

### **The Cover-up in Motion**

There are a great number of scholars who have attempted to bring some very substantial and worthwhile information to public knowledge but who have all have been publicly vilified whether their information was credible or not. Even some people who have just been doing their job have had their lives reduced to tatters for not being prepared to lie in the name of science.

However it has become apparent that the academic community also has in place a very distinct set of double standards when it comes to the free flow of any information. Academia considers Scientists to consist of highly educated, well trained and intellectually capable people and they deduce that *they and only they* are able to assimilate and process scientific information and then make the correct critical distinctions between fact and fiction, reality and fantasy and right and wrong while we, the uneducated and unwashed public is very simply deemed to be incapable of functioning on this 'higher mental plane of superior intellectuality'.

The current Academic community, sadly, has this of demeanour intellectual superiority permeating through it deeply and it has been that way for some time. It is an attitude that is thinly veiled by meticulously planned and carefully and orchestrated public relations. To the public, science and progress can always be seen as by products of each other, but unfortunately such is not always the case, it's just cleverly made to look that way.

In order to work as a functional institution in an open and democratic society, science has to operate within the same parameters as society at large; science by its very nature needs to be open to debate, argument and counter-argument. There is no place for unquestioned authoritarianism and ego in true science. Yet it exists, and in full view. Even Alfred Wegener, the German meteorologist who first purposed the theory of plate tectonics back in 1915 was the subject of some very spiteful attacks and had his discovery buried for some 50 years because he dared to bruise various Academic egos. Einstein was first thought a fool..

It is unfortunate that we now see this same unscientific approach applied to many other fields of study just as has become the 'norm' in modern archaeology and anthropology. More and more often we see situations where scientists quite simply refuse to prove the theories they present to us, yet appoint themselves as the final arbiters of the facts, while the real information is hurriedly suppressed; and this is often done in full view.

We have seen for example, the trouble that was caused for the farmer who discovered the Ica stones in Peru and the extraordinary efforts made to discredit the very significant research and substantial geological testing done on the Sphinx by West and Schoch, even to the extent of banning them from future Giza research. Graham Hancock has also been ferociously attacked for his book '*Fingerprints of the Gods*' in which he put forth several theories containing a great deal of merit concerning a common link between many ancient cultures in the past. Links that point to

one much earlier civilization preceding theirs that they had all had some contact with. His theories contained some extremely valid arguments. But as usual Academia could only wave their doctorates and insult the work without ever being able to present any counter-evidence to back up their own claims, while Hancock's book actually contained a substantial amount of validating research. And take the quite high profile case of Dr Virginia Steen-McIntyre as another fine example of the Academic bottom line:

McIntyre was a geologist who worked for the US Geological Survey (USGS). In the 1970s she was sent to an archaeological site in Mexico to date a particular group of artifacts. To conduct the tests she used state-of-the-art equipment and even backed up and confirmed her results by employing four different methods in the testing, but her findings in all of the tests were just way too astonishing for her peers. You see the projects lead archaeologist at the site had been expecting a date of about 25,000 years or less for the artifacts but McIntyre's results produced a date of 250,000 years or more. The problem was that a figure of 25,000 years or less was needed to validate the accepted 'Bering Strait Crossing' theory and so the lead archaeologist dismissed McIntyre's findings and asked for a new set of tests. Dr. McIntyre was then asked to retract her conclusions and present the team with a 'more satisfactory finding' but she refused, saying the tests she had already conducted were most definitely correct.

Since that time Dr. McIntyre, who is a very talented scientist, has found it extremely difficult to get any of her papers published and was dismissed from her teaching position at an American University. Her case aptly illustrates just how far established scientists are prepared to go to safeguard orthodox tenets, and it would appear that ruining a person's life to preserve the academic '*status quo*,' as in the case of Dr. McIntyre, who had literally studied for years to obtain her credentials, and had produced accurate results in the tests, is certainly no cause for concern.

There was also an amazing case in New Zealand where the Government even went as far as enacting a new law preventing the public from entering a site that was considered to be particularly controversial and the issue too 'sensitive.' In this bizarre series of events we can see quite well that it's not only the Academic Community that is concerned with protecting the orthodox views that have been presented to us.

This particular controversy first erupted around a site that was located in the Waipoua Forest in New Zealand. Excavations at the location had amazingly revealed evidence of an ancient non-Polynesian culture that far pre-dated the Maori once having existing on the Islands. The Maori people learned of these findings before they were officially released and were not at all happy about them as they considered it to be an 'infringement on their heritage'. They gathered together a spokes-team and proceeded to complain bitterly about the results to the New Zealand government. However the Public soon got word of what the Maori people were up to and they also complained, but of course, the Government denied the entire affair.

However the outcome of the original meeting, when the complaint was made by the Maori, was an Official Archival Document that is still in existence today which actually shows that an embargo had indeed been placed on the Waipoua site by the New Zealand Government. This archival document aptly demonstrates the New Zealand government's clear intention to withhold vital archeological information from the public through legal means for a period of 75 years.

In his book '*Ancient Celtic New Zealand*,' author Mark Doutré says that he is very personally concerned about the issue because he believes valuable artifacts that were removed from the site, proving that there was indeed an earlier culture existing on the Islands which preceded the Maori, are now also missing from museums: "*Where are the ancient Indo-European hair samples (wavy red brown hair), originally obtained from a rock shelter near Watakere, that were on display at the Auckland War Memorial Museum for many years? Where is the giant skeleton found near Mitimati?*" Doutré asks, and with good cause, as the disappearance of these artefacts and any of these sorts of occurrences are very real attempts to defraud the world out of its true heritage and factual history.

The case of the Takla Makan Desert mummies which were found in western China is another fine example of this hidden agenda in scientific attitude.

In case you missed it, it all went down in a now all too predictable fashion:

The remains of an unaccounted-for and previously unknown Caucasian culture were unearthed in the Takla Makan area in the 1970s. What was discovered at the site were the remains of a blond-haired, blue-eyed people who had apparently once lived in pre-dynastic China. The arid desert environment had also preserved the mummies very well. All of the specimens that were recovered were dressed in colourful robes, boots, stockings and hats and even though there were a number of Asian bodies that were found buried beside the Caucasian mummies, the Chinese were not at all pleased about the discovery and greatly downplayed the enigmatic find.

A writer for *'National Geographic Magazine'* Thomas B. Allen, commented about a pottery shard that he had found at the location which still bore a fingerprint of the potter who had made it. When he inquired of a Chinese scientist who was present if he was able to take the fragment to a forensic anthropologist for investigation, the Chinese scientist then asked him if he would be able to tell from the fingerprint whether the potter was a white man or a Chinese man. Allen replied that he wasn't sure whether the tests would show either way but maybe, he would have to see what the forensics guy said. The response of the Chinese scientist was to quietly pocket the fragment and quickly walk away. Yes, there always seems to be an innumerable amount of things to get in the way of anything but orthodox scientific discovery and disclosure.

Unfortunately we are seeing Governments, and even many peoples, around the world now viewing such archeological evidence of ancient races as a threat to Ethnocentrism more and more. Such a notion is, of course, ridiculous because to acknowledge the existence of an ancient civilization does not in any way detract from the achievements of any subsequent civilization that may have risen in the same place. It does however; prevent people from claiming to have built monuments that they in fact didn't, as in the case of the monuments at Baalbeck and Egypt.

But let's face it folks, if the Egyptians really did build the pyramids way back then, they would be able to do it now – and they (*or anyone else for that matter*) can't do it now, so it is quite reasonable to surmise that they didn't do it then either. And as we have already noted, the pyramids are a source of immense National pride for the Egyptians and they would simply hate to have to admit they didn't build them, even though the obvious truth that has now been long since proven is that they were well known of at least as far back as 4000 BC, as they have been found depicted on clay tablets and stele from that period.

Yet another remarkable and very well documented instance is the case of Michael Cremo; which again, is a very good example of just how far the Academic Community is prepared to go to suppress quite valid information.

Cremo's highly controversial book *'Forbidden Archaeology'* discusses numerous examples of enigmatic ancient artifacts, such as those mentioned in chapter 2, all of which have been ignored and all of which prove beyond any shadow of doubt that the antiquity of modern man far exceeds the timeframe that is presented to us in orthodox chronologies.

Cremo's book was extremely well researched and presented some very substantial arguments and so, in 1996, the NBC used some material from the book to feature in an excellent TV special entitled *'The Mysterious Origins of Man'*

However, when the NBC aired the presentation, the reaction from the Academic Community was like a shockwave. In a seething mass of abuse, the NBC was literally inundated with letters and calls from irate members of various faculties accusing the network of 'deception' and calling the producer a 'fraud'. Still others called the whole program a 'hoax' and a 'sham,' and claiming the airing of it was a 'lie the public!' But because the evidence displayed on the program was so damaging to the deception that Academia is intent on perpetuating, merely complaining was not all they did. They actually attempted to *force* the NBC not to run the program a second time. The NBC simply ignored them and aired it again anyway and so a group of scientists then took the most radical step imaginable:

In their fear and desperation that people may actually *believe* the findings reported in the TV Special, they gathered their trusty Doctorates together and presented their case to the Federal Government, *formally requesting* that the Federal Communications Commission step in and *ban* the NBC from ever airing the program again! And you don't have to just believe me; this is all very well documented. A letter that was written to the FCC during the affair by a Dr Allison Palmer who is the President of the Institute for Cambrian Studies is also quite revealing:

“At the very least, NBC should be required to make substantial prime-time apologies to their viewing audience for a sufficient period of time so that the audience clearly gets the message that they were duped. In addition, NBC should perhaps be fined sufficiently so that a major fund for public science education can be established.”

Public Science education? What on earth is that supposed to mean? ...Freudian slip maybe? And seriously, they actually want to *fine* a television station for airing a scientific theory because it differs from the orthodox tenet? And fine them to the extent that a *major fund* can be established? Isn't that possibly a little extreme? Beside I thought that schools and Universities were supposed to incorporate such things as science into their curriculum. So then, it really must be questioned what exactly they intend to actually teach at such a 'Public Science' centre? Or are we to assume that there is a difference between 'Science' and 'Public Science.' It seems pretty obvious that such a centre would merely be a venue for displaying neat tricks and orthodox theories and be far more involved and concerned with teaching people *what* to think rather than *how* to think.

These actions by Academia against the NBC represent a very real attempt to impede commerce and a blatantly visible infringement of free speech, *and* an obvious attempt at the open censorship of free and democratic intellectual discourse. Can you imagine the reaction of the world if anyone tried to suppress any information that is presented to us by orthodox scientists or academics? The reaction would be one of united outrage from all quarters – people, scientists *and* governments.

There are an endless amount of these blatant moves to stifle valid information and I could probably fill an entire book with case histories very similar to those I have just presented to you.

Even as recently as September 2005 court action was commenced against an American Public School for daring to incorporate the mere possibility of creation by intelligent design into it's curriculum. Suffice to say for now that there are an alarming number of such cases but I think you probably get the point I'm trying make here by now.

But no matter how much the facts are twisted by Academia, no matter how often the data is concealed by ruthless Scientists and no matter how constantly reality is denied by Governments, the truth will always have a way of rearing its ugly head and ultimately shining through the murk.

### ***A Mosaic of History***

Because the real facts are kept so well hidden by “The Powers That Be,” getting to the real truth and trying to piece together all the pieces, hints, myths, legends, evidences and texts, and then separate the true facts from the enormous amounts of dis-information that is circulated can sometimes be an extremely daunting task. But eventually, as new evidence comes to light, a coherent picture begins to form and some realities can be gleaned.

It has been abundantly shown through our discussions so far that an incredible number of enigmatic artifacts do actually exist that can only be explained by accepting the reality that the people of ancient times did in fact possess an advanced scientific knowledge and the history we have been presented with by academia is completely wrong.

The main objective of this book so far has been to provide information to the reader in order to illustrate the point that, in regards to history, things are not at all what they seem and from looking at the previous evidence we can at this point safely deduce the following points:

1. It is an undeniable fact that the very first civilization that existed in our records possessed very detailed astronomical, astrological and cosmological knowledge right from its very inception, that such knowledge can only possibly be discovered through the use of advanced science and we have amply demonstrated the impossibility of man ever coming up with such information as precession of the Zodiac through his own devices in ancient times. It has also been abundantly demonstrated by many scholars and authors that the correlations between the structures, temples alignments and numerical references in the myths and legends from a great number of vastly different ancient races, coupled with the nature of the myths and legends themselves, all undeniably point to a common link in our distant past.

2. We have seen geological and fossil records displaying indisputable proof it is a fact that modern man existed contemporaneously with prehistoric life forms that lived, apparently, millions of years old and yet at the same time discovered irrefutable genetic evidence, proving beyond doubt the essence of man, the human genome, is no more than 200,000 years old. We have also seen the very same genetic studies provide evidence of the vast differences between man and primates proving *beyond doubt* the fact that Darwin's theory of evolution is essentially flawed, that man could never possibly have evolved from primates through evolution on its own and we have now, even more recently, witnessed the discovery of an entirely new species of miniature humans further confounding believers of both Darwin's theory and in of religious creationism. We have also demonstrated evidence of genetically manipulated plants that have existed all over the earth since far ancient times.

3. This information has had the tangential effect of providing credible evidence to suggest that dinosaurs did not in fact, die out 65 million years ago but survived a great deal longer and we have in turn discovered quite recently that dinosaurs were warm blooded creatures more resembling birds and not the slow moving reptiles they were once thought to be.

4. Indisputable evidence, now recognized by scholars and theologians alike, has also shown us it is an absolute fact that all creation stories stem from the one ancient account. An account that has been now demonstrated to in fact be a vividly detailed narrative of a series of dramatic celestial and genetic events the details of which were first recounted by the ancient Sumerians.

5. Modern scientific and astronomical data now parallels this Sumerians story of the creation of our solar system inscribed on clay tablets thousands of years ago and it has also been openly admitted by scientists that the data received from the Voyager Spacecraft showed us that everything we thought we knew about the cosmos before that point was entirely wrong. Yet by way of comparison we have seen that the Ancient Sumerian accounts adequately and satisfactorily explain every single enigmatic aspect of our Solar System, right down to the eccentricities of Pluto's orbit, the sideways rotation of Uranus, the asteroid belt and the existence of the comets and their elongated and retrograde (*clockwise*) orbits.

6. We can also see in these tales, vast evidence that suggests a detailed knowledge of still other information that we are still now discovering, such as DNA. We have also had it made clear to us by the Sumerian account that there is yet another, still yet unknown, planetary body in our solar system and this information has only now been confirmed as recently as 2005 and even more of the Sumerian accounts are being backed up by modern scientific data. Even the enigmatic face on Mars and its nearby ruins is mentioned in the ancient Sumerian texts.

7. It has been demonstrated that these texts also provide 6000 year old documented reports and pictorial evidence that the pyramids existed even in ancient Sumerian times adding noticeable details like mentioning the enigmatic sealed ascending passage, the lack of remains within and the strange twisting 'well shaft' of the great pyramid. All are adequately explained by Sumerian texts. We have discussed how this timeframe is still further supported by geological evidence proving it to be a fact that the Sphinx is at least 10,500 years old, further attesting to the existence of the far greater antiquity of the Giza site. We have then shown that in Egypt, actual texts exist that explain the processes involved in the synthesis of hardened limestone and amply demonstrated that these methods do in fact work, indicating that the pyramids were most likely

cast in a manner similar to concrete and it has also been shown that it is quite possible to soften stone through use of common plant extracts in order to build megalithic structures like the ancient Mayan temples. We can see that the practice is even still performed in modern times by witch doctors in the making of stone idols. Ancient texts have told us of ancient water treatment and ore refinery plants in South America and we have located ancient enigmatic structures at the sites that contain complex networks of sluice tunnels made from smoothed mica that are perfect for the task and the true purpose of these structures has been abundantly proven by authors such as Zechariah Sitchim.

8. We have also seen it is a fact that megalithic ruins do exist on the sea bed in various places throughout the Atlantic and Pacific Oceans proving the reality of sunken cities global cataclysms and even recently found the traces of an ancient global alphabet. We have viewed artifacts from all over the world that prove it is a fact that Ancient man had machinery capable of manufacturing precision made devices of intricate complexity. This has been reinforced by the discovery of ancient texts that contain well documented, highly detailed and credible accounts of flying machines, texts that serve no religious or moral accord but serve only as technical manuals and these texts have then been corroborated by artifacts at ancient sites that present pictorial evidence of such machines in tombs and on stele from antiquity.

9. We have further discussed the Sumerian and Indian legends of great wars that were fought in the past using incredible weapons and then seen evidence of such wars in radioactive skeletal remains, numerous vitrified ruins, the enigmatic plains of blackened plains of the Sinai and the strange Libyan Desert Glass, and we have further seen that such weapons are absolutely possible through recent advances in our own sciences.

10. We have heard talk of an ancient race who built cities along a route leading to a spaceport and we have seen located, all of the sites of these ancient places and also discovered an immeasurably ancient, 88 x 44 meter platform made of 300 ton stone blocks surrounded by a retaining wall containing three 800 ton blocks of hewn stone that are well beyond our current transportation capabilities at the very site where the spaceport landing pad was said to have been located.

11. We have demonstrated the physical evidence on both earth and mars that exists of a dramatic celestial impact in the past and we have learned the important lesson demonstrated by Comet Levy-Shoemaker Nine, in that comets actually do hit planets. We have seen evidence that both Gradual and Cataclysmic geographical changes occur on Earth and been made abundantly aware that Polar reversals are an absolute scientific fact.

12. We have also quite adequately shown that the people of our ancient past already knew all of these things and that their science had evolved to such a degree that their science, their religion and their entire way of life were all intertwined into one entity.

We have in fact seen Indisputable evidence that everything we thought we knew about our history and everything that is being taught to our children in schools about it as *fact* is quite simply, *wrong* or highly suspect and very debatable to say the least. And not only that but that this information is actually quite well known to academia but despite that fact things that are known to be fallacious about our true past are still being presented and taught as absolutes.

So the real question becomes why? Why are we being lied to; and why are the continuous attempts to keep the information suppressed so intense and dramatic? Why is the *real* information, so closely hoarded and then so viciously guarded?

Why don't they want anyone to know the truth? Is it just because they think the truth is too shocking for us or are there more significant reasons?



### *The Politics of Control*

The truth can sometimes be a pretty scary thing if it's not approached with a certain amount of respect and understanding. People really need to be educated in the realities of the universe and man's relationship to it before things can ever make any true sense.

The unfortunate situation is that a great many people in modern times are also caught so far up in religion that it becomes extremely difficult for them to accept the fact that their faith has been misplaced. The sad truth is that, most people in those situations become very hostile and angry when faced with indisputable evidence, and often to the extent where calm and rational debate can become impossible. Some people, in shocking acts of irresponsibility, religious insecurity and ego will even quite often destroy contrary texts or legitimate proofs and fake other, 'more acceptable' evidence in order to reinforce their personal beliefs.

These sorts of acts make it very difficult for mankind to ever discover the real truths. Maybe I'm slightly more wary than some but I have always considered truth to be the ultimate goal in any quest for knowledge.

One day it may be realized that facts are simply facts; nothing more, nothing less. Facts, when properly understood, do not need to encroach on people's Racial Prides or National Heritages or Ethnocentric Insecurities.

In truth possibly the most malicious, irresponsible and dangerous act that has been ever committed against mankind as a whole is the conscious and willful suppression of knowledge and the pure and utter fabrication that is perpetuated by academia on a daily basis, for in truth, all the peoples of the world, the entirety of Humankind have had their true heritage stolen from them and purposely and systematically hidden from view by Financial, Political, Theological and Academic Megalomaniacs whose only desire is control. This fact has been proven time and time again. These actions, which can be held wholly responsible for most of the bloodshed that has occurred the last 2000 years, knowingly performed by the very people who hold the keys to our knowledge and our future, represent a crime beyond comparison. As history has now shown, their suppression of real truths has placed mankind in an extremely unbalanced and perilous situation. With proper education and open and free societies the world would be free of most of its troubles because control through Political and Religious means could never work on an educated population. With proper education the idea of one person killing another over a stolen story that has been contrived into a religious doctrine and written in a book would be openly seen to be as ridiculous as it is obscene.

But the problem for governments is that with proper education the world would also never let our corrupt leaders or Multinational Corporations abuse their power the way they have done and still now continue to do. For this reason people are kept too busy to be aware of many of these things that are going on around them and often the hidden truths go unnoticed because of the constant barrage of media propaganda and the rigors of daily life.

If you keep people busy enough and distracted enough, they simply don't notice what is going on around them. In this way entire populations are unwittingly controlled every day.

Even now, still more discoveries are being made that challenge our traditional tenets such as the first ever fossilized dinosaur heart that was discovered in 1993. Now this may not sound like much of a find to you at first but it was one that absolutely rocked the paleontology world because the heart was discovered to have *four* ventricles. This of course means dinosaurs were warm blooded and *that* means that they were not actually the slow moving, cumbersome reptiles that had been previously imagined but were in fact, quite swift and agile. But, consider this, it also means that they were not even reptiles as had been previously surmised because reptiles have hearts containing only three ventricles and are essentially cold blooded creatures. Then, in 2004, the actual remains of a dinosaur bone was found, *with a feather still attached to it!*

This immediately causes one to pause and reflect on the myriad of South American accounts of Quetzalcoatl, Viracocha, Voltan etc and of the possible reality of Feathered Serpents...

In 2003, the remains of an entirely new species of previously unknown one meter tall humans was discovered in a cave called Liang Bua on the Indonesian island of Flores, about 400 miles east of Bali, and not just one, but the remains of a whole tribe that had apparently been living on a quite populated island up until possibly as recently as 200 or 300 years ago. Even more recently a formerly unknown member of our solar system has been confirmed and photographed.

And there is a substantial amount of other new evidence that suggests the very real possibility that some of the things that were supposed to have happened in our 'prehistory,' may not have really actually occurred, quite that long ago at all.

### *Of Hobbits, Dinosaurs & Alphabets*

The human remains that were discovered in 2003 on Flores totally shocked the scientists involved in the find because the skeletons were of a previously unknown *miniature* human species. The full-grown human skeleton that was recovered from the site was barely a meter tall (*about the height of a three year old*) with a skull about the size of a grapefruit and some researchers claim that the discovery is now proof positive that the human species is actually far more diverse than had ever been previously believed. The remains of a cranium both right and left legs, a hand and other smaller bone fragments were recovered from the site. The diminutive size of these human remains can be easily seen by a simple comparison of the skull of the Flores skeleton with that of a normal sized human (*fig.155*).

The researchers also determined that the skeleton was not that of a dwarf or otherwise abnormal in any way, but was in fact perfectly proportioned for its size exactly like a normal adult only considerably smaller in size. The team also found the remains of a number of other similar sized humans in the cave as well, confirming that the area was once home to a reasonably sized population of the little people which have been named Homo- Florensiensis (*fig.156*).



Fig.155

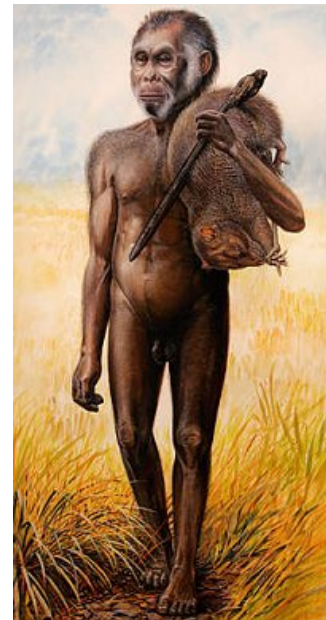

Fig.156

The discovery of these remains absolutely confounded the Archeology and Anthropology worlds. According to Darwin's theory of evolution, researchers had previously believed that any people with a brain and body of such minute size could only possibly have walked the Earth at a period of no less than 3 million years ago. The find was indeed so surprising that the associate Professor of Archaeology at the University of New England in Armidale Australia, Professor Peter Brown commented: *"I would have been less surprised if my colleagues had found an alien*

*spacecraft!*" The research team has not ruled out the possibility that the small human species may actually have survived on the island until as recently as the 1500s. This idea is also greatly supported by local folk tales. The local legends tell us that the little people lived in caves in the forests and were well known to the local villagers who would leave food outside at night for the little people to collect mostly in louver gourds and according to the co-author of the study, a Richard Roberts of the University of Wollongong: *"Legend has it these were the guests from hell; they'd eat everything – including the gourds."*

The local legends actually go a good deal further than that and it may be this diminutive race of forest dwellers became more than just the guests from hell and became too much for the local inhabitants. One tale has it that in times when food was scarce the little folk would come down from the mountains and steal food from the villagers. Locals report that only a few generations ago, on one such occasion while conducting one of these raids, they also stole a baby from a villager. The angry villagers, knowing of the mountain cave where the little folk dwelt, formed an angry mob and made their way to cave you retrieve the infant. Upon their arrival they found the child long dead and so in their wrath they set fire to the cave and fueled the fire so they would be rid of the forest people for ever.

If such a tale is indeed true then it is not unreasonable to surmise that there may well have been more than just a single colony of such forest people who may well have taken fright at the fiery demise of their brethren and moved deeper into the jungle and if that be the case, they will still be living in some remote area..

Sightings of such small forest people have occurred in New Guinea and in Queensland Australia in an area of Lamington National Park known as "the Lost World" a dense subtropical rainforest location of very mountainous and rugged terrain, though none of these sightings have been 'confirmed', in other words, they haven't managed to catch or kill one yet.

It is interesting to note here that if one is to study the timeframe of our history and also the timeframe of evolution as it presents itself, but also take the Sumerian account of creation at face value a startling possibility presents itself.

Why were the Gods of old always depicted as being of greater stature than man and spoken of as giants? If indeed they were giants and if indeed they mixed their DNA with Hominid DNA to create man as the texts suggest then it is not entirely unreasonable to imagine that Homo-Florensiensis may well be the origin of the Earthly DNA that was used. This race may now be where man would have actually progressed to if he had been left to his own evolutionary devices in the time that has passed since Neanderthal.

Could it not be possible that our current size, which is larger than Homo-flores and yet still smaller than that of the 'Gods' could well be the result of an intermingling of the two 'gene pools' of the larger and smaller races.

Could it be that Homo Flores is actually the missing genetic link so sought after? That would simply turn evolution on its head. Time may show the discovery of this new human species to be the final nail in the Darwinian coffin and I imagine that Theologians will be equally mortified.

I'm not saying that such a thing is so, I'm just mentioning that it's an interesting thought and if one is consider all the evidence it's not entirely outside the realms of possibility. Time will tell.

The first-ever discovery of traces of a dinosaur heart in a fossil discovered in Raleigh, North Carolina (*fig.157*) has also now provided equally disturbing evidence that a large number of the long-extinct beasts were not the slow and plodding creatures that had so far been imagined but were in fact quick and agile, even quite similar to birds!

The fossil, now on display at the South Dakota museum, was exceptionally well-preserved and a 3-D view of the heart absolutely astounded researchers because the heart contained four highly developed chambers and a single arched aorta!

*"The single aorta completely separates the oxygen-rich blood from the oxygen-poor blood and sends it to all parts of the body,"* said Russell. *"This challenges some of the*

*most fundamental theories about how and when dinosaurs evolved. Most reptiles have three-chambered hearts, but even in those with four chambers, such as the crocodile, the blood is pumped through double arteries that mix oxygen-heavy blood with oxygen-lean blood, cold blooded reptiles are dependent on the environment for body heat. Warm blooded mammals and birds generate their own body heat and are more tolerant of temperature extremes.”*



Fig.157

Another brief, though quite interesting article concerning an ancient alphabet that had been discovered, virtually worldwide also appeared in 2004, suggesting further evidence of a widely dispersed culture in remote prehistory.

The alphabet had been found and successfully translated on six continents and so far translations and grammar suggest a global human culture thrived in antiquity!

The alphabet is similar to ancient writing found in other locations around the globe and the author of the article suggests that this is the result of a cultural migration. The site where it was located, near La Junta, has been dated to before 800 BC. While in the Negev desert of Israel, the same alphabet has been dated to 1500 BC. In South Australia the same alphabet is estimated to be over 5000 years old and similar alphabets have also been discovered in Oklahoma, Mexico, Peru, Bolivia, Brazil and in Western Asia indicating a common culture that was virtually globally dispersed (*fig.158*).

The Discovery of this alphabet is very significant and as the diagram clearly shows, it is indeed quite widely dispersed and may still yet be found in other locations. Hmmm, perhaps these were the people who planted all those bananas...

Many things have been lost in the course of mans history but one of the saddest of these has been the loss of our history itself and though we still continue to search for explanations to the riddles that plague our past, the longer it takes to find the pieces we need, the harder the quest becomes. The entire Sinai area where the answers to many of the great mysteries of mankind lie has been kept a war zone by banking interests, squabbling religious fanatics and oil companies for so long now that any trace of the answers we seek may well come way to late if they still remain

at all. However the hoarding of information and the steady and methodical dismantling of our true history by Academia is the real root cause of many of the Maladies mankind now faces.

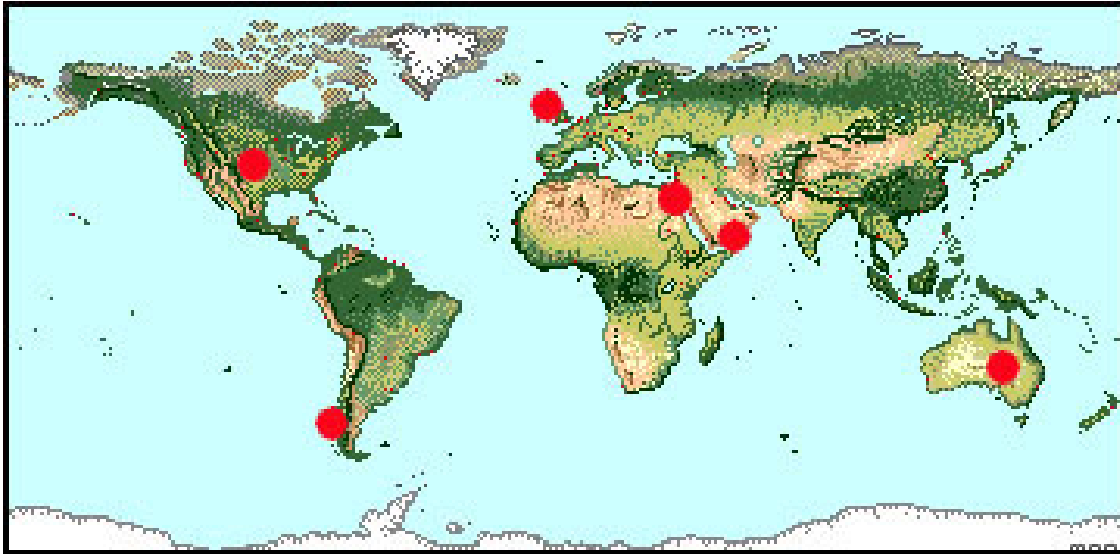

Fig.158



# Forgotten Codes



## *The Great Puzzle*

The main aim of this book has to provide people with information designed to make it abundantly clear to you that the history we have been led to believe is irrefutably wrong. This is virtually an established fact no matter what academia asks us to believe. It has also hopefully provided you with some sort of insight into what the ancient legends suggest to be a possibility and the evidence that can be gathered to support these 'myths'.

But to where, does all this lead? Do the answers lie in the Myths, somehow locked into the alignments of the ancient ruins, or hidden in the texts?

Do they tell us to watch for certain astronomical or celestial signs that warn of impending disaster? Is that what the monuments and astronomical alignments are trying to tell us? Could it be a global catastrophe or polar reversal? Could that be one of the things we are being told about or warned of in ancient texts and myths?

The computer code or algorithm that has been discovered running through the entire Hebrew Bible appears to speak of or predict all major world events past, present and future. The code has been confirmed as being real by many of the world's leading mathematicians, and simply has no right being there unless someone or something put it there purposely. Encoded are a myriad of incredibly accurate modern day events: The assassination of Yitzhak Rabin, The Clinton Presidency and his affair with a 'maidservant,' the collapse of the twin towers, Al Gore winning the vote but having 'evil done against him' and GW Bush then becoming President by fraudulent means, and a great deal more extremely accurate information that simply defies all analysis can all be found quite clearly encoded within the text. The code also contains numerous references to a coming World War. Could this hidden book within the bible be the hidden book the bible tells us will be opened at the end of days? Could the Bible code be the biblical book with 7 seals that will be opened at the beginning of the end that we are told of in Revelations?

Who was it who encoded this information?

Was it the Gods of old, the Anunnaki of ancient Sumer who created it all?

Or was it just God?

When considering the remains of the ancient temples that we find dotted across our globe the question that instantly arises is, why the absolutely ridiculous obsession with temple alignments and astronomy? What was the meaning behind it all? Because they were awe-struck by the celestial display of stars? To predict the equinoxes for crop cycles as some have suggested? But if it was simply for crops, why go to all that trouble to get it so precise -why not just ask a farmer? Why devote so much attention to alignments? Is there knowledge we can glean from them?

And then there are all the myths and legends.

By examining the brilliant work of authors such as Zechariah Sitchin we have seen it explained to us what the uses of many ancient places actually were: the mines and metallurgy facilities in South America, The landing platforms at Baalbeck and Jerusalem, the pyramid beacons in the Nile Valley. But it still goes further than that.

One of the first notable scholars who believed that the ancient scriptures and temple alignments held the secrets to an ancient and hidden knowledge was the great scientist Isaac Newton who spent his life secretly trying to decipher them. Newton was once asked a question by a student or colleague regarding the planets and gravity which he was unable to answer at the time so he retired to his study. The resulting thesis he delivered on gravity and planetary rotation (*after a subsequent labor of three years*) is still considered by many to be one of the most comprehensive and brilliant scientific papers ever written. Yet secretly, Newton hearts desire was to acquire knowledge of the secrets of divine creation known only to God. He believed the secrets were locked within the ancient scriptures and that the key to unlocking them lay in Alchemy.

For years, many had practiced the forbidden science of Alchemy – seeking the secrets of turning base metals into the purest gold, yet Newton had a grander vision for the secret craft. He believed that the bible and other texts contained, disguised within their narrative in numerology, Alchemical formulas and recipes, the discovery of which would teach him the secrets of creation, of all life and of the universe. He too, also believed that the Christian story of creation could be clearly seen within the ancient Babylonian creation epic

The suggestion that the Biblical story of Genesis actually had its origins in a much earlier Babylonian creation myth (*as recounted in the Enuma Elish*) and that the Babylonian version seemed to be derived from a still earlier source, was probably first put forth academically by a British museum worker called George Smith who worked for years piecing together fragmented clay tablets from Mesopotamia and eventually published his findings in a quite extraordinary book entitled '*The Chaldean Genesis*'.

Now, due to the recent discovery of fragments of a much earlier Sumerian version of the Enuma Elish, it is universally agreed that the Babylonian Epic of Creation has its origins in the much more complete Sumerian tale and it is Sitchin who ascertains that it is by interpreting the references and cosmology that underlies the Enuma Elish as actually being Sumerian and not Babylonian that the true nature of the tale finally emerges.

It can be noted that in the earlier Sumerian version the invader was not named Marduk but Nibiru, It has now been established that the reference in the Babylonian text to Marduk as being the ultimate God who created the Earth and ultimately man and everything else, is actually a forgery where the name Marduk was inserted to replace Nibiru and that this variation in the tale most likely occurred when Ra/Marduk seized control of Babylon and he and his followers were anxious to portray their ruling deity as being the supreme creator of all life as well as the lord of the earth..

I have absolutely no doubt that Sitchin is completely correct in his assertion that if one realizes the actual origin of the Biblical story of Genesis and interprets it and the many other tales concerning creation, not as myths and allegorical stories, but as actual factual accounts of a series of celestial events, a surprisingly coherent and confirmable version of earths true history can finally be discovered.

## *Science and Religion*

Consider for a moment that if man was forced to start again right from this point, right now. Consider what would happen if there was some kind of major cataclysm like a comet impact right now, today, and pockets of survivors were forced back to the stone-age to begin culture and society anew. What faiths would they keep, adhere to or create? What sciences would they eventually discover, develop and embrace? Would it be the sciences we have knowledge of now or would the evolution of the craft branch off in another completely different direction?

Before his death Einstein was already working on the concept of the unified field and now in modern days we can see some of that vision a reality with the advent of quantum physics and string theory. It is common knowledge that all matter is ultimately composed of light and sound, vibrating at specific frequencies. Einstein theorized that gravity also had a specific frequency of vibration and that if it could be discovered then the correct frequency of sound directed at any given object should render the object weightless. It is not unreasonable to suppose that when the actual sound frequency of gravity is discovered and directed into harmony with the frequency of biological 'strings' then levitation may even become common place. Feats of levitation have often been reported and in some cases even witnessed by people in their observations of some Shaolin Monks of Tibet who have been seen levitating heavy stones to the top of steep cliffs.

Think for a moment what the technology we possess today would have seemed like to those who lived in times past – Electric lights, cars, aeroplanes, television, cell phones, microwave ovens; all these things are common place today yet to them would have appeared more like magic than science. If another race exists in the billions of stars that supports planets then that race is likely many thousands perhaps millions of years in advance of ours and the technologies they may conceivably possess would most likely appear to be impossible to us as much as ours would appear so to those who lived a thousand years ago.

In truth, ancient man did not practice religion as we conceive it today. In past civilizations science and religion were intrinsically intertwined, they were not practiced as such; they were simply a way of life. Man was aware of himself and his relationship to the universe, the creator and those 'Gods' in between because it was simply the way things were – so how could it be perceived to be any different. Of course there was the worship of mighty Gods who were held in great fear and reverence but they were celestial gods, the planets. And again, Why? Did ancient man have telescopes? Surely not... Did they know some of the tiny lights in the night sky were really planets and not stars?

Of course they did.

The question is – Without telescopes, how did they know?

Would you, if you looked up to the night sky, discern and count the planets and observe their movements? Would you be capable of predicting their orbits? Would you observe the phenomenon of precession, a movement of 1 degree every 72 years? No, of course you wouldn't.

And yet they knew. When man still believed the Earth was flat he knew of the precession of the Zodiac, the entire notion is nonsensical.

The Sumerians tell us that the Zodiac was created by the Gods.

Ok, but if we take that on face value, why would the Gods even do it?

Sitchin tells us it was done to keep track of the enormously long passages of time dealt with in tracking the orbital movements of Nibiru the planet of the Gods.

Could this truly be the case?

When examining all the aspects of these ancient religions surprisingly many of their mythologies seem to have their basis in science and astronomy and the references are always the same: 12 Signs of Zodiac, 12 months in the year, 12 ancient Gods, 12 disciples etc, there is also the appearance of the number 432 or 432,000 and the continual use of the number 52, in various different mythologies. There are always the same mathematics and astronomical references, whatever the culture. The same can even be further seen now in the Christian religion with the discovery of the Bible Code.



The bible code itself is one of the most enigmatic things imaginable.

The code that has been found running through the text of the Hebrew Bible by the renowned mathematician Elijah Rips has stood up to the most rigorous mathematical tests available and is most certainly a definite reality.

The author of the books on the code, Michael Drosnin, is himself convinced that an actual key to unlocking the code in its entirety may even exist so it may even be possible to view the code 'en masse.' He also believes that the finding of such a key may then even divulge to us who the original encoder actually was. He may well be right; the bible code itself even seems to strongly suggest that very possibility.

Rips found the hidden code by removing all the punctuation from the Hebrew bible thus reducing it to one long string of letters and then applying a computer program to it that was designed to look for letter skips. It is no surprise that only in such a fashion could the discovery of the bible code have been achieved as the entire book of the old testament is actually reported to have been delivered to Moses on mount Sinai as one long string of letters. This is perhaps why the Hebrew version has always remained true to its original form without one letter changed.

The Hebrew bible is not the words of God and does not really contain the *words* of God, but is, in fact, the *word* of God in the singular form.

It has always been referred to in this manner and this of course implies that it was always really meant to be just one word, one long contiguous letter string that is in itself, essentially a single word, possibly even like an anachronism for something else hidden. The word of God is an immense singular word of 304,805 letters into which could theoretically be encoded a myriad of other seemingly endless possibilities. The bible code itself appears to function in this way and to be an incredibly complex, yet somehow simplistically perfect, complete mathematical formula that encompasses all of life, the earth and our history – within a story. Truly – a divine code and to change even one letter would totally invalidate the entire mathematical formula.

Drosnin is certain that the bible code itself states that the key to unlocking the complete code is secreted in an 'ark' of some kind, a container or sealed vessel of metal and has something to do with an obelisk or pillar that may well be buried somewhere in Jordan. Most of the evidence he has managed to gather so far from the code itself strongly indicates an area in the Northern Sinai in the vicinity of Mazra near the Lisan peninsula, a small and inhospitable piece of land that juts into the southern Dead Sea.

Who could have come up with a code that encompasses all the secrets of our world and concealed them in a lost book that could not be opened until the invention of the computer? And then secreted the key to this incredible mathematical formula for life in a metal box, information about which is inscribed on an obelisk or pillar?

Was it God? Was it Aliens?

Maybe it was a time traveler who had an awfully good knowledge of history?

Or was it one 'God' in particular who may not have actually been a God at all?

### ***Divine Codes***

In his search for the key that may break the bible code, the 'ark' in which it was hidden and the enigmatic obelisk that was mentioned by the code, Drosnin discovered another truly enigmatic message that said '*Steel Vehicle*' which was crossed by '*His Vehicle He Threw into the Sea.*', which was a somewhat bizarre statement to find in the bible code.

Drosnin was stunned at these results and further investigation of the code in search of its key produced even more cryptic results: '*Garden of Lisan*' was found, and then '*I will place the language gene*' was crossed by '*I will make intelligent*'.

Now thoroughly perplexed he continued, soon discovering all in one area, '*Code*', '*Key*', '*His Tablet Vitalized the Obelisk*' and '*The Origin of it, This is the area of the Engraved Letters, Hidden*' which was crossed by '*Birth Pangs of Language*'.

Drosnin's discovery of these cryptic references kept continuing: 'In Lisan DNA/In the language of DNA' was crossed by 'A Copy of Everything was brought'. 'In Lisan DNA' was crossed by 'Mazra/Seeded' and 'DNA Code' was crossed by 'On Obelisk' and 'In Adam the Template'. All were all found by Drosnin within the bible code.

Now if my attention was not pricked at the start of the book, which it most certainly was, it was most definitely fully aroused now. As I stared at these cryptic messages and read of Drosnin's bewilderment at finding them, something began to dawn on me.

When I had read Michael Drosnins books 'The Bible Code' and 'The Bible Code 2' I was dumbfounded when I saw the cryptic clues he was receiving in his search for the key and its mysterious encoder. What struck me was that these clues sounded awfully like references to the ancient Sumerian account of the arrival of the Anunnaki and the creation of man by genetic engineering, and more!

In the Bible code we see: "He Threw His Vehicle Into The Sea" and in Sitchin's translation of the arrival of the first team of Anunnaki, as told in a personal account written by the first leader Anunnaki himself in "The Lost Book of Enki" we read: "...into the waters down it splashed, into the depths not sinking" Drosnin also found references to a "steel vehicle" and sections of the code suggesting that such a vehicle may still exist somewhere in the area of Lisan in the dead sea.

This is remarkable because the arrival and wading ashore of a God in a fish suit who was the creator of mankind is a theme that is in fact, common to many cultures According to Sumerian texts the Lord Ea later to become known as Enki is said to have worn a "fish suit" and an "eagle mask" as he waded ashore through the marshes. The event is also recalled in Greek mythology as story of Oannes wading ashore and creating mankind and civilization. Oannes is also often depicted in a fish suit (fig.159) and it is notable that Oannes has also been at times depicted as a serpent fish (fig.160) in an obvious reference to the Sumerian god Enki. Enki himself also appeared in a fish suit in early Sumerian depictions (fig.161). The mysterious Dogon tribe from Mali, West Africa also worship a God donned in a Fish suit and a helmet of some kind who they say started mankind (fig.162).

The similarities between these legends coming to us from vastly differing cultures just cannot be understated or easily dismissed.



Fig.159

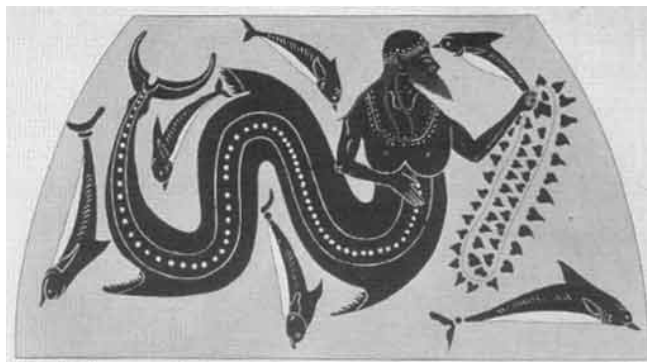

Fig.160

The Philistines also worshipped a fish god called Dagon and symbol of the fish is still used today in Christianity. The cross is also a very significant Christian symbol and not simply because it was the method of execution used in the crucifixion of Christ. But it is worth questioning if it could be in any way possible that the symbol of the Christian cross could have its true origins and elongated shape in the Early Sumerian references to the Planet of the 'Crossing' and its elongated orbit? (Fig.163). I am not saying that this is so of course. I am merely asking if it could perhaps be possible.

Ancient Legends from countless ancient sources tell of the Egyptian God Thoth at one time writing a book in his own hand then secreting it in a metal box or ark of some kind and inscribing

a pillar or pillars with the information that would reveal its location. This mysterious “Lost Book of Thoth” has been one of the most sought after artifacts in all of history, right up there with the Holy Grail and the Ark of the Covenant and there are some interesting legends attached to this book. According to the story of Setna, the Book of Thoth lies in an iron box hidden beneath a place once known as Koptos, thought to be near the middle of the Nile. The location was said by Setna to be the tomb where Nefrekeptah, the son of Amen-Hotep lies with his wife Ahura and son Merab. On the chest of Nefrekeptah lies an iron box. Within this iron box is a box of made of bronze; inside the bronze box is a box made from sycamore wood; within the sycamore box is another box constructed from ivory and ebony; inside the ivory and ebony box is a silver box, while within the silver box is at last a golden box - inside that golden box lies the coveted Book of Thoth. All about the iron box are twisted snakes and scorpions and it is said to be guarded by a serpent that cannot be slain.



Fig.161



Fig.162

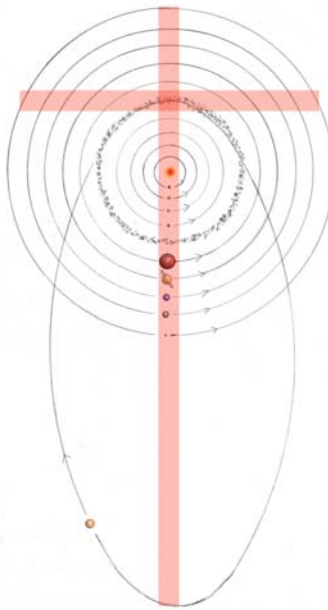

Fig.163

When considering the clues that were uncovered by Drosnin in his search for information concerning the mysterious encoder of the bible code, the legend of the metal box containing the lost book of Thoth immediately springs to mind. Could it not be reasonable to suppose that each of these two references which both refer to a secreted metal box containing incredibly significant and advanced information, may in fact, be references to exactly the same lost artifact?

Could the bible code be providing us with still further confirmation to the factual reality of the ancient Sumerian accounts?



## Chapter Fifteen

# After-thoughts



“In the absence of Evidence to the Contrary the Simplest Solution is usually correct”  
- Occams Razor

Though Darwinism has stood virtually unchallenged and has always been generally regarded as fact in the Academic Community and the Biblical story of Genesis has managed to maintain its tenacious, though now somewhat precarious grip on its own captive audience, as we have abundantly shown there are numerous types of quite significant other evidences which greatly question the validity of both theories even to the point of utterly disproving them.

Not only does this new evidence challenge these theories but it also bring into question a number of other things that have been presented to us as ‘fact’, even challenging the very fabric and foundations of our beings and who we thought we were.

### *A God of Science & Numbers*

It should by now be abundantly clear that not all in our history, or indeed in our world, is what it appears to be and certainly is not what is perpetually promoted to us as factual. Evidence proves beyond any shadow of doubt that an ancient civilization even more advanced than ours did indeed once exist on this frail little ball in space that is our home. All evidence indicates that they existed around circa 11.500 BC and then destroyed themselves in a nuclear holocaust of catastrophic proportions at around circa 2020 BC. The evidence tells us that the event took place in the Sinai Peninsula and that aerial battles were also fought over the Libyan Desert scalding the surface into the acres of strange yellow glass that still lies there today. Academics dispute the possibility of this mainly due to the timeframe, flatly stating in no uncertain terms that at circa 2000 BC mankind was still hunters and gatherers.

But the answer to that is yes, indeed they were, and yet evidence irrefutably proves such a civilization did in fact exist. This in itself *proves* that man was not in fact responsible for the civilization that we find so many traces of, which in turn indicates that it was built by someone

other than man. The obvious conclusion is that it was built by exactly whom *all* the legends of old from *all cultures* say it was built by. It was built by the 'Gods' of ancient legend.

Those same beings were responsible for the enigmatic structures, devastating wars we are told of in great detail in Sumerian texts, and for the vitrified ruins and deserts that ensued. The gods from ancient Sumer who were also well known in Egypt and Babylon, Greece, Rome and India; The Giants of South American legends who were also mentioned in the biblical texts as 'giants' and named in the Hebrew Bible as the Elohim and the Nephilim. 'Those who from Heaven to Earth Came' Those whom Sumerian texts call the Anunnaki. I have little doubt that the Adamu worker race the Sumerian texts tell us was created in the E.DIN was indeed the very story of the creation of the biblical Adam in Eden.

That the event was once common knowledge can be clearly seen in our modern medical symbol. Does it not seem strangely coincidental to you that the modern medical symbol consists of two intertwining serpents surmounted by a sphere and two wings. Here we see a perfect representation of DNA, that has been in use for centuries – and since long before the discovery of DNA. Yet it is quite obvious that the symbol does indeed represent the twisting nature of the human genome and its creator Enki who was always signified by the symbol of the Serpent. I believe the modern medical symbol is probably even a representation that signifies the actual event, the very moment when man was created in the Anunnaki medical centre in the E.DIN that has remained in a surprisingly consistent state and actually changed very little with the passage of time. From the Mesopotamian tree of life with the Winged disc representing the home of the creator of the tree - the planet Nibiru at the top (*fig.164*), to the Olmec tree of life (*fig.165*); to the Greek, Caduceus and the Staff of Asclepius (*fig.166*); and then through to the modern medical symbol (*fig.167*). All of these symbols, both ancient and modern, are a clear representation of what we now know to be the spiraling double helix form of human DNA (*fig.168*) many years and even centuries before it was discovered. The inclusion of a winged object at the crest is also significant.

The Sumerian tales speak of how the great pyramid was constructed by the son of the great lord Enki who had created man with the aid of his half-sister Ninmah.

Enki had six sons. One of these sons was the Sumerian god Ningishzidda, known in Egypt as Thoth, the great Master of Science and numbers, in South America as Quetzalcoatl the Great Benefactor and bestower of knowledge, and in Greek myths as Hermes the Master of Science and Mathematics.

Legends throughout all mythologies recall Thoth as one of the wisest and most benevolent Gods of all. Thoth is said to have created countless wonders. It was Thoth who was always consulted in the construction and astronomical lines of the temples, it was Thoth who added the leaves of knowing to mans tree of life, it was Thoth who gave Ka-in his mark. Thoth inseminated Isis with the seed of her murdered husband Osiris resulting in the birth of Horus, and it was Thoth who designed and constructed the miracle that is the great pyramid. Several mathematical and astronomical similarities between Egypt and the enigmatic structures at Stonehenge also strongly suggest that Thoth may have had a hand in the construction of that site too.

Legends tell us of Thoth writing a secret book containing all the information and knowledge he had learned from his father Enki and all the knowledge he had acquired himself when the Anunnaki left Earth. Thoth is said to have then hidden it in a secret and secure underground location and to have then inscribed information pertaining to the book and maybe more on a pillar or possibly even two pillars.

These pillars or obelisks were known to the Greeks and the Phoenicians as the Pillars of Hercules. The Egyptian historian Manetho mentions the existence of two such pillars and tells us that Thoth inscribed the pillars with hieroglyphs containing all of the ancient wisdom. A golden pillar inscribed with hieroglyphics was also described by Plato. Alexander the Great is reported to have inspected large pillars of gold bearing unusual hieroglyph markings. Proclus mentioned that Crantor visited 'Sais' in Egypt and had been shown a golden pillar inscribed with hieroglyphics.

A Jewish historian called Josephus mentions that Thoth inscribed some pillars with knowledge: “in order that wisdom and astronomical knowledge should not perish” and described “two pillars, one of stone and one of brick in which he inscribed this knowledge for posterity, said pillars still existing in the land of ‘Siriad’ to this day”

The secret and scientific information most valued by the Anunnaki is said to have been kept on small devices that you could hold in your hand similar to modern CD’s, the texts called these enigmatic objects ME’s. The ME’s were said to contain the secrets of the ‘Tablets of Destinies.’ These have been assumed by many as being either astronomical information or fixed flight plans,



Fig.164



Fig.165



Fig.166



Fig.167

Celestial orbits and flight paths that were unalterable, among other things. But having such an in depth knowledge of the celestial and mathematical workings of our universe as the Anunnaki seem to have had, may the tablets of destinies not have also contained information on the destinies and both alterable and unalterable fates of mankind, and even the Gods themselves?

The tablets of destinies were said to be the most coveted and also the most closely guarded of all the Anunnaki technology.

The bible code itself states that it was “done on a computer.” Could it be in any way possible for the information contained and hidden within the bible code to have come from the, computer-disc-like, ME’s of the Anunnaki?

And could it also be possible for Thoth to have encoded all the information contained on all of man kinds ‘Tablets of Destinies’ within the narrative of the one book that he knew would last this long on Earth - ‘so the information would not be lost’?

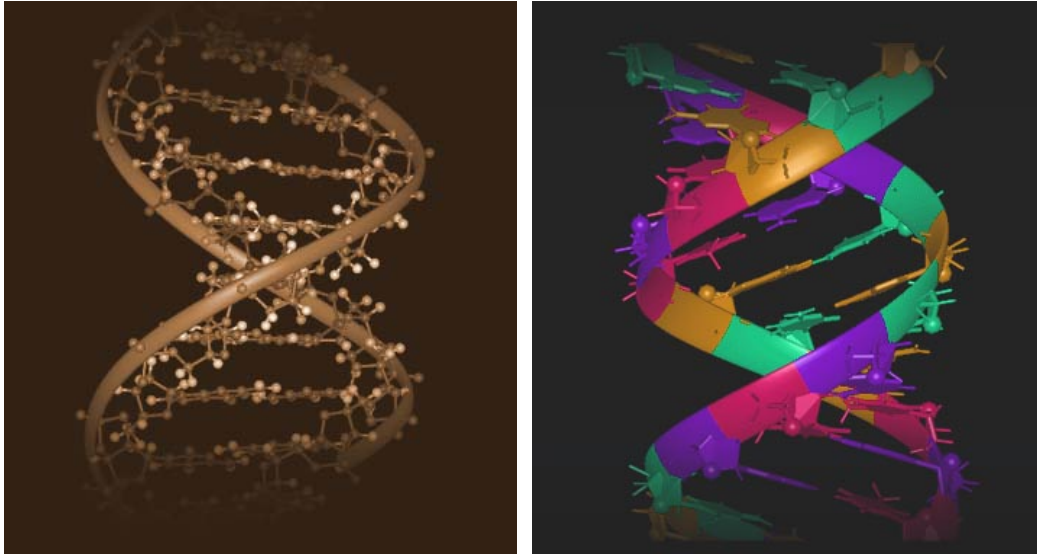

Fig.168

Could he have then hidden the code to unlocking the book, perhaps even the enigmas ME’s themselves in a vessel, chest or ‘ark’ somewhere underground? Maybe in the land that was the dwelling place of the last Anunnaki ruler on earth known in Egypt as Sin and whose land still bears their name today ‘*Sin’s Land*’ – Sinai.

Could the Lost Book of Thoth actually have been right here under our noses all along, hidden within the Bible? Was it Thoth who appeared to Moses on Mount Sinai? Was Thoth the one who made an appearance that day as the Hebrew God Yahweh?

Could Thoth, the Sumerian God Ningishzidda the great Master of Science and Mathematics, the master architect, builder of the pyramids, creator of the calendar, actually be the encoder of the mysterious and so very accurate Bible Code?

As a side note, in Sumerian texts, we are told of the existence the mysterious objects known as ‘M.E.’s’ that they were small enough to hold in ones hand and yet contained vast amounts of information. This description instantly brings to mind something along the lines of our modern CD’s or portable Ram Drives. The Sumerian tales tell of Lord Enki being the custodian of the ME’s and also of Enki setting up mining operations in the Abzu which has now been clearly identified as Africa. In considering this ones mind is immediately drawn to the hundreds of mysterious small metal spheres some with parallel bands running around them that have been found and continue to be found in deep underground mines in Africa at an impossible strata depth of 2.8 billion years (*see Chapter 2: “Riddles from the Past”*). Could there be a link?

It’s an interesting thought to say the least.

### **Our Newest Neighbor**

On Monday August 2<sup>nd</sup> 2005 scientists absolutely confirmed the existence of another planetary body that is part of our solar system thus bringing the number of orbiting planets known to be in our solar system to a confirmed 10. However if one considers the Sun to be a system member and



the Earth and the Moon as being a double planetary system as the ancient Sumerians did then the actual number of bodies existing in our Solar System is now raised to 12 thereby confirming the 6000 year old Sumerian accounts. The Astronauts of the Space Shuttle Discovery also spent time observing and photographing the planet (*which also has at least one moon*) during their August 2005 mission to the international Space Station (*fig.169*).

This discovery is of enormous significance.

As yet too little is known about the new celestial body to announce anything significant except that it is most certainly there. Even its actual size is still a matter for dispute. Some have estimated its size to be smaller than Pluto and some have estimated it to be larger than Earth. As yet the planet is still too far away to be certain of much at all except the fact that it is definitely orbiting our Sun. However since this planet was first noticed in 1985, again in 1995 and is now easier to discern and has just been positively confirmed as solar member in 2005, it is then reasonable to assume that it is slowly getting closer which indicates the distinct possibility that it follows a vast elliptical orbit. This fact is also of significant importance because it also validates the Sumerian accounts.

The Official Nasa press release number 05-209 reads as follows

#### Scientists Discover Tenth Planet

A planet larger than Pluto has been discovered in the outlying regions of the solar system.

The planet was discovered using the Samuel Oschin Telescope at Palomar Observatory near San Diego, Calif. The discovery was announced today by planetary scientist Dr. Mike Brown of the California Institute of Technology in Pasadena, Calif., whose research is partly funded by NASA.

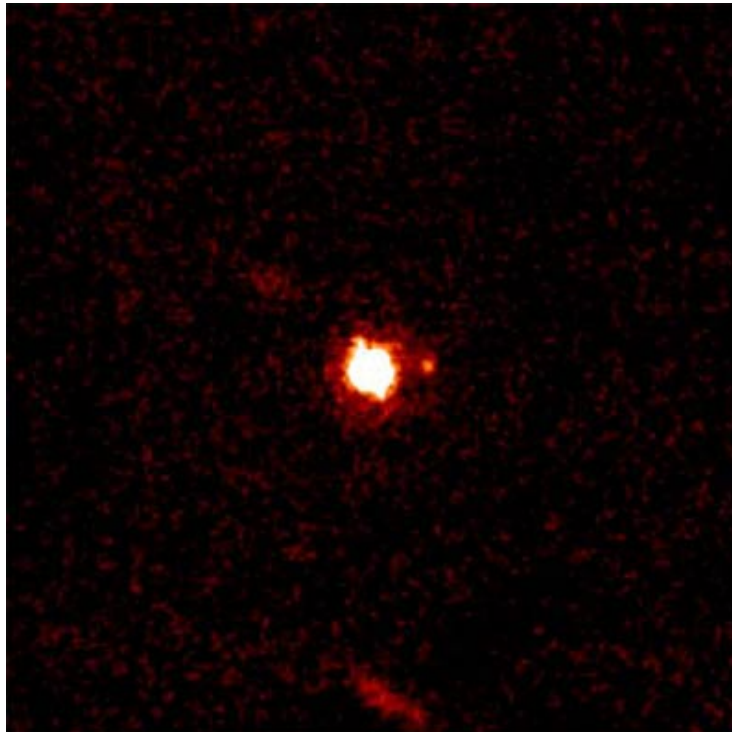

Fig.169

The planet is a typical member of the Kuiper belt, but its sheer size in relation to the nine known planets means that it can only be classified as a planet, Brown said. Currently about 97 times further from the sun than the Earth, the planet is the farthest-known object in the solar system, and the third brightest of the Kuiper belt objects.

*"It will be visible with a telescope over the next six months and is currently almost directly*

*overhead in the early-morning eastern sky, in the constellation Cetus,"* said Brown, who made the discovery with colleagues Chad Trujillo, of the Gemini Observatory in Mauna Kea, Hawaii, and David Rabinowitz, of Yale University, New Haven, Conn., on January 8.

Brown, Trujillo and Rabinowitz first photographed the new planet with the 48-inch Samuel Oschin Telescope on October 31, 2003. However, the object was so far away that its motion was not detected until they reanalyzed the data in January of this year. In the last seven months, the scientists have been studying the planet to better estimate its size and its motions.

*"It's definitely bigger than Pluto,"* said Brown, who is a professor of planetary astronomy.

Scientists can infer the size of a solar system object by its brightness, just as one can infer the size of a faraway light bulb if one knows its wattage. The reflectance of the planet is not yet known. Scientists can not yet tell how much light from the sun is reflected away, but the amount of light the planet reflects puts a lower limit on its size.

*"Even if it reflected 100 percent of the light reaching it, it would still be as big as Pluto,"* says Brown. *"I'd say it's probably one and a half times the size of Pluto, but we're not sure yet of the final size."*

*"We are 100 percent confident that this is the first object bigger than Pluto ever found in the outer solar system,"* Brown added.

A name for the new planet has been proposed by the discoverers to the International Astronomical Union, and they are awaiting the decision of this body before announcing the name.

### **A New Doctrine**

Religious texts and mythologies from all quarters hint of something really big happening at the end of things. In the bible it says "The end days will be as the beginning days", but what was at the beginning?

The Sumerians tell us that it was an enormous and devastating cosmic collision.

Is that what the end times will be? Is that why the ancients were so obsessed with the calendar and the movements of the planets? Was it to track these orbital periods so these times of mass extinction could be predicted? Is that why they dealt with such enormously long periods of time?

A good deal of the evidence that we have previously discussed says it may well be so. If the Mayan Long Count was indeed started by Thoth could that be the reason why it is a count of 432,000 years? The Sumerians tell us that this same period of time 120 shars or 432,000 years is the time that had passed since the arrival of the Anunnaki and the deluge. Are these types of events to be expected when another 120 shars has passed?

The bible and many other texts say that the end times will be as the beginning times. The Sumerians say cosmic collision. It seems apparent that Nibiru seems to cause a great deal of mayhem to the inner planets not on its every passage, but certainly every few orbits and a new planet has just now come into view in our solar system.

It is urgent that some group of scientists and mathematicians begin constructing a computer simulation to see exactly what the orbit of this new solar member is and what harm the close passage of such a celestial body may actually cause.

However, the real path to safety and building a harmonious future for our race and our planet lies in the education of the people; Mass education, on a global scale, if mankind is to survive. Education is mans greatest natural resource.

Remember how the Mayans claim to have had an earlier, harmonious and scientific approach to worship that they had received from Quetzalcoatl but over many years it had become overtly permutated and corrupted by other influences? It is this Authors opinion that an extremely valuable lesson can be learned from that story, for it seems that though traces of the ancient beliefs still run through modern religions with noticeable starkness, the stories themselves have

now become so corrupted and twisted by outside influences that they now bear little resemblance to the original concepts and messages they were once meant to convey.

Modern religions teach little of the old knowledge but instead exert control over their practitioners by enforcing a blind adherence to rigid rules through fear of an unseen and wrathful retribution to be inflicted upon them by a God they claim to be 'pure love.' The very concept is pure contradiction right from the very start.

Modern religious texts also teach that all other texts are to be ignored. This is of course to hide the fact that the doctrines have been borrowed and permuted and can quite easily be disproved through investigation, and then control is lost.

It is a well known fact that the Christian religion even taught reincarnation as part of its doctrine until it was removed from the texts in the fifth century while even in semi modern times we have seen those Christians who claim to adhere most stringently to biblical texts actually alter them to suit their own needs as with the Catholic Religion adding the 'no divorce' decree that has never appeared in any other version and indeed, never appeared in the Hebrew texts from which the catholic version was derived. The Mormon religion claims to be Christian but actually follows their own doctrine as described in the 'Book of Mormon' and it is similar with the Jehovah's Witnesses. More recently we have also witnessed the same in both 'mainstream' and evangelical Christian Religious movements with the introduction of the 'Good News' version of the bible where even a cursory glance reveals that almost every word of the original text has been changed to produce 'modernized' and very slanted versions and in some case quite inaccurate translations of the original stories making any serious investigation or assimilation of the true textual concepts quite literally impossible.

Similar insecurities can be seen in the Islamic religion where virtually all outside influences are banned and constant reinforcement of belief is required through rigorous prayer. These types of practices quite obviously and very logically reveal glaring insecurities in any establishment and even more so when applied to organized religions.

If a religion is so stringent that it cannot be faced by outside facts or influences then the faith it is based on is obviously resting on a very thin foundation and blind belief in any such establishment can only be badly placed. And the same is true of any movements that require 'blind faith', religious, Political, Educational or otherwise.

Proper and complete global education is in truth, the greatest resource available to aid in the continued survival of our planet and of mankind. True education is what is required to assist in the building of a harmonious future for us all. Yet so stupid is the modern political mindset that in 2005, on television news program, in an appalling and almost unfathomable lack of intelligence, compassion and reasoning, I personally heard the Australian Minister for education at the time, Mr. Brendan Nelson actually comment that, in his view: "**education is a privilege and not a right!**" And just consider for a moment that this mental midget was actually in a position of power and is able to make decisions that affect our children on a daily basis while openly maintaining this type of unconscionable attitude. Not only is Mr. Nelson profoundly stupid and an obvious fool, but when his ego and position of power is combined with the stark realities of his obvious intellectual inaptitude it all compounds to make him a very dangerous fool. A minister blatantly announcing and promoting the concept that education should be given only to the privileged, spells a great danger for our future.

Education is mankind's greatest resource. Proper and truthful education would dispel 90% of mankind's afflictions. The repression of real information and true education can be held solely responsible for the situation the world now faces.

Ninety percent of all wars that have been fought in the last 2000 years have been waged for religious or territorial reasons and yet, as we have seen, all religions ultimately stem from the same source. We have easily seen how the much earlier Sumerian story, from whence all of the creation tales originally came, encompasses them all in an extremely scientific way and we can see quite obviously, that ancient man had no religion, as such, but instead had a deep knowledge

of true reality, a science and religion that were integrally combined into a way of life. If all of mankind was truly educated and the true source of all religions, how could there possibly be wars fought over doctrines described in books? Still many other wars have been fought from a lust for power and an expansion of national boundaries but if all mankind was truly educated in the actual realities of our history and accepted each other for who they were, what power would be needed by individual countries? Another hidden but simple truth is that behind each one of these wars has been one controlling banking system that has profited greatly from each conflict.

Throughout this entire work I have attempted to remain neutral and have attempted to avoid any political viewpoint either one way or the other. I have tried to remain focused on the matter at hand which is one of history and not political commentary. However, in closing a few points need to be mentioned.

It is this Author's opinion that the world needs to drastically rethink its approach to pretty well, most things about our societies, our past and the direction we need to take for the future. Things have gotten incredibly bad since the tragic events of September 11<sup>th</sup> 2001 and though it is not the purpose of this book to comment on who the actual perpetrators were or their reasons may have been, it must be noted that since that day occurred an escalation in the suppression of information, more wars of contrivance, and further erosion of human rights has been taking place on a daily basis in all countries of the world, and on a scale that has never before been seen.

In third world countries it is happening by violent and oppressive means where possible, and through 'free trade agreements' or the manipulation of currencies by large banks where needed. In 'civilized' nations it's happening through more nefarious and ambiguous means that are, in their own way, no less oppressive, as in the gradual and subtle dismantling of various national constitutions and everyday rights of the people in order to "protect them" from a shadowy, ill-defined and wholly manufactured enemy - and they are getting away with it through a constant barrage of propaganda. It should also be noted that this has only been made possible due to the fact that the American Government is now firmly in the hands of the Military-Industrial-Complex that President Eisenhower, in 1960, warned the people to be vigilant for and to make sure was never allowed to happen.

In many ways it is very obvious that the closed societies we have constructed for ourselves are in virtually all ways, dysfunctional. It is an admirable quality to take pride in one's heritage and to be proud of one's nation but in reality a great deal of mankind's true heritage has been robbed from us, and this is true for all nations, while Nationalism in its present form, can never have any possibility of succeeding in any concept of a global 'family.' Nationalism undermines the very concept of Human kind peacefully coexisting on one planet. It has become quite obvious that we will never learn to function as a responsible species that can live in harmony together while each country and each faith continues to embrace the concepts of National, Racial, Doctrinal or Religious supremacy. It is clear that the world needs to be governed by one competent and just global body. Yet the key words here are *competent* and *just*. Can such a thing be possible with current Oligarchy of liars and bankers who are presently in control of the world's resources being the ones who will bring about such a governing body? Or does this concept spell the introduction of a one world government where the majority is controlled by the few? The fascist New World Order that many have feared for so long, the New Reich we are even now seeing erected by the Bush Administration and the UN?

It has not been my desire to attempt to say for certain whether the true answers to the mysteries of our past lie in Darwinism or Religion, whether the data that has been provided to us by the ancient texts and monuments is correct, or to confirm the validity or accuracy of the ancient Sumerians account. My main desire has been to provide the reader with information so that they may investigate further and make up their own minds on these matters. However, if there is even a remote chance that any of these tales could be true then they hold grave and important information for all peoples and all races.

For my part however, I believe the people of the world have been duped. I believe we have been systematically and deliberately lied to and that the Emperors new clothes syndrome and a fear of speaking out independently has been deeply ingrained into our psyche.

As our solar system orbits our sun, our sun in turn orbits its own parent star Oberon. Then Oberon in turn orbits another star and so on throughout our galaxy. Our galaxy itself orbits around a black hole at its center. Our solar system is located on the very outer reaches of the Milky Way. As we complete one great cycle around our galaxy our solar system travels slowly up and down in a manner similar to a painted pony on a carousel, occasionally passing through the denser center parts of the flat spiral where there are more asteroids, comets and debris. We are currently in this denser more active section of the galaxy and are due to complete one of these great cycles in 2012. The long count of the Mayan calendar, due to come to its conclusion on December 21<sup>st</sup> 2012, reveals an ancient awareness of this great celestial cycle as does the number 432,000 or fractional divisions thereof, that is found in virtually all mythologies.

We have examined some very important facts throughout this work. We have seen that ancient knowledge of the zodiac irrefutably reveals advanced scientific know-how in ancient times. We have seen it proven that man could not possibly have evolved from apes and that human genome is a mere 200,000 years old. We have learned that many ancient accounts of the “wars of the Gods” can be adequately verified and that these beings in question were in fact no more gods than you or I. We have learned that polar reversals and other cataclysmic upheavals are a proven scientific reality and seen that great civilizations have indeed come and gone in our planets history. We have found credible data to suggest that such upheavals are triggered by predictable, regular, celestial events. And we have learned other important lessons from our observations of the surface features of mars, from our observations of the comet levy-shoemaker nine, and indeed from traces to be found here on Earth – that is that comets and/or asteroids DO actually hit planets.

It is this author’s opinion that instead of focusing our attentions on Wars of contrivance in support of corporate control of resources, thinly veiled as a fight against an unseen shadowy enemy of pure invention, we need to focus on the real issues at hand that are affecting our planet. I believe all the relevant data concerning the issues raised in this work should be investigated openly and en-masse.

In writing this book my main desire has been to simply alert you to the fact that these historical anomalies and religious texts exist, and of the scientific, anthropological, astronomical, geological and genetic studies that have been mentioned. It is my sincere hope that this book will serve as a starting point for you to now go out and research the accuracy of the information that has been presented to you in these pages for yourselves.

Just the mere existence of the many anomalies that have been listed in this book is enough to demonstrate that our past is quite obviously not what we have led to believe. This fact alone makes it at once worthy of further investigation by any reasoning individual. It is not my desire that you blindly believe anything that is written in these pages, but that you now use your powers of reasoning to investigate this information and decide for yourself where the real truths may lie.

The fact also remains that the Bible Code is a reality. It is there. I personally believe it is imperative that an independent scientific research team be able to investigate the Lisan area of Jordan in an attempt to locate the artifacts mentioned by the bible code. Perhaps Drosnin is confining his searches too much. Many Obelisks have been removed from the areas in question, perhaps all the obelisks now found throughout the world should be examined for clues that may help to reveal the location of the mysterious metal box mentioned in the code, the box that may well contain the Lost Book of Thoth, for I believe they may indeed be one and the same. I also feel that it would be prudent for someone to design a 3D computer program to track and predict the orbital movements of our newly discovered celestial companion in relation to the rest of our solar system. Specifically what kind of an effect its close passage would have upon the earth.

Unfortunately, the regions of our earth where the answers to many of these questions may lie are kept in a constant state of strife and political tension. Due to this fact alone, most attempts to uncover the truth in many of these matters has been, and still remains, extremely difficult. Since 2002, in an act of ecological, historical and cultural vandalism never before seen or imagined, these areas have been further devastated by the unwarranted and ruthless bombing campaigns that have been recently carried out by the USA's Bush Administration.

From this point any future chances for research into some these areas, which are in fact some of the most important and relevant areas of our planet have also now been dramatically reduced by the continual use of depleted uranium weapons in the region in the illegal and totally unprovoked invasions of Iraq and Afghanistan, thereby reducing the entire region into a toxic and highly radioactive wasteland.

Depleted Uranium (*banned for use in weapons since 1996*) has a half-life of 4.5 Billion Years. The desert sands in the area are now rife with around 350,000 tons of ultra fine Uranium 238 dust that is reactivated into the air with every desert wind.



Part Four

# Appendices

# Appendix 1



## A HISTORY IN MYTH

Truly, one of the most difficult tasks in attempting to understand what many of the ancient texts are actually trying to say to us is breaking through the layers of metaphor and myth. People have sometimes commented to me that it would be nice if some of these stories just came right out and said what they mean, but it must be understood that some of these tales are extremely ancient and when you consider the options, the reasons for preserving the information as colorful myths are really very simple and quite clever too, I might add.

In reality, it's much easier to preserve a nice story than it is to preserve technical information as people always prefer to listen to a nice story. Let's imagine for example, that we wished to preserve the event of the Comet, Levy-Shoemaker-nine, impacting with Jupiter. Rather than give dates and names for things that we're not even sure will be understood thousands of years from now we could associate the event with a grandly tale involving people and preserve it as a myth.

Let's for arguments sake, pretend that Mars and Venus were in alignment when the event occurred. We could create a simple tale of three Gods:

"There was once, a mighty warrior God who one day, while making a long voyage, met a beautiful maiden in a gown of blue at the edge of a great expanse of ocean. The maiden was his sister, a Goddess and the two tarried together a while conversing, for they had not seen each other in many years. But meanwhile, as they spoke together, their mighty brother God, a Giant with a single great red eye who adorned himself in robes of many colors, was attacked by an outside invader. At first, seeking to catch the giant off guard, the invader appeared as only one solitary attacker but soon cast off its disguise and divided, to reveal a force of 9 strong. It then became clear to the Giant that the attackers were his subjects, mainly cobblers who were angry at the unfair levy the God has imposed upon their trade and seeking retribution. However the force was no match for the solitary giant who, though wounded in the battle, fought back bravely and withstood the blows which numbered 20, finally devouring his foes and absorbing their essences into his Godly self."

OK, so now all we need to do is leave behind enough information for people in the future to be able to associate the warrior with Mars and his sister in blue with Venus and The Giant in many



colors with the great red eye, with Jupiter. We have comfortably dated the event by incorporated the alignment between Mars and Venus by our brother and sisters 'meeting' and dalliance at a far off place when Jupiter was attacked. We have even been able to make a reference to Levy-Shoemaker Nine, and the fact that it broke into 20 pieces with our inference to a force of nine 'cobblers' angry at a new 'levy' delivering 20 blows. We have covered the fact that some severe and visible wounds were left on Jupiter from the impacts and also shown that the fragments were ultimately absorbed into the mass of the planet.

So there we have a nice little 'Myth,' to explain the event of comet levy-shoemaker nine impacting with Jupiter, though please understand that there was no actual alignment between Venus and mars during the comet impact I'm referring to. It was a fictitious event merely used to demonstrate a point. But as you can easily see from this example, an event described in metaphor and presented as a story, is much more likely to be actually told and accurately handed down in oral traditions or written down to be read by people than technical data because names and dates are forgotten, event continuity becomes muddled, and quite frankly, technical data simply confuses too many people whereas campfire tales do not.

It's easy to see how and why many actual events have been recorded and preserved in the form of myths. There is no reason to believe that people, thousands of years into the future, will ever be able to translate your language in entirety, look at all the nuances and double meanings in English for example. It's much easier to preserve an event in myth and then leave behind the means to associate the characters with their celestial and terrestrial counterparts. This has been clearly demonstrated in the Babylonian description of the cosmic collision described in Sumerian texts, as Marduk, the king of gods defeating Tiamat, the Goddess of Chaos, in a great cosmic battle, splitting her in two and forming heaven and earth from her two halves. Interestingly, in this case, 'chaos' could very easily be interpreted as being similar to the biblical terminology of "void and without form" that is used in genesis. Chaos also figures prominently in Greek mythology as being the stuff from which the earth was formed before the creation of the gods. The Babylonian version also contains obvious and substantial elements of the earlier Sumerian account.

The real beauty of using myth as a means of transmitting complicated information is that you can rely on uneducated people to transmit the information with a certain degree of accuracy. Then, as long as those who live in the future have the means to decipher the code you have used correctly, the knowledge is secure.

The only two coded languages you need to use are astronomy and mathematics and in all reality, these are the only two languages available to you because they are the only two languages that are guaranteed to remain consistent over exceptionally lengthy periods of time.



# Appendix 2



## ENUMA ELISH THE BABYLONIAN EPIC OF CREATION

(from: *The Seven Tablets of Creation.*)

### THE FIRST TABLET:

When in the height heaven was not named,  
And the earth beneath did not yet bear a name,  
And the primeval Apsu, who begat them,  
And chaos, Tiamut, the mother of them both  
Their waters were mingled together,  
And no field was formed, no marsh was to be seen;  
When of the gods none had been called into being,  
And none bore a name, and no destinies were ordained;  
Then were created the gods in the midst of heaven,  
Lahmu and Lahamu were called into being...  
Ages increased,...  
Then Ansar and Kisar were created, and over them....  
Long were the days, then there came forth.....  
Anu, their son,...  
Ansar and Anu...  
And the god Anu...  
Nudimmud, whom his fathers, his begetters.....  
Abounding in all wisdom,...'  
He was exceeding strong...  
He had no rival -  
Thus were established and were... the great gods.  
But Tiamat and Apsu were still in confusion...

They were troubled and...  
In disorder...  
Apsu was not diminished in might...  
And Tiamat roared...  
She smote, and their deeds...  
Their way was evil...  
Then Apsu, the begetter of the great gods,  
Cried unto Mummu, his minister (*also translated as messenger*), and said unto him:  
"O Mummu, thou minister that rejoicest my spirit,  
Come, unto Tiamut let us go!  
So they went and before Tiamat they lay down,  
They consulted on a plan with regard to the gods, their sons.  
Apsu opened his mouth and spake,  
And unto Tiamut, the glistening one, he addressed the word:  
...their way...  
By day I can not rest, by night I can not lie down in peace.  
But I will destroy their way, I will...  
Let there be lamentation, and let us lie down again in peace."  
When Tiamat heard these words,  
She raged and cried aloud...  
She... grievously...,  
She uttered a curse, and unto Apsu she spake:  
"What then shall we do?  
Let their way be made difficult, and let us lie down again in peace."  
Mummu answered, and gave counsel unto Apsu,  
...and hostile to the gods was the counsel Mummu gave:  
Come, their way is strong, but thou shalt destroy it;  
Then by day shalt thou have rest, by night shalt thou lie down in peace."  
Apsu harkened unto him and his countenance grew bright,  
Since he (Mummu) planned evil against the gods his sons.  
... he was afraid...,  
His knees became weak; they gave way beneath him,  
Because of the evil which their first-born had planned.  
... their... they altered.  
... they...,  
Lamentation they sat in sorrow  
.....  
Then Ea, who knoweth all that is, went up and he beheld their muttering.

[about 30 illegible lines]

... he spake:  
... thy... he hath conquered and  
... he weepeth and sitteth in tribulation.  
... of fear,  
... we shall not lie down in peace.  
... Apsu is laid waste,  
... and Mummu, who were taken captive, in...  
... thou didst...  
... let us lie down in peace.  
... they will smite....

... let us lie down in peace.  
... thou shalt take vengeance for them,  
... unto the tempest shalt thou...!"  
And Tiamat harkened unto the word of the bright god, and said:  
... shalt thou entrust! let us wage war!"  
... the gods in the midst of...  
... for the gods did she create.  
They banded themselves together and at the side of Tiamat they advanced;  
They were furious; they devised mischief without resting night and day.  
They prepared for battle, fuming and raging;  
They joined their forces and made war,  
Ummu-Hubur [Tiamat] who formed all things,  
Made in addition weapons invincible; she spawned monster-serpents,  
Sharp of tooth, and merciless of fang;  
With poison, instead of blood, she filled their bodies.  
Fierce monster-vipers she clothed with terror,  
With splendor she decked them, she made them of lofty stature.  
Whoever beheld them, terror overcame him,  
Their bodies reared up and none could withstand their attack.  
She set up vipers and dragons, and the monster Lahamu,  
And hurricanes, and raging hounds, and scorpion-men,  
And mighty tempests, and fish-men, and rams;  
They bore cruel weapons, without fear of the fight.  
Her commands were mighty, none could resist them;  
After this fashion, huge of stature, she made eleven [kinds of] monsters.  
Among the gods who were her sons, inasmuch as he had given her support,  
She exalted Kingu; in their midst she raised him to power.  
To march before the forces, to lead the host,  
To give the battle-signal, to advance to the attack,  
To direct the battle, to control the fight,  
Unto him she entrusted; in costly raiment she made him sit, saying:  
I have uttered thy spell, in the assembly of the gods I have raised thee to power.  
The dominion over all the gods have I entrusted unto him.  
Be thou exalted, thou my chosen spouse,  
May they magnify thy name over all of them the Anunnaki."  
She gave him the Tablets of Destiny, on his breast she laid them, saying:  
Thy command shall not be without avail, and the word of thy mouth shall be established."  
Now Kingu, thus exalted, having received the power of Anu,  
Decreed the fate among the gods his sons, saying:  
"Let the opening of your mouth quench the Fire-god;  
Whoso is exalted in the battle, let him display his might!"

#### THE SECOND TABLET:

Tiamat made weighty her handiwork,  
Evil she wrought against the gods her children.  
To avenge Apsu, Tiamat planned evil,  
But how she had collected her forces, the god unto Ea divulged.  
Ea harkened to this thing, and  
He was grievously afflicted and he sat in sorrow.  
The days went by, and his anger was appeased,

And to the place of Ansar his father he took his way.  
He went and, standing before Ansar, the father who begat him,  
All that Tiamat had plotted he repeated unto him,  
Saying, "Tiamat our mother hath conceived a hatred for us,  
With all her force she rageth, full of wrath.  
All the gods have turned to her,  
With those, whom ye created, they go at her side.  
They are banded together and at the side of Tiamat they advance;  
They are furious, they devise mischief without resting night and day.  
They prepare for battle, fuming and raging;  
They have joined their forces and are making war.  
Ummu-Hubur, who formed all things,  
Hath made in addition weapons invincible; she hath spawned monster-serpents,  
Sharp of tooth, and merciless of fang.  
With poison, instead of blood, she hath filled their bodies.  
Fierce monster-vipers she hath clothed with terror,  
With splendor she hath decked them; she hath made them of lofty stature.  
Whoever beholdeth them is overcome by terror,  
Their bodies rear up and none can withstand their attack.  
She hath set up vipers, and dragons, and the monster Lahamu,  
And hurricanes and raging hounds, and scorpion-men,  
And mighty tempests, and fish-men and rams;  
They bear cruel weapons, without fear of the fight.  
Her commands are mighty; none can resist them;  
After this fashion, huge of stature, hath she made eleven monsters.  
Among the gods who are her sons, inasmuch as he hath given her support,  
She hath exalted Kingu; in their midst she hath raised him to power.  
To march before the forces, to lead the host,  
To give the battle-signal, to advance to the attack.  
To direct the battle, to control the fight,  
Unto him hath she entrusted; in costly raiment she hath made him sit, saying:  
I have uttered thy spell; in the assembly of the gods I have raised thee to power,  
The dominion over all the gods have I entrusted unto thee.  
Be thou exalted, thou my chosen spouse,  
May they magnify thy name over all of them  
She hath given him the Tablets of Destiny, on his breast she laid them, saying:  
'Thy command shall not be without avail, and the word of thy mouth shall be established.'  
Now Kingu, thus exalted, having received the power of Anu,  
Decreed the fate for the gods, her sons, saying:  
'Let the opening of your mouth quench the Fire-god;  
Whoso is exalted in the battle, let him display his might!'"  
When Ansar heard how Tiamat was mightily in revolt,  
he bit his lips, his mind was not at peace,  
..., he made a bitter lamentation:  
... battle,  
... thou...  
Mummu and Apsu thou hast smitten  
But Tiamat hath exalted Kingu, and where is one who can oppose her?  
... deliberation  
... the ... of the gods, -Nudimmud.

[A gap of about a dozen lines occurs here.]

Ansar unto his son addressed the word:

"... my mighty hero,  
Whose strength is great and whose onslaught can not be withstood,  
Go and stand before Tiamat,  
That her spirit may be appeased, that her heart may be merciful.  
But if she will not harken unto thy word,  
Our word shalt thou speak unto her, that she may be pacified."  
He heard the word of his father Ansar  
And he directed his path to her, toward her he took the way.  
Ann drew nigh, he beheld the muttering of Tiamat,  
But he could not withstand her, and he turned back.  
... Ansar  
... he spake unto him:

[A gap of over twenty lines occurs here.]

an avenger...

... valiant  
... in the place of his decision  
... he spake unto him:  
... thy father  
"Thou art my son, who maketh merciful his heart.  
... to the battle shalt thou draw nigh,  
he that shall behold thee shall have peace."  
And the lord rejoiced at the word of his father,  
And he drew nigh and stood before Ansar.  
Ansar beheld him and his heart was filled with joy,  
He kissed him on the lips and his fear departed from him.  
"O my father, let not the word of thy lips be overcome,  
Let me go, that I may accomplish all that is in thy heart.  
O Ansar, let not the word of thy lips be overcome,  
Let me go, that I may accomplish all that is in thy heart."  
What man is it, who hath brought thee forth to battle?  
... Tiamat, who is a woman, is armed and attacketh thee.  
... rejoice and be glad;  
The neck of Tiamat shalt thou swiftly trample under foot.  
... rejoice and be glad;  
The neck of Tiamat shalt thou swiftly trample under foot.  
O my son, who knoweth all wisdom,  
Pacify Tiamat with thy pure incantation.  
Speedily set out upon thy way,  
For thy blood shall not be poured out; thou shalt return again."  
The lord rejoiced at the word of his father,  
His heart exulted, and unto his father he spake:  
"O Lord of the gods, Destiny of the great gods,  
If I, your avenger,  
Conquer Tiamat and give you life,  
Appoint an assembly, make my fate preeminent and proclaim it.  
In Upsukkinaku seat yourself joyfully together,

With my word in place of you will I decree fate.  
May whatsoever I do remain unaltered,  
May the word of my lips never be chanced nor made of no avail."

*THE THIRD TABLET:*

Ansar opened his mouth, and  
Unto Gaga, his minister, spake the word.  
"O Gaga, thou minister that rejoicest my spirit,  
Unto Lahmu and Lahamu will I send thee.  
... thou canst attain,  
... thou shalt cause to be brought before thee.  
... let the gods, all of them,  
Make ready for a feast, at a banquet let them sit,  
Let them eat bread, let them mix wine,  
That for Marduk, their avenger they may decree the fate.  
Go, Gaga, stand before them,  
And all that I tell thee, repeat unto them, and say:  
'Ansar, vour son, hath sent me,  
The purpose of his heart he hath made known unto me.  
The purpose of his heart he hath made known unto me.  
He saith that Tiamat our mother hath conceived a hatred for us,  
With all her force she rageth, full of wrath.  
All the gods have turned to her,  
With those, whom ye created, they go at her side.  
They are banded together, and at the side of Tiamat they advance;  
They are furious, they devise mischief without resting night and day.  
They prepare for battle, fuming and raging;  
They have joined their forces and are making war.  
Ummu-Hubur, who formed all things,  
Hath made in addition weapons invincible; she hath spawned monster-serpents,  
Sharp of tooth and merciless of fang.  
With poison, instead of blood, she hath filled their bodies.  
Fierce monster-vipers she hath clothed with terror,  
With splendor she hath decked them; she hath made them of lofty stature.  
Whoever beboldeth them, terror overcometh him,  
Their bodies rear up and none can withstand their attack.  
She hath set up vipers, and dragons, and the monster Lahamu,  
And hurricanes, and raging bounds, and scorpion-men,  
And mighty tempests, and fish-men, and rams;  
They bear merciless weapons, without fear of the fight.  
Her commands are miahty; none can. resist them;  
After this fashion, huge of stature, hath she made eleven monsters.  
Among the gods who are her sons, inasmuch as he hath given her support,  
She hath exalted Kingu; in their midst she hath raised him to power.  
To march before the forces, to lead the host,  
To give the battle-signal, to advance to the attack,  
To direct the battle, to control the fight,  
Unto him hath she entrusted; in costly raiment she hath made him sit, saying:  
I have uttered thy spell; in the assembly of the gods  
I have raised thee to power,

The dominion over all the gods have I entrusted unto thee.  
Be thou exalted, thou my chosen spouse,  
May they magnify thy name over all of them ... the Anunnaki."  
She hath given him the Tablets of Destiny, on his breast she laid them, saying:  
Thy command shall not be without avail, and the word of thy mouth shall be established."  
Now Kingu, thus exalted, having received the power of Anu,  
Decreed the fate for the gods, her sons, saving:  
Let the opening of your mouth quench the Fire-god;  
Whoso is exalted in the battle, let him display his might!"  
I sent Anu, but he could not withstand her;  
Nudimmud was afraid and turned back.  
But Marduk hath set out, the director of the gods, your son;  
To set out against Tiamat his heart hath prompted him.  
He opened his mouth and spake unto me, saying: "If I, your avenger,  
Conquer Tiamat and give you life,  
Appoint an assembly, make my fate preeminent and proclaim it.  
In Upsukkinaku seat yourself joyfully together;  
With my word in place of you will I decree fate.  
May whatsoever I do remain unaltered,  
May the word of my lips never be changed nor made of no avail."  
Hasten, therefore, and swiftly decree for him the fate which you bestow,  
That he may go and fight your strong enemy.  
Gaga went, he took his way and  
Humbly before Lahmu and Lahamu, the gods, his fathers,  
He made obeisance, and he kissed the ground at their feet.  
He humbled himself; then he stood up and spake unto them saying:  
"Ansar, your son, hath sent me,  
The purpose of his heart he hath made known unto me.  
He saith that Tiamat our mother hath conceived a hatred for us,  
With all her force she rageth, full of wrath.  
All the gods have turned to her,  
With those, whom ye created, they go at her side.  
They are banded together and at the side of Tiamat they advance;  
They are furious, they devise mischief without resting night and day.  
They prepare for battle, fuming and raging;  
They have joined their forces and are making war.  
Ummu-Hubur, who formed all things,  
Hath made in addition weapons invincible; she hath spawned monster-serpents,  
Sharp of tooth and merciless of fang.  
With poison, instead of blood, she hath filled their bodies.  
Fierce monster-vipers she hath clothed with terror,  
With splendor she hath decked them, she hath made them of lofty stature.  
Whoever beboldeth them, terror overcometh him,  
Their bodies rear up and none can withstand their attack.  
She hath set up vipers, and dragons, and the monster Lahamu,  
And hurricanes, and raging hounds, and scorpion-men,  
And mighty tempests, and fish-men, and rams;  
They bear merciless weapons, without fear of the fight.  
Her commands are mighty; none can resist them;  
After this fashion, huge of stature, hath she made eleven monsters.  
Among the gods who are her sons, inasmuch as he hath given her support,



She hath exalted Kingu; in their midst she hath raised him to power.  
To march before the forces, to lead the host,  
To give the battle-signal, to advance to the attack, To direct the battle, to control the fight,  
Unto him hath she entrusted; in costly raiment she hath made him sit, saving:  
I have uttered thy spell; in the assembly of the gods I have raised thee to power,  
The dominion over all the gods have I entrusted unto thee.  
Be thou exalted, thou my chosen spouse,  
May they magnify thy name over all of them...the Anunnaki.  
She hath given him the Tablets of Destiny on his breast she laid them, saving:  
Thy command shall not be without avail, and the word of thy mouth shall be established.'  
Now Kingu, thus exalted, having received the power of Anu,  
Decreed the fate for the gods, her sons, saying:  
'Let the opening of your mouth quench the Fire-god;  
Whoso is exalted in the battle, let him display his might!'  
I sent Anu, but he could not withstand her;  
Nudimmud was afraid and turned back.  
But Marduk hath set out, the director of the gods, your son;  
To set out against Tiamat his heart hath prompted him.  
He opened his mouth and spake unto me, saying:  
'If I, your avenger,  
Conquer Tiamat and give you life,  
Appoint an assembly, make my fate preeminent and proclaim it.  
In Upsukkinaku seat yourselves joyfully together;  
With my word in place of you will I decree fate.  
May, whatsoever I do remain unaltered,  
May the word of my lips never be changed nor made of no avail.'  
Hasten, therefore, and swiftly decree for him the fate which you bestow,  
That he may go and fight your strong enemy!  
Lahmu and Lahamu heard and cried aloud  
All of the Igigi [The elder gods] wailed bitterly, saying:  
What has been altered so that they should  
We do not understand the deed of Tiamat!  
Then did they collect and go,  
The great gods, all of them, who decree fate.  
They entered in before Ansar, they filled...  
They kissed one another, in the assembly...;  
They made ready for the feast, at the banquet they sat;  
They ate bread, they mixed sesame-wine.  
The sweet drink, the mead, confused their...  
They were drunk with drinking, their bodies were filled.  
They were wholly at ease, their spirit was exalted;  
Then for Marduk, their avenger, did they decree the fate.

#### THE FOURTH TABLET:

They prepared for him a lordly chamber,  
Before his fathers as prince he took his place.  
"Thou art chiefest among the great gods,  
Thy fate is unequalled, thy word is Anu!  
O Marduk, thou art chiefest among the great gods,  
Thy fate is unequalled, thy word is Anu!

Henceforth not without avail shall be thy command,  
In thy power shall it be to exalt and to abase.  
Established shall be the word of thy mouth, irresistible shall be thy command,  
None among the gods shall transgress thy boundary.  
Abundance, the desire of the shrines of the gods,  
Shall be established in thy sanctuary, even though they lack offerings.  
O Marduk, thou art our avenger!  
We give thee sovereignty over the whole world.  
Sit thou down in might; be exalted in thy command.  
Thy weapon shall never lose its power; it shall crush thy foe.  
O Lord, spare the life of him that putteth his trust in thee,  
But as for the god who began the rebellion, pour out his life."  
Then set they in their midst a garment,  
And unto Marduk, - their first-born they spake:  
"May thy fate, O lord, be supreme among the gods,  
To destroy and to create; speak thou the word, and thy command shall be fulfilled.  
Command now and let the garment vanish;  
And speak the word again and let the garment reappear!  
Then he spake with his mouth, and the garment vanished;  
Again he commanded it, and the garment reappeared.  
When the gods, his fathers, beheld the fulfillment of his word,  
They rejoiced, and they did homage unto him, saying, " Marduk is king!"  
They bestowed upon him the scepter, and the throne, and the ring,  
They give him an invincible weaponry which overwhelmeth the foe.  
Go, and cut off the life of Tiamat,  
And let the wind carry her blood into secret places."  
After the gods his fathers had decreed for the lord his fate,  
They caused him to set out on a path of prosperity and success.  
He made ready the bow, he chose his weapon,  
He slung a spear upon him and fastened it...  
He raised the club, in his right hand he grasped it,  
The bow and the quiver he hung at his side.  
He set the lightning in front of him,  
With burning flame he filled his body.  
He made a net to enclose the inward parts of Tiamat,  
The four winds he stationed so that nothing of her might escape;  
The South wind and the North wind and the East wind and the West wind  
He brought near to the net, the gift of his father Anu.  
He created the evil wind, and the tempest, and the hurricane,  
And the fourfold wind, and the sevenfold wind, and the whirlwind,  
and the wind which had no equal;  
He sent forth the winds which he had created, the seven of them;  
To disturb the inward parts of Tiamat, they followed after him.  
Then the lord raised the thunderbolt, his mighty weapon,  
He mounted the chariot, the storm unequalled for terror,  
He harnessed and yoked unto it four horses,  
Destructive, ferocious, overwhelming, and swift of pace;  
... were their teeth, they were flecked with foam;  
They were skilled in... , they had been trained to trample underfoot.  
... . mighty in battle,  
Left and right....

His garment was... , he was clothed with terror,  
With overpowering brightness his head was crowned.  
Then he set out, he took his way,  
And toward the raging Tiamat he set his face.  
On his lips he held ...,  
... he grasped in his hand.  
Then they beheld him, the gods beheld him,  
The gods his fathers beheld him, the gods beheld him.  
And the lord drew nigh, he gazed upon the inward parts of Tiamat,  
He perceived the muttering of Kingu, her spouse.  
As Marduk gazed, Kingu was troubled in his gait,  
His will was destroyed and his motions ceased.  
And the gods, his helpers, who marched by his side,  
Beheld their leader's..., and their sight was troubled.  
But Tiamat... , she turned not her neck,  
With lips that failed not she uttered rebellious words:  
"... thy coming as lord of the gods,  
From their places have they gathered, in thy place are they! "  
Then the lord raised the thunderbolt, his mighty weapon,  
And against Tiamat, who was raging, thus he sent the word:  
Thou art become great, thou hast exalted thyself on high,  
And thy heart hath prompted thee to call to battle.  
... their fathers...,  
... their... thou hatest...  
Thou hast exalted Kingu to be thy spouse,  
Thou hast... him, that, even as Anu, he should issue decrees.  
thou hast followed after evil,  
And against the gods my fathers thou hast contrived thy wicked plan.  
Let then thy host be equipped, let thy weapons be girded on!  
Stand! I and thou, let us join battle!  
When Tiamat heard these words,  
She was like one possessed, .she lost her reason.  
Tiamat uttered wild, piercing cries,  
She trembled and shook to her very foundations.  
She recited an incantation, she pronounced her spell,  
And the gods of the battle cried out for their weapons.  
Then advanced Tiamat and Marduk, the counsellor of the gods;  
To the fight they came on, to the battle they drew nigh.  
The lord spread out his net and caught her,  
And the evil wind that was behind him he let loose in her face.  
As Tiamat opened her mouth to its full extent,  
He drove in the evil wind, while as yet she had not shut her lips.  
The terrible winds filled her belly,  
And her courage was taken from her, and her mouth she opened wide.  
He seized the spear and burst her belly,  
He severed her inward parts, he pierced her heart.  
He overcame her and cut off her life;  
He cast down her body and stood upon it.  
When he had slain Tiamat, the leader,  
Her might was broken, her host was scattered.  
And the gods her helpers, who marched by her side,

Trembled, and were afraid, and turned back.  
They took to flight to save their lives;  
But they were surrounded, so that they could not escape.  
He took them captive, he broke their weapons;  
In the net they were caught and in the snare they sat down.  
The ... of the world they filled with cries of grief.  
They received punishment from him, they were held in bondage.  
And on the eleven creatures which she had filled with the power of striking terror,  
Upon the troop of devils, who marched at her...,  
He brought affliction, their strength he...;  
Them and their opposition he trampled under his feet.  
Moreover, Kingu, who had been exalted over them,  
He conquered, and with the god Dug-ga he counted him.  
He took from him the Tablets of Destiny that were not rightly his,  
He sealed them with a seal and in his own breast he laid them.  
Now after the hero Marduk had conquered and cast down his enemies,  
And had made the arrogant foe even like  
And had fully established Ansar's triumph over the enemy  
And had attained the purpose of Nudimmud,  
Over the captive gods he strengthened his durance,  
And unto Tiamat, whom he had conquered, he returned.  
And the lord stood upon Tiamat's hinder parts,  
And with his merciless club he smashed her skull.  
He cut through the channels of her blood,  
And he made the North wind bear it away into secret places.  
His fathers beheld, and they rejoiced and were glad;  
Presents and gifts they brought unto him.  
Then the lord rested, gazing upon her dead body,  
While he divided the flesh of the ... , and devised a cunning plan.  
He split her up like a flat fish into two halves;  
One half of her he established as a covering for heaven.  
He fixed a bolt, he stationed a watchman,  
And bade them not to let her waters come forth.  
He passed through the heavens, he surveyed the regions thereof,  
And over against the Deep he set the dwelling of Nudimmud.  
And the lord measured the structure of the Deep,  
And he founded E-sara, a mansion like unto it.  
The mansion E-sara which he created as heaven,  
He caused Anu, Bel, and Ea in their districts to inhabit.

#### THE FIFTH TABLET:

He made the stations for the great gods;  
The stars, their images, as the stars of the Zodiac, he fixed.  
He ordained the year and into sections he divided it;  
For the twelve months he fixed three stars.  
After he had ... the days of the year ... images,  
He founded the station of Nibir to determine their bounds;  
That none might err or go astray,  
He set the station of Bel and Ea along with him.  
He opened great gates on both sides,

He made strong the bolt on the left and on the right.  
In the midst thereof he fixed the zenith;  
The Moon-god he caused to shine forth, the night he entrusted to him.  
He appointed him, a being of the night, to determine the days;  
Every month without ceasing with the crown he covered him, saying:  
"At the beginning of the month, when thou shinest upon the land,  
Thou commandest the horns to determine six days,  
And on the seventh day to divide the crown.  
On the fourteenth day thou shalt stand opposite, the half....  
When the Sun-god on the foundation of heaven...thee,  
The ... thou shalt cause to ..., and thou shalt make his...  
... unto the path of the Sun-god shalt thou cause to draw nigh,  
And on the ... day thou shalt stand opposite, and the Sun-god shall...  
... to traverse her way.  
... thou shalt cause to draw nigh, and thou shalt judge the right.  
... to destroy..."

[Nearly fifty lines are here lost.]

The gods, his fathers, beheld the net which he had made,  
They beheld the bow and how its work was accomplished.  
They praised the work which he had done...  
Then Anu raised the ... in the assembly of the gods. He kissed the bow, saying, " It is...!"  
And thus he named the names of the bow, saying,  
"'Long-wood' shall be one name, and the second name shall be ...,  
And its third name shall be the Bow-star, in heaven shall it...!"  
Then he fixed a station for it...  
Now after the fate of...  
He set a throne...  
...in heaven...  
[The remainder of this tablet is missing.]

#### THE SIXTH TABLET:

When Marduk heard the word of the gods,  
His heart prompted him and he devised a cunning plan.  
He opened his mouth and unto Ea he spake  
That which he had conceived in his heart he imparted unto him:  
"My blood will I take and bone will I fashion  
I will make man, that man may  
I will create man who shall inhabit the earth,  
That the service of the gods may be established, and that their shrines may be built.  
But I will alter the ways of the gods, and I will change their paths;  
Together shall they be oppressed and unto evil shall they....  
And Ea answered him and spake the word:  
"... the ... of the gods I have changed  
... and one...  
... shall be destroyed and men will I...  
... and the gods .  
... and they..."

[The rest of the text is wanting with the exception of the last few lines of the tablet, which read as follows.]

They rejoiced...

In Upsukkinnaku they set their dwelling.  
Of the heroic son, their avenger, they cried:  
" We, whom he succored.... !"

They seated themselves and in the assembly they named him...,  
They all cried aloud, they exalted him...

THE SEVENTH TABLET:

O Asari, [Marduk] "Bestower of planting," "Founder of sowing"  
"Creator of grain and plants," "who caused the green herb to spring up!"  
O Asaru-alim, [Marduk] "who is revered in the house of counsel," "who aboundeth in counsel,"  
The gods paid homage, fear took hold upon them!

O Asaru-alim-nuna, [Marduk] "the mighty one," "the Light of the father who begat him,"  
"Who directeth the decrees of Anu Bel, and Ea!"

He was their patron, be ordained their...;

He, whose provision is abundance, goeth forth...

Tutu [Marduk] is "He who created them anew";

Should their wants be pure, then are they satisfied;

Should he make an incantation, then are the gods appeased;

Should they attack him in anger, he withstandeth their onslaught!

Let him therefore be exalted, and in the assembly of the gods let him... ;

None among the gods can rival him!

15 Tutu [Marduk] is Zi-ukkina, "the Life of the host of the gods,"

Who established for the gods the bright heavens.

He set them on their way, and ordained their path;

Never shall his ... deeds be forgotten among men.

Tutu as Zi-azag thirdly they named, "the Bringer of Purification,"

"The God of the Favoring Breeze," "the Lord of Hearing and Mercy,"

"The Creator of Fulness and Abundance," " the Founder of Plenteousness,"

"Who increaseth all that is small."

In sore distress we felt his favoring breeze,"

Let them say, let them pay reverence, let them bow in humility before him!

Tutu as Aga-azag may mankind fourthly magnify!

"The Lord of the Pure Incantation," " the Quickener of the Dead,"

"Who had mercy upon the captive gods,"

"Who removed the yoke from upon the gods his enemies,"

"For their forgiveness did he create mankind,"

"The Merciful One, with whom it is to bestow life!"

May his deeds endure, may they never be forgotten ,

In the mouth of mankind whom his hands have made!

Tutu as Mu-azag, fifthly, his "Pure incantation" may their mouth proclaim,

Who through his Pure Incantation hath destroyed all the evil ones!"

Sag-zu, [Marduk] "who knoweth the heart of the gods," " who seeth through the innermost part!"

"The evil-doer he hath not caused to go forth with him!"

"Founder of the assembly of the gods," who ... their heart!"

"Subduer of the disobedient," "...!"

"Director of Righteousness," "...,"

" Who rebellion and...!"

Tutu as Zi-si, "the ...,"

"Who put an end to anger," "who...!"

Tutu as Suh-kur, thirdly, "the Destroyer of the foe,"

"Who put their plans to confusion,"

"Who destroyed all the wicked," "...,"

... let them... !

[There is a gap here of sixty lines. But somewhere among the lost lines belong the following fragments.]

who...

He named the four quarters of the world, mankind hecreated,

And upon him understanding...

"The mighty one...!"

Agil...

"The Creator of the earth...!"

Zulummu... .

"The Giver of counsel and of whatsoever...!"

Mummu, " the Creator of...!"

Mulil, the heavens...,

"Who for...!"

Giskul, let...,

"Who brought the gods to naught....!"

.....

... " the Chief of all lords,"

... supreme is his might!

Lugal-durmah, "the King of the band of the gods," " the Lord of rulers."

"Who is exalted in a royal habitation,"

"Who among the gods is gloriously supreme!

Adu-nuna, " the Counselor of Ea," who created the gods his fathers,

Unto the path of whose majesty

No god can ever attain!

... in Dul-azag be made it known,

... pure is his dwelling!

... the... of those without understanding is Lugaldul-azaga!

... supreme is his might!

... their... in the midst of Tiamat,

... of the battle!

[Here follows the better-preserved ending.]

... the star, which shineth in the heavens.

May he hold the Beginning and the Future, may they pay homage unto him,

Saying, "He who forced his way through the midst of Tiamat without resting,

Let his name be Nibiru, 'the Seizer of the Midst'!

For the stars of heaven he upheld the paths,

He shepherded all the gods like sheep!

He conquered Tiamat, he troubled and ended her life,"

In the future of mankind, when the days grow old,  
May this be heard without ceasing; may it hold sway forever!  
Since he created the realm of heaven and fashioned the firm earth,  
The Lord of the World," the father Bel hath called his name.  
This title, which all the Spirits of Heaven proclaimed,  
Did Ea hear, and his spirit was rejoiced, and he said:  
"He whose name his fathers have made glorious,  
Shall be even as I, his name shall be Ea!  
The binding of all my decrees shall he control,  
All my commands shall he make known! "  
By the name of "Fifty " did the great gods  
Proclaim his fifty names, they, made his path preeminent.

*EPILOGUE:*

Let them [i.e. the names of Marduk] be held in remembrances and let the first man proclaim them;  
Let the wise and the understanding consider them together!  
Let the father repeat them and teach them to his son;  
Let them be in the ears of the pastor and the shepherd!  
Let a man rejoice in Marduk, the Lord of the gods,  
That he may cause his land to be fruitful, and that he himself may have prosperity!  
His word standeth fast, his command is unaltered;  
The utterance of his mouth hath no god ever annulled.  
He gazed in his anger, he turned not his neck;  
When he is wroth, no god can withstand his indignation.  
Wide is his heart, broad is his compassion;  
The sinner and evil-doer in his presence...  
They received instruction, they spake before him,  
... unto...  
... of Marduk may the gods...  
... May they ... his name...  
... they took and...

*So Ends the Babylonian Epic of Creation and The Battle with Tiamat.*





# Appendix 3



## THE MAYAN CALENDAR

The Ancient Mayans actually used a very sophisticated and quite complex calendar that was extremely accurate. It is obvious that they had a very detailed understanding of planetary movements and by using this calendar they were accurately able to predict events, such as eclipses, hundreds of years in advance. Recent knowledge of Sunspot cycles has also revealed that the ancient Mayans also knew of these cycles and that they too were incorporated into the calendar.

The Mayan Calendar was depicted in the form of a disc called a 'Sunstone' and is now quite a well known motif, displayed in most Mexican food stores and other places (*fig.110.*).

The Sunstone actually displays 3 separate calendars: The Long Count, the Vague Year Calendar or 'Haab' and the Ritual Year Calendar or 'Tzolkin'. The events in these three calendars were also influenced by a series of "Calendar Rounds".

The Mayans used a base 20 system of counting and their numerals consisted of three distinct and easily identifiable symbols: a sea shell for zero, a dot for one and a bar for a five. Another curved symbol was also occasionally used as a divider or filler and was sometimes just used aesthetically as decoration around other characters or numbers.

***The Long Count:*** The timeline of the current Mayan calendar began on the 13<sup>th</sup> of August, 3114 BC. This date is also the starting point of the current Mayan Long Count. The calendar is split into 6 time divisions. These divisions are:

1. 1 kin = 1 day
2. 20 kins = 1 Unial (20 days)
3. 18 Unials = 1 Tun (360 days)
4. 20 Tuns = 1 Katun (7,200 days)
5. 20 Katuns = 1 Baktun (144,000 days or about 394.25 years)
6. 13 Katuns = 1 Great Cycle (1,872,000 days or about 5,125.25 years)

One Great Cycle was also known as a 'Sun'. The Mayans counted time in cycles of 5 Suns which is a time span of 9,360,000 days or around 25,627 years. The Mayan legends state that at the end of each sun there is a cataclysm or catastrophe of some kind which is then followed by a

renewal. The Mayans believe that we are now nearing the end of our Fifth Sun in the Great Cycle and that the Fifth Sun will end and a new *First Sun* will begin on December 23<sup>rd</sup> 2012.

This Mayan calendar event also significantly coincides with the orbit of Earth's Solar system around its Galactic Center. One Galactic Orbit takes our solar system about 25,600 years to complete. The 5 suns cycle adopted by the Mayans also aptly demonstrates their accurate knowledge of this great orbital cycle and of the procession of the equinoxes.



Fig.110

**The Haab or Vague Year:** The Mayans were aware that the length of a Solar year is about 365.25 days but they preferred use a calendar of 365 days and not to use leap-years. Due to the fact that it did not follow a true solar year it was referred to as the vague calendar or Haab.

The Haab calendar was divided into 20 months of 18 days each, coming to a total of 360 days which was then followed by a 5 day period. The months were numbered from 0 to 19 and each month was named after a Mayan God:

0. Pop
1. Wo
2. Sip
3. Sots'
4. Sek
5. Xul
6. Yaxk'in
7. Mol
8. Ch'en
9. Yax
10. Sak
11. Keh
12. Mak
13. K'ank'in
14. Muwan
15. Pax
16. K'ayab
17. Kumk'u
18. Wayeb
19. -

**The Tzolkin or Ritual Calendar:** the other calendar used was the Ritual calendar which consisted of 13 months with 20 days each, coming to a total of 260 days per year. This 260 day cycle is thought by many scholars to be based on the rotational movements of Venus though this is highly dubious and due to recent discoveries it is now much more reasonable to assume a geographic reasoning behind the invention. It is true however, that the Mayans were aware that the morning star and the evening star were both the same object and kept accurate tables on the rotation and movements of the planets.

The Tzolkin months did not have names but the days were named as follows:

1. Imik
2. Ik
3. Akbal
4. Kan
5. Chicchan
6. Simmi
7. Manik
8. Lamat
9. Maluc
10. Oc
11. Chueb
12. Eb
13. Ben
14. Ix
15. Men
16. Cib
17. Caban
18. Etz'nab
19. Cauac
20. Ahua

In this calendar method the number from 1 – 13 increased along with the days. For example: The first day in the Cycle was 1.Imik the second was 2.Ik and so on. Eventually, after 260 days, every possible combination of name and number (1 – 13) would have been achieved.

**The Calendar Round:** Every 52 years both the Haab and the Tzolkin would coincide and begin on the same day, this was always considered to be a time of great renewal and worthy of celebration. On such occasions temples would be refaced, houses built and repaired and other more ritualistic acts. A longer cycle of 22 calendar rounds was also followed. This cycle consisted of 13 'Heavens' followed by 9 'Hells'. The last completed cycle was in 1987 which places us currently in the first Heaven.

It is now known that the Mayan Civilization was preceded by the Toltecs who were in turn preceded by the Olmecs and that this is most likely where the Maya obtained their astronomical information and there is also the persistent Mayan legend of a great teacher named Quetzalcoatl.

There have been huge debates over the end of this particular Sun of the Mayan Calendar due to the fact that it's the end of the 5 sun cycle and the date corresponds so closely to the completion of a 26,000 year Galactic Orbital cycle and a significant and previously unrecorded sunspot event.

Sunspot activity can greatly affect things on Earth such as electro-magnetism and radio and television communications and can produce brilliant auroras at the Earths poles. This Sunspot activity happens in 11 year cycles. But more major events of increased activity also occur in longer cycles of 33, 110 and sunspot activity of unprecedented proportions is predicted by scientists to occur in late 2012.

One fact that seems to have gone unnoticed by many scholars is the fact that the Mayan Haab calendar is exactly the same as the ancient Egyptian calendar. It is also known that the Egyptian Calendar was directly influenced by the Sumerian Calendar that first originated in Nippar. These facts can be confirmed by a simple investigation into each of the calendars.



# Appendix 4

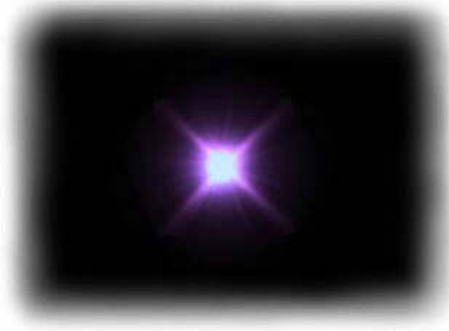

## THE HOPI BLUE STAR PROPHECY

The Elders of the Hopi tribe of North America traditionally pass warnings and prophecies down from generation to generation through oral traditions and references to ancient stone tablets and rock pictographs. One ancient Hopi Indian prophecy states that "When the Blue Star Kachina makes its appearance in the heavens, the Fifth World will emerge". They also believe that this will be the 'Day of Purification'. It is thought by many scholars that 'Blue Star Kachina' is the Hopi name for the star Sirius though this is uncertain. They believe the day will come when the Saquasohuh (Blue Star) Kachina dances in the plaza and removes his mask.

This particular Hopi Prophecy has been interpreted as speaking of various different things depending on the interpreter: twin Kachinas - white and blue. Twin - Merging of Self - Twin Pyramids - DNA - Twin Towers falling.

It is known as the Hopi Blue Star or Blue Kachina Prophecy of White Feather of the Bear Clan.

***This is the First Sign:*** We were told of the coming of the white-skinned men, like Pahana, but not living like Pahana -- men who took the land that was not theirs and who struck their enemies with thunder. (Guns)

***This is the Second Sign:*** Our lands will see the coming of spinning wheels filled with voices. (Covered wagons)

***This is the Third Sign:*** A strange beast like a buffalo but with great long horns, will overrun the land in large numbers. (Longhorn cattle)

***This is the Fourth Sign:*** The land will be crossed by snakes of iron. (Railroad tracks)

***This is the Fifth Sign:*** The land shall be criss-crossed by a giant spider's web. (Power and telephone lines)

***This is the Sixth Sign:*** The land shall be criss-crossed with rivers of stone that make pictures in the sun. (Concrete and bitumen roads with their heat-haze and mirage-producing effects.)

***This is the Seventh Sign:*** You will hear of the sea turning black, and many living things dying because of it. (Oil spills)

***This is the Eighth Sign:*** You will see many youth, who wear their hair long like our people, come and join the tribal nations, to learn our ways and wisdom. (Hippies)

***And this is the Ninth and Last Sign:*** You will hear of a dwelling-place in the heavens, above the earth, that shall fall with a great crash. It will appear as a blue star. Very soon after this, the ceremonies of the Hopi people will cease.

***These are the Signs that great destruction is here:*** The world shall rock to and fro. The white man will battle people in other lands - those who possessed the first light of wisdom. There will be many columns of smoke and fire such as the white man has made in the deserts not far from here. Those who stay and live in the places of the Hopi shall be safe. Then there will be much to rebuild. And soon, very soon afterward, Pahana will return. He shall bring with him the dawn of the Fifth World. He shall plant the seeds of his wisdom in our hearts. Even now the seeds are being planted. These shall smooth the way to the Emergence into the Fifth World.

So ends the Hopi Blue Star, or Blue Kachina, Prophecy



## Sources

### Publications:

- Aeronautics, a Manuscript from the Prehistoric Past* by the International Academy of Sanskrit  
*A Game Warden on Safari* by A. Blayney Percival  
*A Game Warden Takes Stock* by Colonel C.R.S. Pittman  
*Ancient Astronauts: A Time Reversal?* By Robin Collyns  
*Ancient Celtic New Zealand* by Mark Doutré  
*Ancient Engineers, The* by L. Sprague de Camp  
*Anti Gravity and the World Grid* by David Hatcher-Childress  
*Anti Gravity Handbook, The* by David Hatcher-Childress  
*Bible Code, The* by Michael Drosnin  
*Bible Code 2, The* by Michael Drosnin  
*Chaldean Genesis, The* by George Smith  
*Colony Earth* by Richard Mooney  
*Cosmic Conspiracy, The* by Stan Deyo  
*Critius* by Plato  
*Divine Encounters* by Zechariah Sitchin  
*Earth Chronicles, The (series)* by Zechariah Sitchin  
    1. *The 12<sup>th</sup> Planet*  
    2. *The Lost Realms*  
    3. *The Stairway to Heaven*  
    4. *The Wars of Gods & Men*  
    5. *When Time Began*  
    6. *The Cosmic Code*  
*Egyptian Book of the Dead, The*  
*Encyclopedia Britannica*  
*Enuma Elish the Babylonian Epic of Creation*  
*Everything You Know Is Wrong. (series)* by Lloyd Pye  
    *Book 1: Human Origins*  
*Exploration Fawcett* by Col. P.H. Fawcett  
*Fingerprints of the Gods, The* by Graham Hancock  
*Forbidden Archeology* by Michael Cremo  
*Great Pyramid Decoded, The* by Peter Lemesurier  
*Hamlets Mill* by Giorgio De Santillana & Hertha Von Dechend  
*Holy Bible, The* (King James Edition)  
*Into the Unknown* Readers Digest publication  
*In Witch-Bound Africa* by Frank H Mellard  
*Jerusalem Bible, The* 1992 Edition  
*Keeper of Genesis, The* by Graham Hancock & Robert Bauval  
*Legend of Mu, The (series)* by James Churchward  
    1. *The Lost Continent of MU*  
    2. *The Children of MU*  
    3. *The Sacred Symbols of MU*  
    4. *The Cosmic Forces of MU*  
    5. *The Second Book of the Cosmic Forces of MU*  
*Lemurian Fellowship Lessons, The* by The Lemurian Fellowship  
*Living Water: The Story of Viktor Schauberger* by  
*Lost Book of Enki, The* by Zechariah Sitchin  
*Lost Continents* by L. Sprague De Camp  
*Lost Cities (series)* by David Hatcher-Childress  
    1. *Lost Cities & Ancient Mysteries of South America*

2. *Lost Cities of Ancient Lemuria & the Pacific*
3. *Lost Cities & Ancient Mysteries of Africa and Arabia*
4. *Lost Cities of Europe & the Mediterranean*
5. *Lost Cities of North & Central America*
6. *Lost Cities of China, Central Asia & India*

*Mahabharata, The*

*Maps of the Ancient Sea Kings* by Charles Hapgood

*Mars Mystery, The* by Graham Hancock & Robert Bauval & John Grigsby

*Mysteries of Time & Space* by Brad Steiger & Ron Calais

*Myths, Tales & Poetry from Ancient Mesopotamia* by Benjamin Foster

*Old Fourlegs- The Story of the Coelocanth* by J.L.B. Smith

*Orion Mystery, The* by Robert Bauval

*Our Senseless Toil* by Viktor Schauberger

*Pyramids: an enigma solved, The* by J. Davidovits

*Ramayana, The*

*Relacion* by Don Juan de Santa Cruz Pachacuti-Yumqui Salcamayhua

(translated into English by Clemens Markham),

*Secret Doctrine, The* by H.P. Blavatsky

*Secrets of the Lost Races* by Rene Noorbergen

*Samaranga Sutradhara, The*

*Story of Atlantis and the Lost Lemuria, The* by Scott Elliot

*Timaeus* by Plato

*Ultimate Frontier, The* by Eklal Kueshana

*Vyamaanika-Shaashtra, The* by Marharshi Baradwaaja

*Vimana Aircraft of Ancient India & Atlantis* by David Hatcher-Childress

*Weird America* by Jim Brandon

### **Newspapers:**

*New York Herald Tribune*

*New York Herald*

*Morrisonville Times* June 11, 1891

*New York Times* May 21, 1978

*The Lanzhou Morning News.* June 26, 2002

### **Periodicals:**

*Scientific American* June, 1851

*Nature* 1952. no. 170

*Rocks and Minerals* 1972. no. 396

*Scientific American* August, 1978

### **Internet Articles**

*Are Pyramids Made out of Concrete?* an article by the Geopolymer Institute

*Evidence for creation by Outside Intervention* an article by Lloyd Pye

*Ooparts* an article by about.com

*The Enigmatic Lines of the Nazca Pampa* an article by Kathy Doore

*The Evidence for Ancient Atomic Warfare* an article by David Hatcher-Childress

*The Ica Stones of Peru* an article by crystallinks.com

*The Ramayana* by Larry Tominberg

*The Mahabharata* Ancient Scriptures and Folklores



## List of Plates

1. The Piri Reis Map
2. The Orontius Fineus Map
3. The Bauche Map
4. The Franco Rosselli Map
5. The Mercator Map
6. Aztec Earplugs
7. Metal Vase
8. The Puma Punka Stone
9. Nazca Runway
10. Nazca monkey
11. Nazca Hummingbird
12. Nazca Astronaut
13. Nazca Plain
14. Ica Stone fish
15. Ica Stone Dino
16. Ica Stones
17. Ica Stone Triceratops
18. Ica Stone Medical
19. Ica Stone Comet
20. Ica Stone Map
21. Ica Stone Nazca Lines
22. Ancient Nanotec
23. Spark Plug 1
24. Spark Plug 2
25. Spark Plug 3
26. Hand tools
27. Hand Print
28. Antikythira Device
29. Baalbeck
30. Trillithon 1
31. Trillithon 2
32. The stone of the Pregnant woman
33. Iron Pot
34. Petrified Skull
35. Laden Jar
36. Egyptian Electricity
37. Crookes Tube
38. Shoe Print
39. Dropa Skeleton
40. Dropa Stone
41. Finger
42. Bell
43. Rhodesian Man
44. Iron Pillar
45. Metal Spheres
46. Mitchell-Hedges Crystal Skull
47. British Crystal Skull
48. Paris Crystal Skull
49. Amethyst Crystal Skull
50. Rose Quartz Crystal Skull
51. Aztec Crystal Skull
52. The Dogon
53. Dogon Village
54. Sirius Binary system
55. Sirius Telescope
56. Sirius Orbital Path
57. Costa Rice Stone Ball
58. Lanzhou Stone
59. South America Map
60. Fawcett

61. Matto Grosso
62. Basalt Image
63. Basalt Image cuniform
64. Cuzco Wall
65. Sacsayhuaman wall
66. Ollantaytambo wall
67. Sacsayhuaman wall detail
68. Ollantaytambo wall detail
69. Ollantaytambo side wall
70. Giza
71. Great Pyramid
72. Great Pyramid Plan
73. Pyramid Indentations
74. Sphinx
75. Sphinx Profile
76. Sphinx plan
77. Sphinx Stele
78. Sumerian Giza Tablets
79. Sphinx buried
80. Sphinx partially buried
81. Sphinx new work
82. Sphinx Enclosure Wall Erosion
83. Kings Chamber roof
84. Famine Stele
85. Geopolymer
86. Geopolymer detail
87. Mars cap
88. Mars Erosion
89. Line of Dichotomy
90. Mars
91. Olympus Mons
92. Valles Marinares
93. Tikal Stele
94. King Henry's Map
95. Benincasa Map
96. Bimini Road
97. Chuchward Map
98. Popul Vuh Painting
99. Japan Underwater Column
100. Japan Underwater Terraces
101. Underwater building plan
102. Bird object
103. Abydos stele
104. Gold Jet
105. Tucson Artifacts
106. Saxon Shield
107. Mesopotamian Cylinder seal
108. Yarru
109. Turkish Urn
110. Corythosaurus
111. Carlisle Cathedral
112. Ica Stone
113. Indian Rock art
114. Egyptian Dinosaurs
115. Hierakonpolis slate palette
116. Acambaro artifacts
117. Scaphognathus
118. Sumerian Tablet
119. Nibiru relative size
120. Nibiru orbit
121. Celestial Collision 1
122. Celestial Collision 2
123. Serpent Stele

124. Anunakki Control Centres
125. Pre-Deluge Flight Path
126. Post-Deluge Flight Path
127. Face on Mars Viking
128. Face on Mars Surveyor
129. Mars complex
130. Ishtar coin
131. Quetzalcoatl
132. Mayan Star of David
133. Olmec Head
134. African Man
135. Manco Capac
136. Bronze Staples
137. Solar System
138. Sumerian Solar System
139. Salcamayhua's sketch
140. Umbilical Cutter
141. Ninmah & Enki
142. Izapa Stele 5
143. Star of the four regions
144. Izapa Stele Detail
145. Tiahuanaco
146. Titicaca
147. Scarab
148. LDG
149. Mohenjo-Daro
150. Mohenjo-Daro skeletons
151. Tektites
152. Nar
153. The Harpoon of Horus
154. Sinai Scar
155. Homo Florentis skull
156. Homo Florentis
157. Dino Heart
158. Alphabet map
159. Oannes 1
160. Oannes 2
161. Enki
162. Dogon God
163. Solar crucifix
164. Sumerian Tree of Life
165. Olmec Tree of Life
166. Staff of Asclepius
167. Medical Symbol
168. DNA
169. New Neighbour