

# Vimana Aircraft of Ancient India & Atlantis

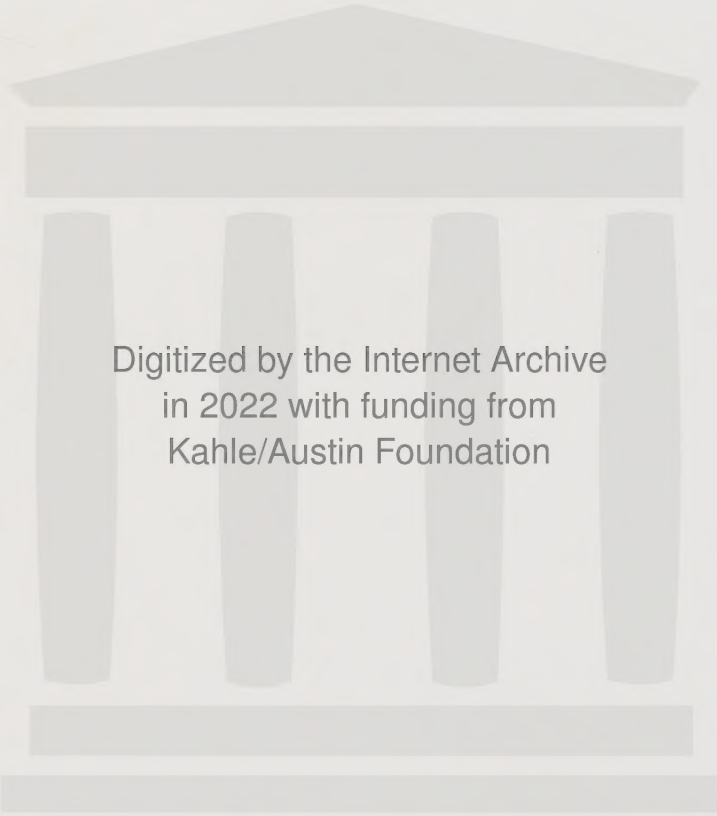

By DAVID HATCHER CHILDRESS

INTRODUCTION BY IVAN T. SANDERSON.  
THE COMPLETE VIMAANIKA SHASTRA TEXT.  
SECRET LIBRARIES & ANCIENT SCIENCE.  
ATLANTEAN AIRCRAFT & TECHNOLOGY.  
SANSKRIT SCHOLARS & VIMANA TEXTS.



Digitized by the Internet Archive  
in 2022 with funding from  
Kahle/Austin Foundation

**Vimana Aircraft  
of  
Ancient India  
&  
Atlantis**

Special thanks to Bangalor Sanskrit professor G.R. Josyer, Ivan T. Sanderson, Desmond Leslie, Harry Osoff, John Tyson, Bob Richardson, Bill Clendenon, Carole Gerardo, Howard Zitko, Robert D. Stelle & others! Without their help, it never would have been possible.

**The New Science Series:**

- THE FREE ENERGY DEVICE HANDBOOK
- THE FANTASTIC INVENTIONS OF NIKOLA TESLA
- THE ANTI-GRAVITY HANDBOOK
- ANTI-GRAVITY & THE WORLD GRID
- ANTI-GRAVITY & THE UNIFIED FIELD
- ETHER TECHNOLOGY
- THE ENERGY GRID
- THE BRIDGE TO INFINITY
- THE HARMONIC CONQUEST OF SPACE
- VIMANA AIRCRAFT OF ANCIENT INDIA & ATLANTIS

Write for our free catalogue of other unusual books.

# Vimana Aircraft of Ancient India & Atlantis

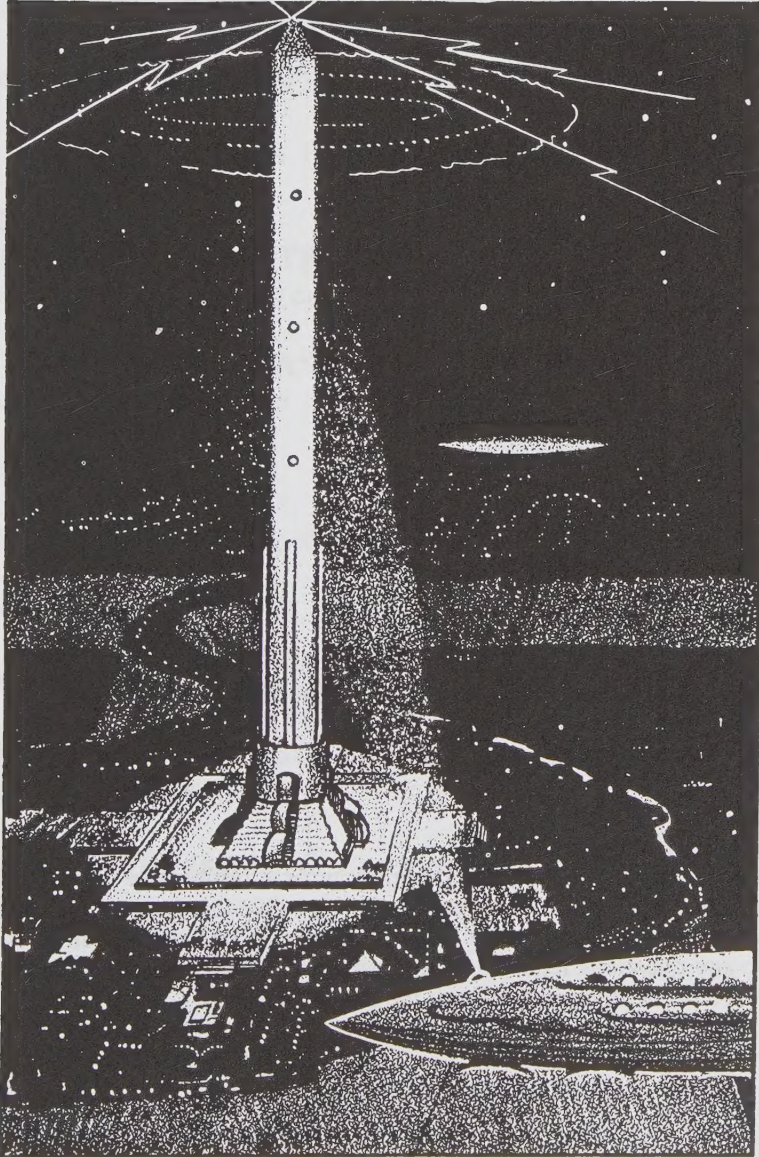

**Vimana Aircraft of  
Ancient India & Atlantis**

Copyright 1991, 1999  
Adventures Unlimited Press

All Rights Reserved\*

Printed in the United States of America  
Sixth Printing April 1999

ISBN 0-932813-12-7

Published by Adventures Unlimited Press  
One Adventure Place, Kempton, Illinois 60946 USA

email: [auphq@frontiernet.net](mailto:auphq@frontiernet.net)

\*Adventures Unlimited gives permission for a limited use of all material contained in this book. We just ask that you give this book and the author you are quoting proper credit and send us a copy of the publication. If you have any questions regarding the reuse of any of this material please write to Adventures Unlimited Press at the above address.

Write for our free catalog of unusual books & videos

# TABLE OF CONTENTS

INTRODUCTION: THE ANCIENT INDIAN VIMANAS by Ivan T. Sanderson	9
BOOK ONE VIMANA AIRCRAFT	
1. SECRET LIBRARIES & ANCIENT SCIENCE	17
2. VIMANAS IN ANCIENT INDIAN TEXTS	33
3. THE ANCIENT RAMA EMPIRE OF INDIA	51
BOOK TWO THE VIMAANIKA SHASTRA	
4. Foreword by G.R. Josyer	97
5. THE VIMAANIKA SHASTRA An Ancient Treatise on Aeronautics	107
BOOK THREE ATLANTEAN AIRCRAFT	
6. MERCURY VORTEX ENGINES	249
7. ATLANTIS & THE ATLANTEAN VAILX	269
8. VIMANAS TODAY	289
Appendix A: Aerial Warfare In Ancient India by Ramachandra Dikshitar	321
Appendix B: Bibliography & Footnotes	329



*Legendary flying chariot of a Chinese prince.*





One of the Gopurams (gateways) in the Temple of Madurai in southern India. Carved into rock are scenes from India's great Epic, *The Ramayana*. Detailed friezes depict the well-known and incredible tale of Rama, Sita, Hanuman and the flights between Ayodha and Lanka.



The spiral nebula in Coma Berenices, a distant island universe seen on edge. Its similarity to flying saucer shapes is significant, showing that the forces and that the vortex mechanics of the universe are operational from the smallest scale to the largest. Photo courtesy of Mount Wilson Observatory.

# INTRODUCTION

by

IVAN T. SANDERSON

## THE ANCIENT INDIAN VIMANAS



There is a tremendous volume of published material in almost all western languages on a subject that somewhere along the line and about a century ago was tabbed “the Ancient Writings.” About 99 percent of this is not only drivel but pure fabrication. It has become the bible of the mystics, psuedoscientists, and crackpots and it—or specific parts of it, such as “The Tibetan Mysteries,” the “Atlantean Texts,” and so forth—are now quoted as a sort of gospel. However, if you ask any Orientalist, historian, or librarian in any of the great museums of the world, you will encounter a wry smile. No such works have ever been known to exist outside the imagination of the mystics. Nonetheless, there are some truly ancient and authenticated texts, notably of Indian origin, which is to say from various parts of that great subcontinent, and handed down from various of its cultures from various dates.

It is, moreover, from these authenticated texts, mostly in poetic form, that some truly astonishing concepts have been derived. Poetic they may be; and nothing more than myth, legend, or folklore may they purport to record; but

they make statements that are more than just surprising. Several are, what is more, couched in perfectly straightforward terms and are, time and time again, stated to be not legendary but technological, and thus called *Manusa*. These are said by the writers to explain how certain devices were constructed for aerial flight, but not *how* to so construct them because the inventors and the establishment did not want such things to be mass-produced and get into the hands of any other than the rulers, commonly called “kings” and “princes.” What is more, among the non-technical works devoted to the more poetic stories, and known as *Daiva*, there would appear to be more than ample suggestion, if not evidence, that such airships could be and were put to the most gruesome and devastating use in wartime.

These texts make most fascinating reading, but being unable to read the originals or copies of them in the language in which they were written, I appealed to friends who were either Orientals themselves or students of Oriental literature. Among these was the late Dr. Ranjee Shahani, who at the time of his death was Professor of English Literature at Seton Hall University. Dr. Shahani had published considerably on these texts, and I derive most of the following from his works. At the same time, I quote certain passages as published (in translated form) by the British author, Desmond Leslie,<sup>1</sup> by kind permission of the author and publishers. From these sources we are told that:

In the *Manusa*, the most elaborate details for building (such aerial machines) are set down. The *Samarangana Sutradhara* says that they were made of light material, with a strong, well-shaped body. Iron, copper, and lead were used in their construction. They could fly to great distances and were propelled by air. This text, according to Leslie, devotes 230 stanzas to the building of these machines, and their uses in peace and war. This author then goes on to state that this same text says:

“Strong and durable must the body be made, like a great flying bird, of light material. Inside it one must place the *Mercury-engine* with its iron heating apparatus beneath.

By means of the *power latent in the mercury* which sets the driving *whirlwind* in motion, a man sitting inside may travel a great distance in the sky in a most marvelous manner.

“Similarly by using the prescribed processes one can build a vimana as large as the temple of the God-in-motion. Four strong *mercury* containers must be built into the interior structure. When these have been heated by controlled fire from iron containers, the vimana develops thunder-power through the mercury. And at once it becomes a pearl in the sky.

Moreover, if this iron engine with properly welded joints be filled with mercury, and the fire be conducted to the upper part it develops power with the roar of a lion.”

Leslie and several others who at least tried to take a serious view of these odd statements subsequently indulged in some perfectly valid speculations as to just what the significance of mercury might be. These are both sensible and permissible but lead off into matters that do not concern us here. Needless to say, they did not encompass the basic observation that a circular dish of mercury revolves in a contrary manner to a naked flame circulated below it, and that it gathers speed until it exceeds the speed of revolution of said flame. I fancy that Mr. Leslie will be enchanted with this new observation.

Here is the projection of energy by an exceedingly simple process. Should the ancients have stumbled across this process—though how in the dickens they might have done so is almost beyond comprehension—they might well have followed up the lead and ended up by finding out how to tap and channel such energy. Take this lead far enough and one can suggest the development of an “engine” employing it and being put to use to do (as the engineers say) work.

Desmond Leslie’s theme is that this was one type of engine developed for aerial flight, and he extrapolates therefrom to the suggestion that it may have been developed far enough for space travel, and that something on this

principle powers some UFOs.

*Herr Theodor Schwenk on Vortices*

Vortices, or in more popular parlance whirlpools, constitute a subject of considerable complexity. They are individual entities being born due to a particular set of circumstances, having a life span that, given precise knowledge of enough factors, is predictable, and eventually dying through slow disintegration or accident. They form in gases—including, of course, air—liquids of all kinds, and even in solids when they are in a plastic state. The vortex as a structure liked at the very core of existence, as in the atom and apparently down to the behavior of quanta.

The origin of vortices, their structure, and their behavior constitute a somewhat complex subject calling for mental visualization of three-dimensional movement. They are whirligigs, the centers of which have been pulled either downward or upward, and mostly downward in the case of air and water. As a geometric form they permeate the whole of life as well as mere matter. The best exposition of vortices, and one that is couched in terms that are understandable to anybody, may be found in a book entitled *Sensitive Chaos*, by Theodor Schwenk.<sup>2</sup> Therein there is a passage on p. 39 which succinctly describes the causes of vortices as follows: “Wherever any qualitative differences in a flowing medium come together, these isolated formations (vortices) occur. Such differences may be: slow and fast, solid and liquid; liquid and gaseous. We could extend the list: warm and cold; denser and more tenuous; heavy and light (for instance, salt and fresh) viscous and fluid; alkaline and acid...At the surfaces of contact there is always a tendency for one layer to roll in upon the other. In short, wherever the finest differentiations are present the water acts as a delicate ‘sense organ’ which as it were perceives the differentiations and then in a rhythmical processes causes them to even out and to merge.”

It should be noted that in vortices in a liquid such as

water, objects are sucked inward and downward, whereas in a gas such as air they go upward and outward, as in tornadoes. Our Vile Vortices would appear to coincide with larger vortices in the surface layers of the oceans, but we are not presuming to suggest that these ever form gigantic maelstroms that have a hold going down the middle into which ships could be sunk. Rather, the alleged action of the VVs would seem to be in the atmosphere above these vast, comparatively placid whirligigs. In this medium, things would be sucked up and then tossed out over the upper rim of the vortex. Considering the power of tornadoes or twisters over the sea, it is just conceivable that lighter planes might be so whirled upward and tossed far away where search parties would never think of looking for them. However, the idea is neither proven nor altogether tenable from a purely physical point of view. While the VVs do appear to be associated with natural vortices, the mysterious effects that have been described as occurring within them do not seem to be purely mechanical, and we have to investigate a number of other factors.

In the same book named above, there is another most pertinent passage which applies to the centers of vortices and which provides a very neat and simple explanation of what is called suction-pressure. This states:

“Imagine we have some kind of filled space—we will call it A and place a plus sign in front of it (+A). Now we can make the space emptier and emptier, whereby A gets smaller and smaller; but there is still something in the space, therefore we still use the + sign. We can imagine that it could be possible to create a space which is entirely empty of air, although this is not possible under earthly conditions because a space can only be made approximately empty. Were it possible, however, to make a space entirely void, it would contain nothing but space. Let us call it nought; the space has zero contents. Now we can do with the space as you can do with your purse. When you have filled it you can take out more and more, until at last there is nothing left in it. If then you still want to go on spending

money, you cannot take out any more, but you can incur debts. But if you have made debts there is less than nothing in your purse. This, then is how you can imagine the space—not only empty, but one might say sucked out, filled with less than nothing (- A).”

Just how you borrow against a nothingness, vacuum, or space I leave to the cosmologists; but I am wondering if this is not where anti-matter, counter-matter, and things like Gravity II might not come in. Vortices generated great energies the origin of which has not yet been sufficiently explained. From, in what, and from what fields are they generated? Do purely mechanical vortices stimulate others in other fields such as the electromagnetic, magnetic, gravitic, and other?

1. Leslie, Desmond, and Adamski, George. *Flying Saucers Have Landed*. New York: The British Book Centre, 1953, pp. 90-94.

2. London: Rudolph Steiner Press, 1965.

From *Invisible Residents*,  
1970, World Publishing, Cleveland.

Many thanks to Ivan T. Sanderson, a great scientist.



# BOOK

# 1

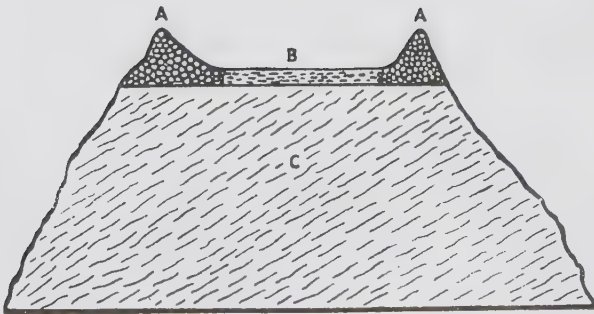

Cross section of a vitrified stone fort in Scotland. The stones were literally fused together by intense heat thousands of years ago.

# AIRCRAFT

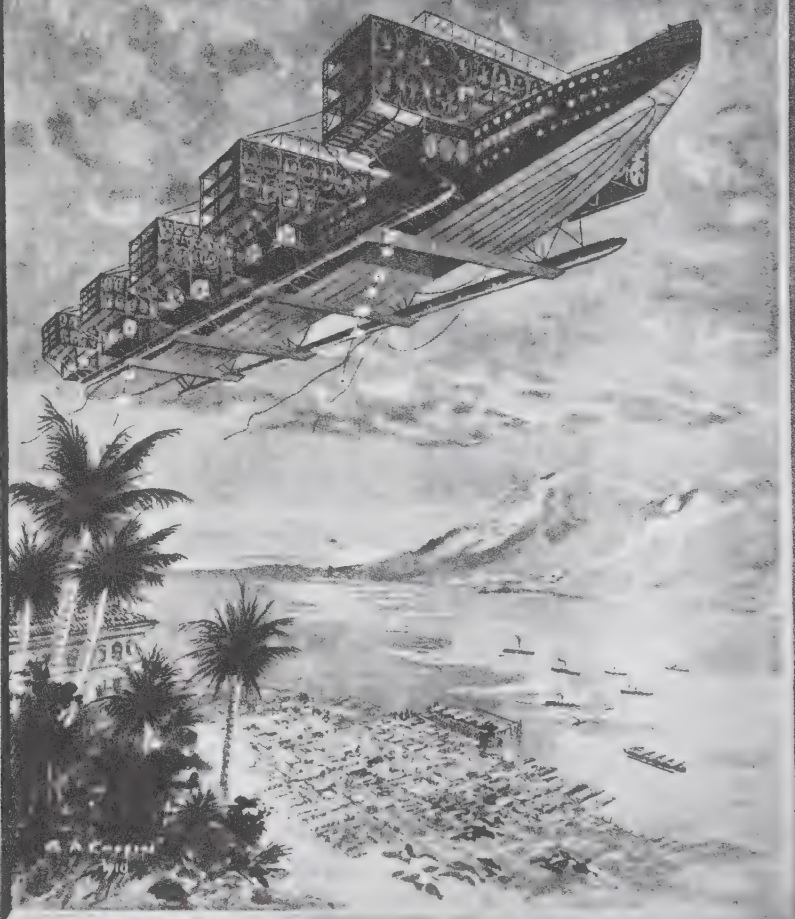

March, 1910

Edited by ALFRED W. LAWSON

10 Cents a Copy

The March, 1910 cover of *AIRCRAFT* magazine, with a large boat shaped aircraft taking into the skies. This elongated airship design became popular at the turn of the century, along with the concept of ancient powered flight.

# 1

## SECRET LIBRARIES & ANCIENT SCIENCE



*In these dusty books, which the student  
doesn't bother to consult until the eve  
of the exam, there are marvels, miracles!*

— H.G. Wells, *The Invisible Man*

The subject of ancient Indian aircraft, called *Vimanas* by the ancient “Indians” themselves, is no doubt one of the most fascinating subjects of both modern and ancient science!

For the skeptic, this book hopes to cancel all doubt that the subject of *Vimanas* is a genuine one, though various interpretations of the texts can be assumed. That ancient man was capable of building flying machines there seems no doubt. After all, the human beings of ten, twenty or a hundred thousand years ago were of the same brain size and mental capability as today's modern man. Therefore any mechanical or scientific achievement that

modern man was capable of, ancient man was capable of as well. However, the question that the skeptic may ask is, "Did ancient man actually achieve the goal of flight and mechanical motive power?"

A large part of esoteric information, including some material on *Vimanas* and ancient technology, allegedly comes from secret libraries supposedly kept in various places around the world. These secret libraries are often underground beneath ancient monasteries or temples, or sometimes walled up in caves until they can be found later.

To many critics of the belief in advanced ancient civilizations, the notion of secret libraries in Tibet, India or elsewhere and tablets with ancient, unintelligible symbols on them was just as absurd. Yet, if these critics bother to check their history, they would know that such libraries are a fact.

In the year 1900 at Dunhuang, a small desert town on the border of northern Tibet, a Taoist monk found a hidden library inside a cliff honeycombed with caves. The room had been walled up with bricks in the eleventh century to keep it from falling into the hands of invading barbarians. For eight hundred years the books had lain there, preserved by the dry desert air and maintained in excellent condition. Then the famous explorer and archaeologist Sir Aurel Stein passed through Dunhuang in 1907 and persuaded the monk to allow him to view the treasure, which was, at that time, still kept in the secret cave.

He found Buddhist texts in many languages—Chinese, Tibetan, Sanskrit—and some in languages that were completely unknown! Just how old some of the texts were was impossible to tell, but they had probably already been copied over several times from earlier texts. The originals had been written hundreds and in most cases, thousands of years ago. <sup>12,13,14</sup>

Throughout history huge archives and libraries have

been purposely destroyed. According to the famous astronomer Carl Sagan, a book entitled *The True History of Mankind Over the Last 100,000 Years* once existed and was housed in the great library in Alexandria, Egypt. Unfortunately, this book, along with thousands of others, was burned by fanatical Christians in the third century A.D. Any volumes which they might have missed were burned by the Moslems to heat baths a few hundred years later.

All ancient Chinese texts, especially those of Lao Tzu and Confucius, as well as the I Ching, speak of the ancients and the glory of their civilization. They were presumably speaking about the people living at least at the time of the "Five Monarchs" and probably before. Possibly, they are really referring to the people of the "Motherland, Mu."

Unfortunately, not much is known about the early part of Chinese history, from the first millennia B.C. and before. Just before he died, in 212 B.C., Emperor Chi Huang Ti ordered that all the books and literature relating to ancient China be destroyed. Vast amounts of ancient texts—virtually everything pertaining to history, astronomy, philosophy, and science—were seized and burnt. Whole libraries, including the royal library, were destroyed. Some of the works of Confucius and Mencius were included in this destruction of knowledge.

Fortunately, some books survived because people hid them in various underground caves, and many works were hidden in Taoist temples where they are even now religiously kept and preserved. They are on no account shown to anyone, but kept hidden away as they have been for thousands of years. The recent persecution and closing of religious temples by the Red Chinese Government indicates that the lamas still have cause to keep their ancient books hidden. It is known that the Russians have suppressed a great many religious texts that have been discovered in

Soviet Union, because they are afraid these would give the churches a boost.

Doubtless, there was a great deal of history relating to the early days of ancient China lost. What caused the emperor Chin to want to destroy any record of the past just prior to his death? Was he such a megalomaniac that he wanted history to start with him, or was he influenced by the same evil forces that inspired Genghis Khan and Hitler to the same sort of book burning?

The Spanish conquistadors had every Mayan codex that they found destroyed. Out of many thousands of Mayan books found by the Spanish, only three are known to exist today. Like the fanatical Christians of the third century and Emperor Chin in the second century B.C., they wanted to erase all knowledge of the past and the knowledge that it contained.

While despots, fanatics and cruel conquerors have been busy throughout history trying to destroy knowledge and erase the memory of the dim past, others have been attempting, like those who walled the library of Dunhuang up inside a cave, to save this precious knowledge.

When the patriarch of Constantinople, Nestorius, was deposed at the Council of Ephesus in 431 A.D. for the heresy of believing that Christ was in fact two persons, the Archangel Melchizedek and the human Jesus of Nazareth, son of Joseph and Mary, he was banished to the Libyan Desert. The followers of Nestorius were then persecuted for their Christian beliefs which ran against the newly created Catholic Church. They moved eastward from Constantinople, first to Edessa (the modern Urfa) in Mesopotamia, and later to Baghdad, India and Central Asia. There was a medical school in Edessa, and in this scientific community they translated into Syriac—which had become the common language of western Asia—the works of Aristotle, Plato, Euclid, Archimedes, Heron, and Ptolemy

and many other books of philosophy and science. These Syrian books were then later translated into Arabic in Baghdad and other places.

These Syrian books then formed the basis for Arabian science and philosophy which flowered during the dark ages of Europe when the Catholic church had imposed ignorance and superstition on the people, and destroyed those books as heresy. In the course of time, the Syriac works, now in Arabic, were then translated into Latin, Hebrew, and modern western languages. Ancient science reached us in a round about way, and were it not for the Nestorian Christian refugees and their libraries, we would not have these books today!<sup>28</sup>

Even in modern times knowledge has been purposely destroyed, even in the United States! While we all know that the Nazis destroyed books, it is less well known that the U.S. government ordered all of the works of the Austrian psychologist Wilhelm Reich's destroyed by court order in 1954. His works, curiously, had a great deal to do with free energy devices and "strange" technology.

To any student of ancient history and lover of ancient knowledge, I think that it is painfully obvious why secret libraries and the preservation of books is actually necessary if ancient wisdom and technology were to be preserved!

Something else which lends credibility to the belief that these secret libraries exist is the fact that many references are made to them in Central Asian literature. It is said that they can be found in many temples in India, Nepal and Tibet. They probably can also be found in China and Mongolia as well.

About forty years ago, a Chinese representative of the Rosicrucian Brotherhood visited the Rosicrucian Fraternity in San Jose, California. He brought with him a manuscript which had been kept in a secret Asian archive for thousands of years. It was said to have been authored by the Egyptian

Pharaoh Akhnaton, historically the founder of monotheism. The Rosicrucians translated this book and published it under the title *Unto Thee I Grant*.<sup>22,25</sup> The appearance of this book would seem to illustrate that such archives do in fact exist, and that knowledge is occasionally disseminated from them. Furthermore, the Rosicrucians claim to have access to a number of secret libraries in Tibet.

§§§

Extant Chinese texts state that the first of the dynasties was that of the “Five Monarchs,” in which there were, confusingly, nine rulers whose combined reigns lasted from 2,852 to 2,206 B.C., which is just after the time at which the archeologists date the Ban Po Neolithic Site. Confucius ascribed to one king, Yao, whose reign started around 2,357 B.C., “...kindliness, wisdom, and sense of duty.” He was succeeded by Shon, who built a vast network of roads, bridges, and passes through the enormous land, and many scholars attribute the building of the Silk Road to him.

One of the great proponents of ancient civilizations and advanced technology of the past was James Churchward, an Anglo-American who spent a great deal of his life in India. Here he was initiated into certain eastern esoteric “truths,” being shown, supposedly, some ancient tablets in an Indian/Tibetan monastery. (There have been many Tibetan monasteries in India for hundreds, if not thousands of years.) He was taught how to read the tablets and was told many fascinating things about ancient history. Then, after traveling all over the world, he wrote a series of very popular books. These were *The Lost Continent of Mu*, *The Children of Mu*, *The Sacred Symbols of Mu*, *The Cosmic Forces of Mu*, and *The Second Book of the Cosmic Forces of Mu*. He died just as the last book was being published in 1935.



In the late eighteen hundreds, there was a French traveler and writer by the name of Louis Jacolliot (1837-1890) who collected a great many Sanskrit myths on his travels to India. According to him, the Hindu classics told of a former continent in the Pacific which they called Rutas. This continent was where civilization had begun, and it had sunken into the ocean in remote antiquity, leaving only a bunch of small islands.<sup>57</sup>

Jacolliot's tales are remarkably similar to Churchward's, and he is one of the few sources that back up Churchward's tales of stone tablets which say pretty much the same things about ancient Indian sources and a lost continent in the Pacific. The Ring of Fire is certainly the most active earthquake zone in the world, and there is some archeological evidence of an advanced civilization in the Pacific, such as the gigantic megalithic stone city of Metalanim (Nan Modal) on small, sparsely populated Ponape Island not to mention evidence on mysterious Easter Island and other islands scattered throughout the Pacific.

The great Chinese philosopher, Lao Tzu, often talked of the "Ancient Ones" in his writings, much as Confucius did. They were wise and knowledgeable, human beings that were as Gods — powerful, good, loving, and all-knowing. Born around 604 B.C., Lao Tzu wrote the book which is still perhaps the most famous Chinese classic of all time, the *Tao Te Ching*. When he finally left China, at the close of his very long life, he journeyed to the west, to the legendary land of *Hsi Wang Mu*, which may have been the headquarters of the "Ancient Ones," the *Great White Brotherhood*. It was as he was leaving at one of the border posts of China that a guard persuaded him to write down the *Tao Te Ching*, so that Lao Tzu's wisdom would not be lost. No one ever heard of Lao Tzu again, though it is

presumed that he made it to the Land of Hsi Wang Mu.

The Ancient Masters were subtle,  
mysterious, profound, responsive.  
The depth of their knowledge is unfathomable.  
Because it is unfathomable,  
all we can do is to describe their appearance.  
Watchful, like men crossing a winter stream.  
Alert, like men aware of danger.  
Courteous, like visiting guests.  
Yielding, like ice about to melt.  
Simple, like uncarved blocks of wood.

—*Lao Tzu, Tao te Ching (Chapter 15)*

Hsi Wang Mu is also another name for the popular Chinese Goddess Kuan Yin, the “Merciful Guardian” and “Queen Mother of the West.” Therefore, this land, traditionally located in the Kun Lun mountains, was known as the “Abode of the Immortals” and “The Western Paradise.” Other ancient Chinese also went off to the “Abode of the Immortals;” the Chou-dynasty emperor “Mu” (1001-946 B. C.) journeyed to the Kun Lun mountains to find the land, and is said to have actually had an audience with “Goddess Hsi Wang Mu” on the bank of Jasper Lake in the Kun Lun range. Over the years of Chinese history, expeditions were sent out to the Kun Lun mountains, the “Mount Olympus” of ancient China, in order to contact the “Ancient Ones.”<sup>38</sup>

A secret library was possibly underground, and it has been said by many to be near Lhasa, possibly connected to the underground tunnels beneath the Potala, the Dalai Lama’s fabulous skyscraper. The tunnels, however, being reportedly quite extensive, would be very difficult to explore, and certainly such a library would be ingeniously hidden. The prolific occult writer T. Lobsang Rampa tells

an interesting story of the exploration of these underground tunnels beneath the Potala in his fascinating books, *The Third Eye and Cave of the Ancients*.

While the story is somewhat dubious, it does at least indicate that there is a great deal of myth about the existence of such tunnels. Rampa reports them as very extensive, and including a large underground lake. Nicholas Roerich also mentions tales of the tunnels and lake beneath the Potala, perhaps it is from here that Rampa learned of such things, if not from actual experience.<sup>69</sup>

Just north of the Kun Lun mountains, in Sinkiang, the famous Russian artist, explorer and mystic, Nicholas Roerich heard of the "Valley of the Immortals" just over the mountains. "Behind that mountain live holy men who are saving humanity through wisdom; many tried to see them but failed — somehow as soon as they go over the ridge, they lose their way," he was told. A native guide told him of huge vaults inside the mountains where treasures had been stored from the beginning of history. He also indicated that tall white people had been disappearing into those rock galleries.<sup>93</sup>

Nicholas Roerich at one time was in the possession of a fragment of "a magical stone from another world," called in Sanskrit the Chintamani Stone. Alleged to come from the star system of Sirius, ancient Asian chronicles claim that a divine messenger from the heavens gave a fragment of the stone to *Emperor Tazlavoo of Atlantis*<sup>94</sup> A fragment of this stone was supposedly sent to Europe to help aid in the establishment of the League of Nations.

With the failure of the League of Nations, Nicholas Roerich then had the stone in his possession. On one of his expeditions in the 1920's he returned the fragment of the stone to its rightful owners, whoever they were. The stone has been described as being the size of a small finger in the shape of a fruit or heart, shiny gray in color with four

unknown hieroglyphs inscribed on it. It has certain magical properties, and can be used for divination.<sup>94</sup>

Roerich may have taken the stone to the “Valley of the Immortals” in the Kun Lun Range, or possibly to Lhasa, where it is also said that the Thirteenth Dalai Lama was also in possession of a fragment of the stone (perhaps this was the one sent to Europe). The Thirteenth Dalai Lama was a man of certain mystery. Tibetan tradition had it that would be but one more Dalai Lama after him who is the Dalai Lama of today.

The Potala Palace is a fairly recent structure, built by the fifth Dalai Lama, Ngwang Lobsang Gyatso who was born in 1617. It was he who persuaded the Mongol king and the Chinese emperor to recognize his suzerainty over Tibet. The Potala, the most famous building in Tibet, is a tall, massive, imposing mud-and-brick skyscraper, now turned into a museum by the Chinese.

Recently, Sanskrit documents discovered by the Chinese in Lhasa were sent to India to be studied by experts there. Dr. Ruth Reyna of the University of Chandigarh said that the manuscripts contain directions for building interplanetary spaceships!

In any case, Dr. Reyna explained that the document stated that the method of propulsion was “anti-gravitational.” On board these machines, which were called “astras,” the builders of these crafts could have sent a detachment of men to any planet. The manuscripts do not say that any interplanetary communication was achieved, but do mention a trip from the earth to the moon, though it is not clear whether the trip was just planned or actually carried out.

Indian scientists were at first extremely reserved about the value of these documents, but became less so when the Chinese announced that certain parts of the data were being studied for inclusion in their space program!<sup>14</sup>

These “Astras” of Dr. Reyna’s manuscript are no doubt what other Indian texts describe as *vimanas*. It is also interesting to note that the Great White Brotherhood is said to be in possession of a number of such airships, similar to these “astras” or the *vimanas* and *vailxi* of the Rama Empire and Atlantis. These airships, perhaps powered by “anti-gravity,” as the document found by the Chinese suggests, are theoretically kept in secret bases. These airships, virtual UFO's, may actually be the cause of some UFO sightings, especially those in Central Asia. Interestingly, the Kun Lun mountains and the Lop Nor desert nearby are the center for Central Asia's main UFO mystery!

§§§

Of a more recent date, historically speaking, are the ancient books and library of Asoka, the great Indian emperor who lived circa 274-232 B.C. and is well known for his *Edicts* which was an early code of ethics, moral law and a “Bill of Rights.” According to the French authors of the well known book, *Morning of the Magicians*,<sup>29</sup> Asoka formed a secret society of scientists known as the *Nine Unknown Men*. There were nine books, one written by each of the scientists in the employ of Asoka. Book number six was a treatise on the Secrets of Gravitation!

One wonders if this book was perhaps the *Vaimanika Shastra* of Maharishi Bharadwaja? It is also interesting to note here that Asoka’s empire in India was immediately after the attempted invasion of the Indian subcontinent by Alexander the Great, whose army retreated and all attempts were given up to subdue India, after his army was “attacked” by what Greek historians later called, “fiery, flying shields”!<sup>19,21</sup>

The idea of a secret society keeping secret knowledge is

hardly very fantastic. Dr. J. Allen Hynek, the American astronomer who served for over twenty years as the Air Force's scientific consultant on UFOs, explained his term The Invisible College in an article called "The UFO Mystery" published in the *FBI Bulletin* (February 1975):

"Way back in the 'dark ages' of science, when scientists themselves were suspected of being in league with the Devil, they had to work privately. They often met clandestinely to exchange views and the results of their various experiments. For this reason, they called themselves the *Invisible College*. And it remained invisible until the scientists of that day gained respectability when the Royal Society was chartered by Charles II in the early 1660s." 25

§§§

To let understanding stop at what cannot be understood,  
is a high attainment.

Those who cannot do it  
will be destroyed on the lathe of heaven.

—*Chuang Tzu*

One alleged possessor of ancient aircraft (vimana, as the ancients called it) was the noted Biblical king, Solomon. Some researchers point out that there is some evidence of a strong connection between Kashmir and ancient Israel, indicating that it was Kashmir that was the "Promised Land" rather than Palestine. Today in Kashmir, there are ancient places with names like, "The Tomb of Moses," the "Throne of Solomon" (which is a mountain), the last resting place of Mother Mary, just near Rawalpindi a few miles away in Pakistan, and the *Garden of Solomon*.

Most Kashmiris genuinely believe that Moses is buried in Kashmir, and that the forty years of wandering and

hostile tribes were not in the Sinai, but across Asia to Kashmir. After all, forty years is a long time to wander around the Sinai Peninsula, which could be walked across in a few days, and is virtually uninhabited, with no hostile tribes to be found, then or today. <sup>56</sup>

One of the most interesting features concerns the mountain known as the “Throne of Solomon.” There is at least one other “Throne of Solomon” mountain in Central Asia and it is in Iran. Why should a mountain be called “The Throne of Solomon?” According to an ancient Ethiopian text, the *Kebrā Nagast*, Solomon had some kind of airship with which he would fly great distances, probably landing on top of mountains. The ancient kingdom of Ethiopia was founded by the son of Solomon, born to him and the Queen of Sheba. The *Kebrā Nagast* says that Solomon had a “heavenly car” which he inherited from his forefather (King David, I suppose) and used frequently. “The King...and all who obeyed his word, flew on the wagon without pain and suffering, and without sweat or exhaustion, and traveled in one day a distance which took three months to traverse (on foot),” says the *Kebrā Nagast*. <sup>34</sup>

Could it be that Solomon possessed a vimana airship, left over from the days of the Rama Empire and Atlantis, some several thousand years before? Did he use his “heavenly car” to fly to “Solomon’s Throne” in Iran and Kashmir?

According to Nicholas Roerich, other “Thrones of Solomon” can be found elsewhere in Tibet and Central Asia. That Solomon flew there in his airship is a popular belief throughout Central Asia. <sup>69</sup> Perhaps the mountain in Iran, which, like the one in Kashmir, is flat-topped, was a landing pad between Israel and Kashmir. If so, are some of these airships still around today, and is someone operating them from a secret base in some remote hinterland of Central Asia, South America, a remote Pacific Island, or

somewhere else? Could they be responsible for some of the UFO sightings? The thought is mind-boggling!

Kashmir is also connected with the fantastic war in ancient times that destroyed the Rama Empire. The massive ruins of a temple called Parshaspur can be found just outside Srinagar. It is a scene of total destruction, huge blocks of stone are scattered about a wide area giving the impression of explosive destruction. The large dressed blocks of stone are reminiscent of the massive stone slabs at Puma Punku, near Tiahuanaco on the Altiplano of Bolivia.<sup>81</sup>

Was Parshaspur destroyed by some fantastic weapon during one of the horrendous battles detailed in the *Mahabharata*?



In this ancient Assyrian Cylinder Seal from the British Museum, a winged disc-shaped object, without occupants (at least visibly) can be seen to the left. A rocket-shaped object can be seen to the right of the horseman.





One of the scrolls written in an unknown language, found in the secret library in a cave in Dunhuang, China in 1910 by Sir Aurel Stein. They are now in the British Museum.



An alchemist confers with an “Ancient Master” on alchemical matters. Notice the triangular pyramid, symbolizing knowledge, superimposed on the head of the “Master.”



Two alchemists, possibly preparing mercury from cinnabar are depicted in this woodcut from a 16th-century translation of *Summa Perfectionis*, an 8th century work by the alchemist Geber.

# 2

## VIMANAS IN ANCIENT INDIAN TEXTS



Kill, therefore, with the Sword of Wisdom, the doubt born of ignorance that lies in thy heart. Be one in self harmony, in yoga,—and arise, great warrior, arise!

*Krishna to Arjuna in the Bhagavad Gita (4:42)*

Throughout history there have been many common myths and legends of flying machines or devices—the familiar flying carpets of ancient Arabia; Biblical figures such as Ezekial and Solomon flying from place to place and the “magical chariots,” or *Vimanas*, of ancient India and China.

There are many Chinese legends of flight, including a legendary flying chariot belonging to an ancient Chinese prince and the more recent Wan Hoo—of the 15th century A.D. or so. He allegedly built a sturdy wooden framework around a comfortable chair and attached 47 skyrockets to the back of the seat. Atop it he fastened two large kites.

After strapping himself to the chair, he raised his hand and servants carrying blazing torches advanced toward the vehicle and ignited the skyrockets. A moment later there was a mighty blast, followed by an impressive cloud of black smoke. Wan Hoo vanished, leaving nothing behind but a legend.<sup>88</sup>

A UPI report by Tony Samstag originating in Oslo, Norway in the early 1980s was entitled *Hunt for 1633 Rocket* and was a brief article about how Norwegian and Turkish scientists hope to collaborate “history’s first manned rocket” from beneath the Bosphorus Straits of Turkey. According to the story, the rocket, fueled by gun powder, was fired in 1633, according to records in the Topkapi Museum with a pilot named Hasan Celebi aboard. The 10 foot long projectile had a central fuel-driven motor with six smaller engines fastened on the outside.

Said Norwegian engineer Tore Thoerud “It is not immediately clear where the pilot sat as he flew 300 metres (980 feet) over the Bosphorus before launching himself in the world’s first hang-glider.”

Yet it is apparent that the *Vimanas* of ancient times were not powered by rocket technology.

The best place to begin a discussion of *Vimanas* is to discuss the ancient texts themselves.

Among the more famous ancient texts that mention aerial cars (*Vimanas*) are the *Ramayana* and *Mahabharata*. Other lesser known texts include the *Samarangana Sutra-dhara*, the *Yuktikalpataru of Bhoja* (12th century A.D.) the *Mayamatam* (attributed to the architect Maya celebrated in the *Mahabharata*), the *Rg Veda*, the *Yajurveda* and the *Ataharvaveda*.

According to the Indian historian Ramachandra Dikshitar who wrote the still classic text on ancient Indian warfare,<sup>5</sup> other texts which mention aerial vehicles and travels are the *Satapathya Brahmanas*; the *Rg Veda*

*Samhita*; the *Harivamsa*; the *Makandeya Purana*; the *Visnu Purana*; the *Vikramaurvasiya*; the *Uttaramacarita*; the *Harsacarita*; the Tamil text *Jivakacintamani*; and the *Samaranganasutradhara*.<sup>5</sup> The complete text of Dikshitar's discussion on aerial warfare and *Vimanas*, with some passages in Sanskrit can be found in Appendix A of this book.

§§§

In the *Manusa*, the most elaborate details for building aerial machines are set down. The *Samarangana Sutrathara* says that they were made of light material, with a strong, well-shaped body. Iron, copper, mercury and lead were used in their construction. They could fly to great distances and were propelled by air by motors. The *Samarangana Sutrathara* text devotes 230 stanzas to the building of these machines, and their uses in peace and war:

“Strong and durable must the body be made, like a great flying bird, of light material. Inside it one must place the *Mercury-engine* with its iron heating apparatus beneath. By means of the *power latent in the mercury* which sets the driving *whirlwind* in motion, a man sitting inside may travel a great distance in the sky in a most marvelous manner.

“Similarly by using the prescribed processes one can build a *vimana* as large as the temple of the God-in-motion. Four strong *mercury* containers must be built into the interior structure. When these have been heated by controlled fire from iron containers, the *vimana* develops thunder-power through the mercury. And at once it becomes a pearl in the sky.

“Moreover, if this iron engine with properly welded joints be filled with mercury, and the fire be conducted to the upper part it develops power with the roar of a lion.”<sup>1</sup>

The *Ramayana* describes a vimana as a double-deck, circular (cylindrical) aircraft with portholes and a dome. It flew with the “speed of the wind” and gave forth a “melodious sound” (a humming noise?). Ancient Indian texts on *Vimanas* are so numerous it would take several books to relate what they have to say. The ancient Indians themselves wrote entire flight manuals on the control of various types of *Vimanas*, of which there were basically four: the Shakuna Vimana, the Sundara Vimana, the Rukma Vimana and the Tripura Vimana.

At the *World Space Conference* on October 11, 1988 in Bangalore, India, as reported in the local newspaper called *The Hindu*, an Italian by the name of Dr. Roberto Pinotti addressed the delegates and spoke on ancient Indian *Vimanas*. After briefly telling them what *Vimanas* were, he went on to say that the *Tripura Vimana* was powered by motive power generated by solar rays and had an elongated form similar to a modern blimp.

He went on to say that the “ancient Aryans knew the use of the element ‘fire’ as could be seen from their ‘Astra’ weapons that included *soposamhara* (a flame belching missile), *Prasvapna* (which caused sleep) and four kinds of *Agni Astras* that traveled in sheets of flame and produced thunder.”

While Dr. Pinotti concluded his talk by telling the delegates that they should take the subject of *Vimanas* seriously, he was really speaking to the foreign delegates, as most Indians, especially Hindus or those of religions derived from Hinduism such as Buddhism or Jainism, already believe that their ancestors had such a technology.

Pinotti also mentioned (as does Desmond Leslie<sup>1</sup>) the the *Samara Sutradhara* is a scientific treaty dealing with every possible angle of air travel in a *Vimana*. There are 230 stanzas dealing with construction, take-off, cruising for thousands of miles, normal and forced landings, and even

possible collisions with birds.

The *Vaimanika Sastra*, (sometimes spelled *Vimanika Shastra* or *Vymaanika-Shaastra*) perhaps the most important ancient text on Vimanas (reprinted in full in this book) was first reported to have been found in 1918 in the Baroda Royal Sanskrit Library. Baroda is located north of Bombay and south of Ahmedabad in Gujerat. No earlier copies have been reported, however, Swami Dayananda Saraswati in his comprehensive treatise on the *Rg Veda* dated 1875 references the *Vaimanik Sastra* in his commentary, as well as other manuscripts on Vimanas.<sup>3</sup>

The *Vaimanika Sastra* refers to 97 past works and authorities, of which at least 20 works deal with the mechanism of aerial Flying Machines, but none of these works are now traceable.<sup>3</sup> Says Sanskrit literature professor Dileep Kumar Kanjilal, Ph.D. of the West Bengal Senior Educational Service, "Since the transcripts of the work date from early 20th century the authenticity of the Vai. Sastra may be pertinently questioned. On careful analysis it has been found that the work retained some antique features pertaining to an old *Sastra*. Like the Sutras of Panini the rules have been laid down in an aphoristic style with the explanation couched in Vrittis and Karikas. The Sutra style is to be found in the earliest works on grammar, Smrti and Philosophy, while the use of Karikas is as old as Batsyayana, Kautilya and others of the early Christian era. Bharadwaja as the author of a Sruta Satra and Smrti work is well-known and a sage Bharadwaja as the seer of the 6th Mandala of the *Rg Veda* is also well-known. Panini also referred to him in VII. II.63. Kautilya had also shown that Bharadwaja was an ancient author on Politics. The Mbh. (*Mahabharata*, Santiparva Ch. 58.3) refers to Bharadwaja as an author on politics. Authors on politics have very often been found to have written on the technical sciences also. The genuineness, therefore, of any

treatise on technical sciences composed by Bharadwaja cannot be ignored.<sup>3</sup>

With the authenticity of the *Vaimanika Sastra* verified, Professor Kanjilal then struggles to ascertain the date in which Bharadwaja assembled the manuscript from earlier sources. According to Kanjilal, only four out of the 97 works and treatises quoted in the *Vaimanika Sastra* are still extant. Says he: "It appears that most of these works were very old and are now lost."<sup>3</sup>

The *Vaimanika Sastra* refers to no less than thirty-six authorities on various technical sciences, all of which date from at least the 8th century B.C. and most, if not all, from much earlier. Chronologically the authorities mentioned in the *Vaimanika Sastra* are: Valmiki, the legendary author of the *Ramayana* (circa 3000 to 1000 B.C.); Apastamba (450 B.C.); Gobhila (4th century B.C.); Usanas (3rd Century B.C.); Vasistha (circa 2nd century B.C.); Atri (before the 3rd century B.C. as cited by the Sanskrit historian Manu); Garga, an astronomer and astrologer cited in the *Mahabharata* (Kanjilal places him prior to 500 B.C., he is more likely from a period much earlier, at least 900 B.C.); Vyasa, the legendary author of the *Mahabharata* (although another Vyasa was a writer on "Smrti" was much later, circa 200 A.D.); Angiras (c. 1st century A.D. according to Kanjilal); Gautama (Buddha? circa 500 B.C.); Jaimini (c. 500 B.C.); Gobhila, author of "Saruta" and "Grhyasutra" (c.500 B.C.); Saunaka, probable author of the "Saruta" and "Grhyasutra" (c. 500 B.C.); Saunaka (as author of the "Rkpratisakhya" he can be placed earlier 500 B.C.); and Sakatayana (before the 5th century B.C.).<sup>3</sup>

Most of the above authorities are from the 5th century B.C. which tends to place the origin of the *Vaimanika Sastra* at the 4th century B.C. However, anomalies such Angiras and other authorities mentioned in



the text such as Lalla, Vachaspati Isvara and Samba (not mentioned above) may be from the period of the 6th century A.D. Yet, it seems that none of these persons can be clearly identified, as these names, strange to Westerners, are quite common in Hindi/Sanskrit, and while well known persons having these names may have existed in the 5th, 6th or 9th century A.D., the actual works cited by Bharadwaja are unknown. Therefore, the actual authors being referred to may easily be from the 5th century B.C. or earlier. For instance, Kanjilal says that Samba may be the Samba who is the author of the "*Samba Purana*" of the late 9th A.D. or he may be the Samba who is identified in the Mahabharata as the son of Krishna (or another person entirely).<sup>3</sup> Considering the thrust of Bharadwaja's *Vaimanika Sastra*, the latter identity as Krishna's son is more likely, considering that two other persons from the *Mahabharata* are referenced.

Therefore, it can be concluded that the *Vaimanika Sastra* was written, at the very latest, in the 10th century A.D. and apparently at the very earliest, in the 4th century B.C. It is unquestionably taken entirely from earlier texts, as the author, Bharadwaja, himself says frequently. These ancient texts probably reference still earlier texts, many in Dravidian, the language of the Rama Empire. That India is really the only ancient country in which ancient books have actually survived the ravages of history and purposeful destruction of libraries is discussed in the next chapter.

Says the *Vaimanika Sastra* about itself: "In this book are described in 8 pregnant and captivating chapters, the arts of manufacturing various types of Aeroplanes of smooth and comfortable travel in the sky, as a unifying force for the Universe, contributive to the well-being of mankind.

"That which can go by its own force, like a bird, on earth, or water, or in air, is called '*Vimana*.'

“That which can travel in the sky, from place to place, land to land, or globe to globe, is called ‘*Vimana*’ by scientists in Aeronautics.”<sup>48</sup>

The ancient manuscript claims to give: “The secret of constructing aeroplanes, which will not break, which cannot be cut, will not catch fire, and cannot be destroyed.

“The secret of making planes motionless.

“The secret of making planes invisible.

“The secret of hearing conversations and other sounds in enemy planes.

“The secret of receiving photographs of the interior of enemy planes.

“The secret of ascertaining the direction of enemy planes’ approach.

“The secret of making persons in enemy planes lose consciousness.

“The secret of destroying enemy planes.”<sup>48</sup>

The manuscript is highly detailed and gives such information and advice as: ... “Just as our body, if complete in all its limbs, can achieve all things, so an Aeroplane should be complete in all its parts in order to effective. Commencing from the photographing-mirror underneath, an aeroplane should have 31 parts.”

“The pilot should be provided with different materials of clothing according to differences in seasons, as prescribed by Agnimitra.”

“Three varieties of food should be given to pilots, varying with the seasons of the year, as Kalpa-Sastra. 25 kind of of poisons which arise in the seasons are destroyed the above changes in diet.”

“Food is of five forms, cooked grain, gruel, paste, bread, and essence. All of them are wholesome and body-building.”

“Metals suitable for Aeroplanes, light and heat-absorbing, are of sixteen kinds, according to Shaunaka. Great sages have declared that these metals alone are the best for aeroplane construction.”<sup>48</sup>

§§§

There are many other ancient texts from India that provide fascinating and incredible information on the highly technological ancient world, of which ancient India was only a part. The *Bhagavad Gita* (known as *Srimad-Bhagavatam* to Hindus) is part of the *Mahabharata*. In text 19 of the Third Canto we read (as translated by Bhaktivedanta Swami Prabhupada, founder of the ISCON movement):

“The elder child, Hiranyakasipu, was unafraid of death from anyone within the three worlds because he received a benediction from Lord *Brahma*. He was proud and puffed up due to this benediction and was able to bring all three planetary systems under his control.”

That Hiranyakasipu was in control of three planetary systems is an incredible statement, and one that seems a bit out of line for a supposedly primitive people whose main interest was growing food, hunting and gathering and fending off wild animals. Yet, these “cave-men” were, by their own written records, quite sophisticated and in possession of not only aircraft, but spacecraft as well.

It is interesting to conjecture as to what three planetary systems they are talking about. It may be assumed that earth is one of these systems. Considering the fascinating photos of pyramids and other structures found on Mars by NASA, we may believe Mars to have been a planet worthy of “bringing under control.” Perhaps Venus (sometimes referred to as *Hesperus*) is the third planet. Even more interestingly, perhaps this third planet is that of

“Maldek” a planet that supposedly once existed between Mars and Jupiter, where the asteroid belt exists today.

This planet allegedly blew itself up many thousands of years ago, while playing around with some very dangerous and destructive technology — a lesson that our planet at this point in time and space might be well to learn before we repeat such a cosmic disaster.

The idea of the three planetary systems being brought under control would seem to have to be done via physical travel in a space ship, though the fascinating book *Easy Journey To Other Planets*, also written by Bhaktivedanta Swami Prabhupada, founder of the *ISCON* movement. This book is about astral travel, however, and not about visiting other planets in mechanical devices.

One Sanskrit authority who has held to the idea of the Vimanas of ancient India texts as genuine flying machines of the past is Dr. V. Raghavan who wrote the classic book *Yantras or Mechanical Contrivances in Ancient India*.<sup>96</sup> This book was first published in 1952 by *The Indian Institute of Culture* in Bangalore and republished in 1956 with a second introduction by the author.

The short book, to be used as a school text by students of ancient Indian literature and science, is a reference to all kinds of mechanical contrivances, including robots, war machines and aircraft, in classical Indian literature. Dr. Raghavan (a professor at the University of Madras) answers his critics in the preface to the second edition (1956) by saying: “Regarding these critics I only want to emphasize what I have clearly stated in the opening of my lecture as to my exact intention in presenting this material. In the whole thesis, I have not myself made any claim or argued that aeroplanes were roaring across the skies in ancient India. I have not pressed into service any unpublished manuscript said to exist in secret or private possession and claiming to contain precious information on

the construction of *Vimanas* or aerial vehicles. I have, on the contrary, used only the most reputed works, the references to different *yantras* in which have to be explained, if one does not want to close his eyes to them.”<sup>96</sup>

Indeed, Dr. Raghavan is possibly referring to such secret libraries as Churchward claimed to have consulted (of dubious value to the scholar, certainly) and discounting his own treatise in such light, as all of his references are from freely available sources. One need not turn to obscure sources on *Vimanas* when a great deal of material is available. Dr. Raghavan’s answer to those critics who object to his discussions of ancient Indian aircraft is “What meaning do the critics propose to attach to the manifold *yantra* references in the epics...?”<sup>96</sup>

Dr. Raghavan quotes many sources and his book is filled with classical stories of people and their flying machines, artisans whose specialty is to construct aircraft, and amusing tales of robots and other strange, exotic “contrivances.” He quotes from the *Samarangana-sutradhara* attributed to Bhoja at length. This ancient text, “in many ways, a rare treatise in Sanskrit literature” says Raghavan, is particularly revealing because it goes into great detail on the construction, propulsion and uses of aircraft. Bhoja, with Raghavan’s commentary, gives certain details on the mercury engine that propelled the craft.

Dr. Raghavan also gives details on how *Vimanas* were used to frighten war elephants (a more common scene usually ascribed to ancient India), and even on mechanical birds that flew, mainly as toys and amusement devices. Apparently some *Vimanas* were similar to cylindrical airships and “flying saucers” while other *Vimanas* were more typical of an airplane with wings, modeled after nature’s own invention of birds and other flying animals.

Ancient artifacts of aircraft with wings have been found. In 1898 a model was found in an Egyptian tomb

near Sakkara. It was labeled a "bird" and cataloged object 6347 at the *Egyptian Museum* in Cairo. Then in 1969 Dr. Khalil Messiha was startled to see that the bird not only had straight wings, but also an upright tailfin. To Dr. Messiha, the object appeared to be that of a model airplane.

It is made of wood, weighs 39.12 grams and remains in good condition. The wingspan is 18 cm, the aircraft's nose is 3.2 cm long and the overall length is 14 cm. The extremities of the aircraft and the wingtips are aerodynamically shaped. Apart from a symbolic eye and two short lines under the wings, it has no decorations nor has it any landing legs. Experts have tested the model and found it airworthy.

After this sensational discovery, the Minister for Culture, Mohammed Gamal El Din Moukhtar, commissioned a technical research group to put other birds under the microscope. The team nominated on Dec. 23, 1971 consisted of Dr. Henry Riad, Director of the *Museum of Egyptian Antiquity*, Dr. Abdul Quader Selim, Deputy Director of the Egyptian Museum for Archaeological Research, Dr. Hismat Nessiha, Director of the Department of Antiquities, and Kamal Naguib, President of the Egyptian Aviation Union. On January 12, 1972, the first exhibition of Ancient Egyptian model aircraft was opened in the Hall of the *Egyptian Museum for Antiquities*. Dr. Abdul Quader Hatem, Representative of the Prime Minister, and the Air Minister Ahmed Moh presented fourteen Ancient Egyptian model aircraft to the public.

Another curious exhibit at the Egyptian Museum in Cairo is a large display of boomerangs found in the tomb of King Tutankhamen. While boomerangs may not be models of ancient aircraft, they demonstrate that the Egyptians were highly interested in the mechanics of flight, as few devices operate like a boomerang after being

thrown. A number of Egyptian reliefs show Egyptians hunting with boomerangs.

It has long been shown by the pundits of higher learning that ancient texts, legends, traditions and even actual artifacts such as models and frescoes are not sufficient proof of anything, especially when it runs contrary to the established academic dogma.

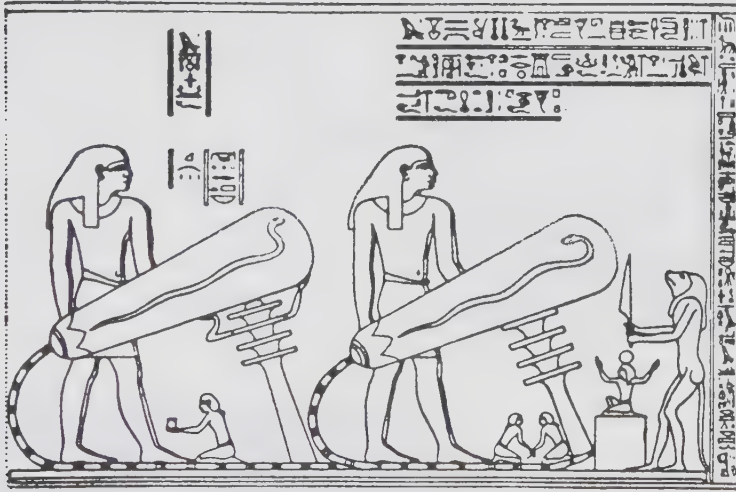

A relief from the underground chamber in the Temple of Hathor at Dendera, Egypt. It shows priests carrying devices attached by a braided cable to an altar. Supporting the "light bulbs" are Djed columns, associated with the Egyptian god Osiris. Are these ancient electrical devices?

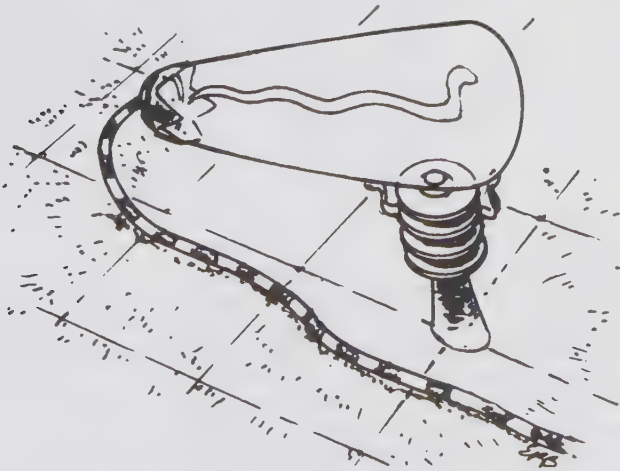

A perspective drawing by artist Eliot Brown of the device at the Temple of at Dendera, Egypt. Was it used to light the temples?

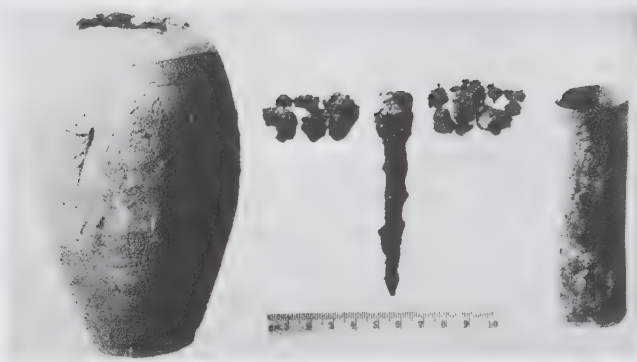

That electricity was known to the ancients is proved by these electric batteries from the first century B.C. now in the Bagdad Museum in Iraq.

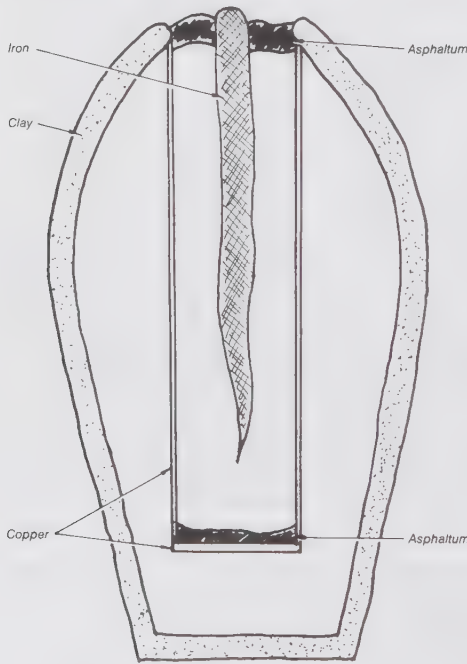

Baghdad Battery. Willard Gray of the General Electric High Voltage Laboratory produced the sketch above based on the specifications of the 2000-year-old Baghdad battery. With the addition of copper sulfate, acetic acid, or even citric acid, this battery will produce an electrical current. In the *Grand Dictionnaire Universel du 19th Siecle* the French archaeologist Auguste Mariette writes that while excavating in the area of the Great Pyramid at a depth of 60 feet, he discovered gold jewelry whose thinness and lightness "make one believe they had been produced by electroplating."



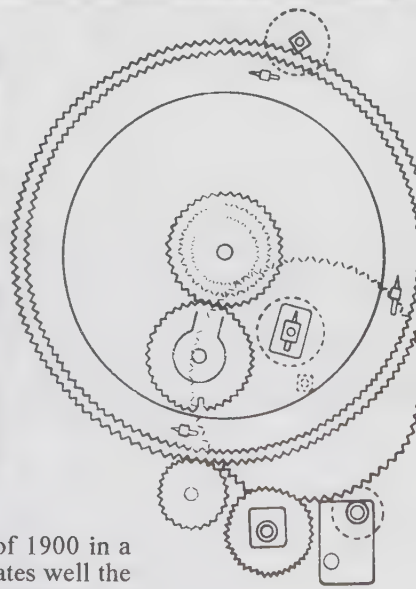
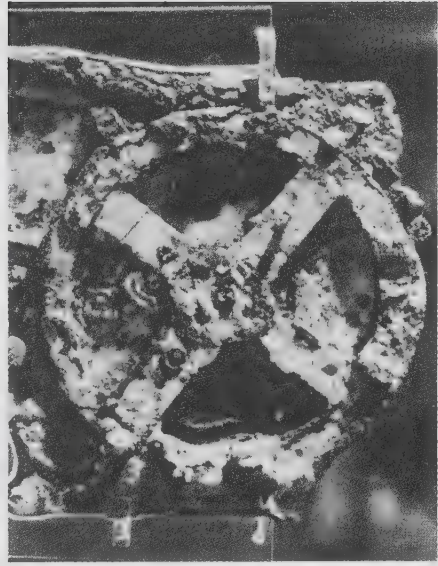
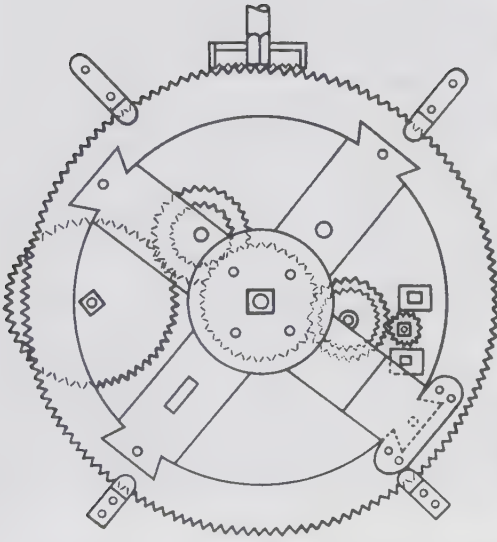

The Antikythera Machine, discovered during Easter of 1900 in a submerged Greek shipwreck by a sponge diver, illustrates well the sort of mechanical technology used three to four millenia ago. It contained no less than 40 cog wheels with a central wheel of 240 teeth.



Three men or “gods” are apparently hovering in a flying machine above a half-moon in this cylinder seal from the British Museum in London. On the left is an unexplained rocket-like object.



A common Assyrian symbol found on cylinder seals and other reliefs. It may show an ancient *Vimana*

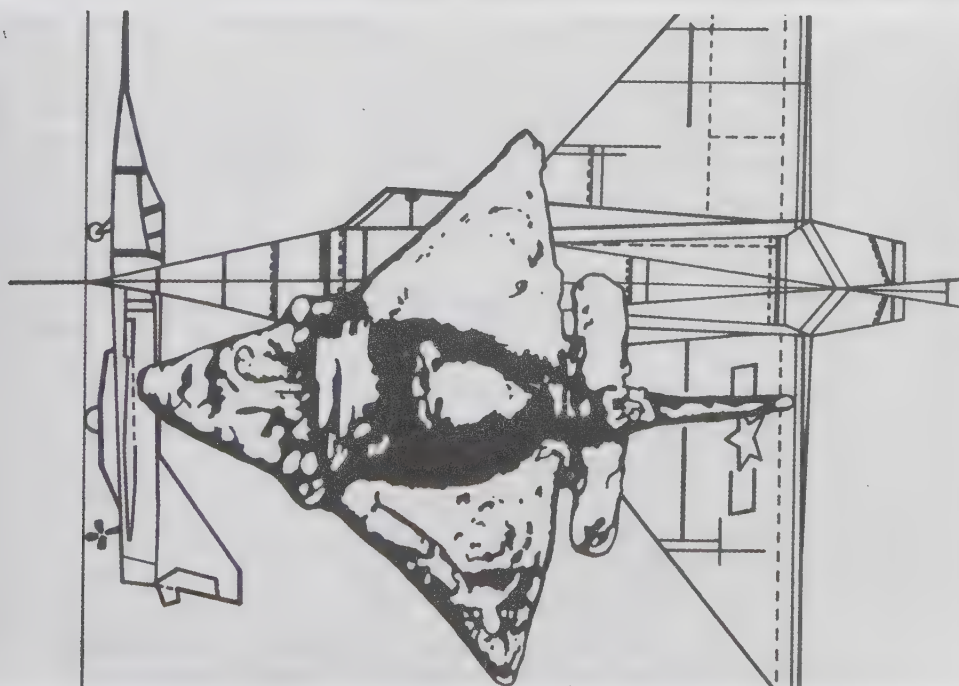
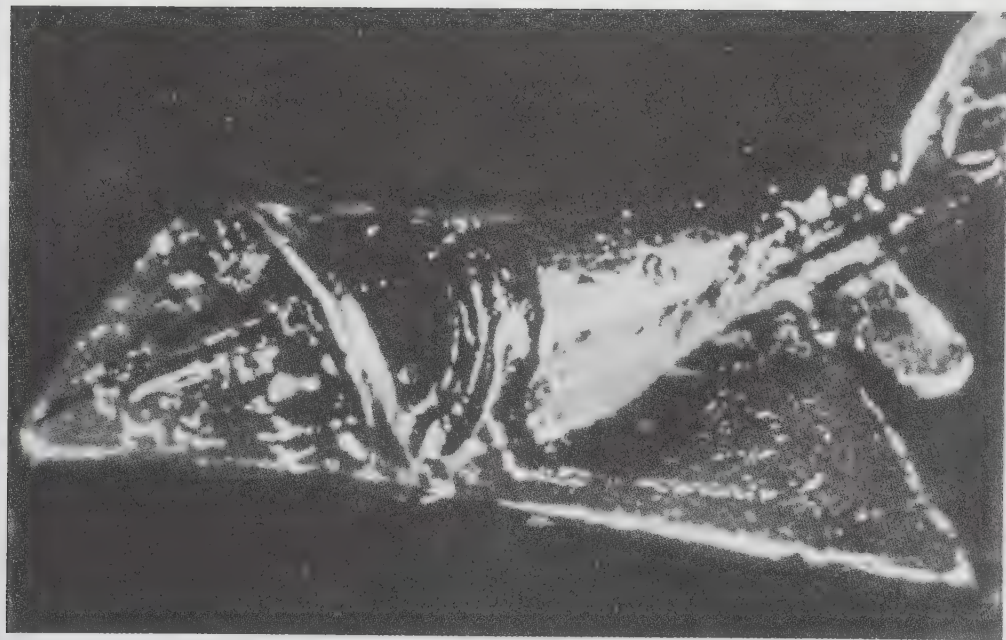

A solid gold model of an aircraft on show at the State Museum in Bogota, Columbia. It, and several others like it have been called religious objects, bees, birds, stingrays and other things. Technical tests prove that it is airworthy.

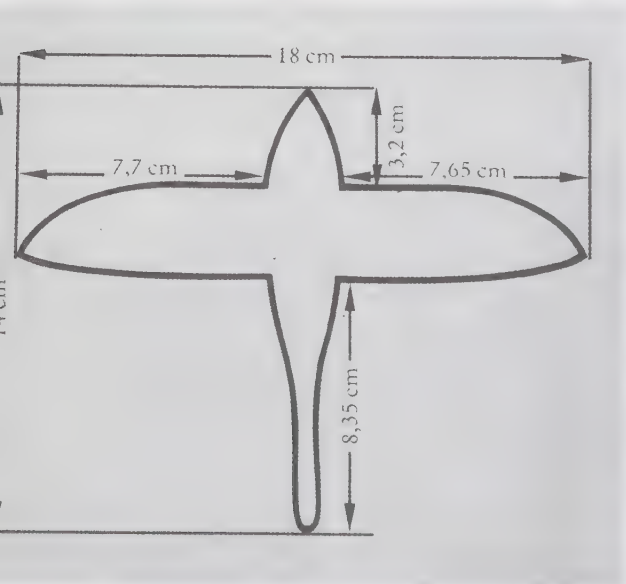
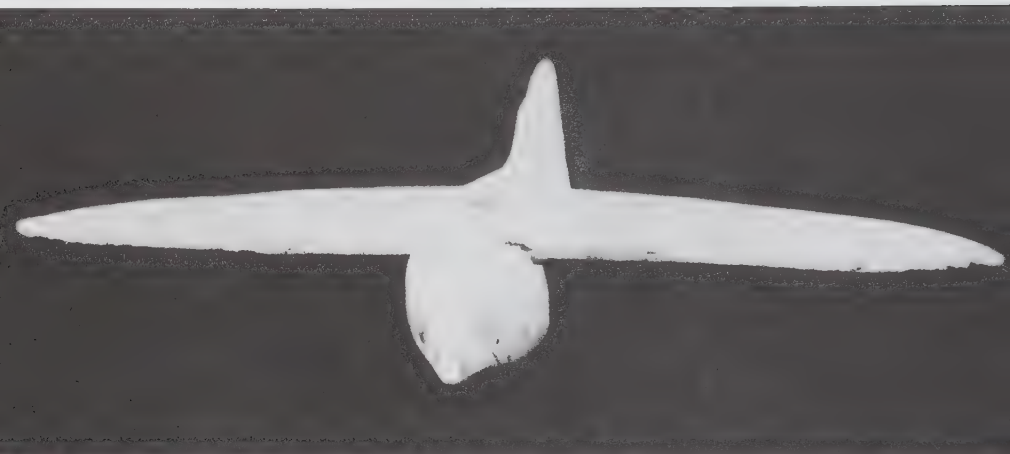

This apparent model of a  
airplane was found in a  
Egyptian tomb in 1898 and  
kept in the Cairo Egyptian  
Antiquities Museum. In 196  
it was brought to the world  
attention by Dr. Khalid  
Missiha because he noticed  
that the "bird" (catalogue  
6347) had straight wings and  
a tail fin.

# 3

## THE ANCIENT RAMA EMPIRE OF INDIA

Rama ruled the earth for eleven thousand years.  
He gave a year-long festival  
in this very Naimisha Forest.  
All of this land was in his kingdom then;  
one age of the world ago;  
long, long ago;  
long before now, and far in the past.  
Rama was King from the center of the world  
to the four Oceans' shores.  
—The *Ramayana* by Valmiki



Perhaps the best evidence for advanced civilizations and the use of aircraft in the remote past is the remarkable pre-Aryan Indian Epic of the *Ramayana*.

The *Ramayana* (literally, "Rama's Way") is one of the great Indian Epics, handed down over thousands of years to the twenty-first century. Even the author to which the *Ramayana* is attributed, the poet Valmiki, has achieved a legendary status. The *Ramayana* is some 25,000 verses long. It tells a story of romantic courtly intrigue, heroic

renunciation, fierce battles and the triumph of good over evil. The hero is Prince Rama of Ayodhya. Born into a family of noble rulers, the treacherous machinations of his stepmother force him to abdicate his claim to the throne of Ayodhya in favor of his half-brother, Bharata. Rama withdraws into the forest for thirteen years accompanied by his faithful wife Sita and devoted half-brother, Lakshmana. Here they battle demons called the Rakshasas, who kidnap the beautiful Sita. The evil demon king Ravana takes her away in his Vimana, or flying machine, to his capital on the island of Lanka (Ceylon). He urges her to yield to him and be his queen, but she remains faithful to her husband, Rama.

Meanwhile, Rama and Lakshmana search frantically for signs of Sita. They go from one witness to another to learn her whereabouts. Finally, they ally themselves with an army of talking monkeys and bears. The army operates under the generalship of the great monkey, Hanuman. The animals discover that the place where Sita is kept prisoner is Ceylon and Hanuman crosses the water to visit her.

After setting fire to the city he returns to Rama who decides he must rescue his wife by force. With the help of thousands upon thousands of monkeys they build a causeway between the mainland and the island. A frightful battle ensues and hosts of monkeys and demons are slaughtered. Both sides use devastatingly powerful weapons which are hurled from their flying machines and which destroy whole cities and disintegrate whole armies at a time. Naturally, Rama and his buddies win, Sita is saved, and they go back to Ayodhya in a flying machine, where Rama is crowned king. Unfortunately, in the end, vicious rumors about Sita's purity are spread, Rama is forced to banish her to the forest where she gives birth to Rama's two children, and the poet Valmiki helps her to raise them. Thus, the story comes full circle back to the story teller, Valmiki.<sup>37</sup>

The *Ramayana*, and its companion The *Mahabharata*, are something like a combination of George Lucas' *Star Wars* and J.R.R Tolkien's *Lord of the Rings*. In texts thousands of years old, the combatants fly around in metallic flying machines that run on some sort of "anti-gravity" mechanism and battle each other with particle beam weapons and horrifying explosive devices.

Many historians discount the *Ramayana* as being nothing more than the vivid opium dreams of a bunch of stone-age Indians. Fortunately, other more "open-minded" historians discern a thread of authenticity present in these great epics, and indeed, clues to the mysterious and fabulous past of ancient India, Ceylon, and even of Atlantis and "Mu."

According to the Indological Newsletter of Motilal Banarsidass Newsletter (Delhi) of January, 1989, in a 1988 conference in India, historians have claimed that Rama, the son of Dasharatha, ruled over Ayodhya during 5000 B.C. This theory was expounded by Dr. Kunwarlal Jain Vyas "who has tried to establish the date after an in-depth study of puranic sources and literature. Several papers were read regarding dates of the events of Pre-Mahabharata period on the occasion of this conference called "Itihasa Bharati." The papers said that Manu existed 31,000 years ago, Harinya-Kashyap 12,000 B.C.; Indra, Vishnu and Bali lived 11,000 B.C. in the seventh yuga while Parshurama, Rama and Dasharatha belong to the twenty-fourth yuga, i.e. 5,000 B.C. This is proved by the literatures of India and its neighboring countries. On the basis of his study, Dr. Vyas determined the period of a historical cycle to be of 360 years. He told that there is an interval of 71 cycles between Manu and Mahabharata period, which comes out to be 26,000 years. So Manu can be ascribed a period of about 31,000 years from now."

The same newsletter, speaking about the same conference says that the Hindu historian Acharya Ram Dayal exposed the trick played by western historians when

discussing Indian history. Although the newsletter does say what this trick is, one can easily guess that the trick is a manipulation of dates to make Indian history much more recent than the ancient epics distinctly proclaim. Certainly 31,000 years of history in India is bound to raise even the most liberal eyebrows of academia!

§§§

It is only by Shiva's grace that my composition can be beautified, as is the night by the moon and her company of stars. Those who will hear and repeat this story with love and understanding will be purged of the defilement of the *Kaliyuga* and, loving the feet of *Rama*, shall enjoy heavenly felicity.

If the grace of Shiva and Parvati be at all truly with me, even in dream, then all the influence I claim for my verses, composed in the vulgar tongue, shall come true.

I reverence the very holy city of *Ayodhya* and the river Sarayu that washes away the impurities of the *Kaliyuga*; and again I do reverence to the inhabitants of that city, who enjoy the affection of the Lord in no small degree.

—The Shriramacharitamansa  
by Tulasidasa, Twelfth Century A.D. Hindu  
commentary on the Ramayana of Valmiki.

The devastating wars of the Ramayana and particularly of the Mahabharata are said to have been the culmination of the terrible wars of the last Kali Yuga. The dating process is difficult, in that there is no exact way to date the yugas because there are cycles within cycles and yugas within yugas. A greater yuga cycle is said to last 6000 years while a smaller yuga cycle is only 360 years in the theory expounded by Dr. Kunwarlal Jain Vyas. His papers said that Rama belongs to the twenty-fourth small yuga cycle and



that there is an interval of 71 cycles between Manu and Mahabharata period, which comes out to be 26,000 years.

In the large yuga cycle as expounded at the Mount Abu Raja Yoga center, we are now at the last few moments of a 6,000 year greater Kali Yuga cycle, ending in the year 2000 or so. The last ending of a greater Kali Yuga cycle was 24,000 years ago, or 22,000 B.C. According to the *Lemurian Fellowship*, an esoteric brotherhood formed in the 1930s, this is the time of a cataclysmic shift in the earth's tectonic plates and the sinking a large continent in the Pacific, generally known as Lemuria or Mu, but sometimes called Pan, Rutas, Hiva or Pacifica.

Other cataclysmic earth shifts were occur later (a natural cyclic occurrence, they and others claim, happening ever seven to ten thousand years, depending on accumulated ice at one or more of the poles, planetary positions and other factors. They place the time of Atlantis and Rama, as well as Osiris (in the Mediterranean and North Africa) and the Uigers of the fertile Gobi Desert area as being of a time after that Kali Yuga, a golden age from approximately 22,000 B.C. to 16,000 B.C. when man lived in peace with his fellow man and in harmony with nature, much as it had been prior to 28,000 B.C. during the height of the so-called Mukullian Empire on the Pacific continent (Mu, or whatever). This was two Treta Yugas ago (34,000 to 28,000 B.C.) The last Treta Yuga 10,000 to 4,000 B.C., which was the period of the decline of Atlantis and Rama and the period when Valmiki probably wrote the ancient Ramayana (circa 4,000 B.C.) in ancient Dravidian, a now extinct language from which Tamil is partially derived.

According to the *Lemurian Fellowship*, Lemuria sank at about 24,000 B.C., which would place it at the end of a Kali Yuga and the beginning of a new Krita Yuga. In Indian cosmology, the Krita Yuga marks a time which is a "Golden Age" of enlightenment. Each Yuga becomes progressively worse, until a cataclysmic destruction at the end of the Kali

Yuga destroys the world. Then a new Golden Age starts again. Auspiciously, we are at the end of a Kali Yuga.

Interestingly, the *Ramayana's* time line fits in well with the occurrence of cataclysmic changes and civilizations outlined by the *Lemurian Fellowship*. Says the *Ramayana*: "We live now in the third age of Time, and Rama lived in the second age of the world." Perhaps the time of Mu, the supposed Mother-Civilization of the World was the first age, the time of Atlantis and Rama the second age, as the *Ramayana* says; the time after the destruction of Atlantis and Rama, and the time when the great epics were written was the third age, and the fourth age is the time in which we are now living.

The Kali Yuga which is referred to by Tulasidasa, of the Twelfth Century A.D. is therefore a small yuga cycle, lasting 360 years. It is fascinating to think that we are only just now completing a 24,000 year cycle which began approximately 22,000 B.C. Traditionally, Kali Yugas end with a massive and devastating world war in which the combatants virtually wipe each other out, taking most of civilization with them. Who can deny that we are apparently on the verge of such an event ourselves?

It is especially ironic to consider, especially in the light of so-called free energy motors, anti-gravity, gyroscopes, magnets, crystals and vortex technology as apparently used in Vimanas and other craft, that our current "war of Armageddon" is largely due to oil, energy cartels, and maintaining a certain amount of out-dated technology, coupled with religious and political fanaticism! One wonders if the fantastic wars of the past were fought for similar purposes?

Another fascinating thought along those same lines is that even the combatants in these wars, the leaders and common soldiers being sent to the sudden and violent termination of their current incarnations, may be the reincarnated souls from previous wars, working out their

collective and personal karma for better or for worse.

It is a well known fact that the famous American WWII General George Patton believed himself to be the reincarnation of a Roman General, and believed many Nazi German Generals and leaders to have been the reincarnations of the Huns and Vandals who had destroyed Rome.

Similarly, it has been reported that Saddam Hussein, the Military Dictator of Iraq believes himself to be the reincarnation of the Babylonian king Nebucaneezer whose army destroyed Jerusalem, the Temple, and took the Israelites into captivity in Babylon, present day Iraq!

According to adepts of Raja Yoga, the man of violence and war will reincarnate during the periods of Kali Yuga (and other times as well). Each a chance to change their way of thinking and therefore their entire life, and so improve their karma. However, many are sucked deeper into negative karmic situations by participating in violence and destruction for what they believe to be a justifiable cause.

Perhaps this is why Christ told his disciples that “the meek shall inherit the earth,” because the man of violence and war will be removed from incarnation in the next Yuga, the Krita Yuga.

§§§

One way to unravel the tangled web of the *Ramayana* is to go back to *The Lemurian Fellowship* lessons’ accounts of ancient Mukulia and see what sense can be made out of the *Ramayana* story.

According to their lesson material, the non-citizens of Mukulia divided into two opposing factions, which had grown to be poles apart in philosophy. The first group, the “Phrees” prized practicality. Generally they worked in the

Empire as highly skilled laborers and professionals. The second group, the “Katholis”, prized spirituality and were more interested in “artistic” pursuits. The Citizenry of the Empire by contrast were “balanced” mentally; they could see the value of both sides. As open conflict manifested between the two groups, the government encouraged the emigration of these peoples to hitherto uninhabited lands. The main colony of the Phrees was established upon an island group in the Atlantic Ocean called Poseid, while the main colony of the Katholis was established in India.<sup>60</sup>

Even today, Indians, especially the women, prize spirituality above all things. Throwing oneself on the funeral pyre of one’s husband is still customary in many parts of India today. Atlantis, by many reports (all rather difficult to verify, unfortunately) developed a technology which was described as being extremely advanced and rather war-like.

The *Lemurian Fellowship* lessons state that the destruction of Lemuria occurred circa 24,000 B.C. The civilization which developed in ancient India afterwards was known as the Rama Empire, and was ruled by Priest-Kings called “Rishis” who were “Adepts”. Rishi is a Sanskrit term meaning “Master” or “Great Teacher.” The Rishis were wise and kind and possessed considerable “yogic” powers. The Rama Empire spread out to include most of the Indian sub-continent. It probably extended as far west as Iran or so, and as far east as Burma. There were seven capital cities known as “The Seven Rishi Cities of the Rama Empire.” The Lemurian Fellowship does not say which cities these were, but my guess is that they included Ayodhya, Nagpur, Mathura, Mohenjo Daro, Lothal, Kot Diji, Kalibangan, Dwarka and Harappa. It is also probable that both Benares (Varanasi) and Madurai (in southern India) were inhabited cities during the Rama Empire. This would probably make them the oldest inhabited cities in the world!

§§§

During the heyday of Atlantis and Rama, both the Ramayana and the *Lemurian Fellowship* agree that other advanced civilizations were also in existence. According to the *Lemurian Fellowship* the Osiris Civilization existed in what is today North Africa and the Mediterranean Basin, and the Uiger Empire ruled over what is today the Gobi Desert. Yet of all of the civilizations, Atlantis and Rama were supposedly the two most developed.

These two cultures had developed advanced technology, which they shared between themselves and the rest of the world. It had been mainly developed in Atlantis and would seem like science fiction to us today, just as the *Ramayana* and *Mahabharata* seem like science fiction. Not only did they have aircraft such as vimanas and vailxi (as the Atlantean craft was called), they had weapons such as fireballs that could destroy a whole city, “Kapilla’s Glance” which could burn fifty thousand men to ashes in seconds and flying spears that could ruin whole “cities full of forts.”<sup>37,58,46,47,49</sup>

According to The Lemurian Fellowship, as Atlantis and Rama each reached the height of civilization, war broke out between them. The Atlanteans, a highly technical, patriarchal and war-like culture were bent on conquering the world. Subjugating the Rama Empire was an important step in their plan.

Although both sides had airships, Atlantis had developed military applications for its technology, while the Rama Empire had always applied its technology towards peaceful purposes. The main vehicles for both nations during their war were airships, called Vimanas in Indian Epics, and Vailxi by the Atlanteans.

An interesting episode in Atlantean history as related by The Lemurian Fellowship involves the Atlanteans sending a

well-equipped army to India in order to subjugate the Rama Empire and bring it under the sovereignty of Atlantis. Equipped with “a formidable array of weapons,” the Atlanteans landed their vailxi outside one of the Rishi cities. They got their troops in order and sent a message to the ruling Priest-King of the city that they should surrender. The Priest-King sent word back to the Atlantean general: “We of India have no quarrel with you of Atlantis. We ask only that we be permitted to follow our own way of life.”

The Atlanteans regarded the Rishi’s mild request as a confession of weakness. Expecting an easy victory, as the Rama Empire did not possess the technology of war nor the aggressiveness of the Atlanteans, the general sent another message: “We shall not destroy your land with the mighty weapons at our command provided you pay sufficient tribute and accept the rulership of Atlantis.”

The Priest-King of the city responded humbly again, seeking to avert war: “We of India do not believe in war and strife, peace being our ideal. Neither would we destroy you or your soldiers who but follow orders. However, if you persist in your determination to attack us without cause and merely for the purpose of conquest, you will leave us no recourse but to destroy you and all of your leaders. Depart, and leave us in peace.”

Arrogantly, the Atlanteans did not believe that the Indians had the power to stop them; certainly not by technical means. At dawn, the Atlantean army began their march on the city. Sadly, the Priest-King watched the army advance from a high point of view. He raised his arms heavenward and, using a mental technique supposedly known to certain yogis in the Himalayas today, he caused the general and each officer in descending order of rank to drop dead in their tracks, apparently of a heart attack. Without leaders, the panicked Atlantean force fled to the waiting airships, and retreated back to Atlantis! Of the siege of the Rishi City, not one man from the Rama Empire

was lost! 19

The Indian Epics, especially the Mahabharata, pick up the thread of the tale from here and go on to tell the rest of the horrible story; a story of devastation and destruction. Apparently Atlantis, rather displeased at its humiliating defeat, decided that they were no longer interested in subjugating the Rama Empire, and decided instead to annihilate the major cities using weapons so destructive that Sanskrit scholars could not comprehend what was being described in the Epics until the first dropping of atomic bombs on Japan.

These are authentic verses from the Indian Epics:

“Gurkha, flying a swift and powerful vimana,  
hurled a single projectile  
charged with all the power of the Universe.  
An incandescent column of smoke and flame,  
as bright as ten thousand suns,  
rose with all its splendor.

It was an unknown weapon,  
an iron thunderbolt,  
a gigantic messenger of death,  
which reduced to ashes  
the entire race of the Vrishnis and the Andhakas.

The corpses were so burned  
as to be unrecognizable.  
Hair and nails fell out;  
Pottery broke without apparent cause,  
and the birds turned white.

. . .After a few hours  
all foodstuffs were infected. . .  
. . .to escape from this fire  
the soldiers threw themselves in streams

to wash themselves and their equipment.”

—The Mahabharata

“(It was a weapon) so powerful  
that it could destroy the earth in an instant—  
A great soaring sound in smoke and flames—  
And on it sits death. . .”

—*The Ramayana*

“Dense arrows of flame,  
like a great shower,  
issued forth upon creation,  
encompassing the enemy. . . .  
A thick gloom swiftly settled upon the Pandava hosts.  
All points of the compass were lost in darkness.  
Fierce winds began to blow.  
Clouds roared upward,  
showering dust and gravel.

Birds croaked madly . . .  
the very elements seemed disturbed.  
The sun seemed to waver in the heavens.  
The earth shook,  
scorched by the terrible violent heat of this weapon.  
Elephants burst into flame  
and ran to and fro in a frenzy . . .  
over a vast area,  
other animals crumpled to the ground and died.  
From all points of the compass  
the arrows of flame rained continuously and fiercely.”

—*The Mahabharata*

§§§

THE QUEST FOR ANCIENT LANKA



Sri Lanka (formerly Ceylon) is about the size of Indiana, and is made up of low, rolling hills which culminate in a mountain range and jungle in the south central part of the island. Its history extends far back into the world of myth and legend; Sri Lanka plays a major part in the ancient Indian Epic of the Ramayana.

The earliest recorded history of Ceylon only goes as far back as the sixth century B.C. These records tell of a Prince Vijaya who was banished from India by his father, and who embarked on ships with seven hundred companions in search of a new home. Most scholars believe that Prince Vijaya was of Aryan stock, and came from northwestern India. Vijaya landed in Ceylon, and the reports he sent back home must have been encouraging, for soon he was joined by other princes and their followers. The new arrivals subdued the "savage inhabitants": the Yakkhas and Nagas, who already existed on the island.

The descendants of these ancient people can still be found in remote parts of the island. They are called Veddas, which in their own, obscure language means "hunter." Standing about five feet tall, with dark skin and frizzy hair, they wear clothes made of bark cloth. They live a nomadic existence sleeping in caves or crude huts. With bows, arrows, stone axes and hunting dogs, they hunt and gather fruit, wild yams, honey, truffles and fish.<sup>41</sup>

The prehistory of Ceylon is rather mysterious. It is generally believed that prior to Prince Vijaya, nothing more than stone-age men lived in Ceylon, yet there is a certain amount of evidence to indicate that this is not the case.

Modern history on the island begins with the advent of Buddhism in the third century B.C. Mahinda, son of the converted Buddhist Emperor Asoka, came from India to the court of the Devanampiya Tissa, who was a Sinhalese descendant of Prince Vijaya. After a series of sermons delivered at Anuradhapura, the king and most of the court

converted to Buddhism, a religion that stresses good deeds, positive thinking, harmless living and high moral conduct.

Later, Mahinda's sister brought a cutting from the Bodhi Tree to Ceylon; the tree under which the prince Siddhartha, later Gautama Buddha, had become enlightened according to Buddhist tradition. This tree was planted at Anuradhapura, and is still growing today, two and half thousand years later! After Siddhartha's cremation (the term Buddha actually means "wise one" in Sanskrit), his remains had been divided into eight main parts and then subdivided into more. When Mahinda's sister came she also brought Buddha's right collar bone and begging bowl and she enshrined them in a dagoba, or stupa. In the fourth century A.D. the left eyetooth of the Buddha was brought to Anuradhapura and preserved in a noble shrine; it was exhibited once a year. This tooth is now kept in the Temple of the Tooth in Kandy.

Anuradhapura has some of the most magnificent structures in the world! The largest is carved out of solid rock, covered with brass, and is larger in size than the Great Pyramid of Egypt. The Ruwanweli Pagoda, built in 144 B.C. is constructed on a base of solid silver. The silver is over 500 square feet in area and is seven inches thick. The value of the metal used in the foundation alone is estimated to equal over three million dollars!<sup>42</sup>

In the late 19th century when the British excavated the ancient city which had been abandoned in the 11th century because of an invasion from Southern India, they uncovered an extremely sophisticated irrigation system. An engineer called Parker, who worked for the Irrigation Department of Ceylon was astounded at the skill of his ancient Ceylonese counterparts. Not only had they successfully created large reservoirs as early as the 4th century B.C., but by the 3rd century B.C., they were using a highly sophisticated discharge system: the valve-pit.

This involved a stone-lined sluice which had a gate that

could be raised or lowered to control the discharge of water from the reservoir. Its stones were finely worked to create a completely smooth internal face. Probably it had been originally lined with wood to make the sluice completely watertight. Parker marveled at the competent way in which the prehistoric engineers had coped with the problems of gravity and flow speed. The system fed three large man-made lakes that served as reservoirs.<sup>39</sup>

The British and other western archaeologists had been impressed at how a bunch of islanders had accomplished fairly modern engineering feats, though such an irrigation system would have been necessary for the prosperity of the culture since the northern part of Sri Lanka is quite arid. Also, the existence of modern technology in ancient cultures of India, including cultures that are far older than Anuradhapura, has been already been proven many times. What amazes the academics is that their findings consistently push the beginnings of technology and civilization farther and farther back in time. Suddenly, the mystics who have insisted that civilization hadn't started in Sumeria five thousand years ago, and that ancient peoples in India were quite sophisticated, have become correct.

§§§

From Paradise to Taprobane  
is forty leagues:  
There may be heard the sound of  
The Fountains of Paradise.

—*Traditional*

*Reported by the Friar Marignolli, A.D. 1335*

In 1893, a young British officer named Percy Fawcett was stationed in Ceylon. Operating out of Trincomalee and

keenly interested in archaeology, history and Buddhism, he would often take long walks, sometimes lasting for days, into the remote jungle areas of the island. On one such trek, he was overtaken by a storm, which forced him to seek shelter beneath some trees for the night. As dawn broke into a new, sunny day, he found himself near an immense rock, covered with strange inscriptions of unknown character and meaning.

He made a copy of the inscriptions, and later showed them to a local Buddhist priest. This priest said the writing was similar to that used by the old Asoka-Buddhists, and was in a cypher which only those ancient priests could understand. His assertion was confirmed ten years later by a Ceylonese Oriental scholar at Oxford University, who claimed that he was the only man alive who could read the script.<sup>54,55</sup>

Young Percy Fawcett, later to become a respected Colonel and one of the most famous South American explorers of all time, believed that the letters which he had seen on the ancient, vine covered wall in Ceylon, had been taken from the ancient Sansar alphabet. This alphabet was first discovered by the French traveler and missionary, Abbe Huc, in 1845 while visiting a lamasery on the frontier of Tibet and China. The lamasery, known as the monastery of Sinfau or Sifau, or more popularly, the Kumbum Monastery, contained the "mystic Kounboum tree"; upon each leaf of this tree a Sansar character was allegedly written. Kunbum or Kounboum means "ten thousand images" referring to the images on the leaves of the tree.

According to the report given to Huc, the tree and alphabet came from the drowned land of Rutas, which in central Asian mythology, is identical with Mu, Lemuria, or a lost Pacific continent. The tree itself was a white sandal tree of some sort, and was located in a great brick-walled court-yard of the Buddhist temple at the foot of a mountain. Each leaf of the tree bore a different character

of Sansar, or ancient Sanskrit, the “language of the sun in the drowned land of sun-worshippers of Rutas.” Other legend has it that the tree sprang from the Tibetan saint Tsong Khapa’s hair. Given these two choices, the idea that tree came from a lost continent seems all the more likely (though probably both are equally false)!

Huc said the sweat mounted to his forehead in his effort to detect any lamaic fraud about the tree, which he added, “is very old, about eight feet high, with brilliant scarlet flowers, and nowhere else exists, and cannot be propagated from seeds or cuttings.”<sup>54</sup> It is said that sometimes the tree will hold images of Buddha on its leaves, as well.

While legends in Central Asian monasteries do include stories of Rutas and Sansar, the “magical” Kounboun tree appears to have been a fraud. The Prussian traveler, Kreitner, visited the same lamasery in 1880 and saw neither letters nor Buddhas on the leaves of its trees. He says he did detect, however, an ironic smile on the corner of the mouth of the lama guide when asked about such images, and he suspected trickery with acids. Other travelers who visited the monastery at the turn of the century saw no images on the leaves. Robert Ripley, of the famed *Ripley’s Believe It or Not* claimed he saw the images, or at least he included them in his feature, and an article appeared on them in a well known London Sunday paper in 1940.<sup>54</sup>

Lamas have been known to pull tricks to impress visitors, and it seems probable that the Kounboun tree may have been dressed up for important visitors. But even if the lamas had used acids to inscribe characters on leaves, what were these unknown characters? Were they truly Sansar, an ancient language from Mu?

A number of events were set into motion by young Percy Fawcett’s finding of these strange characters on a rock wall in Ceylon, some involving mysteries still to be worked out. Colonel Fawcett set off from Cuyaba in the Mato Grosso in Brazil in 1925 to find a lost city in the

jungle. He believed there was a connection between the city and the letters he had found in Ceylon. Neither he nor his two companions were ever seen again, and their expedition became the archetypical "lost expedition" (for more information on the fascinating story of Colonel Fawcett and his lost city, see my book, *Lost Cities & Ancient Mysteries of South America*).

If it is true, as Colonel Fawcett and certain Ceylonese scholars believed, that an ancient and vanished civilization once existed in Sri Lanka, where are the ruins of that civilization's cities? In the ancient Tamil literature of southern India there is a flood myth which tells of a destructive cataclysm and of two lost cities named Tenmaturai and Kapatapuram. These cities were two of three sites on which literary academies had been established. The third was at "Maturai," which is apparently the present day city of Madurai, near the southern tip of India. According to ancient tradition, there were forty-four rulers at Maturai before the great flood. Many cities were lost, but Maturai was reestablished afterward.<sup>36</sup>

Some sense of the time scale we are dealing with when looking at myths from Indian literature can be gleaned by recognizing that the length of time that each of the literary academies existed were 4440 years for Tenmaturai, 3700 years for Kapatapuram and 1850 years for Maturai.<sup>36</sup> Assuming the existence of these literary academies to be factual (Maturai is a very real place, indeed), it would not be unreasonable to suggest that Tenmaturai and Kapatapuram were lost in a cataclysmic flood that in all probability took place thousands of years ago. This being the case it would not be difficult to place the dates of these cities back to five or six thousand years B.C. if not earlier. Fantastic? These stories and dates are tame by comparison to other stories in the incredible realm of Indian literature!

According to the Ramayana, the ancient home of

Ravana, evil kidnapper of Rama's wife Sita, was the island of Lanka. Yet if Ceylon, officially named Sri Lanka now, is really the home of Ravana and the bad guys, where are the ancient cities, that were supposedly destroyed by the Vimanas and weapons of Rama? Perhaps they are there waiting to be discovered in the jungle growth. Recently some such megalithic cities in the interior of the island have been found!

The Sri Lankan archaeologist A. D. Fernando in an article in the Journal of the Sri Lanka Branch of the Royal Asiatic Society (1982)<sup>61</sup> cites what may be one source of information about such a city. The Mahawamsa, the Buddhist "Bible" of the Sri Lankans which portrays the conquest of the island and building of Anuradhapura by Prince Vijaya, says that the early inhabitants of the island, the Yakkhas, had great skill in metallurgy. Reference is made to a temple with "gold images of 4 great kings, 32 maidens, 28 Yakkha chiefs, devas, dancing devetas playing instruments, devas with mirrors in hand and a host of other devas with flowers, lotus, swords and pitchers."<sup>61,44</sup>

Fernando claims that the true hydraulic engineers of Sri Lanka and Anuradhapura were the Yakkhas. According to the Mahawamsa, the Yakkhas were celebrating the marriage of the Yakkha king's daughter in the palace of the great city of Lanka, when Vijaya and his "lion soldiers" struck and conquered them. The official history of the island begins after this point.

Where the ancient Yakkha city of "Lanka" was located, we don't know for certain. It might be the megalithic fortress of Ariththa, presently located at Ritigala, where large prehistoric monoliths in perfect rectangular shapes standing 18 feet high by 6 feet by nearly 2 feet, and bearing a great similarity to Stonehenge in England can be found. Another city which Fernando discovered by air was that of Vijithapura covering 250 acres.

Perhaps the most incredible discovery of all occurred

when Sri Lankan engineers wanted to place a dam at Maduru Oya thereby drowning a large valley. As the bulldozers set to work they began to scrape against bricks which already lay in the ground. To everybody's amazement it turned out that prehistoric engineers had made the same calculations and had built a dam at the very same spot!<sup>61,44</sup>

The Norwegian archaeologists visited the site and reported that the grandeur of these prehistoric megalithic waterworks would have impressed a Pharaoh. Heyerdahl says that much of the water system was constructed out of 15 ton blocks of stone 33 feet high and arranged in the shape of square tunnels and brick walls. The dams had sluices measuring more than 6 miles in length to control the water flow to a series of artificial lakes. Millions of tons of water had been regulated by this huge and sophisticated dam.<sup>44</sup>

Suddenly we realize that the primitive Yakkhas of Sri Lanka had not been so primitive after all, but instead were highly ingenious, sophisticated builders. Upon their conquest, the society gradually degenerated into a tribe of roving hunters; they probably became hunted themselves by the Sinhalese. Once again our dating for the rise of civilization has been pushed further back in time, and the great epic of the Ramayana is further vindicated. Could the Yakkhas have been the ancestors of the "evil" Ravana and his people who were defeated by Rama?

Another theory suggests that the "Lanka" of the Ramayana was actually located along the west coast of India in lands that are now submerged.

This area today is the Lacadive and Maldive islands. The Lacadive islands are part of India, while the Maldive islands are an independent nation to the south of them. Says James Churchward, author of the popular "Mu" series, "In the Indian Ocean, adjoining the West Coast of India, there exists a large area of submerged lands with structures



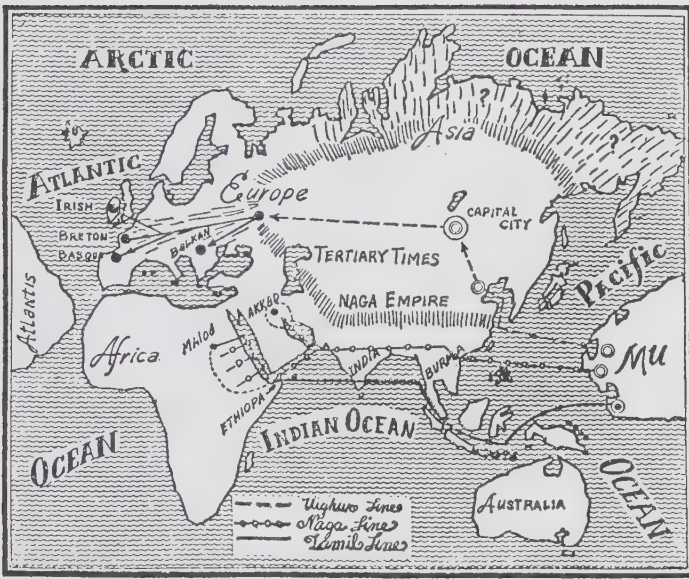

James Churchward's drawing of the dispersion of tribes from the ancient Pacific continent called variously Mu, Lemuria or others. The Naga Empire allegedly founded the Rama Empire.

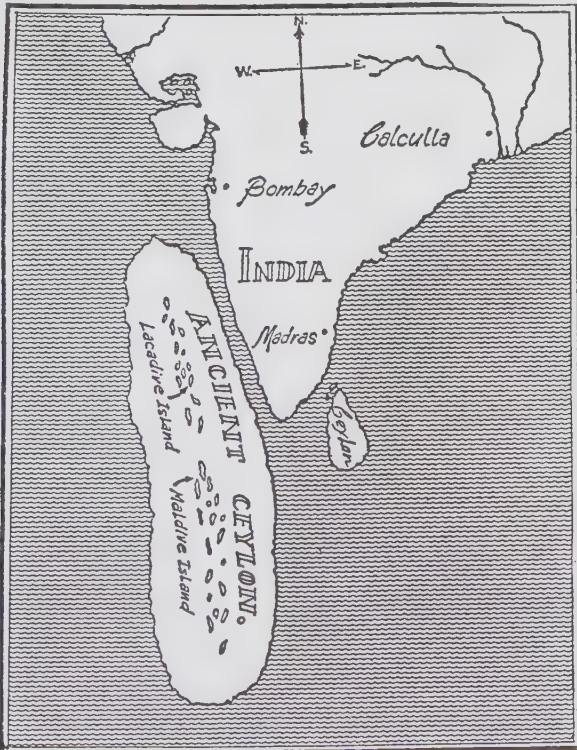

Churchward's drawing of ancient Ceylon, which is instead a large island that includes the Laccadive and Maldive Islands.

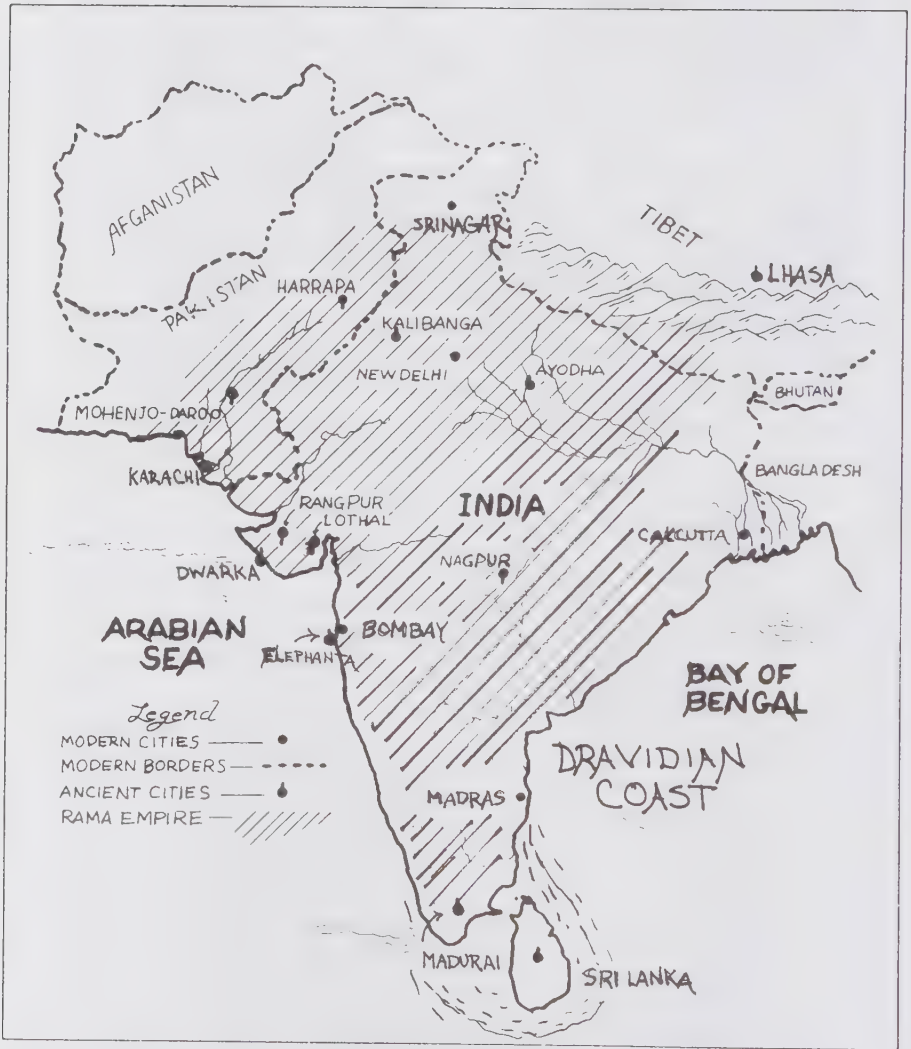

A map of the Rama Empire showing a few of the ancient cities in respect to modern India and Central Asia.

# MOHENJO-DARO

## THE CITADEL

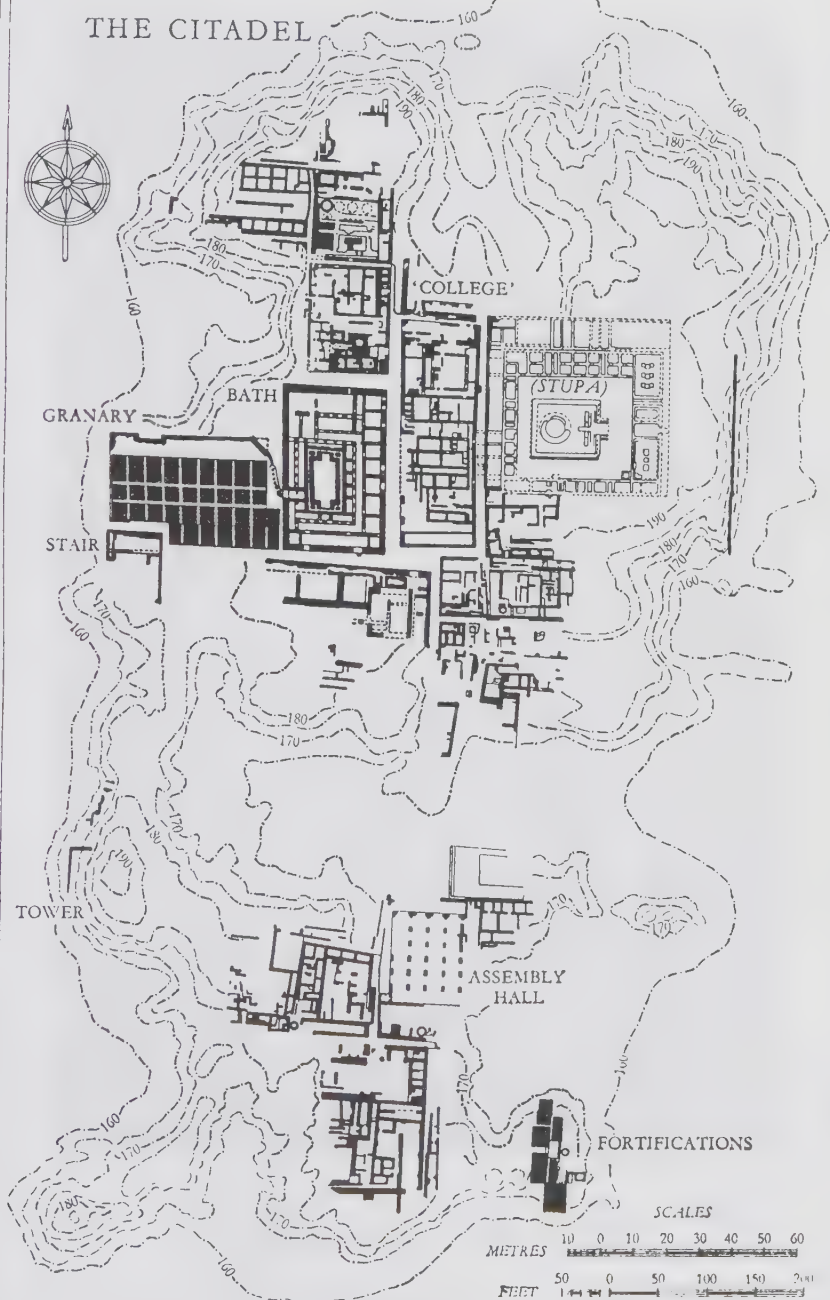



A so-called Priest-King from Mohenjo Daro. Is it possible that he was one of the adepts who ruled the Rama Empire?

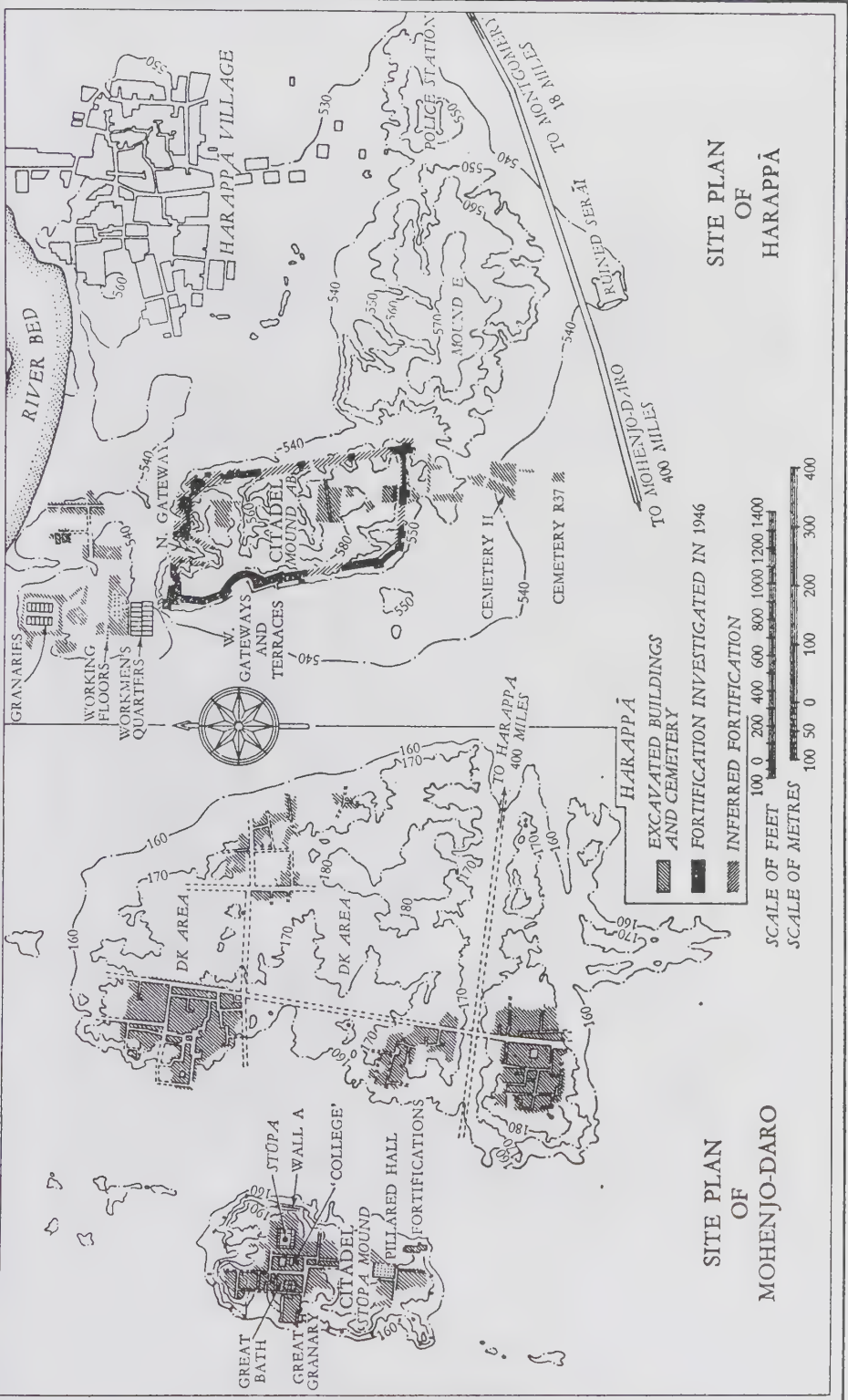

Comparative layout of Mohenjo-daro and Harappa.



MOHENJO-DARO  
AIR AREA  
AND SECTIONS

Plan of Mohenjo-daro

showing thereon. Like the remains of the South Sea Islands, these structures are prehistoric. These submerged lands commence at about 231 degrees north latitude, or just below the mouth of the river Indus, and extend south to about the equator. These submerged lands are apparently of an elongated oval shape. The Lacadive and Maldivé groups of low-lying islands are within the boundaries of this oval.

“Although I have several times passed quite close to them, I have never been on any of them, so I cannot say whether they are parts of the sunken land still above water, or whether they are the subsequent work of coral insects. There is a long stretch of very shallow water both north and south of these islands with various channels of deeper water crossing them, through which ships have to pass going to or from India. This geological phenomenon has never been noted by any geologist or archaeologist as far as I can ascertain or by any historian.

“On days when conditions are favorable—that is, water and sky—imposing remains of ancient structures are clearly to be seen on the shallow water within the oval mentioned. These submerged lands are well known to the fisherman along the coast; as a matter of fact, it was through them that I became aware of this submersion. Hindu scientists also know of them; no one, however, can account for structures being at the bottom of the ocean as the submergence is not spoken of in Hindu history no matter how far one goes back.

“I have never come across any references to the submersion either in India or elsewhere, so the probability remains that it took place during those five to seven thousand years when apparently no history was being written in any part of the world. Yet this submergence is a fact because the submerged structures can be seen. To my mind, there is not the slightest doubt what caused this submergence and that the present island of Ceylon was raised through it.”<sup>8</sup>

underwater and even into outer space. The *Vimana* chase was of epic proportions, and the *Lemurian Fellowship* even alleges that a *Vimana* battle took place on the moon! Eventually, Sita's Indian boyfriend managed to recapture her, she returned to India with her reputation slightly tarnished, and life went.

The *Lemurian Fellowship's* version of the story behind the *Ramayana* is a tale of hot-rodding, hot-blooded young adults of royal parentage who use their vimanas to chase each other when a girl friend is stolen or runs-off with with a rival. In any case, she returns to her old boyfriend.

Whether political problems between the two countries developed at this time is not said. Eventually, war did break out between the two countries, and it is probable that portions of this war are described in the *Mahabharata*.

§§§

## ARCHAEOLOGICAL EVIDENCE

For a long time, Indian civilization was not believed to go back farther than about 500 B.C. which is only a few hundred years prior to Alexander the Great's invasion of the subcontinent. In the past century, however, the extremely sophisticated cities of Mohenjo Daro ("Mound of the Dead") and Harappa have been discovered in the Indus Valley of what is today Pakistan by British Engineers.

Once called Brahminadad, Harappa was brought to light by two brothers, John and William Brunton, who were engineers for the East Indian Railway. In 1856, they were looking for ballast on which to lay the railway tracks; locals told them that not far away was an ancient ruined city. They looted the ancient city and obtained ninety-three miles of good kiln-fired brick ballast at little expense from the ancient city (This has been the unfortunate fate of many ancient cities; they are looted of their building materials to



build other cities. That is why today many megalithic remains have very little substance to them aside from some megalithic blocks; all of the smaller stones that were movable have been taken!). Eventually, the Director-General of the Indian Archaeological Survey became aware of the site, and began to excavate it.

India's own records of their history claim that their culture has been around for literally tens of thousands of years. Yet, until 1920, all the "experts" agreed that the origins of the Indian civilization should be placed within a few hundred years of Alexander the Great's expedition to the sub-continent in 327 B.C. However that was before another similar city, Mohenjo-Daro (Mound of the Dead), was discovered 350 miles south, and eventually other cities with the same plan were found and excavated, including Kot Diji, near Mohenjo-Daro, Kalibangan, and Lothal, the port in Gujerat, Lothal being discovered just in the past thirty years.<sup>50</sup>

The discoveries of these cities forced archeologists to push the dates for the origin of Indian civilization back thousands of years, just as Indians themselves insisted. A wonder to modern-day researchers, the cities are highly developed and advanced. The way that each city is laid out in regular blocks, with streets crossing each other at right angles, and the entire city laid out in sections, causes archaeologists to believe that the cities were conceived as a whole before they were built: a remarkable early example of city planning. Even more remarkable is that the plumbing-sewage system throughout the large city is so sophisticated, it is superior to that found in Pakistan, India, and most Asian countries today. Sewers were covered, and most homes had private toilets and running water. Furthermore, the water and sewage systems were kept well separated.<sup>50, 51, 43</sup>

This advanced culture had its own writing, never deciphered, and used personalized clay seals, much as the

build other cities. That is why today many megalithic remains have very little substance to them aside from some megalithic blocks; all of the smaller stones that were movable have been taken!). Eventually, the Director-General of the Indian Archaeological Survey became aware of the site, and began to excavate it.

India's own records of their history claim that their culture has been around for literally tens of thousands of years. Yet, until 1920, all the "experts" agreed that the origins of the Indian civilization should be placed within a few hundred years of Alexander the Great's expedition to the sub-continent in 327 B.C. However that was before another similar city, Mohenjo-Daro (Mound of the Dead), was discovered 350 miles south, and eventually other cities with the same plan were found and excavated, including Kot Diji, near Mohenjo-Daro, Kalibangan, and Lothal, the port in Gujerat, Lothal being discovered just in the past thirty years.<sup>50</sup>

The discoveries of these cities forced archeologists to push the dates for the origin of Indian civilization back thousands of years, just as Indians themselves insisted. A wonder to modern-day researchers, the cities are highly developed and advanced. The way that each city is laid out in regular blocks, with streets crossing each other at right angles, and the entire city laid out in sections, causes archaeologists to believe that the cities were conceived as a whole before they were built: a remarkable early example of city planning. Even more remarkable is that the plumbing-sewage system throughout the large city is so sophisticated, it is superior to that found in Pakistan, India, and most Asian countries today. Sewers were covered, and most homes had private toilets and running water. Furthermore, the water and sewage systems were kept well separated.<sup>50, 51, 43</sup>

This advanced culture had its own writing, never deciphered, and used personalized clay seals, much as the

Chinese still do today, to officialize documents and letters. Some of the seals found contain figures of animals that are unknown to us today.

These cities, which allegedly date back to the Rama Empire, are laid out in regular blocks, with the streets crossing at right angles to one another. Archaeologists who have excavated the cities theorize from this that the cities were planned before they were built, which is highly unusual in the ancient world (and in the modern one also, for that matter). Even more remarkable, is that the plumbing and sewage systems found throughout the “*Indus Valley Culture*” are well laid out and planned. So much so that they are superior to sewage systems found today in Pakistan, India and most Asian countries. Sewers were covered, and most homes had private toilets and running water. Plus water and sewage were kept well separated.<sup>50,43,51,39</sup>

So the cities were sophisticated, but is there any evidence of the devastating wars spoken of in the Indian Epics? Hold onto your seat for a reality-shaking ride to Harappa and Mohenjo Daro! When archaeologists reached the street levels of these two cities during their excavation in the early fifties, they discovered skeletons scattered about the city, many just lying in the streets and some holding hands! It was as if some horrible doom had taken place, annihilating the inhabitants in one fell swoop. These skeletons are among the most radioactive ever found, on a par with those at Nagasaki and Hiroshima. At another site in India, Soviet scholars found a skeleton with a radioactivity level in excess of fifty times that which is normal.<sup>13,39,50,64,31</sup>

Thousands of lumps, christened “black stones”, have been found at Mohenjo Daro. These are apparently, fragments of clay vessels that melted together in extreme heat and fused. Other cities have been found in northern

India that indicate explosions of great magnitude. A city was found between the Ganges and the mountains of Rajmahal which seems to have been subjected to intense heat. Huge masses of walls and the foundations of an ancient city were found fused together, literally vitrified!<sup>13,39,50,64</sup>

Vitrified structures have been found in Turkey, France, Scotland, Ireland and Peru. No explanations for this fusing of rock has been volunteered, since heat of such an intense nature is not normally generated by natural means. A news item that appeared in the New York Herald Tribune on February 16, 1947 (and repeated by Ivan T. Sanderson in Pursuit, January, 1970) reported that "(archaeologists) have been digging in the ancient Euphrates Valley (Iraq) and have uncovered a layer of agrarian culture 8000 years old, and a layer of herdsman culture much older, and a still older caveman [sic] culture. Recently, they reached another layer. . .of fused green glass."<sup>28</sup>

When the first atomic bomb went off at Alamogordo in New Mexico, it turned the desert sand to green glass! Interestingly, Dr. Oppenheimer, the "Father of the H-Bomb," was also a Sanskrit scholar. Once when speaking of the first atomic test, he quoted the *Mahabharata* saying, "I have unleashed the power of the Universe. Now I have become the destroyer of worlds." Asked at an interview at Rochester University seven years after the Alamogordo nuclear test whether that was the first atomic bomb to ever be detonated, his reply was: "Well, yes," and added quickly, "in modern history."<sup>9</sup>

Fused glass and stone has often been used as evidence for atomic war in the ancient past, although traditional archaeologists have of course rejected that notion, attributing fused rock to weird, unexplained fires usually in a war situation and fused patches of glass to meteor strikes or bizarre lightning phenomena.

In an article called *Libyan Desert Glass* from *Eos*

magazine (70:379, 1989) and quoted in the Science Frontiers newsletter from the Sourcebook Project in Bethesda, Maryland, the author, A.V. Murall discusses the characteristics of “natural glass fragments” found in the western desert of Egypt. These pieces of glass weigh as much as 16 pounds each and are found in an oval area measuring approximately 130 by 53 kilometers. The clear-to-yellowish-green pieces are concentrated in sand-free corridors between north-south dune ridges.

Says the article, “... We made a systematic study (employing INAA, microprobe and mass spectrometry techniques) of several varieties of LDG (Libyan Desert Glass) and locally associated sand and sandstone to provide insight into the nature and formation of these enigmatic glass fragments.... The gases in the vessels of LDG (N<sub>2</sub>, Ar, O<sub>2</sub>, CO<sub>2</sub>, H<sub>2</sub>O and their dissociation products) are present in proportions consistent with derivation from the terrestrial atmosphere. Dark streaks present in some samples of LDG contain significantly higher siderophile element abundances (Ir, ~ 0.5 ppb), possibly representing a meteoritic residue.

“Our studies suggest that LDG is the product of meteorite impact into quartz-rich surficial eolion and alluvial sand, and perhaps also into quartz-rich sandstone, of the western desert of Egypt.”

*Science Frontiers* newsletter editor William Corliss comments however “the origin of this immense deposit of glass has been attributed by some to ancient nuclear explosions and alien activities, but investigating scientists have always been satisfied with a meteor-impact hypothesis...although no one has found a crater of suitable size or other supporting evidence.”

If we then proceed from the assumption that the ancient Indian Epics are based on real events, related as a kind of mythicized version of the conflicts between India, Atlantis

and the rest of the world, Rama himself would then seem to be the personification of the ancient Rama Empire; not necessarily a real person, but rather a combination of persons and events.

The great Indian philosopher, poet and writer Rabinath Tagore (1861-1941) agreed with this view of the hero Rama. Said Tagore in *A Vision of India's History*<sup>70</sup> "As the leading figures of the movement which sought to embrace both Aryan and non-Aryan in a larger synthesis, we find the names of three Kshatriyas (belonging to the second highest caste among Hindus, traditionally warriors) most prominent in the story of the Ramayana: Janaka, Visvamitra and Rama-chandra; they are related not merely by kinship and affection, but by the same ideal. What if, as a matter of historical fact, Janaka, Visvamitra and Rama may not have been contemporaries? That does not diminish their nearness in idea....In the history of an idea, a hero often represents the ideal of his race, and in Aryan history, Janaka and Visvamitra, as well as Rama, have become historical symbols; they are composite pictures of numerous personalities having a common purpose."<sup>70</sup>

Tagore sees the Mahabharata and Ramayana as Aryan epics, though he admits that (speaking of the creation of a modern Indian state, always referred to as female, as in Mother India): When she now tried to know and name herself, she recalled the empire of Bharata, a legendary suzerain of by-gone days, and defining her boundaries accordingly, she called herself Bharata-varsha. In order to restore the fabric of her original civilization, she tried to tie together the lost threads of earlier achievements. Thus, collection and compilation, rather than any new creation, were characteristics of this age. The great sage of this epoch, Vyasa, who is reported to have performed this function, may not have been a real person, but he was, at any rate, the personification of the spirit of the times....Let no one imagine, however, that the non-Aryan contributors

were received only because of circumstance, and that they had no value of their own. As a matter of fact, the old Dravidian culture should in no way be underrated; the result of its combination with the Aryan was the Hindu civilization, which acquired both richness and depth from the Dravidians.”<sup>70</sup>

An important personality from the *Mahabharata*, Krishna, may well have been a real person as described in the *Bhagavadgita*, a sub-book within the *Mahabharata*. Tagore agrees that Krishna was a real person: “...the fact that the two nonmythical human avatars of Vishnu, Krishna and Ramachandra, were both Kshatriyas, and the Vaishnava religion of love was spread by the teaching of the one the life of the other.”<sup>70</sup>

According to the *Motilal Banarsidass Indiological Newsletter* of October, 1990, “There is conclusive evidence that the legendary city of Dwaraka (or Dwarka) did exist until it was submerged in the sea, lending credence to the view that ‘underlying the many of myth in the *Mahabharata* there is a nucleus of truth,’ said Dr. S.R. Rao of the National Oceanography Institute. In a paper presented at the 33rd International Congress of Asian and North African Studies in Toronto (Canada) Dr. Rao said recent excavations under the sea on the Dwaraka site off the Gujerat coast have yielded scientific evidence which confirm it as the one mentioned in the *Mahabharata*.”

Central India, the site of Churchward’s ancient capital of Dravidia, is also loaded with unexcavated ruins. Says a 1958 book published for the British Scientific Book Club, “[buried cities] waiting for the spade and shovel to reveal their secrets to a civilization remote in time to that which peopled them. There are many such cities in central India, which were buried some time before the Christian era, but which have never since been properly excavated. More than eighty large towns were said to have been covered with a ‘shower of earth’. Coins have been found there and various

utensils. Pillars of stone and brick walls have also been discovered, as well as fossilized wood of an extraordinary hardness. No doubt a wealth of treasure lies buried there, and a rich harvest awaits the antiquary, for India was a centre of art and learning at that time, when much of the Western world was barely civilized.”<sup>79</sup>

Evidence for the former glory of ancient India and its fantastic level of civilization, virtually equivalent to ours today (though probably with a greater understanding of “cosmic law”) continues to pile up, and anyone who is aware of the many discoveries and advances in Indian archaeologist will readily admit that ancient India was not a primitive country at all.

§§§

The Mahabharata and the Drona Parva, two ancient Indian epics, speak of the war and of the weapons used: great fireballs that could destroy a whole city, “Kapilla’s Glance” which could burn fifty thousand men to ashes in seconds, and flying spears that could ruin whole “cities full of forts.”<sup>9, 43, 13</sup>

According to Churchward, the Rama Empire was started by the Nagas (Naacals) who had come into India from Burma and ultimately from “the Motherland to the east” if the tablets that James Churchward claims to have read are correct. After settling in the Deccan Plateau in northern India, they made their capital in the ancient city of Deccan, where today the modern city of Nagpur stands.

The empire of the Nagas apparently began to extend all over northern India to include such cities as Harappa, Mohenjo-Daro, and Kot Diji, now in Pakistan, and Lothal, Kalibanga, Mathura, and possibly other cities such as Benares and Pataliputra. Cities like Dwarka are now



underwater, while port cities like Lothal are now several miles inland. The ancient Sumerian City of Ur, and others in Saudi Arabia, are similarly port cities now located many miles from the coast (see my book *Lost Cities & Ancient Mysteries of Africa & Arabia* for more information on port cities in the desolate Arabian interior).

Just exactly which were the seven cities of the Rama Empire is anyone's guess, though it seems fairly certain that Ayodhya and Deccan (Nagpur) was among them, as well as Dwarka, and that Mohenjo-Daro, Harappa, and Lothal were important centers, if not one of the Rishi cities. Probably there were many thriving cities in the Rama Empire and there were seven capitals, which became known as the "Rishi Cities." Rishi is a Sanskrit term meaning "Master" or "Great Teacher."

It was these "Great Teachers, "or "Masters" that were the benevolent aristocracy of the Rama civilization. Today, they are generally called "Priest-Kings" of the Indus Valley civilization, and a number of statues of these so-called "Gods" have been discovered. In reality, apparently their mental-psychic powers were of a degree that seems incredible to most people of today. It was at the height of power for both the Rama Empire and Atlantis that the war broke out, seemingly because of Atlantis' attempt to subjugate Rama.

Evidence of a world-wide influence of the Rama Empire can be found across South-East Asia, into the Pacific and to South & Central America. The plain of Nazca in Peru is very famous for appearing from high altitude as a rather elaborate, if confusing, airfield. Some researchers have theorized that this was some sort of Atlantean outpost. It is also worth noting that the Rama Empire had its outposts: Easter Island, almost diametrically opposite Mohenjo-Daro on the globe, astonishingly developed its own written language, an obscure script lost to the the present inhabitants, but found on tablets and other carvings. This

odd script is found in only one other place in the world: Mohenjo-Daro! Could it be that a trade network, operating even across the Pacific Ocean, was used by the Rama Empire and the Atlanteans? It seems incredible. However, it's interesting that pottery found at Nazca has drawings of zeppelin-like airships, much as described in Indian epics. 52, 31

The Rama Empire and the devastating war fought there have even been mentioned several in TIME magazine, a publication note usually noted for reporting on such controversial and esoteric topics.

In an article in TIME on March 26, 1990, entitled *A Digger's Life On a Big Ditch*, the author Edward W. Desmond profiles a ditch digger Tiloka Ram who is working on 587-mile Indira Gandhi Canal which stretches from the northern state of Punjab south into the Thar Desert of Rajasthan. Begins the article: "According to ancient chronicles, it began during a battle among the gods when one of Rama's flaming arrows landed in the heart of Hindustan. The impact made a desert of the land just east of the Indus River, an area known today as the Thar Desert of Rajasthan. There is no record as to whether Rama worried about the environmental impact of his action...."

Desmond goes on to mention in the article that Tiloka Ram is an Oad Rajput, "one of as nomadic caste in Rajathan whose members are, and always have been, diggers. In mythical times, the Oad Rajputs are said to have helped Rama build a bridge to Sri Lanka so that he could finish off an enemy."

While it may seem the stuff of exaggerated mythology, that the Thar Desert of Rajathan was created by a devastating missile during the war described in either the Ramayana or the Mahabharata is hardly so fantastic, especially considering the wealth of written material on the subject, and the archaeological evidence that remains.

It is said in esoteric literature, that Atlantis at the same

time, or shortly afterwards, also attempted to subjugate a civilization extant in the area of the Gobi Desert, which was then a fertile plain. By using so-called “Scalar Wave Weaponry” and firing through the center of the earth, they wiped out their adversaries, and, possibly at the same time, did themselves in! Much speculation naturally exists in connection with remote history, we may never actually know the complete truth, though ancient texts are certainly a good start!



The ruins of Kot Diji.

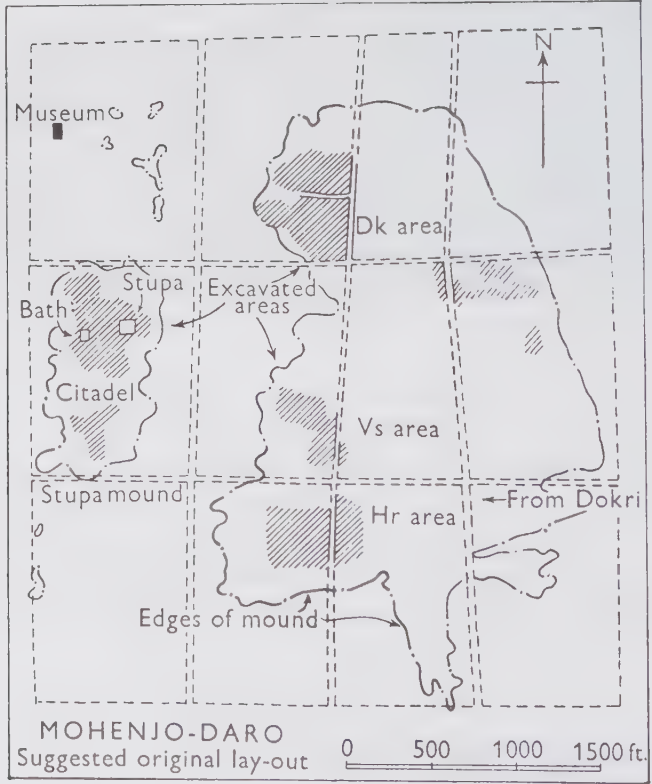



When Mohenjo Daro was first excavated, people were just lying dead in the streets, often holding hands, just like the ancient Indian epics had indicated.



The excavation of the Great Bath at Mohenjo Daro, built out of high quality, kiln fired brick. It and hundreds of other cities flourished many thousands of years ago in the Indian sub-continent.



An inscribed stamp seal found in the ruins of Mohenjo Daro. It depicts an extinct animal, some sort of bull. Possibly a relative of the auroch and the modern brahma bull, it was probably the result of thousands of years of breeding by the "Indus Valley Culture" otherwise known as the Rama Empire. The inscription remains undeciphered.

Indus Valley	Easter Island	Indus Valley	Easter Island	Indus Valley	Easter Island	Indus Valley	Easter Island
I	II	III	IV	V	VI	VII	VIII

Writing from Mohenjo Daro, Harappa, Kot Diji and other ancient cities has never been deciphered. Some linguists point to the similarity between its writing and that of also undeciphered Rongo Rongo writing from Easter Island. Currently, Ancient Dravidian, related to Tamil, is being used to try and decipher the Harappan writing.



Portion of the ancient port of Lothal, now several miles from the coast.



The flight of Rama as he returned from Lanka as mentioned in the *Ramayana*.

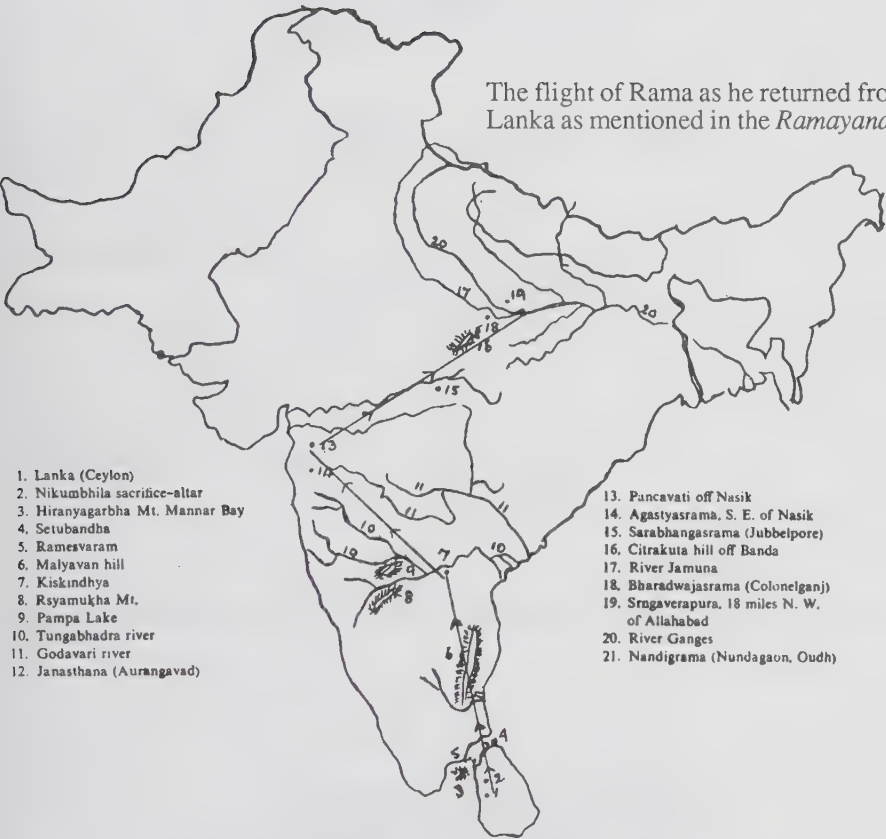

- 1. Lanka (Ceylon)
- 2. Nikumbhila sacrifice-altar
- 3. Hiranyagarbha Mt. Mannar Bay
- 4. Setubandha
- 5. Ramesvaram
- 6. Malyavan hill
- 7. Kiskindhya
- 8. Rsyamukha Mt.
- 9. Pampa Lake
- 10. Tungabhadra river
- 11. Godavari river
- 12. Janasthana (Aurangavadi)

- 13. Pancavati off Nasik
- 14. Agastyasrama, S. E. of Nasik
- 15. Sarabhangasrama (Jubbelpore)
- 16. Citrakuta hill off Banda
- 17. River Jamuna
- 18. Bharadwajasrama (Colonelganj)
- 19. Srugaverapura, 18 miles N. W. of Allahabad
- 20. River Ganges
- 21. Nandigrama (Nundagaon, Oudh)



The Temple of the Sun at Konarak, Orissa, India. It is built as a model of a huge sun chariot.

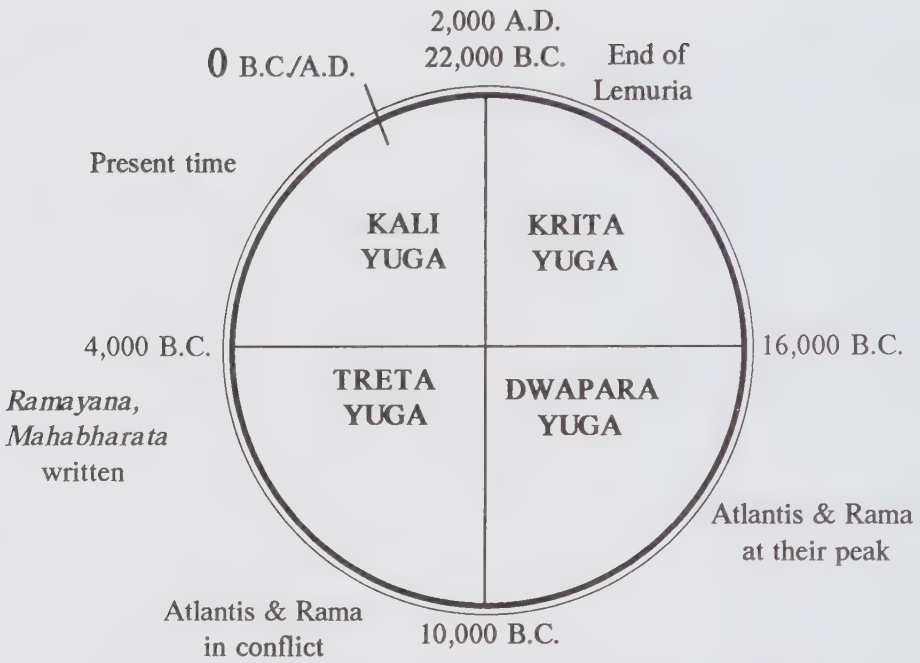

Yuga Cycles of 6000 years beginning 22,000 B.C. and ending 2,000 A.D.

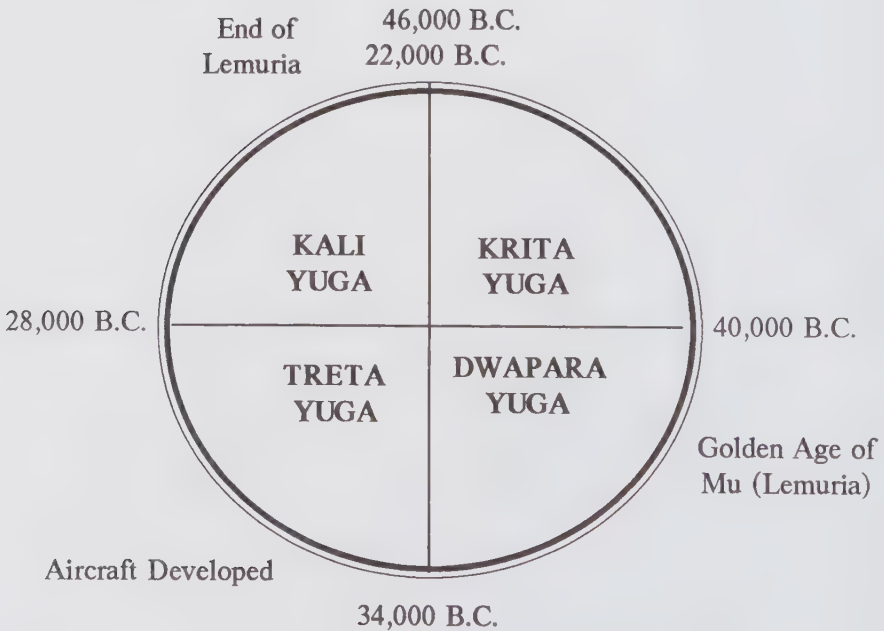

The Great Yuga Cycle starting 48,000 years ago and ending 22,000 B.C.

# BOOK

# 2

## THE VIMAANIKA SHAstra



# FOREWORD

On 25-8-1952 the Mysore representative of the Press Trust of India, Sri N. N. Sastry, sent up the following report which was published in all the leading dailies of India, and was taken up by Reuter and other World Press News Services :

“Mr. G. R. Josyer, Director of the International Academy of Sanskrit Research in Mysore, in the course of an interview recently, showed some very ancient manuscripts which the Academy had collected. He claimed that the manuscripts were several thousands of years old, compiled by ancient rishis, Bharadwaja, Narada and others, dealing, not with the mysticism of ancient Hindu philosophy of Atman or Brahman, but with more mundane things vital for the existence of man and progress of nations both in times of peace and war.

“Mr. Josyer’s manuscripts dealt in elaborate detail about food processing from various indigenous materials like grass, vegetables and leaves for human consumption, particularly during times of famine.

“One manuscript dealt with Aeronautics, construction of various types of aircraft for civil aviation and for warfare. He showed me plans prepared according to directions contained in the manuscript on Aeronautics of three types of aircraft or Vimanas, namely, Rukma, Sundara and Shakuna Vimanas. Five hundred slokas or stanzas dealing with these go into such intricate details about choice and preparation of metals that would be suitable for various parts of vimanas of different types, constructional details, dimensions, designs and weight they could carry, and purposes they could be used for.

“Mr. Josyer showed some types of designs and drawing of a helicopter-type cargo-loading plane, specially meant for carrying combustibles and ammunition, passenger aircraft carrying 400 to 500 persons, double and treble-decked aircraft. Each of these types had been fully described.

“In the section giving about preparation and choice of metals and other materials that should go into such construction of aircraft, details were specified that the aircraft, (these metals are of 16 different alloys), must be “un-reakable, which cannot be cut through, which would not catch fire, and cannot

be destroyed by accidents." Details as to how to make these vimanas in flight invisible through smoke screens are given in Vimanasastra of Maharshi Bharadwaja.

"Further description and method of manufacturing aircraft, which will enable pilots not only to spot enemy aircraft, but also to hear what enemy pilots in their planes were speaking, on principles akin to radar, have all been given in elaborate detail with suitable explanatory notes. There are eight chapters in this book which deal with construction of aircraft, which fly in air, go under water, or float on water.

### TRAINING OF PILOTS

"A few slokas deal with qualifications and training of pilots to man these aircraft. These ancient types of aircraft are provided with necessary cameras to take pictures of approaching enemy planes. Yet another set of slokas deals with the kind of food and clothing to be provided for pilots to keep them efficient and fit in air flying conditions.

"Mr. Josyer said he was attempting to publish these manuscripts suitably translated in English.

"Another manuscript dealt with ancient Indian architecture, fully illustrated to facilitate construction. This treatise is ascribed to Maharshi Narada, and gives elaborate details about choice of constructional material for various types of buildings, even 15 storeys high. Sectional drawing has also been provided. A few chapters deal with construction of villages, cities and towns, fortresses, palaces and temples. This manuscript is full of plans and engineering constructional details to guide engineers.

"Yet another manuscript from which Mr. G. R. Josyer read out passages referred to preparation of imitation diamonds and pearls. He also showed me another remarkable manuscript which deals in detail about food processing for invalids, for youth and for old and debilitated persons."

A mild avalanche of letters blew towards us during the following days from all over India. One of the first was from James Burke of "Life International", from Delhi asking if he could come and see the Mss. We replied, "Please wire 1000 dollars, and then come." He was taken aback, and wrote that he thought people here felt honoured by being mentioned in "Life Inter-

national," but that we seemed to be different. We did not reply. Now James Burke is dead ; and great "Life International" also is no more ! Such is human evanescence !

Miss Jean Lyon, journalist of Toronto and New York, wrote from Delhi that she would visit us. She came and saw the Mss, and recorded her interview with us in her book "Just Half a world Away" in a chapter headed "Science by Sutras", concluding with the charge that we were guilty of a rabid nationalism, seeking to wipe out everything since the Vedas !

That is no way for a journalist to judge persons. We only hold that for Indians, or others, to wipe out the Vedas is absurd ! We are neither rabid, nor national. God has created the Earth like a round ball, all its contents forming one compact unit, not a hundred and odd broken units as in the League of Nations. Only in maps is the earth shown broken into 2 hemispheres. If you actually break the Earth into 2 hemi-spheres, you will be having Doomsday !

Ours is not nationalism, rabid or tame, but one world humanism, or world-citizenship. That should not shock Miss Jean Lyon.

Others who wrote to enquire with excited wonder were Governor R. R. Diwakar of Behar, Maharaja of Kashi, Dr. Trivedi of "Searchlight," Patna, Professor Dwivedi of Gorakhpur, Professor Chauhan of Seoni, Professor Theeanee of Madras, Swamy Chaitanya of Mussoorie, H. R. Sharma of Phagwara, Harit Krishna Deb of Calcutta, R. B. Lal of Allahabad, P. S. Bharathi of Ootacamand, Miss McIntyre of Bangalore, M. V. Sharma, Industrialist, Madras, D. V. Potdar of Poona, Raja A. K. N. Singh of Ramnagar, U. P., Rao Bahadur M.A. Rangaswamy, Patna, N. Anandalwar, Bangalore.

S. M. Sharma, editor, wrote in "Searchlight," Patna, "To an eminent Sanskrit scholar, Shri G. R. Josyer, Director of the International Academy of Sanskrit Research, Mysore, we owe the discovery of the manuscript on Vimanas by Maharshi Bharadwaja. Shri Josyer is already more than 70. Many will share my hope and prayer that the Nehru Government would lose no time in acquiring the manuscript, which, according to my information, is most unique." Editor Sharma too is no more !

The Mss. came to us by Divine grace ! When on 28-6-1951 we got H. H. the Maharaja of Mysore to inaugurate the International Academy

of Sanskrit Research, evidently it was an auspicious occasion. The Academy has truly attained International fame, and has become known from one end of the globe to the other!

One of the guests coming from Bangalore for the ceremony brought a small manuscript in exercise book form containing the beginning of Maharshi Bharadwaja's "Vymanika Sastra." We were struck by it, and exhibited it along with our other Mss. in various stages of decay, to H. H. The Maharaja and Chief Minister K. C. Reddy and others when we took them round.

After the function the Mss. was returned to the guest, who gave it back to the custodian of Pandit Subbaraya Sastry's literary records, Sri Venkatrama Sastry, B.A., B.L., Advocate of the Bangalore Bar. Subsequently we contacted him, and on our promise of doing our best to publish them, he was good enough to let us have copies of some of the manuscripts. The message of the Press Trust of India was with reference to them. The fan mail resulting therefrom brought enquiries from personages such as Air Commodore Goyal of the Western Command, Bangalore, The Editor of the Kesari and Mahratta, Poona, Major Gadre of Saraswati Mahal, Tanjore, Minister A. G. Ramachandra Rao, Bangalore, Sri Swamy of Bhandarkeri Mutt, M. G. Seth, Bombay, P. D. Padam Chand, Delhi, P. M. Kabali, Bombay, Aeronautical Society of India, Ministry of Scientific and Cultural Affairs, Delhi, the Director General of Civil Aviation, the Hindustan Aircrafts, Ltd.

We then commenced printing the original in Sanskrit, and had made some progress, when suddenly there came a harsh letter from the donor, Sri Venkatrama Sastry, accusing us of exploiting the manuscripts for our personal benefit. Having had no such idea ourselves, it evoked disgust, and we replied that he could take back the manuscripts, and discontinued the printing !

But then letters continued to come from far away, from estimable men avidly interested in the manuscript, and organs of learned Associations and books by scholars of the abstruse began to quote us as intending to bring out the publication. Seigfried Hansch, Deschenes, Canada, Hans krefft, Berlin, Blaes-Gustaf-Nordquist, Stockholm, Sweden, Bjorn Loven, Innsbruck, Austria, Joachim Rothaner, Kellerburg, Austria, Jan Wallgren, Stockholm, P. Salzmann de la Mar, Eskilstuna, Sweden, Hans-Werner-Von Engel, Bad Gadesberg, West Germany, Sten Lindgreu, Stockholm, Lars Eric

Helin, Kalender, Gothenburg, Sweden, W.M. Dawson & Sons, London, Charles Danois, Kristianstad, Sweden, James Alves, Sao Paulo, Brazil, Torbjorn Holmquist, Vetlanda, Sweden, Ernest Heinrich, Homburg, Klaus Aarsleff Jorgensen, Skellingsted, Denmark, Gosta Karlsson, Stockholm, Peter Bernin, Malmo, Sweden, Dr. Curtis J Mccall, Lake Worth, Florida, Robert Ashley Falk, Auckland, New Zealand, Terry W. Colvin, Evansville, U.S.A., Sven Bertil Hansson, Malmo, Sweden, Kjell Ericson, Borlonge, Maurice T. Caison, North Carolina, M. A. Gresham, Jr. Atlanta, U.S.A. Alan Y. Wilcox, Lauderdale, Florida, Strubes, Copenhagen, Denmark, Alan D. William, Downey, California, Stuve Sundquist, Uppsala, Bo H. Svensson, Sweden, Karen Kesti, Republic WA, U.S.A., Richard Watson, New South Wales, Australia, Ontario College of Art, Toronto, Canada, Dr. Jacq Eskens, Rotterdam, Netherlands, Bernin Co Moberg, Montmartre, Paris, L.S.U. Rydberg, Stockholm, Chairman, E. A. G. Mackay, British Unidentified Flying Object Research Association, London, Mrs. Annica Foxcraft, Transvaal, Oliver Williams, Weimar, Texas, Jan Swagermann, Ship "Johannra", Amsterdam, Robert B. Young, Jr. Radco Incorporated, Houston, Texas, Sam J. Lundwall, Askild and Karnekull, Stockholm, Dr. Cedric Leonard, Oklahoma, Gwendelholm, Stockholm, Michele Bonamici, Milan, Italy, Jose M. Fernandez, Goteborg, Sweden, President Lennort Lidfoss, Spectrum, Forlags, A. B. Danderyd, Sweden.

The "Clima Astral" of Brazil, "The Mexican News" of Mexico, The "Spectrum" and "Pursuit" of U.S.A. and three Swedish books on ancient and astral research, "Kulturer Fore Istiden" by Ivan Troing, "Forntidens Teknik" by H. Kjellson, and "Flygande Tefat" by Max B. Miller, reproduced our original descriptive leaflet, and announced that we expected to publish the remarkable volume. The Maharaja of Mysore invited us, and after offering Tea, wanted the Manuscript for being shown to Dr. Thacker, the National Scientist of India. We reminded him that Sanskritists were averse to parading knowledge before idle curiosity, and that the manuscript had to be translated into English and tested by research, and then only made available for the public gaze. Four scientist Doctors from the Indian Institute of Science, Bangalore, came with a letter of Introduction from the Head of The Department of Power Engineering, Dr. M.A. Tirunarayanan, and sought clarification from us!

It was as if the orange-shaped Earth had become a porcupine, and was shooting its quills at us from all sides, in order to goad us into the task, which we had been reluctant to take up as being too onerous for us!



We had therefore to gather strength from the cumulative good-will of the world-wide public, and gird ourselves up for the strenuous undertaking.

To be really of value the volume had to include the Sanskrit original, its translation in English as demanded by western readers, and sketches showing the designs of the Vimanas for further clarification. It had to be a beautiful volume commensurate with the magnificence of its subject, and the high expectations of the public awaiting its publication.

Thus, at the age of 81 we had to sit up and translate the technical Sanskrit into readable English, and scrutinise the printing of both the Sanskrit and English, involving the strain of multiple proof-reading. The finance required was considerable, and as no help was forthcoming, we had to scrape together the meagre savings of a life-time, procure needful printing equipment at mounting costs, engage labour at emergency rates, and at long last, with the help of Divine grace, are able to herald the birth of the volume, which has been in gestation for over ninety years !

“Vymaanika Shastra” consists of nearly 6000 lines, or 3000 verses of lucid Sanskrit, dealing with the construction of Vimaanas or Aeroplanes. That the vocabulary of ancient Sanskrit could in simple flowing verse depict the technical details with effortless ease is a tribute to the language, and the greatness of the author.

Maharshi Bharadwaja is an august name in the pantheon of Hindu Sages who recorded Indian civilization, in the spiritual, intellectual, and scientific fields in the hoary past. They transmitted knowledge from mouth to mouth, and from ear to ear, for long eras. Written transmission through birch-barks or palm-leaves, or home-made paper, are from this side of a thousand years. Even they are to be found in mangled forms owing to the depredation of time, weather and insect hordes. There is no-written material for the vast volume of Vedas, Upanishads, Shastras, and Puranas, which have come down for over 10000 years as a patrimony, not only for India, but for mankind in general. They remain imbedded in the ether of the sky, to be revealed—like television,—to gifted mediums of occult perception.

Venerable Pandit Subbaraya Sastry, who has left the legacy of manuscript treasures including “Vymanika Shastra”, was a simple, orthodox, intellec-

tual Brahmin with spiritual gifts, who was esteemed by all who knew him, Englishmen and anglicised or educated Indians, in various walks of life.

He was a walking lexicon gifted with occult perception. His sole aim was to transmit his knowledge to posterity. He lived a life of poverty, like Socrates, and sought no gains for himself.

In 1885 Mr. B. Suryanarain Rao, B.Sc., M. R. A. S., distinguished Astrologer and Editor, first met him and became his devoted exponent. In 1911 he started a Magazine in Madras named "Bhowthika Kalaa Nidhi," or "Treasure house of physical sciences", and published extracts from the revelations of the venerable scholar. We are in possession of 6 issues of that rare Journal which came to us by Divine grace.

On 1-8-1918 he began to dictate "Vymanika Sastra" to Mr. Venkatachala Sarma, who took down the whole in 23 exercise books up to 23-8-1923.

That gave manuscript shape to Maharshi Bharadwaja's "Vymanika Sastra". Then by a flash of genius he engaged a draughtsman, and got drawings of some varieties of the Vimanas prepared under his instructions, which form an indispensable adjunct to the manuscript proper. That was in 1923. India was then under British rule. Gandhi's Non-co-operation movement was catching fire. And, it is said, Pandit Subbaraya Sastry was arrested ! Yeoman efforts procured his release. But his activities had to remain confined. In 1928 he addressed a letter to the Maharaja of Darbhanga for aid in publication of the manuscripts. But the rich in India have got deaf ears, and warped minds! Then, disappointed and broken-hearted, in the early 30's, venerable Subbaraya Sastry passed out of this world, and left it the poorer thereby !

For some 20 years his literary treasures remained as under frigidaire, guarded by his daughter and young Mr. Venkatrama Sastry. Then the Unseen Powers began to play, and the manuscripts were released to light. And at last it has pleased God to enable us to present Maharshi Bharadwaja's "Vymanika Sastra" to the world's elite, and pay our tribute to the memories of Maharshi Bharadwaja and venerable Subbaraya Sastry.

We thank God for His gracious favour. We thank Mr. Venkatrama Sastry who made the manuscript available to us ; our first son, G. S. Josyer, M.A., B.ED., who contacted Mr. Venkatrama Sastry and brought the Mss.,

prepared it for the press, and even composed a portion of the Mss., and met an untimely death in the midst of his useful career; our younger son, G. N. Josyer, B.E., who has been helping us in seeing the work through ; and our consultants in the course of the work, Sris. Alwar Tirumaliengar and M. A. Tirunarayan, B.E., M.I.E., M. N. Srinivasan, B.Sc, Hons, LL.B., Professor M. A. Tirunarayanan, D.Sc, and Sris M. C. S. Chari, B.Sc., N. Narasimhan, B.E., R. T. Krishnan, B.E., Pandit K. Ramaswamy Iyengar, and Mr. N. N. Sastry of P.T.I., and other associates and assistants.

Sanskrit and English have been our two eyes since some 75 years, and we are placing the unique volume before the elite of the world as an outstanding contribution to world literature from the ever-living past. We hope they will deem it an invaluable addition to their libraries, and find it an ever interesting companion.

The 20th century may be said to be made historic by 2 achievements, the bringing of Moon-rock from outer space, and the publication of "Vymanika Sastra" from the unknown past. The Moon-rock is just rock, not a cluster of shining pebbles from Kimberley of South Africa. But the "Vymanika Sastra" is a Cornucopia of precious formulas for the manufacture of Aeroplanes, which should make Lindbergh, Rolls, Zeppelin, De Havilland, Tupolev, and Harold Gray of Pan American, gape in astonishment, and if duly worked up, herald a new era of Aeroplane manufacture for the benefit of Mankind !

G. R. JOSYER

Hon. Director, International  
Academy of Sanskrit Research,

15-3-1973

Mysore-4, India.

श्रीमहर्षिभरद्वाजप्रणीत  
“यंत्रसर्वस्वा”न्तर्गत

## वे मानिकप्रकरणम्

श्री बोधानन्दमुनिवरेण्य प्रणीत  
विवृत्या समुद्धसितम्

श्री पण्डितवर्य सुवायशास्त्रिभिः  
दैवकृपया समुलभ्य  
हस्तलिखित मातृकारूपेणानुगृहीतम्

उभयभाषाविदुषा  
गोमठं रामानुज ज्यौतिषिकेण  
यथामति संशोध्यपरिष्कृत्य  
आंग्लेय भाषान्तरेणमह

मैसूरु कारोनेषन् मुद्रणालये  
लाकोपकागय मुद्राप्य प्रकटीकृतम्

॥ ओम् तत् सत् ॥

MAHARSHI BHARADWAAJA'S  
**VYMAANIKA-SHAASTRA**  
OR  
SCIENCE OF AERONAUTICS



Part of his unknown work  
"YANTRA SARVASVA"  
or  
"ALL ABOUT MACHINES"



as revealed to venerable  
Pandit SUBBARAYA SASTRY  
and recorded in hand-written  
Sanskrit Manuscript Form

translated into English by  
G. R. JOSYER, M.A., Hons., F.R.E.S., M.R.S.L.  
Founder Director,  
INTERNATIONAL ACADEMY OF SANSKRIT RESEARCH.

Printed at the  
CORONATION PRESS, MYSORE 4, INDIA.

Original Title Page of Josyer's English translation of the *Vymaanika-Shastra*,  
found in 1908 in the Royal Baroda Library.

# CONTENTS

	Page
<b>FIRST CHAPTER</b>	
1. Definition	2
2. The Pilot	3
3. Aerial Routes	7
4. Aeroplane Parts	8
5. On Clothing	10
6. On Food	11
7. On Metals	15
<b>SECOND CHAPTER</b>	
8. Heat Absorbing Metals	18
9. Melting	19
<b>THIRD CHAPTER</b>	
10. Mirrors	22
<b>FOURTH CHAPTER</b>	
11. Power	28
<b>FIFTH CHAPTER</b>	
12. Yantras or Machinery	31
13. Parts of Yantras	36
<b>SIXTH CHAPTER</b>	
14. Varieties of Aeroplanes	84
15. Shakuna Vimana	89
16. Sundara Vimana	94
17. Rukma Vimana	107
18. Tripura Vimana	111



Maharshi Bharadwaaja's  
**VYMAANIKA SHAASTRA**

**FIRST CHAPTER**

**Maharshi Bharadwaaja :**

I make obeisance to the Divine Being, who is visible on the crest of the Vedas, who is the fountain of eternal bliss, and whose abode is reached by Vimaanas or Aeroplanes. Having studied the Shaastraas or sciences propounded by previous men of science to the best of my ability, for the benefit of mankind, I shall deal with the science of Aeronautics, which is the essence of the Vedas, which will be a source of joy and benefit to humanity, which will facilitate comfortable travel in the sky from world to world, in eight chapters, consisting of 100 topics, in 500 sutras or cryptic pronouncements.

**Commentary by Bodhaananda :**

I bow to God Mahadeva and His Consort, to Saraswathi Goddess of learning, to Ganapathy guardian of benevolent efforts, and to my venerable preceptor, and I bow to Maharshi Bharadwaaja. In Addition to my own knowledge of Logic, I have five times turned over Vaalmeeke's Mathematics, 'Pari-bhaashaa Chandrikaa,' and 'Naamaarthhakalpaka,' and aided by their authority, I, Swaamy Bodhaananda, for the easy understanding of the young, have written this 'Bodhananda Vritti,' to elucidate Maharshi Bharadwaaja's concisely worded text on Aeronautics.

At the outset Maharshi Bharadwaaja invokes God in the traditional manner for the successful commencement, progress, and completion of his great literary work. Attaining mastery over the Vedas by Divine Grace, and studying the works of earlier Aachaaryaas or preceptors, he has churned the Vedic lore, and extracting the cream, presented it to mankind for reaping untold benefits, in the work named 'Yantrasarvasva.' In the fortieth chapter therein he deals with the science of Aeronautics, explaining the construction and use of many kinds of aeroplanes, in 8 chapters, containing 100 subject heads, comprising 500 sutras or oracular pronouncements.

In the first stanza the reference is to the teaching of the sacred works, "Uttara-taapaneeya," "Shaibya-prasna," "Kaataka," and "Maandookya," that the symbolic letter, 'Om,' leads to the knowledge of God and Salvation. Bharadwaaja implies that the Vimaana or aeroplane constructed according to Vymaanika Shaastra, may enable men to reach God, and enjoy the benefits of His Divine abode.

The previous Aachaaryaas Bharadwaaja refers to are named by Vishwanaatha as,—Naaraayana, Shownaka, Garga, Vaachaspathi, Chaakraayani and Dhundinaatha, venerable authors of "Vimaana-Chandrikaa", "Vyomayaana-Tantra," "Yantra-Kalpa", "Yaana-Bindu," "Khetayaana Pradeepikaa," and "Vyomayaana-Arkaprakaasha," respectively.

Bharadwaaja thus defines the word Vimaana :

☞ Vega-Saamyaaat Vimaano Andajaanaam. Sootra 1.

"Owing to similarity of speed with birds, it is named Vimaana."

**Bodhaananda Vritti :**

The word "andaja" means "egg-born", and includes eagles and other birds which fly by their own volition. The Vimaana is a vehicle which flies in the sky with speed comparable with birds.

Lallachaarya says, "That which can fly in the sky with speed equal to that of birds, is called Vimaana."

Aachaarya Naaraayana says,

"That which can speed on earth, on water, through air, by its own power, like a bird, is a "Vimaana."

Shankha says, "Experts in the science of aeronautics say, "That which can fly through air from one place to another is a Vimaana"

And Vishwambhara says, "Experts say that that which can fly through air from one country to another country, from one island to another island, and from one world to another world, is a "Vimaana"."

Having thus defined the name of the Vimaana, the sage proceeds to describe its details.

☞ Rahasyagnyodhikaaree. Sootra 2.

"The pilot is one who knows the secrets."

**Bodhaananda :** Scientists say that there are 32 secrets of the working of the Vimaana. A pilot should acquaint himself thoroughly with them before



he can be deemed competent to handle the aeroplane. He must know the structure of the aeroplane, know the means of its take off and ascent to the sky, know how to drive it and how to halt it when necessary, how to manoeuvre it and make it perform spectacular feats in the sky without crashing. Those secrets are given in "Rahasya-Lahari" and other works, by Lalla and other masters, and are described thus :

"The pilot should have had training in maantrica and taantrica, kritaka and antaraalaka, goodha or hidden, drishya and adrishya or seen and unseen, paroksha and aparoksha, contraction and expansion, changing shape, look frightening, look pleasing, become luminous or enveloped in darkness, deluge or pralaya, vimukha, taara, stun by thunderous din, jump, move zig-zag like serpent, chaapala, face all sides, hear distant sounds, take pictures, know enemy manoeuvres, know direction of enemy approach, stabdhaka or paralyse, and karshana or exercise magnetic pull.

These 32 secrets the pilot should learn from competent preceptors, and only such a person is fit to be entrusted with an aeroplane, and not others.

They are explained thus by Siddhanaatha :

1. **Maantrika** : As prescribed in "Mantraadhikaara," by invoking the mantras of Chhinnamasta, Bhairavee, Veginee, Sidadhaamba, acquire the powers of ghutikaa, paadukaa, visible and invisible and other mantras with potent herbs and efficacious oils, and Bhuvaneswaree Mantra which confers spiritual and mesmeric powers, to construct aeroplanes, which don't break cannot be cut, cannot be burnt, and cannot be destroyed.

2. **Taantrika** : By acquiring Mahaamaaya, Shambara, and other taantric powers, to endow the plane with those powers.

3. **Kritaka** : By study of architects like Vishwakarma, Chhaayaa-parusha, Manu, Maya and others, to construct aeroplanes of various patterns.

4. **Antaraala** : In the wind-swept atmospheric region of the sky, in the clash at the borders of mighty currents, an inadvertent plane is likely to be smashed to pieces. But by getting warned of the approach of such danger spots, the plane could be halted and steered with care.

5. **Goodha** : As explained in 'Vaayutatva-Prakarana', by harnessing the powers, Yaasaa, Viyaasaa, Prayaasaa in the 8th atmospheric layer covering the earth, to attract the dark content of the solar ray, and use it to hide the Vimaana from the enemy.

6. **Drishya** : By collision of the electric power and wind power in the atmosphere, a glow is created, whose reflection is to be caught in the Vishwa-Kriyaa-darapana or mirror at the front of the Vimana, and by its manipulation produce a Maaya-Vimaana or camouflaged Vimana.

7. **Adrishya** : According to "Shaktitantra", by means of the Vynarathya Vikarana and other powers in the heart centre of the solar mass, attract the force of the ethereal flow in the sky, and mingle it with the balaahaa-vikarana shakti in the aerial globe, producing thereby a white cover, which will make the Vimana invisible.

8. **Paroksha** : According to "Meghotpatthi-prakarana," or the science of the birth of clouds, by entering the second of the summer cloud layers, and attracting the power therein with the shaktyaakarshana darpana or force-attraction mirror in the Vimana, and applying it to the parivesha or halo of the Vimaana, a paralysing force is generated, and opposing Vimaanas are paralysed and put out of action.

9. **Aparoksha** : According to 'Shakti-tantra,' by projection of the Rohinee beam of light, things in front of the Vimaana are made visible.

10. **Sankochā, or Contraction** : As prescribed in the Yantraangopasamhaara section, when the Vimaana is flying at speed with fully extended wings, and there is danger ahead, turning the 7th switch in the Vimana, its parts can be made to contract.

11. **Vistrita** : According to 'Akaashatantra', when the Vimana is in the central air flood in the third and first regions of the sky, by turning the switch in the 11th section of plane, it becomes expanded suitably according to "Vaalmeeke Ganita."

12. **Viroopa Karana** : As stated in "Dhooma Prakarana", by producing the 32nd kind of smoke through the mechanism, and charging it with the light of the heat waves in the sky, and projecting it through the padmaka chakra tube to the bhyravee oil-smearred Vyroopya-darpana at the top of the Vimaana, and whirling with 132nd type of speed, a very fierce and terrifying shape of the Vimana will emerge, causing utter fright to onlookers.

13. **Roopaantara** : As stated in "Tylaprakarana," by preparing griddhrajihwaa, kumbhinee, and kaakajangha oils and anointing the distorting mirror in the Vimaana with them, applying to it the 19th kind of smoke

and charging with the kuntinee shakti in the Vimana, shapes like lion, tiger, rhinoceros, serpent, mountain, river will appear and amaze observers and confuse them.

14. **Suroopa** : By attracting the 13 kinds of Karaka force mentioned in "Karaka prakarana" applying snow-surcharged air and projecting it through the air conveying tube to the pushpinee-pinjula mirrors in the front right side of the Vimana, and focusing on it the suragha beam, a heavenly damsel bedecked with flowers and jewels will appear to onlookers of the Vimana.

15. **Jyotirbhaava** : As stated in "Amshubodhinee," out of Samgnaana and other 16 digits of the solar glow, by attracting the 12th to the 16th digits and focusing them on the air force in the Mayookha section in the fourth pathway in the sky, and similarly by attracting the force of the etherial glow and mingling it with the glow in the 7th layer of air mass, and then by projecting both these forces through the 5 tubes in the Vimana on to the section of the guhaa-garbha mirror, a rich glow like the morning glow of the sun will be produced.

16. **Tamomaya** : As described in "Darpana Prakarana," by means of the dark force mirror, capture the force of darkness, pass it through the Thamo-Yantra in the north-west side of the Vimana, and by turning a switch produce at noon-day the utter darkness of the night of the new-moon.

17. **Pralaya** : As described in the magic book of destruction, attract the 5 kinds of smoke through the tube of the contracting machine in the front part of the Vimana, and merge it in the cloud-smoke mentioned in "Shad-garbha Viveka", and pushing it by electric force through the five-limbed aerial tube, destroy everything as in a cataclysm.

18. **Vimukha** : As mentioned in "Rig-hridaya", by projecting the force of Kubera, Vimukha and Vyshawaanara poison powder through the third tube of the roudree mirror and turning the switch of the air mechanism, produce wholesale insensibility and coma.

19. **Taara** : By mixing with etherial force 10 parts of air force, 7 parts of water force, and 16 parts of solar glow, and projecting it by means of the star-faced mirror through the frontal tube of the vimana, the appearance of a star-spangled sky is created.

20. **Mahaashabda Vimohana** : By concentrating the air force in the seven tubes of the Vimana, and turning the switch, produce, as stated in "Shabda prakaashikaa" a crescendo of thunderous din, which stuns people, and makes them quake with fear and become insensible.

21. **Langhana** : As stated in "Vaayu tattva prakarana" When crossing from one air stream into another, the Vimana faces the baadaba glow of the sun and catches fire. In order to prevent that, the electric force and air force in the Vimana should be conjoined and centred in the life-centre of the Vimana, and by turning the switch, the Vimana will leap into safety.

22. **Sarpa-Gamana** : By attracting the dandavakra and other seven forces of air, and joining with solar rays, passing it through the zig-zagging centre of the Vimana, and turning the switch, the Vimana will have a zig-zagging motion like a serpent.

23. **Chaapala** : On sighting an enemy plane, by turning the switch in the force centre in the middle section of the Vimana, a 4087 revolutions an hour atmospheric wave speed will be generated, and shake up the enemy plane.

24. **Sarvatomukha** : When a formation of enemy planes comes to attack one's Vimana, by turning the switch at the crown of the Vimana, make it revolve with agility and face all sides.

25. **Parashabda Graahaka** : As explained in "Sowdaaminee kalaa" or science of electronics, by means of the sound capturing yantra in the Vimana, to hear the talks and sounds in enemy planes flying in the sky.

26. **Roopaakarshana** : By means of the photographic yantra in the Vimana to obtain a television view of things inside an enemy plane.

27. **Kriyaagrahana** : By turning the key at the bottom of the Vimana, a white cloth is made to appear. By electrifying the three acids in the north-east part of the Vimana, and subjecting them to the 7 kinds of solar rays, and passing the resultant force into the tube of the Thrisheersha mirror and making the cloth screen face the mirror, and switching on the upper key, all the activities going on down below on the ground, will be projected on the screen.

28. **Dikpradarshana** : Turning the key at the front of the Vimana the dishaampati yantra will show the direction from which the enemy plane is approaching.

29. **Aakaashaakaara** : According to "Aakaasha-tantra", by mixing black mica solution with neem and bhoonaaga decoctions and smearing the solution on the outer body of the Vimana made of mica plates, and exposing to solar rays, the plane will look like the sky and become indistinguishable.

30. **Jalada roopa** : Mixing pomegranate juice, bilva or bael oil, copper-salt, kitchen smoke, granthika or gugul liquid, mustard powder, and fish scale decoctions, and adding sea-shell and rock-salt powder, and collecting smoke of the same solution and spreading it with solar heat enveloping the cover, the Vimana will have the appearance of a cloud.

31. **Stabdhaka** : By projecting apasmaara poison-fume smoke through the tube on the north side on the Vimana, and discharging it with stambhana-yantra, people in enemy planes will be made unconscious.

32. **Karshana** : When enemy planes come in strength to destroy one's Vimana, by setting aflame the Jwaaline shakit in the Vyshwaanara-naala or pipe located at the navel of the plane, and switching the keys of the two wheels to 87 degrees of heat, the burning shakti will envelope the enemy plane and destroy it.

These are the 32 rahasyaas or secrets which should be known by pilots according to Siddhanaatha.

**"Maargaadhikaranam" Aerial Routes :**

 Panchagnyascha. Sootra 3.

"The pilot should know five things."

**Bodhaananda Vritti :**

As the secrets of aeronautics are indicated in the second sutra, the five atmospheric regions are referred to in the third sutra. According to Shownaka, the regions of the sky are five, named, Rekhaapathha, Mandala, Kakshya, Shakti, and Kendra.

In these 5 atmospheric regions, there are 5,19,800 air ways traversed by Vimanas of the Seven Lokas or worlds, known as Bhooloka, Bhuvarkala, Suvarloka, Maholoka, Janoloka, Tapoloka and Satyaloka.

Dhundinaatha and "Vaalmeeki Ganita" state that Rekha has 7,03,00,800 air routes, Mandala has 20,08,00200 air routes, Kakshya has 2,09,00,300 air routes, Shakti has 10,01,300 air routes, and Kendra has 30,08,200 air routes.

According to "Vaalmeeki Ganita" in the Rekhaapathha region, sections 1 to 4 are suitable for the passage of the Vimanas of this Bhooloka. In the Mandala region sections 3 to 5 are suitable for Vimanas of Bhuvarkola, Suvarlola, and Maholola dwellers. For the Janolola Vimanas sections 2 to 5 in the Kakshya region are suitable. Section 1 to 6 in the Shakti region are suitable for the Vimanas of Tapolola. For the dwellers of Bramhalola sections 3 to 11 in the Kendra region are suitable, according to shastras like "Vaalmeeki Ganita" and others.

### **Maharashi Bharadwaja :**

☞ Aavartaascha. Sootra 4.

"Whirl-Pools"

Aavartaas or aerial whirlpools are innumerable in the above regions. Of them the whirlpools in the routes of Vimanas are five. In the Rekhapathha there occurs "Shaktyaavarta" or whirlpool of energy. In Mandala-pathha there occurs the whirlpool of winds. In Kakshyaa-pathha there occurs Kiranaavarta or whirlpool from solar rays. In Shakti-pathha there occurs shytyaavarta or whirlpool of cold-currents. And in Kendra-pathha there occurs gharshanaavartha or whirl-pool by collision. Such whirlpools are destructive of Vimanas, and have to be guarded against.

The pilot should know these five sources of danger, and learn to steer clear of them to safety.

### **Maharshi Bharadwaja :**

☞ Angaanyekatrimsat. Sootra 5.

"The parts are thirty one"

### **Bodhaananda Vritti :**

Just as the human body, if it is complete in all its limbs, is best able to accomplish things, the Vimana, if it is complete in all its parts, will be capable of functioning efficiently. From the location of the Vishwakriyaadarpana

31 locations of Vimana components are mentioned.

According to "Chaayaapurusha Snaastra" they are :

1. Vishwakriyaadarpana or mirror of outside views.
2. Shaktyaakarshana or energy attracting mirror.
3. Parivesha mechanism above the hood of the Vimana.
4. Angopasamhaara yantra or folding up yantra at the 7th bindu-keelaka.
5. Vistritakriyaa or opening out yantra location in the middle of the 11th section.
6. Vyroopya darpana and
7. Padmachakramukha at the shirobhaaga or crest of the Vimana.
8. The Kuntinee-shakti mechanism is to be in the neck of the Vimana.
9. Pushpinee and Pinjulaa Mirrors are to be in the right side of the centre.
10. At the front of the left side are to be located the Naalapanchaka or 5 pipes.
11. Guhaagarbha mirror yantra is to be in the front part of the stomach of the plane.
12. Thamoyantra at the north western side.
13. Pancha-vaataskandha-naala on the western centre.
14. Rowdree mirror.
15. Vaataskandha keelaka at the bottom centre.
16. Shaktisthaana at the front and right sides.
17. Shabda-kendra-mukha at the left side.
18. Vidyuddwaadashaka at the north-east side.
19. Praanakundala at the moola of the Vimana.
20. Shaktyudgama at the navel of the Vimana.
21. Vakraprasaarana at the side of Vimanaadhaara.
22. Shaktipanjara in the central portion.
23. Shirahkeelaka at the head of the Vimana.
24. Shabdaakarshaka yantra at the shoulder.
25. Pata-prasaarana at the bottom centre.
26. Dishaampati yantra at the left front.
27. Pattikaabhraka at the centre of the hood of the Vimana.
28. Solar power attractor at the top of the Vimana.

29. Apasmaara or poison gas at the sandhi-naala mukha or junction tube front.
30. Sthambhana yantra at the bottom.
31. Vyshwaanara-naala at the navel centre.

This is the placing of the 31 components of the Vimana.

### “Yasthraadhikaranam”: On Clothing

#### Maharashi Bharadwaaja :

☞ “Yantu-praavaraneeyow prithak prithak ritubhedaat.” Sootra 6.

“The clothing should be different for different seasons.”

The sootra defines the clothing which is to be provided to the pilot in accordance with different seasonal conditions. The impact of the sun's myriad rays on the revolving earth causes seasonal climatic changes. Their effects on human life are either wholesome or unwholesome, as the case may be. The latter cause cramps, drain blood, and denude the body of fat, flesh, and other ingredients. The evil forces of the seasons are reckoned as 25, and affect the skin, bone, flesh, fat, muscles, nerves, joints and other parts of the pilots' body. The clothing provided to them should be such as to safeguard against such effects, and maintain their efficiency.

According to “Pata-samskaara Ratnaakara”, silk, cotton, moss, hair, mica, leather, are to be purified by 25 processes, washed with mica-saturated water, and spun into yarn as prescribed by Gaalava. Then fibres from the ketaki flower palm, arka or swallow wort or madar, sun flower tree, cocoanut and jute, should each be purified 8 times as prescribed and by 19 processes, spun into yarn, and woven into cloth. Then the cloth should be soaked in the oils of linseed, tulasi or basil, goose berry, shamee or acacia suma, bael, and mustard, and dried in the sun 5 times daily for 7 days. Then yellow ochre, lac, tamarind, honey and gingelly manure and mica in equal parts and yena-kshaara salt, put in a crucible vessel, placed in koorma furnace, and boiled with the aid of 3 faced bellows. 8 seers of linseed juice should be added to it. Bees wax, mica, shinjeera, vajra, borax, and ashoka fruit should be boiled, and their oil mixed with the other composition, and boiled in garbhataapana yantra. Then the cloth should be soaked in that decoction and dried 5 times. With this material, fashioning the apparel and



clothes of the pilots handsomely, according to the types of the cloth and requirements the crew, as prescribed by Agnimitra, and handing it to them to wear, they should be conferred benediction, given a protective amulet and then sent out with cheers. It will ward off evils, promote fitness of body and health of mind, and improve their strength, energy, and competence.

### **Aahaaraadhikaranam: On Food**

**Maharshi Bharadwaaja :**

☞ “Aahaarah Kalpabhedaat” Sootra 7.  
“Food according to Seasons.”

**Bodhaananda Vritti :**

As stated in Kalpa Sootra, the food of the pilots is of three kinds, according to the seasons. “Ashana-Kalpa” or “Principles of Diet”, says-“During the spring and summer months, the pilot’s food should consist of buffalo-milk among liquids, among grains aadhaka or tuvar-dhal, and among flesh, the flesh of sheep.

In the 4 months of rains and autumn, cow’s milk among liquids, wheat and black-gram among grains, and flesh of cocks and hens.

In the 4 months of winter and snow, goat’s-milk, yava and black-gram among grains, and flesh of sparrows.

For pilots belonging to the three Dwija castes of Braahmin, Kshatriya and Vyshya, the food will not include flesh.

**Maharshi Bharadwaaja :**

☞ “Visha Naashas Tribhyaha” Sootra 8.  
“The three Varieties ward off seasonal evil effects”

**Bodhaananda Vritti :**

The 25 kinds of poisonous effects of the seasons are warded off by alteration in the food so as to suit the seasonal conditions.

“Vishanirnaya-adhikara” states, -

The seasons are each differently conditioned by the changes in the watery forces in the sky. The 101 forces in the aerial atmosphere, colliding with the 1/16th force in the watery sky in the seventh region, at the sineevaalee and kuhoo yogas or full-moon and new-moon conjunctions, produce maleficent and beneficent effects. The beneficent forces are 7,58,00,700 in number, and the maleficent forces also are of the same number, according to “Vaalmeeeki Ganita”. The beneficent effects are during the full moon period, and the maleficent effects during the new-moon period. 25 maleficent poisonous forces known as Bhedinee, tend to paralyse the pilots’ physical efficiency. That is avoided by altering their food according to seasons. So says Sage Shaataatapa.

By such adjustment the pilots’ physical fitness will be maintained.

**Maharashi Bharadwaja :**



“Tat Kaalaanusaraat iti”

Sootra 9.

“That at set times”

**Bodhaananda Vritti :**

Having defined the seasonal types of food, the meal times are now defined. According to Shownaka, the times for taking meals are prescribed as follows : Family men should take food twice a day, or once a day. Ascetics should take food once a day. Others can take food four times a day. Air pilots should take food 5 times a day. And yogis may take as many times as they like.

According to “Lalla-kaarika” or “Diet Rules” by Lalla,

Food should be taken at the end of the 2nd **yaama**-(**yaama**=3 hours) in the day time, and at the end of the 1st **yaama** in the night. That is for family men. If they take only one meal a day, it should be during the 3rd and 4th **yaamas**. Sanyaasis or ascetics who eat only once a day should dine as above. For the labouring classes the times are thrice during day time, and once in the night. For pilots of **Vimanas** the meals are thrice during day time, and twice at night.

**Maharshi Bharadwaaja :**

☞ “Tadabhaavay Sathva-Golovaa” Sootra 10.

“If unavailable, then vitamin pills or food-balls”

Bodhaananda Vritti :

If the prescribed food-stuffs are not available for use during their flights, then essence extracts made by proper cooking with admixture of spices and condiments into potable and eatable form, or food balls-made out of them should be supplied to the pilots for consumption on flights.

Says “Ashana kalpa” or “Food manual”,

“There are 5 kinds of food, that are nutritious and wholesome; cooked rice or grain, gruel, cooked flour, baked flat bread, and preparations made out of essence-extracts from food materials. The last named are superior to all the others”.

“Paakasarvasva” or “Art of cooking” observes,

“Removing the husk and other non-food parts from it by machines, the grain should be made into flour and cooked in a suitable vessel and when it has reached the 8th degree of reduction, add essences, sweets, condiments, and ghee, and prepare food-balls, having nice flavour and delicious taste, and being nourishing to the body.

**Maharshi Bharadwaaja :**

☞ “Phala Moola Kanda Saarovaa.” Sootra 11.

“Or essence of fruits, roots, and bulbs.”

Bodhaananda Vritti :

In this sootra it is stated that preparations made from edible roots, potato and other bulbous vegetables, and from fruits are also suitable as food.

“Ashana-Kalpa” says,

If food made of grains is not available, that from roots, bulbs, and fruits may be used as food, in the form of flour, sugarcandy, manjoosha or jaggery, honey, milk, ghee, oily-products, and roots and berries which

contain sweet, salt, pungent, acrid, and alkaline tastes. Such roots are said to be 56 in number. They should be purified, powdered, and duly cooked, and made into balls, and given out for use as food.

Similarly the bulbous vegetables which are of 16 kinds, and fruits which are of 32 kinds, and food prepared out of them are excellent food, Food from roots develops brain, nourishes the body, strengthens the bones, and gives virility. Food from bulbs promotes brilliance, and bodily vigour, and strengthens the life current. Food from fruits nourishes mind, intelligence, blood, flesh, and vital liquids. Therefore these alternatives are recommended for pilots of Vimanas.

### **Maharshi Bharadwaaja :**

☞ “Apicha Trinaadeenam.” Sootra 12.

“Even grasses, herbs and shrubs.”

### **Bodhaananda Vritti :**

This sootra indicates that even grasses, herbage, and creepers, could be made to yield food.

Says “Ashana-Kalpa”,

Like roots, bulbs and fruits, grasses, shrubs and herbs, provide good food for men. Six kinds of doorva grass, 6 kinds of munja hemp, 6 kinds of darbha or long grass, 6 kinds of shoundeera, and 6 kinds of Ashwakarna or sal, or mimordica charantia, Shatamoolee of 3 kinds, Kaaruvellie, Chandravellee, Madhuvellie, Varchulee, Makutee vellee, sugandhaa, and sooryavellee may be made to yield good food, nutritious and bracing.

Selected by men who know them well, these vegetation, including their flowers, shoots, and leaves, by proper cleaning and cooking, may be made to yield solid or liquid food, which will serve as satisfactory substitute food for pilots of Vimanas. And Somavallee or moon-plant, Chakrikaa, Rasavallikaa, Kooshmandavallee, Ikshuvallee, Pishtavallaree, Sooryakaanta, Chandrakaanta, Meghanaada, Punarnava, Avantee, Vaastu, Matsyaakshee, and Rukma and others, provide good bases for lasting food, duly mixed with sweets and condiments.

## Lohaadhikaranam : Metals

**Maharshi Bharadwaaja :**

“Athha Yaana Lohaani.”      Sootra 13.

“Next, the Metals for aeroplanes”

**Bodhaananda Vritti :**

Having dealt with clothing and food for pilots, now the metals suitable for aeroplanes are being dealt with.

**Says Shounaka :**

There are 3 kinds of metals named somaka, soundaalika, and mourthwika. By mixing them, 16 kinds of heat-absorbing metals are produced.

Their names are ushnambhara, ushnapaa, usnahana, raajaamlatrit, veeraha, panchaghna, agnitrit, bhaarahana, sheetahana, garalaghna, amlahana, vishambhara, vishalyakrit, vijamitra and Vaatamitra etc.

“Maanibhadra Kaarika,” or “Dictas of Manibhadra,” Says, “Metals which are light, and are suitable for producing aeroplanes are 16. They are heat absorbing, and should be used in the manufacture of aeroplanes.”

Saamba also says that the 16 metals formed by mixing the root metals, soma, soundaala and mourthwika, are non-heat-conductors and are useful for Vimanas. Their characteristics are now examined.

In the 7th layer of the earth, in the third mine therein, metals of the Soma series are found. They are of 38 kinds. Among them there are three from which Ooshmalohas or heat resisting metals are to be extracted. “Lohatantra” or “Science of Metals” also says that in the 3rd section of the 7th layer of the earth, Metals of Souma class, possessed of 5 special qualities, are called “beejalohas” or “root-metals”.

There are 3000 metal bearing layers within the earth. Of them 1300 layers contain the better quality. In the 7th layer metals are of 27 types. The 3rd type of metals are of five-fold qualities, and are known as root metals. The origin of metals of the Soma class is thus described in “Lohakalpa.” :

“The gravity of the centre of the earth, the gravity of global earth, the solar flood, the air force, the force emanating from the planets and stars, the sun’s and moon’s gravitational forces, and the gravitational force of the Universe, all together enter the layers of the earth in the proportion of 3, 8, 11, 5, 2, 6, 4, 9, and, aided by the heat and moisture therein, cause the origin of metals, of various varieties, grades and qualities.”

The Souma group of metals are named, as per sage Atri, in “Naamaartha Kalpa”. “Souma, Sowmyaka, Soundaasya, Soma, Panchaanana, Praanana, Shankha, Kapila are the names of the Souma metals, with distinct qualities indicated by their names.”

The name “Souma” consists of sounds, s, ou, ma, and ha. “Paribhaasha Chandrika” and “Vishwambhara Kaarika” state, “The oceanic force and solar force instil 4 kinds of forces into root metals. The sum total of the forces are said, according to “Vaalmeeki Ganitha” to number 1, 67, 768. Some of these forces are indicated by the sound “s”. Some of the forces emanating from the sun and the elements are indicated by the sound “ou”. Similarly other concerned forces are indicated by the letters “ma” and “ha”.

The Varuna and Soorya force contents of all root metals are of four groups. In each group the force content is said to be 1, 67, 768. Of the Koorma and Kashyapa forces of Vaaruna group, the 67th from Ooshaa koorma, and the 85th Kaashyapa force, called “Kaala”, are indicated by the letter “Sa”.

Of the solar group of forces, maartaanda and bhoota 71st, and the ruchika force 160 are indicated by the sound “ra”. Similarly, of the forces of sun and stars in aditi, the 9th called “Sundaa”, and the stellar force 101 called “Bhowma” are indicated by the letter “Ma”. And in the dhruva varga, soma and baadaba forces, 109 and 14 respectively, are indicated by the visarga sound “ha”.

The four forces working inside the earth, by flux of time mature into the Souma type metal.

In Soundaala metal, the 11th force, dhanadaa, in Koorma is indicated by letter “sa”. The 110th Kaashyapee force, rook, is indicated by the sound

“ow”. The sun’s 100 powered dravamukhee shakti, and bhoota-shakti known as anvee 700 powered, are together indicated by the anuswaara sound “m”. The sun’s kaantaa shakti 49, and the stars’ 25 shaktis, varchaa, are indicated by the letter “da”. Similarly the soma forces in dhruva varga, is indicated by the long “aa” in “daa”. The moon’s 364 ujwala and baadabaa’s 500 known as kaala are indicated by the letter “la”.

That is “Soundaala”.

Regarding the third, “Mourtwika”, Koormashakti, paarthiva 1300, is indicated by the letter “ma”. Kaasyapa shakti, kaalima 2001, is indicated by the sound “ow”. Maartaanda shakti, laaghava 260, is indicated by the sound “r” : bhootashakti, vaarchulee 37, by the letter “tha” : stellar force, rukshmaka 1063, is indicated by the letter “va”. Arkashakti, varuna 113, is indicated by the sound “e” : soma force rijukaa 8009, and pooshnikaa 1012, are indicated by the letter, “ka”.

### Lohashuddhyadhikaranam : Purification of Metals.

#### Maharshi Bharadwaaja :

☞ “Tatchhuddhir yathaa shodhanaadhikaaray.” Sootra 14.

“Their purification is as per shodhanaadhikara”.

#### Bodhaananda Vritti :

Taking soma metal first, it should be filled in a wide-brimmed vessel and adding jамbeera or citron juice, likucha or lime juice, vyaaghra or castor, chinchaa or tamarind, and jamboo or rose apple juices, it should be boiled to 27th degree of heat for a day. Then taking it out and washing it, it should be boiled in 5 kinds of oils, 4 kinds of acids, and 7 kinds of decoctions.

They are named in “Samskaara Darpana” :

Gunjaa or wild liquorice, Kanjala, castor, kunjara, and karanja or Indian beach oils, praana-kshara, viranchi, kanchuki, and khura acids, and hingoo or asafoetida, parpata, ghontikaaa, jataa-maamsee or spikenard, white gourd or Vidaaraanginee, and matsyaakshee decoctions.

That is the process of purification of soma metal.

The purification of soundaala metal is like that of soma with regard to boiling in the cauldron, but the process of purification is with 6 acids, 7 oils, and 5 decoctions. They are, according to Samskaara Darpana.”—

Ingaala or, ingudee, gouree or reddish herb, couries, grapes, rata, aapya, and ulbana oils, ankola, mshti, shankha, bhallaataka, kaakola, and virancha acids, and kuluththa or horsegram, nishpaava, sarshapa or mustard, aadhaka, and wheat decoctions or gruels.

Mourthweeka metal also should be baked like soundaala, and then should be boiled with shivaari oil, kudupa acid and vishambharee leather decoction.

Having defined the root-metals and their purification, we next consider the casting of Ooshmapaa loha.



## SECOND CHAPTER

**Maharshi Bharadwaaja :**

☞ “Ooshmapaastriloha Mayaaha.” Sootra 1.

“Ooshmapaa metals are made up of 3 metals.”

**Bodhaananda Vritti :**

The heat-proof metals are made out of the three, Souma, Soundaala, and Morthweeka mentioned in the previous chapter. It is said in “Loha Ratnaakara” that each of the three yields varieties of seed metals. Their names are, in souma group,—souma, soumyaka, sundaasya, soma, panchaanana, ooshmapa, shaktigarbha, jaangalika, praanana, shankha, and laaghava; The names of the metals of soundeera origin, are viranchi, souryapa, shanku, ushna, soorana, shinjikka, kanku, ranjika, soundeera, mugdha, and ghundaaraka. In the mourthweeka group, the 11 are anuka, dvyanuka, kanka, tryanuka, shvetaambara, mridambara, baalagarbha, kuvarcha, kantaka, kshvinka and laghvika.



**Maharshi Bharadwaaja :**



“Melanaath”

Sootra 2.

“By Mixing”

**Bodhaananda Vritti :**

The said metals are to be mixed in requisite proportions and melted. It is said in “ Lohatantra ” that ushnambhara metal is produced by mixing numbers 10, 5, 8 of soma, soundala, mourthweeka groups of metals respectively in the proportion of 1, 3, 7, and mixing with one third the quantity of tankana or borax and melting in the crucible. Similarly taking metals no, 3, 5, and 7 respectively in the three groups in the proportion of 4, 1, and 8, and mixing with tankana, and melting in crucible, the metal ooshma is obtained. Metal ooshmahana is produced by melting metals 2, 5, and 9 from the three groups in the proportion of 6, 3, and 7, with tankana. Metal Raaja is produced by melting nos. 3, 8, and 2 of the three groups as before. Similarly metal Aamlatrit is produced by taking numbers 9, 7, 1 in the three metal groups, in the proportion of 10, 7, 8 and mixing with tankana and melting as prescribed.

Similarly metals 6, 4, 5, respectively in the proportion of 5, 5, 12, melted with tankana or borax, will yield the metal veerahaa. The metal panchaghna is got by taking numbers 8, 6, and 4 of the three groups in the proportion of 20, 18, 26, and mixing with tankana or borax and melting.

The metal agnitrit is produced by mixing numbers 5, 2, 10, in the proportion of 30, 20, and 10, and melting with borax in the crucible. The metal bhaarahana is produced by mixing numbers 7, 11, and 6 in the three groups in the proportion of 5, 12, and 7, mixing with borax, and melting in the crucible.

To produce metal sheetahana, metals 10, 9, and 3 in the three groups respectively, in the proportion of 22, 8, and 10, should be mixed with borax and melted in the crucible. Garalaghna is produced by taking numbers 11, 10, and 11 in the three groups in the proportion of 20, 30, and 8, and melting with borax in the crucible.

Similarly Aamlahana is produced by taking numbers 11, 8, and 4 in the three groups in the proportion of 20, 12, 36, and melting with borax in the crucible. Metal Vishambhara is produced by taking numbers 19, 8, and 10 in

the three Ooshmapa groups respectively in the proportion of 20, 12, and 6, and melting with borax in the crucible.

Metal vishalyakrit is produced by taking numbers 3, 5, and 11, in the proportion of 20, 12, and 6, and melting in the crucible with borax. Dwijamitra is produced by taking numbers 8, 3, and 9 in the proportion 5, 8, 10, and melting with borax in the crucible. And metal Vaatamitra is produced by taking numbers 8, 6, and 5 in the three groups of Ooshmapa metals, in the proportion of 22, 8, and 10, and adding borax and melting in the crucible.

### Mooshaadhikaranam : The Crucible.

**Maharshi Bharadwaaja :**

☞ “ Panchamaad dwitheeyay ” Sootra 3.

“From the 5th variety in the 2nd group.”

Bodhaananda Vritti :

According to “ Nirnayaadhikaara ”, the melting of the superior, medium, and inferior kinds of metals is to be done in 407 different kinds of crucibles. They are divided into 12 groups. For the melting of the root-metals the second group of crucibles is considered the best.

Lallacharya also states that metallurgists mention 12 kinds of metals : kritaka or artificial, apabhramshaka or corrupted, sthalaja or mud-born, khanija or found in mines, jalaja or aquatic, dhaatuja or mineral-born, oshadhivargaja or vegetation-born, krimija or evolved from vermin, maamsaja or flesh-born, kshaaraja or grown from salts, baalaja or hairborn, and andaja or resultant from eggs. Different classes of crucibles are to be used for melting different kinds of metals. In the second class of crucibles there are said to be 40 varieties. Of them, number 5, known as antarmukha or inward-mouthed, is prescribed for melting the root-metals.

It is described in “ Mooshaakalpa ” or art of making crucibles. 8 parts of gingelly manure or black-gram flour, 4 parts of metal rust, 3 parts of metal, 3 parts of laangalee or jussieuca repens or gloriosa superba, 6 parts of gum arabic, 2 parts of ruruka, 3 parts of salt-petre, 5 parts of creepers, 6 parts of charcoal, 5 parts of 5 kinds of grasses, 4 parts of paddy husk ashes, 2 parts of red arsenic, 2 parts of naagakesara, 5 parts of varolika

flower, 5 parts of borax, 2 parts of black laamancha or scented grass or andropogon muricatus, 5 parts of sindoorā or red ochre, 2 parts of gunja seeds or wild liquorice, 4 parts of sea-foam, all these are to be ground and made into fine flour, to which are added equal quantity of gum and 5 parts of earth and dust, and the whole is baked in a vessel with shivaaree oil for 3 yaamaas or 9 hours. When the contents have unified and become properly fluid, it should be poured through the nozzle into the crucible mould, and allowed to rest. The resultant crucible, known as "antarmukha," would be best suited to melt the metals required for producing a Vimaana.

### **Athha Vyaasatikaadhikaranam : The Fire-place.**

**Maharshi Bharadwaaja :**

☞ "Athha Kundas-Saptamay-Nava". Sootra 4.

"Then fire-place, number 9 in class 7."

**Bodhaananda Vritti :**

Having dealt with crucible in the last sootra, we now consider the fire-place.

Experts mention 532 varieties of vyaasatikaas or fire-places. Of them Koorma-vyaasatika, or tortoise-shaped fire-place is best suited for melting the seed-metals for the Vimaana.

Kunda-kalpa or the art of furnace construction mentions 532 kinds of furnaces. They are divided into seven classes, each including 76 varieties. Furnace no. 9 in the 7th class, is best suited for melting the requisite metals of the vimaana, and its name is koorma-vyaasatika, or tortoise-shaped furnace.

It is said in "Kunda-nirnaya", that on a prepared ground, a quadrilateral or circular shaped furnace 10 feet wide should be constructed, shaped like a tortoise. In order to place the bellows, there should be constructed a pedestal shaped like a tortoise, and with five faces. In the middle of the furnace arrangements should be made for placing the crucible. On either side of the furnace there should be an enclosure for stocking charcoal. And on either side there should be a mechanism for receiving the molten metal.

### Athha Bhastrikaadhikaranam : The Bellows.

**Maharshi Bharadwaaja :**

☞ “Syaad-bhastrikaashtame Shodashee” Sootra 5.

“The bellows should be number 16 in the 8th class.”

Bodhaananda Vritti :

The making of bellows is referred to in this sootra. It is said in “Bhastrikaa Nibandhana,” that as there are 532 kinds of furnaces, there are 532 kinds of bellows. Narayana also says that there are 532 varieties of bellows used in melting metals. They are divided into 8 classes. In the eighth class, the variety numbered 16 is the one suited for the tortoise-shaped furnace. The construction of bellows is described in the work “ Bhastrikaa-Nibandhana ”, as follows :

The barks of suitable trees, leather, thick cloth made from milk cream, bark of areca-nut palm tree, and trinetra (bael ? Bengal Quince ?), shundeera, suranji, silk-cotton, sheneera, munjaakara, and jute by due processing yield suitable cloth of 605 varieties with which pretty and attractive bellows could be made, with fittings of wood or copper.



## THIRD CHAPTER

### Darpanaadhikaranam : Mirrors & Lenses.

**Maharshi Bharadwaaja :**

☞ “Darpanaashcha” Sootra 1.

“Mirrors”.

Bodhaananda Vritti :

This chapter deals with the mirrors and lenses which are required to be installed in the vimaana. They are seven different ones. Their names are

given by Lalla in “ Mukura-kalpa ” as Vishwakriyaadarpana, or television mirror, Shaktyaakarshana darpana or power-capturing mirror, Vyroopya darpana or appearance changing mirror, Kuntinee darpana, Pinjulaa darpana, Guhaagarbha darpana, and Rowdree darpana or terrifying darpana.

Vishwakriyaa darpana is to be fixed on a revolving stand near the pilot so that he could observe whatever is happening outside on all sides. Its manufacture is thus described in Kriyaasaara :

Two parts of satva, 2 parts of shundilaka, one part of eagle bone, 5 parts of mercury, 2 parts of the foot-nails of sinchoranee, 6 parts of mica, 5 parts of red lead, 8 parts of pearl dust, 18 parts of the eyeballs of sowmyaka fish, one part burning coal, 8 parts of snake's slough, 3 parts of eye pigment, 6 parts of maatrunna, 10 parts of granite sand, 8 parts of salts, 4 of lead, 2 parts of sea foam, 3 parts of white throated eagle's skin, 7 parts of bamboo salt, 5 parts of vyraajya or white keg tree bark, these ingredients should be purified, and weighed, and filled in a beaked crucible and placed in the furnace called chandodara and subjected to a 800 degree heat, and when duly liquified, should be poured into the funnel of the kara-darpana yantra or hand-mirror mould. The result will be an excellent mirror in which will be reproduced minute details of the phenomena outside.

Next Shaktyaakarshana darpana :

As the vimaana flies through the regions of the sky, three classes of destructive forces tend to overcome it. This mirror is capable of neutralising and overcoming their effects.

Dhundinaathaachaarya also says : The wind, solar rays, and fire are known as trivargas. Each of the three has 122 evil effects on the plane's pilot. Those evil forces this mirror will absorb and nullify.

Paraankusha also says : There are certain crucial regions in the air routes of the vimaana, at which the wind, solar heat and fire have 366 malefic influences, and shaktyaakarshana mirror is meant to safeguard against them. It is to be prepared as follows :

5 parts of haritaala or yellow orpiment, 5 parts of virinchi, 8 parts of salts, 4 parts of gingelly husk, 6 parts of diamond, 1 of red mica, 8 parts of burning coal, 3 parts of sand, 2 parts of tortoise egg, 3 parts of bhaarani, 3 parts of kanda, 5 parts of powshkala, 5 of coral, 2 of pearl, 6 of sea-shell,

8 of borax, 3 parts of Bengal quince seed, and 5 of shankha or conch, cleaned, powdered, filled in swan crucible, placed in mandooka furnace and boiled to 500 degrees and poured slowly into vistritaa-mirror yantra will yield a fine shaktyaakarshana mirror.

#### The Vyroopya-darpana Mirror :

When enemy planes with men intent on intercepting and destroying your vimaana attack you with all the means at their disposal, the viroopya-darpana will frighten them into retreat or render them unconscious and leave you free to destroy or rout them. The darpana, like a magician, will change the appearance of your vimaana into such frightening shapes that the attacker will be dismayed or paralysed. There are 27 such different shapes that are said to be possible. Sammohana-kriyaa-kaanda, or the work dealing with the methods causing insensibility, mentions 17 of them. They are fire, water, wind, thunder, lightning, fumes, scorpion, bear, lion, tiger, and giant-sized frightful birds.

The manufacture of this mirror is thus given in Darpana-prakarana :

5 parts of bone salt, 3 parts zinc, 3 of lac, 8 of iron, 3 parts of shashabola, 2 of raajakurantika, 8 parts of charcoal ashes, 3 of borax, 8 parts of nakhaa, 7 of sand, 6 of matrunna, 2 of sun-crystal, 3 parts of poora or lime, 25 of mercury, 3 of yellow orpiment, 4 parts of silver, 6 of kravyaada, 8 of garada, 3 of pishta, 4 parts of arshoghna root, 3 parts of vaaraaha pittha, 3 of ammonium chloride, 25 of liquorice oil, taking these and 7 times purifying, filling in crucible, and placing in furnace and boiling it to 800 degrees and pouring into Darpanaasya yantra, will yield an excellent Vyraajaka mirror.

#### The Kuntinee Mirror :

We now consider the Kuntinee mirror. The wise say that the mirror by the glare of whose rays people's minds get deranged is Kuntinee mirror. Paraankusha says that in the region of the solar electric heat waves of the sky, seven streams of poisonous whirl-winds derange the mind. Scientists have discovered the Kuntinee mirror as a protection against that evil effect.

In "Sammohana-kriyaa-kaanda," the evil forces are described as follows :

Fat, blood, flesh, marrow, bone, skin, intelligence are adversely affected by the evil wind currents known as gaalinee, kuntinee, kaalee, pinjulaa, ulbanaa, maraa, in the electric heat wave regions of the upper sky.

The manufacture of this mirror is thus explained in "Darpana-prakarana":

5 parts of sowraashtra earth, 7 parts of snake's slough, 3 of sea-foam, 5 of shanmukha seeds, 8 of zinc, 3 parts of rhinoceros' nails, 8 of salts, 7 of sand, 8 of mercury, 4 of conch, 6 parts of matrunna, 3 parts of yellow orpiment, 4 of elephant and camel salts, 7 parts of suranghrikaa, 5 of gingelly oil, 8 of pearl-shells, 3 of sea-shells, 4 parts of camphor, purified and filled in shinjikaa crucible, and placed in shinjeeera furnace and boiled to 700 degrees, the fluid poured into the Darpanaasya yantra, will form into a morning sun-like kuntinee mirror.

The Pinjulaa mirror :

The conflicting inter-action of the solar rays is called pinjulaa. It has deleterious effect on the black eye-balls of the pilots. The pinjulaa mirror, by intervening will prevent the eye-balls being blinded by the evil rays.

It is said in "Amsubodhinee", or the work on solar rays, "There are four directions, east, west, north and south, and four corner directions, south-east, south-west, north-east and north-west. The solar force of each direction has got its own intensity, owing to different fire-force, different seasonal force, the effect of the five winds, combined with the vaarunee or liquid force of the clouds, and the resulting tension gives rise to four evil forces, andha, andhakaara, pinjoosha, and taarapaa, whose glows, known as rakta, jaathara, taaraagra, and prabha, striking the eye-balls result in blindness of both eyes."

The manufacture of this mirror is thus described in "Darpana prakarana":

6 parts of goat's milk, 5 parts of red-lead, 8 parts of salts, 7 parts of sand, 5 parts of tree-gum, 8 parts of borax, 2 parts of dambholi essence, 8 parts of mercury, 2 parts of copper and 2 of lead, 4 parts of surolika essence, 8 parts of twak, 3 parts of vaardhyushika, 3 of kanda, 4 parts of pishta or gingelly husk, 3 parts of orpiment, 7 parts of Tinneveli senna, 4 parts of vrikodaree seeds, these 18 to be purified, powdered, and filled in crucible, and placed in furnace and boiled to 700 degrees, and poured into Darpana yantra, will yield an excellent pinjulaa mirror.

### Next Guhaa-garbha darpana :

“The conflict between the electricity in the clouds, wind, and rays, generates forces harmful to pilots. The guhaa-garbha darpana, by attracting them and projecting them by electric force against enemy planes, renders the persons inside them physically disabled and incapable of fighting.”

“Prapanchasaara” also says :

“In the Middle of the two shells above kashyapa, there is vaarunee force. Between the shell and vaarunee force 5000 wind currents subsist. Similarly there are disease causing rays numbering 80 millions. The various winds and rays by mutual action result in flows and counter flows. When the cloud force, wind force, and solar force interplay they give rise to various harmful forces like bubbles.”

Lallaacharya also avers, “In accordance with the 110 th principle, when the cloud-power, wind-power and sun-power meet with force and collide, they produce poisonous effects which are dangerous to mankind.”

Vasishtha says in “Swatassiddha-Nyaaya” or “self-evident truth”, that when alien forces cross one another, a poisonous flow will result naturally as an egg comes out of a tortoise.

“Sammohana kriyaa-kaanda” explains :

“By the conflict of cloud force, wind force and solar forces, 305105 poisonous waves known as guha and others emanate, and cause, kushtha, apasmaara, grihinee, khaasa, and shoola. Chief among them are five, known as gridhnee, godhaa, kunjaa, roudree, and guhaa. By accelerating them and directing them against the enemy, the guhaa-garbha mirror disables them.”

“ Darpana prakarana ” describes its manufacture thus :

7 parts of couries, 3 parts of manjula or madder root, 6 parts of sea-foam, 8 parts of ranjaka or phosphorous, 6 parts of mandoora or rust, 8 parts of mercury, 3 parts of orpiment, 7 parts of brahmika, 2 parts of lead, 8 parts of eye pigment, 6 parts of matrunna, 8 parts of sand, 6 parts of kishora, 5 of muchukunda, 2 parts of gingelly oil, 25 of lohika, 5 parts of mridaani garbha essence, 8 of sowraashtra earth, 5 parts of sphatika, 3 of bones, 15 of indusatva or moonstone ?, and 5 of dambholi taakaa dwaya satva,



taking these 22, purifying and powdering them and filling crucible, and placing in furnace and boiling to 700 degrees, and cooled in yantra, guhaa garbha darpana is produced.

Rowdree-darpana is a mirror or lens which liquefies everything that it flashes against.

Paraankusha says that where Rudraanyosharaa and abhralinga come into contact, a fierce force called roudree comes into being. Mingling with solar rays it melts everything. "Sammohana kriyaa kaanda" says :

"By the mixing of roudree and solar rays an evil force called maarikaa is generated, and impelled by the solar electricity, it destroys the enemy planes."

Darpanaa prakarana describes its manufacture :

8 parts of lead, 3 parts of shaalmali, 7 of durvaara, 8 parts kudupinjara, 21 parts of droonee, 8 parts sun-crystal, 27 parts of rudraanee-graavoshara, 6 parts betel leaves, 8 parts of kowtila, 30 of veeraabhra linga, 8 parts of salts, 7 of sand, 6 parts of matrunna, 3 of dimbhika, 8 of zinc, 13 of ant-hill earth, 6 of gum, 3 of kumbhinee, 3 parts sweet oil, 27 of Tinnevelly senna, 6 of godhaamla, 8 of silk cotton, 8 parts of virinchi satva, 5 parts of kanda, 3 parts of yellow orpimet, 7 parts of kaarmukha, or brown barked acacia ?, these 26, powdered, purified, and filled in crucible and placed in furnace and boiled to 800 degrees, and poured into Darpana yantra, will yield a fine roudrikaa-darpana.



## FOURTH CHAPTER

### Shaktyadhikaranam : The Power.

**Maharshi Bharadwaaja :**

☞ “Shaktayassapta” Sootra 1.

“The power sources are seven.”

**Bodhaananda Vritti :**

In this chapter the motive power of the vimaana is explained. In the functioning of the vimaana, there are 7 distinct operating forces. They are named udgamaa, panjaraa, sooryashaktyapa-karshinee or that which extracts solar power, parashaktyaakarshinee or that which extracts opposite forces, a set of 12 shaktis or forces, kuntinee, and moolashakti or primary force. At set spots in the vimaana, the motors which produce these 7 powers should be installed, duly wired and equipped with springs and wheels, as prescribed.

It is said in “Yantra-sarvasva :”

“The seven kinds of powers which are required for the Vimaana are produced by 7 motors which are named tundila, panjara, amshupa, apakarshaka, saandhaanika, daarpanika, and shaktiprasavaka. Each of these produces its specific power. Thus tundilaa produces udgamaa shakti, panjaraa produces the panjaraa shakti, shaktipaa produces the power which sucks solar power, apakarshaka produces the power which plucks the power of alien planes, sandhaana yantra produces the group of 12 forces, daarpanikaa produces kuntinee shakti, and shakti-prasava yantra produces the main motive power.

Shownaka-sootra also says :

“There are seven sources of power of the vimaana : fire, earth, air, sun, moon, water and sky. The seven kinds of powers are named udgamaa, panjaraa, solar heat absorber, alien force absorber, solar electric dozen, kuntinee, and primary force.”

“Soudaaminee-kalaa” says :

Ma, la, ya, ra, sa, va, na constitute the seven vimanic forces. Ma is udgamaa, la is panjaraa, ya is solar heat absorber, ra is the solar dozen, sa is alien force absorber, va is kuntinee, and na is primary force.

Their actions are thus defined in “Kriyaa-saara” :

“The ascent of the vimana is by udgamaa shakti. Its descent is by panjaraa-shakti. Solar heat absorbing is by shaktyapakarshinee. Alien force restraining is by parashakty snatcher. Spectacular motion of the vimaana is by the vidyud-dwaadashaka-shakti. All these various activities are by the prime force of the vimana.”

Vidyuddwaadashaka is thus explained in “Soudaaminee-kalaa” :

“The spectacular motions of the vimaana are of 12 kinds. Their motive forces are also 12. The motions and the forces are, proceeding, shuddering, mounting, descending, circling, speeding, circumambulating, side-wise motion, receding, anti-clockwise motion, remaining motionless, and performing miscellaneous motions.”

**Maharshi Bharadwaaja :**

☞ “Shaktayah-pancha-iti-Narayanaha.” Sootra 2.

“Narayana holds that the forces are five only, and not twelve.”

**Bodhaananda Vritti :**

Five forces are generated by the yantra or dynamo called Sadyojaata, and they produce all the spectacular motions of the vimana.

Says “Shakti sarvasva” :

“The motions of a vimaana are five, Chaalana, Gaalana, Panjaraprerana, Vakraapasarpna, and Spectacular manoeuvring.”

**Maharshi Bharadwaaja :**

☞ “Chitrinyeveti sphotaayanah.” Sootra 3.

Sphotaayana holds that chitrinee is the sole shakti.

**Bodhaananda Vritti :**

Sphotaayana declares that the force called chitrinee shakti is the one which enables the vimana to perform spectacular manoeuvres.

“Shakti-sarvasva” says that both from experience and scientific knowledge Sphotaayana propounds the view that 32 various kinds of motions of the vimaana are solely by the power of Chitrinee-shakti.

“Kriyaa-saara” also states that Chitrinee force of the 17th quality is solely responsible for the 32 types of aeronautical motions.

**Maharshi Bharadwaaja :**

☞ “Tadantarbhavaavat Saptaveti” Sootra 4.

“The shaktis are 7 only, and include all others”

**Bodhaananda Vritti :**

Out of the five forces produced by the sadyojaata mechanism, panjaraa shakti is the most important. The other shaktis are incidental to it, just as sparks are incidental to fire. Chaalana and other motions may therefore be said to result from panjaraa shakti.

Says “Shaktibeeja” : “It is by the panjaraa shakti generated by sadyojaata yantra that the chalana and other shaktis branch out.”

“Shakti kousthubha” also says, “From the panjaraa shakti produced by sadyojaata, emanate the chalana and other 4 shaktis.”

Thus since the other shaktis branch out from panjaraa shakti, they may be said to be in essence identical with it. That panjaraa and chitrinee are included in the seven shaktis which have been enumerated by Maharshi Bharadwaaja. Hence there cannot be said to be any conflict of opinions. Some even hold the view that each one of the seven shaktis is capable of producing all the 32 motions of the vimaana. But since each of the several motions of the plane is definitely ascribed to a particular kind of force, it would be incorrect to hold that one force could be responsible for the whole gamut of motions. Any attempt to give practical effect to such a theory would prove disastrous. Therefore the right conclusion is that the seven forces are the true cause of the 32 kinds of aerial activities of the vimaana.

## F I F T H   C H A P T E R

**Yantraadhikaranam : Yantras : Machinery.**

**Maharshi Bharadwaaja :**

☞      “Athha Upyantraani.”      Sootra 1.

“The Mechanical Contrivances.”

Bodhaananda Vritti :

Having described the forces or energies required for the various functions of the vimaana, now the mechanisms necessary for these activities are described.

“Kriyaa-saara” says :

“As stated by the eminent Bharadwaaja in “Yantrasarvasva”, the mechanical equipments necessary for the vimaana are 32. They are vishwakriyaadarsa or universal reflecting mirror, shaktyaakarshana yantra or force absorbing machine, pariveshakriyaayantra or halo-producing machine, angopasamhara yantra or machine for folding up or contracting its parts, vistrutakriyaa yantra, or expanding yantra, vyroopyadarpana or fantastic mirror, padmachakra-mukha, kuntinee shakti yantra and pushpinee shakti yantra, pinjula mirror, naalapanchaka and guhaa-garbhahidha yantras, tamo-yantra or darkness spreading machine, pancha vaataskandhanaala, roudree mirror, vaataskandha naalakeelaka, vidyudyanttra or electric generator, and shabdakendra mukha, vidyuddwaadashaka, praanakundalinee, shaktyudgama, vakraprasaarana, and shaktipanjara keelaka, shirah-keelaka and shabdaakarshana, pataprasaaranayantra, dishaampati yantra, pattikaabhraka yantra, suryashaktyapakarshana yantra or collector of solar energy, apasmaaradhooma prasaarana or ejector of poisonous fumes, stambhana yantra, and vyshwaanara naalayantra.”

They are thus described in “yantrasarvasva,” chapter 7, by the illustrious Maharshi Bharadwaaja.

**Maharshi Bharadwaaja :**



“Athopayantraani.”

Sootra 1.

“Subsidiary Yantras.”

**Bodhaananda Vritti :**

Prepare a square or circular base of 9 inches width with wood and glass, mark its centre, and from about an inch and half thereof draw lines to the edge in the 8 directions, fix 2 hinges in each of the lines in order to open and shut. In the centre erect a 6 inch pivot and four tubes, made of vishvodara metal, equipped with hinges and bands of iron, copper, brass or lead, and attach to the pegs in the lines in the several directions. The whole is to be covered.

Prepare a mirror of perfect finish and fix it to the danda or pivot. At the base of the pivot an electric yantra should be fixed. Crystal or glass beads should be fixed at the base, middle, and end of the pivot or by its side. The circular or goblet shaped mirror for attracting solar rays should be fixed at the foot of the pivot. To the west of it the image-reflector should be placed. Its operation is as follows :

First the pivot or pole should be stretched by moving the keelee or switch. The observation mirror should be fixed at its base. A vessel with mercury should be fixed at its bottom. In it a crystal bead with hole should be placed. Through the hole in the chemically purified bead, sensitive wires should be passed and attached to the end beads in various directions. At the middle of the pole, mustard cleaned solar mirror should be fixed. At the foot of the pole a vessel should be placed with liquid ruchaka salt. A crystal should be fixed in it with hinge and wiring. In the bottom centre should be placed a goblet-like circular mirror for attracting solar rays. To the west of it a reflecting mechanism should be placed. To the east of the liquid salt vessel, the electric generator should be placed and the wiring of the crystal attached to it. The current from both the yantras should be passed to the crystal in the liquid ruchaka salt vessel. Eight parts of sun-power in the solar reflector and 12 parts of electric power should be passed through the crystal into the mercury and on to the universal reflecting mirror. And then that mirror should be focussed in the direction of the region which has to be photographed. The image which appears in the facing lens will then be reflected

through the crystal in the liquid salt solution. The picture which will appear in the mirror will be true to life, and enable the pilot to realise the conditions of the concerned region, and he can take appropriate action to ward off danger and inflict damage on the enemy.

Next Shaktyaakarshana yantra :

“Yantra sarvasva” says, “Owing to the etherial waves and raging winds of the upper regions in accordance with the seasons, evil forces are generated which tend to destroy the vimaana. The Shaktyaakarshana yantra in the vimaana is meant to subdue those forces and render them harmless.”

Narayana also says :

“Three fierce forces arise from the fierce winds and ethereal waves, and cause destruction of the plane. The shaktyaakarshana yantra by its superior force subdues them and ensures safety of the vimaana.”

Its construction is as follows :

The base is to be 3 feet long and 2 feet wide, and made of krouncha metal. A 12 inch tall 3 inch wide pole or peg made of 27th kind of glass should be fixed in its middle. To the east of it, as also to the west, 3 centres should be marked on each side. To the north and south also 2 centres should be marked on each side. At each centre screw-bolts should be fixed. Then tubes made of the 107th glass, with cleaned wiring should be fixed. A goblet shaped 15 inch sized glass vessel should be fixed on the base of the central peg. A 1 foot circular glass ball with three holes should be fixed in the main centre. A triangular shaped 1 foot sized mirror made of Aadarsha glass should be fixed on the 3rd kendra. Two circular rods made of magnetic metal and copper should be fixed on the glass ball so as to cause friction when they revolve. To the west of it a globular ball made of vaatapaa glass with a wide open mouth should be fixed. Then a vessel made of shaktipaa glass, narrow at bottom, round in the middle, with narrow neck, and open mouth with 5 beaks should be fixed on the middle bolt. Similarly on the end bolt should be placed a vessel with sulphuric acid ( bhraajaswad-draavaka ). On the pegs on southern side 3 interlocked wheels should be fixed. On the north side liquefied mixture of load-stone, mercury, mica, and serpent-slough should be placed. And crystals should be placed at the requisite centres.

“ Maniratnaakara ” says that the shaktyaakarshana yantra should be equipped with 6 crystals known as Bhaarakdwaja, Sanjanika, Sourrya, Pingalaka, Shaktipanjara, and Pancha jyotirgarbha.

The same work mentions where the crystals are to be located. The sourrya mani is to be placed in the vessel at the foot of the central pole. Sanjanika mani should be fixed at the middle of the triangular wall. Pingalaka mani is to be fixed in the wide mouthed glass globe. Bhaarakdwaja mani should be fixed in the opening in the naala-danda. Pancha-jyotirgarbha mani should be fixed in the sulphuric acid vessel, and Shakti-panjaraka mani should be placed in the mixture of magnet, mercury, mica, and serpent-slough. All the five crystals should be equipped with wires passing through glass tubes.

Wires should be passed from the centre in all directions. Then the triple wheels should be set in revolving motion, which will cause the two glass balls inside the glass case, to turn with increasing speed rubbing each other, the resulting friction generating a 100 degree power. That power should be conveyed through wires to the sanjanika mani. Mingling with the force existing therein, that force issues out and should be transmitted through wires to the sourrya mani. On contact of the power therein the force will split into 5 streams. Each of the five power streams should be connected with one of the manis, Bhaarakdwaja, Sourrya, Pingala, Pancha-jyotirmani, and Shakti-panjara mani. Mingling with the force in each mani, they form five forces, which are named by Atri maharshi as Raja, Mourtiva, Chundeera, Shoonya, and Garbha-vishodara. These should be passed by wires to the sulphuric acid vessel. They then form 3 forces, named marthanda, rowhinee, and bhadra. Marthanda shakti should be passed into the load-stone, mercury, mica, and serpent slough liquids. The resulting current should then be passed through wires to the wide mouthed glass globular vessel. Solar force pregnant with etherial force should be passed into the Naaladanda, and thence to the vessel with marthanda shakti. The power of the solar rays entering that vessel mingles with the marthanda shakti inside, and the resultant force has to be focussed towards the adverse force of the etherial current which will be thereby nullified and the vimaana will be protected.

Then the Rohinee shakti should be passed through wires into the vessel containing the fivefold loadstone, mercury, mica, serpent slough acid,



and the resulting current passed to the Bhrajasvaddraavaka or luminous acid vessel at the foot of the central pole. Then from the air-route collect the wind-force impregnated solar rays and pass them also into the above vessel. Mingling with the rowhinee shakti therein a super-force will be created which should be passed through the northern pivot, into the rowhinee power vessel. The united force should then be directed against the malefic wind force in the air-route, so that it will tame the evil force and protect the Vimaana.

Then from the suragha tube Bhadraa shakti should be passed into five fold acid vessel. The resulting force should be passed through wired tubes to the foot of the triangular wall, and thence to the pivot on the southern side. The force should then be directed against the evil roudree force in the air-route. Neutralising that third destructive force in the sky, the vimaana will be allowed smooth passage in the sky.

The Parivesha-kriya yantra :

According to Yantra-sarvasva, by manipulating the five forces a halo is formed around the vimaana, and by drawing the solar rays into contact with it, the rays will speed the aeroplane along the rekhaamaarga or safety line. This is achieved by the operation of the above said yantra.

Narayanacharya also says :

“The mechanism which will manipulate the five forces so as to create a halo round the plane, and attracting the solar rays and contacting them with the plane, make them draw the plane smoothly and speedily along the air route without swerving into danger, is called parivesha-kriyaa yantra or halo-forming mechanism.”

Soudaminee kalaa says, “The forces of ksha, ja, la, bha, and ha, when united attract solar rays.”

According to “Gopatha-kaarika,” the forces in shireesha or Indra or lightning, clouds, earth, stars; and sky, are indicated by the letters ksha, ja, la, bha, and ha. By combining these five forces a halo, like that around the solar orb, will be created, and it will have the power of attracting solar rays.

Kriyaa-saara says Shireesha has 2 parts, Clouds have 8 parts, Earth has 5, Stars have 7, and Aakaasha or Sky or Ether has 10. The Aakarshana

yantra should attract these forces and unify them. Then through the mirror above the vimaana attract solar rays, and apply them to the unified forces.

A halo will be created, and that halo, in combination with the solar rays, will draw the plane through a safe course like a bird held by a string. Its formation is thus explained in Yantra-sarvasva :

“ Athha Yantraangaani ”

We now deal with the parts of the yantra :

A foot-plate : 23 main centres to be marked on it, with lines connecting the centres. Similar number of revolving screws, wired tubes, pole with three wheels, eight liquids, eight crystals, eight liquid containers, mirror to attract the forces of shireesha, cloud, earth, stars, and aakaasha, five electric mechanism, five barks of trees, copper coated wires, five leathers, hollow screws, revolving screw with wire, vessels for storing the energies, vessel for mixing the energies, smoke-spreading yantra, air-fanning yantra, halo-creating tube made of milky-leather, solar ray attracting mirror tube, tube for collecting the solar rays reflected in the mirror at the top portion of the vimaana, crest-crystal, screw for connecting the solar rays to the vimaana. These are the 23 parts of halo producing yantra.

Its construction is now explained: A wooden base 23 feet square, made of black pippala or holy fig tree. 23 centres enclosed in a case made of 35th type of glass. 23 lines to the centres. Revolving keys to be fixed at the 23 centres. Wired glass tubes should connect one centre with another. A glass pole made of the 37th type of glass, 5 feet long, 1 foot thick in the middle, 18 inches thick at the neck, with a 10 feet wide top, should be fixed as the central pillar, with 3 revolving wheels. Eight acids should be placed in the eight directions from the north-east side. Their names are rubnaka, kraantaja, taarkshya, naaga, gowree, vishandhaya, khadyota and jwalana.

The rubnaka acid is to be placed in the north-east centre, kraantaja in the centre, naaga at the southern centre, gowree at the south-west corner, vishandhaya in the western centre, khadyota at the north-west centre, and jwalana at the northern centre in 8 glass vessels.

The names of the vessels are also given by Shaarikaanaatha: shila, abhra, paara, vyrinchika, vaaluka, asuragranthika, sphutika, and pancha-mrith,

The 8 vessels are made out of these 8 elements by process defined in "Darpana-prakarana."

The rubnaka acid should be filled in shila-darpana vessel ; kaarshnya-acid in abhrakaadarsha ; kraantaja acid in paaraadarsha vessel ; naagadraava in vyirinchi-aadarsha vessel ; khadyota acid in sphutikaadarsha ; gowree acid should be filled in vaalukaadarsha vessel ; vishandhaya acid should be filled in suragrathika vessel ; and jwalana acid in panchamrid vessel.

In the 8 acid filled vessels 8 crystals are to be inserted. As mentioned in " Maniprakarana " their names are dhoomaasya, ghanagarbha, shalyaaka, shaarika, tushaasya, somaka, shankha, and amshupa.

Having mentioned their names, we now explain their disposal. Dhoomaasya mani is to be placed in rubna acid vessel. Ghanagarbha mani should be placed in kraantaja acid vessel. Shalyaaka in kaarshni acid vessel. Shaarika in naaga acid vessel. Tushaasya is to be placed in gowree acid, Shankha in jwalana acid ; Somaka in vishandhaya acid; and Amshupa mani is to be placed in khadyota acid vessel.

In front of these manis, eight shaktyaakarshana, or energy-imbibing mirrors are to be fixed. Their names according to Bharadwaja are taaraasya, pavanaasya, dhoomaasya, vaarunaasya, jalagarbha, agnimitra, chhaayaasya, and bhanukantaka. Their location is as follows : Six inches in front of dhoomasya mani the taaraasya mirror with an iron rod with a switch attached to it should be fixed. Pavanaasya mirror should be fixed similarly in front of ghanagarbha mani. Dhoomaasya mirror should be fixed 6 inches in front of shalyaaka mani. Vaarunaasya mirror should be fixed in front of shaarikaa mani. Jalagarbha mirror should be fixed in front of somaka mani. Agnimitra mirror should be fixed in front of tushaasya mani. Chhayaasya mirror should be fixed in front of shankha mani. And Bhanukantaka mirror should be fixed in front of amshupaa mani.

Then in the western centre should be installed the electric generator with switch. Copper-coated wires covered with five kinds of skins, should be spread all-round, proceeding from the shakti-yantra or electric generator. The names of the five skins, according to " Kriyaa-saara," are rhinoceros, tortoise, dog, rat or hare, and crocodile.

According to "Twangnirnaya-adhikaara," or chapter on skins, for seats in vimaanas, and, for containing acids, and covering wires, five kinds of skins are mentioned by the learned ; skins of rhinoceros, tortoise, dog, rat or hare, and crocodile. These five are to be used for the purposes of covering, and seating. Wires covered with these skins are good conductors of electricity. The bhraamane keela, or central revolving pole should be fixed in the centre so that when it revolves all the other 'pivotal' centres also revolve. Eight energy storing vessels should be placed in the 9th, 8th, 10th, 12th, 13th, 15th, 16th and 11th centres. The sammelana vessel or coordinating vessel should be placed in the front of the 23rd centre. To the south of it at the 21st centre the wind blowing mechanism should be fixed.

The Vaata-prasaarana or wind-blowing yantra is thus described : In the central pivot there are to be 5 wheels which will turn with 100 linka revolutions by contact with electric wires : in the east and west two bellows on pivots : two air-containers with 3 mouths or openings : 6 wheels which prevent air-motion : two tubes with switches which will cause spreading : wheels with keys that will induce speed, or full speed, slow, very slow or stop, shaped like a tortoise, having two bharas or parts?, and having a wheel fixed at the top. That is a vaata-prasaarana yantra.

The dhooma—prasaarana yantra or smoke—spreading yantra is as follows : with three openings, 5 satchels inside, 8 wheels, three keelakas or switches, encircled by electric tube, provided with smoke—generating mani or crystal, and equipped with 5 acids, with two churning wheels with keys, with two smoke containers attached to the bellows tube, with smoke—spreading yantra, and it is to be fixed at the 20th centre.

The parivesha—kriyaa naala or halo—creating tube is thus explained. Out of 5 milks from 5 kinds of milk trees, 6 barks of trees, and 2 valkalas (hemp, jute), cloth is fashioned. And that cloth should be used in preparing the parivesha—kriya or halo—forming tube.

It is stated in "Ksheeree—pata kalpa" :

In the realm of milk-yielding trees, dugdha—pranaalee, patapaadapa, payodharee, panchavatee, and virinchi are the 5 most suitable for manufacture of milk—cloth useful for vimaanas.

“Patapradeepikaa” also says, “Among the milk-trees, the best for producing milk-cloth are the following five, payodharee, panchavatee, viranchi, patapaadapa and dugdhapranalika.

The six bark-trees are godaakanda, kurangaka-niryaasa, aandolikaa-viyatsaara, lavika, prishatka, and kshmaamala. In conjunction with the milk from milk-trees these barks produce cloth which is flawless, strong, and soft.

For the two valkalas, according to “Agatatva-nirnaya” out of 5000 kinds of valkalas from shaarikaa to panchamukhee, the two named simhikaa and panchaanga are said to be excellent for producing the milk-cloth required for vimaanasa.

The composition of the cloth is as follows :

Dugdhapranalika milk 8 parts, 10 parts of the milk juice of the patavriksha, 7 parts of payodaree or cocoanut milk, 18 parts of the milk of the 5 vata or ficus trees, and 12 parts of virancha tree.

The ambikaa-shatka composition is 10 parts of godaa-kanda, 17 parts of gum from kurangaka, 15 parts of aandolikaa viyatsaara, 12 parts lavika, 20 parts of prishatka, and 15 parts of kshmaamala.

The two jute cloth proportions are given in “Shana-nirnaya chandrikaa,” as 28 parts of simhikaa jute, and 18 parts of panchaanga-valkala jute.

These proportions of 5 ksheera or milk, 6 ambika or barks, and 2 valkalas or jutes, should be mixed together and unified, and boiled in paakaadhaana yantra and churned a number of times, and processing with acids 12 times, should be filled in pata-garbha kriya or cloth-making yantra, and milk-cloth of excellent quality obtained. The parivesha kriyaa-tube made out of this cloth will, by manipulation of the concerned switch, expel smoke from the vimaana, and by quick advancing and reverse revolutions of the wheel will spread the smoke all round so as to envelope the vimaana by means of the smoke-screen.

The Kiranaakarsha-Naala :

16 parts of the 305th variety of glass, 5 parts of kaancholikaabharana, 6 parts of nagakesara or merua ferrea,—aletris hyacinthoides, 4 parts of

couries, sunflower, and Indian spikenard, 8 parts of pure borax, iron dross, onion juice, cuscus grass powder, ruby glass, the three varieties of salt-petre, sand, essence of suranjikaa, viranchi flour, essence of black-mica, essence of bael fruit, and juice of flower buds, these twelve ingredients, in the proportion of 27, 5, 7, 3, 8, 7, 3, 11, 8, and 12, are to be filled in the frog-shaped crucible, and placed in the frog-shaped furnace, and melted with 300 degrees of heat with the help of two-winged bellows. The resulting liquid is to be poured into the darpana yantra or glass-making machine, so as to produce the kiranaakarshana or rays-attracting yantra.

The tube made of this glass should be fixed at the top of the concerned yantra.

Next the pratibimba-arka-kiranaakarshana naala, or tube for attracting the reflection of the solar rays :

According to "Naalikaa-nirnaya," the essence of squash gourd, juice of momardica, 2 parts of the salt of the two wheeled root vegetable, 3 parts of salt of simhamoola, 122nd type of glass, essence of white mica, jelly stone, borax, root of Bengal-madder, thorn at the root of bamboo, lead, mercury, these 15 ingredients are to be mixed in the proportion of 5, 12, 4, 3, 7, 3, 11, 4, 9, 12, 20, 18, 12, 5, 20. The mixture should be filled in the crucible known as samavargika, and heated in the furnace of the same name, and heated to the degree of 315, with the aid of bellows called suraghaa. The resulting liquid should be poured into the mirror-making machine. The resulting product will be a fine bimbaarka-kiranaadarsha, or reflected solar ray attracting mirror. This should be fixed in the central portion of the vimaana and in the 10th kendra, with five circled screws.

Now we deal with the crest crystal of the vimaana. The crest-crystals are of 103 kinds. They are named in "Mani-kalpa-pradeepika" as belonging to the 12th class of 32 groups of crystals. Their names are shankara, shaantaka, kharva, bhaaskara, Mandana, kalaantaka, deeptaka, nandaka, chakra-kantha, panchanetra, Rajamukha, Raakaasya, kaalabhyrava, chintamani, koushika, chitraka, bhaskara, uduraaja, viraaaja, kalpaka, kaamikodbhava, panchasheersna, paarvanika, panchaaksha, paaribhadra, isheeka, kaasha-bhrit, kaala, kanjaasya, kowtika, kalaakara, kaarmika, vishaghna, panchapaavaka, symhikeya, roudramukha, manjeera, dimbhika, pingala, karnika,

krodha, kravyaada, kaala-kowlika, vinaayaka, vishwamukha, paavakaasya, kapaalaka, vijaya, viplava, praanajanghika, kaarmukha, prithu, shinjera, shibika, chanda, jambaala, kutilormika, jrimbhaka, shaakamitra, vishalya, kanka-gowrabha, suragha, suryamitra, shashaka, shaakala, shaktyaakara, shaambhavika, shibika, shuka, bherunda, mundaka, kaarshnya, puruhoota, puranjaya, jambaalika, sharngika, jambcera, ghanavarshnaka, chanchvaaka, chaapaka, ananga, pishanga, vaarshika. Raajaraaja, naagamukha, sudhaakara, vibhakara, trinetra, bhoorjaka, kumuda, koorma, kaarmuka, kapila, granthika, paashadhara, damaruga, ravi, munjaka, bhadra.

These are the 103 crystals suitable for being fixed as crest-jewels of the vimaana. One of them is to be fitted to the central pinnacle at the top of the vimaana, and the wires from the electric dynamo should be connected to it, so that it might be supplied with power. On the upper side should be attached wires for collecting solar rays, so that the two forces might act in combination.

The switch-gear for connecting the vimaana with the solar energy is explained in "Brihath-kaandika." Sandhaana-keelakaas are of 25 kinds. Their names are pinjuleeka, keeranaka, dimbhaka, paarvateeyaka, kachchapa, gaaruda, uddanda, shaktipa, govidaaraka, pavanaasya, panchavaktra, vajraka, kankana, ahirbudhnya, kundalika, naakula, oornanaabhika, trimukha, sapta-sheershanya, panchaavartha, paraavatha, aavarta, naabhika, oordhvaasya, shilaavarta.

Amongst these the 9th, govidaaraka, is best suited to connect the vimaana with the solar beams for safe navigation. This is Pariveshakriyaayantra.

Next Angopasamhaara yantra :

During the passage of sun and other planets in the 12 houses of the zodiac, owing to the varying speeds of their progressive and retrogressive motions, conflicting forces are generated in the zodiacal regions, and their collisions will let loose floods of fierce forces which will reduce to ashes the parts of the plane which get involved with them. The pilot should get warned by the ushna-pramaapaka yantra, or heat-measuring instrument, and quickly fold the concerned parts and ensure their safety.

It is described in "Yantrasarvasva" as follows :

Purifying the metal sumrileeka mixed with manjeera, a pedestal should be cast, 12 feet long, 18 inches thick, and shaped as a square or circle. Then mixing the magnetic stone and dimbika, after purifying them with acids, cast a pole 3 feet thick and 30 feet tall, with springs, as in an umbrella, at the foot, in the middle and at the upper end, and fix it in the centre of the pedestal. Rods made of mixed metal like umbrella rods, provided with 5 springs, should connect the springs in the pole with the several limb mechanisms of the vimaana. Two revolving wheel springs with two tubes with 3 faces and 3 wheeled springs should be fixed at the bottom of the pole, near the spring. Above there should be fixed an oiling tube which will keep all the springs well-oiled. When a particular limb of the plane has to be contracted the spring at the foot of the pole should be turned so as to induce the spring of the part to operate so as to contract or open up the part as need be so that the danger to the part will be prevented. By the operation of the angopasamhaara yantra, any part of the plane can be folded up to avoid danger and opened out subsequently.

Vistritaasyaa kriyaa yantra or wide-opening mechanism :

When the various powers, subterranean, eight cardinal points, earth, cloud, electricity, and oceanic, consemble in padma-mukha, a power called vishambharee is generated. It breaks through the earth, emitting great heat, mounts with a 300 linka spread to the upper sky regions, and reaching the aerial routes, envelopes the vimaana, and affects the personnel inside causing grave physical disabilities, and paralysing the brain. For the purpose of curbing it and nullifying it, the vistritaasyakriyaa yantra is to be installed in the vimaana.

According to "Yantrasarvasva," a foot-plate, of an arm's length, and 22 inches thick, and round-shaped, is to be made of the wood of the sacred peepul tree. A pole of an arm's thickness, and 32 inches high, is to be fixed in the middle of it. Reversible wheeled double-switches should be fixed along its height, connecting each of the sectional mechanisms in the vimaana, through tubes reaching to the bhastrikaa naala or bellows tube attached to the mechanisms. At the foot of the pole three revolving wheels, and at its back the contracting switches, have to be fixed.



First peetha or footplate, then pillar, then revolving springs, jointure tubes, two-wheeled keelakas, two-winged bellows, three wheel moving mechanism, contracting mechanism, are eight constituent parts of this machine.

First the triple wheeled mechanism should be switched on. That will set the double wheels in motion. That will make all the springs attached to the pillar begin to operate. The two winged bellows attached to the double-wheels will open up. Wind will rush out and force through all the sandhi-naalas or jointure tubes. That will set the the bellows in the central operating ; thereby the bellows of the sectional mechanisms will come into play, and air will flow out in a flood, and taking hold of the vishambharaa shakti expel it to the aerial regions where it will get lost. Thus the personnel inside the vimaana will be saved from disabilities and restored to normalcy.

Vyroopya mirror : Says “Yantrasarvasva”,

When enemy planes come intent on destroying the vimaana, the vyroopya mirror is intended to frustrate them. Its parts are, peetha or stand, central switch-gear, electric pole, smoke tube, betel-nut oil, triple-wheeled spring, three satchels, smoke light, and contraction tube.

The peetha or seat should be 2 feet wide and 2 feet tall, and circular, and made of bael tree wood. 12 centres are to be marked therein. At each centre revolving joints should be fixed. Jyotistambha or electric pole, 24 inches thick and 24 inches tall and made of vyroopya darpana glass, is to be fixed in the centre. In front of it the electric machine should be fixed in the 2nd kendra. In the 3rd kendra should be fixed the turning smoke tubes with winding wires. The oil vessel should be fixed in the 5th kendra. The 3 satchels, with 3 mouths, one foot high and made of milk-leather should be fixed in the 6th 7th, 8th and 9th kendras, up to the smoke tube. In the tenth kendra should be fixed the smoke-extinguishing tube mechanism, and the light-extinguishing tube in the eleventh kendra. The winding wire tube should be fixed in the 12th kendra.

The operation of the mechanism is as follows :

Drawing the electrical energy from the dynamo, it must be applied to the triple-wheeled mechanism. That will be set in motion. The wires

proceeding from there will convey the power to all the other mechanisms and set them in motion. Kendras 3, 4, and 5, will become active. When kendra 9 is switched on the koshas attached thereto will become active. From the 5th kendra the current should be passed to the oil vessel. The oil will then convert itself into poisonous gas. The gas should be filled in the 3 satchels and the 3 tubes. The fumes from two of the tubes should then be discharged towards the enemy planes. They will encircle the enemy planes and envelope them with a smoke-screen. Then the betelnut oil should be lighted, and fixed in the jyoti stambha or light-pillar. The light within the pillar will suffuse it with red glow like a china rose; and pervade the sky. Then the electric glow should be applied to that glow. The resulting glow will be multi-coloured like a rain-bow, with violet, indigo, blue, green, yellow, orange, and red. Then the poison-fumes from the 3rd tube should be drawn through the air tube, and let into the multicolour-glowing light-pillar. The fume will burst into light, and then should be passed through tube into the vyroopya-darpana. The light glow will pervade the mirror and attain 3000 degree intensity, causing a blinding glare and paralising the enemy. Then the gas in the three satchels should be projected with 25 linka speed towards the smoke screen enveloping the enemy. Then the smoke from the tubes should be projected with 28 linka speed into that screen. Then the smoke filled glow will flood over the enemy personnel and affect their body joints, organs, mind, vision, and induce inertness, and make them all fall down senseless. Then the pilot could change his air-route and proceed forward safely.

Then Padmachakra mukha yantra :

According to "Yantra sarvasva," its parts are, peetha or pedestal, pillar, tubular pole, electric wiring, glass lotus petals, lotus formation process, places where the lotuses are to be located, wind inhaling and leather-bellows mechanism, contracting and expanding switches, triple-wheel fixing arrangement, air flow outlets, folding up mechanism. These are the 12 parts of the padmachakra mukha yantra.

The peetha or seat should be made of the wood of pippala or the holy fig tree, 8 feet and 3 feet high, and square or circular. Mark 12 fixing centres on it. From the central pillar draw lines towards the 12 spots. The central pole, two tubular posts on either side of it, electric wire in eastern centre,

lotus petals in the north, formation of lotus in the northern and southern centres, fixing of the lotuses from the north-east to the south-east corner, to the east air-filling bellows. In the north west corner the contracting switch, and the expansion switch in the south-west corner, triple-wheel revolving mechanism on the eastern side, air flow outlets underneath each lotus. To its south, the contraction switch.

These are the 12 parts to be fixed in the 12 centres.

The production of the parts is as follows :

The central pivot should be made of abhra-mrid-darpana, or mica-sand glass. According to "Darpana-prakarana"—

5 parts of rambhasatva (plantain stem ?), 8 of manjoosha (madder root ?), 5 parts of kaanta (ayaskaanta ? sooryakaanta ?), 8 parts of kravyaada (jataamaamsi), 3 parts of aadhaka essence, 7 parts of tortoise shell essence, 18 of bhalyatvak, 3 essence of kudmala or flower buds, 8 of bamboo salt, 3 of hooves, 28 parts of shoonya-mrid or mica ash, 4 of trivikrama kshaara, 2 of conch, 5 of mercury, 8 of salts, 1 of creepers, 3 of silver, 3 of eye-ointment, these 18 ingredients, purified, filled in crucible, placed in varaatakunda furnace and boiled to 200 degrees, and slowly filled in darpana yantra, will yield an excellent abhra-mrid darpana.

Two tubular poles of the size of an arm, made of this glass, should be placed on either side of the pivot. From the central pole electrical wiring should be connected to the 12 centres. In the centre of the switch tubes should be placed the lotus petals, and 150 finely made glass lotus petals should be spread on the northern side electric wires.

The petals are to be made, according to Lalla, by mixing 15 parts of the mica glass, with 4 parts of sourika salt, duly mixed and finely powdered and melted in pattikaa machine, when like onion-skin layers, petals will take shape. Then the wires attached to the petals should be brought together from the several centres, and attached to the lotus forming mechanism. By turning the concerned wheel the petals will move towards the centre and form a lotus. Each petal will then become a tube, and by their juggling each

tube will form 2 petals. The air-attracting mechanism should be placed in front and set to work. With a shrieking noise the air will be sucked in by each tube and the petals will shoot the air far into the outer air.

It is said in “sandhaana-patala—”

The scattering of a blizzard which may obstruct the progress of the vimaana is only possible by means of the padma-sandhaana and not otherwise. Therefore the spots where the lotuses are to be inserted are now indicated. On the eastern side from the north east to the south east the lotuses are to be erected in seven places in close order. Beneath the seven lotuses should be fixed seven leathern bellows capable of deep draughts of air. On the north west corner should be fixed the double-wheeled contracting mechanism.

According to “Kriyaa saara,” by turning the main wheel in right motion, and the upper wheel in reverse motion at full speed, the yantra will suffer contraction. This machine is composed of 6 wheels spread out, 5 naalaas or tubes, 12 wires and 12 openings, and 12 keys which will cause contraction of the 12 parts, with widened mouth at the upper and lower parts, and provided with 2 revolving keys. By placing such a contracting machine in the north-west corner, the machine could be contracted when desired.

Now we shall deal with the expanding mechanism. It is round like a water pot, with 12 wheels and mouths, having 12 tubes with rods inside with 12 revolving springs for ascending motion, and with a central spring for filling with air. With such a mechanism the yantra can be made to stretch its parts. This should be fixed in the south west corner.

Then at the eastern face the triple-wheeled revolving spring, called “bhraamane-keelaka”, should be fixed.

It has 3 ivory wheels, consists of 3 poles, wooden top shaped like shimshumaara, with wheels with spring on top. By its operation the several parts of the yantra are set in motion, and by the operation of the concerned springs, the yantra will expand. Therefore the 3 wheeled bhraamane mechanism should be properly fixed at the eastern kendra with 5 bolts.

Underneath the lotuses air flow routes should be provided. There should be openings 12 inches wide, 2 inches high, be leather-covered, made

of pippala wood, with 7 tubes for the flow of wind. Seven such tubes should be fixed beneath the seven lotuses, and provided with keys.

In the southern centre the contracting mechanism or upasamhaara keela, with 12 outlets, should be fixed.

Owing to the seasonal changes forces will generate in the joints of the outer space, and combining with the oceanic forces will reach the realm of air and cause a commotion which will spread out with fierce force into the farthest air pockets, and let loose typhoons which reach the vimaana, and produce a dusty excrescence which will induce chicken-pox-like skin eruptions on the pilots and other occupants, and also break up the vimaana. In order to suck up that foul wind-flow, and expel it out of the vimaana, the padma-patra-mukha yantra is prescribed.

Next Kuntinee-shakti-yantra :

Now we shall deal with kuntinee-shakti yantra. In mid-summer, out of the myriad heat rays of the sun, by the union of the 3, 5, and 10th class of rays, a fierce force of blazing heat named kulakaa is generated.

It is said in "Ritukalpa",

From the solar heat generative source 3 Mahaakshoni and 21 crores 500 lakhs 16 thousand and nineteen heat rays emanate. They are classified into 5 crores 8 thousand and 107 groups in Vaalmeeki ganita. Each group is divisible into 100 sub-groups. Of these when the rays of sub-groups 3, 5, 10 from the second group get mixed up in the heart of summer, a force called Kulakaa with fiery intensity is generated; and when it moves into the path of the flying vimaana, the plane will be reduced to ashes. To protect against that the kuntinee-shakti yantra should be installed in the neck portion of the vimaana.

Sage Narayana also says :

Amongst the divisions of the heat rays of the summer sun, the second group has 85000 rays. Out of them those numbered 8, 3, and 10 are specially intense, and they attract the pramlochana shakti from koorma portion of the universe, and produce a fierce heat-wave called kulikaa. If a vimaana happens

to encounter it in its course, it will be burnt to ashes. To safeguard against that the kuntinee-shakti yantra should be installed in the neck section of the vimaana.

Lallaachaarya also confirms :

Out of the many groups of the heat-rays of summer, numbers 3, 5, and 10 in the 32nd division of the 2nd group of rays' tend to contact the pramlochana shakti in koorma and produce a fierce force called kulakaa which will destroy the vimaana. The erection of the kuntinee-shakti yantra in the vimaana will prevent it from such destruction.

According to "Yantra Sarvasva",

Among the constituent yantras of the vimaana, the kuntinee-shakti yantra is required to protect it from the combustible heat waves known as kulikaa in summer. Its parts are ground-plate, central switch-board, acid vessel cloth, with folds, chakradanti naala, milk cloth, tube covering switches, revolving wheel equipped with electric wiring, and contracting mechanism.

The peetha or ground-plate should be 3 feet wide and  $\frac{1}{2}$  foot high, and round like a drinking bowl, seven kendras or centres commencing from the eastern side, turning switches in the seven centres, the acid vessel in the central kendra.

"Kriyaasaara" Says :

For capturing kulikaa the oil from gunja or the seeds of the shrub abrus and tobacco leaves, and mercury and shanaka crystal are recommended for use. The oils or acids of the seeds and tobacco leaves are to be filled in goblet like cup made of glass made of naaga, crownchika, and sowrambha metal, add purified mercury, and fix in the central kendra. Then apply the solar rays to the vessel. By the action of the rays on the acids the crystal in the vessel will become charged with a cold frigid force called krownchinee. Then when the kulikaa force enters the vessel with its fierce heat, it will be sucked in by the cold-storage crystal.

In the left kendra the cloth with folds should be fixed. Says "Patakalpa.—"

In order to confine in the crystal the fierce heat of kulikaa it should be wrapped in the folds of a cloth of fine and strong texture made of spikenard and jute yarn, with 5 folds and 3 openings. From the openings 3 glass tubes should be projected with downward bends into 3 wide mouthed vessels. To the north-east must be fixed the chakradanti naala for attracting the kulikaa force. Snake-skin, gum of srini, woollen yarn, soft grass, should be boiled together and lac-coloured cloth-like glass prepared, and purified with sundikaa wood oil. It should be rolled in coils just as a snake circles up in coils and sleeps. The tiny glass tubes should be attached at the bottom of the chakradanti as directed.

Then ksheeree-pata naala, or milk-cloth tube is to be fixed. Made of milk-cloth with wide-opening, strong, soft, a tube should be inserted in the mouth of the chakradanti, and its end should be made to reach the hole in the peetha. Through that the kulikaa force makes its exit. After placing ksheeree pata naala like this with key, the electric wire connected central operating switch should be placed in the west. And to the north-east of it the vistritaasya or opening out switch should be fixed.

Says "Kriyaasaara":

It should have two satchels, two openings, two right-revolving and reverse-revolving wheels. In the eastern opening should be fixed the 2 right-revolving wheels. And in the northern mouth should be fixed the 2 reverse motion wheels. And as in an umbrella, sticks connecting all the parts with the centre, for the purpose of expansion and contraction by turning a switch. By operating the switch in the eastern opening all parts will open out or expand. By operation of the northern switch all parts will close up. This is the upasamhaara keelakaa.

Having enumerated the parts of the yantra, their operation is now given. First the electric switch. By putting it on, the Bhraamanee chakra or pivotal wheel will revolve setting in motion individual parts as and when desired by turning their respective switches. Then electric current should be passed to the acid containing the crystal. Solar rays also should then be passed into it. Thereby, in the acid there will be generated a female shakti of 5 nyankas called sowlikaa. Similarly in the crystal there will be generated a male shakti of 8 nyankas called chulikaa. By operation of the electric

current the two shaktis will get unified and produce an extremely cold shakti called "crownchinee," capable of attracting the kulikaa. That crownchinee force should be projected through naala or tube towards the kulikaa, like imbedding a gunja pea in a lump of lac. Thereby the crownchinee will drag the kulikaa inside the yantra through the tube and drop it into the acid vessel where it will be imbibed by the crystal.

Then the patormikaa key should be turned, whereby the patormikaa will become wide open preventing any air from entering the crystal by covering it completely. Then the chakradanti key should be turned slowly, so that its mouth opens out and sucks the hot kulikaa from the crystal, and stores it inside itself. Then the key of the sookshmaadarsa naala, fine mirror tubes, should be operated. The kulikaa in chakradanti will emerge through the 3 tubes. Then the vistritaasya key should be operated quickly so that all the parts will open out, and the kulikaa shakti will get out and disappear, and the danger to the pilot will have passed. Then by operating the upasamhaara keelaka, the expanded parts will close up and the yantra will return to normalcy.

Now we shall deal with Pushpinee yantra. When the pilot has to travel during spring and summer months, the pushpinee yantra is intended to provide him with necessary comforts.

According to "Khetavilaasa" :

In spring a force called sowrikaa emanates from the south-east. And in summer a force called panchashikhaa arises in the north-west and is intensified by the sun's rays. Panchashikhaa contains two kinds of poisons. Sowrikaa having fire and moon contents is cold and hot, cold internally, and hot externally. It generates warmth in all creations, making the human kind perspire, and the trees and vegetation bring out their milk and gums. Thereby their bodies are relieved of harmful materials likely to lead to diseases.

By its cold effect and attracting the spring effect from the solar rays, it permeates all things, and brings out shoots, tendrils, flowers and a glow in all trees and creepers. Similarly it effects the 7 physiological components of the human body and increases their vigour, strength, growth, and glow.



Panchashikhaa shakti or force effects movable and immovable life adversely by its stultifying influence, shrinks and dries up the growth process of both vegetable and animal life and causes deterioration. To counteract this harmful effect of the season on the personnel of the vimaana, the pushpinee yantra is commended as one of the constituents of the aeroplane.

Its parts are, the base, the cold processing mirror, keelaka or key, cold generating crystal, acid vessel, electric wheel with 100 spokes.

The sunda-mud made glass is prepared, according to "Paarthiva-paaka Kalpa" as follows. Take salt, shinjeera, bone, and betel-nut salt, durona, kuruvinda grass (*Cyperus rotundus*), gum, sowraashtra mud, virinchi vatika or banyan bark, silk cotton tree bark, and coir salt, these ingredients are to be taken in the proportion of 5, 12, 2, 3, 8, 3, 30, and 6, purified, filled in the crucible, and placed in the tortoise shaped furnace, boiled 32 times in 100 degree heat with the help of two faced bellows, and the resulting fluid poured into the cooling yantra. A pure and fine sunda-mud-glass will be formed.

With the glass thus produced by boiling 32 times, a base is to be formed 12 inches wide, 3 inches high, four-square or circular. From the centre of it 4 kendras or centres are to be marked. In the centre an arm-sized pivot made of the said glass should be fixed. On top of it is to be fixed the cold-processing mirror key. At its centre should be fixed the cold producing crystal. At the eastern centre should be placed the acid vessel.

Dravapaatra or acid vessel is described in "Kriyaasaara." It should be 12 inches wide and 12 inches high, shaped like a tumbler, circular, and hard like a cocconut shell, and be made of the sheeta-ranjikaa glass.

The glass is described in "Darpana Prakarana". Shasha-piththa, udupiththa, borax, kutmala, jyotsnaa saara, rasonta kanda flour, kudupa-salt, mica salt, shoundeera jangha shalya flour, vaatohara, white niryaasa earth salt, and uragha.

These 12 ingredients should be taken in the proportion of 5, 3, 5, 1, 10, 10, 11, 8, 7, 2, 20, and 6, and after properly purifying them, fill them in lotus-shaped crucible, and placing it in the lotus shaped furnace filled with

burning charcoal, and with the aid of the five-mouthed bellows blow the heat to 323 degrees temperature, and pour the liquid into the yantra. The resulting glass is called sheeta-ranjikaadarsa or cold-receptacle glass.

Cold-producing crystal is described in "Maniprakarana": 5 parts of couries and manjula powder, 4 parts udumbara salt, 3 of rubhna, 8 parts of varchulaka, 7 of sheeta ranjikaadarsha, 3 of vatu, 28 of shaalmali, 3 of salts, 7 of mercury, 8 of white mica, 8 of karkataanghri salt, 5 of chowlika satva, 15 of niryaasa earth, 25 of sampaathi bird kneebone—

These 14 ingredients, in the named proportions are to be purified and filled in mritkundala-moosha or earthen crucible, and placed in kulakundika furnace, and with the aid of tryambaka bellows blown into 300 degree temperature. Fill the boiled liquid into the mani-prasoothika, or crystal forming yantra. The crystal produced will be pure, hard, and intensely cold.

In front of it should be fixed the electric pankha wheel, with 100 spokes and electric wiring, and purified by 3 acids.

As per "Kriyaasaara," 12 parts of copper, 3 of collyrium, 8 of zinc, should be mixed and melted with 100 degree heat. It will become pure like gold, yellow, fine, soft, and strong. It is called pancha-loha or five-in-one metal by those who know. 100 leaves like those of lotus should be formed out of them. Then 3 navels, three navel keys, and 3 wires, and a sounding keelaka or key, or switch, or wheel.

First the navel wheels with hinged rods should be fixed so that the 100 petals will be made to revolve with due speed on the four sides of the wheel. Similarly by the side of the wheel in front of it, another 100 petals should be properly fixed for revolving in reverse direction. And electric wires should be fixed on both sides of the centre of the western wheel, for operating the 100 spoked electric pankha or fan. Then the vessel should be filled with the cold generating acid. And encircling the cold-generating mani or crystal, it should be placed in another vessel in the centre. And copper wiring enclosed in milk-cloth should be attached to the wire in the acid vessel. Two wires from there with switches should be connected with the cold ranjika glass or mirror in right-turning fashion. Then current should be switched into the electric wiring in the crystal and acid. Then by the contact of the electric current the forces within the crystal and the acid will get active and their

combined cooling and comforting quality will enter the cold ranjanikaa mirror and concentrate in it. On operating the switch attached to it, the cold effect will spread out all over the interior of the vimaana, and overcoming the scorching seasonal effect, make it comfortable and pleasant for the pilot, and restore his efficiency. Similarly the 100 spoked pankha (fan?) should be switched on, when a breeze will be generated and air-condition the atmosphere of the pilots. Thus by the use of the crystal, acid, and pankha, a state of pleasant comfort will be induced, and vigour, exhilaration, and competence will be injected into all the limbs of the body. Therefore this Pushpinee yantra should be installed in the southern section of the vimaana.

#### Next Pinjula Aadarsha or Pinjulaa Mirror :

By the collision of two winds giving rise to a whirlwind, and the fierce solar ray dashing against it, a lightning bolt erupts and strikes the unwary vimaana. To protect against such an event, the pinjula mirror is to be installed. An eight petalled lotus is to be made of the pinjula glass. Where the petals join, a circular dandaakaara should be made. At the back two hinged bolts should be fixed. They should be wound round by wires from the cold mirror. The back should be covered with a coir-made cloth covering. It should be fixed in the southern side of the vimaana, at an arm's height, facing the sun. The lightning will be absorbed by the projecting rods coiled with wires from the cold aadarsha mirror, and no evil effect will occur, and the pilot can proceed in safety.

#### And Naalapanchaka or Five tubes :

If the smoke from the kitchen over of the vimaana spreads, it will cause discomfort for people inside. Therefore the five tubes or pipes should be inserted for the smoke to go out and the air become clear. The pipes are to be manufactured as follows. Magnetic iron, pinjula mica, ghontaara metal, dhoomapaasya metal, and tortoise shell, are to be taken in the proportion of 1, 7, 5, 5, 8, purified, filled in crucible, and melted with 100 degree heat, and when ultimately cooled, a fine metal called vaataayaneer metal, or window metal will result shining like gold.

With that metal 5 tubular outlets, 12 inches in diameter and 12 inches in length, should be fashioned. At one end of each of the tubes should be fixed

a smoke-absorbing crystal. The tubes should be inserted in the 4 sides of the vimaana, forming outlets. One tube should be fixed at the ceiling. The dhoomapa crystals will attract the smoke and pass it to the outside, and clear the vimaana of its discomfort. Hence the necessity for the naalapanchaka, or five tubes.

Then Guhaa-garbha aadarsha yantra, or hidden mine discovering mechanism :

According to "Yantra Sarvasva" enemies would have placed mines and bombs underground for the destruction of the vimaana, unless they are discovered and de-fused in time there would be danger. Therefore the mine-finder yantra has to be installed in the vimaana.

Says kriyaasaara, out of the 72nd type of glass, make a triangular, a circular, and a quadrangular shaped glass mirrors. These are to be fixed as follows with bolts made of pancha-dhaaraa metal in a frame made of the wood of the anjishtha tree. The circular mirror should be fixed at the bottom facing downwards. The quadrangular mirror should be fixed facing upwards. The triangular mirror should be fixed to the west of these two, with a pancha-mukha keelee or 5 faced hinge. From the main pivot of the quadrangular mirror to the foot of the bolt at the south-east corner of the yantra, wires made of copper, tiles, and panchaasya metal should be drawn and connect them, and then the wire ends and chumbaka crystal should be placed in the mercuric-sulphur acid vessel. Four other wires should be made to circle the triangular mirror, pass through the mirror facing upwards, and fixed to the centre of the down-ward facing mirror. Then solar rays should be let in from the western side. A screen cloth coated with mirror-like gum should be placed opposite to the triangular mirror. Then the solar rays and electric current should be passed into the acid vessel containing the crystal. When the electrified rays from the crystal are passed on to the downward facing mirror, they will explore the ground over which the vimaana is to pass, and discover mines and bombs like mahagola and agni-garbha, which may have been inserted there and reflect their complete picture in the crystal in the acid vessel. The picture will then be projected to the screen opposite in clear detail, and by washing with chemicals present a perfect photograph of the buried mines and bombs, which could then be destroyed by due safety measures. Therefore the guhaa-garbha aadarsha yantra or mine-discovering yantra is essential for a vimaana.

Its parts are as follows :

First the 72nd type of mirror, known as suranjitaadarsha. "Darpana Prakarana" says :

Madder-root, live coal, ox-gall, snake-gourd, mercury, karanja or gale-dupia arborea, copper, 3 kinds of sharkara (sugar or sand?), borax, sulphur, chaaru or silk-cotton bark, lac, kuranga, rouhinee, iron-rust, panchaanana, liquid amber, shiva or brionia laciniosa, vishwa, mica, paarvanija, vydoorya gem stone, in the proportion of 11, 27, 5, 7, 7, 3, 7, 5, 20, 3, 7, 3, 1, 32, 30, 38, 8, 7, 3, 9, 30, duly pulverised and filling in a beaked crucible, placed in a vaaraaha furnace, and heated to the 100th degree with the aid of the tortoise-shaped bellows. When the finely boiled liquid is poured in the cooling yantra, suranjika glass of exquisite quality will result, out of which three mirrors have to be fashioned for the guhaa-garbha-aadarsha yantra.

#### Aanjishtha Tree

Kriyaasaara says, "Many kinds of trees are suitable for use in making yantras. Of them all the tree called aanjishtha is the finest." "The trees having 5 qualities are 87 in number. The best among them all is aanjishtha," says "Udbhijya tatva saaraayanee."

Agatatvalaharee also says, the five qualities such as the capacity to capture reflections, and others, are found inherent in the Aanjishtha (or madder root) tree. Therefore out of all woods the wood of that tree is most suitable for use in this yantra.

#### Pancha-dhaara-loha

In making yantras, pivots of various metals are being used. But for use in connection with the guhaa-garbha-aadarsha, or hidden mine discovering instrument, the shankus or pivots made of pancha-dhaara-loha or five alloy metal are the best.

Kshvinkaa, iron-pyrites, copper, indra, and ruruka, purified, powdered, and filled in mrugendra moosha crucible and boiled to 300 degree heat with beaked bellows, will yield a 5 alloy metal, strong and heavy.

Paara-granthika acid for insertion of the crystal, is described in "Moolikaarka prakaashikaa." Mercury, bamboo salt, Indian spikenard joint, paarvanika or clerodendrum phlomides, svarna seeds or Indian labernum seeds ? or yellow thistle seeds ?, and ghatotkaja or American aloe, in equal quantities, should be filled in a big bellied earthen pot, heated to yield a golden hued shining liquid, which is very useful for capturing reflections.

Chumbaka crystal is the one most suited for use in capturing reflections of objects. It is manufactured as per "Manipradeepikaa," with the following ingredients. Magnet, sand, borax, ivory, shoundika or long pepper, mercury, paarvana or clerodendrum phlomoides, copper, vermillion, iron-pyrites, grudhnika, souri or marking nut, buffalo hoop, vishwakapaala, cleaned and powdered, and filled in karpala crucible and baked in a furnace with the aid of owl-nosed bellows to 100 degrees, will yield a fine image producing crystal.

Pigment for coating the screen so as to present a clear picture, is called "Roopaakarshana-niryaasa," or image reproducing niryaasa or varnish. Out of 360 such varnishes that is the best.

Says "Niryaasa kalpa" :

Moonstone, crownchaka, bamboo rice, five milks from banyan, fig, keg etc., trees, magnet, udusaara, mercury, mica, pearl, earth from ant-hill, saarasvata oil, and nakha or nail ? these 16 articles to be taken in equal parts, purified, should be ground for a period of 30 days in the juice of the peacock's egg, then mixed with bilva oil and boiled for four yaamaas or twelve hours until it becomes a perfect gum or varnish. Some call it reflector varnish. Some call it virinchi-varnish.

The varnish is to be evenly spread on the special cloth called pata-darpana, so that it may present as on a cinematograph screen, the pictures reflecting the location of anti-aircraft mines discovered by the roopaakarshana yantra.

The production of Pata-darpana is described in "Darpana-prakarana" :

Gum, cotton, pratolikaa, kuranga or pallatory root, maatanga or keg tree bark, cowries, kshonceeraka, gholikachaapa, granite sand, parotikaa, sea-foam, priyangava, ghanjhotikaa, sugar-cane, rukma or argemone mexicana,

kesara or mesua ferra gum, earthen salt, suvarchala, urugha, bydaara oil, muchukunda flour, sinjaanu, anchaalika, turmeric, kaarmuka or acacia catechu, these ingredients in the proportion of 100, 58, 25, 28, 4, 12, 5, 3, 1, 30, 10, 5, 8, 12, 3, 13, 22, 27, 28, 3, 24, 7, 3, 13, should be cleansed, powdered, filled in a vessel, and boiled in the furnace with 100 degree heat, and the unified fluid should be poured on a flat surface so as to form an even surfaced sheet. After drying, the photographic niryaasa varnish is to be used to coat this sheet, for use in the Guhaa-garbha aadarsha-yantra.

#### Thamo yantra or Darkness creating yantra :

Vimaanaas are liable to be attacked by enemies with poison fumes of Rouhinee or krakachaarimani rays. As a protection against it the thamo yantra has to be installed in the vimaana. Out of 132 types of thamo-yantras, the 62nd variety is said to be the best for safe-guarding against poison fume and ray attacks by the enemy.

Black lead, aanjanika (collyrium ?), vajra-tunda are to be powdered and mixed in equal quantities, filled in fish-shaped crucible and placed in crow shaped furnace, heated to 100 degrees, and poured into the cooling receptacle will yield a fine, light, strong thamo-garbha-loha, or darkness impregnated alloy metal, useful for making Thamo-yantra.

The peetha or stand is to be 3 feet wide and  $\frac{1}{2}$  foot high, square or round. In the centre of it is to be fixed the pivot. At its front should be placed the vessel of the acid of guggala or Indian dellium. To the west should be fixed the mirror for enhancing darkness, and in the east should be fixed the solar ray attracting tube. In the centre should be fixed the wire operating wheel, and to its south should be fixed the main operating wheel or switch.

Its working is as follows. On turning the wheel in the south east, the two faced mirror fixed to the tube will revolve and collect the solar rays. By operating the wheel in the north west, the acid in the vessel will begin functioning. By slightly moving the wheel in the south-east, the solar rays will enter the crystal in the acid vessel. By turning the wheel in the west, the darkness intensifying mirror will begin to function. By turning the central wheel the rays attracted by the mirror will reach the crystal and

envelop it. Then the main wheel should be revolved with great speed, when the darkness will be produced enveloping the vimaana and making it invisible, and the efforts of the enemies to attack it with poison gas and rays will miss their target and become ineffective. This yantra should be placed in the north-west sector of the Vimaana Panchavaataskandha-Naala.

Iron rust, shaarana, copper, suvarchala salt, in equal parts, to be filled in mayookha crucible, placed in jumboo-mukha furnace, and using kaaka-mukha bellows boiled to 102 degrees and cast in the yantra, will yield a pure, light, soft, strong, nice cool metal known as vaatadhaarana loha.

4 tubes, each 2 yards long and 1 yard high, should be prepared. Like the circular opening in the top of the vimaana two openings on each and one at the bottom should be prepared. Each tube should be inserted in the said openings. Another tube 12 feet long and 3 feet high should be fixed on the western side in the opening at the top. To each tube should be attached bellows' mouth operated by wheels. By turning the wheels of the 5 tubes the 5 poisonous winds will be sucked in and passed into the tubes to make their exit, without causing harm to the plane.

Lohasarvasva says :

There are 13 air layers known as Vrishni and others. By the force of the Panktiraadhasa Kendra, they tend to jostle each other, and generate fierce forces which will be destructive to the unwary vimaana which may get involved in them. Therefore the Pancha-Vaata-Skandha-Naala Yantra is to be inserted in the back portion of the vimaana, to safeguard against evil consequences.

#### Roudree Darpana Mirror.

From the south-eastern side of the earth-sun axis solar rays touch the turbulent forces in the etherial regions, and burst into flames, and vimaanas which may be out on their course may be destroyed by the flames. To prevent such a happening the roudree-darpana yantra should be installed in the bottom of the vimaana.

Says "Yantrasarvasva", "At the time when spring passes into summer, the forces in the junctional regions of the sky, on contact by fierce solar



rays, burst into tumultuous flames, and destroy all things that pass through. Therefore the roudree darpana should be fitted in the vimaana as a safe-guard against that.”

According to “Darpana Prakarana,” iron rust, magnet, veera iron, borax, panchaanana metal, mica, honey, red castor bark, banyan, surya-varchula or sweet-salt, gold, alika, shaarkara or benzoin tree bark, pancha tikta or 5 sours, snake gourd, and paaduka, are to be powdered, cleaned, and in equal quantities filled in padmaasya crucible, and placed in vishvodara furnace and heated to 200 degrees. The molten liquid poured into the mould will yield excellent flame-proof roudree-darpana glass.

With this roudree-darpana glass a plank of 16 feet in dimension should be prepared. A pivot 25 inches thick should be fixed at the centre of the plank. At the edge of the pivot, two wheels should be fixed revolving with right motion and reverse motion for expanding and contracting. A wheel equipped with rods for spokes should be fixed, the spokes being 15 inches from each other. Sheets made of roudree glass, washed with linseed, drona or lucas aspera, liquid amber, and madder root oils should be fixed to the rods with hinges. Similarly crystals made of roudree-darpana glass, with 5 facets, cleaned with the oils should be fixed at the end of the rods. Between each rod 18 leaves like lotus leaves with revolving keys should be fixed. The instrument is to be shaped like an umbrella. The leaves should be fixed at the pivot top with 8 keys.

When the burning flames are imminent, the pilot should turn the expansion wheel vigorously, and the umbrella will open up and provide a shielding cover for the vimaana. The lotus petals, the crystals, and the enveloping cover will protect the vimaana from the threatened danger.

Next, the Vaata-skandhana-naala.

According to “Gati-nirnaya-adhyaaya”

In the Aavaha and other giant wind spheres there are 122 kinds of different motions of the wind. In the summer season the 79th kind of motion occurs mostly. When the vimaana travels in the 4th region of the sky, it tends to zig-zag owing to the wind currents, and cause hardship to pilots and other occupants. Therefore as a safe-guard against it, the Vaastambhana-naala-yantra should be installed in the bottom section of the vimaana.

Says "Yantra Sarvasva",

The vaastambhana naala yantra should be manufactured with the vaastambhana metal only. According to "Lohatva prakarana," dantee or croton seeds, suvachala or sun-flower salt, mayoora or sulphur, loha-panchaka or copper, brass, tin, lead, and iron, bhrisundika, suranjika or sulphate of mercury, varaahaanghri loha, virohina or creya arboria, kuberaka, muraarikaanghri metal, ranjika or phosphorus, suhamsanetraka, dala or folia malabathy, courie sea-shell, mrinaalikaa or lotus stalk, to be powdered, cleaned, and in equal quantities filled in matsya or fish-shaped crucible, and placed in maaghima furnace, and with the aid of vijrimbhana bellows duly melted, will yield a molten liquid which when poured into the mould and cooled will yield an excellent vaastambhana loha.

With that metal 6 naalas or tubes of 15 inches diameter, with wide openings should be prepared and fixed in the tail and centre and front of the vimaana 10 inches deep, east to west and north to south, and held together with hoop iron binders. At the mouth of each tube a vaatapaa or air imbibing crystal should be fixed by wires. Between the tubes flags or pennants made of cotton-cloth duly processed, should be tied. And wheels made of the special metal should be fixed above each pennant. When the vaataayanee wind blast blows, the pennants will flutter noisily, and the wheels fixed underneath them will also revolve as also the crystals. The fluttering pennants pass the blowing wind to the wheels which pass them on to the crystals, which will pass them into the tubes from which they will be ejected through openings to the outside. That will protect the vimaana from their interference.

Next Vidyuddarpana Yantra.

Sowdaaminee kalaa explains it as follows :

During the rainy season, when rain clouds gather in the sky, lightnings of five kinds begin to play. They are named vaaruni, agnimukha, danda, mahat, raavanika. Of them, vaaruni and agnimukha are very active and fearful and are likely to be attracted by the roudree-darpana and other mirrors and cause fires which destroy the vimaana. In order to prevent that the vidyud-yantras should be installed in the front and the right side of the aeroplane.

According to Yantra-Sarvasva :

In order to protect the plane from lightning, vaaruni and agni, the vidyuddarpana should be installed in the vimaana.

Darpana Prakarana explains its structure :

Kuranga or pallatory root, panchaasya metal, virinchi, shonaja or red lead, sand, alum, kutbha or hellebore, pearl, sundaaliga, mercury, yavakshaara or salt-petre, borax, bidouja salt, pingaaksha or terminalia chebula (?), cowries, and karbura or hedychum specatum, powdered and purified, in the proportion of 10, 7, 4, 3, 12, 2, 3, 7, 11, 27, 14, 3, 22, 18, 5, and 11, filled in padmaasya crucible, placed in vishvodara furnace, and with the aid of the 5 mouthed bellows heated to 500 degrees, the molten liquid will yield in the cooling mould a glass which is impregnated with 300 shaktis or forces, and can overpower the lightning blasts from the vaaruni and agni forces, shining with wonderful rays, and capable of spreading its own lighting force within 2 kshanas or a few seconds to a distance of 5 yojanas or 15 miles.

With that lightning darpana glass should be constructed the Vidyud-darpana yantra. A plank, 20 feet in diameter and 1 foot high, square or circular in shape should be prepared, 4 glass tubes of crescent moon shape should be fixed around the peetha or plank. In the centre should be fixed a cage made of chumbuka glass, fitted with wires and 5 faced switches at each face, and 5 goblets made of vidyuddarpana. In the centre should be fixed a spire made of the same glass with 7 cross spokes and tubes, 8 faced and 10 angled. By turning the key inside, the spire is to revolve with speed. That will attract and contain the lightning emitted by the clouds. The rays will expel it to the outer air region, and incapacitate it. Then a snow-like cool temperature will render the interior of the vimaana safe and pleasant for the pilot and other occupants. Therefore this vidyuddarpana yantra should be installed duly in the vimaana.

Shabda-Kendra Mukha Yantra.

“Kriyaasaara” says—

The spots from which sounds emanate in the sky are called shabda-kendras or sound centres. The different directions from which the sounds

are projected are called shabda-kendra mukhas. The yantra which is meant to control the sounds so projected is called shabda-kendra mukha yantra.

Out of 304 classified sounds the sounds of water-laden clouds, wind, and lightning are said to be fiercest. In the 8th region of the sky these three sounds unify in the shishira Ritu or February-March period, and produce ear-splitting thunders. They would deafen pilots and others in the vimaana. As protection against that the shabda-kendra mukha yantra is to be installed.

It is said in Shabda-nibandhana, "By the combination of water, fire, air, and sky, sound is generated both among living and life-less objects. The sounds in the word "Shabdaha," i. e., sha, b, d, and ha, indicate water, fire, air, and sky symbolically."

"Naamarthha-kalpa" says,

We shall deal with the nature of sound or "shabdaha". The word consisting of sounds sha, ba, da, and ha, stands for water, fire, air, and sky. By the combination of these four forces in various proportions, 304 different kinds of sounds are generated.

The Braahmana bhaaga of the Veda also says shabdaas are of 304 kinds, such as sphota or embryo, very feeble sound, feeble sound, manda or soft, very soft, fast, very fast, medium, very medium, great sound, thunder sound, and thunder-bolt sound.

It is said in Yantra-Sarvasva,

In the 8th region of the sky, by the concatenation of water-cloud, wind and fire, an extremely fearful thunder clap will occur which will blast the ears of pilots who may enter the region. To safeguard against that the vaatas-kandha mukha yantra is to be installed in the vimaana.

In the 8th region of the sky there are 307 centres of sound. From the 70th centre a fierce sound proceeds by the force of water. From the 312th centre a fierce sound produced by wind will emanate. Similarly from the 82nd centre a fierce sound generated by lightning will emanate. By collision of the three a terrible sound will result which will deafen the pilots of the vimaana. Therefore facing each sound emanation centre the shabdopasamhaara yantra is to be established.

The construction of the yantra is as follows :

Gavyaarika, monkey's skin, duck-weed, shana-kosha or jute product, crouchika or lotus stalk, vaaripishtaka or shag, roonthaaka, flesh, elephant trunk, and tin, are to be purified, and the nine elements, other than the skin, in equal parts, filled in niryaasa yantra and baked for 3 days with buffalo bile, will yield a decoction of fine scarlet colour. Seven times this decoction should be spread on the skin, and left to dry in the sun. The skin will then acquire the capacity to suppress sound.

A box 2 feet long and 1 foot high made of badhira or deaf metal is to be made. Two pipes made of the same metal shaped like crane's beak, should be fixed inside it. Above it should be fixed an umbrella made of shabdapaa darpana, or sound-drinking glass. A crystal washed with tulasee or basil seed oil should be placed inside the monkey skin and sealed with rhinoceros gum. The sealed skin with crystal should be placed in the central pipe inside the box. Monkey skin alone should be placed in the pipe on the left side. Thin wires should connect them all and be fitted with hinges and switches. Above the canopy of the box a monkey skin shaped like lion's mouth should be connected by wire through a pipe to the crystal in the tube inside the box. The top of the box should be covered, securely.

Badhira loha or deaf-proof metal is explained in Lohatantra-Prakarana ; lime fruit, laguda or sweet-scented oleander, virinchi, rishika or water-calteop, maalooru or Bengal quince, panchaanana metal, luntaaka, varasimhika or solenum xunthokurpum, kuravaka or gigantic swallow-wort, sarpaasya or mesua ferrea, vaakula or surinam medlar, jack-fruit, camphor and vatika or salvinia cusullata, in equal parts, purified, and filled in tryutee crucible, and heated in the furnace, will when cast produce a metal, cold, dark, sound-proof, powerful, able to control bleeding, and draw out missile parts from the war wounds of soldiers and healing them, and capable of reducing the effect of thunder claps.

The simhaasya bellows is to collect the fierce sound and transmit it to the crystal inside the metal box so that the monkey skin will absorb it and stifle its intensity. Therefore shabda-kendra mukha yantra should be installed in the vimaana.

Vidyud-dwaadashaka Yantra, or Yantra of 12 lightnings is explained in Kriyaasaara.

In the realm of the comets and shooting stars in the sky, at the 8th region there are 30703221 shooting stars. 8000 of them are prone to lightnings, and 12 of them known as mahaakaala etc., are of importance.

Shakti-tantra says, "The 12 lightnings which form the eyes of the shooting stars are named, rochishee, daahakaa, simhee, patanga, kaalancraikaa, lataa, vrindaa, rataa, chandee, mahormee, paarvance, mridaa."

Kheta-sarvasva Says :

Mahaakaala, mahaagraasa, mahaajwaalaamukha, visphulinga mukha, deerghavaala, khanja, mahormika, sphulinga-vamana, ganda, deergha-jihva, duronaka, and sarpaasya are 12 comets with 12 lightning eyes.

The lightning effects of the comets are extremely severe in the period of sharat or autumn, October and November, and vasanta or spring, March and April. By the collision of the solar rays and the lightnings a force called ajagara is created. When the vimaana reaches the 20th region of the sky, that force paralyses the plane. To protect against such happenings the vidyuddwaadasha yantra is to be installed.

Yantra Sarvasva also Says :

Vidyuddwaadasa yantra is excellent in protecting against the lightning effect of comets. Its details are as follow. First duly coated jataghana should be prepared. It should have 22 folds so as to cover the vimaana. Poundraka and other crystals should be fixed in each of the folds. Then mahorna acid should be placed inside in the north-east side of the vimaana. 8 rods, each of 6 arms length, made of anti-lightning glass should be fixed in the 8 directions over the cover of the vimaana. At the begining, middle, and end of the vimaana canopy, spring wheels made of dambholee metal, 5 faced and interconnected should be fixed with revolving bolts. Cages made of wire should enclose the poundraka crystals, and the wire terminals should be attached to the spring wheels. The wire ends from 4 of the cages should have a common switch.

On the main wheel being put in speedy motion the 12 crystal cages will revolve, the enveloping cloth cover will spread out, and the lightning

absorbing power of the cloth will be activated. The crystals will attract the ajagara lightning, bifurcate the comet lightning from the solar rays, and transmit it to the 8 rods. The rods will absorb and then transfer the lightning power to the folds of the power proof cloth. By operating the central switch in the enclosure, a force called vidyut-kuthaarika, or lightning-axe, will be generated in the acid, and it will attract the comet force from the cloth, and submerge it in the acid. Then by operating the end switch in the enclosure, the ajagara force in the acid will dart towards the pataghana cloth-cover and take refuge, where upon the blowing wind will evaporate it and nullify its effects, and the vimaana will be out of danger.

According to Darpana Prakarana,

Shundaala metal, mridakaantaka or mountain ebony, ghanodara, budilaakara or tamarind, vatsanaabha poison, pankaja or eclipta prostrata, kutilaraga, naga or mesua ferrea, white sand, vara or syndhava salt, garada, mica, garala, or honey product, mukha, shringa, sphatika crystal, avara, muktaaphala or pearl? guggulu or boswellia glabra, kaanta or steel, kuranja or Indian beach, natron, salt-petre, borax, copper, snake scale, udupa, barren tree, sonamukhee or Tinnevelly senna, brown barked acacia, jaambalika or citrus grass? lemongrass? kusha grass, kudmala or flower bud, gold, these 26 ingredients, purified and filled in crucible and placed in padmaakara furnace, and with the aid of simhaasya or lion-faced bellows heated to 300 degrees, and poured into the mould, will yield a fine anti-lightning glass.

Dambhola loha or thunderbolt metal is thus described in

Lohatantra-Prakarana :

Urvaaraka, kaaravika, kuranga, shundaalika, chandramukha, virancha, kraantodara, yaalika, simhavaktra, jyotsnaakara, kshwinka, pancha-mourtwika, metals should be purified and placed in mandooka-or frog-crucible, placed in the five faced furnace, and with the aid panchamukha or 5 mouthed bellows heated to 500 degrees, will yield the dambholi alloy.

Poundrika crystals are described in Maniprakarana which describes the poundrika crystal.

Poundrika, jrimbhaka, shibira, apalochana, chapalaghna, amshupa-

mani, veeragha, gajatundika, taaraa mukha, maandalika, panchaasya, amrita sechaka, these 12 crystals are destroyers of ajigara.

Draavaka prakarana explains mahorna acid : pynaaka, panchamukha, ammonium chloride, wild liquorice, iron-pyrites, kudupa, vajrakanda, budila, mercury, steel, charcoal, mica, these in equal parts purified and boiled in acid boiler, will yield mahorna acid.

### Praana-Kundalinee Yantra.

According to "Kheta-Sarvasva," where the contact of smoke, lightning and wind courses in the sky occurs is the praanakundalee position. The yantra which can control, restrain, and set in motion the forces of these three in their several courses, is called praana-kundalee yantra.

According to Kriyaasaara, the yantra which is installed in the praana-kundalee kendra of the vimaana in order to control the forces of lightning, wind, and smoke, and adjusts their movements is called praana-kundalinee yantra.

Says Yantra-sarvasva, "In order to control the movements of the forces of smoke, electricity and wind, and make them disperse, move, halt, or make stunt move or reverse move, the praana-kundalinee yantra is installed in the vimaana. A peetha or stand 3 feet in diametre and 3 feet high, square or circular, should be made of vrishala metal, with 8 kendras or central spots. In each central spot, two wheels with revolving hinges; small peethas or plates with 3 holes, 4 teeth, 3 pivots, in their middle a central pivot, three red-coloured tubes or pipes with opening and closing wheels, and switches for right motion, and reverse motion, with a shabda-naala in the centre, with wheels (with hinges and rods) which will flap the wings; from the north-east and south-east kendras and the middle-kendra in the west up to the middle of the course of the yaana kundalinee revolving wheels with pivots. Motions are by means of hand wheels. By the operation of the several wheels the plane will be set in motion. From the central pivot of the 8 kendras strong wires should pass the eastern peetha or footboard through randhras or holes and reach the tops of the 3 tubes at the window. The 3 forces should be made to aid the motion of the vimaana, and the remnant of the force should be passed through the 8 tubes and get lost in the sky, leaving the vimaana unperturbed."



## Shaktyudgama Yantra

The eight powers of the planets and stars, at the time of full moon in the month of kaartika,—i.e., November–December, are pulled forcefully by mahaa-vaarunee shakti or great cold force. In the 137th route in the sky there is a jala-pinjooshikaa shakti which will attract and spread them all over, and there will be a fierce outburst of dew and snow. Then 3 currents will be generated: one will be a damp cold air flow; the second will be a wet dewy flow; and the third will be a cold air flow. When the vimaana approaches that region, the first force will divest it of all power. The second force will benumb the pilots and operators. The third force will envelop the vimaana and make it invisible. Thus overcome, the vimaana will crash. As protection against such a happening the shaktyudgama yantra should be fixed in the navel spot of the vimaana.

“Khetasangraha” says,

“Eight planets are, Mars, Sun, Saturn, Venus, Mercury, Moon, Jupiter, and Ruru. And krittika, shatabhisha, makha, mrigashiras, chitra, shravana, pushya, and ashvinee are eight luminous stars. In the course of their transit through space the planets and stars approach each other in the period of sharat or autumn generating eight forces.”

“Chaara-nibandhana” also says, “According to the science of astronomy, planets and stars in the course of their perambulations happen to approach one-another. Then conflict arises between the magnetic and electric forces of planet and star, and eight cold forces are generated in consequence.”

“Shakti-sarvasva” says, “When the star krittika comes near planet Mars, a force called shaktyudgamaa is generated. Similarly, by the star shatabhisha coming near the planet, Sun, a cold force called jwaalaamukhee is generated. By the nearness of mrigashiraa and Venus a damp cold windy force called mahojjwala is generated. By the approach of star makhaa to planet Saturn a force called shytya-damshtaa is generated. By the approach of chitta to Mercury a force called shytya-hymaa is generated. By the approach of shravana to Moon a cold wave force called sphorane is generated. By the nearness of pushya to Ruru a force called mahormilaa is generated. And by the approach of ashvinee towards Jupiter a force called mandookinee is generated.

These eight forces, shytyodgamaa, sheeta jwaalaa-mukhee, shytya-damshtraa, sheetarasa-jwaalaa, shytya hema, sphoranee, sheetarasa-ghanaatmikaa, and shytya-mandookinee, by mutual inter-play according to the seasons, will become six new forces."

Says "Ritukalpa,"—"In spring the differing forces will be 5, in summer 7, in the rainy season 8, in autumn 3, in hemanta or cold season 10, and in winter 2.

The 3 forces during autumn are as follows. The planet-star forces by contact with the sun's rays, assume 3 forms. Sheeta-jwaala, shytya-damshtraa, and shytyodgamaa, coalesce and become sheetarasa-vaata shakti. Shytya-rasa-jwaalaa, shytya hymaa, and sphoranee coalesce and become vaari sheetasheekaraa shakti. Shytya-ghanarasaa and shytya mandookinee become sheeta-vaata-rasa-praavaahika shakti."

Yantra Sarvasva Says,

"To protect the vimaana from the effects of these three forces the shaktyudgama yantra should be installed.

First with the shytyagraahaka loha or cold-absorbing metal, protective hoods should be prepared both for the pilot and for the plane. At the front and tail portion of the aeroplane cover should be fitted switches for contraction and expansion. In the front or elbow hinge of the supporting beam of the covers the two sandhi-keelie should be fitted. Three tubes should be prepared out of the cold-proof glass, and should be fitted in front and on either side of the pilot's cock-pit. Bhraamane chakra or wheel should be fitted at the front. When the three shaktis or forces attack the vimaana, the expansion wheel should be revolved vigorously, It will first cover the pilots and then cover the entire plane also. By operating the bhraamane wheel the attacking forces will be slowly absorbed, and the shaktis will be forced through the cold air tubes. By operating the main switch of the naala tantries, or wires, the forces will be made to go through the tubes into the outside air, and vanish therein. The pilot and the vimaana will both be saved from danger.

"Loha-tantra" describes the shytya-graahaka loha, or cold absorbing metal as follows :

Blue lotus, crowdika or rhinoceros horn or vaaraahi root, somakanda,

vishwaavasu, crownchika alloy, chandrakaanta or moon-stone, vaardhyashvaka alloy, varuna tree, 5 kudmalas, simhaasya, shankhalavaa, and goose-berry, to be purified and in equal quantities filled in shundaalaka crucible, placed in chanchoomukha kunda, and with panchaanana bellows heated will yield a fine cold-capturing alloy.

“Darpana prakarana” describes cold-proof glass: lead, kapaalee, moonstone, castor, margosa seed, trinaanga or cus-cus grass, kshaara-traya or natron, salt-petre, and borax, suvarchalaa or sun-flower?, fine sand, bhaarika, collyrium or eye-black, kuranga or pallatory root, panchormikaa, chandrasa, and shivarika, purified and in equal quantities filled in simhika crucible, placed in padmaakara furnace, and with the aid of shoorpodara bellows heated to 300 degrees, and poured into mould and cooled, will yield an excellent sheetaghna darpana or cold-proof glass.

#### Vakra-prasaarana Yantra :

Enemies attempt to destroy one's vimaana by missiles and dambholi and other mechanisms. The pilot should discover them by means of mukura and other yantras and immediately change course and avoid the trouble. Therefore the Vakraprasaarana yantra, or diversion enabling mechanism should be installed in the vimaana.

Yantra Sarvasva says,

“When there is danger from dambholi and 8 other kinds of destructive mechanisms contrived by enemies, in order to escape that danger the vakra-prasaarana yantra is prescribed :

Sulphate of iron, sacred peepul gum, and copper 16 parts, krishnaaguru or black sandalwood 3 parts, zinc 5 parts, collyrium 1 part, should be purified and mixed and boiled with 100 degree heat. Aaraara copper alloy will be formed, goldish and light and hard. A wheel 3 feet wide and 3 feet high should be made out of it. It should have a pivot, and be installed in the bottom of the eeshaadanda axle moola of the vimaana. Four inches thick and of arm's length, with 16 wheels having band-saw toothed edges attached to two pivots, oil-cleaned, with 3 joints, with oil-cleaned rods attached to the saw-toothed wheels, with keys; in the middle should be fixed 2 keys which will eject

smoke, and 2 keys which will shut off smoke. Proper wiring should connect the several parts. This will enable the vimaana to zigzag like a serpent, to reverse, and to divert so as to avoid the danger zone, and get out safely."

### Shakti Panjarakeela Yántra :

In order to provide electric force to all parts of the vimaana and make them operate smoothly the shakti-panjara-keela yantra is to be installed.

According to Yantrasarvasva, "As a means of charging all parts of the vimaana with electric current the shakti-panjara-keela is prescribed. It is made as follows :

Steel, crownchika alloy, and iron, in the proportion of 10, 8, and 9, to be powdered and filled in crucible, and placed in aatapa furnace and heated to 100 degrees and charged with 10 degrees of electric current, will yield Shakti-garbha metal with which the yantra is to be made.

A peetha or plank of arm's length and equal height, should be made out of above metal. In the middle and at either end of the peetha three pivots with half moon shaped hinges should be fixed. A flat bar made of copper should be fixed and tightened with bolts. Pipes with holes are to be made out of the metal and equipped with rods fixed in the holes, and connected all round with wires, forming a strong caged globe. The cage should be fixed at the top of the copper band. For the rods and wires in the cage to receive electric current a switch should be duly fixed at the bottom of the cage. And switches should be provided for all the 32 parts of the vimaana for electric connection and disconnection. This enables the plane to career through the sky in any desired direction."

### Shirah-Keelaka Yantra.

It is said in Kriyaa-saara, "When the plane is passing through a region of overhanging clouds, there is possibility of lightning striking and destroying the plane. As protection against that the shirah-keelaka yantra should be installed at the crest of the vimaana."

The Yantra is described in Yantra Sarvasva :

"When there is danger of lightning striking the plane, the shirah-keelaka yantra is to protect it. Therefore it is explained below. An umbrella, of the

same size as the top of the vimaana, with ribs and metal covering should be made out of vishakantha metal. The umbrella stick, of arm's length, and peetha or stand, circular in shape, should be made out of the same metal. Then out of baka-tundila metal three wheeled keelakaas or hinges should be fixed at the front, back, and middle of the vimaana. The umbrella rod should be fixed in the middle of two keelakas.

The agnikuthaara crystal with metal cage should be fixed at the top like a crown. A three wheel switch revolving key should be fixed by the side of the pilot. Then wires made of kulishadhwamsa metal should be run from the crystal to the three wheeled revolving keelaka. In front of it shabda-naala tube with switch should be fixed. The yantra should be enclosed in a cover made of suranjikaa glass. When there is anticipatory thunder in the clouds, the glass covering cracks, and the tube of the wiring will emit sounds, and the wires will be severely shaken. When the pilot notices these signs, he should quickly set in motion the three-wheel keelce, which will revolve the umbrella with 100 linka speed. Then the crystal switch should also be turned, whereupon the crystal will also revolve with intense speed. By the speed of the revolution of the umbrella, the force of lightning will be stemmed, and the danger will be passed, leaving the vimaana and the pilot safe. That is the use of the shirah-keela yantra."

#### Shabdaakarshana yantra :

In order to tap or discover the sounds in the 8 directions of the vimaana, wired or wireless, up to 12 krosas or 27 miles, caused by birds or quadrupeds or by men, with 8 mechanisms, the shabdaakarshana yantra is prescribed to be fixed in the shoulder of the vimaana. A peetha or foot-plate four-cornered or round should be made out of bidaala metal, with a pivot in the centre. On either side should be fitted machines which will attract any kind of sound and repeat it. With the soft leather of roruva or grinjinee bird two ball-shaped domes should be fixed. Between them in a suraghaadarsa vessel katana-drava acid should be filled and the vessel should be installed. Above the acid vessel and between the two globes should be fixed sound spotting rod made of sound capturing ghantaara metal, fitted with a bunch of wires. It should be enclosed in a cover made of kwanaka glass. In the corner three thumb size wheeled knots should be fixed. From them to the rod fine strong wires should be connected. Enclosing the wires a karanda or

container made by kwanaadarsa glass, with small holes should be placed. A vessel made of the same glass, shaped like a drona or grain measurer, should be placed on top of it. In the east and west and north and south 4 crystals named rudantee-ratikaa should be arranged with wires. Above it shabda-phenaka covering, with small shankus or screws fixed, should be placed. It should be covered by a covering made of kwanaadarsa glass, with 8 small holes. Wires starting from the screws and passing through the holes should reach the top of the covering. In the centre of it in an inch size hole simhaasya-danda-naala or tube should be fixed. In front of it a vaataapaakarshana chakra or wind wheel with 16 spokes with wires should be fixed. The wheels should be fixed in all 8 directions. In the simhaasya mukha naala or lion-faced tube on 8 sides revolving wheels should be fixed. 8 goblet like vessels made of pure vajeemukha metal should be fixed. Wires from the 8 holes of the covering should be placed in them. Similarly from the wind wheel wires should be connected to 8 screws in the 8 goblets on the simhaasya. Then from the 8 screws in shabda-phena, wires should be connected to the crystal in the acid vessel.

By the flow of wind the wheel turns with speedy right and left motion, and will set in motion the shabda-phena wheel. Then the wheels on the 8 screws also will turn. Then the sound detection rod made of sound-capturing ghantaara metal will be set in motion. Thereupon the two globes made of roruva-grinjinee skin will attract all sounds clearly and store inside themselves. By moving the central switch there the sounds will pass through the simhaasya tube and enter the dronaasya vessel, and make the sounds clearly audible to the hearer. The pilot will listen to the voices and direct the plane away from the vicinity of danger. Hence the shabdaakarshana yantra is prescribed.

This yantra is in 32 varieties. And it is distinct from the 32 parts constituting the vimaana.

Of the materials required for this yantra,—Byndaala Metal, according to Lohasarvasva, is made as follows :

Zinc, sharkara or quartz powder ?, kaanta or steel, mica, shilaarasa, kamatha or benzoin, dimbhaari, areca-nut, karagrathinee, copper, virinchi, karna or sal tree, patalee or long blue cucumber, gumbhalee, dumbholika alloy, kshaara or chloride, kraantika, simha, panja or momordika, dalinee, mercury, eye-black powder or surma ?, kshonika, veera or red-lead, yellow

thistle, madder-root, mridarutee, brass, iron, these articles should be powdered, and purified in equal quantities, filled in shashamoosha crucible, placed in mandooka furnace, and with five-mouthed bellows heated to 200 degrees and melted to eye-level, when cast will yield a fine, light, blue, bydaala alloy.

Rutana acid is explained in "Moolikaarka prakaasikaa" as follows :

Yellow thistle, karanda or iron pyrites, wild liquorice, paarvani or chlorodendrum phlomaides, chanchooli or red castor, bhantikaa or madder root, kaarambha, vishwesa, chandikaa or sesbenia grandiflora, amara or Indian turnsole ?, shundaalika, barbaraasya, sowrambha or tooth-ache tree ?, praana-ksaara or ammonium chloride, virinchi, borax, arka or calotropis gigantia, surubhee or basil, these in the proportion of 4, 3, 3, 5, 7, 12, 15, 1, 3, 10, 24, 25, 30, 12, 20, 8, purified and filled in vessel and boiled to 108 degrees, will become a fine yellow rutana-draavaka acid.

Ghantaarava metal is explained in Lohatantra :

Bell-metal, aaraara, ruchaka or natron ?, gaaruda or emerald stone ?, shalyakrintana, panchaasya, veerana, rukma or gold-metal, shukatunda, and sulochana, these 10 metals purified and powdered in the proportion of 5, 3, 12, 2, 3, 7, 5, 30, 4, 24, should be filled in shukti crucible, wrapped all round with earth, placed in alaabu shaped furnace, and boiled to 500 degrees up to eye level, should be poured into the mould. A fine, light, scarlet metal which will record all sounds will result.

Kwanadarpana mirror is explained in Darpana Prakarana :

Wild liquorice seeds, red catechu, false catechu, white catechu, garadaka or a poison, 8 kinds of salt, salyaaka, vara or sodium chloride, sharkaraa or granite powder, budilaka salt, jwaalaamukha or wolf's bane ?, tundila or kayidonda, bydaala or arsenic ?. shukatunda, ravimukha or magnifying glass, chancholika or red castor seed, arjuna or tin, luntaaka, varataala or yellow orpiment ?, kuravaka or crimson thorny amaranth, kambodara, kaamuka or punnaaga or Alexandrian laurel or pinnay oil tree, these ingredients, after triple cleaning, are to be filled in padma crucible, placed in padmaakara furnace, and heated to 700 degrees, and poured in mould, will yield an excellent kwanadarpana glass.

Rudantee-mani is explained in "Mani Prakarana" :

Kshaaratraya or natron, salt-petre, borax, aanjanika or eye-black powder, kaanta or sun crystal, sajjeeka, vara or sodium chloride, karna or oxide of arsenic, cowrie shells, maakshika or iron pyrites, sharkara or granite grains, sphaatika or alum, kaamsya or bell-metal, mercury, taalaka-satva or yellow orpiment, gyra or marking nut, ruruka, rouchyaka, kudupa, garada or acnite, panchamukha metal, shingara or iron dross, and shundolika or great leaved caledium, these 21 articles, purified, and filled in aanika crucible, placed in shouktika furnace and boiled to 103 degrees, and cast into manyantra mould, becomes a fine rudantee crystal.

Ruchika mani also is explained in Maniprakarana :

Sea-foam, chamaree cat's nail and mouth bones, steel, paarthiva, granite grains, shilaarasa or liquid amber, mercury, praana-kshaara or ammonium chloride, alum, naaga, cowrie, maakshika or iron pyrites, shundaala or great-leaved caledium, rundaka or eagle wood, kudupa, suvarchala or natron, jambaalika, musk-cat's tooth, or yellow orpiment?, ranjaka, manjishtha or madder root, paarvani or stag-horn, rukma or gold quartz, yellow thistle, owl's nails, vara or ammonium chloride, oyster shell, these ingredients, purified and filled in equal proportion in nakhamukha crucible, placed in mahodara furnace and heated with the aid of six-faced bellows to eye-level, and poured into mould will yield a strong, dark, heavy rutikaa crystal.

Shabda phena mani is described in "Shabda-Mahodadhi" :

"Take badaba sound from the sky, life-giving trait from water, the fire of air from the atmosphere, the echoing quality from boulder, the splitting quality from solar-rays, moss layer, sea-foam, bamboo, conch, manjishtha or madder root, kusha grass, gribhdnaka, rudra-shalya, gokarna or sal?, and musali or curculigo orchioides, in the proportion of 7, 22, 45, 13, 32, 19, 38, 14, 22, 38, 42, 13, 25, 9, and 23. These purified and boiled will yield shabdaphena."

From moss-layer to musali the ingredients should be purified, and in the said proportions should be filled in phenaakara yantra, should be baked for 3 days, and for a week the sankalana key-wheel of the yantra should be turned in full speed for half a ghatika daily, when foam will be formed. The foam should be filled in shakti-sammelana yantra. Then through 6 tubes



the 6 shaktis or powers from praanana to sphotana should be injected into the foam patiently. On either side of the yantra switches should turn the mixing or churning wheel inside the yantra. Then moderate heat should be applied from praanana to sphotana power infusion. Then keeping it in the sun, electric power should be applied to the foam up to 85 degrees. This electric cooking should be done for 6 days. Then carefully extracting the foam from the yantra, it should be stored in the vaajeemukha metal box. That shabda-phena would be able to attract and record all kinds of sounds.

Vaajeemukha metal is described in "Lohatantra":

Copper 3 parts, sonamukhee or iron pyrites 2 parts, zinc 8 parts, veera or black metal 2 parts, kaanta or steel 3 parts, bambhaarika 1 part, kamsaarika 3 parts, panchaanana 6 parts, gowreemukha or mica? 2 parts, shundaalaka 6 parts, these 10 articles to be purified and filled in shundaalaka crucible, placed in shoorpaasya furnace and heated with vajraanana bellows and poured in vajraanana yantra and churned energetically for proper cohesion of the liquid, will yield vaajeemukha loha of light reddish brown colour.

Pataprasaarana yantra is described in Kriyaasaara:

In order to realise dangers to the vimaana en route, and shift directions towards safety, pataprasaarana yantra is prescribed. Says Patakhalpa:

"Munja grass, lac, sal, red brinjal, shaambaree or arjuna tree bark, jute, raajaavarta or sphatikaari or hydrorgirum sulphuratum, darbha grass, kravyaada or Indian spikenard, with triple purification, and thrice exposing to soorya-puta or sun-baking, placing them in the cooking vessel, and baking for 3 days. Then the product should be filled in kuttinee yantra, and churned for 3 yaamaas or  $\frac{3}{4}$  of a day, then placed in cooking vessel and rebaked for 3 days. Then it must be poured into patakriyaa yantra or cloth-forming machine and churned, so as to form an even emulsion, and that will form a fine artificial cloth. It should then be coloured with seven colours. It should be rolled round a long pole, and the pole fixed in thrimukhee-naala yantra, and equipped with a key should be installed in the shoulder of the vimaana.

When the flag-like contraption shows red indicating danger ahead the pilot should loose height and reach safety. When favourable colours are

shown, the pilot should note their significance and move the vimaana in the favourable direction.

**Dishaampati Yantra :** says “Kriyaasaara,”

“In its passage in the sky in the eight directions, the vimaana is likely to meet 15 fierce hurricanes called kowbera by the effects of the planetary forces with solar rays and unfavourable seasonal conditions. They will cause baneful skin effects on the occupants of planes and throat and lung troubles. To protect against that the Disaampti yantra is to be installed in the left shoulder of the vimaana.”

**The yantra is described in “Yantra Prakarana” :**

“In order to act as antidote to the poisonous effects of the kowbera winds, I shall describe the disaampati yantra. A peetha or foot plate, quadrangular or circular, should be made of paarvane wood cured three times with requisite acids.”

**Paarvane wood is described in “Agatatwa Laharee” :**

“Parvane wood is wood which has very close joints as in sugarcane. It is red coloured, long leaved, decked with red flowers. It has small thorns, is antidote for snake-poison, is acrid in taste, and is used in driving away demons and other evil forces. It blooms in the dark half of the month.”

In the centre of the peetha, a tube or pivot made of the 19th type of glass, with 9 holes, 9 switches, and 9 wires, and of arm’s length, should be fixed. Eight kendras or centres should be spotted in its 8 directions. 8 naalas, pipes, or tubes, should be made 2 feet long, 6 feet high and 3 feet wide, and round in the middle. A lotus with 8 petals should be prepared and fixed on the top of the pivot. The whole should be covered with hare-skin. Manchoolika linen should cover its mukha or entrance. The wires in the tubes should be taken to the petals above the lotus and fixed in the joints.

**Manchoolikaa linen is explained in “Pata-pradeepikaa” :**

Vasantee or gaertnera racemosa creeper, mrida, ranjikka or betel or madder root, ruchikka or citron or castor, samvartakee or myrabalan belliriki, phalgune or sepistan plum, chanchora or red castor, arunakaanta

or sun-flower, kudalinee, mandoorika or iron dross, maarikaa or cubed pepper, lankaari, kapivallaree or elephant pepper, vishadharaa, samvaalikaa, manjaree or ashoka, rukmaangaa or cassia fistula, dhundikaa or acacia sirisa, arka or gigantic swallow wort or madar, garudaa or coculus cordifolious, gunjaa or wild liquorice, and janjharaa.

Taking the twigs, shoots, leaves, buds, tendrils and barks of the above ingredients, and putting them in the baking vessel, they should be well cooked. Then add crowncha acid and boil again for 3 days. That will produce a soft white, pure, strong, fine manjoolikaa linen cloth.

Vaatapaa crystal should be placed in it. Amshupaa mirror should be placed at its front. When the Kowbera whirlwind contacts solar rays, then the amshupaa mirror will show a red and blue tinge. Then the keys of the nine tubes should be turned with great speed. By this a force will be generated in each tube, and passing to the hare-skin, a strong force called sammarshtikaa will be generated. The manjoolika cloth will receive that force and pass it to the lotus petals, and the petals by means of wires will transmit the force to vaatapaa crystal. The crystal, will, with the aid of sammarshtika force, absorb the Kowbera evil wind and throw it out through the lotus petal tube to merge in the outside atmosphere, and no harm will be caused to the occupants of the vimaana. Therefore disaampati yantra should be installed in the vimaana.

19th type mirror is described in Darpana prakarana :

Uraga-twak or snake-scales, pancha-mukha, vyaaghradanta or tiger's tooth, sand, salt, mercury, lead, white gum or shweta-niryaasa, mrittikaa, sphaatika or alum, ruruka, veera or red lead ? mrinala or lotus tendril, ravi-karpata, chanchola or red castor, vaalaja, panchapraanasaara or urinal salt of man, horse, ass, ox, and sheep, or ammonium chloride, shashodupa or benzoin shoot. These 18 ingredients in the proportion of 3, 7, 5, 22, 4, 15, 2, 5, 20, 7, 30, 15, 40, 23, 27, 13, 19, 18, purified thrice, filled in matsya moosha crucible, placed in nalikaa furnace, and with the aid of gomukhee bellows boiled to 99th degree, and poured into the mould, will yield pingala mirror.

**Pattikaabhraka Yantra :**

Says Kriyaasaara,

“In order to safeguard against the fires generated by the juxta-position of planets during its course, the pattikaabhraka yantra is to be installed in the centre of the vimaana.”

It is said in "Yantrasarvasva,"

In the course of its planetary motions, two planets sometimes get too near each other, when by the conflict of their giant forces, fires will burst out. They are known as jwaalaamukhee or flame-tongued, and will destroy the vimaana and those inside it. As protection against it, pattikaabhraka yantra should be installed in the vimaana.

The yantra should be made out of the 3rd type of mica amongst the 3rd group of its classification.

It is said in "Shownakeeya,"

"The names of mica belonging to the 3rd group are shaarada, pankila, soma, maarjaalika, rakta mukha, and vinaashaka. The yantra should be made of soma variety."

Somaabhra is described in Loha-tantra :

"It is sky-coloured, fine, strong, absorbent, cure for eye diseases. Its touch is cooling to the body. It has diamond content, and is cure for urinal trouble. It exhibits scarlet lines with whirls. These are the qualities of somaabhraka."

The mica should be purified twice with brinjal and mataa seed oil and melted, and a pattika two feet wide and of arm's length high should be fashioned. A koorma peetha or tortoise-shaped foot-plate 16 inches wide and arm's length high should be made with vaari vriksha. A shanku or pivot should be made like the pattika. Revolving wheels with keys and shoundeerya manis or crystals should be fixed. From the main centre wires should be attached to it to the end of the pattika. On the other side an ivory vessel should be fixed and filled with shyvaala acid, and adding mercury ravichumbaka mani or crystal should be placed in it. The wires should be connected to the inside of the vessel containing these things. From the pivot it should be covered with shringinee. The root of the naala or pivot should be fixed to face the sky. The mica shanku with five revolving wheel key attachments should be fixed in the centre of the peetha, and the acid purified pattika should be fixed on top of it in the centre of the vimaana covering.

When the jwaalaamukhee erupts from the planetary contact and reaches the direction of the vimaana, the main switch of the pivot should be operated, a cold wave will arise through the wires from the acid vessel, and passing

through the five wheels reach the pattika, and contacting the jwaalaamukhee force will draw it and push it to the crystal in the centre of the enclosure, and the crystal will thrust it through the naala or pipe to the outside atmosphere where the flame force will get extinguished.

### Soorya Shaktyapakarshana Yantra

or Solar heat extracting Yantra :

In order to relieve the excessive cold of the winter months, the soorya shaktyapakarshana yantra should be installed on the vimaana.

Says Yantra Sarvasva,

“In order to protect from the cold of the 4 winter months the solar heat storing machine is now explained. The 27th kind of mirror capable of capturing solar heat is to be used in its making.”

It is said in Darpana prakarana :

Sphatika or alum, manjula or madder root, sea-foam, sarja salt or natron, sand, mercury, garada or aconite, kishora or wild liquorice, gandhaka or sulphur brimstone, karbura or yellow orpiment, praanakshaara or ammonium chloride, in the proportion of 12, 1, 5, 1, 13, 12, 8, 10, 27, 4, 3, 7, 8, 5, 1, 5, 8, 3, 9, 2, purified, to be filled in antarmukha crucible, placing it in shuka-mukha furnace, and boiled. Then pour it into antarmukha yantra or vessel and turn the churning key. When cooled in the mould a fine, light, strong, golden coloured, solar heat collecting glass will be formed.

From this glass prepare a pattika or plank, 80 inches long, 20 inches wide, and 1 inch thick. Three spots are to be marked on it. Two naalaas or pipes of arm's size, with a 10 inch mouth, crescent shaped peetha should be prepared. Another peetha, 2 feet long, and 6 feet high, should be prepared. The crescent shaped peetha should be fixed in it. On its two sides the 2 naalaas should be fixed. Between them a pivot 88 inches long and 3 inches wide should be fixed. The other pattika should be fixed on its top. At its 3 marked spots, lotus shapes with petals made of the above glass with two faces with goblets on them should be fixed. The two naalaas or pipes should be filled with shyvaala or moss acid and shrini acid. Chhaayaamukha crystal should be placed in them. At the foot of the shanku jyotsnaa acid should be placed. Cold absorbing wires with key switches with ball bearings should be fixed in

the jyotsnaa acid. The wires should be taken between the neighbouring naalas, taken round the two lotus positions on the sides of the pattika, and then made to surround the central lotus, and lead on and placed inside the jyotsna acid. Then the other naala should be made to cover the acid vessel, and fixed so as to have its opening through the bottom of the vimaana.

On the approach of winter cold into the vimaana, the main wheel at the foot of the shanku should be turned at high speed. That will energise the head wires of the pattika, making the lotus petals active, and the wind will draw the cold and pass to the central acid vessel through the wires, and the acids in the 2 naalas will draw in the cold and pass to the chaayaamukha mani, which by its own force will pass the cold force to the jyotsnaadravaka, which will eject it through the naala to the atmosphere outside for being dissolved. The vimaana will thus be saved from the cold force through the soorya-shaktyapakarshana yantra.

**Apasmaara dhooma prasaarana yantra**

or poison-gas fume spreading machine :

Says Kriyaasaara,

“When the enemy plane is trying to destroy your vimaana, Apasmaara dhooma prasaarana yantra should be provided in the vimaana to combat it.”

**Yantra Sarvasva Says :**

“Apasmaara dhooma prasaarana yantra is prescribed for protection of vimaana from enemy planes. It should be manufactured with kshoundeera metal only, and not with anything else.”

**Kshoundeera loha** is described in Lohatantra :

8 parts of kshwinka or zinc, 5 parts of mercury, 7 parts of krowncha alloy, 3 parts of kaanta or steel, 4 parts of hamsa or metallic silver, 1 part of maadhweeka, and 5 parts of ruru, these ingredients to be purified and filled in crucible, placed in chhatreemukha furnace, and with the acid of surasa bellows heated to 100 degrees heat, and cast in mould will yield excellent kshoundeera alloy.

Filling this loha in pattikaayantra, applying 300 degree heat and churning, a fine strong pattikaa will be formed. With that, a shape like bellows, 5 arm's length high, and 3 arm's wide should be formed. It should be provided

with a mukha-naala or nozzle 6 feet in size. Its mouth should be like that of peshanee yantra. The opening should be covered and keyed. Three satchels should be attached at its bottom. In the middle an aavarana or covering with hare-skin, circular and provided with switch. Smoke or gas filling switch should be provided at its base. Above it a choorna paatra or powder vessel should be fixed. The switch key should be beneath the middle of the vessel. Thus four bellows should be prepared.

When the enemy plane's attack is expected, the aavaaraka bhastrika or enveloping bellows should shield the vimaana, and the 4 bellows should be fixed on the dikpeethaas or side seats above the aavarana or covering, and electricity should be applied to the choorna-paatra or powder keg. Immediately the powder becomes smoke. The bellows' mouth should be opened and the key turned. The emerging smoke fumes will enter the 4 small bellows, and from them reach the central kunda and spread all around and reach the bellows' mouth. Then on turning that key, the fumes will be emitted from all the bhastrikaas or bellows, and encompass the enemy plane and disable its occupants. That plane will be destroyed and the danger to one's vimaana overcome.

Stambhana Yantra  
or Halting machine :

Kriyaasaara says,

When power is generated by conflicting forces in the water-charged regions, shrieking hurricanes and whirl-winds will arise and set out in a mad career of destruction. To safeguard against their onslaughts, the Stambhana yantra should be installed in the bottom of the vimaana.

Yantra sarvasva says,

In order to protect the plane from the attacks of giant wind blasts, vimaana stambhana yantra is described as follows :

A peetha, one fourth the size of the vimaana floor, quadrangular, should be made out of vakratunda metal, three feet in thickness. In its 8 quarters spots should be marked for fixtures. An enclosure with openings, revolving toothed wheels made of the same metal, wheel rods with revolving keys, a metal band which is to encircle it thrice, toothed wheels, pivots, and switches and hinges, and three-stranded wire ropes, should also be of the same metal. In the 8 selected spots naalaas or pivots with wheels and wiring should be fixed. Through the naala or pipe at the contraction switch of the vimaana,

wires should be passed through the other naalas to the central pivot, and tied at the foot of the revolving wheel. When the dreaded wind current is observed the switch or wheel for the contraction or folding of the expanded vimaana parts should be turned, as also the 8 side wheel turning switches. That will reduce the speed of the vimaana. Then the switches of the 8 pivots on the peetha or foot-plate should be turned. The entire speed of the vimaana will be extinguished thereby. The wheel at the central pivot of the peetha should then be turned, so that the vimaana will be halted completely. Then the switch of the plane-wings should be turned. The flapping of the wings will produce winds which will encircle the vimaana and form a globe protecting it. Then by turning the switch of the brake-rod, the vimaana becomes motionless. Therefore the Yaana-sthambhana yantra should be fixed at the bottom centre of the vimaana.

#### Vyshvaanara-naala yantra :

Kriyaasaara says,

For the purpose of providing fire for passengers to perform agnihotra or daily fire rituals, and for the purpose of cooking food, Vyshvaanara naala yantra is to be fitted up at the navel centre of the vimaana.

Yantra-sarvasva says,

To provide fire for travellers in vimaanas, vyshvaanara naala yantra is now described. A 2 feet long and 12 inches wide peetha or foot-plate should be made out of naaga metal, quadrangular or circular in shape. Three kendras or spots should be marked thereon. Three vessels should be made of copper and karpara or (black jack ?) zinc blended metal. One vessel should be filled with sulphur-brimstone acid. Another should be filled with rookshaka bdellium acid, or croton seed acid? And manjishta or madder root acid should be filled in another vessel. The three vessels should be placed on the 3 kendra spots on the peetha.

In the sulphur acid vessel the prajwaalaka mani or flame producing crystal should be placed. In the rookshaka acid vessel the dhoomaasya mani or smoke crystal should be placed. In the manjishtha acid vessel the mahoshnika mani, or heat producing crystal should be placed.

In the places in the vimaana where kitchens are located, and where sacred agnihotra fires are needed by passengers, keelaka sthambhas or pivots should be fixed. The acid vessels should be connected with power wires from the central pivot. The wires should be attached to the manis or crystals in



the acid vessels. At the top of the central pole jwaalaamukhee mani should be fixed in the centre of chumbakee keela with glass covering. On either side of it sinjeeraka mani and dridhikaa mani should be fixed. From each mani a wire should be stretched from the top of the central pole and fixed at the granthikeela at the foot of the pole. From there up to the cooking spots and agnihotra spots, a circle should be formed like a kulya, and metal tubes should be fixed therein. Wires should be drawn through the tubes to the fire places and fixed to the kharpara metallic pattikas therein.

First the bhadramushti keelaka should be revolved. The acid in the vessel will become heated. The heat generated in the rookshna acid will pass into the manjishtha mani, and generate smoke in the mahoshnika mani. By the force of that acid intense heat will be generated. And by the heat generated in the sulphuric acid vessel flames will erupt in the prajwaalika mani. The smoke, heat and flames will pass through the wires to the sinjeeraka, dridhikaa and jwaalaa-mukhee manis. Then the chumbaka wheel should be turned vigorously, whereupon the smoke, heat, and flames will reach the key at the top of the central pole. And on that keelee being turned, they will reach the central switchboard keelee at the foot of the pole. When that switch is put on, the heat and flames will reach the metal bands of the cooking ovens and religious fire places, and generate fires. Therefore vyshwaanara naala yantra should be fixed at the navel centre of vimaana.

We have so far dealt with anga yantras or constituent machines of the vimaana. We proceed next to deal with Vyoma-yaanas or Aeroplanes.



## SIXTH CHAPTER

**Atha Jaatyadhikaranam: Varieties of Vimaanas.**

**Maharshi Bharadwaaja :**

☞ Jaati tryvidhyam Yugabhedaad Vimaanaanaam. Sootra 1.  
“Three types according to changing Yugas.”

**Bodhaananda Vritti :**

According to the differences in yugas, there are three different types of planes :

Having dealt with the constituent mechanical parts of the Vimaana, we shall now deal with the Vimaanas according to their different classes.

The sootra indicates that there are different types of planes, and that they are of 3 types.

In the Krita Yuga, Dharma or Righteousness was four-footed, that is, it was four-square, fully established, all paramount, and it was adhered to implicitly by men. The men were inherently noble-born and were possessed of remarkable powers. Without needing to go through yogic discipline to attain special powers, or practise mantras which secured extraordinary results, the men of that yuga, merely by their devotion to dharma, became Siddha-purushaas or gifted with superhuman powers. They were virtuous men and men of learning and wisdom. Going in the sky with the speed of wind by their own volition was natural to them. The eight super-sensory, and now superhuman, attainments, known as animaa, mahimaa, garimaa, laghimaa, praaptih, praakaamyaa, eeshatwa, and vashitwa, were all possessed by them. That is, animaa is assumption of infinitesimal shape ; mahimaa is growing into gigantic shape ; garimaa is becoming astonishingly heavy ; laghimaa is becoming weightless ; praaptih is securing any desired thing ; praakaamyam is becoming rid of desires ; eeshatwa is attaining paramountcy ; and vashitwa is becoming extremely pliant.

\*

\*

\*

\*

- |                                  |                                  |
|----------------------------------|----------------------------------|
| I. Krita yuga-1728000 years.     | II. Threthaa yuga-1296000 years. |
| III. Dwaapara yuga-864000 years. | Kaliyuga-432000 years.           |

Therefore in Krita Yuga, or first epoch, the ancients say, there were none of the three classes of Vimaanas.

Krita Yuga passed ; and Tretaa Yuga commenced. Dharma then became limp of one foot. It served with 3 feet only, and grew gradually less efficient. So men's minds became dense, and the conception of Vedic truths, and anima and other super-sensory powers, became scarcer. Therefore, by the corrosion of Dharma or righteousness, men lost the power of flying in the sky with the speed of wind.

Perceiving this, God Mahadeva, desiring to confer the power of understanding the Vedas properly on the Dwijas, or brahmins, kshatriyas, and vasyas, graciously descended on earth in the form of Dakshinaamurthy, and through the instrumentality of Sanaka and other anointed sages, classified the Veda mantras, and then bestowing his benedictory glance on the worshipping Munis or ascetics, he blessed them with the gift of Vedic perception. And then to ensure that they were properly receptive, he embraced them and entered their hearts and illuminated their memories. The munis, overwhelmed by the Divine grace, aglow with horripulation, with voice choked with emotion, praised the Supreme with shata-rudreeya and other hymns, and manifested profound devotion.

Pleased with their receptiveness, divine Dakshinaamurthy, favouring them with a benign glance, and with smile on his face, said to them, "Till now you have been known as "Munis" or ascetics. Henceforth, having by my grace attained insight into the Vedas, you shall be known as "Rishis" or seers. You will cultivate the Vedic mantras, and practising celebacy, you will adore the divine Goddess of the Vedas, and winning her favour, and approaching the Great God Easwara by Yogic Samadhi, ascertain His mind, and by His and my grace, rising to the pinnacle of intellectual vision, become adepts in the meaning and purport of the Vedas ; and confirming by them your own experiences and meditative introspection, you will create the Dharmashastras or moral codes, Puranas and Itihaasas, and physical and material sciences, in conformity to the truths of the Vedas, for the benefit of mankind. And for travelling in the sky, propagate the art of manufacturing Vimaanas, and for attaining wind-speed, evolve Ghutica and Paadukaa methods through Kalpashastras or scientific treatises."

Then those munis or seers, enshrining in their hearts God Mahadeva in the form of Dakshinaamurthy, produced the Dharmashastras or ethical codes, epics, chronicles, manuals on rituals, treatises on the arts and sciences, ritualistic and sacrificial codes, in conformity to the Vedas, and propagated them among men. Amongst them it is said that there are six treatises bearing on the manufacture of Vimaanas produced by the ancient seers. In them are described three classes of vimaanas, known as maantrikaas, taantrikaas, and kritakaas, capable of flying everywhere.

It is said in Vimaana Chandrika,

“I shall indicate the different kinds of vimaanas. In Tretaa yuga as men were adepts in mantras or potent hymns, the vimaanas used to be produced by means of maantric knowledge. In Dwaapara yuga as men had developed considerable tantric knowledge, vimaanas were manufactured by means of tantric knowledge. As, both mantra and tantra are deficient in Kaliyuga, the vimaanas are known as kritaka or artificial. Thus, owing to changes in dharma during the yugas, the ancient seers have classified the vimaanas of the 3 yugas as of 3 different types.”

“Vyomayaana Tantra” also says,

“By the influence of mantras in Tretaa, vimaanas are of maantrika type. Owing to the prevalence of tantras in Dwaapara, the vimaanas are of taantrika type. Owing to decadence of both mantra and tantra in Kaliyuga, the vimaanas are of artificial type.” Thus 3 classes of vimaanas are mentioned in shastras by ancient seers.

In “Yantra Kalpa” also,

“Vimaanas are classified into mantra and other varieties by experts according to differences in yugas. They are defined as maantrika, taantrika, and kritaka.”

The same is expressed in “Kheta yaana pradeepika,” and also “Vyoma Yaana Arkaprakaashikaa.”

Thus according to shaastras vimaanas are divided into 3 classes, on the basis of differences in the modes of their manufacture.

### **Maharshi Bharadwaaja :**

☞ “Pancha-vimshan Maantrikaaha Pushpakaadi  
Prabhedena” Sootra 2.

“Maantrika Vimaanas are of Pushpaka and other 25 Varieties.”

### **Bodhaananda Vritti :**

In the previous sootra vimaanas were specified as of 3 types owing to differences in the 3 yugas. In this sootra maantrika vimaanas or vimaanas flying by maantrik power are said to be 25.

Shounaka Sootra says,

Maantrika vimaanas in Tretaayuga are 25. Their names are pushpaka, ajamukha, bhraajasvat, jyotirmukha, kowshika, bheeshma, shesha, vajraanga, dyvata, ujvala, kolaahala, archisha, bhooshnu, somaanka, panchavarna, shanmukha, panchabaana, mayoora, shankara, tripura, vasuhaara, panchaanana, ambareesha, trinetra and bherunda.

In Maanibhadraakarikaa,

The vimaanas of Tretaayuga are 32 of the maantrika type. Their names as given by Maharshi Gowtama are Pushpaka, ajamukha, bhraaja, swayamjyoti, kowshika, bheeshmaka, shesha, vajraanga, dyvata, ujvala, kolaahala, archisha, bhooshnu, somaanka, varnapanchaka, shanmukha, panchabaana, mayoora, shankara priya, tripura, vasuhaara, panchaanana, ambareesha, trinetra, and bherunda, etc.

### **Maharshi Bharadwaaja :**

☞ “Bhyravaadi Bhedaat Tantrikaa-shshat-panchaashat.” Sootra 3.

“Taantrika Vimaanas are of Bhyrava and other 56 varieties.”

### **Bodhaananda Vritti :**

In previous sootra the names of maantrika vimaanas were mentioned. In this sootra the names of taantrika vimaanas of Dwaapara yuga are mentioned.

In shape, movement and speed there is no difference between maantrika and taantrika vimaanas. There is however one difference in taantrika vimaanas, that is, the way in which the shakti or power at the junction of sky and earth is incorporated.

Lalla also says,

There is only one difference between taantrika vimaanas and maantrika vimaanas: the adaptation of the power of sky and earth. In shape, and movement variations, they are identical. The taantrika vimaanas are of 56 varieties.

In Shounaka Sootra,

In Dwaapara taantrika vimaanas are 56. Their names are, bhyrava, nandaka, vatuka, virinchi, vynateya, bherunda, makaradwaja, shringaataka, ambareesha, sheshaasya, saimtuka, maatrika, bhraaja, paingala, tittibha, pramatha, bhoorshni, champaka, drownika, rukmapunkha, bhraamani, kakubha, kaalabhyrava, jambuka, garudaasya, gajaasya, vasudeva, shoorasena, veerabaahu, bhusunda, gandaka, shukatunda, kumuda, krownchika, ajagara, panchadala, chumbuka, dundubhi, ambaraasya, maayooraka, bheerunalika, kaamapaala, gandarksha, paariyaatra, shakunta, ravimandana, vyaaghramukha, vishnuratha, sowarnika, mruda, dambholi, brihathkunja, mahaanata, etc.

In Maanibhadraakarika :—

In Dwaapara yuga taantrika vimaanas are said to be 56. Their names according to sage Gowtama, are bhyrava, nandaka, vatuka, virinchika, tumbara, vynateya, bherunda, makaradhwaja, shringaataka, ambareesha, sheshaasya, symhika, maatraka, bhraajaka, pyngala, tittibha, pramatha, bhoorshnika, champaka, drownika, rukmapunkha, bhraamanika, kakubha, kaalabhyrava, jambuka, gireesha, garudaasya, gajaasya, vasudeva, shoorasena, veerabaahu, bhusundaka, gandaka, shukatunda, kumuda, krownchika, ajagara, panchadala, chumbaka, dundubhi, ambaraasya, mayoora, bheeru, nalikaa, kaamapaala, gandarksha, paariyaatra, shakuntaka, ravimandana, vyaaghramukha, vishnu ratha, souvarnika, mruda, dambholce, bruhatkunja, mahaanata.

These 56 are taantrika vimaanas of Dwaaparayuga.

**Maharshi Bharadwaaja :**

☞ “Shakunaadyaah Panchavimshat Kritakaah.” Sootra 4.  
 “Shakuna and other 25 types of Vimaanah are Kritakaah.”

Bodhaananda Vritti :

In shape and movements there is no difference in the vimaanah, except in the matter of the use of mantras and tantras. The kritaka or artificial vimaanah are of 25 varieties.

According to Shownaka sootra :

“Tishyay kritaka bhedaah panchavigamshatih ! tesham naamaanyanukramishyaamah : shakuna sundararukma mandala vakratunda bhadra ruchaka vyraaja bhaaskara gajaavarta powshkala virinchi nandaka kumuda mandara hamsa shukaasya somaka krownchaka padmaka symhika panchabaana owryaayana pushkara kodanda iti.”

Says “Maanibhadra Kaarika” :

In Kaliyuga, the kritaka or artificial vimaanah are said to be 25. Their names are given below as indicated by sage Gowtama : shakuna, sundara, rukma, mandala, vakratunda, bhadra, ruchaka, viraajaka, bhaaskara, gajaavarta, powshkala, viranchika, nandaka, kumuda, mandara, hamsa, shukaasya, sowmyaka, krownchaka, padmaka, symhika, panchabaana, owryaayana, pushkara, and kodanda.

**Maharshi Bharadwaaja :**

☞ “Raaja-lohaadetesam Aakaara Rachanaah.” Sootra .5.  
 “These should be built out of Raajaloha.”

Bodhaananda Vritti :

These 25 kinds of vimaanah are to be made of Raajaloha metal only.

Says Kriyaasaara,

In manufacturing artificial aeroplanes the best of metals are those known as Ooshmapaa or heat-imbibing or heat resisting metals. Out of them the variety known as Raajaloha or king of metals is most suited to Shakuna and other vimaanah.

Three kinds of metals, soma, soundaala, and maandweeka, in the proportion of 3, 8, and 2, adding borax, to be filled in crucible or smelter, and placed in furnace, and heated to 272 degrees, and melted thoroughly, and churned, will result in the alloy Raajaloha.

Vishwambhara also says,

“In the science of metals, for the manufacture of aeroplanes, 16 types of Ooshmapaa or heat-sucking lohas or metals are the very best. The fourth in that series, is called Raajaloha. Out of that alone should shakuna vimaana be constructed.”

The parts of shakuna vimaana are :

Peetha or floor board ; hollow mast ; three wheeled keelakas with holes ; 4 heaters, air-suction pipes, water-jacket, oil tank, air heater, chhullee or heater, steam boiler, vidyud-yantra or electric generator, air propelling yantra, vaatapaa yantra or air-suction pipe, dikpradarsha dhwaja or direction indicating banner, shakuna yantra, two wings, tail portion for helping vimaana to rise, owshmyaka yantra or engine, kiranaakarshana mani or sun-ray attracting bead. These 28 are parts of Shakuna vimaana.

The construction of the vimaana :

The floor-board or base should be made of levelled Rajaloha sheet, shaped quadrangular, circular, or cradle shaped. The weight of the peetha should be one-hundredth of that of the plane, and its width should be half the height of the vimaana. In the centre of the peetha the hollow mast should be fixed with screw joints.

Lalla defines the mast in “Yantra kalpataru”. The stambha or mast should be made of haatakaasya metal and not otherwise.

Haatakaasya metal is described in “Lohatantra” : 8 parts of suvarchala or natron, 16 parts of laghu-kshwinka or light zinc, 18 parts of laghu bambhaari, and 100 parts of copper, filled in smelter, placed in koorma vyaasatika furnace, and with the aid of mahormi bellows boiled to 307 degrees, will yield haatakaasya metal.



### The Peetha :

The height of the peetha should be 80 feet. It should be 56 feet in length and breadth, 70 feet high on the north and south sides. The tip should be three-cornered. This is for shakuna vimaana.

### Naalastambha or Hollow Mast :

At the bottom the mast should be of 35 feet diameter outside, and 30 feet inside. At the middle the mast should be of 25 feet diameter outside and 20 feet inside. Higher up it should be of 20 feet diameter outside and 15 feet diameter inside. The height of the mast should be 80 feet. It should be made of Raajaloha. In order to fix the mast in the peetha screw joint should be made. And in order to adjust the air-speed as required, 6 wheels should be inserted inside the mast.

### The Wheels :

Inside the mast at the height of 4 feet above the peetha, three wheels should be provided, of  $15\frac{1}{2}$  feet diameter, with holes. The wheels above and below should be fixed with bolts, and unmoving. In order to revolve the middle wheel keys should be fixed outside on the mast, As there are holes in the wheels, as two wheels do not move, and as the middle wheel revolves in a group with the other two wheels, movement of air is allowed or stopped by the turning of the key outside.

Similarly at the height of 44 feet above the peetha three wheels corresponding to those below should be fixed and operated similarly.

### Window dome :

The window dome should be of  $15\frac{1}{2}$  feet outside circumference. Its inside should be five feet wide and it should be 2 feet high. It should be fixed on the top of the mast.

### Sun-crystal :

A sun crystal 7 feet round, and 2 feet wide and 2 feet in height should be fixed so as to crown the window dome.

10 feet above the bottom peetha, on a floor-board 3 inches thick, three floors or tiers should be built, each 14 feet high, with 3 inch

floor-boards, the upper two floors being supported by pillars fixed at 10 feet intervals with screw joints and strong bolts. In the four corners 4 heating yantras should be fixed, 10 feet in circumference and 8 feet high. On the ground floor along the supporting pillars accommodation for passengers should be provided in the form of individual boxes.

On the second floor booths should be constructed to accommodate the anga-yantras, or the various mechanisms recommended for the safety of the vimaana. It should be 60 feet wide and 14 feet high with 3 inch thick ceiling board.

The third floor should be 40 feet wide and 14 feet high.

The partitioning boxes for passengers as well as the booths of the various machines should be divided off by railings starting from the hollow mast to the side walls in all the four directions.

Beneath the ground-floor board a 7 feet high cellar should be constructed. In it the several necessary yantras should be located. In the centre is the foot of the hollow mast. On the four directions from it 4 air pumping machines should be fixed. In order to stimulate them 4 steam engines also should be installed. On the two sides of the vimaana two air expelling machines, and an air heater machine, and 2 machines to keep the heater supplied with air from outside, should be erected.

In order to enable the wings on either side to spread and flap, proper hinges and keys should be provided for, safely fixing them to the sides of the vimaana, and for enabling them to fold and open easily.

The revolving tractor blades in the front should be duly fixed to the heating engine with rods so that they could dispel the wind in front and facilitate the passage of the vimaana.

The wings are two, one on each side, very strongly fixed to the vimaana with bolts and hinges. Each wing should be fixed in a 1½ foot scabbard up to 20 feet length, where it would be 10 feet wide, widening further up to 40 feet at the end of its 60 feet length, besides its first 20 feet of scabbard length.

The tail should be 20 feet long, and 3½ feet wide at the start, and 20 feet wide at the end.

### The air-blower and heater :

The length of the air-blower should be 15 feet, and width 3 feet. The naalaas or pipes should be 3 feet wide, and their outer circumference should be 4 feet. The rods and hinges and other equipment should be suitably prepared.

The vaatapaa yantra or air blower should be 12 feet long and  $9\frac{1}{2}$  feet wide. Inside it should be covered with circling wires. A pipe should be fixed inside, for air flow. By the hot oil fumes from the heated tank, the air becomes heated and should be passed into the owshmya yantra or heater, while the cold air from outside should also be let in. Tubes and fixings should be provided in the yantra. In order to emit the fumes of the oil flames to the outside, a 6 inches pipe should be fixed from the yantra to the foot of the mast. Air blowers should be installed with 10 feet wheels to pump in fresh cold air from outside.

To the east of the air machine should be placed a light burner in order to aid combustion of the oil. An electric generator provided with switches should light the burner. When the light is off the oil should be kept duly sealed. A rope should be tied to the tail joint, for the pilot to manipulate the fluttering of the tail to help the ascent or descent of the vimaana. Similarly ropes should be tied to the hinges of the two wings, and passed to the pilot like reins, so that he might spread them out or close them as needed.

Ten feet beneath the passenger floor of the vimaana, to a height of  $2\frac{1}{2}$  feet from the bottom plate there should be a cellar-like enclosure. The bottom of the vaatanaala mast should be fixed in its centre with firm screw joints. In this cellar should be located two oil tanks 15 feet by  $9\frac{1}{2}$  feet by 4 feet, with water jackets.

Four bellows of 15 feet by  $2\frac{1}{2}$  feet by  $6\frac{1}{2}$  feet, should be provided for storing the air pumped in by the air-blowers, and letting it out as required.

And underneath, on all the four sides wheels of 7 feet circumference should be fixed for the movement of the vimaana on the ground.

This vimaana is named **SHAKUNA VIMAANA.**

# SUNDARA VIMAANA

**Maharshi Bharadwaja :**



“Sundarothha.”

Sootra 6.

“Next Sundara.”

**Bodhaananda Vritti :**

Next Sundara vimaana will be described. It has got 8 constituent parts.

First peetha or ground plate, smoke chimney, 5 gas-engines, bhujya metal pipe, wind blower, electricity generator, and four-faced heater, and vimaana nirnaya, or outer cover.

**The Peetha or ground plate :**

It should be made of Raajaloha metal only. It should be square or round, and of 100 feet in circumference, or any other desired size. It should be 8 feet thick. Seven times the peetha has to be heated with manchuka or madder root oil. Then spots should be marked in it at 10 feet distance from each other, totalling 24. The size of each kendra or centre is 15 feet. In the centre a dhooma-prasaarana or fume distributing naala or pipe 12 feet high should be erected.

**Naalastambha, hollow mast :**

The naalastambha should be 56 feet high, and 4 feet in diameter. For storing gas, at its base, a 8 feet long, circular, and 4 feet high vessel should be provided. A six feet size water vessel should be arranged. A 4 feet size oil tank should be fixed at its centre. At its foot an electric storing crystal of 1 foot size should be fixed with necessary hinges and keys.

The vessel should be filled with 12 parts of dhoomanjana oil, and 20 parts of shukatundika or bignonia Indica? (egg-plant?) oil, and 9 parts of kulakee or red-arsenic oil. To conduct electricity, two wires should be passed through the pipe and fixed to the crystal. In the middle of the naalastambha or mast, for the smoke fumes to be restrained or speeded out, triple wheels with holes should be fixed. In order to work the wheels from outside, two right turning and left turning wheels

should be attached outside the pole, and connected to the wheels inside. Three wires should be drawn inside the naala and fixed at the foot, the middle, and at the top.

**Dhoomodgama Yantra :**

Because it ejects smoke fumes with speed it is called Dhoomodgama yantra.

Hima samvardhaka, soma, and sundaala, in the proportion of 32, 25, and 38, should be filled in pipe crucible, placed in chakra-mukha furnace, and with the help of ajaamukha bellows heated to 712 degrees and properly churned. It will yield excellent dhooma-garbha alloy. With that alloy the dhoomodgama yantra should be constructed.

Underneath the centre of the 15 feet long peetha, for the control of the gas fumes a 10 feet high pipe with right revolving wheel should be fixed. On its 2 sides, to south and north, 2 water steam pipes should be erected. At the foot of the 2 pipes 4 feet long 3 feet high pots should be formed for containing the fumes. Two pipes shaped like goblets, 1 foot by 8 feet by 3 feet, should be fixed at the top of the fume container. A water vessel at its foot, and an oil-vessel at its centre, and in front of it the switches of the electric ray crystals, as in the dhooma prasaarana naala stambha.

On either side of the heat tube, two water jackets should be placed. A pipe with wires should be taken from the electric generator and connected to the hinges of the crystals. Electric current of 80 linkas should be passed to the crystals, whose motion will cause friction and generate heat of 100 degrees (kakshyas). Thereby the oil in the vessel will get heated and boil and emit fumes.

The electric power should then be passed through the smoke pipe between the two water jackets. By this the water will be converted into hot steam. The oil fumes should be filled in the oil fume pipe and the steam in the steam pipe. Then by operating the switches, both the fumes will fly up at 500 degree temperature. The switches should restrain the fumes or pump them out as needed. 40 such yantras should be prepared and should be fixed on the peetha in groups on

the four sides. Then connected with the bases of the dhooma-naalas, sundaalas or elephant trunks, one foot wide and 12 feet high should be erected on the four sides, to enable the vimaana to fly with speed.

Sundaala is described by Lallachaarya :

The sundaala should be installed for using the oil fumes and steam fumes for the motion of the vimaana. There are varieties of ksheera vrikshaas or milk-trees according to shaastraas. Vata or banyans, manjoosha or madder root, maatanga or citron?, panchashaakhee (five branched), shikhaavalee (crested), taamra sheershnee (copper-crested), brihatkumbhee (big bellied), mahishee, ksheeravallaree, shona parnee (crimson-leaved), vajramukhee, and ksheerinee (milky). From these the ooze or milk should be collected, and in the proportion of 3, 5, 7, 10, 11, 8, 7, 4, 7, 30, 12, filled in a vessel. Then granthi metal, naaga or lead, vajra, bambhaarika, vynateya, kanduru, kudapa, and kundalotpala, these in equal parts should be filled in the vessel in equal proportion to the milk contents, and boiled with 92 degree heat. Then the molten liquid should be filled in the milk-cloth machine, and churned. When cooled and put through the levelling machine, it will yield a strong, soft, cool, heat proof, and uncuttable ash-coloured cloth sheet.

This cloth should be boiled in rouhinee taila or oil of black hellebore for 3 yaamaas or 9 hours, and then washed with water. Then it should be boiled in atasee or linseed oil as before. Then it should be kept in ajaa-mootra or goat's urine for one day and kept in the sun. Then it should be dried and painted with kanakaanjana paint and dried. Then the cloth will glow with a golden hue. With this cloth should be made the shundaala or elephant trunk, 12 feet high, 1 foot round, and with pipe-like opening inside.

Two mechanisms for rolling it and unrolling it should be properly attached to it. By the rolling switch the shundaala will coil round like a snake and remain on the floor. By the unrolling switch it will uncoil and stand erect like a raised arm. From the fume generating yantra connecting links to the shundaala should be provided for the fumes to pass through it to the outside air. And to attract outside air into the sundaala a pump-like arrangement should be provided as in an inflator.

Three switches should be provided as in the water tapping yantra. By revolution of its wheel the fumes will go out through the shundaala and 82 linka of fresh air will come in. The direction in which the fumes will emerge from the shundaala will be the direction of the course of the vimaana. The 3 wheels in the shundaala will cause the vimaana to wheel around or make ascent, or to drop height.

At the foot of each dhoomodgama yantra 2 shundaalas should be duly fixed. And on the 4 sides of the dhoomaprasaarana-naala-stambha 4 shundaalas should be erected.

In order to protect against the intense heat from fire and sun inside and outside the vimaana, it should be provided a covering made of the 6th type of Ooshmapaa loha or heat-proof metal. At the top and bottom and on the sides keys should be provided for the movement of the fumes. 40 such dhoomodgama yantras should be properly fixed in the selected spots of the peetha with screw fittings. The vimaana will be enabled to fly smoothly by so doing.

## ELECTRIC DYNAMO

Says Yantra Sarvasva :

There are 32 kinds of yantras for generating electricity, such as by friction, by heating, by waterfall, by combination, by solar rays, etc. Out of these, saamyojaka or production by combination is the one most suitable for vimaanas. Its manufacture is explained by Sage Agastya in Shaktitantra :

The peetha or foot-plate should be made of saamyojaka metal, 35 feet in diametre. 5 spots should be marked in it in a circle, 5 feet in diametre, with a spot in the centre. Vessels should be prepared for each kendra, 4 feet wide, 2 feet high, shaped like a pot. On each a cylindrical pipe 1 foot wide and 1 foot high, should be fixed. The top of the cylinder should be 4 feet wide and round.

Then get a Jyotirmukha or flame-faced lion's skin, duly cleaned, add salt, and placing in the vessel containing spike-grass acid, boil for 5 yaamas or 15 hours. Then wash it with cold water. Then take

oils from the seeds of jyothirmukhee, or staff-tree, momordica charantia, and pot herb, in the proportion of 3, 7, and 16, and mix them in a vessel, add  $\frac{1}{4}$  part of salt. The skin should be immersed in this oil and kept for 24 days in solar heat. It will get a scarlet sheen. The skin should be cut to the size of the top opening of the vessel cylinder, with 5 openings in it. Cover the cylinder with the skin with bolts. All the 5 vessels should be similarly covered, and placed in the 5 selected centres on the peetha. Then 16 drona measures of asses' urine, 16 linka measures of mined charcoal, 3 linkas of salt, 2 linkas of snake-poison, and 2 linkas of copper, should be filled in the vessel on the eastern side.

Then in the vessel on the western side, 7 vidyudgama mani or load-stone, 13 praana-kshaara or ammonium chloride, 22 hare-dung, should be filled and made into a decoction. Two parts of camel urine should be mixed with one part of the above. Then 50 linkas of rhinoceros bones, 30 linkas of sulphur, and 16 linkas of tamarind tree salt, and 28 linkas of steel should be added to that. And 117 tatin-mitra manis should be placed in the centre of the vessel.

Next the following materials should be filled in the northern vessel :

Eleven parts of oil of apaamaarga or achyranthus aspera seeds, 32 parts of oil seeds of sarpaasya or mesua ferrea, 40 parts of ayaskaantha or oil of steel, in 83 parts of elephant's urine, all these to be put in the northern vessel and mixed together properly. Then add mercury, symhika salt, and paarvanika or bamboo rice, 30, 20, and 25 palas respectively, or 120, 80, and 100 tolas. Sun-crystal of the 800th type, mentioned in Maniprakarana, cleaned in oil, should be put in the vessel.

Next in the vessel on the southern side, put in grandhika draavaka or long-pepper decoction, panchamukhee draavaka, and shveta-punja or white liquorice decoctions, in proportion of 12, 21, and 16, and mix together, add cows' urine 5 parts more than the above liquids, 47 parts of jyotirmayookha root, 28 linkas of kaanta metal, 28th and 10th kind of kudupa 32 parts. 92 jyotirmanis purified in milk should be placed in it, according to Chaakraayani. This is the southern vessel.

Then in the central vessel electric current should be stored. That vessel should be made of chapala-graabaka metal only.



Chapala-graahaka metal is explained in Lohatantra :

Quick-lime, marble stone, lac, sowraashtra earth, glass, root of the elephant trunk tree, bark of karkata tree, cowries, cubeb pepper gum, in the proportion of 8, 11, 7, 27, 8, 5, 3, 7, and 12 parts of tankana or borax, to be filled in urana crucible, placed in kundodara furnace, and with 3 faced bellows, boiled to 427 degrees, will yield, when poured into the cooler and cooled, chapalagraahaka metal.

The electricity storage vessel should be manufactured as follows : A foot-plate 5 feet long, 8 feet high, 1 foot thick, half-moon shaped, should be made of above metal. The vessel should be shaped like a big pot, with a cylindrical top. It should have a glass covering. 2 pipes 3 feet wide 6 feet high should be fixed in the vessel in the northern and southern sides. They should also be covered with glass. Between the two pipes two wheels with hinges and switches etc. should be fixed. When the switches are put on or turned, causing the two wheels to revolve, electricity will flow from the bottom of the 4 vessels into the two pipes and ascend. Two tubes, 6 inches long, should be prepared, wound round with deer skin, tied with silk thread or silk cloth. The Vajramukhee copper wires cleaned with acids, should be passed through each tube, and taken to the two pipes in the vessel and be fixed with glass cups. 8 palas or 32 tolas of mercury should be placed in the energy container vessel. 391st vidyunmukha mani, wound round with copper wiring with mixing switch, should also be inserted. Then taking the wires in the pipes they should be connected with the wiring of the mani through the kaachakanku hole. In each of the vessels, excepting the middle one, two churning rods should be fixed in the centre. The rods should be made of steel or shakti skandha. They should be 3 feet high and 1 foot thick. Keys should be fixed in them for obverse and reverse churning. To the east of the churning machine wheels should be fixed for raising and lowering. An 8 inches high naala or tube should be fixed. On either side of it should be fixed 5 wheels of 5 inches height, like the wheel of the water lifting machine. 2 inches wide flat pattis made of shakti skandha metal should be passed from the wheels inside the Aavritta-naala to the keys of the wheels in the churning yantra. Then revolving wheels should be attached to the naalas or tubes of the stambha or big pipe. By the turning of these keys, it will operate like the turning of the churn-

ing rod back and forth as in churning curds by drawing and relaxing the rope ends.

Then according to Darpana-shaastra, four vessels, shaped like the bamboo cylinder used on the pounding mortar, should be made out of ghrinyaakarshana glass or solar-heat absorbing glass and fixed on the mouth of the 4 vessels.

The vessel is described by Lallaacharya: 8 inches wide and 1 foot high, and then 2 feet wide and 6 feet high, and at the top a 6 feet wide mouth.

25 palas or 100 tolas of bamboo salt, should be put in it. Then amsupaa mani or solar-ray crystal of the 325th kind, duly cleaned in acid, should be put in it with rice salt. Then rice hay should be spread over it tightly, and facing the sun. The rays from all sides are imbibed by them, and will enter the vessel daily to 105 degrees' strength. If kept thus in the sun for 12 days, 1080 linkas of electric power will be accumulated in each vessel.

In order to store this power in the storage vessel six inches long steel tubes should connect the bottom of the vessel with the storage vessel. They should be covered by deer skin and wound round with silk cloth or yarn. Two copper wires should be passed through the tubes and connected to the storage vessel. 100 palas of mercury should be put in the vessel. And a 391th type of sun crystal duly wired should be placed in the mercury, and the wires coming from the tubes should be connected to it.

The well-oiled keys in the 4 vessels should be revolved with speed, to 200 degrees heat, when the liquids in the vessels will be boiled by the heat rays. Then the keys should be hastened up to 2000 degrees. By the liquids in each vessel 800 linkas of electricity will be generated. The power should be conveyed by the wires in the kaanta metal tubes to the storage vessel. The crystal will absorb and fill the vessel with the power. In front of the storage vessel a five feet long, 3 feet high circular vessel should be installed. It should be covered all round with the bark of vaari-vriksha.

Always water will be flowing in it. So instead of water, water skin is indicated. It will give the vessel the effect of water-immersion. Then in that vessel glass cups containing the decoction of shikhaavalee or lead-wort? or *achyranthes aspera*?, 18 parts of ayaskaanta or loadstone? or steel acid?, and 12 parts of vajrachumbaka acid, should be placed. Then power should be drawn from the storage vessel through the wires inside the glass-covered tube, and 4 wires with glass wheel key be let into the acid vessels. Then from the bottom of the vessels 2 wires fitted with keys should be taken in a right circle to the front of the smoke-outlet stambha or pipe, and attached to the wires inside the bhujyu metal tube. The wires should also be connected to the keys of the electric friction crystals in the dhoomodgama stambha or pillar, as also to the key in the stambha. Thereby electricity will be spread in all parts of the vimaana. Therefore the vidyud-yantra or electrical machine should be installed in the left side of the vimaana.

### Vaata-prasaarana Yantra

Air Spreading Machine.

Kriyaasaara says:

In order to enable the vimaana to ascend, vaataprasaarana yantra is necessary.

Therefore it is now being described. It should be made out of vaatamitra metal only.

Lohatantra describes vaatamitra loha. 13 parts of rasaanjanika or extract of Indian berbery, 27 parts of prabhanjana, and 37 parts of paraankusha, should be filled in sarpaasya or serpent-faced crucible, placed in chakramukha furnace, and with the aid of vaaranaasya bhastrika or bellows, heated to 216 degrees. Then filled in the sameekarana yantra or churner, and next poured out and cooled, it will yield vaatamitra loha, or air-companion metal.

First the foot plate, then the naala-stambha or tubular pole, air pumping wheel with keys, air attracting bellows-like mechanism, and mechanism for contracting and expanding the mouth, out-flow and inflow tubes with keys, covering for the yantras, wind pipes, vaatodgama

pipe, bhastrikonmukha, vaatapoorakeelakas, vaata nirasana pankha keelaakas, or air-expelling fan keys, these 12 are the organs of the yantra.

#### The Peetha or foot plate.

The peetha should be 6 feet long, 1 foot thick, square or round, with two spots on the northern and southern side of it for erecting three-wheeled tubular poles.

The 3 weeled naala stambha is described in "Yaana bindu":

Three feet long and 8 feet high tubular poles should be fixed on 2 sides of the peetha or foot-plate. At the foot and the middle and the top of the pole three openings should be provided for fixing 3 wheels.

In the pole should be fixed tubes, one foot wide and 2 feet long, for drawing in air, and wheels 1 foot wide with teeth as in hack-saw, revolving both ways, be fitted to the tubes. The vaata-pooraka or air-filling naala should be fixed in the middle of the wheel. By turning the fly wheel, the wheel will turn, making the naala move up and down sucking in air. The air pumping wheel keys should be thus fixed in the two poles. The keys at the mouth of the bellows should be connected to these keys.

### **Bhastrikaa-Mukha-Yantra**

#### Bellows' mouth mechanism

Taking pig-skin, duly cleaning it with putrajeevi or wild olive oil, boil it for 3 days, wash it with clean water. Smear it with gajadantika oil frequently exposing to sun for 5 days, and fashion out of it a 6 foot bellows, three feet wide at bottom, 4 feet wide in the middle, and 1 foot wide at the mouth. Two keys working conversely to each other should be fixed at the mouth. A stick should be inserted between them. The two keys should be capable of being put into quick motion, or left at rest. By turning the keelakas the piston rod is moved, and from its speed, the bellows' mouth also will start in motion, and also the vaataakarshana naala. By putting the naala at the mouth of the bhastrika or bellows, quick air entry from inside the mouth will occur. By starting all the keelakaas in all the centres there will be airflow in the three wheel tubular stambhas. By turning the

keelakas with 20 heat-degree force, in the naala stambhas air will rush out with 100 shaker speed. From the bellows' mouth also air will blow with 2000 prenkhana or shaker speed. And these air flows will speed the motion of the vimaana. Therefore in front of the vaatodgama yantra 12 such yantras should be installed on the four sides, 3 on each side. And aavarana or covering should be provided for them according to their measurements. And 12 naala stambhas, 3 feet wide and 12 feet high, should be prepared, and fixed on the top covering of the yantras, for the air to flow out. From each stambha air will blow with 2600 prenkhana speed. The yantras are individually prescribed so that some may rest when not required. The high flight will be helped by these machines. Having thus described the individual sources of air supply for the vimaana, we shall now describe the Brihat-stambha or main mast.

It should be 4 feet wide and 30 feet high, and called vaatodgama naala stambha. It should be erected centrally amidst all the yantras. The bhastrikonmukha yantras should be fixed at the foot of the stambha so that the air flows from the yantras could pass into the stambha. The wind-naalaas or pipes should be connected to the stambha-moola fitted with keys. At the opening of the naala-stambha at the top on the 8 inch wide opening a vessel one foot high and 3 feet wide should be fixed. The wind from the stambha or tunnel will pass out through it in wavy billows. The dhoomodgama yantra or smoke pipe should be provided with triple keys or fixtures, for the expulsion of smoke and blowing in of air. By operating those keelakas the supply of smoke and air could be controlled according to need. Wind expelling fan wheels should be put in, so that by their quick motion the motion of the vimaana could be facilitated.

## **Vimaana-aavarana-nirnaya**

### **Covering of the Vimaana**

Covering the dhoomodgama yantras and kudyaas or side walls, as in the case of the Shakuna Vimaana, the covering of the Sundara vimaana should be done by raajaloha only. The covering should accommodate the number of partitions or booths required as in Shakuna Vimaana. The location of the 32 component yantras should be determined.

In the centre of the booths for locating the four-faced heat machinery, a thirty feet square area should be set apart. There the four-faced heat yantra should be erected.

Says Yantrasarvasva :

The chaatur-mukha owshnya yantra should be made out of kundodara metal only. Kundodara metal is defined in Lohasarvasva.

Soma, Kanchuka, and shundaala metals in the proportion of 30, 45, and 20 to be taken, cleaned and filled in padma crucible, placed in chhatramukha furnace, and with vaasukee bellows heated to 716 degrees, aa-netraanta, and poured into the yantra for cooling. A blue, fine, light, alloy, capable of bearing 2000 degree heat, and which cannot be blasted even by shataghnee and sahasraghnee canons, and very cold, is kundodara alloy. With this alloy the owshnyaka yantra should be fashioned.

#### Yantraangas or parts of the Machine.

Peetha or foot-plate, smoke container kunda or vessel, water container, fire oven, turret covering, covering of water container, twin wheels for projecting and restraining smoke, window rods, padmachakras or wheels, aavritta chakra keela, heat indicator, speedometer, time clock, ravaprasaarana keelaka naala or sound transmitting instrument, antardandaaghaata naala, air-bellows, long sundaala pipes, twin copper pipes, air dividing wheel keys, these 18 parts constitute the ooshmyaka yantra.

The peetha, tortoise-shaped, should be 25 feet long and wide. At peethaadi or starting end should be fixed the agni-kosha or fire place, the water vessel in the middle, and the smoke-container should be fixed at the other end.

The 3 koshaas are explained by Budila :

Ravi or copper, manchoulika, and tigma in equal parts should be mixed with kundodara metal, and be made into 3 inches thick pattika or flats. One pattika should be fixed on the peetha. In the fire place kendra on the peetha a 4 feet long 6 feet high fire-place should be made. For stocking coal or wooden billets, a sort of walled table should be formed. Next a triangular fire-place should be formed,

with rods at the bottom for the ashes to fall down. In between the 2 parts the flat sheet should be fixed, fitted with keelakas or hinges for moving the peetha as desired. Three keelakas should be fixed at the fire place, one to fan the flames and straighten them, one to moderate or stimulate the flames, and one to distribute the flames evenly. A naala or pipe should be fixed on the fire kosa. Another pipe with wiring, is to be fixed at the end of the fire-kosa pattika with a smoke transmitting pipe which will convey the smoke of the fire-place to the jalakosa or water container. From the fire kosa to the covering of the water kosa water pipes should be adjusted. In the water kosa enclosure the heat will rise to 5000 linkas in these tubes. The heated water will then give out hot smoke.

The size of the jalakosa or water container is 8 feet. Three triple-wheeled naalas or pipes should be fixed in the jalakosa: one to restrain the heated smoke from the water, one to amass the smoke, and one to lead the smoke into the dhoomakosa or smoke-container. The Dhoomakosa should be 6 feet wide and 4 feet high. In order to fill the kosha with smoke, necessary fittings should be provided. Above the jalakosa a dome-like covering should be erected. It should be provided with fittings, for folding up and opening out. To the front of the smoke container, two pattikaa wheels with holes should be fixed in order to let out the smoke or to restrain it. In order to operate the wheels two bhraamane keelakaas or revolving switches should be provided. To the east of the Dhooma-kunda, 8 inches long window bars should be fixed with one inch spacings. Then in front of the yantra, in the middle, at top, at bottom, and on both sides, twin padmachakra keelakas should be fixed for spreading the smoke or restraining it. For storing the wood or coal a hole  $1\frac{1}{2}$  feet wide should be arranged. The door covering it should be provided with needful fittings. To the north and south of the keelaka the heat-measure and speedometer should be fixed. Above them the timepiece. To the south, a telephonic device called ravaprasaarana or sound ringer, which will give alarm with 1212 sound wave speed, and which gives warnings for the plane's moving, halting, speeding, overspeeding, and danger imminence. An equipment with 5 holes giving 5 different sounds to indicate the above should be installed. On either side of the above, two 6 inches wide, 26 feet tall, Aaghaatha-naalas or pipes should be fixed. Between them two 5 inches thick metal rods are to be adjusted. At the foot, middle, and top of the naalas revol-

ving wheel keelakas should be fitted. By their revolving, the rods will strike each other. That will increase the speed of the plane. On the top of the naala pipes, air bellows with fittings should be fixed. Thereby the air force in the naalas will shoot up, and the speed of the vimaana will double. Then on the four sides of the heated smoke kosha or container, shundaalas or elephant-trunk-like pipes should be fixed with wheeled keys as in vaatodgama yantra. By filling the shundaalas with the smoke and turning the keys as required, the movement of the vimaana in one direction or another, its gaining height and speeding out or halting, will be facilitated. Keys should be adjusted so as to make the shundaalas coil down like a water hose or keep erect. Two pipes made of 3rd division copper should be wound round the agnikosa, water kosa, and smoke kosa, or fire, water and smoke koshas, in order to absorb the excessive heat in them.

In order to part the wind in front of the vimaana, vaata-vibhajana chakra keela or wind-dividing-wheel fittings should be fixed.

Having thus prepared the chaaturmukhoshmyaka yantra, or four-faced heating machine, it should be installed in the centre of the vimaana. By the air, smoke, and heat of the yantras below, the ascent and flight of the vimaana will be facilitated.

Regarding the speed of the vimaana, we have to consider the speed of smoke and other accessories mathematically, and conclude the possibility of the speed of the vimaana. The speed of the smoke from dhooma yantra is 2113 linkas. The speed of wind from the air blowing machine 2500 linkas. Wind from the naala-stambha blows at the speed of 600 linkas. This is the speed of the forces from the 3 machines on the peetha. Of the forces from the upper portion of the vimaana, from the chatur-mukhoshmyaka yantra, heat force of 3400 linkas emanates. By the four-faced heat yantra, and by operating the keys of the shundaalas, and the force of the wind, smoke and heat machines, the vimaana would be capable of a speed of 400 yojanas or 3600 miles.

This is Sundara Vimaana, and it has been described after consulting ancient works, and according to my humble capacity, says Maharshi Bharadwaaja.



## RUKMA VIMAANA

“Atha Rukma Vimaana Nirnayaha”

Next the principles of Rukma Vimaana.

**Maharshi Bharadwaaja :**

☞ “Rukmascha” Sootra 1.  
“Rukma too”

**Bodhaananda Vritti :**

This vimaana is of golden colour. Therefore it is called Rukma vimaana, Rukma meaning gold. The Rukma should be made out of Raajaloha only. By duly processing, Raajaloha can be made to assume golden colour. That metal should be used for the vimaana.

“Yaana-Bindu” says,

“After first producing golden colour for Raajaloha, the vimaana should be formed.”

“Varna-sarvasva” mentions the colouring process :

Praana-kshaara or ammonium chloride 4 parts, wild Bengal gram 32 parts, shashakanda (or lodhra?) benzoin? 18 parts, naaga or lead 20 parts, sea-foam 16 parts, maakshika or iron pyrites 6 parts, panchaanana or iron 20 parts, paara or mercury 15 parts, kshaara-traya or 3 kinds of salt: natron, salt-petre, borax, 28 parts, panchaanana or mica 20 parts, hamsa or silver 17 parts, garada or aconite 8 parts, and panchaamrita or 5 sweets—curds, milk, ghee, sugar, honey, these should be filled in the melter, and after boiling, and drawing the liquid through two outlets, fill in the crucible and place in furnace, and blow to 800 degrees’ heat, and then transfer it to the cooler.

That will be Raajaloha, pure, golden-coloured, tensile, and mild. The vimaana, made out of this loha or alloy, will be very beautiful and delightful.

**The Peetha**

The peetha or ground plate of the Rukma vimaana should be tortoise-shaped, 1000 feet long, and 1 foot thick, or any other desired

size. On its eight sides, 20 feet long spaces should be fixed underneath the peetha. At each centre fixtures like birds' beaks should be attached with revolving keelakas. Then double iron-balls or wheels, in couples, should be fixed in each of the 8 centres.

### Ayas-chakra

Lalla gives the form of ayaschakra-pinda :

12 feet long and wide, and 8 kankushtas in weight, they should be made round like a grind-stone. They should be inserted in the beaks at the 8 centres. From each chakra-pinda up to the electrical generator chain wires should be connected with switches.

### Batinikaa-Stambha

Or Button-switch pole

One foot wide and 4 feet high poles should be fixed. They should have switches wired up to the electric pole. 8 inches wide wheels should be fixed in the middle of the pole, on either side, with wires. From the electric pole chain wires should enclose the wheels and be fixed in another pole with inside hinges. On the top of the poles should be fixed goblet shaped cups with button-switches like half-blooms with wheels and keys, so that on pressing the button with the thumb the wheels in the other pole will revolve from electric contact. Then the wheels in the electric pole will also revolve, producing 5000 linkas of speed.

### Flying

Due to this electrical force, the ayah-pinda wheels beneath the peetha will beat against it and make it rise and move upwards. And by moving the switches of the wheeled poles above the peetha, the poles will revolve with speed, and accelerate the speed of the vimaana. By the concussion of the wheels underneath, and the action of the poles above, the vimaana will move upwards and gain height and fly with dignity.

Electric tube wheels aiding flight :

Above the peetha, naalas or tubes should be fixed at 1 foot intervals. On both sides of each naala toothed wheels 2 feet wide and 1 foot high should be fixed with proper keelakas. Taking electric wires through

the keelakas, and passing over the wheels and reaching the foot of each naala, they should be attached to wheels 3 feet wide and 3 feet high. In the midst of 20 naalas a pole should be fixed in the centre.

Narayana says :

Preparing a pillar 4 feet wide and 4 feet high, and making a 2 feet opening in its middle, fix keelakas at the top, middle, and lower end of the opening. Two keelakas with 6 wheels, with glass coverings, with wires, and naala and leather covering should be fixed at the lower end for attracting electricity. In the middle part of the opening, for transmitting the current, a five-faced keelaka should be fixed, with 5 wheels, glass covering, 2 naala tubes, two wires, attached to 3 rods, and vessel containing veginee oil. By the flow of the current the wheels in the upper end should be made to whirl by properly adjusting keys. In front of the opening a big wheel should be fixed with gumbha keelakas. Similarly wheels should be fixed at the foot of each pillar. On top of them a four inch wide pattika or flat band should be adjusted commencing from the samsarga key chakra up to the front of the electric yantra. By operating that key, power will flow through the wires, and entering the key at the foot of the pillar set the wheels in motion. On the motion of the big wheel the sandhi-wheels in the naala-dandas will also revolve with speed, and the current will enter the 5 faced keelaka, and entering the oil vessel it will gather force, and passing through the 2 naalas, set all the wheels in the pillar in forceful motion, generating 25000 linkas speed, which will give the vimaana 105 krosa or nearly 250 miles speed per ghatika, or 24 minutes.

Having dealt with the mechanism for setting the vimaana in motion, we now consider the mechanism for giving direction to the vimaana in its course. In the 8 diks or directions of the peetha, pillars made of mica and shining like panchakantha, 2 feet thick and 15 feet high should be fixed at intervals of 10 feet. On the pillars should be built the passenger seating arrangements, and booths or locations for the machinery, as in the case of the Sundara Vimaana. The pillars should be made of mica only.

Its production is given in Kriyaasaara :

Shaara-graava or lime 25 parts, kshwinkaasatva or iron-sulphate 30 parts, gunja or wild-liquorice 28 parts, tankana or borax 12 parts,

roudree moola 8 parts, chaandree or kantakaari...solanum xanthocarpum flower salt 1 part, purified shoonya or mica 100 parts, to be filled in koorma crucible, and heated in paadma furnace with blower to 800 degrees, and then poured into the cooler, will yield mica alloy most useful and attractive. Fashioning the pillars or walls or partitions and booths, and fixing the mechanisms for turning, circling, diving, and manoeuvring, in the fore and middle and aft of the vimaana, it could be moved in any direction as desired.

Lallaacharya says :

In order to make the vimaana change its course from one path to another or one direction to another, revolving keelakas should be fixed on the eight sides of the vimaana. Two keelakas should be made, purva and apara, or right side and left side. They should be fitted together.

By operating it, the vimaana could be made to change its course one way or another. In order to operate the keelaka, at the peetha moola, on the 4 sides crescent shaped naalaas or tubes, 2 feet wide and 2 feet high should be fixed. 4 inches long metal rods should be fixed inside the naalaas on either side. One foot wide and 1 foot high wheels should be fixed in them. They should be wired all around. Such crescent naalas should be fixed on the 4 sides of the peetha. In order to set the wheels in the naalas in motion big wheels should be fixed at the beginning, middle, and end of the naalas. By turning the top wheel with speed the wheels inside the naalas will revolve. That will force the keela-shankus to twist round so as to force the vimaana to change its course in the required direction.

## TRIPURA VIMAANA

**Maharshi Bharadwaja :**

☞ “Tripurothha.” Sootra 2.  
“Next Tripura.”

**Bodhaananda Vritti :**

Having explained the vimaanas commencing from Shakuna to Simhikaa, Tripura vimaana will now be dealt with.

This vimaana has 3 enclosures, or aavaranas or tiers. Each aavarana is called “Pura.” As it consists of 3 aavaranas it is called “Tripura” vimaana. It is operated by the motive power generated by solar rays.

**Narayana also says :**

The vimaana which naturally can travel on land, sea, and in the sky by alteration of its structure is called Tripura Vimaana.

It has got 3 parts. The first part can travel on land. The second part can travel under and over water. The 3rd part travels in the sky. By uniting the 3 parts by means of keelakas, the plane can be made to travel in the sky. The plane is divisible into 3 parts so that it might travel on land, sea, or air. The construction of the 1st part is now explained. Tripura vimaana should be made out of Trinetra metal only.

**Trinetra loha is explained by Shaakataayana :**

Jyotishmatee loha 10 parts, kaanta-mitra 8 parts, vajramukha loha 16 parts, these 3 to be filled in crucible, then adding tankana or borax 5 parts, trynika 7 parts, shrapanikaa 11 parts, maandalika 5 parts, ruchaka or natron 3 parts, mercury 3 parts, then filled in crucible in padma-mukha furnace and heated to 631 degrees with trimukhee bellows, the resulting liquid, if poured into cooler, will yield a metal, shining like peacock feather, unburnable, unbreakable, weightless, impregnable by water, fire, air and heat, and indestructible.

With that metal the peetha should be prepared, of any desired size. The following is given as an example. It may be 100 feet wide

and 3 feet thick, round or square. Leaving 20 feet on the western side, at intervals of 10 feet 80 spots should be marked for wheeled boats. 80 feet long, 3 feet wide, 5 feet high boat shaped dronies or containers should be fixed on the marked lines. Three feet wide openings should be made in the top of the dronies, so as to raise the wheel inside them quickly and cover them underneath. There should be fittings which enable the wheels to be lowered on land, and raised and covered underneath when going in water. The wheels should have axle rods with fittings to attract electric power. The axle rods should be  $2\frac{1}{2}$  feet long and 1 foot thick. The wheels should be 3 feet wide and 1 foot thick, have, 5, 6, or 7 spokes, fixed in the rims, and covered with musheeka up to 4 inches from the edge. Holes with glass coverings should be made in all the wheels. These 12 wheels, or 8, or 6, or 4, should be fixed inside the boat-like structure. For transmitting power wires made of somakaanta loha should be fixed in the holes made in the wheels. In the middle of each wheel electric aaghaata keelakas should be fixed, and in them chhidraprasaarana keelakas. Over all the chakradronee boats, copper wire pairs should be fixed on both sides, and in the joints of the wheels. Rods should be attached to the wires so that power could be drawn from the wires and passed to the top of the wheels. And power should be passed to the wires underneath the wheels. In climbing hills, and going down slopes, by adjusting the power at the top or the bottom of the wheels, smooth progress is made possible. By adjusting the necessary keelakas it is possible to accelerate the speed, or in going down, to restrain the flow of the current, and put brake on excess speed.

For attracting power from the generator a naala or pipe with wires should be fixed at the front of the peetha through 5 faced wheel keelakas, and the wires should be connected to the fittings at the top and bottom of the wheels, with glass cups.

In order to put covering over the boat formations, pillars should be fixed between each boat line, and covered with mica sheets, as per architectural rules.

**Maharshi Bharadwaaja :**

☞ “Shuddhhaambaraattadhi.” Sootra 3.  
“Out of pure mica alone”

Bodhaananda Vritti :

The vimaana should be made out of pure mica alone.

Mica is described in “Dhatu sarvasva”. There are four kinds of mica, white mica, red mica, yellow mica, and black mica. The white mica has 16 varieties. Red mica has 12 varieties. The yellow mica has 7 varieties. And the black mica has 15 varieties. Thus there are 50 varieties in all.

Shownakeeya also says :

We shall now describe the nature of abhraka or mica. They are of 4 castes, like brahmin, kshatriya, vysya, and sudra. They are of 50 varieties. The brahmin mica has 16 varieties. The kshatriya mica has 12 varieties. The vysya mica has 7 varieties. And the sudra mica has 15 varieties, totalling 50 in all. Their names are as follows. The brahmin mica varieties are ravi, ambara, bhraajaka, rochishmaka, pundareeka, virinchika, vajragarbha, koshambara, sowvarchala, somaka, amritanetra, shytyamukha, kuranda, rudraasya, panchodara and rukmagarbha. The kshatriya varieties are shundeeraka, shambara, rekhaasya, owdumbara, bhadraka, panchaasya, amshumukha, raktanetra, manigarbha, rohinika, somaamshaka, and kourmika. The vysya varieties are krishnamukha, shyaamarekha, garalakosha, panchadhaara, ambareeshaka, manigarbha, and krownchaasya. The shoodra varieties are gomukha, kanduraka, showndika, mugdhaasya, vishagarbha, mandooka, thailagarbha, rekhaasya, parvanika, raakaamsuka, praanada, drownika, raktabandhaka, rasagraahaka, vranahaarika.

Out of these, pundareeka from the 1st class, rohinika from the second, panchadhaara from the third, and drownika from the 4th class are good for use in constructing the vimaana. These should first be purified as per rules.

The process of purification is given in “Samskaara Ratnaakara”: skandhaaraka or salt of roitleria tinctoria?, shaaranika or rubus salt?, pinjulee or yellow orpiment?, cowries, borax, kaakajanghaa or wild

liquorice?, moss, rowdrikaa, salt-petre, douvaarika, shambara or benzoin, and phosphorus. These should be separately filled in the smelter. The decoctions should be filled in glass vessels. The mica is to be purified with each one of these.

The mica is to be powdered, put in skandhaavaara acid in smelting vessel. It should be boiled for 3 days in fire, and for 3 days in electric heat. Then take the liquid and put it in a bronze vessel, pour in shaaranika acid and keep it in sun for 3 days. Then add pinjulee acid and keep buried in earth for 5 days. Afterwards add cowri acid, and boil in bhoothara yantra for one day. Then add mustard, and adding borax acid and burning arjuna, myrabolan wood, place it in brown-barked acacia cinders for 3 days. Then add wild liquorice acid and expose it to the full moon rays on the 14th and 15 days. The mica is to be then taken out and washed in hot water. Then add wild corn, and pouring in moss acid place it under earth for 6 days. Then take out the mica, add roudri acid, place the vessel in a big fire-place, and burn in 64 feet of dried cowdung. Next taking out the mica put it in sesamum oil for 1½ days, and expose to the sun from morning to sundown. Then take out the mica, wash it clean, put in bronze vessel with salt-petre solution with dattoori or yellow thistle seeds, place it in a heap of burning kundalee or mollugo stricta leaves. Then take out the mica, add dourvaarika acid and bake for a day with hay-fire. Then put the mica in benzoin acid for 3 days. Next add one-fourth as much of camphor, and placing it in the churning machine, churn for a day. Then placing it in Simhaasya crucible cook with boiling water. Add ranjaka or phosphorus acid, 3 palas or 12 tolas of tankana or borax, 12 tolas of lime, 4 tolas of soorana root or tacca, karkotaka 20 tolas, vrishala or onion 28 tolas, koorma-tankanaka 8 palas or 32 tolas, rouhinaka or red sandal 40 tolas, shambara 80 tolas, muchukunda 12 tolas. These cleaned and filled in the crucible, and placed in simhamukha furnace filled with charcoal, and melted with 800 degrees heat will yield a metal shining like a precious stone, very light, unbreakable, unburnable and indestructible.

With that the vimaana is to be constructed.

We shall now consider the parts of the vimaana: 2 feet thick and 3 feet high pillars, painted in different colours and adorned with



pictures, should be prepared, and 80 of them should be fixed in the spaces between the boats. On the pillars 10 feet wide pattikas or sheets, and of the same length as the boats, should be fitted with screws, and two-faced hinges.

In order to accommodate crew and passengers of the vimaana, and store luggage, rooms and partitions should be constructed with decorations. In order to provide secrecy, doors should be provided as also ventilators. Revolving wheels with necessary fittings and switches should be fixed so that by putting on a switch the rooms would revolve. Wheels should be fixed in the lanes between the boats. Air-pipes with wheels should be fixed. In order to ensure supply of air, tubes with wheels, and bellows with wide mouths, leaving 20 junctional centres, should be fixed. In the front, two faced tubular wheels should be fixed to dispel the air downwards or upwards or side ways, at 30 feet intervals from the aavrutta or enclosed pradesha of the vimaana. At the bottom of the vimaana metal balls with chain-wirings should be fixed for operations in the course of flight.

The 1st floor will be 7 feet high, with the roofing duly fixed with nalikaa-keelakas with 10 feet intervals. With 20 feet interval in the middle, wires with beaked ends should be attached to each keela. The fittings should be such as to enable opening and shutting like an umbrella. The cloth covering like a tent top should cover the entire floor.

The second aavarana should be made of trinetra metal.

**Maharshi Bharadwaaja :**

☞ “Taduparichaanyaha.” Sootra 4.  
“Another above it.”

Bodhaananda Vritti :

Having described the first floor above, now the second floor is being described. The second floor should be slightly smaller than the first floor. If the first floor is 100 feet wide, the second should be 80 feet wide. The floor should be 80 feet wide, and 3 feet thick, and made of trinetra metal. Its fittings should be like those on the first floor, and be duly connected with electric wiring from the generator.

In order to take the vimaana through water, first the wheels at the bottom used for land route should be drawn up, and in order to prevent water coming up, the bottom should be completely covered up with ksheeree-pata or milk cloth. Four inches thick metal rods, 12 inches long, to which wheels 1 foot wide and  $\frac{1}{2}$  foot thick, and shaped like frog claws, are fixed, should be adjusted on both sides of the dronee or boat lines. Similarly in the front portion of the vimaana, on both sides two such wheeled rods should be fixed in order to divert water. By switching on power the main wheels will revolve, making all the wheels revolve, and expelling water, and aiding the progress of the vimaana forward.

For the supply of air inside, on the sides of the 2nd floor, should be fixed, air pipes 6 inches wide and made of ksheeree pata or milk cloth, cleaned with acid, from the partitions in the 1st floor up to the top of the vimaana, their tops being covered with revolving metal covers, with air sucking pumps worked by power. The air so pumped into the pipes will fill both the second and 1st floors, and provide air comfort for the crew and passengers of the vimaana.

Above the roofing of the two floors all round, spreading out and closing up keelakas should be fixed. So as to separate the floors, foldable chain fittings should be fixed at 10 feet intervals. Wires from the electrical generator should be connected to the fittings, so that by their operation the floors will be separated, and the separated floors simultaneously move on land and in the air.

In the 2nd floor also cabins, partitions and seating and doors and windows should be constructed as attractively as in the first floor. The enclosing walls of the floor should be 7 feet high from its peetha, and half a foot thick. In order to draw electric current from the third floor two poles should be erected in the back room with transmitter from which wires will pass the current to the various fixtures on the floor.

At the front of the vimaana a mast should be erected. At its foot two bells made of bronze should be fixed in order to indicate time to the crew and passengers. In every room on the floor alarm

chains, as in railways, should be fixed so that the occupants may call for help in times of danger. On hearing the call the crew will rush to the room and attend to the requirements of the passengers. Sound transmitter, image transmitter, direction indicator, time-piece, and cold and heat gauges should be installed on either side of the floor, with necessary cable connections.

Then in order to protect against excessive wind currents, storms, and heat-waves, three machines should be installed at the back, on either side, and on both sides of the turret.

They are described in "Yantra Sarvasya" as three-faced air protection yantra, solar-blaze conditioning yantra, and rain storm protection yantra. Their construction is given here as per shastras.

First, three-faced air force reducing yantra.

It must be made of Vaaruna Metal:

Vaaripanka, vishaari, borax, jaalika, mango, vishodara, vaari-panchaka, kshaarasaptaka, kshona, manjula or madder root, godhara, vaarunaasyaka, paarvana or chlorodendrum phlomoides, aruna, kaakatunda, bhoo dhara, vaarunaabhraka, natron, kundaaleemukha, lodhra or benzoin, varikudmala or water flower, shaarikaarasa, panchabaanasahodara, lead 5 parts, soorana or tacca, honey 8 parts, vaata, kankanikodara, sunda, anjana or eye-black, kukkutaandaka, khaadira or brown-barked acacia, loddhruka, simhikaa-mukha, koormajangha, and masoorika or lentil, all these to be cleaned, and filled in crucible, placed in padmamukha furnace, and heated to 700 degrees with 5 faced bellows, poured into equifying yantra and churned, will yield a light, smoke-coloured, impregnable vaaruna metal.

Then it is to be purified, according to "Kriyaasaara." First, place it in shundeera acid (great-leaved laburnum?) and boil for 3 days, and then with kuttinee yantra beat it into flat pattis, make thick decoction of soorana root or tacca, and smear it to 1 inch thickness on it and heat it for 3 yaamaas or 9 hours. Then mritsaara, vaagura, opium, should be boiled together for a day. The concoctions will become red like lac. The metal patti should be smeared with it and heated in the taapana yantra for a yaama or 3 hours. Then keep it

in the sun for a day. Then kantaka or small caltrap, heranda, dhavalodara, and chaaraka, and gingelly should be mixed together, and the oil extracted. The metal should be smeared with it and kept in the sun for 3 days, and then heated in the sun for a day. Then paste the gum of kankola or cubeb pepper 1 inch thick, and stick into it thumb-sized vaatakuthaaraka manis, place in furnace of brown-barked acacia and cool for 9 hours. The metal will become like diamond.

Out of this a cover should be made for the vimaana, with necessary fittings for spreading over and folding up, connected with electric wires drawn from inside the vimaana. The charge of electricity will permeate all over, as well as the manis on the pattika. Three serpent-faced keelakas should be fixed. These will suck in the fierce wind as it blows, and belch it out to the upper regions, so that the wind force on the vimaana will be curbed, and danger therefrom averted.

The rain storm protection yantra should be made of crowncha metal. Says "Kriyaasaara", The metal that can destroy the drava-praanana force of water is krowncha loha. Therefore the varshopa-samhaara yantra should be made out of that alone.

Krowncha loha is described in "Yantra Sarvasva" as follows: Jyotirmukha or rose-coloured red-wort 8 parts, tryambaka or copper 11 parts, humsa-tunda 12 parts, camphor 7 parts, tankana or borax 8 parts, sand 4 parts, choorna or lime 12 parts, ovrwaara or cucumber?, ruruks 5 parts, patola or snake-gourd 27 parts, and vaardhyushika or sea-foam 1 part, these to be cleaned and placed in crucible, and heated in padma-furnace to 512 degrees with 3 faced bellows, poured into churning yantra, and then cooled, will yield, a metal, honey-coloured, light, strong, rain-storm antidote, and heat-impregnated. Extracting oil from the seeds of basil, rukma or yellow thistle, punkha, red wort, trijataa or bael, and pancha-kantaki or 5 thorny trees, the metal should be smeared and heated. The metal is to be made into pattis with kuttinee yantra, make pipes out of them 3 feet wide of the same height as the vimaana, and fix them properly all around. In front of the vimaana-aavarana also 3 feet high pipes should be fixed with keelakas or hinges. The pipes should be smeared with chana or gram decoction 1 inch thick. On that vajragarbha decoction or triangular spurge milk should be

smear'd thrice, which will make it hard as diamond. On the pipes, at 12 inches intervals, sinjeera vajra should be smear'd and heated by fire. Then thumb-size panchaasya manis which will counteract the effects of water, should be imbedded on the smear'd pipes. Then the pipes with proper fittings at both ends should be fixed on the 8 sides of the vimaana. Wires proceeding from the electric generator should be taken through glass tube and connected to the pipes. When the current passes through them to the panchaasya mani, the concentrated force in it blending with the electric force will fiercely oppose the forces of the rain storm and disturb the atmosphere so as to dilute and weaken the storm, and render it ineffective. Therefore the varshopahaaraka yantra should be fixed on the vimaana.

Sooryaathapopasamhaara yantra or the burning-sun protection machine :

It is to be made out of the aathapaashana loha. It is explained in Kriyaasaara: Aatapaashana loha protects against burning sun. Therefore Aatapa samhaara yantra should be made with that metal. "Lohatantra" describes that metal. Owrvaaarika, kowshika, gaaruda, soubhadra, chaandrika, sarpanetra, sringuataka, sowmyaka, chitraloha, vishvodara, panchamukha, virinchi, these twelve metals should be put in equal parts in padma-moosha crucible. Borax 7 parts, chowlika 5 parts, cowree salt 6 parts, kunjara 12 parts, sand 9 parts, camphor 4 parts, cardamom 16 parts, powshnika 10 parts, should be added to them, and placing it in nalikaa furnace heated to 725 degrees with mooshakaasya bhastrika bellows. Then the liquid should be put in the mixing machine, and afterwards poured into the cooler. The resulting alloy will be light, orange coloured, heat proof, and unbreakable, for the making of sooryaathapopasamhaara yantra, after being duly purified, says Yantra-sarvasva.

Kriyaasaara explains its purification :

Ashwaththa or sacred fig tree, mango, plantain, aala or banyan, baadava or peepul, trimukhee, trijata or bael, gunja or wild liquorice, sherinee, patolika or snake gourd, the bark of these trees should be powdered, should be filled in vessel with 10 times as much water, and boiled down to one-tenth measure.

Then taking the 11 kinds of salts, bidaa-lavana or table-salt, syndhava or rock-salt, oushara or saline earth, budila salt, maacheepatra salt or

solanum indicum?, praanakshaara panchaka, or 5 urine salts or ammonium chloride? and saamudra or sea-salt, these eleven salts, should be placed in dravaakarshana yantra or dehydration machine and boiled. Taking the previous decoction, add half as much this decoction, put the aatapaashana metal in it and boil for 5 days, then wash with water, and anoint with honey, and place in hot sun for 3 days, then wash it, and use it for producing the yantra.

First pattikas should be made from the metal with kuttinee yantra, 2 feet square, or circle, and 3 feet thick. On that 3 pipes, 1 foot wide and 5 feet high, should be fixed. Three triangular glass bowls should be placed underneath the pipes. In each of them one prastha or seer of somadraavaka or white acacia juice should be filled. In each vessel a heat proof crystal of the 121st class should be cleaned with acid and placed. Then an umbrella shape 10 feet wide should be made out of the metal, and fixed so as to cover the 3 pipes, with revolving keelakas fixed half-a-foot underneath the umbrella cover. Above that 3 kalasas, 3 feet wide and shaped like cooking vessel, should be fixed. At their centre circular chaalappattikas should be fixed. Upon that three cold-diffusing crystals of the 185th number, should be fixed. On them three black mica wheels should be fixed. They should be covered with chandrikaa toolikaa or white silk cotton. On that should be placed a vessel with acid of manjoosha or madder root, in which a heat-resisting crystal is immersed. In the front part the toothed mica wheels fitted with bhraamanee-danda keelakas should be fixed. And in order to revolve that keelaka 3 wheeled keelaka should be fixed. By its motion the umbrella will revolve disturbing the heat wave. Then the heat-absorbing mica wheels will absorb the heat, which, passing down to the madder-root acid, will become cold and get extinguished. And the crew and passengers will be saved from its evil effects.

#### The Third Floor :

In erecting the 3rd floor of the vimaana, the same procedure as was followed in erecting the second floor should be followed. Like the fixtures in the flooring of the 2nd aavarana and roofing of the 1st aavarana, fixtures should be put in connecting the roofing of the 2nd aavarana and the peetha of the 3rd aavarana. The peetha of the 3rd floor should be 5 feet less than the peetha of the 2nd floor, and be

square or circular like it. The cabins, doors, walls, and furniture on the 3rd floor should be on the same lines as in the 2nd floor. In the north eastern part of the 3rd floor, a cabin should be prepared for housing the electric generator. It should be made out of somaanka loha.

Somaanka loha is explained in "Lohatantra" as follows: Lead, panchaasya, and copper, 7 parts each, Chumbaka or loadstone 9 parts, nalikaa or Indian spikenard bark, sharaanika or rubus salt?, and borax, in equal parts, to be filled in sarpamukha crucible, and placed in naagakunda furnace, filled with coal, and heated to 353 degrees with shashamukha bellows. After melting the liquid should be filled in the mixer, and after churning be poured out to cool. The resulting metal will be a fine, light, electricity-impregnated somaanka loha. Out of that metal pattikas should be made with kuttince yantra, or hammering yantra.

A cradle-like vessel, 3 feet wide and 8 feet high, should be made out of it, and be covered with a pattika with hinges. On the eastern and northern part of the cover two holes  $1\frac{1}{2}$  feet wide should be made. The cradle should be fixed in the electric cabin. Below the holes, two peethas should be fixed in the cradle. Two vessels 2 feet wide and 4 feet high should be prepared. Eight goblets 6 inches wide and 1 foot high should be made, and 4 each should be placed in the two vessels, in their four corners. In the middle of the 4 goblets, a big goblet should be placed so as to contact all the four. 2 vessels covered with patties having 5 holes should be placed inside the 2 holes in the cradle cover. Teethed churners 5 inches in size, 8 inches in height, like those of sugarcane machines, 8 in number, should be placed in the 8 goblets in the two vessels in the cradle. 2 churners, bigger than these should be placed in the two central goblets beneath the two holes. Fixtures should be fixed on the central churner so that by their turning all the other churners will turn.

The procedure for extracting electricity out of solar rays is as follows. 8 naalas or tubes should be prepared out of the 192nd kind of amshupa glass. The naalas should be fixed on the 4 corners of each vessel. Panchamukhi karnikaas should be placed on them, filled with rukmapunkhaa shana, and with electric crystals in them. Covering them

with the amshupaa glass cover, 5 spires should be formed on it. The top of each spire should be like an open beak, and in it should be inserted sinjeeraka crystal and amshupaa crystal. On the central spire amshu-mitra mani should be fixed. Above the 4 crystals should be fixed 4 glass tubes made of kiranaakarshana glass, 6 inches wide and 3 feet high. On them should be carefully fixed 4 feet-wide-mouthed vessels, acid cleaned. They should be filled with Rudrajataa-vaala or aristolochia indica linn. Revolving ghutikas should be placed in their centre. The ghutikaas will attract the solar rays and send them through the tubes. The crystals in the spire beaks will suck them in. So does the shinjeera crystal inside, as also the amshu-mitra crystal. The power will be absorbed by the glass-covering, and sent to the electric crystal. Then the karnikas inside will receive it and send down to the central tube with force. When the central churner revolves the other churners also revolve. The power will enter the acid, and the crystals in it will whirl with great speed, intensifying the power force to the extent of 1080 linkas. That force should be collected by the ganapa-yantra in front of the cradle, and stored in the central storage.

The Ganapa-yantra is a machine shaped like Vighneshwara, 1 foot broad, and 3 feet high. From its head a tubular projection like



Vighneshwara

elephant's trunk, covered with glass and with wires inside should be fixed at the front of the cradle, and connected to the Ganapa image from the neck to the navel. Three-inch toothed wheels should be so fixed that a big wheel at the neck of the image, by force of the current coming through the trunk or proboscis will whirl, setting the other wheels in motion. A coil of wire should be placed in the centre. On it a sapta-shashti shankha or conch called simhikaa should be placed, with covering made of kravyaada metal. 5 spoonfuls of jeevaa-vaka acid (ditamine?) should be filled in the conch, and 217



bhaamukha graamukha manis or beads should be placed inside. 5 umbrellas, 2 inches wide, should be made, and 5 sun-crystals of the size of big liquorice, should be stuck on them. The umbrellas should be fixed on the conch, with amshupa glass covering. This should attract the force of the sun rays, and pass to the crystals on the umbrellas, making the crystals and the umbrellas whirl with fierce force of 1000 linkas, and the force passing to the acid in the conch and the crystal inside, will thence pass westwards, and could be transmitted through wires for any desired use. To measure its exact force a meter should be fixed in, along with thermometer and other needful equipments.

## THE GROUND WHEELS

When the vimaana has to move on the ground, the electric current is switched on the electric motor in the hub of each wheel, thus causing the rim to revolve and move the vimaana.

But when entering water the wheels are drawn in by the movements of toothed segment and the pinion, the latter being revolved by an electric motor attached to the shaft. The openings in the bottom of the vimaana are closed by the sliding covers moved by the rack and pinion arrangement, the pinion being worked by an electric motor.

The movements of the hinged joints of the folding links will raise or lower the second floor over the first floor.

## ELECTRIC GENERATOR

Two jars are placed on the peetha or stand. Each jar contains five cups filled with acids. Each cup has a churning rod with gear-wheels connected together. The wheels are revolved by hand while starting, and by the generated electric power afterwards. A darpana or mirror and gharshana manis are fixed above the gear wheels. The darpana and the manis absorb the sun's energy and transmit it to the acid cups. The acids, being churned, convert the absorbed energy into electric current, which will pass through the pancha-mukhee naala, or five-way-switch, to different points, and work the machines there.

## THE ELECTRIC MOTOR

The electric motor consists of a loop of fine wire coil, with a fine wire cage in the centre. The current from the generator is brought to the wire coil through a glass tube. Suitable wheels are attached to the wire cage to connect to the churning gears of the generator or the shaft of the pinion.

The Simhika shankha on the top of the motor contains an acid and the bhaamukha-graahinee mani or crystal. Five rods with amshupaa-mitra manis are fitted to the top of the shankha, and toothed wheels are fitted to these rods to revolve together and rub against the inner surface of amshupaa mirror at the top. The solar power absorbed by the mirror is stored in the shankha, and given out by the bhaamukha graahinee mani to the various motors in the vimaana.

❖❖❖ Thus concludes the description of Tripura Vimaana. ❖❖❖



And that brings us to the end of the

### WONDER MANUSCRIPT

left behind for the edification of Mankind  
by the venerable mystic

### ANEKAL SUBRAAYA SASTRI

whose occult powers visualised this much from the

### “VYMAANIKA SHAASTRA”

section of the giant

### “ENCYCLOPAEDIA OF MACHINES”

or

### “YANTRA SARVASVA”

of divine sage

## MAHARSHI BHARADWAAJA



# RUKMA VIMANA

## PROFILE

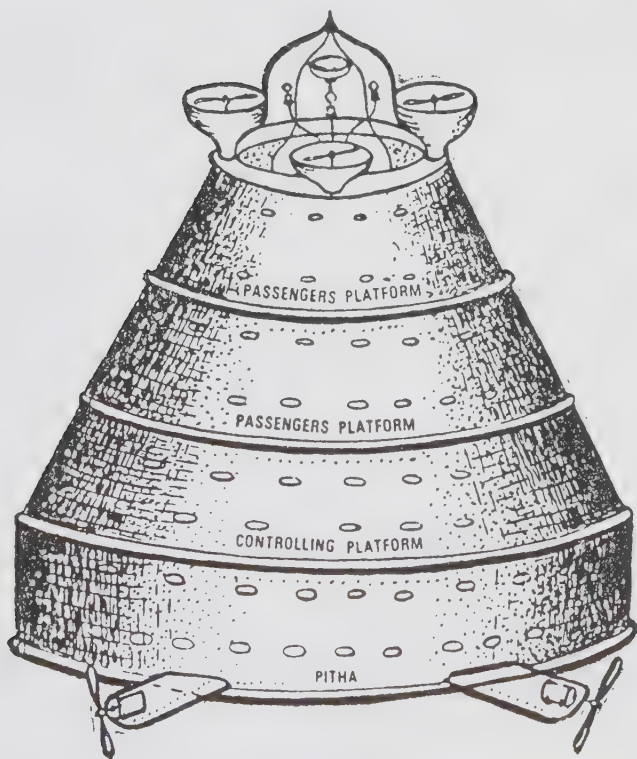

A 1923 drawing by T.K. Ellappa of Bangalore, India of a Vimana (Vimaana) prepared under instruction from Pandit Subbaraya Sastry of Anckal, Bangalore.

# SHAKUNA VIMANA

## HORIZONTAL SECTION

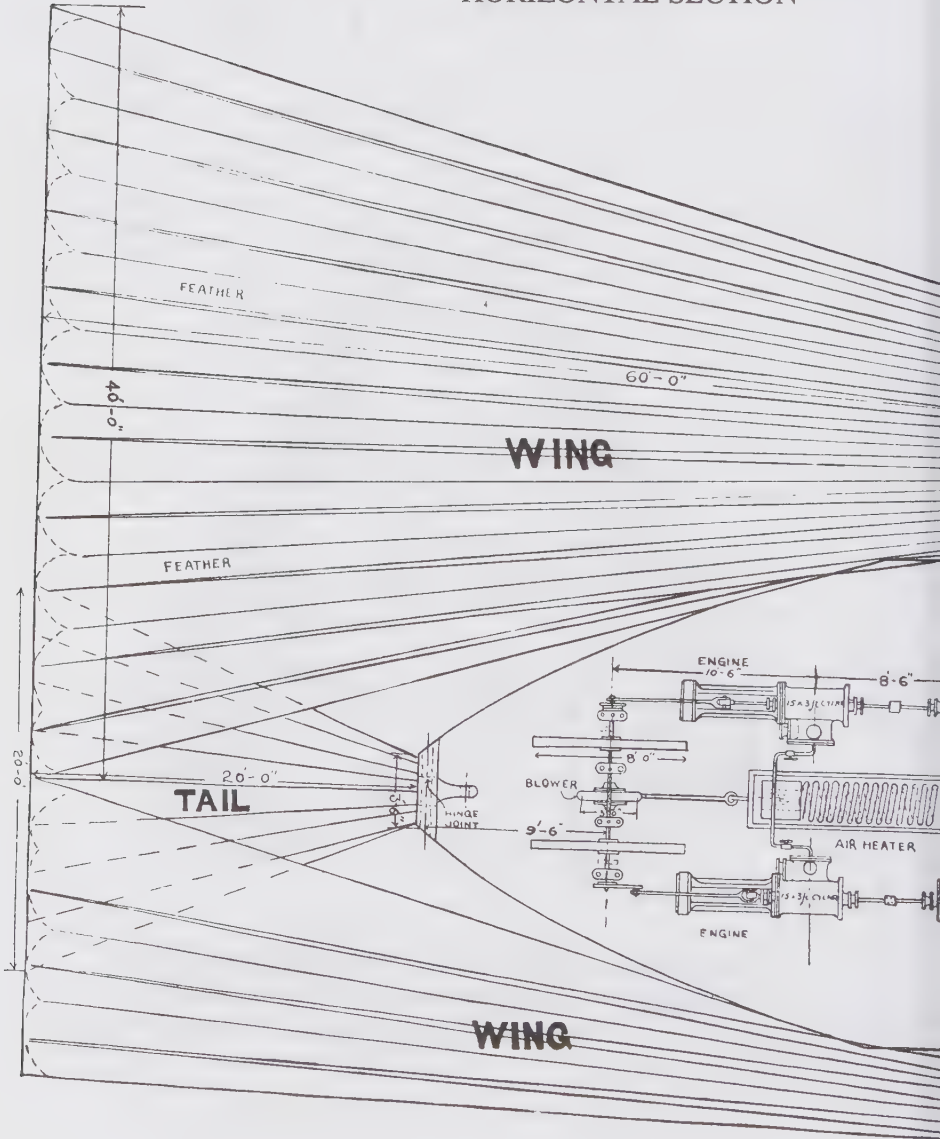

A 1923 drawing by T.K. Ellappa of Bangalore, India of a Vimana (Vimaana) prepared under instruction from Pandit Subbaraya Sastry of Anckal, Bangalore. This early drawing was based on their own turn-of-the-century ideas of flight and the Vimanya Shastra text.

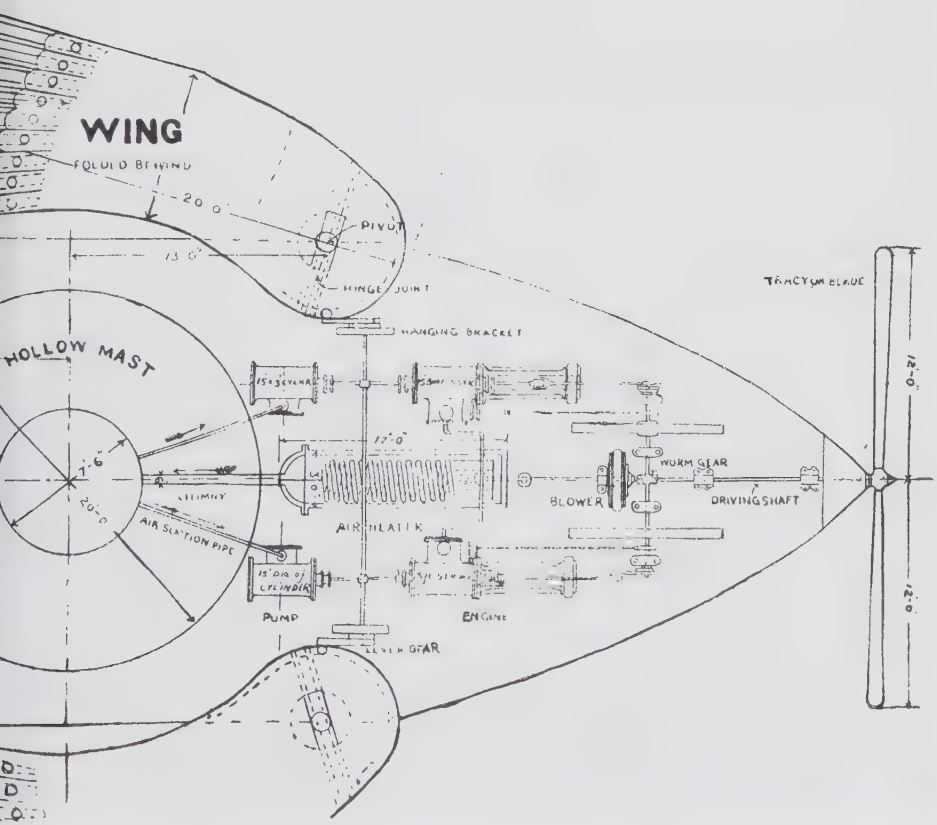

## Location of Yantras

1. Vishvakriyaa Mirror.
2. Roopaakarshana yantra.
3. Parivesha kriyaa yantra.
4. Angopasamhaaraka yantra.
5. Vistrita kriyaa yantra.
6. Vyroopya Darpana yantra.
7. Padmachakramukha yantra.
8. Kuntinee Shakthi yantra.
9. Pushpinee yantra.
10. Pinjulaadarsa yantra.
11. Naalapanchaka yantra.
12. Guhaagarbha yantra.
13. Thamo yantra.
14. Panchavaataskandhanaala yantra.
15. Roudree Darpana yantra.
16. Vaathaskandha naala keelaka yantra.
17. Vidyudyantra.
18. Shabda Kendra mukha yantra.
19. Vidyuddwaadashaka yantra.
20. Praana Kundalinee yantra.
21. Shaktyudgama yantra.
22. Vakra prasaarana yantra.
23. Shakthi panjara keelaka yantra.
24. Shirah keelaka yantra.
25. Shabdaakarshana yantra.
26. Pataprasaarana yantra.
27. Dishampathi yantra.
28. Pattikaabhakra yantra.
29. Sooryarashmyapakarshana yantra.
30. Apasmaaradhooma prasaarana yantra.
31. Sthambhana yantra.
32. Vyshwaanara Naala yantra.

BY THE

SHRI

MAHARAJA

SHRI

MAHARAJA

BY MAHARAJA BHARADWAJ IN VALMIKIKA PRAKARANA

MAHARAJA

MAHARAJA

ADJUSTABLE DROPPER

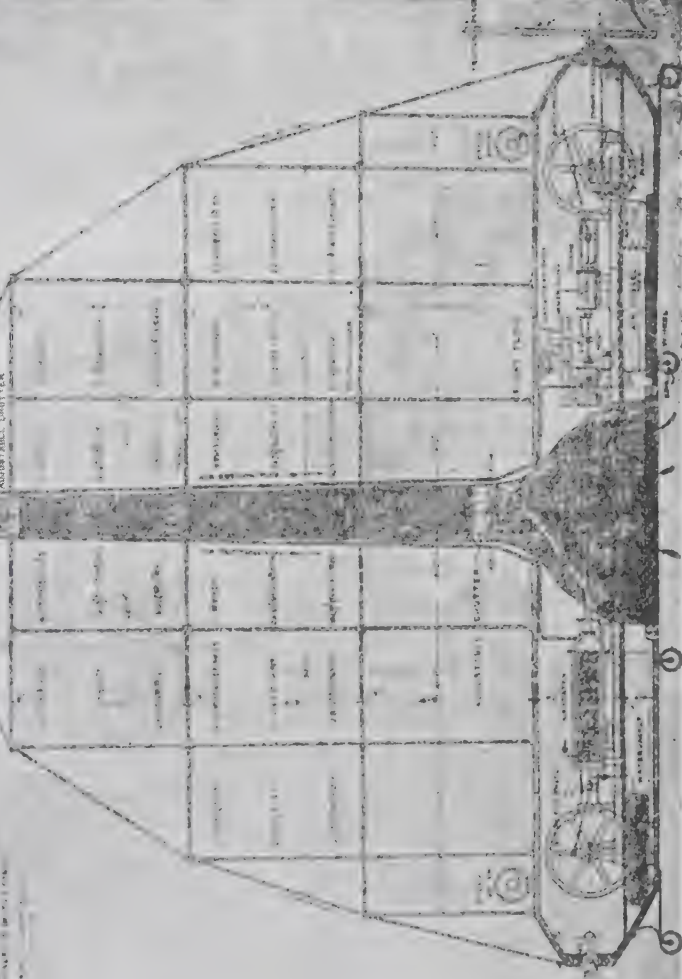

TAIL

# RUKMA VIMANA

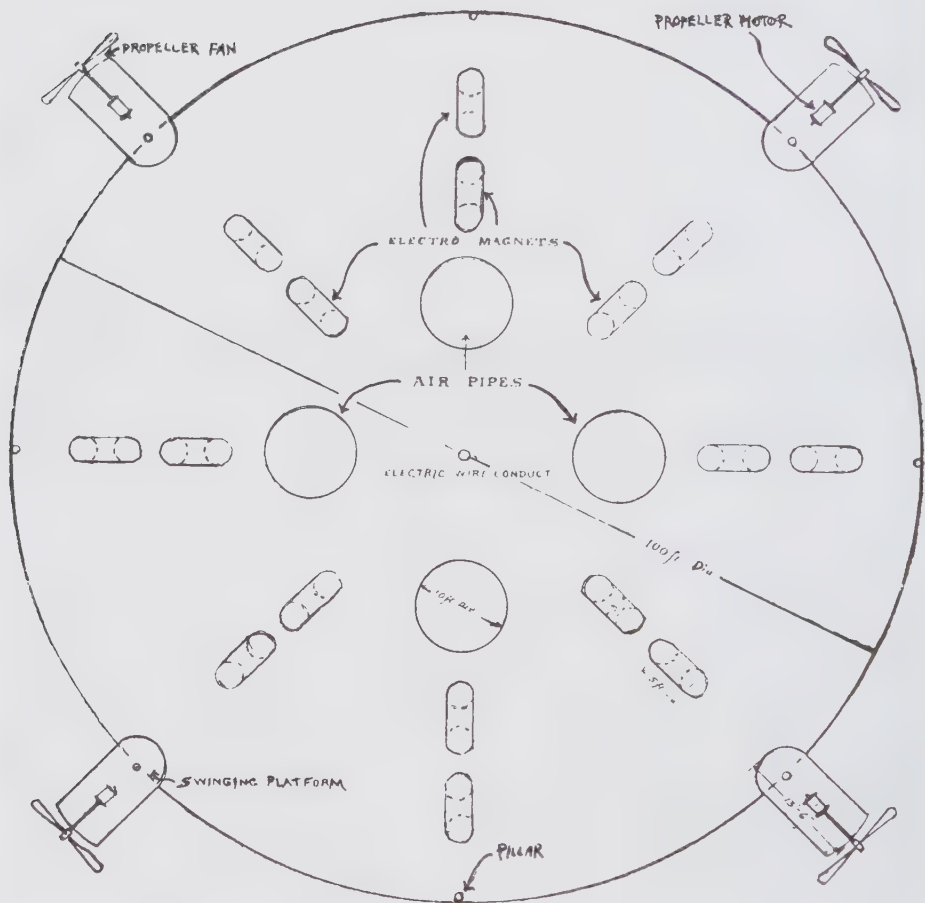

## PLAN OF BASE OR PITHA

A 1923 drawing by T.K. Ellappa of Bangalore, India of a Vimana (Vimaana) prepared under instruction from Pandit Subbaraya Sastry of Ankal, Bangalore.



# RUKMA VIMANA

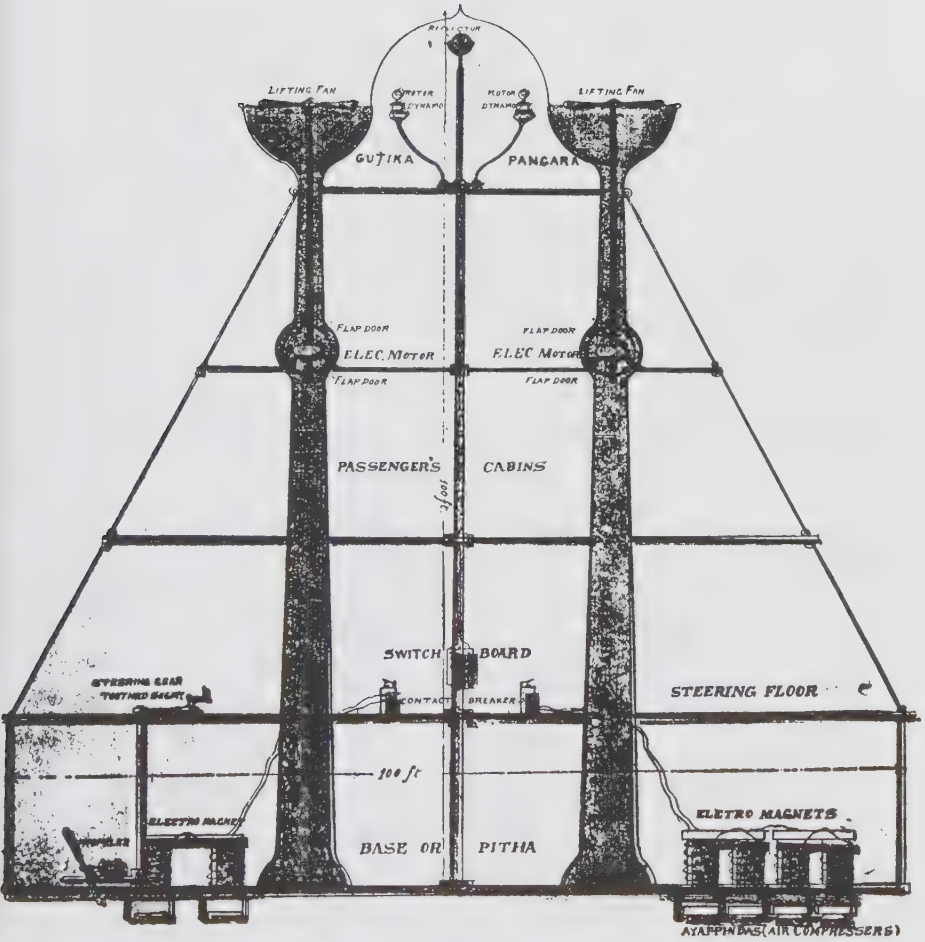

A 1923 drawing by T.K. Ellappa of Bangalore, India of a Vimana (Vimaana) prepared under instruction from Pandit Subbaraya Sastry of Anckal, Bangalore.

# TRIPURA VIMANA

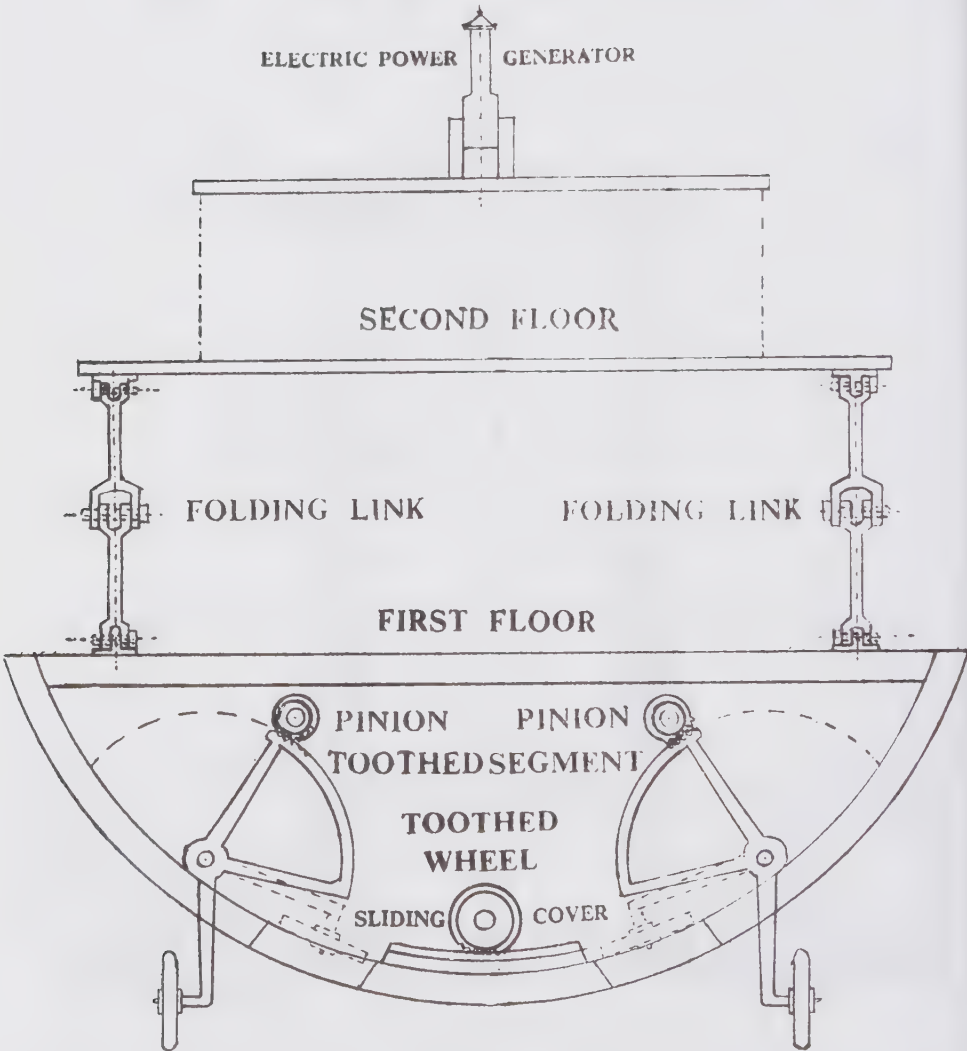

A 1923 drawing by T.K. Ellappa of Bangalore, India of a Vimana (Vimaana) prepared under instruction from Pandit Subbaraya Sastry of Ankal, Bangalore.

# SUNDARA VIMANA

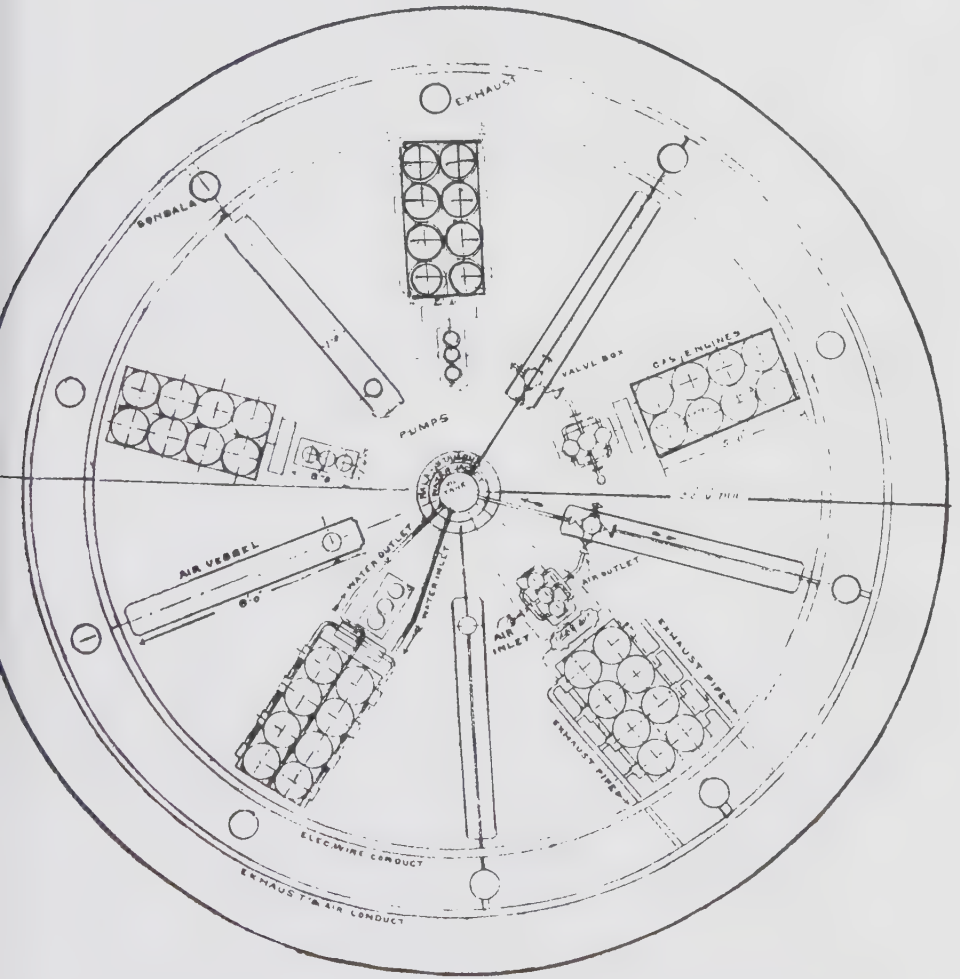

A 1923 drawing by T.K. Ellappa of Bangalore, India of a Vimana (Vimaana) prepared under instruction from Pandit Subbaraya Sastry of Anckal, Bangalore.

# SUNDARA VIMANA

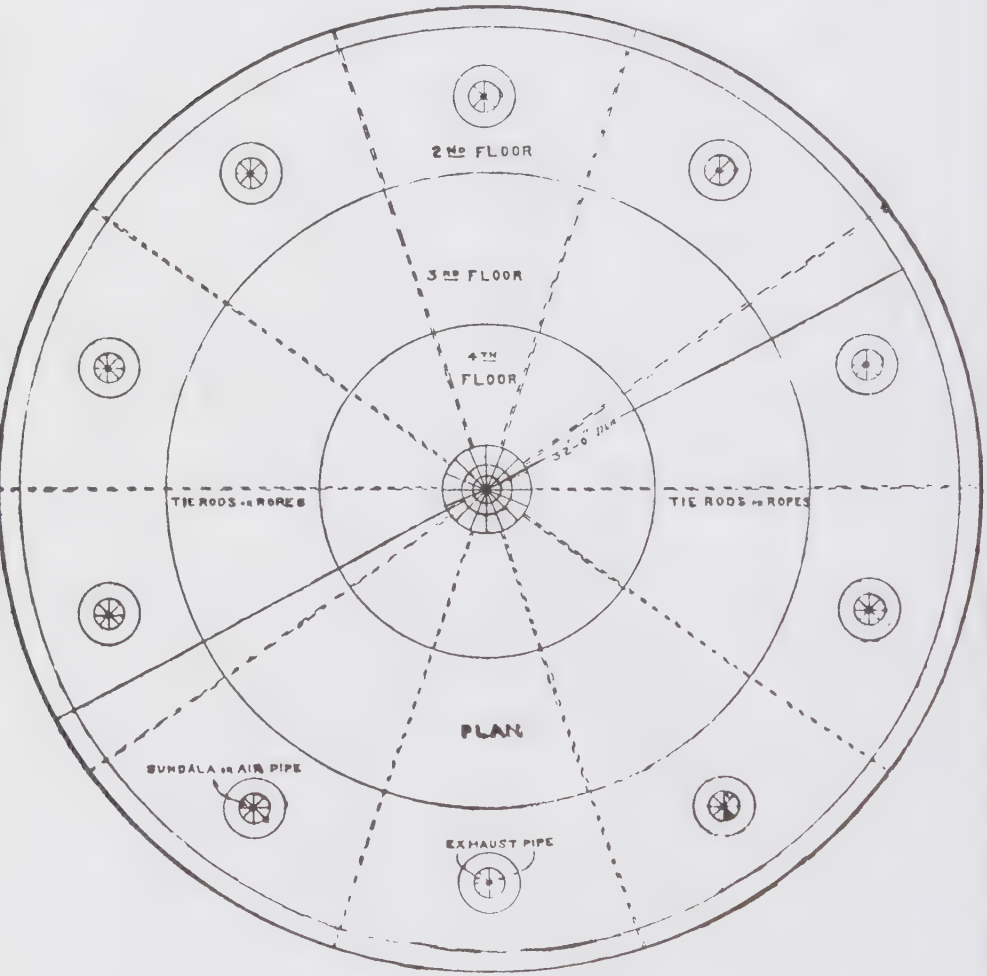

A 1923 drawing by T.K. Ellappa of Bangalore, India of a Vimana (Vimaana) prepared under instruction from Pandit Subbaraya Sastry of Anckal, Bangalore.

# TRIPURA VIMANA

## PERSPECTIVE VIEW

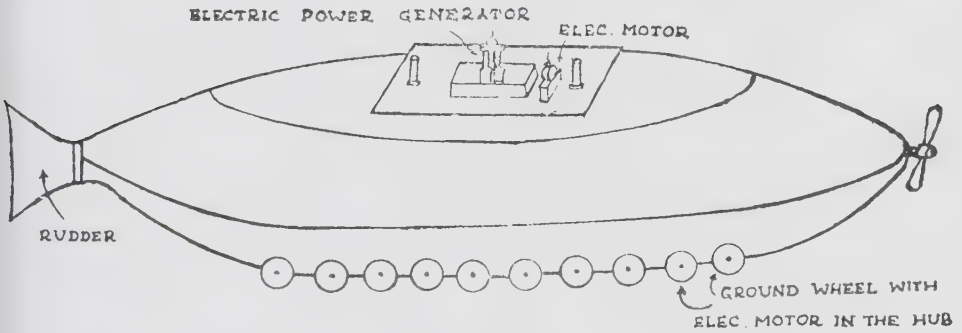

## VERTICAL SECTION

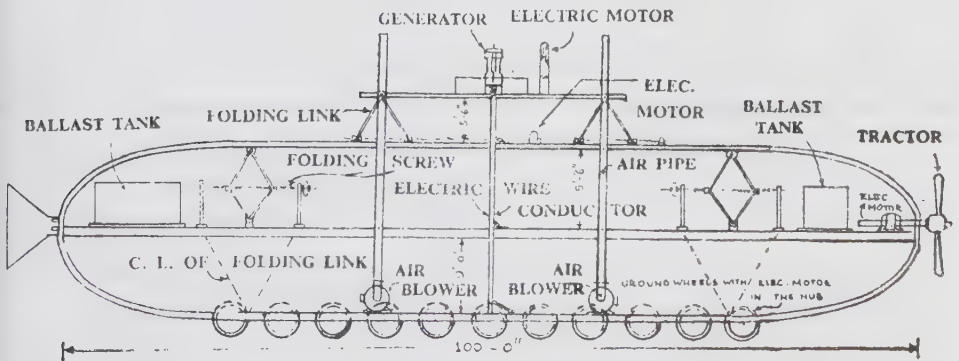

A 1923 drawing by T.K. Ellappa of Bangalore, India of a Vimana (Vimaana) prepared under instruction from Pandit Subbaraya Sastry of Ankal, Bangalore.

# ELECTRIC POWER GENERATOR TOP VIEW

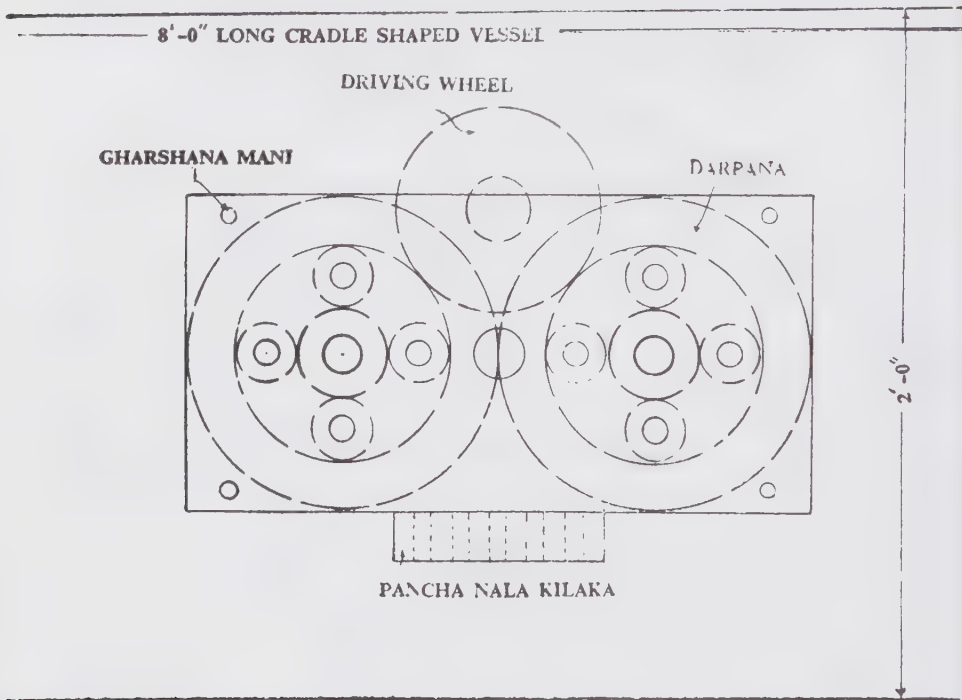

# ELECTRIC MOTOR

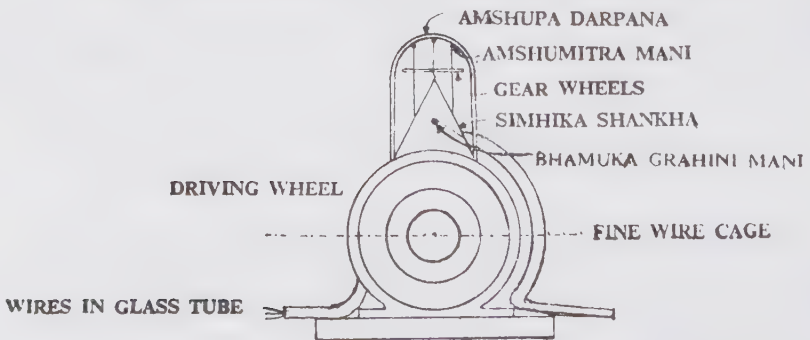

A 1923 drawing by T.K. Ellappa of Bangalore, India of a Vimana (Vimaana) prepared under instruction from Pandit Subbaraya Sastry of Anckal, Bangalore.

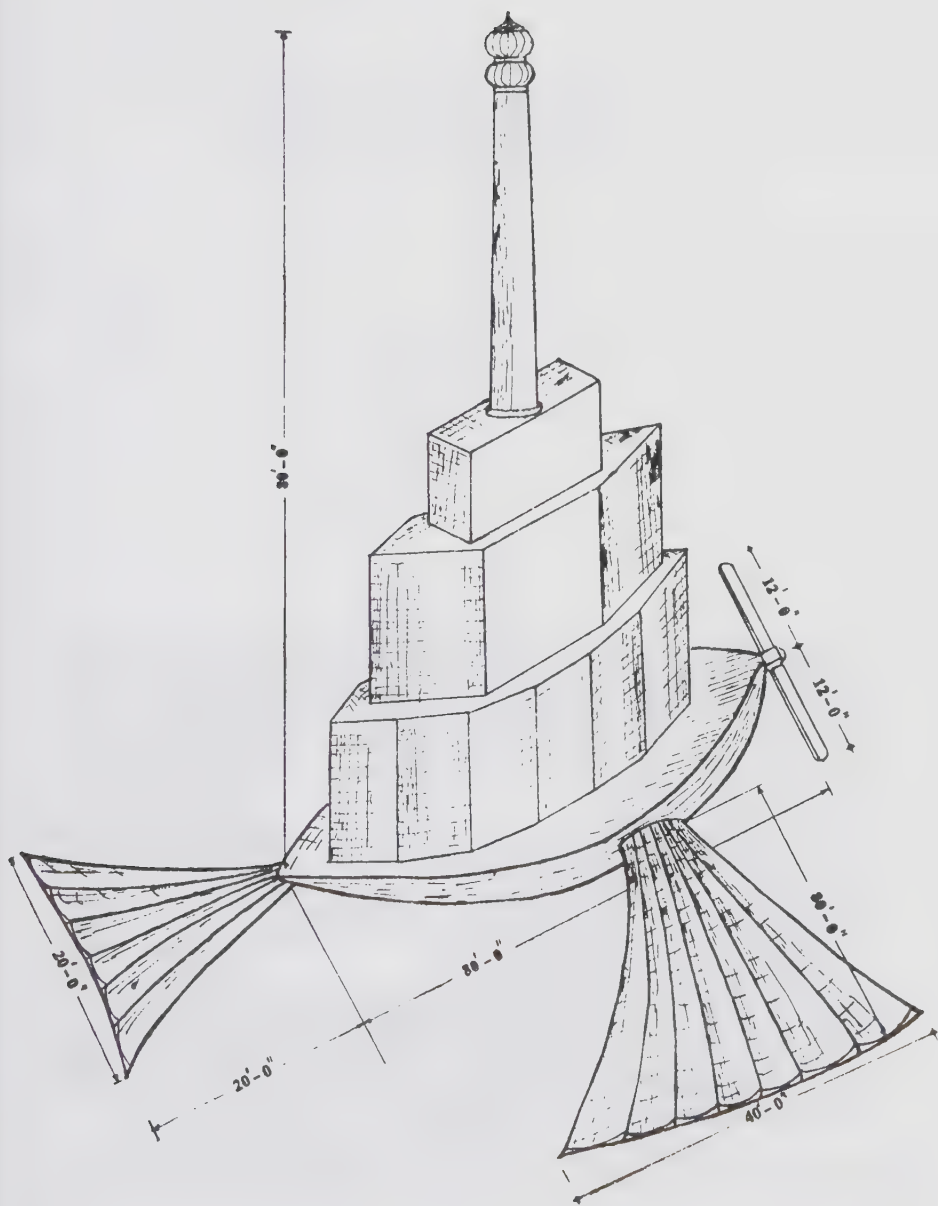

A 1923 drawing by T.K. Ellappa of Bangalore, India of a Vimana (Vimaana) prepared under instruction from Pandit Subbaraya Sastry of Anckal, Bangalore.

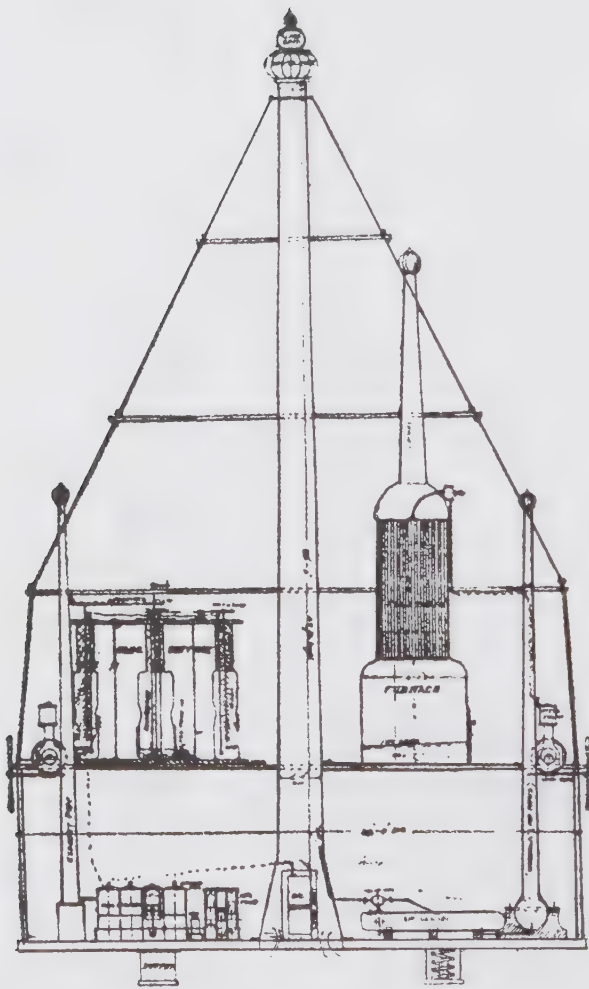

A 1923 drawing by T.K. Ellappa of Bangalore, India of a Vimana (Vimaana) prepared under instruction from Pandit Subbaraya Sastry of Anckal, Bangalore.



# BOOK

## 3

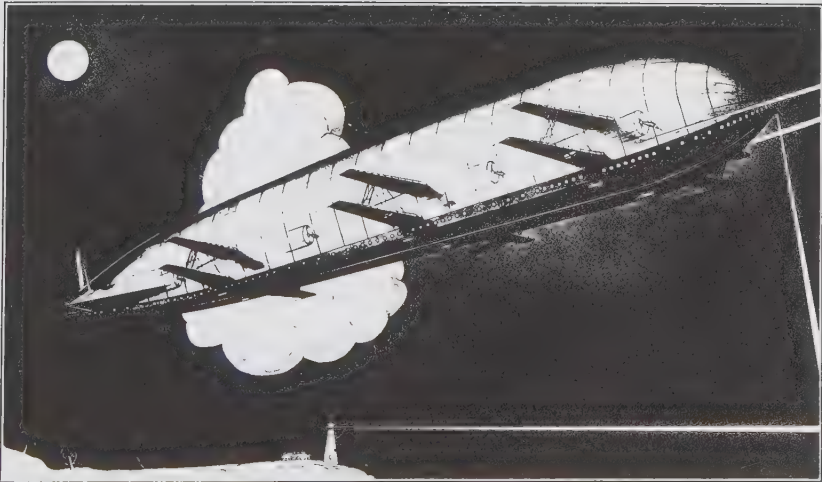

The concept of airflight in 1922 was often geared toward zeppelin and cylindrical vimana designs.

The Caduceus, Magic Wand of Mercury, Messenger of the Gods, is an ancient symbol of electromagnetic flight and cosmic energy.



According to Clendenon, the Caduceus is a simplified diagram of a Mercury Vortex Engine:

- A. Air is the flight propellant/propeller/wings
- B. Expansion of vortex coils/cooling
- C. Compression of vortex coils/heating

1. Liquid metal mercury, the bearer of electro-magnetic energy.
2. Mercury boiler
3. Antenna/starter/core
4. Closed circuit serpentine heat exchanger/condenser coils
6. Poisonous mercury vapor reservoir

# 6

## MERCURY VORTEX ENGINES

§§§

Perhaps the most valuable information that has been gotten from the *Vimaanika Shastra* of Bharadwaaja is the description of what are known today as *Mercury Vortex Engines*.

In chapter five of the *Vimaanika Shastra*, Bharadwaaja describes from the ancient texts which are his reference, how to create a mercury vortex engine.

“Prepare a square or circular base of 9 inches width with wood and glass, mark its centre, and from about an inch and half thereof draw lines to edge in the 8 directions, fix 2 hinges in each of the lines in order to open shut. In the centre erect a 6 inch pivot and four tubes, made of *vishvodara* metal, equipped with hinges and bands of iron, copper, brass or lead, and attach to the pegs in the lines in the several directions. The whole is to be covered.

“Prepare a mirror of perfect finish and fix it to the *danda* or pivot. At the base of the pivot an electric *yantra* should be fixed. Crystal and glass beads should be fixed at the base, middle, and end of the pivot or by its side. The circular or goblet shaped mirror for attracting solar rays should be fixed at the foot of the pivot. To the west of it the image-reflector should be placed. Its operation is as follows:

“First the pivot or pole should be stretched by moving the

*keelee* or switch. The observation mirror should be fixed at its base. A vessel with mercury should be fixed at its bottom. In it a crystal bead with hole should be placed. Through the hole in the chemically purified bead, sensitive wires should be passed and attached to the end beads in various directions. At the middle of the pole, mustard cleaned solar mirror should be fixed. At the foot of the pole a vessel should be placed with liquid *ruchaka* salt. A crystal should be fixed in it with hinge and wiring. In the bottom centre should be placed a goblet-like circular mirror for attracting solar rays. To the west of it a reflecting mechanism should be placed. To the east of the liquid salt vessel, the electric generator should be placed and the wiring of the crystal attached to it. The current from both the *yantras* should be passed to the crystal in the liquid *ruchaka* salt vessel. Eight parts of sun-power in the solar reflector and 12 parts of electric power should be passed through the crystal into the mercury and on to the universal reflecting mirror. And the that mirror should be focussed in the direction of the region which has to be photographed. The image which appears in the facing lens will then be reflected through the crystal in the liquid salt solution. The picture which will appear in the mirror will be true to life, and enable the pilot to realize the conditions of the concerned region, and he can take appropriate action to ward off danger and inflict damage on the enemy.”<sup>48</sup>

Two paragraphs later Bharadwaaja says, “... Two circular rods made of magnetic metal and copper should be fixed on the glass ball so as to cause friction when they revolve. To the west of it a globular ball made of *vaatapaa* glass with a wide open mouth should be fixed. Then a vessel made of *shaktipaa* glass, narrow at bottom, round in the middle, with narrow neck, and open mouth with 5 beaks should be fixed. Then a vessel made of *shaktipaa* glass, narrow at bottom, round in the middle, with narrow neck, and open mouth with 5 beaks should be fixed on the middle bolt. Similarly on the the end

bolt should be paced a vessel sulfuric acid (*bhraajaswad-draavada*). On the pegs on southern side 3 interlocked wheels should be fixed. On the north side liquefied mixture of load-stone, mercury, mica, and serpent-slough should be placed. And crystals should be placed at the requisite centres.

“ ‘*Maniratnaakara*’ (here Bharadwaaja is referring to an ancient authority, now lost, -ed.) says that the *shaktyaakarshana* yantra should be equipped with 6 crystals known as *Bhaaradwaaja* , *Sanjanika* , *Sourrya* , *Pingalaka* , *Shaktipanjara*, and *Pancha-jyotirgarbha*

“The same work work mentions where the crystals are to be located. The *sourrya* mani is to be placed in the vessel at the foot of the central pole. *Sanjanika mani* should be fixed at the foot of the central pole. *Sanjanika mani* should be fixed at the middle of the triangular wall. *Pingalaka mani* is to be fixed in the opening in the *naala-danda* . *Pancha-jyotirgarbha* mani should be fixed in the sulfuric acid vessel, and *Shaktipanjara mani* should be placed in the mixture of magnet, mercury, mica, and serpent-slough. All the five crystals should be equipped with wires passing through glass tubes.

“Wires should be passed from the centre in all directions. Then the triple wheels should be set in revolving motion, which will cause the two glass balls inside the glass case, to turn with increasing speed rubbing each other the resulting friction generating a 100 degree power....”<sup>48</sup>

From the text of the *Vimaanika Shastra* it is apparent that mercury, copper, magnets, electricity, crystals, gyros (?) and other pivots, plus antennas, are all part of at least one kind of *Vimana* The recent resurgence in the esoteric and scientific use of crystals is interesting in the context of the *Vimaanika Shastra*. Crystals, *mani* in Sanskrit, are apparently as integral a part of *vimanas* as they are today in a digital watch. It is interesting to note here that the familiar Tibetan prayer Om Mani Padme Om, is an invocation to the “Crystal (or jewel) inside the Lotus (of the mind)”.

While crystals are no doubt wondrous and important technological tools, it is mercury that concerns us here.

Mercury is an element and a metal. According to the *Concise Columbia Encyclopedia*, Mercury is a “metallic element, known to the ancient Chinese, Hindus, and Egyptians.” The chief source of Mercury is cinnabar HgS, a mineral. According to *Van Nostrand’s Scientific Encyclopedia*,<sup>15</sup> Mercury was mined as early as 500 B.C. out of cinnabar crystals which are usually “small and often highly modified hexagonal crystals, usually of rhombohedral or tabular habit. Its name is supposed to be of Hindu origin.”<sup>15</sup>

Mercury was most certainly mined and used earlier than 500 B.C., though scientific encyclopedias and such are usually overly conservative. The metal was named after the messenger of the Gods in Roman mythology. It is a heavy, silver white liquid with the symbol Hg. The symbol for Mercury is derived from the Greek word *Hydrargos* meaning water, silver or liquid gyro. It is a liquid at ordinary temperatures and expands and contracts evenly when heated or cooled.

The liquid metal mercury when heated by any means gives forth a hot vapor that is deadly. Mercury is generally kept or confined to glass tubes or containers that are sealed, and therefore harmless to the user. Present day *Mercury Vapor Turbine Engines* use large quantities of mercury but little is required renewal because of its closed circuit systems. Mercury and its vapor conducts electricity, its vapor is also a source of heat for power usage. Mercury amplifies sound waves and doesn’t lose timber in quality. Ultrasonics can be used for dispersing a metallic catalyst such as mercury in a reaction vessel or a boiler. High frequency sound waves produce bubbles in the liquid mercury when the frequency of the bubbles grow to match that of the sound waves the bubbles implode, releasing a sudden burst of heat.

According to William Clendenon, well-known UFO investigator and the author of the book *Mercury: UFO Messenger of the Gods*<sup>16</sup> a mercury-filled flywheel can be used

for stabilization and propulsion in discoid aircraft/spacecraft. *Liquid Mercury Proton Gyroscopes*, according to Clendenon, can be used as direction sensing gyros if placed 120 degrees apart on the rotating stabilizer flywheel of a discoid craft.

*Liquid Mercury Proton Gyroscopes* have several advantages, says Clendenon. Firstly, the heavy protons found in mercury atoms are the very stable. Secondly, such gyros do not require a warm-up period as mechanical gyros do. Thirdly, the gyro using stable mercury protons is not affected by vibrations and shock. Fourthly, the Liquid Mercury Proton Gyroscope has no moving parts and can run forever. And lastly, the mercury atom offers the most stable gyro device in nature and has the additional advantages of saving space and weight. This is particularly valuable on long distance flights where all space and weight must be very carefully calculated and conserved.<sup>16</sup>

## DIRECTIONAL GYROS

Clendenon's version of mercury directional gyros is that three *Liquid Mercury Proton Gyroscopes* are mounted on and rotate with the rotating stabilizer flywheel of the craft. The three sensing cells are rigidly attached 120 degrees apart on the rotating flywheel of the discoid craft. The three movable coils of the sensing cells are constantly moving in and out or back and forth each in turn as chosen by the computer when the craft flies on a straight course and is rotating. Signals will be generated by the three mercury proton gyros resistance to the three coils movements. The signals can then be measured by computer to determine the speed and direction of the craft.

Further information on Mercury Engines used in vimanas can be found in the ancient Indian text called the *Samarangana Sutradhara*. The *Samarangana Sutradhara*, as quoted by Ivan T. Sanderson,<sup>17</sup> and Desmond Leslie<sup>1</sup> says that

they were made of light material, with a strong, well-shaped body. Iron, copper, and lead were used in their construction. They could fly to great distances and were propelled by air. This text devotes 230 stanzas to the building of these machines, and their uses in peace and war. Quoting from the text:

“Strong and durable must the body be made, like a great flying bird, of light material. Inside it one must place the *Mercury-engine* with its iron heating apparatus beneath. By means of the *power latent in the mercury* which sets the driving *whirlwind* in motion, a man sitting inside may travel a great distance in the sky in a most marvelous manner.

“Similarly by using the prescribed processes one can build a vimana as large as the temple of the God-in-motion. Four strong *mercury* containers must be built into the interior structure. When these have been heated by controlled fire from iron containers, the vimana develops thunder-power through the mercury. And at once it becomes a pearl in the sky.

Moreover, if this iron engine with properly welded joints be filled with mercury, and the fire be conducted to the upper part it develops power with the roar of a lion.”

Sanderson then goes on to make the basic observation that a circular dish of mercury revolves in a contrary manner to a naked flame circulated below it, and that it gathers speed until it exceeds the speed of revolution of said flame. Sanderson’s observation of revolving mercury is one of the first references to what we now call *Mercury Vortex Engines*.

## THE CADUCEUS

Mercury, the Messenger of the Gods, carried with him his magic wand or caduceus, the winged staff with which he could perform many wondrous feats. In one form or another, the ancient symbol has appeared throughout the world, though its actual origin remains a mystery. The caduceus staff of the God *Mercury* (Hermes to the Greeks) was a rod entwined by two



serpents and topped with a winged sphere. Clendenon<sup>16</sup> likens the entwined serpents to an identical energy as that of the kundalini energy of India.

Today the caduceus is used by the medical profession as their symbol, a practice that apparently stems from the Middle Ages. Probably, the use of the caduceus as a medical symbol stems from the symbolism of the wings for speedy medical attention and the entwined snakes as chemical or medical symbols.

The mythical god Mercury was a messenger of the Gods, he flew through the air rapidly bearing important tidings and official news from kings, gods, or sovereign powers. It was said that if the gods wanted to communicate, carry on commerce, to move things swiftly from one place to another over a long distance safely, they made use of Mercury to accomplish their goals.

Researcher Clendenon<sup>16</sup> believes that the caduceus is an ancient symbol of “electromagnetic flight and cosmic energy.” The entwined snakes are the vortex coils of the propellant, the rod the mercury boiler/starter/antenna and the wings symbolical of flight.

Clendenon’s basic turbo-pump engine has four main sections: compressor, combustion (or heat chambers), turbo-pump and exhaust. Burning gases are exhausted through the turbo-pump wheel to generate power to turn the electric generator:

1. Propellant tanks will be filled with liquid air obtained directly from the atmosphere by on-board reduction equipment.

2. Liquid air may be injected into expansion chambers and heated by the metal working-fluid mercury confined in a boiler coupled to a heat exchanger.

3. the super heated magneto-hydrodynamic plasma (or air) will expand through propellant cooled nozzles.

4. the ship may recharge its propellant tanks with liquid air and condensate water collected directly from the upper

atmosphere by the on-board reducing plant.

Clendenon's interpretation of the *Samarangana Sutradhara* is then as follows: "*Inside the circular air frame, place the mercury-engine with its electric/ultrasonic mercury boiler at the bottom center.*" — Inside the circular air frame, place the mercury-engine with its electric/ultrasonic mercury boiler at the bottom center.

"By means of the power latent in the mercury which sets the driving whirlwind in motion a man sitting inside may travel a great distance in the sky in a most marvelous manner." — The unchained heat unchained heat energy from the hot mercury vapor sets the air pump/turbine in motion.

"Four strong mercury containers must be built into the interior structure. When these have been heated by controlled fire from iron containers, the vimana develops thunder-power through the mercury. And at once it becomes like a pearl in the sky." — One mercury boiler and three mercury flux valve sensor units must be installed in the propulsion system within the center of the circular air frame. When these mercury containers have been heated by electrically-controlled fire (hot mercury vapor) from the containers, the aircraft develops ultrasonic power through the mercury. And at once, the ionized recirculating air flow flow becomes like a pearl in the sky because of magneto-hydrodynamic plasma.<sup>16</sup>

The ball of light that surrounds the scout ship is the magneto-hydrodynamic plasma, a hot, continuously recirculating air flow through the the ship's gas turbine and is ionized (electrically conducting). According to Clendenon, at times a shimmering mirage-like effect caused by heat, accompanied by pulsations of the ball of light makes the craft appear to be alive and breathing. This has, at times, suggests Clendenon, made witnesses to certain UFOs think that they were seeing a living thing. For some of the above reasons, the ship may seem to suddenly disappear from view, though it is actually still there and not de-materialized. The ionized bubble of air surrounding the UFO may be controlled by a

computerized rheostat so the the ionization of the air may shift through every color of the spectrum obscuring the aircraft from view.

Clendenon's view of a great deal of discoid craft seen since 1947 is that many are *vimanas*, either of ancient manufacture, or modern manufacture. He believes that the famous "scout ship" observed by George Adamski (and later by other witnesses) is neither a hoax or an interplanetary space craft. His mercury vortex engines are not capable of interplanetary flight, he says, but, like this version of a vimana, are for terrestrial flight only.

## ELECTROMAGNETIC LIFT AND REPULSION

Clendenon's *vimana*, modeled after Adamski's scout ship, consists of a circular air frame that is partly a powerful electromagnet though which is passed a rapidly pulsating direct current.

The Electromagnetic field coil which consists of the closed circuit heat exchanger/condenser coil circuit containing the liquid metal mercury and/or its hot vapor, is placed with its core axis vertical to the craft.

A ring conductor (directional gyro-armature) is placed around the field coil (heat exchanger) windings so that the core of the vertical heat exchanger coils protrudes through the center of the ring conductor (directional gyro-armature).

When the electromagnet (heat exchanger coils) is energized, the ring conductor (or armature) is instantly shot into the air, taking the craft as a complete unit along with it.

If the current is controlled by a computerized resistance (rheostat), the ring conductor armature and craft can be made to hover or float in the Earth's atmosphere.

The electromagnet (heat exchanger) hums and the armature ring (or torus) becomes quite hot. In fact, if the electrical current is high enough, the ring will glow dull red or rust orange with heat.

The phenomenon (outward sign of a working law of

nature) is brought about by an induced current effect identical with an ordinary transformer.

As the repulsion between the electromagnet (heat exchanger) and the ring conductor (armature) is mutual, one can imagine the craft being effected and responding to the repulsion phenomenon as a complete unit.

Lift or repulsion is generated because of close proximity of the field magnet (heat exchanger) to the ring conductor (armature). Clendenon says that lift would always be vertically opposed to the gravitational pull of the planet Earth, but repulsion can be employed to cause fore and aft propulsion. For more information on Clendenon's technical details on his proposed craft, see his book, *Mercury, UFO Messenger of the Gods*.<sup>16</sup>

## VORTEX PROPULSION

Once a vortex field has been created, the propulsion of the craft is seemingly quite natural.

A number of authors, including John Walker in his article on vortex technology in *Anti-Gravity & the Unified Field*<sup>91</sup> point out that a vortex IS a gravity focal point. That the very motion of rotating or spinning indicates an exchange is taking place between the center and the outside of the motion.

Walker discusses the "Searl Ether Converter" and then tells how he would build a vortex craft: "John Searl was living in England in 1949 and employed at the time as an electrical fitter and cultivated much interest in electricity even though he had no formal education on the subject other than required by his job. Undaunted by conventional ideas he carried out his own investigations into electrical motors and generators. During work on this he noticed that a small EMF was produced by spinning metal parts whereby he proceeded to augment the effect by using slip rings in various ways. He noticed that when the annulus were spinning freely his hair

bristled in the field created. He decided to build a generator based on the principle.

“By 1952, the first generator (converter of ether) had been constructed and tested by Searl and a friend. It was about three feet in diameter and was set in motion by a small engine. The device produced the expected electrical power, but at an unexpectedly high potential on the order of 100,000 volts. While still speeding up the generator broke loose from the engine and rose to a height of about 50 feet. Here the rotor stayed for a while, still speeding up, with the air in the immediate vicinity of the rotor turning a pink like halo around it. Finally the whole works accelerated at a fantastic rate and is thought to have gone off into space. Since that day, Searl and others have made a number of small flying craft, some of which have also been lost. A form of control was developed and later craft 12 to 30 feet in diameter have been built.

“Some interesting side light to the effects produced by the craft are:

“1. Levity

“2. Very high electrostatic fields.

“3. The fields generated interact with radio receivers in the area.

“4. Once the machine passes a threshold of potential, the energy output exceeds the energy input.

“5. Above threshold potential, the generator (read: converter) becomes inertia free. It has no apparent mass.

“6. The effects of the field around the craft that ionize the local air, also produce a near vacuum around it. However, the effects especially around the equatorial plane of the craft, have a tendency to push outside matter away from it. A type of force field as it were.

“7. The preferred direction of travel at ultra-high speeds is away from the planet, the plane of the generator-rotor being at 90 degrees to the gravity field. When in horizontal flight the craft takes up an angle to the gravity field suggestive of the balance between two similar vector fields. In other words, the craft tilts or dips in the horizontal direction it is going.

“8. Matter snatch during acceleration. This occurs when the craft is on the ground, and the drive is suddenly turned on. The rising craft takes part of the ground with it. If it were flying low over water, the water would peak up toward the bottom of the craft. The device cannot possibly be pushing itself away from the Earth if it is picking up matter from underneath.

“9. If the craft hovers low to the ground too long, the ground becomes warm and the grass burnt. Also when flying in humid conditions precipitation or slight small cloud formations occur on the top side or around the craft.

“The last effect, precipitation, was also noted by Nikola Tesla in his laboratory, for his energy producing coils were spiral configurations which created gravity focal points where water molecules became attracted above and around the top of the coil.

“It should be pointed out with Searl’s craft, that only a small amount of space fabric (ether) is converted for energy. However, small changes in the ether lead to large physical effects because of the wave energy’s high potential.

“What I’ve listed above have been noted at one time or another as being effects from UFO activity as well. The Searl Ether Converter is real and is being worked on somewhere in the world. I can explain ALL of these effects simply by overlapping them with Gravity Vortex Mechanics.”<sup>91</sup>

Walker goes on to say, “If I were to build a ring or rotor based motion system, the most natural type of vessel to contain it in would be round like a common motor. If I were to design my rotor like a flat plate, naturally my containment vessel would be saucer or convex lens shaped. The fact that it is lens shaped also assists the whole craft to act as a focussing instrument. If you’ve ever seen a magnifying lens used to make a fire, the smoke allows you to see light streams pass through the lens to create a cone. Where the cone is smallest at its apex, that’s the energy concentration point.

“Essentially the form of a saucer follows exactly its

function to create a rotating potential — gravity vortex. It works with nature. The reason a disc craft would have more of a structure to it on the top side indicates room for pilot quarters and focal control coils, or in the case of remote craft, just the coils.

“If you just build a flat rotor that produced a rotating field, space would curve in toward the center and then it would curve back out again. However, if you added a couple of more coils above the rotor, the top one being smallest, now you are shaping the field. A good example for a model would be a 3 foot rotor, a 2 foot coil above that, and your top coil is say - 9 inches in diameter. Now space curves in and is confined to smaller and smaller concentric rings. By the time it is leaving the topside it is almost pointed. It is focused. Focusing coils are not a new concept I just thought of. If you know even the basics of television you would know that focus coils are utilized to pinpoint and direct the tube electron beam against the screen. The principles speak for themselves.”<sup>91</sup>

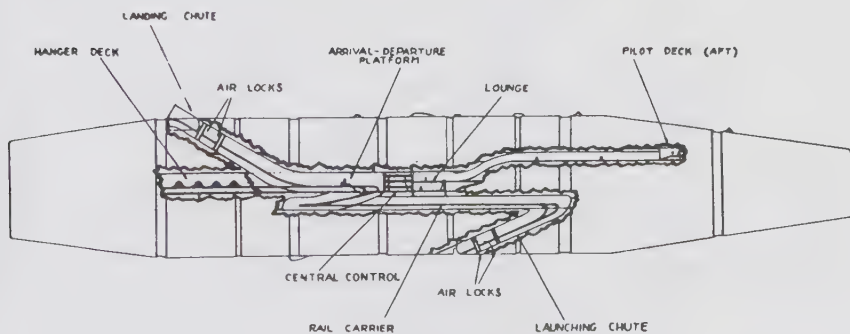

ILLUSTRATED BY  
GLENN PASSMORE

A technical drawing of the interior of the spaceship that George Adamski claimed to have traveled in.





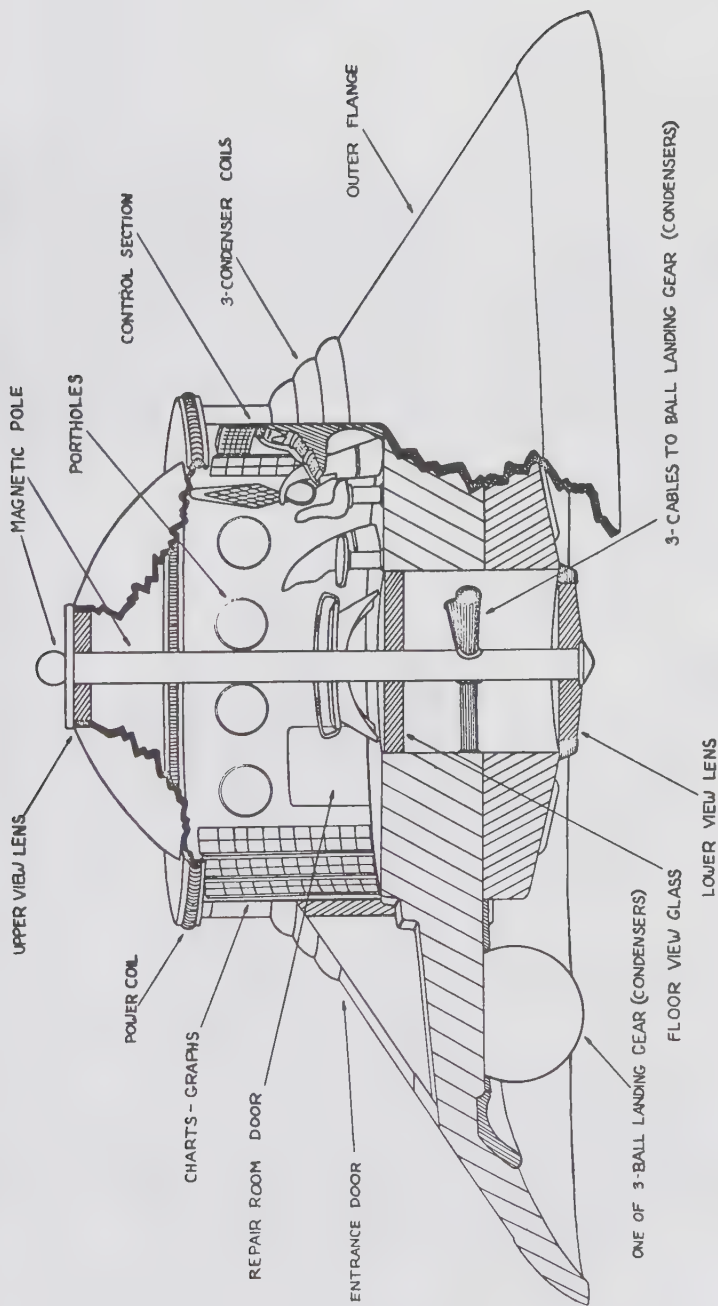

ILLUSTRATED BY  
GLENN PASSMORE

A technical drawing of a "scout ship" that George Adamski claimed to have ridden in during the early 1950's. Clendenon argues that this craft was powered by Mercury Vortex motors utilizing the condensers, coils and electromagnetic fields set up within the craft.

NOTE: ADDITIONAL REMARKS, ETC.

1. COMPUTER AIDED PROPULSION TECHNOLOGY ENABLES AIRCRAFT TO MAINTAIN STABILITY WITH CLIMATIC, VERTICAL STABILIZER (QUANTUM), ETC.
2. A FLY-BY-WIRE SYSTEM CONSISTS OF AN ELONGATED NETWORK OF SENSORS (3) WHICH FEED INTO THE AIRCRAFT'S DIGITAL COMPUTER, WHICH IS CONTROLLED BY A COMPUTER.
3. THE SENSORS MONITOR PITCH AND YAW CONSTANTLY DURING FLIGHT. THE SYSTEM SENDS SIGNALS OVER ELECTRICAL CIRCUITS TO CONTROL ACTUATORS WHICH SERVE TO ADJUST THE AIRCRAFT'S AERODYNAMIC ATTITUDE.
4. THIS AERODYNAMIC STABILITY CAN BE ELIMINATED BY THE AIRCRAFT'S INFLATE VERTICAL STABILIZERS.

NOTE: TO START THE AERO-PROPULSION SYSTEM, THE AIRCRAFT MUST BE LAUNCHED BY A PULSED LASER BEAM. THE LASER BEAM IS FOCUSED ON THE AIRCRAFT'S AIR INTAKE, WHICH HEATS THE AIR TO A POINT WHERE IT EXPANDS AND IS DRAWN INTO THE ENGINE. THE AIRCRAFT'S PROPULSION SYSTEM IS THEN INITIATED BY THE LASER BEAM.

NOTE: THE AIRCRAFT'S PROPULSION SYSTEM IS CONTROLLED BY A COMPUTER. THE COMPUTER RECEIVES SIGNALS FROM THE SENSORS AND SENDS SIGNALS TO THE ACTUATORS. THE ACTUATORS ADJUST THE AIRCRAFT'S ATTITUDE TO MAINTAIN STABILITY. THE AIRCRAFT'S PROPULSION SYSTEM IS INITIATED BY A PULSED LASER BEAM WHICH HEATS THE AIR IN THE AIR INTAKE.

NOTE: THE AIRCRAFT'S PROPULSION SYSTEM IS CONTROLLED BY A COMPUTER. THE COMPUTER RECEIVES SIGNALS FROM THE SENSORS AND SENDS SIGNALS TO THE ACTUATORS. THE ACTUATORS ADJUST THE AIRCRAFT'S ATTITUDE TO MAINTAIN STABILITY. THE AIRCRAFT'S PROPULSION SYSTEM IS INITIATED BY A PULSED LASER BEAM WHICH HEATS THE AIR IN THE AIR INTAKE.

NOTE: THE AIRCRAFT'S PROPULSION SYSTEM IS CONTROLLED BY A COMPUTER. THE COMPUTER RECEIVES SIGNALS FROM THE SENSORS AND SENDS SIGNALS TO THE ACTUATORS. THE ACTUATORS ADJUST THE AIRCRAFT'S ATTITUDE TO MAINTAIN STABILITY. THE AIRCRAFT'S PROPULSION SYSTEM IS INITIATED BY A PULSED LASER BEAM WHICH HEATS THE AIR IN THE AIR INTAKE.

NOTE: THE AIRCRAFT'S PROPULSION SYSTEM IS CONTROLLED BY A COMPUTER. THE COMPUTER RECEIVES SIGNALS FROM THE SENSORS AND SENDS SIGNALS TO THE ACTUATORS. THE ACTUATORS ADJUST THE AIRCRAFT'S ATTITUDE TO MAINTAIN STABILITY. THE AIRCRAFT'S PROPULSION SYSTEM IS INITIATED BY A PULSED LASER BEAM WHICH HEATS THE AIR IN THE AIR INTAKE.

VTOL (Vertical Take-Off and Landing) System

- NOTE: LATE LIQUID AIR CYCLE ENGINE (GAS TURBINE) ELECTRO-MAGNATIC

NOTE: THE AIRCRAFT'S PROPULSION SYSTEM IS CONTROLLED BY A COMPUTER. THE COMPUTER RECEIVES SIGNALS FROM THE SENSORS AND SENDS SIGNALS TO THE ACTUATORS. THE ACTUATORS ADJUST THE AIRCRAFT'S ATTITUDE TO MAINTAIN STABILITY. THE AIRCRAFT'S PROPULSION SYSTEM IS INITIATED BY A PULSED LASER BEAM WHICH HEATS THE AIR IN THE AIR INTAKE.

NOTE: THE AIRCRAFT'S PROPULSION SYSTEM IS CONTROLLED BY A COMPUTER. THE COMPUTER RECEIVES SIGNALS FROM THE SENSORS AND SENDS SIGNALS TO THE ACTUATORS. THE ACTUATORS ADJUST THE AIRCRAFT'S ATTITUDE TO MAINTAIN STABILITY. THE AIRCRAFT'S PROPULSION SYSTEM IS INITIATED BY A PULSED LASER BEAM WHICH HEATS THE AIR IN THE AIR INTAKE.

NOTE: THE AIRCRAFT'S PROPULSION SYSTEM IS CONTROLLED BY A COMPUTER. THE COMPUTER RECEIVES SIGNALS FROM THE SENSORS AND SENDS SIGNALS TO THE ACTUATORS. THE ACTUATORS ADJUST THE AIRCRAFT'S ATTITUDE TO MAINTAIN STABILITY. THE AIRCRAFT'S PROPULSION SYSTEM IS INITIATED BY A PULSED LASER BEAM WHICH HEATS THE AIR IN THE AIR INTAKE.

NOTE: THE AIRCRAFT'S PROPULSION SYSTEM IS CONTROLLED BY A COMPUTER. THE COMPUTER RECEIVES SIGNALS FROM THE SENSORS AND SENDS SIGNALS TO THE ACTUATORS. THE ACTUATORS ADJUST THE AIRCRAFT'S ATTITUDE TO MAINTAIN STABILITY. THE AIRCRAFT'S PROPULSION SYSTEM IS INITIATED BY A PULSED LASER BEAM WHICH HEATS THE AIR IN THE AIR INTAKE.

NOTE: THE AIRCRAFT'S PROPULSION SYSTEM IS CONTROLLED BY A COMPUTER. THE COMPUTER RECEIVES SIGNALS FROM THE SENSORS AND SENDS SIGNALS TO THE ACTUATORS. THE ACTUATORS ADJUST THE AIRCRAFT'S ATTITUDE TO MAINTAIN STABILITY. THE AIRCRAFT'S PROPULSION SYSTEM IS INITIATED BY A PULSED LASER BEAM WHICH HEATS THE AIR IN THE AIR INTAKE.

NOTE: PILOT PLIES BY MIND-CONTROLLED GUIDANCE SYSTEM (PILOT CONTROL)

- NOTE: THE AIRCRAFT'S PROPULSION SYSTEM IS CONTROLLED BY A COMPUTER. THE COMPUTER RECEIVES SIGNALS FROM THE SENSORS AND SENDS SIGNALS TO THE ACTUATORS. THE ACTUATORS ADJUST THE AIRCRAFT'S ATTITUDE TO MAINTAIN STABILITY. THE AIRCRAFT'S PROPULSION SYSTEM IS INITIATED BY A PULSED LASER BEAM WHICH HEATS THE AIR IN THE AIR INTAKE.

NOTE: THE AIRCRAFT'S PROPULSION SYSTEM IS CONTROLLED BY A COMPUTER. THE COMPUTER RECEIVES SIGNALS FROM THE SENSORS AND SENDS SIGNALS TO THE ACTUATORS. THE ACTUATORS ADJUST THE AIRCRAFT'S ATTITUDE TO MAINTAIN STABILITY. THE AIRCRAFT'S PROPULSION SYSTEM IS INITIATED BY A PULSED LASER BEAM WHICH HEATS THE AIR IN THE AIR INTAKE.

NOTE: THE AIRCRAFT'S PROPULSION SYSTEM IS CONTROLLED BY A COMPUTER. THE COMPUTER RECEIVES SIGNALS FROM THE SENSORS AND SENDS SIGNALS TO THE ACTUATORS. THE ACTUATORS ADJUST THE AIRCRAFT'S ATTITUDE TO MAINTAIN STABILITY. THE AIRCRAFT'S PROPULSION SYSTEM IS INITIATED BY A PULSED LASER BEAM WHICH HEATS THE AIR IN THE AIR INTAKE.

NOTE: THE AIRCRAFT'S PROPULSION SYSTEM IS CONTROLLED BY A COMPUTER. THE COMPUTER RECEIVES SIGNALS FROM THE SENSORS AND SENDS SIGNALS TO THE ACTUATORS. THE ACTUATORS ADJUST THE AIRCRAFT'S ATTITUDE TO MAINTAIN STABILITY. THE AIRCRAFT'S PROPULSION SYSTEM IS INITIATED BY A PULSED LASER BEAM WHICH HEATS THE AIR IN THE AIR INTAKE.

NOTE: THE AIRCRAFT'S PROPULSION SYSTEM IS CONTROLLED BY A COMPUTER. THE COMPUTER RECEIVES SIGNALS FROM THE SENSORS AND SENDS SIGNALS TO THE ACTUATORS. THE ACTUATORS ADJUST THE AIRCRAFT'S ATTITUDE TO MAINTAIN STABILITY. THE AIRCRAFT'S PROPULSION SYSTEM IS INITIATED BY A PULSED LASER BEAM WHICH HEATS THE AIR IN THE AIR INTAKE.

NOTE: THE AIRCRAFT'S PROPULSION SYSTEM IS CONTROLLED BY A COMPUTER. THE COMPUTER RECEIVES SIGNALS FROM THE SENSORS AND SENDS SIGNALS TO THE ACTUATORS. THE ACTUATORS ADJUST THE AIRCRAFT'S ATTITUDE TO MAINTAIN STABILITY. THE AIRCRAFT'S PROPULSION SYSTEM IS INITIATED BY A PULSED LASER BEAM WHICH HEATS THE AIR IN THE AIR INTAKE.

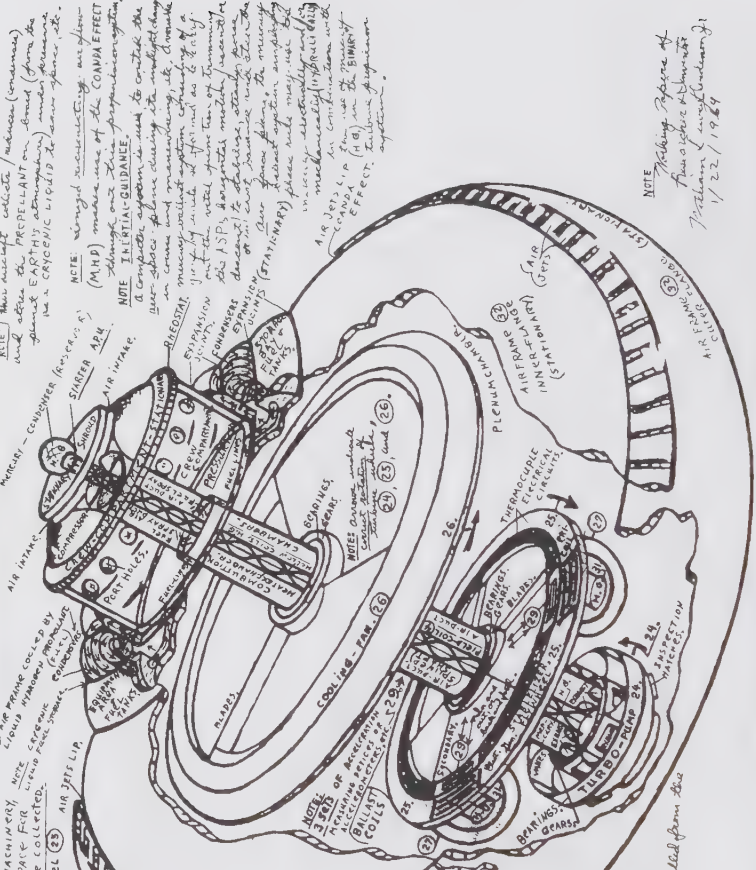

NOTE: Working Paper of  
Aerospace Research  
Institute of Aeronautics & Astronautics  
1/22/1984

W.D. Clendenon's illustration of his concept of a Mercury Vortex Discoid craft. This is his basic concept of the propulsion of at least one type of UFOs. Many current UFOs may well use a variant on this design. Clendenon believes that George Adamski's craft was also a Mercury Vortex Vimana.



At 3:00 in the afternoon on March 8, 1964, Harry Hauxler of West Germany took this photo of discoid craft through the window of a train near Oberwesel. Note the whirling dark vortex beneath the rising craft. This craft may well be a Vimana with a mercury vortex propulsion system. Photo courtesy of UFO Photo Archives, Tuscon, Arizona.

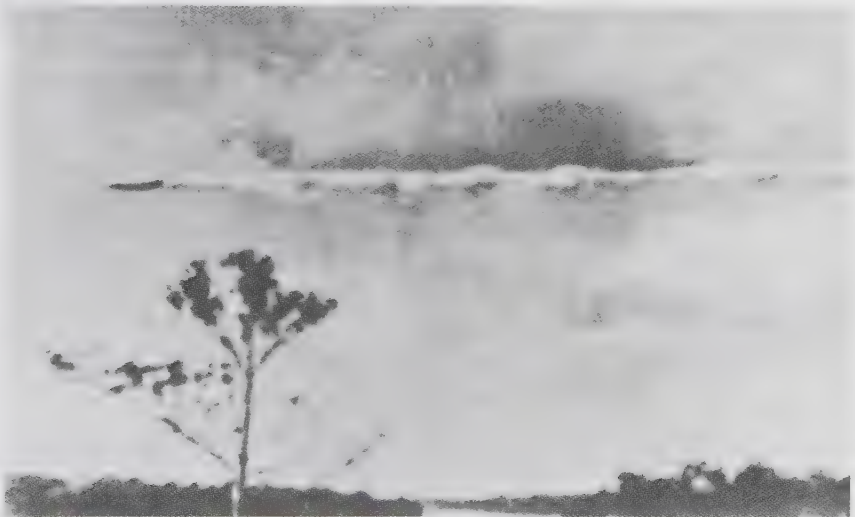

At about 4:30 in the afternoon on July 19, 1952, Customs Inspector Domingo Troncoso took this photo at Puerto Maldonado, Peru. The object was estimated to be over 100 feet long with a thick vapor, smoke or whitish substance coming out of the back. At a time when cylindrical airships were no longer being manufactured (officially) this craft seems very similar to many vimanas and vailxi as described in texts. Photo courtesy of UFO Photo Archives, Tuscon, Arizona.

# DIRECTIONAL GYRO

Flew along the path defined by a space stabilized directional gyro, it would be flying straight in space. This could not be the same as flying North, since flying North is a curved line in space. This effect is sometimes called apparent drift due to meridian convergence. It is also called North steaming error--and the amount of error depends upon speed and latitude.

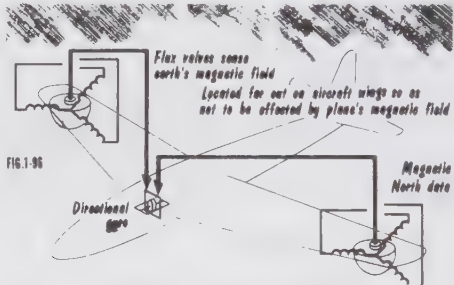

NOTE: "Two ping pong balls on bottom side of airplane wing." B. Clendenon

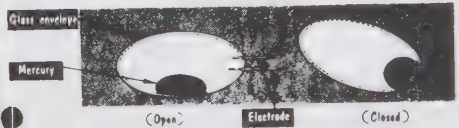
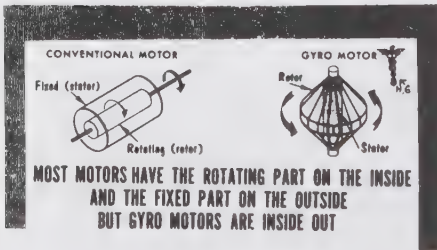
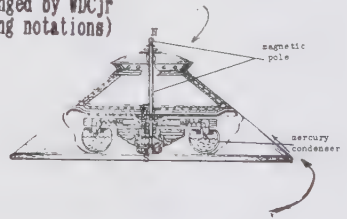
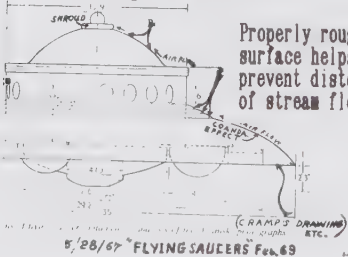

FIG. 1-76 MERCURY SWITCH MAY BE USED IN A BANG-BANG ERECTION SYSTEM

Information compiled and arranged by WDCjr (including notations)

Better flow of air adhering to surface here to get to shaft duct.



Slit inclined at 45 degree angle from horizontal so that jet is directed upward.

Clendenon claims that directional gyros are already in use in many craft.

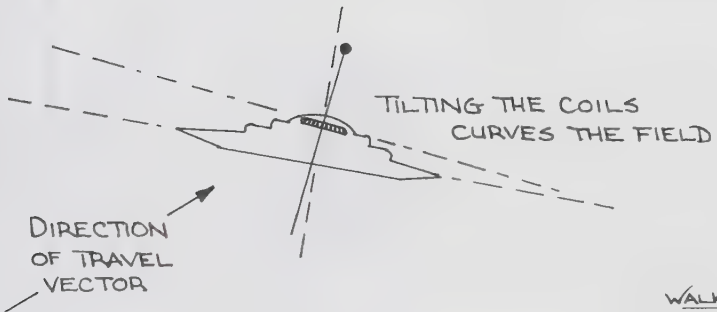
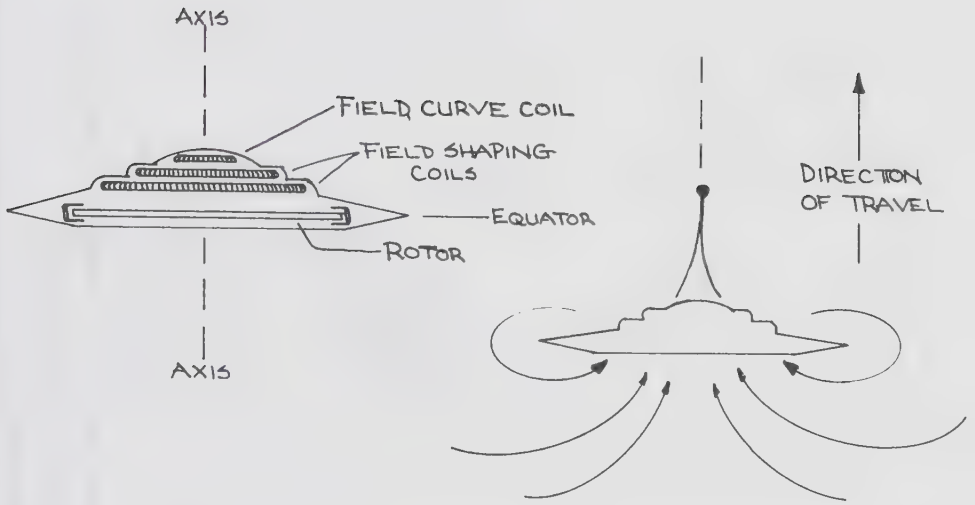

WALKER '89

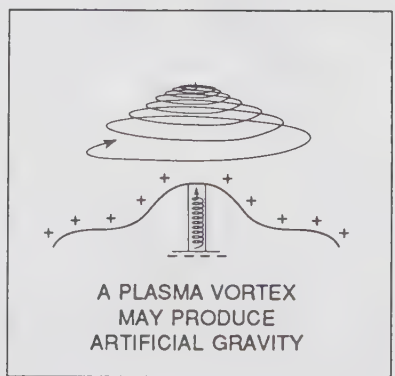
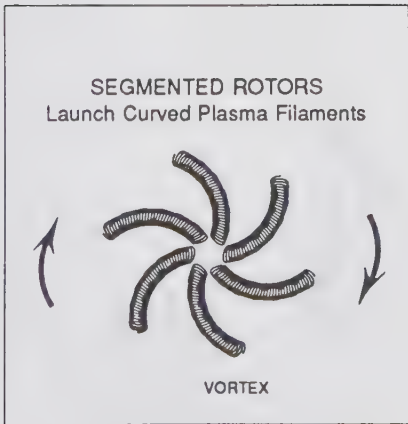

DISC DYNAMICS - Shaping and directing the vortex for travel by levity.

NOTE: 2 is now energized, concentration of force now at 2 causes aircraft to continue on original line of flight, etc.



NOTE: Three housing globes (27), 1, 2, and 3, are fixed 120 degrees apart on the stabilizer flywheel (25). Rotation of stabilizer flywheel (25) causes the three sensors (29) and their three housing globes (27) to continuously follow each in its own firing order 1, 2, and 3, right behind the other, as they rotate with and as a part of the rotating flywheel (25), etc.

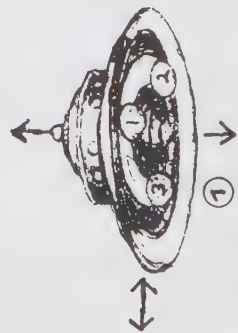

NOTE: Sensor units (29) 1,2,3 electrically energized, all forces equal, aircraft stabilized in hover mode.

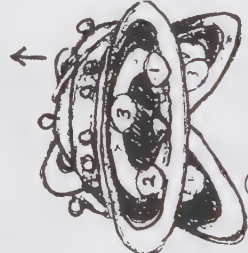

NOTE: 1, 2, 3 energized, all forces changing, aircraft unstable.



NOTE: 3 energized, concentration of force at 3 causes aircraft to move off line of flight indicated.

Clendenon's illustration of how a discoid Vimana would use the electrified mercury vortex housing globes (directional gyros) for travel.

# 7

## ATLANTIS & THE ATLANTEAN VAILX

You were an engineer and manufacturer during many of your incarnations in the *Poseid Empire*. The device for taking motive power directly from the atmosphere was perfected about twenty thousand years ago, and you were among the many who understood its workings. Perhaps you may be instrumental in its rediscovery.

—*The mysterious Dr. White to a young man in the 1963 book, The Ultimate Frontier*<sup>46</sup>



The subject of Atlantis and the aircraft allegedly used by this famous, though controversial, lost civilization is a far more difficult topic to discuss than that of Vimana's used in ancient India. While authentic texts still exist from ancient India with which we can base our study of ancient Indian aircraft, the same cannot be said for Atlantis.

It is the advantage of ancient India over other ancient

civilizations that many of the ancient books have been kept safe and retranslated from the distant days of the Rama Empire, while most other nations of the time have had most of their ancient records destroyed, such as in China, Egypt, Central America, Peru and other areas. Many of these ancient nations are now either desert wastelands, swallowed by thick jungle or literally at the bottom of some ocean or sea. Yet, India, despite devastation by wars and invasion, managed to maintain a large part of its ancient history.

It is not the purpose of this book to argue for or against the existence of a former continent in the Atlantic Ocean called Atlantis. Rather, for the sake of the discussion at hand, that of ancient aircraft used approximately six to sixteen thousand years ago, we will assume that such a nation existed and that they had a high form of technology similar to that of ancient India.

The knowledge of this technology comes largely from metaphysical texts such as Edgar Cayce, the Theosophical Society, the Lemurian Fellowship and other similar groups. For this book we will focus largely on two sources, that of Edgar Cayce and the books *A Dweller On Two Planets* and *An Earth Dweller Returns*.

Known as the “sleeping clairvoyant,” Edgar Cayce was born on March 18, 1877 on a farm near Hopkinsville, Kentucky. Even as a child he displayed powers of perception which seem to extend beyond the normal range of perception. In 1898 at the age of twenty-one he became a salesman for a wholesale stationery company and developed a gradual paralysis of the throat muscles which threatened the loss of his voice. When doctors were unable to find a cause for the strange paralysis, he began to see a hypnotist. During a trance, the first of many for Cayce, he recommended medication and manipulative therapy which successfully restored his voice and cured his throat trouble.

He began doing readings for people, mostly of a medical nature, for people and on October 9, 1910, *The New York*



*Times* carried two pages of headlines and pictures on the Cayce phenomenon. By the time Edgar Cayce died on January 3, 1945, in Virginia Beach, Virginia, he left well over fourteen thousand documented stenographic records of the telepathic-clairvoyant statements he had given for more than eight thousand different people over a period of forty-three years. These typewritten documents are referred to as “readings”. Important to our discussion in this book is that many of these “readings” concern Atlantis, persons former lives in Atlantis, and the airships and motive power used in Atlantis.<sup>65</sup>

In reading 2437-1; Jan. 23, 1941 told his subject: “in Atlantean land during those periods of greater expansion as to ways, means and manners of applying greater conveniences for the people of the land—things of transportation, the aeroplane as called today, but then as ships of the air, for they sailed not only in the air but in other elements also.”

A number of persons who came to Cayce for individual life readings were, according to Cayce’s reading, once navigators or engineers on these aircraft: “in Atlantean land when there were the developments of those things as made for motivative forces as carried the peoples into the various portions of the land and to other lands. Entity a navigator of note then.” (2124-3, Oct. 2, 1931)

“in Atlantean land when peoples understood the the law of universal forces entity able to carry messages through space to the other lands, guided crafts of that period.” (2494-1; Feb. 76, 1930)

Cayce called the motive power used in these vessels the “nightside of life.”: “in Atlantean land or Poseidia—entity ruled in pomp and power and in understanding of the mysteries of the application of that often termed the nightside of life, or in applying the universal forces as understood in that period.” (2897-1; Dec. 15, 1929)

“in Atlantean period of those peoples that gained much in understanding of mechanical laws and application of

nightside of life for destruction.” (2896-1; May 2, 1930)

Cayce speaks of the use of crystals or “firestones” for energy and related applications. He also speaks of the misuse of power and warnings of destruction to come: “in Atlantean land during the periods of exodus due to foretelling or foreordination of activities which were bringing about destructive forces. Among those who were not only in Yucatan but in the Pyrenees and Egyptian land, for the manners of transportation and communications through airships of that period were such as Ezekiel described at a much later date.” (4353-4; Nov. 26, 1939. See Ezekiel 1:15-25, 10:9-17 RSV.)

“...in Atlantis when there were activities that brought about the second upheaval in the land. Entity was what would be in the present the electrical engineer—applied those forces or influences for airplanes, ships, and what you would toady call radio for constructive or destructive purposes.” (1574-1; April 19, 1938)

“...in Atlantean land before the second destruction when there was the dividing of islands, when the temptations were begun in activities of Sons of Belial and children of the Law of One. Entity among those that interpreted the messages received through the crystals and the fires that were to be the eternal fires of nature. New developments in air and water travel are no surprise to this entity as these were beginning development at that period for escape.” (3004-1; May 15, 1943)

“...in Atlantean land at time of development of electrical forces that dealt with transportation of craft from place to place, photographing at a distance, overcoming gravity itself, preparation of the crystal, the terrible mighty crystal; much of this brought destruction.” (519-1; Feb. 20, 1934)

“...in city of Peos in Atlantis—among people who gained understanding of application of nightside of life or negative influences in the earth’s spheres, of those who gave much understanding to the manner of sound, voice

and picture and such to peoples of that period.” (2856-1; June 7, 1930)

“...in Poseidia the entity dwelt among those that had charge of the storage of the motivative forces from the great crystals that so condensed the lights, the forms of the activities, as to guide the ships in the sea and in the air and in conveniences of the body as television and recording voice.” (813-1; Feb. 5, 1935)

The use of crystals as an important part of the technology is mentioned in a very long reading from Dec. 29, 1933: “About the firestone—the entity’s activities then made such applications as dealt both with the constructive as well as destructive forces in that period. It would be well that there be given something of a description of this so that it may be understood better by the entity in the present.

“In the center of a building which would today be said to be lined with nonconductive stone—something akin to asbestos, with . . . other nonconductors such as are now being manufactured in England under a name is well known to many of those who deal in such things.

“The building above the stone was oval; or a dome wherein there could be . . . a portion for rolling back, so that the activity of the stars—the concentration of energies that emanate from bodies that are on fire themselves, along with elements that are found and not found in the earth’s atmosphere.

“The concentration through the prisms or glass (as would be called in the present) was in such manner that it acted upon the instruments which were connected with the various modes of travel through induction methods which made much the [same] character of control as would in the present day be termed remote control through radio vibrations or directions; though the kind of force impelled from the stone acted upon the motivation forces in the crafts themselves.

“The building was constructed so that when the dome was rolled back there might be little or no hindrance in the

direct application of power to various crafts that were to be impelled through space—whether within the radius of vision or whether directed under water or under other elements, or through other elements.

“The preparation of this stone was solely in the hands of the initiates at the time; and the entity was among those directed the influences of radiation which arose, in the form of rays that were invisible to the eye but acted upon the stones themselves as set in the motivating forces — whether the aircraft were lifted by the gases of the period; or whether for guiding the more-of-pleasure vehicles that might pass along close to the earth, or crafts on the water or under the water.

“These, then, were impelled by the concentration of rays from the stone which was centered in the middle of the power station, or powerhouse (as would be the term in the present).

“In the active forces of these, the entity brought destructive forces by setting up—in various portions of the land—the kind that was to act in producing powers for the various forms of the people’s activities in the same cities, the towns, and the countries surrounding same. These, not intentionally, were tuned too high; and brought the second period of destructive forces to the people of the land—and broke up the land into those isles which later became the scene of further destructive forces in the land.

“Through the same form of fire the bodies of individuals were regenerated; by burning—through application of rays from the stone—the influences that brought destructive forces to an animal organism. Hence the body often rejuvenated itself; and it remained in that land until the eventual destruction; joining with the peoples who made for the breaking up of the land—or joining with Belial, at the final destruction of the land. In this, the entity lost. At first it was not the intention nor desire for destructive forces. Later it was for ascension of power itself.

“As for a description of the manner of construction of

the stone: we find it was a large cylindrical glass (as would be termed today); cut with facets in such manner that the capstone on top of it made for centralizing the power or force that concentrated between the end of the cylinder and the capstone itself. As indicated, the records as to ways of constructing same are in three places in the earth, as it stands today: in the sunken portion of Atlantis, or Poseidia, where a portion of the temples may yet be discovered under the slime of ages of sea water—near what is known as Bimini, off the coast of Florida. And (secondly) in the temple records that were in Egypt, where the entity acted later in cooperation with others towards preserving the records that came from the land where these had been kept. Also (thirdly) in records that were carried to what is now Yucatan, in America, where these stones (which they know so little about) are now—during the last few months—being uncovered.” (440-5; Dec. 20, 1933)

§§§

Even more specific material on the airships of Atlantis, or Poseid, as the country was allegedly known to its occupants, can be found in two unusual books, *A Dweller On Two Planets*<sup>71</sup> and *An Earth Dweller Returns*.<sup>72</sup>

*A Dweller On Two Planets* was first dictated in 1884 by “Phylos the Thibetan” to a young Californian named Frederick Spencer Oliver who wrote the dictations down in manuscript form in 1886. The book was not published until 1899, when it was finally released as a book. In 1940, the sequel, *An Earth Dweller Returns* was published by The Lemurian Fellowship of Ramona, California. Also accredited to “Phylos the Thibetan” this book was allegedly dictated to Beth Nimrai. Both books are the long and complicated history of a number of persons and the karma created by each of them during their many lives, especially the karmic relationships and events of the “amanuensis” Frederick Spencer Oliver and his different lives as

Rexdahl, Aisa and Mainin with the many lives of "Phylos" as Ouardl, Zo Lahm, Zailm and Walter Pierson.

Both books are a complicated, and often difficult to follow collection of past lives and the cycles of karma and rebirth between no less than eight people, men and women, which also includes Beth Nimrai, the amanuensis of the later book *An Earth Dweller Returns*.

*An Earth Dweller Returns* is largely an attempt to correct and clarify much of the material in *A Dweller On Two Planets* and both books contain a great deal of detailed information on the life, times, culture and technology of ancient Atlantis, including the airships which were called Vailxi in plural and Vailx in singular.

*A Dweller On Two Planets* has remained a popular occult book for a nearly a century largely because it contains detailed descriptions of devices and technology which were unquestionably well in advance of the time frame in which it was written. As the book cover of one of the editions of the book states "One of the greatest wonders of our times is the uncanny way in which *A Dweller On Two Planets* predicted inventions which modern technology fulfilled after the writing of the book."<sup>71</sup>

Among the inventions and devices mentioned in both books are Air Conditioners, to overcome deadly and noxious vapors; Airless Cylinder Lamps, tubes of crystal illuminated by the "night side forces"; Electric Rifles, guns employing electricity as a propulsive force (rail-guns are similar, and very new invention); Mono-Rail Transportation; Water Generators, an instrument for condensing water from the atmosphere; and the Vailx, an aerial ship governed by forces of levitation and repulsion.

Much of the wording and terms are identical to the Edgar Cayce readings, such as "night side forces" and the term "Poseid" for Atlantis. While verification of any of the information in both books is impossible, the material is fascinating and of definite interest to any student of the Vimanas of ancient India. In chapter two of *A Dweller On*

*Two Planets* the hero, Zailm (an earlier incarnation of Phyllos and Walter Pierson) visits Caiphul, the capital of Atlantis, and views many wonderful electronic devices and the monorail system.

In chapter four the electromagnetic airships of Atlantis are introduced along with radio and television (don't forget, this book was written in 1886). It is explained that the airships, similar to zeppelins, but more like a cigar-shaped airship, are electro-magnetic-gravitational and are capable of entering the water as a submarine or traveling through the air. Later, in chapter sixteen, Zailm takes a journey via Vailx to "Suern" which is apparently ancient India or thereabouts.

In chapter eighteen Zailm visit "Umaurean" (present day American) colonies of Poseid. In a fascinating portion of the book, the Vailx stops for the night to visit a building on the summit of the Tetons. According to the text, "On the tallest of these had stood, perhaps for five centuries, a building made of heavy slabs of granite. It had originally been erected for the double purpose of worship of Incal (the Sun, or God), and astronomical calculations, but was used in my day as a monastery. There was no path up the peak, and the sole means of access was by vailx."

Frederick Spencer Oliver then alleges in a break in the story that such massive, granite slab-walls were discovered in 1886 by a Professor Hayden, allegedly the first person to climb Grand Teton. Whether such massive granite slabs, certainly in poor condition and probably thought to be naturally, do indeed exist on or near the summit of Grand Teton, I have no way of knowing.

Afterwards they visit the ancient copper mines of the Lake Superior region (which do indeed exist and are archaeological fact, nor satisfactorily explained) and then return to Poseid, making part of the journey underwater.

Back in Atlantis (Poseid) Zailm makes the mistake of getting involved with two women at the same time and karmic repercussions are severe when, about to marry one

of the women, the other exposes him and tragedy follows when both women are killed. One commits suicide and the other stands in the Maxin Light, a kind-of super energy beam in the center of the great temple, analogous to the similar Edgar Cayce reading (440-5; Dec. 20, 1933). This Maxin Light is also similar to the giant energy towers designed by the great inventor Nikola Tesla to be built in the 1930s, but never produced.

In chapter eighteen, Zailm speeds away in his private Vailx and wanders for a time searching for gold in South America, using an electronic mineral detector, a water generator and an electric rifle. While searching for gold he is trapped in a small cavern by the evil priest Mainin (who is an early incarnation of Frederick Spencer Oliver, the amanensis of the book) and dies.

Later in the book, a few incarnations later, Zailm (Phylos) is taken astral traveling to Venus, hence the title of the book *A Dweller On Two Planets*. This part of the book is somewhat reminiscent of the Hari Krishna publication *Easy Journey To Other Planets* by Swami Prabhupada.<sup>77</sup>

The second book, *An Earth Dweller's Return*,<sup>72</sup> much of the text is used in explaining elements of *A Dweller On Two Planets* that was left unexplained, particularly the karmic relationship between Phylos himself and Frederick Spencer Oliver. However a great deal of this book goes into the science of Atlantis including the cause of gravitational attraction; heat, magnetism and motion, transmutation of matter, the Maxin Light, another energy tower known as the Maxt, airless cylinder light, levitation and much more.

Part Five of the book is entitled *Description Of A Journey By Vailx*. According to the text, "the Atlantean vailx was an air vessel motivated by currents derived from the Night Side of Nature.

"Altitude was dependent wholly upon pleasure. For this reason wide views were possible with a great variety of scenery. The rooms of the vailx were warmed by *Navaz* (Night Side of Nature) forces and furnished with the



proper density of air by the same means. So rapidly did the aspect of things change beneath, that the spectator, looking backwards, gazed upon a dissolving view.

“The currents, derived from the Night Sides of Nature, permitted the attainment of the same rate of speed as the diurnal rotation of the earth. For example, suppose we were at an altitude of ten miles and that the time was the instant of the sun’s meridian. At that meridian moment, we could remain indefinitely bows on, while the earth revolved beneath at approximately seventeen miles per minute. Or the reverse direction keys could be set, and our vailx would rush away from its position at the same almost frightful speed—frightful to one unused to it, but not so to the returning Atlanteans who, in the Aquarian Age to come, will travel the highways of the land, sea and air without a thought of fear.”<sup>72</sup>

On the trip in the Vailx is beset by a storm: “The repulse keys were set., and presently we were so high in the air that all about our now closed ship were cirrus clouds—clouds of hail held aloft by the uprising of the winds which were severe enough to have been dangerous had our vessel been propelled by wings, fans, or gas reservoirs.

“But as we derived our forces of propulsion and repulsion from Nature’s Night Side, or in Poseid phraseology, from *Navaz*, our long white aerial spindles feared no storm however severe. . . .The evening had not far advanced when it was suggested that the storm would most likely be wilder near the earth, and so the repulse keys were set to a fixed degree, making nearer approach to the ground impossible as an accidental occurrence.”

The chapter continues to speak of the journey, mentioning the destination, Suernis (India) and the air dispensers with wheels and pistons that pressurize the cabin. In Section 418 of the text it states, “The vailx used was about the middle traffic size. these vessels were made in four standard lengths; number one, about twenty-five feet; number two, eighty feet; number three about one hundred

fifty-five feet; while the largest was approximately three hundred feet in length.

“These long spindles were round, hollow needles of aluminum, comprising an outer and an inner shell between which were placed many thousands of double ‘T’ braces, an arrangement productive of intense rigidity and strength. Other partitions made other braces of additional resistant force. From amidships the vessels tapered toward either end to sharp points. Most vailxi were provided with an arrangement which allowed an open promenade deck at one end. The vailx which Zailm used was about fifteen feet and seven inches in diameter.

“Crystal windows of enormous resistant strength were arranged in rows like port holes along the sides, with a few on top and several others set in the floor, thus affording a view in all directions.”<sup>72</sup>

What is fascinating in reading descriptions of so-called Atlantean Vailxi in these books, as well as their brief descriptions in the Edgar Cayce readings, is their similarity to the descriptions of Vimanas in ancient Indian texts and their similarity with a number of UFO craft seen in present times.

As the back cover paragraph on *A Dweller On Two Planets* points out, this book, and its description of a long, cylindrical, cigar-shaped aircraft, is a haunting premonition of not only many UFOs seen today, but of a type of craft that may yet be produced by a manufacturer in the near future!

At least several types of Vimana aircraft is described by the ancient texts as circular in characteristics, which can either mean it is discoid, as in the mercury vortex type of propulsion, or it is cylindrical, as in the Vailx type of craft allegedly of Atlantis. That some of the UFO sightings of similar type craft of the past forty years might somehow be Atlantean or Indian type Vailx or Vimana is a fantastic notion that apparently has never been considered by either the scientific community nor by current UFO investigators.



*A Vailx during a storm in an 1884 illustration from *A Dweller On Two Planets*.  
Note the lights along the side of the craft.*



A Vailx enters the water in an 1884 illustration from *A Dweller On Two Planets*.  
Note the lights along the side of the craft.

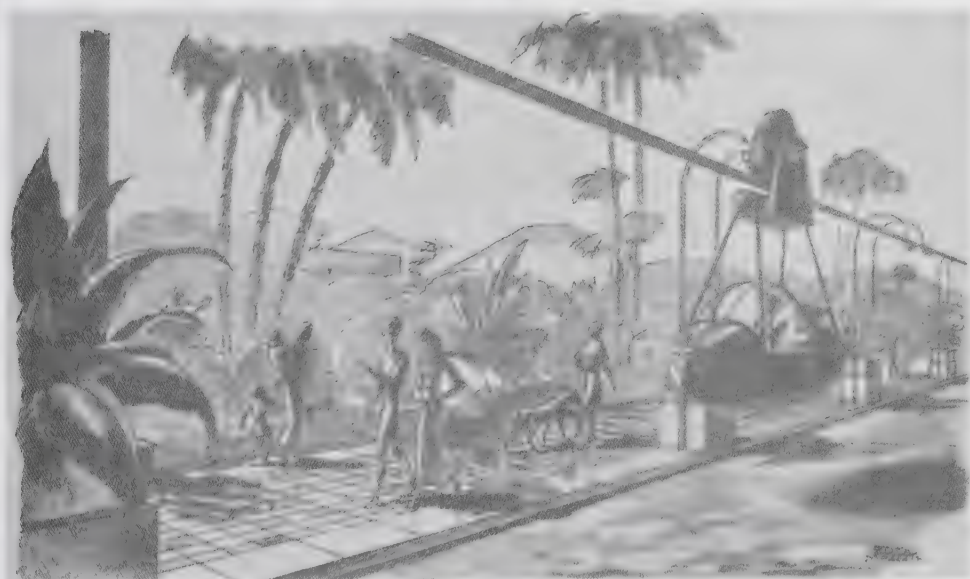
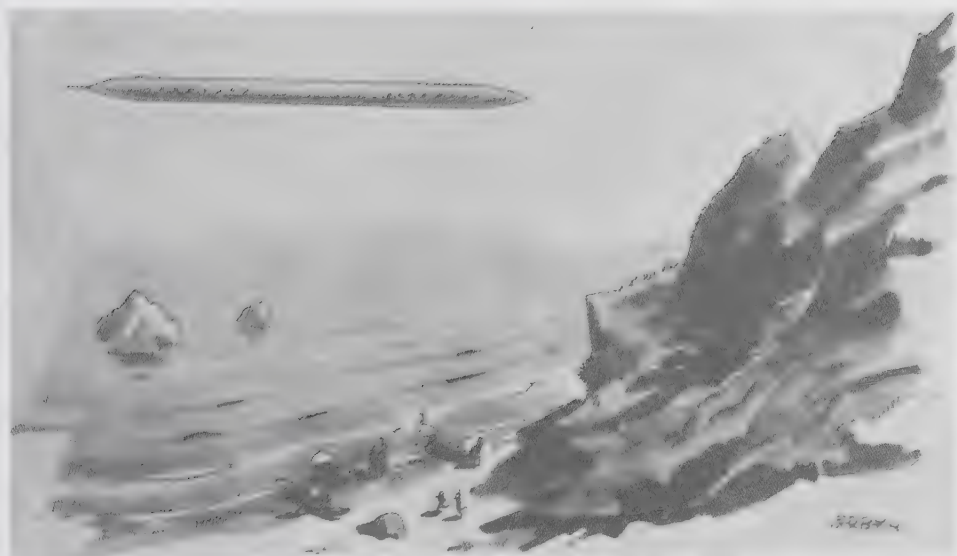

Above: An Atlantean Vailx leaves the shore upon a journey. Notice its similarity to certain needleshaped UFOs. Below: An electro-odic transit carriage scene from Atlantis illustrating some of the technology. Both drawings from the 1940 book *An Earth Dweller's Return*.

# *Atlantean Inventions*

- AIR CONDITIONER — *Deadly and noxious vapors overcome by purification.*
- AIRLESS CYLINDER LAMPS — *Tubes of crystal illuminated by the Night Side Forces.*
- BOOK MACHINE — *A psychic apparatus to reproduce the voice of characters in literature.*
- CALORIVEYANT INSTRUMENT — *Heat producing apparatus powered by the Night Side of Nature.*
- CRIME CURING APPARATUS — *A machine designed to transmute desires of convicted criminals.*
- ELECTRIC RIFLES — *Guns employing electricity as propulsive force.*
- GRAND ORGAN — *Color and tone instrument soon to be rediscovered.*
- IRIDESCENT LIGHTS — *High tension odic-electric lamps diffusing a multi-colored radiance.*
- MAXIN LIGHT — *An Unfed Light sustained by super physical power.*
- MONO-RAIL TRANSPORTATION — *Locomotion in use for high speed transit.*
- NAIM — *Radio and Television*
- NOISELESS MACHINERY — *Machines cushioned by synthetic shock absorbers.*
- TRANSMUTATION OF METALS — *Apparatus powered by electrical action.*
- VAILX — *An aerial ship governed by forces of levitation and repulsion.*
- WATER GENERATOR — *An instrument for condensing water from the atmosphere.*
- VOCAL NEWS RECORD — *A machine for printing the spoken word.*

From the Lemurian Fellowship, 1940.

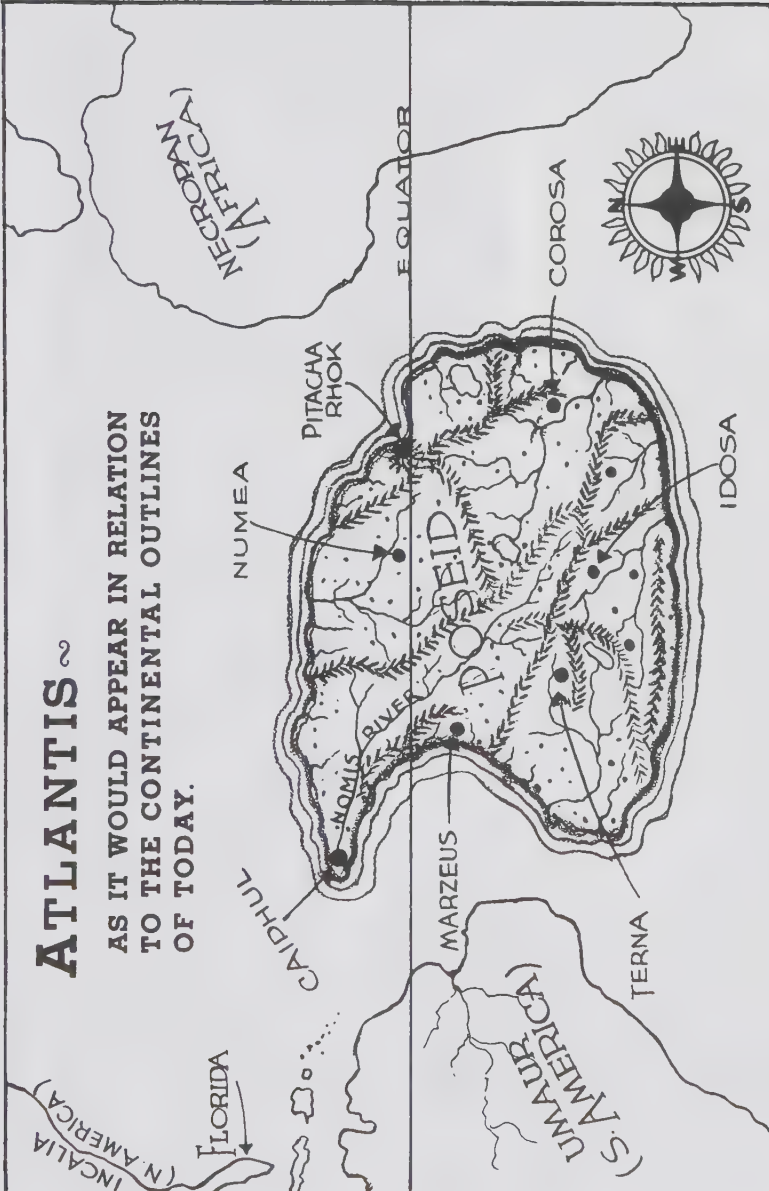

The Lemurian Fellowship's concept of the island of Atlantis circa 10,000 B.C. It includes several major cities that supposedly existed at that time.

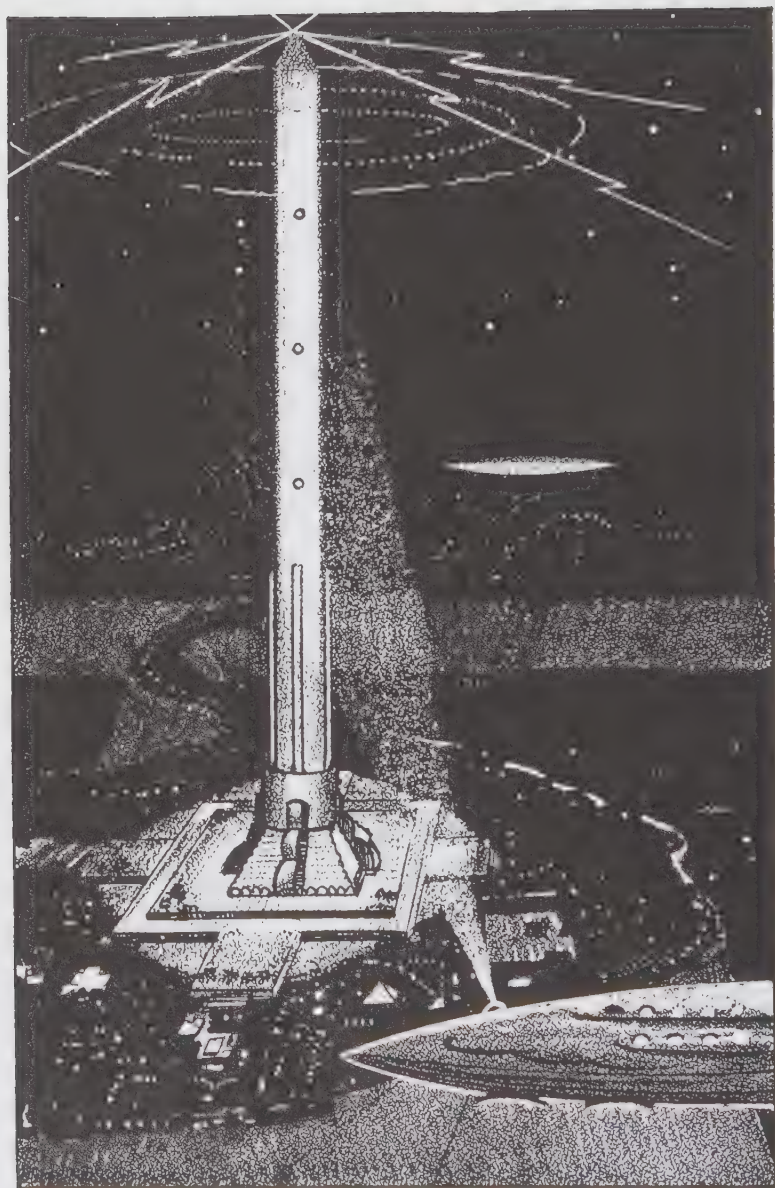

The giant Maxt Light that radiated power into the atmosphere as a kind of radio station sending out electricity to the world. From the Lemurian Fellowship, 1940.





This drawing of Nikola Tesla's Warcliff Tower being built in Long Island, New York, appeared in the June, 1919 issue of *Electrical Experimenter*. Like the alleged Maxt or Maxin Light of Atlantis, it was to broadcast power to the world. An anti-gravity airship, drawing power from the tower, hovers nearby. Note the powerful searchlight on the front of the ship.

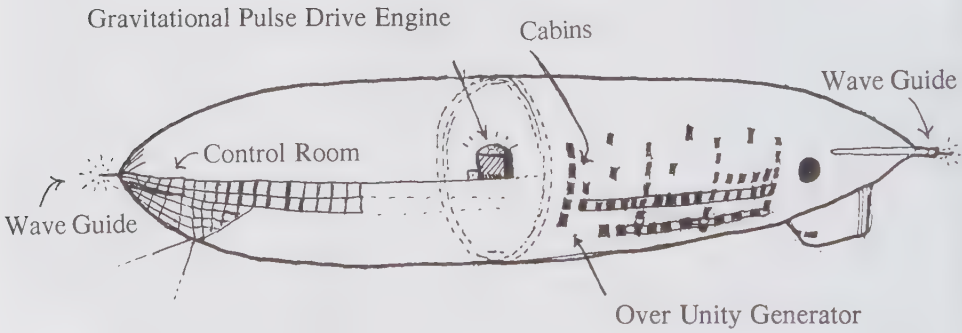
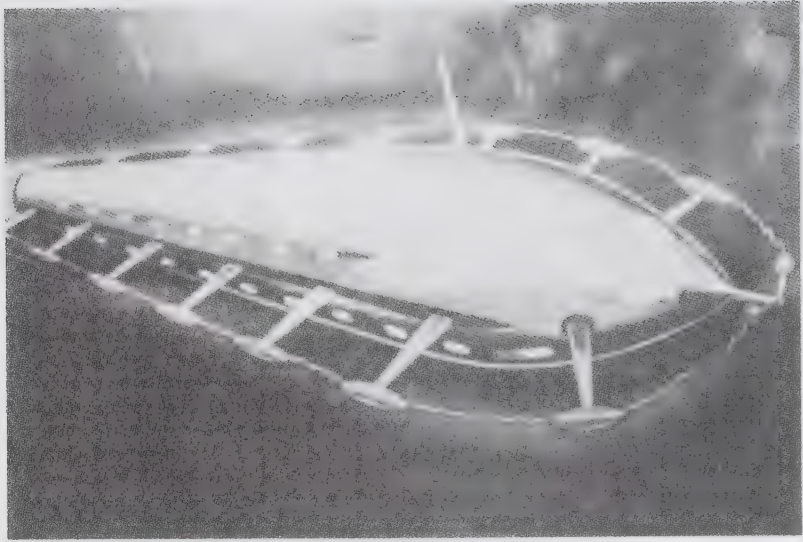

Two concepts of a cylindrical vimana craft powered by electro-gravitic motors and devices.

# 9

## VIMANAS TODAY



In the late years of the last century, a number of unusual airship sightings were made which may well have been of Vimana craft. In 1873 at Bonham, Texas, workers in a cotton field suddenly saw a shiny, silver object that came streaking down from the sky at them. Terrified, they ran away, while the "great silvery serpent" as some people described it, swung around and dived at them again. A team of horses ran away the driver was thrown beneath the wheels of the wagon and killed. A few hours later that same day in Fort Riley, Kansas, a similar "airship" swooped down out of the skies at a cavalry parade and terrorized the horses to such an extent that the cavalry drill ended in a tumult.

The great "Airship Flap of 1897" actually started in November, 1896 in San Francisco, California when hundreds of residents saw a large, elongated, dark object that used brilliant searchlights and moved against the wind, traveling northwest across Oakland. A few hours later reports came from other northern California cities; Santa Rosa, Chico, Sacramento and Red Bluff, all describing what appears to be the same airship, a cigar shaped craft. It is quite possible that this craft was heading for Mount Shasta in northern California.

The airship moved very slowly and majestically, flying low at times, and at night, shining its powerful searchlight on the ground. It is worth noting here, as Jacques Vallee did in his book *Dimensions*,<sup>25</sup> that the airship could do exactly as it cared to, because unlike today, it ran no risk of being pursued. There were no jet squadrons to be scrambled after the aerial intruder, nor anti-aircraft guns or surface to air missiles to shoot down this trespassing craft in the sky.

However, the airship, clearly not a typical balloon or gas-filled airship of the time, did at times move erratically, sometimes it would depart "as a shot out of a gun," change course abruptly, change altitude at great speed, circle and land and, as previously mentioned, use powerful searchlights to sweep the countryside.<sup>25</sup>

These mysterious airships were seen across the United States, from California to Nebraska, Texas, Colorado, Kansas, Iowa, Missouri, Wisconsin and Minnesota, including many heavily populated urban areas such as Omaha and Milwaukee. On April 10, 1897, thousands of people in Chicago reported seeing a cigar shaped airship.

It is generally agreed that the many accounts of the airship could not be attributed to known airships or technology of the time. The first powered flight was Giffard's steam airship built in 1852, while the Tissandier brothers built the first electric airship in 1883. Renard and Krebs's electric airship, the *La France*, was first flown at Chalais-Meudon in 1884. The Schwartz aluminum rigid airship was first flown at Tempelhofer Field, Germany, in 1897 and the first "successful" airship, the *Lebaudy* was test flown in Paris in 1903.<sup>83</sup>

A great deal has been made of the airship flap of 1897 in UFO circles, typically seeking to prove that the airships were extraterrestrial vehicles. Yet, as Jacques Vallee points out in *Dimensions*,<sup>25</sup> the evidence does not point toward extraterrestrial occupants because those airship operators

who engaged in conversation with witness “were indistinguishable from the average American population of the time.”

Many occupants did indeed converse with locals and occasionally offered them rides, though no one ever seemed to taken up the offers. In a curious incident at Hot Springs, Arkansas (a sight of natural crystals, essential for Vimanas, according to Indian texts) on the night of May 6, 1897, Constable Sumpter and Deputy Sheriff McLemore witnessed an airship land on a rainy night. Drawing their Winchesters they demanded an occupant to identify himself and the airship. A man with a long dark beard came forth with a lantern in his hand (possibly electric?) and “on being informed who we were proceeded to tell us that he and the others—a young man and a woman—were traveling through the country in an airship. We could plainly distinguish the outlines of the vessel, which was cigar-shaped and about sixty feet long, and looking just like the the cuts that have appeared in the papers recently. It was dark and raining and the young man was filling a big sack with water about thirty yards away, and the woman was particular to keep back in the dark. She was holding an umbrella over her head. The man with the whiskers invited us to take a ride, saying that he could take us where it was not raining. We told him we believed we preferred to get wet.

“Asking the man why the brilliant light was turned on and off so much, he replied that the light was so powerful that it consumed a great deal of his motive power....Being in a hurry we left and upon our return, about forty minutes later, nothing was to be seen. We did not hear or see the airship when it departed.”<sup>25</sup>

In another fascinating and revealing report, this one from the *Houston Post* of April 22, 1897, a Mr. John M. Barclay living near Houston witnessed an airship on the ground on the night of April 21 at about 11:00 P.M. “It was

a peculiar shaped body, with an oblong shape, with wings and side attachments of various sizes and shapes. There were bright lights, which appeared much brighter than electric lights. When he first saw it, it seemed perfectly stationary about five yards from the ground. It circled a few times and gradually descended to the ground in a pasture adjacent to his house. He took his Winchester and went down to investigate. As soon as the ship, or whatever it might be, alighted, the lights went out.

The night was bright enough for a man to be distinguished several yards away, and when within about thirty yards of the ship he was met by an ordinary mortal, who requested him to lay his gun aside as no harm was intended. Whereupon the following conversation ensued. Mr. Barclay inquired: "Who are you and what do you want?" "Never mind about my name, call it Smith. I want some lubricating oil and a couple of cold chisels if you can get them, and some bluestone. I suppose the saw mill hard by has the two former articles and the telegraph operator has the bluestone. Here is a ten-dollar bill: take it and get us these articles and keep the change for your trouble."

"Mr. Barclay said, "What have you got down there? Let me go and see it." He who wanted to be called Smith said: "No, we cannot permit you to approach any nearer, but do as we request you and your kindness will be appreciated, and we will call you some future day and reciprocate your kindness by taking you on a trip."

"Mr. Barclay went and procured the oil and cold chisels, but could not get the bluestone. They had no change and Mr. Barclay tendered him the the ten-dollar bill, but same was refused. The man shook hands with him and thanked him cordially and asked that he not follow him to the vessel. As he left Mr. Barclay called him and asked him where he was from and where he was going. He replied, "From anywhere, but we will be in Greece day after tomorrow." He got on board, when there was again the

whirling noise, and the thing was gone, as Mr. Barclay expresses it, like a shot out of a gun. Mr. Barclay is perfectly reliable.”<sup>25, 84</sup>

While such incidents are baffling to most people, in the context of a Vimana, they do not seem so extraordinary. Jacques Vallee thinks the statement from the stranger that he is “From anywhere, but we will be in Greece day after tomorrow,” is absurd. Yet what is absurd about a vague answer as to one’s origins and that he plans to be in Greece in two days? In 1897, by the airship technology of the time this was impossible, and what extraterrestrial, asks Vallee, would state that they would be in Greece in two days? For a human Vimana pilot on his way to Greece, the answer seems quite sensible, and that would probably be the amount of time for such a trip.

The airship wave of 1896/1897 will never be fully solved. Of the 100 or so reported sightings across the country, some were obvious hoaxes and fabrications based on the many newspaper articles appearing at the time. Yet, with those genuine sightings, considerable doubt remains as to the nature of these craft. Says Wallace Chariton at the end of his book *The Great Texas Airship Mystery*<sup>84</sup>: “Many 1897 witnesses said they heard a peculiar whirring or whizzing sound that could not be identified. There were several reports that the flying machine hovered in one spot for some time then quickly disappeared traveling at a high rate of speed. There was always at least one light that was frequently described as being the brightest light the witnesses had ever seen and was often said to be considerably more powerful than any incandescent light, which was the only kind they had in 1897. Some witnesses said they saw a bright, fluorescent glow about the ship and many others claimed there were multicolored lights along the sides. If you do any research into reported modern UFO sightings you will find that similar statements occur frequently.”



Closer to our own time period are other disturbingly familiar encounters with ordinary humans in unusual craft. At approximately 11:00 A.M. on April 18, 1961, sixty-year-old chicken farmer Joe Simonton of Eagle River, Wisconsin had a highly unusual encounter. He was attracted outside by a peculiar noise similar to “knobby tires on a wet pavement.” Stepping into his yard, he faced a silvery saucer-shaped object, “brighter than chrome,” which appeared to be hovering close to the ground without actually touching it. The object was about twelve feet high and thirty feet in diameter.

A hatch opened about five feet from the ground and Simonton saw three men inside the machine. One was dressed in a black two-piece suit. The occupants were about five feet tall. Smooth-shaven, they appeared to “resemble Italians.” They had dark hair and skin and wore outfits with turtleneck tops and knit helmets.

One of the men held up a jug apparently made of the same material as the saucer. His motioning to Joe Simonton seemed to indicate that he needed water. Simonton took the jug, went inside the house, and filled it. As he returned, he saw that one of the men inside the saucer was “frying food on a flameless grill of some sort.” The interior of the ship was black, “the color of wrought iron.” Simonton saw several instrument panels and heard a slow humming sound, similar to the hum of a generator. When he made a motion indicating he was interested in the food, one of the men, who was also dressed in black but with a narrow red trim along the trousers, handed him three cookies, about three inches in diameter and perforated with small holes.

The whole affair lasted about five minutes. Finally, the man closest to the witness attached a kind of belt to a hook



in his clothing and closed the hatch in such a way that Simonton could scarcely detect its outline. Then the object rose about twenty feet from the ground before taking off straight south, causing a blast of air that bent some nearby pine trees.

Along the edge of the saucer, the witness recalls, were exhaust pipes six or seven inches in diameter. The hatch was about six feet high and thirty inches wide, and, although the object has always been described as a saucer, its actual shape was that of two inverted bowls.

Simonton later reported to two Sheriff's deputies that he ate one of the cakes, and thought it "tasted like cardboard." The United States Air Force, which examined the remaining two cakes put it more scientifically: "The cake was composed of hydrogenated fat, starch, buckwheat hulls, soya bean hulls, wheat bran. Bacteria and radiation reading were normal for this material. Chemical, infrared and other destructive type tests were run on this material. The Food and Drug Laboratory of the U.S. Department of Health, Education and Welfare concluded that the material was an ordinary pancake of terrestrial origin."<sup>25</sup>

To well-known UFO investigator Jacques Vallee, this case is credible, yet absurd! What sort of extraterrestrials look like ordinary humans, wear coveralls (Oshkosh-by-gosh!) and hand out perfectly ordinary buckwheat pancakes to chicken farmers in Wisconsin? Interdimensional ones, he concludes.

It is interesting to put this unusual UFO case into the context of Vimanas, which have a terrestrial, although admittedly unusual, origin. One wonders what sort of kitchen facilities might be inside a Vimana, and what do its occupants eat while on a journey. We can dispel (I think) the idea of a stewardess warming up some tasteless, pre-prepared meal. Ancient Indians and Tibetans might have gotten by with a handful of nuts and dried fruits while cruising the Asian skies, yet a simple electric griddle with

which to fry pancakes and flat breads makes a great deal of sense. It is curious that the occupants did not speak Simonton, perhaps this is because they were aware that Simonton did not speak ancient Sanskrit or Dravidian, and they did not speak English!

Many of the UFO cases reported in Vallee's book *Dimensions*<sup>25</sup> are puzzling to Vallee because they appear to be contacts with ordinary humans, rather than extraterrestrials.

On December 3, 1967, a patrolman named Herb Schirmer, of Ashland, Nebraska, had an unusual experience. After writing in his logbook that he "saw a flying saucer at the junction of highways 6 and 63. Believe it or not," and realizing that twenty minutes were missing in his life, he was put under hypnosis.

Schirmer reported he had seen an object with a row of flickering lights on the highway takeoff. The patrolman decided to follow it and drove up a dirt road toward the intense light. He tried to call the police in Wahoo, Nebraska, but his radio would not work. His car died (typical of being around a strong electromagnetic field) and he stared at the object which was metallic and football shaped and surrounded by a silvery glow. It was making a "whooshing" sound, and the lights were flickering rapidly. Legs appeared under the craft, and it landed. Schirmer wanted to drive home, but he was "prevented by something in his mind."

The occupants of the craft came toward the car. He was unable to draw his revolver. A greenish gas was shot toward the car and an occupant pulled a small object from a holster, flashed a bright light at him, and he passed out.

The next thing Schirmer remembered, under hypnosis, was rolling down the car window and talking to the occupant of the craft, who pressed something against the side of his neck and asked him: "Are you the watchman over this place?" then pointed to a powerplant that was

visible and asked him, "Is this the only source of power you have?"

Schrimer was taken aboard the craft. He saw control panels and computer-like machines. The occupants appeared to be normal human beings and were wearing coveralls with an emblem of a winged-serpent. They told him their craft operated by reverse electromagnetism and they drew their power from large water reservoirs.

"To a certain extent they want to puzzle people" Schrimer reported under hypnosis. In an apparent attempt at disinformation, they told him they were from another galaxy, that he would not remember being inside the ship, and concluded: "You will not speak wisely about this night. We will return to see you two more times."

And at one point, one of the men took Schrimer to the large window of the ship, pointed to the deserted landscape around them and said gravely, "Watchman, someday you will see the Universe!"<sup>25</sup>

In a similar incident near Temple, Oklahoma on March 23, 1966, an instructor in aircraft electronics at Sheppard Air Force Base was driving to work at 5:00 A.M. on Route 65 and approached the intersection with Highway 70. In a telephone interview he told UFO researcher Jacques Vallee, "One mile before the intersection I saw a very bright light a mile or so to my right, and I supposed it was a truck having trouble on the highway. I went on to turn west on Highway 70. I went a quarter of a mile or so, and changed my mind and thought that it was a house that was being moved down the highway in the early morning hours.

"...It was parked on the highway and I got within a hundred yards of it and stopped, got out of the car, and started trotting towards the object, leaving the car lights on and my engine running. I got about fifteen steps or so, and I happened to think I had a Kodak on the front seat, and I would like to get a picture. I hesitated just a second, and while I did, why this man that was dressed in military

fatigues, which I thought was a master sergeant... this insignia was on his right arm, and he had a kind of cap with the bill turned up, weighed approximately 180 pounds and about 5'9" ...."

"He looked perfectly ordinary?" asked Jacques Vallee.

"Oh, yes, he was just a plain old G.I. mechanic ... or a crew chief or whatever he might happen to be on that crew. He had a flashlight in his hand, and he was almost kneeling on his right knee, with his left hand touching the bottom of the fuselage."

The object looked like an aluminum airliner with no wings or tail and with no seams along the fuselage. It lifted up vertically for about fifty feet and headed southeast almost straight backward, off by about ten degrees, at a speed estimated to be about 720 mph, judging by the barns it illuminated along its path across the valley. It was the size of a cargo plane, but had no visible means of propulsion. The witness was grilled by a roomful of officers at the Air Force base. A truck driver down the road had observed the same object.

Concludes Vallee on this sighting, "Whoever he was, the man in the baseball cap was no interplanetary explorer. This is only one of many sightings in which the pilots are described as ordinary humans. Whatever they are, the occupants of such craft are not genuine extraterrestrials."<sup>25</sup>

What is fascinating about these and many other encounters, is that aside from the "fact" that each involves an aircraft of a completely different design than we are accustomed to seeing in this century, each of these events appears to be a highly mundane encounter with perfectly normal human beings of this planet who are neither threatening or even apparently observing the witnesses, but merely going about their own business (whatever that may be) or repairing some malfunction on their craft.

In the case of Ashland, Nebraska sighting, the occupants may have been looking for a source of power or something

to refuel their ship. Upon seeing the electrical generating station they were prompted to ask (perhaps in surprise at its primitiveness) "Is this the only source of power you have?" Later when Schrimmer is informed that "one day he will see the universe," this may merely mean that space travel is within the easy reach of all mankind.

Each one of these reports describes human-occupied craft that corresponds to descriptions of ancient Vimanas from Indian texts as well as the descriptions of Vailxi from Atlantis. One solution is that some of this craft has been lingering, secretly, for the last several millennium, while another suggestion is that we have some sort of time travel phenomenon.

§§§

That some lingering Vimanas were still around several thousand years after the destruction of Rama and Atlantis is evidenced by certain "UFO" accounts in ancient history. According to several researchers, when Alexander the Great invaded India in 326 B.C., two shining silvery shields spitting fire around the rims dived repeatedly on the Greek columns descending the mountain-passes into the Punjab, stampeding horses and elephants. The shields then returned to the skies and vanished. Alexander's men refused to go further than the river they had been attempting to cross, and Alexander's conquest of India was abandoned. Alexander personally led his army back through the desert, reaching Susa in Persia in 324 B.C., dying one year later at the age of 33. Were these left-over Vimanas still in use 2300 years ago, and many thousands of years after the decline of the Rama Empire?<sup>19, 21</sup>

Curiously, several ancient texts on *Vimanas* state that *Vimanas* are especially suited to the purpose of frightening armies of war elephants! The Sanskrit scholar V. Raghavavan, the author of *Yantras or Mechanical*

*Contrivances in Ancient India*,<sup>96</sup> comments on one text: “A heavier (*alaghu*) Daru-vimana is then described (97-98); it contains, not one as in the previous case, but four pitchers of mercury over iron ovens. The boiling mercury ovens produce a terrific noise which is put to use in battle to scare away elephants; by strengthening the mercury chambers, the roar could be increased so that by it elephants are thrown completely out of control. This specific military use of aircraft against elephants tempts one to suggest that the *Hasti-yantra* advocated by Kautilya against elephants was something like the heavier *Daru-vimana* described by Bhoja.”<sup>96</sup>

§§§

The incredible search for Vimanas today leads us to highly remote areas of the world and on an intellectual journey bound to stretch the very fabric of reality for many people. We are led on an occult trip through Tibet, China, the remote Himalayas, Hindu Kush and Karakoram mountains. We must examine areas of the Gobi, remote arctic areas of Siberia, Alaska and the Yukon. The trail leads to remote mountain and jungle areas of South America, and even to such well known areas as Mount Shasta and the Bermuda Triangle. Ancient legend exists that the Vimanas of ancient India and Atlantis have not completely disappeared. Some are kept today in remote caves and “hollowed-out” mountains, similar to Cheyenne Mountain outside of Colorado Springs where the NORAD defense command is currently located.

While some ancient Vimanas may still be sitting idle beneath the Potala Palace in Tibet, and even more astonishing thought is that some of these Vimanas are still in use today! One can only wonder, what kind of group is operating these craft and who are their pilots? Are they reincarnated pilots who continue to keep coming back so

they can pilot the ancient craft. Are the pilots kept in suspended animation to be awakened whenever a trip is to be made? Do we have an ancient Brotherhood of Masters who routinely fly their craft from Vimana hangers in Tibet to visit their friends at other *Vimana* bases in Mount Shasta or the Andes? Perhaps the moon or the "Hollow Earth" has whole cities of ancient *Masters* where they and certain extraterrestrial races meet and talk about the old days.

Interestingly, Vallee quotes from the twenty century old Indian book of astronomy called the *Surya Siddhanta* which says that, "Below the moon and above the clouds revolve the Siddhas (perfected men) and the *Vidyaharas* (possessors of knowledge)." Vallee goes on to quote the late Australian writer Andrew Tomas who says that Indian tradition holds that the Siddhas could become "very heavy at will or as light as a feather, travel through space and disappear from sight."<sup>25</sup>

Vallee also quotes from the Archbishop of Lyons, Agobard, who was born in Spain in 779 and came to France when three years old, became archbishop at thirty-seven and died in 840, "one of the most celebrated and learned prelates of the ninth century."

Says Agobard of a peculiar incident: "We have seen and heard many men plunged in such great stupidity, sunk in such depths of folly, as to believe that there is a certain region, which they call Magonia, whence ships sail the clouds, in order to carry back to that region those fruits of the earth which are destroyed by hail or tempests; the sailors paying rewards to the storm wizards, and themselves receiving corn and other produce. Out of the number of those whose blind folly was deep enough to allow them to believe these things possible, I saw several exhibitions in a certain concourse of people, four persons in bonds—three men and a woman who they said had fallen from these same ships; after keeping them in captivity they brought them before the assembled multitude, as we have

said, in our presence to be stoned. But truth prevailed.”<sup>25</sup>

That ancient *Siddhas* have roamed the skies in ancient airships throughout history right up to modern times is an amazing theory!

That the “land,” or secret base of their origin was called *Magonia* by Medieval Europeans is curious. Perhaps this is a corruption of the word Mongolia. Is it possible that some *Vimanas* are coming from a secret, inaccessible region on Central Asia? Buddhist and other Asian legend says that such a secret area exists, and it is sometimes called Shambala, Agartha, Valley of the Immortals or the land of Hsi Wang Mu.

Information on Shambala and Agartha is widely varied and contradictory. In some texts, Agartha and Shambala are said to be underground cities, or kingdoms, somewhere in Central Asia where occults live and study. Shambala is said to be north of Lhasa, possibly in the Gobi Desert, perhaps in Mongolia. Shambala and Agartha are sometimes said to be at odds. In some traditions Agartha is the right-hand path, the “white occult” group, while Shambala is the left-hand path, or “black occult” group. Also, it is conversely said that Agartha is occupied by dark forces and Shambala is the abode of the “Masters of the World” and a place of goodness.<sup>38, 33, 29</sup>

Sometimes Shambala is associated with The Great White Brotherhood, and the “Valley of the Immortals.” Much information indicates that some sort of “black occult” group is operating out of Central Asia, and they usually call themselves the Shambala. The term “Shambala,” like the term, “Great White Brotherhood,” are quite ambiguous, and can be used by anyone. The term Shambala may have originally been used by a group of adepts in Central Asia, and then the name corrupted and used by other groups for their own purposes.

Shambala is sometimes associated with Shangri-la, a fictional valley of wise initiates in Tibet described in the



book *Lost Horizon*. According to ancient legends, familiar to the occult societies at the turn of the century, and related in the book *Le Roi du Monde* by Rene Guenon, there was a cataclysm in the Gobi desert, so the “Sons of Intelligences of Beyond” took up their abode in the vast underground encampment under the Himalayas. There inside these caves, they split up into two groups; one, the Agarthi, supposedly following the “right-hand way” of meditation and goodness, and the other, the Shambalists, following the “left-hand way” of evil and violence.

Shambala, according to Guenon, was a city of black occults located underground whose forces commanded the elements and the masses of humanity through telepathic hypnosis, mediumship and other occult means, hastening the arrival of the human race to the “turning point in time,” which might be construed to mean “Armageddon.”<sup>20</sup>

A story is told of a Polish nobleman who was studying in Tibet entering a smoking cavern and penetrating it into Shambala. Upon his return to the monastery where he was staying, he began to disclose the location of the cave community, but the lamas immediately cut out his tongue to prevent him from telling the secret of Shambala.<sup>38</sup>

Tradition places Shambala to the north of Lhasa, possibly in the Gobi Desert. Apparently, the Buddhists of Lhasa and the Bon had an uneasy truce. The Dalai Lama used to go every year to Mongolia, and at one point their caravan stopped as the animals all began trembling for no apparent reason. The reason, the Dalai Lama explained, was that they were passing through the forbidden territory of Shambala.<sup>38</sup>

The Hungarian philologist, Csoma de Koros, who spent four years in a Buddhist monastery in Tibet from 1827 to 1830, gave the location of Shambala as 45 to 50 degrees latitude, beyond the river Syr Daria, which would place Shambala in southern Mongolia. The Panchen Lama, head of the Tashi Lhunpo monastic citadel near Shigatse and no

great friend of the Dalai Lama's, was said to be able to issue passports to Shambala, though he would never disclose its location. According to tradition, both Shambala and Agartha were connected to all the major monasteries of Tibet by a system of underground tunnels, and the monastery of Shigastse is either near, or at the actual entrance to Agartha.<sup>38</sup>

§§§

It is quite possible that the occult cities of Shambala and Agartha are really crude, dirty hovels in some remote area, probably underground in extensive caves, quite possibly beneath Kunchenjunga or the Shigatse Monastery for the Agarthi, and in other caves to the north for the Shambalists. The occultists who lived there, so legend goes, had the ability to create, in the minds of their visitors, visions of a magnificent city by use of a kind of telepathic hypnosis. They might even create hypnotic visions of aircraft, UFOs, alien encounters and the like, if their legendary mental powers are any indication of reality.

Shambala, in many traditions, is said to be a wonderful, lush valley in the high mountains with a tall, ornate solid jade tower from which a brilliant light shines. In Agartha and Shambala, fantastic inventions and artifacts could theoretically be seen; and visitors came away absolutely stunned by the splendor and beauty of these places, through it was, apparently, a mental illusion.<sup>38</sup>

In contrast, a real secret headquarters, called the "Valley of the Immortals" may be located in the Kun Lun Mountains of north western Tibet. While the cave communities may be illusions, an actual "secret city" may in fact exist somewhere. Here really are ancient artifacts of a time gone by watched over by "Masters." Yet, it is unlikely that any person not chosen specifically by those who are the caretakers of this repository, would be allowed

inside. Nor would those who had entered (such as possibly Nicholas Roerich) ever reveal the location or what they had seen there.

Other such secret retreats are said to exist in other remote areas, much like Superman's *Fortress of Solitude*, complete with crystal library and special machines. One such place that also has a strong reputation for mysterious people as well as strange craft is Mount Shasta, located in northern California. It has been said to be (or have been) the location of a group of "Masters" and within their secret fortress deep within Mount Shasta are said to be a few aircraft, spacecraft or airships. Might we call them *Vimanas*? It is an amusing to note the similarities between the Sanskrit work *shastra* and the native Indian word for the mountain, *Shasta*.

As incredible as it may seem, it is quite possible that some ancient aircraft from the Rama Empire has survived to this day and is kept in the secret headquarters of a fraternity of adepts who are watching over mankind. Are their ancient airships still cruising the skies, perhaps on a mission or visit to others of their fraternity?

In a letter to *Strange Magazine* (issue No. 6, 1990, page 2), Charles A. Dunphy, Sr. of Gardner, Massachusetts told of a wartime experience that he and a friend had during World War II. "It was in the year 1943, in Gordonvale, Australia. I do not remember the month. I was a soldier in the 503rd Parachute Inf. Regiment. My friend Nickolai Valvanis and I were lying in our cots. The rest of the Co. D had gone out on some night maneuvers. We had been left behind. I can't remember the reason why. It was dark. Some people came into the tent and went over to where Valvanis was.

"I heard a commotion and then they were leaving. I got up and followed along. We went out to where there was an open area, there was this strange ship with stairs going up to it. It was a flying saucer. They had not named them as

yet. We all went into the ship.

“It was not large, but circular. There were about five men and an officer, Valvanis and I. The officer was in a light blue uniform and on his hat was a white star. The men were in green uniforms, a fatigue type of uniform.

“They were Asiatic or Oriental. There were no words spoken. the Officer was sitting across from me. He turned his head towards his right shoulder and I saw his lips sort of move, but no sound.

“After that, there was sensation, and I knew that we were moving. There was not any sound. After a short while, and I can’t say how long, we were landed somewhere, we all got out, and Valvanis and I ran like Hell.

“It was a place called the Markham Valley, about 15 miles behind Lae, New Guinea. The reason I know this is because later that year my regiment parachuted in that area, our first time in combat. I recognized the area when we jumped there.

“I must be very honest with you, I do not know how Valvanis and I ever got back to Gordonvale, Australia.

Valvanis always said that I saved his life. His hands were bound and I cut him loose.”

Charles Dunphy, Sr. then concludes his bizarre letter with these final three sentences: “These people were not from Outer Space. They looked Japanese. But they did have a white star on their hats.”

It does not appear that the visitors meant any harm and it seems strange that the two should be taken to an area where they were later to parachute into during combat. If there is anything more than fantasy to this story (unverified, to say the least) then we might conjecture that the occupants were not Japanese, that they were possibly Tibetan, and that perhaps modern day pilots of Vimanas wear hats with a little white star!

§§§

The Rama Empire reaches to us and is in the news to this very day. As of the spring of 1991, the nation of India was in severe political and religious turmoil directly related the *Ramayana*, Rama and his capital city, Ayodhya. Since Ayodhya was the glittering capital of a golden age of India gone-by, a modern Hindu revival has threatened split India in two and plunge the country into civil war.

*TIME* magazine ran a special story on Ayodhya and Rama in its November 12, 1990 issue: "Militant Hindus marching on the town last week were bent on reclaiming what they believe to be Rama's birthplace, a site now occupied by a dilapidated mosque. If Moslems note that their shrine has stood there for centuries, Hindu revivalists cite as proof nothing less than divine lightning and the appearance of a mysterious black icon.

"Supposedly, it was on the night of Dec. 22, 1949, that a thunderbolt struck Ayodhya and an eerie light emanated from the rear of the Babri mosque's central prayer hall. A bystander, so the story goes, witnessed the brief appearance of a child at the light's source, a spot where later investigation discovered a black stone *murti*, or divine likeness. In Hinduism, Rama was not just a celebrated warrior and king; he was an incarnation of *Vishnu the Preserver*, one of the trinity of supreme gods. As such, his victorious labors in pursuit of Sita—aided by the ingenious Hanuman, magical king of the monkeys—ushered in a golden age of righteousness known as the Ram Rajya.

"As the *Ramayana* describes Ayodhya, it was a palatial metropolis of broad avenues, brilliant gardens and mighty walls. Historically, however, the site of present-day Ayodhya became a mini-Jerusalem, a holy place for many faiths where the Buddha's legendary Toothbrush Tree grew and where a Jain saint was born. In the 16th century, Islam arrived. The commingled armies of Babur, a Central Asian warlord, swept down from Afghanistan to found the

Mughal dynasty in northern India. And in 1528, Mir Baqi, one of Babur's commanders, established in Ayodhya the Babri mosque, named for his emperor.

"It stands today as one of the religious world's strangest hybrids: a triple-domed Islamic edifice with statuary portraying Rama inside, an outer courtyard reserved for Hindu devotions and, beyond that, a high-fenced, barbed-wire security perimeter monitored by closed-circuit TV".

Continued the TIME report, The mosque was declared off-limits in 1949 following the reputed appearance of the child Rama. In the wake of gruesome Hindu-Muslim massacres accompanying the partition of British India in 1947, a local magistrate feared that the incident would inflame animosities. Many Hindus continue to accept the vision as a miracle, but others, with backing from the police report, say that Hindu militants sneaked inside the mosque, placed the *murti* in its strategic niche and then spread a supernatural tale.

"Wonders aside, defenders of the site as Rama's birthplace point to what they call hard evidence: column sections in the mosque that predate its construction and feature ornaments in a much older Indian style. As believers see it, these formed part of an ancient Rama shrine, one superseding, perhaps, the original temple of legend that was built of black stone fetched from Lanka by Rama's simian lieutenant.

"Moslems opposing the campaign to remove the mosque dismiss such claims and have won support from some prominent historians and social activists. Last year a report by 25 distinguished Indian historians found what Romila Thapar, a scholar on ancient India, called "really no evidence" suggesting that the site is one of great antiquity linked to Rama. She added, "There is also no record of the destruction of a temple." In the panel's view, the mosque's Hindu or Jain structural elements could have been collected from ruins elsewhere."

The TIME article concludes: "The dispute is under review by the state high court. Whatever the facts, however, to militant Hindus the birthplace theory is an article of faith. Since a court granted them access to the site in 1986, they have intensified their movement to build a new temple after relocating the mosque or, failing that, destroying it. In the words of Murli Manohar Joshi, one of the movement's top ideologues, Rama "is not a Hindu god but a national hero, and every Indian irrespective of his religion must accept that."

"Scholars believe that the Ramayana records some of the earliest conquests of southern India by the proto-Hindu Aryans sometime before 500 B.C. By contrast, the Babri mosque symbolizes Islam's later triumph. If Hindu revivalists have their way, they would turn the tables decisively by upsetting modern India's secular political order. Of the temple dispute, political commentator M.N. Buch concludes, "It is immaterial who wins, because India will lose in any case."

As militant Hindu groups marched on Ayodhya to demolish the mosque and build a new shrine to Rama, the Indian army blocked roads into Ayodhya, battles with the police occurred in which at least 80 persons were killed and Lal Kishen Advani, the political head of the Bharatiya Janata Party (BJP) was arrested in November, 1990.

Advani actually toured India raising support for the new temple to Rama in a "flying chariot" from the Ramayana; that is, a *Vimana*! It was not a real *Vimana*, of course, but a wooden model with swans as the sort of *Vimana* that Rama and Sita had returned to Ayodhya from Lanka in.

While the glory, history and incredible technology of the ancient Rama empire of India is missed by most journalists and western educated "Indiologists," most Hindus in India are firm believers in the reality of Rama, his exploits and Ayodhya as the former capital city.

The *Ramayana*, as TIME says, is not the depiction of the

Aryan invasion of India (Bharat), as the Ramayana was probably written many thousands of years earlier in Dravidian, and clearly states the time of the events of the Ramayana as still earlier. More correctly, it is the *Rg Veda* (*Rig Veda*) that is a chronicle of the Aryan invasion of India.

While India breaks into a religious war trying to regain a glorious past, the legacy of the ancient Rama empire and its fantastic technology lives on. Yet, it seems that mankind has not learned even the most basic lesson of the ancient Indian chronicles: that war does not solve mankind's problems, and we must learn to cooperate with our neighbors and live in peace!

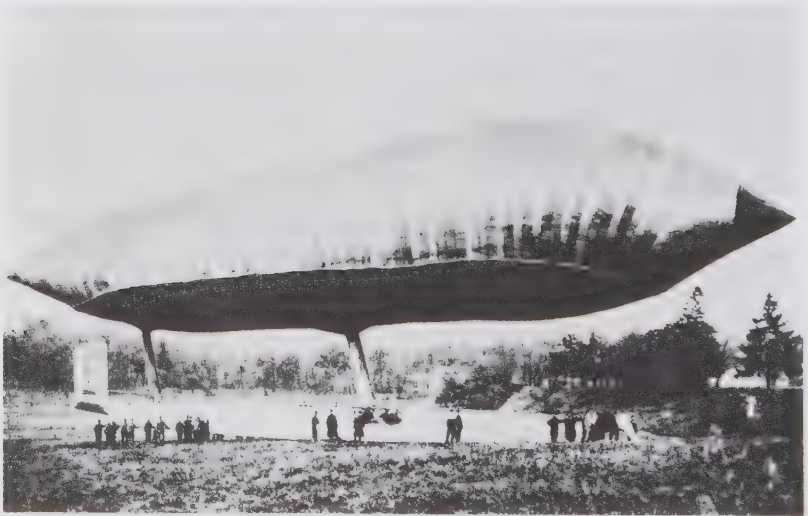

Renard and Krebs's electric airship *La France* at Chalais-Meudon, 1884



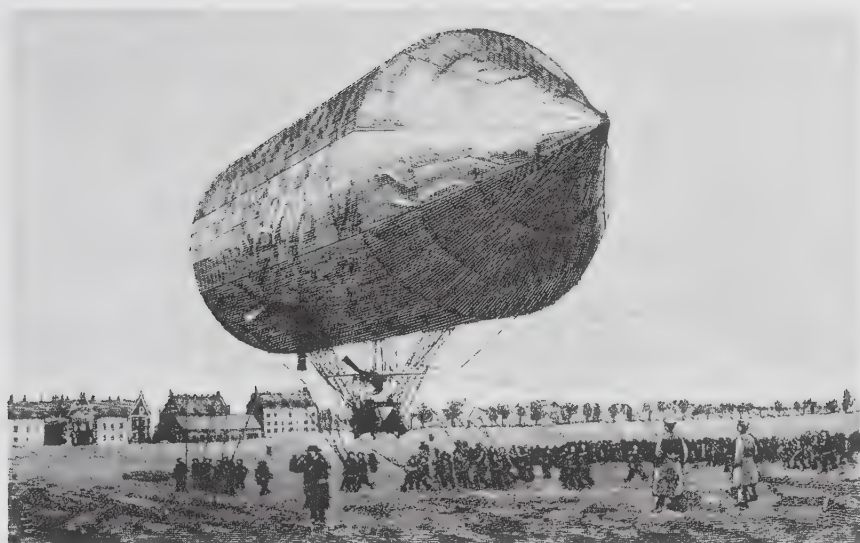

Schwartz aluminium rigid airship at Tempelhofer Field, 1897

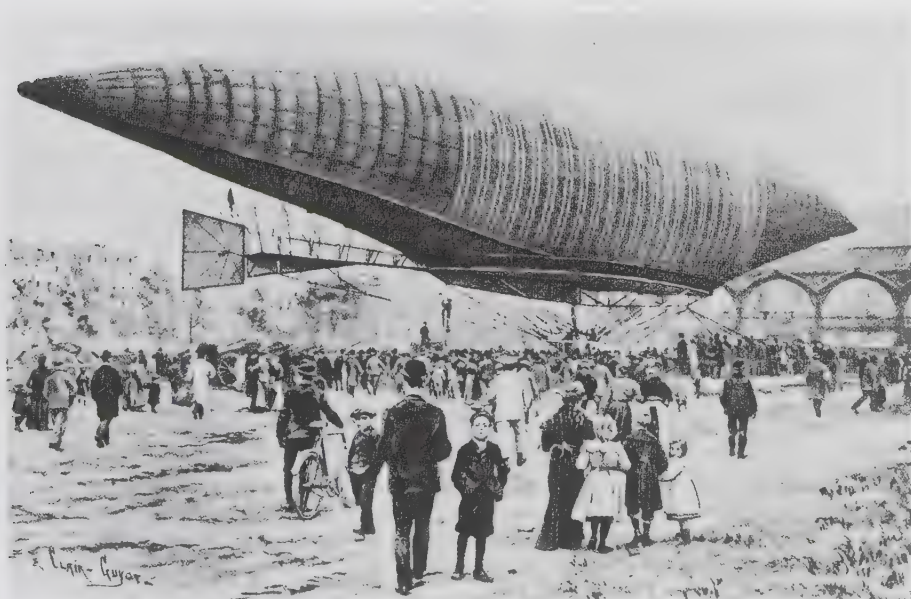

The first successful airship: the Lebaudy lands on the Champs de Mars, Paris, 1903

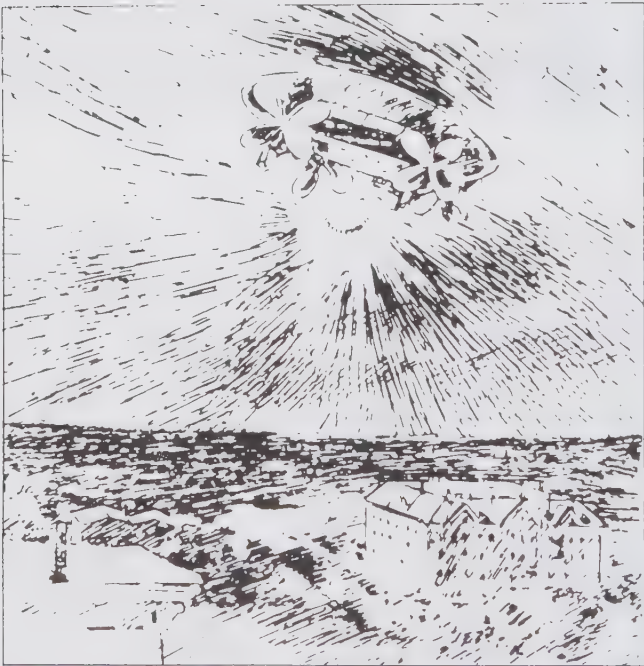
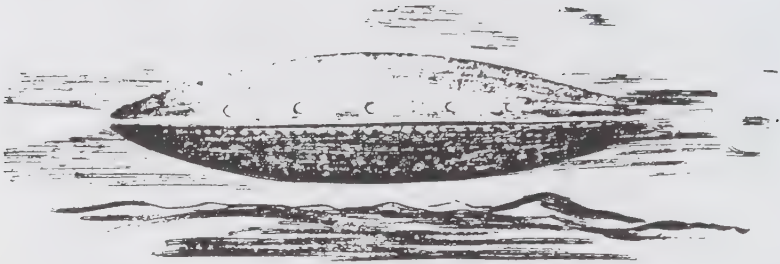

Two drawings from the 1896 airship flap in California, Texas and throughout the U.S. Notice the powerful searchlights on the aircraft and their cylindrical shape, with window or light along the sides, much as Vailx and Vimanas have been described.

C. A. SMITH.  
AIR SHIP.

No. 565,805.

Patented Aug. 11, 1896.

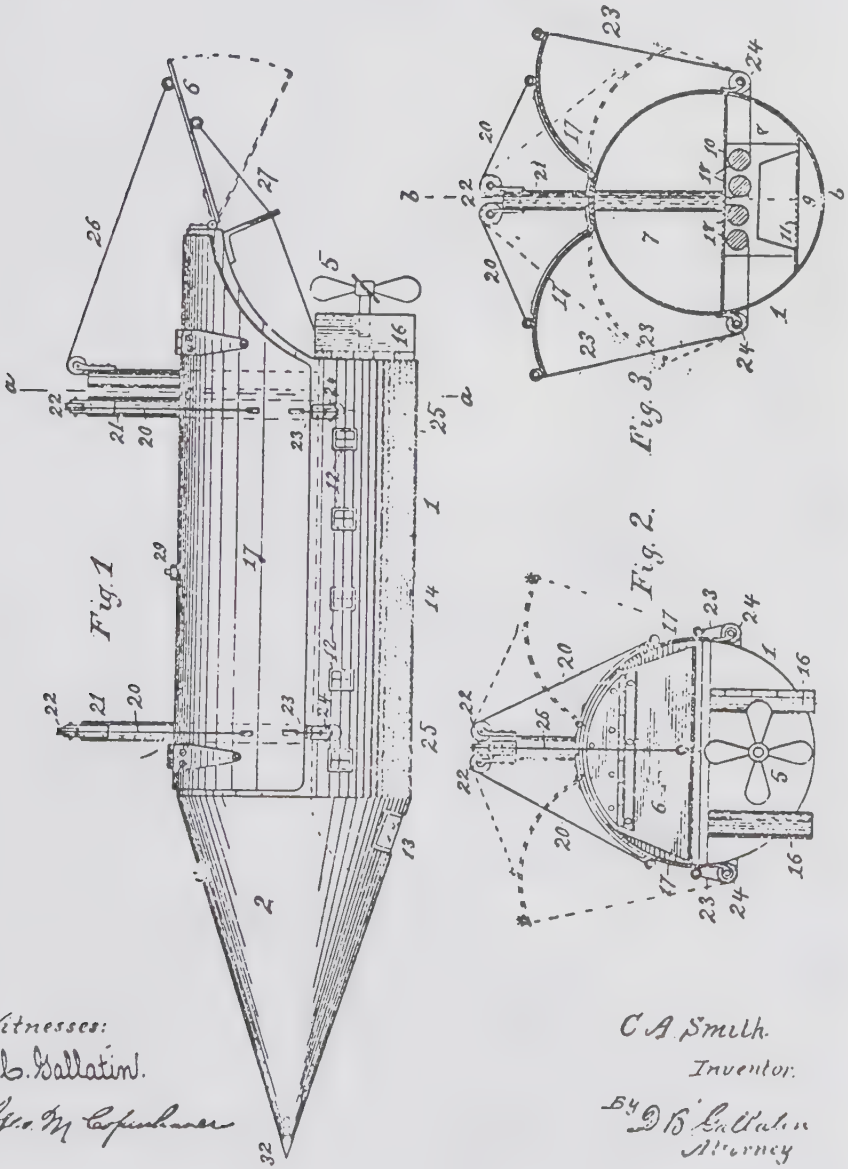

Witnesses:  
H. B. Ballantine.

Geo. W. Carpenter

C. A. Smith.  
Inventor.

H. B. Ballantine  
Attorney

# THE CHICAGO LEDGER

VOL. XXXVIII, NO. 18.

CHICAGO, ILL., SATURDAY, APRIL 30, 1910.

SINGLE COPIES 5 CENTS.



A 1910 cover illustration from the *Chicago Ledger*. Note the discoid craft, looking like flying shields or saucers in a story about early adventurers on a quest to Halley's Comet which was passing close to earth at the time. Even in 1910 the concept of discoid craft was already being popularized!



A German zeppelin spotlights the seaside town of Yarmouth, England, during World War I, in a composite photograph (1915). UPI

During World War I, the fear of German airship attacks led to illustrations such as these. The airship flap of 1896 and earlier Vailx reports were nearly identical in nature. Note the powerful searchlights always depicted in conjunction with such cylindrical craft. Was some of it some sort of premonition or have tubular craft existed for thousands of years?



The German airship scare: current fears reflected in the popular press. [*The Queen*, 1913]



On a late January night in 1966, this photograph of a UFO with a powerful searchlight and an apparent vortex underneath it was taken at the Wanaque Reservoir in New Jersey. Sightings went on for weeks at a time.



On June 3, 1967 at 7:15 in the evening, Joseph L. Ferriere took the above photo, printed in two densities, at Cumberland, Rhode Island. Notice the long cylindrical shape, its similarity to Adamski's craft and how it matches the description of even earlier craft.



Medieval mural of a "saint" or Angel flying through the air in what appears to be a spherical machine. Might we call this a "vimana"? From the Desani Monastery in Jugoslavia.



**In his travel diary** of 1926 Nicholas Roerich, a well-known artist and explorer, told of a strange sighting in northern China:

On August 5th—something remarkable! We were in our camp in the Kukunor district not far from the Humboldt Chain. In the morning about half-past nine some of our caravaneers noticed a remarkably big black eagle flying above us. Seven of us began to watch this unusual bird. At this same moment another of our caravaneers remarked, “There is something far above the bird.” And he shouted in his astonishment. We all saw, in a direction from north to south, something big and shiny reflecting the sun, like a huge oval moving at great speed. Crossing our camp this thing changed in its direction from south to southwest. And we saw how it disappeared in the intense blue sky. We even had time to take our field glasses and saw quite distinctly an oval form with shiny surface, one side of which was brilliant from the sun. [Nicholas Roerich, *Altai-Himalaya: A Travel Diary*, pp.361-62]

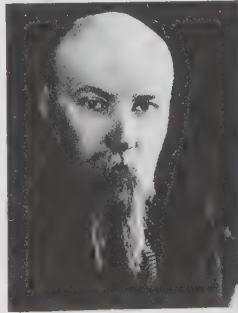

*Nicholas Roerich was a Russian landscape painter and archaeologist who traveled widely in India and Asia from 1923 until 1928. New York City's Roerich Museum houses several hundred of his paintings.*



1942, Tientsien, Hopeh Province, North China. A Chinese street photographer captured this photograph of a cone-shaped structured craft of considerable size flying down the street of the city. A witness in the picture points to the object as the picture is taken.



This illustration, on a photographic plate, was allegedly given to George Adamski on December 13, 1952 in the California desert. Adamski claimed that a "Venusian" had given it to him and that it contained "writing from another planet." It is possible that it shows the concept of a Mercury Vortex engine, written in an ancient language that is now extinct. Note the Swastika (running to the right, rather than the left as Nazi and Bon Swastikas run) as a symbol of vortex movement and the possible Central Asian origin of the text.

# Appendix A: Aerial Warfare In Ancient India

by Ramachandra Dikshitar  
From *War In Ancient India*  
First published 1944  
by the University of Madras  
Chapter VII, pages 277-286

No question can be more interesting in the present circumstances of the world than India's contribution to the science of aeronautics. There are numerous illustrations in our vast Purāṇic and epic literature to show how well and wonderfully the ancient Indians conquered the air. To glibly characterize everything found in this literature as imaginary and summarily dismiss it as unreal has been the practice of both Western and Eastern scholars until very recently. The very idea indeed was ridiculed and people went so far as to assert that it was physically impossible for man to use flying machines. But to-day what with balloons, aeroplanes and other flying machines<sup>1</sup> a great change has come over our ideas on the subject.

The use and value of air forces is not hard to assess. Their chief use lay until recently in the rapidity and skill with which the men flying did the scouting and reported to headquarters. They located the position of the enemy, which enabled them to direct the attack. We know from modern history that the French were the first to use balloons for this purpose. The discovery of aeroplanes has revolutionised the realm of strategy and

<sup>1</sup> See in this connexion Golikere: *Through Wonderlands of the Universe* (1933), esp. ch. vi ff.

tactics. The present World War has demonstrated that before the air arm everything else pales into insignificance.

Turning to Vedic literature, in one of the *Brāhmaṇas* occurs the concept of a ship that sails heavenwards. The ship is the Agnihotra of which the Āhavanīya and Gārhapatya fires represent the two sides bound heavenward, and the steersman is the Agnihotrin who offers milk to the three Agnis.<sup>2</sup> Again in the still earlier *Ṛg Veda Saṁhitā* we read that the Aśvins conveyed the rescued Bhujya safely by means of winged ships.<sup>3</sup> The latter may refer to the aerial navigation in the earliest times.

In the recently published *Samarāṅga Sūtradhāra* of Bhoja, a whole chapter of about 230 stanzas<sup>4</sup> is devoted to the principles of construction underlying the various flying machines and other engines used for military and other purposes. The various advantages of using machines, especially flying ones, are given elaborately. Special mention is made of their attacking visible as well as invisible objects, of their use at one's will and pleasure, of their uninterrupted movements, of their strength and durability, in short of their capability to do in the air all that is done on earth. After enumerating and explaining a number of other advantages, the author concludes that even impossible things could be effected through them. Three movements are usually ascribed to these machines,—ascending, cruising thousands of miles in different directions in the atmos-

2 *Satapatha Brāhmaṇa*, II, 3, 3, 15.

3 *Ṛg Veda*, I, 117. 14 and 15. Here 'wings' may be 'sails'.

4 Ch. 31. (Gaekwad Oriental Series).

phere and lastly descending. It is said that in an aerial car one can mount up to the Sūryamaṇḍala, 'solar region' and the Nākṣatra maṇḍala (stellar region) and also travel throughout the regions of air above the sea and the earth. These cars are said to move so fast as to make a noise that could be heard faintly from the ground.<sup>5</sup> Still some writers have expressed a doubt and asked 'Was that true?' But the evidence in its favour is overwhelming.

The make of machines for offence and defence to be used on the ground and in the air is described. Some of these are water machines, musical instruments, door-keeper machines, streets, houses and pillars by means of 'yantra' or machine, and other varieties. These require separate study. Considering briefly some of the flying machines alone that find distinct mention in this work, we find that they were of different shapes like those of elephants, horses, monkeys, different kinds of birds, and chariots. Such vehicles were made usually of wood. We quote in this connexion the following stanzas so as to give an idea of the materials and size, especially as we are in the days of rigid airships navigating the air for a very long time and at a long distance as well.

यन्त्राणामाकृतिस्तेन निगंतुं नैव शक्यते ।  
यथावद्बीजसंयोगः सौशिलष्टयं श्लक्ष्णतापि च ।  
अलक्षता निर्वहणं लघुत्वं शब्दहीनता ।  
शब्दे साध्ये तदाधिक्यमशैथिल्यमगाढता ॥  
वहनीषु समस्तासु सौशिलष्टयं चास्वल्लङ्घति ।  
यथाभीष्टार्थकारित्वं लयतालानुगाभिता ॥

5 *Samar*. Ch. 31, 45-79.

जायन्ते यन्त्रानिर्माणाद् विविधानोप्सितानि च ।

दुष्करं यद्यदन्यश्च तत्तद् यन्त्रात् प्रसिध्यति ॥ 31. 45-79.

An aerial car<sup>6</sup> is made of light wood looking like a great bird with a durable and well-formed body having mercury inside and fire at the bottom. It has two resplendent wings, and is propelled by air. It flies in the atmospheric regions for a great distance and carries several persons along with it. The inside construction resembles heaven created by Brahmā himself. Iron, copper, lead and other metals are also used for these machines. All these show how far art was developed in ancient India in this direction. Such elaborate descriptions ought to meet the criticism that the vimānas and similar aerial vehicles mentioned in ancient Indian literature should be relegated to the region of myth.

The ancient writers could certainly make a distinction between the mythical which they designated daiva and the actual aerial wars designated mānuṣa. Some

- 6 लघुदारुभयं महाविहङ्ग दृढसुशिलघृतनुं विधाय तस्य ।  
 उदरे रसयन्त्रमादधोत ज्वलनाधारमधोऽस्यचाम्निपूर्णम् ।  
 तत्रारूढः पुरुषस्तस्य पक्षद्वन्द्वोश्चालप्रोञ्जितेनानिलेन ।  
 सुप्तस्यान्तः पारदस्यास्य शक्त्या चित्रं कुर्वन्नम्बरे याति दूरम् ॥  
 इत्थमेव सुरमन्दिरतुल्यं सञ्चलस्य लघुदारुविमानम् ।  
 आदधीत विधिना चतुरोऽन्तस्तस्य पारदभृतान् दृढकुम्भान् ॥  
 अयःकपालहितमन्दवह्निप्रतप्ततत्कुम्भभुवा गुणेन ।  
 व्योम्नोः झगित्याभरणत्वमेति सन्तप्तगर्जद्रसराजशक्त्या ॥  
 वृत्तसन्धितमथायसयन्त्रं तद् विधाय रसपूरितमन्तः ।  
 उच्चदेशविनिधापिततप्तं सिंहनादमरजं विदधाति ॥ *Ibid.*, 95-99.

wars mentioned in ancient literature belong to the daiva form, as distinguished from the mānuṣa. An example of the daiva form is the encounter between Sumbha and the goddess Durgā. Sumbha was worsted and he fell headlong to the ground. Soon he recovered and flew up again and fought desperately until at last he fell dead on the ground.<sup>7</sup> Again, in the famous battle between the celestials and the Asuras elaborately described in the *Harivaṁśa*, Māya flung stones, rocks and trees from above, though the main fight took place in the field below.<sup>8</sup> The adoption of such tactics is also mentioned in the war between Arjuna and the Asura Nivātakavaca,<sup>9</sup> and in that between Karṇa and the Rākṣasa<sup>10</sup> in both of which, arrows, javelins, stones and other missiles were freely showered down from the aerial regions.

King Śatrujit was presented by a Brahman Gālava with a horse named Kuvalaya which had the power of conveying him to any place on the earth.<sup>11</sup> If this had any basis in fact it must have been a flying horse. There are numerous references both in the *Viṣṇupurāṇa* and the *Mahābhārata* where Kṛṣṇa is said to have navigated the air on the Garuḍa.<sup>12</sup> Either the accounts are imaginary or they are a reference to an eagle-shaped machine flying in the air. Subrahmaṇya used a peacock as his vehicle and Brahmā a swan. Further, the Asura, Māya by name, is said to have owned an animated golden car with four

7 *Mākaṇḍeya Purāṇa*, ch. 90.

8 *Harivaṁśa*. ch. 56.

9 *Vana*. ch. 172. Cp. *Rāma*, V. 47.5, 33; VI. 50.51.

10 *Drona*. ch. 176, 50.

11 *Mārkaṇḍeya Purāṇa*, ch. 20.

12 *Viṣṇu Purāṇa*, IV, ch. 30, 64-66; *Harivaṁśa*, ch. 44.

strong wheels and having a circumference of 12,000 cubits, which possessed the wonderful power of flying at will to any place. It was equipped with various weapons and bore huge standards. And in the battle between the Devas and the Asuras in which Māya took a leading part, several warriors are represented as riding birds.<sup>13</sup>

In the *Rāmāyaṇa* when Rāvaṇa was flying with Sītā in his aerial car to Lankā, Jaṭāyu, a giant bird, charged him and his car and this led to a duel between the bird and the Rākṣasa king. Golikere draws attention to a number of instances where fierce duels have been fought between man and bird of prey resulting in the damage of the aeroplane and its inmates, in some cases leading to a forced landing.<sup>14</sup> Again, the Rākṣasa Droṇamukha offers his services to Rāvaṇa in his encounter with the vānara hosts to fight them either on the sea or in the sky or in subterranean regions.<sup>15</sup> After the great victory of Rāma over Lankā, Vibhīṣaṇa presented him with the Puṣpaka vimāna which was furnished with windows, apartments, and excellent seats. It was capable of accommodating all the vānaras besides Rāma, Sītā and Lakṣmaṇa.<sup>16</sup> Rāma flew to his capital Ayodhyā pointing to Sītā from above the places of encampment, the town of Kiṣkindhā and others on the way. Again Vālmiki beautifully compares the city of Ayodhyā to an aerial car.<sup>17</sup>

13 *Harivaṃśa*, ch. 43.

14 *Through the Wonderlands of the Universe*, pp. 124-126.

15 *Yuddha*, ch. 8.

16 *Ibid.*, ch. 123.

17 *Bāla*, ch. 5.



This is an allusion to the use of flying machines as transport apart from their use in actual warfare. Again in the *Vikramaurvaśīya*, we are told that king Purūravas rode in an aerial car to rescue Urvaśī in pursuit of the Dānava who was carrying her away. Similarly in the *Uttararāmacarita* in the fight between Lava and Candraketu (Act VI) a number of aerial cars are mentioned<sup>18</sup> as bearing celestial spectators. There is a statement in the *Harṣacarita*<sup>19</sup> of Yavanas being acquainted with aerial machines. The Tamil work *Jīvakacintāmani* refers to Jīvaka flying through the air.<sup>20</sup>

But it has to be inferred that being very costly, their use was more or less the exclusive privilege of kings and aristocrats. Another reason why they did not become common is found in the following lines from the *Samarāṅganasūtradhāra*:

यन्त्राणां घटना नोक्ता  
गुण्यर्थं नाज्ञतावशात्  
तत्र हेतुरयं ज्ञेयो व्यक्ता नैते फलप्रदाः  
कथितान्यत्र बीजानि यन्त्राणां घटना न यत् *ibid.*

This supplies a certain clue to the right understanding of the decline of this art. The make and construction of these contrivances were usually kept secret lest others should get a knowledge of them and use them for wrong ends.

18 *Uttararāmacarita*, Act. VI.

19 Daṇḍopanatayavana nirmītena Nabhastalayāvinā yantra-yānena: VI ucchvāsa.

20 XIII. 2614 (5).

But to the common people and even to the military officials, the use of carrier-pigeons was of the utmost importance. There is enough to show that their use was well known to ancient peoples. Pliny relates that Brutus sent these pigeons, at the siege of Modena in 43 B.C., to his friends for help. Again, we find that they were used in 1167 A.D. as a means of communication between Syria and Bagdad. The letters were usually fastened to the wings. Despite the improved methods of communication by post and telegraph, even to-day they have their value. For when wars break out, there is every possibility that postal and telegraphic communication will be cut off or otherwise interrupted to the great detriment of the belligerent parties. But no one can prevent these birds from carrying information to the desired destination. Therefore even to-day in some countries in Europe the shooting and hunting of these birds is treated as an offence and severely punished.<sup>21</sup> Coming to our own country, Kauṭalya also makes a side reference to pigeon houses that served as military stations, an indication of the use of the birds in early days. This is perhaps why we find them among the several presents given to kings.<sup>22</sup>

To conclude, the flying vimāṇa of Rāma or Rāvaṇa was set down as but a dream of the mythographer till aeroplanes and zeppelins of the present century saw the light of day. The mohanāstra or the "arrow of unconsciousness" of old was until very recently a creature of legend till we heard the other day of bombs discharging poisonous gases. We owe much to the energetic scientists and researchers who plod persistently and carry their torches deep down into the caves and excavations of old and dig out valid testimonials pointing to the misty antiquity of the wonderful creations of humanity.<sup>23</sup>

21 Hildebrandt, *Airships Past and Present*.

22 *Cambridge History of India*, Vol. I, p. 399.

23 *Introduction to Indian Architecture*, Vol. III.

**APPENDIX B:  
BIBLIOGRAPHY  
&  
FOOTNOTES**

1. **Flying Saucers Have Landed**, Desmond Leslie and George Adamski, 1953, The British Book Centre, New York.
2. **Sensitive Chaos**, Theodore Schwenk, 1965, Rudolph Steiner Press, London.
3. **Vimana In Ancient India**, Dileep Kumar Kanjilal, 1985, Sanskrit Pustak Bhandar, Calcutta.
4. **Atlantis, The Antidiluvian World**, Ignatius Donnelly, 1882, Harper & Row, NYC.
5. **War In Ancient India**, Ramachandra Dikshitar, 1944, Motilal Banarsidass, Delhi.
6. **The Bhagavad Gita**, translated by Juan Mascaro, 1962, Penguin Books, NYC.
7. **The Book of the Damned**, Charles Fort, 1919, Ace Books, NYC.
8. **Children of Mu**, James Churchward, 1931, Ives Washburn Inc, NYC.
9. **Doomsday 1999 A.D.**, Charles Berlitz, 1981, Doubleday & Co., Garden City, NJ.
10. **Fate Magazine**, Sept. 1983, Highland Park, IL.
11. **Forgotten Worlds**, Robert Charroux, 1971, Popular Library, NYC.
12. **The Four Books**, Confucius, various translations and editions.
13. **Gods of Air and Darkness**, Richard Mooney, 1975, Stein & Day, NYC.
14. **The Gods Unknown**, Robert Charroux, 1969, Berkley Books, NYC.
15. **Van Nostrand's Scientific Encyclopedia**, Douglas Considine, Ed., 1983, Van Nostrand Reinhold Co. New York.
16. **Mercury, UFO Messenger of the Gods**, William Clendenon, 1990, Adventure Survival Productions, Biloxi, Mississippi.
17. **Invisible Residents**, Ivan T. Sanderson, 1970, World Publishing, Cleveland, Ohio.
18. **Inside the Spaceships**, George Adamski, 1955, Adelard-Schuman, New York City.
19. **Stranger Than Science**, Frank Edwards, 1959, Lyle Stuart, NYC.

20. **Legacy of the Gods**, Robert Charroux, 1965, Robert Laffont Inc., NYC.
21. **Gods and Spacemen in the Ancient East**, W. Raymond Drake, 1968, Sphere Books, London.
22. **Gods, Demons, and Others**, R.K. Narayan, 1964, Bantam Classic Editions, Bantam Books, NY.
23. **Levitation**, Steve Richards, 1980, The Aquarian Press, Wellingborough, Northamptonshire, England.
24. **The Lost Continent of Mu**, James Churchward, 1931, Ives Washburn Inc., NYC.
25. **Dimensions**, Jacques Vallee, 1988, Ballantine Books, NY.
26. **The Mahabharata**, translated by Protap Chandra Roy, 1889, Calcutta.
27. **Masters of the World**, Robert Charroux, 1967, Berkeley Books, NYC.
28. **Mysteries of Time & Space**, Brad Steiger, 1974, Prentice Hall, NYC.
29. **The Morning of the Magicians**, Louis Pauwels & Jacques Bergier, 1960, Stein & Day, NYC.
30. **The Edicts of Asoka**, N.A. Kikam & Richard McKeon, 1959, University of Chicago Press.
31. **Not Of This World**, Peter Kolosimo, 1971, University Books, Seacaucus, NJ.
32. **Lost Cities of China, Central Asia & India**, David Hatcher Childress, 1987, AUP, Stelle, Illinois.
33. **One Hundred Thousand Years of Man's Unknown History**, Robert Charroux, 1965, Robert Laffont Inc., NYC.
34. **The Queen of Sheba and Her Only Son Menyelek** (Kebra Nagast), translated by Sir E.A. Wallis Budge, 1932, Dover, London.
35. **The Ramayana**, R.C. Prasad, 1988, Motilal Banarsidass, Delhi.
36. **Legends of the World**, R. Cavendish, 1982, Orbis Publishing, London.
37. **Secrets of the Past**, Reader's Digest, 1980, Berkeley Books, NYC.
38. **Shambala**, Andrew Tomas, 1977, Sphere Books, London.
39. **The Atlas of Archaeology**, 1982, St. Martin's Press, NYC
40. **Tao Te Ching**, Lao Tzu, various translations and editions.
41. **The Land & People of Ceylon**, Donald Wilber, 1963, Lippincott Co. Philadelphia.
42. **Great Temple of the East**, Sacherell Sitwell, 1962, Obolensky Inc. NYC.
43. **Timeless Earth**, Peter Kolosimo, 1973, Bantam Books, NYC.

44. **The Maldive Mystery**, Thor Heyerdahl, 1986, Adler-Adler, Bethesda, MD.
45. **2000 AC Distruzione Atomica** (Atomic Destruction 2000 BC), David Davenport, 1979, Milan, Italy.
46. **The Ultimate Frontier**, Eklal Kueshana, 1963, The Stelle Group, Stelle, Illinois.
47. **Vanished Civilizations**, Max Parrish, 1963, Thames & Hudson, London
48. **Vymaanika-Shaastra Aeronautics**, Maharishi Bharadwaaja, translated and published 1973 by G.R. Josyer, Mysore, India.
49. **The World Almanac Second Book of the Strange**, 1981, NYC.
50. **Lost World's**, Alastair Service, 1981, Arco Publishing, Ny.
51. **The World's Last Mysteries**, Reader's Digest, 1976, Pleasantville, NY.
52. **The World Alamanac First Book of the Strange**, 1977, Signet, NYC.
53. **We Are Not the First**, Andrew Tomas, 1971, Souvineer Press, London.
54. **Mysteries of Ancient South America**, Harold Wilkins, 1946, Citadel, NYC.
55. **Lost Cities & Ancient Mysteries of South America**, David Hatcher Childress, 1986, AUP, Stelle, Illinois.
56. **Christ In Kashmir**, Aziz Kashmiri, 1973, Roshni Publications, Srinigar, India.
57. **Lost Continents**, L. Sprague de Camp, 1954, Ballantine Books, NYC.
58. **Science Digest**, August 1981, Hearst Corp., NYC.
59. **Discovery of Lost Worlds**, J. Thorndike Jr.,ed., 1979, American Heritage, NYC.
60. **The Lemurian Fellowship Lessons**, 1936, Lemurian Fellowship, Ramona, CA.
61. **The Ancient Hydraulic Civilization of Sri Lanka in Relation to its Natural Resources**, A.D. Fernando, 1982, Journal of the Sri Lanka Branch of the Royal Asiatic Society (Colombo), Vol. XXVII.
62. **Magic and Mystery in Tibet**, Alexandra David-Neel, 1929, Dover, NYC.
63. **Himalayas: Abode of Light**, Nicholas Roerich, 1930, Roerich Museum, NYC.
64. **Into the Unknown**, 1981, Readers Digest Ass., Pleasantville, NY.
65. **Edgar Cayce On Atlantis**, Hugh Lynn Cayce, 1968, A.R.E., Virginia Beach, VA.

66. **Analects**, Confucius (Kung-Fu-Tzu), various translations.
67. **Chuang Tzu**, Chuang Tzu , various translations & publishers.
68. **The Dictionary of Imaginary Places**, A. Manguel & G. Guadalupi, 1980, Macmillan, NYC.
69. **Shambala**, Nicholas Roerich, 1930, Roerich Museum, NYC.
70. **A Tagore Reader**, Edited by Amiya Chakravarty, 1961, Macmillan Company, NY.
71. **A Dweller On Two Planets**, Phyllos the Thibetan, 1884, Borden Publishing, Alhambra, California.
72. **An Earth Dweller's Return**, Phyllos the Thibetan, 1940, Lemurian Fellowship, Ramona, CA & Borden Publishing, Alhambra, CA.
73. **The Encyclopedia of the Strange**, Daniel Cohen, 1985, Avon Books, NYC.
74. **The Dark Gods**, A. Roberts, G. Gilbertson, 1980, Panther, London.
75. **Secret of the Ages**, Brinsley Le Poer Trench, 1974, Pinnacle, NYC.
76. **Lost Cities**, Leonard Cottrell, 1957, Robert Hale & Co., London.
77. **Easy Journey to Other Planets**, Swami Prabhupada, 1970, Bhaktivedanta Book Trust (ISKCON), Los Angeles.
78. **The Silk Road**, Irene Franck & David Brownstone, 1986, Facts On File Pub., NYC.
79. **From Earthquake, Fire & Flood**, R. Hewitt, 1958, Scientific Book Club, London.
80. **Life and Teaching of the Masters of the Far East**, Vol. 1 - 5, Baird T. Spalding, 1924, DeVorss & Co. Santa Monica, CA.
81. **Pathways To the Gods**, Erich von Daniken, 1982, Berkley Pub., NYC.
82. **A Search In Secret India**, Paul Brunton, 1935, Dutton & Co., NYC.
83. **The Aeronauts**, L.T. C. Rolt, 1966, Walker & Co. New York.
84. **The Great Texas Airship Mystery**, Wallace O. Chariton, 1991, Wordware Publishing, Plano, Texas.
85. **The Mysticism and Magic of India**, Ormond McGill, 1977, Barnes & Co., Cranbury, NJ.
86. **The Fringe of the Unknown**, L. Sprague de Camp, 1986, Prometheus, Buffalo, NY.
87. **Spaceships in Prehistory**, Peter Kolosimo, 1975, University Books, Seacaucus, NJ.
88. **2000 Years of Space Travel**, Russell Freedman, 1963, Collins, London, UK.
89. **Anti-Gravity & the World Grid**, D.H. Childress, ed. 1987, Adventures Unlimited Press, Stelle, Illinois.

90. **Altai-Himalaya: A Travel Diary**, Nicholas Roerich, 1929, Roerich Museum, New York.
91. **Anti-Gravity & the Unified Field**, D.H. Childress, ed. 1990, AUP, Stelle, Illinois.
92. **UFOs Over Modern China**, P. Dong, W. Stevens, 1983, UFO Photo Archives, Tuscon, AZ.
93. **Heart of Asia**, Nicholas Roerich, 1930, Roerich Museum, NYC.
94. **On Eastern Crossroads**, J. Saint-Hilaire (H. Roerich), 1930, Roerich Museum, NYC.
95. **The Genius of China: 3,000 Years of Science, Discovery and Invention**, Robert Temple, 1987, Simon & Schuster, NYC.
96. **Yantras or Mechanical Contrivances in Ancient India**, V. Raghavan, 1956, Indian Institute of Culture, Bangalore, India.



The following item appeared on the internet in 1998 concerning the U.S. government's secret aircraft called the TR-3B which was claimed to be powered by a mercury vortex drive as described in the Vimanika Shastra:

The TR-3B Triangular Anti-Gravity Craft, by Ed Fouche

A very important speech was given by Ed Fouche to the 1998 Summer Sessions at the International UFO Congress, describing the 200 foot across (600 foot operational model?) triangular UFO "anti-gravity" craft being built and tested in area S-4 inside Area 51 in Nevada. Supposedly uses a heated mercury vortex to offset gravity "mass."

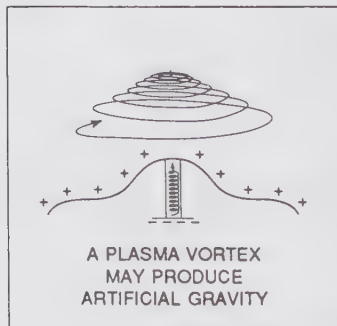



# NEW BOOKS FROM ADVENTURES UNLIMITED

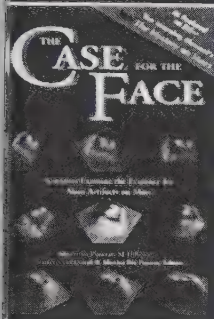

## THE CASE FOR THE FACE

*Scientists Examine the Evidence for Alien Artifacts on Mars*  
edited by Stanley McDaniel and Monica Rix Paxson  
Mars Imagery by Mark Carlotto

The ultimate compendium of analyses of the Face on Mars and the other monuments in the Cydonia region. *The Case For the Face* unifies the research and opinions of a remarkably accomplished group of scientists, including a former NASA astronaut, a quantum physicist who is the chair of a space science program, leading meteor researchers, nine Ph.D.'s, the best-selling science author in Germany and more. The book includes: NASA research proving we're not the first intelligent race in this solar system; 120 amazing high resolution images never seen before by the general public; three separate doctoral statistical studies demonstrating the likelihood of artificial objects at the Cydonian site to be over 99%; and other definitive proof of life on Mars. Solid science presented in a readable, richly illustrated format. This book will also be featured in a Learning Channel special featuring Leonard Nimoy.

320 PAGES, 6X9 PAPERBACK, ILLUSTRATED, INDEX & BIBLIOGRAPHY, \$17.95, CODE: CFF

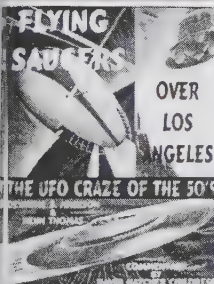

## FLYING SAUCERS OVER LOS ANGELES

*The UFO Craze of the '50s*

by DeWayne B. Johnson & Kenn Thomas  
commentary by David Hatcher Childress

Beginning with a previously unpublished manuscript written in the early 1950s by DeWayne B. Johnson entitled "Flying Saucers Over Los Angeles," this book chronicles the earliest flying saucer flap beginning June 24, 1947. The book continues with other sightings into the late '50s, including many rare photos. It also presents one of the first analyses of the sociological and psychological dimensions of the UFO experience, from a vantage point of certainty that flying saucers are real—borne out by the actual news and witness accounts. Starting with such cases as the Roswell crash and the Maury Island incident, it continues to little-known sightings; this manuscript offers contemporaneous view of the earliest UFO excitement in America, unvarnished by the accumulated speculation of the last 46 years. A more detailed account of the many early sightings has never before been published. Additionally, the book contains a gazetteer of UFO sightings from 1947 up to the late-'50s.

256 PAGES, 6X9 PAPERBACK, ILLUSTRATED, BIBLIOGRAPHY & INDEX, \$16.00, CODE: FSLA



## HAARP

*The Ultimate Weapon of the Conspiracy*

by Jerry Smith

The HAARP project in Alaska is one of the most controversial projects ever undertaken by the U.S. Government. Jerry Smith gives us the history of the HAARP project and explains how it can be used as an awesome weapon of destruction. Smith exposes a covert military project and the web of conspiracies behind it. HAARP has many possible scientific and military applications, from raising a planetary defense shield to peering deep into the earth. Smith leads the reader down a trail of solid evidence into ever deeper and scarier conspiracy theories in an attempt to discover the "whos" and "whys" behind HAARP and their plans to rule the world. At best, HAARP is science out-of-control; at worst, HAARP could be the most dangerous device ever created, a futuristic technology that is everything from super-beam weapon to world-wide mind control device. The Star Wars future is now.

248 PAGES, 6X9 PAPERBACK, ILLUSTRATED, BIBLIOGRAPHY & INDEX, \$14.95, CODE: HARP

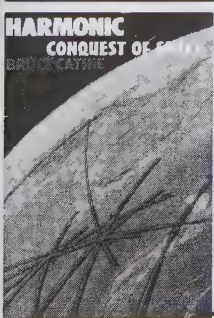

## THE HARMONIC CONQUEST OF SPACE

by Captain Bruce Cathie

A new, updated edition with additional material. Chapters include: Mathematics of the World Grid; the Harmonics of Hiroshima and Nagasaki; Harmonic Transmission and Receiving; the Link Between Human Brain Waves; the Cavity Resonance between the Earth; the Ionosphere and Gravity; Edgar Cayce—the Harmonics of the Subconscious; Stonehenge; the Harmonics of the Moon; the Pyramids of Mars; Nikola Tesla's Electric Car; the Robert Adams Pulsed Electric Motor Generator; Harmonic Clues to the Unified Field; and more. Also included in the book are tables showing the harmonic relations between the Earth's magnetic field, the speed of light, and anti-gravity/gravity acceleration at different points on the Earth's surface.

248 PAGES, .X9, TRADEPAPER, ILLUSTRATED, BIBLIOGRAPHY, \$16.95, CODE: HCS



## RETURN OF THE SERPENTS OF WISDOM

by Mark Amaru Pinkham

According to ancient records, the patriarchs and founders of the early civilizations in Egypt, India, China, Peru, Mesopotamia, Britain, and the Americas were colonized by the Serpents of Wisdom—spiritual masters associated with the serpent—who arrived in these lands after abandoning their beloved homelands and crossing great seas. While bearing names denoting snake or dragon (such as Naga, Lung, Djedhi, Amaru, Quetzalcoatl, Adder, etc.), these Serpents of Wisdom oversaw the construction of magnificent civilizations within which they and their descendants served as the priest kings and as the enlightened heads of mystery school traditions. The Return of the Serpents of Wisdom recounts the history of these "Serpents"—where they came from, why they came, the secret wisdom they disseminated, and why they are returning now.

332 PAGES, 6X9 PAPERBACK, ILLUSTRATED, REFERENCES, \$16.95, CODE RSW

24 HOUR CREDIT CARD ORDERS—CALL: 815-253-6390 FAX: 815-253-6300

email: [auphq@frontiernet.net](mailto:auphq@frontiernet.net) <http://www.azstarnet.com/~aup>

# THE LOST CITIES SERIES



## LOST CITIES OF NORTH & CENTRAL AMERICA

by David Hatcher Childress

Down the back roads from coast to coast, maverick archaeologist and adventurer David Hatcher Childress goes deep into unknown America. With this incredible book, you will search for lost Mayan cities and hoards of gold, discover an ancient canal system in Arizona, climb gigantic pyramids in the Midwest, explore megalithic monuments in New England, and join the astonishing quest for the lost cities throughout North America. From the war-torn jungles of Guatemala, Nicaragua and Honduras to the deserts, mountains and fields of Mexico, Canada, and the U.S.A., Childress takes the reader in search of sunken ruins, Viking forts, strange tunnel systems, living dinosaurs, early Chinese explorers, and fantastic lost treasure. Packed with both early and current maps, photos and illustrations.

590 PAGES. 6X9 PAPERBACK. PHOTOS, MAPS, AND ILLUSTRATIONS. FOOTNOTES & BIBLIOGRAPHY. \$14.95. CODE: NCA

## LOST CITIES & ANCIENT MYSTERIES OF SOUTH AMERICA

by David Hatcher Childress

Rogue adventurer and maverick archaeologist David Hatcher Childress takes the reader on unforgettable journeys deep into deadly jungles, high up on windswept mountains and across scorching deserts in search of lost civilizations and ancient mysteries. Travel with David and explore stone cities high in mountain forests and hear fantastic tales of Inca treasure, living dinosaurs, and a mysterious tunnel system. Whether he is hopping freight trains, searching for secret cities, or just dealing with the daily problems of food, money, and romance, the author keeps the reader spellbound. Includes both early and current maps, photos, and illustrations, and plenty of advice for the explorer planning his or her own journey of discovery

381 PAGES. 6X9 PAPERBACK. PHOTOS, MAPS, AND ILLUSTRATIONS. FOOTNOTES & BIBLIOGRAPHY. \$14.95. CODE: SAM

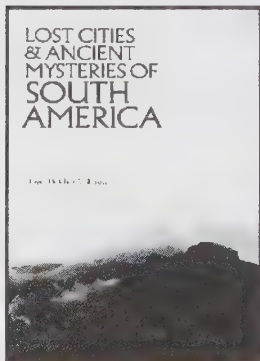

## LOST CITIES & ANCIENT MYSTERIES OF AFRICA & ARABIA

by David Hatcher Childress

Across ancient deserts, dusty plains and steaming jungles, maverick archaeologist David Childress continues his world-wide quest for lost cities and ancient mysteries. Join him as he discovers forbidden cities in the Empty Quarter of Arabia; "Atlantean" ruins in Egypt and the Kalahari desert; a mysterious, ancient empire in the Sahara; and more. This is the tale of an extraordinary life on the road: across war-torn countries, Childress searches for King Solomon's Mines, living dinosaurs, the Ark of the Covenant and the solutions to some of the fantastic mysteries of the past

423 PAGES. 6X9 PAPERBACK. PHOTOS, MAPS, AND ILLUSTRATIONS. FOOTNOTES & BIBLIOGRAPHY. \$14.95. CODE: AFA



## VIMANA AIRCRAFT OF ANCIENT INDIA & ATLANTIS

by David Hatcher Childress

Introduction by Ivan T. Sanderson

Did the ancients have the technology of flight? In this incredible volume on ancient India, authentic Indian texts such as the *Ramayana* and the *Mahabharata* are used to prove that ancient aircraft were in use more than four thousand years ago. Included in this book is the entire Fourth Century BC manuscript *Vimaanika Shashtra* by the ancient author Maharishi Bharadwaja, translated into English by the Mysore Sanskrit professor G.R. Josyer. Also included are chapters on Atlantean technology, the incredible Rama Empire of India and the devastating wars that destroyed it. Also an entire chapter on mercury vortex propulsion and mercury gyros, the power source described in the ancient Indian texts. Not to be missed by those interested in ancient civilizations or the UFO enigma.

334 PAGES. 6X9 PAPERBACK. RARE PHOTOGRAPHS, MAPS AND DRAWINGS. \$15.95. CODE: VAA

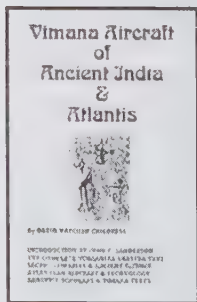

24 HOUR CREDIT CARD ORDERS—CALL: 815-253-6390 FAX: 815-253-6300

email: [auphq@frontiernet.net](mailto:auphq@frontiernet.net) <http://www.azstarnet.com/~aup>

# THE LOST CITIES SERIES

## LOST CITIES OF ATLANTIS, ANCIENT EUROPE & THE MEDITERRANEAN

by David Hatcher Childress

Atlantis! The legendary lost continent comes under the close scrutiny of maverick archaeologist David Hatcher Childress in this sixth book in the internationally popular *Lost Cities* series. Childress takes the reader in search of sunken cities in the Mediterranean; across the Atlas Mountains in search of Atlantean ruins; to remote islands in search of megalithic ruins; to meet living legends and secret societies. From Ireland to Turkey, Morocco to Eastern Europe, and around the remote islands of the Mediterranean and Atlantic, Childress takes the reader on an astonishing quest for mankind's past. Ancient technology, cataclysms, megalithic construction, lost civilizations and devastating wars of the past are all explored in this book. Childress challenges the skeptics and proves that great civilizations not only existed in the past, but the modern world and its problems are reflections of the ancient world of Atlantis.

524 PAGES. 6X9 PAPERBACK. ILLUSTRATED WITH 100S OF MAPS, PHOTOS AND DIAGRAMS. BIBLIOGRAPHY & INDEX. \$16.95. CODE: MED

## LOST CITIES OF CHINA, CENTRAL INDIA & ASIA

by David Hatcher Childress

Like a real life "Indiana Jones," maverick archaeologist David Childress takes the reader on an incredible adventure across some of the world's oldest and most remote countries in search of lost cities and ancient mysteries. Discover ancient cities in the Gobi Desert; hear fantastic tales of lost continents, vanished civilizations and secret societies bent on ruling the world; visit forgotten monasteries in forbidding snow-capped mountains with strange tunnels to mysterious subterranean cities! A unique combination of far-out exploration and practical travel advice, it will astound and delight the experienced traveler or the armchair voyager.

429 PAGES. 6X9. PAPERBACK. PHOTOS, MAPS, AND ILLUSTRATIONS WITH FOOTNOTES & BIBLIOGRAPHY \$14.95. CODE: CHI

## LOST CITIES OF ANCIENT LEMURIA & THE PACIFIC

by David Hatcher Childress

Was there once a continent in the Pacific? Called Lemuria or Pacifica by geologists, Mu or Pan by the mystics, there is now ample mythological, geological and archaeological evidence to "prove" that an advanced ancient civilization once lived in the central Pacific. Maverick archaeologist and explorer David Hatcher Childress combs the Indian Ocean, Australia and the Pacific in search of the surprising truth about mankind's past. Contains photos of the underwater city on Pohnpei; explanations on how the statues were levitated around Easter Island in a clock-wise vortex movement; tales of disappearing islands; Egyptians in Australia; and more.

379 PAGES. 6X9. PAPERBACK. ILLUSTRATED. FOOTNOTES & BIBLIOGRAPHY \$14.95. CODE: LEM

## ANCIENT TONGA

& the Lost City of Mu'a

by David Hatcher Childress

*Lost Cities* series author Childress takes us to the south sea islands of Tonga, Rarotonga, Samoa and Fiji to investigate the megalithic ruins on these beautiful islands. The great empire of the Polynesians, centered on Tonga and the ancient city of Mu'a, is revealed with old photos, drawings and maps. Chapters in this book are on the Lost City of Mu'a and its many megalithic pyramids, the Ha'amonga Trilithon and ancient Polynesian astronomy, Samoa and the search for the lost land of Hawaiiki, Fiji and its wars with Tonga, Rarotonga's megalithic road, and Polynesian cosmology. Material on Egyptians in the Pacific, earth changes, the fortified moat around Mu'a, lost roads, more.

218 PAGES. 6X9 PAPERBACK. ILLUSTRATED. COLOR PHOTOS. BIBLIOGRAPHY. \$15.95. CODE: TONG

## ANCIENT MICRONESIA

& the Lost City of Nan Madol

by David Hatcher Childress

Micronesia, a vast archipelago of islands west of Hawaii and south of Japan, contains some of the most amazing megalithic ruins in the world. Part of our *Lost Cities of the Pacific* series, this volume explores the incredible conformations on various Micronesian islands, especially the fantastic and little-known ruins of Nan Madol on Pohnpei Island. The huge canal city of Nan Madol contains over 250 million tons of basalt columns over an 11 square-mile area of artificial islands. Much of the huge city is submerged, and underwater structures can be found to an estimated 80 feet. Islanders' legends claim that the basalt rocks, weighing up to 50 tons, were magically levitated into place by the powerful forefathers. Other ruins in Micronesia that are profiled include the Latte Stones of the Marianas, the menhirs of Palau, the megalithic canal city on Kosrae Island, megaliths on Guam, and more.

256 PAGES. 6X9 PAPERBACK. HEAVILY ILLUSTRATED. INCLUDES A COLOR PHOTO SECTION. BIBLIOGRAPHY & INDEX. \$16.95. CODE: AMIC

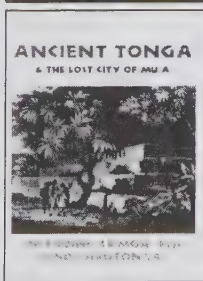
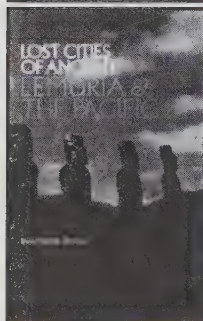
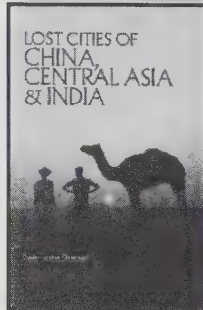
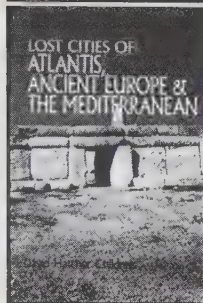

24 HOUR CREDIT CARD ORDERS—CALL: 815-253-6390 FAX: 815-253-6300

email: [auphq@frontiernet.net](mailto:auphq@frontiernet.net) <http://www.azstarnet.com/~aup>

# ANTI-GRAVITY

## THE ANTI-GRAVITY HANDBOOK

*Edited by David Hatcher Childress, With Arthur C. Clarke, Nikola Tesla, T.B. Paulicki, Bruce Cathie, Leonard G. Cramp and Albert Einstein*

The new expanded compilation of material on Anti-Gravity, Free Energy, Flying Saucer Propulsion, UFOs, Suppressed Technology, NASA Cover-ups and more. Highly illustrated with patents, technical illustrations and photos. This revised and expanded edition has more material, including photos of Area 51, Nevada, the government's secret testing facility. This classic on weird science is back in a 90s format!

- How to build a flying saucer.
- Arthur C. Clarke on Anti-Gravity.
- Crystals and their role in levitation.
- Secret government research and development.
- Nikola Tesla on how anti-gravity airships could draw power from the atmosphere.
- Bruce Cathie's Anti-Gravity Equation.
- NASA, the Moon and Anti-Gravity.

230 PAGES, 7X10 TRADEPAPER, BIBLIOGRAPHY/INDEX/APPENDIX. HIGHLY ILLUSTRATED WITH 100'S OF PATENTS ILLUSTRATIONS AND PHOTOS, \$14.95. CODE: AGH

## ANTI-GRAVITY & THE WORLD GRID

*edited by David Hatcher Childress*

Is the earth surrounded by an intricate network of electromagnetic grid network offering free energy? This compilation of material on ley lines and world power points contains chapters on the geography, mathematics, and light harmonics of the earth grid. Learn the purpose of ley lines and ancient megalithic structures located on the grid. Discover how the grid made the Philadelphia Experiment possible. Explore the Coral Castle and many other mysteries; Including acoustic levitation, Tesla Shields and scalar wave weaponry. Browse through the section on anti-gravity patents, and research resources.

274 PAGES, 150 RARE PHOTOGRAPHS, DIAGRAMS AND DRAWINGS, 7X10 PAPERBACK, \$14.95. CODE: AGW

## ANTI-GRAVITY & THE UNIFIED FIELD

*Edited by David Hatcher Childress*

Is Einstein's Unified Field Theory the answer to all of our energy problems? Explored in this compilation of material is how gravity, electricity and magnetism manifest from a unified field around us. Why artificial gravity is possible; secrets of UFO propulsion; free energy; Nikola Tesla and anti-gravity airships of the 20's and 30's; flying saucers as superconducting whirls of plasma; anti-mass generators; vortex propulsion; suppressed technology; government cover-ups; gravitational pulse drive, spacecraft & more.

240 PAGES, 7X10 PAPERBACK, HEAVILY ILLUSTRATED. \$14.95. CODE: AGU

## ETHER TECHNOLOGY

*A Rational Approach to Gravity Control*  
**Rho Sigma**

This classic book on anti-gravity & free energy is back in print and back in stock. Written by a well-known American scientist under the pseudonym of "Rho Sigma," this book delves into international efforts at gravity control and discoid craft propulsion. Before the Quantum Field, there was "Ether." This small, but informative book has chapters on John Searle and "Searle discs;" T. Townsend Brown and his work on anti-gravity and ether-vortex-turbines. Includes a forward by former NASA astronaut Edgar Mitchell. Don't miss this classic book!

108 PAGES, 6X9 TRADEPAPER, ILLUSTRATED WITH PHOTOS & DIAGRAMS. \$12.95. CODE: ETT

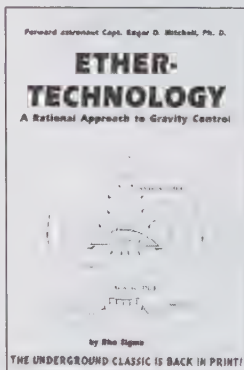
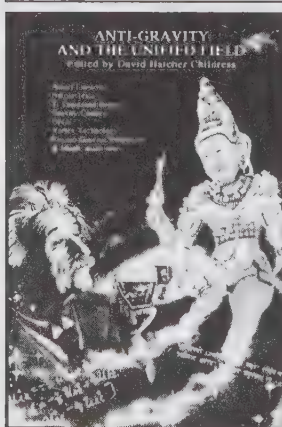
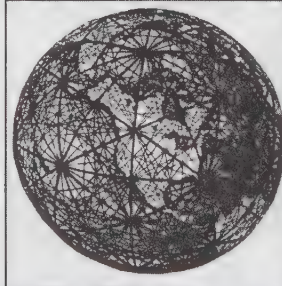
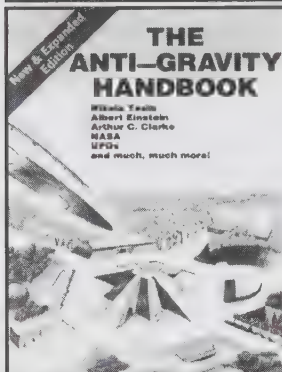

24 HOUR CREDIT CARD ORDERS—CALL: 815-253-6390 FAX: 815-253-6300

EMAIL: AUPHQ@FRONTIERNET.NET HTTP://WWW.AZSTARNET.COM/~AUP

# ANTI-GRAVITY

## THE FREE-ENERGY DEVICE HANDBOOK

A Compilation of Patents & Reports



## THE FREE-ENERGY DEVICE HANDBOOK

*A Compilation of Patents and Reports*  
by David Hatcher Childress

A large-format compilation of various patents, papers, descriptions and diagrams concerning free-energy devices and systems. *The Free-Energy Device Handbook* is a visual tool for experimenters and researchers into magnetic motors and other "over-unity" devices. With chapters on the Adams Motor, the Hans Coler Generator, cold fusion, superconductors, "N" machines, space-energy generators, Nikola Tesla, T. Townsend Brown, and the latest in free-energy devices. Packed with photos, technical diagrams, patents and fascinating information, this book belongs on every science shelf. With energy and profit being a major political reason for fighting various wars, free-energy devices, if ever allowed to be mass-distributed to consumers, could change the world! Get your copy now before the Department of Energy bans this book!

292 PAGES. 8X10 TRADEPAPER, ILLUSTRATED, BIBLIOGRAPHY. \$16.95. CODE: FEH

## UNDERGROUND BASES & TUNNELS

*What is the Government Trying to Hide?*

by Richard Sauder, Ph.D.

Working from government documents and corporate records, Sauder has compiled an impressive book that digs below the surface of the military's super-secret underground! Go behind the scenes into little-known corners of the public record and discover how corporate America has worked hand-in-glove with the Pentagon for decades, dreaming about, planning, and actually constructing, secret underground bases. This book includes chapters on the locations of the bases, the tunneling technology, various military designs for underground bases, nuclear testing & underground bases, abductions, needles & implants, Is the Military Involvement in "alien" cattle mutilations?, more. 50 page photo & map insert.

201 PAGES. 6X9 PAPERBACK, WELL ILLUSTRATED. \$15.95. CODE: UGB

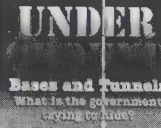

## UFOS AND ANTI-GRAVITY

*Piece For A Jig-Saw*

by Leonard G. Cramp

Leonard G. Cramp's 1966 classic book on flying saucer propulsion and suppressed technology is available again. *UFOS & Anti-Gravity: Piece For A Jig-Saw* is a highly technical look at the UFO phenomena by a trained scientist. Cramp first introduces the idea of "anti-gravity" and introduces us to the various theories of gravitation. He then examines the technology necessary to build a flying saucer and examines in great detail the technical aspects of such a craft. Cramp's book is a wealth of material and diagrams on flying saucers, anti-gravity, suppressed technology, G-fields and UFOS. Chapters include Crossroads of Aerodynamics, Aerodynamic Saucers, Limitations of Rocketry, Gravitation and the Ether, Gravitational Spaceships, G. Field Lift Effects, The Bi-Field Theory, VTOL and Hovercraft, Analysis of UFO photos, more. "I feel the Air Force has not been giving out all available information on these unidentified flying objects. You cannot disregard so many unimpeachable sources."

— John McCormack, Speaker of the U.S. House of Representatives.

388 PAGES. 6X9 PAPERBACK, HEAVILY ILLUSTRATED. \$16.95. CODE: UAG



## MAN-MADE UFOS 1944—1994

*Fifty Years of Suppression*

by Renato Vesco & David Hatcher Childress

A comprehensive look at the early "flying saucer technology" of Nazi Germany and the genesis of early man-made UFOS. This book takes us from the work of captured German scientists, to escaped battalions of Germans, secret communities in South America and Antarctica to today's state-of-the-art "Dreamland" flying machines. Heavily illustrated, this astonishing book blows the lid off the "government UFO conspiracy" and explains with technical diagrams the technology involved. Examined in detail are secret underground airfields and factories; German secret weapons: "suction" aircraft; the origin of NASA; gyroscopic stabilizers and engines; the secret Marconi aircraft factory in South America; and more. Not to be missed by students of technology suppression, secret societies, anti-gravity, free energy conspiracy and World War II! Introduction by W.A. Harbinson, author of the Dell novels *GENESIS* and *REVELATION*.

318 PAGES. 6X9 TRADEPAPER, ILLUSTRATED, INDEX & FOOTNOTES. \$18.95. CODE: MMU

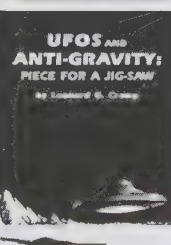

## THE COMING ENERGY REVOLUTION

*The Search For Free Energy*

by Jeane Manning

Free energy researcher and journalist Jeane Manning takes us for a great look at the breakthrough technologies, inventions and inventors that will change the way we live. Chapters on Nikola Tesla, Solid-State Energy Devices and their Inventors, Floyd Sweet—Solid State Magnet Pioneer, Rotating-Magnet Energy Innovators, Cold Fusion, Hydrogen Power, Low-Impact Water Power—A New Twist on an Old Technology, Harassing the Energy Innovators. 15 chapters in all.

230 PAGES. 6X9 PAPERBACK, ILLUSTRATED, GLOSSARY, BIBLIOGRAPHY, INDEX. \$12.95. CODE: CER

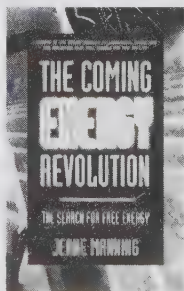

24 HOUR CREDIT CARD ORDERS—CALL: 815-253-6390 FAX: 815-253-6300

EMAIL: AUPHQ@FRONTIERNET.NET HTTP://WWW.AZSTARNET.COM/~AUP

# MYSTIC TRAVELLER SERIES

## MYSTERY CITIES OF THE MAYA

By Thomas Gann



Mystic Travellers Series

## MYSTERY CITIES OF THE MAYA

*Exploration and Adventure in Lubaantun & Belize*  
by Thomas Gann

First published in 1925, *Mystery Cities of the Maya* is a classic in Central American archaeology-adventure. Gann was close friends with Mike Mitchell-Hedges, the British adventurer who discovered the famous crystal skull with his adopted daughter Sammy and Lady Richmond Brown, their benefactress. Gann battles pirates along Belize's coast and goes upriver with Mitchell-Hedges to the lost city of Lubaantun where they excavate a strange lost city where the crystal skull was discovered. Lubaantun is a unique city in the Mayan world as it is built out of precisely carved blocks of stone without the usual plaster-cement facing. Lubaantun contained several large pyramids partially destroyed by earthquakes and a large amount of artifacts. Gann was a keen archaeologist, a member of the Mayan society, and shared Mitchell-Hedges' belief in Atlantis and lost civilizations, pre-Mayan, in Central America and the Caribbean. Lots of good photos, maps and diagrams from the 20s.

252 PAGES, 6X9 PAPERBACK, ILLUSTRATED, \$16.95, CODE: MCOM

## THE MYSTERY OF EASTER ISLAND

by Katherine Routledge

The reprint of Katherine Routledge's classic archaeology book on Easter Island which was first published in London in 1919. Portions of the book later appeared in *National Geographic* (1924). Heavily illustrated with a wealth of old photos, this book is a treasure of information on that most mysterious of islands: Rapa Nui or Easter Island. The book details Katherine Routledge's journey by yacht from England to South America, around Patagonia to Chile and on to Easter Island. Routledge explored the amazing island and produced one of the first-ever accounts of the life, history and legends of this strange and remote place. Routledge discusses the statues, pyramid-platforms, Rongo Rongo script, the Bird Cult, the war between the Short Ears and the Long Ears, exploring the secret caves, ancient roads on the island, and more. This rare book on Easter Island serves as a sourcebook on the early discoveries and theories on the island. Original copies, when found, sell for hundreds of dollars so get this valuable reprint now at an affordable price.

432 PAGES, 6X9 PAPERBACK, ILLUSTRATED, \$16.95, CODE: MEI

## IN SECRET TIBET

by Theodore Illion

Reprint of a rare 30's travel book. Illion was a German traveller who not only spoke fluent Tibetan, but travelled in disguise through forbidden Tibet when it was off-limits to all outsiders. His incredible adventures make this one of the most exciting travel books ever published. Includes illustrations of Tibetan monks levitating stones by acoustics.

210 PAGES, 6X9 PAPERBACK, ILLUSTRATED, \$15.95, CODE: IST

## DARKNESS OVER TIBET

by Theodore Illion

In this second reprint of the rare 30's travel books by Illion, the German traveller continues his travels through Tibet and is given the directions to a strange underground city. As the original publisher's remarks said, this is a rare account of an underground city in Tibet by the only Westerner ever to enter it and escape alive!

210 PAGES, 6X9 PAPERBACK, ILLUSTRATED, \$15.95, CODE: DOT

## IN SECRET MONGOLIA

*Sequel to Men & Gods In Mongolia*  
by Henning Haslund

Danish-Swedish explorer Haslund's first book on his exciting explorations in Mongolia and Central Asia. Haslund takes us via camel caravan to the medieval world of Mongolia, a country still barely known today. First published by Kegan Paul of London in 1934, this rare travel adventure book in print after 50 years. Haslund and his camel caravan journey across the Gobi Desert. He meets with renegade generals and warlords, god-kings and shamans. Haslund is captured, held for ransom, thrown into prison, battles black magic and portrays in vivid detail the birth of new nation. Haslund's second book *Men & Gods In Mongolia* is also available from Adventures Unlimited Press.

374 PAGES, 6X9 PAPERBACK, ILLUSTRATED WITH MAPS, PHOTOS AND DIAGRAMS, BIBLIOGRAPHY & INDEX, \$16.95, CODE: ISM

## MEN & GODS IN MONGOLIA

by Henning Haslund

First published in 1935 by Kegan Paul of London, Haslund takes us to the lost city of Karakota in the Gobi desert. We meet the Bodgo Gegen, a God-king in Mongolia similar to the Dalai Lama of Tibet. We meet Dambin Jansang, the dreaded warlord of the "Black Gobi." There is even material in this incredible book on the Hi-mori, an "airhorse" that flies through the air (similar to a Vimana) and carries with it the sacred stone of Chintamani. Aside from the esoteric and mystical material, there is plenty of just plain adventure: caravans across the Gobi desert, kidnapped and held for ransom, initiation into Shamanic societies, warlords, and the violent birth of a new nation.

358 PAGES, 6X9 PAPERBACK, 57 PHOTOS, ILLUSTRATIONS AND MAPS, \$15.95, CODE: MGM

## THE MYSTERY OF EASTER ISLAND



THE MYSTERY OF EASTER ISLAND

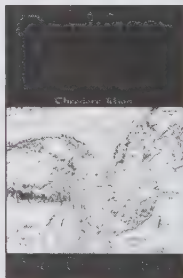
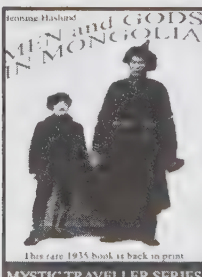
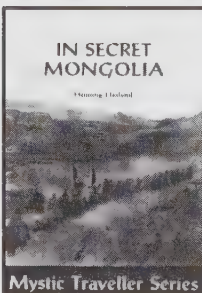
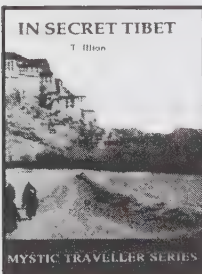

24 HOUR CREDIT CARD ORDERS—CALL: 815-253-6390 FAX: 815-253-6300

EMAIL: AUPHQ@FRONTIERNET.NET HTTP://WWW.AZSTARNET.COM/~AUP

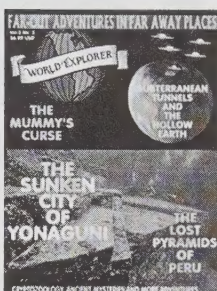
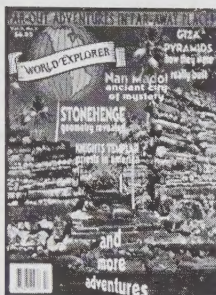
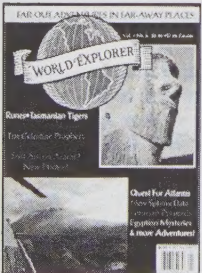
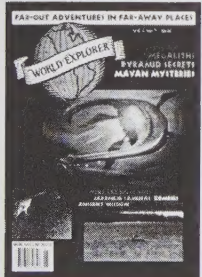

**WHAT IS YOUR IDEA OF EXCITEMENT? OUR LATEST ISSUE**

- ✓ DIVING to explore mysterious underwater ruins?
- ✓ HACKING through thick jungle in search of lost cities?
- ✓ TREKKING shifting sands to a lost city in the Kalahari?
- ✓ CLIMBING the Himalayas to remote monasteries?
- ✓ DIGGING for treasure on remote tropical islands?
- ✓ DISCOVERING previously unknown animal species?

**AS A MEMBER OF THE WORLD EXPLORERS CLUB, YOU'LL...**

- ✓ Read fascinating first-hand accounts of adventure and exploration in our magazine *World Explorer*;
- ✓ Have access to the **World Explorers Club's** huge archive of history, archaeology, anthropology materials, and map room;
- ✓ Be eligible to participate in our expeditions;
- ✓ Receive discounts on **World Explorers Club** merchandise, travel related services and books you won't find anywhere else.

If this is excitement to you, then you should be a member of the **World Explorers Club**, a new club founded by some old hands at exploring the remote, exotic, and often quite mysterious nether regions of planet Earth. We're dedicated to the exploration, discovery, understanding, and preservation of the mysteries of man and nature. We go where few have gone before and dare to challenge traditional academic dogma in our effort to learn the truth.

**World Explorers Club** • 403 Kemp Street • Kempton, Illinois 60946-0074 USA  
24 Hr Credit Card Orders • Telephone: 815-253-9000 • Facsimile: 815-253-6300

<b>Name:</b>	<b>Don't miss another exciting issue of <i>World Explorer</i></b>
<b>Address:</b>	
<b>Telephone:</b>	
<input type="checkbox"/> Regular Membership, US\$25: Subscription to the <i>World Explorer</i> , free classified ad, Expedition Discounts.	
<input type="checkbox"/> Regular Membership: Canada: US\$30: Same as Regular, Airmail.	
<input type="checkbox"/> Regular Membership: All Other Foreign: US\$35: Airmail.	
<input type="checkbox"/> Couple Membership: US\$35: Same as Regular Membership.	
<input type="checkbox"/> Contributing Membership: US\$50: All of the above plus a World Explorers Club T-Shirt.	
<input type="checkbox"/> Supporting Membership: US\$80: All above plus a free book from the <i>Explorers Library</i> & a Thor Heyerdahl/Expedition Highlights video.	
<input type="checkbox"/> Check enclosed.	
<input type="checkbox"/> Please charge my VISA/Discover/Mastercard/AmEx.	
Card#	Exp.







# DID THE ANCIENTS HAVE THE TECHNOLOGY OF FLIGHT?

IN THIS INCREDIBLE VOLUME ON ANCIENT INDIA, AUTHENTIC INDIAN TEXTS AND EPICS SUCH AS THE **RAMAYANA** AND THE **MAHABHARATA**, ARE USED TO PROVE THAT AIRCRAFT WERE IN USE MORE THAN FOUR THOUSAND YEARS AGO.

## INSIDE:

- THE ENTIRE 4TH CENTURY B.C. MANUSCRIPT **VIMAANIKA SHASTRA** BY THE ANCIENT AUTHOR MAHARISHI BHARADWAJA, TRANSLATED INTO ENGLISH BY G.R. JOSYER OF THE INTERNATIONAL ACADEMY OF SANSKRIT RESEARCH.
- THE SECRETS OF **MERCURY VORTEX PROPULSION**.
- THE INCREDIBLE **RAMA EMPIRE** OF INDIA AND THE DEVASTATING WARS THAT DESTROYED IT.
- SECRET LIBRARIES & ANCIENT SCIENCE.
- **ATLANTEAN** AIRCRAFT & TECHNOLOGY.
- SANSKRIT SCHOLARS COMMENTING ON THE **VIMANA** TEXTS.
- PROFUSELY ILLUSTRATED WITH DRAWINGS AND PHOTOGRAPHS.
- ALL THIS AND MUCH, MUCH MORE.



ADVENTURES UNLIMITED/  
PUBLISHERS NETWORK

ISBN 0-932813-12-7



EAN

9 780932 813121

5 1 5 9 5

