

SCIENCE, RELIGION, AND SOCIETY

AN ENCYCLOPEDIA
OF HISTORY, CULTURE,
AND CONTROVERSY

EDITED BY
ARRI EISEN AND GARY LADERMAN

SCIENCE,
RELIGION,
AND
SOCIETY

SCIENCE,
RELIGION,
AND
SOCIETY

AN ENCYCLOPEDIA
OF HISTORY, CULTURE,
AND CONTROVERSY

VOLUME ONE

FOREWORD BY THE DALAI LAMA

EDITED BY
ARRI EISEN AND GARY LADERMAN

M.E. Sharpe
Armonk, New York
London, England

M.E. Sharpe, Inc.
80 Business Park Drive
Armonk, NY 10504

© 2007 by M.E. Sharpe, Inc.

All rights reserved.

No part of this publication may be reproduced, stored in a retrieval system or transmitted in any form or by any means, electronic, mechanical, photocopying, recording, or otherwise, without the prior permission of the copyright holders.

Library of Congress Cataloging-in-Publication Data

Science, religion, and society : an encyclopedia of history, culture, and controversy / Arri Eisen and Gary Laderman, editors.

p. cm.

Includes bibliographical references and index.

ISBN-13: 978-0-7656-8064-8

ISBN-10: 0-7656-8064-5 (set: hc: alk. paper)

1. Religion and science. 2. Religion and science—History. I. Eisen, Arri, 1963–

II. Laderman, Gary, 1962–

BL240.3.S37 2006

201'.65—dc22

2005026762

Printed and bound in the United States of America

The paper used in this publication meets the minimum requirements of American National Standard for Information Sciences—Permanence of Paper for Printed Library Materials, ANSI Z 39.48.1984.

BM (c) 10 9 8 7 6 5 4 3 2 1

Cover photos courtesy of Photos.com.

Chapter 76 reprinted by permission of Sage Publications Ltd. from *Journal of Health Psychology* 7, no. 4 (July 2002): 365–80.

The gh font used for chapter 69 was created by Feedel Software and is used with permission.

Contents

Volume 1

Foreword by The Dalai Lama	xi
Preface	xv
Acknowledgments	xix

General Overviews

Introduction to General Overviews	3
1 Integrating Science and Religion <i>John Polkinghorne</i>	7
2 Integrating Science and Religion—A Jewish Perspective <i>Norbert M. Samuelson</i>	18
3 Islam and Science <i>Toby E. Huff</i>	26
4 The Place of Science in the Hindu Worldview <i>P. Venugopala Rao</i>	36
5 Science and Religion in Africa <i>Gloria Emeagwali</i>	42
6 Science and Native American Communities <i>Keith James</i>	48
7 Native Spirituality and Science <i>Phillip H. Duran</i>	61
8 Knowing the World <i>Vine Deloria Jr.</i>	73
9 Issues in Science and Religion: A Critical Evaluation <i>Laurence I. Gould</i>	81
10 Intersecting Frontiers in Science and Religion <i>Paul Utukuru</i>	91

11	A Superior Road for Life's Journey: A Scientist Explores Reality <i>Jagdish N. Srivastava</i>	100
12	Ichi Tante Mind: A Zen Buddhist Perspective <i>Leslie A. Real</i>	110
13	Islam and Science: Notes on an Ongoing Debate <i>Ibrahim Kalin</i>	112
14	Taoist Contributions to Science in China <i>Jiang Sheng</i>	119
15	Religious Pluralism and Science in Asia <i>Shigeru Nakayama</i>	131
16	Diversity of the Religious Experience <i>Ralph W. Hood Jr.</i>	133
17	Multicultural Perspectives on Issues in Science and Religion <i>Barbara Strassberg</i>	142
18	Learning Science in a Multicultural, Multifaith World <i>Eva Krugly-Smolksa</i>	153

Historical Perspectives

	Introduction to Historical Perspectives	163
19	Religion in Ancient Western South America <i>Charles Stanish</i>	168
20	Science in Pre-Hispanic Western South America <i>Charles Stanish</i>	176
21	Science in the Classical Hindu World <i>V.V. Raman</i>	182
22	Joseph Needham and Taoism <i>Shigeru Nakayama</i>	193
23	Islam and Premodern Science <i>Muzaffar Iqbal</i>	196
24	Islam and Modern Science <i>Muzaffar Iqbal</i>	203
25	Science, Philosophy, and Religion in Ancient Greece and Rome <i>Louis A. Ruprecht Jr.</i>	210
26	Patristic Theology and Greek Natural Philosophy <i>Matthew F. Dowd</i>	221
27	Religion and Science in the Middle Ages <i>Edward Grant</i>	230

28	Greco-Roman Conceptions of the Natural World, Religion, and Leadership in the Later Roman Empire <i>Walter Roberts</i>	244
29	Knowledge and Accuracy in Early Greek Historical Writing <i>Gordon Shrimpton</i>	251
30	The Development and Diffusion of Alchemy from Antiquity to the Renaissance <i>Brenda S. Gardenour</i>	262
31	Women's Bodies, Women's Souls: Perspectives in the Middle Ages <i>Brenda S. Gardenour</i>	273
32	Religion and Geography in the Early Middle Ages <i>Natalia Lozovsky</i>	283
33	The Western Calendar: Religion and Science Intertwined <i>Matthew F. Dowd</i>	290
34	Extraterrestrial Life and Christianity <i>Michael J. Crowe</i>	297

Creation, the Cosmos, and Origins of the Universe

	Introduction to Creation, the Cosmos, and Origins of the Universe	307
35	Creation and Origins of the Universe <i>Marcelo Gleiser</i>	310
36	African Cosmologies Past and Present <i>Hazel Ayanga</i>	325
37	Creation Myths of Africa <i>Gloria Emeagwali and Ayele Bekerie</i>	332
38	The Biblical View of Nature <i>Stephen D. Snobelen</i>	338
39	Galileo, Science, and Religion <i>Mariano Artigas</i>	350
40	Isaac Newton: His Science and Religion <i>Stephen D. Snobelen</i>	355
41	God and the Big Bang <i>Theodore Schick Jr.</i>	370
42	Cosmology and the Anthropic Principle <i>Victor J. Stenger</i>	380
43	Creationism <i>Jeffrey Koperski</i>	390

44	Science and the Bible: Two Views of One Reality <i>Gerald Schroeder</i>	399
45	Is Cosmology Religiously Significant? <i>Willem B. Drees</i>	406
46	Space in Ancient Mesoamerica <i>Rex Koontz</i>	415

Volume 2

Ecology, Evolution, and the Natural World

	Introduction to Ecology, Evolution, and the Natural World	423
47	Natural Theology, Deism, and Early Modern Science <i>Peter Harrison</i>	426
48	Process Theology <i>Joseph Bracken</i>	434
49	Evolution <i>Francisco J. Ayala</i>	442
50	Evolution and Natural Selection <i>Christopher W. Beck</i>	457
51	Intelligent Design <i>Michael J. Behe</i>	467
52	Evolution and Religion <i>Scott Atran</i>	475
53	The Environment in an African Spirituality <i>Adam K. arap Chepkwony</i>	484
54	Environmental Ethics <i>Celia Deane-Drummond</i>	492
55	Science and the Sacred <i>John Ikerd</i>	499
56	Science, Religion, and Sustainable Development <i>Mikael Stenmark</i>	506

Consciousness, Mind, and the Brain

	Introduction to Consciousness, Mind, and the Brain	517
57	The Psychology of Religion <i>Christopher Peterson and Nansook Park</i>	520
58	Consciousness and Neurotheology <i>Kelly Bulkeley</i>	527

59	Neurotheology <i>Carol Rausch Albright</i>	536
60	Neurobiology and Consciousness <i>Andrew B. Newberg</i>	543
61	The Ethics of Psychosurgery and Deep Brain Stimulation <i>Sarah Vinson, Kelly D. Foote, and Michael S. Okun</i>	555
62	The Mind-Body Problem <i>J.P. Moreland</i>	565
63	Extraordinary Aspects of Reality in Altered States of Consciousness <i>Imants Barušs</i>	575
64	Consciousness, Ritual, and Belief <i>Kenneth R. Livingston</i>	584
65	Cognitive Science of Religion <i>D. Jason Slone</i>	593
 Healers and Healing		
	Introduction to Healers and Healing	607
66	Shamanism <i>Alexander Escobar</i>	611
67	Shamanism and Science: Ancient Pathways to Healing and Understanding <i>E. Barrie Kavasch</i>	615
68	Shamanism: A Biogenetic Perspective <i>Michael Winkelman</i>	621
69	Spiritual Healing in the Ethiopian Orthodox Church <i>Getatchew Haile</i>	633
70	African Traditional Medicine: Healing and Spirituality <i>Adam K. arap Chepkwony</i>	642
71	AIDS, Science, and Religion in Africa <i>Hazel Ayanga</i>	649
72	Nuwati: Native American Medicine, Healing, and the Sacred Way of Being <i>Michael Tlanusta Garrett</i>	654
73	Navajo Spirituality: Native American Wisdom and Healing <i>Lori Arviso Alvord</i>	665
74	The Role of Religion and Spirituality in Conventional Medical Treatment <i>William T. Branch Jr.</i>	670

75	Interdisciplinary Approaches to Faith Healing <i>Lisa J. Schwebel</i>	677
76	Does Religion Cause Health? <i>Doug Oman and Carl E. Thoresen</i>	685
Dying and Death		
	Introduction to Dying and Death	699
77	The Blurred Boundary: When Death Displaces Life <i>Joanne D.S. McMahon</i>	703
78	Judaism and Ethical Issues in End of Life Care <i>Elliot N. Dorff</i>	712
79	Hospice <i>Charles A. Corr</i>	720
80	Prolonging Living and Dying <i>Kathy Kinlaw</i>	731
81	Near Death Experiences <i>Bruce J. Horacek</i>	739
82	Dissection and Autopsy <i>Toby E. Huff</i>	746
Genetics and Religion		
	Introduction to Genetics and Religion	757
83	Genetics, Society, and Spirituality <i>Gaymon Bennett</i>	763
84	Biotechnology and Theology <i>Celia Deane-Drummond</i>	780
85	Religion, Ethics, and the Human Genome Project <i>Margaret R. McLean</i>	787
86	Human Reproductive Cloning: Assessing the Concerns <i>Timothy Caulfield</i>	795
	Bibliography	803
	About the Authors	845
	Index	859



THE DALAI LAMA

Foreword

Today, our world requires us to accept the oneness of humanity. In the past, isolated communities could afford to think of each other as fundamentally separate. But nowadays, whatever happens in one region eventually has repercussions elsewhere. Within the context of the new interdependence that globalization has brought about, self-interest clearly lies in considering the interests of others.

Many of the conflicts and problems that challenge us today arise because we have lost sight of the common experience that binds us all together as a human family. We tend to forget that, despite our diversity of race, religion, ideology, and so forth, people share a basic wish for peace and happiness.

The very purpose of life is to be happy. From the very core of our being, we desire contentment. However, since we are not solely material creatures, it is a mistake to place all our hopes for happiness on external development alone. The key instead is to develop inner peace. To achieve it we need to nurture and cultivate such basic human qualities as love and compassion. Because human beings naturally possess diverse temperaments and interests, our different religious traditions emphasize different philosophies and modes of practice. However, perceiving forgiveness, patience, and compassion as practical qualities of great value, all religions counsel ways to cultivate them. Since the essence of these diverse religious traditions is to achieve our individual and collective benefit, it is crucial that we maintain harmony and mutual respect among them. I am convinced that religious differences should not be grounds for antagonism. Religion should rather be the basis for friendship, for brotherhood and sisterhood.

With the advent of science in the seventeenth century, spirituality suffered setbacks in that some religious traditions lost followers. Since then, many people have felt that science and spiritual matters are quite separate and have regarded them as contradictory, with no connection between them. However, with the ever-growing impact of science on our lives, religion and spirituality have a greater role to play in reminding us of our humanity and our responsibilities.

One of the dangers of science and technology is that, because of the sheer power they harness, we may disturb the natural balance of the world. On the other hand, one of the wonderful things about science and technology is that they bring such immediate satisfaction. Still, there is a risk that when we rely too much on the external achievements of science, we pay less attention to the need for corresponding inner growth. Confusion already abounds about how best we are to conduct ourselves in life. In the past, religion and ethics were closely intertwined. Now, many people, believing that science has disproved religion, make the further assumption that morality itself has been discredited.

We need to strike a balance. I believe that in the foreseeable future religion, historically the source of many of our societies' values, will remain influential. However, the essential qualities we need are compassion and forgiveness. These are the qualities that form the basis of human survival. But it is compassion rather than religion that is important to us. Religion involves compassion, but compassion does not necessarily involve religion.

In relation to science, we should always adopt the view that accords with the facts. If, upon investigation, we find that there are reasons and proofs for a conclusion, then we should accept it. However, a clear distinction should be made between what is not found by science and what is found to be nonexistent by science. What science finds to be nonexistent we should all accept as nonexistent, but what science merely does not find is a completely different matter.

An example is consciousness itself. Although sentient beings, including human beings, have experienced consciousness for centuries, we still do not know what consciousness actually is, how it functions or what is its complete nature. Things that have no form are a category of phenomena that cannot be understood in the way external phenomena are investigated. Therefore, I believe that a study of consciousness involving both scientists and experienced meditators could be an excellent example of the potential of a synthesis of science and spiritual experience.

Recently, more and more people have been questioning the conventional boundaries between science and religion. Scientists themselves are venturing into exciting new areas of research and collaboration in such fields as medicine and the health sciences, physics and environmental studies, and neuroscience and biology. A reawakened appreciation for connections on the frontiers of science with ancient and modern traditions of religion and spirituality is the focus of many of the diverse, wide-ranging essays in these volumes. Here readers will find contemporary attempts to answer such questions as: How does the mind work? Are there genes for religion? What do we mean by health and healing and how can we best attain and maintain them? How do we live sustainable lives? How did human beings get here in the first place? And what insights does a historical appreciation of these questions give us?

These are only a few of the questions that are explored by the authors in this encyclopedia. This collection incorporates a wider, more global range of

voices than usual and provides avenues to better understand the dynamics between science and religion in specific cultural and historical contexts. Readers will find here radically different viewpoints on evolution, stem cell research, end-of-life decisions, and creation myths and can read about interactions of science and religion in Africa, pre-Columbian South America, and medieval Europe, as well as perspectives from within Jewish, Buddhist, Hindu, Christian, and other traditions.

What these dialogues between scientists, religious scholars, and others make clear is that there is real potential for an exchange of knowledge between some aspects of science and some aspects of religion. It is not a case of one approach to knowledge proving or validating the other, but an opportunity to enrich each other's understanding. If this ongoing conversation is pursued with open-mindedness and candor, I believe the results will be fruitful for all concerned.

A handwritten signature in black ink, appearing to read 'H. C. Brown', with a long, sweeping flourish extending to the right.

August 19, 2006

Preface

Seven years ago we sent out an open invitation to the faculty at our university to participate in a science and religion reading group. We hoped to attract a dozen or so colleagues to share ideas and readings over weekly lunches for a semester. More than sixty professors from disciplines as diverse as medicine, physics, ethics, public health, biology, and religion wrote us back, eager to attend. As we have discovered, more than a casual interest in interdisciplinary ideas inspired such a surprisingly large response. From this beginning came more faculty reading groups, undergraduate courses, grants from within and outside our institution, publications, and several well-attended public symposia—all around topics lying at the crossroads of science and religion. And this is just our work at one university; many others at our school and other universities have established centers of scholarship and initiated rigorous research programs in mind and body, complementary and alternative medicines, and other areas where science and spirituality overlap.

The interest extends far beyond the bounds of the university, too. The public is hungry for material that explores how religion and science overlap, as well as how the tensions between them are negotiated in political, legal, scientific, and theological terms. The volatile debates around evolution, the extraordinary discoveries in physics, the spiritual dilemmas faced at the end of life—these are just a few of the familiar issues that have recently captured the public's attention and demanded increased collective reflection on deeply fundamental questions about human existence.

Why has there been such an explosion of popular interest in science and religion in the last few decades? A major reason we developed this encyclopedia is to find answers to this question. At least four very general answers have emerged to help explain what is driving this significant societal interest:

- People are more aware of the influence of science in realms of human life that have traditionally been considered personal and spiritual—end-of-life decisions and fertility, for example—and many are concerned

about therapies that might affect complex human behaviors and diseases, such as brain analysis techniques, pharmaceuticals, stem cell research, and gene therapy.

- In the United States especially, the science versus religion discussion, usually within the realms of politics and education—evolution versus creationism being the most well known—polarizes communities and creates well-trodden media stories that do not capture the complexities and confusions surrounding what are presented as antagonistic perspectives.
- Recent research has probed the deep mysteries of the mind and the cosmos—resulting, for example, within the study of consciousness in the development of the new fields of neuroethics and neurotheology, and within the study of physics in the emergence of profound questions about the makeup of the universe.
- The science and religion conversation has opened up to include more voices from around the globe and more awareness of other perspectives—for example, the relationship between the two terms that is perceived by someone in India who is contending with postcolonial linguistic and political realities and has a non-monotheistic point of view.

In this encyclopedia we focus on the *collaborative* angle, to discover how to bring the best of *both* science and religion to the table to address these and other issues. As readers will discover, there is much to learn from a collaborative approach that bridges disciplines but also religions and regions of the world.

The science and religion discussion is richly multidisciplinary; scholars from nearly every field have performed research in the areas examined in these volumes. We learned from our initial reading group that engaging a broad spectrum of disciplines and traditions in the discussion is vital; thus, contributors to these volumes include clergy, physicians, art historians, psychologists, geneticists, ethicists, theologians, historians of science, physicists, and philosophers, as well as scholars from the fields of religion, physics, neuroscience, biochemistry, history, ecology, evolution, and cosmology. And contributors are Christian, Muslim, Buddhist, Hindu, Jewish, Taoist, as well as agnostic and atheist, and from African and Native American traditions. With all of this in mind, we thought it best *not* to claim that the encyclopedia is working with one specific definition of each term, “science” and “religion.” One of the most striking impressions from reading all of these essays is the divergence, as well as occasional convergence, in how writers understand the meanings of each term separately and both together.

To make it easier to examine the diverse and varied responses these essayists provide, we divide the encyclopedia into eight topical sections, fully aware that these divisions are in some sense arbitrary and also create artificial differences as well as areas that overlap with other sections. Each section opens with an introduction outlining its major themes and framing that section’s

essays, trying to highlight commonalities between them but also recognizing the particularities of each one.

The first section, *General Overviews*, is a good starting point for readers who want to explore some of the larger, more wide-ranging perspectives on science and religion. With broad personal and scholarly stories from an array of viewpoints, essays in this section provide a road map for exploring the major challenges and questions in science and religion. This section is followed by *Historical Perspectives*, which grounds these major questions in the past and demonstrates how they have developed into the six broad areas of contemporary research and discussion that follow. These sections—*Creation, the Cosmos, and Origins of the Universe*; *Ecology, Evolution, and the Natural World*; *Consciousness, Mind, and the Brain*; *Healers and Healing*; *Dying and Death*; and *Genetics and Religion*—represent one attempt at organizing the questions and research that undergird the enormous, unabating interest in science and religion today, an interest we think is more compelling when it is informed by a multitude of views and a variety of positions.

Acknowledgments

We thank our many colleagues and students at Emory who have inspired us to explore religion and science across disciplines. Conversations in classes, seminars, and in various other stimulating settings established the groundwork for this encyclopedia. We also thank student assistants Kelley Friedgen, Paula Shakelton, and especially Ajay Pillarisetti for their strong logistical support in developing and executing this project, and both Todd Hallman and Cathy Prisco from M.E. Sharpe for their editorial guidance and advice. This encyclopedia is dedicated to our families.

General Overviews

Introduction to General Overviews

In recent years, many of us have become very familiar with the public debates surrounding science and religion. These debates often surface in the midst of compelling, controversial moral quandaries faced by communities struggling with the limits of scientific authority. The place of evolution in public education, human interventions at the beginning and end of life, the role of prayer in healing, and environmental crises in the face of diminishing natural resources are only a few of the contemporary topics that bring religious and scientific views into sharp relief and a shared frame of reference.

In Western societies, the terms of these debates draw from a common conceptual heritage, deeply rooted in but not entirely limited to historical and cultural developments in Christianity, particularly after the scientific revolution. Are science and religion in *conflict*? Do they represent two separate, *independent* spheres of knowledge and experience? Can they be in *dialogue* to probe the intricacies and mysteries of the universe? Can they be *integrated* to produce dramatically new visions, grounded in science and theology, of the cosmos? Historian of science and physicist Ian Barbour popularly and convincingly argued that the relationship between science and religion can be reduced to these four possibilities.

Our contention in the production of this encyclopedia is that the range of possible interactions between religion and science is much more complex, confusing, and confounding than any schematic representation could possibly convey. Indeed, it will become clear to the reader that even the very notion that the two central concepts can be defined in any fixed, universal, essentialist way begins to crumble in light of the wide-ranging, interdisciplinary, cross-cultural spread of essays contained in this encyclopedia. These essays seek to explore the interconnections, interactions, and intersections of science and religion in a variety of cultural and historical settings throughout time and around the globe. In doing so, they broaden and enrich but also problematize the relevant terms and concepts in the ongoing public conversations about science and religion in human society.

The essays in the first section provide the reader with a series of general overviews, offering perspectives on science and religion from a variety of cultural and religious vantage points. Some essays provide a larger historical framework within which to think about relations between science and religion in specific cultural contexts (compared with more focused historical discussions of specific eras, figures, cultures, and issues in the next section). Well-known physicist, philosopher, and theologian Sir John Polkinghorne, for example, explores the longstanding efforts to integrate science and religion in Western Christian cultures from Augustinian thought in the fourth century to process theology in the twentieth. Norbert Samuelson, a professor of Jewish studies, covers Jewish perspectives on integrating the two—both of which, in his words, shared the same goal of intellectual wisdom from experience (what he identifies as “science”) and from holy scriptures (“religion”)—in the classical and modern periods. Historian Toby Huff covers the critical history of Islam, another monotheistic faith, and the rise of “Islamic science” as a vital source and influence in the emergence of a number of scientific fields, including astronomy, mathematics, and medicine. (Huff also notes that there is no equivalent word for “science” in Arabic—or, for that matter, in Greek or Chinese.) Physicist P. Venugopala Rao provides both historical and philosophical material to explain how science and religion coexist in the worldview of Hinduism, beginning with Indus civilization but also carefully exploring the impact of colonialism and nationhood on Indian perspectives.

Also included in this section are more wide-ranging, less historically grounded explorations of science and religion in different cultural settings, though often authors return to an undeniable theme throughout many essays in this encyclopedia: the political and social impact of Western science on non-Western, nonindustrialized communities around the globe. Yet these essays do not only retell stories of conflict, conquest, and colonization; they also engage with indigenous views and practices that blur the lines between science and religion, and they raise questions about how adequate these categories are for a range of cultural phenomena. Historian Gloria Emeagwali writes about the intersections of science and religion, looking at the development of medicine, metallurgy, and mathematics in various parts of Africa. She begins with reflections from philosophers of science, including Paul Feyerabend and Karl Popper, who broaden and complicate traditionally narrow understandings of science. This is a common theme the reader will encounter in the general essays in this section but also in the more specific cases described in the other sections, where simplistic definitions of science—and of religion, for that matter—no longer adequately capture the realities on the ground.

Native American perspectives included here are particularly attentive to the glaring differences between Western science and indigenous views of the surrounding environment that survived the cultural upheavals of colonization. But they also explore how the systems overlap at some points and, in some cases, how they might work together in common cause, a consideration

found in a few essays that discuss interactions of indigenous systems and Western science. Keith James, a professor of social and organizational psychology, covers some of the potential risks and benefits of combining Western scientific views with native perspectives and practices to mitigate the wide-ranging social dilemmas faced by Indians in contemporary society. Physicist Phil Duran compares the dominant Western epistemology that treats the earth as a commodity with indigenous spirituality and knowledge about reality, looking specifically at recent developments in physics to think across what has been seen as an unbridgeable divide between the two cultural systems. Finally, Indian activist and writer Vine Deloria Jr. discusses the epistemological and practical differences between traditional tribal knowledge and advances in Western science.

In a similar vein, but with an entirely different perspective, Laurence I. Gould writes about epistemology, and specifically the ultimately incompatible methods to gain knowledge operating in religion and science: faith for the first, reason for the second. Physicist Paul Utukuru sees other possibilities, offering commentary on the intersections of religion and spirituality, more generally conceived, and science in light of recent advances in a number of domains, including physics, biology, and the neurosciences. In a more idiosyncratic, personal style, mathematician Jagdish Srivastava recounts his own personal journey, beginning with life in independent India in 1947, into a life of science and the implications this life had on his religious views. In another idiosyncratic contribution, biologist Leslie Real provides an overview, extraordinarily brief though it is, on Zen perspectives, encouraging the reader to close the gap separating science and religion.

Ibrahim Kalin provides readers with more extensive “notes on an ongoing debate” taking place in the Muslim world over the value and purpose of modern science, a compelling, complicated debate in a culture that has made tremendous contributions to intellectual and scientific inquiry—and one that still can, primarily by offering a nonreductionist framework with which to study nature while preserving its sanctity. After reading Jiang Sheng’s examination of science and religion in China, the reader will understand that these two categories cannot be separated in the Taoist context, where the driving force that unites both is the search for immortality. Shigeru Nakayama, a professor emeritus in the history of science, compares the cultural settings tied to monotheism in the West with the religious pluralism of East Asia, contrasting the two settings by focusing on the place, and rigidity or flexibility, of science in each.

With training in the psychology of religion, Ralph Hood Jr. presents a general discussion about the wide-ranging diversity of religious and spiritual experiences, including those that will be addressed in other sections of the encyclopedia, such as near death experiences and the effects of prayer and meditation on health. Sociologist Barbara Strassberg and education specialist Eva Krugly-Smolka turn our attention to the necessity of placing discus-

sions about science and religion in a multicultural frame of reference. Strassberg brings a distinctly social scientific perspective to the real-life dynamics between science and religion, focusing on the significance of cultural inclusiveness in these discussions. Krugly-Smolka considers how science is taught in schools and argues for the need to see science as a cultural form.

Many of these essays will raise questions that will be taken up in more detail in other sections of this encyclopedia, questions often focusing on but not limited to the adequacy of conventional definitions for science and religion. Our goal here is to provide readers with an assortment—admittedly fragmented and incomplete—of more general perspectives on science and religion, putting on display the incredible, nearly inexhaustible array of topics that come to mind for these authors. We also hope that these essays, and the essays in the rest of the encyclopedia, contribute to public awareness of just how complicated the relations between religion and science can be when the conversation includes a range of cultural views on these matters.

1 Integrating Science and Religion

John Polkinghorne

Science plays an influential role in contemporary thinking, both through the content of its actual discoveries and through its style of evidence-based thinking. If religion is to retain credibility, it must find a voice that is audible in this intellectual setting. It is no wonder, therefore, that today vigorous activity is taking place across the science and religion frontier. However, the attempt to integrate these two great aspects of human enquiry is not just a current concern, for it has had a long history.

The Abrahamic faiths, Judaism, Christianity, and Islam, all understand the world to be God's creation. Consequently they see the world as expressing something of the character of its creator. This attitude is at least as old as the wisdom writings of the Hebrew Bible. In contrast to the other biblical authors, the sages did not appeal much to the unique events of salvation history, but they reviewed the generality of human experience. Culture is the medium for expressing and reflecting upon that experience, and so the interaction between culture and religion has had a long history. Science's study of the pattern and history of the natural world has made a significant contribution to this process.

Augustine took the science of his day seriously; in fact, his disillusionment with Manichaeism partly arose because he noticed its adepts were less accurate in the prediction of eclipses than were secular astronomers. Later he was to say that if an interpretation of scripture seemed in conflict with well-established natural knowledge, then that interpretation should be reconsidered.

In the later Middle Ages, the rediscovery of the ideas of Aristotle proved of great significance for the Abrahamic faiths. In the case of Christianity, the effect was principally conveyed through the influence of Thomas Aquinas. Science in a recognizably modern form may be dated from the publication of Nicholas Copernicus's heliocentric theory in 1543, and its full flourishing began with the work of Galileo and his successors in the seventeenth century. It has been argued that an important ideological foundation for this development was provided by the doctrine of creation. If God was rational, there had to be an order to the universe—hence the scientific expectation that a cosmic

pattern was discoverable. Yet, since God's creative will was freely exercised, the order of the universe could not be deduced from thinking about a supposed logical necessity. Rather, one had to look to see what God had actually done—hence the need for observation and experiment. Moreover, since the world was a divine creation, it was a worthy object for study, and because its own nature was not divine, it could be interrogated without impiety. All these understandings were certainly encouraging to the development of science.

The Galileo affair was unfortunate, but the issues involved were more complex than a simple confrontation between scientific truth and religious error. Galileo was a religious believer, as were most of the founding figures of modern science, even if some, like Isaac Newton, had difficulties with Christian orthodoxy. The pioneers certainly wished to hold religion and science together, typically claiming that God had written two books, the book of nature and the book of scripture, which, when read aright, could not contradict each other because they had the same divine author.

In the Scholium that Newton added to his *Principia*, he expressed his admiration for the divine handiwork revealed in the structure of the cosmos. Other scientists shared this feeling, which was reinforced by biological studies of the marvelous adaptive powers of creatures, leading to an argument from design, or “physico-theology,” classically expressed in John Ray's *The Wisdom of God in the Works of Creation* (1691). Writers such as William Paley, in his celebrated *Natural Theology* (1802), continued these lines of argument, which were aimed at integrating scientific and religious understanding. However, this harmonious phase, based on a rather direct argument from design, came to an end with the publication in 1859 of Charles Darwin's *Origin of Species*. Its author had shown how the patient accumulation and sifting of small differences could, over long periods of time, produce the appearance of design without the need for the direct intervention of a designer.

The publication of the *Origin of Species* is another event in the complex history of the interaction between science and religion that is often presented, like the Galileo affair, in the oversimplified terms of implacable confrontation. In fact, Christian thinkers such as Charles Kingsley and Frederick Temple welcomed Darwinian insights from the first, seeing an evolving world as being a creation “allowed to make itself.”

Even so brief a survey illustrates something of the complex interaction between science and religion in the course of an intellectual history characterized both by dispute and by fruitful exchange. The last forty years have seen particularly vigorous activity on this frontier. Ian Barbour examined the forms of contemporary interplay through a fourfold taxonomy that has become something of a classic grid. It is based on the contrasting relationships of conflict, independence, dialogue, and integration. The last category has been relabeled assimilation in the discussion below. Before making use of these categories, however, let us consider a set of metaphysical issues of particular significance: realism and limit questions.

Realism

A central question in philosophy concerns what relationship should be held to exist between epistemology and ontology, between human knowledge and what is actually the case. Immanuel Kant took the view that the appearances of phenomena are no reliable guide to the nature of noumena, things in themselves. Scientists, on the other hand, have almost all taken a realist position, believing that what we know is a reliable guide to what is the case. It would be difficult to see what justified the great labor of scientific research if it were not telling us what the physical world is actually like.

Scientific realism, however, has to be a critical realism, based not on a simplistic concept of naive objectivity but on an altogether more nuanced line of argument. The intertwining of theory and experiment in the interpretation of scientific evidence introduces a degree of circularity into the discussion, yet because of the explanatory power and long-term fruitfulness of what is discovered, this circle is believed to be benign and not vicious. Science often speaks of entities not directly observable, such as the quarks and gluons that are considered constituents of nuclear matter. Support for belief in such unseen realities is based on an appeal to intelligibility. The assumed existence of the invisible quarks enables physicists to make sense of great swaths of more directly accessible experience. Science cannot claim to attain comprehensive knowledge, but it can persuasively assert its ability to make reliable maps of physical reality, trustworthy on a given scale even if not affording a total description of the intellectual terrain. Its achievement is verisimilitude rather than absolute truth.

Thinkers in the field of science and religion have mostly adopted a critical realist position, not only in relation to science but also in relation to theology. While recognizing that human knowledge does not rest on unshakeable foundations, they have largely been inclined to trust human rational powers and not to give way to an extreme postmodernist feeling of despair of the prospect of gaining universally acceptable knowledge. In theological thinking, the adjective “critical” carries peculiar force. The infinite reality of God will never adequately be caught in finite, human, rational nets. Religion must heed the warnings of an apophatic theology, emphasizing the mystery of God, while at the same time not abstaining from kataphatic utterance, since it believes that God has acted to make the divine nature known through creation and through revelatory acts in history.

Limit Questions

Science purchases its great success by the modesty of its ambition. An honest science does not pretend to ask and answer every question about the nature of reality. Instead, it restricts itself to asking questions of process (the way things happen), while it brackets out questions of meaning and purpose (what is

going on in what is happening). The insufficiency of a solely science-based understanding is made clear when questions arise from doing science that seem clearly meaningful and necessary to ask, but that science cannot answer. Questions of this kind are called metaquestions or limit questions. Seeking their answers offers the opportunity to extend the frontiers of understanding beyond those set by science alone, through the discovery of a complementary source of insight. In fact, the integration of science and religion is encouraged by recognizing the power of theological thinking to respond to science's limit questions.

Three kinds of limit questions have proved particularly significant. The first asks why science is possible at all. Of course, evolutionary insight into survival needs is sufficient to explain the human ability to make sense of the everyday world of direct experience. However, science goes far beyond any such mundane necessities, as it comprehends the quantum world of subatomic entities and the vast realms of cosmic, curved space-time. Both regimes are remote from direct impact on humanity, and both require highly counter-intuitive modes of thinking for their proper understanding. The universe is deeply intelligible to us, and our experience of its rational transparency goes far beyond anything that could plausibly be considered simply a spin-off from evolutionary necessity. Furthermore, science has discovered that the universe is also rationally beautiful. Scientists speak frequently of the experience of wonder, which is the reward for all the weary labor involved in doing research. In fundamental physics, an actual technique of discovery is to seek equations that are endowed with the unmistakable quality of mathematical beauty. This is no mere aestheticism on the part of the theorists, for it has been a continuing scientific experience that only equations possessing this character will exhibit the long-term fruitfulness that persuades scientists of their verisimilitude as descriptions of the physical world.

None of this is explained by science itself, which is content simply to exploit the opportunities thereby afforded. Yet these facts are too remarkable to be treated as if they were just happy accidents. One could summarize the universe's rational character by saying that it appears to be a world shot through with signs of mind, and the religious believer can claim that this is so because it is indeed the mind of the creator that lies behind its wonderful order. In this view, science is possible because the world is a creation.

The second kind of limit question asks where the laws of nature come from and why they have their particular character. Scientists study the history of the universe over the 13.7 billion years from the Big Bang that have seen an expanding ball of energy become a world of rich and fertile diversity. In the course of understanding many of the details of this fruitfully evolving process, cosmologists have come to realize that its possibility depended on the laws of physics taking a very particular—one might say “finely tuned”—form. While life took billions of years to appear and develop, the universe was pregnant with the possibility of life essentially from the Big Bang onward.

The chemistry of life is the chemistry of carbon. The only source of carbon lies in the interior nuclear furnaces of the stars. The delicate processes by which carbon is produced depend critically on the laws of nuclear physics being what they are in their quantitative detail, and no different. Stars have a second important role to play. Development of life on Earth was possible because it was fuelled by our local star, the sun, burning reasonably steadily over billions of years. If the strength of gravity had been different, stars might have burnt too feebly to support life or so furiously that they could not have lasted for more than a few million years before exhausting their energy supplies. Life needs an energy supply continuing for billions of years for the possibility of its evolutionary development.

Many considerations of this kind have been discovered. They have been collected together under the rubric of the anthropic principle (that is, the structure of the universe is directly related to human existence). A cosmos that is capable of generating carbon-based life is not just any old world but has to be a very special universe indeed. Once again science points to circumstances that do not look like mere happy accidents. Yet science is unable to offer an explanation of anthropic fine-tuning, for it treats the laws of nature as brute facts, the given basis for its thinking, and it then has no more to say about their character. To get beyond this requires a metascientific response. There has been much disagreement about what form it should take. Two contrasting strategies have been employed.

One proposes that there are many different universes, all with different laws of nature. Given this multiverse, then, it would not be all that surprising if one of them, by chance, was suitable for carbon-based life. Since all the other universes are inaccessible to us, this proposal is metaphysical in its character. Many think that it exhibits a high degree of ontological prodigality.

An alternative metaphysical possibility is theistic. Perhaps there is just one universe, which is indeed not any old world, for it is a creation. In that case, it is intelligible that the universe has been endowed by its creator with precisely the fine-tuned laws that have enabled it to have a fruitful history. Once again one sees the possibility of a mutually enlightening complementarity between science and religion.

The third kind of limit question relates to the coming-to-be of persons. The emergence of self-conscious beings on planet Earth is one of the most astonishing developments in cosmic history of which we are aware. In our ancestors, the universe became aware of itself. This seems an event of such significance that many believe the category of happy accident is inappropriate. Persons are perceivers of value. They are moral beings whose ethical intuitions, for example of unconditional altruism, seem to go beyond the genetic survival imperatives of evolutionary thinking. Personal experiences of beauty have such a profound quality that many cannot treat them simply as epiphenomenal froth on the surface of a fundamentally materialistic reality. The human encounter with the sacred to which the faith traditions attest has

an authenticity that demands deep respect. All these experiences lie outside the domain of science, but they fall well within the concerns of religion. An adequate metaphysics must find room to take them seriously.

Religious responses to limit questions form the basis of a natural theology, the attempt to learn something of God through the use of reason and the inspection of the world. This activity affords a means of integrating science and religion in a complementary relationship. Contemporary natural theology differs from its predecessors, associated with such names as Aquinas, Ray, and Paley, in important ways.

First, in no way does it seek to rival science within the latter's domain. Scientific questions (such as the origin of the eye) are expected to receive scientific answers (such as an evolutionary account). The so-called "God of the gaps," religion's ill-judged attempt to fill in temporary patches of scientific ignorance by appeal to direct divine action, was a bad theological mistake. The raw material for a true natural theology is furnished by the limit questions, which go beyond science's explanatory powers. It is surely significant that someone like Paul Davies, who stands outside any religious tradition, should be inclined to take a kind of theistic view by considerations of this sort.

Second, the new natural theology is modest and does not talk about "proofs of God's existence," as if atheism were simply a logical mistake. Instead, its character is insightful rather than demonstrative. Its claim is that taking a theistic view explains more than atheism can. In the realm of metaphysics, no one can aspire to more than that, for no overarching worldview can legitimately claim absolute logical necessity.

Conflict

In Barbour's grid of the interplay of science and religion, the conflict category regards science and religion as rivals that can give no quarter to the other point of view. People who take this stance frequently point to the Galileo and Darwin affairs, historically misunderstood as occasions of implacable confrontation. That the relation is one of conflict can be asserted either from the standpoint of religion or from the standpoint of science. The religious version is most clearly expressed in the cruder forms of creationism. The Bible is read not only as the deposit of religious truth and experience, but also as a divinely given textbook of science, so the Genesis stories of creation are considered a literal account of how the world came to be. The scientific version is expressed through a triumphalist scientism. In its most extreme form, it claims that the only questions worth answering are scientific, and the only knowledge one can have is that which science can provide. Religion is dismissed as antiquated and fantastic, at best irrelevant and at worst untruthful distortion.

Both versions are implausibly imperialistic. They fail to acknowledge the authenticity of different kinds of enquiry into different kinds of experience.

Not all questions are scientific; not all answers are religious. A just encounter with reality will be concerned both with the uniqueness of personal experience (which lies at the root of religion) and with the repeatability of impersonal experience (which is the subject matter of science). Scientists need to recognize the frontiers of their discipline and the kind of limit questions that take the enquirer beyond that domain. Religious believers need to recognize that the creator acts through nature as well as in other ways, and that what science tells us of nature's character and history is a gift worthy of grateful acceptance and respect.

Independence

The independence stance aims to achieve a degree of harmony between science and religion based on their peaceful and strictly separated coexistence. The possibility of such a truce is commonly held to arise from a series of dichotomies: science is concerned with the impersonal, religion with the personal; science is concerned with facts, religion with values; science is concerned with public knowledge, religion with private opinion. The two subjects are supposed to represent what Stephen J. Gould called "non-overlapping magisteria." Let them go their own separate ways in peace. The stance of independence is popular among scientists who do not want to be wholly dismissive of religion, but who also do not want to take its cognitive claims with any seriousness. Despite its appearance of modest reasonableness, independence is unsatisfactory, for it is based on half-truths about its two subjects.

Their differences do not hold science and religion in complete separation from each other; instead, these differences place them at opposite ends of a single spectrum of human enquiry into the nature of reality. There is a greater degree of mutual influence and cousinly connection than independence is able to acknowledge. Science does not deal in simple facts, for all interesting scientific facts are necessarily interpreted facts and, as theory and experiment inextricably intertwine, the role of interpretation introduces an element of opinion into scientific thinking. Religion is not merely based on internalized opinion, but faith appeals to motivated belief as the ground of its commitment. The question of truth is as fundamental to religion as it is to science, and the appeal to experience, albeit of a kind that cannot be replicated at will, is central to theological thinking.

As a matter of observable fact, science and religion do not exist in insulated isolation from each other. Scientific discoveries about the universe (Big Bang cosmology) and the history of life (evolution) have demonstrably influenced theological thinking about creation. It has already been argued that religion's answers to limit questions complement a scientific understanding of the world. There is no direct entailment between science and religion, but the stance of independence fails to do justice to the substantial amount of mutual interaction.

Dialogue

The dialogue stance is based on taking seriously the mutual exchange between science and religion as they seek together to provide as comprehensive an account of reality as possible. The discoveries of science do not determine theological discourse, but they place constraints on what can properly be said. Religion is not in a position to give the answers to scientific questions, but by its responses to limit questions, it can set scientific knowledge within a broader context of understanding. There has to be mutual consonance between the discourses of the two subjects. In consequence, a continuing and fertile conversation is possible between them. Many examples can be given of this fruitful exchange.

Science's discovery of the evolutionary character of the world encouraged theology to explore the concept of continuous creation. The history of the universe is not to be taken as the performance of a fixed score, composed by a creator in eternity, but it has the character of an unfolding improvisation in which creatures and their creator all play a part. This idea has been particularly developed in the writings of Arthur Peacocke.

A world "making itself" in this evolutionary way can be seen as a greater good than one brought into being ready-made at the command of its creator. The God of love will not create a cosmic puppet theater in which creatures must all dance to the divine tune and where all is under tight control, but creatures are given the freedom to be themselves, to explore and bring to birth in their own way the potentiality with which they have been endowed. This insight helps religious thinking with its greatest perplexity: the presence of evil and suffering in the world. A creation making itself is a great good, but it has a necessary cost. There will inevitably be ragged edges and blind alleys in the course of its history. Genetic mutation has been the fertile driving force of the development of life, but genetic mutation is also the source of malignancy. The sad fact of the presence of cancer is not gratuitous, something that a more compassionate or competent creator might have avoided. It is the necessary cost of a creation making itself. Natural disasters, such as earthquakes, occur because entities like tectonic plates are allowed to behave in accordance with their nature. Elsewhere I have called this "the free process defense," paralleling for inanimate objects the free will defense in relation to the evils acts of human beings who have been given the good of moral freedom.

In the 1990s the principal discussion in relation to science and religion was concerned with the issue of divine providential action. Given science's account of the causal structure of the world, was it still possible to believe that God acts in history in particular ways on particular occasions? Twentieth-century physics had seen the death of a merely mechanical view of the world. The widespread presence of intrinsic unpredictabilities, first noted in quantum physics and then in chaos theory, meant that the processes of the world were not as tame and controllable as classical Newtonian thinking had seemed to suggest. Unpredictability is an epistemological property (one cannot know

what future behavior will be) and, once again, one faces the issue of the nature of the relationship between epistemology and ontology. Is the matter just a case of unavoidable ignorance, or are intrinsic unpredictabilities signs of an ontological openness to the future? The latter possibility would correspond to the conventional physical account that the action of causal principles goes beyond the exchange of energy between constituents. The assumption of ontological openness would be a legitimate move for a critical realist to make.

A variety of metaphysical conjectures were proposed to express an openness present within the grain of nature, some looking mainly to quantum effects for their basis and others appealing principally to chaos theory. No universally agreed-on, detailed understanding has emerged. However, it has become clear that the “defeaters” (those who claimed that science had ruled out divine providence) have been defeated. To make the assertion that divine action was excluded by physics was, in fact, to make a metaphysical claim open to rational refutation. Given philosophical perplexities about the nature of causality, general argument could hardly be expected to lead to a more specific result. After all, science is currently unable to give a detailed account of how it is possible for human beings to act as intentional agents. Yet if we can influence the future in this way, it would be highly surprising if God were to be totally bereft of a similar capacity.

Assimilation

The assimilation stance has the ambitious aim of constructing a single account that unites the insights of science and religion in an overarching metaphysical scheme. The most widely pursued example of this kind of endeavor has relied on process thinking, deriving from the philosophical ideas of Alfred North Whitehead. Its most prominent supporter in the field of science and religion has been Ian Barbour.

Process thought sees reality as composed of discrete events (“actual occasions”). Each event comprehends what has happened previously and is open to a variety of future outcomes. In a process called concrescence, God is a party to each actual occasion, seeking to lure it toward a divinely desired result, but the determination of that result lies with the event itself. Process thinking envisages a continuous ontological spectrum linking proton to person, an idea that its critics tend to refer to as panpsychism and its defenders as panexperientialism. Of course, the experiential component of an atom is considered to be at a very low, residual level. Even so, process panexperientialism has seemed unappealing to many.

Process ideas face two further major difficulties. The punctuated, event-dominated picture of reality does not cohere well with the account of modern physics, which exhibits a great deal of continuity as well as some degree of discontinuity. Theologically, the God of process theology seems to be too evacuated of power, acting only through persuasion (“lure”). To many, this appears too weak an account of divine interaction with creation.

In general, unitive strategies seem often to grant too much influence to scientific ideas, risking the subordination of theological insights (which is why I have chosen the less flattering word assimilation in preference to Barbour's integration). In consequence, the most favored form of integration between science and religion has proved to be some version of dialogue.

Time

The nature of time is a matter of significance for both science and religion. If the world is open to its future, then it is a world of true becoming. The future is not up there, waiting for the present to arrive, but it is brought into being as processes unfold. Theology believes that God knows things truly, according to their actual nature. This has seemed to many to imply that if reality is temporally unfolding in an open way, God will know creation in its becomingness. This means that God will not simply know that events are successive, but God will know them in their succession. There must be an experience of time in God.

Such a view stands in stark contrast to the tradition of classical theology, from Augustine to Aquinas and beyond, which had pictured the eternal God as knowing creation atemporally. The whole of created history, past and future, was supposed to be laid out before its creator, to be taken in by the divine gaze all at once, "totum simul," in the classic phrase of Boethius. Today many adopt a more complex view of God's relation to time. While there must be an atemporal aspect of the divine nature, corresponding to God's unchangeable attributes and eternal existence, there is also believed to be a temporal aspect of the divine nature, through which the creator engages with the temporally unfolding reality of creation. This dipolar way of thinking about God was pioneered by process theologians, but it has received wide acceptance beyond the process community. The divine polarity of eternity/time appears highly consistent with the biblical picture of God, both eternally steadfast in the divine love and also intimately engaging with the twists and turns of history.

If the future is not yet there to be known, even God cannot yet know it. Theists will certainly wish to assert divine omniscience—but in a world of becoming, this has to take the form of a current omniscience (knowing now all that can be known now), rather than an absolute omniscience (knowing all that will ever be knowable).

This insight forms part of an important concept of twentieth-century theology, recognizing that the divine act of creation is also a divine act of self-limitation, or kenosis. This was first acknowledged in relation to divine power. If creatures are allowed to make themselves and to be themselves, then not all that happens (a murder, an earthquake) will be in accordance with God's good and perfect will, though it is permitted because of the creator's gift of freedom to creatures. In this way, God has freely limited the operation of divine power. Mainstream Christian theology sees this limitation as internally accepted within

deity, as an expression of the divine love, though process theology regards it as a necessary metaphysical limitation enforced on the divine nature.

God's acceptance of a current omniscience can similarly be understood as a further free act of divine self-limitation. It is the kenosis of absolute omniscience.

Future Developments

The recent history of the integrative discourse between science and religion has had the spiral character of circling inward toward matters of increasing theological specificity. Certain frontier topics, such as natural theology and creation, will always engage attention but are rather general in their character. Most of what is said about them is as consistent with the distant God of deism, who simply set the worlds spinning and then left them to it, as it is with the providentially active God of theism. Twenty-five years ago these general issues tended to dominate the dialogue. The concentration in the 1990s on the question of divine action turned the discussion in a distinctly more specific theological direction. Recently there has been some interesting dialogue on eschatological matters, taking seriously science's prognostications of the eventual collapse or decay of the universe. One may hope that this tendency will continue, with the result that theology will play a greater role in setting the agenda for the dialogue.

A great deal of the activity in the discourse between science and religion has originated from within the Christian community. Another hope for the future is that there will be increasing participation by the other world faith traditions. Not only will this provide complementary sources of religious insight, but the activity will also offer opportunities for the faiths to meet each other in a context of serious significance, yet one that does not pose an immediate threat or challenge to any tradition's core beliefs. The integration of science and religion may play a modest but useful role in the ecumenical dialogue among the world religions.

Bibliography

- Barbour, Ian. *Religion and Science*. San Francisco: HarperCollins, 1998.
- Brooke, John Hedley. *Science and Religion*. Cambridge: Cambridge University Press, 1991.
- Clayton, Philip. *God and Contemporary Science*. Edinburgh: Edinburgh University Press, 1997.
- Davies, Paul. *The Mind of God*. New York: Simon and Schuster, 1992.
- Gould, Stephen J. *Rock of Ages*. New York: Ballantine, 1999.
- Jaki, Stanley. *The Road of Science and the Ways to God*. Chicago: University of Chicago Press, 1978.
- Peacocke, Arthur. *Theology for a Scientific Age*. London: SCM Press, 1993.
- Peters, Ted, ed. *Science and Theology*. Boulder, CO: Westview, 1998.
- Polkinghorne, John. *The Faith of a Physicist*. Minneapolis: Fortress, 1996.
- . *Scientists as Theologians*. London: SPCK, 1996.
- . *Belief in God in an Age of Science*. New Haven, CT: Yale University Press, 1998.
- Rolston, Holmes. *Genes, Genesis, and God*. Cambridge: Cambridge University Press, 1999.
- Watts, Fraser. *Theology and Psychology*. Aldershot, UK: Ashgate, 2002.

2 Integrating Science and Religion— A Jewish Perspective

Norbert M. Samuelson

Ian Barbour diagramed four modes of possible relationship between science and religion—conflict, independence, dialogue, and integration. His model was developed primarily to schematize the interaction between Christian churches and universities in Western civilization. However, the model is also adaptable to understanding how the Jewish people have related their pursuit of wisdom through the use of human intellect in conjunction with both human experience and professed revealed scriptures. We can for our purposes call the intellectual striving for wisdom from experience “science” and the same endeavor out of holy scriptures “religion,” even though these terms were not used until the twentieth century. With respect to the Jewish people, “religion” refers to all study of professed revealed texts (scriptures) and their associated commentaries, or what in terms of premodern Judaism is called the way of law (Dat) or the tradition (Halakha) or simply “Torah” in a very broad sense. Similarly, the term “science” refers to all study of texts of natural philosophy, both Jewish and non-Jewish, by Jewish thinkers with the intent either to interpret the meaning of the revealed texts or to interpret human experience of the world.

Classical Judaism

How Jewish intellectuals have understood the relationship between religion and science has changed as the cultural background of Judaism has changed. The earliest records are of the Judaism of the Hebrew scriptures when the dominant cultural influences came from the ancient Near East. That understanding changes when the succeeding empires of Greece and Rome conquer the nation of Judea, and the system of Jewish belief undergoes an even more radical change when the Sassanid Empire, whose dominant religion was Zoroastrianism, gains hegemony over the Jewish people. This postbiblical un-

derstanding of the relationship between science and religion is contained in the collected writings of the Midrash and in the Talmud.

In the case of the Hebrew scriptures, the discussion turns on the pursuit of what the text calls “wisdom” (*hakhmah*). In the early rabbinic texts of the Midrash and the Talmud, this biblical pursuit for wisdom becomes interconnected with the study of Hellenistic philosophy (*filosofia*). The combination of these two traditions—biblical and Talmudic, wisdom and philosophy—constitutes what I would call the thought of “classical Judaism.”

Wisdom (Hakhmah) in the Hebrew Scriptures

The narrative of the Pentateuch speaks of certain people being “wise,” which seems consistently to mean people who have mastered an art or a craft. A notable example is the carpenter Bezalel, who designs the tabernacle. A different example is found in the “wise men” of Pharaoh’s court who attempt to duplicate the magic that Moses performs with his staff. They have limited success, which means that the craft that Moses can do through the power of the God of Israel is greater than the craft that the Egyptian wise men can do through the power of their deities. It seems reasonable to infer that the biblical authors’ implicit model of the relationship between scientists (here meaning the wise men who master practical skills) and religionists (here meaning the prophets or priests who communicate with the deities) is integration. Both kinds of men serve the good of the nation through communication with the national deity. In fact, the two are the same. Those who learn the will of the deity are men of wisdom who, in virtue of their wisdom, are God fearers. “God fearers” would be in my judgment the biblical counterpart to what we would call religious people. Bezalel is the purest example of such a man. His task is a skilled service on behalf of the liturgical cult. That he performs this simultaneously artistic and religious commission with excellence is what earns him the appellation “wise man.”

What is stated only inferentially within the narrative of the Pentateuch is made quite explicit in the book of Proverbs. There “wisdom” is described as the goal of human existence. This “wisdom” is what fulfills a human being, what makes a person both complete and happy. These two moral expressions of the end of human life—completion and happiness—are called by a single term in Hebrew: *osher*. This form of happiness (*osher*), which is identified with wisdom (*hakhmah*), is the goal of the observance of “Torah,” which is the way that guides those who are religious: “those who fear the Lord” (*yirei adonai*).

Philosophy (Filosofia) in the Talmud

The understanding of an identity between wisdom and the fear of God becomes a guiding principle in the rabbinic literature. The rabbis understood their detailed development of the political and liturgical laws of the Torah that

comes to define the rabbinic Jewish state as a philosophy. Better, they understood it to be “the” philosophy, for they recognized that out of the Hellenistic world there has arisen other philosophies—notably Platonism, Aristotelianism, Megarianism, Cynicism, and most importantly, Epicureanism and Stoicism. Of these philosophies, the one that is closest to the values expressed in the earlier rabbinic literature is Stoicism, which at the time of the composition of the Mishnah was the leading philosophy of the Roman world.

Hence, to the extent that Stoicism can be called “science,” the rabbinic understanding of science and religion is one of integration. If by “science” we mean Aristotelianism or even Platonism, then the relationship between science and religion in the early rabbinic period would be one of indifference, since at this stage of development, the rabbis exhibit little knowledge of these philosophical traditions. If we identify science with Epicureanism or even Cynicism, then clearly the rabbis saw what they believed to be in conflict with science. However, to treat the relationship as one of integration with the science (i.e., philosophy) of Stoicism seems more accurate than the other alternatives. All rationalists who affirm the value of science do so in terms of what they judge to be good science, and based on that judgment, they are in conflict with what they would call bad science. Particularly if the analyses of Fischel and Neusner are correct, for the rabbis it is Stoicism that is both good science and good religion.

Medieval Judaism

The texts of classical Judaism provide the foundation for sophisticated, technical discussions of the relationship between science and Judaism in the Middle Ages. By “medieval Judaism” I mean the periods of the hegemony of the Muslim world (roughly from the eighth through the eleventh centuries in southern Spain, North Africa, and the Middle East), followed by the hegemony of the Roman Catholic Church in feudal, Western Europe. This medieval period divides intellectually as well as politically. During the earlier Muslim period, the dominant form of the relationship between science and Judaism is rationalist and integrative. However, as Jewish intellectual life develops in the later medieval, Christian period, the dominant form of relationship becomes mystical and conflictual.

Integration in Muslim Jewish Philosophy

By the tenth century, what we are calling “science” but they called “philosophy” consisted of a synthesis of valued texts of Hellenistic schools of thought, interpreted by Muslim and Jewish commentators. Similarly, what we call “religion” they identified with “revealed texts,” namely the Hebrew scriptures as interpreted by a recognized chain of rabbinic tradition. The generally accepted attitude to these two canons, one scientific and the other religious, was first

explained by Saadia Gaon in his *Book of Beliefs and Opinions* in the tenth century as what we have been calling integration.

More specifically, Saadia argued that since reason is a gift of creation from a perfectly good deity, and since reason purports to present what is true, then properly reasoned conclusions must be true. Similarly, Saadia argued that since the Hebrew scriptures also are a gift of revelation from a perfectly good deity, then what scripture says, when properly interpreted, also is true. Furthermore, since there only is one truth, just as there is only one God, so the proper conclusions of reasoning from sense experience (science) and the proper interpretations from reading the Hebrew scriptures (religion) must be in agreement. If they do not agree, then an error must have been made, either in interpreting the scriptures or in reasoning from sense experience.

Saadia also affirmed that the two domains of what is knowable through science and what is knowable through religion are identical. This latter judgment becomes modified in the subsequent course of medieval Jewish philosophy. In general the realm of what is knowable from reason was increasingly seen to be narrower than the realm of the knowable through revelation, and in those cases of separation, what was judged knowable through revelation alone became more valued.

One notable exception to this generation is Levi Gersonides, who lived in southern France in the fourteenth century. Gersonides distinguished himself both as a commentator on the Hebrew scriptures in his Jewish world and as an astronomer in Christian Europe. For Gersonides, there was nothing of reality that cannot be known both by reason and by revelation, and when both are properly understood, they will be seen to be in agreement. More representative of the late Middle Ages was the position of Maimonides, who argued that the most fundamental doctrines of religious belief were beyond what human beings without divine help can understand. These doctrines include the origin and end of the universe, the nature of God, and the nature of Mosaic prophecy.

In terms of Barbour's categories, the philosophies of some of the rabbis, notably Saadia and Gersonides, are almost pure examples of integration. Other Jewish philosophers, notably Judah Halevi (in eleventh-century Andalusia) and Hasdai Crescas (in fourteenth-century Italy), presented almost pure examples of conflict. For them, little of value for human happiness can be learned from science. Human well-being was dependent solely on the teachings of the Torah, and while the meaning of those scriptures can be attained through the guidance of rabbinic commentaries, the interpretations of the philosophers were of no value whatsoever. However, the prevailing position among Jewish philosophers up to the modern period was that of Maimonides. For him, most of the teachings of Judaism and science were integrated, while some teachings were not. However, in the latter case, the relationship is not, as it was for Halevi and Crescas, one of conflict. Rather, it was one of indifference. Science was not opposed to these teachings of Judaism. Rather, science simply had no basis to make a judgment one way or the other.

Conflict in Christian Jewish Mysticism

Where the positions of those philosophers who saw the relationship of science and religion to be one of conflict became most influential was in the increased popularity of Kabbalah in the intellectual life of Jews in the late Middle Ages and the early modern period. Whereas the philosophers had deprecated literature and imagination as a source for knowledge in favor of science and reason, the Kabbalists did the opposite. Hence, where the philosophical commentators showed that at its deepest level the words of the Hebrew scriptures are to be understood scientifically, the Kabbalists in books such as the *Zohar* wrote fanciful and highly imaginative interpretations of the scriptures, filled with elaborate emotive pictures rather than abstract logical arguments.

Despite their differences, what the mystics and the philosophers shared was the belief that the Torah, when properly understood, contains the secrets for living a fulfilled and happy life, and both advocated the interpretation of scriptures as the highest form of religious activity. The issue between them was the extent to which science contributes to this enterprise of spiritual text reading. In the modern period, this controversy will be reversed. Science will become dominant, while the moral, intellectual value of the study of scriptures will fall into epistemic disrepute.

Modern Judaism

The final period of major change in the Jewish understanding of the relationship between science and religion takes place in the modern period, first where the dominant cultural influence is the European Protestant nation, especially in the Netherlands and Germany, and finally where the dominant cultural influence is the post-French Revolution, secular nation state, especially in North America. In the modern period, the understanding of science and religion becomes primarily a political issue. The earlier modern focus on the relationship between the synagogue and the state in Protestant countries becomes transformed into a concentration on the distinction between the so-called secular and religious, especially as it is related to the question of the pursuit of happiness in ethics.

Separation with Respect to Synagogue and State

Our prime example of a Jewish theologian who deals with the relationship between science and religion is Spinoza. The text where he discusses that relationship is his *Treatise on Religious and Political Philosophy* (1670), the only book he himself published during his lifetime. If Spinoza were to locate his thought within Barbour's four classes of ways to relate science and religion, he undoubtedly would opt for independence. For him, the purpose of religion is to promote good citizenship within the state, and the clergy are masters of politi-

cal rhetoric, which has nothing to do with the pursuit of truth. Conversely, for Spinoza, the purpose of science is to discover truth, and in that pursuit politics, religion, and other imaginative activities are irrelevant. However, the way Spinoza experienced the relationship between science and religion in his own life was in terms of conflict. He suppressed his own writings from the public precisely because he feared religious and political condemnation. Many of the people Spinoza respected intellectually were condemned by their specific churches, and Spinoza was excommunicated by the Amsterdam rabbinate.

However, in many respects the case of Spinoza is *sui generis*. First, his Jewish community was composed largely of Spanish Conversos who had several generations earlier lost any real contact with more representative European Jewish communities. Second, Spinoza's own thought was centuries ahead of his time, especially in Jewish history; not until the nineteenth century would we again encounter a significant number of individuals educated both in Judaism and modern science who would attempt to determine the relation between the two. Of course, there were Jews before the nineteenth century who, like Spinoza, worked in science. Several Jews wrote on subjects as diverse as astronomy, human physiology, botany, zoology, and mineralogy. Among the most important of these are David Ganz and Joseph Solomon Delmedigo. However, they, like Spinoza, in no way reflect the age in which they lived. Yet, unlike Spinoza, they were committed to rabbinic Judaism, and also unlike Spinoza, they made no known intellectual effort to correlate their two intellectual backgrounds.

Nineteenth-century German Jewish intellectuals sought to reconcile their identity to the Jewish people with their desire to be accepted as citizens in a German nation state, and the argument for acceptance often turned on the ability of these Jews to demonstrate that in their professed age of enlightenment, Judaism qualified as a rational religion. The most important Jewish theologian to make this kind of an argument was Hermann Cohen. Grounding himself in his own interpretation of the philosophy of Immanuel Kant on the basis of a method of reasoning he developed from his work as a philosopher and logician of science, Cohen formalized the characteristics of an ideal religion whose doctrines were in accord with the best science of his age. Then he argued that, properly understood, the classical texts of rabbinic Judaism in fact constitute a paradigm of his idealized religion of reason.

In so arguing, Cohen explicitly had Spinoza in mind. His goal clearly was to integrate at least Judaism and science to serve any number of political and religious ends—to support an understanding of Judaism compatible with the pursuit of science as an ethical commitment, and to support the emancipation of the Jews in Germany at a time of growing prejudice against the Jews as a people.

Integration of the Secular/Religious Pursuit of Happiness

Despite the efforts of Cohen and Jewish theologians like him, the dominant model for a relationship between science and religion in the twentieth century

was independence, bordering on conflict. The position of separation adopted by the overwhelming number of Jewish-born intellectuals who became scientists was the position of Spinoza. The key difference was that these contemporary Jewish scientists in no way had Spinoza's knowledge of Jewish texts, from the Bible to its major medieval Jewish commentaries. Most of these scientists had even less knowledge than Albert Einstein. Einstein had studied the Bible at the age of twelve but gave it up after he learned something about modern critical theories about the Bible. His own thought about science and religion is close to Spinoza's, but he did not learn it from reading Spinoza's writings, to which he was introduced for the first time when he was seventy-one years old.

The modern Jewish scientists' understanding of the relation between science and religion as one of independence, which would be better described as indifference, was based on three primary factors. First, they had had negative experiences with the authoritarian quality of rabbinic education when they were children. Second, they accepted the view, focused around the trials of both Galileo and Scopes, that religion is the enemy of honest scientific research, and that progress is made in science despite religion. Third, they were affected by the principle of separation of church and state, which removes religious references from public education, thus limiting the public's understanding of religion.

However, this situation of independence/indifference may now be changing. As departments of religious studies expand across America, an increasing number of American students, no matter what their intended professions, are taking university-level courses in the history, thought, and practices of world religions. As this knowledge expands, many American intellectuals seem to be reassessing their prior negative judgments about the role of religion in society, and their own religious commitments. A significant body of literature is emerging that adopts an integrative stance toward science and religion.

This general change in intellectual life, at least in the English-speaking world, has its parallel in Jewish life. Several factors turned many intellectuals away from science. One was the great harm to humanity that science's hand-made, technology, produced in the form of modern weapons of mass destruction, ranging from repeater rifles (in the American Civil War) to machine guns and tanks (in World War I) to planes and bombs (in World War II). For Jews, the experience was magnified by the Holocaust. Judeophobia (a term coined by the Zionist ideologue Leon Pinsker for an irrational fear of the Jew) was not new, but the use of the work of nineteenth-century evolutionary biologists such as Darwin and Lamarck provided the conceptual foundation for a new form of Jew hatred, called anti-Semitism, that increased the venom of the belief exponentially. Older forms of Judeophobia were based on religion or culture, both of which could be changed. However, the new form, anti-Semitism, was based on race, and for a perceived racial deformity the only cure could be extermination. Again, it was science that provided the means to

carry out that extermination to a degree that in previous ages was not imaginable. After World War I, German Jewish theologians—notably Martin Buber and Franz Rosenzweig—adopted a romantic form of antirationalism that fueled the adoption by post–World War II theologians of an attitude of hostility toward science far beyond the medieval sources in Halevi and Crescas and their separatist model for understanding science and religion.

There are as yet few signs of the attitude of indifference/independence among religiously committed Jewish theologians. However, there are some signs of change among trained scientists who are beginning anew to explore the parallels between rabbinic Judaism and modern science—especially in terms of Big Bang cosmology in correlation with the doctrine of creation, of evolutionary psychology in correlation with traditional conceptions of humanity, and of principles of uncertainty in quantum mechanics in correlation with issues of human volition in rabbinic ethics.

Bibliography

- Barbour, Ian. *Religion and Science: Historical and Contemporary Issues*. San Francisco: HarperCollins, 1997.
- Brooke, John Hedley. *Science and Religion: Some Historical Perspectives*. Cambridge: Cambridge University Press, 1999.
- Fischel, Henry A. *Rabbinic Literature and Greco-Roman Philosophy: A Study of Epicurea and Rhetorica in Early Midrash*. Leiden: E.J. Brill, 1973.
- Neusner, Jacob. *Handbook of Rabbinic Theology*. Leiden: E.J. Brill, 2002.
- Samuelson, Norbert. *Judaism and the Doctrine of Creation*. Cambridge: Cambridge University Press, 1994.
- . *Revelation and the God of Israel*. Cambridge: Cambridge University Press, 2002.

3 Islam and Science

Toby E. Huff

“Islamic science” is currently the preferred term for the scientific activities carried on mainly, but not exclusively, by Muslims of various ethnic backgrounds throughout the greater Middle East from the inception of Islam up until the early modern era. The geographic area of these activities extended from Morocco to Afghanistan. Important Muslim scientific scholars lived in the famous cities of the Middle East, such as Baghdad, Damascus, Cairo, Tunis, and Fez, but also in Samarkand and Bukhara (Uzbekistan), Rayy (Iran), and Gazna (Afghanistan). The principal language used by these researchers was Arabic, and for that reason historians have also referred to the scientific work of these scholars as “Arabic science.” Yet this designation is inadequate and misleading. For while the main language of inquiry was Arabic, many of the active scholars were not ethnic Arabs. On the other hand, the term “Islamic science” evokes the theocratic nature of Islamic civilization, thus giving a religious component to scientific knowledge that was absent from the great philosophical minds of the golden era of Islamic intellectual development.

In the earliest phases of this new civilization-based activity, Christians, Jews, but also pagans, many of them living in or around Baghdad, took the lead. By the early eleventh century, Muslims became dominant as they became the demographic majority.

The Hellenic Heritage

Scholars in the Western world trace the evolution of modern science over a long history from the pre-Socratic Greeks through the Arabic-Islamic period of ascendancy, to the revolution of the sixteenth and seventeenth century. In the case of Islamic science, however, prior to the rise of Islamic civilization toward the end of the seventh century, there was in the Arabian peninsula, no “high culture,” no libraries, no significant repository of written records. Consequently, the early Muslim leaders, but especially the ruling dynasty of Abbasids located in Baghdad (beginning in the eighth century), launched a

robust translation program whereby virtually all of the available Greek scientific and philosophic heritage was translated into Arabic. Likewise, major scientific and philosophical materials in Persian and Sanskrit sources were translated into Syriac and Arabic.

To be sure, the translations were selective, but it was one of the most amazing and creative appropriations by one civilization of ancient and foreign materials from another. Inevitably conflicts would arise between the philosophical and metaphysical presuppositions of Hellenic culture and those of Islam. On a philosophical level, there would be a major intellectual conflict over the idea of natural causation, an important feature of all of Aristotle's writings. On a still higher level, there was a controversial question about whether the world was "created," or whether it had existed eternally as Aristotle postulated. This idea of the eternity of the world clashed with the fundamental creation doctrine of the three Abrahamic religions: Judaism, Christianity, and Islam. Similarly, discussions arose about the nature of matter, how it comes into being and whether it persists forever, whether human beings are only physical beings or whether they also have eternal "souls." This led to denials of bodily resurrection, as in the writings of the philosopher and physician Ibn Sina (Avicenna, 980–1037).

Lastly, it should be noted that despite the ubiquity of our term "science," there is no equivalent single term in either ancient Greek or Arabic (or Chinese for that matter). Indeed, the word "scientist" was only coined by the English philosopher William Whewell in 1838. Thus even with Greek texts, translators must make many linguistic choices when they come upon words that would be translated more literally as "wisdom" (*sophos*), "philosophy" (*philosophia*), "certain knowledge" (*epistemé*), and even "craft" (*tekne*) in the sense of "practical knowledge" of how things work or how to do something. Depending on the context, each of these could be rendered as "science."

The evolution of philosophical thinking in the Western world has resulted in our assumption that "science" or "scientific knowledge" is the queen of all forms of knowledge. Furthermore, in Aristotle's scheme of things, this knowledge was knowledge of first principles, of causes, and these latter were thought to be embedded in the nature of things. Through intense investigation, unaided by revelation, the "truth" could and would be found. Furthermore, Aristotle held that knowledge acquired *for its own sake* was higher and more worthy than practical knowledge.

In the Islamic world of the seventh and eighth centuries, this was not the case. There is no specific word in Arabic, even today, for "science." Instead, all forms of knowledge are referred to as *ilm* (knowledge), as in *ilm al-fiqh* (knowledge of jurisprudence), *ilm al-kalam* (knowledge of theology), *ilm al-hisab* (knowledge of mathematics), *ilm al-tabi'i* (knowledge of nature), and so on. Consequently, the "one who knows" is the *alim*, or scholar, and the plural form is *ulama*. This latter term is generally translated as "religious scholars," but depending on the context, the same word is translated as "scientists."

Moreover, in the Islamic tradition, religious knowledge is unquestionably the highest form of knowledge. Many Muslims throughout the world and over the centuries have accepted the Quran as a complete book of knowledge, following such Quranic verses as “We have sent down to thee the Book, explaining all things” (Q. 16:89), and “We have ignored nothing in the Book” (Q. 6:38). This has led Muslims to claim that all knowledge, even scientific knowledge, is to be found in the Quran. A whole body of literature grew up called “Prophetic medicine,” which purports to contain medical remedies derived from the sayings and the practice (sunna) of the Prophet, Muhammad. While many Muslims have objected to the practice of trying to find passages in the Quran that foreshadow all of the most recent discoveries of science, all agree that one should not use the insights of modern science to elucidate the Quran. This differs from the practice of early modern Christians, as early as the twelfth and thirteenth centuries in Europe, of using science to elucidate scripture. Instead, for Muslims, science is assumed to confirm the Quran.

Given this context, it is easy to understand that at a fundamental epistemological level, there was an inevitable conflict between the assumptions of Greek philosophy, especially the Aristotelian articulation of that philosophy, and strictly Islamic assumptions. It must be emphasized, however, that the early generations of Muslim scholars, from al-Kindi (died c. 873)—called “the philosopher of the Arabs”—through al-Farabi (870–950), Ibn Sina (980–1037), and al-Biruni (973–1048), wholeheartedly embraced the spirit of Greek philosophy. At the same time that they explored the deep assumptions and metaphysical implications of Hellenic thought (especially the two strands represented by Plato and Aristotle), they assumed that they were pursuing a universal mode of knowing the world, one that transcended its Greek, Indian, or later Arabic and Islamic idioms. In other words, they were not of the opinion that “Islamic science” was independent of the Aristotelian methodological and epistemological moorings, but that these were universal assumptions shared by all those who sought to advance the naturalistic understanding of the cosmos. Not all of their coreligionists shared such a view, and indeed, a number of groups of Muslims even today want to appropriate the term “Islamic science” to mean a kind of scientific inquiry that is exclusively rooted in their understanding of the Quran and the Islamic heritage.

Science in the Service of Islam

It could be argued that the translation movement from the late eighth to the end of the ninth centuries brought together in one language community (Arabic) the largest and most diverse concentration of scientific materials in the history of the world up to that time. These covered arithmetic, geometry, astronomy, medicine, optics, geography, and other areas. Moreover, it has to be said that many of the recipients of these new materials embraced them with enthusiasm as well as originality.

Perhaps no other field of inquiry had more effort and resources devoted to it than astronomy, including the building of observatories of short-lived duration. From the late eighth century onward, Arab and Muslim astronomers devoted huge efforts to understanding the technical workings of the heavenly spheres. On the one hand, this was the result of having received the *Almagest*, the magisterial astronomical work by Ptolemy (c. 100–170), and then discovering that Ptolemy's theoretical models contained breached assumptions, implausible outcomes, and predictions that diverged from empirical observations. Consequently, from the ninth century to the fifteenth, first-rate Middle Eastern astronomers proposed corrections and alternatives to Ptolemy's models, although actual alternatives to the Ptolemaic models did not appear until the thirteenth century.

On the other hand, the celestial environment represents a cosmic time-keeping framework that could be usefully conjoined with fundamental Islamic beliefs—if a mathematical apparatus were also devised. That is, two fundamental Islamic imperatives stipulate that during prayer the believer orient himself or herself toward the direction of Mecca (the *qibla*), and that prayers be performed five times a day: in the early morning before sunrise, at noon, in mid-afternoon, before sunset, and after nightfall. Of course, such intervals could be determined by using simple shadow-casting devices (as they were by the religious scholars, the *fuqaha*), although the early morning interval is visually problematic, especially during full moon. But if the muezzins (those who call the faithful to prayer) in each of the local mosques were expected to issue the call to prayer in a somewhat synchronized fashion, then the prayer times would need to be standardized, or at least independent scholars might take on the task of establishing exact times themselves. In fact, mathematical astronomers did take upon themselves the task of working out both the times of prayer in particular locations and the direction of the *qibla*, using spherical geometry and trigonometry. Only by using these tools of mathematical astronomy could close approximations to the true direction of Mecca be arrived at for Muslims living far away from the sacred shrine. Likewise, timekeeping required mathematics.

With these inspirations at work, Muslim mathematicians and astronomers contributed significantly to the development of just about every domain of mathematics between the eighth and fifteenth centuries. Perhaps the most significant of the early innovations was the development of algebra in the early ninth century by al-Khwarizmi (780–c. 850). Successors to al-Khwarizmi began to systematize the Hindu-Arabic numerals while proceeding to make advances in algebraic analysis, number theory, geometry, and trigonometry. These mathematical advances, especially in geometry and trigonometry, enabled others to carry out remarkable works in geography, cartography, and mathematical astronomy. Some of these mathematical techniques were also used to make calculations of the areas of arches and the volumes of vaults in architectural plans.

For the purpose of travel and for orienting oneself to the *qibla* in distant places, Muslim mathematical astronomers created tables of directions and distances to Mecca for wide areas of the “middle belt” of the world, extending from the islands off the coast of Morocco to China. The first and most significant of such tables were those of al-Biruni in the tenth century. Creating such tables of directions and distances to Mecca became a common activity among Muslim mathematical geographers into the nineteenth century.

At the same time, Muslim astronomers and timekeepers (*muwaqqits*) developed extraordinary tables of planetary observations—*zij* tables—that would allow one to tell the time of day in any location by making simple observations of the sun’s height using an astrolabe or quadrant and consulting a *zij* table. Some of these tables had hundreds of thousands of entries. Today, standard tables for the times of prayer are produced and sold in every corner of the Muslim world.

Despite all these technical advances, Middle Eastern scholars were not able to bring about the revolution in astronomy that is associated with the names of Copernicus and Galileo. More remarkable still is the fact that the Damascene astronomer and *muwaqqit* Ibn al-Shatir (1305–1375) developed astronomical models that were in most respects identical to those of Copernicus, except for their geocentric orientation maintained by the Ptolemaic system. In that sense, Muslim astronomers, despite their great mathematical virtuosity, were not able to make the transition from the “closed world to the infinite universe,” to use the phrase of French historian of science Alexandre Koyré.

Instead, the most notable revolution in physical science in the Middle Eastern world occurred in the science of optics. This was carried out by Ibn al-Haytham (c. 965–1040), working in Cairo, who performed many experiments demonstrating the rectilinear transmission of light from an object to the eye of the observer. Ibn al-Haytham overcame various alternative theories derived from Plato’s theory of knowledge that postulated the emission of rays from the observer’s eye to the object. He also countered the theory that objects in our surroundings transmit invisible forms (or “eidolas”) from the original objects to our eyes. After discovering the rectilinear propagation of light in all directions, al-Haytham worked out the nearly point by point transmission of light from an object to the surface of the eye, as well as the angles of reflection on the eye, while giving the mind the task of assembling the meaning of this “image” within. This new theory could be reached only by using geometrical diagrams and solving fourth-degree algebraic equations. Subsequently, all pioneering work in optics in Europe and elsewhere built on these foundations established by Ibn al-Haytham.

Ibn al-Haytham’s work clearly revived the study of optics in the Arab-Muslim world, as well as in Europe. One of the next problems that al-Haytham’s work gave rise to was the explanation of the rainbow. Two Persian scholars, Qutb al-Din al-Shirazi (1236–1311) and Kamal al-din al-Farisi

(c. 1260–1320), both arrived at the conclusion that the rainbow is the result of two refractions and one reflection of the sun's light in a drop of water. Kamal al-Din performed experiments with a vial of water to arrive at his conclusions. Both men were preceded by Theodoric of Freiburg (c. 1250–1310), who came up with the same explanation independently but who was also influenced by the work of Ibn al-Haytham.

The other field in which Arabs and Muslims made significant contributions was that of medicine. With the translation of the seminal works of Hippocrates and Galen into Arabic, the foundation was laid for a renaissance of medical teaching and inquiry in the Arab-Muslim world. Among the early synthesizers of the medical corpus from Persian, Greek, and Indian sources, al-Razi (c. 865–958) and Ibn Sina were the most significant. Each was very astute at medical diagnosis as well as articulate with medical descriptions, and each prepared a canon of medical knowledge. Al-Razi is credited with the first clinical description of smallpox. Building on al-Razi's work, Ibn Sina compiled a great canon of medical knowledge that served as a physician's handbook and manual for instruction for many centuries. Indeed, about a hundred years after the death of Ibn Sina, the canon was translated into Latin and soon thereafter became a major component of medical education in European universities until the sixteenth century.

Many other Middle Eastern physicians contributed to medical practice, and even to the art of surgery. A famous book of surgery written by Abul al-Qasim al-Zahrawi (Albucasis, c. 936–1013) was also translated into Latin in the twelfth century. Although al-Qasim's work contains exacting details of surgical procedures, it is unknown whether these procedures were employed in the Middle Eastern world. Nevertheless, the arrival of the book in Europe inspired new thought and inquiry about the practice of surgical intervention with human subjects.

In the thirteenth century, Cairo and Damascus emerged as the two great centers of medical practice in the Arab-Muslim world. This was reflected in the work of Ibn al-Nafis (1210–1288) and Ibn al-Quff (1233–1286), who worked in the important hospitals of the two cities at one time or another. These hospitals had separate wards for various ailments, injuries, and areas of medicine, such as ophthalmology and gynecology. In addition to describing the cavities of the heart with surprising accuracy, al-Nafis deduced the "lesser circulation" of the blood from the heart through the lungs and back to the heart. Similarly, Ibn al-Quff provided an amazing description of the valves of the heart, as well as the stages of growth of the human embryo, and this despite an implicit ban on the practice of dissection. Indeed, al-Nafis affirmed that he avoided human dissection for religious reasons.

In addition to these aspects of medical practice, there was also a very sophisticated branch of pharmacological knowledge used by physicians. This was based on the work of Discorides (c. 40–90) and his famous *Materia medica*. Arab and Muslim physicians devoted considerable energy to understanding

all the materials described by Discorides, and went on to identify dozens, if not hundreds, of new medically useful ingredients.

Despite the advances in anatomical description, Islamic medicine was not able to go forward in the study of anatomy because of the ban on human dissection. This stands in contrast to the situation in Western Europe. Within a couple of decades of al-Nafis's death, European physicians published textbooks of anatomy along with descriptions of the process of human dissection that was being brought into the medical colleges attached to universities in Europe. This tradition culminated in the publication in Brussels in 1543 of the results of Andreas Vesalius's anatomical work in Padua, accompanied by highly detailed, realistic drawings of human anatomy. This book, *The Fabric of the Human Body*, laid the foundations of modern anatomy, as well as modern medicine. In the Arab-Muslim world, however, the primitive, pre-Islamic models of human anatomy were still being reproduced in the nineteenth century.

Religious Reactions

Although the Islamic world had to its credit the many advances mentioned earlier, the natural sciences in the Islamic world began to stagnate. Royal patrons supported many of the early pioneers in the study of natural philosophy in the greater Middle East. When they lost that patronage, they frequently fell into disfavor and danger, for there was always an undercurrent of suspicion directed toward natural philosophy on the part of the traditional religious scholars. Even al-Biruni in his great work on the directions and distances to Mecca felt compelled to counteract the view that all knowledge that is not "useful" for religious purposes is against the spirit of Islam. It was said that pursuing such knowledge was an imitation of foreigners and nonbelievers, and therefore should be avoided. But the sharp-witted al-Biruni remarked that foreigners also eat, so if one objects to all the things that foreigners do, then "don't eat!"

But the most severe reaction against philosophy and the natural sciences came from al-Ghazali (1058–1111). Al-Ghazali was undoubtedly one of the most gifted philosophers the world of Islam ever produced, but he turned his talents against the "speculative" and hypothetical side of scientific knowledge. In his famous work *The Incoherence of the Philosophers*, he singled out the work of Plato, Aristotle, Hippocrates, and Galen as antithetical in large part to the spirit and practice of Islam. He then directed his attacks against al-Farabi and Ibn Sina for their acceptance of the philosophical views entailed in the idea of the eternity of the world, their doubts about the resurrection of the body, and their belief in natural causation, which would limit the power of God and prevent miracles.

Although Ibn Rushd (Averroës, 1126–1198) wrote a powerful rebuttal to al-Ghazali, his reply fell on deaf ears in the Muslim world. Al-Ghazali's views, especially his championing of "occasionalism," carried the day. According to

Islamic occasionalism, a view developed by the theologian al-Ash'ari (c. 873–935), every action in the world is the product of God's will, or of God's "habitual action" that produces the apparent regularities of the world. Natural causation is but an illusion that always depends on God's will. This view was also applied to human action, though it obviously raised deep questions about human "free will" and responsibility. If every act is willed by God, then God has predetermined all our actions and it would be impossible to hold individuals responsible for their acts. Islamic thinkers saw this contradiction but were not able to resolve the philosophical quandary. Islamic thought continued to insist that God is in control of the world at every moment, and this is why al-Ghazali attacked so severely the naturalistic view of causation.

Islamic doctrine also insists that God is the only "creator" and that, unlike the Christian tradition, human actors do not share any attributes with God, especially divine rationality. This stands in contrast to the Christian view that human beings are made "in the image of God" and thus share reason and "inner light" with God.

Apart from these philosophical and theological issues, other impediments in Islamic thought prevented the institutionalization of science and natural philosophy in the Muslim world. These stem from the belief that Islamic *law* is the operative intellectual structure guiding all proper Islamic conduct. Islamic law is based on the Quran and the sayings (*hadiths*) of the prophet Mohammad. Since these are the sacred and unchanging sources of all Islamic legal prescriptions, and have been interpreted authoritatively by many legal scholars (*fuqaha*), the sense emerged in the tenth century that legal thought had arrived at a complete and standard view of the basic legal principles and structures of Islamic law. But one of the missing components in Islamic law was the idea of a "fictional legal personality," that is, a corporate identity shared by a group of individuals, treated as if they had "one will" and were collectively endowed with a bundle of legal rights. Such a legally autonomous entity would allow groups of individuals to distinguish themselves from others as citizens with their own rights and privileges, or as members of legally autonomous residential communities (cities and towns), or as professionals in a guild, such as a guild of lawyers, doctors, or merchants. But such legal differentiation was antithetical to the universalism of Islamic law and therefore did not emerge.

Consequently, when the distinctive Islamic form of higher education emerged, the madrasa, it was conceived as a religious trust (*waqf*), and within such an entity both the spirit and the letter of Islamic law had to be observed. Hence, the madrasas were established to defend and preserve Islamic thought and teachings, and since many components of the natural sciences and metaphysics were perceived as un-Islamic, the curriculum excluded the study of natural philosophy and natural science, as well as natural theology. Moreover, since every madrasa is created with a specific founding document and no possibility of amending it later, the madrasas were not able to evolve in the

direction of European universities, which were legally autonomous corporations. The latter could establish their own curricula and change their rules and regulations over time. Furthermore, the creators of the European universities intentionally incorporated the naturalistic teachings of Aristotle, along with many Arab commentaries, into their curricula.

Decline

The current historical evidence suggests that the high point of Islamic mathematical astronomy occurred during the Mamluk period (1250–1517). Despite their impressive levels of mathematical acumen and prowess in instrumentation, Muslim astronomers were not able to break out of the Ptolemaic framework. As we saw earlier, scientific thought in both optics and medicine had reached an apogee by the early fourteenth century. Consequently, during the Ottoman period (1517 and thereafter), the gradual decline of original thought accelerated, which is reflected in the practice of writing commentaries on commentaries, rather than attempting original work. Moreover, the profound intellectual shifts occurring in Western Europe, the humanistic renaissance of the fourteenth century and the revolutions in medicine and astronomy of the sixteenth century, passed virtually unnoticed in the Ottoman world. This was the state of thought that Napoleon's men found when they invaded Egypt in 1798. Investigations by historians of science and reports from eighteenth-century travelers to the Middle East confirm the view that all of the major scientific discoveries of the sixteenth, seventeenth, and early eighteenth centuries in Europe—in medicine, biology, chemistry, and physics—were unknown in the Middle East at the end of the eighteenth century. Those who may have known about the Copernican revolution, for example, were uninterested in it. Reconciliation of Islamic thought with the implications of modern natural science had to wait until the end of the nineteenth century.

The Present

The production of scientists and engineers in the Muslim world has lagged considerably behind other parts of the world, despite the fact that engineering is one of the most popular career choices of Middle Eastern students. The Muslim world has just two Nobel Prize winners, whereas Switzerland, a country of 7 million today, has twenty-five Nobel prizes to its credit. The Muslim winners include the Pakistani Abdus Salam for work in physics (1979) and Egyptian-born Ahmed Zewali in chemistry (1999). Not surprisingly, the work for which each of these scientists was awarded the prize was carried out either in Britain or the United States. Abdus Salam received a Ph.D. in theoretical physics at the University of Cambridge in 1949, after having won the Smith Prize from Cambridge for the most outstanding predoctoral work in physics. Ahmed Zewali, whose doctoral training was at the University of Pennsylva-

nia, received his award for pioneering the study of rapid chemical and physical processes using short laser flashes.

It is true that the high-level study of the natural sciences has not been fully institutionalized in predominantly Muslim countries, but there is great interest in the modern sciences and engineering in the Muslim world, especially by “Islamists.”

Bibliography

- al-Ghazali. *The Incoherence of the Philosophers*. Trans. and Intro. Michael E. Marmura. Provo, UT: Brigham Young University Press, 1997. (Parallel English-Arabic text.)
- Gutas, Dimitri. *Greek Thought, Arabic Culture: The Graeco-Arabic Movement in Baghdad and Early 'Abassid Society (2nd–4th/8th–10th Centuries)*. New York: Routledge, 1998.
- Huff, Toby E. *The Rise of Early Modern Science: Islam, China, and the West*. 2nd ed. Cambridge: Cambridge University Press, 2003.
- Makdisi, George. *The Rise of the Colleges: Institutions of Learning in Islam and the West*. Edinburgh: Edinburgh University Press, 1981.
- Nasr, Seyyed Hossein. *Science and Civilization in Islam*. New York: New American Library, 1968.
- Sabra, A.I. “The Appropriation and Subsequent Naturalization of Greek Science in Medieval Islam: A Preliminary Statement.” *History of Science* 25 (1987): 223–43.

4 The Place of Science in the Hindu Worldview

P. Venugopala Rao

Hinduism as we understand it today has its roots in the soil of India some six thousand years ago. Some of the key concepts that became part of the present-day Hindu worldview can be traced back to the ideas first articulated in the hymns of the Vedas, the sacred literature of Hindus. However, views about nature, human beings, the divine, and the relationships among these have evolved since then. While one cannot claim that all Hindus subscribe to one coherent picture of their world and their place in it, it is possible to recognize a worldview that influences their lives in a general way and is the source of the inspiration by which they guide their lives. In the context of understanding the growth of scientific knowledge, it helps to know how a given culture perceives and organizes the world around it. The worldview of a people acts as a lens through which they examine their world, sometimes helping them with clear vision, sometimes distorting their perceptions, and many times inspiring them to act wisely and conduct themselves morally. How does scientific activity fit into the worldview and life of Hindus? To answer this question, we must first look at the basic elements of their worldview and then examine the history of the growth of their science.

Rita and Dharma: Concepts of Cosmic Order

Within Hinduism, the single idea that seems to have an overarching influence is that of Rita, which means cosmic order. Rita is an eternal law that controls, unifies, and orders all phenomena throughout the universe. It is Rita that directs the manifestation, dissolution, and reappearance of existence at the cosmic level. It combines our ideas of norm, order, rhythm, and structure. We encounter this concept first in the *Rig Veda*, the earliest compilation of the sacred texts of Hinduism. In the later sacred literature, the concept is also known as dharma. Rita is manifest as the law of universal causation in the physical domain and as moral causation for human beings. The special case of moral law has come to be known as karma.

The relevant aspect of Rita in the context of science is the acknowledgement of the strong, irrevocable relationship between cause and effect. Our ordered universe and Rita are of the same ontological category. Hindu thought often emphasizes the notion that each thing functions according to its own structure and nature in interaction with other things. All change and development occur according to this law-governed nature of things. These individual relationships are part of the dharma that holds the universe together. We human beings must strive to indulge in appropriate modes of action that are consistent with and embody Rita. This ordered wholeness became Brahman in the Upanishads. In theistic versions of Hinduism, God (Isvara) becomes the supervisor of this eternal law. The basic presupposition of scientific enquiry, which is the causal principle and keeps us motivated to search for explanations of phenomena, is a reflection of this Rita. The scientific attitude of inquiring and knowing has thus become a legitimate and prescribed mode of existence for all sentient beings in the Hindu worldview.

The Darsanas: Six Systems of Philosophy

Rita and dharma are not the only ideas that define the Hindu worldview. Distinct layers of significant intellectual activity shaped Hindu thought over the millennia, resulting in multiple traditions of looking at the world. Six systems of thought constitute the Hindu exploration of the nature of the universe and related fundamental questions. These are referred to as darsanas (views). They include a philosophical theory of reality and a plan to guide humans toward reaching that reality in their own existence. The six darsanas have some common features because the common reservoir of thought from which they derive their inspiration is what is said in the Vedas. The real is not just that which is extended in space and time: there is something deeper. There is a universal rhythm consisting of vast periods of manifestation, maintenance, and dissolution. In each new phase of the universe, the unexhausted potencies of the past are provided opportunities for fulfillment.

The six darsanas are Mimamsa, Nyaya, Vaiseshika, Samkhya, Yoga, and Vedanta. A detailed exposition of these darsanas, touching on various other aspects such as religious and spiritual values and moral conduct, can be found in the classic works on Indian philosophies by Sarvepalli Radhakrishnan. What follows is only a brief summary of each school of thought.

Mimamsa views the world as real and eternal, with no beginning and end, and consisting of many things. Action is the primary mode of existence and controls the universe. As individuals, we participate in and contribute to this action. Life is meant for eternal activity. God has no place in this system.

Nyaya is concerned about our way of knowing the world. It insists that we should know the nature of reality as it is. But we should also know how we can know and what we can know. Thus logic and epistemology are important and essential in Nyaya discourse. Vaiseshika supplies the metaphysical foun-

dations for the Nyaya school of thought. The world and its processes, including the activities of sentient beings, are described in terms of particulars (*viseshas*), which are independent of one another, infinite in number, and cannot be reduced to anything common. The world is pluralistic and real.

Samkhya, unlike Nyaya and Vaisesika, treats the world as unity. The apparent plurality of our world is derived from this unity through a process of evolution. Everything that is manifested is already potentially existing in this unity, which is called *prakriti*. The first evolute, or manifestation, of *prakriti* is reason (*buddhi* or *chitta*). Thus reason acquires an ontological significance. Since everything is due to the transformation of this first evolute, controlling it gives the power of understanding and controlling everything. Existence is made up not only of the evolutes of *prakriti* but also *purushas* (or *atmans*) that are infinite in number and are by nature pure existence and consciousness. (*Prakriti* and *purusha* are sometimes equated with the concepts of matter and soul, respectively.) When *purusha* desires, *prakriti* evolves the world—and withdraws it when *purusha* is no longer interested. Our phenomenal being is composed of this *prakriti* associated with *purusha* and derives all its faculties from *prakriti*. It is an atheistic philosophy. Yoga darsana has borrowed this metaphysics and added the notion of *Isvara* (God). Samkhya and Yoga together have become a foundation for the working philosophy of individuals.

Vedanta is built on the philosophical views developed in the Upanishads. The ground of all beings and all that exists is one indescribable unity called *Brahman*. *Brahman* is immanent as well as transcendent. Many elements from Samkhya darsana are incorporated into this system under the commanding and overshadowing concept of *Brahman*. We are all members of this *Brahman* and carry its essence in us, but we are not aware of it and are even ignorant of it. The goal of all human beings is to strive for the experiential realization of this true source of our existence. This state of realization is to be understood as a state of liberation or salvation (*moksha*).

Nature and Science

Summarizing the foundational premises of Hindu thought, and keeping in mind that Vedanta emerged finally as the most influential and accepted mode of thinking, we can say the following about the Hindu worldview. We live in an interconnected world of ordered wholeness, of which we are mostly ignorant, being only a small part of it. But we have the potential to understand it and even to experience its essence. Knowing oneself and the universe is an essential activity of any intelligent being. For a Hindu, nature includes not only the physical universe, but also celestial beings and cosmic forces. And there are very meaningful relationships among the various components. Combining through the many Hindu myths, we find many facets to this relationship.

A Hindu celebrates while participating in the act of understanding nature. If science were to be understood as such an activity, every Hindu must be living like

a scientist. But, although the Hindu worldview is hospitable to a scientific attitude, India does not have a strong connection to the origins of modern science.

Harappan (Indus) Civilization

Historians of science in India record that the foundations of scientific thought were laid down as early as the Harappan civilization, also known as the Indus civilization, which lasted from roughly 3100 to 1900 BCE. Facts supplied by archaeologists support this thesis. Covering a little less than half a million square miles, the Harappan civilization was a complex of city-centered communities of agriculturists and craftspeople. The Harappans were a disciplined people, and this discipline was visible in all walks of life. For example, they have been credited with the knowledge of the science of yoga. The Harappans invented an alphabetic system of writing that simplified a partly pictographic script, using simple cursive signs with basic phonetic values. Harappans became pioneers in studying tides, waves, and currents and put their knowledge to practical use to build tidal docks. There is circumstantial evidence for maritime trade. Extensive trade provided the stimulus for the development of an elaborate system of weights and measures. Archaeologists have also found evidence of a rudimentary astronomical system.

Vedic Times

The Vedic literature (c. 1500–500 BCE) provides us with evidence of astronomy. The development of geometrical, mathematical, and astronomical knowledge was preserved in the Sulbasutras, composed and systematized somewhere between 800 and 600 BCE. We also know the work of the grammarian Panini, of c. 600 BCE, which is considered an intellectual achievement for all time.

A few centuries later, mathematical and astronomical knowledge represented a shift away from earlier dependence on religion. The most well-known text of this period is the *Surya Siddhanta* (400 CE), a repository of astronomical knowledge. A key innovation arising from the *Surya Siddhanta* was the use of the sine of an angle. The period spanning the first millennium CE witnessed the work of the famous Hindu mathematicians and astronomers Aryabhata, Varahamihira, Bhaskara I, Brahmagupta, Mahavira, Sridhara, Aryabhata II, and Bhaskara II. Historians of science and mathematics find the numerals and zero of modern mathematics in use in ancient India.

Along with these branches of science, a range of medical systems developed and flourished. The best known of these is Ayurveda, meaning the knowledge of long life. Key texts of this discipline are the *Caraka Samhita* and *Susruta Samhita*. The growth of medical knowledge also stimulated the development of a number of auxiliary systems of knowledge in botany and chemistry. By the end of the first millennium, the pursuit of knowledge through critical inquiry appears to have reached maturity.

Medieval Times

Medieval India, as described by Rahman, is characterized by a high degree of economic and manufacturing enterprise, which is seen in the extensive maritime trade in cotton textiles, iron, and steel that ranged from Southeast Asia, to Africa, to Western Europe. The keen interest in astronomy shown by Mughal emperors Babar, Humayun, Akbar, and Jahangir was well documented. The widespread use of astrology, which is closely dependent upon astronomy, and the felt need to compile and reform different systems of calendars kept astronomy a highly patronized area of interest. The five gigantic observatories designed and constructed by Raja Jai Singh in the early eighteenth century stand as the most spectacular expression of the patronage accorded to astronomy by the rulers of the land.

If we take into account all of this, it is not unreasonable to assume that there did exist in medieval India a fair degree of development of technology and the necessary science that goes along with it. But compared to earlier periods in history, the medieval times were a period of stagnation, lacking the challenge of new problems that required new knowledge to solve them. Even though these were times of considerable social change, India remained largely an agricultural society, one fragmented with castes. The Muslim invaders did not bring their glorious tradition of science, which once benefited the European countries, into India. Attempts to control the spread of knowledge, scientific or otherwise, and limit it to a small elite stifled the growth of science.

Colonialism

For almost two hundred years before independence, India was under the influence of British colonialism, first under the East India Company and later under the direct rule of the British government. The early colonial rulers were very careful to legitimize their presence and their power, for example by discrediting the existing social structures, and they did not initially consider it necessary to educate Indians in the sciences they knew. But soon they found it necessary to impart some useful education to their Indian subjects. They needed local personnel to fill in the positions of colonial administration and to serve in the large-scale, state-sponsored enterprises such as railways and public engineering works. But this minimal science education was imparted only as a means through which to expand and consolidate their empire in India and to extract maximum profit from the natural resources of the country with the help of local manpower. Teaching science for the sake of knowledge did not fit into the colonial scheme.

However, Western science and technology trickled through during this phase of British rule, and Indians appreciated what they came to learn. As Satpal Sangwan writes, "The appearance of the surveyor, the plant collector, the mineralogist and the introduction of steam vessel, steam railway, electric tele-

graph, printing press, telescope and a host of other inventions began to arrest the attention of the local populace. The Hindus, the Muslims, the artisans, the cultivators, the feudal lord or the local ruler, all were aware of the magical spell of the new phenomenon, and therefore approved its diffusion. The elite members of the Indian society became the active agents in the transmission and spread of the new scientific world view.”

By the late nineteenth century, there was increasing and enthusiastic demand for the introduction of Western science and technology. It was in such an atmosphere that the Indian Association for the Cultivation of Science was established in 1876. The institution was to correct the exclusive emphasis of the colonial rulers on technical education and to provide opportunities for teaching and research in basic sciences. The association trained a number of scientists in basic research, who later played an active role in the development of scientific institutions in India.

Science in Independent India

Nourishing and promoting a scientific temper has become a goal of supreme importance to India since it achieved independence in 1947. India may be the only nation that has officially designated the development of science as the responsibility of the government. In 1958, the Indian parliament adopted a Scientific Policy Resolution, drafted and introduced by Pandit Jawaharlal Nehru. According to this resolution: “It is only through the scientific approach and method, and the use of scientific knowledge that reasonable material and cultural amenities and services can be provided to every member of the community, and it is out of recognition of this possibility that the idea of a welfare state has grown.”

The growth and accumulation of scientific knowledge on Indian soil has its ups and downs, which are largely due to social, economic, and political factors rather than any limitations imposed by the worldview of the majority of its inhabitants. After its independence in 1947, India launched programs to develop science and technology with speed and intensity. Their success is testimony to the fact that the Hindu worldview is open to scientific endeavor.

Bibliography

- Chattopadhyaya, D.P., and Ravinder Kumar, eds. *Science, Philosophy, and Culture in Historical Perspective*. New Delhi: Project of History of Science, Philosophy, and Culture, 1995.
- Pappu, S.S. Rama Rao, ed. *The Dimensions of Karma*. Delhi: Chanakya Publications, 1987.
- Radhakrishnan, S. *Indian Philosophy*. Delhi: Oxford University Press, 1923.
- Rahman, A., ed. *History of Indian Science, Technology, and Culture AD 1000–1800*. New Delhi: Oxford University Press, 1999.
- , ed. *Science and Technology in India*. New Delhi: Indian Council for Cultural Relations, 1973.
- Sangwan, Satpal. *Science, Technology, and Colonization: An Indian Experience 1757–1857*. Delhi: Anamika Prakashan, 1991.
- Sharma, V.N. *Sawai Jai Singh and His Astronomy*. Delhi: Motilal Banarasidass, 1995.

5 Science and Religion in Africa

Gloria Emeagwali

In various regions of Africa, and over a long history, we see the intersection of science and religion. African spiritual values and religious practices have links with the ideals and outcomes that we associate with science: the discovery of natural and physical phenomena through observation, conjecture, experimentation, and problem solving. Several distinguished philosophers of science have contributed to a view of science as epistemologically diverse, multi-regional, and multidimensional. Paul Feyerabend (1924–1994), for example, argued against placing science in a straitjacket. Science emerges out of various contexts and manifests itself in various ways, he asserted. Karl Popper (1902–1994) defended the interaction of body and mind in the creation of knowledge and scientific ideas. He argued also that all organisms are problem finders and problem solvers, and that scientific knowledge is as old as life itself and very much a product of multiple interactions. For these scholars, science emerges in the context of humanity's innate quest for survival within a specific environmental, ecological, and social context. For these and other philosophers the line of demarcation between scientific knowledge and religion is somewhat blurred except for some basic enduring features.

One important distinction between religion and science seems to be the range and scope of the exercise engaged in by the two communities. The religious enterprise is often exclusively linked to a supernatural world of spiritual entities and divinities and is often constructed on an edifice of faith. The community of scientists retains a healthy skepticism even while conceding that a world of unseen intelligence may exist around us. Experimentation is a crucial aspect of science and so, too, are bold conjectures and hypotheses about the physical and material world. In the interactionist model of Feyerabend, for example, the intersection of mind and body, idealism and reality, or subjectivity and objectivity does not mark an end to science but presents a challenge.

We find many examples of the interaction between science and religion before the twentieth century in Northeast Africa and West Africa, especially

in the field of medicine. Other examples are found throughout Africa in the development of metallurgy and mathematics, as well as in ecology and animal conservation policies.

Northeast Africa

Some of the earliest links between science and religion are found in ancient Northeast Africa dating from the middle of the fourth millennium BCE. As many as 1,500 officially recognized spiritual entities called *neteru* pervaded the Egyptian-Nubian universe. Local villages, communities, towns, and provinces paid homage to these popularly recognized deities who were believed to preside over air, the planetary bodies, rivers, and other waterways. Some of the *neteru* were believed to be the product of spontaneous self-creation, the finest example of this being Khepera and Ausares. In *The Book of Knowing the Evolutions of Ra and of Overthrowing Apep*, Khepera affirms: "I am he who came into being in the form of the god Khepera and I am the creator of that which came into being." Nun and Temu were also among the self-created *neteru*. Yet others were the reincarnation of ancestral spiritual entities. The spirits of dead ancestors were believed to live on to protect the living, and concepts of evolution and reincarnation were significant in the belief system. Transformation into a snake, crocodile, or lotus in the after-life necessitated invocations.

Among the ancient Egyptian temple officials in the fourth to the second millennium BCE and "servants of the gods" was the *kher heb*. This priest used protective amulets in his quest to communicate with and control the all-pervasive spiritual world, and he foretold the future, explained portents, and exorcised evil or angry spirits. The *kher heb*, a master of words, perfected the art and science of communicating with the unseen and the unknown. There was an underlying assumption that spiritual forces were generally positive and negative, and that the appropriate offering or amulet could attract the good forces or deter the bad. Sacred protective amulets and charms became an important aspect of religious activity and the *kher heb* played a major role in their creation. Recital of appropriate religious formula and special inscriptions enhanced their efficacy. The ankh and the scarab were among the most common amulets, and those who wore them felt fortified. Should a good or evil spirit inhabit the body of the *kher heb*, he would temporarily exhibit the body movement, speech, or character of the entity. The *kher heb* could cast out such invaders from his body with or without the help of others, depending on his powers. Masks were worn on special occasions, and during certain ceremonies the skins of animals and animal tails were worn.

The *kher heb* were simultaneously guardians of spirituality and master healers, employing a holistic paradigm in their approach to the treatment of illnesses. Egyptian medical knowledge expanded considerably in the context of this model of healing. Incantations, chants, and the invocation of spiritual forces were done in conjunction with various herbal and other

medicaments. In the Ebers Papyrus (c. 1550 BCE), for example, we come across various diagnoses and herbal, vegetable, and animal-based prescriptions. Specialization in various medical fields would be accomplished in time, and there is evidence of brain surgery and eye operations, but the world of the ancient Egyptian doctor-priest was pervaded by spiritual energies, ancestral spirits, and the manipulation of negative and positive forces, as was the case in other regions of the African continent in the arena of health care and medicinal practice.

West Africa

As in Northeast Africa, the indigenous medical traditions of West Africa that existed for centuries were holistic, embodying significant naturalistic and spiritual elements. Medical practitioners engaged in some of the methodologies used by the *kher heb*. No aspect of human existence was isolated from the spiritual world and its agencies. Unseen intelligence and energy forces were thought to permeate every segment of human existence. Diedre Badejo estimates 400 spiritual entities in this region, while Claudia Zaslavsky estimates as many as 1,600. Belief in teleportation, spirit possession, and out of body experiences merged with more naturalistic and empirical accounts. However, the Cartesian-Newtonian perception of the body as a mechanistic device, with body parts that could be given separate medical treatments, clashed with the holistic, organic model in the modern era. The human body was believed to be as permeated with spiritual forces as the rest of the natural world. The West African scholar Malidoma Some, writing about the Dagara of Burkina Faso, points to the dominant conviction that spirit and matter were fused and that the visible part of nature was only a small portion of what nature actually was. Illness was a physical manifestation of spiritual decay, and religious intervention was as important as the treatment of the illness with medicine. For the practitioners in the community, the ailment affecting the patient was not as important as the person possessing the illness.

The Yan Bori cult of spirit possession among the Hausa in Nigeria and Niger illustrates further the interplay between religion and medicine in ancient West Africa. An etiology was developed to explain pathological conditions. Illnesses were diagnosed. Pre-Islamic deities were invoked. Preventive and curative techniques were implemented. Effective treatment was prescribed. At the center of treatment were the trees believed to be inhabited by the spiritual agencies responsible for specific ailments. The patient was given infusions of the bark or leaves of the appropriate tree, and the necessary sacrifices were made to the spirits associated with it. Over time, Bori practitioners accumulated a rich database of the active ingredients and properties of the botanical world around them.

Ismail Abdalla points out that among the Hausa medical practitioners was the *bokaye*, an itinerant pharmacist who limited his practice to treating com-

mon colds, headaches, indigestion, and impotence. He, too, invoked divinities and spiritual powers. Health care practitioners in Hausaland and other parts of West Africa included cultists, itinerant and sedentary pharmacists, specialists in the removal of cataracts, bone setters, midwives, and other experts in medicine. They collectively engaged in hydrotherapy, heat therapy, spinal manipulation, inoculation, massage, fumigation, and surgery. In most cases, however, the naturalist aspect of their treatment and the multiple therapeutic systems intersected with religious values and clearly defined propositions about the world of unseen energies.

By the fifteenth century, Islam became a factor in Nigerian medical practice. New medical treatises and values were added to existing systems of preventive and curative medicine. In the nineteenth century, Nigerian scholars such as Muhammad Tukur and Muhammad Bello produced numerous treatises on medicine, including the *Muawanet al-ikhwan* and the *Talkhma* on the treatment of various illnesses. Having read over 2,000 books in the field, Muhammad Bello wrote a total of sixty-five books on the sciences. Ten of these focused on ailments such as piles, the use of purgatives, and the treatment of the eye. In the work of these nineteenth-century Islamic scholars, the interplay between spirituality and medicine would remain, but within a new paradigm.

Metallurgy and Mathematics

Empirical observation and experimentation were crucial to the metallurgical process in Africa, including Nigeria and other regions in West Africa. Among the activities of blacksmiths and smelters was ore identification, an activity generally dependent on knowledge of the texture of the soil and its accompanying undergrowth. Metallurgists engaged in the separation of precious metals from ore-bearing rocks by extreme temperatures and the compounding of alloys. Schmidt and Kriger point out that the spiritual world was never excluded in the smelting process. Sacrifices were given to the spiritual agencies associated with the earth during smelting. Rituals and divination processes were carried out routinely. A bad outcome could be blamed on malevolent and negative forces.

Metallurgists were distinguished from other members of society and were simultaneously feared, scorned, respected, and admired because of the spiritual and psychic powers they were assumed to have. Some of the royal clans had mythical, mystical, and spiritual associations with blacksmiths. Iron production was couched in fertility symbolism. The technological developments involved in processing gold, copper, tin, iron, and steel were not devoid of religious connotations.

In a similar vein, there was interconnection between the development of mathematics and spirituality. Orunmila, the oracle god of the Yoruba of West Africa, was consulted in the context of Odu Ifa, the corpus of sacred texts associated with Yoruba divination. Skills in numeracy and computation were

enhanced in the course of this exercise, which involved a challenging system based on the number 20. Not all numbers had the same function, and distinctions were made between prime numbers and multiples. Various terms and symbols evolved for quantities that were less than a whole. Some numbers were believed to have a spiritual dimension. A priest-scholar, the *babalawo*, was central to the divination exercise associated with the Ifa system. He was a master of cosmological, spiritual, and intellectual ideas for his people. Religions of African derivation such as Candomble in Brazil and Santeria in Cuba also operated within this spiritual milieu.

Divination was associated with the manipulation of magic squares in Kano in Nigeria, as well as in other parts of the African continent with an Islamic heritage. Ahmad Kani points out that the science of magic squares, or *ilm al-awfaq*, was highly advanced in Hausaland and the Borno empire in the seventeenth century. Interested scholars from various parts of East and West Africa traveled to Borno, Katsina, and Yandoto to acquire skills in this area. Another boost to the development of mathematics was the system of *zakat*, or taxes, which necessitated complex accounting methodologies to calculate contributions. It is not surprising that Muslim believers were obliged to study mathematics, which was considered one of the religious sciences.

Animal Conservation and Ecology

In ancient Northeast Africa, animal symbols of various kinds had spiritual significance. Apes, bulls, rams, hippos, serpents, crocodiles, lions, ibises, vultures, and hawks were sometimes viewed as the dwelling places of venerated ancestors and ancestral spirits. The pervasive spiritual forces and energies of the universe temporarily resided in their animal hosts. The concept of “the rebel serpent” became an important aspect of Egyptian religion. The double-headed pharaonic crown bore a serpent as well as a vulture. Cats were mourned and embalmed. Eels, geese, and hippos were sacred to Nile dwellers. Snails were sacred to Amon. Although crocodiles were apparently eaten in some areas, they were revered and treated with special care in several regions along the Nile. We are told by Herodotus that Egyptian disdain for Greeks was high because they slaughtered and consumed cows. The Egyptian pharaoh was known as the Mighty Bull, and two highly venerated bulls, Hap (Apis) and Mer-ur (Mnevis), were specially honored in national festivals and ceremonies.

In various parts of Africa, divine animals and sacred groves populated the ecological landscape. Cutting down the trees associated with certain spiritual agencies amounted to a serious offence in some parts of the continent. The Ashanti of West Africa treated scorpions with respect. The turtle epitomized wisdom in some parts. Serpents were part of the crown and an emblem of power in the kingdom of Benin. They were also messengers of the ancestors and participants in the art of healing and initiation. Frogs were associated

with the resurrection of the dead, as were bats. The oba (king) of Benin was called the leopard of the city, and leopard objects and masks were reserved for him. The status of the hippopotamus in Mozambique, in southern Africa, paralleled its status in the ancient northeast. Pregnant women and babies were believed to be protected by it. In the Congo region in Central Africa, the falcon was associated with light, and vultures were believed to have within them the souls and spirits of the animals they ingested.

This spirit-based value system led to conservationist philosophies applicable to the botanical and zoological worlds. It is interesting to note that ancient Egyptians and Nubians did not construct their pyramids on arable land, but on barren soil, so their massive constructions did not hinder agricultural growth. Hundreds of monasteries emerged in the Ethiopian highlands, directly and indirectly dedicated to meditation, seclusion, and the conservation of animal and plant species. The indiscriminate consumption of animals was discouraged here and in diverse parts of the continent, where the protection of sacred and secluded groves helped to perpetuate the diversity of animal and plant species. African religious systems thus had a positive impact on the environment and laid a foundation for contemporary conservation programs.

Bibliography

- Abdalla, Ismail. *Islam, Medicine, and Practitioners in Northern Nigeria*. Lewiston, NY: Edwin Mellen, 1997.
- Badejo, Diedre. *Osun Seegesi: The Elegant Deity of Wealth, Power, and Femininity*. Trenton, NJ: Africa World, 1995.
- Budge, E.A. Wallis. *Legends of the Egyptian Gods*. New York: Dover, 1994.
- . *Osiris and the Egyptian Resurrection*. Vol. 1. New York: Dover, 1973.
- Emeagwali, Gloria T., ed. *Science and Technology in African History*. Lewiston, NY: Edwin Mellen, 1993.
- Faulkner, R.O. *The Egyptian Book of the Dead: The Book of Going Forth by Day*. San Francisco: Chronicle, 1994.
- Grimal, Nicolas. *A History of Ancient Egypt*. Trans. Ian Shaw. Oxford: Blackwell, 1992.
- Herodotus. *The Histories*. Vol. 1, book 2. Cambridge, MA: Harvard University Press, 1986.
- Kani, Ahmad. "Mathematics in the Central Bilad Al-Sudan." In *Historical Development of Science and Technology in Nigeria*, ed. Gloria T. Emeagwali, 33–39. Lewiston, NY: Edwin Mellen, 1992.
- Kriger, Colleen. *Pride of Men: Ironworking in 19th Century West Central Africa*. Portsmouth, NH: Heinemann, 1999.
- Mokhtar, G. *Ancient Civilizations of Africa*. Vol. 1. Oxford: Heinemann, 1992.
- Sauneron, Serge. *The Priests of Ancient Egypt*. Ithaca, NY: Cornell University Press, 2000.
- Schmidt, Peter R. *Iron Technology in East Africa: Symbolism, Science, and Archaeology*. Bloomington: Indiana University Press, 1997.
- Siculus, Diodorus. *The Library of History*. Vol. 1, book 1. Cambridge, MA: Harvard University Press, 1933.
- Some, Malidoma. *The Healing Wisdom of Africa*. New York: Penguin Putnam, 1999.
- . *Of Water and the Spirit*. New York: Penguin, 1995.
- Spencer, A.J. *Early Egypt: The Rise of Civilisation in the Nile Valley*. London: British Museum, 1993.
- Watterson, Barbara. *The Peoples of Africa: The Egyptians*. Oxford: Blackwell, 1997.
- Zaslavsky, Claudia. *Africa Counts*. New York: Lawrence Hill Books, 1990.

6 Science and Native American Communities

Keith James

Native American communities face major dilemmas when it comes to mainstream science. Their goals and needs could potentially benefit from contributions by science, but mainstream science has generally, historically, served nonnative cultures to the detriment of native communities. However, science may be changing for the better, relative to Native American communities and worldviews. Traditional knowledge and social-justice concerns have gained some influence with some mainstream scientists and science organizations. New advances in science and technology have created new opportunities for Native American communities to develop their economies, improve their health, and revitalize their cultures. New advances in science and technology are also, however, creating new risks and expanding some existing ones. Thus science presents Native American communities with an approach-avoidance dilemma.

According to Hopi geneticist Frank Dukepoo, Native Americans often seem to believe that “science is not for indigenous people.” This perception exists for a variety of reasons. Western science has a long history of denigrating indigenous peoples’ knowledge and beliefs, violating their cultural values, appropriating their technologies, and supporting appropriation of their lands. The traditional values of most Native American cultures differ significantly from the values of mainstream science. Native Americans are also substantially underrepresented, relative to their proportions in the U.S. and Canadian labor pools, in almost all scientific and technological fields. However, Native American communities face a variety of problems and opportunities that science and technology could help address. For example, Native Americans suffer from poorer health than any other group in the United States. Similarly, Native American communities tend to suffer greater damage from environmental exploitation and benefit less from natural resources than do nonnative communities. Indigenous communities worldwide face the same high levels of health and environmental problems.

In the sections that follow, which draw primarily on the North American experience, the respective cultures of native peoples and mainstream science are examined, as is some of the history that promotes Native American distrust of mainstream science. Health and environmental issues are explored as examples of the science-related problems, needs, and dilemmas facing Native Americans. The discussion concludes with an examination of how mainstream science and Native American communities might find common ground to the benefit of each.

Native American Ethos

Traditional Native American cultures are varied. North American communities, for example, range across deserts, river valleys, mountains, plains, subtropical swamps, and arctic tundra. Prior to alienation from traditional patterns, lifestyles included large-scale agriculture, gathering of natural plants and small-game hunting, high-volume mechanized fishing, and big-game hunting. Social organizations ranged from small extended family bands to large long-term settlements, and from autocracies to democracies. Not surprisingly, a great range of cultural practices and behavioral norms developed across these various groups. Length of contact with and degree of assimilation to mainstream society add to the complexity of understanding the cultures of modern Native Americans. In one comparison of eight different Native American communities in the United States, for instance, I found that the percentage of community members who spoke their traditional tribal language ranged from about 3 percent to nearly 75 percent.

Care must be taken, then, when speaking of “Native American” values. Those are likely to differ depending on which Native Americans one means. The same is of course true when speaking of mainstream scientists. Despite these caveats, however, for purposes of analysis and discussion, it may be possible to make some general distinctions between some widely shared Native American values, perspectives, and norms, and contrasting values, norms, and perspectives that tend to dominate mainstream society and the vast majority of mainstream scientists.

Native American cultures and values grew out of strong adaptation to place, and they continue to include a practical, experiential perspective of living symbiotically with other creatures and the processes of nature. According to several theorists and researchers, Native American cultures are generally characterized by an orientation toward harmony with nature, an ambiguous view of technical prowess as yielding harm with good, an orientation toward tradition (history) rather than progress (future), and values of group solidarity and personal humility.

Historians and scientists find as well that many Native American cultures share a number of principles: (1) an equal respect for and valuation of nonhuman and human beings; (2) a belief that inevitable bonds exist between hu-

man well-being and the well-being of nonhumans; (3) an emphasis on the importance of place, and the uniqueness of each locality; (4) a perception that the spiritual and the material are in harmony with each other; (5) a belief that there are multiple ways of knowing and that the scientific and the spiritual ways are equally valuable and equally required for complete understanding; and (6) a unique time perspective that includes longer timeframes for judging behavior and experiences, and circular rather than linear conceptions of time and cause and effect.

Relatively strong valuation of social group memberships (i.e., collectivism) and relatively strong valuation of independence and individuality (i.e., individualism) seem to be two fundamental approaches to life that help to define cultures and individuals. Native American cultures have generally been characterized as relatively collectivistic, while mainstream cultures are seen as relatively individualistic.

Many traditional Native American perspectives also emphasize the need to satisfy the spiritual and ancestral world. Tradition-minded Native Americans see themselves as obligated to serve ancestors and sacred sites as well as living community members and current material demands. Misperceptions and conflicts arise when nonnative decision makers either lack awareness of or are unwilling to take into account these spiritual obligations. A Native American perspective on environmental decision making is more likely to take into account the health and well-being of the local ecology and community over the long term, both past and future. The Native American approach gives consideration to sacred sites and spiritual powers held by animals or plants in the ecological system, and inputs from the spiritual realm contribute unique elements to environmental decision making.

Group-derived self-images also incorporate the general values that characterize a group. Cultures are largely characterized by patterns of specific values, and the internalization of values into self-images is largely how culture affects individual thinking and behavior. Components of the internalized sense of a Native American's identity may be one source of the difficulty that Native American individuals have with mainstream science. Many Native Americans believe that science and technology have historically been biased against their group, or are the source of historic damage to their group's culture and well-being. These perceptions lead to suspicion of and hostility toward mainstream science and technology. From the late 1800s through at least the 1960s, U.S. federal policy was aimed at promoting the full assimilation of Native Americans into mainstream U.S. society. Efforts were consistently made to break down indigenous cultures and social patterns through, among other things, forcibly inculcating the language, values, and behavior patterns of mainstream American society. The policy in Bureau of Indian Affairs boarding schools, in mission schools, and in other types of schools was to eliminate Native American cultures, communities, and ways of life. Education in the sense of imparting knowledge and skills typically took second place. Conse-

quently, negative views of mainstream science and values were established among many Native Americans and persist to some extent today.

Some of my own research (largely supported by the National Science Foundation) on Native American identity illustrates the operation and implications of native peoples' beliefs about their own identity and values, and their beliefs about the identity and values of science. In one of my studies, identity as a Native American was associated with relatively collectivistic cultural values, as well as a relatively high orientation toward harmony with nature. Mainstream science and technology, on the other hand, were perceived among Native Americans as promoting social and environmental damage. Native Americans also perceived little benefit for themselves in mastering advanced technologies.

The Ethos of Mainstream Science

The mainstream science ethos is derived from cultural tendencies within mainstream Western societies, for example as found in Europe, the United States, Canada, and Australia. The consensus from research seems to be that scientists are oriented toward mastery of nature, technology, progress (a better future), individualism, and personal prestige and achievement.

While the ideal of U.S. individualism is self-sufficiency and independence of thought, all too often in recent decades, mainstream individualism has been more self-serving and hedonistic than independent. Many academic administrators and faculty are driven by desires for personal comfort, power, and money, and they perceive conformity to group norms as likely to produce those outcomes. Corporate scandals at companies such as Enron illustrate how hedonism and conformity among organizational leadership can promote greed and abuse of employees and the public trust.

Conformity pressures and normative patterns of thinking and behaving also affect the practitioners of mainstream science. Moreover, science and science education are inclined toward reductionism and specialization, so issues and problems are often addressed in isolation from each other. Although the real cutting edge of science does recognize integration and complexity as critical, this has not affected how most of mainstream science or science education is organized. Because science departments have historically had the political clout to control university norms, policies, and reward systems, these tendencies toward reductionism and specialization also affect how science education, science policy, and science application systems are designed.

Reductionism and specialization have some worth. For instance, when knowledge, skills, and techniques are rapidly shifting (as they are in most scientific and technical disciplines), great pressure for functional specialization occurs because it greatly assists training and continued mastery. However, excessive functional specialization has also been shown to reduce creativity and the coordination of the multiple types of knowledge and skills that are necessary to address complex issues and goals. Reductionism and specializa-

tion are not evil a priori, but they tend to be overly valued by mainstream science and mainstream academics, to the extent that complexity and integration are often ignored or may be greeted with hostility even when circumstances really demand them. Analyses and judgments may have a very narrow focus regardless of the breadth of the issue. Thus many Native Americans, whose values tend more toward integration and synthesis, tend to be driven away from scientific and technical fields, and higher education in general.

Another aspect of mainstream science is what has been called the technological-fix mentality. A significant part of North American society sees technology as capable of solving almost any problem, and technical virtuosity is admired. Thus many scientists and engineers immediately define problems in technological terms, and technical solutions are sought regardless of the true nature of the issue. In recent research, I have found that Native American students and adults with strong Native American identities are less likely to accept the technological-fix mentality. Thus, the technological orientation of science and higher education fits poorly with the Native American ethos and creates difficulties with efforts to make science serve the needs of Native American communities.

Other problems with mainstream science are hubris and frequent assertions of objectivity and orientation toward “the greatest good for the greatest number.” Far from addressing the universal want of some amorphous general society, mainstream science more typically reflects the issues of interest to particular groups possessed of significant economic and political power. Not surprisingly, the benefits of addressing those problems typically go to those powerful groups, while more of the costs typically fall on less powerful social groups. Scientists and engineers, far from being objective in this process, are generally part of the very elites that benefit.

Native American Health and Medical Science

Native Americans experience higher levels of many health problems and generally have poorer access to health care than other social groups. They differ as well in the factors behind some health problems. The somewhat unique health outcomes and mechanisms among Native Americans probably mean that courses of prevention and treatment also need to be somewhat different to be effective for them.

Cardiovascular illnesses, for instance, are more common among Native Americans than among individuals from all other ethnic groups except African Americans. The causes of these relatively high rates, however, have been the subject of less research than have the causes of the relatively high rates among other groups. The limited research that has been done indicates that some precursors to cardiovascular illness among Native American males and females show opposite patterns to those among white males and females. For instance, hypertension is significantly more common among Native Ameri-

can females than among Native American males, while it is seen much more frequently among white males than among white females. The reasons for this difference in hypertension prevalence across sex-by-race categories are unclear and deserve greater research attention.

Moreover, Native American women experience lower overall rates of breast cancer than white or Hispanic women. Among women who do develop breast cancer, however, the five-year survival rate for Native American women in the continental United States is lower than for Native Hawaiian, Hispanic, white, or African American women. The causes of these differences are, again, unclear. Many cancers are known to have a strong genetic component; environmental toxins are clearly implicated in others; in general, it is safe to assume that cancers of all types will eventually be linked to a variety of genetic facilitators and environmental triggers. Native American populations have some genetic distinctiveness relative to other North American residents; some also experience somewhat different environmental conditions and engage in somewhat different patterns of behavior than the bulk of the nonnative population. Increased research into the influence of these differences on the incidence and progression of breast cancer could help clarify the causes and consequences of the disease, benefiting Native Americans and nonnatives.

The clearest example of relatively distinctive factors potentially influencing Native American health outcomes, as well as of the approach-avoidance dilemma Native American communities face in attempting to engage science toward improving such outcomes, is diabetes. Diabetes contributes to many negative health outcomes, including kidney disease, heart disease, and severe circulatory problems to the extremities that can sometimes necessitate amputations. Diabetics have a significantly lower life expectancy than nondiabetics. Recent media attention has described a spike in type 2 diabetes rates in the general U.S. population. A similar spike began occurring among Native American groups, however, as much as seventy years ago, and rates of diabetes among Native Americans continue to be substantially higher than among white Americans. For a long time, the diabetes epidemic received little attention from research communities in the private and public sectors, but it has been drawing increasing attention from biomedical researchers. Young points out that research on Native American populations has contributed to our understanding of the causes and mechanisms of disease, and that “much of what endocrinologists know about human diabetes today is derived from studies conducted among the Pima in Arizona.” Native Americans, however, have long been somewhat resistant to studies conducted by outsiders (as indicated, for instance, by low rates of participation in the U.S. Census), and this resistance seems to be increasing.

Frank Dukepoo, a member of the Hopi tribe with a Ph.D. in genetics, argues that genetic research on Native Americans will result in exploitation for the benefit of drug and biotechnology companies, universities, and nonnative scientists. Patents on genes and the drugs or genetic treatments that are devel-

oped from studying them are of great potential value. Because of Native Americans' distinctive genetic makeups, they have been a target of biotechnology companies. Dukepoo urged Native American communities to take control of researching their own genes rather than cooperating with nonnative genetic researchers. Some Native American leaders, such as the tribal council of the Salt River Tribe in Arizona, have opted for a different approach: collaboration with nonnative researchers that involves joint decision making and control. The Salt River Tribe decided to contribute a few million dollars from tribal gaming revenues to support genetic and health research on the tribe. Their ability (relatively unusual, despite the developing stereotype of tribes made wealthy by casinos) to finance that research has also given them the ability to largely dictate how discoveries resulting from it should be used. Native American communities must develop strategies to control their own destinies and reap all of the benefits of new health knowledge.

Native American Communities and the Environment

Native American lands are substantial throughout North America. Native groups' cultural, spiritual, and historical roots to places are, even if sometimes legally unrecognized, even more extensive. Very often in American history, the experiences of native peoples and their lands have foreshadowed experiences that affected nonnative people not many years later. The large-scale social and economic disruptions and the dislocations from the land that affected Native Americans in the 1700s and 1800s also visited nonnatives from the 1800s through the 1900s as technology, the economy, and social systems all went through a series of revolutionary changes. The Navajo nation experienced drought and major soil erosion problems well before the beginning of the dust-bowl era in the western plains. The same federal government that worked for nonnative people against Native Americans in the nineteenth century and much of the twentieth came to be seen as overbearing and unresponsive by many nonnatives during the last third of the twentieth century.

So, too, the current and sometimes extreme experiences of Native Americans with pollution and modern climate changes may foretell what will eventually be widespread outcomes. Global warming has been affecting arctic and subarctic areas faster and more extremely than the temperate zones, and Native American populations in Alaska and Canada are being disproportionately impacted. The desert and semidesert regions of the Navajo reservation in Arizona, New Mexico, and Utah are showing the effects of persistent drought: soil erosion, water-source loss, and plant changes. In North America, native peoples have higher than average levels of fat-soluble toxins in their systems. Unique disease outbreaks have occurred in Native American lands, such as the Hanta virus in the southwestern United States, shellfish-derived bacteria toxins in Washington State, and salmonella from contaminated drinking wa-

ter in Ontario. The responses in Native American communities to such disease outbreaks and to climate change may provide valuable approaches to the larger, initially better insulated communities of mainstream America.

But environmental policies have often revealed conflict between Native American and mainstream cultures. Crowfoot and Wondolleck define environmental conflict as the “fundamental and ongoing differences, opposition, and sometimes coercion among major groups in society over their values and behaviours toward the natural environment.” Such conflict often stems from differences in perceived understanding of the interrelationships between humans and the environment. It frequently stems from deep-rooted value conflicts, strongly held identity frames, and historical intergroup relation patterns.

Environmental justice refers to the right of all people to a clean and healthy environment. The Universal Declaration on Human Rights recognizes the rights of all peoples to a clean environment and to participate in decisions concerning their environments and resource management. It particularly singles out the rights of native peoples to self-determination and environmental control. The U.S. Environmental Protection Agency has recently expanded their conception of environmental justice to reflect similar ideas, identifying violations of environmental justice as including not only intentional discrimination but also unintended disparate impacts. Native peoples often argue that their rights to environmental justice are ignored in the decision making, policies, and development plans for natural resource management. Moreover, they often extend environmental justice to nonhuman components of the environment, as well as to the spiritual dimension of places and natural phenomenon. Mainstream systems of environmental justice and the environmental evaluations and management that they inform typically do not include those elements.

Many Native American groups have a collectivistic or common-property cultural orientation to land management. This is codified and given legal force by many treaties and some of federal Indian law. An integral part of decision fairness for many Native Americans is broad community input into and consent for land management decisions. Not infrequently, however, tribal councils that are not in accord with traditional collectivism make environmental decisions without bringing them to the broad community. This lapse can occur within Native American communities and between them and nonnative parties to common environmental issues.

Since the local ecology forms a central element of Native American identity and spirituality, Native Americans may feel their personal identities affronted by decisions that cause ecological harm. When core cultural identity values, beliefs, and relationships are threatened or not respected, conflict may result. Indeed, I have suggested elsewhere that identity plays a central role in perceptions of decision issues and of decision partners from other groups, and therefore in the development and maintenance of resolutions to conflicts.

Outside parties have also frequently, historically, manipulated and interfered with identity and in-group/out-group mechanisms in order to gain access to Native American communities' environmental resources. In addition, mainstream science and society have historically exploited Native American environmental knowledge for locating and extracting natural resources, and making use of medicinal plants for commercial purposes. Native American communities have rarely benefited economically, however. In fact, they have often found their lands expropriated and environments stripped because of knowledge they helped outsiders develop. As a result of all this, Native Americans frequently form negative assessments of environmental policies and practices, and environmental science education and research.

Policy changes, monitoring environmental indicators, environmental interventions, dissemination of information, and adaptive changes to human behavior are key factors for effectively managing interactions between humans and the environment. But for several reasons, these can be more difficult in Native American communities than elsewhere. Infrastructure on reservations is generally poor. For instance, 14.2 percent of Native American households have no electricity and 23.4 percent of rural Native American households have no telephone service. In some areas, such as the Navajo nation and much of Alaska, telephone service is even less available, and lack of either sewage links or modern septic systems is common. The social dynamics of Native American communities can pose unique challenges for climate intervention efforts. There can be complex political and social structures within tribal governments, and Native American communities often comprise complex clan, extended family, and other informal social networks. These formal and informal social systems must be understood and successfully negotiated for service projects, such as the dissemination of information and the establishment of protocols that minimize uranium-related adverse health effects, to succeed.

Also, myriad intergovernmental connections affect the management of Native American lands. Authority and responsibility for regulation and management of such lands is often divided among the tribal government or native corporation leadership, the federal government, state governments, and sometimes, private corporations or private individuals. The Navajo nation, for instance, has a large number of internal regional governing units, straddles three states (Arizona, Utah, and New Mexico), and spans three different federal Environmental Protection Agency regions. A greater than normal number of federal government agencies, policies, and laws are also involved when Native American lands and groups are the focus, rather than nonnative lands or groups.

Much of mainstream environmental science and most mainstream government environmental agencies continue to view environmental policy as fundamentally a matter of how to effectively exploit natural resources for immediate mainstream economic benefit. And compared to traditional Native

American approaches, they have a simple view of the relationship of people and environment. Mainstream society has also only begun to acknowledge and respect the roles that indigenous animals play in maintaining the balance of the environment. Mainstream managers and scientists have a tendency to compartmentalize, and to want to be very objective, which leads them to look at the physical aspects of the land as discrete and unrelated resources. They also tend to look only at the physical aspect of the land rather than at its cultural and spiritual components. The Native American tradition, however, recognizes that ties exist between the physical and spiritual worlds, and among earth, animals, and humans. All of these ties are necessary for the health of any of the parties involved in them.

Indigenous Knowledge, Indigenous Science

The ways of constructing, organizing, using, and communicating knowledge that have been practiced by indigenous peoples for centuries have come to be recognized as constituting a form of science with its own integrity and validity. Mainstream science also has its distinctive ways of constructing, organizing, using, and communicating knowledge. While these systems overlap in some areas, they diverge in ways important to how science is learned and applied. Native American scholars have been actively contributing their insights to the growing body of literature around the themes of indigenous science and knowledge making.

Traditional tribal knowledge and the unique concepts and perspectives of indigenous cultures create the potential of unique contributions to science and technology. For instance, in North America, Native Americans evolved their distinctive cultures in close association with the land and other living creatures. Their careful observations and field experimentation over many generations have yielded indigenous ecological knowledge that mainstream society and science have recently begun to respect. It is increasingly recognized that traditional ecological knowledge and indigenous environmental perspectives can help mitigate human contributions to natural disasters and promote ecological health.

To realize the potential benefits of indigenous science and traditional knowledge, though, efforts are needed to increase the numbers of indigenous individuals in science and technology professions. Initiatives are needed that broaden scientists' perspectives and that systematically integrate indigenous perspectives and knowledge with mainstream science. Integrating indigenous perspectives and knowledge into mainstream science would increase the number of indigenous individuals succeeding in training as scientists and technicians.

For practical reasons relating to the interrelationships among goals and needs, and for cultural and historic reasons, rote scientific approaches are unlikely to be effective among Native Americans. One of the lessons of Native

American experience is that, while reductionism and limited and linear goals have utility at times, when they are the only focus, they can create problems for the health of humans and the environment. More particularly, human health and environmental health are linked, and maximizing each for the long haul requires that at some point we attend both to the *connections among* biological, social, economic, and environmental elements, and to the details of the functions of those elements *in isolation*. Mainstream science and the technologies and practices it promotes have been strong on the latter but weak on the former. Damage from that imbalance seems to be accumulating not just for Native American communities and lands, but for everyone and in many milieux. Native American communities, having suffered such outcomes earlier and more extremely, would seem a good place to start with efforts to counter the damage. Connecting Native American perspectives with quality science would seem to hold major promise as a potential promoter of integrative well-being.

A recent experience I had with a white scientist sums up many of the ideas and issues explored here. With a group of colleagues, I have been working on a comprehensive intervention and research program designed to help promote weight loss and prevent diabetes and other illnesses at one particular Native American reservation in the United States. Our project idea integrates research into genetic influences on carbohydrate processing and diabetes development among Native Americans, an understanding of the need and desire for a cultural revitalization in that particular community in order to change negative (for physical health) behavior patterns, and a model program that is working for the Tohono O'odham people of southern Arizona. We want to combine science-based nutrition and health education with a program to promote a return to traditional foods within a broader cultural revitalization effort, and a collectively based and reinforced effort to increase health-promoting behaviors such as exercise.

A colleague invited a mainstream nutrition researcher to attend a planning meeting for the project. The researcher admitted to knowing nothing of the literature on Native American genetic influences, next to nothing about Native American culture or history, and nothing about Native American reactions to mainstream approaches and interventions. That did not stop him from denigrating our general project concept, however, with the claim that diabetes is the same for everyone, that calorie balance and individual lifestyle choices are the key issues everywhere, and that he and his mainstream science friends had the answers if only we would listen to the wisdom of their pet disciplines. As he left the meeting, he mentioned that he had "a little Native" in him, and that he was consequently interested in projects with Native American groups. It is possible that he may, indeed, have "a little Native" in him. It is certain, however, that the arrogance and insularity he and too many scientists and science institutions exhibit make it unlikely that what he knows could well serve Native American communities.

Bibliography

- Anderson, E.N. *Ecologies of the Heart: Emotion, Belief, and the Environment*. New York: Oxford University Press, 1996.
- Assembly of First Nations. *Banishing the Indian Agent, Choices for Change: Restoring First Nation Governments*. Ottawa: Assembly of First Nations, 2000.
- Atleo, C. "Land, Science, and Indigenous Science: Tales from a Modern Treaty Negotiation Process." In *Science and Native American Communities*, ed. K. James, 127–34. Lincoln: University of Nebraska Press, 2001.
- Battiste, M., and J.Y. Henderson. *Protecting Indigenous Knowledge and Heritage: A Global Challenge*. Saskatoon: Purich, 2000.
- Berkes, F. *Sacred Ecology: Traditional Ecological Knowledge and Resource Management*. Philadelphia: Taylor and Francis, 1999.
- Bureau of Primary Health Care. *Breast Cancer Awareness*. Washington, DC: Government Printing Office, 1998.
- Cajete, G. *Native Science: Natural Laws of Interdependence*. Santa Fe, NM: Clear Light, 2000.
- Cox, P.A. "Will Tribal Knowledge Survive the Millennium?" *Science* 287 (2000): 44–45.
- Crowfoot, J.E., and J.M. Wondolleck. *Environmental Disputes: Community Involvement in Conflict Resolution*. Washington, DC: Island, 1990.
- Deloria, Vine, Jr. *Red Earth, White Lies: Native Americans and the Myth of Scientific Fact*. Golden, CO: Fulcrum, 1997.
- Dorgan, C.A. *Statistic Record of Health and Medicine*. New York: Gale Research, 1995.
- Dukepo, F. "The Native American Honor Society: Challenging Indian Students to Achieve." In *Science and Native American Communities*, ed. K. James, 36–42. Lincoln: University of Nebraska Press, 2001.
- Egash, R. "Computation, Complexity, and Coding in Native American Knowledge Systems." In *Changing the Faces of Mathematics: Perspectives on Indigenous People of North America*, ed. J.E. Hanks and G.R. Fast. Reston, VA: National Council of Teachers of Mathematics, 2002.
- Freedman, B.I. "Susceptibility Genes for Hypertension and Renal Failure." *Journal of the American Society of Nephrology* 14:2 (2003): 192–94.
- Gedicks, A. *The New Resource Wars: Native and Environmental Struggles against Multinational Corporations*. Boston: South End, 1993.
- Goldenfeld, N., and L.P. Kadanoff. "Simple Lessons from Complexity." *Science* 284 (1999): 87–89.
- Huntington, H.P., and N.I. Myrmin. "Traditional Ecological Knowledge of Beluga Whales: An Indigenous Knowledge Pilot Project in the Chukchi and Bering Seas." Inuit Circumpolar Conference, Anchorage, AK, 1996.
- Jackson, D.N. "Scientific and Technological Innovation: Its Personological and Motivational Context." In *Scientific Excellence: Origins and Assessment*, ed. D.N. Jackson and J.P. Rushton, 149–64. Newbury Park, CA: Sage, 1987.
- James, K. "Process and Cultural Impediments to Health-Care Innovation." *Hospital and Health Services Administration* 35 (1990): 395–407.
- James, K. "American Indians, Science, and Technology." *Social Science Computer Review* 18 (2000): 196–213.
- . "Identity, Values, and American Indian Beliefs about Science and Technology: A First Wave of Data." *American Indian Culture and Research Journal*, in press.
- . "Transforming the Academy with Native Values and Perspectives." In *Indigenizing the Academy*, ed. Devon Mishesuah and Angela Wilson. Lincoln: University of Nebraska Press, 2004.
- James, K., Willie Wolf, Chris Lovato, and Steven Byers. *Barriers to Workplace Advancement Experienced by Native Americans*. U.S. Department of Labor, Glass Ceiling Commission Monograph Series. Washington, DC: U.S. Department of Labor, 1995.
- Kawagley, O. *A Yupiaq World View: A Pathway to Ecology and Spirit*. Prospect Heights, IL: Waveland, 1995.
- Lambert, L. "From 'Savages' to Scientists: Mainstream Science Moves Toward Recognizing Traditional Knowledge." *Tribal College Journal of American Indian Higher Education* 15:1 (2003): 11–12.

- Martinez-Maldonado, M. "Hypertension in Hispanics, Asians and Pacific Islanders, and Native Americans." *Circulation* 83 (1991): 1467–69.
- Mitchell, B., ed. *Resource and Environmental Management in Canada: Addressing Conflict and Uncertainty*. Toronto: Oxford University Press, 1995.
- Nason, J.D. "Native American Intellectual Property Rights: Issues in the Control of Esoteric Knowledge." In *Borrowed Power: Essays on Cultural Appropriation*, ed. B. Ziff and P.V. Rao, 237–54. New Brunswick, NJ: Rutgers University Press, 1997.
- Northrup, T.A. "The Dynamics of Identity in Personal and Social Conflict." In *Intractable Conflicts and Their Transformation*, ed. L. Kriesberg, T.A. Northrup, and S.J. Thorson, 55–82. Syracuse, NY: Syracuse University Press, 1989.
- Pacey, A. *The Culture of Technology*. Cambridge, MA: M.I.T. Press, 1983.
- Pierotti, R., and D. Wildcat. "The Science of Ecology and Native American Traditions." *Winds of Change* (1997): 94–98.
- Rico, Gabriela. "Preserving Health and Culture." *Tucson Citizen*, December 3, 2003.
- Rybczynski, W. *Taming the Tiger: The Struggle for Control of Technology*. New York: Viking, 1983.
- Suzuki, D.D., and P. Knudtson. *Wisdom of the Elders: Sacred Native Stories of Nature*. New York: Bantam, 1992.
- Trimble, J.E. "Value Differences Among American Indians: Concerns for the Concerned Counselor." In *Counseling Across Cultures*, ed. P. Pedersen, W.J. Lonner, and J.G. Draguns, 65–81. Honolulu: University of Hawaii Press, 1976.
- Vozarova B., et al. "The Interleukin-6 (-174) G/C Promoter Polymorphism Is Associated with Type-2 Diabetes Mellitus in Native Americans and Caucasians." *Human Genetics* 112:4 (2003): 409–13.
- Weatherford, J. *Indian Givers: How the Indians of the Americas Transformed the World*. New York: Crown, 1988.
- Young, B.A., C. Maynard, and E.J. Boyko. "Racial Differences in Diabetic Nephropathy, Cardiovascular Disease, and Mortality in a National Population of Veterans." *Diabetes Care* 26:8 (2003): 2392–99.
- Young, T.K. *The Health of Native Americans: Toward a Biocultural Epidemiology*. New York: Oxford University Press, 1994.

7 Native Spirituality and Science

Phillip H. Duran

Every summer since 1999, a group of quantum physicists, linguists, and Native American scholars convene at the Language of Spirituality Conference in Albuquerque, New Mexico, to discuss the underlying principles of the universe. Sponsored by the Source for Educational Empowerment and Community Development (SEED), the sessions are conducted in the tradition of the late physicist David Bohm, a colleague of Albert Einstein, who authored several books on quantum physics and philosophy and was known for the penetrating approach to communication that he comprehensively documented in his book *On Dialogue*. As part of the SEED inner circle, I was introduced to the useful notion of suspending our “tacit infrastructure”—the implicit worldview or paradigms that operate within each of us—in order to allow ideas to flow freely during communication, in accordance with the dialogic process used by Bohm.

The tacit infrastructure is the foundational philosophy from which an individual approaches knowledge, interprets experience, and asserts what is real. It finds expression in statements that are made openly and believed to be true, although the individual making those assertions may not be aware of the deeply rooted assumptions on which they are based. It is one’s perception of the universe. It is the inner point of reference that interprets how everything else is related to oneself, and it determines how a person internally categorizes people into groups. Just as individuals have a tacit infrastructure, so do cultures. Thus a culture’s particular epistemology, or theory of knowledge, encompasses the doctrines and assumptions of that culture while addressing such questions as what it means to know and how knowledge is validated.

Western culture has created a powerful science. However, many scientists from the Western tradition, including Bohm, have recognized the constraints imposed by the scientific method and have called for a new paradigm. A major assumption of Western science is that our knowledge of the real world comes only from what can be measured. Native peoples, on the other hand, embrace the whole of human experience rather than limiting themselves to what can be

gathered and interpreted through the physical senses. (*Native, indigenous, aboriginal, and first nations* are the terms most often used with reference to the people originally living in a particular territory, before their encounter with Europeans.) An essential element of native spirituality is the reciprocal relationship between humans and the natural world, which includes not only the plant and animal nations but also the entire cosmos. Native spirituality is not simply a belief system; it is a way of life that incorporates this relationship as an essential part of indigenous traditional practices, which represent empirical science.

Science and Culture

Because science is a human activity as well as a body of knowledge, it is deeply influenced by a culture's epistemology. Western science developed within Western culture, which is rooted in ancient Greece, and one of its dominant characteristics is to bifurcate life into sacred and secular realms. Another assumption of Western science is a mechanistic philosophy that causes it to focus only on the purely material aspects of reality. These assumptions, which are deeply embedded in American life, are alien to native cultures.

By the fifteenth century, when Western culture was imported to North America by European immigrants, it had already deviated from the original worldview of the Greeks, who did not conceive of science, philosophy, and religion as separate entities until the fifth century BCE, when a historic split between matter and spirit occurred, as Fritjof Capra points out in *The Tao of Physics*. Consequently, science and religion went separate ways and today are still at odds with each other, with scientists typically claiming that the former is connected with knowledge and the latter with belief, which is often considered irrational or superstitious. If the split had not occurred, perhaps the clash between Western and tribal cultures would not have been as severe and the violence that ensued as European immigrants moved westward, scorning Indian ways, might have been averted.

The existence of different epistemologies and knowledge bases are evidence of the earth's human diversity. One point of divergence between Western and indigenous thought is how science is defined. Western thought limits science to the information that can be counted and measured. Indigenous knowledge systems, on the other hand, encompass the whole of experience, including spirit, language, culture, community, and customs. The worldviews of tribal societies include the cosmos, or universe; thus, in the physical realm, they have at least the same scope as Western science.

Science textbooks are not always free of cultural content due to the inclusion of tacit assumptions by some authors. For example, textbooks that echo Hans Eysenck's dictum "if it cannot be measured, it does not exist," or make assumptions about what is animate and what is inanimate, or denigrate tribal cultures as "primitive," are using references and innuendos that are outside of science. It is also common to find references to the Greeks and other pioneers

of science from Western culture as “our ancestors.” Although innocently stated, they give students the false impression that indigenous and other non-Western cultures have nothing of value to contribute to science.

According to Glen Aikenhead, scholars began in 1975 to “demythologize” the scientific fundamentalism that exalts Western science. Aikenhead, from the University of Saskatchewan, has written extensively about aboriginal science education in Canada. When science education transmits the cultural values of the scientific community, that is fine for most students, but when cultural content (not scientific fact) conflicts with tribal values, it adds to other factors that discourage tribal students from entering science careers. Instructors who can incorporate relevant tribal knowledge and perspectives in science are obviously needed.

It is perhaps during critical times that a society’s most deeply rooted beliefs and passions are expressed. For example, in the wake of the *Columbia* space shuttle disaster, which claimed the lives of seven astronauts in February 2003, NASA officials and other scientists, science educators, news editors, and columnists were already looking beyond the grieving period and expressing the firm conviction that the space program must continue. Why didn’t they wait in reverent silence until fellow Americans could get over the initial shock from the tragic event? It seems that certain cherished values and overriding concerns were more important.

People from various sectors of American society repeated the same themes about the reasons to continue the space program: to follow the natural instinct of human nature (or the human spirit or the human heart); to push the envelope of science and soar to new heights; because the unknown and the unexplored world is there, though it is not always hospitable. Two weeks shy of the first anniversary of the shuttle disaster, President George W. Bush announced plans for U.S. space explorers to return to the moon and eventually reach Mars. “Mankind is drawn to the heavens for the same reason we were once drawn into unknown lands and across the open sea,” he said. The announcement drew a parallel between Lewis and Clark’s exploration of new lands “in the spirit of discovery” and America’s venture into space.

The dominant notions about human nature and the goals of science reflected in the above statements stem from assumptions and doctrines that are deeply seated in U.S. culture. Frankly, some of the claims are arrogant and erroneous, and President Bush’s parallel is unrealistic: Lewis and Clark came upon a world that was already inhabited by fully functioning societies; it was not unexplored and unknown territory. Long before the arrival of Europeans, the tribes were intimately familiar with those landscapes that had sustained and nurtured their people. To the foreigners, the West was “uncharted” and “wild” because they viewed it as a strange and hostile place. Even today, many Americans still have not learned to connect with the land in a loving way.

The triumphal language is reminiscent of the doctrine of Manifest Destiny: the tenet held by immigrant leaders and politicians that their expansion

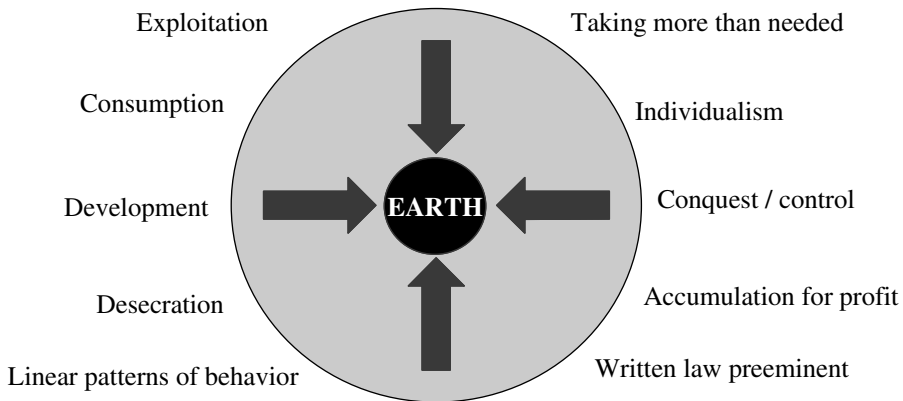
Figure 7.1 **Western Paradigm**

westward to take over the lands and establish their own institutions, displacing the tribes who were perceived to be incapable of self-government, was divinely ordained. In the Western worldview, humans tend to be seen as progressively overcoming barriers along a path that will achieve the ultimate human potential. Figure 7.1 depicts a Western paradigm in which the world is treated as a commodity. The arrows in the figure indicate the earth under attack. Humans create written laws that are considered preeminent, the world exists in order to be explored and exploited, nature is deprived and must be tamed, and all things must succumb to the human will. These notions of conquest, linear progression, and human hegemony over nature do not reflect sustainable science. While many Americans express these views with great confidence, they are not valid in an indigenous worldview.

Indigenous Spirituality and Traditional Knowledge

The United Nations (UN) has long recognized the right of existence of entire human groups. In 1948 it unanimously adopted the Convention on the Prevention and Punishment of the Crime of Genocide to protect groups from extinction. According to the Center for World Indigenous Studies, there are some 3,000 indigenous nations (peoples) in the world today, and fewer than 200 nation-states within the United Nations. Approximately 550 federally recognized tribes (tribal nations) live within the territorial boundaries of the United States, a nation-state.

The UN also recognizes the wealth of traditional knowledge possessed by indigenous peoples, as Patricia Cochran (Aleut), executive director of the Alaska Native Science Commission, affirms in “What Is Traditional Knowledge?” *Traditional knowledge* refers to the knowledge that indigenous peoples have amassed over centuries or millennia of living close to nature in their respective environments. In parts of Canada, the term *aboriginal knowledge*

is used for knowledge that has been accumulated experientially over time without the use of modern instrumentation, and that is local to the particular place inhabited by a people. Traditional or aboriginal knowledge requires direct observation of how each ecosystem functions, the proper management practices and techniques required to sustain them, and a deep understanding of appropriate relationships to the plants and animals. It has to be reliable, for the people depend on it for their survival.

Because ecologies vary from place to place, different knowledge systems exist throughout the world, but all are vulnerable to external influences, such as intrusions by other humans or governments seeking to extract resources. The Cross-Cultural Science and Technology Units Project at the University of Saskatchewan in Canada and the Alaska Rural Systemic Initiative at the University of Alaska are two examples where systemic integration of indigenous and Western scientific knowledge is occurring.

An important aspect of these knowledge systems is that the biodiversity of a particular place (i.e., the range of organisms present in a given ecological community) is the collective result of transformations created over time by the people's own science across generations. Lorenzo Muelas Hurtado, from Movimiento Autoridades Indígenas de Colombia, explains that the indigenous peoples of Colombia do not dissociate traditional knowledge from the resource. It is not possible, because the people and the natural resources they have cultivated both possess that knowledge; it is attached to the resource as part of the same biodiversity. Unlike the manner in which Western scientists acquire and catalog knowledge into compartments through specialization, indigenous peoples generally view the world as a unified whole.

In an indigenous worldview, knowledge transcends the physical and involves the whole of human experience. Humans are spiritual as well as physical beings, and the world is an intimate relationship of living things in which everything is connected. It is an experiential principle not arrived at through dogma. Because of it, wider paths to discovery have been possible than by assuming the limited notion of a material world consisting of measurable objects.

A conscious awareness of the unseen world of spirit and a respect for the powers in the universe characterize the spirituality of indigenous societies. Spirituality is tied to the specific homeland, the familiar landscape that nurtures the tribe, where traditions, customs, teachings, beliefs, prayers, ceremonies, and language form a complete and harmonious world. It is not an abstract notion, political ideal, or set of doctrines that brings the comfort of belief at the expense of the continuous pursuit of knowledge. All living things are seen as relatives. The people are in a covenant or reciprocal relationship with the land as stewards and guardians of the part of the biosphere that they occupy. Traditional knowledge employs the indigenous peoples' own science as a way of life. The knowledge systems are unique to the indigenous societies living within their environments. The people know they belong to the land.

In industrial societies, reliance on technologies tends to suppress the use of

human powers. Native peoples living without modern conveniences, however, have had to acquire skills in order to survive. For example, indigenous inhabitants of the arctic regions have learned to predict the weather before going out on dangerous hunts that last several days. Yupiaq educator and author Angayuqaq Oscar Kawagley tells the story of a man who is stranded on an iceberg and needs to walk on ice that, depending on the season of the year, is either forming or melting between the iceberg and the shore. Is the ice thick enough for him to cross over? First, he tests the ice by dropping his ice pick from a known distance. Deciding to cross, he walks at a steady pace with great concentration, in rhythm with the vibrations of the ice and the sea, drawing energy from nature and allowing the feeling of lightness and buoyancy to be conveyed to his physical being. Stopping or running would cost him his life.

This story indicates the ability of native science (traditional knowledge) to arrive at solutions without building complicated mathematical models that would require, in this case, measuring the buoyant force of the seawater from the volume of ice and estimating the frequency and length of the wave. The man interacted intuitively with nature and in harmony with it, becoming a single system with the ice and the sea.

The universe is alive and imbued with spirit. As a physicist, I have no difficulty in identifying spirit with the energy that is known to pervade the universe. As spiritual beings, we all sense this energy in everyday life. The Maya long ago perceived the soul as the manifestation of spirit, which Hunbatz Men calls intellectual energy. Modern physics makes this notion even more credible, since transformations between matter and energy are always occurring. If the soul perceives the mind, which is not material, then energy (spirit) must be manifesting itself. Long before Einstein wrote his famous paper on the equivalence of matter and energy, the pre-conquest Maya were saying that all matter is vibrating energy.

Native peoples see traditional knowledge as “good” science. An indigenous worldview requires respect for all living things, as the Lakota expression *mitakuye oya’sin* (“all my relatives”), often expressed at the end of a prayer, implies. In the indigenous paradigm, other entities have the right to exist, they have a purpose for having been created, and this purpose is dynamic; that is, they work out their purpose in community with humans. In practice, this worldview widens the scope of experience, and every experience is given significance. In the indigenous worldview depicted in Figure 7.2, the people live in deference to a physical and spiritual universe through a reciprocal relationship of respect. They pattern their lives according to natural law and follow the natural cycles.

Effects of Colonization on Native Science

In the 1850s, during a terrible period in America known as the “Indian wars,” Sweet Medicine of the Cheyenne addressed his people and foretold that an-

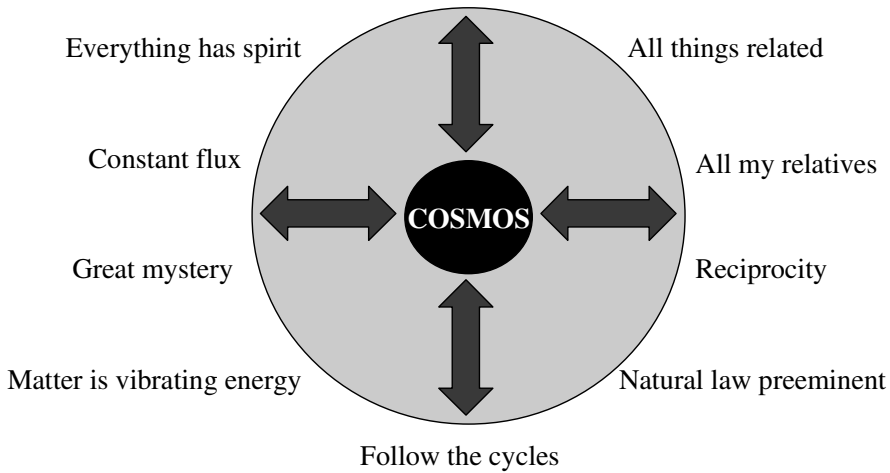
Figure 7.2 **An Indigenous Worldview**

other people would soon come seeking a certain stone (gold). He said these newcomers would not get tired. They would tear up the earth and cause his people to forget their own teachings. And so it happened that the knowledge and perspectives which guided his people and other tribes were scorned by the immigrants in favor of a worldview that is unsustainable because it treats the earth with disrespect, as a commodity and a bottomless resource—a view that violates the reciprocal relationship that must exist between human and nonhuman life. Earth cannot continue to give indefinitely; it is a law of nature, a spiritual law.

During an era that began in the 1880s and lasted almost 100 years, the United States separated Indian children from their parents and placed them in boarding schools in an attempt by national policy to eradicate all forms of Indian life. Charles Eastman, also known by his Dakota name Ohiyesa, tells us in *The Soul of an Indian* that many studies about Indians occurred during a transitional period when they were undergoing profound changes due to assimilation and other efforts to “civilize” them. Many of the original beliefs and philosophies that were hidden from the observer underwent rapid disintegration. Much of the documented material created by non-Indians is modernized and hybrid, an Anglicized mixture of Caucasian philosophy and biblical content, and many accounts about Indians are superficial. When non-Indians appropriate traditions such as the drum, the feathers, the sweat house, and the songs in search of satisfying experiences, many do so without understanding their deep significance or the centuries of struggle it has taken to preserve them. Indigenous science needs to be recognized for its authenticity, not reduced to a New Age faddism.

The physical comforts of technology introduced into the Western hemi-

sphere to benefit the immigrants' physical world had a deleterious effect on the indigenous spiritual world. Perhaps the greatest damage to the tribes, after severe depopulation, was a spiritual wound that has not yet healed. When a people are forced to abandon their homeland and way of life, even if the colonization is not complete, the consequent social and spiritual devastation is difficult to imagine. This is evident across Indian country. (*Indian country* refers generally to American Indians as they encounter life in the United States.) Pueblo psychologists Eduardo Duran and Bonnie Duran, and others working in tribal communities, refer to the *soul wound*, the image that seems to best conceptualize the effects of American Indian history.

Science has suffered as a result of Indian depopulation and colonization. Indigenous traditional practices that once supported a subsistence way of life became a thing of the past for many tribes. Indian customs and language were either suppressed by federal Indian education policy or criminalized by the government. Science also suffered because it was not allowed to develop within a holistic worldview. Viewing Indians as "ignorant savages," European immigrants failed to see the hidden wisdom of Indian traditional ways that cared about the whole human being in relationship to the natural world. Instead of the spiritual health that once prevailed in Indian communities, a standard of living based on materialism characterizes today's American society, whose science is not sustainable.

Native science is not just for native peoples; it is needed to address the problems of this century. Our relationships to creator, to ourselves, to the natural world, and to other human beings and nations are suffering. Restoring the balance will require a revolutionary change in mainstream thought and practice. Even the language needs to change to reflect a better worldview, for scientists and others still talk about the "environment" as if humans were separate from the nature that sustains them. We must also listen to indigenous elders from all regions who collectively tell us that humanity must awaken to the urgent need to care for the earth and all life. For example, the Kogi people, who moved to the high mountain regions of Colombia after the arrival of Columbus, and the Inuit of Sachs Harbor in the polar region of Canada have reported warming trends and issued urgent warnings to the rest of the world about the declining condition of the biosphere. These climate trends are indicators that conventional paradigms about our relationship to the natural world need to change.

Already some signs of positive change are evident. Western scientists have begun to use more holistic approaches to address environmental problems. We are also witnessing a shift from a science of specialization that reduces facts into seemingly unrelated fragments to a science that recognizes the more realistic complexity of self-organizing systems at work in the natural world. Both of these trends overlap with indigenous worldviews. Although neither of these trends is motivated by an awareness of traditional knowledge, they nonetheless represent a positive trend.

Modern Physics and Indigenous Perspectives

What are the ultimate constituents of the universe? How does the universe work? To address these questions and their relevance to native spirituality, we first need to introduce some concepts from classical physics. Early in an elementary physics course, before studying Newton's laws of motion, students learn about inertia, the property of every object to resist a change in its current state of rest or motion. Inertia is measured in terms of mass. According to Newton's Second Law, when a force is applied to an object, the object accelerates in a manner that is directly proportional to the applied force and inversely proportional to the object's mass. The force *causes* the object to accelerate, and this introduces the concept of *causality*. An extrapolated belief associated with this is that, behind every change in the universe, there is a cause. Newtonian, or classical, physics is a science of causality and determinism, because theoretically, if the physical state of a collection of objects is known at a given time, the state of that system at a later time can be predicted exactly.

In a mechanistic, or reductionist, view of the world, everything in the universe, even biological systems, can be reduced to physical entities as the ultimate constituents of reality. This view assumes that a system can be taken apart and put back together by considering only the individual properties of each part. For this to be true, each part would have to behave the same whether in isolation or as part of the system. However, scientists are discovering that the world is not a machine, as physicist Fred A. Wolfe asserts in *Taking the Quantum Leap*. They are increasingly recognizing the existence of *emergent* properties in natural systems; that is, parts of a system are able to function together and self-organize in ways that they would not be capable of by themselves. As a result, some of the specialized disciplines in science, such as biology and ecology, are being merged into larger domains that consist of combined disciplines. Geology, for example, is seen as part of earth system science, which views the whole earth as a single system.

Nature itself demands that existing relationships be recognized, a principle practiced by native peoples and embodied in the phrase "all things are related." Native peoples believe that existence is an unbroken whole consisting of the visible world and the unseen world of spirit. And this coincides with the worldview that Bohm proposes in *Wholeness and the Implicate Order*, which describes his theory of cosmology. There he states that a new, nonfragmentary worldview is needed in science. It is needed in modern physics, he states, because the current approach to analyzing the world as independent parts is inadequate. He calls the visible world of ordinary time, space, continuity, and causality (in which the laws of classical physics apply) the *explicate* order and the unseen world of the quantum, which is profoundly different, the *implicate* order. These two worlds are in ceaseless movement in an endless process of unfolding (into the explicate order, such as when a wave becomes a

particle) and enfolding (into the implicate order, such as when a particle becomes a wave).

Bohm used wholeness as a basic concept for his approach to quantum theory—the same premise that indigenous peoples have always incorporated into their own traditions, not as religious dogma but as science. And Bohm’s picture of an enfolding/unfolding universe is so analogous to what is known about the cosmology of the people of the Andes that it is worth mentioning here. Oakley Gordon says that he arrived at an approximate understanding of their cosmology after listening to spiritual leader and teacher Américo Yábar. In metaphoric terms, the cosmos is a vast web of filaments of energy. Points where they join together form a node, and each node represents what is experienced as an object (which seems to correspond to a visible manifestation of Bohm’s explicate order). In this model, the universe is a single, unified entity, everything is interconnected, and there is little or no distinction between animate and inanimate. Such a metaphor, as Gordon explains, aids in understanding an epistemology other than one’s own, especially if the other system is based on experience. It cannot be adequately conveyed through language alone, because language coevolves with the epistemology and belongs to it.

To illustrate the difference between holistic and fragmented views of the world, Bohm uses the metaphor of a watch. If the watch is carefully taken apart, it can be reconstructed by noticing how each component relates to all of the other components. But if the watch is shattered with a hammer, the result is a pile of fragments that no longer reveals the relationships among components, making it impossible to reconstruct the watch.

Bohm argues that modern languages fragment the totality of existence with their subject-verb-object structures, which force us to think of the subject and object as separate entities. In contrast, if the world is viewed as a coherent whole, the language should reflect the unbroken, two-way flow between experience and thought. Quantum processes are action-based and require such a language. To correct this shortcoming, Bohm created a new mode of language, called the *rheomode*, which gives the verb a primary role. But as physicist David Peat reveals in *From Certainty to Uncertainty*, not long before his death, Bohm met native speakers of the Algonquian language and discovered a perfect bridge between their language and the new worldview he said was needed to describe quantum physics. What he had invented already existed.

Author Joseph Rael, of Picuris Pueblo, tells us that the Tiwa language has no nouns or pronouns. He says that at Picuris, things do not exist as distinct objects. Everything is a motion and is seen in its relationship to other motions. Werner Heisenberg, known in physics for the uncertainty principle, argued that quantum reality cannot be represented by electrons and protons acting as “building blocks” of matter. They are visible manifestations of quantum processes based on relationships that exist within the flux of energy and processes of quantum nature. Particles are always in a state of flux (between matter and energy) and do not always transform back into the same particles.

The discovery of the quantum over a century ago changed physicists' concepts about reality. The quantum world is so incredibly small that it is impossible for an observation not to disturb the system; thus objectivity, a cherished value among Western scientists, is lost in quantum observations. In quantum mechanics, the future state of a system cannot be predicted except within a range of probabilities. And the flow of time is absent. Unlike the "ordinary" world in which Newton's laws work, in the quantum world there is no determinism, continuity, or causality. According to physicist Paul Davies, many physicists have argued that the act of observation, which involves consciousness, prompts nature to make up its mind. Incorporating a certain amount of mysticism into quantum theory, some physicists today take the view that subatomic particles only come into existence in the presence of an observer, when the system is measured, in a kind of observer-created reality.

Unfortunately, much mainstream science is still fragmented and so is humanity. Despite new discoveries and progress toward understanding the universe, the principles of environmental sustainability and wholesome human relationships have been set aside in favor of a destructive path that conquers nature and nations. As individuals, we seem powerless before our own government to determine our destiny. The split between spirit and matter seems more evident now than ever, appearing in artificial forms: religion versus science, church versus state, fundamentalism versus liberalism, and creationism versus scientific naturalism. But a third alternative is available, the unifying and holistic principles embodied in native spirituality, which accommodates science, revelation, and conscience. Chief Seattle once expressed the important connection between native spirituality and the future of humanity: "What befalls the earth befalls all the sons and daughters of the earth."

Bibliography

- Aikenhead, Glen. "Integrating Western and Aboriginal Sciences: Cross-Cultural Science Teaching." <http://www.usask.ca/education/people/aikenhead/risearticle.htm>.
- Alaska Rural Systemic Initiative*. Alaska Federation of Natives, University of Alaska. <http://www.ankn.uaf.edu/ars.html>.
- Berardi, Gigi, et al. "Science and Environmental Education in Tribal Homelands." *Environmental Practice* 4:2 (2002): 70–71.
- Bohm, David. *On Dialogue*. London: Routledge, 1996.
- . *Wholeness and the Implicate Order*. London: Routledge, 1980.
- Brooks, Drex. *Sweet Medicine: Sites of Indian Massacres, Battlefields, and Treaties*. Albuquerque: University of New Mexico Press, 1995.
- Cajete, Gregory. *Native Science: Natural Laws of Interdependence*. Santa Fe, NM: Clear Light, 2000.
- Capra, Fritjof. *The Tao of Physics*. Berkeley, CA: Shambhala, 1975.
- Cochran, Patricia A.L. "What Is Traditional Knowledge?" http://www.nativescience.org/html/traditional_knowledge.html.
- Davies, Paul. "That Mysterious Flow." *Scientific American* 287:3 (September 2002): 40–47.
- Duran, Eduardo, and Bonnie Duran. *Native American Postcolonial Psychology*. Albany: State University of New York Press, 1995.
- Gordon, Oakley. *An Environmental Epistemology of the Andean People of Peru*. <http://www.psych.utah.edu/gordon/AndeanResearch/FullPaper.html>.

- Hurtado, Lorenzo Muelas. "Access to the Resources of Biodiversity and Indigenous Peoples." Edmonds Institute occasional paper, Bogota, Colombia, 1998.
- Kawagley, Angayuqaq Oscar. "Alaska Native Education Research: Reaching into the Profound Silence of Self." Paper presented to the International Arctic Social Sciences Association, Rovaniemi, Finland, May 1995. Published by the IASSA, Spring 2002.
- Krishnamurti, J., and D. Bohm. *The Ending of Time*. San Francisco: Harper, 1985.
- Men, Hunbatz. "Reconsecrating the Earth." In *Profiles in Wisdom*, ed. Steven McFadden, 225–41. Santa Fe, NM: Bear, 1991.
- . *Secrets of Mayan Science/Religion*. Santa Fe, NM: Bear, 1990.
- Napoleon, Harold. *Yuyyaraq: The Way of the Human Being*. Fairbanks: Alaska Native Knowledge Network, 1996.
- Nerburn, Kent, ed. *The Soul of an Indian and Other Writings from Ohiyesa (Charles Alexander Eastman)*. 2nd ed. Novato, CA: New World Library, 2001.
- Nichol, Lee, ed. *On Dialogue*. London: Routledge, 1996.
- Peat, F. David. *From Certainty to Uncertainty*. Washington, DC: Joseph Henry, 2002.
- "President Bush Announces New Vision for Space Exploration Program." *White House Press Release*, January 14, 2004.
- Rael, Joseph. *In the House of Shattering Light: Life as an American Mystic*. Private limited edition, 2002.
- Rekindling Traditions: Cross-Cultural Science and Technology Units Project, University of Saskatchewan. <http://capes.usask.ca/ccstu>.
- Wolfe, Fred Alan. *Taking the Quantum Leap*. New York: Harper and Row, 1981.

8 Knowing the World

Vine Deloria Jr.

An increasingly popular field of study is the traditional knowledge of indigenous peoples. Recognizing that nearly two-thirds of the useful domestic food plants have their origin in the Western hemisphere, scholars, native and otherwise, have been investigating the possibility that non-Western peoples have a science of their own capable of making profound discoveries about the usefulness of the natural world. Drug companies scour the jungles of Central and South America in search of medicinal plants from which chemicals can be derived that will prove effective in the fight against disease. In short, the traditional knowledge of indigenous people is big business in both private and public spheres of inquiry.

Native scholars now address meetings of professional societies that previously would have ridiculed the idea of allowing a native to attend their sessions, let alone make a presentation. Quantum physicists and astronomers now visit tribal reservations and talk with native peoples to find useful concepts that might speak to unresolved problems in their areas of expertise. Some native languages have concepts of time and space more akin to current thinking in physics than to the Newtonian absolutes. When archaeoastronomers restrict their understanding of native astronomy to measuring the angles in medicine wheels, they overlook stories of radical changes in the sky remembered in the memory and folklore of the tribe.

A strongly held belief of the movement toward integration is that basic concepts such as space and time can be transferred from the native tradition to mainstream Western scientific paradigms without any considerable loss of meaning or function. In some cases a strong argument can be made that native knowledge both supplements and complements areas where Western science has stumbled, since the results of native observations and scientific experimentation often coincide. On the native end of the philosophical spectrum, scholars such as Gregory Cajete and Daniel Wildcat have compiled an impressive body of evidence that suggests the two bodies of knowledge can be placed side by side, exchanging concepts occasionally, and arriving at jointly

shared conclusions. We can only applaud their efforts to establish clear lines of communication so that constructive dialogues can take place.

Some danger exists in this enterprise. Western science has its roots in the admonitions of Francis Bacon, who counseled that nature must be forced to surrender its secrets so it can better serve humans. Thus this body of knowledge has never given us much information on how nature functions in its normal rhythms, absent the tortures imposed on it by our experiments. Some sciences, particularly astronomy and geology, can only be observational in that the phenomena they investigate are too large to be significantly affected by our efforts to force information from them. In this sense they are very close to the traditional Indian practice of observing nature without demanding answers to a set of hypothetical questions. Some doubt exists whether data gained from experiments in which artificial conditions are imposed should be granted equal status with the neutral observation of extraordinary events.

Traditional tribal knowledge relies on the remembered sequence of the unusual incident and therefore preserves a substantial heritage of raw empirical data because it remembers the extreme fluctuations that natural rhythms can take on occasion. A good deal of knowledge, on the other hand, derives from dreams and visions in which certain verifiable facts are imparted to the individual. It was generally the practice of most tribes that anyone claiming to have received special messages or new powers must demonstrate his newly acquired gifts before the community. This requirement ensured that fraudulent claims were held to a minimum, for it was foolhardy to make claims that could not be verified empirically.

Both bodies of knowledge are cumulative, although they arrange the data in entirely different but easily retrievable ways. Science tends to build on previous experiments and doctrines, and the development of knowledge is conceived as stretching along a linear historical progression that produces occasional paradigm shifts but still nevertheless maintains a continuity so that the thinking processes can be understood and repeated by succeeding scientists. Higher education then consists of memorizing what has gone before and trying, within the acceptable paradigm, to move the mass of data forward to become evidence to support the most general doctrines of science. The goal is identifying, testing, and adding more data not previously included as evidence for the validity of the paradigm.

A problem with the accumulation of evidence is that data are frequently excluded if they do not support accepted doctrines. The history of science shows that a considerable number of anomalies are cast aside because they do not fit a particular paradigm. Instead the anomalous data may be ridiculed, declared the result of a fraud, or simply not mentioned in polite society. Or scenarios are invented to explain why the anomaly exists. Some explanations are so bizarre, they raise questions about the sanity of the scholar proposing them. The idea of the intrusive artifact in archaeology, for example, purports

to explain how an artifact might gradually work itself through various strata to be found where it is not supposed to be.

Traditional indigenous knowledge avoids such escape mechanisms. We can visualize traditional knowledge as a massive fan or delta-like formation rather than a linear sequence. Alongside regular behavior are placed the phenomena that violate expectations and the new experiences for which there is no precedent or model. Anomalies are therefore as valid as memories that uphold the general rules. One could say that traditional knowledge consists of a large number of case studies (or memories) available for comparison with new experiences. Since past events are a part of the data, interpretations begin with the closest similar event and attempt to conform themselves to the immediate situation. Where they do not conform, they provide another model for future comparisons.

Western science purports to eliminate the subjective element in the observation, experimentation, and interpretation of data, but its critics argue that subjectivity is a substantial presence, particularly when intellectual loyalty is surrendered to the reigning paradigm. As Stephen Jay Gould demonstrates in *The Mismeasure of Man*, some studies of the human skull that were done in an effort to predict intelligence and personality were slanted in favor of existing doctrines, or were examples of outright fraud, making the data conform to popular ideology.

Traditional indigenous knowledge readily admits, even welcomes, the subjective experiences of individuals and communities as part of the data to be considered. Dream and vision experiences are considered as part of everyday life, giving directions on the proper way to live and offering valuable information on the use of plants for food and medicinal purposes or directing hunting and warfare activities. Predictions about future events are also received from these sources, indicating that time, while apparently a routine function of natural cycles, also has an element of determinism that structures our lives. There appears to be, therefore, a superior developmental process that reveals a more profound dramatic sequence. Chaos theory may eventually find an ally in the traditional way of examining data.

Technology has enabled scientists to observe entities and processes that were previously unknown when data were gathered with the naked eye. Thus micro and macro levels of cosmic existence come under our control or observation, and we can make predictions that were previously beyond our ability. We now know that inert matter contains tremendous reservoirs of energy, and that small computer chips can contain data that would fill hundreds of libraries. We are on the threshold of changing the morphology and life expectancy of organic entities by changes in genetic codes.

Indigenous peoples believed that the world was alive and had numerous entities that were willing to develop a personal relationship with humans. The result of these partnerships was manifested in the ability of the indigenous practitioner to learn more about the inner secrets of the world and to perform

feats that otherwise could not be conceived or attempted. It came as no surprise to traditional people that the rock or mineral could be harnessed in certain ways to make it serve our needs. They understood stones as living entities, worthy of respect, with inherent energy within themselves. They thought certain stones were perfect communities, capable of many things, but awaiting a human relationship that could help bring their wisdom to fruition by transmitting their knowledge and using their assistance. Certain stones, although regarded as sacred, generally performed rather mundane and routine tasks, such as locating lost objects and offering advice on decisions to be made, thus validating empirically the status of nonhuman entities in the world.

Although beginning with philosophers who sought to understand the world as being composed of a single substance or defined by one principle or concept, Western science developed over centuries into a set of specialist areas as the vast body of evidence became impossible for one person to comprehend. Alfred North Whitehead's metaphysics sought to describe an organic universe, but his new language describing phenomena proved too exotic to be incorporated in regular technical scientific language. Albert Einstein's effort to explain the world in terms of relativity involved new ways of viewing the world, rather than discovering a universal principle that was applicable to all areas of science.

Traditional peoples began with specialist understandings, since first dreams and then visions informed people of the larger and mostly invisible realm of spirits, giving instructions and offering assistance. These experiences had their own narrative lines, so there were no mysterious symbols of the other world as are found in more developed religious traditions. Each person encountering the spirits was given specific new powers that could be used in conjunction with the creatures that instructed the person how to invoke their presence and assistance. Thus proper diagnosis of a problem, be it a healing or seeking advice, was the task of the assisting entity, be it a bird, animal, or rock. Once the need was precisely defined, medicine people would identify the person most likely to have the powers needed to solve the problem. Sometimes the powers descended through families, so the spirit animal helpers and their powers were known to exist with them.

The primary question of Western science seems to be whether or not a theoretical course of action is possible. Whether the course of action will ultimately have positive or negative results seems of less importance. If we can do it, our attitude is to go ahead without considering the possible dangers, for example, in disrupting a part of nature to make something new. But gathering a group of traditional spiritual people to work on splitting the atom, for instance, would be impossible in an indigenous society for moral reasons, since it would be intruding on another entity at a fundamental level. Some Western scientists, on watching the first atomic explosion in New Mexico, expressed deep regrets about what they had done and began to show concern about the moral dimension of science. In indigenous societies, the misuse of

powers does not go unpunished. In some traditions, for example, anyone suspected of witchcraft or misuse of special powers might be exiled to prevent social discord.

Two major topics seem to dominate scientific inquiry: the makeup of the universe, and the origin of the world and organic life. Some quantum physicists speculate that the universe is mind or some form of gigantic thought. Expectations rise high that upon locating the hypothetical particle called the Higgs boson, the final logical ingredient of quantum physics will be identified and scientists will be able to completely describe the physical universe. A number of Indian tribes also believe the physical world is composed primarily of mind and recorded this belief either in their creation stories, as did the Hopi, or in their description of what lay beneath natural phenomena. In the traditions of the Sioux, Muskogee, Chippewa, Omaha, Blackfeet, Iroquois, and many other tribes, the world is the expression of a great mind, and physical life is an essential way of expressing the spiritual patterns and entities that compose the larger intelligible world. In this respect, Indians are very Platonic, seeing our physical world as the corrupted and incomplete representations of the real world of spirits. But the theories of many indigenous peoples differ from those of mainstream science in a fundamental way. Indigenous peoples begin with the idea that the world is spiritual, and they seek ways to live in harmony with the larger spiritual expressions and concerns. In some traditions, people believe that they knew the secrets of the spiritual universe before they were born, but forgot them when taking on flesh. Unusual events are one way the spiritual world seeks to reawaken us to their presence. Here Indian beliefs are close to Gnostic beliefs.

Personality characterizes the traditional Indian conception of the universe, and the intangible manifestation of personalities encountered in dreams and visions is considered an indicator of the correctness of this belief. In many traditional societies, the practice of changing names reflects this understanding of personality. As people develop a discernible personality and accomplish significant deeds in the eyes of their peers, they are given names that more adequately describe them. The great mysterious power that sustains life has many names to describe the various ways in which this power manifests itself in the physical world. Indian languages are complete and complex, so that accuracy in describing behavior can be achieved. General terms are always modified to catch the nuances of new perceptions.

In a universe peopled with personality, alliances with superior personalities enhance the capability of humans to succeed and prosper in a world where unusual things can happen. In many Indian traditions, contact with local animals was the first step in adjusting to the environment and fulfilling human destiny. The people believed they could communicate with birds and other animals, and some even claimed to speak the animal languages. Black Elk relates that, lost in a blizzard, he heard a coyote howl and suddenly understood that the next day he would find two people who had also survived the

snow and, with them, would find buffalo to hunt to feed his family. Everything happened as he had been told.

The cumulative effect of the human-nonhuman alliances is the creation of a cooperative enterprise in which all entities are involved. Traditional Indian knowledge recognizes that we are cocreators of the future and have a responsibility to advance our kind to its fullest possible expression of integrity. Development of personality seems to be the highest priority in life, and yet a pattern has been given to each entity that has to be fulfilled. Creature integrity becomes possible if there is some knowledge of what is expected of each entity. Every bird builds a nest and has a general idea of what the nest should be; however, each bird builds a different kind of nest and has its place in the world. Animals from the smallest to the largest form social groups that have certain standards of behavior, and in many instances Indians adopted those standards in their own lives. Each entity, it is said, knows when it will die, and this knowledge is given to every creature except humans. For humans, there were often predictions on how long one would live or the circumstances under which one would die, and this information proved reliable most of the time. The universe is therefore a realization of completeness at any moment, with “strings” of probabilities extending into the anticipated future. Thus a kind of string theory developed through human emotional concerns and made the universe a place where full realization of ideas is possible.

In Western culture we tend to arrange our experiences along a linear time sequence that we call “history,” a practice tailor-made for the theory of evolution: that organic life is produced by miniscule changes in genetics and morphology over billions of years. Cumulative changes have produced what we see today. Yet recent data from astronomy suggests that large objects occasionally or periodically visit the earth from outer space, with a resulting destruction of the biosphere. Estimates are that there have been seven or eight major destructions in which 70–90 percent of creatures in the biosphere were exterminated.

In some indigenous traditions, instead of linear, gradual change, the people speak of a series of worlds that were created following a major destruction. Each era of earth history was brought to a close by catastrophic actions of fire, flood, cold, or winds. Survivors of these destructions then received instruction on how relationships will exist in the newly manifested world. The Sioux speak of a previous world filled with very large creatures that were reduced in size during a disaster. Downsizing of biota did occur sometime during the Cenozoic period, and animals such as the bison, mammoth, beaver, wolf, and armadillo became their present size while having ancestors of much larger proportions. As Western scholars attempt to understand how earth and its creatures have changed, traditional Indian knowledge will provide plenty of raw data for consideration.

A primary component of traditional knowledge is the song. The earth makes sounds through the songs of different birds and other animals. Favored people are given special songs in dreams and visions. The native perspective sees

sound or vibration as critically important to the functioning of the cosmos. We know that some of the planets in the solar system give off radio noises, which would not surprise traditional people. Ancient peoples talked about the music of the spheres. As yet no effort has been made to coordinate songs used for rituals involving the stars and tribal constellations. However it would not be surprising if some correlation could be found.

Old stories relate that with the right combination of songs and prayer, medicine men could create small universes or scenarios inside medicine lodges. It is reported that the Navajo could cause a little sun to rise on the east side of their medicine lodge and watch it as it crossed the ceiling, finally setting on the western side. It is said that the Arikara bear society once created a little scenario of clay men, horses, and buffalo, then animated them and watched the hunt, and finally ordered the little figures to race into a fire to cease their existence. While these things seem impossible, some testimony exists from skeptical non-Indians who swear that such an event happened and that they could never explain it satisfactorily.

The display of the powers of the practitioners of traditional knowledge is usually interpreted by non-Indians as sleight-of-hand magic tricks, mass hysteria, or hypnosis. This criticism derives from the belief that the world is primarily material and has little or no spiritual counterpart. If we look at phenomena with a philosophical eye, however, and consider that we do not misexperience things, we only misinterpret our experiences, then we can treat experience as raw data in our effort to probe the secrets of the unseen universe. But the feats of a shaman are not reducible to the mathematical formulas used by Western scientists to represent subatomic entities that cannot be seen or touched, while the Higgs boson, when it is finally located, will be but a mathematical expression.

If shamans can transport themselves to other places, or cure an illness by singing a particular song, or converse with birds and animals, instead of being dismissed as part of a system based on superstition, these phenomena should be indicators of the universe we live in. As scientists explore the structure of the near death experience, a body of data will support that there are more things available to us in the world than forcing nature to perform unnatural acts. At present we are taking the long way to find correspondences between traditional knowledge and Western scientific findings. Instead of our usual focus on the hard sciences, we should emphasize matching discoveries in psychology with traditional knowledge, since the primary concern of Indians was to find the proper path of behavior that would enable them to live comfortably in the world.

Bibliography

- Cajete, Gregory. *Look to the Mountain: An Ecology of Indigenous Education*. Durango, CO: Kivak, 1994.
- Deloria, Vine, Jr., and Daniel Wildcat. *Power and Place: Indian Education in America*. Golden, CO: Fulcrum, 2001.

Densmore, Francis. *Teton Sioux Music and Culture*. Lincoln: University of Nebraska Press, 1992.

Grinnell, George Bird. *The Cheyenne Indians: Their History and Ways of Life*. Lincoln: University of Nebraska Press, 1972.

Neihardt, John. *Black Elk Speaks*. Lincoln: University of Nebraska Press, 2000.

Schlesier, Karl. *The Wolves of Heaven: Cheyenne Shamanism, Ceremonies, and Prehistoric Origins*. Norman: University of Oklahoma, 1993.

Vestal, Stanley. *Warpath: The True Story of the Fighting Sioux Told in a Biography of Chief White Bull*. Lincoln: University of Nebraska Press, 1984.

Waters, Frank. *Masked Gods: Navaho and Pueblo Ceremonialism*. Athens, OH: Swallow, 1950.

9 Issues in Science and Religion: A Critical Evaluation

Laurence I. Gould

In the year 1633, the eminent scientist named Galileo (1564–1642) was forced to stand trial before the Holy Inquisition at Rome. His crime was that he continued to put forth a position held by Copernicus—that the planet Earth, instead of being at rest at the center of the universe, actually moved about the sun. This was not the first time Galileo had run into trouble with the Catholic Church. He had written earlier letters concerning science and religion that, as Drake mentions, “held and propagated heretical views on the interpretation of Scripture.” But this was the last time: he recanted his Copernican position under threat of torture, was forbidden to publish anything else, and was placed under house arrest for the remainder of his life. Thus culminated one of the most striking clashes between science and religion. Was this merely a dispute between different opinions, or were there more fundamental issues involved?

Recently, much has been written concerning the possibility of agreement between the areas of science and religion. Some scientists and theologians have argued that there is no conflict between those disciplines. Others have argued as forcefully that there is a conflict. The thesis of this article is that because of certain key approaches taken by science and religion, there is a lack of fundamental reconciliation between them.

Aspects of Science

The consequences of an advanced, highly technological science are all around us: in the materials and construction methods of our houses and other buildings; in the appliances (including computers) we use and the electricity that powers them; in our means of transportation, whether by road, rail, or air; in the plethora of life-saving diagnostic tools and means of treatment in modern medicine; and in high-speed communication, through optical fibers and through the air, which enables seemingly instantaneous contact around the globe. And the evidence goes on and on, through an ever-lengthening list.

The origins of science go back millennia. Science starts from observations of the world. Humans wondered about what makes the stars shine, and what produces the sounds and flashes from the sky that we call “thunder” and “lightning.” But wondering alone does not constitute science. Some humans wanted to know both *how* and *why* things behaved as they do. The ancient Egyptians, for example, in order to transport massive blocks of stone and arrange them into the shape of a giant pyramid, sought to understand how materials behaved under great loads, and why some materials were more useful than others for the project. The ancient Greeks made scientific investigations that were rudimentary compared to modern methods. Renaissance scientists such as Leonardo da Vinci (1452–1519) undertook careful investigations into how birds fly and how the eye sees. But science in the modern sense only got started around the time of Galileo, because he was the first to extensively use the language of mathematics to describe phenomena in the physical world.

Science can be defined, based on characteristics just indicated, as a rational and systematic study of the natural world with the objective of formulating general laws or theories. *Rational* means “based on reason,” which is the use of logic in conjunction with the evidence of the senses. Today, the term *science* (*scientia* is a Latin word for “knowledge”) usually refers to what we call the “natural sciences” (such as physics and chemistry) and the “life sciences” (such as biology and zoology), although the term was once more generally employed. For example, Aristotle (384–322 BCE) includes metaphysics, a branch of philosophy, as a science.

Although science is often thought of as “cold”—impersonal or emotionless—the pursuit of science can bring profound emotional reward to those who engage in it. Einstein said he experienced a “cosmic religious feeling.” But, he continued, it is a “religious feeling which knows no dogma and no God conceived in man’s image.” Instead, it comes from “a deep conviction of the rationality of the universe and . . . a yearning to understand” and “to experience the universe as a single significant whole.”

Aspects of Religion

Even in an ostensibly secular society, there are many places of worship. One reason for this is the large number of religions: Roman Catholic, Anglican, Greek Orthodox, Jewish, Islamic, Hindu, Buddhist, Christian Science, Amish, Mormon, Baptist, Seventh-Day Adventist, Southern Baptist, Church of Christ, Jehovah’s Witness, Pentecostal, and many more. Some of these faiths have great influence and go back thousands of years.

Religion, like science, involves questions about the operation of the world, but it attributes phenomena to the actions of conscious beings thought of as gods or God. In ancient Greece, for example, a belief was that the god Zephyr’s breath produced the west wind, that Apollo’s chariot pulled the sun across the sky, and that Zeus controlled both thunder and lightning. Why did people think

the forces of nature were due to gods? One insight might be provided by child psychology. Some young children attribute consciousness to things that appear to move on their own. They think that the wind is conscious, or the clouds. This animism appears to be one of the stages of consciousness discussed by Piaget.

As noted by Santayana, the forces of nature were considered the action of powers external to our consciousness that possessed a will of their own. It could therefore be an advantage to humans if they were in contact with the agents behind the forces. So humans tried to propitiate the gods in order to bring the forces of nature in line with human desires. This attempted propitiation was done through personal prayer and offerings, as well as through intermediaries—for example, priests or shamans—who were supposed to have special abilities to relate to the gods.

A religion, according to Walsh, “is a system of beliefs and practices resting on the assumption that events within the world are subject to some supernatural power or powers such that human needs, either physical or psychological, can be satisfied by [humans’] entering into relations with such powers. The supernatural powers in question are called supernatural in virtue of the fact that they can allegedly be known, related to or influenced primarily by means other than those of reason and sense experience,” or in other words, by means of faith.

Some human desires can be satisfied through religion. Religion can give, with its definitive rituals and beliefs, a sense of *order and stability* to the world (e.g., through the belief that God created things for certain purposes). It can offer a source of *consolation* (such as for those who, feeling unloved, believe that God loves them). It can also fulfill a longing for the *ideal* (e.g., the joys of heaven or the infallibility of a supreme being). A desire for *mystery* can find outlet through believing in that which one cannot understand (“The Lord works in mysterious ways.”). Or it can explain the unexpected (as when people say “Thank God!” after something occurred that they worried would not happen). One can be uplifted through religion via *feelings of worship* (of God or Zeus or Allah) or through experiencing the *grandeur* of great cathedrals or the music of a religious service (which can also be experienced by people who are not religious in the traditional sense). Perhaps one of the strongest appeals of religion is that it can fill the need of a *moral code* for providing guidance in living one’s life.

Aspects of Philosophy

Some people have called philosophy “the handmaiden of religion.” But philosophy deals with much broader perspectives than either science or religion, although it is the source of certain basic principles used implicitly or explicitly in each. Everyone’s beliefs assume philosophical ideas, and an awareness of the fundamentality of philosophy gives us the option of deciding whether our philosophical ideas remain *implicit* or *explicit*.

The main areas of philosophy considered here are metaphysics, epistemol-

ogy, ethics, and politics. The first three can be linked through the questions: What exists (*metaphysics*)? How do you know (*epistemology*)? What should you do about it (*ethics*)? *Politics* is derived from the other three in the realm of social interaction. These areas are discussed below, along with a critical analysis of their relation to central issues of science and religion. Epistemology is the most significant in distinguishing science from religion.

Epistemology

If there is a claim that something exists—whether it is a painting by Rembrandt, an atom of hydrogen, or Christ, or Allah—the natural question to ask is: How do you know? That is, what are the methods you employ to arrive at your beliefs? (That *something* exists is a primary. If there was not anything, there would not be anything to know, nor would there be anything that *could* know.) The area of philosophy pertaining to “the study of the origins, nature, and limitations of knowledge,” as Jones notes, is referred to as *epistemology*.

One of the things to notice about science and religion is the methodology each uses and the type of conclusions obtained by each. The methodology is the key thing that separates science from religion. In science, there is one fundamental methodology—*reason*. Its signature is the acquisition of knowledge.

Science and Knowledge

Scientific ideas must not contradict each other within a discipline or across disciplines. For example, principles of physics, such as Newton’s laws of motion, must not contradict principles of biology, such as Darwin’s theory of evolution. And explanations obtained from one area, such as how stones fall (physics), must not contradict those from another, such as how organisms propagate through the generations (biology). If a contradiction is found, this indicates to the scientist an error in thought that must, sooner or later, be resolved. Notice the word “must”—it points up a required way of action and, as will be shown later, is intimately tied to ethics. Contradictory claims about the world are, for the scientific mind, not admissible. The hallmark of scientific methodology is that *science uses reason—it proceeds to know the world using logic along with the evidence of the senses*.

Here is one example of how science proceeds: Einstein’s theory of special relativity led to the conclusion that no matter how hard it is pushed, an electron cannot reach the speed of light. An earlier theory, however, Newton’s Second Law of Motion, led to the conclusion that if an electron is pushed hard enough, it can not only reach the speed of light but exceed it. The two theories give contradictory results. They both could be wrong, but they certainly could not both be correct. Indeed, we have learned that Newton’s theory has a relatively limited (though very wide) applicability, because experiments on high-speed electrons agreed with Einstein’s theory.

For scientists, saying that beliefs about the world are “true” depends on fitting those beliefs, without contradiction, into the context of the entirety of scientific knowledge. Such beliefs can therefore change if new experiments, in conjunction with theory, show that the correction is warranted. That is the way science has made progress through the centuries.

Religion and Knowledge

Religion encompasses many different beliefs, which result from different belief systems. But the epistemology is different from that of science because religion is primarily (but not exclusively) based on the method of *faith*. Such a commitment can hold to the existence of certain things, such as God or gods or angels, even in the absence of, or in conflict with, evidence. Faith does not concern itself with the necessity of resolving any contradictions that may arise from comparing its claims with other claims about the world. For example, if someone believes that water can, by an incantation, be changed into wine, it may be irrelevant to this person that such a belief is inconsistent with scientific knowledge that incantations cannot change nuclear and chemical compositions (distinctive to each substance) from one form into another. Thus it would be mistaken to believe that one can have “faith in reason.” Faith and reason as methods of knowing contradict each other.

Metaphysics

Metaphysics is the branch of philosophy that includes the study of *being*, or what it means to *be* anything. We frequently use its principles when we discuss the existence of specific somethings, in either science or religion. A fundamental principle of metaphysics is that no thing which exists has contradictory properties. For example, an object cannot, at the same time and in the same respect, be both three feet long and *not* three feet long. So to hold that it is, say, three feet long and also two feet long would be a contradiction. The argument for that principle was given by Aristotle (who was not only referring to natural science) over 2,000 years ago.

Existence claims are made in various religions as well as in science. In the Judeo-Christian and Islamic religions, for example, God or Allah is believed to exist. In science, atoms, planets, and stars are held to exist. All these things are believed to be “out there,” independent of anyone’s thoughts. The following are examples of some existence claims along with possible arguments in considering them.

Gravity Gremlins

Let us say that someone is investigating how a dropped object, such as a stone, falls to the ground. Observations show that as the stone falls, its speed increases.

We could claim that it does so because there exist invisible “gravity gremlins.” One gremlin standing on the ground has another gremlin standing on its shoulders, which in turn has a gremlin standing on its shoulders, and so on, all the way up to the top gremlin who has grabbed the stone that was just released. The grabbed stone is then passed down the line of gremlins in such a way that as it gets closer to the ground, the gremlins pass the stone along faster and faster.

But this is not a *rational* explanation, for several reasons. (1) No argument is given for why the invisible source has to be gremlins. It could as well be angels, or the ghosts of all scientists who died within the last 2,000 years. (2) There is no description of *how* the stone speeds up. For example, when the stone is halfway to the ground, is it going half as fast as when it is just about to strike the ground? (3) There is no explanation of why gremlins work faster when they are closer to the ground. (4) There is no explanation of why a stone takes longer to reach the ground when it is released at a greater height.

On the other hand, with a high degree of accuracy, Newton’s Second Law of Motion, in conjunction with his Universal Law of Gravitation, can account for the various aspects of a stone’s motion when it is released. The Newtonian predictions have been confirmed in countless experiments. They are not held to be true based on faith, as would be the case if someone were to claim: “I believe in the sanctity of Newton’s laws as the only laws governing the physical world.”

Supreme Beings

In a debate with the Nobel Prize–winning physicist Stephen Weinberg, the physicist and theologian John Polkinghorne stated that he does not think it possible to prove either that God exists or that God does not exist. (A transcript of their debate is available at <http://www.counterbalance.org>.) But Polkinghorne’s assertion offers us no reason to accept God’s existence.

One might argue that eminent people believe in God, and that people all over the earth believe in some form of supreme being. However, that appeal to authority and to numbers does not examine the validity of the claim that such a being exists. Acceptance of such claims would thus be an example of fallacious reasoning. One can fall into the trap of any number of other fallacies in reasoning, so, as Kelley points out, being able to identify the various logical fallacies is valuable.

Another problem is that there are many religions and many deities, as well as many beliefs about their relation to human existence and the natural world. For example, in the Judeo-Christian religions, the world was created in six days. For the Mescalero Apache, as noted by Farrer, it was created in four days. This and other contradictory claims between these religions would seem to rule out the existence of at least one of the deities. (There is, of course, no problem if these stories are considered mythical. If taken as literal, however, then at least one of the stories would have to be false.)

Possibly the most common and persistent argument for the existence of a supreme being is that the universe cannot have arisen out of nothing and therefore needed a creator. But this argument depends on our understanding of the terms “universe” and “nothing.” For example, there is the “universe” used in astronomy, and the “multiple universes” that come up in one interpretation of quantum physics. But let us say that “universe” means “everything that exists.” If “nothing” means “the absence of *literally* anything,” then it follows that no thing can arise out of the (literal) absence of anything. So it would then be true that the universe did not come from nothing. However, it does not follow that the universe needed a creator, for the creator, if it is something, must be a part of the universe.

It is reasonable, based on our experience, to believe that any thing must come from another thing or things. Chairs are made from wood; good grades result from studying; children are born of parents. Perhaps this is a reason people believe a creator must exist. However, even if a creator is believed to exist, the natural question would be “Who, or what, created the creator?” This would lead to an infinite regress, without an answer to the question.

Believing in the existence of a supreme being or even invisible gremlins may be satisfying, but there is no reason to believe that such a being or beings exist. The scientific attitude would be: “Based on the evidence, or more precisely, the lack of it, the belief in such beings is an arbitrary assertion.” So the scientist is not agnostic about the existence of gremlins or supreme beings, since, in science, *positive* evidence must be provided in order for an existence claim to be admissible. If the evidence changes, the scientist can reexamine existence claims about anything that is currently believed, without evidence, to exist.

Ethics

One of the most ever-present questions each person confronts is: How should I act? In other words, what is “right” and what is “wrong”? Answers may vary depending on one’s religious or philosophical views. The branch of philosophy pertaining to the study of what one *ought* to do, or how one *should* act, is *ethics*. An ethical code can be based on faith or on reason.

People know from their own experience that they are sometimes harmed and sometimes helped as a result of their own actions, the actions of others, or forces in nature. They know that some things are beneficial for them, while other things are detrimental. They know, for example, that it is wise to pay attention when crossing the street so they can avoid being injured by an automobile.

Many people think that one “simply knows what is right and what is wrong” (see Weinberg’s position in the transcript of his debate with Polkinghorne). But that is probably a result of their not reflecting sufficiently on the sources of their belief. Indeed, principles of ethics are often drummed in by one’s

parents, one's religious organization, or the wider culture in which one lives. A child is told that it is wrong to take a playmate's toy; a teenager is told that it is wrong to take drugs; worshippers at synagogue are told that it is wrong to take the name of the Lord in vain and that it is right to love the Lord and follow His commandments.

Ethics and Religion

Ethical principles often have their base in religious doctrine. In several religions, a creator or supreme being is believed to have dictated ethical principles. For people of ancient civilizations, the idea of an omnipotent, supernatural deity who could destroy them may have been a stabilizing threat—more stabilizing, perhaps, than local laws prohibiting the taking of human life. The same perceived threat may be effective for people in the modern world who believe that various deities exist: to not obey these deities is to put oneself in danger of their wrath, in this life or in an “afterlife.” Consider, for instance, the belief that one will “burn in hell” for certain transgressions.

But if you compare some of the ethical principles found in various religions with those found in secular philosophies, there is considerable overlap as well as some clear distinctions. For example, good will and helpfulness toward others can be found throughout society, not only among the advocates of a religion that emphasizes benevolence. And many religions and societies share, albeit very inconsistently, a belief in the value of human life. Hence the “Thou shalt not kill” of the Old Testament reflects the principle of trying to preserve human life in general.

In the Judeo-Christian religions, the first of the Ten Commandments says, “I am the Lord thy God; thou shalt have no other gods before me.” This is not an invitation to think about whether or not this God exists. On the contrary, it is a command to accept the claim of God's existence *without question*. If you do not accept it, then you have done wrong and will be in some way punished. It is this commandment that sets the stage for all the others. And it is this believe-it-or-else attitude that puts a fundamental proscription on where the human mind is permitted to venture (including the choosing of ethical principles). As the Talmud says: “Whoever reflects on four things, it were better that he had never been born. What is above, what is beneath, what is before, and what is after.”

In the Judeo-Christian tradition, original sin is the belief that each person is guilty because Adam and Eve (the first man and woman), in strict violation of God's order, ate of the tree of knowledge of good and evil. There is a problem with this belief on ethical grounds: it holds one person guilty for the actions of another, actions over which the person had no control. Given that people have the capacity to choose what they do, it is rational to hold them responsible for their own actions. But it is not rational to hold them responsible for, say, something their grandparents did before they were born, much

less for what a pair of imagined people did back at the supposed beginning of humankind.

Ethics and Reason

Earlier we examined the word “must” as it pertains to principles of science, to one’s not accepting contradictions. But it is also related to ethics, if one chooses reason as one’s epistemological method and as primary, not only in the pursuit of values but also in the choosing of values. Not to choose reason is to leave the realm of ethics open to arbitrary and contradictory choices of values.

Life is conditional, both in its continuance and in its quality. Some courses of action will tend to enhance it, while others will tend to destroy it. An obvious example of a life-enhancing course is seen in people who choose to work hard to provide happiness for themselves and their families. Using reason is another life-enhancing action.

Reason enables us to better reflect upon which choices can be optional, and on the importance of emotions in the service of our life. “Ethics,” Tara Smith says, “is not a bitter wind in one’s face, stinging a person with injunctions to act against his interest, but a breeze at one’s back, aiding a person toward the achievement of life-enhancing values.” She argues for the significance of reason in ethics against a contrasting background of other ethical systems.

Politics

Politics is the branch of philosophy that deals with the interactions of people in society, and it includes the proper function of government. Politics is dependent on the three branches previously discussed, most directly on ethics. For example, when you vote for candidates for public office, you normally do so because you believe that their policies will be, on balance, “good” for you. Similarly, you do not vote for someone whose policies you believe will be “bad” for you. When candidates get into office, they can be successful at putting laws into effect. Such laws then become enforceable by the official agents of the government. These are the only agents to have a *legal monopoly* on the use of force, two examples being the police and the army.

There is wide agreement among people of many religions and philosophies that certain laws—for instance, ones that make it a crime to steal someone else’s property—are moral and that certain other laws—for instance, those passed against the Jews by the government of Adolph Hitler—are immoral. But beyond this wide category of agreement, there is much variation in opinions of particular laws. Should there be a law banning the teaching of evolution? Should there be a law banning the words “under God” from the U.S. “Pledge of Allegiance”? Should there be a law banning abortion, or a law making it mandatory in certain circumstances? Should there be censorship laws?

Whether we consider a particular law moral or immoral depends on the ethical system that provides the basis for our judgments. Our system of ethics—itself a belief system—is, in turn, based on other beliefs. And those beliefs ultimately rest on an epistemology guided by reason or by faith.

In Galileo's trial and punishment at the hands of the Inquisition, we have a dramatic and historic example of the clash between reason and faith. The most fundamental difference lies in their respective approaches to *epistemology*—in the method by which each attempts to gain knowledge. For science the basic method is *reason*. For religion the basic method is *faith*. The methods of faith and reason affect what we believe to exist (metaphysics). Our stand on epistemology and metaphysics in turn affects what we deem proper and improper, good and bad, right and wrong (ethics), which in turn affects our political beliefs.

Bibliography

- Dawkins, Richard. *The Blind Watchmaker: Why the Evidence of Evolution Reveals a Universe without Design*. New York: W.W. Norton, 1986.
- Drake, Stillman, trans. *Discoveries and Opinions of Galileo*. Garden City, NY: Doubleday Anchor, 1957.
- Einstein, Albert. *The World As I See It*. Trans. Alan Harris. New York: Philosophical Library, 1949.
- Farrer, Claire R. *Living Life's Circle: Mescalero Apache Cosmivision*. Albuquerque: University of New Mexico Press, 1991.
- Free Inquiry*. Summer 2000 and Fall 2000. <http://www.secularhumanism.org>. These issues contain further readings about science and religion.
- Jones, W.T. *A History of Western Philosophy*. New York: Harcourt, Brace and World, 1952.
- Kelley, David. *The Art of Reasoning*, expanded version. New York: W.W. Norton, 1990.
- McKeon, Richard, ed. *The Basic Works of Aristotle*. Book 4, chap. 3. New York: Random House, 1941.
- National Center for Science Education. <http://www.ncseweb.org>.
- Piaget, Jean. *The Child's Conception of the World*. Trans. Joan Tomlinson and Andrew Tomlinson. Savage, MD: Littlefield Adams, 1951.
- Post, John F. *Metaphysics: A Contemporary Introduction*. New York: Paragon House, 1991.
- Santayana, George. *The Life of Reason: Or the Phases of Human Progress—Reason in Religion*. New York: Charles Scribner's Sons, 1928.
- Skeptical Inquirer*. Special Issue 1999 (on science and religion), July/August 2001, September/October 2001, March/April 2002. <http://www.csicop.org.si>. These issues contain an extensive collection of articles about science and religion.
- Smith, Tara. *Viable Values*. New York: Roman and Littlefield, 2000.
- Stossel, John. *The Power of Belief*. ABC News Home Video Library, 1998.
- Walsh, George. *The Role of Religion in History*. New Brunswick, NJ: Transaction, 1998.

10 Intersecting Frontiers in Science and Religion

Paul Utukuru

Awareness of its own identity and awareness of the environment around it as separate from itself are central to the acquisition of knowledge by any organism. The sensory and interpreting apparatuses of any given organism are the means by which knowledge is acquired, and these means vary widely. For this reason, different species, different humans, and different disciplines comprehend themselves and the world around them differently. As humans, we have learnt to augment our senses in spectacular ways by our technologies, our concept-forming abilities, our linguistics, and our abilities to transfer knowledge from generation to generation. Nevertheless, there are upper limits to what we can comprehend even as humans. And those limits are set primarily by our genes and secondarily by our senses, our brains, and our vocal cords.

In spite of these limitations, spectacular advances have been made in our comprehension of life and nature, especially during the last six or seven hundred years by the methods of science. These advances in turn have led to technologies that are giving more and more credence to their underlying foundations. For this reason, modern scientific research often proceeds under the assumption that there is a body of absolute knowledge out there that will all be worked out some day fully by the methods of science. However, as Thomas Kuhn has articulated so well in *The Structure of Scientific Revolutions*, all knowledge is ultimately paradigm dependent. Furthermore, our perceptions are structured in space and time, and as physicist Paul Davies points out, we give primacy over the position variable rather than the momentum variable. In other words, all human understanding is limited to our perceptual limitations resulting from our very existence in time and space. Mystics tell us that these limitations can be transcended. If that is indeed true, it raises the question as to why a functioning brain is necessary even for that to occur.

In any case, it is universally recognized that science deals with objectively verifiable knowledge only. But human knowledge is not limited to verifiable

knowledge. Knowledge inspired, captured, and communicated through literature, mythology, music, and the arts is beyond the scope of objective scientific verification through assessment of cause and effect relationships and probabilities—an issue well articulated by British intellectual C.P. Snow. No scientist could have marveled more at the ultimate mysteries of life and nature than Albert Einstein, who said that the most incomprehensible thing about nature is that we comprehend it at all.

Given the limitations to understanding that are imposed on us by the very nature of our being, what paradigms can we come up with to integrate the numerous knowledge databases that have evolved in human civilizations? One major conflict in this regard is between science and religion. Religious mythologies have evolved in human societies along with other cultural phenomena, such as literature and the arts, which are beyond science. Concepts such as gods, angels, devils, the soul, the afterlife, spirit worlds, reincarnation, and eternal life are beyond objective rational science. One can argue, however, whether the numerous biological species on earth have evolved progressively from lower to higher forms entirely by virtue of random mutations and natural selection, or whether there are as yet undiscovered natural or supernatural mechanisms involved. In any case, it is worthwhile to seek out the unifying threads between science and religion, and to explore the interface between the two.

Religion and Spirituality

Science does not address the inequities in our lives and our finite mortality on earth. Nor does it set standards for morals and ethics. Most religions are primarily concerned with such issues. When religious faith impinges on the average believer, it is not at the level of an actual encounter with God or a deity or a miraculous revelation or a profound spiritual transformation. Rather it often offers its adherents comfort and strength to accept one's lot in life with dignity and with expectations of a better life after death, or a perceived fulfillment of earthly desires through prayers and rituals. Religion is perhaps the most successful psychological therapy ever invented. Its positive impact on the physical and emotional well-being of individuals and groups is substantial. But then, religion has also been responsible for numerous rivalries, atrocities, and bloodbaths throughout our history. Within Christianity have arisen hundreds of denominations with significant doctrinal differences. Similarly, Judaism has distinct branches, as does Islam. Religious movements such as Sikhism, the Bahai faith, Hinduism, and Buddhism have not been spared numerous divisions and subdivisions.

Fundamentalist movements are found in most religions. Religious fundamentalists do not seek to identify the common elements in all religions. Rather they focus on their own interpretation of the dogma of their own religion. But among the many religions are numerous similarities. Initiation ceremonies,

wedding vows, and funeral rites can be strikingly similar. Kneeling or bowing in front of deities and praying with folded hands are traditions in many religions. Prayers are often counted on the beads of a chain. The postures of Jesus, the Buddha, and some of the Hindu gods are very similar in icons. Ringing a bell, lighting a lamp or a candle, burning incense, and immersion in water are shared practices in many faiths. Meatless days and fasting routines are prescribed by many religions. The more similarities you seek, the more you will find.

A recent spiritual trend is the spread of various forms of meditation and physical activities such as yoga and tai chi in addition to traditional prayers and rituals. These practices have the endorsement of medical researchers for their usefulness in promoting emotional and physical health. Such recognition indicates one area of connection between science and religion. But it is the underlying core of all religious thinking that we need to seek out, rather than the specifics of any given religion, if we are to find connections among the religions, and between religion and science.

Intersections of Physics and Religion

The most recent advances in physics suggest that the perceptual world is a mere illusion or shadow play, just as mystics have been saying for ages. Causality and determinism (even in a probabilistic sense) are seen as relevant only within the framework of our own space and time perceptions. Outside of that, past, present, and future all appear to be relative, again echoing the conclusions of mystics and saints from times remote. Besides, any observation, with or without the aid of instruments, not only may interfere with what is observed but may change the very mechanics of the process, which includes the observer, the observed, and the act of observing. Physicists might find it interesting to explore chapter 13 of the Hindu *Bhagavad Gita*, in which Lord Krishna discusses the issue of observer (Kshetragna) and the observed (Kshetra) extensively in spiritual terms.

Chronologies based on the Bible suggest that the world was created around 4000 BCE. According to one version of Hindu cosmology, the present evolutionary subcycle known as Kaliyuga is said to have begun after the death of Lord Krishna in 3102 BCE, a date close to the time when Noah is said to have built his ark. According to this version of Hindu cosmology, the present universe began more than 19 billion years ago, and life on earth began almost 2 billion years ago, figures close to those of modern science.

Then there is the enigma of time itself, which has relevance to both religion and modern physics. According to the Christian theologian Saint Augustine, God created the universe not *in* time but *with* time. Hindu Vedanta asserts that the universe into which we are born, in which we live, and in which we die originates from and is sustained by that which is beyond time and within time at the same time. Most modern cosmologists operate under the assump-

tion that time began with the Big Bang. Others operate under the assumption that while our universe has an age, the medium that produced it has none. Physicist Julian Barbour concludes that the unification of Einstein's general relativity and quantum mechanics may very well spell the end of time. Time may be an illusion bringing into focus the Hindu notion of maya, which some people equate with the Christian notion of original sin.

Developments in physics such as the EPR (Einstein, Podolsky, and Rosen) paradox, Bell's theorem, and the Aspect experiment have led some physicists to the possibility of nonlocal interactions even at the level of the most fundamental constituents of our universe. Recognition of nonlocal events in macroscopic phenomena is central to all religious mythologies. How nonlocal interactions in the microcosm evolve into more and more sophisticated manifestations in the macroworld is worthy of pursuit by modern physicists. Still another recent discovery in physics is the distinction between Fermionic behavior and Bosonic behavior at the level of elementary particles. Fermionic interactions seem to result in disorder and increases in entropy, while Bosonic interactions result in harmony, order, and decreases in entropy. Extrapolating these discoveries to the biological world, it may very well be that Fermionic behavior is implicated in selfishness and the survival drive, while Bosonic behavior results in cooperative action among biological species. The challenge for science is to bridge the gap between microscopic and macroscopic manifestation of such properties.

Intersections of Biology and Religion

The issues of design, order, and randomness are central to modern biological research. Most biologists operate on the assumption that genes, random mutations, and natural selection are adequate to explain all biological processes, including human evolution. Religions have different assumptions. According to the Quran, Allah told the prophet Mohammad: "I was a hidden treasure, I wanted to be known, and I created the world so that I would be known." The *Rig Veda* tells us that before the beginning there was neither existence nor non-existence. All this world was unmanifest energy. The One breathed without breath, by his own power, and the universe came into being. Evolution is said to be a process involving the dynamic realization of an otherwise static state of Brahman. Creation is said to begin with an impulse in Brahman to realize his own potential. The Jewish Kabbalist Moses Cordoviro is believed to have said: "There is nothing not pervaded by the power of divinity. God is in everything that exists though everything that exists is not God." An Eastern analogy to this would be: the clay is in the pot, but the pot is in the clay only in terms of its potential.

Many religions view our emotional life as a constant struggle between two opposing forces: good and evil, light and darkness, or God and the devil. God represents the creative force that propels forward our evolution as individu-

als, and the devil represents a disruptive force that retards it. But what is the intended direction? Christians see it as eternal life in heaven for those that have been saved. Hindus see it as a return to the source after a series of births and deaths. The Sufi mystic Rumi writes: “For millions and millions of years, I lived as a mineral. Then I died and became a plant. For millions and millions of years, I lived as a plant. Then I died and became an animal. For millions and millions of years, I lived as an animal. Then I died and became a man. Now what have I lost by dying?”

These pronouncements imply that there was intelligence before creation and in creation, and that intelligence is more primal than matter. William Dembski and other proponents of the intelligent design movement are attempting to demonstrate with scientific rigor that certain complex features of living cells and lower organisms cannot be adequately explained by evolutionary biology. Their work appeals to many scientists who are religiously inclined, especially within the context of a belief in a transcendent God. Many mainstream scientists, however, hold that although biological organisms may have the appearance of a design in their evolution and function, they can be fully explained in terms of current principles of physics, chemistry, and biology.

It is true that our current scientific knowledge in physics and biology is inadequate to answer a whole lot of questions about the mysteries of nature, such as the phenomenon of life, emotions, suffering, and values. What we have are working theories that enable us to move forward. The concepts of natural selection, random mutations, Big Bang cosmology, or the unifying theory of modern physics will never be able to answer every question we can ask. Nevertheless, these theories have provided valuable frameworks within which to advance science. The same cannot be said of the intelligent design hypothesis, yet I am one with those who believe there is more to evolution than random mutations and natural selection. We may discover that natural selection and random mutations are a subset of many other interactive forces among biological organisms, similar to the way Einstein’s theory of special relativity is a more comprehensive generalization of Newtonian mechanics.

Ultimately we may end up recognizing evolution as a process that involves progressively increasing realization of the infinite potentiality of the underlying *Ultimate Reality*, referred to as God in religious parlance. This process may involve both bottom up and top down interactions, as elaborated in books by Arthur Peacocke, John Polkinghorne, and Nancey Murphy and George Ellis. The bottom up category involves such things as atoms becoming molecules, and molecules becoming gross substances. Top down interactions would be a volcano disrupting the harmony of multitudes of ensembles of organic and inorganic matter, or intention being the first step in the movement of a hand or the utterance of a word. Modern scientific theories clarify the role of only the bottom up interactions in the evolutionary process. Many top down interactions involve an element of choice, either individually or collectively by the evolved entities. The choice element is observed not only in the bio-

logical world but is also suspected in certain types of subatomic phenomena. Still higher levels of top down interactions include such things as emotions, values, and group action.

Recognition of both top down and bottom up interactions in evolution implies interactions between the evolving or evolved entities and God, the *Ultimate Source* of all bottom up and top down interactions throughout nature. Evolution will then be seen as rooted in its own history, as implied in the recent publications of neuroscientists such as the Nobel laureate Gerald Edelman, as well as by the mystics of all religions. Recognition of the involvement of top down interactions at the level of the human implies that the future direction of evolution depends not only on the operative principles of natural selection, but also considerably on the steps we take as a species. Putting all these ideas into a single paradigm, I have argued elsewhere that evolution is a two-dimensional process, with God's involvement from the bottom and from the top everywhere and everywhen.

Religious Phenomena and the Neurosciences

Modern neuroscientific research offers the greatest promise for dealing with religious phenomena by the methods of science. Medical researchers Andrew Newberg, Eugene d'Aquili, and Vince Rause have discussed the issue of religious transformation in the context of seven cognitive operators in the human cortical brain. They point out that the seven cognitive operators refer to specific ways in which the brain operates on the sensory and cognitive inputs arriving at the brain. They are all involved in our daily activities, including learning and routines, which include many religious activities. One of the seven, the "holistic operator," which resides in the parietal lobe in the right hemisphere of the brain, can give rise to an infinite variety of brain states ranging from extreme isolation to a sense of growing connectedness to a family, a circle of friends, a community, a religious group, or a nation, depending on the multitudes of sensory and cognitive inputs. Through MRI and PET imaging studies conducted on Buddhist meditators and Franciscan nuns, Newberg and his associates have shown that "the events they considered spiritual were, in fact, the result of observable neurological activity. The holistic operator can lead the subject eventually at times into profound mystical states in which there is a sense of unity with the universe as a whole." They have documented the metabolic changes that occur during the transformation process. Religious beliefs and repetitive rituals like chanting and meditation seem to be extremely powerful vehicles to enhance the potential for this transformation experience.

Such findings suggest that the predominant seat of the transformation process may be the right parietal lobe of the human cerebral cortex. Other regions of the brain may also be involved. The most important contribution of Newberg and his associates, however, is the demonstration that religious trans-

formation is the sense of belonging to a group, a family, or a community taken to its upper limit. The lower limit is the feeling of total separation and isolation from the environment. Like all other sensations, religious transformation is the result of numerous but specific sensory and cognitive inputs to the brain. These inputs may in part be genetically and naturally inherited and in part nurtured by the environment. It is in the context of the latter that religious upbringing and associated activities like prayer, meditation, ritual, and chanting come into the picture.

With these insights from neuroscience, it is easy to appreciate the connection that religious mystics make between the ego and desires and the transformation experience. A transformed individual almost always displays a much lower craving for ego boosts and sensory gratification. For this reason, it is worthwhile to investigate what role voluntary efforts to subordinate the ego and the craving for sensory gratification through fasting, sleep deprivation, and other ascetic practices play in the initiation of a state of enlightenment in an individual. Remember that Jesus and other religious figures are said to have fasted before transformative experiences.

Most neurologists believe that our identity is nothing more than the behavior of a vast assembly of neurons. Neurologist Ramachandran associates divine visions with disorders of the left temporal lobe, based on his observations of one of his epileptic patients, who claimed to have felt oneness with his creator during a seizure. If this connection can be proved, it should be possible to develop neurological stimulation techniques to enable everybody to experience that oneness at will. Impressed by the similarities between mystical claims and altered states of consciousness induced by psychedelic drugs like LSD, some scholars are suggesting that Vedic hymns might have resulted from the intake of soma and that Moses's claim of interaction with God might have been due to the ingestion of some theotoxin.

Psychiatrist Dennis Gersten, on the other hand, looked at the subjectively reported experiences of thousands of his patients and came to the conclusion that, while most of their out-of-the-normal experiences could be accounted for as being due to deficiencies in their brain chemistry, there were many that could not be explained away without acknowledging the possibility of interactions in supernormal ways. Michael Persinger, an authority on magnetism within the brain, conducted some studies in which subjects were exposed to specific series of pulses from a transcranial magnetic stimulator. Some of the subjects described feeling an invisible presence near them or feeling connected to the whole world.

Other Intersections

Anthropologists and evolutionary biologists continue to seek naturalistic explanations for religious beliefs and religious phenomena. Pascal Boyer provides an excellent review of past attempts and comes up with one of his own.

The historical and psychophysical aspects of our religions and the personalities behind them have become targets for exploration by numerous authors. The main trend here seems to be to analyze the personal lives of religious personalities and even mythological figures within the context of modern psychoanalytical constructs such as the Oedipus complex, sexual perversions, and infantile trauma. Some scholars examine the resurrection of Jesus on the basis of new sources of historical evidence and archeological finds, or whether he married Mary Magdalene and had children.

Meanwhile, many artificial intelligence enthusiasts are convinced that silicon-based intelligence will be with us soon. Indeed, Gerald Edelman has already come up with a recipe for the development of software agents that live, eat, mate, and play. These developments do not necessarily negate the notion of an ultimate higher intelligence as the central feature of all that exists.

As of now, matters of extraterrestrial intelligence and spirit worlds, characteristic of most religious beliefs, are out of the reach of fundamental sciences like physics and biology. But issues related to the enigmas of time and space, cycles of evolution, and multiple universes might all be helped by digging into ancient religious concepts, especially when supplemented by the interpretations of the mystics arising from time to time within the context of all religions.

Cognitive scientists can make a contribution to religion by investigating the role different types of religious beliefs and rituals play in dealing with health issues, physical as well as emotional. They can also strive to determine if the types of beliefs, practices, and spiritual technologies one follows make a difference. Psychiatrists should continue to evaluate all types of reported psychic and paranormal phenomena and validate them where appropriate, as Dennis Gersten has done. It is also worthwhile to conduct more studies of the effects of transcranial magnetic stimulation on the brain using techniques such as magnetic resonance imaging and positron tomography. Such studies may also enable us to discover if there is indeed such a thing as direct transfer of information to the human brain by electromagnetic signals from outside. If we do discover such phenomena, we will open the door for clarifying the mechanics of revelation and psychic powers by the methods of science. In addition, it is useful to carry out animal experiments and case studies of patients with pathological disorders to understand the mechanisms by which the brain gives rise to the differentiation between self and non-self, and how far down the evolutionary scale such differentiation exists.

Scientists can make a positive contribution to religion by acknowledging that ethics, morals, values, and matters of the spirit are not their province of enquiry. They will also do a great service to society by acknowledging that all knowledge is species limited and paradigm dependent. Scientists will do a great disservice to human societies if they endorse a particular belief system as being unique or absolute. Such assertions would aggravate the already existing conflicts among different religious groups.

Everything we do in life appears to be a consequence of our inherited genetic makeup and the environmental forces around us as we grow up, as well as the physiological and pathological variants in our behavior resulting from their interaction. These parameters form the backbone for all our biases, all our vanities, and all our pursuits. Even mystics who rise above all other vanities tend to retain the vanity of their mysticism. There is only one thing that is absolute, and that is the underlying substrate of all that exists, the ultimate driving force no matter what name you give to it. In essence, that is the underlying core of all religions and all forms of spiritual expression. And that will be the conclusion of science, too, before long. In the meanwhile, only a rare sage recognizes that there is only one ultimate truth. Only a rare scientist like Werner Heisenberg recognizes that knowledge can never mean anything more than the perception of connections in the manifold.

Bibliography

- Barbour, Julian. *The End of Time*. London: Orion, 1999.
- Boyer, Pascal. *Religion Explained: The Evolutionary Origins of Religious Thought*. New York: Basic Books, 2001.
- Dembski, William, and James Kushiner. *Science of Intelligence*. Grand Rapids, MI: Brazos, 2001.
- Edelman, Gerald. *A Universe of Consciousness*. New York: Basic Books, 2000.
- Gersten, Dennis. *Are You Getting Enlightened or Losing Your Mind?* New York: Random House, 1998.
- Kuhn, Thomas. *The Structure of Scientific Revolutions*. Chicago: University of Chicago Press, 1993.
- Murphy, Nancey, and George Ellis. *On the Moral Nature of the Universe*. Minneapolis: Fortress, 1996.
- Newberg, Andrew, Eugene d'Aquili, and Vince Rause. *Why God Won't Go Away*. New York: Ballantine, 2001.
- Peacocke, Arthur. *Theology for a Scientific Age*. London: SCM, 1993.
- Persinger, Michael. *Neuropsychological Bases of God Beliefs*. Westport, CT: Greenwood, 1987.
- Polkinghorne, John. *Belief in God in an Age of Science*. New Haven, CT: Yale University Press, 1998.
- Ramachandran, V.S., and Sarah Blakeslee. *Phantoms in the Brain*. New York: Morrow, 1998.
- Rao, Gopala. *A Two Dimensional Model of Evolution*. <http://www.metanexus.net>.
- Snow, C.P. *The Two Cultures*. Cambridge: Cambridge University Press, 1993.
- Utukuru, Paul. "Paradigm Dependencies in Science and Religion." May 31, 2002. http://www.metanexus.net/metanexus_online/show_article.asp?6415.

11 A Superior Road for Life's Journey: A Scientist Explores Reality

Jagdish N. Srivastava

I was about fourteen years old in 1947 when India became independent. The communal riots that followed, particularly the assassination of Mahatma Gandhi, were widely blamed on “religious elements.” The wind of socialism blew hard. Some of my friends made a study circle to read the book on dialectical materialism by Marx and Engels, which had been recently translated into Hindi under the title *Dwandwa-aatmak-Bhautik-vaad* by Rahul Saankratayan, an Indian ambassador in Moscow. I soon learned that “religion is the opium of mankind.” Thus, even though born into a religious family, by the age of sixteen I had developed an atheistic outlook.

Is There a God?

Like all new converts, I had a passion for arguing that God does not exist. Soon, I developed a major war plan. When any argument-battle began, I could say: “Okay, you prove that there is a God.” Then, when the opponent came out with an argument, I could attack some cleverly chosen statement in the infrastructure of the worldly aspect of the argument, punch a hole in it, and thus cut it down. After a few such attempts, the opponent had to give up, and at least seemingly, I would win. I had many victories of this kind.

One day, when I was about twenty-two, a friend who was otherwise quite brilliant engaged in the debate. After a heated discussion, he left, quite frustrated in that there seemed to be no way for him to win. My circle, which had by now much expanded, admired me greatly. But that night, I wondered if my friend would simply turn the tables on me and say: “Okay, you prove that there is no God.” He could cut down every argument of mine by proceeding in the same way I did. I thought about this and related matters for several months, asked my comrades and their teachers, but no progress was made.

After about a year, I came across the word *agnostic*, learned that Prime Minister Nehru was one, and decided to embrace agnosticism, since no one

had been able to help me keep my previous position. I thought, why should I worry about God when we cannot see him, and when he does not seem to enter into any worldly matter one way or the other? The purpose of life should be to serve mankind. Also, science appears to be the major activity that has the power to modernize the world, produce wealth, and solve the various day-to-day and also long-term problems that the peoples are confronted with. I therefore felt that, for me, one way to serve mankind would be to try to be a good scientist.

It was in this frame of mind that I entered the United States in 1959 as a doctoral student. My professors were among the very top in their fields. I asked them and other distinguished people what was the purpose of life and, in particular, what should I do. Almost invariably, they exhorted me to be a good scientist, since it was there that I was developing expertise. However, my interest in fundamental questions about nature and reality lingered on.

Many people think that the purpose of life should be fairly obvious to a person of even an average level of intelligence. Is it not clear that one should try to make as much money as possible, because, through money, one can have any material object that one wishes to have? Moreover, common sense makes it perfectly clear that material objects are the only tangible things, and that rationality therefore requires that one be totally materialistic. Thus, the purpose of life should be to make as much money as possible, and to satisfy the senses as much as possible by making available the appropriate material objects.

Furthermore, many people would say that it is okay to study nature, but this should be done from the pragmatic and utilitarian point of view. We should try to subdue nature to the human will. But, apart from the above, what other reality is there? In other words, the material world around us (including the social and political picture) is the real tangible thing, and is therefore of interest. But outside this physical realm, in the world of metaphysics, there is no point in wasting one's time, because there is no proof even of its existence, in the sense that no experimental evidence points toward that.

What About Life After Death?

While I was agnostic, I happened to talk about all these thoughts with a friend who was strongly religious. He told me that my thinking was incomplete because it ignored the life that would come after death. He said that no one had proven that "life after death" was nonexistent. He stressed that more people believed in life after death than thought such life did not exist. I was told that listening to "the voice of the majority" was the wise thing to do in such matters. He further informed me that "God" (who is compassionate) creates everyone, and everyone is offered the choice of being a believer or a nonbeliever. The believer is rewarded with material and sensual joys, not only in this life but also in the "next," wherein one would enjoy wealth and women and comforts forever. On the other hand, the nonbeliever would forever burn in hell.

I mentioned this to some friends from other religions. They gave a more complex picture of the “next” world, but added that in “paradise,” all kinds of “good” comforts would be available. I also noted that in some religions, landing in heaven or hell is expected to be an everlasting event, because a human being gets exactly two lives. One of these lives is a life here on this earth, and the other one is a life after death that is forever spent either in heaven or in hell, depending on one’s belief and the follow-up actions. This contrasted with some other religions where one keeps on getting recycled between a human life and a stay in heaven or in hell.

In spite of all this information, I did not, could not, rush into any of the aforesaid belief systems. All religions seemed to criticize materialism in the day-to-day world. But it seemed to me that while materialism (of the atheists) related only to this world, some of these religions were really selling, mainly, a materialism of both worlds. If materialism is bad, why should I waste my time praying or practicing it both here and hereafter?

Also, if “God” really did create people, some of whom are eventually going to burn everlastingly in hell (because of sins committed during their short sojourn on the earth), then he had a rather cruel sport. Somehow, deep down, I felt that if “God” did exist, then he would at least be consistent with himself.

I saw that for most people, making both ends meet was enough work to keep them busy more than twenty-four hours a day, and therefore the opportunity for contemplation on whatever else life offers was rather little. Because of this situation, I felt that the “voice of the majority” could not be taken as a reliable guide.

Yes, common sense does seem to say that the material objects are the tangible things, but I felt that joy or happiness does not come from material objects alone, but also from other things. When I came to America, I became separated from my parents, wife, and children. Even though, here, I had a car and also other goods of the day, I yearned to be with my family. Reading or thinking about a beautiful poem was often more enjoyable than the comfort of having a washer and dryer, a television, or a car. These objects had a role to play in making life easier, but the joy of the meaning of the poem was a different kind of joy; in many ways its taste was superior.

The Thrill of Science and Other Intangibles

A new dimension to such joys from intangible sources was added as I went deeper and deeper into the study of science. I began to slowly realize why many scientists, even though they are not rewarded well enough financially, spend day and night working very hard to prove a theorem, establish a theory, or do an experiment. They experience that great exhilaration which comes from the intangible source of seeing a piece of Truth face to face. It is true even more in the case of good researchers. They see the Truth face to face.

Also, because they know that, among humans, they are probably the first ones to see that primeval pristine beauty, they experience an extra element of joy.

The more I thought, the more I felt that the world of intangible sources of joy may be at least as big as that of the materialistic sources, because the former could also be very diverse. Take the case of a sailor who wishes to cross the Atlantic alone, all by himself, in a fourteen-foot sloop. He has his wife and children at home. He also has various material goods that he can enjoy. But there is an intangible source deep down within him that makes him feel compelled to undertake the journey, risking even his life.

Thus, the attitude that one should spend one's time making as much money as possible appeared to have a fundamental deficiency. It ignores the fact that we do not live by bread alone. The basic necessities that we crave are joy and happiness. Money does play a role. It can provide some tangible goods, which can make life easier. But, after a while, the gain in the easiness of life that one gets from making more money is found to be rather little relative to the joy one would have had if the time lost and the energy spent in the pursuit of money were diverted toward the intangible sources.

So, the question as to what ought to be the purpose of life is a valid one, even though everyone may not have the luxury or the inclination of asking it. Not only is it valid, but also it is important, because it is surely proper for us to reach the full potential that our life offers us.

Some might argue at this point that the world of intangible sources is well covered by human activities such as sports, social and political interests, dedication to the arts such as painting, sculpture, music, and literature, and work in science. All such activities are well recognized as rational and respectable. We just do not need to bring in the metaphysical elements, because they are unproven and thus a waste of time.

Yet, when Einstein died, many remarks attributed to him were published in the newspapers, and several of those seemed to say that Einstein valued "spirituality," and felt that a person who has not tasted the same has wasted his or her life. One thing he said was that theory precedes experimentation. In other words, ideas that inspire an experiment are not ideas that are already proven by previous experiments. These ideas seem to belong to the realm of metaphysics.

However, one may argue against this last statement, on the ground that spirituality cannot be a "sensible activity." One may argue that inspiration to do an experiment comes from the scientist developing a feeling that looking at a phenomenon in a particular new way will be fruitful. This feeling, in turn, is only a result of previous experiments and analyses of the same.

But, even though I was an agnostic, I was not satisfied by such arguments. I wondered how Einstein's theory of relativity arose. All the experimental results that were known before surely played some role in organizing the thoughts of Einstein. However, a million different theories could have been spun out of those results. Why did Einstein dart out on a bizarre, totally untrod

path, which is highly contrary to common sense? Because of this and other reasons, I felt there was another source behind Einstein's insights. Indeed, even in day-to-day scientific work, I felt that one does not usually proceed by enumerating and inspecting all possibilities dictated by the known facts. There seemed to be some other element inside the mind that is at work. Thus, I felt that there must be deeper and more fundamental strata of reality hidden from our view that would be of prime interest to humans. Hence, my interest in fundamental questions about life lingered on, even though I had an interest in studying the more routine and utilitarian aspects of nature.

Goedel's Theorem and Reality

Around 1965, even though I was now a full professor of mathematics and statistics, I developed the feeling that in order to investigate the more fundamental layers of reality, further expertise in physics would be necessary for me. I therefore revived my study of physics, particularly quantum mechanics. In this connection, I also happened to study logic, wherein I came upon the famous "Goedel's theorem." To say the least, I found this result very fascinating.

This result is probably the most famous result in the field of logic. Indeed, it is one of the most profound facts in all of knowledge that we currently possess. The proof of this result covers more than a hundred pages, and is quite intimidating. But I do believe that its basic message should be accessible to, and can be grasped by, a person who really takes interest. It offers insight into some fundamental aspects of reality, and clarifies the nature of science and its limitations. This result provided light to me in a basic way and influenced the direction of my future deliberations. Let me first state the main result in simple language. Then I will try to explain the various terms and concepts by giving examples and illustrations.

Basically, Goedel's theorem says that if there is any mathematical system (which involves the integers 0, 1, 2, and so on), then there are questions in the system that cannot be answered by using the rules that define the system. To answer a given question, one may create a new rule so that the question at hand gets answered. (Of course, the new rule will have to be determined in such a way that it does not in any way contradict the earlier rules.) But, after including the new rule among the rules of the system, we shall get a new system to which Goedel's theorem shall be applicable. Now there will be new questions that cannot be answered by using the rules of the (new) system. To answer a given new question, we can add a new rule to the new system, but this will create another, newer system that will have questions that cannot be answered using the rules of the (newer) system. And so on. In other words, whatever set of rules we have will always fall short of answering all the questions.

The rules governing a system are often called the axioms of the system. The axioms are said to be inconsistent if there is an axiom that is contradicted by a statement that is deducible from the other axioms. To give an example,

consider a system with the following axioms: (I) Let there be a set of objects each one of which is called a goat. (II) Each goat has at most one mother, of which it is called a child. (III) Goat X has two children, a and b. (IV) Goat Y has children c and d. (V) Goats b and c are identical. (VI) Goat X is distinct from Y. Notice that axioms III, IV, and V together imply that goat b has both X and Y as its mother. Using II, we then conclude that X and Y must be the same goat. But this contradicts axiom VI. Thus, we showed that axioms II, III, IV, and V together lead to a statement that contradicts VI. Hence the set of the six given axioms is inconsistent.

Now, consider a system based on axioms I–V only. I leave it to the reader to verify that the axioms I through V taken together are not inconsistent—that is, they are mutually consistent. Now, in this system, consider the question: If goat X has n children, what is the value of n ? Notice that, from axiom III, n must be at least 2. If goats a and d are distinct, n will be at least 3. But, besides a, b, c, and d, we do not know what other children X has or does not have. Thus, we cannot answer the question because we cannot tell the value of n . The set of axioms I–V is incomplete, in the sense that there exists a question about the system that cannot be answered by using the axioms of the system.

Here is another example. Consider a system with the following axioms: (i) Let there be two kinds of objects in the system, respectively called points and lines. (ii) Each point lies on at least two lines. (iii) Each line has at least two points that lie on it. (iv) Given any two distinct lines, there are exactly two points that lie on both of them. Does this system contain an infinite number of lines? To answer this, we consider two cases.

Firstly, consider a system that has exactly four points (p, q, r, s) and exactly four lines (W, X, Y, Z), where for each line the points are shown (in the parentheses following it): $W(p, q, r)$, $X(p, q, s)$, $Y(p, r, s)$, and $Z(q, r, s)$. Clearly, this example satisfies the axioms of the system, showing that the number of lines could be finite.

Now, consider a ball. Each circle on the ball whose center is identical with the center of the ball shall be called a line of the system. Points on the ball shall be called points of the system.

Thus, we provided two examples of systems satisfying i–iv such that one involves a finite and the other an infinite number of lines. Thus, the question as to whether the system ruled by axioms i–iv has an infinite or a finite number of lines cannot be answered yes or no; hence the set of axioms is incomplete.

Next, suppose that we add this axiom: (v) The number of lines in the system is infinite. In the new system based on axioms i–v, let us ask the question: Is the number of points infinite? Recall that, two paragraphs above, we gave an example with an infinite number of points. Consider now a new example in which only the north and south poles on the ball are called points, and only the circles passing through them are called lines. Then, this system satisfies axioms i–v, but has only two points. Thus, in a system ruled by axioms i–v,

the question of whether the number of points is finite or not cannot be answered yes or no, showing that the set of axioms is incomplete.

The system based on the four points and four lines is a finite system, and thus does not involve all the integers (0, 1, 2, and so on). Goedel's theorem does not apply to such an example; here all questions can be answered. But an infinite system (like, for example, with an infinite number of lines and points on the ball) is a system to which the theorem does apply. In such a system, irrespective of how many axioms we add, the set of axioms shall always remain incomplete.

Limits of Science

What does all this have to do with nonmathematical topics like religion, agnosticism, and metaphysics? The answer is that Goedel's theorem points out a basic limitation of science. Let me elaborate. We notice that all of science taken as a whole is an example of an infinite mathematical system to which Goedel's theorem does apply. The axioms of the system may be taken to be the "laws" or theories that have been discovered in the various disciplines. Giving credit to the scientists, let us assume that the laws discovered by them have been thoroughly examined so that they are not mutually contradictory. In other words, we are assuming that the set of axioms is not inconsistent. This is a statement in favor of science, because if the axioms are indeed inconsistent, then as it stands now, there is something wrong in science that needs to be rectified.

We can now apply Goedel's theorem. We conclude that the set of laws that we have is incomplete, that there exist questions in the system that cannot be answered yes or no using these laws. The system under consideration is nothing but nature itself, so we conclude that the laws of science as they stand now cannot answer all questions about nature. Now, take a particular question. To answer it, we shall need to add a new axiom—that is, discover a new law. This particular question will now get answered, but science will now be a new system to which Goedel's theorem shall again apply. Now there will be some other question that cannot be answered.

Notice that this process will never come to an end. Even if we worked for a million years, science at that time would still be an incomplete bunch of axioms, and there would be questions about nature that cannot be answered yes or no. We thus conclude that science has a basic limitation: that there will be no time in the future when it has completely fathomed the depths of nature. It is a set of axioms that will always remain incomplete. This is a fact that gives us a glimpse into reality.

Direct Perception and Intuition

This is the point I had reached in the mid-1960s. I began to see that my deity, science, was after all deficient. But if science cannot do it, is there something

else that can? As I pondered over the matter, I recalled that when I was a teenager, my father used to say that according to the ancient Indian sages, deeper knowledge comes from “direct perception.” One day, as I was passing through the university student center, I saw displayed a translation of the *Bhagavad Gita* and one part of the Upanishads, which I immediately purchased. A look through these two books further enforced in my mind the validity of my father’s assertion. I slowly began to feel that direct perception is probably akin to what is usually called intuition.

Meanwhile, seeing the limitations of my cherished deity, science, I felt a bit exhausted. I temporarily quit physics and logic and concentrated on my work as a professor. Soon, I realized that in spite of my detour into the fundamentals of science and reality, I was doing very well (indeed, far above average) in my own field. Even though I was spending relatively little time in my own field, I was producing a disproportionately large amount of research. Slowly, it occurred to me that intuitive ideas come to me rather frequently, that they are quite often correct, and that is why with only the expenditure of a small amount of time, I am able to produce results. So, after all, there is probably some truth in the assertion of the sages!

The attitudes I had developed during my study circle days were not only thoroughly shaken, they were on the point of being reversed. Still, however, I felt attached to them and would not let go. Could there be something stupid within me that was leading me away from those logical and rational attitudes? After all, if they were not logical and rational, why would so many seemingly intelligent people adhere to them? I felt it was necessary to check this out with other people.

Fortunately, I knew a relatively large number of people in my profession who were among the very best in the world. Indeed, I knew some similar people in other fields as well. I decided to check with some of them. I noted that my own teacher was always busy in traveling and giving parties. But he published a lot, his work was deep and difficult, and yet large numbers of his papers did not have even one coauthor. In other words, much of the work was done entirely by him only. So, one day at an opportune time, I broached the topic. I told him that he produced enormous amounts of work, yet I do not find him working hard at all. What is the secret?

He smiled. First, he went into technical matters. But then, when he saw that I was talking at general levels, he brightened up. “Srivastava!” he said. “You have to realize that great scientific work is generally not a result of working day and night, attacking problems by brute force. It is not that you figure out all the possibilities that could exist, examine each one, and select the promising ones, and further examine, and so on. You have to have intuition.” He said he felt there were two things at work: a basic intuitive ability, and the utilization of this ability. He gave me a very valuable lecture on how to put one’s basic ability to maximum use. So far as the basic ability itself was concerned, he said he was not sure if all of it was by birth. He said that adopt-

ing a lifestyle in which too many worldly interests did not burden the mind could probably enhance this direct perception of facts.

I was stunned. I had given him no inkling of the debate my mind was engaged in for years, but he was using even the same phrases, like direct perception. I continued this conversation on the secret behind great research and writing with other great scientists and literary personalities. Invariably, though sometimes in very different ways, the conversation ended up in much the same way, namely, that intuition, or direct perception, played the most important role in doing excellent and significant work. Again, I had given no reasons to anyone as to why I was interested in questions of this sort. Each of the conversations, therefore, constituted a kind of independent verification that direct perception was the secret. The sages had turned out to be right.

According to dictionaries, the word *dialectic* means the examining of opinions and ideas logically. To determine how correct an opinion is, one could engage in questions and answers. The philosopher Hegel said that an opinion or thesis, on examination, would be found to lead to its antithesis; the reconciliation of the two would be synthesis. Marx and Engels took these ideas of Hegel and coined the phrase *dialectical materialism* for their philosophy, because they saw that material objects were all that the world was constituted of, and hence that these objects are all that should be of interest to humans.

I noticed that I, too, was pursuing ideas in a more or less logical fashion, as Hegel had suggested. After all, I was using Goedel's insight, and Goedel is considered to be the greatest logician. Thus, I was proceeding in the dialectical way. Now, logic is a part of science. Thus, science had revealed to me one of its basic limitations. What was the source of error, then, in my thinking before I came to Goedel? Obviously, it was *materialism*, the narrow view that the material objects constitute the basic reality and should therefore be the source of all our motivations. But why does materialism come into the picture here? It does because science itself is created largely through direct perception, a phenomenon that obviously transcends matter totally.

Spirituality and Reality

I reached this point in the late 1960s. The sleep that began with the days of the study circle was now ending. Shyly, hesitatingly at first, I began to embrace spirituality, which to me was the attitude that reality would lead one to. I saw that reality has no horizons; I decided to let myself go wherever it leads me. I decided to dedicate myself to research on science and spirituality. Since then, I have developed a theory of reality and consciousness, which is already at the point where scientific formalism can begin. Science does not stand in contradiction to spirituality; the former is a tiny and important lower part of the latter. My theory, which I cannot share here for lack of space, is in conformity with the spiritual facts recorded in human experience.

As I developed more understanding, I saw that dialectical materialism is

the way of the grounded ones with the wings shorn. Dialectical spiritualism is for the ones who wish to fly. If one wishes to travel, why not travel first class? Why not take the superior road for life's journey?

The price of this travel ticket is not paid in dollars. Rather, one needs to unburden oneself so that one can proceed, for only people are allowed to go on this trip—no baggage is allowed. The more baggage one cannot shed, the slower will be one's progress. Even the opium of religion is too much luggage to carry; one shall have to ingest only the spiritual part and throw the rest out. The road will quickly come out of the terrain of class and other struggles. It will pass through a terrain of peace, that passeth understanding.

One will enjoy the music on this trip most when one offers oneself to be a flute that the divine can play on. But remember, for the bamboo to be a flute, holes have to be carved in its bosom. Thus, one has to offer oneself to be pierced, cut, and carved. If one is found worthy, one will be shaped.

On this journey, one does not yearn after reaching here or there, getting this or that. As the mind is extricated from attachments, aversions, and selfish worldly desires, one reaches a state of indifference toward whatever one knows now about the material world and whatever one may come to know about it in the future. For what one acquires on the spiritual path cannot be even dreamt of by those who have not experienced it. Indeed, consciousness increases, leading to a very changed perspective and to new abilities. If one gets attracted to this and wishes to enjoy it, one's progress stops. Otherwise, one continues on. As the progress continues, the lures increase greatly, and the chance of further progress is sharply reduced. It is in this sense that the road becomes increasingly difficult, as we move further.

So, shedding the selfish worldly fever, giving up the luggage of mine-ness, stopping the entertaining of selfish worldly hopes, renouncing all actions to the divine, filled with determination to continue moving, let us proceed on the superior road. Why settle for less?

Bibliography

- Srivastava, J.N. "Life Comes from Life, Part I: An Overview. Savijnaanam." In *Scientific Exploration for a New Paradigm*, vol. 1, 21–30. Kolkata: Bhaktivedanta Institute, 2002.
- Stapp, H.P. *Mind, Matter, and Quantum Mechanics*. New York: Springer Verlag, 1993.
- Wang, Hao. *Reflections on Kurt Goedel*. Cambridge, MA: MIT Press, 1988.
- Wick, D. *The Infamous Boundary: Seven Decades of Controversy in Quantum Physics*. Boston: Birkhauser, 1995.

12 Ichi Tante Mind: A Zen Buddhist Perspective

Leslie A. Real

The academic scientist side of me is well prepared to wax on—page after page—with deep insights about the common foundations, the subtle distinctions, and the ultimate domains of demarcation between science and religion. The Zen priest side of me would be equally prepared to wax off what had just been waxed on. Today, the Zen side wins, so I will keep my comments very short.

The Buddha is well-known for refusing to speculate on a particular set of fourteen questions that were metaphysical in nature: for example, “What happens to us when we die?” I am sure that if he were alive today, the relations between science and religion would become his fifteenth question. Speculation is not prized very highly in Buddhism, and especially avoided in Zen. I recall the story of a very distinguished university approaching a famous Zen master from Japan to come and give a public lecture. The Zen master repeatedly refused, but the university professors persisted. Zen masters like persistence, so he finally gave in. A large auditorium was filled with eager students and faculty, and the Zen master was introduced with much praise. The old man tottered up to the lectern, looked out at the audience, and struck the podium with his fist—WHAM!—and sat down. That was it. A rather stunned university president thanked him for coming, and that was the end of the evening.

Every Zen teacher, at every moment, is pointing to “Right here, right now.” This is how Zen teachers teach. The old master from Japan was not trying to make some subtle, discursive point about the futility of language or the materiality of the world we live in, nor was he posing some great paradox. If we walk away from that WHAM on the podium speculating on its subtle meaning, then we lose its meaning entirely. What was he doing? Just WHAM—that’s all. Nothing outside this moment of engaged living. Right here, right now. WHAM! What a wonderful lecture.

In Japanese, we call this “ichi tante mind.” *Ichi tante* means “just this.” Ichi tante is the complete expression of the Buddha’s enlightenment. At every moment, from the very beginning, everything, everyone is whole and complete, endowed with virtue, lacking nothing. Seeing this fact is difficult. To see this fact is to manifest ichi tante mind. To manifest ichi tante mind is to completely live our lives, fully engaged with every moment. Woody Allen once said that 80 percent of success is showing up. In Zen, the number jumps to 100 percent. Just show up. WHAM!

Showing up is how we close the gaps in our lives. There are so many gaps—gaps between ourselves and nature, gaps between ourselves and each other, gaps between ourselves and ourselves. To live ichi tante mind is to close the gaps. If you see a gap between science and religion, close it. When you look through a microscope—just look. When you sing a hymn—just sing. This is ichi tante mind. Right now, I’m tapping away at my computer keyboard—tick, tick, tick, tick . . . —that’s it. The discourse on science and religion is complete.

Bibliography

- Maezumi, Taizan. *On Zen Practice*. Somerville, MA: Wisdom, 2002.
 Shibayama, Zenkei. *A Flower Does Not Talk*. North Clarendon, VT: Tuttle, 1970.
 Uchiyama, Kosho. *Opening the Hand of Thought*. Somerville, MA: Wisdom, 2004.

13 Islam and Science: Notes on an Ongoing Debate

Ibrahim Kalin

In his preface to Werner Heisenberg's *Physics and Philosophy*, renowned scholar F.S.C. Northrop made the following observation on the spread of modern science to non-Western societies:

Modern ways are going to alter and in part destroy traditional customs and values. It is frequently assumed by native leaders of non-Western societies, and also often by their Western advisers, that the problem of introducing modern scientific instruments and ways into Asia, the Middle East and Africa is merely that of giving the native people their political independence and then providing them with the funds and the practical instruments . . . one cannot bring in the instruments of modern physics without sooner or later introducing its philosophical mentality, and this mentality, as it captures the scientifically trained youth, upsets the old familial and tribal moral loyalties.

Northrop, who made these remarks more than four decades ago, did not have to wait too long to see his predictions come true. The changes brought about by modern science in the minds and lives of people in the Muslim world have been no less profound and deep seated than they are for people living in the western hemisphere. The crisis of legitimacy and the dissolution of traditional certainties, closely related to the scientific worldview of modern natural sciences, have a deep impact on how people in the Islamic world relate to the question of science on the one hand, and their intellectual and scientific tradition on the other. The wide spectrum of views on the issue range from Muslim scientists and professionals who take science to be a pure and disengaged study of natural phenomena with no hidden or explicit ideological assumptions, to those who consider modern science essentially materialistic, reductionist, and thus in conflict with a religious view of the universe. Regardless of what particular position one takes in this debate, the urgency of addressing the question of (modern) science is as fresh and challenging today as it was more than a century ago for Jamal al-Din

Afghani, the father of Islamic modernism in the nineteenth century, and his generation.

There are two important components to this debate. The first one pertains to the practical needs and concerns of Muslim countries. Keeping up with modern science and technology is the number one priority of governments in the Muslim world, as it is everywhere else, and every year billions of dollars are allocated for science education, research, and transfer of technology. From Mustafa Kemal Ataturk, the founder of modern Turkey, to Mahathir Muhammad, the prime minister of Malaysia, the goal has remained the same: to fill the gap between Western and Islamic societies by empowering Muslim countries with the tools and blessings of modern science. Not only the ruling elites but also the populace at large are convinced of the intrinsic power and necessity of science and technology, for this is where the superiority of the West lies. In this sense, the Islamic world is no less pragmatic and utilitarian in its quest for power-through-technology than its European and American counterparts.

The second component of the debate over Islam and science in Muslim societies concerns the intellectual domain, which links the discussion both to modern science and its philosophical foundations and the Islamic scientific tradition as an alternative way of studying the order of nature. The philosophical foundations and, by derivation, built-in presuppositions of modern science and its historical rise in Europe have long been debated and well analyzed. Long before the Kuhnian and postmodernist criticisms of modern science as a cultural product, a number of important studies showed how philosophical, cosmological, religious, and metaphysical ideas played instrumental roles in shaping the modern scientific worldview from Galileo to Newton. Texts such as Edmund Burt's *The Metaphysical Foundations of Modern Physical Sciences* and Frances A. Yates's *Giordano Bruno and the Hermetic Tradition* were major challenges to the nineteenth-century view of science as studying natural phenomena from a standpoint that Thomas Nagel calls a "view from nowhere," that is, seeing the world not from a particular point in it but over it, hence assuming an ahistorical position toward it. There is no need to reiterate the main arguments of scientific historicism here. But how did the Muslim world respond to this debate, and what positions may arise from these responses?

Scientific Universalism versus Cultural Particularism

The participation of Muslim philosophers and scholars in the debate over the historicity of modern science has added a new dimension to the debate. The defenders of a scientific tradition rooted in Islamic metaphysics and cosmology have clearly argued for the cultural specificity and differentiation of scientific traditions. Such advocates of Islamic science as Seyyed Hossein Nasr, Naquib al-Attas, Osman Bakar, to name a few, have defended a cultural particularism of some kind against scientific universalism. In their view, the

ahistorical claims of modern scientism (and not science as such) to universal truth and validity should be rejected, and alternative ways of studying the order of nature should be maintained against the onslaught of scientific materialism and reductionism. This is best illustrated in the sharp contrast between the religious-sacred view of nature and the secular outlook of modern science. While the various religious traditions developed a complex cosmology and approached the world of nature as imbued with intrinsic meaning, order, and even bliss as a way of marveling at the work of the Great Artisan, scientism regards such metaphysical and aesthetic considerations as philosophically unfounded and inconsequential for the work of the scientist.

Bertrand Russell's essay "A Free Man's Worship" was written as a testimonial to this view of science. If we accept, according to Russell, the scientific view of the universe as a *theory of everything*, we will be saved from the "confusions" of both philosophy and religion at once.

Such in outline, but even more purposeless, more void of meaning, is the world which Science presents for our belief. Amid such a world, if anywhere, our ideals henceforward must find a home. That Man is the product of causes which had no prevision of the end they were achieving; that his origin, his growth, his hopes and fears, his loves and his beliefs, are but the outcome of accidental collocations of atoms; that no fire, no heroism, no intensity of thought and feeling, can preserve an individual life beyond the grave; that all the labors of the ages, all the devotion, all the inspiration, all the noonday brightness of human genius, are destined to extinction in the vast death of the solar system, and that the whole temple of Man's achievement must inevitably be buried beneath the debris of a universe in ruins—all these things, if not quite beyond dispute, are yet so nearly certain, that no philosophy which rejects them can hope to stand.

Although Russell's radical scientism has lost much of its elan today, it remains the unwritten code of the popular perceptions of science. Furthermore, the stark contrast that we see between Russell's view of science and traditional cosmologies is also to be found within the Western intellectual tradition in various controversies such as evolution versus creationism. But the contrast is sharper in the case of Islamic thought because the Islamic world has not been as exposed and vulnerable to the effects of secularization as the Judeo-Christian thought has been in the last three centuries.

It is obvious that construing modern science as a particular and not the only way of studying natural phenomena poses a serious challenge to the exclusivist and absolutist claims of modern natural sciences that reduce reality to what can be measured empirically. To better understand how this criticism applies to modern Western science, we should remember an important distinction made in philosophy of science between the context of discovery and the context of justification. The context of discovery refers to what the scientist actually does in a lab; the context of justification refers to how the scientist's work is interpreted and articulated in different frameworks of analysis. Insofar as the context of discovery is concerned, we may be justified in

assuming a linear historical line that connects Ptolemy, Abu Bakr al-Razi or Nasir al-Din al-Tusi to Newton or Max Planck: the successes or failures of these scientists of different historical periods and cultural settings can be explained in terms of the accumulation of scientific knowledge, refinement of measurement, exactitude in prediction, and advancement in taxonomy. What they all have in common is the continuity of the context of discovery whereby religious and cultural elements have a relatively small role to play.

The issue takes on a substantially different form when we move to the context of justification, in which we attempt to understand and interpret the *meaning* of the empirical work of the scientist. Here, we are no longer in the world of “bare facts” without suppositions. Science is no longer a mirror juxtaposed against the world and the scientist the incorrigible interpreter of the reality of things. Rather, every interpretation, extrapolation, deduction, induction, and even prediction is screened through a set of philosophical assumptions, whether they are articulated explicitly or remain tacit. At this level of analysis, science becomes a cultural artifact bound by particular traditions, postulations, and needs. The basic tenets of modern science, which make it a secular enterprise, are all produced in the context of justification and can be accepted, questioned, or rejected primarily on philosophical grounds. Even the concept of “bare facts” as the building blocks of scientific procedures is open to question.

In this sense, the multiplicity of scientific worldviews, if we may use such a term, is part of every scientific tradition. The findings of a particular scientist or in a particular field of science are interpreted in a variety of ways that may or may not agree with other interpretations. This was the case in traditional societies, where we have multiple cosmologies both across and within specific traditions. Take the case of Islamic and Christian cosmologies. Both traditions produced elaborate cosmological schemes tightly linked to the astronomy and physics of their times, the Ptolemaic-Aristotelian astronomy. Naturally, the cosmology of Dante’s *Divine Comedy* was structured along the lines of biblical and Christian thought, whereas Islamic cosmology was the result of a deliberate attempt to reconcile Greek-Aristotelian cosmology with Quranic theology and eschatology. We find still more cases of plurality within each of these traditions. The Scholastic-Thomistic view of nature is not the same as St. Francis of Assisi’s mystical and poetical deliberations of nature. In the same way, certain parts of Ibn Sina’s Neoplatonic cosmology or that of the Brethren of Purity are considerably different from Ibn al-’Arabi’s “Five Divine Presences” and Mulla Sadra’s *mundus imaginalis*.

The case for particularism and the multiplicity of interpretations within and across various cultural traditions does not lead to parochialism. It is always possible to draw multiple conclusions from the same data, both in science and philosophy. Plurality does not invalidate the veracity and relevance of divergent readings. One may even argue that the apparent diversity of traditional cosmologies is rooted in an underlying unity: such postulates as the

universe as a sign of God (*ayat Allah* in Arabic and *vestigia Dei* in Latin), teleology, intrinsic intelligibility of the world, and order and harmony are all shared by various schools of thought.

The concept of Islamic science has a lot to offer to the current religion-science debate, especially if this term is understood in a broader sense to include the reassertion of the religious view of the universe as an alternative vision to the profane and secular worldview of modern scientism. Considering the eroding impact of scientism on traditional beliefs and practices and the disastrous consequences of scientific and technological development without boundaries, the Islamic world can make a strong case for a new vision of science that will both cater to the practical needs of modern society and preserve the spiritual and ethical significance of the world of nature. People of all religious traditions must collaborate to foster a science that is in peace and harmony with both heaven and earth.

The Islamic World and Science Today

The Islamic intellectual and scientific tradition, going back to the rise of Islam as a world civilization in the ninth and tenth centuries, remains a major source of knowledge and inspiration for the contemporary Muslim world in its quest for self-identity and self-esteem. The glory of Islamic civilization stretching from Andalusia and the Balkans to Persia and India, and the historic contributions of such Muslim scientists as Ibn al-Haytham, Khwarazmi, Ibn Sina, and Nasir al-Din al-Tusi to the development of science, are remembered throughout the Islamic world as more than mere grandeur of the past. Rather, this tradition of remarkable scientific achievement and philosophical articulation is a witness to the study of the world of nature within a religious and sacred framework that delivered to both the spiritual and practical needs of human society. In this sense, the historical experience of Islamic science is an invaluable asset for the development of an Islamic philosophy of science today. Through it we address the first aspect of the Islamic debate about science: how to use science and technology to serve the practical needs and concerns of Muslim countries.

The big challenge facing the Islamic world is to show the relevance of this tradition today. This brings us to the second aspect of the science debate in the Islamic world: how to deal with modern science without succumbing to the temptations of secular scientism. There is a world of difference between Ibn Sina's Neoplatonic cosmology and modern science, not only in terms of cumulative knowledge and heuristic advancement but also in the philosophical outlook of the two systems of the universe. For a devout follower of modern science like John Searle, "there is really nothing in the universe but physical particles and fields of force acting on physical particles," and this makes matters supposedly easier once we rest our case for a spiritual vision of the universe. The question for the Islamic world, however, is this: after four centuries

of not practicing science in full scale, and for the last century trying to transfer science and technology from the West, will the Islamic world ever be in a position to put its own paradigm in place and redevelop a scientific tradition that will be in harmony with its religious tenets and aspirations while catering to its practical needs?

The confusion that plagues the minds of countless Muslim scientists arises from a lack of balance between the discourse and practice of science in an Islamic context. For some, the question of religion or any other philosophical consideration is simply not there. Although scientists tend to go about their work and fulfill their function in the scientific community without bothering themselves with any such philosophical issues, most Muslim scientists are split between their profession as a scientist and their value system as a believer. Muslim scientists thus end up having split identities, with very little ground to integrate the two in a meaningful and cogent manner.

Part of the problem has to do with the resistance of scientific Muslim professionals to alternatives to modern science, except when it comes to ethical and environmental misdeeds. But the groundwork for an Islamic concept of science and its conceptual scheme has already been done by a long list of Muslim scholars that includes S.H. Nasr, Rene Guenon, O. Bakar, Alparslan Acikgenc, Muzaffar Iqbal, Mahdi Golshani, Ziauddin Sardar, Zaki Kirmani, and many others, with important differences among them. The task at hand, however, is rendered more difficult by the absence of a strong and parallel scientific tradition in the Muslim world. The possibility of applying an Islamic framework of science to actual scientific work is alarmingly limited; the level of scientific infrastructure in Muslim countries, from physics and engineering to medicine and astronomy, is not comparable with that of the West, which controls the pace and direction of scientific research and technological innovation. Furthermore, the global network of scientific programs and technological novelties, funded by governments and powerful transnational corporations, makes it extremely hard for a scientist to go against the grain and open up new venues for an alternative vision of the universe beyond the parameters of modern science. This we see clearly in how Muslim scientists deal with such controversial issues as evolution versus creationism, genetic engineering, human cloning, and nuclear technology. An indication of the gravity of the problem is that some people in the Islamic world take pride in Muslim scientists' creation of an atomic bomb, an "Islamic bomb," which they see as a token of the return of the glory of Islamic civilization.

All these problems speak to the urgency of the question of science in the Muslim world. Until the Islamic world recovers its intellectual and scientific tradition, and comes to terms with the challenges of modern science, we will either join the camp of scientific universalism and reduce reality to what the natural sciences can reveal, or join the camp of postmodernist antirealism, as has often been the case among Muslim critics of secular science, and deny any validity to science or any other human endeavor. Within the Is-

lamic intellectual and scientific tradition is a comprehensive framework that will address the challenge of studying the universe in a nonreductionist way and preserve the sacred meaning of nature—a framework shared by other religious traditions, from Judaism and Christianity to traditional Hinduism and Buddhism.

Bibliography

- Burtt, Edmund A. *The Metaphysical Foundations of Modern Physical Sciences*. London: Routledge, 1924.
- Heisenberg, Werner. *Physics and Philosophy: The Revolution in Modern Science*. New York: Harper and Row, 1958.
- Kalin, Ibrahim. “Three Views of Science in the Islamic World.” In *God, Life, and the Cosmos: Christian and Islamic Perspectives*, ed. Ted Peters, Muzaffar Iqbal, and Syed Nomanul Haq, 43–75. Hampshire, UK: Ashgate, 2002.
- Peters, Ted, Muzaffar Iqbal, and Syed Nomanul Haq, eds. *God, Life, and the Cosmos: Christian and Islamic Perspectives*. Hampshire, UK: Ashgate, 2002.
- Russell, Bertrand. *Mysticism and Logic*. New York: Doubleday Anchor, 1957.
- Searle, John. *The Rediscovery of Mind*. Cambridge, MA: MIT Press, 1994.
- Yates, Frances A. *Giordano Bruno and the Hermetic Tradition*. Chicago: University of Chicago Press, 1991.

14 Taoist Contributions to Science in China

Jiang Sheng

In the ancient system of Taoism, the goal is to become immortal. The pursuit of immortality allows for no boundaries in the Taoist world of imagination. This ideal gives Taoists strong motivation for thinking about, observing, exploring, and practicing techniques for life improvement. Throughout the history of China, Taoists have contributed important discoveries and theories in areas such as medicine, biology, chemistry, physics, geography, and other disciplines of science.

Medicine and Biology

Taoist spirituality and ideology are of cardinal importance to the development of Chinese science and medicine. Many Taoists in ancient China were renowned scientists or doctors. Hua Tuo, a famous Taoist doctor of the third century who treated the powerful leader Cao Cao's headaches, is believed the first who applied anesthesia in surgery, using a powder called "Ma Fei San." He formulated a kind of gymnastic technique called "Wu Qin Xi" (imitation of five animals playing) for nourishing vitality of life. A text of Taoist prescription, *Zhou Hou Bai Yi Fang*, written by Ge Hong and enlarged by Tao Hongjing, recorded for the first time in the world the disease smallpox. It also recorded techniques such as artificial respiration, catheterization, and debridement. What is particularly worth mentioning is that the text recorded the practice of treating malaria by using southernwood (*Artemisia annua L.*). In the 1970s, scientists in China extracted artemisinin from southernwood, which is a significant discovery in the history of malaria therapies after the medicines of the quinoline category. A report by Narendra P. Singh and Lai H. on artemisinin shows that it is active in killing cancer.

Sun Simiao, a great Taoist doctor of the Tang dynasty (618–907), summed up in the seventh century the prevention of struma (goiter) by using animal thyroid, and the prevention of nyctalopia (night blindness) by using animal livers. His treatment for a disjointed mandible is still in use. *Jin Si Xuan*

Figure 14.1 **Pictures of human parasites in the Taoist text of parasitology *Jin Si Xuan Xuan*.**

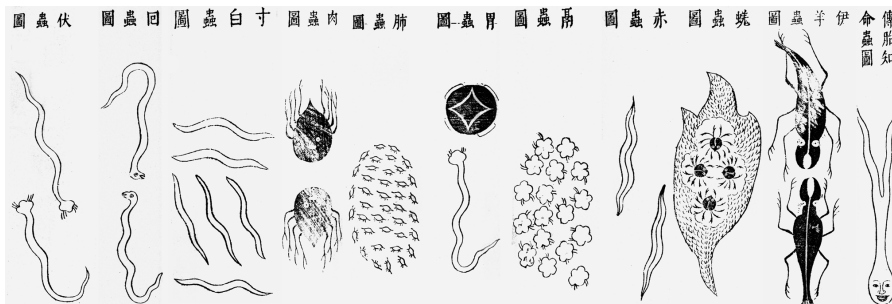

Xuan, a Taoist text of parasitology, contained illustrations of various kinds of parasites, as well as figures of their evolutionary patterns (see Figure 14.1). According to a famous Chinese medical text of the early Qing dynasty, *Dou Zhen Ding Lun*, the earliest one who began to spread the technique of vaccination against smallpox was a mysterious Taoist nun called Tian Mu Niang Niang (Heavenly Mother Goddess), who lived as a hermit in the E’Mei Mountains in southwest China in the early eleventh century.

In seeking elixirs from humans themselves (called “inner elixirs”), Taoists made great advances in the field of biochemistry. Joseph Needham and Lu Gwei-Djen hold that the medicine named “Qiushi” made by medieval Taoists is a quite pure preparation of urinary steroid hormones. In the early years of the twentieth century, this was made in the west by a German biochemist. The progress made by Taoists in the pursuit of “inner elixirs” is illustrated in the drawings of human anatomy entitled *Drawings of the Inner World* (see Figure 14.2) in the Taoist Yan Luo Zi’s *Ti Ke Ge* (Song of the Body), which emerged in the mid-tenth century.

Chemistry and Physics

Taoists acquired profound knowledge of certain chemical reactions processes. They accurately described the reversible reactions between mercury and thiosugar. *Long Hu Huan Dan Jue*, written by Jin Ling Zi, a Taoist expert in alchemy in the Tang dynasty, recorded precise methods of making arsenic-copper alloy and of extracting pure copper developed by Taoists over many generations. Instead of the old Taoist tradition of keeping secret key links or using obscure words, this text stated clearly and definitely the strict rules of operation similar to those of modern chemical experiments.

The basic composition of gunpowder in ancient China was niter, sulfur, and carbonaceous matter, which were frequently used in Taoist alchemical experiments, and the invention of gunpowder can be dated back to the Taoist writings in the Han dynasty. The formula included in *Bao Pu Zi Nei Pian*,

Figure 14.2 The earliest drawings of human anatomy entitled *Drawings of the Inner World* in the Taoist scripture *Song of the Body* by Yan Luo Zi (the *Daoist Canon*, volume 4, page 690).



written by Ge Hong in the fourth century, already covered the basic composition of gunpowder. In the middle of the ninth century, the Taoist scripture *Zhen Yuan Miao Dao Yao Lue* recorded the definite composition of gunpowder. Obviously, the time of its invention is much earlier.

Many Taoists are also metallurgists. For instance, the hydrometallurgical technique of smelting copper from cupric sulfate liquor was initiated in China in Taoist alchemic practices. It can be traced back to *Huai Nan Zi*, a Taoist text written in the early years of the first century, and it formally appeared in Taoist texts of the Tang dynasty, becoming the prevailing technique of copper production in the Song dynasty (960–1279). No later than the Song dynasty, Taoists had recognized and purified arsenic. Around the year 550, a Taoist practitioner invented a technique of steel production called “Guan Gang Fa,”

Figure 14.3 **Diagram of the scaled water clock invented by Taoist Li Lan (Hua, 1991, page 76).**

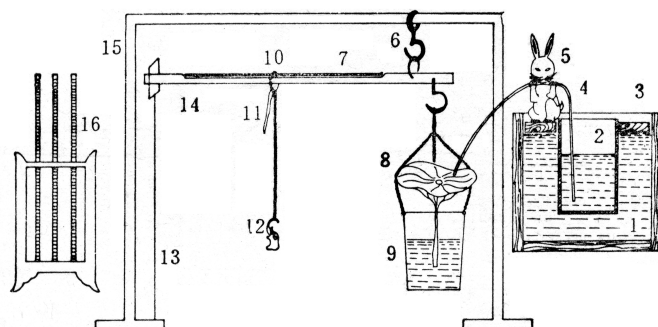

in which pig iron and wrought iron were heated together to a certain temperature for higher-quality steel. With its moderate content of carbon, this kind of steel was ideal for making advanced tools of production. This technique was widely used and improved in China in the following thousand years.

Taoists used in their alchemy the earliest fireproof sealing material, called “Six-one Lute,” which has been confirmed as useful and unique by modern scientific experiments. Taoists made glass and preserved valuable technical data in their writings. They wrote works on casting techniques, such as *Shen Xian Lian Dan Dian Zhu San Yuan Bao Zhao Fa*, in which they recorded in detail the techniques of quality control in the course of casting that had been kept secret in the grasp of Taoists. Ever since *Huai Nan Zi* (Book of Master Huainan) in the Han dynasty, Taoists used mercury-tin alloy and later added lead-amalgam as an ideal media for bronze mirror polishing.

Taoists used suspended magnetized needles to test the quality of lodestone, one of the major medicaments in alchemy. Eventually, this helped the invention of the magnetic needle compass in Taoism. Precise clock devices are of great importance in Taoist practices, and throughout history, many Taoists participated in the invention and improvement of water clocks in China. The famous “Cheng Lou,” a scale-controlled water clock (see Figure 14.3) invented by a Taoist named Li Lan, was widely used between the fifth and eleventh centuries, and served longer as an important component of various types of compounded clock devices in China. It was also used in the medieval Islamic world; Sleeswyk demonstrates that the technology was probably learned from the Chinese. Taoists of the Quanzhen sect invented portable water clock devices; the technical details of their production, debugging, and precision control were recorded in the text *Quanzhen Zuo Bo Jie Fa*.

Ancient Taoists made drawings suggesting some quartz or jade may have been used as refractors (see Figure 14.4). Zhang Zhihe, a Taoist in the Tang dynasty, described the phenomenon of duration of vision (as it is called in modern optics). In the tenth century, the Taoist Tan Qiao discussed the phe-

Figure 14.4a (Left): **Photos showing a beam of light refracted (up) by chicken-egg-shaped quartz (middle) as proof that a body holds splendid 5-colored light.**
 Figure 14.4b (Right): **The photo of 5-grade colors of light spectrum (bottom) revealed by a legendary jade. See *Xiu Zhen Li Yan Chao Tu*, in the *Daoist Canon* (volume 3, page 114).**

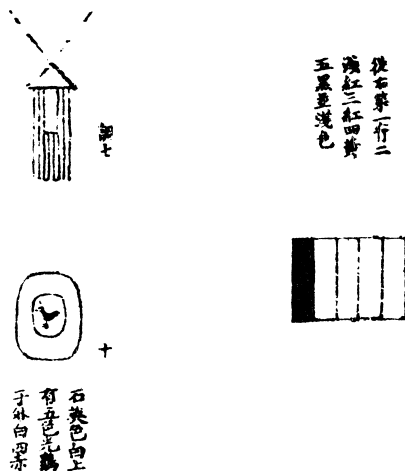

nomenon of reflection of plane mirrors. Zhao Youqin, a Taoist of the Quanzhen sect, wrote the famous scientific work *Ge Xiang Xin Shu* (New Book on Astronomy) in the Yuan dynasty (1260–1368), two centuries before Galileo, and conducted a series of large-scale experiments on geometric optical problems, such as light rectilinear propagation, hole imaging, and intensity of illumination. Youqin came to correct conclusions in these fields. His rough conclusion that “illumination intensifies as the intensity of light source enhances, but decreases as the image distance increases” was made four hundred years earlier than Lambert’s formula of qualitative illumination published in 1760, according to which “illumination is in reverse proportion to distance squared.”

Studies of Heaven and Earth

Modern scientists found that the maps in *Wu Yue Zhen Xing Tu* (Maps of the True Topography of the Five Sacred Mountains) roughly reflected the local terrain and routes of the mountains (see Figure 14.5). *Chang Chun Zhen Ren Xi You Ji*, a famous Quanzhen Taoist text, recorded many important materials of early thirteenth-century geography, such as the route from east China to “the Great Snow Mountain” (now in Afghanistan) where in 1222 the Mongol ruler Genghis Khan (1162–1227) had an interview with the Quanzhen Taoist leader Qiu Chuji (1148–1227).

Ancient Taoists are good at the observation of nature, including climate. A Taoist doctor named Wang Bing in the eighth century noted that topography height degrees correlate to a difference in temperature; it is believed he is the first to propose this concept of a horizontal gradient of earth tempera-

- Figure 14.5a (Left) **Modern contour map of Mount Tai (up); an ancient version (bottom).** (Ogawa, 1910).
- Figure 14.5b (Right) **Another ancient version of Map of the True Topography of the East Sacred Mount (Mount Tai) in the *Daoist Canon* (volume 6, page 740).**

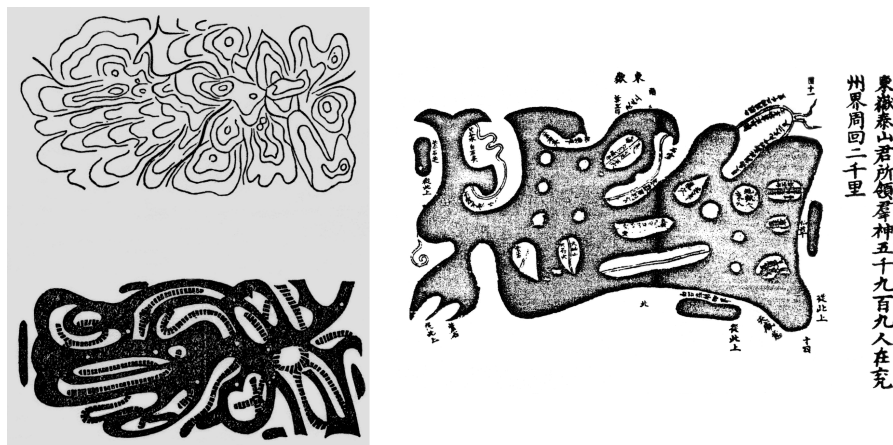

ture. He also discussed the reasons for the formation of orographical (mountain) rain. To avoid losses in their alchemic process and for many other religious practices—like praying for rain—Taoists conducted weather observations and made forecasts. The secret Taoist text *Yu Yang Qi Hou Qin Ji* analyzed the causes of wind and rain and recorded in terse but vivid verses observations consistent with modern meteorological science. The text includes illustrations of various cloud types (see Figure 14.6).

One driving force in Taoist philosophy is to know “where.” This gives Taoists the will to explore the heavens. Many Taoist scriptures are written to help followers know the shape and location of different parts of the heavens, including the constellations. One must find the gate to ascend to the heavens when the time comes. This helped drive the development of astronomical observation and mathematics in ancient China.

There are very rich ideas about heaven and earth in Taoism, many of which are in accordance with modern cosmology. Taoism holds that the universe is created from emptiness. Taoist philosopher Lao-Tzu writes in the *Tao Te Ching*, “Tao gives birth to one, one gives birth to two, two gives birth to three, and three gives birth to everything . . . everything in the world comes from being, and being comes from nonbeing.” This shares similarities with the Big Bang theory of contemporary cosmology. Lao-Tzu’s idea is taken as an important effort to explain what happened at the very beginning of our universe, and therefore the origin of human beings and their possible future, such as becoming immortal by practicing Taoism.

Modern cosmologists draw inspiration from the sayings of *Huai Nan Zi*, in which Taoists state a cosmogony that consists of seven stages: “There is a

Figure 14.6 “Cloud pictures” for weather forecasts in Taoist text *Yu Yang Qi Hou Qin Ji* (the *Daoist Canon*, volume 32, page 598–599).

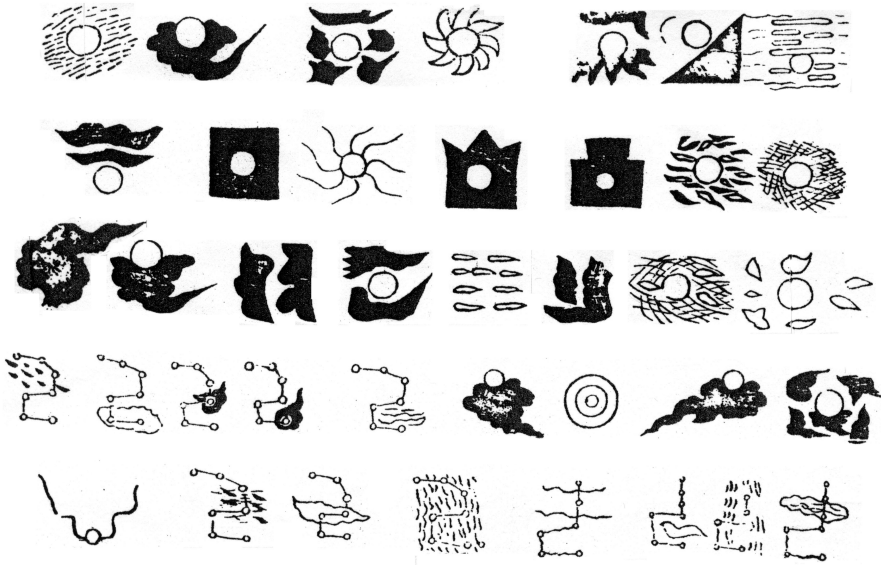

beginning. There is not yet beginning to be a beginning. There is a not yet beginning to be a not yet beginning to be a beginning. There is being. There is nonbeing. There is a not yet beginning to be nonbeing. There is a not yet beginning to be a not yet beginning to be nonbeing.” This is also reminiscent of ideas outlined in the Big Bang theory.

Ge Hong writes that “Heaven is like an egg, with the earth inside like yolk. Heaven is big while the earth is small. The surface of heaven is full of water. The air supports heaven, and the earth is on the water. The cycle of heaven is 365.25 degrees and it was divided into two halves: one half is floated on the earth and the other is under the earth, so the twenty-eight constellations are faintly discernible. Heaven turns around like the cargo wheel.” Zhang Pingzi and Lu Gong supported the theory, and observed heaven with instruments they made themselves. Ge Hong also affirmed the theory and developed it further.

An important idea of Ge Hong’s cosmology is found in his book *Zhen Zhong Shu*: as yin and yang had not emerged in the primitive phase, there was no universe, no earth, no moon, and no stars. It was yet like an egg that was gloomy. Gradually, it underwent the first period when there was nothing but the original shape. Then, in the second period, yin and yang emerged. The universe became true and then the original life came to exist.

The Book of the Supreme Venerable Sovereign’s Opening of the Heavens says that the evolutionary process of the universe is made up of many phases, such as great origin, chaotic origin, supreme beginning, supreme start, supreme simplicity, chaos, nine palaces, and original sovereign. Although such a theory is

within the religious realm, it initiates an understanding of the universe and catalyzes study of the science of the universe. Taoists came to know that the universe had gone through an evolutionary process of growing from small to large.

Ge Hong adopted the view that Pangu created the world, which is mentioned in the text *Three-Five Calendar* by Xu Zheng of the third century. In this view, “before the formation of the heaven, the earth, the sun and the moon, the universe was in the shape of an egg; it is chaotic, with color of black and yellow,” and heaven and earth were not created until Perfect Man Pangu roamed in the universe and created the sun and the moon.

A Taoist explanation of the structure of the universe is the theory of integral heaven. Heaven is a ball-shaped shell wrapping the earth, which floats in the ball of heaven in the shape of a board. The sun, moon, and stars are attached to the ball of heaven. The buoyant force of the “tie of the vital breath” enables heaven and earth not to fall down.

The Quanzhen Taoist Hao Datong was an expert of calendrics and arithmetic, while Zhao Youqin studied solar and lunar eclipses and did optical experiments. Some of his experiments and discoveries recorded in his *Ge Xiang Xin Shu* (New Book on Astronomy) were revolutionary in the history of astronomy. Zhao Youqin combined the skills of his scholarship (as an astronomer, mathematician, and physicist) with the charisma of a patriarch of the Quanzhen sect of Song-Yuan times. Zhao discussed practically all traditional topics related to astronomy and the calendar.

Taoist Dreams of Space Travel

Along with the impulse to know “where,” Taoist philosophy is driven by the impulse to know “how.” Taoists not only dreamed and observed the space that is believed to be the immortal world, but they also wanted to navigate this space. The “flying vehicle made of jujube heart timber” recorded by Ge Hong in his *Bao Pu Zi Nei Pian* has been regarded as the earliest design of propeller aircraft and revealed the Taoist knowledge of aerodynamics. Modern scientists have restored the vehicle according to Ge Hong’s records and showed it technically reasonable. Ge Hong also noted that when rising to a height of forty Li (about 12.44 miles), one reaches the space where the air is powerful enough to support flying objects, helping them to fly naturally by inertia instead of motive forces. This observation or supposition is close to the law of the First Cosmic Velocity in modern astronautics.

In the fourth century, the hermit Taoist Wang Jia wrote in *Shi Yi Ji* of a huge aircraft named “Cha” ridden by the immortals. It took the sea as its base for launching and landing, and kept navigating around the four seas, completing a circuit every twelve years. In the medieval Taoist encyclopedia *Tao Fa Hui Yuan*, drawings of magic flying figures strongly suggest the shape of modern airplanes (see Figure 14.7). These were to be used to pursue the aircraft of devils or witches.

Figure 14.7 Drawings of flying magic figures used by Taoists to pursue devil witchcraft that strongly indicate the shape of modern airplanes. From chapter 264 of *Dao Fa Hui Yuan*.

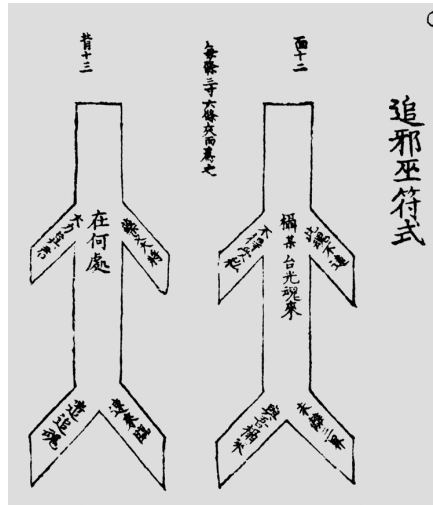

With the invention of gunpowder and the emergence of applied techniques for the control of its explosive power, aircraft had the possibility of using “the fourth power” as a propellant. In the fifteenth century, a Ming dynasty official named Wan Hoo attempted the first manned rocket flight, using forty-seven rockets propelled with gunpowder; he died for his efforts.

In a Taoist biographical text formally printed in 1909, there was a description of a Taoist beauty who was weary of her husband, a dull Confucian scholar. She said good-bye to him, poured a lot of cyprinid fat (derived from carp) into a well, then jumped into it, launching herself into the heavens from the well by riding a carp (see Figure 14.8). It is interesting to see in this tale some basic elements necessary for modern rocketry: the propellant (cyprinid fat), the vehicle (a carp), and the silo (a well).

In the same text, another vivid instance demonstrates Taoist dreams of space-ships. A poor boy named Lu Qi, accompanied by a woman matchmaker Ma, experienced space navigation by driving a calabash to visit a possible wife, an important figure in the immortal world. The travel began with thunder and wind while ascending to heaven. In the journey through the “heaven of super clarity,” the roaring of huge waves filled the ears; the experience was like being in icy snow. The travelers had to add to three layers of oil-painted dresses to keep their bodies from cold. After a short time, Ma told Lu that they were 40,000 kilometers from Luo Yang; after a long time, the calabash stopped and they arrived at the marvelous building of the goddess (see Figure 14.9). The story of the journey suggests knowledge in concord with modern space travel. We do not know how the Taoists reached these ideas, but Taoism places great merit in imagination and observation of nature.

Figure 14.8 **Zhang Hao (sitting on knees), a dull Confucian scholar, seeing his beautiful Taoist wife off—by launching her aircraft into the heavens from a silo by a propellant compounded from cyprinoid fat.** From *A Pictorial Biography of the Immortals of Every Dynasty*.



The drive for scientific exploration comes from the structure of the Taoist belief in immortality. In essence, “science” has always been a natural part of Taoist “theology”; however, Taoists neither recognized nor wanted to develop “science.” Taoists made rich contributions in many scientific fields, including geology, botany, zoology, pharmaceuticals, architecture, acoustics, and psychology. All the efforts they made, however, were directed to serve the ideal of human life transformation from mortal to immortal. It is impossible for science to emerge from the celestial dream, become the goal of Taoism, and lead it into the modern way of scientific discovery, and it seems subjective and unfair to expect the integration of modern science into the culture of Taoist tradition.

Figure 14.9 **Poor young man Lu Qi, accompanied by the woman matchmaker Ma, experienced space navigation by driving a calabash to visit his possible future wife who is an important official in the immortal world. From *A Pictorial Biography of the Immortals of Every Dynasty*.**



Bibliography

- Capra, Fritjof. *The Tao of Physics*. Berkeley, CA: Shambhala, 1975.
- Clarke, J.J. *The Tao of the West: Western Transformations of Taoist Thought*. London: Routledge, 2000.
- Holmes, Welch. *Taoism: The Parting of the Way*. Rev. ed. Boston: Beacon, 1957.
- Hua, Tongxu. *Water Clock in China*. Hefei: Anhui Science and Technology, 1991.
- Jiang, Sheng, and Waihop Tong, eds. *The History of Science and Technology in Taoism*. Vol. 1. Beijing: Science, 2002.
- Jin, Zhengyao. *Taoism and Science*. Beijing: Chinese Social Sciences, 1991.
- Ke, Zineng, and Qun Huang. "The Development of Six-one Lute in History." *Studies in World Religions* 3 (2004): 77–83.
- Kohn, Livia, and Yoshinobu Sakade, eds. *Taoist Meditation and Longevity Techniques*. Ann Arbor: Center for Chinese Studies, University of Michigan, 1989.
- Lu, Gwei-Djen, and Joseph Needham. "Medieval Preparations of Urinary Steroid Hormones." *Nature* 200 (1963): 1047.
- Needham, Joseph. *The Grand Titration*. Toronto: University of Toronto Press, 1969.
- . *Gunpowder as the Fourth Power, East and West*. Hong Kong: Hong Kong University Press, 1985.
- . *Science and Civilisation in China*. Vols. 2–4. Cambridge: Cambridge University Press, 1956–1965.
- A Pictorial Biography of the Immortals of Every Dynasty*. A lithographic printed edition, 1909.
- Singh, Narendra P., and H. Lai. "Selective Toxicity of Dihydroartemisinin and Holotransferrin Toward Human Breast Cancer Cells." *Life Sciences* 70 (2001): 49–56.
- Sivin, Nathan. "On the Word 'Taoist' as a Source of Perplexity: With Special Reference to the Relations of Science and Religion in Traditional China" and "Taoism and Science." In *Medicine, Philosophy, and Religion in Ancient China: Researches and Reflections*, ed. Nathan Sivin. Aldershot, UK: Variorum, 1995.
- Sleeswyk, W.A. "The Celestial River: A Reconstruction." *Technology and Culture* 19:3 (1978). *The Taoist Canon*. Beijing: Wenwu, 1988.
- Volkov, Alexei. "Science and Daoism: An Introduction." *Taiwanese Journal for Philosophy and History of Science* 5:1 (1996): 25–28.
- Wang, Bing. *Commentaries on Chapter Suwen of Huangdi Neijing*. Published in 762.
- Wang, Guowei. *Commentaries on Chang Chun Zhen Ren Xi You Ji*. Beijing: Beijing Institute of Qinghua, 1926.
- Wang, Ming. *Bao Pu Zi Nei Pian Jiao Shi*. Beijing: Zhong Hua Publishing House, 1985.
- Yoshinobu, Sakade. *A Study of Chinese Thought: Essays on Traditional Medicine, Pharmacy, Nourishing Vitality, and Science*. Osaka: Kansai University Press, 1999.
- Zhao, Kuanghua, and Jiahua Zhou. *A History of Science and Technology in China: Chemistry*. Beijing: Science, 1998.
- Zhu, Cungu. *Dou Zhen Ding Lun* (Final Conclusions on Smallpox). Published in 1713.
- Zhu, Yaping. *Taoism Culture and Science*. Hefei: University of Science and Technology of China Press, 1995.
- Zim, Herbert S. *Rockets and Jets*. New York: Harcourt Brace, 1945.

15 Religious Pluralism and Science in Asia

Shigeru Nakayama

Historians interested in climatology have argued that, because Jewish monotheism and its offshoots Christianity and Islam originated in a harsh desert climate, they envisioned a creator deity, a supreme and almighty god, who demanded submission and rigorous distinctions between good and evil. This contrasts with the densely populated lands of East Asia, where getting along implies religious tolerance. When one lives in such close proximity to so many others, this view assumes, one becomes tolerant without having to make an issue of it.

Religious pluralism is the belief that religious differences can be overcome. Due to the recent expansion of Christian as well as Islamic fundamentalism, Europeans have called for religious toleration. These discussions seldom mention such East Asian religions as Confucianism, Buddhism, and Shinto. Institutionalized fundamentalism and uprisings of religious cults are not unknown in East Asian history, and they can be found even today. Nevertheless, religious fundamentalism was not as serious a problem as elsewhere, perhaps because East Asian cultures are pluralist from the religious point of view.

Joseph Needham, throughout his series *Science and Civilisation in China*, depicted Confucianism and Taoism as fundamentally opposed, so that the latter was a kind of opposition to the imperial officialdom (he did not distinguish religions from philosophies). Although this may seem analogous to the confrontation between Catholics and Protestants, Needham was misreading the relationship. There was no Confucian religion aside from the rituals of the state. Executive officials, not ritualists, saw any group competing for popular loyalty as an enemy. Masters in the Taoist religious movements, on the other hand, consistently sought state patronage and recognition; modern scholars of their history have failed to find any such movement that opposed the government. Nor did Taoist movements have members in the sense of Christian congregations.

From the layman's point of view, a variety of beliefs could peacefully co-exist in one's mind. Thus we have the hoary cliché about ancient Confucian

bureaucrats who read Buddhist or Taoist books in the evening for their personal salvation. This receptivity arose from the understanding that all systems of belief were manifestations of the Way, the Tao. It still animates today's pattern in Japan of celebrating the birth of a child at a Shinto shrine, arranging a Christian marriage ceremony (sometimes because it is cheaper than the alternatives), and carrying out a Buddhist funeral service.

As for the science of different cultures, a monotheistic way of thinking often leads people to think of nature reductionistically, in a hierarchy of cause and effect. Polytheism implies, in place of such relationships, religious tolerance and a preference for correlative thinking and harmony. Western science is, in a sense, monotheistic and fundamentalist. In the Enlightenment's deistic science, a transcendent God ruled over all. Just as men had to obey His will, nature was constrained to obey His laws.

It appears that Greek polytheistic science is exceptional, but as early as the fifth century BCE, Plato attacked traditional pantheism and replaced it with the notion of a single God. Platonism is a philosopher's monotheism, hierarchically distinguishing phenomena from unchanging regularity. This faith that all things are obedient to laws stimulated the quest for reductionist basic principles and axiomatic truths that hammered out universal laws and forged binding chains of cause and effect.

In the pluralistic tradition of East Asia, few showed interest in the problem of cause and effect. Even when mutual relationships were recognized, no one attempted to discover a single chain of causes and effects that might consequentially link phenomena. But in the West, scholars insisted that all natural phenomena be crammed into a single lawful box. Asian pluralists were satisfied to conclude that some physical phenomena simply were not lawful. Little was challenged, confuted, rejected, or debated; all physical data were accepted, preserved, and allowed to rest in peace and harmony, without provoking a normative crisis. There was thus less likelihood of scientific revolutions than in the West.

In such pluralistic societies, relativism prevails. When Western scientific ideas such as those of Copernicus and Darwin were introduced to East Asia, they did not cause any general tension. In China and other East Asian cultures, there was no absolute system that had to be defended from the aggression of Western ideas.

Bibliography

- Nakayama, Shigeru. *Academic and Scientific Traditions in China, Japan, and the West*. Tokyo: University of Tokyo Press, 1984.
- Needham, Joseph. *Science and Civilisation in China*. Cambridge: Cambridge University Press, 1954.

16 Diversity of the Religious Experience

Ralph W. Hood Jr.

Since the time of William James's classic *The Varieties of Religious Experience*, social scientists who study religion have focused on experience rather than belief. This has allowed social scientists to explore similarities in experiences that previously were masked by a focus on how the experiences were interpreted, often in terms of prior religious beliefs. Not all scholars accept this distinction between experience and interpretation. Some argue that to identify any experience requires language and beliefs that therefore help constitute what is experienced. Also, differing judgments about which religious beliefs are most valid have created divisions within and among the various faith traditions. Such concerns have led many to contrast being religious with being spiritual. Being spiritual is identified with a wide variety of experiences of transcendence, while being religious is identified with formal institutions, clearly specified beliefs (dogma) and ethical behaviors, and obedience to ecclesiastical authority. While most religious persons identify themselves as both religious and spiritual, many spiritual persons refuse to identify themselves as religious. The distinction is less about whether we have similar experiences and more about how we interpret experience.

What Saint Augustine said of time can be paraphrased to apply to experience: everyone knows what it is to have experiences, even though it is difficult to define exactly what experience is. But scholars disagree on whether there are uniquely religious or spiritual experiences, as opposed to experiences that are religious only because they are interpreted within religious language. For some, the language within which an experience is described identifies the experience as either religious or secular. A simple example is dreams. Rare is the individual who has never dreamt. Yet for some, dreams are not attended to as meaningful; for others, dreams are interpreted in secular terms; for still others, dreams are understood in religious language as communication from God or other spirits. Obviously, to attend to a dream as a sign from God is to meaningfully alter what otherwise might simply be a dream that remains a curiosity, or is simply ignored as random brain activ-

ity. Thus, many experiences are religious simply because they are so interpreted. For some without religious beliefs, what others might identify as religious experiences are considered simply anomalous experiences. For those who identify themselves as religious or as religious and spiritual, the varieties of religious and spiritual experience are as diverse as the ways in which they can be described. Our focus here is first on the varieties of religious and spiritual experience, and then on experiences that are more universally recognized as inherently spiritual regardless of specific variations in interpretation.

Varieties of Religious and Spiritual Experience

Near Death Experiences

The near death experience has been recorded in art and literature throughout history but has only recently been a topic of systematic scientific investigation, where it is commonly referred to as NDE. While there is no precise definition of the near death experience, the term refers to a cluster of phenomena reported by people who have survived an acute trauma or medical condition that was almost terminal. A number of individuals in a near terminal state have reported experiencing a series of phenomena that appear to be nearly universal and independent of culture. Likely to be included in any NDE are a sense of being absent from one's physical body, a sense of being surrounded by or going through a tunnel of white light, a profound sense of peace, and a confrontation with a significant figure, often identified in religious terms such as Shiva or Christ, who indicates that it is not time to die and orders a return of the self to the body. People often report that as a consequence of such an experience, they have a renewed sense of purpose in life, a deepened or newly discovered religious faith, and a conviction that there is life after death.

Some scientists attribute these experiences to such factors as oxygen deprivation and the secretion of endorphins generated by the brain as the body begins to die. Thus, while few dispute the reality of near death experiences, whether they are religious or not depends on how they are interpreted. People within faith traditions that emphasize the reality of an afterlife often find confirmation of this belief in a near death experience, and they identify the figures that appear in NDEs as significant figures within their religious tradition. After a near death experience, some individuals without any faith tradition may seek out a faith tradition that supports the reality of what they experienced. For others, the phenomena are merely phantasms produced by a brain near death. Those who are spiritual use noncommittal language to describe an experience that for the religiously devout can be explicitly described in the language of their faith. A small number of near death experiences are quite negative, and some are described in language suggesting a confrontation with the demonic.

Apparitions and Visions

Unlike near death experiences, most visions and apparitions are reported by healthy people under normal circumstances. Visions or apparitions are seen with eyes open, as with normal perception of physical objects. Many visions and apparitions can easily be dismissed as hallucinations typically associated with psychopathology rather than spirituality. The experience gains religious significance when the figures are understood within a particular faith tradition or culture that supports the reality of spiritual beings. In the religious context, visions typically are of identifiable figures of high status within a given faith tradition, such as the Virgin Mary among Catholics or Shiva among Hindus. The phenomena of apparitions and visions have yet to be fully explained by scientists. Secular scientists are likely to identify them simply as hallucinations and give them no ontological credence. Only faith traditions that encourage such visions provide the frame within which they become endorsed as religious experiences.

Prayer and Meditation

Every major faith tradition supports prayer. There are a variety of types of prayer, ranging from petitionary prayer (asking for something) to meditative prayer in which one seeks to be aware of the presence of God. Each form of prayer provides a different experience. Those who engage in petitionary prayer are acutely aware of what they lack and desire to have, and there is the anticipation that if they communicate to a divine reality, what they desire may be provided. There is a sense of dialogue with a divine being. In meditative prayer, one seeks an awareness of being in the presence of a divine being, often with a loss of sense of self. Prayer typically is done with various prescribed postures, often with eyes closed and a sense of withdrawal from the normal, everyday participation in the world. Many faiths specify postures and rituals to be used to enter a prayerful state, such as bowing prostrate toward Mecca in the Islamic tradition. Perhaps the most studied form of petitionary prayer is that of asking for healing of self or others. Such prayers have been associated with enhanced immune system functioning, as have positive moods or attitudes. What is most unique to prayerful healing is an interpretation that whatever outcome occurs is ordained and in the hands of a divine being. Thus, even if physical health is not restored, a sense of spiritual or religious health is often achieved.

In meditation, one withdraws from a preoccupation with sense perception and instead seeks to “still the mind” in an inwardly focused awareness. This effort to achieve a state of pure awareness need not be interpreted in religious language. In some traditions, Zen for instance, no interpretations are sought. The experience itself is nonconceptual and hence nothing can be said of it. Many forms of meditation exist, and some have parallels with religiously

interpreted meditative prayer. Scientists are making progress in identifying the neurophysiological activities associated with various forms of mediation and prayer.

Glossolalia

A form of prayer found throughout the world is glossolalia, or speaking in tongues. Within American Pentecostalism, it is considered evidence of baptism of the Holy Ghost and thus a profound religious experience. For some, it is direct communication with God. Some people are believed to have the gift to interpret glossolalia. The universality of glossolalic utterance across cultures is attributed by some anthropologists to the fact that glossolalia seems to be emitted in a trance state. However, many psychologists believe glossolalia is a learned behavior that does not require a trance state to occur. Some scientists believe it is merely phonologically structured human sound. Others attribute the phenomenon to mental illness. But because glossolalia is normative in many faith traditions, the experience can be given a profound religious meaning. For the religious believer, speaking in tongues provides a sense of communion with God that is both emotionally fulfilling and expressive.

Serpent Handling

In the handling of poisonous snakes, we see that an otherwise problematic experience can be meaningfully religious. For some American Pentecostal sects, biblical passages that justify glossolalia also justify serpent handling (e.g., Mark 16:17–18). Accepting “thou shall take up serpents” as a mandate from Christ, contemporary serpent handlers, largely centered in Appalachia, regularly handle and are bitten, maimed, and even killed by poisonous serpents. However strange this ritual appears to the outsider, studies of handlers reveal they feel empowered as they handle serpents in obedience to their God. The intensity of the experience is likely unmatched by rituals that do not endanger life. Some individuals approach the serpent boxes with fear and uncertainty; others have a sense of being anointed by God, assured that a divine hedge surrounds them and they will not be hurt. However, many believers have died from this practice, and some states have passed laws against serpent handling. But handling in defiance of secular laws heightens the experience for some handlers as they engage in what they believe is obedience to God’s law.

While handling serpents based on a textual mandate is unique to America, serpents are handled in other cultures. In India, the high priests of the Manasa sect handle and allow themselves to be bitten by poisonous cobras as a sign of their faith. Serpent symbolism is common across many religious traditions, but few traditions have actually incorporated the handling of serpents into religious rituals that elicit intense experiences due to the fact that the serpents can maim and kill.

Psychedelics or Entheogens

One of the more controversial forms of religious experience is experience facilitated by the use of drugs. It has long been recognized that many religions have incorporated various naturally occurring substances in their religious rituals. However, until the discovery of psychedelic drugs, it was widely assumed that the use of drugs to facilitate religious experiences was associated with less advanced cultures and was thus the proper concern of anthropologists. Some anthropologists speculate that the origin of religion is in states of consciousness produced by drugs. Similarities between drug-induced states of consciousness and some experiences noted in many of the world's sacred texts have led contemporary psychologists to try to elicit religious experiences by administering drugs.

Early investigators favored the term *psychedelic* for drugs that produced profound alterations in consciousness. More recently, the term *entheogen* is favored by investigators who believe these drugs can facilitate primary religious experiences (the Greek word *entheos* means "god within"). No drug by itself produces a religious experience. However with proper set and setting, religious experiences are widely acknowledged to be facilitated by entheogens. While mainstream American churches are reluctant to accept drug-facilitated experiences as genuine, the phenomenological characteristics of such experiences are identical to those that occur spontaneously or by such practices as fasting, meditation, or prayer. In many religious traditions, entheogens have been incorporated into religious rituals. Ayahuasca, a naturally occurring entheogen, is common in Brazil and is served as a sacrament in the Christian-oriented Church of Santo Daime. Peyote is used in some Native American religious rituals. In such instances, the entheogens are used to facilitate intense experiences that are meaningful as interpreted within the religious symbols and beliefs of the tradition.

Conversion

William James identified two basic ways in which individuals experience their religion. Some are temperamentally oriented into the acceptance of life as good and, should they be raised within a religious tradition, are satisfied with everyday experiences that confirm their faith and beliefs. Others are sick-souled individuals concerned with the evils of the world, the suffering of persons, and a chronic awareness of death. It is the sick-souled who are ripe for religious conversion. The conversion experience is likely to be sudden, elicited by a crisis, and experienced as a resolution. The sudden conversion has been closely identified with American Protestantism. The prototype is Paul's conversion on the road to Damascus. Sudden conversions are most likely to be preceded by emotional turmoil and lead to dramatic changes in behavior once the new religious belief system is adopted.

Contrasted to sudden conversion are more gradual conversions that can occur several times. Here the convert is an active seeker focusing more on self-realization and growth than the resolution of emotional turmoil. Active seekers may convert to a given faith tradition, or they may select beliefs and practices from a variety of traditions. These active seekers are more likely to identify themselves as spiritual rather than religious, and to seek self-actualization and a sense of transcendence that is not bound by any one faith tradition. Dramatic changes in personality are uncommon with gradual conversion. Gradual conversions are more likely to result in finding new meanings or a new sense of purpose in life.

Cults and Coercive Persuasion

Like sects, cults are religious groups whose beliefs and practices place them in tension with the larger culture. They are differentiated from sects by the fact that cults are led by a charismatic leader. There have been sensational claims that cults brainwash their converts, especially when the cults have been associated with mass suicide as in Heaven's Gate or Jonestown. A more appropriate term is *coercive persuasion*, which can include forced isolation, physical debilitation, and the creation of confusion and uncertainty about current belief and practices. Efforts are often made to induce guilt and humiliation for one's past lifestyle. These techniques converge to produce a sense that one is becoming a member of a select group whose leader is, if not a god, privileged with respect to receiving revelations from a supreme being. Converts to cults comply with the dramatic behaviors and beliefs of the group as long as isolation and control are maintained. Converts may initially become infatuated with the cult leader. However, true internalization of the cult's beliefs are rare. Notions that cult converts must be "deprogrammed" because they have been "brainwashed" simply plays one unscientific concept off another. The majority of converts to cults become disenchanting and leave of their own free will.

A Continual Sense of the Sacred

While social scientists tend to study intense experiences, this is not to deny that simple socialization into a faith tradition produces what can be identified as a continual sense of the sacred. Many fundamentalist sects, for example, adhere to a way of life that accords with the imperatives of a sacred text or an oral tradition. For members of such a sect, everyday life may contrast sharply with the lifestyle of the majority culture. Various Amish groups have distinctive clothing and lifestyles that are protected from radical change. Amish children are not educated beyond the eighth grade; automobiles are avoided in favor of horse-drawn buggies; phones are forbidden or restricted; farming is done with horses or tractors without rubber tires (so they are not drivable on paved roads). What emerges is a life carefully crafted to avoid the larger culture in favor of a con-

tinually lived religious view. Other groups, such as orthodox Jews with distinctive dietary requirements, or Mormons with distinctive undergarments, or Buddhist monks who beg for food, engage in common everyday practices marked less by identifiable intense experiences than a continual religious sense experienced throughout the day in what would otherwise be simply routine acts.

Universal Spiritual Experience

It is apparent from the examples above that many different experiences are religious at least partly because they are interpreted within a religious worldview. Thus, one cannot identify an experience as religious independent of its interpretation. We refer to experiences interpreted within a religious worldview as modes of experiencing religion. As suggested above, the modes of experiencing religion are as diverse as the various religious frameworks that can be applied to experiences. However, some experiences are neither bound by religious tradition nor created by the language in which it is described. These experiences are seen as inherently religious or spiritual. Two forms of this more universal experience are numinous and mystical experiences.

Numinous Experiences

Numinous experiences are an awareness of a holy other beyond nature with which one feels in communion. In this sense, it is a personal experience of the divine. The German theologian Rudolf Otto outlined the phenomenology of this experience in *The Idea of the Holy*. A nonrational component is characterized psychologically by a numinous consciousness in which a divine reality is disclosed. The numinous consciousness is compelled to explore this transcendent object but is also repelled by the majesty and awfulness of this object in whose presence one's creaturehood is accentuated. To describe a numinous experience, people may use the concept of a Holy Other such as God or Allah or Yahweh. The study of numinous experiences has largely focused on responses to surveys that ask if one has ever experienced a sense of the presence of a transcendent power, whether identified as God or not. Reports of such experiences are common in most cultures. In the United States, numinous experiences are reported by people who identify themselves as religious and spiritual and by those who report that they are spiritual but not religious. Even people whose religious self-identification is "none" report such experiences. This is consistent with the view that numinous experiences are of a reality that exists and which various faith traditions attempt to describe.

Mystical Experiences

Mystical experience has been a topic in the psychology of religion and in the field of religious studies. Some mystical experiences reflect a common core

that is universal despite variations in the language in which this experience is expressed. Research has focused on two forms of mysticism: introvertive and extrovertive. In an introvertive mystical experience, the self is felt to be one with God or reality in an undifferentiated unity. In an extrovertive mystical experience, the individual perceives a unity within the multiplicity of the world, and all things are experienced as one. These common unity factors are inherent in the nature of the experience, suggesting that despite various interpretations, mystical experience is of a reality often identified as God. As with numinous experiences, mystical experiences of unity are reported across cultures and among all ages. They also are reported by individuals who identify themselves as religious and spiritual, and as spiritual but not religious. The implication once again is that faith traditions attempt to express in language a reality that is in essence ineffable and may be a fundamental experience of the divine available to all.

The brief overview presented here of the diversity of religious experience reveals that almost any experience can be religious if it is understood as such within some faith tradition. However, one group may reject what another group accepts as a religious experience. Some scholars have argued that numinous and mystical experiences may be unique. Whether expressed in religious language or not, they have an identifiable phenomenology that appears to be identical across diverse cultures, and that occurs universally. They suggest that the reality described by modern science need not exclude the possibility that a divine reality may also exist and be revealed in human experience.

Bibliography

- Austin, J.H. *Zen and the Brain*. Cambridge, MA: MIT Press, 1998.
- Bowker, J. *The Sense of God: Sociological, Anthropological, and Psychological Approaches to the Origin of the Sense of God*. Oxford: Clarendon, 1973.
- Cardeña, Etzel, Steven J. Lynn, and Stanley Krippner, eds. *Varieties of Anomalous Experience: Examining the Scientific Evidence*. Washington, DC: American Psychological Association, 2000.
- Hood, Ralph. W., Jr. *Dimensions of Mystical Experiences: Empirical Studies and Psychological Links*. Amsterdam: Rhodopi, 2002.
- . "American Primitive: In the Shadow of the Serpent." *Common Review* 2:2 (Spring 2003): 28–32.
- James, William. *The Varieties of Religious Experience*. Cambridge, MA: Harvard University Press, 1902/1985.
- Kraybill, Donald. B., and Marc A. Olshan, eds. *The Amish Struggle with Modernity*. Hanover, NH: University Press of New England, 1994.
- Maloney, H. Newton, and A. Adams Lovekin. *Glossolalia: Behavioral Science Perspectives on Speaking in Tongues*. New York: Oxford University Press, 1985.
- Otto, Rudolf. *The Idea of the Holy: An Inquiry into the Nonrational Factor in the Idea of the Divine and Its Relation to the Rational*. Trans. H.J. Harvey. London: Oxford University Press, 1923.
- Poloma, Margaret. M., and George H. Gallup Jr. *Varieties of Prayer: A Survey Report*. Philadelphia: Trinity Press International, 1993.
- Rambo, Lewis. R. *Understanding Religious Conversion*. New Haven: Yale University Press, 1993.

- Roof, Wade C. *A Generation of Seekers: The Spiritual Journeys of the Baby Boom Generation*. San Francisco: HarperSanFrancisco, 1993.
- Shanon, Benny. *The Antipodes of the Mind: Charting the Phenomenology of the Ayahuasca Experience*. New York: Oxford University Press, 2002.
- Wiebe, Phillip. *Gods and Other Spirits*. New York: Oxford University Press, 2004.
- Zaleski, Carol. *Otherworldly Journeys: Accounts of Near-Death Experiences in Medieval and Modern Times*. New York: Oxford University Press, 1987.

17 Multicultural Perspectives on Issues in Science and Religion

Barbara Strassberg

In order to appreciate the real-life dynamics between religion and science, we need to get down to individual and group experience. Scholars, theologians, and scientists engaged in the religion and science dialogue often focus on a very theoretical and abstract analysis that suggests the application of an essentialist approach both to religion and science. The debate addresses the questions of whether religion is a threat to science or science is a threat to religion; whether they are separate or overlapping; whether one can be used in support of the other. Moreover, the interest seems to be directed toward questions that religion and science ask rather than answers they are believed to provide, with ‘why?’ reserved for religion and ‘how?’ for science.

However, if we supplement these voices with a social scientific approach, we realize more fully the importance of the answers people believe religion and science supply. These are the answers people believe to be true, that energize their behavior toward themselves, toward others within their own group, toward out-groups, and toward the rest of the natural environment. Both religion and science are created through thoughts and actions by means of which people assign meanings to their surroundings. Since both are engaged in human interactions and struggles for power, they have real consequences for people’s lives.

There is a need for cultural inclusiveness in the examination of contemporary issues from the perspective of science and religion. The social scientific multicultural approach allows us to develop a social and cultural criticism of religion and science, and of their multiple possible relationships, on the level of lived religion and lived science. Lived religion manifests itself in behavior justified by religion-based group ethics and individual morality, and lived science manifests itself in technology available to individuals and groups in a given cultural context. In everyday life, religion is often used to sacralize specific individual or collective goals (why we need to do this), and science is often

used to sacralize the means for attaining those goals (how we need to do this). A framework for further exploration of multicultural perspectives on science and religion is sketched below, followed by a discussion of the interplay between religion and science in the context of contemporary issues that operate on the macro or global level and on the micro level of individual experience.

Theoretical Framework

One important factor that shapes the perception of the relationship between religion and science is the diversity of religious beliefs and scientific disciplines. The several major world religions are all divided into numerous, often competing local interpretative dialects, and they function side by side with hundreds of local religions. The several major scientific disciplines are divided into multiple subdisciplines, and every one of them comprises distinct, often competing theoretical and applied approaches. However, the actual religion- and science-related experiences of most people are embedded in only one specific religious dialect and only one specific scientific interpretation of a given phenomenon.

Most individuals and groups develop worldviews, in which the relationship between religion and science reflects the views commonly accepted by their society. A worldview occurs on group and individual levels and reflects a society's and an individual's perceptions of the world and life. It helps to explain the meaning of life and why things are the way they are, and to prescribe how things ought to be, and it thus makes sense of the past and present social orders. Its normative aspect manifests itself in group ideologies that offer different, often competing visions of desired future social arrangements, and in legal codes that set out how we should behave and why we should behave that way.

Throughout history, both religion and science have been incorporated into collective and individual worldviews. Some people believe that there is a divide between religion and science that cannot and should not be bridged, and others believe that these two ways of knowing are seamlessly fused together. Between the two opposing views, there is a continuum of possibilities in the perception and interpretation of the relationship between religion and science. Social institutions and ideologies they promote, and political institutions and the policies they formulate and enforce, create opportunities for and limitations of the individual and group choices among the existing alternatives.

Individual choices, however, are heavily influenced by a much narrower social context, which is defined by the position of a person in a society and by the social roles performed within the existing hierarchy of stratification. This context provides the foundations for the processes of socialization within the family, among peers, in social institutions, and in the larger culture that shapes individual worldviews. It shapes the individual's ability to notice, understand,

appreciate, and adopt any of the alternative, competing systems of meaning offered by the globalizing world of high-speed communication technologies. Also, it shapes the individual's chances to contribute to the modification of the collective worldview.

Such ability and chances, in turn, depend on the scope and intensity of individual and group religiosity and "scientificity." I refer here to beliefs in specific interpretations of religious and scientific truths, feelings about such truths, and the predisposition to conform to the dictates of a given social entity and to act according to patterns of behavior prescribed for a given context. The group religiosity and scientificity shape individual beliefs, feelings, and predispositions toward actions, and those feed back into the collective worldviews. Once a sufficient number of individuals incorporate new ideas into their worldviews, the collective worldview starts to change. It's an exercise in democracy, except that special interest groups, which are more vociferous, have disproportionate influence on the collective worldviews of human societies.

As a result of those influences, religion and science are reenacted in a much different way within an individual worldview of a religious leader or a theoretical scientist than in a worldview of a religion teacher or a science teacher. A still different dynamic between religion and science is going to characterize the worldview of a person unaffiliated with any institutional religion or a person who has no interest in science, even though such a person might freely use science in its applied form of technology.

On a continuum between *producers* and *consumers* of religion and science, with these categories not being mutually exclusive, we find a great number of human experiences that underscore the complexity of the role religion and science play in everyday human life. These experiences are also modified by the fundamental social differentiations that arise from the cultural construction of age, gender, sexuality, race, ethnicity, and social class by particular societies. They contribute to the differences in the level and character of general, religious, and scientific literacy and competence among various categories of people in a society.

The complex relationship between religion and science within the collective and individual worldviews becomes clearer when we introduce the concepts of *essentialism* and *hybridity*. These terms are used to describe the characteristic features of reality and to define the ways in which cultures are perceived by individuals and groups who create cultures, as well as those who look at them from the "outside."

"To essentialise is to impute a fundamental, basic, absolutely necessary constitutive quality to a person, social category, ethnic group, religious community, or nation," according to Werbner and Modood's *Debating Cultural Hybridity*. This way of describing reality implies that cultures are characterized by timeless continuity, organic unity, and boundedness in space; they are internally the same and externally different from other cultures. This percep-

tion of cultures allows people to view them as “things,” separated and different from each other to the point that in certain political circumstances people representing one culture might define those who represent another as less human, and thus legitimize exploitation of the other or even genocide. According to Werbner and Modood, “The communities essentialised by perpetrators of violent acts of aggression are . . . defined as fixed, immoral and dangerous. In being demonized, they are reified.” Therefore, as scholars studying religion and sciences from a multicultural perspective, we need to ask who essentializes whom, when, and for what political purposes, and whether the scaffoldings for this essentialization are founded in religion or science or both.

The second perspective presupposes that cultures are hybrids. Werbner and Modood describe it as the view that “despite the illusion of boundedness, cultures evolve historically through unreflective borrowings, mimetic appropriations, exchanges and inventions. There is no culture in and of itself.” If cultures are perceived as fluid, hybridal, and open, then people are able to view the other as an extension of the self. This becomes possible because the emphasis is placed on similarities and unity, on interdependence and fusions, in spite of conflicts, debates, or differences of opinion. Thus, the awareness and acceptance of hybridization as a characteristic feature of reality widens intellectual horizons and permits the construction of a more complex, internally diversified, but still coherent worldview.

Throughout history, the processes of cultural evolution have brought almost all human cultures to a very high level of hybridization. However, even today, we observe an ongoing dialectical interaction between hybridal cultures and essentialist perceptions of those cultures, especially when political and economic gains are desired.

If we agree that all cultures are hybrids, then all elements of cultures, including religion and science, are hybrids as well. The processes of cultural mixing, crossovers, and inversions produce religious and scientific hybrids that, according to Werbner and Modood, “juxtapose and fuse objects, languages and signifying practices from different and normally separated domains and . . . challenge an official, puritanical public order.” However, as described by Bakhtin, hybridization of cultures, including religion and science, might be either unconscious and organic or conscious and intentional. This distinction is important because spontaneous hybridization does not challenge the sense of order or continuity; it does not present itself as a threat to the purity of any component of culture; when discovered *ex post facto*, it is simply accepted as an interesting observation. On the other hand, intentional hybrids are perceived as internally dialogical, fusing the unfusible. They are perceived as threatening both the social order and individual identity, and typically are countered by negative evaluations and vigorous opposition—usually unsuccessfully.

The perception of threat and opposition is usually linked to the definition of religions and sciences in essentialist terms. Essentialists believe that indi-

viduals can be classified based on some shared, static quality linked to the adherence to a particular belief system based on faith or a given scientific theory. This approach usually leads to a complete separation of religion and science within a collective or individual worldview, or to their incorporation as two separate, parallel ways of knowing. As a result, notes Epstein, some experiences are ignored or even degraded while others are privileged and no “interference,” no mutual action of several “cultural waves” is permitted. Such essentialist interpretations can also be found in the traditional theoretical model of difference applied within “mosaic multiculturalism,” which tends to emphasize the pluralistic world of self-enclosed cultures, each valuable in itself.

The American cultural context—with its dominant unique version of Protestant Christianity and the dominant uniquely strong trust in science—provides some good examples of essentialist practices within a hybrid culture. Even though both religion and science function as powerful organizing principles in American society, and are strongly fused together within the fabric of society and culture, in certain empirical political situations the line dividing religion and science might be intentionally constructed as very clear and well defined. This makes the exploitation of that line for various political purposes relatively easy, by denying economic and political resources to the side of the equation that has less power. In some situations, religion might be politically more powerful than science. This might be seen in laws banning the theory of evolution from school curricula, or laws to stop research on stem cells or human cloning. In some situations, one religion might be politically more powerful than another. Laws might then ban the practices of certain religions, or be used to eliminate a specific religion, such as the Davidians from Waco, Texas. The first case exemplifies the essentialist approach to religion and science, and the second illustrates the essentialist approach to specific religious systems. Such tendencies might also be observed when competing scientific disciplines are essentialized and put in a hierarchical order, with philosophy or mathematics considered the “key” to the understanding of all reality.

What happens on a macro social level is reflected in the experiences of individuals. Living within changing hybrid cultures, individuals continuously interact with hybrid cultural elements. As far as religion and science are concerned, most often the line dividing those two elements does not present itself as a static, insurmountable divide between two different components of a worldview, but rather as a line where they meet and fuse. It seems to operate in lived experience as a line not to be crossed but followed along, every time decisions are made that require a level of engagement both of religious and scientific beliefs. Moreover, since people think, talk, write, and theorize simultaneously in religious and scientific terms all the time, they participate in the spontaneous fusion of religion and science, whether they are aware of it or not. This usually occurs on the level of religion-based ethics and science-based technology. A good example is the application of life-support technology. For many people the use of such technology is religiously justified by

the idea of the sanctity of human life, and unplugging the equipment is strongly opposed as an act against God's will. Technology-assisted conception is accepted as adhering to God's mandate of reproduction. Such empirically occurring fusions, however, do not mean that people who experience them do not view religion and science in essentialist terms. The hiatus between belief and practice is not an unusual phenomenon.

Today, globalization and McDonaldization have increased the speed and complexity of spontaneous and intentional hybridization. Globalization gradually leads to a hybrid global civil society and culture. The globalism ideology helps the producers of globalization to sacralize their goals. On the other hand, McDonaldization leads to the hybrid means that are most efficient, simple, and easy to calculate and control for the implementation of globalization. McDonaldization is linked to highly developed technology and science-based management and administration that help sacralize the means.

Simultaneously with these two processes of change, however, are processes that pull the globalizing and McDonaldizing social reality in an opposite direction. They are manifestations of the resistance to change, and of an effort to reessentialize the emergent fusions. These are fragmentation, localization, and de-McDonaldization, and they reflect the attempts made by some societies, groups, and individuals to reessentialize their identity, integrity, or autonomy.

The global and the local are two aspects of the same phenomenon and cannot be separated from each other on an empirical level. The interference of the global and the local, sometimes called globalization, produces unique outcomes in different cultural settings.

People who acknowledge hybridization of cultures and their components understand that all religious systems and scientific theories are hybrids and thus are transcultural in their essence. Religion and science are seen as supporting each other's claims in some cases and challenging those claims in others. Elements of religious and scientific systems of meaning are seen as interwoven into one complex tapestry of individual and collective worldviews. Some people who spontaneously fuse the religious and scientific components within their worldview might be perceived by essentialists as confused, suspect, or lacking or selling out firm principles. Sometimes people confronted with extraordinary circumstances insist on the intentional construction of a religion-science hybrid that can respond to the situation. This might cause the institutional gatekeepers of religion or science to send their border patrols to protect the line of separation, regardless of the consequences for people directly involved in an experience that requires fusion.

People caught up in extraordinary situations understand that the interactions between religion and science are neither simple, nor static, nor easy to grasp. In some situations there is a need to intentionally create a new religion-science hybrid, because the ones that have been constructed spontaneously over time are no longer sufficient. People who go through a transcultural experience on the borderline between religion and science are aware that such

experience cannot be framed by the language that emphasizes divisions and presents reality only in terms of “either-or.”

The possible relationships between religion and science can be illustrated through several global phenomena that are anchored in and shape individual experience. Terrorism and war are examples of hostile human interactions. The HIV/AIDS pandemic and the world trade in human organs reveal the unintended outcomes of the most intimate human interactions. Societal responses to these contemporary issues in terms of religion and science are the focus of the section that follows.

Religion, Science, and Contemporary Issues

Terrorism and war are good examples of a fusion of essentialist religious beliefs with science. In this case religion and science operate together but remain separate, parallel, and equally important, and they address different questions. The September 11, 2001, attack on the World Trade Center, for example, showed a pragmatic fusion of the essentialist religious beliefs of Islamic fundamentalism with the technology and scientific knowledge embodied in jet planes and high-rises. This fusion is particularly interesting because it links religious beliefs that oppose science and technology with the very science and technology that are the target of the attack.

The U.S. response—a global war on terrorism—shows a similar fusion, but this time essentialist beliefs rooted in American Protestantism are fused with the means of industrialized killing rooted in science. Both sides of the conflict use their essentialist interpretations of religion to define the opponent as evil and thus less human, and they use technology to perform the job of killing effectively, efficiently, and in a relatively controlled way. Religion is used to sacralize the goals, to help people understand why they are doing what they are doing and why what they are doing is the right thing to do, and thus to accept their own conduct as congruent with ethical norms they were taught to follow. Fused with those beliefs is science, which is used to sacralize the means by providing technology and skills to perform the job of reaching the goals. On an individual level, the fusion of religion and science comprises elements of ideology promoted by political and religious leaders, knowledge of technology and science, and elements of the individual’s life context. Together they are powerful enough to push people to kill themselves, to kill others, and to die in combat.

If science provided the answers to “why” questions, and religion provided the answers to “how” questions, the outcomes could be quite different. In scientific terms, there is no way to support the idea that some people are less human than others, or that killing is a right thing to do, since the scientific data only supply the evidence that we all are one species. And religious systems do not contain instructions pertaining to how to kill and how to remain safe. If people constructed a hybrid of religion and science that would try to

answer the questions simultaneously from both points of view, fusions like the one that permits killing out-group members would not be as powerful as they are now. People would see that both parties involved, whether in a conflict or a peaceful relationship, regardless of how they might be defined by the others, are human and thus actively play their roles as individual or collective agents. Both are motivated to action by their own interpretation of religious beliefs that they accept as true, and both have access to technological means and scientific know-how. We frequently see war as something we do and terrorism as something they do, instead of seeing both as actions undertaken by two parties engaged in one interaction. Our confusion results from the simultaneous essentialist fusions of religion with science by both parties involved. Each party sees such fusion among the opponents but denies its existence within their own ranks, thus making it possible to interpret the conflict as a negative outcome of such a fusion constructed by the enemy. As a result, the fusion itself might be perceived in negative terms.

The fusion of religion and science is seen as well in responses to the outcomes of the most intimate human interactions possible. The exchange of body fluids between two people, for example, through sexual contact or other means, can pass along HIV/AIDS if either of the individuals carries the infection. The condition, if untreated, causes an early death in the infected individuals, and the spread of HIV/AIDS has reached the level of a pandemic. Another example is seen in the exchange of body parts through transplant surgery. A global trade in human organs has developed, which might cause a live donor to die or suffer for the sake of the recipient who gains a chance to live or to live longer. These examples differ, however, in intentionality, since the exchange of body fluids, except in some isolated cases, does not involve the intention of spreading the virus.

Most religious systems provide guidelines for sexual behavior, and many believers consider epidemics a penalty applied by the sacred to people for their sexual transgressions. Throughout history, people affected by the epidemic outbreak of a deadly disease have been suspected of engaging in unacceptable conduct and viewed as sinners. At first, religions addressed both the how and the why questions. In many cases, infected people were stigmatized, isolated from their communities, and left to die. With the development of biological and medical sciences though, more and more people started to understand contagious diseases and the ways in which they can be controlled or eliminated. Medical science acquired the ability to address the how questions, but the why questions in many cases remained in the domain of religion.

Thus, the fusion of religion and science in this area was similar to the one that characterized war and terrorism, with religion and science engaged in answering different questions. In the case of a pandemic, however, there is an ongoing tension between religion and science within the fusion of beliefs rooted in traditional interpretations of religions, and beliefs rooted in modern

biological and medical sciences. This tension is caused by the lack of intentionality to spread the disease on the part of individuals involved in the exchange of body fluids and, at the same time, the threat it presents to the survival of humanity. Religious interpretations are applied to people infected only *ex post facto* and not to construct them as potential targets.

HIV/AIDS can spread by means other than sexual contact, such as blood transfusions, needle sharing, and exposure in the womb. In most cases, the virus is transmitted through sexual intercourse or from a mother to her child. The speed with which HIV/AIDS is spreading within particular social and cultural contexts shows different outcomes of the tension between religion and science. For example, in the United States, the scientific worldview manages to overcome the traditional religious narratives that stigmatize people on the grounds of sexual conduct. Even if some stigmatization still takes place, in most cases it does not lead to isolation, rejection, or refusal of medical care. Moreover, we observe a growing movement among religious leaders, medical professionals, and social workers to intentionally construct a religion and science hybrid that would counter the pandemic more effectively.

On the other hand, in many developing countries, the fight between the two worldviews takes place in a culture that favors religious beliefs and creates obstacles for the work undertaken by global and local medical establishments to control or stop the spread of the pandemic. In the case of postcolonial societies, this is not necessarily the result of the superior strength of the religious component of a worldview. In some of those contexts, the religious beliefs are intentionally used as the sole source of answers to questions related to the pandemic, because the Western medical sciences are perceived as a threat to the newly acquired political, economic, or social autonomy. However, in all cultures and subcultures, there are individuals and groups more responsive to scientific approaches to disease, and those who prefer to follow traditional religious beliefs.

Organ transplantation illustrates one more possible interaction between religion and science. Beside instructions related to sexuality and illness, most religious systems also put forth presuppositions about the human body, its integrity, and the relationship between organs and the body, and they formulate explicit guidelines according to which the body needs to be handled. They emphasize the value of human life and address situations in which for the sake of saving a human life other religious guidelines are suspended, and situations in which the loss of life is justified by some still higher goals.

Throughout history, religious teachings about the body formed a continuum, from a command to maintain it intact in life and death on one end, to acceptance of the separation of body parts on the other. The belief in the body's integrity functioned in cultural systems side by side with a belief that dismembering was one of the most severe penalties for crime, a form of revenge, or a treatment appropriate only for the most hated enemies. Dismembering the body after death and throwing the parts in different directions was be-

lieved to ensure that the person would not be resurrected or enjoy the after-life. On the other end of the continuum were various forms of ritual cannibalism, the consumption of human organs and bodies for purposes well defined by religious myths that emphasized the benefits to the consumers. Religious teachings about the integrity of the human body were overridden by teachings about the priority of life. The medical practice of organ transplantation often found legitimization in the interpretation of organ donation as a gift of life, the ultimate gift one human being can offer another.

Today, technology permits transplantation of organs from dead and living donors, from those who expressed their consent and those whose organs were harvested during some medical intervention into their bodies. As a result, a world trade in human organs has developed, and organs are bought by brokers who sell to recipients at high prices. This developing practice of organ sales or theft makes it difficult to maintain the religious gift-of-life narrative and leads back to the tension between religious beliefs and medical science, and even to a complete disconnection of medical procedures from the religious views on life and the body. The donors are no longer donors, the gift is no longer a gift, and the life, either saved or extended, is a commodity that can be purchased by those who can afford it. At the same time, those who supply organs suffer all the medical consequences of this transaction, including death. Contrary to the HIV/AIDS example, the case of organ transplantation illustrates an almost complete disconnection of scientific medical practices from traditional religious beliefs.

The importance of a multicultural social scientific approach to the religion and science dialogue needs to be emphasized. Religion and science both occupy central positions in human societies. They both function as ways of knowing; both serve the continuation of societal institutions and structures; both provide individuals with a tangible link between past, present, and future. However, both religion and science are interconnected and interdependent processes that unfold within the tapestry of other processes characteristic of a particular culture, of many cultures, or the entire human family.

Also at work in the examples presented above are the global social, economic, and political inequalities deepening with the processes of globalization and McDonaldization. Most often it is the poor and the powerless who turn into terrorists, join the armies, suffer and die of HIV/AIDS, and provide organs for transplantation. The rich and the powerful buy the troops, buy the means to live with HIV/AIDS, and more easily receive necessary organs. And this dimension is one more important contemporary issue that should be included in future discussions on religion and science.

The brief social scientific analysis of the religion and science dialogue presented here seems to suggest that, in order to conduct transcultural studies of the relationship between these two ways of knowing, we need “a *processual* theory of hybridity,” as described by Werbner and Modood, that would differentiate “between a politics that proceeds from the legitimacy of difference, in

and despite the need for unity, and a politics that rests on a coercive unity, ideologically grounded in a single monolithic truth.” Such a theory might help us explain more fully the complexity and dynamics of human experience that takes place on the borderline between religion and science, and that requires simultaneous activation of the religious and scientific tools embedded in an individual or collective worldview.

Bibliography

- Bakhtin, Mikhail. *The Dialogical Imagination*. Austin: University of Texas Press, 1981.
- Barbour, Ian. *Religion in an Age of Science*. San Francisco: HarperSanFrancisco, 1990.
- Bauman, Zygmunt. *Globalization*. New York: Columbia University Press, 1998.
- Cohen, Lawrence. “Where It Hurts: Indian Material for an Ethics of Organ Transplantation.” *Zygon* 38:3 (2003): 663–88.
- Dalmage, Heather M. *Tripping on the Color Line*. New Brunswick, NJ: Rutgers University Press, 2000.
- Delmonico, Francis, and N. Scheper-Hughes. “Why We Should Not Pay for Human Organs.” *Zygon* 38:3 (2003): 689–98.
- Epstein, Mikhail. “The Unasked Question.” *Common Knowledge* 10:1 (2004): 42–60.
- Haight, John. *Science and Religion*. Mahwah, NJ: Paulist, 1995.
- Lewis, James, ed. *From the Ashes*. Lanham, MD: Rowman and Littlefield, 1994.
- Pence, Gregory, ed. *Flesh of My Flesh: The Ethics of Cloning Humans*. Lanham, MD: Rowman and Littlefield, 1998.
- Polkinghorne, John. *Belief in God in an Age of Science*. New Haven, CT: Yale University Press, 1998.
- Ritzer, George. *The McDonaldization of Society*. Thousand Oaks, CA: Pine Forge, 2000.
- Ritzer, George, and Mike Ryan. “Towards a Richer Understanding of Global Commodification.” *Hedgehog Review* 5:2 (2003): 66–76.
- Steger, Manfred. *Globalism*. Lanham, MD: Rowman and Littlefield, 2002.
- Stine, Gerald. *AIDS Update 2002*. Upper Saddle River, NJ: Prentice Hall, 2002.
- Strassberg, Barbara. “Religion and Science: The Embodiment of the Conversation.” *Zygon* 36:3 (2001): 521–39.
- Werbner, Pnina, and T. Modood, eds. *Debating Cultural Hybridity*. London: Zed Books, 2000.
- Youngner, Stuart. “Some Must Die.” *Zygon* 38:3 (2003): 705–24.

18 Learning Science in a Multicultural, Multifaith World

Eva Krugly-Smolka

Most countries mandate science as a compulsory subject in elementary and secondary schools. The reasons vary from country to country, but all acknowledge the importance of science and technology in our world, and many argue that performing well in science is critical to economic development in a global economy. While the evidence of a direct relationship between science education and global competitiveness is sketchy at best, most curriculum guides assert the relationship. In addition, aims of science education are two pronged: the education of future scientists, and the education of a knowledgeable public that lives, works, and votes (in some cases) in a world infused with science and technology. The recognized importance of both these aspects has resulted in a recent slogan in science education: science for all.

Unfortunately, whether we use the yardstick of people entering the scientific professions or the results of international tests of achievement, it is evident that science is not for all. This is especially the case for women and many minority groups, both in North America and elsewhere in the world. One possible explanation for these results is the role of culture, and the general concept of culture will be examined here. But science may be considered a culture, and there may be many sciences. Learning science is like learning another culture, and impediments must be overcome in this process. Some of these are discussed here, with suggestions for classroom teachers on how to overcome them.

Culture

Culture is one of those concepts that we all seem to understand yet find difficult to define when pressed to. To define culture is especially difficult because the concept is used in so many different ways, depending on the context. The word originally comes from the Latin verb meaning to grow. This meaning is evident when we talk about agriculture, or a culture in a petri dish in which bacteria are grown. Another meaning is the one we understand when

we talk about high culture or pop culture. In this case we are talking about things such as art, music, literature, and the other products that are studied in the humanities as part of the best that civilization has produced. This is the way that Matthew Arnold used the term, although he tended to think of it in connection with what Western civilization had produced. Scientific knowledge is now also part of this sense of culture, as evident in C.P. Snow's *The Two Cultures*. Snow was one of the first to also consider science as a culture in another sense, the one in which we are interested here: culture from an anthropological and sociological perspective.

Anthropology provides the most comprehensive understanding of the concept of culture. In this discipline, it is considered part of all human experience and the medium through which people interact with their environment. But even in anthropology there are different understandings of the concept, especially as the discipline has evolved. Perhaps the least controversial understanding is that culture is a whole way of life of a people or a particular society. Sometimes it is used to refer to the people who share that way of life, often in the same sentence. Sometimes culture is considered an object of study, while at other times the concept is used as the framework of analysis of something else. While all this may seem confusing, it is important to recognize that choice of definition is a problem only if we believe that it describes a true essence of what we are describing, rather than providing a way of recognizing that about which we are talking. While "a whole way of life" is uncontroversial, it does not help if we really want to be able to decide if something is a culture or not, or to understand aspects of a culture, such as its transmission from generation to generation.

Let me propose a more comprehensive description of the concept. This involves thinking of culture as the shared knowledge of a group of people, including expectations of one another that members of a society share, as well as basic categories that people in that society use to make sense of the world and how to act on it. In other words, it is shared knowledge about technology and skills; customary behaviors, attitudes, values, and beliefs; and the historic past, all of which give meaning to, and allow the society to cope with, the present and anticipated problems of existence. All this knowledge is embodied in symbolic and nonsymbolic communication systems. Some of this knowledge deals with idealistic and mythological aspects of the culture that do not necessarily correspond to reality. Having access to the shared knowledge allows one to be a member of that culture.

As a culture becomes more and more complex, the amount of knowledge acquired also becomes so great that no one individual could possibly have access to it all. Thus various institutions and systems are developed in order to spread the knowledge throughout the culture. Differentiation of roles develops. We can distinguish subcultures because now there are groups of people with knowledge that others do not have. Perhaps inevitably, some forms of knowledge come to be more valued than other forms, especially those that have to do with survival. Access to valued knowledge provides an individual with cultural capital, similar to monetary capital.

Cultural Transmission

Regardless of the amount of knowledge and its value, a core of knowledge, for example the shared language, is required to maintain the cohesiveness of the society, and the rules of participation need to be passed on to future members. This cultural transmission occurs through a process of enculturation, including socialization, by parents and other members of the society, sometimes through initiation rites and more generally through education. Much of it is very subtle and unconscious. It has been noted that very young children reinforce this process by teaching each other and reproducing gender roles, for example. Cultural transmission is not exact and acquisition is not totally successful, but this then introduces variation into the culture to allow for adaptation as environmental conditions change. Culture, therefore, is not static.

Another way that cultures change is through contact with each other. Such contact has occurred to greater or lesser extent throughout human history, but it is perhaps at its greatest in our current era. The threat of cultural extinction in some societies is very real. Sometimes for protection, cultural borders are set up to limit access to outsiders and their influences. Such borders are also evident in subcultures, to which access may not be permitted unless one has the appropriate cultural capital. But borders are crossed, members welcome new members for various reasons, and an individual who wants to become a member needs to acquire the knowledge necessary to belong. This can happen either by adding to cultural knowledge which already exists, a process called acculturation, or by forgetting or negating previous knowledge as the new is acquired, which we call assimilation. These two options are somewhat equivalent to additive and substitutive bilingualism, respectively, in second language learning.

Now that we have some common understandings about culture, it is time to examine in what ways science can be considered a culture, and the process of its acquisition.

Scientific Culture

In all cultures, knowledge about nature and the environment is highly valued. To be able to anticipate the weather or other aspects of nature, such as the behavior of fauna or deciding which flora are beneficial and which are noxious, is important for the survival of the community. All cultures have some process of acquiring and passing on this knowledge. This knowledge, obtained in a systematic way, is science. In order to contrast it with modern science, some refer to it as technical ecological knowledge. But the shared knowledge of science does not become a culture until the criteria we established above are met.

Science as currently practiced has the goal of creating new knowledge about the physical world, not only to understand it but also to control it. This is accomplished by a group of members (scientists) who share a common lan-

guage, technology and skills, behaviors, values, and beliefs. The language of science has a unique vocabulary; in fact, some everyday words take on special meanings in the language of science. It also uses mathematics and chemical symbols and formulae as part of its language. Scientists share a belief in the supremacy of scientific knowledge, but also in the values of tentativeness of that knowledge, its universality, its replicability, and an organized skepticism toward it, among other beliefs. Scientists also share a materialistic worldview. This worldview may also be a paradigm, or framework, within which they do all of their research. It determines the questions that are asked and the metaphors that guide both the research and the theoretical frameworks that allow for prediction and new questions. The history of science provides evidence of these paradigms and how they change.

However, science is not a stand-alone culture. It is a subculture embedded in the larger culture. It is for this reason that we can talk about scientific cultures. Donna Haraway in *Primate Visions* describes the difference in focus between American and Japanese primatologists in observing individuals versus groups of primates. Because their practices were influenced by their respective cultures, they arrived at different data and findings, and the American primatologists did not initially acknowledge the Japanese results. While much of the influence of the dominant culture on the subculture of science is usually subtle and unconscious, that is not always the case. Governments can have a more explicit influence through allocation of research funding, or even more overtly, as was the case in Soviet Russia.

Perhaps as a result of the success of European scientific culture during the time of the Industrial Revolution and after, as well as the imperialist tendencies from then to the present, when we think of science and scientific culture now, it is invariably Western science that is being discussed. The Western scientific community has tended to think that theirs is the only science, and knowledge created in other cultures does not become part of science unless validated by this community. This is one of the reasons that indigenous scientific knowledge has not been accepted as part of science, although that is now changing.

That the scientific community is now international does not preclude my point. To become members, individuals need to be acculturated, or more often, assimilated into the community. This is no small feat, as there are many gatekeepers at the borders, such as editors of scientific journals and their reviewers. Using appropriate language and style in reporting on one's research, as well as working in the currently accepted paradigm, is important cultural capital for crossing the border. Those who did not quite fit in were actively excluded, as David Noble describes in *A World without Women*.

While international members may add to the number of scientists in the community, reinforcements are always necessary. Cultural reproduction and maintenance depend on transmitting the culture to future members, as discussed above. For the culture of science, this occurs mostly through science education;

later, an apprenticeship model of cultural transmission is applied to those who were successful in science education. Let us now examine that process.

Science Education

Because science education occurs in the context of broader education, it has the dual function of transmitting the general dominant culture as well as the culture of science. Exposure to science does not occur only in the classroom, but also in everyday life. The media present aspects of scientific culture on a regular basis. The relative success of this is evident in the number of scientific terms and concepts that have become part of everyday culture. But shared cultural knowledge about scientific culture varies from individual to individual. Students coming into a science classroom have different amounts and kinds of cultural capital as a starting point. Those that have exposure to scientific knowledge from multiple sources will have an easier time of it.

The role of science education in cultural transmission is not often made explicit but can be seen in goal statements about scientific literacy and objectives in the curriculum that refer to knowledge, skills, and attitudes. The version of science that gets transmitted in the science classroom is an idealized one, and even though the rhetoric is about science for all, the goal of educating future scientists continues to be more prominent in science classrooms. More time is spent on learning science than learning about science, in spite of the efforts of science educators involved in teacher education.

The messages received in science classrooms do not, as mentioned above, reflect reality but some version of it. For example, many students continue to describe scientists as white males in laboratory coats. This was partially encouraged by textbooks that contained pictures of males doing experiments. While textbooks now present a more balanced view, long-standing beliefs are difficult to change. Alison Kelly argued that science is masculine in four senses: (1) in the number of males who study it, teach it, and practice it; (2) in the examples and applications studied; (3) in that the behaviors and interactions follow what society has described as male patterns; and (4) because the thinking commonly labeled scientific appears to embody a male worldview. One could add to this that the choice of analogies and metaphors used to teach science and to build explanations of phenomena are more common to male experience.

Also evident in science classrooms, according to Smolicz and Nunan in a now classic article on science education, are four ideological pivots or implicit value-systems: (1) an anthropocentric view, which presents man as the master and manipulator of nature and stereotypes the scientist as the controller of nature with his technologically induced powers; (2) quantification, which tends to dehumanize scientists and reduce all things to machine-like objects; (3) the positivistic ideal, which implies that theories should be organized only according to the canons of logic and presents a linear image of progress in science; and (4) the analytic ideal, which promotes a mechanistic view of

science and is reflected in schools by a reliance on simplified mechanistic models as aids to understanding conceptual material. To this description one could add the espoused value of reductionism in studying phenomena.

My own research in science classrooms supports the views presented here of what gets transmitted in science classrooms and adds that scientific knowledge tends to be presented as “truth” through a top-down approach. With respect to the language of science, grade 9 students learn a larger vocabulary in a science classroom than they do in a French language classroom. Most evaluation is written and tends to focus on memory work, with exact definitions being more valued than paraphrased ones. In some situations, students had to learn not only a concept, but the analogy that was being used to explain the concept. All of this implies an assimilation approach to cultural transmission. Given that situation, let us now consider the implications of this in a multicultural science classroom.

Cultural Dissonance

If we take the discussion of subcultures located in dominant cultures to heart, we can see how every classroom is multicultural. Because of students’ locations in these subcultures—whether gender, rural, urban, class, ethnic, or some other—each student brings a unique amalgam of cultural knowledge (in the broad sense described above) to science learning. Furthermore, every classroom has a unique subculture as well. Various aspects of culture have been linked with difficulties in learning in school. These include language, family structure and roles, values and beliefs, notions of time and space, as well as cognition, teaching and learning styles, communication styles, interaction, socialization, and motivation. While it is not possible to review the research in all of these areas here, it is important to note that none is deterministic. This means that differences in these areas do not, in and of themselves, imply difficulties in learning science. What is made of these differences, both by students and teachers, is important.

Cultural dissonance, or disharmony, can exist between the culture of the student and the culture of the science classroom. Students react to mismatches in a variety of ways. When students talk about science being hard or boring, an active or passive resistance to science learning will become evident. Other students will see science as a challenge and actively engage. What happens depends on a variety of complex factors, including whether the knowledge and cultural capital the student brings to the classroom is valued or denigrated. Furthermore, students may sometimes exaggerate the differences, as their identities may be perceived to be at risk when they are required to take on another culture. When assimilation rather than acculturation is the goal, there is likely to be more resistance. Some examples of mismatches are in order.

I have already mentioned the need to learn the language of science, but for many immigrant and ethnic minority students it is also necessary to learn the

language of the classroom. Part of this process is also learning when and how it is appropriate to use that language. This is referred to as communicative competence. Generally in North American classrooms, the usual pattern of engagement is that the teacher initiates an interaction, a particular student is usually required to respond, and this is followed by an evaluative response by the teacher. Students are usually allowed to speak one at a time at the teacher's discretion and wait until a speaker has finished speaking. This is not a universal pattern. In some cultures, students respond more as a group, or speak over each other, overlapping one person's speech with another. Students who behave this way in a different dominant culture may be accused of misbehaving. Science teachers might consider allowing for multiple patterns of engagement, and they might explicitly teach that expectations vary from context to context, not that they are wrong. Another area of communication where teachers can help students who are learning in a second language is to signal switches from everyday uses of particular vocabulary or concepts to scientific ones.

Perhaps a more obvious area of mismatch is when the values and beliefs of students differ from those represented in the science classroom (some of which were discussed above). One example of this that has received much attention is the teaching of evolution in science classrooms. This has disturbed many who believe in creationism. The solution here is to accept that people believe in creationism, but to make clear that this is not an acceptable belief in the culture of science. Students should not have to make a choice between the two if an acculturation position is evident in the classroom. A student does not necessarily have to "believe" in evolution, but if that student wants to participate in the culture of science, it is necessary to recognize that evolution is a fundamental paradigm of explanation in that culture. Holding two concurrent belief systems for different contexts is not necessarily a problem unless one is forced to make a choice.

Dissection in science classrooms is another area where cultural values may come into conflict. Imagine a Hindu or Muslim student being required to dissect a cow's eye or fetal pig, respectively. An even more frequent mismatch occurs when students who believe in animal rights are disturbed at having to perform dissections. While dissection is a valuable skill for those who may want to be biology researchers, it is not necessary for others. It is still possible to be a scientist and never have to do a dissection, but in a classroom where assimilation is the focus, students are penalized for not wanting to participate in dissections.

Are science teachers gatekeepers, deciding who may become future members of the science community, or are they cultural brokers or translators, extending an invitation to all to become members? If we really believe in "science for all," then they need to be the latter. One way they can do that is to show students that all are able to do science and that all are welcome. This can be accomplished by talking about scientific contributions from a variety of cultures, and indicating that science is found in all cultures. Furthermore, students

can be helped in becoming acculturated to scientific culture when the examples used to teach concepts are familiar to all, not just to some students.

A variety of evaluation techniques should be used. For example, multiple choice tests have been shown to discriminate against girls because girls tend not to be reductionist in their thinking. Such tests also tend to focus on what students do not know, rather than what they do know. Difficulties in speaking or writing English do not necessarily mean that students do not understand the science. In fact, many immigrant students know more science than their native-born contemporaries at the same grade level.

To conclude, learning science is learning another culture. The closer match there is between the cultural capital a student brings to the classroom and the cultural capital valued in the science classroom, the more likely students will be successful. However, if students have beliefs that are inconsistent with those in science, or if students perceive a threat to their identity, it is possible the students will be resistant to learning science. This is more likely to happen in a classroom where the goal is assimilation rather than acculturation. It is up to teachers to make classes more inviting to students that bring with them different cultural capital, and to acknowledge that science is one source of knowledge among many, but that it is a powerful one in the domain in which it operates.

Bibliography

- Aikenhead, Glen S. "Science Education: Border Crossing into the Subculture of Science." *Studies in Science Education* 27 (1996): 1–52.
- Cobern, William W., ed. *Socio-cultural Perspectives on Science Education: An International Dialogue*. Dordrecht: Kluwer, 1998.
- Graham, Loren H. *Science in Russia and the Soviet Union: A Short History*. Cambridge: Cambridge University Press, 1993.
- Haraway, Donna. *Primate Visions: Gender, Race, and Nature in the World of Modern Science*. New York: Routledge, 1989.
- Kelly, Alison, ed. *Science for Girls?* Philadelphia: Open University Press, 1987.
- Krugly-Smolka, Eva. "Culture and Science Education." Ph.D. dissertation, University of Toronto, 1989.
- . "An Examination of Some Difficulties in Integrating Western Science into Societies with an Indigenous Scientific Tradition." *Interchange* 25:4 (1994): 325–34.
- . "Mainstreaming Multicultural Education: The Role of Science Education." *Canadian Ethnic Studies* 24:3 (1992): 137–44.
- . "Scientific Culture, Multiculturalism, and the Science Classroom." *Science and Education* 5 (1996): 21–29.
- Montgomery, Scott L. *The Scientific Voice*. New York: Guilford, 1996.
- Noble, David. *A World Without Women*. New York: Oxford University Press, 1992.
- Oakes, J. "Opportunities, Achievement, and Choice: Women and Minority Students in Science and Mathematics." *Review of Research in Education* 16 (1990): 153–222.
- Schott, T. "The World Scientific Community: Globality and Globalization." *Minerva* 29:4 (1991): 440–62.
- Smolicz, J.J., and E.E. Nunan. "The Philosophical and Sociological Foundations of Science Education: The Demythologizing of School Science." *Studies in Science Education* 2 (1975): 101–43.
- Snow, C.P. *The Two Cultures and a Second Look*. Cambridge: Cambridge University Press, 1965.
- Sutton, Clive. *Words, Science and Learning*. Milton Keynes: Open University Press, 1992.

Historical Perspectives

Introduction to Historical Perspectives

Essays on the specificity of interactions between science and religion in historical and cultural contexts offer a very different set of issues than essays that explore the larger, broader characterizations of these interactions. This section provides nuanced, detailed discussions of religion and science that take into account the particular circumstances of a time and place, or explore the nature of these interactions by focusing on a particular theme. While other sections contain essays that are grounded in history overviews, this group contains writings that emphasize how notions about science and religion change over time and are embedded in prevailing mentalities and practices.

The pressing questions that bring science and religion together, or conversely, render them asunder, in the twenty-first century are in many ways similar to questions humans have faced for millennia. What is the relationship between humans and the surrounding natural environment? What is the nature and substance of the material universe, and how did it come into being? What is the nature and substance of the physical body, especially in light of illness, sexuality, and death? How does one account for change in physical bodies and the material universe, and the passage of time generally? What is the meaning of life in this world, and is there life in other worlds? These and other perennial questions stay the same, but the answers to them are as varied as cultures that have existed through time and around the globe.

Today our answers to these questions include dramatic, far-reaching theories—many compatible with each other, more in serious conflict—that reflect the current state of knowledge about the cosmos, as well as emerging and prevailing ideological and religious commitments in communities that produce or receive this knowledge; contemporary perspectives on these issues are dispersed throughout this encyclopedia and have become quite familiar in the public arena: evolution, creation science, process theology, intelligent design, genetics, the anthropic principle, near death experiences, environmental ethics, and quantum physics, to name a few.

As the diverse essays in this section make clear, answers to these questions

in the past also reflected the established state of knowledge about the cosmos, as well as emergent and prevailing ideological and religious commitments in communities that produced or received this knowledge. Yesterday as well as today, however, the quest for knowledge about the universe and the place and meaning of human existence in it has real-world political and social consequences, often reaffirming dominant power structures, but also occasionally undermining and transforming the status quo. Many key concepts in this quest are determined by any number of sources, including folk knowledge based on practical know-how, authority based on tradition or acknowledged leaders, or philosophical speculation based on reason or more empirical investigations. This quest is also, in many cases, highly volatile and politically charged when it comes to the production, conservation, and disruption of knowledge.

Charles Stanish, an anthropologist at the University of California, Los Angeles, separates science and religion in his two essays on precontact South America. He gives broad, anthropological definitions for both science and religion, and discusses some of the general cultural and historical characteristics of each. In his piece on ancient religions, Stanish describes many key religious principles operating in South America before European contact and colonization. Beginning around the fifth millennium BCE, with the mummification practices of the Chinchorro, and ending with pilgrimage destinations in the Incan empire in the sixteenth century CE, Stanish excavates the thriving, complex religious cultures that have virtually disappeared over the course of history. He also highlights the profound difficulties of reconstructing the religious traditions and practices of these religions without the benefit of written textual documents, relying on an assortment of sources for scientific study that include iconography, burial practices, and artifacts from archaeological sites.

Focusing on science, Stanish covers bridge building and road systems, agricultural technologies, and architectural wonders by the Maya, Inca, Aztec, Moche, and other cultures in pre-Hispanic western South America. With these kinds of accomplishments in mind, he suggests that Western definitions of science tied to the Enlightenment and scientific revolutions are too narrow. Instead, science as a cross-cultural, anthropological phenomenon refers to reasoned enquiry into the material world that is based on more than metaphysical or folk knowledge and leads to the creation of esoteric knowledge associated with socially marked specialists who eventually pass this knowledge on to subsequent generations.

V.V. Raman, emeritus professor from the Rochester Institute of Technology, examines science and speculative thinking in ancient India and classical Hindu culture. From mathematics to medicine and other domains, early Hindu texts and practices demonstrate an intriguing and illuminating scientific spirit of engagement with the cosmos. Although focused on a particular historical era associated with the rise of Hinduism, Raman also touches on cultural comparisons between ancient India and other cultures to raise questions about

the peculiar status of scientific thinking in Hindu culture. Historian of science Shigeru Nakayama looks specifically at the impact and influence of Joseph Needham on popularizing and understanding Chinese thought, particularly Taoism, as containing distinctive scientific philosophy. The cultural force of Needham's work for scholars in the West and in the East has led some to appropriate and others to contest his highly significant theses about Chinese culture, religion, and science.

In two historical essays, Muzaffar Iqbal, a chemist and Islamic scholar who directs the Center for Islam and Science, discusses the relationship between Islam and science before and after the rise of modern science. Iqbal traces the significant Muslim contributions to science since the founding of the religion. He also explores the integral connections between the visible, physical world and the larger "sacred sciences" described by various Muslim theologians, philosophers, and mystics that focus on the invisible, transcendent realms.

In his second essay, Iqbal discusses the complicated and conflicted place of modern science in Islamic cultures, especially in light of colonial enterprises, empire building, and other social and political circumstances in the last two centuries. Separating out Islamic metaphysics behind scientific enterprises in the modern era from modern Islamic attitudes toward modern science, Iqbal deftly and cogently unpacks how recent historical forces have over time both constrained and liberated scientific discourse and practice in Muslim communities. He also covers the dramatic developments surrounding the scientific enterprise in Islamic cultures, particularly as they relate to the restoration of an earlier perspective rooted firmly in the Quran, the Sunnah, and other critical Islamic metaphysical frameworks, to understand the true nature of reality.

Turning to ancient Greece and Rome, the early Christian world, and the Middle Ages, three of the essays in this section consider the historical and cultural contexts for the rise of Western science. In a wide-ranging discussion, religious scholar Louis A. Ruprecht Jr. asks the reader to consider a chief paradox of Western science: its origins and impulses are embedded in Eastern religions. Ruprecht examines the writings of crucial Greek philosophers—the bridge builders, he suggests, between East and West—whose speculations encompassed and integrated such seemingly disparate and discipline-specific fields as theology, science, philosophy, mathematics, and ethics. Beginning with Pythagoras, Ruprecht illuminates the revolutionary, and religious, character of these foundational philosophies emerging in this time and place.

History Professor Matthew F. Dowd examines how the foundational, "classical" culture of the Greeks collided with and at times buttressed emerging Christian theology. Dowd presents the mixed reaction of early church fathers to Greek natural philosophy, sometimes drawing on its authority to glorify the power and presence of God, other times seeing the multiple dangers it posed to the final authority of the Christian church.

Natural philosophy as inherited by the Greeks and distilled through the theological writings of the church fathers in early Christian communities continued to play an integral role in the Middle Ages in the West. Edward Grant, an emeritus professor of history and philosophy of science, provides a learned overview of how natural philosophy, and especially the lingering, deep-rooted presence of Aristotle, played a role in the politics of knowledge surrounding science and religion in the period between roughly 500 and 1500 CE.

Other essays in this historical section address topics in early Western culture that illuminate specific issues bearing on various interactions, evolutions, and conflicts surrounding science and religion. Two essays written by historians stay grounded in antiquity. Walter Roberts provides an intriguing exploration of leadership in the Greco-Roman worlds. He finds that religion and science were “inextricably bound” in conceptions of leadership, particularly in terms of a leader’s ability to ensure harmonious relations with the natural world and the divine world. Gordon Shrimpton, on the other hand, focuses on early Greek historical writing to highlight how a new form of narrative, and a touchstone in the emergence of the social sciences, reshaped how Greeks understood the past and represented it to themselves and others. His discussion of historical and cultural context gives the reader a solid background in the writing of history and the vexing questions, so relevant in the larger conversations about science and religion, about how communities understand “facts.”

Brenda S. Gardenour, a historian of science at Boston University, has written two essays for this section, one on the history of alchemy from antiquity to the Renaissance, the other on female biology and shifting perceptions of women’s bodies in medieval Europe. Both of these topics and the formative theories so critical to their subsequent cultural trajectories in the West are traced back to early Greek sources, and both describe how religion and science are implicated in the histories of each. Gardenour provides important political, social, and religious contexts that shaped the history of alchemy, a science but also a technical craft and a mystical art, including key contributions by Arabic and Jewish figures. In her discussion of female biology, she emphasizes elite theories of women’s bodies and souls, and the more popular, care-based knowledge found in, for example, midwives’ handbooks.

Historian Natalia Lozovsky writes about geography and religion in medieval Europe, giving the reader an informed perspective on how classical geographical knowledge fit into the emerging dominant Christian worldview of the period. In contrast to modern geography, the goals of this branch of knowledge as pursued by Christian scholars in medieval culture were grounded in descriptions of the earth understood as the creation of God as well as in classical knowledge based on the study of the Bible. Although integrally tied to the worldview of the Christian church, Lozovsky also argues that medieval geography was not “slavishly dependent on the classical and Christian tradition,” but instead showed signs of innovation and independent thinking.

Matthew Dowd contributes another essay in this section on how science and religion intersected in the creation and maintenance of the Western calendar. More scientific perspectives are relevant to the motions of the sun and moon, while religious concerns, as they relate to the celebration of key festivals, play a key role in the marking of time. Although Dowd's analysis has a more general application across cultures, he looks specifically at the calendars of Rome and Christian Europe to give a more detailed view of how science and religion contributed to various theories about calendars, how they function in society, and how they were corrected with the acquisition of new knowledge.

Historian Michael J. Crowe offers an intriguing essay about the debates surrounding extraterrestrial life, particularly as they developed within Christianity over centuries. Contrary to conventional wisdom that this only became a pressing issue within the last century, Crowe asserts that as early as antiquity, and certainly in the early years of Christianity, the question about life on other planets was a consistent concern. He follows these debates up through the twentieth century, including discussions of how theology, astronomy, poetry, and philosophical, and other modes of thought played various roles in this revealing history.

19 Religion in Ancient Western South America

Charles Stanish

The first humans to immigrate to the Americas were fully modern *Homo sapiens*, with the complete biological and intellectual capacity of people today. The intellectual capacity for the symbolizing behavior necessary for religious and scientific concepts most likely developed late in the Middle Paleolithic period in Africa, Asia, and Europe. Contemporary researchers disagree on the timing of these genetic changes, and estimates range from as early as 1 million years ago to as late as 50,000. Yet even the latest date for the origins of what we refer to as subjective consciousness or the “mind” in human populations would still be well before the first immigrations to the western hemisphere. Thus the earliest development of religion and scientific thought in South America was purely a cultural and social process; there is no biological cause for the development of the different kinds of religions and worldviews that developed in this hemisphere.

There is little controversy that the first humans migrated from northeast Asia, although whether they arrived relatively late, around 14,000 years ago, or early, around 25,000, is still hotly debated. Some scholars now believe that early migrants arrived by boats along the coast and there was no need for a land route. Genetic and linguistic data confirm the archaeological data on this point of origin for Native American peoples, both in North America as well as South America. In spite of this, there are virtually no direct links in iconography or ideology between American cultures and those of the Old World. Therefore, the religious doctrines that developed in the Americas appear to have been original to these migrant populations.

At first glance, it would appear very difficult to reconstruct ancient religions in the Americas. With a few notable exceptions such as the Zapotec, Maya, and other Mesoamerican cultures, people in the Americas did not develop writing systems. As a result, it is difficult to directly describe most prehistoric religious systems. However, the peoples of South America did

leave a number of important clues, such as elaborate religious designs on pottery, textiles, stone monuments, and other media. We likewise have historical documents from the sixteenth century and later that describe much of the religious doctrines of the indigenous peoples. Another critical source of information is the treatment of the dead. Tombs and graves represent important windows on past religious beliefs, and how people treat the dead reflects many of their cultural values. For the first humans who immigrated into South America, virtually no tombs have been found, but it is likely their burial rituals were similar to hunter and gatherer cultures documented at the time of European contact in the sixteenth century.

The Chinchorro

Sometime in the fifth millennium BCE, a few peoples on the far northern coast of Chile and the far southern coast of Peru began to treat their dead with a reverence never before seen in the Americas. These people, known today as the Chinchorro, gently preserved the remains of adults and children with mud plaster and adornments. Bernardo Arriaza describes this burial tradition in great detail, noting that this was the first documented case of intentional mummification and elaborate treatment of the dead. The Chinchorro mummies and burial practices provide evidence for some kind of religious sensibility that links the living with the dead, and most likely the dead with some kind of afterlife.

The earliest Chinchorro bodies were eviscerated and the bones were defleshed. The body was reconstructed with vegetal matter and other materials, and then resurfaced with mud mortar. Masks were made with facial features, and clay sexual organs were molded. The bodies were covered in black or red pigments. A black pigment was at first favored. Around 2500 BCE, according to Arriaza and his colleagues, Chinchorro peoples shifted to red, perhaps reflecting a shifting religious belief. Of particular interest is the shift to open eyes and mouths for the facial features. Arriaza suggests that this may have been to “feed” the mummies, a practice documented among central Andean peoples millennia later by European writers. At the end of this millennium, complex processing of the bodies gave way to simple natural desiccation and plastering with mud.

Researchers note that the Chinchorro mummies were continually repaired. This is an extremely important observation. Such a practice means that the mummies were periodically removed from their resting place and used in some sort of ritual. It is highly likely that such a practice indicates that the Chinchorro people recognized some kind of relationship between the living and the dead. It suggests that they had a clear sense of the afterlife, in that the mummy embodied some kind of soul or essence of the dead person. Few goods were left with the burials, but the kinds of goods that they left were typical of daily life, such as fishing implements and

basketry. This practice suggests that their conception of the afterlife was similar to the earthly life and that they gave the dead the tools for “living” in their new state.

All kinds of people in Chinchorro society were mummified, children as well as adults, and the mummies reflect differing social status. Unlike other religious traditions around the world and those described below for later periods in Andean prehistory, the Chinchorro mortuary practices suggest that all people reaped the same fate upon death. This distinction and the lack of any kind of religious icons in the burials suggest that there were few or no formal religious rituals or requirements to enter the Chinchorro afterlife.

First Signs of Religion Reflected in Art

The first artistic motifs in western South America with imagery evocative of religious beliefs were produced sometime between 2700 and 1800 BCE on the Peruvian coast. Michael Moseley’s research has provided examples from this era of gourds and textiles with condor heads, fish, eels, and double-headed serpents from the early monumental site of Huaca Prieta in northern Peru. These motifs reoccur throughout three more millennia of Peruvian art. In later periods, these motifs are found on more complex imagery with clear mythical import. The information from the history of art suggests that tangible concepts of a religious nature developed in the third millennium BCE. The development of these concepts is related to the beginning of settled village life where the people built large public monuments.

A stunning archaeological example was excavated from the small Pyramid of the Sacrifices at the site of Aspero in the Peruvian north coastal valley of Supe. Robert Feldman excavated a level that dated to between 2500 and 3000 BCE, where burials of an infant and adult were found. These burials were carefully prepared and placed on the top of this temple, and they were accompanied by high-value items such as shells, beads, a beautiful carved stone basin, a cotton textile, and a fine cap. Traces of red pigment were found as well. On the nearby Pyramid of the Idols, Feldman found at least thirteen broken clay figurines, eleven of which were females in a seated position.

The Aspero cache is typical of this time period around coastal South America. The entire complex, a series of low platform temples with carefully deposited burials of humans and artificial representations of humans, represents a different kind of religious conception than that of Chinchorro. Unlike the Chinchorro mummy burials, Aspero burials have fancy objects not used in everyday life. Can we interpret this to suggest that the Aspero conception of the afterlife was not one of an “earthly” experience, but one that was metaphysically different from the corporeal life? One cannot precisely know the religious meaning held by a nonliterate people five millennia ago, but the

Aspero burial practices were decidedly different from the Chinchorro and suggest a major shift in such concepts in the coast of western South America at this time.

The Aspero monuments, like hundreds more that were built throughout western South America at this time, represent the first complex architecture in the history of the continent. Many scholars interpret these first monuments as temples or central places where ritual was conducted by the community as a whole. As a general principle, we can therefore say that the formalization of religious concepts, as embodied in art, coevolves with the development of social stratification and large buildings that had religious functions.

Origins of Metaphysics and Myth

Metaphysical concepts were clearly developed by the middle of the second millennium BCE in western South America. Numerous archaeological sites exhibit art that almost certainly depicts religious concepts involving mythic animals, powerful individuals, and other themes. The architecture of the public buildings in central settlements suggests they were built to orchestrate processions of a political or ritual nature. The famous site of Cerro Sechin in the Casma Valley of northern Peru is a classic example. The site was built against a low mountain. Its adobe and stone buildings enclose a space of highly restricted access. Along the front wall of the site is a series of carvings depicting macabre scenes of war, decapitations, trophy heads, body parts, kings, captives, and warriors. The art most likely depicts scenes of actual political and social violence prevalent in that society. However, it is also likely that such art, designed to last for generations, had multiple meanings. Richard Burger describes the Sechin art as an example of a major building “decorated with religious and mythical themes.”

Moxeke and Cerro Sechin, two other major settlements in the same valley, are contemporary with Sechin Alto. The sites of these large, elaborate settlements contain carved stone blocks with serpents, hands, and multicolored clay sculptures. The elaborate buildings have restricted access and most certainly had religious functions of some sort. The restricted access and the carvings placed along walls and steps suggest orchestrated movement in ritual processions. Such architecture is generally understood to be the product of a priestly class that creates and maintains religious dogma. Throughout the Andes, we find settlements of this time with similarly complex architecture and art. We can therefore say with some confidence that the first evidence of a priesthood, or at the very least a ritual-specialist class, developed in the second millennium BCE in western South America.

In the period 1500–500 BCE, we see a more coherent and rich suite of iconographic motifs in the art and architecture of the cultures of the Andes. The culture of Chavin is emblematic of this tradition. To many scholars,

Chavin art represents the first truly esoteric religious tradition in western South America. Chavin art and presumably religious ideology spread throughout the central Andes, over a vast area. The main site of Chavin is a large, proto-urban center with massive temples, underground chambers, large open courts, staircases, and elaborate carved stone. Burger notes that Chavin art is fundamentally representational with natural forms intentionally mystified by their artists. The sculpture and bas reliefs are dominated by images of tropical forest animals such as caymans and jaguars, serpents, birds of prey, and other symbols sometimes associated with shamanistic visions. Anthropomorphic heads with some animal elements, such as fangs, are also common. Burger views Chavin art as “primarily a vehicle to imbue worldly matter with a transcendent message belonging to the religious system.” Regardless of our interpretations, there is little question that by the first millennium BCE in the central Andes, a complex religion had developed. This religion included an esoteric component that would have required the intervention of a priestly class to execute. These religious principles spread throughout a number of cultures in Andean South America at this time.

More Formalized Religion

The formalization of religious concepts continued in the Moche state around 150 BCE to 700 CE. The Moche built spectacular temples and palaces adorned with friezes that depict mythological and processional scenes. Moche potters produced some of the finest ceramic art in the world. These media contain a rich suite of motifs of mythical beings, anthropomorphized animals, scenes of procession, sacrifice, war, and priestly office. Christopher Donnan, who has studied these motifs for decades, notes that there are basic themes in Moche iconography that last for centuries, suggesting that these represent some basic principles in their religious canon. He has demonstrated that there were clear “offices” in Moche ritual life, and he sees analogies to the bishops and cardinals of the Catholic Church, with their distinctive dress and regalia. Ritual processions, led by religious specialists, are clearly evident in Moche art. The architecture of temple pyramids, with their adorning friezes and paintings, is consistent with such an orchestration of ritual activity.

In this sense, we see that the formalization of religious concepts and ritual specialists, first evident in Chavin and related cultures, is firmly established in the Moche. By the beginning of the first millennium CE, the concept of a formal religious canon along with a full-time priestly class was established in western South America.

Similar formal religious traditions existed in the other two great Andean states of the first millennium CE: Tiwanaku and Wari. Both were highland cultures, and much of their iconography derives from the earlier Chavin tradi-

tions. As in Moche, it is likely that there were priestly classes in these two states. A rich suite of repetitive imagery characterizes the religious art of both cultures, indicating again the existence of some kind of formal, shared ideology that spread over a wide area for centuries.

The beginning of the first millennium CE in western South America was a time of great upheaval. The Moche state collapsed around 800, and Tiwanaku and Wari were gone by 1000. On the coast, Moche traditions largely disappeared and were replaced with a series of regional cultures. In the highlands of Peru, Ecuador, and northwestern Bolivia, there is evidence of great strife. Few scholars doubt that the collapse of the great art traditions of the first millennium CE paralleled a dramatic shift in the religious traditions of these cultures as well.

The Rise of the Inca

In this context of warring ethnic groups, the Inca Empire arose in the fourteenth or early fifteenth century. The Inca, like all successful premodern empires, fashioned a complex, bureaucratic religion that served to integrate their empire. Thanks to the writings of Spanish and indigenous scholars of the sixteenth century, we have a good understanding of the theology and structure of the Inca religion. Inca religious doctrine at its height around the time of European conquest in the sixteenth century was a product of at least three generations of development.

The Inca were Quechua speakers who first developed as a recognizable political entity around 1300 in the central highlands in the Vilcanota river valley in what is now the Cusco area. A set of local folk beliefs was slowly converted into an elaborate religion by the religious specialists in the empire. At its height, Inca religion was highly bureaucratic. At the apex of the religion was the emperor. Below the emperor were a number of offices that paralleled the political bureaucracy. Male priests and “chosen women,” who also had religious duties, lived in religious buildings around the empire. Local religions were not suppressed, but all peoples were expected to recognize the divinity of the Inca gods.

The Inca also worshipped mountains, caves, springs, and other natural features of the landscape. These features, known as *huacas*, were considered to be endowed with a sacred animus or power. At the time of the Spanish conquest, there were thousands of minor and dozens of major huacas throughout the Andes. The most important shrines required substantial amounts of goods for their maintenance and were attended by hundreds of retainers.

The sun and moon were central to Inca cosmology and religious beliefs, particularly those concepts surrounding the huacas. The empire established several major pilgrimage centers around the empire at the major huacas. The most important pilgrimage destination was in Cusco, the capital. The building complex known as the Coricancha, or enclosure of gold, was dedicated to

various deities, including the sun, moon, stars, thunder, the rainbow, and the creator god Viracocha. The Inca conceived of their lands as a giant human body, and the Coricancha represented the navel of their universe. The outside walls of the Coricancha were reportedly covered in sheet gold. As the pilgrims made their way to Cusco and arrived from either mountain chain, they would have been awed with the glistening gold building.

A second pilgrimage destination was the site of Pachacamac on the coast, near modern-day Lima. Pachacamac held an idol that was created before the Inca Empire began. Both archaeology and documents confirm that this was a famous center for centuries before the Inca. Pachacamac was an oracle center, surrounded by an urban population, and greatly admired by many peoples in Peru. In a sense, Pachacamac functioned like Delphi in ancient Greece. The Inca elaborated on the architecture of the site, building some spectacular temples to their religion. They also built residences for the chosen women and priests.

Perhaps the most famous of the pilgrimage destinations in the Inca Empire was a building complex on the Islands of the Sun and Moon, in the southern Titicaca basin. The first Spaniards who arrived in Peru were told of mysterious islands in an inland sea where the sun and moon were born. According to Inca religion, the founding couple of the Inca state emerged from these islands, near a great natural rock called the Titikala. The Inca built a massive complex on the two islands, as well as structures in the nearby Copacabana peninsula area. There was a temple to the sun and other sky deities, a large residence for the chosen women, and various waystations and offering platforms. It is likely that the Inca also established a number of religious buildings on the many smaller islands in the lake to create a water pilgrimage route.

The Island of the Sun was one of the greatest of the huacas. The main focus was the Titikala or Sacred Rock. *Titicaca* most likely derives from the native term *Taksi Kala*, meaning “fundamental stone of origin.” The actual Sacred Rock is a large exposed outcrop of reddish sandstone near the center of what would have been the sanctuary area. Early documents indicate that the rock was covered with fine cloth and faced with plates of gold and silver. Corn beer and other liquids were poured into small channels directly in front of the outcrop. This was one of the most sacred areas in the ancient Andes, a place where tens of thousands of pilgrims visited over the life of the empire.

The religions of ancient South America were rich and profound. By any measure, they were as complex and sophisticated as any religion created in the Western world, Asia, or Africa. They gave comfort to their adherents, they served the interests of the many empires and states, and they served to integrate the multifaceted lifestyles and cultures of these extraordinary peoples.

Bibliography

- Arriaza, Bernardo. *Beyond Death: The Chinchorro Mummies of Ancient Chile*. Washington, DC: Smithsonian Institution, 1995.
- Bauer, Brian, and Charles Stanish. *Ritual and Pilgrimage in the Ancient Andes*. Austin: University of Texas Press, 2001.
- Burger, Richard. *Chavin and the Origins of Andean Civilization*. London: Thames and Hudson, 1995.
- Cobo, Bernabe. *Inca Religion and Customs*. Austin: University of Texas Press, 1990.
- Donnan, Christopher. *Moche Art of Peru*. Los Angeles: Museum of Cultural History, University of California, 1978.
- Feldman, Robert A. "Pre-ceramic Corporate Architecture: Evidence for the Development of Non-egalitarian Social Systems in Peru." In *Early Ceremonial Architecture in the Andes*, ed. Christopher B. Dunn, 71–92. Washington, DC: Dumbarton Oaks, 1982.
- Moseley, Michael. *The Incas and Their Ancestors*. London: Thames and Hudson, 1992.

20 Science in Pre-Hispanic Western South America

Charles Stanish

At the time of European contact, the indigenous peoples of the Americas had created some of the most sophisticated civilizations in world history. Aztec engineers reconstructed the giant lake in the central basin of Mexico. They understood the principles of water salinization and built engineering features to protect a good portion of their water supply. Inca engineers built bridges that spanned vast canyons and a road system that may have reached as long as 40,000 kilometers, according to John Hyslop. Maya scholars excelled in mathematics and astronomy, making precise calculations of the planetary bodies. Massive irrigation canals over 50 kilometers in length were built through harsh deserts and mountainous terrain by the Moche, Chimu, and Inca peoples of Peru from the middle of the first millennium CE to the middle of the second. The ancient peoples of the Americas also excelled in architecture, metallurgy, boating technologies, and many other achievements that required precise scientific knowledge.

Although it is difficult to understand the scientific principles of people who for the most part did not have writing systems, we can deduce many of these principles from their material achievements. In many cases, we have the objects that were used in the construction of these engineering features. Also, Spanish writers of the sixteenth century documented the peoples and cultures of these lands.

Defining Science

The most restricted definitions of *science* focus on the kind of enquiry into the natural world that began in the European Enlightenment, when natural philosophers rejected metaphysical explanations for material phenomena and instead attempted to understand the material world in strictly material terms. In the modern view, we focus on observation, the creation of testable

propositions, experimentation, peer review of hypotheses, and a set of social rules whereby ideas are supported or discarded. Definitions of modern science tend to focus on the means by which ideas about the natural world are accepted or rejected.

Anthropological definitions of science—that is, those that can encompass a broader number of cultures without compromising on the basic tenets of scientific enquiry—are necessary to understand non-Western scientific traditions. From this perspective, we can easily incorporate the achievements in mathematics, architecture, and engineering of Greco-Roman and Arab cultures in the first millennium BCE, as well as those achievements by African and Asian peoples during and since that time.

From an anthropological perspective, we can define science as a kind of enquiry of the material world that relies on human reasoning without recourse to the metaphysical. Thus science is seen in the creation of an esoteric knowledge by a group of specialists who go beyond the rich traditions of folk knowledge and metaphysical beliefs. While folk knowledge can be very sophisticated, and can result in technological products, it is understandable by the bulk of a society and does not involve the creation of esoteric knowledge or concepts. An example here would be the production of agricultural products in premodern societies. While such work requires knowledge and learning by farmers, the basic principles of planting and harvesting do not require concepts beyond those of everyday experience.

Science in contrast, as defined here, requires specialists who create knowledge about the material world not immediately understandable through everyday experience and who pass this knowledge down through generations. By definition, science requires specialists who are recognized by the community at large and who form a distinct social and possibly political class. The line between craft specialists who control some esoteric knowledge that is passed down to children or apprentices and actual “schools” of technical specialists is not a very definitive one. Returning to the example of agriculture, we see that it indeed requires technological skill and great ability to know weather patterns, soil conditions, and so forth. But it is a skill that can be learned relatively quickly, and almost any person can participate in a relatively short period of time.

In contrast, the mathematical principles developed by Maya astronomers were not readily apparent through everyday experience. In some cases, these principles were counterintuitive (like understanding that the world is round instead of flat). The same can be said for the principles of canal building, suspension-bridge construction, and architecture that were employed by the ancient peoples of the Americas. In short, an anthropological definition of science focuses on the creation of principles about the material world that are not the products of everyday experience, but rather are the result of “schools” of scholars working together to observe, refine, utilize, and perpetuate these principles in their community.

Ancient Western South America

In South America, there is evidence for elaborate and sophisticated folk knowledge from earliest times. At the beginning of the third millennium BCE, people in settled villages built pyramids and created beautiful craft products. By the beginning of the second millennium BCE, they also used elaborate architecture, and by the middle of that millennium they produced highly sophisticated stone carvings, elaborate adobe friezes, and large pyramids. These settlements were similar in sophistication and scope to their counterparts in the Near East and Egypt. They were achievements of great complexity that required the coordinated activity of many people over many generations.

It was not until the beginning of the first millennium BCE, however, that we see evidence of a school of architecture that worked from esoteric principles that fit our expanded definition of science. Chavin de Huantar, in the central highlands of Peru, flourished from at least 800 to 250 BCE. At its height, the site contained an impressive complex of buildings that exhibited very sophisticated engineering features suggestive of the existence of a body of esoteric architectural principles. In particular, the temples at Chavin de Huantar are not solid rubble construction like most earlier and contemporary temples in the Andes. Rather, the temples have a number of underground galleries roofed with stone slabs. As Michael Moseley and John Rick describe it, the platform is filled with multilevel tunnels, stairways, and a maze of small vents and drains. Luis Lumbreras and his colleagues analyzed the hydrology of these constructions and concluded that they were intended to be filled with water to create a spectacular roaring sound as the water was released. As Moseley notes, this construction was not the result of just the efforts of talented craftspeople, but a group of professional engineers. Rick and his students have conducted architectural analyses showing that the growth of the temple complex was a highly sophisticated and precise process. Chavin represents an architectural and engineering construction that was based on an esoteric scientific knowledge created and passed on by a professional specialist class.

The Moche

The Moche peoples of the north coast of Peru flourished in the first millennium CE. They created great works of art and impressively large and planned cities. In particular, their ceramic art reached a level of technological sophistication that easily equaled or surpassed the contemporary art of Europe and Asia. Christopher Donnan has demonstrated the profound technical sophistication of Moche craft production. Individual schools of artists can be identified. These schools passed this knowledge on through generations. A group or guild of metal and pottery workers created and passed on highly valued esoteric knowledge on the techniques of these crafts. The high quality of the

pottery required some very sophisticated techniques in firing and manufacture, and most certainly approached our definition of a scientific culture.

Moche architects also perfected many of the principles of procession, movement of people, and their participation in the great ceremonial centers. Moche pyramids were built with a highly sophisticated, preconceived plan to orchestrate human performance and activity. From the remaining architecture and from ceramic models discovered in Moche towns, we can deduce that Moche architects created a highly patterned complex of buildings, friezes, stairwells, and other accoutrements that made for a powerful human experience. In this sense, the Moche architects were able to achieve the kinds of experiences for their people that their counterparts in Europe achieved when they built the great cathedrals.

The Tiwanaku

The agricultural technology of the Tiwanaku peoples in the south central Andes represents another case in which an indigenous science developed over several generations. Most of the agricultural technology of the Tiwanaku state around 600–1000 CE was based on folk knowledge created by village farmers over centuries. Among the most ingenious folk constructions were the raised fields constructed in swampy land. Clark Erickson and others have shown that the fields were built as early as 1200 BCE in the Titicaca basin. Vast numbers of these fields were built over the generations, leaving massive landscapes altered by ancient farmers. These fields were most likely run at the household or community level and do not exhibit any level of technology beyond a folk knowledge.

However, some aspects of raised field technologies suggest that a few of the more complex systems may have been built by a professional engineering class. The engineer and archaeologist Charles Ortloff has identified features in some field complexes that exhibit advanced principles of hydrology and ambient temperature control. Ortloff believes that some of the fields were intentionally placed to capture solar radiation and therefore raise the surface temperatures of the fields. In the frost-prone environment of the high Andes, this would add precious time to the growing season and increase crop productivity.

Ortloff also believes that Tiwanaku engineers used sophisticated techniques to manipulate water speeds and movement to maximize the agronomic potential of the fields. He notes that some of the fields near the Tiwanaku heartland in Bolivia were designed to manipulate groundwater inputs. They were also designed to control runoff from the monsoon rains that fall in the region from November to April. These features suggest a degree of engineering and planning not seen in other field systems in the region. Others have pointed out that the fields are designed to maximize nutrient cycling. Field construction techniques allow nitrogen to cycle instead of being leached out into the subsoil.

Around 600–700 CE, the capital of the Tiwanaku state was rebuilt accord-

ing to an urban plan. This center of at least 30,000 people was built in geometric patterns with an elaborate sewer system that had to have been preplanned prior to major construction of the principal buildings. Alan Kolata describes one complex under the major pyramid as a sophisticated and vast system of surface and subterranean drains that were linked together in what was most certainly a planned construction. These drains may have served as more than sewers. Kolata believes that the surface and subsurface canals were intentionally designed for ceremonial and theatrical effects, used in huge public feasts that characterized Tiwanaku society. Complementing these canals were massive stone-faced pyramids, large walled enclosures, and other buildings. The center of the Tiwanaku capital was in many ways a great theatre designed to provide a religious and social environment, as much as a place to live and work. The architectural principles underlying this capital represented some of the finest examples of indigenous science in the world.

The Incas

Science and engineering principles were well developed in the Inca Empire that flourished from the fourteenth century CE to the Spanish conquest in the early sixteenth century. The Inca are famous for their road system that spanned the length and breadth of their empire. Many of the roads were inherited from earlier cultures; others were reconstructed, and some were new. Hyslop calculates that there were at least 23,000 kilometers (approximately 14,000 miles) of roads in the Inca Empire. Inca engineers built their roads over some of the driest deserts in the world, over snow-capped mountain peaks, and into the forests of the Amazonian drainages.

Most Inca roads were two to five meters in width. Often they were stone lined, some were stone paved, and many were built up with artificial embankments, terraces, and other features. The earliest Spanish sources describe the use of culverts, drains, and other features to divert water runoff and protect the roads. The most spectacular constructions in the road system were the suspension bridges. Hundreds of these bridges, made with fiber materials, were found throughout the 1 million square kilometer empire. As Hyslop tells us, the first Spaniards to encounter these bridges were apprehensive about their strength. Eventually, however, they would cross the swaying bridges with their horses. These bridges spanned considerable distances, up to at least 45 meters in the case of the bridge over the Apurimac River in Peru. Inca engineers developed other types of single-row and multiple-row cantilever bridges, as well as stone ones and causeways of various types. Some of the causeways were scores of kilometers in length, built through swampy land throughout the empire.

The principle behind the Inca road system was to cut the travel time between the seventy or so provinces in their empire. The Inca had four large armies of about 30,000 troops each at the time of the Spanish contact. These

armies had to cover a huge distance, and each bridge considerably cut the time between strategic locations. They likewise served to facilitate the movement of peoples, pilgrims, goods, and animal caravans.

The Incas and their predecessors of ancient western South America achieved scientific and engineering feats of great sophistication. Their monuments, canals, bridges, and other great works attest to the great achievements of the ancestors of the people of the Andes and beyond who still live with these great legacies of knowledge.

Bibliography

- Donnan, Christopher, and Donna McClelland. *Moche Finesline Painting: Its Evolution and Its Artists*. Los Angeles: University of California Press, 1999.
- Erickson, Clark. "The Lake Titicaca Basin: A Precolumbian Built Landscape." In *Imperfect Balance: Landscape Transformation in the Precolumbian Americas*, ed. David L. Lentz. New York: Columbia University Press, 2000.
- Hyslop, John. *The Inka Road System*. New York: Academic, 1984.
- Kolata, Alan. *The Tiwanaku*. Cambridge, MA: Blackwell, 1993.
- Lumbreras, Luis. *The Peoples and Cultures of Ancient Peru*. Washington, DC: Smithsonian Institution, 1974.
- Moore, Jerry. *Architecture and Power in the Ancient Andes*. Cambridge: Cambridge University Press, 1996.
- Moseley, Michael. *The Incas and Their Ancestors*. London: Thames and Hudson, 1992.
- Ortloff, Charles. "Engineering Aspects of Tiwanaku Groundwater-controlled Agriculture." In *Tiwanaku and Its Hinterland*, ed. A. Kolata, 153–67. Washington, DC: Smithsonian Institution, 1996.
- Stanish, Charles. *Ancient Titicaca*. Berkeley: University of California Press, 2003.

21 Science in the Classical Hindu World

V.V. Raman

The origins of Indic civilization are shrouded in the mists of very ancient history. Some archeological finds suggest that it dates back to 7000 BCE. In India too, as with all ancient science, speculations sometimes took precedence over observation, and qualitative descriptions over quantitative measurements. Yet there is much of relevance and interest in the scientific investigations and reflections of ancient Indic thinkers. In many fields of sustained research, such as mathematics, physics, astronomy, chemistry, and medicine, Hindu investigators observed and speculated insightfully.

Mathematics

The Vedas, which date back prior to 3100 BCE, are the classical sacred texts of mainstream Hinduism. Vedic literature prescribing rules for the construction of sacrificial altars imply a knowledge of basic geometry. The skills required for these included the fundamental operations of arithmetic and measurement, as well as abstract mathematical thinking. Already in the fifth century BCE, a text entitled Chandahashastra used what is essentially a binary system of numeration. This work also contains the *Meru Prastara*, an arrangement of numbers in pyramidal form that resembles the Pascal triangle in modern mathematics.

In the first centuries CE, there were references to the representation of numbers. By the seventh century, such notations became quite common in India. Indian thinkers were among the first to use the place value system of numeration. This system was imported to Europe via Arab scholars in the Middle Ages.

The decimal notation is related to the concept of zero. An important term for zero was *sunya*: void, emptiness. (Another was *kha*.) This was a metaphysical view of reality as nothingness. This speculation on the empty led to one of the most fruitful concepts in mathematical thought. The idealist extreme of regarding the world as a passing illusion provoked by the senses

called for a symbolic representation of the reality behind it. Initially, this was represented by a simple dot, and the dot grew into a small circle.

Indian mathematicians had great skill in computational arithmetic, and they developed ingenious methods for arithmetical calculations. They handled numbers of incredibly large magnitudes. The *Yajur Veda Samhita* listed multiples of ten up to a trillion, giving names to each. Another text, the *Sankhyayana Srautasutras*, extends the list even further. A Buddhist text, *Lalitavistara*, introduces a dialogue in which a student recites powers of ten up to 10^{53} . This number is called *tallakshana*.

Reducing fractions was common practice in ancient India. References to fractional numbers occur in Vedic writings. A second-century text states that the expert mathematician, “in order to simplify operations, removes common factors from the numerator and the denominator of a fraction.” Operations with fractions as well as the extraction of square and cube roots were well known in ancient India.

Hindu thinkers expressed the concept of infinity in a metaphysical way. The invocatory verse of the *Isopanishad* says, in rough translation: “That which is produced of the perfect, is also perfect in itself. Even if complete units emanate from the perfect, the latter still remains perfect.” If we replace the word *perfect* with *infinity*, the statement expresses the insight that infinity divided by anything is also infinity, and that infinity minus infinity is again infinity. The mathematical idea of infinity (*ananta*: endless) was extrapolated into other domains as well. Thus, one spoke of nominal infinity (greatness), epistemic infinity (enormous knowledge), one-dimensional infinity (observation along a line of sight), numeric infinity (a fraction with zero in denominator), and temporal infinity (eternity).

Some Hindu arithmeticians used negative numbers. Although the idea of negative numbers is fairly simple to us, at one time it was quite intriguing. The seventh-century mathematician Brahmagupta I was one of the first to use negative numbers. It may be recalled here that negative numbers came into use in Europe only from the sixteenth century with the work of Jerome Cardan and Thomas Harriot.

Hindu mathematicians explored algebra, which was called *avyakta-ganita*: mathematics of the unknown. They were among the first to investigate quadratic equations, recognizing both rational and irrational roots, as well as positive and negative ones. The ninth-century mathematician Mahavira, while grappling with quadratic equations, stumbled upon what we now call imaginary numbers. But he discarded them because the idea of a number whose square is negative was unacceptable.

Geometrical figures were studied systematically, often in the context of constructions for religious purposes. The *Sulba Sutras*, dating back to the seventh century BCE, prescribe dimensions of well-defined geometrical forms and patterns, to be used as altars. Familiarity with these enabled mathematicians to determine the midpoints of lines and to state methods for bisecting

angles and evaluating areas. Rules were given for transforming rectangles into square areas, and the value of pi was approximated.

Hindu geometry also referred to properties of similar triangles and to formulas for the solution of triangles. Hindu mathematicians were acquainted with the Pythagorean property of right triangles. A work by Baudhayana (600 BCE) contains the equivalent of the theorem associated with Pythagoras in the Western tradition.

Bhaskara II (twelfth century CE) evaluated the volume of a sphere by subdividing it into many pyramids, a technique that is akin to integration. He also introduced a concept in the study of planetary motions that suggests the notion of instantaneous velocity; and this is closely linked to the derivative. Developed in the context of astronomy, a number of trigonometric formulas were developed in India from the fifth century onward. The *Paulisa Siddhanta* was one of the first works to introduce a definition of the sine of an angle. Tables of this function were also constructed.

In the fourteenth through sixteenth centuries there flourished in Kerala mathematicians who developed some key notions of the calculus, gave the equivalent of series expansions of trigonometric functions, and did observational work in astronomy. It has been suggested that the early European traders to Kerala transferred some of the things they learned there to scholars in Europe.

Astronomy

Vedic hymns reveal astounding symmetries in their poetic meters. Careful analysis of these by some scholars suggests that their authors in evoking the gods of fire and sky were also correlating the patterns in the numbers of syllables, lines, and verses with celestial motions. Vedic rituals and sacrifices had to be performed on well-defined days of the year, and at precisely specified hours. This required exact time divisions and reckonings. Astronomy inevitably came into play. Vedic astronomical views continued to have their impact at later times. Vedic astronomy makes references to calendar divisions. The solar year, or *samvatsara*, had 360 days.

Hindu astronomers divided the path of the moon around the earth into twenty-seven or twenty-eight *nakshatras*: lunar mansions or asterisms. This was a kind of lunar zodiacal division that referred to certain constellations. The names of the months in the Hindu calendar are derived from the names of the *nakshatras*. The Tamil calendar in southern India has a sixty-year cycle, each year bearing a different name. The sixty-year cycle arises from the fact that Jupiter and Saturn align themselves in the same region of the sky every sixty years.

Periods involving multiples of years were considered. These were called *yugas*. In Vedic astronomy, one spoke of *yugas* made up of four, five, or even six years. In later Hindu astronomy, *yugas* came to mean much longer periods, involving hundreds of thousands of years. In the text *Surya Siddhanta*,

for example, the *yuga* is stated as consisting of 4,320,000 years. Hindu astronomers also spoke of the *kalpa*, which was equivalent to 8,640,000,000 years: a day in the life of Brahma, the creator. Time scales of this magnitude do not seem to have any parallels in the history of human thought until the advent of twentieth-century cosmology.

Another idea in the *yuga* concept is that the world is more or less completely destroyed at the end of each *yuga*, to be recreated again by Brahma. At the end of each *kalpa*, the universe regresses into its pristine state, only to reemerge again with new law and order. The modern concept of an oscillating universe seems to echo this ancient suggestion.

The Scientific Method

The *Chândogya Upanishad*, dating back to the sixth century or earlier, is a very revered text. It treats of ritual chants, of the primordial significance of the sun, breath, and food, of the genesis of Vedic hymns, and much more. In the midst of all this, we encounter a personage by the name of Uddâlaka Âruni. He instructs his son on the ultimate essence of things. He refers to water as essential for physical life, and food as essential for the mind. He demonstrates this by asking his son to live only on water for fifteen days. The son obeys, and is unable to recall whatever he had learned. Then he is instructed to feed himself well and return after fifteen days. The son obeys and is now able to recite the verses he had learned. In this way Uddâlaka Âruni experimentally proves to his son what he had stated.

This is a very significant episode, but as it is buried in metaphysical musings, its unusual empirical undertone escaped the scrutiny of scholars. Debprasad Chattopadhyaya, a modern historian of Hindu science has drawn attention to its relevance and argues that it entitles Uddâlaka, rather than Thales of Miletus, to be regarded as the first scientific thinker in history.

The Physical Sciences

In their interpretation of the physical world, Hindus developed theories similar in some aspects to those of the ancient Greek and Chinese sciences, and there were certainly mutual influences. Jaina speculations dating back to the sixth century BCE reflect an atomic theory. This underwent modifications in the course of time. Ancient Indian thinkers seem to have realized the ultimate minuteness of atoms, for they stated that their existence could be only inferred, never directly put into evidence.

Hindu doctrines on the nature of the physical world were extensive and sophisticated. Ether, space, and time were the arena of the world. The ultimate material unit in the physical world was called *anu*. One imagined a primordial, prematerial potential, called *tanmatra*, pervading the universe, containing the five roots of sensations. Thus, with the *tanmatra* are associated

shabda (which can be heard), *sparsha* (which can be touched), *rupa* (which can be seen), *rasa* (which can be tasted), and *gandha* (which can be smelled). The *tanmatra* evolves into innumerable *anu*.

Combinations of *anu* arise from invisible factors, referred to as *adrshita*. *Adrshita* is a metaphysical notion that extends beyond gross matter to souls also. Then there was the idea of the *paramanu*, the rough equivalent to the Democretan (Greek) atoms. These were eternal, and of different kinds.

The *mahabhutas* or basic elements of ancient science were *prithivi* (earth), *ap* (water), *vayu* (air), and *tejas* (fire), and were said to be made up of *paramanu*. The *paramanu* of different substances have different qualities. The *paramanu* of *prithivi* are endowed with the qualities of color, taste, odor, and touch; those of *ap* with color, taste, and touch; those of *tejas* with color and touch; those of *vayu* only with touch. The various *paramanu* have a number of other qualities of which number, dimension, distinctiveness, conjunction, and disjunction are common to all.

The *Vaiseshika Sutra* discusses the nature of motion. Motion could exist only for a few moments, as it has no intrinsic quality of its own. It ceases to exist as soon as it produces an effect. Motion is also described as something that can be both cause and effect. If we consider the kinetic energy aspect of motion, this view makes much sense. One also finds in these writings glimmers of the concepts of impetus, force, and momentum. There is even a suggestion that perpetual motion is impossible. The phenomena of falling bodies and arrows in flight are often cited as examples.

Heat and light were regarded as related because of the commonality of their source: fire. The heating of a body was analyzed in terms of different stages through which its atoms pass. Flame was regarded as a large collection of particles of light. Hindu physicists did speak of light corpuscles, but some of them also believed that such particles emanated from the eye, and that by falling on bodies, they rendered them visible.

The phenomenon of falling bodies was attributed to two of the four elements, earth and water. Calling this property *gurutva*, they regarded it as the qualitative attribute of all material substances, rather than as resulting from external causes. *Gurutva* was also looked on as a macroscopic property that the individual atoms did not possess.

Other properties of matter that were defined and studied in classical Hindu science included fluidity, viscosity, and elasticity. All these were explained in terms of the corresponding properties of the constituents. Thus atoms of water, fire, and earth were taken as having fluidity, while viscosity was a property only of water. Only earth substances were endowed with elasticity.

Hindu thinkers explored the notions of space and time. They regarded space as a substance that has its own individuality. It was all pervading, eternal, and a fundamental cause of physical phenomena. It was suggested that the sun, by its rising and setting, specified the cardinal directions. The sun was deemed responsible for our recognition of the flow of time. If the sun stood still, the

day would not advance, and there would be no perception of cosmic time advancement. Some considered the notion of a time atom, called *truti*. This corresponded to 1.33750 seconds.

The universe was imagined to have arisen from water, an idea that is reminiscent of Thales of Miletus. In one of the Upanishads we read, "It is simply water that has solidified: the earth, the air, the sky, the gods and men; beasts and birds, grass and trees, animals and worms, flies and ants; all these are just water solidified." The idea that everything in the universe is fundamentally interconnected in some subtle and all-embracing way is a view implicit in ancient Hindu science and is found now in quantum physics.

Chemistry

Our interaction with matter is as old as human culture. In the processes of shaping clay and forging metals, humans developed a keener understanding of materials and their properties. Thus did chemistry arise from the most ancient times. But substances are not only handled and molded. Some of them are also ingested. Food is an important subset of material things. We chew and swallow not only for palatal pleasures and the necessary nourishment, but also on occasions to rid ourselves of ailments. Medicinal materials need to be studied, and this becomes a topic for chemistry. Herbs, plants, and mineral concoctions can cure diseases and bestow health and strength. Can they also restore youth and prolong life indefinitely? Such were the inspirations for alchemy, the progenitor of chemistry.

Immortality is not just imperishability, but continuation without damage or decay. Some materials seem to persist forever, but even they rust and rot. But gold and silver seem beyond corruption. So they have been venerated from time immemorial, and one investigated methods for transforming ordinary substances into these immortals of the material world. Alchemy dominated the scene for at least five centuries in medieval India, from the tenth to the fourteenth century. It became wedded to mythology and mysticism; as elsewhere, it developed secret ways and some grotesque methods in attempts to achieve impossible goals.

Mercury was the supreme substance of sanctity for alchemists. Struck perhaps by its unusual state (the only metallic substance liquid at ordinary temperatures), alchemists revered it and imagined it had extraordinary powers. Mercury was called *rasa* (Sanskrit for essence), and alchemy was known as *rasavidya*: knowledge of essence.

The investigation of mercury is elaborated in the tenth-century text *Rasarnava* (Sea of Mercury). Here it is stated that the material is to be treated in eighteen different ways before its full potential can be realized. These include steaming, grinding, distillation, and blending. Rules prescribed the construction of the room where alchemical inducements were to be carried out. The laboratory had to be in a region blessed with medicinal plants. There

were to be four principal doors, furnaces had to face the southeast, the instruments had to be in the southwest. The chemical laboratory contained a variety of apparatuses such as sieves, bellows, crucibles, pans, and retorts.

Chemistry apart from alchemy flourished in India in the arts of metallurgy and ceramics, in smithies and idol factories. One also explored substances to beautify the body and add fragrance to the skin. Explosive salts were prepared for pyrotechnic spectacles. Candles were made and oils extracted.

Hindu chemistry had significant metallurgical achievements. There stands to this day near New Delhi an impressive iron pillar, over twenty-four feet tall and weighing more than six tons, that is known to have been erected sometime in the fifth century. Chemical analysis reveals that it contains minute proportions of carbon, silicon, sulfur, and phosphorus. The pillar has not suffered from the passage of time. V. Ball, an English geologist in the late nineteenth century, had this to say about this marvel of ancient metallurgy: "It is not many years since the production of such a pillar would have seemed an impossibility in the largest foundries of the world, and even now there are comparatively few places where a similar mass of metal could be turned out."

Medicine and Psychology

The goal of medicine being good health and longevity, the ancient Hindus called their medical science *Ayurveda*: science of longevity. Ayurvedic treatises date back to the early centuries of the Christian era. But their framework was already laid in Vedic literature. The two most outstanding names that occur in the classical medical texts are Charaka and Sushruta. Their works have survived almost in their entirety and are the sources of our knowledge of ancient Hindu medicine. The age in which these men lived and practiced is not known with certainty. The *samhitas* (treatises) by these authors suggest that medical practice was much more ancient than their names. Somewhat like Galen in the European tradition, Charaka and Sushruta were the spiritual masters of Indian medical writers for many generations. Their analyses of medical knowledge and rules governing good health and medical practice have inspired Hindu physicians from time immemorial. In 150 short chapters, Charaka covered a long list of topics that included prognosis, pathology, the influence of environmental factors, and such various complications as tetanus, convulsions, nasal catarrh, insanity, abdominal pains, disgust of foods, jaundice, swelling of the scrotum, and ingestion of poisons.

One ancient Hindu theory of diseases is that a human being is made up of three components: soul, mind, and body. As long as all three are in equilibrium, we are in good health. Any perturbation in their mutual balance results in a disease. Such perturbations may be caused by abnormal correlations between time, mind, and the senses. These are described as adverse, null, or excessive. Time refers not only to clock or calendar time, but also to internal, personal time: one's age and stage in life. When a youth runs for an hour

without stopping, he may not be affected at all, whereas when an old man does the same, unpleasant consequences may follow. Here we have cases of null and excessive correlations.

There are three factors in the body which must also be in proper balance: *vayu* (wind), *pitta* (bile), and *kapha* (phlegm). These terms do not refer to products within the body, but to certain overall states of the body. Any disturbance in their equilibrium is called a *dosha*. Specific medications are prescribed for each *dosha*.

The origin of diseases is traced to three factors. First, there are factors that come from conception and birth. These give rise to constitutional (genetic) diseases. Next, diseases could arise from unexpected events over which the sufferer has no control, such as snakebites or epidemics. These are accidental diseases. Finally, there are diseases arising from the wrath of a god or a demon, or from time and old age. These are inevitable and incurable.

Although the physical basis of diseases was recognized, there was also a strong belief that magical influences were present in all cases. Hence, associated with all medicines were spells and incantations, prayers, and pilgrimages. In many instances, these did have therapeutic effects, if only because of the psychological basis of many common diseases.

Careful diagnosis was stressed. Charaka warned that the “physician who, without carefully ascertaining the disease, commences his treatment, seldom meets with success even if he be well conversant with medicines and methods of application.” He went on to say that the cure of an ailment results from the physician’s effective manipulation of the patient, and from the drugs and the nurse.

Several hundred concoctions of plant, mineral, and animal origin are listed in medical works. Mercury and gold, herbs, salts and gems, the urine of animals, milk, and marrow was used in preparing a whole range of medications.

Sushruta was the greatest of ancient Hindu surgeons. His treatise discusses surgery with references to the dissection of cadavers. He has left behind an impressive listing and classification of surgical instruments. Razors, forceps, pincers, needles, and hooks were among the many tools of the surgeon mentioned in this text.

The ethical framework of physicians is illustrated in a passage from the *Charaka Samhita*: “Of all the physicians, he is best who practices medicine, not for wealth or personal gratification, but purely out of compassion for life. Those who exploit medical knowledge as just another commodity, purely for monetary gains, run after a heap of dust while ignoring the real mound of gold. None offers greater blessings, moral or material, than the physician who severs the death-noose, and restores life and health to the victims of fierce disease. He who performs the healing art with care and compassion, regarding this as the noblest of professions, is entitled to the greatest happiness.”

Ancient texts list diseases of the eye, lungs, heart, and urinary tract. There are references to skin eruptions, rheumatism, asthma, epilepsy, tuberculosis,

leprosy, simple headache, and loquacity. Other items mentioned in some of the medical works include amputation, rhinoplasty, and trepanning. Strict rules of hygiene were prescribed. Principles governing sexual encounters were enunciated. Even hypnotism seems to have been practiced for curative purposes.

Hindu science also probed into psychology and consciousness. Some modern theories in psychology have been influenced by Hindu insights into the nature of the human mind. One detects in the works of Carl Jung and Ken Wilber, for example, reformulations of Hindu views. In the Hindu framework, experienced consciousness is part of a grander consciousness that is freed from ordinary experience. Science explores experienced consciousness with its methodological and conceptual tools. But for many ages, Hindu experimentalists have probed the mystery of other dimensions of consciousness through sophisticated yogic disciplines.

Grammar

Hindus approached grammar as a subject matter for scientific study. Careful and systematic analysis of spoken Sanskrit as well as of the Sanskrit hymns must have been carried out from the most ancient times. The works of generations of scholars culminated in a classic treatise called *Ashtadhyayi* (Eight Chapters) by Panini. This work was most probably composed during the fourth century BCE. Panini's chapters consist of nearly 4,000 aphorisms that describe and prescribe the correct use of the language. It has been suggested that Panini himself, if not some earlier grammarian, gave literary language the name Sanskrit, which essentially means "that which has been elaborated or cultured," in order to distinguish it from vulgar speech.

Panini's great insight was the recognition that the words of a language spring from some basic roots by means of inflections and other modifications. He listed 2,000 such roots for Sanskrit. He stated strict rules for the combination of words in accordance with the laws of euphony. In Panini's analysis of phonology, morphology, and syntax, modern investigators have detected parallels with concepts in computer programming.

Hindu Science in a Global Context

Ancient and classical India made impressive progress in craft, technology, and science. In astronomy and in mathematics, in alchemy and in medicine, inquiring minds have been active in the Indian subcontinent from time immemorial. There were exchanges and interactions with contemporaneous science and civilization in other parts of the world, notably with China, Greece, and later the Arab world. The overall framework of science in the Hindu context was that the cosmic divisions of earth (lower/material), atmosphere (connecting region), and sky (higher/immaterial) are mirrored in the human body, breath, and mind.

One may wonder why such an intellectually alert people did not bring about the scientific and industrial revolutions. But then, the same questions may be asked with respect to Egypt, Babylon, and other cultures. In general terms, it may be said that no people or nation continues with a high level of progress and creativity indefinitely. External or internal forces arise, overtly or subtly, to stifle the victories and vitality of a people after a span of robust activity. In the case of India, inordinate reverence for ancient writings because of their inseparable association with religious practice carried over to scientific matters as well. This tended to diminish independent thought and the spirit of questioning. Also, in one phase, excessive preoccupation with spiritual liberation tended to draw the energies of people to metaphysical realms. It has also been suggested that the scientific development of medicine was a threat to the highly organized religious orthodoxy. Because of this, the more rationalistic and secular aspects of medical theories were condemned by an establishment that would rather stress the ritualistic and mystic sides. This self-serving preoccupation of the priestly class, contends one scholar, thwarted the full blooming of science in ancient India.

Then again, a series of external forces in the form of invaders often put the people on the defensive. Foreign cultural intrusions have the effect of pushing a people even more ardently to whatever they can claim as their own. This too is not conducive to the development of new ideas and perspectives. Finally, in order for science in the modern sense to arise, knowledge must become more widespread, rather than be confined to a handful of pundits who guard it jealously. This could not be achieved before the invention of printing and other social changes.

After India's contact with Europe, Indian scientific minds were drawn to the mainstream of modern science. Since that time, scientists from India have grown in numbers. Their contributions to international science have been increasing in quantity and in quality.

Bibliography

- Bag, A.K. *Science and Civilization in India*. Vol. 1. New Delhi: Navrang, 1985.
- Bose, D.M., S.N. Sen, and B.V. Subbarayappa, eds. *A Concise History of Science in India*. New Delhi: Indian National Science Academy, 1971.
- Chattopadhyaya, D. *History of Science and Technology in Ancient India*. 2 vols. Calcutta: Firma KLM, 1986 and 1991.
- Datta, B., and A.N. Singh. *History of Hindu Mathematics*. Lahore: Motilal Banarsi Das, 1935 and 1938.
- Dutt, U.C. *Materia Medica of the Hindus*. Calcutta: Thacker, Spink, 1877.
- Gangooly, P. *The Surya Siddhanta*. Trans. E. Burgess. Varanasi: Indological Book House, 1977.
- Hoernle, A.F.R. *Studies in the Medicine of Ancient India*. Columbia, MO: South Asia Books, 1994.
- Joshi, S.D. *History of Metal Founding on the Indian Subcontinent since Ancient Times*. Ranchi: Mrs. S.S. Joshi, 1970.
- Kak, S. *The Astronomical Code of the Rgveda*. New Delhi: Aditya Prakashan, 1994.
- Keith, A.B. *Indian Logic and Atomism*. Oxford: Oxford University Press, 1921.

- Kuiper, F.B.J. *Ancient Indian Cosmogony*. Delhi: Vikas, 1983.
- Mishra, U. *The Conception of Matter According to Nyaya Vaisesika*. Allahabad, India: M.N. Pandey, 1936.
- Rahman, A., ed. *History of Indian Science and Technology and Culture AD 1000–1800*. Delhi: Oxford University Press, 1999.
- Ray, P.C. *History of Hindu Chemistry*. London: Williamsgate, 1909.
- Sarkar, B.K. *Hindu Achievements in Exact Sciences*. London: Longmans, Green, 1918.
- Subbarayappa, B.V., and S.R.N. Murthy, eds. "Source Materials on Indian Mathematics and Astronomy." *Scientific Heritage of India: Proceedings of a National Seminar*. September 19–21, 1986, the Mythic Society, Bangalore, 1988.

22 Joseph Needham and Taoism

Shigeru Nakayama

Taoism was responsible for the development of science in China: those who explore the more than twenty volumes of Joseph Needham's *Science and Civilisation in China* (the first volume of which was published in 1954) encounter this message again and again. This huge and massively documented compendium is often described as a definitive survey of China's technical activity—although its author emphasized that it is a tentative reconnaissance. That Taoism was a scientific philosophy is one of Needham's celebrated theses.

Joseph Needham (1900–1995), a pioneering, innovative biochemist, favored the unconventional and unorthodox, and he eagerly tried out tentative hypotheses. He preferred the organismic thought characteristic of the life sciences to the reductive, mechanistic thinking of the physical sciences. He was convinced that mystical and magical traditions inspired scientific empiricism. He was greatly influenced by Lynn Thorndike's magisterial *History of Magic and Experimental Science*, published between 1923 and 1958, a work that most of his colleagues rejected in favor of the rationalism that had animated the scientific revolution. They also dismissed the idea that early non-European scientific thought was worth taking seriously. The largest achievement of Needham's later life was to demolish this uninformed bias.

In studying Chinese thought, like most scholars of his time Needham did not distinguish the Taoist quietist philosophies of the third century BCE, recorded in the *Laozi* and *Zhuangzi* books, from the organized Taoist religious movements that appeared after 180 CE, or the popular religion that preceded both and is still vibrant in China. He opposed this *Taoism to Confucianism*, an equally ambiguous term often used for conventional attitudes, the state bureaucracy, its ideology, and so on. Needham's Taoism was the resistance to these reactionary forces—and science, a manifestation of the creative imagination, was its product. According to Needham, “Many of the most attractive elements of the Chinese character derive from Taoism.”

For most East Asian nonacademics today, science is a modern, Western, purely rational construct, and Taoism is a variety of folk rituals and supersti-

tions that are dying out as education spreads. They find Needham's claim laughable. Only a few experts have taken Needham's hypothesis seriously. It has heuristically inspired some, both pro and con, to begin exploring the vast but neglected riches of the Taoist scriptures. A very few, unprepared to critically examine the ancient Chinese texts that Needham quoted, simply accept his claims, with misunderstanding often the result. Needham's message encouraged a few well-known critics of modern science, of whom the most widely read was Fritjof Capra.

Capra often quoted Needham, for instance, on *wu-wei* in Taoist philosophy. The term means literally "nonaction" but was translated by Needham as "refraining from activity contrary to nature." This interpretation by Needham had already drawn academic criticism. Nevertheless, Capra found it congenial and used such examples to liken contemporary physics to Eastern mysticism. He inspired a rash of popular writings on "new age science" in the late 1970s. But the discrepant purposes and aspirations of religion and science make them difficult to link. The elaborate attempt of Robert K. Merton to prove that a Protestant ethic encouraged the rise of modern science prompted a large literature of point-by-point refutations.

Nathan Sivin, the most prominent successor of Needham in the Western world, took Needham's claims seriously enough to closely reexamine his original sources. He also drew on modern studies of the Taoist religious movements from 1973 on, evaluating his predecessor's conception of Taoism and claims that Taoists were crucial in the evolution of science. Sivin concluded that Needham (like others in the 1950s) used *Taoist* so vaguely that most of his claims have nothing to do with any meaningful sense of the word. Sivin also found that many specific claims rested on faulty historical reasoning. Surveying important Chinese scientists and technologists through history, he showed that most were conventional literati or officials, and that only a handful were initiated Buddhists or Taoists.

Needham's heuristic influence prompted leading scholars in China to compile a large anthology of native and foreign studies, edited by Lui Dun and Wang Yangzong, on Chinese science and Needham. Not a single essay was devoted to Taoism. This suggests that those capable of resolving the problem have finally laid it to rest.

Bibliography

- Capra, Fritjof. *The Tao of Physics*. Berkeley, CA: Shambhala, 1975.
- Lui, Dun, and Wang Yangzong, eds. *Chinese Science and Scientific Revolution: Selected Essays on Needham's Puzzle and Related Researches*. Shenyang shi: Liaoning, 2002.
- Merton, Robert K. "Science, Technology and Society in Seventeenth Century England." *Osiris* (1938).
- Needham, Joseph. *Science and Civilisation in China*. Cambridge: Cambridge University Press, 1954.
- Sivin, Nathan. "On the Word 'Taoism' as a Source of Perplexity." *History of Religions* 17 (1978): 303–30.

- . “Taoism and Science.” *Medicine, Philosophy, and Religion in Ancient China: Researches and Reflections*. Aldershot, UK: Variorum, 1995.
- Thorndike, Lynn. *History of Magic and Experimental Science*. New York: Columbia University Press, 1923–1958.
- Zezong, Xi, ed. *Zhong-guo Dao-jiao Ke-xue Ji-zhu-shi* (The History of Science and Technology in Taoism). Beijing: Kexue chubanshe, 2002.

23 Islam and Premodern Science

Muzaffar Iqbal

The relationship between Islam and premodern science was molded by a worldview that constructed the world of nature as one dimension of a created order that encompasses two distinct realms: the visible and the invisible. Furthermore, this worldview considered the visible world (*al-zahir*) not only a thing in itself, but a sign that pointed to a reality beyond itself. This dual aspect of the visible world imparted a transcendent quality, which made the sciences that explored the visible world an integral part of sacred sciences of Islam. Astronomy, physics, chemistry, and other sciences that explored the physical world thus explored one aspect of a vast reality within the context of a scheme of existence that continuously pointed to a transcendent reality. This worldview, which took nature and all that it contains as a sign of the transcendent reality, is shared by all three Abrahamic faiths: Judaism, Christianity, and Islam.

This essential aspect of the Islamic scientific tradition was built into its very matrix and, hence, there was no need to explore the nexus between the religion Islam and the scientific tradition that emerged in the Islamic civilization through any external devices and methodologies. Rather, it was an organic relationship that extended to all branches of science.

The physical cosmos, according to Islam, observes a divine law, just as humans are supposed to. Thus, the Quran tells us about the revelation sent to the bee (Q. 16:68); it mentions the submission of the heavens and the earth to God (Q. 41:11); it celebrates the glorification of God by all that exists in nature (Q. 59:1, 61:1, 62:1, 64:1). The Quran unifies the whole of creation in a grand order and establishes the source and origin of that order and then, in a sweeping manner, states that all of this is destined to exist merely for a short duration, after which all will perish—all except God. This emphasis on the transient nature of the created world reverberates throughout the text as a reminder that none other than God is to be worshipped, for all others are mere creatures who owe their existence to His Will.

Within this broad creation theme, the “sign verses” of the Quran establish

a nexus between the physical cosmos and the metaphysical realm by making the physical entity a projection of the unseen wherein resides its sustaining and governing principle. This fundamental characteristic is quite different from the neo-Platonic concept. In Islam, the natural world is placed in a created order in space and time. But this is done in a metaphysical way, which takes us into the very heart of the Quranic message: the unique oneness of the Creator: “Is He not the One who made the earth a stable abode and created rivers flowing through it, created the mountains therein and created a barrier between the two seas?” the Quran asks rhetorically. “Is there, then, another god than Allah? Yet, most of them do not know” (Q. 27:61). In addition, in the general sweep of its narrative, the Quran mentions the rain-bearing clouds and vegetation kingdom; it specifically cites the case of “dead earth” revived by God: “A Sign for them is the earth that is dead; We give it life, and produce grain therefrom of which ye eat; and We caused to grow in it gardens of palms and vines, and We caused springs to gush forth therein; that they might eat fruits; although it is not their hands that wrought this; will they not, then, give thanks?” (Q. 36:35). In fact, it makes the whole cosmos a witness (*shahid*) to the transcendent oneness of the Creator.

The Quran treats as given the basic enigmas of life: birth (described as an embryogeny in several stages, Q. 23:12–14, 40:69), death, resurrection, and life after death. It gives humans (and *jinn*s) the moral choice of accepting or rejecting its message: there is no compulsion in religion (Q. 2:256). It prescribes the legal limits of human activity and gives humans the freedom to choose between the two paths (Q. 90:10).

It was left to the Islamic dialectical theology, Kalam, to formulate in precise terms the mode of existence of things. And it was the function of the Islamic cosmological sciences to explain how things came into existence and how they were related to each other as well as to the whole. The theologians (*mutakallimun*), the philosophers (*filasifa*), and the mystics (*sufis*) formulated various cosmogonies to elucidate modes of existence. Because all of these traditional cosmogonies addressed the same questions, though from different vantage points, they are all considered valid within the framework of the Quranic revelation. This is the basis of the existence of multiple cosmogonies in the Islamic tradition; they all sought to explain the cosmos in the light of the doctrine of *al-Tawhid*, the unicity of God, which made it impossible for two cosmic orders to coexist.

The nexus between nature and the Quran exists at various levels—from semantics to metaphysics. This unity of existence, a recurrent theme of the Quran, relates the cosmic unity to the concept of *Tawhid*, the unicity of God. Through this operation, the realm of nature, which is ontologically dependent on the Creator, becomes more than the mere physical entity that it is; it becomes a sign, an *ayah*—a word also used for the verses of the Quran—pointing to the transcendent reality beyond itself. But this elegant nexus between the world of nature and the word of God is much more than mere semantics;

it is an essential feature of the Quranic metaphysics of nature, which establishes an inalienable link between various levels of created things by relating them to an all-encompassing (*al-Muhit*) and all-knowing (*al-Alim*) God who is above and beyond all human conceptions.

Given these metaphysical assumptions that operated behind scientific theories, the relationship between Islam and premodern science developed in a harmonious manner along with other intellectual developments that shaped Islamic civilization. This is not to say that there were no tensions in this relationship. In fact, the translation movement in the eighth to tenth centuries, which brought a large amount of scientific data into the Islamic tradition, also brought numerous theories and philosophical assumptions that did not fit well in the framework of the Islamic worldview. But in time, most of these tensions were creatively resolved. *Tawhid*, the most fundamental principle of Islam, acted as a prism through which these theories were passed in order to test their validity. It was this powerful doctrine, situated at the very heart of the Quranic message, which made it possible for Muslim scientists and scholars to transform those Greek theories about nature that conflicted with revelation. But it was not an arbitrary act of faith; rather, it was a consistent operation that derived its primary kinetic energy from the Quran and then branched out in various spheres. It was through the inherent power, simplicity, and uniformity of the principle of *Tawhid*—that was operative in all realms of knowledge—that a coherent Islamic scientific worldview appeared. Through this operation, even Aristotle's *materia prima* could be appropriated into the Islamic cosmogonies.

In addition to this metaphysical nexus, a direct relationship existed between certain sciences and the religious requirements of the Muslim community. These included the sciences to determine *qiblah* (the direction of prayer), certain branches of astronomy that were used to determine the lunar cycles for accurate determination of the beginning and the end of fasting and hajj, and the science of time-keeping needed for the daily five obligatory prayers.

This high degree of integration and association of science and religion made the scientific enterprise in Islam an extension of its religious practices. In fact, numerous scientists were attached to the mosque-madrassa complexes, and this vast system of education and research provided a natural link to the religion. More than anything, it is these institutional ties between the places of worship and places of scientific research that provided an overall religious institutional framework for the scientific enterprise. This does not mean that the scientific data had to filter through any religious authority—for no such authority exists in Islam. And there were independent scientists as well as those who were engaged in scientific research for no religious reasons. However, in spite of certain notable exceptions, the overall scientific activity in Islamic civilization had integral links with the worldview that envisioned the realm of nature and its diverse processes as beneficial expressions of God's sustaining power (*Rabubiah*), so poignantly expressed in the Quran.

The question of the origin of the world, which is a major aspect of the contemporary religion and science discourse, is also central to the understanding of the relationship between Islam and the premodern scientific tradition that was cultivated mainly in Islamic civilization. A large amount of literature deals with the design, harmony, and beneficial nature of the universe. This systematic treatment of numerous natural processes construes the cosmos as originating through an act of God, designed for human habitation, and destined to exist until an appointed term.

God, called the Originator (*al-Badi'*) by the Quran, designed and fashioned it through a simple command, *Kun* (be). The role of the scientist was to discover the modalities of creation, the hidden and apparent harmonies that existed between various realms of creation. The scientist-scholar or scientist-philosopher attempted to draw relationships between the physical and non-physical worlds—all of which were ontologically linked and existentially dependent upon God. This intrinsic nexus between various levels of existence forms the vertical axis of the Islamic concept of nature and runs through all formulations. The ultimate foundation of the interrelatedness of the world of nature and humanity at the existential plane is the ontological dependence of both on God. This common ontological foundation made it possible for the Islamic scientific tradition to forge links and share a language of discourse with other disciplines of knowledge, which were all arranged in a hierarchy.

Since all things exist through and because of God, their ontological dependence on the Creator simultaneously ennobles them by raising their status from being mere things to signs of a transcendent Real (*al-Haqq*) that nevertheless remains beyond them. Thus rather than being mere dialectical utterances, the “sign verses” of the Quran linked the scientific enterprise in Islam to the irresistible urgency to which the Quran draws our attention, in order to take us beyond the realm of this world to the hereafter, which it formulates as a logical conclusion of this world.

Sanctified and ennobled, the world of nature thus becomes an object of study within a grand narrative of creation, death, and resurrection. This makes the rhythmic alternation of the day and the night (Q. 2:164) and the regularities in the movement of the sun—which “traverses its course by the decree of the All-Knowing; and the moon—[for which God] has made stations [to traverse], till it becomes like an old [and withered] stalk of date-palm” (Q. 33:38–39)—and numerous other natural, commonly observable phenomena, indicators to a reality beyond them.

The Quranic scientific data, such as references to the orderly movement of the planets, were central elements of the scientific enterprise of Islamic civilization, which saw in the world of nature a design that pointed to the Grand Designer, the Creator. Thus, the Quran drew the attention of Muslim scientists to the fact that “the sun does not catch up to the moon and the night cannot outstrip the day; [rather] each revolve in their own orbit” (Q. 33:40), and asserted that this was not merely the result of certain laws of nature.

Rather, these were “signs” for those who reflect. The concept of “laws of nature” independent of a lawgiver is essentially a post-Renaissance concept that did not exist in the Islamic tradition; in Islam, the authority to make laws rests with God alone.

A large amount of literature existed on what can be called an “intelligent-design” model of the universe. These teleological studies pursued two distinct lines: the evidence of design on a minor scale and on a cosmic scale. The evidence of design in both cases was either the functionality of nature or an aesthetic quality in nature, its orderliness and beauty. The second line of teleological arguments spans the whole cosmos. Both of these lines of teleological arguments lend themselves to a demonstration of unity in the universe; this was particularly true for the second line that took the whole cosmos as its point of departure. If there was beauty, compelling harmony, functionality, and interdependency, it was argued, then there must be a single, overall design, and by extension a single designer.

These ancient arguments had arrived in the Islamic intellectual tradition after the transmitted sciences had been thoroughly established during the first two centuries of Islam, which was a period of an intense reflection on the Quran. Among the most astonishing aspects of the Quran was an emphatic invitation to all humankind to reflect on the grand design in nature that exhibits itself in such a compelling manner that no one with heart and soul and mind can fail to recognize an underlying unity in the cosmos and hence a single designer, Allah. However, these are not the arguments that were used to establish a nexus between faith and science in the Islamic scientific tradition, because it was recognized that these arguments originate in a text that skeptics did not accept. Hence they would easily render these powerful arguments irrelevant by stating that had they accepted the Grand Designer, they would not be arguing against the Design. Islamic teleological texts, therefore, do not rest on the Quranic data; rather, they build their arguments through the methods of dialectic theology. Let us, however, note that the Quran does not use its own ontological premise while inviting humankind to reflect on the signs that are spread throughout the universe—signs that speak to the innate human intelligence in the most extraordinary manner. These include the water cycle; the regeneration of earth after it has been dead; the periodic and orderly movement of the heavenly bodies; the alternation of night and day “so that ye may rest during the night and seek sustenance during the day”; the six stages of development of a fetus in the womb; and a host of other natural phenomena (Q. 2:164, 3:190, 30:20–25, 45:3–5). Indeed, an oft-repeated refrain in the Quran is “in this are signs for those who reflect.”

Another unique aspect of the relationship between Islam and the Islamic scientific enterprise is the epistemological foundation of the scientific methods used by Muslim scientists. Muslim scientists and scholars recognized many methods of acquiring scientific knowledge. From empirical observations to experimentation and from deduction and demonstration to intellec-

tual intuition, this large range of methods was scrutinized and classified for its proper usage and then relationships were established between these methods. A hierarchy was created which found its own proper place within Islamic epistemology. This gave birth to a large body of literature on the classification of sciences. Various modes of knowing were linked to the revealed knowledge because epistemology reflects ontology. Thus knowledge attained through revelation, intellection, reasoning, and empirical methods was placed within a coherent epistemology linked to an ultimate purpose of attaining knowledge—a purpose that was, in turn, related to the very purpose of existence.

This coherent view of nature and its relationship with Islam the religion was to suffer a violent fissure with the rise of modern science, which began in Europe with the scientific revolution. This was, however, not due to any scientific discovery that challenged the revealed message of the Quran; rather, this fissure arose out of a dynamic recasting of scientific enterprise in European civilization. This cleavage became more pronounced as time passed because—unlike the process of appropriation of Greek, Persian, and Indian scientific traditions—modern science has never been appropriated by Islamic civilization through a creative process. This is why the exploration of the relationship between Islam and modern science demands a distinctively different treatment from the one that can be used for exploring the relationship between Islam and premodern science.

Bibliography

- Açikgenç, Alparsalan. *Islamic Science: Towards a Definition*. Kuala Lumpur: International Institute of Islamic Thought and Civilization, 1996.
- Al-Attas, Syed Muhammad Naquib. *Islam and Secularism*. Kuala Lumpur: International Institute of Islamic Thought and Civilization, 1993.
- . *Prolegomena to the Metaphysics of Islam*. Kuala Lumpur: International Institute of Islamic Thought and Civilization, 1995.
- Babar, Zaheer. *The Science of Empire*. Albany: State University of New York Press, 1996.
- Bakar, Osman. *Classification of Knowledge in Islam*. Kuala Lumpur: Institute for Policy Research, 1992.
- . *Tawhid and Science*. Kuala Lumpur: Secretariat for Islamic Philosophy and Science, 1991.
- Burckhardt, Titus. *Alchemy, Science of the Cosmos, Science of the Soul*. Cambridge: Quinta Essentia, 1995.
- . *Mirror of the Intellect: Essays on Traditional Science and Sacred Art*. Cambridge: Quinta Essentia, 1987.
- Chittick, William C. *The Sufi Path of Knowledge: Ibn Al-Arabi's Metaphysics of Imagination*. Albany: State University of New York Press, 1989.
- Craig, William Lane. *The Kalam Cosmological Argument*. London: Macmillan, 1979.
- Golshani, Mehdi. *The Holy Qur'an and the Sciences of Nature*. Binghamton, NY: Institute of Global Cultural Studies, Binghamton University, 1999.
- Hahn, Lewis Edwin, Randall E. Auxier, and Lucian E. Stone Jr. *The Philosophy of Seyyed Hossein Nasr*. Chicago: Open Court, 2001.
- Haq, Syed Nomanul. *Names, Nature, and Things*. Dordrecht: Kluwer, 1994.
- Hourani, George F., ed. *Essays on Islamic Philosophy and Science*. Albany: State University of New York Press, 1975.
- Iqbal, Muzaffar. *Islam and Science*. Aldershot, UK: Ashgate, 2002.

- Izutsu, T. *God and Man in the Koran: Semantics of the Koranic Weltanschauung*. Tokyo: Keio Institute of Cultural and Linguistic Studies, 1964.
- Nasr, Seyyed Hossein. *An Introduction to Islamic Cosmological Doctrines*. Albany: State University of New York Press, 1993.
- . *Islamic Life and Thought*. Albany: State University of New York Press, 1981.
- . *Knowledge and the Sacred*. Edinburgh: Edinburgh University Press, 1981.
- . *Religion and the Order of Nature*. New York: Oxford University Press, 1996.
- . *Science and Civilization in Islam*. Cambridge, MA: Harvard University Press, 1968.
- Netton, Ian Richard. *Allah Transcendent*. Richmond, UK: Curzon, 1989.
- Northbourne, Lord. *Looking Back on Progress*. London: Perennial Books, 1970.
- Peters, F.E. *Aristotle and the Arabs*. New York: New York University Press, 1968.
- Peters, Ted, Muzaffar Iqbal, and Syed Nomanul Haq. *God, Life, and the Cosmos: Christian and Islamic Perspectives*. Aldershot, UK: Ashgate, 2002.
- Piamenta, M. *The Muslim Conception of God and Human Welfare*. Leiden: E.J. Brill, 1983.
- Pines, Shlomo. *The Collected Works of Shlomo Pines*. Vol. 2. Studies in Arabic Versions of Greek Texts and in Medical Science. Leiden: E.J. Brill, 1986.
- Rahman, F. *Major Themes of the Qur'an*. Minneapolis: Bibliotheca Islamica, 1980.
- Sabra, A.I. *Optics, Astronomy, and Logic*. Brookfield, VT: Variorum, 1994.
- Saliba, George. *A History of Arabic Astronomy: Planetary Theories During the Golden Age of Islam*. New York: New York University Press, 1994.
- Sardar, Ziauddin. *Explorations in Islamic Science*. London: Mansell, 1989.
- , ed. *The Touch of Midas: Science, Values, and Environment in Islam and the West*. Petaling Jaya, Malaysia: Pelanduk, 1988.
- Sharif, M.M. *A History of Muslim Philosophy*. Karachi: Royal Book, 1983.
- Stenberg, L. *The Islamization of Science: Four Muslim Positions, Developing an Islamic Modernity*. Ludwig: Lund Studies in History of Religions, 1996.
- Whitall, Perry N. *The Widening Breach: Evolutionism in the Mirror of Cosmology*. Cambridge: Quinta Essentia, 1995.

24 Islam and Modern Science

Muzaffar Iqbal

The discourse between Islam and modern science is defined by several historical anomalies, the most important being the initial encounter. Modern science arrived in the Muslim world at a time when most of the traditional Muslim lands were under direct colonial occupation. This first encounter is also intimately connected with a much larger transformation of the traditional Muslim lands that defined, to a large extent, the nature of the relationship that developed between Islam and modern science during the nineteenth and first half of the twentieth centuries. The relationship was also defined by connections between modern science and the colonial designs for the people of the occupied lands. All of these factors transformed the discourse between Islam and science that had existed for eight hundred years prior to the arrival of modern science.

The relationship between modern science and Islam also needs to be distinguished from Muslim attitudes toward modern science. The former is concerned with an exploration of the metaphysical underpinnings of the enterprise of science in modern times in the light of revelation; the latter reflects time-dependent, historically construed interactions between individuals belonging to a faith tradition and an equally time-dependent human enterprise entrenched in social, political, and economic conditions.

The Muslim attitudes toward modern science have been largely conditioned by the initial encounter between the Muslim world and the West in which the entire Muslim world was colonized. Leading Muslim intellectuals of the eighteenth and nineteenth centuries attributed this downfall to inferior scientific knowledge. In retrospect, this prognosis seems to be merely one aspect of the global shift in the balance of power. For the reformers, however, acquisition of modern science by Muslims was a rallying cry. This produced a peculiar discourse in which Islam was used to sanctify acquisition of modern science.

The second important aspect of the Muslim attitude toward modern science evolved out of a large-scale effort to implant new scientific institutions in the colonies. These institutions, which were integrally linked to the eco-

nomic and political designs of the colonizing powers, produced a new generation of Muslim scientists who had almost no intellectual affinity with the Islamic scientific tradition. These new institutions remained under the shadow of their prototypes in France and England and merely regurgitated scientific knowledge being produced in Europe. This secondhand science could not have any relationship with religion because it was concerned with materials and techniques rather than creative and imaginative activity that envisions grand theories and seeks relationships between different domains of reality.

After World War II, direct colonial rule ended rather hurriedly, and almost all Muslim lands attained a certain degree of autonomy—though not complete independence, for most of the ruling institutions retained their colonial vintage. The discourse between Islam and modern science now began to acquire maturity. During the last fifty years, there have been rapid developments in this discourse. For a better understanding of these developments, four distinct phases can be identified: colonial, postcolonial, liberated, and metaphysical.

The Colonized Discourse

The first phase of the discourse between Islam and modern science emerged during the colonial era. It was marked by the violent uprooting of the Islamic tradition—an organic relationship between Islam and various branches of knowledge, including sciences that had formed over the course of centuries. This resulted in a chasm between Muslim scientists and their non-Muslim peers. This was not because modern science came with new facts about nature that could not be reconciled with Islam; rather, this chasm was due to the absence of any grounding of modern science in Islamic intellectual tradition.

Moreover, this colonial-era discourse between Islam and modern science was hindered by extraneous baggage that affected the relationship well into the twentieth century: (1) the self-assessment of Muslims who saw their subjugation to Europe in terms of having missed the scientific revolution; (2) rhetoric that turned the discourse into an apology for Islam; and (3) foreignness—the idea that modern science is a product of a foreign civilization that needs to be imported at all cost. These extraneous issues defined the contours of the Islam and science discourse to such an extent that the real issues were seldom addressed during the nineteenth century, and these three aspects continued to dominate the discourse during the first half of the twentieth century. This heavy overlay expressed itself in two major ways: through various attempts to “Islamize” modern science, and through the production of an extensive literature that attempted to prove the existence of various modern scientific facts and theories in the Quran.

Another issue that clouded the discussions pertaining to Islam and science was the discourse about Islam and modernity. This topic was important to the Arab *Nahda* (renaissance, rebirth) movement of the nineteenth century, which

was shaped by the works of Muslim reformers and thinkers such as Jamal al-Din Afghani, Rifa'ah al-Tahtawi, and Muhammad 'Abduh. Also at issue was the question of the decline of science in Islamic civilization. This discussion was dominated by an Orientalist reconstruction of the problem. The most widely accepted Orientalist formulation posited "Islamic Orthodoxy" against science in order to establish that Islam was opposed to science.

In addition, the Islam and science discourse of this era was shaped by various secular responses to the general social and political condition of the Muslim world. These include nationalism and Marxism, both of which emerged in the Muslim world as part of its efforts to dislodge the colonial yoke but which also affected educational, scientific, and social institutions and hence Islam and science discourse.

It was also during this period that the proponents of the new discourse sought legitimacy and sanction for their program through scientific exegesis (*al-tafsir al-'ilmi*) of the Quran. Beginning in 1880, when the Egyptian physician Muhammad ibn Ahmad al-Iskandrani published a book titled *The Unveiling of the Luminous Secrets of the Qur'an in Which Are Discussed Celestial Bodies, the Earth, Animals, Plants and Minerals*, a new vista was opened for those modernist thinkers who were interested in justifying an agenda of reform, predominantly based on urging Muslims to acquire modern science. After this publication, the trend of writing scientific exegeses of the Quran gained momentum. Al-Iskandrani published another book in 1883 that dealt with the "Divine Secrets in the world of vegetation and minerals and in the characteristics of animals." Al-Iskandrani repeatedly construed his explanations of the Quran to prove the presence of specific European inventions and discoveries in its verses. In the Indian subcontinent, Sayyid Ahmad Khan had a similar approach, attempting to motivate Muslims to acquire modern science by using the Quran.

By the end of the nineteenth century, scientific exegesis had established itself as an independent discipline, though it still lacked general acceptance. The twentieth century saw a steady stream of such works in several languages. This trend reached a high point in 1931 with the publication of the twenty-six volume *tafsir* of Tantawi Jawhari, illustrated with drawings, photographs, and tables. This is one of the earliest comprehensive scientific exegeses in which the author expressly states that he prayed to God to enable him to interpret the Quran in a way that includes all the sciences that were attained by humans so that Muslims could understand the cosmic sciences. The author also believed that the suras (chapters) of the Quran complement things that were discovered by modern science.

The Postcolonial Phase

As Muslim intellectuals and reformers gained more intellectual independence in their postcolonial societies, they began persistently calling their brethren in

faith to acquire modern science. This view was supported by many groups within Islamic culture, as well as by many leaders of the newly independent states. Acquisition of modern science became the battle cry, except for a small segment of traditional *ulama* (religious scholars) who called for a revival of the Islamic spiritual and ethical norms, rather than acquisition of Western science, as a cure for their societies.

In this postcolonial phase, the trend of writing scientific *tafsir* abated, but publication of secondary literature on the Quran and modern science attained new records. This trend slowly gathered momentum during the 1960s and burst into sudden flowering in the late 1970s, when a number of social, political, and economic factors contributed to its spread and popularity. Various state-sponsored institutions organized conferences and seminars in which scientists linked specific verses of the Quran to specific data and theories of modern science to prove (1) the Quran is really a book of God, revealed to the Prophet of Islam, because such specific scientific information was unknown during his life, and (2) the Quran contains all scientific knowledge and it is for science and scientists to discover this knowledge in the Quran. This approach, which is encumbered with an emotional, psychological—even political—baggage, has been challenged by serious scholarship, but its mass popularity remains uncontested. This has given rise to mountains of apologetic literature. The enormously popular *The Bible, the Quran, and Science*, by the French Muslim Maurice Bucaille, was first published in 1976 and since then has been translated into nearly every language spoken in the Muslim world. Hundreds of websites now attempt to prove that the Quran is the word of God because it contains scientific theories and facts that modern science has only recently discovered.

The rise, popularity, and mass distribution of this literature also stem from the oil boom and politics of the late 1970s and early 1980s. It was during this time that a “Commission for Scientific Miracles of Quran and Sunna” was established at Mecca under the aegis of the World Muslim League with six goals and objectives, all of which relate to the same agenda of proving the divine origin of the Quran through science. This profanation of the religious text, patronized by powerful state institutions, received little opposition from the religious quarters.

Liberation of the Discourse

A small number of Muslim scholars have attempted to study the relationship of modern science to their faith through new tools developed in the West to investigate the enterprise of science. These scholars use Western paradigms and frameworks of philosophy of science such as the theory-observation dichotomy and the fact-value distinction, and related concepts such as the very notion of scientific community, history, and sociology of science. These studies produced “Islamic” critiques of modern science—based primarily on the

works of philosophers of science such as Thomas Kuhn, Karl Popper, and Paul Feyerabend. This effort resulted in an “epistemic correction” of sorts, which attempted to “Islamize” modern science.

These attempts share a common notion that science is primarily an epistemic enterprise that attempts to explain the order of physical reality within the exclusive framework of the scientific method. This trend was championed by Ziauddin Sardar and a few closely associated scholars who once called themselves “Ijmalis.” Sardar and his associates contributed to the liberation of the colonized discourse by forcefully articulating that all knowledge, including that of the natural sciences, is socially constructed and is instrumental. Sardar’s major work, *Explorations in Islamic Science*, is based on the assumption that the purpose of science is not to discover some great objective truth; indeed, reality, whatever it may be and however one perceives it, is too complex, too interwoven, and too multidimensional to be discovered as a single truth. Sardar saw science as a tool that can be used to solve problems, relieve misery and hardship, and improve the physical, material, cultural, and spiritual lot of humans. His working hypothesis conceives Western science as only *a* science of nature and not *the* science.

But by situating science within the social realm, and insisting on its utilitarian aspect, Sardar reduces all aspects of philosophy of science to sociology of science. In this culture-specific construction, Sardar and others have built a case for each civilization producing its own specific kind of science within its own worldview, but their formulations are not without serious problems that stem from the very assumptions on which their case rests.

A different movement originated from a deep concern with the epistemology of modern knowledge. Its foremost advocate, Ismail al-Faruqi, argued against dividing education into two systems, modern and Islamic. He supported the unification of the two systems and the “Islamization of knowledge.” This idea led to the establishment of the International Institute of Islamic Thought (IIIT), which continues to pursue al-Faruqi’s vision. However, the exclusion of natural sciences from this plan has been a major handicap. It has produced the illusion that natural sciences create knowledge in the epistemological framework established by the social scientists. This equates the very concept of knowledge (*al-ilm*) with social sciences.

Metaphysical Aspects of the Discourse

A handful of scholars have placed the discourse on Islam and science within a metaphysical framework that derives its principles from the immutable teachings of divine revelation. In contrast to the philosophical and sociological views of science, this metaphysical view of science reiterates the view that nature is sacred because it is a sign (*Ayah*) of the Creator. Science, insofar as it investigates nature, ought to have a sacred dimension. This approach has been used by René Guénon, Frithjof Schuon, Titus Ibrahim Burckhardt, Mar-

tin Lings, Charles Le Gai Eaton, Syed Muhammad Naquib al-Attas, and Seyyed Hossein Nasr. In this view, modern science is a tool with which to study nature and cosmology within a larger framework of knowledge.

Sometimes called the traditionalists, these scholars argue that metaphysical and ontological principles derived from the divine revelation ought to guide all aspects of science. Thus elevated above the historical and geographical planes, this view links all sciences cultivated in the traditional societies to their metaphysical principles. According to this view, the cosmos is teleological and displays a remarkable degree of order and purpose. This *telos* is, moreover, built into the very nature of the cosmos and is not something imparted to it by the observer. This view also holds that metaphysical knowledge should be used to interpret knowledge gained by specific physical sciences, not the other way around. Furthermore, the knowledge gained from the specific physical sciences should be integrated into the framework provided by *sophia perennis* (perennial philosophy), rather than by Cartesian bifurcation and quantitative reductionism. Knowledge that is available to the intellect, moreover, is contained in the heart of all religions or traditions, and its realization and attainment is possible only through those traditions, and by methods, rites, symbols, images, and other sanctified means. The epistemology provided by *sophia perennis* opens the way for relating all acts of knowing to the intellect and, finally, to the Divine.

This metaphysical view restores to the contemporary discourse on Islam and science a perspective that goes back to the revealed sources of knowledge in Islam, the Quran and the Sunnah. It brings the Islamic scientific tradition into the discourse through its exposition of sciences of nature, which admits no reductionism. And it uses a language of discourse that has an affinity with key traditional concepts such as hierarchy, interconnectedness, isomorphism, and unity—qualities built into the very structure and methodology of traditional sciences of nature. As opposed to various attempts to graft Islamic ethics and epistemology onto modern science through artificial means, this approach (1) reestablishes the deeper metaphysical framework of inquiry, (2) constructs a concept of nature according to these metaphysical principles, and (3) explains the contours of sciences of nature within this framework.

Bibliography

- Açikgenç, Alparsalan. *Islamic Science: Towards a Definition*. Kuala Lumpur: International Institute of Islamic Thought and Civilization, 1996.
- Al-Attas, Syed Muhammad Naquib. *Islam and Secularism*. Kuala Lumpur: International Institute of Islamic Thought and Civilization, 1993.
- . *Prolegomena to the Metaphysics of Islam*. Kuala Lumpur: International Institute of Islamic Thought and Civilization, 1995.
- Babar, Zaheer. *The Science of Empire*. Albany: State University of New York Press, 1996.
- Bakar, Osman. *Classification of Knowledge in Islam*. Kuala Lumpur: Institute for Policy Research, 1992.
- . *Tawhid and Science*. Kuala Lumpur: Secretariat for Islamic Philosophy and Science, 1991.

- Burckhardt, Titus. *Alchemy, Science of the Cosmos, Science of the Soul*. Cambridge: Quinta Essentia, 1995.
- . *Mirror of the Intellect: Essays on Traditional Science and Sacred Art*. Cambridge: Quinta Essentia, 1987.
- Chittick, William C. *The Sufi Path of Knowledge: Ibn Al-Arabi's Metaphysics of Imagination*. Albany: State University of New York Press, 1989.
- Craig, William Lane. *The Kalam Cosmological Argument*. London: Macmillan, 1979.
- Golshani, Mehdi. *The Holy Qur'an and the Sciences of Nature*. Binghamton, NY: Institute of Global Cultural Studies, Binghamton University, 1999.
- Hahn, Lewis Edwin, Randall E. Auxier, and Lucian E. Stone Jr. *The Philosophy of Seyyed Hossein Nasr*. Chicago: Open Court, 2001.
- Haq, Syed Nomanul. *Names, Nature, and Things*. Dordrecht: Kluwer, 1994.
- Hourani, George F., ed. *Essays on Islamic Philosophy and Science*. Albany: State University of New York Press, 1975.
- Iqbal, Muzaffar. *Islam and Science*. Aldershot, UK: Ashgate, 2002.
- Izutsu, T. *God and Man in the Koran: Semantics of the Koranic Weltanschauung*. Tokyo: Keio Institute of Cultural and Linguistic Studies, 1964.
- Mabud, Shaikh Abdul. *Theory of Evolution: An Assessment from the Islamic Point of View*. Cambridge: Islamic Academy, 1991.
- Nasr, Seyyed Hossein. *An Introduction to Islamic Cosmological Doctrines*. Albany: State University of New York Press, 1993.
- . *Islamic Life and Thought*. Albany: State University of New York Press, 1981.
- . *Knowledge and the Sacred*. Edinburgh: Edinburgh University Press, 1981.
- . *Religion and the Order of Nature*. New York: Oxford University Press, 1996.
- . *Science and Civilization in Islam*. Cambridge, MA: Harvard University Press, 1968.
- Netton, Ian Richard. *Allah Transcendent*. Richmond, UK: Curzon, 1989.
- Northbourne, Lord. *Looking Back on Progress*. London: Perennial Books, 1970.
- Peters, F.E. *Aristotle and the Arabs*. New York: New York University Press, 1968.
- Peters, Ted, Muzaffar Iqbal, and Syed Nomanul Haq. *God, Life, and the Cosmos: Christian and Islamic Perspectives*. Aldershot, UK: Ashgate, 2002.
- Piamenta, M. *The Muslim Conception of God and Human Welfare*. Leiden: E.J. Brill, 1983.
- Pines, Shlomo. *The Collected Works of Shlomo Pines*. Vol. 2. Studies in Arabic Versions of Greek Texts and in Medical Science. Leiden: E.J. Brill, 1986.
- Rahman, F. *Major Themes of the Qur'an*. Minneapolis: Bibliotheca Islamica, 1980.
- Sabra, A.I. *Optics, Astronomy, and Logic*. Brookfield, VT: Variorum, 1994.
- Saliba, George. *A History of Arabic Astronomy: Planetary Theories During the Golden Age of Islam*. New York: New York University Press, 1994.
- Sardar, Ziauddin. *Explorations in Islamic Science*. London: Mansell, 1989.
- , ed. *The Touch of Midas: Science, Values, and Environment in Islam and the West*. Petaling Jaya, Malaysia: Pelanduk, 1988.
- Sharif, M.M. *A History of Muslim Philosophy*. Karachi: Royal Book, 1983.
- Stenberg, L. *The Islamization of Science: Four Muslim Positions, Developing an Islamic Modernity*. Ludwig, Sweden: Lund Studies in History of Religions, 1996.
- Whitall, Perry N. *The Widening Breach: Evolutionism in the Mirror of Cosmology*. Cambridge: Quinta Essentia, 1995.

25 Science, Philosophy, and Religion in Ancient Greece and Rome

Louis A. Ruprecht Jr.

In these higher regions, in which science is synonymous with the search for truth, science partakes of the nature of religion. It purifies its votaries; it speaks to them in cryptic language, revealing certain exalted realities not unrelated to the realities of music, or of poetry and religion. The men through whom this enthusiasm for pure science passes are surely, each in his degree, transmitters of heroic influence; and, in their own way, they form a kind of priesthood. It must be confessed, too, that this priesthood is peculiarly the product of the nineteenth century.

John Jay Chapman, "Learning"

It is one of the chief paradoxes of "Western" science that its roots actually lay in "Eastern" religion. That may sound bizarre to most modern people, given our implicit assumptions about the *separateness* of religion and science. In order to make sense of it, then, we need a historical investigation of the terms we are using. Part of the story of the history of Western science is, after all, the story of the creation of a vocabulary designed to handle increasingly abstract scientific concepts. The constant challenge of scientific and religious speculation is that we are trying to speculate about things for which our words inevitably fall short. Among the Greeks, providing such a new language was the work of philosophers.

If the body of human knowledge may be imagined as a kind of rising pie, then the ancients did not have as large a pie, and they did not cut that pie into the same number, nor even the same kind, of disciplinary slices as we do, today. They did not discriminate so neatly between philosophy, theology, and science. The work of one discipline was necessarily folded into the others. And the Greeks seemed content to call this complex work "philosophy," the wondering aspiration to a better kind of wisdom.

Yet philosophy—both the word and the work—grew out of Eastern forms of religious speculation. Greek philosophy grew out of Eastern religion, and Western science grew out of Greek philosophy. Greek philosophy, then, is the bridge linking Eastern religion and Western science—and therefore it provides us with a helpful starting point for our investigations.

Pythagoras and Thales

The Roman writer Diogenes Laertius, in his *Lives of Eminent Philosophers* (written c. 250 CE), attributes the start of philosophy to the Greeks. “There are some,” he frowns in the Prologue, “who say that the study of philosophy had its beginnings among the barbarians. They trace it to the Persian Magi, the Babylonian or Assyrian Chaldeans, the Gymnosophists of India, or even the Druids and Holy Ones of the Celts and Gauls.” Diogenes disagreed with this, insisting that “not only philosophy, but the whole human race (genos anthrôpôn) comes from Greece.” So the ancient Greeks must surely have created this most noble art of ancient wisdom; “even the name (onoma) of philosophy (philosophia) resists translation into a foreign language (barbaron),” he states. Diogenes adds that the first man to imagine the word “philosophy,” and to refer to himself as a “philosopher,” was Pythagoras, a truly “religious” mystic if ever there were one.

While little is known about Pythagoras (he wrote nothing down, leaving only a religious brotherhood behind when he died, around the turn of the fifth century BCE), two things may be said about him with confidence. First, the term “philosopher” had a religious valence for him. He apparently insisted that human beings may be called “wisdom-lovers,” but not “wise”—because only God is truly wise. The term “philosophy,” then, is intended to mark a sharp distinction between the human and divine experience. Greek philosophy will never cease to grapple with that division.

The second important thing to note about Pythagoras is where and when he lived. He was born around 570 BCE on the Greek island of Samos, just off the coast of Asia Minor, close by what is now Kusadarsi, Turkey. He left the island at some point in early adulthood (c. 530 BCE) and traveled west to Italy, where he established his mystic brotherhood in the city of Croton, on the very sole of the boot of Italy, in an old Greek colony of ancient standing. Pythagoras, then, is an important early Greek philosophical voice, born where philosophy itself was born—in the wealthy Greek trading colonies along the coast of Asia Minor in the sixth century BCE. While much of Pythagorean doctrine, to the degree that we can reconstruct it, seems strange to modern eyes and ears, it traces out all of the main interests that Greek philosophy will have thereafter.

Pythagoras was interested in the fate of reincarnated souls; his vegetarianism was derived from his belief that these souls may be incarnated as animals and as people in various lifetimes. He was fascinated by numbers, and especially by numerical relations. Perhaps his greatest single discovery was the

arithmetic ratios that exist along the musical scale and that may all be explained in terms of the numbers one through four. Pythagoras was to build an entire cosmology out of this wonderful insight. Indeed, kosmos is yet another Pythagorean invention. He envisioned the universe as a well-defined (and living) whole, one whose various parts were defined in relation to one another. The main thrust of his thought was centered on those relations and ratios. He insisted that the kosmos could not be unlimited, since limit and definition were the very ordering principles of his worldview.

The idea of infinity terrified Pythagoras, as it offended most early Greek thought (myria, ten thousand, was the largest number in ancient Greek). Limited things exist in proper harmonies, Pythagoras believed, and even the burgeoning science of medicine would later be conceived as the elucidation of right relations between various bodily qualities and fluids. Early Greek medicine was almost entirely Pythagorean in inspiration—from Pythagoras’s disciple on Croton, Alcmaeon (who, Aristotle says, “was in the prime of life when Pythagoras was old”), to the slightly later and far better-known Hippocrates (also from the fifth century BCE), who lived nearer to Pythagoras’s birthplace, on the eastern Greek island of Kos.

While Pythagoras clearly represents the fascinating range of interests, which came together under the aegis of “philosophy,” there are anomalous features of his thought. While he was a major influence on Plato, who presumably met Pythagoreans during his long stay in Sicily, Pythagoras did not write anything down himself. And there is something essentially un-Greek, or at least un-Platonic and unphilosophical, about that literary silence.

Pythagoras also abandoned Greece and fled west, where he could conduct a rather non-Ionian lifestyle on what was then the frontier of the western, Greek-speaking colonial world. The real heartland for developments in Greek philosophy and science was well to the east, on the coast of Asia Minor, not far from where Pythagoras had been born and raised, especially the wealthy city of Miletus. We still refer today to the “Milesian School” of Greek philosophy. And its founding father was a mysterious man named Thales.

Philosophy, according to Aristotle’s summary of the discipline, was born of two things. A sense of wonder—or better, the human capacity for wonderment—is the necessary starting point without which there cannot be a true aspiration toward a more deliberate life of wisdom. But this seems to be a character trait, the kind of thing one either has or does not have. It is not really learnable. What *is* learnable, and presumably teachable, is the habitual posing of the fundamental question out of which all such philosophical speculation emerges: the innocent-seeming question *ti estin*, “what is it?” As Socrates’s tragic career made clear, there was nothing innocent about this question at all; he was executed for asking it so relentlessly, and the institutions that felt most threatened by the question were clearly religious and moral institutions. The troubled relationship between traditional religion on the one hand, and philosophy and science on the other, is neither a new nor a modern thing.

But our stage is not yet set for Socrates. What is important to emphasize is that this primordial philosophical question allows different sorts of answers, which we may divide into materialist, functionalist, and formalist answers. The philosopher, confronted with a table, may answer the question “What is a table?” in different ways. The explanation might be a *materialist* account, which tells us what the table is made of: a table is wood and nails and glue. Most of the early Ionian philosophers, whom we might reasonably think of as early scientists, were philosophers of this sort, and Thales was the first of them. But we might also get a *functionalist* answer: a table is designed to hold books and papers, or food and drink. Moral evaluations have a place in this second scheme, though not in the first. We may distinguish between various tables according to how well they serve the proper function of tablehood. Those teleologists who emphasize the end (telos) toward which such things aim find their founder in Aristotle. Finally, a philosopher confronted with the question about tables, and overwhelmed by the variety of tables available for study and comparative analysis, might speculate as to the ideal form of tableness in which all tables participate. Those who seek the single form behind the many manifestations are formalists, or idealists, of the Platonic stamp. It will be noted that we have not yet placed Socrates within this tradition. This is deliberate; his position within these various traditions of philosophical speculation is complex.

In order to understand why, let us return to Thales, and the alleged “birth” of Greek philosophical science at Miletus. We do not know as much about Thales, nor any of the early Ionian philosophers, as we would like. While they all, unlike Pythagoras and Socrates, wrote treatises, none of these texts survives, except for fragmentary lines and half-lines, oracular-seeming pronouncements quoted by later Roman writers such as Diogenes Laertius. Thales’s writings were already lost in Aristotle’s day. Thales seems clearly to have been a cosmologist, a philosopher who devoted his speculative energies to asking “what is the kosmos?” His answer was a materialist answer; one of the few phrases that survives and may be attached with some certainty to his name claims that the origin (archê) of the kosmos is in water. It is difficult to know how to hear such a pronouncement today.

The difficulty is that Thales was not a materialist in the sense that a Marxist philosopher is a materialist. The Ionian philosophers lived prior to an age in which the distinction between matter and spirit had been made. Thus the distinction between materialist and idealist philosophy would have made little sense to them. They were contemplating the kosmos, an entity they imagined as both finite and alive. These philosophers endeavored to determine something about its underlying substance and structure. These questions went together. What is it made of, and how does it work, and what is it for? These were the central philosophical and scientific questions.

It is telling that the various Ionian philosophers worked through all the cardinal elements as they meditated on such cosmologies. Where Thales fo-

cused on water, his successor Anaximenes (fl. c. 545 BCE) focused on air, and Heraclitus (fl. c. 500 BCE) meditated on fire, among other things. What they meant by such pronouncements is unclear—Heraclitus was actually nicknamed “the Obscure”—and it is complicated still further by the subtle meditations of other Ionian philosophers, such as Anaximander (c. 612–545 BCE), who located the essence of the kosmos in warring principles rather than in a single substance. (Heraclitus, with his interest in fire and strife, said similar-sounding things as well, and was believed to have been an early, if ultimately negative, influence on Plato.) Anaximander noted the curious oscillations between hot and cold, moist and dry, and believed the universe to consist of cyclic eruptions and alterations. So, clearly, these men were not interested simply in the materials out of which the kosmos is made, but also in its character, what kind of thing is made of such a substance, the principles by which it moves, changes, and lives. That oscillation, between a static and dynamic kosmos, the fascination with changeableness and eternity, form the crucible out of which most of the rest of the Greek philosophical sciences emerged.

But we are not yet done with Thales. Several stories told about him complicate our picture of the man and the philosophy. Herodotus tells a famous story about Thales’s prediction of an eclipse; this was likely the solar eclipse of May 28, 585 BCE. Later writers such as Diogenes attribute the discovery of the equinox and the solstices to Thales as well. He was thus an astronomer, among other things, a student of the sorts of wisdom at which the eastern Chaldeans excelled. Philosophically speaking, then, Thales was a Greco-Babylonian, a student of the stars. And it is interesting that he should be remembered as a student of eclipses—it is almost as if he were an adept at finding the patterns hidden in the midst of cosmic change. It was the *predictive* power of his studies that inspired the greatest wonder in those around him.

A second famous story about Thales makes this even clearer; it was well enough known that Plato refers to part of it importantly in the *Sophist*, and Aristotle explicates the rest more fully in the *Politics*. The Milesian philosopher was reputedly led outside to study the stars one evening. Gazing upward, he failed to notice a ditch—or was it a well?—and he fell inside. The old Thracian servant-woman who had been leading him around mocked him as he cried out for help. “How can the philosopher claim to be wise about the heavens,” she wondered, “when he doesn’t know what’s lying at his own feet?” We are in the presence, apparently, of one of the oldest tropes in the world: the absent-minded professor, the man of brilliance who is nonetheless completely unequipped for *practical* life in the “real” world. According to a later tradition, Thales, still bristling at the mockery, used his vast meteorological knowledge to predict a very good year for olives, rented out all the mills in the area around Miletus and on the island of Chios, then made a killing in the local oil trade. The interest of this story for our purposes is the way it carefully marks philosophy’s *practical* side. Thales thus “succeeded in proving

that it is easy for philosophers to become rich if they so desire, though this is not the business which they really care about.”

And that is how Thales is remembered—not as a pie-in-the-sky cosmologist, nor as a philosophical weirdo, but rather as an adept in all fields. His career began in politics, Diogenes tells us; he was a latecomer to astronomy. He was sought out for political advice just as surely as the other Seven Sages were. Thales was the first such Sage of all.

Intriguingly, Thales was believed to have traveled to Egypt, at least once. According to Aristotle, Egypt was the birthplace of the mathematical sciences. Impressed by the ancient pyramids, Thales was challenged to discover how tall they were; he landed on a brilliant solution to this intellectual puzzle. He waited until the time of day when his own shadow was precisely the same length as his body, then he measured the shadow cast by the pyramid at this same moment. And so—far more empirically, and far less poetically, than Oedipus—Thales solved this crucial Egyptian riddle.

I emphasize all of this because it is a significant complicating factor in what is otherwise indisputably the major difference between ancient and modern science. Ancient science was not, by and large, empirical. The definitive modern cycle of hypothesis-experiment-revision was largely unknown to the ancients. The Ionian cosmologists who floated theory after theory about the material or organizing principles of the kosmos simply speculated about them. They proposed theories, coined phrases, and argued. But they did not try to trump one another’s theories with empirical observation or experimental evidence. Why, we may well wonder, did they not?

Anaxagoras and Socrates

While the rise of modern empirical science is a complex matter, there is a simple way with which to begin. The Greek philosophers did not trust human sense perceptions about an ever-changing world. They were all skeptics in this sense (*skepsis* is the word for “thought” in Greek). “Natural philosophers,” as they were called, were required to reflect upon nature, but nature is ever changing, impossible to pin down. What is remarkable about the Ionian school is how constant this concern appears to have been. The world is a world of flux and change; the philosopher’s task is to try to find some order, some permanency and stability, in it. It is unclear whether such a thing is possible; the world may just *be* flux and change.

Anaxagoras (c. 500–428 BCE) is a crucial transitional figure in this line of thought. He was also from the coast of Asia Minor, born near the colony of Smyrna (present-day Izmir). He later lived and taught in Athens, under the sponsorship of Pericles, and he was exiled from the city later still—whether for religious or political motives is difficult to tell, precisely because this is yet another distinction the Greeks did not make as clearly as we in the West do today. What is crucial about Anaxagoras is that he seems to have enabled a

major shift in Greek philosophical speculation: from matter to the mind. And it was Mind (nous), according to Anaxagoras, that created order out of chaos, imposing form on formless matter. Mind—not one of the cardinal elements, be sure to note—was the real organizing principle, or *archê*, of the kosmos.

In Plato's *Phaedo*, Socrates refers to his early attraction to the ideas of Anaxagoras—which, he mentions quite tellingly, he first encountered in a *book*. Socrates had heard of a new philosopher and a new philosophy, one whose novel ideas located the really important realities in Mind, not in matter. That, Socrates tells us, was the sort of book he'd been looking for, and he turned to it with great enthusiasm. Socrates's enthusiasm did not last, he explains, for the simple reason that, once having mentioned Mind, Anaxagoras fails to assign anything of importance to the mind at all. Socrates's reaction to the failed promise of Anaxagoras's philosophy inspired him to what he famously calls philosophy's "second sailing." It is an idiomatic, nautical term. When a ship is becalmed at sea, then the sailors pull out the oars and start rowing. It is harder work, and you don't get as far as fast, but at least you move. So, too, with Socrates's plodding, stop-start philosophy. It would have been a marvelous thing, Socrates admits, if the Ionian philosophers had been able to answer their own questions, and had been able to get at the fundamental cosmological mysteries. But they failed to deliver, and Socrates seems content to leave such questions to religious institutions. Socrates's "second sailing" involves the decisive shift from natural and cosmological speculation to more human affairs—to moral and political philosophy, as we would call it today.

Socrates (c. 469–399 BCE) was significant in many ways because he looked so different from the other "philosophers" of his day. Most philosophers traveled widely; Socrates never wanted to leave his city, and he left only when sent by his military leaders. Socrates would rather be executed than exiled; Anaxagoras, who was not originally from Athens, felt the reverse. Most philosophers took money to teach; Socrates famously never charged anyone, feeling that he had nothing to sell. And, whereas most other philosophers demonstrated remarkable ingenuity with natural and cosmological interrogations, Socrates demonstrates a surprising lack of interest in such things. We can get much farther, he argued, with human questions. That decisive shift—from natural to moral and political philosophy—represents the most decisive and intriguing shift in Greek philosophy after Socrates. Philosophy is being detached from what we today would recognize as science. And the relation of either one of these forms of enquiry to religion has yet to be properly understood.

If there is one traditionally religious word that still figures prominently in Socrates's philosophical vocabulary, that word is *therapeia*. It is a word with a powerful medicinal resonance. Healing sanctuaries, especially those dedicated to Asclepius, were a major feature of the ever-changing Greek religious landscape in Socrates's day. To "serve" the gods, one engaged in a practice of *therapeia*. And Socrates famously declared, with Plato's cautious

evangelizing, that philosophy might be best conceived as a form of therapy for the soul. Neither Socrates nor Plato seems to have been “practical” in any other sense; Socrates was notoriously executed by his own city, and Plato’s one attempt to institutionalize his radical political ideals met with dismal failure and eventual banishment in Sicily. Greek philosophy, at least in Athens, would not return to any kind of empirical interests until Plato’s most notable pupil, Aristotle.

Aristotle and Alexander

If Socrates was unlike his Ionian forebears, then Aristotle was rather unlike his Athenian forefathers. He was not from Athens, to begin with, and he spent his long residence there as a metic, a resident alien unable to vote or hold land in the city. His father had been a medical doctor, and through this, Aristotle seems to have inherited an empirical and experimental mentality of his own. Aristotle is the arch-collector; he collects everything, from eyewitness accounts of different forms of animal and plant life, to different forms of political constitutions from different cities. It is very difficult to imagine Socrates or Plato involved in the dissection of a dead animal in order to learn about its physiology. The only people who did such things were priests, and they were interested in reading auguries, not biology. Aristotle was a dissector, as Anaxagoras had been before him.

Aristotle is the great summarian of all the previous generations, and all the enquiry the Greeks had come to think of as “philosophical.” And for Aristotle, virtually everything is philosophical. He wrote about moral and political philosophy. He wrote about natural philosophy, about animals and plants and the like. He also wrote about the soul, and about the gods. While he clearly distinguished between kinds of enquiry that were scientific (*epistêmê*) and those that were more technical or artistic (*technê*), he was deeply involved in both kinds of work. He is the encyclopedist for the entire antecedent tradition of Greek philosophy.

Aristotle’s career overlapped with that of Alexander the Great, a pupil whose lightning strike divided the Greek world into a before and after. On the negative side, Alexander represented the death of the old Greek political order; the fearsome rivalries between fiercely independent city-states were brought into a new kind of imperial order. On the positive side, Alexander expanded the cultural influence of Greek philosophy and culture from its Aegean heartland to the mountains of Afghanistan and North India. The Greeks after Alexander would live in a much larger world, and a whole new body of philosophical questions emerged from these experiences of travel and conquest—in all fields, from natural science, to ethics and politics, to philosophy and law.

Alexander represents the symbolic beginning of the Hellenistic age. He died unexpectedly in 323 BCE. The three major Hellenistic schools that emerged in subsequent generations—Skeptic, Epicurean, and Stoic—all considered them-

selves engaged in a practice Socrates would have embraced. All three schools returned to that fundamental philosophical interest in *therapeia*. But Stoicism did far more than this; Stoicism claimed to be a *complete* philosophy for a complete way of life. The soul's therapist also needed to be a moralist, *and* a religionist, *and* a scientist. The Stoics were the first great know-it-alls, and were even mocked as such by those who remained unconvinced.

The Hellenistic age was also the first age of the library—most famously the one built in Alexandria, Alexander's great port city by the Egyptian Sea. Aristotle had already made himself famous for the size and extent of his own private library. But the new Hellenistic libraries would be seen as the great repositories of all the collected wisdom of the known world. Men would go to astonishing lengths to gain an appointment as chief librarian in such a place. The first medical, and even gynecological, handbooks were composed in this age, as empirical medicine became a science, or rather an art, in its own right. Geography and ethnography were new fields of scientific enquiry based on the same sudden experience of cultural diversity, an experience of the world's vastness and complexity. Curiously, while the first world map was publicly installed by Agrippa (c. 64–12 BCE) at his own expense in Rome, Anaximander was believed to have been the first man ever to have drawn a map and built a globe.

Stoicism, a new philosophical movement initiated by Zeno—who hailed from the island of Cyprus but enrolled his services in Athens—became the preeminent new philosophy for the new Hellenistic world. The Stoics were interested in questions of comparative ethics and comparative law. How might different peoples be organized in a single empire? How were disputes between rival ethical or legal systems to be adjudicated? What is the essence of human nature or of natural human rights? If these questions have a contemporary air about them, the Stoics were the first Western thinkers to pose them. This philosophical movement, begun in Athens, was institutionalized first on the island of Rhodes, not far from the Ionian birthplace of philosophy itself. It was here that as late a figure as Cicero studied Stoicism. But then the school moved to Rome, the emerging imperial capital of the entire Mediterranean basin, and a new world was to be born.

Rome

The shift from the Hellenic to the Roman may be read in many ways. One notable feature is characteristic of the larger change. Although Roman philosophy and literature were often imitative, when not actually derivative, what was altogether novel was the engineering. The Romans were not merely empirically minded; with them, it is the undeniable technological power of the well-organized empirical mind that becomes evident. We live in the midst of a similar sea-change today, one that arguably began in the mid-twentieth century, with the rise of a distinctively North American technocracy. We learn first to conceive of heat as atomic and molecular motion. Then we learn to

agitate atoms with microwaves. And so a radically new form of oven is born. There were far more serious technological effects to the new physics as well.

It is one thing to learn, after Einstein, that matter and energy are intimately related in ways we scarcely imagined before; it is quite another to use that knowledge to change the very nature of the political world we inhabit. I may know that a table is composed mostly of empty space, yet practically, I can still deal with it as if it were a solid object. Our knowledge of atomic matter and energy did not long remain at this level of abstraction, of course. These conceptual ideas possessed enormous technological and military power at the end of the Second World War, and it is hard to imagine meditating on modern politics without facing up to the Bomb. Theoretical science first established its practical edge among the Romans; we live much farther down a road that they, and not the Greeks, paved first.

The Romans were arguably the greatest military and civil engineers the world has ever seen. They were preeminent in the arts of water management. Still today, two of the premier symbols of Roman power and Roman prestige are their aqueducts and bathhouses. That emblematic Roman commitment to the creature comforts of daily living was one of the empire's singular achievements. And it has a great deal to do with being very scientific about the movement and distribution of clean water. These still potent images were selected to represent Europe on its new paper currency, the euro.

It is more than merely suggestive, then, to note that the story of Greek philosophical science began on the coast and began with water. Thales made water the universal element of the kosmos; it was an especially pregnant choice for a man who may have been a Phoenician as well as a Greek. The Greeks were sea-people, and they spread their culture by sea. These ancient philosophers who traveled so widely did so by sea. It is unsurprising, then, that they identified their kosmos with water. If there is a line to be drawn from the earliest Ionian speculation to the regime of modern science, then it may be right to draw it here. Our contemporary cosmologists, from the late Carl Sagan to Stephen Hawking, all appeal significantly backward to the Greek origins of what they are doing. We still call the planets and stars by Greek and Latin names; we still call our cosmic explorers "astronauts," literally those who sail the stars. The question of how best to inhabit our own modern ether—whether speculatively as philosophers, or technically as engineers—is quite possibly the question modern science shares most profitably with its ancient Greek forebears.

Bibliography

- Burnet, J. *Early Greek Philosophy*. New York: Blackwell, 1930.
 Casson, Lionel. *Libraries in the Ancient World*. New Haven, CT: Yale University Press, 2001.
 Chapman, John Jay. "Learning." In *Unbought Spirit*, ed. Richard Stone, 72–92. Champaign: University of Illinois Press, 1998.
 Cornford, Francis M. *Before and After Socrates*. Cambridge: Cambridge University Press, 1966.

- . *From Religion to Philosophy: A Study in the Origins of Western Speculation*. Princeton, NJ: Princeton University Press, 1912, 1991.
- Diels, H. *Die Fragmente der Vorsokratiker*. Berlin: Wiedmann, 1906.
- Dilke, O.A.W. *Greek and Roman Maps*. Ithaca, NY: Cornell University Press, 1985.
- Green, Peter. *Alexander to Actium: The Historical Evolution of the Hellenistic Age*. Berkeley: California University Press, 1990.
- Guthrie, Kenneth S. *The Pythagorean Sourcebook and Library*. Grand Rapids: Phanes, 1987.
- Guthrie, W.K.C. *The Greek Philosophers: From Thales to Aristotle*. New York: Harper and Row, 1950.
- Heidegger, Martin. *Early Greek Thinking: The Dawn of Western Philosophy*. Trans. David F. Krell and Frank A. Capuzzi. New York: Harper and Row, 1975.
- Kirk, G.S., J.E. Raven, and M. Schofield, eds. *The Presocratic Philosophers*. Cambridge: Cambridge University Press, 1983.
- Lloyd, G.E.R. *Early Greek Science: Thales to Aristotle*. London: Chatto and Windus, 1970.
- . *Greek Science after Aristotle*. New York: New York University Press, 1973.
- . *Magic, Reason, and Experience: Studies in the Origin and Development of Greek Science*. Cambridge: Cambridge University Press, 1979.
- . *Science, Folklore, and Ideology: Studies in the Life Sciences in Ancient Greece*. Cambridge: Cambridge University Press, 1983.
- Nietzsche, Friedrich. *Philosophy in the Tragic Age of the Greeks*. Trans. Marianne Cowan. Chicago: Regnery, 1962.
- Nussbaum, Martha C. *The Fragility of Goodness: Luck and Ethics in Greek Tragedy and Philosophy*. Cambridge: Cambridge University Press, 1986.
- . *The Therapy of Desire: Theory and Practice in Hellenistic Ethics*. Princeton, NJ: Princeton University Press, 1994.
- . *Upheavals of Thought: The Intelligence of Emotions*. Cambridge: Cambridge University Press, 2001.
- Phillips, E.D. *Greek Medicine*. London: Thames and Hudson, 1973.
- Romm, James. *The Edges of the Earth in Ancient Thought*. Princeton, NJ: Princeton University Press, 1992.
- Sagan, Carl. *Cosmos*. New York: Harper and Row, 1975.
- Smith, W.D. *The Hippocratic Tradition*. Ithaca, NY: Cornell University Press, 1979.
- Temkin, Owsei. *Hippocrates in a World of Pagans and Christians*. Baltimore: Johns Hopkins University Press, 1991.

26 Patristic Theology and Greek Natural Philosophy

Matthew F. Dowd

In the first century CE, the new religion of Christianity began to spread across the Mediterranean world. Over the next four centuries, theologians, ministers, and eventually councils of the church worked through various theological controversies and issues. One significant problem for the early church was to sort out the proper relationship between Christianity and the classical culture in which large portions of the educated population were raised. It is at this intersection of Christianity and classical culture that the relationship of science and religion had to be worked out.

In the classical world, no profession of science existed as we understand it today. Artisans and craftspeople worked with physical materials, whereas natural philosophers contemplated and theorized about the functioning of the physical world. In the former category, practitioners kept private among themselves much of their craft knowledge, which in any event had more of the character of trial and error methods than scientific experimentation. In the latter category, a wide range of theories and acceptable methods of investigation were promoted. Thus the early Christian writers faced neither a single account of nature nor a unified group of professional individuals who could be identified as scientists.

Also, the aspects of classical culture that we might identify as scientific were not identified as a distinct subset of classical culture. Wrapped up in ideas about the physical world and the means to investigate it were various ideas about ultimate reality, ethics, and religious belief. For example, an examination of astronomy would reveal not just observational data and mathematical models but also ideas about the influence of celestial matter or beings on human free will and action, as well as the nature of God or gods and their role in the motions of the heavens. Thus Christian writers had the task of understanding the proper relationship not only between science and religion, but also between the claims of Christian faith and the ideas of classical philosophy more generally.

Nevertheless, Christian writers were forced to deal with issues of a generally scientific character—that is, questions about the physical world—because one important aspect of the Christian understanding of the world was that the world was created. So issues of how the world functions were significant in understanding God’s relationship to humanity, as well as the ramifications of our own nature as created beings. Yet because of the influence of classical culture on centuries of thought about how the world functions, Christian authors had access to a ready supply of intellectual material regarding the topic. This could be both a valuable tool, if one accepted the received picture of the world as a basis on which to speculate, and a challenge, if the tenets of natural philosophy seemed to contradict religious thought—for example, when astrological principles threatened the Christian principles of free will and responsibility.

Thus scientific material was bound up in a broader classical culture, and issues of a scientific nature were caught up in theological demands. These complicating factors led to a wide variety of Christian responses. No Christian theologian of the patristic period dealt with issues of science and religion in the same fashion we might today, due to the simple fact that science did not exist as we think of it today, but similar issues arose. Moreover, no single response dominated Christian theology in the patristic period. Theologians had mixed reactions to Greek philosophy, seeing both benefits and dangers in using its resources to understand the physical world.

Negative Appraisals of Greek Philosophy

Some theologians of the Christian church had a generally negative reaction to classical culture and philosophy, though rarely was that negative reaction explicitly limited to natural philosophy. These authors emphasized a number of general features of classical culture as a threat to Christian thought and pedagogy: the ubiquitous assumption of false (to Christian minds) pagan gods; the reliance, implicit or explicit, on the human mind alone for understanding issues of great magnitude, such as the nature of the world, or moral and ethical philosophy; the shameful depictions of divine and human behavior in works of literature and history, which were an integral part of the classical educational curriculum; and the lack of recognition of the importance of Christ’s incarnation for the salvation of humanity. Yet even those who had negative reactions often used Greek philosophy, at least implicitly through their methods, concepts, and vocabulary, to elucidate Christian theology.

Examples of Christian theologians who distrusted Greek philosophy can be drawn from a variety of times within the patristic period (indeed, this kind of mistrust of non-Christian sources of ideas still exists in some current controversies surrounding science and religion). Here, we will examine the early thinkers Justin Martyr and Irenaeus, the North African theologian Tertullian, and the biblical scholar Jerome. Natural philosophy was not a particularly significant aspect to their rejection of classical culture, though their mistrust

or blanket condemnation surely included natural philosophy, and thereby much of the contemporary tradition that we most closely identify with science.

Justin Martyr and Irenaeus, both active in the second century, were concerned with establishing proper Christian belief, the former by writing apologetic works that defined Christian belief, and the latter by attacking what he labeled heretical views. In both cases, Greek philosophy was identified either explicitly or implicitly as a part of the improper beliefs of their opponents. For Justin Martyr, Greek philosophers, especially the Platonists, had identified certain aspects of the divine correctly. Because they did not have the true Christian belief, however, their philosophy was not only incorrect but actually dangerous to believers' souls, for it could lead them into error. For Irenaeus, Greek philosophy was not his major concern; rather, he focused on opponents who saw themselves as part of the Christian community. Greek philosophy was not identified explicitly as dangerous or threatening. But Greek philosophy received implicit criticism because of its similarities with the beliefs of opponents of Irenaeus—such as the followers of Marcion and the people Irenaeus labels “gnostics”—on issues of knowledge of God and God's relationship to the world. A suspicion of Greek natural philosophy could easily arise out of such blanket condemnations of heretical Christian beliefs.

Tertullian, a North African who flourished around 200, is often presented as antirationalist, and particularly as anti-Greek. No doubt his famous question “What has Athens to do with Jerusalem?” contributes to this generalization. But like the other theologians discussed here, Tertullian was clearly an educated man of his times; he shows great familiarity with the pagan writers that formed part of a classical education, in some places even knowing enough philosophy to recognize the contradictions between competing schools of thought. But it was not rationalism per se to which Tertullian objected. Rather, he saw around him, built into the contemporary culture, the rejection of Christian attitudes and the active persecution of those who lived a pious life. Apologetically defending Christianity, he urged his fellow Christians to distance themselves from the sin and worldliness that he saw among his contemporaries, and therein lies his rejection of “Athens.” As with the earlier apologists, natural philosophy was never Tertullian's main target, but it was easily lumped into a rejection of things unnecessary to Christianity.

Jerome was active in the fourth century, when Christianity had become favored in the Roman Empire. Growing up in a wealthy Christian family, Jerome was educated in Rome, where he received a thorough grounding in grammar and rhetoric through study of the classics, such as Virgil and Cicero, although he likely did not study much philosophy until later in life. In middle age, as he recounts in his famous Letter 22, Jerome had a life-changing episode. Jerome had a habit of reading Cicero and Plautus, even though he was planning to devote himself to Christianity. In a dream, he was accused of being a follower of Cicero, rather than Christ. At that point, he says, he gave up the texts of humans for the divine. Natural philosophy apparently played

no part in this episode, and yet it is significant for what it demonstrates about one Christian reaction to classical philosophy: that it misleads the believer and that at best it is trivial, at worst downright dangerous. And this position had the authority of a major Christian intellectual, responsible for important works of biblical scholarship, the promotion of asceticism, and translations of various Greek, Christian writers into Latin.

Positive Appraisals of Greek Philosophy

Just as many theologians found classical culture a threat, many of them embraced Greek philosophy as a useful tool for theological investigation and educational practices. That the New Testament was written in Greek, for example, made sophisticated analysis of the scriptures impossible without a thorough understanding of the language. But none of the Christians thinkers who generally accepted Greek philosophy did so without some reservation: they always recognized mistakes and failings, as they understood the situation, in the works of the pagan philosophers. Here, we will look at two sets of Christian thinkers who were intellectually linked: first, a pair of North African theologians, Clement and Origen, perhaps teacher and student, and certainly both advocates of using Greek philosophy to elucidate Christian thought; and, second, the three Cappadocians, Gregory of Nazianzus, Basil of Caesarea, and Gregory of Nyssa, related in training and in thought, as well as, in the case of the latter two, by blood.

Clement of Alexandria, who flourished in the decades surrounding the year 200, is known especially for a trio of works: the *Exhortation to the Greeks*, the *Paedagogue*, and the *Stromateis*. These works metaphorically demonstrate his own life of being brought up in a pagan intellectual climate, his conversion to Christianity, and his eventual career as a theologian and catechetical instructor. In the *Exhortation*, Clement attempts to bring those raised in pagan culture to belief in Christianity. He does so not by condemning classical culture, but by using it to commend Christianity, holding the latter up as the ethical and aesthetic fulfillment of the promise of much Greek philosophy and literature. In the *Paedagogue*, Clement offers instruction for the proper Christian way of life, both in terms of belief and behavior—though not explicitly as a negative assessment of pagan life—and sometimes even using classical sources to reinforce his claims. In the *Stromateis*, Clement attempts to construct a true (as opposed to the incomplete, Greek) philosophy from Christianity. Much of the first book deals with arguments anticipating those who would object to his use of Greek philosophical and literary sources. He explicitly formulates the position that the Greeks knew much of God, though certainly not fully, and thus much of value can be taken from them. Greek philosophy had made much progress in understanding the divine and its relationship to the world, including the expectations for human belief and behavior that this relationship entails.

Origen, active in the first half of the third century, was known especially for his biblical exegesis and his place in later controversies in which various of his positions were condemned by the church. He was probably a student of Clement and certainly belonged to the same tradition of appropriating Greek philosophy on behalf of Christian theology. Origen's interests and contributions were many and varied, including biblical scholarship and commentary, works of theology, and an active ministerial life. In *On First Principles*, he presents ideas about the physical cosmos as it is to be understood within Christian belief. Proceeding from a discussion in which he demonstrates the created nature of the world, Origen goes on to discuss various aspects of the greatly varied nature of the world and the living creatures within it. Relevant to this kind of discussion are the nature and causes of matter and substance. All of these considerations were important questions for Greek natural philosophy. Thus it is clear both that natural philosophy is relevant for Christian belief and that Christian theology must make clear how such questions are to be answered within the confines of Christian belief. Origen thus validates the pursuit of natural philosophical questions, while at the same time using and transforming the Greek natural philosophy that had already addressed these questions.

A century later, a trio of closely connected theologians formulated important claims about the status of classical education and philosophy for Christian belief, and in addition had much to say about natural philosophy and the sciences. The brothers Basil of Caesarea and Gregory of Nyssa together with their friend Gregory of Nazianzus are collectively known as the Cappadocians. All three were born into well-to-do Christian families and lived during a period when Christianity was both a legal religion and in the ascendancy within the Roman Empire (having been embraced for a number of decades by members of the imperial family). Their similarity in these biographical details to Jerome is striking, but they had a very different notion regarding the place of a classical education and Greek philosophy in the intellectual life of the Christian believer.

All three Cappadocians were quite comfortable with their classical education, and each recognized the benefits that could accrue to a Christian grounded in the skills of rhetoric that their education had emphasized. Basil, in his *Address to Young Men on Reading Greek Literature*, wholeheartedly endorsed a classical education—as a means to train the mind—though always under the assumption that it was supplemented by Christian belief. The comfort with which the Cappadocians dealt with Greek classical culture is likely due to two related factors: they were raised in a period when Christianity was in ascendancy, and they came from families made up of devoted practitioners of Christianity. In such an environment, the potential threat of the pagan content of classical culture was undermined by the presumption that classical authors had performed their work in a world created by God. Thus the Cappadocians could confidently usurp, for example, Platonic thought that was compatible with Christian belief.

Within the specific context of science and religion, Basil is the most interesting of the Cappadocians because of his sermons on the creation story in Genesis, his *Hexameron*. These sermons are replete with allusions and explicit references to Greek natural philosophical theories, thus demonstrating Basil's understanding of the relationship between science and religion. Basil uses Greek science to explain difficult passages in Genesis; for example, he uses Greek elemental theory to explain why the dry land is called "earth." Basil also notes that Greek science can lead to a greater appreciation of God's work in creation: the miracles of nature illustrate God's power, the perfect adaptations of plants and animals to their environments show God's foresight, and the arrangements made for human flourishing demonstrate God's care for humanity. Scientific knowledge can even correct human belief about God; for example, that hemlock is poisonous to humans but not to starlings shows that God cares not just for humans but also for all of creation. Basil argues (perhaps humorously to the modern mind) that the creator provides certain animal behaviors as examples for humans to emulate, such as cranes' care for their elderly, showing humans that they too ought to care for their elderly.

Basil does not, however, accept Greek natural philosophy without certain caveats. He warns that natural philosophy by itself will not lead one to consideration of God, and indeed that Greek scientists have neglected to consider the creator while they carefully examine the creation. And Basil points out that Greek natural philosophy is full of contradictions, such as debates over the number of elements or the shape of the earth, and that it can lead to false beliefs about the world that revelation has shown to be incorrect, such as astrology. So even though Basil admires much that Greek natural philosophy has to offer and is confident that its methods are an aid to understanding God's contingent creation, he does not wholly endorse contemporary science as the most valid form of knowledge.

A Compromise Position

In nearly all the cases discussed above, no theologian's carefully considered position completely rejects or accepts the legacy of Greek philosophy. Even had they desired to reject Greek philosophy, it proved impossible to do without the language and ideas that were a prominent part of the intellectual milieu of late antiquity. And if they wished to use in a robust sense Greek philosophy, they discovered that certain ideas and attitudes from within that philosophy either failed to live up to the revelation of true belief or even constituted dangers to Christian tenets.

In the end, the dominant position of Christian theology toward Greek philosophy, and Greek natural philosophy in particular, became a utilitarian one. So long as the dangers of Greek philosophical positions were clearly enumerated, the potential benefits could be used profitably. That such a position came about after Christianity had been formally legalized within the Roman Em-

pire is no accident, because it was only from a position of strength that Christian thought could confidently use the intellectual apparatus that had formerly been seen as a serious threat. Likewise, only from a position of confidence could theologians pick and choose which parts of natural philosophy would prove helpful to Christian communities.

This compromise, utilitarian position toward natural philosophy is best typified in the writings of Augustine. Although Augustine's mother was a devout Christian, Augustine initially rejected Christianity, in part, according to his own account in the *Confessions*, because he found the scriptures poorly written compared with the works of classical literature in which he reveled. Spending many years in search of truth, Augustine investigated classical philosophy and Manichaeism before returning to Christianity, eventually becoming a bishop in North Africa. His prodigious writings made him one of the most important Latin theologians of the church.

Like many of his predecessors, Augustine received a thorough education in the classical tradition, and with his acceptance of Christianity, he had to sort out precisely what role that background could validly serve. In his *Confessions*, Augustine demonstrates that classical literature misled him, both with its moral example and with the devious way its attractive style insinuated itself with young persons. And in his monumental *City of God*, Augustine points out many errors of Greek philosophy, made obvious in his mind not only by the revelation of Christ but by the operation of reason. So the undercurrent of mistrust of classical philosophy and education is apparent in Augustine. Yet Augustine also saw much of benefit in the classical background of his education. He credited the philosophers, for example, with leading him to certain intellectual positions that helped him reject mistaken opinions, such as Manichaeism, and left him more open to Christianity. He also recognized that his training in rhetoric enabled him to proclaim the Christian message more effectively.

In the arena of natural philosophy, Augustine had much to say, though some of his positions must be surmised from context rather than explicit statements. The heart of his position is that much of the natural philosophy available from the Greeks gets certain things right, but ultimately that these things are not essential to the Christian. Augustine's knowledge and use of astronomy and astrology will help to demonstrate this position. Augustine was, for a time, a devotee of astrology, proficient enough to cast horoscopes for a friend. (In late antiquity, astrology was not a fringe science, but was part and parcel of the study of astronomy; the point of studying the motions of the celestial bodies was to understand their effect on the terrestrial realm.) Part of Augustine's reasons for rejecting Manichaeism was that Faustus, who had been held up as having answers to many of Augustine's vexing questions, understood astronomy less ably than Greek natural philosophy. So Augustine knew enough astronomy to be confident that it was correct in its descriptions. However, the fifth book of his *City of God* contains an extended argument that uses both scripturally based and purely rational means to refute astrology.

Yet even with his denunciation of the astrological principles of Greek natural philosophy, Augustine still found the study of natural philosophy useful for the Christian. For one thing, knowledge of natural philosophy could prevent the Christian from looking the fool in discourse with nonbelievers, by preventing the Christian from mistakenly holding erroneous positions about matters that could be clearly demonstrated by reason. Natural philosophy could be helpful for biblical exegesis, as demonstrated through Augustine's *On the Literal Meaning of Genesis*, which makes use of a great deal of natural philosophy. And finally, Augustine notes that science has purely practical benefits, such as the way in which astronomy aids agriculture and navigation.

While he lauds Greek natural philosophy and certain aspects of Greek philosophy more generally, Augustine is still wary of the dangers of its study, perhaps cognizant of his own prior infatuation with literary classics and astrology. He acknowledges that natural philosophy can cause one to concentrate on unimportant matters. The time and care it takes to understand astronomy, for example, could lead one to pay too much attention to phenomena that are essentially trivial. Ultimately, while this knowledge is not dangerous in and of itself, though its study can be distracting, it is also not of utmost importance to the Christian believer, for it does not lead to the salvation of souls.

Like other theologians before him, Augustine adopted a nuanced position regarding Greek philosophy, accepting certain aspects of it as potentially helpful while simultaneously insisting that dangers lurk within its study. His explicit concern with issues of natural philosophy arose out of his particular circumstances and background, but it reflects his position regarding classical education and philosophy more generally.

Augustine's position represents the most important theological response to natural philosophy in the Western, Latin tradition. His understanding of the situation, however, represents only one of a range of options available during the patristic period. Some Christian theologians saw Greek philosophy, and thus by association natural philosophy, as a danger to Christian belief. Others saw relatively little danger in the use of an appropriated philosophy, properly modified by Christian understandings of the world. Thus Greek natural philosophy could usefully be put to Christian purposes, even illuminating the nature of God and the study of scripture. The vibrant, active theology of the patristic period did not speak with one voice, but expressed many different positions regarding the relationship between science and religion.

Bibliography

- Augustine. *City of God*. Trans. Henry Bettenson. New York: Penguin, 1984.
- . *Confessions*. Trans. F.J. Sheed. Indianapolis, IN: Hackett, 1993.
- . *On the Literal Meaning of Genesis*. Trans. John Hammond Taylor. *Ancient Christian Writers*, vols. 41–42. New York: Newman, 1982.
- Barnes, Timothy David. *Tertullian: A Historical and Literary Study*. New York: Oxford University Press, 1971.

- Basil of Caesarea. *Address to Young Men on Reading Greek Literature*. In *St. Basil: The Letters*, vol. 4, 379–435. Loeb Classical Library, vol. 270. Trans. Roy Joseph Deferrari and Martin R.P. McGuire. Cambridge, MA: Harvard University Press, 1934.
- . *Exegetical Homilies*. Trans. Sister Agnes Clare Way, C.D.P. Fathers of the Church, vol. 46. Washington, DC: Catholic University of America Press, 1963.
- Brown, Peter. *Augustine of Hippo*. Berkeley: University of California Press, 1967.
- Clement of Alexandria. *Fathers of the Second Century*. The Ante-Nicene Fathers, vol. 2. Grand Rapids, MI: Eerdmans, 1989 (reprint).
- Cochrane, Charles Norris. *Christianity and Classical Culture: A Study of Thought and Action from Augustus to Augustine*. London: Oxford University Press, 1944.
- Jerome. *Principal Works of St. Jerome*. Trans. W. H. Fremantle. The Nicene and Post-Nicene Fathers, second series, vol. 6. Grand Rapids, MI: Eerdmans, 1989 (reprint).
- Kelly, J.N.D. *Jerome: His Life, Writings, and Controversies*. New York: Harper and Row, 1975.
- Lindberg, David C. “Early Christian Attitudes toward Nature.” In *The History of Science and Religion in the Western Tradition*, ed. Gary B. Ferngren, 47–56. New York: Garland, 2000.
- . “The Medieval Church Encounters the Classical Tradition: Saint Augustine, Roger Bacon, and the Handmaiden Metaphor.” In *When Science and Christianity Meet*, ed. David C. Lindberg and Ronald L. Numbers, 7–32, 288–91. Chicago: University of Chicago Press, 2003.
- Origen. *On First Principles*. Trans. G.W. Butterworth. Gloucester, MA: Peter Smith, 1973.
- Pelikan, Jaroslav. *Christianity and Classical Culture: The Metamorphosis of Theology in the Christian Encounter with Hellenism*. New Haven, CT: Yale University Press, 1993.
- Rousseau, Philip. *Basil of Caesarea*. Berkeley: University of California Press, 1994.
- Tertullian. *The Writings of Tertullian*. The Ante-Nicene Fathers, vol. 3. Grand Rapids, MI: Eerdmans, 1993 (reprint).
- Trigg, Joseph Wilson. *Origen: The Bible and Philosophy in the Third-century Church*. London: SCM, 1985.

27 Religion and Science in the Middle Ages

Edward Grant

Although it is customary to use the terms *religion* and *science* in any discussion about the interrelationships between these two broad subjects during the Middle Ages (c. 500–1500), it would be more accurate to substitute *theology* and *natural philosophy*, reserving *science* for the exact sciences that were dependent on mathematics: astronomy, optics, and mechanics. To these, the very inexact science of medicine might be added, since it was regarded as an independent discipline from the days of the great Greek physician Hippocrates in the fifth century BCE. If we confined our attention to the relations between religion and the exact sciences and medicine, there would be little to say, largely because there were no significant issues involving these subject areas during the Middle Ages.

With the exception of the exact sciences and medicine, the operations and structure of the rest of the cosmos was studied by natural philosophy, a discipline that was largely derived from the works of the great Greek philosopher and scientist Aristotle in the fourth century BCE. Natural philosophy, as it was understood from the early centuries of Christianity to the end of the Middle Ages, was the study of change and motion in the physical world. Because its domain was the whole of nature, natural philosophy did not, and could not, represent any single science. Instead, it embraced bits and pieces of numerous sciences, such as physics, cosmology, geology, meteorology, biology, and psychology. It also included theories of the origins of the world, whether it had a beginning or always existed; how animate and inanimate bodies are generated and how they are corrupted and come to an end; how and why bodies fall or rise, and what causes them to move from one place to another; how bodies would act under certain imaginary conditions within or beyond our world.

The secular discipline of natural philosophy raised concerns for the Christian church, which at times attempted to eliminate any claims that seemed hostile to the religion. But the efforts to protect Christians were only temporary reactions, eventually replaced by a full acceptance of that important discipline.

Early Christianity and Greek Science

During the early centuries following the birth of Christianity, the Greek church fathers played an instrumental role in shaping Christian attitudes toward pagan learning, especially Greek science and natural philosophy. Because they came from different backgrounds, the Greek church fathers were hardly of one mind. Some were hostile to science, fearing it as a rival to the faith and as potentially subversive. Others, such as Clement of Alexandria (c. 150–215) and his disciple Origen of Alexandria (c. 185–254), were convinced that Christians stood to profit from knowledge of Greek philosophy and science, so long as these subjects were not studied for their own sakes, but only as “handmaidens to theology,” a procedure already advocated early in the first century CE by Philo of Alexandria, or Philo Judaeus, a resident of the Jewish community of Alexandria. The “handmaiden” approach won widespread support within Christianity and triumphed over the rival approach that sought to avoid all contact with Greek science and learning. It was a compromise between the total rejection of pagan learning and its full acceptance. Christians felt free to use Greek philosophy and science to explicate holy scriptures as well as to elucidate problems in other aspects of their lives. To explain Genesis, with its description of the six days of creation, Greek science and natural philosophy were essential, as is evident in the three great commentaries on Genesis by Basil, Ambrose, and Augustine, which were influential throughout the Middle Ages.

During the first six centuries of Christianity, pagan Greeks continued to contribute to the storehouse of Greek science and natural philosophy. Treatises were written that significantly advanced mathematics, astronomy, medicine, and engineering. In the fifth and sixth centuries, commentaries were written on the scientific works of Aristotle that would play an influential role in medieval natural philosophy. The cultural context within which science and natural philosophy functioned, however, was altered when the Roman Empire split into two parts. The eastern part, which became the Byzantine Empire, survived until 1453; the western part fell into serious decline under the impact of barbarian invasions between the fifth and tenth centuries.

The Introduction of Aristotle’s Natural Philosophy

By the eleventh century, a new Europe was emerging that differed greatly from the Roman Empire. There was a great emphasis on agriculture, urbanization, and education. Europeans knew they were impoverished in the sciences and natural philosophy and wished to remedy this deficiency. To do this they had to translate Greek and Arabic works into Latin, a process they eagerly began in the twelfth century and continued to the end of the thirteenth. When the process was completed, translators in Western Europe had translated into Latin most of the great works from Greek and Arabic authors. This literature ranged over the

exact sciences, medicine, and especially natural philosophy. In the latter category, the most important works were those of Aristotle (384–322 BCE), probably the greatest philosopher and scientist of the ancient world.

Aristotle's works on logic and natural philosophy came to dominate intellectual discourse throughout the late Middle Ages to the end of the seventeenth century. The core treatises in his natural philosophy are commonly titled: *Physics*, *On the Heavens*, *On Generation and Corruption*, *Meteorology*, and *On the Soul*. His works on logic and metaphysics were also extremely important, as were his treatises on biology, politics, and rhetoric. But Aristotle's works on natural philosophy proved controversial and, for some, threatening. The hostile reaction to Aristotle's natural philosophy occurred largely in the thirteenth century, the first century when most of Aristotle's works were available for study and discussion. Prior to the translations from Greek and Arabic into Latin, Western Europe was largely ignorant of the great works of science and natural philosophy that were long known in the Byzantine Empire and Islam. With the influx of such a large body of translated science, it is appropriate to inquire how Christians responded to a body of literature with which they were unfamiliar, but eagerly sought, even though they were probably aware that lurking in that literature were potential problems for the faith.

Even before the great age of translation, Europe was astir in the twelfth century, when the major source of natural philosophy was Plato's *Timaeus*. The better-known natural philosophers of this period—Honorius of Autun, Thierry of Chartres, William of Conches, Adelard of Bath, and others—began to challenge ecclesiastical authority by rejecting causal explanations of natural phenomena that invoked God's omnipotence or relied on biblical passages. Appeals to divine causation came to be regarded as little more than confessions of ignorance. Many scholars in the twelfth century were convinced that only natural explanations could properly explain natural phenomena. In the dynamic society that emerged in the twelfth century, human reason was given a central role that it had not previously had. William of Conches (c. 1080–1154), for example, exalted reason over ecclesiastical authority when he criticized "modern priests" who "do not want us to inquire into anything that isn't in the Scriptures, only to believe simply, like peasants." Although he conceded that it is not lawful to speak against the faith or against the church fathers, William insisted: "in those matters concerning philosophy, if they err in any respect, it is permissible to differ from them. For even though they were greater men than we are, yet they were men."

With the ready availability of new Latin translations of Aristotle's natural philosophy in the thirteenth century, reason was given a central role that it had not had before. For the first time in the history of Latin Christendom, an extensive, powerful body of learning, rich in natural knowledge, metaphysics, logic, and reasoned argumentation, was available for study and use as a basic curriculum in the new universities that had come into being by 1200 in Paris, Oxford, and Bologna. Some, if not many, theologians grew alarmed at

the prospect of a rival, secular body of knowledge that seemed capable of subverting scripture and the revealed truths of the faith.

The Theological Reaction to Aristotle

Aristotle's description of the cosmos was, unlike Plato's, in direct conflict with the Christian account in Genesis of a world created by God. Aristotle assumed an eternal, uncreated world, without beginning or end. He assumed the existence of a God, but one utterly unlike the Christian God. Moreover, Aristotle's God has no knowledge of the world's existence. Aristotle's natural philosophy disagreed with the Christian faith on other serious points, enough to worry the theological authorities in Paris, home of the University of Paris, the most prestigious university in Christendom. They were fearful that Aristotle's natural philosophy was too popular, especially since it was already being used as the basis for the curriculum in the faculty of arts at the University of Paris, and at other universities.

The first significant reaction came in 1210 when the members of the provincial synod of Sens, which included the bishop of Paris as a member, issued a denunciation of various individuals they viewed as heretics, after which they declared that "Neither the books of Aristotle on natural philosophy nor their commentaries are to be read at Paris in public or secret, and this we forbid under penalty of excommunication." The prohibition was probably ineffective, as evidenced by the fact that it was essentially repeated in 1215. A milder approach was taken in 1231, when Pope Gregory IX established a three-man committee to "entirely exclude what you shall find there erroneous or likely to give scandal or offense to readers, so that, what are suspect being removed, the rest may be studied without delay and without offense." Pope Gregory invoked the biblical account of the Hebrews despoiling the Egyptians by taking the gold and silver vessels and leaving those of rusty copper or clay. As far as is known, the committee never submitted a report, and the effort to expurgate Aristotle's natural philosophy was never carried out.

Presumably, the ban on reading Aristotle's natural philosophy remained in effect between 1210 and around 1255. During this period, only Aristotle's ethical and logical works were taught publicly in Paris; his natural philosophy was probably read in private. Whatever the efficacy of the ban, it came to an end no later than 1255, when a list of textbooks in use at the University of Paris included all of Aristotle's books on natural philosophy. Thus did the scholars of Paris join their Oxford University colleagues, who had always enjoyed the privilege of lecturing and commenting on all the works of Aristotle.

The Thirteen Errors and the Oath of 1272

By the 1260s conservative theologians adopted a new tactic: instead of banning entire works, they began to condemn particular ideas in Aristotle's

works that they regarded as dangerous and offensive. One of the leaders of the conservative faction was Bonaventure (John Fidenza, 1221–1274), a knowledgeable Aristotelian scholar who thought some of Aristotle's ideas were too dangerous for the faith and should be rejected by all Christians. In 1270, he and his colleagues persuaded the bishop of Paris, Etienne Tempier, to condemn thirteen errors that were derived from the works of Aristotle and his Muslim commentator Averroës. Three errors were directly relevant to the relations between natural philosophy and theology. Two condemned, in different ways, the belief that the world is eternal, and a third condemned the idea that all phenomena below the moon depended on the celestial bodies, which was the basis for astrology, a widely used discipline opposed by the church.

As a further protection against the potential dangers of natural philosophy, a papal legate in 1272 convinced the professors of logic and natural philosophy in the faculty of arts at the University of Paris to swear an oath that “no master or bachelor of our faculty should presume to determine or even to dispute any purely theological question, as concerning the Trinity and incarnation and similar matters.” Because arts masters were not trained to consider theological questions, they now had to swear that they would not do so, a practice that remained until the end of the fifteenth century. If any arts master perhaps inadvertently confronted a question that touched both faith and philosophy, he had to resolve it in favor of the faith or be excommunicated. Only students or masters of theology were judged qualified to apply natural philosophy to theological problems. While arts masters were not to mix natural philosophy and theology, theologians could use as much natural philosophy as they wished to resolve or explain any theological question.

As a consequence of the oath of 1272, natural philosophy remained relatively free of religious considerations, focusing exclusively on natural causation. In stark contrast, theology, as we shall see, imported so much natural philosophy into routine theological questions that they transformed theology into an analytical discipline that had little religious content.

A genuine rivalry existed between the arts and theology faculties at the University of Paris in the thirteenth century. The arts faculty was not regarded as the equal of the theology faculty, because the guardians of revelation were valued more highly than those who relied on human reason. This relationship was but a reiteration of the old doctrine that secular learning is the handmaiden to theology. Moreover, professional theologians, whether or not they were members of a faculty of theology, were important and often powerful members of the church. In Paris, they would have had ready access to the bishop or papal officials. It is not surprising, therefore, that they could easily dominate the arts faculties, whose teachers might have had clerical status but were neither theologians nor members of the clergy.

The Condemnation of 1277

Despite the condemnation of thirteen errors in 1270 and the oath of 1272, conservative theologians in Paris were convinced that numerous ideas and arguments contrary to the faith were being discussed and defended orally, and even written and disseminated. News of the disagreements in Paris reached Pope John XXI, who instructed the bishop of Paris, still Etienne Tempier, to investigate. Within three weeks, Tempier, at the instigation of his advisers and without final approval by the pope, issued a massive condemnation of 219 propositions drawn from many sources, including the works of Thomas Aquinas. Many of them were relevant to science. Some twenty-seven proclaimed, in one form or another, the eternity of the world, which contradicted church teachings about creation.

The eternity of the world became the most important philosophical and theological issue of the late Middle Ages. It was as central to medieval thought as the Copernican heliocentric theory was for the sixteenth and seventeenth centuries and the Darwinian theory of evolution from the nineteenth century to the present. A number of medieval natural philosophers believed that, in terms of natural arguments, the world is uncreated, but they then yielded to the faith and conceded that God has supernaturally created the world. Although he firmly believed in the creation of the world, Thomas Aquinas argued that no conclusive argument could be presented in favor of either creation or eternity. But faith requires one to believe in the creation of the world.

The Condemnation of 1277 had a considerable impact on natural philosophy and the way it was done. To discuss one of Aristotle's conclusions that was contrary to some article of faith, a natural philosopher would cast the argument into a hypothetical format, so that the authorities would not think the author accepted it as true. For example, in considering the eternity of the world, an author might declare that he was assuming, along with Aristotle, the eternity of the world, from which assumption he could show that no species of being could have been actualized from a previous state of potentiality. Thus every species of being in existence must have been in existence previously and therefore had no beginning, and would presumably have no end, clearly indicating the eternity of the world. To avoid charges of heresy, a natural philosopher would usually declare, as did Siger of Brabant in the thirteenth century, that "we say these things as the opinion of the Philosopher [that is, Aristotle], although not asserting them as true."

It was common for natural philosophers to use the expression "speaking naturally" when they wished it understood that they were speaking solely in terms of natural philosophy without regard to any theological implications. However, all natural philosophers knew that where pronouncements of faith conflicted with Aristotle's conclusions, the faith must prevail.

God's Absolute Power

Various articles in the Condemnation of 1277 shaped a different type of hypothetical argument, which was directed against Aristotle's natural philosophy and rested instead in God's absolute power to do anything short of a logical contradiction. Thus various interpretations that Aristotle had regarded as impossible—that is, which he regarded as “natural impossibilities” within his world system—came to be treated as hypothetical possibilities, solely because God could create such conditions by supernatural means.

The Possibility of Other Worlds

Condemned article 34 declares that “the first cause [that is, God] could not make several worlds.” This proposition was condemned because it upheld Aristotle's opinion (in *On the Heavens*) that “there is not now a plurality of worlds, nor has there been, nor could there be.” Only one world is possible. The implication of Aristotle's position is that if a plurality of worlds is impossible, not even God could create another world. Anyone who agreed with article 34 would be excommunicated. Although all were expected to concede that God could create other worlds, no one was required to believe that He had actually done so.

Despite the common belief in the Middle Ages that God did not and would not create other worlds, natural philosophers and theologians found it challenging to assume hypothetically that God had indeed done so. They then sought to determine what such worlds would be like, and whether they could coexist with our world. It was not unusual for natural philosophers to imagine that God created other worlds in different arrangements. He might have created an infinite number of successive worlds and may continue to do so into an eternal future; or He may have chosen to create a multiplicity of simultaneously existing worlds. Nicole Oresme, one of the most famous theologians and natural philosophers of the late Middle Ages, imagined concentric worlds: a world within our earth and a world enclosing our world. He even suggested that a world might exist within the moon. Although the existence of such worlds is improbable, they are not impossible, Oresme insisted, because “the contrary cannot be proved by reason nor by evidence from experience.”

Medieval natural philosophers usually imagined that if God did create other worlds to coexist with ours, these worlds would be replicas of our world, although each would be self-contained and operate independently of all other worlds. Thus, contrary to Aristotle's central argument that only one center and circumference could exist and therefore only one world, scholastics believed that it was at least possible many worlds could coexist simultaneously, and consequently so could many centers and circumferences.

God and Infinite Void Space

Aristotle had argued that nothing existed beyond our unique world—neither matter, nor vacuum, nor place, nor time. Medieval natural philosophers agreed with Aristotle that these entities did not exist beyond our real physical world. But in the hypothetical worlds that God might create, they imagined that matter could indeed exist beyond our world if God chose to create other worlds beyond ours. Moreover, they imagined that if God did create those other worlds, void spaces would exist between them, and hence contrary to Aristotle's claim, the existence of void space was at least possible. In fact, despite Aristotle's rejection of extracosmic void space, a number of medieval theologians assumed the actual—not hypothetical—existence of such a space. Theologians were concerned about God's location in the world. They were convinced that God could not be confined to the finite world He had created. As an infinite being, it was only fitting that He be omnipresent in an infinite void space. Indeed, they identified the infinite void space with God's infinite immensity.

Because God was regarded as an incorporeal being without dimensions, theologians insisted that the infinite void space, which was identified with God's immensity, was itself dimensionless. As Thomas Bradwardine, an eminent fourteenth-century theologian and mathematician, expressed it: God "is infinitely extended without extension and dimension." The belief that God is omnipresent in an infinite, extracosmic void space became commonplace in the early seventeenth century. It was accepted by the great English scientist Isaac Newton, who assumed the existence of an infinite void space in which God was substantively omnipresent and, as Newton explained, "suffers nothing from the motion of bodies" and where "bodies find no resistance from the omnipresence of God." But Newton and others in the seventeenth century regarded void space as three-dimensional and therefore that God is a three-dimensional being, thus radically departing from their medieval predecessors.

Motion in Void Space

Medieval natural philosophers agreed with Aristotle that in our cosmos no vacuum could exist, or come to exist, by natural means, a belief that was summed up by a famous aphorism: "nature abhors a vacuum." This dictum was accepted without dissent during the Middle Ages and remained unchallenged until the seventeenth century, when experiments finally led to its rejection. Despite their unanimous agreement with Aristotle that nature abhors a vacuum, medieval natural philosophers departed radically from Aristotle's interpretations. Although they readily conceded that vacua could not exist by natural means, they assumed that God annihilated all the matter within the world, or part of the world. They also questioned Aristotle's most important conclusions about motion in void space. Aristotle's view was that such mo-

tion would be unintelligible and impossible, because in the absence of any material resistance, a body's motion in void space would be instantaneous—that is, it would be moved with an infinite velocity.

In responding to Aristotle, scholastic authors devised a series of interesting counterarguments to show that if a vacuum did exist, motion in it would be finite and therefore like any ordinary terrestrial motion. They argued that bodies moving in a void space possessed their own internal motive force and internal resistance to that motive force. In this manner, they met Aristotle's preconditions for finite motion in the real physical world, namely a motive force and a resistance to that motive force to prevent the body from moving instantaneously.

Another significant proposition condemned in 1277, article 49, asserted that "God could not move the heavens [or world] with a rectilinear motion; and the reason is that a vacuum would remain." To deny that God could move the world with a rectilinear motion just because a vacuum would remain where once the world had rested was tantamount to restricting God's absolute power and supporting Aristotle, who had rejected the existence of void space anywhere, and under any circumstances. Although they might have ignored this article, some theologians were moved to inquire what would happen if God did indeed move the world with a rectilinear motion. Nicole Oresme regarded such a motion as an absolute motion, since there would be no other motion to which it could be compared. Within Aristotle's system of the world, such a rectilinear motion was inconceivable.

Natural Impossibilities

Medieval scholastic theologians departed from Aristotle's physics and cosmology on many vital points. They did this by showing that phenomena Aristotle regarded as impossible were indeed possible by God's supernatural power. Some of these phenomena were derived from articles condemned in 1277; others were extensions of God's absolute power to situations not included in the articles. What emerged was a series of interesting speculations, or thought experiments, in which certain Aristotelian principles were challenged and even subverted. The invocation of God's absolute power to annihilate all matter or move the world with a rectilinear motion despite leaving behind a void space proved to be powerful methodological tools. In the seventeenth century, they were adopted by natural philosophers such as Pierre Gassendi and Thomas Hobbes. Walter Charleton, an English follower of Gassendi, declared that the most laudable act of philosophers was to assume "natural impossibilities."

Medieval appeals to God's absolute power, however, had little, if any, religious motivation. Wherever we find it in medieval theological and scientific literature, it is almost never intended to make a religious point. Theologians had become addicted to an analytical approach to theology that used natural

philosophy, logic, and even mathematics to explicate a great variety of questions that were only superficially theological. They were actually exercises in philosophical analysis. The most significant form of medieval scholastic literature in both natural philosophy and theology was in the form of questions, almost always beginning with the word “whether.” There were questions about other worlds, about God’s powers, about the infinite and infinity, and numerous questions on various aspects of motion, including the motion of angels. Theologians often asked whether God could make other worlds; whether God could make a better world than this world; whether God knew that He would create a world from eternity; whether God could make a creature exist for only an instant; whether God could make some actual infinite with respect to dimension or multitude; whether an angel could be moved from place to place successively in some time; whether an angel could be moved from place to place in an instant. The replies to these questions were usually couched in the analytic language of logic and natural philosophy.

The criterion for determining whether God could or could not do any particular act was the principle of noncontradiction, which asserts that a statement and its negation cannot both be true at the same time. If the action involved God in a contradiction, it followed that God could not perform the act in question; if no contradiction was involved, it was assumed that God could perform the action. For example, some theologians and natural philosophers denied that God could make an actually infinite thing or dimension, because if God did create an actual infinite, He could not create anything greater than that infinite, because it is absurd to suppose that there is anything greater than an infinite. Although this was equivalent to setting limits on God’s absolute power, it was an essential move, because it is a contradiction to suppose the possible existence of anything greater than an actual infinite.

Some theologians conceived of yet other paradoxical ways by which God’s power might be thwarted by imaginary theological dilemmas using logical and mathematical arguments. In the fourteenth century, English theologian Robert Holkot applied the medieval doctrine of first and last instants to the following imaginary situation: A man is alternately meritorious and sinful in the last hour of his life. He is meritorious during the first proportional part of his last hour and sinful in the second proportional part; he is again meritorious in the third proportional part, and again sinful in the fourth proportional part, and so on through the infinite series of decreasing proportional parts up to the instant when death occurs. Because the instant of death is not part of the infinite series of decreasing proportional parts of the man’s last hour, it follows that there is no last instant of his life and, therefore, no last instant in which he could be either meritorious or sinful. Therefore God cannot judge him. In this rather strange, even bizarre, manner, Holkot devised a logical argument in which God is stymied and unable to render a judgment on someone just deceased. Holkot, however, was simply applying the medieval concept of first and last instants to the infinite divisibility of a continuum. Many

theologians engaged in similar tactics, since virtually all of them were familiar with such logico-mathematical techniques that were frequently used to resolve paradoxical situations.

Theologian Natural Philosophers

The emergence of the theologian natural philosophers in the late Middle Ages was a monumental occurrence and was instrumental in shaping the history of science in Western Europe. All theologians who wrote more than cursorily on natural philosophy, whether in straightforward treatises on natural philosophy or by importing natural philosophy into their theological commentaries, may be appropriately characterized as theologian natural philosophers. Earlier in the history of Western Christianity, Greek natural philosophy and science were to be used only as “handmaidens to theology,” not studied for their own sakes. Relatively little natural philosophy posed a direct challenge to the church until Greco-Arabic science and natural philosophy, especially Aristotle’s natural philosophy, became available in the twelfth and thirteenth centuries. Its eager acceptance by both arts masters and most theologians worried more conservative theologians, who used their influence to ban or expurgate the works of Aristotle. There is no doubt that the reaction to the Condemnation of 1277 played a significant role in reshaping medieval Aristotelian natural philosophy. Appeals to God’s absolute power to do anything short of a logical contradiction produced a series of bold, hypothetical questions about the physical world and beyond that world. Such stimulating, imaginary questions—most of them about “natural impossibilities” in Aristotle’s physical world—emerged in both natural philosophy and theology.

By the end of the thirteenth century, the old “handmaiden to theology” role was occasionally paid lip service but was largely ignored. The explanation is simple: theologians were as enthusiastic about Aristotle’s logic and natural philosophy as were the arts masters in the faculties of arts. Theologians studied these disciplines as much for their own sakes as for their utility in explaining scripture and the articles of faith. Even conservative theologians, such as Bonaventure, recognized the great utility of Aristotle’s natural philosophy, not just for explaining matters of faith, but also for understanding the operations of the physical world. Indeed, if theologians had decided to oppose Aristotelian learning as dangerous to the faith, Aristotle’s works could not have become the focus of studies at the universities. But they had no good reason to oppose it, since Western Christianity had a long tradition of using pagan thought for its own benefit. Difficulties arose as they adjusted to Aristotle’s thought, but in time—by the end of the thirteenth century—that adjustment had been made and many came to study Aristotle because of their genuine interest in natural philosophy for its own sake.

It should be emphasized that no effort was ever made in the West to Christianize Aristotle and secular learning. Natural philosophy was viewed as an

essential discipline for understanding a world that God had created but left to operate rationally, according to natural laws He had devised. Natural laws were not to be explained by appeals to holy scriptures or miracles. It was the business of natural philosophy, not theology and religion, to explain the natural workings of the world. Ironically, it was theologians, thoroughly trained in natural philosophy when they were students in the arts faculties before matriculating in the higher faculty of theology, who were the most innovative and imaginative interpreters of Aristotle's natural philosophy. Because of this dual capacity, it is appropriate to regard them as a class of theologian natural philosophers.

To understand why theologian natural philosophers were more important for the development of natural philosophy than the arts masters who taught natural philosophy and logic, one need only understand that arts masters were not trained in theology and were either forbidden to introduce theological issues into their natural philosophy, as at the University of Paris, or were reluctant to do so, because they knew theologians would be weighing their every word and would denounce them if they were viewed as jeopardizing the faith in any manner. By contrast, the theologians, who were trained in both theology and natural philosophy, could readily apply science or natural philosophy to theology and, conversely, theology to science and natural philosophy. But while they frequently applied natural philosophy to theology, they rarely ever applied theology to natural philosophy, because, like their colleagues in the arts faculties, theologians used natural philosophy to provide natural—not supernatural—explanations for the physical phenomena of the world.

Reason and the Medieval University

The natural philosophy that was developed in the medieval universities in both the arts and theology faculties was firmly based on the use of reason. For virtually all questions considered, the authors presented affirmative and negative arguments and then defended the position they deemed correct. All scholastic natural philosophers were trained to argue in rational, analytic terms, and medieval natural philosophy is a model of reasoned argumentation. Theologians were not only the most imaginative contributors to natural philosophy, but some also made significant contributions to science and mathematics, as the names of Albertus Magnus, John Pecham, Theodoric of Freiberg, Thomas Bradwardine, and Nicole Oresme bear witness. Theologians had a remarkable degree of intellectual freedom and were careful not to allow their theology to hinder inquiry into the structure and operation of the physical world. Biblical texts were not used to “demonstrate” scientific truths by blind appeal to divine authority. That would have been regarded as futile and unproductive.

Christianity benefited from the fact that it developed within the Roman Empire and thereby had an opportunity to adjust to secular, pagan learning, which

it used to help explain the faith. For the long term, it was also important that Western Christianity, unlike the Byzantine Orthodox Church or Islam, accepted a separation between church and state, and analogously kept natural philosophy and theology as distinct disciplines. The emergence of early modern science was greatly facilitated by the fact that medieval theologians did not inject the supernatural into natural philosophy. They were interested in resolving virtually all questions by means of logic and reason. Indeed, both natural philosophy and theology became analytic disciplines. It was because of this great emphasis on reason, that medieval scholars prepared the way for the emergence of early modern science in the sixteenth and seventeenth centuries.

But the emphasis on reason alone would not have been sufficient. The techniques of analysis and argument that were developed at the medieval universities had to become widely disseminated and deeply rooted. Natural philosophy was an old discipline, but never in any society had it been extensively practiced and widely disseminated. It was always the study of a few individuals located here and there. But the medieval university changed all that. Universities were located all over Europe; by 1500 there were approximately seventy-five, each teaching logic and natural philosophy as a basic curriculum. Since all the sciences that emerged as independent subjects centuries later were fragmentarily embedded in medieval natural philosophy that was taught at the universities, one can legitimately claim that science and scientific modes of thought were already deeply embedded in medieval society.

Important features of science—such as experiment, careful observation, and the consistent application of mathematics to real physical problems—were not part of the approach to medieval science. Natural philosophers and scientists would add them in the seventeenth century. But the indispensable use of reason and analysis were made routine during the Middle Ages, without which modern science could not have come into being. The emergence of the universities and the class of theologian natural philosophers made it possible for natural philosophy to develop and flourish in ways that had never before been feasible. This background to early modern science explains why, after the thirteenth century, there was a general absence of a science-theology controversy in Western Europe until the condemnation of Galileo in 1633.

Bibliography

- Clagett, Marshall. *Greek Science in Antiquity*. London: Abelard-Schuman, 1957.
- Gillispie, Charles C., ed. *Dictionary of Scientific Biography*. 16 vols. New York: Charles Scribner's Sons, 1970–1980.
- Gilson, Etienne. *Reason and Revelation in the Middle Ages*. New York: Charles Scribner's Sons, 1938.
- Grant, Edward. "The Condemnation of 1277, God's Absolute Power, and Physical Thought in the Late Middle Ages." *Viator* 10 (1979): 211–44.
- . *The Foundations of Modern Science in the Middle Ages: Their Religious, Institutional, and Intellectual Contexts*. Cambridge: Cambridge University Press, 1996.
- . *God and Reason in the Middle Ages*. Cambridge: Cambridge University Press, 2001.

- . “God, Science, and Natural Philosophy in the Late Middle Ages.” In *Between Demonstration and Imagination: Essays in the History of Science and Philosophy Presented to John D. North*, ed. Lodi Nauta and Arjo Vanderjagt, 243–67. Leiden: E.J. Brill, 1999.
- . *Much Ado about Nothing: Theories of Space and Vacuum from the Middle Ages to the Scientific Revolution*. Cambridge: Cambridge University Press, 1981.
- . “Science and Theology in the Middle Ages.” In *God and Nature: Historical Essays on the Encounter Between Christianity and Science*, ed. David C. Lindberg and Ronald L. Numbers, 49–75. Berkeley: University of California Press, 1986.
- . *A Source Book in Medieval Science*. Cambridge, MA: Harvard University Press, 1974.
- Hyman, Arthur, and James J. Walsh, eds. *Philosophy in the Middle Ages: The Christian, Islamic, and Jewish Traditions*. Indianapolis, IN: Hackett, 1974.
- Knowles, David. *The Evolution of Medieval Thought*. Baltimore: Helicon, 1962.
- Leff, Gordon. *Paris and Oxford Universities in the Thirteenth and Fourteenth Centuries: An Institutional and Intellectual History*. New York: John Wiley and Sons, 1968.
- Lindberg, David C. *The Beginnings of Western Science: The European Scientific Tradition in Philosophical, Religious, and Institutional Context, 600 B.C. to A.D. 1450*. Chicago: University of Chicago Press, 1992.
- . “Science and the Early Church.” In *God and Nature: Historical Essays on the Encounter between Christianity and Science*, ed. David C. Lindberg and Ronald L. Numbers, 19–48. Berkeley: University of California Press, 1986.
- Lloyd, G.E.R. *Aristotle: The Growth and Structure of His Thought*. Cambridge: Cambridge University Press, 1968.
- . *Greek Science after Aristotle*. New York: W.W. Norton, 1973.
- Murray, Alexander. *Reason and Society in the Middle Ages*. Oxford: Oxford University Press, 1978.
- Oresme, Nicole. *Nicole Oresme: Le livre du ciel et du monde*. Ed. Albert D. Menut and Alexander J. Denomy. Trans. and Intro. Albert D. Menut. Madison: University of Wisconsin Press, 1968.
- Ridder-Symoens, Hilde de. *A History of the University in Europe*. Vol. 1, *Universities in the Middle Ages*. Cambridge: Cambridge University Press, 1992.
- Stahl, William H. *Roman Science: Origins, Development, and Influence to the Later Middle Ages*. Madison: University of Wisconsin Press, 1962.
- Stiefel, Tina. *The Intellectual Revolution in Twelfth-Century Europe*. New York: St. Martin's, 1985.
- Thorndike, Lynn. *University Records and Life in the Middle Ages*. New York: Columbia University Press, 1944.
- Wallace-Hadrill, D.S. *The Greek Patristic View of Nature*. Manchester, UK: Manchester University Press, 1968.

28 Greco-Roman Conceptions of the Natural World, Religion, and Leadership in the Later Roman Empire

Walter Roberts

Thinkers in the Greco-Roman world of the late fourth century CE would have been puzzled by the attempts of modern Western cultures to separate issues of science from issues of religion. In the ancient world the two were inextricably bound, a link that was most noticeable in conceptions of leadership. One of the most notable areas of interest in the ancient world that we would classify as scientific was that of the natural world, that is, the entire Mediterranean and Western European ecosystems—their geography and the various flora and fauna therein. Greco-Roman thinkers had certain basic notions about the environment in which they lived. Among these views was the conception that the natural world and humanity were linked to the divine as emanations from a supreme creative force. A leader who was in harmony with the natural world was seen to be in harmony with the divine. Through appropriate observance of religious rituals, leaders in the ancient world could reap the bounty of the environment for the well-being of the community. Failure to propitiate the gods properly could bring the terrible retribution of nature, a sign of divine displeasure.

One way that such ideas penetrated the Mediterranean and European worlds was the imposition of Greco-Roman structures of leadership throughout these regions, culminating in the Roman Empire. In the fourth century CE, however, a major event occurred that altered the view of the natural world, divine power, and issues of leadership. This was the advent of Christianity as the imperial religion.

Notions of the Natural World, the Divine, and Leadership Before Christianity

The three main philosophies that informed Greco-Roman religious thought before the coming of Christianity were Stoicism, Aristotleanism, and Platonism.

From these systems of thought, Greco-Romans formed their views of the natural world and its relation to the divine. This subject was of supreme importance because through this link, humanity's relationship with the divine could be discovered. In the dialogue *Timaeus*, written in the fifth century BCE, Plato set forth fundamental links between leadership, the divine, and the natural world. Such was the importance of this work and its ideas that it would be one of the few Platonist texts to be transmitted to the West during the early Middle Ages.

According to the *Timaeus*, humans were part of the natural world, which in turn was an offshoot of the divine. Every citizen in society, including leaders, had a place in the divine order of things. It was the duty of communal leaders to obey the divine laws, which allowed the leaders to achieve a certain harmony with the natural world. The community took this harmony as a sign that their leaders had a divine mandate to rule.

Aristotle, Plato's pupil, was even more emphatic concerning the connection between the natural world, the divine, and the establishment of leadership in human society. The relationship between ruler and ruled was one of natural order, of form fitting function. Those who ruled had the ability of greater reasoning than those who were ruled. The family was the basic structure, which gave way to the village (a collection of families), which finally gave way to the city-state, the political and social order that still dominated the Greek world of Aristotle's day. For Plato and Aristotle, even though humans were part of the natural world, their capacity of rational thought set them apart.

The basic position of Plato and Aristotle on the subject of the natural world, leadership, and their relationship to the divine can also be found in Stoicism, and it was through this school of thought that earlier Greek conceptions passed into the late Roman republic. A key difference, however, was that Plato and Aristotle stressed the internalization of human reason, while Stoicism held that rational examination of the natural world could also help leaders access the divine will.

We know Stoic thought only through fragments or the interpretation of later writers, such as Cicero. In *Concerning Divination*, written sometime after 44 BCE, Cicero sought to debunk the practice of divination, which was the practice of reading signs in the natural world in order to ascertain the will of the gods for the community. Through this discourse on divination, he articulated a conception of leadership that melded the three positions of Aristotle, Plato, and the Stoics. According to Cicero, those who saw divination as the command of the gods misunderstood the process. Rather than mindlessly obeying the signs of the natural world, it was the duty of political leaders to reach harmony with the natural world and harness its power for the good of society.

Concerning Divination is set up in the form of a Platonic dialogue in which Cicero's brother Quintus supports divination and Cicero refutes this argument. In the dialogue, Quintus recounts the consulship of Cicero in 65 BCE as an example that divination was necessary for leadership. Divination done by the augurs, those men in charge of reading signs and portents, had foretold

the upcoming destruction of many monuments and statues on the Capitoline hill during the year. Cicero, heeding the advice of the augurs, took steps to save funds for their restoration. When a lightning strike and fires destroyed many of the statues, Cicero was able to restore them. Quintus's point is not that the destruction was foretold, but that Cicero, guided by divine inspiration, was able to mitigate the damage. Quintus argues furthermore that if divination seems to fail in certain cases, such as when it could not foretell the military defeats of Pompey, Cato, and Cicero, this is because of the imperfections of the human agents who interpret the signs.

Cicero's counterargument is that the practice of divination is superstition—a mindless enslavement to ritual in which the diviner gives up his rational thought processes. Divination lets the natural world control the actions of humans, giving a passive role to humanity in its relations with the divine; Cicero calls for more aggressive participation by humans in the process. For Cicero, the real function of the college of augurs is not divination, but rational operation of the religious rituals that connect human society and the divine. If the rituals are performed properly, then Roman leaders can achieve a harmony with the natural world.

This philosophy, based in part on Platonism with a healthy dose of Stoicism thrown in, could also be applied to political and military leaders, according to Cicero. For example, the practice of not holding elections when lightning lit the skies over the city of Rome was not so much obeying the will of the gods, but using a rational control of religious observance as a political tool. Cicero went on to use Hannibal and Caesar as examples of great leaders who ignored the portents of the natural world. They reached a harmony with the natural world and achieved glory, Caesar in particular, who braved the winter weather, not in a foolish manner, but through careful planning, in a Mediterranean crossing during one of his campaigns.

Cicero presented the conceptions of Plato, Aristotle, and the Stoics concerning the relationship between the divine, the natural world, and leadership in a form that had probably evolved over the life of the Roman republic. Cicero saw humans and the natural world as divine emanations, but humanity had a clear advantage through the capacity of reason. In addition, Cicero borrowed the Stoic notion that such wisdom was accessible through a rational use of religious ritual. Unlike the Stoics, however, who thought that humanity had to wait for nature to give up its secrets, Cicero believed that humans could take a much more active role and gain knowledge of the divine from the natural world by dint of their superior reasoning. These Late republican notions were passed down to Augustus as part of his imperial ideology.

The First Three Centuries of Roman Imperial Rule

When Augustus assumed power as the first Roman emperor in 27 BCE, he brought an end to the civil wars that had marred the last days of the Roman

republic. His ideals of leadership, however, were nothing new. He reworked traditional Greco-Roman ideas of leadership to fit the realities of his time, retaining standard ideas concerning the relationship between the divine, the natural world, and leadership. These ideas were manifested in religious rituals, and it was Augustus who was the chief religious figure in the Roman world. In his public monument recounting the deeds of his reign, he claimed that he became the head of the seven major organizations of priests in Rome at the time. In the Greco-Roman world, it was a typical practice for leaders to associate themselves with religious organizations of the community as a show of political power.

The imagery of the Augustan era clearly shows how the political and religious functions of the emperor combined in a mission of leadership. The Altar of Peace, created by the Roman senate between 13 and 9 BCE as a show of gratitude to Augustus, has many images of Augustus in harmony with the natural world. He offers sacrifices of animals to the gods in his role as chief priest, and there are images of bounteous crops, which are clearly the result of divine approval for his reign.

Augustan notions of harmony between the divine, the natural world, and the leaders of society continued through the second and third centuries CE. Cassius Dio, a Roman senator and historian writing in the early third century, related how the emperor Marcus Aurelius, incidentally a major figure in Stoic philosophy, with the aid of some priests invoked a storm that helped his legions win a decisive battle with barbarian enemies in 174 CE. This event showed that Marcus's reign was divinely ordained, because the emperor was in tune with nature enough that his priests were able to bring rain for the benefit of his troops.

Marcus Aurelius was considered by contemporaries the last of the good Roman emperors. Beginning with the death of Septimius Severus in 211 CE, economic, political, and military instability over the ensuing three-quarters of a century, caused by generals fighting for the ultimate honor of the imperial purple, created a fundamental crisis in the belief that an emperor was necessary in the Roman world. This development greatly altered conceptions of the office of the emperor and its role in society. The populace turned to alternate sources of leadership. These included regional military officers, imperial bureaucrats, local aristocracies, and Christian bishops and monks. The weakening of imperial power and the growth of Christianity further altered basic Roman conceptions of the relationship between the natural world, the divine, and leadership.

The Fourth Century CE

Beginning with the ascension of the emperor Diocletian in 284 CE, emperors in the late third and fourth centuries tried to win back the confidence of the populace. Imperial power and its symbols became even more ubiquitous. For

most of the fourth century, there was usually more than one emperor; typically they shared power, sometimes they fought. The notion of emperors as manifestations of a harmony between the divine and the secular, however, still remained. Furthermore, this notion was informed by the Christian belief that was adopted by the emperor Constantine as the preferred religion of the empire in 312 CE. Along with these transformations the role that the natural world played in achieving harmony between the divine and the leaders of the earthly realm also changed.

Christian belief challenged the traditional Neo-Platonic philosophical models that held sway in the fourth century. Eusebius, a Christian bishop of Caesarea as well as adviser to and biographer of the emperor Constantine, was the first prominent Christian thinker to weld evolving Christian theology to notions of imperial power. According to Eusebius, the relationship between the natural world and humans was adversarial. The bishop took a dim view of the non-Christian religious practice of incorporating the natural world into its rituals. For Eusebius, as with most Christians, the natural world was deeply flawed because it was a created entity. The natural world was only of limited use as a guide to God. Instead, divine wisdom on how to run society was to be found in heeding the spiritual advice of the bishops, who based their knowledge on understanding the revealed word of God through sacred texts and the shared teachings of the body of faithful Christians as it had developed over the previous three and a half centuries.

This view is explicitly stated in Eusebius's account of Constantine's victory over his rival Licinius in 324 CE. Licinius was a pagan who argued that Constantine was not fit to be emperor because he advocated the new and strange religion of Christianity. In one passage from his biography of Constantine, Eusebius has Licinius haranguing his troops with invective against the Christian roots of Constantine's reign. Licinius makes this speech in a pagan grove surrounded by soothsayers making animal sacrifices, observing the flight patterns of birds, and consulting oracles, all of which foretell a victory for Licinius. Eusebius then gleefully relates Constantine's victory, a clear vindication of Christianity. Implicit is a defeat of the pagan belief in nature as a conduit to the divine and its relationship to leadership. Divine wisdom and guidance are achieved through partnership with Christian priests, not through diviners and soothsayers who read the signs of nature. Of course, Eusebius misunderstood, or chose to ignore, the subtleties of non-Christian thought on this subject, but he did strike at a key difference between the two strands of thought.

The Christian notion of the natural world as something flawed, indeed corrupted, can also be seen in one of the most famous pieces of Christian literature from the fourth century, the *Life of Saint Antony*. This work, a biography of one of the first Christian monks, was written by Athanasius, bishop of Alexandria in the mid-fourth century. Antony presented a new type of Christian leadership. He rejected his life in a traditional Roman community and

moved into the deserts of the Near East to contemplate his relationship with God through an ascetic lifestyle. Soon, people from various communities in the region, disaffected from imperial rule, began to seek him out for advice. One of Antony's core beliefs was that the natural world was a barrier to be overcome in achieving communion with God. This belief was based on interpretations of biblical passages, specifically the book of Genesis, which saw the natural world as a place of temptation that had lured Adam and Eve away from intimate communion with God. Antony hoped that by moving into the wilderness and overcoming its temptations, which were established by the devil, he would be able to achieve a closer connection with God.

Looking further into the biography of Antony, however, reveals a more subtle issue than one man's attempt to get closer to God. There are also issues of leadership and Antony's contemporary Roman community and the world. Through his role as a monk who rejected the natural world as corrupt, he was able to act as an intercessor to God for his followers. Several chapters deal with Antony's attempts to repudiate high-ranking soldiers, local elites, pagan philosophers, and local residents who seek him out in his solitude for words of wisdom on leadership. Antony was seen as wise for having overcome the natural world and its temptations. This is a stark contrast from non-Christian notions that called for a less adversarial relationship with the natural world. Antony was portrayed by Athanasius as the role model for a new type of leadership centered on monks, and also implicitly bishops, as spiritual intercessors. In the course of the fourth through the sixth centuries, this notion of bishops and monks as spiritual intercessors slowly crept into imperial ideology, transforming the nature of emperorship.

The confluence of these developments can be seen in the career of the emperor Theodosius. When he came to power in 379 CE, he moved the empire toward Christianity even more firmly than had Constantine. By 392, Christianity had not just become a favored religion of the imperial family, but by imperial decree it was now the official religion of the empire. Accounts of Theodosius's reign are replete with examples of the new Christian conception of the natural world and its relationship to leadership. In his last battle against the usurper Eugenius in 394, the key to victory was a fierce wind that blew against Theodosius's enemies, blinding and demoralizing them. The Christian sources that trumpeted this victory saw the wind as a sign that God favored Theodosius; after all, he was in battle against a pagan who was leading the last organized resistance of the senatorial aristocracy against the inevitable triumph of Christianity. But Theodosius did not achieve harmony with the natural world by acting as the main religious leader of society; rather, God intervened and used the natural world to aid Theodosius through the intercession of Christian priests present in the emperor's army. This view of the divine, the natural world, and the duties of leadership were passed on by Theodosius to his two sons when he died in 395.

As a result of the adoption of Christian ideals regarding leadership, the

natural world, and religion by society in the later Roman Empire, Christian authors began to rewrite the Roman past to accommodate their own vision of history. This was a vision of a Christian world that achieved communion with God not through rational study of the natural world, but through revealed religious beliefs. The emperors represented a secular form of leadership, while it was left to the monks and bishops to provide spiritual guidance to their Christian communities. The natural world was now something to be conquered and overcome, not something to be worked with and revered. This fundamental shift in emphasis concerning the natural world, religion, and leadership would be passed down to medieval society, and would in turn inform the medieval relationship between science and religion.

Bibliography

- Aristotle. *Politics*. Loeb edition. Trans. H. Rackham. 1932. Reprint, Cambridge, MA: Harvard University Press, 1990.
- Athanasius. *Life of Antony*. In *Early Christian Lives*, trans. and ed. Carolinne White. New York: Penguin, 1998.
- Boys-Stones, G.R. *Post-Hellenistic Philosophy: A Study of Its Development from the Stoics to Origen*. Oxford: Oxford University Press, 2001.
- Brown, Peter. *The World of Late Antiquity*. New York: W.W. Norton, 1989.
- Cassius Dio. *Dio's Roman History*. Loeb edition. Trans. Earnest Cary. Cambridge, MA: Harvard University Press, 1982.
- Cicero. *Concerning Divination*. Loeb edition. Trans. William Armistead Falconer. In *Cicero: De Senectute, De Amicitia, De Divinatione*. Cambridge, MA: Harvard University Press, 1964.
- Collins, Roger. *Early Medieval Europe 300–1000*. 1991. Reprint, New York: St. Martin's Press, 1995.
- Elliot, Alison Goddard. *Roads to Paradise: Reading the Lives of the Early Saints*. Hanover, NH: University Press of New England, 1987.
- Eusebius. *Life of Constantine*. Trans. Averil Cameron and Stuart G. Hall. Oxford: Oxford University Press, 1999.
- Gordon, Richard. "From Republic to Principate: Priesthood, Religion, and Ideology." In *Pagan Priests: Religion and Power in the Ancient World*, ed. Mary Beard and John North, 178–98. London: Duckworth, 1990.
- Hughes, J. Donald. *Pan's Travail: Environmental Problems of the Ancient Greeks and Romans*. Baltimore: Johns Hopkins University Press, 1994.
- Orosius. *The Seven Books of History Against the Pagans*. Trans. Roy J. Deferrari. Washington, DC: Catholic University Press of America, 1964.
- Plato. *Timaeus*. Loeb edition. Trans. R.G. Bury. In *Plato: Timaeus, Critias, Cleitophon, Menexenus, Epistles*. Cambridge, MA: Harvard University Press, 1964.
- Verbeke, Gerard. *The Presence of Stoicism in Medieval Thought*. Washington, DC: Catholic University Press of America, 1983.
- Wells, Colin. *The Roman Empire*. 2nd ed. 1992. Reprint, Cambridge, MA: Harvard University Press, 1997.
- Zanker, Paul. *The Power of Images in the Age of Augustus*. Trans. Alan Shapiro. Ann Arbor: University of Michigan Press, 1988.

29 Knowledge and Accuracy in Early Greek Historical Writing

Gordon Shrimpton

We expect historians to describe real things done by real people in real places at specific times; unreal events or people are the subject of fiction. Nevertheless, within certain limitations, our preconceptions of history and historical writing and our understanding of what constitutes historical fact have evolved. From antiquity to the present, history has developed alongside and in response to a changing intellectual climate.

The roots of historical writing are scarcely traceable, owing to the loss of all Greek prose written before Herodotus (c. 484–425 BCE) and much of the poetry as well. Nevertheless, the evidence we have points to history's origins on the eastern side of the Aegean Sea, the result of cultural cross-fertilization between the eastern Greek communities and the non-Greek occupants of Anatolia.

Early Greek historical writing took three principal forms: (1) deeds of individuals, a form of biography; (2) local (or “epichoric”) history, the history of individual city-states or nationalities; and (3) generalizing or universal history. The purpose in writing about an individual was probably to heap praise on the person (if not to heap abuses). The evidence we have for local histories (all of which are lost to us) suggests that they celebrated the importance of a community by trumpeting its great deeds. The generalists like Herodotus and Thucydides (c. 460–400 BCE), on the other hand, tried to maintain a posture of impartiality.

While the Greeks did not write pure fiction, in the eighth century BCE they produced narratives in the form of epic poems, most famously Homer's *Odyssey* and *Iliad*. Though these epic poems ostensibly described past events, in fact their primary function was to transmit traditions of a bygone heroic age. Gods and supernatural beings played significant roles, particularly in the *Iliad*. Perhaps the most delightful part of the *Odyssey* tells of the hero, Odysseus, and his encounters with weird denizens of outlandish places: one-eyed Cyclopes, gigantic Laestrygonians, a deathless nymph called Calypso, and the witch Circe, who turns Odysseus's men into animals.

In the fifth century BCE, a new approach to storytelling emerged. Herodotus's *Histories* embraced the east–west conflict that began with Croesus of Lydia and culminated in Xerxes of Persia's invasion of Greece in 480 BCE. It was published about the year 425 BCE. Approximately three decades later, Thucydides's unfinished *Peloponnesian Wars* appeared. It described the struggle between Athens and Sparta that resulted in Athens's ruin (431–404 BCE). These works were serious attempts at describing real occurrences—events that still lived in the memories of the Greek communities that had experienced them. As such, they deserve to be recognized as examples of early historical writing.

Several characteristics set early historical writing apart from epic. First, secular knowledge: the writers told the stories as their own knowledge, or the knowledge of the Greek community. This knowledge was about humans, not gods for the most part, and it was guaranteed almost entirely by human informants rather than by divine sources (such as the Muses). Second, early historical writing presented itself as particular descriptions of specific events. The Homeric epics, by contrast, exhibited a very low degree of specificity; they captured the nature of heroism more than the deeds of precise historical figures—the *experience* of war (in the *Iliad*) or the struggle to find a way home (in the *Odyssey*). Third, historians took special care to search for the causes of the events they narrated. Fourth, the writers were aware of the need for credibility: Herodotus frequently related stories only to criticize them as unbelievable; Thucydides asserted that the poets (such as Homer) were prone to exaggeration. Fifth, the ancient historians' concern for credibility implies that they had in mind a basic threshold of truthfulness and, quite possibly, a method or set of criteria with which they could ascertain the reliability of a story. And finally, if the historian is free to establish criteria, this freedom implies an absence of centralized control or censorship; the ancient Greeks generally were accustomed to free speech and a political environment in which no one dictated what must be written or believed.

The Intellectual Climate and the Development of Greek History

The intellectual climate in ancient Greece influenced historians' views of causation. If history is a study of human actions, then we might expect historians to explain those actions in terms of human feelings such as love, greed, and fear. Less personal influences on human activity—natural conditions like drought and epidemics, for example, or such developments as technological change—also demand consideration as causes.

The age into which Herodotus was born was infinitely richer intellectually than any before it. He came from Halicarnassus, on the eastern side of the Aegean Sea, where Ionian natural philosophers since Thales of Miletus (early sixth century BCE) had been developing theories about the very foundations of the phenomenal world for about a century before Herodotus's time. Other

thinkers from the same region, like Hecataeus of Miletus (late sixth century BCE), had compiled stories about geography and mythical heroes. While Herodotus was composing his *Histories*, moreover, two important intellectual movements appeared: the Hippocratic school of medicine, and Sophistry.

The Hippocratic movement featured careful observation of diseases and their progress, systematic recording of those observations, and the development of theories about the relationship between human characteristics, diseases, and local climates. These medical writings were given the name “inquiry” or *historia* in Greek; Herodotus took that term and applied it to his *Histories*.

The Sophists were itinerant teachers of rhetoric. They contributed an array of verbal and conceptual tools that proved convenient for the refinement of historical writing. The two most famous Sophists of the age were Gorgias of Leontini (c. 485–380 BCE) and Protagoras of Abdera (c. 490–420 BCE). Both were relativists in a world that generally inclined toward absolutism. Gorgias was a master of style; he taught the persuasive power of the spoken word. For him, the true nature of things was relatively insignificant. Far more important was what you could persuade people to *think* of the nature of things. Gorgias’s influence can be seen particularly in the speeches that Thucydides writes for the protagonists in his *Peloponnesian Wars*. Protagoras’s famous dictum—“Man is the measure of all things: of things that are that they are, and of things that are not that they are not”—indicates that humans alone, without the gods, were able to determine the truth for themselves, and that whatever they saw as true *was* true for them, regardless of the views of others. The relativism of Protagoras is evident throughout Herodotus, whose *Histories* ranges from the Greek west (Italy and Sicily) to the Persian east (as far as Babylon) and describes a rich fabric of human customs and lifestyles, with an interest that was usually nonjudgmental.

A clear example of Herodotus’s relativist perspective is found in a story in Book 3 regarding the Persian king Darius. The king once summoned to his presence a group of Greeks and a group of Indians, people from the furthest extremities of his empire. Herodotus reports that the king then asked of the Indians what would induce them to burn their dead, and of the Greeks what would persuade them to eat theirs. The Greeks at that time did burn their dead, so the story goes, while the Indians were in the habit of eating theirs. When the king’s question was posed, both groups cried out in horror at the suggested sacrilege. Herodotus’s conclusion is that there are no universal absolutes to guide human conduct: custom reigns supreme.

Since the eighth century BCE, Herodotus’s fellow Greeks had been discovering and colonizing extensive parts of the coastline of the Mediterranean and the Black Sea (Hecataeus’s lost work—*Periodos Ges*, “Tour around the World”—apparently provided an ethnogeographical tour of their shores). And many Greeks had been living as mercenaries and traders deep in the heart of the Persian Empire and Egypt. Thus, Herodotus could easily have collected

stories about lands and peoples from Italy to the Indus valley and from Egypt to north of the Danube by touring the Greek diaspora.

Herodotus engaged passionately in debates over geographical questions such as the boundaries of the continents, the source of the Nile, and the reason for the river's annual flooding. Though we can never be certain that the views he expresses are entirely his, the explanation that he provides for the aggressive imperialist tendencies of some peoples, and the softness and passivity of others, followed the lead of the Hippocratic movement by relating national inclinations to such things as climate, soil productivity, or harsh living conditions. On the level of human causation, he ascribed Darius's desire to subjugate Athens in the 490s to a lust for revenge for the Athenian support of the Ionian revolt against his rule, and the revolt itself to the foolish ambition of two Milesians. But the *Histories* also assumes deeper motivations: an underlying propensity of empires to expand and press upon their neighbors. And though he avoids explicit statements regarding the supernatural, Herodotus's interest in underlying forces is apparent. While the assaults on Greek city-states by the Lydian king Croesus and his predecessors in the sixth century BCE are related as matters of fact that need no further explanation, of greater interest is the story he tells to explain Xerxes's decision to attack Greece in 480 BCE. According to Herodotus, Xerxes was hesitant to attack, but he was compelled by a terrifying dream to accept his mission and embark on the campaign. Thus, the drive to expand seems to be a necessity for empires, perhaps even a supernatural one.

Thucydides's observations are less complex in some ways, but considerably more profound in others. He explains the outbreak of the Peloponnesian War on two levels. First, he identifies three proximate causes: two aggressive acts by Athens aimed at embarrassing Corinth, Sparta's only powerful maritime ally; and a new alliance struck between Athens and Corcyra, a colony of Corinth. But Thucydides declares that the real cause of the war was one less talked about: the growing power of Athens and the fear it inspired in the minds of the Spartans. He does not specify what he means by "the growing power of Athens." But Athens had colonized the mineral-rich area of the Strymon River in Thrace in 437, which gave Athens access to great wealth. And the subsequent alliance with Corcyra, which had a navy as large as Corinth's and about half the size of that of Athens, was probably enough to convince the Spartans to take steps to limit further Athenian expansion.

Thucydides was no explorer of the natural world; his interest was in human nature. He admired few (Themistocles and Pericles were notable exceptions), and he was generally pessimistic about the motives of the politicians and generals about whom he wrote. He was fascinated by power and understood instinctively its relationship to fear and how both fear and the lust for power affected both the strong and the weak. The weak fear the strong, but the strong fear the loss of power and possible revenge from wronged victims. Fear drives the strong to displays of strength in order to intimidate the weak. This need to

display power relentlessly, avoiding no challenges lest avoidance be seen as irresolution, exposes the strong to the danger of overextension. The continuous display of power, with its consequent risks, also tends to brutalize—to promote corruption, self-absorption, and greed in imperial rulers, and desperation in the oppressed.

Of course, historians such as Herodotus and Thucydides were not the only ones to comment on human behavior. Dramatic poets like Aeschylus, Sophocles, Euripides, and Aristophanes also developed similar pictures of human failings. Indeed, Aristotle declared that poetry was more “serious” than history because it addressed universals (e.g., the *experience* of war rather than a specific sequence of battles fixed in time and geographical space), while history addressed only unique events. This judgment is rooted in the Greeks’ attitude toward reality as they saw it and tried to express it in words. The Greeks spoke of three levels of reality: *onta* (things that are what they are), *phainomena* (things that appear to be what they may or may not be), and *genomena* (things that have happened). We derive the terms *ontology* and *phenomenology* from the first two expressions; *genomenology* would be a natural derivative from the third. The Greeks’ analysis was really a hierarchy, with *onta* at the top of the reality scale and *genomena* at the bottom. On the face of things, historians collected and reported *genomena*. As a consequence, their work seemed trivial to serious thinkers like Aristotle.

But both Herodotus and Thucydides are clearly interested in the permanent realities (*onta*) that can be seen beneath the surface. Thucydides saw patterns in events. He regarded his account of the devastating civil war in Corcyra, presented in grim detail, as typical of all the other civil conflicts that erupted throughout Greece during the Peloponnesian War. He narrated each decision taken during the war as an illustration of human nature. In the opening remarks of his *Peloponnesian Wars*, he announced that, human nature being what it was, similar conditions would recur in the future. He saw constancy behind upheaval, and even in unforeseen chance that dashes expectations.

Herodotus was equally preoccupied with patterns. Empires behaved predictably. It was not within the power of even the greatest monarch, Xerxes himself, to bridle the urge for conquest. Extensive parts of Herodotus’s *Histories* read like studies of a particular phenomenon. Superficially, Book 3 is an account of Darius’s seizure of the Persian throne, followed by the organization of his empire, interrupted by a seemingly endless parade of digressions on other monarchs and tyrants. We can read the book as a simple history if we choose, but there is surely a deeper message: the book is a study of the very nature of monarchic rule.

Ultimately, what set ancient historical writing apart was its attention to particular *knowledge* of events and peoples from the past. Both Herodotus and Thucydides saw their task as more than that of a teller of tales about the past: they were dealing with knowledge.

Knowledge, Fact, and Truth in Ancient Greece

The Greeks typically regarded sure knowledge of something as information derived from an eyewitness. Herodotus's word for "I know" (*oida*) means literally "I have seen." He explicitly identifies his account of the beginning of the east–west conflict as knowledge. Early in Book 1 of the *Histories*, after briefly recounting tales of the origins of the conflict—tales that Herodotus attributes to unnamed Persian wise men and that look like historicizations of Greek myths—he dismisses them and declares that he will begin with the person he "knows" began hostilities between Greeks and non-Greeks: Croesus, king of Lydia.

If being an eyewitness to events or speaking with one was not possible, the ancient historian resorted to the next best thing he could devise—and by so doing developed an early form of historical method: visiting the places he wrote about in the *Histories*, or identifying people with exceptional knowledge about the past. These informed sources were most notably priests in important temples, because the temples for generations had been storehouses for votive offerings from nations or significant persons. Each offering had a story preserved by the keepers of the sanctuary and passed on from priest to priest. After his visits to these temples, Herodotus would record descriptions of the contents of the shrines and put together a narrative of the past from the stories told to him by the priests. He employed this method of historical reconstruction during his visit to Egypt, with results that have inspired fierce scholarly debate. The results were less controversial when he visited the shrine to Apollo at Delphi and wrote about the early history of eastern Greek relations with Lydian monarchs, who had sent many spectacular gifts to the shrine.

As the importance of eyewitness accounts implies, the ancients did not value "depersonalized" information in the same way that we do today. In our modern intellectual environment, we gather information from books, mass media, and the Internet. Usually we have no personal knowledge of the source of the information. By contrast, the ancients' reliance on written text was minimal. For them, information was as good as the person who remembered and supplied it.

Ancient writers put great faith in human memory. The word for "truth" used most commonly by the historians and philosophers was *aletheia*, which means "the absence of forgetfulness" or "the absence of obscurity." Today, modern studies, such as those from Bartlett and Harrison, throw considerable doubt on the reliability of human memory. But the Greeks did not question that something clearly remembered, especially by a number of eyewitnesses, was unquestionably true. If an account were not true, then the eyewitness was lying; weakness of memory was never a consideration. Confused or disorderly recollection was a sign of an uneducated mind; a wandering or crooked memory was a sign of falsehood. By extension, words from ancient Greek that are often translated as "accuracy" really reflect *memorative quality* rather

than what we would consider *factual accuracy*. Thucydides's favorite word was *akribeia*, which meant "orderly precision" in the fifth century.

Indeed, in a famous passage that is regularly misunderstood, Thucydides enunciated his method of fact gathering. He declared that he had taken great care not to receive information from chance informants, but had put himself out considerably for people who possessed this special quality of *akribeia*; he was referring to educated elites, who had trained memories. Herodotus's preferred expression was *atrekeie*, which means "straightness." Educated Greeks who trained themselves in mnemonics knew that a key to memorative accuracy was orderliness or "straight" thinking.

The fact that the Greek word for "I know" (*oida*) means "I have seen" suggests that the Greeks trusted their senses to provide secure knowledge. This is very different from today, when so much of what we "know" cannot be observed with our senses alone. We cannot *see* the bacteria or viruses that cause diseases without the aid of a microscope, and we do a great deal of testing and deduction to establish that what we see through the microscope is in fact the organism that is the source of our discomfort. We *see* the sun revolving around us and the planets moving against a backdrop of nearby stars. But thanks to more careful observation through telescopes, mathematics, and Newton's theory of gravity, we "know" that Earth and the other planets circle the sun in a vast universe.

The ancients, however, relied on the experiences of informants. The generalists in particular relied on personal informants and rarely on documents. The reason they spurned documents appears to lie in their need to maintain the appearance of neutrality. There is evidence that local histories made considerable use of archival records and public inscriptions, but the purpose in citing these documents, compatible with the purpose in writing the local history itself, was to celebrate local achievements rather than supply impartial proof. Generalists who cited such documents were identifying themselves with the celebratory traditions of the locality, and thereby compromising their narrative. This absence of documentation tended to eliminate the unique aspects of an event from the record. Studies from Bartlett have shown that personal informants, on whose memories the generalists relied almost exclusively, would drop specific details from their memories and reshape their descriptions along the lines of widely held public beliefs and expectations.

Intellectual Freedom

It is easy to overlook the importance of intellectual freedom in the development of good historical writing. History that is influenced by a "party line" is compromised. Most ancient civilizations were monarchies or theocracies; this usually meant that all records of the past came under scrutiny—whether for political or theological orthodoxy. In Persia and Egypt, the only people who could write were under the influence of the king or the pharaoh. In China, the

historian Sima Qian (c. 145–85 BCE) was castrated for recording events in a way that displeased the emperor. By contrast, the Greeks cultivated political freedom and prized free speech. Living in independent city-states, they were not used to centralized governments controlling their lives and seeking to influence their thoughts.

The Greek historians did write for an audience, however, and hoped for approval. The Athenians reportedly paid Herodotus handsomely for giving readings from his work. But audience sentiment could also go the other way. According to Herodotus, when the tragedian Phrynichus presented a play to the Athenians about the fall of Miletus, the reaction was violent. Outraged, the Athenians imposed a heavy fine on the playwright and forbade all future performances of that work. A far more notorious case regarding intellectual freedom was the trial and execution of Socrates in 399 for unorthodoxy toward the gods of the state and for corrupting the youth of Athens. Despite the appearance of free speech, then, there remains the possibility that Greek historians were inhibited by an undercurrent of strong public opinion, or by what John Stuart Mill would much later call the “silent majority.” From this distance, the impact of this presumed “silent majority” is difficult for us to measure, because the known examples of its open expression, though often violent, are still quite rare.

But while Mill wrote in an environment in which a predominantly Christian moral orthodoxy was thundered from pulpits, reiterated by print media, and sometimes enforced by police and public prosecutors, ancient Athens, like most other Greek city-states (until Macedonian times at least), was generally unencumbered by these conditions: there were no pulpits, no print media, no state police, and prosecutions were conducted sporadically by citizen volunteers. In short, there is no reason to think that the ancients were more subject to intimidation than historians in modern democracies, who may still face public outcries if their ideas are seen to be deviant. On the contrary, ancient Greek writers enjoyed freedom to seek out the truth and record it as they saw fit, to a degree that is rare for any period in history.

The Greek community influenced the individual’s intellectual freedom in a more subtle way, however. The ancient historians had no way of asserting personal ownership of their material, especially after it was released on papyrus. The knowledge they passed on remained in some sense the property of the larger community. It was not until the seventeenth century, with the work of Francis Bacon and Robert Boyle, that intellectuals sought to commodify the knowledge that resulted from their investigations. Bacon argued that scholars should cease to rely on trained memories (as the medieval scholars had done) and should instead trust their discoveries to print for wide and immediate circulation. Boyle, an Irish scientist perhaps most famous for his attempt to prove the possibility of a vacuum by using an air pump, put Bacon’s idea into practice—but with unexpected results. At first, Boyle asserted his discoveries were openly available to all; however, people began to publish his

findings as their own, and in 1688 he circulated an “Advertisement about the Loss of his Writings” deploring the theft. The offense of plagiarism had to be identified and exposed through his pamphlet.

Boyle’s actions gave birth to two important ideas: the notion of intellectual property and the claim that discovery conferred ownership. Boyle and Bacon signaled a sharp departure from scholarship in the Middle Ages, which relied heavily on tradition (preserved in writing but also committed to memory) and included no concept of intellectual property. As for the Middle Ages, so for antiquity: the ancient historian was more a transmitter of traditions somehow still “owned” by the larger community than a discoverer of truth.

The Study of Unpredictable Human Behaviors

At the turn of the twentieth century, the study of history was regarded as highly as any other. In the decades that followed, however, history, as Novick points out, began to suffer by comparison to the hard sciences, such as physics and chemistry. The most obvious difference between history and these other studies was the linearity of many of the sciences. Scientists could predict outcomes from known beginnings in a way that historians could not. Hydrogen combines with oxygen in a ratio of two parts to one to make water, and always will. The orbits of the planets can be calculated and their positions predicted for centuries into the future. Historians, for all their knowledge of the past, can predict nothing with precision. With the passage of time, scientists expect to accumulate precise knowledge sufficient to resolve present controversies; in contrast, the passage of time seems only to increase historians’ uncertainty.

Most recently, chaos theory, which studies the less predictable aspects of nature, like the earth’s atmosphere, has offered historians a more attractive model by removing linearity as a prerequisite for scientific knowledge. History as a study of a massive system of relatively unpredictable human behaviors might very well find a home with this new theory.

Thucydides’s assumed interest in information (rather than informants) makes him look deceptively modern, but the information age in which we live began with the seventeenth century and has little to do with ancient Greek culture. The ancients’ reliance on human memory (as opposed to documents) to preserve what was important to them gave a special shape to what they took for knowledge. It made ancient history less specific in detail than its modern counterpart. At the same time, Greek history’s attention to “real” subjects gave it a frame of reference that was far more precise than epic poetry.

Beyond that, the Greek historians’ belief that the stability of universal laws (*onta*) lay behind the complexity of specific, transient events (*genomena*) gave a poetic dimension to their work that escaped Aristotle. It transformed their writing of history into a kind of philosophy or, as Dionysius of Halicarnassus (first century BCE) said of Thucydides’s work, “philosophy teaching by examples.”

Research for this essay was made possible thanks to a generous grant from the Social Sciences and Humanities Research Council of Canada. Special thanks to Helene Cazes and Jillian Shoichet.

Bibliography

- Arnold, P.E. "The Persuasive Style of Debates in Direct Speech in Thucydides." *Hermes* 120 (1992): 44–57.
- Bakker, Egbert J., Irene J.F. De Jong, and Hans Van Wees, eds. *Brill's Companion to Herodotus*. Leiden: E.J. Brill, 2002.
- Bartlett, F.C. *Remembering: A Study in Experimental and Social Psychology*. 1932. Reprint, Cambridge: Cambridge University Press, 1950.
- Boardman, John. *The Greeks Overseas*. 4th ed. Harmondsworth, UK: Penguin, 1973.
- Brown, T.S. *The Greek Historians*. Lexington, MA: D.C. Heath, 1973.
- Brunt, P.A. "Introduction to Thucydides." In *Thucydides*, ix–xxxiv. New York, 1963. Reprinted with a postscript (1991) on the funeral speech in *Studies in Greek History and Thought*, 137–80. Oxford: Oxford University Press, 1993.
- Carruthers, Mary. *The Book of Memory: A Study of Memory in Medieval Culture*. Cambridge: Cambridge University Press, 1990.
- Cawkwell, George. *Thucydides and the Peloponnesian War*. London: Routledge, 1997.
- de Romilly, J. *La construction de la vérité chez Thucydide*. Paris: Juillard, 1990.
- . *The Great Sophists in Periclean Athens*. Trans. Janet Lloyd. Oxford: Clarendon, 1992.
- Dewald, Carolyn, and John Marincola. "A Selective Introduction to Herodotean Studies." *Arethusa* 20:1–2 (1987): 9–40.
- Dover, K.J. "The Freedom of the Intellectual in Greek Society." In *The Greeks and Their Legacy*, vol. 2, 135–58. Oxford: Blackwell, 1988.
- Edmunds, Lowell. *Chance and Intelligence in Thucydides*. Cambridge, MA: Harvard University Press, 1975.
- Evans, J.A.S. *Herodotus, Explorer of the Past: Three Essays*. Princeton, NJ: Princeton University Press, 1991.
- Finley, M.I. *Ancient History: Evidence and Models*. New York: Chatto and Windus, 1986.
- Fogel, R.W., and G.R. Elton. *Which Road to the Past? Two Views of History*. New Haven, CT: Yale University Press, 1983.
- Fornara, C.W. *Herodotus: An Interpretative Essay*. Oxford: Clarendon, 1971.
- . *The Nature of History in Ancient Greece and Rome*. Berkeley: University of California Press, 1983.
- Fussell, Paul. *The Great War and Modern Memory*. New York: Oxford University Press, 1975.
- Gould, John. *Herodotus*. London: Weidenfeld and Nicolson, 1989.
- Guthrie, W.K.C. *The Sophists*. Cambridge: Cambridge University Press, 1971.
- Harrison, Tom. *Living Through the Blitz*. London: Collins, 1986.
- Hart, John. *Herodotus and Greek History*. London: St. Martin's, 1982.
- Hornblower, H. *Thucydides*. London: Duckworth, 1987.
- . "The Religious Dimension to the Peloponnesian War; or, What Thucydides Does Not Tell Us." *Harvard Studies in Classical Philology* 94 (1992): 169–97.
- Hunter, Virginia. *Thucydides the Artful Reporter*. Toronto: Hakkert, 1973.
- Kagan, Donald. *The Outbreak of the Peloponnesian War*. Ithaca, NY: Cornell University Press, 1989 (first published 1969).
- Kraus, Christina Shuttleworth, ed. *The Limits of Historiography. Genre and Narrative in Ancient Historical Texts*. Leiden: E.J. Brill, 1999.
- Lateiner, Donald. *The Historical Method of Herodotus*. Toronto: University of Toronto Press, 1989.
- Lawson, Thomas, E. "Counterintuitive Notions and the Problem of Transmission: The Relevance of Cognitive Science for the Study of History." *Historical Reflections/Reflexions historiques* 20 (1944): 481–95.
- Marincola, John. *Authority and Tradition in Ancient Historiography*. Cambridge: Cambridge University Press, 1997.

- Momigliano, Arnaldo. *Studies in Historiography*. New York: Harper and Row, 1966.
- . *The Classical Foundations of Modern Historiography*. Berkeley: University of California Press, 1990.
- . *The Development of Greek Biography*. 2nd ed. Cambridge, MA: Harvard University Press, 1993.
- Murray, Oswyn. "Greek Historians." In *Greece and the Hellenistic World*, ed. John Boardman, Jasper Griffin, and Oswyn Murray, 187–88. Oxford: Oxford University Press, 1986.
- Nagy, Gregory. "Herodotus the *Logios*." *Arethusa* 20:1–2 (1987): 175–84.
- Novick, Peter. *That Noble Dream: The Objectivity Question and the American Historical Profession*. Cambridge: Cambridge University Press, 1988.
- Ostwald, Martin. "Tragedians and Historians." *Scripta Classica Israelica* 21 (2002): 9–25.
- Packman, Zola Marie. "The Incredible and Incredulous: The Vocabulary of Disbelief in Herodotus, Thucydides, and Xenophon." *Hermes* 119 (1991): 399–414.
- Parry, Adam Milman. "Logos and Ergon in Thucydides." Ph.D. dissertation, Harvard University, 1957; reprint, 1981.
- Pearson, Lionel. "Credulity and Scepticism in Herodotus." *Transactions of the American Philological Association* 72 (1941): 335–55.
- Prior, Moody E. "Bacon's Man of Science." In *Essential Articles for the Study of Francis Bacon*, ed. Brian Vickers, 140–63. Hamden, CT: Archon Books, 1968.
- Seldon, Anthony, ed. *Contemporary History: Practice and Method*. Oxford: Blackwell, 1988.
- Shapin, Steven. *A Social History of Truth: Civility and Science in Seventeenth-Century England*. Chicago: University of Chicago Press, 1994.
- Shapin, Steven, and Simon Schaffer. *Leviathan and the Air-Pump: Hobbes, Boyle, and the Experimental Life*. Princeton, NJ: Princeton University Press, 1985.
- Shrimpton, G.S. *History and Memory in Ancient Greece*. Montreal: McGill-Queen's University Press, 1997.
- . "Accuracy in Thucydides." *Ancient History Bulletin* 12:3 (1998): 71–82.
- . "Beyond the Limits. New Thoughts on the Origin and Development of Ancient Historical Writing." *Ancient History Bulletin* 15:2 (2001): 50–62.
- . "Herodotus' Intellectual Context: A Review Article." *Ancient History Bulletin* 17:3–4 (2003): 149–57.
- Stephens, James. *Francis Bacon and the Style of Science*. Chicago: University of Chicago Press, 1975.
- Thomas, Rosalind. *Herodotus in Context: Ethnography, Science, and the Art of Persuasion*. Cambridge: Cambridge University Press, 2000.
- Warmington, E.H. *Greek Geography*. London: J.M. Dent, 1973.
- Whitehead, David. "Thucydides: Fact-Grubber or Philosopher?" *Greece and Rome* 27 (1980): 158–65.

30 The Development and Diffusion of Alchemy from Antiquity to the Renaissance

Brenda S. Gardenour

The Oxford English Dictionary defines alchemy as the art and science of transforming base metals into gold, particularly through the use of the universal solvent, or philosopher's stone. Alchemists believed that, by applying the universal solvent, any metal could be purified into gold, which was merely the perfect state of all metals. It was thought that even iron, if left to grow in the ground over time, would mature into gold; alchemical practice merely expedited this natural process. Alchemy involved techniques originally developed by craftspeople seeking to create objects of simulated gold, silver, gems, and pearls, as well as by dyers who attempted to counterfeit the rare and valuable Tyrian purple dye. Elements of alchemy also evolved from the demands of medical practice and pharmacology.

Alchemy has a second, mystical component. The alchemist sought not only the universal solvent, but the universal panacea or elixir, a miraculous substance that, when applied to the body, had the power to heal or even provide immortality. The elixir allowed for the purification and perfection of the human body, just as the philosopher's stone affected base metals. Alchemy, then, was a process by which the practitioner sought to uncover divine truths, hidden in nature behind the veil of physical forms. The uncovering of the occult, the perfection of metal, healing, and immortality were all made possible because of the connections that were believed to exist between the macrocosm, especially the cosmos beyond the moon, and the microcosm, including both the earth and the human body. The alchemist, if pure of spirit and intent, and connected to the greater forces of creation, could rearrange matter and manipulate it into the desired form.

Two major challenges are presented in this discussion of alchemy. First, alchemy was not one thing, but many things at the same time; it was never solely theoretical, technical, or spiritual, but was almost always a combination of the three, each in varying amounts. The second challenge is the elusive

nature of alchemical practice. Alchemists sought to keep their art a secret, and so wrote treatises in a cryptic style, filled with allusions and veiled secrets. Alchemical works were often written under pseudonyms and attributed to gods, goddesses, and heroes of the alchemical world. The authors and dates of manuscripts are not easily discernable; lines of transmission are difficult, if not impossible, to identify. Just as the sources for a single manuscript are multifold, so are the various influences on alchemy as a whole. There was no single alchemical tradition; instead, it is an amalgamation of ideas and practices from China, India, Persia, and Greece, and Jewish, Christian, and Islamic traditions. The alchemical undercurrent pulses beneath the surface of these diverse regions and cultures, from antiquity to early modern Europe, maintaining many tributaries, all of them interconnected in diverse and subtle ways. This connectivity must be born in mind through the following discussion of the theoretical, technical, and mystical aspects of alchemy, and alchemy's impact on history. For each facet of the alchemical gem we view, several are obscured.

Ancient Greek Sources

The roots of alchemical theory can be found in the philosophies of Milesians in the sixth and fifth centuries BCE. From their poleis on the coast of Ionia, they pondered the nature of the cosmos. No longer satisfied with mythological explanations for natural phenomena, they developed their own epistemologies. Key to the development of alchemy was the belief in an ultimate substance from which all things are made. Thales believed that the underlying substance of creation was water. Anaximander postulated that a vast nothingness called the "apeiron," from which emerged a seed, was the source of all creation. Other theories abounded: Anaximenes cast his lot for air, rarified and condensed; Heraclitus of Ephesus, for fire; and Leucippus of Miletus, for tiny particles called atoms. While these philosophers were not alchemists, their theories were essential to the development of alchemical theory. For if there is a single substance from which all matter is made, then copper is in essence the same as gold, with only a different physical appearance.

In the fourth century BCE, Aristotle, like the Milesians, believed in a universal *prima materia*. Objects in nature were composed of "matter," the underlying substance from which all things are made, and "form," the qualities impressed upon the matter to create different objects. While the form of objects might change, the matter itself did not. Aristotle postulated that change in matter took place through the shifting balances of the four elements: earth, water, air, and fire. The foundation of the four elements were the four qualities: dry, wet, cold, and hot. The combination of cold and dry yielded earth, cold and wet yielded water, hot and wet yielded air, and hot and dry yielded fire. Aristotelian elemental theory is of the greatest importance for alchemical theory. Not only is all of creation made of the same substance, but the form of matter can be manipulated through processes of combination and dissolution.

Belief in an ultimate substance and Aristotelian elemental theory contributed to the understanding of the physical nature of matter. Stoicism, which developed between the fourth and third centuries BCE, explored the spiritual dimension of matter. Stoics argued for the power of pneuma, or breath, in the creation of matter and the generation of all of its physical qualities. Heavenly pneuma descends to create matter; therefore, within matter is the indwelling nature of the divine. Future Gnostics, Hermeticists, and alchemists would seek to commune with the heavenly pneuma and, through divine revelation, understand the fundamental workings of the physical world. Stoicism introduced the link between the practitioner and the divine. For later alchemists, Stoicism was to provide the foundation for their belief that the state of the practitioner was elemental to the success of the experiment. Only the alchemist who was rightly guided and spiritually pure would be able to manipulate the elements of nature to create noble substances.

While elements of alchemy are founded in Greek philosophy, still others find their sources in the techniques developed by Greek, Egyptian, and Mesopotamian artisans and magicians. As theorists like Aristotle contemplated the nature of matter, potters mixed various glazes, experimenting to discover which provided the best luster. As the Stoics discoursed, jewelers attempted to augment gold and silver, and other craftspeople sought to create the illusion of gold, even if only its color, in their works. Cloth workers experimented with different dyes, mixing and matching different substances until the perfect color was reached.

The attempt to alter nature was important also to the practitioner of magic. Despite the work of historians such as Lynn Thorndike, Richard Kieckhefer, Valerie Flint, and Karen Jolly, many still consider magic the folly of the ancients. However, magic at all levels, particularly the use of ritual incantation and recipes, is vital to the development of alchemy. Whether practicing natural or demonic magic, individuals believed it possible to manipulate nature and the forces behind it in order to procure a desired effect. Perhaps to the modern mind, combining experimentation with natural elements and spiritual practices seems primitive and ineffective; nevertheless, we must accept that such practices were in force throughout the period, that many of those who practiced the magical arts believed in their efficacy, and that the attitudes inherent in the practice of magic were fundamental to the development of alchemy, and perhaps even to modern science.

Hellenistic Sources

In the Hellenistic Period, Egypt was believed to be the birthplace of the alchemical art, in part because of the high level the metallurgic craft had reached there, but also because ancient Egypt was imagined as the source of magical practices and as possessing secret wisdom. Although the etymology of the word *alchemy* is the Arabic prefix *al-* plus the Greek word *chemeia* or *chymeia*,

meaning “to melt,” practitioners claimed that Egypt was once known as the land of “Khem” and argued that this was the root which, with the addition of the Arabic prefix, became “al-Khemia.” Authors of alchemical treatises purposefully invoked the name and images of ancient Egypt as a source of prestige for their craft, similar to the way in which they attributed authorship of treatises to Egyptian deities such as Isis and Hermes Trismegistos (Greek for the Egyptian god Thoth). In this way, the use of Egyptian identities and imagery in alchemical works can be seen as topoi.

While the role of ancient Egyptians in the development of the technologies that would be used in alchemy is vital, the Egyptian contribution to alchemical *theory* is unclear. The first alchemical treatises do emerge in Egypt, but in the Hellenistic period, and in the Greek language. They may claim for themselves interesting lines of transmission, but most of these are impossible to verify. These treatises deal not only with theory, but also praxis, and include recipes for concoctions and decoctions, as well as instructions for the construction of alchemical equipment. Between the first and fourth centuries, several alchemical treatises by unidentifiable authors were in circulation, including those contained in the Leiden and Stockholm Papyri and the Hermetic corpus, as well as works attributed to Isis, Kleopatra, Sophia, and Agathodaemon.

The first known alchemical treatise by an identifiable author is the *Physica Kai Mystika* of Pseudo-Democritus, which may have been the pen name of Bolos of Mendes, who flourished sometime between 100 BCE and 100 CE. In this treatise, Bolos reveals the threefold doctrine taught to him by his master, the magus Ostanos. The threefold doctrine is a system of sympathies, in which nature enjoys nature, nature conquers nature, and nature dominates nature, and by which different qualities within a substance can be mutated through the manipulation of physical qualities. Parts of the *Physica Kai Mystika* are written in Hebrew. Because of this, and because of references within the text to keeping the secrets of the alchemical art among the followers of Abraham, Patai has argued that Bolos the alchemist was a Hellenized Jew.

A second alchemical corpus, dating possibly from the early third century CE, is attributed to Maria the Jewess, or Maria Hebraea, whose works we learn through the writings of Zosimus of Panopolis, who flourished in Alexandria around 300 CE. A prolific writer, he not only produced alchemical treatises, many of which have survived, but also a twenty-eight volume chemical encyclopedia, coauthored with his sister, Eusebeia. In his treatises on alchemy, he quotes frequently from earlier sources, sometimes from Bolos of Mendes but most frequently from Maria the Jewess, to whom he attributes the invention and improvement of several pieces of alchemical equipment, including the water-bath or “balneum mariae,” the three-pronged still, called the tribikos, and another type of distillation device called the kerotakis. Maria not only improved the technology of alchemy but also contributed to the development of alchemical theory. Through Zosimus, we learn that Maria held all of nature

to be composed of an underlying substance; that metals had bodies, souls, and spirits, just like human beings; and that the incorporeal spirits of metals were the conduit for manipulation and change. Metals grew slowly in the ground, but could also mature into gold, as well as die in the fire. Maria also held that there were female and male metals, and that through their union, a third entity could be created, and then a fourth, through which unity of substance would be achieved.

Zosimus used not only Neo-Platonic and Gnostic sources in developing his alchemical theory but also Hebrew scripture. He is the first to describe the biblical origin of alchemy, positing that the name Adam actually stood for the four elements as well as the four cardinal points on earth. In his *Book of Imouth*, Zosimus writes that alchemy is the art of angels. Relying on the apocryphal Hebrew *Book of Enoch* (first century CE), Zosimus recounts the tale of how rogue angels fell in love with beautiful human women and not only mated with them but also taught them the secret art of alchemy. The belief that alchemy was a divine secret, revealed through Adam, angels, the prophets, and select Jewish alchemists, would have a long life in alchemical history.

Patai asserts that some of the earliest alchemists were Jewish, including Bolos of Medes, Maria, and perhaps Zosimus himself. There were undoubtedly a myriad of Jewish alchemists in the Hellenized world, especially at Alexandria, the scientific center of learning. Jews who practiced alchemy, like most other alchemists, engaged in activities other than the alchemical arts, and were probably involved in trade, handcrafts, literary and religious arts, and politics. The Jews of the Hellenized world maintained a broad network of connections, extending throughout the Roman Empire and into the Middle East, where the next stage in the development of alchemy would commence.

Arabic Alchemy

Zosimus was the last of the truly inventive alchemists of the Hellenized world. The fifth century, for alchemy and for the arts and sciences in general, was a period of decline in the Greek orbit, a time in which encyclopedias, aimed at retaining information, replaced in-depth treatises on specific subjects. Alexandria became a storehouse of alchemical knowledge rather than a dynamic center of experimentation. At this point we must shift our focus from the Hellenized world to that of the Arabian peninsula. The advent of Islam in the seventh century acted as a catalyst to development in the Middle East. The Abbasid revolution of 750 continued the process of vitalization and, with the founding of Baghdad and the translation movement of the eighth and ninth centuries, changed the course of the arts and sciences, including that of alchemy.

The Arabic translation movement, often portrayed as a monolithic event with clear boundaries and even steps, took place via many pathways. Nestorian Christians performed the translation of Greek texts into Syriac, and some of

these were then translated into Arabic from Syriac. This is especially true of medical texts translated at Jundishapur, an early Christian center of learning. Individual scholars also sought out Greek and Syriac texts for translation. The greatest impetus for translation, however, was the cultural milieu of Baghdad itself, which attracted Arab and Persian Muslim, Zoroastrian, Christian, Jewish, and Hindu scholars, each of which contributed to the selection and translation of texts. Al-Mamun's founding of the Bayt al-Hikma, or House of Wisdom, was neither the earliest nor the sole cause of the translation movement, but it acted as a catalyst for the continued translation and absorption of much of Greek science. As the libraries of the Hellenistic world were brought back to Baghdad, alchemical treatises traveled along with other scientific works and entered into the orbit of Islam, where they were absorbed and augmented by Muslim and Jewish practitioners.

Arabic alchemy remained consistent with Hellenistic theory and practice, while continuing to emphasize the biblical basis of the art, including the belief that alchemical secrets were revealed by Allah to Adam, and that this knowledge was not only passed on through Jewish family lines but also revealed to the prophets of the Hebrew Bible, Isa, Muhammad, and in Shiite sources, Ali. From the prophet Muhammad, alchemists claimed that occult wisdom was passed down to three individuals: Khalid ibn Yazid (660–704), Jafar al-Sadiq (d. 765), and Jabir ibn Hayyan (d. 812). Alchemical authors in the ninth century traced their knowledge back to these individuals and even assigned authorship to them. Over a century after his death, Khalid ibn Yazid, not an alchemist but an Umayyad prince, was falsely credited with writing the *Liber Secretorum Alchimiae*, *Firdaws al Hikma*, and the *Liber Secretorum Artis*. He was also at different points believed to have had as a master a Byzantine monk, Morenus, or an unnamed Jewish alchemical master. Later tradition claims that Khalid was a Jew. The true author of the treatises, Pseudo-Khalid, may very well have been Jewish and certainly knew Hebrew.

While the identity of Pseudo-Khalid cannot be solved here, it does serve to remind the student that, like the Persian and Egyptian Magician, the Jewish Alchemist must be seen not only as a potentially real individual, since there were myriad Jews involved in all levels of translation, science, and medicine, but also as a stock character, a stereotype used to evoke a set of images and presumptions in the reader. The ambivalent image of the Jewish Alchemist in the Islamic world was transformed into the negative image of the Maleficent Jew in the medieval Christian world. In evoking Jewish roots, Arabic alchemists not only honored the wisdom of their Jewish predecessors but also played on the topos of Judaism as a repository for esoteric and occult knowledge. Throughout alchemical history, Jewish scripture was seen as particularly laden with alchemical secrets, and Hebrew seen as the mother tongue of alchemy.

The Jabir or Geber corpus contains several alchemical treatises, including the *Liber Misericordia*, *The One Hundred Twelve*, *The Book of Balances*, *Liber Fornacum*, and *De Inventione Veritatis*. The research of Paul Kraus, building

on that of Julius Ruska, indicates that the treatises of the Jabir corpus were written by a variety of individuals, many with Shiite leanings, between the ninth and tenth centuries. While the provenance of the treatises attributed to Jabir, or Geber, cannot be ascertained, this does not lessen the validity of the treatises themselves, which evidence the presence and growth of the alchemical art in Islamic science. The Jabir corpus not only contains translations and fragments of earlier alchemical works but also develops the art of manipulating the letters of creation, “alef, mem, and shin” in Hebrew, and “ain, mim, and sin” in Arabic. God created the cosmos through words composed of these letters; therefore, the letters must retain some element of creative power, as well as holding the secrets of nature within them. Furthermore, numbers could be transformed into letters, letters into numbers. Such ideas not only acted as a catalyst for the development of science in general but also for the development of the Jewish Kabbalah.

Arabic alchemy was furthered by Abu Bakr Muhammad ibn-Zakariyya al-Razi (825–924), a physician who also authored works of poetry, philosophy, and practical alchemy. Healing and alchemy were closely allied sciences, due not only to the understanding of basic chemical processes necessary for pharmacology, but also to the belief that inner healing, or the healing of the spirit, led to the healing of the body. On the later topic, al-Razi wrote *The Spiritual Physic*; on the former, he is credited with *The Book of Alums and Salts*, although Ruska attributes this alchemical text to an eleventh-century Iberian scholar. *The Book of Alums and Salts* exists in Hebrew, Arabic, and Latin versions; the Hebrew version appears to be the source text, although this is a matter of dispute as well. The text deals with basic alchemical processes but also discusses the properties and souls of minerals and how they can be combined to form a medicine for lesser metals, bringing them to wholeness and healing in the form of perfect gold. The *Liber Secretorum*, also attributed to al-Razi, classifies and describes in detail various minerals, salts, and liquids, as well as specialized equipment and alchemical procedures. The *Turba Philosophorum*, perhaps spurious, seeks to synthesize elements of alchemy, Hellenistic philosophy, and the Quran.

While some Muslims saw alchemy and Islam as mutually exclusive, most were ambivalent, admitting that elements of alchemical practice were useful, but doubting its ability to radically transform matter. Representative of this latter attitude was Ibn Sina (Avicenna, 980–1037), the poet, philosopher, and physician. His works include a compendium on medical practice called *Al-Qanun*, which he also produced in a poetic and therefore easily memorized form. Although he occasionally alludes to alchemical processes, in his *Kitab al-Shifa* he denies the possibility of transmutation of base metals into noble ones without first reducing the elements to their “primal matter.” Since this primal matter cannot be discerned, Ibn Sina believed alchemy impossible. In arguing against alchemy, however, he illuminates the persistence of alchemical tenets in scientific culture.

Alchemical treatises, and the technology contained in them, circulated throughout the Muslim world, from Samarkand to the northern limits of the olive on the Iberian peninsula. Arabic alchemy contributed to advances in the distillation process and the development of specialized equipment, such as the Moor's Head still. Albucasis built a multilevel distillation device for the production of medicines and refining perfumes. Attributed to Arabic chemists also are the discovery of alcohol, the perfection of petroleum distillates, refined petroleum oil, various types of waxes, sulfuric acid, hydrochloric acid, alkalis, refinement of natron, caustic soda, and soaps. Perhaps the most valuable contribution of Arabic and Jewish alchemists is the development of a concise, technical vocabulary; many of its terms would remain in European alchemy from the twelfth century forward.

Alchemy in the West

The eleventh and twelfth centuries mark the shift to the next geographical stage in the story of alchemy. Alchemical knowledge, based on treatises from the Hellenistic world, translated and augmented by Arabic and Hebrew authors, circulated throughout the Islamic world, including the Kingdom of the Two Sicilies and the Iberian peninsula. The Arabic to Latin translation movement germinated in Toledo, which in 1085 had been conquered by Alfonso VI and incorporated in the Christian kingdom of Leon. As urban areas once under Islamic control fell to the Christians, vast Arabic libraries became available for translation. Twelfth-century Christian scholars such as Gerard of Cremona, Plato of Trivoli, Herman of Carinthia, and Robert of Ketton traveled to the Iberian peninsula in order to translate scientific works from Arabic into Latin; peninsular translators include Hugh of Santalla, Dominicus Gondisalvi, Petrus Alphonsi, Savasorda, and Abraham ben Ezra. To facilitate this process, Latin scholars often worked in translation teams with peers fluent in Hebrew and Arabic. Soon the works of Aristotle and texts discoursing on physics, optics, surgery, medicine, and alchemy were circulating throughout medieval Europe, at first in the monasteries but ultimately in the urban milieu of the developing urban universities. Alchemy as art and science was never accepted into the curriculum of the medieval universities, but alchemical texts were still sought for translation by scholars.

Alchemical treatises of the twelfth through fourteenth centuries fall roughly into four categories: translations, encyclopedias, treatises seeking to interpret the alchemical tradition, and manuals for the practice of the alchemical arts. The first category would include Michael Scot's translation *Alchimia* and Robert of Ketton's translation *De Compositione Alchemiae* (1144), taken from Morenus. The encyclopedic tradition is represented by Bartholomew Anglicus, a Franciscan who composed *On the Properties of Things* (1260), a compendium of natural philosophy for the general reader, and by Vincent of Beauvais, a Dominican who produced two volumes on natural philosophy, the *Specu-*

lum Doctrinale and *Speculum Naturale* (1244–1250). Interpretive treatises were written by Albertus Magnus, whose *De Mineralibus* (1250) postulated the alchemical healing of metals, achieved by strengthening the spiritual and celestial powers within them, and thus perfecting them. Albertus Magnus argued that it was not the alchemist who transmuted the metal; instead, like the priest performing a baptism, he only prepared it for a more perfect form provided by heaven. Roger Bacon, in his *Opus Tertium* (1266), also wrote on alchemy, which he argued should be the basis of reforming the university curriculum. In his *Communium Naturalium*, Bacon further argued that alchemy, especially the transmutation of metals, was realistically possible.

As in the Hellenistic and Arabic worlds, alchemy was seen as the art of a select few. Treatises were often written in an enigmatic format, using the same ancient symbolism present in Bolos of Mendes and Zosimus. Like their ancient predecessors, medieval alchemical authors who sought to expound upon the actual practice of alchemy often wrote under pseudonyms; alchemical treatises were attributed to Albertus Magnus, Roger Bacon, Arnau de Vilanova, Ramon Llull, Avicenna, and Aristotle.

Jewish alchemists continued to translate texts and participate in the alchemical arts. Representative would be the thirteenth-century Gershon Ben Shlomo of Arles, a Provençal scholar who wrote a summa of the natural sciences, including alchemy, called the *Gate of Heaven*. In this treatise, he borrows heavily from an Arabic text by Abufalah. While texts flowed across cultural borders in large numbers during the translation movements, we must always bear in mind the connectivity of the Jewish communities of the Mediterranean. As an alchemist, Gershon ben Shlomo had access to a wide variety of texts from varied traditions. The major contribution of the medieval West to alchemy was the act of translation and synthesis of alchemical ideas; the true revolution in alchemical theory came in the thirteenth century with the development of the Jewish Kabbalah.

From Kabbalah to Renaissance Magus

The first practitioners of the Kabbalah flourished in Jewish communities of mid-twelfth-century Provence. The first surviving Kabbalistic treatise is the *Sefer Yetzira*. From Provence, the Kabbalah traveled to thirteenth-century Spain, gravitating toward Toledo and then spreading northward. The most important book in the Kabbalistic corpus is the *Sefer ha-Zohar* of Rabbi Moses of Leon (fl. 1275). From the thirteenth to the fifteenth centuries, the Kabbalah developed in various directions as it gained in popularity. The expulsion in 1492 brought Jews from Spain to Italy in large numbers, and with them the Kabbalah, especially the *Zohar*. Flavius Mithridates, a Florentine scholar who flourished in the early sixteenth century, translated a variety of Kabbalistic texts, thus making them available to a Latinate public. Humanists such as Pico Della Mirandola and Marsilio Ficino adopted ideas from the Kabbalah,

especially those concerning the manipulation of numbers and letters in an attempt to uncover occult knowledge.

Kabbalistic techniques of exegesis, coupled with Neo-Platonic philosophy and the recovery of the Hermetic corpus, served as a powerful tool for Renaissance occultists. These three elements breathed new life into the art of alchemy. Alchemists no longer constrained themselves to traditional recipes; instead, they experimented with different materials, hoping to find the hidden truths stored in them. They believed that God had conveyed the secrets of the cosmos to Hermetic Adam, that part of the alchemist still connected with prelapsarian perfection. The Renaissance magus, a reflection of Hermetic Adam, was thought to have mastered the skills necessary to refine nature, manipulate astrological powers, talk to angels, see the future, and create gold from base metals. This confidence led alchemists to explore nature in search of the divine secrets hidden there. While they searched, they experimented, making discoveries about the substances that they manipulated. Suddenly, nature was worth exploring and examining, if only in search of hidden knowledge.

In the sixteenth century, the occult remained important; however, as books of alchemical and Hermetic secrets were published, a change occurred. No longer was it necessary to be an initiate, to have a master, to speak the language of alchemy. Alchemical books of the sixteenth and seventeenth centuries read like how-to manuals, and their secrets were open to all who could read. The development of print culture allowed scientists to critique and correct earlier treatises; the mystical elements of alchemy were neutralized, leaving behind the elements from which modern chemistry would emerge.

Alchemy is often dismissed as a failed science. Alchemists never found the philosopher's stone, never created gold from lead, and never discovered the elixir of life. However, the importance of alchemy isn't in its success rate but in its failures. The history of science is not only that of grand experiments but also botched ones; the scientist can learn from both. The alchemical tradition was composed of science, technical craft, and mystical art in varying proportions. Alchemical knowledge in all of its forms was passed from culture to culture, its exterior changing while its essence remained indelibly the same. The mystical aspects of alchemy intensified with the advent of the Kabbalah, and its incorporation into Renaissance Hermeticism. Not until the nineteenth-century advent of modern chemistry were craft and science separated from mysticism and spirituality. Alchemical curiosity, with all of its dubious sources and impossible dreams, served as a foundation for scientific inquiry. Perhaps the questions we ask of past sciences should not be why they failed, but why they were so persistent.

Bibliography

Dobbs, Betty Jo Teeter. *The Foundations of Newton's Alchemy: Or, "The Hunting of the Greene Lyon."* Cambridge: Cambridge University Press, 1975.

- Eamon, William. *Science and the Secrets of Nature*. Princeton, NJ: Princeton University Press, 1996.
- Flint, Valerie I.J. *The Rise of Magic in Early Medieval Europe*. Princeton, NJ: Princeton University Press, 1991.
- Glick, Thomas F. "From the Sarton Papers: Paul Kraus and Arabic Alchemy." *Cronos* 2:2 (1999): 221–24.
- Harkness, Deborah E. *John Dee's Conversations with Angels: Cabala, Alchemy, and the End of Nature*. Cambridge: Cambridge University Press, 1999.
- Jolly, Karen. *Witchcraft and Magic in Europe*. Philadelphia: University of Pennsylvania Press, 2002.
- Kieckhefer, Richard. *Magic in the Middle Ages*. Cambridge: Cambridge University Press, 1990.
- Lindberg, David C. *The Beginnings of Western Science: The European Scientific Tradition in Philosophical, Religious, and Institutional Context, 600 B.C. to A.D. 1450*. Chicago: University of Chicago Press, 1992.
- Lindsay, Jack. *The Origins of Alchemy in Graeco-Roman Egypt*. London: Muller, 1970.
- Patai, Raphael. *The Jewish Alchemists: A History and Source Book*. Princeton, NJ: Princeton University Press, 1994.
- Roberts, Gareth. *The Mirror of Alchemy: Alchemical Ideas and Images in Manuscripts and Books from Antiquity to the Seventeenth Century*. London: British Library, 1994.
- Sarton, George. *Introduction to the History of Science*. Baltimore: Williams and Wilkins, for the Carnegie Institution of Washington, 1962.
- Thorndike, Lynn. *A History of Magic and Experimental Science*. New York: Columbia University Press, 1923–1958.
- Yates, Frances. *Giordano Bruno and the Hermetic Tradition*. London: Routledge and Kegan Paul, 1964.

31 Women's Bodies, Women's Souls: Perspectives in the Middle Ages

Brenda S. Gardenour

The history of women's bodies is one of shifting perceptions. Theoreticians, such as Hippocrates and Aristotle, developed various systems to explain the structure and function of female anatomy. They contemplated not only the differences between male and female, but also the characteristics and functions that made the female body unique. Although not alone in their quest to understand the female body, Hippocrates and Aristotle were the most influential of their time period, and their ideas were the most persistent in the development of medieval medicine. Aristotelian logic, especially its use of categories, would influence medieval perceptions of the female body and the types of female bodies that were possible, leading to the construction of two dialectical categories: the miraculous body of the virgin, and the maleficent body of the witch. The medieval belief that body and soul were integrated meant that female biology was thought to have spiritual consequences and, reciprocally, that the state of a woman's soul could affect the functioning and composition of her physical body.

But the theories developed by academics, who were elite members of a literate, Latinate culture, were not the only ideas about women's bodies prevalent in the Middle Ages. Beside their theoretical approach existed another tradition, that of practical care. Midwives handbooks, for example, found wide circulation and often contained a mixture of elements, from snippets of theoretical medicine to therapeutics, practical advice, recipes, and natural magic. Women's bodies were portrayed in realistic terms, with detailed descriptions of actual female anatomy, physiology, and the procedures needed to maintain a healthy system.

Theoretical Bodies: Ancient Greece

The first sources for the biology of women's bodies originated in ancient Greece. Hippocrates of Cos (c. 460–370 BCE), a practicing physician, wrote

extensively on the theoretical functions of the human body. The fundamental contribution of Hippocrates to ancient and medieval biology was the theory of the four humors, which were based on Empedocles's four elements: earth, air, fire, and water. Hippocrates asserted that there were four bodily humors: phlegm, blood, black bile, and yellow bile. Each contained a pair of elemental qualities: phlegm was cold and wet, blood was hot and wet, black bile was cold and dry, yellow bile was hot and dry. According to humoral theory, food was digested in the stomach and turned into blood; from there, the body refined the blood into phlegm, yellow bile, or black bile, as necessary. Bodily health was directly related to the balance of the humors; if any one humor was retained or produced in excess, the body would manifest symptoms from which the physician could diagnose the cause of the illness.

Of the sixty works in the Hippocratic corpus, ten deal with women's bodies and the problems specific to them. Hippocrates postulated that women and men were very different creatures, and that women had their own, unique systems that demanded specific treatments. Women were thought to be composed of a different type of tissue than men; whereas men were firm and compact, women were soft and spongy, cold and moist. Women, being spongy, not only retained their humors more easily than men but also lacked the ability to refine their blood into humors as quickly as men, and so were left with an excess that they could not process. Hippocrates asserted that this excess, in the form of blood, was retained in the spongy tissue until menstruation, when the blood would descend into a woman's uterus and out through the vagina. For Hippocrates, menstruation was the natural cleansing process of the female body, a necessary function to maintain humoral balance. The menstrual cycle was so vital to the maintenance of women's health that disruption of menstruation was seen as dangerous. Women who were unable to menstruate were bled by a physician once a month in order to maintain humoral balance.

Aristotle (384–322 BCE), a philosopher rather than a practitioner of medicine, believed that men and women were not as drastically different as Hippocrates would have allowed. Understanding a complete parallelism to exist between the categories of male and female, Aristotle sought to reconcile each male organ with a female organ of similar function. The male sexual organ was the penis, while the female sexual organ was the womb. Because of his desire to force men and women's bodies to fit this symmetrical construct, Aristotle was forced to ignore or deny certain organs, such as the clitoris. Since there was no obvious parallel for the clitoris in the male, then it was simply a fold of skin, and not an organ. Furthermore, since men produced only one sexual residue, semen, women could have only a single residue, the menses. In this way, Aristotle denied the possibility that women might produce seed as men did. Women were allowed to be somewhat different, somewhat alike, but never to have *more* than men.

Aristotle's perception of women as weaker, softer, and less perfect men is evident in his theories of menstruation and conception. Like Hippocrates,

Aristotle believed that women could not fully digest their food and so produced an excess of blood. However, he also postulated that, because women were colder and moister, they did not produce sufficient heat to reduce the resultant blood into humors. Men were hotter and drier, and so could refine blood into muscles, sweat, and hair, thus their different appearance. Women, however, retained excess blood, which trickled slowly into the womb throughout the month, where it became corrupt. At the end of their monthly cycle, women discharged this toxic brew as menstrual blood. Aristotle also thought that because the womb collected blood throughout the month, it was closed to the reception of male seed except for the few days following menstruation, when the uterus was essentially empty. After the male seed had entered the womb, menstrual blood could be used to nourish a fetus.

Hippocrates and Aristotle had similar theories about the anatomy of the womb, which was believed to be a soft vessel, like a bladder. The fallopian tubes were often referred to as horns, or tentacles, and ancient Greek physicians believed they were mouths through which the womb sucked bodily fluids. The cervix was considered a third mouth that served as an external opening. The womb was believed to contain pockets. If sperm entered the left pocket, which was cold and moist, a female would be born. If sperm entered the right pocket, which was hot and dry, a male would be born. Although the right side of the womb was hot and dry, the womb itself was cold and moist in nature.

Ancient physicians believed that changes in the natural state of the womb might cause it to wander throughout the body. Hippocrates explained its movements as a desire for moisture: when the uterus was not lubricated with semen, it dried out, became thirsty, and traveled to other organs for relief. The condition known as hysteria was thought to result when the uterus visited the brain, which was considered one of the moistest areas in the body and thus a favorite destination for the womb. The liver and the heart were also areas that attracted the wandering womb.

The womb was thought to move through large tunnels, called phlebes, the largest of which was thought to extend from the uterus through the diaphragm and up into the nostrils. Hippocrates postulated that a woman's fertility could be ascertained by placing garlic near the opening of her vagina; if the garlic could be smelled on her breath or through her nose, her main phlebe was unobstructed, and thus her womb was healthy and fertile. To coerce a wandering womb back into its proper place, foul-smelling substances were placed near a woman's nostrils, while sweet-smelling substances were placed near the mouth of her vagina. The womb would be attracted to the sweeter smell and descend back toward it. To cure a prolapsed womb, the process was reversed, thus luring the womb upward. None of the ancient sources explains why the womb was thought to have a sense of smell.

Where Hippocrates advocated for a central tube linking womb and mouth, Aristotle theorized that the transference of odors between womb and mouth took place through a relay of bodily fluids. If women collected corrupt blood

and potentially poisonous humors in their wombs, the vapors from these humors could travel through the phlebes or mix with the fluids of the head and lungs. Therefore, it was physiologically possible for women to excrete poisonous substances in their saliva, breath, and tears. Poisonous vapors could be emitted from the eyes with the *pneuma* that was necessary for sight to take place, so the “evil eye” could be truly deadly. Aristotle postulated that a menstruating woman could look into a mirror and “dim it with a bloody cloud.” Women’s bodies were not only different from men’s, but also much more dangerous, and thus powerful. The wandering womb and the passageway between womb and mouth were two of the most persistent cultural ideas about the physiology of women’s bodies, ideas that would affect medical theory and practice through the Middle Ages.

Virgin and Witch

Medical treatises circulated widely through the ancient Mediterranean. Many ultimately were housed in Alexandria, where they were used in the schools through the fourth and fifth centuries. By the eighth century, the Islamic Empire had absorbed many regions previously within the Greek orbit, including Alexandria. Under the Abbasid caliphate, medical treatises were translated into Arabic, some by Nestorian Christians in the Persian city of Jundishapur, but mostly by scholars attracted to the intellectual center at Baghdad. Physicians such as al-Razi and Ibn Sina (Avicenna) enriched the received medical tradition, and their texts, along with translations, commentaries, and original works on philosophy, especially of Aristotle, circulated throughout the Muslim world. In eleventh-century Sicily and Iberia, Western Europeans began to translate and absorb Greek and Arabic medicine and philosophy. In the developing medieval universities, these texts, especially by Aristotle, became the foundation of study. By the thirteenth century, all university students were required to study Aristotelian logic; in particular, the Dominicans espoused Aristotelian logic and the creation of opposing categories in their attempt to understand their world. Important for our discussion is the constructed category of the miraculous virgin, and the inversion of this category, the maleficent witch.

Virgin women were seen as ideal women, unaffected by physical and emotional lust for sexual intercourse. Because of this spiritual and sexual purity, the virgin body was believed to be a potential conduit for the word of God. At first, this would seem paradoxical; medical theory taught that the female body was deficient and corrupt, the female will weak, and the female mind clouded and unable to comprehend complicated matters such as theology. However, it was this very weakness that allowed Hildegard of Bingen to claim authority for herself. An eleventh-century Benedictine nun, Hildegard wrote treatises on medicine and mystic revelation, and she composed letters to the pope and emperor expressing her opinions. Barbara Newman has argued that Hildegard

of Bingen was able to act in such a straightforward manner because of her virginity and her perceived female weakness. The idea that her revelations were from God was taken seriously, because it was thought biologically impossible for a woman to have conceived of such complicated truths through her own intellect.

Male theologians saw virgin women's bodies as vessels for the revelations of God; exceptional, saintly women, chosen by God, could act as spokeswomen for the almighty. The weakness of their constitutions made possible the miraculous, but the true miracle was the working out of God's plan in the fullness of time. By the thirteenth and fourteenth centuries, however, there was a shift in the perceptions of women's bodies as miraculous in and of themselves. Thomas Cantimpre, a Dominican intensely interested in the religious experiences of the Beguines, women who formed secular communities similar to a religious order, wrote biographies of Christina Mirabilis and Lutgard of Aywieres. In recording the stories of these exceptional women, Cantimpre did not focus on their spiritual revelations but on their miraculous bodies.

Christina Mirabilis's transformation began with her desire for union with Christ. Her quest drove her into a state of lovesickness, a medical condition with symptoms including sleeplessness, loss of appetite, racing heart, and intermittent periods of elation and depression. Ultimately, her body began to fail, and she appeared to die. It was in this state that her spirit left the earth to travel to the world beyond the moon, beyond time, to join with Christ. Her *unio mystica* complete, Christina returned to her earthly body and physically came back from the dead. Christina's union with God had reordered her spirit, which in turn had a corresponding effect on her body. Her body was no longer the chaotic body of those who live below the moon, but instead the resurrected body of the inhabitants of the heavenly Jerusalem. Just as God took the chaos of the primordial world and ordered it into creation, so too had he taken the chaos of Christina's body and ordered it into a new one, a body with qualities very different from those of ordinary bodies. Among her new capabilities were contortions, such as rolling around like a hoop, levitation (since she was no longer tethered to the earth), and the power of healing. Christina's body was no longer a natural body, nor was it any longer a female body, subject to humoral imbalances and menstrual cycles. As an ordinary woman, her connection with the divine would have been physically impossible. Thus, Cantimpre recreated her, defeminized her, and gave her a body of resurrected flesh that existed beyond gender.

Cantimpre portrayed Lutgard of Aywieres in a similar fashion, attempting to fit her unusual experiences into a categorical framework. Like Christina Mirabilis, Lutgard longed for union with Christ, and like Christina, she achieved her goal. After their communion of hearts, Lutgard physically shared in Christ's suffering and felt on her own flesh the invisible marks of the stigmata. Still, this was not enough for Lutgard. One night, as she lay in bed, pleading for martyrdom, her desire became so strong that a vein burst

close to her heart and she began to bleed from her side as did Christ on the Cross. She bled so much that it soaked her tunic. As she awoke, Christ appeared to her and informed her that she had died a martyr for his love. Lutgard's effusion of blood resulted in the total defeminization of her body. When Lutgard's vein ruptured, she was drained of her sinful blood, purged of all impurities. Just as Hippocrates had prescribed bleeding to relieve excess blood in women, so also Christ had prescribed an extreme bleeding for Lutgard. The hemorrhage that she experienced from her side was in fact to be the last menstruation of her earthly life. Since she now dwelled in a resurrected, perfect body, there was no need for her to menstruate, to cleanse her body of poisons, to regulate her humors. There was, really, no need for her to even be a *woman*.

Cantimpre portrayed women obsessed with their bodies, women who could only experience the divine through physical means. They waxed hysterical; their wombs seeking moisture, until Christ ultimately healed them, purging them of their humors, blood, and ultimately their woman-ness. But these weren't real women's bodies, nor were they real women's experiences. In his attempt to classify these women, and to validate their visions, he resorted to categorization of their bodies. The ideal holy woman was both virgin and miraculous; to prove that the ecstatic experiences of Christina and Lutgard conformed to the ideal, and were not due to hysteria, Cantimpre recreated them to fit the category of the miraculous, resurrected, asexual body.

Just as academics created a category for exceptionally good women, so also they created a category for exceptionally bad women; the witch was an inversion of the virgin category. The witch inhabited an upside-down world that mirrored the hierarchy of the Christian church. Just as the church had at its head God, the diabolical church had the devil. The priest entered the church in pure white robes; the head sorcerer entered Satan's synagogue walking backward and wearing black. In the diabolical church, angels were replaced by demons, the liturgy was read backward, and the kiss of peace became a kiss of the devil's anus. The church had virgins and female saints, and the diabolical church had witches.

Just as theologians used ideas about women's bodies to support their theories of sanctity, so too did they use their understanding of the way women's bodies worked to explain the existence and powers of witches. Witches' bodies were inverted versions of virginal bodies. Unlike the body of a virgin, the body of a witch had experienced sexual intercourse. Widows were seen as most likely to succumb to the wiles of the devil; although accustomed to sexual activity, they had not sought to replace their partner through marriage and were considered suspect. And because the witch embodied the worst of all female qualities, she could not control her tongue, her emotion, her mind, or her body. The witch's physical yearning for intercourse, caused not only by her weak constitution but also because of her womb, which was searching for moisture, drove her to accept the favors of any man, even if he were a demon

or the devil himself. As the virgin experienced spiritual union with God, so the witch longed for carnal union with the devil.

Where a virgin was physically pure, a witch's body was corrupt. Unlike Christina and Lutgard, whose bodies had become perfectly ordered, the body of the witch was chaos, seething with corrupt humors. The uterus demanded moisture and sought it through sexual activity. If it was not satiated, the uterus might detach and wander through the body, causing hysteria. Unpurged seed might also become corrupt and the vapors rise to the brain, causing madness. The uterus also contained menstrual blood, considered a toxic brew of humors; these poisons traveled as gas, according to Hippocrates, and as a fluid, according to Aristotle, and could be emitted through the breath, saliva, and tears of a witch. The witch not only contained poisons in her own body but also controlled the poisons in nature. Where the virgin had forsaken the natural world and contemplated heaven, the witch had mastered the meaner elements of nature, and with the help of demons knew the secrets hidden in herbs and animals. The witch appeared to be a healer but actually caused infertility and abortions. She received communion at Easter, only to spit the wafer into the privy at home. The Virgin Mary had nurtured and cherished baby Jesus, but witches killed and sometimes consumed infants.

The characteristics of the witch were built upon beliefs about women's bodies and the way they functioned. Academics were not interested in the anatomy and physiology of actual women, but in the ways that abstract theories about women's bodies could be used to support artificial categories constructed for the classification of women, such as virgin and witch. Elements of folklore, popular beliefs, natural and demonic magic, natural science, and mysticism all went into the construction of the witch category; these elements, however, were arranged in such a way as to counterbalance the qualities of the virgin. Ideas about maleficent women and virgin women were present in the general culture, but the witch was not a category described by theologians. There were undoubtedly exceptional women, both good and wicked, in the medieval world, but it is unlikely that they fit into the constructs demanded by Aristotelian thinkers.

Practical Care

Theories about women's bodies that were originally developed in ancient Greece were persistent in medieval learned culture. Humoral theory, the anatomy and appetites of the uterus, the wandering womb, the toxicity of menstrual blood, all were used by thirteenth- and fourteenth-century academics to defend the dialectical categories developed to define types of women. At various levels, these theories about women's bodies impacted general perceptions about women, but they were not the predominant way of understanding women's bodies and their functions. While dominant male academic culture debated and classified women's bodies according to theory, and ascribed all

manner of paradoxical qualities to women's anatomies, a more prevalent tradition existed which treated with compassion and practical care the bodies of real women.

The practical care of women's bodies found its source in the work of Soranus of Ephesus, a second-century CE practitioner of methodism, a sect of medicine that focused on therapeutics, or the relaxation and constriction of tissues, instead of theory. Soranus's treatise on women's health, *Gynecology*, survived through the translation of the sixth-century encyclopediast Caelius Aurelianus. The *Gynecology* assessed not only the specific maintenance needs of women's reproductive parts but also techniques for intervention when these organs malfunctioned. One section discussed normal female functions, including the physiology of the uterus, menstruation, conception, contraception, abortion, pregnancy, parturition, and delivery. A second section discussed abnormal female functions, including the retention of the menses, hysterical suffocation, wind in the uterus, bloody flux, and the ascent of the uterus. Another section treated abnormalities in labor, including the various positions of a fetus, the turning of a malpositioned fetus, removal of a dead fetus, prolapse of the womb, and the repair of a torn peritoneum. Also included in the *Gynecology* was advice on how to choose a wet nurse, how to care for an infant, and how to be a good midwife.

Soranus described the best midwife as trained in all branches of therapy. She was to be calm in demeanor, since she would be called on to share the many secrets of life. The midwife was to have small, soft, closely manicured hands to travel into small, delicate places. Furthermore, like Soranus himself, she was to shun superstition and look only to the disease as it presented itself and the therapies that had been proven to work. Soranus's manual did not contain the elaborate theories of Hippocrates and Aristotle; as a methodist, he found these unnecessary in the care of women. A woman with a disease was a woman suffering, and the job of the midwife was to alleviate this suffering through therapeutics. She was to observe her patient as an individual, to learn her patient's own unique systems and cycles, and to treat her accordingly. Soranus did not demand that all women's bodies behave or function in exactly the same manner, nor did he separate them into constructed categories. He rejected superstitious beliefs such as a wandering, smelling womb and the toxic nature of menstrual blood. Yet he allowed for the use of talismans and other ritual objects, not because of their efficacy in physical healing, but because they might provide comfort to a woman in pain.

Soranus's *Gynecology* provided medieval healers with various therapies, long proven effective in the care of women's bodies. In Soranus, we see the basic medical procedures that would endure well into the Middle Ages, including the use of potions, salves, ointments, pessaries, purgatives, and dietary regimens, as well as the physical techniques of massage, baths, and exercise. Medieval gynecology, practiced mostly by midwives and wise women, was an amalgamation, combining elements of theoretical medicine,

especially the humoral theory, superstitions about women's bodies, practical therapeutics, and folk medicine and magic. Many of these elements can be seen to coexist in medieval gynecological handbooks, such as those attributed to Trotula of Salerno.

Trotula, an eleventh-century woman healer, stands out not only as the author of at least one treatise on gynecology but also as a literate medieval woman. She based her work on translations of Soranus, her understanding of the humoral theory, recipes that she had heard of and perhaps tried, and local traditions of healing. Handbooks for midwives circulated in Latin throughout the twelfth and thirteenth centuries. However, the majority of women healers were illiterate. While it is possible that some midwives had treatises read to them, it is most likely that midwives learned their healing therapies from other women healers. They also relied on local traditions of natural magic as well as trial and error.

With the increase in lay literacy in the fourteenth and fifteenth centuries, midwives' handbooks were translated into the vernacular. Some handbooks were very small, meant to be carried by the midwife on her many errands about her community. Simply written, these manuals combined elements of theoretical medicine, such as the humoral theory and the wandering womb, therapies originally prescribed by Soranus and Trotula, and recipes and incantations passed down through oral tradition. The salient feature of medieval handbooks for midwives, however, was their concern for the compassionate and practical care of real women's bodies. Each body was considered individually, with its own diseases, cycles, and needs.

Theoreticians such as Hippocrates and Aristotle developed ideas about the differences between male and female anatomies and tried to explain female physiology. Concepts such as the humoral theory and the wandering womb were persistent in both the ancient and medieval worlds. Aristotle's system of logical categories and his arguments for the toxicity of women's bodies affected the way some medieval academics perceived women in general, providing them with the tools to develop categories such as virgin and witch. Female anatomy and physiology had spiritual consequences, since body and soul were interconnected, and the condition of the one had a reciprocal effect on the other. Medieval theoreticians did not conceive of the body as a precise machine, but as a complex system subject to the sympathetic influence of natural elements, planets and stars, spirits and demons. Women, having been defined as the weaker sex from earliest times, were thought to be more open to these cosmic forces than men.

Theoreticians and academics sought to explain women's bodies in terms of systems and functions, both physical and spiritual. Some of their ideas, such as hysteria and the powers of the witch, have persisted into our own day, if only as stereotypes and categories. However, these ideas about women circulated in an elite, literate milieu populated by men, many of whom had little direct experience of women's bodies. Alongside this elite, theoretical tradi-

tion there existed a popular, practical culture of healing. Medieval midwives sought to provide compassionate care, through whatever means necessary. They were not concerned with developing a rational system of medicine, but instead combined paradoxical elements from the various traditions, using prayer alongside talismans, and salves and ointments alongside purges and incantations. Medieval midwives were not concerned with types or categories of women, but with individual women whose bodies and problems were unique.

Bibliography

- Barratt, Alexandra. *The Knowing of a Woman's Kind in Childing: A Middle English Version of Material Derived from the Trotula and Other Sources*. Turnhout, Belgium: Brepols, 2001.
- Cadden, Joan. *The Meaning of Sex Difference in the Middle Ages*. Cambridge: Cambridge University Press, 1993.
- Caelius Aurelianus. *On Acute Diseases and on Chronic Diseases*. Ed. I.E. Drabkin. Chicago: Chicago University Press, 1950.
- Dean-Jones, Lesley Ann. *Women's Bodies in Classical Greek Science*. Oxford: Oxford University Press, 1996.
- Greene, Monica H. "The De Genecia Attributed to Constantine the African." *Speculum* 62:2 (1987): 299–323.
- . *The Trotula*. Philadelphia: University of Pennsylvania Press, 2000.
- Jacquart, Danielle, and Claude Thomasset. *Sexuality and Medicine in the Middle Ages*. Princeton, NJ: Princeton University Press, 1988.
- Kieckhefer, Richard. *Magic in the Middle Ages*. Cambridge: Cambridge University Press, 1989.
- Newman, Barbara. "Hildegard of Bingen: Visions and Validation." *Church History* 54:2 (1985): 163–75.
- Rowland, Beryl. *Medieval Woman's Guide to Health*. Kent, OH: Kent State University Press, 1981.
- Sharpe, William D. "Isidore of Seville: The Medical Writings. An English Translation with an Introduction and Commentary." *Transactions of the American Philosophical Society* 54, part 2 (1964).
- Soranus. *Gynecology*. Trans. Owen Temkin. Baltimore: Johns Hopkins University Press, 1956.

32 Religion and Geography in the Early Middle Ages

Natalia Lozovsky

Geographical studies in medieval Europe, like other branches of knowledge in that period, developed by incorporating scientific and philosophical achievements of classical Greece and Rome into the framework of Christianity. Geographical interests formed an important part of medieval education and worldview, but geography was not instituted as a separate discipline and geographical studies did not yet have a distinctive name. The term *geographia* was used very rarely until the fifteenth century, and special geographical texts usually bore titles such as *Cosmographia* (Cosmography) or *De Orbis Terrae* (On the Earth). Different genres could accommodate geographical information: biblical commentaries, encyclopedias, histories, special geographical treatises, and accounts of pilgrimage.

Many scholars, from the eighteenth century to modern times, have pointed to the tight connections between geographical material and the Christian worldview characteristic of medieval thought as the main cause of the decline of geographical studies in the Middle Ages. This view, however, is anachronistic. Medieval geographical studies did not pursue the same goals as modern geography, and they used different methods of collecting and evaluating information. Medieval maps, unlike their modern counterparts, did not always accompany geographical texts, and until the arrival of the portolans, or sea charts, in the thirteenth century, they were not meant for practical use in the modern sense. Thus mappamundi, or maps of the world, which ranged from schematic drawings to large and detailed pictures, presented the same worldview as medieval geographical writings, compiling information from biblical and classical sources and sometimes adding contemporary data.

Geography in the System of Christian Knowledge

Medieval geographical studies, as practiced by Christian scholars, described the earth as part of the material world created by God. Christian scholars

believed that God was both the source and the ultimate goal of all knowledge and that studying the Bible was the best way to approach the understanding of the divine. The tradition of using classical knowledge in Christian culture originated in the first centuries of Christianity in the works of the fathers of the church, although they disagreed on the extent and exact contents of the classical learning useful to Christians. In their influential works, Augustine of Hippo (354–430) and Basil of Caesarea (c. 330–379) endorsed the use of classical knowledge and set up models for the Middle Ages to follow. Augustine explained that in order to understand the Bible and to attain an understanding of divine things (*sapientia*), a good Christian needed some knowledge of secular subjects (*scientia*), including geography. Augustine also demonstrated how to use classical geographical information in the Christian context in his own biblical commentaries. Augustine's ideas, expressed in Latin, formed the foundation of learning and education in Western Europe, where Latin was the language of learning. Basil's *Hexameron* was a commentary in Greek on the biblical account of the first six days of creation. In his discussion of the biblical text, Basil used and adapted geographical and physical concepts of Platonic and Aristotelian philosophy. His ideas strongly influenced discussions of geographical questions in Greek-speaking Byzantium. Translated into Latin by Ambrose of Milan (c. 340–397), Basil's *Hexameron* also became influential in the West.

The program of Christian studies and the classification of knowledge proposed by Augustine was further developed in the West by Cassiodorus (c. 490–580) and Boethius (480–524). They fully incorporated the program of the seven liberal arts, inherited from antiquity, into Christian education. This program consisted of the verbal arts of the trivium (grammar, rhetoric, and dialectic) and the mathematical arts of the quadrivium (arithmetic, geometry, astronomy, and music). Geography did not explicitly appear in any medieval classifications, but it had a place within the studies of the created world (*scientia*), to which the liberal arts belonged. Cassiodorus included geographical readings in the program of education that he proposed for his monks. During the later centuries, medieval schools also taught geography, often as part of geometry, in the context of the quadrivium. Medieval historians also included geographical material in their books, often dedicating special sections to the description of the world and its regions. Thus geography functioned in various contexts, all ultimately serving the goals of edifying Christians.

Because Christian authorities endorsed the use of classical learning, the main features of Greek and Roman geography were preserved and transmitted to posterity. Among these were theoretical ideas, such as the conception of the spherical earth, the division of the earth into climatic zones, and the existence of three continents. Christian Europe also inherited descriptions of the regions based on old Roman provinces, as well as ethnographic tales about barbarians and monsters who lived at the edges of the earth. The Latin West

acquired its knowledge of classical geography from books by Pliny the Elder and Pomponius Mela (both wrote in the first century), Solinus (third century), Macrobius (c. 400), and Martianus Capella (fifth century). Also popular was the geographical description of the known world with which Orosius, a Christian scholar of Spanish origin, began his *Histories against the Pagans* (written around 416). Orosius's geographical introduction was entirely based on classical sources. The Greek-speaking East had access to classical geography in the book written by Strabo (first century), as well as in the writings of the fathers of the church. Manuscripts transmitting these works were copied throughout the Middle Ages, and Christian scholars used them to study and teach geography and as sources of data in composing their own treatises.

The Christianization of the Picture of the World

Early medieval scholars borrowed from the previous tradition the essential features of the classical picture of the world, placed them in a Christian context, and adapted them to the biblical worldview. To reconcile classical information with Christian doctrine, scholars proposed various theories about geographical matters. Cosmas Indicopleustes, a Byzantine merchant, wrote his *Christian Topography* in Greek between 535 and 547. In this book he offered a thoroughly Christianized vision of the world, refuting the theory of the spherical shape of the earth and debating with classical Greek authorities. In his view, the world is shaped like the Tabernacle of Moses; the earth is flat and rectangular and surrounded by the ocean. In addition to theoretical ideas, Cosmas included descriptions of places that he had visited during his trade expeditions. Some manuscripts of Cosmas's book include maps that represent his ideas: some of them show the rectangular earth, surrounded by the ocean; others demonstrate the great mountain located in the north that he thought accounted for the setting and rising of the sun.

Modern scholars often cite Cosmas's work to demonstrate the decline of geography in the Middle Ages due to the pernicious influence of religion. But Cosmas is an isolated example. His book did not enjoy wide circulation; it was little known in Byzantium and inaccessible to the Latin-speaking West. Thus, the theory of a flat earth remained marginal to medieval geography, whereas the mainstream adopted classical ideas of the spherical world.

Classical geographical ideas entered the mainstream of Christian thought and education via compendia of Christian knowledge, which followed the influential model established by Isidore of Seville (c. 570–636). In his *Etymologies*, Isidore collected information from classical authorities and placed it in a Christian context. He presents information about peoples and languages, rivers and seas, regions of the earth, and measurements of distance. His geographical outline of the world in its details follows Pliny, Solinus, and Orosius, but it is structured and complemented by biblical references in such a way as to create a Christianized picture of the world. His earth is spherical, and his

account of its regions begins with Paradise and ends with Hell. In between he lists the old provinces of the Roman Empire and follows the classical division of the earth into three continents: Asia, Africa, and Europe. Throughout his encyclopedia, Isidore provides etymological explanations of names and words, borrowed from classical and Christian sources. Isidore's encyclopedia, transmitted in hundreds of manuscripts, influenced later geographical accounts both in its material and its method.

Hrabanus Maurus in his encyclopedia *On the Natures of Things* (*De Rerum Naturis*), composed between 842 and 847 as a reference tool for reading scripture, continued Isidore's tradition and went even further in his Christianization of the classical geographical material. Borrowing both the contents and the etymological method from Isidore, Hrabanus adds to them the exegetical methods of biblical commentaries. He looks for symbolic meanings behind the physical world. For instance, the division of the earth into the three continents, according to Hrabanus, signifies the Trinity. Structuring his account of the regions along Christian lines, he places Jerusalem at the center of the earth, and in describing Palestine he often associates places with biblical events.

In the second half of the ninth century, John Scottus Eriugena, the first major medieval philosopher in the West after Augustine, included theoretical geographical material in his magisterial synthesis of Christian knowledge, *On Natures* (*Periphyseon*). When discussing the created world, he treated in detail the shape and size of the earth and reported the Greek philosopher Eratosthenes's calculations of the earth's circumference. Analyzing the symbolism of the numbers in Eratosthenes's result, John Scottus connected these calculations to Pythagoras's idea of numerical and musical proportions underlying the structure of the world. He concluded that all these numbers and proportions reveal the structure and harmony of the world as being entirely in accordance with the scriptures.

In subsequent centuries, the compendia of Christian knowledge followed the same pattern, including geographical information among other data about the created world and drawing on established authorities, both Christian (Isidore and Orosius) and pagan (Pliny). Among these encyclopedias were Honorius of Autun's *Imago Mundi* (c. 1110), Lambert of St. Omer's *Liber Floridus* (1112–1121), Gervase of Tilbury's *Otia Imperialia* (1211–1214), Vincent of Beauvais's *Speculum Maius* (c. 1260), and Roger Bacon's *Opus Maius* (1266–1267).

While working with classical information, medieval scholars were particularly concerned to reconcile it with the Bible. Many geographical concepts and places mentioned in the Bible and particularly important to Christianity had little or no equivalent in classical geography. One such place was Paradise, or the Garden of Eden, described in Genesis 2:8–14, and not mentioned in classical descriptions of the world. According to the biblical account, the Garden of Eden, where God put the first man, was located in the East. It pleasantly abounded with trees, and a great river ran through it. Be-

yond its boundaries, the river divided and became four rivers, named the Phison, the Geon, the Tigris, and the Euphrates. Since Genesis implies that the Garden of Eden was located on earth but does not specify where, it left abundant room for Christian scholars to speculate on the location. The predominant medieval geographical and cartographical tradition, from Isidore of Seville on, placed Paradise in the East. It also usually identified the biblical river Geon as the Nile and the Phison as the Ganges, but some remarkable exceptions placed the Phison in Europe and thus connected Paradise to that part of the world. A biblical commentary composed in Canterbury between 650 and 750 displayed rather vague ideas about European geography, suggesting that the Phison was the same river as the Rhône, which in turn was the same as the Danube. The cosmography of Pseudo-Aethicus, composed between the fifth and the eighth centuries, mentions a river Geon beginning in the fields of Gaul. One ninth-century monastic history claims that the Geon is the same river as the Seine, where the monastery was located.

Medieval scholars also used classical information to explain and elaborate on other biblical passages, which in their turn endorsed classical concepts. Thus, an account in Genesis 9:18–19 reports that after the Flood, the earth was populated by the descendants of the three sons of Noah. Christian writers, turning to classical geography, explained that when Noah distributed the earth among his three sons, Shem received Asia, Japhet Europe, and Ham Africa. The tripartite division of the earth, inherited from Greek and Roman geography, thus received a biblical explanation and justification and was widely used in geographical descriptions and maps. In accordance with Ezekiel 5:5, many medieval maps and geographical accounts place Jerusalem at the center of the earth, combining this biblical postulate with depictions and descriptions borrowed from classical geography. The biblical accounts of Gog and Magog (Ezekiel 39:2 and Revelation 20:8), two figures or apocalyptic nations that were to bring devastation in the end of times, were combined with the classical tradition and produced the story of Alexander the Great enclosing these dangerous nations behind a wall. The lands of Gog and Magog found their place in medieval texts and maps, among other Christian and classical information. Throughout the Middle Ages, particularly feared peoples, such as the Mongols, were identified as “Gog and Magog.”

Pilgrimage and Descriptions of the Holy Places

Pilgrimage was a way for medieval people to share in the sacred. Travel to the holy land allowed people to see the locations where biblical events occurred, to pray there, and thus to approach a better understanding of the Bible, this ultimate source of Christian wisdom. According to the medieval tradition, travel to places that witnessed the activity of the saints or contained their relics, such as Rome, Canterbury, or Santiago de Compostela, brought people in direct contact with the power of the saints, which they believed could heal

their bodies and save their souls. Numerous pilgrims who traveled to the holy land, such as Egeria (late fourth or fifth century), Bernard (ninth century), and John of Würzburg (twelfth century), left detailed accounts of their journeys, enumerating the holy places and recalling connected places in scripture. Some accounts conveyed firsthand experience; others were based on literary sources and other people's travels. Adomnan in his *On Holy Places* (*De Locis Sanctis*) recorded the pilgrimage of Arculf, around 683–684, while Bede (673–735) composed his book of the same name using Adomnan's text and other sources. Useful reference tools, such as Eusebius's *Onomasticon* in Greek and its Latin translation by Jerome, focused on etymologies and the biblical significance of place names. Bede's book, based on Jerome's Latin version of the *Onomasticon* and the history by Josephus Flavius, performed the same service.

While pilgrims' accounts described specific sights, there also existed special itineraries and guidebooks composed for pilgrims to help them find their way to the holy places. The anonymous Bordeaux Itinerary (333) lists the routes leading from Bordeaux to the holy land, also mentioning the number of miles on each leg of the journey, important stations, and changes of direction. The twelfth-century pilgrims' guide to Santiago de Compostela, written in French, indicates several routes leading to the shrine from different places in Europe and gives information about the locations and peoples they pass through.

Medieval maps often included various holy places, from Jerusalem to European shrines. The mosaic map from the church in Madaba (sixth century) represents the holy land at the Byzantine period and quotes passages from the Bible corresponding to locations. With east on the top, it places a plan of Jerusalem with several important churches in the center. The map also contains plans of several other cities. Like other medieval maps, this one was not drawn to scale and was not meant as a practical guide for travelers. Rather, this representation of the holy land and the surrounding areas, laid out on the floor of the church as it was, may have served as a symbol of the earthly space within the cosmic space symbolized by the entire church building.

Geography continued to develop in the context of religion throughout the almost one thousand years of the medieval period. Its main theoretical postulates and the principles of place descriptions remained remarkably stable and changed only little. However, it would be wrong to conclude that medieval geography was slavishly dependent on the classical and Christian traditions. Medieval authors complemented the traditional information with new data and thus modified the picture of the world. Two ninth-century writers, Dicuil in *On the Measurement of the Earth* (*De Mensura Orbis Terrae*) and an anonymous author in *On the Location of the Earth* (*De Situ Orbis*), built on the classical tradition, but each chose and reorganized the classical data in such a way as to shift the emphasis from the Mediterranean area, the focus of Roman geography, to the European regions closer to home. Dicuil, an Irish scholar

who worked at the courts of Charlemagne and Louis the Pious, gives an account of world geography with particular attention placed on dimensions and distances. He meticulously compared the data of classical sources and criticized some of them because they contradicted his own experience or the experience of other people. He also supplemented information drawn from books by reports of travelers about northern islands and the Nile.

A tenth-century historian, Richer, when describing France, complemented the classical account of Gaul composed by Julius Caesar in the first century BCE with contemporary names of the regions. Explanatory notes left by medieval scholars in the margins of manuscripts updated classical information by filling in contemporary names for peoples and locations. Scholars such as Bede and Albertus Magnus (c. 1200–1280), while relying on authorities, used their own observations of the natural world. The creators of the Hereford Map (1300) based their large and detailed map of the world on classical information but also included some recent and local data.

The main principles of medieval learned geography in Europe, its reliance on authorities, its essentially bookish character, and its tight connection to a religious worldview were to give way only in the course of the great social, cultural, and intellectual changes that Europe experienced between 1400 and 1700. These changes, brought about by geographical explorations and discoveries and the new value placed on experience and observation, would transform medieval knowledge about nature, separate it from religion, and ultimately turn it into modern science. The processes that took place during the course of the medieval centuries, the growing extent of travel, the overseas expansion, and the rising interest in new knowledge paved the way for this transformation.

Bibliography

- Beazley, Charles R. *The Dawn of Modern Geography: A History of Exploration and Geographical Science*. 3 vols. London: Frowde, 1905.
- Edson, Evelyn. *Mapping Time and Space: How Medieval Mapmakers Viewed Their World*. London: British Library, 1997.
- Friedman, John Block, Kristen Mossler Figg, and Scott D. Westrem, eds. *Trade, Travel, and Exploration in the Middle Ages: An Encyclopedia*. New York: Fairleigh Dickinson University Press, 2000.
- Harley, J.B., and David Woodward, eds. *The History of Cartography*. Vol. 1, *Cartography in Prehistoric, Ancient, and Medieval Europe and the Mediterranean*. Chicago: University of Chicago Press, 1987.
- Kimble, George H.T. *Geography in the Middle Ages*. New York: Russell and Russell, 1968.
- Lozovsky, Natalia. “*The Earth Is Our Book*”: *Geographical Knowledge in the Latin West ca. 400–1000*. Ann Arbor: University of Michigan Press, 2000.

33 The Western Calendar: Religion and Science Intertwined

Matthew F. Dowd

Calendars represent an important arena in which religion and science have historically operated fruitfully together. Calendars typically incorporate both scientific material, such as the motions of the sun and moon, and religious concerns, such as the proper celebration of religious festivals. Because temporality is an element essential to many religious practices, properly understanding the functioning of the regular natural processes used to mark time becomes an essential ingredient in the creation of a calendar. We are not talking here about the physical object of a calendar, though that is part of the regulation and promotion of a calendrical system. Our subject is the calendar as a theoretical construct: the periodic natural phenomena used to mark time and the points in time that are set down as being important to the culture that uses the calendar. This analysis will focus only on selective aspects of the calendars of Rome and Christian Europe (the latter of which eventually became the most commonly used calendar in the world), but similar remarks apply to the calendars of many different cultures of many different periods.

Fundamentally, calendars are purely human inventions. They need not follow any particular natural processes; however, because calendars delineate recurrent events, only a limited number of reliable, periodic natural phenomena are useful for a calendar. The most commonly used phenomena are the movements of the sun and moon, and indeed these motions have been the basis of the Western calendars.

The length of the solar year is approximately 365.242 days. Because a calendar year uses a whole number, 365 days, a calendar based on the sun must periodically intercalate, or insert, an extra day to compensate for the extra time (a little less than one-quarter of a day) that accumulates with each passing year, or else the date will begin to drift in relation to the seasons or with respect to the stars. The length of the lunar month (the period between the same lunar phases, such as the full or new moon) is approxi-

mately 29.53 days, and lunar calendars typically alternate between months of 30 and 29 days. A lunar year, or twelve lunar months, is about 354 and one-third days, about eleven days short of a full solar year. Thus, to keep in line with a solar year and to deal with the fractional difference between the lunar period and whole numbers of days, an extra month or day, respectively, must occasionally be intercalated. These problems lead to serious difficulties when one tries to combine the motions of the sun and moon within a single calendrical system.

Calendars also represent human choices about important events to be marked down or celebrated. Holidays and festivals are the most obvious religious events that calendars mark. And, as we will see below, natural phenomena are often used to set down the proper date for events, either at the same time each year (using the sun, or sometimes the moon, to date the events) or on moveable dates (which typically use a combination of the motions of the sun and moon).

The Roman Calendar

The origins of the Roman calendar are lost in antiquity. The Romans, however, attributed the origin of the calendar to the first two, semimythical kings of Rome: Romulus and Numa. Romulus was said to have created the initial calendar, and Numa was said to have modified it and to have instituted the college of *pontifici*, a category of priests whose responsibilities included monitoring and regulating the calendar. Very little reliable knowledge of the precise history of the calendar of the Roman republic is available, but certain general characteristics can be gleaned from ancient sources.

The first thing to note about the Roman calendar is that it was simultaneously a civil and religious calendar. The Romans believed that the proper functioning of society arose from maintaining the proper relationship to the gods, which entailed making the proper sacrifices to propitiate the gods. Only when the divine powers were propitiated could human society function in an orderly manner. This meant that various religious festivals had to be celebrated both in the proper fashion and at the proper time throughout the year. It was the responsibility of those who held priestly offices to make sure this happened, and the calendar was one important means by which they did so.

The calendar also performed the very practical function of setting out what sorts of activities could take place on which days. Each day of the year had one or more labels applied to it, indicating what kind of activity could take place on those days (we can see similarities in the modern calendar in the way holidays or religious worship take place on certain days). The *dies fas* were days on which legal business could be conducted, while the *dies nefas* were days on which legal business was not permitted. On the *nefas feriae publicae*, public festivals, which included propitiatory sacrifices to the gods, took place. Assemblies (political, legislative, and so on) were held on the *comitalis*, and

markets were held on the *nundinae*. Essential elements—economic, legislative and political, and religious—of the proper functioning of society were embodied in the calendar.

The Roman calendar appears to have arisen out of a lunar calendar. According to later Roman authors, the calendar reform of Numa made the year 355 days long, with months of 31 or 29 days, but 28 for February, plus an intercalated month to keep the calendar in step with the seasons. Another indication is the system of referring to dates of the year according to the kalends, ides, and nones. The kalends of a month was the first day of that month, which originally may have corresponded to the new moon. The ides would then fall close to the full moon, which meant the 13th or 15th of the month (depending on the number of days in the previous month). The full system of naming the days can be understood in relation to these two important days of the month. The ides fell on the 13th or 15th of the month; the prior days, counting backward (the Roman calendar employed backward counting when it came to naming the days), would be referred to as the day before ides, the third day of ides, and so on. In the case of the ides, this ran for eight days each month, which gets one back to the 5th or 7th day. The 5th or the 7th day was then known as the nones of that month. Similar backward counting went on for the four or six days of the nones, which got one back to the kalends on the first day. The kalends then ran backward into the previous month (for example, the last day of January would have been referred to as the day before the kalends of February) until one reached the ides of that month, and hence there could be between sixteen and nineteen kalends for a month.

Because of the difficulty of maintaining congruence between solar and lunar elements in the calendar, the Romans faced numerous calendrical difficulties, particularly when the religio-civil officials in charge of its upkeep could not accomplish their task (for example, because of war or political struggles). By the time of the late republic, the calendar was in need of reform. Julius Caesar, who had been in the college of *pontifici* some years previously and was now dictator of Rome, undertook such a reformation in 46 BCE. He instituted what has since taken his name: the Julian calendar. On the advice of the astronomer Sosigenes, Caesar changed the number of days in each month (and Augustus, some years later, changed them to have the modern values) to make the calendar a solar year: 365 days per year, with a day intercalated every four years to account for the extra part of a day that accumulates each year.

The Roman calendar, then, shows a mix of astronomical and religio-civil concerns. Both the moon and the sun are used to mark time through the use of measurement of physical quantities. But the reasons for doing so are quite outside what we think of as scientific: to keep society functioning properly by helping Romans to observe and preserve the inseparable civil and religious aspects of their culture that they understood to be vital to maintaining their society.

The European Christian Calendar

When the Western Roman Empire began to dissolve in the fifth and sixth centuries CE, being replaced by successive Germanic kingdoms, Christianity had already taken on a prominent cultural role within the region. To continue to make use of the Roman calendar was only natural, especially given that Christianity had become intertwined with the Roman Empire when it was made the legal religion of the empire at the end of the fourth century. But the Roman calendar was in certain ways inappropriate for a Christian community. Three particular concerns led to significant changes in the calendar during late antiquity and the early Middle Ages: the numbering of years, the problem of pagan religious festivals, and the dating of Easter. Each of these led to modifications of the calendar, though only the last required significant astronomical science (the replacement of pagan festivals sometimes was peripherally related to astronomical phenomena).

The Romans had typically referred to a year in one of two ways: either by the rulership of its leaders (for example, the consuls or the emperors) or by reference to the mythical founding of Rome (753 BCE by modern reckoning). Dionysius Exiguus, a monk living in the early sixth century CE, proposed instead numbering the years according to the birth of Christ, so that the first year of the Christian era would begin on the first day of January after the nativity. Due to a mistake in reckoning, he chose a year that was apparently three years too late, placing Jesus's birth in the year 4 BCE, rather than 1 BCE. Some modern scholars speculate that the birth may have occurred some years prior to that. What is important, however, is not whether Dionysius got it right but that, in a conscious rejection of traditional practice, he changed the calendar to fit a cultural demand, replacing a secular event (the founding of Rome) with a religious event (the birth of Jesus) as the founding event on which the calendar would be based. By doing so, Dionysius was self-consciously incorporating religious belief into the calendar. Though Dionysius's change was adopted only sporadically and over centuries, it eventually became common across Europe.

As the Christian church spread across the Roman world and northern Europe, it confronted older religious traditions in which festivals and observances celebrated astronomical events or were tenuously tied to celestial events to fix the time of the holiday. It was a common Christian practice to replace these traditional celebrations with Christian festivals. Certain practices of a holiday might be kept or altered, but the reason for the event was replaced with a thoroughly Christian one. One famous example is the replacement of Samhain, a Celtic holiday oriented around the position of the sun, with the Christian holiday of All Saints Day. In this case, ecclesiastics self-consciously and explicitly stated that church officials should try to replace the traditional celebrations with ones of a more Christian tenor, or at least modify existing customs to be in keeping with Christian celebration. Other examples abound,

both in the patristic period, when the Roman religion was the object of attack, and in the early medieval period, when the Germanic or Celtic religions were seen as a threat. In all cases, the calendar was a means by which to convey religious beliefs and counteract undesired influences.

The final issue for the Christian calendar during this period was the dating of Easter, and thereby all the moveable feasts. A moveable feast was a religious celebration or observation that had a different date from year to year. Easter is dated according to a lunar calendar because of the biblical narrative and the sequence of the passion following the commencement of the Jewish Passover festival, the date of which was fixed by the moon. Easter was to be celebrated on the first Sunday after the first full moon after the spring equinox; thus the phases of the moon had to be calculated in order to know the date of Easter, and thereby to work back to the other moveable feasts of the year, such as Lent. There were controversies over how the calculation should be made; for example, Bede, in his *History of the English Church and People*, recounts the events of the famous synod of Whitby at which rival claimants to ecclesiastical authority debated the proper method of determining the date of Easter.

However, the Roman calendar had long ago lost its lunar character. In order to calculate the dates of Easter, the church adopted a nineteen-year cycle of lunar months, with occasional intercalated days, so that it would be easy to know when the new and full moons would occur. This cycle could then be superimposed on the Julian calendar, and one could calculate ad infinitum when Easter and the moveable feasts should fall. A nineteen-year cycle was chosen because this allowed a close correspondence between the solar and lunar calendars. This led to a new science of calendrical computation known as *computus*, the texts for which frequently incorporated various other elements of the physical sciences. Thus computistical works were often the vehicle by which more general scientific education could be accomplished.

The correspondence between the nineteen-year lunar cycle and solar calendar was not perfect, and as centuries passed, it also became clear that the solar calendar had gotten off track. Fairly simple observations showed that full moons and eclipses were not occurring at the times that the calendar said they should, and therefore the nineteen-year cycle was in error. Eventually it also became clear that the solstices, the most northern and southern points that the sun reaches, were not occurring at the expected times, showing that the solar calendar was in error. The calendar clearly needed to be fixed.

The Gregorian Reform

During the twelfth and thirteenth centuries, Latin Europe learned that the Arabic world was far more advanced scientifically, both because they had preserved the Greek science that Latin literature hinted at and because Islamic scientists had preserved and improved upon ancient science. Various Latin scholars began to seek out and translate Greek and Arabic scientific

works, a process that has since come to be known as the translation movement. The appropriation of this scientific corpus had a significant effect on the Western European calendar, as scholars soon learned that errors in the calendar could be remedied. It would take centuries, however, for the reform of the calendar to be enacted, and additional centuries for the new calendar to be adopted around the world.

Some of the earliest calls for reforms came from the English scholar and ecclesiastic Robert Grosseteste. In his *Computus correctorius*, probably written in the 1220s, Grosseteste argued that various phenomena showed that the contemporary calendar was in error, and that the work of the Arabic astronomers could be used to correct the calendar. He was, however, not very explicit on how the fundamental nature of the calendar might be changed to correct these errors. For example, he knew the length of the solar year must be calculated more precisely, but he did not offer practical advice for how this would be accomplished.

The problem of errors in the calendar was not merely a scientific one. The real issue was that errors could lead to the improper celebration of religious festivals like Easter. And this had clear theological implications, especially since the celebration of religious festivals was understood as important to salvation. Science might be the means to correct errors, but the goal in so using it was a religious one.

Despite repeated calls for reform, the issue of correcting the calendar did not spur ecclesiastical officials to take action until late in the sixteenth century. Pope Gregory XIII brought together a commission to resolve the issues of correcting the calendar and officially announced the reform of the calendar in 1582. The lunar cycle was modified to be more precise. A few intercalated days were removed. And to bring the solstices and equinoxes back to their “proper” dates, ten days were removed from the year 1582: October 5 through 14. Thus in 1582, October 15 followed October 4.

The Gregorian reform was not immediately adopted across Europe. In Catholic realms, it carried the weight of the pope’s official backing and was adopted very quickly. Most Protestant regions, however, refused to change their calendars for many years. Germany finally adopted a similar reform in 1700, whereas England waited until 1752 to do so. The rejection of the reform had little to do with the scientific work of Gregory’s commission but was instead due to the authority that tried to impose it: the Roman Catholic Church. Just as religious reasons were at the heart of calls for reform, the unwillingness to adopt this particular reform was fueled by religious and thereby political sentiment, namely, that the Roman Catholic pope had no authority in those places. But the practical considerations of operating under separate calendars proved too difficult, and eventually all of Europe was unified under a single calendrical system. Due to the economic and political clout of Europe in the succeeding centuries, the Gregorian calendar spread across the world and now is used nearly everywhere.

The calendar is one arena in which religious and scientific concerns by necessity run concurrently. Scientific information and analysis are vital to creating a calendar that can serve its purpose: tracking recurrent cycles of time. But in many cases, the parameters of what counts as important for the calendar—the dates that need to be figured, the cycles that need to be tracked—are not based on scientific goals or theories. Rather, the history of the Western calendar shows that religious concerns have been an important factor both in creating the calendar and in conducting scientific investigation regarding it.

Bibliography

- Blackburn, Bonnie, and Leofranc Holford-Strevens. *The Oxford Companion to the Year: An Exploration of Calendar Customs and Time-reckoning*. Oxford: Oxford University Press, 1999.
- Borst, Anno. *The Ordering of Time: From the Ancient Computus to the Modern Computer*. Trans. Andrew Winnard. Chicago: University of Chicago Press, 1993.
- Coyne, G.V., M.A. Hoskin, and O. Pedersen, eds. *Gregorian Reform of the Calendar: Proceedings of the Vatican Conference to Commemorate Its 400th Anniversary*. Vatican City: Specola Vaticana, 1983.
- Declercq, Georges. *Anno Domini: The Origins of the Christian Era*. Turnhout: Brepols, 2000.
- McCluskey, Stephen C. *Astronomies and Cultures in Early Medieval Europe*. Cambridge: Cambridge University Press, 1998.
- Michels, Agnes Kirsopp. *The Calendar of the Roman Republic*. Princeton, NJ: Princeton University Press, 1967.
- Richards, E.G. *Mapping Time: The Calendar and Its History*. Oxford: Oxford University Press, 1998.
- Samuel, Alan E. *Greek and Roman Chronology: Calendars and Years in Classical Antiquity*. Munich: Beck, 1972.
- Wallis, Faith. *Bede: The Reckoning of Time*. Liverpool: Liverpool University Press, 1999.
- . "Chronology and Systems of Dating." In *Medieval Latin: An Introduction and Bibliographic Guide*, ed. F.A.C. Mantello and A.G. Rigg, 383–87. Washington, DC: Catholic University of America Press, 1996.
- Ware, R. Dean. "Medieval Chronology." In *Medieval Studies: An Introduction*, 2nd ed., ed. James M. Powell, 252–77. Syracuse, NY: Syracuse University Press, 1992.

34 Extraterrestrial Life and Christianity

Michael J. Crowe

The debate about whether intelligent extraterrestrial life exists began in antiquity and has continued almost without interruption since then. Religion has frequently played a major role in responses to questions about the possible plurality of worlds, an issue religious authors have been dealing with for centuries. More than a century ago, three Christian religious denominations incorporated extraterrestrials into their scriptures.

Ancient and Medieval Ideas on Plural Worlds

As early as Greek antiquity, the extraterrestrial life debate was underway. Arguing in support of extraterrestrials were the atomist philosophers Leucippus (fl. 480 BCE) and Democritus (d. 361 BCE). Later ancient atomists, such as Epicurus (342–270 BCE) and the Roman poet Lucretius (99–55 BCE), ably continued their advocacy. Epicurus, for example, asserted in his “Letter to Herodotus” that “there are infinite worlds both like and unlike this world of ours. For the atoms being infinite in number . . . are borne far out into space.” Arguing against extraterrestrials were Plato (428–348 BCE), who maintained that the uniqueness of the demiurge implies the uniqueness of the world, and Aristotle (384–322 BCE), who cited both theological and physical arguments against the atomists’ claims.

Because early Christian authors typically favored the philosophies of Plato and Aristotle over the materialist, frequently atheistic claims of the atomists, these Christians tended to oppose the idea of a plurality of worlds, as belief in the existence of extraterrestrial intelligent life was called for many centuries. Augustine of Hippo (354–430 CE), for example, criticized this doctrine in his *City of God*, though he was more concerned to criticize the Stoic notion of successive worlds in time.

The interest evoked by the question of extraterrestrials was evident in the thirteenth century when Albertus Magnus (1193–1280) suggested: “Since one of the most wondrous and noble questions in Nature is whether there is one

world or many, . . . it seems desirable for us to inquire about it.” Nonetheless, he concluded in the negative as did his most prominent pupil, Thomas Aquinas (c. 1225–1274), who devoted an article of his *Summa theologiae* to critiquing, largely on Aristotelian grounds, the idea of a plurality of worlds. Shortly after this, the debate among Christians took quite a new direction when in 1277 the bishop of Paris, Etienne Tempier, became concerned that philosophers and theologians were overstepping themselves in making claims about how God must have worked in the universe. In response, Tempier issued the famous Condemnation of 1277, in which he criticized claims that seemed to limit God’s powers. One of the propositions condemned, article 34, was “that the First Cause [God] cannot make many worlds.” This opened the door for Christian authors to explore the idea of a plurality of worlds in a manner quite different from how it had been done within Aristotelian cosmology. This freedom influenced such fourteenth-century authors as Jean Buridan (c. 1295–1358), rector of the University of Paris, Nicole Oresme (1325–1382), eventually bishop of Paris, and the Franciscan philosopher William of Ockham (c. 1280–1347), all of whom criticized some of the (mainly Aristotelian) arguments against the doctrine, even though they too ended up rejecting claims for extraterrestrials.

No such scruples were evident when in 1440 Nicholas of Cusa (1401–1464) published his famous *Of Learned Ignorance*, in which he devoted a chapter to advocating the possibility of extraterrestrial life even on the moon and sun. Rather than being censured for this view, he was named a cardinal a few years later. The debate took yet another turn when William Vorilong (d. 1463) raised, apparently for the first time, the question of whether belief in extraterrestrials is compatible with the central Christian notions of a divine incarnation and redemption. In his commentary on the *Sentences* of Peter Lombard, Vorilong gave reasons for believing that God could create another inhabited world, then added: “If it be inquired whether men exist on that world, and whether they have sinned as Adam sinned, I answer no, for they would not exist in sin and did not spring from Adam. . . . As to the question whether Christ by dying on this earth could redeem the inhabitants of another world, I answer that he is able to do this even if the worlds were infinite, but it would not be fitting for Him to go unto another world that he must die again.”

Extraterrestrials and the Scientific Revolution

In 1543 a brilliant if largely unknown cleric published a book so mathematical that few could read it, so shocking that few would at first believe it, and so important that it is arguably the keystone work of modern physical science. This book was *De Revolutionibus Orbium Coelestium*, its author was the Polish astronomer Nicholas Copernicus (1473–1543), and its message was the heliocentric theory, the claim that the sun, not the earth, is at the center of our universe. In the fullness of time, astronomers and many others came to see that this theory turned earth into a planet, planets into earths, stars into suns

(themselves possibly orbited by planets), and humans into denizens of a portion of a vast universe that was possibly packed with other intelligent beings. Although nowhere in Copernicus's writings did he express himself on extraterrestrials, it was not long before others raised this issue. Already in 1550 in his *Initia Doctrinae Physicae*, the prominent Lutheran theologian Philip Melancthon (1497–1560) warned against the Copernican cosmology and the idea that Christ's incarnation and redemption could have occurred on another planet: "the Son of God is One; . . . Jesus Christ was born, died, and resurrected in this world. Nor does he manifest Himself elsewhere, nor elsewhere has He died or resurrected. Therefore it must not be imagined that Christ died and was resurrected more often, nor must it be thought that in any other world without the knowledge of the Son of God, that men would be restored to eternal life."

The sixteenth-century author who most boldly pressed the possible implications of the Copernican theory for the extraterrestrial life debate was Giordano Bruno (1548–1600). In the last two decades of the century (and his life), he published three books in which he not only argued for extraterrestrials, but also asserted that they roamed the planets of our solar system and the planetary systems that he postulated must orbit other stars. So enthusiastic was Bruno for extraterrestrial life that he attributed souls to planets, stars, meteors, and the universe as a whole. Bruno was burned at the stake in 1600 by the Catholic Inquisition, but there is no clear evidence to justify the claim that he was a martyr for extraterrestrials. Scholars for the most part agree that the range of heresies Bruno championed, including his denial of the divinity of Christ, were most probably what led the inquisitors to sentence him to death.

The most astronomically astute astronomers at the time of Bruno's death, Galileo Galilei (1564–1642) and Johannes Kepler (1571–1630), distanced themselves from his claims. Although Galileo in his *Siderius Nuncius* (1610) had reported observations made with the newly invented telescope that indicated such terrestrial features as mountains on the moon, in his famous defense of the Copernican system, his *Dialogue on the Two Chief World Systems* (1632), Galileo suggested that if life existed on the moon, it must be "extremely diverse and far beyond our imagining." Kepler, although the author of a fictional account of life on the moon, worried when he heard reports of Galileo's early observations, but upon reading the *Siderius Nuncius*, as he wrote in his *Conversation with Galileo's Sidereal Messenger* (1610), he was delighted to find that it contradicted "Bruno's innumerabilities." In the same book, Kepler went to some lengths to design a universe in which the earth retained a primacy, in which humankind was the "predominant creature" in all creation.

One of the chief sources of Bruno's advocacy of the existence of extraterrestrials was his commitment to a religious and metaphysical claim that Arthur Lovejoy has called the principle of plenitude, the doctrine that "no genuine potentiality of being can remain unfulfilled, that the extent and abundance of

the creation must be as great as the possibility of existence and commensurate with the productive capacity of a ‘perfect’ and inexhaustible ‘Source,’ and that the world is better, the more things it contains.” In the sixteenth and seventeenth centuries, this notion of plenitude and the associated idea of a great chain of being combined with the growing evidence for the Copernican theory to make the idea of a plurality of worlds seem plausible.

Two very influential books advocating extraterrestrials appeared in the latter half of the seventeenth century. In 1686, Bernard le Bovier de Fontenelle (1657–1757) attracted a huge audience for his *Entretiens sur la pluralité des mondes*, which was translated into at least nine languages and went through dozens of editions. Whereas his contemporaries deemed it delightful, the Roman Catholic Church designated it as dangerous, placing it on the Index of Prohibited Books in 1687. The other book appeared in 1698, written by Christiaan Huygens (1629–1695), who ranked second only to Newton among late-seventeenth-century physical scientists in the magnitude of his scientific contributions. Entitled *Cosmotheoros*—its English title was *Celestial Worlds Discover’d: Or, Conjectures Concerning the Inhabitants, Plants, and Productions of the Worlds in the Planets*—it was soon available not only in its original Latin but in five other languages. Because Huygens possessed far more credibility in scientific matters than Fontenelle, his book carried more weight than Fontenelle’s charming advocacy.

In the Enlightenment, poets as prominent as Alexander Pope, Edward Young, and Friedrich Klopstock celebrated the idea of a plurality of worlds, while philosophers as famous as Voltaire and Kant championed it. The pioneers of stellar astronomy—Thomas Wright, Immanuel Kant, Johann Lambert, and William Herschel—developed its astronomical implications. There was a paucity of scientific evidence for extraterrestrials, but the argument derived from the principle of plenitude—that God would not waste space by leaving planets uninhabited—created the assumption that probably every planet in our solar system and others was inhabited. Moreover, many intellectuals assumed there were extraterrestrials on the moon, and scientists as prominent as Johann Bode, Roger Boscovich, and William Herschel populated even the sun and stars.

As this suggests, theism seemed to present few obstacles for belief in life elsewhere; in fact, it could be used to support it. Nonetheless, tensions did develop, especially after 1793, when Thomas Paine published his *Age of Reason*. One question was whether the Christian notions of a divine incarnation and redemption on this planet were believable in a universe of vast size and, it seemed, populated by extraterrestrials. In his book, Paine argues that although the existence of intelligent life only on the earth is not a specific Christian doctrine, it is nonetheless “so worked up therewith from . . . the story of Eve and the apple, and the counterpart of that story—the death of the Son of God, that to believe otherwise . . . renders the Christian system of faith at once little and ridiculous.” Paine challenges the “strange conceit” that Christ would “come

to die in our world because, they say, one man and one woman had eaten an apple! And, on the other hand, are we to suppose that every world in the boundless creation had an Eve, an apple, a serpent, and a redeemer? In this case, . . . the Son of God . . . would have nothing else to do than to travel from world to world, in an endless succession of death.”

Reconciling Extraterrestrials and Christianity

Thomas Paine’s claim that belief in Christianity cannot be reconciled with belief in extraterrestrials attracted widespread attention, some challenging it and others supporting it. One alternative view came from Thomas Chalmers (1780–1847), who in the period from about 1820 to 1847 was not only Scotland’s leading evangelical but also the most prominent Scottish religious figure. Chalmers rose to fame in 1817 with the publication of his extraordinarily widely read *Astronomical Discourses on the Christian Revelation*, based on a series of sermons he had given in Glasgow. In a deeply moving manner and with elegant prose, Chalmers sketched a universe that seemed open to extraterrestrials yet compatible with Christianity.

Ellen White (1827–1915), chief foundress of the Seventh-Day Adventist Church during the second half of the nineteenth century, would incorporate a similar idea into the scriptures she supplied that denomination. Not only did the Seventh-Day Adventists incorporate extraterrestrials into their scriptures, but two other religious denominations founded during the eighteenth and nineteenth centuries did likewise, although in a quite different manner. These are the Church of the New Jerusalem (also known as the Swedenborgians) and the Church of Jesus Christ of Latter-Day Saints (the Mormons).

Most educated people in the early nineteenth century believed that life was widely spread throughout the universe. Although no substantial evidence of extraterrestrials had become available, arguments for alien life based on natural theology continued to carry conviction. That situation began to change in 1853 when an anonymous book, *Of the Plurality of Worlds: An Essay*, created a sensation by challenging belief in extraterrestrials. The book’s author, the British scientist William Whewell (1794–1866), was also an Anglican priest and master of Trinity College at Cambridge University. He correctly anticipated the shock his book would create; in its preface, he observed: “It will be a curious . . . event, if it should now be deemed as blamable to doubt the existence of inhabitants of the Planets and Stars as, three centuries ago, it was held heretical to teach that doctrine.” In this volume, Whewell dissected the arguments, both theological and scientific, that had been cited in support of intelligent life throughout the universe. He noted, for example, that the inner planets must receive far more heat from the sun than is compatible with living forms, and that the planets beyond Mars must receive far less heat than needed for life and are of such low density that they probably lack a solid surface.

In response to the theological argument that God’s efforts would have been

wasted were celestial bodies bereft of intelligent life, Whewell stressed that geologists, although assigning a vast age to Earth, had concluded that humans appeared only comparatively recently. This, Whewell asserted, shows that the manner in which God works, whatever that may be, is compatible with vast periods (and correspondingly vast spaces) lacking intelligent life. A key factor in the gradual acceptance of Whewell's claims was the conversion of Richard Proctor (1837–1888), a prolific British writer about astronomy, to what he called the “Whewellite” position.

Near the end of the nineteenth century, the only other planet in the solar system that seemed capable of sustaining life was Mars. The theory that Martians might exist gained support in 1877 when the respected Italian astronomer Giovanni Schiaparelli (1835–1910) reported sighting what have been described as canals on the surface of the planet. From 1877 to 1915, dozens of books, hundreds of telescopes, thousands of articles, and millions of people were focused on Mars as possibly the best hope for extraterrestrials in our solar system. Percival Lowell, Camille Flammarion, and others championed Schiaparelli's observations, whereas E.W. Maunder and Eugène Antoniadi, among others, countered the claims for the canals and for Martian life. By 1915, at least among the astronomical community, the latter scientists had succeeded.

Around the time that the Martian canal claims were abandoned, serious difficulties beset the island universe theory, the claim that other Milky Ways exist in the universe. During the 1920s, however, Edwin Hubble and others successfully resurrected the theory, providing evidence of the vast number of galaxies comparable in size to but far beyond our own. Another theory was the nebular hypothesis, the idea that planetary systems form from rotating and condensing nebular material, and that stars probably are surrounded by planets. The nebular hypothesis was replaced for a time by encounter theories of planetary formation, which entail that planetary systems are rare. During the 1940s, the nebular hypothesis regained credibility.

These theories as well as the development after World War II of radio telescopes capable of receiving signals from distant regions of space led to increased interest in the possibilities of intelligent extraterrestrial life. The recognition around 1970 of various extremophiles, terrestrial organisms capable of existing in what had seemed forbidding environments, for example, at temperatures near the boiling or freezing points of water, led some astronomers to argue that lower forms of life may be fairly widespread in the universe. On the other hand, astronomers since perhaps 1990 have come to recognize that the conditions necessary for the development of intelligent life are sufficiently restrictive that it is possible that intelligent life is quite rare.

Throughout the extraterrestrial life debate, astronomy and religion have frequently interacted. Theological reasons have been cited both for and against the existence of intelligent extraterrestrials. Moreover, authors have attempted to marshal extraterrestrials both for and against numerous religious, ethical,

and metaphysical positions. In general, theism and belief in extraterrestrial life claims have rarely been in tension, although specific aspects of the Christian religion have in the eyes of some believers created significant tensions. But these difficulties have been addressed over a number of centuries by an array of theologians and religious writers, to an extent that were Earth to come into contact with an extraterrestrial civilization, Christians would have an extensive theological literature to draw on in attempting to assess the religious significance of this development.

Bibliography

- Ashkenazi, Michael. "Not the Sons of Adam: Religious Responses to ETI." *Space Policy* 8 (1992): 341–50.
- Crowe, Michael J. *The Extraterrestrial Life Debate 1750–1900: The Idea of a Plurality of Worlds from Kant to Lowell*. Mineola, NY: Dover, 1999.
- Dick, Steven J. *The Biological Universe: The Twentieth-Century Extraterrestrial Life Debate and the Limits of Science*. Cambridge: Cambridge University Press, 1996.
- , ed. *Many Worlds: The New Universe, Extraterrestrial Life, and Its Theological Implications*. Philadelphia: Templeton Foundation, 2000.
- . *Plurality of Worlds: The Origins of the Extraterrestrial Life Debate from Democritus to Kant*. Cambridge: Cambridge University Press, 1982.
- Guthke, Karl S. *The Last Frontier: Imagining Other Worlds from the Copernican Revolution to Modern Science Fiction*. Trans. Helen Atkins. Ithaca, NY: Cornell University Press, 1990.
- Hennessey, Roger. *Worlds Without End: The Historic Search for Extraterrestrial Life*. Stroud, UK: Tempus, 1999.
- Lovejoy, Arthur. *The Great Chain of Being: A Study of the History of Ideas*. New York: Harper and Brothers, 1950.
- O'Meara, Thomas. "Christian Theology and Extraterrestrial Intelligent Life." *Theological Studies* 60 (1999): 3–30.
- Whewell, William. *Of the Plurality of Worlds: An Essay*. 5th ed. London: John W. Parker and Son, 1959.

Creation, the Cosmos, and Origins of the Universe

Introduction to Creation, the Cosmos, and Origins of the Universe

A father and his two-year-old son had the following conversation one night when the child was getting ready for bed:

Son: Dad, where do things come from?

Father: You mean like the things in this room?

Son (waving his hands to include the surroundings): No, *everything*.

Where do we come from, and what happens to us after we die? Why are we here? How and when did the earth and the universe begin?

These cosmological (or origins) questions arise early in human consciousness—both developmentally speaking, as the story with the father and son illustrates, and in terms of human history, as discussed in the previous section of the encyclopedia. Religions are built around answers to these questions; scientists are deeply engaged in them, and science and religion converge, conflict, and compromise on them to varying degrees.

Although the essays in this section directly address cosmological questions, most sections of the encyclopedia also at least touch on them in some way. Many authors in the General Overviews and Historical Perspectives sections explore how people synthesize religious and scientific views to prevent conflict or demonstrate consensus. Why we ask cosmological questions in the first place is explored in the sections on Consciousness, Mind, and the Brain; Genetics and Religion; and Ecology, Evolution, and the Natural World. Many issues discussed in Health and Healing and in Death and Dying are rooted in the answers different disciplines and religions have to these fundamental questions.

In this section we have brought together scholars from history, physics, philosophy, religion, art history, African studies, ethics, and the history of science and technology. They hail from the United States, the Netherlands, Africa, Canada, Italy, and Israel. Each gives a small taste of the ideas in this area of origins questions and how those ideas integrate with and challenge elements of both science and religion.

Of course, for nearly all of the time humans have existed, we had no need to integrate, accept, ignore, embrace, or reject science, because there was no science as we know it. Explanations of cosmological questions were looked at, one imagines, less as “explanations” and more as “the way it is.” Marcelo Gleiser, a professor of physics and astronomy, traces the first glimmers of thinkers thousands of years ago who began to address origins questions, and he follows those glimmers as they gain energy and slowly move away from the supernatural through Aristotle, the Enlightenment, Einstein, to the quantum and expanding universe models of today.

Gleiser also examines the power of myth in creation stories then and now, and Hazel Ayanga as well as Gloria Emeagwali and Ayele Bekerie, scholars in African studies, lead readers through African tribal creation myths in other essays—exploring parallels and similarities across many of these stories. Historian Stephen Snobelen looks specifically at the Judeo-Christian Bible and the views of nature and cosmology developed therein. These writers begin to explore in what ways the original cosmological explanation stories have held sway and still greatly influence the views and day to day lives of Africans and Westerners, despite scientific discoveries and the mixing in of other religions and cultures and their accompanying explanation stories.

But what does happen when modern science challenges culturally ingrained answers to cosmological questions? One unquestionable principle, for example, was that the earth was at the center of our astronomical universe, and the sun and other planets moved around it. In separate essays, philosopher Mariano Artigas and Stephen Snobelen write of two great figures who straddled ancient and modern science, Galileo and Newton. Although both men’s science was profoundly affected by their spiritual beliefs, they ironically became iconic representatives of modern science—that practice intentionally devoid of religion. Artigas points out that the famous case of Galileo and the Catholic Church, although historically critical perhaps in establishing in the West a “science versus religion” paradigm, was actually less about science and religion than about politics. Snobelen explores recent discoveries relating to Newton’s personal beliefs (including his significant immersion in alchemy, a school of thought addressed by Gardenour in her essay on the female body in *Historical Perspectives*), their effects on his science, and the myth-making by his fellow scientists surrounding his groundbreaking work. The beginnings of a “science versus religion” conceptual framework were emerging.

The very concept of science versus religion, especially in the discussion of creation and evolution, appears to be an especially nonproductive idea. As noted in the introduction to the first section, our goal is to explore but also move beyond such conflict. In this section, essays engage both religious and scientific ideas to discuss, analyze, and come to some conclusions about cosmological questions. Theodore Schick Jr., Victor Stenger, Jeffrey Koperski, and Gerald Schroeder take aim at this challenging goal, using different approaches and different cosmological questions as entry points.

If the universe was created by God, gods, or the Big Bang, what was there *beforehand*? Schick, a philosopher, discusses this question and its implications for both science and religion. Stenger, a physicist and philosopher, dissects the anthropic principle, a concept that unites ideas from the realms of both physics and the spiritual. This theory argues that, yes, science is right, but with the slightest change in the physics or chemistry of our world before, during, or after the Big Bang, life and humans could not have arisen, thus opening the door to a nonscientific force that might have been responsible for creating the just-right conditions.

Koperski, a philosopher, writes on creationism and its different philosophical flavors throughout history. These move on a spectrum from varying degrees of acceptance of scientific ideas to outright rejection; different versions have waxed and waned in the past centuries. Schroeder, a physicist and biblical scholar, has no problem seeing agreement between modern science and the Old Testament, and he gives several intriguing illustrations. For example, he calculates that the early “days” of the universe were much longer than current days because, according to Einstein’s theory of relativity, *time took longer* directly and soon after the Big Bang. Thus, the six days of creation are actually about the right amount of time science says it took to get what we have today.

Philosopher and ethicist Willem Drees takes a different tack. He suggests that science and religion be left as they are and that we develop a new cosmology or mythology, rooted in science and religion, that reflects the best of both. His discussion recalls many of the essays in the opening General Overviews section of the encyclopedia. Finally, Rex Koontz, an art historian, shows how ancient Mesoamerican views of space and the cosmos are directly reflected in the architecture of those cultures and the designs of their towns and open spaces. His essay strikingly illustrates how critical our seemingly abstract discussions of cosmological questions are, and how they are concretely reflected in our everyday lives.

35 Creation and Origins of the Universe

Marcelo Gleiser

Imagine that on a nice summer night you look up and see hundreds of minuscule shimmering dots of light, immersed in the most absolute darkness. There seems to be no end to it, its vastness beyond anything you can comprehend. The word “infinity” springs to your mind. An unpleasant feeling of loneliness starts to creep in. You long for company, for a sense of closeness. But there is no one in sight. Just you, stars, and darkness. You shake off these thoughts by reasoning that it’s impossible to know for sure how vast it all is. For all you can see—even if you *know* this can’t be right—it seems equally reasonable that the stars are plastered in some kind of celestial sphere that slowly rotates westward with the night. Maybe the cosmos is bounded by some kind of celestial dome, like an all-encompassing womb. Why not? Much cozier this way, right? Infinity is a weird concept; you can’t put your hands on it. In fact, why not add spheres to carry each of the planets and the moon as well? Better make them out of crystal so you can still see through them. There, the night sky has some order now, the cosmos is finite and it all feels much better. It’s hard for us to tolerate the unknown.

Anaximenes, a Greek philosopher who lived around 540 BCE, was the first to propose this sort of cosmos of transparent spheres, like the rings of an onion. He also believed that stars and planets were made of exhalations that ascended from Earth and turned fiery in the heavens. Although he thought Earth floated on air, he assumed it was flat like a leaf. His cosmos was more like a half-onion, a hemispherical world. With these images, he was trying to explain the astronomical phenomena he observed with the tools available at the time, mostly his eyes and rudimentary geometry. His ideas seem far-fetched, after four hundred years of modern science, but much credit must be given to Anaximenes and Thales and Anaximander for being the first not to invoke gods or supernatural causes to explain what they couldn’t understand about the world. Instead, they used reasoning and common sense. They took the first baby steps toward science.

The night sky fills us with a deep sense of awe. Perhaps some of this sense has been taken away by the comforts and distractions of modern life, but hidden somewhere inside our minds is a primal connection with the unknown. To sense it you must be exposed to it, like a seed that needs water to germinate. The imaginary scene described above illustrates how the night sky inspires not only awe but also a disquieting uncertainty. The more you allow yourself to think about it, the more bizarre it all seems. If you let yourself go, your mind will be assaulted by questions that have been with us for as long as we know: Is there life elsewhere in the cosmos? Does the universe go on forever, or does it have an edge, like Anaximenes thought? If it does, what lies beyond? How did the universe come to be? What about us? Are we special? Do we have a “cosmic mission” or are we just here for the ride, a random accident among nature’s myriad creations?

Historical records dating back to the Babylonians—a thousand years before Anaximenes—show how deliberately they followed the motions of the constellations and planets across the sky, registering them in clay tablets. For example, the Venus tablets of Ammizaduga (c. 1580 BCE) detailed the risings and settings of Venus over a period of twenty-one years. The Babylonians viewed the heavens as holy; the relative positions between the constellations, sun, moon, and planets were a message from their gods, which could be translated by their priests. This interpretation of the heavens gave rise to the earliest forms of astrological forecasting and divination. The Babylonian fascination with the skies is in essence not so different from the need we have to understand our connection to this vast and unpredictable cosmos. Horoscopes are as popular as ever. At a more serious level, as modern-day astronomers point their telescopes to the sky, trying to uncover its mysteries, they are following in the footsteps of the ancient Babylonian priesthood, extracting meaning from methodical observations of natural phenomena. There is a road connecting our actions to theirs, a road starting well before the Babylonians, with the first hunter-gatherers that roamed the planet.

German philosopher Martin Heidegger once wrote that the essence of humanity is in the form of a question. No question is more fundamental than that of our origin. In attempting to answer this question, we define our age, values, and traditions. Different faiths clash with one another, and faith clashes with scientific reasoning. However, and this is a key point, even though the answers are distinct, the question remains the same. In what follows, we will visit a few of the milestones along this noble road, starting with a sample of the first answers to the question of creation, which are necessarily religious, and ending with the most recent ones, which are necessarily scientific. In doing so, we will be peering into humanity’s quest for coming to terms with existence.

The Beginning: Creation of Myths

The power of a myth is not measured by its reality but by its effectiveness. Myths give meaning to people's lives, defining the most fundamental values of a given culture. Thus, when one hears a myth from a different culture, it is foolish to try to interpret it out of context. As fast-paced globalization erases native cultural values, it is easy to toss aside ancient mythical narratives about the origin of the cosmos as quaint or nonsensical. But these stories address themes we still debate, even if we are armed with the conceptual and technological sophistication of science.

Thinking about the origin of everything invariably leads to confusion. After all, if I tell you that everything came into existence some time in the distant past, you may legitimately ask "And what existed before that?" If I reply that nothing existed before, you might say "But how could *something* come out of *nothing*?" I might tell you that this is a very special kind of nothing. "Oh yeah?" you'd say, "And what kind of nothing is that?" What this "primordial nothingness" is depends on where and when you live, and if you are religious or not. Describing this primordial nothingness is the main goal of this essay.

Prescientific narratives dealt with the question of creation in two ways: either (1) the cosmos had an origin some time in the past, a birthday or moment of creation, or (2) the cosmos is eternal, its existence stretching from the infinite past to the infinite future. Within these two broad classes of myths—creation and no-creation—there are subclasses. Figure 35.1 summarizes the basic types of myths about the origin of the cosmos.

In the no-creation myths, those that do not assume a particular moment of creation, there are two possible approaches: (1) either the cosmos has existed forever, never beginning and never ending, or (2) the cosmos exists and is destroyed in cycles that succeed one another throughout eternity. The idea of an uncreated cosmos can be found in a text attributed to Jinasena, a teacher of Jainism who lived around 900 CE: "The doctrine that the world was created is ill-advised and should be rejected. . . . If God created the world, where was he before creation? . . . Know that the world is uncreated, as time itself is, without beginning or end. . . . Uncreated and indestructible, it endures under the compulsion of its own nature."

An example of a cyclic cosmos is symbolized by the dance of Shiva, the Hindu god, who "rises from rapture and, dancing, sends through inert matter pulsing waves of awakening sound, and lo! matter also dances. . . . Dancing, He sustains its manifold phenomena. In the fullness of time, still dancing, He destroys all forms and names by fire and gives new rest." Shiva repeats his choreography for all eternity, every cycle renewing the world and all material and living forms in it. No one cycle is more important than any other.

Creation myths, those in which the world has a beginning, can be divided into three basic types: (1) creation by a supernatural being or beings, (2) cre-

Figure 35.1

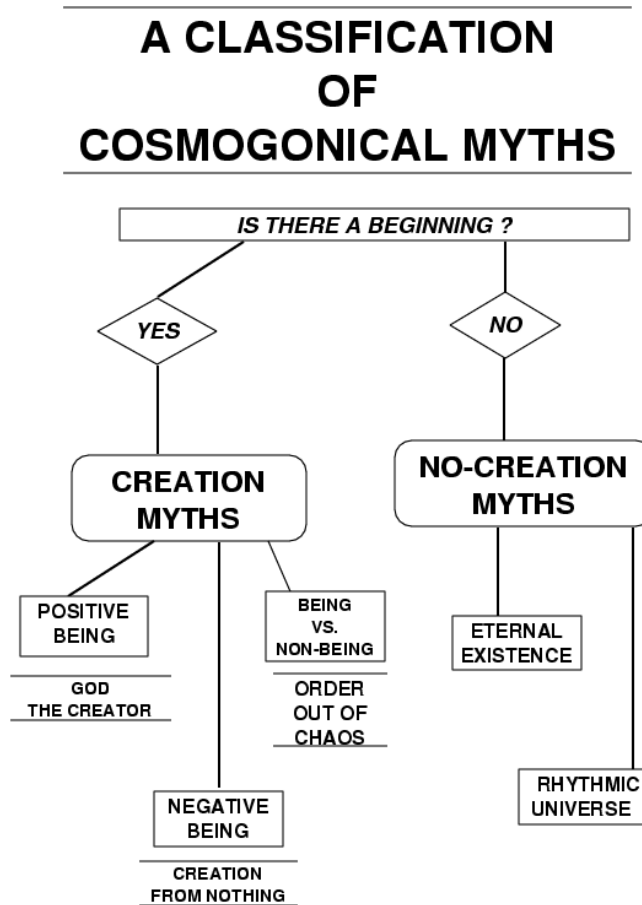

ation out of nothing, and (3) creation out of chaos. Most creation myths fall within the first group, myths where the world is created somehow by one or more supernatural beings. As the compilations by Sproul and Freund illustrate, there are hundreds of colorful variations, from the Old Testament narrative of Genesis—“In the Beginning God created the heavens and the earth”—to narratives in which a god sacrifices himself and the world sprouts from different parts of his body, or two gods copulate to create the world, or a mother goddess gives birth to the world, or gods decide to fashion the world out of clay.

These narratives assume that the gods responsible for the creation of the world, and its living forms, exist in a timeless reality. In the realm of the gods, the concept of time is inexistent. Immortality renders time useless. It is only when the world comes into existence that time as we know it begins to exist. The origin of time heralds the beginning of history. The Bible opens without time and closes without it, at the end of Revelation, when evil is defeated. For

myths assuming that supernatural beings created the world, “primordial nothingness” signifies the realm of the gods before they engage themselves in creation. Time as we know it appears with the world.

The second type of creation myths assumes that the world came into being out of nothing. There were no gods, no supernatural deeds responsible for creation. The world just came into being out of a primal urge to exist, without any interference from an external agent. An example of this kind of myth can be found in chants by the Maori natives of New Zealand:

From nothing the begetting,
From nothing the increase,
From nothing the abundance,
The power of increasing the living breath;
It dwelt in empty space,
And produced the atmosphere which is above us.

Here “primal nothingness” means the absence of everything, material or immaterial. One cannot fall into the trap of using dialectic logic here, and argue that “empty space” means the existence of something. When the Maori say “nothing,” they mean it in an absolute sense.

The third type of creation myths assumes that creation was the result of a primal tension between chaos and order. There were no supernatural agents to supervise creation. The cosmos emerged spontaneously as order finally broke loose from chaos and material forms coalesced into being. Complexity emerged from disorder as a spontaneous manifestation of self-organization. A Taoist myth from around 200 BCE describes it this way: “In the beginning there was chaos. Out of it came pure light and built the sky. The heavy dimness, however, moved and formed the earth from itself. Sky and earth brought forth the ten thousand creations, the beginning, having growth and increase, and all of them take the sky and earth as their mode. The roots of Yin and Yang—the male and female principle—also began in sky and earth. Yang and Yin became mixed, the five elements separated themselves from it and a man was formed.”

These basic types of creation and no-creation myths thus give us five answers to the question of how the world originated. Together, these five archetypes of creation exhaust all possible scenarios designed to explain cosmogenesis. Any attempt to explain creation, scientific or not, will necessarily borrow from one or more of the archetypes.

First Transition: From a Finite to an Infinite Cosmos

We have seen that Anaximenes believed the cosmos was shaped like a half-onion, with stars carried by some sort of crystalline sphere in their orbs about Earth. Even if somewhat lopsided, his was a closed universe, bounded by the outmost sphere of the stars. Many Greek thinkers, from the Pythagoreans to

Aristotle and others, refined the concept of a finite cosmos. Perhaps the best-known rendering of the finite Aristotelian cosmos is found in Dante's *Divine Comedy* (1321), although here it is infused by medieval Christian theology. Earth stood immobile at the center, surrounded by seven spheres carrying the moon, Mercury, Venus, the sun, and the three outer planets known then: Mars, Jupiter, and Saturn. An eighth sphere carried the fixed stars. A ninth sphere, known as the *Primum Mobile*, was responsible for generating the motions of the inner spheres. Aristotle (whose cosmos was more complicated, featuring over fifty spheres, several for each celestial body) referred to this as the Unmoved Mover, the one who moves for all eternity without ever stopping or needing to be moved by another cause. This is Aristotle's solution to the problem of the first cause, that is, the first link in the world's chain of causation. Clearly, even in Aristotle's mechanistic cosmos of spheres within spheres, the first cause had theological undertones.

Aristotle's claim that the cosmos was eternal and uncreated presented a dilemma for Christian theologians. The solution was to add a final tenth sphere, the Empyrean Sphere, "the dwelling place of God and the elect." The Empyrean Sphere was immobile, as time played no role in God's existence: motion was intrinsically related to change and God was unchangeable. Thus, according to Christian theology, God ruled the universe from the outside, as far from Earth and its citizens as possible. Much closer was Lucifer, who sat in Hell at the center of Earth.

The notion of a closed universe would survive through the Renaissance, even after the shift from an Earth-centered to a sun-centered cosmos perpetrated by Copernicus, Galileo, and Kepler. The shift of the cosmic center clashed with the basic precept of Aristotelian physics that objects always moved toward their places of origin. To Aristotle, earthy things fell because they were returning to where they came from. Fire rose because it had to float toward the upper parts of the sky, under the sphere of the moon. Since the sun and the other celestial luminaries were made of a fifth substance, the ether, placing the sun at the center disrupted the natural order of things: earthy objects such as stones could not fall toward something made of ether. Furthermore, Aristotle supposed that the natural motion of ethereal objects was circular, not linear like objects made of the four elements found on Earth: earth, water, wind, and fire. That being the case, how could the sun stand still and Earth circle around it?

Copernicus did not try to seriously address the physical consequences of this new sun-centered astronomy. Kepler was the first to propose a way out, suggesting that a force emanating from the sun was responsible for the motions of the planets. This was a groundbreaking insight, the precursor of a theory of gravity, which Newton would take up a few decades after Kepler's death. Before Kepler, no physical causes were sought to explain planetary motions.

Kepler still believed in a closed cosmos, as did Galileo. Only with Newton

was there a clear break, triggered by his theory of gravity. Five years after he published his masterful *Mathematical Principles of Natural Philosophy*, where he laid down the foundations of mechanics and gravitation, Newton exchanged a few letters with Richard Bentley, the chaplain to the Bishop of Worcester. Bentley was writing a set of lectures in which he attempted to use Newton's new science to argue for the existence of God. If the universe was finite, reasoned Bentley, and the attractive force of gravity governs every bit of matter, how come matter had not collapsed into a great big lump in the middle? Newton replied that the universe was not finite but infinite, and that all cosmic bodies were kept in equilibrium, being equally attracted in all directions. He conceded this to be a very unstable type of equilibrium, comparing it to balancing infinitely many needles vertically. "Yet," Newton wrote, "I grant it possible, at least by a divine power." So, to Newton, an infinite universe was only possible if regularly kept in check by God. His new theory of gravity compelled him to propose an infinite universe where God was ever present.

Newton's successors did away with the notion that God was a sort of ever-present cosmic mechanic, keeping the orbits of celestial bodies in check. The increased sophistication of Newtonian mechanics and its successful applications to widespread phenomena led to a more materialist approach to science, which left little room for spiritual speculations. A famous aphorism by Pierre Simon de Laplace summarizes this change of attitude. When Napoleon, after reading a copy of Laplace's *Celestial Mechanics*, asked him where was God in his universe, Laplace replied, "Sir, I have no need for that hypothesis." God gradually disappeared from scientific rhetoric. There was no need to mention religious or spiritual beliefs in scientific manuscripts. Many scientists are religious, but their beliefs are usually kept away from discussions with their scientific colleagues and from their technical publications.

Second Transition: From an Infinite Cosmos to and Expanding Universe

The next great step in our understanding of the physical nature of the universe came with Einstein's general theory of relativity. For Newton's mysterious action at a distance, Einstein substituted the concept of a gravitational field that acts on the geometry of space and the flow of time. According to Newtonian gravitation, any two massive bodies attract each other with a force proportional to the product of their masses and inversely proportional to the square of their distance. When pressed (also by Bentley) to explain what was it in the bodies that caused them to attract each other, Newton replied that he "feigned no hypothesis." He argued that his theory described very well the observational data, even if at the cost of supposing the existence of a force that emanated mysteriously from massive bodies. That, by the way, is an excellent example of how science progresses: not by supplying all answers at once, but by providing workable models that describe observed phenomena.

Einstein proposed that the presence of a massive body bends the geometry of space around it. More precisely, given that the theory of relativity describes space and time as joined in a four-dimensional space-time, masses also affect the flow of time. The confirmation of this theory has been one of the great triumphs of the human imagination. And yet, here too there is an unexplained hypothesis, that masses (or better, energy) can affect the geometry of space-time. Once again, the success of the theory justifies its acceptance. We can describe how masses affect geometry, but we don't know why they do it. It is a matter of personal opinion whether one should care about this.

In the limit of small masses or weak gravitational fields, Einstein's theory reproduces Newtonian gravitation. Thus, it can be regarded as a generalization of Newton's gravity, albeit with a very different conceptual structure. Just as Newton wondered about the implications of his theory to the structure of the universe as a whole, so did Einstein, who proposed applying his theory to cosmology, pioneering the study of what is now known as relativistic cosmology. His basic idea was simple: since matter determines geometry, if we knew how much matter there is in the universe, we could apply the theory to obtain its geometry: its shape and size.

At the time, there was no compelling evidence to suppose the universe was changing in time. So Einstein proposed a static universe with the closed geometry of a sphere: it should be visualized as a three-dimensional generalization of the surface of a ball, which is two-dimensional. Its geometry is called closed because, just as with a ball, if you move in one direction you will end up coming back to your starting point.

Einstein implicitly assumed that his universe was eternal and uncreated, curiously reminding us of Aristotle's model. The choice of spherical symmetry had the added advantage of providing a finite cosmos without a boundary: on the surface of a sphere, no point is more important than any other. This was reflected in Einstein's "cosmological principle," which stated that on average (and the average here is taken over very large distances, of millions of light-years) the universe looks the same everywhere.

A flurry of activity followed Einstein's first cosmological model. By 1930, several models had been proposed, each with its own predictions about the geometry and behavior of the universe as a whole. These were the "desktop universes," cosmological solutions to Einstein's equations obtained by varying the assumptions about the material content of the universe. The most notable were those found by the Russian scientist Alexander Friedmann in 1922, which have the distinction of being the first to suggest that the universe expanded in time.

Friedmann suggested that the fate of the universe depends on the amount of energy (matter is a form of energy, but not the only one) it contains: if above a certain critical value, the universe would eventually cease its expansion and recollapse into a point of infinite energy and density. This cycle of expansion and contraction could in principle repeat itself throughout eter-

nity, an image reminiscent of the Hindu creation myth based on the rhythmic dance of Shiva. If, on the other hand, the amount of energy were equal or smaller than the critical value, the universe would keep expanding forever. So Friedmann turned the universe into a dynamical entity, endowed with its own history.

When the American astronomer Edwin Hubble proposed in 1929 that distant galaxies were receding from each other with velocities proportional to their distances, cosmology entered a new era, driven not only by theoretical speculation but also by astronomical observation. Although Hubble did not subscribe to the interpretation that the recession of galaxies implied an expanding universe, the evidence quickly became compelling, if not yet conclusive.

The Belgian cosmologist and priest Georges Henri Lemaître, a pioneer of the desktop universes period, took the idea of an expanding universe to its logical consequence: if the universe is expanding now, it must have had a beginning some time in the distant past. In 1931, he suggested that the cosmos was initially like a giant atomic nucleus, the “primeval atom.” Just as large nuclei are radioactively unstable, Lemaître’s primeval atom spontaneously decayed, emitting different kinds of radiation. As it did so, it also generated the space where it existed: “The disintegration of the atom was thus accompanied by a rapid increase in the radius of space which the fragments of the primeval atom filled, always uniformly.” Lemaître never speculated on how the primeval atom appeared in the first place, trying to avoid mixing his physics with his Christianity. He did, however, suggest that the decay of the atom resulted in the creation of “fossil rays,” a sort of radiation left over from the first moment after the beginning. His vision was amazingly prescient.

The notion of a universe with a beginning rapidly generated friends and foes. During the late 1940s, two rival cosmological models pitched for dominance. Their key difference was how they handled the question of the beginning. Herman Bondi and Thomas Gold, and, independently, Fred Hoyle, all from Cambridge University in England, proposed a cosmological model without a beginning. They generalized Einstein’s cosmological principle to a “perfect cosmological principle,” wherein not only all points in the universe were alike, but also all moments in time. As no moment in time is more important than any other, they proposed a cosmos without a history, which reminds us of the Jain creation narrative of an eternal, uncreated universe.

In order to accommodate the recession of galaxies observed by Hubble, the trio suggested that as the universe expanded and the density of matter decreased, more matter would be created to maintain its average density constant. To the critics who said that matter creation violated the law of conservation of energy, the trio responded that in order to keep things as they are, only about an atom of hydrogen would need to be created in a cubic of half-meter size per century. Clearly, such a minuscule amount of energy violation would be impossible to test in the laboratory. What we know of nature is based on

the accuracy of our observational tools; if we cannot measure a small violation, we cannot state with certainty that energy is perfectly conserved. Due to the balance between dilution of matter and its creation, this model became known as the “Steady State” model.

The competing model was proposed by the Russian-American George Gamow in 1946, and refined through several works with Ralph Alpher and Robert Herman. It assumed the universe had a very hot and dense infancy and has been expanding and cooling ever since. Although Gamow and his collaborators did not speculate on the very early stages of the cosmic evolution, their model was compatible with a universe with a beginning some time in the distant past. Their interest was not to solve the question of creation, but to understand the physical processes responsible for generating the chemical elements that make up the matter in stars, galaxies, and people. Gamow believed that the nuclei of the chemical elements were formed by a continuous aggregation of protons to neutrons as the universe expanded and cooled. In this sense, the matter we are made of is a fossil from the earlier stages of the universe’s history.

Their main idea is that, early on, the universe was too hot for protons and neutrons to bind to each other and form atomic nuclei. However, as the universe expanded and cooled, the strong attraction between protons and neutrons eventually prevailed, and the first chemical elements formed, starting with hydrogen (one proton and no neutron) and its isotopes (deuterium with one neutron, and tritium with two), and helium (two protons and two neutrons) and its isotope (with one neutron). This process, known as nucleosynthesis, started roughly when the universe was one second old and ended when it was three minutes old. Although Gamow originally proposed that all chemical elements were forged in the primeval furnace, we now know that only the lightest elements—hydrogen, helium, and lithium—and their isotopes are primordial. All heavier elements are made in the interior of stars in a process known as nuclear fusion. Still, nucleosynthesis predicted the cosmic abundances of the lightest elements to be 75 percent for hydrogen and 24 percent for helium, which are in excellent agreement with observations. Most of the matter in the universe consists of its two lightest chemical elements.

During a 1949 debate with Gamow, Fred Hoyle referred to this concept derisively as the “Big Bang.” The name stuck, and that is how the model is now widely known. The distinctive prediction that finally determined the advantage of the Big Bang over the Steady State model was the existence of a background radiation, a fossil left over when electrons finally bound to protons to form the first hydrogen atoms. Present-day calculation sets the time of hydrogen synthesis at about 400,000 years after the “bang.” Gamow and his collaborators not only proposed the existence of these fossil rays (as suggested in Lemaître’s primeval atom) but also computed what its present-day temperature should be. Their numbers varied between three and ten degrees above absolute zero (-273 Celsius), or Kelvin. The present-day value is of 2.75 degrees Kelvin. The dis-

covery of this cosmic background radiation in 1965 by Arno Penzias and Robert Wilson resolved, in the minds of most but not all cosmologists, the dispute between the two rival models. The Big Bang model is now accepted as the best description we have for the early history of the universe.

Third Transition: From a Classical to a Quantum Universe

Any physical theory has a range of applicability, determined by certain parameters. For example, Newtonian mechanics works well for speeds sufficiently below the speed of light, and for distances sufficiently larger than atomic and subatomic scales. High-speed motion needs Einstein's relativity theory. But Einstein's theory doesn't let us describe the very first moments of cosmic history. Nor does it explain the motion of atomic and subatomic entities; for that, we need quantum mechanics.

Classical (Newtonian) physics describes the transfer of energy between two systems (e.g., an ice cube melting in a glass of water) or the motion of objects as continuous. But in quantum physics, the world of the very small, energy is transferred in little bits called quanta. We are familiar with several quantized systems in our everyday life. The most common is the monetary system: the quantum of the American monetary system, for example, is the cent. In this system, no denomination can be smaller than a cent, and all financial transactions proceed in multiples of this fundamental quantity.

If energy is quantized, how come we don't perceive this? Imagine a very large number of small objects piled up on each other: individual ones are imperceptible. If you look at a beach from afar, the sand appears continuous, a frozen light brown substance. But if you sit on a sandy beach and focus on the small patch around you, you begin to differentiate the individual grains. In the classical physical world, transactions involve so many quanta of energy that they appear continuous, even though they aren't.

The quantized nature of quantum processes has several amazing consequences. In classical physics, once a ball is at rest, it will stay at rest unless disturbed. In quantum mechanics, there is no such thing as absolute rest. In the world of the very small, everything jiggles. As a consequence, the values of physical quantities are fuzzy. We don't really understand why this is so, but we know that it is so. The uncertainty principle, proposed by Werner Heisenberg in 1926, refers to this jiggling. The principle encapsulates the unavoidable clash between the way we picture the world classically and the abstruse reality of the quantum world. We describe reality and objects in terms of images, such as a particle (a small, localized object) or a wave (a widespread, regularly patterned object). What experiments have shown is that quantum objects such as electrons or atoms can manifest themselves as either particles or waves, depending on how we look at them. The point is, a quantum object is neither particle nor wave. It is neither localized nor widespread. And yet, it is both at once. In the absence of an ideal picture, it is best to imagine quantum

objects as perpetually jittering things. And if they are always jittering, their energies can never be zero, since they are never truly at rest.

At very short distances, gravity must also be quantized. And since Einstein's relativity theory describes gravity as the curvature of *space-time*, the four-dimensional continuum where physical events take place, quantizing gravity means quantizing space and time. No more treating space as an inert, smooth arena where events take place, or time as a river resolutely flowing forward always at the same rate. In quantum gravity, the geometry of space and the flow of time can fluctuate. If gravity is fuzzy, there are no more well-defined points in space.

For cosmology, this means that considering the universe as having started from a singular point in space with infinite energy density is too simplistic a view. It seems better to say that, in the beginning, there was a quantum era of cosmology, when quantum effects dominated the scene and space-time was fuzzy. Our cosmos emerged from this quantum cosmological realm as a bubble in a boiling soup, so to speak. This does away with the issue of "But what happened before the Big Bang?" After all, if a streaming time is a classical concept, one can only talk about the flow of time within the framework of Einstein's theory, which is applicable only up to when quantum effects dominate. It is best to describe the cosmos as having a transition from a quantum era, where no single time-flow really exists, to a classical era, where time flows as we are used to. The remaining question, then, is what is this quantum cosmological era? Our present answers, at least within quantum cosmology, are compelling, but still incomplete.

Rethinking the Cosmic Origin

Much of the modern rethinking of cosmic origins happened during the 1980s. Influenced by Edward Tryon's ideas dating back to 1973, James Hartle and Stephen Hawking, and, independently, Alexander Vilenkin and Andrei Linde, assumed that the initial state of the universe was a pure quantum state. Therefore, it had to obey the rules of quantum mechanics as they applied to the gravitational field. The same way that an electron orbiting an atom obeys an equation that predicts the probability of finding the electron in this or that energy level (the Schrödinger equation), it should be possible to write an equivalent equation determining the probability that the universe will have this or that geometry. This program, known as quantum cosmology, treats the whole universe as a quantum system. And, as in any quantum system, a quantum universe would have counter-intuitive behavior. The most important for cosmology is the concept of "tunneling." Quantum systems that are constrained by a certain obstacle (a force, an energy barrier) can traverse it and emerge on the other side. Some refer to this as "barrier penetration." An equivalent phenomenon would be water that leaks spontaneously through glass, or, more dramatically, a person going through a wall, like a ghost.

A quantum universe is a hard thing to fathom. A useful image is that of a boiling liquid. Bubbles emerge and disappear in rapid succession, some of them living long enough to escape into the air. Picture the primordial universe as a quantum soup of geometries, possible space-times of different geometries popping randomly in and out of existence. The Big Bang model, our classical universe described by the general theory of relativity, corresponds to a specific fluctuation, that is, a specific space-time geometry. It is the one bubble that managed to escape the quantum soup, tunneling into existence like the bubble that reaches the surface of the boiling pot. This quantum soup of space-time geometries is the modern version of “primordial nothingness.” (But Barrow and Cole describe other kinds of nothingness as well.)

According to this picture, our universe is just one of a multitude, or perhaps infinitely many universes out there, which may pop out of the eternally boiling quantum geometry soup. Some call this entity a multiverse or a metaverse, and each of the bubbly attempts at existence is called a cosmoid. Most cosmoids live an ephemeral existence, reverting back to the primordial soup before they can grow into anything noticeable. We happen to live in a cosmoid that is somewhat special. It had the right combination of physical parameters to have survived for 14 billion years and to have allowed for complex structures to emerge, from stars and galaxies to lobsters and philosophers. Many questions are probably bubbling in your mind, just as cosmoids do in the quantum soup. If there are other universes out there, can we ever find out about them? Why is our cosmoid so special? Are we somehow related to its existence, perhaps even being its purpose? Is the universe purposeful?

If there is indeed a multiverse, we may never be able to communicate with its other parts. We live within a bubble with a radius of 14 billion light-years, the distance traveled by light since the beginning of (classical) time. Hence, we cannot receive or send signals beyond our bubble. True, as our bubble grows, it may brush against other cosmic patches. But we are talking of billions or even trillions of years. Could we tunnel into another universe through objects called wormholes, hypothetical shortcuts across the cosmic geometry? This situation calls into question how scientific the idea of a multiverse really is. After all, physics must be empirically validated; ideas must be confirmed by observations to be accepted as valid descriptions of nature. Without a specific test, such notions may as well be relegated to metaphysics. We need to be able to prove what theories are wrong in order to improve those that are right.

To think that our cosmoid is special in some way is also a very difficult concept to swallow. By special it is meant that only a very small subset of all possible universes could have evolved to become this way. But if our universe is special, so must we be, since we are the ones here thinking about it. This general line of reasoning is referred to as the anthropic principle. Its main idea is to use what we know about the universe (that it is old, that it has

complex structures, that it has life) to learn about its fundamental properties, such as how much and what kind of matter it has, and what sort of infancy it had. But the anthropic principle is burdened by a posteriori reasoning: it works backward. It does not explain what physical mechanisms determined the universe's age or parameters; it simply affirms that it could not have been otherwise. We need to be more ambitious with our theories, even at the risk of having fewer satisfactory answers.

So, What *Can* We Say?

Some people get frustrated when they hear that scientists still don't have an accepted explanation for the origin of the universe. They want to know, and they want to know in simple, comprehensible terms. This expectation is derivative of religious zeal; for those who believe in the mythic explanations of religious texts, faith is enough to settle the question. Anyone who takes an interest in the history of religion, however, knows that religious texts are open to multiple interpretations. In any case, the mechanisms of religious and scientific enquiry are very different. Science will never have all the answers. It is a continuous process of discovery, based on the acquisition of empirical data and the subsequent organization of that information into explanatory and predictive mathematical models. As we develop new tools, we will also probe into new unknowns for which new science will be needed. Thinking about the origin of the universe, for example, forces us to deal with the nature of time.

The origin of the universe may never be fully explained within science. For science is built on sets of rules and only functions within these rules. If in the future someone develops a flawless model of quantum cosmology that is perfectly in accordance with observations, even to the point of predicting new phenomena that are subsequently observed, can we then claim to have understood the origin of the universe? Not really. After all, we can always ask where the set of rules used to build the model came from. Why should the universe obey the rules of general relativity and quantum mechanics? To say that other universes may not and we are one in infinitely many possibilities doesn't help at all. (Proving convincingly that this is true, however, may.) Science, as it is presently conceived, cannot explain itself. Unless some new kind of conceptual framework is developed for science, and that is always a possibility, we must be content with what we can do with the one we have, trying to change it here and there as we go along. And this is not so bad.

The most important lesson to be learned from science is that ignorance is a key to progress, that only by not knowing can we know more. To not have all the answers is a good thing. So, even if we may never fully explain the origin of the universe with our present scientific framework, the road leading to the answer will be full of wonders. We have only gotten started on a very long trek.

Bibliography

- Alpher, Ralph A., and Robert Herman. *Genesis of the Big Bang*. New York: Oxford University Press, 2001.
- Barrow, John D. *The Book of Nothing: Vacuums, Voids, and the Latest Ideas about the Origin of the Universe*. New York: Pantheon Books, 2000.
- Barrow, John D., and Frank J. Tipler. *The Anthropic Cosmological Principle*. New York: Oxford University Press, 1986.
- Cole, K.C. *The Hole in the Universe: How Scientists Peered over the Edge of Emptiness and Found Everything*. New York: Harcourt, 2001.
- Davies, Paul C.W. *The Mind of God: The Scientific Basis for a Rational World*. New York: Simon and Schuster, 1992.
- Freund, Philip. *Myths of Creation*. New York: Washington Square Press, 1966.
- Gleiser, Marcelo. *The Dancing Universe: From Creation Myths to the Big Bang*. New York: Dutton, 1997.
- . *The Prophet and the Astronomer: A Scientific Journey to the End of Time*. New York: W.W. Norton, 2001.
- Greene, Brian. *The Elegant Universe: Superstrings, Hidden Dimensions, and the Quest for the Ultimate Theory*. New York: W.W. Norton, 1999.
- Hetherington, Norris S., ed. *Cosmology: Historical, Literary, Philosophical, Religious, and Scientific Perspectives*. New York: Garland, 1993.
- Kirk, G.S., J.E. Raven, and M. Schofield. *The Presocratic Philosophers: A Critical History with a Selection of Texts*. Cambridge: Cambridge University Press, 1983.
- Linde, Andrei D. "Quantum Cosmology, Inflation, and the Anthropic Principle." In *Science and Ultimate Reality: Quantum Theory, Cosmology and Complexity*, ed. John D. Barrow, Paul C.W. Davies, and Charles L. Harper Jr. Cambridge: Cambridge University Press, 2004.
- Munitz, Milton K., ed. *Theories of the Universe: From Babylonian Myth to Modern Science*. New York: Free Press, 1965.
- North, John. *The Norton History of Astronomy and Cosmology*. New York: W.W. Norton, 1995.
- Smolin, Lee. *The Roads to Quantum Gravity*. New York: Basic Books, 2001.
- Sproul, Barbara C. *Primal Myths*. San Francisco: HarperSanFrancisco, 1979.

36 African Cosmologies Past and Present

Hazel Ayanga

Human beings are curious creatures. They ask questions about themselves and their social environment as well as about their origin and their destiny. Cosmology is one way in which human beings have sought to answer some of these questions. Specifically, cosmology tries to answer questions relating to human existence and why things are the way they are.

In trying to answer these questions, human beings are confronted with the existence of their physical environment and the possible existence of forces beyond themselves and beyond this immediate environment. Cosmology is an attempt to articulate the relationship between human beings, their physical and social environment, and other forms of existence. All human cultures try to do this in their own different ways. Consequently, one basic function of any culture is to give members of the cultural group information about their origin and their destiny. Cosmology is about events that have taken place from the beginning of time to the end. It is an articulation of the events by which the observable universe came into being, and how this same universe can be maintained or brought to an end.

The articulation of cosmologies makes use of another important product of culture: language, a creation of society in time. Language is a major component of the symbol system of any culture. Society uses language to explain what took place at the beginning of time. Cosmology therefore requires an element of imagination as well as the ability to analyze and understand the observable world in time.

Many cosmologies are intricately related to people's socioeconomic experiences. For example, disease, sickness, and death are important aspects of people's stories of the beginnings. How did sickness and death begin, and how will they be brought to an end? Scientific cosmology tends to be different. It uses research particularly in the physical world to find out why the universe is the way it is and what its future might be.

Sources of African Cosmology

Traditional African cosmology is not contained in books. It is not based on intricate scientific research and experimentation. Rather it is based on the life experiences of the people. It is an attempt to explain the reasons behind and the meaning of these experiences. It is the result of the people's observations of their environment and the attempts to understand it. Thus, African cosmology is found in the stories that the people tell. It is found in the myths that are passed on from one generation to the other.

Africa is a large continent with over one thousand different linguistic and ethnic groups. Each of these groups speaks its own language. Sometimes each language has as many as ten variations. Each of the groups claims a different history and a different understanding of its own origin. Consequently, there are literally thousands of stories or myths of origin, not just of the tribal or ethnic group, but of the universe as a whole. However, the stories, varied as they are, reveal a general picture of African cosmology. Aspects of the stories are common to most if not all the groups in Africa. Some of the stories are merely variations of the same story. African cosmologies or aspects of them may also be found in proverbs and riddles. Rituals that the people perform may also be indicative of their cosmological beliefs. Rituals are generally a repetition of how things were at the beginning of time. They are a reenactment of the situation as described in the myths. Thus the sacrifices that are offered as well as rites of passage may be analyzed as reflecting the sources of African cosmology.

God as Creator

One of the basic teachings of African cosmology is that God created the universe. African peoples do not generally question the existence of God. Consequently, their myths of origin do not try to answer the question of the origin of God. The myths do not speculate about what or who existed before the creation of human beings. The beginning of African cosmology is always God, whose existence is assumed. The Swahili and others believe that God existed in a distinct kind of universe that cannot be comprehended by human beings. Others believe that God lived in the marshy waters before creating the sky to which he retreated. However, there are no myths that try to fully describe God's abode.

African cosmology describes God's being, actions, and emotions in very human terms. The use of human characteristics is common. This is clearly necessary in order to communicate information about God's nature and actions as understood by human beings and in relation to the human experience. God is known or referred to by different names in the different languages of Africa. Often, there are many names for God. Several of them are descriptive and indicative of God's creative power. The Shilluk of Sudan refer to God as Jwok, which means one God who created the world. The Yoruba of Nigeria

speak of Eledaa the creator. The Gikuyu and Maasai of Kenya refer to God as Ngai, the apportioner. This implies that God has put everything in its place. This idea is also found among the Abaluyia of western Kenya, who refer to God as Nyasaye Khakaba, which means that God divides and apportions not just the personal attributes to human beings but also physical space to the different people of the world. The Akan of Ghana say that Onyame, or God, is Borebore, meaning that Onyame is the maker.

Although African cosmology is theistic, it is not necessarily monotheistic. The supreme being is often portrayed as the chief or master creator. But according to some of the myths, he may have been assisted by lesser gods or by his children. The Yoruba of Nigeria say that Orishanla assisted Oludumare in creation. The Pokot of Kenya and Uganda say that Tororot has a wife, Seta, as well as a younger brother, and these together participated in the creative process. Tororot and Seta have several children, who include Arawa, the moon, and Tapoh, the evening star.

Some other people, including those of east Guinea, believe that there were two creators: Alatangana and Sa. Alatangana lived just above the earth, while Sa's dwelling place was on earth. Alatangana was responsible for creating the solid earth and for giving it vegetation. His marriage to Sa's daughter resulted in the first human beings. Sa appears to have been responsible for more practical matters. For example, he gave his grandchildren tools and the ability to use them. These tools included a hoe, a machete, and an axe. He also gave them paper, pen, and ink. Sa created light in order to get rid of the darkness in which Alatangana and his children lived.

Origin of the Universe

God created both the universe and the natural environment, either singly or with the help of assistants. Many myths indicate that parts of the universe were a result of sexual union between God and the earth. This explains the respect many Africans give the earth. The Dogon of Mali say that the sun was god's first creation. It was created from clay. The moon was the second creation. The shining black people (the Dogon) were created out of the sunlight. White people were made out of the moon. Another belief is that God made the earth in the shape of a female body. The head faced north, while the legs were toward the south. God, Amma, had sexual union with the earth. Different animals were born out of this union.

The rain did the second fertilization of the earth. This resulted in the birth of twins whose name was Namma, which means water. The twins became the grass and other plants. However, they still lived with their father in the sky. Looking down, they were saddened to see their mother's nakedness. They clothed her with reeds and shrubs. Thus the vegetation of the earth was created. According to this myth, the stars were created by scattering pieces of the sun across the sky.

Origin of Humanity

According to many African stories of origin, human beings are at the very center of creation. The creative acts of God are centered on humanity and their well-being. The creation of the waters, the soil, the trees, and the animals is connected to the welfare of the people. God makes the waters so that people may drink from them and quench their thirst. He makes the fire so that they can cook their food and keep themselves warm. The earth is created so that people can till it and grow their food. Trees are intended for the construction of houses and the provision of firewood.

Some of the stories put the creation of humanity at the beginning of the creative process. Others put it at the end of the initial process. The Nandi of Kenya say that Asis, the creator, first made the world order by separating the earth from the sky. Other elements of nature like fire, water, thunder, and lightning were created before other living things. According to the Manda of Mali, God first created seeds out of which he made human beings. The Yoruba of Nigeria say that Orinshanla first created the earth, the palm tree, the coconut, and the kola trees before finally creating the people.

God created human beings either by the spoken word or from the earth. The Shilluk say that God created human beings from the earth. White people were made from white loam, Arabs from brownish earth. The fertile black clay found along the banks of the river Nile was set aside for the creation of black people, particularly the Shilluk. Some groups in Botswana say that the gods first created one man known as Tauetona followed by his brothers. Animals were made next. The first man was required to give names to the animals. Men and women were created separately and at first occupied different parts of the universe. With the help of the giraffe, they met and started families.

Other groups believe that the lizard was created first. The human being came next and initially looked like a lizard but without the tail. The creature was soaked in the river until God called it out. Other myths indicate that God first made semihuman creatures who later procreated, giving birth to human beings as we know them today.

Origin of Death

People have constantly sought to know the origin of death. They have wanted to know what happens after death and whether death is reversible. Many African myths have tried to answer these questions in different ways. In all the stories, death is described as not being part of God's original plan for human beings. Many of the stories indicate that death came as a result of a mistake made either by the human beings or by some other animal. The chameleon features in most of the myths. The chameleon was sent by God to deliver the message of immortality to human beings. However, he was

too slow. In the meantime, another animal was sent with a message saying that human beings will die after all. Some stories say that this message of mortality was carried by the fast-running hare, while others say that it was either a lizard or a bird. This later messenger arrived long before the chameleon. Thus, human beings received the message of mortality. Death was introduced as a part of the human experience. The chameleon did arrive, but God, who is unchanging, could not change his word, which the people had already received.

In some societies, death is linked to the separation of heaven and earth. The sky and the earth were originally connected. Human beings moved freely from the sky to the earth, ostensibly in search of food. Although death existed in some form, it was not a permanent state. Human beings would be rejuvenated after a while and would continue their normal life. However, at some point the connection between heaven and earth was severed. This made death a permanent feature of the human condition. The severing of the connection is sometimes attributed to the mischievous hyena, who was curious to see what would happen if the connecting rope was cut. Tired old people who would climb to heaven for rejuvenation used the rope. This may explain why, in many African societies, the death of the aged does not cause as much sorrow as that of a young person. Death as a result of old age is generally welcomed and even celebrated. The old people who die do not come back, but they move on to the world of ancestors. Since they have lived their lives to the full, there is no reason for regret. Explanations are often sought for the death of one in the prime of youth. The answer is often found in witchcraft, sorcery, and the evil eye.

The Baganda of Uganda blame the forgetful woman for bringing death. When the first people set off for their journey to the earth, the first woman, Nambi, forgot to take with her the millet needed to feed her chicken. Although God had strictly told them not to go back once they started the journey, the woman felt that she had to do this. Nambi went back for the millet. She returned from heaven carrying the millet in a basket, but at the bottom of the basket was death. As a consequence of disobeying God's instruction, death became an ever-present member of the human family.

The Bakongo of Zaire believe that death was part of the creator's plan. But it was not intended to be permanent. However, the first couple disobeyed God, forcing him to make death a permanent feature of human experience. The couple had been instructed to keep the dead under layers of firewood rather than bury them in the earth. The dead would then be revived after three days. But because of the stench from their dead child, the couple decided to bury the body in the ground. By doing this, they invited the wrath of the creator, who punished them and their offspring by revoking their immortality.

African cosmology does not have the notion of the "end" of death. It would appear that once God spoke the word, there was no going back on it.

Modern Cosmology

Africa is a continent in transition. It is somewhere between traditional customs and modernity. This situation shows itself in every sphere of life. People desire to borrow Western ideas that are generally believed to be modern and progressive, but as Jan Knappert says, "The impact of the colonial period has been to destroy the fine fabric of beliefs and morality in the traditional societies." Western Christian missionaries also contributed significantly to this destruction. Africans were incessantly told that they did not have a religion and that what they believed in was mere superstition. They were told that what they practiced was idolatry. The educated and those who had come in contact with Western culture did not want to be associated with what was seen as primitiveness. They therefore ignored and even publicly criticized or even denounced traditional beliefs and practices.

However, Africans have been known to tenaciously hold to some of their traditional beliefs, particularly in times of crisis. This is seen in the crises of childlessness and death. Although these conditions are regarded as unnatural states, contrary to the will of God, people tend to believe that they cannot happen without the help of evil men and women. Barrenness is often blamed on women with the evil eye. Whereas all death is unacceptable and painful, the death of a young person is viewed as possibly the worst tragedy for any family. It always sends the community back to reexamine the origin of death and its meaning. It is a constant reminder that death was not God's original plan for humanity. Something or somebody else is always responsible for such a death. Although one may be quite aware of the physical and medical causes for a young person's death, there is always another cause for it. These nonmedical reasons are generally related to cosmological beliefs about the origin of death.

When death occurs, the body of the deceased must be accorded all the proper funerary rites. This includes being buried on the ancestral land. Urban dwellers insist on transporting the deceased back to their rural homes for burial. There are two main reasons for this, and both are related to cosmological beliefs. One belief is that the departed must be laid to rest with the ancestors. The other reason has to do with the land that God gave to the people. In other words, it has to do with land ownership. Burial usually puts a permanent stamp of ownership on a piece of land by the surviving members of the family. No one would want to buy a piece of land with a stranger's grave on it.

It would therefore not be entirely true to say that contemporary African cosmology is entirely divorced from tradition. There is an intricate interplay between traditional and contemporary scientific cosmologies. Traditional cosmologies have tended to be replaced by either Christian or Islamic ones. In general however, there is a tendency to mix or weave aspects of the three religious cosmologies together.

Scientific cosmologies seem to be relegated to academic lecture theaters

and academic discussions. Knappert concludes that “In spite of the attrition by modern ‘civilization’ many religions are still alive or . . . still remembered by the elders of the clan.” But we can go a step farther and say that many of the religions are alive in people’s daily lives and experiences.

The thousands of stories of origin that form the basis of African cosmology all have their roots in the socioeconomic and political experiences of the people. They are an attempt to understand and explain aspects of the human condition. African myths do not tell us why creation took place. They do not emphasize the method that was used in the creation process. This may be because these aspects are not particularly important. What are important are the implications that the stories have for human life. They have implications for human relationships as well as human behavior. For example, the Maasai of Kenya believe that at the beginning of time, God gave them the cow. Consequently, cows are the most precious possession any Maasai can have. They claim that all the cows in the world actually belong to them. Thus, Maasai would do anything to protect the cows in their possession. They can also do anything to acquire more. The Gikuyu say that God gave their forefathers tools for agriculture and the knowledge to use them. Consequently the Gikuyu strive to excel in farming. They also lay great emphasis on land ownership. They buy it wherever it is available. They would do anything to protect their land.

Traditional African cosmology tends to agree with aspects of modern scientific cosmology. In some cases the creator molded the earth from the marshy waters; in some stories the chicken scattered the soil, creating dry land. The timeframe is opened ended, and in both cases the belief is that creation is still going on. Examples are found in the stories that say God first created semihuman creatures that became human with time. Creation in a moment of time, as described in the Christian tradition, is rarely found in African stories. This is why many Africans easily accept the idea that creation is a continuing process.

Bibliography

- Adegbola, E. Ade, ed. *Traditional Religion in West Africa*. Nairobi: Uzima, 1983.
- Knappert, Jan. *The Aquarian Guide to African Mythology*. Wellingborough, UK: Aquarian, 1990.
- Mbiti, John S. *Introduction to African Religion*. 2nd ed. Nairobi: East African Educational, 1992.
- Olupona, James, ed. *African Traditional Religion in Contemporary Society*. New York: Paragon House, 1991.
- Ray, Benjamin C. *African Religions*. London: Prentice Hall, 1976.
- Ryker, Leland, et al., eds. *Dictionary of Biblical Imagery*. Leicester, UK: Inter-Varsity Press, 1998.

37 Creation Myths of Africa

Gloria Emeagwali and Ayele Bekerie

A number of concepts are associated with the creation myths of Africa: evolution, creationism, incarnation, reincarnation, biological reproduction, and resurrection. Although many of the examples discussed here come from north-east Africa, some common trends and models of explanations cut across the continent of Africa as a whole. As pointed out by the historian Jan Vansina, myths of origin describe three main aspects of origin: (1) the creation of the world and humankind; (2) mythological genealogies, reconstructing the relationship of various African nationalities; and (3) legends of various migrant communities' initial point of departure.

The ancient Egyptian *Book of Knowing the Evolution of Ra and of Overthrowing Apep* and the *Book of the Dead* integrate several key concepts into an explanation of the origins of the universe and humankind. "I produced myself from the primeval matter which I made," declares the self-created divine entity Nebertcher that emerges out of the inert watery mass called Nu, a celestial ocean that gives rise to a process of evolving creation. This creator force makes heaven and earth, the streams and waters, the hours and days, light and darkness—none of which existed before this remarkable process of creation. At the center of this explanation is the assumption that matter contains the embryonic germs of life, though inert. A transformative dynamic emerges from a state of inactivity to active life. Nebertcher, the creator of the universe, manifests itself in various forms and transforms into various divine entities, including Khepera, Ra, and Temu:

I have made the hours, I have created the days,
I bring forward the festivals of the year,
I create the Nile-flood. I make the fire of life and I provide food in the houses.
I am Khepera in the morning, I am Ra at noon and I am Temu at evening.
(Budge, *The Gods of the Egyptians*)

In the *Book of the Dead*, Nu, the watery abyss, is at the center of the process of transformation and regeneration:

I am Tem in rising; I am the only One
 I came into being in Nu.
 I am Ra who rose in the beginning.

The creation and reproduction of humans by means of sexual and non-sexual activity is crucial to the Egyptian model of origins. In one myth, Nebertcher produces men and women through masturbation. Another myth tells us that humans emerged from the tears of Khepera: "Cried my eye and thus came into being mankind." Shu and Tefnut were produced in a similar fashion by Khepera. Thus emerged the triad or trinity of Khepera, Shu, and Tefnut, divine entities associated with regeneration, the atmosphere, and liquids, respectively. The sky goddess Nut and the earth god Keb, the offspring of Shu and Tefnut, would be the direct progenitors of five major spiritual entities: Ausares (Osiris), Auset (Isis), Heru (Horus), Set, and Nephthys. Auset becomes associated with virgin birth, and in her capacity as "neter mut," mother of god, she becomes an icon of the Egyptian holy family. Her husband, Ausares, would be a victim of treachery, his body cut into numerous pieces and dispersed. But the mother and child, Auset and Heru, prevail. Ausares regenerates and through resurrection becomes the guardian of heaven. He is the ancestor god, the moon god, and judge of the dead.

A tree trunk is among the various icons of creation associated with the worship of Ausares. Various other icons of origin emerge in the theology, including the beetle, associated with Khepera. Incarnations and reincarnations of diverse species of the animal world abound, including various serpents. At the shrine of Nefer Abt was worshipped a huge serpent, a manifestation of Tem. This was only one of the forms under which Tem was worshipped. Nebertcher was reincarnated as Ausares. There are other manifestations of the divine. Dead ancestors commonly reincarnate in animal form.

Recent paleontological discoveries establish Ethiopia, another region of north-east Africa, as a key center of human origin. This region, the source of the Blue Nile, has been a center of major finds. For instance in 1974, in the Afar region of Ethiopia, a humanlike female figure was unearthed. Referred to as Dinqnesh, also Lucy, this human ancestor is 3.18 million years old. Furthermore, a more immediate ancestor to all modern humans was reported from the same region in 2003. This ancestor, Idaltu, is about 160,000 years old.

Human beings have perhaps the longest existence in Ethiopia, attested to by the presence of a remarkably diverse African population, differentiated both culturally and physically. Ethiopia is a land of at least eighty-seven ethnic or linguistic groups. These groups have affirmed their distinct identities not only by their specific languages, but also by composing myriad myths about their origins. Ethiopian creation myths have been preserved through oral and written traditions. They do not, of course, include the paleontological facts just discussed. Their formula begins with the creator of sky and earth, water and fire. The Christianized Ethiopians attribute creation to

Igzabiher, the sole creator of earth and sky. Some of the major non-Christian traditions identify Waqa, Tosa, and Zar as their supreme deities. They reside in the sky and are responsible for the creation of water.

Creation myths may have gone through three major phases in Ethiopia. In the first phase, myths are invented and propagated from generation to generation exclusively through oral traditions. In the second phase, they are reconstructed and disseminated through visual media, such as writing systems. In the third phase, revealed religion in conjunction with scripts effectively disseminates myths, many of which are rooted in the Bible. The written myths tend to be representations of myths collected and resynthesized from oral versions. In other words, the anteriority and indestructibility of the oral myths can be confirmed by the fact that the Christian and written mythologies have borrowed some elements from the former.

Creation, in the myths from the oral phase, was almost always perceived in association with the sun, moon, stars, earth, water, trees, or other animate or inanimate objects. For instance, the Oromos believe that they were created from the waters of Lake Hor Wilabo in southern Ethiopia. As a result, they sanctified the lake. It is still absolutely forbidden for either people or animals to drink from it. All Oromos pay homage to the lake by sacrificing oxen, heifers, sheep, and goats to it.

The supreme importance of water can also be seen among the creation myths of the Kambatias, who reside in the southwestern region of Ethiopia. They identify the river's spirit as Chanzula. Among the Didinga of Ethiopia, the river and lake spirits incarnate into fish, which therefore become sacred.

In both the oral and written traditions, rituals are the primary vehicles through which the knowledge of creation is passed on from one generation to another. For instance, totemic practices are symbolic expressions of ancestral links, and they are practiced at least once a year, by ceremoniously invoking the sacred plants and animals. Ancestral presence is assured by honoring animals, such as lions (Gondar, Tigre, and Shoa, northern Ethiopia), crocodiles (Yamma and Zala, southern Ethiopia), and spiders (Wolaita, southern Ethiopia).

The *Kebra Negast* is an authoritative Ethiopian classical work that combines local and regional oral traditions. The style and substance of this text are derived from the Old and New Testaments and patristic writings, various apocryphal texts, and Jewish and Islamic commentaries. In this work it is proposed that Adam was the first creation of Igzabeher, the name Ethiopians use for God. To most scholars of ancient Ethiopia, the *Kebra Negast* is a myth of the founding of the Ethiopian nation. It is an imaginative work that embodies crucial formative events in the national history, perhaps comparable to the *Book of the Dead* or the *Aeneid*.

According to the *Kebra Nagast*, between Adam and Noah, there were ten continuous generations. During the time of Noah, three significant branches emerged: Sem, Kam, and Yafet. Kam further branched out into three ancestral lines, namely Kusa or Ethiopia, Misrai or Egypt, and Libya. Present-day Ethio-

pia is a direct descendant of the line of Kusa. Four different names prevail for Ethiopia: Kam (used also to refer to the whole continent of Africa), Kusa, Saba, and Ethiopis—names derived from former kings.

In terms of genealogical mythology, perhaps the most popular account is the legendary story of the Queen of Sheba, also known as Makeda or Azeb. In Ethiopia the legend survived through oral traditions. The story is also traditionally represented in forty-four framed pictures depicting the life of Makeda, Queen of Ethiopia. The pictures are usually arranged in a panel that has four rows and eleven columns.

The introduction of monotheistic traditions since the time of the Queen of Sheba, approximately 3,000 years ago, brought a new sense of creation. The Genesis story appears with significant modifications to satisfy the local conditions. With the introduction of the New Testament, the reckoning of time, previously based on the Old Testament tradition, was supplemented with a new mode of time reckoning. Ethiopia recognizes Adam I and Adam II (Jesus) as eponymous ancestors in a fusion of biblical traditions and Ethiopian religious experience.

According to the Tigrean tradition, Ethiopia used to be ruled by Zendo, or dragonlike animals called Agabos. The people used to offer to the king of the Agabos large quantities of sweet beer and milk and eldest daughters. Thus, Makeda was tied to a tree as an offering to Agabos. When four saints stopped underneath the tree for its shade, they felt teardrops and, looking up, saw a crying girl who was urging them to flee. One of the saints, Abba Mentelios, killed the dragon with his cross and freed Makeda. Unfortunately some blood from the dragon spilled on one of Makeda's heels and it turned into a donkey's hoof. When the people saw the dead dragon, they made Makeda their ruler.

According to this mythological genealogy, one of Makeda's first acts as a leader was to find a cure for her deformed foot. Disguised as men, Makeda and a female official left for Jerusalem to visit the wise king Solomon, who was reputed to have medical skills. As soon as she arrived at King Solomon's court, her deformed foot recovered its natural form. Solomon invited his guests to a big feast, at which the two guests ate little. This made Solomon suspect that his guests might be women. Two beds were made for the guests in Solomon's bedroom, and honey was kept in a bowl. Solomon caught both women eating honey, and he slept with both of them. Makeda became the mother of Menelik, the founder of the Solomonic dynasty, while her companion became the mother of the ancestor of the Zagwe dynasty.

The story has been modified over time and often reflects the influence of a given era. The Tigrean version is perhaps the most recent, for it is constructed in the context of the adoption of Ethiopian Christianity in the fourth century and the establishment of the Zagwe dynasty in the tenth to thirteenth centuries. For instance, in other versions of the story, the father of the Queen of Sheba killed Agabos, was crowned king, and was later succeeded by his daughter.

In the biblical version, the Queen of Sheba traveled to Jerusalem with precious gifts with the aim of testing the wisdom of King Solomon. The king gave answers to all her questions. He impressed her with his wealth. She told him that all she had heard about him was more than true and Israel was blessed because the Lord had chosen him to execute justice and righteousness. She returned to her land after giving the king 120 talents of gold and after he gave her everything she desired.

In the Quran, the source of the most popular version in Yemen, Solomon was in his court among his subjects. Among his birds, he could not find his favorite one, the hoopoe. The hoopoe eventually appeared and informed the king that it had been in the kingdom of Saba, where it found a woman ruler with a magnificent throne. Solomon invited the queen to his palace and asked her to submit to Allah, instead of the sun god. When she entered the palace, which was paved with slabs of glass, thinking she was walking over water, the queen lifted up her skirt and exposed her legs. She apologized for her indiscretion and submitted fully to Allah. It is clear that the myth is significantly modified in this version to fit into an Islamic tradition.

According to the *Kebrā Negast*, the only source of the love story between Makeda and Solomon, the Ethiopian empire started with the union of Makeda and Solomon as well as the transfer of the Ark of the Covenant from Jerusalem to Aksum. Menelik brought the Ark and established what is referred to as the Solomonic dynasty. He was the first king of the dynasty, and the late Emperor Haile Selassie I was the 225th and, for now, the last ruler of the dynasty. Yeshak is believed to be the compiler of the *Kebrā Negast* in the thirteenth century, when the Solomonic dynasty was restored by Emperor Yukno Amlak.

Both Ethiopia and Yemen claim the Queen of Sheba. In Yemen, she is called Bilquis. It is possible that she may have ruled both lands from Aksum, which controlled the trade routes along the Red Sea until the rise of Islam in the region.

Other areas of Africa have mythological genealogies and narratives about creation. Clay, water, and grassy reeds are used as metaphors for divine creation in parts of southern Africa. The Sotho locate the creation of life in a swampy region. Moist clay is the basis of creation by the creator god Wuro in some parts of Burkina Faso, West Africa. For the Senufo of Côte d'Ivoire, Kolotyolo is the creator and life giver to the first human family. His counterpart in western Nigeria, the Yoruba deity Olodumare, delegates the creation of humans to Obatala and later Oduduwa. The Bamana of Mali propose that the creator god N'gala, or Pemba, manifested himself as a grain that became a tree. In most parts of the continent, there is the recognition of a supreme spiritual entity deemed directly or indirectly involved in the creation process. Spiritual entities inhabit flora and fauna in the context of a philosophy that proposes that God is the universe and his manifestations are diverse.

Bibliography

- Bekerie, Ayele. *Ethiopic: An African Writing System: Its History and Principles*. Lawrenceville, NJ: Red Sea, 1997.
- Brooks, Miguel F., ed. and trans. *Kebrā Nagast* (The Glory of Kings). Lawrenceville, NJ: Red Sea, 1995.
- Budge, E.A. Wallis. *The Dwellers of the Nile*. New York: Dover, 1977.
- . *An Ethiopian Book of the Dead: The Bandlet of Righteousness*. London: Kegan Paul, 2002.
- . *The Gods of the Egyptians*. New York: Dover, 1969.
- . *Legends of the Egyptian Gods*. New York: Dover, 1994.
- . *Osiris and the Egyptian Resurrection*. New York: Dover, 1973.
- Gabra Maryam, Taye. *Yethiopia Hezb Tarik* (History of the People of Ethiopia). Trans. Grover Hudson and Tekeste Negash. 1922. Uppsala, Sweden: Centre for Multiethnic Research, 1987.
- LaGamma, Alisa. *Genesis: Ideas of Origin in African Sculpture*. New York: Metropolitan Museum of Art, dist. Yale University Press, 2002.
- Legesse, Asmarom. *Gada: Three Approaches to the Study of African Society*. New York: Free Press, 1973.
- Levine, Donald. *Greater Ethiopia: The Evolution of a Multiethnic Society*. 2nd ed. Chicago: University of Chicago Press, 2000.
- Lewis, H.S. "The Origins of the Galla and Somali." *Journal of African History* 7 (1966): 27–46.
- Lvova, Eleonora. "Traditional Beliefs of Ethiopian Peoples: The Stages and the Tendency." *New Trends in Ethiopian Studies: Papers of the 12th International Conference of Ethiopian Studies*. Michigan State University, September 5–10, 1994. Ed. Harold Marcus and Grover Hudson. Vol. 1, 830–39.
- Marcus, Harold. *A History of Ethiopia*. Updated ed. Berkeley: University of California Press, 2000.
- Triulzi, Allesandro. "Oromo Traditions of Origin." Paper presented at the International Conference of Ethiopian Studies, Paris, 1987.
- Vansina, Jan. *Oral Tradition as History*. Madison: University of Wisconsin Press, 1985.

38 The Biblical View of Nature

Stephen D. Snobelen

The book of Genesis heads both the Jewish and Christian canons. It is self-consciously a book of beginnings, not only of the people of the covenant, but of time and space. It begins with a creation account that itself commences with the ultimate beginning, as summarized in the first verse: “In the beginning God created the heavens and the earth” (Genesis 1:1, English Standard Version). This sweeping statement, along with the emphasis throughout the creation account on a single God working alone to create the entire cosmos, reflects the universalizing monotheism of the ancient Hebrew religion. The genius of Genesis is that a narrative originally meant for ancient agriculturalists and pastoralists also contains a majestic vision with timeless appeal that has long continued to inform Western religion and thought. The Genesis creation narrative provides the foundation of the biblical view of nature.

The account of creation is twofold: an initial broad overview of the creation of the universe and humans, followed by a more specific narrative of the individual creation of man and woman in the Garden of Eden, their immediate environment. A series of topical threads tie together the general overview (the macrocosm) and the detailed account of the creation of humans and the Garden (the microcosm). These accounts are complementary rather than contradictory and taken together form a literary unit. This twofold generic-specific structure is found among other narratives of the ancient Near East, where general statements are followed by restatements with greater or supplementary detail. On a smaller scale, a generic-specific progression is commonly found in the parallelism of Hebrew poetry, where the first line of a couplet expresses a general idea and the second line expresses an intensification through greater focus or additional particulars (e.g., Job 41:24; Psalms 12:2, 114:1).

The main purpose of the creation account is suggested by the structure of the book of Genesis, which is divided into twelve sections separated by eleven occurrences of the word *toledoth* (e.g., 2:4, 5:1, 6:9, 10:1). This Hebrew word can be translated as “begettings,” “generations,” or “history”; the Greek equivalent is *genesis*, providing the common name of the book. All but the

Table 38.1

The Two Triads of the Hexaemeron or First Six Days

	Forming		Filling
Day 1	Realm of Light	Day 4	Rulers of Light
Day 2	Realms of Sky and Sea	Day 5	Creatures of Sea and Sky
Day 3	Realm of Land	Day 6	Creatures of Land

first two of these sections explicitly begin with human genealogies or accounts of family origin. As is often the case in other ancient Near Eastern literature, these genealogies have theological significance. The inference is, then, that the first two sections represent “genealogies” of creation, an inference apparently supported in James 1:17 in the New Testament, where God is called “the Father of lights,” an allusion to Genesis 1:3 and 1:14.

The structure, metaphors, and language of the Genesis creation narrative befit an oral culture and encapsulate a wealth of meaning into a discrete and memorable literary space. What at first glance seems a simple account of a seven-day creation week reveals deep literary structure on more extensive analysis. The most obvious structural feature comes in the parallels between the two triads of the first six days. These two triads are separated into three days of “forming” and three days of “filling,” a bipartite structure perhaps signalled by the expression “without form and void,” which describes a featureless and empty earth immediately prior to the main acts of creation. The description of “the Spirit of God . . . hovering over the face of the waters” asserts God’s control over nature and presents his power poised for creative action. The two triads can be laid out in the following way:

The intersection, or chiasm, formed by the respective sequences in the second and fifth days strengthens the parallel structure of the two triads. Through the complete sequence of the six days, the originally unformed and unfilled earth is transformed from a dark, disordered, indistinct, amorphous, and lifeless world into one manifesting light, order, distinctions, boundaries, and life. The literary structure and plot lines of the creation account bring out a powerful sense of divinely sanctioned order, progression, and purpose. Everything has its place and nature is neither random nor capricious.

There is no attempt in the Genesis creation account to present a philosophy of nature; the main intentions are theological, didactic, and apologetic—that is, defending the doctrine set forth. Two pivotal biblical doctrines are set out in Genesis 1 and 2: the doctrine of creation itself, and the uniqueness and unchallenged sovereignty of God. The centrality of God is emphasized through the lack of direct mention of creative intermediaries, the repetition of the divine creative word, and the use of a verb for “create” that is only used in the Hebrew scriptures of divine activity. By prefixing an account of the universal creation at the beginning of a history of the people of the covenant, Genesis

portrays the creator as not merely the God of Israel, but the God of all nature and the entire universe.

A comparison with other ancient Near Eastern creation stories reveals a sharp contrast between the austere monotheism of Genesis 1 and 2 and the polytheistic and mythological tendencies of the other accounts. In the Genesis creation narrative, there are no cosmic battles between competing bloodthirsty deities, only a single God working with a single-minded creative purpose. Contrary to polytheistic accounts in which nature gods meld with nature, there is a radical separation in Genesis between the creator and the created. As if to highlight this distinction, the sun and moon mentioned in the fourth day are referred to simply as “lamps,” rather than by their common Semitic names, which were also the names of deities in the polytheistic Semitic religion. The message here is that the sun and moon are not gods but were created by the one true God. The sun, moon, and stars are not given any astrological import; instead, they are set in the heavens to mark the days, years, and seasons. Nor does the Genesis narrative attempt to explain the mechanisms for the creation and maintenance of life. Avoiding all hints of magic and mythology, the text simply describes God speaking into existence the world and all that it contains.

A sense of a divine plan for creation is brought out through the emphasis on God’s creative word, as seen in the expression “and God said,” which repeatedly punctuates the account. Creation is the result of the divine spoken word, itself the vocalization of a thought or preexisting plan whose realization is heralded by the repeated clause “and it was so.” The result of the divine word is a creation that may not be strictly perfect, but is nevertheless described as “good.” Affirmations of the goodness of creation and nature abound in Genesis 1 and 2. Creation is not only repeatedly termed “good” but is summarized as “very good.” Eden is portrayed as a place of delight, with trees that are “pleasant to the sight and good for food.” God also affirms creation by planting a garden and walking in it. The fundamental holy day of Israel (the Sabbath) and the fundamental social unit (marriage) are presented as rooted in the created order at the end of the general and specific narratives of creation. The covenant name of God (Yahweh), associated elsewhere in the Hebrew scriptures with the people of the covenant, is used extensively in the specific account of the creation of humans, but not in the general account that precedes it (which employs only the generic word for God). In sum, the narrative of Genesis 1 and 2 provides a creation hymn of praise that would have served perfectly the theological and ritualistic needs of the monotheistic religion of ancient Israel.

Nature in the Genesis Creation

Although the primary purpose of the Genesis creation account appears to be theological, the narrative speaks eloquently of the views of nature held by the

ancient Hebrews. One of the central elements of nature as portrayed in Genesis 1 and 2 is underpinned by the central theological tenet of the Hebrew religion. The unity of creation and natural phenomena derive from the unity of God. One universal God is responsible for the creation in Genesis, not a range of competing and local deities. We do not encounter a god of the sky, a god of the earth, and a god of the sea, but one God of sky, earth, and sea—one God of all, with a universal dominion.

The universality of both God and creation implies the consistency and uniformity of the operations of nature throughout the physical universe. Associated with this fundamental unity is a strong sense of interrelatedness, seen not only in the crafting of appropriate environments for the living creatures, but also in the correspondence of male to female and the provision of vegetation as food for animals and humans. Moreover, the created world is predictable and regular, rather than chaotic; plants and animals reproduce according to individual kind. As intuitive and as rudimentary as they are, these conceptions nevertheless reveal the beginnings of an understanding of nature as an interconnected, balanced, and regular system. This strong belief in purpose and order also differs sharply from views of nature elsewhere in the ancient Near East. The capricious gods of the pagan pantheons were not moral and did not underlie a moral order. The Mesopotamians, it has been said, suffered from “overtones of anxiety” because the gods were indifferent and did not guarantee a stable cosmos. As Sarna points out, the moral and just nature of the God of Genesis guarantees the order of humanity and nature.

The twofold structure of creation’s six days is also seen in the division of *static* (unmoving) spaces and features in the first triad and *dynamic* (moving) creation and creatures in the second. The two triads speak of habitats and inhabitants. The distinction between the plants and trees of the triad of unmoving things and the “breathing” marine, aerial, and terrestrial creatures in the triad of moving things is intuitive and comparable to the modern distinction between *flora* and *fauna*. The breathing creatures of the second triad are themselves distinguished using a tripartite taxonomy of locomotion: swimming, flying, and walking, modes of locomotion suited for the marine, aerial, and terrestrial spheres respectively. A concern for taxonomy is also hinted at in the account of Adam naming the creatures of the Garden. The triads also display vertical registers, with the celestial at the top and the terrestrial at the bottom.

The plot structures of both triads lead up to crescendos of creation. The most verbally rich thirds of each triad are the final days, highlighting the importance of what is created on the third and sixth days: plants and trees on the one hand, and land animals and humans on the other. The most detailed element of the six days is the account of the creation of humans, who are thus depicted as the climax of creation. Their creation is heralded with God’s declaration: “Let us make man in our image, after our likeness.” Humans alone are granted this noble status.

Humans are also entrusted with stewardship over nature, and in this they have the example of God, who not only sustains the world but also is described as planting the Garden, which grew “every tree that is pleasant to the sight and good for food.” A picture of completeness and peace in the natural world is provided by the account of the seventh day, during which God is described as resting and which has particular import to human life by way of analogy. A similar sense of completeness and balance is given at the end of the elaborated account of the creation of man and woman that speaks of their complementary relationship and the institution of marriage. The conclusion of each account with the founding of an institution (the Sabbath and marriage) serves to emphasize the importance of the creation account to the religious and civic life of ancient Israel.

Biblical Portrayals of the Natural World

Creation themes resonate throughout Hebrew and Christian scripture, from Exodus all the way to Revelation at the conclusion of the New Testament. These range from brief allusions to creation (e.g., Exodus 20:11; Psalms 102:25; Romans 1:20; Hebrews 11:3) and concise formulaic references to the pattern of forming and filling (Deuteronomy 10:14; Nehemiah 9:6; Psalms 146:6; Acts 14:15, 17:24; Revelation 10:6), to larger-scale poetic paraphrases of the creation account (e.g., Job 38–39; Psalms 104, 136:5–9, 148; Proverbs 8:22–31). Also sustained throughout the Bible is a dual understanding of the purpose of the created world, in which nature is presented as both intended for the habitation of humans and as a sign of the glory of God. Both themes come together in Isaiah 45:18: “For thus says the Lord, who created the heavens (he is God!), who formed the earth and made it (he established it; he did not create it empty, he formed it to be inhabited!): I am the Lord, and there is no other.” As in the Hebrew scriptures, nature is represented as a blessing. The apostle Paul reminds those at Lystra that God “did good by giving you rains from heaven and fruitful seasons, satisfying your hearts with food and gladness” (Acts 14:17).

An important image is the garden, beginning with the archetypal garden in Eden. The image of the garden is associated with themes of creation and redemption. The garden is not only the location of the creation of man and woman but also the scene of their fall, described in Genesis 3. Sin and rebellion are injected into the first garden as foreign entities not natural to it; thus the man and woman are expelled from the garden and the tree of life, while the ground outside is cursed. The vision of the Hebrew prophets includes the promise of the land being returned to an Edenic state (Isaiah 51:3; Ezekiel 36:35). Gardens provide arenas for Christ’s last struggles before his crucifixion (John 18:1) and his death, burial, and resurrection (John 19:41, 20:15). That a garden is the site of the resurrection of Christ suggests a redemptive theme of renewal that links with the garden of humanity’s birth.

In the final book of the New Testament, the tree of life and the “paradise of God” are used as symbols for human immortality (Revelation 2:7). A garden with a river and the tree of life in its midst are also featured near the end of Revelation in a vision that reinforces the theme of a return to the initial conditions of Eden, which come after the rebirth of humanity and heaven and earth (Revelation 20:4–6, 21:1–7, 22:1–5). In depicting the future of human salvation within a renewed earth, the biblical tradition once again testifies to the essential goodness of physical reality and rejects dualistic worldviews that distinguish between a material world that is evil and a transcendent realm that is good. The biblical God is the creator of “the heavens and the earth” (Genesis 1:1).

Nature, Poetry, and the Glory of God

Biblical portrayals of the natural world often make explicit reference to nature’s createdness as its fundamental asset (e.g., Job 38–39). This belief in a divinely and benignly created world shapes the scriptural understanding of the natural realm, which is frequently conceived in teleological senses, both as a blessing for humanity and as a testimony to God’s greatness and glory. A key feature of poetic accounts of creation in the Bible, such as the hymn to the creator in Psalm 104, is an emphasis on the glory of creation and its creator. The Bible does not attempt to present a philosophical or scientific account of nature. Nature is either described simply as it appears from the perspective of the common people (often with an emphasis on its practical benefits), or it is portrayed with poetry meant to highlight its manifest beauty and wisdom.

In the book of Psalms, the contemplation of the beauty of the cosmos is linked to an appreciation for the glory and greatness of God. The eighth Psalm opens with a declaration of God’s glory “above the heavens” and contains the expostulation: “When I look at your heavens, the work of your fingers, the moon and the stars, which you have set in place, what is man that you are mindful of him, and the son of man that you care for him?” (Psalms 8:3–4). Similar themes are evinced in Psalm 19, another Davidic Psalm: “The heavens declare the glory of God, and the sky above proclaims his handiwork. Day to day pours out speech, and night to night reveals knowledge. There is no speech, nor are there words, whose voice is not heard” (Psalms 19:1–3). Nature, brought forth by a verbal divine command, is also represented as a text written by God that bespeaks his glory. Personified, creation sings the praises of God in Psalm 148: “Praise him, sun and moon, praise him, all you shining stars! Praise him, you highest heavens, and your waters above the heavens!” (Psalms 148:3–4). The Psalmists marvel at the aesthetic beauty of creation, not at any mathematical harmonies that may be latent in it. The chief end is the glory and worship of the creator.

In many cases, metaphorical depictions of nature blend with phenomenalist descriptions. In Psalm 19:4–6, the sun is described as moving across the sky

like a man running a race. A range of metaphors for nature can be found in Job 38, which portrays clouds as the garment of the sea, a dwelling place for light, storehouses of snow and hail; constellations are chains and cords; rain is a tipping out of the waterskins of heaven. The metaphorical description of creation is a different style of discourse from the scientific analysis of the physical world. Because the intuitive poetic metaphors of the Bible do not deploy the language of scientific or philosophical analysis, they transcend centuries and cultures.

Nature as a Product of Divine Wisdom

Although there is no strong emphasis on a fundamental mathematical reality underpinning creation as in Plato's *Timaeus*, there is nevertheless a clear sense in the Bible that nature is the product of great wisdom. This is seen when God asks Job, "Where were you when I laid the foundation of the earth?" and then proceeds to contrast human pride with the manifest wonders and wisdom of the created world (Job 38–39). This theme is especially evident in Proverbs 8, where wisdom, personified as a woman, is described as being with God prior to and through the events of creation. Wisdom is the first of God's works: "The Lord possessed me at the beginning of his work, the first of his acts of old." Thus, although the overall focus is on the glory of creation and its aesthetic qualities, there is also an understanding that creation was governed by reason.

If the world is the product of mind as outlined in the Bible, then evidence of divine reason should be seen in nature. Paul makes precisely this argument in Romans 1:20: "For [God's] invisible attributes, namely, his eternal power and divine nature, have been clearly perceived, ever since the creation of the world, in the things that have been made. So they [the ungodly] are without excuse." Paul is arguing that if nature reveals God, then even those without the benefit of scriptural revelation should understand that there is a God—a moral corollary expanded in later Christian natural theology. Paul goes on to condemn the worship of nature in place of the creator, thereby stressing a distinction maintained throughout the Bible.

In Hebrews, the emphasis is on the response of faith to the witness of the universe: "By faith we understand that the universe was created by the word of God, so that what is seen was not made out of things that are visible" (Hebrews 11:3). The texts in Romans and Hebrews argue that God's hand in nature can be seen through induction and the eyes of faith. These arguments were hinted at centuries before in Psalm 19, which ties together the dynamics of God's glory and wisdom.

Sustaining the Natural World

The God of the Bible is a transcendent deity who is over and separate from creation yet also acts in and through it. Many of the great miracles of the Bible, such as the plagues of Egypt, the parting of the Red Sea, and the

resurrection of Christ, exhibit God controlling nature. This God preserves creation (Nehemiah 9:6), and his love and faithfulness are described as reaching to the heavens and the clouds (Psalms 36:5–6). This care extends to the seemingly insignificant, for even the fall of a small sparrow to the ground is said not to escape the attention of God (Matthew 10:29). In creating and sustaining the natural world, God is likened to a lawgiver uttering decrees to nature. The creation of the sun, moon, and stars is compared to God giving an irrevocable decree (Psalms 148:3–6), with their ongoing operations also defined by this divine regulation (Jeremiah 31:35–36). In Job, God gives a decree for rain (Job 28:26) and ordinances for the heavens (Job 38:33). God is also described as setting fixed boundaries for the sea (Job 38:8–11; Psalms 104:9; Proverbs 8:29; Jeremiah 5:22) and between light and darkness (Genesis 1:4; Job 26:10). In the poetry of Job 38–39, God’s account of the natural world draws attention to his faithfulness, foresight, and overall sovereignty.

While in Greece, Paul challenges Epicurean and Stoic philosophers with the Judeo-Christian view of God and nature (Acts 17:22–34). He tells the Athenians about a God who is omnipotent, unbounded, unable to be represented with images, the source of all things and all life, the controller of providence and the judge of humanity. The Bible affirms God as both the creator and preserver of nature. But the biblical view of nature does not countenance a rigid determinism; the sparrow is still allowed to fall, just as the people of God are permitted the free will to make mistakes and rebel against their maker.

A distinctive aspect of biblical thought is the unidirectional flow of time. Through God’s providence, the created world moves toward a goal. Although the book of Ecclesiastes speaks of cycles (Ecclesiastes 1), these are seasonal and natural cycles that are subordinated to the inexorable and overarching progression of time. The endless cosmic cycles described in Eastern religions and Greek Stoic thought are completely foreign to the Bible. Emerging powerfully from the writings of the Hebrew prophets is a vision of the goal of history: a global kingdom of God characterized by peace, prosperity, and justice for humanity. The prophet Isaiah borrows from the language of creation to describe this state, referring to it as “new heavens and a new earth” (Isaiah 65:17). Nations will not make war, the desert will blossom, and there will be peace among humans and animals alike (Isaiah 2:1–5, 35, 65:17–25). This language suggests a reestablishment of the conditions of Eden that involves both the human and natural worlds.

Yet this is not one immense cycle; the future paradise is universal, perfect, and immune from any decline. It is a new state of being. The “new heavens and new earth” of Revelation are a fundamentally different time and place than the original Eden. God dwells openly with humans, and tears, death, mourning, and pain are things of the past (Revelation 21:1–4). Also absent in this new state are the sea, sun, and night. God himself provides the light (Revelation 21:1, 23–25, 22:5). The tree of life is fully accessible and the curse of Eden is gone (Revelation 22:1–3).

Humans and Nature

In a two-staged creation that mimics the forming and filling of Genesis 1, Adam is first formed from the ground and then filled with breath: “the Lord God formed the man of dust from the ground and breathed into his nostrils the breath of life, and the man became a living creature” (Genesis 2:7). Far from suggesting the division of the human into an organic body and an immaterial soul, the stress here is on human life as wholly physical. Where the Platonists saw psychosomatic dualism, the ancient Hebrews saw psychosomatic unity. Breathing is a physical process, just as the body is a physical being.

Like vegetation and animals, Adam is made of the earth. This association with the ground is also emphasized in the word used for human and Adam in the Hebrew: much like the relationship between the words *human* and *humus*, the Hebrew word *'adam* (human) is cognate with *'adamah* (ground). As an organic being, the human returns to the earth at death (Genesis 3:19; Job 10:9; Psalms 103:14, 104:29; Ecclesiastes 3:18–20, 12:7). As conceived in the Bible, resurrection is an awakening from a metaphorical sleep in the dust (Daniel 12:2), an image that suggests the creation of the first human from the dust (Genesis 2:7).

Immortality in the biblical texts is not an intrinsic element of the human, but rather a gift for the righteous granted after resurrection (Romans 2:7, 6:23; 1 Corinthians 15:42–49). It is the whole human being (body and thoughts) who dies and the whole human being (body and thoughts) who is resurrected. The teaching of the bodily resurrection provides yet another biblical affirmation of the essential goodness of the physical world.

Ecology, Dominion, and Stewardship

In the Genesis account, men and women came with responsibilities to the natural world. Humans were given “dominion” over the creatures of the sea, sky, and land and were commanded to “be fruitful and multiply and fill the earth and subdue it.” Lynn White Jr. and others have argued that this language of dominion causes exploitation of the environment to the point of crisis, but more recent biblical scholarship has countered White’s argument. For example, the creation of the Garden of Eden in Genesis 2 may suggest that the scope of the dominion was seen primarily as local rather than global. The dominion Adam enjoys seems limited to the care of the domestic plants, trees, and animals in his immediate environment—the level of contact with nature that was common among nonnomadic agriculturalists and pastoralists in antiquity. The language of Genesis 1:28–29 is certainly susceptible to universalization, but the practical application of it in Genesis 2 concerns a more limited scope of activity such as the tending of domestic crops and livestock.

Positive affirmations of the care of creation are found in the Bible. The Hebrew word used for “keeping” the garden in Genesis 2:15 means to guard as

in setting a hedge around, with the added sense of protecting and preserving. In Genesis, the model humans are given to follow is that of God, who takes barren land and transforms it into a garden through the planting and irrigation of trees (Genesis 2:5, 8–10)—the reverse of deforestation and desertification. Noah is instructed to take on board the ark not only the clean (ritually edible) animals, but also the unclean animals and birds, “to keep their offspring alive on the face of all the earth” (Genesis 7:2–3). Added to this are the frequent scriptural expressions of the glory and beauty of the created world. These examples intimate an appreciation in the Hebrew mind of the intrinsic value of all forms of life, whether or not they directly serve humanity’s material ends.

There is no justification for the interpretation of the biblical word “dominion” as “domination.” A careful reading of Genesis 1 and 2 strongly suggests a stewardship model of dominion in which the human mirrors the qualities of the creator. If God is the model for dominion and the superintendence of creation—as he manifestly is in Genesis 1 and 2—then the conception of dominion encapsulates qualities of benevolence, foresight, and creativeness rather than avarice, rapacity, and destruction.

Moreover, biblical portraits of nature act as a positive stimulus for a growing number of environmentalists. The model in Genesis 1 and 2 is benevolent intervention rather than *laissez-faire* nonintervention. In the biblical vision, God sustains the world, but humans have important responsibilities to care for the world as stewards of creation. Humans are not portrayed as wholly other than nature, standing over it or oppressing it. Nor are humans seen as helpless victims at the mercy of nature as in some of the ancient nature religions. The biblical paradigm is of humans working with nature to preserve it.

Science and the Biblical View of Nature

The Western worldview is founded on the twin pillars of Hellenic and Judeo-Christian thought. Much the same can be said of Western science. Modern science was stimulated by Greek rationalism and mathematics, but it was also shaped by an antipanteistic and antimagical empirical emphasis that often derived from monotheistic Hebraic culture. The fascination with origins and genealogies exemplified in the book of Genesis captures the kind of fascination that drives sciences such as cosmology and biology. The interest in taxonomy, belief in the unity of creation, and the awareness of the regularity of nature displayed in the Bible all helped establish Western science. When John Ray and Carolus Linnaeus began to develop taxonomic systems for classifying plants in the early modern period, they were working with an understanding of nature that assumed a well-ordered divine creation. Also rooted in biblical beliefs was Linnaeus’s idea of nature as an “economy” or fully interconnected system, which provided the foundations for the modern study of ecology. The idea that creatures are designed for their particular environments, as described

in the Genesis creation narrative, has resonances with the idea of adaptedness in modern biology.

A belief in nature as ordered and regular, as opposed to chaotic and capricious, is a *sine qua non* for the emergence of modern science. The conception of a universal lawgiver provides a backdrop to the emergence of the modern scientific concept of laws of nature. Recent research has confirmed that Isaac Newton's conception of universal gravitation is strongly related to his biblical belief in God's omnipresence. Likewise, Newton's ideas of absolute space and time were based on scriptural teachings of God's spatial ubiquity and eternal duration. The three arrows of time common in modern science—the thermodynamic arrow (increasing entropy), the cosmological arrow (the expanding universe), and the arrow of complexification (increasing complexity)—all align with the biblical concept of unidirectional time.

Many historians of science believe that biblical modes of thought played a role in shaping the modern scientific empirical method. The notion of a natural world that “speaks” of God's glory when one observes it suggests that knowledge of nature should come through observation and reflection. Malcolm Jeeves and R.J. Berry argue that the biblical tradition says: “If we wish to discover the patterns of order in nature we must have recourse to experiment and experience; intuition or reason alone are insufficient.”

Also important is the distinction between God's will and God's wisdom, suggesting on the one hand that nature's form is contingent rather than necessary, and on the other hand that it is reducible to reason. As Ian G. Barbour puts it, “It is the combination of contingency and intelligibility that prompts us to search for new and unexpected forms of rational order.”

The tradition of natural theology (the conclusion that God is revealed in nature) and the doctrine of the two books (the belief that God speaks in the books of nature and scripture), which have antecedents in the Bible (Psalms 19; Romans 1:20; Hebrews 11:3), likewise played a role in the rise of empiricism in the West. Natural theology, and the argument from design it helped generate, encouraged the exploration of nature, as many early modern natural philosophers such as Robert Boyle and Newton sought to find the hand of God in nature and believed this study was akin to an act of worship.

The sociologist Robert K. Merton contends that the work-ethic characteristic of Calvinism helped stimulate the study of nature in Protestant Europe. According to Reijer Hooykaas, because the Bible honors manual labour, sees it as holy, and uses positive artisanal metaphors, it provides Protestants (and particularly Calvinists) with a biblical sanction to engage in manual labour and empirical investigations of nature. Peter Harrison argues that the shift from allegorical understandings of scripture in the Middle Ages to the literal-historical mode of biblical hermeneutics, developed mainly by Protestant exegetes, helped precipitate a related shift from an emblematic view of nature to the modern empirical and realist one. Such a shift was possible precisely

because of the tradition of the two books, which stressed that both scripture and nature could be read as texts.

The biblical tradition still has the power to inform today. The Garden of Eden is a symbol in Western culture not only of human peace and tranquillity, but also of the peace and balance of nature. The rediscovery of a positive view of nature in the Bible is helping to animate a growing environmental movement. A belief that creation is incomplete and requires human participation provides Carl Feit, a Jewish Talmudic scholar and oncologist, with an imperative to work in medicine. The example of the healing ministry of Jesus motivates Francis Collins, a Protestant and the head of the Human Genome Project, to work in genetics to discover cures for life-threatening illnesses. All of this underscores the ongoing importance of the biblical view of nature, which has helped to inspire and shape science.

Bibliography

- Barbour, Ian G. *Religion and Science: Historical and Contemporary Issues*. San Francisco: HarperSanFrancisco, 1997.
- Bouma-Prediger, Steven. *For the Beauty of the Earth: A Christian Vision for Creation Care*. Grand Rapids, MI: Baker Academic, 2001.
- Harrison, Peter. *The Bible, Protestantism, and the Rise of Natural Science*. Cambridge: Cambridge University Press, 1998.
- Hess, Richard S., and David Toshio Tsumura, eds. *"I Studied Inscriptions from before the Flood": Ancient Near Eastern Literary and Linguistic Approaches to Genesis 1–11*. Winona Lake, IN: Eisenbrauns, 1994.
- Jeeves, Malcolm A., and R.J. Berry. *Science, Life, and Christian Belief: A Survey and Assessment*. Leicester, UK: Apollos, 1998.
- Ramm, Bernard. *The Christian View of Science and Scripture*. London: Paternoster, 1955.
- Russell, Robert John. "Five Attitudes Toward Nature and Technology from a Christian Perspective." *Theology and Science* 1 (2003): 149–59.
- Sarna, Nahum. *Understanding Genesis*. New York: Schocken Books, 1970.
- White, Lynn, Jr. "The Historical Roots of Our Ecological Crisis." *Science* 155 (1967): 1203–7.

39 Galileo, Science, and Religion

Mariano Artigas

The Galileo affair—in which the scientist was called before the Inquisition for advocating the Copernican theory that the earth revolved around the sun—has been presented by some as an example of the necessary conflict between science and religion, and by others as an unnecessary conflict provoked by Galileo's vanity and lack of prudence. The real story is much more complicated than either of these extremes reflects. It took place across many years, and many people and circumstances played important roles.

The astronomer and mathematician Galileo Galilei (1564–1642) resided for much of his life in the Italian grand duchy of Tuscany, primarily in Florence. He did not invent the telescope, but he refined it and used it to make astronomical discoveries, which he published in *The Messenger of the Stars* in 1610. He showed that the surface of the moon is irregular, that Jupiter has four satellites, that Venus shows phases like the moon, that the Milky Way is composed of a very large number of stars, and that Saturn has something around it. His merits were recognized, and he received a public homage in the College of the Jesuits in Rome.

When Galileo used his discoveries to argue for the Copernican theory that the earth revolves around the sun, he faced the opposition of Aristotelian philosophers and the theological argument that the Copernican view contradicted holy scripture as it has been interpreted by the Catholic tradition. It was the time of the Counter-Reformation, and Roman Catholic authorities tended to insist on the traditional interpretation of scripture. Galileo argued in his famous letters to Father Benedetto Castelli and the grand duchess Cristina that the scriptures, when dealing with natural matters, employ the ideas and language of their own time. But he was told that the traditional interpretation should not be abandoned unless a real necessity required it.

A copy of Galileo's letter to Castelli was sent by the Dominican Niccolò Lorini to the Holy Office in Rome in 1615, and Galileo decided to go to Rome to defend himself and to prevent the condemnation of the Copernican theory. But his activity in Rome provoked the contrary result. On February 24, 1616,

eleven consultants of the Holy Office unanimously reported that saying the sun is in rest at the center of the world is absurd in philosophy and heretic in theology. They contended that it contradicts a series of biblical passages as they are interpreted by the Holy Fathers, and to say the earth moves is also absurd philosophically and erroneous in the faith. On February 26, Cardinal Robert Bellarmine officially notified Galileo that he should abandon Copernican views, or at least not defend them. On March 5, the Congregation of the Index issued a decree including Galileo's book among the forbidden books until it was corrected, and forbidding all books defending the Copernican theory, which was considered a false doctrine and contrary to the scriptures (although it was not qualified as heretical).

The events of 1616 were not, properly speaking, a process against Galileo. Nevertheless, they would form a basis for the trial of 1633. Bellarmine's injunction was recorded in the archives. Even though the validity of one of the documents has been doubted, there is no doubt that Bellarmine's notification took place, as it is clearly recorded in other places, and Galileo remembered it in his subsequent trial. But for the time being, Galileo obeyed and did not publish anything referring to the Copernican theory.

The Dialogue

In 1623, Cardinal Maffeo Barberini, an admirer and friend of Galileo, was elected pope, taking the name Urban VIII. Some friends of Galileo were placed in influential places in Rome. The pope received Galileo in 1624 with extreme cordiality. Galileo thought he could now argue for the Copernican theory, provided he presented his arguments in a hypothetical way. Galileo therefore wrote his *Dialogue on the Two Great Systems of the World, the Tolemaic and the Copernican*. The book presented the arguments through a dialogue between the characters Salviati, representing Galileo's position, and Simplicio, representing Aristotle's, with a character called Sagredo acting as moderator. In fact, the *Dialogue* was a long argument in favor of Copernicus's theory, and Galileo confided that the intelligent reader would appreciate the truth of the arguments.

At the end of the book, Galileo presented the favorite argument of Pope Urban VIII, that we cannot be sure of the truth of the Copernican theory because the effects that we observe could be the result of different causes unknown to us, otherwise we should limit God's omnipotence. The argument is accepted by Salviati, who represents Galileo, but it is expounded by Simplicio, the Aristotelian simpleton who always was the loser in the arguments. Galileo's foes could thus accuse Galileo of ridiculing the pope.

Galileo finished the *Dialogue* in 1630 and wanted to publish it with the approval of the Vatican authorities. The Dominican Niccolò Riccardi, a friend of Galileo, was the Master of the Apostolic Palace and, as such, he had to give the approval. Riccardi was reluctant, however, because he realized the book

could provoke trouble. Galileo pressed Riccardi, using the authority of the grand duke of Tuscany. Finally the book was published in Florence on February 21, 1632.

When Urban VIII was informed of the contents of the *Dialogue*, he was very angry, and he felt Galileo had deceived him. The circumstances were bad for Galileo, whose most influential friends in Rome were at this time either dead or in disgrace with the pope. The Thirty Years War (1618–1648) divided Europe along Catholic and Protestant lines, and the Spanish ambassador, Gaspar Borgia, accused the pope of favoring Protestants because of his good relations with France, which supported the Protestant forces. In these circumstances, Urban VIII felt obliged to show that he defended Catholic orthodoxy. He appointed a special commission to examine the book, and finally he sent the affair to the Holy Office. Galileo was summoned to Rome.

The Trial of 1633

Galileo arrived in Rome on February 13, 1633, and resided in the home of Francesco Niccolini, Tuscany's ambassador. Galileo was called to appear before the Holy Office on April 12. He wanted to defend his arguments but, counseled by Niccolini, he said that in his book he did not defend the Copernican theory. On April 17, three official reports concluded instead that he did. One cause of Galileo's problems was his presumed disobedience to the injunction of 1616. Galileo argued that he only remembered what Bellarmine (who was now dead) had communicated to him: that Copernicus's theory had been banned by the Index.

Father Maculano, the Commissary of the Holy Office, counseled Galileo to acknowledge his error. Galileo followed his advice and, on April 30, declared to the tribunal that he had realized that his arguments in favor of Copernicus went too far, out of the vanity he experienced in showing his mastery of the subject. That same day, Galileo was allowed to return to the house of the Tuscan ambassador, where he stayed, except when he was at the Holy Office. As a privilege, he used rooms at the Holy Office, and meals were carried to him there from the Tuscan embassy.

On June 16, when the cardinals of the Holy Office had their usual meeting with the pope, it was decided that Galileo should be asked about his real intention under the threat of torture. This was considered merely a formal requisite; apparently there was no intention of torturing him. On June 21, this formal declaration took place. Galileo declared that, after 1616, he had never held the Copernican theory (surely a lie, understandable under the circumstances), nor had he advocated it in the *Dialogue*. He was threatened with torture, and he repeated his declaration. He was then told to sign it and was released. On June 22, Galileo was led to the convent of Santa Maria sopra Minerva, where he heard the sentence before the cardinals of the Holy Office and afterwards read his abjuration. He was condemned to prison, which was

commuted the following day, June 23, for arrest at the villa of the grand duke of Tuscany in Rome.

On July 6, 1633, Galileo left Rome and went to Siena, to the palace of his friend Archbishop Piccolomini. In December, Galileo was allowed to return to his home near Florence, where he remained until the end of his life in a kind of house arrest. There he wrote his most important scientific work, *Discourses and Demonstrations on Two New Sciences*, published in 1638. Eventually he became blind. Nevertheless, his young pupil Vincenzo Viviani, who accompanied him during the last thirty months, testified that he had projects until a few months before his death on January 8, 1642.

Reconciling Galileo and Religion

A key factor in the idea that science and religion are at war was the publication, in the nineteenth century, of two best-selling books that portrayed religion as the enemy of science. The first, by John Draper, was called *History of the Conflict Between Science and Religion* (1874). The other, by Andrew Dickson White, the first president of Cornell University, was a detailed, two-volume work called *A History of the Warfare of Science with Theology in Christendom* (1896). According to Draper, the Roman Catholic Church ferociously suppressed every attempt at progress. White, whose book was extremely influential, saw the Galileo affair as nothing less than an episode in “a war waged longer, with battles fiercer, with sieges more persistent, with strategy more shrewd than any of the comparatively transient warfare of Caesar or Napoleon.” The warfare view became deeply entrenched in many people’s minds, and it continued to influence thinking throughout the twentieth century. This is particularly so in America, where even today, conflicts between science and religion tend to be much more bitter and divisive than in other Western nations.

An opposite view of Galileo’s trial was presented by Arthur Koestler, one of the most influential scientific journalists of the twentieth century. In his widely read book *The Sleepwalkers*, he argued that Galileo’s trial should not be seen as the outcome of a deep-seated ideological opposition between science and religion, but as the result of personality clashes between a proud scientist and an equally proud pope. Koestler painted Galileo as the culprit of the whole affair.

One source of misinterpretations about Galileo and religion is Bertolt Brecht’s play *The Life of Galileo*, which is still part of the repertoire of many theatres. Many people may think it is a faithful account of what actually happened, but it is riddled with inaccuracies and is more a work of propaganda than an accurate depiction of events.

Although Galileo was never physically harmed and his sentence of imprisonment was immediately commuted to house arrest, it is frequently said that he was put in chains and subjected to torture. While some legal texts have

been interpreted as showing Galileo was tortured, other documents show that torture never took place.

In Dava Sobel's *Galileo's Daughter*, one of the best books on Galileo to have appeared in the last fifty years, the letters that Galileo's daughter wrote to him offer invaluable insight into Galileo's inner world. He was a religious man who thought that the Copernican theory did not threaten Christian doctrine. He tried to prevent the condemnation of Copernicus's theory, and he attributed his failure not to the church, but to his enemies. When Pope John Paul II appointed a commission to reexamine the issue, he was indicating a new line of dialogue and cooperation between science and religion. At the conclusion of the work of the commission on October 31, 1992, and on other occasions, John Paul II expressed regret about the Galileo affair and showed appreciation for Galileo's views about the relationship between science and religion. For instance, in the encyclical *Fides et Ratio*, we read:

[Galileo] declared explicitly that the two truths, of faith and of science, can never contradict each other, "Sacred Scripture and the natural world proceeding equally from the divine Word, the first as dictated by the Holy Spirit, the second as a very faithful executor of the commands of God," as he wrote in his letter to Father Benedetto Castelli on 21 December 1613. The Second Vatican Council says the same thing, even adopting similar language in its teaching: "Methodical research, in all realms of knowledge, if it respects . . . moral norms, will never be genuinely opposed to faith: the reality of the world and of faith have their origin in the same God." . . . Galileo sensed in his scientific research the presence of the Creator who, stirring in the depths of his spirit, stimulated him, anticipating and assisting his intuitions.

Bibliography

- Fantoli, Annibale. *Galileo for Copernicanism and for the Church*. 2nd ed. Notre Dame, IN: University of Notre Dame Press, 1996.
- Finnocchiaro, Maurice A., ed. *The Galileo Affair: A Documentary History*. Berkeley: University of California Press, 1989.
- Galileo Galilei. *Le Opere di Galileo Galilei*. Ed. Antonio Favaro. Florence: Barbèra Editore, 1890–1909. Reprint, 1968.
- Langford, Jerome J. *Galileo, Science, and the Church*. South Bend, IN: St. Augustine's Press, 1998.
- Pedersen, Olaf. "Galileo's Religion." In *The Galileo Affair: A Meeting of Faith and Science*, ed. G.V. Coyne, M. Heller, and J. Zycinski, 75–102. Vatican City: Specola Vaticana, 1985.
- Sharratt, Michael. *Galileo: Decisive Innovator*. Cambridge: Cambridge University Press, 1996.
- Shea, William R., and Mariano Artigas. *Galileo in Rome: The Rise and Fall of a Troublesome Genius*. New York: Oxford University Press, 2003.
- Sobel, Dava. *Galileo's Daughter: A Historical Memoir of Science, Faith, and Love*. New York: Walker, 1999.
- Westfall, Richard S. *Essays on the Trial of Galileo*. Notre Dame, IN: Vatican Observatory, 1989.

40 Isaac Newton: His Science and Religion

Stephen D. Snobelen

“In the eighteenth century and since, Newton came to be thought of as the first and greatest of the modern age of scientists, a rationalist, one who taught us to think on the lines of cold and uninctured reason.” Thus wrote the British economist John Maynard Keynes in the early 1940s in a paper he had prepared for the tercentenary of Isaac Newton’s birth. The man that Keynes describes is the Newton of contemporary popular culture. This is the Newton of scientific rationalism, the modern secular age, and the clockwork universe. The roots of this conception can be traced back to Enlightenment apologists who championed Newton’s empiricism and the mechanistic features of the *Principia* while they downplayed or neglected Newton’s theological agenda for his natural philosophy. In the writings of Voltaire, in D’Alembert’s Preliminary Discourse to the *Encyclopédie* (1751), and in numerous other works of the Enlightenment, Newton was presented as the patron saint of the Age of Reason.

During the eighteenth century there was a greater awareness of Newton’s natural theology in his native Britain than in France, and several of Newton’s earliest British supporters drew attention to the brief excursions into natural theology found in the Queries to the *Opticks* and the General Scholium to the *Principia*. Nevertheless, little was known of Newton’s personal religious faith. British poet and artist William Blake came to see Newton as epitomizing cold, soulless reason. In Blake’s 1795 painting of Newton, the scientist gazes down on a geometrical figure of the earth, not up to the dwelling place of God in heaven. If Blake had known Newton’s private thoughts rather than the public image, he likely would have found more of a kindred spirit than the object of animus and scorn.

The lingering awareness of Newton’s theological interests caused concern for some apostles of secular science. Two French scientists, Pierre-Simon de la Place and Jean-Baptiste Biot, were instrumental in the construction of a legend that Newton turned to theology when he suffered a breakdown after a putative 1693 fire incinerated stacks of his manuscripts. This implied that Newton’s greatest achievement (the *Principia*) was not tainted by theological

speculation. Although the story has been disproved, many still argue that Newton's later addition of the General Scholium to the *Principia* is evidence that he superadded theology to a treatise that had nothing to do with it. It is also argued that despite Newton's keen interest in religion and natural theology, he somehow managed to keep his physics separate from his faith. Recent developments in Newton scholarship make both of these views untenable.

Unravelling the Myth

When Newton died on March 20, 1727, he left behind a treasure trove of manuscripts. These unpublished writings—many of them on alchemy, theology, church history, and biblical prophecy—dwarf what was released to the public in his lifetime. It is the invisibility of these papers—documents that detail a very different Newton from the one of public conception—that allowed the creation of the myth of Newton as a herald of the Age of Reason. Newton himself is largely to blame for this, as he kept his manuscripts from all but a few of his most trusted friends. Due in part to the heretical nature of some of the theological manuscripts, Newton's collateral descendants kept a tight lid on the chest that contained them, only occasionally allowing access to scholars. All of this changed in 1936, when the Earl of Portsmouth (whose family owned the manuscripts since 1740) had the alchemical and theological manuscripts auctioned at Sotheby's in London.

The two largest collections of alchemical and theological papers were those purchased by John Maynard Keynes and Abraham Yahuda. Keynes was stunned by what he saw. After writing the sentence quoted at the beginning of this article about Newton's reputation as "the first and greatest of the modern age of scientists," Keynes asserted: "I do not see him in this light. I do not think that any one who has pored over the contents of that box which he packed up when he finally left Cambridge in 1696 and which, though partly dispersed, have come down to us, can see him like that. Newton was not the first of the age of reason. He was the last of the magicians, the last of the Babylonians and Sumerians."

Keynes left his collection to King's College, Cambridge, in the 1940s. Yahuda's larger collection arrived in Israel in the late 1960s and now forms part of the holdings of the Jewish National and University Library in Jerusalem, which also owns some of the papers of Albert Einstein. By the 1970s, the majority of the manuscripts had found their way into libraries and other institutions. In 1991, most of Newton's manuscripts were released on microfilm, and the study of the "other" Newton began in earnest. The foundation of the Newton Project in 1998, which provides online access to electronic editions of Newton's manuscripts, opened up new possibilities for textual analysis. The manuscripts paint a picture of an active alchemist and passionate lay theologian who spent the better part of the decade preceding his composition of the *Principia* leaning over his alchemical crucible and leafing through his Bible.

The Birth of a Searching Mind

Isaac Newton's birth at Woolsthorpe Manor in Lincolnshire on Christmas Day 1642 seemed inauspicious enough. He was born after the death of his father, and the women attending his mother were convinced that he would not survive the day. The English Civil Wars of the 1640s formed a backdrop to his earliest years, and the biblical piety of Puritanism associated with this period helped shape the young Isaac's religion and morality. He suffered the temporary loss of his mother from age three to eleven when she married a clergyman and left Newton in the care of his grandmother. Newton apparently resented this marriage. He was reunited with his mother after the clergyman's death, but two years later he was shipped seven miles north to the King's School in Grantham, where he lodged with an apothecary. It was at the King's School that Newton's promise as a scholar was first recognized.

A new world opened up before Newton when he arrived at the University of Cambridge in 1661. Although the training at Cambridge was still dominated by a medieval curriculum that focused on classical authors such as Plato and Aristotle, Newton was soon attracted to the figures of the new mechanical philosophy, and chief among these was René Descartes. A notebook Newton began as an undergraduate reveals the direction in which his thought was moving. Two pages of notes on Descartes are followed by a series of notes on a wide range of topics that include attraction, comets, colors, cosmology, gravity, light, matter, optics, time, vortices, and the vacuum.

Two other features of this notebook signal interests that would become lifelong passions. First, the notes show that Newton began to take an interest in ancient alternatives to Aristotelian philosophy, such as Epicureanism (although Newton always rejected atheistic readings of this school). Second, several examples from the notebook demonstrate that Newton was already integrating theological considerations into his study of natural philosophy. Partly due to these two interests, Newton's confidence in modern Cartesian physics gradually began to erode. An important dynamic here was the troubling sense that Descartes's mechanical philosophy left little or no room for God. The Cambridge Platonist Henry More and the Cambridge mathematician Isaac Barrow were also raising similar concerns.

Meanwhile, Newton became a fellow of Trinity College and in 1669 was appointed Lucasian Professor of Mathematics at Cambridge, at the age of twenty-six. Shortly before this, he had taken up alchemical experimentation in earnest. Shortly after this, Newton came to the attention of the world of natural philosophy through his invention of the first working reflecting telescope and his revolutionary paper on colors, published in 1672 in the *Philosophical Transactions of the Royal Society*. This paper demonstrated inductively through the experimental use of common glass prisms the counterintuitive conclusion that white light is not homogeneous, as previously

thought, but heterogeneous, consisting of all the colors of the rainbow. Newton's place in the history of science was secure.

The Principia Mathematica

It was not until the early 1680s that Newton completely broke with Cartesian physics. Descartes had hypothesized that the planets were carried around the sun in vortices of ether particles, much like corks in a whirlpool. This provided an intuitive explanation for the orbits of planets, travelling as they did in the same direction and on the same plane. But when Newton concluded that comets, too, orbited the sun in closed orbits (albeit in extremely elongated ellipses), the vortex was unable to account for their motion, travelling as they did in many different directions. In August 1684, Newton received a visit from Edmond Halley, who asked him if he could provide a mathematical demonstration for the elliptical orbit of a planet caused by the attraction of the sun, which decreases in a proportion inverse to the square of the distance between them. This elicited from Newton his nine-page "De Motu" (On Motion). But this was only the beginning. For nearly two years he worked at a feverish pitch until he had solved to his own satisfaction the problems of terrestrial and celestial mechanics. The final product of these years was the *Philosophiae Naturalis Principia Mathematica* (Mathematical Principles of Natural Philosophy) published in 1687. Historians of science see the *Principia* as the single greatest work of the scientific revolution, if not the entire history of science.

The new cometography, the Inverse-Square Law, and much else besides found their way into the three books of the *Principia*. Shunning the causes and metaphysics of the medieval Scholastic natural philosophers, Newton deploys a majestic mathematical physics to describe his three laws of motion and universal gravitation. Over the course of the three editions of this book, Newton also outlined four "rules of reasoning" that centered around the parsimony principle, the universality of natural phenomena, and the inductive method. The *Principia* also represents the culmination of a movement that had begun almost a century and a half earlier with the heliocentric theory of Copernicus, namely, the unification of terrestrial and celestial physics. The grandest achievement of the *Principia* is its mathematical description of the motions of the heavenly bodies, found in Book 3. Such is the effectiveness of the physics of the *Principia* that it continues to serve science well in the space age.

Although the first edition of the *Principia* appears to be secular work, there is more there than meets the eye. For example, in Book 3, Newton observes that the smallest and densest planets are nearest to the sun and concludes that "God placed the planets at different distances from the sun so that each one might, according to the degree of its density, enjoy a greater or smaller amount of heat from the sun." Moreover, the four rules of reasoning are similar to rules of prophetic interpretation he had set down over a decade earlier, at the

beginning of a long treatise on the Apocalypse. As he wrote to the Cambridge clergyman Richard Bentley in 1692: “When I wrote my treatise about our System I had an eye upon such Principles as might work with considering men for the belief of a Deity and nothing can rejoice me more than to find it useful for that purpose.”

Little in this great work suggested that Newton believed he was recovering lost ancient wisdom, rather than discovering things previously unknown, but he prepared a different version of Book 3 that eventually made this clear. In his introduction to this alternate version, which was published posthumously in 1728 under the title *The System of the World*, Newton wrote that “in the earliest ages of philosophy” it was believed that the earth was a planet, that it “described an annual course about the sun . . . and that the sun, as the common fire which served to warm the whole, was fixed in the centre of the universe.” This, Newton contended, was taught by Aristarchus, the Pythagoreans, Anaximander, and other ancient philosophers. The heliocentric system was commemorated in the architecture of the ancient temples, which were situated around a central fire to symbolize the sun. The notion of crystalline spheres to explain the circular motion of the planets was a later corruption, Newton related, “when the ancient philosophy began to decline, and to give place to the new prevailing fictions of the Greeks.”

The *Prisca Sapientia* and the Classical Scholia

Newton’s introduction to *The System of the World* confirms that he accepted the Renaissance concept of *prisca sapientia*, or ancient wisdom, the belief that the ancients had once possessed pure forms of philosophical and theological truths that were subsequently lost or grossly corrupted. Although he suppressed this manuscript, in the early 1690s Newton toyed with the idea of including even bolder statements in a second edition of the *Principia*. The Scottish mathematician David Gregory learned of these intentions during a May 1694 visit with Newton at Cambridge. Gregory recorded that Newton “will spread himself in exhibiting the agreement of [his] philosophy with that of the Ancients and principally that of Thales. The philosophy of Epicurus and Lucretius is true and old, but was wrongly interpreted by the ancients as atheism.”

In the surviving drafts of this material, now referred to as the Classical Scholia, Newton contends that the ancients (including the pre-Socratic Ionian Greeks and the Pythagoreans) possessed a heliocentric view of the solar system and a knowledge of universal gravitation. Anaxagoras, Newton argues, knew about the heaviness of the moon (many later Greek philosophers thought it was light and ethereal) and the gravitational powers of the moon and the sun but hid these concepts in the figures of a lion falling from the moon and a stone falling from the sun. Newton concluded that “the mystic philosophers usually hid their tenets behind such figments and mystical language.”

Elsewhere in the Classical Scholia, Newton suggests that the ancients cloaked their knowledge of the Inverse-Square Law of gravitation behind the figure of Apollo and his seven-stringed lyre. “Through this symbol,” Newton explains, “they indicated that the sun acts on the planets with its force in the same harmonic ratio to the different distances as that of the tensile force to strings of different length, i.e., in a duplicate inverse ratio to the distances.” In all this, Newton insinuates that the ancient philosophers were like the sect of the Pythagoreans and the early modern alchemists, revealing their secrets only to their initiates and presenting them in public only through coded language.

The Recovery of Primitive Christianity

One of the requirements of Newton’s fellowship at Trinity College was that he be ordained by 1675, and in the early 1670s he began to study theology and church history in earnest. This intensive study led him to conclude that the central doctrine of orthodox Christianity, the Trinity, was a corruption based on a misreading of the Bible and ideas from Greek metaphysics. Such was Newton’s character that he could not in good faith become an Anglican clergyman, since it would mean accepting all Thirty-Nine Articles of the Church of England, including the Trinity. Although he had accepted them when he became a fellow of Trinity in 1668, after the early 1670s he could never do this again. The Anglican Church considered such views heresy, but Newton revealed his belief only to his closest associates, and he was able to obtain a special dispensation that exempted the Lucasian Professor from taking holy orders. Newton was to remain a lay theologian.

The most important result of his study of the Bible and church history was his conclusion that the doctrine of the Trinity was a corrupt dogma that did not accurately reflect the biblical teaching on the oneness of God. In a 1670s list of twelve statements distinguishing Christ from God, Newton wrote: “Whenever it is said in the scriptures that there is but one God, it is meant of the Father;” and “It is a proper epithet of the father to be called almighty. For by God almighty we always understand the Father.” For Newton, only the Father is the one true God.

Newton believed that Jesus Christ preexisted his human birth and was miraculously born through the agency of the Holy Spirit, making him the son of God in a literal sense. But he concluded that the Bible does not speak of Christ as consubstantial with the Father; they are united in will but not substance. The introduction of the doctrine of three consubstantial, coeternal persons Newton attributed to the corrupting influence of Athanasius in the fourth century. While in the annals of orthodoxy Athanasius is a champion of truth who merits his title as a saint, for Newton he was the author of error and a scoundrel. Newton also came to believe that the immortality of the soul is an unbiblical doctrine, concluding instead that the afterlife is attained only through the bodily resurrection.

Many elements of Newton's theology resemble views held by the antitrinitarian Socinians on the continent and the nascent Unitarians in England. While we now know that he consulted the works of his fellow antitrinitarians, much of what Newton believed came from his own personal encounter with the biblical text. He was also influenced by Christian primitivism, the belief that the earliest forms of Christianity were the purest and thus must be recovered at all costs. It would be a mistake to conclude that Newton's antitrinitarianism reflects an incipient rationalism rather than a strong biblical faith and a powerful primitivist drive, or that his denial of the Trinity renders him a proto-deist when in fact his thought was powerfully antideistic in tone and intent. Newton was no more a deist than advocates of Judaism, who also believe in a unipersonal God who acts in the world. Nor would a deist see, as Newton surely did, a role for Christ as a redeeming savior and a coming judge.

Prophecy and Revelation

Newton's prophetic thought also demonstrates his distance from deism. True deists looked askance at biblical prophecy. Not only did Newton affirm a generally literal view of the fulfilment of the prophecies of the Bible, but he found in the fulfilment of prophecy one of the best arguments for the existence of God and, in opposition to deism, the activity of providence in history. In his premillenarian eschatology and historicist approach to the interpretation of prophecy, Newton followed the lead of Joseph Mede (1586–1638) of Christ's College, Cambridge. Newton wrote several long treatises on the interpretation of the book of Revelation (the Apocalypse), including a 550-page text dating from the 1670s. Another treatise dates from the period of the composition of the *Principia*, while yet another was written in the first decade of the eighteenth century.

Newton believed that prophecies in the Old and New Testaments foretold the return of the Jews to Israel, the rebuilding of the Jewish Temple in Jerusalem, the battle of Armageddon, the return of Christ to the earth, and the establishment of a global kingdom of peace for one thousand years. He also believed that the 1,260 days of Daniel and Revelation pointed to 1,260 years of the corruption of the church. Holding that this likely began when the papacy gained temporal power, he combed the annals of history for a plausible commencement date for this prophetic time period. He considered 607 and 609 and, later in life, 800, which would mean the apocalyptic events foretold in the Bible would begin around 1867, 1869, or 2060, long after his death.

At the center of Newton's prophetic scheme is his animus toward the Roman Catholic Church, which he charged with corrupting the primitive simplicity of Christianity through ungodly alignments with temporal authorities, the corruption of the text of the Bible, and unscriptural doctrines such as the Trinity. This church, Newton believed, was the apocalyptic Babylon that would be destroyed by Christ at his second coming, opening up the way for the restoration of the primitive monotheistic Christian faith.

As in his study of nature, Newton approached much of his study of scripture methodically. His treatise on the Apocalypse from the 1670s begins with a series of “Rules for interpreting the words and language in Scripture.” These rules had particular import for interpreting prophecy. His second rule of interpretation reads: “To assign but one meaning to one place of scripture, unless it be perhaps by way of conjecture, or where the literal sense is designed to hide the more noble mystical sense as a shell the kernel from being tasted either by unworthy persons, or until such time as God shall think fit.” Rule five commences: “To acquiesce in that sense of any portion of Scripture as the true one which results most freely and naturally from the use and propriety of the Language and tenor of the context in that and all other places of Scripture to that sense.”

Thus Newton compared scripture with scripture and determined universal meanings for certain key prophetic symbols such as the sun (representing ruling powers) and beast (representing empires). Newton’s prophetic rules closely parallel the natural philosophical method he later developed in the *Principia*, including his emphasis on the parsimony principle (that the simplest explanation is preferable to the more complex) and his belief that once a phenomenon in nature has been established, it applies universally throughout nature. For Newton, scripture and nature were written by the same author, a God of order and not confusion, and thus similar interpretative strategies should be employed for both.

Newton also crafted several apocalyptic charts as part of his effort to interpret the symbols and time periods of the book of Revelation. He sent one of these charts to his friend the philosopher John Locke, with whom he often discussed biblical theology. But Newton’s extensive prophetic researches were unknown to the world at large until the posthumous publication of his *Observations upon the Prophecies of Daniel, and the Apocalypse of St. John* (1733). Little known outside certain Protestant circles, this work was often cited by Protestant historicist exegetes in the nineteenth and twentieth centuries. Newton’s status as an icon of the Enlightenment notwithstanding, the *Observations* played a bit part in the development of Protestant fundamentalism.

The “Origines”

In his long and complicated Latin manuscript “Theologia Gentilis Origines Philosophicae” (Philosophical Origins of Gentile Theology), Newton writes about a primitive monotheistic Ur-religion practiced by Noah and his family that was gradually corrupted into idolatry by the pagan nations. Periodically, God brought about reformations that restored this original belief in the oneness of God, the two most notable being those initiated by Moses and Christ. In addition to explaining the origin of idolatry and polytheism, Newton also argues that many of the early nations acknowledged the heliocentric system in the architecture of their temples or prytanea, which were constructed around

central fires that represented the sun. In the Jewish Tabernacle and Temple, for example, the altar of burnt offerings was this central fire.

In an English manuscript related to the “Origines” that dates from the early 1690s, Newton wrote: “as the Tabernacle was contrived by Moses to be a symbol of the heavens (as St. Paul and Josephus teach) so were the Prytanæa amongst the nations.” In the same manuscript, Newton elaborates on the purpose of the ancient temples: “So then ’twas one design of the first institution of the true religion to propose to mankind by the frame of the ancient Temples, the study of the frame of the world as the true Temple of the great God they worshipped. And thence it was that the Priests anciently were above other men well skilled in the knowledge of the true frame of Nature and accounted it a great part of their Theology.” Thus, for Newton, the ancients combined religion and the study of nature, with the latter being “a great part” of the former. The ancient priests, such as the Persian magi and the Chaldeans of Babylon, were at once astronomers and theologians.

Newton believed that the primeval religion could be reduced to two fundamental principles: the love of God and the love of neighbor. These are the two greatest commandments articulated by Christ in the New Testament (Matthew 22:34–40), and Newton often repeated them in his private writings. It is significant that this primeval religion for Newton also involved an empirical, monotheistic natural theology. In his posthumously published *Chronology of Ancient Kingdoms Amended* (1728), he brings these elements together: “the believing that the world was framed by one supreme God, and is governed by him; and the loving and worshipping him, and honouring our parents, and loving our neighbour as our selves, and being merciful even to brute beasts, is the oldest of all religions.” This expression of belief in a *prisca theologia* provides yet another example of the primitivism that permeated his religious and natural philosophical thought.

A Science That Leads to God

Newton was a passionate advocate of natural theology and the idea of design in nature. Already in his undergraduate notebook of the 1660s, Newton was musing about symmetry in the physiological structure of humans and animals. In his 1692–1693 letters to Bentley, Newton argued that the well-ordered structure of the solar system bespeaks the creative hand of God. Bentley had sought Newton’s assistance when writing up his Boyle lectures for publication. These lectures constitute not only the first significant English-language popularization of the physics of the *Principia* but also the first public use of Newton’s physics to contend for the existence of an omniscient and omnipotent deity.

In his letters to Bentley, Newton argued that the complicated system of planets moving in the same direction on the same plane and comets moving in every direction and angle around the sun implied design rather than chance. “To compare and adjust all these things together in so great a variety of bodies,”

Newton writes, “argues that cause to be not blind and fortuitous, but very well skilled in Mechanics and Geometry.” He also argued that the various planetary systems in the universe would all fall together toward the middle of the universe through the power of gravity “without a divine power to conserve it,” suggesting that the universe is upheld through the continuous operation of providence. This conforms to what Gregory wrote after his visit to Newton in 1694, namely that the latter believed “a continual miracle is needed to prevent the Sun and the fixed stars from rushing together through gravity.” Newton’s natural theology does not portray the clockwork universe often associated with Newtonianism, but a powerful God of dominion akin to the view of divine providence espoused by John Calvin, who wrote that by providence he meant “not an idle observation by God in heaven of what goes on in earth, but His rule of the world which He made; for He is not the creator of a moment, but the perpetual governor.”

Although the first edition of Newton’s *Opticks* (1704) contained no overt natural theology, a draft preface demonstrates that he contemplated including assertions of natural theology at the beginning of the work. In the draft preface, Newton contends that one of the best arguments in favor of an infinite, eternal, omniscient, and omnipotent God is “the frame of nature and chiefly the contrivance of the bodies of living creatures.” When Newton added several queries to the 1706 Latin translation of the *Opticks*, he made explicit the argument about design. In what became Query 28 in the second English edition of 1717, he attacks the mechanical philosophy of men like Descartes, whom he charges with banishing nonmechanical causes from natural philosophy, “feigning Hypotheses for explaining all things mechanically, and referring other Causes to Metaphysics: Whereas the main Business of Natural Philosophy is to argue from Phenomena without feigning Hypotheses, and to deduce Causes from Effects, till we come to the very first Cause, which certainly is not mechanical.” By this, of course, Newton means God.

Newton employs stronger language in relevant unpublished manuscripts, where he uses an empirical natural theology to attack atheism. In a manuscript draft of Query 28, he asserts that “arguments for a Deity if not taken from Phenomena are slippery and serve only for ostentation.” Near the end of this draft he writes: “We see the effects of a Deity in the creation and thence gather the cause and therefore the proof of a Deity and what are his properties belongs to experimental Philosophy. ’Tis the business of this Philosophy to argue from the effects to their causes till we come at the first cause.”

Newton was convinced that inductive rather than deductive reasoning provided the most secure arguments for the existence of God from natural philosophy. Ontological arguments for the existence of God such as those used by Descartes are to be shunned; instead, as he writes in a manuscript from the early 1690s, “God is known from his works.” Newton’s study of “the frame of nature” (the structure of the universe) reinforced his belief that the

universe was designed by God. He also believed the evidence uncovered by his natural philosophy would lead an unbeliever to belief. The British Newtonians Richard Bentley, William Whiston, Roger Cotes, and others agreed, taking up their pens in defense of Newton's arguments about God's design in nature.

Time and Space

Philosophers of science have long been fascinated with Newton's distinction between absolute and relative time, space, place, and motion. With respect to time, he writes in the *Principia*: "Absolute, true, and mathematical time, in and of itself and of its own nature, without reference to anything external, flows uniformly and by another name is called duration," whereas "relative, apparent, and common time is any sensible and external measure (precise or imprecise) of duration by means of motion; such a measure—for example, an hour, a day, a month, a year—is commonly used instead of true time." Similar distinctions are made between absolute and relative space, place, and motion. For Newton, absolute space is immovable, and it provides his physics with an absolute (unmoving) frame of reference against which relative motion occurs, just as his conception of absolute time provides him with an absolute temporal frame of reference against which relative time occurs.

Like so much of his natural philosophy, Newton's views on absolute time and space are closely tied to his theology and in particular his conceptions of God's temporal and spatial ubiquity. An unpublished manuscript believed to date from the early 1690s provides insight into Newton's theology of time and space. Building on the language of Revelation 1:8, Newton argues that God is "the one who was and is and is to come." God's eternity is not timelessness or a point on an arrow moving infinitely into the future; instead, God's eternity fills past, present, and future time. Newton is beginning to think of time as a dimension. The same manuscript shows that Newton believed God is not localized in any way, but rather is infinitely extended and perfectly omnipresent. Thus God fills space just as he fills time.

For Newton, God's eternal duration and infinite extension gave rise to absolute time and space. A manuscript list of twelve statements distinguishing God from Christ according to his biblical unitarian theology confirms this association and reveals that it has a heretical corollary. Newton asserts that it is only the Father who is "ever-living" and "immoveable." Christ is excluded from these uniquely divine attributes. While Newton believed that only philosophers were aware of the distinction between the absolute and the relative, a *Principia*-related manuscript dating from between 1684 and 1686 also hints that Newton believed only the omnipresent and omniscient God can really distinguish absolute motions from apparent motions. An awareness of these theological backdrops is crucial to understanding Newton's conception of absolute time and space.

The General Scholium

Newton's agendas in natural philosophy and theology come together in the General Scholium, which he added to the second edition of the *Principia* in 1713. This tightly written text begins with a polemical statement directed against Descartes's idea of fluid vortices, which is rendered untenable in the face of empirical evidence that comets move in every direction and at every angle around the sun. Newton moves on to discuss the structure of the solar system and the movement of bodies in the solar system without resistance according to the law of gravity. He then returns to one of the arguments he raised in his letters to Bentley, namely that a purely mechanical cause could not have produced a system that both includes planets moving in the same direction on the same plane and comets that "go freely in very eccentric orbits and into all parts of the heavens."

Instead, Newton proclaims that "this most beautiful system of the sun, planets, and comets could not have arisen without the design and dominion of an intelligent and powerful being." For Newton, both the initial design of an intelligent God and the dominion of a powerful being are required for the universe he observed. "And if the fixed stars are the centers of similar systems, they will all be constructed according to a similar design and subject to the dominion of *One*, especially since the light of the fixed stars is of the same nature as the light of the sun, and all the systems send light into all the others." Newton saw a direct relationship between the unity of God and the unity of creation. He next argues that the placement of the stars at immense distances from each other offers another example of design and foresight, as this layout prevents the stars from falling together as a result of gravity.

At this point Newton launches into a majestic description of the God he found in nature and scripture. This being "rules all things, not as the world soul but as the lord of all. And because of his dominion he is called Lord God *Pantokrator*." Then follows an account of God's eternity and omnipresence that is shot through with biblical language. Newton's God is sovereign over time and space. This twofold sovereignty, Newton suggests, ultimately underpins all things in time and space: "All the diversity of created things, each in its place and time, could only have arisen from the ideas and will of a necessarily existing being." Once again we see the emphasis on both God's mind and will. At the end of the explicitly theological section of the General Scholium, Newton writes: "This concludes the discussion of God, and to treat of God from phenomena is certainly a part of experimental philosophy" (changed to "natural philosophy" in the 1726 third edition of the *Principia*). Thus for Newton, discussions about God and design are not to be kept separate from natural philosophy, but rather are integral to it.

After making this bold statement, Newton describes the phenomenon of universal gravitation. As to the cause of gravity, Newton implies that he does not think it is mechanical, but states that he does not want to attempt to posit

a cause, declaring: “I do not feign hypotheses” (*hypotheses non fingo*). Although this famous declaration fits into his attempt to provide a mathematical *description* of gravitation instead of an argument for its ultimate cause, his foregoing discussion of God’s ubiquity in space provides an internal hint that he believes God is ultimately behind the phenomenon. After all, the only two things Newton speaks about as being spatially universal are God’s omnipresence and gravitation. Whether or not Newton is publicly hinting at this conclusion in the General Scholium, it is now known that this was a conclusion he strongly contemplated in private.

The General Scholium also contained a coded attack against the Trinity. In his discussion of God’s attributes of eternal duration, omnipresence, and unchallenged dominion, Newton asserts that “God” is a relative term that derives its meaning from God’s dominion over servants. The unmentioned backdrop to this assertion is a contemporary debate in which Trinitarians argued that “God” denotes divine substance and essence, while Unitarians insisted that the term primarily refers to power and dominion. Newton, like other antitrinitarians of his period, cites Exodus 4:16, Exodus 7:1, Psalm 82:6, and John 10:35 as evidence that humans are called “god” in the Bible in an honorific or official sense when they act as God’s representatives.

This also means that when Christ is called God in the Bible, it is in an honorific sense. Although not made explicit in the General Scholium, Newton’s unpublished theological papers confirm that this is what Newton believed. Even without an explicit clarification, Newton’s argument was understood by those few of his readers familiar with the debates then raging between Trinitarians and Unitarians. In the General Scholium, Newton takes the side of the persecuted latter party. The second and third editions of the *Principia* thus conclude with an attack on the central dogma of the institutional church. In composing the General Scholium, Newton adopted the Pythagorean style that he wrote about two decades earlier in the Classical Scholia, hiding the higher truths from the common people, while providing enough clues for his adept readers to discern his true meaning.

A Unified System

It has long been clear that Newton’s piety and commitment to natural theology helped to stimulate his work in natural philosophy and allowed him to find greater satisfaction in it. But increasingly, scholarship indicates that some of Newton’s religious ideas helped to shape the cognitive content of his natural philosophy (and vice versa). When Newton’s natural philosophical writings are studied together with his theological papers, they point to the unity of Newton’s thought.

While Newton recognized disciplinary distinctions, he held to a powerful belief in the unity of truth. For Newton as for many of his theist contemporaries, God wrote two books: the book of nature and the book of scripture. As Newton

did not believe God was the author of confusion, he concluded that there must be a fundamental unity between creation and the Bible and thus between natural philosophy and true theology. This unity extended in part to method. Thus several scholars have recently pointed to methodological links between Newton's empirical natural philosophy and his empirical biblical hermeneutics.

These relationships exist not only between Newton's natural philosophy and theology in a general sense, but between his natural philosophy and his unique heretical theology. Just as he believed that failure to distinguish between the absolute and relative in physics could lead to errors, so he concluded that the failure to distinguish the relative meanings of the term "God" from God's absolute reality led to the doctrinal error of the Trinity. Newton's belief in the oneness of God underpins his belief in the unity of natural phenomena. It is the One God, who exists everywhere, who makes universal gravitation possible.

Newton was isolated by his agile mind and religious nonconformity. He longed to see primitive Christianity restored, and he inserted some suggestive words about this at the end of Query 31 of the *Opticks*: "And if natural Philosophy in all its Parts, by pursuing this Method, shall at length be perfected, the Bounds of Moral Philosophy will be also enlarged. For so far as we can know by natural Philosophy what is the first Cause, what Power he has over us, and what Benefits we receive from him, so far our Duty towards him, as well as that towards one another, will appear to us by the Light of Nature." The light of nature, Newton contends, will illuminate the two chief principles of the primeval religion: the love of God and the love of neighbor. In addition to the Bible, the study of nature should lead humanity to God and to altruistic action. Along with the central tenet of God's oneness, these principles formed part of Newton's agenda for his natural philosophy. Just as the book of scripture speaks of the oneness of God and two core ethical principles, so does the book of nature.

In the final sentence of Query 31, Newton contends that if the pagan Gentiles had not been led astray by idolatry and polytheism, "they would have taught us to worship our true Author and Benefactor, as their Ancestors did under the Government of Noah and his Sons before they corrupted themselves." Thus he concludes the later editions of the *Opticks*, shedding light on the dual reformation that he wrote about in his private manuscripts, hinted at in his publications, but kept from the general public. Newton's *Principia* and *Opticks*, therefore, were in part meant to reform natural philosophy from its corruption and restore it to its original purity as a science that leads to God.

Bibliography

- Calvin, John. *Concerning the Eternal Predestination of God*. Trans. J.K.S. Reid. London: James Clarke, 1961.
- Cohen, I. Bernard, and George E. Smith, eds. *The Cambridge Companion to Newton*. Cambridge: Cambridge University Press, 2002.
- Dobbs, Betty Jo Tetter. *The Janus Faces of Genius: The Role of Alchemy in Newton's Thought*. Cambridge: Cambridge University Press, 1991.

- Fauvel, John, Raymond Flood, Michael Shortland, and Robin Wilson, eds. *Let Newton Be! A New Perspective on His Life and Works*. Oxford: Oxford University Press, 1988.
- Force, James E., and Richard H. Popkin, eds. *Newton and Religion: Context, Nature, and Influence*. Dordrecht: Kluwer, 1999.
- Keynes, John Maynard. "Newton, the Man." In *The Royal Society: Newton Tercentenary Celebrations*, 27–43. Cambridge: Cambridge University Press, 1947.
- Manuel, Frank. *The Religion of Isaac Newton*. Oxford: Clarendon, 1974.
- McGuire, J.E. "Newton on Place, Time, and God: An Unpublished Source." *British Journal for the History of Science* 38 (1978): 114–29.
- . "Newton's 'Principles of Philosophy': An Intended Preface for the 1704 *Opticks* and a Related Draft Fragment." *British Journal for the History of Science* 5 (1970): 178–86.
- McGuire, J.E., and P.M. Rattansi. "Newton and the 'Pipes of Pan.'" *Notes and Records of the Royal Society of London* 21 (1966): 108–42.
- Newton, Isaac. *The Chronology of Ancient Kingdoms Amended*. London, 1728.
- . *The Correspondence of Sir Isaac Newton*. Ed. H.W. Turnbull, J.F. Scott, A. Rupert Hall, and Laura Tilling. 7 vols. Cambridge: Cambridge University Press, 1959–1977.
- . *Newton: Texts, Backgrounds, Commentaries*. Ed. I. Bernard Cohen and Richard S. Westfall. New York: W.W. Norton, 1995.
- . *Observations upon the Prophecies of Daniel, and the Apocalypse of St. John*. London: J. Darby and T. Browne, 1733.
- . *The Principia: Mathematical Principles of Natural Philosophy*. Trans. I. Bernard Cohen and Anne Whitman, assisted by Julia Budenz. Berkeley: University of California Press, 1999.
- . *Sir Isaac Newton's Mathematical Principles of Natural Philosophy and His System of the World*. Trans. Andrew Motte and revised by Florian Cajori. Berkeley: University of California Press, 1962.
- Schüller, Volkmar. "Newton's *Scholia* from David Gregory's Estate on the Propositions IV through IX Book III of His *Principia*." In *Between Leibniz, Newton, and Kant: Philosophy and Science in the Eighteenth Century*, ed. Wolfgang Lefèvre, 213–65. Dordrecht: Kluwer, 2001.
- Snobelen, Stephen D. "'God of Gods, and Lord of Lords': The Theology of Isaac Newton's General Scholium to the *Principia*." *Osiris* 16 (2001): 169–208.
- . "Isaac Newton, Heretic: The Strategies of a Nicodemite." *British Journal for the History of Science* 32 (1999): 381–419.
- . "To Discourse of God: Isaac Newton's Heterodox Theology and His Natural Philosophy." In *Science and Dissent in England, 1688–1945*, ed. Paul B. Wood, 39–65. Aldershot, UK: Ashgate, 2004.
- Westfall, Richard H. *Never at Rest: A Biography of Isaac Newton*. Cambridge: Cambridge University Press, 1980.

41 God and the Big Bang

Theodore Schick Jr.

The relationship between science and religion is often portrayed as one of warfare. In *A History of the Warfare of Science with Theology in Christendom* (1896), for example, Andrew White, co-founder of Cornell University, details many of the beliefs once sanctioned by religion that science has shown to be false, such as the belief that the earth is flat, that the earth is the center of the universe, or that the universe is only 6,000 years old. So it is an event of some note when a scientific theory seems to support a religious view, and that is just what the Big Bang seems to do. According to that theory, the universe came into existence about 15 billion years ago in an explosion of unimaginable power. The Judeo-Christian tradition has always taught that the universe came into existence at some time in the past. It now seems that science endorses that view.

Some physicists, among them Stephen Hawking, have hailed the Big Bang theory as “the discovery of the century, if not of all time.” But if the universe began with a big bang, what caused it? Its cause would seem to be something outside our universe. Could that something be God? As astrophysicist Allan Sandage puts it, “The big bang is best understood as a miracle triggered by some transcendent power.” Physicist Hugh Ross goes even farther and identifies that transcendent power with the God of the Bible. The question before us, then, is whether God provides the best explanation of the Big Bang.

The Universe Is Neither Eternal nor Static

The notion that the universe is eternal can be found in cultures and religions of both the East and the West. The ancient Greek philosopher Aristotle, for example, argues that matter can be neither created nor destroyed, while Hindus believe that the universe goes through an endless and beginningless cycle of creation and destruction. There is much to recommend the view that the universe has always existed, for it seems to be the only view that is consistent with the principle “From nothing nothing comes” (*ex nihilo nihil fit*). Since

the universe is the totality of all that exists, if it came into being, it must have come into being from nothing. But you can't get something from nothing. So the universe must have always existed.

Most scientists of the modern era followed Aristotle in believing that the universe was eternal and unchanging on a global scale. Newton realized, however, that his law of gravity—which maintains that every object in the universe attracts every other—seemed to imply that everything in the universe would be drawn together into one massive object. To explain why such a gravitational collapse had not occurred, Newton hypothesized that the universe is infinite in extent, and populated uniformly with stars. In such a universe, there is no center of gravity and thus no place for all the matter to congregate.

When Einstein formulated his theory of gravity in 1915, he too had to deal with the problem of the effect of gravity on the large-scale structure of the universe. To uphold his view that the universe is unchanging, he originally postulated an infinite universe. But correspondence with Willem de Sitter convinced him that this view had no advantage over Newton's. So in 1917, he proposed a finite or "closed" model of the universe and added a term to his equations known as the "cosmological constant," which served to keep the force of gravity in check. This allowed him to maintain his view of a static universe but at the price of making his theory more complex.

In the 1920s, the Russian meteorologist Alexander Friedmann and the Belgian priest and cosmologist Georges Henri Lemaître demonstrated that Einstein's original 1915 equations—the ones without the cosmological constant—predicted that the universe was expanding. Tracing the expansion backward in time, Lemaître concluded that at some point in the past, all of the matter in the universe must have been concentrated in a single primeval atom of inconceivable density. American astronomer Vesto Slipher was the first to observe the expansion of the universe. At the Lowell Observatory in Flagstaff, Arizona, he detected dozens of galaxies rushing away from each other. Lemaître and Slipher independently shared their results with Einstein, but Einstein did not accept them. So wedded was he to the notion of a static universe, he was convinced there must be a mistake in their calculations.

In 1929, however, Edwin Hubble demonstrated conclusively that it was Einstein who was mistaken. His observations at the Mt. Wilson observatory outside Pasadena, California, showed that hundreds of galaxies were receding from one another. Still unconvinced, Einstein made a number of trips to Pasadena during the 1930s to look through Hubble's telescope. Only after he had seen Hubble's evidence with his own eyes did he consider it likely that the universe was not static. He was later to say that the introduction of the cosmological constant into his equations was the biggest mistake of his life.

Einstein was not the only physicist who abhorred the thought of the universe springing into existence from a giant explosion. Fred Hoyle, for example, thought that an explosion was an undignified way for a universe to

begin, something like a party girl jumping out of a cake. In a BBC interview, he referred to this explosion as “the big bang.” Given Hubble’s evidence, Hoyle couldn’t deny that the universe is expanding. But he could deny that the universe began with the Big Bang, because there was, in his words, no “fossil evidence” for it, no telltale signs. To explain the expansion, he formulated what came to be known as the Steady State theory. According to this theory, matter is constantly forming in empty space, thus driving the expansion and keeping the average density of the universe constant. Advocates of the Big Bang, such as George Gamow, hypothesized that all of the elements of the universe were created in the first few minutes after the Big Bang. Hoyle proposed that they were created as a result of fusion reactions inside stars or as the result of supernova explosions. Hoyle’s theory turned out to be the correct one.

In 1965, however, Arno Penzias and Robert Wilson discovered the “fossil evidence” that Hoyle had sought. While attempting to refurbish a large radio antenna in Holmdel, New Jersey, they found a background noise that they couldn’t eliminate. That background noise turned out to be the residual radiation left over from the Big Bang. You can observe that background radiation by tuning your television to an unused channel; scientists estimate that between 1 to 10 percent of the dots on the screen are caused by photons left over from the Big Bang.

Further investigation has confirmed other predictions made by the Big Bang theory. For example, in order for stars and galaxies to form, the Big Bang could not have been totally homogenous. This lumpiness (or anisotropy) should show up in a variation of the temperature of the background radiation. In 1989, the Cosmic Background Explorer (COBE) satellite was launched to study the background radiation. It found the predicted variation in temperature. When George Smoot, head of the COBE research team, announced the results, he remarked to a reporter, “If you’re religious, it’s like looking at God.” Why? Because something must have caused the Big Bang, and for many people, God seems the most likely candidate.

Who Started It?

The scientific evidence for the Big Bang has been used to refurbish one of the oldest arguments for the existence of God: the first cause or cosmological argument. In its current guise, it goes like this:

1. Whatever begins to exist has a cause.
2. The universe began to exist.
3. Therefore, the universe has a cause, namely God.

This argument is known as the Kalam cosmological argument. It gets its name from the Arabic word *kalam*, which means “to argue or discuss.” The Kalam

cosmological argument originated with Islamic theologians who sought to challenge the Greek view of the eternity of matter.

Notice that the first premise of this argument does not say everything has a cause. If it did, the cause of the universe would itself have to have a cause, and we would be off on an infinite regress. Eternal things, according to this argument, don't need a cause. Since God is presumably eternal, he doesn't need a cause. But the universe, as the evidence for the Big Bang suggests, is not eternal. So it does need a cause.

Defenders of the Kalam cosmological argument, like Hugh Ross and William Lane Craig, claim that the cause of the Big Bang is the traditional God of theism: a personal being that interacts with the world and is all powerful, all knowing, and all good. However, the Kalam argument gives us no reason to believe that the cause of the universe has these attributes. To arrive at the conclusion that God caused the universe, a separate argument is required. Such an argument cannot be based on scientific evidence alone, because bringing a universe like ours into existence does not require infinite power, knowledge, or goodness. According to English philosopher and social reformer John Stuart Mill, the very fact that there is a universe shows that its creator is not all-powerful. The creator, if he exists, supposedly had a reason for creating the universe. There must have been some goal he was trying to achieve. But if he needs a universe to achieve this goal, he's not all powerful. An all-powerful being should be able to accomplish his purposes directly, without the use of any tools or implements. If god needs the universe to achieve his goals, his power must be limited.

Furthermore, an all-knowing being would know everything there is to know about every possible world, including how to bring every possible world into existence. We are only acquainted with one possible world, however. So we can't legitimately draw any conclusions about the knowledge of its creator, if it has one. Maybe our world is the only world the creator knew how to create. If so, the creator is not all knowing.

An all-good being does not like to see creatures suffer unnecessarily. But the world seems to be filled with all sorts of unnecessary suffering. Think of all the suffering caused by such natural disasters as earthquakes, hurricanes, floods, droughts, plagues, and forest fires. How could an all-good, all-powerful, all-knowing being allow such suffering to occur? If all knowing, he knows that such suffering exists. If all good, he doesn't want there to be such suffering. And if all powerful, he can prevent it. So why is there so much unnecessary suffering? This is the traditional problem of evil. Theories that attempt to solve this problem are known as "theodicies." Anyone who claims that the traditional God of theism caused the universe owes us a theodicy, because the existence of unnecessary evil seems to show that such a being does not exist.

No one to date has provided a theodicy that meets with anything approaching universal consensus. It is quite a long step from proving a first cause to proving the traditional God of theism. So the Kalam cosmological argument,

even if sound, does not provide a reason for believing in God as traditionally conceived. But there is reason to believe that the Kalam argument is not sound, for both of its premises are dubious.

A Causal Agent Is Not Necessary

The first premise of the Kalam cosmological argument says that whatever begins to exist has a cause. Although this principle may seem to be a matter of common sense, science has proven that it is false. Quantum mechanics, the branch of physics that explains the interactions among the smallest constituents of the universe such as subatomic particles, atoms, and molecules, claims that some events, like the radioactive decay of an atom, are purely random; they are not caused by any prior event; they just happen. Einstein never liked this aspect of quantum mechanics. His dislike is captured in his famous quip “god does not play dice with the universe.” He believed that there must be “hidden variables” whose values, if known, would allow us to accurately predict the occurrence of every event, even those at the subatomic level.

Then in 1965, John Bell, of the Lawrence Livermore laboratory, showed that a hidden variables theory like Einstein’s makes predictions that are at odds with quantum mechanics. The equipment needed to test these predictions was not available until 1980. But when the experiments were conducted, they always came out in favor of quantum mechanics. As a result, hidden variables theory is dead. Our inability to predict the occurrence of subatomic events is not due to our ignorance of the underlying processes or to the limitations of our measuring apparatus. It is due to the basic nature of the universe itself. Parodying Einstein’s quote, physicist Stephen Hawking sums up current thinking this way: “god not only plays dice, he throws them in the corner where you can’t see them.” The upshot is that the first premise of the Kalam cosmological argument is false, for it is demonstrably not the case that whatever has a beginning has a cause.

One sort of uncaused event predicted by quantum mechanics is the spontaneous emergence of particles from a vacuum. Known as a vacuum fluctuation, it is a fundamental quantum mechanical process that has been linked to a number of observable phenomena such as the Casimir effect, Van der Waal forces, and the Plank blackbody radiation spectrum. Just as quantum mechanics permits particles to spontaneously emerge from a vacuum, so it seems to permit an entire universe to spontaneously come into being from a vacuum. Physicist Edward Tryon of New York University was the first to spell out this implication of quantum mechanics. He demonstrated that if our universe has a zero net value for all conserved quantities, then it may be the result of a vacuum fluctuation. Quantum mechanics predicts that everything that can happen eventually will happen. So once there’s a vacuum, quantum mechanics predicts that sooner or later there will be a universe.

Tryon’s vacuum fluctuation theory shows that the Big Bang need not be

the result of any sort of external influence. Universes can come into existence on their own without any outside help. A vacuum fluctuation is not the creation of something out of nothing, however, for empty space is not a mere nothing. So we seem to be left with the question: where did the vacuum come from? But in the context of the Kalam cosmological argument, this is not a problem, for unlike the universe, there is no evidence that the vacuum had a beginning. The vacuum may be eternal. If so, it does not need a cause.

Black Holes and Infinity

The second premise of the Kalam cosmological argument, namely, that the universe began to exist, is also questionable. Friedmann was the first to realize that if there was enough matter in the universe, the force of gravity would eventually overcome the force of the initial explosion and the universe would start collapsing back on itself. This process has come to be known as “the Big Crunch.” If it occurred, all matter would eventually be drawn back into an infinitely dense point. Since matter can supposedly not be squeezed out of existence, some have speculated that in this extremely dense state, some quantum mechanical event would trigger another big bang. So the Big Bang that created our universe could have been the result of a prior Big Crunch, which was the result of a prior big bang, and so on. This oscillating model of the universe is reminiscent of the Hindu view, with its eternal cycles of creation and destruction.

Recent research suggests that there is not enough matter in the universe to cause it to collapse back on itself. But even if the universe as a whole does not collapse, we know that certain regions of it do, such as massive stars that have burned up their nuclear fuel. Once a star has used up its fuel, it starts to contract. If the star is massive enough, the contraction results in a supernova explosion and the creation of a black hole. The matter in a black hole is compressed by gravity into a point of infinite density known as a “singularity.” Physicist Lee Smolin believes that the matter contained in a black hole may be emitted in another region of space-time, thus giving birth to a new universe. In a sense, then, our universe may reproduce itself by budding off. Smolin’s vision of a self-reproducing universe is an appealing one. It suggests that the universe may be more like a living thing than an artifact, and thus that its coming into being does not require an external agent.

In principle, it seems possible that the budding off process, like the expansion-contraction process, has been going on forever. Our universe may be the offspring of a parent universe, which is itself the offspring of another parent universe, and so on *ad infinitum*. Defenders of the Kalam cosmological argument, however, claim that this is not possible because there cannot be an actual infinity of past events.

Whether there can be an actual infinity of things has been a bone of contention since the ancient Greek philosopher Zeno of Elea began exploring the

implications of infinity around 500 BCE. It lies behind the famous conundrum: how many angels can fit on the head of a pin? If God is all-powerful, it would seem that he could put an infinite number of angels on the head of a pin. If there cannot be an actual infinity, however, then not even God can place an infinity of angels on the head of a pin.

Philosopher William Lane Craig believes that there cannot be an actual infinity of anything. To prove his point, he cites some of the peculiarities associated with actual infinities highlighted by mathematician David Hilbert. Consider, for example, an infinite library in which every other book is colored either red or black. This library would have some rather remarkable—and to Craig’s mind, impossible—properties. You could add any number of books to this library without increasing the number of books in the library (since by definition infinity plus or minus any number is still infinity). Similarly, you could check out any number of books from it without decreasing the number of books in it. For example, you could check out all of the red books in the library and there would still be an infinite number of books left. No actual library could have these properties, claims Craig. Since there cannot be an infinite library, Craig concludes that there cannot be an infinite series of past events.

This is an argument from analogy, and the strength of such arguments is determined by the number of similarities between the things being compared; the more dissimilarities, the less convincing the argument. There are a great number of dissimilarities between an infinite number of books and in infinite series of past events, however. For one thing, events cannot be removed from the past in the way books can be removed from a library. For another, they cannot be moved around in the way that books can. So the paradoxes that seem to arise for an infinite library do not necessarily arise for an infinity of past events.

In 1882, the German mathematician Georg Cantor developed a consistent theory of infinite numbers, thus proving that the notion of an actual infinite is not self-contradictory. Craig does not dispute this fact. Nevertheless, he believes that an actual infinite cannot exist because it is absurd. To show how a formally consistent notion can be absurd, he offers the following example: “Some prime numbers weigh more than Jackie Gleason.” That statement is not formally self-contradictory, yet we know that it cannot be true because it is absurd; the property of being a prime number and the property of weighing more than Jackie Gleason cannot be had by the same object.

Intuitions about possibility are notoriously unreliable, however. For millennia, mathematicians and philosophers thought it was impossible for there to be a geometry that did not conform to Euclid’s axioms and postulates. In the nineteenth century, however, a number of mathematicians, including Janos Bolyai, Nikolay Lobachevsky, and Georg Riemann, showed that there are consistent geometries that reject one or more of Euclid’s postulates. Riemann’s geometry later became the basis of Einstein’s theory of relativity. So the fact

that someone finds something absurd is no guarantee that it is impossible, especially when it has been shown to be free from contradiction.

Craig's rejection of the actual infinite is somewhat surprising, given his view that God does not have a beginning in time. Ordinarily, that would be taken to imply that God had existed for an infinitely long time and had infinitely many thoughts. That, of course, is impossible in Craig's view, because the infinity of God's thoughts would be an actual infinity, and such things cannot exist. Craig avoids this consequence by claiming that God existed outside of time prior to the Big Bang and in time after the Big Bang. So God's thoughts are only finite in number.

But if God had no thoughts prior to the Big Bang, it's difficult to see how he could have had a reason for creating the universe. Certainly God could not have deliberated before the Big Bang, because deliberation takes time, and according to Craig, God was not in time prior to the Big Bang. But if God had no reason for creating the universe, then attributing the Big Bang to God is no better than saying that it happened for no reason at all.

In any event, placing God outside of time prior to the Big Bang and in time after it seems an ad hoc attempt to save the God hypothesis from self-contradiction. Given his position on actual infinities, Craig cannot allow there to be an actual infinity of God's thoughts. So he placed God outside of time prior to the creation of the universe. In so doing, he makes it difficult to see how the creator of the universe could be the traditional God of theism, because that God is a personal God, and all of the activities normally associated with personhood, such as thinking, reasoning, and deliberating, take time.

There seems to be no solid philosophical grounds for rejecting those scientific theories, such as Tryon's and Smolin's, that take the universe to be eternal. Since these theories are consistent with all known physical evidence and all known physical laws, there is reason to believe that the second premise of the Kalam cosmological argument is incorrect. The universe may well be eternal (endless and beginningless), despite the evidence for the Big Bang.

The God Hypothesis

Tryon's and Smolin's theories are not the only ones that explain the Big Bang without appealing to the supernatural. Paul Teinhardt of Princeton University and Neil Turok of Cambridge University have proposed a new oscillating theory of the universe in which the universe is brought into existence as the result of a collision between giant membranes of matter. Andre Linde has proposed a self-reproducing theory of the universe where the budding-off process is driven by scalar fields (phenomena, such as temperature, in which each point in space can be defined by a number) rather than black holes. And Stephen Hawking has proposed that although the universe is finitely old, it had no beginning in time because, as Augustine suggests, time came into existence with the universe.

Although many scientific theories can account for the Big Bang without invoking God, one might object that the God hypothesis is just as good as they are, because there is no “fossil evidence” to help us decide among them. But fitting the evidence is not the only criteria used in deciding among competing theories.

We seek explanations because we seek understanding. The best explanation, then, is the one that produces the most understanding. The amount of understanding produced by an explanation is determined by how well it systematizes and unifies our knowledge. We begin to understand something when we see it as part of a pattern. The more that pattern encompasses, the more understanding it produces. The extent to which a hypothesis synthesizes and unifies our knowledge can be measured by various criteria of adequacy such as consistency (freedom from contradiction), simplicity (the number of independent assumptions made), scope (the amount of diverse phenomena explained), conservatism (fit with established findings), and fruitfulness (ability to successfully predict novel phenomena).

On all of these criteria, the God hypothesis fares worse than a comparable natural one. To begin with, is the traditional theistic conception of God consistent? It is often claimed that God is perfectly merciful and perfectly just. But if he is perfectly merciful, he lets everyone off, and if he is perfectly just, he makes sure that everyone gets what’s coming to them, which does not seem to be the case. Until the advocates of the God hypothesis provide us with an internally consistent account of God, the hypothesis cannot be considered credible.

The God hypothesis is also usually less simple than naturalistic theories because it postulates an entity, namely God, not found in any naturalistic hypothesis. In this regard, it violates Occam’s razor, a concept that tells us not to multiply entities beyond necessity. If a phenomenon can be explained without assuming the existence of a certain entity, then that phenomenon provides no reason for believing in the existence of that entity. The God hypothesis is lacking in scope because it raises more questions than it answers, and the questions it raises seem unanswerable. How did God do what he did? Why did he do it? What kind of force, energy, or power, did he use?

The God hypothesis also tends to be less conservative because it suggests that certain natural laws have been violated, such as the law of conservation of mass/energy. It lacks fruitfulness because it has not successfully predicted any new phenomena. The predictions that can be derived from it, for example, that its design should be perfect and that there should be no evil in the world, appear to be false. So in terms of the amount of understanding produced, the God hypothesis is not as good as a comparable scientific one.

As Plato points out in the *Cratylus*, to say that God did something is not to explain it but merely to offer an excuse for not having an explanation. Unless and until the God hypothesis better meets these criteria, it cannot be considered the best explanation of the Big Bang.

Bibliography

- Aristotle. *Metaphysics*. Trans. Joe Sachs. Santa Fe, NM: Green Lion, 1999.
- Craig, William Lane, and Quentin Smith. *Theism, Atheism, and Big Bang Cosmology*. Oxford: Oxford University Press, 1995.
- . “Graham Oppy on the *Kalam* Cosmological Argument.” *Sophia* 32 (1993): 1–11.
- . “In Defense of the *Kalam* Cosmological Argument.” *Faith and Philosophy* 14 (1997): 236–47.
- . *The Kalam Cosmological Argument*. New York: Barnes and Noble, 1979.
- Davies, Paul. *God and the New Physics*. New York: Simon and Schuster 1983.
- . *The Mind of God*. New York: Simon and Schuster, 1992.
- Drange, Theodore. “Incompatible Properties Arguments: A Survey.” *Philo* 2 (Fall–Winter 1998): 49–60.
- Einstein, Albert. “The Einstein-DeSitter-Weyl-Klein Debate.” In *The Collected Papers of Albert Einstein*. Vol. 8, *The Berlin Years: Correspondence, 1914–1918*, ed. Robert Schulmann, A.J. Knox, Michel Jansen, and Jozsef Illy, 351–57. Princeton, NJ: Princeton University Press, 1998.
- Gribbin, John. *In the Beginning: The Birth of the Living Universe*. Boston: Little, Brown, 1993.
- Guth, Alan. *The Inflationary Universe: The Quest for a New Theory of Cosmic Origins*. Reading, MA: Addison-Wesley, 1997.
- Hawking, Stephen. *A Brief History of Time*. New York: Bantam, 1988.
- Linde, Andrei. *Inflation and Quantum Cosmology*. New York: Academic Press, 1990.
- . “The Self-Reproducing Inflationary Universe.” *Scientific American*, November 1994, 48–55.
- Mill, John Stuart. “Three Essays on Religion.” In *Essays on Ethics, Religion and Society*, ed. J.M. Robson. Toronto: University of Toronto Press, 1969.
- Morrison, Wes. “Craig on the Actual Infinite.” *Religious Studies* 38 (2002): 147–66.
- . “Must the Beginning of the Universe Have a Personal Cause?” *Faith and Philosophy* 17:2 (2000): 149–69.
- Plato. *Cratylus*. Trans. and Intro. C.D.C. Reeve. Indianapolis, IN: Hackett, 1998.
- Ross, Hugh. *The Creator and the Cosmos*. Colorado Springs: NavPress, 1995.
- Sandage, Alan. Quoted in “Science Finds God.” *Newsweek*, July 20, 1998, 46.
- Smolin, Lee. *The Life of the Cosmos*. New York: Oxford University Press, 1997.
- Steinhardt, Paul, and Neil Turok. “A Cyclic Model of the Universe.” *Science*, May 24, 2002, 1436–39.
- Tryon, Edward. “Is the Universe a Vacuum Fluctuation?” *Nature*, December 14, 1973, 396–97.
- White, Andrew Dickson. *A History of the Warfare of Science with Theology in Christendom*. 1896. Reprint, New York: Peter Smith, 1990.

42 Cosmology and the Anthropic Principle

Victor J. Stenger

Does Earth, and with it human life, possess a unique place in the cosmos? Or does human life exist within an unexceptional, almost negligible pinpoint of space and time? In recent years, new arguments have emerged that aim to establish human beings as the focus of existence. The anthropic principle, generally speaking, claims that the universe appears to be highly fine-tuned for human life.

The only form of life in the universe of which we are aware is that found on our home planet. That life is based on the chemical element carbon, whose four-valence structure and other properties make it particularly well suited as the framework on which molecules containing many atoms in a wide range of complex shapes and properties can be assembled. While other elements, such as silicon and germanium, have similar structures, and indeed are used in semiconductor technology to manufacture devices with complex properties of their own, carbon seems best suited for a form of life to evolve under the conditions that exist on Earth and perhaps elsewhere in our universe.

Whatever elements serve as the building blocks of complex structures, they did not exist in nature when our universe first formed 14 billion years ago. Cosmologists and physicists now have a reliable theoretical picture of those early stages. Beginning in a tiny region of space far smaller than an atomic nucleus, the universe emerged as an expanding ball of hot gas and radiation through a process known as the Big Bang. After a few minutes, that gas cooled to the point where atoms could hold together without being ionized by the radiation. One out of every billion of the primordial bodies was a hydrogen atom, with even smaller amounts of helium and lithium. These are the first three elements of the chemical Periodic Table that we see hanging on the wall of many science classrooms. Over a period of perhaps 100 million years, these elements were gathered by gravity into the first stars.

Another billion years or so was needed for stars to produce the carbon and other ingredients needed for the evolution of life. The main source of energy production in stars is the fusion of hydrogen nuclei into helium. The larger a

star, the faster it evolves. When its hydrogen is used up, other nuclear processes take over and synthesize carbon and the other heavier elements. If the star is at least ten times as massive as our sun, it will produce a gigantic explosion called a supernova, in the process blasting the newly made elements into interstellar space. Once there, this matter can be assembled, by gravity, into planets like Earth. And so, Earth formed 6 billion years ago, 8 billion years after the Big Bang, with a heavy core of iron and a surface containing enough carbon, oxygen, and other substances needed for life to form. In 1952, astronomer Fred Hoyle calculated that sufficient carbon would not be produced in stars unless the nucleus of carbon contained a previously unknown excited state of a specific energy. A laboratory experiment, proposed by Hoyle, shortly confirmed the existence of this state.

The properties of atomic nuclei are determined by fundamental constants of nature, such as the masses of the proton and neutron and the strength of the nuclear force. The values of these constants were already set billions of years before Earth formed, and indeed long before the formation of the first star. Yet these constants seem specially selected to allow for the eventual development of carbon-based life.

The Anthropic Coincidences

For many years, physicists have pondered why the constants of physics have the particular values they do. Perhaps the biggest puzzle is the huge difference between the strengths of the gravitational and electromagnetic force. Consider the hydrogen atom, which is composed of a proton and electron of equal and opposite electric charge. The electrical attraction between these two particles is thirty-nine orders of magnitude greater than the gravitational attraction. Why thirty-nine orders of magnitude? Why not 58 or 137?

What if the two forces—electrical attraction and gravitational attraction—were equal? A star is maintained in equilibrium by a balance between the attractive force of gravity and the pressure of the outgoing electromagnetic radiation that is produced by the nuclear processes going on at the star's core. If gravity were the same strength as electromagnetism, a star would quickly collapse—long before any heavy elements could be made. So, once again, we seem to have a tuning of the parameters of physics to allow time for the elements of life to be fabricated and spread throughout space. The seeming connections between physics parameters and life are called the *anthropic coincidences*.

In their 1986 book *The Anthropic Cosmological Principle*, physicists John Barrow and Frank Tipler assembled a large number of examples to illustrate how the laws and constants of physics appear to be fine-tuned for the evolution of life as we know it. In many cases, changing a constant by a tiny amount is sufficient to make life as we know it impossible.

For example, the element-synthesizing processes in stars depend sensitively

on the properties and abundances of deuterium (heavy hydrogen) and helium produced in the early universe. Deuterium would not exist if the difference between the masses of a neutron and a proton were just slightly displaced from its actual value. The relative abundances of hydrogen and helium also depend strongly on this parameter. These abundances also require a delicate balance of the relative strengths of gravity and the weak nuclear force, which is responsible for energy production in stars. With a slightly stronger weak force, the universe would be 100 percent hydrogen. In that case, all the neutrons in the early universe would have decayed, leaving none around to be saved in deuterium nuclei for later use in the element-building processes in stars. With a slightly weaker weak force, few neutrons would have decayed, leaving about the same numbers of protons and neutrons. In that case, all the protons and neutrons would have been bound up in helium nuclei, with two protons and two neutrons in each. This would have led to a universe that was 100 percent helium, with no hydrogen to fuel the fusion processes in stars. Neither of these extremes would have allowed for the existence of stars and life based on carbon chemistry.

The electron also enters into the tightrope act needed to produce the heavier elements. Because the mass of the electron is less than the neutron-proton mass difference, a free neutron can decay into a proton, electron, and antineutrino. If this were not the case, the neutron would be stable and most of the protons and electrons in the early universe would have combined to form neutrons, leaving little hydrogen to act as the main component and fuel of stars. It is also essential that the neutron be heavier than the proton, but not so much heavier that neutrons cannot be bound in nuclei, where conservation of energy prevents the neutrons from decaying.

The Cosmological Constant

Another puzzling example of an anthropic coincidence is the cosmological constant problem. When Einstein first wrote down his equations of general relativity in 1915, he saw that they allowed for the possibility of gravitational energy stored in the curvature of empty space-time. This vacuum curvature is expressed in terms of what is called the *cosmological constant*. The familiar gravitational force between material objects is always attractive. A positive cosmological constant produces a repulsive gravitational force. That is, anti-gravity is allowed by Einstein's theory.

At the time, Einstein and most others assumed that the stars formed a fixed, stable system, or in the language of the Bible, a stable firmament. A stable firmament is not possible with attractive forces alone, so Einstein thought that the repulsion provided by the cosmological constant might balance things out. However, when Edwin Hubble discovered that the universe was not a stable firmament but expanding, the need for a nonzero cosmological constant was eliminated. Over the years since, the data gathered by astronomers have indicated that the cosmological constant is at most very small and very possibly zero.

Elementary particle physicists, however, found that they cannot understand why the cosmological constant should be so small—the corresponding energy density is far lower than expected from theoretical estimates. Calculations indicate a value of the resulting *vacuum energy* density is at least 120 orders of magnitude higher than the astronomically observed upper limit for this energy. Those calculations are clearly wrong.

Dark Energy

In 1998, two research groups studying distant supernovae were astonished to discover, against all expectations, that the expansion of the universe is accelerating. More recent observations have confirmed this result. The universe, to put it simply, is falling up! This can only be explained by a gravitational repulsion. While the notion of antigravity may seem like science fiction, gravitational repulsion is allowed by general relativity. Einstein's equations give a gravitational repulsion whenever the pressure of a gravitating medium is sufficiently negative. A positive cosmological constant is one way to achieve this—but not the only way.

The observations of an accelerating universe indicate that whatever is producing this repulsion represents 70 percent of the total mass-energy of the universe. This component has been dubbed *dark energy* to distinguish it from the gravitationally attractive *dark matter* that constitutes another 26 percent of the mass-energy. Neither of these ingredients is visible, nor can they be composed of ordinary atomic and subatomic matter like quarks and electrons. Familiar luminous matter, as seen in stars and galaxies, makes up only 0.5 percent of the total mass-energy of the universe, with the remaining 3.5 percent residing in ordinary but nonluminous matter like planets.

This result makes the cosmological constant problem even more problematic. The energy densities of dark energy, dark matter, and familiar matter are currently of the same order of magnitude. If the dark energy resides in a cosmological constant, the corresponding energy density is constant. On the other hand, the energy density of matter and radiation vary as the universe expands. So we have another anthropic coincidence in which the cosmological constant was originally fine-tuned to select out our particular moment, a few million years in the 14 billion years of our universe's existence. Thus, more ammunition is supplied to those who would see humanity as occupying a special place in the cosmos.

Versions of the Anthropic Principle

In 1974, Brandon Carter introduced what he, to his later regret, called the “anthropic principle.” He proposed two versions. His *weak anthropic principle* states: “We must be prepared to take into account the fact that our location in the universe is *necessarily* privileged to the extent of being compatible

with our existence as observers.” His *strong anthropic principle* says: “The Universe (and hence the fundamental parameters on which it depends) must be such as to admit the creation of observers within it at some stage.” These ideas offered an explanation, of sorts, to the anthropic coincidences. If the universe were not the way it is, we would not be here to talk about it.

However, many authors have read deeper meanings into the anthropic principle and presented their own versions. Barrow and Tipler, for example, proposed three versions. The first two rephrase Carter’s wording. Their weak anthropic principle reads: “The observed values of all physical and cosmological quantities are not equally probable but take on values restricted by the requirement that there exist sites where carbon-based life can evolve and by the requirement that the Universe be old enough for it to have already done so.” Note that Barrow and Tipler require the existence of “carbon-based life” while Carter simply refers to the existence of “observers.” Barrow and Tipler’s strong anthropic principle reads: “The Universe must have those properties which allow life to develop within it at some stage in its history.” Note that all three authors say that the universe “must” have the properties that allow for the creation of life, or at least observers. Thus, the strong anthropic principle seems to imply some intent or purpose within the universe.

Barrow and Tipler offer three possible reasons for the strong anthropic principle:

- (A) There exists one possible Universe “designed” with the goal of generating and sustaining “observers.”
- (B) Observers are necessary to bring the Universe into being.
- (C) An ensemble of other different universes is necessary for the existence of our Universe.

Reason (A) has two further possibilities, depending on the meaning of “designed.” Many authors with religious agendas have interpreted the designer as a creator God, although nothing in the above discussion requires that this God be the one of any particular faith. Indeed, “design” might be interpreted as a purely natural process, perhaps an evolutionary one akin to the design inherent in Darwinian natural selection or just some structure built into the universe that science has not yet explained.

Reason (B) arises from a mystical misinterpretation of quantum mechanics that has formed the basis of a large literature in recent years. In quantum mechanics, the detection apparatus plays a large role in determining the outcome of an experiment. When you measure a particle property, such as a localized position, then the object being measured is described as a particle. When you measure a wave property, such as wavelength, the object being measured is described as a wave. This has led some to suggest that a human observer creates her or his own reality. So why not the universe itself?

However, nothing in experiment or theory supports this interpretation. No

human need be involved in physical processes and no incompatibility exists in the wave-particle descriptions used in quantum theory. Obviously the act of observation requires an interaction with the system being observed, and the theory must properly take that into account when, as occurs on the atomic and subatomic scale, this interaction cannot be neglected.

Reason (C) introduces the notion that multiple universes exist and so we happen to just live in that universe which is suitable for the evolution of our kind of life.

Barrow and Tipler round out their various anthropic principles with the *final anthropic principle*: “Intelligent information processing must come into evidence in the Universe, and, once it comes into existence, it will never die out.”

How Fine-tuned?

Many scientists find the whole anthropic argument circular, or at least posed in a rather twisted way. Of course the constants of nature are suitable for our form of life. If they were not, we would not be here to talk about it.

Consider the fact that we live on Earth, rather than Mercury, Venus, Mars, or some other planet in the known solar system. The temperature range on Earth is just right for life, while Mercury and Venus are too hot and Mars is too cold. Mercury has no atmosphere, while the atmosphere of Venus is too thick for the sun’s rays to penetrate to the surface, and the atmosphere of Mars is too thin to provide sufficient oxygen and water.

Earth’s atmosphere is transparent to the same spectrum of light to which our eyes are sensitive. Anthropic reasoning would have it that the atmosphere was fine-tuned so that humans and other animals could see at a distance. The transparency also happens to match the spectral regions within which the electromagnetic radiation from the sun is maximal. Again, anthropic reasoning would attribute this to design with humans in mind.

But, rather obviously, life evolved on Earth because conditions here were right. The type of life that evolved was suitable for those conditions. Life did not evolve, to the best of our current knowledge, anywhere else in the solar system because of the unsuitability of any of the other planets that orbit our sun. But with 100 billion stars in 100 billion galaxies in the visible universe, and countless others likely to lie beyond our horizon, the chances seem good for some form of life developing on some planets somewhere. Indeed, many of the chemical ingredients of life, such as complex molecules, have been observed in outer space. Of course, we will not know for sure until we find such life.

Still, we expect any life found in our universe to be carbon based, or at least based on heavy element chemistry. The fine-tuning argument implies that this is the only form of life that is possible, and that is a huge assumption. Even if all the forms of life in our universe turn out to be of this basic structure, it does not follow that life is impossible under any other arrangement of physical laws and constants.

Some physicists imagine that someday we will be able to derive all physical laws and parameters from a few basic principles, that only one set will be shown to be possible in an ultimate “theory of everything.” We have not reached that stage, and another possibility has also been widely discussed.

Many “laws” of physics can be shown to follow naturally from basic symmetries of space and time and the requirement that physical theories must first of all be objective, that is, they must not be formulated in such a way that they single out the point of view of a particular observer. These laws include some of the most important: the great conservation principles such as energy conservation, Newton’s laws of motion, special and general relativity, and quantum mechanics. Both gravity and electromagnetism also follow from this simple principle. Thus these principles can be expected to apply in any conceivable universe that would be formed in the absence of any external agency.

Furthermore, some of the fundamental constants that are often used in the fine-tuning arguments are conventions whose values are arbitrarily chosen in order to define the system of units being used. For example, the speed of light in a vacuum defines the unit of length in terms of the international standard unit of time, the second. Similarly, the Planck constant and Newton’s gravitational constant are arbitrary and so cannot be fine-tuned.

On the other hand, certain fundamental parameters may be the random, uncaused result of a process called *spontaneous symmetry breaking*. This includes the masses of the elementary particles, the relative strengths of the forces by which they interact, and other details that enable the universe to develop complex structures. In this picture, our universe starts out in a highly symmetric state but certain symmetries are broken as the universe expands and cools.

The mechanism is essentially that of the familiar phase transitions that occur as a gas cools to a liquid and then a solid. At each transition, the system moves from a more symmetric to less symmetric state, but one with more structural complexity and apparent organization. For example, as the temperature decreases, a sphere of water vapor is composed of randomly moving molecules, becomes a liquid with more orderly molecules, and then a solid crystal of ice in which the molecules occupy fixed positions.

One symmetry that is expected to have existed in the very early stages of the universe was a balance between matter and antimatter. If that symmetry had been maintained, the current universe would be almost pure radiation resulting from matter-antimatter annihilation. No structures such as stars, planets, and living organisms would exist. In fact, the current universe has about a billion particles of normal matter for every antiparticle, and structures are maintained without the threat of annihilation. To achieve this, the symmetry between matter and antimatter had to have been broken within the first few minutes of the Big Bang. This might have happened by means of some dynamic process that could be described as lawlike. However, spontaneous symmetry breaking—random rather than dynamic—remains a viable alternative.

The highly successful standard theory of elementary particles and forces

contains about twenty parameters that are neither arbitrary nor predetermined by known fundamental principles but must currently be inferred from experiments. However, only a few parameters are needed to specify the broad features of the universe. One of these features, which we may reasonably deem as necessary for the ultimate evolution of life, is the existence and long lifetime of stars. Recall that large stars need to live about a billion years or more to allow for the fabrication of heavy elements. Smaller stars, such as our sun, also need about a billion years to allow life to develop within its solar system of planets.

In my own research, I have studied how the minimum lifetime of a typical star depends on three parameters: the masses of the proton and electron and the strength of the electromagnetic force. If we vary these parameters by ten orders of magnitude around their present values, we find that over half of the stars will have lifetimes exceeding a billion years. Anthony Aguirre has examined the universes that result when six cosmological parameters are varied by orders of magnitude and found that they do not preclude the existence of intelligent life.

One of the mistakes made by those who claim that the constants of nature are fine-tuned for life is to vary one constant while holding all the others fixed. As Aguirre and I have independently shown, changes in other parameters may compensate for the change in a selected parameter, allowing more room for a viable, livable universe than might otherwise be suspected. We and others have concluded that the fine-tuning is not as fine as some have argued.

Quintessence

The cosmological constant problem has a very specific, plausible solution that does not require fine-tuning. As we have seen, the cosmological constant problem is really a vacuum energy problem. Estimates made for the vacuum energy density exceed the empirical upper limit by over 120 orders of magnitude. We can safely conclude that those estimates are grossly wrong. In fact, a closer look at these calculations reveals that they are very crude and based on unsupportable assumptions. Furthermore, until we have a working theory of quantum gravity, we have no way of making such a calculation reliable. Certainly this is a “problem,” but not anything so anomalous as to require drastic solutions at our current level of knowledge. There are even some good reasons for thinking that the vacuum energy density is in fact zero.

In that case, what is the dark energy? Theoretical physicists have proposed models in which the dark energy is not a vacuum energy, but rather a dynamic, material energy field dubbed *quintessence*. This field has negative pressure and repulsive gravity. The energy density of quintessence is not constant but evolves along with the other matter/energy fields of the universe and, thus, need not be fine-tuned. While the questions of the nature and amount of dark energy and vacuum energy in the universe are still open, they do not point to any particularly strong need to invoke anthropic arguments.

The Multiverse

Usually we think of the “universe” as encompassing all that is. However, modern usage of this term is gradually changing to refer to all that arose from the original Big Bang 14 billion years ago. This includes all that is within our “horizon,” that is, objects near enough to Earth that their light can reach us in less than the age of the universe. It also includes anything that might be beyond that horizon but arose from the same source. Indeed, if modern inflationary cosmology is correct, the part of our universe within our horizon, all 100 billion galaxies, is an almost negligible fraction of the total.

Stupendous as this seems, there may be much more. Nothing in our current knowledge requires that this universe, our universe, is all there is. While we cannot see through the chaos of the first moments of the Big Bang, the same equations that describe that event and the expanding universe that resulted work equally well for the time before what we call “ $t = 0$.” Another universe could very well have existed at that time, contracting from our point of view to the tiny region that then exploded into our universe.

In fact, since the direction of time is not an inherent property of nature, appearing in no physics equations but merely a convention we choose as the direction of increasing entropy, time would run in the opposite direction to ours in that universe on “the other side of time.” And given that so much of what happens in our universe is the result of random, spontaneous processes, we would not expect that universe to be exactly like ours.

But this is not all. Modern cosmology suggests that the same process that produced our universe could happen in many other places outside our universe. None of these universes, which form what is called the *multiverse*, would be identical. They would be expected to have many of the same basic “laws” as ours, such as energy conservation, which follow from symmetries. But we can conjecture that these other universes will differ in those properties that are accidental, the result of spontaneous symmetry breaking.

In this case, the anthropic coincidences are readily explained by Barrow and Tipler’s proposal (C) discussed above. There exists an ensemble of universes with a wide range of properties, and we are in the one that had those properties necessary for carbon-based life to form. In short, the universe is not fine-tuned for us. We are fine-tuned to our universe.

Bibliography

- Aguirre, Anthony. “The Cold Big-Bang Cosmology as a Counter-example to Several Anthropic Arguments.” *Physical Review D* 64 (2001): 083508.
- Barrow, John D., and Frank J. Tipler. *The Anthropic Cosmological Principle*. Oxford: Oxford University Press, 1986.
- Bostrom, Nick. *Anthropic Bias: Observation and Selection Effects in Science and Philosophy*. New York: Routledge, 2002.
- Carter, Brandon. “Large Number Coincidences and the Anthropic Principle in Cosmology.” In *Confrontation of Cosmological Theory with Astronomical Data*, ed. M.S. Longair, 291–98. Dordrecht: Reidel, 1974. Reprinted in Leslie, 1990.

- Dicke, R.H. "Dirac's Cosmology and Mach's Principle." *Nature* 192 (1961): 440.
- Drees, Willem B. *Beyond the Big Bang: Quantum Cosmologies and God*. La Salle, IL: Open Court, 1990.
- Ellis, George. *Before the Beginning: Cosmology Explained*. London, New York: Boyars/Bowerdean, 1993.
- Glynn, Patrick. *God: The Evidence*. Rocklin, CA: Prima, 1997.
- Guth, Alan. *The Inflationary Universe*. New York: Addison-Wesley, 1997.
- Hawking, Stephen. *A Brief History of Time: From the Big Bang to Black Holes*. New York: Bantam, 1988.
- Hogan, Craig J. "Why the Universe Is Just So." *Reviews of Modern Physics* 72 (2000): 1149–61.
- Hoyle, F., D.N.F. Dunbar, W.A. Wensel, and W. Whaling. "A State in C12 Predicted from Astrophysical Evidence." *Physical Review Letters* 92 (1953): 1095.
- Krauss, Larry. *Quintessence: The Mystery of Missing Mass in the Universe*. New York: Basic Books, 2000.
- Leslie, John. *Universes*. London: Routledge, 1989.
- , ed. *Physical Cosmology and Philosophy*. New York: Macmillan, 1990.
- Linde, Andrei. *Particle Physics and Inflationary Cosmology*. New York: Academic Press, 1990.
- . "The Self-Reproducing Inflationary Universe." *Scientific American*, November 1994, 48–55.
- Ostriker, Jeremiah P., and Paul J. Steinhardt. "The Quintessential Universe." *Scientific American*, January 2001, 46–53.
- Overman, Dean L. *A Case Against Accident and Self-Organization*. New York: Rowman and Littlefield, 1997.
- Perlmutter, S., et al. "Measurements of Omega and Lambda from 42 High-Redshift Supernovae." *Astrophysical Journal* 517 (1999): 565–86.
- Reiss, A., et al. "Observational Evidence from Supernovae for an Accelerating Universe and a Cosmological Constant." *Astronomical Journal* 116 (1998): 1009–38.
- Ross, Hugh. *The Creator and the Cosmos: How the Greatest Scientific Discoveries of the Century Reveal God*. Colorado Springs: NavPress, 1995.
- Rugh, S.E., and Henrik Zinkernagel. "The Quantum Vacuum and the Cosmological Constant Problem." *Studies in History and Philosophy of Modern Physics* 33 (222): 663–705.
- Smith, Quentin. "A Natural Explanation of the Existence and Laws of Our Universe." *Australasian Journal of Philosophy* 68 (1990): 22–43.
- Smolin, Lee. *The Life of the Cosmos*. New York: Oxford University Press, 1997.
- Stenger, Victor J. *Not by Design: The Origin of the Universe*. Amherst, NY: Prometheus Books, 1988.
- . *The Unconscious Quantum: Metaphysics in Modern Physics and Cosmology*. Amherst, NY: Prometheus Books, 1995.
- . *Timeless Reality: Symmetry, Simplicity, and Multiple Universes*. Amherst, NY: Prometheus Books, 2000.
- . *Has Science Found God? The Latest Results in the Search for Purpose in the Universe*. Amherst, NY: Prometheus Books, 2003.
- Swinburne, Richard. "Argument from the Fine-Tuning of the Universe." In *Physical Cosmology and Philosophy*, ed. John Leslie, 154–73. New York: Macmillan, 1990.
- Taylor, Stuart Ross. *Destiny or Chance: Our Solar System and Its Place in the Cosmos*. Cambridge: Cambridge University Press, 1998.
- Tegmark, Max. "Is 'The Theory of Everything' Merely the Ultimate Ensemble Theory?" *Annals of Physics* 270 (1998): 1–51.
- Tipler, Frank J. *The Physics of Immortality: Modern Cosmology and the Resurrection of the Dead*. New York: Doubleday, 1994.
- Weinberg, Steven. "The Cosmological Constant Problem." *Reviews of Modern Physics* 61 (1989): 1–23.

43 Creationism

Jeffrey Koperski

While debates surrounding creationism are not confined to one religion, it is a defining issue for many contemporary Protestant Christians, and it is usually framed in terms of “The Creation versus Evolution Debate.” But the controversy is older than Darwin and touches on far more than biological evolution. It involves broad questions about the origin of the universe and the relation between science and scripture. How old is the universe? If the universe was created, how was that done? How should we interpret the account of creation in the early chapters of Genesis? There are four main approaches to these questions. One is *naturalism*: nothing exists beyond the realm of nature, material objects, and energy. Most naturalists consider religious beliefs to be purely matters of faith, making no contribution to history or science. Although naturalism and atheism are not synonymous, when it comes to matters of religion, they are essentially the same. Another view is *young earth creationism*, which takes a literal interpretation of Genesis and the six days of creation. The two other main views are *progressive creationism* and *theistic evolution*. Both reject a literal interpretation of scriptural accounts and agree with contemporary science about the age of the universe, but they differ from each other over God’s activities after the initial creation of the cosmos. The rest of this essay will examine the three theistic positions in more detail.

Young Earth Creationism

The core of young earth creationism is that the book of Genesis should be taken as a literal account of the prehistory and early history of the earth. The description of the creation week is taken at face value: consecutive twenty-four-hour periods adding up to six calendar days. Allowing for gaps in Old Testament genealogies, this means that the universe was created between 10,000 and 20,000 years ago. Young earth creationists hold that geological data, including the fossil record, should be understood in light of the worldwide flood depicted in the account of Noah and the ark.

History

With some notable exceptions, young earth creationism was the majority view among Jews, Christians, and Muslims from ancient times until the nineteenth century. With little scientific evidence to contradict a recent creation, scripture and tradition were the only sources available on the origin question. A dramatic change began around 1800. As geology matured into a distinct science, unexpected data began to emerge from studies of extinct volcanoes in central France and the consistent order found among fossils in the geological strata. Geologists wanted to appear more empirical in the age of Newtonian mechanics, which influenced the rules for theory formation. Instead of finding explanations in stories of catastrophes, such as a great flood, early nineteenth-century scientists sought geological explanations in observed processes, such as erosion, that they hypothesized to have been at work at the same rate and strength for millions of years. By the middle of the century, an old-earth view had taken hold. One American commentator writing in 1852 estimated that one-half of the Christian public had come to believe that Genesis did not need to be interpreted in a young earth fashion.

By the early twentieth century, young earth creationism had fallen into a minority position with few visible supporters among Christian leaders. The only denomination to take a young earth as established doctrine was the Seventh-Day Adventists, whose prophetess Ellen G. White claimed that God had shown her the creation days in a vision. The young earth view was adopted by some fundamentalist groups by World War II, but it was catapulted into the broader Christian community by seminary professor John Whitcomb Jr. and professor of civil engineering Henry Morris through the publication of *The Genesis Flood* (1961). Young earth creationism has since become a popular view among evangelical Christians and has been incorporated into the doctrinal statements of a number of churches, seminaries, and independent ministries.

Scripture

In young earth creationism, scriptural interpretation is straightforward: Genesis should be taken as a simple, historical record without metaphor or symbolism. The length of each day is the same as the length of any other day found elsewhere in the Bible. Young earth creationists accept the story of Noah and believe the flood described in Genesis 6–9 was a worldwide event. Moreover, they believe there were no animal deaths before the fall of Adam and Eve in Genesis 3, contrary to the evolutionary view that carnivores have existed for eons. This last point may seem minor, but young earth creationists claim that it is central to the fall and redemption doctrines of Christianity. Allowing for a reinterpretation of Genesis with an old earth and animal deaths prior to the fall, they argue, undermines this framework of sin and salvation.

A less than literal interpretation is seen as a slippery slope toward a loss of biblical authority and capitulation to a naturalistic worldview.

Flood Geology

Modern young earth creationism is not merely a set of religious doctrines about the Old Testament. Most creationists believe that their views will be vindicated by science, or at least would be if science could be freed from its philosophical commitment to naturalism. In order to counter scientific claims that the earth is over 4 billion years old, most young earth creationists advocate a biblical flood geology. Instead of the millions of years required to create fossil fuels such as coal, flood geologists claim that they were formed within a year under the tremendous pressure of the floodwaters described in the story of Noah. As for the consistency of fossils found at certain layers of the strata, rather than a given kind of fossil being found at all levels, flood geologists have three main answers: (1) if a creature lived on the ocean floor, it tended to be covered first; (2) denser creatures tended to sink and be buried faster than lighter creatures; and (3) larger, mobile creatures could escape the rising flood waters and were buried last.

Surprisingly, Whitcomb and Morris originally considered neither the historical sciences (geology, paleontology, and biological evolution) nor biblical flood geology as truly scientific. Since each of these deal with the prehistoric past and are therefore not open to direct observation or repeatable experiments, they believed that such investigations were “by definition” not science. (Although as competing models, predictions could be derived from both that would in turn be tested scientifically.) One’s choice of model, they claimed, was determined not by empirical data but by worldview.

For many young earth creationists today, the debate is a dilemma: either one is a Christian upholding the truth of the scriptures, or one has fallen under the sway of atheistic naturalism. Many believe that since this choice cannot be decided on purely scientific grounds, unless one begins with the only reliable source of information for the origin of the universe—God’s special revelation—it is impossible to get the right answers. Since the Old and New Testaments are considered inerrant and teach that the earth is less than 20,000 years old, any evidence that science might present to the contrary must be wrong.

The Appearance of Age

If the earth was created no more than 10,000–20,000 years ago, as young earth creationists believe, then what about the starlight from distant galaxies? Such light would have taken millions of years to reach earth, yet early civilizations saw the same constellations we do. How could distant stars be seen if the universe is less than 20,000 years old? To answer this objection and a number of others like it, all young earth creationists to some degree employ the notion

that a recent creation must have “the appearance of age.” For example, Adam and Eve were created as fully grown adults. And since they needed food, many plants were likewise created whole. Thus, a recent creation requires that some things appear to have age at the instant they were brought into being. This provides a way to explain starlight: both the stars and the light en route from those stars were part of the initial creation. Scientists wrongly infer that the light has been traveling for millions of years because they begin from naturalistic presuppositions rather than the truth of revelation.

Appealing to the appearance of age becomes the final line of defense against any seemingly incontrovertible evidence for an old earth. If data cannot be accounted for in terms of flood geology or changes in the laws of nature, creationists claim that things merely look extremely old from a naturalistic point of view. Stars, radioactive isotopes, continental plates, and coral reefs merely have the appearance of age; they were initially created much the way they are.

Critics object that this makes God a deceiver: he has created a universe that falsely implies an ancient origin. Young earth creationists reply that there can be no deception if God explicitly tells us that the earth is young, which he has done in Genesis.

Creation Science

The most familiar form of young earth creationism is known as creation science or scientific creationism. In the early 1970s, young earth creationists wanted to promote flood geology in the public school system, which was teaching standard earth science. The earlier view that the credibility of flood geology rested on a prior commitment to a literal six-day interpretation was abandoned. A new literature was produced in order to reach the same conclusions without direct references to the Bible.

Creation research institutes started to form at this time, including the Institute for Creation Research near San Diego. These institutes generally focused more on the promotion of creation science than actual research. In the early 1980s, Arkansas and Louisiana passed laws that required creation science to be taught alongside evolution; however, the U.S. Supreme Court in 1987 declared such laws unconstitutional.

There is now a vast creationist literature with many permutations. Some young earth creationists believe, for example, that Big Bang cosmology is approximately true, but the earth and the Garden of Eden were miraculously created relatively recently. Others agree with mainstream science that flood geology is a failure but still hold to young earth creationism for theological reasons.

Progressive Creationism

Although today the word *creationism* connotes a literal reading of Genesis, this was not always the case. Progressive or “old earth” creationism holds that

while God made the universe and continues to act within it, the days of Genesis 1 are not consecutive twenty-four-hour periods. The six days of creation instead are thought to refer to an unspecified length of time. Most progressive creationists believe that God directly created life as well as human beings. But since no age of the universe can be inferred from the text, they accept the findings of modern cosmology and geology. Most hold that Noah's flood was a local phenomenon.

History

Although the term *progressive creation* was popularized in 1954 by philosopher and theologian Bernard Ramm, a nonliteral view of early Genesis can be found in ancient sources. Among these are the Jewish philosopher Philo of Alexandria (c. 20 BCE–50 CE) and the historian Flavius Josephus (c. 37–95), as well as Christian theologians Origen (c. 185–254) and Augustine of Hippo (354–430). By the early twentieth century, virtually all well-known Christian leaders believed in an old earth: leaders of the Fundamentals movement such as D.L. Moody, conservative theologians Charles Hodge and B.B. Warfield, and William Jennings Bryan, who famously criticized Darwinism in the Scopes “Monkey Trial.”

Progressive creationism remains strong among theologically conservative scientists and intellectuals, but it has declined somewhat in the broader Protestant culture in the wake of young earth creationism's reemergence in the 1960s. Progressive creationists and young earth creationists continue to reject the theory of Darwinian evolution, especially in the case of humans.

Scripture

Progressive creationists believe that the creation account is one of many passages in the Bible that should be taken figuratively. Angels are said to stand at the four corners of the earth (Revelation 7:1), but no one today thinks the earth is flat or square. There are also references to the sun rising (Judges 9:33; Matthew 5:45), and to the sun standing still only in exceptional circumstances (Joshua 10:13). Taken literally, the sun is pictured as the body in motion within a geocentric (earth-centered) universe. Once the Copernican revolution took hold, exegetes began to question whether the naive interpretation of scriptures was required or had simply been assumed all along. Theologians saw these as new interpretive questions that no one had previously thought to ask, not as a capitulation to science. Progressive creationists take a similar approach today when it comes to the creation account and geology. They argue that the traditional interpretation was dominant for so long only because there had been little reason to question the simple reading of Genesis 1. Now there are such reasons, and sound exegesis shows that the simple interpretation is not the only permissible one.

Table 43.1

Literary Framework View of Genesis 1

Day	Separated	Day	Created
1	light from darkness	4	sun, moon, and stars
2	waters from sky	5	fish and birds
3	land from seas	6	animals and man

How then should the creation passages be interpreted? There are several approaches. One is *gap theory*. One of the most popular views at the turn of the nineteenth century was that there is an unspecified gap of time between Genesis 1:1 and 1:2. In Genesis 1:1, God is said to have “created the heavens and the earth.” One English translation of Genesis 1:2 reads “it *became* without form and void,” implying some sort of catastrophe—possibly divine judgment associated with the fall of Satan. In this “ruin and reconstruction” view, what is described in Genesis 1:3–2:3 is actually a second creation. This view is no longer widely held. A more popular gap theory takes the days of creation as actual twenty-four-hour periods separated by an unspecified length of time. In this “intermittent day” view, God’s intervention on specific, nonconsecutive days in the course of cosmic history is summarized in Genesis.

The most widely held progressive creationism interpretation appears to be the *day-age theory*. In this view, each day in Genesis 1 refers to an indistinct period of time, in some cases billions of years. This interpretation relies on how the Hebrew word *yôm* (day) is used in the Genesis account and elsewhere in the Bible. Progressive creationists point to passages where *yôm* refers to periods other than twenty-four-hours: for example, “on that day the Lord will extend his hand” (Isaiah 11:11) and “in the day that the Lord God made the earth and the heavens” (Genesis 2:4). Taking the days as long ages resolves some of the tensions with modern science, but not all. In particular, the days in the Genesis account are out of sequence from a scientific point of view. Plants and trees appear on day three; the sun and moon were created on day four. Another interesting theory is C. John Collins’s *analogical days* interpretation.

One recent approach is known as the *literary framework*, which emphasizes that Genesis 1 is not a scientific or historical description of the timing and mechanisms of creation. The point of the Genesis text is that Yahweh, the God of the Israelites, rather than the Canaanite god Baal, is the creator of heaven and earth. The sun, moon, land, and seas were brought into being by Yahweh. He, not they, should be worshiped. To make this point, the author of the biblical account arranged the six days topically, not chronologically. The realms of creation are separated in days one through three. The rulers over those respective realms are created in days four through six.

Critics complain that the parallel is not as neat as it might appear. For example, fish inhabit the seas (day three), not merely the waters (day two).

Advocates of this view contend that even if this parallelism fails, the point remains that the purpose of early Genesis is not about strict history or science, but rather to prove Yahweh's sovereign creation and reign.

A theory that has received much recent attention is *intelligent design*, which cuts across young earth creationism and progressive creationism. Design theorists believe that traces of purpose and intelligence have been discovered in nature, but they are officially neutral with respect to the old earth/young earth controversy. They are also officially neutral with respect to the identity of the creator, and some design theorists are not even theists. Critics charge that intelligent design is merely the newest version of creation science intended for promotion in the public schools. Ironically, many young earth creationists reject design theory. They think that its "official neutrality" on critical issues lacks sufficient respect for the authority of scripture.

Theistic Evolution

Theistic evolutionists believe that the age of the universe debate has been dominated by a false dilemma: *either* supernatural interventions were needed to create the earth and its creatures, *or* purposeless, cosmic evolution produced everything purely by chance. When faced with this choice, conservative Christians naturally see one side as orthodox and the alternative as atheistic. Theistic evolutionists believe there is a middle ground and that their religious views are fully compatible with modern cosmology, geology, and biological evolution.

Many theistic evolutionists see young earth creationism and progressive creationism as the naive intrusion of religion into purely scientific matters. They contend that scripture is not directly applicable to questions of geology and cosmology. Scientific concepts should refer only to properties of nature, a view in the philosophy of science known as "methodological naturalism." In this approach, science must proceed as if naturalism were true. Since the acts of God are by definition supernatural, they cannot be used in scientific explanations. However, theistic evolutionists emphasize that "nonscientific" is not equivalent to "not true." Methodological naturalism as an approach to research is to be strongly distinguished from a naturalistic worldview, which theistic evolutionists reject. They claim that theological truths are beyond the reach of science. While theistic evolutionists often hold something like the literary framework view of Genesis, many consider the Genesis account an ancient myth with nothing more than aesthetic interest for modern readers.

The universe has evolved, according to theistic evolution, just as science has taught us. The Big Bang, the gradual formation of stars and planets, the self-organization of complex life, and natural selection were God's chosen means for bringing about the present universe. God foresaw the outcome and set the initial conditions in place that were required for this world.

Differences among theistic evolutionists tend to hinge on the nature of

God's ongoing guidance of the universe. Most hold some form of noninterventionism, the view that God's main (and perhaps only) action after the initial creation is a continuous sustaining of the physical universe, rather than episodic interruptions. In other words, God upholds the natural order and the lawlike regularities studied by science but does not violate the laws of nature. Since God was able to foresee the outcome, there was never a need for direct intervention or special creation within the natural order. Everything required for the present cosmos to evolve with all of its complexity was frontloaded at the initial creation. This is contrary to both young earth creationism and progressive creationism, which hold that natural processes and ordinary providence are not adequate to explain many complex systems in the world. All the critics of theistic evolution, including naturalists, object that in this view God is a superfluous addition to natural laws. If everything is explainable using the laws of nature, why should one believe in the supernatural?

Other theistic evolutionists believe that God continues to directly act within nature, but only in ways that do not violate the laws of physics. For example, quantum mechanics seems to indicate that nature is fundamentally probabilistic rather than deterministic. That means that some events at the subatomic level are purely matters of chance; the laws of physics do not determine their outcome. If so, then different outcomes are physically possible. Such causal gaps allow God to influence the behavior of the material world without violating its laws. Some theistic evolutionists believe that God influences the behavior of natural systems through such means—a view that comes very close to progressive creationism. The difference has to do with our ability to detect such action. Progressive creationists believe that, at least in principle, the acts of God are empirically detectable and can be found in traces of design, purpose, and intelligence. Theistic evolutionists generally reject this: specific acts of God within the causal gaps of nature cannot be detected.

A Variety of Beliefs

Great variety exists among theists on questions of creation and divine action. Contrary to the popular image, the debate is not primarily Science versus Religion, although it comes close in the case of young earth creationism. Even there, the key question has to do with trustworthiness of sources—inerant scripture or current scientific theory—rather than an inherent conflict.

Young earth creationists believe they will eventually be vindicated by science. Progressive creationists respect young earth creationists for their faithful devotion to scripture, but they disagree about the interpretive rules one should bring to the creation texts. Theistic evolutionists agree with progressive creationists on this, but then go on to reject divine intervention in nature after the Big Bang. Young earth creationism continues to be popular among conservative Christians but has made little or no headway in the broader culture. Progressive creationism, at least in the form of intelligent design theory,

has a tenuous toehold in academia but has yet to produce the scientific results needed to keep it there. Theistic evolution has the most respect among intellectuals, but it has the weakest theological content of the three. How will the debate shape up in the next fifty years? As the surprising reemergence of young earth creationism shows, it is truly anyone's guess.

Bibliography

- Collins, C. John. *Science and Faith: Friends or Foes?* Wheaton, IL: Crossway, 2003.
- Moreland, J.P., and John Mark Reynolds, eds. *Three Views on Creation and Evolution*. Grand Rapids, MI: Zondervan, 1999.
- Morris, Henry M. *Scientific Creationism*. El Cajon, CA: Master, 1974.
- Morris, Henry M., and Gary Parker. *What Is Creation Science?* San Diego: Creation-Life, 1982.
- Numbers, Ronald L. *The Creationists: The Evolution of Scientific Creationism*. Berkeley: University of California Press, 1992.
- Pennock, Robert T. *Tower of Babel: The Evidence against the New Creationism*. Cambridge, MA: MIT Press, 1999.
- Presbyterian Church in America. "Report of the Creation Study Committee." June 21, 2000. <http://www.pcanet.org/history/creation/report.html>.
- Ratzsch, Del. *The Battle of Beginnings: Why Neither Side Is Winning the Creation-Evolution Debate*. Downers Grove, IL: InterVarsity Press, 1996.
- Van Till, Howard. *The Fourth Day*. Grand Rapids, MI: Eerdmans, 1986.
- Whitcomb, John, Jr., and Henry M. Morris. *The Genesis Flood*. Philadelphia: Presbyterian and Reformed, 1961.

44 Science and the Bible: Two Views of One Reality

Gerald Schroeder

The flow of data from the space-based Hubble telescope and its Earth-bound counterparts raises a barrage of questions. Skeptics and believers alike want to know if the biblical description of our cosmic origins can jibe with the scientific account of the Big Bang. How can 15 billion years of cosmology be squeezed into the six days of Genesis 1? And if the biblical calendar reports God created humans less than 6,000 years ago, how can Cro-Magnon *Homo sapiens* fossils be 50,000 years old?

As a scientist, I hear these and similar questions. In the following sections are the questions I am asked most frequently, and the replies I am able to provide while standing on one foot. For the two-footed answers, see my books *Genesis and the Big Bang*, *The Science of God*, and *The Hidden Face of God*.

Creation? We Call It the Big Bang

In the early 1600s, James Ussher, archbishop of Armagh, Ireland, calculated that the creation of the world took place in the year 4004 BCE. On October 23. At high noon. Such precision sounds silly. But why should a cleric know about cosmology? Not surprisingly, a contemporary of Ussher, the astronomer Johannes Kepler, sought to correct him. Kepler is the scientist who discovered that planets move about the sun in elliptical orbits and not circles, as had been previously assumed. He knew more than just a bit about the world around us. Kepler calculated that the creation was not in October of 4004 BCE but in the spring of that year! Like Ussher, Kepler based his computations on biblical accounts.

Today their use of the Bible as a tool for cosmological inquiry seems mightily misplaced. So let me put their “error” into perspective. In 1959, a survey was taken among leading scientists in the United States. Among the questions was one querying their estimate of the age of the universe. Of those that re-

plied, two-thirds responded: Age? There is no age. The universe is eternal. Plato and Aristotle taught us that.

Then came 1965, and Arno Penzias and Robert Wilson's discovery of the blackbody cosmic background radiation that fills all space. Penzias and Wilson had discovered the echo of our creation, the remnant of the radiation created in the Big Bang. With that discovery, the most fundamental of paradigms was forced to change. There was a beginning to our wonderful universe. Questions may arise as to the details of that beginning and whether there are other universes, but the overwhelming evidence is that some 14–15 billion years ago, the time-space matter and laws of nature that make up our universe came into being from what appears to be absolute nothingness. Human logic had sided with the Greek view of the universe, but it was in error. The claim of Genesis 1:1 had been proven correct. For all the chortling about the exaggerated exactness of Ussher and Kepler, they had been closer to the truth than the majority of scientists in that 1959 survey.

Make no mistake about it. Science has taken the largest step it can ever take in closing ranks with the Bible. It has confirmed the first part of the first sentence of the Torah. There was a beginning. Skeptics can take heart however. According to the laws of nature as we understand them, primarily quantum mechanics, there is a possibility that creation was spontaneous, without a creator. So the second half of Genesis 1:1, that God did the creating, is still open to question.

Was a Day a Day at the Beginning?

In Genesis 1, day by day, the key events in the six days of creation are ticked off. But wait. The sun does not appear until day four. So how can there have been days before then? The ancient commentators who deal with the meaning of “day” during the creation week of Genesis tell us it refers to a duration of twenty-four hours, regardless of whether or not there was a sun. Sources for this view include the 1,500-year-old Talmud, the twelfth-century biblical commentator Rashi, and the Kabbalah of Nahmanides (1250). But although those six days were each twenty-four-hours long, the commentators also tell us that those six days contained all the ages and all the secrets of the universe.

Days containing ages? Sounds strange. Nevertheless that is what we twice read in Genesis. The exact wording varies from one version of the Bible to the next, but the text in the Hebrew Bible is: “These are the generations of the heavens and the earth when they were created in the day that the Eternal God made heaven and earth” (Genesis 2:4). And “This is the book of the generations of Adam in the day that God created Adam” (Genesis 5:1). Generations within a day? It took an Einstein to discover how that could happen. The laws of relativity taught the world that the passage of time and the perception of time's flow vary from place to place in our most amazing universe. A minute on the moon passes more rapidly than a minute on Earth. A minute on the sun

passes more slowly. The duration between the ticks of a clock or the beats of a heart, or the length of time it takes to ripen oranges, stretches and shrinks. Wherever you are, time seems normal because your body is in tune with your local environment. Only when looking across boundaries to very different locations can we observe the relativity of time. The phenomenon has been confirmed a myriad of times in laboratories around the world.

We look back in time, studying the history of the universe, and from our vantage we find billions of years have passed. But to understand the opening chapter of Genesis, we must identify its perspective of time. In the Hebrew Bible, we read: “and there was evening and there was morning day one” (Genesis 1:5). Ancient commentators asked why this was recorded as “day one” and not the “first day.” After all, the remaining days are “second,” “third,” and so on. The commentators’ answer is that “one” is absolute; “first” is comparative. The Bible uses day one, the Kabbalah states, to teach that the Bible views time from near the beginning looking forward, and not backward, as we do, into history. It was a moment when no other time existed. By the second day, there was already the previous day with which to compare it, and hence the statement “and there was evening and there was morning a second day” (Genesis 1:8), second relative to the first day.

Only when the first stable matter formed from the energy of the Big Bang did “time grab hold.” That moment in modern terms would be called the era of quark confinement. Viewing the events of our unfolding universe from that beginning holds the answer to how our generations fit into those days. The universe we live in is not static. It is expanding. The space of the universe is actually stretching. If we took a trip back to that early moment from which Genesis views time, we would be in our universe when it was vastly smaller—a million million times smaller—than it is today. This huge compression of space would equally compress the perception of time for any series of events. As the string of information that described those events traveled back in time, the space through which it was passing was shrinking, squeezing the data ever closer together. In the jargon of cosmology, the data would be blue shifted: blue because of shorter wavelength of blue light relative to the longer wavelength of red light.

To calculate the effect of that million million compression, we must divide the 15 billion years we observe looking back in time by the million million. The result: it is possible a mere six days passed as viewed from the beginning. Genesis and the science of cosmology tell the same account, but it is seen from two vastly different perspectives.

Evolution in the Bible?

The Bible is well aware of evolution, or development. But the Bible is not very interested in the details of the process. It describes all of animal evolution in a mere seven sentences (Genesis 1:20–26). Genesis tells us simple

aquatic animals were followed by land animals, mammals, and finally humans. That is also what the fossil record tells us, but of course with much more detail than these few biblical verses provide. The Bible makes no claims as to what drove the development of life. It leaves that for science to discover.

Genesis does record in detail a case of micro-evolution, when during the ten generations following the flood at the time of Noah, the span of a life gradually fell tenfold, to what it is today. The medieval philosophers Maimonides and Nahmanides suggested that changes in the environment resulted in shorter longevity.

The Bible has no problem with the idea that life developed from simple forms to the more complex. Is this consistent with neo-Darwinian theory, which combines Darwin's ideas with others on gradual evolution through random genetic mutations in response to environmental conditions? In the late 1970s, Harvard professor Elso Barghoorn discovered fossils that indicated life in the form of simple cells appeared on Earth almost 4 billion years ago, soon after the molten globe had cooled sufficiently for liquid water to form. The fossil record also tells us that some 550 million years ago, in what is known as the Cambrian explosion, the basic forms of the animal life that we know today seemed to burst upon the scene, but the fossil record does not tell us much about life forms in the preceding period. Why some life forms seem to have made a sudden appearance remains a mystery. It is no wonder that Darwin, in his *Origin of Species*, repeatedly implores the reader to ignore the fossil record if we wish to understand his theory. He urges, "Use your imagination."

The gap in the fossil record argues for a teleology helping evolution along. But there is also evidence that random mutations coupled with natural selection are behind the process. Either way, something exotic is at work.

Which of Adam's Ribs Did Eve Come From?

The Talmud has a variety of answers for the question of which rib Adam spared for Eve, but there is no clear conclusion. Here are two Talmudic replies. The Hebrew word *tslah* usually translated as "rib" for the making of Eve (Genesis 2:21–22) appears repeatedly throughout the Torah with the meaning "side." Based on this, the Talmud suggests that Adam and Eve were both fully formed beings who were joined at the side, and God separated them. This is in line with Genesis 1:27 and 5:2, where we are informed that God "created them male and female and blessed them and called their name [*their* name, not *his* name!] Adam in the day they were formed." Only later did they have separate names, when the male Adam named his spouse Eve.

The other Talmudic suggestion is that the entire building of Eve (Genesis 2:22) is God taking a fully formed Eve aside, braiding her hair, and then presenting her to Adam. The Talmud bases this opinion on the use of the word "build" in villages by the sea to mean the waves braiding one upon the other as they reach the shore.

If Adam and Eve Are the First Humans, What about Hominids?

Genesis 1:26 tells us about God *making* Adam, but Genesis 1:27 tells us about Adam's *creation*. One relates to forming Adam's body. The other relates to the creation of the human soul—in Hebrew, the *neshama*. The 1,500-year-old Talmud is replete with descriptions of beings we would call hominids. They have the same shape and intelligence as humans, but they are not human. They lack the *neshama*. The Talmud was redacted a millennium and a half before paleontology raised the scientific question of prehuman hominids. The Talmud's information about hominids is derived from nuances in the text of Genesis and not from some exhibit in a local museum. The later scientific discoveries seem consistent with Genesis.

Museums make the break between prehistory and history at about 6,000 years ago, with the invention of writing. The expansion of clan-sized settlements into cities necessitated commerce and administration, which in turn required recordkeeping, hence writing. Was it the creation of the *neshama* that enabled clans to reach out and join together into cities? That is a question unanswerable by science.

Why Do Bad Things Happen?

The God of the Bible is described as merciful and long suffering, filled with righteousness and truth (Exodus 34:6). At the end of the six days of creation, God saw all that was done, and “behold it was very good” (Genesis 1:31). Not just good, but *very* good. So why is there bad in the world? Science can explain some of the processes of disease and natural disasters. But if the world was created by a God who is merciful and good, why do young children get MS and earthquakes shake down buildings to crush the innocent? The same God that streaks the sky with red at sunrise and produces the beauty of a flower must also take responsibility for these horrors.

We may see it as unfortunate, but bad things happening to good people is consistent with the biblical description of God's role in the world. By the fourth chapter of the Bible, Cain has murdered his brother Abel. And Abel was the good guy! God had accepted his special offering while rejecting Cain's run-of-the-mill sacrifice. God had the power to prevent the murder but chose not to. So by chapter four, we learn the bitter truth of reality. Good guys sometimes get killed. Isaiah hints at why.

“I am the Eternal, there is no other. I form light and create darkness. I make peace and create evil” (Isaiah 45:6–7). The infinite source of light creates darkness. How? By withdrawing some of the light. The infinite source of peace creates evil by shielding a portion of the peace. The biblical definition of creation is the partial withdrawal of God's presence. God pulls back, and in doing so creates the universe with its laws of nature. For the most part, nature takes its natural course. A natural-looking world is an essential part of the

biblical game plan: choice. “I call to you witness today the heavens and the earth, I have placed life and death before you, the blessing and the curse, therefore choose life that you may live, you and your progeny” (Deuteronomy 30:19). If humans are to have free will, the world must look natural. A natural world has radiation producing crippling mutations and earthquakes crushing the innocent. And enough free will for humans to kill their fellows. The Bible tells us so as well as the daily newspapers. The Bible tells us about a world that is real. The beautiful bushes of roses also have thorns.

Why Doesn't the Bible Mention Dinosaurs?

In a way, the Bible mentions dinosaurs, or at least large reptiles, which is what dinosaurs were. In Genesis 1:21, we learn that God created the big *taninim*. This is the only animal in the creation account with a size attributed to it. *Taninim* is occasionally translated as whale, crocodile, lizard, or even dragon. But *taninim* must be a general category of animal, since the only specific animal mentioned in Genesis 1 is Adam. The confusion over the meaning of *taninim* is surprising since *taniin*, the singular of *taninim*, is a word known in the Torah. In Exodus 3, God spoke to Moses from the burning bush, telling him to return to Egypt to lead the Hebrews to freedom. Moses asked God for a sign, and his shepherd's staff turned into a snake, a *nahash* in Hebrew (Exodus 4:3). When Moses used the sign in front of Pharaoh, the staff became a *taniin* (Exodus 7:10), which a few verses later is referred to as a *nahash* (Exodus 7:15). *Taniin* is a general category within which *nahash*, snake, falls. The general category for snakes is reptile. Genesis 1:21 reads “and God created the big reptiles.” Dinosaurs were certainly big reptiles. But they had disappeared 65 million years before the Bible existed. Whoever wrote the Bible had some exotic source of information. Could it be God?

Was There a Global Flood?

There are no archaeological indications of a worldwide deluge approximately 4,100 years ago, the time of the flood of Noah. Also, archaeological lines of civilizations do not show a break at this time. There is one subtlety in the biblical text, however, that indicates the flood may have been local and not global. Just prior to the flood, God announces that all life will be destroyed from the face of the *adamah* (Genesis 6:7). *Adamah* can mean soil or the entire earth. For the entire flood account, though, the reference is to the face of the *aretz*, not *adamah*. *Aretz* can also mean the entire globe, but it often refers to the local civilized world. The switch in the text from *adamah* to *aretz* may indicate a change of “venue.” It comes directly after God announces that “Noah found favor in the eyes of the Eternal” (Genesis 6:8). Things were bad, but not hopeless. Some good was still around.

Who Started This Whole Controversy Between Bible and Science?

If I had to choose a single source for the science versus religion travesty, I would be forced to lay the blame on the religious community. Some theologians with limited scientific knowledge have been willing to trash every scientific discovery related to the cosmos or the development of life that seems to encroach on their sacred turf. When Copernicus in the 1500s had the audacity to suggest that the planet Earth moved around the sun, this was unacceptable to the religious establishment, even though the opening sentence of the Bible places the heavens before the earth. Copernicus was a believing Catholic, and the discovery didn't shake his faith. The Bible makes no claims for the positioning of Earth. A hundred years later, Kepler shook the religious world by claiming that Earth moved in an ellipse. This humiliated the clergy. Would not a perfect God produce a perfectly circular orbit? But the Bible never made any claim about circles.

The next century brought Newton and the laws of inertial motion. It must have come as a bolt out of the blue for him to find he was accused of bringing in "occult qualities" that were "subversive to revealed religion." With inertial motion, the planets could keep moving by themselves, without God's constant push. One would have to search far and wide today to find a cleric who is against the laws of motion. But with each stage, the popular impression was that science had proven the Bible wrong, although the Bible had made no claims in any of these fields.

The topics of the controversy have changed but the claims remain. In a world so oriented toward science, it would bode well if the clergy had an inkling of what the claims of science really are. As Maimonides wrote 800 years ago in the introduction to *Guide for the Perplexed*, "The only path to knowing God is through the study of science and for that reason the Bible starts with a description of the creation."

Bibliography

- Darwin, Charles. *On the Origin of Species*. Cambridge, MA: Harvard University Press, 1859; facsimile reprint, 1964.
- Maimonides, Moses. *Guide for the Perplexed*. New York: Dover, 1956.
- Schroeder, Gerald. *Genesis and the Big Bang*. New York: Bantam, 1990.
- . *The Hidden Face of God*. New York: Touchstone, 2001.
- . *The Science of God*. New York: Broadway, 1997.

45 Is Cosmology Religiously Significant?

Willem B. Drees

The universe is not a static background, a container of space and time within which interesting processes such as star formation take place. We now study the structure of the universe itself, and we have discovered that the universe is a changing reality. Any change invites questions regarding the general characteristics of the process, the driving factors, and how it began.

Cosmology is the scientific discipline that deals with the universe. It draws on the repertoire of physics, developing hypotheses regarding the conditions in the early universe, tested against a variety of precise observational data. The present state of the universe is the result of a long historical and causal process. All seems to be in flux. Yet we have the illusion of eternal, unchanging heavens against an earthly realm of change. The notion “cosmos” suggests something well ordered and beautiful. Does cosmology have significance for our moral appreciation of the universe? Can we connect the scientific understanding of the universe to the philosophical, often evaluatory themes associated with the cosmos, and perhaps even to the role of myths and religion?

A Beginning

The theory of the universe and its origins that developed during the twentieth century proposed a limiting point zero, a beginning referred to as the Big Bang. In the 1960s, Stephen Hawking and Roger Penrose proved that such zero points, or singularities—where matter is condensed to a point of infinite density—was a feature that followed from the underlying theory of general relativity and some very general assumptions regarding matter and energy. Cosmology had to address conditions such as this zero of time and its infinite density.

The Big Bang model is an extremely fruitful framework for research, well supported by evidence on distribution of matter, velocity-distance relationships, cosmic background radiation, and other areas of scientific investigation. It is highly adequate for explaining processes well within the first second

of the universe's beginning. But the model has some arbitrary or contingent elements that have not been explained. The arbitrariness of some elements was resolved in the early 1980s in inflationary models, which suggested that around 10–35 seconds after zero, the universe underwent an extreme exponential expansion. But inflationary models, like Big Bang models, require specific initial conditions, so contingency is relocated rather than removed. Besides, the contingency resides not only in special initial conditions but also in various “constants of nature,” which define the basic masses and coupling strengths of various particles and fields.

The Big Bang model suggests an initial moment, $t = 0$ (t stands for time). How can one understand such a beginning? Basically, we have two alternatives: to treat it as a beginning of the universe *in* time, or as the beginning *of* time. The first alternative is more like any beginning—of my life, of a work of art, of a city, or whatever. Time is considered an ongoing background. Somewhere on the timeline, my life begins, a piece of art is created, a city is founded. In some cases, such as the beginning of a city, it may be hard to define a precise moment, but the basic idea remains that beginnings can be located on a continuum. And hence, one may ask what went on before: before I was there, my parents met, and longer before, my grandparents; or the artist had a certain idea, and so on. If one thinks of the universe as beginning *in* time, the suggestion of a before arises. What went on before? One further disadvantage of such an approach is that time is treated as a given background, which goes against the theory of general relativity. Models that assume a beginning in time also make it hard to imagine why the universe started at that particular moment in time, rather than any earlier time. With the infinity of earlier times, why did it not start an infinitely long time before?

A similar problem was raised by the early Christian theologian Augustine in his *Confessions*. What was God doing all those ages before God created the world? Augustine concludes that time is bound up with the created order. When there was no creation, there was no before, and hence no reason to ask what God was doing before he created the world. Time came into being *with* the created order. Whether this is a solution or a cop-out is not clear, but it gives us one way to understand the issue of $t = 0$. It avoids the idea that time is a container, from past infinity to future infinity. Perhaps we have to think of the beginning of the universe as the beginning *of* time.

The Big Bang theory does not deal with the Big Bang itself. At the moment of the Big Bang, the conditions were so extreme that we cannot use current physics. The basic theories—quantum physics and general relativity—need to be integrated in ways not yet known. Hence, the Big Bang theory helps us understand the evolution of the universe, but the moment of the Big Bang is hidden in mist—and whether there has been such an absolute beginning cannot be decided on the basis of the Big Bang theory. New observations and studies will result in modifications of the theories that deal with the very early universe. However, when it comes to the origins of the universe, we are quite

far removed from ordinary science that can be tested in a laboratory. Thus, on the speculative end of cosmology, there will be competing proposals for a complete and unified explanation.

One proposal comes from Peter Atkins, an eloquent defender of the view that science leaves nothing to be explained. He puts great weight on the idea of reduction to simplicity: beings such as elephants and humans arise through an evolutionary process, given sufficient time and atoms. Atoms arise from even more simple constituents. Perhaps the ultimate unit still to be explained is, as Atkins suggests, space-time or knots of space-time points. The second major component in his argument is chance: through fluctuations, nothingness separates into +1 and -1. With such dualities, time and space come into existence. The +1 and -1 may merge again into nothingness. However, by chance, a stable configuration may come into existence—such as our space-time, with its three spatial dimensions and one temporal dimension. But James B. Hartle and Stephen Hawking wrote in an article on no-boundary cosmology that the wave function made it probable for the universe to appear from nothing.

Such theories are judged in several ways. Aesthetic judgments, for example, may lead us to favor one theory over another. However, what one person considers elegant, another may reject. And could a single and relatively simple complete theory be fair to the complexity of the world? Or is there a trade-off between the simplicity and unity of the theory, and the many possibilities described by the theory? It seems that any simple unified theory will leave something to chance (contingency).

We should also consider that a vacuum is not nothing. The universe might be equivalent to a vacuum as far as conserved quantities go. Those conservation laws that are believed to be valid for the universe as a whole conserve a total quantity, which may be zero. Take, for example, electric charge. Negative charges of electrons are matched by positive charges of protons. Atoms are electrically neutral. And so is, it seems, the observable universe. With respect to mass and energy, the negative energy due to gravitational binding might equal the positive energy. Hence, the universe might well be equivalent to a vacuum as far as energy is concerned.

Such an equivalence of the universe to “nothing” is like someone borrowing a million dollars and buying stock for that amount. That person would be as wealthy, fiscally speaking, as someone with no debts and no assets. However, the first person would be of more significance on the financial market than the second. The first strategy also assumes more than the second: the financial system is taken for granted. As far as the laws of conservation are concerned, the universe might come from a vacuum, but such a vacuum is not nothing. It would be a vacuum that behaves according to the (quantum) laws that allow for fluctuations to happen—just as the apparent millionaire can only get started once there is the concept of money and borrowing.

When we explain particular facts, we assume a framework of relevant laws. A framework can be explained in a wider framework—as Ohm’s law on elec-

trical currents can be explained in the context of a more general theory of electromagnetism in combination with some solid state physics. There are sequences of explanations. The chemist refers to the astrophysicist for the explanation of the elements, and to the quantum physicist for the explanation of bonds between atoms. Somehow, these sequences converge. Questions about the structure of reality are passed along until they end on the desk of fundamental physicists (who deal with quantum theory, superstrings, etc.), and questions about the history of reality end on the desk of the cosmologist. Sometimes the physicist and the cosmologist may well say “Only God knows.” That physicists and cosmologists are at the convergence point in the quest for explanations may explain to some extent why they seem to get drawn into philosophical and theological disputes more easily than geologists, biologists, or chemists. In cosmology and physics, we face *limit questions* to the scientific enterprise.

We might say it is naturalistic that all phenomena can be explained in a framework that would be incomplete only with respect to limit questions about the basic structure and the whole. Lightning, superconductors, planets, bacteria, and humans with their emotions and moral judgments—all events, processes, and entities are manifestations of reality. This does not degrade humans to the level of mere matter, but rather upgrades our view of matter, since it is capable of all these forms. Such a naturalistic view of reality fits contemporary science but is at odds with the quest for divine action in natural processes, including complex, chaotic, and quantum processes. However, a naturalistic view does not exclude all religious significance. There still may be speculative theological answers to questions about the framework, laws, and initial conditions of the universe. But religious explanations of the universe, its existence, and its laws may need assumptions about disembodied persons or values that are as problematic as unexplained contingencies. Not being able to accept the finality of a scientific or a religious explanation, one might be guided by the physicist Charles Misner: “To say that God created the Universe does not explain either God or the Universe, but it keeps our consciousness alive to mysteries of awesome majesty that we might otherwise ignore.”

A Cosmos Just Right for Humans

Traditionally, views of the universe have been closely related to our own existence. Geocentrism, for example, was basic to Aristotelian and Ptolemaic cosmology. Assuming the Earth to be the center of the universe, however, need not be understood as self-elevation, since the earthly realm was imagined as the farthest removed from God and heaven, and closest to hell. A major step in the rise of modern cosmology was the widespread adoption of Copernican assumptions. Not only has Earth been removed from the center of the system of sun, moon, and planets, but the solar system is seen as one among many such systems, and our galaxy one of many. The earliest relativ-

istic cosmological models explicitly assumed homogeneity and isotropy. Such strong assumptions have been relaxed somewhat, but the general tenor continues to be a denial of any privileged position of human observers.

But a different perspective on modern cosmology comes from proponents of the anthropic principle. Rather than seeing human significance in terms of a prominent position in space, attention has shifted to the properties of our particular universe relative to a wider class of possible universes. Our universe has various features that seem contingent—they could have been different. The simplest version of the anthropic principle is that the universe is the way it is in order to allow life as we know it. It has been fine-tuned for human life.

But the anthropic principle does not function properly in scientific explanations. Either the contribution is trivial, as is the case for the weak anthropic principle, or the contribution is metaphysical, as is the case for the strong anthropic principle. Nor does anthropic reasoning provide arguments from science in favor of certain metaphysical positions, for instance the existence of God. Rather, the anthropic principle presupposes certain metaphysical positions which, once accepted, imply certain views of the universe.

Let us distinguish a few forms. The weak anthropic principle states that what we see must be compatible with our existence. We see a universe with planets, as we depend on planets. We see a universe that has existed for some billions of years, as it took billions of years to develop beings capable of thinking about the age of the universe. It has the nature of a selection rule: our observations are biased in favor of situations where we exist. The strong anthropic principle suggests that life must come into existence in any universe. This is not a statement about what we actually observe but about the class of possible universes. Some have related this idea to design, and hence to a creator who prefers to create a universe with life, or perhaps even sentient and conscious life.

The universe is enormous compared to human dimensions, even when compared with the human enterprise that reaches farthest: space travel. And the age of the universe is more than a million times the typical age of a human civilization. However, other things being equal, the age and size of the universe might be related to our existence. We need certain types of atoms, like carbon and oxygen. These atoms are produced by nuclear processes in stars and distributed by supernova explosions. Our kind of life became possible only after the interstellar gas had been enriched sufficiently with heavier elements produced and distributed by these processes. Biological evolution took another couple of billion years to produce complex, intelligent, observing, and amiable beings—us.

Turning this description upside down, it is argued that intelligent observation by natural beings is only possible after a couple of billion years, say 10 billion years. Thus, biological beings can only observe a universe that is at least 10 billion years old. Along this line, the weak anthropic principle “explains” the observed age of the universe.

Similar reasoning is used for the density of the universe. A universe with a much larger density would have collapsed at an early stage, while a universe with less matter would have been too diluted to allow the formation of stars. A weak anthropic principle “explanation” turns this around. We can only exist in a universe that does not collapse too early and that also allows the formation of stars. Thus, our existence implies—and hence “explains”—that we observe a nearly flat universe, or at least a nearly flat region of the universe. Here is a more simplified example:

- (1) Assume that we know that life depends on liquid water.
- (2) We observe the existence of life—for instance, ourselves.
- (3) The weak anthropic principle then predicts that our environment, our planet, will have a surface temperature between zero and one hundred degrees centigrade (too warm for the water to freeze, and too cool for the water to turn into a gas). Thus, the existence of life explains the temperature on our planet.

This is no explanation. It is the common use of evidence: we observe A (life, item 2 above), we know that A and B go together (item 1, life needs liquid water), and hence B (item 3, there must be liquid water). This does not explain why A and B are there, why there are living beings and planets with the right temperatures. Nor does it explain why A and B go together. The anthropic reasoning repeats the first assumption: the two go together. There is nothing wrong about the argument, but there is no reason to call the weak anthropic principle a “principle.”

The weak anthropic principle is in itself *true but devoid of relevance*. The explanation of an event is in general something different from the explanation one offers when asked “How do you know?” From the existence of a book you, as a reader, can infer the existence of its author. You can show the book when challenged by someone to explain how you know about that person. However, the book does not explain the existence of the author. It only provides the grounds for your belief in the author’s existence. Retrograde reasoning justifies beliefs, but it does not explain why the situation was that way.

The weak anthropic principle might explain something if it is combined with the assumption that there are *many worlds*, that is, regions that are different with respect to the relevant property. The realization of a property with a non-zero probability becomes very probable if there are many occasions, and it becomes certain if there are an infinite number of occasions. If one has an extremely large number of monkeys typing for some time, there might be one typing flawlessly a play of Shakespeare—as well as many more typing the play almost flawlessly. However, this does not explain the typing monkeys (the many worlds), nor the possibility and probability of the event. A weak anthropic argument with many worlds does not explain why we have precisely this universe and not one that is slightly less isotropic. It would be more probable to pick one of the many plays that are complete except for one period.

The metaphysical issue with religious significance here is not so much whether the principle of selective observation is valid and useful, but rather, the relation between *the actual and the possible*. If one assumes that all possibilities of a theory are realized (plenitude), one has a job for a weak anthropic selection rule to explain certain features of our observations as typical for regions in which observers can exist. But the real philosophical issue is in the assumption of plenitude, that is, in the understanding of possibilities.

The strong anthropic principle states that any possible universe must have the properties for life—or intelligent and observing life. This is a statement not only about the observable universe but about the class of all possible universes. This leads to an explanation of properties of the universe in terms of purpose: a property that is necessary for life is necessary for the universe.

If such a teleological approach is applied on a small scale, say as “planets must have the properties that allow for the development of life in some stage of their history,” a strong anthropic principle is surely false. But the example shows the nature of the strong anthropic principle. It is like the old teleological arguments: everything must have a function, and therefore the moon must be populated, as the ancient philosopher Plutarchus argued. Although we are no longer able to maintain that the moon is populated, it is still possible to maintain that the moon has a function for life—for instance in the development of life on Earth through tidal effects. A teleological view of the universe is not something that follows from science. It is a metaphysical view, which fits well with belief in a creator who likes living beings and therefore created one or more universes—an idea that might be called the theistic anthropic principle.

Strong anthropic arguments have some disadvantages. Properties of other possible universes are untestable, as we do not have access to those other universes. Thus, strong anthropic reasoning must be justified by the coherence of the view supported. Also, anthropic arguments might offer predictions about possible universes but assume “life” to be “life as we know it.” However, life is in its richness only partly understood. This is even more the case for consciousness. To explain properties of the universe by reference to life or consciousness is like the lame and the blind guiding each other. Besides, other forms of life might develop in zillions of years in completely different stages of the universe, or other forms of life might be possible in other possible universes. Last but not least, strong anthropic principle explanations are vulnerable to the future development of scientific theories. Subsequent theories have, in general, fewer and fewer unexplained parameters (constants, boundary conditions).

Plenitude (many worlds) and a (teleological) strong anthropic principle are metaphysical principles. The supposed necessity of life has not been established as a fact independent of specific metaphysical positions. Hence, the anthropic principle is more appropriately considered as an alternative to the idea of divine design, equally beyond (and to some extent in tension with) science.

A Sense of Place

If we cannot prove the universe to be a cosmos, an orderly world in which we are at home, a world made just right for us, can we at least imagine it to be one? Are there contemporary myths that may do justice to scientific knowledge while at the same time offering us a sense of “being at home in the universe”? Let me offer two versions—one focusing on place and one on time.

In an educational video called *Powers of Ten*, the initial scene is a homely one: a couple picnicking at Soldier Field in Chicago, near Lake Michigan. The camera zooms out, as if we are looking at it from a greater distance—a factor ten in a fixed amount of time. And again it zooms out a factor ten. And so on. We eventually recognize our home, planet Earth. A few steps later, we see our galaxy. Though this sequence of images may be interpreted as relativizing our significance, showing us as nothing but a speck of dust in a huge universe, it also may achieve the opposite. Even though we may not always notice it, due to the scale of observation, we are there, in the center of the picture. We are at home in the universe. A similar sense may be evoked by pictures that show Earth rising above the horizon of the moon, a pale blue dot that is our home.

Our stone-age minds are not well suited to handling logarithmic (or exponential) scales. We may understand the mathematical trick, but we may not be as familiar with the images thus presented as we are with those in distances understood along linear scales. Thus, it may be an interesting challenge to educators and artists to convey this sense of distance and of our place, and thereby to induce a sense of awe and reverence for the majestic universe we are part of, as well as a sense of responsibility for the tiny part that is our more immediate home.

Traditional myths do not only locate us in a spatial world, but also in time. We need to reimagine our existence in relation to our scientific understanding. This could be articulated in terms of “the evolutionary epic.” An epic is more than just a sequence of events. Such epic presentations of our world may induce in us a sense of reverence and wonder, an awareness of our dependence on what has gone on before us and who preceded us, and a responsibility for the web of life, just as traditional creation myths were to support moral and religious attitudes.

Grand visions and epics need not induce such responses. We are not used to timescales that transcend our horizon of a few human generations, nor to distances that are way beyond what we can travel ourselves. Not only are we not psychologically prepared, but philosophically the mix of elements in myths is problematic as well. Was there ever a satisfactory connection between the descriptive and the prescriptive elements? Any transition from facts to values, from *is* to *ought*, has been deemed a naturalistic fallacy, and rightly so. The practice of science is at its best when we free it from unwarranted anthropocentrism and anthropomorphism in attitudes and explanations.

Unifying scientific and existential concerns—seeing our universe as a cosmos—is not warranted in scientific or logical terms. However, as a human imaginative project, it may well be of value to us, shaping our self-understanding in a helpful way. Cosmology, our understanding of the universe, is religiously significant, because it is the story we tell also about ourselves and our place in the scheme of things.

Bibliography

- Atkins, Peter W. *The Creation*. Oxford: Freeman, 1981.
- Barrow, John D. *The World Within the World*. Oxford: Clarendon, 1988.
- Barrow, John D., and Frank J. Tipler. *The Anthropic Cosmological Principle*. Oxford: Oxford University Press, 1986.
- Drees, Willem B. *Beyond the Big Bang: Quantum Cosmologies and God*. La Salle, IL: Open Court, 1990.
- . *Creation: From Nothing until Now*. London: Routledge, 2002.
- Eames, Charles, and Ray Eames. *Powers of Ten*. Armonk, NY: IBM, 1968. Instructional video.
- Hartle, James, and Stephen Hawking. “Wave Function of the Universe.” *Physical Review D* 28 (1983): 2960–75.
- Misner, Charles W. “Cosmology and Theology.” In *Cosmology, History, and Theology*, ed. W. Yourgrau and A.D. Breck. New York: Plenum, 1977.
- Rockwell, Thomas. “Visual Technologies, Cosmographies, and Our Sense of Place in the Universe.” *Zygon: Journal of Religion and Science* 37:3 (September 2002): 605–21.
- Weinberg, Steven. *Dreams of a Final Theory*. New York: Pantheon, 1992.

46 Space in Ancient Mesoamerica

Rex Koontz

The peoples of ancient Mesoamerica (roughly modern Mexico, Guatemala, and Belize) developed complex urban civilizations in the 3,000 years before the coming of the Spanish in 1519. An essential aspect of these civilizations was a shared conception of space. Mesoamerican ideas about space can be seen in the construction of buildings, the story of cosmic creation, and the layout of city centers. While the activities involved in building structures or planning urban spaces may seem removed from stories explaining the creation of the universe, Mesoamericans' basic ideas about space drew all of these together into a coherent, meaningful whole.

Construction Space

Mesoamerican architects used regular lengths of cord to lay out a building. But this unit varied from place to place because it was cut based on different segments of the human body, such as the distance from hand to hand when the arms are stretched out to their maximum. An exact unit of measure, like the modern meter or yard, did not seem to interest these builders. Instead, they were intent on creating certain relationships or ratios between the different parts of the building. In eastern Mesoamerica, in what is today southern Mexico, Belize, and Guatemala, ancient Maya architects began their stone buildings by laying out a rough square with the cord. They would then adjust the square by making sure both diagonals were equal. Later they might modify the square by adding a rectangle. This rectangle had a certain proportion of long to short sides that is called the "golden section," a ratio that appears in a great many building traditions, including those of ancient Greece and modern Europe. It is clear, however, that the golden section was independently invented in ancient Mesoamerica. Maya peoples living today in Mexico and Guatemala also lay out their houses (and often their cornfields) according to the system of cord measurement described above. They view these proportions as natural and good, comparing them to the ratios found in plants.

Creating the Cosmos

The gods created the cosmos by laying out a square like the one described above. This creation involved stretching cords across space to measure out the cosmos, creating four sides and thus four sacred world directions. The gods then gave each of these directions a particular nature, or essence. They also created the names of the days and related these days to the world directions. All over Mesoamerica, the same days were related to the same directions. In this way, space and time were related through the shared nature of days and directions. Several ancient Mesoamerican books are specifically concerned with relating the day names to the four directions. The *Codex Borgia* (now in the Apostolic Library of the Vatican) is one of the most beautiful and complete records of the relations between days and directions. These relations were and are particularly important for Mesoamerican diviners, or soothsayers. These religious specialists must undergo rigorous training in the nature of the days and the directions before they can counsel others in the almost endless combination of meanings communicated to us by space and time.

We can see the same spatial conceptions at work in humble village rites recorded by a Spanish priest in the sixteenth century. Before a ceremony could be conducted, the undesirable spirit or energy had to be removed from the area. This cleansing began with four figures who sat on four stools at the corners of the space. They formed a square by stretching cords between each other but omitting the diagonals. This square was like the one seen at the creation of the universe. The priest would then place himself at the very center of this square and conduct the ritual.

Entire cities were organized around the same principles of four directions and a center. This is especially true of the Late Postclassic period, immediately before the coming of the Spanish. The most important temple or temple group was placed at the heart of the city, identified as the conceptual center. This temple could be the home of the patron deity of the community, a significant sacred place, or the burial place of an especially revered ancestor. Around this temple were arranged minor temples, religious houses, and palaces. The four directions were indicated by large roads radiating from the central temple area. These roads eventually served as the main exits from the city, as well as the space for directional rituals that included processions from the outskirts to the central temples.

Center and Wilderness

By creating the four world directions, the gods also created a center. Mesoamericans believed this center existed in the fire kept in the center of each house, as well as in the great temples located in the very center of their cities. The farther one traveled from the center, the more dangerous and unpredictable the world became. The space completely outside the power of the urban center or the house fire, such as the forest, was considered supremely wild and danger-

ous. This basic division of all space into two types—one civilized, safe, and ordered (the city, town, or house), and the other wild and dangerous (the jungle, mountain, cave, or other area outside human habitation and control)—was of great importance to the way Mesoamericans experienced space.

Many of the most holy shrines, such as certain mountaintops or caves, existed mainly outside the city or town in the wild area. Here Mesoamericans could most easily encounter the supernatural, a process that was also riddled with danger. A key function of the Mesoamerican city was to capture the power of these wilderness shrines and bring them into the city center, where they would be made safer, more orderly, and more available to the religious worshiper. Moving a sacred mountain was clearly impossible, so the Mesoamericans constructed their own mountains of stone. The monumental buildings that are today known as pyramids were called mountains by the Mesoamericans, and they were viewed as equivalent to the sacred mountains in the wilderness. False caves or tunnels were created in some buildings to bring the power of those wild and dangerous spaces into the heart of the city. The Temple of the Sun at Teotihuacan, finished by 150 CE and one of the largest pyramids built by ancient Mesoamericans, contained an entire network of tunnels running beneath it. For centuries, these tunnels were the place of important rituals at that great city.

Redefining Space and Reviving Time

The Aztec New Fire ceremony exhibits many aspects of Mesoamerican thought on space and time. The Aztec lived near Teotihuacan in what is now Mexico City. As a renewal festival that occurred every fifty-two years, the New Fire ceremony was one of the most sacred rites in the Aztec religion. The festival began with the priests and nobles walking out from the city to a sacred mountain called Hill of the Star. They brought with them a captive warrior prepared for sacrifice. Once on top of the mountain, they waited for the Pleiades to appear overhead in the night sky. They then tore out the heart of the sacrificial warrior and made a fire in his chest. This fire was taken back to the Great Temple at the very center of the city, twenty kilometers away. The Great Temple was called both Mountain of Sustenance and Snake Mountain, although it was a constructed pyramid. The sacred fire moved from a wild and sacred mountain to the mountain built in the center of the city, thus capturing the sacred for urban, civilized humans.

From the central temple, the fire was distributed to all Aztec towns and cities. In this way, the priests and rulers associated with the Great Temple were able to assert their primacy in space. The distribution of fire is even more impressive and important when one imagines the absolute darkness that would have enveloped that night, for all fires had been extinguished in anticipation of the ceremony. It is only with the arrival of the sacred fire from the Great Temple that people were able to relight their own torches and hearths.

During the New Fire ceremony, the Aztec were not only redefining space but

also reviving time. Every fifty-two years (or more precisely, every 18,980 days), the two most important Mesoamerican calendars—a 260-day sacred calendar and a 365-day solar calendar—returned to the same date. The first day of the new fifty-two-year cycle marked by the New Fire ceremony was the beginning of a new era. Everyone destroyed their pots and commissioned new cookware for the new age. Old ceramics, like old fires, had to be destroyed because they would have been tainted with the essence of the last fifty-two-year period.

Mesoamerican Urban Space

Mesoamericans referred to their largest cities as *Tollan* (Place of the Rushes) or *altepetl* (water-mountain). Both these metaphors express fundamental Mesoamerican ideas about urban space. Tollan was viewed as the source of all artistry and urbanity. The Toltec (people of Tollan) are often described as the ultimate artificers. Tollan was described as containing beautiful temples covered in gold and precious materials, the most finely crafted sculptures and paintings, and supremely well-ordered citizens. It was, in short, the sacred, “ideal” city that every actual city strove to be. Little wonder that a description of its basic layout was very much like what we find in the centers of numerous Mesoamerican cities.

Rushes and associated reeds are indicative of swampy areas and the areas near streams and rivers. The Mesoamerican insistence on these plants in their definition of urbanity refers to the presence of streams and rivers near the great majority of Mesoamerican cities. Certainly the first Mesoamerican cities, found in southern Veracruz state (Mexico) and dated to about 1500–400 BCE, existed in a rich, tropical, riverine environment where such plants thrive. Rushes are also found in the highlands around rivers and canal systems, such as the one that supported the enormous early city of Teotihuacan (c. 150–600 CE) near present-day Mexico City. What is certain is that by the seventh century CE, the Maya people referred to Teotihuacan with a glyph resembling reeds and that almost certainly signifies what would later be expressed as *Tollan*. Towering over Teotihuacan to the north is Cerro Gordo, a mountain containing significant underground streams. These streams are so prominent and so near the surface that one can hear the water flowing while standing on certain parts of the mountain. Here again is a basic Mesoamerican metaphor for the city, *altepetl* (water-mountain).

Teotihuacan, then, is the first recorded Mesoamerican Tollan, but is it the origin of the Mesoamerican urban ideal? Perhaps, but earlier, preliterate cities may very well have used such symbolism that would now be found only in the art and urban layout. Certainly, the ideal itself would have gone through changes over the course of the 3,000-year history of Mesoamerican urbanism. That said, it is very useful to look at the rich documentation on urban spaces and their meaning immediately before the Spanish invasion (c. 1500 CE) in the largest and most important city in the area, Tenochtitlán.

Tenochtitlán was the capital of one group of Aztec, the Mexica, although both that group and related groups who spoke the same language but may or may not have been allied with the Mexica are often referred to as Aztec. On the eve of the Spanish invasion, the Mexica and their Aztec allies constituted the most powerful and important group in Mesoamerica. Tenochtitlán was the seat of power and the largest urban conglomeration that Mesoamerica had yet seen. But it was not the first city built by the Mexica, according to their own accounts. Instead, the first urban experience for the Mexica was a settlement called Snake Mountain, which is described as near Tollan. These descriptions contain certain landmarks and names that allowed the researcher Wigberto Jiménez Moreno to identify the area of Snake Mountain as present-day Tula, Hidalgo. *Tula* is a Spanish corruption of the indigenous *Tollan*.

According to Mexica accounts, the city layout was given to them by their patron god, who commanded them to build a central temple (later replicated in the Great Temple of the New Fire ceremony), a ball court for playing the rubber ball game, and a skull rack for the display of sacrificial victims. Each of these architectural elements was given a specific function and meaning by the actions of the patron deity. For example, when a rival group of supernaturals threatened the patron deity and his mother, the patron defeated the rivals in battle and sacrificed several in the ball court. It is this action that gave the ball court its sacrificial function and meaning, and later Mexica kings were simply recreating the original sacrifice when they took war prisoners and sacrificed them in the ball court.

The Great Temple at the center of the capital of Tenochtitlán was in part a recreation of the original temple at Snake Mountain near Tollan. Mexica urbanistic ideals, especially as they concerned the sacred center of the city, were viewed as copies of this original Tollan and Snake Mountain complex. Huge roads that radiated from this sacred precinct went in the four world directions. This plan demonstrates the incorporation or overlap of urban symbolism involving Tollan with the directional symbolism used in building construction and found in stories about the creation of the cosmos. This combination of basic spatial symbolism and the more elaborate symbolism based on sacred stories like that of Tollan reflected a dynamic process that already had a 3,000-year history by the time of the Mexica kings and their fateful meeting with the Spanish in 1519.

Bibliography

- Carrasco, David. *Religions of Mesoamerica*. Prospect Heights, IL: Waveland, 1998.
- Coe, Michael. "A Model of Ancient Community Structure in the Maya Lowlands." *Southwestern Journal of Anthropology* 21 (1965): 97–114.
- Freidel, David, Linda Schele, and Joy Parker. *Maya Cosmos: Three Thousand Years on the Shaman's Path*. New York: William Morrow, 1993.
- Stone, Andrea. "From Ritual in the Landscape to Capture in the Urban Center: The Recreation of Ritual Environments in Mesoamerica." *Journal of Ritual Studies* 6:1 (1992): 109–32.

Ecology, Evolution, and the Natural World

Introduction to Ecology, Evolution, and the Natural World

Eighty-two percent of Americans, according to a 2005 CBS/*New York Times* poll, believe that humans were either created in our present form by God (55 percent) or that we evolved from less advanced life forms in a process guided by God (27 percent).

How we came to exist on Earth is a central question of humanity—one of the great origin questions discussed in the Creation, the Cosmos, and Origins of the Universe section of this encyclopedia. Clearly, the great majority of Americans see God as somehow involved. Forty percent see a role for evolutionary processes. Can science and religion be joined in serious discussions of issues related to creation and evolution, and can these discussions be fruitful, leading to insights and questions for further discussion and research? Exploration of that question is one purpose of this section of the encyclopedia.

The evolution/creation conversation can become confrontational because its starting point is often in the emotional arenas of public school curricula or polarizing political, us-versus-them debates. For the discussions and essays here, remember this: *scientific explanations do not exclude God, or vice versa*. Consider the issue of how humans came to be. One way to shift the conversation toward more productive ends is to view the issue through the lens of this question: “What is our relationship with nature, the environment, and our ecological system—the other humans around us, the plants and other animals and their niches, the weather we experience, the air we breathe?”

The essays in this section trace a convincing arc demonstrating that (1) the answer to this question, and even how and if it is asked, has shifted dramatically in the last several centuries, and (2) this shift is largely due to the emergence of modern science and the rigorous intellectual efforts to integrate this new science with (or, in some cases, to separate it from) religion.

The theme of “environment” is woven throughout the essays in this section, from diverse yet interrelated perspectives, including environment as:

- A foundational concept in theological views.
- A driver of biologic evolution.
- A key player in our belief in God.
- A focus of current crisis.
- A nexus of biological, ethical, religious, and philosophical worldviews.
- A source of physical and mental healing and well-being.

The essay by philosopher and historian Peter Harrison sets the historical stage in Europe, starting with the Reformation, for the emergence of modern science and the initial attempts to integrate its findings into religious views of the time. What is the difference between truths garnered from science and philosophy on the one hand, and truths from God on the other? What if they appear to be inconsistent? What if our planet is not the physical center of the universe? Does the environment shape us and all other species? Are nature and God separable? As discussed in previous sections of this encyclopedia, many prominent scientists during the centuries when modern science was developing, scientists such as Isaac Newton, Johannes Kepler, and Robert Boyle, had little problem putting ideas from science and religion together in the same worldview. They saw their work as deeply religious and saw themselves as “priests of nature.” Later scientists, such as Darwin, were more worried about the impact of their work on religious ideas.

Harrison explores deism and natural theology, which strove to formalize worldviews that integrated the new science with Christianity. Many such ideas and concepts, and others like them born during the Enlightenment, are still very much a part of contemporary discussions on the same topics. The theologian Joseph Bracken in his essay, for example, gives his twist on one of these newer schools of thought, process theology, which emphasizes the close interaction of nature, God, and humans. What is the relationship between God and the physical, God and experience? Does God make choices?

The environment, for Bracken (and for Alfred North Whitehead, founder of this idea), is the source of “the momentary subjects of experience” which compose the ultimate units of physical reality. The difference from the physicists’ view of reality is that these ultimate units in process theology are *immaterial* entities, not atoms and molecules—although the views of physicists like David Bohm have many parallels to these ideas. These and other conceptual frameworks that have the goal of integrating science and religion are discussed more broadly in the General Overviews section.

Evolutionary biologists Francisco Ayala, a former priest, and Chris Beck describe natural selection, Darwin’s explanation of how the environment shapes all organisms. We are, of course, part of our own environment, and we shape our own and other organisms’ biology. These authors discuss how evolution can occur without divine intervention. Ayala calls evolution a creative process, but one that does not require an intelligent designer, because the environment, using the *random* changes that result from mutation, selects in a

nonrandom fashion those versions of organisms that work best in a given environment. Michael Behe, a biochemist, drawing on ideas that first emerged in the Enlightenment (discussed by Harrison in his essay), outlines why he sees intelligent design as a better explanation for the development of life as we know it. Behe's point is that the complexity of molecular biochemistry, unknown in Darwin's time, cannot be accounted for in Darwin's theory of evolution. The idea that complexity requires design or purpose recalls the anthropic principle discussed in the Creation, the Cosmos, and Origins of the Universe section.

In anthropologist and psychologist Scott Atran's essay, which is closely related to the essays on cognitive psychology in the Consciousness, Mind, and the Brain section, humans' desire or likelihood of believing in God is directly linked with responses to their environment. His and others' experiments suggest that exposure to traumatic events like death affects whether people believe in the supernatural, and that such beliefs might actually help us heal from physical and mental trauma.

Adam arap Chepkwony, a scholar in religion, details how the concept of environment as a source for healing has been a traditional part of African cultures (and many others, as described in the Healers and Healing section) for millennia. To these traditional cultures, illness means being out of balance with one's environment; arap Chepkwony explores ways this traditional view can be connected to today's efforts to improve health of individuals and the larger society.

Biologist and theologian Celia Deane-Drummond, agricultural economist John Ikerd, and religious philosopher Mikael Stenmark emphasize how central the environment is to our lives and how science and religion can, perhaps must, come together effectively to sustain the environment and therefore us. If society as a whole is out of balance with the environment, what must we do to heal while allowing for growth and productivity? A discussion of whether science or religion may be the root cause of this imbalance can be useful to ensure we do not repeat the problems of the past, but perhaps more important is how to learn and move forward. This is where the knowledge, beliefs, and ideas of both science and religion could work cooperatively, and more effectively than independently, to ensure that however we got here, we stick around a while longer.

47 Natural Theology, Deism, and Early Modern Science

Peter Harrison

One of the most far-reaching consequences of the Protestant Reformation of the sixteenth century was a crisis of authority that pervaded the whole of Western Christendom. The aftermath of the Reformation saw the development of an unprecedented diversity of religious beliefs and practices in Europe, along with destabilizing wars of religion and the vigorous persecution of religious minorities. In this context the need for a criterion of religious truth became particularly acute. During the medieval period, tradition, scripture, reason, and experience had all been acceptable sources of religious authority, although they were mediated by the magisterium of the Catholic Church. Following the religious upheavals of the sixteenth century, serious challenges were issued to each of these long-established sources of authority. These challenges were underscored by new developments in the natural sciences. Copernican ideas and the revival of ancient atomism called into question long-standing scientific beliefs and prompted a reevaluation of the medieval understanding of the relationship between science and theology.

Reason and Revelation

Integral to early modern debates about the relative merits of the various sources of religious authority was the fundamental issue of the relationship between reason and revelation. Some thought that reason was the only impartial way to adjudicate between the mutually exclusive claims of various confessional groupings and to heal the deep-seated rifts that had shattered the religious unity of Europe. In its more extreme manifestations, the appeal to reason characterized that disparate group of individuals known as deists. But the appeal to reason raised significant questions about how truths of reason, including philosophical and scientific truths, could be related to truths of revelation—the latter usually being associated with the content of scriptures or, less commonly, truths known through personal religious experience.

An influential answer to this question had already been provided by Thomas Aquinas (c. 1225–1274). Aquinas suggested that human reason, unaided by divine revelation, is capable of arriving at certain truths about God, such as his existence and his governance of the world. Only through divine revelation, however, could human beings become acquainted with such specifically Christian truths as the incarnation, the triune nature of God, and Christ’s atonement for human sin. Those things that could be known about God through reason alone were the province of what became known as “natural theology,” while truths divulged by divine revelation belonged to “revealed theology” (although Aquinas did not himself employ this terminology). Examples of the former were Aquinas’s celebrated “five ways”—five rational arguments for the existence of God—which include proofs based on the causal order of the world (the cosmological argument) and on the apparent design of the world (the teleological argument). In articulating these arguments, Aquinas drew on the science of Aristotle, in keeping with his view that pagan philosophy could make valid contributions to the enterprise of natural theology.

A third kind of argument, the ontological argument, first articulated by Anselm of Canterbury (c. 1033–1109), proposed that God existed because the idea of God existed. Aquinas rejected this kind of argument, in part because it was based on purely logical considerations and did not draw on observations of the natural world. Here again, Aquinas was relying on the Aristotelian view that genuine knowledge begins with the senses. Anselm’s ontological argument proved acceptable to other medieval philosophers such as Duns Scotus (c. 1265–1308), however, and it is usually accorded a place within the scope of natural theology.

For Aquinas, natural theology provided a rational foundation on which the superstructure of revealed theology could rest. Revealed truths, appropriated by faith, complemented natural truths, grasped by reason. Moreover, while the content of revealed theology could not be known through the exercise of reason, it did not follow that truths of revelation had no rational support. Aquinas suggested that the truths of revealed theology were attested to by the authority of the church and, more importantly, received indirect support from miracles and prophecy. Thus readers of the gospels could have confidence in the veracity of Christ’s message because he had performed miracles and had confirmed prophecies made centuries before. The performance of miracles also signified the special status of saints.

The Thomist view of the relationship between natural and revealed theology did not go unchallenged during the Middle Ages. William of Occam (c. 1285–1349), for example, thought that the domains of nature and grace were rather more independent than Aquinas had thought them to be. But for the most part, the complementary nature of these two domains was generally accepted. This Thomist understanding also became the standard view in the early modern period. As philosopher and scientist René Descartes (1596–1650) observed: “some things are believed through faith alone—such as the mystery of

the Incarnation, the Trinity, and the like. . . . other questions, while having to do with faith, can also be investigated by natural reason: among the latter, orthodox theologians usually count the questions of the existence of God.”

The notion that the “mysteries” of revealed theology received indirect support through miracles and prophecy was not neglected. Such figures as scientist Robert Boyle (1627–1691) and philosopher John Locke (1632–1704) stressed the importance of these supernatural attestations. According to Boyle, the evidence of miracles is “little less than absolutely necessary to evince . . . that the Christian [religion] does really proceed from God.” Running parallel to the distinction between natural and revealed theology there developed the idea of two kinds of “evidences” for Christian beliefs. “Internal evidences” consisted of rational arguments for God’s existence; “external evidences” were related to arguments based on miracles and fulfilled prophecies.

Natural Theology, Design, and Natural Philosophy

One of the challenges faced by champions of the new science, or “natural philosophy” as it was then known, was to recast natural theology in ways that made it consistent with recent scientific discoveries. The “five ways” of Aquinas had been couched in terms of Aristotle’s science and relied on Aristotelian presuppositions. It was important for the legitimization of non-Aristotelian natural philosophy that it not be seen as undermining theological arguments that relied on Aristotelian premises. But specific doctrines of the new science appeared to conflict with traditional Christian views. Most notoriously, the Copernican hypothesis called into question the central place of human beings in the cosmos and seemed at odds with literal readings of scripture. Equally significant, the newly revived atomic or “corpuscular hypothesis” was traditionally associated with atheism. Advocates of these novel scientific views thus had to make the case for their compatibility with Christianity.

Several strategies were employed. Descartes argued that the whole of philosophy, including natural philosophy, was premised on the existence of God. Some of the arguments of natural theology were thus required to provide a foundation for natural philosophy. Francis Bacon (1561–1626) linked the reformation of natural philosophy to the reformation of religion, suggesting that the new science was a means of partially restoring to humanity a God-given dominion over nature. But far and away the most popular approach, in England in particular, was to argue that new scientific discoveries provided irrefutable evidence of divine design, and in a manner far superior to the older Aristotelian science. The natural sciences, it was claimed, provided an ever-increasing body of evidence that established beyond doubt that the world was the product of God’s wisdom and providential design. Robert Boyle encapsulated this approach in his *Usefulness of Experimental Natural Philosophy* (1664). The more we study the things of nature, he wrote, “the more Footsteps and Impressions we discover of the Perfections of their Creator; and our

utmost Science can but give us a juster veneration of his Omniscience.” Isaac Newton (1642–1727) concurred with this judgment, observing in his magnum opus the *Principia* (1687) that “this most elegant system of the sun, planets, and comets could not have arisen without the design and dominion of an intelligent and powerful being.”

So convinced was Robert Boyle of the importance of a partnership between science and natural theology that he made provision in his will for the endowment of an annual series of eight lectures for the purpose of “proving the Christian Religion, against notorious Infidels, viz Atheists, Theists [i.e., Deists], Pagans, Jews and Mahometans.” Appropriately enough, the very first Boyle lecturer, Richard Bentley, employed Newton’s theory of gravitation as his central argument for the existence of God. Bentley also referred to the findings of a long list of scientists, including such leading naturalists as Marcello Malpighi, Francesco Redi, Jan Swammerdam, and Anton van Leeuwenhoek, all of whose work was cited as providing evidence of God’s wisdom in the creation. The precedent thus set, many subsequent Boyle lecturers used the empirical findings of natural history and natural philosophy to arrive at their theological conclusions. For the majority of its chief advocates, then, the new science was a most congenial partner for natural theology.

The increasing involvement of natural philosophers in the sphere of natural theology meant that to some extent those laboring within the sphere of natural science could regard themselves as theologians of a kind. Johannes Kepler (1571–1630) and Robert Boyle, while engaged in quite different branches of science, regarded their activities as fundamentally religious and referred to themselves as “priests of nature.” According to Boyle, the new science was really a kind of “philosophical worship” of God. In a similar vein, Isaac Newton remarked in his *Opticks* (1730) that natural philosophy, properly pursued, would ultimately lead to the first cause—God. Sentiments such as these have led some historians to suggest that what distinguishes early modern natural philosophy from the naturalistic science that was later to emerge in the nineteenth century is the intrinsically religious orientation of the former.

One consequence of the close connection between natural science and natural theology was a restriction of the scope of natural theology to topics that fell within the domain of science, and natural history in particular. Because of this, the teleological argument for the existence of God, which was based on the observation of design in nature, displaced the more abstract ontological and cosmological arguments, which were not based on the scientific principle of induction. In time, virtually the whole domain of natural theology (what we could know about God through reason) was occupied by a single argument—the argument from design. This argument was incorporated into the explanatory framework of seventeenth- and eighteenth-century natural history and natural philosophy. Even the powerful criticisms of philosopher David Hume (1711–1776) had little impact on its popularity.

But by the nineteenth century, natural theology had become precariously

reduced to the single argument that we can know of God's existence because of the evidence of design in nature. Thus it was vulnerable when Charles Darwin (1809–1882) provided an alternative scientific explanation of organic adaptation. However, for the duration of the seventeenth and eighteenth centuries, natural science and natural theology formed such a powerful alliance that it was difficult to see where the boundary between them lay.

Deism and Early Modern Science

It is sometimes assumed that the fruitful union between science and natural theology pushed revealed theology into the background. A common view is that the leading figures of early modern science—Descartes, Boyle, and Newton—promoted a deistic understanding of God's relation to the cosmos: the great designer, having created this vast clockwork system, simply left it to run, happy in the knowledge that it would be sustained by the inviolable laws of nature. Science, it is argued, brought about a disenchantment of the world, and the idea of an intervening deity—a God who would reveal himself in the midst of mundane reality—simply became untenable.

There is an element of truth in this common view. Descartes introduced the idea of a world governed by divinely imposed laws—a view that was subsequently taken up by Newton and others. If God controlled the operations of nature through an imposition of unchanging laws—and Descartes had suggested that this necessarily followed from the immutability of God—then it was a relatively small step to the claim that nature operated independently, according to its own intrinsic principles. It must be pointed out that most early modern understandings of natural laws, including those of Descartes, Boyle, and Newton, still called for God's constant activity in order to preserve the cosmos and to sustain its complex motions. Newton seemed to argue at one point that the force of gravity was nothing other than God's constant efficacious willing, and he vehemently denied that gravity was an intrinsic property of matter. However, there was nothing to stop his successors from adopting a different view. If early modern natural philosophers did not themselves actively promote deism, it might be said that they indirectly contributed to it.

A related issue concerned miracles and their place in a clockwork cosmos. If God had meticulously planned a particular order for the natural world, then any subsequent intervention in that order would imply some deficiency in the original plan. The very notion of a law of nature seems to imply that there are no exceptions. But if there are no exceptions to laws of nature, there can be no miracles, no revelatory interventions into the natural order by God, and no external evidences to support the Christian revelation.

It has been suggested that early modern natural philosophers made a contribution to the disenchantment or desacralization of the world. But the agents they dispelled from nature were the intelligences and immanent tendencies

(Aristotle's "unmoved movers") of Aristotelian science, and not the Christian God. Indeed, the expulsion from the world of these intrinsic powers *made possible* the reimposition of God's direct control of nature, albeit a control mediated for the most part by regular laws. Arguably, a far more significant source of desacralization was the Protestant Reformation, with its "this world" orientation, its iconoclasm, its critical stance toward the sacraments and the cult of saints, and its denial of contemporary miracles. Some historians argue that Protestantism promoted the emergence of modern science by creating space in the material world for naturalistic explanation.

A more significant deficiency in the view that attributes the emergence of deism to modern science relates to a confusion about what deism actually is. The vast majority of seventeenth-century deists were motivated by religious rather than scientific considerations and had only a peripheral interest in such philosophical issues as laws of nature and the divine governance of the world. It is important to observe a distinction between two senses of the term *deism*—the metaphysical and the historical. In the broader, metaphysical sense, deism refers to the idea of an absentee God. But deism is also used in a narrower sense, to describe a particular tendency of early modern thought that originated in England and became prominent in Enlightenment Europe.

Historical deists had a loosely shared commitment to a simple and minimalist religious creed based on reason. In their view, the putative truths of revealed theology were a perennial source of religious conflict because they lay beyond the bounds of human reason and were thus not amenable to rational adjudication. Religious concord, in their view, could be achieved only if the dispute-engendering claims of revealed theology were set aside. True religion, to paraphrase the prominent English deist John Toland (1670–1722), included nothing that was "contrary to reason," nor even "above reason." Many deists contended that the first religion of the human race had been a universal religion of reason, which in all cultures and periods of history had been corrupted by the mysterious additions of priests and politicians.

It might be thought that with their emphasis on the sufficiency of natural theology, deists would draw considerable comfort from the doctrines of natural philosophy. As it turned out, in England at least, the most prominent natural philosophers were vehement opponents of the deists. Robert Boyle thus insisted that the Christian revelation was attested to by miracles and prophecies, and that God could intervene at will in his creation. One of the chief groups against whom the Boyle lectures were to be directed were "theists," by which Boyle meant deists. Newton believed that the Christian scriptures contained important revelatory truths. As for miracles, he asserted that at some future time, God would intervene in the natural order to correct irregularities in the orbits of planets. This prompted German philosopher G.W. Leibniz (1646–1716) to suggest that Newton's intervening deity was like an incompetent watchmaker, compelled to make running repairs in his flawed productions.

The controversy between Newton and Leibniz betrays something of the difference between England and the Continent on these issues. The relationship between natural philosophy and deism in France, for example, took a different trajectory than it had in England. Here it is possible to discern a link between metaphysical deism and natural philosophy. Descartes's insistence on the immutability of God not only guaranteed the constancy of the laws of nature but also made additional divine activity in the world superfluous. By invoking divine immutability, Descartes paradoxically succeeded in liberating natural philosophy from a reliance on theistic explanations. Blaise Pascal (1623–1662) complained that Descartes would have liked to dispense with God but needed him to set the world in motion. Even when Descartes ventured into the sphere of natural theology, he invoked the ontological rather than the teleological argument for God's existence, attesting to his desire to keep the realms of religion and science distinct. The ontological argument is the only traditional proof that does not rely on some claim about the nature of the empirical world.

Descartes apparently recognized that the admission of God as the cause of an otherwise inexplicable phenomenon would compromise the integrity of scientific explanation. Descartes supposed, in his hypothetical account of the cosmos, "that God will never perform any miracle." This naturalistic stance eventually ceased to be a methodological assumption and became a metaphysical commitment.

In sum, the seventeenth and eighteenth centuries in England witnessed the development of a mostly congenial relationship between science and natural theology. Minimalist deist creeds could draw little support from the sciences, which were usually allied with religious orthodoxy. On the Continent, a different pattern emerged. In eighteenth-century France, a more conservative religious establishment opposed the forces of reason and enlightenment. In France, a rationalist belief in the constancy of nature meshed more neatly with metaphysical deism. The nineteenth century brought major changes to the alliance between science and natural theology that had flourished in England. A once fruitful partnership was subjected to increasing pressures from the growing professionalization of science, the questioning of traditional patterns of belief from within the religious establishment itself, and the challenge to the idea of design presented by the theory of natural selection.

Bibliography

- Boyle, Robert. *Some Considerations Touching the Usefulness of Experimental Natural Philosophy*. London: H. Herringman, 1663.
- . *The Works of the Honourable Robert Boyle*. 6 vols. Ed. Thomas Birch. Hildersheim: Georg Olms, 1966.
- Brooke, John Hedley. *Science and Religion: Some Historical Perspectives*. Cambridge: Cambridge University Press, 1991.
- Cunningham, Andrew. "Getting the Game Right: Some Plain Words on the Identity and Invention of Science." *Studies in History and Philosophy of Science* 19 (1988): 365–89.

- Descartes, René. *The Philosophical Writings of Descartes*. 3 vols. Ed. J. Cottingham, R. Stoothof, and Douglas Murdoch. Cambridge: Cambridge University Press, 1984.
- Harrison, Peter. *The Bible, Protestantism and the Rise of Natural Science*. Cambridge: Cambridge University Press, 1998.
- . “Religion” and the Religions in the English Enlightenment. Cambridge: Cambridge University Press, 1990.
- Lindberg, David, and Ronald Numbers, eds. *When Science and Christianity Meet*. Chicago: University of Chicago Press, 2003.
- Newton, Isaac. *The Principia: Mathematical Principles of Natural Philosophy*. Trans. I. Bernard Cohen and Anne Whitman. Berkeley: University of California Press, 1999.
- Raven, C.E. *Natural Religion and Christian Theology*. Cambridge: Cambridge University Press, 1953.
- Toland, John. *Christianity Not Mysterious*. London, 1696.
- Verbeek, Theo. “The Invention of Nature: Descartes and Regius.” In *Descartes’ Natural Philosophy*, ed. Stephen Gaukroger, John Schuster, and John Sutton, 149–67. London: Routledge, 2000.

48 Process Theology

Joseph Bracken

Within the contemporary religion and science debate, process theology is controversial. Some, like Ian Barbour in *Religion and Science* (1997), see in the process-related metaphysics of Alfred North Whitehead a philosophical underpinning for the discussion of key issues separating scientists and theologians. An event-oriented or process-oriented ontology is in their view likely to make more sense to scientists than the classical metaphysics based on substance and accident. Others, however, like John Polkinghorne in *The God of Hope and the End of the World* (2002) and Arthur Peacocke in *Theology for a Scientific Age* (1993), are more reserved. As they see it, process theology eliminates or dramatically reinterprets Christian doctrines in the light of Whitehead's metaphysics, rather than revising Whitehead's philosophy in the context of traditional Christian belief. Hence, what process theology gains in terms of possible acceptability to scientists, it loses in terms of acceptability to theologians with responsibilities to their faith communities.

But if we modify one element of Whitehead's metaphysics, the concept of "society," we can justify a process-oriented trinitarian understanding of the God-world relationship. This evokes a new understanding of doctrines such as *creatio ex nihilo* (creation of the world out of nothing) and life after death for human beings and other sentient creatures. Such a reinterpretation of the basic presuppositions of process philosophy and theology may not be acceptable to all scientists and theologians, but it will at least make clear that process philosophy and theology are by definition in process, always facing an unfinished task in the light of contemporary issues and problems.

A New Approach to Society

Perhaps the most notable accomplishment of Alfred North Whitehead in setting forth his metaphysics is the totally new concept of an "actual entity" or "actual occasion," that is, a momentary subject of experience that

emerges from the overall environment in which it finds itself through a self-constituting “decision” reflecting all the physical and conceptual data available to it. A good example of such an actual occasion would be a single moment in human consciousness when each of us, without thinking about it, imaginatively integrates sense perceptions, memories, thoughts, feelings, and desires into a composite whole for just that moment. Arguing that what thus consistently happens in human consciousness is paradigmatic for what is invisibly going on everywhere in the world of Nature. Whitehead effectively challenged one of the basic philosophical presuppositions of early modern science: that the world is made up of inert bits of matter. Instead, the ultimate units of physical reality are immaterial entities, which by their dynamic interplay produce the effect of material reality on the senses of human beings and other sentient creatures. Yet Whitehead still accepted the bias toward philosophical atomism in early modern science. As he notes in *Process and Reality*, “the ultimate metaphysical truth is atomism.” This implies, however, that the nexuses or linkages of actual entities which together give the appearance of material objects are in the end only aggregates of such actual entities with a “common element of form” or sufficiently similar internal self-constitution. The whole, in that case, is nothing more than the sum of its parts, even when some of those parts are in Whitehead’s words “regnant” over other parts for the overall internal structure and organization of the aggregate.

Whitehead was well aware of the need for a principle of continuity in a world of constant change. In *Adventures of Ideas* (1967), he likened his notion of a society to an Aristotelian substance: “A society has an essential character, whereby it is the society that it is, and it has also accidental qualities which vary as circumstances alter.” In his analysis of “The Order of Nature” in *Process and Reality*, he notes: “Every society must be considered with its background of a wider environment of actual entities, which also contribute their objectifications to which the members of the society must conform.” Every society of actual entities, therefore, fits into a hierarchy of Whiteheadian societies organized into “layers of social order,” with the broader, more loosely constituted societies conditioning the existence and activity of the more tightly organized societies.

On the basis of this set of texts, I have over the years developed the hypothesis that Whiteheadian societies should be understood as enduring structured fields of activity for their constituent actual entities. A field, after all, is not simply a region of empty space, but the necessary context or regulated environment for the succession of events (actual occasions) taking place within it. And like Aristotelian substances, fields can be said to possess an enduring structure or pattern of organization even as their constituent actual entities keep changing. The interplay of actual entities from moment to moment sets the pattern for the field, but the field preserves the pattern between successive generations of actual entities so as to guarantee continuity of existence and activity for the society.

Creation and the God-World Relationship

Given this rethinking of Whitehead's notion of a society, we can justify a trinitarian understanding of God within a process-oriented frame of reference and then proceed to a new understanding of the classical Christian doctrines of creation and life after death. As I have argued in *The One in the Many* (2001), because only individual actual entities exist, Whitehead was logically forced to conceive God as an actual entity, albeit a transcendent actual entity with a never-ending process of self-constitution or "concrecence." And societies are aggregates of actual entities. But if societies are also enduring structured fields of activity for their constituent actual entities, then the three divine persons of the Trinity can share a common field of activity for their dynamic interrelation with one another. The field is their common nature or essence as a divine community, that which endures with a definite structure or pattern of organization as a result of their ongoing interrelationship. The field, in other words, is what in classical Christian theology would be called the Godhead, the mysterious ground of being or vital source for the existence and activity of the three divine persons as one God. The field does not preexist the divine persons, nor do the divine persons preexist the field. Rather the field and the divine persons co-constitute one another. As in the trinitarian theology of Thomas Aquinas, "person" and "nature" are only rationally distinct from one another as different dimensions of one divine being.

Furthermore, if the divine persons share a common source of existence and activity, then that same all-embracing field of activity could serve as the ground of being or vital source for the world of creation. By their conjoint free decision, the three divine persons could decide to share their own divine life, albeit in a finite way, with creatures whose participation in the divine life would differ according to their natural capacity or aptitude. One might argue that this is not *creatio ex nihilo* but *creatio ex Deo*, thus raising the specter of pantheism. But the core of the classical Christian doctrine of creation is the necessary independence of God from creation and the corresponding independence of the individual creature from God. The three divine persons are free to create or not to create a finite world apart from themselves. If they choose to do so, they act out of self-giving love, the desire to share their divine life with creatures according to the varying capacity of the individual creature. It is not an exercise of unilateral power on the part of the divine persons, as David Griffin and other process-oriented theologians have argued in criticizing the classical doctrine of creation. It is rather a sharing of divine creativity, the power of radical self-determination which the divine persons possess in its fullness but which they freely choose to share with their creatures, albeit in a finite way.

While the creatures exist in the Godhead as the vital source of their own finite existence and activity, they are independent of the three divine persons insofar as they too are self-constituting subjects of experience. Subjects of

experience, in other words, must perforce exist apart from one another, even as they by their dynamic interrelation create a common ground or space (what Martin Buber called the *Between*) for their ongoing conjoint existence and activity. Instead of pantheism, whereby either the world is absorbed into God or God is identified with the world, we have *panentheism* as the appropriate model for the God-world relationship. The three divine persons and all their creatures share a common ground or vital source for their separate existence and activity as autonomous self-constituting subjects of experience. Yet, because of this shared ground, the three divine persons are necessarily engaged with their creatures in co-determining what happens in this world.

In classical trinitarian theology, the role of creator is appropriated to God the Father, the role of redeemer to God the Son, and role of sanctifier to God the Holy Spirit. Within the process-oriented trinitarian scheme sketched above, God the Father, as creator, communicates a finite share of divine creativity to each creaturely actual entity at the start of its process of concrescence, along with a directionality or what Whitehead calls “an initial aim” for its self-constitution. In this way, God the Father creates the finite actual entity, but in such a way that the entity is empowered to complete the process of creation by its own self-constituting decision. God the Son, as the eternal respondent to the Father’s initiatives within the divine community, has the work of redeeming a fallen human race and transforming by degrees the material universe into the fullness of the kingdom of God. The Son, above all as incarnate in the person of Jesus of Nazareth, serves as the focal point for the collective response of creaturely actual entities to the Father’s initial aims. All these creatures are thus invited to join with Jesus in the latter’s obedience to the Father, thereby bringing about the kingdom of God on earth. The Holy Spirit, as the mediator between the Father and Son within the divine community, is the sanctifier within the cosmic process. The Spirit facilitates this exchange between the Father, Jesus as the incarnate Word of God, and all creaturely actual entities by empowering the Father to offer divine initial aims to the world of creation and by empowering the creatures, beginning with the person of Jesus, to respond wholeheartedly to the Father’s will for the salvation of the temporal order.

If “nothing” in the expression “creation out of nothing” includes the “nothingness” of the Godhead or vital source of the divine being that serves as the ground of being for the world of creation, then we can say that all the major features of the classical Christian doctrine of creation have been rationally justified in this trinitarian reconstruction of Whitehead’s metaphysics. The three divine persons freely chose to share their divine life with a world of creatures. The creatures are created by the divine persons in such a way that they participate in their own self-constitution from moment to moment. Creatures thus exist in God but retain their status as autonomous subjects of experience distinct from the divine persons with whom they progressively co-create the kingdom of God, both in this life and in the world to come.

Life After Death and the Transformation of the Physical Universe

Whitehead's process-oriented metaphysics offer a rational basis for the possibility of eternal life. Whitehead proposed that "the final real things of which the world is made up" are actual entities, momentary immaterial subjects of experience that by their dynamic interplay generate the experience of materiality for all sentient beings in this world. Thus Whitehead does not have to explain how matter can be transformed into spirit at the end of the world; from the beginning of the cosmic process, matter has existed only as a by-product of immaterial subjects of experience in dynamic relation. Even subatomic particles are societies of actual entities (immaterial subjects of experience) with a specific form of material existence and activity.

The problem for a justification of eternal life within Whitehead's philosophy lies elsewhere, namely, within Whitehead's understanding of "prehension." To prehend is to grasp and appropriate data, for the most part subconsciously and unreflectively (as in the example from human consciousness cited earlier). Actual entities prehend their predecessors from a moment ago, but they prehend them as "superjects" or purely objective realities, not as subjects of experience who have just completed their process of concrescence. This holds true for God as well as for finite actual entities within Whitehead's scheme, since in his mind a subject of experience by definition cannot be prehended. It is still involved in its own process of becoming a determinate reality and thus is not available for objective prehension by another actual entity. Hence, God can only prehend and incorporate into the divine being (for Whitehead, the divine "consequent nature") finite actual entities as objective data, not as living subjects of experience. God, in other words, can only grant to creaturely actual entities objective immortality within the divine memory, not subjective immortality within the divine life.

One of the more distinguished disciples of Whitehead, however, Marjorie Suchocki, has set forth a mediating position that brings Whitehead's philosophy more into conformity with traditional Christian belief in life after death. Suchocki argues that God, unlike creaturely actual entities, perfectly prehends other actual entities. Thus God should be able to prehend a creaturely actual entity in a fleeting moment of "enjoyment" when its process of concrescence is complete and it has not yet become a "superject," a totally objective reality. God, in other words, should be able to prehend a creaturely actual entity as both subject and superject and thus be able to incorporate the creaturely actual entity into the divine "consequent nature" as a still-existing subject of experience "enjoying" what it has just become. The creaturely actual entity, to be sure, now lives in virtue of the divine life and thus must come to terms with how it has been prehended by God and how it now relates to other creaturely actual entities within the divine life. Its understanding of its own intrinsic worth (or its relative lack of real worth) has been enormously expanded and changed. Hence, it must pass through a stage of enlightenment and spiri-

tual purgation before finally coming to accept itself for what it really is in God's eyes, and thus experience redemption and peace.

Certainly this is a highly creative rethinking of Whitehead's metaphysical scheme, but further retooling seems necessary to make it fully compatible with traditional Christian doctrine about the afterlife. First of all, Suchocki has implicitly introduced intersubjectivity into Whitehead's notion of the God-world relationship. Whitehead thought of prehension in terms of a subject-object relationship. God as the sole enduring actual entity prehends creaturely actual entities as soon as they complete their process of concrescence and incorporates them into the divine consequent nature, the divine memory of the cosmic process wherein all conflicting aims and values that exist here and now in the temporal order are ultimately reconciled. But Suchocki logically presupposes a subject-subject relationship between God and all God's creatures. The creatures are not absorbed without remainder into the divine being; they must exist in their own right as enduring subjects of experience within the divine being. But then how are they conjoined with God to form one corporate reality, the kingdom of God as a never-ending reality?

My hypothesis that Whiteheadian societies are structured fields of activity for their constituent actual entities could provide an answer to this speculative issue. If societies are constituted by the dynamic interplay of actual entities at any given moment, then the three divine persons and all their creatures together can constitute the all-embracing higher-order society corresponding to the kingdom of God: that which will endure for all ages even after the end of the current cosmic process. Together the divine persons and all their creatures are progressively co-constituting that which will have eternal value and significance beyond the transient successes and failures to be found in this world at any given moment. Furthermore, not just the divine persons but all human beings and presumably other sentient creatures (to the degree that they are self-aware in this life) will eventually experience this ongoing transformation of meaning and value implied by the term "eternal life."

But there is another metaphysical problem. As an orthodox Whiteheadian, Suchocki focuses on the progressive incorporation of individual actual entities into the divine consequent nature. She does not give sufficient attention to the way in which these transformed actual entities must relate to one another within the divine being so as to form the unitary reality of a redeemed self (in the case of a human being) or a transformed physical reality (in the case of nonhuman animal and plant species). The problem of metaphysical atomism within Whitehead's philosophy recurs, this time within the context of proposals for the nature of eternal life. But regarding Whiteheadian societies as structured fields of activity for their constituent actual entities might solve the problem.

It is not necessary for all the actual entities that ever existed in the temporal order likewise to exist eternally within the divine being. What endures is the society as a field of activity structured by successive generations of actual

entities. This finite field of activity at every moment is being incorporated into the all-embracing divine field of activity and thereby is being given objective immortality within God. Only one actual entity or only one set of interrelated actual entities is required at any given moment to give a society its necessary subjective focus. Hence, only the final actual entity (in the case of the human soul) or the final set of actual entities (in the case of the human body or any other material reality) will presumably experience incorporation into the divine being and therewith eternal life.

All antecedent actual entities will have left their mark on the finite field (or fields) to which they belonged, but as momentary subjects of experience they are now gone. Only the final actual entity or set of actual entities will pass into eternal life to inherit and appropriate for itself what its predecessors in the same society have achieved (or failed to achieve) in the temporal order.

Postscript

As systems philosopher Ervin Laszlo notes in his book *The Connectivity Hypothesis*, the notion of “field” has been employed by natural scientists since Isaac Newton proposed his theory of gravitation in the eighteenth century. But it received much more attention with the discovery of the properties of the electromagnetic field by James Clerk Maxwell in the nineteenth century. Laszlo believes that the surprising connectivity between members of systems (physical, biological, transpersonal) so as to constitute higher-level ontological unities within nature is best explained in terms of a primordial field at the quantum level and its further specification in terms of hierarchically ordered subfields of activity. Hence, my efforts to rethink Whiteheadian societies as structured fields of activity for their constituent actual entities receives unexpected confirmation from Laszlo as a systems philosopher and natural scientist.

My speculative reconstruction of the philosophy of Alfred North Whitehead accommodates it better to traditional Christian beliefs. Whether this particular scheme will be acceptable to orthodox Whiteheadians or to more classically oriented Christian theologians is probably less important than the way in which it makes clear the latent vitality and creativity of Whitehead’s thought for reconceiving contemporary Christian theology. Process philosophy and process theology are, after all, still a work in progress. Whitehead’s genius lay in opening up possibilities for a radically new worldview, a new conception of the nature of reality, not in determining for all future generations specific details for any one worldview, his own included.

Bibliography

- Aquinas, Thomas. *Summa Theologiae*. Madrid: Biblioteca de Autores Cristianos, 1951.
 Barbour, Ian. G. *Religion and Science: Historical and Contemporary Issues*. San Francisco: HarperCollins, 1997.

- Bracken, Joseph A. *The One in the Many: A Contemporary Reconstruction of the God-World Relationship*. Grand Rapids, MI: Eerdmans, 2001.
- Buber, Martin. *I and Thou*. Trans. Walter Kaufman. New York: Scribner's, 1970.
- Griffin, David Ray. "A Naturalistic Trinity." In *Trinity in Process: A Relational Theology of God*, ed. Joseph A. Bracken and Marjorie Hewitt Suchocki. New York: Continuum, 1997.
- Laszlo, Ervin. *The Connectivity Hypothesis: Foundations of an Integral Science of Quantum, Cosmos, Life, and Consciousness*. Albany: State University of New York Press, 2003.
- Peacocke, Arthur. *Theology for a Scientific Age*. Minneapolis: Fortress Press, 1993.
- Polkinghorne, John. *The God of Hope and the End of the World*. New Haven, CT: Yale University Press, 2002.
- Suchocki, Marjorie Hewitt. *The End of Evil: Process Eschatology in Historical Context*. Albany: State University of New York Press, 1988.
- Whitehead, Alfred North. *Adventures of Ideas*. New York: Free Press, 1967.
- . *Process and Reality: An Essay in Cosmology*. Corrected edition. Ed. David Ray Griffin and Donald W. Sherburne. New York: Free Press, 1978.

49 Evolution

Francisco J. Ayala

Charles Darwin argued that organisms come about by evolution, and he provided a scientific explanation, essentially correct but incomplete, of how evolution occurs and why organisms have features—such as wings, eyes, and kidneys—clearly structured to serve specific functions. Natural selection was the fundamental concept in his explanation. Genetics, a science born in the twentieth century, revealed in detail how natural selection works and led to the development of the modern theory of evolution. Since the 1960s, a related scientific discipline, molecular biology, has enormously advanced knowledge of biological evolution and has made it possible to investigate detailed problems that seemed completely out of reach a few years earlier. We have learned, for example, how similar the genes of humans, chimpanzees, and gorillas are: they differ in about 2 percent of their DNA.

The evolution of organisms—that is, their common descent with modification from simple ancestors that lived many million years ago—is at the core of genetics, biochemistry, neurobiology, physiology, ecology, and other biological disciplines, and the concept makes sense of the emergence of new infectious diseases and other matters of public health. The evolution of organisms is universally accepted by biological scientists. As evolutionary biologist Theodosius Dobzhansky has written: “Nothing in biology makes sense except in the light of evolution.”

The evolution of organisms is often accepted by theologians and religious leaders and found not to be incompatible with religious beliefs. Pope John Paul II stated on October 22, 1996: “New knowledge has led us to realize that the theory of evolution is no longer a mere hypothesis. It is indeed remarkable that this theory has been progressively accepted by researchers, following a series of discoveries in various fields of knowledge. The convergence, neither sought nor fabricated, of the results of work that was conducted independently is in itself a significant argument in favor of this theory.” The Lexington Alliance of 1981, signed by seventy-eight ministers and religious leaders, states: “We find no incompatibility between the God of creation and a theory

of evolution which uses verifiable data to explain the probable process by which life developed into its present form.”

Natural selection was the concept proposed by Darwin primarily to account for the adaptive organization of living beings. The process of natural selection promotes or maintains adaptation and thus gives the appearance of purpose or design. Evolutionary change through time and evolutionary diversification (multiplication of species) are not directly promoted by natural selection, but they often ensue as by-products of natural selection as it fosters adaptation to different environments. Darwin’s theory of natural selection is summarized in the *Origin of Species* as follows:

As many more individuals are produced than can possibly survive, there must in every case be a struggle for existence, either one individual with another of the same species, or with the individuals of distinct species, or with the physical conditions of life. . . . Can it, then, be thought improbable, seeing that variations useful to man have undoubtedly occurred, that other variations useful in some way to each being in the great and complex battle of life, should sometimes occur in the course of thousands of generations? If such do occur, can we doubt (remembering that many more individuals are born than can possibly survive) that individuals having any advantage, however slight, over others, would have the best chance of surviving and of procreating their kind? On the other hand, we may feel sure that any variation in the least degree injurious would be rigidly destroyed. This preservation of favorable variations and the rejection of injurious variations, I call Natural Selection.

The most serious difficulty facing Darwin’s evolutionary theory was the lack of an adequate theory of inheritance that would account for the preservation through the generations of the variations on which natural selection was supposed to act. Mendelian genetics provided the missing link. Mendel’s theory accounts for biological inheritance through particulate factors (genes) inherited one from each parent, which do not mix or blend but segregate in the formation of the sex, cells, or gametes. The discovery in 1900 of Mendel’s theory of heredity ushered in an emphasis on the role of heredity in evolution. In the 1920s and 1930s, geneticists demonstrated that continuous variation (in such characteristics as size, number of eggs laid, and the like) could be explained by Mendel’s laws, and that natural selection acting cumulatively on small variations could yield major evolutionary changes in form and function. Distinguished members of this group of theoretical geneticists were R.A. Fisher and J.B.S. Haldane in Britain and Sewall Wright in the United States. Their work had a limited impact on contemporary biologists because it was almost exclusively theoretical, formulated in mathematical language and with little empirical corroboration.

A major breakthrough came in 1937 with the publication of *Genetics and the Origin of Species* by Theodosius Dobzhansky, who advanced a reasonably comprehensive account of the evolutionary process in genetic terms, laced with experimental evidence supporting the theoretical argument. Other writers who importantly contributed to the formulation of the synthetic theory

were the zoologists Ernst Mayr and Julian Huxley, the paleontologist George G. Simpson, and the botanist George Ledyard Stebbins. By 1950, acceptance of Darwin's theory of evolution by natural selection was universal among biologists, and the synthetic theory had become widely adopted.

Evolution Issues

Three different but related issues have been the main subjects of evolutionary investigations: (1) the fact of evolution, that organisms are related by common descent with modification; (2) evolutionary history, the details of when lineages split from one another and the changes that occurred in each lineage; and (3) the mechanisms or processes by which evolutionary change occurs.

The fact of evolution is the most fundamental issue and the one established with utmost certainty. Darwin gathered much evidence in its support, but the evidence has accumulated continuously ever since, derived from all biological disciplines. The second and third issues go much beyond the general affirmation that organisms evolve. The theory of evolution seeks to ascertain the evolutionary relationships between particular organisms and the events of evolutionary history, as well as to explain how and why evolution takes place. These are matters of active scientific investigation. Many conclusions are well established. For example, chimpanzees and gorillas are more closely related to humans than any of those three species are to baboons or other monkeys. And natural selection explains the adaptive configuration of such features as the human eye and the wings of birds. Some other matters are less certain, some are conjectural, and still others—such as precisely when life originated on Earth and the characteristics of the first living things—remain largely unresolved.

The Evidence for Evolution

That organisms are related by common descent with modification has been demonstrated by evidence from paleontology, comparative anatomy, biogeography, embryology, biochemistry, molecular genetics, and other biological disciplines. The idea first emerged from observations of systematic changes in the succession of fossil remains found in a sequence of layered rocks. Such layers have a cumulative thickness of many scores of kilometers and represent at least 3.5 billion years of geological time. The general sequence of fossils from bottom upward in layered rocks had been recognized before Darwin perceived that the observed progression of biological forms strongly implied common descent. The farther back into the past one looked, the less the fossils resembled recent forms, the more the various lineages merged, and the broader the implications of a common ancestry appeared.

Paleontology, however, was still a rudimentary science in Darwin's time, and large parts of the geological succession of stratified rocks were unknown

Table 49.1

First Appearance of Different Life Forms

Life form	Millions of years since first appearance
Microbial (procaryotic cells)	3,500
Complex (eukaryotic cells)	1,400
First multicellular animals	670
Shell-bearing animals	540
Vertebrates (simple fishes)	490
Amphibians	350
Reptiles	310
Mammals	200
Nonhuman primates	60
Earliest apes	25
Earliest hominids	6
<i>Homo sapiens</i> (modern humans)	0.15 (150,000 years)

Source: Created by author.

or inadequately studied. Darwin, therefore, worried about the rarity of truly intermediate forms. Although gaps in the paleontological record remain even now, many have been filled by the researches of paleontologists since Darwin's time. Hundreds of thousands of fossil organisms found in well-dated rock sequences represent a succession of forms through time and manifest many evolutionary transitions. Microbial life of the simplest type (i.e., procaryotes, which are cells whose nuclear matter is not bounded by a nuclear membrane) was already in existence more than 3 billion years ago. The oldest evidence suggesting the existence of more complex organisms (i.e., eukaryotic cells with a true nucleus) has been discovered in fossils that had been sealed in flinty rocks approximately 1.4 billion years old. More advanced forms like true algae, fungi, higher plants, and animals have been found only in younger geological strata. Table 49.1 presents the order in which progressively complex forms of life appeared. The sequence of observed forms and the fact that all except the first are constructed from the same basic cellular type strongly imply that all these major categories of life (including plants, algae, and fungi) have a common ancestry in the first eukaryotic cell.

Inferences about common descent derived from paleontology have been reinforced by comparative anatomy. The skeletons of humans, dogs, whales, and bats are strikingly similar, despite the different ways of life led by these animals and the diversity of environments in which they have flourished. The correspondence, bone by bone, can be observed in every part of the body, including the limbs: a person writes, a dog runs, a whale swims, and a bat flies with structures built of the same bones. Scientists call such structures homologous and have concurred that they are best explained by common descent. Comparative anatomists investigate such homologies, not only in bone structure but also in other parts of the body as well, working out relationships

from degrees of similarity. Their conclusions provide important inferences about the details of evolutionary history that can be tested by comparisons with the sequence of ancestral forms in the paleontological record.

Biogeography also has contributed evidence for common descent. The diversity of life is stupendous. Approximately 250,000 species of living plants, 100,000 species of fungi, and 1.5 million species of animals and microorganisms have been described and named, each occupying its own peculiar ecological setting or niche, and the census is far from complete. Some species, such as human beings and our companion the dog, can live under a wide range of environmental conditions. Others are amazingly specialized. One species of the fungus *Laboulbenia* grows exclusively on the rear portion of the covering wings of a single species of beetle (*Aphaenops cronei*) found only in some caves of southern France. The larvae of the fly *Drosophila carcinophila* can develop only in specialized grooves beneath the flaps of the third pair of oral appendages of the land crab *Gecarcinus ruricola*, which is found only on certain Caribbean islands.

How can we make intelligible the colossal diversity of living beings and the existence of such extraordinary, seemingly whimsical creatures as *Laboulbenia*, *Drosophila carcinophila*, and others? Why are island groups like the Galápagos inhabited by forms similar to those on the nearest mainland but belonging to different species? Why is the indigenous life so different on different continents? The scientific explanation is that biological diversity results from an evolutionary process whereby the descendants of local or migrant predecessors became adapted to their diverse environments.

A testable corollary of this hypothesis is that present forms and local fossils should show homologous attributes indicating how one is derived from the other. Also, there should be evidence that forms without an established local ancestry had migrated into the locality. Wherever such tests have been carried out, these conditions have been confirmed. A good example is provided by the mammalian populations of North and South America, where strikingly different endemic forms evolved in isolation until the emergence of the isthmus of Panama approximately 3 million years ago. Thereafter, the armadillo, porcupine, and opossum—mammals of South American origin—were able to migrate to North America along with many other species of plants and animals, while the placental mountain lion and other North American species made their way across the isthmus to the south.

The evidence that Darwin found for the influence of geographical distribution on the evolution of organisms has become stronger with advancing knowledge. For example, approximately two thousand species of flies belonging to the genus *Drosophila* are now found throughout the world. About one-quarter of them live only in Hawaii. More than a thousand species of snails and other land mollusks are also found only in Hawaii. The natural explanation for the occurrence of such great diversity among closely similar forms is that the differences resulted from adaptive colonization of isolated environments by

animals with a common ancestry. The Hawaiian Islands are far from and were never attached to any mainland or other islands, and they have had few colonizers. Organisms that reached these islands found many unoccupied ecological niches where they could then undergo separate evolutionary diversifications. No mammals other than one bat species lived on the Hawaiian Islands when the first human settlers arrived; very many other kinds of plants and animals were also absent. The scientific explanation is that these kinds of organisms never reached the islands because of their great geographic isolation, while those that reached there multiplied in kind, because of the absence of related organisms that would compete for resources.

Embryology, the study of biological development from the time of conception, is another source of independent evidence for common descent. Barnacles, for instance, are sedentary crustaceans with little apparent similarity to such other crustaceans as lobsters, shrimps, or copepods. Yet barnacles pass through a free-swimming larval stage, in which they look unmistakably like other crustacean larvae. The similarity of larval stages supports the conclusion that all crustaceans have homologous parts and a common ancestry. Human and other mammalian embryos pass through a stage during which they have unmistakable but useless grooves similar to gill slits found in fishes—evidence that they and the other vertebrates shared remote ancestors that respired with the aid of gills.

Molecular Biology

The substantiation of common descent that emerges from all the foregoing lines of evidence has been validated and reinforced by the discoveries of molecular biology, a biological discipline that emerged in the mid-twentieth century. This new discipline has unveiled the nature of hereditary material and the workings of organisms at the level of enzymes and other molecules. Molecular biology provides very detailed and convincing evidence for biological evolution.

The hereditary material, DNA, and the enzymes that govern all life processes hold information about an organism's ancestry. This information has made it possible to reconstruct evolutionary events that were previously unknown and to confirm and adjust the view of events that already were known. The precision with which events of evolution can be reconstructed is one reason the evidence from molecular biology is so compelling. Another reason is that molecular evolution has shown all living organisms, from bacteria to humans, to be related by descent from common ancestors.

Genes and proteins are long molecules that contain information in the sequence of their components in much the same way that sentences of the English language contain information in the sequence of their letters and words. The sequences that make up the genes are passed on from parents to offspring, identical except for occasional changes introduced by mutations. The similarity

between the sequences is evidence that they derive from a common ancestor; the differences make it possible to reconstruct the evolutionary history of the organisms. To illustrate, assume that two books are being compared. Both books are 200 pages long and contain the same number of chapters. Closer examination reveals that the two books are identical page for page and word for word, except that an occasional word—say one in 100—is different. The two books cannot have been written independently; either one has been copied from the other or both have been copied, directly or indirectly, from the same original book. Similarly, if each DNA component (nucleotide) is represented by one letter, the complete sequence of nucleotides in the DNA of a higher organism would require several hundred books of hundreds of pages, with several thousand letters on each page. When the “pages” (or sequence of nucleotides) in these “books” (organisms) are examined one by one, the correspondence in the “letters” (nucleotides) gives unmistakable evidence of common origin.

The evidence of evolution revealed by molecular biology goes one step further. The degree of similarity in the sequence of nucleotides or of amino acids can be precisely quantified. For example, cytochrome *c* (a protein molecule) of humans and chimpanzees consists of the same 104 amino acids in exactly the same order, but it differs from that of rhesus monkeys by one amino acid, that of horses by 11 amino acids, and that of tuna by 21 amino acids. The degree of similarity reflects the recency of common ancestry. Thus, the inferences from comparative anatomy and other disciplines concerning evolutionary history can be tested in molecular studies of DNA and proteins by examining their sequences of nucleotides and amino acids.

The authority of this kind of test is overwhelming; each of the thousands of genes and thousands of proteins contained in an organism provides an independent test of that organism’s evolutionary history. Not all possible tests have been performed, but many hundreds have been done, and not one has given evidence contrary to evolution. There is probably no other notion in any field of science that has been as extensively tested and as thoroughly corroborated as the evolutionary origin of living organisms. There is no reason to doubt the evolutionary theory of the origin of organisms any more than to doubt the heliocentric theory of the revolutions of the planets around the sun.

Genetics and Natural Selection

The central argument of Darwin’s theory of evolution starts from the existence of hereditary variation. Experience with animal and plant breeding demonstrates that variations can be developed that are “useful to man.” So, reasoned Darwin, variations must occur in nature that are favorable or useful in some way to the organism itself in the struggle for existence. Favorable variations are ones that increase chances for survival and procreation. Those advantageous variations are preserved and multiplied from generation to generation at the expense of less advantageous ones. This is the process known as natural selection.

Natural selection can be defined as the differential reproduction of alternative hereditary variants. Differential reproduction comes about because some variants (i.e., combinations of genes) increase the likelihood that the organisms having them will survive and reproduce more successfully than will organisms carrying alternative variants. Selection may be due to differences in survival, in fertility, in rate of development, in mating success, or in any other aspect of the life cycle. All of these differences can be incorporated under the term “differential reproduction” because all result in natural selection to the extent that they affect the number of progeny an organism leaves.

Darwin explained that competition for limited resources results in the survival of the most effective competitors. But natural selection may occur also as an effect of some aspect of the physical environment, such as inclement weather. Natural selection is quantified by a measure called Darwinian fitness, or relative fitness. Fitness in this sense is the relative probability that a hereditary characteristic will be reproduced; that is, the degree of fitness is a measure of the reproductive efficiency of the characteristic.

The information encoded in the nucleotide sequence of DNA is, as a rule, faithfully reproduced during replication, so that each replication results in two DNA molecules that are identical to each other and to the parent molecule. But occasionally “mistakes,” or mutations, occur in the DNA molecule during replication, so that daughter cells differ from the parent cells in at least one of the letters in the DNA sequence. A mutation first appears on a single cell of an organism, but it is passed on to all cells descended from the first. The consequences of gene mutations may range from negligible to lethal. Some have a small or undetectable effect on the organism’s ability to survive and reproduce, because no essential biological functions are altered. But when the active site of an enzyme or some other essential function is affected, the impact may be severe.

Mutations that arise in an organism are more likely to be harmful than beneficial to their carriers, because mutations are random events with respect to adaptation; that is, their occurrence is independent of any possible consequences. Harmful mutations are eliminated or kept in check by natural selection. Occasionally, however, a new mutation may increase the organism’s adaptation. The probability of such an event’s happening is greater when organisms colonize a new territory or when environmental changes confront a population with new challenges. In these cases, the established adaptation of a population is less than optimal, and there is greater opportunity for new mutations to be better adaptive. This is so because the consequences of mutations depend on the environment. Increased melanin pigmentation may be advantageous to inhabitants of tropical Africa, where dark skin protects them from the sun’s ultraviolet radiation; but it is not beneficial in Scandinavia, where the intensity of sunlight is low and light skin facilitates the synthesis of vitamin D.

Mutation rates are low, but new mutants appear continuously in nature, because there are many individuals in every species and many genes in every individual. The process of mutation provides each generation with many new

genetic variations. More important yet is the storage of variation, arisen by past mutations, that is present in each organism. Typically, the genome of an organism possesses about one mutation for every thousand nucleotides (the letters that sequentially carry the genetic information). One human genome consists of 3 billion nucleotides and therefore carries about 3 million mutations, which are transmitted from parent to offspring. By comparison, new mutations add little to an organism's genetic variability. New mutations occur between 1–10 per 100 million nucleotides, per generation. Thus, each human genome acquires between 30 and 300 new mutations each generation, in addition to the 3 million inherited from each parent.

Evolution as a Creative Process

If mutation were the only process of evolutionary change, the organization of living things would gradually disintegrate, because mutations occur at random, without regard for the consequences such changes may have in the organisms' ability to survive and reproduce. The effects of mutation alone would be analogous to those of a mechanic who changed parts in an engine at random, with no regard for the role of the parts in the engine. Natural selection keeps the disorganizing effects of mutation and other processes in check because it multiplies beneficial mutations and eliminates harmful ones.

Natural selection has been compared to a sieve that retains the rarely arising useful genes and lets go the more frequently arising harmful mutants. Natural selection acts in that way, but it is much more than a purely negative process, for it is able to generate novelty by increasing the probability of otherwise extremely improbable genetic combinations. Natural selection is thus creative in a way. It does not create the entities upon which it operates, but it produces adaptive genetic combinations that would not have existed otherwise.

The creative role of natural selection must not be understood in the sense of the "absolute" creation that traditional Christian theology predicates of the divine act by which the universe was brought into being *ex nihilo*. Natural selection may rather be compared to a painter who creates a picture by mixing and distributing pigments in various ways over a canvas. The canvas and the pigments are not created by the artist, but the painting is. It is conceivable that a random combination of the pigments might result in the orderly whole that is the final work of art. But the probability of Leonardo's *Mona Lisa* resulting from a random combination of pigments, or St. Peter's Basilica resulting from a random association of marble, bricks, and other materials, is infinitely small. In the same way, the combination of genetic units that carries the hereditary information responsible for the formation of the vertebrate eye could have never been produced by a random process like mutation. Not even if we allow for the 3 billion years plus during which life has existed on earth. The complicated anatomy of the eye and the exact functioning of the kidney are the result of a nonrandom process—natural selection.

Critics of Darwin's theory of evolution have argued that random processes cannot yield meaningful, organized outcomes. For example, they point out that a series of monkeys randomly striking letters on a typewriter would never write *The Origin of Species*, even if we allow for millions of years and many generations of monkeys pounding at typewriters. This criticism would be valid if evolution depended only on random processes. But natural selection is a nonrandom process that promotes adaptation by selecting combinations that "make sense," that are useful to the organisms. The analogy of the monkeys would be more appropriate if a process existed by which, first, meaningful words would be chosen every time they appeared on the typewriter. Then we would also have a kind of typewriter with previously selected words, rather than just letters in the keys, and there would be a process to select meaningful sentences every time they appeared in this second typewriter. If such sentences became incorporated into keys of a third type of typewriter, in which meaningful paragraphs were selected whenever they appeared, it is clear that pages and even chapters "making sense" would eventually be produced.

We need not carry the analogy too far, since the analogy is not fully satisfactory, but the point is clear. Evolution is not the outcome of purely random processes, but rather there is a "selecting" process, which picks up adaptive combinations because these reproduce more effectively and thus become established in populations. These adaptive combinations constitute, in turn, new levels of organization on which the mutation (random) plus selection (non-random or directional) process again operates.

Here is an example of how natural selection can generate novelty in the form of accumulated hereditary information. Some strains of the colon bacterium *Escherichia coli*, in order to be able to reproduce in a culture medium, require that a certain substance, the amino acid histidine, be provided in the medium. When a few such bacteria are added to a cubic centimeter of liquid culture medium, they multiply rapidly and produce between 2–3 billion bacteria in a few hours. Spontaneous mutations to streptomycin resistance occur in normal (i.e., sensitive) bacteria at rates of the order of 1 in 100 million cells. In our bacterial culture, we expect between 20–30 bacteria to be resistant to streptomycin due to spontaneous mutation. If a proper concentration of the antibiotic is added to the culture, only the resistant cells survive. The 20–30 surviving bacteria will start reproducing, however, and allowing a few hours for the necessary number of cell divisions, several billion bacteria are produced, all resistant to streptomycin. Among cells requiring histidine as a growth factor, spontaneous mutations able to reproduce in the absence of histidine arise at rates of about 4 in 100 million bacteria. The streptomycin resistant cells may now be transferred to a culture with streptomycin but with no histidine. Most of them will not be able to reproduce, but about a hundred will start reproducing until the available medium is saturated.

Natural selection has produced in two steps bacterial cells resistant to streptomycin and not requiring histidine for growth. The probability of the two

mutational events happening in the same bacterium is about 4 in 10 million billion cells. An event of such low probability is unlikely to occur even in a large laboratory culture of bacterial cells. With natural selection, cells having both properties are the common result.

As illustrated by the bacterial example, natural selection produces combinations of genes that would otherwise be highly improbable, because natural selection proceeds stepwise. The vertebrate eye did not appear suddenly in all its present perfection. Its formation requires the appropriate integration of many genetic units, and thus the eye could not have resulted from random processes alone. The ancestors of today's vertebrates had for more than half a billion years some kind of organs sensitive to light. Perception of light, and later vision, were important for these organisms' survival and reproductive success. Accordingly, natural selection favored genes and gene combinations increasing the functional efficiency of the eye. Such genetic units gradually accumulated, eventually leading to the highly complex and efficient vertebrate eye.

Natural selection can account for the rise and spread of genetic constitutions, and therefore of types of organisms, that would never have existed under the uncontrolled action of random mutation. In this sense, natural selection is a creative process, although it does not create the raw materials—the genes—upon which it acts.

A painter usually has a preconception of what he or she wants to paint and will consciously modify the painting so that it represents what the painter wants. Natural selection has no foresight, nor does it operate according to some preconceived plan. Rather it is a purely natural process resulting from the interacting properties of physicochemical and biological entities. Natural selection is simply a consequence of the differential multiplication of living beings. It has some appearance of purposefulness because it is conditioned by the environment: which organisms reproduce more effectively depends on what variations they possess that are useful in the environment where the organisms live. But natural selection does not anticipate the environments of the future; previously thriving organisms may be overcome by drastic environmental changes.

Another flaw in the typing monkey analogy is that it assumes there is "somebody" who selects letter combinations and word combinations that make sense. In evolution, no one selects adaptive combinations. These select themselves because they multiply more effectively than less adaptive ones. Natural selection does not strive to produce predetermined kinds of organisms, but only organisms that are adapted to their present environments. Which characteristics will be selected depends on which variations happen to be present at a given time in a given place. This in turn depends on the random process of mutation, as well as on the previous history of the organisms (i.e., on the genetic makeup they have as a consequence of their previous evolution). Natural selection is an "opportunistic" process. The variables determining in what

direction it will go are the environment, the preexisting constitution of the organisms, and the randomly arising mutations.

Thus, adaptation to a given environment may occur in a variety of different ways. An example may be taken from the adaptations of plant life to desert climate. The fundamental adaptation is to the condition of dryness, which involves the danger of desiccation. During a major part of the year, sometimes for several years in succession, there is no rain in a desert. Plants have accomplished the urgent necessity of saving water in different ways. Cacti have transformed their leaves into spines, having made their stems into barrels containing a reserve of water. Photosynthesis is performed in the surface of the stem instead of in the leaves. Other plants have no leaves during the dry season, but after it rains they burst into leaves and flowers and produce seeds. Ephemeral plants germinate from seeds, grow, flower, and produce seeds—all within the space of the few weeks while rainwater is available; the rest of the year the seeds lie quiescent in the soil.

Natural selection accounts for the “design” of organisms, because adaptive variations tend to increase the probability of survival and reproduction of their carriers at the expense of maladaptive, or less adaptive, variations. The traits that organisms acquire in their evolutionary histories are not fortuitous but determined by their functional utility to the organisms, and they come about by small steps that accumulate over time, each step providing some reproductive advantage over the previous condition.

Unintelligent Design

The English theologian William Paley, in his *Natural Theology* (1802), elaborated the “argument from design” as a forceful demonstration of the existence of a creator. The functional design of the human eye, argued Paley, provides conclusive evidence of an all-wise creator. It would be absurd to suppose, he wrote, that the human eye by mere chance “should have consisted, first, of a series of transparent lenses . . . secondly of a black cloth or canvas spread out behind these lenses so as to receive the image formed by pencils of light transmitted through them, and placed at the precise geometrical distance at which, and at which alone, a distinct image could be formed . . . thirdly of a large nerve communicating between this membrane and the brain.”

The strength of the argument against chance derives, Paley tells us, from what he names “relation,” a notion akin to what contemporary authors have named “irreducible complexity.” “When several different parts contribute to one effect, or, which is the same thing, when an effect is produced by the joint action of different instruments, the fitness of such parts or instruments to one another for the purpose of producing, by their united action, the effect, is what I call *relation*; and wherever this is observed in the works of nature or of man, it appears to me to carry along with it decisive evidence of understand-

ing, intention, art . . . all depending upon the motions within, all upon the system of intermediate actions.”

The outcomes of chance, Paley argues, do not exhibit relation among the parts or, as we might say, organized complexity: “the question is, whether a useful or imitative conformation be the produce of chance. . . . Among inanimate substances, a clod, a pebble, a liquid drop might be; but never was a watch, a telescope, an organized body of any kind, answering a valuable purpose by a complicated mechanism, the effect of chance. In no assignable instance has such a thing existed without intention somewhere.”

Paley’s *Natural Theology* exhibits extensive and profound biological knowledge. He discusses the human eye, the air-bladder of fish, the fang of vipers, the claw of herons, the camel’s stomach, the woodpecker’s tongue, the elephant’s proboscis, the hook in the bat’s wing, the spider’s web, the compound eyes of insects, metamorphosis, the glowworm, univalve and bivalve mollusks, seed dispersal, and on and on. And he does so with accuracy and as much detail as was known to the best biologists of his time. Paley, moreover, takes notice of the imperfections, defects, pain, and cruelty of nature, and he seeks to account for them in a chapter entitled “Of the Personality of the Deity,” which is surely unsatisfactory in view of the knowledge we now have.

Michael Behe, who has reformulated Paley’s argument for the existence of a creator from evidence of design, responds to the critics who point out the imperfections of organisms much as Paley did: “The most basic problem is that the argument [against intelligent design] demands perfection at all. Clearly, designers who have the ability to make better designs do not necessarily do so. . . . The reasons that a designer would or would not do anything are virtually impossible to know unless the designer tells you specifically what those reasons are.” So God may have had reasons for not designing organisms as perfect as they could have been.

A problem with this explanation is that it destroys “intelligent design” as a scientific hypothesis. If we cannot reject intelligent design because the designer may have reasons that we could not possibly ascertain, there would seem to be no way to test intelligent design by drawing out predictions, logically derived from the hypothesis, that are expected to be observed in the world of experience. Intelligent design as an explanation for the adaptations of organisms could be (natural) theology, as Paley would have it, but it is not a scientific hypothesis.

Moreover, the response just quoted is unsatisfactory for another reason. It is not only that organisms and their parts are less than perfect, but also that they exhibit deficiencies and dysfunctions that are incompatible with *intelligent* design. Consider the human jaw. We have too many teeth for the jaw’s size, so that wisdom teeth need to be removed and orthodontists make a decent living straightening the others. Would we want to blame God (or whoever else is the designer of the universe) for such defective design? A human engineer could have done better.

Evolution gives a good account of the jaw's imperfection. Brain size increased over time in our ancestors, and the remodeling of the skull to fit the larger brain entailed a reduction of the jaw. Evolution responds to the organisms' needs through natural selection, not by optimal design but by tinkering, by slowly modifying existing structures. Consider the birth canal of women, much too narrow for easy passage of the infant's head, so that thousands upon thousands of babies die during delivery. Surely this is not an intelligent design, nor will we want to blame God for the children's deaths. Science makes this defective design understandable, a consequence of the evolutionary enlargement of our brain, and thus head sizes too large for the birth canal to easily accommodate. Females of other animals do not experience this difficulty. Theologians in the past struggled with the deficiencies and dysfunctions of organisms, because they thought these aberrations had to be attributed to God's design. Science, much to the relief of many theologians, provides an explanation that convincingly attributes defects, deformities, and dysfunctions to natural causes.

Examples of deficiencies and dysfunctions in all sorts of organisms can be endlessly multiplied, reflecting the opportunistic, tinkering character of natural selection, rather than intelligent design. The world of organisms also abounds in characteristics that might be called "oddities," as well as those that have been characterized as "cruelties," an apposite qualifier if the cruel behaviors were designed outcomes of a being holding on to human or higher standards of morality. Among the oddities, we may recall whimsical creatures like *Laboulbenia* and *Drosophila carcinophila*, mentioned earlier, as well as the hundreds of *Drosophila* and snail species that populate Hawaii. Did an intelligent designer go on and on producing more and more fruit fly and snail species while forgetting the creation of other kinds of animals, including land mammals?

The cruelties of biological nature are only metaphoric cruelties when applied to the outcomes of natural selection. Predators tear apart their prey (a chimpanzee, for example, may hold onto a small monkey and bite large flesh morsels from it as the monkey screams), and parasites destroy the functional organs of their hosts. But cruelty also exists abundantly between organisms of the same species, even between individuals of different sexes in association with their mating. A well-known example is the female praying mantis that devours the male after coitus is completed. Less familiar is that, if she gets the opportunity, the praying mantis female will eat the head of the male before mating. The headless male mantis then thrashes into spasms of "sexual frenzy" that allow the female to connect his genitalia with hers. Male cannibalism is known in dozens of species, particularly spiders and scorpions.

The defective design of organisms might be attributed to the gods of the ancient Greeks, Romans, and Egyptians, who fought with one another, made blunders, and were clumsy in their endeavors. But it is not compatible with

special action by the omniscient, omnipotent, and benevolent God of Judaism, Christianity, and Islam.

Bibliography

- Behe, Michael J. *Darwin's Black Box: The Biochemical Challenge to Evolution*. New York: Touchstone, 1996.
- Dobzhansky, Theodosius. "Nothing in Biology Makes Sense Except in Light of Evolution." *American Biology Teacher* 35:3 (1973): 125–29.
- Paley, William. *Natural Theology*. New York: American Tract Society, 1802.

50 Evolution and Natural Selection

Christopher W. Beck

If we stop for a moment and consider the vast diversity of living things that surround us—over 1 billion species of animals (of which 300–400 million species are beetles), 248,000 species of plants, and about 5,000 species of bacteria—we cannot help but be in awe. What has led to this great diversity? Yet, as more genomes—the complete genetic blueprints of organisms—get sequenced, we find great similarities among very different organisms. For example, humans and the bacterium that causes cholera are 34 percent identical in protein sequence for the gene coding HMG CoA reductase, a metabolic enzyme important in the production of cholesterol in humans. Why are organisms that appear so different really so similar at the genetic level? Evolution by natural selection is fundamental to our understanding of the similarities and differences among all organisms at the many different levels of organization, from gene sequences to physiological processes to complex behaviors. Indeed, as stated by evolutionary biologist Theodosius Dobzhansky, “Nothing in biology makes sense except in light of evolution.”

Even though the theory of evolution is central to our understanding of biology, it has been the flashpoint for conflict between science and religion since the time that Charles Darwin first proposed the theory. Much of the conflict is based on a misunderstanding of the theory of evolution and what its implications are for our understanding of religion. Therefore, a complete understanding of evolution and natural selection is critical to understanding not only the world around us but also the relationship between science and religion.

Evolution

Simply put, evolution is change over time. The concept of evolution is not limited to biological systems; the idea can be applied to almost any system, as most systems change over time. For example, in geology, rock formations evolve due to weathering and erosion by wind and water. Our solar system evolved from a solar nebula to its current state. In its broadest form, evolution

can be applied to systems outside the realm of science. For instance, the church historian Philip Schaff, a contemporary of Charles Darwin, viewed the Christian church as gradually changing over time, or evolving. However, unlike the evolution in biological systems, evolution of the church, in the view of Schaff, was progressive with an ever increasing understanding of God.

In biological systems, evolution is defined generally as a change in a group of individuals of the same species (i.e., a population) over time. To early evolutionary thinkers, such as Charles Darwin, this change was a change in the physical appearance of individuals of a species over time. In his book *The Origin of Species*, Darwin did not use the term evolution, but the phrase “descent with modification.” During the first half of the twentieth century, Mendelian genetics (the study of how traits are inherited, as first proposed by Gregor Mendel) was integrated into the study of evolution in what was termed the “modern synthesis.” Accordingly, the definition of biological evolution changed. Evolution was then defined as a change in the appearance of individuals in a population as a result of a change in genetic makeup of a population over time. Today, evolutionary biologists continue to define biological evolution in terms of a change in appearance (phenotype) that is caused by a change in the genetic characteristics (frequencies of alleles or types of genes or frequencies of genotypes, the genetic makeup of an individual) of a population over time.

The concept of biological evolution—that species change over time—was not first proposed by Darwin in *The Origin of Species*. His grandfather, Erasmus Darwin, was also a naturalist and writer. In his poetry, Erasmus Darwin suggested that complex animals and plants evolved from microscopic forms over multiple generations. However, perhaps more important in bringing the idea of evolution to the forefront of discussion in scientific circles of the time were the writings of the French scientist Jean-Baptiste Lamarck. In his book *Philosophie Zoologique*, Lamarck argued that species were not created by God in their current state and then remained immutable; instead, species changed over time into new species.

Although the idea that species evolved was beginning to be accepted during Darwin’s time, what was missing was a mechanism for the changes. In 1858, in two papers read together before the Linnean Society of London, Darwin and Alfred Russel Wallace, a British naturalist collecting specimens in Malaysia for private collectors, proposed natural selection as the mechanism for “descent with modification.” In the following year, Darwin published *The Origin of Species*, in which he detailed evidence for the theory of evolution by natural selection.

Natural Selection

Natural selection as an explanation for evolution is elegant in its simplicity. For evolution by natural selection to occur, only four conditions must be met.

1. Individuals in a population must vary in their characteristics, such as size, behavior, or physiology.
2. These differences among individuals must be passed down from one generation to the next.
3. There must be a “struggle for existence,” as Darwin put it. In other words, more offspring are born than can survive and reproduce.
4. Individuals with certain traits must be more likely to survive and reproduce or produce more offspring than individuals without those traits. This fourth condition is, itself, natural selection. It is very important to note that the differences in survival and reproduction are not random, but depend on whether individuals have certain characteristics.

Each of these four conditions for evolution by natural selection is testable by observation or experiment. In other words, we can actually determine whether evolution by natural selection is occurring. For condition 1, we need only look around to notice that different individuals of the same species vary in their characteristics. This is most evident in our own species, as we are attuned to those differences. However, a careful eye—and careful measurement—will show that all species vary in any number of traits. To test condition 2, we need to determine whether the differences among individuals are inherited from one generation to the next. Most often, this is done by looking at the characteristics of parents and their offspring. If parents and their offspring more closely resemble one another for a particular trait than unrelated individuals, then condition 2 is met for that particular trait.

Conditions 3 and 4 are often examined together. To test these two conditions, we need to show that not all individuals are equally likely to survive and reproduce. Again, thinking about our own species, we quickly realize that not all individuals live to the same age and have the same number of children. The same is true for all other species. We also need to show that the differences in survival and reproduction are due to differences in a certain trait. One way that we can do this is to compare traits, such as body size or color pattern, of individuals that survive to different ages or have different numbers of offspring. For example, in a population of water snakes on islands in Lake Erie, snakes without bands of color are more likely to survive and reproduce than those with bands. Thus conditions 3 and 4 are met in this population: natural selection is occurring on bands of color.

Although we can easily show that any of the four conditions for evolution by natural selection occurs in a population, how often has it been shown that all four conditions are met? The answer is many times, in many different species. Perhaps one of the best studied examples of evolution by natural selection is the evolution of beak size and shape in finches on the Galápagos Islands. Peter and Rosemary Grant have been studying the evolution of many species of these small songbirds for over thirty years. By marking birds with individual leg bands, the Grants were able to test the four conditions for evo-



Banded water snake without bands



Banded water snake with bands

Photos by David Scott/SREL. Reprinted with permission.

lution by natural selection in a natural population. In one species, the medium ground finch, beak depth (the size of the beak from top to bottom) is quite variable (condition 1). Some birds had beaks as small as 6 mm in depth; the largest beaks were twice that size. To test condition 2, the Grants compared the beak depths of parents and offspring. They found a high degree of correspondence between the beak depths of parents and their offspring. Parents with deep beaks had offspring with deep beaks, and parents with shallow beaks had offspring with shallow beaks. This observation suggests that differences in beak depth can be inherited and that condition 2 is met.

During 1977, a severe drought occurred in the Galápagos. As a result, food resources, in this case seeds, were limited and 84 percent of the population died (condition 3). By comparing the beak depths of birds before and after the drought, the Grants found that birds with deeper beaks were more likely to survive than those with shallower beaks. In other words, survival during the drought was nonrandom, and natural selection had occurred (condition 4). Birds with deeper beaks were more likely to survive the drought because they could more easily crack open and eat the larger, harder seeds that were most plentiful. As compared to before the drought, average beak depth increased from about 9.5 mm to greater than 10 mm. Evolution had occurred, and it was due to natural selection, as all four conditions were met.

Issues of Evolution and Natural Selection

Natural selection provides an elegantly simple explanation for evolution. However, despite its simplicity, many misconceptions about evolution by natural selection remain.

Natural Selection and Evolution

Perhaps the biggest misconception is that evolution and natural selection are one in the same. Yet, evolution is the consequence of natural selection, and

Figure 50.2 **Natural Selection and Darwin's Finches**

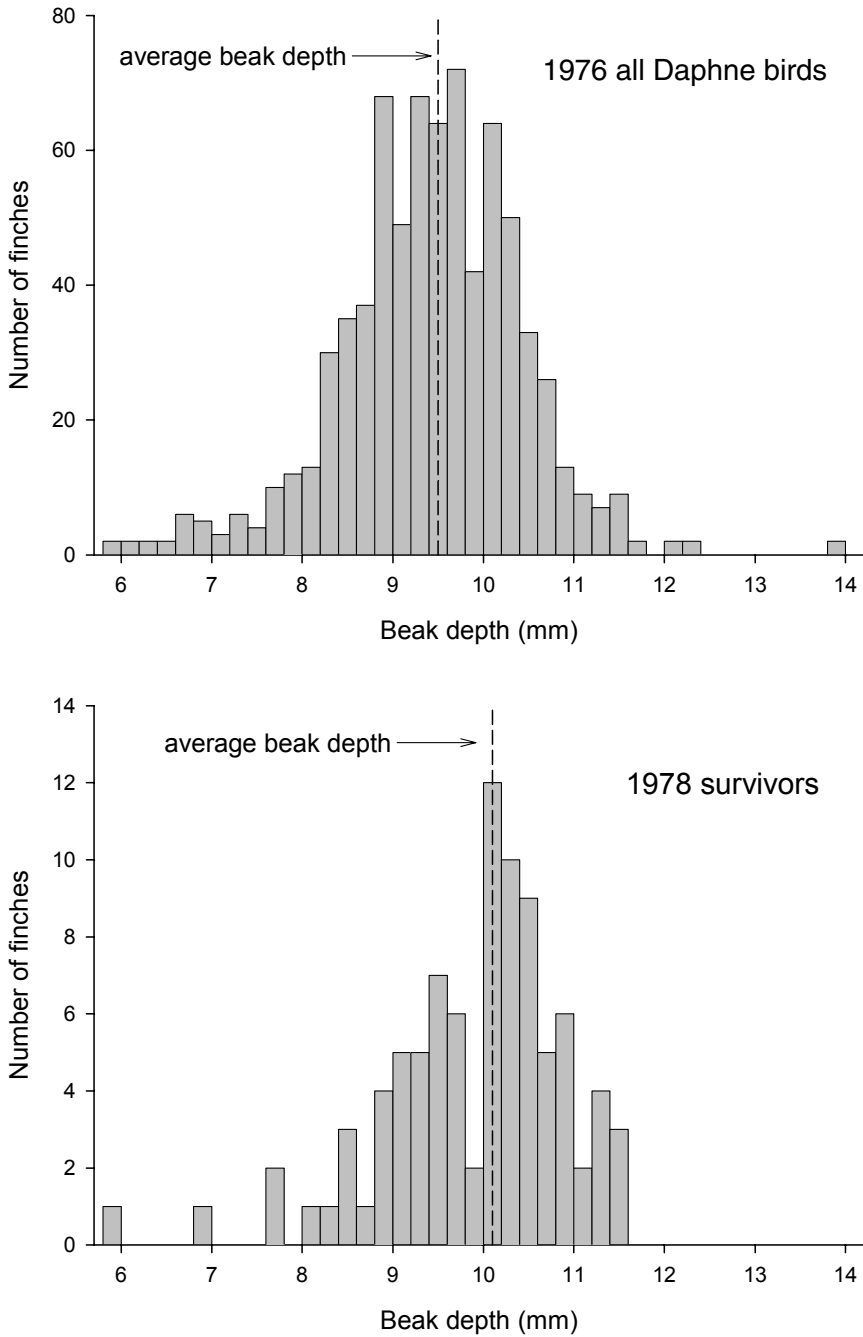

Source: Adapted from data in P.T. Boag and P.R. Grant, "The Classical Case of Character Release: Darwin's Finches (*Geospiza*) on Isla Daphne Major, Galapagos." *Biological Journal of the Linnean Society* 22 (1984): 243–87.

natural selection is the main mechanism of evolution. Because they are not the same, evolution can occur without natural selection, and natural selection can occur without leading to evolution. Recall that evolution is a consequence of a change in the genetic composition of a population over time. Therefore, any process that leads to such genetic change can result in evolution. Natural selection is one such process, but not the only one. For example, if individuals from one population with unique genes immigrate into another population, the genetic composition of that population has changed because new genes have been introduced. Evolution has occurred due to immigration, without natural selection.

Understanding how natural selection can occur without leading to evolution requires that we return to the four conditions necessary for evolution by natural selection. Condition 4 is natural selection. Yet, for evolution to occur as a result of natural selection, not only does condition 4 need to be met, but also conditions 1–3. Natural selection without evolution can occur when differences among individuals are caused by environmental differences and not genetic differences, and thus cannot be passed down from one generation to the next. To think about how this might happen, imagine two plants that are genetically the same, but one is grown in full sun and the other in shade. Because of differences in the amount of light they receive, the plants may differ in height or leaf shape. If differences in plant height or leaf shape lead to differences in survival or reproduction, natural selection will occur, but without evolution.

Evolution and natural selection differ in two other fundamental ways. First, natural selection acts on individuals. The characteristics of individuals determine whether they survive or reproduce. However, individuals do not evolve. The genetic makeup of an individual does not change as a result of natural selection. The genetic characteristics of populations change as a result of natural selection. So the consequence of natural selection—evolution—occurs in populations. Second, natural selection acts on differences in the appearance, or phenotype, of individuals. But evolution results in changes in the genetic makeup, or genotypes, of populations. The consequence of this difference, as discussed above, is that natural selection can occur without evolution if differences among individuals are not caused by genetic differences.

Natural Selection and Perfection

Over multiple generations, evolution by natural selection leads to adaptation of individuals to an environment. In other words, individuals are better able to survive and reproduce in that environment. Despite the continual process of adaptation, natural selection does not lead to perfect individuals with perfect traits.

The absence of perfection can be explained in a variety of ways. First, there may be trade-offs between traits that prevent all traits from being perfectly adaptive in an environment. For example, imagine that the “perfect” wildebeest

is both large in size and fast, as both would enable it to escape from lions. However, because of the increased weight associated with large size, larger individuals tend to be slower. That is, there is a trade-off between size and speed. So wildebeests can either be large and slow, or small and fast, but can't be both large and fast. As a result, the "perfect" wildebeest can't evolve.

Second, evolution by natural selection depends on differences among individuals in survival and reproductive success relative to one another, not on an absolute scale. Individuals don't have to be perfectly adapted to the environment to survive and reproduce; they just have to be better adapted than other individuals in the population. A wildebeest doesn't have to be the fastest wildebeest to survive and reproduce; it just has to be faster than the slowest wildebeests.

Third, natural selection can only act on the differences in phenotypes that occur in a population. It can't act on phenotypes that don't exist. No matter how well adapted an individual is, we can always imagine another new trait or variation of an existing trait that would increase its ability to survive and reproduce—that would make the individual more "perfect." But if that trait doesn't exist in the population, it can't be selected, and a more "perfect" individual will not evolve. It's possible that the trait just hasn't arisen by mutation yet, and when it does it will be selected. However, the trait may never arise, because of constraints of genetics, physiology, or morphology.

Finally, individuals are best adapted for the environment in which their parents lived, not the environment in which they live. In other words, evolution by natural selection is always one step behind. This happens because the individuals that we see today are the offspring of those individuals that were best adapted to the environment in the previous generation and as a result left the most offspring. If the environment changes from one generation to the next, evolution by natural selection can't catch up, and "perfect" individuals can't evolve. A related misconception is that organisms can be adapted for future changes in the environment. Again, natural selection is based on which individuals are best adapted to the current environment, and the consequences of selection don't appear until the subsequent generation. There is no way that natural selection can predict what phenotypes are going to be more adaptive or more "perfect" in the future.

Natural Selection and Progress

As emphasized above, natural selection is a nonrandom process. Some have interpreted the nonrandom nature of natural selection to imply that evolution is progressing toward a predetermined goal, and that that goal is increasingly complex organisms. Throughout the evolutionary history of life on Earth, we do see a trend for increased complexity. However, in many cases, evolution has led to a decrease in complexity. For example, many species of animals that live in caves are blind, even though they evolved from species that had

functional eyes. Furthermore, less complex organisms are often better adapted to living in certain environments than are more complex organisms. Single-celled organisms belonging to the Archaea, one of the three domains of living organisms along with Bacteria and Eucarya, thrive in hot springs, where more complex organisms would not survive. In this case, evolution by natural selection resulted in simplicity rather than complexity. Evolution by natural selection doesn't always lead to increased complexity, but it does always lead to organisms that are better adapted to their environments.

Natural Selection, Novel Traits, and New Functions

Novel traits can arise in individuals. Once they arise, they can be acted on by selection. If they increase an individual's ability to survive and reproduce, the novel traits will increase in frequency in the population. The two mechanisms by which novel traits arise are mutation and recombination. Mutation is any random change in the genotype of an organism, and it is the ultimate source of new genetic variation in a population. If a mutation results in a change in an individual's phenotype, then it can be acted on by natural selection and lead to the evolution of a new trait in a population. Recombination is limited to organisms that reproduce by sexual processes. By fusion of egg and sperm during sexual reproduction in eukaryotes, such as plants and animals, or by exchanges of DNA molecules in prokaryotes like bacteria, existing genes are brought together in new combinations that may produce novel traits.

In another kind of change, existing traits—whether they are morphological structures, behaviors, or proteins—can evolve new functions. The molecular biology of the lenses of animal eyes illustrates how proteins can evolve new functions, leading to the evolution of complex novel structures. About one-third of the lens of an animal eye is composed of lens crystallins, which are proteins that form arrays that refract light. A wide variety of different types of crystallins are found in animal eyes. Some of the most interesting crystallins are identical to enzymes that have functions outside of the eye. For example, in chickens, a single gene codes for a protein that acts as a metabolic enzyme outside of the eye and also as a crystallin in the eye. This same protein is found in other species that use it as a metabolic enzyme, but not as a crystallin, which suggests that in an evolutionary ancestor of chickens, this existing metabolic protein evolved a new function as a lens crystallin.

A Unified Understanding of Life

We began with two observations. First, we are surrounded by a great diversity of organisms. Second, despite this diversity, all organisms are similar, at least at the genetic level. With a full understanding of evolution by natural selection, now we can explain both of these seemingly contradictory observations.

What has led to the great diversity of organisms? Natural selection is a

powerful force for evolutionary change and the creation of new species. Over time, organisms from the same species in different environments will evolve divergent characteristics that allow them to best survive and reproduce in their respective environments. If these evolved differences prevent the organisms in the two environments from successfully interbreeding, then two new species have evolved from one ancestral species. Given enough time—and life on Earth has existed for about 4 billion years—this process of speciation due to the accumulation of changes that result from evolution by natural selection can generate a vast number and diversity of species.

Recent evidence from developmental genetics has provided a mechanism by which the great diversity of body plans of animals may have evolved. Homeotic genes are responsible for controlling development of body plans. With a few simple changes in when or where the homeotic genes are turned on, we see vast changes in a body plan. Millipedes and ants have the same homeotic genes. Only timing and place of the expression of those genes differ. As a result of such changes in gene expression, millipedes have lots of legs, whereas ants have only six. With a few changes in homeotic genes and natural selection for different body plans in different environments, the wide array of species we see could easily evolve.

Why are organisms that appear so different really so similar at the genetic level? The similarity among all organisms at the genetic level is strong evidence that all organisms evolved from a single common ancestor. It is more likely that a trait such as the gene for HMG CoA reductase, a metabolic enzyme, will arise once in a common ancestor and be passed down to all descendant species than it is for the trait to arise in each species independently. In general, evolution does not reinvent the wheel (although sometimes this, too, may happen—in processes called parallel and convergent evolution). In each new species, as long as individuals with a functioning metabolic enzyme are favored by natural selection, the gene will persist and change little.

We are often in awe of the diversity of life that surrounds us. In a sense, we are in awe of the power of natural selection. The power of natural selection is in its simplicity: very few conditions must exist for evolution by natural selection to occur. The power of natural selection is also in its ability to explain such divergent observations as the diversity of life and the unity of all living things. Evolution by natural selection serves to unify our understanding of all of life.

Bibliography

- Darwin, Charles. *The Origin of Species*. London: John Murray, 1859.
- Dawkins, Richard. *The Blind Watchmaker: Why the Evidence of Evolution Reveals a Universe Without Design*. New York: W.W. Norton, 1986.
- Dobzhansky, Theodosius. "Nothing in Biology Makes Sense Except in the Light of Evolution." *American Biology Teacher* 35:3 (1973): 125–29.
- Freeman, Scott, and Jon C. Herron. *Evolutionary Analysis*. 3rd ed. Upper Saddle River, NJ: Pearson Prentice Hall, 2004.

- Jones, Steve. *Darwin's Ghost: The Origin of Species Updated*. New York: Ballantine, 2000.
- Lamarck, Jean-Baptiste. *Philosophie Zoologique*. Paris: G. Bailliére, 1830.
- Mayr, Ernst. *What Evolution Is*. New York: Basic Books, 2001.
- Miller, Kenneth R. *Finding Darwin's God: A Scientist's Search for Common Ground Between God and Evolution*. New York: Cliff Street Books, 1999.
- Schaff, Philip. *What Is Church History?* Philadelphia: Lippincott, 1846.
- Weiner, Jonathon. *The Beak of the Finch: A Story of Evolution in Our Time*. New York: Knopf, 1994.
- Wilson, Edward O. *The Diversity of Life*. New York: W.W. Norton, 1992.
- Zimmer, Carl. *Evolution: The Triumph of an Idea*. New York: HarperCollins, 2001.

51 Intelligent Design

Michael J. Behe

Driving down a road in South Dakota, a foreign visitor to the United States might come upon the odd mountain formation pictured in Figure 51.1. Even though he had never seen nor heard of Mount Rushmore, it would not cross his mind to imagine that wind, erosion, earthquake, or some other wholly unintelligent process forged the remarkable likenesses to human visages (even if he didn't recognize them as American presidents). Rather, he would immediately grasp that someone sculpted the faces on the mountain. Somehow he knows that the images were intelligently designed by a conscious agent.

We humans are good at recognizing the effects of intelligence in our world. From fraudulent manipulations of manmade systems (such as lotteries) to purposeful arrangements of pieces of the natural world (such as flowers in a garden), we often conclude with firm certainty that something was not the result of chance alone, that it was constructed or guided or maneuvered by a conscious being. Sometimes we spend a lot of money, effort, and technical expertise to detect the presence of intelligence. For example, in the SETI (Search for Extraterrestrial Intelligence) project, scientists try to detect the existence of intelligent space aliens by scanning the skies for radio signals that may have intentionally or inadvertently been sent to our corner of the universe.

But what if we find the equivalent of Mount Rushmore or an alien radio program in basic parts of nature? What if the fundamental laws of the universe or the foundation of life strike us as designed? Can we then conclude that nature or life was designed by an intelligent agent? Advocates of the design argument contend yes. Critics of the argument say the perception of design in nature is an unreliable intuition.

The History of Intelligent Design

The design argument—that is, the argument that we can know an intelligent being created the world because of the evidence of design in nature—has

Figure 51.1 **Mount Rushmore**

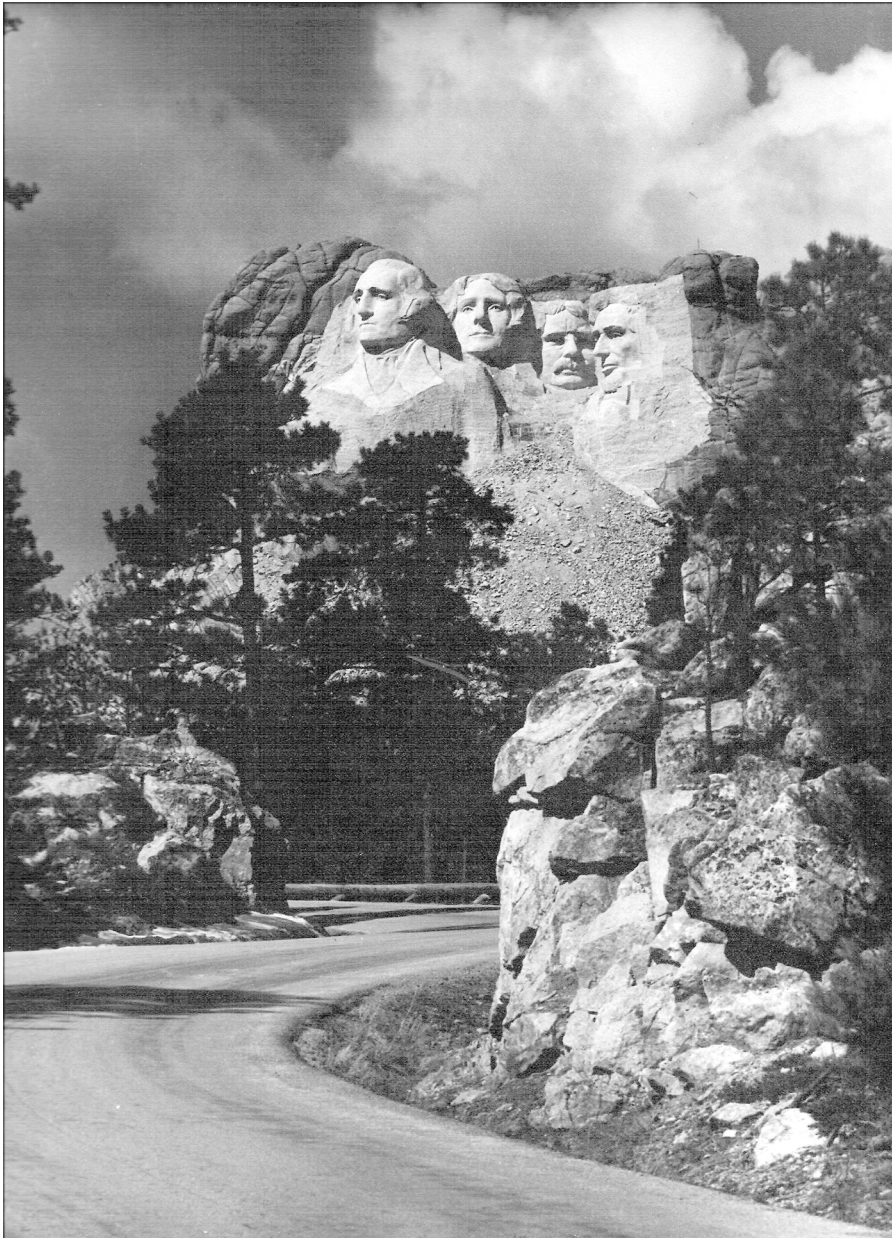

been debated since antiquity, although it has varied in form and emphasis. The Greek philosopher Aristotle thought the fact that nature seems to work toward a goal—that rocks fall down, that cuts heal, that acorns grow into oaks—is evidence of design, since intelligent agents work toward goals. In his proofs for the existence of God, the medieval philosopher Thomas Aquinas echoed Aristotle, remarking that natural bodies act for a purpose, yet mind-

less bodies can only act for a purpose if they are directed by an intelligence, as an arrow is directed by an archer. Aquinas went beyond Aristotle in claiming that the source of the directing intelligence was not in nature itself; it was beyond nature in the being we call God.

The most famous version of the design argument is attributed to William Paley, an Anglican clergyman. In *Natural Theology*, published in the early nineteenth century, Paley contrasted our likely reactions to finding a stone and finding a watch.

In crossing a heath, suppose I pitched my foot against a *stone*, and were asked how the stone came to be there, I might possibly answer, that for any thing I knew to the contrary it had lain there forever; nor would it, perhaps, be very easy to show the absurdity of this answer. But suppose I had found a *watch* upon the ground, and it should be inquired how the watch happened to be in that place, I should hardly think of the answer which I had before given, that for any thing I knew the watch might have always been there. Yet why should this answer not serve for the watch as well as for the stone; why is it not as admissible in the second case as in the first? For this reason, and for no other, namely, that when we come to inspect the watch, we perceive—what we could not discover in the stone—that its several parts are framed and put together for a purpose, *e.g.* that they are so formed and adjusted as to produce motion, and that motion so regulated as to point out the hour of the day; that if the different parts had been differently shaped from what they are, or placed after any other manner or in any other order than that in which they are placed, either no motion at all would have been carried on in the machine, or none which would have answered the use that is now served by it. . . . This mechanism being observed—it requires indeed an examination of the instrument, and perhaps some previous knowledge of the subject, to perceive and understand it; but being once, as we have said, observed and understood, the inference we think is inevitable, that the watch must have had a maker—that there must have existed, at some time and at some place or other, an artificer or artificers who formed it for the purpose which we find it actually to answer, who comprehended its construction and designed its use.

Paley raises points not previously considered by Aristotle. He notes that our apprehending that the watch had a maker requires an “examination” and understanding of the watch. In other words, we must know what the watch is for and how it works. This implies that our awareness of the design of an object will depend on our state of knowledge about it. Paley also moves beyond Aristotelian “purposes” to consider how separate parts of the watch work together. If the parts of the watch were not fitted to each other, he notes, it would not work. From this, Paley concludes, we know the watch had a designer. In *Natural Theology*, Paley cites many examples from nature that he thinks are similar to watches in that they have interacting parts, such as mammary glands and hearts.

In the late eighteenth century, some years prior to Paley’s work, the philosopher David Hume criticized the design argument on philosophical grounds. Hume reasoned that likening plants and animals to machines was not a legitimate comparison, since there are so many differences between living and nonliving things that one could not be sure any similarities were due to simi-

lar causes. Just because machines required design said nothing about whether animals required design. Hume also contended that, in order to have reason to believe that animals in our world were designed, we would have to have experience of animals being designed in other worlds. Since we have no such experience, we have no basis to conclude animals in our world are designed. Clever as Hume's reasoning might be, books of design arguments continued to be published, perhaps because the appearance of design in nature was so strong that, in order to supplant it, an alternative, positive explanation for the appearance of design was required. That was given by Darwin.

As a young man, Charles Darwin admired Paley's *Natural Theology*. However, Darwin's voyages on the HMS *Beagle* and his subsequent thinking eventually led him to a radically different explanation for the appearance of design in nature—the theory of evolution by natural selection. From his observations, Darwin realized that there is variation in all species—not all members of a particular species are identical. From his reading of Thomas Malthus's work on the geometric growth of populations, Darwin realized that a struggle for existence would result as organisms competed for resources. In such a struggle, if the chance variation of an organism happened to give it any advantage, then on average it would tend to survive and leave offspring. If the offspring inherited the variation, then over time the characteristics of the species would change, as the percentage of the population that had the inherited, advantageous variation increased. With many repetitions of the same scenario, over great periods of time, great changes might occur, until the descendants were hardly recognizable as members of the original species.

Here was a positive explanation for how the appearance of design could arise in nature without the need for an intelligent agent. Over long time periods, by small steps, natural selection honed the shape and structure of biological features until they were so well fitted to their function that they appeared as if they had been made to order. Unlike Hume's work, Darwin's positive theory signaled the precipitous decline of the influence of the design argument. It should be noted that none of the biological features that Paley had advanced as examples of design was actually demonstrated to be able to be produced by natural selection. Rather, after Darwin the presumption shifted. Since a plausible general mechanism for producing the appearance of design was available, the design argument lost its force.

The Revitalization of the Design Argument

In the past several decades, the design argument has made a remarkable comeback from its low point in the years after Darwin's work. The key has been a facet of the argument recognized by William Paley—that the design argument depends on our understanding of nature. Advances in science can drastically affect our evaluation of the strength of the argument, and science has advanced tremendously since the nineteenth century.

The revitalization of the design argument has been led by physics. Progress in physics has shown that many features of the universe must be finely tuned to permit life to exist. One of the first examples of such a feature was noted by the physicist Fred Hoyle, who predicted that the nuclear resonance levels of certain elements would have to occur at very particular frequencies to allow the synthesis of carbon in the nuclear furnaces of stars. Without carbon, life as we know it would be impossible. Hoyle's prediction was later born out by experiment. Taken aback, Hoyle remarked that it appeared a superintellect had manipulated the laws of physics.

In the mid 1970s, the physicist Brandon Carter coined the term "anthropic principle" to indicate that the universe appears remarkably fine-tuned to allow for life to occur. If any of a number of factors had been different by a small degree, life would not have been possible. Such factors include the value of the charge on the electron, the strength of the fundamental forces of nature, and the rate of expansion of the Big Bang. Some proponents of the design argument contend that the felicity of the many conditions in our universe that permit life are indicative of purposeful design.

The argument for an intelligent designer can be extended from fundamental laws and constants of the universe to finer levels of physical structure. Habitable planets, for example, cannot occur just anywhere throughout a galaxy; many regions of a galaxy are closed off to life because of high fluxes of radiation, frequent supernovas, a paucity of metals, and other factors. Given the physical conditions required, Earth may be uniquely able to support intelligent life. The chemical structure of DNA, the strength of the weaker bonds between biological molecules, and other factors required for life are also finely tuned, suggesting that intelligent design may extend deep into the physical structure of the universe, from the value of the gravitational constant to the chemical properties of the metal molybdenum, which is necessary for incorporating nitrogen into the stream of life.

Some skeptics of the design argument have questioned just how fine-tuned the laws of nature really are. Others speculate about multiple universes coupled to a selection effect. In this view, our universe is only one of very many—perhaps infinitely many—in which the forces and constants of nature can take different values. Since life cannot exist in a universe that does not have the conditions to support it, critics contend it is unsurprising that we find ourselves in a universe compatible with life. Design proponents answer that experimental evidence for an infinite number of universes is lacking, and that speculative, unseen universes are no less metaphysical than an unseen supernatural designer.

The Argument from Biochemistry

Darwin proposed his theory in the nineteenth century, when the molecular basis of life was unknown. The cell then was thought to be a simple structure,

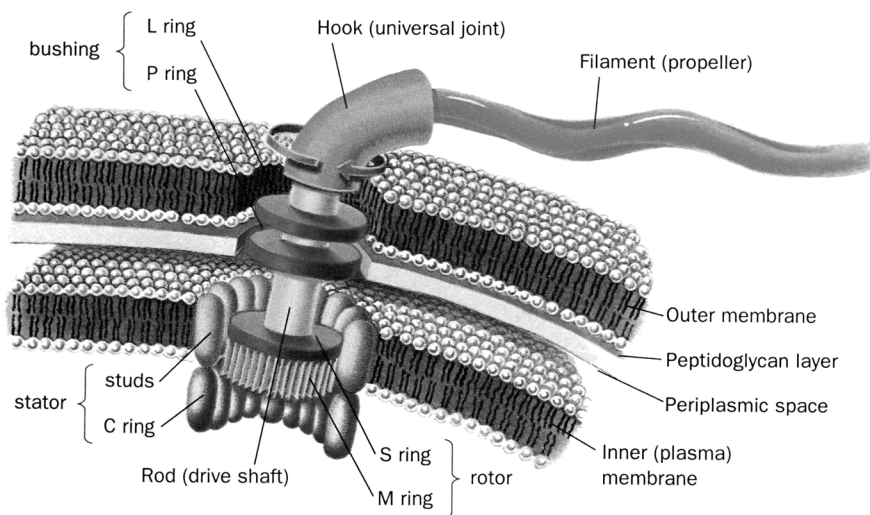
Figure 51.2 **Bacterial Flagellum**

Reprinted, with permission, from the *Annual Review of Biophysics and Biomolecular Structure*, Volume 23 © 1994 by Annual Reviews. www.annualreviews.org.

essentially a microscopic piece of Jell-O. In the intervening years, and especially in the late twentieth century, science has learned that the cell is exceedingly complex, and that life depends on the existence of intricate molecular machines—quite literally, machines made of molecules—such as the bacterial flagellum pictured in Figure 51.2, which is a rotary-powered motor that many bacteria use to swim. Our knowledge of biology has greatly advanced since Darwin, which raises the question of whether his theory can wholly account for what has been learned. Proponents of intelligent design argue it cannot.

The argument of design proponents echoes words of Darwin himself who, when discussing the complexity of the eye in *On the Origin of Species*, remarked: “If it could be demonstrated that any complex organ existed, which could not possibly have been formed by numerous, successive, slight modifications, my theory would absolutely break down. But I can find out no such case.” Darwin was emphasizing that his was a gradualistic theory, in which natural selection improved features slowly in small steps over great periods of time. If a complex feature appeared quickly by large leaps, then Darwin thought natural selection acting on random variation would be an unlikely explanation.

In *Darwin’s Black Box: The Biochemical Challenge to Evolution*, I have argued that a challenge to Darwin’s theory is found in systems that are irreducibly complex. An irreducibly complex system has a number of parts, all of the parts contribute to the function, and the removal of any part causes the system to cease functioning. An example of an irreducibly complex system

Figure 51.3

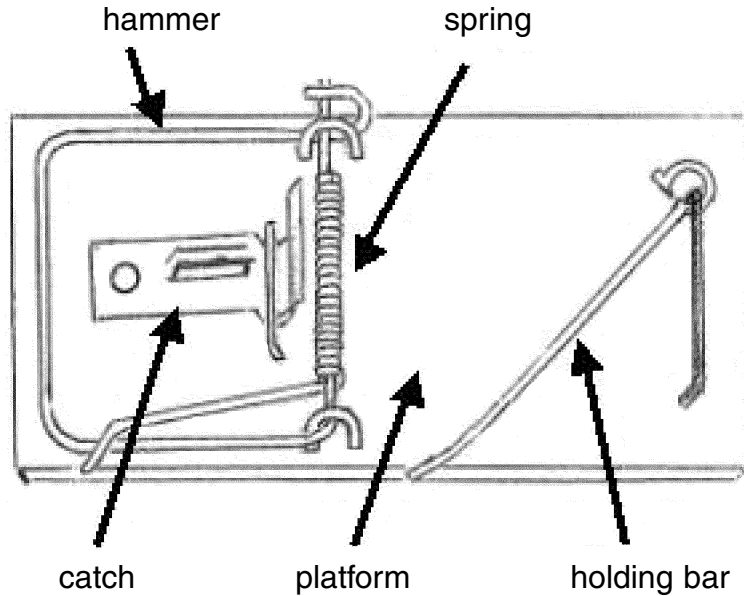

from everyday life is a mechanical mousetrap (Figure 51.3). All of the parts of the pictured mousetrap are required for it to work, and if one is removed, it no longer works. Since the function of such a system only appears when it is completely built, their gradual evolutionary construction in small steps by “numerous, successive, slight modifications” is problematic; irreducibly complex systems are difficult to fit into a Darwinian framework.

Yet, many biochemical systems are irreducibly complex, such as the bacterial flagellum pictured in Figure 51.2. The flagellum is constructed of thirty to forty separate protein parts, the great majority of which are required for it to work. Moreover, the problem of the evolutionary construction of systems like the flagellum is even more difficult than simply manufacturing parts. In our world, intelligent agents physically put together parts of machines, such as mousetraps, to make a functioning whole. In the cell, however, molecular machines have to assemble themselves. To do this, parts of molecular machines must have their surfaces shaped to be exactly complementary to the parts they bind to.

Many see in irreducibly complex systems the hallmarks of intelligent design. Whenever we see complex interactive systems such as a mousetrap, we conclude that the systems were designed. Unexpectedly science has discovered such systems at the molecular foundation of life, and design proponents claim it is a compelling conclusion that those systems too were designed. If this is the case, then intelligent design is not confined to the laws of nature; it extends deep into life itself.

Some critics argue that, although irreducibly complex systems may not evolve directly for their modern function, they may have evolved indirectly by Darwinian processes, with the system changing functions over time and recruiting new parts from other systems. Others remark that experiments already reported in scientific publications show how such systems could arise in small steps. Proponents of intelligent design respond that the significance of the reported experiments is either exaggerated or misconstrued, and that the indirect evolution of irreducibly complex biochemical systems is an exercise in imagination with no experimental support. Some critics of the argument for intelligent design state that science cannot support a theory that invokes the supernatural, since science studies only natural phenomena. Proponents of design answer that the argument does not invoke the supernatural, it invokes intelligence, and that the evidence used to support the conclusion is the data of nature, not mystical revelations.

The intelligent design argument is quite controversial, with the controversy increasing the further into biology design is claimed to extend. Being controversial, however, is a big step up from being forgotten, as the design argument once was. As William Paley knew, the argument's fortunes depend on our knowledge of nature and, surprisingly to some people, have improved as science has advanced. Since the progress of science continues at breathtaking speed, the coming decades may see a more definitive judgment on the intelligent design argument.

Bibliography

- Barrow, John D., and Frank J. Tipler. *The Anthropic Cosmological Principle*. Oxford: Oxford University Press, 1986.
- Behe, Michael J. *Darwin's Black Box: The Biochemical Challenge to Evolution*. New York: Free Press, 1996.
- Conway Morris, Simon. *Life's Solution: Inevitable Humans in a Lonely Universe*. Cambridge: Cambridge University Press, 2003.
- Davies, Paul. *God and the New Physics*. New York: Simon and Schuster, 1983.
- Dawkins, Richard. *The Blind Watchmaker: Why the Evidence of Evolution Reveals a Universe without Design*. New York: W.W. Norton, 1986.
- Dembski, William A. *Intelligent Design: The Bridge between Science and Theology*. Downers Grove, IL: InterVarsity Press, 1999.
- Denton, Michael J. *Nature's Destiny: How the Laws of Biology Reveal Purpose in the Universe*. New York: Free Press, 1998.
- Miller, Kenneth R. *Finding Darwin's God: A Scientist's Search for Common Ground between God and Evolution*. New York: Cliff Street Books, 1999.
- Paley, William. *Natural Theology*. Philadelphia: John Morgan, 1802.
- Pennock, Robert T. *Intelligent Design Creationism and Its Critics: Philosophical, Theological, and Scientific Perspectives*. Cambridge, MA: MIT Press, 2001.
- Tegmark, M. "Parallel Universes." *Scientific American*, May 2003, 40–51.
- Ward, Peter D., and Donald Brownlee. *Rare Earth: Why Complex Life Is Uncommon in the Universe*. New York: Copernicus, 2000.

52 Evolution and Religion

Scott Atran

In the field of neuropsychology, religion and an awareness of the supernatural are seen as by-products of several cognitive and emotional mechanisms that evolved under natural selection. We use religion and belief in the supernatural to help us solve inescapable, existential problems that have no apparent worldly solution. Among these are the inevitability of death and the threat of deception by others. Religion involves a costly and hard-to-fake commitment to a counterfactual world of supernatural agents that master such existential anxieties. The greater one's display of costly commitment to that world—as in the scriptural account of Abraham's willingness to sacrifice his son—the greater society's trust in one's ability and willingness to help out others with their inescapable problems.

The Supernatural Agent: Hair-Trigger Folk Psychology

A growing number of cross-cultural experiments on “domain-specific cognition” emanating from developmental psychology, cognitive psychology, and cognitive anthropology indicate that human minds are innately endowed with core cognitive faculties for understanding the everyday world of readily perceptible substances and events. These core faculties are activated by stimuli that fall into a few areas of intuitive knowledge, such as folk mechanics (object boundaries and movements), folk biology (biological species configurations and relationships), and folk psychology (interactive agents and goal-directed behavior). The term *folk* is used in these labels to indicate ordinary commonsense understandings or knowledge bases. When something shakes our basic assumptions about how things work in the real world, counterintuitions result that form the basis for constructing special sorts of counterfactual worlds, including the supernatural. In some cultures, this counterfactual world may include intelligent mineral substances, such as a crystal ball or a talisman. Some counterfactual worlds include beings that can pass through solid objects, such as angels, ghosts, or ancestral spirits.

Humans operate on a number of basic assumptions about objects and events. For example, as noted by Spelke, even infants assume that a naturally occurring rigid body cannot occupy the same space as another (unlike shadows), or follow discontinuous trajectories when moving through space (unlike fires), or change direction under its own self-propelling initiative (unlike animals), or affect the behavior of another object without physical contact (unlike people). When experimental conditions simulate violation of these universal assumptions, as in a magic trick, infants show marked surprise. Children initially expect shadows to behave like ordinary objects, and even adults remain uncertain as to how shadows move. This kind of uncertainty often evokes the supernatural.

Religions invariably center on *supernatural agent* concepts, such as gods, goblins, demons, witches, fairies, and jinns. The concept of *agency* is a central player in what cognitive and developmental psychologists refer to as “folk psychology,” referring to the study of people’s ordinary knowledge or interpretations of agents and goal-directed behaviors. Certain hair-trigger responses evolved in humans so we can react almost automatically under stressful conditions of uncertainty. Our understanding of agency helps us respond swiftly to potential threats from predators, or to opportunities and potential protectors.

By our instinctive understanding of agency, we have a sort of “innate releasing mechanism,” according to Tinbergen. The proper evolutionary domain of this mechanism is animate objects, but it inadvertently extends to such phenomena as moving dots on a computer screen, voices in the wind, faces in clouds, and virtually any complex design or uncertain circumstance of unknown origin. Numerous experiments show that children and adults spontaneously interpret the contingent movements of dots and geometrical forms on a screen as interacting agents who have distinct goals and internal motivations for reaching those goals. Such a biological processing program allows rapid and economical reaction to a wide range of stimuli and would have been understandably helpful for our ancestors in their rougher and more dangerous environments. Mistakes, or false positives, would have carried little cost, whereas a true response could have provided the margin of survival.

Our brains are trip-wired to spot lurkers and to seek protectors where conditions of uncertainty prevail, as they do when we are startled or in unfamiliar environments, or during sudden catastrophe, or when facing solitude, illness, or the prospect of death. Perhaps the most dangerous and deceptive predator for humans has been other humans. Thus concealment, deception, and the ability to generate and recognize false beliefs in others would favor survival. In potentially dangerous or uncertain circumstances, it would be best to anticipate and fear the worst of all likely possibilities: the presence of a deviously intelligent predator. How else could humans have managed to survive such deadly competitive groups as the Iatmul headhunters of New Guinea or the Nāga of Assam in northern India? According to Crooke:

All the Nāga tribes are, on occasion, head-hunters, and shrink from no treachery in securing these ghastly trophies. Any head counts, be it that of a man, woman, or child, and entitles the man who takes it to wear certain ornaments according to the custom of the tribe or village. Most heads are taken . . . not in a fair fight, but by methods most treacherous. As common a method as any was for a man to lurk about the water Ghat of a hostile village, and kill the first woman or child who came to draw water. . . . Every tribe, almost every village is at war with its neighbour, and no Nāga of these parts dare leave the territory of his tribe without the probability that his life will be the penalty.

From an evolutionary perspective, it's better to be safe than sorry regarding the detection of agency under conditions of uncertainty. This cognitive proclivity would favor the emergence of a belief in malevolent deities, just as the propensity to attach to protective caregivers would favor a belief in benevolent deities. For the Carajá Indians of central Brazil, intimidating or unsure regions of the local ecology are religiously avoided, as Lipkind writes: "The earth and underworld are inhabited by supernaturals. . . . There are two kinds. Many are amiable and beautiful beings who have friendly relations with humans. . . . The others are ugly and dangerous monsters who cannot be placated. Their woods are avoided and nobody fishes in their pools." Nearly identical descriptions of supernaturals can be found in ethnographic reports throughout the Americas, Africa, Eurasia, and Oceania.

In addition, humans *conceptually create* information to mimic and manipulate conditions in ancestral environments that originally triggered our evolved cognitive and emotional dispositions. Humans habitually fool their own innate releasing programs, as when people become sexually aroused by makeup (which artificially highlights sexually appealing characteristics), perfumes, or pornographic pictures. Indeed, much of human culture—for better or worse—can be attributed to focused stimulations and manipulations of our species' innate proclivities.

These manipulations can activate and play on several different cognitive and emotional faculties at once. Thus, masks can trigger our innate, hyperactive facial-recognition schema. Masks can activate, amplify, and confound emotions by highlighting, exaggerating, or combining certain facial expressions. Moreover, like two-dimensional drawings of the Necker cube for which there is no stable three-dimensional interpretation, masks can produce feelings of unresolved anxiety or "uncanniness." In some religious ceremonies, for example, a mask rotates away from an onlooker to reveal not the mask's hollow back, but a three-dimensional face inside the back of the mask. Such manipulations can serve cultural ends far removed from the ancestral adaptive tasks that originally gave rise to those cognitive and emotional faculties that are triggered.

Recently, numbers of devout American Catholics eyed the image of Mother Theresa in a cinnamon bun sold at a shop in Tennessee. Latinos in Houston prayed before a vision of the Virgin of Guadalupe, whereas Anglos saw only the dried remnants of melted ice cream on a pavement. Cuban exiles in Mi-

ami spotted the Virgin Mary in windows, curtains, and television afterimages as long as there was hope of keeping young Elian Gonzalez from returning to godless Cuba. After the terrorist attacks on the World Trade Center, newspapers showed photos of smoke billowing from one of the towers that the *Philadelphia Daily News* described as looking like “the face of the Evil One, complete with beard and horns and malignant expression, symbolizing to many the hideous nature of the deed that wreaked horror and terror upon an unsuspecting city.”

In all these cases, there is a culturally conditioned emotional priming in anticipation of agency. This priming, in turn, amplifies the information value of otherwise doubtful, poor, and fragmentary agency-relevant stimuli. This enables the stimuli (e.g., cloud formations, pastry, sounds of dubious origin) to achieve the minimal threshold for triggering hyperactive schemata that humans possess for identifying agents. The “buzzings” associated with the Fatima Marian apparitions in Portugal in 1917 and Bernadette Soubirous’s “visions” of the Virgin Mary at Lourdes in France some decades earlier were possibly expressions of this pancultural disposition.

In sum, supernatural agents are readily conjured up because natural selection has trip-wired cognitive schema for agency detection in the face of uncertainty. Uncertainty is omnipresent; so, too, is the hair-triggering of an agency-detection mechanism that readily promotes supernatural interpretation and is susceptible to various forms of cultural manipulation. Cultural manipulation of this mechanism can facilitate and direct the process. Because the perceived phenomena readily activate intuitive processes, they are more likely to survive transmission from mind to mind under a wide range of different environments and learning conditions than entities and information that are harder to process. As a result, they are more likely to become enduring aspects of human cultures, such as belief in the supernatural.

Existential Anxiety: An Experiment on What Motivates Belief

If we believe that supernatural agents are intelligent and possess hidden knowledge and powers, then we may believe that they can be invoked to ease our existential anxieties about death, deception, and other threats. I recently undertook an experiment with psychologists Ara Norenzayan and Ian Hansen linking adrenaline-activating death scenes to an increased belief in God’s existence and the efficacy of supernatural intervention in human affairs. Our experiment builds on a study by Cahill and colleagues dealing with the effects of adrenaline on memory. In their study, college students were shown a series of slides and a storyline about a boy riding a bike. Some subjects were exposed to an uneventful story: the boy rides his bike home, and he and his mother drive to the hospital to pick up his father (who is a doctor). For the

other participants, the story begins and ends in much the same way, but the middle is very different: the boy is hit by a car and rushed to the hospital's emergency room, where a brain scan shows severe bleeding and specialized surgeons struggle to reattach the boy's severed feet. After exposure to the stories, and before being tested for recall, half the subjects were given either a placebo pill or a drug (propranolol) that blocks the effects of adrenaline. The placebo and drug groups recalled the uneventful story equally well. But only the placebo group remembered the emotional story more accurately than the uneventful one.

In our experiment, our hypothesis was that existential anxieties (particularly death) not only deeply affect how people remember events but also their propensity to interpret events in terms of supernatural agency. We primed each of three groups of college students with one of three different stories (Table 52.1): the uneventful story (neutral prime) and stressful story (death prime) from the Cahill experiment, and another uneventful story whose event-structure matched the other two stories but which included a prayer scene (religious prime). Afterward, each group of subjects read an October 2, 2001, *New York Times* article whose lead ran: "Researchers at Columbia University, expressing surprise at their own findings, are reporting that women at an in vitro fertilization clinic in Korea had a higher pregnancy rate when, unknown to the patients, total strangers were asked to pray for their success." The article was given under the guise of a story about "media portrayals of scientific studies." Finally, students rated the strength of their belief in God and the power of supernatural intervention (prayer) on a 9-point scale. Our results show that strength of belief in God's existence and in the efficacy of supernatural intervention is reliably stronger after exposure to the death prime than to the neutral or religious prime (there were no significant differences between either uneventful story). This effect held even after controlling for religious background and prior degree of religious identification.

Terror management theory maintains that a person's cultural worldview is a principal buffer against the terror of death. Accordingly, experiments performed by Greenberg and colleagues and by Pyszczynski and colleagues show that thoughts of death function to get people to reinforce their cultural (including religious) worldview and derogate alien worldviews. Thus awareness of death should enhance belief in a worldview-consistent deity but diminish belief in a worldview-threatening deity. My colleagues and I hypothesized that the need for belief in supernatural agency overrides worldview defense needs for death-aware subjects.

We tested this idea in a follow-up to our earlier study. This time, seventy-three American undergraduates were told that the prayer groups who were praying for the success of women at an in vitro fertilization clinic were Buddhists in Taiwan, Korea, and Japan. Supernatural belief was measured either shortly after the primes, or after a significant delay between the primes and

Table 52.1

**Three stories with matching events used to prime feelings of religiosity:
Neutral (uneventful), Death (stressful), Religious (prayer scene)**

	Neutral	Death	Religious
1	A mother and her son are leaving home in the morning	A mother and her son are leaving home in the morning	A mother and her son are leaving home in the morning
2	She is taking him to visit his father's workplace	She is taking him to visit his father's workplace	She is taking him to visit his father's workplace
3	The father is a laboratory technician at Victory Memorial Hospital	The father is a laboratory technician at Victory Memorial Hospital	The father is a laboratory technician at Victory Memorial Hospital
4	They check before crossing a busy road	They check before crossing a busy road	They check before crossing a busy road
5	While walking along, the boy sees some wrecked cars in a junk yard, which he finds interesting	While crossing the road, the boy is caught in a terrible accident, which critically injures him	While walking along, the boy sees a well-dressed man stop by a homeless woman, falling on his knees before her, weeping
6	At the hospital, the staff are preparing for a practice disaster drill, which the boy will watch	At the hospital, the staff prepares the emergency room, to which the boy is rushed	At the hospital, the boy's father shows him around his lab. The boy listens politely, but his thoughts are elsewhere
7	An image from a brain scan machine used in the drill attracts the boy's interest	An image from a brain scan machine used in a trauma situation shows severe bleeding in the boy's brain	An image from a brain scan that he sees reminds him of something in the homeless woman's face
8	All morning long, a surgical team practices the disaster drill procedures	All morning long, a surgical team struggles to save the boy's life	On his way around the hospital, the boy glances into the hospital's chapel, where he sees the well-dressed man sitting alone
9	Make-up artists are able to create realistic-looking injuries on actors for the drill	Specialized surgeons are able to re-attach the boy's severed feet, but cannot stop his internal hemorrhaging	With elbows on his knees, and his head in his hands, the man moves his lips silently. The boy wants to sit beside him, but his father leads him away
10	After the drill, while the father watches the boy, the mother leaves to phone her other child's pre-school	After the surgery, while the father stays by the dead boy, the mother leaves to phone her other child's pre-school	After a brief tour of the hospital, while the father watches the boy, the mother leaves to phone her other child's pre-school
11	Running a little late, she phones the pre-school to tell them she will soon pick up her child	Barely able to talk, she phones the pre-school to tell them she will soon pick up her child	Running a little late, she phones the pre-school to tell them she will soon pick up her child
12	Heading to pick up her child, she hails a taxi at the number nine bus stop	Heading to pick up her child, she hails a taxi at the number nine bus stop	Heading to pick up her child, she hails a taxi at the number nine bus stop

the belief measures. When the primes were recently activated, as expected there was a stronger belief in the power of Buddhist prayer in the death prime than in the control prime. Remarkably, death-primed subjects who previously self-identified as strong believers in Christianity were *more* likely to believe in the power of Buddhist prayer. In the neutral (control) condition, there was no correlation between Christian identification and belief in Buddhist prayer. Given a choice between supernatural belief versus rejecting an alien worldview (Buddhism), Christians chose the former. This finding is difficult to explain in terms of bolstering a cultural worldview.

In a cross-cultural extension, seventy-five Yukatek-speaking Maya villagers were tested, using stories matched for event structure but modified to fit Maya cultural circumstances. They were also asked to recall the priming events. We found no differences among primes for belief in the existence of God and spirits (near ceiling in this very religious society). However, subjects' belief in efficacy of prayer for invoking the deities was significantly greater with the death prime than with religious or neutral primes. Awareness of death more strongly motivates religiosity than mere exposure to emotionally nonstressful religious scenes, like praying. This supports the claim that emotionally eruptive existential anxieties motivate supernatural beliefs.

We found no evidence for differences in recall of priming events after subjects rated their strength of belief in God and the efficacy of supernatural intervention. With this in mind, as discussed in McReady, note that uncontrollable arousal mediated by adrenergic activation (e.g., subjects chronically exposed to death scenes) can lead to post-traumatic stress syndrome if there is no lessening of terror and arousal within hours. However, adrenergic blockers (e.g., propranolol, guanfacine, possibly antidepressants) can interrupt neuronal imprinting for long-term symptoms, as can cognitive-behavioral therapy. Heightened expression of religiosity following exposure to death scenes that provoke existential anxieties may also serve this blocking function. We plan to test the further claim that existential anxieties not only spur supernatural belief, but that these beliefs are in turn validated by assuaging the very emotions that motivate belief in the supernatural.

This does not mean that *the* function of religion and the supernatural is to promise resolution of all existential anxieties, or that it is to neutralize moral relativity and establish social order, give meaning to an otherwise arbitrary existence, or explain the unobservable origins of things. Religion has no evolutionary functions per se. It is rather that existential anxieties and moral sentiments constitute—by virtue of evolution—ineluctable elements of the human condition. And the cognitive invention, cultural selection, and historical survival of religious beliefs owe, in part, to success in accommodating these elements. There are other factors in this success, involving naturally selected elements of human cognition. These include the inherent susceptibility of religious beliefs to conceptual processing systems, such as folk psychology, that favor survival of the supernatural within and across minds.

Bibliography

- Alexander, R. *The Biology of Moral Systems*. New York: Aldine de Gruyter, 1987.
- . “Evolution of the Human Psyche.” In *The Human Revolution*, ed. C. Stringer. Edinburgh: University of Edinburgh, 1989.
- Atran, S. “Basic Conceptual Domains.” *Mind and Language* 4 (1989): 7–16.
- . “Folkbiology and the Anthropology of Science: Cognitive Universals and Cultural Particulars.” *Behavioral and Brain Sciences* 21 (1998): 547–609.
- . “Genesis of Suicide Terrorism.” *Science* 299 (2003): 1534–39.
- . *In Gods We Trust: The Evolutionary Landscape of Religion*. New York: Oxford University Press, 2002.
- . “The Neuropsychology of Religion.” In *NeuroTheology*, ed. R. Joseph. San Jose, CA: San Jose University Press, 2002.
- . “The Trouble with Memes.” *Human Nature* 12 (2001): 351–81.
- Atran, S., and A. Norenzayan. “Religion’s Evolutionary Landscape: Counterintuition, Commitment, Compassion, Communion.” *Behavioral and Brain Sciences* 27 (2004): 713–70.
- Atran, S., and D. Sperber. “Learning Without Teaching.” In *Culture, Schooling, and Psychological Development*, ed. L. Tolchinsky-Landsmann. Norwood, NJ: Ablex, 1991.
- Bateson, G. *Naven*. Stanford, CA: Stanford University Press, 1958.
- Bloom, P., and C. Veres. “The Perceived Intentionality of Groups.” *Cognition* 71 (1999): B1–B9.
- Bowlby, J. *Attachment and Loss*. Vol. 1, *Attachment*. New York: Basic Books, 1969.
- Boyer, P. *The Naturalness of Religious Ideas*. Berkeley: University of California Press, 1994.
- Cahill, L., B. Prins, M. Weber, and J. McGaugh. “Beta-adrenergic Activation and Memory for Emotional Events.” *Nature* 371 (1994): 702–4.
- Crooke, W. *The Native Races of Northern India*. London: Archibald Constable, 1907.
- Csibra, G., G. Gergely, S. Bíró, O. Koós, and M. Brockbank. “Goal Attribution without Agency Cues.” *Cognition* 72 (1999): 237–67.
- Dawkins, R. *Unweaving the Rainbow*. New York: Houghton Mifflin, 1998.
- Dunbar, R. *Grooming, Gossip, and the Evolution of Language*. London: Faber and Faber, 1996.
- Geary, D., and K. Huffman. “Brain and Cognitive Evolution.” *Psychological Bulletin* 128 (2002): 667–98.
- Greenberg, J., et al. “Evidence for Terror Management Theory II.” *Journal of Personality and Social Psychology* 58 (1990): 308–18.
- Guthrie, S. *Faces in the Clouds*. New York: Oxford University Press, 1993.
- Heider, F., and S. Simmel. “An Experimental Study of Apparent Behavior.” *American Journal of Psychology* 57 (1944): 243–59.
- Hirschfeld, L., and S. Gelman, eds. *Mapping the Mind*. Cambridge: Cambridge University Press, 1994.
- Kirkpatrick, L. “God as a Substitute Attachment Figure.” *Personality and Social Psychology Bulletin* 24 (1998): 961–73.
- Lack, D. *Ecological Adaptations for Breeding in Birds*. London: Methuen, 1968.
- Lettvin, J., H. Maturana, W. Pitts, and W. McCulloch. “Two Remarks on the Visual System of the Frog.” In *Sensory Communication*, ed. W. Rosenblith. Cambridge, MA: MIT Press, 1961.
- Lipkind, W. “Carajá Cosmography.” *Journal of American Folk-Lore* 53 (1940): 248–51.
- McReady, N. “Adrenergic Blockers Shortly after Trauma Can Block PTSD.” *Clinical Psychiatry News*, February 1999.
- Nesse, R. “Evolution of Commitment and the Origins of Religion.” *Science and Spirit* 10 (1999): 32–36.
- Pinker, S. *How the Mind Works*. New York: W.W. Norton, 1997.
- Premack, D., and A. Premack. “Origins of Social Competence.” In *The Cognitive Neurosciences*, ed. M. Gazzaniga. Cambridge, MA: MIT Press, 1995.

- Pyszczynski, T., J. Greenberg, and S. Solomon. "A Dual Process Model of Defense Against Conscious and Unconscious Death-Related Thoughts: An Extension of Terror Management Theory." *Psychological Review* 106 (1999): 835–45.
- Seligman, S. "Phobias and Preparedness." *Behavioral Therapy* 2 (1971): 307–20.
- Spelke, E., A. Phillips, and A. Woodward. "Infants' Knowledge of Object Motion and Human Action." In *Causal Cognition*, ed. D. Sperber, D. Premack, and A. Premack. Oxford: Clarendon, 1995.
- Sperber, D. *Explaining Culture*. Oxford: Blackwell, 1996.
- Tinbergen, N. *The Study of Instinct*. New York: Oxford University Press, 1951.
- Wilson, D.S. *Darwin's Cathedral*. Chicago: University of Chicago Press, 2002.

53 The Environment in an African Spirituality

Adam K. arap Chepkwony

The scientific and technological innovations of the twentieth century brought new visions of the universe and the place of human beings in it. Unfortunately, in spite of these great scientific strides, the greatest threat to life in the twenty-first century is the degradation of our environment globally. Scientific knowledge has given us an understanding and appreciation of the role that environment plays in the survival and sustenance of all creatures. It also provides the knowledge, skills, and technology to manage a safe environment. This know-how, however, does not seem to help us take the necessary precautions to avoid the catastrophe of environmental degradation. Instead, humans have continued to indiscriminately destroy the environment, not only to the detriment of other creatures, but their own as well.

Environmental crises such as deforestation, climate change, mass extinction of animal and plant species, acid rain, ozone holes, soil erosion, and air and water pollution affect all of us. And concerted efforts are needed to solve these problems. Solutions will not come from science alone. No single discipline or perspective can meet the challenges posed by the threat of environmental degradation. Many communities must collaborate on these issues. Some approaches that will protect and rejuvenate the health of our planet can be found in an African spirituality.

African spirituality maintains that the sustenance of environmental life systems is a religious responsibility. Nature is believed to be the basic foundation of life and a gift from God. A harmonious relationship between humans and nature is therefore the foundation of physical and spiritual healing. To understand the deep connection to nature and spirituality in Africa, it is necessary to first survey the state of the environment in developing countries.

Environment in Developing Countries

To meet the challenges of environmental degradation, the global community has devised new and innovative strategies and held numerous scientific con-

ferences, workshops, and seminars on environmental crises. In spite of this activity, the developed countries continue to produce more than 90 percent of the world's hazardous waste. More disturbing is the fact that due to the increased environmental concerns and the high cost of disposal of such waste in developed countries, much of it is dumped in developing countries, many of which are in Africa. According to a report by the United Nations Environment Program, "Some toxic waste export deals reported to have taken place in over 20 African countries, legally and illegally included an offer of \$50 per tonne to the government of Guinea, \$40 per tonne to Guinea-Bissau and \$2.50 per tonne to Benin, as one time payments compared to \$4,000 per tonne for legal disposal in the United States."

The effects of such toxic dumping are disturbing. A World Health Organization report indicates that exposure to pesticides, toxic fumes, and hazardous waste results in chronic health effects on the community and often results in serious accidents. "WHO estimates that, in developing countries, 3 million people suffer from effects of single short time exposure including 220,000 deaths, and over 700,000 people a year may be suffering from chronic effects of long term exposure."

Besides its effect on human beings, the hazardous waste pollutes oceans, seas, lakes, rivers, and springs, which in turn destroy fishes, animals, and plants. Indeed, fish industries continue to collapse because fish stocks are getting seriously depleted. Similarly, tropical forests have continued to be exploited by large landholders and companies. And deforestation has apparently accelerated in developing countries, where it is estimated that forest areas have been halved within the past century.

Over the years, many countries have attended conventions and signed treaties supporting environmental conservation. In spite of these steps, the problems of environmental degradation continue to increase. Although the signatory countries promise to abide by the rules stipulated in the various conventions, the problems persist as the same countries fail to implement their obligations.

The causes of environmental crisis are well known, as are the solutions. The knowledge, technology, and resources to manage these problems to acceptable standards are available. Yet the developed countries continue to dump hazardous waste in Africa and other regions when they have the resources and the technology to destroy waste completely or recycle it safely. For the sake of making more profit, large corporations deny their responsibility to life.

But developing countries also share some of the blame. Developing countries have neglected traditional institutions that assured sustainability. Poverty and avarice have encouraged poor countries to accept unsustainable practices and even to use their countries as dumping grounds for hazardous waste for very little profit. Surprisingly, some of the best ideas on how to conserve the environment are found among the values cherished in developing countries. In particular, the African concept of cosmic harmony can provide the world community with some solutions.

The Environment and the Supreme Being

Africans believe in a supreme being, known to them by different names. The supreme being created and controls the universe and continually nurtures it in a benevolent manner. The earth is understood as a garden where human beings and all the creatures coexist. The supreme being thus expects human beings to live in the world harmoniously with the rest of creation. Among the Shona of Zimbabwe, for example, Mwari (the supreme being) is traditionally conceived as an ecological deity, provider of life-giving rain and fertility in creation. Mwari thus expects humans, both the living and the dead, other creatures, inanimate objects, and the environment as a whole to exist in harmony. The interface of this reality among the Shona people is indicated in the personification of trees, animals, birds, water, land, and other entities. It is this understanding of kinship with other creatures that enforces human respect and responsibility for the care of the earth.

To maintain a healthy relationship with creation, human beings are supposed to seek harmony on a cosmic scale. This can be achieved when human beings act righteously by following the acceptable moral values that ensure harmony. Africans believe that any disorder in the universe causes disunity with the supreme being. Among the Kipsigis of Kenya, for example, this belief is based on the concept of *ngogisto*, the perception that Asis (the supreme being) is the ultimate upholder of tribal sanctity and the final arbiter of justice. Asis therefore sees all evildoers and punishes them, regardless of whether there was any litigation against them. The idea suggests that the universe is a rigidly structured and ordered system such that any disruption of its normal function is followed by a counterreaction. Whoever abuses the harmonious relationship that exists between the supreme being and his creation is due for punishment for upsetting the proper state of equilibrium. Cosmic harmony is a widely acknowledged concept among various African communities. Among the Bambuti of Congo, cosmic harmony is of capital importance and it is the basis of their ethics.

Among Africans, cosmic harmony is enhanced through proper relationships. The ethical relationships concern the behavior of the individual or community toward the supreme being, ancestors, human beings, other creatures, the environment, and the spirits. Bad relationships bring disharmony or ill health, while good ones bring harmony and prosperity. In other words, the African code of ethics that governs these relationships controls not only the entire community, but also the cosmos and its creator.

The alliance between the supreme being and humans depends on whether humans maintain good relationships with other creatures, the environment, and the spirits. The key idea behind environmental sustainability is to maintain harmony with the supreme being and the rest of creation. It is only when this harmony exists that good health is enjoyed by the individual and the community at large.

The Power of Nature

For Africans, the natural world is an integral part of a community. The way human beings relate to the natural world and its natural laws determines the levels of living standards. Hence the manner in which humans treat the mountains, forests, rivers, animals, minerals, and other resources is of paramount importance. For example, it is the responsibility of the Chagonda clan among the Shona of Zimbabwe to protect Mount Rasa and its environs. Mount Rasa is perceived as the source of rain, agricultural produce, and herbs, and it is the habitat of animals and spirits. According to Marthinus Daneel, in *African Earthkeepers* (2001), the Chagonda clan pleases the supreme being Mwari and their ancestors by protecting the vegetation and animal life on the slopes of Mount Rasa, which is their sanctuary. In this way, they contribute to the equilibrium between the living and the spirit world that is necessary for good rainy seasons.

The Acholi of Uganda also believe that human beings are expected to behave well toward nature. It is said that Alice Lakwena, the prophetess who led the Holy Spirit Movement Forces against the National Resistance Army of Yoweri Museveni in Uganda in 1986, was called upon by nature—that is, animals, forests, and mountains—to deliver the people of Uganda from the sins committed by human beings against nature. The Acholi thus recognize the power of nature and expect good behavior from human beings toward nature to stabilize life and order. Holger Bert Hansen, in *Religion and Politics in East Africa* (1995), notes: “In Acholi, the order of nature and moral order were thus not separate but formed a continuum, which made it possible to causally connect natural events with moral feelings. A catastrophe could be seen as punishment for infringing upon the natural or social order, and the end of a plague could be seen as forgiveness.”

In other words, the absence of respect for nature will bring about disharmony and ill health to the community. Similarly, Samson Gitau, in *The Environmental Crisis* (2000), notes that the Maasai of Kenya attribute irregular natural happenings like drought, epidemics, famine, locust invasions, and earthquakes to disobedience of the society as a whole. The implication is that when human beings cause havoc on nature, nature retaliates and causes stress on human beings.

The power of nature is also evident in the healing process. In *The Healing Wisdom of Africa* (1997), Malidoma Patrice Some discusses at length nature’s healing power. According to him, nature is the foundation of healing and the storehouse of remedies for human ills. He explains how every tree, plant, hill, mountain, rock, and each thing that was here before us emanates or vibrates a subtle energy that has healing power whether we know it or not.

Fauna and Spirituality

In many African societies, the relationship between humans and other living creatures is enhanced through the totemic system in which each clan has a

totem in the form of an insect, bird, or animal. A Gikuyu (Kenya) song that exhorts people to rise up before dawn for work, for example, refers to the guinea fowl affectionately as “my dear brother.” Similarly, the Kalenjin of Kenya refer to their clan totem as *manyun*, which means “my relative.”

The concept of totems provides a fundamental unity between humans and the animal world. Due to this, Africans do not kill their totemic animal unless it becomes a threat to humans or domestic animals or is needed for food. In this way, indiscriminate destruction of animals is restrained. The animals are treated with kindness, and their right to existence is respected. Indeed, animals that take refuge near homes or inside a house while being chased and gestating animals are protected no matter how dangerous they are. Daneel tells us that the Rufura tribe of Zimbabwe has elaborate restrictions and hunting rules to protect and preserve animals. The rules prohibit hunting during winter, killing young animals, and killing females in foal. They also set a quota system for individual hunters, restrict hunting for commercial reasons, and protect certain birds and animals considered sacred.

Alice Lakwena is said to have used animals as her allies against the NRA soldiers. In particular, snakes and bees were significant. According to Hansen, the bees participated in the fights by driving the enemies away. They were also responsible for preserving the infrastructure of the country, besides giving honey that was used as medicine to heal wounds. Snakes watched over the Holy Spirit soldiers and flushed out the enemies in the forest. Whenever the soldiers encountered a snake in the forest, they said, “You are my fellow soldiers. Give me respect.”

In addition to these relationships, humans use fauna for food, medicine, sacrifice during healing rituals, clothing, and many other things. This African wisdom of kinship relationships with fauna enables one to find a balance among the supreme being, community, environment, and self.

Flora and Spirituality

The affinity between human life and nature is an organic relationship, not a mechanical one. What transpires in the natural world corresponds to the activities in the world of human affairs, and in the same way, when human beings do things, nature responds accordingly. Flora may exhibit stress because of human acts like deforestation, wars, destruction of human life, and pollution of environment.

The Kipsigis community in Kenya, for example, realizes that their social cohesion and harmony within the cosmos is only definable in terms of their total environment. Since the society is dependent on arable and pastoral production, as well as harvesting wild flora, sustainability of the production is essential. Land and vegetation are perceived as the source of life. The entire ecosystem is purposeful. Similar to the totemic system, some clans have sacred plants that they protect. The forest and bushy areas are used as sacred sanctuary

where Kapkoros, the sacred shrine, is built. The groves and valleys are homes to the spirits, medicinal herbs, and sacred plants, and they also serve as water catchment sites. No one is allowed to cut down sacred trees or medicinal plants. Trees near homesteads and springs and along rivers are also protected.

Among the Shona of Zimbabwe, individuals identify with specific trees as their kin. The individuals become the trees they are related to by adopting the character traits that are symbolized in the tree of their choice. This is one way humans maintain a relationship with nature. But humans are also expected to observe all the rules that preserve and sustain the environment in order to maintain good health.

The Power of Community

Africans believe that human beings are social creatures, and that they are at their best when they belong to a community. A person can exist only by belonging both to a viable community and the ancestral community. Individuals value themselves in terms of the community they belong to. John S. Mbiti, in *African Religion and Philosophy* (1967), expresses this concept well when he says that Africans see their existence because of others' existence. The maxim "I am because we are, and since we are therefore I am" makes the point clear.

The implication is that a human being cannot exist alone. The absence of human companionship can cause sickness and even death. Some have suggested that the human need for another human arises because humans crave the full realization of their innate gifts and to have these gifts approved, acknowledged, and confirmed. He writes: "our inner authority needs the fuel of external recognition to inspire us to fulfill our life's purpose, and until this happens, we wait in paralysis for the redemptive social response that rescues us from the dungeon of anonymity."

Healthy human relationships are expected to begin at the family level. Husband and wife must respect one another. The Bambuti of Congo believe that friction and hostility within the band, especially between husband and wife, are an offence against the forest, against God who loves peace. Mutual respect and performance of communal duties by a couple attract blessings from God and especially the gift of procreation. Procreation takes place when there is a balance and harmony in human acts. Children are expected to respect and obey the elders and care for their parents. If they do not, they may suffer a curse. When human-to-human relations are strained, then the environment also becomes strained. This can result not only in a lack of procreation, but in poverty, disease, and epidemics.

The Kalenjin of Kenya are expected to be kind, hospitable, and helpful to one another, especially the poor, the disabled, and strangers. By assisting the weak, one reduces their pain and suffering and accumulates blessings to one's credit. The concern for others is expressed in the aphorisms, "Do not eat while a suffering person is watching" and "A stranger should not be turned away

from a feast.” While the former dictum exhorts people to always remember to help the poor, the latter teaches that strangers need to be shown hospitality. This is because all human beings are the children of the supreme being.

Africans also believe that ancestral and natural spirits constitute members of the community. They believe that the spirits of dead relatives have great influence on the living. The benevolent spirits control and sanction the moral standards of their living relatives and serve as the guardians of traditions. To do so successfully, the spirits maintain tight control on virtually every crisis in a family. Pestilence, sickness, and death can be attributed to unhappy spirits. When they cause trouble, the spirits make known their will through a diviner, who in turn may advise on corrective measures.

When the proper and harmonious relationship between the living and the spirits is interrupted, trouble is inevitable. The spirits punish those who fail to follow the accepted customs. They also punish those who neglected to fulfill the wishes of the spirits at the end of their life, and those who ignored the spirits when they were still alive. The spirits can ruin a person, his or her family, and the clan if the situation is not rectified.

Given that spirits have great power over the living, precaution is taken to appease them. Harmony must be maintained with the spirits, for they play a critical role in the social unity of African communities by binding them to their traditions. By following the traditions, Africans create harmony with other humans and with fauna, flora, and the spirits.

In *African Earthkeepers*, Marthinus Daneel quotes Al Gore: “We must take bold and unequivocal action: We must make the rescue of the environment the central organizing principle for civilization.” This statement should not be underestimated, especially in this era when the environment is threatened globally. Religions, philosophies, and the sciences should capture the minds of scholars and leaders in general, prompting them to search for answers for the groaning universe.

One area we can turn to for answers is African spirituality. Africans perceive an organic interconnectedness among humans, nature, and the supernatural that provides possible solutions for the earth’s sickness. A good example where past experience has proved practical is in Zimbabwe. The Shona have demonstrated the ability of the traditional custodians (chiefs, mediums, spirits, and headmen) of the land to appropriate and revitalize Africa’s religious values in a modern environmental reform program. According to Daneel, the Association of Zimbabwean Traditional Ecologists (AZTREC) “has achieved what the Forestry Commission of Zimbabwe, by its own admission, has not been able to do.” African spirituality can lead the world community to effective environmental stewardship.

Bibliography

arap Chepkwony, Adam K. “African Religion in the Study of Comparative Religion: A Case Study of Kipsigis Religious Practices.” D. Phil. dissertation, Moi University, Kenya, 1997.

- Byaruhanga, A.B.T. "The Theology of Medicine." *Journal of African Religion* 2:1 (1991): 23–33.
- Daneel, Marthinus L. *African Earthkeepers*. Maryknoll, NY: Orbis, 2001.
- Gitau, Samson K. *The Environmental Crisis*. Nairobi: Acton, 2000.
- Hansen, Holger Bert. *Religion and Politics in East Africa*. Nairobi: E.A.E.P., 1995.
- Mbiti, John S. *African Religion and Philosophy*. London: Heinemann, 1969.
- Some, Malidoma Patrice. *The Healing Wisdom of Africa*. London: Thorsons, 1997.
- United Nations Environment Program. *Poverty and the Environment*. Nairobi: UNEP, 1995.

54 Environmental Ethics

Celia Deane-Drummond

Environmental problems will not go away. In fact, the slow degradation of natural resources, climate change, loss of biodiversity, and pollution of the commons seem set to remain on the global agenda for many years to come. The difference between now and the 1970s is that green issues no longer seem so shocking, nor is it necessary to be politically left wing in order to be concerned about environmental issues. Yet underlying the broadened environmental concern and the more widespread commitment to tackle environmental issues are varied philosophies and religious frameworks. The broad spectrum of environmental ethics includes the religious views of Christian theologians and their range of possible responses to the environmental problems at hand.

The Abrahamic faiths—Judaism, Christianity, and Islam—all affirm belief in a creator God and a special relationship between humans and the creator. It is hardly surprising that these faiths share a common concern for humanity to take particular responsibility for the environment. Humans, as stewards of the earth, act as God's vice-regents on earth, since the created world is God's gift to humanity. Lynn White, writing in the 1960s, argued that stewardship was not so benign. He suggested that the command in Genesis to have dominion over the earth encouraged *domination* of the earth, leading to its exploitation. Of course, biblical scholars leapt to the defense of the text. The impression remained that perhaps there was an element of truth in what he said, that somehow Christians could not altogether detach themselves from environmental destruction. For even if a focus on the worth of humans, or anthropocentrism, is deeply embedded in Greek culture, long before Christianity, it seems fair to say that Christianity did not attempt to challenge this notion. In addition, the Calvinistic tradition reinforced the possibility of exploitation by its concentration on the benefits of the work ethic, indirectly excluding ecological responsibility. Some evangelical scholars remain convinced that stewardship is an appropriate ethical model for those of religious faith, but it is couched in the language of care for the earth, not its exploitation. A possible alternative

includes a focus on the value of all parts of the earth, or biocentrism, which tries to dethrone humanity from its elevated position.

Philosophical Debates

The underlying objection to anthropocentrism is that it affirms a dualistic philosophy: a separation of humanity and nature, mind and body, spirit and earth, men and women. The third wave of feminism has sometimes been termed *ecofeminism*, the joining together of discussion about the oppression of both women and nature, opposing all dualisms. Ecofeminists are almost all biocentric in their philosophy; just as women and men need to be valued equally, so the value of the earth needs to be affirmed. Ecofeminists come from a number of religious traditions. Some suggest that the earth has sacred qualities, that in the earth we see the Goddess. But ecofeminists debate how far nature should be treated as divine. Sallie McFague, for example, prefers to think of the earth as the body of God and argues that humanity needs to perceive the earth as sacred.

Anne Primavesi uses the scientific Gaia hypothesis devised by James Lovelock in order to ground her theological approach. Gaia is a way of seeing the earth as a giant organism, a geophysiology, in which biological species give rise to changes in the biosphere, rather than the other way round. It is a radical alternative to individualism, for it implies that it is impossible for each species to operate in isolation from the unified networks in which it finds itself. The Gaia hypothesis has attracted intense debate, not just among scientists but among others wanting to take up its religious associations as well. Could, for example, Gaia be another name for the Virgin Mary, as Lovelock suggests, or is she the sacred Goddess of the earth, the divine in nature? Or is Gaia somehow representative of the Holy Spirit, or an angel, a mediator between God and humanity? These theological alternatives for Gaia all imply ecological responsibility. For Gaia to work effectively as a system, however, the microorganisms and algae are the most significant; their overall impact on the composition of the atmosphere is much greater than that of higher species. One might even think, in this scheme, that humans are parasites on the planet, to be disposed of when they transgress the limits that Gaia has put in place.

A philosophical alternative to the holism that Gaia represents is to argue for anthropocentrism, but one that resists exploitation of the earth. The Eastern Orthodox Church, for example, shows commitment to working toward ecological responsibility but retains a traditional understanding of the high place of humans in the universe. One difference with Western Christianity is that the Eastern eucharistic celebration is inclusive of the whole of the created order, not just humanity. There is a strong belief that the created world in some sense is ordered through the word (*logoi*) of God, and that the created world, in turn, is offered back to God through liturgy. While God remains

fiercely distinct from creation, due to the unbridgeable gap (*diastema*) between God and the created order, this does not preclude the created world receiving, via humanity, something of participation in the energies (*energia*) of God. The radical dualism between God and the world, between humanity and nature remains, but this is not the last word; the created world is valued as God's creation. Thus it is possible to have a strong religious sense of environmental responsibility while adhering to dualism and anthropocentrism.

In the Western world, many theologians concerned with environmental responsibility have rejected dualism in favor of various degrees of holism. Michael Northcott and Holmes Rolston, for example, sit between the two extremes of anthropocentrism and biocentrism. Many consider Rolston the father of the whole philosophical field of environmental ethics. Rolston introduces the idea of systemic value: the value of systems as such. He rejects naturalism, the view that just because something is natural, it is also good. Northcott, who is deeply concerned with the social history leading up to environmental devastation, elaborates on how natural law theory should recover its original basis in the natural world and take on environmental responsibility. Natural law theory argues that the basis of human conduct is human nature in the context of a rational universe. Once natural law became associated with, literally, laws in nature, it seemed to fall into the naturalistic fallacy, the idea that whatever is natural is good. Northcott believes that the problems associated with the naturalistic fallacy are less acute than problems associated with anthropocentrism.

The philosopher Robin Attfield has written widely in the area of environmental ethics. He addresses the dichotomy between cosmopolitanism and communitarianism. It is very easy for authors such as Northcott, for example, to look back to ideal forms of community that seemed to be more ecologically responsible. For Northcott, they are also more religious. The work of Aldo Leopold, which puts great emphasis on the community of the land and all creatures, becomes a paradigm for ethical action. Attfield resists this trend, suggesting that it becomes too locally focused; instead, cosmopolitanism gives much higher priority to the global picture. Attfield rejects communitarianism but still wants to affirm biocentrism. He argues for the moral value of the nonhuman world. However, unlike Rolston, he argues against the idea that ecosystems as such have moral standing. For Attfield, the notion of stewardship is sufficient. Here we have an interesting combination of stewardship with biocentrism.

Ecology and Ethics

Implicit in much of the discussion above is an assumption that ecological systems are stable, interrelated systems that need to be preserved at all costs. This view reflects the equilibrium paradigm that dominated ecological science for nearly ninety years. In this paradigm, ecological systems are essen-

tially closed, self-regulating, in equilibrium, and free of disturbance, independent of human influences. The same idea is likely to be behind the belief in the positive good of wilderness. Yet many ecologists challenge the idea that ecosystems are stable and in equilibrium. Gradually, a new paradigm is emerging that puts more emphasis on nonequilibrium states. The cultural idea of the balance of nature has come under severe scrutiny, but the cultural assumption may explain why the equilibrium view of ecology held sway for so long in the scientific community. According to the nonequilibrium view, ecological systems are in a continual state of flux, open to external influences, subject to a multiplicity of controls, and subject to disturbance from a number of internal and external factors, including human beings.

These discoveries portray the fragile nature of ordering that is characteristic of ecosystems. On a global scale, some of these changes may be ironed out, as suggested by the Gaia hypothesis. Hence, while at the local ecosystem level there is dynamic flux, change, and disturbance, much of this cannot be observed at a very large scale. Ecologists also recognize the importance of taking into account the scale of measurements, from those at the level of the single leaf through to the whole organism, community, and so on. Disputes among ecologists may sometimes be the result of their working at a different scale. It is important, therefore, when considering theological concepts, such as natural law, to be clear about the particular level or scale that is under discussion. Natural law is perhaps best understood in terms of animal behavior, rather than ecology understood as stability, unless measurements are at the largest scale when perturbations are invisible. The most basic tendency in all life forms, which is associated with the secondary principle of natural law, is self-preservation. This drive for self-preservation could be seen as implicit in the flexible potential for adaptation following disturbance of natural systems.

Biodiversity is another area worth consideration in environmental ethics. An ecological community rich in biodiversity is much more able to adapt to hostile influences than an ecological system lacking in biodiversity. This is one of the reasons commercial agriculture is so vulnerable to attack by insects, disease, and other pests; the lack of genetic variation in the crop prevents natural forms of resistance. While crops may be bred or genetically modified in order to introduce resistance, there is an ongoing battle against new variants of pests and disease. The justifications for preserving biodiversity include anthropocentric reasoning: the species of plant, animal, or insect may be valuable as a resource for humanity. Loss of that species would amount to a loss of use, perhaps for food or drugs, as in the case of the rare plant Rosy Periwinkle (*Catharanthus roseus*) found in Madagascar. Vinblastine, a drug extracted from Rosy Periwinkle plants, is used in the treatment of leukemia. It cannot be produced artificially, so there is no alternative. It is worth noting that very little of the profit made from sale of the drug has found its way back to Madagascar.

Environmental ethicists who are more holistic in orientation argue for preservation of biodiversity on the basis of the worth of the creatures themselves;

each species has a right to exist. More radical forms of biocentrism make no distinction among creatures: a loss of an insect species is as wrong as the loss of a monkey. More moderate views stress the importance of considering where a species lies on the evolutionary scale, so that insects would have lower inherent worth than higher animals. Yet the overall function of an ecosystem may depend as much on creatures lower down the scale, so care is needed in discerning both the long- and short-term impact of loss of different species.

The International Union for the Conservation of Nature (IUCN) regularly updates its database on the status of species, whether they are endangered, critically endangered, extinct in the wild, or extinct. Conservationists pay special attention to those species that are endangered or critically endangered. Of course, not all species that are endangered can be helped. The situation is made worse by enormous ignorance about overall species diversity. Only about 10 percent of the total species in the world have been identified, according to some estimates. This means that the loss visible to human beings represents a small slice of the actual loss that is occurring. Ruth Page's work is grounded in theological considerations of the worth of biodiversity to God: all creation is good and reflects the goodness of God. Thus all creatures deserve human respect, as all living creatures, including humans, are integrated in a web of creation.

Those campaigning for the rights of animals sometimes object strongly to keeping animals in zoos, or other artificial programs for their preservation. The focus for ethical action in this case is the sentience of the animals concerned. The views of Peter Singer, whose influential work on animal liberation championed the importance of sentience in ethical considerations, are highly controversial among those concerned for the disabled. The debates between those who support animal rights and those who argue for more moderate animal welfare positions continue to generate controversy, both politically and socially. The clash with biocentric positions becomes clear: animal rights are justified on the basis of the individual rights of animals, while biocentrists argue for equal treatment of a broader spectrum of creatures. Animal rights are an extension of human values into the animal sphere in a way that anthropocentrists believe is unjustified and biocentrists believe is still wedded to anthropocentrism.

Ethical Alternatives

More often than not, environmental ethical decision making is based on the precautionary principle: the view that action can be taken only if there is proof of no harm. Yet this concept is suggestive of a number of different alternatives. The precautionary principle may be used, for example, by a multinational company to justify action where there is ignorance of damaging outcomes. More radical activists would insist that this is an insufficient degree of precaution; positive proof of no harm has to come first. Given the ambiguity in the interpretation of the precautionary principle, are there other frameworks that might prove useful in environmental decision making?

A possible alternative is the notion of prudence, or practical wisdom. Prudence, in being a virtue or habit of mind, focuses on the person, but challenges that person to make decisions in certain ways, according to the good of the individual and the common good. In ecological terms, the common good is inclusive of the nonhuman as well as the human community. What are the advantages of a recovery of practical wisdom for ecological ethics? Different facets of prudence are helpful in this respect. One facet is the ability to deliberate. Moreover, deliberation relies not just on the expertise of a few, but on common deliberation of citizens drawing on their own experience. The capacities to make decisions in emergency situations, to take advice from others, to have foresight in a way that accurately anticipates the future as far as it is feasible to do so—all these qualities of prudence are vital in environmental decision making. One way of extending the notion of prudence so that it takes account of the individual worth of all creatures is through the theological concept of wisdom, in which the world is orderly and reciprocally balanced. It is after the pattern of divine wisdom that creaturely existence is called into being. In this, humanity has supreme responsibility to care for the earth, not out of a sense of duty toward other creatures in a narrow legalistic sense, but in expressing divine wisdom more fully in the world.

How to think about the earth continues to be an area of active controversy among theologians, philosophers, and ethicists. Theologians align themselves with a variety of views, ranging from anthropocentrism to more radical forms of holism. More anthropocentric versions tend to focus on human responsibility as stewards to God's creation, while more holistic versions focus on the worth of creation as good in and of itself, independent of human valuing. All environmental ethicists resist pure instrumental use of nonhuman species, though conservation movements may include this option where the goal for conservation is viewed in terms of human benefits. Such benefits may be direct, as in food or drugs, or indirect, as in recreation or aesthetic value. There needs to be a clear basis for decision making in order to meet the constant challenge of a clash of interests—for example, between developing a deprived area in need of social housing and the effects development will have on endangered wildlife. Many use the precautionary principle as a way of judging whether an action is acceptable in environmental terms, but the degree of precaution can be interpreted in different ways. Finding new ways of navigating through this difficult and complex territory obviously deserves high priority, for the answers to environmental questions are not simply of cosmetic interest. They affect the survival of all species, including *Homo sapiens*.

Bibliography

- Attfield, Robin. *The Ethics of the Global Environment*. Edinburgh: Edinburgh University Press, 1999.
- Berry, R.J. *God's Book of Works: The Nature and Theology of Nature*. London: Continuum, 2003.

- Clark, Stephen R.L. *How to Think about the Earth: Philosophical and Theological Models for Ecology*. London: Mowbray/Continuum, 1993.
- Deane-Drummond, Celia. *A Handbook in Theology and Ecology*. London: SCM Press, 1996.
- . *The Ethics of Nature*. Oxford: Blackwell, 2003.
- Gottlieb, Richard S., ed. *This Sacred Earth: Religion, Nature, Environment*. London: Routledge, 1996.
- Gross, Rita, and Rosemary Radford Ruether. *Religious Feminism and the Future of the Planet: A Buddhist Christian Conversation*. London: Continuum, 2001.
- McFague, Sallie. *Super, Natural Christians: How We Should Love Nature*. London: SCM Press, 1997.
- Merchant, Carolyn. *Radical Ecology: The Search for a Liveable World*. New York: Routledge, 1992.
- Northcott, Michael. *Christianity and Environmental Ethics*. Cambridge: Cambridge University Press, 1996.
- Page, Ruth. *God and the Web of Creation*. London: SCM Press, 1996.
- Primavesi, Anne. *Gaia's Gift: Earth, God and Ourselves after Copernicus*. London: Routledge, 2003.
- Rolston, Holmes, III. *Environmental Ethics: Duties to and Values in the Natural World*. Philadelphia: Temple University Press, 1988.
- . *Genes, Genesis, and God: Values and Their Origins in Natural and Human History*. Cambridge: Cambridge University Press, 1999.
- Ruether, Rosemary Radford. *Women Healing Earth: Third World Women on Ecology, Feminism, and Religion*. London: SCM Press, 1996.
- Singer, Peter. *Animal Liberation: A New Ethics for Our Treatment of Animals*. London: Jonathan Cape, 1986.
- White, Lynn. "Historical Roots of Our Ecological Crisis." *Science* 155, (1967): 1203–7.

55 Science and the Sacred

John Ikerd

Over the past four centuries, science has systematically diminished the realm of the sacred in human society. The sacred includes those things considered holy, worthy of reverence, or attributed to God—or to a “higher power” by some other name. In times past, people believed that God created the earth and all of the living things upon it. Life was considered sacred, because only God could give life and allow life to be taken away. God was even given credit for the weather, both fair and foul. People prayed for rain and gave thanks to God for their daily bread and for the farmers who brought it forth from God’s earth. Over time, however, as science revealed the secrets of nature, much of the sacred was transformed into the logical and rational.

Since the beginning of modern science, in the late 1600s, humans have been systematically solving the mysteries of the universe. René Descartes, an early modern scientist, suggested that the universe, Earth, and the things upon Earth worked like a giant complex machine—specifically, like a clock. Anything could be taken apart and examined, piece by piece, to discover what made it tick. The scientific method provided a systematic process for isolating and defining specific cause and effect relationships among the various parts of the mechanisms of Earth. As we understood more about the functioning of the individual parts, we understood more about the nature of the whole. The more we could understand and explain through observation, logic, and reason, the less we needed to attribute to God. The expansion of human knowledge inevitably led to the contraction of the realm of the sacred and the holy. The more we believed in science, the less we needed to believe in God.

Today, scientists believe the planet Earth, along with the rest of the universe, was created by the Big Bang—a rapid expansion of matter beginning some 10–20 billion years ago and continuing today. Science suggests that all living things on Earth today evolved from a common origin, beginning with the spontaneous emergence of the first self-reproducing organism out of some prehistoric chemical soup. Today, birth and death are considered natural consequences of the continuing self-making process of reproduction and evolu-

tion, often occurring by chance or accident rather than by any natural order or intelligent design. Weather, both fair and foul, is caused by changing patterns of temperature and moisture resulting from the interaction of solar energy with the physical elements of Earth. While weather may still defy accurate prediction, it is always explainable. And most farmers today rely on selective breeding, irrigation, and chemical fertilizers and pesticides to bring forth the bounty of the earth. Why should people thank God for food they get from Wal-Mart or McDonald's? Today, even the "miracle of life" is being removed from the realm of the sacred, as scientists are reengineering the basic patterns of life, using new biological technologies. Who needs God when we have modern science and technology?

Benefits and Costs of Science and Technology

Advancements in science and technology have resulted in many magnificent and undeniable benefits for human society. Science laid the conceptual foundation for the Industrial Revolution and the resulting manifold increases in human productivity and wealth. Most people in the more technologically advanced societies of the world have been freed from persistent ill health, hunger, and drudgery. Few people today would choose to return to a prescience, preindustrial world. However, the advancements in science and technology have not been achieved without significant negative ecological and social consequences.

During the last half of the twentieth century, people in the industrial nations of the world became increasingly aware of the negative ecological consequences of modern industrial technologies. Water and air were becoming increasingly polluted and made unusable by industrial chemical and biological wastes. Nonrenewable energy resources, specifically fossil fuels, were being depleted at unsustainable rates. Other living species were becoming extinct at rates historically associated with catastrophic global events. In the United States, the formation of the Environmental Protection Agency and the Department of Energy during the 1970s and 1980s was a reflection of growing public awareness of the ecological consequences of industrialization. More recently, concerns have shifted from point sources of pollution and degradation, such as factories, to nonpoint sources such as industrial farming operations. While some progress has been made in protecting the environment from pollution, rates of resource depletion appear to have accelerated.

Unfortunately, the negative social consequences of industrialization remain largely ignored or denied. Relationships among people within the industrial societies of the world—most prominently in the United States—have become increasingly disconnected and dysfunctional. Personal relationships have been reduced to transactions and contracts rather than mutual concerns and commitments. The nature of these impersonal relationships is defined by rules and regulations, rather than ethics and trust. This depersonalization of rela-

tionships was an unavoidable consequence of economic industrialization with its specialization, standardization, and consolidation of control. Relationships based on believing, trusting, caring, and sharing are obstacles to economic efficiency. Thus the economic benefits of industrialization could not be realized without creating social costs.

Robert Putnam, a Harvard University political scientist, documents some of the social costs of modern society in his book *Bowling Alone*. Data for measure after measure—including voting in elections, participating in social, political, and civic organizations, writing letters to editors, visiting in people’s homes, and joining groups such as bowling leagues—indicate that Americans are about 30–50 percent less connected today than in the 1950s. Putnam refers to this growing disconnectedness as a loss of “social capital”—a loss in the ability of people to relate to each other in positive, mutually beneficial ways.

He also documents some of the logical consequences of this loss of social capital, although he is careful not to suggest proven cause and effect relationships. Since the late 1960s, Americans have experienced a tenfold increase in mental depression and a tripling and quadrupling of suicide among young adults and adolescents respectively. Incidents of malaise—headaches, sleeplessness, indigestion—are much more common indicators of mental stress and show trends similar to those for more serious mental problems. In addition, each generation of Americans reaching adulthood since the 1960s has indicated they are less satisfied with life and less happy than the previous generation.

Science and technology have provided greater wealth and material well-being but have done so at the expense of the health and integrity of the natural ecosystem and human society. To restore our broken relationships with the natural world and with each other, we must reclaim the sacred in our lives.

The Search for Purpose and Meaning

Scientists apparently felt they needed to abandon the sacred in order to achieve greater objectivity and clarity of understanding. But something essential to true understanding was lost in the process. In our attempts to isolate and identify separate causes and effects, we lost our sense of wholeness. We lost our sense of interconnectedness and interdependence with other living and non-living entities and our sense of place within the larger whole—within the higher order of things. As Dick Thompson, an Iowa farmer, is fond of saying, “we became smart in the parts but dumb in the whole.”

In losing our sense of wholeness, we lost our sense of purpose and meaning. Science is capable of answering questions of “how” and “why,” but not the fundamental questions of why we are here and what our purpose is. In science, we find no clue to purpose and meaning for our lives. We become preoccupied with “doing things right,” according to good science, with no real assurance that we are “doing the right things.”

An understanding of the purpose of anything, including life, must be derived from the purpose of the whole of which it is a part. For example, the purpose of the human heart is derived from its functions in supporting the human body—the larger whole. Apart from the body, the heart has no unique or significant purpose or meaning. The purpose of an individual human life, likewise, must be derived from its role and function within the larger human society—the whole of which it is a part. The purpose of human society, in turn, must be derived from that of the global biosphere, and the purpose of the global biosphere from some still larger whole. Thus, some whole larger than the biosphere, even larger than the universe, must exist; otherwise, life would be meaningless. The “higher order,” in this case, implies an order so great that it transcends all human observation, logic, and reason, and thus, an order that can be understood only through our insight into the realm of the sacred, the spiritual, or God. To restore a sense of wholeness, purpose, and meaning, we must reclaim the sacred in our lives.

Ecology: A Matter of Relationships

In reclaiming the sacred, we need not discard modern science, but we must place science within its proper context. We must find the appropriate place for the scientific method within a more inclusive ecological approach to scientific inquiry. Ecology is the study of relationships. Biological ecology addresses the nature of relationships among living things and between living things and their environment. Social ecology deals with relationships between human beings and their environment. Ecology, in general, relates to balance and harmony among all living things and between living things and their environment.

“You can’t do just one thing.” This is a fundamental principle of ecology. From an ecological perspective, everything is interconnected with everything else. Thus, when you do “one thing,” you are always affecting “other things,” regardless of your intention. Thus, it is impossible to isolate a single effect associated with any single cause. In ecology, priority is given to understanding the nature of the whole as a prerequisite to understanding the nature and significance of the interrelationships among the parts. The parts matter, but so does the whole.

In ecology, harmony and balance among the component parts—rocks, soil, plants, animals, people—can be defined only in relation to some accepted “natural order of things.” Disharmony and imbalance implies that components are in conflict or out of balance with the “way they should be.” Thus, ecology always implies some normative assumption, stated or unstated, concerning “what should be” and “why,” as well as “how things function.” Thus, ecology is intrinsically rooted in a belief in a “natural order of things”—a belief in the sacred.

An Ecological Approach to Science

A mechanistic approach to science may be appropriate in situations where connections among most parts of a whole are weak, and thus, specific rela-

tionships can be effectively separated, if not isolated. For example, in engineering a steel bridge or combining chemicals to produce plastic, the interconnections between the steel and plastic and their environments are relatively weak in comparison to the interconnections involved in the mechanical and chemical structures. The steel eventually will rust or erode and the plastic will deteriorate, but likely only after a significant period of usefulness. Thus, the mechanistic approach to science has worked very well for the hard sciences such as physics, chemistry, geology, and astronomy.

However, mechanistic approaches have been less successful and less useful in situations where interconnections are many and strong, and thus, specific relationships are difficult to separate and impossible to isolate. For example, significant unintended consequences may result when science is used to manipulate plants, animals, or other living organisms. Many of the problems associated with fertilizer and pesticide residues in food and water, antibiotic-resistant disease organisms, and pesticide-resistant insects and weeds are the unintended consequences of yesterday's scientific solutions. An ecological approach to animal or plant science, including human health and nutrition, would have given priority to the whole, and thus, to relationships among all of the parts. An ecological approach to science would have allowed scientists to anticipate the unintended consequences.

The mechanistic approach to science is least well suited for the study of human organizations, specifically economies, communities, governments, and societies. In all human organizations, relationships among people are invariably significant, both positive and negative, and thus, wholes always embody far more than the simple sums of their parts. In addition, human systems are intrinsically dynamic. Humans learn from experiences and may react differently to a stimulus today than they did at some time past. Thus, each cause creates many unpredictable effects as people relate, directly or indirectly, with many other people and learn from their experiences. The contributions of the scientific disciplines of economics, sociology, and psychology to human society usually pale in comparison to physics, chemistry, geology, and astronomy. But an ecological scientific paradigm would give priority to the study of human relationships and to finding balance and harmony among the living parts of dynamic organizations. An ecological science would encourage us to reclaim the appropriate place of the sacred in science as well as in life.

The Sacred Order of Ecology

Throughout human history, people have openly proclaimed their belief in the existence of a higher power or higher order of things—be it an order defined by the laws of God or the laws of nature. Many considered nature worthy of reverence and respect, even if it was not considered holy or attributed to God, and many scientists expressed their belief in a higher order. Einstein, for example, believed in a universe of absolute law and order. He is quoted as once saying, “God may be sophisticated, but he is not malicious.”

Throughout human history, people have openly proclaimed their belief in the existence of the spiritual. The spirit was the immaterial part of a human—the soul, the essence of one’s moral and emotional being. The spiritual was neither tangible nor material; it existed only in the abstract. Religion is but one means of expressing one’s spirituality. The philosopher William James referred to religion as an attempt to be in harmony with an unseen order of things. Spirituality might be defined as a belief in a higher, unseen order.

Within the last few decades, it has become common for human societies, at least in the developed nations, to allow science and economics to guide their decisions of what should be done and how to do it. Historically, scientists and economists relied on ethics and morality to provide answers to what we should do and why. However, today we allow economics to define the what and why and allow science to follow blindly with the how. Science, driven by economics, is charging boldly into the realm of the sacred and holy, committed to redesigning the nature of human relationships and to reengineering the very nature of life. But if we treat the spiritual wisdom of the ages as mere foolishness, we will again reap the unintended consequences of our ignorance and unwillingness to accept our appropriate place within the unalterable order of the whole of nature.

However, through a new ecological science, we can restore respect for the sacred without diminishing the true value of modern science. Through a new ecological science, we can restore balance and harmony within and among ecosystems and human organizations. We can continue to search for causes and effects within separable, if not isolated, components of wholes, but the roots of this new ecological science will forever remain in the realm of the sacred. The order within which we must find balance and harmony exists at a higher level—a level accessible to mortal humans only through our spiritual sense of ethics and morality. To unlock the secrets of ecological relationships, we must reclaim the sacred in our lives and in our science.

Ecology, the Sacred, and Sustainability

The best hope for a new ecological approach to science in the future lies in a growing awareness that the industrial approach to economic development is not sustainable. The material economic benefits of the industrial paradigm continue to decline as its ecological and social costs continue to climb. Perhaps humans are incapable of destroying the planet, but the blind pursuit of ever greater economic growth is threatening the future existence of human life on Earth. The search for a sustainable approach to development will require an ecological approach to science rooted in the sacred.

Sustainable development must meet the needs of the present while leaving equal or better opportunities for those of the future. It is fundamentally dependent on living organisms and organizations—microorganisms, plants, animals, people, families, communities, economies, and societies. Only living

things are capable of capturing solar energy and thus are capable of the self-renewal, reproduction, and regeneration essential for long-run sustainability. Dead things, by nature, dissipate energy in their cycles of decay and reuse. Industrial economic development is by nature an extractive, exploitative process. Sustainable development must be a living, ecological process.

Sustainable development reflects a reverence and respect for nature, for relationships among people, and for relationships between people and nature. Sustainable development requires balance and harmony among the economic, social, and ecological; among the personal, interpersonal, and intergenerational; and among the physical, mental, and spiritual. Sustainable development must respect the higher order, within which balance and harmony bring peace and happiness. Sustainable development must be built upon an ecological approach to science that respects and honors the sacred.

Bibliography

- Ayers, Ed. *God's Last Offer: Negotiating a Sustainable Future*. New York: Four Walls Eight Windows, 1999.
- Leopold, Aldo. *A Sand County Almanac*. Commemorative edition. Oxford: Oxford University Press, 1989.
- Meadows, Donella H. *Limits to Growth*. New York: New American Library, Penguin, 1977.
- Putnam, Robert D. *Bowling Alone*. New York: Simon and Schuster, 2000.
- Savory, Alan. *Holistic Resource Management*. Covelo, CA: Island, 1988.
- Swenson, Rod. "Thermodynamics, Evolution, and Behavior" In *The Encyclopedia of Comparative Psychology*, ed. G. Greenberg and M. Haraway, 217–26. New York: Garland, 1997.
- World Commission on Environment and Development. *Our Common Future*. Oxford: Oxford University Press, 1987.

56 Science, Religion, and Sustainable Development

Mikael Stenmark

The world's ecological crisis gives a new urgency to the dialogue between science and religion. Unless people of different worldviews (religious or secular) can arrive at a shared concern for the natural world, the ecological integrity of our planet is in danger of being completely undermined. In response to the world's ecological crisis, the governments of the world have united behind a common vision for the future: the vision of a sustainable society or a sustainable development, and a policy program for its implementation in the twenty-first century. The program, known as Agenda 21, calls for development that meets the needs of the present without compromising the ability of future generations to meet their own needs. To obtain this goal, we have to ensure that natural resources are not used inefficiently or shortsightedly. The carrying capacity of the planet's ecosystems must not be jeopardized today or in the future. Many are convinced that to achieve this, we need a new ethic, one of sustainable development. What is the content of this new ethic? And what roles do science and religion play in it?

The Ethic of Sustainable Development

Ancient Greek philosophy and the Judeo-Christian tradition have constituted the basis for the Western worldview, which has also developed through the ideas of the Enlightenment and scientific discovery. Some of the key elements of this worldview are:

- (1) Human beings are the only creatures on Earth who are made in the image of God.
- (2) God has given human beings dominion and responsibility over the Earth, which entails that they have a right to use the Earth as a resource to satisfy their needs.

- (3) No part of nature is a divine being or a spirit, and it can therefore be investigated without impiety.
- (4) Nature can successfully be investigated because it is a creation by a rational divine being (God) and therefore real (and not an illusion) and a cosmos (not chaos).

For the ethics of nature—what is called “environmental ethics”—this means that (1) and (2) together imply that human beings have a higher value than other living beings, or alternatively that only humans have intrinsic value. If the latter is the case, then everything else in nature has only an instrumental value or a resource value. Elements (1) and (2) support a *hierarchical view of nature*. Element (3) implies that, if we want to, we can change nature or processes in nature, and (4) implies that we can do this successfully. Both of these ideas have been very important for the development of science and industrialization. Here we then have a *view of the order and alteration of nature*.

It is important that we identify a few more elements of this worldview, namely:

- (5) Human beings differ so radically from all other forms of life on Earth that they cannot be seen as part of nature (*the man-apart-from-nature view*).
- (6) The assets nature bestows on human beings are so great that they are inexhaustible (*the view of unlimited natural resources*).
- (7) Nature has a capacity that always allows it to absorb human waste (*the view of nature’s robustness*).

Elements (6) and (7) should be understood as presuppositions rather than direct claims that people live as if (6) and (7) are true.

The acceptance of these views has in general led, consciously or unconsciously, to the adoption of a kind of ethic that is often called “anthropocentrism” and what here shall be called “traditional anthropocentrism.” It consists of the claims that (a) only humans have moral standing, that is, can be treated morally rightly or wrongly; (b) consequently nature has only instrumental value; and (c) our moral obligations are limited to human beings that are now alive. This is the “old” ethic that until recently guided people’s relationship to nature in the West. It should be replaced by the new ethic of sustainable development.

The ethic of sustainable development shares with the old ethic the idea that human well-being is the ultimate goal of all environmental and development policies. The first principle of the 1992 Rio Declaration states that human beings are at the center of concerns for sustainable development. Part of this ethic, however, is also the idea that we should consider not only the needs of people now alive but also the needs of future generations. If we accept the idea of sustainable development, we must also accept that we have a moral obligation to future generations. It is thus a question of a temporally extended

principle of justice. We are therefore not free to exhaust natural resources, because in so doing we would diminish the range of choice and the well-being of future generations. In this respect, the ethic of sustainable development is a genuinely new ethic. Never before, at least in the West, have we considered that we had moral obligations that go far beyond those we have to our children and grandchildren, even extending to distant generations. Hence the number of individuals we have to take into account in our actions and policies has grown considerably.

What motivated this change in ethical outlook? Part of the answer is that new scientific knowledge has contributed to a new, emerging worldview. Some of these scientific insights are:

- (8) There is an interaction and interdependence between human beings and all other organisms in the system of nature; human beings form an integrated part of nature (*the view of human-nature interdependence, or ecological holism*).
- (9) The natural resources available to human beings are not inexhaustible; some will come to an end in the near future (*the view of limited natural resources*).
- (10) There is a limit to the ecosystem's capacity to absorb human waste, and in several areas we have reached this limit (*the view of nature's vulnerability*).

Elements (8), (9), and (10) replace (5), (6), and (7) in the old worldview. The new ethical components are:

- (11) We have moral obligations to future generations of human beings (*the principle of intergenerational justice*).
- (12) Human use of natural resources should be efficient and farsighted (*the principle of efficiency and farsightedness*).

If natural resources were inexhaustible and if nature could always absorb human waste, there would perhaps be no reason to reflect on whether we have any moral obligation to generations hundreds of years in the future. But when our perceptions about the structure and composition of nature and its robustness change and we see that natural resources are not inexhaustible, that we have not used these resources efficiently and farsightedly, and that there is a limit to the ecosystem's capacity to absorb human waste, the issue of a just distribution of resources between present and future generations arises. If we accept elements (9), (10), and (11), it follows that we ought to accept (12). Since our natural resources are limited, we can only satisfy our moral obligations to future generations if we use these resources in an efficient and farsighted way.

Central to the vision of sustainable development is the idea of economic

growth. It accounts for a key part of the term “development” in the notion of sustainable development. Although economic growth is assigned an important significance in this vision, this value judgment is nevertheless derived and is therefore not on the same normative level as, for instance, the principle of intergenerational justice. The reason for this is that the aim behind sustainable development is ultimately to satisfy the basic needs of human beings alive at present and in the future. It is only to the extent that economic growth is an efficient means in achieving this goal that such growth is compatible with the notion of sustainable development or of a sustainable society. Consequently if economic growth does not show itself to be an efficient means in this respect, we ought not to pursue it. In other words, it is appropriate to formulate the normative principle regarding economic growth as a conditional statement:

- (13) We ought to strive for economic growth provided that such growth contributes to ensuring that the basic needs of all human beings are satisfied and that such growth takes place in an ecologically sustainable way (*the principle of economic growth*).

The two new value components (11) and (12) make this ethic into a different kind of ethic than traditional anthropocentrism. But it is still an anthropocentric ethic, since people are at the center of concern for sustainable development. And the only ethical limitation set for our use of nature is that we ought to be efficient and not jeopardize the carrying capacity of the planet’s ecosystem. Because of element (11), we could call this environmental ethic “intergenerational anthropocentrism.” It is the view that only humans in nature have moral standing but that our moral obligations are not limited to human beings now alive; they include future human generations as well. Individual behavior and environmental policy making should be judged on the basis of how they affect people who are alive now and future generations.

Still unclear is what the talk about intergenerational justice really means. This ambiguity is not surprising, since the idea of a responsibility with respect to future generations is something new in our worldview. What we need to know is when a distribution of natural resources between present and future generations is just and when it is unjust. We need guidelines for how to deal with situations where the interests of people alive at present conflict with those of future generations.

So part of the vision of a sustainable society is the idea of intragenerational justice. But we also ought to achieve a more just distribution of resources between rich and poor. Sustainable development requires equitable access to the constrained resources. This means meeting at least the basic needs of all, and extending to all the opportunity to satisfy their aspirations for a better life. We do not have a duty to see that all people achieve the same standard of living or quality of life. But we are morally obliged to try to even out differ-

ences to some extent in standards of living. Hence we can add the following element to the previous ones:

- (14) We have a moral obligation to use natural resources in such a way that at least the basic needs of all people who are alive at present can be satisfied (*the principle of intragenerational justice*).

But should we extend this way of thinking also to future generations? If the answer is yes, we could reformulate element (11) as follows:

- (11') We have a moral obligation to use natural resources in such a way that not only people who are alive at present but also future generations can satisfy their basic needs (*the weak principle of intergenerational justice*).

This implies that we have a moral duty not to place at risk future generations' possibilities of achieving at least a minimal standard with respect to food, water, housing, energy, health care, and education. We have a responsibility to future generations to see to it that there is productive agricultural land so they can eat adequately, that there are productive woodlands so they can build houses, and that the pollution of air and water does not threaten their well-being. But we have no responsibility to ensure that they can achieve a standard of living or a quality of life that is equal to our own.

Another possibility is then to reformulate (11) as follows:

- (11'') We have a moral obligation to use natural resources in such a way that future generations can expect to achieve a quality of life equal in value to that enjoyed by us (*the strong principle of intergenerational justice*).

This means, for instance, that when people consume nonrenewable natural resources such as fossil fuels, future generations are denied the possibility of using these resources. Since we cannot repay them for the loss of the energy source by returning the energy after we have used it, according to the strong principle of justice we must in some sense compensate them for this loss. We can do this by developing substitute products in the form of alternative energy sources which will allow succeeding generations to expect a standard of living equal to that of our generation.

Which one of these understandings of intergenerational justice the vision of sustainable development embraces is unclear. And it is not uncommon that in some environmental policy documents, certain policies are based on the weak principle of intergenerational justice, while others are based on the strong.

The Role of Science and Religion

We have seen ways in which both religion and science add elements to the worldview within which the vision of a sustainable development is elaborated, and in this way contribute to a solution of the ecological crisis we face. Some critics, however, maintain that science and religion actually are the main cause of this crisis, or that at least one of them is.

Lynn White, for instance, in a famous article called “The Historical Roots of Our Ecological Crisis,” contends that the crisis is primarily due to the orthodox Christian arrogance toward nature. The idea of God giving humans domination over nature is what we have to reject. Much better for the environment is the kind of religion, for instance, of many Native American tribes, who regard every part of the land as sacred. Hence elements (2) and (3) in the old worldview should be rejected. Alister McGrath argues, in *The Re-enchantment of Nature* (2002), that our problem arises from a deliberate decision to reject the idea of God in order to promote human freedom. He contends that the emergence of atheism or materialism, and with it the disenchantment of nature, is the ground of our crisis. But if our environmental crisis is caused by Christianity or atheism, why are other parts of the world experiencing the same crisis when people living there are primarily neither Christians nor atheists, yet believing that nature is divine in one way or another? Although there could be significant truths in the perspectives of White and McGrath, a more plausible account of the causes of the ecological crisis must be more complex in character.

Some argue that the scientific rejection of the man-apart-from-nature view and the adoption of the view of human-nature interdependence, or more broadly ecological holism, may have serious consequences for theistic religions. A belief in the interdependence of humans and nature supports a nonanthropocentric ethic and entails a different conception of God. The core idea is that the new ecological insight expressed in (8) undermines element (2), or at least one interpretation of it, as well as element (3). In the light of the scientific developments, element (3) ought to be replaced by:

- (15) Nature is divine in the sense that God and nature are one (pantheism) or in the sense that nature constitutes a part of God (panentheism).

Sallie McFague offers both of these ideas, although different scholars have developed them in different ways. She claims in *Models of God* (1987) that to appreciate the extent to which we are embedded in the evolutionary ecosystem requires an act of imagination, since the Western sensibility has traditionally been nurtured by an atomistic, reductionistic perspective that separates human beings from other beings and reduces all that is not human to objects for human use. McFague also thinks that the new ecological paradigm sup-

ports a panentheistic conception of God in which nature is understood as God's body.

But McFague on the first point seems to confuse ecological holism, which is a factual view, with an evaluative view, namely "ethical holism." Ethical holism is roughly the view that the ecosystems and all their inhabitants have intrinsic value or moral standing. This confusion could perhaps also explain why advocates of sustainable development, even though they accept ecological holism, still endorse anthropocentrism.

Nevertheless, element (2) in the old Western worldview could be given a nonanthropocentric interpretation. And perhaps McFague and others are right that this is what we need if we are to overcome the ecological crisis. It would then not be sufficient to talk about nature merely as a resource, even if we grant that the use of it should be efficient and farsighted. This reinterpretation is possible if we introduce a distinction between "moral standing"—what in nature must be taken into account in our moral evaluations—and "moral significance"—the extent to which we should take into account those things that have moral standing. Element (2) could then be understood in such a way that it expresses the idea that other things besides humans have moral standing, such as animals and plants, species or ecosystems, but that human beings still have the highest moral significance of all things in nature. But some people claim the following:

(16) Human beings are plain members and citizens of the biotic community.

This of course denies the highest moral significance of humans. Some could even claim that humans have less moral significance than keystone species and ecosystems. Quite different versions of nonanthropocentrism are possible. Perhaps the future development of the vision of sustainable development should contain a rejection of anthropocentrism and the adoption of at least a weak form of nonanthropocentrism.

Be that as it may, the advocates of sustainable development do not think that such a revision of our ethics is needed simply because of the change in our worldview from (5) to (8). Nor do they suggest that it should lead to a rejection of a conception of God in which nature is understood to be distinct from God but dependent on God for its continuing existence. It is indeed difficult to see how a scientific claim about the interdependence among all organisms (humans included) would have any bearing on a conception of God in which no part of nature is understood to be a part of the divine. If God and nature are believed to have some parts in common, things could of course be quite different. Some other scientific insights or, more likely, some other kind of insight from philosophy could perhaps provide good reasons for a rejection of classic monotheism and an adoption of either panentheism or pantheism. But ecological holism does not entail ethical holism or divine holism (or for that matter anthropocentrism or classic monotheism).

Nevertheless, it remains true that how we should treat nature, what envi-

ronmental policies we should adopt, and why we should adopt them depends on insights obtained from both science and religion. The future of the planet depends on the ability of people of different faiths and ideologies to arrive at a shared concern of the natural world that is informed by the best scientific theories available.

Bibliography

- Gottlieb, Roger S., ed. *This Sacred Earth: Religion, Nature, Environment*. 2nd ed. London: Routledge, 2004.
- McFague, Sallie. *Models of God: Theology for an Ecological Age*. Philadelphia: Fortress, 1987.
- McGrath, Alister. *The Re-enchantment of Nature: Science, Religion, and the Human Sense of Wonder*. London: Hodder and Stoughton, 2002.
- Pojman, Louis P. *Global Environmental Ethics*. London: Mayfield, 2000.
- Rolston, Holmes, III. *Conserving Natural Value*. New York: Columbia University Press, 1994.
- Stenmark, Mikael. *Environmental Ethics and Policy-Making*. Aldershot, UK: Ashgate, 2002.
- United Nations. *Agenda 21*. New York: United Nations Publications, 1992.
- . *Rio Declaration*. New York: United Nations Publications, 1992.
- White, Lynn, Jr. "The Historical Roots of Our Ecological Crisis." *Science* 155 (1967): 1203–7.
- World Commission on Environment and Development. *Our Common Future*. Oxford: Oxford University Press, 1987.

Consciousness, Mind, and the Brain

Introduction to Consciousness, Mind, and the Brain

Nobody knows what consciousness and mind really are. Are mind and brain the same thing? If one can literally change one's mind with drugs or neurosurgery that physically alters the brain or its components, does this mean everything that is brain is also mind? Or are the physical and the mental still separable? If we could make a computer that thinks like humans do, would we have proven mind equals brain?

What do these questions have to do with science and religion/spirituality? They bear on the nature of mind and brain and consciousness, which many thinkers through history say are tightly linked to religious belief, experience, and ritual. If our brains are made of molecules, such as the proteins encoded in our genes, integrated with the sum of our experiences that then result in our behaviors, this raises a set of questions that weave science and religion into one tapestry:

- Are our brains hard-wired for religion? For ritual? For belief in a higher being?
- What does it mean to believe in something?
- If we can identify areas of the brain as responsible for certain feelings, mood, or belief in God, should we?
- Is it okay to control or alter these areas with drugs and surgery? With meditation?

For centuries, humans have been tackling big questions that bridge religion and science. René Descartes, Sigmund Freud, Carl Jung, and William James all addressed what was known about the body and brain in relation to their theories of the mind. Thinkers across broad areas have been drawn to these questions because they are so central to who we are. This section brings together scholars from philosophy, medicine, theology, neurosurgery, psychology, and history to weigh in on the topic.

Clinical psychologists Christopher Peterson and Nansook Park present an overview of the history of the psychology of religion and how it began to set the foundation for and now complements much of the psychiatric and other biomedical work in this area. This biomedical research, due in large part to an array of new technologies, has led to the emergence of a whole new discipline, neurotheology, discussed in the essays by Kelly Bulkeley, a theologian and scholar of dreams, and Carol Albright, a scholar of religion and neuroscience. Neurotheology is reshaping the consciousness/mind/brain conversation. Techniques such as PET scans, fMRI, and neurosurgery on conscious patients (see the essays by neuroscientist Andrew Newberg and neurosurgeons Sarah Vinson and colleagues) have allowed physicians and natural scientists, in collaboration with humanists and social scientists, to study and literally observe the brains of people while they are, for example, weighing an ethical issue or listening to music. These techniques are still new and evolving and have led to some overblown conclusions based simply on correlations, but it is clear they represent an early generation of technology that will significantly aid in answering some of the central questions raised above.

Some fear that if humans can develop a scientific, or even a molecular, explanation of belief or religion, it will make these concepts less meaningful or mysterious, less real or true. Others, as philosopher J.P. Moreland discusses in his essay, put forward that science may be able to address these questions at a crude level, but more profound concepts like love and God are unexplainable by science, or at least by science alone. Still others, as explored in the essay by psychologist Imants Barušs, suggest that science may take itself into new realms beyond its current limits, hinting at a convergence of traditional science and previously unknown realities (also see the essays on near-death experiences in the *Death and Dying* section).

Is everything eventually explainable through science? If a phenomenon cannot be explained through science, does that mean the phenomenon is not “true” or somehow less true than what is explainable through science? A 2005 column on *edge.org* asked many leading thinkers a question that begins to get at the heart of the belief/proof conundrum: “What do you believe is true even though you cannot prove it?” Most intriguing are the responses from the natural scientists, many of whom discuss the questions raised here. Several mention their beliefs in issues of mind and brain but present them as beliefs that will eventually be proven through science, although they have not been yet. Scott Atran, an anthropologist and psychologist who has contributed a piece in the *Ecology, Evolution, and the Natural World* section, gives another kind of answer to the question: “There is no God that has existence apart from people’s thoughts of God.” Psychologist David Buss believes in “true love”—a state of love beyond the usual that he “knows” exists even though he cannot define or measure it. Such ideas can probably never be proven in the scientific sense.

These scientists separate belief from fact, but their thoughts highlight the close links between the two. In essays in this section, psychologist Kenneth

Livingston and philosopher Jason Slone explore their ideas about belief and religion as they relate to evolution and biology in examining explanations for religion in general and religious rituals and beliefs specifically. For example, common characteristics and rituals of different religions in different parts of the world might indicate a common underlying biology, that is, a common brain structure.

If complex behaviors such as those associated with religion do indeed map to brain structures, then such behaviors must eventually map in part to specific sets of genes that, together with the environment, make those brain structures what they are (see the Genetics and Religion section). Thus, biology and evolution would have a significant influence on religion at both the societal and individual level, helping explain (eventually) why religions and spirituality exist in the first place. They might also lend insight into how we think and believe as we do.

All this suggests we are on an exciting and dangerous voyage afloat in a sea of scientific and religious ideas, beliefs, facts, and experiments, near an understanding, at least at the biological level, of how we become what we are. Will such an understanding, if ever achieved, sink us, allow us to travel further, or have little or no effect? If we understood through genetics why we believe certain things and to what degree, would that change the nature of belief, God, or religion? Or is such knowledge really little more than what we already possess?

At the end of his response to the edge.org question about belief, the renowned neuroscientist Robert Sapolsky says jokingly, but with a kernel of seriousness: “I might even continue to believe there is no god, even if it was proven that there *is* one. A religious friend of mine once said to me that the concept of god is very useful, so that you can berate god during the bad times. But it is clear to me that I don’t need to believe that there is a god in order to berate him.”

Regardless of how new scientific discoveries change our beliefs and religions, they will assuredly change our ability to artificially (through surgery, targeted psychomedications, genetic changes, or combinations of these) and noninvasively (through meditation) control and alter behavior in a much more precise way than we do now. As we have seen in society in relatively small doses already, it will take all that is good about science and religion to deal with the questions and implications that will then come into play.

57 The Psychology of Religion

Christopher Peterson and Nansook Park

Psychologists have long been interested in religion. The first great psychologist in the United States, William James, was deeply concerned with religious phenomena. His 1902 book *The Varieties of Religious Experience* remains in print more than a century later and is notable for its focus on the subjective experience of religion. James was especially interested in topics like conversion, mysticism, trance states, saintliness, and repentance. Another American psychologist, G. Stanley Hall, established a journal devoted to the psychology of religion that was published between 1904 and 1915. Hall was a developmental psychologist often credited with “inventing” the concept of adolescence, and he also pioneered the use of the questionnaire as a research tool. He was most interested in the moral and religious training of youth.

Religion all but fell off the radar screen of psychology from 1930 to 1960. Various reasons can be cited. Behaviorism held sway within much of psychology, and researchers and theorists tended to focus on what people and animals had in common, which obviously did not include religion. The associated philosophical stance of logical positivism created a strict fact-value distinction, and religion was seen by many psychologists as too value-laden to be a suitable subject for a scientifically objective psychology. Some have speculated that twentieth-century psychologists were not an especially devout group, which means that religion did not strike many of them as especially interesting or important. Finally, large state universities, where many of the leading figures in psychology worked, usually did not have separate departments of religion or religious studies, the presence of which might have spurred interest in the psychology of religion.

Nonetheless, there were sporadic forays into the psychology of religion. For example, in well-known works like *Totem and Taboo*, *Moses and Monotheism*, and *The Future of an Illusion*, Sigmund Freud proposed that religion emerged as a consequence of the human need to defend against infantile impulses and fears. God and other divine figures are inventions (illusions) that fulfill the human wish for an omnipotent father whose love and protec-

tion have the kind of enduring power that could never be achieved by actual fathers.

Here we see the beginning of an issue that still characterizes the psychological study of religion. Can (or should) religion be reduced to the merely psychological? To do so strips religion of its presumed sacred significance and makes it no different in principle from any other activity or experience that galvanizes people. But not to do so seems to move religion outside the realm of a deterministic science. Said another way, the issue for psychologists is whether their attempts to link religion to psychological phenomena have the effect of “explaining” religion or “explaining it away.” The distinction may be largely in the eye of the beholder. Regardless, religion is an extremely important factor in the lives of many people, as shown by its link with all manner of thoughts, feelings, and actions.

In 1950, Harvard psychologist Gordon Allport made an important distinction between *extrinsic religiosity* (religion as a means to other ends) and *intrinsic religiosity* (religion as an end in itself). The distinction still undergirds a great deal of theory and research in the psychology of religion. The extrinsically religious participate in institutionalized religion because it provides security, satisfies social needs, or confers status. The intrinsically religious, in contrast, internalize religious beliefs and bring their other needs into harmony with them.

To measure these two orientations, Allport and his colleagues developed a brief self-report questionnaire that still finds widespread use. One of the widely disseminated findings was that extrinsically motivated people were the most likely to be prejudiced, a result which did not burnish the reputation of religion among liberal psychologists. More likely to be overlooked was the additional finding that intrinsically motivated people were the least likely to be prejudiced. Indeed, if we limit our attention to church attendees, the most actively and intrinsically involved among them are still among the least prejudiced in the contemporary United States.

When researchers did include religion in their studies, it was not usually a main focus. They usually did little more than ascertain a handful of simple indices like church attendance, which fail to make important distinctions like the one between extrinsic and intrinsic motivation. What resulted was an amorphous depiction of religion that did not do much to inspire further research.

Matters started to change around 1960. Journals like the *Review of Religious Research* and the *Journal for the Scientific Study of Religion* were founded and served as outlets for empirical research articles. Textbooks on the psychology of religion were written, and courses began to be offered. In 1975, an American Psychological Association division devoted to the psychology of religion was created.

As clinical and counseling psychologists began to take seriously the diversity of their clients, explicit interest in therapy with religious individuals began to emerge. Today, many of the books and articles written about the

psychology of religion are framed within the context of therapy. Private foundations like the Fetzer Institute and the John Templeton Foundation began to support research into the psychology of religion. Measures were devised and disseminated. There is even a psychology of religion webpage, which contains a variety of useful resources for psychology researchers and instructors (see <http://www.psywww.com/psyrelig/>).

Research findings began to accumulate showing that religion had certain benefits in a variety of psychological domains. The general public was captivated by the possibility that religious beliefs could help a person cope with problems and avoid physical illness. Faith-based organizations were found to be particularly effective in providing social and community services. Whether or not one agrees that governments should formally support such organizations, their success is clear.

Following the lead of the larger U.S. culture, psychologists began to distinguish between *religiosity* and *spirituality*. The former term subsumes traditional (religion-based) ways of experiencing the sacred and transcendent, whereas the latter term is an ever expanding one that may include religious experience but also one's compassionate experience of nature or humanity. Thus people may describe themselves as spiritual because they feel elevated in a beautiful setting, but they may not believe in God or congregate with like-minded individuals in worship. This seems an important distinction, but too much emphasis on it overlooks the facts that however they are defined, religiousness and spirituality overlap substantially in their features and usually occur together in people.

Concerns about the definitions of spirituality and religiousness highlight long-standing questions about how we can know that a phenomenon is religious (or spiritual) or not. One tradition that can be traced to William James suggests that religious events are extraordinary happenings characterized by mystical experiences. Another view is that religious events are not in themselves extraordinary or transcendent but are simply those attributed by the individual to divine forces.

A final distinction that can be made is between the *psychology of religion* (the use of psychological theory and research to understand religious experience and activity) and *religious psychology* (the use of given religious doctrines to understand psychology).

Psychology of Religion Today

Contemporary approaches to the psychological study of religious and spiritual life tend to fall into several general domains. One important body of work is largely theoretical in nature. Here several influential schools of thought exist. The *psychoanalytic school* draws on the work of Freud and emphasizes the role of unconscious motives for religious belief. Contemporary psychoanalytic theorists are not necessarily as hostile toward religion as was Freud.

The *analytic school* is based on the ideas of Freud's one-time follower Carl Jung; well-known is Jung's theorizing about universal archetypes (symbols), many of which have religious significance. The *object relations* school draws on more contemporary psychodynamic theorizing and often emphasizes maternal influences. The *transpersonal school* assumes that religious phenomena, although immaterial, are nonetheless real and can be studied directly. Finally, the *phenomenological school* attempts to describe religious experiences as given to the individual.

Another approach to the psychology of religion is a body of work that attends to quantitative measurement. What are the important domains of religious and spiritual experience? How can they be measured? What are the psychometric properties (reliability and validity) of these empirical measures?

It seems unfortunate that the measurement tradition is often separate from the rich theoretical traditions represented by the influential schools of thought, which tend to rely on single case studies and other forms of qualitative research. One would think that theory and quantitative research could mutually inform one another. Regardless, the measurement tradition has yielded a variety of intriguing findings about the psychology of religion.

For example, professed religiousness among young people is associated with a tendency to avoid all manner of antisocial activities. Children and adolescents who score higher on indices of religiousness (i.e., church attendance) show greater emotional self-regulation, engage in fewer acts of aggression, have better records of academic performance, are less likely to use drugs and alcohol, and tend to delay their sexual involvement. They see the world as more coherent. Much the same results are found for adults. Furthermore, religious involvement among adults is a robust correlate of individual happiness and family well-being.

Another line of work is more sociologically oriented. It maps patterns of involvement in institutionalized religion and delineates the impact of involvement on social cohesion. Churches, particularly those with strong social justice and service orientations, play demonstrably important roles in providing a range of resources that benefit the communities in which they are found. These churches are able to instill in their congregations a sense of civic responsibility shown in volunteerism and other forms of civic involvement. African American churches play particularly important roles in promoting the well-being of their communities by providing a range of services, including education, psychological counseling, financial support, housing, clothing, and food to those who are in need.

Following the early example of Hall, researchers have again turned their attention to religious socialization. For example, what role do parents play in the religious beliefs and practices of their children? There is some evidence that fathers and mothers play distinct roles. Fathers appear to structure the formal religious involvement of their children, whereas mothers play a more central role in the ways that their children apply the principles of religion in everyday

life. At least within the United States, children raised in nuclear families, children whose mothers are not employed full-time, and children whose parents share similar religious beliefs are more likely to be religiously involved.

Under the rubric of positive psychology—a new field that calls for the study of those things that make life most worth living—there has been increased interest in character strengths and virtues, including the explicitly theological (faith, hope, and charity) and the more secular but still religiously derived (gratitude and forgiveness). What are their causes and consequences? How can they be encouraged among youth?

Finally, there is a body of work that examines the neurophysiology of religious and spiritual experience. These investigations spill into a related line of theoretical work that addresses religion and spirituality in broadly biological—usually evolutionary—terms. The argument is that people are hard-wired (biologically predisposed) to seek the sacred. For example, anthropologist Lionel Tiger proposed that hope, typically embedded in religious beliefs, arose in the human species to counteract the despair that resulted from people's growing capacity to contemplate their own demise.

Critique

Most commentators believe that the psychology of religion has yet to arrive fully within mainstream psychology. The field still tends to be marginalized in specialty journals, books, and courses. Researchers often seem apologetic and are occasionally suspected by their colleagues of having an agenda. The trajectory is nonetheless upward. However, most of the research done under the psychology of religion umbrella is done in the United States, and it should most accurately be described as the psychology of mainstream Protestantism, reflecting the makeup of the typical sample of research participants. For the most part, researchers have been reluctant to compare people following different religions, which means that the resulting data are not at all fine grained.

Interesting exceptions do exist, which underscore the potential utility of comparative studies. One study has shown that religious fundamentalists—whether Christian, Jewish, or Muslim—are more optimistic than their liberal counterparts. Another study has shown that Jews are more likely than Christians to judge morality in terms of people's overt actions, as opposed to their thoughts and intentions.

The United States has been characterized as a particularly religious nation. As many as 46 percent of Americans attend weekly religious services, in contrast to only 4 percent of adults in Japan. If we take these data at face value, they may reflect the historical fact that the United States was largely settled by religious refugees from Europe seeking freedom to worship as they wished. But another interpretation is that these data are an artifact of researchers using Western (Christian) conceptions of religion and what it means to be devout. Because Japanese are mostly Shintoists or Buddhists, they are more likely to

seek the sacred in the mundane. Church attendance is a category mistake when used to judge how religious they are. Regardless, the psychology of religion needs to be extended to all forms of religion. Whether findings established among U.S. Protestants generalize to Jews, Muslims, Hindus, Buddhists, and others—inside and outside the United States—is a critically important question that deserves much more attention than it has so far received.

With fascinating exceptions that include investigations of conversion and apostasy, the psychology of religion often follows the lead of psychology *per se* by studying unselected samples of college students enrolled in introductory psychology courses. They are given batteries of questionnaires to complete, including measures of religiosity and spirituality, and the correlations among these measures are explored. Although the religious experience of young adults can be interesting in its own right, given that late adolescence is a time of intellectual exploration and identity consolidation, this is far from an ideal research strategy if one's interest is in the psychology of religion more broadly construed.

Many researchers to date have also been content to use very simple research designs, which hamper interpretation. For example, a study may show that people who frequently attend church have better physical health than those who do not. We might be tempted to conclude that church attendance is good for one's health, but such data may show instead that health is good for one's church attendance or that some unmeasured third variable (e.g., affluence) may be responsible for both. In fairness, researchers are recognizing the need for more sophisticated research designs that follow individuals over time and control for confounding variables. The unsurprising but meatier conclusion from more sophisticated studies is that religion confers physical health benefits when it has been well integrated into the individual's life.

Still not established to any certainty is the means by which religion confers benefits. Are the relevant processes intrapsychic (emotional or cognitive) or interpersonal? Do these mechanisms differ in accord with the consequence of interest? Do they differ from person to person even for the same consequence? Again, more sophisticated research designs are needed.

A final point is that those who study the psychology of religion at times seem almost too respectful of their subject matter. After decades of neglect if not outright antipathy toward religion, psychology today seems to be uncritically and ecumenically enthusiastic about the benefits of religion. But surely there are both psychologically healthy and psychologically unhealthy aspects of religion, both of which deserve acknowledgment and study if our understanding is to be advanced.

Kenneth Pargament, one of today's leading psychologists of religion, has phrased well the need for more articulate research questions: "Religion is a richer, more complex process than psychologists have imagined, one that has the potential both to help and to harm. Questions about the general efficacy of religion should give way to the more difficult but appropriate question, How

helpful or harmful are particular forms of religious expression for particular people dealing with particular situations in particular social contexts according to particular criteria of helpfulness or harmfulness?"

In sum, the psychology of religion is a moving target. As analytic questions like those posed by Pargament begin to be answered, the field may be increasingly embraced by the larger discipline.

Bibliography

- Allport, G.W. *The Individual and His Religion*. New York: Macmillan, 1950.
- Beit-Hallahmi, B. "Psychology of Religion 1880–1930: The Rise and Fall of a Psychological Movement." *Journal of the History of the Behavioral Sciences* 10 (1974): 84–90.
- Cohen, A.B., and P. Rozin. "Religion and the Morality of Mentality." *Journal of Personality and Social Psychology* 81 (2001): 697–710.
- Emmons, R.A., and R.F. Paloutzian. "The Psychology of Religion." *Annual Review of Psychology* 54 (2003): 377–402.
- Fetzer Institute. *Multidimensional Measurement of Religiousness/Spirituality for Use in Health Research*. Kalamazoo, MI: Fetzer Institute, 1999.
- Freud, S. "The Future of an Illusion." In *The Complete Psychological Works*, ed. and trans. J. Strachey, vol. 21, 1–56. London: Hogarth, 1927, 1953.
- Gorsuch, R.L. "Psychology of Religion." *Annual Review of Psychology* 39 (1988): 201–21.
- Hall, G.S. "The Moral and Religious Training of Children." *Princeton Review* 9 (1882): 26–48.
- Hill, P.C., and R.W. Hood, eds. *Measures of Religiosity*. Birmingham, AL: Religious Education, 1999.
- Hood, R.W. "Psychology of Religion." In *Encyclopedia of Religion and Society*, ed. W.H. Swatos and P. Kvisto, 388–91. Walnut Creek, CA: AltaMira, 1998.
- Ingelhart, R., and P. Norris. *Sacred and Secular: Religion and Politics Worldwide*. New York: Cambridge University Press, 2004.
- James, W. *The Varieties of Religious Experience*. Cambridge, MA: Harvard University Press, 1902, 1985.
- Kalb, C. "Faith and Healing." *Newsweek*, November 10, 2003, 44–56.
- McCullough, M.E., et al. "Religious Involvement and Mortality: A Meta-analytic Review." *Health Psychology* 19 (2000): 211–22.
- Miller, W.R., and C.E. Thoreson. "Spirituality, Religion, and Health: An Emerging Research Field." *American Psychologist* 58 (2003): 24–35.
- Nielsen, M.E. *Psychology of Religion in the USA*. 2000. <http://www.psywww.com/psyrelig/USA/html>.
- Pargament, K. *The Psychology of Religious Coping*. New York: Guilford, 1997.
- . "The Bitter and the Sweet: An Evaluation of the Costs and Benefits of Religiousness." *Psychological Inquiry* 13 (2002): 168–81.
- Peterson, C., and M.E.P. Seligman. *Character Strengths and Virtues: A Classification and Handbook*. New York: Oxford University Press; Washington, DC: American Psychological Association, 2004.
- Sethi, S., and M.E.P. Seligman. "Optimism and Fundamentalism." *Psychological Science* 4 (1993): 256–59.
- Spilka, B., R.W. Hood, and R.L. Gorsuch. *Psychology of Religion: An Empirical Approach*. Englewood Cliffs, NJ: Prentice Hall, 1985.
- Tiger, L. *Optimism: The Biology of Hope*. New York: Simon and Schuster, 1979.
- Wulff, D.W. *Psychology of Religion: Classic and Contemporary Views*. New York: Wiley, 1991.

58 Consciousness and Neurotheology

Kelly Bulkeley

Neurotheology is an imperfect, catch-all term for the work of a small but growing cluster of researchers who are exploring the connections between religion and contemporary brain/mind science. The idea that neuroscientists are zeroing in on “the God part of the brain” has spread to the broader public, generating tremendous excitement about the possibility of creating a higher synthesis of religion and science. Although much of the research being done in this area suffers from serious conceptual and methodological flaws, the findings are extremely provocative, and future progress is likely to be rapid.

Two prominent definitions of neurotheology illustrate the problematic nature of the term. In *The Humanizing Brain*, Ashbrook and Albright speak of neurotheology as the effort to “explore the neural underpinnings of meaning-seeking, of the complex whole and the elegant parts,” while in *The Mystical Mind*, d’Aquili and Newberg define the term thus: “By neurotheology we mean that we will examine how the mind/brain functions in terms of humankind’s relation to God or ultimate reality.” These are clearly quite different research projects. Ashbrook and Albright want to foreground the distinctively human capacity for symbolic communication, cultural creativity, and meaning-seeking, while d’Aquili and Newberg focus their attention on mystical experiences of radically altered consciousness produced by meditation and prayer. If we are to continue speaking of “neurotheology,” we will have to acknowledge that many different and not entirely compatible approaches are being employed in its name.

Further complicating efforts at definition is the *theology* side of the term. Buddhism is a resolutely nontheistic tradition, yet much of neurotheology research (in the d’Aquili and Newberg vein) takes Buddhist meditation as the supreme form of religious practice. Nor does the term properly apply to the work of an atheistic materialist like Michael Persinger—it would be perverse to refer to him as a neurotheologian, yet his work is exactly like that of d’Aquili and Newberg in trying to correlate religious experience and brain function-

ing. A more accurate and inclusive term is clearly needed in this area, but for the moment *neurotheology* holds linguistic sway.

The common denominator of the various studies conducted under the neurotheology rubric is a desire to reconsider religion, spirituality, and anomalous modes of consciousness in light of the best available empirical knowledge about the brain/mind system. Understood in this way, neurotheology has a long intellectual history, reaching back at least as far as the pioneering psychological investigations of Sigmund Freud, Carl Jung, and William James. Freud began his professional career as a clinical neurologist, and he developed his theory of psychoanalysis on the foundation of what he knew about current scientific research on the brain. Jung was also a trained medical doctor, and throughout his career he looked for ways to connect his archetypal psychology with the latest advances in physical science. And James, in *The Varieties of Religious Experience*, used recent discoveries from experimental psychology to argue that religious experience is, on its “hither” side, a continuation of the subconscious realm of mental functioning.

A list of even earlier progenitors of neurotheology would have to include Friedrich Nietzsche, the nineteenth-century German philosopher, who sought the psychophysiological bases of religion and morality; Emanuel Swedenborg, the eighteenth-century Swedish scientist and mystic, who offered an elegant system of bodily and spiritual integration; René Descartes, the seventeenth-century philosopher, whose anatomical studies of the brain led him to claim the pineal gland was the seat of the human soul; and reaching back into the Greco-Roman cultural tradition, naturalistic philosophers like Cicero, Lucretius, and Aristotle, who explained seemingly divine dreams, visions, and prophecies as nothing more than the function of natural bodily processes.

Few contemporary researchers in neurotheology show sufficient awareness of their indebtedness to these earlier investigators. To avoid the danger of what Jeremy Carrette calls “disciplinary amnesia,” neurotheology will need to cultivate a greater historical self-understanding and a greater appreciation for the influence of broader social, cultural, political, and economic forces on the study of religion and brain/mind science.

Neurotheological Research Today

What makes neurotheology so exciting today is the use of highly sophisticated and precise technologies to localize, analyze, and measure brain activity. The most important of these technologies are electroencephalography (EEG), which uses electrodes attached to the scalp to measure patterns of electrical activity across the brain; positron emission tomography (PET) and single photon emitting computerized tomography (SPECT), both of which involve a radioactive solution being injected into the bloodstream, which is then tracked to reveal variations in the metabolic activity of the brain; and functional magnetic resonance imaging (fMRI), which also measures regional

blood flow in the brain but does so by placing the subject within a very intense fluctuating magnetic field.

Each of these technologies has advantages and disadvantages. The EEG allows subjects to move around and engage in a wide variety of ongoing activities, but it is poor at measuring the activity of deeper brain structures. PET and SPECT scans allow for much more precise measurements than the EEG, but they are invasive procedures, and the time required to develop the images (from a few seconds to minutes) means that rapid changes in brain activity cannot be detected. The fMRI produces by far the clearest and most detailed pictures of the brain, but it requires subjects to remain motionless for long periods of time (thereby limiting their range of activities), and the high-power magnetic fields necessary for producing the images are potentially dangerous if used for more than brief periods of time.

All of these technologies are expensive to operate, and competition is fierce for the monetary grants necessary to make use of them. Researchers who want to use EEG, PET, SPECT, or fMRI devices to study religion are thus compelled to justify their projects to the satisfaction of governmental and institutional funding authorities. This is an important factor to consider in evaluating the directions taken by future research in neurotheology.

What follows are brief synopses of some of the leading studies in neurotheology over the past few years.

Transcendental Meditation

The earliest and most intensely studied subject of neurotheological research has been Transcendental Meditation (TM). Since the early 1970s, hundreds of experimental studies have been performed that investigate the physiological effects of the meditation technique taught by TM's founder, Maharishi Mahesh Yogi. According to these studies, TM produces a significant drop in respiration, heartbeat, and oxygen consumption. EEG readings show a dramatic shift from the alpha wave activity predominant in quiet restfulness to a much slower pattern of theta waves. In especially deep meditational states, an overlay of faster beta waves emerges. Most intriguingly, some studies have shown that the electrical activity of the brain tends toward synchronization and cross-brain coherence during meditation. EEG monitors tracked the new brain wave patterns (presumably initiated by the concentration of the meditator) as they gradually spread throughout the brain, to the point where the EEG readings from multiple scalp locations showed a uniformity of frequency, amplitude, and wave form.

Relaxation Response

One of the pioneering researchers in the experimental study of TM and meditation more generally is Herbert Benson, who has invented a contemplative

technique based on “the relaxation response,” which he claims is an evolutionarily conserved phenomenon analogous to the “fight or flight” response. Benson’s technique involves two components. The first involves a focus on a repeated sound, word, phrase (either silently or aloud), or a muscular activity (e.g., walking, dancing, bowing), or a fixed gaze at a special object (e.g., icon, mandala). The second component is a passive disregard for distracting everyday thoughts and a continual return to one’s focus. Benson and his research colleagues have documented not only the physiological changes that are produced by his technique (decreased metabolism, heart rate, blood pressure, respiratory rate) but also the therapeutic effectiveness of eliciting the relaxation response in people who are suffering from stress, chronic pain, and other health problems. Benson is forthright in his conviction that the technique represents a universal core of mystical experience.

Intercessory Prayer

Dozens of studies have investigated the possibility that one person’s prayer can affect another person’s health. Well-designed and methodologically sound studies on prayer have produced suggestive results. For example, Randolph Byrd found that cardiac patients who received prayer were significantly less likely to develop additional health complications than patients who received no prayer. But skeptics have not yet been persuaded that such results are statistically meaningful. Even the advocates of prayer cannot say with any exactitude how these apparent effects are generated, beyond the obvious fact that the person praying is striving to focus all his or her mental energy on positive thoughts aimed at the patient.

A study of prayer as religious experience was performed by Nina Azari and colleagues at University Hospital Dusseldorf. Twelve subjects from an evangelical church in Germany prayed using the first verse of Psalm 23 while a PET scan was performed on their brains. It was found that the intense prayer experiences activated a frontal-parietal circuit that, according to other studies, is key to our capacity for sustained reflexive evaluation or thought. One important implication is that religious experience need not always involve heightened emotional activation (the limbic region was not unusually active in these subjects), but may engage the “highest” processes of consciousness and self-reflection.

Christianity

In addition to the prayer studies, a literature has developed on the neuroscientific basis for traditional Christian conceptions of faith, the immortal soul, and God’s action in the world. Ashbrook and Albright’s *The Humanizing Brain* is the most prominent work from this perspective. It relies heavily on neurophysiologist Paul MacLean’s notion of the “triune brain,” by

which the structural evolution of the human brain is seen to consist of a “reptilian” behavioral core (the brain stem), a “mammalian” middle region for emotions, memory, and sociability (the limbic system), and the “human” outer region (the prefrontal cortex) that allows us to concentrate, plan, and make volitional decisions.

At each level of neural organization, Ashbrook and Albright see correlations between brain/mind functioning and trinitarian Christian doctrine. Thus the brain stem’s role in basic bodily functioning and psychophysiological homeostasis is said to reflect the numerous biblical portrayals of God as “territorial, hierarchical, watchful, persistent, unchanging,” with the deceptive serpent of Genesis 3 serving as an apt image of the reptilian brain’s tendency toward selfish cunning and sudden aggression. The limbic system provides the emotional basis for social relatedness and the formation of communities, and Ashbrook and Albright take this as neurobiological evidence in support of God’s benevolent action in endowing us with a divine capacity to love our neighbors. Research on the neocortex, with its capacity for complex and purposeful cognitive processing, is in their view not only compatible with but actually enhances the traditional Christian theological portrait of God: “We propose that the God of this universe is *complexifying, interactive, dynamic, and loving*, and that the combination of these characteristics indicates a God who is *purposeful*.”

It should be noted that MacLean’s theory is but one of many vying for conceptual dominance, and neuroscientists like Joseph LeDoux have explicitly rejected the triune brain model as overly simplistic and misleading.

Buddhist Meditation

The most dynamic area of current neurotheology research revolves around various types of Buddhist meditation. A pioneer in this area is James Austin, who wrote *Zen and the Brain* (1998). Austin is a longtime practitioner of Zen Buddhist meditation, and he attributes the passion of his research interests to a sudden, surprising moment of revelation in a London subway station: “Time was not present. I had a sense of eternity. My old yearnings, loathings, fear of death and insinuations of selfhood vanished. I had been graced by a comprehension of the ultimate nature of things.” Austin took this wonderful experience as the inspiration to use his neuroscience training to investigate the neural processes underlying moments of enlightenment like his own. He says such experiences involve diminished activity in the limbic system, particularly the fear-detection circuits of the amygdala; diminished activity in the parietal lobe areas responsible for orientation in space and self-world distinction; and diminished activity in the prefrontal systems involved in the executive functions of ordinary conscious awareness.

The capacity for mystical experiences is an essential feature of being human, according to Austin, and he presents his work as a new scientific ad-

vance on earlier theories of religious experience. “Aldous Huxley called mankind’s basic trend toward spiritual growth the ‘perennial philosophy.’ Herein, I take a different perspective. To me, the trend implies a dynamic, intimate perennial *psychophysiology*. It is a series of processes, slowly evolving, that culminate in defining moments of an extraordinary character.”

Several other studies involving Buddhist meditation should be mentioned. Richard Davidson at the University of Wisconsin conscripted a group of employees from a nearby biotechnology company called Promega and had twenty-five of them participate in an eight-week training in mindfulness meditation. At the end of the eight weeks, he used EEGs to compare the activation patterns of the twenty-five meditators and those of sixteen Promega employees who did not receive the training. The meditators showed greater activation in the left anterior region of the prefrontal cortex, a region associated with positive emotional states. Davidson also tested the immune systems of both groups and discovered that the meditators developed significantly more antibodies in response to a shot of flu vaccine than did the control group. Furthermore, the meditators who demonstrated the greatest increase in left-side brain activation also produced the strongest immunological response.

Newberg and d’Aquili used the resources of the radiology laboratory at the University of Pennsylvania to do SPECT scans of the brains of Buddhist meditators and Franciscan nuns in prayer. They found that during states of intense meditation and prayer, the areas of the brain responsible for sensory perception and orientation essentially shut down due to a lack of meaningful input, while the prefrontal executive regions responsible for the abilities “to concentrate, plan future behavior, and carry out complex perceptual tasks” become highly activated. In such a neurological condition, lacking any of the information normally used to define self and world and yet highly aroused and attentive, the brain interprets its experience as suddenly devoid of boundaries: “The brain would have no choice but to perceive that the self is endless and intimately interwoven with everyone and everything the mind senses. And this perception would feel utterly and unquestionably real. This is exactly how [our subject] Robert and generations of Eastern mystics before him have described their peak meditative, spiritual, and mystical moments.”

Yogic Practice

Hans Lou and colleagues at the Kennedy Institute in Denmark used PET scans to study the brain functioning of a group of highly experienced yoga teachers during a relaxation meditation called yoga nidra. The meditation involved listening to an audiotape providing forty-five minutes of guided imagery, with the subjects attending sequentially to their bodies, abstract joy, visualization of a beautiful nature scene, and visualization of an abstract perception of the self as a golden egg. The PET scans revealed heightened activation in exactly those brain systems corresponding to the guided imagery tasks: the supple-

mentary motor area responsible for bodily planning and attention was activated during meditation on the weight of the limbs; the left hemisphere (including Wernicke's region, responsible for spoken words) was activated during the abstract meditation on the word *joy*; the regions of the posterior cortex involved in voluntary visual imagery were activated during the nature visualization; and parietal lobe regions in both hemispheres responsible for bodily representation were activated during the meditation on the self. Of particular significance, the subjects' brains showed a selective deactivation of those prefrontal regions involved in the executive functions of volition, selective attention, and goal-oriented action. In this regard, the yoga nidra practice resembles REM sleep in diminishing the activity of the prefrontal executive system and stimulating the activity of the posterior visual system.

A study by Sara W. Lazar and colleagues at Harvard Medical School used the fMRI technique to study the brain activation patterns of a group of subjects who had practiced Kundalini meditation daily for at least four years. The Kundalini technique is similar to the relaxation response approach (Herbert Benson is one of Lazar's colleagues) insofar as it involves close attention to one's breathing, silent recitation of a mantra, and a passive attitude toward intruding thoughts and feelings. It was found that this meditational technique "activates neural structures involved in attention (frontal and parietal cortex) and arousal/autonomic control (pregenual anterior cingulate, amygdala, mid-brain, and hypothalamus)." Lazar and colleagues further discovered that this distinctive pattern of neural activation became more pronounced the longer the meditation went on: "These findings suggest that neural activity during meditation is dynamic, slowly evolving during practice."

Prospects for the Future

As this review of current research suggests, the findings of neurotheology do not fit into any neat theoretical framework. Different types of religious and spiritual practice are correlated with different patterns of brain activity. Based on the evidence gathered so far, there is no one pure, ultimate, absolute form of mystical experience, but rather a colorful variety of extraordinary states of brain-mind functioning. This means that neurotheology cannot continue to grow as a field if it uses a universalistic, "one size fits all" approach to religion. Rather, a pluralistic approach is needed that can recognize broad similarities and unique differences in religious experience.

Neurotheology will need to overcome several other obstacles if it is to prosper in the future, including the distorting influence of the lab effect, the limiting focus on Christianity and Buddhism (for a healthy corrective, see Ramachandran and Blakeslee's *Phantoms in the Brain*), the privileging of meditation and prayer as the supreme forms of religious practice, the instrumental attitude that useful techniques for modern stress reduction can simply be extracted from religious traditions, and as mentioned earlier, the danger of

a disciplinary amnesia that ignores, neglects, or represses the historical context in which present-day neurotheology is conducted (for further discussion see my *The Evolution of Wonder*). Should researchers succeed in meeting these admittedly formidable conceptual and methodological challenges, the prospects for neurotheology—or whatever new name we one day decide to call it—are bright indeed.

Bibliography

- Alper, Matthew. *The "God" Part of the Brain: A Scientific Interpretation of Human Spirituality and God*. New York: Rogue, 2001.
- Andresen, Jensine. "Meditation Meets Behavioral Medicine: The Story of Experimental Research on Meditation." In *Cognitive Models and Spiritual Maps*, ed. J. Andresen and R.K.C. Forman. Thorverton, UK: Imprint Academic, 2000.
- Ashbrook, James B., and Carol Rausch Albright. *The Humanizing Brain: Where Religion and Neuroscience Meet*. Cleveland: Pilgrim, 1997.
- Azari, Nina, et al. "Neural Correlates of Religious Experience." *European Journal of Neuroscience* 13 (2001): 1649–52.
- Banquet, J.P. "Spectral Analysis of the EEG in Meditation." *Electroencephalography and Clinical Neurophysiology* 35 (1973): 143–51.
- Begley, Sharon. "Religion and the Brain: In the New Field of 'Neurotheology,' Scientists Seek the Biological Basis of Spirituality. Is God All in Our Heads?" *Newsweek*, May 7, 2001, 50.
- Benson, Herbert, and Miriam Klipper. *The Relaxation Response*. New York: Harper Torch, 1975.
- Benson, Herbert, and Marg Stark. *Timeless Healing: The Power and Biology of Belief*. New York: Fireside, 1996.
- Bloomfield, H.H., M.P. Cain, D.T. Jaffe, and R.B. Kory. *TM: Discovering Inner Energy and Overcoming Stress*. New York: Delacorte, 1975.
- Brown, Warren, Nancey Murphy, and H. Newton Maloney, eds. *Whatever Happened to the Soul? Scientific and Theological Portraits of Human Nature*. Minneapolis: Fortress, 1998.
- Bulkeley, Kelly. *The Evolution of Wonder: A Critical Dialogue between Religious Studies and Cognitive Neuroscience*. New York: Routledge, 2004.
- Byrd, Randolph C. "Positive Therapeutic Effects of Intercessory Prayer in a Coronary Care Unit Population." *Southern Medical Journal* 81 (1988): 826–29.
- Carrette, Jeremy R. "Post-structuralism and the Psychology of Religion: The Challenge of Critical Psychology." In *Religion and Psychology: Mapping the Terrain*, ed. W.B. Parsons. London: Routledge, 2001.
- . "The Return to James: Psychology, Religion and the Amnesia of Neuroscience." In *The Varieties of Religious Experience*, centenary edition, ed. J.R. Carrette. New York: Routledge, 2002.
- Connor, Steve. "God Spot Is Found in Brain." *The Sunday Times*, November 2, 1997, 19.
- D'Aquili, Eugene, and Andrew Newberg. *The Mystical Mind: Probing the Biology of Religious Experience*. Philadelphia: Fortress, 1999.
- Davidson, Richard J., et al. "Alterations in Brain and Immune Function Produced by Mindfulness Meditation." *Psychosomatic Medicine* 65 (2003): 564–70.
- Dossey, Larry. *Healing Words*. New York: Harper, 1993.
- Glueck, B.C., and C.F. Stroebel. "Biofeedback and Meditation in the Treatment of Psychiatric Illnesses." *Comprehensive Psychiatry* 16 (1975): 303–21.
- Hogue, David. *Remembering the Future, Imagining the Past: Story, Ritual, and the Human Brain*. Cleveland: Pilgrim, 2003.
- James, William. *The Varieties of Religious Experience*. New York: Mentor, 1958.
- Lazar, Sara W., et al. "Functional Brain Mapping of the Relaxation Response and Meditation." *NeuroReport* 11:7 (2000): 1581–85.
- LeDoux, Joseph. *The Emotional Brain: The Mysterious Underpinnings of Emotional Life*. New York: Touchstone, 1996.

- Lou, Hans C., et al. "A 150-H2O PET Study of Meditation and the Resting State of Normal Consciousness." *Human Brain Mapping* 7 (1999): 98–105.
- MacLean, Paul D. *The Triune Brain in Evolution: Role in Paleocerebral Functions*. New York: Plenum, 1990.
- Newberg, Andrew, Eugene d'Aquili, and Vince Rause. *Why God Won't Go Away: Brain Science and the Biology of Belief*. New York: Ballantine, 2001.
- Pace-Schott, Ed, Mark Solms, Mark Blagrove, and Stevan Harnad, eds. *Sleep and Dreaming: Scientific Advances and Reconsiderations*. Cambridge: Cambridge University Press, 2003.
- Persinger, Michael. *Neuropsychological Bases of God Beliefs*. New York: Praeger, 1987.
- Ramachandran, V.S., and Sandra Blakeslee. *Phantoms in the Brain: Probing the Mysteries of the Mind*. New York: Quill, 1998.
- Russell, Robert John, Nancey Murphy, Theo C. Meyering, and Michael A. Arbib, eds. *Neuroscience and the Person: Scientific Perspectives on Divine Action*. Notre Dame, IN: Notre Dame University Press, 1999.
- Shear, Jonathon. "Experimental Studies of Meditation." In *Religion and Psychology: Mapping the Terrain*, ed. W.B. Parsons. London: Routledge, 2001.
- Thompson, Richard F. *The Brain: A Neuroscience Primer*. New York: Worth, 2000.
- Watts, Fraser. *Theology and Psychology*. Burlington, VT: Ashgate, 2002.
- Wulff, David. *Psychology of Religion: Classic and Contemporary*. New York: Wiley, 1997.

59 Neurotheology

Carol Rausch Albright

Debate about the mind-God problem has continued at least as long as discussion of the mind-body problem, and roughly in parallel. Conclusions on how, or if, one may comprehend or apprehend a deity depend, of course, on whether God is seen as imminent or transcendent, impersonal or personal, predictable or volitional. They also depend on ideas about the origin, embodiment, and abilities of mind.

The current conversations about the intersection of cognitive science and religion are sometimes grouped under the heading “neurotheology.” A key assumption common to most current participants is that, however religious belief or experience is defined, it necessarily operates by means of the brain. Some participants in the conversation believe scientific findings undermine or negate belief in God. Others claim that the existence or nonexistence of God is not germane, for whether God actually interacts with human beings or religious experience is self-generated, the experience must of necessity proceed through the mind/brain.

The Neurosciences

Through advances in brain imaging and other research, understanding of the brain has greatly expanded in recent years, though much remains unknown. The interrelationships of neurons, the operation of various mental functions through neuronal networks, and the roles of the many neurotransmitters are better understood, but consciousness itself remains a mystery. Two important advances concern neurogenesis and neuroplasticity. It is now known that the brain generates new neurons (a process known as *neurogenesis*) in some areas associated with memory and possibly in the cerebral cortex.

Equally important, we now know that the brain wires and rewires itself in response to life experience, education, and thought. This process occurs most readily in children but continues throughout life, so long as the brain remains healthy. This ability is called *neuroplasticity*. We have also learned that the

brain works not only bottom up but top down. As neuroscientist Joseph LeDoux notes, the assembly of the self was once attributed to

processes that work more or less automatically, from the bottom up. But this is only part of the story. . . . Thoughts and memories placed in working memory, for example, can influence what we attend to, the way we see things, and the way we act. . . .

If a thought is embodied as a pattern of synaptic transmission within a network of brain cells, as must be the case, then it stands to reason that the brain activity that is a thought can influence activity in other brain systems involved in perception, motivation, movement and the like. But there's one more connection to make. If a thought is a pattern of neural activity in a network, not only can it cause another network to be active, it can also cause another network to change, to be plastic. . . .

If cells processing sensory events can undergo plasticity as a result of the kind of activity those events trigger in sensory systems, then why can't cells processing a thought change the connections of the cells with which they communicate? Obviously, they do . . .

In other words, we now understand the self as partly specified by the genes, but also as a product of our relationships, culture, nutrition, education, and personal thoughts and decisions. The results are not only expressed in one's character, but also embodied in one's brain.

Complexity Studies

Such findings in neuroscience have important implications for our understanding of religious life. But before we proceed to theological considerations, we need to consider a burgeoning scientific area that bears on these issues: complexity studies. Since the Big Bang, our universe has become increasingly organized. Atoms and molecules, stars and planets appeared. On planet Earth, organic chemicals formed and became self-replicating, and the resulting simple bacteria gave rise to ever more complex plants and animals. Living things formed ecosystems and societies that are even more complex. As Arthur Peacocke inquired,

If something akin to human intelligence had been able to witness the original "hot big bang" some 12 or so billion years ago, would it ever have predicted from the properties of the quarks, the laws of quantum theory and of gravity, and the nature of the four fundamental forces that the process would complexify and self-organize over the aeons in at least one small range of space-time to become persons who can know not only the processes by which they have emerged but also each other and could be creative of truth, beauty and goodness?

Complexity studies seek the laws that influence this process. A few are becoming clear. We know that at each level of organization, the whole truly is greater than the sum of its parts, having effects that the parts individually cannot produce. We have seen that the human brain, acting as a whole, can in fact influence and even modify its parts.

New and unforeseeable outcomes of complexification are called *emergents*. If they prove successful, they, in turn, interact and give rise to still more that is new. As emergents become interrelated, their powers reinforce one another. In this way, complexification gives rise to *synergy*.

In order for parts to form a synergistic whole, certain conditions are necessary. The environment must be partly predictable, partly unpredictable. In other words, certain laws of nature or forms of social organization must be dependable, but not so rigid as to prevent innovation, whether through genetic mutation, social invention, or other means. And in fact, the brain *does* work fairly predictably—yet decisions and experiences change its organization. Therefore, a human brain can—and often does—complexify. It can innovate in response to opportunity and challenge, and these changes, in turn, affect character and ability.

Religious Experience

Can new knowledge in neuroscience and complexity studies enrich religious understandings? Can theology provide depth for these sciences? In order to address such issues, understandings of religious experience should be clarified. Too often, scholars from outside theology or religious studies seem somewhat naive about religious experience, reducing it, for example, to “belief in supernatural agency” or “the belief that one has interacted with a supernatural being.”

In fact, religious experience is multifaceted, and its interpretation is colored by cultural conditions and personal beliefs. To widen our definition, consider a sampling of the breadth of religious experience.

Some Kinds of Religious Experience

Mysticism, with its sense of the actual presence of God, occurs within subsets of all the major world religious traditions, including Shamanism, Buddhism, Judaism, Islam, Hinduism, and Christianity. Within Christianity, for example, Pentacostalism, Roman Catholicism, and Eastern Orthodoxy in particular include strains of mysticism, either quietistic or ecstatic.

Ritual is a feature of religions worldwide (and of many events that are not religious, such as parades, academic processions, and football games). Ritual engages a part of consciousness beyond language, lends gravitas to occasions, creates a feeling of bonding among participants, and often stirs people to action. It can serve as a powerful affirmation of religious belief.

Group bonding is often a result of ritual, whether participants are in a sports audience, a patriotic rally, or a church service. Although religious ritual underscores feelings of group solidarity and empowerment, feelings of belonging and support may result from experiences as basic as sharing religious beliefs and commitments. For many people, these are powerful rewards for participation in religious activities.

Sin and forgiveness, guilt and its expiation, are central to much religious experience. People of course continually transgress group norms or their own personal values, and many religions provide a way through these problems. A sense of forgiveness, of “grace,” may be experienced as deeply religious.

Sudden personality change or the “born-again” experience and its ecstatic parallels in non-Christian traditions have been documented by such secular observers as A.H. Maslow. Following a period of turmoil and a religious commitment or a “peak experience,” an important personality reorganization may take place, with long-lasting consequences. Writing in 1902, William James described a similar process, and others before him observed it as well.

Orientation within the life process is, for many, an important motivator for religious interest. The question “What is life all about?” puzzles people everywhere. Grounding in purpose and meaning based on religious experience can be central, especially for those who have pursued spirituality over a period of years. The resulting sense of calling and identity may feel deeply rewarding.

Empowerment to take actions essential to personal and spiritual growth often accompanies orientation within the life process. Considered risks can be taken because missteps can be forgiven. Energy wells up through the conviction that the blessings of religious faith merit a wholehearted response embodying all of the self.

Neuroscience of Religious Experience

The attentive reader will have noted that the sequence in which experiences were noted implies increasing spiritual maturity. In terms of complexity theory, one might say that parts of the personality begin to work in synergy and thus give rise to emergent traits. (Though some would argue that mysticism has a maturity of its own, I would caution that unless it also includes love, it has an important missing element.) And because experience and mental ability are mediated through the capacities of the brain, the brain must reflect these changes as well. That is, its design, being plastic, will change to reflect the new abilities and understandings. The modified neuronal structure, in turn, will influence how events are experienced and conceptualized and the responses that are chosen.

Neuroscientists have begun to study spiritual activity through brain imaging and experimentation. Best known, perhaps, is the work of Andrew Newberg and Eugene d’Aquili, who imaged activity in the brains of Tibetan Buddhist monks and Franciscan nuns, all of whom had invested many years honing their ability to reach a peak of spiritual experience. During these peak moments, brain activity in both groups was similar, although each no doubt interpreted the experience within the context of his or her own tradition.

Canadian psychologist Michael Persinger has reported inducing a “‘sensed presence’ of a Sentient Being” in himself and several experimental subjects

by magnetically stimulating parts of the temporal lobes. U.S. neuroscientist V.S. Ramachandran writes that a small percentage of those epileptics whose disease involves the left temporal lobe experience intense religious ecstasy during a seizure. Furthermore, after several such seizure-related experiences, they often become obsessively preoccupied with religious and moral issues.

Most religious experiences are so complex that current brain imaging technology cannot address them, although research continues and new studies are being designed and conducted. We *can* deduce which parts of the brain may be involved, since we know in broad terms which brain areas support various mental activities. For example, neural networks involved in feelings of personal attachment surely support religious group bonding and feelings of love of God. Ritual involves some brain structures that are evolutionarily very old (birds and reptiles also engage in rituals). Reasoned interpretation of belief uses brain networks that construct symbols and employ language.

Emergence and Spiritual Growth

It seems clear that increasing spiritual maturity is a process of personal complexification and emergence. At early stages of religious maturity, people focus mainly on themselves: their own behavior, their own virtue, their own salvation, their own well-being. Their sense of self is poorly defined and their interrelationships are not very complex.

With spiritual growth, the personality complexifies, and new abilities and behaviors emerge. Able to interact more fully with others and to draw on more resources with greater synergy, the person gains in insight and empowerment. Personality becomes more sharply defined, and a sense of individual calling emerges. The focus is less on personal well-being, more on one's part in the entire human enterprise—past, present, and future. Within this enterprise, a spiritually complexifying person is defining his or her unique set of abilities, responsibilities, and opportunities. Also, new opportunities tend to arise as complexity and empowerment increase. Such a person loves the world with increasing depth, yet relaxes the need to control it. Broad perspective is often combined with gentle humor.

Of course, personal complexity, synergy, and emergence must also involve neuronal complexification. Neuronal networks probably become increasingly integrated, and they in turn provide further empowerment of character and give rise to emergent traits and abilities.

Neurotheology

Space constraints permit only a few reflections on what this new knowledge might mean for our theological views. Many conventional scientists fear any sort of teleology and see all complexification as the result of random “frozen accidents.” A different view is advanced by the distinguished biologist and

philosopher Harold Morowitz, who concludes that “the emergences are not completely matters of chance, but are governed by physics, chemistry, geophysics, ecological principle, and other laws of science that reduce the universe of chance to zones of the probable. . . . The unfolding of the universe is not totally determined; neither is it totally random.” A theist like myself may conclude that God created a universe where conditions not only enable but in fact bring about complexification, while allowing latitude for contingency and choice.

Chemist and theologian Arthur Peacocke observes: “What we now see today, in the light of the whole epic of evolution and our understanding of complex systems, is that the very processes of the world are inherently creative of new realities.” According to Peacocke, “this God-given existence is autonomous in developing its own possibilities by its own inherent, God-endowed capacities and laws.” Peacocke continues, wondering whether “these new, emergentist monist insights into the inbuilt creativity of our world through its complexifying and self-organizing capacities open up a vista of continuity between the physical, the mental, and the spiritual which could, in this new century, break down the parallel barricades mounted in the last, both between the ‘two cultures’ of the science and the humanities—and between the experiences of nature and of God, the sciences and religion?”

The new ideas seem to demonstrate that God endorses creativity and growth in the creation, and this has implications for ethics. Henry Nelson Wieman, a Chicago theologian ahead of his time, advocated an ethic based on increase of complexification and emergence—though he wrote before the vocabulary of complexity studies had been invented. In this direction, he believed, lay “the creation of some new power of mind and personality by the integration of meanings or the looming of wider horizons and . . . increase of fellowship.”

But caveats based on neuroscience and complexity studies are edgy as well. They of course imply that we cannot simply relax in the belief that “God is in control.” We share responsibility for our world, at a time when many crucial issues seem to hang in the balance. (I need not enumerate them; readers have their own list.) My best recommendations (and they may seem puny) are that each of us seek to support truly synergistic goals—which of course require love—and to discern our calling within the larger tapestry of being. I believe that the weaver of the tapestry envisions a picture larger than our own.

Bibliography

- Ashbrook, James B., and Carol Rausch Albright. *The Humanizing Brain: Where Religion and Neuroscience Meet*. Cleveland: Pilgrim, 1997.
- D’Aquili, Eugene, and Andrew Newberg. *The Mystical Mind: Probing the Biology of Religious Experience*. Minneapolis: Fortress, 1999.
- James, William. *The Varieties of Religious Experience*. New York: Simon and Schuster, 1997. Originally published 1902.
- LeDoux, Joseph. *Synaptic Self: How Our Brains Become Who We Are*. New York: Viking, 2002.

- Maslow, A.H. *Religions, Values, and Peak-Experiences*. Columbus: Ohio State University Press, 1964.
- Morowitz, Harold J. *The Emergence of Everything: How the World Became Complex*. New York: Oxford University Press, 2002.
- Peacocke, Arthur. "Complexity, Emergence, and Divine Creativity." In *From Complexity to Life*, ed. Niels Henrik Gregersen. New York: Oxford University Press, 2003.
- Persinger, Michael A. "Experimental Simulation of the God Experience." In *Neurotheology: Brain, Science, Spirituality, Religious Experience*, ed. R. Joseph. San Jose, CA: San Jose University Press, 2002.
- Polkinghorne, John C., ed. *The Work of Love: Creation as Kenosis*. Grand Rapids, MI: Eerdmans, 2000.
- Ramachandran, V.S., and Sandra Blakeslee. *Phantoms in the Brain: Probing the Mysteries of the Human Mind*. New York: William Morrow, 1998.
- Specter, M. "Rethinking the Brain." *New Yorker*, July 23, 2001, 42–53.
- Wieman, Henry N. *The Source of Human Good*. Carbondale: Southern Illinois University Press, 1946.

60 Neurobiology and Consciousness

Andrew B. Newberg

To understand the neurobiology of consciousness, it is first necessary to understand the problems that consciousness poses in general. To an adult human being with a normally functioning brain, reality, at first pass, seems to be composed of two vividly real categories: the conscious self, and the external reality composed of things that appear to have an inherent reality separate from the conscious self. The things in external reality also appear to be represented in, or known by, the conscious self. Thus the classical philosophical problem of subjectivity versus objectivity is only a problem because the brain, under ordinary conditions, insists on processing reality in this manner. To the naive observer, there is an absolutely certain sense that there is a reality external to the self which appears to be characterized by a heavy, substantive reality often termed “matter” or “material” reality. The naive observer also has the absolutely certain sense of a conscious self that seems to have a light, changeable, and ethereal quality often termed “mind,” “spirit,” or sometimes “soul.” Unfortunately, this naive terminology is anything but exact.

These two senses of reality are so vivid and appear so real that early philosophy did not seriously question the fundamental nature of this duality. For the first thousand years of its existence in the West, philosophy began its work by concentrating primarily on the substantiality of reality. This was the heyday of ontology. However, beginning with René Descartes, followed by George Berkeley among the British empiricists and Immanuel Kant on the European continent, the emphasis shifted to mind as the philosophical starting point, and to how one can know external reality, or anything at all for that manner. With the seventeenth century, therefore, came the heyday of epistemology, with its emphasis on how we know and, in its extreme manifestation, the assertion that all reality is consciousness. At first, modern science sided with the old ontology, naively assuming the existence of external reality as typically represented in consciousness. Since the beginning of the twentieth century, and particularly since the development of quantum theory, science has found itself caught between ontology and epistemology, with old certainties vanishing like smoke.

The problem of the relationship of conscious awareness to external material reality began to achieve a modern focus with Descartes's dualism. Descartes saw the mind as a conscious awareness that contained ideas corresponding (or sometimes not corresponding) to what was in the external world. For Descartes, the mind ordinarily represented the world in a one-to-one correspondence except for the occasional glitches that generated error. This view of the mind as representational of the external world reached its peak in the late nineteenth and early twentieth century, with the work of Franz Brentano. According to Brentano, all states of awareness are *of* or *about* something. For Brentano, mental states must necessarily have "reference to a content" or "direction toward an object." He called this characteristic of mental states "intentionality." This vivid directedness or intentionality was, for Brentano, the defining characteristic of consciousness.

Edmund Husserl, often called the father of phenomenology, was one of Brentano's students. Husserl began trying to develop a specific procedure for examining the structure of intentionality, which was the structure of experience itself, without making any reference to a factual empirical world, and especially without any assumption of its actual existence. This rigid formal procedure he called *epoche* or "bracketing," for it required that one bracket, or suspend belief in, one's ordinary judgments about the relation between experience and the world "out there." Husserl termed these ordinary judgments a "natural attitude." When raised to the level of a philosophical school, it is called "naive realism." By bracketing what he came to see as the "hypothesis of the natural attitude," Husserl attempted to study the intentional contents of the mind purely internally, without tracing them back to what they *seemed* to refer to in the external world. By this approach, he claimed to present a new domain of knowledge that was absolutely prior to any empirical science.

Starting with pure experience, and eschewing all assumptions implicit or explicit about the nature of reality, Husserl embarked on a sort of philosophical introspection that he called *Wesenschau* or "intuition of essences." By this process, Husserl attempted to reduce experience to essential structures, groupings of perceptual and functional aspects that suggest each other as one idea or type, and then demonstrate how our human world was generated from them. One can now see how far Husserl's rigorous approach to conscious awareness eventually led him from Descartes's and Brentano's mental representationalism. Husserl's rigorous phenomenological approach had put an independent isomorphic external world on very shaky ground indeed.

Expanding upon the work of Husserl, Maurice Merleau-Ponty (1906–1961) recognized the enormity of the problem for both science and philosophy of trying to meaningfully relate conscious awareness to the vivid sense of external reality or to the sense of world. In his *Phenomenology of Perception*, Merleau-Ponty clearly recognized the need for a bridge between self and world, between the apparent inner and the apparent outer. Unfortunately, his astuteness in defining the problem was not matched by his ability to solve it.

More recently, Daniel Dennett and Steven Pinker have explored different approaches to mind and consciousness. Some of these approaches are more philosophical and others more biological, with most having some integration of the two. In one view, a central processing area in the brain is the “theater” of conscious perceptions. Others see a more integrated network pieced together from numerous parts of the brain.

In the past two decades, especially with the 1990s being declared the “Decade of the Brain,” the expanded development and use of brain imaging techniques has greatly added to our knowledge about the brain and conscious experience. It is necessary to consider the strengths and weaknesses of such techniques in their attempts to unlock the mysteries of human consciousness. But it will also be necessary to review the inherent problems with studying consciousness from a neurobiological or materialistic perspective and find out what may happen to neurobiology if consciousness is viewed first from the phenomenological perspective.

Brain Imaging Studies of Different States of Consciousness

Functional and anatomical neuroimaging techniques have contributed dramatically to our understanding of the causes of various neurological disorders and in their diagnosis and management. Anatomical imaging techniques such as magnetic resonance imaging (MRI) and X-ray computed tomography (CT) are useful for determining structural changes in the brain. Functional imaging methods such as single photon emission computed tomography (SPECT) and positron emission tomography (PET) have been useful for measuring changes in blood flow, metabolism, and neurotransmitter activity in neuropsychiatric processes.

In the past decade, brain activation studies have used neuroimaging techniques to explore cerebral function during various behavioral, motor, and cognitive tasks. These studies, usually done with PET or SPECT, and more recently functional MRI, have helped to determine which parts of the brain are responsible for a variety of neurocognitive processes. These imaging techniques have also allowed for the uncovering of complex neural networks and cognitive modules that have become a basis for neuroscience research. Functional MRI, which has been extensively developed in the past several years, provides high-resolution images of the changes in cerebral activity during various cognitive, sensory, and motor activation tasks. These functional imaging techniques have been employed to determine the areas in the brain that are involved in the production and understanding of language, visual processing, and pain reception and sensation. Such studies, particularly when targeting tasks involving conscious or unconscious awareness, should provide important neurobiological information regarding the underlying mechanism of human consciousness.

One of the major advantages of PET and SPECT is that, in addition to

general brain function as measured by cerebral blood flow and metabolism, these imaging techniques offer the opportunity to explore a wide variety of neurotransmitter systems within the brain. In fact, a large number of radiopharmaceuticals have been developed over the past thirty years that may be of use for studying the effects of consciousness and conscious experience. Neurotransmitter analogues have been developed for almost every neurotransmitter system, including the dopamine, serotonin, benzodiazepine, opiate, and cholinergic receptor systems. These receptor systems, in addition to many others, may be useful in the future investigation of the neurophysiological correlates of consciousness.

For any study of human consciousness, one would have to begin by defining the specific operationalized paradigm through which consciousness would be explored. Some studies evaluate various sensory experiences to determine when, where, and how such experiences enter consciousness. Other studies explore practices such as meditation that are specifically designed to alter consciousness. These different states of consciousness can theoretically be studied using the various imaging techniques. Depending on what elements of consciousness are the focus of a given study, each of the functional imaging techniques provides different methodological advantages and disadvantages. Functional magnetic resonance imaging, has improved resolution over SPECT, and probably PET, as well as the ability to perform immediate anatomic correlation. Thus, functional MRI can produce functional images that can be directly mapped onto the anatomical structures, thereby helping to pinpoint areas of the brain associated with various activation tasks. (PET and SPECT can also be co-registered with structural MRI images, but this often involves complex computer programs to overlay the functional image with the anatomical ones.) However, the MRI scanner requires the individual to lie down in a confined space and makes a significant amount of noise, both of which could be very disturbing to various types of practices such as meditation or could interfere with other tasks that might be designed to explore consciousness.

PET imaging provides better resolution than SPECT and has the important ability to make quantitative measures of activity. This could be very important, since certain tasks or experiences may either diminish or augment activity in some areas and not others, and this may be missed if absolute quantitation is not performed. However, if one strives to make the environment relatively distraction free, it is sometimes beneficial to perform these studies after hours, which may complicate the use of PET because the radiopharmaceuticals such as fluorodeoxyglucose may not be readily available. Furthermore, PET is the most expensive of the imaging techniques. SPECT imaging is the most readily available and rivals MRI in low cost per study. And SPECT has the advantage, as well as PET, in being able to study subjects outside the scanner.

With SPECT, for example, a subject can meditate until experiencing a peak in the meditation. At this point, a radioactive tracer can be injected through an

Figure 60.1

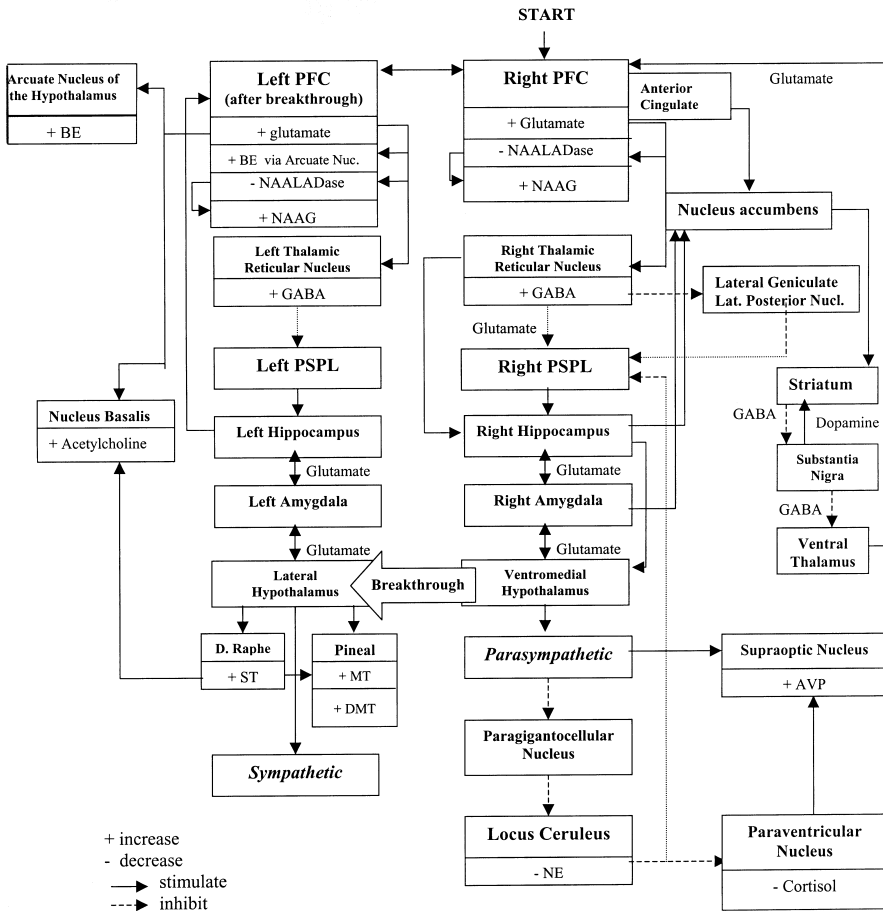

Schematic overview of the neurophysiological network possibly associated with meditative states. The circuits generally apply to both hemispheres, however, much of the initial activity is on the right.

indwelling intravenous catheter while the subject continues to meditate. The tracer is fixed in the brain at the time of injection, so even though the images are acquired twenty minutes later, they reflect the cerebral blood flow during the peak. These studies help us develop complex neurobiological models of practices such as meditation that can dramatically alter a person’s consciousness. We have current models for structures such as the prefrontal cortex, parietal lobe, limbic system, thalamus, and hypothalamus, and for neurotransmitters such as glutamate, gamma aminobutyric acid (GABA), dopamine, and serotonin, as well as for hormonal, autonomic, and immune changes (see Figure 60.1).

One issue that arises regarding imaging studies is not so much what is

measured on the scan, but whether the scan corresponds to the subjective state that one is trying to measure. In the meditation study described above, for example, it was not possible to “interrupt” the practitioner during the meditation to ask what is being experienced, and therefore it can never be known if the scan corresponds to a specific subjective state of consciousness. In studies that attempt to measure changes in the brain, subjects must indicate when a sensory experience does in fact enter their consciousness. The problem here is that there is a necessary delay between when they experience something and when they actually respond. Furthermore, the response itself can alter brain physiology. Thus neurobiological research into the subjective nature of consciousness is quite difficult, and findings need to be interpreted carefully. On the other hand, neuroimaging techniques continue to make major advances and provide the best window into the underlying neurobiological processes associated with consciousness.

Considering Consciousness If External Reality Is Primary

What is the relationship between neurobiology and consciousness? Can we explain consciousness and conscious awareness from the viewpoint of material reductionism, which holds that matter is the primary “stuff” of the universe? If external material reality is accepted as primary, how is consciousness generated by the biological processes of the brain and nervous system?

Up to the present, and parallel to Brentano’s philosophy, neurobiologists have always understood consciousness to refer to consciousness of something. That some form of a Pure Consciousness, devoid of content, might exist has generally not even been entertained as a problem. Therefore, obviously, there has been little attempt at understanding the physical basis of pure consciousness. We will return to this issue below. First, let us consider the basic and classical neurobiological problem of how consciousness of anything is possible.

Strictly speaking, consciousness involves the generation of a self as an element in conscious awareness. In other words, the brain perceives its multiple activities and organizes them into a reified category, which is called the self. Simply put, conscious awareness is consciousness without a clear reified self, and consciousness is conscious awareness with a reified self.

Considered evolutionarily, self-reflexive consciousness only becomes possible with the elaboration of the inferior parietal lobule and its interconnections with various sensory association areas. These structures are known to be the parts of the brain where we sort classes of objects to generate abstract categories. If this is so, then the neuroanatomical requirements of “selfhood” must restrict the clear sense of self to higher primates, and especially to the genus *Homo*. For example, only higher primates and possibly dolphins respond to their image in a mirror as if it were a representation of themselves. All other animals apparently perceive another beast. Moreover, the inferior parietal lobe

and interconnected sensory association areas can operate on, and serve as the physiological location of the self perceiving the self, generating what has been called reflexive consciousness. It is generally thought that clear reflexive consciousness is only a property of *Homo sapiens*. However, this is still an open question, and some anthropoid apes or dolphins may possess it.

Perhaps the biggest problem currently faced by neurobiologists and neuropsychologists is how recognition or awareness of sensory input comes about. This has come to be known as the “binding” problem. It is known that the brain breaks down sensory input into many constituent parts. These constituent parts are analyzed and physically stored in different parts of the brain. Within each sensory modality or input constituent part, the specific identifying elements or “recognition features” are stored in physically different locations within the brain’s association areas for that modality. For recognition of a sensory input, it is necessary to somehow bring together at least the essential recognition features both within a given sensory modality and then across modalities. Most neuroscientists agree that the binding of these disparate elements to match new sensory input, generating recognition, is a temporal more than a spatial phenomenon. In other words, the various recognition features stored physically apart are probably not reassembled in one place in the brain, like a mosaic, which is then compared with input, thus generating recognition. Rather, it seems that all of the relevant features are somehow activated where they are stored at precisely the same time. This temporal binding of recognition features apparently underlies conscious awareness and recognition.

Recent research suggests that cells in the thalamus encode each recognition feature and send pulses of a certain frequency, which generate corresponding pulses in the neurons storing these recognition features throughout the brain. The simultaneous pulses of the same frequency in all the relevant storage areas, even across sensory modalities, somehow result in the binding of these features and in recognition of the incoming material. Imagining a scene may involve the reverse phenomenon of multiple bits of stored information all beginning to pulse at the same frequency at the same time, creating an activation of corresponding cells in the thalamus. Thus, awareness and recognition of incoming sensory input, or imagining objects in a scene, all result from a sort of thalamic/cortical dialogue. This model, which would solve much of the binding problem, allowing awareness of our external environment or even of imagined entities, still has many problems and raises many questions.

Whatever the ultimate mechanism of binding may be that underlies conscious recognition and imagination, it is becoming clearer that the association areas involved with each sensory modality seem to be somehow responsible for conscious awareness in that modality. The evidence is particularly strong with vision. There may be a similar condition with other sensory modalities when their association areas are destroyed but their primary

cortical areas are intact. If further evidence bears this out, especially in sensory modalities other than vision, it is reasonable to assume that conscious awareness arose with the evolution of sensory association areas. The binding problem and the specific function of the sensory association areas are two major research issues that neurobiologists are currently investigating to obtain an understanding of conscious awareness either of the external world or of imagined concepts and ideas. All of this discussion refers to the mechanisms underlying *awareness of something*.

However, one might question whether neurobiology can explore the notion of *pure consciousness*—consciousness devoid of content—sometimes described as a clear and vivid consciousness of nothing, or perhaps of everything at the same time. Certain states of consciousness, often named “mystical,” are described in all of the world’s great religions, as well as attested to by modern secular mystics. In experiences of Pure Consciousness, there are no boundaries of discrete beings, there is no sense of the passage of time, no sense of the extension of space, and the self-other dichotomy is totally obliterated. The state consists of an absolute sense of unity without thought, without words, without sensation, and not even being sensed to be inherent within a subject.

There may be neurobiological correlates of such states, such as the inhibition of sensory input into the posterior superior parietal lobe, especially on the right. This area of the brain is responsible for the orientation of objects in three-dimensional space. If it is denied of all sensory input as a result of mechanisms generated during practices such as profound meditation, the result may be a sense of pure space. Since space has no subjective reality unless it relates things to each other, the subjective experience is one of total spacelessness or of total perfect unity. It is interesting that there is evidence that the posterior superior parietal lobe in the left hemisphere may play a major role in creating our self-other dichotomy. During profound meditation, if the posterior superior parietal lobe on both sides is totally inhibited, this may be associated with the obliteration of the distinction between self and other. Such neurobiological mechanisms have been supported by preliminary brain imaging research of meditative states, but more data are necessary to confirm such hypotheses.

The problem with everything considered up to this point is that while these neurophysiological mechanisms may be correlated with consciousness and may even be the causes of consciousness, they do not explain the stuff of consciousness itself. This raises the biggest problem of all when one begins the analysis with the primacy of external reality. The problem is why should conscious awareness exist at all? If every change in awareness, every change in the contents of awareness, and even the generation of pure consciousness are all caused by physical (i.e., neural) events, then why should consciousness exist? There is no reason why the entire social universe—with every product of human individual endeavors, every product of human social inter-

actions, and every psychological or cultural product from science through art and religion—should not be produced by biologically evolved robots that do not possess conscious awareness. In other words, an objective observer—for example, from another galaxy—could view everything as it is on Earth today, including the appearance of conscious awareness, without there ever having to be any actual consciousness.

The central nervous system is an electrical input/output system of immense complexity. However, it is no more than that, or so it would appear. No matter what degree of complexity the nervous system has attained or will attain in the future, this complexity never implies in itself the existence of conscious awareness. It might produce the appearance of conscious awareness to an external observer, but there is no reason why conscious awareness should, in fact, exist. Actually, there is no reasonable hypothesis to explain conscious awareness arising out of an electrical input/output system, no matter what its complexity. The material nature of the causes of awareness and awareness itself seem to be incommensurables, although obviously, awareness depends on its neurophysiological substrate. Again, all this is true only if one begins the philosophical analysis of reality with the primacy of external material reality.

In fact, it seems that if one starts the philosophical analysis with the reality of matter and the external world, then there are fundamentally two great discontinuities in the universe. The first discontinuity is the Big Bang, or more specifically why there is something rather than nothing. This is the question that plagued Heidegger and many philosophers since. The second great discontinuity in the physical universe is the existence of consciousness. It represents an unexplainable jump from material organization to a level of reality of another order, analogous to the jump from nothing to something. Again, all this is true only if one assumes the primacy of material reality as our philosophical starting point. However, there is another alternative in which consciousness itself is primary, and this has important implications for the neurobiological study of consciousness.

Considering Conscious Awareness as Primary

It is possible to challenge the premise that external material reality is primary and conscious awareness is derived from it. Indeed, as Husserl implied, the only thing that is certain is that all of material reality, including the laws of science and the brain itself, exists within conscious awareness. What are the advantages and disadvantages of starting the analysis of the relationship of conscious awareness to external material reality by granting the primacy of conscious awareness? The greatest advantage is that the problem of explaining the development of conscious awareness and consciousness evaporates, since conscious awareness is the fundamental given matrix that permeates everything. In this case, the problem becomes explaining how external material reality comes into being.

Thus it is not a question of conscious awareness arising out of material reality, but of material reality in some sense arising out of conscious awareness. From this perspective, all of physical reality exists in present conscious awareness, including the knowing brain, the laws of science, the compelling sense of the otherness of external material reality, the compelling sense of a past of completed events and a future of possible ones. Since all of material reality exists *at least* in the mind of the analyzing knower, and since one would have to step outside conscious awareness to ascertain if any reality other than conscious awareness exists, then one is constrained to see material reality (its past and future), the laws of nature, and science as aspects of present conscious awareness. As disagreeable as such an epistemological position might be to those trained in Western science, it is the only possible rigorous stance, unless one wishes to make a complete act of faith that the vivid sense of the otherness of external reality, which certainly exists in conscious awareness, reflects a kind of parallel universe outside of conscious awareness. From a pragmatic point of view, such an act of faith is not so terrible. We all make it almost all the time, and we use it as a basis for our actions. But if one wishes to take a rigorous phenomenological approach, it is clearly impossible to get outside of conscious awareness to determine the existence of a corresponding alternate reality.

On the positive side, if conscious awareness is primary, there are no discontinuities in the universe. The Big Bang becomes an aspect of conscious awareness, a conclusion tending to support the strong anthropic principle, although for reasons somewhat different from those usually put forward in support of it. And with the priority of conscious awareness, there is no question of conscious awareness *per se* evolving from a material system, since material externality is itself an aspect of conscious awareness.

The major disadvantage of such an approach is solipsism, the view that only the self is real. Practical problems would arise from solipsistic behavior. If indeed there is a world of other subjectively aware beings as external realities with whom the subjectively aware philosopher must interact as if they have individual external integrity, then behavior based on solipsism could appear psychotic and result in our philosopher's admission to a mental hospital.

So there are problems whether one believes in the primacy of external material reality or in the primacy of conscious awareness. Is there a solution to the dilemma?

An Integrated Approach to the Problem of Conscious Awareness and Material Reality

Can consciousness and neurobiology be integrated in a way that circumvents the problems when we assume the primacy of either material reality or conscious awareness? Possibilities could be found in studies of states of pure

consciousness. Such mystical experiences are devoid of the perception of discrete reality. One has no sense of the passage of time, no sense of the extension of space, and no sense of the self-other dichotomy. It is pure consciousness without content. Research on meditative states suggests there may also be a biological correlate. What is particularly interesting about the state is that neither during the experiencing of pure consciousness nor upon subsequent recollection is this state ever perceived as subjective. Although it is attained by going deeply within oneself, once it is attained, it is perceived as neither subjective nor objective. Thus, such states may provide important information that is necessary for the adequate interpretation not only of consciousness itself, but of neurobiology as well as the rest of external reality.

The neurobiology of consciousness is a fascinating and growing area of scholarly activity. The continued development of brain imaging technologies and scientific methodology will continue to yield significant advances in the study of the mind and consciousness. This should lead to ever more precise conceptions of consciousness and how consciousness is related to the biology of the brain. On the other hand, there is a great deal to be learned from conscious experience itself, particularly when one considers unusual states of consciousness. These states, often occurring during specific practices, can provide a unique perspective on reality and possibly even turn the tables on what science can say about that reality. Science appears forever locked within the conscious awareness of the world, but absolute unitary states may provide a way of bridging the gap between subjective and objective reality. In the end, it would seem that an adequate analysis of consciousness requires both a scientific and phenomenological perspective, combining the best of experience and empiricism in order to fully understand the true nature of consciousness.

Bibliography

- Austin, James. *Zen and the Brain: Toward an Understanding of Meditation and Consciousness*. Cambridge, MA: MIT Press, 1998.
- Brentano, Franz. *Psychology from an Empirical Standpoint*. London: Routledge and Kegan Paul, 1973.
- D'Aquili, Eugene, and Andrew Newberg. *The Mystical Mind: Probing the Biology of Religious Experience*. Minneapolis: Fortress, 1999.
- Damasio, Antonio R. *The Feeling of What Happens: Body and Emotion in the Making of Consciousness*. New York: Harcourt Brace, 1999.
- Dennett, Daniel. *Consciousness Explained*. New York: Little, Brown, 1992.
- Descartes, René. *The Philosophical Works of Descartes*. Vol. 2. Trans. E.S. Haldane and G.R.T. Ross. Cambridge: Cambridge University Press, 1911.
- Gazzaniga, Michael S., ed. *The New Cognitive Neurosciences*. Cambridge, MA: MIT Press, 2000.
- Husserl, Edmund. *Ideas: General Introduction to a Pure Phenomenology*. Trans. W.R. Boyce Gibson. London: Allen and Unwin, 1931.
- . *The Crisis of European Sciences and Transcendental Phenomenology*. Trans. D. Carr. Evanston, IL: Northwestern University Press, 1970.
- Merleau-Ponty, Maurice. *Phenomenology of Perception*. Trans. C. Smith. London: Routledge and Kegan Paul, 1962.

- Newberg, Andrew, and Alavi Abass. "Role of Positron Emission Tomography in the Investigation of Neuropsychiatric Disorders." In *Diagnostic Nuclear Medicine*, 4th ed., ed. Michael Sandler et al., 783–819. Philadelphia: Lippincott Williams and Wilkins, 2003.
- Newberg, Andrew, and Jeremy Iversen. "The Neural Basis of the Complex Mental Task of Meditation: Neurotransmitter and Neurochemical Considerations." *Medical Hypothesis* 61:2 (2003): 282–91.
- Newberg, Andrew, et al. "The Measurement of Regional Cerebral Blood Flow During the Complex Cognitive Task of Meditation: A Preliminary SPECT Study." *Psychiatry Research: Neuroimaging* 106 (2001): 113–22.

61 The Ethics of Psychosurgery and Deep Brain Stimulation

Sarah Vinson, Kelly D. Foote, and Michael S. Okun

Most people trust medical professionals with the physical body. Patients routinely submit themselves to invasive procedures. Informed of the risks, they are willing to take them in hope of cure or alleviation of disease symptoms. But in neurosurgery, and psychosurgery in particular, patients must entrust physicians with the body and the mind. When a patient considers the risks, fear, caution, and uncertainty are understandable. Psychosurgery began to gain support in the 1930s, only to fall out of favor in the late 1940s due to concerns over personality changes following surgery. The faith once placed in surgical procedures was rerouted to newly introduced psychoactive medications. Drug treatment unfortunately was not beneficial to all psychiatric patients and led to side effects. Thus psychosurgery reemerged later in the century, but with the same ethical dilemmas.

What follows will establish a historical and medical context for the ethical debates surrounding psychosurgery. Brief descriptions are given of several disorders that might be treated with psychosurgical techniques. We then provide a historical review of psychosurgery, a review of psychosurgery techniques, and a description of the latest psychosurgery, deep brain stimulation. Finally, we discuss the ethical issues regarding deep brain stimulation and the treatment of psychiatric disorders.

Disorders That May Be Treated with Psychosurgery

Psychosurgery might be used for a number of psychiatric disorders, especially if medications prove ineffective in treatment or cause severe side effects.

Depression

Major depression is the leading cause of disability in the industrialized world. During the course of a year, close to 10 percent of the U.S. population, or

about 18.8 million American adults, suffer from a depressive illness. As one woman described the experience: “It was really hard to get out of bed in the morning. I just wanted to hide under the covers and not talk to anyone. I didn’t feel much like eating and I lost a lot of weight. Nothing seemed fun anymore. I was tired all the time, yet I wasn’t sleeping well at night.” Major depression interferes with a person’s ability to work, read, sleep, eat, and enjoy once pleasurable activities.

Some strategies for the treatment of depression are pharmacological, or drug related. Some are psychotherapeutic, involving counseling, analysis, or similar techniques. These treatments may be used alone or in combination therapy. Electroconvulsive therapy is useful for some patients with severe or life-threatening depression that is resistant to other treatments, or for those who are unable or unwilling to take medications. Medications commonly used to treat depression include tricyclics, selective serotonin reuptake inhibitors (SSRIs), and monoamine oxidase inhibitors (MAOIs). Side effects of tricyclics include dry mouth, constipation, bladder problems, sexual difficulties, transient blurred vision, dizziness, and drowsiness. Common side effects of SSRIs include headache, nausea, nervousness, insomnia, and agitation. Sexual dysfunction may occur with most of these drugs.

Bipolar Disorder or Manic Depression

More than 2 million American adults suffer from bipolar disorder, which is also known as manic depression. Bipolar disorder causes severe shifts of mood, which may occur gradually or suddenly. These shifts may affect a person’s mood, energy, and ability to function. “I’ve had times of feeling ‘down’ and sad most of my life,” one man said. “I used to skip school a lot when I felt like this because I just couldn’t get out of bed. At first I didn’t take these feelings very seriously . . . I also had times when I felt really terrific, like I could do anything. I felt really ‘wound up’ and I didn’t need much sleep. Sometimes friends would tell me I was talking too fast. But everyone around me seemed to be going too slow.”

These exaggerated mood swings can result in damaged relationships, poor job or school performance, and even suicide. Treatment strategies include medication and psychosocial therapies. Medications include mood stabilizers such as lithium and anticonvulsants such as valproate and carbamazepine. Common side effects of medications include weight gain, nausea, tremor, reduced sexual drive or performance, anxiety, hair loss, movement problems, and dry mouth.

Generalized Anxiety Disorder

Generalized anxiety disorder (GAD) is characterized by chronic, thought-consuming worrying and severe feelings of tension. It affects approximately

4 million adults in the United States. One man described his experience this way: “I’d have terrible sleeping problems. There were times I’d wake up wired in the middle of the night. I had trouble concentrating, even reading the newspaper or a novel. Sometimes I’d feel a little lightheaded. My heart would race or pound. And that would make me worry more. I was always imagining things were worse than they really were: when I got a stomachache, I’d think it was an ulcer.”

Often the worry and tension characteristic of GAD are unprovoked. Those with the disorder realize that their anxiety is excessive but still have difficulty suppressing it. Physical symptoms may include fatigue, headaches, muscle tension, muscle aches, difficulty swallowing, trembling, twitching, irritability, sweating, hot flashes, and trouble falling or staying asleep. GAD is commonly treated with psychotherapy and medications including tricyclic antidepressants and benzodiazepines, such as clonazepam and alprazolam. Common side effects of these medications include nausea, tremor, lethargy, dizziness, and sexual dysfunction.

Obsessive Compulsive Disorder

Obsessive compulsive disorder (OCD) is a form of anxiety disorder that afflicts about 3.3 million adults in the United States. One patient said, “Getting dressed in the morning was tough because I had a routine, and if I didn’t follow the routine, I’d get anxious and would have to get dressed again. I always worried that if I didn’t do something my parents were going to die. I’d have these terrible thoughts of harming my parents. That was completely irrational, but the thoughts triggered more anxiety and more senseless behavior. Because of the time I spent on rituals, I was unable to do a lot of things that were important to me.”

OCD often involves uncontrollable anxiety and ritualistic behavior. People with OCD suffer with persistent, unwelcome thoughts or images, called obsessions, which result in an urgent need to perform rituals, called compulsions. These compulsions are often the result of the obsessions, and this behavior sets off a dysfunctional behavioral cycle. OCD is generally responsive to pharmacotherapy or cognitive behavioral therapy. Drug treatments include antidepressants, and SSRIs such as fluoxetine, sertraline, fluvoxamine, paroxetine, and citalopram.

Schizophrenia

Schizophrenia ranks among the top ten causes of disability in developed countries and affects more than 2 million Americans. It may be the most chronic and disabling of the severe mental illnesses. “People with schizophrenia often suffer severe psychiatric symptoms such as hearing internal voices (auditory hallucinations) or believing that other people are reading their minds,

controlling their thoughts, or plotting to harm them (paranoia). These symptoms have devastating social consequences.”

Current treatments help with many symptoms, but most people with the disease will continue to suffer with many of its consequences. A majority of people with schizophrenia show substantial improvement when treated with antipsychotic drugs such as clozapine, risperidone, and olanzapine; however, these drugs are limited in the extent of their actions and have significant side effects. They are particularly effective in alleviating hallucinations and delusions associated with the illness but do little to remedy other symptoms such as reduced motivation and emotional expressiveness, and they usually do not allow for social reintegration into society. Side effects of these antipsychotic drugs may include drowsiness, restlessness, muscle spasms, tremor, dry mouth, and blurring of vision. Tardive dyskinesia (uncontrollable facial and tongue movements) and agranulocytosis (toxicity to the blood cells and bone marrow) are significant long-term side effects. Psychosocial therapy may be used to address the deficits in motivation, communication, and self-care, which are aspects of the disease unresponsive to drug treatment.

History of Modern Psychosurgery

The story of a chimpanzee named Betty spurred a movement that dramatically changed medical history. At the Second International Congress of Neurology in London in August 1935, research psychologist Carlyle Jacobsen told Betty’s story. After partial frontal lobe destruction, the chimpanzee transitioned from “throwing temper tantrums” to acting as if she had “joined a happiness cult.” Upon hearing this, Portuguese neurologist Egas Moniz speculated that frontal lobe surgery in humans could be used to treat anxiety. It took a mere three months before his speculation gave way to a surgical operation: the first modern frontal lobotomy, which Moniz called a leucotomy.

Moniz’s subsequent publications led to the procedure’s rapid spread throughout the United States and Europe, and Moniz received the Nobel Prize in 1949. By 1950 the surgery was being used in 286 U.S. hospitals, and by 1951 there were approximately 18,000 lobotomized patients in the United States. The spread of this treatment across the United States and the public’s interest and acceptance of it were largely the result of the work of an ambitious neurologist named Walter Freeman, who worked with neurosurgeon James Watts. Freeman performed the first leucotomy in the United States and later coined the term lobotomy, refining the surgical procedure and making many alterations to the original one. He cultivated relationships with writers of prominent newspapers, ensuring his lobotomy procedure would be covered in the popular press. Freeman reported results hastily, however, and failed to wait for well-controlled research studies and documentation of long-term side effects.

While lobotomy was being touted in the popular press as a miracle cure, it was regarded as merely an experimental procedure by the American Medical

Association (AMA). In 1941 the AMA had issued a warning about the unintended personality changes observed in lobotomized patients. The frontal lobes were blindly penetrated with the lobotomy procedure. The surgery involved drilling holes into the skull and inserting a knife-like instrument into these holes in order to sever white matter tracts, or alternatively entering the frontal lobes through the eye socket. Studies and observation showed that psychosurgery in the frontal lobes could lead to dramatic, unintended personality changes such as juvenile behavior, lowered moral standards, tactlessness, inappropriate affect, restlessness, talkativeness, apathy, and decreased motivation, initiative, and will. Freeman commented on this substantial shortcoming of the procedure: "Every patient probably loses something by this operation, some spontaneity, some sparkle, some flavor of the personality."

With time, positive societal and medical views of the procedure began to decline, as did the amount of positive press coverage. By the mid-1950s, a decline in the reported benefits of the procedure was accompanied by an increase in the reports of side effects. The surgery was still performed, however, in part due to claims of the effectiveness of new procedures such as transorbital lobotomy. Transorbital lobotomy was touted by Freeman (its inventor) as a procedure that was faster, safer, and able to be used on an outpatient basis. Transorbital lobotomy, he claimed, could even be performed by a psychiatrist without the aid of a neurosurgeon. Psychosurgery soon fell out of favor with the introduction of psychoactive drugs such as chlorpromazine and lithium.

Psychosurgical Techniques

The limbic system of the brain is responsible for behavioral and emotional expression. The major structures of the limbic system are connected in a circular pathway, the Papez circuit, which contains the hippocampal formation, the mammillothalamic tract, the anterior nucleus of the thalamus, and the cingulate gyrus. As would be expected, the targets of psychosurgical procedures often are components of this circuit, or alternatively may include structures in other nonmotor pathways of basal ganglia (limbic, internal capsule, orbitofrontal, anterior cingulate). Several of the common psychosurgeries are described below.

Anterior Cingulotomy

Anterior cingulotomy involves lesioning the anterior cingulate gyrus of the brain in order to treat psychiatric disorders. The primary indication for this procedure is intractable obsessive compulsive disorder. Some patients with chronic anxiety, major affective disorders, and chronic pain have also been considered for treatment. A 1987 study of patients who had undergone cingulotomy at the Massachusetts General Hospital found that 123 of the 198 patients had long-term improvement after their surgical procedure. The treat-

ment seemed most effective for affective and anxiety disorders, in the middle range for obsessive compulsive disorder, and least effective for schizophrenia and personality disorders. Researchers have noted side effects of the procedure. A 2001 study, for example, noted problems in visual cognition and attention following bilateral anterior cingulotomy. Deficits were noted in tasks that required different kinds of visual processing.

Subcaudate Tractotomy

Subcaudate tractotomy targets the frontobasal white matter regions in order to disrupt the frontolimbic brain connections. Indications for the procedure include affective disorders, obsessive compulsive disorder, and anxiety disorders. A 1995 study of a group of patients with unipolar depression and bipolar disorder who had undergone the procedure revealed that the group had improvement in depression, as indicated by decreased scores on Hamilton and Beck depression-rating scales. Studies also indicated that there were few reported long-term cognitive side effects, though patients did experience transient short-term memory loss, which was correlated with the degree of postoperative frontal edema.

Limbic Leukotomy

Limbic leukotomy combines bilateral cingulotomy and subcaudate tractotomy with the intent of disrupting both the frontolimbic and the Papez circuits. Indications for the procedure include obsessive compulsive disorder and other affective disorders. A 1993 study of OCD patients determined that 38 percent of surgical patients demonstrated moderate to marked improvement. It also showed that while surgically treated patients did not display significant differences in intellectual or memory functioning, they did perform worse on a test of frontal lobe dysfunction (Wisconsin Card Sort Test). Side effects can include apathy, which may be transient, and memory problems.

Anterior Capsulotomy

Anterior capsulotomy targets the anterior limb of the internal capsule with the intent of disrupting frontolimbic connections. Indications for the procedure include obsessive compulsive disorder, intractable generalized anxiety disorder, and panic disorder of more than a five-year duration. Multiple studies indicate that significant improvements have been observed for approximately 70 percent of patients with intractable OCD who receive surgical treatment. Though some studies have suggested a low likelihood of adverse side effects from anterior capsulotomy, others have reported significant side effects. Patients may display transient postoperative cognition and affective dysfunction. Of greater concern, a recent long-term study found that nearly

one-third of patients who had been capsulotomized for anxiety disorder other than OCD presented clear hypofrontal personality traits approximately a decade after surgery.

Deep Brain Stimulation and Changes in Mood and Behavior

Deep brain stimulation is a relatively new therapy in which neurologists and neurosurgeons implant a lead in a deep brain structure and use electrical stimulation to change the brain's pathophysiological activity and hopefully improve symptoms. Deep brain stimulation of different brain regions has been shown to produce acute changes in mood and behavior. Observed effects of the stimulation include aggression, mania, mirthful laughter, apathy, anxiety, irritability, abulia, euphoria, inflated self-esteem, and both the alleviation and the induction of depression.

Now that deep brain stimulation has been demonstrated to be able to change mood, researchers are targeting specific brain structures in hopes of improving psychiatric conditions. Benefits unique to deep brain stimulation make it an attractive form of treatment. While standard psychosurgical techniques provide effects through irreversible destruction of tissue, deep brain stimulation provides its effects through electric current. This delivery system allows for some fine-tuning, and physicians are able to perform tests to determine optimized stimulation parameters by manipulating four electrode contacts, varying the combinations used, and adjusting the electrodes' signal intensity based on favorable or unfavorable changes in mood, anxiety, or reduction in obsessive thoughts or actions.

There is accumulating evidence in obsessive compulsive disorder and in Parkinson's disease that deep brain stimulation is useful in treatment of mood and affective disorders. The use of deep brain stimulation to treat Parkinson's tremor has provided insight into the procedure's ability to modulate mood. Surgical lesions and deep brain stimulation have alleviated motor symptoms but have also yielded behavioral changes, both favorable and unfavorable. Parkinson's patients treated with deep brain stimulation have shown impairment of working memory, mental processing speed, coordination, phonemic fluency, consolidation of verbal material, encoding of visuospatial material, and frontal behavioral dyscontrol, with the elderly having been shown to be more vulnerable to disruption of frontal executive functioning. These side effects could not simply be explained by misplacement of electrodes, as psychiatric symptoms were reported even with well-placed electrodes.

Ethics of Changing Mood and Affect

Among the leading causes of disability in developed countries are major depression, bipolar disorder, schizophrenia, and obsessive compulsive disorder. For many people with these disorders, medications will be ineffective or will

cause severe adverse side effects. Despite the shadow cast by the failure of lobotomy, a national commission convened in the 1970s issued a somewhat favorable report on psychosurgery and recommended it as a treatment of last resort, provided it was not performed on minors, prisoners, or patients incapable of giving informed consent. In the case of intractable mental illness, medicine turned to psychosurgery.

In the first half of the twentieth century, however, the absence of stringent experimental protocols, a dearth of scientific understanding, and the sensationalized media coverage proved detrimental to the field of psychosurgery. Though significant progress has been made in the former two areas, these issues continue to make psychosurgery controversial.

Strongly enforced societal and regulatory constraints were not in place in the early era of psychosurgery. Now, institutional boards oversee the selection of psychosurgical candidates at many institutions where such procedures are performed. For example, at Massachusetts General Hospital, one of the major sites of psychiatric surgery in the United States, all patients are carefully screened before surgery. The referring psychiatrist is required to document the ineffectiveness of the patient's previous nonsurgical treatment, and the anterior cingulotomy procedure must be approved by the Cingulotomy Assessment Committee, whose members must be in unanimous agreement that the surgery should be performed.

Progress in brain imaging technology is also working to the advantage of today's psychosurgical candidates. Clinicians now have concrete evidence of a physiological basis of mental disease, something the doctors of the early psychosurgical era lacked. Through the use of these techniques, researchers have correlated abnormally functioning areas and circuits to specific disease, helping to make psychosurgical procedures better targeted and safer. In the early period of psychosurgery, areas affected by brain lesions could only be examined postmortem, making it difficult to study the correlation of lesion size and therapeutic effect. Now the brain can be imaged preoperatively, intraoperatively, and postoperatively. When using deep brain stimulation, corresponding adjustments can be made.

Although techniques are more refined and surgery is better regulated, there is still a risk that media coverage may inflate public expectation and minimize drawbacks. In the information age, with the advent of the Internet and the instantaneous transmission of thirty-second newsbytes across the globe, inadequate or misleading information can spread at an alarming rate. In addition, patients debilitated by intractable mental disease may grow desperate for a treatment and look to psychosurgery, although it may not serve their best interests. Scientists and physicians have made great strides in understanding emotional pathways, but these pathways and the mechanisms by which psychosurgical techniques exert their effect on these pathways are not fully understood. Nearly seven decades after the first lobotomy, deep brain stimulation and standard psychosurgery still present risks.

With so many people afflicted by intractable, debilitating conditions, can risks justify inaction? Some might argue that the field of psychiatry is inherently uncertain. In the words of the medical historian J.D. Pressman, “this is the heart of the psychiatrist’s social function: to care for those whose problems have no certain cure or satisfactory explanation.” While the cure for these patients may not be certain, the reality of their suffering is. For the patient’s sake, medicine must march forward, proceeding with vigilance, mindful not to repeat the mistakes of an era past. Studies of deep brain stimulation will need to be performed in a structured and safe clinical trial so that the mistakes of psychosurgery from the past will not be repeated.

Carefully controlled studies of the reversible therapy known as deep brain stimulation may allow for a better understanding of the circuitry of mood, behavior, and cognition, and ultimately lead to better treatments and humanity for those who suffer from mental disorders. Additionally, therapies like deep brain stimulation that help us understand brain circuitry may allow us to better understand the physiological basis of social interactions and complex topics such as religion and personal life and social preferences.

Bibliography

- Binder, K., et al. “Modern Neurosurgery for Psychiatric Disorders.” *Neurosurgery* 47:1 (2000): 9–21.
- Diefenbach, G., et al. “Portrayal of Lobotomy in the Popular Press: 1935–1960.” *Journal of the History of the Neurosciences* 8:1 (1999): 60–69.
- Freeman, R., et al. *Psychosurgery in the Treatment of Mental Disorders and Intractable Pain*. Springfield, IL: Charles C. Thomas, 1942.
- Hay, P., et al. “Treatment of Obsessive-Compulsive Disorder by Psychosurgery.” *Acta Psychiatrica Scandinavica* 87 (1993): 197–207.
- Hurley, R., et al. “Treatment of Mental Illness: Impact of Imaging.” *Journal of Neuropsychiatry and Clinical Neuroscience* 12:4 (2000): 421–24.
- Kramer, M. “The 1951 Survey of the Use of Psychosurgery in Proceedings of the Third Research Conference on Psychosurgery.” PHS Publication No. 221, 1954.
- Lehman, A., et al. “Translating Research into Practice: The Schizophrenia Patient Outcomes Research Team (PORT) Treatment Recommendations.” *Schizophrenia Bulletin* 24:1 (1998): 1–10.
- Murray, C., et al. *Summary: The Global Burden of Disease: A Comprehensive Assessment of Mortality and Disability from Diseases, Injuries, and Risk Factors in 1990 and Projected to 2020*. Cambridge: Harvard University Press, 1996.
- National Institute of Mental Health. *Anxiety Disorder*. NIH Publication No. 02-3879, 2000.
- . *Bipolar Disorder*. NIH Publication No. 02-3679, 2001.
- . *Depression*. NIH Publication No. 02-3561, 2000.
- . *Facts about OCD*. NIH Publication No. OM-99 4154, 1999.
- . *Schizophrenia*. NIH Publication No. 02-3517, 1999.
- . *Stories of Depression*. NIH Publication No. 02-508, 2003.
- . *A Story of Bipolar Disorder (Manic-Depressive Illness)*. NIH Publication No. 02-5085, 2002.
- Persaud, R., et al. “Should Neurosurgery for Mental Disorder Be Allowed to Die Out?” *British Journal of Psychiatry* 183 (2003): 195–96.
- Porter, R. *The Cambridge Illustrated History of Medicine*. Cambridge: Cambridge University Press, 1996.

- Pressman, Jack D. *Last Resort Psychosurgery and the Limits of Medicine*. Cambridge: Cambridge University Press, 1998.
- Robins, L., et al. *Psychiatric Disorders in America: The Epidemiologic Catchment Area Study*. New York: Free Press, 1990.
- Stefurack, T., et al. "Deep Brain Stimulation for Parkinson's Disease Dissociates Mood and Motor Circuits: A Functional MRI Case Study." *Movement Disorders* 18:12 (2003): 1508–41.
- U.S. Department of Health Education and Welfare. *Report and Recommendations: Psychosurgery*. Publication No. OS77-0001, 1977.
- Valenstein S. *Great and Desperate Cures*. New York: Basic Books, 1996.
- World Health Organization. *Mental Health: New Understanding, New Hope*. Geneva: World Health Organization, 2001.

62 The Mind-Body Problem

J.P. Moreland

The mind-body problem focuses on the makeup of conscious beings, most importantly of human persons. Put crudely, it asks “What am I and my conscious life made of?” Currently, there are two main answers to this question: physicalism and dualism. *Physicalism* claims that a human being is completely physical. *Dualism* maintains that a human being is both body and mind. Dualism itself comes in two major varieties: substance dualism and mere property/event dualism. Physicalism comes in different varieties as well, with type identity and functionalist versions most prominent.

In what follows, the nature of substances, properties, and events is explored in relation to the different views charted above, and the main options in the mind-body problem are explained. We also look at the most important philosophical distinction to keep in mind when opting for a solution to the mind-body problem: the nature of and relationship between identity, causation, and correlation. Finally, we look at the main arguments advanced in the debate and close with a brief examination of the role that science should play in the mind-body problem.

Substances, Properties, and Events

To understand the alternatives for the mind-body problem, it is important to clarify the nature of substances, properties, and events. A *substance* is an entity like an acorn, a carbon atom, a dog, or an angel. Substances have a number of important characteristics. First, substances are particular, individual things. Second, substances are continuants—a substance can change by gaining new properties and losing old ones, yet remain the same thing throughout the change. An acorn can change colors and still be the same thing. Third, substances are basic, fundamental existents, and they *have* properties. Substances are not *in* other things, nor are they *had by* other things. On the other hand, *properties* are *in* things and are *had by* them. The dog Fido is not in or had by something more basic than he. Rather, properties such as brownness are in substances like Fido.

Figure 62.1

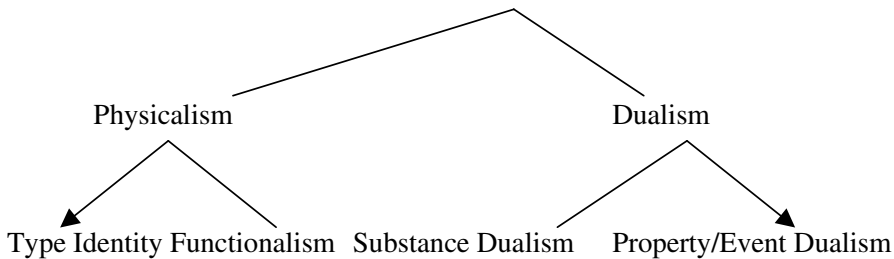

A *property* is an attribute or quality such as brownness, triangularity, and painfulness. Usually, we use words that end in “ness” or “ity” to refer to properties. Two features of properties are important for our purposes. First, they do not change. When a leaf goes from green to red, the *leaf* changes by losing an old property and gaining a new one. But the property of redness does not change and become the property of greenness. Properties can come and go, but they do not change in their internal nature. Second, properties can (or perhaps must) be in or had by other things more basic than they. Properties are in the things that have them. For example, redness is in the apple. The apple has the redness. One does not find redness existing all by itself. In general, when we are talking about a property, it makes sense to ask “What is it that has that property?” However, that question is not appropriate for substances (a dog or an apple), for they are among the things that have the properties (brownness or juiciness). Substances have properties; properties are had by substances.

Finally, there are *events*. Examples of events are a flash of lightning, the dropping of a ball, the having of a thought, the change of a leaf, and the continued possession of sweetness by an apple. Events are states or changes of states of substances. An event is the coming or going of a property in a substance at a particular time, or the continued possession of a property by a substance throughout a time. “This shirt’s being green now” and “this acorn’s changing shape then” are both examples of events.

Physicalism

Physicalism is the view that a human being is merely a physical entity. The only things that exist are physical substances, properties, and events. The human, therefore, is a physical substance—namely, a material body—with a brain and central nervous system. The physical substance called the brain has physical properties—a certain weight, volume, size, electrical activity, chemical composition, and so forth.

There are also physical events that occur in the brain. For example, the brain contains a number of elongated cells, called *neurons*, which carry vari-

ous impulses. Neurons make contact with other neurons through connections or points of contact called *synapses*. *C-fibers* are certain types of neurons that innervate the skin (supply the skin with nerves) and carry pain impulses (or signals) to the brain. When someone has an occasion of pain or an occurrence of thought, physicalists hold that these are merely physical events—events where certain C-fibers are firing or certain electrical and chemical events are happening in the brain and central nervous system.

Thus, physicalists believe that we are merely a physical substance (a brain and central nervous system plus a body) that has physical properties and in which occur physical events. One's conscious mental life of thoughts, emotions, and pain are nothing but physical events in one's brain and nervous system. The neurophysiologist can describe these events solely in terms of C-fibers, neurons, and the chemical and physical properties of the brain. For the physicalist, a human being is merely a functioning brain and central nervous system enclosed in a physical body. Each of us is a material substance, a creature made of matter—nothing more, nothing less.

There is no clear definition of matter, but examples are not hard to come by. Material objects are things like computers, carbon atoms, and billiard balls. Material properties are

- *publicly accessible* in the sense that no one person is better suited to have private access to a material property than anyone else.
- such that an object must be *either spatially located or extended* to be considered having material properties.
- such that when a strictly material object has physical properties, *that object does not behave in a goal-oriented or purposeful (teleological) manner* (i.e., it does not undergo change for the sake of some end or purpose—what Aristotle referred to as a “final cause”).

Physical properties are the properties that one finds listed in chemistry or physics books. They are properties such as hardness; occupying and moving through space; having a certain shape; possessing certain chemical, electrical, magnetic, and gravitational properties; having density and weight; and being breakable, pliable, and elastic. A physical event would be the possession, coming, or going of one or more of these properties by a physical substance.

A crucial point about material substances, properties, and events is this: no material thing presupposes or requires reference to consciousness for it to exist or be characterized. You will search in vain through a physics or chemistry textbook to find consciousness included in any description of matter. A completely physical description of the world would not include any terms that refer to or characterize the existence and nature of consciousness.

Let us assume that matter is what our chemistry and physics books tell us it is. Now picture a universe in which no conscious, living beings came to be. In such an imaginary world, there would be no consciousness anywhere in the

universe. However, in this imaginary world, matter would still exist and be what scientists tell us it is. Carbon atoms would still be carbon atoms; electrons would still have negative charge. An electron is still an electron regardless of whether conscious minds exist in the world. This is what we mean when we say that the existence and nature of matter are independent of the existence of consciousness.

Two main versions of physicalism are currently prominent. The first is *type identity* physicalism. In this view, mental properties or types of mental states—for example, being in pain—are identical to physical properties or types of physical states—for example, being a type of C-fiber firing pattern. Moreover, identity statements asserting the relevant identities are construed as contingent identity statements employing different yet co-referring expressions. For example, the statement “Red is identical to wavelength X” is contingently true; it could have been false (unlike “ $2 + 2 = 4$,” which is a necessary truth). And the terms “red” and “wavelength X” both refer to the same thing (namely, a specific wavelength), even though the terms do not have the same dictionary definition. Likewise, “Painfulness is identical to a type of C-fiber firing pattern” is a contingent identity statement. The truth of these identity statements is an empirical discovery, and the statements are theoretical identities.

The second main version of physicalism is *functionalism*. Functionalists employ a topic neutral description of mental properties/states in terms of bodily inputs, behavioral outputs, and other mental state outputs. By “topic neutral” is meant a characterization of a mental state in terms that are neutral as to whether the state turns out to be physical or mental. Such a characterization depicts a mental state in terms of its functional role in behavior and its extrinsic relationships to bodily inputs, and mental and bodily outputs, not in terms of its intrinsic attributes.

For example, a pain is whatever state is produced by pin sticks or similar events and which causes a tendency to grimace and desire pity. The state of desiring pity is, in turn, spelled out in terms of other mental states and bodily outputs. Mental properties are functional kinds. Machine functionalists characterize the various relations that constitute a functional state in terms of abstract computational, logical relations. Causal role functionalists spell them out in terms of causal relations. Either way, a mental property such as painfulness turns out to be the second-order property. Being colored is a second-order property of being red; having pain is a second-order property of nervous system signaling. In this way, “mental properties” are treated very much like computer software. Type identity physicalism is a hardware view; functionalism is a software position.

Dualism

Dualists disagree with physicalists. According to dualists, genuinely mental entities are real. As with matter, it is hard to give a definition of mental enti-

ties. But examples of mental entities are easy to supply. First, there are various kinds of *sensations*, such as experiences of colors, sounds, smells, tastes, textures, pains, and itches. Sensations are individual things that occur at particular times. I can have a sensation of red after looking in a certain direction or by closing my eyes and daydreaming. An experience of pain will arise at a certain time, such as when I am stuck with a pin.

Further, sensations are natural kinds of things that have, as their very essence, the felt quality or sensory property that makes them what they are. Part of the very essence of a pain is the felt quality it has; part of the very essence of a red sensation is the presentation of a particular shade of color to my consciousness. Sensations are not identical to things outside a person's body—for instance, a feeling of pain is not the same thing as being stuck with a pin and shouting "Ouch!" Sensations are essentially characterized by a certain conscious feel, and thus, they presuppose consciousness for their existence and description. If there were no conscious selves, there would be no sensations.

Second, there are things called *propositional attitudes*: certain mental attitudes involving a proposition that is part of a *that* clause ("I hope that . . ." or "I fear that . . ."). For example, one can hope, desire, fear, think, believe the proposition "The Kansas City Royals are a great baseball team" or "There is a severe thunderstorm outside." Propositional attitudes include at least two components:

- a. There is *the attitude itself*. Hopes, fears, dreads, wishes, thoughts, and the like are all different attitudes or different states of consciousness, and *they are all different from each other based on their conscious feel*. A hope is a different form of consciousness from an episode of fear. A hope that it will rain is different from a fear that it will rain. A hope has a *very different conscious feel* from a fear.
- b. There is *a content or a meaning* embedded in the propositional attitude. While a person has a propositional attitude like a hope that it will rain, in addition to the hopeful attitude, there is the mental content "that it will rain" that is equally defining of the mental state. My hope that it will rain is different from my hope that taxes will be cut. The contents of these two hopes have quite different *meanings* in my consciousness.

If there were no conscious selves, there would be no propositional attitudes.

Third, there are *acts of free will or purposings*. What is a purposing? If, unknown to me, my arm is tied down and I still try to raise it, then the purposing is *the trying to bring about* of the event of raising my arm. Intentional actions are acts of will performed by conscious selves. That is, they are the exercising of one's will or power to act by conscious selves wherein and whereby they do various actions. If there were no conscious selves, there would be no acts of free will or purposings.

To summarize, dualists argue that sensations (such as my awareness of redness), propositional attitudes (“I hope/fear that . . .”), and purposings (attempting to bring something about) are all examples of genuine mental—not physical—entities. In addition to these differences between physicalists and dualists, there is also an intramural debate between *property dualists* and *substance dualists*.

Property dualists believe there are some physical substances that have only physical properties: for example, a billiard ball is hard and round. They also maintain that there are no mental *substances*. On the other hand, they contend there is *one* material substance that has *both* physical *and* mental properties—the brain. When I experience a pain, there is a certain physical property possessed by the brain (a C-fiber stimulation with chemical and electrical properties) and there is a certain mental property possessed by the brain (the pain itself with its felt quality). The brain is the possessor of all mental properties. I am not a mental self that *has* my thoughts and experiences. Rather, I am a brain and a series or bundle of successive experiences themselves. Moreover, property dualists claim that, just as wetness is a real property that comes about with (or supervenes upon) a water molecule, so mental properties arise from (or supervene upon) brain states.

In contrast with property dualism, *substance dualism* holds that the brain and the mind/soul are two distinct things or substances: the brain is a physical thing that has physical properties, and the mind or soul is a mental substance that has mental properties. When one is in pain, the brain has certain physical properties (electrical, chemical), and the soul or mind has certain mental properties (the conscious awareness of pain). The mind/soul is the possessor of its experiences. It stands behind, over, and above them and remains the same throughout one’s life. The soul/mind and the brain can interact with each other, but they are different particulars with different properties. Since the soul is not to be identified with any part of the brain or with any particular mental experience, then the soul may be able to survive the destruction of the body. Substance dualists accept the existence of both mental properties and substances.

Identity, Causation, and Correlation

It is time to turn to a topic that is central to the mind-body debate: the nature of *identity*. The eighteenth-century philosopher and theologian Joseph Butler once remarked that *everything is itself and not something else*. This simple truth has profound implications. Suppose you want to know whether J.P. Moreland is Eileen Spiek’s youngest son. If J.P. Moreland is identical to Eileen Spiek’s youngest son (everything true of one is true of the other), then in reality, we are talking about one single thing: J.P. Moreland, who *is* Eileen Spiek’s youngest son. However, if even one small thing is true of J.P. Moreland and *not* true of Eileen Spiek’s youngest son, then these are two entirely differ-

ent people. Furthermore, J.P. Moreland is identical to himself and not different from himself. So if J.P. Moreland is *not* identical to Eileen Spiek's youngest son, then in reality we must be talking about two things, not one.

This illustration suggests a truth about the nature of identity known as Leibniz's Law of the Indiscernibility of Identicals, which states that if you have two truly identical things (e.g., J.P. Moreland, Eileen Spiek's youngest son, who are really one and the same), then there is only one thing you are talking about—not two. Any truth that applies to one will apply to the other. This suggests a test for identity. Given entities x and y , if you could find one thing true of x that is not true of y , or conversely, then x is not identical to y . Further, if you could find one thing that could *possibly be* true of x and not y , or conversely, even if it is not *actually* true, then x cannot be identical to y . If J.P. Moreland is 5' 8" tall, but Eileen Spiek's youngest son is 6' tall, then they are not the same thing. Further, if J.P. Moreland is 5' 8" tall and Eileen Spiek's youngest son is 5' 8" tall but it would be possible for J.P. to be 5' 8" tall while the actual person who is Eileen's youngest son is 5' 10" tall, then they are not the same thing either.

What does this have to do with the mind-body problem? Simply this: physicalists are committed to the claim that alleged *mental* entities are *really identical* to *physical* entities—brain states, properties of the brain, overt bodily behavior, and dispositions to behave. For example, pain is just the tendency to shout "Ouch!" when stuck by a pin, instead of pain being a certain mental feel. If physicalism is true, then everything true of the brain (and its properties, states, and dispositions) is true of the mind (and its properties, states, and dispositions), and vice versa. But if we can find just one thing true or even possibly true of mental states or the mind that is not true of physical states or the brain, then either property or substance dualism is established.

Keep in mind that the relation of identity is different from any other relation, such as the relation of causation or constant connection. With regard to the relation of *causation*, it may be that brain events cause mental events, or vice versa. Having certain electrical activity in the brain may cause me to experience a pain; having an intention to raise my arm may cause bodily events. It may be that for every mental activity, a neurophysiologist can find a physical activity in the brain with which it is correlated, and on that basis claim either that the brain event causes the mental event, or vice versa. But just because A causes B, or just because A and B are constantly correlated with each other, that does not mean A is identical to B. Causation is not the same thing as identity.

We can make a similar point with regard to the relation of constant correlation. For example, something is trilateral if and only if it is triangular. But trilaterality (the property of having three sides) is *not identical* to triangularity (the property of having three angles), even though they are *constantly conjoined*.

Therefore—and this is critical—physicalism *cannot* be established on the

basis that mental states and brain states are merely (a) causally related or (b) constantly conjoined with each other in an embodied person. It's here that we see how important the *identity* relation is: *physicalism needs identity to make its case*. And if something is true—or even possibly true—of a mental substance, property, or event that is *not* true or possibly true of a physical substance, property, or event, then physicalism is false.

Central Issues about Consciousness and the Self

Are properties such as *being a thought* or *being a pain* and the events composed of them (a pain or thinking event) genuinely *mental* or *physical*? Property dualists argue that mental states are in no sense physical, since they possess five features that physical states don't have:

- a. There is a raw qualitative feel or a “what it is like” to have a mental state such as a pain.
- b. Many mental states have intentionality—*ofness* or *aboutness*—directed toward an object.
- c. Mental states are inner, private, and immediate to the subject having them.
- d. Mental states require a subjective ontology—namely, mental states are necessarily owned by the first-person sentient subjects who have them (“*I* own them; they are *mine*; they are directly accessible to *me*”).
- e. Mental states fail to have crucial features (e.g., spatial extension, location) that characterize physical states and, in general, cannot be described using physical language.

Physicalists respond by trying to show either that mental properties may be identified with types of states of the brain (e.g., being in pain is identical to a type of C-fiber firing state), or that they are identical to a software functional role realized by the brain (e.g., pain is being in a brain state caused by inputs such as pin sticks and which causes outputs such as desiring pity and grimacing).

Substance dualists agree that consciousness and mental properties are genuinely nonphysical, but they go on to argue that the self is also immaterial. They appeal to such things as the basic unity of the self at a moment of time and the self's literal sameness through change; the conceivability and thus real possibility of disembodied existence, of body-switch thought experiments in which one survives while being placed in another body or while losing one's memories and personality traits; and the reality of genuine libertarian freedom of the will. Substance dualists claim that the most reasonable metaphysical ground for these alleged facts is the reality of an immaterial self. Physicalists either deny the facts to which dualists appeal (e.g., physicalists could deny the basic unity of the self or the reality of libertarian free will) or try to provide an explanation of those facts consistent with physicalism.

Science and the Mind-Body Problem

Many would argue that although logically possible, dualism is no longer plausible in light of the advances of modern science. Dualism cannot be *proven* false—a dualist can always appeal to correlations or functional relations between soul and brain/body—but advances in science make it a view with little justification. This opinion reflects scientism, the view that science is the very paradigm of truth and rationality. If something does not square with currently well-established scientific beliefs, if it is not within the domain of entities appropriate for scientific investigation, or if it is not amenable to scientific methodology, then its truth or rationality is highly suspect. Applied to the mind-body problem, scientism implies that one should try to solve problems about the mind by the methods of neurophysiology and computer science and not by philosophical argument. When one takes this approach, some form of physicalism is required.

In contrast with advocates of scientism, many thinkers accept the principle of autonomy: among the central questions of philosophy that can be answered by one standard theoretical means or another, most can in principle be answered by philosophical investigation and argument without relying substantively on the sciences. Proponents of the autonomy principle claim that the resolution of the mind-body problem has very little to do with scientific discoveries and is largely a philosophical matter.

Who is right—advocates of scientism or advocates of the autonomy principle? To answer this question, let us look at an expanded list of the central topics that form the core of the debate between dualists and physicalists. The first-order topics revolve around three interrelated issues constituted by the following kinds of questions:

1. **Ontological Questions:** To what is a mental or physical property identical? To what is a mental or physical event identical? To what is the owner of mental properties/events identical? What is a human person? How are mental properties related to mental events (e.g., do the latter exemplify or realize the former)? Are there (Aristotelian or Leibnizian) essences, and if so, what is the essence of a mental event or of a human person?
2. **Epistemological Questions:** How do we come to have knowledge or justified beliefs about other minds and about our own minds? Is there a proper epistemic order to first-person knowledge of one's own mind and third-person knowledge of other minds? How reliable is first-person introspection and what is its nature? If reliable, should first-person introspection be limited to providing knowledge about mental states, or should it be extended to include knowledge about one's own ego?

3. Semantic Questions: What is a meaning? What is a linguistic entity and how is it related to a meaning? Is thought reducible to or a necessary condition for language use? How do the terms in our common-sense psychological vocabulary get their meaning?

The main second-order topics central to the physicalist–dualist debate are these:

4. Methodological Questions: How should one proceed in analyzing and resolving the first-order issues that constitute the philosophy of mind? What is the proper order between philosophy and science? Should we adopt some form of philosophical naturalism, set aside so-called first philosophy, and engage topics in philosophy of mind within a framework of our empirically best-attested theories relevant to those topics? What is the role of thought experiments in philosophy of mind and how does the “first-person point of view” factor into generating the materials for formulating those thought experiments?

It seems obvious that stating, defending, or criticizing positions on the questions in these four areas is almost entirely a philosophical matter. If the reader disagrees with this claim, he or she should try to state the scientific discovery that would be relevant and weighty in resolving one of these questions.

If the autonomy thesis is correct, does that mean science plays no role in philosophical discussion? No, it does not. Science is especially important when it comes to studying details about the causal relations between mind and body. And when philosophers have erred in the past, they have done so when they have used philosophical theses to answer empirical, causal questions (e.g., using vitalism or animal spirits in an attempt to answer causal questions about the nature of mind-body interaction). But the areas where science is relevant are not part of the core topics in the mind-body problem.

Bibliography

- Corcoran, Kevin, ed. *Soul, Body, and Survival*. Ithaca, NY: Cornell University Press, 2001.
- Foster, John. *The Immaterial Self*. London: Routledge, 1991.
- Hasker, William. *The Emergent Self*. Ithaca, NY: Cornell University Press, 1999.
- Kim, Jaegwon. *Philosophy of Mind*. Boulder, CO: Westview, 1996.
- . *Mind in a Physical World*. Cambridge, MA: MIT Press, 1998.
- Moreland, J.P., and Scott B. Rae. *Body and Soul*. Downers Grove, IL: InterVarsity Press, 2000.
- Swinburne, Richard. *The Evolution of the Soul*. Revised edition. Oxford: Oxford University Press, 1997.
- Taliaferro, Charles. *Consciousness and the Mind of God*. Cambridge: Cambridge University Press, 1994.

63 Extraordinary Aspects of Reality in Altered States of Consciousness

Imants Barušs

Most of the time we find ourselves in the ordinary waking state of consciousness, although the experience differs from one person to another, and there are variations within the state itself. Reality has a particular appearance in the ordinary waking state of consciousness, and we usually take that appearance to be the only correct portrayal of reality, against which all other variations are judged. But a variety of alterations of consciousness occur, in which aspects of reality seem to be revealed that are quite different from everyday reality.

Altered States of Consciousness

The most common altered state of consciousness is sleep. During sleep, we may dream. In addition to ordinary dreams, we could have lucid dreams, in which we know we are dreaming, and precognitive dreams, in which we appear to dream of events before they occur. Sleep has historically served as a prototype for other altered states of consciousness and, in particular, hypnosis. Hypnosis is a state of apparently heightened suggestibility. It appears to be due to a compliant attitude toward hypnotic suggestions, the capacity for vivid fantasy, or the dissociation of elements of the psyche, depending on the individual. The state of being hypnotized has often been regarded as a trance: a state in which a person behaves as though aware of what she or he is doing, but in which the person is actually acting involuntarily, with decreased responsiveness to surrounding events. Trance can occur in contexts other than hypnosis, such as possession, in which a person appears to have come under the influence of an unseen spirit, or mediumship, in which there is apparent communication with the dead or other ostensibly nonphysical entities.

Altered states of consciousness can be induced by drugs, and in particular by psychedelic drugs. For example, d-lysergic acid diethylamide is a powerful synthetic psychedelic that can produce physiological arousal, perceptual distortions, extreme mood swings, and profoundly meaningful experiences.

Ayahuasca is a brew made in the Amazon basin from naturally occurring substances usually containing beta-carbolines and N,N-dimethyltryptamine (DMT), and it has been used by indigenous people as a means of extrasensory empowerment, among other things. Although considerable scientific research into the therapeutic benefits of psychedelic drugs was carried out in the 1950s and 1960s, their use, even for medical purposes, became almost entirely illegal in North America in 1970.

Altered states of consciousness can occur in the context of psychopathology. Of note is dissociative identity disorder (DID), in which a person's psyche appears to have fragmented so that different personalities are present at different times. There has been a tendency to assume that altered states of consciousness that we do not understand must be mental disorders. Such has been the case with alien abduction experiences, in which people come to believe that they have been abducted by alien beings. However, no known pathological syndrome corresponds to the details of some alien abduction experiences, nor are the everyday lives of experiencers necessarily impaired, as would be required in order to label the occurrence of alien abduction experiences a mental disorder.

There are altered states of consciousness associated with death. Near death experiences, for example, in which a person seems about to die, can include feelings of peace, apparent visual awareness of one's dysfunctional body, encounters with deceased relatives, entering a loving light, and a life review. In past-life experiences, a person comes to identify with someone who has lived previously. This is most apparent in children who may behave as though they are a deceased person, apparently possessing information about the deceased person's life that they have no way of knowing, and sometimes having birth marks or birth defects corresponding to the manner of death of the previous personality.

There are numerous altered states in addition to the ones already mentioned. For example, restriction of sensory input can lead to states of deep relaxation and heightened flexibility of mind. A multitude of types of meditation can be used to induce relaxation or varying degrees of transcendence of the everyday world. Transcendent states of consciousness, including mystical experiences, can also occur spontaneously. Mystical experiences can be characterized, in part, by a sense of unity with nature or the ground of being, identification with an eternal aspect of oneself, activation of new ways of knowing, and feelings of bliss.

Ontological Awakening

In some cases, an altered state of consciousness can lead to such a profound reevaluation of one's understanding of reality that it can be characterized as an ontological awakening. The old ways of understanding reality are no longer adequate, and new ways suggest themselves or must be found. Sometimes Plato's allegory of the cave described in the *Republic* is used to illustrate such awakening.

In the allegory, Socrates describes a group of people who have been chained since birth in an underground cave so that they can see only the back of the cave. Behind them is a fire, and between the fire and group is a low wall behind which other people are walking and talking, sometimes carrying objects that appear above the wall. The chained individuals can hear only the echoes of the voices and see only the shadows of the objects. Suppose, says Socrates, that one of the prisoners could turn around and see the actual situation. Suppose, in addition, that he was taken from the cave into the sun and learned to live in the real world. He would lose all interest in the old life of the cave. And if he were to return to the cave, it would take time for his eyes to adjust, and in the meantime he would be unable to compete in describing the shadows with those who had remained. The chained prisoners would conclude that it was dangerous to leave the cave and they might kill anyone who tried to release any of the other prisoners.

This analogy has been used to characterize the effects of having had a near death experience. Those who have had a near death experience often are changed by it. They may come to believe that they have experienced what happens when someone dies, and they may feel that death is not the end of one's personal existence. They may come to reevaluate their priorities in life so that the expression of love and the development of wisdom become primarily important to them. There can be a reorientation from a materialistic to a spiritual worldview.

Ontological awakening can occur with the use of psychedelic drugs. On April 20, 1962, ten divinity students were each given 30 milligrams of the psychedelic substance psilocybin prior to a Good Friday service in Marsh Chapel in Boston as part of a study at Harvard University. Another ten were given niacin, a vitamin with no psychoactive effects. The ten participants who had been given psilocybin scored higher on measures of having had a mystical experience than those who had been given niacin. In particular, one of the participants who received psilocybin has subsequently said that what had been previously intellectually interesting religious ideas were now grounded in something much deeper. Psychedelic drugs, under some conditions, appear to awaken people to aspects of reality that are ordinarily hidden from them.

The same type of process can occur with alien abduction experiences. These often consist of terrifying events in which experiencers believe they have been taken against their will, sometimes on a regular basis, into a rounded room in an alien spacecraft, where they have been subjected to degrading procedures such as the injection of fluids, extraction of sperm, and removal of fetuses. In some cases, experiencers may come to appreciate the ontological shock that awakens them to what they believe to be dimensions of reality that they had not known previously to exist. Indeed, alien abduction experiences, whatever the actual ontological status of the abduction events, have been characterized as contemporary conversion experiences and fundamentally spiritual in nature.

Perhaps the most obvious cases of ontological awakening are those associ-

ated with transcendent states of consciousness that have occurred spontaneously or been invoked through a process of spiritual self-transformation. After twenty-four years of effort, in 1936, Franklin Merrell-Wolff entered transcendent states of consciousness in which the separation between the subject and object disappeared and in which he believed himself to be identified with that which sustains the universe. Merrell-Wolff maintained that there was an inverse relationship between appearance and reality, so that the more something could be grasped through the senses or with the rational mind, the less it contained of reality. Conversely, the less something could be grasped, the more it was real. In particular, for Merrell-Wolff, the abstract concepts of mathematics are more real than the physical objects of everyday life.

Intrusions of Another Reality

In cases of ontological awakening, we could say that a person enters a different reality which then has a profound effect. But there are also situations in which extraordinary aspects of reality appear to intrude within the ordinary structure of life. These can be subtle or dramatic.

Sensory restriction refers to the attenuation of the magnitude or variation of sensory input. There are two main methods of deliberately restricting sensory input. In the floatation restricted environmental stimulation technique, a person lies in a quiet, dark tank of water and Epsom salts for about forty-five minutes. In the chamber restricted environmental stimulation technique, a person lies on a bed in a quiet, dark room for about twenty-four hours. One of the possible effects of sensory restriction is the occurrence of sensed presences. This is the impression that other beings are present, although no one is actually physically present. This effect can occur also during naturally occurring sensory restriction. For example, Charles Lindbergh, during his solo transatlantic flight from New York to Paris in 1927, could see presences in the cockpit of his aeroplane who, he claimed, assisted him with his flight.

Another kind of intrusion is found in dreams. Some people have found their dreams to be meaningful and have made practical use of the knowledge obtained from them. Dream events are usually symbolic in nature, so that the dreamer needs to find real-life associations to the dream images in order to interpret their meanings. Through interpretation, dreams can reveal insights about the dreamer or the world that were not apparent to her or him before the occurrence of the dreams.

Perhaps the most dramatic dreams are those in which there is a correspondence between dream events and actual future events. For example, Malcolm Bessent, known for his ability to have precognitive dreams, participated in several studies at the Maimonides Medical Center in Brooklyn, New York, in 1969 and 1970. In one study, he was awakened during the night to report his dreams; the following evening, he watched a slide show; then he reported his dreams again on the night following the slide show. This process was re-

peated eight times. There was better correspondence between the contents of the slide show and the dreams of the night before than between the slide show and the dreams of the following night. Most impressive were his dreams one night of the color blue, water, and birds. At one point, Bessent said that the target material was going to be about birds. And indeed, the following evening's slide show was about birds.

Intrusions of extraordinary aspects of reality can ostensibly occur in cases of mediumship and possession, whereby a person's psyche dissociates and she or he appears to come under the influence of unseen entities. Such influences can be subtle. A person could remain fully aware of her or his own thought processes and surroundings, with the influences manifesting as images in the mind. At the other end of the spectrum, such influences can be dramatic. A person can lose control and act as though she or he were another being, unable to recall afterwards what had happened. Such latter cases could be manifestations of dissociative identity disorder. In just over one-quarter of those with dissociative identity disorder, such personalities have been alleged to be demons, and in just under one-quarter they have been alleged to be dead relatives.

Sometimes an unseen entity reveals itself to be someone who has died and provides information to a medium that apparently only the dead person could know. In a study at the Human Energy Systems Laboratory at the University of Arizona in Tucson in 1999, five mediums participated in a study in which they gave information, ostensibly provided by the dead, about several people who were unknown to them. The accuracy of the information given by the mediums was about 80 percent correct, whereas the accuracy of student participants who guessed at the information was only 36 percent correct.

Deliberately Accessing Another Reality

There are ways of deliberately altering consciousness in order to experience extraordinary aspects of reality. Three methods are considered here: the ganzfeld procedure, guided imagery, and meditation.

The ganzfeld procedure is a form of sensory restriction in which a red floodlight is directed at a person's eyes, which have been covered by ping-pong ball halves, and white noise is played through headphones placed over the ears. The result is a uniform perceptual environment that is thought to enhance the possibility of noticing extrasensory signals normally masked by more dominant sensory input. In a series of studies reported by Daryl Bem and Charles Honorton, a participant who acted as a receiver was subjected to the ganzfeld procedure while another participant in another room, who acted as a sender, viewed a still picture or video segment and tried to mentally communicate it to the receiver. After thirty minutes, the receiver was asked to choose from four samples, one of which had been the actual target. Whereas 25 percent of the targets should have been identified by chance, in fact, 32

percent of the targets were correctly identified. When twenty fine arts undergraduate students attempted this experiment, they correctly identified 50 percent of the targets. These results suggest that there are aspects of reality that allow for the transfer of information through nonsensory means.

Guided imagery consists of deliberately visualizing a sequence of images for any of a number of purposes. Hypnotic induction in which a hypnotic subject is told to pay attention to the hypnotist's voice and to relax and go into a deep sleep is an example of guided imagery. Or subjects can visualize their cancer cells being destroyed in an effort to heal themselves of cancer. Guided imagery may also be used to try to access latent psychological resources. A person could imagine ascending a mountain and meeting a wise being at the top. The supposition here is that the symbolic act of mountain climbing would have the psychological effect of bringing a person in touch with wiser aspects of herself or himself. In this case, the guided imagery procedure consists not only of deliberate thinking, but also spontaneous thinking. Any images of a wise being and any communication of wisdom would not be part of the guided imagery script but would emerge spontaneously from the person's psyche.

Meditation refers to a variety of techniques, usually restricted to Eastern spiritual traditions, where the essential purpose is to transcend the limitations of the mind. The Westernization of meditation, however, has led to its use as a means of relaxation to counteract the effects of stress. There are three main styles of meditation, depending on the manner in which the psychological faculties of attention, introspection, and will are deployed. In *witnessing meditation*, a person allows the occurrence of whatever thoughts come into the mind and notes their occurrence, with the will being used to ensure the continuation of such mindfulness. In *concentrative meditation*, a person uses the will to pay attention to a single theme, often symbolized by an image, and returns attention to that theme whenever thoughts stray. In *reflexive meditation*, attention can remain on whatever contents of experience are present, but the will is used to seek the source of one's identity, not as an object of experience, but as the subject. It is the last of these techniques that Franklin Merrell-Woff used leading to his transcendent state of consciousness.

A Critical Evaluation

Experiences in altered states of consciousness can be quite interesting, but is it possible that the attributions made about such experiences are simply mistaken? These experiences could be nothing but fantasies, hallucinations, delusions, hoaxes, and manifestations of pathology. After all, they fail to conform to a scientific view of the world. Or do they?

It is true that experiences in altered states of consciousness are not always what they appear to be. The purpose of hypnosis, for example, is precisely to manipulate the hypnotic subject's experience to conform to the hypnotist's suggestions. This can often be beneficial, as in the case of suggesting to the

subject that she or he will no longer smoke cigarettes. But even when hypnosis is used to try to increase the accuracy of one's perception of reality, it can have the opposite effect. This can occur when hypnosis is used to try to recover memories of past events and erroneous impressions are reported, often with a great degree of conviction, rather than descriptions of actual events.

The power of suggestion can be seen in other altered states as well. Psychedelic drug-induced experiences are sensitive to both the characteristics and expectations of the person taking the drug and the environment in which the psychedelic drug is taken. The set and setting, as these factors are usually known, was deliberately maximized in the Good Friday experiment to encourage the occurrence of mystical experiences by choosing divinity students and giving them a psychedelic drug prior to a Good Friday service. Near death experiences, for all that they have common features, also differ among cultures. For example, the presence of tunnels in near death experiences in Western societies may reflect exposure during one's psychological development to a technological environment, since images of tunnels appear to be missing from non-Western accounts.

Similarly, whether or not one were to think of them as suggestions, the events of a person's life can occur in some form in a person's dreams. More directly, individuals can deliberately suggest to themselves before they fall asleep that they will become aware in their dreams that they are dreaming, along with imagining themselves becoming aware that they are dreaming in a dream that they previously had. That particular strategy is, in fact, a method for increasing the occurrence of lucid dreams. The point is that the contents of experiences in altered states often reflect ordinary life events and hence may not be extraordinary at all.

As implied by some of the previous examples, the sense of conviction associated with ontological awakening can also be mistaken. It is possible that feelings of reality can become detached from whether or not something is actually real, giving a false impression of knowledge. Those who have had a near death experience often become convinced that they have seen what reality is really like. One woman reported a distressing near death experience in which she encountered a group of black and white circles in space that clicked back and forth between black and white and mocked her with the message that she had never existed and that it had all been a joke. Such ontological convictions can also occur with psychedelic drugs. One woman under the influence of DMT reported encountering a terrifying cosmic diamond cat that filled all of space and which she was convinced was the only reality she had ever known. It is not without reason that psychedelics have sometimes been labeled psychotomimetic, imitating psychosis, in addition to having been regarded as entheogens, substances that can awaken mystical experiences.

But our feelings of reality are not a good measure of ordinary reality, which usually feels so real to us. For example, we know from physics that matter does not have the properties of solidity that we naturally attribute to it, but

consists of a superposition of possible states of manifestation until such time as an observation is made and subatomic events occur that create the impression of solidity. Or at least, that is the standard interpretation. The situation may be even more radical in that consciousness at some level may ultimately create the impression of the existence of matter. These are questions that have yet to be answered in physics. What is known is that our naive intuitions about the nature of matter are illusory. In other words, our feelings about what is real are not a good indication of what reality is actually like in neither its extraordinary nor ordinary aspects.

The purpose of science is to establish knowledge for humanity. There is sometimes a tendency to assume that a scientific worldview is necessarily a materialistic one that excludes the possibility of the existence of unusual events. But the theories of reality proposed by science have to follow the evidence wherever it may lead, no matter how contrary that evidence may be to accepted versions of reality. Among the descriptions of experiences in altered states of consciousness given in this chapter have been some that have occurred in the context of empirical studies. Such studies lend credibility to the actual presence of extraordinary aspects of reality, although the details of such aspects have yet to be determined through further research.

Any of the altered states of consciousness, perhaps precisely because they get us away from our ordinary ways of experiencing the world, can reveal aspects of reality that are normally hidden from us. Some altered states experiences can absorb us and lead us to a profound ontological awakening. In some experiences, apparently extraordinary aspects of reality merely intrude into this reality, although such intrusions could also force us to reexamine our beliefs. It is also possible to alter our consciousness with the intention of seeking unusual experiences. Overall, the contents of altered states of consciousness are a mixture of fantasy and reality, with the need to determine that balance in every particular case. The scientific evidence suggests that at least some altered states experiences do reveal extraordinary aspects of reality. And in doing so, science, in its quest for knowledge, encroaches on territory that has been previously within the domain of the world's religions. It is hoped that this incursion by science will bring with it greater clarity concerning the nature of reality.

Bibliography

- Barušs, Imants. *Authentic Knowing: The Convergence of Science and Spiritual Aspiration*. West Lafayette, IN: Purdue University Press, 1996.
- . *Alterations of Consciousness: An Empirical Analysis for Social Scientists*. Washington, DC: American Psychological Association, 2003.
- Bem, Daryl J., and Charles Honorton. "Does psi exist? Replicable evidence for an anomalous process of information transfer." *Psychological Bulletin* 115 (1994): 4–18.
- Cardeña, Etzel, Steven J. Lynn, and Stanley Krippner, eds. *Varieties of Anomalous Experience: Examining the Scientific Evidence*. Washington, DC: American Psychological Association, 2000.

- Grinspoon, Lester, and James B. Bakalar. *Psychedelic Drugs Reconsidered*. New York: Basic Books, 1979.
- Jacobs, David M., ed. *UFOs and Abductions: Challenging the Borders of Knowledge*. Lawrence: University Press of Kansas, 2000.
- Kirsch, Irving, Antonio Capafons, Etzel Cardeña-Buelna, and Salvador Amigó, eds. *Clinical Hypnosis and Self-regulation: Cognitive-Behavioral Perspectives*. Washington, DC: American Psychological Association, 1999.
- Kryger, Meir H., Thomas Roth, and William C. Dement, eds. *Principles and Practice of Sleep Medicine*. 3rd ed. Philadelphia: W.B. Saunders, 2000.
- Merrell-Wolff, Franklin. *Franklin Merrell-Wolff's Experience and Philosophy: A Personal Record of Transformation and a Discussion of Transcendental Consciousness*. Albany: State University of New York Press, 1994.
- . *Transformations in Consciousness: The Metaphysics and Epistemology*. Albany: State University of New York Press, 1995.
- Michelson, Larry K., and William J. Ray, eds. *Handbook of Dissociation: Theoretical, Empirical, and Clinical Perspectives*. New York: Plenum, 1996.
- Stevens, Anthony. *Private Myths: Dreams and Dreaming*. Cambridge, MA: Harvard University Press, 1995.
- Stevenson, Ian. *Reincarnation and Biology: A Contribution to the Etiology of Birthmarks and Birth Defects*. Westport, CT: Praeger, 1997.
- Ward, Colleen A., ed. *Altered States of Consciousness and Mental Health: A Cross-cultural Perspective*. Newbury Park, CA: Sage, 1989.

64 Consciousness, Ritual, and Belief

Kenneth R. Livingston

Any religion is a many-faceted thing and cannot be fully understood without some appreciation of all of its varied aspects. All religions prescribe certain actions that a member in good standing should perform, and certain beliefs that should be held. There is also usually a list of actions that should *not* be taken, and beliefs considered heretical. There is ordinarily a specialized language for talking about religious actions and beliefs. Religions often specify musical forms, particular articles of clothing, and other ritual objects that help to indicate when one is involved in a sacred activity. Religions also typically identify some people as unique and important links to the divine or sacred—mystics, priests, rabbis, monks, and so forth.

A great deal is known about the cognitive processes that underwrite many of these facets of religion, but just how they are integrated into whole systems remains something of a puzzle. But profound religious experience can be seen as the linchpin around which the many facets of a religion are organized. And the content of religious belief can be linked to the nature of ritual practice. This will help to explain why some people may play a particularly important role in the development of religious systems. It will also raise hard questions about the nature of consciousness, that most enigmatic of human endowments.

Understanding Religious Experience

Many kinds of experiences have religious content: prayers, the thoughts people have when reading or hearing about religious texts, and participation in religious rituals are just a few obvious examples. The profound experiences that anchor religious systems, however, are more dramatic and less common. Although they are often described as impossible to capture fully in words, descriptions of such experiences share certain themes. The experience is described as transcending normal time and space, and even the sense of a self or “I” is lost in some cases. Very frequently there are descriptions of direct encounters with supernatural beings like angels or demons or gods. Finally, there is typically an

intense emotional component to such experiences, either of terror and awe, or of ecstasy, bliss, or peace. Profound experiences give those who have them the sense of having made direct contact with an ultimate reality more fundamental and more important than the day to day reality of ordinary experience.

Such experiences play a special role in religious systems because people are tempted to take them as evidence that there really is a supernatural realm that transcends the world as we know it on a daily basis. Such evidence helps sustain the belief that being a member in good standing of the religious community will give its adherents access to the special powers of that supernatural world. Indeed, until the beginning of the modern era and the rise of science, with its competing view of how knowledge should be gathered and justified, the idea that profound religious experience was a window into ultimate reality was rarely questioned. Since the late sixteenth century, however, there have been several efforts to explain profound religious experience as anything but evidence for the supernatural. Karl Marx famously thought that religion in general was a social construction designed to continue an oppressive class structure by diverting people's attention away from their suffering in this world and onto the promise of a better life in the supernatural world. Sigmund Freud saw religion and religious experience as neurotic manifestations of unresolved Oedipal conflicts. B.F. Skinner and the behaviorists denied the utility of talking about experience at all; they explained the tendency to do so as just one more example of conditioned superstitious behavior.

Marxism, psychoanalysis, and behaviorism have all been discredited to various degrees, and no longer play a major role in the scientific effort to explain human thought and behavior, including religious thought and behavior. However, the idea that religious experience can be explained by reducing it to something more fundamental is alive and well, and flourishing in the neurosciences. The concept of explanatory reduction is far too complex to treat in detail here, but the basic idea is easy enough to grasp from a few cases (see Bickle's *Psychoneural Reduction: The New Wave* for a thorough discussion). The temperature of an object, for example, is nothing more than a measure of the amount of energy in the motion of its molecules. The hardness of a diamond can be fully explained by the structure of the bonds that link its carbon atoms. The reproduction of life itself reduces to the actions of molecules of DNA and RNA operating in the right chemical environment. In all of these cases, a complex phenomenon at one level of investigation reduces to simpler processes at a more basic level of explanation. In an analogous way, many neuroscientists argue that religious experience is reducible to anomalous patterns of activity in the human nervous system.

The Brain and Religious Experience

Everything that makes a human being a fully functioning person depends on the activities of the brain. Brain circuitry is assembled from roughly 100 bil-

lion specialized cells called neurons, along with another 1 trillion or so support cells. Neural cells can be stimulated to produce traveling waves of electrical activity called action potentials. These signals can trigger the release of specialized chemicals called neurotransmitters across the tiny gaps that separate cells. At any given moment, the human nervous system is engaged in billions of these electrochemical processes, which together make it possible to sense the world, understand language, stand without falling, dream, or perform any of the thousands of mental and physical activities that make up a day in the life of a person.

It was not until the first half of the twentieth century that this picture of how the brain works began to emerge. The insight that the brain is an electrochemical device led relatively quickly to the invention of a device, called the electroencephalograph (EEG), for measuring some part of that electrical activity. To make an EEG recording, researchers place metal electrodes on the scalp to detect the tiny variations in voltage being produced by the brain. These fluctuating voltages, commonly referred to as brain waves, are then amplified and recorded for later study.

There were several important early discoveries using the EEG, but two are especially relevant for studies of religious experience. The first finding is that patterns of activity in the brain vary with mental state. When we are awake and active, the brain is producing low-voltage, high-frequency waves, called beta waves, fluctuating at the rate of between 12 and 30 times per second, or 12 to 30 Hertz (Hz). When we are awake but very relaxed, especially with eyes closed, the voltages become larger and slower, in the range of 8 to 12 Hz. These are referred to as alpha waves. In that twilight state experienced when we drop off to sleep, the waves may slow even more, into the theta range of 3 to 7 Hz. Still other patterns are associated with different stages of sleep.

The second important discovery from the early EEG work is that seizure disorders, like epilepsy, are related to very dramatic departures from any of the normal EEG patterns. There are many different kinds of seizure disorders, and each is related to a different kind of disturbance in the EEG. In all cases, however, one sees sudden, high-voltage spikes in the recording. These spikes reflect a failure of circuits that normally dampen or inhibit brain activity to keep it coherent and coupled to the events taking place in the world.

The interesting thing about epilepsy for students of religion is that even in ancient times, long before it was known that the brain was involved in the disorder, epilepsy was known as the “sacred disease,” because epileptics seemed often to describe their experiences in mystical terms. The story has become even more interesting in the wake of the discovery that several of the most common epileptic patterns have their origins in the temporal lobes of the brain. As the name suggests, this part of the brain lies just beneath the temple region of the skull. Activity in the cortical or outer layers of this part of the brain is necessary for object recognition, including the recognition of social objects like people. Activity in other regions of the temporal lobes is

associated with how we hear, including how we hear and understand speech. If you look deeper inside the temporal lobes, you find structures involved in establishing the links between objects and emotional reactions to those objects, and a formation called the hippocampus is essential for laying down memories that keep track of where and when things happen.

Taking all of this together, it seems plausible that disorganized activity in this part of the brain could give rise to experiences of things like being in the presence of a speaking agent who inspires strong feelings, either of awe or ecstasy, but who seems to transcend ordinary time and space. It has been suggested that both Paul's visions on the road to Damascus and Muhammad's frequent visions recorded in the Quran could be the result of epileptic seizures.

Of course not everyone who reports having a religious experience has epilepsy. What is the explanation for their experiences? One answer is that there is a continuum of susceptibility to what have been called temporal lobe transients (TLTs) or more minor spiking events that aren't as dramatic or chronic as full-blown epilepsy. Epilepsy defines one extreme of this continuum, and at the other end are the large numbers of people, maybe as many as half the population, who are relatively immune to such brain anomalies. In between lies the interesting group of human beings who are more or less prone to TLTs. For some people, the events may be so mild and brief that they are barely noticed. Experiences of *déjà vu*, for example, have been linked to microseizures. For some people, TLTs may be more easily triggered, and anomalous mystical experiences more frequent as a result.

Neuropsychologists have documented a surprisingly strong relationship between vulnerability to TLTs and reports of mystical experiences. The more susceptible one is, the more likely that one will report having been in God's presence, seen angels, heard voices, or otherwise experienced the supernatural. It has even been possible to produce such experiences in the laboratory by subjecting people to strongly rhythmic stimuli like loud drumming or pulsing electromagnetic fields. People who report having had mystical experiences in the past are most susceptible to these manipulations, and also show anomalous EEG patterns while they are having the experiences triggered by the researchers. These studies go beyond mere correlation to suggest that religious experiences can be directly caused by changing the state of the brain.

Not all religious experiences, however, involve visions of supernatural agents. For example, in the Buddhist tradition, the experiences that transcend the ordinary are described quite differently. Instead of visions of supernatural agents with accompanying intense emotional reactions, people describe feelings of relaxation, low anxiety, and an especially profound loss of awareness of the distinctions between objects, including between one's own self and everything else. EEG studies of people in these states show unusually slow alpha rhythms over large portions of the brain, and in some cases considerable theta band activity of a kind not normally seen in people who are awake and responsive.

Even more interesting are recent studies that reveal just where changes in brain activity are taking place. The technique used in these studies is known as single photon emission computed tomography (SPECT). The participant in one of these studies is injected with a special radioactive tracer that is taken up by tissues of the brain. The more active a part of the brain is, the more of the radionucleotide it absorbs, and the more radioactive emissions it produces. These emissions can be recorded, and computer algorithms can reconstruct where in the brain they originated, giving a picture of relative brain activity in different regions of the brain. These pictures reveal that a person in the midst of an experience of relaxation and depersonalization is undergoing a relative increase in activity in the frontal lobes, located just behind the forehead, and a decrease in activity in the parietal lobes (if you put your hands on your head, base of your palms at the tops of your ears and fingers touching at the top of your head, the area under your fingers is roughly the parietal region).

What makes this pattern so interesting is that the parietal lobes play a unique role in keeping track of where your body is in space and what is happening to it. In addition, circuits involving both the parietal and frontal lobes play an important role in human attention, particularly in the process of disengaging attention from the inputs coming from the senses. The experience of losing one's self, of becoming one with the universe, is quite consistent with observed patterns of change in brain activity.

Ritual, Brain, and Experience

The remarkable thing about the two different patterns of brain change just described is how well their associated experiences correspond to basic concepts in two different religious traditions. People in traditions that speak of anthropomorphic supernatural agents capable of operating outside of ordinary space and time tend to show the temporal lobe pattern and have experiences that confirm this picture. People in traditions that speak of suffering as the consequence of the illusion of the permanent self tend to show the parietal lobe pattern in which bliss is achieved as self is lost. How is it that people wind up having just the kinds of experiences that confirm the beliefs of the tradition they practice?

One crucial part of the answer to this question is found in a close examination of the ritualized practices of the different traditions. It is no accident that there are powerful, polyrhythmic structures in many of the rituals that accompany worship or supplication in the temporal lobe religions. From the intense dances of the Sufi to the soulful music of Southern Baptists, we see a set of practices that seem well designed to provoke TLTs, and thus experience of the divine, among those who are prone to them. Very different religious practices provoke the parietal lobe pattern. Here we find heavy reliance on techniques of meditation that shift the focus of attention in exactly the ways

necessary to produce the brain changes associated with a loss of sense of self and feelings of transcending normal existence. In both cases, religious practice, as prescribed by religious tradition, provokes brain changes associated with conscious experiences that are taken as evidence in support of core beliefs in the religious system.

This is not, however, the whole story. The experiences that accompany ritual-induced brain changes are usually very ambiguous. Seeing vaguely human forms or hearing voices could be taken as evidence of many different religious beliefs. Whether the entity in a vision is seen as the angel Gabriel, the Hindu god-aspect Vishnu, Satan, or any of hundreds of other supernatural agents seems to depend on the ideas one already has learned about the supernatural. The same problem extends to experiences of diminished self-awareness and a loss of contact with the external world. Does this indicate a merging back into the one true reality, or a crossing over into paradise? The answer, it appears, depends on what one already believes.

A number of empirical studies now suggest that people interpret experiences induced by the same practices in different ways. People who are not religious, for example, rarely use religious language to interpret altered states of consciousness, while people who are religious before they have those experiences overwhelmingly report them as religious manifestations. If such experiences occur in an environment filled with religious symbols or other references, they are much more likely to be interpreted as religious than if there are no environmental cues of a religious nature. To summarize, any given religious tradition develops ritualized practices that tend to provoke altered brain states associated with anomalous experiences that can then be understood using concepts from that same religious tradition.

There are, however, two important caveats to this. First, not everyone will have such experiences, so there must be other reasons to join a religious community. Second, at least occasionally people will interpret their anomalous experiences in ways that challenge rather than support established doctrine. Martin Luther, who launched the Protestant revolution in Christian Europe, is one prominent example. Others, less well known, did not survive the challenge, having been branded heretics and executed. Established religions must carefully balance the power of such experiences to support the tradition against the power of such experiences to undermine it.

Evaluating the Evidence from Religious Experience

There is no denying that people have profound experiences that depart in dramatic ways from the mundane. The available research suggests that each religious tradition tends to develop practices designed to provoke the kinds of experiences that can be interpreted as providing evidence in support of ideas that are central to the tradition. These experiences are most likely to be interpreted as evidence in this way by people who already understand those core

ideas of the tradition. If this analysis is correct, what kind of evidence is the evidence from profound religious experience?

There are two different answers to this question in the literature. Among some philosophers and many theologians, the answer is that profound religious experience is evidence for the existence of the supernatural. The fact that such experiences are associated with changes in brain activity simply reflects the fact that the gods make contact with us, or we with them, by way of the only instrument available to us. The fact that such experiences are interpreted differently simply reflects the imperfect nature of human understanding. For other philosophers and most scientists who study such phenomena, the association of such experiences with disordered, atypical brain activity, and the variations in interpretation, suggests that any religious meaning is entirely the construction of the believer. In this view, anomalous experiences are fully understood as departures from normal brain activity, and have no intrinsic meaning.

Of course, the details of both answers are far more complex than this brief summary suggests, and it simply is not possible to address them fully in so short a space. There are, however, things we have come to understand about the nature of consciousness, and about the uniquely human cognitive processes that it supports, that must be taken into account by parties on both sides of this conceptual divide.

The ordinary, commonsense view of consciousness is that it is *diaphanous*. A diaphanous object is one that is so insubstantial as to be essentially transparent, having no effect on things that would pass through it. That is how people ordinarily think the mind works, including when it is having unusual, mystical experiences. If I am experiencing a powerful presence, it can't be because my consciousness is acting up, because my consciousness has no nature of its own. It is merely a kind of empty receptacle or stage for things as they are. Therefore, my experience must be the result of something external, and if I can't locate a cause in the natural world, then the cause must lie in the supernatural world.

But contemporary cognitive science makes it clear that this is a mistaken view. It ignores the fact that the mind is a complicated network of physically based causes and effects, and these determine the *form* that any experience will take. When regulated by input from the world, the forms taken reflect that world. That's how we manage, most of the time, to respond adaptively to the world as it really is. But failure of that regulation doesn't result in formlessness; the brain is still operating according to its own nature, and it produces experiences that reflect prior learning (see Kelley's *The Evidence of the Senses* for a more complete discussion). Thus, to claim a supernatural cause for altered states of consciousness, one must first show that perfectly natural processes of brain-based consciousness can't explain the phenomenon.

In spite of the force of this argument, it hardly settles the matter, for the simple reason that scientists still cannot tell a complete causal story about consciousness. Just why, and how, we feel and think remains unclear. This

leaves an explanatory gap into which mystical, supernatural ideas, grounded in reports of powerful experiences, can fit, which is one of the major reasons that people who have such experiences play such important roles in anchoring systems of religious belief and practice. On the other hand, one of the serious difficulties for those who endorse supernatural gap-filling is just how many different ideas there are about how to do it. These differences are codified in a remarkable variety of systems of religious belief and practice, and those systems tend to develop in ways that are self-confirming. Furthermore, each of these systems makes a more or less emphatic claim to have the one and only true explanation of how to fill the gap, and there are no agreed upon procedures for settling the matter.

Science, on the other hand, has a robust and well-established method for settling even hard philosophical disputes, given time and energy enough. And the amount of research on the nature of religious thought and behavior is increasing quite dramatically. For the time being, however, we lack a complete scientific account of conscious religious experience. Meanwhile, the diversity of religious systems, with their powerful mechanisms for confirming prior beliefs about such experiences, virtually guarantees that profound religious experience will continue to play a dynamic role in modern culture and politics in general, as well as in religion in particular.

Bibliography

- Austin, James H. *Zen and the Brain: Toward an Understanding of Meditation and Consciousness*. Cambridge, MA: MIT Press, 1998.
- . “Your Self, Your Brain, and Zen.” *Cerebrum* 5:1 (2003): 47–66.
- Bickle, John. *Psychoneural Reduction: The New Wave*. Cambridge, MA: MIT Press, 1998.
- Blackmore, Susan. *Consciousness: An Introduction*. Oxford: Oxford University Press, 2004.
- Boyer, Pascal. *Religion Explained: The Evolutionary Origins of Religious Thought*. New York: Basic Books, 2001.
- Devinsky, Orrin. “Religious Experiences and Epilepsy.” *Epilepsy and Behavior* 4:1 (February 2003): 76–77.
- Franks-Davis, Caroline. *The Evidential Force of Religious Experience*. Oxford: Oxford University Press, 1989.
- Freemon, Frank R. “A Differential Diagnosis of the Inspirational Spells of Muhammad the Prophet of Islam.” *Epilepsia* 17:4 (December 1976): 423–27.
- Freud, Sigmund. *Totem and Taboo*. New York: W.W. Norton, 1913, 1950.
- Kelley, David. *The Evidence of the Senses: A Realist Theory of Perception*. Baton Rouge: Louisiana State University Press, 1986.
- Landsborough, D. “St. Paul and Temporal Lobe Epilepsy.” *Journal of Neurology, Neurosurgery, and Psychiatry* 50:6 (1987): 659–64.
- Livingston, Kenneth R. “Religious Practice, Brain, and Belief.” *Journal of Cognition and Culture* 5:1 (2002): 75–117.
- Makarec, Katherine, and Michael A. Persinger. “Temporal Lobe Signs: Electroencephalographic Validity and Enhanced Scores in Special Populations.” *Perceptual and Motor Skills* 60:3 (1985): 831–42.
- Marx, Karl. “Critique of Hegel’s ‘Philosophy of Right.’” Trans. Annette Jolin and Joseph O’Mally. Cambridge: Cambridge University Press, 1844, 1970.
- McCauley, Robert N., and E. Thomas Lawson. *Bringing Ritual to Mind: Psychological Foundations of Cultural Forms*. Cambridge: Cambridge University Press, 2002.

- Newberg, Andrew B., and Eugene G. d'Aquili. "The Neuropsychology of Religious and Spiritual Experiences." *Journal of Consciousness Studies* 7:11–12 (2000): 251–66.
- Persinger, Michael A. "The Neuropsychiatry of Paranormal Experiences." *Journal of Neuropsychiatry and Clinical Neurosciences* 13:4 (2001): 515–23.
- Persinger, Michael A., and Faye Healey. "Experimental Facilitation of the Sensed Presence: Possible Intercalation between the Hemispheres Induced by Complex Magnetic Fields." *Journal of Nervous and Mental Disease* 190:8 (2002): 533–41.
- Schomer, Donald L., et al. "Temporolimbic Epilepsy and Behavior." In *Principles of Behavioral and Cognitive Neurology*, 2nd ed., ed. M. Marsel Mesulam, 373–405. Oxford: Oxford University Press, 2000.
- Shepherd, G. *Neurobiology*. Oxford: Oxford University Press, 1994.
- Skinner, B.F. *Science and Human Behavior*. New York: Macmillan, 1953.
- Whitehouse, Harvey. *Arguments and Icons: Divergent Modes of Religiosity*. Oxford: Oxford University Press, 2000.
- Yandell, Keith E. *The Epistemology of Religious Experience*. Cambridge: Cambridge University Press, 1993.

65 Cognitive Science of Religion

D. Jason Slone

The cognitive science of religion is a new approach to the scientific study of religion. Cognitive science is the set of disciplines that investigate the mind-brain processes involved in human thought and behavior. Scholars in the cognitive science of religion explain features of religious thought and behavior that recur across cultures and eras in terms of the mental processes involved in their production and transmission. Religion, along with other forms of culture like music, art, and literature, is understood by cognitive scientists as a natural by-product of the ways our mind-brains function.

Importantly, cognitive scientists of religion are primarily interested in explaining religion, which they distinguish from theology. Religion is the set of actual religious concepts people have in their heads and behaviors they perform. Theology is the set of creeds clergy instruct people to believe. Also, the cognitive science of religion is methodologically agnostic in nature and universal in scope. We are interested in neither the veracity of theological claims nor the religious experiences of mystics. What is of primary interest to cognitive scientists of religion is explaining why most people in most places at most times have strikingly similar types of religious thoughts in their heads.

The cognitive science of religion began with the publication of E. Thomas Lawson and Robert N. McCauley's *Rethinking Religion: Connecting Cognition and Culture* in 1990. Its foundations, however, are much older. The broad theoretical framework of cognitive science was formally established in the 1950s by scholars like George Miller, Noam Chomsky, Allen Newell, and Herbert Simon. These scholars challenged the dominant theory in psychology at the time, behaviorism, which avoided mentalist constructs—thoughts—in explanations of behavior on the grounds that human thought processes could not be, and need not be, studied scientifically. The early cognitive scientists argued that it was both necessary and possible to do so to fully understand human behavior. This argument was based in part on the success of mentalist theories in computer science, linguistics, and other fields.

The article usually credited for starting the “cognitive revolution” in the

human sciences is Miller's 1956 "The Magical Number Seven, Plus or Minus Two." Through simple recall experiments, Miller showed that people could overcome the short-term memory constraints of 7 + 2 bits of data at a time by "recoding" those bits into smaller "chunks" of data. To illustrate, you can more easily remember the string of numbers 1492177618652005 by chunking them into 1492, 1776, 1865, and 2005. Using similar types of recall experiments, Miller showed in a scientific way that the reorganization processes of memory could not be accounted for unless one invoked mental constructs like the processes of "recoding." Thus he showed that the scientific study of mental constructs was both necessary and possible for understanding human thought and behavior.

The dominant model in the cognitive sciences today is the computational-representational model of mind, which imagines the mind as an information-processing computer. But some evolutionary psychologists, cognitive scientists whose theories are informed by the selectionist framework of evolutionary biology, have gone further and theorized that the mind is composed of numerous "modules," each of which is an evolutionary adaptation that solved a particular problem in our species' past. Such modules include a module for perception, a module for detecting social cheaters, a module for acquiring language, and so on. These modules are theorized to be hardwired in our minds, and include a host of representational information about the world that gets triggered by environmental cues.

The modularity model allows scholars studying cultural phenomena to employ an epidemiological framework to explain how certain cultural concepts become widespread in populations. All human societies, as far as we know, contain similar types of art, music, religion, and other cultural forms. The reason is that these cultural forms trigger cognitive systems (designed for other tasks) and therefore are good "fits" for consumption. Music, for example, is like auditory cheesecake because it fits so well with various cognitive systems. The sounds are pleasing to hear and the stories that the lyrics tell are pleasing to follow, even though our cognitive "sound systems" and "story systems" evolved to solve adaptive problems, not for acquiring music per se. Such cultural forms spread easily from mind to mind across populations, and in turn are, in evolutionary terms, "selected for" over generations. Similar to music, the same types of religions show up all over the world because they are also good fits for cognitive consumption.

Most cognitive scientists of religion adopt at least a weak version of the modularity model. The mind is not, most believe, a single all-purpose, problem-solving organ but rather is composed of various cognitive "systems" that are designed to solve particular problems. Importantly, religion is not a cognitive adaptation itself; there is no "religion module" or "religion system" in the mind. Rather, religion is a by-product of cognitive systems that have other primary functions. The central goal of the cognitive science of religion is, therefore, to connect the recurrent features of religion that anthropologists

and historians of religion have documented across cultures and eras to the cognitive processes involved in their production and transmission.

An important first step in cognitive explanations of religion is to understand that “religion” is a collection of features that coalesce, more or less, into (symbolic) cultural systems. Most religions include a belief in supernatural agents such as gods, goddesses, angels, and demons. They also include ritual actions in which people traffic with those supernatural agents; ethical mandates that regulate behavior; social commitments that result in the separation of people into in-group and out-group members; afterlife beliefs and death rituals; metaphysics that provide teleological explanations for personal and world events; and in religions with official theologies, attempts to centralize beliefs and practices across disparate populations. These features of religion all trigger cognitive systems that evolved for other purposes, namely to solve problems posed by our ancient evolutionary environment (including problems of group living). The cognitive explanations for these seven features of religion are discussed in the sections that follow.

Gods

The central feature of religion is the belief in supernatural agents. We will call them “gods” in this discussion, just for convenience, but the label includes goddesses, ghosts, demons, saints, sorcerers, and so forth. Despite their apparent differences, gods are represented quite similarly across cultures. That is, there is a limited catalogue of god concepts that recur. Cognitive scientists of religion argue that this is due to the constraints of our “intuitive ontology.”

An intuitive ontology, or folk understanding of what things in the world are like, develops very early in life and without explicit cultural instruction. For example, our intuitive ontology allows us to distinguish “agents” and “objects.” We know that objects (e.g., rocks and chairs) don’t move on their own, don’t need to eat, and don’t respond to communicative gestures. In contrast, we know that agents (humans and many animals) move on their own (and their behaviors are goal driven), need to eat, and respond to communicative gestures. The most important difference between the two, however, is agents have minds that govern their behavior and objects don’t.

More specifically, objects and agents can be classified into four categories. Objects are either (1) natural objects (e.g., rocks) or (2) artifacts (e.g., statues), and agents are either (3) animals, or (4) humans. Each category contains a host of tacit information about the properties of its members, information that delineates what a particular thing is. In other words, the tacit information about the properties of each domain’s members is “default” information. For example, as described by Hirschfeld and Gelman, tacit information about rocks is that they are solid, don’t have minds, don’t eat, and won’t move unless pushed by another (solid) object. Importantly, this ontological knowledge is part of our natural cognition. Intuitive ontology is not acquired from culture.

God concepts are constrained by this intuitive ontology in the sense that they violate a small number of the intuitive default expectations about agents. They either *breach* expectations of a single category or they *transfer* expectations from one category to another. For example, gods are persons that can see everywhere at once, a concept that breeches our expectations about human vision. And a talking statue transfers expectations from the category of “person” (can talk) to the category of “artifact.” God concepts are not, it turns out, supernatural; they are just modestly counterintuitive.

It is important to emphasize that successfully transmitted concepts, religious or otherwise, tend to contain only modest (vs. minimal [one] or radical [many]) violations of intuitive ontology. Modestly counterintuitive concepts are attention grabbing yet retain all of the other expectations of natural kind concepts, making them easy to represent. The more violations a concept contains, the more counterintuitive it is and thus the harder it is to represent.

Cognitive scientists who study memory have shown that humans are better at remembering intuitive and modestly counterintuitive ideas than maximally counterintuitive ideas. These findings suggest that the types of god concepts that recur across religions constitute a memory optimum. God concepts are attention grabbing but easy to process, represent, and store.

In addition to being attention grabbing and believable, god concepts are also salient because of their personal and social relevance. By having powerful epistemic abilities, or super-knowledge, gods are represented as having full access to what we think and do. As discussed by Boyer, this feature of god concepts triggers important biases in our “social intelligence” system.

Our social intelligence system evolved to handle the various adaptive problems posed by small-group living (fewer than 150 people) in ancient evolutionary environments where resources were scarce. In such environments, your social reputation was critical to survival and successful mating. If you became known as selfish or untrustworthy (a “cheater”), you risked not having allies or mates. In contrast, if you developed a reputation as generous and trustworthy (a “cooperator”), you improved your chances of gaining allies and mates. What other persons knew about you was of vital importance because a great deal of your fate rested in the hands of others. Someone who possessed strategic knowledge of your thoughts and behaviors held great power over you. Pleasing that person would be of great benefit, while displeasing that person could result in great costs either directly (a potential mate turned you down) or indirectly (that person spread knowledge about your “bad character” to others).

God concepts trigger this system because gods are represented as “full access agents.” Gods know everything you think and do, even when you (think you) are alone. This postulation has enormous relevance for people, for obvious reasons. Gods are like Santa Claus, whose relevance is captured in the Christmas song “Santa Claus Is Coming to Town”:

He sees you when you're sleeping.
 He knows when you're awake.
 He knows if you've been bad or good,
 So be good for goodness sake.

Cognitive scientists of religion think that god concepts recur across cultures because of the personal and social relevance their postulated epistemic powers trigger.

Rituals

The cognitive system that underpins ritual performance is an “action representation system.” This system represents rituals as an *agent* performing an *action* on a *patient*: *agent* → *action* → *patient*

Religious rituals conform to this structure, with the additional variable that gods serve as either the agent or patient of a ritual, or gods are instrumental in the action:

gods → action → patient
 agent → action w/ **gods**' instrument → patient
 agent → action → **gods**

The constraints of this action representation system mean that there are only three types of ritual actions possible. Lawson and McCauley call these “special agent,” “special instrument,” and “special patient” rituals:

1. *Special agent rituals*: gods are the agents and people are the patients. Examples include weddings and baptisms.
2. *Special instrument rituals*: agents use an instrument that represents the gods on patients. An example is a blessing using holy water.
3. *Special patient rituals*: gods are the patients and people are the agents. Examples include taking communion and making offerings.

Gods, of course, do not *actually* perform or receive rituals “in person.” Clergy, as representatives of gods (a status obtained via ordination rituals), act on their behalf.

Typically, special agent rituals are performed relatively infrequently, and they are surrounded with relatively high levels of “sensory pageantry.” That is, they are usually performed only once in a lifetime to the patient, are exciting, and involve significant material accoutrements. In contrast, special patient rituals are performed frequently and have low levels of sensory pageantry.

This “ritual form hypothesis” makes additional predictions, for example, about the potential longevity of religious systems altogether. Religions with ritual systems that are “balanced”—contain enough special patient rituals to keep folks busy, punctuated by the occasional special agent ritual to generate

excitement—are likely to be long-lived. In contrast, religions with ritual systems that have no special agent rituals are “unbalanced” and as such are susceptible to schisms, if not outright dissolution. New religious movements are particularly interesting test cases for this hypothesis, as those that survive long enough to become part of mainstream society are likely to have balanced ritual systems. Those that do not are likely to have unbalanced ritual systems. In this way the ritual form hypothesis provides a kind of evolutionary explanation for which religions survive.

Ethics

Cognitive scientists of religion believe that ethical mandates recur across religions because they trigger our intuitive “morality” system. This morality system develops naturally in (normal) human beings. Religious ethics do not create morality; they trigger the natural moral sense.

The moral sense is governed by the social intelligence system. As noted above, the social intelligence system is designed to detect and punish “cheaters” (those who steal, are aggressive, don’t share) and to detect and reward “cooperators” (those who don’t steal, are not aggressive, share). Whether or not an act is moral depends on its social impact. For example, honesty is generally good because it encourages trust by eliminating the problem of deception. But even some lying is acceptable if no one is harmed: “Yes, Virginia, there is a Santa Claus.”

Importantly, human ethical judgments are not necessarily conscious deliberations. Instead, humans possess a moral *sense*. Our ethical judgments are based on “gut feelings” about whether acts are good or bad, feelings that are reinforced by emotions like guilt (which follows from having done something wrong, even if never detected), joy (which comes from giving to others), anger (at cheaters or their injustices, even if they have no impact on your life), and other emotions. If they do so at all, people search for ethical creeds post facto to justify their intuitive feelings about morality. For this reason, ethical creeds are culturally selected, based on how well they map onto our moral sense.

Religious ethics, at least those found in most long-lived religions, tend to map neatly onto this intuitive moral sense. Not coincidentally, what religious ethical systems usually deem “good” tends to involve socially desirable behaviors and avoidance of socially undesirable behaviors. Religious ethical systems benefit society by encouraging good acts by individuals, who are rewarded for being good with improved chances of gaining mates later on (by signaling that they are trustworthy cooperators). Thus the social nature of morality is ironic; being good is an effective strategy for our species’ “selfish genes.”

Finally, the socially desirable behaviors our moral-sense-based religious ethics motivate result in social “cohesion.” The social commitments that religious ethics generate might be so strong, in some cases, as to trigger the kinship selection biases that are normally reserved for genetic relatives. Religions function

as fictive families, which is evident by the use of familial language in many religions—brothers and sisters of Islam; God the Father and Jesus the Son; Kali, the Mother Goddess of Shakta Hindus. Regardless, the same types of religious ethical schemes recur across religions because they trigger our moral sense and thereby help to maintain group solidarity by encouraging socially desirable behavior and discouraging socially undesirable behavior.

Sects: In-Groups and Out-Groups

Religions tend to be “sectarian.” That is, most religions claim that they are the one true faith and that others are false. Committing to a sect, therefore, involves particular judgments about the “rightness” of one group over another. Membership in such groups is gained through costly social commitments, both resources (e.g., tithes) and behaviors (e.g., circumcisions) that signal one’s choice to commit to cooperate with the sect. Such “in-group” representations in turn trigger the representation, sometimes explicit other times implicit, that outsiders are foes. This insider-outsider feature of religion explains the seemingly paradoxical (given the “golden rule” to treat others as you wish to be treated) nature of religiously motivated violence toward members of other religions. Cognitive scientists of religion believe that sectarianism triggers our cognitive system of “coalitionism.”

Humans are naturally coalitional, which is explained by the theory of “inclusive fitness” discussed by Hamilton. According to inclusive fitness theory, individuals act in ways that promote not only their own well-being but also the well-being of those with whom they share genes, their kin. Additionally, people categorize nonkin into one of two groups, allies or foes, based on their potential to help or harm. Allies are those we trust to be cooperators, and foes are those we distrust as cheaters or predators. Thus we possess an evolved predisposition for creating coalitions that include kin and allies.

There is, however, a computational difficulty in judging whether another person is trustworthy or not—the problem of deception. Because a person’s “character” must be inferred from her or his behavioral patterns, we are susceptible to being deceived. Cheaters can perform a few good deeds as a strategy for winning you over temporarily in order to steal from you later. To manage the problem of deception, people stereotype others through the processes of “essentialism” and “group entativity.” Essentialism involves representing people as having an “essence,” either good or bad, which governs their behavior and determines whether they are trustworthy or not. Group entativity involves representing all members of a group as possessing the same essence. Thus a single person shares the essence of the group, and the group shares the essence of the person. For examples, Hirschfeld mentions “men are jerks” and “Muslims are terrorists.”

Combined, essentialism and group entativity lay the foundations for racism, sexism, ethnocentrism, and religious bigotry. As noted above, religions trigger

our kinship selection biases by, for example, using familial language. Non-relatives in the sect become “brothers and sisters”—a designation that is purchased with costly acts of commitment. On the other hand, the representation of other sects as out-groups triggers the fear of foes that can’t be trusted. In cases of intergroup conflict, enemies are even represented as different species altogether, being dehumanized as “evil beasts,” “pigs,” “snakes,” “dogs,” “rats,” and so forth. Cognitive scientists of religion believe that religions are sectarian in such ways because they trigger our natural predisposition toward coalitionism.

Afterlife Beliefs and Death Rituals

Most religions claim that death is not final but rather is a transition to existence somewhere else. The cognitive systems involved in afterlife beliefs are mental essentialism and object permanence. The belief in afterlife recurs across religions because humans have difficulty representing the psychological cessation of agents. We think that if an agent exists, it must always exist.

The developmental psychologist Jean Piaget theorized that humans develop the capacity to know that things exist even if we can’t see them. He called this capacity “object permanence.” Object permanence develops in the first year of life (thus accounting for toddlers’ fascination with the games of “peek-a-boo” and “hide and seek”), long before the acquisition of religion. Thus, the theory goes, the biases about objects’ permanence that stem from this capacity result in the representation that people don’t die *per se*. Instead, dead people just go somewhere else.

This Piagetian theory is insightful but not entirely accurate. Recently, psychologists have refined this theory by showing that people don’t represent agents as singular units. Rather, we are natural “dualists.” We represent people as being composed of two substances, a body and a mind. And among the two, we tend to privilege the mind as the real essence of what makes a person a person. The insight that persons have bodies and minds, but that the mind is the “essence” of a person, better explains the precise types of afterlife beliefs that recur across cultures and eras. When people die, their bodies might cease but their souls, or minds, live on.

This neo-Piagetian theory has not only empirical support from world religions, but also experimental support. In a particularly clever psychological experiment, children saw a puppet show in which a mouse became lost from its family and at the end of a long, hard day was eaten by an alligator. After making sure that the children understood that the mouse was dead, the experimenters asked the children questions about what was happening—if anything—to the (dead) mouse. The results were striking. When asked questions about the mouse’s biological functioning (e.g., “Will the mouse eat dinner tonight?”), the children overwhelmingly responded, “no.” However, asked questions about the mouse’s psychological functioning (e.g., “Is the mouse angry at the alligator for eating it?”), most children responded, “yes.” The results, as pointed

out by Bering and Bjorklund, suggest that children intuitively represent death as the cessation of biological functioning but not psychological functioning. In our minds, the mind lives on.

If the mind lives on, what happens to the body? In most cultures, we dispose of dead bodies. In most cases, the disposal is performed *publicly*, in burial or cremation. Boyer has theorized that death rituals are widespread because dead bodies trigger our “toxin avoidance” system. The human toxin avoidance system involves feelings of “disgust” toward potentially toxic substances. Substances that trigger very strong feelings of disgust are feces, rotting meat, and dead bodies, in part because the toxins in these substances are invisible and can infect even in the smallest of doses and through various means of contact. We evolved, presumably, a hypersensitive disgust of these substances because the risk is so great. Thus, the disposing of dead bodies publicly is an effective way to assure everyone that the toxic threat of the corpse has been eliminated.

Thus, while death rituals and afterlife beliefs might perform the functions, as Freud said, of reducing neurotic tensions and mortality anxiety, that is not why they are so widespread. Rather, cognitive scientists of religion believe that these features of religion are widespread because they trigger ordinary cognitive systems. Afterlife beliefs recur across religious systems because our mind has difficulty representing the psychological cessation of agents, and death rituals recur across cultures because corpses trigger our toxin avoidance system.

Metaphysics

Religions provide people with explanations of where we came from and why things happen in the ways they do. That is, religions provide metaphysics. Importantly, a limited number of metaphysical schemes recur across religious systems. This suggests that religious metaphysics are constrained by our more basic intuitive systems, notably our “folk physics” system that includes intuitions about proximate and ultimate causality.

The conceptual schemes of most religions state that things happen “for a reason.” In other words, events happen not only as a result of a discernible cause, but also because a causer caused the event to happen when, where, why, and how it did. The developmental psychologist Deborah Keleman has termed the tendency to overattribute purpose in the world “promiscuous teleology.” And she has shown experimentally that this tendency is a natural developmental capacity.

Keleman showed children pictures of various items, including fictive animals (e.g., “footles,” horselike creatures with a long sticklike protrusion on the back) and relatively unusual objects (e.g., pointy rocks). She then asked the subjects how those things got the way they are. More often than not, children responded with teleological explanations—those things were that way for a reason (e.g., “to scratch with”). Even when primed with the evolutionary

biological principles of random mutation and natural selection and then asked “Do you think that thing could have gotten that way by accident?”, children still preferred teleological explanations; they answered, “no.”

Similarly, E. Margaret Evans has shown experimentally that the tendency to attribute intentionality as the ultimate cause of things and events accounts for the widespread belief in creationism. This also explains the correspondingly low levels of comprehension of Darwinian theories of evolution by natural selection. Tapping children’s intuitions about how things got the way they are, Evans found little difference in creationist inferences by children from fundamentalist Christian families and children raised without strong religious instruction. Subjects from both groups tended to say that someone had to have made things the way they are now.

This research suggests that we naturally infer agents at work in the world, even where data do not warrant such inferences. In this regard, Barrett has theorized that humans might possess a “hyperactive agency detection device” (HADD) that is primed to detect agents. It makes good evolutionary sense, of course, to possess a HADD, given the possibility of lurking predators in our ancient evolutionary environments. Being hyperactive in detecting agents would be of great benefit in avoiding predators and come at little cost in false positives. Occasionally mistaking rocks for bears would be relatively harmless. Mistaking bears for rocks could be deadly.

Thus, cognitive scientists of religion believe that certain metaphysical themes recur across religious systems because they trigger our ordinary “folk physics.” We are primed to overrepresent agents as causes of events, as creators of existing things, and as pulling strings behind the curtain of reality. In addition, the biases of hyperactive agency detection might help to account for the widespread recurrence of anthropomorphism—representing gods as special persons or animals. Regardless, we don’t find metaphysics recurring across religions because they give us explanations per se, but rather because religious metaphysics tend to trigger our “folk physics” cognitive system.

Theological Incorrectness

One other feature that seems to recur across religions is “theological incorrectness.” Theological incorrectness is another term for intrasystem conceptual variation: specifically, when people have religious ideas that differ from the official creeds of their religions—ideas they “shouldn’t” have. Such conceptual variation seems to be the rule, not the exception, in religious systems with established official theologies. But if religion provides people with ideas to believe, and people believe in those ideas, why would they believe other ideas that they shouldn’t?

The simplest explanation for why theological incorrectness recurs across cultures is that theological concepts are too maximally counterintuitive to be employed in everyday reasoning tasks. Theological concepts, like scientific

concepts, can be memorized but have little effect on people's daily lives. For example, physicists insist that there are no true straight lines in the universe. However, while memorizable, this concept has little effect on how people hang picture frames in their homes. Likewise, religious people can learn theological concepts like "god controls everything" and yet live their lives as if they in fact have control. As noted above, people simply have great difficulty representing concepts that violate too many of the expectations in our intuitive ontology (in this case, self-agency).

Theological god concepts are hard to represent because it is difficult to generate (concrete) images of maximally counterintuitive concepts. Allan Paivio has shown that any images with low levels of concreteness (e.g., beauty, justice) are harder to construct in memory than concepts with high levels of concreteness (e.g., house, tree). Theological concepts typically have low levels of concrete imagery. It is literally impossible to image what "a god who exists everywhere at once" actually looks like. In contrast, "folk" religious concepts generally have high levels of concrete imagery. A concept like "god is a big guy in the sky" is much easier to represent than a god who exists everywhere at once. This, too, might account for the widespread tendency for people to anthropomorphize images of deities.

Of course, the fact that theology is a poor fit with cognition begs the question of how it develops in the first place. Importantly, however, theology is relatively unusual in the history of religion. Like other cognitively burdensome concepts, like scientific concepts, theology requires the use of external (to cognition) storage devices, such as texts, for successful transmission. With texts, any concept, no matter how complex, can be stored and transmitted for a long time. Moreover, storing concepts "artificially" (in artifacts) allows for the ratchet effect in cultural elaboration, as subsequent generations expand on previous creations. In this way, theological concepts tend to drift relatively far from ordinary cognition as they accumulate complexity over generations of transmission. Examples from Christianity include the doctrines of the Trinity, original sin, Calvinist predestination, and Christian evolution (e.g., a biological era is one day in biblical time).

Thus theological incorrectness is a natural product of the constraints of ordinary cognition. This does not mean, of course, that people are incapable of memorizing theology, nor even of acquiring it with enough training and effort. All else being equal, anyone can become an expert, in other words a theologian. But even if acquired (stored in memory), theology is unlikely to be employed in everyday thought.

The cognitive science of religion seeks to explain such recurrent features of religion by connecting them to cognitive systems involved in their production and transmission. This approach both divides religion into various features and deflates religion into a by-product of natural mental processes. There are at least two significant advantages to such an approach to the study of religion. This approach naturalizes the study of religion by making it a trac-

table scientific subject rather than a philosophical mystery, and connecting religion with cognition allows scholars to employ the full resources of the cognitive sciences. This means that scholars interested in understanding religion have robust metatheoretical and theoretical frameworks from which to work, and powerful methodological techniques to employ. For these reasons, the cognitive science of religion is poised to be one of the most important developments in the scientific study of religion.

Bibliography

- Atran, Scott. *In Gods We Trust: The Evolutionary Landscape of Religion*. Oxford: Oxford University Press, 2002.
- Barrett, Justin. *Why Would Anyone Believe in God?* Walnut Creek, CA: AltaMira, 2004.
- Bering, Jesse, and David Bjorklund. "The Natural Emergence of Reasoning about the Afterlife as a Developmental Regularity." *Developmental Psychology* 40 (2004): 17–233.
- Boyer, Pascal. *The Naturalness of Religious Ideas: A Cognitive Theory of Religion*. Berkeley: University of California Press, 1994.
- . *Religion Explained: The Evolutionary Origins of Religious Thought*. New York: Basic Books, 2001.
- Buss, David. *Evolutionary Psychology: The New Science of Mind*. 2nd ed. Needham Heights, MA: Allyn and Bacon, 2003.
- Evans, E. Margaret. "Cognitive and Contextual Factors in the Emergence of Diverse Belief Systems: Creation versus Evolution." *Cognitive Psychology* 42 (2001): 217–66.
- Freud, Sigmund. *Civilization and Its Discontent*. Trans. J. Strachey. New York: W.W. Norton, 1961.
- Guthrie, Stewart. *Faces in the Clouds: A New Theory of Religion*. Oxford: Oxford University Press, 1993.
- Hamilton, William. "The Genetical Evolution of Social Behavior." *Journal of Theoretical Biology* 7 (1964): 1–52.
- Hirschfeld, Lawrence. *Race in the Making: Cognition, Culture, and the Child's Construction of Human Kinds*. Cambridge, MA: Bradford Books, 1996.
- Hirschfeld, Lawrence, and Susan Gelman. *Mapping the Mind: Domain Specificity in Cognition and Culture*. Cambridge: Cambridge University Press, 1994.
- Kelemen, Deborah. "Why Are Rocks Pointy? Children's Preferences for Teleological Explanations of the Natural World." *Developmental Psychology* 35 (1999): 1440–52.
- Lawson, E. Thomas, and Robert N. McCauley. *Rethinking Religion: Connecting Cognition and Culture*. Cambridge: Cambridge University Press, 1990.
- McCauley, Robert N., and E. Thomas Lawson. *Bringing Ritual to Mind: Psychological Foundations of Cultural Forms*. Cambridge: Cambridge University Press, 2002.
- Miller, George. "The Magical Number Seven, Plus or Minus Two." *Psychological Review* 63 (1956): 81–97.
- Paivio, Allan. *Imagery and Verbal Processes*. New York: Holt, Rinehart and Winston, 1971.
- Piaget, Jean. *The Construction of Reality in the Child*. Trans. M. Cook. New York: Basic Books, 1954.
- Pinker, Steven. *The Blank Slate: The Modern Denial of Human Nature*. New York: Viking, 2002.
- Slone, D. Jason. *Theological Incorrectness: Why Religious People Believe What They Shouldn't*. Oxford: Oxford University Press, 2004.
- Tomasello, Michael. *The Cultural Origins of Cognition*. Cambridge, MA: Harvard University Press, 2000.
- Wright, Robert. *The Moral Animal: Evolutionary Psychology and Everyday Life*. New York: Pantheon, 1994.

Healers and Healing

Introduction to Healers and Healing

Healing is a perennial concern in human cultures, and chosen individuals who have the expertise, know-how, and confidence to lead community members on the road from illness to health are often especially esteemed for the services they provide. From the most ancient societies to those in the twenty-first century, healing is assumed to be a noble, humane, and often-dangerous activity. In many cultural contexts, it is also an inherently religious activity that bears on ultimate truths in the cosmos and profoundly meaningful perspectives on bodies, spirits, and power.

Most human cultures have designated healers and healing systems of knowledge and practice that are brought to bear on the physical, emotional, mental, and spiritual sufferings of those who are not well. The universal realities of sickness and disease, pain and illness, have to be addressed in all societies. But despite the universality of these conditions, societies often have multiple, sometimes contradictory, sometimes converging strategies to restore health to the sick and ward off death, if only temporarily. The resources used in this endeavor—the materia medica for special-made remedies, the spirits from the other world, the folk knowledge easily accessible, or the more learned knowledge reserved for the select few—boggle the imagination but also give striking evidence of the diversity of cultural systems behind this vast range of items, theories, practices, forces, and figures involved in healing.

The last century witnessed striking, dramatic revolutions in healing and medicine, and the spread of one dominant system of healing with an undisputable source of authority: experimental science. From the early 1900s, with the rise of hospitals, professionalization of the medical field, and fantastic advancements in biomedical knowledge and technologies, to the late 1990s, when health care systems teetered on the brink of collapse, medical costs soared to astronomical heights, and public awareness of alternative healing strategies openly challenged biomedical dominance, the cultural context in which healers cared for the ill changed like never before. But contrary to

conventional wisdom about the twentieth century, these transformations did not simply entail the triumph of science and the disappearance of religion from the context of healing until the last few decades.

Instead, we are beginning to recognize how widespread religious sensibilities and practices remained in the biomedical world of the late nineteenth and most of the twentieth centuries. The religious motivations of many doctors and nurses, the abiding presence of God in the lives of many hospital patients, the religious language and metaphors—the “miracle” drugs of the 1950s, for example—so prevalent in popular culture, and a host of other indicators suggest that with religion and medicine, like with religion and science generally, the so-called split between them overstates the reality.

Additionally, biomedical orthodoxy, born and embedded in Western cultures, has struggled with and often against competing systems of medicine and healing around the world. From a global perspective, many medical anthropologists argue, biomedicine is simply one health care system among many, and like others, it is a cultural and social construction, a form of symbolic reality that is grounded in the particularities of historical and material circumstances.

Just about every discussion on the topic of healers, science, and religion inevitably turns to the figure of the shaman. Who is this figure that has captured the imagination of explorers, missionaries, anthropologists, and now a host of others interested in alternative healing strategies outside biomedical culture? How do we understand the techniques—peculiar to many in the late twentieth and early twenty-first centuries who are used to biomedicine as the standard measure for theories, practices, and interventions—employed by those to bring health, balance, and succor to those who suffer? Historically, the origins of shamanism emerged some 40,000 years ago, and although many agree on the etymology of the word and its earliest manifestations in northern Asia, and primarily in Siberia, the application of this designation for certain healers has become widespread and quite varied.

In this section, three separate essays directly address and explore different aspects of shamanism, sometimes emphasizing scientific, sometimes religious and cultural dimensions. Biologist Alexander Escobar provides a brief background on shamanism in the context of Latin America, describing the frequent interactions shamans have with the spirit world and the role of plants with psychoactive qualities in the quest to heal others who are ill. Writer E. Barrie Kavasch offers additional background on shamanism as a cultural phenomenon not limited to any region or time, though easily and often misunderstood by outsiders in certain regions and historical periods. Not a religion itself, shamanism is a pathway into the unknown, in Kavasch’s words, and shamans play a vital role in bridging the known and the unknown. Anthropologist Michael Winkelman takes an entirely different approach to exploring connections among science, religion, and shamanism, though he too emphasizes the cross-cultural existence of shamanic healers in early hunter-

gatherer societies and subsequent societies around the world and throughout time. Applying a biogenetic model to the study of shamanism, Winkelmann identifies the evolutionary and neurological characteristics that have undergirded critical experiences and rituals tied to healing. This is reminiscent of ideas and connections explored in Atran's essay in *Ecology, Evolution, and the Natural World* and in Livingstone's and Slone's essays in *Consciousness, Mind, and the Brain*.

Moving from these discussions about certain general features in shamanism, the next essays turn to more specific aspects of healers and healing in Africa. Scholar and priest Getatchew Haile examines spiritual healing in the Ethiopian Orthodox Church, covering church views on causes of illness, ailments, and the healing practices centered on prayer and rituals, including the Unction of the Sick. But he also presents background on other popular, often noninstitutional healing strategies that Ethiopians rely on in times of illness, like the use of amulets, holy water, and the vow.

Adam K. arap Chepkwony, a professor of religion, offers an informative historical overview of healers and healing in precolonial, colonial, and postcolonial times, covering the tensions, conflicts, and collaborations between the traditional forms of African medicine integrally tied to spirituality and the colonial, generally Christian views about African traditions that were grounded in monotheism and biology. Religionist Hazel Ayanga focuses even more on the complicated tensions surrounding healing in modern Africa by addressing AIDS, one of the greatest medical challenges to face not only the continent of Africa but also the globe. Through this informed consideration of how African peoples and their leaders have responded, Ayanga raises the political, cultural, and religious stakes in the efforts to treat those who have been stricken by HIV/AIDS.

The next set of essays moves the reader from Africa to North America. Michael Tlanusta Garrett addresses the many misunderstandings in popular perceptions of Native American spirituality, generally by exploring what it means to "walk in step" in traditional societies. More specifically, he presents stories and insights based on Cherokee medicine, or "Nuwati," to provide the reader with a better sense of how religion, healing, and culture intersect and are integrated in this Native society. Surgeon Lori Arviso Alvord picks up this thread but looks at medicine from the vantage point of Navajo spirituality. Her essay concentrates on Navajo ceremonies as a critical element of healing, but it also makes the strong point that Western medicine is finally becoming aware of healing powers existing beyond the realms of orthodox biomedicine. Physician William T. Branch Jr. discusses the role of spirituality in the practice of medicine, both in the lives of patients and in the care of doctors. He gives some background on the purported division between science and religion but ultimately argues that the two must be incorporated into the practice of medicine and, despite the challenges, embraced by physicians as not antithetical to their work, but integral in the confrontation with suffering.

The last two essays in this section offer the reader two wide-ranging overviews from very different angles of vision. Lisa J. Schwebel, a professor of religion, offers an interdisciplinary discussion of faith healing, an often-derided phenomenon that has deep historical roots across cultures but currently is a vigorously researched area at the intersections of religion and medicine. Given the recent upsurge in studies about the relationship of religion to health, Doug Oman and Carl E. Thoresen, professors in the fields of public health and education, respectively, provide a helpful clarification over the much debated but quite confusing research question “Does religion causally influence health?” Their essay raises some of the common problems surrounding multiple definitions of key terms and divergent interpretations of the data in many studies, and ultimately argues the unlikelihood of agreement on one single, consensual explanation that answers the question.

66 Shamanism

Alexander Escobar

The word *shaman* comes from the word *saman*, used by north Asian peoples to designate the one “who knows.” But we can find shamans in North and South America, Africa, and other parts of the world. They are the traditional healers in many cultures. These individuals remind us of a time before the tremendous amount of specialization that characterizes our modern society. Shamans take us back to a time when the healer and the spiritual leader were one, and people would consult the same person for maladies of the soul as well as the body. Indeed, the role of the shaman is at the heart of a worldview that is integrated and whole. Within this worldview there is no separation between the spirit world and the material world. The two are understood to overlap, so it is possible to stand on the margin shared by both and to communicate with both worlds. This margin is the domain of the shaman, who can pass from one side to the other with ease.

Spirits

The shaman can be seen in traditional art from around the world. Pottery displaying figures that are half-animal and half-human have been taken by anthropologists to indicate the transformation of shamans in those societies. In many animistic belief systems, humans are protected and guided by animal spirits. By assuming the shape of the animal with which the shaman identifies, the shaman connects with the animal spirit and communicates with it. Through this communication, shamans access information they would not otherwise have.

The connection with the spirit world can take many forms. In the valley of Otovalo in Ecuador, local shamans claim that their connection is with the two volcanoes that dominate the landscape. Here these healers perform ceremonies with cane alcohol and candles. As they walk around the person being healed, they chant, take sips of cane alcohol, and breath fire toward the center. The chanting, smoke, and vapor envelop you as the spirits of the volcanoes

Figure 66.1 **A shaman blows fire while invoking the power of the ancient volcanic spirits of Otavalo, Ecuador.** (*Alexander Escobar*)



are invoked to provide a cure. The ceremony is designed to put you in the cauldron of fire and connect you with the vulcan spirits.

In the lush Amazon, it is no surprise that shamans communicate with the plant spirits of the jungle. As with animals, each type of plant is thought to have a spirit, and these spirits give healing information. One of the common misconceptions in Western societies is that knowledge of the plant pharmacopeia that shamans use in treating disease has evolved through time by trial and error. Although it must be true that some experimentation takes place, many shamans say that the plant spirits tell them which plants to use for treat-

ing various symptoms. A common response when asked how they received the information about which plants to use is that the plants talked to them.

Many of these plants are known to contain bioactive molecules that have medicinal properties. Often a plant will contain many different substances that can be used for various treatments. Modern science is slowly learning more about plants from places like the Amazon that could harbor many medicines. These traditional healers may have much to offer modern society.

Not all of the spirits with which shamans interact are considered good or helpful. Some spirits will try to cause harm, and sometimes the spirits will not help. In one ceremony within the Amazon, a shaman entered into the spirit world accompanied by his companions, other members of the tribe. The shaman explained that his companions were there to give him aid should there be trouble in the spirit world with ill-behaved spirits or those that would overpower him. So in this worldview, the spirit world is not without its hazards, and shamans must be on their guard as they would in this world.

From the examples given above, you can see that nature is thought of as being alive and full of spirits. Spirits can be invoked and asked for help, although they may not always do so. In either case, there is open communication between the shaman and the spirit world, blurring the lines between the two. Being a shaman is no easy task and requires skill as well as apprenticeship. Not everyone can be a shaman. The current shaman of a tribe usually selects the next shaman, based on the person's natural abilities. This may include visions or dreams of special significance at an early age. Since these abilities arise independent of gender, in many societies a shaman can be a woman just as often as a man.

Transitions

The ceremonies of shamans often involve the use of psychoactive materials such as peyote buttons, psilocybin mushrooms, and ayahuasca vines. The sources are often processed in specific ways to extract the active ingredients and prepare them for use. Ceremonies vary greatly from the strictly traditional to those that incorporate elements from different belief systems. Throughout Latin America, for example, it is possible to see ceremonies that blend traditional native beliefs with Christian beliefs.

At some point in the ceremony, the healer takes the hallucinogen and begins to chant. This eventually leads to a state where the healer interacts with the spirits and then shares that information with those being healed. He or she then performs some healing act or says a prayer over those in need. If the spirit indicates that a certain plant should be used, this is prescribed to those being healed, although they may not receive this information until the following morning. Often those being healed also take the psychoactive materials and enter the spirit world with the healer. In this case, it is understood that the shaman will serve as a guide and will act as an interpreter and intermediary.

These psychoactive materials are also key for achieving the transformations from human form to animal form. Whether this transformation is understood as a physical transformation or a transformation of spirit is not clear. Shamans describe this process differently based on their experience of it.

Becoming a shaman requires another form of transition. In becoming a shaman, one accepts the responsibility that comes along with that role. This responsibility is not an easy one. One is agreeing to become the healer of the group, recognizing that the functions of the shaman can be physically taxing. At the very least, the repeated use of psychoactive materials and the “on guard” stance while in the spirit world take their toll.

Since the role of the shaman requires the individual to take on this greater responsibility and to display abilities beyond the norm, becoming a shaman is not easily achieved. Initiation often requires a trial by fire. Shamans may have to fight their way back from a near fatal infection or other malady. By doing so, the shaman demonstrates resolve and the ability to heal. This trial is understood as not only a physical healing of the body but also the successful negotiation through the spiritual forces that come into play during any healing.

Bibliography

- Arvigo, Rosita. *Sastun*. San Francisco: HarperSanFrancisco, 1995.
Plotkin, Mark. *Tales of a Shaman's Apprentice: An Ethnobotanist Searches for New Medicines in the Rain Forest*. New York: Penguin, 1994.

67 Shamanism and Science: Ancient Pathways to Healing and Understanding

E. Barrie Kavasch

I believe in shamans. If it were up to me, I would go back to the law of the Inuit, the law of nature. I would live like that while checking e-mail in the morning, calling halfway round the world to do business, watching wars in my living room on television. It is possible to do both in this day.

—Zacharias Kunuk, *Inuk filmmaker, 2002*

Shamanism stands at the core of deep understanding. Shamanism is an ancient, universal pathway into the unknown in order to seek wisdom and solutions. Shamans were the first priests, doctors, and scientists in the world, in every culture and society. Their early observations remain in cave paintings and rock art—primal societies' first books—found often in abundance across the world.

Shaman is a Tungus (Siberian) word for a person who can communicate with spirits to seek enlightenment, and whose own spirit can travel freely through other realities and return to the body safely. It comes from the root word *saman*, meaning “wise one.” Some people have exceptional abilities, especially enhanced with training, to communicate with spirits to solicit their intervention and kindness on behalf of the individual, family, clan, or community. These men and women are the shamans.

Shamanism is the practice of connecting with and working within the spirit realms for healing, to counter soul loss, to help spirits pass over into the afterlife to the final resting place, and to discern critical information. Shamanic practice is universal. Perhaps because of shamanism's more mystical qualities, it was often considered a religion, but it is not a source of deepening spiritual fulfillment, nor does it take the place of organized religion. However a religious figure can also be a shaman or become a shamanic practitioner.

Shamanism can augment and strengthen religious practices in many valuable ways. Shamans can journey in trance to religious figures to ask for particular knowledge, or they can study with the spirits of earlier church leaders and ask for special healing. Early priests and other church leaders viewed shamans as competition, often able to do things that they could not. Organized religions sought to stamp out shamanism as a perceived threat to its hierarchy. This unfortunate stigma has haunted shamanism for many centuries, eclipsing the many valuable objectives that shamanic work achieves. Shamanism transcends both science and religion, yet it can complement both. Shamanism, science, and religion create a valuable triumvirate, as each has unique strength and they can strengthen each other in many ways.

Concepts of shamanism are often cloaked in mysticism and misunderstanding by people who have not made careful studies of these realms. Many still equate shamanic work with witchcraft and mind-altering drugs because some tribes imbibed hallucinogenic substances in order to enter realms beyond the ordinary. Such tribes are relatively few and isolated from the mainstream. In fact, mind-altering substances can cloud true shamanic results. Training and focus are necessary tools for successful shamanic journeywork. Trained shamans can enter the spirit realm in states of altered consciousness and learn many valuable details.

Ancient shamans and their magical, otherworldly visions are taking on new meanings. Their traces can be found from the weathered outcroppings of North American and African rock shelters and escarpments, to the dank insides of massive Irish and French stone tombs, to the shadowy recesses of Spanish, French, and North and South American caves. Pictures of hands that were pecked or etched on rock surfaces were powerful symbols of ownership, possession, and shamanic abilities. Shamans and their apprentices would return during seasonal rituals to emblazon rock outcroppings and sacred cave walls with emblems of their visions and supernatural powers. Perhaps this shamanic art was created as a means of gaining control over wary game animals, cycles of droughts, and human sickness.

The Science of Shamanism

Shamanism is a way to seek wisdom and solutions. After careful preparations, and sometimes to the sound of methodical drumbeats or rattling, the shaman enters a trance state and his or her spirit journeys deep into the spirit world in search of vital information. Shamans often have one or more “power animals” that accompany, guide, and protect each journey. A shaman may choose to shapeshift into the power animal in order to go more quickly or secretly in search of a missing person or game animals, to divine the causes of illness, to intercede with troubling spirits, or to help wandering ghosts pass over into the spirit world. Shapeshifting is like walking into a deep fog until totally enveloped by it.

One needs a quiet, undisturbed place in order to commune with the spirits and enter the trance state. Many shamans perform a simple preliminary ceremony of lighting a candle, smudging with sage, cedar, lavender, or rosemary, and centering the self in a peaceful state of mind. Some prepare an altar filled and surrounded with good intentions. Ten to fifteen minutes of rhythmic drumming helps the mind shift into a meditative mode conducive for shamanic journeywork. (Scientists have found that this strengthens the immune system.) Shamans may journey accompanied by steady monotonous sounds of drumming, rattling, chanting, bells, Tibetan singing bowls, didgeridoo, and mouth harp, or the sound of frogs, wind, or ocean waves. Skilled shamans can journey without accompaniment or fanfare.

Shamanism has many modern applications, especially in the fields of medicine and psychotherapy, as well as in science and engineering. The human psyche can derive many therapeutic benefits from shamanism, especially in the areas of soul loss, which occurs when a fragment of one's soul disappears in trauma. (Soul loss is a form of survival and adaptation when we are stretched beyond our will and natural capabilities.) Sometimes the fragments return naturally and reunite within the person, but often it requires a shaman's skill to go in search of scattered soul fragments that were stolen or lost, or are too frightened to return.

Native American societies believed in an inherent responsibility to maintain harmony in the natural world on which they depended. One way to ensure harmony was by performing various rites and rituals. Early hunting societies blessed the spirits of game animals in order to assure their abundance and acquiescence. Farming cultures blessed the seeds, fields, and planting times to ensure bountiful harvests. Fishing and gathering cultures blessed their seasonal resources to petition for continuing abundance. Shamans were gifted with exceptional abilities to act on behalf of their communities in these rituals. They could unleash their spirits from their own bodies to journey and intercede with the necessary nature spirits and petition for successful survival for their people.

Cosmology and Ecology of Shamanism

At several places in the Coso Mountains of eastern California, ghostly images graven in the rocks confront the modern observer. Stylized humans, dogs, antelope, and bighorn sheep share space with abstract zigzags, chains, snakes, lightning bolts and dozens of other shapes and creatures. . . . The Shoshone and Paiute people who live here call these sites "houses of power": places where shamans can access their poha, ritual powers emanating from the spirit world.

—Paul Souders, "*Houses of Power*"

We can imagine how ancient shamans worked in prehistoric times, based on the scattered remnants left behind, like stone, ivory, and bone amulets, painted clay pots, exotic pipes and stone points, rare masks, carved effigies, and pictographs and petroglyphs that embellish cave walls and rock outcroppings. Pictographs of humans wearing horned headdresses and carrying rattles, and surrounded by lightning bolts, star beings, spirals, and snakes, hold certain reverence for traditional tribes today who exhibit similar styles and accoutrements in their sacred ceremonies. Kokopelli and the sacred Kachina cults were recorded more than a millennium ago in the rock paintings of their native ancestors in the desert Southwest.

Danger Cave, on the edge of the Great Salt Desert, sits above a desolate moonscape environment. Its most frequent visitors are persistent winds. This, along with other caves in the region, sheltered nomadic wanderers more than 11,000 years ago. Excavations here show a series of occupations and evidence of shamanic involvement in daily lifeways.

Rock carvings in Wyoming's Big Horn Basin depict an ancient shaman in elaborate regalia carrying a rattle and a hand drum. Plains Indians understood the importance of guarding the Sacred Hoop of Life and keeping the circle unbroken. Much of their tribal shamanism was cloaked in mystical symbolism and secret rituals. Oglala Sioux shamans, *wicasa wakans*, associated with the supernatural powers that connected them to the Thunderers, and they spoke in an esoteric language so different from everyday speech that their people could not understand them. They helped locate buffalo, elk, and antelope, which sustained the life of their people, and they often donned horned headdresses in sacred shamanic rites and hunting rituals to honor these animals.

Pawnee shamans, *iruskas*, governed the most complex cosmology of all Plains tribes, which was based on the movements of stars and the positions of constellations. The Skidee Pawnee created a sophisticated star chart on a buckskin map, representing the night sky in mid-summer, showing the star clusters along the Milky Way. Their ceremonial cycles began with spring's first thunder, as thunder was considered the Voice of Heaven calling supernatural songs and hurling lightning bolts to the giant Thunderbirds. Their shamans were so powerful that they would hold public contests of supernatural strength, which could include firewalking and handling glowing coals. Some could even dismember the human form and then return it to normalcy.

Shamans were the dignitaries who could interweave each clan, band, or culture's cosmology within its ecology and with vital applications for survival. The universal animistic experience recognizes that all things have souls and are alive. Shamans are aware of this and can alter their state of consciousness and contact these soul essences, asking for help when necessary. Shamanic training often required years of practical tuition and study as apprentice to older shamans.

Shamans were dreamers first; in fact, many individuals were called to the shamanic pathway through dreams. Shamans could deal directly with the dream

world and even reenter powerful dreams in order to tease out further details. Native American traditions honored dreams. Dreams held power, could foretell future events, bring insights about healing, and bridge the spirit world to visit ancestors and loved ones in the afterlife. Shamans as well as ordinary people drew inspiration and strength from dreams. Everyday dreams were significant and might suggest a particular course of action. Native families would often discuss their dreams together each morning to determine if immediate attention was necessary.

Rock drawings along the Rio Grande in New Mexico show symbols of shamans as sacred horned deities. Some of these pictographs are more than a thousand years old. Perhaps these are ancestors of sacred Pueblo Kachinas who have danced through countless centuries to benefit the Hopi, Zuni, and other Pueblo peoples, who continue to honor cycles of Kachina rituals today.

Painted Cave near Santa Barbara supports impressive examples of Chumash cave paintings. Chumash shamans, *alchuklash*, used this sacred site often and painted over many complex arrangements of figures and power symbols. Red pigments dominate the sloping cave walls, highlighting sunbursts, medicine wheels, starbursts, zigzags of lightning, and haunting birdman figures. These designs represent many elements from Chumash mythology, especially the celestial powers and star people, as these shamans were also astronomers and sky priests.

In some Native American cultures, shamans' identities remained hidden, or at least half-hidden. The shamans performed through special masked and costumed ceremonies, as in the Kachina rites in the desert Southwest, the Iroquois False Face Ceremonies in the Northeast, and the masked rituals of Athapaskan-speaking tribes of the sub-Arctic and Great Lakes. Secrecy was an important tool to protect identities in small, closed societies and to enhance the power and impact of shamanic work.

Contemporary Shamanism

Shamanism is both extremely ancient and entirely modern because it suits human needs for inquiry into the vast unknown realms. There is no other pathway to access the same information. Some of shamanism's greatest assets are in helping people explore dreams, mend from psychic traumas, and learn more about health and healing issues. The integrity of our shamanic practice today bears respect for all our unique backgrounds. We practice shamanism with renewed authenticity as we empower these multicultural gifts of knowledge and enlightenment. We journey to persistent rhythmic drumming or other sounds as we explore endless levels of the underworlds, the middleworlds, innerworlds, wateryworlds, and upperworlds. Shamans can journey to seemingly endless realms as the spirit flies free. The animal spirits or power animals await.

We form shamanic circles and societies, having greater freedom and re-

spect in the twenty-first century than in some earlier times. We use shamanism to help police and the military track lost individuals or find criminals and terrorists. Shamans journey to the spirits of world leaders to work for world peace. Shamanism is also the tool for dreamers to exact deeper meaning from ordinary dreams. Shamanic journeywork and soul retrieval help to ease the pain of surgery and various medical and emotional conditions, and can limit excessive bleeding and trauma.

Men and women, adults and children, will continue to train as shamanic practitioners in order to gain further access to creative potentials and learn more about science, dreams, emotional problems, and healing. Absolutely nothing else can take the place of shamanism. This is something that ancient people simply knew; yet it has taken modern people an amazing amount of time to grasp this concept.

Today we live in a world enhanced and enlivened by the ways of our ancestors. Perhaps now we are at the intersection, integrating science, religion, and spirituality in ways we have never known. Shamanism is an ancient practice now evolved into modern concepts that can help us find solutions to problems we have not yet resolved. The pathways are open and the journeys are most unusual.

Bibliography

- Benedict, Ruth F. "The Concept of the Guardian Spirit in North America." Memoir No. 9, American Anthropological Association, 1923.
- Bierhorst, John. *The Sacred Path: Spells, Prayers, and Power Songs of the American Indians*. New York: Quill, 1984.
- Brasser, Ted J. "The Creative Visions of a Blackfoot Shaman." *Alberta History* 23:2 (1975).
- Eliade, Mircea. *Shamanism: Archaic Techniques of Ecstasy*. Revised and enlarged from original French edition. Bollingen Series 76. New York: Pantheon, 1951.
- Halifax, Joan. *Shamanic Voices: A Survey of Visionary Narratives*. New York: Dutton, 1979.
- Harner, Michael. *The Way of the Shaman*. 3rd ed. San Francisco: Harper, 1990.
- Hultkrantz, A. *Shamanic Healing and Ritual Drama: Health and Medicine in Native North America*. New York: Crossroads, 1992.
- Hunt, Norman Bancroft. *Shamanism in North America*. Buffalo: Firefly, 2003.
- Kalweit, Holger. *Shamans, Healers, and Medicine Men*. Boston: Shambhala, 1992.
- Souders, Paul. "Houses of Power: Rock Art, Shamanism, and Subsistence in the Coso Mountains of California." 1997. <http://axoplasm.com/archeology/>.

68 Shamanism: A Biogenetic Perspective

Michael Winkelman

Shamanism refers to a variety of spiritual healing practices found in premodern societies around the world. By the time of the Enlightenment, however, it was viewed as a form of the irrational other. Twentieth-century scholar Mircea Eliade provided a different view of the shaman as someone who entered “ecstasy” to interact with spirits on behalf of the community. Eliade pointed to similar spiritual healing practices in societies around the world. Shamans typically engage the entire local community in all-night ceremonies. The shaman’s dancing, drumming, and chanting are accompanied with a dramatic recounting of mythological themes, struggles with the spirits, and a “soul flight,” a departure of the shaman’s consciousness from the body. In this soul journey into the spirit world, the shaman appears unconscious but is engaged in a dramatic encounter with spirits and natural forces, as well as other shamans and entities.

Shamanic rituals constitute the most important social events in hunter-gatherer societies, structuring the relationships of individuals to the collectivity and cosmology. The shamans’ spirit encounters are basic to their societies’ cosmology, hunting practices, and ecological and community relations and healing. The shaman heals patients through the recovery of their souls or personal power, or by removing negative influences sent by spirits or sorcerers. Shamans are assisted in their professional tasks by their allies and guardians, generally animal spirits acquired during arduous training.

Shamans’ training generally involves a protracted period of isolation from the community, alone in the forest, mountains, or desert. There they engage in prolonged fasts, exhausting exercise, and physical pain. They often ingest powerful plant medicines that produce experiences of the spirit world. During training, shamans go through a process of death and rebirth that instills them with animal spirit powers, the source of shamans’ capabilities. Spirits are controlled with rituals and the shaman’s own personal qualities. These spirits are the basis for healing, divination and clairvoyance, communication with the dead, recovery of lost souls, protection against spirits and sorcerers, assistance in hunting, and determining distant conditions.

Shamanism emerged some 40,000 years ago in the transition to contemporary culture. Cave art illustrates shamanic cosmology and activities and reflects shamanism's central role in the symbolic productions that gave rise to culturally modern humans. Shamanic practices facilitated adaptation to changing ecological and social conditions, promoting group bonding through rituals that enhanced symbolic identity formation. The practices developed out of a substrate of mammalian and primate ritual, providing mechanisms for the psychological, social, and cognitive integration required by an increasingly complex modular structure of mind and social relations.

Claims to the universal applicability of the concept of shaman have been challenged, but cross-cultural research confirms similarities in the characteristics of the spiritual healers of hunter-gatherer societies worldwide. Among the common characteristics and practices are ecstasy or altered states of consciousness known as a soul journey or vision questing; altered states of consciousness induced with fasting, chanting, drumming, and dancing; initiatory death and rebirth experiences; mediation of community relations with spirits and entry into the spirit world; identity and powers derived from animal spirits and the shaman's transformation into an animal; healing of injuries, attacks by spirits and sorcerers, and soul loss; use of physical medicine involving plants, massage, and simple surgery; divination, diagnosis, and prophecy through visions; charismatic group leadership; and the potential for malevolent acts such as sorcery.

Shamanistic healers are also found outside hunter-gatherer societies. These practitioners use altered states of consciousness to interact with spirits on behalf of their communities, providing the group with critical healing activities. They can be shamans, shaman/healers, healers, mediums, or similar figures. They vary with respect to the characteristics of the societies where they are found, the spirits to which they relate, their socioeconomic and political status, the selection and training procedures for the profession, the characteristics of their altered states (e.g., soul flight vs. possession), the sources of their power (rituals, mana), and any additional religious activities (e.g., propitiation, fertility rites). The original basis of shamanism in hunting and gathering societies was transformed by sociocultural evolution, which produced other forms of shamanistic healers. Agriculture produces shaman/healers, and political integration and social stratification give rise to healers and mediums.

Neurological Foundations of Shamanism

The universal characteristics of shamanism have foundations in hominid evolution and human biology. The biological bases include neurognostic structures, processes of knowing based in biological structures, the communication functions of ritual and mimesis, and a biologically based sickness and healing response. Humans have innate representational capacities, the ability to create analogic or metaphoric representations of nature, others, self, and society.

This helps us process information regarding ourselves, social others, and the natural world, and it provides the basis for shamanistic animism, animal spirits, and guardian spirit allies.

Shamanic Universals as Neurognostic Structures

The universals of shamanism reflect *neurognostic* structures, fundamental biological and structural features of the brain and consciousness that underlie gnosis, or knowledge. These innate representational modules provide the basis for perception, knowledge, and universal aspects of mind and psychosocial relations, constituting neurological foundations for shamanic universals. Shamanism reflects an evolved or “natural” psychology derived from structures of the brain/mind; practices providing integrative cognitive processing; a natural form of physical, emotional, psychological, and social healing; and the original neurotheology, biologically based spirituality.

Neurognostic structures underlie the ecstasy that shamans use to engage with spirits. This trance state engages fundamental psychosocial structures of consciousness (represented in spirits) and evokes community healing responses (based in the mammalian opioid systems). These shamanistic universals reflect human biological, psychological, and social adaptations involving the effects of altered states of consciousness on mind and body; spirit representations of human emotional dynamics; and the role of social rituals in group communication, bonding, and opioid-based therapeutic processes. Other universals of shamanism—drumming and dancing, visionary experiences, soul journey, animal identities, initiatory death, healing processes—also reflect the operation of innate modules of the brain related to self and other and the metaphoric representations formed with innate representation systems.

Ritual and Mimesis

Shamanic rituals are similar to animal rituals involving group vocalizations, dancing, and enactments used for communication and group coordination and bonding. Animal rituals facilitate the flow of information to coordinate the behavior of members of a group. This ancient channel of communication evolved into a symbolic capacity of mimesis during hominid evolution, and into shamanic practices. The evolutionary basis of shamanic ritual is illustrated by shared features found in human shamanic rituals and animal rituals referred to as formalizations, fixed action patterns, and displays. Animal rituals provide mechanisms for communication and coordinating relations among members of a species by making internal information available to others. The primary biological function of ritual is to facilitate the flow of information to synchronize individual behaviors into group action by coordinating the responses of individuals.

Ritual communication involving group chanting is an expressive community

practice with deep evolutionary roots found in the song, call, and vocal expressive systems of animals. Vocalizations express emotional states, maintain social contact and group bonding, and enhance cohesion and unity of the group. Chimpanzees in territorial groups engage in excited synchronous singing and dancing, behaviors homologous with human rituals. Their activities include panting or hooting, foot stomping, tree hitting, and exaggerated leaps, as well as primitive dancing in a circle, which has been observed in captive chimps.

Shamanic rituals make use of mimetic processes. Mimesis is a prelanguage symbolic system based in bodily enactment, and it makes use of the uniquely human ability to entrain the body to external rhythms. Core to shamanic activity is mime and dancing, ritual enactments of struggles with the spirits combined with chanting, singing, and imitative vocalization. Humans have innate rhythmic modules of the brain that provide an expressive system for communicating emotion. This evolved to enhance social bonding and communication of internal states. Group ritual dances and vocal imitation of animals were among the first of human mimetic activities. Mimesis provides a basis for a shared culture through enacted symbolism, a backbone of ritual behavior and communication. These rituals express fundamental emotions and a mythic ethos that was enacted early in human evolution in activities involving collective participation.

Ritual Healing Responses in Evolutionary Perspective

Ritual healing embodies altruistic and caring behaviors characteristic of primates; it is a genetically based empathetic and emotional response to others' distress. There is an evolutionary basis for the social institutions concerned with sickness and healing. Common behaviors are used to express and respond to disease and injury. The healing response is a biological adaptation embedded in social behavior involved in supporting others and helping them, an autonomous response of the organism to counteract disease by restabilizing homeostatic balance through innate knowledge about self-healing. This response produces healing through psychosomatic mediation of physiological and hormonal changes.

As Fábrega shows, these healing adaptations reflect an evolutionary trend specialized in the hominid line to enhance harmony when sickness destabilizes social relations. The way chimpanzees respond to the ill, wounded, or dying illustrates that the healing response is a generalized ability within the hominoid lineage (humans and great apes). Fábrega attributes the origins of healing responses to biologically rooted sociality involved in the care of infants and children and helping needy relatives. Healing behaviors reflect the dynamics of parental investment, the care of the young, and self-care activities.

Healing abilities involve a response to emotional displays of others, manifested in expressions of empathy and sympathy. Responding to the pain, suffering, and distress of others draws on one's capacities of empathy, compassion,

and altruism. Healers have the ability to interpret others' signals to assess their conditions. This engages an innate module, the capacity to make appropriate attributions to others and inferences of their needs. Healing requires awareness of self and others, knowledge of others based on social attributions, and empathic internalizations. Healing abilities involve mechanisms underlying social exchange, sharing, and reciprocity, particularly social bonds among family, kin, and social alliances.

These face-to-face interactions among family and group members contributed to the evolution of spiritual and religious concerns. The innate healing impulses of the human lineage are directly related to concerns involving religiosity. Healing behaviors were necessarily linked to awareness of death, since sickness often ends in death. This linkage of healing and death extends healing relations into care of the deceased and ideas about the afterlife, spiritual domains, and ultimately religion. This dynamic of addressing death was incorporated into the shaman's role and shamanic healing practices. These adaptations for healing through group ceremonies helped produce a number of levels of integration within the group from biological through social, psychological, and cognitive levels.

The community rituals fundamental to shamanistic healing practices produce psychosocial influences through community cohesion and social support, and biosocial effects involving bonding and attachment mechanisms mediated by the opioid system. Shamanic healing rituals produce a release of endogenous opiates in several ways. The presence of social others with strong affective bonds evokes innate releasing mechanisms, and procedures such as austerities, fasting, water restriction, strenuous exercise, and hyperstress of emotions evoke the opioid responses. Opioid release enhances affective bonding and produces psychobiological synchrony within the group.

Ritual evocation of the opioid release and the enhanced social bonding produce emotional and physiological associations with ceremonial symbols. These simultaneous associations produce cross-conditioning of symbolic and biological systems, linking physiological, mythological, and personal levels of the organism and providing mechanisms for symbolic elicitation of physiological responses. Opioids provide healing through stimulation of the immune system, enhanced psychosocial bonding, and benefits of euphoria, certainty, and belongingness. Opioids also enhance coping skills, maintenance of bodily homeostasis, pain reduction, stress tolerance, environmental adaptation, and group synchronization at biological levels.

Shamanism and the Triune Brain

Shamanic practices integrate what MacLean calls the triune brain, three evolutionary strata—the reptilian brain; the paleomammalian (limbic or emotional) brain; and the neomammalian (frontal cortex and symbolic) brain—that manage behavioral, social-emotional, and symbolic information. These three

levels use distinctive thought processes and provide the basis for different behavioral, psychological, and mental functions. The reptilian brain mediates basic behaviors, the paleomammalian brain provides the emotional influences, and the neomammalian brain uses symbols to integrate basic behaviors and emotions with higher-level information processing. The reptilian and paleomammalian brains are fundamental to basic behaviors and emotions that underlie social interaction, but they tend to operate outside of awareness of the frontal neomammalian brain. Interactions among these levels of the brain are principally through nonlanguage forms of representation, primarily a visual information processing system operating on intuitive representations, affective associations, and subsymbolic processes from a level prior to that of verbal language.

In shamanic ritual, the neomammalian brain, which provides the basis for symbolic processes, language, and culture, receives information produced in lower brain structures. Ritual processes activate connections between the reptilian and paleomammalian brains, providing information from these lower systems to the symbolic mechanisms of the frontal brain. This engagement permits the symbolic reprogramming of the emotional dynamics and behavioral repertoires of these lower centers of the brain through the “language” of ritual and their psychophysiological effects.

Ritual and the Reptilian Brain

The reptilian brain’s programs underlie stereotyped behaviors—instincts, survival activities and daily routines, behavioral communication, and repetitively structured social interaction. The relationship of ritual to functional brain structures is revealed in the cross-cultural similarity in the behavioral, ideational, and structural features of rituals and their relationship to characteristics of the biologically based obsessive-compulsive disorder. Obsessive-compulsive disorder and sacred rituals share concerns about the necessity of appropriate behavior; pollution and purity; fear about something terrible happening to oneself or significant others; the integrity of the self and relationships with significant others; bodily processes, secretions, and grooming; sexual impulses and aggression; thresholds or entrances; and the special significance of colors. These are central to the functions of the reptilian and paleomammalian brains.

The correspondences of sacred rituals with features of obsessive-compulsive disorder indicate that human rituals reflect a specific human neurological capacity and compulsion, a drive with a neurophysiological basis. Dulaney and Fiske hypothesize this must be similar to the neurological mechanisms underlying obsessive compulsive disorder, involving functions of the basal ganglia (of the reptilian brain) and its management of fixed action patterns and species-typical self-protective behaviors. Basal ganglia are central to motor control and have circuitry that extends to the thalamus and frontal cortex to coordinate complex motor acts. The basal ganglia also engage previously

learned rules that are based on environment and context. Serotonin mechanisms are directly implicated in obsessive-compulsive disorder behaviors, as serotonin reuptake inhibitors are effective in reducing the behaviors.

Other common features of rituals and obsessive-compulsive disorder behaviors associated with reptilian brain management are routinization and temporal sequencing of behavior; rigidly structured subroutines; isopraxic behaviors (performed in the same way or manner) used in interspecies recognition; tropistic behaviors (unlearned responses manifested in innate motion patterns and fixed action patterns); repetitious or preservative behaviors involving repeated performances of meaningfully interrelated specific acts; re-enactment behavior involving ritualized repeated actions; and deceptive behaviors.

Ritual and the Paleomammalian Brain

Ritual concerns with fear about threats to the integrity of self, relations with significant others, bodily processes, grooming, sexual impulses, and aggression implicate the paleomammalian brain. This brain level mediates emotions and one's sense of self derived from the attachments to others, and regulates sexual feelings, compulsions, species preservation activities, and the emotional behaviors of anger, aggression, protection, caressing, and searching. The paleomammalian brain manages attachment needs and emotional security produced by relations with family and others, mediating social signaling that promotes a sense of community and cooperation that enhances human survival. Facial expressions, vocalizations, and gestures provide information about others' minds and their emotions. The paleomammalian brain integrates emotions into behavior, manages expressive emotional states related to sociability, and regulates the interaction of organic systems and psychosocial dynamics, guiding behavior required for self and species preservation.

Fundamental to shamanic healing is the symbolic manipulation of paleomammalian brain processes that have profound physiological effects on the organism and the autonomic nervous system. The relationships among innate drives, social and biological needs, and social and cultural influences produce many kinds of health problems: conflicts, anxiety, fears, behavioral disorders, excessive emotionality, obsessions, dissociations, and repressions. Personal well-being is deeply intertwined with a sense of community, a social identity where empathy with other humans provides the basis for self and security. The paleomammalian brain and its social and self activities are managed by ritual practices that manipulate emotions, social attachments, and interpersonal relations to achieve therapeutic effects. Shamanic ritual, especially altered states of consciousness, activates limbic brain linkages with the reptilian brain, driving the representations of these preverbal processes into the frontal cortex and conscious experience.

Altered States and Integrative Consciousness

Central to shamanic practice is ecstasy, or an altered state of consciousness. Shamanic altered states of consciousness are typically referred to as a soul flight or journey, with basic structural and experiential characteristics similar to modern astral projection and out of body and near death experiences. Shamanic altered states are typically induced through singing, chanting, drumming, and dancing. Other practices facilitating induction of altered states of consciousness include fasting and dehydration, prolonged periods of sleeplessness, overnight activities and the deliberate induction of dreams through incubation processes, extreme temperature exposures, painful mutilations of the body, and ingestion of hallucinogens, emetics, and other plant medicines.

The diverse practices used to induce altered states of consciousness share overall physiological effects. Shamanic altered states typically activate the sympathetic division of the autonomic nervous system (through activity or drugs) to the point of exhaustion and collapse, with dreamlike vivid internal visual and emotional consciousness. The collapse is a physiological response like sleep and dreaming, evoking the body's relaxation response and natural recuperative processes. This natural response is a basic mode of consciousness involving elicitation of slow wave discharge patterns that produce synchronized brain waves. These wave patterns synchronize across functional levels of the brain, producing physiological, behavioral, and psychological integration. This integrative mode of consciousness can be evoked by many practices, reflecting its basis in a natural response of the brain.

Shamanic altered states of consciousness are typically characterized as a soul journey, an out of body experience where an aspect of the person leaves the body. Altered states of consciousness engage the same nonverbal symbolic process that underlies dreaming. Shamans use this process to enhance awareness and create self-transcendence. Hunt characterizes the shaman's altered state as a complex synesthesia producing a third-person perspective on self by taking the perspectives of the "other" toward one's self. The symbolic representation of the soul's flight is reflected in meanings of *ecstasy* in the Greek root *ekstasis*, "to stand outside oneself." The soul flight provides a self-reference linked to and apart from the "body image," a natural symbol system derived from neurognostic models for organizing experience. This hardwired body image constitutes a neurological foundation for all human experience and knowing, making the body foundational to all metaphoric or analogic thinking. This universal body-based representational system provides a template for human symbolism at all levels of organization, from metabolic levels through self-representation and advanced conceptual functions.

Analogical Thought in Shamanism

A number of the fundamental features of shamanism—animism, totemism, and animal spirits—also reflect preverbal representational systems produced

by innate processing modules. These shamanic universals are based in representations of self, processes of mental attributions regarding self and social others, and natural history intelligence, a specialized capacity for differentiating animal species. Central to these shamanic beliefs is the use of an epistemology or “theory of mind” involving the attribution of mental states to others based on one’s own mental states and feelings. This tendency to attribute one’s own qualities to others is extended to the unknown, leading to the perception of spirits with characteristics that reflect the dynamics of social and interpersonal relations.

Fundamental to shamanism is a universal of religion: animism, or the spirit world. Animism involves an understanding of the unknown through the use of innate representation modules for understanding self. Human mental, self, and social capabilities are projected onto animals or other parts of the natural environment and the unknown. One’s own mental states serve as a model for the “other.” The spirits engaged in shamanic healing practices are “sacred others” that represent personal qualities and social expectations, and they provide models for self-development and individuation.

Animal allies, guardians, and totems enable representation of diverse personal and social qualities through the innate systems provided by the natural history module. This specialized capacity for organizing knowledge about animal species provides a natural analogical system for creation of meaning, differentiation of self, and formation of personal and social identities. Shamans use spirits to manipulate self and identity, engaging symbolic complexes that operate independent of ordinary awareness. This produces healing by restructuring and integrating unconscious dynamics, and mediating between different instinctive levels of the brain and a hierarchy of goals.

Self-transformations underlie the shamanic death and rebirth experience involving attacks by spirits leading to the experience of death and dismemberment. The subsequent reconstruction of the body provides spirit allies and powers. This is a natural process of self-transformation that occurs under overwhelming stress. Laughlin and colleagues view this breakdown of ego structures as an “autosymbolic image” that activates innate drives toward the psychological integration that constitutes a basic aspect of shamanic healing.

Shamanic Therapeutics

Shamanism involves a variety of healing capacities based in altered states of consciousness, ritual, community bonding, psychosocial and psychobiological interactions, and symbolic healing processes. Shamanic healing is biological, psychological, and social, addressing many levels of human well-being, and it takes place in a social context that links the individual with the community. Core shamanic concepts of disease include soul loss/retrieval, object intrusion/extraction, and possession/depossession.

Soul loss, or power animal loss, represents the loss of or injury to the personal essence of an individual. It is manifested in disharmony in life and

feelings of disconnectedness with others. Soul recovery restores a sense of identity and emotional well-being through therapeutic processes involving the participation of the entire community, providing healing through enhanced social bonding.

Possession is more associated with other shamanistic healers rather than core shamanism, but it is treated by shamans. Possession is the control of a person by spirits. It produces changes in personality, consciousness, or awareness, and it is interpreted in Western traditions as psychiatric illness. Possession may also have important positive cultural functions in diagnosis, healing, self-development, projection of responsibility, personal expression, and intragroup mediation. Possession may constitute an empowering aspect of the professional development of mediums, who acquire powers by being possessed by spirits.

A number of shamanic capacities depend on or are enhanced by a genetically based propensity underlying hypnotic susceptibility. McClennon illustrates how the shamanic healing capacity builds on inherited qualities related to hypnotizability, which produces physiological and psychophysiological responses through suggestibility. Hypnotic induction enhances belief and expectation, producing placebo effects with physiological consequences. Hypnotic capacities in other primates suggest it was an ancient adaptation that provided mechanisms for reducing stress and engaging the relaxation response. Altered states of consciousness are induced by a general tendency toward hypnotizability. Shamanism exploits tendencies toward hypnotizability, dissociation, fantasy proneness, and thin cognitive boundaries to enhance connections between unconscious and conscious aspects of the mind. Shamanistic rituals stimulate therapeutic states of consciousness, derived from the hominid capacity for hypnotizability that facilitates psychosomatic change and healing.

Shamanism integrated a mammalian caring heritage into community rituals to provide humanity's original spiritual, biological, psychological, and social healing practices. These practices provide:

- physiological effects of altered states of consciousness and elicitation of parasympathetic responses and the opioid and serotonergic neurotransmitter systems.
- symbolic-psychophysiological dynamics from ritual manipulation of emotions, self-structures, and the nervous system.
- plant medicine, particularly hallucinogens or psychointegrators.
- social therapies engaging community participation and social symbol systems engaging self-development.
- psychological and self therapies engaging spirits as psychocultural systems, and innate psychological dynamics of the self represented in animal spirits and death and rebirth experiences.

Shamanic ritual evolved as a system for managing the relationships among innate drives and needs, social bonding processes, and cultural representational systems, providing a system for managing health problems derived from anxiety, fears, conflicts, excessive emotionality, obsessions, and compulsions.

The concept of shamanism has undergone rehabilitation. Once dismissed as a delusion or fraudulent manipulation, it is now perceived as an adaptive form of spiritual healing embedded in human biology. The biogenetic model of shamanism provides a paradigm for interpreting ancient human cultural activities, the rise of modern symbolic consciousness, and the worldwide distribution of strikingly similar healing practices. These universals of shamanism reflect an evolved psychology; a biological, psychological, and social dynamic of thought; and a healing and community integration with deep evolutionary roots in the hominid heritage. Shamanic practices continue to be relevant in the modern world, responding to humans' innate healing needs and capacities.

Bibliography

- Clottes, J., and D. Lewis-Williams. *The Shamans of Prehistory: Trance and Magic in the Painted Caves*. New York: Harry Abrams, 1998.
- Donald, M. *Origins of the Modern Mind*. Cambridge, MA: Harvard University Press, 1991.
- Dulaney, S., and A. Fiske. "Cultural Rituals and Obsessive-Compulsive Disorder: Is There a Common Psychological Mechanism?" *Ethos* 22 (1994): 243–83.
- Eliade, M. *Shamanism: Archaic Techniques of Ecstasy*. New York: Pantheon, 1964.
- Fábrega, H. *Evolution of Sickness and Healing*. Berkeley: University of California Press, 1997.
- Fiske, Alan, and Nick Haslam. "Is Obsessive-Compulsive Disorder a Pathology of the Human Disposition to Perform Socially Meaningful Rituals? Evidence of Similar Content." *Journal of Nervous and Mental Disease* 185:4 (1994): 211–22.
- Frecska, E., and Z. Kulcsar. "Social Bonding in the Modulation of the Physiology of Ritual Trance." *Ethos* 17:1 (1989): 70–87.
- Hunt, H. *On the Nature of Consciousness*. New Haven, CT: Yale University Press, 1995.
- Laughlin, C. "Body, Brain, and Behavior: The Neuroanthropology of the Body Image." *Anthropology of Consciousness* 8:2–3 (1997): 49–68.
- Laughlin, C., J. McManus, and E. d'Aquili. *Brain, Symbol, and Experience toward a Neuropsychology of Consciousness*. New York: Columbia University Press, 1992.
- Lewis-Williams, D. *The Mind in the Cave*. London: Thames and Hudson, 2002.
- Mandell, A. "Toward a Psychobiology of Transcendence: God in the Brain." In *The Psychobiology of Consciousness*, ed. D. Davidson and R. Davidson, 379–464. New York: Plenum, 1980.
- McClennon, J. *Wondrous Healing: Shamanism, Human Evolution, and the Origin of Religion*. DeKalb: Northern Illinois University Press, 2002.
- McLean, P. *The Triune Brain in Evolution*. New York: Plenum, 1990.
- Rapoport, J., and A. Fiske. "The New Biology of Obsessive-Compulsive Disorder: Implications for Evolutionary Psychology." *Perspectives in Biology and Medicine* 41:2 (1998): 159–75.
- Winkelman, M. "Altered States of Consciousness and Religious Behavior." In *Anthropology of Religion: A Handbook of Method and Theory*, ed. S. Glazier, 393–428. Westport, CT: Greenwood, 1997.
- . "Magico-Religious Practitioner Types and Socioeconomic Analysis." *Behavior Science Research* 20:1–4 (1986): 17–46.

- . “Shaman and Other “Magico-Religious Healers”: A Cross-cultural Study of Their Origins, Nature and Social Transformation.” *Ethos* 18:3 (1990): 308–52.
- . “Shamanism and Cognitive Evolution.” *Cambridge Archaeological Journal* 12:1 (2002): 71–101.
- . “Shamanism as Neurotheology and Evolutionary Psychology.” *American Behavioral Scientist* 45:12 (2002): 1875–87.
- . *Shamanism: The Neural Ecology of Consciousness and Healing*. Westport, CT: Bergin and Garvey, 2000.
- . *Shamans, Priests, and Witches: A Cross-cultural Study of Magico-Religious Practitioners*. Anthropological Research Papers 44. Tempe: Arizona State University Press, 1992.
- Winkelman, M., and W. Andritzky, eds. *Sacred Plants, Consciousness, and Healing: Yearbook of Cross-cultural Medicine and Psychotherapy*. Vol. 6. Berlin: Verlag und Vertrieb, 1996.

69 Spiritual Healing in the Ethiopian Orthodox Church

Getatchew Haile

Spiritual healing—healing effected by a supernatural power—takes numerous and widely followed forms in Ethiopian religious life. Ethiopian Orthodox Christianity not only serves the spiritual needs of the faithful but also attends to their bodily ailments and social ills. Undoubtedly, the widespread appeal of spiritual healing and the specific practices discussed below were informed both by the manner in which Christianity came to Ethiopia and by the country's historic isolation and underdevelopment.

Christianity was first introduced to Ethiopia by Red Sea traders, most likely in the first century. It was elevated to the status of state religion in the fourth century, following the emperor's conversion to the new religion and the ordainment of bishops who were dispatched from Alexandria to serve in the country's major cities. The new religion was thus superimposed, as elsewhere, upon the native culture, and elements of that pre-Christian culture—such as the belief in sorcerers and the power of black magic—survived within the framework of Ethiopian Christianity. Furthermore, the populace's openness to spiritual healing was reinforced by Ethiopia's poverty and lack of access to medical science. In the absence of alternatives, people often had no choice but to seek the spiritual healing promised by the religious literature.

Moreover, whether because Judaism took root in Ethiopia before Christianity, as tradition maintains, or because those who brought Christianity to the country were Christians with Jewish backgrounds, Judaic practices are well preserved in Ethiopian religious life.

The Causes of Illness

According to the teachings of the Ethiopian Orthodox Church, illness has spiritual causes. One reaches this conclusion from the basis of the ritual of the Unction of the Sick (James 5:13–15):

Are any among you suffering? They should pray. Are any cheerful? They should sing songs of praise. Are any among you sick? They should call for the elders of the church and have them pray over them, anointing them with oil in the name of the Lord. The prayer of faith will save the sick, and the Lord will raise them up; and anyone who has committed sins will be forgiven.

Ethiopian clergy have understood the message of this biblical text to be that prayer heals the sick and also that sickness is the direct result of sin. Natural disasters—such as earthquake, drought, famine, and epidemics—are understood as God’s punishment for the nation’s ungodly life. This belief has been emphasized in several sources, especially in a homily (which has not been translated into any Western languages) composed in honor of the archangel Michael. The homily specifies that all kinds of diseases are caused by demons ordered by the Lord to attack sinners. The demons carry out their orders swiftly to inflict illnesses on individuals or bring natural disasters to a given region. They are not, however, allowed to take lives; death is the domain of the Angel of Death.

The hagiographical story of Krəstos Sämra, a fourteenth-century Ethiopian saint who lived at the time of the bubonic plague known as the Black Death, details the social life of these demons, using, not surprisingly, the terminology of feudal Ethiopia. From this text we learn that the demons’ existence replicates the worldly kingdom (of Ethiopia). The demons marry, produce children, grow old, and die. They serve a king who has an army with generals, lieutenants, majors, captains, and noncommissioned officers. This army launches campaigns to bring plagues and other punishments to designated regions in ways that echo the actions of feudal armies. For the Ethiopian faithful, who have until very recently lived within such a monarchical system, it has been easy to recognize the sort of social and military organization described in the sources.

The belief that disease is caused by demons was reinforced by the hostility to medicine set forth in the *Sinodos*, which was translated into Ethiopic (or Gə‘əz, the language of the Ethiopian Orthodox Church) and became the official canon law of the church, probably as early as the seventh century. In one of its articles, the *Sinodos* condemns the use of medicine for combating illnesses. Instead, the text recommends that the faithful sprinkle holy water or rely on exorcism to cast out evil spirits, “the cause of all kinds of diseases.”

The influence of the *Sinodos* is illustrated in an incident documented in the history of Ḍṣṭifanosite monks who lived in the fifteenth century:

There was a monk who lived in the neighborhood of [the Ḍṣṭifanosite monks in exile], who’s name was Yafqərännä Ḍgzi’. He was a physician [*bä’alä fäws*]. He cut plants and dug the ground for roots. He [prepared] some [of them] as a potion, some as a salve, and some as a spray. For this reason, people liked him and received him very well. . . . Then [the Ḍṣṭifanosite monks] met this monk and talked about religious matters and about abiding by the rules of the law of the New and Old Testaments. He took a liking to them and asked them to visit him. When they

came to his house, they saw leaves steeped in water. They asked him, "What is this?" He answered them, "Cure [*fäws*]." They said to him, "Why do you do [this]? Is this not vain? Our fathers, the Apostles, have said [in the *Sinodos*], 'If there is anyone who comes to our law [i.e., converts to Christianity] who practices medicine [*šərayat*], let him either abandon [the practice] or be expelled.' And you, as a monk, do not do [things] like this." [This] did not please the monk.

It displeased not only the monk "Doctor" Yafqərännä Əgzi', but also the patients he treated and all who wished well for the nation. For the Church medicine is both a form of sorcery and black magic; all are called *šəray* (or *šərayat*, plural). Whether or not it is enforced, the book of Penance contains, in fact, an article of penance against one "who seeks medicine for his body."

The Ailments

Throughout its recorded history, Ethiopia has suffered from debilitating natural disasters and difficulties. Historical documents show that over the centuries the populace has sought supernatural or spiritual help against a wide range of problems or conditions. Physical ailments detailed in the sources include eye disease, stomachache, liver ache, rheumatism, wounds or lacerations, colic, bleeding (menstruation), smallpox, fever or malaria, alopecia, nausea or vomiting, diarrhea, syphilis, gonorrhoea, goiter, cancer, rabies, sudden death, infant death, epilepsy, chapping, itch, jaundice, leprosy, cough, facial melanosis, acne, gum disease, backache, blockage of the urinary tract, tuberculosis, and snake bites. Natural disasters to be combated were wild animals, especially hyenas that attacked donkeys and goats, leeches, hail, fire, thunderstorms and lightning, frost, and drought. Regarding human relations, the medical documents address impotence, shyness, barrenness, malicious tongue, and the challenge of winning a woman's love.

Other concerns reflected the needs of specific groups. Ethiopian students, for example, have always been interested in medicines that help them to learn quickly and retain what they have memorized. This is because traditional Ethiopian education requires students to memorize every text studied, including the liturgical prayers, the numerous hymns, and biblical commentaries. Another such group is the *däbtära*, a class of clergy whose work it is to study and copy texts such as biblical scriptures and service books, to compose and sing hymns, and to play musical instruments. For them, there are prayers meant to improve manual dexterity for better penmanship and handling musical instruments.

Against this long litany of problems or concerns, the citizenry welcomed spiritual intervention, so much so that unscrupulous scribes seem to have taken advantage of and even defrauded believers, the majority of whom are illiterate peasants. The methods of intervention have been studied by European explorers ever since such travelers became interested in Ethiopian social history and culture.

The Healing Practices

Spiritual healing can be effected through a number of prayers and rituals involving different mediums, such as the cross or holy water or certain plants over which a prayer is uttered. Officially, such prayers come in variations of the well-structured ritual of the Unction of the Sick (based on James 5:13–15) and in appeals made directly to God or his saints. Unofficially, such treatments involve the combination of prayer with traditional African medicine, a practice sometimes called magic or magico-religious prayer.

The Unction of the Sick

In principle, Unction of the Sick is an official church sacrament. There are at least four versions of prayers used in this ritual. The first, in two recensions (revisions), is *Fäws Mänfäsawi* or “Spiritual Healing.” The second is *Mäṣṣafä Qändil* or “Book of Candle.” The third is *Mäṣṣafä Baḥrəy* or “Book of Pearl” and *Šälotä Zäyt* or “Prayer of Oil.” The fourth is *Mäṣṣafä Qedär* or “Book of Fate.” The first two came from the Coptic Orthodox Church of Alexandria, while the third is the creation of King Zär’a Ya’əqob, who drastically reformed the church in the fifteenth century. All three use oil and are intended to heal the sick spiritually and bodily. The fourth, the *Mäṣṣafä Qedär*, also came from Egypt, but its purpose is to cure the spiritual pollution caused by bodily intimacy with infidels (and all nonmembers of the Ethiopian Orthodox Church).

It is not clear which recension the clergy use when performing the ritual today. As the majority of churches in fact possess none of the three copies, it may be that (unlike the other rituals, such as for baptism or funeral) the church does not enforce the sacrament very strictly. In any event, if the sacrament is performed, there is a set of prayers common to all three versions, followed by special prayers and scriptural reading. Prayers are said over the water and oil that will be used in the ritual. The water is sprinkled over the sick person, and the oil is salved on designated parts of the body. Following the ritual, the sick person is expected to receive the Holy Communion, which could in fact be the reason the ritual is not widely practiced. Unlike in other churches, in the Ethiopian Orthodox Church only children and the elderly receive Holy Communion, which is considered a form of medicine. Holy Communion is the body of the savior of the world, or in the Ethiopic appellation, *Mädḥane ‘Aläm*, which if translated precisely means “healer or medicine of the world.” Children take Holy Communion to help them grow in good health, whereas the elderly take it to purify their body and soul before they depart. Unction of the Sick heals spiritual and bodily pain, the pain of sin and illness.

Amulets

Many religious manuscripts preserve curative prescriptions for illness. Some manuscripts detail what the sick person should do to cure a given ailment.

Other manuscripts are themselves cures or protection to be carried somewhere on the body. It is not unusual, for example, to see children in highland Ethiopia wearing *kitab*s (small scrolls or amulets) on their necks to ward off illness. Amulet scrolls are decorated with heads of angels whose eyes, as guardians, are wide open to catch demons and ward them off the carrier of the scrolls. Elaborated letters of the alphabet, called *ṭälsäm* (talisman), are added to the spell inscribed in the scroll. The content of one scroll may differ from another, but they are all amulets against evil spirits.

Tabots

The Ethiopian faithful believe that spiritual healing comes not only from God but also from his saints—archangels, desert fathers, and martyrs—who have the power to answer prayers through their *tabots*. Strictly speaking, a *tabot* is a container or ark in which the *ṣəllat*, supposedly a replica of the tablets of Moses, is placed. But by tradition, the term refers to both the container (the ark) and its contents (the *ṣəllat*). The *ṣəllat* is sculpted from wood or marble in the name of a saint such as Mary, archangel Michael, George, or Täklä Haymanot. It is then blessed by a bishop and is ceremoniously housed in the church dedicated to the saint.

The *tabot* is meant to serve as a tablet, placed on the altar, on which to break the Eucharist. But the faithful understand it as the personification of the saint to whom it and the church are dedicated. They also understand the church to be a house where the spirit of the saint resides, rather than just a memorial. Each day of the month is dedicated to one or more saints, either because the saint died on that day or a miraculous event attributed to the saint occurred on it. On regular days the faithful go to their parish church. But on a particular saint's day, they go, if they can, to the church dedicated to that saint, the assumption being that a saint hears prayers best when they are prayed in a church dedicated to him or her.

When a just person reaches the degree of sainthood, the Lord appears to the person to say that he is pleased with the person's dedication and devotion to him, and that the person will join the community of the other saints in paradise. According to Tadesse Tamrat, the saint asks the Lord for a covenant—his word, in return for the saint's endeavors—that he will answer the prayer of a person who prays in the saint's name and who is charitable to the poor or the church in the saint's name. Common charitable deeds include observing the saint's anniversary with almsgiving and building a church dedicated to the saint.

Asmat

“Demon-inflicted” calamities can be fought only by God and his saints. Therefore, any search for an effective cure concentrates on identifying tested and proven prayers. The starting point for such searches is an examination of the

words of the prayers of Jesus Christ. Christ used such prayers in healing the sick and raising the dead, and during his own agony just before his arrest and on the cross. Such prayers, it is assumed, must be very effective indeed. The teachers, especially the *däbtära*, believe that these same prayers can be used by others. They believe that these words are secret names, or *asmät*, of God. If invoked, they have the power to oblige the almighty to respond favorably. Some of these phrases have been recorded in the Gospels, such as *Tabitha cum* (Mark 5:41), which Jesus uttered when he raised the daughter of the leader of the synagogue, or *Eli, Eli, lema sabachthani* (Matthew 27:46), which he uttered on the cross. These are Aramaic sentences that the Evangelists, who wrote their gospels in Greek, kept in transliteration and that later, when the Gospels were translated into other languages, including English and Ethiopic, passed into them as well.

The idea of *asmät* has at times reached significant levels. For example, it is said that the authority Jesus gave to his disciples to cure the sick (Luke 10:9) and the keys of the kingdom of heaven which he gave to Peter (Matthew 16:19) were prayers containing secret names of God. The existence of such names is believed to have been recognized in the scriptures: "His eyes are like a flame of fire, and on his head are many diadems; and he has a name inscribed that no one knows but himself" (Revelation 19:12).

Over the course of time, the number of these prayers increased dramatically. Some were locally produced and some were translated and transliterated from the Arabic-speaking world, Christian as well as Muslim. Despite the fact that the church is officially opposed to *asmät* prayers, they have become an important part of Ethiopic literature. Indeed, the clergy have divided certain prayers into seven parts so that they may be used on each day of the week. The prayers are technically an underground practice, but judging from the number of copies of this weekly prayer book in the Ethiopian Manuscript Microfilm Library's collection of manuscripts, one wonders whether there are any church authorities who do not have their own copy.

In the fifteenth century, King Zär'a Ya'äqob (1434–1468) claimed that several palace dignitaries, including his own son and brother-in-law, were plotting to overthrow him with the help of *asmät* prayers and sorcerers. He wrote a series of treatises describing the prayers and other "black magic" as evil and un-Christian, and he issued royal decrees proscribing their practice. Despite the inhumane punishments meted out for violation of the decree, however, Zär'a Ya'äqob was not successful in eradicating the practice. To the contrary, the wording of his decree actually encouraged the use of *asmät*. The king wrote that only the names of God from the church's canonical books should be invoked, and some of the *däbtära* found ways to convince their clients that their *asmät* were, indeed, secret names from reliable sources. For example, the apocryphal prayers of Mary, whom King Zär'a Ya'äqob adored, are replete with the so-called names of God. The Blessed Virgin was said to have

secured some of these names from her son by insisting that he tell them to her: “Tell me your name.”

Asmat prayers are not only curative and protective but can also be aggressive. Examples of *asmat* prayers affirmatively deployed against an enemy are the prayers supposedly used by Moses when he appeared before the pharaoh of Egypt and by David when he faced Goliath.

Holy Water

Täbäls, springs of water believed to be holy and to have the power to heal the sick, are found throughout the country. They are discovered when a messenger of God appears in a dream to a child or an elderly person (that is, an innocent and pure person, usually abstaining from sexual intercourse) and tells the person that in such and such place a *täbäl* has sprung in the name of such and such saint. The incident usually happens close to a church dedicated to that saint. As soon as the *täbäl* shows its healing power with one or two sick people, its fame is quickly broadcast, and the afflicted flock to it from far and near.

Practically every *täbäl* is crowded with the sick and with others who are there to obtain a jar of holy water for those who cannot make the journey themselves. Visitors drink the *täbäl* or baptize themselves with it, and stories are abundant of people who go home healed from all kinds of ailments—skin disease, liver, kidney, and heart problems, and even cancer. The reliance on *täbäls* undoubtedly reflects the scarcity of rural health centers. Moreover, consistent with the belief in the spiritual source of illness, people often have more trust in *täbäls* than in physicians.

Some *täbäls* are believed to be particularly effective and are especially famous. People do not question this relative effectiveness even though the source of each *täbäl*'s power is one and the same. For the sick, the difference is just like the difference between a famous physician and another who is less famous. If a person is not healed at one *täbäl*, he or she visits another.

The Vow

Another popular means of spiritual healing is through *sälät*, or “vow,” or *bəz'at*, “dedication” or “promise as a reward.” The word *sälät* comes from a verb that means “to ask in prayer, to beseech, or to solicit.” It emphasizes the request, while *bəz'at* puts more weight on the promised reward. In practice, *sälät* and *bəz'at* are promises a person in difficulty makes to a saint in exchange for the saint's intervention on that person's behalf. The faithful address all imaginable difficulties in *sälät*. Sick people, barren women, and families who have lost children or domestic animals are common supplicants. The *sälät* may be made by the person in distress or on that person's behalf by close relatives.

The promises made are often quite impressive. A person might promise to

buy a carpet or a richly decorated ceremonial umbrella, to deliver gold or cash or an animal to the saint's church, or to make a pilgrimage of many miles to the church, with part of the journey to be made on the knees. A *sälät* or *bəz'at* made to a saint must be paid at the church where, or to whom, it was made, and this form of spiritual intervention is so popular that the income some churches receive from these vows surpasses their annual budget.

Some saints are believed to be more responsive than others. For example, Gabriel of Qullubi, in Harerge, is famous nationwide for answering prayers more favorably than other saints, even more so than the same Gabriel venerated in other churches and localities. On Taḥśás 19 (December 28), the annual feast day of Saint Gabriel, flights to Qullubi are fully booked, trains are packed, and the roads leading to the church are full of pilgrims arriving on foot. The Qullubi Gabriel pilgrimage is similar to the pilgrimages believers make to several holy places in southern France, and the pilgrims often include foreigners and parishioners from other dioceses whose churches are also dedicated to Saint Gabriel.

Black Magic

The literature on spiritual healing shows that, in traditional Ethiopia, black magic (*śaray*) was universally dreaded. For example, people believe that an enemy—a rival or a disputant (usually a litigant in court)—could go to a *däbtära* to seek help in destroying them by harnessing the harmful power of demons. The sources reflect a relatively large amount of literature dedicated to undoing the *śaray*, called *mätəhe śaray*, and hardly any for actually performing the *śaray*. The most notorious black magic is that of the *andärəbbi* demon. It is believed that this evil demon can burn or raze houses if unleashed against its inhabitants; it is said to have the power to change food to dung or other filthy matter. Again, the manuscripts contain no trace of the spells that could be used to command the *andärəbbi* spirit. Nevertheless, the fear of black magic, *andärəbbi* or otherwise, is both widespread and deep.

The Five Hundred and Eight Medicines

The widespread belief that bacteria and viruses are literally demons has discouraged scientific examination into the actual causes of illnesses and their cures. However, there is an interesting popular anecdote about medicine that indicates Ethiopia could have become an important center of medical research. According to this story, when King Solomon asked God to tell him the means for healing (*fäws* or “medicine”), the Lord said to him, “I have given you five hundred and eight plants [trees, herbs, and shrubs] by which you may be healed. The bees will tell you [or] take honey.” This story might have encouraged the search for many beneficial plants in the dense woods of Ethiopia, but any interest in such research was discouraged by the adoption of the *Sinodos*.

Happily, however, the prohibition has not been totally observed: the *däbtära* have developed an impressive list of medicine extracted from plants. The major sources have been published by Stefan Strelcyn in his voluminous *Médecine et plantes d'Éthiopie les traités médicaux éthiopiens*, the “Geez-Amharic Magic Manuscript” studied by Thomas L. Kane, in the “Ethiopian Text-Book” compiled by Gerazmač Gäbräwäld Arägahāñ, and in the British Library Ethiopic manuscripts edited by Haddis Gabra Masqal in his *Mashafa Madhanit*. Undoubtedly, some of these medicines are effective. The most well-known of all is the *koso*, used against tapeworm, which one gets from eating raw meat, considered a delicacy in Ethiopia. Kane defines *koso* as a “tree resembling the sumac (*Hagenia abyssinica* . . . or *Brayera anthelmintica* . . .) which bears a flower used to make an anthelmintic medicine.” *Koso* is so bitter that it and *ret*—aloe—are used to define the term “bitterness.” A less bitter medicine, which is also effective against tapeworm, is the *əqnoqqo* fruit (*Embelia ashimpera*). Most of the other medicines listed in these volumes, however, await scientific investigation to prove their efficacy.

Bibliography

- Budge, E.A. Wallis. *A History of Ethiopia: Nubia and Abyssinia*. Vol. 1. 1928. Reprint, Oosterhout, The Netherlands: Anthropological Publications, 1970.
- Getatchew Haile. “The Case of the Ἐstifanosites: A Fundamentalist Sect in the Church of Ethiopia.” *Paideuma* 29 (1983): 115–16.
- . *A Catalogue of Ethiopian Manuscripts Microfilmed for the Ethiopian Manuscript Microfilm Library, Addis Ababa, and for the Hill Monastic Manuscript Library, Collegeville*. Vol. 9. Project Numbers 3501–4000. Collegeville, MN: Hill Monastic Manuscript Library, 1987.
- Haddis Gabra Mascal. *Mashafa Madhanit: Traditional Ethiopian Medicine*. London: 1988.
- McCrinkle, J.W. *The Christian Topography of Cosmas, an Egyptian Monk*. London: Hakluyt Society, 1897.
- Mercier, Jacques. *Ethiopian Magic Scrolls*. New York: George Braziller, 1979.
- Rufinus. *Historia Ecclesiastica*. In *Patrologia Latina*, ed. J.P. Migne, vol. 21, cols. 478–80. Alexandria, VA: Chadwyck-Healey, 1995.
- Strelcyn, Stefan. “Les Ecrits Médicaux Ethiopiens.” *Journal of Ethiopian Studies* 3:1 (1965): 82–103.
- Tadesse Tamrat. *Church and State in Ethiopia 1270–1527*. New York: Oxford University Press, 1972.
- Tsehai Berhane Selassie. “An Ethiopian Medical Text-Book Written by Gerazmač Gäbräwäld Arägahāñ Däga Damot.” *Journal of Ethiopian Studies* 9:1 (1971): 95–180.
- Ullendorff, Edward. “Hebraic-Jewish Elements in Abyssinian (Monophysite) Christianity.” *Journal of Semitic Studies* 1:3 (1956): 216–56.

70 African Traditional Medicine: Healing and Spirituality

Adam K. arap Chepkwony

The various cultures of Africa have practiced their own systems of medicine from time immemorial, and these traditional methods persist today, in spite of the infiltration of Western culture and medical practices. The traditional experts are known as healers, while the practice is referred to as healing. According to Tessema, an African traditional healer is someone the community recognizes as “competent to provide healthcare by using vegetable, animal and mineral substance and certain other methods based on the social, cultural and religious background as well as on the knowledge, attitudes, and beliefs that are prevalent in the community regarding physical, mental, and social well-being and the causation of disease and disability.” Healing, on the other hand, is “the sum total of all the knowledge and practices, whether explicable or not, used in diagnosis, prevention and elimination of physical, mental or social imbalance and relying exclusively on practical experience and observation handed down from generation to generation, whether verbally or in writing.”

Africans harnessed their knowledge of medicine over a long period of time. They acquired the knowledge by observation and experimentation. According to Dopamu, it is the African curiosity that led them to a knowledge of phenomena through observation of animal and plant behavior, and to the discovery of the therapeutic properties of natural objects. The approach of observation and experimentation makes healing in Africa a scientific inquiry like any other medical or scientific endeavor.

However, the use of African medicine goes well beyond mere scientific findings of the healing ingredients. Instead, the African traditional worldview emphasizes the interrelatedness of healing and spirituality. The efficacy of traditional medicine is always interpreted as the work of a supreme being. This makes the practice of medicine in African traditions more of a religious than scientific activity. Dopamu tells us that medicine, magic, and religion

“all operate on the belief that there is a transcendental power, the supernatural, a power which is beyond man.”

No healing can take place simply because the herbs administered to a sick person contain curative elements. Instead, healing is realized due to the intervention of the supreme being. Among the Kipsigis of Kenya, for instance, as medicine men and women give a potion to a patient, they pronounce that theirs is to administer the medicine, while it is God who heals.

Healing in the Precolonial Period (before 1900)

In the precolonial period, traditional healers controlled the entire discipline of medical science in Africa. They were found in every society and in each locality. Both men and women practiced the trade. These were God-fearing individuals who were blessed with talents and skills of healing. In turn, they rendered their services to people for a modest fee, normally regulated by the community to avoid exploitation. The healers can be classified in various categories, such as medicine men and women, diviners, mediums, seers, priests, and ritual elders.

Medicine Men and Women

Medicine men and women differed in their approach and skills. Some acquired their knowledge through inheritance, some through revelation, and some through training and observation. They also differed in the sense that some specialized in certain diseases while others dealt with general ailments. Some concentrated on common physical diseases, while others specialized in surgery, bone fractures, or mental illnesses. The more complicated the disease, the fewer experts in that area, and often people had to travel long distances in search of specialized medical attention.

The majority of medicine men and women treated their patients with herbal formulations. The herbs were generally derived from roots, barks, leaves, and fruits. They also used bones, excreta, oils, skins, fur, feathers, fishes, other animal products, and other ingredients suitable for yielding medicinal extracts. These substances were usually processed into powders, liquids, or oils. Herbs were generally used to treat common ailments such as stomach upsets, malaria, migraines, asthma, arthritis, wounds, and skin ulcers.

The bone specialists, apart from using herbal jellies, adjusted sprained and fractured bones with dexterity comparable to any surgical operation today. Thairu describes surgeons as “specialized in the treatment of fractures and in suturing wounds and even in some cases in performing real operations.” Thairu further notes: “The best example of traditional surgery perhaps hails from Western Uganda. . . . It was recorded in 1884 that African surgeons from this region used to perform caesarean sections using sharp knives which were first heated till red hot and then dipped in beer.” Craniotomies were also performed in Kenya to help those with painful headaches.

Prayers always accompanied treatments and operations. It is also important to note that, apart from curative medicine, the medicine men and women also provided preventive and promotive medicine.

Diviners, Mediums, and Seers

Diviners, mediums, and seers acted as laboratory technicians to reveal the difficult and unique causes of illness that the medicine men and women failed to discern. Although some of them doubled up their specialty with medicine, the majority worked with medicine men and women in consultation. Their main responsibility was to find out hidden secrets and knowledge that would explain the major cause of illness. It was assumed that if a medical treatment failed, there was a hidden reason, which could only be revealed by a diviner, medium, or seer.

The diviners, mediums, and seers prayed to ancestors or the supreme being to reveal to them why someone continued to be unwell, the appropriate medication required, or which healer could ably assist them. Diviners mainly used items such as shoes, stones, or pebbles to cast lots and divine for their clients.

Mediums, mostly women, would go into a trance and allow the spirits to speak through them. Sometimes a medium would require the assistance of ritual drumming, dancing, and singing to become possessed in order to communicate with the spirit world. In such circumstances, the medicine person or the priest in charge of the medium would interpret the message, for the medium might not know or remember what transpired during the process. According to John S. Mbiti, the medium can reveal "Where to find lost things, who may have bewitched the sick, what type of ritual and medicine are necessary for the cure of people's troubles, whether an intended journey will be a success or not, which of the living dead may have a request to make and what kind, and many other things."

Seers, on the other hand, were the equivalent of biblical prophets. African seers had natural or God-given powers to know the future. They assisted the communities by warning them of impending calamities and events. Since the science of medicine in Africa also involved protective medicine, it was important for the medicine person to know what was to come. Knowledge of an impending epidemic, for example, could help the medicine person prepare people.

Ritual Elders

Ritual elders were men and women who performed healing rituals for individuals or for the entire community. Among them were priests, rulers, and rain callers. These men and women were well versed in all matters pertaining to their communities, such as religious knowledge, myths, beliefs, traditions, and religious practices. Every village had such ritual elders. Ritual practices were an indispensable aspect of African healing.

Ritual practices themselves served as remedies for certain illnesses, and in certain cases, medicines were accompanied by rituals for them to be potent. Rituals were also effective in treating certain diseases that were thought to be brought about by unsettled matters in one's life. Rituals were necessary for certain ailments that could not be resolved by words or herbs alone. Malidoma Patrice Some has summarized the importance of rituals thus: "As much as our body required food for nourishment, our souls and spirits require rituals to stay whole. It is as if without the spirit being nourished in us, the body pays for the consequences. The food of psyche is the symbol, and it is through ritual that our spirit is fed."

This African wisdom of healing through rituals enabled one to find new balance between the supreme being, community, environment, and the self. It is this balance and harmony with the rest of creation that restores, retains, and replenishes good health.

Healing in the Colonial Period (1900–1960)

The introduction of Christianity and the dawn of colonization in the nineteenth century marked the decline of the practice of healing in Africa. The missionaries and colonial governments looked down upon and greatly discouraged African beliefs and practices. Christian missionaries perceived Africans as pagans, superstitious, ignorant, and a lost lot in the abyss of darkness. The colonists believed that all African medicine was evil and their healers, or witch doctors, practiced "black magic." Concerted efforts were put in place by the colonists to accelerate the disintegration of the African social and religious fabric. Jomo Kenyatta, in *Facing Mount Kenya*, observed that the missionaries were "set out to uproot the African body and soul, from old customs and beliefs. . . . With all his tribal traditions shattered and his institutions trampled upon."

The attitudes of missionaries and colonists toward African beliefs greatly affected the African traditional healer and healing practices throughout Africa. The Africans believed that their God was the creator, the almighty, and most importantly, the healer and provider of all their needs. But the missionary churches admonished the new converts to refuse and disown all African healing practices and to reject the healers. Bascom and Herskovits report an early sermon by a priest among the Kikuyu of Kenya who taught African Christians to "trust God, do not trust the medicine man. . . . I know some of you are hiding amulets beneath your garments. Those can not protect you."

The teaching against African healers and healing practices was incorporated into the catechism. This was used to induct new converts into Christianity. The Catholic catechism of 1926, for example, states that the first commandment forbade "pagan practices," among which were "to believe in things forbidden by the church, like dreams, divination." Similarly, the catechism of 1947, stipulates that "the forbidden pagan beliefs are: to practice false medicine and amulets, to divine."

In the place of African healers and healing, the missionaries and colonial governments introduced Western doctors, modern medicine, and hospitals. Therefore, in the minds of the majority of Africans, Western medicine has always been associated with Christianity.

It is during this period that the institution of African medicine suffered most. The healers were forced to burn their healing regalia publicly and were forced to confess that the practice was evil. Due to such developments, African healers were threatened. It became not only unfashionable but criminal to pay homage to them and seek their specialized intervention. Indeed, it was illegal in Uganda to claim to be a healer. Anyone who did so risked imprisonment for up to five years. Tanganyika penalized those who claimed occult power or knowledge with a year in prison or a fine. Similarly, the Kenya ordinance of 1928 penalized any person who pretended to exercise supernatural powers.

The traditional healers thus treated their patients under great fear and with no external supervision at all. Whereas healing had been a public matter conducted in the public domain, it became a private and backroom matter performed in utmost secrecy. And Africa's most experienced healers died, leaving no one to take over and propagate their trade. At the same time, the most valuable herbs and healing practices were lost. Some herbs were taken abroad, where their ingredients were extracted, processed, and then returned to Africa as modern medicine for which the Africans had to pay dearly.

By the time most African countries started attaining their independence, the Christian teachings against African healers and healing were very strong. African Christians, the African elite, and African governments supported the missionaries in this campaign.

Healing in the Postcolonial Period (after 1960)

The Africa Regional Committee of the World Health Organization made a resolution in September 1990 that urged African governments to promote and develop the use of traditional and alternative medicine. Some countries have been rather slow in effecting this initiative. The use of traditional medicine in Africa has increased tremendously, however, in the last two decades. Traditional medicine is becoming more and more popular in many parts of Africa. This is prompted by the prohibitive costs of some commercial medicines, as well as their apparent failure to effectively combat certain illnesses. This is coupled with the fact that in many rural areas in Africa today, modern medical facilities remain grossly inaccessible to the majority of the population.

These are the major reasons that have prompted African governments to see the wisdom of seeking an integration of the two approaches to medicine. After all, a vast majority of Africans use the two medical practices concurrently. For indeed, the aims of the two are similar, and that is to make life more comfortable for humanity.

It is an indisputable fact that herbal medicine plays a major role in the

management of various illnesses that Western medicines have failed to address adequately. Referring to Yoruba healers, Dr. Samuel Akinnuli observes: “there have been many cases where orthodox medicine failed and the traditional medicine proved useful in the treatment of chronic diseases.”

The issue of African healing practices therefore is of importance for African countries. However, a number of issues need to be considered. First, Africans have used traditional medicine from time immemorial, and no one will deny that herbs and other healing processes in Africa are effective. The use of these healing methods is part and parcel of African culture. Yet, unfortunately, African and Western medics have failed to appreciate this valuable alternative therapy. Fortunately, there are signs that some are now beginning to acknowledge Africa’s contribution to the world of medicine and healing. This is essential if Africa is to improve the health care of its citizens.

Second, the biggest obstacle facing traditional medicine is lack of standards of measuring accurate doses and appropriate methods of production. Collaboration between traditional medicine and modern medicine can assist in organizing, distributing, and administering care for the sick.

Third, African traditional medicine is a secretive practice. The majority of traditional healers are reluctant to divulge their knowledge and skills to anybody. This attitude has created skepticism among conventional medical practitioners about the efficacy of traditional herbs. It has also allowed some individuals to falsely claim to be practitioners of African medicine. Legalizing traditional medicine will make sure that practitioners of African medicine are scrutinized, which will stop quack herbalists and other healers.

Finally, because of the secretive nature of African practitioners, it has not been possible to document the findings of African medicine. Thus the wisdom of African medicine is in danger of extinction. At the same time, it is open to abuse. If African medicine is openly accepted, this will ensure that the art is not open to abuse, and those who claim they can cure all sorts of ailments can be curtailed.

Partnership as the Way Forward

The way forward for African health care is for the two medical practices to take a symbiotic approach. Partnership in this case should be inspired by interdependence where each partner will seek the betterment of the other party. Such partnership would be characterized by a sense of responsibility, willingness, trust, and the desire to work together toward a common goal. The relationship between the two practices will require mutual understanding of each others’ strengths, weaknesses, and uniqueness, as well as the belief that each party has something to offer toward attaining the intended goal.

It is only with this partnership that the use of traditional medicine in Africa can be developed. Here are some suggestions on how to make this partnership a reality and at the same time ensure a healthy and productive relationship.

1. The practitioners of traditional and conventional medicine need to tolerate one another. The struggle for superiority usually evident between modern and traditional medicine is uncalled for. The two practices follow different methods to achieve the same goal. The different methods and approaches should therefore not cause any friction. Instead, the practitioners should respect and consider each other as partners whose goal is to provide good health care.
2. The two approaches to medicinal practice are very rich in resources. In a healthy situation, the two practices should be complementary to each other. Each practice should accept, use, and promote whatever is acceptable from the other. The general attitude should be that there is no limit to knowledge and those who have knowledge should seek to know even more. Traditional practitioners should therefore accept and use what is available and effective from modern medicine, and vice versa.
3. If we accept that the two approaches to medicinal practice are different, we should not insist on subjecting one practice to the method of another. One cannot, for example, establish laboratories to test the efficacy of all of the practices of traditional healing. One should not automatically condemn one practice as wrong should it fail the test of the other practice.
4. Certain traditional herbal medicines could be tested in scientific laboratories to ascertain their ingredients and efficacy. Western technology can then be used to ascertain the correct dosage and to produce the medicine commercially for easy availability. This is an aspect where African practitioners could benefit from Western technology and create good partnership.
5. Aspects of African medicine that cannot pass a scientific test should not be rejected outright. Instead, there is need to put more effort into the study of such remedies. It is important to accept that African medicine is an art that has been practiced for ages and discovered by experience and common sense. In addition, healing is based on a strong belief that the supreme being is the ultimate healer.

Bibliography

- Bascom, William R., and Melville J. Herskovits. *Continuity and Change in African Culture*. Chicago: University of Chicago Press, 1959.
- Dopamu, A. "Health and Healing within the Traditional African Religious Context." *Orita-Ibadan Journal of Religious Studies* 17:2 (1985): 66–80.
- Kenyatta, Jomo. *Facing Mount Kenya*. Nairobi: Heinemann Kenya, 1938.
- Mbiti, John S. *Introduction to African Religion*. London: Heinemann, 1975.
- Parrinder, E.G. *Witchcraft*. Bristol, UK: Penguin, 1958.
- Some, Malidoma Patricia. *The Healing Wisdom of Africa*. London: Thorsons, 1997.
- Tessema, S.S. "Traditional Medicine: Past Growth and Future Developments in East Africa." *East Africa Medical Journal* 57:1 (1980): 48–54.
- Thairu, K. *The African Civilisation*. Nairobi: East Africa Literature Bureau, 1975.

71 AIDS, Science, and Religion in Africa

Hazel Ayanga

The interaction between humans and their environment often leads to negative effects on the human body, mind, and spirit. Historical documents describe various diseases that have affected human beings, as well as accounts of medical treatments. Religious texts also contribute to these accounts of diseases and their management. The Bible, for example, describes how the Hebrew people understood and responded to illness, disease, and death. The accounts depict a largely prescientific view of illness. This is a view that was shared by most of the other preindustrial societies.

Some societies have not changed this view in any significant way, despite the influence of modern science and technology. This prescientific view posits forces outside of the immediate physical environment as playing a significant role in disease causation. The understanding of illness affects the way people respond to it and endeavor to manage the problem. With the influence of science and its many discoveries, many people now seek scientific explanations of disease and scientifically proven ways of responding to it. Scientific medicine often has been effective in responding to many of the ills that human beings have had to face, but this is not always the case. The greatest challenge to both traditional and modern medicine in Africa today is HIV/AIDS.

HIV/AIDS in Africa

In the early 1980s, the existence of AIDS was made known to Africans as a disease of foreign origins. It was also introduced as one that primarily affected people with “perverted” sexual behavior, or more precisely, homosexuals. Generally, therefore, African communities did not think they were in any real danger from AIDS. They thought it was unlikely that foreigners would pass it on to them; also, sexual behaviors like homosexuality were rare and strictly punished wherever they existed. However, time has proved both these notions of security to be false and extremely dangerous.

The spread of AIDS takes place in many circumstances. In Africa the major form of transmission is heterosexual rather than homosexual behavior. The reality of the situation and the terrifying proportions of the epidemic became apparent in the late 1980s. According to the World Health Organization, the figures rose from a mere 31 cases in 1986 to 2,627 in February 1987. Currently, the global rate of infection is estimated at over 6,000 cases per day. The majority of these new infections are reportedly in Africa.

HIV/AIDS is no longer just a medical problem. In Africa, it goes hand in hand with other very pressing social problems. It is closely associated with poverty. Thus it is an economic problem. It is associated with gender disparity. Therefore it is a social problem. It is a psychological problem, as it has a lot to do with attitudes toward the disease and its transmission. It also has to do with attitudes toward those who are HIV positive. AIDS in Africa is a spiritual problem. It must be understood in the context of the people's beliefs in relation to disease causation and its eventual management. It is a problem of culture. AIDS in Africa must therefore be understood within the context of African cultural beliefs. These beliefs are often understood and transmitted through the religious teachings and ritual practices of the community.

AIDS and Traditional Culture in Africa

With their current level of education and awareness, Africans largely understand illness in fairly scientific terms. But even with the acceptance of scientific medicine, it would appear that whenever a new disease comes, people quickly revert to nonscientific explanations and management procedures. One such case is the onset of HIV/AIDS.

The AIDS epidemic has been understood and interpreted according to African cultural ways of explaining disease. In the early days, it was believed to be the result of either witchcraft or the evil eye. People were reluctant to seek modern scientific help. This was in the context of the general belief that illnesses that come about as a result of witchcraft have no scientific, medical solution. The fact that there was no cure for AIDS lent further credence to this belief. People therefore sought help from diviners, witch doctors, and traditional medicine men and women.

With time it was realized that HIV/AIDS was not this simple. Illnesses that appeared incurable were often interpreted as resulting from unnatural causes. In many cases a curse was suspected. The disease had all the symptoms that accompany the curse of either the gods or the ancestors. A curse means divine judgment and divine vengeance. These were experienced because of either individual or group sin. The curse resulted in bad social relationships and unnatural behavior among those affected by it. Again AIDS seemed to fit the picture. Among many traditional African communities, for example among the Luo of Kenya, severe weight loss, incessant coughing, boils, and diarrhea characterized the curse. Disease and illness resulting from a curse would suck

life out of the victims. Because HIV/AIDS was thought to be curse related, the need for modern scientific medical help was not immediately seen. Medical explanations of the disease and its transmission were largely ignored.

This attitude further worsened the stigmatization of those affected by AIDS. They were easily ostracized because they had apparently broken societal taboos in one way or another. They must have offended God and the ancestors. They deserved this punishment.

A discussion of AIDS and related issues is necessarily a discussion about sex and related issues. This is not easy in some cultures. In some traditions, sex and sexuality were discussed only in the context of initiation. In modern times, initiation is no longer performed, leaving a vacuum in the socialization process of individuals. Contemporary faith communities have not offered effective alternatives to the teaching aspects of traditional initiation. Thus HIV/AIDS was not openly talked about for a long time. In the meantime, it spread unabated.

AIDS in Current Context

Traditional beliefs and attitudes, justified as they may have appeared, contributed to the rapid spread of HIV/AIDS. Because a curse, for example, cannot be transmitted from one person to another, there seemed to be no need for protection or abstinence in sexual matters. Most faith communities were not actively involved in the fight against the disease. In fact, the church largely supported traditional attitudes and for a long time did not recognize AIDS as a problem for its members. The Muslim community found it hard to imagine that AIDS could affect any of its members. AIDS was a punishment from God for those who had gone astray. It was for those who sought to ape Western ways indiscriminately. Thus the contribution of religion in the creation of awareness was generally slow in coming. Active involvement in the fight against AIDS was even slower.

However, the situation has been gradually improving. Both traditionalists and contemporary faith communities have come to the realization that the problem of AIDS is not going to be wished away. Practical involvement is required. These groups are now making concrete efforts in the fight against AIDS. Areas of involvement now include creation of awareness among members and the use of education and media to inform the public that AIDS is real and not a result of witchcraft or even the curse. Faith communities, particularly Christian churches, are involved in mobilizing communities and even government leaders in the fight.

Religion has been challenged to reexamine its attitude to culture. There is now the recognition that cultural beliefs and practices cannot be changed overnight. But when the issues involved are properly understood and viable alternatives offered, even the deeply rooted but negative values are given up. There is need to encourage those cultural values that affirm and enhance life. In

Africa as in other places, the church has been reluctant to emphasize certain forms of protection, particularly the use of condoms. Culture and faith communities agree that the best form of protection is abstinence.

AIDS and Science

The current shift in the attitude of faith communities can be attributed to a more scientific understanding of the problems related to AIDS. Most of the scientific information available in Africa is from the West, but African scientists are beginning to make an impact. In Kenya, for example, research is going on in search of an AIDS vaccine. New information is being generated about the virus and how it is spread among Africans. Traditional medical practitioners are making a huge contribution. Many traditional herbal medicines are being made available to those affected by AIDS. Modern scientific medicine and traditional medicine are being forced by AIDS to cooperate in the search for an answer.

In some countries, governments are running the two types of medical systems side by side. This is happening in Uganda and Tanzania. In Kenya, there is collaborative research between traditional practitioners and the Kenya Medical Research Institute (KEMRI). The collaboration is based on the understanding that many of the opportunistic diseases that AIDS patients endure can be treated with traditional approaches. If these are incorporated in conventional medical practice, they go a long way in making the life of AIDS patients tolerable. The high cost of many commercial medicines makes traditional herbal medicine a viable option for many.

AIDS in Africa is a multifaceted problem. It is imperative that a holistic approach be taken to manage it. Religion and science need to work hand in hand. This is beginning to happen. It must continue and every effort made to encourage every little achievement, regardless of the source. Herbal medicine is accessible and affordable, for example, and people should be encouraged to access it wherever it is available. Also, many diseases that resist other forms of treatment respond to traditional medicine. This raises people's confidence in the traditional healer, and thus the negative attitude toward traditional healers has begun to wane. This is not only a result of the efficacy of the herbs; it is also because many of those practicing healing are educated and respectable members of society. Some seek the help of those trained in scientific experimentation to discover the medicinal property of their herbs.

Current research indicates that matters of religious faith may be clinically relevant in enhancing health. This has been the traditional African view. Now many people in Africa are reclaiming this view and incorporating it in their health systems. They have come to the realization that they do not necessarily have to choose between science and their religious faith, especially in the management of HIV/AIDS.

Bibliography

- Barnett, T., and P. Blackie. *AIDS in Africa: Its Present and Future Impact*. London: Relhaven, 1992.
- Hermann, Robert, ed. *God, Science, and Humility*. Philadelphia: Templeton Foundation Press, 2000.
- Sindiga, Isaac, ed. *Traditional Medicine in Africa*. Nairobi: East African Educational Publishers, 1995.
- Thomas-Emeagwali, Gloria, ed. *African Systems of Science, Technology, and Art: The Nigerian Experience*. London: Karnak House, 1993.
- Turner, Edith, et al. *Experiencing Ritual: A New Interpretation of African Healing*. Philadelphia: University of Pennsylvania Press, 1992.

72 Nuwati: Native American Medicine, Healing, and the Sacred Way of Being

Michael Tlanusta Garrett

Everyone knows that grandparents and grandchildren often have a very special bond that goes beyond words. Still, from time to time, the way grandchildren act can get on the nerves of grandparents (and, of course, the way grandparents act can get on children's nerves too). When he was a child, my father, Tsayoga (Bluejay) as his grandpa called him, was a good little boy, sensitive, quiet, inquisitive, but also very stubborn. He was a good boy, but he had to do things his own way, and he couldn't always understand why things weren't the way he thought they should be. "But why?" he might ask his grandfather—over and over and over. Sometimes, Grandpa would get a little frustrated with the boy, who might be busy listening but not hearing.

"Tsayoga," the old man would say abruptly sometimes. "Does the worm live in the ground, or does the worm fly in the sky?"

"Grandpa," the little boy would answer, "the worm lives in the ground . . ."

"Well okay then," Grandpa would reply.

Native American Spirituality

There seems to be a great deal of misunderstanding these days as to what Native American spirituality actually means and what it involves. This misunderstanding in mainstream American culture has developed for a number of reasons, including the historical exploitation of Native culture, and the often-stereotyped portrayal of Native Americans in the media as faithful sidekick to the white hero, or as noble savage with mystical power, or hostile Indian bent on destruction. Also, more recently, misunderstanding has developed as a result of non-Native Americans attempting to interpret or conduct Indian ceremonies or spiritual practices without always having a true understanding of the meaning or power of those ceremonies or practices for the Indian nation from which it comes, or without being "qualified" to do so (i.e., being trained as a Medicine person).

For this and other historical reasons, many Native American traditionalists often share very little of the “true knowledge” of certain beliefs or ceremonies for fear that this knowledge will be misunderstood or misused as it has been historically. Bear in mind, it has only been since 1978, with the passage of the American Indian Religious Freedom Act, that Native Americans were able to legally practice their spirituality and traditional ways in this country for the first time in over a century. That is not a long time. Moreover, many Native elders are the products of decades of governmental abuse through forced boarding-school experiences, the relocation programs of the 1950s, the intentional exploitation of Native lands and resources, and the abuse of Native legal rights. Then there are the day-to-day experiences of racism in general. Given this history, trust is a critical aspect of life when it comes to preserving all that is sacred. For Native American traditionalists, protecting the sacred ways is a matter of survival, but it is also a matter of respect for the power that is involved in such ways. This power goes beyond any one individual and, according to the traditions, must be respected and treated with great care so as to not do harm.

So who are Native Americans, and what is this power to which we refer? Across the United States, there are more than 558 federally recognized and several hundred state recognized Native American nations. Given the wide-ranging diversity of this population consisting of 2.3 million people, it is important to understand that the term “Native American spirituality,” encompasses the vastness and essence of more than 500 different tribal traditions represented by these hundreds of Indian nations. Navajo, Catawba, Shoshone, Lumbee, Cheyenne, Cherokee, Apache, Lakota, Seminole, Comanche, Pequot, Cree, Tuscarora, Paiute, Creek, Pueblo, Shawnee, Hopi, Osage, Mohawk, Nez Perce, Seneca—these are but a handful of the hundreds of tribal nations that exist across the United States. Is it possible to grasp the essence of so many rich and diverse spiritual traditions? One wonders how Grandpa might respond.

In order to better understand some of the basic concepts relating to Native American spirituality, and Cherokee Indian Medicine more specifically, it is necessary to consider some of the underlying values that permeate a Native worldview and existence. Several authors have described common core values that characterize “traditionalism” across tribal nations. Some of these values include the importance of community contribution, sharing, acceptance, cooperation, harmony and balance, noninterference, extended family, attention to nature, immediacy of time, awareness of the relationship, and a deep respect for elders. Overall, these traditional values show the importance of honoring, through harmony and balance, what is believed to be a very sacred connection with the energy of life; this is the basis for Native spirituality across tribal nations.

Different tribal languages have different words or ways of referring to this idea of honoring one’s sense of connection, but the meaning is similar across nations in referring to the belief that human beings exist on Mother Earth to

be helpers and protectors of life. In Native communities, it is not uncommon to hear people use the term “caretaker.” Therefore, from the perspective of a traditionalist, to see one’s purpose as that of caretaker is to accept responsibility for the gift of life by taking good care of that and all gifts of life in the surrounding beauty of this world in which we live. Among the basic cultural elements that underlie Native American spirituality as a way of life are medicine, relation, harmony, and vision. But it is important to begin by considering what it means to “walk in step” from a traditional Native American perspective.

Walking in Step

As you hear the sound of the drum rumbling low to the sharp, impassioned cries of the singers, the vibration moves through you like a storm that rises in the distance, building slowly in the azure sky, then unloading in a rhythmic yet gentle pounding of the soil. Anyone, Native or non-Native, who has ever had the opportunity to experience the colors, movement, sounds, tastes, and smells of the powwow (a pantraditional, ceremonial giving of thanks) understands the feeling that passes through you. It is different for every person, but if you really experience the feeling, you know that it is connection. For some, it is a matter of seeing old friends or making new ones. For some, it is the image of the dancers moving in seemingly infinite poses of unity and airy smoothness to every flowing pound of the drum. For some, it is the laughter and exchange of words and gestures. For some, it is silent inner prayer giving thanks for another day of life. For some, it is the delicious taste of your second and third helping of that piping hot fry-bread. Whatever it is, in the end, it is coming together on one level or another, and walking in step with the Greater Circle.

As one reads the above description of what it is like to experience a powwow, it becomes easier to relate to the experience of someone who might actually be there by paying attention to the senses and to the resulting emotional experience of the event. The powwow, though originating with the Plains tribes of the Midwest, has been adopted by many, many tribal nations as a way of celebrating what it means to be Indian. The powwow, then, offers important insights into a traditional Native worldview, both in the symbolism and deep cultural meanings associated with the experience as well as in the importance placed on the sensory experience of the event. More or less, the essence of Native American spirituality involves feeling a sense of connection with oneself, with one’s family and community, and with one’s surroundings, all as integral parts of one’s spiritual existence. That feeling of connection is available to all of us, though it may be experienced in differing ways. However, for many Indian people, that feeling of connection is completely central to a life directed at seeking harmony and balance in all things.

It is important to note that the spiritual beliefs of Native Americans depend

on a number of factors, including level of acculturation (traditional, marginal, bicultural, assimilated, pantraditional), geographic region, family structure, religious influences, historical context, and tribally specific traditions. However, it is possible to generalize, to some extent, about a number of basic beliefs characterizing Native American traditionalism and spirituality across tribal nations. The following, adapted from Locust, elaborates on a number of basic Native American spiritual and traditional beliefs:

1. There is a single higher power known as Creator, Great Creator, Great Spirit, or Great One, among other names (this being is sometimes referred to in gender form but does not necessarily exist as one particular gender or another). There are also lesser beings known as spirit beings or spirit helpers that can exist in many forms and even take different forms.
2. Plants and animals, like humans, are part of the spirit world. The spirit world exists side by side with, and intermingles with, the physical world. Moreover, the spirit existed in the spirit world before it came into a physical body and will exist after the body dies.
3. Human beings are made up of a spirit, mind, and body. The mind, body, and spirit are all interconnected; therefore, illness affects the mind and spirit as well as the body.
4. Wellness is harmony in body, mind, and spirit; unwellness is disharmony in mind, body, and spirit.
5. Natural unwellness is caused by the violation of a sacred social or natural law of creation (e.g., participating in a sacred ceremony while under the influence of alcohol, drugs, or having had sex within four days of the ceremony).
6. Unnatural unwellness is caused by conjuring (witchcraft) from those with destructive intentions.
7. Each of us is responsible for our own wellness by keeping ourselves attuned to self, relations, environment, and universe.

This list of beliefs in Native American spirituality crosses tribal boundaries, but it is by no means a comprehensive list. It does, however, provide a great deal of insight into some of the assumptions that may be held by a “traditional” Native person. In order to better understand more generally what it means to “walk in step” according to the perspective of Indian Medicine, it is important to discuss individually the four basic cultural elements: medicine, relation, harmony, and vision.

Medicine

Everything is alive. Walk into any classroom of children these days and ask them playfully, “Have you had your Medicine today?” and many of them will

tell you yes. If you ask them what kind of Medicine, sadly, they will tell you Ritalin, or aspirin, or some type of cold medicine. In Native tradition, the concept of “Medicine” is starkly different from what medicine has become in mainstream American society. So what is Medicine? Here are the words spoken in 1890 by Crowfoot, a Blackfoot leader, as he lay dying: “What is life? It is the flash of a firefly in the night. It is the breath of a buffalo in the winter time. It is the little shadow which runs across the grass and loses itself in the Sunset.”

In Crowfoot’s words, the importance of experiencing life through the senses and through one’s emotional experience becomes apparent. The words give us a way of understanding Indian Medicine, or Nuwati, as it is called in Cherokee. In the traditional way, Medicine can consist of physical remedies such as herbs, teas, and poultices for physical ailments, but Medicine is simultaneously something much more than a pill you take to cure illness, get rid of pain, or correct a physiological malfunction. Medicine is everywhere. It is the very essence of our inner being; it is that which gives us inner power. Medicine is in every tree, plant, rock, animal, and person. It is in the light, the soil, the water, and the wind. Medicine is something that happened ten years ago that still makes you smile when you think about it. Medicine is that old friend who calls you up out of the blue just because he or she was thinking about you. There is Medicine in watching a small child play. Medicine is in the reassuring smile of an elder. There is Medicine in every event, memory, place, person, and movement. There is even Medicine in empty space if you know how to use it.

In many Native traditions, every living being possesses this inner power called Medicine, which connects us to all other living beings through the heart. However, if we fail to respect our relations—with all living beings, the creator, Mother Earth, ourselves, and the Four Directions—and to keep ourselves in step with the universe, we invite illness by falling out of harmony and balance, much like a dancer failing to move in step with the rhythm of the drum. A person’s Medicine is his or her power, and it can be used for creative purposes or destructive purposes—either contributing to or taking away from the Greater Circle of Life. Being in harmony means being “in step with the universe”; being in disharmony means being “out of step with the universe.”

Harmony

Everything has purpose. Every living being has a reason for being. Traditional Native Americans look upon life as a gift from the creator. As a gift, it is to be treated with the utmost care out of respect for the giver. This means living in a humble way and giving thanks for all of the gifts that one receives every day, no matter how big or small. The importance of humility is illustrated in the words spoken by Tecumseh, the Shawnee leader, over a century ago: “When you arise in the morning, give thanks for the morning light, for your life and strength. Give thanks for your food and the joy of living. If you see no reason for giving thanks, the fault lies in yourself.”

One of the reasons it is so important in the traditional way to maintain a humble stance is not for fear of punishment by the creator, but rather, to maintain a keen awareness of all the gifts that surround you, and to keep your spirit open and receptive. In this way, you are able to be of service to others, and much more able to walk the path of peace. The person who walks with their peace is very difficult to get off balance.

Acceptance is a very important part of living in harmony and balance in a worldview, which emphasizes that everyone and everything has a reason for being. There is no such thing as a good experience or a bad experience, as everything that happens is of value in offering us the opportunity to learn and see more clearly how to live in harmony. Therefore, in the traditional way, trying to control things or people is considered a waste of energy, since it is believed that everything is as it should be at any given point in time.

Native American spirituality often places great emphasis on the numbers four and seven. The number four represents the spirit of each of the directions, east, south, west, and north, usually depicted in a circle. The number seven represents the same four directions as well as the upper world (Sky), lower world (Earth), and center (often referring to the heart, or sacred fire) to symbolize universal harmony and balance (visualized as a sphere). In the traditional way, you seek to understand what lessons are offered to you by giving thanks to each of the four directions for the wisdom, guidance, strength, and clarity that you receive. Not every tribe practices the directions in this way, but almost all tribes have some representation of the four directions as a circular symbol of the harmony and balance of mind, body, and spirit with the natural environment (and spirit world).

It is interesting to note, however, that unlike other religious traditions, in Native American spirituality, it is considered disrespectful, even arrogant, for a person to “ask” anything of the creator. Rather, people give thanks for what they do have. It is assumed with the creator, as with people, that if something is to be revealed to you, it will be revealed when it is time. This emphasizes, once again, the values of respect and humility. Traditionalists seek help and guidance more directly from spirit helpers or spirit guides. The creator is one to be honored and revered by walking the path of harmony and balance, respecting all one’s relations.

Relation

All things are connected. Central to Native American spiritual traditions is the importance of “relation” as a total way of existing in the world. The concept of family extends to brothers and sisters in the animal world, the plant world, the mineral world, Mother Earth, Father Sky, and so on. The power of relation is symbolized by the Circle of Life (sometimes referred to as the Web of Life), so commonly represented throughout the customs, traditions, and art forms of Native people. This Circle of Life is believed, in many tribal tradi-

tions, to consist of the basic elements of life: fire or sunlight, earth, water, and wind. These four points also denote, in Cherokee tradition for instance, spirit, nature, body, and mind, referred to as the Four Winds (or the Four Directions). The concept of relation is illustrated by the words of Black Elk, an Oglala Lakota Medicine man:

You have noticed that everything an Indian does is in a circle, and that is because the Power of the World always works in circles, and everything tries to be round. . . . The sky is round, and I have heard that Earth is round like a ball, and so are all the stars. The wind, in its greatest power, whirls. Birds make their nests in circles, for theirs is the same religion as ours. . . . Even the seasons form a great circle in their changing, and always come back again to where they were. The life of a person is a circle from childhood to childhood, and so it is in everything where power moves.

The Circle thus reflects not only the interrelationship of all living beings, but the natural progression or growth of life itself. Harmony and balance are necessary for the survival of all life. Thus, living in “good relations” or giving thanks to “all our relations” are common phrases in Indian country.

Respect for Medicine also means practicing respect for the interconnection that we share. Across tribal nations, there are certain natural or social laws that must be observed out of respect for relation. These often point to restrictions on personal conduct regarding such things as death, incest, the female menstrual cycle, witchcraft, certain animals, certain natural phenomena, certain foods, marrying into one’s own clan, and strict observance of ceremonial protocol. Respecting one’s relations in Native tradition means (a) never take more than you need; (b) give thanks for what you have or what you receive; (c) take great care to use all of what you do have; and (d) give away what you do not need (or what someone else may need more than you).

Vision

Embrace your vision by embracing the Medicine of every living being. Across tribal nations, there are many different ceremonies used for healing, giving thanks, celebrating, clearing the way, and blessing. A few examples of ceremonies are sweatlodge, vision quest, clearing-way ceremony, blessing-way ceremony, pipe ceremony, sunrise ceremony, sundance, and many, many others. One of the functions of ceremonial practice is to reaffirm one’s connection with that which is sacred and keep oneself in good relations. In American mainstream ideology, the purpose of life consists of “life, liberty, and the pursuit of happiness.” From a traditional Native perspective, a corollary would be “life, love, and the pursuit of harmony.” Once you understand and respect the Medicine, learn to live in harmony, and honor your relations, the final important step in the traditional way is knowing what to do with the gift of life with which you have been blessed. This can be summarized as follows:

In a conversation with his aging grandfather, a young Indian man asked, “Grandfather, what is the purpose of life?” After a long time in thought, the old man looked up and said, “Grandson, children are the purpose of life. We were once children and someone cared for us, and now it is our time to care.”

—Brendtro *et al.*, *Reclaiming Youth at Risk: Our Hope for the Future*

Now, that is not to say that Native Americans believe that the purpose of everyone’s life is to go out and have children. But the deeper value of the relationship as an integral part of seeking purpose is evident. In the traditional way, one moves through the “life circle” from *being cared for* to *caring for*.

It is important throughout life to either seek your vision or continue honoring your vision. In Native tradition, vision is an inner knowledge of your own Medicine and purpose in the Greater Circle revealed to you through your spirit helpers. This means connecting with your inner power and opening yourself to the guidance of the spirit world. This may happen in ceremony, or it may happen in other ways such as through dreams, particular signs, animal messengers, or certain experiences or events that come your way for a reason. Understanding one’s vision is understanding the direction of one’s path as a caretaker moving to the rhythm of the sacred heartbeat. As Black Elk put it, “the good road and the road of difficulties, you have made me cross; and where they cross, the place is holy.”

The Way of the Circle

In my family, grandparents have helped children learn a right way to live life through stories, quiet observation, and listening with both mind and heart for generations and generations. Within Native spirituality, there is a set of unspoken rules across tribal lines for how one is to act in this world in order to respect the gift of life, and to move through this world learning what one is here to learn and contribute. These rules are not written down anywhere; often they are learned through experience and observation. And these unspoken rules don’t even really have a name, so we could call them the “Indian commandments,” but in order to capture the true essence, it may be best to just call them the Way of the Circle. They are as follows:

1. When you first arise in the morning, give thanks to the creator (Great Spirit, Great One, Great Creator), to the four directions, Mother Earth, Father Sky, all of our relations, for the life within you, and for all the life around you.
2. All things are connected.
 - Remember that all things have purpose, everything has its place.
 - Honor others by treating them with kindness and consideration; always assume that a guest is tired, cold, and hungry, making sure to provide him or her with the best of what you have to offer.

3. If you have more than you need for yourself and your family, consider performing a “giveaway” by distributing your possessions to others who are in need.
4. You are bound by your word that cannot be broken except by permission of the other party.
5. Seek harmony and balance in all things.
 - It is always important to remember where you are in relation to everything else, and to contribute to the Circle in whatever way you can.
 - Sharing is the best part of receiving.
 - Practice silence and patience in all things as a reflection of self-control, endurance, dignity, reverence, and inner calm.
 - Practice modesty in all things; avoid boasting and loud behavior that attracts attention to yourself.
 - Know the things that contribute to your well-being, and those things that lead to your destruction.
6. Always ask permission, and give something for everything that is received, including giving thanks and honoring all living things.
7. Be aware of what is around you, what is inside of you, and always show respect:
 - Treat every person with respect, from the tiniest child to the oldest elder.
 - Do not stare at others; drop your eyes as a sign of respect, especially in the presence of elders, teachers, or community leaders.
 - Always give a sign of greeting when passing a friend or stranger.
 - Never criticize or talk about someone in a harmful, negative way.
 - Never touch something that belongs to someone else without permission.
 - Respect the privacy of every person, making sure to never intrude upon someone’s quiet moments or personal space.
 - Never interfere in the affairs of another by asking questions or offering advice.
 - Never interrupt others.
 - In another person’s home, follow his or her customs rather than your own.
 - Treat with respect all things held sacred to others whether you understand them or not.
 - Treat the Earth as your mother, give to her, protect her, honor her; show deep respect for the animal world, plant world, and mineral world.
8. Listen to guidance offered by all of your surroundings; expect this guidance to come in the form of prayer, dreams, quiet solitude, and in the words and deeds of wise elders and friends.

9. Listen with your heart.
10. Learn from your experiences, and always be open to new ones.
11. Always remember that a smile is something sacred, to be shared.
12. Live each day as it comes.

As a way of illustrating the way of the Circle, let me relate a true story that my father has told me many times. It holds a special place in my heart, as I imagine my father as a little boy down by the Oconaluftee River with his grandfather (as I recount it in *Medicine of the Cherokee*):

Some of my fondest memories of when I was still a little one go back to times spent with my grandfather, Oscar Rogers, who was Eastern Cherokee. We would spend time sitting on the rocks by the Oconaluftee River in Cherokee, North Carolina. "What do you see when you look into the water?" he would inquire, as he sat on a rock enjoying the afternoon sun. I would look closely to see the water rushing quickly downstream. My eyes would catch the glimpse of a fish, water beetles, flies touching the water, soaked wood floating along at the will of the water, rocks, and green plants.

"I see the water," I said. "What else do you see?" he asked. "Well, I see the fish," I answered, because there were little minnows swimming around in the water. "What else do you see?" he asked. "I see the rocks," I said. "What else do you see?" he asked again. My eyes began to water a little as I stared intently, wanting so much to please my Grandfather by seeing everything he saw.

"Ah, I see my reflection," I responded proudly. "That's good," he replied confidently. "What you see is your whole life ahead of you. Know that the Great One has a plan for you to be the keeper of everything you see with your eyes, 'cause every living thing is your brother and sister." "Even the rocks?" I questioned. "Yes, even the rocks," he answered, "because they have elements of Mother Earth and Father Sky, just as we do."

"Remember to give thanks every day for all things that make up the Universe," said my Grandfather. "Always remember to walk the path of Good Medicine and see the good reflected in everything that occurs in life. Life is a lesson, and you must learn the lesson well to see your true reflection in the water."

From a traditional Native perspective, as members of the Greater Circle of Life, we each have the responsibility and privilege of being able to serve as a helper in some way as we all walk our own Medicine path, seeking our own vision. This is the meaning and responsibility of being a caretaker. Archie Fire Lame Deer, a Lakota Medicine man, described the role of the caretaker this way: "To be a Medicine person, you have to experience everything, live life to the fullest. If you don't experience the human side of everything, how can you help teach or heal? To be a good Medicine person, you've got to be humble. You've got to be lower than a worm and higher than an eagle."

Though it is not each person's job to be a Medicine person in the Native traditional sense of healing, every person can serve as some form of helper, and life has a way of providing some of the most unexpected opportunities for that to happen. One wonders, as we reflect on Native American spirituality, about the question that my great-grandfather posed to my father many times when he was being a stubborn, inquisitive little boy: "Does the worm live in

the ground, or does the worm fly in the sky?" Perhaps this is a question we should ask ourselves the next time a delicate, colorful butterfly wanders past us, reminding us of the intricate tapestry woven by medicine, harmony, relation, and vision. Things are not always as they seem. The limitation of human perception is the beauty of Nuwati offering us an opportunity to see things as they are in essence rather than simply the way we want to see them. Perhaps that is what makes life so worth living as we fulfill our purpose of discovering that which is true, while learning to take care of this sacred gift of life.

Bibliography

- Brendtro, L.K., M. Brokenleg, and S. Van Bockern. *Reclaiming Youth at Risk: Our Hope for the Future*. Bloomington, IN: National Education Service, 1990.
- Dufrene, P.M. "Exploring Native American Symbolism." *Journal of Multicultural and Cross-Cultural Research in Art Education* 8 (1990): 38–50.
- Garrett, J.T., and M.T. Garrett. *The Cherokee Full Circle: A Practical Guide to Ceremonies and Traditions*. Rochester, VT: Bear, 1996.
- . *Medicine of the Cherokee: The Way of Right Relationship*. Santa Fe, NM: Bear, 1996.
- Garrett, M.T. "Reflection by the Riverside: The Traditional Education of Native American Children." *Journal of Humanistic Education and Development* 35 (1996): 12–28.
- . *Walking on the Wind: Cherokee Teachings for Harmony and Balance*. Santa Fe, NM: Bear, 1998.
- . "Understanding the 'Medicine' of Native American Traditional Values: An Integrative Review." *Counseling and Values* 43 (1999): 84–98.
- Good Tracks, J.G. "Native American Non-interference." *Social Work* 17 (1973): 30–34.
- Herring, R.D. "The Clown or Contrary Figure as a Counseling Intervention Strategy with Native American Indian Clients." *Journal of Multicultural Counseling and Development* 22 (1994): 153–64.
- Lake, M.G. *Native Healer: Initiation into an Ancient Art*. Wheaton, IL: Quest Books, 1991.
- Locust, C. "Wounding the Spirit: Discrimination and Traditional American Indian Belief Systems." *Harvard Educational Review* 58 (1988): 315–30.
- Matheson, L. "Valuing Spirituality Among Native American Populations." *Counseling and Values* 41 (1996): 51–58.
- Red Horse, J.G. "Indian Elders: Unifiers of Families." *Social Casework* 61 (1980): 490–93.
- . "Traditional American Indian Family Systems." *Families, Systems, and Health* 15 (1997): 243–50.
- Russell, G. *American Indian Facts of Life: A Profile of Today's Tribes and Reservations*. Phoenix, AZ: Russell, 1997.
- Tafoya, T. "Native Gay and Lesbian Issues: The Two-Spirited." In *Ethnic and Cultural Diversity among Lesbians and Gay Men*, ed. B. Greene, 1–10. Thousand Oaks, CA: Sage, 1997.
- Vick, R.D., L. M. Smith Sr., and C. Iron Rope Herrera. "The Healing Circle: An Alternative Path to Alcoholism Recovery." *Counseling and Values* 42 (1998): 132–41.

73 Navajo Spirituality: Native American Wisdom and Healing

Lori Arviso Alvord

I am a member of the Navajo tribe, and the first female member to become a surgeon. I currently practice at Dartmouth Medical School. My surgical practice is based on years of careful, disciplined, and extraordinarily difficult training to master the art and science of medicine and my specialty in general surgery. In my professional life, I am able to bring healing to my patients using the benefits of this long training, drawing together the best of medical research and surgical innovation gained over the last century of medical progress.

Yet I also carry with me another kind of long learning as a person, which comes from my people—the Navajo. This learning cannot be dated. It includes senses of the word *healing* that are quite different from what the term usually connotes in the halls of Dartmouth Medical School. Part of my vision of life is to combine what is best from both worlds—as different as they are. And, even more ambitiously, I hope that the world of medical research will understand the insights we Navajo cherish—and expand and multiply them. Spirituality and healing are intertwined in our ceremonies. An examination of some of the principles of our ceremonies may provide one vision of what “expanding spiritual information” can be.

If we contemplate the existence of our creator, we could imagine that our creator would provide a spirituality that would not be separate from the rest of daily living, but rather, interwoven, united with all things. And this spirituality would mirror the beauty and vastness of the created world.

When Europeans first encountered Native American culture, they dismissed much of it as inferior. Indigenous religions were considered primitive compared with other theologies. Yet a deeper look reveals a connectedness and complexity that rivals that of the universe itself. In the belief system of my tribe, the Navajo, ceremonies are used as blueprints for how to live a life that is whole and balanced, a life connected to all of creation, a life that honors all

living things. Navajo ceremonies teach that all wisdom, all life, arises from one source: “Sa’a naghahi bik’e hozho,” which means, “To live one’s life with spiritual beauty.” This is also the name of a unifying force that is within all things, connects all things, and creates all things.

Healers, medicine men in our tribe, have described it as “universal mind,” indicating that this force has consciousness and exists throughout the universe. Because it is within all things, we humans are not separate from other humans or the rest of our world. It is said that First Man carried this force up through four previous worlds in his medicine bundle. This journey, by the way, mirrors evolution. The First World was filled with “mist beings,” the Second with insects and small animals, the Third with larger animals, and the Fourth with humans.

The ceremonies teach Navajos to live in “hozho,” a word that describes a combination of beauty, balance, and harmony. It includes the teaching that humans should honor and respect other humans. When practiced, this is capable of creating family and workplace stability—and may reduce stress. Additionally, practice of this worldview reduces the likelihood of destructive relationships. When others are honored and respected, the self-esteem of all rises, and the by-products of low self-esteem—hatred of self and others, depression, and fear—are diminished. Strong interpersonal relationships help build strong families and communities. In many Native cultures, an intergenerational approach to raising children creates a safety net that protects them in the event that the “nuclear family” is ineffective. We also learn that elders should be respected for their wisdom; this helps counteract elder abuse or neglect.

The concept of “hozho” is extended to the realm of thoughts. In this world, it is possible to “speak something into existence.” Therefore, Navajos avoid speaking in a negative way about the future. The expectation of good outcomes, also known as “positive thinking,” is a cornerstone of Navajo culture. Positive thinking has been embraced by Western civilization and shown to produce positive outcomes. Optimists live longer; athletes who visualize success are more likely to achieve it. It actually *is* possible to think something into existence. “Hozho” and positive thinking have another benefit. The practice of seeking to live in harmony and to reduce conflict reduces stress, and stress reduction has been found to have healthy side effects. The field of psychoneuroimmunology, also known as “mind-body medicine,” has shown that stress and depression are capable of suppressing the immune system, which in turn impedes our ability to fight infections and to defend against cancer.

Ceremonies encourage this process as well through physical, mental, and spiritual purification. The prayers and chants are vivid examples of “guided imagery” and create powerful images for the mind to use for rebalancing. Here is an example from “The Night Chant,” our winter ceremony, which includes over 750 chants, including this one:

House made of Dawn
 House made of Morning Light
 House made of Evening Light,
 With the light fall of the she-rain,
 With the jagged lightning high above,
 On the trail of pollen,
 With Beauty (Hozho) before me,
 There may I walk.
 With Beauty behind me,
 There may I walk.
 With Beauty above me,
 There may I walk,
 With Beauty below me,
 There may I walk,
 With Beauty all around me, there may I walk.
 In Beauty (Hozho) it is finished.

Recently, art has been shown to be a healing force. When the mind encounters certain forms of art, the joy, delight, or awe it experiences can relieve stress or counteract depression, thereby possibly helping the immune system. Those who produce art sometimes say that it comes through them, rather than from them. The creation process has its own energy. Navajo ceremonies include layers upon layers of art—from multiple sources, but designed to be woven together, integrated. From the power and beauty of the chants and the images they evoke, to the powerful rhythms of the drums, and the music that carries the words forward, art moves through ceremonies as both the background and the foreground, as both the earth and the air.

Art is expressed in paintings created with sand. The Yeiis (katchinas), our spiritual guardians, are represented in the sandpainting images, visual metaphors of the stories the ceremonies describe. These intricate designs are created with great attention to detail, but their images are returned back to Mother Earth at the end of the ceremony. In the same way, art is made manifest by dancers who represent the spiritual beings and animal guardians described by the ceremonies. Headdresses are created of deerskin, buffalo skins, eagle feathers, and spruce branches; buckskin clothing and moccasins are created. Beauty and art are present in even the smallest objects used in ceremonies. Medicine bundles contain beautiful buckskin bags of corn pollen, prayer feathers, small carved animal spiritual guardians, and bundles of earth from the four sacred mountains. The combined effect is a tapestry that deeply endorses the belief that art has the power to heal, that art is not separate from spirituality.

This spirituality goes beyond the individual to elements that strengthen the health of entire communities and the natural world. Ceremonies reinforce the belief that we live in harmony with the animal world and the natural world. Humans value many things, but they often assign greatest value to family, or

that which they consider sacred. Many Native American tribes have assigned both a spiritual and a familial value to the animal world and the environment. The earth is “mother,” the sky is “father.” The eagle and bear are “brother.” Mother Earth is sacred in her mountains and valleys. The relationship of humans and their environment is one of deep respect, a desire to protect and defend the animal world and the environment. The protective element provided by spirituality has direct healing effects on human beings. By keeping the environment protected, we have clean air to breathe, clean water to drink, clean earth in which to grow plants. We are shielded from the illness that results when our world becomes toxified.

A message of sustainable living is found within our ceremonies. “The Night Chant” carries a warning within it in a story known as “The Dream of the Blue Rams.” Ages ago, it is said, a boy had a dream. In the dream, rams with blue faces came and told the boy that the men of the tribe who hunted game had taken more food than they needed and that this had thrown the world off balance. They added that if this continued, the rams would make the game scarce, and the people would starve. The boy awoke and went to the men who led the hunting and told them about the dream. The men replied, “Return to your dreaming, and let us do the hunting.” Then the prediction of the dream came to pass, and the game became scarce. The people suffered. The tribe then remembered and hunted only the game they needed. Even today, Navajos remember and practice the teachings of “The Night Chant”: “Never take more than you need, use everything fully, give some of what you have to those who cannot hunt for themselves, and leave everything the way it was found—there should be no sign that a human has passed this way.” We are taught that the natural world has spirit and life. These teachings contain powerful principles for how we use the resources of the natural world.

Luther Standing Bear, an Oglala Sioux chief, expressed this concept well: “I am going to venture that the man who sat on the ground in his tipi meditating on life and its meaning, accepting the kinship of all creatures, and acknowledging unity with the universe of things, was infusing into his being the true essence of civilization.”

Ceremonies are often performed for the purposes of healing. Many of the forces of healing used in ceremonies have already been described. The effects of stress and depression on the immune system are better understood, and the effects of ceremonies are easily understood in this context. These principles are now beginning to be used by other healing systems as well. Western medicine is waking up. It has started to realize the power of healing that exists beyond the realms of procedures and medications. Studies have started to prove the healing power of such realms as support group therapy, music therapy, healing and the arts, spirituality and medicine, pet therapy, massage therapy, and so on. We are learning that healing can be influenced by multiple forces within our lives, that we are deeply interconnected to all aspects of our lives, and that we can immerse ourselves in many areas to achieve healing.

During my training as a surgeon, I was unable to harmonize my background as a Navajo with my medical world. Initially, I did not encounter a healing environment but a place that needed as much healing as the patients it treated. I hope that healing environments can be created that incorporate many aspects of ceremonies. Among these are creating a space of trust and deep support for patients, developing an environment for staff that is supportive and that encourages building teams that have good working relationships, and developing spaces that are visually beautiful and comfortable for both patients and families. We have moved away from cold, sterile medical surroundings, but we still have worlds of healing that are waiting to be included in medical models of the future.

By examining the extraordinary complexity and interrelatedness of our natural world, we may begin to understand that, in much the same way, elements of art, ceremonies, sustainability, and healing are deeply woven and interconnected. The cultures of Native people encourage the recognition of interconnectedness, a “systems dynamics” interpretation of the world. The beauty and complexity of our world is not an accident. It is the mirror of a universal spirituality.

Bibliography

- Alvord, Lori A., and Elizabeth Cohen van Pelt. *The Scalpel and the Silver Bear*. New York: Bantam, 1999.
- Between Sacred Mountains: Stories and Lessons from the Land*. Chinle, AZ: Rock Point Community School, 1982.
- Coulehan, J.L. “Navajo Indian Medicine: Implications for Healing.” *Journal of Family Practice* 10:1 (1980): 55–61.
- Gold, Peter. *Navajo and Tibetan Sacred Wisdom: The Circle of the Spirit*. Rochester, VT: Inner Traditions International, 1994.
- Kavasch, B., and K. Baar. *American Indian Healing Arts*. New York: Bantam, 1999.
- Kiecolt-Glaser, J.K. “Psychoneuroimmunology and Cancer: Fact or Fiction?” *European Journal of Cancer* 35:11 (1999): 1603–7.
- Samuels, M. “Environmental Design Technologies: Strategies for Incorporating Art as a Healing Force.” *Journal of Healthcare Design* 8 (1996): 137–38.
- Tusak, D.L., J.M. Church, S.A. Strong, and J.A. Grass. “Guided Imagery: A Significant Advance in the Care of Patients Undergoing Elective Colorectal Surgery.” *Diseases of the Colon and Rectum* 40:2 (1997): 172–78.

74 The Role of Religion and Spirituality in Conventional Medical Treatment

William T. Branch Jr.

Physicians have begun discussing spirituality and religion, especially with their terminally ill patients. Persons facing the end of life face huge existential questions about love for family, the meaning of relationships, life's integrity and purpose, their relationship to the deity, their place in the larger scheme of things. Dying and seriously ill patients seek sources of support and comfort. Many feel unable to discuss their deepest concerns with family members, physicians, and others. They fear discussion will place a burden on their family members. Physicians might not be seen as interested or capable of discussing deeply and personally meaningful issues.

As worsening illness and dying are painful to watch, caregivers may often avoid contact with dying patients. The palliative care movement may now have reversed this unfortunate tendency. One way to remain supportive of dying patients is by engagement concerning the issues of most concern to the patients. Thus, spirituality and religion, love of family, and dealing with life's meaning are subjects for engagement. When these patients are seeking emotional as opposed to physical comfort, religion and spirituality may be a common ground for physicians and other caregivers to meaningfully interact with dying and seriously ill patients.

Science, Religion, and the Practice of Medicine

A historical rift between science and religion has led many recent thinkers to seek ways to reconcile them. From the earliest religions and extending through the nineteenth century, much of faith was based on observations of nature: its clockwork intricacy, apparent teleology, and awesome splendor. Particularly Darwin's theories but also the contributions of many other scientists then seemed to discredit basing religion on observations of nature. When medical students dissect cadavers, they actually see the human body as a system of

muscles and joints moved hingelike by tendons resembling pulleys, inflatable lungs like balloons, and a pumplike heart with pipes for circulation. Dissection of the human body, taken at face value, promotes scientific materialism. No human spirit is found in a cadaver. Perhaps to deal with harsh realities like dissecting a body, some draw a bright line between science and religion. Science, they say, deals with verifiable empirical observations. Science forever evolves as new paradigms replace the old ones that less adequately explain observations. Religion deals with values and first causes, forever beyond the realm of science. But many eminent scientists have expressed spiritual beliefs.

The Big Bang and quantum theory have led some to reconcile scientific observations with religious viewpoints. And the very realization that science leaves much unexplained has encouraged a new respect among scientists, physicians, and others for religious beliefs and spiritual practices. What we know of the universe—with galaxy after galaxy extending to infinity—inspires thoughts akin to spirituality in many who embrace science.

With maturity, many physicians experience spirituality in medical practice. They gain firsthand knowledge of suffering in their patients and patients' families. This calls into question the meaning of the suffering. It shows the physician that there is a spiritual dimension to human existence. Physicians may indeed occupy a unique position from which they can visualize the relationship of science to religion. Although medicine is based on empirical scientific evidence, medicine is also very much a humanistic endeavor. The practice of medicine necessarily applies science and human values side by side to patient care. As pointed out by Daaleman et al., 80–90 percent of patients embrace religious and/or spiritual beliefs. The number of physicians who classify themselves as religious or having spiritual beliefs is significantly less, in the range of 40–60 percent. Yet many physicians appear to develop deeply felt humanistic values, which provide a purpose to their work with patients. And, despite differences in viewpoint, physicians are ethically bound to respect their patients' beliefs and work with any system that provides benefit to patients.

The practice of medicine must therefore incorporate both science and religion. Recently, physicians have realized the importance of this concept, partly as a result of the palliative care movement. How they go about it has been the challenge. Meeting this challenge ranges all the way from achieving proficiency in communication skills to profound questions such as understanding one's own beliefs with sufficient depth and clarity to communicate sincerely with patients who have differing belief systems.

The Influence of Spirituality on Sickness and Health

No study has proved that religion or spirituality directly influences health. What has been proved, with mounting evidence, is that belief systems that promote well-being benefit health. A growing body of knowledge shows that the immune system, the endocrine system, and likely the cardiovascular sys-

tem function more optimally in persons with strong and satisfying social relationships. Healthy emotional attachments within families, lifestyles of moderation, and belief systems that promote personal satisfaction are strongly associated with lesser incidences of chronic diseases, and with better functioning and improved physical health.

Humanists define spirituality as a sense of purpose and meaning in life. By this definition, spirituality is likely to promote good health. That minority of people who view their vocations as a calling, who feel they are growing psychologically and in a broad sense spiritually, who can relate to others with compassion and respect, who avoid addictions and extremes in day to day living, these persons are likely to enjoy better health. The Institute of Medicine's report on the need for strengthening behavioral and social sciences in medical education cites ample empirical evidence to this effect. The evidence is scientific, that is, observable, reproducible, and predictable. It does not necessarily imply any type of supernatural mechanism. This evidence is explainable based on the biochemical and physiological effects of the mind on the body. It can be shown, for example, that stress, family disorder, poverty, social isolation, and disorganization are linked to chronic diseases and poor health outcomes.

Personal and social well-being leads to good health, but the relationship between health and religious belief is more complex. Organized religions in some communities provide the major source of social stability. The ten-step approach incorporates faith and acknowledgement of a higher power and has been shown to be as effective, if not more effective, than other approaches to addiction disorders. These are genuine beliefs, not simply contrived approaches. Hence, sincerity, respect, authenticity, and genuine compassion are qualities needed in the physician to maximally help patients on the level of their religious and spiritual beliefs, their most important relationships, their essential well-being, and life's purpose. This cannot be faked. The physician must approach the patient in a serious, honest *I/thou* relationship. Half of medical practice deals with applying rigorous scientific evidence to curing and treating. The other half deals with suffering and caring. The two approaches are inextricably intertwined in medical practice, the most humanistic of sciences.

Spirituality and Religion as Comforts to Patients

To Grady Memorial Hospital, an urban hospital, are admitted the sickest and most indigent patients residing in Fulton and Dekalb Counties, Georgia. Many are African American. My colleague Alexia Torke and I interviewed terminally ill patients at Grady to explore their sources of comfort and support in an open-ended fashion. We incorporated several questions related to spirituality and religion, such as "Are you a religious person?" and "Do you have religious beliefs?" followed by what we call "prompts," for example, "How do you practice your religion?" and "How is religion important to you in dealing with your disease?" Independently of our questions on the topic, we

found religion and spirituality were raised at almost every turn in these interviews, which averaged about forty-five minutes in duration. We also found that patients readily opened up to us, especially regarding their religious beliefs. They spoke of how religion and spirituality were profoundly comforting to them. They revealed their core belief systems to us.

Their first core belief combines what others have called the *omniscience and providence of God*. Almost every patient expressed in one form or another that God controls all events down to minute details, including all events in the lives of these patients, who believed that their illnesses and death would be determined by God. This belief comforted our patients. Sickness and death were not in the patient's hands. The patient might seek medical treatment, but the outcome depended on a higher power. This belief gave their lives a profound meaning. They could accept their sicknesses based on their incorporation into a divine plan for their lives. Even those who felt their life had twisted in undesirable ways, including drug addiction, AIDS, illegitimacy, extreme poverty, and breakup of relationships, expressed the hope that God would be there for them, that a larger meaning encompassed their sins and suffering. They often expressed the desire for atonement, and the belief that their sins would be forgiven if they sincerely repented.

These beliefs were as much spiritual as religious. For the most part, these dying patients practiced their religion and spirituality through prayer. Their second core belief involved this connection to God through prayer. The connection was one to one. This could well be true for any person who is facing death. Persons facing death seem to seek a connection to God. These very indigent persons with disordered lives did not have the same memberships in organized religions as many other people. Nevertheless, with beliefs mostly centered on Christianity and based on coming from a Christian tradition, even those with AIDS acquired through intravenous drug usage found solace in the feeling that God gave meaning to their lives, might forgive them, and was accessible through prayer.

Our talks with these patients led us to believe that learning about the patients' spirituality would be helpful to us in providing compassionate care. And how a physician responds once a patient has revealed his or her spirituality is profoundly important. Listening closely and acknowledging and reflecting back the patient's own words, is important and likely to be beneficial. But once the subject of spirituality has been broached, and the patient has confided in the physician, a more meaningful human response is required and should be on the level of one person to another.

Issues Related to Patient-Doctor Communication

When the doctor brings spirituality and religion into the conversation with a sick or dying patient, he or she crosses the boundary from the physician's benign equanimity or distanced empathy into a more personal relationship.

The doctor has invited the patient to speak about his or her core beliefs. Whether these are spiritual beliefs related to prayer, religious beliefs related to a religious worldview, or a more humanistic belief related to life's meaning and purpose, the conversation is personal and important. The first step for the physician who wishes to have these conversations is achieving self-awareness of his or her own attitudes and core values. The inner attitude of the physician matters in this conversation with the patient. So this step takes priority over communication skills.

Respect is the most essential precondition for having the conversation. *Empathy* is equally important. To respect is to hold the other person and his or her beliefs in esteem. If the physician holds this attitude, he or she will approach the patient with utmost seriousness, with dignity, and with sincere appreciation for the patient's willingness to share his or her beliefs. *Authenticity* is the next most important inner attitude. Authenticity means that there is no falsity in one's interaction with the patient. The physician is not pretending to be anything he or she is not. Beginning with attitudes of respect for the patient and honesty in the interaction, one may now learn how to sincerely express compassion from experts in communication.

Thus, mastery of advanced skills in communication is essential for the physician who wishes to incorporate discussions of spiritual beliefs into his or her interactions with patients. The physician caring for a dying patient needs to establish trust in the relationship. At the very outset, the physician may need to deal with personal issues related to fear and loss. A prerequisite for dealing with these emotionally laden issues is to be comfortable in responding directly when the patient brings them up. Lo, Quill, and Tulsky describe how physicians and other caregivers can compassionately address painful topics brought up by the patient. In one example, a dying patient describes how painful it is to feel her daughter's dread in being with her, brought on by the visibly deforming effects of cancer. Their suggestions of responses are beautifully direct and compassionate: "What would you wish to say to your daughter if you could?" "You love your daughter so much." "It must be terrible to think of leaving her." "How could your time with your daughter be as meaningful as possible?" This alternation of empathy with questions that go to the heart of the matter, and use of words like "love" that many physicians might find difficult to say, ask more of the doctor than merely practicing saying the phrases. The inner attitude of care and love has to be there before one can say the words with compassion. This requires the doctor to move away from professional benign equanimity toward a more deeply human one-to-one relationship.

Our experience with cross-cultural interviews exploring spirituality and religion leads us to make additional observations regarding communication. Generally having established the relationship around issues that tend to come up early, such as loss and love of family, spirituality may naturally enter the conversation. If, however, the physician wishes to introduce this topic, approaching the patient in a highly respectful, compassionate, and honest man-

ner, the physician should carefully explain that he or she hopes discussing beliefs and values will be helpful. The physician then checks to be sure the patient is comfortable and willing to talk about spirituality and religion. Sufficient and convenient time should have been set aside for the discussion.

When the physician introduces the topic, semistructured questions seem most helpful. There is openness to the questions, but with enough structure that the patient knows what is being asked. "Are you a religious person?" is a good example. Also, the use of a few follow-up questions or prompts will guide the patient without specifying an answer, hence avoiding creating discomfort by ceding control of the conversation to the patient. Once the conversation is underway, a purely patient-centered approach is preferred. This requires that you follow the patient's lead in formulating questions and responses.

Reflections, using the patient's own words, are highly useful and respectful, because they do not require the patient to go into any territory he or she does not wish to enter. So, for example, if the patient says, "I pray a lot," the physician could respond, "So, you are praying a lot at this time." The physician can then wait in silence for the patient's next response, as opposed to formulating a question immediately, like "Prayer is very comforting to you?" which could be putting words in the patient's mouth. Wait for the patient to indicate that prayer is a comfort, which allows one to reflect back empathically, "So prayer is a comfort." This patient-centered approach ensures that the physician does not create his or her own agenda but addresses the patient's concerns.

The Physician's Role in Patient Spirituality

Many experts advocate exploring spirituality with patients. A common question is whether the physician should pray with the patient. Another question is whether the physician should share his or her own religious beliefs with the patient. Respect and authenticity come into play when a doctor and patient discuss spirituality or religion. One could argue that a physician who authentically believes it would help to share his or her religious fervor with a patient should proceed. Respect tempers what would be rash behavior. The physician should not only respect the patient but should also abide by the fundamental tenet of medical ethics, namely, the primacy of the patient, as Blank and colleagues note. The doctor is there for the patient's benefit, not to express his or her own beliefs.

Being respectful requires listening, appreciating the patient's beliefs, and responding honestly to the patient without imposing, philosophizing, or taking any other action that might not be fully patient centered. Self-disclosure is therefore discouraged. However, self-disclosure can be the most powerful expression of empathy possible if done with sincerity and genuine feeling, and done solely for the purpose of benefiting the patient. How should one resolve this quandary? Make self-disclosures rarely and only in circumstances when much is needed to comfort a patient, and when one feels certain that the disclosure will draw the patient closer to the doctor. Statements such as "When

my mother passed away, I was really sad for a long time. Losing someone close to you hurts” can foster caring and create a bond between the doctor and patient. But, if done too readily, if seemingly related to the doctor’s desire to tell his or her own life story, such disclosures may push the patient away.

Listening to a patient’s spiritual or religious beliefs is a therapeutic act. It is bearing witness to a person who may be sick or dying. One should strive to witness effectively. Listening is the main goal. One does not want in any way to minimize the importance of witnessing by interjecting oneself into the conversation. Thus, the physician’s presence is among the most therapeutic of acts. If the patient has discussed spirituality or religion, then one should proceed cautiously in adding anything from one’s own perspective. It will be likely that the physician and patient do not share the same religious and spiritual beliefs. Even if they do, many patients prefer any extensive discussion of religion to take place with a chaplain, rabbi, priest, or minister. One should always inquire if this is the case.

Responses beyond listening, then, might best consist of expressing sincere appreciation. One may appreciate that the patient is willing to share his or her beliefs. One may appreciate that religion or spirituality is a comfort. One might frame the physician’s role, assuming this is authentic, in the context of the patient’s beliefs. An example would be, “As your doctor, I do my part in the larger scheme of things. I can be with you and can help make you comfortable during your illness.”

I agree with those who say physicians should not offer prayer. But if requested by a patient to pray, I believe that a physician should remain totally sincere. Sincerity may consist of asking if it is all right to listen, head bowed, while the patient prays. Just as one listens when a patient cries, one may be profoundly supportive to a patient by one’s presence during prayer. If the physician honestly feels that he or she should join in the patient’s prayers, then so be it. Like touching a patient, to pray requires intuition. It requires the physician’s inner certainty that his or her action will benefit the patient.

Bibliography

- Blank L., H. Kimball, W. McDonald, et al. “Medical Professionalism in the New Millennium: A Physician Charter 15 Months Later.” *Annals of Internal Medicine* 138 (2003): 839–41.
- Cooper-Lewter, N., and H.H. Mitchell. *Soul Theology: The Heart of American Black Culture*. Nashville, TN: Abington, 1991.
- Daaleman T.P., and B. Frey. “Spirituality and Religious Beliefs and Practices.” *Journal of Family Practice* 48 (1999): 98–104.
- Institute of Medicine. *Improving Medical Education: Enhancing the Behavioral and Social Science Content of Medical School Curricula*. Committee on Behavioral and Social Sciences in Medical School Curricula. Washington, DC: National Academy, 2004.
- Lo, B., T. Quill, and J. Tulsky. “Discussing Palliative Care with Patients.” *Annals of Internal Medicine* 130 (1999): 744–49.
- Torke A., N. Garas, W. Sexson, and W.T. Branch Jr. “Medical Care at the End of Life: Views of African American Patients in an Urban Hospital.” *Journal of Palliative Medicine* (2005): 593–602.

75 Interdisciplinary Approaches to Faith Healing

Lisa J. Schwebel

The transcultural association between religion and healing is long-standing and well known. In ancient Japan, physicians were believed to be descendants of the sun goddess, the first healer, who passed her divine healing knowledge down to them. The first Chinese medical texts were attributed to three legendary divine emperors for whom both disease and cure were the result of spirit forces in nature. The roles of priest and physician were concentrated in one person in Taoism and Buddhism: the power to heal being linked to knowledge of natural and supernatural elements. The strong relation between religion and medicine was evident in the Indian belief that illness was caused by the accumulation of harmful *karma*. Tibetan medicine was exclusively the province of religion, being taught and practiced only in Buddhist monasteries. In the Hebrew Bible, illness and health were seen as God's punishment or reward for moral transgression, and New Testament stories show that Jesus instructed his disciples in healing through "casting out" unclean spirits. Islam prescribed a variety of religious rituals for ridding the body of *jinn* (demonic entities) believed to be carriers of disease.

In the West, the development of medicine into a separate and secular science was slow; for most of the last 2,000 years, medicine was held in very low esteem. Doctors were thought to be at best of meager use and at worst dangerous. Until roughly the last 150 years, little was known about the origin of disease or how to cure it. A person born in the United States prior to the mid-nineteenth century had less than a 50 percent chance of surviving to adulthood. Thus people lived in a state of chronic anxiety, powerlessness, and fear about their mortality. Not surprisingly, they turned to religion for both solace and also explanation.

The belief that disease was caused by sin, and that confession, penance, and prayer could restore health, had the advantage of reducing anxiety by providing people with the feeling of having control over and some measure of

hope about the future. The anthropologist Bronislaw Malinowski claimed that one impulse in the face of death was to despair, while the other, a “culturally valuable attitude,” was a belief in spirits and immortality. “By sacralizing and thus standardizing the other set of impulses,” he argued, religion gives us “the gift of mental integrity.” According to Malinowski, “religion counteracts the centrifugal forces of fear, dismay, demoralization, and provides the most powerful means of reintegration of the group’s shaken solidarity and of the re-establishment of its morale.”

In the 1870s, the germ theory of disease showed that microorganisms, not sins, were the cause of infection. Seventy years later, antibiotics, not confession, were seen as the proper course of treatment. The influence of religion in healing receded. In less than a hundred years, people went from falling to their knees to stretching out on an MRI table. While faith in God still played a part in people’s reaction to illness, faith in technology quickly took over as the main line of attack against disease.

The medical revolution of the late nineteenth century ushered in a materialistic, mechanistic approach in which the human organism was regarded as a network of independent systems functioning according to universal, fixed, deterministic, causal principles. This view, which focused almost exclusively on therapies that treated the physical body (e.g., drugs and surgery), not only rejected any role for faith in healing, but omitted the mind altogether (reducing it to an epiphenomenon of brain activity) as a factor in either illness or health.

The estrangement between religion and medicine in the twentieth century was not, however, complete. Throughout this period, scientists were applying their experimental methods and new statistical formulas to religion. They demonstrated that religion could be studied objectively, yielding sound, empirically verifiable data. The result is an illuminating and provocative body of research—undertaken by sociologists, psychologists, epidemiologists, engineers, physicists, molecular biologists, neurologists, immunologists, and clinical physicians—that indicates faith may prevent illness, promote health, and play a therapeutic role in healing. The irony is that the very tools of mechanistic science that once derided faith’s role in healing are now being used to reestablish its importance. Some of the connections between faith and health are surveyed in the sections that follow, which draw on the fields of sociology, psychology, parapsychology, and theology.

Sociology

A recent area of research, called the epidemiology of religion, looks at connections between religion and health by drawing on the field of epidemiology, which studies the occurrence and distribution of disease in a given population. Jeff Levin, a leading researcher in the epidemiology of religion, located over 250 peer-reviewed articles of studies done in the last century

testing the statistical effect of religion on health. He notes that virtually every disease has been studied in relation to religion, and that all of the studies led to the same conclusion: “religious affiliation, whatever the religion, seemed to be associated with lower rates of disease and death, whatever the cause of the illness. In the special language used by epidemiologists, lack of religious affiliation was apparently a new and potent risk factor for ill health across the board.” Studies showed that religious affiliation has a protective function against heart disease, hypertension, tuberculosis, cancer, and a range of ailments and conditions from allergies to ulcerative colitis. In one study of 7,000 Californians, researchers found that lack of religious affiliation increased the risk of death by 1.4 times.

Most religions, in seeking to promote the health and well-being of their followers, have rules forbidding certain behaviors while encouraging others. Some faiths prohibit the use of alcohol, caffeine, or tobacco; many have dietary restrictions; still others have views about sexual practices, blood products, drugs, and exercise. All of these are known to have an impact on health. People who identify themselves with a religion (regardless of whether they are members of a particular congregation or regularly attend services) are likely to follow its guidelines, some of which correlate with healthy behaviors known to protect against illness and improve health. Significantly, religious affiliation was also found to have a protective function even when people engaged in harmful behaviors.

A strong link has been established between religious attendance and health. A Johns Hopkins University study using data from a census of more than 90,000 people discovered that less than monthly attendance “doubled and even tripled the risk of death due to arteriosclerotic heart disease, pulmonary emphysema, cirrhosis of the liver, suicide, and cancers of the rectum and colon.” A follow-up study disclosed a “dose-response” link between frequency of attendance and total deaths. Attending services at least once a week “reduced by almost 50 percent the risk of death the following year.” William Strawbridge found that the benefits of frequent religious attendance extended over a twenty-eight-year period. Attending services in 2004 could reduce the risk of dying in 2032.

Levin’s own study revealed that not only was religious participation a strong factor in health, but study subjects reported it was more important than health as a determinant of well-being. Since social scientists had long assumed that health was the key factor in assessing well-being, they tended to marginalize the role of religion. This study helped revise that assumption. Levin and his colleagues were able to replicate their results in three national studies.

Regular religious attendance appears to act as a buffer against the stresses that are risk factors for illness by providing the social support long associated with health. People who regularly attend religious services are more likely than nonattenders to have a network of positive social relationships to draw on for both tangible (financial, physical) and intangible (emotional) assis-

tance during difficult times. From a sociological perspective, religious affiliation promotes health-maintaining behaviors, and religious attendance provides stress-reducing supportive communities. Religious people, on average, feel better and live longer.

Psychology

Religious worship produces emotional responses believed to protect against disease and activate healing processes. Studies such as those by Greeley show the health benefits of personal prayer, the most popular form of religious worship in America, extend beyond that of affiliation and attendance alone. People who prayed frequently reported greater life satisfaction and well-being, regardless of religious affiliation, rate of attendance, social isolation, medical history, and mental stability. Moreover, three different studies described by Levin in 2001 showed a “longitudinal effect” to prayer: the more frequently people prayed, the longer the experience of well-being lasted.

By the 1950s, Western medicine had moved beyond a purely mechanistic model of health and healing to one in which emotions were admitted to affect the body—either negatively in the form of “psychosomatic diseases,” or positively through the power of suggestion and expectation, the “placebo effect.” The therapeutic effect of religious belief and prayer—claims of faith healing—were treated as the result of suggestion on diseases known to be susceptible to emotional influence. Cases that did not fit the model were largely ignored or dismissed as misdiagnosed by the medical community. But some religious groups championed them as miracles and evidence of divine reality.

This situation began to change in the 1980s with reports of the work on mental states and biological systems done by Candace Pert and her colleagues in the field of psychoneuroimmunology. Pert discovered that peptides (information-bearing compounds of amino acids) are the chemical correlates of emotions, and that peptides are found throughout the body, including the brain and the immune system. This meant that the conceptual barriers islanding off mind and body in healing were crumbling. The new research points to one unified, fully integrated, multidimensional *body-mind* entity in which emotions have a direct—and directing—influence over immunological processes. The act of feeling is the act of the endocrine-immune-neurological system.

Neuropeptides (as informational substances) tell the body what to do, and since it isn’t possible to do everything, emotions prioritize the information competing for body-mind attention. Chronic, inescapable, or unpredictable stress is, Pert says, one of the most significant causal factors in disease. It generates feelings of helplessness and hopelessness that can lead to social withdrawal and emotional repression. Habitual repression has been correlated with immunological dysfunction, which reduces resistance to infectious diseases, and to aggravating factors in some tumors. According to Pert, if emotions direct healing resources, then long-term repression of

emotional response would have a profound obstructive impact on healing. “This line of reasoning leads inevitably to the hypothesis that emotional expression, disinhibition, and self-actualization would strengthen the healing system. There is now experimental, longitudinal, and clinical evidence to support this hypothesis.”

Pert argues that the prioritizing process is generally unconscious, but through visualization techniques, hypnosis, meditation, and prayer, people can actively direct body-mind attention to particular areas. For example, when a tennis player with a broken elbow was informed that poor blood flow was the reason the break was taking so long to heal, he significantly hastened his recovery by focusing every day for twenty minutes on increasing blood flow to his elbow.

Religious worship that encourages social participation and full emotional expression (of both good and bad feelings) strengthens “host defenses” (the innate ability to withstand infection) and mobilizes healing forces. This may lead, as Pert notes, to breakthroughs in illnesses heretofore unresponsive to treatment, and to progress in diseases believed to be untreatable. “Therapeutic interventions can bring unconscious mental processes into awareness, and psychosocial and behavioral changes can . . . result in concomitant physiological changes. Interventions designed to facilitate emotional expression are prime examples of the interpolations of conscious into otherwise (unconscious) psychobiological processes, resulting in beneficial health outcomes.” A study by Spiegel, for example, showed the physical effects of emotional expression on women with metastasized breast cancer.

From a psychoneuroimmunological perspective, prayer and other forms of religious worship serve as “therapeutic interventions,” and cases of faith healing may be the best examples of how the process works. Thus, anything that produces heartfelt emotional responses—and religious worship clearly does so—will have an effect on biological processes. In a story in the New Testament, when a woman with hemorrhages is cured upon touching Jesus’s cloak, Jesus responds, “Daughter, your faith has made you well” (Mark 5:25–34). Her cure may show the effect of emotion peptides stimulating her immune system.

Dossey, Green, and Levin reported on studies showing the psychophysical benefits of love for healing. Bernie Siegel, a physician, writes: “If I told patients to raise their blood levels of immune globulins or killer T cells, no one would know how. But if I can teach them to love themselves and others fully, the same change happens automatically. The truth is: Love heals.” Religious affiliation, attendance, belief, and worship promote behaviors, relationships, and emotions designed for the very purpose of expanding and maximizing love: self-love (through generating feelings of self-worth); love of and by God (imaged as a personal deity or as a higher force); and love of others (including, family, co-religionists, and the wider community). According to Green: “Because ‘energy’ is defined as the capacity to produce effects, love may be referred to as an energy.”

Does research showing the effect of religious attendance and worship on health prove the existence of God? No. Religious faith has been scientifically and theoretically shown to produce significant physiological changes independently of whether any divine being exists. But “hope and expectation seem capable of miracles.” That is, believing that God exists appears sufficient to produce the effects observed.

Parapsychology

The psychiatrist Daniel Benor, a leading authority on faith healing, located more than two hundred studies on spiritual healing. Spiritual healing is an umbrella term for a range of unorthodox healing practices, including intercessory prayer, focused meditation, laying on of hands, visualization, shamanistic healing, and spirit intervention. Randolph Byrd, a cardiologist in San Francisco, conducted the first large-scale, rigorously controlled study of prayer, charting the progress of 393 coronary care patients, some of whom were prayed for and others not. Patients were randomly assigned to “born again” Christian (Protestant and Catholic) intercessors who were given patients’ first names along with general information on their condition. The intercessors then prayed daily for the patients’ rapid recovery and the prevention of complications. The data showed that those prayed for “had less congestive heart failure, required less diuretic and antibiotic therapy, had fewer episodes of pneumonia, had fewer cardiac arrests, and were less frequently intubated and ventilated.” William Harris replicated the study, with similar positive findings. It is noteworthy that both articles were published in conventional medical journals—Byrd’s in the *Southern Medical Journal*, Harris’s in the *Archives of Internal Medicine*.

Similarly, Elizabeth Targ’s study of the effect of distant healing on forty advanced AIDS patients was published in the mainstream *Western Journal of Medicine*. Targ found decreased medical utilization, fewer and less severe new illnesses, and improved mood for the treated as opposed to the control group; overall, a positive therapeutic effect for distant healing. Distinct from Byrd’s study, healers were drawn from Christian, Jewish, Buddhist, Native American, and shamanic traditions, as well as from bioenergetic and meditative healing schools.

Researchers have also conducted experiments on nonhuman targets (mice, yeast, barley, plants, blood, bacteria, enzymes, and DNA) in order to eliminate suggestion and expectation as factors. Benor’s review of 191 controlled experiments (including human and nonhuman subjects) showed that two-thirds demonstrated a significant effect of distant healing. The conservative *Annals of Internal Medicine* conducted its own assessment of distant healing studies and concluded that continued research was warranted. Courses on spiritual healing are now taught in most medical schools around the country, and research in distant healing, funded by the National Institutes of Health and other

groups, is conducted by scientists at institutions such as Harvard, Stanford, Princeton, Columbia, Cornell, Duke, and the Mayo Clinic.

Can research on intercessory prayer and distant healing be used to prove the existence of God? While scientists do not know how intercessory prayer and distant healing work (a number of theories have emerged), this does not warrant recourse to divine intervention. To do so is to make faith hostage to the historical moment, to the limit of scientific knowledge at a particular time. For example, in 2001 researchers discovered that the heart and pancreas could regenerate their own cells—overturning enshrined medical truths concerning the body's ability to repair itself. How many cures attributed to God were actually the result of similar natural but as yet unknown processes? If the definition of miracle is based on accepted scientific knowledge, then what happens when that knowledge changes? Are there outdated miracles? Since today's scientific impossibility is more than likely tomorrow's medical truism, any judgment about miracles ought to be provisional. After all, it was always true that the heart and the pancreas could grow new cells—just nobody knew it.

Theology

Psychological, sociological, and parapsychological research shows that faith can be protective against illness, productive of well-being and health, and potentially effective in healing at a distance. These approaches can further understanding of some of the effects observed at healing shrines like Lourdes, which is the only one with an established medical bureau to investigate miracle claims.

Nowhere are the sick less isolated than at Lourdes; it is a city devoted to serving them. In fact, according to psychiatrist Jerome Frank, the very decision to go to Lourdes is sufficient to release repressed emotions and stimulate immune system functioning. Planning for as well as undertaking the trip puts the ordinarily marginalized patient at the center of a whirlwind of social activity, involving the participation of the patient's immediate family and usually the wider church community as well. The excitement of the trip is punctuated by prayer services and other religious rituals associated with the pilgrimage. The main religious ceremony at the shrine is the procession, whose overwhelming emotional power is evidenced by the fact that the majority of healings are reported to take place during the procession and not at the pool.

If the research is correct, then the entire trip to Lourdes acts as a "therapeutic intervention" capable of producing profound physiological changes. Moreover, as research in distant healing suggests, pilgrims at Lourdes may be able to influence not only their own body-mind system but also that of their fellow pilgrims. The power of the conscious, dedicated, focused, intense prayers of thousands at a religious healing shrine must be at least as good as, if not significantly greater than, that occurring in distant healing experiments.

Bibliography

- Benor, Daniel. *Healing Research*. Oxford: Helex, 1992.
- . *Spiritual Healing*. Southfield, MI: Visions, 2001.
- Byrd, Randolph. "Positive Therapeutic Effects of Intercessory Prayer in a Coronary Care Unit Population." *Southern Medical Journal* 81 (1988): 826–29.
- Cranston, Ruth. *The Miracle of Lourdes*. New York: Doubleday, 1955.
- Dossey, Larry. *Healing Words*. San Francisco: HarperSanFrancisco, 1993.
- . *Reinventing Medicine*. San Francisco: HarperSanFrancisco, 1999.
- . "The Return of Prayer." *Alternative Therapies in Health and Medicine* 3 (1997): 10–17, 113–20.
- . "What's Love Got to Do with It?" *Alternative Therapies* 2 (1996): 8–15.
- Frank, Jerome. *Persuasion and Healing*. Baltimore: Johns Hopkins University Press, 1961.
- Greeley, Andrew. "Devotions, Defections, Activities, and Attitudes." *Religious Change in America*. Cambridge, MA: Harvard University Press, 1989.
- Green, Judith. "The Healing Energy of Love." *Alternative Therapies* 2 (1996): 46–56.
- Harris, William. "A Randomized, Controlled Trial of the Effects of Remote, Intercessory Prayer on Outcomes in Patients Admitted to the Coronary Care Units." *Annals of Internal Medicine* 19 (1999): 2273–78.
- Levin, Jeff. *God, Faith, and Health*. New York: John Wiley and Sons, 2001.
- . "The Power of Love." *Alternative Therapies* 5 (1999): 79–86.
- Malinowski, Bronislaw. *Magic, Science, and Religion*. New York: Doubleday, 1948.
- Marnham, Patrick. *Lourdes: A Modern Pilgrimage*. New York: Image Books, 1980.
- Moyers, Bill. *Healing and the Mind*. New York: Doubleday, 1993.
- Pert, Candace. *Molecules of Emotion*. New York: Touchstone, 1997.
- . "The Psychosomatic Network: Foundations of Mind-Body Medicine." *Alternative Therapies* 4 (1998): 30–41.
- Sicher, Fred, Elisabeth Targ, Dan Moore, and Helene S. Smith. "A Randomized, Double-blind Study of the Effects of Distant Healing in a Population with Advanced AIDS." *Western Journal of Medicine* 169 (1998): 356–63.
- Spiegel, David. "Effects of Psychosocial Support on Patients with Metastatic Breast Cancer." *Journal of Psychosocial Oncology* 10 (1992): 113–20.
- Strawbridge, William. "Frequent Attendance at Religious Services and Mortality over 28 Years." *American Journal of Public Health* 87 (1997): 957–61.

76 Does Religion Cause Health?

Doug Oman and Carl E. Thoresen

Relationships between religion, spirituality, and health are drawing increasing attention from the scientific community, as reflected in growing numbers of publications in major biomedical, public health, and social science journals over the past decade. In the United States, the National Institutes of Health recently published a panel report on the topic as a special issue of *American Psychologist* and requested funding applications for studies of spirituality and alcohol abuse. Special issues of other scientific journals have also focused on the topic, and more than half of U.S. medical schools now offer course material on religion, spirituality, and health. The American Psychological Association has published books about the implications of religious perspectives for psychological science, including implications for physical health and health psychology.

Interest in the effects of religion, and indirectly in spirituality, is surging, in part because of a small but growing body of high-quality published studies, especially in epidemiology. Most striking are over two dozen studies associating attendance at religious services with lower rates of death. One of the most thorough, by Hummer and colleagues, is an eight-year follow-up of more than 20,000 adults representative of the U.S. population. The study found a life expectancy gap of more than seven years between persons never attending services and those attending more than once weekly, “similar to the female-male and white-black gaps in U.S. life expectancy.” Among African Americans, the life expectancy gap associated with religious attendance was nearly fourteen years. After adjusting for differences in demographics, socioeconomic status, health status, health behaviors, and social ties, the risk of mortality was elevated nearly as much among nonattenders (50 percent elevation) as among heavy smokers (63 percent elevation). Similarly, a recent analysis of over forty independent samples containing more than 120,000 persons found that religiously involved persons experienced a significantly longer life. The critical review by the National Institutes of Health, mentioned above, concluded that evidence is now “persuasive” that frequent religious atten-

dance (i.e., once weekly or more) predicts longevity, independently of other well-established risk factors.

In other well-designed studies, reviewed by Koenig and colleagues, religious involvement has been assessed primarily as religious service attendance, private devotional activity, or religious experiences (e.g., perceived strength and comfort from religion), and has been found to be associated with a wide range of health benefits, including lower mortality due to a wide spectrum of specific causes, lower blood pressure, lower incidence of physical disability, less depression, greater well-being, less spousal abuse, better health practices among adolescents, reduced alcohol and substance abuse, and greater adoption and maintenance of positive health behaviors such as exercising and not smoking. Other studies have found that religious involvement mitigates the effects of unemployment and is associated with reduced racial self-stigmatization and reduced dependence on physical self-concepts.

Many observers welcome the increasing attention to religion. Others, however, express profound discomfort. Some emphasize potential dangers in current trends, such as that physicians might impose their religious beliefs on their patients. Others note that scientists might seriously misrepresent the phenomena of religion and spirituality. In view of such controversy, it seems natural to wonder whether people all mean the same thing when they ask, “Does religion (or spirituality) cause health?” We argue that the answer is no, and that some of the current controversy arises from confusion among at least four natural but strikingly different interpretations:

- Does religious or spiritual involvement causally reduce morbidity or mortality in any way?
- Does religious or spiritual involvement reduce morbidity or mortality through direct mind-body pathways?
- Does religious or spiritual involvement reduce morbidity or mortality through supernatural or other unconventional pathways?
- Does religious or spiritual involvement improve health behaviors (e.g., by helping a person quit smoking or avoid heavy drinking)?

Such diverging interpretations are perhaps not surprising, since religion and spirituality each represent complex, multidimensional constructs. Furthermore, although some dimensions of religion, such as attending services or reading religious literature, can be readily observed (and assessed), other dimensions, such as faith or transcendental experiences, are not readily observable by others, nor easily described by many. But divergent meanings of “Does religion cause health?” are perhaps better understood against the background of a *web of causality*: the interrelations among a set of hypothesized mechanisms or processes by which religion (or spirituality) might “cause” benefits to health in more or less direct ways.

Using the notion of a causal web, we seek to clarify the meaning and impor-

tance of diverse interpretations of the question “Does religion causally influence health?” In what follows, we review hypothesized causal mechanisms, illustrating how different interpretations of the question lead to different propositions in a causal web. Many common interpretations do not map cleanly, in a one-to-one fashion, onto causal pathways hypothesized by experts in the field. We conclude by arguing that diverse interpretations of “Does religion cause health?” will not soon give way to a single dominant interpretation.

The Causal Web

To account for the better health observed among religiously and spiritually involved persons, reviews commonly identify at least four major categories of mechanism. Partially overlapping rather than competing, many or all of these mechanisms may operate simultaneously:

1. *Health Behaviors.* Behaviorally strict religious groups, such as Mormons or Seventh-Day Adventists, may discourage smoking and drinking of alcohol or encourage good diets. More broadly, many denominations may encourage good health behaviors out of respect for the body as an instrument of God’s service.
2. *Social Support.* Religious or spiritually involved persons may experience social contact with co-religionists, which could lead to larger and stronger social networks and a greater availability of social support, a well-established factor promoting health. Like religion and spirituality, social support is multidimensional, and it may help people maintain better mental health and health behaviors.
3. *Mental Health.* Religiously or spiritually involved persons may experience better mental health and more positive psychological states, such as joy, hope, and compassion, perhaps from using religious coping methods to buffer stress, or from adhering to spiritually related goals and personal strivings learned in part from family, community, or historical exemplars (e.g., “What would Jesus do?” or “What would Martin Luther King do?”). Such states may include reduced negative emotions (e.g., fear, sadness, anger), as well as positive attitudes or emotions such as optimism and faith, meaning, conscientiousness, and perceptions of abilities to control oneself or one’s environment. Positive emotional states may lead to improved physical health through mind-body processes such as reduced cardiovascular reactivity and enhanced immune and endocrine function. Mental health and positive psychological states derived from spiritual or religious coping may also assist people in overcoming internal barriers to adopting positive health behaviors or forming supportive social connections.
4. *Superempirical or “Psi” Influences.* Certain religious practices, such as intercessory prayer, may act partially through natural laws (per-

haps governing “subtle energies”) that are beyond current modern scientific understanding. Such laws and the phenomena they seek to explain, commonly called “psi” phenomena in psychology, may in time be comprehended by science. Some distinguish “superempirical” influences that are naturalistic, law governed, and potentially knowable by science from possible “supernatural” influences, such as intervention by God.

The first three categories—health behaviors, social support, and mental health—correspond more or less to major causal mechanisms generally recognized by researchers in a wide variety of fields within biomedicine and the social and behavioral sciences. As noted above, these major pathways are commonly situated within a causal web, an increasingly dominant conceptual framework within many social sciences and within epidemiology, the study of disease patterns in populations. A causal web is often represented as a path diagram (e.g., Figure 76.1) that incorporates assumptions derived from prior conceptual and empirical investigation of how the world is likely to work. In empirical studies, the conceptual web of causation guides the conduct of statistical analyses for estimating the strength or weakness of influences represented by each pathway within the causal web. Here, we focus on conceptual steps that *precede* the statistical analysis.

Figure 76.1 offers a causal web that might be used to study the preventive effects of religious or spiritual variables on a range of physical health outcomes. Religion is seen as influencing health through pathways that we have labeled “HB” (health behaviors), “SS” (social support), and “MH” (mental health). Like all presumed causal models, the network represented in Figure 76.1 is imperfect, incomplete, and debatable. For example, Figure 76.1 ignores multidimensionality of religion, spirituality, mental health, and social support. It also ignores how influence from religion may vary between diseases and by stage of disease, ignores possible negative consequences from religion or social support, and ignores possible curative (rather than preventive) influences from religion. However, these imperfections do not detract from the usefulness of the model in Figure 76.1 for showing how alternative interpretations of “Does religion cause health?” can manifest as entirely different questions about the strength of different causal pathways.

Remarkably, in view of current controversies about religion and health, most biomedical researchers and a majority of the general public seem to have a long-standing acceptance that certain types of religious practice—such as Mormonism and Seventh-Day Adventism—do *causally* benefit physical health by fostering various positive health behaviors. That is, once smoking and high-fat diets were identified as risk factors, a general acceptance seemed to emerge that adhering to Mormonism or certain other behaviorally strict religious faiths does very likely provide health benefits (via improved health behaviors, the first causal pathway described above).

Figure 76.1 **Prevention Model Depicting Possible Causal Effects of Religion and Spirituality on Health**

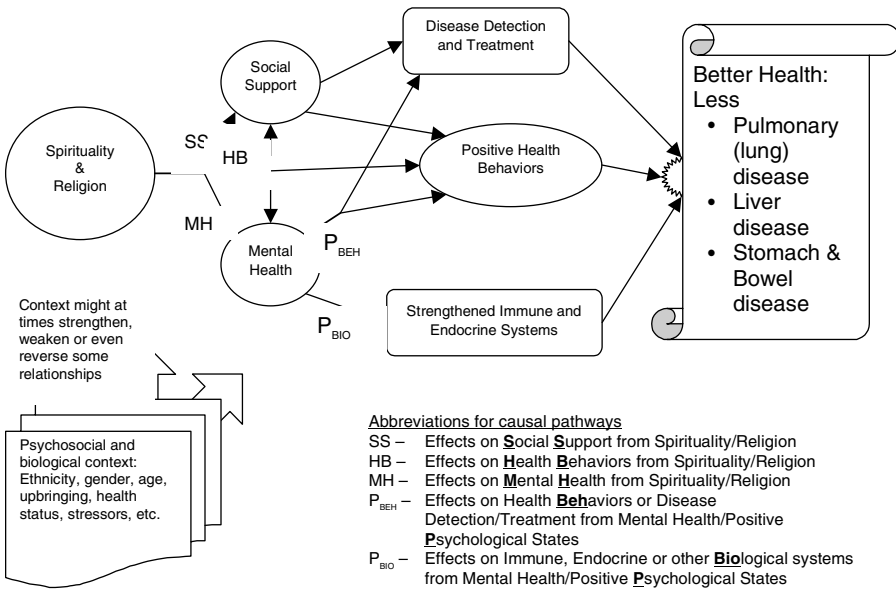

Nevertheless, claims that religious involvements cause health benefits remain highly controversial if not confused. For example, Sloan and colleagues argued in the *Lancet* that “evidence of an association between religion, spirituality, and health is weak and inconsistent,” despite the authors’ paradoxical concession of causal benefits to health from “adherence to codes of conduct that proscribe behaviors associated with risk” by Mormon priests, Trappist and Benedictine monks, and Roman Catholic priests and nuns.

Diverse Interpretations of a Common Question

If health benefits due to following strict religious practices are commonly acknowledged, then why is there controversy? Part of the controversy derives from confusion among the four major interpretations commonly given to the question “Does religion cause health?” These diverging interpretations arise *prior* to examining empirical data, not from disagreements over data or over statistical analyses. Rather, peoples’ diverse personal curiosities and professional interests give rise to diverging approaches to operationalizing the religion and health question as a *proposition about the causal web* connecting religion to health. Recognized as such, these terminological and operational differences can be clarified. Unrecognized, these differences in how words are used can masquerade as fundamental differences in ideology or scientific judgment.

Figure 76.2

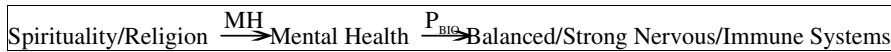

Little confusion would emerge if everyone's attention was captivated by the simplest and most basic of the possible interpretations, which we call the "any pathway" interpretation:

1. *The "Any Pathway" Interpretation:* Does religion or spirituality cause health benefits through *any* causal pathway, including health behaviors, social support, mental health, *or* superempirical pathways? (Do any of the pathways "HB," "SS," or "MH" in Figure 76.1 operate positively?)

Yet for many persons, both researchers and members of the lay public, the possibility that religious involvement may facilitate better health behaviors or expanded social networks is commonly viewed as uninteresting. Instead, such persons seem inclined toward interpreting "Does religion cause health?" in a way that emphasizes a more novel set of pathways:

2. *The "Psychobiological" (Mind-Body) Interpretation:* Does religion or spirituality cause health benefits through pathways that specifically involve mental health and positive psychological states—through improved immune and endocrine systems, *above and beyond* any benefits that religion may confer through improved health behaviors and expanded social support? (Are pathways "MH" and "P_{BIO}" positive in Figure 76.1?) These pathways correspond respectively to the propositions that (a) religious involvement *directly* causes positive psychological states, and (b) positive psychological states *directly* benefit the body:

Still other persons may regard mind/body pathways as less interesting than psi pathways, and focus on a third interpretation:

3. *The "Superempirical" or "Psi" Interpretation:* Does religion or spirituality cause health benefits through superempirical pathways, *above and beyond* any benefits that it may confer through improved health behaviors, social support, and mental health? (Do unexplained effects of religion on health remain after taking into account pathways "HB," "SS," and "MH" in Figure 76.1?)

Finally, for some persons—perhaps especially those professionally or personally combating substance abuse, such as participants in twelve-step

Figure 76.3



programs—a natural interpretation of “Does religion cause health?” emphasizes the added psychological resources that religion may contribute for improving health behaviors:

4. *The “Psychobehavioral” Interpretation:* Does religion or spirituality cause health benefits by fostering psychological conditions—character, will-power, self-efficacy, focused attention, enhanced motivation—that lead to improved health behaviors, disease detection, and compliance with treatment, *above and beyond* any benefits conferred through expanded social networks and social support? (Are pathways “MH” and “P_{BEH}” positive in Figure 76.1?)

Each of the four interpretations described above is concerned with distinguishing truly causal relationships from situations where religion or spirituality is a *result* rather than a cause (e.g., if preexisting poor health causes low attendance at worship services). However, the four interpretations differ radically regarding which causal pathways merit special attention. They differ also regarding which pathways are *dismissed* as being of lesser interest, or perhaps too obvious even to spend time discussing. Disentangling such clashing foci of interest can help clarify some of the debates regarding religion and health.

Viewed in the light of this analysis, the conclusion by Sloan and colleagues in the *Lancet* that evidence of an association is weak clearly did not use the most straightforward “any pathway” interpretation, because it in effect dismissed the health behavior pathway as of little interest. But neither did the conclusion offer readers an alternative interpretation. Each reader was forced to read in his or her own interpretation of what type of causal benefit was under review, and less attentive readers might mistakenly conclude that the review systematically evaluated all causal pathways.

Similarly, diverging interpretations of “Does religion cause health?” can create confusion when trying to interpret individual studies. An often cited study at Duke University by Koenig in 1997 examined the relationship between religion and immune function. A reader might naturally assume that this study would address the “psychobiological” interpretation, which focuses directly on a mind-body pathway. However, because the study failed to include measures of health behaviors and nonreligious social support, it seems more prudent to classify the study as addressing the “any pathway” interpretation. Unexplored in the Duke study was whether the association of religious attendance with immune function might be “explained” by greater social sup-

port available to frequent attenders, or by a combination of support with advantageous health behaviors (e.g., less smoking, more exercise).

On the other hand, empirical studies that report the results of fitting several different models involving different sets of adjustment variables may offer evidence bearing upon answers to more than one interpretation of the religion and health question. For example, Strawbridge and colleagues found that religious attendance predicted lower all-cause mortality after adjustments for demographics and health status, supporting a “yes” answer to the “any pathway” interpretation. Their report that further adjustments for health behaviors and social support reduced but did not eliminate the association of religion with reduced mortality supported a “yes” answer to the “psychobiology” (mind-body) interpretation. Finally, their report that religious individuals were more likely to improve their health behaviors over time suggested a “yes” answer to the “psychobehavioral” interpretation.

Confusion among diverse interpretations of “Does religion cause health?” would perhaps be tolerable if the only result was occasional misunderstanding by researchers. But, as noted above, the stakes are much higher. Ambiguity about how to interpret “the effects of religion or spirituality” undermines the ability of the empirical literature to inform the public and health professionals about the justifiable and ethical roles of religion in health care. This prevents optimal collaboration among patients, physicians, nurses, public health professionals, faith communities, and interdisciplinary teams of health professionals and researchers.

Historical Background

The pressing need to disentangle varying interpretations of “Does religion cause health?” is a relatively recent phenomenon. Before the 1990s, confusion about the religion causing health question seldom arose, perhaps because few studies focused directly on religion. If measured at all, religious factors were usually thought of as proxies (substitutes) for other variables that were of primary interest, such as health behaviors or social support.

For example, many early studies examined behaviorally strict religious denominations or orders, such as Mormons or Benedictine monks. Differences in denomination or order were viewed as representing health behaviors, and “the effect of religion on health” was implicitly interpreted as “the effect of religious group on health through health behaviors.” In effect, such studies used a variant of the “psychobehavioral” interpretation described above, assuming that group differences relating to other pathways besides health behaviors were unimportant. Other earlier studies measured frequency of attendance at religious services, treating it as simply a measure of social support, thereby conceptualizing religion’s effects according to a variant of the “any pathway” interpretation.

Only in the late 1980s did religion start to be conceptualized in a manner

sophisticated enough to permit confusion. Scientific articles were published that reviewed previous studies and systematically described the same general classes of possible underlying mechanisms that we have described here. Observational studies attempting to disentangle psychological effects of religion from social support effects began to emerge in the 1990s.

However, an additional source of present confusion, if not heated controversy, arises from recent studies that are largely irrelevant to the “any pathway,” “psychobiological” or “psychobehavioral” interpretations. Instead they bear upon the “psi” interpretation of “Does religion cause health?” These studies became prominent when Byrd reported a groundbreaking clinical trial in which 393 hospitalized heart patients were randomly divided into two groups: those receiving the usual care condition, and those who were also “treated” by having interdenominational groups of Christians pray for each patient’s recovery. Researchers found that patients in the prayed-for group exhibited significantly better recovery than controls in several areas (e.g., less intubation/ventilation, less antibiotics), and had significantly better overall improvement scores. More recent studies of similar design have sometimes failed and sometimes succeeded in generating similar findings but are not yet perceived by most scientists as offering conclusive proof of the efficacy of intercessory prayer.

In their methods and concepts, such prayer studies are much closer to clinical trials of alternative or complementary health care practices (e.g., acupuncture) than to most other prominent studies of religion and health, which rely on methods from mainstream psychosocial epidemiology. Mainstream modern science has difficulty in formulating *any* plausible naturalistic mechanism by which distant intercessory prayer might “get into the body” of its intended beneficiary. Furthermore, measurement difficulties make it unclear how studies of religion and spirituality within a population-based approach can incorporate “healing prayer” as a possible explanatory variable. For example, how can one assess the extent that a study participant is being prayed for by *all* other persons? On average across populations, do more numerous or more fervent prayers plead for the health of religious men, women, and children than for the health of their nonbelieving brothers and sisters? Might some religious persons, like Christian “good shepherds” who “leave the ninety and nine in the wilderness, and go after that which is lost” (Luke 15:4), actually offer *more prayers* for nonbelievers? If so, then wouldn’t such prayers lead to better health among nonreligious rather than religious persons? These topics have apparently never been addressed empirically.

From Confusion to Clarity in Diversity

We believe that the diverse meanings embedded in the question “Does religion cause health?” are here to stay, not only in popular culture but also among health professionals. The “any pathway” interpretation, the “psychobiology”

interpretation, the “psychobehavioral” interpretation, and the “psi” interpretation are each likely to remain common. Each has continuing importance for specific groups of researchers, primary care professionals, and members of the general public. Different researchers are likely to focus on different interpretations, in part because religious and spiritual involvement seem likely to have much greater impacts on some health outcomes (e.g., cardiovascular diseases) than on other health outcomes (e.g., expression of certain genetic diseases). Like human groups everywhere, different groups of researchers are likely to develop their own vernacular speech habits that reflect their own ongoing concerns, and employ different interpretations of “Does religion cause health?” We believe that such linguistic diversity is inevitable, and that efforts to impose a strictly standardized vocabulary are unlikely to succeed.

Instead, to foster successful and necessary collaboration, we contend that all persons concerned about the relationship of religion and spirituality with health should familiarize themselves with the range of meanings of “Does religion cause health?”—not only the four interpretations we describe above, but also any additional interpretations that may emerge. Uniformity of terms and methods is a hallmark of a mature science and has its place, but if imposed prematurely, it can stifle inquiry and retard understanding, especially in terms of creating more sensitive assessments and more comprehensive models. Greater awareness of this spectrum of interpretations will encourage more effective communication and collaboration among health professionals, religious organizations and individuals, spiritual persons not affiliated with organized religion, and others in the general public. Such collaboration may be essential for maximally reducing disease and promoting health and well-being in the twenty-first century.

Acknowledgments

We are grateful to Sage Publications for permission to reproduce substantial portions of the original article on which this was based (Oman and Thoresen, 2002). Writing of the original article was supported in part by the Training Grant T32 HL07365-21 from the U.S. National Heart, Lung, and Blood Institute (first author), as well as grants from the John Templeton Foundation and the Fetzer Institute (second author). We also benefited from critical readings by members of the Behavioral Factors Seminar at the University of California, Berkeley, especially Beverly A. Davenport, John W. Frank, and William Klitz.

Bibliography

- Byrd, Randolph C. “Positive Therapeutic Effects of Intercessory Prayer in a Coronary Care Unit Population.” *Southern Medical Journal* 81:7 (1988): 826–29.
- House, James S., Karl R. Landis, and Debra Umberson. “Social Relationships and Health.” *Science* 241:4865 (1988): 540–45.
- Hummer, Robert A., Richard G. Rogers, Charles B. Nam, and Christopher G. Ellison. “Religious Involvement and U.S. Adult Mortality.” *Demography* 36:2 (1999): 273–85.
- Koenig, Harold G., Harvey Jay Cohen, Linda K. George, Judith C. Hays, David B. Larson, and Dan G. Blazer. “Attendance at Religious Services, Interleukin-6, and Other Biological Parameters of Immune Function in Older Adults.” *International Journal for Psychiatry in Medicine* 27:3 (1997): 233–50.

- Koenig, Harold G., Michael E. McCullough, and David B. Larson. *Handbook of Religion and Health*. New York: Oxford University Press, 2001.
- Levin, Jeffrey S. "How Prayer Heals: A Theoretical Model." *Alternative Therapies in Health and Medicine* 2:1 (1996): 66–73.
- McEwen, Bruce S. "Protective and Damaging Effects of Stress Mediators." *New England Journal of Medicine* 338:3 (1998): 171–79.
- Miller, William R., and Carl E. Thoresen. "Spirituality, Religion, and Health: An Emerging Research Field." *American Psychologist* 58:1 (2003): 24–35.
- Oman, Doug, and Carl E. Thoresen. "'Does Religion Cause Health?': Differing Interpretations and Diverse Meanings." *Journal of Health Psychology* 7:4 (2002): 365–80.
- . "Spiritual Modeling: A Key to Spiritual and Religious Growth?" *International Journal for the Psychology of Religion* 13:3 (2003): 149–65.
- Pargament, Kenneth I. *The Psychology of Religion and Coping: Theory, Research, Practice*. New York: Guilford, 1997.
- Powell, Lynda H., Leila Shahabi, and Carl E. Thoresen. "Religion and Spirituality: Linkages to Physical Health." *American Psychologist* 58:1 (2003): 36–52.
- Sloan, Richard P., E. Bagiella, and T. Powell. "Religion, Spirituality, and Medicine." *Lancet* 353:9153 (1999): 664–67.
- Strawbridge, William J., Richard D. Cohen, Sarah J. Shema, and George A. Kaplan. "Frequent Attendance at Religious Services and Mortality over 28 Years." *American Journal of Public Health* 87:6 (1997): 957–61.
- Thoresen, Carl E., Doug Oman, and Alex H. S. Harris. "Religious Practices and Their Effects on Health: Judeo-Christian and Scientific Perspectives." In *Judeo-Christian Perspectives on Psychology: Human Nature, Motivation, and Change*, ed. William R. Miller and Harold D. Delaney. Washington, DC: American Psychological Association, 2004.

Dying and Death

Introduction to Dying and Death

More than any other aspects of human experience, death and dying inspire the imagination, ingenuity, and intelligence of individuals who must cope with and make sense of these fundamental realities across time and around the world. Science and religion, sometimes in collaboration, sometimes in conflict, are critical resources in the inevitable encounter with mortality. They provide the tools, symbolic as well as practical, to face death either in the form of a fresh human corpse or of a suffering individual who is still alive but on the verge of passing on.

The conventional view that has dominated the modern era is rather simplistic and naive: science is best suited to respond to the physical, bodily dimensions associated with dying, with medical science as the driving force employed to prevent death and prolong the life of the biological organism or, when those efforts fail, to carefully examine the corpse and discover the specific causes in order to better treat the still living; religion, on the other hand, concentrates on the soul or spirit, the immaterial dimensions associated with the transition from this life to the next, with religious teachings, leaders, and institutions as the primary resources available to the dying and to family members so they may prepare for and manage the reality of death.

But this kind of dichotomy, between body and soul, science and religion, does not really hold up under scrutiny. In the context of this encyclopedia project, with broadened understandings of each term and with a more global scope, intersections and connections between science and religion more often than not are highlighted as a dynamic, vital element in the confrontation with the end of life. In some cases, science is inspired by religious views to battle against death; in others, religion fits comfortably with scientific efforts to care for the dying. Sometimes religious traditions have very clear guidelines dealing with ethical issues and medical treatment at the time of death; other times, science becomes a vehicle with which to explore rationally the possibility of life after death.

The recent frenzy surrounding the death of Terri Schiavo, however, also indicates the potential volatility and political contentiousness that can erupt over the publicized death of a member of society, especially in circumstances in which others—a spouse, family members, even the state—have a stake. Schiavo had been in a persistent, vegetative state before her feeding tube was disconnected at the request of her husband, but against the wishes of her parents, the governor of Florida, and other politicians who wanted to keep her alive. The clash and attendant media circus over the fate of this woman reminds us of the all-too-common tendency to set science up against religion, but also suggests that the lines of argumentation and action are often more mixed up than they might first appear: Senate majority leader Bill Frist, a doctor, led the charge of the political right, condemning the euthanasia efforts on religious grounds, but many supporters of the husband also turned to religion to argue for a humane, scientific-based intervention that would end her life with dignity.

Who has the authority to determine when a life can and should end? What is the definition of death that is operating in a particular cultural context—final breath, cessation of heartbeat, lack of brain functions, separation of soul from body—and how are differences about this definition negotiated? Where is the appropriate place for the transition from this life to the next: in the home, in a religious institution, in a medical institution, or somewhere that can combine elements from all three? Why do most societies keep track of the dead, either as physical material with revealing truths contained within the decomposing flesh of the cadaver, or as spiritual entities with mysterious destinies limited not by the boundaries of the flesh but by the limitations of human knowledge and technology?

The answers to these kinds of questions are no longer in the hands of religious leaders on the one hand or medical scientists on the other, and they are definitely not clear-cut at the dawn of the twenty-first century. Scientists are now grappling with explicitly religious questions about ethics and meaning, diversity and spirituality. And religious authorities are now inspired by and struggling with a panoply of medical technologies, interventions, and sensibilities that bear on the most profound questions at the boundaries of life and death. Perhaps this complicated but more accurate picture accounts for the highly contested nature of many issues situated at these boundaries: euthanasia, abortion, institutions for the dying, near death experiences, treatment of the dead. The traditional arguments for separating science and religion into distinct spheres are no longer as compelling as they once were. Those who live with and understand the contradictions, confusions, and convergences of science and religion in the face of mortality in many cases draw from both in the pursuit of ill-defined but sacred notions of dignity, respect, and honor for the dead and dying.

The essays in this section provide insightful, but very different, views on how science and religion intersect when death is at hand. The topic is enor-

mous, to be sure, and the authors offer particular reflections, case studies, and descriptions that provide the reader with a glimpse of the sometimes strange, often fascinating research at the frontier of life and death, from psychological research and parapsychology to dissection and autopsies, from hospice care to core principles within a specific religious tradition. Our goal in this section is not to present a comprehensive range of how religious traditions view the end of life, or how science is conquering the frontiers of death. Instead, it is simply to present a sampling of how these intersections are imagined and studied, expressed and analyzed, by informed scholars writing in the twenty-first century.

Parapsychologist Joanne D.S. McMahon, for example, writes in her essay on the “blurred boundary” of death that there is no clear, universally accepted definition of death. After surveying some religious views on the topic, she turns to psychological research on apparitions, then wonders if the living are doing all they can to help the dead, especially in the short, three to five day period after death. When the boundaries between death and life are not determined by physically measured factors or by religiously sanctioned beliefs, how does a culture provide for the dead in this critical, transitional period? Professor of philosophy and Jewish theology Elliot N. Dorff, on the other hand, gives a very concise overview of Jewish views on the ethics of end of life care. Dorff presents Jewish perspectives on the definition of dying in a variety of specific cases, including suicide and assisted suicide, foregoing life-sustaining treatments, and heroic measures; he then covers a range of relevant topics, including organ transplantation, distribution of health care, disposition of the dead—issues that Jewish theology cannot consider without taking into account the scientific medical advancements of the last century.

Charles A. Corr, professor emeritus in philosophy and well-known author in the field of death education, covers the recent and signally important hospice movement, tracing its history from its origins in Great Britain to its contemporary status in American society. The space of dying, once securely situated for most people in the home and around the deathbed, changed dramatically in the twentieth century. The domestic space was very quickly replaced for most people by the new institution for dying: the hospital. Corr explains how the hospice became an alternative, and increasingly popular, holistic space for dying that cared for the terminally ill with a combination of patient and family-centered practices, clinical expertise, scientific research, and spiritually focused treatments. Kathy Kinlaw, a bioethicist with a master’s degree in divinity, examines the thorny issues surrounding prolonging life and, from the biomedical point of view, the conundrums many must face when a loved one is confronting the boundary of life and death. She addresses the Schiavo case, but also gives a more comprehensive overview of euthanasia, advance care planning, and physicians’ commitments to sustaining life and the emerging area of palliative care. Her admission that, given new advancements in medicine and technology, it is ambiguous whether doctors are pro-

longing life or prolonging death is a refreshing, informative perspective on this very difficult topic.

The final essays in this section go in two rather different directions when approaching death and the end of life. Gerontologist Bruce Horacek has written extensively on near death experiences, an arena of inquiry with a long, sometimes contentious history, dating at least to Plato in the fourth century BCE. Horacek reminds us that perspectives in this history have often combined scientific and religious views in unexpected ways. Here, death is not the end but a spiritual transition out of the body and into another realm, and near death experiences are one way to unlock the mysteries of death. For those who claim to have temporarily gone to the other side, for theologians who spend their lives contemplating the passage from this life, and now for many medical clinicians, social researchers, and a wide-ranging reading public, the research into near death experiences provides compelling data.

Historian Toby Huff, on the other hand, stays focused on the body after death, and particularly what is inside the corpse. He presents a brief but eye-opening history of how global cultures and world religions have viewed the practice of dissection. Moving from the three Abrahamic traditions to Asian traditions, then to Christian Europe, before ending with contemporary American attitudes, Huff considers deep-rooted religious strictures against mutilating a dead body. Yet he also notes the growth of anatomical knowledge and recorded descriptions of the interior of bodies that developed from ancient Greece, and especially from the work of Galen of Pergamum (126–216 CE) that dominated medical perspectives until the emergence of revolutionary new attitudes toward dissection in European higher education in the twelfth and thirteenth centuries. Huff, a specialist in Islamic history, contrasts Christian Europe and Islam to explore why this new attitude surfaced in the one civilization and not the other. In this essay, death is not the end but the beginning of modern medical knowledge and insight about the workings of live bodies, a valuable body of knowledge that challenges, in Huff's words, "the limits of the permissible" in modern religious cultures.

77 The Blurred Boundary: When Death Displaces Life

Joanne D.S. McMahon

“When all is said and done it seems ironic that the end point of existence, which ought to be clear and sharp as in a chemical titration, should so defy the power of words to describe it and the power of men to say with certainty, ‘It is here.’” This was the conclusion of an editorial published in the 1968 *Journal of the American Medical Association* as part of a response to Christian Barnard’s first heart transplant. Though it would appear that much has changed since then, the medical community is still in a quandary about declaring time of death with certainty. In fact, it has been argued that there is no moment of death. No transition, it appears, is more enigmatic than that between life and death.

Defining Death

Customarily, death in animals and plants is viewed as the permanent cessation of all vital phenomena without capability of resuscitation. Much of the difficulty in defining the death of a human being, however, stems from the notion of vital phenomena and whether we are addressing physical (organic) death or death of personhood. Medical and legal definitions are designed to mark the end of the organism, while psychology and philosophy ponder the death of the person. Theologically, death is considered the separation of the body from the soul. From the outset then, we can see that these standards make for very different perspectives on what constitutes the death of a human being.

The determination of physical death has always been problematic and a source of considerable controversy. Historically, various methods have been used to determine if death has occurred. For the most part the tests were designed to detect the cessation of respiration and circulation. Placing a mirror under the nostrils of the deceased, though tremendously unreliable, is a clas-

sic example. A simple test for circulation involved tying a piece of string tightly around the finger. If the digit turned blue and began to swell, the person was presumed to be alive; if the finger remained white, death was likely. Ultimately, the onset of putrefaction was the only reliable indicator that an individual had died.

Acknowledging this, waiting mortuaries were built in nineteenth-century Germany to keep watch over the presumed dead. Bodies were washed and dressed, then placed in a room filled with flowers to cover the smell. In other countries, fear of being buried alive was a very real concern, and elaborate systems were put in place to assure that one was indeed dead when instated in the final resting place. Ingenious mechanical devices such as bells and alarms were designed to rescue those who might recover once entombed. Since the discovery of formaldehyde in 1867, modern embalming techniques guarantee that people will not be revived.

Perplexing issues in declaring death have arisen in the last century with the advent of resuscitation procedures and technological marvels such as ventilators. A heart that has stopped working may be restarted and allowed to continue beating with mechanical assistance, and heart transplantation has only added to the dilemma. The technology is available to put the heart of one person into another, but in order for a heart to remain viable, it must be transplanted within six hours. Essentially, the heart must be functioning in one person to be usable in another. It is important to maintain the circulatory system for successful transplantation, so the donated heart must come from what is known as a "beating heart cadaver." Declaration of death needs to be made, or a transplant team will be viewed as murderers for removing vital organs from a live person. But definitions of death centering on the cessation of the circulatory and respiratory systems are inadequate.

Since 1968, medical and legal definitions have emphasized brain death. Brain death provides a way to declare death while respiratory and circulatory systems continue to function, albeit artificially. As Pernick outlines, it was not transplantation that called for a new definition of death. The controversy was well underway, but the public perception fueled by media attention brought the issue to the fore.

Brain death is the irreversible cessation of the entire brain, including the brain stem. Determination of brain death, however, is quite complicated and includes coma or unresponsiveness, absence of brain stem reflexes, and apnea (cessation of breathing). Reviewing the tests performed to determine brain death, one is struck how much some harken back to previous centuries. For example, "grimacing in response to pain can be tested by applying deep pressure to the nail beds, supraorbital ridge, or temporomandibular joint."

Brain death is now accepted in the United States as the standard for determining death, though it has been challenged in other countries. Denmark was the last country in Western Europe to accept brain death as the standard, doing so in 1990. Despite its technological sophistication and increasing need

for organ transplants, Japan has been slow to recognize brain death. About half of the members of the Japanese Association for Philosophical and Ethical Research in Medicine opposed legislation supporting it. A very vocal grassroots group has actively campaigned against using brain death as a standard. The resistance is rooted in cultural interpretations of death as a process. This and other cultural factors have been researched by Lock.

But brain death criteria are now coming under fire. Neuroscience is finding that consciousness is not centered in the neocortex. “Consciousness requires neocortical activation by lower brain structures, although there is no clear understanding of the status of consciousness when the activation of the neocortex is destroyed but neocortical activity remains,” says Miles in *The Definition of Death*. Van Lommel and colleagues offer a compelling argument based on studies of patients reporting near death experiences. Their patients were clinically dead—that is, absence of all functions of the cortex and the brain stem—yet that is precisely when they later reported episodes of clear cognitive functioning or out of body experiences. Van Lommel compared brains to televisions in that they receive and transform images and sensations but are not the producers of those experiences. In other words, a functioning brain is required to turn consciousness into waking consciousness. In the absence of such function, memories and consciousness exist but the reception is lost. This research calls into question the belief that the brain produces and mediates all experience.

Debate over the definition of death rages, with some experts calling for multiple definitions and more personal choices. There is no real consensus about when death occurs. But, even with the inevitable destruction of the organism, what can be said about the person? When and how do we determine the end of personhood?

Cultural and Religious Beliefs

For the most part, society accepts that death is a transition from one state of being to another (even if one contends that the “other” is a state of nonbeing). In most societies, a ritual or rite of passage marks the change. A funeral, for example, is an organized, purposeful, time-limited, group-centered response to death involving rites and ceremonies, during some or all of which the body of the deceased is present. The obvious purpose of the ritual is to dispose of the body. Psychologically, it can serve to help the living adjust to life without the deceased. Each culture dictates the form a funeral will take, and embedded in the ceremony is ideology as to what happens to the person thereafter. For many non-Western cultures, the funeral is a method by which the living can assist the dead in the transition while simultaneously warding off potential malevolence of the dead toward the living.

Surveying religious beliefs and social representations of afterdeath systems by using questionnaires, art, poetry, articles, and photographs, Miller

noted a consistency among most cultures. The afterdeath state is not static; it is not a location but involves change and movement. The afterdeath state, she came to realize, is perceived as a journey. By comparing various cultural systems, a pattern of four stages emerged. The first stage is what she refers to as a "waiting place." This meets the deceased's need for rest and adjustment. The deceased "is transformed from a physical to a spiritual being in order to make the trip." The dead are said to be in a state of relaxation, often taking on a new body or new characteristics. Three stages follow: a judgment phase, the realm of possibilities, and the return.

According to Miller, the rituals occurring when one is in the waiting place "bring order in times of potential emotional chaos." Hampton, a Theosophist, drew similar conclusions and outlined very specific guidelines for the change. Those with little or no spiritual training or understanding and those who die suddenly often need more time to settle into their new existence. "Many of those killed in accidents, many suicides, many soldiers killed suddenly, do not know immediately that they are dead," according to Hampton. Also at this time, the dead and the living are considered to remain close and can communicate. Habenstein and Lamers noted that in many cultures the soul is said to remain near the body for a certain amount of time. For example, in Japanese village funerals, because it is believed the deceased can hear after death, the relatives describe aloud what they are doing as they shroud the body.

Some cultures are more specific than others as to the time spent in the "waiting place." Many systems indicate a time period between three and seven days. The Ashanti, for instance, bury their dead on the third day after death but the "deceased enters the spirit land" on the sixth day. In Tibetan Buddhism, the deceased is believed to be in a trance state for three and a half or sometimes four days after the death. Some specify that the deceased hovers around the body even though disposition of the body takes place between the fourth and tenth day. Additionally, at some point during the first twenty-one days following the death, a transference of consciousness ritual is performed by the lama, whereby the deceased is instructed how to break the attachment of the body. Tradition holds that "the clairvoyant consciousness of the dead person is seven times clearer than the consciousness of a living person." This is the time when the dead have the strongest connections to the living and the living have the greatest access to the dead.

For the Mordun people of Estonia, a person's soul is considered to remain nearby for forty days following the death. A simple altar is constructed in the corner of the room and bread, water, and honey are placed on it daily in the belief that the soul will take nourishment from them. In Australia, Hmong funerals are elaborate rituals lasting for three days, during which food, water, clothing, money, and a traveling companion (in the form of an animal sacrifice) are provided the deceased for the journey to the afterlife. According to Korean tradition, a "box of soul" is held open above the grave and the person's name is spoken. The box is brought home from the funeral, where it will

remain for a year. At the end of the year, the box is burned and the soul is said to ascend to heaven.

What is striking about these ritual prescriptions is that they appear to have physiological correlates. The parallels between the actions of the body and cultural beliefs are compelling—the most striking being the significance of the three-day period following the approximate time of death. After the heart stops, blood flow ceases, and brain activity is nonexistent, certain changes take place. Body temperature, color, and rigidity are altered; these are known as *algor mortis*, *livor mortis*, and *rigor mortis*, respectively. Rigor mortis is a process familiar at least in name to most people. Immediately after death, the muscles in the body completely relax. A constricting of the muscles, however, sets in between two and six hours after death. The rigidity begins in the face, specifically the eyelids, neck, and jaw. It then spreads over the trunk, limbs, and internal organs, including the heart. This condition will remain for anywhere from ten to seventy-two hours. After that, the muscles will again relax, following the same order in which they began to constrict. Once the rigor has passed, it does not return. It is then that the more dramatic signs of putrefaction begin, normally between two and three days.

Rigor mortis is an intriguing process because, much like the determination of death, little is known about it. Evans provides a lengthy chemical explanation for the process and concludes that the key to the problem of rigor mortis now appears to be the adenosine triphosphate cycle. Though it was long believed that chemical changes in acidity caused rigor, further research has shown that “rigor mortis may be the cause of the acid formulation rather than the result of it.” Iserson speculates that it is the result of either “coagulation of muscle proteins or a shift in the muscle’s energy containers (ATP-ADP).”

What is certain is that rigor, like the waiting place, is transitory and temporary. It will disappear naturally, though it can be broken up by massage, bending, flexing, or rotating. It is a “chemical phenomenon” but has no direct association with the processes or reactions of the living body, according to Strub and Frederick. The factors influencing the onset and duration of rigor are fascinating but rarely discussed outside the fields of chemistry, pathology, and mortuary science. People with well-developed muscle tone experience more intense rigor than children, the elderly, and the debilitated. Additionally, fear and anger can accelerate rigor.

A rare but relevant phenomenon related to rigor mortis is cadaveric spasm, which appears as an immediate and spontaneous rigor brought on by great mental tensions before death. It is seen in some suicidal deaths where the deceased remains holding the weapon after the act. Under normal circumstances, the gun or knife should fall, since the typical reaction after death is muscle relaxation. People have been found after an accidental fall still grasping branches of trees or shrubs. During war, soldiers are sometimes still holding their rifles. Though cadaveric spasm is not truly a form of rigor mortis, since there is no initial period of flaccidity, it mimics rigor in many ways. The

reason for rigor mortis and cadaveric spasm remains a mystery. Note that both Hampton, in his outline of those who have trouble adjusting, and Strub and Frederick, describing cadaveric spasm, single out the same individuals—those who died tragically, following accident or suicide.

Seeing these parallels prompts one to speculate if people in a bygone era noted the physiology and concluded that the soul was leaving the body simultaneously. It is not our purpose to draw cause and effect conclusions but to bring the correspondences to the fore. The fact that the parallels are mirrored by the data of psychic research only makes them more compelling.

Psychic Research and Parapsychology

Psychic research and parapsychology are the systematic investigations of “psi,” the direct acquisition of information about the environment by means other than known sensory channels. Much of the research into the possibility of an afterlife has focused on the examination of mediumship and exploration of ghosts and hauntings. What has been determined from this research is that a variety of psychic experiences are reported at or near the time of death. There is an exceptional body of research on deathbed visions. A rare but impressive subset of these occurrences is what is known as “Peak in Darien” experiences, cases in which the dying person reports seeing someone who is later found to have died, although the dying person was unaware of this other death. Enhanced psychic ability is also seen in many near death experiences where the clinically dead individual returns to life with information they would not have ordinarily known.

The study of apparitions has long been a fruitful endeavor within psychic research, allowing for some of the best-documented cases. Myers noted that “the recognized apparitions decrease rapidly in the few days after death, then more slowly; and after about a year’s time they become so sporadic that we can no longer include them in a steadily descending line.” Green and McCreery confirm this observation; the cases reported to them occurred “most frequently within a week of the death.” Unlike many spectral appearances, crisis apparitions seem to display a purpose, a consciousness if you will, and often transmit a message of some kind. The communication will occasionally include information previously unknown. Some have even indicated the manner in which they died, such as pointing to wounds they may have incurred. As crisis apparitions, these appearances often center on a tragic event or untimely death, though not exclusively so.

It should be noted that crisis apparitions differ from the ghosts perceived in haunting experiences. Specters of the haunting variety are typically unrecognized by the percipient. They display little if any personality and do not interact directly with the living. These ghosts are often likened to videotape images that are replayed on the environment, without regard to the observers or current circumstances. In this way, they are seen walking through walls or performing acts seemingly inappropriate.

Apparitional sightings at the time of death are consistent with findings in psychology, except that they are referred to as hallucinations. Hallucinations of the bereaved are often seen shortly after the death of a loved one. So common is the occurrence that “hallucinating” is now considered a “normal” part of grief. Lindemann was one of the first to report on such hallucinations when he outlined the symptomatology of grief. Vargas, Loya, and Hodde-Vargas reported that 64 percent of those surveyed reported not only visions, but hearing voices, feeling the touch, and hearing the footsteps of the departed.

Apparitional experiences of the bereaved could be explained as the product of psychological needs and desires. But what if someone who lacks those emotions also saw or in some way experienced the presence of the dead? Anecdotal reports are available of psychics and mediums seeing or in some fashion experiencing the deceased at the deceased’s own funeral. One psychic explained that she has “always felt the spirit sort of sticks around until the rituals are completed.”

In a survey of funeral directors and apprentices, a surprising 80 percent reported some form of contact with the dead, from sensing emotion to experiencing apparitions, mysterious sounds, and anomalous mechanical failures. The more dramatic experiences centered on those who died tragically and the newly dead. The newly dead, described as those who were not coroners’ cases or those who spent little time in the morgue, were the focus of activity. The funeral directors were sure that this was not due to the fact that the body looked more like a living one or for any other discernable reason. They had no explanation as to why the newly dead would evoke more experiences. One explanation could be that clairvoyant consciousness is stronger for the newly dead than for those who had been dead for a longer period of time.

The End Point

The end point of existence is definitely not clear and sharp; the boundary between life and death is blurred. It would appear that the three to seven days following a death are meaningful for the bereaved as well as the deceased. Additionally, it seems that fear and anxiety are factors that have a significant impact. Given the importance of this interval and the emotions at the time of death, it may be crucial to examine the way in which we handle the end of life. Are we doing all we can to help the living and the dead?

In the 1960s, Ruth Harmer and Jessica Mitford’s exposés of the funeral industry sparked a change from elaborate ceremonies to efficient, practical rites. The trend of simple funerals and quick disposition has recently given way to a reevaluation of how we treat the dead and the rituals we perform. Society’s desire for alternative expressions of remorse and sorrow are demonstrated in the increasing popularity of unique, personalized funerals. Christine Pepper, executive director of the National Funeral Directors Association in Brookfield, Wisconsin, reports, according to Schwartz, that funerals are

now “about the experience. It’s about the funeral director being an event planner and not selling goods and services.” Gary Laderman, professor of religion at Emory University, sees the trend as a celebration of the individual and notes that the “past few decades has seen a great deal of change in what people do with the dead.” Additionally, spontaneous acts of remembrance have appeared in the form of roadside and sidewalk memorials. It is an all too common sight to see flowers, candles, and mementos placed at the location of an accident or murder.

Our culture appears to be endeavoring to find creative, appropriate ways to respond to death. Though the aging of the Baby Boom generation is seen as the reason, it may very well be that we as a culture are responding to more basic needs. Are we unconsciously returning to what is truly important—honoring and assisting the dead? There is no one answer to this question, as there is no definitive answer to what happens to us when we die. What we do know is that it will happen to all of us, and the transition from life to death will take time.

Bibliography

- Emerick, Elizabeth J. “Death and the Corpse: An Analysis of the Treatment of Death and Dead Bodies in Contemporary American Society.” *Anthropology of Consciousness* 11:2–3 (2000): 33–47.
- Engelhardt, H. Tristram. “Redefining Death: The Mirage on Consensus.” In *The Definition of Death: Contemporary Controversies*, ed. Youngner et al., 319–31.
- Evans-Wentz, W.Y. *The Tibetan Book of the Dead*. New York: Oxford University Press, 1960.
- Falk, Catherine. “Upon Meeting the Ancestors: The Hmong Funeral Ritual in Asia and Australia.” <http://www.como.stpaul.k12.mn.us>.
- Fenwick, Peter, and Elizabeth Fenwick. *The Truth in the Light: An Investigation of Over 200 Near-Death Experiences*. New York: Berkley Books, 1995.
- Goss, Robert. “Tibetan Buddhism and the Resolution of Grief: The Bardo-thodol for the Dying and the Grieving.” *Death Studies* 21:4 (1997): 377–95.
- Green, Celia E., and C. McCreery. *Apparitions*. New York: St. Martin’s, 1975.
- “Guidelines for the Determination of Brain Death.” Report of the Medical Consultants on the Diagnosis of Death to the President’s Commission for the Study of Ethical Problems in Medicine and Biomedical and Behavioral Research. *Journal of the American Medical Association* 246 (1981): 2184–86.
- Gurney, E., and F.W.H. Myers. “On Apparitions Occurring Soon after Death.” *Proceedings of the Society for Psychical Research* 5 (1888–1889): 403–85.
- Habenstein, Robert W., and William M. Lamers. *Funeral Customs the World Over*. Milwaukee: Bulfin, 1960.
- Haraldsson, Erlundur. “Survey of Claimed Encounters with the Dead.” *Omega* 19:2 (1988–1989): 103–13.
- Harmer, Ruth Mulvey. *The High Cost of Dying*. New York: Crowell-Collier, 1963.
- Iserson, Kenneth V. *Death to Dust: What Happens to Dead Bodies?* Tucson, AZ: Galen, 1994.
- Jones, Constance. *R.I.P.: The Complete Book of Death and Dying*. New York: HarperCollins, 1997.
- Journal of the American Medical Association*. Editorial. 204:6 (1968): 539–40.
- Kalish, R.A., and D.K. Reynolds. “Phenomenological Reality and Post-death Contact.” *Journal for the Scientific Study of Religion* 12 (1973): 209–21.
- LaGrand, Louis E. *After Death Communication: Final Farewells*. St. Paul, MN: Llewellyn, 1998.

- Lama, Uday. "Funeral Rites of the Hindus and the Buddhists." <http://www.webhealing.com/articles/lama.html>.
- Lindemann, Eric. "Symptomatology and the Management of Acute Grief." *Journal of Psychiatry* 101 (1944): 141–48.
- Lock, Margaret. *Twice Dead: Organ Transplants and the Reinvention of Death*. Berkeley: University of California Press, 2002.
- Mikkor, Marika. "On the Customs Related to Death in the Erza Villages of Sabajevo and Povodimovo." <http://haldjas.folklore.ee/folklore>.
- Miles, Steven. "Death in a Technological and Pluralistic Culture." In *The Definition of Death: Contemporary Controversies*, ed. Stuart J. Youngner et al., 311–18. Baltimore: Johns Hopkins University Press, 1999.
- Miller, Sukie. *After Death: Mapping the Journey*. New York: Simon and Schuster, 1997.
- Mitford, Jessica. *The American Way of Death*. New York: Simon and Schuster, 1963.
- Osis, Karlis. *Deathbed Observations of Physicians and Nurses*. New York: Parapsychology Foundation, 1961.
- Pernick, Martin S. "Brain Death in a Cultural Context: The Reconstruction of Death, 1967–1981." In *The Definition of Death: Contemporary Controversies*, ed. Youngner et al., 3–33.
- Perry, David L. "Ethics and Personhood: Some Issues in Contemporary Neurological Science and Technology." <http://www.scu.edu>.
- Rees, W.D. "The Bereaved and Their Hallucinations." In *Beyond Grief*, ed. Eric Lindemann, 66–71. New York: Jason Aronson, 1979.
- Rix, Bo Andreassen. "Brain Death, Ethics, Politics in Denmark." In *The Definition of Death: Contemporary Controversies*, ed. Youngner et al., 227–38.
- Strub, Clarence G., and L.G. "Darko" Frederick. *The Principles and Practice of Embalming*. Dallas: L.G. Frederick, 1967.
- Sullivan, Jacqueline, Debbie L. Seem, and Chabalewski, Franki. "Determining Brain Death." *Critical Care Nurse* 19:2 (1999): 37–46.
- Supko-McMahon, Joanne D. "Reported Spontaneous Psi in the Funeral Industry." Ph.D. dissertation, Saybrook Institute, San Francisco, CA, 1987.
- Van Lommel, Pim. "Medical Evidence for NDEs." <http://www.skepticalinvestigations.org>.
- Van Lommel, Pim, Ruud van Wees, Vincent Meyers, and Ingrid Elfferich. "Near-death Experience in Survivors of Cardiac Arrest: A Prospective Study in the Netherlands." *Lancet* 358:9298 (2001): 2039–45.
- Vargas, L.A., F. Loya, and J. Hodde-Vargas. "Exploring the Multidimensional Aspects of Grief Reactions." *American Journal of Psychiatry* 146 (1989): 1484–88.
- Veatch, Robert M. "Defining Death: The Role of Brain Function." *Journal of the American Medical Association* 242:18 (1979): 2001–2.
- . "The Conscience Clause: How Much Individual Choice in Defining Death Can Our Society Tolerate?" In *The Definition of Death: Contemporary Controversies*, ed. Stuart J. Youngner et al., 137–60. Baltimore: Johns Hopkins University Press, 1999.
- White, S.P. "Elwood Worcester and the Case for Survival." *Journal of the American Society for Psychological Research* 43 (1949): 98–107.
- Youngner, Stuart J., Robert M. Arnold, and Reine Schapiro, eds. *The Definition of Death: Contemporary Controversies*. Baltimore: Johns Hopkins University Press, 1999.

78 Judaism and Ethical Issues in End of Life Care

Elliot N. Dorff

Judaism's positions on issues in health care stem from its underlying convictions about who we are and who we should strive to be. Convictions that are relevant to the end of life include these: the body belongs to God; human beings have both the permission and the obligation to heal; ultimately, humans are mortal. Because the body belongs to God, Jews must seek both preventive and curative medical care and follow the expert's advice in preserving their health. When several forms of therapy are medically legitimate but offer different benefits and burdens, the patient has the right to choose which regimen to follow, as long as it fits within the rubric of Jewish law. On the other hand, patients do not have the right to demand of their physicians forms of treatment that, in the judgment of the physicians, are medically unnecessary, unwise, or futile or that violate their own understanding of Jewish law. That is, physicians, just as much as patients, are full partners in medical care.

Because Orthodox and Conservative Jews, at least in theory and often in practice, believe that Jewish law is binding, they will want to know and follow their rabbi's interpretation of Jewish law in determining, for example, whether it is permissible to remove life support systems. The Reform movement, however, champions individual autonomy. Reform Jews may consult a rabbi, but the rabbi's words will not be authoritative law; they are an individual's advice—albeit an individual with expertise in the Jewish tradition.

The Process and Definition of Dying

1. *Suicide and Assisted Suicide; Active and Passive Euthanasia.* Because each person's body belongs to God, the patient does not have the right either to commit suicide or to enlist the aid of others in the act, and anybody who does aid in this plan commits murder. The patient does have the right, however, to pray to God to permit death to come,

for God has the right to govern the time and manner of death of his creatures.

Judaism does permit passive euthanasia. Because until recently physicians could do very little to impede the process of dying, Jewish sources on this are sparse. This leads to considerable disagreement on specific, clinical issues, as described below, and it poses significant methodological questions as to how to apply the tradition to contemporary circumstances very different from the past.

2. *Determining Death.* The traditional criteria of death in Jewish sources are cessation of breath and heartbeat; however, the practice was to wait some time after determining that these signs had occurred before beginning burial procedures. Soon after the Harvard criteria of brain death became standard medical practice, however, Conservative rabbis accepted brain death (including the brain stem) as fulfilling the traditional criteria of cessation of breath and heartbeat. In 1988, the Chief Rabbinate of the State of Israel approved heart transplantation, thus accepting brain death as well. With the exception of a few Orthodox rabbis, that has become the accepted opinion of virtually all Jews.
3. *Forgoing Life-Sustaining Treatment.* When does the Jewish obligation to cure end, and when does the permission (or, according to some, the obligation) to let nature take its course begin? Authorities differ. The most restrictive position limits permission to withdraw or withhold treatment to situations where physicians assume that the patient will die within seventy-two hours—a *goses*. Others define the state of *goses* more flexibly (up to a year or more) or in terms of symptoms rather than time, and they then apply the permission to withhold or withdraw machines and medications more broadly. In a rabbinic ruling approved by the Conservative Movement's Committee on Jewish Law and Standards, I ruled that as soon as a person is diagnosed with a terminal, incurable disease—a *terefah*—patients and doctors have permission to withhold or withdraw medications and machines if it is in the patient's best interests.

Because Jewish law presumes that human beings are not omniscient, doctors are not responsible for knowing what therapy may be developed tomorrow in making these decisions; they should instead decide on the basis of the best interests of the patient in light of the medical care available at the patient's time and place. Whether the patient and doctors decide to proceed with aggressive care or not, doctors should do all they can to make the patient comfortable; the Jewish tradition does *not* construe pain as a religious good.

4. *Artificial Nutrition and Hydration.* Most Orthodox and some Conservative rabbis regard artificial nutrition and hydration as food and liquids, which we all need; therefore, even those who allow removal of

machines and medications require these. On the other hand, the nutrients that enter the body through tubes look exactly like medications administered that way and, more to the point, they lack the usual characteristics of food, such as varying temperature, taste, and texture. Consequently, in my opinion approved by the Conservative Movement's Committee on Jewish Law and Standards, I classified artificial nutrition and hydration as medicine. Thus we may and should use them if there is any reasonable prospect for recovery, but when that is not likely, we may remove them, for then they are just prolonging the dying process. In such cases, we still must go through the motions of bringing in a normal food tray at regular meal times to a comatose patient.

5. *Heroic Measures; Advance Directives.* As long as there is some hope of cure, heroic measures and untested drugs may be employed for that purpose, even though they typically involve an elevated risk of pain and even possibly an earlier death. On the other hand, patients and physicians need not engage in such therapies. The controlling factors as to whether they should are the risk-benefit ratio and the best interests of the patient.

A Jew may sign an advance directive for health care indicating his or her desire to employ or decline heroic care. All four movements in American Judaism have produced their own versions of a Jewish advance directive, each according to its own understanding of Jewish law.

6. *Pain Control and Palliative Care.* The fact that Jewish law does not require the use of heroic measures means that a Jew may enroll in a hospice program. The goal of hospice care is not to cure the disease, but to make the patient as comfortable as possible. In doing so, sufficient pain medication should be used. Patients do have the right, though, to prefer to be in some pain rather than lose consciousness. On the other hand, it is permissible to prescribe a dosage of pain medication that may actually hasten the patient's death, as long as the intent is not to kill the person but rather to alleviate his or her pain. In addition, hospice care crucially includes all the nonmedical ways in which people are supported when they go through crises, including all the forms of care provided by family, friends, nurses, social workers, and rabbis.

Autopsies and Organ and Tissue Transplantation

1. *General Principles.* The treatment of these topics in Jewish law depends on two primary principles: *kavod ha'met*, that we should render honor to the dead body as a way of honoring both the deceased person and God's property; and *pikkuah nefesh*, the obligation to save people's lives.

2. *Autopsies*. A 1949 agreement between the Chief Rabbinate of the State of Israel and Hadassah Hospital that was later adopted as Israeli law states that because autopsies represent an invasion of the body, they are not to be done routinely. They are sanctioned, however, when one of the following conditions obtains:
 - a. The autopsy is required by civil law, typically to allay suspicion of foul play in the person's death or as a public health measure to track and conquer an infectious disease.
 - b. In the opinion of three physicians, the cause of death cannot otherwise be ascertained.
 - c. Three physicians attest that the autopsy might help save the lives of others suffering from an illness similar to that from which the patient had died.
 - d. Where a hereditary illness was involved, performing the autopsy might safeguard surviving relatives.

In each case, those who perform the autopsy must do so with due reverence for the dead and, upon completion of the autopsy, they must deliver the corpse and all of its parts to the burial society for interment. Under these conditions, the autopsy is construed not as a dishonor of the body, but on the contrary, as an honorable use of the body to help the living.

3. *Living Donors*. The command to save lives (*pikkuah nefesh*) requires all Jews who can donate blood with virtually no risk to themselves to do so often. When the risk to the donor is greater, as in bone marrow and organs, Jews may undertake the risk to help others but are not required to do so, because our duty to preserve our own life and health supercedes our duty to help others. The probability of saving the recipient's life must be substantially greater than the risk to the donor's life or health.
4. *Cadaveric Donors*. The default assumption is that a person would be honored to help another live. Nevertheless, all authorities insist that the family agree to use their loved one's body for this purpose, both to accord with American law and also to assure that, even without burial, relatives of the deceased can effectively carry out the mourning process so that they can have psychological closure and return to their lives in full.

Rabbis have differed on the circumstances under which organs may be transplanted. The most restrictive opinion would limit donations to cases in which there is a specific patient before us (*lefaneinu*) who is at risk of losing life or the use of an entire physical faculty (e.g., sight). This opinion would thus prohibit donation to organ banks. Most rabbis, however, including Orthodox ones, would permit transplantation to restore full function (e.g., a cornea for a person with vision in

only one eye), and most rabbis would permit donation to organ banks as long as the organ will eventually, but definitely, be used for purposes of transplantation. So, for example, the Rabbinical Assembly, the organization of Conservative rabbis, approved a resolution in 1990 to “encourage all Jews to become enrolled as organ and tissue donors by signing and carrying cards or drivers’ licenses attesting to their commitment of such organs and tissues upon their deaths to those in need,” and in 1995 the Conservative movement’s Committee on Jewish Law and Standards approved a legal ruling by Rabbi Joseph Prouser making it a positive duty for Jews to make their organs and tissues available for transplant.

As indicated above, most rabbis accept brain stem death as the criterion to determine eligibility for donation. In recent times, some want to return to the old criteria to justify “non-heart-beating donors” even when some brain wave activity is detectable. Others, though, worry that this will all too easily motivate physicians to curtail the treatment of the donor. At this stage, rabbinic opinion on this new procedure has not been settled.

5. *Animal or Artificial Parts and Organs.* Animal or artificial parts (e.g., porcine valves) and, if they prove viable, full animal or artificial organs may be used to save life and restore health. They do not have to be from a kosher animal, for saving a human life takes precedence over the dietary laws. Moreover, those Jews who choose to be vegetarian would nevertheless be obliged to use animal parts for medical purposes if such devices held the greatest promise for cure or saving life.
6. *Donating One’s Body to Science.* Israeli Chief Rabbi Herzog issued the following statement in 1949: “The Plenary Council of the Chief Rabbinate of Israel . . . do not object to the use of bodies of persons who gave their consent in writing of their own free will during their lifetime for anatomical dissections as required for medical studies, provided the dissected parts are carefully preserved so as to be eventually buried with due respect according to Jewish law.”

Conservative Rabbi Isaac Klein cites yet another argument to permit the donation of one’s body to science: “In a country where the Jews enjoy freedom, if the rabbis should refuse to allow the Jewish dead to be used for medical study, their action will result in *hillul ha-shem* [a desecration of God’s Name], for it will be said that the Jews are not interested in saving lives; there is (therefore) reason to permit it.”

These arguments would not apply, however, if there are ample bodies available for dissection. Furthermore, without medical necessity, one may not set aside the honor due a corpse to be properly buried. So if medical schools increasingly use computer programs instead of

corpses to teach anatomy, as the University of California at San Francisco is already doing, permission to donate one's body to a medical school for this purpose would cease.

Distribution of Health Care

Jewish law requires that we provide health care to everyone, regardless of means to pay. That duty devolves first and foremost on physicians by virtue of their specialized medical knowledge, but physicians have a right to earn a living from their profession, and thus ultimately society as a whole is responsible that health care is readily available to everyone. Rabbis derive this duty from "You may not stand idly by the blood of your brother" (Leviticus 19:16) as well as "Love your neighbor as yourself" (Leviticus 19:18).

In our own time, though, health care, especially at the end of life, has become expensive and not always sensible. Because society must provide other services as well, such as safety, education, and aid to the poor, we must carefully ascertain who should get what forms of health care and at whose expense. Individuals have the initial responsibility to provide for their own health care, typically through insurance programs. If they do not, other family members have the responsibility to do what they can. Only after these resources have been exhausted may the individual and family fall back on the Jewish or general society. On the other hand, in our own day, when health care has far exceeded most people's ability to pay, government has the duty to ensure that even the uninsured have access to needed health care.

As Kant pointed out, when we cannot do something, we never have to ask whether we should, but when we can, we must respond to that moral question, for the fact that we can do something does not necessarily mean that we should. With significant advances in health care for the aged and the dying, we as individuals, families, and society as a whole must take the increased moral responsibility to determine which therapies make sense for which sets of conditions, and which do not. We Americans have resisted doing that as a society, leaving it to a person's finances or luck to determine who gets what. The Jewish tradition would require us to face these decisions as a group, so that we can make maximum use of our limited resources to accomplish our goals for society in health care as well as in other important areas. In the meantime, patients and families must make the hard choices themselves—limited only by what their insurance will pay for—as to which therapies to use and which not, presumably and hopefully basing that decision on the best interests of the patient.

Social Support of the Sick

Caring for a person is not a matter of physical ministrations alone. The Jewish tradition therefore imposes the obligation of *biququr holim*, visiting the sick.

Jewish sources maintain that visitors should sit on the same plane of the patient; enable the patient to talk about the illness by asking what the doctor said; ensure that a will has been prepared for the distribution of property and, in our time, an advance directive for health care; help patients with long-term illnesses prepare an ethical will, either in writing or on tape, in which they tell the family story, describe their Jewish commitments and hopes for the family, and express their love; engage the patient in discussion of the usual topics they share (politics, sports, etc.), thus reenforcing the patient's dignity by indicating that the visitor still cares about his or her opinions; and pray with and for the patient. The Jewish tradition, then, not only obligates us to cure, but to care, in fulfillment of the Torah's commandment, "Love your neighbor as yourself" (Leviticus 19:18).

Care of the Deceased

1. *Cremation.* Jewish law prohibits cremation as the ultimate form of dishonor of the dead. Cremation also represents the active destruction of God's property. In the generations after Hitler's gas chambers, burning the bodies of our own deceased seems especially inappropriate. Nevertheless, some Reform rabbis permit cremation.
2. *Burial Concerns and Procedures.* To honor the dead, after death the deceased's eyes are closed. Modesty is maintained even in death, and so men prepare a male body for burial, and women prepare a female body. The body is washed for both hygienic and ritual reasons and then clothed in linen shrouds. Everyone is equal in death. Because the body disintegrates soon after death, Jews are buried in a closed casket so that we remember the deceased as they were in life. Someone stays with the body overnight, usually reciting psalms, to mark that we may not abandon the body in death, and then the body is buried the next day, if possible. Sabbaths, festivals, and waiting a day or two for loved ones to arrive for the funeral may delay the burial for a short time. Then the community has the duty to help the relatives mourn by visiting them during the seven days of mourning (except for the Sabbath), taking over daily chores, providing a prayer quorum for morning, afternoon, and evening prayers, and helping them remember the deceased.

Bibliography

- Dorff, Elliot N. *Matters of Life and Death: A Jewish Approach to Modern Medical Ethics*. Philadelphia: Jewish Publication Society, 1998.
- Jacob, Walter, and Moshe Zemer. *Death and Euthanasia in Jewish Law*. Pittsburgh: Freehof Institute of Progressive Halakhah, 1995.
- Jakovovits, Immanuel. *Jewish Medical Ethics*. New York: Bloch, 1975.

- Jakobovits, Yoel. “[Brain Death and] Heart Transplants: The [Israeli] Chief Rabbinate’s Directives.” *Tradition* 24:4 (1989): 1–14.
- Lamm, Maurice, with Barry Kinzbrunner. *The Jewish Hospice Manual*. North Woodmere, NY: National Institute for Jewish Hospice; Miami, FL: VITAS Healthcare, 2003.
- Mackler, Aaron. *Life and Death Responsibilities in Jewish Biomedical Ethics*. New York: Jewish Theological Seminary of America [Finkelstein Institute], 2000.
- Reconstructionist Rabbinical College. *Behoref Hayamim: A Values-Based Jewish Guide for Decision Making at the End of Life*. Wyncote, PA: Reconstructionist Rabbinical College, 2002.
- Riemer, Jack, and Nathaniel Stampfer. *So That Your Values Live On: Ethical Wills and How to Prepare Them*. Woodstock, VT: Jewish Lights, 1991.
- Steinberg, Avraham. *Encyclopedia of Jewish Medical Ethics*. Trans. Fred Rosner. 3 vols. New York: Feldheim, 2003.

79 Hospice

Charles A. Corr

When the word *hospice* began to be used with some degree of frequency in the United States during the late 1970s, some people asked “What is this *hospick* thing?” Or “What do you mean by *hot spice*?” Misunderstandings like these were charming and harmless, but they also provided opportunities to educate questioners. In fact, the word *hospice* has its roots in a Latin word, *hospes*, that is also the root of *hospital*, *hospitality*, and *hospitable*. And the concept of hospice will be familiar to those who recall the medieval pilgrims who traveled across the Alps in their journey to the Holy Land. For those pilgrims, a hospice was a place where they could obtain shelter, rest, food, and prayer. St. Bernard’s Hospice in the Alps, for example, became famous for providing this type of succor and support, as well as for its distinctive breed of rescue dogs.

The modern hospice movement, however, is essentially concerned with providing care for those who are in the final stages of the journey of life: those who are dying or have no reasonable hope of benefit from cure-oriented interventions. Their family members are included as well. Since caring for members of society who are ill or dying is a community activity as old as human history, it is not surprising that the modern hospice movement has many ancient and honorable historical antecedents.

The modern hospice movement developed during the 1960s and 1970s, when some researchers started to ask whether care provided to those who were dying was properly recognizing and responding to their needs. Research suggested that many caregivers did not always realize or acknowledge the level of pain and other forms of distress being experienced by individuals who were dying, and that many caregivers did not always have or know of resources adequate to respond to the needs of those who were dying. This meant that individuals who were dying were often told things like: “Your pain cannot be as bad as you say it is”; “You can’t really be feeling like that”; “You will just have to get hold of yourself”; “We cannot offer stronger doses of narcotic analgesics or you will risk becoming addicted”; “We have to save the

really strong medications until they are truly needed”; “There is nothing more we can do.”

It was extremely helpful when new forms of narcotic analgesics became available to help dying persons. But new perspectives were also needed to properly appreciate the needs of those who are dying and to correct inadequate understanding or misguided fears about whether or how to mobilize available resources to meet those needs. These new perspectives addressed:

- The situation of those who are coping with dying.
- The nature of pain when one is dying.
- Appropriate therapeutic regimes for those who are dying.
- The value of holistic, person-centered care and interdisciplinary teamwork.
- Ways in which the social organization of programs serving those coping with dying affect the care provided.

The individual who did the most to help develop new initiatives to improve care of the dying was Dr. Cicely Saunders, who founded St. Christopher’s Hospice in southeast London in 1967. Originally trained as a nurse, Saunders retrained as a social worker after injuring her back, and then as a physician in order to pursue her goal of developing and offering better care to the incurably ill and dying. She worked out her views at St. Joseph’s Hospice in the East End of London and did research there on medications for the management of chronic pain in those who are dying. Later, she went outside the National Health Service (NHS) in England to found St. Christopher’s as a privately owned inpatient facility to implement her theories of clinical practice, research, and education in care of the dying.

Soon this original hospice model was followed by inpatient facilities built with private money and then turned over to the NHS for operation, and eventually by inpatient units within some NHS hospitals. More recently, the hospice movement in England has helped to develop home-care teams designed to support the work of general practitioners and district nurses, as well as hospital support teams that advise on the care of the dying in acute-care hospitals and programs of hospice day care.

In Canada, Dr. Balfour Mount and his colleagues developed the Palliative Care Service at the Royal Victoria Hospital in Montreal, which came into being in January 1975. This service included an inpatient unit based in a large acute-care teaching hospital, a consultation service, a home-care service, and a bereavement follow-up program. That structure, centered on a hospital-based inpatient unit, became a prominent model for this type of care in Canada.

In the United States, the hospice movement traces its origins to a community-based home-care program in New Haven, Connecticut, that began offering services in September 1974. By 2002, the National Hospice and Palliative Care Organization (NHPCO) estimated there were 3,200 operational or planned hospice programs in all fifty states, the District of Columbia, Puerto Rico,

and Guam. (For additional information about hospice services, or to find out how to contact a local hospice program, call the Hospice Helpline at 800-658-8898, or contact the National Hospice and Palliative Care Organization, 1700 Diagonal Road, Suite 300, Alexandria, VA 22314; 703-837-1500; fax 703-837-1233; <http://www.nhpco.org>.)

As the hospice movement spread and diversified, it became clear that *hospice is a philosophy* not a facility. In other words, it is not the building or the place in which care is offered that is central to hospice, but the attitudes, approach, outlook, and expertise that distinguish this type of care. It is better to think of hospice not as a noun but as an adjective that is most properly applied to this unique philosophy of care and to the programs that put this philosophy into practice.

Hospice as a Philosophy of Care

As a philosophy of care, hospice is:

- An outlook on care that affirms life.
- A way of thinking about care that links together efforts to minimize sources of discomfort, maximize present quality in living, and provide opportunities for personal growth wherever possible.
- A viewpoint that recognizes human beings as persons with physical, psychological, social, and spiritual dimensions in their lives.
- An approach to care that is focused on the needs, values, and decisions of the person and family unit from diagnosis through bereavement.
- A standpoint that takes into account the concerns of all who are providing care to the ill person and his or her family members, and the needs those providers may have for support in this work.

Perhaps the most important thing about the hospice philosophy of care is found in its single-minded focus on upholding the value and dignity of life embodied in every human being. Care is provided to those who are served because they are alive and, as such, unique and valuable. This is true even when death is near or persons are burdened with multiple health-related and other challenges.

The hospice philosophy strives to minimize sources of suffering and distress, even when their underlying causes cannot be removed. Even when the progression of disease cannot be reversed, halted, or slowed, the hospice philosophy argues that much can be done to modify its negative and distressing influences on quality of life, and to foster opportunities for personal growth. The hospice philosophy firmly rejects the view that "There is nothing more we can do." In fact, this philosophy insists that professional skills and simple human presence have much to offer, even when death is near. Hospice is an active and aggressive mode of care whose focus is the alleviation of distress-

ing symptoms, as well as on prospects for personal growth at the end of life. As Saunders observed, this represents “the unique period in the patient’s illness when the long defeat of living can be gradually converted into a positive achievement in dying.”

The hospice philosophy argues that care should not be limited to one or two aspects of the lives of the persons it serves. Instead, this philosophy advocates for holistic care that is sensitive to the needs, tasks, goals, and desires in all aspects of a person’s life. Recognizing that the people being served are whole human beings, hospice care seeks to enhance quality in living in every dimension of a person’s being—physical, psychological, social, and spiritual.

As a holistic philosophy, hospice offers care to the patient and family unit. The dying person and those whom he or she regards as family form the unit receiving care and helping to give care. Hospice care seeks to provide a sense of security and the support of a caring environment for all who are involved in coping with dying—ill persons together with their families, friends, and other involved persons. The hospice philosophy is sensitive to the values of the individuals and family members being served, as well as to the ethnic, religious, and cultural principles that are important to them. And ongoing support is offered to the bereaved family members and key friends in the months after the death of their loved one.

In addition, the hospice philosophy recognizes that providing good care requires attention to the needs of those who are to provide such care. Caring for those who are coping with dying and working within the structure of a hospice team can be stressful. Thus, staff members and volunteers who take part in hospice care give special attention to supporting each other, and the hospice philosophy leads directly to formal and informal programs of support.

Hospice as a Program of Care

Hospice programs of care are as varied as local conditions may require and as diverse as human imagination can make them. In general, however, as a program of care, hospice is:

- A type of end of life care that affirms life and active living, wherever possible, not death.
- A means of offering holistic care to everyone it serves, including patients, their family members, and their caregivers.
- A way of bringing together through an interdisciplinary team the skills, experiences, and abilities of the patient, family members, professional staff members, and volunteers; the team may include the staff of a hospice program, a home health agency, a long-term care facility, or other relevant care providers.
- A method of insuring coordination and continuity of care in whatever setting is desirable and appropriate to the needs of the patient and family

unit, including care at home, in a long-term care facility, or in a hospice facility.

- A system that makes services available twenty-four hours a day, seven days a week.
- A service that offers continuing care and ongoing support to bereaved survivors, including family members, individuals who may have provided extended care at home or in a long-term care facility, and anyone who may have developed a close, loving relationship with the person who died.
- A practice that offers both formal and informal programs of support to staff members and volunteers in hospice programs and any other institutions who may have taken part in caring for the person who died.

The hard work for hospice programs is in supporting life, not bringing about death. Helping a person to live may be especially difficult when that person is close to death and experiencing distress in dying. Processes of dying often impose special pressures on quality in living. Hospice programs care for and about persons who are coping with dying because they are living and struggling with these special pressures.

The services offered by American hospice programs are distinguished by their emphasis on holistic care to patients and family members alike, as well as to their caregivers. This is accomplished by providing care through an interdisciplinary team. The multidisciplinary approaches of traditional American health care have great strengths in the range and depth of specialized medical and health care skills they command, especially in the hierarchical settings of the best teaching hospitals and medical research centers. What those approaches often lack, however, is the shared input, coordination, and cooperation of hospice interdisciplinary teams. These interdisciplinary teams seek the input of every member in developing and implementing plans of care. Hospice interdisciplinary teams take into account not only professional expertise but also the experiences, abilities, and contributions of patients, family members, caregivers in various settings, and volunteers.

Special expertise in end of life care and in the management of distressing symptoms is essential in hospice care. Expert medical and nursing care is critical. However, the availability of human companionship is undoubtedly important. Professional caregivers can offer human presence, but it is often a special gift of hospice volunteers. Appropriate use of one's expertise and one's presence depends on being available and actively listening in order to understand the real needs of dying persons and their family members. Interdisciplinary teamwork demands respect for the special skills and abilities of others, time to exchange information and insights, and a certain amount of role blurring in assisting all who are being served.

Interdisciplinary teams are essential not only for providing holistic care to patients and family members, but also for insuring coordination and continu-

ity of care as individuals are transferred from one setting to another to meet their changing needs. Sometimes patients and family members must tell and retell their stories innumerable times as they confront what seems to be a never-ending series of new care providers. Staffs change from shift to shift, or patients are moved from one care setting to another, creating opportunities for mistakes and deficiencies in care. An effective hospice program will see that at least one member of its team is in charge of insuring that care is harmonious and seamless.

Effective hospice programs guarantee that someone representing the interdisciplinary team is available twenty-four hours a day, seven days a week, to respond to inquiries and calls for help. That representative will have the authority to insure that effective, timely care is carried out. All of this is essential if hospice programs are to recreate the caring communities that are needed to help dying persons and their families. When such communities already exist naturally, and dying persons and their families are not experiencing significant distress, there may be no need for formal hospice programs. When a need does exist, these programs must be available around the clock, just as a caring community is—perhaps through phone contacts or the ability to have a caregiver come to the dying person's bedside wherever that person may be.

Finally, an effective hospice program does not limit its services solely to ill or dying persons. Instead, hospice programs are sensitive to the needs of family members and others who are closely associated with the ill person. They are attentive to the needs of their own staff members, volunteers, and others who may have been involved in providing care before, during, and after the death of a patient. Therefore, hospice programs offer continuing care to family members before their loved one dies and ongoing support for a reasonable period of time after the death (usually twelve months). Hospice programs also respond to the needs of other care providers who may have taken part in caring for the individual. For this reason, hospice programs develop careful programs of selection, training, and mentoring, along with both formal and informal programs of support, for their own staff members and volunteers.

Defining Hospice and Palliative Care

Hospice is essentially a form of palliative care. It seeks to mitigate suffering. By alleviating distressing symptoms, palliation moderates the effects of a disease even when its underlying cause cannot be affected. Thus, the World Health Organization has defined palliative care as “the active total care of patients whose disease is not responsive to curative treatment. Control of pain, of other symptoms, and psychological, social and spiritual problems, is paramount. The goal of palliative care is achievement of the best quality of life for patients and their families.”

As a philosophy of care, palliation need not be limited to end of life care nor to situations in which there is no reasonable prospect of cure. In fact, far

more of modern medical and health care than we often realize is a form of palliation. For example, there is no cure for the common cold. Even so, aspirin, decongestants, antihistamines, and many other interventions of various types (including rest and good nutrition), as well as simple acknowledgement of the condition, are typically employed to improve quality of life when individuals have a cold. As a result, symptoms are palliated until the cold works through its own biological trajectory and reaches its natural limits. In the meantime, for most individuals the body's immune system and other resources rally to repel the invader and restore the person to a healthier condition. Even though we cannot cure the common cold, everyone is grateful when distress is at least partially relieved in these ways. Thus, palliative care in all its forms means addressing symptoms rather than underlying causes.

Both the Canadian Palliative Care Association and the National Hospice and Palliative Care Organization in the United States have established standards for hospice care. Drawing on work by NHPCO, Connor defined "hospice care" as:

a coordinated program providing palliative care to terminally ill patients and supportive services to patients, their families, and significant others 24 hours a day, seven days a week. Comprehensive/case managed services based on physical, social, spiritual, and emotional needs are provided during the last stages of illness, during the dying process, and during bereavement by a medically directed interdisciplinary team consisting of patients/families, health care professionals and volunteers. Professional management and continuity of care is maintained across multiple settings including homes, hospitals, long term care and residential settings.

Cicely Saunders put this somewhat more simply: "I would define the modern hospice as a skilled community working to improve the quality of life remaining for patients and their families struggling with mortal and long term illness."

Hospice Care in the United States

Since its introduction to the United States in the mid-1970s, the hospice philosophy has been implemented in a wide variety of programs that suit the needs and circumstances of local communities. These programs have become a well-recognized part of the American health care system, and hospice care has become widely known as a skilled and compassionate type of end of life care. As a result, in the United States in the year 2002, over 3,200 hospice providers served an estimated 885,000 patients. According to the National Hospice and Palliative Care Organization, 665,000 Americans who died in 2002 received hospice care, approximately 27 percent of the 2.4 million Americans who died that year. Average length of enrollment in hospice care in 2002 was fifty-one days; the median length of service was twenty-six days.

Hospice patients in 2001 were described by NHPCO as follows:

- 56 percent were female and 44 percent male
- 81 percent of all patients were 65 or older
- 82 percent were Caucasian Americans, 8.2 percent were African Americans, 3.4 percent were Hispanic Americans
- Nearly 95 percent of all hospice days of service were provided in patients' homes
- 52 percent of all hospice deaths occurred in patients' homes and only 10 percent occurred in hospitals; by contrast, for all Americans 56 percent of deaths occurred in hospitals and only 25 percent at home

Hospice programs in the United States in 2001 represented a wide variety of organizational models. Approximately 41 percent were independent free-standing agencies, 32 percent were hospital based, 22 percent were divisions of home health agencies, and 5 percent were based in nursing homes or other auspices. About 72 percent of hospice programs in the United States were nonprofit in character, 24 percent were for profit, and 4 percent were government organizations.

In 1982, funding for hospice care was approved as a Medicare benefit. This benefit emphasized home care for elders who qualified for Medicare. Admission criteria typically required a diagnosis of terminal illness, with a prognosis of fewer than six months to live, and the presence of a primary caregiver in the home. This last requirement no longer applies in most hospice programs. Medicare reimbursement rates are organized in four basic categories: a regular, daily, home care rate; a general inpatient rate; a rate for short-term respite care; and a rate for continuous in-home care (providing for the presence of a trained hospice staff member in specified blocks of time). Each of these rates is adjusted to take into account regional wage differences.

Two things are notable about the Medicare hospice benefit, which pays for approximately 65 percent of hospice services (other hospice funding sources include private health insurance, Medicaid, and charitable donations). First, as a federal funding program, it emphasizes home care and shifts reimbursement from a retrospective, fee-for-service basis to a prospective, flat-rate basis. Thus, a hospice program receives the regular home care rate for each day in which a dying person is enrolled in its care, regardless of the services it actually provides to that person on any given day. Second, all monies provided under the Medicare hospice benefit (except for those paid to an attending primary physician) go directly to the hospice program. Thus the program is responsible for designing and implementing each individual plan of care. That gives the hospice program an incentive to hold down costs and to provide only care that is relevant to the needs of an individual patient and family unit.

The Medicare hospice benefit has become a model for other forms of reimbursement for hospice services in the United States and is available in 91 percent of hospice programs that have qualified for Medicare certification. This benefit is intended to cover all costs of the care provided. Although it does

incorporate upper limits on reimbursement to a hospice program, these are expressed in terms of program averages and total benefit days for which the program will be reimbursed, not figures that apply to any particular individual. In fact, as long as a person has been accepted into a Medicare-certified hospice program and continues to qualify for its services, the law prohibits involuntary discharge—whether or not funds are still flowing for reimbursement.

Hospice care is also covered by Medicaid in forty-three states and the District of Columbia, as well as by the vast majority of managed care plans and most private insurance plans. Since 28 percent of all Medicare costs go toward care of people in their last year of life and almost 50 percent of those costs are expended in the last two months of life, hospice care at home often substitutes for what would otherwise be more expensive hospitalizations.

At first, the modern hospice movement in the United States was primarily concerned with illnesses like cancer and their implications mainly for older adults. Many cancer patients had come to a point in their disease where further interventions were unlikely to be successful and were often attended with unacceptable side effects and costs. As a result, oncologists and other physicians often transferred care of such patients to hospice in order to free their own resources to turn to other more newly diagnosed individuals. In the United States, a significant portion of the early funding for hospice came from the National Cancer Institute. As the hospice movement developed and matured, however, the philosophy was applied to a variety of individuals and their family members coping with life-threatening illness, dying, death, and bereavement. The hospice philosophy can apply to a broad range of diseases at the end of life, such as HIV/AIDS, Alzheimer's, and end-stage renal, heart, and lung diseases, as well as to situations involving children and adolescents. In 2002, approximately 46 percent of all patients served by hospice providers had diagnoses other than cancer.

The Spiritual Impetus Underlying Hospice

Cicely Saunders, the founder of St. Christopher's Hospice, has always given credit to the patients for inspiring the development of hospice care. She also points to its antecedents in the work of many other individuals and organizations (such as the Irish Sisters of Charity). When Saunders became the first medical doctor to receive the Templeton Foundation Prize for Progress in Religion in 1981, she emphasized the spiritual impetus behind her work and her efforts to establish a scientific foundation for hospice care.

Many aspects of the hospice movement are spiritual in nature. Before the modern hospice movement, many individuals who were close to death were shunted aside by busy clinicians and health care institutions. They were regarded as "hopeless cases." Cure-oriented interventions were failing them, and too many institutions lacked the vision and resources to respond appropriately to these patients' continuing needs. But Cicely Saunders and others

like her saw dying persons and others plagued by distressing symptoms as more than just medical problems or psychosocial needs. They were true persons with physical, psychological, social, and spiritual dimensions. And they were seen as part of a family unit, however that family was constructed.

Without dismissing opportunities for cure, the hospice movement recognized that cure was but one facet of care, not the other way around. That is why Enid Henke, a former patient at St. Christopher's Hospice, once drew attention to the parable of the Good Samaritan and commented on what it meant to her as she approached her death. When a friend remarked that it must be hard to be in the role of the wounded person rather than the Good Samaritan, Henke offered the following observations:

It is hard: it would be unbearable were it not for my belief that the wounded man and the Samaritan are inseparable. It was the helplessness of the one that brought out the best in the other and linked them together.

In reflecting on the parable I am particularly interested in the fact that we are not told the wounded man recovered. I have always assumed that he did, but it now occurs to me that even if he did not recover the story would still stand as a perfect example of true neighborliness.

What the Samaritan offers to the wounded man, as Henke points out, is continuing interest and support, as well as a linking together of people on behalf of those efforts.

Bibliography

- Ajemian, I., and B.M. Mount, eds. *The R.V.H. Manual on Palliative/Hospice Care*. New York: Arno, 1980.
- Canadian Palliative Care Association. *Palliative Care: Towards a Consensus in Standardized Principles of Practice*. First phase working document. Ottawa, Canada, 1995.
- Corr, C.A., and D.M. Corr. "Adult Hospice Day Care." *Death Studies* 16 (1992): 155–71.
- , eds. *Hospice Care: Principles and Practice*. New York: Springer, 1983.
- Corr, C.A., K.M. Corr, and S.M. Ramsey. "Alzheimer's Disease and the Challenge for Hospice." In *Living with Grief: Alzheimer's Disease*, ed. K.J. Doka, 211–26. Washington, DC: Hospice Foundation of America, 2004.
- Corr, C.A., C.M. Nabe, and D.M. Corr. *Death and Dying, Life and Living*. 5th ed. Belmont, CA: Wadsworth, 2005.
- DuBoulay, S. *Cicely Saunders: The Founder of the Modern Hospice Movement*. London: Hodder and Stoughton, 1984.
- Egan, K.A., and M.J. Labyak. "Hospice Care: A Model for Quality End-of-Life Care." In *Textbook of Palliative Nursing*, ed. B.R. Ferrell and N. Coyle, 7–26. New York: Oxford University Press, 2001.
- Ford, G. "Terminal Care from the Viewpoint of the National Health Service." In *International Symposium on Pain of Advanced Cancer: Advances in Pain Research and Therapy*, ed. J.J. Bonica and V. Ventafridda, vol. 2, 653–61. New York: Raven, 1979.
- Foster, Z., F.S. Wald, and H.J. Wald. "The Hospice Movement: A Backward Glance at Its First Two Decades." *New Physician* 27 (1978): 21–24.
- Hinton, J. "The Physical and Mental Distress of the Dying." *Quarterly Journal of Medicine*, New Series 32 (1963): 1–21.
- Lack, S.A., and R.W. Buckingham. *First American Hospice: Three Years of Home Care*. New Haven: Hospice, 1978.

- Liegner, L.M. "St. Christopher's Hospice, 1974: Care of the Dying Patient." *Journal of the American Medical Association* 234:10 (1975): 1047–48.
- Marks, R., and E. Sachar. Undertreatment of Medical Inpatients with Narcotic Analgesics. *Annals of Internal Medicine* 78 (1973): 173–81.
- Melzack, R., J.G. Ofiesh, and B.M. Mount. "The Brompton Mixture: Effects on Pain in Cancer Patients." *Canadian Medical Association Journal* 115:2 (1976): 125–29.
- Melzack, R., and P.D. Wall. *The Challenge of Pain*. 3rd ed. New York: Penguin, 1991.
- Miller, P.J., and P.B. Mike. "The Medicare Hospice Benefit: Ten Years of Federal Policy for the Terminally Ill." *Death Studies* 19 (1995): 531–42.
- National Hospice and Palliative Care Organization. *Standards of Practice for Hospice Programs*. Alexandria, VA: NHPCO, 2000.
- . *NHPCO Facts and Figures*. Alexandria, VA: NHPCO, 2003.
- Noyes, R., and J. Clancy. "The Dying Role: Its Relevance to Improved Patient Care." *Psychiatry* 40 (1977): 41–47.
- Rees, W.D. "The Distress of Dying." *British Medical Journal* 2 (1972): 105–7.
- Saunders, C.M. "The Challenge of Terminal Care." In *Scientific Foundations of Oncology*, ed. T. Symington and R.L. Carter, 673–79. London: Heinemann, 1976.
- . "Address by Dame Cicely Saunders." In *The Templeton Foundation Prize for Progress in Religion*, ed. W. Forker, 73–84. Edinburgh: Scottish Academic, 1988.
- , ed. *Hospice and Palliative Care: An Interdisciplinary Approach*. London: Edward Arnold, 1990.
- Saunders, C.M., and R. Kastenbaum. *Hospice Care on the International Scene*. New York: Springer, 1997.
- Saunders, C.M., and N. Sykes, eds. *The Management of Terminal Malignant Disease*. 3rd. ed. London: Edward Arnold, 1993.
- Stoddard, S. *The Hospice Movement: A Better Way of Caring for the Dying*. Rev. ed. New York: Vintage, 1992.
- Wilkes, E., A.G.O. Crowther, and C.W.K.H. Greaves. "A Different Kind of Day Hospital—For Patients with Preterminal Cancer and Chronic Disease." *British Medical Journal* 2 (1978): 1053–56.
- Wilkes, E., et al. *Report of the Working Group on Terminal Care of the Standing Subcommittee on Cancer*. London: Her Majesty's Stationary Office, 1980.
- World Health Organization. *Cancer Pain Relief and Palliative Care*. WHO Technical Report Series 804. Geneva, Switzerland: WHO, 1990.

80 Prolonging Living and Dying

Kathy Kinlaw

One of the most difficult ethical struggles in health care occurs around decisions made as a patient nears the boundary between life and death. Whether the patient is at the end stage after years of chronic illness or has a more recent acute illness or injury, making decisions that are respectful of the patient and in the patient's best interests is far from straightforward. Asking how aggressive the clinical interventions should be shifts the goals of medical care beyond the traditional ones of prevention, improvement of function, and cure to developing new shared goals. What ideally evolves is a holistic concern for the patient's preferences, for comfort and dignity and relief of symptoms, as well as psychological and spiritual support of the patient and family. The goals should include minimizing the harm of medical intervention and maximizing the quality and nature of the life yet to be lived.

A Patient's Story

By age sixty-three, Mrs. Knight had experienced many medical problems. She had adult-onset diabetes, which she had difficulty controlling. She did not follow her suggested diet closely and had trouble consistently taking prescribed medications. Lack of control had led to kidney problems in the last few years and caused her to begin hemodialysis nine months ago. She had experienced a stroke at age sixty, which limited her mobility due to weakness on her left side. Mrs. Knight also had peripheral vascular disease. At the time of her admission to the hospital, she was experiencing weakness and a decreased level of consciousness. While receiving hemodialysis at the hospital, she experienced cardiac arrest. Resuscitating Mrs. Knight took twenty minutes, and she was intubated and placed on a ventilator (a machine that controls breathing). On day four of her admission to the intensive care unit, Mrs. Knight was in a "vegetative state," and the medical team asked the family to meet to discuss whether to continue aggressive treatment.

Most families facing the discussion that Mrs. Knight's family faced would

not be equipped, either emotionally or ethically, to considering forgoing life-sustaining treatment. Few people are prepared for making decisions that lead to or allow a loved one to die.

Religious Perspectives on Prolonging Life

For patients and families who belong to a faith tradition, religious or spiritual teachings may be very influential in determining whether to accept life-prolonging treatments. Catholic theologians have reflected on the ethical obligations regarding prolongation of life through the centuries. Foundational to Catholic teaching and to many other religious traditions is an obligation to protect and preserve human life as a gift from God. Catholic discussion of this obligation was first recorded in the sixteenth century by Dominican theologian Francisco De Vitoria and continued into the 1980 Declaration on Euthanasia by the Congregation for the Doctrine of the Faith. In the context of medical treatment, the obligation to prolong life is moderated by whether the treatment is desired by the patient, offers a reasonable hope of benefit, and is not an excessive physical, emotional, or financial burden for the patient. As theologian James Gustafson says, life is not an absolute good, but rather one that should help the individual pursue higher spiritual goals such as love of God and neighbor.

Many Christian Protestant churches have created position statements that address prolongation of life and the forgoing of life-sustaining treatment. For example, statements from the United Methodist Church, the Episcopal Church, and the Lutheran Church in America parallel the Catholic positions and provide for the permissibility of withholding or withdrawing treatment that causes greater harm than benefit or that prolongs the dying process.

In Jewish tradition as well, life is considered a gift from God and must be protected. It is forbidden to hasten death in any way in the last hours of life. It is also, however, forbidden to delay the natural course of dying; therefore, withdrawal of particular treatments that delay death may be permissible if death is at hand. Conservative and Reformed Jewish tradition typically interpret the law as allowing for the withholding or withdrawal of treatments for patients with incurable illness and the provision of palliative care. This includes the ability to withhold or withdraw artificial hydration (fluids) and nutrition (food).

Current Medical Practice on Withholding or Withdrawing Treatment

Practice and policy guidelines from the American Medical Association (AMA) and many other medical and nursing specialty associations affirm the appropriateness of withholding or withdrawing life-sustaining treatment under certain circumstances. Life-sustaining treatment is considered any medical treatment that prolongs life without reversing the underlying medical condi-

tion. According to the Council on Ethical and Judicial Affairs of the AMA, “even if the patient is not terminally ill or permanently unconscious, it is not unethical to discontinue all means of life-sustaining treatment in accordance with a proper substituted judgment [what the patient would have wanted] or best interests analysis [what outcome would best promote the patient’s well-being].” Where patient preferences to forego treatment are known, or where a legally identified surrogate decision maker determines that life-sustaining treatment is not what the patient would have wanted or is not in the patient’s best interest, physicians are permitted to forego life-sustaining treatment.

Legally the ability to forego treatment is based on (1) the ethical principle of autonomy, or the right of the individual to determine what will be done to his or her body, and (2) constitutionally determined rights of privacy or liberty to refuse medical treatment.

Artificial Hydration and Nutrition

Withholding or withdrawing artificially provided fluids and food (often provided through feeding tubes) is considered a special case of life-sustaining treatment by many, because such sustenance is so basic a need for people. The AMA does not consider artificial nutrition and hydration a special category, but rather one of the life-sustaining treatments that can be withheld or withdrawn.

The Case of Terri Schiavo

The medical, legal, and ethical consensus on the permissibility of withholding or withdrawing life-sustaining treatment is most tested in cases where a patient is diagnosed as being in a persistent vegetative state. The legal permissibility of withdrawing artificial hydration and nutrition was challenged in Florida in the case of Terri Schiavo. In 1990, when she was twenty-six years old, Terri collapsed at home following a cardiac arrest. Controversy surrounded the cause of her condition, but charges that physicians had not adequately monitored her care led to a malpractice award in 1992. Controversy also existed over the accuracy of her diagnosis of persistent vegetative state, a condition in which there is absence of higher brain functions, including awareness of surroundings, voluntary action, or ability to communicate or interact purposefully.

Terri’s husband accepted this diagnosis and her inability to improve, while Terri’s parents believed she was responsive to stimuli in her environment and that she might have potential for improvement. Although Terri’s husband was her legally identified surrogate, in 1998 he petitioned the trial court to serve as the surrogate decision maker to determine whether artificial nutrition and hydration could be removed based on Terri’s prior statement that she did not wish to be kept alive through artificial means. The court ruled there was “clear

and convincing evidence” that Terri would want artificial life support removed. Numerous appeals and court decisions followed, leading to the removal and then reinsertion of Terri’s feeding tube in both April 2001 and October 2003.

The Florida legislature intervened in 2003, passing a bill that allowed Florida Governor Jeb Bush to stop the withdrawal of artificial hydration and nutrition in a patient in a persistent vegetative state where no legal written documentation (advance directive) of the patient’s preferences for removal existed and where family members challenged the withdrawal of artificial feedings. The constitutionality of the governor’s and legislative intervention has been challenged in court. The case also resulted in statements from Catholic Church leaders, including Pope John Paul II, that raised questions about discontinuing artificial hydration and nutrition for patients in a persistent vegetative state where death is not imminent. The final legal outcome upheld the withdrawal of artificial hydration and nutrition.

Advance Care Planning

The lack of clear documentation of Terri Schiavo’s preferences for treatment complicated decision making about her care. Over the last few decades, state and federal law, including court decisions, have affirmed the rights of individuals to be fully informed in decision making and to be able to both consent to and refuse treatment. Respect for the rights of individuals coupled with the increasing technological ability to keep individuals alive led to a broad “advance care planning” movement. Advance care planning allows individuals with decision-making capacity to convey in advance—before they may even foresee a medical condition for which decisions will have to be made—what their preferences for health care would be should they lose the capacity to make those decisions.

Advance care planning includes conversations with family and physicians as well as the recording of those preferences in written documents called “advance directives.” Advance care planning and directives communicate when individuals would not want aggressive life-sustaining treatment to be administered and when particular interventions are desired. Many advance care planning documents also elicit information about such factors as the individual’s beliefs and values regarding health care, quality of life, and independence in decision making; these factors may be important to the individual or family members making treatment decisions.

Federal legislation was enacted in 1991 to encourage both awareness of and honoring of the health care preferences of patients through written advance directives. The federal Patient Self-Determination Act requires that patients at health care organizations receiving Medicare or Medicaid funding be asked whether they have an advance directive (and if so, to provide a copy for the medical record), and they are to be offered and provided information about advance directives if they do not have one. Most states have statutes

allowing for the creation of two types of advance directives: (1) a living will, which provides for specific instruction about life-sustaining treatments under certain medical conditions (e.g., a diagnosis of terminal illness), including in some states the use of ventilators, artificial hydration, and artificial nutrition, and (2) a durable power of attorney for health care, which allows a person to appoint a surrogate who is legally given the right to make health care decisions for the person if the person is unable to do so.

The concept of advance care planning and advance directives encourages individuals to think about their care preferences, communicate these preferences to family members or legal surrogates, and make sure that the decisions made at the end of life are ones that respect the declared wishes of the patient while alleviating some of the burden on loved ones. In certain communities, efforts to educate the public and to increase the number of citizens completing advance directives have been quite successful. LaCrosse, Wisconsin, reports that 85 percent of patients who enter the community hospital have an advance directive. But LaCrosse is the exception; most studies report that 15 to 20 percent of citizens have completed advance directives.

At its best, advance care planning, including written advance directives, is the process of catalyzing conversations between the patient, family members, and clinicians about the core values that inform the patient's view of health and life and how those values would influence medical care decisions. One may not be able to envision the many specific choices that might be faced in a future illness or injury (Mrs. Knight's and Terri Schiavo's cases are good examples), but one could discuss when aggressive intervention would not be wanted and what qualities of existence (or lack of qualities) would characterize that time. When a surrogate decision maker is appointed, the quality of that conversation with the surrogate greatly enhances the chance that the patient's preferences will actually be followed and that the surrogate will be able to act for the patient, because they will have a basis for decision making that honors the patient.

These conversations should not be one-time events. A study by Laraine Winter and colleagues of 384 elderly people in retirement communities in Philadelphia looked at how long people would want to continue living in poor health. Those who were frail expressed more of a preference to live longer under conditions of impaired health than did those who were healthy. The report concluded that health status plays a role in preferences about living in poor health, and the choices one makes while in good health may not be the same that one would make when health deteriorates. Advance directive choices and discussions need to be revisited periodically with family, physician, and others likely to be a part of decision making.

The Perceived Duty to Sustain Life

Health care organizations market the curative or rehabilitative potential of their special care units, rather than their compassionate skill in helping pa-

tients die well. Hospitals announce their success rates with particular conditions, and research organizations benchmark their ability to find a cure for the condition. The move to incorporate specialized medical teams with expertise in providing palliative care—care that relieves pain and other symptoms, sustains or improves quality of life, and provides psychosocial support to patient and family—and end of life care is a recent phenomena for hospitals.

Hospice Care

Hospice is the one component of the health care system that explicitly identifies their mission as caring for the dying. But patient referrals usually occur very late in the life of a dying patient, often hours before death. Such late referrals often mean that the benefits that hospice can provide, such as pain and symptom control and psychosocial support, are minimized. The *Means to a Better End* report on the state of dying in America, published by Last Acts in 2002 and based on 2001 data from the National Hospice and Palliative Care Organization, indicates that the average length of a hospice stay has dropped from 70 days in 1983 to 25.3 days in 2001. Reasons for limited and late use of hospice vary: the patient or family may not be ready to give up hope for a cure or meaningful extension of life; the prognosis may be uncertain; the patient, or more likely the family, may not want to forego curative treatment while accepting palliative care; there may be a concern about maintaining the relationship with the family physician; reimbursement issues could exist about hospice coverage.

Not every patient or family is comfortable or trustful in the discussion about whether to prolong life as long as possible. Physicians, nurses, and other health care professionals are also often reluctant to move from interventions that attempt to sustain life to treatments that focus on the comfort of the patient who will not improve.

When Does Treatment Become Futile?

The question of when continuing treatment becomes medically futile has been a key concern for clinical ethics as our technological abilities have grown. When do our medical interventions become ineffective or serve no purpose? What purposes or goals are reasonable and who determines this? The attempt to determine whether Terri Schiavo would have wanted to continue artificial nutrition and hydration was based on the right of an adult to forego life-sustaining treatment that merely prolongs life without reversing the underlying medical condition. Are there conditions our society could agree on in which continued intervention would not provide medical benefit? Other than very strict physiological examples (providing interventions totally unassociated with a condition; continuing resuscitative efforts that have failed), we have not determined such a definition of futile treatment.

Some procedures have been developed by which continuing treatment may be declared futile or “medically inappropriate” in individual cases. These procedures are implemented only when someone disagrees (usually a family member) with a medical recommendation to discontinue treatment. The American Medical Association has recommended a “fair process approach,” and several states (e.g., Texas and Virginia) have instituted legislation that provides a process by which continuing treatment may be declared medically or ethically inappropriate and such treatment discontinued. Such procedures, which involve multiple steps for review and support, have also been adopted by particular medical centers. Early reports from Texas following implementation in state law indicates that most patient care cases that move through the process lead to the withdrawal of medical treatment with the consensus of all parties involved. The process should avoid unilateral decisions and the perception that it supports physician or medical system authority over individual families and patients. Opportunity exists for the active involvement of individuals and community groups in creating a process for addressing the difficult question of what constitutes medically futile treatment.

Balancing the gift of life with changing quality of life and the hope for dying with dignity and comfort raises significant ethical considerations. Our technological abilities lead to difficult medical decisions where sustaining biological function intersects with the nature of what is beneficial, what constitutes “futility,” how patient preferences can be honored, and what burdens might be caused by life-sustaining interventions. Whether technology is truly life-prolonging or death-prolonging raises complex questions about treatment, our values and religious beliefs, and our ability to communicate our preferences to those charged with our care. There will be times when our highest goal is not prolonging life, but allowing life to be completed with as much comfort, care, and dignity as possible.

Bibliography

- Congregation for the Doctrine of the Faith. “Declaration on Euthanasia.” *Quality of Life*, 1980, 259–64.
- Council on Ethical and Judicial Affairs. “Withholding or Withdrawing Life-Sustaining Medical Treatment.” Opinion 2.20, 2.21. American Medical Association, 1994.
- De Vitoria, Francisco. *Relectiones Theologiae*, Relectio 9, de Temperentia. Lugdini, 1587.
- Emanuel L.L., C.F. von Gunten, and F.D. Ferris. “Gaps in End-of-Life Care.” *Archives of Family Medicine* 9 (2000): 1176–80.
- Field, Marilyn J., and Christine K. Cassel, eds. *Approaching Death: Improving Care at the End of Life*. Committee on Care at the End of Life. Division of Health Care Services, Institute of Medicine. Washington, DC: National Academy, 1997.
- Halevy, A., and B. Brody. “A Multi-Institution Collaborative Policy on Medical Futility.” *Journal of the American Medical Association* 276:7 (1996): 571–74.
- Health Care Ethics Consortium of Georgia. *Report of the Task Force on Futility*. Atlanta: Center for Ethics, Emory University, 1997.
- Last Acts. *Means to a Better End: A Report on Dying in America Today*. November 2002. <http://www.nhpco.org/files/public/MessagesandQAfinal.pdf>.

- Panicola, Michael. "Catholic Teaching on Prolonging Life: Setting the Record Straight." *Hastings Center Report* 31:6 (2001): 14–25.
- SUPPORT Principal Investigators. "A Controlled Trial to Improve Care for Seriously Ill Hospitalized Patients: The Study to Understand Prognoses and Preferences for Outcomes and Risks of Treatments (SUPPORT)." *Journal of the American Medical Association* 274:20 (1995): 1591–98.
- Weir, Robert F., and Larry Gostin. "Decisions to Abate Life-Sustaining Treatment for Nonautonomous Patients." *Journal of the American Medical Association* 264:14 (1990): 1846–53.
- Winter, Laraine, M. Powell Lawton, and K. Ruckdeschel. "Preferences for Prolonging Life: A Prospect Theory Approach." *International Journal of Aging and Human Development* 56:2 (2003): 155–70.

81 Near Death Experiences

Bruce J. Horacek

Although the term “near death experience” was first used by psychiatrist and researcher Raymond Moody in his 1975 book *Life after Life*, the phenomenon goes back thousands of years. Plato’s *Republic*, from the fourth century BCE, includes the story of Er, a soldier who seemed to have died in battle only to revive ten days later on his funeral pyre. Er gave a detailed account of leaving his body and his disembodied soul traveling to a mysterious region where the righteous and unjust are separated. The Christian disciple Paul mentions knowing someone who “was caught up to the third heaven (whether in the body or out of the body I do not know, God knows)” (2 Corinthians 12:1–4). Across differing times and cultures, whether in ancient India, early America, or modern Egypt, near death experiences have been talked about and recorded.

One widely publicized case describes the experience of Pam Najour, also known as Pam Reynolds, who in August 1991, at the age of thirty-five, underwent a radical medical procedure to treat a brain aneurysm. Pam was given a general anesthetic and put on a cardiopulmonary bypass. Her ears were plugged with equipment to measure brain stem viability, and her eyes were covered. Her body was cooled to 58 degrees, which made her heart arrest. Circulating blood volume in her head was drained into a bypass machine and the machine was turned off. In fact, Pam met all the criteria for physical death.

Later, Pam described what she experienced during this time. She reported hearing various sounds, starting with a natural D and then going down the scale. Next she said she “popped out” the top of her head and observed surgeons working on a body that she did not at first identify as her own. Then she became aware of a presence at the end of an “elevator shaft,” an incredibly bright light that was breathing, warm, and alive. Pam was not afraid, and as she got nearer to the light, she saw other presences, including many that she recognized as deceased loved ones. Pam stated that as she approached the light it became harmonious, liquid, and silvery. Eventually she realized that she had to “come back.” She went through the tunnel and returned to her

body. Pam was able to describe the unusual bone saw used by the surgeon, along with other unusual elements of the procedure.

In 1990 at Georgetown University, during a conference sponsored by the International Association for Near-Death Studies (IANDS), I met Raymond. Twenty years earlier, while he was in the army, he almost died of a septic infection. While out of body, he experienced walking on a balance beam, with darkness on his left and light on the right. He stated that he had a choice. He chose to “fall into the light” rather than darkness. When he awakened, he described his experience to his physician, who prescribed an antipsychotic medication. For that reason, Raymond said he had never told another person about his near death experience until that conference. Many people, when telling others about their experiences, get the same reaction as Raymond, that they are crazy, hallucinating, or reacting to medications, and they are reluctant to talk about their experience unless they know it is safe to do so. However, because of medical advances, especially in the area of resuscitation, a great number of people have been near death yet survived and related their stories, forcing medical and social researchers to accept near death experiences as worthy of serious study.

Although near death experiences have been a focus of study for over a quarter of a century, there is no common agreement about what constitutes a near death experience. A working definition would be that a near death experience is a profound subjective and spiritual event with physiological, psychological, and sociological components and consequences that happens to many people who sense they are close to death. Scientists have not yet found any variables that predict who will most likely have a near death experience or what components will be included. The physical and mental health, age, gender, race, religion, and spirituality of near death experiencers are not significantly different from those of nonexperiencers.

A Common Pattern

Near death experiences are not a rare occurrence. A 1991 Gallup Poll estimated that about a third of those who considered themselves on the verge of death have had a near death experience. That is about 13 million Americans, or 5 percent of the population. A 1997 *U.S. News and World Report* poll estimated that 15 million American adults have had a near death experience. Most people say that the experience is ineffable, that it is almost impossible to do justice to it using mere words. While no two near death experiences are exactly alike, and while some are frightening or distressing to experiencers, most follow a pattern that includes all, most, or many of the following components.

First, one senses that one is dead or close to death, physically or psychologically. Various events can trigger near death experiences, including physical accidents, near drownings, choking on food, carbon monoxide poisoning,

hospital operations involving the use of drugs and anesthesia, sudden medical crises such as cardiac arrests, fainting spells, anaphylactic shock, suicide attempts, drug overdoses, and falling or jumping off high places. Twenty years ago it was thought by researchers that one had to be physically close to death in order to have a near death experience. It is now clear that other events can trigger a near death experience. Persons with chronic illnesses such as cancer, congestive heart failure, and cystic fibrosis have experiences called deathbed visions or nearing death awareness experiences. Other triggers can include stress-related events and spiritual experiences such as religious visions and deep meditation. Even migraine headaches, extreme exhaustion, sleep and sensory deprivation, and acute grief have led to near death experiences. Most people report a sense of calmness and peace at this point, as opposed to fear and anxiety.

Next, consciousness seems to separate from the body and move outward or upward from the physical body. This is called an autoscopic out of body experience. You view yourself from afar. Many describe this separated consciousness as having a spiritual bodily shape. You can see and hear things happening around you, like medical personnel working on your physical body. Your thoughts are clear and rational, and you can also hear telepathically what others are thinking, but you cannot communicate with those working on your body. People describe moving through walls, flying overhead, encountering loved ones in the hospital waiting room, and hearing their conversations. The sense of calmness and peace persists, while medical personnel and relatives are often anxious, fearful, or as one experiencer said, "running around like photo mart elves." People can describe conversations that took place among loved ones or medical personnel, and they can give vivid details about what these people did, as well as precise descriptions of medical procedures that were done while they were out of body.

The next stage is a transition. Many describe moving through a dark tunnel, culvert, hallway, drum, pipe, or as a four-year-old girl from the Seattle area described it, "it was like being sucked through a noodle." Up to this point, the experience has been within normal space and time parameters. Now space and time are distorted. One encounters a "spiritual realm" of existence, where space and time are irrelevant, and all of our usual sensual input is intensified. Some mention meeting spirit guides or dead relatives who help them during this transition phase. A number of children encountered deceased pets who assisted them. Others mention hearing humming sounds or music and feeling electrical vibrations.

At the end of the transition phase, experiencers see light at the end of the tunnel. Many describe meeting spiritual beings who radiate this light. Some call them "beings of light." Others describe meeting deceased loved ones or religious personages such as Jesus, Moses, the Buddha, or a Hindu god or goddess, the identification depending on one's beliefs and cultural background. Experiencers recount communicating telepathically with these beings, receiv-

ing information, guidance, and understanding about themselves, what is happening to them, and about the universe. One experiencer named Mark called these beings the “masters” who revealed to him many truths about himself and the universe. Others mention hearing “heavenly” music. Some see beautiful pastoral scenes with valleys, flowers, streams, and sometimes intricate crystal cities.

Next, you enter or are embraced by light. Some talk about the radiant Being of Light. Some call the light God, the force, the omega point, or the creator. The light is the source of everything, the beginning and the end, the alpha and the omega. Some at this point feel they are “home,” their true home in the universe. One experiencer named Kim called it her “homey home.” One child stated that “there are lots of good things in that light.” The experiencer understands everything that has ever happened in history, be it wars, the Holocaust, earthquakes. Some relate that there is no past, present, or future, just “isness.” We have always been and always will be. Some see earthly events that will happen in the future; others see personal events that will unfold in their future. Those who experience these revelations state that they already knew these things, that entering the light reminded them that they always had this wisdom. Several said that they were told they would forget most of this wisdom, remembering parts and pieces as needed in their lives.

Many experience a nearly instantaneous, panoramic review of their lives, reliving every thought, word, and deed and how their life affected other people. This life review can take place during any phase of the experience. Some relate that this is a tremendous learning experience and an event that helps them understand and grow in their lives. Most who have this life review say it is a self-learning encounter, that there is no outside force judging them. Some say they relive the thoughts, words, and deeds of others whose lives they touched in some way. One man who was serving a life sentence for killing a young man in a most heinous way had a near death experience in prison as the result of extreme guilt. A component of his experience was a life review in which he relived the murder not only from his point of view but detail by detail as the young man had experienced it, physically and psychologically.

Finally, the experiencer becomes aware of approaching an uncrossable boundary like a river, water of some kind, or a door, a wall, a mist, a cliff, or some other barrier. The person cannot go beyond this point unless prepared to stay forever. Most say that they have to choose to stay and go beyond the boundary or return to their bodies. Some say that they chose to stay but were “kicked out of heaven.” For many the compelling reason for choosing to return is some unfinished mission in life, like helping their children to grow up or completing some other task.

There have been several attempts to quantify near death experiences based on the elements most often described. Psychologist Kenneth Ring constructed a near death experience index that is a weighted measure of the depth of the experience. It consists of ten components, including a subjective sense of

being dead, feelings of peace, a sense of bodily separation, a sense of entering a dark region, encountering a presence or hearing a voice, taking stock of one's life, seeing or being enveloped in light, seeing beautiful colors, entering into the light, and encountering visible spirits. Psychiatrist Bruce Greyson built a scale that uses four clusters of reported near death experience elements. These clusters include (1) cognitive features of time distortion, thought acceleration, a life review, and revelation; (2) affective features of peace, joy, cosmic unity, and an encounter with light; (3) paranormal features of vivid senses, apparent extrasensory perception and precognitive visions, and an out of body experience; and (4) transcendental features of otherworldly encounters with mystical beings, visible spirits, and an uncrossable border. Using these two scales, just having an out of body experience would fall short of qualifying as a near death experience.

Aftereffects

Following a near death experience, one's personality and life are changed in subtle and dramatic ways, and the changes enhance and complicate one's life. First of all are changes that can be classified as psychological, attitudinal, behavioral, and cognitive effects of the experience. The most studied and pervasive of all aftereffects is the reduced level of death anxiety or fear of death. Depending on the study, 75–98 percent of experiencers report a total elimination of or significant reduction in death anxiety. Being clinically dead or close to death has convinced most experiencers that death is not something to be feared. Flowing from this are two other strong attitudinal effects. Most experiencers are convinced that there is some form of conscious existence after we die, that there is life after death. In addition, the majority say they know God exists. The most common name that they use for God is the light, a guiding benevolent force that emanates in everyone and everything in the universe.

Another strong belief flowing from a near death experience is that life is meaningful, both individually and collectively, that there is a special purpose for everyone. However, a near death experience does not produce instant enlightenment as to what that special purpose is. Each has a mission in life, and each has to search for what that is. What is clear is that this mission involves an increased interest in spirituality versus materialism. Most comment that they are less interested in materialistic goals such as amassing money, power, and success, and are more interested in such goals as forming deep human relationships and helping others. Experiencers say there are only two things that are important in life as well as after death, and these are love and knowledge. Love is connecting with other humans and other life forms, and knowledge is the quality of discerning how we can connect to everybody and everything.

Some changes complicate life. Many experiencers have difficulty recog-

nizing and comprehending boundaries and limits. They have difficulty adjusting to their jobs and other facets of their lives that demand realistic goals. They can become naive and vulnerable in their professional and personal lives. Many experience changes in their personal relationships. Near death experiences often produce significant stresses and strains on relationships with spouses and friends because of the radical changes in personality and goals. For example, because many want to express the unconditional love they felt during their near death experience, they have a hard time individualizing that love with their spouse.

Evidence shows that near death experiences awaken or enhance paranormal abilities. These include telepathy, clairvoyance, and precognition. Some develop healing gifts. Some have spontaneous out of body experiences, the ability to see auras, and the ability to sense the presence of dead loved ones, spirit guides, or malevolent spirits.

There are also physiological changes that accompany near death experiences. A number of experiencers mention an increase in sensitivity to light, sound, electricity, and other environmental stimuli. This hyperesthesia includes such phenomena as being unable to wear digital wrist watches, blowing out computer hard drives, and turning light bulbs off and on. Periods of extreme excitement or stress seem to trigger such events. Studies also point to such physical changes as reduction in blood pressure, body temperature, and metabolism, along with increased energy levels, the need for less sleep, and energy shifts called Kundalini activation.

The Meaning of Near Death Experiences

During the last twenty years, near death experiences have become a focus of media attention, public awareness, and scientific study. Part of this is due to more people coming forward to tell their stories, and part of this is due to the International Association for Near-Death Studies, which presents annual conferences, publishes the *Journal of Near-Death Studies*, and assists local and regional support groups throughout the United States and in other countries.

While many scientific studies have described near death experiences in terms of frequency, components, and aftereffects, some researchers propose that these experiences are the result of wishful thinking, hallucinations caused by anoxia or elevated levels of carbon dioxide, or brain infarcts. These theories persist because the core of the near death experience describes a subjective and spiritual reality that others cannot see, hear, or scientifically measure in the usual sense. The scientific method can neither prove nor disprove that Pam Najour had such a spiritual core experience as she described it. Many attempts at explaining how and why near death experiences happen tend to confuse the physical and medical events that trigger a near death experience with the meaning of the experience itself.

Several recent scientific studies, however, confirm the anecdotal evidence.

For example, in 2001 the *Lancet*, the highly respected international medical journal, published a study by cardiologist Pim van Lommel and others involving cardiac patients who were successfully resuscitated after cardiac arrest. The researchers did follow-up interviews two years and eight years later, assessing patient attitudes on issues such as fear of death and other after-effects. They found statistically significant differences between those who had near death experiences during their cardiac arrests and those who did not. And there was no purely physiological explanation such as cerebral anoxia that would explain the differences between those who had a near death experience and those who did not.

The most promising areas for exploration are the aftereffects or personal transformations associated with near death experiences. Some researchers consider the experience and its aftereffects an example of psychospiritual evolution that has been increasing during the last century and that will eventually affect the entire human race. For now, the most apparent meaning of the near death experience is the personal transformation and healing that it provides.

Bibliography

- Greyson, Bruce. "The Near-Death Experience Scale: Construction, Reliability, and Validity." *Journal of Nervous and Mental Disease* 171 (1983): 369–75.
- Moody, Raymond. *Life After Life*. New York: Bantam, 1975.
- Ring, Kenneth. *Life at Death: A Scientific Investigation of the Near-Death Experience*. New York: Coward, McCann and Geoghegan, 1980.
- Van Lommel, Pim, Ruud van Wees, Vincent Meyers, and Ingrid Elfferich. "Near-death Experience in Survivors of Cardiac Arrest: A Prospective Study in the Netherlands." *Lancet* 358:9298 (2001): 2039–45.

82 Dissection and Autopsy

Toby E. Huff

Many cultures attach an aura of sacredness and inviolability to human remains and view dismemberment or even postmortem examination as desecration. Such considerations and other spiritual ideas about the possible future life of the human personality made it difficult for the early gatherers of scientific knowledge to conduct postmortem examinations for educational and scientific purposes. Not surprisingly, the dissection and vivisection of animals has often been substituted with the resultant misunderstanding of important parts of human anatomy.

Given these constraints, the history of human dissection has been shrouded in mystery. The first systematic dissection of the human body for medical purposes appears to have occurred in the Greek city of Alexandria, Egypt. There, about 300 BCE, Herophilus identified the major internal organs and made the first discovery of the nerves by conducting vivisections and postmortem examinations of the human body. Herophilus is also credited with several unique descriptions of the body, including the brain and the eye. Around 280 BCE, Erasistratus of Ceos continued the tradition by conducting further examinations of the brain.

It was in this tradition of close anatomical study that the great student of human anatomy, Galen of Pergamum (126–216 CE), was trained. He went on to compile seminal works on anatomy and medical treatment that remained authoritative until the end of the sixteenth century. This corpus was fully assimilated by the Arabs during the ascendancy of Islamic civilization. It was then passed back to the Christian world of Europe via Latin translation in the twelfth century and later, along with many additions by Middle Eastern scholars. Nevertheless, Galen's detailed anatomical descriptions relied heavily on the examination of animals, including apes.

Dissection in the Abrahamic Traditions

On the question of dissection of the human body, the Jewish and Islamic traditions followed similar paths, but the Christian tradition eventually opened a new

pathway. Just as the pre-Socratic Greeks eschewed human dissection, so too the Judaic tradition forbade postmortem examinations. Any kind of mutilation of the human body was forbidden unless it was believed that another human life could be saved by such intervention. The first rabbinical but limited permission for a postmortem examination was not granted until the mid-eighteenth century. But Jewish medical students at the University of Padua in the seventeenth century had performed dissections and autopsies on gentile cadavers.

Agreement that mankind benefited unequivocally from dissections and autopsies was not reached by the Jewish community until the twentieth century. With the founding of the medical school of the Hebrew University in Jerusalem in the 1940s, the problem became acute, as autopsies were still not allowed except on non-Jewish bodies. Permission for the use of Jewish bodies, under very strict circumstances, was finally granted in 1944.

The Islamic tradition had similar prohibitions against dissection. With the ascendancy of Islamic civilization in the eighth century, the great medical corpus of Galen was translated into Arabic. But the prohibition against postmortem examinations continued among Muslims as it had under Judaism. Historians of Middle Eastern medicine find no evidence that dissections or autopsies were performed before the twentieth century.

However, the work of several medieval Muslim physicians reveals their intimate knowledge of some aspects of human anatomy and raises questions about what the actual practice might have been. For example, the Syrian Muslim physician Ibn al-Nafis (d. 1288) provided amazing descriptions of the heart, along with the deduction that blood flows from the right side of the heart through the lungs and back to the left side of the heart. Thus he is credited with discovering pulmonary circulation. Although he claimed to have examined a heart, he said that he did not perform dissections due to the religious law and out of respect for the human body. The question remains what kind of heart he examined.

Another Arab physician, Ibn al-Quff (1233–1286), a colleague and former student of al-Nafis, wrote anatomical descriptions such as the following:

The heart has four outlets of which two are on the right side. The one branching from the Vena Cava, carries the blood. In the orifice of this blood vessel—which is thicker than any of the other openings—there are three valves which close from the outside in. The second blood vessel is connected with the arterial vein and through it nourishment from the lungs come. I, heretofore, know of no one ever describing these valves.

Likewise, he wrote an amazing description of the stages of human embryonic development. After providing a general characterization of a human fetus for the first six to seven days and for thirteen to sixteen days, he says that it

gradually is transformed into a clot, and in 28 to 30 days into a small “chunk of meat.” In 38 to 40 days the head appears separate from the shoulders and limbs; the brain and heart are formed before other organs and are followed by the liver. The fetus takes its

food from the mother in order to grow and to replenish what it discards or loses. [Al-Quff continues to describe] three membranes covering and protecting the fetus, of which the first connects arteries and veins with those in the mother's womb through the umbilical cord. The veins pass food for the nourishment of the fetus, while arteries transmit air. . . . By the end of seven months all organs are complete.

These descriptions reveal the state of anatomical knowledge in the Muslim world in the thirteenth century. This latter description suggests a deep knowledge of internal organs, but not necessarily from dissection. A great deal can be known about fetuses through miscarriage and abortion. The fetus at that period is virtually transparent, thereby revealing its internal organs. Likewise, the afterbirth ("three membranes protecting the fetus") is also part of births and miscarriages. Nor should we discount knowledge of fetuses obtained in other cultures, to which al-Quff may have had access.

In short, we have no real evidence that dissections were performed. No fatwas (legal opinions) have ever been found before the early twentieth century that give permission to perform dissections or postmortem examinations. Instead, the view that human dissection was a form of mutilation, and hence desecration, became the prevailing view. Ibn Malik's *Muwatta*, one of the earliest summations of Islamic law, contains an injunction against the mutilation of the human body:

It has been passed down to us that when the Messenger of Allah, may Allah bless him and grant him peace, sent out a raiding party, he would say to them, "Make your raids in the name of Allah in the way of Allah. Fight whoever denies Allah. Do not steal from the booty, and do not act treacherously. Do not mutilate and do not kill children." Say the same to your armies and raiding parties, Allah willing. Peace be upon you.

That this belief was widespread can be gleaned from the fact that several canonical hadith collections contain this same reference. Likewise, the great twelfth-century philosopher and religious scholar Ibn Rushd (d. 1198) repeats the same injunction in *The Distinguished Jurist's Primer*: "The proscription of mutilating the bodies . . . of the enemy is fully established." Many consider this prohibition to be a legal injunction, and if broadly construed, it would be taken as an injunction against human dissection. The strictures against the use of dissection and postmortem examinations would remain in place in the Muslim world until the early twentieth century.

A new attitude toward dissection emerged in Europe, where the universities enjoyed a legal autonomy that allowed them a great deal of freedom not available in the Islamic world. In the twelfth and thirteenth centuries, the universities built their studies around the "New Aristotle," that is, the books of Aristotle that had been recently translated into Latin. Soon thereafter medical schools were set up which taught both Galen (based on fragmentary sources) and the Muslim physician Avicenna (Ibn Sina), as well as Arabic medical sources.

A central subject of medical education was anatomy, which depended on the empirical study of either the human body or those animals whose anatomical structure most closely approximated the human. It is evident that Galen intended his book *On Anatomical Procedures* to be a guide to the practice of dissection. Galen performed innumerable animal dissections and encouraged his followers to be ready for the rare occasion when human dissections would be possible. As more of Galen's writings became available, the more it became feasible to attempt to perform dissections.

An anonymous text of the early thirteenth century laid out the anatomy of a pig. Drawing on the authority of Galen, the author points out that among the lower animals, the structure and arrangement of the internal organs of the pig most resemble those of humans. The pig, of course, was seen as a highly contaminated animal by both Jewish and Islamic culture, but this was not an impediment for European Christians, and by this means the practice of dissection in medical education slowly crept into the curriculum. At Bologna, the pioneering anatomist Mondino dei' Luzzi (c. 1265–1326) wrote a textbook for use in the teaching of anatomy based on human dissection. Mondino is credited with the introduction of the systematic use of human dissection in medical education in Europe.

The introduction of dissection and postmortem examinations in Europe appears to have been facilitated not only by purely academic interests but also by legal concerns. About this time there was an upsurge in the use of postmortem autopsies for forensic purposes. That is to say, various situations arose in which the causes of death were doubtful or suspect. Consequently autopsies were conducted to determine whether the deceased had died of natural causes or whether there had been foul play, such as poisoning or physical assault. Indeed, very early in the thirteenth century, Pope Innocent III (1198–1216) ordered a postmortem autopsy of a person whose death was suspicious.

In 1286, an Italian cleric by the name of Salimbene reported that, in response to the plague that had devastated several Italian cities, a physician opened the bodies of human victims of the plague as well as some chickens. He opened them to determine what was happening to the internal organs of the deceased, both animals and humans. Salimbene's remarks are so offhand as to suggest that this practice of postmortem autopsy had happened before. In 1302, a scholar in Bologna died suddenly, raising the fear of poisoning, so a postmortem was conducted. No poisoning was evident, but a large amount of blood had congealed around the heart, presumably causing his death. Affluent families sometimes authorized postmortems of family members with the hope that the attending surgeon would be able to identify any anatomical abnormalities and warn the family about them.

With the publication in 1543 of Andrea Vesalius's *On the Fabric of the Human Body*, which contained highly detailed anatomical drawings, a huge step was taken with regard to the empirical study of the human body. Vesalius's work laid the foundations for modern anatomy and contributed greatly to the

spread of the practice of dissection in European medical schools. The book was one of the first scientific treatises to be published using the new moveable-type printing technology. Nevertheless, cadavers were still difficult to procure, leading to the practice of grave robbing.

Dissection and Autopsy in Asia

There is evidence that dissections and vivisections were performed on the bodies of Chinese prisoners in the first century and later, but dissection as a medical procedure for purposes of scientific learning was practically nonexistent during the two millennia prior to the twentieth century. In Japan likewise there was an aversion to human dissection, which had been prohibited by imperial decree early in the eighth century. Japanese doctors did not learn of the European system of anatomy until the mid-eighteenth century, when the practice of dissection for purposes of medical understanding was begun.

In both China and Japan, there was a view that human beings had a soul and an animal spirit that lived harmoniously in the body, but disruption of that harmony led to death. The soul was thought to be eternal and occasionally attempted to return to the animal spirit associated with the body. If the body and thus the spirit was destroyed or harmed, the soul could not find it. The soul might then be transformed into a harmful force disrupting the community. This led to laws prohibiting destruction of or tampering with corpses in the T'ang dynasty. However, prisoners and enemies were occasionally exempted from this prohibition.

Nevertheless, there are one or two reported cases in China of human dissections of prisoners in the first century and again in the eleventh that gave rise to anatomical representations. In general, however, postmortem examination of human bodies in China was done primarily for forensic purposes, to determine whether a deceased person had been the victim of poisoning or foul play. The procedures were carried out by uneducated individuals, usually under the supervision of a government official, who was following a manual of official instructions. This manual, *The Washing Away of Wrongs*, written by a Chinese jurist in 1247, became the standard for all official postmortem examinations thereafter, and it was repeatedly reprinted with modifications into the nineteenth century. Since physicians with more learning and didactic purposes were not involved, these procedures did not result in significant advances in anatomical knowledge, nor did they produce a tradition of realistic representation of the body as seen in the work of Vesalius.

The Limits of the Permissible

In the differing views on the practice of dissection, we find deeply embedded religious convictions about what happens to the body after death. Although both Christians and Muslims believe in resurrection of the body after death,

their theological rationales are quite different. In the case of Christianity, the view from the outset was that through resurrection, “not a hair on your head shall perish” (Luke 21:18). For just as Jesus Christ had been resurrected, so too the faithful Christian would be resurrected on judgment day. During the early years of Christianity, officials of the Roman Empire burned, mutilated, and scattered the remains of Christian martyrs, claiming that such fragmented bodies could never be reassembled and resurrected. But the Christian community responded by saying that nothing was impossible for God, that God could reassemble any Christian’s fragmented remains. By the twelfth and thirteenth centuries, this view had become deeply entrenched and widely portrayed in fabulous images in local folklore. Thus nothing done to the body after death, at least to a person of good moral character, had any effect on the person’s departed soul, body, or heavenly fate.

In the case of Islam, we have a different set of attitudes. The standard answer as to why dissection was not practiced in the Muslim world has been that Islamic law forbade dissection, though evidence for this has been hard to assemble. No one has cited a specific legal ruling or legal text that forbids dissection. A study of this issue by Emilie Savage-Smith finds no direct injunction against dissection in Islamic law or tradition. It may be, however, that the reason lies not in a specific religious ruling but in an overlooked hadith, that is, a saying attributed to the prophet Muhammad. This could be a source for the general religious reverence for the body of the dead, though one may say that this reverence would be linked to Islamic law in the broadest sense. As discussed earlier, the prohibition against mutilation found in the Islamic legal tradition was construed as an equally strong prohibition against autopsy and postmortem examination.

Indeed, when the Ayatollah Khomeini came to power in Iran in 1979, one of the first things he did was to proscribe the practice of medical dissections. According to Abdul Karim Soroush, who was a minister of culture in the Khomeini government, the major religious objection to this practice was based on the injunction against mutilation that is deeply embedded in the Islamic tradition. For the short interim during which human dissections were forbidden in Iran after the 1979 revolution, the medical community tried using wax models of cadavers, but this proved unsatisfactory. This practice of using wax models for teaching anatomy goes back at least to the late eighteenth century, when the Ottomans faced the problem of how to train physicians in anatomy without using human bodies. In Iran in the 1980s, the dilemma was finally resolved when leaders of the medical community persuaded Khomeini that what physicians do is not mutilation but a warranted medical procedure providing human benefit.

Other religious sentiments also inhibited the use of postmortem medical examinations in Islamic cultures. Many Muslims believe not only in the resurrection of the body but also in “the punishment of the grave,” and the expected examination of the deceased by the angels of death (Munkar and Nakir)

on judgment day. This anticipated meeting also served in the minds of many Muslims to require the full preservation of the body, whose very organs would testify as to the veracity of the answers given by the deceased at the time of judgment.

Despite the attitudes inhibiting the practice of dissection in the Muslim community, religious scholars since the mid-twentieth century had been considering the issues and enunciating more liberal attitudes. For example, the head mufti in Egypt, shaykh Hasanayan Muhammad Makhluḥ (d. 1990), wrote in the 1940s a widely circulated fatwa outlining the occasions during which postmortem dissection would be permissible. He claimed that considering the good that may be achieved, both in knowledge of human anatomy and possible knowledge of wrongful death in criminal cases, postmortem examinations are permissible and indispensable. As one often finds in Islamic law, there are opposing points of view, so one can only guess at what the consensus may be among religious scholars on this topic today. Nevertheless, in many Muslim countries today, postmortem examinations are frequently performed.

In the United States, however, where postmortem autopsies were once routinely performed after death in hospital contexts, today postmortems are rare. Postmortem examinations in hospital deaths dropped from about 50 percent in the 1960s to 9 percent in the mid-1990s, and in many hospitals none are performed. From a medical point of view, this seems to have serious implications because of the lack of information about a whole range of medical practices. For example, in about 44 percent of postmortem autopsies performed in hospitals, there is a significant discrepancy between clinical diagnosis and findings of the autopsies. The lack of autopsy allows these errors to go undetected.

Likewise, many illnesses, including AIDS, go undiagnosed if autopsies are not performed. Moreover, physicians point out that there is no way to study the natural history of a disease except by careful internal study of the human organs involved that become available after death. Since hospitals generally profit from performing autopsies, the economic factors involved seem to be small. Instead, it appears that we have a major shift away from the belief that autopsies provide beneficial information not available otherwise.

However, this shift does not appear related to any new cultural trends stemming from religious convictions. In contemporary America, it appears that strictly religious scruples regarding postmortem examinations are not strong. The decline in autopsies seems rather to be the result of the emergence of new instruments and techniques that modern medicine has at its disposal. The human body can now be examined in almost infinite detail without noticeably deforming the body. In addition to X-rays, magnetic resonance imaging (MRI), and similar scans, physicians can diagnose pathology through blood and tissue chemistry without performing autopsies. Other forms of experimental medicine have provided knowledge once sought through autopsy. Neverthe-

less, autopsy remains unsurpassed as a teaching procedure and a rich source of information about pathological developments in new and old diseases.

Bibliography

- French, Roger. *Dissection and Vivisection in the Renaissance*. Aldershot, UK: Ashgate, 1999.
- Galen. *On Anatomical Procedures*. Trans. and Intro. Charles Singer. Published for the Wellcome Historical Medical Museum by Oxford University Press, 1956.
- . *Galen on the Usefulness of the Parts of the Body*. Trans. and Intro. Margaret Tallmadge May. 2 vols. Ithaca, NY: Cornell University Press, 1968.
- Gawande, Atul. "The Final Cut." In *Complications: A Surgeon's Notes on an Imperfect Science*, 187–201. New York: Picador, 2002.
- Hamareh, Sami. "The Physician and the Health Professions in Medieval Islam." *Bulletin of the New York Academy of Sciences* 47 (1971): 1088–1110.
- Ibn Rushd. *The Distinguished Jurist's Primer*. Trans. Imran Ahsan Khan Nyazee. Reading, UK: Garnet, 1994.
- Lundberg, George D. "Low-Tech Autopsies in the Era of High-Tech Medicine." *Journal of the American Medical Association* 280:14 (1998): 1273–74.
- Malik ibn Anas. *The First Formulation of Islamic Law*. Trans. Aisha Abdurrahman Bewley. Granada, Spain: Madinah, 1997.
- Rispler-Chaim, Vardit. "Postmortem Examinations in Egypt." In *Islamic Legal Interpretation: Muftis and Their Fatwas*, ed. Muhammad Khalid Masud, Brinkley Messick, and David S. Powers, 278–85. Cambridge, MA: Harvard University Press, 1996.
- Savage-Smith, Emilie. "Dissection in Medieval Islam." *Journal of the History of Medicine* 50 (1995): 67–110.

Genetics and Religion

Introduction to Genetics and Religion

Genetics and its close cousin molecular biology have transformed the way we think about both our present reality and our future lives. By definition, religion and spirituality address and struggle with profound ideas and events that can transform our lives; thus, we find genetics and religion intersecting at many points:

1. DNA is viewed as powerful and even sacred by much of society; genes provide a model for both reality and identity, touching the essence of what it means to be human, and what it is that “natural” means—both deeply religious and spiritual questions.
2. It is not surprising then that isolating, identifying, or altering genes is often considered “playing God,” crossing a line that violates nature.
3. From the perspective of evolution, religion or at least many of its essential components might be literally in our genes—emerging from our evolutionary history as by-products of natural selection.
4. At the individual level, experience and genes are integral and interactive threads of the cloth that is us; religious/spiritual experiences could affect our genes and vice versa.

Here, we briefly discuss the first three points (all of which are expanded in detail in this or other sections of the encyclopedia) but explore the fourth point in more detail.

As described by Gaymon Bennett, a scholar of religion, in the lead essay in this section, the gene and genetics have provided a powerful “model of reality” for over a century—with implications resonating through religion, politics, economics, law, and the environment. The extreme version of this model, referred to as genetic determinism or genetic essentialism, is mentioned implicitly or explicitly by all essayists in this section, whether discussing cloning, genetically modified organisms, stem cells, or the human genome project. This idea that genes equate with identity, that there is a gene for everything

from height to sexuality, has become part of the cultural language in America. This is striking because it is absolutely untrue and yet has become entrenched in the vernacular.

DNA and the gene have taken on a kind of sacred, iconic stature; this is true even among many who realize genetic determinism is a huge oversimplification. A common view, discussed in all the essays in this section, is that working with, altering, or moving genes is “playing God” and negatively affects human dignity (or that of the animals or plants modified). Biologist and theologian Celia Deane-Drummond writes about the unease people feel, for example, when food is altered by introducing disease-resistant genes into a crop or when pig hearts are genetically altered so that their transplantation into humans is less problematic. Ethicist Margaret McLean describes how the early language around the human genome project, the effort to sequence each and every piece of our DNA, often included phrases such as “God’s plan.” Professor of health and law Timothy Caulfield points to perhaps the deepest line in the sand, the area that is the most disturbing to the most people: the cloning of human beings.

A recent illustrative case of the science of genetics mixing with religion, politics, and economics is that of stem cells. Stem cells—cells that have varying degrees of power (depending on their source) to become other types of cells and, thus, theoretically, cure diseases that are the result of dead cells, like Parkinson’s disease—have become a major source of controversy in recent policy discussions and political campaigns in the United States. Embryos are the major source of the type of most powerful stem cells, with the potential to become any kind of cell. The embryos, composed of a few hundred cells and the size of the head of a pin, are products of *in vitro* fertilization (fertilization in a test tube or dish) and are stored in a frozen state at fertilization clinics in case the implantation of a particular couple’s embryo does not work, or in case the couple wants to get pregnant at a later time.

If life begins at fertilization, then all these embryos represent human lives. Many would say that breaking them up into individual cells to grow in dishes and use for research or therapy is murder. On the other hand, research on these embryonic stem cells has the potential to cure paralysis and aid Alzheimer’s patients and many others. In addition, the frozen embryos may well never be used but only thrown away. If the United States does not support this research, undoubtedly someone else will, and may reap enormous profits.

Should we invest tax dollars, or private funds for that matter, in technologies that go strongly against the religious beliefs of some? But if we do not explore the utility of stem cells, we might lose the ability to improve and prolong the lives of many people, and we may lose economic benefits. How should such issues be decided and by whom? Thus, the deep and complex interactions of science, religion, and society are made evident.

Recent work in the diverse and overlapping areas of neuropsychology, behavioral biology, cognitive science, and evolutionary psychology suggest that the genes and groups of genes that make us predisposed to the components of

religion, such as ritual behaviors, altruism, and awareness of the supernatural, may have evolved to handle mundane adaptive tasks that independently have nothing to do with religion. Read philosopher Jason Slone's essay in the Consciousness, Mind, and the Brain section on cognitive science and the brain modules that might have evolved in such a way that religion emerges from them. Also, see psychologist Scott Atran's essay in the Ecology, Evolution, and the Natural World section on how and why humans may have evolved the capacity to have an awareness of a power greater than ourselves.

To see how individual religious experiences could affect one's genes, we take a step back and briefly review a few biological concepts: environment, genes, genomes, and gene expression. While members of the same species evolve at the population level, each individual organism is also experiencing its own unique world and environment. Environment here refers to more than just the world around us. This environment is important, but genes also exist in other environments at the same time—that of a cell, an organ, and an organism before and after birth. All of these environments affect our genes, and all fit under the definition of environment for this discussion. Compare and contrast the discussion of environment here with its use in the introduction and essays in the Ecology, Evolution, and the Natural World section.

The genes of an organism, together known as a *genome*, provide a blueprint for that organism. But blueprints are static; they themselves do not *do* anything. Imagine that you design a plan for a house. You give this plan to four different building teams around the world—one each in Australia, Ghana, Alaska, and Washington, D.C.—and ask them all to build a house from the same plan. What will happen in the end? Depending on the construction crews, the architects, weather, and materials available, while you may be able to tell in the end that all the houses came from the same plan, they will look very different. In Australia, the head contractor turns out to be an alcoholic, loses the plans, and builds from her memory. In Alaska, weather delays the construction so long that the house is stopped halfway through, and another firm completes it two years later based on another plan from another owner. The Ghanaian house has different kinds of wood than any of the other three and only one bathroom, while the Washington, D.C., house is smaller because of city zoning laws, but has two bathrooms—one added at the last minute to accommodate a family member who could not climb stairs.

Our genomes are blueprints in the same way. Even identical twins (who by definition start with the same blueprint) who grow up in the same home environment are different. Why? Because they had different environments—even in the womb. Their genomes began becoming different immediately after they became separate cells. For example, different viruses (and other mobile genetic elements) popped in and out of their genomes and different bacteria infected them. One was born first. They saw and did and liked different things. The twins start with the same genome, or *genotype*, but because of the effects of environment, they develop different *phenotypes* from that same genotype.

Why and how would different experiences change our genomic blueprint? Two things matter: the genes themselves and the genes' *expression*. Genes encode RNA, which encodes protein, and these RNAs and proteins expressed by the genes are the contractors, builders, and painters of our biological lives. And the environment, both inside and outside the cell or organism, affects the gene expression, that is, *when* the genes are turned on or off, for how long, and to what levels. Thus, the science of *proteomics* has evolved to study all the proteins expressed by an organism and when those proteins are expressed.

The environment can affect gene expression in two very broad ways: (1) by changing the actual genetic code or (2) by changing whether or to what level that code is activated to make RNA and protein. In both cases the genome is important and gives the person who has that genome *the potential* of having an array of different phenotypes, depending on the environment (and the expression of other genes). The first case involves actual physical alteration of the genetic code, commonly referred to as a mutation. Mutations can be caused by many diverse agents (mutagens), including sunlight, chemicals in food, air and water, and mistakes made by other parts of the cell when copying the genes. (Virtually all your cells contain the same DNA blueprint encoding another you, and it all must be copied each time each cell divides, which is often.) Only mutations made in sperm or eggs are passed on to the next generation, but other mutations certainly can affect the person in which they occur, and can result in aging, cancer, and any number of other diseases. If mutations occur in parts of the blueprint that are required to make a "good" RNA or protein (contractor or painter), then a "bad" (or no) RNA or protein is expressed.

More interesting in terms of religion is the second way in which environment affects genes—through changes that do not alter the blueprint itself, but instead alter its ability to be expressed. Several stunning examples of these *epigenetic* changes have been discovered. For example, a type of cancer is much more severe and pronounced among people living at high altitudes even though they have the exact same relevant genetic sequence as someone living at sea level (and who experiences little or no illness). And we have discovered that several genes are kept on or off in a newly fertilized egg depending on which parental environment (mother or father) they came from.

We will concentrate on one example that is probably closest to the kind of genetic mechanisms that one day might be discovered to link genes and religious experience. It has long been known that parenting style affects the type of adult a child becomes. How does this happen at the gene level? And how do changes that occur in childhood keep until adulthood?

Biologists often begin to look at such questions in "model" organisms such as fruit flies, yeast, rats, and worms. These organisms are much more ethical and economical to work with than humans and have strikingly similar genomes. For example, the mouse and human genomes have about the same number of genes, and their genomes are 60 percent *identical*, including many of the genes involved in disease.

Baby rats whose mothers give them a high level of care (e.g., licking and grooming) in the first few weeks of their life grow up to be much less fearful and less easy to stress out than rats whose mothers do not pay them such close attention. The high level of attention increases the gene expression for a receptor in part of the brain that regulates stress, leading to more receptors and thus less stressing out behaviors *for the rest of the rat's life*. Researchers identified the exact chemical modifications that result in this altered gene expression pattern (they involve changes in the chemistry of both the DNA and the proteins that control access to the DNA, but do not change the DNA code)—a modification that results in rats born with the same blueprint having very different personality traits.

This effect is not genetic, passed on from parents to offspring, in the classic sense, because young rats raised by mothers who gave only *low* levels of care and attention can still grow up to have calm personalities if they are adopted and raised by a high-level caregiver. Even more interesting, young female rats raised by high level of care mothers become high-level caregivers themselves. Therefore, these complex maternal behaviors and the resulting personality traits in the offspring that experience their environment are passed on nongenetically from mouse mom to mouse baby *without affecting the gene sequence*, only the gene expression of certain key genes.

Could one person be more likely than another to participate in religious rituals or have religious experiences because of other experiences they had and the effect on their particular genes? We must be careful not to draw too much from this one example in rats, because they are rats after all, but this example and others do make clear that different environments can differently alter gene expression, dramatically affecting and even helping cause complex behaviors, which then affect other genes.

The implications of these and similar findings, which sit at the intersection of science and religion, can be overwhelming and awesome. The fears and worries discussed in the essays following about changing our genes, our blueprint, are profound enough. But a whole other vast array of data will be emerging in the coming decades: science will move beyond the genome to the proteome, the envirome, and the metabolome—that is, compiling and comparing comprehensive lists of all the genes, proteins expressed, and possible phenotypes resulting from those proteins and environment combinations. This work is exciting, but with understanding comes the potential to control and change, and to do so with our usual somewhat arrogant assumption that we will be able to grasp all the implications of our changes.

One genetic illness, Huntington disease, causes people to slowly lose their minds and die. Because its effects begin after most people have already had children, the disease is inadvertently passed to the next generation. In one case, a woman murdered her son as symptoms of the disease began to appear, rather than watch him experience the same horrible death she had watched her husband endure. After many years of hard work, biologist Nancy Wexler,

who has the disease in her family, identified the gene that causes it. Huntington disease is atypical among genetic diseases in that it is caused by a change in only one gene. For years, Wexler was driven to find the gene and develop a test for the disease. But when she finally had the test in hand, she realized she did not want to know whether she herself had the disease. The knowledge was there, but she did not want it.

Profound questions of identity, belief, psychology, and biology interweave in issues surrounding this and similar diseases and are brought powerfully to light in a video Wexler shows of people who suspect they may have Huntington disease. One man witnessed his father's slow demise from the disease and grew up with the understanding that he too would experience a similar death. This, as he describes it, shaped his personality, and he became a risk-taker and rarely had long-term relationships, knowing he would die an early death. Then he decided to have the test for Huntington disease. His gene was normal; he did not have the disease. The way this man describes it, instead of rejoicing in this negative result, he instead lost his self, his life crashed down around him, and he had to rethink his place in life and begin anew.

What will even more genetic knowledge bring us in the future? In an ideal world, such knowledge about how and why we do the things we do and become the people we do will integrate well and lead to collaboration with knowledge and studies in religion, the social sciences, and other humanities. This convergence of science and deeply religious and spiritual questions provides an opportunity for collaboration, for enhancement of our species and our world. *Not* taking this opportunity, however, could cost us dearly.

83 Genetics, Society, and Spirituality

Gaymon Bennett

Outfitted with supercomputers and new research strategies, the sciences of life—genetics first among them—are generating voluminous and increasingly complex catalogues of data concerning virtually all life processes. With the mapping of the human genome, few doubt that this knowledge brings with it new capacities to deliberately reform those processes. Indeed, pursuit of genetic knowledge is often predicated on the possibility that it will beget technologies of transformation. For genetics has taught us that DNA is fundamental to all life, and that DNA is extremely malleable.

Calling variously for caution and courage, heralds of this new biological century proclaim the arrival of an unprecedented age of knowledge and intervention. Whether contemporary advances in genetics warrant such epochal representation—either of luminosity or of danger—remains to be seen. Nevertheless, despite the discord, to summarize the diagnosis of anthropologist Paul Rabinow, all parties seem to agree that something about the future is at stake and that there is a pressing obligation to do something about it. What kind of future is at stake and what we are obliged to do, however, remain far from clear.

Genetics: Knowledge of Life

Since at least the end of the eighteenth century, models of reality drawn from science have shaped the imagination of the modern industrial West. These models have been prized for their explanatory and predictive power. Methodologically simplifying complex arrangements into conceptually manageable parts, these models—through the knowledge and the technologies they have generated—have described how the world works and how it might be made to work differently.

The Gene

No biological model of reality has offered more explanatory and predictive power than the gene. For more than a century, the gene, to quote philosopher

of science Evelyn Fox-Keller, has performed tasks that are “veritably Herculean.” For scientists, Fox-Keller continues, this single entity has served as “the guarantor of intergenerational stability, the factor responsible for individual traits, and at the same time, the agent directing the organism’s development.” The social significance of this concept has been equally remarkable. For the modern public, the idea of the gene has increasingly served to explain the nature of embodied existence. As Rabinow puts it, more and more people around the world conceive of genes as containing “precious information that tells the truth about who they, and their pets and plants and food, really are and provides clues to what their future holds.” Theologian Ted Peters offers a similar assessment: people are turning to genetics as they ponder the very nature of nature, asking if DNA answers the age-old question: “Who am I?”

In 1905, British scientist William Bateson proposed that the biological study of heredity be denoted “genetics” (from the Latin for “origin” or “generation”). In reproducing, parents pass to their progeny biological factors—genes—which provide instructions for an organism’s most basic structure and functions, thereby affecting the progeny’s development. The sum total of an organism’s genetic content is thought of as its genome or genotype. The genotype is conceptually distinct from the phenotype, which is the sum total of an organism’s observable traits. Since its inception, genetics has been oriented by two questions. What is the nature of the relationship between an organism’s genotype and phenotype? How can that relationship be made different?

Every living cell contains DNA—deoxyribonucleic acid. DNA consists of a long array of nucleotide base pairs. While nucleotide pairings are always the same—adenine (A) always bonds with thymine (T), and guanine (G) always bonds with cytosine (C)—the sequence of these pairs varies tremendously. Linear segments of these base pairs—*genes*—constitute a set of instructions for the production of the most basic parts and processes in an organism’s body. Perhaps the most vital genetic functions concern the production of proteins. Genes specify the sequence in which chains of amino acids are produced. Amino acids, in turn, constitute the basic building blocks of proteins. Genes also specify the timing and quantity of protein production, thereby coordinating protein interaction. As Michel Morange puts it, genes are the body’s “memory” for protein production and interaction.

Why is this process so significant? Proteins constitute the basic stuff of which organisms are made (cells, tissues, organs, etc.), and they are involved in most processes that take place within an organism. The gene-protein relationship is the foundation of much of contemporary genetics. Two vital principles follow from this relationship. First, if we can sequence the linear array of base pairs in the genome of a given organism, and if we can decipher which proteins these base pairs code for, then we will know the organism’s basic “blueprint.” Second, as we learn how to manipulate an organism’s DNA, we will be able to alter the organism. Thus understanding how genes produce and coordinate proteins will enable us to intervene in an organism’s bodily traits.

Despite its current worldwide impact, modern genetics had inauspicious beginnings. The story begins in nineteenth-century Moravia with the work of Gregor Mendel. Born into a world of peasant farming, he was surrounded by the concerns of agriculture and plant breeding. Mendel had an appetite for science; his university studies included physics, chemistry, botany, and mathematics. In particular he had a penchant for the rigor and precision of mathematics and physics. This concern for agriculture and affinity for scientific precision would prove a scientifically fortuitous combination.

In 1843, Mendel joined the Augustinian monastery of St. Thomas in Brno, which at the time functioned much like a modern scientific research institute. Mendel was given a plot of garden and assigned the duty of conducting agricultural experiments. Here Mendel conducted his now famous experiments on the hereditary development of garden peas. From about 1854 to 1864, Mendel studied over 10,000 pea plants, tracking and analyzing the distribution of characteristics such as height, color, and seed texture. In 1865, with a note of triumph, Mendel announced through publication and lectures the astonishingly simple and scientifically significant results of that study. His findings, however, would go unappreciated for almost half a century.

Through carefully controlled breeding and detailed observation of how particular traits changed as a result of selected fertilization crosses, Mendel hypothesized that characteristics must be passed from one generation to the next by way of hereditarily transmitted entities, which he called “factors.” Mendel’s conclusions about the nature of these hereditary factors would establish the foundational laws of modern genetics. First, hereditary factors, or genes as they would eventually be denoted, determine something about how an organism is structured and how it functions. Today we would say that an organism’s genotype determines something about the organism’s phenotype. Second, organisms of the same species carry different versions of the same hereditary factors (e.g., factors for purple versus white flowers). Third, progeny receive a combination of different genes from the preceding generation in a statistically regular fashion.

With the rediscovery of his work at the beginning of the twentieth century, Mendel’s insights refashioned the science of heredity. Alfred Sturtevant established that genes were located on chromosomes in the nucleus of cells, allowing him and his colleagues to “map” the location of genes on the salivary gland chromosomes of fruit flies whose genetic mutations they had been tracking. Within a few decades, geneticists had taken up the resources of biochemistry and had begun to fashion the conceptual tools needed for an understanding of the molecular constitution and function of genes. The conceptual tools of biochemistry established with certainty what had been suspected since the beginning of the twentieth century, namely that genes were fundamental to the metabolic pathway. In what is often referred to as the “one-gene/one-enzyme” hypothesis, midcentury geneticists discovered that genes are crucial to the production of proteins. What had been for Mendel a purely theoretical

construct useful for interpreting his observations could now be modeled as a physiochemical entity.

In 1953, James Watson and Francis Crick, studying Rosalind Franklin's X-ray diffraction images of DNA, discovered the double-helix structure of the DNA molecule. This was a crucial step in the molecular analysis of genes. Watson and Crick's discovery in combination with the one-gene/one-enzyme hypothesis helped establish what has since been called the central dogma of genetics, namely, that DNA functions as foundational biological information, which, through processes of transcription into RNA and translation into proteins, serves as the blueprint of life itself. These steps in molecular biology allowed genetics, which began as a largely statistical science tracking the likelihood of inherited factors, to become an enterprise capable of describing the most fundamental biochemical processes involved in the generation of life.

Since the 1950s, the expansion of the genetic sciences has been remarkable. With the development of computational technology and the transformation of that technology into tools for automated genetic research, detailed knowledge of how DNA is put together and how it works has accumulated at a tremendous rate. Since the 1960s, new technologies have been developed for gene sequencing, gene mapping, gene splicing, and gene amplification. Perhaps the most significant work has been the projects to map the human genome pursued by an international consortium of publicly funded labs, known as the "Human Genome Project," and by a private corporation, Celera Genomics. Completed in 2001, these projects set out to determine two things: (1) the order of the four base pairs (nucleotides) that make up human DNA molecules, and (2) the position and spacing of the "expressed" genes in the human body.

We are years from interpreting everything about this sequence and this map. For example, how are specific genes and base pairs involved in the body's development? How do the relations among genes affect that involvement? Nevertheless, maps of the human genome represent the most meticulous technical knowledge of the human body in biomedical history.

Francis Collins, the director of the National Human Genome Research Institute, offers several metaphors for the map of the human genome: "It's a history book—a narrative of the journey of our species through time. It's a shop manual, with an incredibly detailed blueprint for building every human cell. And it's a transformative textbook of medicine, with insights that will give health care providers immense new powers to treat, prevent and cure disease."

From Genes to Networks

One might assume that with the completion of genomic mapping projects, we are closer to discovering the nature of the genotype-phenotype relation, and being able to alter that relation. As it turns out, the genomic world is far more

complex than we had imagined. The map of the human genome, to offer a more modest quote from Francis Collins, turns out to be only “the end of the beginning” of our biological self-understanding.

We often frame the relation between an organism’s genotype and phenotype in terms of “the gene for” (e.g., the gene for eye color). The “gene for” language implies a simple one-to-one correspondence between genes and observable traits. But such language vastly oversimplifies an extraordinarily complex relation. Multiple genes are involved in the production of even the most simple proteins. Moreover, innumerable nongenetic, environmental factors impact the long developmental road from the gene to the organism.

While recognizing this complexity in principle, in practice genetics has frequently operated according to a straightforward model of the informational pathway from genes to proteins to cells to tissues to organisms. This approach is referred to as methodological reductionism, the idea that in order to understand a complex system, we must isolate its most basic parts. So to understand the genotype-phenotype pathway, we track that pathway back to its most basic elements—the molecular operations of individual genes. Once this molecular bedrock is reached, it can serve as a foundation for all other biological explanations. As molecular biology continues to mature, however, methodological reductionism, while still necessary, appears insufficient. Genomics is encountering problems it cannot solve. Having reduced living systems—phenotypic traits—to their most basic parts—linear sequences of nucleotides—genetics is finding it difficult to work its way back up again. The complex systems that methodological reductionism helped simplify exhibit properties that cannot be accounted for by an analysis of their basic parts.

Prior to the completion of the map of the human genome, it was assumed that the biological complexity of humans relative to other living organisms would be reflected in a proportionally greater number of genes—more complexity, more genes. But we now know that the human genome contains roughly 30,000 genes; a far cry from early estimates of a hundred thousand. The genome of the worm *Caenorhabditis elegans* contains 20,000 genes. Network scientist Albert-László Barabási notes that those 20,000 genes provide information for the encoding of only 300 neurons, whereas “our extra 10,000 genes have to account for the billion nerve cells present in our brain.”

How are we to account for the biological complexity of the human animal? Barabási and many others have suggested that biological complexity must be accounted for not simply by a study of the individual entities that constitute an organism (genes, proteins, cells, etc.), but by a study of the networks of interactive relationships among these entities. Reconceptualizing the question of genes and complexity in terms of “network thinking,” Barabási emphasizes that the potential number of interactions between entities in a system far outstrips the number of entities themselves. When network complexity is taken into account, Barabási tells us, we are potentially “ $10^{3,000}$ times more complex than our wormy relatives!”

More important than the quantitative complexity of connections in networks are the qualitatively complex properties they exhibit. Networks function in ways that cannot be explained by the properties of any single part, or “node,” in that network. Functions result from particular nodal arrangements. These properties, often referred to as “emergent properties,” confirm that systems must be studied not only through the nodes that make up those systems, but through the relationships or connections among those nodes. The significance of a given node in a system will be understood not only by the properties intrinsic to that node, but also by the relationships within which that node persists.

Network thinking suggests that in order to understand the observable characteristics of an organism—from its protein structures to its social interactions—we need to study much more than the organism’s genes. To understand the genotype-phenotype relation, we need to map out not only the sequence of genes but also the network of interactions among genes, among genes and the proteins they produce, among proteins, among proteins and cells, among cells, and so on. At each network level, we will likely discover that the systems of interactions taken as interconnected wholes exhibit characteristics that could not have been anticipated simply by an analysis of the parts that make up those systems, and that the meaning of each map is dependent on the meaning of the others.

The relationship between an organism’s genotype and phenotype might be thought of as a series of highly interconnected concentric networks, in which microcosmic systems—such as the genomic system—are contained within macrocosmic systems. In this view, we become aware that the pathway between a given gene and those phenotypic traits with which the gene is involved is a winding way through a system of systems. We find that genes are only one—even if essential—part of a much larger whole. Having carried the explanatory weight of the biology world on its shoulders, the gene may be ready to share the load.

Society: The Rationalization of Life

A significant biological threshold was crossed in Western Europe late in the eighteenth century when the interminable cycle of famine and epidemic was interrupted; death ceased to menace life so directly. Economic, particularly agricultural, development allowed the production of resources to outpace demographic growth. Advances in fields of knowledge concerning human life allowed increasing control over the most immanent forms of death. As a space of relief was secured for human biological existence, a new political rationality emerged: in the name of health, well-being, and security, scientific knowledge and political power were conjoined, allowing modern society to take responsibility for organizing and optimizing life. Life—to borrow a term from Max Weber—was “rationalized”; knowledge and techniques of control were brought together and applied in order to improve existence. This process of

rationalization increasingly became the aim of social and political strategies. Thus the science of life took on new social and political functions.

Nature or Nurture?

The rationalization of life characteristic of the modern industrial state developed around two poles: the individual and the population. The success of social mechanisms such as criminal reform, education, health care, and economics depended on understanding how individuals functioned under different arrangements and how those individuals could be made to function optimally. Population groups represented the site where the biological well-being of the human species became visible. Issues such as birth and mortality rates, public health and hygiene, old age, race, and scarcity were articulated and addressed at the level of the population. It was thought that problems could be governed through regulatory mechanisms such as taxation, immigration control, and health insurance.

The rationalization of life depended on detailed knowledge of individuals and populations under specific circumstances. This knowledge, provided by advancing scientific fields, was catalogued, interpreted, and arrayed in relation to norms against which deviations could be measured. These arrays could then be put to use in designing effective techniques for overcoming individual deviations and for regularizing population trends.

The logic was simple: the underlying causes for social ills (e.g., criminality or poverty) could be properly diagnosed and remedied by the methodological tools of empirical science. Once problems of governance were translated into technical terms, the tools of science could be put to use distinguishing social normality, or social health, from deviance from social normality, or social pathology. Mechanisms could be designed for the reduction of pathology and the increase of health—for the organization and optimization of life.

Throughout the nineteenth century, the rationalization of life became entangled in the nature versus nurture debate. While many believed that empirical science could be put to use in the diagnosis of social ills, there was disagreement concerning *which* science should be put to use. The question hinged on the nature of the underlying causes of social pathology. Some argued that the causes were biological and psychological; others argued that the causes were social in character and could not be reduced to either biology or psychology.

This debate had significant consequences for social and political policy. If the causes of social ills were biological, remediation required intervention at the level of nature. In that case, programs of social reform—social nurture—would be ineffective remedies. However, if the causes of social ills were social in character, then biological interventions would prove ineffectual.

During the nineteenth century, the study of heredity emerged as a central

concern of biological investigation. According to historian of science Jean Gayon, “heredity came to be treated as the most fundamental property of living beings.” The study of heredity seemed to draw into a single conceptual framework two vital processes: (1) the biological development of individual organisms, and (2) the biological development of species. Early biological investigators formulated heredity not as simply one biological property among others characteristic of living organisms, but the matrix for the possibility of life itself. Determining whether social ills were propagated by nature or nurture seemed the purview of the hereditary sciences.

In the closing decades of the nineteenth century, Charles Darwin’s theory of natural selection was mixed with the science of heredity to form what would become an infamous concoction: eugenics. The social chemist blending this concoction was British statistician Francis Galton, a cousin of Darwin. As historian Daniel Kevles points out, Galton, like others of his age, was confident that science and technology, as they had done in industry, could successfully engineer progress in human society. If the mechanism of evolution was natural selection of the “fittest,” and if science had uncovered the operation of that mechanism, then was it unreasonable to assume that humans could take charge of their own evolution? Successes in nineteenth-century breeding seemed to suggest that this was indeed possible. Plants and animals had been bred for specific traits. In 1865, the same year Mendel published his research on peas, Galton asked: “Could not the race of men be similarly improved. . . . Could not the undesirables be got rid of and the desirables multiplied?” In the nature versus nurture debate, Galton was firmly on the side of nature. Responsibility for life entailed, that in order for some to live, others would have to die. Galton coupled the rhetoric of responsibility for improving the life of the species with the rhetoric of biological safety.

From Eugenics to Racial Hygiene

In 1895, German scientist Alfred Ploetz sounded the alarm that modern society was failing to work in concert with the processes of nature. Medical care for the weak, he argued, undercut natural struggle for existence. Social welfare allowed the poor and misfits to outbreed the more “fit” classes. Evolutionary “counter selection,” warned Ploetz, was well underway. In support of race improvement, Galton and others took up the cry of Ploetz’s evolutionary racism: cultural and social practices were leading to the evolutionary degeneration of the human species. Responsibility for securing and improving the life of the species required controlling the reproduction of “unfit” populations that were driving species degeneracy.

According to Galton and others, the trends of degeneracy could be reversed. Galton proposed a new empirical science of heredity: eugenics, or “good birth.” For the benefit of the species, eugenics would investigate the factors that influence hereditary qualities and establish scientific criteria for who was fit to

reproduce and who was not. By encouraging specific reproductive practices among certain categories of people, the human species could improve itself, favoring certain hereditary qualities and disfavoring others. As the Eugenics Health Foundation was to put it in 1930, “Eugenics is a new science which has as its object the betterment of the human race, and it embraces all forces and factors, whether hygienic, biologic, social, or economic, which are, or may be, influential in the uplifting and improvement of mankind.”

In the 1880s, German biologist August Weismann had offered a theory of heredity that seemed to support the nature over nurture view. Weismann argued that traits were passed between generations via “germ plasm,” a hereditary substance present in the male and female gametes (reproductive cells). Germ plasm seemed to provide an entity on which selection, natural or eugenic, could act. Weismann’s theory was bolstered by the reappraisal of Mendel’s work in the early years of the twentieth century, and eugenics ideas gained scientific legitimacy. By the 1920s, particularly in the United States, eugenics ideology had spread to the mainstream.

However, eugenics reflected the racist and classist prejudices of its promoters. Characteristics of “good stock,” meaning those fit to reproduce, were associated with the white, typically Anglo, middle and upper classes. But the leading eugenicists and eugenics organizations saw themselves as fostering the public good. For the sake of health, well-being, and security, national germ plasm, or “protoplasm” as it came to be called, had to be protected.

Eugenicists promoted strategies of “positive eugenics.” They published books and pamphlets concerning eugenic public health and family planning. They offered incentives for the “fit” to have more children. Complementing these strategies were programs of “negative eugenics” that discouraged reproduction among the “unfit”: criminals, alcoholics, the mentally ill, the feeble-minded, the sexually deviant, the poor, the sick, and members of selected “racial” groups. At their most coercive, eugenics regimes took the form of public policy. Thirty U.S. states passed involuntary sterilization laws, targeting the allegedly unfit. Though the courts struck many of these laws down, several were successfully implemented. Indeed, sterilization of the mentally ill continued into the 1970s. Before the final laws were taken off the books, more than 60,000 Americans had been forcibly sterilized.

Eugenics found its pathological apex in the Nazi programs of racial hygiene. In 1930, the *National Socialist Monthly* published an article entitled “National Socialism as the Political Expression of Our Biological Knowledge.” National Socialism, the article argued, is nothing more or less than “applied biology”; its methods are “strictly scientific.” In the name of scientific care for the human race, Ploetz and other German eugenicists sought social reforms based on “principles of the optimal conditions for the maintenance and development of the race.” Chief among these reforms was the transformation of traditional medicine. Traditional medicine, Ploetz argued, may help the individual, but in doing so, it hurts the “race.” A new kind of public

hygiene was needed—racial hygiene—which would allow medicine to care not only for the good of the individual, but the good of the race.

Programs were instituted for public education in eugenic health. Incentives were offered to racially “fit” individuals to marry and reproduce. Medical schools began to train thousands of doctors in racial hygiene—“sick genetic lines” needed to be identified. Only science could “legitimately” distinguish between valuable forms of life and “lives not worth living.” Nazi sterilization laws had been passed as early as 1933. Modeled largely on U.S. laws, compulsory sterilization was instituted for “the prevention of genetically diseased offspring.” By the end of the decade, it was no longer considered adequate to simply sterilize those on the growing list of the “unfit.” Genetic deviants did not merely pose a threat to the well-being of future generations; they represented a burden on current society. In 1939, designated the year of “the duty to be healthy,” Hitler commissioned doctors to grant “mercy deaths” to those judged incurably sick. By 1941, 70,000 patients had been killed in German hospitals. And as Robert Proctor soberly concludes, these hospital murders, legitimized in the name of science, were a “rehearsal for the subsequent destruction of Jews, homosexuals, communists, Gypsies, Slavs, and prisoners of war.”

By and large, mainline eugenicists were genetic fatalists. Genes, it was thought, determined intelligence, social conformity, morality, and other crucial aspects of who one was. “Blood will tell,” the eugenics mantra averred. If an individual was the child of a criminal, for example, that individual was biologically destined to the criminal life. And from the eugenicist’s point of view, bad human stock was an evolutionary pathology. The only means of “curing” this pathology was to intervene in human reproduction.

The rhetoric of biological fate provided cover for willful neglect of the socially disadvantaged. If we aid the “unfit” in this generation, we leave their offspring as a burden to future generations. Embracing social policies of “survival of the fittest” could be seen as an expression of altruism to the species.

Genetics After Eugenics

After World War II, eugenics and race biology were discredited. The newly formed United Nations declared that “any doctrine of racial differentiation or superiority is scientifically false, morally condemnable, socially unjust and dangerous, and . . . there is no justification for racial division either in theory or in practice.” While continuing to operate in the name of health, well-being, and security, the rationalizing object of genetics could no longer be the life of the human species; science must focus on improving the life of the human individual.

A further moral and political shift occurred when it became apparent in the late 1990s that global development was perpetuating widespread ecological crises. These crises affected the way in which nature is valued. Many industrial nations that had been dominated by an instrumental treatment of nature saw a resurgence of naturalism. This resurgence affected the way some people viewed

genetics. As Ted Peters puts it: “Naturalism is the belief that nature apart from intervention by human technology is the source of value.” For the naturalist, genetic engineering conducted in the name of human purposes raises the question: “Do we have the right to manipulate nature to meet these purposes?”

These shifts in moral emphasis were aided by developments in molecular biology and computational technology. Prior to the rise of molecular genetics in the 1950s, genetic intervention was in the form of control of reproduction. With advances in molecular genetics, however, intervention could be conducted on the individual organism, bypassing the need for intergenerational manipulation of populations. Science could affect the genetic well-being of the individual directly. In the spring of 2003, Francis Collins and colleagues at the National Human Genome Research Institute published an ambitious “vision for the future of genomics research.” They wrote that “new research strategies and experimental technologies have generated a steady stream of ever-larger and more complex genomic data sets that have poured into public databases and have transformed the study of virtually all life processes.” This transformed study, they wrote, facilitated an understanding of life at “an unprecedented level of molecular detail,” thereby occasioning “the translation of genomic sequence information into health benefits.”

Another shift affecting the relationship between society and genetics was the emergence of bioethics. The discovery of Nazi “medicine” and rapid advancements in postwar research brought increased attention to the social impact of scientific work. Many now questioned the earlier view that negative social consequences of applied science and technology were the result of misapplication or underdevelopment, and that better development and application of scientific knowledge would prevent undesirable impacts. Since the 1960s, scientists, theologians, and philosophers have been meeting at bioethics conferences to discuss ways in which social and ethical questions might finally be inseparable from scientific advance.

Genetic research involves interfering with natural processes that, as one analyst put it, “could destroy or transform nearly every aspect of human life.” Thus political, social, and moral concerns coincide with scientific considerations. Bioethical analysis of genetic research means paying careful attention to the rationales in the name of which genetic knowledge and technology have been brought together and directed toward life. It has become increasingly clear that the scientific-technical question “How can the genotype-phenotype relation be known and changed?” cannot be separated from ethical questions concerning what kind of future this knowledge and change will bring.

The Material and Spiritual Future of Life

If the form of our genetic future remains unclear, this is not for want of prophets telling us what to hope for and what to fear. Scientists, sociologists, theologians, and others have long sought to imagine the contours of our genomic

future. But to imagine the future, we must address the material and spiritual stakes. Material stakes involve questions of health, prosperity, and security. Spiritual stakes concern questions of identity, meaning, and value.

Material Stakes

Those advocating expansion of genetic knowledge and technology imagine a future in which genetics makes health care predictive, preventative, and personalized. Scientists are seeking to identify alleles—particular forms of a given gene—involved in the expression of particular diseases. As these alleles are identified, scientists hope to develop techniques for calculating the probability that the presence of this allele will result in disease manifestation. Scientists might then be able to develop therapies to minimize the odds that the disease will come to expression. If each of us had our genomes sequenced, preventative therapy could be fashioned according to each of our genomic idiosyncrasies.

Advocates forecast economic benefits as well. Proponents of genetic research argue that advances in science will bolster a wide sector of the economy through developments in the biomedical industry and the technological and medical delivery industries connected to biomedicine. Other economic benefits could include inflows of capital investment to health care research; entrepreneurial ingenuity, a significant force for pragmatic and efficient problem solving; and, through the proliferation of labs, the acceleration of genetic research. Proponents of genetic research and technology also anticipate a day when the genetic engineering of crops so increases yield and resistance to blight as to virtually eradicate global scarcity. Indeed, advances in the genetic modification of food are already taking form.

In terms of security, advocates anticipate that DNA testing, DNA fingerprinting, and DNA databases will make law enforcement more effective and more just. Genetically modified plants have been developed that detect the presence of certain munitions, and military scientists are using genetics to develop microbiological antidotes to bioweapons.

Those more cautious about the expansion of genetic knowledge and technology imagine the material stakes of our genomic future in terms of unforeseen social and biological costs. The personalized medicine made possible through genomic sequencing could resuscitate biologically based social discrimination. With the end of state-sponsored eugenics, the biological sciences claimed to have left this form of social violence behind. Indeed, following the completion of the map of the human genome, scientists announced that the genetic differences between members of different population groups were no greater than among members of the same group. Genetic evidence indicates that biological differences between population groups are negligible and social categories of race have no basis in biology. In practice, however, experimental research still functions as if biological differences between population groups do indeed matter.

Two points are crucial here. First, every diagnosis of pathology is made possible by an established norm of health relative to which diseased states are recognized. In order to calculate the probability that an individual with a genetic predisposition to a particular disease will actually develop that disease, geneticists must first understand the frequency of that genotype-phenotype correlation within a larger population group. Second, different population groups have differing levels of susceptibility to different inheritable diseases. For predictive genetic medicine to calculate the probability of an individual's susceptibility to a given disease, genetic norms have to be established for that individual's population group.

These genomic diversity projects can be legitimated on the basis of distributive justice. In order to assure that the benefits of genetic research are equitably distributed to various population groups, it is vital to understand differences in levels of disease susceptibility and in levels of response to therapeutic regimes particular to those population groups. But these projects could be interpreted as new biological conceptualizations of race, and as providing new scientific criteria for social inclusion and exclusion. Critics also hold that the combination of profit motive, private ownership, and minimal public accountability could compromise scientific transparency, exclude research into less profitable but equally important areas of research, and exacerbate the injustices already present in the distribution of technological goods.

Drawing on the insights of network thinking, critics further warn that the genetic modification of organisms could trigger unanticipated consequences. Making certain plants genetically resistant to specific blights could eliminate native nonresistant plants. Genetic modifications intended to increase the shelf life of fruits and vegetables could adversely affect the nutritional value of food. Most significantly, genetic modifications could trigger cascading effects within ecosystems, destabilizing natural environments.

Finally, those more cautious about genetics allow us to imagine the underside of the potential benefits to security. DNA fingerprinting increases the visibility of a given member of society, counter to the right to privacy cherished in liberal societies. DNA databases in the United States consist largely of information on individuals who have been incarcerated. Interpreted outside the context of the social forces driving the disproportion of minorities in the current system, DNA databases could falsely appear to provide biological evidence of predisposition to crime among these minority populations. And any genetic technologies designed to prevent biological warfare could also be used to facilitate it. Genetic knowledge could be used to engineer new varieties of bioterrorism.

Spiritual Stakes

For many, the future at stake in genetic research concerns not only material risks but fundamental questions of identity, meaning, and value. Émile

Durkheim defined the “sacred” as that which a given society holds to be inviolable and which places certain obligations on members of that society. Many people conceive of DNA as if it were sacred and the rhetoric used to frame the significance of the project to map the human genome often took on a religious tone. The human genome was frequently referred to as “the Book of Life.” The projects were described as quests for the “Holy Grail” of biology. These statements resonated in the public imagination. As Rabinow pointed out, people think DNA “tells the truth about who they, and their pets and plants and food, really are and provides clues to what their future holds.” Or as Peters noted, people wonder if DNA can answer the question “Who am I?” To claim that DNA holds the truth to the nature of life, to suggest that it provides clues to the future, is to give it Durkheimian (i.e., sacred) significance.

Though sometimes articulated in terms of the sanctity of nature, the spiritual stakes involved in genetic research are most often considered in terms of human dignity. Since World War II, the ethic of human dignity, with its emphasis on the sanctity of human life, has enjoyed unmatched political and social stature. But few are able to give coherent articulation to the relationship between dignity—a quality of the whole human person—and the genome—a part of the human part. This incoherence proves troublesome.

Those who grant the genome Durkheimian significance tend to conceive of DNA as the most important or essential aspect of the human person. In this “genetic essentialism,” a part of a person is taken as equivalent in value or meaning to the whole. The genome is taken to stand for the essential aspect of the morally dignified person. As Rabinow suggests, this image of the part standing for the whole is a form of “spiritual identity.” Thus manipulation of the genome could be seen as violating human dignity.

Genetic essentialism represents an *archonic* form of spiritual identity. Archonic, from the Greek *arche*, refers to both beginning and governance. The logic of archonic identity suggests that the way something originates decrees or governs its telos—its future trajectory, value, and purpose. When the human genome is referred to as the “blueprint” for human life, the language invests the genome with archonic weight. Conceived as the determiner of who an individual can become, the genome is taken to be a source of moral prescriptions. Technologies that alter the genome would be resisted because they would violate the truth about human life.

The archonic logic of genetic essentialism is troubled by developments in network biology. Genes are vital to living systems, but as the genome mapping projects have suggested, they are far from being able to account for all aspects of these systems. While genes code for proteins, for example, those proteins form systems that function in ways quite distinct from the genomic codes. Not only are the network properties of proteins not reducible to protein-producing genes, but they actually alter the function of these genes. Insofar as network biology considers DNA to be primary, it does so not in the sense of DNA being most essential, but in the sense that DNA is the point of

departure for a series of interconnected systems and processes. Genetic essentialism is scientifically incoherent. Thus the inviolability of the genome, which genetic essentialism presupposes, appears questionable.

If genetic essentialism wanes under the pressure of changing science, will the spiritual stakes of genetic research go away? Will questions of meaning, value, and identity then be ignored? Some fear that if the “do not trespass” sign of genetic essentialism is taken down, human dignity will be violated, and nature will be treated as merely instrumental. This need not be the case. The genome need not be considered sacred for us to treat as sacred those values that inform our relationships to humanity and to nonhuman nature. The spiritual significance of genetic research is not found in the DNA, but in the quality of the relationships that genetic research affects. Human dignity and the value of nature are only experienced when they are bestowed. Genetic research affords the opportunity to bestow dignity—to create desirable situations of meaning, value, and identity.

The archonic logic of genetic essentialism suggests that the future at stake is one of dangerous violations: we are obliged to defend the sanctity of the genome. This logic confines the spiritual stakes of genetic research to what we ought *not* do. This effort to defend the genome risks enforcing the status quo. By contrast, when framed in terms of quality of relationships, the spiritual stakes of genomic research can be understood as responsibility for making the present different and potentially better. To quote Ted Peters: “some things can be done and perhaps should be done to influence the course of our genetic future. Such things might be quite modest on a grand evolutionary scale, yet they can have an immense impact on the quality of life for certain individuals.” Peters’s statement reflects eschatological reasoning—the Greek *eskatos* means “final or ultimate.” Eschatology suggests that meaning and value are constituted not just by what someone was or is, but by what that person can become. Genetic essentialism constitutes an archonic form of spiritual identity, where meaning is rooted in origins. Responsibility for helping to shape the future, a situation in which dignity is fostered rather than defended, represents spiritual identity in an eschatological form.

Genetics and the Future

Contemporary molecular genetics represents a future-oriented mode of engagement. If we understand the determinants of the present situation, we can identify where, through technical intervention, change is possible. By understanding how our genotype contributes to the form of our phenotype, we become capable of technical interventions, effectively redetermining the forces that determine us. But what changes are desirable? What about the present do we want to change? What do we want that change to look like? Answering these questions involves the work of imagining future arrangements (such as improved health), and working back from those arrangements to the present

situation. This future-envisioning informs a set of values and desires that, once transmuted into standards for evaluating our present situation, serve as tools of rationalization—drawing knowledge and technology together in the name of a future end. These standards of evaluation represent the power of our imagined futures operating in the present.

Rabinow's diagnosis holds. Despite the discord with regard to the relative promise and peril of genetics, most parties seem to agree that in genetics there is something vital about the future at stake, and moreover, that we are obliged to do something about it. But what remains unclear is the kind of future at stake, and what we are obliged to do in light of that future. It is becoming increasingly clear, however, that this future is taking shape in the network of relations among genetics, society, and spirituality—a complex set of relations involving events, fields of knowledge, concepts, objects, individuals, institutions, and technologies. Within this network, a conceptual space is opening up for the integration of both the material and spiritual future stakes of genomic research. As we learn to analyze this network, the contours of possible futures are made visible, inviting us to engage in the patient and difficult work of helping to transform our present situations into desirable futures.

This work involves practical difficulties. The sheer number of particular elements coalescing to form that future is overwhelming. More challenging still is the dynamic and open character of this future. As elements change (e.g., a discovery is made, regulatory legislation passed, a new moral argument articulated), configurations shift, generating new arrangements, new functions, new contexts of significance. These practical difficulties invite sensitivity toward—even a sensibility for—constant change, for the genuinely new problems posed by contemporary genomics. To echo Rabinow: a sensibility for constant change invites a certain mode of engagement, one of pleasure and obligation to work continually at grasping and participating in the transformations that constitute a world experienced as complex, contingent, malleable, and open.

Like genetics, this engagement is future oriented. It involves what Peters has described as an exercise of “future freedom,” wherein we work to understand the factors that determine the present so that we can make ourselves a determinant of the future. Future freedom, writes Peters, compels us to “imagine a future that will be different from the past and present.” For good or for ill, genetic research and technology represent an opportunity for the expression of future freedom. In the biological century, something about the future is at stake, and there is a pressing obligation to do something about it.

Bibliography

- Barabási, Albert-László. *Linked: How Everything Is Connected to Everything Else and What It Means for Business, Science, and Everyday Life*. New York: Plume, 2003.
- Collins, Francis S., Eric D. Green, Alan E. Guttmacher, and Mark S. Guyer. “A Vision for the Future of Genomics Research?” *Nature* 422 (2003): 835–47.

- Durkheim, Émile. *The Elementary Forms of Religious Life*. Trans. Karen E. Fields. New York: Free Press, 1995.
- Foucault, Michel. *The History of Sexuality: An Introduction*. Vol. 1. Trans. Robert Hurley. New York: Vintage Books, 1990.
- . “*Society Must Be Defended*”: *Lectures at the Collège de France, 1975–76*. Trans. David Macey. Ed. Mauro Bertani, Arnold Davidson, Alessandro Fontana, and François Ewald. New York: Picador, 2003.
- Fox-Keller, Evelyn. *The Century of the Gene*. Cambridge, MA: Harvard University Press, 2000.
- Gayon, Jean. “From Measurement to Organization: A Philosophical Scheme for the History of the Concept of Heredity.” In *The Concept of the Gene in Development and Evolution: Historical and Epistemological Perspectives*, ed. Peter Beurton, Raphael Falk, and Hans-Jörg Rheinberger. Cambridge: Cambridge University Press, 2000.
- Hood, Leroy. “Biology and Medicine in the Twenty-First Century.” In *The Code of Codes: Scientific and Social Issues in the Human Genome Project*, ed. Daniel J. Kevles and Leroy Hood. Cambridge, MA: Harvard University Press, 1992.
- Jonsen, Albert R. *The Birth of Bioethics*. Oxford: Oxford University Press, 1998.
- Kevles, Daniel J. *In the Name of Eugenics: Genetics and the Uses of Human Heredity*. Cambridge, MA: Harvard University Press, 1995.
- Morange, Michel. *A History of Molecular Biology*. Trans. Matthew Cobb. Cambridge, MA: Harvard University Press, 1998.
- . *The Misunderstood Gene*. Trans. Matthew Cobb. Cambridge, MA: Harvard University Press, 2001.
- “Networks in Biology.” *Science* 301:5641 (September 26, 2003): 1863–77.
- Peters, Ted. *Playing God?: Genetic Determinism and Human Freedom*. 2nd ed. London: Routledge, 2003.
- Proctor, Robert. *Racial Hygiene: Medicine Under the Nazis*. Cambridge, MA: Harvard University Press, 1988.
- Rabinow, Paul. *Anthropos Today: Reflections on Modern Equipment*. Princeton, NJ: Princeton University Press, 2003.
- . *French DNA: Trouble in Purgatory*. Chicago: University of Chicago Press, 1999.
- Tudge, Colin. *The Impact of the Gene: From Mendel’s Peas to Designer Babies*. New York: Hill and Wang, 2001.

84 Biotechnology and Theology

Celia Deane-Drummond

Biotechnology is the use of technology in the biological sphere. But this technology involves more than inanimate tools; its manipulations use biological entities, and this raises a number of cultural and religious issues that other technological applications do not. Of course, the social challenges are more limited when the biological form is low in the evolutionary tree. Yet even in this scenario, important ecological issues may be raised. As manipulation spreads into plant and animal species, new questions emerge about the possible social and environmental impacts. Another concern is animal welfare.

In the human realm, biotechnology sharpens questions about the nature of human nature. Historically, religious believers have greeted technology with either enthusiasm for using gifts that God has given to human beings, or suspicion that such changes undermine a deep structure in the order of things, put in place by a divine creator. Supporters of biotechnology, especially in the form of genetic engineering, tend to argue that biotechnology is simply an extension of cultivation and animal husbandry that has been in place since the dawn of early civilization. In other words, it is the cultural mark of a civilized people to practice biotechnology; any fears are irrational fears against progress. Antagonists point out that there may be historical precedents which have allowed biotechnology to emerge, but this is not necessarily the direction in which human society should go.

As one might expect, issues to do with biotechnology are highly controversial, giving an ambiguous promise that can be interpreted in very different ways. It is one of the reasons discussions about biotechnology are fascinating, but also can lead to heated debate. Biotechnology is, after all, an application of science to particular life forms, which raises important theological and ethical concerns.

Genetically Modified Organisms

A common application of biotechnology is the genetic modification of plants, animals, and bacteria. Genetic engineering of plants often includes the use of

bacterial “vectors,” or agents, which facilitate the movement of genetic material from one plant variety to another. More radical trans-species changes are also possible using genetic technology. Unrelated species can be manipulated so that they share genes, or even have genes added that are entirely artificial. One of the most common modifications involves engineering soybean plants so that they are insensitive to the herbicides that are used to control weeds in the soybean fields. Such a technique, as one might expect, was developed by the company selling the herbicide. Insecticide resistance may also be introduced, so that plants produce insecticides internally and in this way are protected against pests. A host of other genetic modifications are possible. Some include public health programs, such as the introduction of vaccines or vitamins via modification of food sources.

These genetic changes are inherited from one plant generation to the next, unless self-sterile hybrids are used, a common practice in order to prevent farmers from breeding their own genetically modified crops from a prior seed source. Other techniques can be employed to interfere with the fertility of the crops, either making them self-sterile, in other words the seeds are inviable, or only viable if they are sprayed with a chemical spray sold by the company that has developed the genetically modified seeds. These methods, referred to as “traitor” or “terminator” technologies, have been highly controversial because of their impact on subsistence farmers in the developing world, who are forced to buy new seed every year.

The promise of genetic engineering is the aspect most often promoted by the scientists concerned. The frustration of long and slow genetic breeding programs vanishes virtually overnight when genetic technology is used. Patents lead to some lucrative contracts for companies, and the mushrooming of the biotechnology industry over the last quarter of a century is one indicator of the commercial benefits that biotechnology brings. The genetic engineering of bacteria, plants, and in some cases animals in order to produce drugs for health care—a practice called “pharming”—also figures in discussions over the acceptability of genetically modified organisms, or GMOs.

Almost all medical research laboratories rely on biotechnology techniques of one sort or another, and few would wish to restrict such research, though technologies involving human tissue are more controversial. One good example of genetic pharming is the genetic modification of potatoes to produce a human protein called atrial natriuretic factor (ANF). This protein helps repair the body after surgery. Cadavers were previously the only source of the protein. The modified potatoes are grown in a controlled environment and kept separate from food crops.

The threat of GMOs is most commonly characterized in terms of possible effects on other species. Effects can be indirect, through interfering with the food chain of other species reliant on particular sources of food—for example, birds feeding on insects. Or effects can be direct, by spreading the genetic modification to other closely related species. The extent of this spread and its

effects on local ecologies are still the subject of considerable controversy. Transgenic modifications also lead indirectly to an overall reduction in biodiversity, which is an area of concern for ecologists.

Another common anxiety is the possible health effects on humans who consume GMOs, and while this aspect may be exaggerated in the media portrayals of the debate, it is virtually impossible to conduct a long-term trial free of GM since it has so permeated the human food chain. In addition, genetic modification may be seen as a direct threat on the welfare of animals. For example, pigs modified with human growth hormones suffered considerably as a result of this change. Perhaps unsurprisingly, the hormone proved to be unregulated in the new genetic environment of the pig. Biotechnological techniques designed to make animals less stressed in restricted conditions raise similar issues about animal welfare.

The power of GMOs in a social sense is most keenly felt where GMOs become the only option available, thus locking growers into buying new seed every year. It is one reason campaigns against GMOs have been particularly ferocious in the poorer nations of the world. In Europe, where the possibility of contamination with GMOs is a real possibility for organic farmers, hostility toward GMOs has grown. The cultural situation is also one of distrust toward those who are advocating the technology, especially as it is associated with government campaigns. The *GM Nation Report* published in Great Britain in September 2003 showed that about 80 percent of Britons were hostile to the introduction of GMOs for commercial use in crop plants. Claims that genetic modification will help feed the world can be unrealistic. In a limited way, however, GMOs may enhance the range of growth of some species so that they can grow in, for example, more arid conditions than would otherwise be possible.

The response of theologians reflects the ambiguous promise that genetic engineering brings. Those who are more moderate ask what might be justifiable interference, given the belief in a good creator God and the goodness of creation. While some interference may be justified, the overall effects of the biotechnology project need to be taken into account. In particular, theological reflection on the goodness of God cannot be separated from an awareness of the need for social justice, which means that those cases where GMOs are unwelcome or forced on weaker individuals or societies cannot be justified. On the other hand, theological reflection would allow for the possibility of GMOs being used as a way of serving others. Yet such service would require forms of altruism that may be difficult to achieve where biotechnology is necessarily bound up with commercial interests.

Public consultation in Britain over GMOs has shown a remarkable degree of perception of critical social issues, over and above that considered by expert committees. Such social issues include religious concerns about interference with the natural order. Most theologians reject the notion that nature is "sacred" and hence untouchable. But there is a sense that the natural world, as

God's good creation, is in some sense "enchanted" by being in relationship with the creator.

Animal Cloning

Cloning, or asexual reproduction, was for many years restricted to plants and lower animals. A breakthrough occurred in 1997, however, with the cloning of Dolly, a sheep at the Roslin Research Institute in Edinburgh, Scotland. Since then, a number of other higher animals have been cloned, including cats, pigs, cattle, and mice. The technique involves taking a nucleus out of an egg cell, then replacing it with a nucleus of a specialized cell from the body either of the same sheep or another sheep, or a culture of cells maintained in the laboratory. An electric charge is then passed through the cell, and the egg then starts to divide as if it has been fertilized.

The motivation behind cloning was to facilitate genetic engineering of large numbers of sheep, in order to increase the efficiency of drug production in the milk of those sheep; the gene for the drug was introduced through genetic engineering. In the case of Dolly, the drug in question was the human blood clotting factor IX. Dolly was cloned with this human gene included. It took over 270 attempts before Dolly was born. In other attempts, the lambs died at birth or in the womb, often subject to abnormal growth and other physiological problems. Biologists were very surprised that Dolly arrived at all, given the elaborate switching-off process in genes during development.

Theological responses to cloning, like those toward GMOs in general, are both positive and negative, either affirming human ingenuity as God's gift to humans, or resisting the development as unwarranted interference. Scientists have argued that reproductive cloning is more efficient in terms of success rate compared with other GM technologies, which rely on crude methods, such as the injection of naked DNA into egg cells. But many have called into question the long-term commercial viability of cloning technologies for drug production. Nonetheless, by far the most theological discussion has been on the possibility of human reproductive cloning.

Almost all theologians reject the idea of human reproductive cloning, not simply because it is at present far too risky, but also because it seems to violate human dignity. Some theologians argue that cloning represents a step too far in detachment of biological procreation from sexual activity and marriage. It interferes with the parental relationship that arises through sexual reproduction, leading to questions about the identity of the child in the family and in society as a whole. A few theologians would support cloning if it became sufficiently safe, on the basis that a child born in this way could have just as good a relationship as one born through natural reproduction or through *in vitro* fertilization. Some conservative theologians, however, ask whether a child born in this way could have a soul.

Therapeutic cloning through the use of stem cells, while controversial, has been more widely accepted. An early embryo, less than fourteen days old, contains cells that are pluripotent: they are capable of developing into a range of different cell types. Stem cells can be used to treat disease. If derived from a cloned nuclei of the patient being treated, the cells would not suffer from immune rejection responses. Conditions that could be treated include Parkinson's disease, paralysis from damage to the spinal cord, and bone marrow diseases. But is this a permissible use of human embryos? The ontological status of the embryo becomes a significant area of theological debate. Other social concerns are accessibility to treatment, but also the use of women's eggs and the possible exploitation that this might entail.

There are other sources of human stem cells. Some are found in the umbilical cord at birth and in adult cells as well. In these cases, however, the stem cells are not as efficient in terms of their potential to produce different cell types. A report published in 2003 suggests that blood stem cells may be useful in treating paralysis. However, scientists do not fully understand regulation in such stem cells, so there are fears that subsequent growth patterns may not be adequately regulated, leading perhaps to cancers. New technologies involving different sources of stem cells are likely to be developed very rapidly in the years to come.

Cloning remains a controversial area. A motion to ban all forms of cloning came before the United Nations in November 2003. The motion for deferral rather than a complete ban won by a single vote. European countries reflected the divisions on the issue. Germany, France, Great Britain, and Switzerland voted for deferral rather than a complete ban. Austria, Ireland, Spain, and Italy favored a complete ban, in part due to conservative religious sentiments in those countries. Countries voting for deferral acknowledged the risks of reproductive cloning but were concerned that a complete ban would prevent therapeutic forms of cloning.

Human Genetics

The publication of the deoxyribonucleic acid (DNA) sequence for the human genome created a flurry of publicity. One result of the project was surprising: the human genome of 30,000 genes has only 4,000 more genes than a garden weed. The relatively low number of genes compared with the number of proteins sequenced, however, suggests a flexible role for human genes, and multiple effects if genes are manipulated through genetic engineering technology. But the rush to patent parts of the human genome fell flat when it became clear that government-funded projects would make the sequence accessible to all at no charge. Patenting human gene sequences seemed like a step too far in the extension of biotechnological techniques to humans.

At present, most countries impose a ban on germ line therapy, which is manipulation of human genes of egg or sperm cells that will be passed on to

the next generation. Genetic therapy of body or somatic cells is well established, and it can be used to treat patients suffering from single gene defects, such as cystic fibrosis. The results have not proved as effective as many had hoped, no doubt because of the difficulty in targeting a cell site for the introduction of DNA, but also because of the complexity in gene regulation. Many geneticists believe that the next phase in human genetic research is likely to focus on specific drug therapy, where drugs are tailor-made to suit the particular genetic fingerprint of a patient. There are over 4,000 diseases caused by defects in human genes, and many would argue that all diseases have some sort of genetic component.

Theologians and others concerned with ethics raise questions about the permissible limits to interference in human genetic makeup. Supporters argue in favor of the freedom of the scientist to work within genetic science, while the more cautious worry about the wider needs of society and the long-term impact of fundamental changes in human genetics. Another issue is respect for human dignity. Others question access to the technology and the perception that science, rather than religion, is the means to a good life. A particular concern is the need to empathize with those who suffer, and to treat those who suffer from various genetic diseases with sufficient respect. If screening is in place against, for example, Down syndrome, what impact might this have on the Down community? Would they be labeled through the technology as having no right to exist? On the other hand, the practical reality of bringing up severely disabled children is a burden some families believe they cannot bear.

Biotechnology is a relatively recent phenomenon, and controversies continue about its applications. While there are clear advantages to biotechnology as applied to easy production of pharmaceuticals, a detailed understanding of its impact on ecosystems and long-term effects on human health are not fully understood. The ambiguous promise is reflected in the opposing theological positions on biotechnology applied to agriculture, animal and human cloning, and genetic engineering. Theologians most attuned to sociological issues are likely to be cautious. Active resistance may come from those with the most conservative theological approaches to divine creation.

Bibliography

- Bruce, Donald, and Ann Bruce. *Engineering Genesis: The Ethics of Genetic Engineering in Non-Human Species*. 2nd ed. London: Earthscan, 2004.
- Bruce, Donald, and Don Horrocks. *Modifying Creation? GM Crops and Foods: A Christian Perspective*. Carlisle, UK: Evangelical Alliance Policy Commission, Paternoster, 2001.
- Cole-Turner, Ronald. *Human Cloning: Religious Responses*. Louisville, KY: Westminster John Knox, 1997.
- Cole-Turner, Ronald, and Brent Waters, eds. *God and the Embryo*. Washington, DC: Georgetown University Press, 2003.
- Deane-Drummond, Celia. *Theology and Biotechnology: Implications for a New Science*. London: Geoffrey Chapman, Continuum, 1997.

- Deane-Drummond, Celia, and Bronislaw Szerszynski. *Re-Ordering Nature: Theology, Society, and the New Genetics*. London: T and T Clark, Continuum, 2003.
- Messer, Neil, ed. *Theological Issues in Bioethics: An Introduction with Readings*. London: Darton, Longman, and Todd, 2002.
- Reiss, Michael, and Richard Straughan. *Improving Nature? The Science and Ethics of Genetic Engineering*. Cambridge: Cambridge University Press, 1996.
- Shiva, Vandana. *Stolen Harvest*. London: Zed Books, 2001.
- Song, Robert. *Human Genetics: Fabricating the Future*. London: Darton, Longman, and Todd, 2002.

85 Religion, Ethics, and the Human Genome Project

Margaret R. McLean

While cleaning out my mother's garage, I came across a well-worn *Time* magazine. On the cover were two people, male and female, each entwined in a red double helix; between them, in yellow, were the words "The New Genetics: Man Into Superman." The date was April 19, 1971. The associated story speculated about "the promise and peril of the new genetics"—correcting defects, avoiding the ravages of aging, increasing physical and mental ability, shaping *Homo futurus*. All this had become theoretically possible because of the work of scientists James Watson and Francis Crick, who had deciphered the double helical form of the macromolecule deoxyribonucleic acid (DNA) in 1953. Watson and Crick's unraveling of the structure of DNA was world-shattering and has been likened to the publication of Charles Darwin's *On the Origin of Species* and the smashing of the atom. In the now familiar twisted ladder of DNA resides the so-called "secret of life"—mechanisms of heredity, development, disease, and aging.

Although the "new genetics" described in the magazine merely promised what is now possible—in vitro fertilization, genetic testing, mammalian cloning—the religious and ethical concerns raised three decades ago are hauntingly familiar. Should "gene surgery" be confined to disease prevention and treatment or applied toward increasing the human life span? Should humans be "reengineered" with larger heads to accommodate more brain cells? Who, if anyone, ought to be cloned? Should we clone the FBI's J. Edgar Hoover or basketball great Lew Alcindor? Such dilemmas, the article claimed, are rooted in the ever-present temptation for humans "to be like God."

This ancient concern for hubris is a good starting point for a consideration of the Human Genome Project. Its modern incarnation is the frequent warning against "playing God." Although some insist that we ought not "play God" and "fool with Mother Nature," it is important to recognize that "Mother Nature" is constantly impacted by human activity. When we cut the grass or

build a dam, we “fool” with nature. Genetic technology—like all human action—can be aimed at good or bad ends. Neither blanket acceptance nor outright rejection of genetic discoveries and possibilities is an appropriate or helpful response. Instead, we need to discern the ethical and scientific limits of genetic research and its applications. Of course, people of good will can disagree about how and where to set such limits, but that does not excuse us from the responsibility to try.

The Human Genome Project

In 1988, James Watson and others convinced the U.S. Congress to fund an international research project to decode “the human genome,” the estimated 3.2 billion letters of our genes. Spurred on by competition from Celera Genomics, this publicly funded Human Genome Project was completed in April 2003, surprisingly two years ahead of schedule and \$400 million under budget.

The hereditary material of multicellular organisms such as humans is the double helix of DNA, which contains our genes. The double helix is found in chromosomes in the nucleus of a cell. DNA is made up of four chemicals, called bases, that when paired create the rungs of the familiar twisting ladder structure. Each gene is made up of these bases, in different orders and stretching different lengths. The bases—adenine (A), cytosine (C), guanine (G), and thymine (T)—make up the genetic alphabet, which provides information vital to the manufacture of proteins and to passing particular characteristics from generation to generation. Metaphorically, these four letters spell out the code necessary for making and operating a human being. If laid side by side, the letters of the human genome would fill 200,000 phone-book pages. Bases out of place, missing, or incorrectly duplicated can result in a genetic disorder, such as sickle cell anemia, cystic fibrosis, or Huntington’s disease.

Scientists deciphered the human genome by determining the sequence, or order, of all the bases in human DNA. They also made maps showing the location of genes along the chromosomes, much as a highway map shows the location of cities and towns along Interstate 80 from San Francisco to New York.

Somewhat surprisingly, only 2 percent of the human genome contains genes. The remainder—misnamed “junk DNA”—may be important to chromosome structure and regulation. The adjective “junk” should be seen as shorthand for “we don’t exactly know what it does just yet but we are working on it.” The Human Genome Project demonstrated that there are about 30,000 human genes. Taking us down a peg, scientists discovered that we have only twice the number of genes of the roundworm and triple those of the fruit fly. Over 200 genes have come to humans courtesy of bacteria, maintained across the billions of years that separate the two species in evolutionary time.

Human DNA can be likened to a molecular history book of the species that tells us about our origins in Africa and migration into Asia and Europe. Genetically, all humans are 99.9 percent alike. The remaining 0.1 percent—about 3

million out of 3 billion bases—makes us different. This minute genetic variation between people is part of what makes us look different: sex, eye color, and hair color, for example, are genetically determined. It also has a role in our susceptibility to disease and response to medicines. Certain genetic differences can increase our risk of illness. For example, the presence of the gene variant BRCA1 increases a woman's risk for breast and ovarian cancer (although women may develop these cancers without having this variant). Other genetic variations directly cause diseases such as sickle cell anemia, hemophilia, and Huntington's disease. Genetic changes, which produce such adverse effects, are called mutations. In some cases, a mutation in only one gene produces disease, as in Huntington's disease. In many more cases, such as cancer, a disease is polygenic, being associated with multiple mutations in multiple genes at different chromosomal locations. Many variations in DNA occur relatively frequently and have no adverse effect on the individual. The ABO blood groups are an example of such benign variations called polymorphisms.

Scientists are building on the results and technological developments of the Human Genome Project to deepen our understanding of the genetic components of human health and disease. Genetics will assume an increasingly vital role in the diagnosis, monitoring, and treatment of disease. Within the next decade, it is likely that predictive genetic tests will allow us to know our individual risk for future disease and possibly to take preventative measures. It is also likely that we will know ahead of time how effective a particular drug will be based on our genetic profile.

All diseases have a genetic component, whether caused by a mutation or by the interaction between an individual's genome and the environment. The Human Genome Project has pinpointed numerous genes that cause or are associated with disease. Over 4,500 diseases directly involve genetic factors. But having a genetic predisposition for a disease—breast cancer for example—is not the same as having the disease. A positive family history or finding a mutation associated with increased risk is no guarantee of future illness. At most, having a mutation that predisposes one to a certain disease is only one condition that, in association with other factors such as diet, exposure to ultraviolet rays, or cigarette smoke, may result in disease.

The long-term goal of the Human Genome Project is to use genetic information to improve human health by developing new ways to diagnose, treat, cure, and prevent disease. However, the path from diagnosis to treatment to cure is long and winding, and the journey has only begun.

ELSI

A unique component of the Human Genome Project was the commitment of funds—\$76 million through 1999—for ELSI, the “Ethical, Legal, and Social Implications” of this research. The project planners recognized that information gathered about the structure and function of human DNA would have

deep implications for individuals, families, and society. Although such information may vastly improve human health, a number of thorny ethical, legal, and social issues surface. How should genetic information be gathered and used? Who should undergo genetic testing? Should testing be voluntary? Who should have access to an individual's genetic profile? What constitutes misuse of genetic information? The ELSI strategy is extraordinary in that it identifies, analyzes, and discusses the ethical, legal, and social issues associated with genome research at the same time that basic research is being conducted.

Early on, the ELSI working group recognized that genetic diagnosis is not necessarily of benefit if there is nothing to be done, no surgery to undergo, no pill to pop. The completion of the Human Genome Project provides unprecedented opportunity for the development of genetic tests that can confirm or predict disease but can do nothing to treat or to cure. Finding a gene is not the same as finding a cure. Taking a test is not the same as being treated. The ELSI working group predicted that we might spend years living in this "interim phase," a time when tests and diagnoses are plentiful but treatments and cures are few, a time when the most harmful consequences can occur, such as discrimination in employment or insurance and stigmatization.

The ELSI program focuses on how to make use of genomic information in an ethically, legally, and socially responsible fashion. Areas of concern can be put into three basic categories. The first consists of issues surrounding ownership of the genome, including gene patenting. The second focuses on genetic engineering—including reproductive genetic selection—and gene transfer therapy. The third considers the routine gathering and use of genetic information in research and clinical settings. Because this is where most people will first encounter genomics, two particular medical applications of the Human Genome Project's findings merit attention here: genetic testing and pharmacogenomics.

Genetic Testing

The primary product of the Human Genome Project is not a new gizmo, but information—information of a deeply personal nature. Genetic information is increasingly being used to diagnose and predict disease. For example, all fifty states and the District of Columbia screen newborns for phenylketonuria or PKU, a metabolic disorder that causes severe mental retardation if not treated. Over 900 genetic tests are currently available, most of which are being used for newborn screening and in families with a history of a genetic disorder, such as Huntington's disease or hereditary breast cancer. Nonetheless, it seems quite likely that genetic screening (testing an entire population such as newborns to identify those at high risk for a particular disorder or disorders) and genetic testing (testing a given individual or family) soon will be used to identify predispositions to gene-associated disease irrespective of family history.

But mainstreaming genetic testing raises the question of how this information ought to be used and who should have access to it. Should everyone be required to submit to genetic testing before marriage or starting a family? Should an individual's genetic profile be used to set life and health insurance eligibility and premiums? Should employers be able to screen out those who are genetically predisposed to carpal tunnel syndrome or depression? In seeking answers to these and other questions, it is important to remember that, in many cases, genetic tests function more like a weather report than a crystal ball: they predict relative risk, not certain outcome.

Pharmacogenomics

It seems likely that medical records will soon contain not only cholesterol levels but also complete patient genomes together with a list of small genetic variations called SNPs (single nucleotide polymorphisms) that will be used to predict responses to medications. This genetic information will allow medications to be more precise, less burdensome, and more successful.

People respond to medications in different ways. Each year, over 100,000 Americans die from taking medicines that help most of us. Codeine relieves pain for many people but not for everyone. Scientists believe that creating drugs customized to a patient's genetic makeup will result in safer drugs that work better. The knowledge gained from the Human Genome Project is being used to identify genes associated with different drug responses in different individuals. The hope is that medicines can be tailored for specific patient populations or individual patients, resulting in better and safer treatments.

Pharmacogenomics is a form of genetic testing that examines how individual genetic variations affect our responses to drugs. Such differences often occur in genes responsible for metabolizing a drug and can render a medicine ineffective or harmful. Certain genetic variations can speed up drug breakdown, resulting in undertreatment; others can slow down the process, leading to potential overdose.

Currently, if a medication is ineffective or not well tolerated, the dose is changed or a new drug is prescribed until the patient does better. Pharmacogenomics may allow prescriptions matched to an individual patient's genetic identity, or genotype, minimizing adverse reactions and maximizing effectiveness. Genetically designed therapies promise more accurate dosing, shorter recovery times, and less risky drugs and vaccines.

Pharmacogenomics also has the potential to make more medications available to patients. Many drugs never make it to the pharmacy shelf because they work for only some people or they are lethal to some patients. With the ability to tailor drugs to a patient's genetic profile, such medications establish a niche and reach only those patients who would benefit from and not be harmed by them.

The completion of the Human Genome Project has fueled hope for these "designer drugs." Indeed, being handed a prescription specifically tailored to

your drug metabolism genetic profile may be your first direct contact with the fruits of the Human Genome Project. Some have claimed that personalized medicine—“the right medicine, for the right patient, at the right dose”—is merely a matter of clearing a few scientific and regulatory hurdles. However, both pharmacogenomic research and its clinical applications raise ethical issues that deserve careful consideration.

The Future

Genetic testing for disease status or drug design in both research and clinical settings will require long-term storage and extensive use of genetic information, raising questions about privacy, consent, and confidentiality. During clinical trials, pharmaceutical companies and researchers collect and store genetic samples and data from participants. Is the storage of information for test development or pharmacogenomic research different from the storage of other medical information, genetic or not? Should research testing be done anonymously, thereby protecting participants' privacy but denying them access to potentially important information about themselves?

When disease and pharmacogenomic testing moves into the physician's office, there are additional concerns. Certain patients might find it more expensive or more difficult to obtain health, life, or disability insurance because they are predisposed to a disease such as Alzheimer's or are “difficult to treat,” requiring, for example, a brand-name pain reliever rather than a generic. Should health insurance underwriters have access to genetic and pharmacogenomic test results? Ought drug response profiles and other genetic information be treated differently from other medical information such as lipid profiles or blood counts? Careful consideration of the costs and benefits to stakeholders—from individual patients to pharmaceutical companies to local and global communities—is needed.

It is known that disease prevalence varies within and among racial and ethnic groups. In the United States, for example, sickle cell anemia predominantly affects African Americans, while cystic fibrosis predominantly affects European Americans. According to geneticists, race is meaningless on the molecular level. Race and ethnicity are largely nonbiological ideas confounded in the United States by a history of prejudice. But scientists and physicians find it helpful to classify patients by age, sex, and race. Despite significant genetic variation within and between racial groups, there is good evidence that members of different races respond differently to some drugs. An example is the genetic variant CYP2D6, which renders 7 percent of European Americans immune to the pain-killing effects of codeine but affects only 1 percent of Asians.

Practically speaking, the likelihood of finding some genetic variant within one racial group but not within another can influence the design of clinical trials and drug development. Designing medicines or developing tests for a

particular racial group while denying diagnosis and treatment to another is problematic from both scientific and ethical points of view. In addition, care must be taken to avoid using race or ethnicity as an excuse not to test. It could be wrongly assumed that every member of a particular racial or ethnic group would have the same genetic variants and thus the same predisposition to a disease, or that all members of the group would react to a given drug in an identical manner. Even greater care must be taken to treat people fairly. Genetic insights should not be allowed to prop up erroneous views of genes and race and to violate human dignity by deepening patterns of stigmatization and discrimination.

As genetic research continues and genetics enters routine medical practice, religiously and ethically informed views are important for raising concerns and shaping public policy. Religious points of view, informed by long traditions of ethical reflection, can sharpen moral vision by raising questions of meaning and purpose often overlooked by secular ethics. When people of faith express concerns about treating people with respect, about potential misuse of technology, or about the effects on the poor and marginalized, they speak for many. Religious traditions and ethical systems emphasize over-arching values such as human dignity, justice, and the common good, and thus have a great deal to offer our private conversations and public debates about genetic technology.

We have only just begun the age of “the new genetics” promised in that 1971 *Time* magazine, and we are not so much in an era of genetic revolution as genetic evolution. Scientists are building on the Human Genome Project to learn more about human health and disease. But as exciting and compelling as the genomic future appears, that future must include attention to domestic and global health disparities. While considering a future resplendent with “designer drugs” and “personalized medicine,” it is important to remember that health is a social responsibility. It is not only about me and mine, but also about us and ours. It is a matter of human dignity, justice, and the common good. Access to and distribution of basic health care are ethical challenges worthy of the same intensity of purpose and support as the Human Genome Project.

Bibliography

- Chapman, Audrey R. *Unprecedented Choices: Religious Ethics at the Frontier of Genetic Science*. Minneapolis: Fortress, 1999.
- Cole-Turner, Ronald. *The New Genesis: Theology and the Genetic Revolution*. Louisville, KY: Westminster John Knox, 1993.
- Department of Energy. Human Genome Project. http://www.ornl.gov/sci/techresources/Human_Genome/home.shtml.
- Keller, Evelyn Fox. *The Century of the Gene*. Cambridge, MA: Harvard University Press, 2000.
- Kevles, Daniel, and LeRoy Hood. *The Code of Codes: Scientific and Social Issues in the Human Genome Project*. Cambridge, MA: Harvard University Press, 1992.
- National Human Genome Research Institute. <http://www.genome.gov>.

- Nuffield Council on Bioethics. *Pharmacogenetics: Ethical Issues*. London: Nuffield Council on Bioethics, 2003.
- Peters, Ted. *Playing God? Genetic Determinism and Human Freedom*. New York: Routledge, 1997.
- Ramsey, Paul. *Fabricated Man: The Ethics of Genetic Control*. New Haven, CT: Yale University Press, 1970.
- Ridley, Matt. *Genome: The Autobiography of a Species in 23 Chapters*. New York: HarperCollins, 1999.
- Shannon, Thomas A., and James J. Walter. *The New Genetic Medicine: Theological and Ethical Reflections*. Lanham, MD: Rowman and Littlefield, 2003.
- Smith, David H., and Cynthia B. Cohen, eds. *A Christian Response to the New Genetics: Religious, Ethical, and Social Issues*. Lanham, MD: Rowman and Littlefield, 2003.
- Wade, Nicholas. *Lifescrypt: How the Genome Discoveries Will Transform Medicine and Enhance Your Health*. New York: Simon and Schuster, 2001.
- Watson, James D. *The Double Helix: A Personal Account of the Discovery of the Structure of DNA*. New York: Scribner Classics, 1998.
- Watson, James D., with Andrew Berry. *DNA: The Secret of Life*. New York: Alfred A. Knopf, 2003.

86 Human Reproductive Cloning: Assessing the Concerns

Timothy Caulfield

Few scientific techniques have caused as much social controversy as the prospect of human cloning. Though the idea of cloning has been part of popular culture for decades, the international interest in cloning was sparked in 1997 with the birth of Dolly, the first successfully cloned mammal. Dolly was a sheep created at Scotland's Roslin Institute by a research team led by Ian Wilmut. Since her birth, the international community has struggled with the ethical issues associated with human cloning. Many countries have passed laws, and others, such as my country, Canada, are in the midst of developing cloning policies. At the international level, the United Nations has considered a cloning treaty that would ban all reproductive cloning. But why is cloning viewed as so repugnant? Is cloning always morally wrong? And if so, why?

The Science of Cloning

The clone Dolly was created with a procedure called somatic cell nuclear transfer. A cell was taken from an adult sheep. The nucleus from that cell was removed and placed in an egg that was harvested from another adult female sheep. The egg was then stimulated with a mild electric shock, which started its development into an embryo. The embryo was implanted in another female sheep and allowed to mature. Because a nucleus contains almost all of an individual's genetic information, the resultant sheep, Dolly, was an almost complete genetic copy of the source.

Though much of the international debate has focused on human reproductive cloning, Ian Wilmut and his team did not create Dolly in order to facilitate the use of somatic cell nuclear transfer in humans. The cloning technique was developed to allow the creation of animals for medical and research purposes. Because cloning creates a near genetic copy of the source animal, this allows researchers to design animals that have characteristics useful for re-

search or other purposes. For example, researchers could create a goat that produces pharmaceuticals in its milk. Or they could design a pig that could be a source of organs for humans seeking transplantation, an area of research known as xenotransplantation.

Since Dolly was born, many other animals have been cloned, including a cat, rabbit, and horse. But no primate of any kind has been successfully cloned using the Dolly technique. Scientists are unclear why some animals are easier to clone than others. At the current time, however, it appears that primate embryos created through cloning are incapable of developing normally. There may be a biological roadblock stopping the cloning of humans.

Nevertheless, a number of individuals and organizations have claimed they cloned a human. On December 27, 2003, representatives from Clonaid, an organization associated with a religious movement called the Raelians, announced that they had successfully created the first human clone. This announcement made headlines around the world and motivated national and international policy makers to consider laws and treaties that address human reproductive cloning. Since the Clonaid announcement, there have been a number of other cloning controversies. For example, on January 17, 2004, Panos Zavos, a Kentucky fertility specialist, announced that he had successfully implanted a cloned embryo into a thirty-five-year-old woman. Given the available scientific data from animal studies and the fact that no real evidence has been produced to verify the existence of a human clone, such claims should be met with a high degree of skepticism.

One of the reasons policy making in the area is so challenging is that somatic cell nuclear transfer can have therapeutic potential. In a process called both “therapeutic cloning” and “research cloning,” the Dolly technique would be used to grow human tissue for transplantation. Many scientists believe it has great potential. It is hoped that the process could be used to grow tissue to cure individuals with diseases such as diabetes and Alzheimer’s. However, because the process involves the use of the cloning process and requires the creation and destruction of an embryo, it remains highly controversial.

What Is a Clone?

The popular media often portray a clone as an exact copy of the source, with an identical personality and physical appearance. Indeed, clones are often depicted as being the same age and having the same memories as the person who was cloned. From Homer on *The Simpsons* to Arnold Schwarzenegger in the movie *The Sixth Day*, clones are consistently represented as exact duplicates or, in the case of Michael Keaton in the movie *Multiplicity*, a degraded carbon copy of the original.

You could think of a clone and the source person as identical twins separated in time. But a clone and the source are less genetically similar than identical twins. A small portion of our DNA resides outside the cell nucleus,

in the mitochondria, and this genetic material is not passed on when an embryo is created using somatic cell nuclear transfer. Also, unlike identical twins, a clone would mature in a different in utero environment than its source did. That is, the clone would have a different gestational mother from the individual being cloned. And, of course, the clone would, as Duff writes, “come into the world as newborn and would move through the stages of infancy, childhood, adolescence and so on, like everyone else.” The clone would be raised, fed, and educated in a social environment different from the source’s. All of these factors are highly relevant to how we develop as individuals, so it is fair to say that a clone would be a wholly unique person.

However, because a clone has almost the exact same genes as the source, there will be many similarities between the two individuals. For example, superficial traits in which genetics play a large role, such as height and basic physical characteristics, will be very similar. And, as with identical twins, there are likely to be some similarities in basic temperament.

Cloning Concerns

A few vocal individuals have explicitly supported the idea of human cloning, but the public reaction to human cloning has been fairly consistent. Most of the public is strongly against the idea. For example, a 2002 Gallup poll of 1,012 Americans found that 90 percent thought cloning an entire human is morally wrong. Similarly, a 2001 poll found that 88 percent disapprove of “cloning that is designed specifically to result in the birth of a human being.” A 2002 survey done by the Genetics and Public Policy Center, a Johns Hopkins effort funded by the Pew Charitable Trusts, found that 76 percent of Americans oppose scientific research on reproductive cloning. Survey research from other countries has found a similar response. For example, a poll of 1,500 Canadians taken shortly after the Raelians had claimed that the first human clone was born found that 84 percent of those surveyed were against human cloning.

Why has cloning caused so much social controversy? One area of concern where there is almost universal agreement is that human cloning is, at the current time, tremendously risky. Somatic cell nuclear transfer remains a very inefficient and highly unsafe way to reproduce. Experience with animals has shown that the cloning process often results in premature births, severe birth defects, and a host of ailments that often lead to early death. Indeed, Dolly died at the premature age of six. While not definitively traceable to the cloning process, her death again highlighted the possible health risks associated with reproductive cloning. The safety concerns have emerged as a primary justification for not allowing human cloning to proceed.

There is, however, less clarity about many of the other concerns that have been associated with human reproductive cloning. For example, it has been suggested that cloning is contrary to human dignity. Indeed, this concern has been articulated in numerous international policy documents. UNESCO’s

Universal Declaration on the Human Genome and Human Rights recommends a ban on “practices that are contrary to human dignity, such as reproductive cloning.” Similarly, in 1998, the World Health Organization reaffirmed that “cloning for the replication of human individuals is ethically unacceptable and contrary to human dignity and integrity.”

But the specific ways in which dignity might be challenged by human cloning are rarely, if ever, articulated in formal policy. For many, the concern is that cloning will compromise the clone’s autonomy, that is, the clone’s right of self-determination. Individual autonomy is generally believed to be a central element of human dignity. This is an understandable concern. Because our genes are such a significant factor in our development as individuals, having all our genes predetermined by the cloning process would seem to challenge the clone’s future life choices. However, genes are far from the only factor relevant to our development.

Our genes do not bind our future life decisions, and to believe otherwise is to buy into the scientifically inaccurate idea of “genetic determinism.” Many commentators are suspicious of claims that cloning has an adverse impact on autonomy. As summarized by philosopher Bonnie Steinbock, the objections that cloning is a threat to autonomy and individuality are “based on a fallacious assumption: that if you know what your genome is, you will know what your choices, and hence your life, will be. . . . To put it bluntly, we are not our genes, and our genes do not determine what we are or will be.”

The process of cloning may not, on its own, infringe autonomy, but individuals may wish to use cloning in a manner that does. For instance, it is possible that reproductive cloning may be used for the purpose of creating an individual for a particular life role. Let’s use a very speculative example to illustrate how this might happen. If a group developed a program to clone individuals well suited for military service, and their life choices were restricted by the program, this would amount to a restriction on the clones’ autonomy.

Similarly, if a clone were expected to be like the source individual, that might place an unhealthy psychological burden on the clone. For example, if a couple sought to clone a star basketball player in the hope of having a child who would become a wealthy professional athlete, the parental expectations could greatly influence how that child develops and the decisions the child makes. In such a circumstance, the clone’s autonomy may be compromised in a subtle manner. The clone may, for instance, feel pressure to become a basketball player even though he or she would prefer to study cello.

The psychological burden of being a clone was viewed as an important consideration in the 1997 National Bioethics Advisory Commission report *Cloning Human Beings* and the 2002 President’s Council on Bioethics report *Human Cloning and Human Dignity*. The latter committee concluded that what “matters is the cloned individual’s perception of the significance of the ‘precedent life’ and the way that perception cramps and limits a sense of self

and independence.” However, it is the pressure or social expectations placed on the individual clone that challenges the clone’s autonomy, not the actual process of reproductive cloning. And, of course, these kinds of parental expectations are not unique to the cloning context. Parents who procreate the natural way may also place burdensome expectations on their children.

Some commentators have noted that cloning may simply be used as a reproductive technology with the sole motivation of having a biologically related offspring. Though somatic cell nuclear transfer is currently dangerous and inefficient, it is theoretically possible that cloning could be used as a way to help infertile couples and individuals have children. It might also be used as a way for some same-sex couples to have children without involving a third-party donation of sperm or an egg. If cloning were used in this context, the concerns related to autonomy and dignity seem less severe. As suggested by Steven Malby: “From the point of view of dignity, the desire to treat infertility clearly does not violate any of the parameters associated with an objective perspective of dignity.”

There are many other social and ethical concerns about human cloning that reach beyond autonomy and dignity. Some of these concerns focus on the asexual nature of the cloning process. For a number of commentators, the ability to create an individual asexually will have an adverse impact on the role and social definition of family. As one Christian scholar, Albert Mohler, argues: “Modernity’s assault on the family would thus be complete with the development of cloning. Already stripped of its social function, the family would now be rendered biologically unnecessary, if not irrelevant.” In addition, because cloning can be done outside of a sexual relationship, there is a concern that it would lead to a loss in the intangible benefits associated with the natural procreation process. Gilbert Meilaender puts the concern this way: “It is, in fact, hard to imagine human life without sexual reproduction. Sexuality brings with it a certain kind of relationship to the world. It leads us to look out at the world in search of an ‘other’ who is both like us and different from us.”

Of course, many issues are closely associated with a particular worldview or religious perspective, such as the social value and role of the traditional family structure. One study by Sussman found that, for Americans, religious beliefs had the most influence on their opinion regarding the appropriateness of cloning. The study by the Genetics and Public Policy Center at Johns Hopkins found that those who view these technologies in terms of religion and morality are more likely to have disapproving views. While religious perspectives obviously play an important role in framing the public perceptions of cloning, not all religions approach cloning with the same level of concern. To cite one example from Evans’s work, it has been noted that for some within the Islamic community, reproductive cloning may be permissible so long as it is used to help infertility and occurs within a “lawful male-female relationship.” Such a position contrasts sharply with the more

well-known position of the Roman Catholic Church, which objects to all reproduction that does not involve sexual intercourse between a husband and wife.

Most Western societies have become tremendously culturally diverse and increasingly tolerant of a wide range of family structures and modes of reproduction. Single-parent families, sperm and egg donation, and the use of reproductive technologies like in vitro fertilization are now commonplace, although all were once viewed with a degree of social concern. In some American states, there were once calls to criminally ban sperm donation, and many feared that “test tube” babies, those individuals born through the use of in vitro fertilization, would be socially stigmatized. Now both practices are widely accepted and are used as a means of treating infertile couples the world over. Indeed, since the birth of the first “test tube baby” in 1979, in vitro fertilization has been responsible for over 100,000 babies in the United States alone. Could the same social accommodation happen with human cloning? At a minimum, the changing nature of social attitudes should remind us to question our reaction to new technologies. Is our intuitive response based on a lack of familiarity or on ethical concerns that may have enduring relevance?

Some of the concerns associated with human cloning are very speculative. It has been suggested by Bronskill and others that cloning could be used to create an army of “manufactured” soldiers. This hardly seems a realistic or pressing concern. Somatic cell nuclear transfer would require an army of women to carry the cloned embryos to term, and then there would be an army of infants to be fed and raised. Such an approach is far from an efficient way to create an army.

Another speculative concern, one that is theoretically possible, is to use somatic cell nuclear transfer to steal someone’s genome. If a couple wanted a child with a specific individual’s superficial physical traits—say a movie star or a professional athlete—all you would need is a cell from that athlete or actor with an intact nucleus. You could then use that cell to create a clone of the individual. Of course, given the technical barriers and inefficiencies associated with somatic cell nuclear transfer, the use of reproductive cloning in this controversial manner is far from an immediate policy dilemma.

The Challenge of Making Laws

Many countries around the world have laws banning reproductive cloning. In a number of these countries, the laws were already in place prior to the birth of Dolly. For example, Ireland and Austria have long had strict rules governing research involving human embryos. These laws, which reflect a particular position regarding the moral status of the embryo, effectively stop cloning research. In other countries, such as Australia and the Netherlands, specific laws were introduced to ban reproductive cloning. In Canada, a similar law is being considered.

In the United States, despite a good deal of political debate, there is no federal law related specifically to human reproductive cloning. To a large degree, this is due to a lack of agreement on what would be the appropriate breadth of a cloning ban. Some politicians have suggested that only *reproductive* cloning should be banned and that *research* cloning should be permitted, though closely regulated. Others have argued that all forms of cloning should be banned. Senator Sam Brownback, for instance, has suggested: "There's only one type of human cloning and it always results in the creation of a human being." Given this profound lack of moral consensus, the President's Council on Bioethics suggested that a ban on all forms of cloning was not appropriate at the current time.

This lack of consensus on how to handle research cloning has also stymied attempts at the United Nations to create an international cloning treaty. Two proposals have been considered. One would outlaw both reproductive and research cloning. The other would leave room for individual countries to decide how to proceed on the issue of research cloning.

In the end, human reproductive cloning may never have practical use. The health and safety issues are profound and seem likely to endure for decades. This gives policy makers throughout the world a sound and noncontroversial justification for banning the technique. And even if reproductive cloning were safe, it seems likely to remain a highly inefficient way to reproduce. Most couples would prefer to reproduce the old-fashioned way, if possible. Nevertheless, human cloning forces us to confront many profound ethical questions. What role do genes play in our individuality? Should parents be allowed to predetermine the genetic makeup of their children? Is the intuitive reaction against human cloning justified? There remains surprisingly little consensus about the answers to these questions.

Bibliography

- Bonnicksen, Andrea. *Crafting a Cloning Policy: From Dolly to Stem Cells*. Washington, DC: Georgetown University Press, 2002.
- Bronskill, J. "International Ban Proposed on Cloning Humans for Warfare." *Edmonton Journal*, August 1999, A3.
- Caulfield, Timothy. "Human Cloning Laws, Human Dignity, and the Poverty of the Policy Making Dialogue." *BMC Medical Ethics* 4 (2003): 3–10.
- . "The Regulation of Embryonic Stem Cell Research: A Few Observations on the International Scene." *Health Law Journal* 11, Special Edition (2003): 87–95.
- Daar, Abdallah, and Lori Sheremeta. "The Science of Stem Cells: Some Implications for Law and Policy." *Health Law Review* 11 (2002): 5.
- Duff, Nancy J. "Seeking the Significant in the Factual." In *Beyond Cloning: Religion and the Remaking of Humanity*, ed. Ronald Cole-Turner, 84–96. Harrisburg, PA: Trinity Press International, 2001.
- Evans, John H. "Cloning Adam's Rib: A Primer on Religious Responses to Cloning." Report Prepared for the Pew Forum on Religion and Public Life, October 2002. <http://pewforum.org>.
- Genetics and Public Policy Center. "Attitudes about Reproductive Genetics." December 9, 2002. <http://dnapolicy.stage.labvelocity.com>.
- Giles, Jim, and Jonathan Knight. "Dolly's Death Leaves Researchers Woolly on Clone Ageing Issue." *Nature* 421 (2003): 776.

- "Hearing on Cloning Examines What Is Human." United Press International (UPI), March 19, 2003. <http://www.upi.com>.
- Malby, Steven. "Human Dignity and Human Reproductive Cloning." *Heath and Human Rights* 6 (2002): 103–35.
- Meilaender, Gilbert. "A Case Against Cloning." In *Beyond Cloning: Religion and the Remaking of Humanity*, ed. Ronald Cole-Turner, 77–83. Harrisburg, PA: Trinity Press International, 2001.
- Mohler, R. Albert, Jr. "The Brave New World of Cloning: A Christian Worldview Perspective." In *Human Cloning: Religious Responses*, ed. Ronald Cole-Turner, 91–103. Louisville, KY: Westminster John Knox, 1997.
- "Morality, Prejudice, and Cloning." Editorial in *Nature* 415 (2002): 349.
- National Bioethics Advisory Commission. *Cloning Human Beings*. Rockville, MD, 1997.
- Nuffield Council on Bioethics. *Genetics and Human Behaviour: The Ethical Context*. London: Nuffield Council on Bioethics, 2002.
- President's Council on Bioethics. *Human Cloning and Human Dignity*. Washington, DC, 2002.
- "Raelian Leader Says Cloning First Step to Immortality." CNN, December 28, 2002. <http://www.cnn.com>.
- Rhind, Susan, et al. "Human Cloning: Can It Be Made Safe?" *Nature Reviews Genetics* 4 (2003): 855–64.
- Saad, Lydia. "Cloning of Humans Is a Turn-Off to Most Americans." Gallup News Service. May 16, 2002. <http://www.gallup.com>.
- Steinbock, Bonnie. "Cloning Human Beings: Sorting Through the Ethical Issues." In *Human Cloning: Science, Ethics, and Public Policy*, ed. Barbara MacKinnon, 68–84. Chicago: University of Illinois Press, 2000.
- "Test Tube Babies, 25 Years Later." CNN, July 28, 2003. <http://www.cnn.com>.
- "UN Derails Ban on Human Cloning." BBC News, November 6, 2003. <http://news.bbc.co.uk>.
- UNESCO. Universal Declaration on the Human Genome and Human Rights. Paris, 1997.
- USA Today/CNN/Gallup Poll Results. *USA Today*, November 28, 2001. <http://www.usatoday.com>.
- Vogel, Gretchen. "Misguided Chromosomes Foil Primate Cloning." *Science* 300 (2003): 225–27.
- Wilmut, I., et al. "Viable Offspring Derived from Fetal and Adult Mammalian Cells." *Nature* 385 (1997): 810–13.
- World Health Organization. Fifty-second Assembly, provisional agenda item 13, Cloning in Human Health. Report by the Secretariat in pursuance of Resolution WHA51.10, A52/12. April 1, 1999. <http://www.who.int>.

Bibliography

General

- Abdalla, Ismail. *Islam, Medicine, and Practitioners in Northern Nigeria*. Lewiston, NY: Edwin Mellen, 1997.
- Aikenhead, Glen. "Integrating Western and Aboriginal Sciences: Cross-Cultural Science Teaching." <http://www.usask.ca/education/people/aikenhead/risearticle.htm>.
- Aikenhead, Glen. "Science Education: Border Crossing into the Subculture of Science." *Studies in Science Education* 27 (1996): 1–52.
- Alaska Rural Systemic Initiative*. Alaska Federation of Natives, University of Alaska. <http://www.ankn.uaf.edu/arsi.html>.
- Anderson, E.N. *Ecologies of the Heart: Emotion, Belief, and the Environment*. New York: Oxford University Press, 1996.
- Assembly of First Nations. *Banishing the Indian Agent, Choices for Change: Restoring First Nation Governments*. Ottawa: Assembly of First Nations, 2000.
- Atleo, C. "Land, Science, and Indigenous Science: Tales from a Modern Treaty Negotiation Process." In *Science and Native American Communities*, ed. K. James, 127–34. Lincoln: University of Nebraska Press, 2001.
- Austin, J.H. *Zen and the Brain*. Cambridge, MA: MIT Press, 1998.
- Badejo, Diedre. *Osun Seegesi: The Elegant Deity of Wealth, Power, and Femininity*. Trenton, NJ: Africa World, 1995.
- Bakhtin, Mikhail. *The Dialogical Imagination*. Austin: University of Texas Press, 1981.
- Barbour, Ian. *Religion and Science: Historical and Contemporary Issues*. San Francisco: HarperCollins, 1997.
- . *Religion in an Age of Science*. San Francisco: HarperSanFrancisco, 1990.
- Barbour, Julian. *The End of Time*. London: Orion, 1999.
- Battiste, M., and J.Y. Henderson. *Protecting Indigenous Knowledge and Heritage: A Global Challenge*. Saskatoon: Purich, 2000.
- Bauman, Zygmunt. *Globalization*. New York: Columbia University Press, 1998.
- Berardi, Gigi, et al. "Science and Environmental Education in Tribal Homelands." *Environmental Practice* 4:2 (2002): 70–71.
- Berkes, F. *Sacred Ecology: Traditional Ecological Knowledge and Resource Management*. Philadelphia: Taylor and Francis, 1999.
- Bohm, David. *On Dialogue*. London: Routledge, 1996.
- . *Wholeness and the Implicate Order*. London: Routledge, 1980.
- Bowker, J. *The Sense of God: Sociological, Anthropological, and Psychological Approaches to the Origin of the Sense of God*. Oxford: Clarendon, 1973.
- Boyer, Pascal. *Religion Explained: The Evolutionary Origins of Religious Thought*. New York: Basic Books, 2001.
- Brooke, John Hedley. *Science and Religion*. Cambridge: Cambridge University Press, 1991.
- . *Science and Religion: Some Historical Perspectives*. Cambridge: Cambridge University Press, 1999.
- Brooks, Drex. *Sweet Medicine: Sites of Indian Massacres, Battlefields, and Treaties*. Albuquerque: University of New Mexico Press, 1995.

- Budge, E.A. Wallis. *Legends of the Egyptian Gods*. New York: Dover, 1994.
- . *Osiris and the Egyptian Resurrection*. Vol. 1. New York: Dover, 1973.
- Bureau of Primary Health Care. *Breast Cancer Awareness*. Washington, DC: Government Printing Office, 1998.
- Burt, Edmund A. *The Metaphysical Foundations of Modern Physical Sciences*. London: Routledge, 1924.
- Cajete, Gregory. *Look to the Mountain: An Ecology of Indigenous Education*. Durango, CO: Kivak, 1994.
- . *Native Science: Natural Laws of Interdependence*. Santa Fe, NM: Clear Light, 2000.
- Capra, Fritjof. *The Tao of Physics*. Berkeley, CA: Shambhala, 1975.
- Cardena, Etzel, Steven J. Lynn, and Stanley Krippner, eds. *Varieties of Anomalous Experience: Examining the Scientific Evidence*. Washington, DC: American Psychological Association, 2000.
- Chattopadhyaya, D.P., and Ravinder Kumar, eds. *Science, Philosophy, and Culture in Historical Perspective*. New Delhi: Project of History of Science, Philosophy, and Culture, 1995.
- Clarke, J.J. *The Tao of the West: Western Transformations of Taoist Thought*. London: Routledge, 2000.
- Clayton, Philip. *God and Contemporary Science*. Edinburgh: Edinburgh University Press, 1997.
- Cobern, William W., ed. *Socio-cultural Perspectives on Science Education: An International Dialogue*. Dordrecht: Kluwer, 1998.
- Cochran, Patricia A.L. "What Is Traditional Knowledge?" http://www.nativescience.org/html/traditional_knowledge.html.
- Cohen, Lawrence. "Where It Hurts: Indian Material for an Ethics of Organ Transplantation." *Zygon* 38:3 (2003): 663–88.
- Cox, P.A. "Will Tribal Knowledge Survive the Millennium?" *Science* 287 (2000): 44–45.
- Crowfoot, J.E., and J.M. Wondollock. *Environmental Disputes: Community Involvement in Conflict Resolution*. Washington, DC: Island, 1990.
- Dalmage, Heather M. *Tripping on the Color Line*. New Brunswick, NJ: Rutgers University Press, 2000.
- Davies, Paul. "That Mysterious Flow." *Scientific American* 287:3 (September 2002): 40–47.
- . *The Mind of God*. New York: Simon and Schuster, 1992.
- Dawkins, Richard. *The Blind Watchmaker: Why the Evidence of Evolution Reveals a Universe Without Design*. New York: W.W. Norton, 1986.
- Delmonico, Francis, and N. Scheper-Hughes. "Why We Should Not Pay for Human Organs." *Zygon* 38:3 (2003): 689–98.
- Deloria, Vine, Jr. *Red Earth, White Lies: Native Americans and the Myth of Scientific Fact*. Golden, CO: Fulcrum, 1997.
- Deloria, Vine, Jr., and Daniel Wildcat. *Power and Place: Indian Education in America*. Golden, CO: Fulcrum, 2001.
- Dembski, William, and James Kushiner. *Science of Intelligence*. Grand Rapids, MI: Brazos, 2001.
- Densmore, Francis. *Teton Sioux Music and Culture*. Lincoln: University of Nebraska Press, 1992.
- Dorgan, C.A. *Statistic Record of Health and Medicine*. New York: Gale Research, 1995.
- Drake, Stillman, trans. *Discoveries and Opinions of Galileo*. Garden City, NY: Doubleday Anchor, 1957.
- Dukepoo, F. "The Native American Honor Society: Challenging Indian Students to Achieve." In *Science and Native American Communities*, ed. K. James, 36–42. Lincoln: University of Nebraska Press, 2001.
- Duran, Eduardo, and Bonnie Duran. *Native American Postcolonial Psychology*. Albany: State University of New York Press, 1995.
- Edelman, Gerald. *A Universe of Consciousness*. New York: Basic Books, 2000.
- Eglash, R. "Computation, Complexity, and Coding in Native American Knowledge Systems." In *Changing the Faces of Mathematics: Perspectives on Indigenous People of North America*, ed. J.E. Hankes and G.R. Fast. Reston, VA: National Council of Teachers of Mathematics, 2002.
- Einstein, Albert. *The World As I See It*. Trans. Alan Harris. New York: Philosophical Library, 1949.

- Emeagwali, Gloria T., ed. *Science and Technology in African History*. Lewiston, NY: Edwin Mellen, 1993.
- Epstein, Mikhail. "The Unasked Question." *Common Knowledge* 10:1 (2004): 42–60.
- Farrer, Claire R. *Living Life's Circle: Mescalero Apache Cosmovision*. Albuquerque: University of New Mexico Press, 1991.
- Faulkner, R.O. *The Egyptian Book of the Dead: The Book of Going Forth by Day*. San Francisco: Chronicle, 1994.
- Fischel, Henry A. *Rabbinic Literature and Greco-Roman Philosophy: A Study of Epicurea and Rhetorica in Early Midrash*. Leiden: E.J. Brill, 1973.
- Free Inquiry*. Summer 2000 and Fall 2000. <http://www.secularhumanism.org>. These issues contain further readings about science and religion.
- Freedman, B.I. "Susceptibility Genes for Hypertension and Renal Failure." *Journal of the American Society of Nephrology* 14:2 (2003): 192–94.
- Gedicks, A. *The New Resource Wars: Native and Environmental Struggles Against Multinational Corporations*. Boston: South End, 1993.
- Gersten, Dennis. *Are You Getting Enlightened or Losing Your Mind?* New York: Random House, 1998.
- al-Ghazzali. *The Incoherence of the Philosophers*. Trans. and Intro. Michael E. Marmura. Provo, UT: Brigham Young University Press, 1997. (Parallel English-Arabic text.)
- Goldenfeld, N., and L.P. Kadanoff. "Simple Lessons from Complexity." *Science* 284 (1999): 87–89.
- Gordon, Oakley. *An Environmental Epistemology of the Andean People of Peru*. <http://www.psych.utah.edu/gordon/AndeanResearch/FullPaper.html>.
- Gould, Stephen J. *Rock of Ages*. New York: Ballantine, 1999.
- Graham, Loren H. *Science in Russia and the Soviet Union: A Short History*. Cambridge: Cambridge University Press, 1993.
- Grimal, Nicolas. *A History of Ancient Egypt*. Trans. Ian Shaw. Oxford: Blackwell, 1992.
- Grinnell, George Bird. *The Cheyenne Indians: Their History and Ways of Life*. Lincoln: University of Nebraska Press, 1972.
- Gutas, Dimitri. *Greek Thought, Arabic Culture: The Graeco-Arabic Movement in Baghdad and Early 'Abassid Society (2nd–4th/8th–10th Centuries)*. New York: Routledge, 1998.
- Haraway, Donna. *Primate Visions: Gender, Race, and Nature in the World of Modern Science*. New York: Routledge, 1989.
- Haight, John. *Science and Religion*. Mahwah, NJ: Paulist, 1995.
- Heisenberg, Werner. *Physics and Philosophy: The Revolution in Modern Science*. New York: Harper and Row, 1958.
- Herodotus. *The Histories*. Vol. 1, book 2. Cambridge, MA: Harvard University Press, 1986.
- Holmes, Welch. *Taoism: The Parting of the Way*. Rev. ed. Boston: Beacon, 1957.
- Hood, Ralph W., Jr. "American Primitive: In the Shadow of the Serpent." *Common Review* 2:2 (Spring 2003): 28–32.
- . *Dimensions of Mystical Experiences: Empirical Studies and Psychological Links*. Amsterdam: Rhodopi, 2002.
- Hua, Tongxu. *Water Clock in China*. Hefei: Anhui Science and Technology, 1991.
- Huff, Toby E. *The Rise of Early Modern Science: Islam, China, and the West*. 2nd ed. Cambridge: Cambridge University Press, 2003.
- Huntington, H.P., and N.I. Myrmin. "Traditional Ecological Knowledge of Beluga Whales: An Indigenous Knowledge Pilot Project in the Chukchi and Bering Seas." Inuit Circumpolar Conference, Anchorage, AK, 1996.
- Hurtado, Lorenzo Muelas. "Access to the Resources of Biodiversity and Indigenous Peoples." Edmonds Institute occasional paper, Bogota, Colombia, 1998.
- Jackson, D.N. "Scientific and Technological Innovation: Its Personological and Motivational Context." In *Scientific Excellence: Origins and Assessment*, ed. D.N. Jackson and J.P. Rushton, 149–64. Newbury Park, CA: Sage, 1987.
- Jaki, Stanley. *The Road of Science and the Ways to God*. Chicago: University of Chicago Press, 1978.
- James, K. "American Indians, Science, and Technology." *Social Science Computer Review* 18 (2000): 196–213.

- . “Identity, Values, and American Indian Beliefs About Science and Technology: A First Wave of Data.” *American Indian Culture and Research Journal*, in press.
- . “Process and Cultural Impediments to Health-Care Innovation.” *Hospital and Health Services Administration* 35 (1990): 395–407.
- . “Transforming the Academy with Native Values and Perspectives.” In *Indigenizing the Academy*, ed. Devon Mishesuah and Angela Wilson. Lincoln: University of Nebraska Press, 2004.
- James, K., Willie Wolf, Chris Lovato, and Steven Byers. *Barriers to Workplace Advancement Experienced by Native Americans*. U.S. Department of Labor, Glass Ceiling Commission Monograph Series. Washington, DC: U.S. Department of Labor, 1995.
- James, William. *The Varieties of Religious Experience*. Cambridge, MA: Harvard University Press, 1902/1985.
- Jiang, Sheng, and Waihop Tong, eds. *The History of Science and Technology in Taoism*. Vol. 1. Beijing: Science, 2002.
- Jin, Zhengyao. *Taoism and Science*. Beijing: Chinese Social Sciences, 1991.
- Jones, W.T. *A History of Western Philosophy*. New York: Harcourt, Brace and World, 1952.
- Kalin, Ibrahim. “Three Views of Science in the Islamic World.” In *God, Life, and the Cosmos: Christian and Islamic Perspectives*, ed. Ted Peters, Muzaffar Iqbal, and Syed Nomanul Haq, 43–75. Hampshire, UK: Ashgate, 2002.
- Kani, Ahmad. “Mathematics in the Central Bilad Al-Sudan.” In *Historical Development of Science and Technology in Nigeria*, ed. Gloria T. Emeagwali, 33–39. Lewiston, NY: Edwin Mellen, 1992.
- Kawagley, Angayuqaq Oscar. “Alaska Native Education Research: Reaching into the Profound Silence of Self.” Paper presented to the International Arctic Social Sciences Association, Rovaniemi, Finland, May 1995. Published by the IASSA, Spring 2002.
- Kawagley, O. *A Yupiaq World View: A Pathway to Ecology and Spirit*. Prospect Heights, IL: Waveland, 1995.
- Ke, Zineng, and Qun Huang. “The Development of Six-one Lute in History.” *Studies in World Religions* 3 (2004): 77–83.
- Kelley, David. *The Art of Reasoning*, expanded version. New York: W.W. Norton, 1990.
- Kelly, Alison, ed. *Science for Girls?* Philadelphia: Open University Press, 1987.
- Kohn, Livia, and Yoshinobu Sakade, eds. *Taoist Meditation and Longevity Techniques*. Ann Arbor: Center for Chinese Studies, University of Michigan, 1989.
- Kraybill, Donald B., and Marc A. Olshan, eds. *The Amish Struggle with Modernity*. Hanover, NH: University Press of New England, 1994.
- Kruger, Colleen. *Pride of Men: Ironworking in 19th Century West Central Africa*. Portsmouth, NH: Heinemann, 1999.
- Krishnamurti, J., and D. Bohm. *The Ending of Time*. San Francisco: Harper, 1985.
- Krugly-Smolka, Eva. “Culture and Science Education.” Ph.D. dissertation, University of Toronto, 1989.
- . “An Examination of Some Difficulties in Integrating Western Science into Societies with an Indigenous Scientific Tradition.” *Interchange* 25:4 (1994): 325–34.
- . “Mainstreaming Multicultural Education: The Role of Science Education.” *Canadian Ethnic Studies* 24:3 (1992): 137–44.
- . “Scientific Culture, Multiculturalism, and the Science Classroom.” *Science and Education* 5 (1996): 21–29.
- Kuhn, Thomas. *The Structure of Scientific Revolutions*. Chicago: University of Chicago Press, 1993.
- Lambert, L. “From ‘Savages’ to Scientists: Mainstream Science Moves Toward Recognizing Traditional Knowledge.” *Tribal College Journal of American Indian Higher Education* 15:1 (2003): 11–12.
- Lewis, James, ed. *From the Ashes*. Lanham, MD: Rowman and Littlefield, 1994.
- Lu, Gwei-Djen, and Joseph Needham. “Medieval Preparations of Urinary Steroid Hormones.” *Nature* 200 (1963): 1047.
- Maezumi, Taizan. *On Zen Practice*. Somerville, MA: Wisdom, 2002.
- Makdisi, George. *The Rise of the Colleges: Institutions of Learning in Islam and the West*. Edinburgh: Edinburgh University Press, 1981.

- Maloney, H. Newton, and A. Adams Lovekin. *Glossolalia: Behavioral Science Perspectives on Speaking in Tongues*. New York: Oxford University Press, 1985.
- Martinez-Maldonado, M. "Hypertension in Hispanics, Asians and Pacific Islanders, and Native Americans." *Circulation* 83 (1991): 1467–69.
- McKeon, Richard, ed. *The Basic Works of Aristotle*. Book 4, chap. 3. New York: Random House, 1941.
- Men, Hunbatz. "Reconsecrating the Earth." In *Profiles in Wisdom*, ed. Steven McFadden, 225–41. Santa Fe, NM: Bear, 1991.
- . *Secrets of Mayan Science/Religion*. Santa Fe, NM: Bear, 1990.
- Mitchell, B., ed. *Resource and Environmental Management in Canada: Addressing Conflict and Uncertainty*. Toronto: Oxford University Press, 1995.
- Mokhtar, G. *Ancient Civilizations of Africa*. Vol. 1. Oxford: Heinemann, 1992.
- Montgomery, Scott L. *The Scientific Voice*. New York: Guilford, 1996.
- Murphy, Nancey, and George Ellis. *On the Moral Nature of the Universe*. Minneapolis: Fortress, 1996.
- Nakayama, Shigeru. *Academic and Scientific Traditions in China, Japan, and the West*. Tokyo: University of Tokyo Press, 1984.
- Napoleon, Harold. *Yuuyaraq: The Way of the Human Being*. Fairbanks: Alaska Native Knowledge Network, 1996.
- Nason, J.D. "Native American Intellectual Property Rights: Issues in the Control of Esoteric Knowledge." In *Borrowed Power: Essays on Cultural Appropriation*, ed. B. Ziff and P.V. Rao, 237–54. New Brunswick, NJ: Rutgers University Press, 1997.
- Nasr, Seyyed Hossein. *Science and Civilization in Islam*. New York: New American Library, 1968.
- National Center for Science Education. <http://www.ncseweb.org>.
- Needham, Joseph. *The Grand Titration*. Toronto: University of Toronto Press, 1969.
- . *Gunpowder as the Fourth Power, East and West*. Hong Kong: Hong Kong University Press, 1985.
- . *Science and Civilisation in China*. Cambridge: Cambridge University Press, 1954 .
- Neihardt, John. *Black Elk Speaks*. Lincoln: University of Nebraska Press, 2000.
- Nerburn, Kent, ed. *The Soul of an Indian and Other Writings from Ohiyesa (Charles Alexander Eastman)*. 2nd ed. Novato, CA: New World Library, 2001.
- Neusner, Jacob. *Handbook of Rabbinic Theology*. Leiden: E.J. Brill, 2002.
- Newberg, Andrew, Eugene d' Aquili, and Vince Rause. *Why God Won't Go Away*. New York: Ballantine, 2001.
- Nichol, Lee, ed. *On Dialogue*. London: Routledge, 1996.
- Noble, David. *A World Without Women*. New York: Oxford University Press, 1992.
- Northrup, T.A. "The Dynamics of Identity in Personal and Social Conflict." In *Intractable Conflicts and Their Transformation*, ed. L. Kriesberg, T.A. Northrup, and S.J. Thorson, 55–82. Syracuse, NY: Syracuse University Press, 1989.
- Oakes, J. "Opportunities, Achievement, and Choice: Women and Minority Students in Science and Mathematics." *Review of Research in Education* 16 (1990): 153–222.
- Otto, Rudolf. *The Idea of the Holy: An Inquiry into the Nonrational Factor in the Idea of the Divine and Its Relation to the Rational*. Trans. H.J. Harvey. London: Oxford University Press, 1923.
- Pacey, A. *The Culture of Technology*. Cambridge, MA: M.I.T. Press, 1983.
- Pappu, S.S. Rama Rao, ed. *The Dimensions of Karma*. Delhi: Chanakya Publications, 1987.
- Peacocke, Arthur. *Theology for a Scientific Age*. London: SCM, 1993.
- Peat, F. David. *From Certainty to Uncertainty*. Washington, DC: Joseph Henry, 2002.
- Pence, Gregory, ed. *Flesh of My Flesh: The Ethics of Cloning Humans*. Lanham, MD: Rowman and Littlefield, 1998.
- Persinger, Michael. *Neuropsychological Bases of God Beliefs*. Westport, CT: Greenwood, 1987.
- Peters, Ted, Muzaffar Iqbal, and Syed Nomanul Haq, eds. *God, Life, and the Cosmos: Christian and Islamic Perspectives*. Hampshire, UK: Ashgate, 2002.
- Peters, Ted, ed. *Science and Theology*. Boulder, CO: Westview, 1998.
- Piaget, Jean. *The Child's Conception of the World*. Trans. Joan Tomlinson and Andrew Tomlinson. Savage, MD: Littlefield Adams, 1951.

- A Pictorial Biography of the Immortals of Every Dynasty*. A lithographic printed edition, 1909.
- Pierotti, R., and D. Wildcat. "The Science of Ecology and Native American Traditions." *Winds of Change* (1997): 94–98.
- Polkinghorne, John. *Belief in God in an Age of Science*. New Haven, CT: Yale University Press, 1998.
- . *The Faith of a Physicist*. Minneapolis: Fortress, 1996.
- . *Scientists as Theologians*. London: SPCK, 1996.
- Poloma, Margaret M., and George H. Gallup Jr. *Varieties of Prayer: A Survey Report*. Philadelphia: Trinity Press International, 1993.
- Post, John F. *Metaphysics: A Contemporary Introduction*. New York: Paragon House, 1991.
- "President Bush Announces New Vision for Space Exploration Program." *White House Press Release*, January 14, 2004.
- Radhakrishnan, S. *Indian Philosophy*. Delhi: Oxford University Press, 1923.
- Rael, Joseph. *In the House of Shattering Light: Life as an American Mystic*. Tulsa, OK: Council Oak Books, 2003.
- Rahman, A., ed. *History of Indian Science, Technology, and Culture AD 1000–1800*. New Delhi: Oxford University Press, 1999.
- , ed. *Science and Technology in India*. New Delhi: Indian Council for Cultural Relations, 1973.
- Ramachandran, V.S., and Sarah Blakeslee. *Phantoms in the Brain*. New York: Morrow, 1998.
- Rambo, Lewis R. *Understanding Religious Conversion*. New Haven: Yale University Press, 1993.
- Rao, Gopala. *A Two Dimensional Model of Evolution*. <http://www.metanexus.net>.
- Rekindling Traditions: Cross-Cultural Science and Technology Units Project, University of Saskatchewan. <http://capes.usask.ca/ccstu>.
- Rico, Gabriela. "Preserving Health and Culture." *Tucson Citizen*, December 3, 2003.
- Ritzer, George. *The McDonaldization of Society*. Thousand Oaks, CA: Pine Forge, 2000.
- Ritzer, George, and Mike Ryan. "Towards a Richer Understanding of Global Commodification." *Hedgehog Review* 5:2 (2003): 66–76.
- Rolston, Holmes. *Genes, Genesis, and God*. Cambridge: Cambridge University Press, 1999.
- Roof, Wade C. *A Generation of Seekers: The Spiritual Journeys of the Baby Boom Generation*. San Francisco: HarperSanFrancisco, 1993.
- Russell, Bertrand. *Mysticism and Logic*. New York: Doubleday Anchor, 1957.
- Rybczynski, W. *Taming the Tiger: The Struggle for Control of Technology*. New York: Viking, 1983.
- Sabra, A.I. "The Appropriation and Subsequent Naturalization of Greek Science in Medieval Islam: A Preliminary Statement." *History of Science* 25 (1987): 223–43.
- Samuelson, Norbert. *Judaism and the Doctrine of Creation*. Cambridge: Cambridge University Press, 1994.
- . *Revelation and the God of Israel*. Cambridge: Cambridge University Press, 2002.
- Sangwan, Satpal. *Science, Technology, and Colonization: An Indian Experience 1757–1857*. Delhi: Anamika Prakashan, 1991.
- Santayana, George. *The Life of Reason: Or the Phases of Human Progress—Reason in Religion*. New York: Charles Scribner's Sons, 1928.
- Sauneron, Serge. *The Priests of Ancient Egypt*. Ithaca, NY: Cornell University Press, 2000.
- Schlesier, Karl. *The Wolves of Heaven: Cheyenne Shamanism, Ceremonies, and Prehistoric Origins*. Norman: University of Oklahoma, 1993.
- Schmidt, Peter R. *Iron Technology in East Africa: Symbolism, Science, and Archaeology*. Bloomington: Indiana University Press, 1997.
- Schott, T. "The World Scientific Community: Globality and Globalization." *Minerva* 29:4 (1991): 440–62.
- Searle, John. *The Rediscovery of Mind*. Cambridge, MA: MIT Press, 1994.
- Shanon, Benny. *The Antipodes of the Mind: Charting the Phenomenology of the Ayahuasca Experience*. New York: Oxford University Press, 2002.
- Sharma, V.N. *Sawai Jai Singh and His Astronomy*. Delhi: Motilal Banarasisdass, 1995.
- Shibayama, Zenkei. *A Flower Does Not Talk*. North Clarendon, VT: Tuttle, 1970.
- Siculus, Diodorus. *The Library of History*. Vol. 1, book 1. Cambridge, MA: Harvard University Press, 1933.

- Singh, Narendra P., and H. Lai. "Selective Toxicity of Dihydroartemisinin and Holotransferrin Toward Human Breast Cancer Cells." *Life Sciences* 70 (2001): 49–56.
- Sivin, Nathan. "On the Word 'Taoist' as a Source of Perplexity: With Special Reference to the Relations of Science and Religion in Traditional China" and "Taoism and Science." In *Medicine, Philosophy, and Religion in Ancient China: Researches and Reflections*, ed. Nathan Siviv. Aldershot, UK: Variorum, 1995.
- Skeptical Inquirer*. Special Issue 1999 (on science and religion), July/August 2001, September/October 2001, March/April 2002. <http://www.csicop.org.si>. These issues contain an extensive collection of articles about science and religion.
- Sleeswyk, W.A. "The Celestial River: A Reconstruction." *Technology and Culture* 19:3 (1978).
- Smith, Tara. *Viable Values*. New York: Roman and Littlefield, 2000.
- Smolicz, J.J., and E.E. Nunan. "The Philosophical and Sociological Foundations of Science Education: The Demythologizing of School Science." *Studies in Science Education* 2 (1975): 101–43.
- Snow, C.P. *The Two Cultures and a Second Look*. Cambridge: Cambridge University Press, 1965.
- . *The Two Cultures*. Cambridge: Cambridge University Press, 1993.
- Some, Malidoma. *Of Water and the Spirit*. New York: Penguin, 1995.
- . *The Healing Wisdom of Africa*. New York: Penguin Putnam, 1999.
- Spencer, A.J. *Early Egypt: The Rise of Civilisation in the Nile Valley*. London: British Museum, 1993.
- Srivastava, J.N. "Life Comes from Life, Part I: An Overview. Savijnaanam." In *Scientific Exploration for a New Paradigm*, vol. 1, 21–30. Kolkata: Bhaktivedanta Institute, 2002.
- Stapp, H.P. *Mind, Matter, and Quantum Mechanics*. New York: Springer Verlag, 1993.
- Steger, Manfred. *Globalism*. Lanham, MD: Rowman and Littlefield, 2002.
- Stine, Gerald. *AIDS Update 2002*. Upper Saddle River, NJ: Prentice Hall, 2002.
- Stossel, John. *The Power of Belief*. ABC News Home Video Library, 1998.
- Strassberg, Barbara. "Religion and Science: The Embodiment of the Conversation." *Zygon* 36:3 (2001): 521–39.
- Sutton, Clive. *Words, Science and Learning*. Philadelphia: Open University Press, 1992.
- Suzuki, D.D., and P. Knudtson. *Wisdom of the Elders: Sacred Native Stories of Nature*. New York: Bantam, 1992.
- The Taoist Canon*. Beijing: Wenwu, 1988.
- Trimble, J.E. "Value Differences Among American Indians: Concerns for the Concerned Counselor." In *Counseling Across Cultures*, ed. P. Pedersen, W.J. Lonner, and J.G. Draguns, 65–81. Honolulu: University of Hawaii Press, 1976.
- Uchiyama, Kosho. *Opening the Hand of Thought*. Somerville, MA: Wisdom, 2004.
- Utukuru, Paul. "Paradigm Dependencies in Science and Religion." May 31, 2002. http://www.metanexus.net/metanexus_online/show_article.asp?6415.
- Vestal, Stanley. *Warpath: The True Story of the Fighting Sioux Told in a Biography of Chief White Bull*. Lincoln: University of Nebraska Press, 1984.
- Volkov, Alexei. "Science and Daoism: An Introduction." *Taiwanese Journal for Philosophy and History of Science* 5:1 (1996): 25–28.
- Vozarova B., et al. "The Interleukin-6 (-174) G/C Promoter Polymorphism Is Associated with Type-2 Diabetes Mellitus in Native Americans and Caucasians." *Human Genetics* 112:4 (2003): 409–13.
- Walsh, George. *The Role of Religion in History*. New Brunswick, NJ: Transaction, 1998.
- Wang, Bing. *Commentaries on Chapter Suwen of Huangdi Neijing*. Published in 762.
- Wang, Guowei. *Commentaries on Chang Chun Zhen Ren Xi You Ji*. Beijing: Beiping Institute of Qinghua, 1926.
- Wang, Hao. *Reflections on Kurt Goedel*. Cambridge, MA: MIT Press, 1988.
- Wang, Ming. *Bao Pu Zi Nei Pian Jiao Shi*. Beijing: Zhong Hua Publishing House, 1985.
- Waters, Frank. *Masked Gods: Navaho and Pueblo Ceremonialism*. Athens, OH: Swallow, 1950.
- Watterson, Barbara. *The Peoples of Africa: The Egyptians*. Oxford: Blackwell, 1997.
- Watts, Fraser. *Theology and Psychology*. Aldershot, UK: Ashgate, 2002.
- Weatherford, J. *Indian Givers: How the Indians of the Americas Transformed the World*. New York: Crown, 1988.

- Werbner, Pnina, and T. Modood, eds. *Debating Cultural Hybridity*. London: Zed Books, 2000.
- Wick, D. *The Infamous Boundary: Seven Decades of Controversy in Quantum Physics*. Boston: Birkhauser, 1995.
- Wiebe, Phillip. *Gods and Other Spirits*. New York: Oxford University Press, 2004.
- Wolfe, Fred Alan. *Taking the Quantum Leap*. New York: Harper and Row, 1981.
- Yates, Frances A. *Giordano Bruno and the Hermetic Tradition*. Chicago: University of Chicago Press, 1991.
- Yoshinobu, Sakade. *A Study of Chinese Thought: Essays on Traditional Medicine, Pharmacy, Nourishing Vitality, and Science*. Osaka: Kansai University Press, 1999.
- Young, B.A., C. Maynard, and E.J. Boyko. "Racial Differences in Diabetic Nephropathy, Cardiovascular Disease, and Mortality in a National Population of Veterans." *Diabetes Care* 26:8 (2003): 2392–99.
- Young, T.K. *The Health of Native Americans: Toward a Biocultural Epidemiology*. New York: Oxford University Press, 1994.
- Youngner, Stuart. "Some Must Die." *Zygon* 38:3 (2003): 705–24.
- Zaleski, Carol. *Otherworldly Journeys: Accounts of Near-Death Experiences in Medieval and Modern Times*. New York: Oxford University Press, 1987.
- Zaslavsky, Claudia. *Africa Counts*. New York: Lawrence Hill Books, 1990.
- Zhao, Kuanghua, and Jiahua Zhou. *A History of Science and Technology in China: Chemistry*. Beijing: Science, 1998.
- Zhu, Cungu. *Dou Zhen Ding Lun* (Final Conclusions on Smallpox). Published in 1713.
- Zhu, Yaping. *Taoism Culture and Science*. Hefei: University of Science and Technology of China Press, 1995.
- Zim, Herbert S. *Rockets and Jets*. New York: Harcourt Brace, 1945.

Historical Perspectives

- Açikgenç, Alparsalan. *Islamic Science: Towards a Definition*. Kuala Lumpur: International Institute of Islamic Thought and Civilization, 1996.
- Al-Attas, Syed Muhammad Naquib. *Islam and Secularism*. Kuala Lumpur: International Institute of Islamic Thought and Civilization, 1993.
- . *Prolegomena to the Metaphysics of Islam*. Kuala Lumpur: International Institute of Islamic Thought and Civilization, 1995.
- Aristotle. *Politics*. Loeb edition. Trans. H. Rackham. 1932. Reprint, Cambridge, MA: Harvard University Press, 1990.
- Arnold, P.E. "The Persuasive Style of Debates in Direct Speech in Thucydides." *Hermes* 120 (1992): 44–57.
- Arriaza, Bernardo. *Beyond Death: The Chinchorro Mummies of Ancient Chile*. Washington, DC: Smithsonian Institution, 1995.
- Ashkenazi, Michael. "Not the Sons of Adam: Religious Responses to ETI." *Space Policy* 8 (1992): 341–50.
- Athanasius. *Life of Antony*. In *Early Christian Lives*, trans. and ed. Carolinne White. New York: Penguin, 1998.
- Augustine. *City of God*. Trans. Henry Bettenson. New York: Penguin, 1984.
- . *Confessions*. Trans. F.J. Sheed. Indianapolis, IN: Hackett, 1993.
- . *On the Literal Meaning of Genesis*. Trans. John Hammond Taylor. Ancient Christian Writers, vols. 41–42. New York: Newman, 1982.
- Babar, Zaheer. *The Science of Empire*. Albany: State University of New York Press, 1996.
- Bag, A.K. *Science and Civilization in India*. Vol. 1. New Delhi: Navrang, 1985.
- Bakar, Osman. *Classification of Knowledge in Islam*. Kuala Lumpur: Institute for Policy Research, 1992.
- . *Tawhid and Science*. Kuala Lumpur: Secretariat for Islamic Philosophy and Science, 1991.
- Bakker, Egbert J., Irene J.F. De Jong, and Hans Van Wees, eds. *Brill's Companion to Herodotus*. Leiden: E.J. Brill, 2002.
- Barnes, Timothy David. *Tertullian: A Historical and Literary Study*. New York: Oxford University Press, 1971.

- Barratt, Alexandra. *The Knowing of a Woman's Kind in Childing: A Middle English Version of Material Derived from the Trotula and Other Sources*. Turnhout, Belgium: Brepols, 2001.
- Bartlett, F.C. *Remembering: A Study in Experimental and Social Psychology*. 1932. Reprint, Cambridge: Cambridge University Press, 1950.
- Basil of Caesarea. *Address to Young Men on Reading Greek Literature*. In *St. Basil: The Letters*, vol. 4, 379–435. Loeb Classical Library, vol. 270. Trans. Roy Joseph Deferrari and Martin R.P. McGuire. Cambridge, MA: Harvard University Press, 1934.
- . *Exegetical Homilies*. Trans. Sister Agnes Clare Way, C.D.P. Fathers of the Church, vol. 46. Washington, DC: Catholic University of America Press, 1963.
- Bauer, Brian, and Charles Stanish. *Ritual and Pilgrimage in the Ancient Andes*. Austin: University of Texas Press, 2001.
- Beazley, Charles R. *The Dawn of Modern Geography: A History of Exploration and Geographical Science*. 3 vols. London: Frowde, 1905.
- Blackburn, Bonnie, and Leofranc Holford-Strevens. *The Oxford Companion to the Year: An Exploration of Calendar Customs and Time-reckoning*. Oxford: Oxford University Press, 1999.
- Boardman, John. *The Greeks Overseas*. 4th ed. Harmondsworth, UK: Penguin, 1973.
- Borst, Anno. *The Ordering of Time: From the Ancient Computus to the Modern Computer*. Trans. Andrew Winnard. Chicago: University of Chicago Press, 1993.
- Bose, D.M., S.N. Sen, and B.V. Subbarayappa, eds. *A Concise History of Science in India*. New Delhi: Indian National Science Academy, 1971.
- Boys-Stones, G.R. *Post-Hellenistic Philosophy: A Study of Its Development from the Stoics to Origen*. Oxford: Oxford University Press, 2001.
- Brown, Peter. *Augustine of Hippo*. Berkeley: University of California Press, 1967.
- . *The World of Late Antiquity*. New York: W.W. Norton, 1989.
- Brown, T.S. *The Greek Historians*. Lexington, MA: D.C. Heath, 1973.
- Brunt, P.A. "Introduction to Thucydides." In *Thucydides*, ix–xxxiv. New York, 1963. Reprinted with a postscript (1991) on the funeral speech in *Studies in Greek History and Thought*, 137–80. Oxford: Oxford University Press, 1993.
- Burckhardt, Titus. *Alchemy, Science of the Cosmos, Science of the Soul*. Cambridge: Quinta Essentia, 1995.
- . *Mirror of the Intellect: Essays on Traditional Science and Sacred Art*. Cambridge: Quinta Essentia, 1987.
- Burger, Richard. *Chavin and the Origins of Andean Civilization*. London: Thames and Hudson, 1995.
- Burnet, J. *Early Greek Philosophy*. New York: Blackwell, 1930.
- Cadden, Joan. *The Meaning of Sex Difference in the Middle Ages*. Cambridge: Cambridge University Press, 1993.
- Caelius Aurelianus. *On Acute Diseases and on Chronic Diseases*. Ed. I.E. Drabkin. Chicago: Chicago University Press, 1950.
- Capra, Fritjof. *The Tao of Physics*. Berkeley, CA: Shambhala, 1975.
- Carruthers, Mary. *The Book of Memory: A Study of Memory in Medieval Culture*. Cambridge: Cambridge University Press, 1990.
- Cassius Dio. *Dio's Roman History*. Loeb edition. Trans. Earnest Cary. Cambridge, MA: Harvard University Press, 1982.
- Casson, Lionel. *Libraries in the Ancient World*. New Haven, CT: Yale University Press, 2001.
- Cawkwell, George. *Thucydides and the Peloponnesian War*. London: Routledge, 1997.
- Chapman, John Jay. "Learning." In *Unbought Spirit*, ed. Richard Stone, 72–92. Champaign: University of Illinois Press, 1998.
- Chattopadhyaya, D. *History of Science and Technology in Ancient India*. 2 vols. Calcutta: Firma KLM, 1986 and 1991.
- Chittick, William C. *The Sufi Path of Knowledge: Ibn Al-Arabi's Metaphysics of Imagination*. Albany: State University of New York Press, 1989.
- Cicero. *Concerning Divination*. Loeb edition. Trans. William Armistead Falconer. In *Cicero: De Senectute, De Amicitia, De Divinatione*. Cambridge, MA: Harvard University Press, 1964.
- Clagett, Marshall. *Greek Science in Antiquity*. London: Abelard-Schuman, 1957.
- Clement of Alexandria. *Fathers of the Second Century*. The Ante-Nicene Fathers, vol. 2. Grand Rapids, MI: Eerdmans, 1989 (reprint).

- Cobo, Bernabe. *Inca Religion and Customs*. Austin: University of Texas Press, 1990.
- Cochrane, Charles Norris. *Christianity and Classical Culture: A Study of Thought and Action from Augustus to Augustine*. London: Oxford University Press, 1944.
- Collins, Roger. *Early Medieval Europe 300–1000*. 1991. Reprint, New York: St. Martin's Press, 1995.
- Cornford, Francis M. *Before and After Socrates*. Cambridge: Cambridge University Press, 1966.
- . *From Religion to Philosophy: A Study in the Origins of Western Speculation*. Princeton, NJ: Princeton University Press, 1912, 1991.
- Coyne, G.V., M.A. Hoskin, and O. Pedersen, eds. *Gregorian Reform of the Calendar: Proceedings of the Vatican Conference to Commemorate Its 400th Anniversary*. Vatican City: Specola Vaticana, 1983.
- Craig, William Lane. *The Kalam Cosmological Argument*. London: Macmillan, 1979.
- Crowe, Michael J. *The Extraterrestrial Life Debate 1750–1900: The Idea of a Plurality of Worlds from Kant to Lowell*. Mineola, NY: Dover, 1999.
- Datta, B., and A.N. Singh. *History of Hindu Mathematics*. Lahore: Motilal Banarsi Das, 1935 and 1938.
- Dean-Jones, Lesley Ann. *Women's Bodies in Classical Greek Science*. Oxford: Oxford University Press, 1996.
- Declercq, Georges. *Anno Domini: The Origins of the Christian Era*. Turnhout: Brepols, 2000.
- Dewald, Carolyn, and John Marincola. "A Selective Introduction to Herodotean Studies." *Arethusa* 20:1–2 (1987): 9–40.
- Dick, Steven J. *The Biological Universe: The Twentieth-Century Extraterrestrial Life Debate and the Limits of Science*. Cambridge: Cambridge University Press, 1996.
- . *Plurality of Worlds: The Origins of the Extraterrestrial Life Debate from Democritus to Kant*. Cambridge: Cambridge University Press, 1982.
- , ed. *Many Worlds: The New Universe, Extraterrestrial Life, and Its Theological Implications*. Philadelphia: Templeton Foundation, 2000.
- Diels, H. *Die Fragmente der Vorsokratiker*. Berlin: Wiedmann, 1906.
- Dilke, O.A.W. *Greek and Roman Maps*. Ithaca, NY: Cornell University Press, 1985.
- Dobbs, Betty Jo Teeter. *The Foundations of Newton's Alchemy: Or, "The Hunting of the Greene Lyon"*. Cambridge: Cambridge University Press, 1975.
- Donnan, Christopher. *Moche Art of Peru*. Los Angeles: Museum of Cultural History, University of California, 1978.
- Donnan, Christopher, and Donna McClelland. *Moche Finesline Painting: Its Evolution and Its Artists*. Los Angeles: University of California Press, 1999.
- Dover, K.J. "The Freedom of the Intellectual in Greek Society." In *The Greeks and Their Legacy*, vol. 2, 135–58. Oxford: Blackwell, 1988.
- Dutt, U.C. *Materia Medica of the Hindus*. Calcutta: Thacker, Spink, 1877.
- Eamon, William. *Science and the Secrets of Nature*. Princeton, NJ: Princeton University Press, 1996.
- Edmunds, Lowell. *Chance and Intelligence in Thucydides*. Cambridge, MA: Harvard University Press, 1975.
- Edson, Evelyn. *Mapping Time and Space: How Medieval Mapmakers Viewed Their World*. London: British Library, 1997.
- Elliot, Alison Goddard. *Roads to Paradise: Reading the Lives of the Early Saints*. Hanover, NH: University Press of New England, 1987.
- Erickson, Clark. "The Lake Titicaca Basin: A Precolumbian Built Landscape." In *Imperfect Balance: Landscape Transformation in the Precolumbian Americas*, ed. David L. Lentz. New York: Columbia University Press, 2000.
- Eusebius. *Life of Constantine*. Trans. Averil Cameron and Stuart G. Hall. Oxford: Oxford University Press, 1999.
- Evans, J.A.S. *Herodotus, Explorer of the Past: Three Essays*. Princeton, NJ: Princeton University Press, 1991.
- Feldman, Robert A. "Pre-ceramic Corporate Architecture: Evidence for the Development of Non-egalitarian Social Systems in Peru." In *Early Ceremonial Architecture in the Andes*, ed. Christopher B. Dunn, 71–92. Washington, DC: Dumbarton Oaks, 1982.
- Finley, M.I. *Ancient History: Evidence and Models*. New York: Chatto and Windus, 1986.

- Flint, Valerie I.J. *The Rise of Magic in Early Medieval Europe*. Princeton, NJ: Princeton University Press, 1991.
- Fogel, R.W., and G.R. Elton. *Which Road to the Past? Two Views of History*. New Haven, CT: Yale University Press, 1983.
- Fornara, C.W. *Herodotus: An Interpretative Essay*. Oxford: Clarendon, 1971.
- . *The Nature of History in Ancient Greece and Rome*. Berkeley: University of California Press, 1983.
- Friedman, John Block, Kristen Mossler Figg, and Scott D. Westrem, eds. *Trade, Travel, and Exploration in the Middle Ages: An Encyclopedia*. New York: Fairleigh Dickinson University Press, 2000.
- Fussell, Paul. *The Great War and Modern Memory*. New York: Oxford University Press, 1975.
- Gangooly, P. *The Surya Siddhanta*. Trans. E. Burgess. Varanas: Indological Book House, 1977.
- Gillispie, Charles C., ed. *Dictionary of Scientific Biography*. 16 vols. New York: Charles Scribner's Sons, 1970–1980.
- Gilson, Etienne. *Reason and Revelation in the Middle Ages*. New York: Charles Scribner's Sons, 1938.
- Glick, Thomas F. "From the Sarton Papers: Paul Kraus and Arabic Alchemy." *Cronos* 2:2 (1999): 221–24.
- Golshani, Mehdi. *The Holy Qur'an and the Sciences of Nature*. Binghamton, NY: Institute of Global Cultural Studies, Binghamton University, 1999.
- Gordon, Richard. "From Republic to Principate: Priesthood, Religion, and Ideology." In *Pagan Priests: Religion and Power in the Ancient World*, ed. Mary Beard and John North, 178–98. London: Duckworth, 1990.
- Gould, John. *Herodotus*. London: Weidenfeld and Nicolson, 1989.
- Grant, Edward. "The Condemnation of 1277, God's Absolute Power, and Physical Thought in the Late Middle Ages." *Viator* 10 (1979): 211–44.
- . *The Foundations of Modern Science in the Middle Ages: Their Religious, Institutional, and Intellectual Contexts*. Cambridge: Cambridge University Press, 1996.
- . *God and Reason in the Middle Ages*. Cambridge: Cambridge University Press, 2001.
- . "God, Science, and Natural Philosophy in the Late Middle Ages." In *Between Demonstration and Imagination: Essays in the History of Science and Philosophy Presented to John D. North*, ed. Lodi Nauta and Arjo Vanderjagt, 243–67. Leiden: E.J. Brill, 1999.
- . *Much Ado About Nothing: Theories of Space and Vacuum from the Middle Ages to the Scientific Revolution*. Cambridge: Cambridge University Press, 1981.
- . "Science and Theology in the Middle Ages." In *God and Nature: Historical Essays on the Encounter Between Christianity and Science*, ed. David C. Lindberg and Ronald L. Numbers, 49–75. Berkeley: University of California Press, 1986.
- . *A Source Book in Medieval Science*. Cambridge, MA: Harvard University Press, 1974.
- Green, Peter. *Alexander to Actium: The Historical Evolution of the Hellenistic Age*. Berkeley: University of California Press, 1990.
- Greene, Monica H. "The De Genecia Attributed to Constantine the African." *Speculum* 62:2 (1987): 299–323.
- . *The Trotula*. Philadelphia: University of Pennsylvania Press, 2000.
- Guthke, Karl S. *The Last Frontier: Imagining Other Worlds from the Copernican Revolution to Modern Science Fiction*. Trans. Helen Atkins. Ithaca, NY: Cornell University Press, 1990.
- Guthrie, Kenneth S. *The Pythagorean Sourcebook and Library*. Grand Rapids: Phanes, 1987.
- Guthrie, W.K.C. *The Greek Philosophers: From Thales to Aristotle*. New York: Harper and Row, 1950.
- . *The Sophists*. Cambridge: Cambridge University Press, 1971.
- Hahn, Lewis Edwin, Randall E. Auxier, and Lucian E. Stone Jr. *The Philosophy of Seyyed Hossein Nasr*. Chicago: Open Court, 2001.
- Haq, Syed Nomanul. *Names, Nature, and Things*. Dordrecht: Kluwer, 1994.
- Harkness, Deborah E. *John Dee's Conversations with Angels: Cabala, Alchemy, and the End of Nature*. Cambridge: Cambridge University Press, 1999.
- Harley, J.B., and David Woodward, eds. *The History of Cartography*. Vol. 1, *Cartography in Prehistoric, Ancient, and Medieval Europe and the Mediterranean*. Chicago: University of Chicago Press, 1987.

- Harrison, Tom. *Living Through the Blitz*. London: Collins, 1986.
- Hart, John. *Herodotus and Greek History*. London: St. Martin's, 1982.
- Heidegger, Martin. *Early Greek Thinking: The Dawn of Western Philosophy*. Trans. David F. Krell and Frank A. Capuzzi. New York: Harper and Row, 1975.
- Hennessey, Roger. *Worlds Without End: The Historic Search for Extraterrestrial Life*. Stroud, UK: Tempus, 1999.
- Hoernle, A.F.R. *Studies in the Medicine of Ancient India*. Columbia, MO: South Asia Books, 1994.
- Hornblower, H. "The Religious Dimension to the Peloponnesian War; or, What Thucydides Does Not Tell Us." *Harvard Studies in Classical Philology* 94 (1992): 169–97.
- . *Thucydides*. London: Duckworth, 1987.
- Hourani, George F., ed. *Essays on Islamic Philosophy and Science*. Albany: State University of New York Press, 1975.
- Hughes, J. Donald. *Pan's Travail: Environmental Problems of the Ancient Greeks and Romans*. Baltimore: Johns Hopkins University Press, 1994.
- Hunter, Virginia. *Thucydides the Artful Reporter*. Toronto: Hakkert, 1973.
- Hyman, Arthur, and James J. Walsh, eds. *Philosophy in the Middle Ages: The Christian, Islamic, and Jewish Traditions*. Indianapolis, IN: Hackett, 1974.
- Hyslop, John. *The Inka Road System*. New York: Academic, 1984.
- Iqbal, Muzaffar. *Islam and Science*. Aldershot, UK: Ashgate, 2002.
- Izutsu, T. *God and Man in the Koran: Semantics of the Koranic Weltanschauung*. Tokyo: Keio Institute of Cultural and Linguistic Studies, 1964.
- Jacquart, Danielle, and Claude Thomasset. *Sexuality and Medicine in the Middle Ages*. Princeton, NJ: Princeton University Press, 1988.
- Jerome. *Principal Works of St. Jerome*. Trans. W. H. Fremantle. The Nicene and Post-Nicene Fathers, second series, vol. 6. Grand Rapids, MI: Eerdmans, 1989 (reprint).
- Jolly, Karen. *Witchcraft and Magic in Europe*. Philadelphia: University of Pennsylvania Press, 2002.
- Joshi, S.D. *History of Metal Founding on the Indian Subcontinent Since Ancient Times*. Ranchi, India: Mrs. S.S. Joshi, 1970.
- Kagan, Donald. *The Outbreak of the Peloponnesian War*. Ithaca, NY: Cornell University Press, 1989 (first published 1969).
- Kak, S. *The Astronomical Code of the Rgveda*. New Delhi: Aditya Prakashan, 1994.
- Keith, A.B. *Indian Logic and Atomism*. Oxford: Oxford University Press, 1921.
- Kelly, J.N.D. *Jerome: His Life, Writings, and Controversies*. New York: Harper and Row, 1975.
- Kieckhefer, Richard. *Magic in the Middle Ages*. Cambridge: Cambridge University Press, 1990.
- Kimble, George H.T. *Geography in the Middle Ages*. New York: Russell and Russell, 1968.
- Kirk, G.S., J.E. Raven, and M. Schofield, eds. *The Presocratic Philosophers*. Cambridge: Cambridge University Press, 1983.
- Knowles, David. *The Evolution of Medieval Thought*. Baltimore: Helicon, 1962.
- Kolata, Alan. *The Tiwanaku*. Cambridge, MA: Blackwell, 1993.
- Kraus, Christina Shuttleworth, ed. *The Limits of Historiography: Genre and Narrative in Ancient Historical Texts*. Leiden: E.J. Brill, 1999.
- Kuiper, F.B.J. *Ancient Indian Cosmogony*. Delhi: Vikas, 1983.
- Lateiner, Donald. *The Historical Method of Herodotus*. Toronto: University of Toronto Press, 1989.
- Lawson, Thomas, E. "Counterintuitive Notions and the Problem of Transmission: The Relevance of Cognitive Science for the Study of History." *Historical Reflections/Reflexions Historiques* 20 (1944): 481–95.
- Leff, Gordon. *Paris and Oxford Universities in the Thirteenth and Fourteenth Centuries: An Institutional and Intellectual History*. New York: John Wiley and Sons, 1968.
- Lindberg, David C. *The Beginnings of Western Science: The European Scientific Tradition in Philosophical, Religious, and Institutional Context, 600 B.C. to A.D. 1450*. Chicago: University of Chicago Press, 1992.
- . "Early Christian Attitudes Toward Nature." In *The History of Science and Religion in the Western Tradition*, ed. Gary B. Ferngren, 47–56. New York: Garland, 2000.

- . “The Medieval Church Encounters the Classical Tradition: Saint Augustine, Roger Bacon, and the Handmaiden Metaphor.” In *When Science and Christianity Meet*, ed. David C. Lindberg and Ronald L. Numbers, 7–32, 288–91. Chicago: University of Chicago Press, 2003.
- . “Science and the Early Church.” In *God and Nature: Historical Essays on the Encounter Between Christianity and Science*, ed. David C. Lindberg and Ronald L. Numbers, 19–48. Berkeley: University of California Press, 1986.
- Lindsay, Jack. *The Origins of Alchemy in Graeco-Roman Egypt*. London: Muller, 1970.
- Lloyd, G.E.R. *Aristotle: The Growth and Structure of His Thought*. Cambridge: Cambridge University Press, 1968.
- . *Early Greek Science: Thales to Aristotle*. London: Chatto and Windus, 1970.
- . *Greek Science After Aristotle*. New York: New York University Press, 1973.
- . *Magic, Reason, and Experience: Studies in the Origin and Development of Greek Science*. Cambridge: Cambridge University Press, 1979.
- . *Science, Folklore, and Ideology: Studies in the Life Sciences in Ancient Greece*. Cambridge: Cambridge University Press, 1983.
- Lovejoy, Arthur. *The Great Chain of Being: A Study of the History of Ideas*. New York: Harper and Brothers, 1950.
- Lozovsky, Natalia. “*The Earth Is Our Book*”: *Geographical Knowledge in the Latin West ca. 400–1000*. Ann Arbor: University of Michigan Press, 2000.
- Lui, Dun, and Wang Yangzong, eds. *Chinese Science and Scientific Revolution: Selected Essays on Needham’s Puzzle and Related Researches*. Shenyang shi: Liaoning, 2002.
- Lumbreras, Luis. *The Peoples and Cultures of Ancient Peru*. Washington, DC: Smithsonian Institution, 1974.
- Mabud, Shaikh Abdul. *Theory of Evolution: An Assessment from the Islamic Point of View*. Cambridge: Islamic Academy, 1991.
- Marincola, John. *Authority and Tradition in Ancient Historiography*. Cambridge: Cambridge University Press, 1997.
- McCluskey, Stephen C. *Astronomies and Cultures in Early Medieval Europe*. Cambridge: Cambridge University Press, 1998.
- Merton, Robert K. “Science, Technology and Society in Seventeenth Century England.” *Osiris* (1938).
- Michels, Agnes Kirsopp. *The Calendar of the Roman Republic*. Princeton, NJ: Princeton University Press, 1967.
- Mishra, U. *The Conception of Matter According to Nyaya Vaisesika*. Allahabad, India: M.N. Pandey, 1936.
- Momigliano, Arnaldo. *Studies in Historiography*. New York: Harper and Row, 1966.
- . *The Classical Foundations of Modern Historiography*. Berkeley: University of California Press, 1990.
- . *The Development of Greek Biography*. 2nd ed. Cambridge, MA: Harvard University Press, 1993.
- Moore, Jerry. *Architecture and Power in the Ancient Andes*. Cambridge: Cambridge University Press, 1996.
- Moseley, Michael. *The Incas and Their Ancestors*. London: Thames and Hudson, 1992.
- Murray, Alexander. *Reason and Society in the Middle Ages*. Oxford: Oxford University Press, 1978.
- Murray, Oswyn. “Greek Historians.” In *Greece and the Hellenistic World*, ed. John Boardman, Jasper Griffin, and Oswyn Murray, 187–88. Oxford: Oxford University Press, 1986.
- Nagy, Gregory. “Herodotus the *Logios*.” *Arethusa* 20:1–2 (1987): 175–84.
- Nasr, Seyyed Hossein. *An Introduction to Islamic Cosmological Doctrines*. Albany: State University of New York Press, 1993.
- . *Islamic Life and Thought*. Albany: State University of New York Press, 1981.
- . *Knowledge and the Sacred*. Edinburgh: Edinburgh University Press, 1981.
- . *Religion and the Order of Nature*. New York: Oxford University Press, 1996.
- . *Science and Civilization in Islam*. Cambridge, MA: Harvard University Press, 1968.
- Needham, Joseph. *Science and Civilisation in China*. Cambridge: Cambridge University Press, 1954.

- Netton, Ian Richard. *Allah Transcendent*. Richmond, UK: Curzon, 1989.
- Newman, Barbara. "Hildegard of Bingen: Visions and Validation." *Church History* 54:2 (1985): 163–75.
- Nietzsche, Friedrich. *Philosophy in the Tragic Age of the Greeks*. Trans. Marianne Cowan. Chicago: Regnery, 1962.
- Northbourne, Lord. *Looking Back on Progress*. London: Perennial Books, 1970.
- Novick, Peter. *That Noble Dream: The Objectivity Question and the American Historical Profession*. Cambridge: Cambridge University Press, 1988.
- Nussbaum, Martha C. *The Fragility of Goodness: Luck and Ethics in Greek Tragedy and Philosophy*. Cambridge: Cambridge University Press, 1986.
- . *The Therapy of Desire: Theory and Practice in Hellenistic Ethics*. Princeton, NJ: Princeton University Press, 1994.
- . *Upheavals of Thought: The Intelligence of Emotions*. Cambridge: Cambridge University Press, 2001.
- O'Meara, Thomas. "Christian Theology and Extraterrestrial Intelligent Life." *Theological Studies* 60 (1999): 3–30.
- Oresme, Nicole. *Nicole Oresme: Le livre du ciel et du monde*. Ed. Albert D. Menut and Alexander J. Denomy. Trans. and Intro. Albert D. Menut. Madison: University of Wisconsin Press, 1968.
- Origen. *On First Principles*. Trans. G.W. Butterworth. Gloucester, MA: Peter Smith, 1973.
- Orosius. *The Seven Books of History Against the Pagans*. Trans. Roy J. Deferrari. Washington, DC: Catholic University Press of America, 1964.
- Ortloff, Charles. "Engineering Aspects of Tiwanaku Groundwater-controlled Agriculture." In *Tiwanaku and Its Hinterland*, ed. A. Kolata, 153–67. Washington, DC: Smithsonian Institution, 1996.
- Ostwald, Martin. "Tragedians and Historians." *Scripta Classica Israelica* 21 (2002): 9–25.
- Packman, Zola Marie. "The Incredible and Incredulous: The Vocabulary of Disbelief in Herodotus, Thucydides, and Xenophon." *Hermes* 119 (1991): 399–414.
- Pary, Adam Milman. "Logos and Ergon in Thucydides." Ph.D. dissertation, Harvard University, 1957; reprint, 1981.
- Patai, Raphael. *The Jewish Alchemists: A History and Source Book*. Princeton, NJ: Princeton University Press, 1994.
- Pearson, Lionel. "Credulity and Scepticism in Herodotus." *Transactions of the American Philological Association* 72 (1941): 335–55.
- Pelikan, Jaroslav. *Christianity and Classical Culture: The Metamorphosis of Theology in the Christian Encounter with Hellenism*. New Haven, CT: Yale University Press, 1993.
- Peters, F.E. *Aristotle and the Arabs*. New York: New York University Press, 1968.
- Peters, Ted, Muzaffar Iqbal, and Syed Nomanul Haq. *God, Life, and the Cosmos: Christian and Islamic Perspectives*. Aldershot, UK: Ashgate, 2002.
- Phillips, E.D. *Greek Medicine*. London: Thames and Hudson, 1973.
- Piamenta, M. *The Muslim Conception of God and Human Welfare*. Leiden: E.J. Brill, 1983.
- Pines, Shlomo. *The Collected Works of Shlomo Pines*. Vol. 2. Studies in Arabic Versions of Greek Texts and in Medical Science. Leiden: E.J. Brill, 1986.
- Plato. *Timaeus*. Loeb edition. Trans. R.G. Bury. In *Plato: Timaeus, Critias, Cleitophon, Menexenus, Epistles*. Cambridge, MA: Harvard University Press, 1964.
- Prior, Moody E. "Bacon's Man of Science." In *Essential Articles for the Study of Francis Bacon*, ed. Brian Vickers, 140–63. Hamden, CT: Archon Books, 1968.
- Rahman, A., ed. *History of Indian Science and Technology and Culture AD 1000–1800*. Delhi: Oxford University Press, 1999.
- Rahman, F. *Major Themes of the Qur'an*. Minneapolis: Bibliotheca Islamica, 1980.
- Ray, P.C. *History of Hindu Chemistry*. London: Williamsgate, 1909.
- Richards, E.G. *Mapping Time: The Calendar and Its History*. Oxford: Oxford University Press, 1998.
- Ridder-Symoens, Hilde de. *A History of the University in Europe*. Vol. 1, *Universities in the Middle Ages*. Cambridge: Cambridge University Press, 1992.
- Roberts, Gareth. *The Mirror of Alchemy: Alchemical Ideas and Images in Manuscripts and Books from Antiquity to the Seventeenth Century*. London: British Library, 1994.

- Romilly, Jacqueline de. *La construction de la vérité chez Thucydide*. Paris: Juillard, 1990.
- . *The Great Sophists in Periclean Athens*. Trans. Janet Lloyd. Oxford: Clarendon, 1992.
- Romm, James. *The Edges of the Earth in Ancient Thought*. Princeton, NJ: Princeton University Press, 1992.
- Rousseau, Philip. *Basil of Caesarea*. Berkeley: University of California Press, 1994.
- Rowland, Beryl. *Medieval Woman's Guide to Health*. Kent, OH: Kent State University Press, 1981.
- Sabra, A.I. *Optics, Astronomy, and Logic*. Brookfield, VT: Variorum, 1994.
- Sagan, Carl. *Cosmos*. New York: Harper and Row, 1975.
- Saliba, George. *A History of Arabic Astronomy: Planetary Theories During the Golden Age of Islam*. New York: New York University Press, 1994.
- Samuel, Alan E. *Greek and Roman Chronology: Calendars and Years in Classical Antiquity*. Munich: Beck, 1972.
- Sardar, Ziauddin. *Explorations in Islamic Science*. London: Mansell, 1989.
- , ed. *The Touch of Midas: Science, Values, and Environment in Islam and the West*. Petaling Jaya, Malaysia: Pelanduk, 1988.
- Sarkar, B.K. *Hindu Achievements in Exact Sciences*. London: Longmans, Green, 1918.
- Sarton, George. *Introduction to the History of Science*. Baltimore: Williams and Wilkins, for the Carnegie Institution of Washington, 1962.
- Seldon, Anthony, ed. *Contemporary History: Practice and Method*. Oxford: Blackwell, 1988.
- Shapin, Steven. *A Social History of Truth: Civility and Science in Seventeenth-Century England*. Chicago: University of Chicago Press, 1994.
- Shapin, Steven, and Simon Schaffer. *Leviathan and the Air-Pump: Hobbes, Boyle, and the Experimental Life*. Princeton, NJ: Princeton University Press, 1985.
- Sharif, M.M. *A History of Muslim Philosophy*. Karachi: Royal Book, 1983.
- Sharpe, William D. "Isidore of Seville: The Medical Writings. An English Translation with an Introduction and Commentary." *Transactions of the American Philosophical Society* 54, part 2 (1964).
- Shrimpton, G.S. "Accuracy in Thucydides." *Ancient History Bulletin* 12:3 (1998): 71–82.
- . "Beyond the Limits. New Thoughts on the Origin and Development of Ancient Historical Writing." *Ancient History Bulletin* 15:2 (2001): 50–62.
- . "Herodotus' Intellectual Context: A Review Article." *Ancient History Bulletin* 17:3–4 (2003): 149–57.
- . *History and Memory in Ancient Greece*. Montreal: McGill-Queen's University Press, 1997.
- Sivin, Nathan. "On the Word 'Taoism' as a Source of Perplexity." *History of Religions* 17 (1978): 303–30.
- . "Taoism and Science." *Medicine, Philosophy, and Religion in Ancient China: Researches and Reflections*. Aldershot, UK: Variorum, 1995.
- Smith, W.D. *The Hippocratic Tradition*. Ithaca, NY: Cornell University Press, 1979.
- Soranus. *Gynecology*. Trans. Owen Temkin. Baltimore: Johns Hopkins University Press, 1956.
- Stahl, William H. *Roman Science: Origins, Development, and Influence to the Later Middle Ages*. Madison: University of Wisconsin Press, 1962.
- Stanish, Charles. *Ancient Titicaca*. Berkeley: University of California Press, 2003.
- Stenberg, L. *The Islamization of Science: Four Muslim Positions, Developing an Islamic Modernity*. Ludwig, Sweden: Lund Studies in History of Religions, 1996.
- Stephens, James. *Francis Bacon and the Style of Science*. Chicago: University of Chicago Press, 1975.
- Stiefel, Tina. *The Intellectual Revolution in Twelfth-Century Europe*. New York: St. Martin's, 1985.
- Subbarayappa, B.V., and S.R.N. Murthy, eds. "Source Materials on Indian Mathematics and Astronomy." *Scientific Heritage of India: Proceedings of a National Seminar*. September 19–21, 1986, the Mythic Society, Bangalore, 1988.
- Temkin, Owsei. *Hippocrates in a World of Pagans and Christians*. Baltimore: Johns Hopkins University Press, 1991.
- Tertullian. *The Writings of Tertullian*. The Ante-Nicene Fathers, vol. 3. Grand Rapids, MI: Eerdmans, 1993 (reprint).

- Thomas, Rosalind. *Herodotus in Context: Ethnography, Science, and the Art of Persuasion*. Cambridge: Cambridge University Press, 2000.
- Thorndike, Lynn. *A History of Magic and Experimental Science*. New York: Columbia University Press, 1923–1958.
- . *University Records and Life in the Middle Ages*. New York: Columbia University Press, 1944.
- Trigg, Joseph Wilson. *Origen: The Bible and Philosophy in the Third-century Church*. London: SCM, 1985.
- Verbeke, Gerard. *The Presence of Stoicism in Medieval Thought*. Washington, DC: Catholic University Press of America, 1983.
- Wallace-Hadrill, D.S. *The Greek Patristic View of Nature*. Manchester, UK: Manchester University Press, 1968.
- Wallis, Faith. *Bede: The Reckoning of Time*. Liverpool: Liverpool University Press, 1999.
- . “Chronology and Systems of Dating.” In *Medieval Latin: An Introduction and Bibliographic Guide*, ed. F.A.C. Mantello and A.G. Rigg, 383–87. Washington, DC: Catholic University of America Press, 1996.
- Ware, R. Dean. “Medieval Chronology.” In *Medieval Studies: An Introduction*, 2nd ed., ed. James M. Powell, 252–77. Syracuse, NY: Syracuse University Press, 1992.
- Warmington, E.H. *Greek Geography*. London: J.M. Dent, 1973.
- Wells, Colin. *The Roman Empire*. 2nd ed. 1992. Reprint, Cambridge, MA: Harvard University Press, 1997.
- Whewell, William. *Of the Plurality of Worlds: An Essay*. 5th ed. London: John W. Parker and Son, 1959.
- Whitall, Perry N. *The Widening Breach: Evolutionism in the Mirror of Cosmology*. Cambridge: Quinta Essentia, 1995.
- Whitehead, David. “Thucydides: Fact-Grubber or Philosopher?” *Greece and Rome* 27 (1980): 158–65.
- Yates, Frances. *Giordano Bruno and the Hermetic Tradition*. London: Routledge and Kegan Paul, 1964.
- Zanker, Paul. *The Power of Images in the Age of Augustus*. Trans. Alan Shapiro. Ann Arbor: University of Michigan Press, 1988.
- Zezong, Xi, ed. *Zhong-guo Dao-jiao Ke-xue Ji-zhu-shi* (A History of Chinese Taoist Science and Technology). Beijing: Kexue chubanshe, 2002.

Creation, the Cosmos, and Origins of the Universe

- Adegbola, E. Ade, ed. *Traditional Religion in West Africa*. Nairobi: Uzima, 1983.
- Aguirre, Anthony. “The Cold Big-Bang Cosmology as a Counter-example to Several Anthropic Arguments.” *Physical Review D* 64 (2001): 083508.
- Alpher, Ralph A., and Robert Herman. *Genesis of the Big Bang*. New York: Oxford University Press, 2001.
- Aristotle. *Metaphysics*. Trans. Joe Sachs. Sante Fe, NM: Green Lion, 1999.
- Atkins, Peter W. *The Creation*. Oxford: Freeman, 1981.
- Barbour, Ian G. *Religion and Science: Historical and Contemporary Issues*. San Francisco: HarperSanFrancisco, 1997.
- Barrow, John D. *The Book of Nothing: Vacuums, Voids, and the Latest Ideas about the Origin of the Universe*. New York: Pantheon Books, 2000.
- . *The World Within the World*. Oxford: Clarendon, 1988.
- Barrow, John D., and Frank J. Tipler. *The Anthropic Cosmological Principle*. New York: Oxford University Press, 1986.
- Bekerie, Ayele. *Ethiopic: An African Writing System: Its History and Principles*. Lawrenceville, NJ: Red Sea, 1997.
- Bostrom, Nick. *Anthropic Bias: Observation and Selection Effects in Science and Philosophy*. New York: Routledge, 2002.
- Bouma-Prediger, Steven. *For the Beauty of the Earth: A Christian Vision for Creation Care*. Grand Rapids, MI: Baker Academic, 2001.
- Brooks, Miguel F., ed. and trans. *Kebrā Nagast* (The Glory of Kings). Lawrenceville, NJ: Red Sea, 1995.

- Budge, E.A. Wallis. *The Dwellers of the Nile*. New York: Dover, 1977.
- . *An Ethiopian Book of the Dead: The Bandlet of Righteousness*. London: Kegan Paul, 2002.
- . *The Gods of the Egyptians*. New York: Dover, 1969.
- . *Legends of the Egyptian Gods*. New York: Dover, 1994.
- . *Osiris and the Egyptian Resurrection*. New York: Dover, 1973.
- Calvin, John. *Concerning the Eternal Predestination of God*. Trans. J.K.S. Reid. London: James Clarke, 1961.
- Carrasco, David. *Religions of Mesoamerica*. Prospect Heights, IL: Waveland, 1998.
- Carter, Brandon. "Large Number Coincidences and the Anthropic Principle in Cosmology." In *Confrontation of Cosmological Theory with Astronomical Data*, ed. M.S. Longair, 291–98. Dordrecht: Reidel, 1974. Reprinted in Leslie, 1990.
- Coe, Michael. "A Model of Ancient Community Structure in the Maya Lowlands." *Southwestern Journal of Anthropology* 21 (1965): 97–114.
- Cohen, I. Bernard, and George E. Smith, eds. *The Cambridge Companion to Newton*. Cambridge: Cambridge University Press, 2002.
- Cole, K.C. *The Hole in the Universe: How Scientists Peered over the Edge of Emptiness and Found Everything*. New York: Harcourt, 2001.
- Collins, C. John. *Science and Faith: Friends or Foes?* Wheaton, IL: Crossway, 2003.
- Craig, William Lane, and Quentin Smith. "Graham Oppy on the *Kalam* Cosmological Argument." *Sophia* 32 (1993): 1–11.
- . "In Defense of the *Kalam* Cosmological Argument." *Faith and Philosophy* 14 (1997): 236–47.
- . *The Kalam Cosmological Argument*. New York: Barnes and Noble, 1979.
- . *Theism, Atheism, and Big Bang Cosmology*. Oxford: Oxford University Press, 1995.
- Darwin, Charles. *On the Origin of Species*. Cambridge, MA: Harvard University Press, 1859; facsimile reprint, 1964.
- Davies, Paul. *God and the New Physics*. New York: Simon and Schuster, 1983.
- . *The Mind of God: The Scientific Basis for a Rational World*. New York: Simon and Schuster, 1992.
- Dicke, R.H. "Dirac's Cosmology and Mach's Principle." *Nature* 192 (1961): 440.
- Dobbs, Betty Jo Tetter. *The Janus Faces of Genius: The Role of Alchemy in Newton's Thought*. Cambridge: Cambridge University Press, 1991.
- Drange, Theodore. "Incompatible Properties Arguments: A Survey." *Philo* 2 (Fall–Winter 1998): 49–60.
- Drees, Willem B. *Beyond the Big Bang: Quantum Cosmologies and God*. La Salle, IL: Open Court, 1990.
- . *Creation: From Nothing Until Now*. London: Routledge, 2002.
- Eames, Charles, and Ray Eames. *Powers of Ten*. Armonk, NY: IBM, 1968. Instructional video.
- Einstein, Albert. "The Einstein-DeSitter-Weyl-Klein Debate." In *The Collected Papers of Albert Einstein*. Vol. 8, *The Berlin Years: Correspondence, 1914–1918*, ed. Robert Schulmann, A.J. Knox, Michel Jansen, and Jozsef Illy, 351–57. Princeton, NJ: Princeton University Press, 1998.
- Ellis, George. *Before the Beginning: Cosmology Explained*. London, New York: Boyars/Bowerdean, 1993.
- Fantoli, Annibale. *Galileo for Copernicanism and for the Church*. 2nd ed. Notre Dame, IN: University of Notre Dame Press, 1996.
- Fauvel, John, Raymond Flood, Michael Shortland, and Robin Wilson, eds. *Let Newton Be! A New Perspective on His Life and Works*. Oxford: Oxford University Press, 1988.
- Finnocchiaro, Maurice A., ed. *The Galileo Affair: A Documentary History*. Berkeley: University of California Press, 1989.
- Force, James E., and Richard H. Popkin, eds. *Newton and Religion: Context, Nature, and Influence*. Dordrecht: Kluwer, 1999.
- Freidel, David, Linda Schele, and Joy Parker. *Maya Cosmos: Three Thousand Years on the Shaman's Path*. New York: William Morrow, 1993.
- Freund, Philip. *Myths of Creation*. New York: Washington Square Press, 1966.
- Gabra Maryam, Taye. *Yethiopia Hezb Tarik* (History of the People of Ethiopia). Trans. Grover Hudson and Tekeste Negash. 1922. Uppsala, Sweden: Centre for Multiethnic Research, 1987.

- Galileo Galilei. *Le Opere di Galileo Galilei*. Ed. Antonio Favaro. Florence: Barbèra Editore, 1890–1909. Reprint, 1968.
- Gleiser, Marcelo. *The Dancing Universe: From Creation Myths to the Big Bang*. New York: Dutton, 1997.
- . *The Prophet and the Astronomer: A Scientific Journey to the End of Time*. New York: W.W. Norton, 2001.
- Glynn, Patrick. *God: The Evidence*. Rocklin, CA: Prima, 1997.
- Greene, Brian. *The Elegant Universe: Superstrings, Hidden Dimensions, and the Quest for the Ultimate Theory*. New York: W.W. Norton, 1999.
- Gribbin, John. *In the Beginning: The Birth of the Living Universe*. Boston: Little, Brown, 1993.
- Guth, Alan. *The Inflationary Universe: The Quest for a New Theory of Cosmic Origins*. Reading, MA: Addison-Wesley, 1997.
- Harrison, Peter. *The Bible, Protestantism, and the Rise of Natural Science*. Cambridge: Cambridge University Press, 1998.
- Hartle, James, and Stephen Hawking. “Wave Function of the Universe.” *Physical Review D* 28 (1983): 2960–75.
- Hawking, Stephen. *A Brief History of Time: From the Big Bang to Black Holes*. New York: Bantam, 1988.
- Hess, Richard S., and David Toshio Tsumura, eds. “I Studied Inscriptions from Before the Flood”: *Ancient Near Eastern Literary and Linguistic Approaches to Genesis 1–11*. Winona Lake, IN: Eisenbrauns, 1994.
- Hetherington, Norris S., ed. *Cosmology: Historical, Literary, Philosophical, Religious, and Scientific Perspectives*. New York: Garland, 1993.
- Hogan, Craig J. “Why the Universe Is Just So.” *Reviews of Modern Physics* 72 (2000): 1149–61.
- Hoyle, F., D.N.F. Dunbar, W.A. Wensel, and W. Whaling. “A State in C12 Predicted from Astrophysical Evidence.” *Physical Review Letters* 92 (1953): 1095.
- Jeeves, Malcolm A., and R.J. Berry. *Science, Life, and Christian Belief: A Survey and Assessment*. Leicester, UK: Apollos, 1998.
- Keynes, John Maynard. “Newton, the Man.” In *The Royal Society: Newton Tercentenary Celebrations*, 27–43. Cambridge: Cambridge University Press, 1947.
- Kirk, G.S., J.E. Raven, and M. Schofield. *The Presocratic Philosophers: A Critical History with a Selection of Texts*. Cambridge: Cambridge University Press, 1983.
- Knappert, Jan. *The Aquarian Guide to African Mythology*. Wellingborough, UK: Aquarian, 1990.
- Krauss, Larry. *Quintessence: The Mystery of Missing Mass in the Universe*. New York: Basic Books, 2000.
- LaGamma, Alisa. *Genesis: Ideas of Origin in African Sculpture*. New York: Metropolitan Museum of Art, dist. Yale University Press, 2002.
- Langford, Jerome J. *Galileo, Science, and the Church*. South Bend, IN: St. Augustine’s Press, 1998.
- Legesse, Asmarom. *Gada: Three Approaches to the Study of African Society*. New York: Free Press, 1973.
- Leslie, John. *Universes*. London: Routledge, 1989.
- Leslie, John, ed. *Physical Cosmology and Philosophy*. New York: Macmillan, 1990.
- Levine, Donald. *Greater Ethiopia: The Evolution of a Multiethnic Society*. 2nd ed. Chicago: University of Chicago Press, 2000.
- Lewis, H.S. “The Origins of the Galla and Somali.” *Journal of African History* 7 (1966): 27–46.
- Linde, Andrei. *Inflation and Quantum Cosmology*. New York: Academic Press, 1990.
- . “Must the Beginning of the Universe Have a Personal Cause?” *Faith and Philosophy* 17:2 (2000): 149–69.
- . *Particle Physics and Inflationary Cosmology*. New York: Academic Press, 1990.
- . “Quantum Cosmology, Inflation, and the Anthropic Principle.” In *Science and Ultimate Reality: Quantum Theory, Cosmology and Complexity*, ed. John D. Barrow, Paul C.W. Davies, and Charles L. Harper Jr. Cambridge: Cambridge University Press, 2004.

- . “The Self-Reproducing Inflationary Universe.” *Scientific American*, November 1994, 48–55.
- Lvova, Eleonora. “Traditional Beliefs of Ethiopian Peoples: The Stages and the Tendency.” *New Trends in Ethiopian Studies: Papers of the 12th International Conference of Ethiopian Studies*. Michigan State University, September 5–10, 1994. Ed. Harold Marcus and Grover Hudson. Vol. 1, 830–39.
- Maimonides, Moses. *Guide for the Perplexed*. New York: Dover, 1956.
- Manuel, Frank. *The Religion of Isaac Newton*. Oxford: Clarendon, 1974.
- Marcus, Harold. *A History of Ethiopia*. Updated ed. Berkeley: University of California Press, 2000.
- Mbiti, John S. *Introduction to African Religion*. 2nd ed. Nairobi: East African Educational, 1992.
- McGuire, J.E. “Newton on Place, Time, and God: An Unpublished Source.” *British Journal for the History of Science* 38 (1978): 114–29.
- . “Newton’s ‘Principles of Philosophy’: An Intended Preface for the 1704 *Opticks* and a Related Draft Fragment.” *British Journal for the History of Science* 5 (1970): 178–86.
- McGuire, J.E., and P.M. Rattansi. “Newton and the ‘Pipes of Pan.’” *Notes and Records of the Royal Society of London* 21 (1966): 108–42.
- Mill, John Stuart. “Three Essays on Religion.” In *Essays on Ethics, Religion and Society*, ed. J.M. Robson. Toronto: University of Toronto Press, 1969.
- Misner, Charles W. “Cosmology and Theology.” In *Cosmology, History, and Theology*, ed. W. Yourgrau and A.D. Breck. New York: Plenum, 1977.
- Moreland, J.P., and John Mark Reynolds, eds. *Three Views on Creation and Evolution*. Grand Rapids, MI: Zondervan, 1999.
- Morris, Henry M. *Scientific Creationism*. El Cajon, CA: Master, 1974.
- Morris, Henry M., and Gary Parker. *What Is Creation Science?* San Diego: Creation-Life, 1982.
- Morrison, Wes. “Craig on the Actual Infinite.” *Religious Studies* 38 (2002): 147–66.
- Munitz, Milton K., ed. *Theories of the Universe: From Babylonian Myth to Modern Science*. New York: Free Press, 1965.
- Newton, Isaac. *The Chronology of Ancient Kingdoms Amended*. London, 1728.
- . *The Correspondence of Sir Isaac Newton*. Ed. H.W. Turnbull, J.F. Scott, A. Rupert Hall, and Laura Tilling. 7 vols. Cambridge: Cambridge University Press, 1959–1977.
- . *Newton: Texts, Backgrounds, Commentaries*. Ed. I. Bernard Cohen and Richard S. Westfall. New York: W.W. Norton, 1995.
- . *Observations upon the Prophecies of Daniel, and the Apocalypse of St. John*. London: J. Darby and T. Browne, 1733.
- . *The Principia: Mathematical Principles of Natural Philosophy*. Trans. I. Bernard Cohen and Anne Whitman, assisted by Julia Budenz. Berkeley: University of California Press, 1999.
- . *Sir Isaac Newton’s Mathematical Principles of Natural Philosophy and His System of the World*. Trans. Andrew Motte and revised by Florian Cajori. Berkeley: University of California Press, 1962.
- North, John. *The Norton History of Astronomy and Cosmology*. New York: W.W. Norton, 1995.
- Numbers, Ronald L. *The Creationists: The Evolution of Scientific Creationism*. Berkeley: University of California Press, 1992.
- Olupona, James, ed. *African Traditional Religion in Contemporary Society*. New York: Paragon House, 1991.
- Ostriker, Jeremiah P., and Paul J. Steinhardt. “The Quintessential Universe.” *Scientific American*, January 2001, 46–53.
- Overman, Dean L. *A Case Against Accident and Self-Organization*. New York: Rowman and Littlefield, 1997.
- Pedersen, Olaf. “Galileo’s Religion.” In *The Galileo Affair: A Meeting of Faith and Science*, ed. G.V. Coyne, M. Heller, and J. Zycinski, 75–102. Vatican City: Specola Vaticana, 1985.
- Pennock, Robert T. *Tower of Babel: The Evidence Against the New Creationism*. Cambridge, MA: MIT Press, 1999.

- Perlmutter, S., et al. "Measurements of Omega and Lambda from 42 High-Redshift Supernovae." *Astrophysical Journal* 517 (1999): 565–86.
- Plato. *Cratylus*. Trans. C.D.C. Reeve. Indianapolis, IN: Hackett, 1998.
- Presbyterian Church in America. "Report of the Creation Study Committee." June 21, 2000. <http://www.pcanet.org/history/creation/report.html>.
- Ramm, Bernard. *The Christian View of Science and Scripture*. London: Paternoster, 1955.
- Ratzsch, Del. *The Battle of Beginnings: Why Neither Side Is Winning the Creation-Evolution Debate*. Downers Grove, IL: InterVarsity Press, 1996.
- Ray, Benjamin C. *African Religions*. London: Prentice Hall, 1976.
- Reiss, A., et al. "Observational Evidence from Supernovae for an Accelerating Universe and a Cosmological Constant." *Astronomical Journal* 116 (1998): 1009–38.
- Rockwell, Thomas. "Visual Technologies, Cosmographies, and Our Sense of Place in the Universe." *Zygon: Journal of Religion and Science* 37:3 (September 2002): 605–21.
- Ross, Hugh. *The Creator and the Cosmos: How the Greatest Scientific Discoveries of the Century Reveal God*. Colorado Springs: NavPress, 1995.
- Rugh, S.E., and Henrik Zinkernagel. "The Quantum Vacuum and the Cosmological Constant Problem." *Studies in History and Philosophy of Modern Physics* 33 (2002): 663–705.
- Russell, Robert John. "Five Attitudes Toward Nature and Technology from a Christian Perspective." *Theology and Science* 1 (2003): 149–59.
- Ryker, Leland, et al., eds. *Dictionary of Biblical Imagery*. Leicester, UK: Inter-Varsity Press, 1998.
- Sandage, Alan. Quoted in "Science Finds God." *Newsweek*, July 20, 1998, 46.
- Sarna, Nahum. *Understanding Genesis*. New York: Schocken Books, 1970.
- Schroeder, Gerald. *Genesis and the Big Bang*. New York: Bantam, 1990.
- . *The Hidden Face of God*. New York: Touchstone, 2001.
- . *The Science of God*. New York: Broadway, 1997.
- Schüller, Volkmar. "Newton's *Scholia* from David Gregory's Estate on the Propositions IV through IX Book III of His *Principia*." In *Between Leibniz, Newton, and Kant: Philosophy and Science in the Eighteenth Century*, ed. Wolfgang Lefèvre, 213–65. Dordrecht: Kluwer, 2001.
- Sharratt, Michael. *Galileo: Decisive Innovator*. Cambridge: Cambridge University Press, 1996.
- Shea, William R., and Mariano Artigas. *Galileo in Rome: The Rise and Fall of a Troublesome Genius*. New York: Oxford University Press, 2003.
- Smith, Quentin. "A Natural Explanation of the Existence and Laws of Our Universe." *Australasian Journal of Philosophy* 68 (1990): 22–43.
- Smolin, Lee. *The Life of the Cosmos*. New York: Oxford University Press, 1997.
- . *The Roads to Quantum Gravity*. New York: Basic Books, 2001.
- Snobelen, Stephen D. "'God of Gods, and Lord of Lords': The Theology of Isaac Newton's General Scholium to the *Principia*." *Osiris* 16 (2001): 169–208.
- . "Isaac Newton, Heretic: The Strategies of a Nicodemite." *British Journal for the History of Science* 32 (1999): 381–419.
- . "To Discourse of God: Isaac Newton's Heterodox Theology and His Natural Philosophy." In *Science and Dissent in England, 1688–1945*, ed. Paul B. Wood, 39–65. Aldershot, UK: Ashgate, 2004.
- Sobel, Dava. *Galileo's Daughter: A Historical Memoir of Science, Faith, and Love*. New York: Walker, 1999.
- Sproul, Barbara C. *Primal Myths*. San Francisco: HarperSanFrancisco, 1979.
- Steinhardt, Paul, and Neil Turok. "A Cyclic Model of the Universe." *Science*, May 24, 2002, 1436–39.
- Stenger, Victor J. *Has Science Found God? The Latest Results in the Search for Purpose in the Universe*. Amherst, NY: Prometheus Books, 2003.
- . *Not by Design: The Origin of the Universe*. Amherst, NY: Prometheus Books, 1988.
- . *Timeless Reality: Symmetry, Simplicity, and Multiple Universes*. Amherst, NY: Prometheus Books, 2000.
- . *The Unconscious Quantum: Metaphysics in Modern Physics and Cosmology*. Amherst, NY: Prometheus Books, 1995.
- Stone, Andrea. "From Ritual in the Landscape to Capture in the Urban Center: The Recreation of Ritual Environments in Mesoamerica." *Journal of Ritual Studies* 6:1 (1992): 109–32.

- Swinburne, Richard. "Argument from the Fine-Tuning of the Universe." In *Physical Cosmology and Philosophy*, ed. John Leslie, 154–73. New York: Macmillan, 1990.
- Taylor, Stuart Ross. *Destiny or Chance: Our Solar System and Its Place in the Cosmos*. Cambridge: Cambridge University Press, 1998.
- Tegmark, Max. "Is 'The Theory of Everything' Merely the Ultimate Ensemble Theory?" *Annals of Physics* 270 (1998): 1–51.
- Tipler, Frank J. *The Physics of Immortality: Modern Cosmology and the Resurrection of the Dead*. New York: Doubleday, 1994.
- Triulzi, Allesandro. "Oromo Traditions of Origin." Paper presented at the International Conference of Ethiopian Studies, Paris, 1987.
- Tryon, Edward. "Is the Universe a Vacuum Fluctuation?" *Nature*, December 14, 1973, 396–97.
- Van Till, Howard. *The Fourth Day*. Grand Rapids, MI: Eerdmans, 1986.
- Vansina, Jan. *Oral Tradition as History*. Madison: University of Wisconsin Press, 1985.
- Weinberg, Steven. "The Cosmological Constant Problem." *Reviews of Modern Physics* 61 (1989): 1–23.
- . *Dreams of a Final Theory*. New York: Pantheon, 1992.
- Westfall, Richard H. *Never at Rest: A Biography of Isaac Newton*. Cambridge: Cambridge University Press, 1980.
- Westfall, Richard S. *Essays on the Trial of Galileo*. Notre Dame, IN: Vatican Observatory, 1989.
- Whitcomb, John, Jr., and Henry M. Morris. *The Genesis Flood*. Philadelphia: Presbyterian and Reformed, 1961.
- White, Andrew Dickson. *A History of the Warfare of Science with Theology in Christendom*. 1896. Reprint, New York: Peter Smith, 1990.
- White, Lynn, Jr. "The Historical Roots of Our Ecological Crisis." *Science* 155 (1967): 1203–7.

Ecology, Evolution, and the Natural World

- Alexander, R. *The Biology of Moral Systems*. New York: Aldine de Gruyter, 1987.
- . "Evolution of the Human Psyche." In *The Human Revolution*, ed. C. Stringer. Edinburgh: University of Edinburgh, 1989.
- Aquinas, Thomas. *Summa Theologiae*. Madrid: Biblioteca de Autores Cristianos, 1951.
- arap Chepkwony, Adam K. "African Religion in the Study of Comparative Religion: A Case Study of Kipsigis Religious Practices." D. Phil. dissertation, Moi University, Kenya, 1997.
- Atran, S. "Basic Conceptual Domains." *Mind and Language* 4 (1989): 7–16.
- . "Folkbiology and the Anthropology of Science: Cognitive Universals and Cultural Particulars." *Behavioral and Brain Sciences* 21 (1998): 547–609.
- . "Genesis of Suicide Terrorism." *Science* 299 (2003): 1534–39.
- . *In Gods We Trust: The Evolutionary Landscape of Religion*. New York: Oxford University Press, 2002.
- . "The Neuropsychology of Religion." In *NeuroTheology*, ed. R. Joseph. San Jose, CA: San Jose University Press, 2002.
- . "The Trouble with Memes." *Human Nature* 12 (2001): 351–81.
- , and A. Norenzayan. "Religion's Evolutionary Landscape: Counterintuition, Commitment, Compassion, Communion." *Behavioral and Brain Sciences* 27 (2004): 713–70.
- , and D. Sperber. "Learning Without Teaching." In *Culture, Schooling, and Psychological Development*, ed. L. Tolchinsky-Landsmann. Norwood, NJ: Ablex, 1991.
- Attfield, Robin. *The Ethics of the Global Environment*. Edinburgh: Edinburgh University Press, 1999.
- Ayers, Ed. *God's Last Offer: Negotiating a Sustainable Future*. New York: Four Walls Eight Windows, 1999.
- Barbour, Ian. G. *Religion and Science: Historical and Contemporary Issues*. San Francisco: HarperCollins, 1997.
- Barrow, John D., and Frank J. Tipler. *The Anthropic Cosmological Principle*. Oxford: Oxford University Press, 1986.
- Bateson, G. *Naven*. Stanford, CA: Stanford University Press, 1958.

- Behe, Michael J. *Darwin's Black Box: The Biochemical Challenge to Evolution*. New York: Free Press, 1996.
- Berry, R.J. *God's Book of Works: The Nature and Theology of Nature*. London: Continuum, 2003.
- Bloom, P., and C. Veres. "The Perceived Intentionality of Groups." *Cognition* 71 (1999): B1–B9.
- Bowlby, J. *Attachment and Loss*. Vol. 1, *Attachment*. New York: Basic Books, 1969.
- Boyer, P. *The Naturalness of Religious Ideas*. Berkeley: University of California Press, 1994.
- Boyle, Robert. *Some Considerations Touching the Usefulness of Experimental Natural Philosophy*. London: H. Herringman, 1663.
- . *The Works of the Honourable Robert Boyle*. 6 vols. Ed. Thomas Birch. Hildersheim: Georg Olms, 1966.
- Bracken, Joseph A. *The One in the Many: A Contemporary Reconstruction of the God-World Relationship*. Grand Rapids, MI: Eerdmans, 2001.
- Brooke, John Hedley. *Science and Religion: Some Historical Perspectives*. Cambridge: Cambridge University Press, 1991.
- Buber, Martin. *I and Thou*. Trans. Walter Kaufman. New York: Scribner's, 1970.
- Byaruhanga, A.B.T. "The Theology of Medicine." *Journal of African Religion* 2:1 (1991): 23–33.
- Cahill, L., B. Prins, M. Weber, and J. McGaugh. "Beta-adrenergic Activation and Memory for Emotional Events." *Nature* 371 (1994): 702–4.
- Clark, Stephen R.L. *How to Think about the Earth: Philosophical and Theological Models for Ecology*. London: Mowbray/Continuum, 1993.
- Conway Morris, Simon. *Life's Solution: Inevitable Humans in a Lonely Universe*. Cambridge: Cambridge University Press, 2003.
- Crooke, W. *The Native Races of Northern India*. London: Archibald Constable, 1907.
- Csibra, G., G. Gergely, S. Bíró, O. Koós, and M. Brockbank. "Goal Attribution Without Agency Cues." *Cognition* 72 (1999): 237–67.
- Cunningham, Andrew. "Getting the Game Right: Some Plain Words on the Identity and Invention of Science." *Studies in History and Philosophy of Science* 19 (1988): 365–89.
- Daneel, Marthinus L. *African Earthkeepers*. Maryknoll, NY: Orbis, 2001.
- Darwin, Charles. *The Origin of Species*. London: John Murray, 1859.
- Davies, Paul. *God and the New Physics*. New York: Simon and Schuster, 1983.
- Dawkins, R. *Unweaving the Rainbow*. New York: Houghton Mifflin, 1998.
- Dawkins, Richard. *The Blind Watchmaker: Why the Evidence of Evolution Reveals a Universe Without Design*. New York: W.W. Norton, 1986.
- Deane-Drummond, Celia. *The Ethics of Nature*. Oxford: Blackwell, 2003.
- . *A Handbook in Theology and Ecology*. London: SCM Press, 1996.
- Dembski, William A. *Intelligent Design: The Bridge Between Science and Theology*. Downers Grove, IL: InterVarsity Press, 1999.
- Denton, Michael J. *Nature's Destiny: How the Laws of Biology Reveal Purpose in the Universe*. New York: Free Press, 1998.
- Descartes, René. *The Philosophical Writings of Descartes*. 3 vols. Ed. J. Cottingham, R. Stoothof, and Douglas Murdoch. Cambridge: Cambridge University Press, 1984.
- Dobzhansky, Theodosius. "Nothing in Biology Makes Sense Except in the Light of Evolution." *American Biology Teacher* 35:3 (1973): 125–29.
- Dunbar, R. *Grooming, Gossip, and the Evolution of Language*. London: Faber and Faber, 1996.
- Freeman, Scott, and Jon C. Herron. *Evolutionary Analysis*. 3rd ed. Upper Saddle River, NJ: Pearson Prentice Hall, 2004.
- Geary, D., and K. Huffman. "Brain and Cognitive Evolution." *Psychological Bulletin* 128 (2002): 667–98.
- Gitau, Samson K. *The Environmental Crisis*. Nairobi: Acton, 2000.
- Gottlieb, Roger S., ed. *This Sacred Earth: Religion, Nature, Environment*. 2nd ed. London: Routledge, 2004.
- Greenberg, J., et al. "Evidence for Terror Management Theory II." *Journal of Personality and Social Psychology* 58 (1990): 308–18.
- Griffin, David Ray. "A Naturalistic Trinity." In *Trinity in Process: A Relational Theology of God*, ed. Joseph A. Bracken and Marjorie Hewitt Suchocki. New York: Continuum, 1997.

- Gross, Rita, and Rosemary Radford Ruether. *Religious Feminism and the Future of the Planet: A Buddhist Christian Conversation*. London: Continuum, 2001.
- Guthrie, S. *Faces in the Clouds*. New York: Oxford University Press, 1993.
- Hansen, Holger Bert. *Religion and Politics in East Africa*. Nairobi: E.A.E.P., 1995.
- Harrison, Peter. *The Bible, Protestantism and the Rise of Natural Science*. Cambridge: Cambridge University Press, 1998.
- . “Religion” and the Religions in the English Enlightenment. Cambridge: Cambridge University Press, 1990.
- Heider, F., and S. Simmel. “An Experimental Study of Apparent Behavior.” *American Journal of Psychology* 57 (1944): 243–59.
- Hirschfeld, L., and S. Gelman, eds. *Mapping the Mind*. Cambridge: Cambridge University Press, 1994.
- Jones, Steve. *Darwin’s Ghost: The Origin of Species Updated*. New York: Ballantine, 2000.
- Kirkpatrick, L. “God as a Substitute Attachment Figure.” *Personality and Social Psychology Bulletin* 24 (1998): 961–73.
- Lack, D. *Ecological Adaptations for Breeding in Birds*. London: Methuen, 1968.
- Larmarck, Jean-Baptiste. *Philosophie Zoologique*. Paris: G. Ballière, 1830.
- Laszlo, Ervin. *The Connectivity Hypothesis: Foundations of an Integral Science of Quantum, Cosmos, Life, and Consciousness*. Albany: State University of New York Press, 2003.
- Leopold, Aldo. *A Sand County Almanac*. Commemorative edition. Oxford: Oxford University Press, 1989.
- Lettvin, J., H. Maturana, W. Pitts, and W. McCulloch. “Two Remarks on the Visual System of the Frog.” In *Sensory Communication*, ed. W. Rosenblith. Cambridge, MA: MIT Press, 1961.
- Lindberg, David, and Ronald Numbers, eds. *When Science and Christianity Meet*. Chicago: University of Chicago Press, 2003.
- Lipkind, W. “Carajá Cosmography.” *Journal of American Folk-Lore* 53 (1940): 248–51.
- Mayr, Ernst. *What Evolution Is*. New York: Basic Books, 2001.
- Mbiti, John S. *African Religion and Philosophy*. London: Heinemann, 1969.
- McFague, Sallie. *Models of God: Theology for an Ecological Age*. Philadelphia: Fortress, 1987.
- . *Super, Natural Christians: How We Should Love Nature*. London: SCM Press, 1997.
- McGrath, Alistair. *The Re-enchantment of Nature: Science, Religion, and the Human Sense of Wonder*. London: Hodder and Stoughton, 2002.
- McReady, N. “Adrenergic Blockers Shortly after Trauma Can Block PTSD.” *Clinical Psychiatry News*, February 1999.
- Meadows, Donella H. *Limits to Growth*. New York: New American Library, Penguin, 1977.
- Merchant, Carolyn. *Radical Ecology: The Search for a Liveable World*. New York: Routledge, 1992.
- Miller, Kenneth R. *Finding Darwin’s God: A Scientist’s Search for Common Ground Between God and Evolution*. New York: Cliff Street Books, 1999.
- Nesse, R. “Evolution of Commitment and the Origins of Religion.” *Science and Spirit* 10 (1999): 32–36.
- Newton, Isaac. *The Principia: Mathematical Principles of Natural Philosophy*. Trans. I. Bernard Cohen and Anne Whitman. Berkeley: University of California Press, 1999.
- Northcott, Michael. *Christianity and Environmental Ethics*. Cambridge: Cambridge University Press, 1996.
- Page, Ruth. *God and the Web of Creation*. London: SCM Press, 1996.
- Paley, William. *Natural Theology*. New York: American Tract Society, 1802.
- Peacocke, Arthur. *Theology for a Scientific Age*. Minneapolis: Fortress Press, 1993.
- Pennock, Robert T. *Intelligent Design Creationism and Its Critics: Philosophical, Theological, and Scientific Perspectives*. Cambridge, MA: MIT Press, 2001.
- Pinker, S. *How the Mind Works*. New York: W.W. Norton, 1997.
- Pojman, Louis P. *Global Environmental Ethics*. London: Mayfield, 2000.
- Polkinghorne, John. *The God of Hope and the End of the World*. New Haven, CT: Yale University Press, 2002.
- Premack, D., and A. Premack. “Origins of Social Competence.” In *The Cognitive Neurosciences*, ed. M. Gazzaniga. Cambridge, MA: MIT Press, 1995.

- Primavesi, Anne. *Gaia's Gift: Earth, God and Ourselves After Copernicus*. London: Routledge, 2003.
- Putnam, Robert D. *Bowling Alone*. New York: Simon and Schuster, 2000.
- Pyszczynski, T., J. Greenberg, and S. Solomon. "A Dual Process Model of Defense Against Conscious and Unconscious Death-Related Thoughts: An Extension of Terror Management Theory." *Psychological Review* 106 (1999): 835–45.
- Raven, C.E. *Natural Religion and Christian Theology*. Cambridge: Cambridge University Press, 1953.
- Rolston, Holmes, III. *Conserving Natural Value*. New York: Columbia University Press, 1994.
- . *Environmental Ethics: Duties to and Values in the Natural World*. Philadelphia: Temple University Press, 1988.
- . *Genes, Genesis, and God: Values and Their Origins in Natural and Human History*. Cambridge: Cambridge University Press, 1999.
- Ruether, Rosemary Radford. *Women Healing Earth: Third World Women on Ecology, Feminism, and Religion*. London: SCM Press, 1996.
- Savory, Alan. *Holistic Resource Management*. Covelo, CA: Island, 1988.
- Schaff, Philip. *What Is Church History?* Philadelphia: Lippincott, 1846.
- Seligman, S. "Phobias and Preparedness." *Behavioral Therapy* 2 (1971): 307–20.
- Singer, Peter. *Animal Liberation: A New Ethics for Our Treatment of Animals*. London: Jonathan Cape, 1986.
- Some, Malidoma Patrice. *The Healing Wisdom of Africa*. London: Thorsons, 1997.
- Spelke, E., A. Phillips, and A. Woodward. "Infants' Knowledge of Object Motion and Human Action." In *Causal Cognition*, ed. D. Sperber, D. Premack, and A. Premack. Oxford: Clarendon, 1995.
- Sperber, D. *Explaining Culture*. Oxford: Blackwell, 1996.
- Stenmark, Mikael. *Environmental Ethics and Policy-Making*. Aldershot, UK: Ashgate, 2002.
- Suchocki, Marjorie Hewitt. *The End of Evil: Process Eschatology in Historical Context*. Albany: State University of New York Press, 1988.
- Swenson, Rod. "Thermodynamics, Evolution, and Behavior." In *The Encyclopedia of Comparative Psychology*, ed. G. Greenberg and M. Haraway, 217–26. New York: Garland, 1997.
- Tegmark, M. "Parallel Universes." *Scientific American*, May 2003, 40–51.
- Tinbergen, N. *The Study of Instinct*. New York: Oxford University Press, 1951.
- Toland, John. *Christianity Not Mysterious*. London, 1696.
- United Nations. *Agenda 21*. New York: United Nations Publications, 1992.
- . *Rio Declaration*. New York: United Nations Publications, 1992.
- United Nations Environment Program. *Poverty and the Environment*. Nairobi: UNEP, 1995.
- Verbeek, Theo. "The Invention of Nature: Descartes and Regius." In *Descartes' Natural Philosophy*, ed. Stephen Gaukroger, John Schuster, and John Sutton, 149–67. London: Routledge, 2000.
- Ward, Peter D., and Donald Brownlee. *Rare Earth: Why Complex Life Is Uncommon in the Universe*. New York: Copernicus, 2000.
- Weiner, Jonathon. *The Beak of the Finch: A Story of Evolution in Our Time*. New York: Knopf, 1994.
- White, Lynn. "The Historical Roots of Our Ecological Crisis." *Science* 155 (1967): 1203–7.
- Whitehead, Alfred North. *Adventures of Ideas*. New York: Free Press, 1967.
- . *Process and Reality: An Essay in Cosmology*. Corrected edition. Ed. David Ray Griffin and Donald W. Sherburne. New York: Free Press, 1978.
- Wilson, D.S. *Darwin's Cathedral*. Chicago: University of Chicago Press, 2002.
- Wilson, Edward O. *The Diversity of Life*. New York: W.W. Norton, 1992.
- World Commission on Environment and Development. *Our Common Future*. Oxford: Oxford University Press, 1987.
- Zimmer, Carl. *Evolution: The Triumph of an Idea*. New York: HarperCollins, 2001.

Consciousness, Mind, and the Brain

- Allport, G.W. *The Individual and His Religion*. New York: Macmillan, 1950.
- Alper, Matthew. *The "God" Part of the Brain: A Scientific Interpretation of Human Spirituality and God*. New York: Rogue, 2001.

- Andresen, Jensine. "Meditation Meets Behavioral Medicine: The Story of Experimental Research on Meditation." In *Cognitive Models and Spiritual Maps*, ed. J. Andresen and R.K.C. Forman. Thorverton, UK: Imprint Academic, 2000.
- Ashbrook, James B., and Carol Rausch Albright. *The Humanizing Brain: Where Religion and Neuroscience Meet*. Cleveland: Pilgrim, 1997.
- Atran, Scott. *In Gods We Trust: The Evolutionary Landscape of Religion*. Oxford: Oxford University Press, 2002.
- Austin, James H. "Your Self, Your Brain, and Zen." *Cerebrum* 5:1 (2003): 47–66.
- . *Zen and the Brain: Toward an Understanding of Meditation and Consciousness*. Cambridge, MA: MIT Press, 1998.
- Azari, Nina, et al. "Neural Correlates of Religious Experience." *European Journal of Neuroscience* 13 (2001): 1649–52.
- Banquet, J.P. "Spectral Analysis of the EEG in Meditation." *Electroencephalography and Clinical Neurophysiology* 35 (1973): 143–51.
- Barrett, Justin. *Why Would Anyone Believe in God?* Walnut Creek, CA: AltaMira, 2004.
- Barušs, Imants. *Alterations of Consciousness: An Empirical Analysis for Social Scientists*. Washington, DC: American Psychological Association, 2003.
- . *Authentic Knowing: The Convergence of Science and Spiritual Aspiration*. West Lafayette, IN: Purdue University Press, 1996.
- Begley, Sharon. "Religion and the Brain: In the New Field of 'Neurotheology,' Scientists Seek the Biological Basis of Spirituality. Is God All in Our Heads?" *Newsweek*, May 7, 2001, 50.
- Beit-Hallahmi, B. "Psychology of Religion 1880–1930: The Rise and Fall of a Psychological Movement." *Journal of the History of the Behavioral Sciences* 10 (1974): 84–90.
- Bem, Daryl J., and Charles Honorton. "Does psi exist? Replicable evidence for an anomalous process of information transfer." *Psychological Bulletin* 115 (1994): 4–18.
- Benson, Herbert, and Marg Stark. *Timeless Healing: The Power and Biology of Belief*. New York: Fireside, 1996.
- Benson, Herbert, and Miriam Klipper. *The Relaxation Response*. New York: Harper Torch, 1975.
- Bering, Jesse, and David Bjorklund. "The Natural Emergence of Reasoning About the Afterlife as a Developmental Regularity." *Developmental Psychology* 40 (2004): 17–233.
- Bickle, John. *Psychoneural Reduction: The New Wave*. Cambridge, MA: MIT Press, 1998.
- Binder, K., et al. "Modern Neurosurgery for Psychiatric Disorders." *Neurosurgery* 47:1 (2000): 9–21.
- Blackmore, Susan. *Consciousness: An Introduction*. Oxford: Oxford University Press, 2004.
- Bloomfield, H.H., M.P. Cain, D.T. Jaffe, and R.B. Kory. *TM: Discovering Inner Energy and Overcoming Stress*. New York: Delacorte, 1975.
- Boyer, Pascal. *The Naturalness of Religious Ideas: A Cognitive Theory of Religion*. Berkeley: University of California Press, 1994.
- . *Religion Explained: The Evolutionary Origins of Religious Thought*. New York: Basic Books, 2001.
- Brentano, Franz. *Psychology from an Empirical Standpoint*. London: Routledge and Kegan Paul, 1973.
- Brown, Warren, Nancey Murphy, and H. Newton Maloney, eds. *Whatever Happened to the Soul? Scientific and Theological Portraits of Human Nature*. Minneapolis: Fortress, 1998.
- Bulkeley, Kelly. *The Evolution of Wonder: A Critical Dialogue Between Religious Studies and Cognitive Neuroscience*. New York: Routledge, 2004.
- Buss, David. *Evolutionary Psychology: The New Science of Mind*. 2nd ed. Needham Heights, MA: Allyn and Bacon, 2003.
- Byrd, Randolph C. "Positive Therapeutic Effects of Intercessory Prayer in a Coronary Care Unit Population." *Southern Medical Journal* 81 (1988): 826–29.
- Cardeña, Etzel, Steven J. Lynn, and Stanley Krippner, eds. *Varieties of Anomalous Experience: Examining the Scientific Evidence*. Washington, DC: American Psychological Association, 2000.
- Carrette, Jeremy R. "Post-structuralism and the Psychology of Religion: The Challenge of Critical Psychology." In *Religion and Psychology: Mapping the Terrain*, ed. W.B. Parsons. London: Routledge, 2001.

- . “The Return to James: Psychology, Religion and the Amnesia of Neuroscience.” In *The Varieties of Religious Experience*, centenary edition, ed. J.R. Carrette. New York: Routledge, 2002.
- Cohen, A.B., and P. Rozin. “Religion and the Morality of Mentality.” *Journal of Personality and Social Psychology* 81 (2001): 697–710.
- Connor, Steve. “God Spot Is Found in Brain.” *The Sunday Times*, November 2, 1997, 19.
- Corcoran, Kevin, ed. *Soul, Body, and Survival*. Ithaca, NY: Cornell University Press, 2001.
- Damasio, Antonio R. *The Feeling of What Happens: Body and Emotion in the Making of Consciousness*. New York: Harcourt Brace, 1999.
- D’Aquili, Eugene, and Andrew Newberg. *The Mystical Mind: Probing the Biology of Religious Experience*. Minneapolis: Fortress, 1999.
- Davidson, Richard J., et al. “Alterations in Brain and Immune Function Produced by Mindfulness Meditation.” *Psychosomatic Medicine* 65 (2003): 564–70.
- Dennett, Daniel. *Consciousness Explained*. New York: Little, Brown, 1992.
- Descartes, René. *The Philosophical Works of Descartes*. Vol. 2. Trans. E.S. Haldane and G.R.T. Ross. Cambridge: Cambridge University Press, 1911.
- Devinsky, Orrin. “Religious Experiences and Epilepsy.” *Epilepsy and Behavior* 4:1 (February 2003): 76–77.
- Diefenbach, G., et al. “Portrayal of Lobotomy in the Popular Press: 1935–1960.” *Journal of the History of the Neurosciences* 8:1 (1999): 60–69.
- Dossey, Larry. *Healing Words*. New York: Harper, 1993.
- Emmons, R.A., and R.F. Paloutzian. “The Psychology of Religion.” *Annual Review of Psychology* 54 (2003): 377–402.
- Evans, E. Margaret. “Cognitive and Contextual Factors in the Emergence of Diverse Belief Systems: Creation versus Evolution.” *Cognitive Psychology* 42 (2001): 217–66.
- Fetzer Institute. *Multidimensional Measurement of Religiousness/Spirituality for Use in Health Research*. Kalamazoo, MI: Fetzer Institute, 1999.
- Foster, John. *The Immaterial Self*. London: Routledge, 1991.
- Franks-Davis, Caroline. *The Evidential Force of Religious Experience*. Oxford: Oxford University Press, 1989.
- Freeman, R., et al. *Psychosurgery in the Treatment of Mental Disorders and Intractable Pain*. Springfield, IL: Charles C. Thomas, 1942.
- Fremon, Frank R. “A Differential Diagnosis of the Inspirational Spells of Muhammad the Prophet of Islam.” *Epilepsia* 17:4 (December 1976): 423–27.
- Freud, S. *Civilization and Its Discontent*. Trans. J. Strachey. New York: W.W. Norton, 1961.
- . “The Future of an Illusion.” In *The Complete Psychological Works*, ed. and trans. J. Strachey, vol. 21, 1–56. London: Hogarth, 1927, 1953.
- . *Totem and Taboo*. New York: W.W. Norton, 1913, 1950.
- Gazzaniga, Michael S., ed. *The New Cognitive Neurosciences*. Cambridge, MA: MIT Press, 2000.
- Glueck, B.C., and C.F. Stroebel. “Biofeedback and Meditation in the Treatment of Psychiatric Illnesses.” *Comprehensive Psychiatry* 16 (1975): 303–21.
- Gorsuch, R.L. “Psychology of Religion.” *Annual Review of Psychology* 39 (1988): 201–21.
- Grinspoon, Lester, and James B. Bakalar. *Psychedelic Drugs Reconsidered*. New York: Basic Books, 1979.
- Guthrie, Stewart. *Faces in the Clouds: A New Theory of Religion*. Oxford: Oxford University Press, 1993.
- Hall, G.S. “The Moral and Religious Training of Children.” *Princeton Review* 9 (1882): 26–48.
- Hamilton, William. “The Genetical Evolution of Social Behavior.” *Journal of Theoretical Biology* 7 (1964): 1–52.
- Hasker, William. *The Emergent Self*. Ithaca, NY: Cornell University Press, 1999.
- Hay, P., et al. “Treatment of Obsessive-Compulsive Disorder by Psychosurgery.” *Acta Psychiatrica Scandinavica* 87 (1993): 197–207.
- Hill, P.C., and R.W. Hood, eds. *Measures of Religiosity*. Birmingham, AL: Religious Education, 1999.
- Hirschfeld, Lawrence. *Race in the Making: Cognition, Culture, and the Child’s Construction of Human Kinds*. Cambridge, MA: Bradford Books, 1996.

- Hirschfeld, Lawrence, and Susan Gelman. *Mapping the Mind: Domain Specificity in Cognition and Culture*. Cambridge: Cambridge University Press, 1994.
- Hogue, David. *Remembering the Future, Imagining the Past: Story, Ritual, and the Human Brain*. Cleveland: Pilgrim, 2003.
- Hood, R.W. "Psychology of Religion." In *Encyclopedia of Religion and Society*, ed. W.H. Swatos and P. Kvisto, 388–91. Walnut Creek, CA: AltaMira, 1998.
- Hurley, R., et al. "Treatment of Mental Illness: Impact of Imaging." *Journal of Neuropsychiatry and Clinical Neuroscience* 12:4 (2000): 421–24.
- Husserl, Edmund. *The Crisis of European Sciences and Transcendental Phenomenology*. Trans. D. Carr. Evanston, IL: Northwestern University Press, 1970.
- . *Ideas: General Introduction to a Pure Phenomenology*. Trans. W.R. Boyce Gibson. London: Allen and Unwin, 1931.
- Ingelhart, R., and P. Norris. *Sacred and Secular: Religion and Politics Worldwide*. New York: Cambridge University Press, 2004.
- Jacobs, David M., ed. *UFOs and Abductions: Challenging the Borders of Knowledge*. Lawrence: University Press of Kansas, 2000.
- James, W. *The Varieties of Religious Experience*. Cambridge, MA: Harvard University Press, 1902, 1985.
- Kalb, C. "Faith and Healing." *Newsweek*, November 10, 2003, 44–56.
- Kelemen, Deborah. "Why Are Rocks Pointy? Children's Preferences for Teleological Explanations of the Natural World." *Developmental Psychology* 35 (1999): 1440–52.
- Kelley, David. *The Evidence of the Senses: A Realist Theory of Perception*. Baton Rouge: Louisiana State University Press, 1986.
- Kim, Jaegwon. *Mind in a Physical World*. Cambridge, MA: MIT Press, 1998.
- . *Philosophy of Mind*. Boulder, CO: Westview, 1996.
- Kirsch, Irving, Antonio Capafons, Etzel Cardeña-Buelna, and Salvador Amigó, eds. *Clinical Hypnosis and Self-regulation: Cognitive-Behavioral Perspectives*. Washington, DC: American Psychological Association, 1999.
- Kramer, M. "The 1951 Survey of the Use of Psychosurgery in Proceedings of the Third Research Conference on Psychosurgery." PHS Publication No. 221, 1954.
- Kryger, Meir H., Thomas Roth, and William C. Dement, eds. *Principles and Practice of Sleep Medicine*. 3rd ed. Philadelphia: W.B. Saunders, 2000.
- Landsborough, D. "St. Paul and Temporal Lobe Epilepsy." *Journal of Neurology, Neurosurgery, and Psychiatry* 50:6 (1987): 659–64.
- Lawson, E. Thomas, and Robert N. McCauley. *Rethinking Religion: Connecting Cognition and Culture*. Cambridge: Cambridge University Press, 1990.
- Lazar, Sara W., et al. "Functional Brain Mapping of the Relaxation Response and Meditation." *NeuroReport* 11:7 (2000): 1581–85.
- LeDoux, Joseph. *The Emotional Brain: The Mysterious Underpinnings of Emotional Life*. New York: Touchstone, 1996.
- . *Synaptic Self: How Our Brains Become Who We Are*. New York: Viking, 2002.
- Lehman, A., et al. "Translating Research into Practice: The Schizophrenia Patient Outcomes Research Team (PORT) Treatment Recommendations." *Schizophrenia Bulletin* 24:1 (1998): 1–10.
- Livingston, Kenneth R. "Religious Practice, Brain, and Belief." *Journal of Cognition and Culture* 5:1 (2002): 75–117.
- Lou, Hans C., et al. "A 150-Hz PET Study of Meditation and the Resting State of Normal Consciousness." *Human Brain Mapping* 7 (1999): 98–105.
- MacLean, Paul D. *The Triune Brain in Evolution: Role in Paleocerebral Functions*. New York: Plenum, 1990.
- Makarec, Katherine, and Michael A. Persinger. "Temporal Lobe Signs: Electroencephalographic Validity and Enhanced Scores in Special Populations." *Perceptual and Motor Skills* 60:3 (1985): 831–42.
- Marx, Karl. "Critique of Hegel's 'Philosophy of Right.'" Trans. Annette Jolin and Joseph O'Mally. Cambridge: Cambridge University Press, 1844, 1970.
- Maslow, A.H. *Religions, Values, and Peak-Experiences*. Columbus: Ohio State University Press, 1964.

- McCauley, Robert N., and E. Thomas Lawson. *Bringing Ritual to Mind: Psychological Foundations of Cultural Forms*. Cambridge: Cambridge University Press, 2002.
- McCullough, M.E., et al. "Religious Involvement and Mortality: A Meta-analytic Review." *Health Psychology* 19 (2000): 211–22.
- Merleau-Ponty, Maurice. *Phenomenology of Perception*. Trans. C. Smith. London: Routledge and Kegan Paul, 1962.
- Merrell-Wolff, Franklin. *Franklin Merrell-Wolff's Experience and Philosophy: A Personal Record of Transformation and a Discussion of Transcendental Consciousness*. Albany: State University of New York Press, 1994.
- . *Transformations in Consciousness: The Metaphysics and Epistemology*. Albany: State University of New York Press, 1995.
- Michelson, Larry K., and William J. Ray, eds. *Handbook of Dissociation: Theoretical, Empirical, and Clinical Perspectives*. New York: Plenum, 1996.
- Miller, George. "The Magical Number Seven, Plus or Minus Two." *Psychological Review* 63 (1956): 81–97.
- Miller, W.R., and C.E. Thoreson. "Spirituality, Religion, and Health: An Emerging Research Field." *American Psychologist* 58 (2003): 24–35.
- Moreland, J.P., and Scott B. Rae. *Body and Soul*. Downers Grove, IL: InterVarsity Press, 2000.
- Morowitz, Harold J. *The Emergence of Everything: How the World Became Complex*. New York: Oxford University Press, 2002.
- Murray, C., et al. *Summary: The Global Burden of Disease: A Comprehensive Assessment of Mortality and Disability from Diseases, Injuries, and Risk Factors in 1990 and Projected to 2020*. Cambridge, MA: Harvard University Press, 1996.
- National Institute of Mental Health. *Anxiety Disorder*. NIH Publication No. 02-3879, 2000.
- . *Bipolar Disorder*. NIH Publication No. 02-3679, 2001.
- . *Depression*. NIH Publication No. 02-3561, 2000.
- . *Facts about OCD*. NIH Publication No. OM-99 4154, 1999.
- . *Schizophrenia*. NIH Publication No. 02-3517, 1999.
- . *A Story of Bipolar Disorder (Manic-Depressive Illness)*. NIH Publication No. 02-5085, 2002.
- . *Stories of Depression*. NIH Publication No. 02-508, 2003.
- Newberg, Andrew, and Alavi Abass. "Role of Positron Emission Tomography in the Investigation of Neuropsychiatric Disorders." In *Diagnostic Nuclear Medicine*, 4th ed., ed. Michael Sandler et al., 783–819. Philadelphia: Lippincott Williams and Wilkins, 2003.
- , and Eugene G. d'Aquili. "The Neuropsychology of Religious and Spiritual Experiences." *Journal of Consciousness Studies* 7:11–12 (2000): 251–66.
- , and Jeremy Iversen. "The Neural Basis of the Complex Mental Task of Meditation: Neurotransmitter and Neurochemical Considerations." *Medical Hypothesis* 61:2 (2003): 282–91.
- , Eugene d'Aquili, and Vince Rause. *Why God Won't Go Away: Brain Science and the Biology of Belief*. New York: Ballantine, 2001.
- , et al. "The Measurement of Regional Cerebral Blood Flow During the Complex Cognitive Task of Meditation: A Preliminary SPECT Study." *Psychiatry Research: Neuroimaging* 106 (2001): 113–22.
- Nielsen, M.E. *Psychology of Religion in the USA*. 2000. <http://www.psywww.com/psyrelig/USA/html>.
- Pace-Schott, Ed, Mark Solms, Mark Blagrove, and Stevan Harnad, eds. *Sleep and Dreaming: Scientific Advances and Reconsiderations*. Cambridge: Cambridge University Press, 2003.
- Paivio, Allan. *Imagery and Verbal Processes*. New York: Holt, Rinehart and Winston, 1971.
- Pargament, K. "The Bitter and the Sweet: An Evaluation of the Costs and Benefits of Religiosity." *Psychological Inquiry* 13 (2002): 168–81.
- . *The Psychology of Religious Coping*. New York: Guilford, 1997.
- Peacocke, Arthur. "Complexity, Emergence, and Divine Creativity." In *From Complexity to Life*, ed. Niels Henrik Gregersen. New York: Oxford University Press, 2003.
- Persaud, R., et al. "Should Neurosurgery for Mental Disorder Be Allowed to Die Out?" *British Journal of Psychiatry* 183 (2003): 195–96.

- Persinger, Michael A. "Experimental Simulation of the God Experience." In *Neurotheology: Brain, Science, Spirituality, Religious Experience*, ed. R. Joseph. San Jose, CA: San Jose University Press, 2002.
- . "The Neuropsychiatry of Paranormal Experiences." *Journal of Neuropsychiatry and Clinical Neurosciences* 13:4 (2001): 515–23.
- . *Neuropsychological Bases of God Beliefs*. New York: Praeger, 1987.
- , and Faye Healey. "Experimental Facilitation of the Sensed Presence: Possible Interca-
lation Between the Hemispheres Induced by Complex Magnetic Fields." *Journal of Ner-
vous and Mental Disease* 190:8 (2002): 533–41.
- Peterson, C., and M.E.P. Seligman. *Character Strengths and Virtues: A Classification and
Handbook*. New York: Oxford University Press; Washington, DC: American Psychological
Association, 2004.
- Piaget, Jean. *The Construction of Reality in the Child*. Trans. M. Cook. New York: Basic Books,
1954.
- Pinker, Steven. *The Blank Slate: The Modern Denial of Human Nature*. New York: Viking,
2002.
- Polkinghorne, John C., ed. *The Work of Love: Creation as Kenosis*. Grand Rapids, MI: Eerdmans,
2000.
- Porter, R. *The Cambridge Illustrated History of Medicine*. Cambridge: Cambridge University
Press, 1996.
- Pressman, Jack D. *Last Resort Psychosurgery and the Limits of Medicine*. Cambridge: Cam-
bridge University Press, 1998.
- Ramachandran, V.S., and Sandra Blakeslee. *Phantoms in the Brain: Probing the Mysteries of
the Human Mind*. New York: William Morrow, 1998.
- Robins, L., et al. *Psychiatric Disorders in America: The Epidemiologic Catchment Area Study*.
New York: Free Press, 1990.
- Russell, Robert John, Nancey Murphy, Theo C. Meyering, and Michael A. Arbib, eds. *Neuro-
science and the Person: Scientific Perspectives on Divine Action*. Notre Dame, IN: Notre
Dame University Press, 1999.
- Schomer, Donald L., et al. "Temporolimbic Epilepsy and Behavior." In *Principles of Behav-
ioral and Cognitive Neurology*, 2nd ed., ed. M. Marsel Mesulam, 373–405. Oxford: Oxford
University Press, 2000.
- Sethi, S., and M.E.P. Seligman. "Optimism and Fundamentalism." *Psychological Science* 4
(1993): 256–59.
- Shear, Jonathon. "Experimental Studies of Meditation." In *Religion and Psychology: Mapping
the Terrain*, ed. W.B. Parsons. London: Routledge, 2001.
- Shepherd, G. *Neurobiology*. Oxford: Oxford University Press, 1994.
- Skinner, B.F. *Science and Human Behavior*. New York: Macmillan, 1953.
- Slone, D. Jason. *Theological Incorrectness: Why Religious People Believe What They Shouldn't*.
Oxford: Oxford University Press, 2004.
- Specter, M. "Rethinking the Brain." *New Yorker*, July 23, 2001, 42–53.
- Spilka, B., R.W. Hood, and R.L. Gorsuch. *Psychology of Religion: An Empirical Approach*.
Englewood Cliffs, NJ: Prentice Hall, 1985.
- Stefurack, T., et al. "Deep Brain Stimulation for Parkinson's Disease Dissociates Mood and Motor
Circuits: A Functional MRI Case Study." *Movement Disorders* 18:12 (2003): 1508–41.
- Stevens, Anthony. *Private Myths: Dreams and Dreaming*. Cambridge, MA: Harvard Univer-
sity Press, 1995.
- Stevenson, Ian. *Reincarnation and Biology: A Contribution to the Etiology of Birthmarks and
Birth Defects*. Westport, CT: Praeger, 1997.
- Swinburne, Richard. *The Evolution of the Soul*. Revised edition. Oxford: Oxford University
Press, 1997.
- Taliaferro, Charles. *Consciousness and the Mind of God*. Cambridge: Cambridge University
Press, 1994.
- Thompson, Richard F. *The Brain: A Neuroscience Primer*. New York: Worth, 2000.
- Tiger, L. *Optimism: The Biology of Hope*. New York: Simon and Schuster, 1979.
- Tomasello, Michael. *The Cultural Origins of Cognition*. Cambridge, MA: Harvard University
Press, 2000.

- U.S. Department of Health Education and Welfare. *Report and Recommendations: Psychosurgery*. Publication No. OS77-0001, 1977.
- Valenstein S. *Great and Desperate Cures*. New York: Basic Books, 1996.
- Ward, Colleen A., ed. *Altered States of Consciousness and Mental Health: A Cross-cultural Perspective*. Newbury Park, CA: Sage, 1989.
- Watts, Fraser. *Theology and Psychology*. Burlington, VT: Ashgate, 2002.
- Whitehouse, Harvey. *Arguments and Icons: Divergent Modes of Religiosity*. Oxford: Oxford University Press, 2000.
- Wieman, Henry N. *The Source of Human Good*. Carbondale: Southern Illinois University Press, 1946.
- World Health Organization. *Mental Health: New Understanding, New Hope*. Geneva: World Health Organization, 2001.
- Wright, Robert. *The Moral Animal: Evolutionary Psychology and Everyday Life*. New York: Pantheon, 1994.
- Wulff, D.W. *Psychology of Religion: Classic and Contemporary Views*. New York: Wiley, 1991.
- Yandell, Keith E. *The Epistemology of Religious Experience*. Cambridge: Cambridge University Press, 1993.

Healers and Healing

- Alvord, Lori A., and Elizabeth Cohen van Pelt. *The Scalpel and the Silver Bear*. New York: Bantam, 1999.
- Arvigo, Rosita. *Sastun*. San Francisco: HarperSanFrancisco, 1995.
- Barnett, T., and P. Blackie. *AIDS in Africa: Its Present and Future Impact*. London: Relhaven, 1992.
- Bascom, William R., and Melville J. Herskovits. *Continuity and Change in African Culture*. Chicago: University of Chicago Press, 1959.
- Benedict, Ruth F. "The Concept of the Guardian Spirit in North America." Memoir No. 9, American Anthropological Association, 1923.
- Benor, Daniel. *Healing Research*. Oxford: Helex, 1992.
- . *Spiritual Healing*. Southfield, MI: Visions, 2001.
- Between Sacred Mountains: Stories and Lessons from the Land*. Chinle, AZ: Rock Point Community School, 1982.
- Bierhorst, John. *The Sacred Path: Spells, Prayers, and Power Songs of the American Indians*. New York: Quill, 1984.
- Blank L., H. Kimball, W. McDonald, et al. "Medical Professionalism in the New Millennium: A Physician Charter 15 Months Later." *Annals of Internal Medicine* 138 (2003): 839–41.
- Brasser, Ted J. "The Creative Visions of a Blackfoot Shaman." *Alberta History* 23:2 (1975).
- Brendtro, L.K., M. Brokenleg, and S. Van Bockern. *Reclaiming Youth at Risk: Our Hope for the Future*. Bloomington, IN: National Education Service, 1990.
- Budge, E.A. Wallis. *A History of Ethiopia: Nubia and Abyssinia*. Vol. 1. 1928. Reprint, Oosterhout, The Netherlands: Anthropological Publications, 1970.
- Byrd, Randolph C. "Positive Therapeutic Effects of Intercessory Prayer in a Coronary Care Unit Population." *Southern Medical Journal* 81:7 (1988): 826–29.
- Clottes, J., and D. Lewis-Williams. *The Shamans of Prehistory: Trance and Magic in the Painted Caves*. New York: Harry Abrams, 1998.
- Cooper-Lewter, N., and H.H. Mitchell. *Soul Theology: The Heart of American Black Culture*. Nashville, TN: Abington, 1991.
- Coulehan, J.L. "Navajo Indian Medicine: Implications for Healing." *Journal of Family Practice* 10:1 (1980): 55–61.
- Cranston, Ruth. *The Miracle of Lourdes*. New York: Doubleday, 1955.
- Daaleman T.P., Frey B. "Spirituality and Religious Beliefs and Practices." *Journal of Family Practice* 48 (1999): 98–104.
- Donald, M. *Origins of the Modern Mind*. Cambridge, MA: Harvard University Press, 1991.
- Dopamu, A. "Health and Healing within the Traditional African Religious Context." *Oritabadan Journal of Religious Studies* 17:2 (1985): 66–80.

- Dossey, Larry. *Healing Words*. San Francisco: HarperSanFrancisco, 1993.
- . *Reinventing Medicine*. San Francisco: HarperSanFrancisco, 1999.
- . "The Return of Prayer." *Alternative Therapies in Health and Medicine* 3 (1997): 10–17, 113–20.
- . "What's Love Got to Do with It?" *Alternative Therapies* 2 (1996): 8–15.
- Dufrene, P.M. "Exploring Native American Symbolism." *Journal of Multicultural and Cross-Cultural Research in Art Education* 8 (1990): 38–50.
- Dulaney, S., and A. Fiske. "Cultural Rituals and Obsessive-Compulsive Disorder: Is There a Common Psychological Mechanism?" *Ethos* 22 (1994): 243–83.
- Eliade, Mircea. *Shamanism: Archaic Techniques of Ecstasy*. New York: Pantheon, 1964.
- Emerick, Elizabeth J. "Death and the Corpse: An Analysis of the Treatment of Death and Dead Bodies in Contemporary American Society." *Anthropology of Consciousness* 11:2–3 (2000): 33–47.
- Engelhardt, H. Tristram. "Redefining Death: The Mirage on Consensus." In *The Definition of Death: Contemporary Controversies*, ed. Youngner et al., 319–31. Baltimore: Johns Hopkins University Press, 1999.
- Evans-Wentz, W.Y. *The Tibetan Book of the Dead*. New York: Oxford University Press, 1960.
- Fábrega, H. *Evolution of Sickness and Healing*. Berkeley: University of California Press, 1997.
- Falk, Catherine. "Upon Meeting the Ancestors: The Hmong Funeral Ritual in Asia and Australia." <http://www.como.stpaul.k12.mn.us>.
- Fenwick, Peter, and Elizabeth Fenwick. *The Truth in the Light: An Investigation of Over 200 Near-Death Experiences*. New York: Berkley Books, 1995.
- Fiske, Alan, and Nick Haslam. "Is Obsessive-Compulsive Disorder a Pathology of the Human Disposition to Perform Socially Meaningful Rituals? Evidence of Similar Content." *Journal of Nervous and Mental Disease* 185:4 (1994): 211–22.
- Frank, Jerome. *Persuasion and Healing*. Baltimore: Johns Hopkins University Press, 1961.
- Frecska, E., and Z. Kulcsar. "Social Bonding in the Modulation of the Physiology of Ritual Trance." *Ethos* 17:1 (1989): 70–87.
- Garrett, J.T., and M.T. Garrett. *The Cherokee Full Circle: A Practical Guide to Ceremonies and Traditions*. Rochester, VT: Bear, 2002.
- . *Medicine of the Cherokee: The Way of Right Relationship*. Santa Fe, NM: Bear, 1996.
- Garrett, M.T. "Reflection by the Riverside: The Traditional Education of Native American Children." *Journal of Humanistic Education and Development* 35 (1996): 12–28.
- . "Understanding the 'Medicine' of Native American Traditional Values: An Integrative Review." *Counseling and Values* 43 (1999): 84–98.
- . *Walking on the Wind: Cherokee Teachings for Harmony and Balance*. Santa Fe, NM: Bear, 1998.
- Getatchew Haile. "The Case of the Ἐstifanosites: A Fundamentalist Sect in the Church of Ethiopia." *Paideuma* 29 (1983): 115–16.
- . *A Catalogue of Ethiopian Manuscripts Microfilmed for the Ethiopian Manuscript Microfilm Library, Addis Ababa, and for the Hill Monastic Manuscript Library, Collegeville*. Vol. 9. Project Numbers 3501–4000. Collegeville, MN: Hill Monastic Manuscript Library, 1987.
- Gold, Peter. *Navajo and Tibetan Sacred Wisdom: The Circle of the Spirit*. Rochester, VT: Inner Traditions International, 1994.
- Good Tracks, J.G. "Native American Non-interference." *Social Work* 17 (1973): 30–34.
- Goss, Robert. "Tibetan Buddhism and the Resolution of Grief: The Bardo-thodol for the Dying and the Grieving." *Death Studies* 21:4 (1997): 377–95.
- Greeley, Andrew. "Devotions, Defections, Activities, and Attitudes." *Religious Change in America*. Cambridge, MA: Harvard University Press, 1989.
- Green, Celia E., and C. McCreery. *Apparitions*. New York: St. Martin's, 1975.
- Green, Judith. "The Healing Energy of Love." *Alternative Therapies* 2 (1996): 46–56.
- "Guidelines for the Determination of Brain Death." Report of the Medical Consultants on the Diagnosis of Death to the President's Commission for the Study of Ethical Problems in Medicine and Biomedical and Behavioral Research. *Journal of the American Medical Association* 246 (1981): 2184–86.
- Gurney, E., and F.W.H. Myers. "On Apparitions Occurring Soon after Death." *Proceedings of the Society for Psychical Research* 5 (1888–1889): 403–85.

- Habenstein, Robert W., and William M. Lamers. *Funeral Customs the World Over*. Milwaukee: Bulfin, 1960.
- Haddis Gabra Mascal. *Mashafa Madhanit: Traditional Ethiopian Medicine*. London: 1988.
- Halifax, Joan. *Shamanic Voices: A Survey of Visionary Narratives*. New York: Dutton, 1979.
- Haraldsson, Erlundur. "Survey of Claimed Encounters with the Dead." *Omega* 19:2 (1988–1989): 103–13.
- Harmer, Ruth Mulvey. *The High Cost of Dying*. New York: Crowell-Collier, 1963.
- Harner, Michael. *The Way of the Shaman*. 3rd ed. San Francisco: Harper and Row, 1990.
- Harris, William. "A Randomized, Controlled Trial of the Effects of Remote, Intercessory Prayer on Outcomes in Patients Admitted to the Coronary Care Units." *Annals of Internal Medicine* 19 (1999): 2273–78.
- Hermann, Robert, ed. *God, Science, and Humility*. Philadelphia: Templeton Foundation Press, 2000.
- Herring, R.D. "The Clown or Contrary Figure as a Counseling Intervention Strategy with Native American Indian Clients." *Journal of Multicultural Counseling and Development* 22 (1994): 153–64.
- House, James S., Karl R. Landis, and Debra Umberson. "Social Relationships and Health." *Science* 241:4865 (1988): 540–45.
- Hultkrantz, A. *Shamanic Healing and Ritual Drama: Health and Medicine in Native North America*. New York: Crossroads, 1992.
- Hummer, Robert A., Richard G. Rogers, Charles B. Nam, and Christopher G. Ellison. "Religious Involvement and U.S. Adult Mortality." *Demography* 36:2 (1999): 273–85.
- Hunt, H. *On the Nature of Consciousness*. New Haven, CT: Yale University Press, 1995.
- Hunt, Norman Bancroft. *Shamanism in North America*. Buffalo: Firefly, 2003.
- Institute of Medicine. *Improving Medical Education: Enhancing the Behavioral and Social Science Content of Medical School Curricula*. Committee on Behavioral and Social Sciences in Medical School Curricula. Washington, DC: National Academy, 2004.
- Iserson, Kenneth V. *Death to Dust: What Happens to Dead Bodies?* Tucson, AZ: Galen, 1994.
- Jones, Constance. *R.I.P.: The Complete Book of Death and Dying*. New York: HarperCollins, 1997.
- Journal of the American Medical Association*. Editorial. 204:6 (1968): 539–40.
- Kalish, R.A., and D.K. Reynolds. "Phenomenological Reality and Post-death Contact." *Journal for the Scientific Study of Religion* 12 (1973): 209–21.
- Kalweit, Holger. *Shamans, Healers, and Medicine Men*. Boston: Shambhala, 1992.
- Kavasch, B., and K. Baar. *American Indian Healing Arts*. New York: Bantam, 1999.
- Kenyatta, Jomo. *Facing Mount Kenya*. Nairobi: Heinemann Kenya, 1938.
- Kiecolt-Glaser, J.K. "Psychoneuroimmunology and Cancer: Fact or Fiction?" *European Journal of Cancer* 35:11 (1999): 1603–7.
- Koenig, Harold G., Harvey Jay Cohen, Linda K. George, Judith C. Hays, David B. Larson, and Dan G. Blazer. "Attendance at Religious Services, Interleukin-6, and Other Biological Parameters of Immune Function in Older Adults." *International Journal for Psychiatry in Medicine* 27:3 (1997): 233–50.
- , Michael E. McCullough, and David B. Larson. *Handbook of Religion and Health*. New York: Oxford University Press, 2001.
- LaGrand, Louis E. *After Death Communication: Final Farewells*. St. Paul, MN: Llewellyn, 1998.
- Lake, M.G. *Native Healer: Initiation into an Ancient Art*. Wheaton, IL: Quest Books, 1991.
- Lama, Uday. "Funeral Rites of the Hindus and the Buddhists." <http://www.webhealing.com/articles/lama.html>.
- Laughlin, C. "Body, Brain, and Behavior: The Neuroanthropology of the Body Image." *Anthropology of Consciousness* 8:2–3 (1997): 49–68.
- , J. McManus, and E. d' Aquili. *Brain, Symbol, and Experience Toward a Neurophenomenology of Consciousness*. New York: Columbia University Press, 1992.
- Levin, Jeff. *God, Faith, and Health*. New York: John Wiley and Sons, 2001.
- . "The Power of Love." *Alternative Therapies* 5 (1999): 79–86.
- Levin, Jeffrey S. "How Prayer Heals: A Theoretical Model." *Alternative Therapies in Health and Medicine* 2:1 (1996): 66–73.

- Lewis-Williams, D. *The Mind in the Cave*. London: Thames and Hudson, 2002.
- Lindemann, Eric. "Symptomatology and the Management of Acute Grief." *Journal of Psychiatry* 101 (1944): 141–48.
- Lo, B., T. Quill, and J. Tulsky. "Discussing Palliative Care with Patients." *Annals of Internal Medicine* 130 (1999): 744–49.
- Lock, Margaret. *Twice Dead: Organ Transplants and the Reinvention of Death*. Berkeley: University of California Press, 2002.
- Locust, C. "Wounding the Spirit: Discrimination and Traditional American Indian Belief Systems." *Harvard Educational Review* 58 (1988): 315–30.
- Malinowski, Bronislaw. *Magic, Science, and Religion*. New York: Doubleday, 1948.
- Mandell, A. "Toward a Psychobiology of Transcendence: God in the Brain." In *The Psychobiology of Consciousness*, ed. D. Davidson and R. Davidson, 379–464. New York: Plenum, 1980.
- Marnham, Patrick. *Lourdes: A Modern Pilgrimage*. New York: Image Books, 1980.
- Matheson, L. "Valuing Spirituality Among Native American Populations." *Counseling and Values* 41 (1996): 51–58.
- Mbiti, John S. *Introduction to African Religion*. London: Heinemann, 1975.
- McClennon, J. *Wondrous Healing: Shamanism, Human Evolution, and the Origin of Religion*. DeKalb: Northern Illinois University Press, 2002.
- McCrinkle, J.W. *The Christian Topography of Cosmas, an Egyptian Monk*. London: Hakluyt Society, 1897.
- McEwen, Bruce S. "Protective and Damaging Effects of Stress Mediators." *New England Journal of Medicine* 338:3 (1998): 171–79.
- McLean, P. *The Triune Brain in Evolution*. New York: Plenum, 1990.
- Mercier, Jacques. *Ethiopian Magic Scrolls*. New York: George Braziller, 1979.
- Mikkor, Marika. "On the Customs Related to Death in the Erza Villages of Sabajevo and Povodimovo." <http://haldjas.folklore.ee/folklore>.
- Miles, Steven. "Death in a Technological and Pluralistic Culture." In *The Definition of Death: Contemporary Controversies*, ed. Stuart J. Youngner et al., 311–18. Baltimore: Johns Hopkins University Press, 1999.
- Miller, Sukie. *After Death: Mapping the Journey*. New York: Simon and Schuster, 1997.
- Miller, William R., and Carl E. Thoresen. "Spirituality, Religion, and Health: An Emerging Research Field." *American Psychologist* 58:1 (2003): 24–35.
- Mitford, Jessica. *The American Way of Death*. New York: Simon and Schuster, 1963.
- Moyers, Bill. *Healing and the Mind*. New York: Doubleday, 1993.
- Oman, Doug, and Carl E. Thoresen. "Does Religion Cause Health?: Differing Interpretations and Diverse Meanings." *Journal of Health Psychology* 7:4 (2002): 365–80.
- . "Spiritual Modeling: A Key to Spiritual and Religious Growth?" *International Journal for the Psychology of Religion* 13:3 (2003): 149–65.
- Osis, Karlis. *Deathbed Observations of Physicians and Nurses*. New York: Parapsychology Foundation, 1961.
- Pargament, Kenneth I. *The Psychology of Religion and Coping: Theory, Research, Practice*. New York: Guilford, 1997.
- Parrinder, E.G. *Witchcraft*. Bristol, UK: Penguin, 1958.
- Pernick, Martin S. "Brain Death in a Cultural Context: The Reconstruction of Death, 1967–1981." In *The Definition of Death: Contemporary Controversies*, ed. Youngner et al., 3–33.
- Perry, David L. "Ethics and Personhood: Some Issues in Contemporary Neurological Science and Technology." <http://www.scu.edu>.
- Pert, Candace. *Molecules of Emotion*. New York: Touchstone, 1997.
- . "The Psychosomatic Network: Foundations of Mind-Body Medicine." *Alternative Therapies* 4 (1998): 30–41.
- Plotkin, Mark. *Tales of a Shaman's Apprentice: An Ethnobotanist Searches for New Medicines in the Rain Forest*. New York: Penguin, 1994.
- Powell, Lynda H., Leila Shahabi, and Carl E. Thoresen. "Religion and Spirituality: Linkages to Physical Health." *American Psychologist* 58:1 (2003): 36–52.
- Rapoport, J., and A. Fiske. "The New Biology of Obsessive-Compulsive Disorder: Implications for Evolutionary Psychology." *Perspectives in Biology and Medicine* 41:2 (1998): 159–75.

- Red Horse, J.G. "Indian Elders: Unifiers of Families." *Social Casework* 61 (1980): 490–93.
- . "Traditional American Indian Family Systems." *Families, Systems, and Health* 15 (1997): 243–50.
- Rees, W.D. "The Bereaved and Their Hallucinations." In *Beyond Grief*, ed. Eric Lindemann, 66–71. New York: Jason Aronson, 1979.
- Rix, Bo Andreassen. "Brain Death, Ethics, Politics in Denmark." In *The Definition of Death: Contemporary Controversies*, ed. Youngner et al., 227–38. Baltimore: Johns Hopkins University Press, 1999.
- Rufinus. *Historia Ecclesiastica*. In *Patrologia Latina*, ed. J.P. Migne, vol. 21, cols. 478–80. Alexandria, VA: Chadwyck-Healey, 1995.
- Russell, G. *American Indian Facts of Life: A Profile of Today's Tribes and Reservations*. Phoenix, AZ: Russell, 1997.
- Samuels, M. "Environmental Design Technologies: Strategies for Incorporating Art as a Healing Force." *Journal of Healthcare Design* 8 (1996): 137–38.
- Sicher, Fred, Elisabeth Targ, Dan Moore, and Helene S. Smith. "A Randomized, Double-blind Study of the Effects of Distant Healing in a Population with Advanced AIDS." *Western Journal of Medicine* 169 (1998): 356–63.
- Sindiga, Isaac, ed. *Traditional Medicine in Africa*. Nairobi: East African Educational Publishers, 1995.
- Sloan, Richard P., E. Bagiella, and T. Powell. "Religion, Spirituality, and Medicine." *Lancet* 353:9153 (1999): 664–67.
- Some, Malidoma Patricia. *The Healing Wisdom of Africa*. London: Thorsons, 1997.
- Souders, Paul. "Houses of Power: Rock Art, Shamanism, and Subsistence in the Coso Mountains of California." 1997. <http://axoplasm.com/archeology>.
- Spiegel, David. "Effects of Psychosocial Support on Patients with Metastatic Breast Cancer." *Journal of Psychosocial Oncology* 10 (1992): 113–20.
- Strawbridge, William. "Frequent Attendance at Religious Services and Mortality over 28 Years." *American Journal of Public Health* 87 (1997): 957–61.
- Strawbridge, William J., Richard D. Cohen, Sarah J. Shema, and George A. Kaplan. "Frequent Attendance at Religious Services and Mortality over 28 Years." *American Journal of Public Health* 87:6 (1997): 957–61.
- Strelcyn, Stefan. "Les Ecris Médicaux Ethiopiens." *Journal of Ethiopian Studies* 3:1 (1965): 82–103.
- Strub, Clarence G., and L.G. Frederick. "Darko" Frederick. *The Principles and Practice of Embalming*. Dallas: L.G. Frederick, 1967.
- Sullivan, Jacqueline, Debbie L. Seem, and Chabalewski, Franki. "Determining Brain Death." *Critical Care Nurse* 19:2 (1999): 37–46.
- Supko-McMahon, Joanne D. "Reported Spontaneous Psi in the Funeral Industry." Ph.D. dissertation, Saybrook Institute, San Francisco, CA, 1987.
- Tadesse Tamrat. *Church and State in Ethiopia 1270–1527*. New York: Oxford University Press, 1972.
- Tafoya, T. "Native Gay and Lesbian Issues: The Two-Spirited." In *Ethnic and Cultural Diversity Among Lesbians and Gay Men*, ed. B. Greene, 1–10. Thousand Oaks, CA: Sage, 1997.
- Tessema, S.S. "Traditional Medicine: Past Growth and Future Developments in East Africa." *East Africa Medical Journal* 57:1 (1980): 48–54.
- Thairu, K. *The African Civilisation*. Nairobi: East Africa Literature Bureau, 1975.
- Thomas-Emeagwali, Gloria, ed. *African Systems of Science, Technology, and Art: The Nigerian Experience*. London: Karnak House, 1993.
- Thoresen, Carl E., Doug Oman, and Alex H. S. Harris. "Religious Practices and Their Effects on Health: Judeo-Christian and Scientific Perspectives." In *Judeo-Christian Perspectives on Psychology: Human Nature, Motivation, and Change*, ed. William R. Miller and Harold D. Delaney. Washington, DC: American Psychological Association, 2004.
- Torke, A., N. Garas, W. Sexson, and W.T. Branch Jr. "Medical Care at the End of Life: Views of African American Patients in an Urban Hospital." *Journal of Palliative Medicine* (2005): 593–602.
- Tsehai Berhane Selassie. "An Ethiopian Medical Text-Book Written by Gerazmač Gäbräwäld Arägahāñ Däga Damot." *Journal of Ethiopian Studies* 9:1 (1971): 95–180.
- Turner, Edith, et al. *Experiencing Ritual: A New Interpretation of African Healing*. Philadelphia: University of Pennsylvania Press, 1992.

- Tusak, D.L., J.M. Church, S.A. Strong, and J.A. Grass. "Guided Imagery: A Significant Advance in the Care of Patients Undergoing Elective Colorectal Surgery." *Diseases of the Colon and Rectum* 40:2 (1997): 172–78.
- Ullendorff, Edward. "Hebraic-Jewish Elements in Abyssinian (Monophysite) Christianity." *Journal of Semitic Studies* 1:3 (1956): 216–56.
- Van Lommel, Pim. "Medical Evidence for NDEs." <http://www.skepticalinvestigations.org>.
- Van Lommel, Pim, Ruud van Wees, Vincent Meyers, and Ingrid Elfferich. "Near-death Experience in Survivors of Cardiac Arrest: A Prospective Study in the Netherlands." *Lancet* 358:9298 (2001): 2039–45.
- Vargas, L.A., F. Loya, and J. Hodde-Vargas. "Exploring the Multidimensional Aspects of Grief Reactions." *American Journal of Psychiatry* 146 (1989): 1484–88.
- Veatch, Robert M. "The Conscience Clause: How Much Individual Choice in Defining Death Can Our Society Tolerate?" In *The Definition of Death: Contemporary Controversies*, ed. Stuart J. Youngner et al., 137–60. Baltimore: Johns Hopkins University Press, 1999.
- . "Defining Death: The Role of Brain Function." *Journal of the American Medical Association* 242:18 (1979): 2001–2.
- Vick, R.D., L.M. Smith Sr., and C. Iron Rope Herrera. "The Healing Circle: An Alternative Path to Alcoholism Recovery." *Counseling and Values* 42 (1998): 132–41.
- White, S.P. "Elwood Worcester and the Case for Survival." *Journal of the American Society for Psychological Research* 43 (1949): 98–107.
- Winkelman, M. "Altered States of Consciousness and Religious Behavior." In *Anthropology of Religion: A Handbook of Method and Theory*, ed. S. Glazier, 393–428. Westport, CT: Greenwood, 1997.
- . "Magico-Religious Practitioner Types and Socioeconomic Analysis." *Behavior Science Research* 20:1–4 (1986): 17–46.
- . "Shaman and Other "Magico-Religious Healers": A Cross-cultural Study of Their Origins, Nature and Social Transformation." *Ethos* 18:3 (1990): 308–52.
- . "Shamanism and Cognitive Evolution." *Cambridge Archaeological Journal* 12:1 (2002): 71–101.
- . "Shamanism as Neurotheology and Evolutionary Psychology." *American Behavioral Scientist* 45:12 (2002): 1875–87.
- . *Shamanism: The Neural Ecology of Consciousness and Healing*. Westport, CT: Bergin and Garvey, 2000.
- . *Shamans, Priests, and Witches: A Cross-cultural Study of Magico-Religious Practitioners*. Anthropological Research Papers 44. Tempe: Arizona State University Press, 1992.
- , and W. Andritzky, eds. *Sacred Plants, Consciousness, and Healing: Yearbook of Cross-cultural Medicine and Psychotherapy*. Vol. 6. Berlin: Verlag und Vertrieb, 1996.

Dying and Death

- Ajemian, I., and B.M. Mount, eds. *The R.V.H. Manual on Palliative/Hospice Care*. New York: Arno, 1980.
- Canadian Palliative Care Association. *Palliative Care: Towards a Consensus in Standardized Principles of Practice*. First phase working document. Ottawa, Canada, 1995.
- Congregation for the Doctrine of the Faith. "Declaration on Euthanasia." *Quality of Life*, 1980, 259–64.
- Corr, C.A., and D.M. Corr. "Adult Hospice Day Care." *Death Studies* 16 (1992): 155–71.
- , eds. *Hospice Care: Principles and Practice*. New York: Springer, 1983.
- Corr, C.A., C.M. Nabe, and D.M. Corr. *Death and Dying, Life and Living*. 5th ed. Belmont, CA: Wadsworth, 2005.
- Corr, C.A., K.M. Corr, and S.M. Ramsey. "Alzheimer's Disease and the Challenge for Hospice." In *Living with Grief: Alzheimer's Disease*, ed. K.J. Doka, 211–26. Washington, DC: Hospice Foundation of America, 2004.
- Council on Ethical and Judicial Affairs. "Withholding or Withdrawing Life-Sustaining Medical Treatment." Opinion 2.20, 2.21. American Medical Association, 1994.
- De Vitoria, Francisco. *Relectiones Theologiae*, Relectio 9, de Temperentia. Lugdini, 1587.

- Dorff, Elliot N. *Matters of Life and Death: A Jewish Approach to Modern Medical Ethics*. Philadelphia: Jewish Publication Society, 1998.
- DuBoulay, S. *Cicely Saunders: The Founder of the Modern Hospice Movement*. London: Hodder and Stoughton, 1984.
- Egan, K.A., and M.J. Labyak. "Hospice Care: A Model for Quality End-of-Life Care." In *Textbook of Palliative Nursing*, ed. B.R. Ferrell and N. Coyle, 7–26. New York: Oxford University Press, 2001.
- Emanuel, L.L., C.F. von Gunten, and F.D. Ferris. "Gaps in End-of-Life Care." *Archives of Family Medicine* 9 (2000): 1176–80.
- Emerick, Elizabeth J. "Death and the Corpse: An Analysis of the Treatment of Death and Dead Bodies in Contemporary American Society." *Anthropology of Consciousness* 11:2–3 (2000): 33–47.
- Engelhardt, H. Tristram. "Redefining Death: The Mirage on Consensus." In *The Definition of Death: Contemporary Controversies*, ed. Youngner et al., 319–31. Baltimore: Johns Hopkins University Press, 1999.
- Evans-Wentz, W.Y. *The Tibetan Book of the Dead*. New York: Oxford University Press, 1960.
- Falk, Catherine. "Upon Meeting the Ancestors: The Hmong Funeral Ritual in Asia and Australia." <http://www.como.stpaul.k12.mn.us>.
- Fenwick, Peter, and Elizabeth Fenwick. *The Truth in the Light: An Investigation of Over 200 Near-Death Experiences*. New York: Berkley Books, 1995.
- Field, Marilyn J., and Christine K. Cassel, eds. *Approaching Death: Improving Care at the End of Life*. Committee on Care at the End of Life. Division of Health Care Services, Institute of Medicine. Washington, DC: National Academy, 1997.
- Ford, G. "Terminal Care from the Viewpoint of the National Health Service." In *International Symposium on Pain of Advanced Cancer: Advances in Pain Research and Therapy*, ed. J.J. Bonica and V. Ventafridda, vol. 2, 653–61. New York: Raven, 1979.
- Foster, Z., F.S. Wald, and H.J. Wald. "The Hospice Movement: A Backward Glance at Its First Two Decades." *New Physician* 27 (1978): 21–24.
- French, Roger. *Dissection and Vivisection in the Renaissance*. Aldershot, UK: Ashgate, 1999.
- Galen. *Galen on the Usefulness of the Parts of the Body*. Trans. and Intro. Margaret Tallmadge May. 2 vols. Ithaca, NY: Cornell University Press, 1968.
- . *On Anatomical Procedures*. Trans. and Intro. Charles Singer. Published for the Wellcome Historical Medical Museum by Oxford University Press, 1956.
- Gawande, Atul. "The Final Cut." In *Complications: A Surgeon's Notes on an Imperfect Science*, 187–201. New York: Picador, 2002.
- Goss, Robert. "Tibetan Buddhism and the Resolution of Grief: The Bardo-thodol for the Dying and the Grieving." *Death Studies* 21:4 (1997): 377–95.
- Green, Celia E., and C. McCreery. *Apparitions*. New York: St. Martin's, 1975.
- Greyson, Bruce. "The Near-Death Experience Scale: Construction, Reliability, and Validity." *Journal of Nervous and Mental Disease* 171 (1983): 369–75.
- "Guidelines for the Determination of Brain Death." Report of the Medical Consultants on the Diagnosis of Death to the President's Commission for the Study of Ethical Problems in Medicine and Biomedical and Behavioral Research. *Journal of the American Medical Association* 246 (1981): 2184–86.
- Gurney, E., and F.W.H. Myers. "On Apparitions Occurring Soon After Death." *Proceedings of the Society for Psychological Research* 5 (1888–1889): 403–85.
- Habenstein, Robert W., and William M. Lamers. *Funeral Customs the World Over*. Milwaukee: Bulfin, 1960.
- Halevy, A., and B. Brody. "A Multi-Institution Collaborative Policy on Medical Futility." *Journal of the American Medical Association* 276:7 (1996): 571–74.
- Hamarneh, Sami. "The Physician and the Health Professions in Medieval Islam." *Bulletin of the New York Academy of Sciences* 47 (1971): 1088–1110.
- Haraldsson, Erlandur. "Survey of Claimed Encounters with the Dead." *Omega* 19:2 (1988–1989): 103–13.
- Harmer, Ruth Mulvey. *The High Cost of Dying*. New York: Crowell-Collier, 1963.
- Health Care Ethics Consortium of Georgia. *Report of the Task Force on Futility*. Atlanta: Center for Ethics, Emory University, 1997.

- Hinton, J. "The Physical and Mental Distress of the Dying." *Quarterly Journal of Medicine*, New Series 32 (1963): 1–21.
- Ibn Rushd. *The Distinguished Jurist's Primer*. Trans. Imran Ahsan Khan Nyazee. Reading, UK: Garnet, 1994.
- Iserson, Kenneth V. *Death to Dust: What Happens to Dead Bodies?* Tucson, AZ: Galen, 1994.
- Jacob, Walter, and Moshe Zemer. *Death and Euthanasia in Jewish Law*. Pittsburgh: Freehof Institute of Progressive Halakhah, 1995.
- Jakobovits, Immanuel. *Jewish Medical Ethics*. New York: Bloch, 1975.
- Jakobovits, Yoel. "[Brain Death and] Heart Transplants: The [Israeli] Chief Rabbinate's Directives." *Tradition* 24:4 (1989): 1–14.
- Jones, Constance. *R.I.P.: The Complete Book of Death and Dying*. New York: HarperCollins, 1997.
- Journal of the American Medical Association*. Editorial. 204:6 (1968): 539–40.
- Kalish, R.A., and D.K. Reynolds. "Phenomenological Reality and Post-death Contact." *Journal for the Scientific Study of Religion* 12 (1973): 209–21.
- Lack, S.A., and R.W. Buckingham. *First American Hospice: Three Years of Home Care*. New Haven, CT: Hospice, 1978.
- LaGrand, Louis E. *After Death Communication: Final Farewells*. St. Paul, MN: Llewellyn, 1998.
- Lama, Uday. "Funeral Rites of the Hindus and the Buddhists." <http://www.webhealing.com/articles/lama.html>.
- Lamm, Maurice, with Barry Kinzbrunner. *The Jewish Hospice Manual*. North Woodmere, NY: National Institute for Jewish Hospice; Miami, FL: VITAS Healthcare, 2003.
- Last Acts. *Means to a Better End: A Report on Dying in America Today*. November 2002. <http://www.nhpco.org/files/public/MessagesandQAFinal.pdf>.
- Liegner, L.M. "St. Christopher's Hospice, 1974: Care of the Dying Patient." *Journal of the American Medical Association* 234:10 (1975): 1047–48.
- Lindemann, Eric. "Symptomatology and the Management of Acute Grief." *Journal of Psychiatry* 101 (1944): 141–48.
- Lock, Margaret. *Twice Dead: Organ Transplants and the Reinvention of Death*. Berkeley: University of California Press, 2002.
- Lundberg, George D. "Low-Tech Autopsies in the Era of High-Tech Medicine." *Journal of the American Medical Association* 280:14 (1998): 1273–74.
- Mackler, Aaron. *Life and Death Responsibilities in Jewish Biomedical Ethics*. New York: Jewish Theological Seminary of America [Finkelstein Institute], 2000.
- Malik ibn Anas. *The First Formulation of Islamic Law*. Trans. Aisha Abdurrahman Bewley. Granada, Spain: Madinah, 1997.
- Marks, R., and E. Sachar. "Undertreatment of Medical Inpatients with Narcotic Analgesics." *Annals of Internal Medicine* 78 (1973): 173–81.
- Melzack, R., and P.D. Wall. *The Challenge of Pain*. 3rd ed. New York: Penguin, 1991.
- , J.G. Ofiesh, and B.M. Mount. "The Brompton Mixture: Effects on Pain in Cancer Patients." *Canadian Medical Association Journal* 115:2 (1976): 125–29.
- Mikkor, Marika. "On the Customs Related to Death in the Erza Villages of Sabajevo and Povodimovo." <http://haldjas.folklore.ee/folklore>.
- Miles, Steven. "Death in a Technological and Pluralistic Culture." In *The Definition of Death: Contemporary Controversies*, ed. Stuart J. Youngner et al., 311–18. Baltimore: Johns Hopkins University Press, 1999.
- Miller, P.J., and P.B. Mike. "The Medicare Hospice Benefit: Ten Years of Federal Policy for the Terminally Ill." *Death Studies* 19 (1995): 531–42.
- Miller, Sukie. *After Death: Mapping the Journey*. New York: Simon and Schuster, 1997.
- Mitford, Jessica. *The American Way of Death*. New York: Simon and Schuster, 1963.
- Moody, Raymond. *Life After Life*. New York: Bantam, 1975.
- National Hospice and Palliative Care Organization. *NHPCO Facts and Figures*. Alexandria, VA: NHPCO, 2003.
- . *Standards of Practice for Hospice Programs*. Alexandria, VA: NHPCO, 2000.
- Noyes, R., and J. Clancy. "The Dying Role: Its Relevance to Improved Patient Care." *Psychiatry* 40 (1977): 41–47.
- Osis, Karlis. *Deathbed Observations of Physicians and Nurses*. New York: Parapsychology Foundation, 1961.

- Panicola, Michael. "Catholic Teaching on Prolonging Life: Setting the Record Straight." *Hastings Center Report* 31:6 (2001): 14–25.
- Pernick, Martin S. "Brain Death in a Cultural Context: The Reconstruction of Death, 1967–1981." In *The Definition of Death: Contemporary Controversies*, ed. Youngner et al., 3–33. Baltimore: Johns Hopkins University Press, 1999.
- Perry, David L. "Ethics and Personhood: Some Issues in Contemporary Neurological Science and Technology." <http://www.scu.edu>.
- Reconstructionist Rabbinical College. *Behoref Hayamim: A Values-Based Jewish Guide for Decision Making at the End of Life*. Wyncote, PA: Reconstructionist Rabbinical College, 2002.
- Rees, W.D. "The Bereaved and Their Hallucinations." In *Beyond Grief*, ed. Eric Lindemann, 66–71. New York: Jason Aronson, 1979.
- . "The Distress of Dying." *British Medical Journal* 2 (1972): 105–7.
- Riemer, Jack, and Nathaniel Stampfer. *So That Your Values Live On: Ethical Wills and How to Prepare Them*. Woodstock, VT: Jewish Lights, 1991.
- Ring, Kenneth. *Life at Death: A Scientific Investigation of the Near-Death Experience*. New York: Coward, McCann and Geoghegan, 1980.
- Rispler-Chaim, Vardit. "Postmortem Examinations in Egypt." In *Islamic Legal Interpretation: Muftis and Their Fatwas*, ed. Muhammad Khalid Masud, Brinkley Messik, and David S. Powers, 278–85. Cambridge, MA: Harvard University Press, 1996.
- Rix, Bo Andreassen. "Brain Death, Ethics, Politics in Denmark." In *The Definition of Death: Contemporary Controversies*, ed. Youngner et al., 227–38. Baltimore: Johns Hopkins University Press, 1999.
- Saunders, C.M. "Address by Dame Cicely Saunders." In *The Templeton Foundation Prize for Progress in Religion*, ed. W. Forker, 73–84. Edinburgh: Scottish Academic, 1988.
- . "The Challenge of Terminal Care." In *Scientific Foundations of Oncology*, ed. T. Symington and R.L. Carter, 673–79. London: Heinemann, 1976.
- , ed. *Hospice and Palliative Care: An Interdisciplinary Approach*. London: Edward Arnold, 1990.
- , and N. Sykes, eds. *The Management of Terminal Malignant Disease*. 3rd ed. London: Edward Arnold, 1993.
- , and R. Kastenbaum. *Hospice Care on the International Scene*. New York: Springer, 1997.
- Savage-Smith, Emilie. "Dissection in Medieval Islam." *Journal of the History of Medicine* 50 (1995): 67–110.
- Steinberg, Avraham. *Encyclopedia of Jewish Medical Ethics*. Trans. Fred Rosner. 3 vols. New York: Feldheim, 2003.
- Stoddard, S. *The Hospice Movement: A Better Way of Caring for the Dying*. Rev. ed. New York: Vintage, 1992.
- Strub, Clarence G., and L.G. Frederick. "Darko" Frederick. *The Principles and Practice of Embalming*. Dallas: L.G. Frederick, 1967.
- Sullivan, Jacqueline, Debbie L. Seem, and Chabalewski, Franki. "Determining Brain Death." *Critical Care Nurse* 19:2 (1999): 37–46.
- Supko-McMahon, Joanne D. "Reported Spontaneous Psi in the Funeral Industry." Ph.D. dissertation, Saybrook Institute, San Francisco, CA, 1987.
- SUPPORT Principal Investigators. "A Controlled Trial to Improve Care for Seriously Ill Hospitalized Patients: The Study to Understand Prognoses and Preferences for Outcomes and Risks of Treatments (SUPPORT)." *Journal of the American Medical Association* 274:20 (1995): 1591–98.
- Van Lommel, Pim. "Medical Evidence for NDEs." <http://www.skepticalinvestigations.org>.
- , Ruud van Wees, Vincent Meyers, and Ingrid Elfferich. "Near-death Experience in Survivors of Cardiac Arrest: A Prospective Study in the Netherlands." *Lancet* 358:9298 (2001): 2039–45.
- Vargas, L.A., F. Loya, and J. Hodde-Vargas. "Exploring the Multidimensional Aspects of Grief Reactions." *American Journal of Psychiatry* 146 (1989): 1484–88.
- Veatch, Robert M. "The Conscience Clause: How Much Individual Choice in Defining Death Can Our Society Tolerate?" In *The Definition of Death: Contemporary Controversies*, ed. Stuart J. Youngner et al., 137–60. Baltimore: Johns Hopkins University Press, 1999.

- . “Defining Death: The Role of Brain Function.” *Journal of the American Medical Association* 242:18 (1979): 2001–2.
- Weir, Robert F., and Larry Gostin. “Decisions to Abate Life-Sustaining Treatment for Nonautonomous Patients.” *Journal of the American Medical Association* 264:14 (1990): 1846–53.
- White, S.P. “Elwood Worcester and the Case for Survival.” *Journal of the American Society for Psychical Research* 43 (1949): 98–107.
- Wilkes, E., A.G.O. Crowther, and C.W.K.H. Greaves. “A Different Kind of Day Hospital — For Patients with Preterminal Cancer and Chronic Disease.” *British Medical Journal* 2 (1978): 1053–56.
- Wilkes, E., et al. *Report of the Working Group on Terminal Care of the Standing Subcommittee on Cancer*. London: Her Majesty’s Stationary Office, 1980.
- Winter, Laraine, M. Powell Lawton, and K. Ruckdeschel. “Preferences for Prolonging Life: A Prospect Theory Approach.” *International Journal of Aging and Human Development* 56:2 (2003): 155–70.
- World Health Organization. *Cancer Pain Relief and Palliative Care*. WHO Technical Report Series 804. Geneva, Switzerland: WHO, 1990.
- Youngner, Stuart J., Robert M. Arnold, and Reine Schapiro, eds. *The Definition of Death: Contemporary Controversies*. Baltimore: Johns Hopkins University Press, 1999.

Genetics and Religion

- Barabási, Albert-László. *Linked: How Everything Is Connected to Everything Else and What It Means for Business, Science, and Everyday Life*. New York: Plume, 2003.
- Bonnicksen, Andrea. *Crafting a Cloning Policy: From Dolly to Stem Cells*. Washington, DC: Georgetown University Press, 2002.
- Bronskill, J. “International Ban Proposed on Cloning Humans for Warfare.” *Edmonton Journal*, August 1999, A3.
- Bruce, Donald, and Ann Bruce. *Engineering Genesis: The Ethics of Genetic Engineering in Non-Human Species*. 2nd ed. London: Earthscan, 2004.
- , and Don Horrocks. *Modifying Creation? GM Crops and Foods: A Christian Perspective*. Carlisle, UK: Evangelical Alliance Policy Commission, Paternoster, 2001.
- Caulfield, Timothy. “Human Cloning Laws, Human Dignity, and the Poverty of the Policy Making Dialogue.” *BMC Medical Ethics* 4 (2003): 3–10.
- . “The Regulation of Embryonic Stem Cell Research: A Few Observations on the International Scene.” *Health Law Journal* 11, Special Edition (2003): 87–95.
- Chapman, Audrey R. *Unprecedented Choices: Religious Ethics at the Frontier of Genetic Science*. Minneapolis: Fortress, 1999.
- Cole-Turner, Ronald. *Human Cloning: Religious Responses*. Louisville, KY: Westminster John Knox, 1997.
- . *The New Genesis: Theology and the Genetic Revolution*. Louisville, KY: Westminster John Knox, 1993.
- , and Brent Waters, eds. *God and the Embryo*. Washington, DC: Georgetown University Press, 2003.
- Collins, Francis S., Eric D. Green, Alan E. Guttmacher, and Mark S. Guyer. “A Vision for the Future of Genomics Research.” *Nature* 422 (2003): 835–47.
- Daar, Abdallah, and Lori Sheremeta. “The Science of Stem Cells: Some Implications for Law and Policy.” *Health Law Review* 11 (2002): 5.
- Deane-Drummond, Celia. *Theology and Biotechnology: Implications for a New Science*. London: Geoffrey Chapman, Continuum, 1997.
- , and Bronislaw Szerszynski. *Re-Ordering Nature: Theology, Society, and the New Genetics*. London: T and T Clark, Continuum, 2003.
- Department of Energy. Human Genome Project. http://www.ornl.gov/sci/techresources/Human_Genome/home.shtml.
- Duff, Nancy J. “Seeking the Significant in the Factual.” In *Beyond Cloning: Religion and the Remaking of Humanity*, ed. Ronald Cole-Turner, 84–96. Harrisburg, PA: Trinity Press International, 2001.

- Durkheim, Émile. *The Elementary Forms of Religious Life*. Trans. Karen E. Fields. New York: Free Press, 1995.
- Evans, John H. "Cloning Adam's Rib: A Primer on Religious Responses to Cloning." Report Prepared for the Pew Forum on Religion and Public Life, October 2002. <http://pewforum.org>.
- Foucault, Michel. *The History of Sexuality: An Introduction*. Vol. 1. Trans. Robert Hurley. New York: Vintage Books, 1990.
- . "*Society Must Be Defended*": *Lectures at the Collège de France, 1975–76*. Trans. David Macey. Ed. Mauro Bertani, Arnold Davidson, Alessandro Fontana, and François Ewald. New York: Picador, 2003.
- Fox-Keller, Evelyn. *The Century of the Gene*. Cambridge, MA: Harvard University Press, 2000.
- Gayon, Jean. "From Measurement to Organization: A Philosophical Scheme for the History of the Concept of Heredity." In *The Concept of the Gene in Development and Evolution: Historical and Epistemological Perspectives*, ed. Peter Beurton, Raphael Falk, and Hans-Jörg Rheinberger. Cambridge: Cambridge University Press, 2000.
- Genetics and Public Policy Center. "Attitudes About Reproductive Genetics." December 9, 2002. <http://dnapolicy.stage.labvelocity.com>.
- Giles, Jim, and Jonathan Knight. "Dolly's Death Leaves Researchers Woolly on Clone Ageing Issue." *Nature* 421 (2003): 776.
- "Hearing on Cloning Examines What Is Human." United Press International (UPI), March 19, 2003. <http://www.upi.com>.
- Hood, Leroy. "Biology and Medicine in the Twenty-First Century." In *The Code of Codes: Scientific and Social Issues in the Human Genome Project*, ed. Daniel J. Kevles and Leroy Hood. Cambridge, MA: Harvard University Press, 1992.
- Jonsen, Albert R. *The Birth of Bioethics*. Oxford: Oxford University Press, 1998.
- Keller, Evelyn Fox. *The Century of the Gene*. Cambridge, MA: Harvard University Press, 2000.
- Kevles, Daniel J. *In the Name of Eugenics: Genetics and the Uses of Human Heredity*. Cambridge, MA: Harvard University Press, 1995.
- , and LeRoy Hood. *The Code of Codes: Scientific and Social Issues in the Human Genome Project*. Cambridge, MA: Harvard University Press, 1992.
- Malby, Steven. "Human Dignity and Human Reproductive Cloning." *Health and Human Rights* 6 (2002): 103–35.
- Meilaender, Gilbert. "A Case Against Cloning." In *Beyond Cloning: Religion and the Remaking of Humanity*, ed. Ronald Cole-Turner, 77–83. Harrisburg, PA: Trinity Press International, 2001.
- Messer, Neil, ed. *Theological Issues in Bioethics: An Introduction with Readings*. London: Darton, Longman, and Todd, 2002.
- Mohler, R. Albert, Jr. "The Brave New World of Cloning: A Christian Worldview Perspective." In *Human Cloning: Religious Responses*, ed. Ronald Cole-Turner, 91–103. Louisville, KY: Westminster John Knox, 1997.
- "Morality, Prejudice, and Cloning." Editorial in *Nature* 415 (2002): 349.
- Morange, Michel. *A History of Molecular Biology*. Trans. Matthew Cobb. Cambridge, MA: Harvard University Press, 1998.
- . *The Misunderstood Gene*. Trans. Matthew Cobb. Cambridge, MA: Harvard University Press, 2001.
- National Bioethics Advisory Commission. *Cloning Human Beings*. Rockville, MD, 1997.
- National Human Genome Research Institute. <http://www.genome.gov>.
- "Networks in Biology." *Science* 301:5641 (September 26, 2003): 1863–77.
- Nuffield Council on Bioethics. *Genetics and Human Behaviour: The Ethical Context*. London: Nuffield Council on Bioethics, 2002.
- . *Pharmacogenetics: Ethical Issues*. London: Nuffield Council on Bioethics, 2003.
- Peters, Ted. *Playing God?: Genetic Determinism and Human Freedom*. 2nd ed. London: Routledge, 2003.
- President's Council on Bioethics. *Human Cloning and Human Dignity*. Washington, DC, 2002.
- Proctor, Robert. *Racial Hygiene: Medicine Under the Nazis*. Cambridge, MA: Harvard University Press, 1988.

- Rabinow, Paul. *Anthropos Today: Reflections on Modern Equipment*. Princeton, NJ: Princeton University Press, 2003.
- . *French DNA: Trouble in Purgatory*. Chicago: University of Chicago Press, 1999.
- “Raelian Leader Says Cloning First Step to Immortality.” CNN, December 28, 2002. <http://www.cnn.com>.
- Ramsey, Paul. *Fabricated Man: The Ethics of Genetic Control*. New Haven, CT: Yale University Press, 1970.
- Reiss, Michael, and Richard Straughan. *Improving Nature? The Science and Ethics of Genetic Engineering*. Cambridge: Cambridge University Press, 1996.
- Rhind, Susan, et al. “Human Cloning: Can It Be Made Safe?” *Nature Reviews Genetics* 4 (2003): 855–64.
- Ridley, Matt. *Genome: The Autobiography of a Species in 23 Chapters*. New York: HarperCollins, 1999.
- Saad, Lydia. “Cloning of Humans Is a Turn-Off to Most Americans.” Gallup News Service. May 16, 2002. <http://www.gallup.com>.
- Shannon, Thomas A., and James J. Walter. *The New Genetic Medicine: Theological and Ethical Reflections*. Lanham, MD: Rowman and Littlefield, 2003.
- Shiva, Vandava. *Stolen Harvest*. London: Zed Books, 2001.
- Smith, David H., and Cynthia B. Cohen, eds. *A Christian Response to the New Genetics: Religious, Ethical, and Social Issues*. Lanham, MD: Rowman and Littlefield, 2003.
- Song, Robert. *Human Genetics: Fabricating the Future*. London: Darton, Longman, and Todd, 2002.
- Steinbock, Bonnie. “Cloning Human Beings: Sorting Through the Ethical Issues.” In *Human Cloning: Science, Ethics, and Public Policy*, ed. Barbara MacKinnon, 68–84. Chicago: University of Illinois Press, 2000.
- “Test Tube Babies, 25 Years Later.” CNN, July 28, 2003. <http://www.cnn.com>.
- Tudge, Colin. *The Impact of the Gene: From Mendel’s Peas to Designer Babies*. New York: Hill and Wang, 2001.
- “UN Derails Ban on Human Cloning.” BBC News, November 6, 2003. <http://news.bbc.co.uk>.
- UNESCO. Universal Declaration on the Human Genome and Human Rights. Paris, 1997.
- USA Today/CNN/Gallup Poll Results. *USA Today*, November 28, 2001. <http://www.usatoday.com>.
- Vogel, Gretchen. “Misguided Chromosomes Foil Primate Cloning.” *Science* 300 (2003): 225–27.
- Wade, Nicholas. *Lifescrypt: How the Genome Discoveries Will Transform Medicine and Enhance Your Health*. New York: Simon and Schuster, 2001.
- Watson, James D. *The Double Helix: A Personal Account of the Discovery of the Structure of DNA*. New York: Scribner Classics, 1998.
- , with Andrew Berry. *DNA: The Secret of Life*. New York: Alfred A. Knopf, 2003.
- Wilmut, I., et al. “Viable Offspring Derived from Fetal and Adult Mammalian Cells.” *Nature* 385 (1997): 810–13.
- World Health Organization. Fifty-second Assembly, provisional agenda item 13, Cloning in Human Health. Report by the Secretariat in pursuance of Resolution WHA51.10, A52/12. April 1, 1999. <http://www.who.int>.

About the Authors

Carol Rausch Albright is the author or co-author of four books on the interface of neuroscience and religion. She was the executive editor of *Zygon: Journal of Religion and Science* for nine years and served for six years as regional co-director for the Science and Religion Course Program sponsored by the Center for Theology and the Natural Sciences and the John Templeton Foundation. For more information, see www.carolalbright.org.

Lori Arviso Alvord, M.D., is an associate dean of student and multicultural affairs and assistant professor of surgery and of psychiatry at Dartmouth Medical School. She is the author of *The Scalpel and the Silver Bear: The First Navajo Woman Surgeon Combines Western Medicine and Traditional Healing* (Bantam, 1999).

Adam K. arap Chepkwony, a Kenyan, is an associate professor of religion at Moi University in Kenya. He has a bachelor's degree from Houghton College, a master's degree in religion from Asbury Theological Seminary, and a Ph.D. in religion from Moi University. His focus is comparative religion with special emphasis on African religion. His interest in religion and science developed after he was invited to the Center for Theology and the Natural Sciences (CTNS) at Berkeley, California, in 2000. He won a CTNS/Templeton Foundation Science and Religion Course award in 2002 and the Local Societies Initiative award in 2004.

Mariano Artigas, a Roman Catholic priest, has a Ph.D. in both physics and philosophy and is a professor of the philosophy of science at the University of Navarra, Pamplona, Spain. Recent books include *Galileo in Rome* (Oxford University Press, 2003) and *Negotiating Darwin: The Vatican Confronts Evolution, 1887–1902* (Johns Hopkins University Press, 2006).

Scott Atran is director of research at the Institut Jean Nicod in Paris and an adjunct professor of psychology at the University of Michigan. He received his Ph.D. in anthropology from Columbia University. His research in Mesoamerica concerns universal and culture-specific aspects of biological categorization and reasoning and environmental decision making. He is cur-

rently interviewing jihadists in the Middle East, exploring the limits of rational choice and the role of sacred values among suicide terrorists.

Francisco J. Ayala is University Professor and Donald Bren Professor of Biological Sciences at the University of California, Irvine. He has published more than 850 articles and is author or editor of nineteen books. His scientific research focuses on population and evolutionary genetics, including the origin of species, genetic diversity of populations, the origin of malaria, the population structure of parasitic protozoa, and the molecular clock of evolution. He also writes about the interface between religion and science, and on philosophical issues concerning epistemology, ethics, and the philosophy of biology.

Hazel Ayanga, Ph.D., is a senior lecturer in the Department of Religion at Moi University, Kenya, and current department head. She teaches phenomenology of religion, religion and society, and introduction to the study of religion. She participates in the Science and Religion Dialogue activities and is a member of the Ecumenical Association of Third World Theologians (Kenya) and the Circle of Concerned African Women Theologians.

Imants Barušs is a professor of psychology at King's University College, University of Western Ontario, where he teaches courses in consciousness. His research, mostly concerned with fundamental questions about the nature of consciousness, has been published in psychology, philosophy, anthropology, and science journals. He is the author of several books, including *Authentic Knowing: The Convergence of Science and Spiritual Aspiration* (Purdue University Press, 1996) and *Alterations of Consciousness* (American Psychological Association, 2003).

Christopher W. Beck, an ordained elder in the Presbyterian Church (USA), is a senior lecturer in the Department of Biology at Emory University. He received his Ph.D. in ecology from the Institute of Ecology at the University of Georgia, where he studied life history evolution in the southern toad.

Michael J. Behe received his Ph.D. in biochemistry from the University of Pennsylvania, conducted postdoctoral work on DNA structure at the National Institutes of Health, and is now a professor of biochemistry at Lehigh University. He is currently interested in the question of how deeply into life intelligent design extends.

Ayele Bekerie was born in Ethiopia and earned his Ph.D. in African American Studies at Temple University in 1994. His work is published in scholarly journals such as *ANKH: Journal of Egyptology and African Civilizations*, the *Journal of Black Studies*, the *International Journal of Africana Studies*, and *Imhotep*. He is an assistant professor at the Africana Studies and Research Center of Cornell University.

Gaymon Bennett holds a master's degree from the Graduate Theological Union in theological ethics and is a student in the doctoral studies program in systematic theology. He has served as director of communications for the Science and Religion Course Program at the Center for Theology and the Natural Sciences (CTNS) in Berkeley, where his research focuses on the relationship between science, religion, society, and culture, with particular emphasis on bioethics. He is a research assistant to the Ethics Advisory Board of the Geron Corporation, a company focusing on stem cell research and therapeutics. A published author on the topic of genetics and ethics, he is co-editor, with Ted Peters, of the upcoming *Bridging Science and Religion*.

Joseph Bracken, S.J., retired professor of theology at Xavier University, Cincinnati, Ohio, has written extensively on Trinitarian theology, the process philosophy of Alfred North Whitehead, and topics dealing with religion and science. Recent books are *The One in the Many: A Contemporary Reconstruction of the God-World Relationship* (Eerdmans, 2001) and *Sharing the Riches: Spirituality in an Age of Science*, forthcoming from the Templeton Foundation Press.

William T. Branch Jr., M.D., M.A.C.P., is Carter Smith Sr. Professor of Medicine and director of the Division of General Internal Medicine at Emory University School of Medicine. Prior to joining Emory, he was an associate professor of medicine at Harvard Medical School, where he directed the required patient–doctor relationship course for third-year medical students. His research interests span medical education, patient–doctor communication, palliative care, and ethics.

Kelly Bulkeley, Ph.D., is a visiting scholar at the Graduate Theological Union and a faculty member of the Dream Studies Program at John F. Kennedy University. He is the author and editor of several books on psychology, religion, science, and dreaming, including *The Wondering Brain*, *Visions of the Night*, *An Introduction to the Psychology of Dreaming*, and *The Wilderness of Dreams*.

Timothy Caulfield is the Canada research chair in Health Law and Policy at the University of Alberta and research director for the Health Law Institute. Much of his research has focused on the challenges associated with science policy, including the areas of stem cell and human genetic research.

Charles A. Corr, Ph.D., C.T., is a professor emeritus of Southern Illinois University, Edwardsville, a member of the board of directors of the Hospice Institute of the Florida Suncoast, and a member of the Children's Project on Palliative/Hospice Services (ChiPPS) Leadership Committee of the National Hospice and Palliative Care Organization. His publications in the field of dying, death, and bereavement include more than thirty books and booklets,

as well as over eighty articles and chapters. His most recent publication (co-authored with Clyde M. Nabe and Donna M. Corr) is the fifth edition of *Death and Dying, Life and Living* (Wadsworth, 2005).

Michael J. Crowe is Cavanaugh Professor Emeritus in the Program of Liberal Studies at the University of Notre Dame. He is the author of six books, including *The Extraterrestrial Life Debate 1750–1900*, which was first published by Cambridge University Press and is now available through Dover and in a three-volume Japanese translation.

Celia Deane-Drummond has an M.A. in natural sciences from Cambridge University, a doctorate in plant physiology from Reading and Letcombe Research Station, Oxford University, a Ph.D. in Moltmann's theology from Manchester University, and a P.G.C.E. from Manchester Metropolitan University. She has published over thirty articles in science journals and has been active in research, particularly in relating science to theology. Her first major book was *A Handbook in Theology and Ecology* (SCM, 1996). A recent work is *Creation Through Wisdom: Theology and the New Biology* (T & T Clark, 2000). She was recently awarded a chair in theology and the biological sciences at Chester College.

Vine Deloria Jr., deceased, was a member of the Standing Rock Sioux tribe and professor emeritus in history at the University of Colorado and professor emeritus in law at the University of Oklahoma. A prominent social activist on Native American issues, he was the author of more than twenty books including the seminal *Custer Died for Your Sins: An Indian Manifesto* (1969) and *Red Earth, White Lies: Native Americans and the Myth of Scientific Fact* (1995).

Elliot N. Dorff, rabbi, Ph.D., is rector and Distinguished Professor of Philosophy at the University of Judaism in Los Angeles. He is also vice chair of the Committee on Jewish Law and Standards of Judaism's Conservative Movement; a member of the advisory panel for the Dialogue on Science, Ethics, and Religion of the American Association for the Advancement of Science; and a past member of three federal government advisory commissions on health care, sexual ethics, and research on human subjects. He has written over 150 articles and ten books, including *Matters of Life and Death: A Jewish Approach to Modern Medical Ethics*.

Matthew F. Dowd graduated from the doctoral program in history and philosophy of science at the University of Notre Dame in 2003. He has taught at the University of Notre Dame and St. Mary's College. He is currently a manuscript editor for the University of Notre Dame Press.

Willem B. Drees, a professor of philosophy of religion and ethics, is dean of the faculty of theology, Leiden University. He is the author of *Religion, Science,*

and Naturalism (Cambridge University Press, 1996), *Beyond the Big Bang: Quantum Cosmologies and God* (Open Court, 1990), *Creation: From Nothing until Now* (Routledge, 1996), and various other publications. Since 2002 he has served as president of the European Society for the Study of Science and Theology (ESSSAT).

Phillip H. Duran, of Tigua Indian heritage, is author of the book *Bringing Back the Spirit: Indian Ways of Wholeness for Church and Society in Crisis*. A former faculty member and dean of science and mathematics at Northwest Indian College, he has M.S. degrees in physics and computer science and has nearly completed a Ph.D. in computer science and theoretical physics.

Arri Eisen, Ph.D., earned degrees from the University of North Carolina, Chapel Hill, in biology and the University of Washington, Seattle, in biochemistry. He teaches in the Biology Department and in the Center for Ethics at Emory University and directs the Program in Science and Society. He has published an introductory textbook and numerous articles ranging in topics from science and religion to science education, race, research ethics, and the regulation of genes in flies and yeast.

Gloria Emeagwali has a B.A. in history from the University of the West Indies, a Dip. Ed. from the University of London, an M.A. in history from the University of Toronto, and a Ph.D. in history from Ahmadu Bello University in Nigeria. She has taught at the University of Ilorin in Nigeria, the Nigerian Defence Academy, and Ahmadu Bello University. She joined the Central Connecticut State University faculty in 1991 and was the founding coordinator of the university's African Studies Program. She was a visiting scholar and senior associate member at St. Antony's College, Oxford University, and a visiting scholar at Queen Elizabeth House, Oxford. Her areas of specialization include African studies, pre-colonial West Africa, and Northeast Africa.

Alexander Escobar, senior lecturer in biology at Emory University, won the university's Center for Teaching and Curriculum Award for Excellence in Teaching in 2005. In his recent book *Mythology for the New World: A Synthesis of Science and Religion*, he writes passionately about his belief that all of creation is interconnected. He has a B.S. in genetics and a doctoral degree in biochemistry from the University of California system and has published several scientific papers based on his research.

Kelly D. Foote, M.D., is a graduate of the University of Utah, where he completed a B.S. degree in materials engineering as well as his doctorate of medicine. The university's School of Medicine honored him with the Florence M. Strong Award in recognition of his outstanding qualities as a physician dedicated to patients. He did his general surgery internship at the University of

Florida, where he also completed his residency in neurological surgery, including one year of dedicated training in stereotactic and functional neurosurgery under the mentorship of William Friedman.

Brenda S. Gardenour is a Ph.D. candidate at Boston University and a Fulbright Scholar conducting research at the Biblioteca Nacional, Madrid. Her dissertation, “Medicine and Miracle: The Conjunction of Healing Practices and the Dissemination of Greco-Arabic Medicine in Christian Iberia, 11th to 14th Centuries,” explores the complex relationship between science and religion, the extent of the impact of learned medicine on religious modes of healing, what elements of learned medicine were accepted or rejected, and what patterns can be discerned from the selective diffusion of medical knowledge.

Michael Tlanusta Garrett holds a Ph.D. in counseling and counselor education and an M.Ed. in counseling and development from the University of North Carolina, Greensboro, and a B.A. in psychology from North Carolina State University. He has authored *Walking on the Wind: Cherokee Teachings for Harmony and Balance* (1998) and co-authored *Medicine of the Cherokee: The Way of Right Relationship* (1996), *Cherokee Full Circle: A Practical Guide to Ceremonies and Traditions* (2002), and *Native American Faith in America* (2003).

Marcelo Gleiser is the Appleton Professor of Natural Philosophy and a professor of physics and astronomy at Dartmouth College. He shares his time between his research in cosmology and field theory and his writing, believing that scientists should not shy away from public debate about the consequences and challenges of their work.

Laurence I. Gould, professor of physics at the University of Hartford, has taught physics, math, and interdisciplinary courses in astronomy, musical acoustics, reasoning in science, and (one he created) seeing through symmetry. His areas of specialization, mathematical physics and science education, have resulted in publications in such periodicals as the *International Journal of Theoretical Physics*, *American Journal of Physics*, and *Journal of College Science Teaching*. Honors include Yale visiting fellowships, Who’s Who in Science and Engineering, and membership in the Connecticut Academy of Arts and Sciences. He is past chair of the New England Section of the American Physical Society.

Edward Grant is Distinguished Professor of History and Philosophy of Science Emeritus at Indiana University, Bloomington. He has written and edited eleven books on medieval science and natural philosophy, the last two of which, *God and Reason in the Middle Ages* (2001) and *Science and Religion, 400 B.C.–A.D. 1550: From Aristotle to Copernicus* (2004), are devoted to the theme of science and religion.

Getatchew Haile, B.A., B.D., Ph.D., and F.B.A., is a specialist in Ethiopic literature. He has won several awards in recognition of his scholarly research published as books and articles. At present he is Regents Professor of Medieval Studies and cataloguer emeritus of Oriental manuscripts at the Hill Museum and Manuscript Library, Saint John's University, Collegetown, Minnesota.

Peter Harrison is a professor of history and philosophy at Bond University, Australia. He has written numerous articles on science and religion in the early modern period and is the author of *"Religion" and the Religions in the English Enlightenment* (Cambridge University Press, 1990) and *The Bible, Protestantism, and the Rise of Natural Science* (Cambridge University Press, 1998).

Ralph W. Hood Jr. is a professor of psychology at the University of Tennessee, Chattanooga. He is past president of the division of the Psychology of Religion of the American Psychological Association and a recipient of its William James Award. He is a past editor of the *Journal for the Scientific Study of Religion* and a past co-editor of the *International Journal for the Psychology of Religion*. He currently is a co-editor of *Archiv fur Religionspsychologie*.

Bruce J. Horacek, Ph.D., is J. Terrence Haney Distinguished Professor in the Gerontology Department at the University of Nebraska, Omaha, where his teaching and research specialties are dying, death, grieving, and near death and related experiences. He serves on the editorial board of the *Journal of Near-Death Studies*, has published one book and over forty articles, and is president emeritus of the International Association for Near Death Studies.

Toby E. Huff is a sociologist who has studied comparative historical development in the civilizations of Islam, China, and the West. The second edition of his book *The Rise of Early Modern Science: Islam, China, and the West* was published in 2003. Most recently he is the author of *An Age of Science and Revolutions, 1600–1800* (Oxford University Press, 2005), a middle school text. He is Chancellor Professor Emeritus at the University of Massachusetts, Dartmouth.

John Ikerd was raised on a small dairy farm in southwest Missouri and received his B.S., M.S., and Ph.D. degrees from the University of Missouri. He worked in private industry for a time and spent thirty years in various professorial positions at four major land grant universities before retiring from the University of Missouri in early 2000. Since retiring, he spends most of his time writing and speaking on issues related to the sustainability of agriculture.

Muzaffar Iqbal is the founder and president of the Center for Islam and Science (www.cis-ca.org) and editor of the journal *Islam and Science*. He has a Ph.D. in chemistry from the University of Saskatchewan and has held aca-

demic and research positions in various universities in North America and Pakistan. He currently lives in Alberta, Canada.

Keith James is a professor of occupational health psychology at Colorado State University. His special focus is industrial and organizational psychology.

Ibrahim Kalin is a broadly trained scholar of Islamic studies and teaches at the College of the Holy Cross in Worcester, MA. He specializes in later Islamic philosophy and has written on the religion and science debate as well as on relations between the Islamic world and the West.

E. Barrie Kavasch, an authority on native plants, fungi, cultures, healing, spirituality, shamanic dream work, storytelling, and cuisines, is an ethnobotanist and master herbalist, a culinary historian and author, a botanical illustrator and research associate. She is of Scotch-Irish, German, Chickamauga Cherokee, Creek, and early Powhatan Indian descent and can trace her ancestry back fifteen generations to Chief Powhatan through his daughter Pocahontas.

Kathy Kinlaw is acting director for the Center for Ethics at Emory University and director of the center's Program in Health Sciences Ethics. Particular interests include palliative and end of life care, public health ethics, the intersection of theory and practice in clinical and organizational ethics, and the teaching of ethics.

Rex Koontz teaches pre-Columbian art history at the University of Houston. He is the author of *Mexico* (5th edition) with Michael Coe and senior editor of *Landscape and Power in Ancient Mesoamerica*.

Jeffrey Koperski is an associate professor of philosophy at Saginaw Valley State University. He received his Ph.D. in philosophy from Ohio State University. His primary areas of research are the philosophy of science and the philosophy of religion.

Eva Krugly-Smolka is an associate professor of education, Queen's University, Kingston, and part of the Mathematics, Science, Technology Education Group. She has a doctorate in sociology of education, with a focus on science. She teaches science education methods courses at the B.Ed. level and courses on cultural issues and comparative education at the graduate level. Her research interests are multicultural science education and the interrelationships of science and culture, in which areas she has published. She has served as the president of the Comparative and International Education Society of Canada and is a former editor of its journal, *Canadian and International Education*.

Gary Laderman, an associate professor of American religious history and cultures, received his Ph.D. in religious studies at the University of California, Santa Barbara. He is the author of *The Sacred Remains: American Attitudes Toward Death, 1799–1883* (Yale University Press, 1996), and *Rest of Peace: A Cultural History of Death and the Funeral Home in Twentieth-Century America* (Oxford University Press, 2003). He also co-edited *Religion and American Cultures: An Encyclopedia of Traditions, Diversity, and Popular Expressions* (ABC-CLIO, 2003). Laderman is currently writing his next book, *Godless in America: Sacred Anchors in Contemporary American Society* (Basic, forthcoming).

Kenneth R. Livingston is a professor of psychology and a co-founder of the Program in Cognitive Science at Vassar College. In addition to work on the cognitive science of religion, he conducts research on concept learning in adults, children, and mobile robots.

Natalia Lozovsky is a scholar of medieval sciences, particularly geography, and their relationship to religion and philosophy. She is the author of *“The Earth Is Our Book”*: *Geographical Knowledge in the Latin West, 400–1000* (University of Michigan Press, 2000) and is now working on a project that involves imperial ideology and its influence on ideas about lands and peoples in the Middle Ages.

Margaret R. McLean, Ph.D., is the director of Biotechnology and Healthcare Ethics at the Markkula Center for Applied Ethics at Santa Clara University and the director of the Applied Ethics Center at O’Connor Hospital in San Jose. A senior lecturer in religious studies, she teaches a variety of courses on ethics, including health care ethics, biotechnology and ethics, and ethics in science. She was an advisor to the California Senate Select Committee on Genetics.

Joanne D.S. McMahon, Ph.D., has been working in the field of parapsychology for over two decades. She is the co-author of *Shopping for Miracles: A Guide to Psychics and Psychic Powers*, has written numerous articles, and has consulted on television shows and movies. Her primary focus is the connection with thanatology, including grief and bereavement, the dying process, and survival of bodily death.

J.P. Moreland, Distinguished Professor of Philosophy at the Talbot School of Theology, Biola University, has published over sixty articles in journals such as *Philosophy and Phenomenological Research*, the *American Philosophical Quarterly*, and *Philosophia Christi*. He has contributed to over forty books, including *Universals* (McGill-Queens University Press, 2001) and *Body and Soul* (InterVarsity, 2000), co-authored with Scott Rae.

Shigeru Nakayama graduated from the University of Tokyo, where he majored in astrophysics. When his interest shifted to the history of science, a more humanistic aspect of science, he visited the United States as a Fulbright Scholar and received a Ph.D. in the history of science and learning at Harvard in 1959. He worked with Thomas Kuhn at Harvard and with Joseph Needham at Cambridge; he also worked at the Institute of Humanistic Science, Kyoto.

Andrew B. Newberg, M.D. is an assistant professor in the Department of Radiology and Psychiatry at the University of Pennsylvania. His work is focused on the neurophysiology of religious experience, and he is co-author of the best-selling *Why God Won't Go Away: Brain Science and the Biology of Belief* (Ballantine, 2001).

Michael S. Okun, M.D., co-director of the Movement Disorders Center, is a neurologist and movement disorders expert. His work is supported by grants from the National Institutes of Health and the Michael J. Fox Foundation for Parkinson's Disease Research. He is a faculty member in the Department of History at the University of Florida, and, in addition to founding and administering the History of Medicine lecture series, he teaches an honors course on the history of medicine. He has recently published a book of prose and poetry about the medical school experience, *Lessons from the Bedside*.

Doug Oman, Ph.D., is an adjunct assistant professor in the School of Public Health of the University of California, Berkeley. His recent research has examined how one of the most influential psychological theories, Bandura's social cognitive theory, sometimes termed social learning theory, can be applied to religion and spirituality. He is now studying how an integrated academic/theoretical and meditation-based practical toolkit affects college undergraduates, including their career aspirations, ability to learn from spiritual exemplars, and levels of stress.

Nansook Park is an associate professor of psychology at the University of Rhode Island, where she is affiliated with the School Psychology Program. She is interested in the cultivation of character strengths among children and youth.

Christopher Peterson is a professor of psychology at the University of Michigan and is affiliated with the university's Clinical Psychology Program. His area of interest is positive psychology.

John Polkinghorne, an Anglican priest, is the president of Queens' College, Cambridge University, and a former professor of mathematical physics at Cambridge. He resigned his chair in physics to study for the Anglican priesthood. After completing his theological studies and serving at parishes, he

returned to Cambridge. He has written a series of books on the compatibility of religion and science, including *Science and Creation*, *Science and Providence*, and *Gifford Lectures: The Faith of a Physicist*. He was the recipient of the 2002 Templeton Prize.

V.V. Raman is an emeritus professor of physics and humanities at the Rochester Institute of Technology. He is the author of several books and articles on topics related to science and its impacts on society. He is a member of the executive committee of the Institute on Religion in an Age of Science (IRAS) and is on the advisory board of Metanexus.

P. Venugopala Rao, an associate professor of physics at Emory University, is an experimental physicist who has studied quantum physics in atomic and nuclear contexts and has helped describe the behavior of electrons in atoms. He has taught courses in the philosophy of physics, the interaction between science and culture, and the interaction between science and religion. He has had an exhibition of his paintings, published poetry in Telugu, and produced dance dramas based on Indian classical dance. He is also an educator in the areas of Hindu art, philosophy, and religion.

Leslie A. Real is Asa Griggs Candler Professor of Biology at Emory University and director of the Center for Disease Ecology. His research involves the ecological dynamics and evolutionary genetics of infectious disease emergence. He is also an ordained Zen Buddhist priest in the Rinzaï/Soto lineage of Taizan Maezumi Roshi, founder of the Zen Center of Los Angeles.

Walter Roberts received his Ph.D. in history from Emory University in 2003. He is an instructor at the University of Arizona, where he teaches courses on the ancient Mediterranean world while working on his first book, which will focus on the transition of the Mediterranean region from Greco-Roman classical culture to the culture of late antiquity.

Louis A. Ruprecht Jr. is the William M. Suttles Professor of Religious Studies at Georgia State University. He has been a visiting professor at Princeton, Barnard, Emory, and Duke, as well as a research fellow at the American School of Classical Studies in Athens, the American Academy in Rome, and the Vatican Museums Archives. The author of four books, his work focuses on the intersection between ancient cultures and their modern appropriations. He is currently working on two new projects: a meditative study on the first twenty-five chapters of the book of Genesis and a history of the modern public art museum.

Norbert M. Samuelson, the Grossman Chair of Jewish Studies at Arizona State University in the Department of Religious Studies, is the founder and secretary of the Academy of Jewish Philosophy. His scholarship focuses on

Jewish philosophy and theology, and he has written extensively on medieval and modern Jewish philosophy. His books include *The First Seven Days: A Philosophical Commentary on the Creation of Genesis* (1992) and *Judaism and the Doctrine of Creation* (1994). Active in the American Academy of Religion, the Association of Jewish Studies, the American Theological Society, and the American Philosophical Association, he has articulated a distinctly Jewish approach to philosophy and examined the interface of reason and faith.

Theodore Schick Jr., a professor of philosophy at Muhlenberg College and director of the Muhlenberg Scholars Program, received his B.A. from Harvard University and his Ph.D. from Brown University. He is co-author of *How to Think about Weird Things: Critical Thinking for a New Age* and *Doing Philosophy: An Introduction through Thought Experiments* and editor of *Readings in the Philosophy of Science: From Positivism to Post-modernism*. His most recent publications have dealt with science and ethics, philosophy of technology, and philosophy of religion.

Gerald Schroeder earned his B.Sc., M.Sc., and Ph.D. at the Massachusetts Institute of Technology and was on the staff of the Physics Department for seven years prior to moving to Israel. In addition to his current scientific research in environmental radioactivity, he studies the convergence of modern scientific discoveries and ancient biblical commentary. He is the author of *Genesis and the Big Bang*, *The Science of God*, and *The Hidden Face of God*.

Lisa J. Schwebel teaches religion at St. John's University in New York. She is the author of *Apparitions, Healings, and Weeping Madonnas* (Paulist Press, 2004).

Jiang Sheng is Taishan Scholar and Professor of Religion and History as well as director of the Institute of Religion, Science, and Social Studies of Shandong University, China. He is also director of Shandong Province Center for Asian Studies. He received his Ph.D. in philosophy from Sichuan University. His primary areas of research are science and religion, with a concentration on Taoism. He has recently published *Zhongguo daojiao kexue jishu shi (History of Science and Technology in Taoism)*.

Gordon Shrimpton, a professor of Greek and Roman Studies at the University of Victoria, British Columbia, Canada, has a B.A. and M.A. in classics from the University of British Columbia and a Ph.D. from Stanford University. His special interests are ancient Greek language, history, and historical writing. He holds a research grant from the Social Sciences and Humanities Research Council of Canada to investigate ancient mnemonic techniques and the influence of memory and memory systems on early Greek historical writing.

D. Jason Slone is an assistant professor of religious studies at Webster University. He is the author of *Theological Incorrectness: Why Religious People Believe What They Shouldn't* (Oxford University Press, 2004) and the editor of *Religion and Cognition: A Reader* (Equinox, 2006).

Stephen D. Snobelen has a Ph.D. in history and philosophy of science from the University of Cambridge and was a junior research fellow at Clare College, Cambridge, before taking up his current position as assistant professor in history of science and technology at King's College, Halifax, Nova Scotia. He teaches courses on science and religion, the scientific revolution, nineteenth-century natural history, and science and the media. His research interests include biblical and early modern theology. He has published papers on science and religion and is currently writing a book on the religious backdrop to Newton's physics.

Jagdish N. Srivastava, a fellow and past president of several major international organizations in statistics and mathematics, is the founder and editor-in-chief of the *Journal of Statistical Planning and Inference*. He was a research professor at Colorado State University, where he held a joint appointment in philosophy, and he is a major researcher, speaker, and writer in the fields of quantum reality, consciousness, and spirituality.

Charles Stanish is a professor of anthropology and the director of the Cotsen Institute of Archaeology at UCLA. He has worked extensively in South America, specializing in the area of evolution of complex societies.

Victor J. Stenger is an emeritus professor of physics and astronomy at the University of Hawaii, an adjunct professor of philosophy at the University of Colorado, and president of Colorado Citizens for Science. He is the author of five published books and has two more on the way. The latest of these is *The Failed Hypothesis: Why Science Can Now Prove That God Does Not Exist*.

Mikael Stenmark is a professor of philosophy of religion and head of the Department of Theology at Uppsala University, Sweden. Recent publications are *Rationality in Science, Religion, and Everyday Life* (Notre Dame University Press, 1995), *Scientism: Science, Ethics, and Religion* (Ashgate, 2001), *Environmental Ethics and Environmental Policy Making* (Ashgate, 2002), and *How to Relate Science and Religion: A Multidimensional Model* (Eerdmans, 2004).

Barbara Strassberg, a native of Poland, earned master's degrees in English and American literature and in sociology and has a Ph.D. and a postdoctoral degree in sociology from the Jagiellonian University of Krakow, Poland. She completed her doctoral studies in sociology at Ecole Supérieure des Hautes

Etudes, in Paris, France, and conducted postdoctoral research at the Divinity School of the University of Chicago. She has also been involved in a science and religion program. For the past eight years, she has coordinated an annual lecture series at Aurora University. Held in the Spring, the lectures bring to the university outstanding scholars in science and religion.

Carl E. Thoresen is a professor emeritus of education and, by courtesy, psychology and psychiatry and behavioral sciences at Stanford University, where he continues to do research. He is also a senior fellow in the Spirituality and Health Institute at Santa Clara University. He served as principal investigator of the Stanford Forgiveness Project, a large randomized trial of a forgiveness training program, and he has published extensively on science and the psychology of forgiveness, spirituality, and health.

Paul Utukuru is a retired medical physicist from the Johns Hopkins University School of Medicine. He has been active in bringing Eastern voices into the study of the confrontation of science and religion. He writes frequently for www.stnews.org and www.metanexus.net funded by the Templeton Foundation.

Sarah Vinson is a graduate of Florida A & M University and a student at the University of Florida College of Medicine.

Michael Winkelman is an associate professor in the School of Human Evolution and Social Change and head of the sociocultural subdiscipline at Arizona State University. His books on shamanism include *Shamans, Priests, and Witches* (1992) and *Shamanism: The Neural Ecology of Consciousness and Healing* (2000), and he has co-edited several books on traditional healing practices, such as *Divination and Healing* (2004) and *Pilgrimages and Healing* (2005). He is currently studying the petroglyphs of South Mountain in Arizona.

Index

A

- “A Free Man’s Worship” (Russell), 1:114
Æbäl, 2:639
Aboriginal knowledge. *See* Indigenous knowledge
Absurd, 1:376–377
Action representation system, 2:597
Actions, intentional, 2:569
Actual entity, 2:434–436, 439–440
Actual occasion. *See* Actual entity
Adam
 in Ethiopian creation myths, 1:334, 335
 in Judeo-Christian creation myths, 1:346
 in young earth creationism, 1:393
 See also Eve
Adrshta (Hindu), 1:186
Advance directives, 2:734–735
 Jewish law on, 2:714
Advanced care planning, 2:734–735
Adventures of Ideas (Whitehead), 2:435
Africa
 HIV/AIDS, 2:649–651
 metallurgy and mathematics, 1:45–46
 Northeast, 1:43–44, 46–47
 toxic dumping in, 2:485
 West, 1:44–45
 See also African cosmology; African creation myths; African spirituality; African traditional medicine; Congo; Egypt, ancient; Ethiopia; Kenya; Uganda; Zimbabwe
African cosmology, 1:326
 death, 1:328–330
 God(s) as creator, 1:326–327
 humanity, 1:328, 331
 modern, 1:330–331
 the universe, 1:327
African creation myths
 categories of, 1:332
 Christianity and, 1:335–336
 format of, 1:334
 humanity, 1:332–334
 the universe, 1:332–334
African spirituality
 animal totems, 2:487–488
 community and, 2:489–490
 environmentalism and, 2:484, 486, 487
 flora and, 2:488–489
 supreme being, 2:486
African traditional medicine, 2:642–643
 Christianity and decline of, 2:645–646
 classification of, 2:643–644
 colonial, 2:645–646
 contemporary promotion of, 2:646–647
 defined, 2:642
 diviners, mediums, and seers, 2:644
 integrated with Western medicine, 2:646–648, 652
 medicinal herbs, 2:643
 medicine men and women, 2:643–644
 postcolonial, 2:646–647
 precolonial, 2:643–644
 ritual elders, 2:644–645
 secretiveness of, 2:647
Afterdeath. *See* Life after death
Afterlife. *See* Life after death
Agabos, 1:335
Agency, concept of, 2:476
Agenda 21, 2:506
Agent rituals, special, 2:597
Agents, supernatural. *See* Supernatural agents
Agricultural technologies
 genetic engineering, 2:781–782
 of the Tiwanaku, 1:179–180
Aguire, Anthony, 1:387

- AIDS. *See* HIV/AIDS
- Air (one of four elements), 1:263
- Aircraft, Taoist contribution to, 1:126–127
- Alchemy
 ancient Egypt, 1:264–266
 ancient Greece, 1:263–264
 Arabic, 1:266–269
 biblical basis of, 1:267
 definition and components of, 1:262–263
 Hindu contribution to, 1:187–188
 Jews and, 1:266–267, 270
 Renaissance magus and, 1:271
 Taoist contribution to, 1:120–122
 treatises, 1:265–266, 267–270
 Western, 1:269–270
- Alexander the Great, 1:217
- Alien abduction, 2:576, 577
- All Saints Day, 1:293
- Allport, Gordon, 2:521
- Alpher, Ralph, 1:319
- Altepetl (water-mountain), 1:418
- Altered states. *See* Consciousness
- American Pentecostalism, 1:136
- Amish, 1:138
- Amulets
 ancient Egyptian, 1:43
 to ward off illness (Ethiopia), 2:636–637
- Analytic school, 2:523
- Anatomy
 comparative, 2:445–446
 Galen's contribution to, 2:746, 749
 Islam's contribution to, 1:32; 2:747–748
 Vesalius's contribution to, 2:749–750
- Anaxagoras (Greek philosopher),
 1:215–216, 310
 Newton on, 1:359
- Anaximander (Greek philosopher), 1:214
- Anaximenes (Greek philosopher), 1:214
- Ancient wisdom. *See* Wisdom
- Andes
 engineering, 1:178
 religion in art and architecture,
 1:171–172
- Anesthesia, first documented, 1:119
- Animal rights, 2:496
- Animals
 African conservation of, 1:46–47; 2:488
 in African mythology, 1:46–47, 334,
 335
 African totems, 2:487–488
 cloning, 2:783–784, 795–796
 communication with, 1:77–78
 endangered species, 2:496
 for genetic research, 2:760–761
 shamanism and, 2:611, 628–629
See also Environment; Nature
- Animism, 1:83; 2:628–629
- Anomalies, 1:74–75
- Anselm of Canterbury, 2:427
- Anterior capsulotomy, 2:560–561
- Anterior cingulotomy, 2:559–560
- Anthropic coincidences, 1:381–383
- The Anthropic Cosmological Principle*
 (Barrow and Tipler), 1:381
- Anthropic principle, 1:11, 380; 2:471
 fine tuning, 1:385–387
 modern cosmology and, 1:410–412
 versions of, 1:383–385
- Anthropocentrism, 2:493–494, 507
 intergenerational, 2:509–510
See also Nonanthropocentrism
- Anti-Semitism, 1:24
- Antigravity, 1:382, 383
- Antimatter, 1:386
- Antitrinitarians, 1:361
- Anu (Hindu material unit in the physical
 world), 1:185–186
- Anxiety disorder, generalized, 2:556–557
- “Any pathway” interpretation, 2:690
- Apocalypse, Newton and, 1:361–362
- Apparitions, 1:135; 2:708–709
- Aquinas, Thomas
 extraterrestrial life, 1:298
 reason and revelation, 2:427
- Arabic science. *See* Islamic science
- Architecture
 Mesoamerican, 1:415, 416, 419
 religion reflected South American,
 1:170–171
 science reflected South American,
 1:178–179
- Archonic identity, 2:776
- Aristotle, 1:217, 232
 ban on reading, 1:233
 cosmos, 1:315
 elemental theory, 1:263–264
 extraterrestrial life, 1:297
 on matter, 1:263
 natural world, leadership, and the divine,
 1:245
 on poetry and history, 1:255
 study of women's bodies, 1:274–276
 theological reactions to, 1:232–235
 thirteen errors and oath of 1272,
 1:233–234
 translated into Latin, 1:232
- Art
 healing and, 2:667
 religion reflected South American,
 1:170–171
- Artificial life support. *See* Life-sustaining
 treatment
- Artificial nutrition/hydration. *See* Nutrition/
 hydration, artificial

- Ashtadhyayi* (Panini), 1:190
- Asia
 dissection and autopsy, 2:750
 religious pluralism, 1:131–132
- Asis (African deity), 2:486
- Asmat prayer (Ethiopia), 2:637–639
- Aspero archaeological site (Peru), 1:170
- Assimilation (Barbour's)
 medieval Jewish philosophers and, 1:21
 and pursuit of happiness, 1:23–25
 science and religion, 1:15–16
- Assisted suicide, Judaic law on, 2:712
- Astrology, Augustine and, 1:227–228
- Astronomy
 Greek contribution to, 1:214
 Hindu contribution to, 1:39, 40,
 184–185
 Islam's contribution to, 1:29–30, 34,
 199–200
 Taoist contribution to, 1:124, 126
- Athanasius (Christian monk), 1:248, 360
- Atheism, 1:390
 Newton's attack on, 1:364
- Atkins, Peter, 1:408
- Atom, primeval, 1:318, 371
- Atomic hypothesis, 2:428
- Atomic theory, Hindu contribution to,
 1:185–186
- Atomism, 2:435
- Attfield, Robin, 2:494
- Attitude, natural, 2:544
- Attitudes, propositional, 2:569–570
- Augustine, 1:227
 classical knowledge, 1:284
 extraterrestrial life, 1:297
 time, 1:407
- Augustus, 1:246–247
- Aurelius, Marcus, 1:247
- Ausares (African deity), 1:43, 333
- Auset (African deity), 1:333
- Austin, James, 2:531
- Authenticity, physician, 2:674, 675
- Autonomy principle, 2:573
- Autopsies
 in Asia, 2:750
 forensic, 2:749, 750
 Islamic law on, 2:747, 751–752
 Judaic law on, 2:747, 714–715
 United States decline of, 2:752
See also Dissection
- Awareness
 of or about something, 2:544, 550
 states of, 2:544
See also Conscious awareness;
 Consciousness
- Axioms, 1:104–106
- Ayurveda (Hindu medical system), 1:39
- Azeb (Queen of Sheba), 1:335–336
- Aztecs
 New Fire ceremony, 1:417–418
 Tenochtitlán, 1:418–419
-
- B**
-
- Babalawo* (African priest-scholar), 1:46
- Babylonians, 1:311
- Bacon, Francis, 1:258; 2:428
- Bacon, Roger, 1:270
- Banned books. *See* Books, banned
- Barabási, Albert-László, 2:767
- Barberini, Maffeo, 1:351–352
- Barbour, Ian, 1:8; 2:434
- Barghoorn, Elso, 1:402
- Barrow, John, 1:381, 384–385
- Basal ganglia, 2:626–627
- Basil of Caesarea, 1:225–226, 284
- Bateson, William, 2:764
- Beguines, 1:277
- Behe, Michael, 2:454
- Beliefs
 and barriers in the classroom, 1:159
 coexistence of, 1:131–132
 essentialized and hybrid, 1:144–148
- Bell, John, 1:374
- Bellarmino, Robert, 1:351
- Bello, Muhammad, 1:45
- Bem, Daryl, 2:579
- Benor, Daniel, 2:682
- Benson, Herbert, 2:529–530
- Bentley, Richard, 1:316; 2:429
- Bessent, Malcolm, 2:578–579
- Bəz'at*, 2:639–640
- Bible
 creation poetry, 1:343
 evolution in the, 1:401–402
 geography reconciled with,
 1:286–287
 literal interpretation, 1:390, 391–392
See also Hebrew scriptures
- Big Bang Crunch, 1:375
- Big Bang theory, 1:319, 371–372
 chemical elements, 1:380–381
 God and the, 1:372–374, 378
 residual radiation, 1:372
 Taoism and, 1:124–125
 time, 1:406–407
 unexplained phenomena, 1:407
- Bile, 1:274
- Bilquis (Queen of Sheba), 1:336
- Binding, 2:549
- Biocentrism, 2:493, 494, 496
- Biochemistry
 intelligent design and, 2:471–474
 Taoist contribution to, 1:120

- Biodiversity, 2:495–496
 evolution and, 2:445–447, 464–465
 indigenous knowledge and, 1:65
- Bioethics. *See* Ethics
- Biogeography, 2:446–447
- Biological inheritance, 2:443, 447–448, 770
- Biology
 evolutionary, 2:442, 458
 molecular, 2:447–448
 and religion, 1:94–96
 Taoist contribution to, 1:119–120
 of women's bodies. *See* Women's bodies
- Biot, Jean-Baptiste, 1:355
- Biotechnology, 2:780
 animal cloning, 2:783–784
 genetically modified organisms, 2:780–782
 human genetics, 2:784–785
- Biotheology. *See* Neurotheology
- Bipolar disorder, 2:556
- Bishops
 divine wisdom and, 1:248
 as spiritual intercessors, 1:249, 250
- Black bile, 1:274
- Black Elk, 2:660
- Black holes, 1:375
- Black magic (Ethiopian), 2:640
- Blake, William, on Newton, 1:355
- Blood
 menstrual. *See* Menstruation
 one of four humors, 1:274
- Bodily humors, 1:274
- Body, resurrection of. *See* Resurrection
- Body-mind. *See* Mind-body
- Boethius, 1:284
- Bohm, David, 1:61, 69–70
- Bokaye (West African pharmacist), 1:44–45
- Bolos of Mendes, 1:265
- Bonaventure, 1:234
- Bondi, Herman, 1:318
- Bonding, group, 2:538
- Book of Beliefs and Opinions* (Gaon), 1:21
- Book of Knowing the Evolution of Ra
 and of Overthrowing Apep*, 1:332
- Book of the Dead*, 1:332–333
- Books, banned
 Aristotle's natural philosophy, 1:233
 extraterrestrial, 1:300
 Galileo's, 1:351
- Bordeaux Ininteray, 1:288
- Born-again experience, 2:539
- Bosonic behavior, 1:94
- Bottom up interaction, 1:95–96
- Bowling Alone* (Putnam), 2:501
- Boyle, Robert, 1:258–259
 on evidence of God, 2:428–429
 on miracles, 2:428
 opponent of deism, 2:431
- Bracketing, 2:544
- Bradwardine, Thomas, 1:237
- Brahman (Hindu concept), 1:38
- Brain
 basal ganglia (reptilian), 2:626–627
 circuitry, 2:585–587
 cognitive operators, 1:96
 deep stimulation, 2:561
 inferior parietal lobe, 2:548–549
 meditation's effect on, 2:529–533
 neurogenesis and neuroplasticity, 2:536
 and physical events, 2:566–567
 posterior superior parietal lobe, 2:550
 and property vs. substance dualism,
 2:570
 recognition features, 2:549
 and religious experiences, 2:586–589
 sensory modalities, 2:549–550
 separate from mind/soul, 2:570
 temporal lobe transients, 2:587
 temporal lobes, 2:586–587
 temporal vs. parietal lobe patterns, 2:588
 thalamus, 2:549
 transcranial magnetic stimulation, 1:97, 98
 triune, 2:530–531
 shamanism and, 2:625–627
See also Brain death; Brain imaging;
 Brain surgery; Neurobiology;
 Neurosciences; Neurotheology
- Brain death, 2:704–705
 Judaic acceptance of, 2:713
- Brain imaging
 in neurotheology research, 2:528–529,
 539
 states of consciousness, 2:545–548
- Brain surgery
 lobotomy, 2:558–559
 types of, 2:559–561
See also Psychosurgery
- Brecht, Bertolt, 1:353
- Brentano, Franz, 2:544
- Bridges, Inca, 1:180–181
- British colonialism, India and, 1:40–41
- Bruno, Giordano, 1:299
- Bucaille, Maurice, 1:206
- Buddhism, ichi tante mind, 1:110–111
- Buddhist meditation, 2:531–532
- Burial practices
 African, 1:330
 Aspero, 1:170–171
 Chinchorro, 1:169–170
 cognitive explanations of, 2:601
 funerals, 2:705
 Jewish, 2:718
- Bush, George W., 1:63
- Butler, Joseph, 2:570
- Byrd, Randolph, 2:682, 693

C

- Cadavers
 dissection, 2:670–671
 Judaic law on donor, 2:715–716, 747
 spasms, 2:707–708
- Calendars
 computing, 1:294
 European Christian, 1:293–294
 Gregorian reform, 1:294–296
 Mesoamerican, 1:418
 Roman, 1:291–292
 science and religion integrated in, 1:290–291, 292
 Taoist contribution to, 126
 used to convey religious beliefs, 1:293–294
- Canals, of the Tiwanaku, 1:180
- Cantimpre, Thomas, 1:277–278
- Cantor, George, 1:376
- Cappadocians (early Christian theologians), 1:225–226
- Capra, Fritjof, 1:194
- Capsulotomy, anterior, 2:560–561
- Carbon, 1:380
- Caretaker (Native American concept), 2:656, 663
- Carter, Brandon, 1:383–384; 2:471
- Cassiodorus, 1:284
- Catholicism
 catechisms, 2:645
 life-sustaining treatment and, 2:732
See also Trinity
- Causal principle, Hinduism and, 1:37
- Causal web (of religion and health), 2:686–691
- Causality, 1:69; 2:571
- Cave allegory, Plato's, 2:576–577
- Cells, 2:471–472
- Center, conceptual, 1:416–417
- Ceramics, Moche, 1:178–179
- Ceremonies. *See* Ritual
- “Cha,” 1:126
- Chalmers, Thomas, 1:301
- Chandashastra (Vedic text), 1:182
- Chândogya Upanishad* (revered Hindu text), 1:185
- Chanting
 group, 2:623–624
 Navajo, 2:666–668
- Chaos and order, 1:314
- Chapman, John Jay, 1:210
- Charaka (Hindu medical writer), 1:188–189
- Chavin (Andes)
 engineering, 1:178
 religion in art and architecture, 1:171–172
- Chemistry
 Hindu contribution to, 1:187–188
 Taoist contribution to, 1:120–123
- China, dissection and autopsy in, 2:750
- Chinchorro (ancient South America), 1:169–170
- Christian calendar, 1:293–294
- Christian knowledge, geography and, 1:283–286
- Christian primitivism, Newton and, 1:361, 368
- Christian Topography* (Cosmas), 1:285
- Christianity
 environmental degradation and, 2:492
 extraterrestrials and, 1:297–303
 geography and, 1:283–286
 Greek philosophy
 acceptance of, 1:224–226
 rejection of, 1:222–224
 utilitarian approach to, 1:226–227, 231
 neuroscience of, 2:530–531
 picture of the world, 1:285–287
 reactions to Aristotle, 1:232–235
 Rome's adoption of, 1:248, 249–250
See also Genesis story; God; Trinity
- Chronology of Ancient Kingdoms Amended* (Newton), 1:363
- Churches, role of, 2:523
- Cicero, 1:245–246
- Cingulotomy, anterior, 2:559–560
- Circle of Life, 2:659–660
- Cities, Mesoamerican, 1:416–419
- City of God* (Augustine), 1:227
- Classical knowledge
 incorporated into Christian culture, 1:284
 reconciled with the Bible, 1:286–287
See also Greek philosophy
- Classical Scholia (Newton), 1:359–360
- Classrooms, science. *See* Science education
- Clay, in African creation myths, 1:336
- Clement of Alexandria (early Christian theologian), 1:224, 231
- Climatology, Taoist contribution to, 1:123–124
- Clocks, water, Taoist contribution to, 1:122
- Clonaid, 2:796
- Cloning
 animal, 2:783–784, 795–796
 concerns over, 2:797–800
 human reproductive, 2:796, 797–801
 stem cells and, 2:784
- Coalitionism, 2:599
- Codex Borgia* (Mesoamerica), 1:416
- Coercive persuasion, 1:138
- Cognition, domain-specific, 2:475

- Cognitive explanations
of afterlife and death rituals, 2:600–601
of ethics, 2:597–598
of gods, 2:595–598
of metaphysics, 2:601–602
of rituals, 2:597–598
of sects, 2:599–600
of theological incorrectness, 2:602–603
- Cognitive operators, 1:96
- Cognitive science, of religion, 2:593–595
- Cohen, Hermann, 1:23
- Collective worldviews. *See* Worldviews
- Collins, C. John, 1:395
- Colonization
effect on indigenous peoples, 1:68;
2:645–646
effect on Islam and science, 1:203–207
India and, 1:40–41
- Columbia space shuttle, 1:63
- Commodity, world as a, 1:64
- Communication skills, physician, 2:674–675
- Communicative competence, 1:159
- Communitarianism, 2:494
- Community
African belief in, 2:489–490
environmentalism and, 2:494
- Complexification, 2:538, 540–541
- Complexity
irreducible, 2:453, 472–474
network, 2:767–768
studies, 2:537–538
- Concentrative meditation, 2:580
- Conceptual center, Mesoamerican,
1:416–417
- Concerning Divination* (Cicero), 1:245–246
- Conches, William, 1:232
- Condemnation of 1277, 1:235–236, 238,
298
- Confessions* (Augustine), 1:227, 407
- Conflict (Barbour's)
medieval Jewish philosophers and, 1:21,
22
between science and religion, 1:12–13
- Congo, Bambuti of, 2:489
- Connectedness. *See* Interconnectedness
- Conscious awareness
defined, 2:548
existence of, 2:550–551
as primary, 2:551–552
relationship to external reality, 2:544,
551–553
See also Awareness; Consciousness
- Conscious self, 2:543, 548–549
- Consciousness
altered states, 2:575–576
critique of, 2:580–582
shamanic induction of, 2:628
- Consciousness (*continued*)
brain imaging studies, 2:545–548
categories of, 2:543
as diaphanous, 2:590
existence and matter independent of,
2:568
and free will, 2:569
historical studies of, 2:543–545
mystical, 2:550
neurobiology and, 2:548–551
pure, 2:548, 550, 552–553
reflective, 2:548–549, 549
sensation and, 2:569
See also Awareness; Conscious
awareness; Reality; Self
- Conservation of Nature, International Union
for the, 2:496
- Constant correlation, 2:571
- Constantine, 1:248
- Construction. *See* Architecture
- Consumers, of religion and science, 1:144
- Contradiction, 1:84–85
- Conversion, religious, 1:137–138
- Copernican theory
conflicting with Christianity, 2:428
Galileo and, 1:350–351
- Copernicus, Nicholas, 1:298–299
- Cord measurement, 1:415
- Coricancha (Inca), 1:173–174
- Corpuscular hypothesis, 2:428
- Correlation, constant, 2:571
- Cosmas Indicopleustes, 1:285
- Cosmic Background Explorer satellite, 1:372
- Cosmic harmony, 2:486, 502
- Cosmic order, 1:36–37
- Cosmoids, 1:322
- Cosmological argument, Kalam, 1:372–374
- Cosmological constant, 1:371, 382–383
- Cosmology
African. *See* African cosmology
Bohm's theory of, 1:69–70
Greek philosophers and, 1:212–214, 310
Inca, 1:173–174
Islamic, 1:197, 200, 208, 373
Mesoamerican, 1:416
modern, 1:317–320, 409–410
Pythagorean, 1:212
quantum, 1:321–323
relativistic, 1:317
shamanic, 2:617–619, 622
Taoist contribution to, 1:124–125
Thale, 1:213–214
See also Cosmos; Universe
- Cosmopolitanism, 2:494
- Cosmos
classical to quantum, 1:320–323
closed, 1:315

- Cosmos (*continued*)
 cyclic, 1:312
 finite to infinite, 1:314–316
 glory of God and, 1:343
 infinite to expanding, 1:316–320
 of spheres, 1:310, 315
 uncreated, 1:312
See also Cosmology; Universe
- Craig, William Lane, 1:376, 377
- Creatio ex nihilo*, 2:434
- Creation myths, 1:77, 78, 82, 86–87, 93
 African. *See* African creation myths
 Big Bang. *See* Big Bang theory
 classifications of, 1:312–314
 Hindu, 1:187
 Islamic, 1:196–200
 Judeo-Christian. *See* Genesis story
 Mesoamerican, 1:416
 metaphorical, 1:344
 monotheistic vs. polytheistic, 1:340
 pre-scientific, 1:312–314
 Taoist, 1:124–126, 314
See also Cosmos; Universe
- Creation out of nothing, 2:434
- Creation science, 1:393
- Creationism
 progressive, 1:393–396
 science education and, 1:159, 393
 theistic evolution, 1:396–397
 young earth, 1:390–393
- Cremation, Jewish Law on, 2:718
- Crescas, Hasdai, 1:21
- Crick, Francis, 2:766
- Crooke, W., 2:476–477
- Crowfoot, 2:658
- Cruelties, biological, 2:455
- Cults, 1:138
- Cultural dissonance, 1:158–160
- Cultural evolution, 1:145
- Cultural extinction, 1:155
- Cultural particularism, 1:113–116
- Cultural transmission, 1:155, 157–158
- Culture(s)
 definitions of, 1:153–154
 essentialization and hybridization of,
 1:144–148
 religious experiences and, 2:587–589
 scientific, 1:153, 155–157
 shared knowledge and, 1:154–155
See also Subcultures
- Cusco (Inca pilgrimage destination),
 1:173–174
-
- D**
-
- D'Aquili, Eugene, 1:96; 2:532, 539
- Dark energy, 1:383, 387
- Dark matter, 1:383
- Darsanas (Hinduism), 1:37–38
- Darwin, Charles, 1:8; 2:442, 458
 intelligent design and, 2:470
 natural selection, 2:443
- Darwin, Erasmus, 2:458
- Darwin's Black Box* (Behe), 2:472
- Davidson, Richard, 2:532
- Days
 in Genesis, 1:395
 relationship to directions, 1:416
- Death
 in African cosmology, 1:328–329, 330
 altered states of consciousness and,
 2:576, 577
 apparitions and, 2:708–709
 belief in God and, 2:478–481, 673
 the body after, 2:750–751
 brain, 2:704–705, 713
 cultural and religious beliefs, 2:705–708
 defining, 2:703–705
 healing linked with, 2:625
 Judaism and, 2:712–714, 718
 religious affiliation and, 2:679, 685
 rigor mortis, 2:707–708
See also Burial practices; Dying; Life
 after death; Life expectancy; Near
 death experiences
- Death rituals. *See* Burial practices
- Deep brain stimulation, 2:561
- Defects and deformities, 2:455
- Deism, 2:430–432
- Demons, disease caused by, 2:634
- Dennett, Daniel, 2:545
- Deoxyribonucleic acid. *See* DNA
- Depression, 2:555–556
- Desacralization, 2:430–431
- Descartes, René
 divinely imposed laws, 2:430, 432
 Newton and, 1:357, 364, 366
 on reason and revelation, 2:427–428,
 432
 view of the mind, 2:544
- Design in nature
 and evidence of God, 2:428–430
See also Intelligent design
- Design theory. *See* Intelligent design
- Designer drugs. *See* Drugs
- Determinism, genetic, 2:757–758, 798
- Deuterium, 1:382
- Developing countries, state of environment,
 2:484–485
- Dharma, 1:36–37
- Diabetes, Native Americans and, 1:53
- Dialectical materialism, 1:108–109
- Dialectical spiritualism, 1:109
- Dialogue, Barbour's, 1:14–15

- Dialogue on the Two Great Systems of the World* (Galileo), 1:351–352
- Dicuil, 1:288–289
- Dinosaurs, in the Bible, 1:404
- Dinqnesh, 1:333
- Dionysius Exiguus, 1:293
- Direct perception, 1:106–108
- Directions
 - Native American spirituality and, 2:659
 - relationship with days, 1:416
- Discorides, 1:31–32
- Discourses and Demonstration on Two New Sciences* (Galileo), 1:353
- Discovery, context of, 1:114–115
- Disease
 - genetics and, 2:761–762, 789
 - See also* Health care; Illness
- Dissection
 - in the Abrahamic traditions, 2:746–750
 - in Asia, 2:750
 - cadaver, 2:670–671
 - in Europe, 2:749
 - Galen's writings on, 2:749
 - history of, 2:746
 - in medical education, 2:749
 - in science education, 1:159
 - See also* Autopsies
- Dissociative identity disorder (DID), 2:576, 579
- Distant healing, 2:682–683
- Distillation process, alchemy and, 1:269
- Divination
 - Greco-Roman, 1:245–246
 - magic squares (Africa), 1:46
- The divine
 - Augustus's view of, 1:247
 - in book of Genesis, 1:340
 - before Christianity, 1:244–246
 - Cicero's view of, 1:245–246
 - Eusebius and, 1:248
 - evidence of, 2:428–430
 - Greco-Roman ideas of, 1:244–246
 - linked to natural world and leadership, 1:244–245
 - Rome (fourth century CE), 1:248
 - trinity. *See* Trinity
- Divine revelation. *See* Revelation
- Divine wisdom
 - nature as a product of, 1:344
 - stewardship and, 2:497
- Diviners
 - African, 2:644
 - Mesoamerican, 1:416
- DNA, 2:448, 449–450, 764
 - double-helix structure, 2:766, 788
 - human, 2:788–789
 - as sacred, 2:776
- Dobzhansky, Theodosius, 2:443
- Doctors. *See* Physicians
- Dolly (cloned sheep), 2:783, 795–796
- Domain-specific cognition, 2:475
- Donors (organ/tissue), Judaic law on, 2:714–717
- Dragons, in African myths, 1:335
- Draper, John, 1:353
- “The Dream of the Blue Rams” (Navajo story), 2:668
- Dreams, 1:75
 - altered state of consciousness, 2:575
 - interpretation of, 1:133–134; 2:578
 - lucid, 2:581
 - reality and, 2:578–579
 - shamans and, 2:618–619
- Drugs
 - designer, 2:791–792
 - genetic engineering and, 2:781, 783
 - prescription. *See* Pharmacology
 - psychedelic. *See* Psychedelic drugs
 - religious experiences and, 1:137
- Dualism
 - body and mind, 2:565, 568–570, 573–574
 - Descartes's, 2:544
 - humanity vs. nature, 2:494
 - physicalism vs., 2:571–572
 - property vs. substance, 2:570, 572
- Dukepoo, Frank, 1:53–54
- Dying
 - Judaism and, 2:712–714
 - See also* Death; Hospice; Life-sustaining treatment
-
- E**
-
- Earth
 - appearance of age, 1:392–393
 - center of universe, 1:315
 - flat, 1:285, 310
 - formation of, 1:381
 - Jerusalem at center of the, 1:286
 - one of four elements, 1:263
 - sacred, 2:668
 - spherical, 1:284, 285
 - Taoist belief in, 1:124
 - See also* Creation myths; Heliocentric theory; Universe
- Easter, in calendars, 1:294
- Eastman, Charles, 1:67
- Ecofeminism, 2:493
- Ecological crisis, reasons for, 2:511
- Ecological deities, Mwari (Africa), 2:486
- Ecological holism, 2:508, 511, 512
- Ecological systems, 2:494–495

- Ecology
 ancient Northeast Africa, 1:46–47
 and ethics, 2:494–496
 indigenous knowledge and, 1:65
 Native Americans and, 2:668
 relationships, 2:502
 sacred order of, 2:503–504
 science and, 2:502–503, 504
 shamanic, 2:617–619, 622
See also Animals; Environment; Flora; Nature; Stewardship; Sustainable development; Sustainable living
- Economic growth, sustainable development and, 2:509
- Ecuador, Otovalo, 2:611–612
- Education
 creationism, 1:393
 dissection in medical, 2:749
 Ethiopian, 2:635
 higher Islamic, 1:33–34
 science. *See* Science education
- EEG. *See* Electroencephalography
- Egypt, ancient
 alchemy, 1:264–266
 spiritual entities, 1:333
- Einstein, Albert, 1:24
 cosmological constant, 1:371, 382–383
 cosmological model, 1:317
 hidden variables, 1:374
 on religious feeling of science, 1:82
 theory of gravity, 1:371
 theory of relativity, 1:316–317
- Elders, African, 2:644–645
- Electroconvulsive therapy, 2:556
- Electroencephalography (EEG), 2:528, 529, 586
- Electromagnetic force, 1:381
- Electrons, 1:382
- Elemental theory, 1:263–264
- Elementary particles, 1:94, 386–387
- Eliade, Mircea, 2:621
- Elixirs, inner, 1:120
- ELSI, 2:789–790
- Embryology, 2:447
 Islam's contribution to, 2:747–748
 stem cell research, 2:758, 784
- Emergence, 2:540–541
- Emergents, 2:538, 540
- Emotions, effect of prayer on, 2:680–681
- Empathy, physician, 2:674, 675
- Emperors
 political/religious power, 1:247–249
 secular leadership, 1:250
See also Imperial power
- Empowerment, 2:539
- Empyrean Sphere, 1:315
- Encounter theories, 1:302
- End of life care. *See* Palliative care
- Endangered species, 2:496
- Energy, 1:66
 dark, 1:383
- Engineering
 Inca, 1:180–181
 Rome's contribution to, 1:219
 Tiwanaku, 1:179–180
- Entativity, group, 2:599
- Entheogenic drugs, 1:137
- Entities
 actual, 2:434–436, 439–440
 mental, 2:569, 571
 physical, 2:571
- Environment
 African spirituality and, 2:484, 486, 487–489
 conservation, 2:496
 degradation
 in Africa, 2:485
 Christians and, 2:492
 worldwide, 2:500
 in developing countries, 2:484–485
 gene expression and, 2:760–761
 global warming, 1:54
 healing power and, 2:487
 Native American vs. mainstream cultures, 1:54–57
 practical wisdom and, 2:497
 precautionary principle and, 2:496
 toxic dumping in Africa, 2:485
See also Animals; Ecology; Flora; Nature; Stewardship; Sustainable development; Sustainable living
- Environmental crisis. *See* Ecological crisis
- Environmental ethics, 2:494–497
- Environmental justice, 1:55
- Epic, evolutionary, 1:413
- Epic poems, early Greek, 1:251, 252
- Epicurus (ancient atomist), 1:297
- Epidemiology, of religion, 2:678–679, 685–686
- Epigenetic change, 2:760
- Epilepsy, 2:586–587
- Epistemology, 1:84–85
- Epoche, 2:544
- Er, story of (Plato), 2:739
- Eriugena, John Scottus, 1:286
- Esoteric knowledge, 1:177
- Essences
 intuition of, 2:544
 loss of. *See* Soul, loss of
- Essentialism, 1:144–149; 2:599
 genetic, 2:757, 776–777
- Eternal life. *See* Life after death
- Eternity of the world, 1:235
- Ethical holism, 2:512

- Ethics, 1:87–89
 African cosmic harmony, 2:486, 487
 bioethics, 2:773, 785, 798
 cloning, 2:797–800
 cognitive explanations of, 2:597–598
 ecology and, 2:494–496
 environmental, 2:494–497
 genetic testing, 2:791, 792–793
 Human Genome Project, 2:789–790
 psychosurgery, 2:561–563
 reason and, 1:89
 religion and, 1:88–89
 religion-based, 1:146–148; 2:598–599
 sustainable development, 2:507–510
- Ethiopia
 adoption of Christianity, 1:335–336;
 2:633
 ailments, 2:635
 amulets, 2:636–637
 Asmat, 2:637–639
 black magic, 2:640
 creation myths, 1:333–335
 holy water, 2:639
 human origin in, 1:333
 medicinal plants, 2:640–641
 tabots, 2:636–637
- Ethiopian Orthodox Church
 causes of illness, 2:633–635
 spiritual healing, 2:633, 636–640
 Unction of the Sick, 2:633–634, 636
- Eugenics, 2:770–772
- Euphrates river, 1:287
- Europe, translation movement, 1:231–232,
 269
- Eusebius (Christion bishop), 1:248
- Euthanasia, Judaic law on, 2:713
- Evans, E. Margaret, 2:602
- Eve
 Adam's rib and, 1:402
 in young earth creationism, 1:393
See also Adam
- Events, 2:566
 physical, 2:566–567
 random, 1:374
 uncaused, 1:374
- Evidence, 1:87
- Evil, unnecessary, 1:373, 403–404
- Evolution
 in the Bible, 1:401–402
 bottom up/top down interactions,
 1:95–96
 change over time, 2:457–458
 critics of, 2:451
 cultural, 1:145
 of life, 1:380–381
 oddities and cruelties, 2:455
 religion and, 2:442–443, 524
- Evolution (*continued*)
 science education, 1:159
 sciences supporting, 2:444–448
 theistic, 1:396–397
See also Genetics; Natural selection
- Evolutionary epic, 1:413
- Evolutionary racism, 2:770–771
- Exact sciences. *See* Science, exact
- Exegesis
 of classical geography, 1:286–287
 of the Quran, 1:205, 206
- Existential anxiety, 2:478–481
- Experiences
 pure, 2:544
 religious/spiritual interpretation of,
 1:133–134
See also specific experience
- Explanations, sequences of, 1:409
- Explicate* order (Bohm's), 1:69
- External reality. *See* Reality
- Extinction
 cultural, 1:155
 species, 2:496
- Extraterrestrials, 1:236–237
 ancient and medieval ideas on,
 1:297–298
 Martians, 1:302
 modern theories of, 1:302
 reconciling Christianity and, 1:301–303
 and the Scientific Revolution, 1:298–301
- Extrinsic religiosity, 2:521
- Extrovertive mysticism, 1:140
- Eyewitness accounts, 1:256
-
- F**
- Faith, 1:85
- Farisi, Kamal al-din al-, 1:30–31
- Faruqi, Ismail al-, 1:207
- Fauna. *See* Animals
- Female body. *See* Women's bodies
- Fermionic behavior, 1:94
- Fertility, theories of, 1:275
- Festivals. *See* Holidays and festivals
- Feyerabend, Paul, 1:42
- Fidanza, John, 1:234
- Field technologies. *See* Agricultural
 technologies
- Fields of activity, 2:435, 436, 439–440
- Fire
 Aztec ceremony, 1:417–418
 one of four elements, 1:263
- Fire Lame Deer, Archie, 2:663
- Fisher, R.A., 2:443
- Five ways, Aquinas's, 2:427, 428
- Flood, biblical, 1:404
- Flood geology, 1:392, 393

- Flora
 African spirituality and, 2:488–489
 African use of medicinal, 2:643
 endangered species, 2:496
 Ethiopian use of medicinal, 2:640
 genetically modified, 2:780–782
 shamanic use of, 2:612–613
 fMRI, 2:528–529, 545–546
 Folk psychology, 2:475–478, 601
 Folk understanding, 2:595
 Fontenelle, Bernard la Bovier de, 1:300
 Forgiveness, 2:539
 Formalism, philosophical, 1:213
 Fossil evidence
 Big Bang, 1:372
 evolution and, 2:444–445
 flood geology and, 1:392
 gaps in, 1:402
 Four bodily humors, 1:274
 Four directions
 Mesoamerican, 1:416
 Native American, 2:659–660
 Four elements, 1:263
 Fox-Keller, Evelyn, 2:764
 “Free process defense,” 1:14
 Free will, 2:569–570
 Freedom, intellectual, 1:257–259
 Freeman, Walter, 2:558–559
 Freud, Sigmund, 2:520, 528
 psychoanalytic school, 2:522
 view of religion, 2:585
 Friedmann, Alexander, 1:317–318, 371, 375
 Frontal lobes, 2:559
 Functional magnetic resonance imaging
 (fMRI), 2:528–529, 545–546
 Functionalism, 1:213; 2:568
 Funeral directors, contact with the dead,
 2:709
 Funerals. *See* Burial practices
-
- G**
- Gabriel of Qullubi, 2:640
 Gaia hypothesis, 2:493
 Galápagos Islands, 2:459–460
 Galen of Pergamum, 2:746, 749
 Galileo affair, 1:350–354
 Galileo, 1:7, 8, 81, 299
Dialogue, 1:351–352
Discourses, 1:353
 John Paul II and, 1:354
 theology heretic, 1:351
 trial and imprisonment, 1:352–353
Galileo’s Daughter (Sobel), 1:354
 Galton, Francis, 2:770
 Gamow, George, 1:319, 372
 Ganzfeld procedure, 2:579–580
 Gaon, Saadia, 1:21
 Gap theory, for interpreting Genesis, 1:395
 Garden of Eden
 in book of Genesis, 1:342–343
 in book of Revelation, 1:345
 location of, 1:286–287
 Gardens, in creation myths, 1:342–343
See also Garden of Eden
 Ge Hong, 1:121, 125, 126
 Geber corpus (alchemy), 1:267–268
 Gender stereotypes, of scientists, 1:157
 Genealogical mythology
 African, 1:335–336
 in book of Genesis, 1:339
 General Scholium (Newton), 1:366–367
 Generalized anxiety disorder (GAD),
 2:556–557
 Genes, 2:763–765, 788
 expression, 2:760–761
 relationship with proteins, 2:764
 and religious experiences, 2:760–761
See also Genetics; Genomes
The Genesis Flood (Whitcomb & Morris),
 1:391
 Genesis story
 African adaptation of, 1:335
 compared with other creation stories,
 1:340
 days and time, 1:395, 400–401
 interpretation
 literal (by young earth creationists),
 1:390, 391–392
 by progressive creationists,
 1:394–396
 literary structure and format, 1:338–339
 nature depicted in, 1:338, 340–342,
 346–347
 pivotal doctrines in, 1:339
 Genetic determinism, 2:757–758, 798
 Genetic diseases, 2:761–762, 789
 Genetic engineering
 agricultural, 2:781–782
 animal, 2:783–784
 human, 2:784–785
 theological responses to, 2:781, 783, 785
 Genetic essentialism, 2:757, 776–777
 Genetic pharming, 2:781
 Genetic research
 material stakes of, 2:774–775
 spiritual stakes of, 2:775–777
 Genetic testing, 2:790–791
 future and ethics of, 2:792–793
 pharmacogenomics, 2:791–792
 Genetically modified organisms (GMOs),
 2:780–782
 Genetics
 diversity and unity, 2:464–465

- Genetics (*continued*)
 and the future, 2:777–778
 history of, 2:765–766
 human, 2:784–785
 Mendelian, 2:443, 458, 765
 model for identity, 2:757
 model of reality, 2:757, 763
 mutation, 2:449–450, 464, 760, 789
 naturalism and, 2:773
 network complexity, 2:767–768
 "playing God," 2:758, 787
 recombination, 2:464
 religion intersecting with, 2:757
See also Genes; Genomes
- Genetics and the Origin of Species*
 (Dobzhansky), 2:443
- Genomena* (Greek level of reality), 1:255
- Genomes
 as blueprints, 2:759–760
 mapping, 2:766
 patenting, 2:784
 phenotypes and, 2:764, 767, 768
See also Genes; Genetics
- Genotype. *See* Genomes
- Geography
 Christianization of, 1:286–289
 medieval, 1:283–287
- Geology
 creationism, 1:391
 flood, 1:392, 393
- Geometry, 1:376
 cosmos and, 1:317
- Geon river, 1:287
- Germ line therapy, 2:784
- Germ plasm, 2:771
- Germany, Nazi, racial hygiene,
 2:771–772
- Gershon ben Shlomo, 1:270
- Gersonides, Levi, 1:21
- Ghazali, al-, 1:32
- Global warming, 1:54
- Globalization, 1:147
- Glossolalia (speaking in tongues), 1:136
- God
 absolute power of, 1:236–240
 in African cosmology, 1:326–327
 body belongs to (in Judaism), 2:712
 debating existence of, 1:100–101
 evidence of, 2:428–430
 genetics and playing, 2:758, 787
 glory of (in Genesis), 1:343–344
 knowing through reason and revelation,
 2:426–428
 noninterventionist view of, 1:397
 as omnipresent, 1:237
 sovereignty of (in Genesis), 1:339–341
 terminal illness and, 2:673
- God (*continued*)
 trinitarian understanding of, 2:436–437,
 531
- Godel's Theorem, and reality, 1:104–106
- Godhead, 2:436
- Gods
 cognitive explanations of, 2:595–598
 creation and, 1:313
- Gog, 1:287
- Gold, Thomas, 1:318
- Golden section, 1:415
- Gordon, Oakley, 1:70
- Gorgias of Leontini (Sophist writer), 1:253
- Grammar, Hindu contribution to, 1:190
- Grant, Peter, 2:459–460
- Grant, Rosemary, 2:459–460
- Gravitational collapse, 1:371, 375
- Gravitational repulsion, 1:383
- Gravity
 force of, 1:381
 Newton's law of, 1:316, 358, 366–367,
 371
- Gravity gremlins, 1:85–86
- Great mind, 1:77
- Great Temple (Aztec), 1:417, 419
- Greek philosophy, 1:210–211
 alchemy in, 1:263–264
 Christianity and
 acceptance, 1:224–226
 rejection, 1:222–224
 utilitarian approach, 1:226–227, 231
 shift from natural to moral/political,
 1:216
See also Classical knowledge; specific
 philosopher
- Greek writing
 epic poems, 1:251
 historical
 epic compared to, 1:252
 forms of, 1:251–252
 intellectual climate and, 1:252–255
 intellectual freedom and, 1:257–259
 knowledge, fact and truth in,
 1:256–257
 medical, 1:253
 Sophist, 1:253
- Gregorian calendar, 1:294–295
- Gregory, David, 1:359
- Gregory of Nazianzus (early Christian
 theologian), 1:225
- Gregory of Nyssa (early Christian
 theologian), 1:225
- Greyson, Bruce, 2:743
- Grief, hallucinations and, 2:709
- Grosseteste, Robert, 1:295
- Group bonding, 2:538
- Group entativity, 2:599

Group worldviews. *See* Worldviews, collective
 Guided imagery, 2:580, 666
 Gunpowder, Taoist contribution to, 1:120–121
Gurutva (Hindu), 1:186
 Gynecology, medieval, 1:280–281
Gynecology (Soranus), 1:280

H

Haldane, J.B.S., 2:443
 Halevi, Judah, 1:21
 Hall, Stanley G., 2:520
 Hallucinations
 of bereaved, 2:709
 See also Psychedelic drugs
 “Handmaiden approach” to theology, 1:231, 240
 Hao Datong, 1:126
 Harappan civilization (India), 1:39
 Harmony
 cosmic, 2:486, 502
 Native American, 2:658–659, 666
 Harris, William, 2:682
 Hartle, James B., 1:408
 Hawaiian Islands, 2:447
 Hawking, Stephen, 1:374, 377, 408
 Haytham, Ibn al-, 1:30
 Healers and healing, 2:607–608
 African, 2:642–645
 art and, 2:667
 death linked with, 2:625
 distant, 2:682–683
 emotions and, 2:680–681
 environment and, 2:487
 Ethiopian, 2:633, 636–640
 evolutionary basis of, 2:624–625
 love and, 2:681
 Navajo, 2:668
 prayerful, 1:135; 2:636, 638–639
 shamanic, 2:611–614, 629–630
 spiritual, 2:682
 Healing shrines, 2:683
 Health
 Native American problems, 1:52–55
 religious affiliation and, 2:679
 religious attendance and, 2:679–680, 685–686
 spirituality’s effect on, 2:671–672
 See also Health care; Health promotion; Illness; Mental health
 Health benefits. *See* Health promotion
 Health care
 advanced directives, 2:734–735
 genetic testing, 2:790–791
 Judaic law and, 2:717

Health care (*continued*)
 See also Healers and healing; Health promotion; Hospice; Illness; Medicine; Physicians; Wellness
 Health promotion
 religion and, 2:679–680, 687–689
 See also Wellness
 Heavenly pneuma, 1:264
 Heavens, Taoist, 1:124–126
 Hebraea, Maria, 1:265–266
 Hebrew scriptures, 1:18–22
 alchemy in, 1:266, 267
 Heisenberg, Werner, 1:320
 Heliocentric theory, 1:298, 315, 359
 See also Galileo; Newton
 Helium, 1:380, 382
 Hellenic works, translated into Arabic, 1:27
 Hellenistic age, 1:217–218
 alchemy, 1:264–266
 science, 1:221
 Henke, Enid, 2:729
 Heraclitus (Greek philosopher), 1:214
 Herbs. *See* Flora
 Here and now, 1:110–111
 Heredity, 2:443, 447–448
 study of, 2:769–770, 771
 Heredity factors, 2:765
 Hereford Map, 1:289
 Herman, Robert, 1:319
 Hermetic Adam, 1:271
 Herodotus (Greek writer)
 historical writing method, 1:256
 Histories, 1:252, 253–256
 reality and, 1:255
 relativism and, 1:253–254
 Heroic measures, Judaic law on, 2:714
 Herophilus, 2:746
 Heru (African deity), 1:333
Hexameron (Basil), 1:284
 Hidden variables theory, 1:374
 Higgs boson, 1:77
 Higher education, Islamic, 1:33–34
 Hilbert, David, 1:376
 Hildegard of Bingen, 1:276–277
 Hindu contributions
 astronomy, 1:39, 40, 184–185
 chemistry, 1:187–188
 grammar, 1:190
 mathematics, 1:39, 182–184
 medicine, 1:188–190
 physical sciences, 1:185–187
 psychology, 1:190
 Hinduism
 cosmic order, 1:36–37
 nature and science, 1:38–39
 science in a global context, 1:190–191
 systems of thought (darsanas), 1:37–38

Hippocrates, 1:273–276
 Hippocratic movement, 1:253
 Historical writing, early Greek.
 See Greek writing
Historias (Herodotus), 1:252, 253–256
History of the Conflict Between Science and Religion (Draper), 1:353
History of the Warfare of Science with Theology in Christendom (White), 1:353, 370
 HIV/AIDS, 1:149–150
 in Africa, 2:649–652
 HMG CoA, 2:465
 Holidays and festivals, Christian
 replacement of pagan, 1:293–294
 Holism, 2:493, 494
 ecological, 2:508, 511, 512
 ethical, 2:512
 Holistic medicine. *See* Medicine, holistic
 Holkot, Robert, 1:239
 Holy land pilgrimage. *See* Pilgrimage
 Holy water, 2:639
 Homer, 1:251
 Hominids, 1:403
 Honorton, Charles, 2:579
 Horus (African deity), 1:333
 Hospice
 defining, 2:725–726
 history of, 2:720–722
 last minute referrals, 2:736
 as a philosophy, 2:722–723
 programs of care, 2:723–725
 spiritual impetus of, 2:728–729
 in the United States, 2:726–728
 Hoyle, Fred, 1:318, 371–372, 381; 2:471
 Hozho, 2:666
 Hrabanus Maurus, 1:286
 Hua Tuo, 1:119
Huacas (Inca), 1:173, 174
 Hubble, Edwin, 1:302, 318, 371
 Human Genome Project, 2:766, 788–789
 ethics, 2:789–790
 Human-nature interdependence view, 2:508, 511
 Human origin
 in African cosmology, 1:328, 331
 in African creation myths, 1:333
 Ethiopia, 1:333
 in Judeo-Christian creation myths, 1:338, 341, 346
 Human reproductive cloning. *See* Reproductive cloning
 Human soul. *See* Soul
The Humanizing Brain (Ashbrook & Albright), 2:530–531

Humans
 alliance with non-humans, 1:78
 as stewards of nature. *See* Stewardship
 Hume, David, 2:469–470
 Humoral theory, 1:274
 Huntington disease, 2:761–762
 Husserl, Edmund, 2:544
 Huygens, Christiaan, 1:300
 Hybridization, 1:144–147
 Hydration, artificial. *See* Nutrition/hydration, artificial
 Hydrogen, 1:380, 382
 Hyperactive agency detection device (HADD), 2:602
 Hypnosis, 2:575, 580–581
 shamanic healing, 2:630

 I

Ibn Sina (Avicenna), 1:31, 268
 Ichi tante mind (Buddhist), 1:110–111
 Idaltu, 1:333
 Idealism, philosophical, 1:213
 Identicals, indiscernibility of, 2:571
 Identity, 2:570–572
 archonic, 2:776
 genetics and, 2:757
 Identity disorder, dissociative, 2:576, 579
 Identity physicalism, 2:568
 Igzabiher (African deity), 1:334
 Ijmalis, 1:207
Illiad (Homer), 1:251
 Illness
 amulets used to ward off, 2:636–637
 influence of spirituality on, 2:671–672
 religious affiliation and, 2:679
 spiritual causes
 for Ethiopians, 2:633–634
 for Native Americans, 2:657
 See also Health; Health care; Terminally ill
 Immortality, Taoist, 1:128
 Immunological processes, 2:680–681
 Imperial power
 Christianity and, 1:248, 249
 See also Emperors
 Inca
 engineering and road system, 1:180–181
 religious beliefs, 1:173–174
 Inclusive fitness theory, 2:599
The Incoherence of the Philosophers (al-Ghazali), 1:32
 Independence (Barbour's)
 modern Judaism and, 1:24
 science and religion, 1:13
 Spinoza and, 1:22

- India
 colonialism, 1:40–41
 Harappan (Indus) civilization, 1:39
 Hinduism. *See* Hinduism
 Medieval times, 1:40
 postcolonial, 1:41
 Vedic times, 1:39
- Indian medicine. *See* Native Americans, medicine
- Indicopleustes, Cosmas, 1:285
- Indigenous knowledge, 1:57–58, 62, 64–65
 anomalies, 1:75
 colonization's effect on, 1:68
 compared with Western science, 1:74–78
 integration of Western knowledge, 1:65, 68, 73–74
 passed via ritual, 1:334
 subjectivity, 1:75
See also Indigenous peoples; specific group/tribe
- Indigenous peoples
 colonization's effect on, 1:68
 knowledge. *See* Indigenous knowledge
 spirituality. *See* Spirituality
 worldview, 1:61–62, 65, 66
See also Indigenous knowledge; specific group/tribe
- Indigenous science. *See* Indigenous knowledge
- Indiscernibility of identicals, 2:571
- Individual worldviews, 1:143–144
- Indus civilization (India), 1:39
- Industrialization, 2:500–501
- Inferior parietal lobe, 2:548–549
- Infinite void spaces, 1:237
- Infinity, 1:183, 375–377
- Inheritance, biological, 2:443, 447–448
 “Inner elixirs,” 1:120
- Instrument rituals, special, 2:597
- Intangible sources, 1:102–104
- Integration (Barbour's). *See* Assimilation (Barbour's)
- Intellectual energy, 1:66
- Intellectual freedom, 1:257–259
- Intellectual property, 1:258–259
- Intelligent design, 1:95, 396
 biochemistry and, 2:471–474
 Darwin's effect on, 2:470
 history of, 2:467–470
 in Islamic literature, 1:200
 lacking scientific hypotheses, 2:454–455
 revitalization of, 2:470–471
See also Design in nature
- Intentional actions, 2:569
- Intentionality, 2:544, 602
- Intercessory prayer, 2:530
 research on, 2:682–683, 693
- Interconnectedness
 loss of, 2:501
 Native American spirituality and, 2:656, 659–660
 nature and, 2:502
 Navajo spirituality and, 2:665–666
- Intergenerational anthropocentrism, 2:509–510
- Intergenerational justice, 2:508, 509
- International Institute of Islamic Thought, 1:207
- International Union for the Conservation of Nature, 2:496
- Interpretations, multiplicity of, 1:115–116
- Intragenerational justice, 2:509, 510
- Intrasystem conceptual variation. *See* Theological incorrectness
- Intrinsic religiosity, 2:521
- Introvertive mysticism, 1:140
- Intuition, 1:106–108
- Intuition of essences, 2:544
- Intuitive ontology, 2:595–596
- Inverse-Square Law, 1:358, 360
- Irenaeus (early Christian theologian), 1:223
- Irreducible complexity, 2:453, 472–474
- Isidore of Seville, 1:285–286
- Isis (African deity), 1:333
- Iskandrani, Muhammad ibn Ahmad al-, 1:205
- Islam
 cosmology, 1:197, 200, 208, 373
 decline of original thought, 1:34
 education, 1:33–34, 207
 and modernity, 1:204–205
 translation movement, 1:27, 28, 266–267
See also Islamic law; Islamic science
- Islamic law, 1:33
 autopsies and dissection, 2:747–748, 751–752
- Islamic science, 1:28–32
 alchemy, 1:266–269
 attitudes toward modern, 1:203–204
 challenges of, 1:116–118
 colonization and modern, 1:203–207
 cultural particularism and, 1:113–116
 decline of, 1:34, 205
 forms of knowledge, 1:27–28
 Hellenic heritage and, 1:26–28
 integrated with religion, 1:198, 200
 metaphysics and, 1:197–198, 207–208
 modern, 1:203–208
 postcolonial modern, 1:205–206
 premodern, 1:196–201
 Quran and. *See* Quran
 religious reactions to, 1:32–34
 visible/invisible realms and, 1:196
 Western paradigms and, 1:206–207
 worldview and, 1:196

Islamic Thought, International Institute of, **1:207**
 Island universe theory, **1:302**
 Islands of the Sun and Moon (Inca), **1:174**

J

Jabir corpus (alchemy), **1:267–268**
 Jabir ibn Hayyan, **1:267**
 Jafar al-Sadiq, **1:267**
 James, William, **2:520, 528**
 Japan, dissection and autopsy in, **2:750**
 Jawhari, Tantawi, **1:205**
 Jerome (early Christian theologian), **1:223**
 Jerusalem, at the center of the earth, **1:286**
 Jews, alchemy and, **1:266–267, 270**
 Jin Ling Zi, **1:120**
 Jinasena, **1:312**
 John Paul II, **1:354**
 on evolution theory, **2:442**
 John Scottus Eriugena, **1:286**
 Judaic law
 autopsies, **2:714–715, 747**
 death and dying, **2:712–714**
 health care, **2:717**
 organ/tissue transplantation, **2:714–717**
 supporting the sick, **2:717–718**
 See also Judaism
 Judaism
 burial practices, **2:718**
 classical, **1:18–20**
 Kabbalah, **1:22, 270–271**
 medieval, **1:20–22**
 modern, **1:22–25**
 See also Hebrew scriptures; Jews;
 Judaic law
 Judeophobia, **1:24**
 Julian calendar, **1:292**
 Jung, Carl, **2:528, 523**
 Justice
 intergenerational, **2:508, 509**
 intragenerational, **2:509, 510**
 Justification, context of, **1:114–115**

K

Kabbalah, **1:22, 270–271**
 Kalam cosmological argument, **1:372–374**
 Keb (African deity), **1:333**
Kebra Negast, **1:334–335, 336**
 Keleman, Deborah, **2:601**
 Kelly, Alison, **1:157**
 Kenya
 Kalenjin of, **2:489**
 Kipsigis of, **2:486, 488**
 Maasai of, **2:487**
 Kepler, Johannes, **1:299, 315, 399; 2:429**

Keynes, John Maynard, **1:355, 356**
 Khalid ibn Yazid, **1:267**
 Khepera (African deity), **1:43, 332–333**
Kher heb (Northeast African priest), **1:43**
 Khwarizmi, al-, **1:29**
 Knowledge
 animal, **1:78**
 classical, **1:284, 286–287**
 cultural transmission of, **1:155–158**
 esoteric, **1:177**
 indigenous. *See* Indigenous knowledge
 Islamic forms of, **1:27–28, 207**
 shared, **1:154–155**
 writing about secular, **1:252**
 Koestler, Arthur, **1:353**
 Kosmology. *See* Cosmology
 Kundalini meditation, **2:533**
 Kunuk, Zacharias, **2:615**

L

Lakwene, Alice, **2:487, 488**
 Lamarck, Jean-Baptiste, **2:458**
 Land management, Native Americans and, **1:55, 56**
 Language
 and classroom barriers, **1:159**
 Hindu contribution to, **1:190**
 of science, **1:156**
 worldview and, **1:70**
 Lao-Tzu, **1:124**
 Laplace, Pierre Simon de, **1:316**
 Laszlo, Ervin, **2:440**
 Latin Christendom, **1:232**
 Law, **1:89–90**
 Laws of nature
 early modern understanding of, **2:430**
 Hindu, **1:37**
 limit questions and, **1:10–11**
 Lawson, E. Thomas, **2:593**
 Lazar, Sara, **2:533**
 Leadership
 Augustus's ideas of, **1:247**
 before Christianity, **1:244–246**
 Cicero's ideas of, **1:245–246**
 Greco-Roman ideas of, **1:244–247**
 linked to the divine and natural world, **1:245**
 new type of Christian (fourth century CE), **1:248–249**
 Saint Antony and, **1:248–249**
 LeDoux, Joseph, **2:537**
 Leibniz, G. W., **2:431**
 Leibniz's Law, **2:571**
 Lemaître, Georges Henri, **1:318, 371**
 Leopold, Aldo, **2:494**
 Leucotomy. *See* Lobotomy

- Levi, Jeff, 2:678–679
 Lexington Alliance, 2:442–443
 Liberal arts, in Christian education, 1:284
 Libraries, Hellenistic, 1:218
 Licinius, 1:248
 Life
 eternal. *See* Life after death
 evolution of. *See* Evolution
 organic, 1:77
 prolonging. *See* Life-sustaining treatment
 rationalization of, 2:768–769
 Life after death, 1:101–102
 Aspero, 1:170–171
 Chinchorro, 1:169–170
 cognitive explanations of, 2:600–601
 reconstruction of Whitehead and,
 2:438–440
 reincarnation, 1:43, 333
 resurrection. *See* Resurrection
 stages of, 2:706
 transcultural belief in, 2:705–706
 Life expectancy
 religious affiliation and, 2:679
 religious attendance and, 2:685
The Life of Galileo (Brecht), 1:353
Life of Saint Antony (Athanasius),
 1:248–249
 Life process, orientation within the, 2:539
 Life support, artificial. *See* Life-sustaining
 treatment
 Life-sustaining treatment
 advanced care planning, 2:734–735
 Christian perspective of, 2:732
 Jewish perspective of, 2:713, 732
 Terri Schiavo and, 2:700, 733–734
 when to continue, 2:736–737
 withholding/withdrawing, 2:732–735
 Limbic leukotomy, 2:560
 Limit questions, 1:9–12, 12, 409
 Lin Lan, 1:122
 Lindbergh, Charles, 2:578
 Linde, Andre, 1:377
 Linear time, 1:78
 Linnaeus, Carolus, 1:347
 Lived religion, 1:142
 Lived science, 1:142
 Living donors, Judaic law on, 2:715
 Living wills, 2:735
 Lobotomy, 2:558–559
 Locke, John, 2:428
 Logic, Godel’s Theorem, 1:104–106
 Lou, Hans, 2:532–533
 Lourdes, 2:683
 Love, healing and, 2:681
 Lucid dreams. *See* Dreams
 Lucy, 1:333
 Lunar calendars, 1:290–291
 Lutgard of Aywieres, 1:277–278
 Luzzi, Mondino dei’, 2:749
-
- M**
-
- MacLean, Paul, 2:530
 Madrasas, 1:33–34
 Magic, 1:264
 black (Ethiopian), 2:640
 Magic squares (Africa), 1:46
 “The Magical Number Seven, Plus or
 Minus Two” (Miller), 2:594
 Magnus, Albertus, 1:270, 297–298
 Magog, 1:287
 Maimonides, 1:21
 Makeda (Queen of Sheba), 1:335–336
 Makhluḥ, Hasanayan Muhammad, 2:752
 Malaria, treatment for, 1:119
 Malik, Ibn, 2:748
 Malinowski, Bronislaw, 2:678
 Man-apart-from-nature view, 2:507,
 511
 Manic depression, 2:556
 Manifest Destiny, 1:63–64
 Maori (New Zealand tribe), 1:314
 Maps
 medieval, 1:287, 288–289
 Taoist contribution to, 1:123
 Maria the Jewess, 1:265–266
 Mars, 1:302
 Martians, 1:302
 Martyr, Justin (early Christian theologian),
 1:223
 Marx, Karl, 2:585
 Masks, human reaction to, 2:477
 Material properties, 2:567
 Material reality. *See* Reality
 Materialism
 dialectical, 1:108–109
 philosophical, 1:213
 Mathematics
 Africa’s contribution to, 1:45–46
 Hindu contribution to, 1:39, 182–184
 Islam’s contribution to, 1:29–30, 34
 Newton and, 1:358
 Matter
 antimatter and, 1:386
 Aristotle on, 1:263
 black hole, 1:375
 examples of, 2:567
 human perception of, 2:581–582
 split between spirit and, 1:62
 Stoicism and, 1:264
 McCauley, Robert N., 2:593
 McDonaldization, 1:147
 McFague, Sallie, 2:511–512
 McGrath, Alister, 2:511

- Meaning
 loss of, 2:501–502
 question of, 2:539
- Measurement, cord, 1:415
- Medicaid, hospice and, 2:728
- Medical education, dissection in, 2:749
- Medical writing, in early Greece, 1:253
- Medicare, hospice and, 2:727–728
- Medication. *See* Pharmacology
- Medicine
 development of secular, 2:677–678
 four humors, 1:274
 Hindu contribution to, 1:39, 188–190
 Hippocrates, 1:273–276
 Hippocratic movement, 1:253
 holistic
 African, 1:43–45
 hospice and, 2:724
 Islam's contribution to, 1:31–32;
 2:747–748
 Prophetic, 1:28
 Taoist contribution to, 1:119–120
 West Africa's contribution to, 1:45
 See also African traditional medicine;
 Health care; Life-sustaining
 treatment; Pharmacology;
 Physicians; Wellness
- Medicine men and women, African,
 2:643–644
- Medicine (Native American concept),
 2:657–658
- Meditation, 1:135–136
 neurobiological study of, 2:529–533,
 546–547
 Western, 2:580
 See also specific type
- Mediums, 2:579
 African, 2:644
- Melanchthon, Philip, 1:299
- Mendel, Gregor, 2:443, 458, 765
- Menstruation
 Aristotle's theory of, 1:274–275, 276
 Hippocrates's theory of, 1:274
- Mental entities, 2:569–570, 571
- Mental health, religion and, 2:687–688, 691
- Mental states, 2:544, 568
 animism and, 2:629
 brain activity and, 2:586
 features of, 2:572
- Mercury, Hindu investigation of, 1:187–188
- Merleau-Ponty, Maurice, 2:544
- Merrell-Wolff, Franklin, 2:578
- Meru Prastara, 1:182
- Mesoamerica
 architecture, 1:415, 416
 calendar, 1:418
 conceptual center, 1:416–417
- Mesoamerica (*continued*)
 creation myths, 1:416
 fire ceremonies, 1:417–418
 physical space, 1:416–419
- Meta questions. *See* Limit questions
- Metallurgy
 Africa's contribution to, 1:45–46
 Hindu contribution to, 1:187–188
 Taoist contribution to, 1:121–122
- Metaphysics, 1:85–87
 ancient South American, 1:171–172
 cognitive explanations of, 2:601–602
 Hindu science and, 1:183–186
 Islamic science and, 1:197–198, 207–208
 Whitehead's, 2:434–435
- Meteorology
 Greek contribution to, 1:214
 Taoist contribution to, 1:123–124
- Methodological naturalism, 1:396
- Methodological reductionism, 2:767
- Methodology, scientific, 1:84
- Mexica (Aztec group), 1:419
- Mice, used in genetic research, 2:760
- Midwifery, 1:280–281
- Military, Roman, 1:219
- Mill, John Stuart, 1:258, 373
- Miller, George, 2:594
- Mimamsa (Hindu darsana), 1:37
- Mimesis, 2:624
- Mind, 1:77
 conscious self, 2:543
 essence of person, 2:600
 external world and, 2:544
 ichi tante (Buddhist), 1:110–111
 modularity model, 2:594
 philosophy shifts from matter to, 1:216;
 2:543
 separate from brain, 2:570
- Mind-body, 2:565
 afterlife and, 2:600–601
 emotions and immunology, 2:680–681
 for Native Americans, 2:657
 scientism vs. autonomy principle, 2:573
- Minerals, 1:76
- Mirabilis, Christina, 1:277
- Miracles, 2:428, 430, 431, 432
- Misner, Charles, 1:409
- Moche (ancient South America)
 religion in art and architecture, 1:172–173
 technological sophistication, 1:178–179
- Modern science. *See* Western science
- Modularity model, 2:594
- Molecular biology, 2:447–448
- Moniz, Egas, 2:558
- Monks
 as spiritual intercessors, 1:249, 250
 Eṣtīfanosite, 2:634–635

- Monotheism, 1:132
 in Genesis, 1:338, 340
 Moody, Raymond, 2:739, 740
 Moon
 calendars based on the, 1:290–291
 life on the, 1:299
 Moral sense, 2:598
 Moral significance, 2:512
 Moral standing, 2:512
 Morals
 intergenerational anthropocentrism, 2:509
 science and, 1:76
 See also Ethics
 Morowitz, Harold, 2:541
 Morris, Henry, 1:391
 Mortuary practices. *See* Burial practices
 Mosaic multiculturalism, 1:146
 Mother Earth, 2:668
 Motion in void space, 1:237–238
 Mount, Balfour, 2:721
 Mount Rasa (Africa), 2:487
 MRI, functional. *See* Functional magnetic resonance imaging
 Muhammad Bello, 1:45
 Muhammad Tukur, 1:45
 Multiculturalism, mosaic, 1:146
 Multiverse, 1:322, 385, 388, 410
 Mummification, Chinchorro, 1:169–170
 Muslims and science. *See* Islamic science
 Mutation, 2:449–450, 464, 760, 789
Muwatta (Ibn Malik), 2:748
 Mwari (African deity), 2:486, 487
 Mystical experiences, 1:139–140; 2:553
 temporal lobe transients and, 2:587
 See also Religious experiences
 Mysticism, 1:140; 2:538
-
- N
-
- Nafis, Ibn al-, 1:31; 2:747
 Naive realism, 2:544
 Najour, Pam, 2:739–740
 Names, changing, 1:77
 Native Americans
 ceremonies, 2:660, 665–668
 environmental issues, 1:54–57
 ethos & beliefs, 1:49–51
 harmony, 2:658–659, 666
 hostility toward mainstream science, 1:48–51
 medical science and health of, 1:52–54
 medicine (concept of), 2:657–658
 Navajo. *See* Navajo
 non-Indians appropriating traditions of, 1:67
 numbers four and seven, 2:659
 powwows, 2:656
 Native Americans (*continued*)
 relation, 2:659–660
 spirituality, 2:654–656
 traditional beliefs, 2:657
 traditional values, 2:655
 tribal knowledge and science, 1:57–58
 vision, 2:660–661
 walking in step, 2:656–657
 Way of the Circle, 2:661–663
 See also Indigenous peoples
 Native science. *See* Indigenous knowledge
 Natural attitude, 2:544
 Natural impossibilities, 1:238–240
 Natural law theory, 2:494, 495
 Natural phenomena
 created by God, 1:341
 universality of, 1:358
 used in calendars, 1:290, 291
 Natural philosophy
 condemnation of 1277, 1:235–236, 238, 298
 conflicting with Christianity, 2:428
 defined, 1:230
 and deism, 2:432
 early Christians and, 1:222–227, 231
 medieval, 1:236–242
 natural theology and, 2:428–430
 theologians' development of, 1:240–241
 theological reactions to Aristotle's, 1:232–236
 Natural selection
 conditions for evolution, 2:458–460
 creative role of, 2:450–453
 genetics and, 448–450
 novel traits and functions, 2:464
 perfection and, 2:462–463
 simplicity vs. complexity, 2:463–464
 with or without evolution, 2:460–462
 See also Evolution
 Natural theology, 1:348
 natural philosophy and, 2:428–430
 Newton's, 1:355–356, 362–367
 revealed theology vs., 2:427–428
 Natural Theology (Paley), 2:453–454, 469
 Natural world
 Augustus and the, 1:247
 Christian notion as flawed, 1:248–249
 Cicero's view of the, 1:245–245
 divination, 1:245–246
 Greco-Roman ideas of, 1:244–246
 linked to the divine and leadership, 1:244–245
 for Plato and Aristotle, 1:245
 post-Christianity, 1:250
 pre-Christianity, 1:244–246
 sustaining, 1:344–345
 See also Nature

- Naturalism, 1:390
 methodological, 1:396
 resurgence of, 2:772–773
See also Nature
- Nature
 alchemy and, 1:271
 attempt to alter, 1:264
 biblical metaphors for, 1:343–344
 in book of Genesis, 1:336, 340–342, 346–347
 diversity of. *See* Biodiversity
 and evidence of God, 2:428–430
 God's control over, 1:345; 2:431
 Hinduism and, 1:38–39
 humans as stewards. *See* Stewardship
 Inca and, 1:173–174
 indigenous peoples and, 1:62
 Islam and, 1:196–201, 207
 laws of. *See* Laws of nature
 in Mesoamerican cities, 1:418–419
 product of divine wisdom, 1:344
 science and the biblical view of, 1:347–349
 vs. nurture, 2:769–770
 worldviews of, 2:507
See also Animals; Ecology; Environment; Flora; Natural world
 “Nature abhors a vacuum,” 1:237
- Navajo
 ceremonies, 2:665–668
 connectedness, 2:665–666
 sustainable living, 2:668
See also Native Americans
- Nazis, racial hygiene, 2:771–772
- Near death experiences, 1:134; 2:576, 577, 581
 aftereffects of, 2:743–744
 frequency of, 2:740
 Pam Najour, 2:739–740
 patterns of, 2:740–742
 quantifying, 2:742–743
 research on, 2:744–745
- Nebertcher (African deity), 1:332–333
- Nebular hypothesis, 1:302
- Needham, Joseph, 1:131, 193–194
- Nephyths (African deity), 1:333
- Neshama* (human soul), 1:403
- Neteru* (Northeast African deities), 1:43
- Network complexity, 2:767–768
- Neurobiology, consciousness and, 2:548–551
- Neurogenesis, 2:536
- Neuroimaging. *See* Brain imaging
- Neuropeptides, 2:680
- Neurophysiology, religious/spiritual experiences and, 2:524
- Neuroplasticity, 2:536
- Neurosciences, 2:536–537
 of Christianity, 2:530–531
 religious experiences and, 2:539–540
 religious phenomena and the, 1:96–97
See also Brain
- Neurotheology
 definitions of, 2:527–528
 history of, 2:528
 imaging technology, 2:528–529
 research, 2:529–533
- Neutrons, 1:382
- New Fire ceremony (Aztec), 1:417–418
- New science. *See* Natural philosophy
- Newberg, Andrew, 1:96; 2:532, 539
- Newton, Isaac, 1:8
 ancient wisdom and, 1:359–360
 belief in God, 2:429
 bio and education, 1:357, 360
 disbelief in the Trinity, 1:356
 General Scholium, 1:366–367
 God's infinite void space, 1:237, 316, 348
 law of gravity, 1:316, 371
 on miracles, 2:431
 natural theology, 1:355–356, 362–367; 2:430
 the Origines, 1:362–363
Principia Mathematica, 1:355–356, 358–359
 prophecy and revelation for, 1:361–362
 theology of, 1:360–361, 366
 on time and space, 1:365
 unity and, 1:367–368
 unpublished writings, 1:356
- Newton Project, 1:356
- Ngogisto* (African concept), 2:486
- Niccolini, Francesco, 1:352
- Nicholas of Cusa, 1:298
- “The Night Chant,” 2:666–667, 668
- No-creation myths, 1:312
- Nonanthropocentrism, 2:512
See also Anthropocentrism
- Nonlocal interactions, 1:94
- Northcott, Michael, 2:494
- Northrop, F.S.C., 1:112
- Nothing
 creation out of, 2:434
 something rather than, 2:551
- Nothingness, 1:408
 primordial, 1:312, 314, 322
- Novel traits, 2:464
- Nu (watery abyss), 1:332–333
- Nucleotide pairings, 2:764
- Numa (semimythical Roman king), 1:291
- Numinous experiences, 1:139
- Nun (Northeast African deity), 1:43
- Nunan, 1:157

Nut (African deity), 1:333
 Nutrition/hydration, artificial
 Jewish law on, 2:713–714
 Terri Schiavo and, 2:733–734
 withholding/withdrawing, 2:733
 Nuwati. *See* Native Americans, medicine
 Nyaya (Hindu darsana), 1:37–38

O

Oath of 1272, 1:234
 Object permanence, 2:600
 Object relations school, 2:523
 Objects, classification of, 2:595
 Observation, 1:93
 anthropic principle and, 1:384–385,
 410–412
Observations upon the Prophecies
 (Newton), 1:362–363
 Obsessive compulsive disorder (OCD),
 2:557
 ritual and, 2:626–627
 Occasion, actual, 2:434–435
 Occasionalism, 1:32–33
 Oddities, biological, 2:455
Odyssey (Homer), 1:251
Of Learned Ignorance (Nicholas of Cusa),
 1:298
Of the Plurality of Worlds: An Essay, 1:301
 Ohiyesa, 1:67
 Old earth creationism. *See* Progressive
 creationism
On the Fabric of the Human Body
 (Vesalius), 2:749–750
 One-gene/one-enzyme hypothesis, 2:765, 766
The One in the Many (Bracken), 2:436
Onta (Greek level of reality), 1:255
 Ontological argument, Anselm's, 2:427
 Ontological awakening, 2:576–578, 581
 Ontology, intuitive, 2:595–596
 Opioid release, 2:625
 Opposing forces, 1:94–95
 Optics
 Islam's contribution to, 1:30
 Taoist contribution to, 1:123
Optiks (Newton), 1:364, 368; 2:429
 Oresme, Nicole, 1:236
 Organ transplantation, 1:150–151
 Judaic law on, 2:714–717
 Organic life, origin of, 1:77
 Organisms, genetically modified, 2:780–782
 Origen (early Christian theologian), 1:225,
 231
Origin of Species (Darwin), 1:8; 2:443, 458,
 472
 Original sin, 1:88
 The "Origines" (Newton), 1:362–363

Orosius (Christian scholar), 1:285
 Orunmila (West African deity), 1:45
 Osher, 1:19
 Osiris (African deity), 1:333
 Out of body experiences, autoscopic, 2:741

P

Pachacamac (Inca pilgrimage destination),
 1:174
 Page, Ruth, 2:496
 Pain control, Judaic law on, 2:714
 Paine, Thomas, 1:300–301
 Paleomammalian brain, and ritual, 2:627
 Paleontology, 2:444–445
 Paley, William, 1:8; 2:453–454, 469
 Palliative care
 definition of, 2:725–726
 Jewish law on, 2:714
 See also Hospice
 Panentheism, 2:437, 511
 Pangu (Taoist creator of the world), 1:126
 Panini (Hindu grammarian), 1:39, 190
 Paradise, location of, 1:286–287
Paramanu (Hindu), 1:186
 Parapsychology, death and, 2:708–709
 Parasitology, Taoist contribution to, 1:120
 Pargamet, Kenneth, 2:525–526
 Parkinson's disease, 2:561
 Particles, elementary, 1:94, 386–387
 Particularism, cultural, 1:113–116
 Pascal, Blaise, 2:432
 Past-life experiences, 2:576
 Patient-doctor relationships
 communication, 2:673–675
 physician role in patient spirituality,
 2:675–676
 physician self-disclosure, 2:675–676
 Patient rituals, 2:597
 Patient Self-Determination Act, 2:734
 Patients, terminally ill. *See* Terminally ill
 Patristic period, 1:221–222
 Peacocke, Arthur, 2:434, 537, 541
 "Peak in Darien" experiences, 2:708
Peloponnesian Wars (Thucydides), 1:252,
 254
 Pentateuch, 1:19
 Pentecostalism, American, 1:136
 Penzias, Arno, 1:320, 372, 400
 Peptides, 2:680
 Perception, direct, 1:106–108
 Persinger, Michael, 2:539–540
 Personality, 1:77, 78
 spiritual growth and, 2:540
 Personality changes
 lobotomy and, 2:559
 sudden, 2:539

- Persuasion, coercive, 1:138
 Pert, Candace, 2:680–681
 Peru (ancient)
 engineering and architecture of, 1:178
 religion in art, 1:170–171
 PET. *See* Positron emission tomography
 Petitionary prayer, 1:135
Phainomena (Greek level of reality),
 1:255
 Pharmacogenomics, 2:791–792
 Pharmacology
 Hindu contribution to, 1:189
 Islam's contribution to, 1:31–32
 shamans and, 2:612–613
 Taoist contribution to, 1:119
 West Africa's contribution to, 1:44–45
 See also Drugs; Medicine;
 Psychopharmacology
 Pharming, 2:781
 Phenomenological school, 2:523
Phenomenology of Perception (Merleau-
 Ponty), 2:544
 Phenotype, 2:764, 767, 768
*Philosophical Transactions of the Royal
 Society* (Newton), 1:357
Philosophie Zoologique (Lamarck), 2:458
 Philosophy
 aspects of, 1:83–90
 epistemology, 1:84–85
 ethics, 1:87–89
 Greek. *See* Greek philosophy
 Hellenistic age, 1:217–218
 Hindu, 1:37–38
 hospice, 2:722–723
 Islam and, 1:32
 medieval Jewish, 1:20–22
 metaphysics, 1:85–87
 natural. *See* Natural philosophy
 politics, 1:89–90
 Roman age, 1:218–219
 shift from natural to moral/political,
 1:216
 in the Talmud, 1:19–20
 Phison river, 1:287
 Phlegm, one of four humors, 1:274
Physica Kai Mystika (alchemical treatise),
 1:265
 Physical entities, 2:571
 Physical properties, 2:566–567
 Physical sciences, Hindu contribution to,
 1:185–187
 Physical world
 classical culture and, 1:221
 early Christian writers and, 1:222
 Islamic, 1:196–197
 makeup of the, 1:77
 natural philosophy and, 1:230
 Physicalism, 2:565, 566–568
 dualism vs., 2:571–572, 573–574
 Physicians
 communication skills, 2:674–675
 listening as a primary goal, 2:676
 role in patient spirituality, 2:675–676
 self-disclosure to patients, 2:675–676
 spirituality of, 2:671
 See also Medicine
 Physico-theology, 1:8
 Physics, 1:69–71
 anthropic principle and, 1:381–382
 classical to quantum, 1:320–321
 intelligent design and, 2:471
 laws of, 1:386
 and religion, 1:93–94
 Taoist contribution to, 1:120–123
 Piaget, Jean, 2:600
 Pilgrimage, medieval, 1:287–289
 Pinker, Steven, 2:545
 Place, Pierre-Simon de la, 1:355
 Place, sense of, 1:413–414
 Plants. *See* Flora
 Plato, 1:132, 217
 cave allegory, 2:576–577
 extraterrestrial life, 1:297
 story of Er, 2:739
 Timaeus, 1:245
 Platonism, 1:132
 “Playing God,” genetics and, 2:758, 787
 Ploetz, Alfred, 2:770
 Plural worlds. *See* Extraterrestrials
 Pluralism, religious, in Asia, 1:131–132
 Pneuma, 1:264
 Poetry
 biblical accounts of creation, 1:343
 epic Greek, 1:251
 Genesis and Hebrew, 1:338
 Politics, 1:89–90, 146
 Polkinghorne, John, 1:86; 2:434
 Polytheism, 1:132
 Popper, Karl, 1:42
 Population trends, 2:769
 Positive psychology, 2:524
 Positive thinking, 2:666
 Positron emission tomography (PET),
 2:528, 529, 545–546
 Possession, 2:579, 630
 Posterior superior parietal lobe, 2:550
 Postmortem exams. *See* Autopsies
 Pottery, Moche (ancient South America),
 1:178–179
 Power of attorney, durable, 2:735
Powers of Ten, 1:413
 Powwows, 2:656
 Practical wisdom, 2:497
 Prakriti (Hinduism), 1:38

- Prayer, 1:135–16
 Asmat (Ethiopia), 2:637–639
 intercessory, 2:530, 682–683, 693
 of terminally ill, 2:673
 types of, 1:135
 wellness and, 2:680–681
- Prayer times, Islamic, 1:29, 30
- Prayerful healing, 1:135
 Ethiopian, 2:636, 638–639
 research on, 2:682–683
- Precautionary principle, 2:496
- Prediction, 1:75, 374
- Prehension, 2:438–439
- Prescription drugs. *See* Pharmacology
- Priests
 ancient South American, 1:171–173
babalawo (Africa), 1:46
kher heb (Northeast African), 1:43
- Primeval atom, 1:318, 371
- Primeval religion, Newton's, 1:363
- Primitivism, Christian. *See* Christian primitivism
- Primordial nothingness, 1:312, 314, 322
- Primum Mobile*, 1:315
- Principia Mathematica* (Newton), 1:355–356, 358–359; 2:429
- Prisca sapientia*, 1:359
- Process and Reality* (Whitehead), 2:435
- Process theology, 2:434
- Process thought, 1:15
- Proctor, Richard, 1:302
- Producers (of religion & science), 1:144
- Progressive creationism, 1:393–396
- Promiscuous teleology, 2:601–602
- Properties, 2:565–566
 material, 2:567
 mental, 2:570
 physical, 2:566–567
- Property dualists, 2:570, 572
- “Prophetic medicine,” 1:28
- Propositional attitudes, 2:569–570
- Protagoras of Abdera (Sophist writer), 1:253
- Proteins, 2:764
- Proteomics, 2:760
- Protestant Reformation
 desacralization, 2:431
 religious authority and, 2:426
- Protestants, and life-sustaining treatment, 2:732
- Protons, 1:382
- Prudence, 2:497
- Psalms, book of, 1:343
- Psi phenomena, 2:687–688, 690
- Psychedelic drugs, 1:137; 2:575–576, 581
 ontological awakening and, 2:577, 581
 shamanic use of, 2:613–614
- Psychic research, death and, 2:708–709
- Psychoanalytic school, 2:522
- “Psychobehavioral” interpretation, 2:691
- “Psychobiological” interpretation, 2:690
- Psychology
 emotions and prayer, 2:680–681
 folk, 2:475–478, 601
 Hindu contribution to, 1:190
 positive, 2:524
 of religion. *See* Psychology of religion
 religious, 2:522
See also Mental health
- Psychology of religion
 contemporary schools of thought, 2:522–523
 critique of, 2:524–526
 history, 2:520–521
 religious psychology vs., 2:522
 research, 2:521–525
- Psychoneuroimmunology, 2:680–681
- Psychopathology, 2:576
- Psychopharmacology, 2:556–558
- Psychosurgery
 disorders treated with, 2:555–558
 ethics, 2:561–563
 history of modern, 2:558–559
 techniques, 2:559–560
See also Brain surgery
- Ptolemy, 1:29
- Pure consciousness. *See* Consciousness
- Purpose
 loss of, 2:501–502
 Native American beliefs and, 2:658, 660–661
 question of, 2:539
- Purposings, 2:569–570
- Purushas (Hinduism), 1:38
- Putnam, Robert, 2:501
- Pyramid of the Sacrifices (Peru), 1:170
- Pyramids, Mesoamerican, 1:417
- Pythagoras, 1:211–212

 Q

- Quantum cosmology, 1:321–323
- Quantum objects, 1:320–321
- Quantum physics, 1:70–71, 77, 320–321
 particles and waves, 1:384–385
 randomness and prediction, 1:374
- Queen of Sheba, 1:335–336
- Quff, Ibn al-, 1:31; 2:747–748
- Quintessence, 1:387
- Quintus, 1:245–246
- Qullubi, Gabriel of, 2:640
- Quran, 1:28, 196–201
 scientific exegesis of, 1:205, 206

R

- Ra (African deity), 1:332
 Racial hygiene, 2:771–772
 Racism, eugenics and, 2:770–772
 Radiation, residual, 1:372, 400
 Rainbow, Islamic science and, 1:30–31
 Ramachandran, V.S., 2:540
 Ramm, Bernard, 1:394
 Random events, 1:374
 Rationalization, of life, 2:768–769
 Rats, used in genetic research, 2:761
 Rause, Vince, 1:96
 Ray, John, 1:8
 Razi, Abu Bakr Muhammad ibn-Zakariyya al-, 1:268
 Razi, al-, 1:31
 Realism, 1:9
 naive, 2:544
 Reality
 accessing another, 2:579–580
 essentialism and hybridity, 1:144–145
 external material, 2:543–544, 551–553
 genetics as a model of, 2:757, 763
 Godel's Theorem, 1:104–106
 Greek, 1:255
 intrusions, 2:578–579
 naturalistic view of, 1:409
 ontological awakening, 2:576–578, 581
 spirituality and, 1:108–109
 See also Consciousness
 Reason
 ethics and, 1:89
 and the medieval university, 1:240–242
 relationship with revelation, 2:426–428
 role of in 12th c. Europe, 1:232
 Saadia Gaon on, 1:21
 science and, 1:82, 84
 vs. ecclesiastical authority, 1:232
 Recognition, 2:549
 Recombination, 2:464
 Reductionism (in science), 1:51–52, 69
 Reeds, Mesoamerican, 1:418
 Reflective consciousness. *See* Consciousness
 Reflexive mediation, 2:580
 Reincarnation. *See* Life after death
 Relationships
 depersonalization of, 2:500–501
 ecological, 2:502
 Relativism, in Sophist writing, 1:253–254
 Relativistic cosmology, 1:317
 Relativity, Einstein's theory of, 1:316–317
 Relaxation response, 2:529–530
 Religion
 aspects of, 1:82–83, 92–93
 biology and, 1:94–96
 Religion (continued)
 cognitive science of. *See* Cognitive science, of religion
 conversion, 1:137–138
 defined, 1:83
 epidemiology of, 2:678–679, 685–686
 ethics and, 1:88–89
 genetics intersecting with, 2:757
 lived, 1:142
 physics and, 1:93–94
 psychology of. *See* Psychology of religion
 separate from state, 1:22–23
 separation from science, 1:62
 service attendance and health, 2:679–680, 685–686
 similarities of, 1:92–93
 social cohesion and, 2:598–599
 theology distinct from, 2:593
 at war with science, 1:353, 370
 See also Religiosity; Religious experiences; Sects; Theology; specific religion
 Religion-science hybrids, 1:147–148
 Religiosity
 extrinsic vs. intrinsic, 2:521
 spirituality vs., 1:133; 2:522
 Religious experiences
 analysis of, 2:589–591
 apparitions and visions, 1:135
 brain and, 2:586–589
 cults and coercive persuasion, 1:138
 culture and, 2:587–589
 genes and, 2:760–761
 glossolalia (speaking in tongues), 1:136
 interpretation of, 1:133–134
 neuroscience of, 1:96–97; 2:539–540
 prayer and meditation, 1:135–136
 profound, 2:584–585
 psychedelics or entheogens, 1:137
 sense of the sacred, 1:138–139
 serpent handling, 1:136
 types of, 2:538–539
 See also Mystical experiences; Near death experiences; Spiritual experiences
 Religious maturity, 2:540
 Religious pluralism, in Asia, 1:131–132
 Religious socialization, 2:523–524
 Religious tolerance, 1:131–132
 Renaissance magus, 1:271
 Reproductive cloning, 2:797–800
 laws banning, 2:800–801
 Reptilian brain, and ritual, 2:626–627
 Respect, physician, 2:674, 675

- Resurrection
 Christian belief in, 2:750–751
 in Judeo-Christian creation myths, 1:346
 Muslim belief in, 2:751–752
Rethinking Religion: Connecting Cognition and Culture (Lawson & McCauley), 2:593
 Revealed theology, 2:427–428
 Revelation
 nature in the book of, 1:345
 reason and, 2:426–428
 Reynolds, Pam, 2:739–740
Rheomode (Bohm's), 1:70
 Riccardi, Niccolò, 1:351–352
 Riemann, Georg, 1:376
 Rigor mortis, 2:707–708
 Ring, Kenneth, 2:742
 Rita, 1:36–37
 Ritual
 brain changes and, 2:588–589
 cognitive explanations of, 2:597–598
 definition of, 2:538
 evolutionary/biological basis of, 2:623–624
 knowledge passed via, 1:334
 Native American, 2:660, 665–668
 obsessive compulsive disorder and, 2:626–627
 paleomammalian brain and, 2:627
 reptilian brain and, 2:626–627
 types of, 2:597
 Ritual elders, African, 2:644–645
 Road system, Inca, 1:180–181
 Rocketry, Taoist contributions, 1:127
 Rocks, 1:76
 Rolston, Holmes, 2:494
 Roman age, 1:218–219, 246–247
 Roman calendar, 1:291–292
 Christian changes to, 1:293
 Roman Catholic Church
 and Galileo affair, 1:350–353
 Newton and the, 1:362
 Romulus, 1:291
 Rosy Periwinkle plant, 2:495
 Ruler, relationship with ruled, 1:245
 Rumi, 1:95
 Rushd, Ibn, 1:32; 2:748
 Russell, Bertrand, 1:114
-
- S**
-
- Saadia Gaon, 1:21
 Sacred
 defined, 2:499
 diminishing belief in, 2:499–501
 reclaiming, 2:502, 504
 sense of the, 1:138–139
 Sacrifice, Aztec, 1:417, 419
 Saints, spiritual healing and (Ethiopia), 2:637, 640
 Salam, Abdus, 1:34
 Salimbene, 2:749
 Samhain (Celtic holiday), 1:293
 Samkhya (Hindu darsana), 1:38
 Sämra, Krästos (Ethiopian saint), 2:634
 Sardar, Ziauddin, 1:207
 Saunders, Cicely, 2:721, 726, 728
 Schiaparelli, Giovanni, 1:302
 Schiavo, Terri, 2:700, 733–734
 Schizophrenia, 2:558
 Science
 ancient vs. modern, 1:215
 anomalies in, 1:74–75
 anthropological definitions of, 1:177
 aspects of, 1:81–82
 benefits and costs of, 2:500–501
 commencement of modern, 1:7
 as a culture, 1:153–154
 defining, 1:82, 176–177
 different meanings of, 1:62
 ecological, 2:504
 vs. mechanistic, 2:502–503
 ethos of mainstream, 1:51–52
 exact, 1:230
 language of, 1:156
 limit questions, 1:9–12
 limits of, 1:106
 lived, 1:142
 modern. *See* Western science
 morality and, 1:76
 multiple interpretations, 1:115–116
 separation from religion, 1:62
 turning away from, 1:24
 at war with religion, 1:353, 370
See also Scientists; Western science
 Science education
 creationism and, 1:159, 393
 and cultural dissonance, 1:158–160
 and cultural transmission, 1:62–63, 157–158
 Science-religious hybrids, 1:147–148
 Science teachers, as cultural brokers, 1:159–160
 Scientific creationism, 1:393
 Scientific cultures, 1:155–157
 Scientific method, 1:84
 Hindu, 1:185
 Islamic, 1:200–201
 Scientific realism, 1:9
 Scientific Revolution, extraterrestrials and the, 1:298–301
 Scientific universalism, 1:113–116
 Scientism, 1:114; 2:573

- Scientists
 culture of, 1:155–156
 gender stereotypes, 1:157
 Sects, 1:138; 2:599–600
 Seers, African, 2:644
Sefer ha-Zohar (Kabbalistic corpus), 1:270
 Seizures, 2:540, 586–587
 Səlä́t, 2:639–640
 Self
 conscious of, 2:543, 548–549
 immaterial, 2:572
 solipsism, 2:552
 See also Consciousness
 Sensations, 2:569–570
 Sensory pageantry, 2:597
 Sensory restriction, 2:578–580
 Separation
 essentialism and, 1:144–146
 of religion and state, 1:22–23, 242
 September 11, essentialism and, 1:148
 Sequences, 1:409
 linear, 1:78
 Serpent handling, 1:136
 Set (African deity), 1:333
 Seventh-Day Adventists, 1:301, 391
 Sexual intercourse, witches and, 1:278–279
 Shamans and shamanism, 1:79; 2:616–617, 621–622
 altered states of consciousness, 2:628
 analogical thought, 2:628–629
 biological/evolutionary basis, 2:622–623
 healing practices, 2:625
 neurognostic structures, 2:623
 ritual and mimesis, 2:623–624
 contemporary, 2:619–620, 631
 cosmology and ecology, 2:617–619, 622
 healing, 2:611–614, 629–630
 meaning of, 2:615
 organized religions opposition to, 2:616
 plant pharmacopeia, 2:612–613
 responsibility of, 2:614
 shapeshifting, 2:614, 616
 spirit world and, 2:611–612
 triune brain and, 2:625–627
 use of psychoactive materials, 2:613–614
 Shapeshifting, 2:614, 616
 Shared knowledge, 1:154–155
 Shatir, Ibn al-, 1:30
 Sheba, Queen of, 1:335
 Shirarzi, Qutb al-Din al-, 1:30
 Shiva (Hindu god), 1:312
 Shona, of Zimbabwe, 2:486, 487, 489
 Shu (African deity), 1:333
 Sickness. *See* Illness
 Silent majority, 1:258
 Sin, 2:539
 Single photon emitting computerized tomography (SPECT), 2:528, 529, 545–546, 588
 Singler, Peter, 2:496
 Singularities, 1:406
Sinodos, 2:634
 Sivin, Nathan, 1:194
 Skinner, B.F., 2:585
 Sleep, 2:575
The Sleepwalkers (Koestler), 1:353
 Slipher, Vesto, 1:371
 Smallpox vaccinations, Taoist contribution to, 1:120
 Smolicz, 1:157
 Smolin, Lee, 1:375
 Smoot, George, 1:372
 Snake handling, 1:136
 Snake Mountain (Aztec), 1:417, 419
 Snow, C.P., 1:154
 Sobel, Dava, 1:354
 Social capital, loss of, 2:501
 Social cohesion
 healing rituals and, 2:625
 religion and, 2:598–599
 Social ills, nature vs. nurture debate, 2:769–770
 Social intelligence system, 2:596, 598
 Social support
 religious attendance and health, 2:679–680, 687–688
 of the sick (in Judaism), 2:717–718
 Socialization, religious, 2:523–524
 Society
 depersonalization of, 2:500–501
 Whiteheads, 2:435, 436, 439
 and worldviews, 1:143–144
 Socrates, 1:213, 216–217
 intellectual freedom and, 1:258
 in Plato's cave allegory, 2:577
 Solipsism, 2:552
 Solomon
 in creation myths, 1:335–336
 healing plants and, 2:640
 Song, 1:78–79
 Soothsayers, Mesoamerican, 1:416
 Sophists, historical writing, 1:253
 Soranus of Ephesus, 1:280
 Souders, Paul, 2:617
 Soul, 1:66, 403
 after death, 2:706
 box of, 2:706–707
 loss of, 2:617, 629–630
 separate from brain, 2:570
 Soul journey, 2:628
The Soul of an Indian (Eastman), 1:67
Soul wound, 1:68

- South America (ancient Western)
 agricultural technology, 1:179–180
 ceramics, 1:178–179
 Chinchorro burial practices, 1:169–170
 engineering and architecture, 1:178
 formalized religion, 1:172–173
 metaphysics and myth, 1:171–172
 religion reflected in art, 1:170–171
 rise of the Inca, 1:173–174
- Space
 absolute, 1:365
 Hindu notion of, 1:186
 Newton on, 1:365
 physical, Mesoamerican, 1:416–419
- Space travel, Taoist contributions,
 1:126–128
- Speaking in tongues, 1:136
- Special agent rituals, 2:597
- Special instrument rituals, 2:597
- Special patient rituals, 2:597
- Specialization (in science), 1:51–52
- Species, endangered, 2:496
- SPECT, 2:528, 529, 545–546, 588
- Spherical earth. *See* Earth
- Spinoza, 1:22–23
- Spirit, 1:66
 matter and, 1:62
- Spirits
 African belief in, 1:43–47; 2:490
 Native American belief in, 1:50; 2:657
 realm of, 1:76
 shamans and, 2:611–613, 629
- Spiritual experiences
 interpretation of, 1:133–134
 near death, 1:134
 numinous, 1:139
 prayer and meditation, 1:135–136
See also Mystical experiences; Religious experiences
- Spiritual growth, 2:540
- Spiritual healing. *See* Healers and healing
- Spiritual maturity, 2:540
- Spiritualism, dialectical, 1:109
- Spirituality
 effect on sickness and health, 2:671–672
 indigenous peoples and, 1:61–62, 65, 68,
 77
 mathematics and, 1:45–46
 Native American, 2:654–656
 neuroscience and, 1:96–97
 in Northeast Africa, 1:43–44
 and reality, 1:108–109
 religiosity *vs.*, 1:133; 2:522
- Spontaneous symmetry breaking, 1:386
- Stars
 lifetime, 1:387
 properties, 1:380–382
- State, separate from religion, 1:22–23
- Steady State theory, 1:319, 372
- Steel production, Taoist contribution to,
 1:121–122
- Stem cell research, 2:758, 784
- Sterilization laws, 2:771, 772
- Stewardship
 divine wisdom and, 2:497
 in Judeo-Christian creation myths, 1:342,
 346–347; 2:492, 506–507
- Stoicism, 1:20, 217–218, 245
 spiritual dimensions of matter, 1:264
- Stones, 1:76
- String theory, 1:78
- Sturtevant, Alfred, 2:765
- Subcaudate tractotomy, 2:560
- Subcultures
 in classrooms, 1:158–160
 knowledge and, 1:154
 scientific, 1:156
See also Culture(s)
- Subjectivity, 1:75
- Substance dualists, 2:570, 572
- Substances, 2:565
 mental, 2:570
 physical, 2:566–567
- Suchocki, Marjorie, 2:438–439
- Sudden personality change, 2:539
- Suffering, unnecessary, 1:373, 403–404
- Suicide, Judaic law on, 2:712
- Sun
 calendars based on the, 1:290
 center of universe, 1:298, 315
See also Heliocentric theory
- Sun Simiao, 1:119
- Superempirical influences, 2:687–688,
 690
- Supernatural agents, 2:475–478
 cognitive explanations of, 2:595–598
 detecting, 2:602
 existential anxiety and, 2:478–481
- Supreme beings, 1:86–87
- Surgery
 Islam's contribution to, 1:31
 precolonial Africa, 2:643
- Surya Siddhanta (Vedic text), 1:39
- Sushruta (Hindu medical writer), 1:188
- Sustainable development, 2:504–505
 Agenda 21, 2:506
 economic growth, 2:509
 ethics of, 2:507–510
- Sustainable living, Navajo and, 2:668
- Symmetry breaking, spontaneous, 1:386
- Synergy, 2:538
- Synthetic theory, 2:443–444
- The System of the World* (Newton), 1:359
- Systemic value, 2:494

T

- Täbäls, 2:639
 Tabots, 2:637
 Tacit information, 2:595
 Tacit infrastructure, 1:61
 Tang, Elizabeth, 2:682
Tanimim, 1:404
Tanmatra (Hindu), 1:185–186
Tao Te Ching (Lao-Tzu), 1:124
 Taoism, Joseph Needham and, 1:193–194
 Taoist contributions
 chemistry and physics, 1:120–123
 medicine and biology, 1:119–120
 space travel, 1:126–128
 studies of heaven and earth,
 1:123–126
Tawhid (Islam), 1:197–198
 Taxonomy, in biblical texts, 1:341, 347
 Technological-fix mentality, 1:52
 Technology
 benefits and costs of, 2:500–501
 science-based, 1:146–148, 151
 Tefnut (African deity), 1:333
 Teinhardt, Paul, 1:377
 Teleology, promiscuous, 2:601–602
 Televisions, residual radiation on, 1:372
 Tem (African deity), 1:333
 Tempier, Etienne (bishop of Paris), 1:298
 Temple, Great Temple (Aztec), 1:417, 419
 Temple of the Sun (Mesoamerican), 1:417
 Temporal lobe transients (TLTs), 2:587
 Temu (African deity), 1:43, 332
 Tenochtitlán (Mesoamerican city),
 1:418–419
 Teotihuacan, 1:417, 418
 Terminally ill
 Judaic law on, 2:713
 listening to, 2:676
 physician communication with,
 2:674–675
 physician self-disclosure to, 2:675–676
 physician's role in patient spirituality,
 2:675–676
 spirituality and religion of, 2:672–673
 See also Life-sustaining treatment
 Terror management theory, 2:479
 Terrorism, essentialism and, 1:148–149
 Tertullian (early Christian theologian),
 1:223
 Thalamus, 2:549
 Thales (Greek philosopher), 1:212–215
 Theistic evolution, 1:396–397
 Theodicies, 1:373
 Theodosius, 1:249
 “Theologia Gentilis Origines Philosophicae”
 (Newton), 1:362
 Theologians
 medieval, 1:236–239
 natural philosopher, 1:240–241
 response to genetic engineering, 2:782,
 783, 785
 response to human cloning, 2:799
 See also Theology
 Theological incorrectness, 2:602–603
 Theology
 “handmaiden approach” to, 1:231
 natural. *See* Natural theology
 neurotheology. *See* Neurotheology
 process. *See* Process theology
 religion distinct from, 2:593
 revealed, 2:427
 See also Religion; Theologians
 Therapeia, 1:216
 Thirteen errors, 1:233–234
 Threefold doctrine (alchemy), 1:265
 Thucydides (Greek writer), 1:252, 254, 255,
 257
 Tian Mu Niang Niang, 1:120
 Tigris river, 1:287
Timaeus (Plato), 1:245
 Time, 1:93–94
 absolute, 1:365
 Aztec, 1:417–418
 Big Bang theory and, 1:406–407
 Hindu exploration of, 1:186
 inexistent for gods, 1:313–314
 marking of, 1:290
 Newton on, 1:365
 science and religion, 1:16–17
 unidirectional, 1:345, 348
 universe and, 1:377
 Tipler, Frank, 1:381, 384–385
 Tissue transplantation, Judaic law on,
 2:714–717
 Tiwa language, 1:70
 Tiwanaku (Andes)
 agricultural technology of, 1:179–180
 religion in art and architecture,
 1:172–173
 TLTs. *See* Temporal lobe transients
 Toland, John, 2:431
 Tolerance, religious, 1:131–132
 Tollan (Mesoamerican cities), 1:418, 419
 Top down interaction, 1:95–96
 Totemism
 African, 2:487–488
 shamanic, 2:628–629
 Toxin avoidance system, 2:601
 Traditional knowledge. *See* Indigenous
 knowledge
 Traits, novel, 2:464
 Trance, 2:575
 Transcendent state of consciousness, 2:578

Transcendental meditation, 2:529
 Transcranial magnetic stimulation, 1:97, 98
 Translation movement
 European, 1:231–232, 269
 effect on calendars, 1:294–295
 Islamic, 1:27, 28, 266–267
 Transorbital lobotomy, 2:559
 Transpersonal school, 2:523
 Transplants, organ, 1:150–151
 Judaic law on, 2:714–717
Treatise on Religious and Political Philosophy (Spinoza), 1:22
 Treatment, life-sustaining. *See* Life-sustaining treatment
 Trinity
 brain/mind function and, 2:531
 geography and the, 1:286
 Newton's attack on, 1:360, 367
 process theology and, 2:436–437
 Triune brain, 2:530–531
 shamanism and the, 2:625–627
 Trotula of Salerno, 1:281
 Tryon, Edward, 1:374
 Tukur, Muhammad, 1:45
 Tunneling (quantum cosmology), 1:321
 Turok, Neil, 1:377

U

Uddâlaka Âruni, 1:185
 Uganda
 Acholi of, 2:487
 precolonial surgery, 2:643
 Uncertainty principle, 1:320
 Uction of the Sick, 2:633–634, 636
 Unidirectional time. *See* Time
 United States
 autopsies, 2:752
 hospice, 2:726–728
 involuntary sterilization laws, 2:771
 Universal gravitation, 1:366–367
 Universalism, scientific, 1:113–116
 Universality, of natural phenomena, 1:358
 Universe
 accelerated expansion, 1:383
 collapsing, 1:371, 375, 411
 discontinuities, 2:551, 552
 eternal, 1:370–371
 expanding, 1:317–318, 371–372
 finite, 1:371
 infinite, 1:371
 is mind, 1:77
 makeup of the, 1:77
 multiple, 1:322, 385, 388, 410
 multiverse, 1:322, 385, 388, 410
 and nothing, 1:408
 oscillating, 1:375, 377

Universe (*continued*)
 self-reproducing, 1:375, 377
 and sense of place, 1:413–414
 and time, 1:377
 See also Big Bang theory; Cosmology;
 Cosmos; Creation myths; World
 University of Paris
 ban on Aristotle's natural philosophy,
 1:233
 Oath of 1272, 1:234
 Unpredictability, 1:14–15
 Unwellness. *See* Illness
 Urban space, Mesoamerican, 1:418–419
 Urban VIII. *See* Barberini, Maffeo
Usefulness of Experimental Natural Philosophy (Boyle), 2:428
 Ussher, James, 1:399

V

Vacuum energy, 1:387
 Vacuums, cosmic, 1:237–238, 374–375,
 382–383
 Vaiseshika (Hindu darsana), 1:37–38
Vaiseshika Sutra (Hindu), 1:186
 Vedanta (Hindu darsana), 1:38
 Vedic literature, 1:39, 182, 184, 185
 Venus tablets of Ammizaduga, 1:311
 Vesalius, Andrea, 2:749
 Virgins, 1:276–278
 Visions, 1:75, 135
 Viviani, Vincenzo, 1:353
 Vocalization, group, 2:624
 Void space
 infinite, 1:237
 motion in, 1:237–238
 Volcanoes, healing ceremonies and,
 2:611–612
 Vorilong, William, 1:298
 The vow (Ethiopian), 2:639–640

W

Walking in step, 2:656–657
 Wallace, Alfred Russel, 2:458
 Wan Hoo, 1:127
 Wang Bing, 1:123
 Wang Jia, 1:126
 War, essentialism and, 1:148–149
The Washing Away of Wrongs, 2:750
 Water
 in African creation myths, 1:332, 334
 kosmos origin in, 1:213
 one of four elements, 1:263
 Romans and, 1:219
 Water clocks, Taoist contribution to, 1:122
 Watson, James, 2:766, 788

- Way of the Circle, 2:661–663
 Weather, study of. *See* Meteorology
 Web of Life. *See* Circle of Life
 Weinberg, Stephen, 1:86
 Weismann, August, 2:771
 Wellness, 2:657, 671–672
 prayer and, 2:680–681
 See also Health
 Wesenschau, 2:544
 West Africa
 holistic medicine in, 1:44–45
 metallurgy and mathematics, 1:45–46
 Western science
 assumptions of, 1:61–63
 biblical influence on empirical,
 1:348–349
 compared with traditional knowledge,
 1:74–78
 Eastern religion origins of, 1:210
 effect on non-Western societies,
 1:112
 rise of empirical, 1:215, 218–219
 scientific community of, 1:156
 subjectivity in, 1:75
 See also Science
 Western worldview, 1:63–64
 Wexler, Nancy, 2:761–762
 Whewell, William, 1:301–302
 Whitcomb, John Jr., 1:391
 White, Andrew Dickson, 1:353, 370
 White, Ellen, 1:301, 391
 White, Lynn, 2:492, 511
 Whitehead, Alfred North, 2:434–435
 reconstruction of, 2:436–440
 Wieman, Henry Nelson, 2:541
 Wilderness shrines (Mesoamerican), 1:417
 William of Occam, 2:427
 Wills, living, 2:735
 Wilson, Robert, 1:320, 372, 400
 Wisdom
 ancient, 1:359–360
 divine. *See* Divine wisdom
 in the Hebrew scriptures, 1:19
 Judaism and, 1:18–19
 practical, environment and, 2:497
 science and, 1:18
 Witches' bodies, 1:278–279
 Witnessing meditation, 2:580
 Womb, theories of the, 1:275–276
 Women
 virgins, 1:276–278
 witches, 1:278–279
 Women's bodies
 Aristotle's study of, 1:274–276
 Hippocrates's study of, 1:273–276
 medieval gynecology, 1:280–281
 virgins as vessels, 1:277–278
 witches, 1:278–279
 World
 geographical Christianization, 1:285–289
 origin of, 1:77
 See also Earth; Universe
 Worlds
 counterfactual, 2:475
 plural. *See* Extraterrestrials
 Worldviews
 collective, 1:143–144, 154–155
 death and, 2:479–481
 holistic vs. fragmented, 1:70
 indigenous peoples, 1:61–62, 65, 66
 individual, 1:143–144
 religious vs. scientific, 1:148–151
 Western, 1:63–64; 2:506–507
 Wright, Sewall, 2:443
 Writing, early Greek historical. *See* Greek writing
-
- Y**
-
- Yahuda, Abraham, 1:356
 Yan Bori cult (in Nigeria and Niger), 1:44
 Yellow bile, 1:274
 Yemen, creation myths, 1:336
 Yin and Yang, 1:314
 Yoga (Hindu darsana), 1:38
 Yogic practice, 2:532–533
 Young earth creationism, 1:390–393
Yugas (multiple years—Hindu), 1:184–185
-
- Z**
-
- Zahrawi, Abul al-Qasim al-, 1:31
 Zār'a Ya'eqob, 2:638
 Zavos, Panos, 2:796
Zen and the Brain (Austin), 2:531
 Zero points, 1:406
 Zewali, Ahmed, 1:34
 Zhao Youqin, 1:123, 126
Zij tables, 1:30
 Zimbabwe
 Rufura of, 2:488
 Shona of, 2:486, 487, 489
Zohar (Kabbalistic corpus), 1:270
 Zosimus of Panopolis, 1:265–266

