

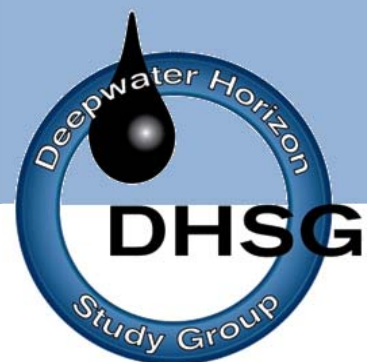

Final Report on the Investigation of the Macondo Well Blowout

**Deepwater Horizon Study Group
March 1, 2011**



The Deepwater Horizon Study Group (DHSG) was formed by members of the Center for Catastrophic Risk Management (CCRM) in May 2010 in response to the blowout of the *Macondo* well on April 20, 2010. A fundamental premise in the DHSG work is: we look back to understand the why's and how's of this disaster so we can better understand how best to go forward. The goal of the DHSG work is defining how to best move forward – assessing what major steps are needed to develop our national oil and gas resources in a reliable, responsible, and accountable manner.



This Page Intentionally Left Blank

In Memoriam

Jason Anderson
Senior tool pusher

Dewey Revette
Driller

Stephen Curtis
Assistant driller

Donald Clark
Assistant driller

Dale Burkeen
Crane operator

Karl Kleppinger
Roughneck

Adam Weise
Roughneck

Shane Roshto
Roughneck

Wyatt Kemp
Derrick man

Gordon Jones
Mud engineer

Blair Manuel
Mud engineer





Table of Contents

In Memoriam	1
Table of Contents	3
Executive Summary	5
Conclusions from Previous Reports	5
Looking Back – Technical Factors	6
Looking Back – Organizational Factors.....	9
Looking Forward	11
Background	14
Chapter 1 – Timeline to Disaster.....	18
<i>The Marianas</i>	18
<i>The Deepwater Horizon</i>	21
The Blowout.....	38
Post Blowout Shutdown Attempts	48
Chapter 2 – Analysis of the Blowout	49
Summary of Factors Leading to Blowout.....	49
Candidate Flow Paths to the Rig Floor.....	52
Phase 1 – Production Casing Design & Construction.....	54
Phase 2 – Temporary Abandonment.....	60
Phase 3 – Attempts to Control the Well.....	68
Summary	73
Chapter 3 – Insights.....	74
Introduction	74
Organizational Accidents Perspectives	75
Production versus Protection Insights	82
Summary	87
Chapter 4 – Going Forward	89
Introduction	89
Observations	89
Findings.....	90
Commentary.....	91
Recommendations.....	94
Summary	98

Deepwater Horizon Study Group
Investigation of the Macondo Well Blowout Disaster

Appendix A – Deepwater Horizon Study Group Members and Affiliations.....99

Appendix B – List of DHSG Working Papers..... 101

Appendix C – Primary Organizations Involved in the Macondo Well Project..... 103

Appendix D – Summary of Risk Mitigating Regulations..... 105

Appendix E - BAST Well Design, Processes, Equipment and Materials Upgrades.....121

Executive Summary

Conclusions from Previous Reports

The first progress report (May 24, 2010) concluded:

“This disaster was preventable had existing progressive guidelines and practices been followed. This catastrophic failure appears to have resulted from multiple violations of the laws of public resource development, and its proper regulatory oversight.”

The second progress report (July 15, 2010) concluded:

“...these failures (to contain, control, mitigate, plan, and clean-up) appear to be deeply rooted in a multi-decade history of organizational malfunction and shortsightedness. There were multiple opportunities to properly assess the likelihoods and consequences of organizational decisions (i.e., Risk Assessment and Management) that were ostensibly driven by the management’s desire to “close the competitive gap” and improve bottom-line performance. Consequently, although there were multiple chances to do the right things in the right ways at the right times, management’s perspective failed to recognize and accept its own fallibilities despite a record of recent accidents in the U.S. and a series of promises to change BP’s safety culture.”

The third progress report (December 1, 2010) concluded:

“Analyses of currently available evidence indicates the single critical element precipitating this blowout was the undetected entry of high pressure – high temperature ‘highly charged’ hydrocarbons into the Macondo well. This important change in the ‘environment’ was then allowed to exploit multiple inherent weaknesses in the system’s barriers and defenses to develop a blowout. Once the blowout occurred, additional weaknesses in the system’s barriers and defenses were exposed and exploited to develop the Macondo well disaster. Investigations have disclosed an almost identical sequence of developments resulted in the Montara well blowout that occurred 8 months earlier offshore Australia (Montara Commission of Inquiry 2010).”

“Analysis of the available evidence indicates that when given the opportunity to save time and money – and make money – tradeoffs were made for the certain thing – production – because there were perceived to be no downsides associated with the uncertain thing – failure caused by the lack of sufficient protection. Thus, as a result of a cascade of deeply flawed failure and signal analysis, decision-making, communication, and organizational - managerial processes, safety was compromised to the point that the blowout occurred with catastrophic effects.”

“At the time of the Macondo blowout, BP’s corporate culture remained one that was embedded in risk-taking and cost-cutting – it was like that in 2005 (Texas City), in 2006 (Alaska *North Slope Spill*), and in 2010 (“The Spill”). Perhaps there is no clear-cut “evidence” that someone in BP or in the other organizations in the Macondo well project made a conscious decision to put costs before safety; nevertheless, that misses

the point. It is the underlying “unconscious mind” that governs the actions of an organization and its personnel. Cultural influences that permeate an organization and an industry and manifest in actions that can either promote and nurture a high reliability organization with high reliability systems, or actions reflective of complacency, excessive risk-taking, and a loss of situational awareness.”

Looking Back – Technical Factors

At approximately 9:47 p.m. (Central Standard Time) on the evening of April 20, 2010, an uncontrolled flow of water, oil mud, oil, gas, and other materials came out of the drilling riser and possibly the drill pipe on the dynamically positioned drilling vessel *Deepwater Horizon* owned by Transocean and contracted by BP to drill the Mississippi Canyon 252 #1 Macondo well in approximately 5,000 ft of water in the northern Gulf of Mexico offshore the coast of Louisiana.

A series of two or more explosions and a huge fire followed shortly after the uncontrolled flow commenced. The fire continued unabated for about two days fueled by hydrocarbons coming from the Macondo well. The *Deepwater Horizon* was abandoned shortly after the fire started, but 11 of 126 persons aboard perished. The vessel sank about 36 hours later and the fire was extinguished. The riser and drill pipe inside bent at the top of the subsea Blowout Preventer (BOP) and dropped crumpled and broken on the seafloor, spewing gas and oil.

During the next 83 days, a series of attempts were made to stop the oil from enter the Gulf of Mexico. These attempts included:

1. Closing the BOP B/S (blind / shear) rams and variable pipe rams with Remotely Operated Vehicle (ROV) intervention (failed).
2. Closing off the end of the drill pipe on the sea floor (succeeded).
3. Capturing oil spewing from the broken riser on the sea floor with a box-like containment device connected to a drilling vessel above (failed).
4. Capturing oil spewing from the riser end with an insertion tube (partially successful).
5. Capturing oil spewing from the BOP top by shearing off the bent over and ruptured riser and drill pipe inside and installing a capture device (called “Top Hat” and Lower Marine Riser Package (LMRP) Cap) (partially successful).
6. Killing the well by injecting heavy mud into the BOP. Flow at the Top Hat still persisted and partial oil capture continued afterward (failed).
7. Removing the remnant riser at the BOP top and bolting on a sealing cap with a BOP above. This succeeded in shutting the well with only a few small leaks.
8. Pumping heavy kill mud into the well to drive well effluent down and reduce pressure at the well head (succeeded).
9. Pumping cement following the kill mud to permanently seal off the flow paths. This succeeded in shutting the well with only a few small leaks.

10. During the foregoing attempts, two relief wells were drilled to provide bottom kill capability. The first relief well was able to intersect the well and *permanently* seal the Macondo well.

The DHSG analyses of the currently available evidence indicates the Macondo well blowout most probably was initiated with a breach in the well structure at its bottom—some 18,000 ft below the sea surface and approximately 13,000 ft below the seafloor. The *Deepwater Horizon* drill crew was in the final hours of preparing the well for later production and for temporary abandonment.

Undetected, a large quantity of hydrocarbons entered the bottom of the well as it was being prepared for temporary abandonment. Multiple tests failed to disclose the breach or the ingress of hydrocarbons into the well. Due to the displacement inside the well of the upper 8,300 ft of heavy drilling fluids with lighter seawater, there were large reductions in pressures inside the well that allowed substantial quantities of gases to evolve from the hydrocarbons.

As the gases rose inside the well bore, they rapidly expanded in volume as they entered the lower pressures near the surface. Seawater, drill mud, and other fluids in the well bore were pushed ahead of the rising and expanding gases. This stream of gases and fluids were followed by high-pressure oil, gases, and other fluids from the reservoir.

Last minute attempts were made on the deck of the *Deepwater Horizon* to divert the gases, oil, and other well fluids into an oil-gas separator. This choice was made rather than diverting the blowing out well directly overboard. The oil-gas separator was intended to prevent contamination of the seawater with the oil-based drill mud as the well fluids and gases were diverted overboard. A similar process had been used successfully several weeks earlier to control a major ‘kick’ encountered during drilling.

The volumes and pressures of the seawater, gases, drilling mud, and other fluids in the well bore overcame the separator allowing gas and the other well fluids to escape onto the drill deck and surrounding facilities. Emergency alarms and shut-down equipment and processes failed to function. The gas ignited resulting in two or more explosions that ultimately reached the drill deck—killing the eleven workers who were struggling to stop the blowout.

The *Deepwater Horizon* lost all primary power generation ability. Critical pieces of emergency control equipment were destroyed and damaged and could not be or were not activated. Emergency back-up power sources could not be started. The rig was in the dark, without power, and without the dynamic positioning thrusters to maintain its location. The rig was tethered to the seafloor with its marine riser and the drill pipe inside the riser. Multiple unsuccessful attempts were made to activate the blowout preventer located at the seafloor. The last defense against a blowout failed.

The hydrocarbons reaching the surface ignited engulfing the *Deepwater Horizon* in flames. The emergency disconnection system meant to allow separation of the *Deepwater Horizon* from the blowout preventer at the sea floor could not be activated; thus trapping the unit under and in the hydrocarbons coming from the well below.

Survivors—injured and uninjured—evacuated in nightmarish ‘Titanic like’ conditions to lifeboats which were lowered to the thankfully calm sea. Because some of the lifeboats were not fully filled and some could not be accessed, personnel left onboard evacuated by jumping overboard. All survivors were rescued by nearby service vessels and other first responders. Heroic actions by those onboard and by the first responders saved many lives.

In the following days, as the well continued to blow out, attempts were made to activate the blowout preventer using an undersea remote operated vehicle. These attempts also failed.

The *Deepwater Horizon* was able to sustain the effects of the blowout and the firefighting for almost two days until it sank to the seafloor some 5,000 ft below. As the drilling unit sank, the marine riser with the drill pipe inside connecting the unit to the blowout preventer and well below separated from the sinking *Deepwater Horizon* and collapsed to the seafloor. Oil, gas, and other reservoir fluids were able to escape from the collapsed and fractured marine riser and drill pipe strewn across the seafloor into the waters of the Gulf of Mexico.

For the next 83 days, multiple attempts were made to catch, contain, disperse, and stop the reservoir fluids from reaching the Gulf of Mexico. All of the approved plans and preparations for controlling and mitigating the blowout repeatedly failed or were ineffective. A series of ad hoc systems were engineered, constructed, and put in place to catch and contain the oil. Another series of systems were engineered, constructed, and implemented in attempts to stop the fluids and gases escaping from the well. The final sequence of steps to work at the Macondo BOP entailed unbolting a riser adapter at the top and bolting on a pressure-bearing cap with additional BOP components incorporated above. This allowed shutting in the well at the BOP and, eventually, kill operations to be conducted from the top. The first of two relief wells intersected the shut-in well near the productive zone shortly thereafter and mud and cement were injected there as well.

Immense amounts of toxic reservoir fluids and gases from the Macondo well were able to escape into the open waters of the Gulf of Mexico. Some of these fluids and gases reached the surface; some did not. An unprecedented amount of dispersants introduced into the well flow stream near the seafloor prevented a large amount of the otherwise buoyant oil from reaching the surface and thereby reduced the *surface* impacts on nearby wetlands, wildlife, beaches, and communities. This dispersed oil and other toxic fluids from the Macondo well reservoir were transported by strong surface and subsea currents to many parts of the Gulf of Mexico.

Hydrocarbons reaching the surface were swept by the same currents into and onto adjacent wetlands and beaches. The hydrocarbon volatile components and gases were dispersed into the atmosphere. Short and long-term effects on the affected communities and marine—coastal environments are still being assessed. Similar to previous experiences associated with clean-up and containment of hydrocarbons in open water, the equipment and processes proved to be relatively ineffective.

The result of this cascade of failures is a disaster unprecedented in the history of the offshore oil and gas industry. While the impacts of these failures can be estimated in terms of the costs associated with immediate and direct injuries to human lives, property, and productivity, the costs—short and long term—to the affected publics, their industries and commerce, and the environment cannot be accurately assessed at this time. However, it is abundantly clear that the consequences of

this cascade of failures—the Macondo well project disaster—exceed by several orders of magnitude those previously experienced or thought possible.

Looking Back – Organizational Factors

The organizational causes of this disaster are deeply rooted in the histories and cultures of the offshore oil and gas industry and the governance provided by the associated public regulatory agencies. While this particular disaster involves a particular group of organizations, the roots of the disaster transcend this group of organizations. This disaster involves an international industry and its governance.

This disaster was preventable if existing progressive guidelines and practices been followed—the Best Available and Safest Technology. BP’s organizations and operating teams did not possess a functional Safety Culture. Their system was not propelled toward the goal of maximum safety in all of its manifestations but was rather geared toward a trip-and-fall compliance mentality rather than being focused on the Big-Picture. It has been observed that BP’s system “forgot to be afraid.” The system was not reflective of one having well-informed, reporting, or just cultures. The system showed little evidence of being a high-reliability organization possessing a rapid learning culture that had the willingness and competence to draw the right conclusions from the system’s safety signals. The Macondo well disaster was an organizational accident whose roots were deeply embedded in gross imbalances between the system’s provisions for production and those for protection.

The multiple failures (to contain, control, mitigate, plan, and clean-up) that unfolded and ultimately drove this disaster appear to be deeply rooted in a multi-decade history of organizational malfunctions and shortsightedness. There were multiple opportunities to properly assess the likelihoods and consequences of organizational decisions (i.e., Risk Assessment and Management) that were ostensibly driven by BP management’s desire to “close the competitive gap” and improve bottom-line performance. Consequently, although there were multiple chances to do the right things in the right ways at the right times, management’s perspective failed to recognize and accept its own fallibilities despite a record of recent accidents in the U.S. and a series of promises to change BP’s safety culture.

Analysis of the available evidence indicates that when given the opportunity to save time and money—and make money—poor decision making played a key role in accident causation. The tradeoffs that were made were perceived as safe in a normalized framework of business-as-usual. Conscience recognition of possible failure consequences seemingly never surfaced as the needle on the real-time risk-meter continued to climb. There was not any effective industry or regulatory *checks and balances* in place to counter act the increasingly deteriorating and dangerous situation on *Deepwater Horizon*. Thus, as a result of a cascade of deeply flawed failure and signal analysis, decision-making, communication, and organizational-managerial processes, safety was compromised to the point that the blowout occurred with catastrophic effects.

In many ways, this disaster closely replicates other major disasters that have been experienced by the offshore oil and gas industry. Eight months before the Macondo well blowout, the blowout of the Montara well offshore Australia in the Timor Sea developed in almost the same way—with very

similar *downstream* effects.¹ The Occidental Petroleum North Sea Piper Alpha platform explosions and fires (1988) and the Petrobras P36 production platform sinking offshore Brazil (2005) followed *roadmaps to disaster* that are very similar to that developed during and after the Macondo well blowout.² These were major *system* failures involving a sequence of unanticipated compounding malfunctions and breakdowns—a hallmark of system disasters.

This disaster also has eerie similarities to the BP Texas City refinery disaster.³ These similarities include: a) multiple system operator malfunctions during a critical period in operations, b) not following required or accepted operations guidelines (“casual compliance”), c) neglected maintenance, d) instrumentation that either did not work properly or whose data interpretation gave *false positives*, e) inappropriate assessment and management of operations risks, f) multiple operations conducted at critical times with unanticipated interactions, g) inadequate communications between members of the operations groups, h) unawareness of risks, i) diversion of attention at critical times, j) a culture with incentives that provided increases in productivity without commensurate increases in protection, k) inappropriate cost and corner cutting, l) lack of appropriate selection and training of personnel, and m) improper management of change.^{3, 4, 5} In both cases—the BP Texas City and the BP Macondo well disasters—meetings were held with operations personnel at the same time and place the initial failures were developing. These meetings were intended to congratulate the operating crews and organizations for their excellent records for *worker safety*. Both of these disasters have served—as many others have served—to clearly show there are important differences between *worker safety* and *system safety*. One does not assure the other.

In all of these disasters, risks were not properly assessed in hazardous natural and industrial-governance-management *environments*. The industrial-governance-management environments unwittingly acted to facilitate progressive degradation and destruction of the barriers provided to prevent the failures. An industrial environment of inappropriate cost and corner cutting was evident in all of these cases as was a lack of appropriate and effective governance—by either the industry or the public governmental agencies. As a result, the system’s barriers were degraded and destroyed to the point where the natural environmental elements (e.g., high-pressure, flammable fluids and gases) overcame and destroyed the system. Compounding failures that followed the *triggering* failures allowed the triggering failures to develop into a major disaster—catastrophe.⁶

¹ “Report of the Montara Commission of Inquiry,” Commissioner David Borthwick AO PSM, June 2010, Barton ACT, Australia.

² “Human & Organizational Factors in Design and Operation of Deepwater Structures,” Robert Bea, Proceedings Offshore Technology Conference, OTC 14293, Society of Petroleum Engineers, Richardson Texas.

³ “Investigation Report, Refinery Explosion and Fire, BP Texas City, Texas,” U.S. Chemical Safety and Hazard Investigation Board, March 2007, Washington DC.

⁴ “The Report of the BP U.S. Refineries Independent Safety Review Panel,” The Baker Panel, January 2007, Washington, DC.

⁵ “Failure to Learn, The BP Texas City Refinery Disaster,” Andrew Hopkins, CCH Australia Limited, Sydney, NSW, Australia.

⁶ “Deep Water, The Gulf Oil Disaster and the Future of Offshore Drilling,” Report to the President, National Commission on the BP Deepwater Horizon Oil Spill and Offshore Drilling, January 2011, Washington DC.

Looking Forward

Short-term measures have been initiated and are being developed by the Department of Interior's Bureau of Offshore Energy Management, Regulation and Enforcement (BOEMRE). The previous Minerals Management Service (MMS) has been reorganized into three organizations, each of which is responsible for different aspects of offshore oil and gas developments (leasing, revenues, and regulation). These measures have addressed both technical and organizational aspects. In some cases, the BOEMRE has proposed long-term technical and organizational measures associated with drilling and production operations in ultra-deepwater (5,000 ft or more) depths.

In addition, the National Commission on the BP *Deepwater Horizon* Oil Spill and Offshore Drilling has addressed both short-term and long-term government regulatory technical and organizational reforms associated with drilling and production operations in high hazard environments—including those of ultra-deep water and in the arctic. U.S. industrial companies and *trade organizations* (e.g., American Petroleum Institute, International Association of Drilling Contractors) also have responded with suggestions for a wide variety of technical and organizational reforms that will be considered for implementation in its future operations. Many international governmental regulatory agencies have and are responding in a similar fashion. There is no shortage of suggested technical and organizational reforms.

Findings

Finding 1 – The oil and gas industry has embarked on an important *next generation* series of high hazard exploration and production operations in the ultra-deep waters of the northern Gulf of Mexico. These operations pose risks (likelihoods and consequences of major system failures) much greater than generally recognized. The significant increases in risks are due to: 1) complexities of hardware and human systems and emergent technologies used in these operations, 2) increased hazards posed by the ultra-deep water marine environment (geologic, oceanographic), 3) increased hazards posed by the hydrocarbon reservoirs (very high potential productivities, pressures, temperatures, gas-oil ratios, and low strength formations), and 4) the sensitivity of the marine environment to introduction of very large quantities of hydrocarbons.

Finding 2 – The Macondo well project failures demonstrated that the consequences of major offshore oil and gas system failures can be several orders of magnitude greater than associated with previous generations of these activities. If the risks of major system failures are to be *as low as reasonably practicable* (ALARP), the likelihoods of major failures (e.g., uncontrolled blowouts, production operations explosions and fires) must be orders of magnitude lower than in the BP Macondo well project and that may prevail in other similar projects planned or underway. In addition, major developments are needed to address the consequences of major failures; reliable systems are needed to enable effective and reliable containment and recovery of large releases of hydrocarbons in the marine environment.

Finding 3 – The Macondo well project failures provide important opportunities to re-examine the strategies and timing for development of important non-renewable product and energy resource. This *final frontier* in the ultra-deep waters of the northern Gulf of Mexico and other similar areas provides access to an important public resource that has significant implications for the future generations and energy security of the United States. These social, economic, and national security

interests, as well as safety and environmental considerations, dictate a measured pace of development consistent with sustainable supplies and development and application of the Best Available and Safest Technology (BAST).

Finding 4 – Major *step change* improvements that consistently utilize the BAST are required by industry and government to enable high hazard offshore exploration and production operations to develop acceptable risks and benefits. Future development of these important public resources require an advanced high-competency, collaborative, industrial-governmental-institutional enterprise based on use of high reliability technical, organization, management, governance, and institutional systems.

Recommendations

A capable and productive industry needs equally capable and productive government—governance. It is clear that the predecessor of the Department of Interior’s Bureau of Ocean Energy Management, Regulation and Enforcement (BOEMRE), the U.S. Minerals Management Service (MMS) was not able to keep abreast of developments associated with ultra hazardous hydrocarbon exploration and production projects. The agency was chronically under staffed and funded. The MMS was confronted with significant internal conflicts with its responsibilities for leasing, revenue, energy management, and enforcement. These conflicts have been recognized and the BOEMRE reorganized into two new, independent agencies responsible for carrying out BOEMRE’s offshore energy management and enforcement functions: The Bureau of Safety and Environmental Enforcement (BSEE) and The Bureau of Ocean Energy Management (BOEM).

If the BOEMRE is to be able to realize its short and long term goals and responsibilities, then it is mandatory that Congress approves and authorizes as soon as possible the required funding and staff additions. However, even with the required funding and staff additions, it will take significant time for the BOEMRE to develop the capabilities to address the system risks associated with ultra hazardous hydrocarbon exploration and production projects. In the interim, it is suggested that BOEMRE employ experienced and qualified non-government consultants, contractors, classification societies, and individuals (e.g., retired industry managers, engineers, operations personnel) having demonstrated capabilities to properly evaluate the BAST required to address system risks associated with high risk hydrocarbon exploration and production projects. This would be similar to the Certified Verification Agent program previously utilized by the MMS for offshore projects that presented exceptional hazards and risks.

Industry also faces needs to further develop its capabilities to consistently apply the BAST in ultra hazardous hydrocarbon exploration and production projects offshore the U.S. Many of the major operators working offshore the U.S. already have developed and demonstrated capabilities to apply the BAST in ultra hazardous hydrocarbon exploration and production projects in their U.S. and international offshore operations. Many of these major operators are very familiar with full-scope life-cycle Safety Cases, RAM, High Reliability Organizations, High Reliability Governance, High Reliability Systems and other advanced processes required to properly address the *system risks* associated with ultra hazardous hydrocarbon exploration and production projects. These operators should take a leadership position to demonstrate that BAST can be consistently and properly applied in U.S. offshore operations—including those performed for the operators by offshore contractors and service companies.

At the same time, it is evident that industry also must address important challenges to upgrade selection (people with the right talents for the tasks to be performed), training (for normal, emergency, and abnormal activities), mentoring, collaboration, and teamwork of management, engineering, and operations personnel (operators, contractors, service companies) who do the work associated with ultra hazardous hydrocarbon exploration and production projects. There are important needs to make design, process, equipment and materials upgrades that will enable consistent realization of BAST in these operations including those in blowout prevention and emergency response systems, well design and construction (e.g., cement and cementing processes), well drilling and completion systems, and oil spill containment and recovery.

Recommendation 1 – Develop and maintain an effective Technology Delivery System (TDS) that will unite industry and government collaboration in exploration for and development of high hazard environment hydrocarbon resources in reliable and sustainable ways.

Recommendation 2 – Develop and maintain industrial and governmental institutions responsible for future development, validation, advancement, and implementation of Risk Assessment and Management (RAM) technology including definition of RAM goals and objectives for exploration and production of high hazard environment hydrocarbon resources.

Recommendation 3 – Implement proven RAM technology within industrial and governmental organizations to create and maintain High Reliability Organizations, Highly Reliable Governance, and High Reliability Systems used in exploration and development of high hazard environment hydrocarbon resources.

Recommendation 3.1 – Develop and maintain industrial and governmental High Reliability Organizations (operators, contractors, and regulators) that maintain adequate and acceptable balances of protection and production. These are organizations having core System Safety Cultures.

Recommendation 3.2 – Develop and maintain advanced RAM technology in life-cycle, full-scope formal system Safety Cases that engage operators, contractors, and regulators in collaborative development and maintenance of high reliability exploration and production systems.

Recommendation 3.3 – Develop and maintain effective and reliable oil spill and blowout response—containment and recovery systems capable of operating in high hazard hydrocarbon exploration and production environments.

Recommendation 3.4 – These recommendations should be fostered by permitting a series of *validation projects* that would engage highly qualified operators, contractors, service companies, classification societies, and consultants in field demonstrations that ultra-hazardous, high-risk exploration and production projects can be performed while properly addressing the system risks associated with such projects.

Background

During May 2010, members of the Center for Catastrophic Risk Management (CCRM)¹ at the University of California Berkeley formed the *Deepwater Horizon* Study Group (DHSG).² The DHSG is an international group (64 members) of experienced professionals, experts, and scholars who have extensive experience in offshore oil and gas facilities and operations, drilling and reservoir engineering, geology, accident investigations, management, organizational behavior, government regulatory affairs, legislative-legal processes, marine ecology and environmental science, and risk assessment and management.

A list of the DHSG members who have approved publication of their names and affiliations is provided in Appendix A. The DHSG would like to express its gratitude to all of its members, collaborators, and supporters for their contributions to this study.

The DHSG has three major goals: 1) to produce a final report documenting results from the studies of the failures of the *Deepwater Horizon* Mississippi Canyon Block 252 Macondo well drilling project and the subsequent containment and mitigation activities; 2) to serve as advisors to the public, governments, industry, and environmental advocates who want timely, unbiased, and well-informed insights and information regarding the failures, 3) to recommend what should be done to reduce the future likelihoods and consequences associated with such failures in high risk offshore hydrocarbon resource developments, and 4) to develop a central digital archive system for data and information accumulated during the investigations that can be used by researchers and others for subsequent analysis and documentation of their investigations, studies, and reports.

A fundamental premise in the DHSG work is: *we look back to understand the why's and how's of this disaster so we can better understand how best to go forward.* The goal of the DHSG work is not to place blame. The goal of this work is to help the public, support our governmental institutions and industrial enterprise, and revisit our environmental stewardship responsibilities in defining how to best move forward—assessing what major steps are needed *looking forward* to develop our national oil and gas resources in a reliable, responsible, and accountable manner.

After more than ten months of investigation, the DHSG has been able to develop findings and recommendations aimed at significant reductions in the risks associated with major failures in oil and gas drilling and production operations in ultra-deepwater and other comparable hazardous areas. While much information and data remains to be made public, sufficient background is available to develop interim conclusions about what happened, plausible explanations for why these things happened, and what can be done to reduce the likelihoods and consequences of similar accidents in the future.

¹ <http://ccrm.berkeley.edu/>

² http://ccrm.berkeley.edu/deepwaterhorizonstudygroup/dhsg_reportsandtestimony.shtml

The DHSG's work was concentrated on three parts of this disaster: 1) the engineering and organizational developments that led to the uncontrolled blowout of the Macondo well, 2) the organizational responses to the blowout and its environmental impacts, and 3) the engineering, organizational, and governance elements focused on improved risk assessment and management of future ultra-hazardous offshore hydrocarbon exploration and production operations.

To develop its findings and recommendations, the DHSG grounded its investigation in scientific, engineering, and management principles. The DHSG relied upon information, data, and testimony developed by the U.S. Coast Guard – Bureau of Energy Management, Regulation and Enforcement (USCG-BOEMRE), National Commission on the BP *Deepwater Horizon* Oil Spill and Offshore Drilling, the National Academy of Engineering and National Research Council Transportation Research Board Committee to examine the probable causes of the *Deepwater Horizon* explosion, fire, and oil spill in order to identify measures for preventing similar harm in the future, the Senate Congressional Committees on Energy and Natural Resources, Environment & Public Works, Homeland Security & Governmental Affairs, and Commerce, Science & Transportation, the House of Representatives Committees on Energy & Commerce subcommittees on Energy and Environment and Oversight & Investigations, Natural Resources subcommittee Energy & Mineral Resources, Natural Resources' subcommittees on Energy & Mineral Resources, Insular Affairs, Oceans & Wildlife, Science & Technology subcommittee Energy & Environment, and Transportation and Infrastructure, and by the BP investigation team. The DHSG consulted with authorities in deepwater drilling and production systems, in investigations of major accidents involving complex technological systems, in legislative and legal practices, and advanced risk assessment and management practices associated with high risk-reliable systems such as nuclear power plants, petrochemical plants, nuclear submarine operations, and commercial aviation.

An important source of information for the DHSG investigations came from the members of the DHSG. Given the large number of investigations into this disaster, the DHSG was concerned about what special contributions it might be able to make to development of an understanding of this disaster and how it might best be mitigated in the future. Fortunately, the DHSG had a very large number of seasoned veterans from the offshore oil and gas industry—including people who had actually help drill, complete, produce, engineer, and manage wells and oil and gas exploration, drilling, and production operations in hazardous onshore and offshore environments around the world. This *experience factor* proved to be of vital importance because as information was developed by other investigations, the information could be tested, validated, and interpreted by people who had in-depth experience and knowledge associated with similar systems and operations. This experience has repeatedly demonstrated that the insights and conclusions drawn from the investigations are heavily dependent upon the knowledge, experience, and motivations of those who develop the insights and conclusions.

The DHSG members have a large number of colleagues in many parts of the industry and governments—worldwide. These colleagues provided valuable sources of information and interpretations of data that was developed by other investigations. Within a matter of weeks following the sinking of the *Deepwater Horizon*, the DHSG was provided with attributed and anonymous transcripts of developments that led to the blowout from workers onboard the *Deepwater Horizon* and from *on the beach* operations support personnel. These transcripts and other documents that were produced provided early clues to how and why this disaster happened.

An important part of the DHSG was its organizational independence. The DHSG did not have nor currently has any organization or organizations to which it reports. The DHSG did its work without financial support—other than provided by its members. The DHSG members have volunteered their time, paid their expenses, and provided other resources without compensation.

The DHSG used multiple sources of information and interpretations to corroborate and validate insights and conclusions derived from available information. A large number of different kinds of *biases*³ can influence deductions, inferences, and conclusions reached during investigations of failures involving complex systems—hindsight does not equal foresight. The DHSG made a concerted effort to nullify potential biases—real and perceived—that could influence the insights and conclusions reached by this group.

Major contributions to the DHSG investigations were made by the DHSG members who elected to author *Working Papers*.⁴ These Working Papers provided a way for the DHSG members to address particular aspects of this disaster—looking back and looking forward—that were within their special domains of knowledge and experience. Each of these Working Papers went through a series of internal, and in some cases, external reviews to help ensure relevance, accuracy, and nullification of biases. These reviews often resulted in intense deliberations, and as a result new insights and conclusions were developed. The Working Papers also were independently edited by DHSG member Mr. Michael Olson to help assure consistency in format and quality of the documents. A list of the 39 DHSG Working Papers is provided in Appendix B. All of the Working Papers are available for downloading from the DHSG web site.²

One of the goals of the DHSG was development of a public web site that would archive the data and information developed during this investigation. This web site contains all of the documentation—written and graphical—developed by the DHSG members during the course of this investigation.⁵ These reference materials can be searched and accessed by category, title word, and key words. In the near future, this web site also will contain seafloor videos taken by remote operated vehicles at the Macondo well site before and after the blowout. A search facility where video clips can be searched for and retrieved by time, date, duration, sequence, and sensor development is under development.

Following the sinking of the *Deepwater Horizon* drilling unit, as the Macondo well began to release its reservoir fluids (water, oil, and gases) into the waters of the Gulf of Mexico, thanks to the extensive media coverage and *live feeds* of videos taken at and near the Macondo well, the world was able to see the extreme challenges faced by those who were attempting to control, cap, contain, clean up, and mitigate the toxic fluids and gases escaping to the Gulf of Mexico. Thanks to the power of the Internet, the DHSG members were contacted early on by hundreds of people in the U.S. and elsewhere. These volunteers contributed their ideas and suggestions for how to improve the capping, containment, clean-up, and mitigation equipment and operations. This included *mystery plumber/s* who provided written and graphical documents describing different types of systems to contain, cap, and seal the well and to contain, clean-up, and mitigate its effects. While the DHSG did not have the resources to vet all of these suggestions, it did the best it could to forward the most

³ Example biases include those of hindsight, rational, control, confirmation, small sample, prediction, knowledge, correlation, perception, recall, and belief.

⁴ http://ccrm.berkeley.edu/deepwaterhorizonstudygroup/dhsg_resources.shtml.

⁵ http://calmap.gisc.berkeley.edu/dwh_parse.html

viable or practical suggestions to those who could take appropriate action. This outreach by the general public is of special importance to the DHSG because it demonstrated how the people of the U.S. and elsewhere can be united in a will to contribute the best of their knowledge and experience to help ‘stop and right severe wrongs’ to the environment and the affected societies. It is unfortunate that there was not a more effective organization or process that facilitated taking better advantage of these public contributions.

The tragic loss of life, property, productivity, and damage to the environment associated with the Macondo well blowout and subsequent sinking of the *Deepwater Horizon* drilling unit have served to demonstrate that this important enterprise has embarked upon operations that involve risks that are substantially greater than previously encountered or recognized. These risks should not be accepted. This industrial-governmental enterprise has the knowledge and other resources required to develop acceptable risks while exploring for and producing this vital public resource. The primary challenge is to resolve that these resources will be appropriately applied and implemented to address this special frontier for hydrocarbon resources.

The eleven workers who sacrificed their lives on the *Deepwater Horizon* on April 20, 2010, believed this enterprise was worth its risks and rewards. They, their families, the affected publics, and environments have paid and will continue to pay a very high price for this disaster. The DHSG dedicates this report to the eleven workers who lost their lives on the *Deepwater Horizon* and to the marine environment that was severely damaged by this disaster.



Professor Robert Bea, PhD, PE
Center for Catastrophic Risk Management
Department of Civil & Environmental Engineering
University of California Berkeley

Chapter 1 – Timeline to Disaster

The Marianas

February 2009 – BP applied to the MMS to drill the Macondo well in Mississippi Canyon Block 252 using Transocean’s dynamically positioned floating drill rig *Marianas*. The permit proposed to use the Best Available and Safest Technology (BAST) as standard operational procedures as specified in the Title 30 CFR 250 lease award agreement.¹ In the initial exploration plan, BP attested to their ability to respond to the “worst case spill scenario” which was estimated to be 162,000 BPD (barrels per day).² However, in the plan BP stated that the likelihood of a spill associated with a blowout was determined to be “unlikely”³ and a scenario for a potential blowout was deemed “not required.”¹ The environmental impact analysis also concluded that “no significant environmental impacts are expected.”⁴ The MMS approved the BP plan during April 2009.⁵

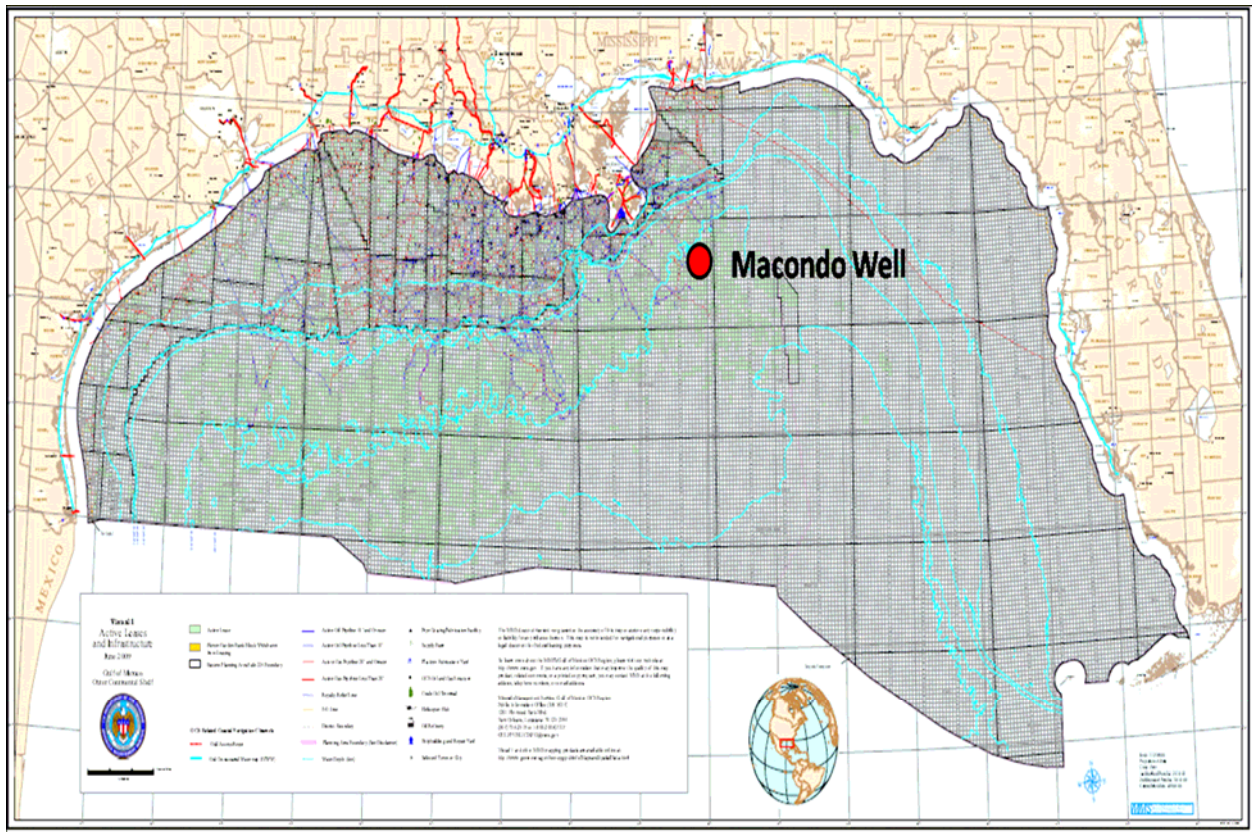

Figure 1.1 – Location of the Macondo well.⁶

¹ BP, *Initial Exploration Plan, Mississippi Canyon Block 252 (OCS-G 32306)*, February 2009, BP Exploration & Production Inc., p2-1.

² Op. ct.1, p7-1.

³ Op. ct 1, p14-3.

⁴ Op. ct 1, p14-5—14-7.

⁵ Eilperin, J., *U.S. exempts BP's Gulf of Mexico drilling from environmental impact study*, The Washington Post, May 5, 2010; November 22, 2010, ref: <http://www.washingtonpost.com/wp-dyn/content/article/2010/05/04/AR2010050404118.html>.

⁶ Image Source: Parsons, P. *The Macondo Well*, Energy Training Resources LLC, July 15, 2010.

September 2009 – BP working with Transocean’s dynamically positioned floating drilling unit *Deepwater Horizon* (Figure 1.2) completed the record setting Tiber well in the northern Gulf of Mexico. The Tiber well was drilled in more than 4,000 ft of water to a total depth of more than 35,000 ft.⁷ The Tiber well penetrated a reservoir estimated to have reserves in excess of 3 billion barrels of oil—a major discovery.⁸



Figure 1.2 – *Deepwater Horizon* semisubmersible drilling rig.⁹

⁷ Transocean website, retrieved November 22, 2010, ref: <http://www.deepwater.com/fw/main/IDeepwater-Horizon-i-Drills-Worlds-Deepest-Oil-and-Gas-Well-419C151.html>.

⁸ SubseaIQ.com, Offshore Field Development Projects, Tiber, Accessed December 3, 2010, ref: http://www.subseaIQ.com/data/Project.aspx?project_id=526.

⁹ Image Source: Rigzone, *How do Semisubmersibles Work?*, Accessed November 23, 2010, ref: http://www.rigzone.com/training/insight.asp?insight_id=338&c_id=24.

October 2009 – Initial drilling of the Macondo well began on October 6, 2009, and was spudded in a water depth of approximately 5,000 ft. BP originally estimated that the Macondo field contained approximately 50—100 million barrels of oil.¹⁰ However, BP later stated that the size of the field was undetermined because engineers had not completed the relevant tests before the explosion on April 20, 2010.

The well was estimated to require 51 days to drill at a cost of \$96 million.¹¹ The original well design consisted of eight casing strings (Figure 1.3), and was planned to be drilled to a total depth (TD) of approximately 19,650 ft; the well was actually drilled to a TD of 18,360 ft and nine casing strings were needed which included a 9 7/8 in x 7 in production casing.¹²

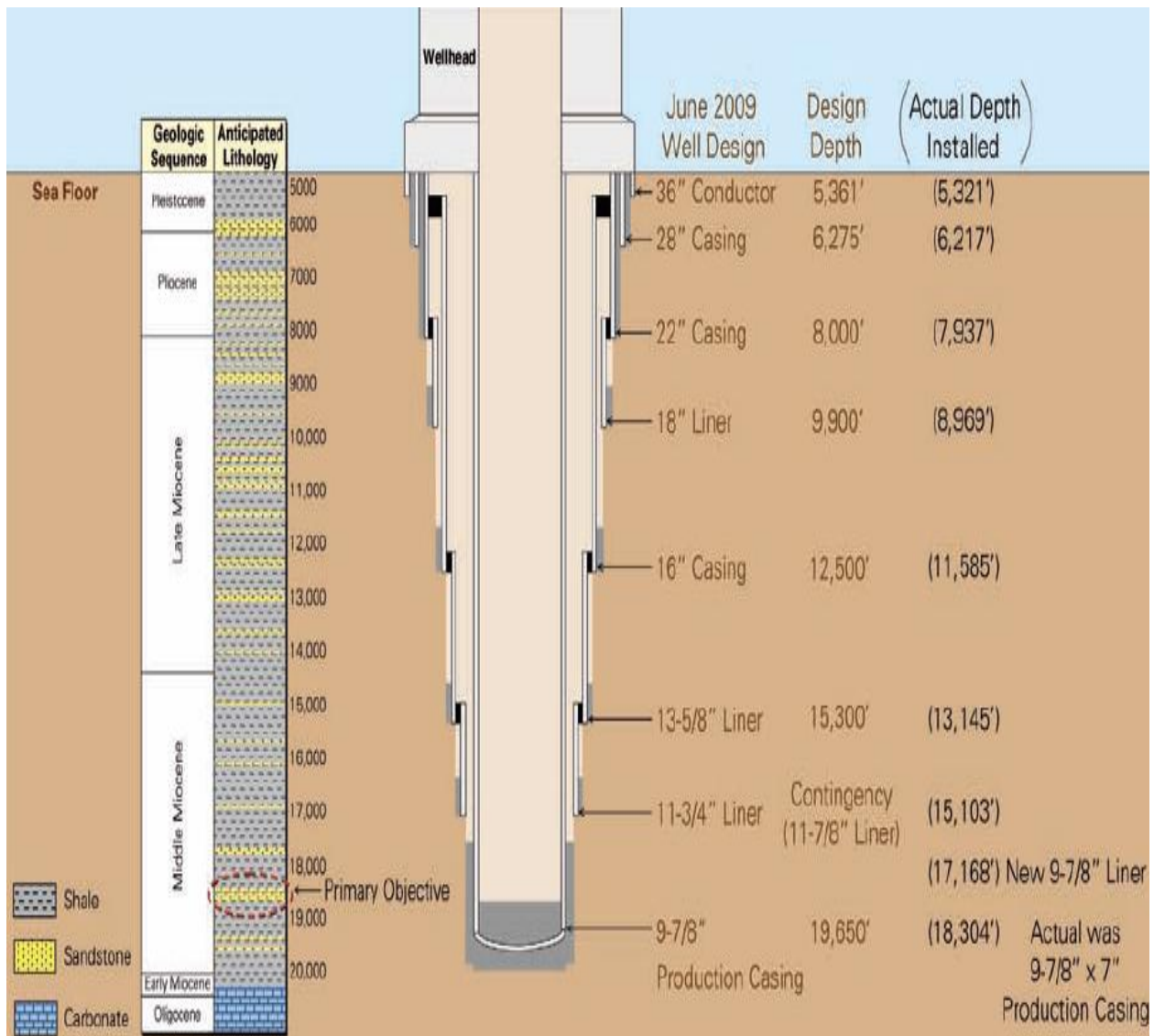

Figure 1.3 – Geology, original well design and installed depth.¹²

¹⁰ CBS News, *Gulf Well Could Contain a Billion Barrels of Oil*, Accessed December 3, 2010, ref: <http://www.cbsnews.com/stories/2010/06/18/national/main6596514.shtml>.

¹¹ BP, *GOM Exploration Wells MC 252 #1 - Macondo Prospect Well information*, September 2009, (BP-HZN-CEC008714).

¹² BP, *Deepwater Horizon Accident Investigation Report*, September 8, 2010.

November 2009 – The well progressed to a depth of about 3,000 ft below the sea floor when Hurricane Ida passed nearby, damaging the *Marianas*.¹³ The well was secured, the rig was disconnected, and then taken to a shipyard for repairs.

The Deepwater Horizon

January 2010 – The *Deepwater Horizon*, which was owned and operated by Transocean and had been under contract to BP, was selected to replace the *Marianas*. On January 14, 2010, the MMS approved an *Application for Revised New Well*, and the Macondo plan was updated according to the replacement of the *Marianas* by the *Deepwater Horizon*.¹⁴ The *Deepwater Horizon* arrived on location on January 31, 2010.¹⁴

February 2010 – The *Deepwater Horizon* resumed drilling of the Macondo well on February 6, 2010.^{13, 14} A leak was noticed on the yellow pod of the blowout preventer (BOP).¹⁵ The BOP contained two independent pods (blue and yellow) which activate hydraulic valves that would close the various devices on the BOP. According to BP, the leak was reduced after switching to the blue pod.¹⁵ It was later discovered that there was insufficient charge on the battery bank in the blue pod.¹⁵ Failures in both of the pods imply that the BOP could not be activated in the case of an emergency.

March 2010 – The drilling of the 14³/₄ in x 16 in hole section began on March 7, 2010.¹⁴ The *Deepwater Horizon* had been scheduled to be drilling at a new location by March 8, 2010, however completing the Macondo well had taken longer than originally planned.¹³ On March 8, the Macondo well had progressed to 13,305 ft TD, (total depth, about 8000 ft below the sea floor), when there was a serious well control event—unexpectedly the well formation fluids “flowed” into the well bore and the influx went unnoticed for approximately 33 minutes.^{14, 16} The event resulted in stuck drill pipe and well logging tools.^{14, 17} The well was side-tracked (Figure 1.4) and by the end of March the well had reached about 11,000 ft below the sea floor (approximately 17,000 ft TD).¹⁴

As a result of the well control event, BP prepared a revised casing design to address the high formation pressure in the borehole.¹⁸ The design was approved by the Minerals Management Service (MMS). The revised design included the addition of a 9⁷/₈ in drilling liner in order for the well to reach the primary pay sands, and the production casing was changed from a 9⁷/₈ in long string to a combination 9⁷/₈ in x 7 in long string (Figure 1.5).¹⁸

¹³ Letter from Henry Waxman to Tony Hayward - June 14, 2010, Accessed March 3, 2011, ref: <http://online.wsj.com/public/resources/documents/WSJ-20100614-LetterToHayward.pdf>.

¹⁴ BP, *Deepwater Horizon Accident Investigation Report*, Op. ct. 12, p17.

¹⁵ BP, *Deepwater Horizon Accident Investigation Report*, Op. ct. 12, p22, 47.

¹⁶ BP, *Deepwater Horizon Accident Investigation Report*, Op. ct. 12, p107.

¹⁷ Schlumberger, *Mississippi Canyon Block 252 Timeline*, Accessed March 3, 2011, ref: <http://bpoilresponse.markimoore.com/blog/bp-media/docs/Schlumberger.MC.252.Timeline.pdf>.

¹⁸ BP, *Deepwater Horizon Accident Investigation Report*, Op. ct. 12, p17.

Well Side Tracking

When an obstruction occurs in a borehole such that it cannot be removed or drilled through, a sidetrack is required to drill around the obstruction, as shown in Figure 1.4.

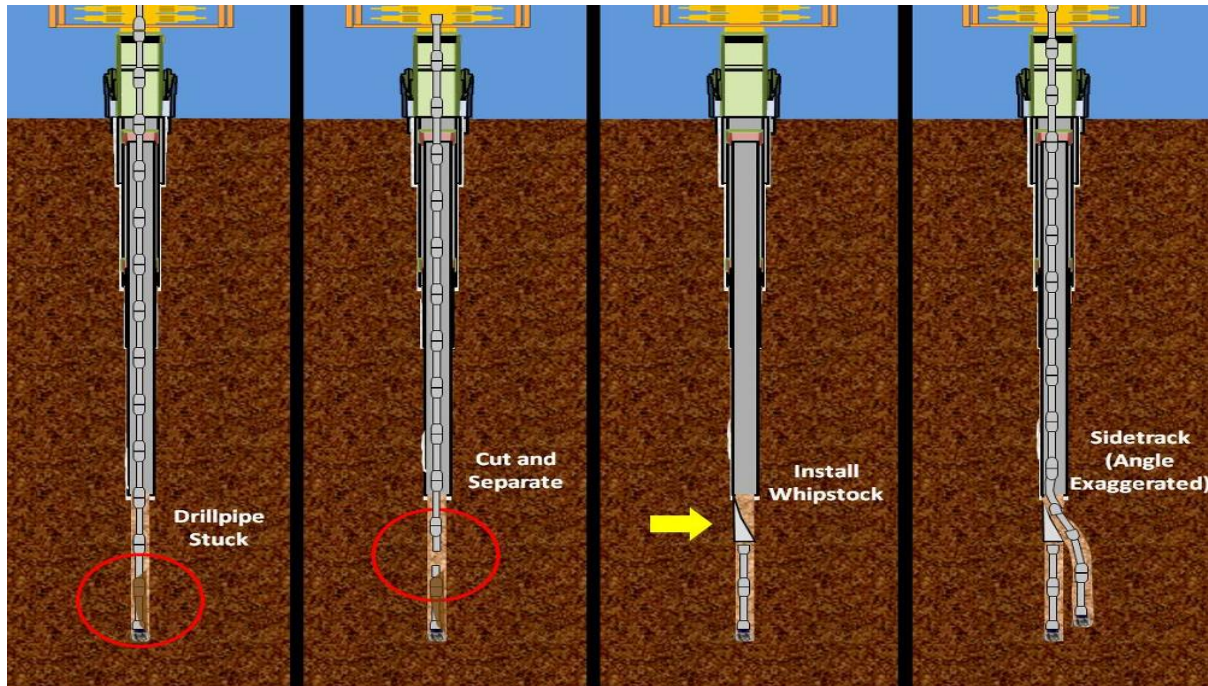

Figure 1.4 – Illustration of sidetrack procedures.¹⁹

Well Control

Well Control events are preventative measures taken to avoid blowouts. This entails preventing fluids from entering the wellbore (kicks), and in the case that they have entered, controlling their flow. A blowout, which is the uncontrolled release of oil and/or gas from a well, is one of the most severe threats facing drilling operations. Therefore, Well Control can also be referred to as Blowout Prevention.²⁰ Proper well control typically consists of the application of two or more independent barriers. The primary barrier is the mud or fluid column which is used to counter balance the formation pressures in the wellbore. The casing pipe strings together with their joints and landing seats provide another well barrier. Internal plugs placed at different strategic places in the well provide other barriers. The *last line of defense* in well control is the blowout preventer (BOP).²¹

¹⁹ Image Source: Parsons, Op. ct. 6.

²⁰ Rigzone, *How Does Well Control Work?*, Accessed November 22, 2010, ref: http://www.rigzone.com/training/insight.asp?i_id=304.

²¹ Schubert, J., *Well Control*, Journal of Petroleum Technology (JPT), Society of Petroleum Engineering, January 2010, p56.

Deepwater Horizon Study Group
Investigation of the Macondo Well Blowout Disaster

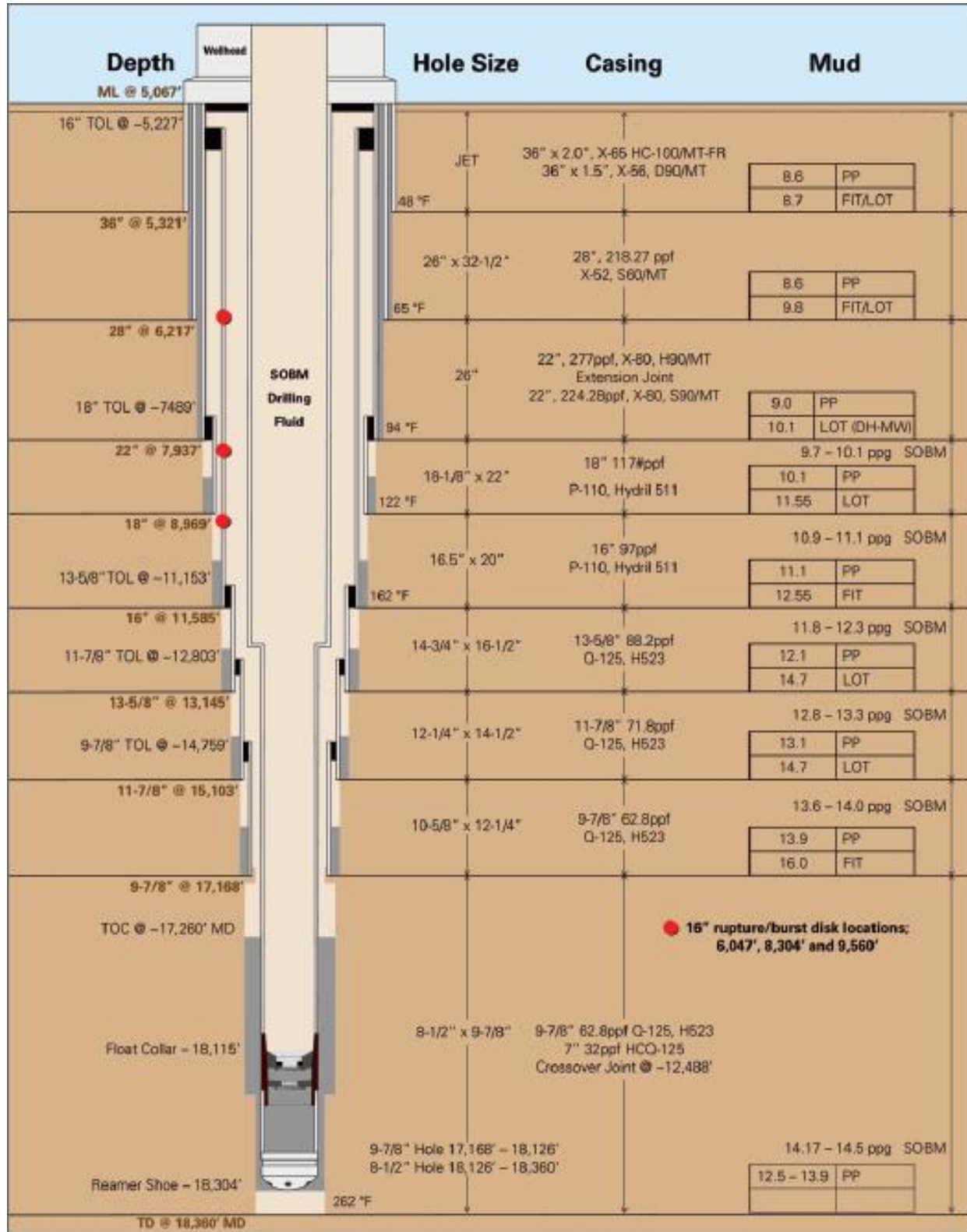
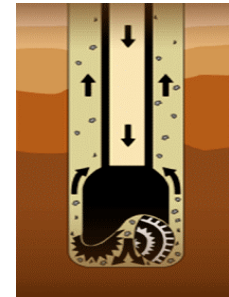

Figure 1.5– The Macondo actual well casing run.²²

²² Image Source: BP, *Deepwater Horizon Accident Investigation Report*, Op ct. 12, p19.

Drilling Fluid (Drilling Mud)

Drilling mud serves a number of purposes in drilling operations, such as removing the cuttings from the borehole, maintaining hydrostatic pressure inside the bore hole, and cooling the drill bit.²³ When a wellbore is drilled, drilling mud is pumped down the hole to create hydrostatic pressure in order to prevent formation fluids from entering into the wellbore which can ultimately result in the borehole collapse and a blowout. Maintaining hydrostatic pressure inside the borehole is a dynamic process. In order to prevent the borehole from collapsing, the density of the mud (often expressed in the weight of the mud per gallon—or pounds per gallon (ppg)) should be such that it can resist the formation pressures—pressure exerted on the borehole from the formation. At the same time, the density of the drilling mud should not be such that it overcomes the fracture pressure of the formation—the pressure which will cause the rock formation to fracture. This pressure zone between the formation pore pressure and the fracture gradient is known as the drilling *window*, as shown in Figure 1.6.



Cuttings in circulating drilling fluids.²³



Figure 1.6 – Illustration of Borehole Pressures and the Drilling “Window”.²⁴

²³ Image Source: Rigzone, *How Do Drilling Fluids Work?*, Accessed November 27, 2010, ref: http://www.rigzone.com/training/insight.asp?insight_id=291&c_id=24.

²⁴ Image Source: National Commission on the BP Deepwater Horizon Oil Spill and Offshore Drilling, Meeting 5 Flash Animation Stills, ref: <http://www.oilspillcommission.gov/meeting-5/meeting-details>.

Blowout Preventer (BOP)

The BOP (Figure 1.7) is a system of valves designed to shut in a well in the event of well control issues such as kicks, or if a sudden increase in wellbore pressures occurs. However the BOP should not normally be used as a first option when dealing with such well control problems. Other procedures such as adjusting the mud weight can be used for this purpose. This is because the BOP is one of the last lines of defense against well control problems, and frequent use of the BOP can result in the wear and tear of the device.

The various shut-in devices on the BOP used on the *Deepwater Horizon* can be seen in Figure 1.8. The use of the various devices depends on the well control situation as well as other factors such as the presence of pipe or casing.

At the depth and pressures encountered by the *Deepwater Horizon* well, MMS regulations require at least four remote-controlled, hydraulically operated valves, or rams during offshore operations.²⁵ All of the rams on the BOP failed to close properly during the blowout event that occurred on the *Deepwater Horizon*.

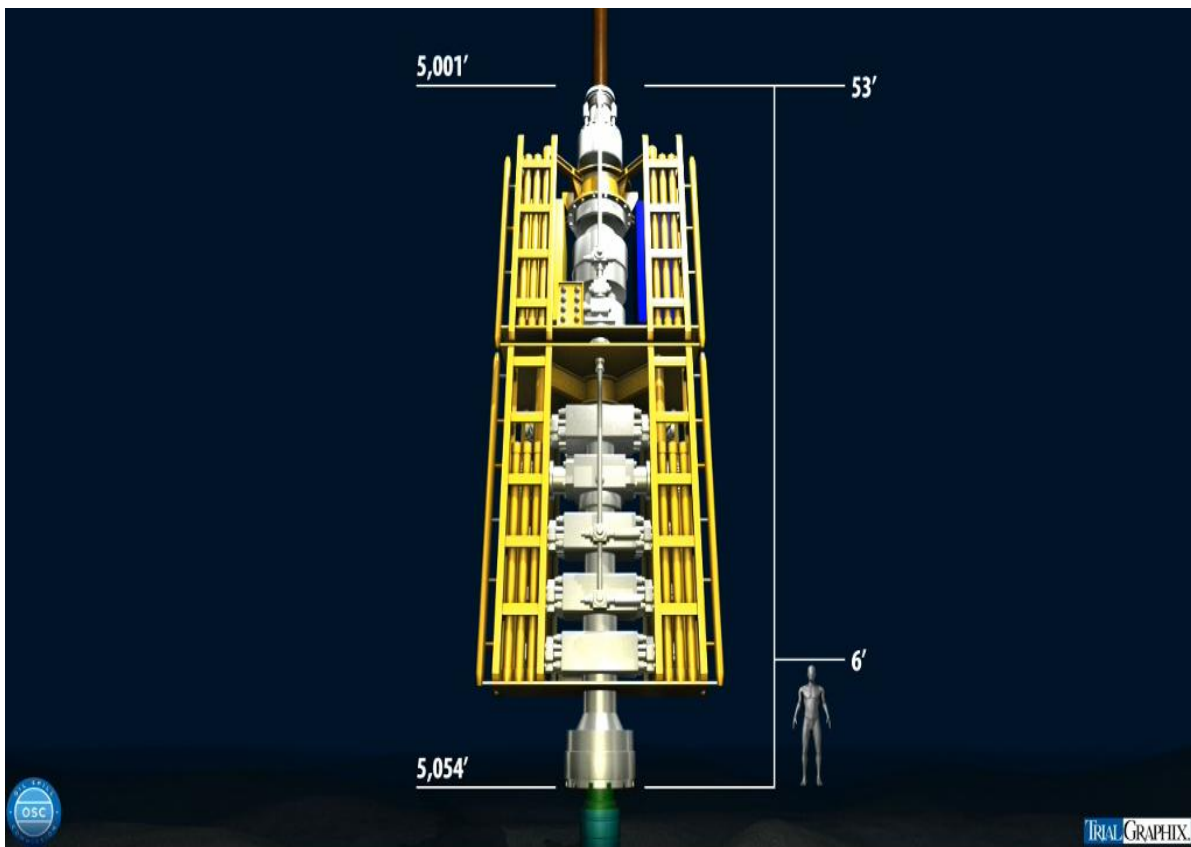

Figure 1.7 – Blowout Preventer (BOP).²⁶

²⁵ 30 C.F.R. § 250.442.

²⁶ Image Source: National Commission on the BP Deepwater Horizon Oil Spill and Offshore Drilling, Op. ct. 24.

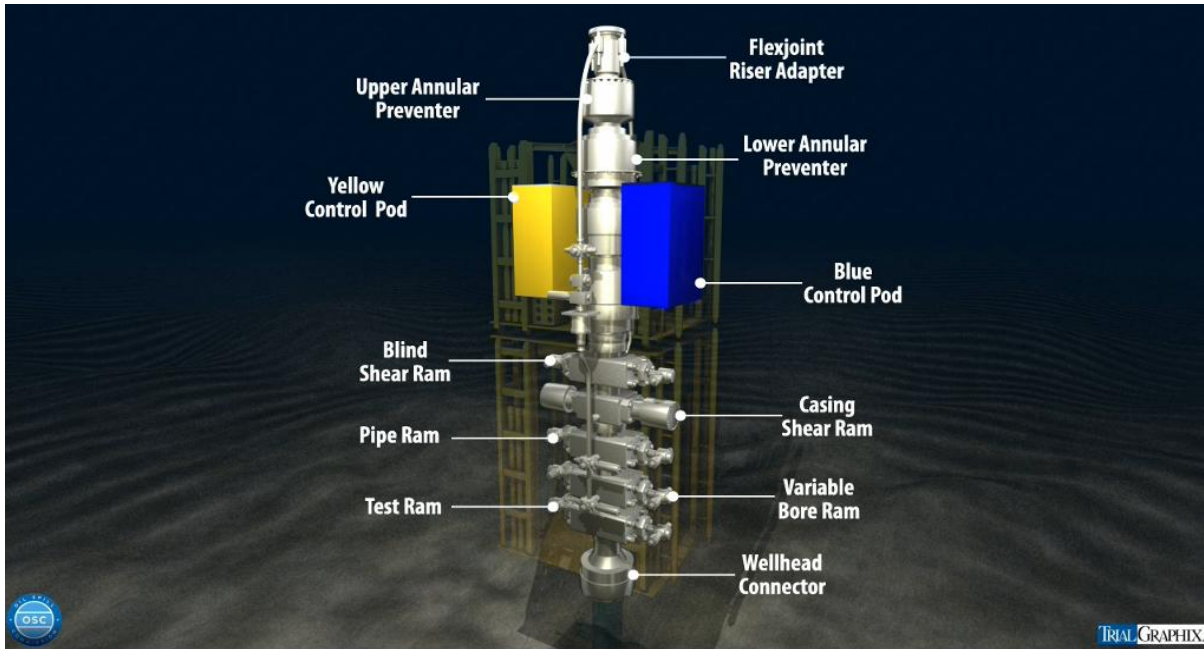

Figure 1.8 – BOP Assembly.²⁷

Annular Preventers (Figure 1.9) are rubber donut shaped seals that close around the pipe sealing the well. They can also seal the well with an absence of pipe in the hole. Stripping occurs if an annular is closed around the pipe, and the pipe is moved upward or downward during this time. Witness accounts stated that stripping had occurred on the *Deepwater Horizon* and pieces of rubber were observed. The stripping could have weakened the annular preventers.

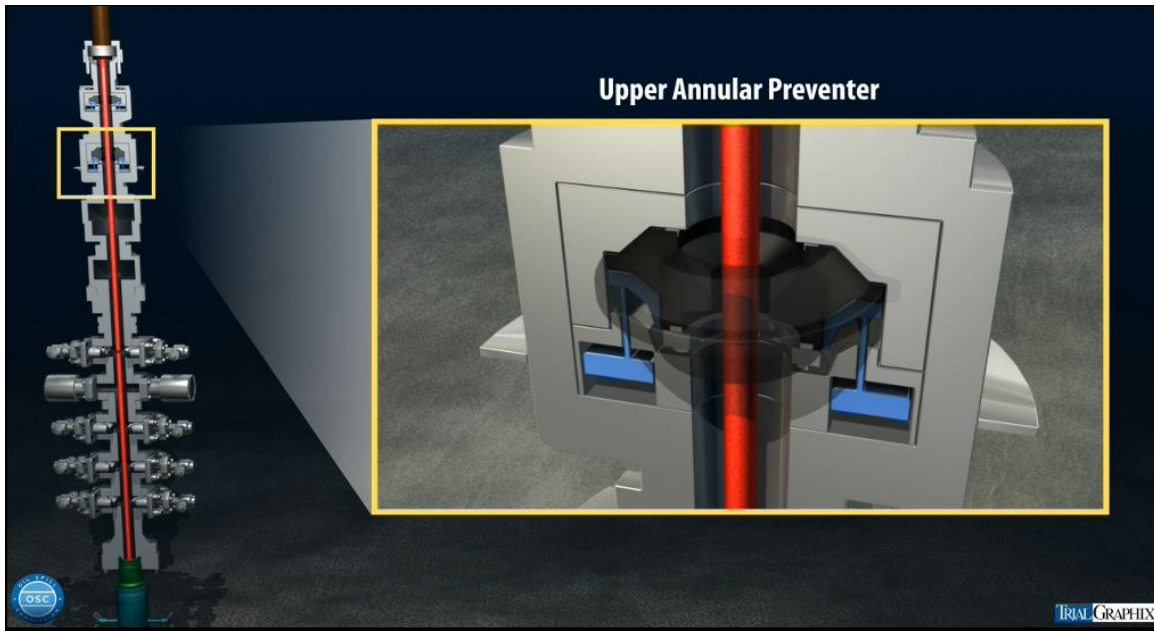

Figure 1.9 – Upper Annular Preventer.²⁷

²⁷ Image Source: National Commission on the BP Deepwater Horizon Oil Spill and Offshore Drilling, Op. ct. 24.

Variable Bore Rams (Figure 1.10) are metal bars with circular ends such that they can seal the well by clamping around the drill pipe, sealing the annulus.

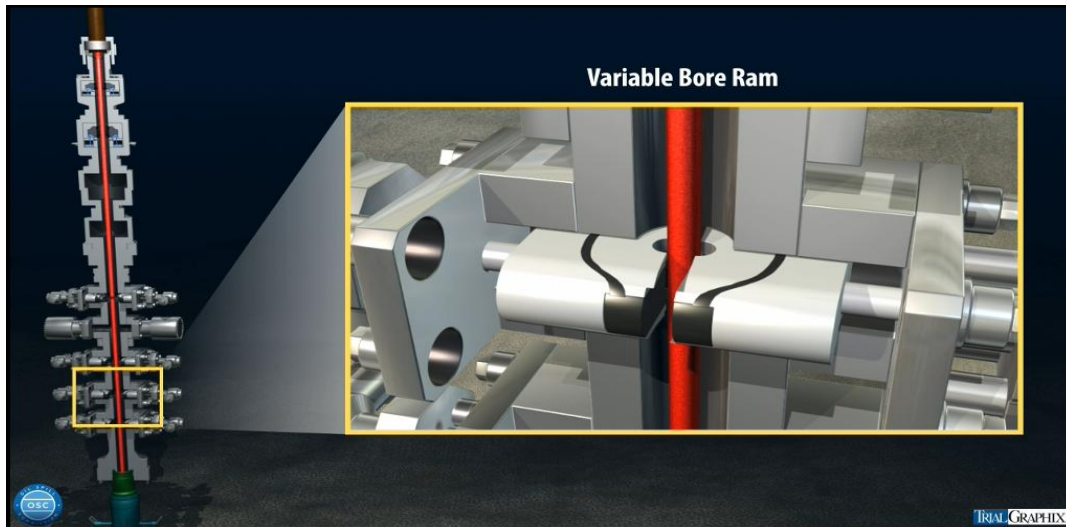

Figure 1.10 – Variable Bore Ram.²⁸

Blind Shear Rams (Figure 1.11) provide the last line of defense among the various devices on the BOP. The blind shear rams seal the well by cutting the drill pipe or other material that is in the well. However the blind shear rams cannot cut through the tool joints, and therefore it is important to keep track of the location of the joints inside the well. As seen in Figure 1.8 and Figure 1.12, there were two shear rams on the *Deepwater Horizon's* BOP; one for the casing, and one for the drill pipe.

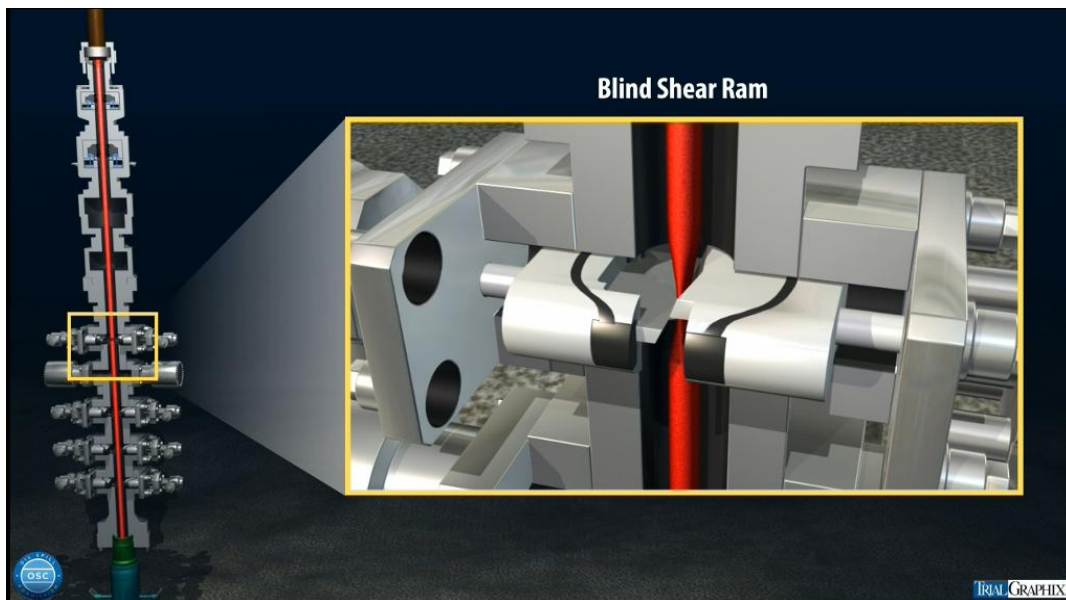
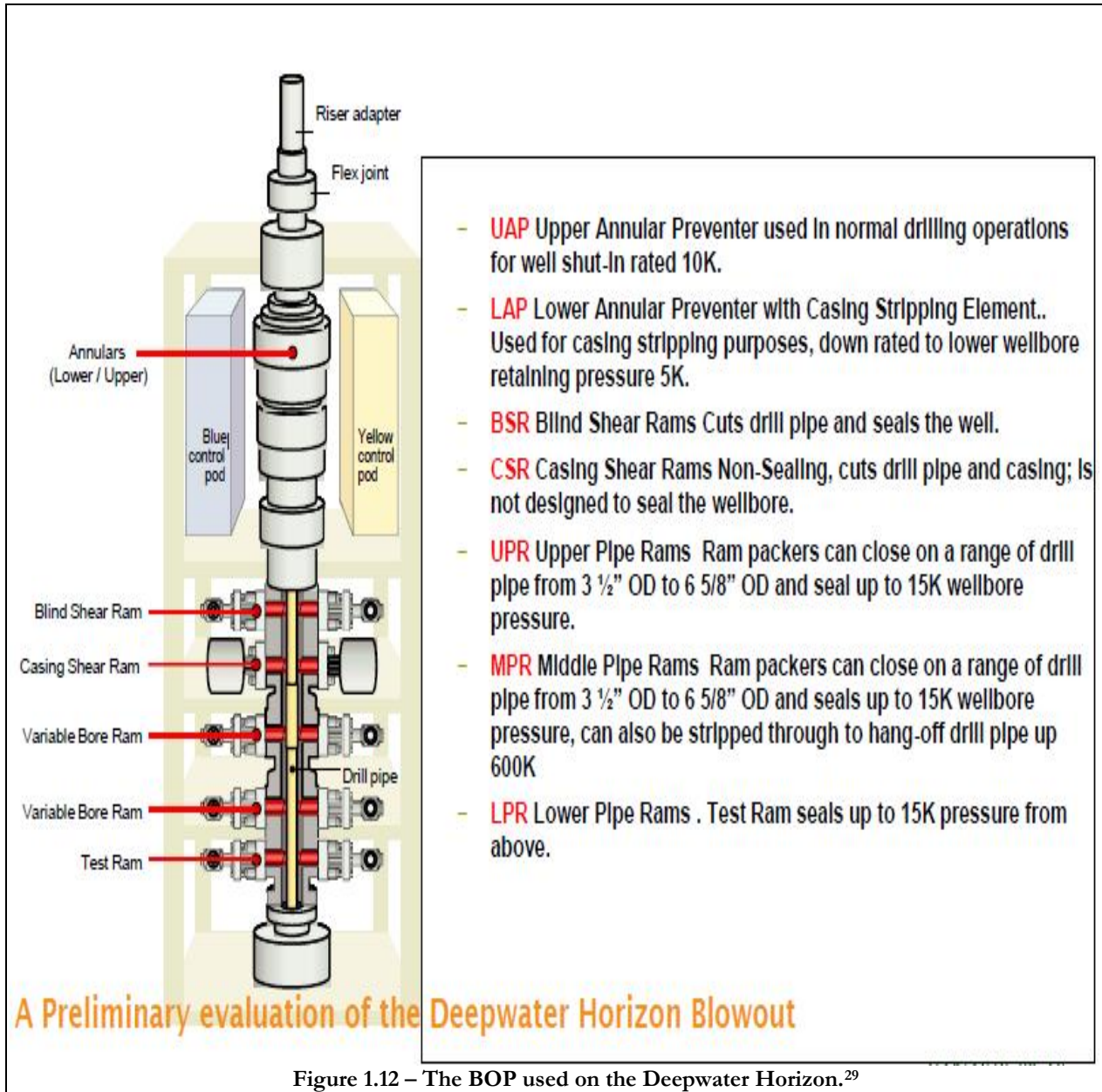

Figure 1.11 – Blind Shear Ram.²⁸

²⁸ Image Source: National Commission on the BP Deepwater Horizon Oil Spill and Offshore Drilling, Op. ct. 24.



April 2 – Drilling of the 8½ in x 9⅞ in final hole section began.³⁰

April 4–7 – Loss circulation occurred at 18,260 ft (about 13,000 ft below sea level).³¹ Lost circulation problems were solved by pumping lost circulation *pills* (high viscosity materials to plug openings and fissures in the formations) down the well and reducing the mudweight from 14.3 ppg to 14.17 ppg. Full Circulation was regained on April 7, 2010.³¹

²⁹ Image Source: Aconawellpro,
ref: http://www.aconawellpro.com/@api/deki/files/251/=MiniSeminar_Macondo_August_2010.pdf.

³⁰ BP, Deepwater Horizon Accident Investigation Report, Op. ct 12.

³¹ BP, *Deepwater Horizon Accident Investigation Report*, Op. ct 12, p17.

Lost Circulation

Lost circulation occurs when the drilling fluid that is being used in the wellbore is lost in the formation rather than flowing up the annulus (Figure 1.13). Problems resulting from lost circulation may vary, but it can ultimately lead to catastrophic loss of well control—a blowout. Essentially, this occurs when the borehole cannot retain the fluid column. If the drilling fluid enters the formation, the fluid levels inside the wellbore will drop, lowering the hydrostatic pressure inside the hole which would allow gas or fluids to enter the borehole and flow up the formation casing or casing annulus.³²

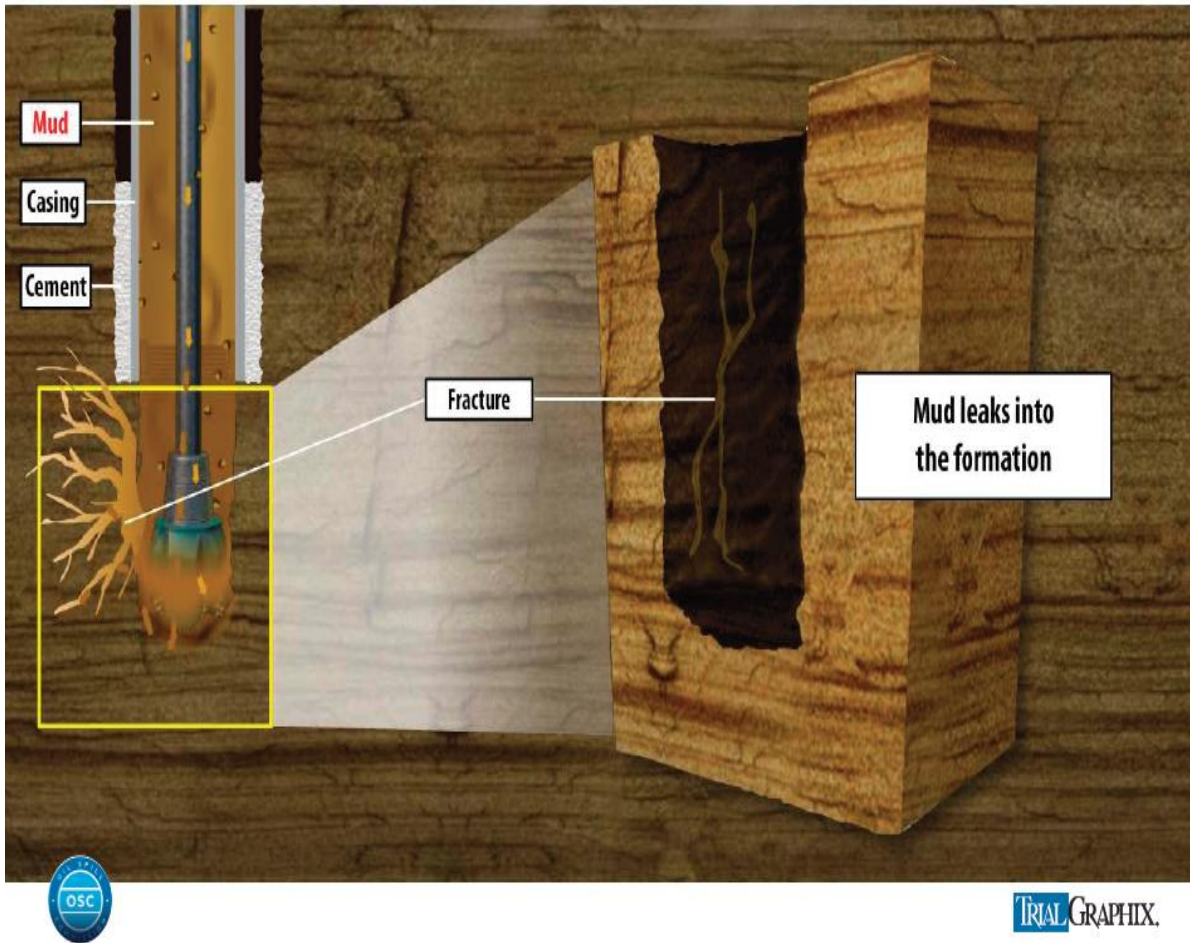

Figure 1.13 – Lost circulation.³³

April 9–14 – The well was drilled to a total depth of 18,360 ft (about 13,000 ft below the sea floor—Figure 1.14).³⁴ Additional well control problems—severe lost circulation into a weak formation was experienced near the bottom of the well. The well was stabilized by pumping lost circulation material into this formation.³⁴

³² Abbas, R., et al, *A Safety Net for Controlling Lost Circulation*, OilField Review, Winter 2003/2004, p22, ref: http://www.slb.com/~media/Files/resources/oilfield_review/ors03/win03/p20_27.ashx.

³³ Image Source: National Commission on the BP Deepwater Horizon Oil Spill and Offshore Drilling, Op. ct. 24.

³⁴ BP, *Deepwater Horizon Accident Investigation Report*, Op. ct 12, p 17.

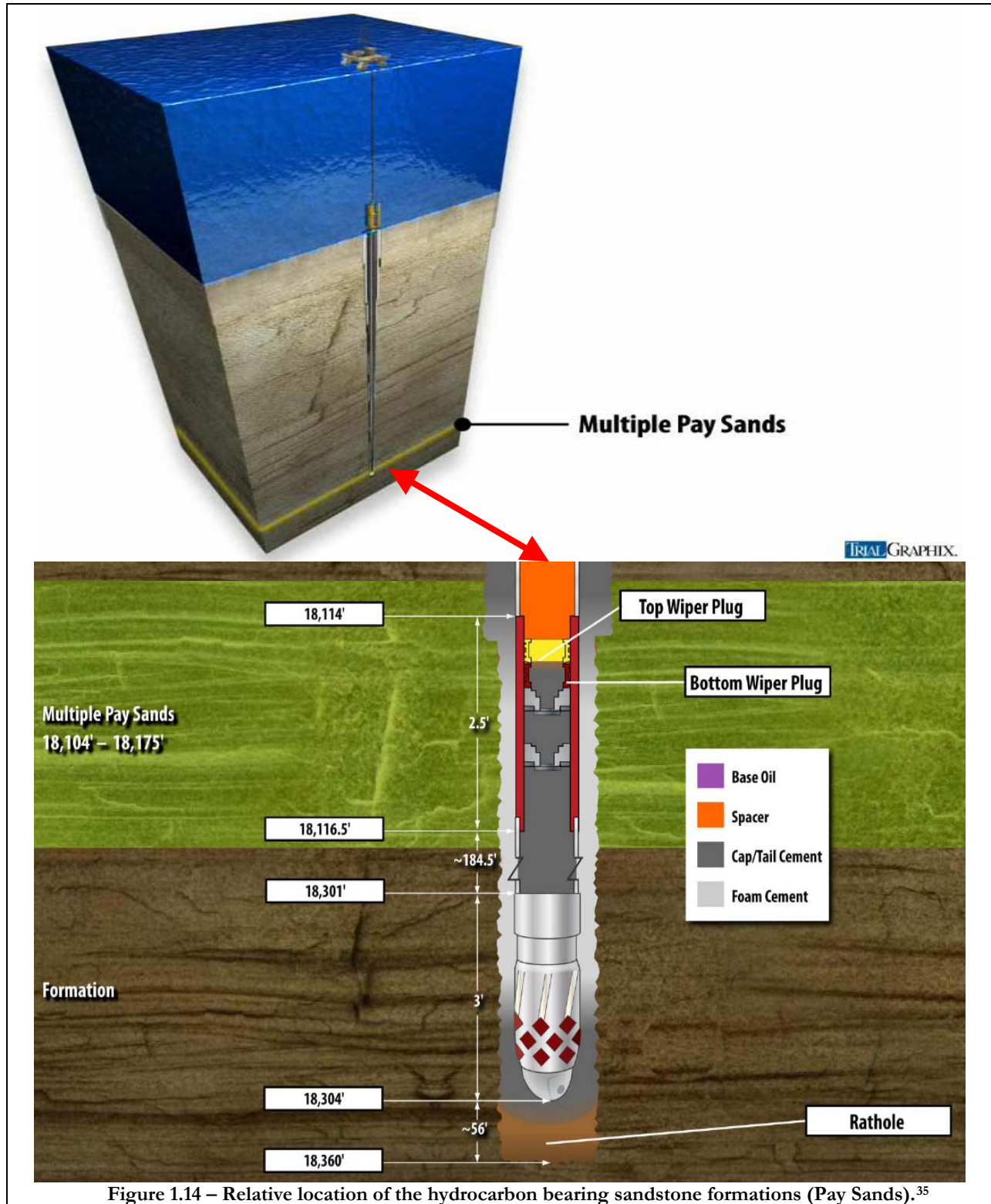

Figure 1.14 – Relative location of the hydrocarbon bearing sandstone formations (Pay Sands).³⁵

³⁵ Image Source: Adapted from the National Commission on the BP Deepwater Horizon Oil Spill and Offshore Drilling, Op. ct. 24.

The well logging contractor, Schlumberger, spent six days performing and evaluating wireline logs which were run in the open hole below the last string of casing.³⁶ Wireline logs measure formation properties in a well.³⁷ Electronic sensors are lowered down the well to gather important information by measuring properties such as resistivity, conductivity, and formation pressure—as well as sonic properties and wellbore dimensions.³⁷ The logs indicated the well had encountered two oil and gas bearing sandstone formations. The first formation was a thin layer beginning at 18,051 ft below the sea floor. The second formation was a 123-foot thick layer in which the top 53 ft contained oil and gas—the *pay zone* (Figure 1.14).

BP made the decision to terminate the well at this depth because “*Drilling ahead any further would unnecessarily jeopardize the well bore. Having a 14.15 ppg exposed sand and taking losses in a 12.6 ppg reservoir in the same hole-section had forced our hand. We had simply run out of drilling margin. At this point it became a well integrity and safety issue. TD was called at 18,360' (MD).*”³⁸

On April 12, 2010, BP asked the cementing contractor Halliburton to perform an analysis of a *long string* tapered production casing design that would utilize the performance of a lighter-weight *nitrogen foamed* cement (Figure 1.15).³⁹ The foamed cement would be used to reduce the bottom hole pressures to avoid losses into the weak formation found near the bottom of the well. Nitrified cement is typically used to minimize circulation problems because it is less dense, and therefore lighter and has less resistance to friction forces while circulating.⁴⁰ The BP decision to use a long-string production casing design rather than a liner and tie-back purportedly was determined by four factors: 1) zonal isolation, 2) annular pressure build-up, 3) mechanical barriers and integrity, and 4) total lifetime cost.⁴¹ The liner and tie-back option would take about 3 days more time and cost about \$7 to \$10 million more than the single long string.⁴² While the tieback well design could provide an additional barrier to hydrocarbon intrusion into the well, BP felt both designs “provided a sound basis for design.”⁴³

Halliburton performed tests on the proposed foamed cement mix that showed no compressive strength at 24 hours after placement. The tests showed it would take 48 hours at a temperature of 180°F to achieve a compressive strength of 1,590 pounds per square inch (psi).⁴⁴ The foam stability test performed by Halliburton indicated the foam was stable.⁴⁵

³⁶ Schlumberger, *Mississippi Canyon Block 252 Timeline*, Op. ct. 18.

³⁷ Rigzone, *How Do Wirelines and Slicklines Work?*, Accessed November 27, 2010, ref: http://www.rigzone.com/training/insight.asp?insight_id=323&c_id=22.

³⁸ E-mail from Bobby Bodek to Michael Bierne, BP America Inc., April 13, 2010.

³⁹ National Academy of Engineering and National Research Council, *Interim Report and Testimony on Causes of the Deepwater Horizon Rig Blowout and Ways to Prevent Such Events*, Nov. 16, 2010. U.S. Coast Guard – Bureau of Ocean Energy, Management and Regulation Joint Investigation hearing transcripts May – October 2010.

⁴⁰ Pritchard, D. and Kotow, K. *The New Domain in Deepwater Drilling: Applied Engineering and Organizational Impacts on Uncertainties and Risk*, Working Paper submitted for the Deepwater Horizon Study Group, October 2010.

⁴¹ BP Deepwater Horizon Accident Investigation Report, Op. ct 12, p75.

⁴² *Letter from Henry Waxman to Tony Hayward* - June 14, 2010 Op. ct. 14.

⁴³ BP, *Deepwater Horizon Accident Investigation Report*, Op. ct.12, p33.

⁴⁴ Transocean Deepwater Horizon Incident - Internal Investigation Interim Report Op. ct. 32.

⁴⁵ National Commission on the BP Deepwater Horizon Oil Spill and Offshore Drilling, Letter from Mr. Bartlit to Oil Spill Commission, October 28, 2010. Accessed: March 3, 2011, ref: <http://www.oilspillcommission.gov/sites/default/files/documents/Letter%20to%20Commissioners%20re%20Cement%20Tests.pdf>.

Despite the use of lighter foamed cement, slow pumping rates to minimize bottom hole pressures, and 10 centralizers to center the long string casing in the open hole (Figure 1.17), the Halliburton report to BP indicated the well was likely to have a “moderate” gas flow problem.⁴⁶

Liner with Tieback vs. Long String Design

A Long String casing design consists of a casing string that is hung from the wellhead and runs the full length of the well. This design requires high quality cementing to prevent the flow of hydrocarbons into the well, because in the case that hydrocarbons bypass the cement, they can flow directly up to the wellhead, causing a potential blowout.

The advantage that the Liner with Tieback casing provides over the Long String design is that it can provide additional barriers to annular flow (the flow of hydrocarbons up through the annulus). A single string of casing provides two barriers to the flow of hydrocarbons up the annular space: the cement at the bottom of the well, and the seal at the wellhead. However, the Liner with Tieback design provides four barriers to annular flow: 1) the cement at the bottom of the well, 2) the hanger seal that attaches the liner to the existing casing in the well, 3) the cement that secures the tieback on top of the liner, and 4) the seal at the wellhead.⁴⁷ Furthermore, primary cementing of a liner is more straightforward and less prone to contamination of the cement mix while displacing it into place.

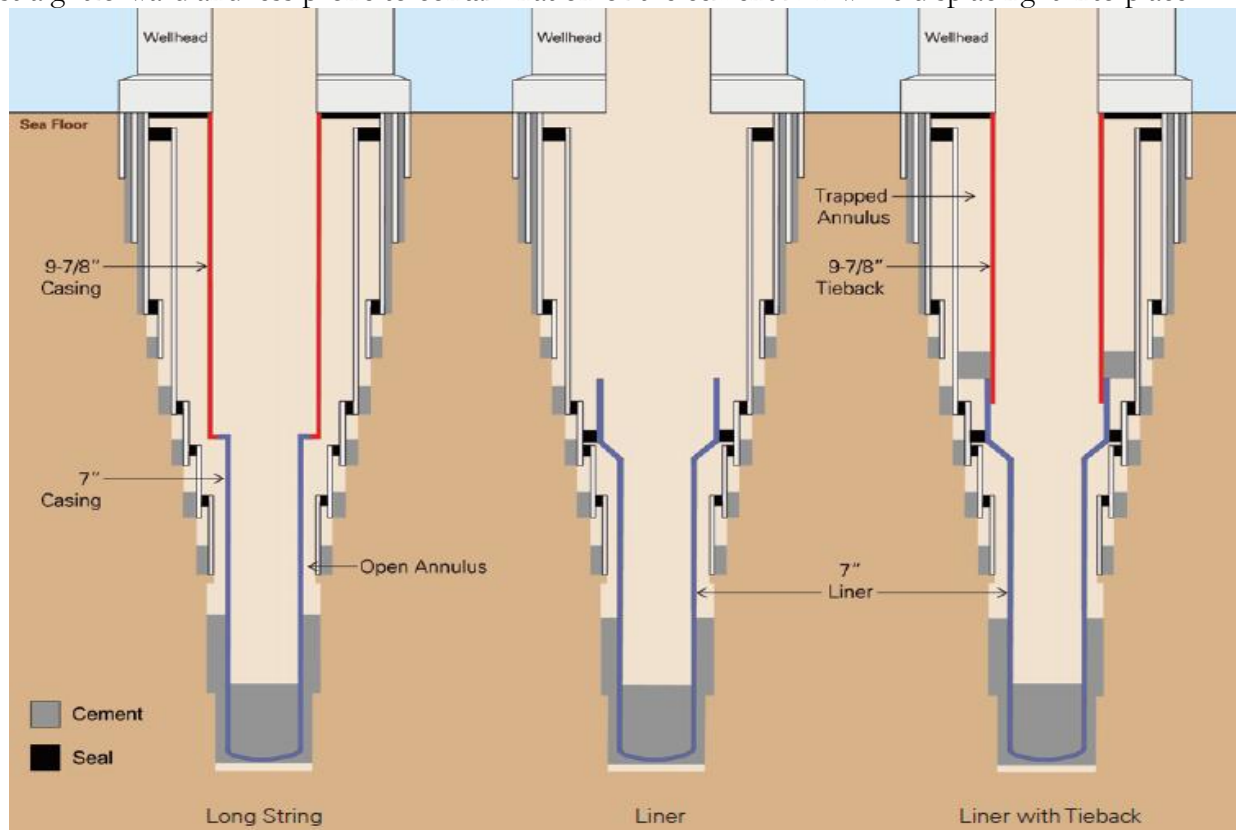

Figure 1.15 – Long String, Liner and Liner with Tieback.⁴⁸

⁴⁶ Letter from Henry Waxman to Tony Hayward - June 14, 2010, Op. ct. 14 .

⁴⁷ Letter from Henry Waxman to Tony Hayward - June 14, 2010 Op. ct. 14.

⁴⁸ Image Source: BP, Deepwater Horizon Accident Investigation Report, Op. ct. 12, p75.

Centralizers

Centralizers are mechanical devices used to keep the casing or liner in the center of the wellbore such that cement can be effectively poured around the casing. If a casing string is not properly centralized, there is a high risk that cement cannot be properly placed around the casing string, resulting in an imperfect seal.⁴⁹ In effect, this would allow for hydrocarbons to flow into and up the annulus.



Figure 1.16 – Centralizers.⁵⁰

April 15 – BP applied to the MMS for a change from an exploration well to a production well. BP proposed a completion design consisting of a single Long String of tapered casing (7 in diameter at the bottom, 9⁵/₈ in diameter at the top) extending from the bottom of the well to the subsea wellhead at the sea floor.⁵¹ The amended permit was approved by the MMS on the same day.⁵¹

BP requested Halliburton analyze the use of 7 centralizers on the long-string casing. The record indicates BP proposed the use of 6 centralizers and the casing on the rig was supplied with 6 centralizers.⁵¹ It is not known why Halliburton analyzed the 7 centralizer design. BP well engineers continued to deliberate the number of centralizers that should be used.

BP's original plan stated the use of 21 centralizers.⁵² BP engineers located the extra 15 centralizers that would be needed for the 21 centralizer option and made arrangements for transportation of the centralizers to the Deepwater Horizon.⁵³

⁴⁹ Schlumberger Website, Oilfield Glossary, Retrieved July 15, 2010,

ref: <http://www.glossary.oilfield.slb.com/Display.cfm?Term=centralizer>.

⁵⁰ Image Source: National Commission on the BP Deepwater Horizon Oil Spill and Offshore Drilling, Op. ct. 24.

⁵¹ Letter from Henry Waxman to Tony Hayward - June 14, 2010, Op. ct 14.

⁵² BP, GOM Exploration Wells MC 252 #1ST00BP01 - Macondo Prospect 7" x 9-7/8" Interval, April 15th, 2010, (BP-HZN-CEC017624), p4.

⁵³ BP, Deepwater Horizon Accident Investigation Report, Opt. ct 12, p 35.

April 16—17 – The additional 15 centralizers were delivered to the *Deepwater Horizon*. According to BP, the engineers erroneously believed that the additional centralizers they had received were of the wrong type, and therefore they decided not to use them.^{53,57}

The drilling mud in the bottom of the well was circulated out to clean out all of the hydrocarbons and settled cuttings.⁵⁴ Then a *wiper trip* was made to ensure the well bore was clear before the long-string casing was installed.⁵⁴ BP set the casing shoe 56 ft above the bottom of the hole,⁵⁵ leaving an uncased area called a *rat hole* at the bottom of the well to allow debris to fall out of the way during the completion work.

April 18 – The long string casing was installed with 6 centralizers^{53,57} by first installing a *shoe track assembly* with the shoe at the bottom and the *float collar* 190 ft above the shoe (Figure 1.17).⁵⁶ Above that assembly, the 7 in diameter casing was connected to a *crossover* to flare out to 9⁵/₈ in diameter connecting to the casing above (Figure 1.15).⁵⁴

Halliburton issued a report to their staff and BP on their recommended procedures for the cementing of the Macondo Well.⁵⁷ Halliburton reported to BP that the well with 7 centralizers was likely to have “severe” gas flow problems.⁵⁸ According to BP, the complete lab test results for the slurry that was designed to be used was not provided to BP before cementing began.

The 9⁵/₈ in diameter casing seal at the sea floor wellhead would be locked down after the cementing at the bottom of the well was completed.

A Schlumberger crew arrived at the *Deepwater Horizon* to be available to perform a cement bond log in order to characterize the integrity of a cement job, as to perform other services required to prepare the well for temporarily abandonment.⁵⁹

⁵⁴ BP, *Deepwater Horizon Interim Accident Investigation*, May 24, 2010.

⁵⁵ BP, *Deepwater Horizon Accident Investigation Report*, Opt. ct 12, p19.

⁵⁶ BP, *Deepwater Horizon Accident Investigation Report*, Opt. ct 12, p 37.

⁵⁷ BP, *Deepwater Horizon Accident Investigation Report*, Opt. ct 12, p 23.

⁵⁸ *Letter from Henry Waxman to Tony Hayward* - June 14, 2010 , Op. ct 14.

⁵⁹ Schlumberger, *Mississippi Canyon Block 252 Timeline* Op. ct. 18.

Shoe Track

The Shoe Track is the space between the float or guide shoe (i.e., reamer shoe in Figure 1.18) and the landing or float collar.⁶⁰ The principal function of this space is to ensure that the shoe is surrounded in high-quality cement and that any contamination that may bypass the top cement plug is safely contained within the shoe track.⁶⁰

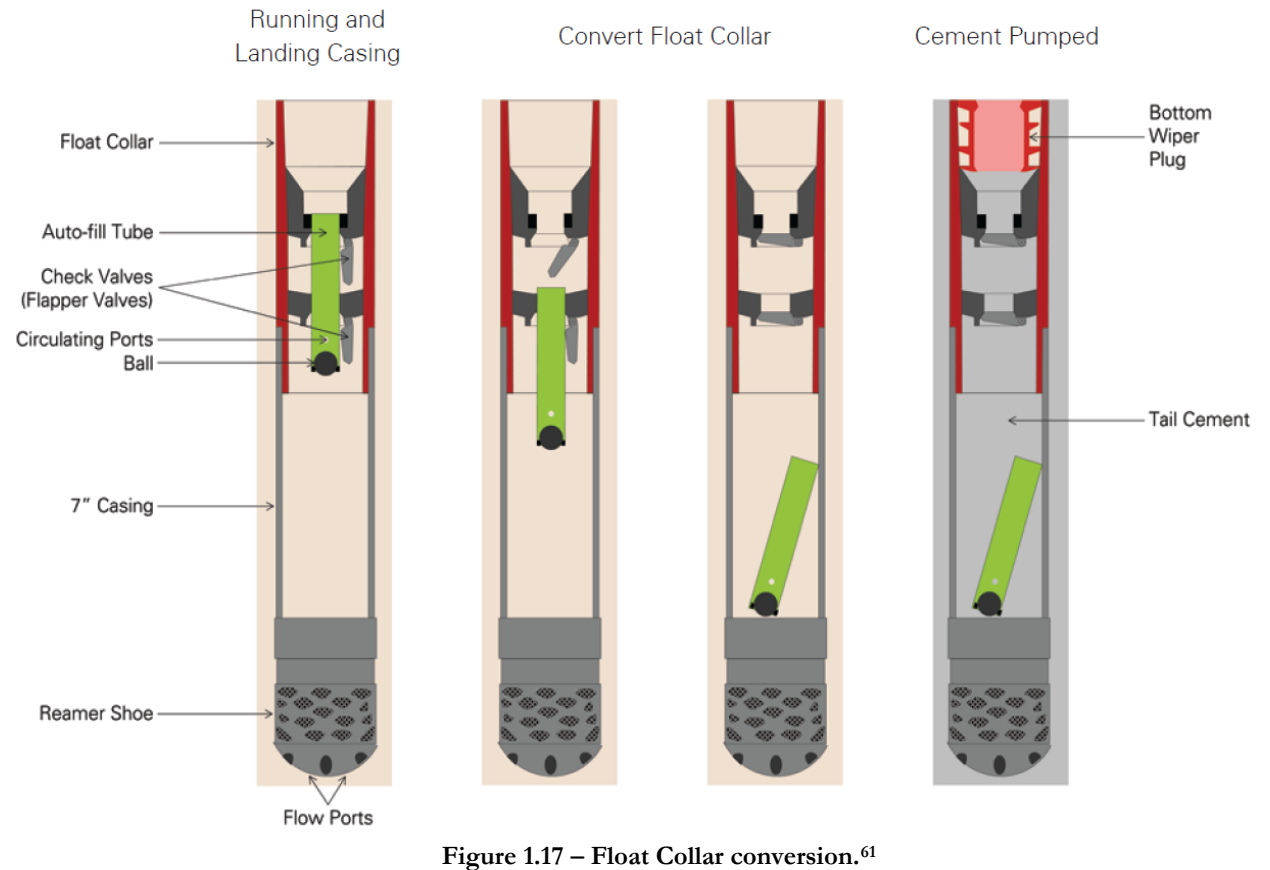

April 19 – The final production casing string with the shoe track and 6 centralizers in place reached the bottom, mud was pumped to create the pressure needed to unlock (convert) the float collar flapper valves. When the shoe track was placed in the well, the autofill tube (Figure 1.17) held the two flapper valves in an open position so drill mud could fill the inside of the long string casing. Once the long string was in place, a ball was seated in the bottom of the fill tube. When the long string was pressured from the inside, the fill tube would be pushed below the flapper valves that would then close to prevent backflow from the well below the flappers—the back flow prevention valves.

⁶⁰ Schlumberger website, Oilfield Glossary, accessed November 28, 2010, ref: <http://www.glossary.oilfield.slb.com/Display.cfm?Term=shoe%20track>.

⁶¹ Image Source: BP, *Deepwater Horizon Accident Investigation Report*, Op. ct. 12, p71.

⁶² BP, *Deepwater Horizon Accident Investigation Report*, Op. ct 12, p23.

An attempt was made to circulate the well; and according to BP either the float collar or reamer shoe was plugged. The establishment of circulation and float collar conversion should have taken one attempt at approximately 400 to 700 psi.⁶³ Instead, the circulation/conversion took nine attempts with gradually increasing pressure until a final pressure of 3,142 psi was developed.⁶³ The high pressures required for the float collar conversion raised concerns about blockage in the reamer shoe at the bottom, breakdown of the weak formations at the bottom of the well, and that the float collar might not have converted. It is unclear as to whether the 3,142 psi of pressure actually converted the float collar or if it just cleared a plugged shoe.⁶³ There were additional concerns with the low circulating pressures following the conversion. It was decided the standpipe gauge pressures were “inaccurate.”⁶⁴

BP made the decision not to do a complete *bottoms-up* circulation of the well before cementing that would remove hydrocarbons and debris in the bottom of the well (Figure 1.18). Due to BP engineer concerns for *wash out* in the weak formation at the bottom of the hole accompanied by disturbance of the lost circulation material that had been placed in this part of the well, only about half of the well-casing volume was circulated out.⁶⁵ The incomplete bottoms-up circulation did not meet Halliburton’s *best practices*.⁶⁶ This incomplete circulation would have left any hydrocarbons that remained in the well lingering in the upper part of the well.

Based on the plan proposed by Halliburton, a *spacer* fluid consisting of oil and mud followed by a *wiper plug* was placed at the bottom of the well. A special wiper plug was required to clean the well bore by removing residual drilling mud because of the variable diameter of the long string casing. The wiper plug was followed with a cement *sandwich* (Figure 1.19) consisting of regular cement followed by the foamed cement followed by regular cement.⁶⁷ BP reported the “job pumped per plan—no cement losses observed.”⁶⁸ This report was challenged during the USCG – BOEMRE hearings and remains to be confirmed.⁶⁹ It should be recognized that the foamed cement volume starts out at the mix unit at almost 100 bbl of mix volume. This is reduced by almost half as it is pumped downhole making volume control for detecting losses difficult—maybe impossible without a computer-generated, simulation table to refer to.

⁶³ BP, *Deepwater Horizon Accident Investigation Report*, Op. ct 12, p70.

⁶⁴ U.S. Coast Guard – Bureau of Ocean Energy Management, Regulation and Enforcement Joint Investigation hearing transcripts, Testimony of Brett Cocalis, Operations Drilling Engineer, BP, August 27, 2010.

⁶⁵ National Academy of Engineering and National Research Council, *Interim Report and Testimony on Causes of the Deepwater Horizon Rig Blowout and Ways to Prevent Such Events*, November 16, 2010, U.S. Coast Guard – Bureau of Ocean Energy, Management and Regulation Joint Investigation hearing transcripts May – Oct. 2010. Macondo Production casing running, cementation, and testing plan, “GoM Exploration Wells MC 252 #1ST00BP01 – Macondo Prospect 7” x 9 7/8” Interval.” Accessed March 3, 2011, ref: <http://bpoilresponse.markimoore.com/blog/bp-media/docs/Macondo.Well.Casing.Production.Operations.pdf>, p8.

⁶⁶ U.S. Coast Guard – Bureau of Ocean Energy, Management and Regulation Joint Investigation hearing transcripts, Testimony of Jesse Gagliano, Halliburton, August 24, 2010.

⁶⁷ BP, *Deepwater Horizon Accident Investigation Report*, Op. ct. 12, p61.

⁶⁸ BP, Op. ct. 56, p14.

⁶⁹ U.S. Coast Guard – Bureau of Ocean Energy Management, Regulation and Enforcement Joint Investigation hearing transcripts, May – October 2010.

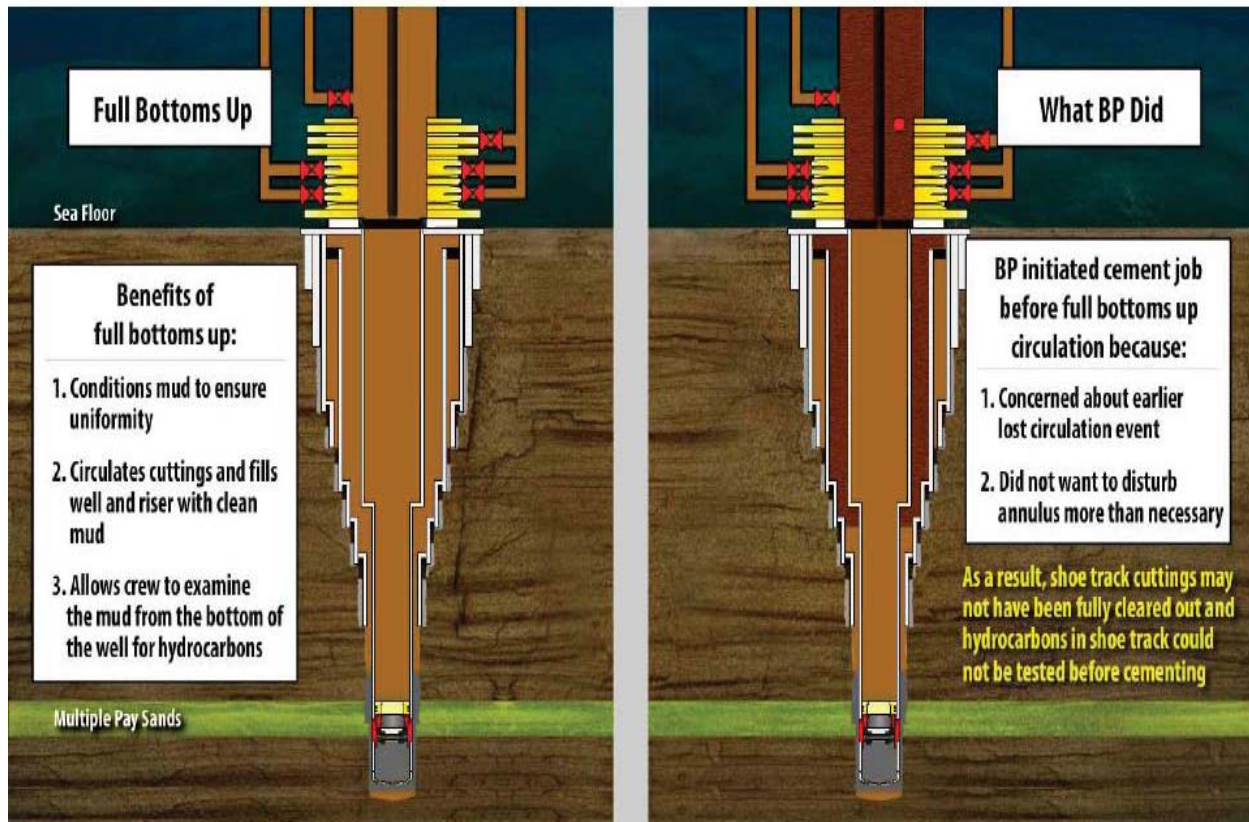

Figure 1.18 – Illustration of *bottoms up*.⁷⁰

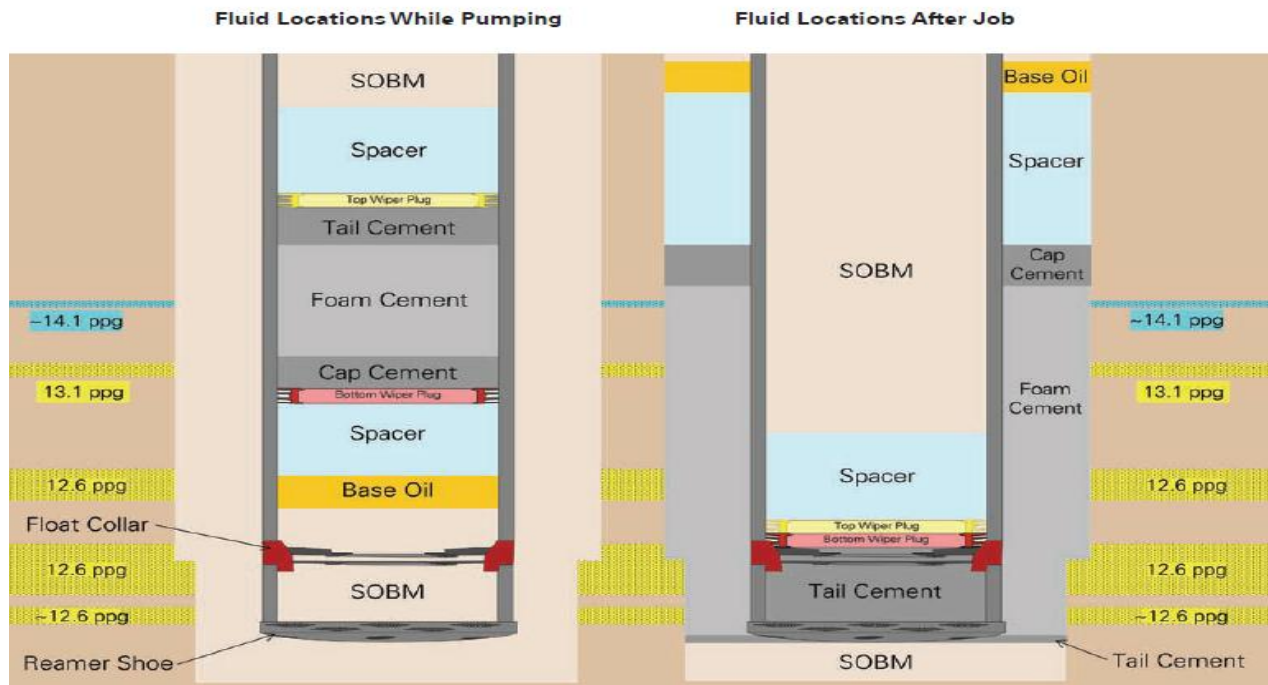

Figure 1.19 – Cement fluid locations.⁷¹

⁷⁰ Image Source: National Commission on the BP Deepwater Horizon Oil Spill and Offshore Drilling, Op. ct. 24.

⁷¹ Image Source: BP, *Deepwater Horizon Accident Investigation Report*, Op. ct. 12, p61.

The Blowout

April 20 – All of the cement was in place by 12:36 a.m.⁷² Pressure monitoring confirmed the floats were holding and the well was *static*. Next, the casing hanger seal at the seafloor wellhead was set between the side of the casing hanger and the wellhead walls to seal off the annulus.⁷² Two pressure tests on the seal were successfully completed.⁷² BP engineers elected to defer installation of the lockdown sleeve until after the upper portion of the well was displaced with seawater.⁷³

As part of BP's plan to temporarily abandon the well, BP intended to install a 300 ft cement plug in the well at a depth of approximately 3,300 ft below the seafloor to prevent wellhead seal area contamination and to provide sufficient weight from the drill string to set the lockdown sleeve. MMS regulations require the plug in the production casing be set no more than 1,000 ft below the mudline, (seafloor).⁷⁴ This plan required two important interconnected simultaneous operations: displacement of the drilling mud with seawater and offloading the drilling mud to a supply vessel.

The plan developed by BP for temporary abandonment of the well consisted of seven major steps: 1) perform a *positive test* on the casing to check and confirm that the casing and wellhead seal assembly can contain the pressure inside the well to assure no fluid was capable of flowing from the well, 2) perform a *negative test* to confirm no fluid was capable of flowing from the producing formation into the well, by testing the integrity of the casing shoetrack, the casing, and the wellhead assembly to withstand the formation pressure, 3) displace the drilling mud in the riser above the location of the surface plug (3,300 ft below the seafloor) with lighter sea water, 4) set a cement surface plug, 5) test the integrity of the surface plug, 6) perform an *impression test* (with a lead block) to assure that the casing hanger was seated properly, and 7) install a *lockdown sleeve* to secure the casing hanger and seal.⁷⁵

The *Deepwater Horizon* had an outstanding record of preventing lost-time incidents. In 2008, the *Deepwater Horizon* had received an award for its safety record, and on the day of the explosion there was a ceremony on board the rig celebrating seven years without a lost-time incident.⁷⁶

April 20, 7:00 a.m. – After a discussion with the Macondo well contractors, as per the well plan *decision tree*, BP concluded that a cement bond log was not required.⁷⁷ BP informed the Schlumberger crew that no wireline cased hole services would be requested. At approximately 11:15 a.m., the Schlumberger crew departed the *Deepwater Horizon* on the regularly scheduled BP helicopter flight.⁷⁸

April 20, 10:55 a.m. – A positive test was performed on the well to determine if there was any outflow from the well. The positive pressure test was performed in two stages. For the first stage, the Blind Shear Rams in the BOP were closed, and the pressure in wellbore was increased through the kill line to 250 psi and held for 5 minutes. When it was concluded that no leaks were detected,

⁷² BP, *Deepwater Horizon Accident Investigation Report*, Op. ct. 12, p23.

⁷³ U.S. Coast Guard – Bureau of Ocean Energy Management, Regulation and Enforcement Joint Investigation hearing transcripts, Testimony of Shane Albers, Project Engineer, BP, July 22, 2010.

⁷⁴ 30 C.F.R. §250.1721.

⁷⁵ BP, *Deepwater Horizon Accident Investigation Report*, Op. ct. 12.

⁷⁶ Casselman, B., *Rig Owner Had Tally of Accidents*, The Wall Street Journal, May 10, 2010.

⁷⁷ BP, *Deepwater Horizon Accident Investigation Report*, Op. ct. 12, p23.

⁷⁸ Schlumberger, Op. ct 18.

for the second stage, the casing was pressured up to 2,700 psi and held for 30 minutes.⁷⁹ This test was performed about 10.5 hours after the cement placement was completed⁷⁷—well before the 48 hours that the Halliburton lab tests indicated necessary for the foamed portion of the cement to develop sufficient strength.⁸⁰ This early testing has raised concerns for disturbance of the uncured cement next to the casing resulting in a *micro-annulus* where fluids could flow even after the cement had hardened.⁸¹ In addition, this test does not test the integrity of the bottom assembly and cement due to the presence of the wiper plug at the top of the assembly.⁷⁹

April 20, 11:30 a.m. – The BP plan for placement of the surface plug after displacement of the upper portion of the drill mud column was reviewed with the Transocean drill crew. Significant concerns for displacement of the drill mud before placement and testing of the surface plug and installation of a lockdown sleeve were expressed. Agreement was reached to proceed with the BP well abandonment plan.⁸²

Drill pipe was run in the hole to 8,367 ft and in preparation for the mud displacement and the negative-pressure test, the displacement procedure was reviewed.⁸³

April 20, 1:28 p.m. – The *Deepwater Horizon* started offloading mud to the supply vessel *Damon Bankston*.⁸³ Concerns were expressed by the mudloggers that given the simultaneous operations the mud pit levels could not be accurately monitored.⁸³ The assistant Driller told the mud logger that once the offloading operations were ceased, a notice would be provided.⁸³

April 20, 3:04 p.m. – The blowout preventer boost, choke, and kill lines (Figure 1.20) were flushed with sea water to displace the mud, and the kill line remained pressurized at 1200 psi.⁸⁴ The *choke* and *kill* lines are valves on the BOP that allow access to the well when the BOP is either fully or partially closed. The purpose of the choke line is to release pressure from the well, while the purpose of the kill line is to pump mud to stop the backflow in the well. The BOP devices and the choke and kill lines are also often used to conduct pressure tests on casing, set seals, activate tools, etc.⁸⁵

⁷⁹ BP, *Deepwater Horizon Accident Investigation Report*, Op. ct. 12, p82.

⁸⁰ Transocean, Op. ct. 32.

⁸¹ National Academy of Engineering and National Research Council, *Interim Report on Causes of the Deepwater Horizon Oil Rig Blowout and Ways to Prevent Such Events*, November 16, 2010.

⁸² U.S. Coast Guard – Bureau of Ocean Energy Management, Regulation and Enforcement Joint Investigation hearing transcripts, Testimony of Jimmy Harrell, Transocean Offshore Installation Manager, May 27, 2010.

⁸³ BP, *Deepwater Horizon Accident Investigation Report*, Op. ct. 12, p24.

⁸⁴ BP, *Deepwater Horizon Accident Investigation Report*, Op. ct. 12, p24.

⁸⁵ Parsons, P. Op. ct. 6.

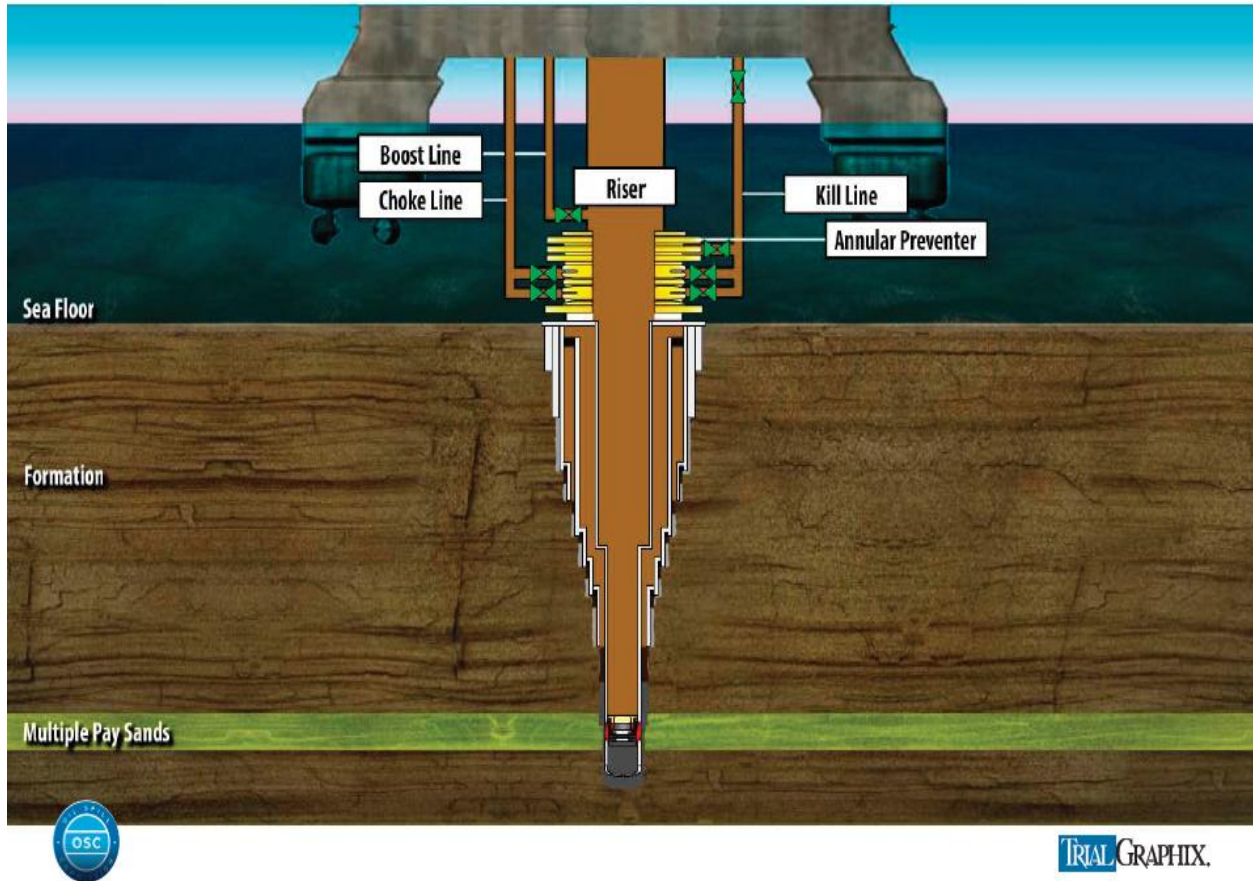

Figure 1.20 – Illustration of the "choke" and "kill" lines.⁸⁶

April 20, 3:56 p.m. – As part of the displacement operations, 424 bbls of 16 ppg spacer mud, followed by 30 bbls of freshwater were pumped into the well. A total of 352 bbls of seawater was used to complete the displacement. This placed the spacer fluid 12 ft above the BOP.⁸⁴

The pumps were then shut down, and the drill pipe pressure was at 2,325 psi while the pressure in the kill line was 1,200 psi. Then the annular preventer was closed for the negative-pressure test. Pressure was reduced in the drill string with concurrent reduction in pressure at the blowout preventer kill line.⁸⁴ The reader is referred to annotated Figure 2.7 of Chapter 2 of this report for the most comprehensive description of what transpired next.

During this period, from approximately 4:00 p.m. to 5:50 p.m., the trip tank was being cleaned.⁸⁷ Because of the simultaneous offloading and cleaning operations, the mud levels in the tank were changing, making it difficult to monitor whether the well was flowing. As a result, the recorded flow data is believed to be unreliable during this period.

⁸⁶ Image Source: National Commission on the BP Deepwater Horizon Oil Spill and Offshore Drilling, Op. ct. 24.

⁸⁷ BP, *Deepwater Horizon Accident Investigation Report*, Op. ct. 12, p24.

Trip Tank

A trip tank is a small tank used to keep track of the amount of mud which is used to replace the volume of the drill string. When a drill string is removed from the hole, a volume of mud must be pumped into the hole to replace the volume of the pipe in order to maintain hydrostatic pressure in the well. The same is true for when a pipe is inserted into the hole; the volume of fluid equal to the volume of the drill string must be removed. During displacement operations, it is important to monitor the amount of mud being pumped into, or being removed from the well so that hydrostatic pressure in the well can be maintained and the crew can determine whether losses or kicks occur. If the volume pumped from the tank into the well, is equal to the volume of mud returned from the well into the tank, then it can be concluded that the reservoir is not flowing into the well.

Other simultaneous operations such as preparing for the setting of the cement plug in the casing and bleeding off the riser tensioners were occurring at the same time, which may have distracted the crew and mudloggers from accurately monitoring the well.⁸⁸

April 20, 5:00 p.m. – This is the first time that the well was underbalanced—pressure at the bottom of the well was less than the formation pressure. If the well were properly sealed, only enough fluid would backflow to account for the pressure release, the pressure in both the drill string and the blowout preventer kill line would drop to zero (atmospheric) and the well would remain static with no backflow. Results from the test were not *positive*—there was more backflow than anticipated and the drill pipe pressure never dropped to zero. Also, it was noticed that the mud level in the riser had dropped about 50 barrels⁸⁷—an indication that the annular preventer had leaked, allowing the heavy mud above the riser to drop into the seawater section.

What the drill crew did not recognize was that not enough seawater had been pumped before the test to move all of the spacer mud above the blowout preventer. The spacer mud was heavy and viscous enough to not only interfere with the pressure results, but also to block flow through the small diameter kill line. The BP investigation concluded that the leaking annular in the blowout preventer allowed the spacer to move across the kill line inlet.⁸⁹

The mud offloading to the *Damon Bankston* stopped at approximately 5:17 p.m., for which the mudlogger was not notified.⁹⁰

The hydraulic pressure on the annular preventer was increased to stop the suspected leak.⁸⁷ The riser was refilled. The drill pipe and kill lines were closed. The drill pipe pressure unexpectedly rose from 273 psi to 1,250 psi in six minutes.⁸⁷ Testimony indicates the Transocean *toolpusher* and BP *company man* deliberated their different interpretations of the negative test results.⁹¹ The tool pusher

⁸⁸ BP, *Deepwater Horizon Accident Investigation Report*, Op. ct. 12, p91.

⁸⁹ BP, *Deepwater Horizon Accident Investigation Report*, Op. ct. 12, p84.

⁹⁰ BP, *Deepwater Horizon Accident Investigation Report*, Op. ct. 12, p25.

⁹¹ U.S. Coast Guard – Bureau of Ocean Energy Management, Regulation and Enforcement Joint Investigation hearing transcripts, Testimony of Christopher Pleasant, Subsea Supervisor, Transocean, May 28, 2010.

asserted the evidence was indicative of a well leak problem. The BP company man asserted that the anomalous results were caused by the riser leak. It was decided to conduct a second negative test.⁹²

April 20, 5:27 p.m. – The second negative test began by bleeding the drill pipe pressure to zero.⁹³ Three and a half barrels of backflow were expected but 15 barrels of backflow were observed.⁹⁴ A valve at the top of the drill pipe was closed to monitor the drill string pressure. Unexpectedly, the pressure quickly rose and then fell, slowly rebuilding to 1400 psi. The kill line was opened, fluid flowed out, and the line was closed. According to a witness account, fluid was still flowing when the instructions to shut the line were given.⁹³ The drill pipe pressure increased from 6:00 p.m. to 6:35 p.m. and reached 1,400 psi.⁹³ The kill line was filled with seawater and then opened to observe backflow. Only a small amount of backflow was observed during this time period. While monitoring the kill line, a discussion occurred regarding the pressure on the drill pipe as the toolpusher mentioned that it was due to *annular compression* and the *bladder effect*.⁹⁵ The flow from the kill line stopped, but the drill pipe pressure remained constant at 1,400 psi.⁹⁴

April 20, 8:00 p.m. – At 7:55 p.m. the negative pressure test result was accepted as a good result despite the high pressure observed in the drill pipe.⁹³ The two negative pressure tests were not clearly *positive*. Yet, they were accepted as positive—a *false positive*. It is likely that spacer mud flowed into the kill line during the second test and blocked the kill line, giving a false result of no flow on a well that was unknowingly capable of flowing.⁹⁶

The internal blowout preventer (IBOP) and the annular preventer were opened and seawater pumping was continued for about the next hour down the drill pipe to displace all mud out of the riser.⁹³ This process continued to reduce the pressures inside the drill pipe. Unfortunately, because seawater was being pumped into the well and the mud pits were only receiving mud coming from the well, it was not possible for the mudloggers to positively determine influx—more fluid coming into the well than out of the well. The inflow and outflow can be monitored from the driller’s data-panel (Figure 1.21). This process is not precise. It is not known how closely the inflows and outflows were being monitored at this time. For certain, a closed system of dedicated mud and seawater volumes (pits) that would have provided direct information on gains or losses was not implemented.

April 20, 8:50 p.m. – At 8:50 p.m. the pumps were slowed to monitor the water-based mud spacer’s arrival so it could be tested to be sure it had not been contaminated with the oil-based drilling mud (*sheen test*).⁹⁷

A decrease in the flow of the spacer was expected as the pumps were slowed; however real time data indicated that the flow actually increased (Figure 1.23 and Figure 1.24).⁹⁸

According to BP, the first indication of flow into the well would likely have been at approximately 8:58 p.m. However, inaccuracies in the trip tank reading (due to the emptying) could have made this influx difficult to observe and detect.⁹⁸

⁹² U.S. Coast Guard – Bureau of Ocean Energy Management, Regulation and Enforcement Joint Investigation hearing transcripts, Testimony of Jimmy Harrell, Offshore Installation Manager, Transocean, May 27, 2010.

⁹³ BP, *Deepwater Horizon Accident Investigation Report*, Op. ct. 12, p25.

⁹⁴ BP, *Deepwater Horizon Accident Investigation Report*, Op. ct. 12, p39.

⁹⁵ BP, *Deepwater Horizon Accident Investigation Report*, Op. ct. 12, p40, 88.

⁹⁶ BP, *Deepwater Horizon Accident Investigation Report*, Op. ct. 12, p84.

⁹⁷ BP, *Deepwater Horizon Accident Investigation Report*, p 22-29.

⁹⁸ BP, *Deepwater Horizon Accident Investigation Report*, p92.



Figure 1.21 – View of the driller's data-panel.⁹⁹

April 20, 9:00 p.m. – Shortly after 9:00 p.m. pressure on the drill pipe increased from 1,250 psi to 1,350 psi. The drill pipe pressure should have decreased due to the removal of the heavier mud (14.7 ppg) and its replacement with the lighter weight seawater (8.6 ppg). This abnormality could have been detected from monitoring the drill pipe pressure data, and could have been the first clear indication of the flow of hydrocarbons into the well, visible to the crew.⁹⁸ Spacer fluid was then observed at the surface.

⁹⁹ Image Source: Adapted from the National Commission on the BP Deepwater Horizon Oil Spill and Offshore Drilling.

Deepwater Horizon Study Group
Investigation of the Macondo Well Blowout Disaster

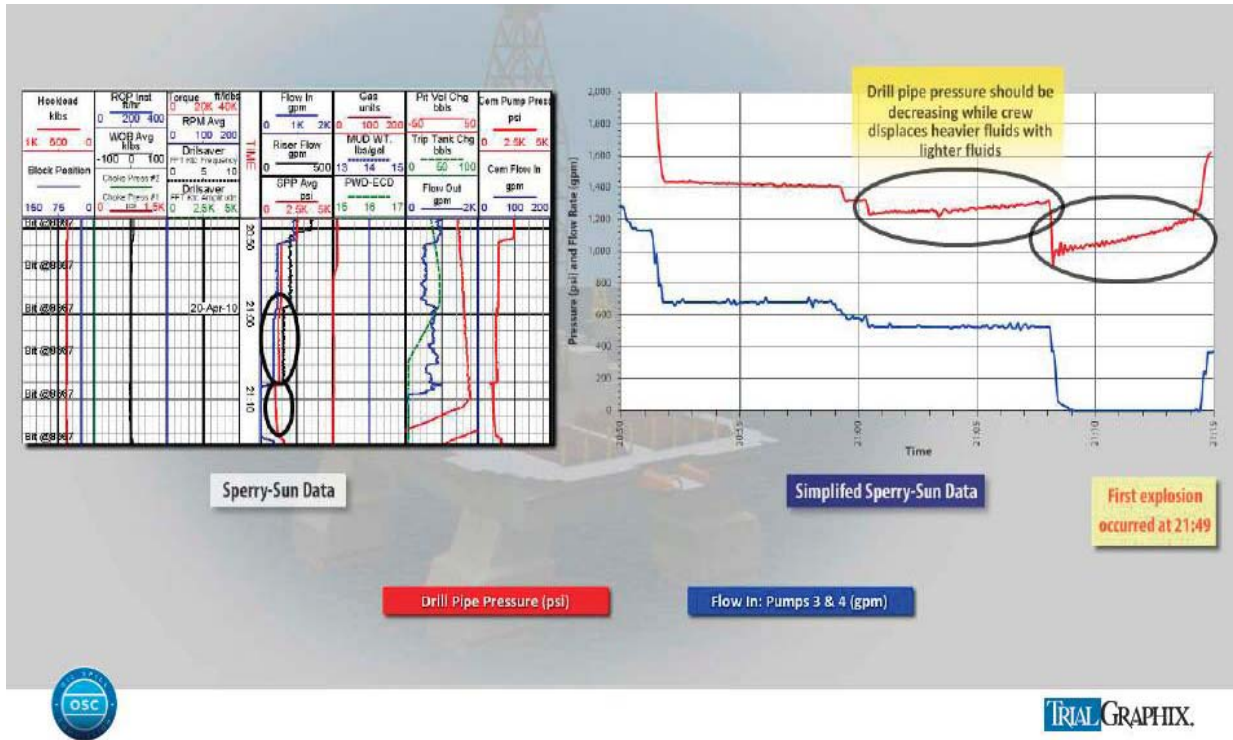

Figure 1.22 – Drill pipe pressure showing pressure increase.¹⁰⁰

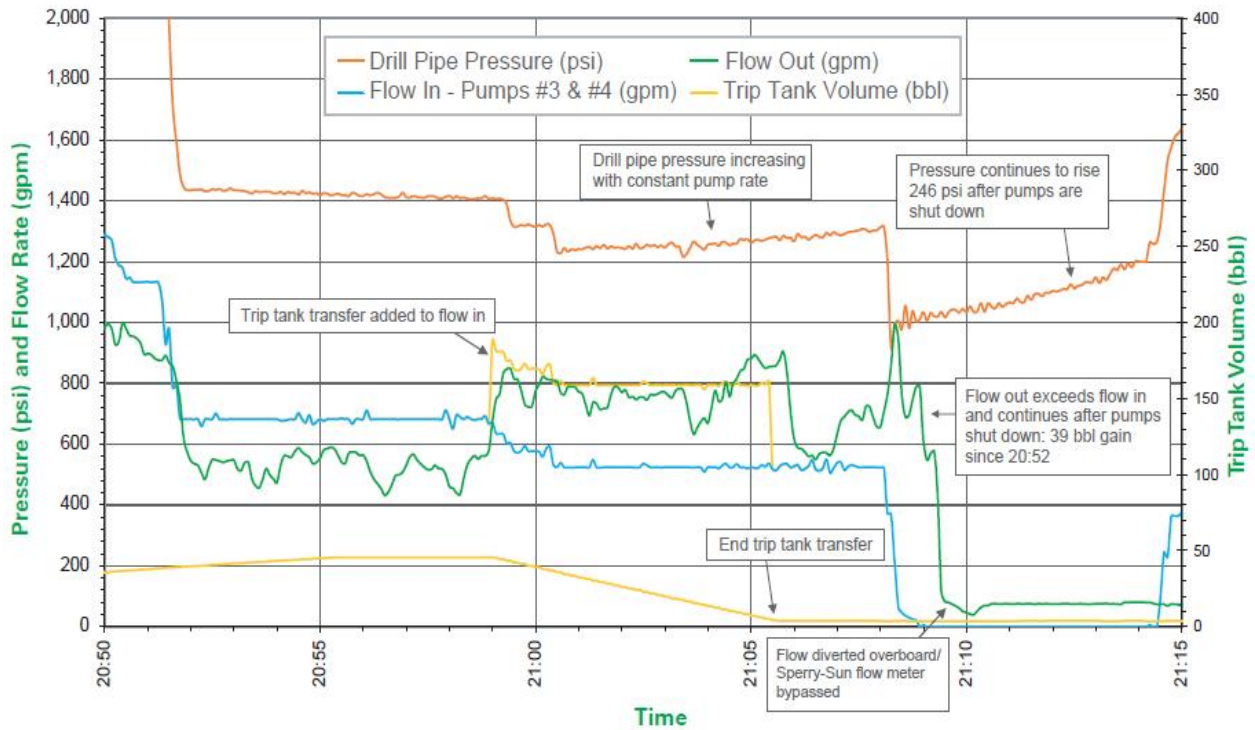

Figure 1.23 – Flow indication graph showing anomalies (real-time data).¹⁰¹

¹⁰⁰ Image Source: National Commission on the BP Deepwater Horizon Oil Spill and Offshore Drilling, Op. ct. 24.

¹⁰¹ Image Source: BP, *Deepwater Horizon Accident Investigation Report*, Op. ct 12, p93.

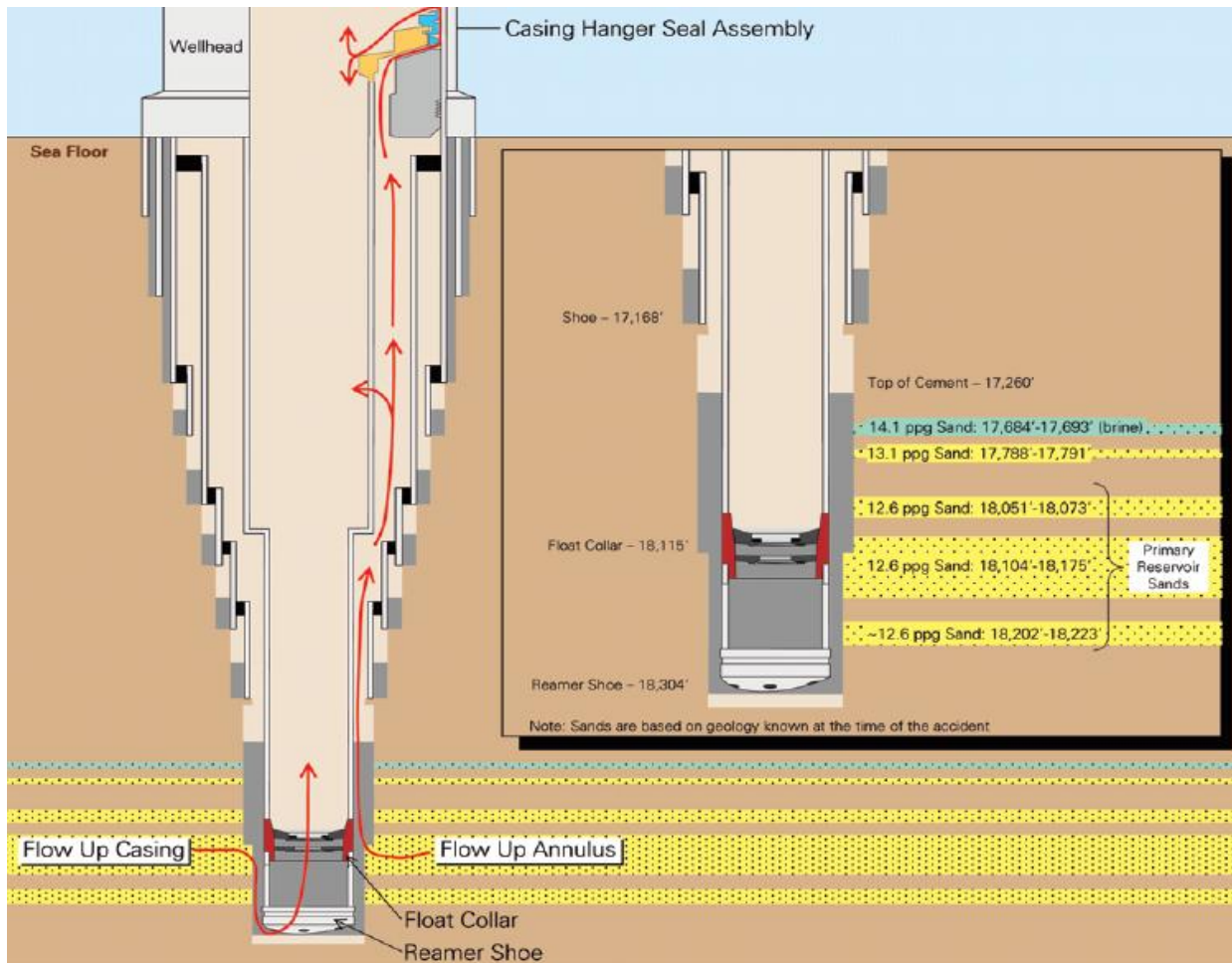

Figure 1.24 – Potential flow paths.¹⁰²

At around 9:08 p.m. the pumps were shut down to allow the sheen test to be performed.¹⁰³ The records indicate that with the pumps off, the drill pipe pressure continued to increase indicating that there was flow into the well.¹⁰³ However it is possible that due to overboard discharge during the sheen test, the inflow could not be directly observed. Following the successful sheen test, at about 9:14 p.m. the pumps were restarted to continue displacement of the spacer fluid overboard, and a spike in pressure occurred when pump #2 was started.¹⁰⁴ The available records of drill pipe pressure show that it continually increased during this period of time.¹⁰⁵ Because of the pumping overboard, there was no method to accurately record the outflow volume.

At approximately 9:20 p.m., the toolpusher told the senior toolpusher that the results of the negative test were “good,” and that the displacement was “going fine.”¹⁰⁶ Overall, the crew seemed unaware of the situation at hand—that the well was flowing.

¹⁰² Image Source: BP, *Deepwater Horizon Accident Investigation Report*, Op. ct 12, p54.

¹⁰³ BP, *Deepwater Horizon Accident Investigation Report*, Op. ct. 12, p93.

¹⁰⁴ BP, *Deepwater Horizon Accident Investigation Report*, Op. ct. 12, p26.

¹⁰⁵ BP, *Deepwater Horizon Accident Investigation Report*, Op. ct. 12, p95.

¹⁰⁶ BP, *Deepwater Horizon Accident Investigation Report*, Op. ct. 12, p98.

April 20, 9:31 p.m. – A sudden decrease in drill pipe pressure occurred.¹⁰⁷ The mud pumps were shut down due to various possible reasons such as troubleshooting the startup of pump #2, responding to the return of the remaining spacer, or responding to the fairly sudden decreasing drill pipe pressure. Over the next few minutes until 9:34 p.m. pressure in the drill pipe started to rebuild from 1,210 psi to 1,766 psi.¹⁰⁷

From 9:36p.m. to 9:38 p.m., another sudden pressure change was experienced. The drill pipe pressure decreased from 1,782 psi to 714 psi, and then increased from 714 psi to 1,353 psi.¹⁰⁷ The information available at this time does not clearly delineate the multiple activities that took place after about 9:30 p.m.

April 20, 9:40 p.m. – The witness testimony indicates that approximately 9:45 p.m., seawater was pushed to the top of the drill derrick followed by drilling mud which flowed uncontrolled onto the rig floor.^{108, 109} The BP investigation indicates the rig crew diverted hydrocarbons coming through the riser to the mud gas separator.¹⁰⁹ This separator was not designed for the volume of gas and well fluids that were being produced by the well—and it was quickly overwhelmed.¹¹⁰ It is not known why the alternative use of diversion overboard was not chosen. Perhaps, concerns for the discharge of the oil-based drilling mud into the sea indicated to the drill crew, that the appropriate alternative was to divert to the mud gas separator. The recorded well data indicates the drill crew tried to shut in the well about this time—most likely using the annular preventer.¹⁰⁹ The first gas alarm sounded at approximately 9:47 p.m.¹⁰⁹ The drillstring pressure began increasing sharply at that time from 1,200 psi and quickly reached 5,730 psi.¹⁰⁹ It is inferred that gas coming out of solution in the well above the blowout preventer was expanding rapidly—pushing the seawater and drill mud ahead of it. Gas flooded onto the rig.¹⁰⁹ Ingestion of gas through the air intakes of the generators resulted in their over-speeding and probable failure.

April 20, 9:49 p.m. – Available information indicates at this time the rig power and recorded data were lost. Attempts to activate the emergency shutdown systems failed. BP's Accident investigation report concluded it is very likely that due to failures in the blue and yellow pods on the BOP, the automatic mode function (AMF, which activates the blind shear rams) could not have been completed.¹¹¹

Attempts to activate the blowout preventer shear rams failed. Attempts to activate the emergency disconnect system (EDS) that would have allowed the *Deepwater Horizon* to separate from the blowout preventers failed, and the Lower Marine Riser Package (LMRP) did not unlatch.¹¹¹ The first explosion is estimated to have occurred within seconds after the power loss, quickly followed by a second explosion (within 10 seconds of the first explosion).¹¹² The conflagration from the blowout of the Macondo well was underway.

April 20, 9:52 p.m.—11:22 p.m. – When the crew on the bridge became aware of the severity of the situation, a mayday call was made by the *Deepwater Horizon*. According to testimony provided at

¹⁰⁷ BP, *Deepwater Horizon Accident Investigation Report*, Op. ct. 12, p27.

¹⁰⁸ U.S. Coast Guard – Bureau of Ocean Energy Management, Regulation and Enforcement Joint Investigation hearing transcripts, Testimony of Paul Erickson, Chief Mate of the *Damon Bankston*, May 11, 2010.

¹⁰⁹ BP, *Deepwater Horizon Accident Investigation Report*, Op. ct. 12, p28.

¹¹⁰ BP, *Deepwater Horizon Accident Investigation Report*, Op. ct. 12, p44.

¹¹¹ BP, *Deepwater Horizon Accident Investigation Report*, Op. ct. 12, p47.

¹¹² BP, *Deepwater Horizon Accident Investigation Report*, Op. ct. 12, p29.

the U.S Coast Guard – Bureau of Ocean Energy Management, Regulation and Enforcement Joint Investigation hearings, various alarms and critical safety systems failed to operate as intended. It was testified that several of the *Deepwater Horizon*'s fire and gas detectors were not functioning or had been inhibited prior to the explosion to avoid waking crewmembers in the middle of the night due to false alarms.¹¹³ This implied that the sensors were able to detect hazards and forward the information to the computer. However, the computer would not have automatically triggered the alarm upon detecting a hazard, requiring manual activation for any further response. The failure of the alarms along with other critical safety systems potentially comprised the time available to the crew to evacuate the rig.

Following the explosion, many of the members did not hear any alarms and began evacuating the rig as soon as they witnessed the impact of the blowout. During this period there was chaos on the bridge, as the crew was trying to assess the situation and perform emergency operations such as shutting down the well and disconnecting from the wellhead. While crew members on the bridge were trying to assess the situation, many people were already mustering near the lifeboats. Some members were hanging on the side rails ready to jump to sea. Eventually the order to muster and evacuate was given, however, rather than waiting for the orders to evacuate and board the lifeboats, some members had already jumped to the sea, bypassing any previously practiced evacuation plan. Others were urging for the lifeboats to be launched despite them being only partially full. As the crew was making their way to the muster stations, many of the egress routes were blocked, and stairways were impaired, as a result of the explosions. Ventilation systems were also reported to be discharging carbon dioxide.

According to testimonies, the evacuation process was chaotic and overwhelming. Nonetheless, the fact that more than 100 of the 126 people on board the *Deepwater Horizon* escaped the rig alive is a sign that the evacuation effort went “pretty well.”¹¹⁴

Two lifeboats were eventually launched with the permission of a senior official who was visiting the rig at the time of the incident. The lifeboats made their way to the *Damon Bankston*, a nearby supply ship which was previously connected to the rig, but was warned to back away when the crew had been experiencing well control problems prior to the explosion.¹¹⁵ An officer on the bridge of the *Deepwater Horizon* communicated for help to the *Damon Bankston*, and in response a Fast Rescue Craft (FRC) was launched to help rescue those at sea. Some of the members who were not able to board the lifeboats used a 25-foot life raft to evacuate, however after the raft had reached the water, the crew realized a line from the rig was attached to the raft, and therefore they could not evacuate the scene. The remaining crew members on the rig had no choice but to jump to the sea. Within minutes, the rescue craft which had been launched by the crew of the *Damon Bankston* was able to rescue the people from the water and make its way to the tethered life raft, cut the line, and tow it to safety.

¹¹³ U.S. Coast Guard – Bureau of Ocean Energy Management, Regulation and Enforcement Joint Investigation hearing transcripts, Testimony of Michael Williams, Chief Engineer Technician, Transocean, July 23, 2010.

¹¹⁴ U.S. Coast Guard – Bureau of Ocean Energy Management, Regulation and Enforcement Joint Investigation hearing transcripts, Testimony of Capt. James Hanzalik, Chief of Incident Response for the U.S. Coast Guard's 8th District, October 4, 2010.

¹¹⁵ BP, *Deepwater Horizon Accident Investigation Report*, Op. ct. 12, p28.

The rescued crew received medical attention on board the *Damon Bankston*, and the seriously injured were airlifted and evacuated by the USCG medevac which had arrived on scene at approximately 11:22 p.m. Of the 126 crew members on board the rig, 11 were killed as a result of the explosion. The remaining 115 were evacuated, including 17 injured.¹¹⁶

Post Blowout Shutdown Attempts

April 21—September 19 – During the next 83 days, a series of attempts were made to stop the oil from entering the Gulf of Mexico. These attempts included:

- 1) Closing the BOP B/S (blind / shear) rams and variable pipe rams with a Remotely Operated Vehicle (ROV) intervention (failed).
- 2) Closing off the end of the drill pipe on the sea floor (succeeded).
- 3) Capturing oil spewing from the broken riser on the sea floor with a box-like containment device connected to a drilling vessel above (failed).
- 4) Capturing oil spewing from the riser end with an insertion tube (partially successful).
- 5) Capturing oil spewing from the BOP top by shearing off the bent over and ruptured riser and drill pipe inside and installing a capture device (called “Top Hat” and Lower Marine Riser Package – LMRP – Cap) (partially successful).
- 6) Killing the well by injecting heavy mud into the BOP. Flow at the Top Hat still persisted and partial oil capture continued afterward (failed).
- 7) Removing the remnant riser at the BOP top and bolting on a sealing cap with a BOP above. This succeeded in shutting the well with only a few small leaks.
- 8) Pumping heavy kill mud into the well to drive well effluent down and reduce pressure at the well head (succeeded).
- 9) Pumping cement following the kill mud to permanently seal off the flow paths. This succeeded in shutting the well with only a few small leaks.
- 10) During the foregoing attempts, two relief wells were drilled to provide bottom kill capability. The first relief well was able to intersect the well and *permanently* seal the Macondo well.

¹¹⁶ BP, *Deepwater Horizon Accident Investigation Report*, Op. ct. 12, p29.

Chapter 2 – Analysis of the Blowout

Summary of Factors Leading to Blowout

The DHSG analyses of currently available information indicate the uncontrolled blowout of the Macondo well developed in three primary decision-making phases.¹ *Phase 1* was associated with the decision to prepare the well for production—the design and construction of the long-string completion casing. This decision introduced added risks that were not fully recognized or otherwise considered and analyzed with regard to the specific geology of the Macondo prospect and the difficult conditions under which cementing operation would have to be conducted. *Phase 2* was associated with the procedure and processes decided upon and used for temporary abandonment of the well. *Phase 2* decisions resulted in hydrocarbons entering the well most likely at the bottom and moving undetected to the drill floor. *Phase 3* was associated with attempts to control the well. This phase included multiple failed attempts to shut-in the well and reestablish control before and after ignition of the escaping hydrocarbons, including disconnecting the drill rig from the well, and activating the BOP.

The well had been drilled to total measured depth 18,380 ft below the rig floor’s Kelly Bushing (KB),² which equated to 13,293 ft below the sea floor, a.k.a., mud-line (Figure 2.1).³ The well had penetrated a hydrocarbon production zone (pay zone) of about 124 ft in thickness.¹ A tapered string of production-type casing was run and cemented using nitrogen-foam cement slurry containing various additives⁴ with the bottom of the 7 in casing shoe sitting at 18,303 ft KB.^{1,5} The crossover from 7 in to 9⁷/₈ in production casing was at 12,487 ft KB.¹

The 9⁷/₈ in casing hanger in the subsea wellhead at 5,067 ft KB was equipped with a seal assembly to seal off the annulus between production casing and the drilling casings used to drill the well.⁶ A trip was made to shed the running tools, and a tapered displacement string was run in to just above the BOP. The casing was tested to 2,500 psi under the closed blind/shear (B/S) rams in the subsea BOP by pressuring up the kill line mounted on the drilling riser.⁷

¹ Gary Marsh, “Causative Technical and Operational Elements of the Deepwater Horizon Blowout,” Deepwater Horizon Study Group Working Paper, January 2011.

² The Kelly Bushing (KB), a.k.a. the Rotary Table or Rotary Kelly Bushing (RKB), serves as a reference point for elevation measurements. The Deepwater Horizon’s KB was reported to be 75 ft above means sea level (MSL).

³ By admin, “U.S. Dept of Energy: MC252 Blowout Preventer and Well Schematic Diagrams,” June 21, 2010, <http://ikonstantin.com/2010/06/mc252%20bop%20and%20well%20schematics/>.

⁴ Testimony of Micah Sandell, Transocean Crane Operator, to CG/MMS Board May 29, 2010 (9); also ref. Letter to OSC Commissioners from Fred Bartlit, October 28, 2010 and Chevron’s Cementing Test Results Letter from Craig Gardner to Deputy Chief Counsel Sam Sankar, October 26, 2010.

⁵ Testimony of Christopher Haire, Halliburton Service Supervisor, from transcript of The Joint United States Coast Guard Minerals Management Service Investigation, Saturday, May 28, 2010, p269-270.

⁶ Testimony of Charles Credeur with Dril Quip, from transcript of The Joint United States Coast Guard Minerals Management Service Investigation, Saturday, May 29, 2010, p59.

⁷ Testimony of Micah Burgess with Transocean [Driller] from transcript of The Joint United States Coast Guard Minerals Management Service Investigation, Saturday, May 29, 2010, p103.

Deepwater Horizon Study Group
Investigation of the Macondo Well Blowout Disaster

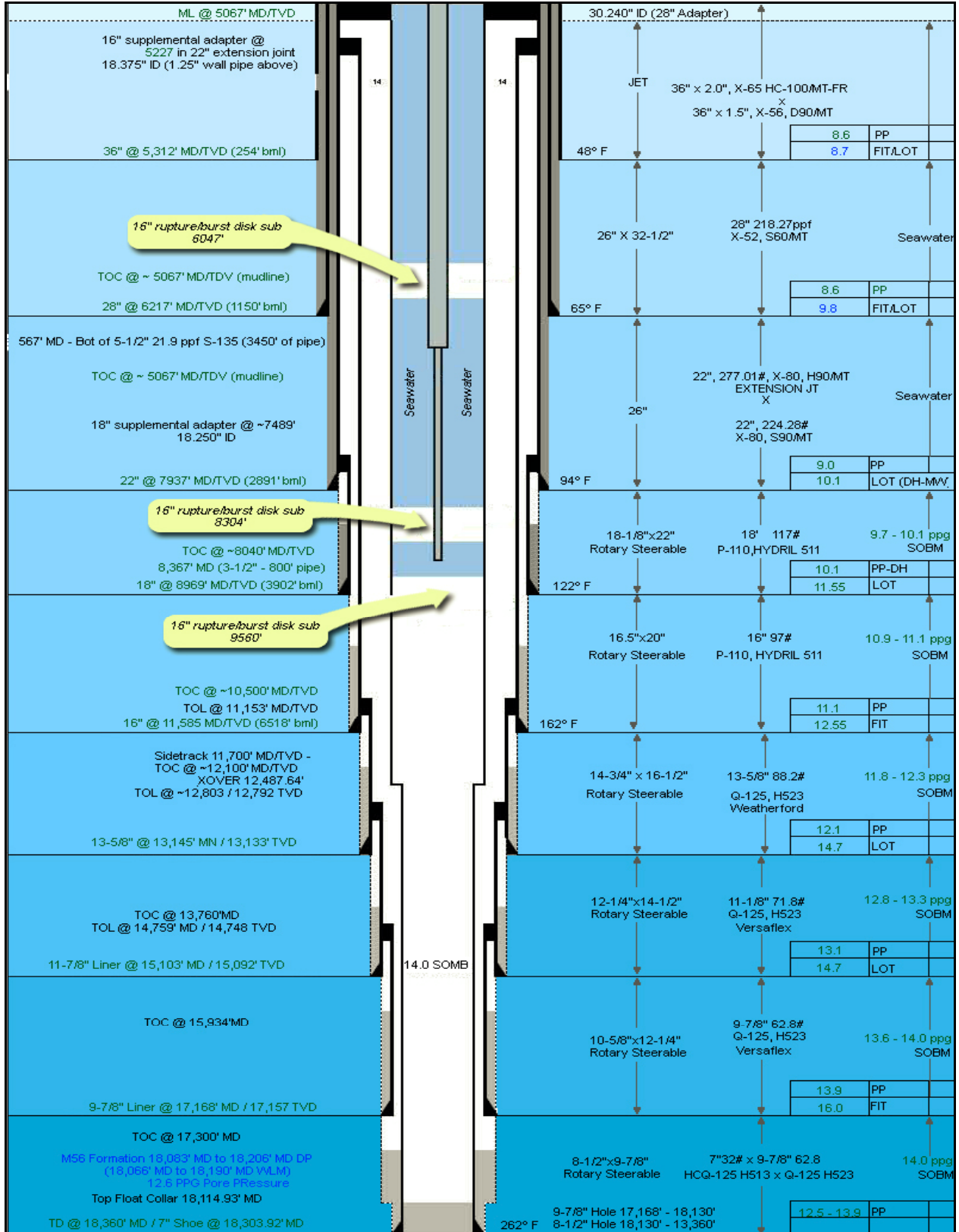

Figure 2.1 – Well schematic.

The tapered drill string was run to 8,367 ft KB and a spacer⁸ and seawater was pumped into the the drill pipe and up the annulus to the BOP.⁹ The annular BOP was closed around the drill pipe to isolate the riser and then pressure was bled-off from of the drill pipe to provide a negative pressure test of the casing, seal assembly, and cement job at total well depth (TD).⁶ This (eventually) provided about a 2,000 psi under-balance as referenced to the estimated production zone pore pressure of about 13,000 psi at TD. A few hours later, a similar second negative test was conducted, except in this instance pressure was bled-off from the top of the kill line.

In some manner, production zone hydrocarbons had entered into the well bore and migrated up the lower marine riser package (LMRP) to the rig floor. There is no definitive public information pinpointing why, how, and where this incursion occurred, nor how the hydrocarbon fluids flowed upward to the rig through via the more-or-less quiescent well fluids in the well below 8,367 ft KB. Above 8,367 ft KB, pumping had been occurring down the 97% in production casing bore on an intermittent basis during the last two hours before the blowout.¹⁰

Last-ditch efforts to control the flow at surface and at the subsea BOP were made, as follows:

- 1) The lower annular in the subsea BOP and the Diverter packer which closes around the drill pipe just below the rig floor were shown to have been activated by indicator lights in the vessel bridge space BOP control panel.¹¹ Unsuccessful diversion of the escaping high momentum and pervasive well fluids allowed internal combustion (IC) engine ingestion of flammable vapors causing engine overspeed. Ignition of the flammable vapor cloud lead to multiple explosions, loss of power, and a massive fire plume that consumed the drilling rig. Emergency Shutdown (ESD) functions were not programmed to be automatically initiated on activation of rig combustible gas detectors, nor was the platform audible general alarm automated.
- 2) The Emergency Disconnect System (EDS) was unsuccessfully triggered manually on the BOP control panel in the vessel bridge space just before the vessel was abandoned.¹² The EDS, however failed to release the *Deepwater Horizon*¹³ from the LMRP and she could not move off-station. On the bridge, the decision to go forward with an EDS was reportedly subject to debate and delay.
- 3) The BOP remained connected to the vessel through the riser up until such time that the vessel sank—continuously feeding the fire for the duration. None of the last-ditch efforts succeeded in stemming the hydrocarbon flow or disconnecting from the well. Firefighting efforts from responding service vessels were ineffective in preventing this casualty.
- 4) After the vessel was abandoned and before and after it sank, extensive operations by Remotely Operated Vehicles (ROV's) were carried out in an attempt to close the

⁸ Spacers are used primarily when changing mud types and to separate mud from cement during cementing operations.

⁹ Testimony of Jimmy Harrell, Transocean OIM to to CG/MMS Board May 27, 2010, p33.

¹⁰ Last two hours of Halliburton PVT,

http://energycommerce.house.gov/index.php?option=com_content&view=article&id=1997:hearing_on_inquiry_into_the_deepwater_horizon_gulf_coast_oil_spill&catid=133:subcommittee-on-oversight-and-investigations&Itemid=73 .

¹¹ Testimony of Christopher Pleasant, Transocean Subsea Engineer to The Joint United States Coast Guard Minerals Management Service Investigation, Friday, May 28, 2010, p164.

¹² *ibid.*, p153.

¹³ *ibid.*, p153.

blind shear (B/S) ram BOP and the variable pipe ram BOP elements. None of the attempts were successful.

Candidate Flow Paths to the Rig Floor

Flow Path 1 has been identified as a path between the production zone into the open hole annular space via channels or voids (*micro-annuli*). The upward flow then enters into annular space between the production casing string and the innermost casing strings used in drilling the well.¹⁴ This flow path must have necessarily triggered failure somewhere else in the well system that allowed well fluids to enter the BOP bore and proceed up through the riser to the rig floor (Figure 2.2). Possible failures causing Flow Path 1 were identified as follows: a) failure of the 9⁷/₈ in production casing (leak or parting), or b) failure of the 7 in production casing (leak or parting). If the production casing did not leak or otherwise fail, then the Flow Path 1 fluids could not escape from the annular space and enter into the BOP bore, the lower marine riser package (LMRP), and reach the vessel.

Flow Path 2 was identified as possible downward flow from the production zone through channels in the cement to the shoe of the production casing, and through the guide shoe and *shoe track*. The shoe track consisted of about 189 ft of 7 in cement-filled casing. From the shoe track, this flow path runs from the float collar and extends upward into the 9⁷/₈ in production casing bore, to the BOP and riser. No other failures other than those of the cement and float shoe assembly would be necessary for the flow path to become open to the BOP, and thence through the riser (or the drill pipe) to the rig.¹⁵

It is possible that fluid incursion occurred via both Flow Path 1 and 2. The risk of fluid incursion due to failure of one or more barriers in the flow paths was increased by the manner in which the well was planned and executed—risk was increased to the point that once the blowout event started, it could not be controlled or contained and proceeded to its catastrophic end.

As was reported in the Master Presentation to the OSC,¹⁶ Slides 118–120, photos of the recovered 9⁷/₈ in hanger seal assembly show erosion damage on the interior side of the seal assembly, but no abrasion or erosion damage is exhibited on its exterior (outboard) side (Figure 2.3). This physical evidence is indicative of a fluid flow path that originated from the bore of the casing, and not up the annulus and past the hanger and seal. Based on detailed analyses of a different set of factors, the BP internal investigation team came to the same conclusion.¹⁷

¹⁴ By admin, “U.S. Dept of Energy: MC252 Blowout Preventer and Well Schematic Diagrams,” June 21, 2010, <http://ikonstantin.com/2010/06/mc252%20bop%20and%20well%20schematics/>.

¹⁵ By admin, “U.S. Dept of Energy: MC252 Blowout Preventer and Well Schematic Diagrams,” June 21, 2010, <http://ikonstantin.com/2010/06/mc252%20bop%20and%20well%20schematics/>.

¹⁶ Bartlit TrailGraphx Presentation to the Commission, November 8, 2010; ref. http://www.oilspillcommission.gov/sites/default/files/meeting5/Master_Presentation_v2.pdf.

¹⁷ Absent physical evidence of abrasion or impact damage, this suggests that the casing hanger was not vertically dislodged (unseated) due to overpressure. However, Flow Path 1 could still have been activated if there were one or more partings in the long-string casing—plausibly at connectors joining the sections of casing. The BP investigation concluded this was not a likely flow path.

Deepwater Horizon Study Group
Investigation of the Macondo Well Blowout Disaster

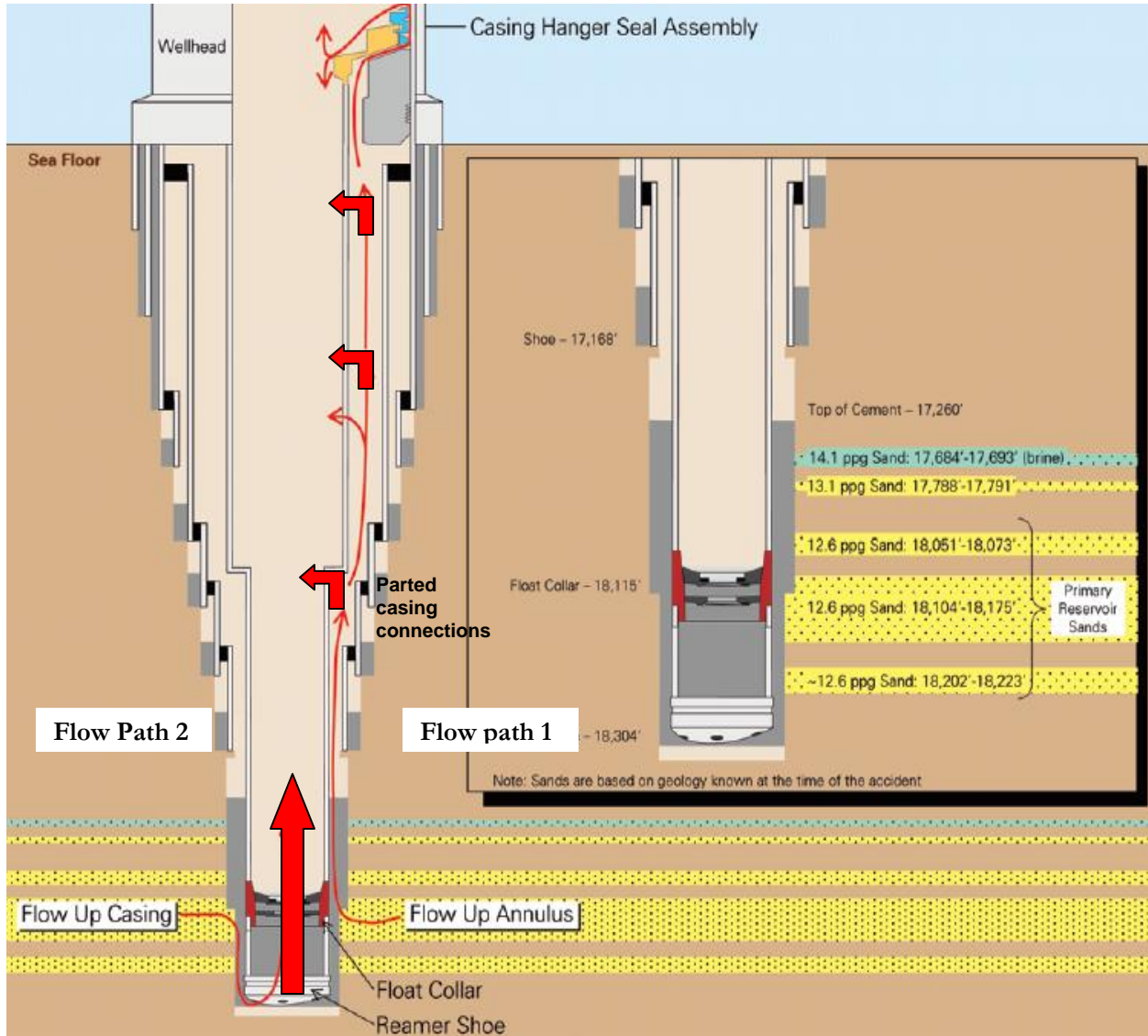

Figure 2.2 - Potential flow paths.¹⁸

¹⁸ Image Source: BP, Deepwater Horizon Accident Investigation Report, Op. ct 12, p53.

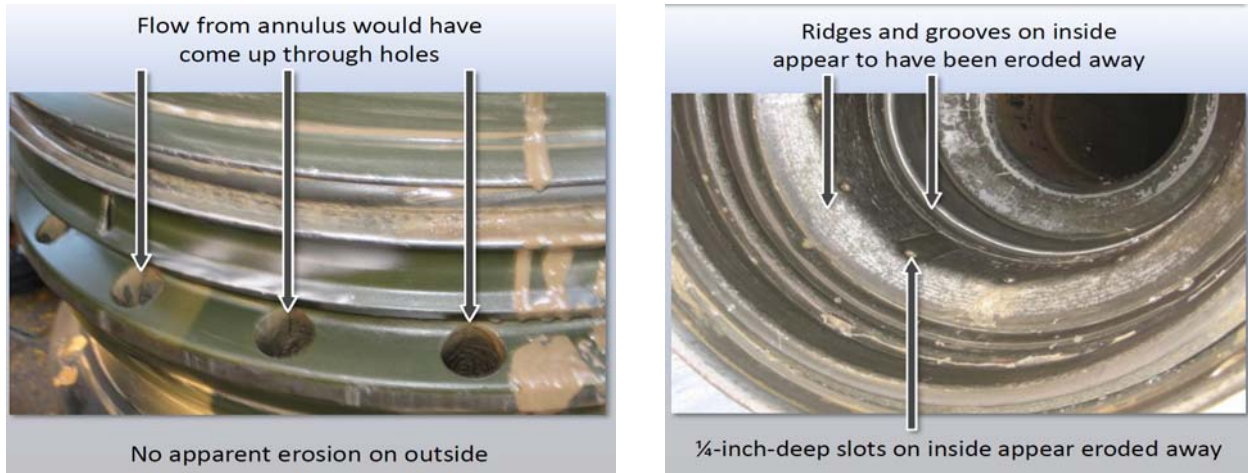

Figure 2.3 – Photographs of exterior (left) and interior (right) of 9⁷/₈ in Hangar Seal Assembly.¹⁹

Phase 1 – Production Casing Design & Construction

As summarized in Chapter 1, this part of the Macondo well development project was particularly challenging. The formation at the bottom of the well had a relatively low fracture pressure gradient. There had been significant lost circulation problems with this portion of the well that required use of loss circulation materials to stabilize the well. Due to the very small *drilling window* (allowable pressure range or *drilling margin*) between the formation pore pressure and fracture pressure, BP decided that it was not feasible to drill the well deeper.²⁰ Rather than proceeding with approved plans to temporarily abandon the well, BP made the decision to first convert the well from an exploratory well to a production well using a long-string casing design before temporarily abandoning the well. This sequence would then allow the well to be re-entered later by another drill rig, allow additional production equipment to be inserted, the installation of a permanent well head, and a pipeline connected to the well. These measures would then allow the well to be produced to nearby production facilities in a more-timely and less costly fashion by shortening the time to production and accelerate the payback period (return on investment).

The decision to use a long-string production casing design rather than a liner and tie-back purportedly was determined by four factors: 1) zonal isolation, 2) annular pressure build-up, 3) mechanical barriers and integrity, and 4) total lifetime cost.²¹ BP determined that either a liner and tie-back or long-string design could achieve zonal isolation. Either option would require adequate centralization, cement design, and placement.²²

¹⁹ Image Source: National Commission Master Presentation, p119-120.

²⁰ Drilling deeper would necessitate running and cementing casing to bottom-hole depth.

²¹ BP, *Deepwater Horizon Accident Investigation Report*, Op. ct 12, p75.

²² BP's design team originally had planned to use a *long string* production casing—a single continuous wall of steel between the wellhead on the seafloor, and the oil and gas zone at the bottom of the well. But after the lost circulation event, they were forced to reconsider. As another option, they evaluated a *liner*—a shorter string of casing hung lower in the well and anchored to the next higher string. A liner would result in a more complex—and theoretically more leak-prone—system over the life of the well. But it would be easier to cement into place at Macondo. On April 14—15, 2010, BP's engineers, working with a Halliburton engineer, used sophisticated computer programs to model the likely outcome of the cementing process. When early results suggested the long string could not be cemented reliably, BP's design team switched to a liner. But that shift met resistance within BP. The engineers were encouraged to engage an in-house BP cementing expert to review Halliburton's recommendations. That BP expert determined that

BP determined that even though burst and collapse (rupture) disks had been placed earlier at strategic locations in the well, the best way to prevent annular pressure build-up was to leave an open annulus at the bottom of the last string of casing (Figure 2.1). While this design would not provide BP the specified 1,000 ft of cement above the uppermost hydrocarbon zone, it would allow placement of the top-of-cement 500 ft above the uppermost hydrocarbon zone, as per MMS regulations. BP's technical requirements specify if less than 1,000 ft of cement is used above a distinct permeable zone, then the top of the cement must be determined by a "proven cement evaluation technique" such as a cement evaluation log, and the plan must include 100 ft of centralized pipe above the permeable zone.

BP determined that when installed correctly both the long string and liner tie-back had the same number of barriers. BP evaluations indicated higher risks of mechanical integrity failure associated with the liner tie-back due to its more difficult installation requirements. BP assessed that the liner tie-back option also would create a trapped annulus that could increase annular pressure buildup risks. BP assessed that the materials and installation costs of the long string would be higher than the initial cost of the liner tie-back option. However, when the installation costs were included, the liner tie-back option would exceed those of the long string. The BP analyses indicated the long-string production casing was an acceptable decision and provided a sound basis of design.

Retracing and amplifying Flow Path 2 as described above,²³ fluid flow could have involved three potential failures that allowed hydrocarbon penetration through (Figure 2.4): 1) the annulus cement barrier outside the shoe track, 2) the *tail cement* inside the shoe track, and 3) the double valve float collar at the top of the bottom assembly.

certain inputs should be corrected. Calculations with the new inputs showed that a long string could be cemented properly. The BP engineers accordingly decided that installing a long string was "again the primary option." Ref. OSC Final Report, Chapter Four, "But, who cares, it's done, end of story, [we] will probably be fine and we'll get a good cement job," p95-96; see <http://www.oilspillcommission.gov/>.

²³ With flow downward from the pay zone to the shoe of the production casing, through the guide shoe and cement-filled "shoe track" and float collar, and on upward into the 9⁷/₈ in. production casing bore.

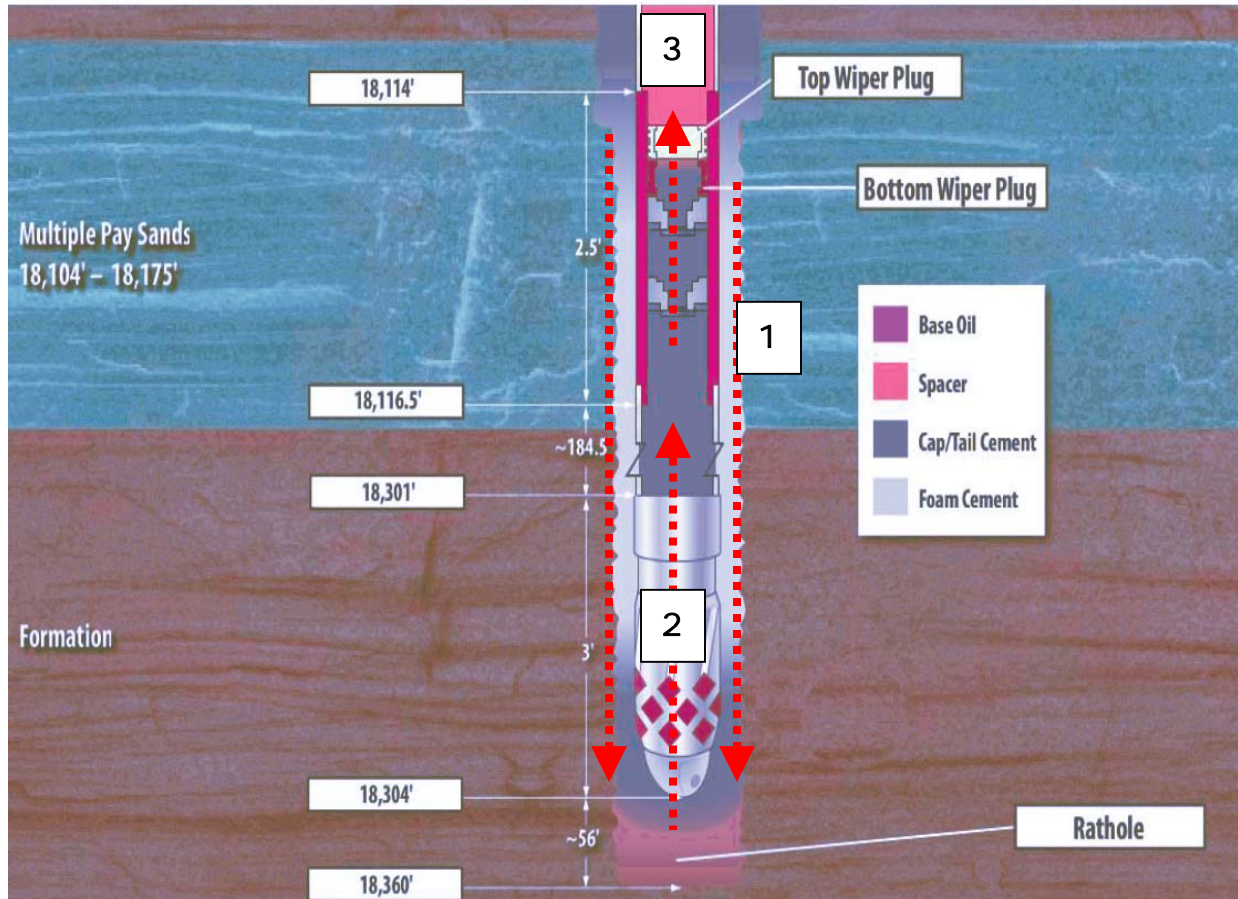

Figure 2.4 – Shoe Track hydrocarbon penetration paths.²⁴

Figure 2.5 shows the planned cement and other well fluids placement under *ideal* conditions at the bottom of the well. Realization of this placement depends on the materials in the well at the bottom of the well after the long-string production casing was run, the performance of the double valve float collar, and the relatively weak formations under and around the float collar. Given the concerns for the weak formations in the bottom of the well, only partial circulation of the well fluids was performed after placement of the production string. This could have left cuttings in the bottom of the well—in and above the *rat hole* below the shoe track and reamer shoe. In addition, the relatively short distance between the bottom of the shoe track and the bottom of the rat hole combined with the lower density of the Synthetic Oil Based Mud (SOBM) relative to the density of the cement (16.7 ppg cap-and-tail cement and 14.5 ppg foamed cement) could have encouraged intermixing of the cement with the well materials and mud in the rat hole.

²⁴Image Source: National Commission Master Presentation, p119-120.

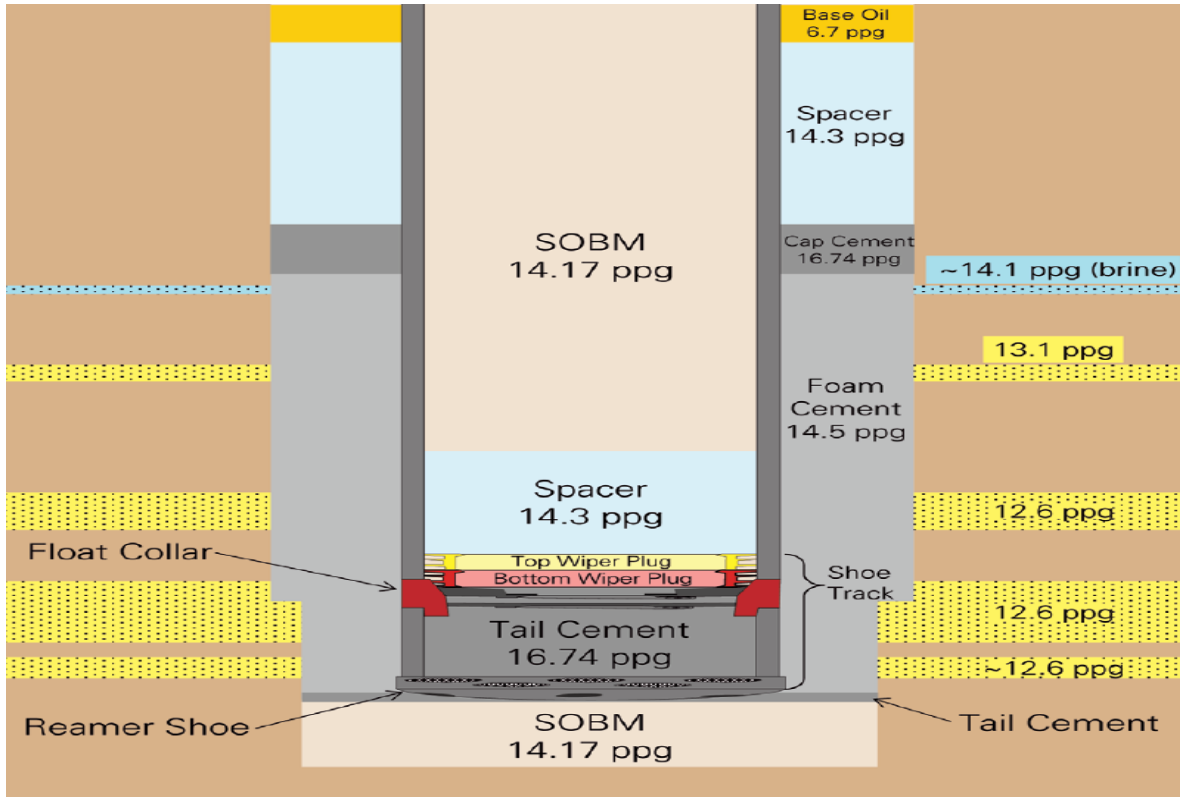

Figure 2.5 – Planned cement placement.²⁵

At the time the production completion was designed, there were significant concerns about the stability, strength, and other important characteristics of the *foamed* nitrogen gas infused cement used in the bottom of the well. Because of the low formation fracture pressure gradient at the bottom of the well (relatively weak formations), this special type of cement was considered needed in order to help lower the density (weight) of the cement used in the bottom of the well. Tests performed by Halliburton on the proposed cement mix in early April showed the proposed foamed cement mixture would not be stable in the well conditions—gas would separate from the cement. Such separation could lead to *micro-channeling* and affect the cement *set-up* or *curing* times—the time for the cement to gain sufficient strength. Tests performed in mid-April indicated a stable mixture could be developed with very high mixing times (3 hours). However, this stable mixture would require 12 to 48 hours to gain minimal strength (2,100 to 3,300 psi). Testing of *similar* foamed cement mixes performed as part of the BP investigations and another series of tests performed as part of the National Commission investigations all indicated that stable foamed cement mixes could not be developed using normal testing methods and conditions.

In addition, the testing indicated that the cement mix used in the Macondo well had excessive fluid loss characteristics—additional indications of an unstable cement mix. This information indicates a high likelihood that the foamed cement was not stable when it was mixed at surface and then displaced to the bottom of the well. Segregation of nitrogen during and after displacement could have seriously impaired the small quantity of 16.7 ppg non-foamed cement used to fill and seal the shoe track. In addition, the small amount of time between placement of the cement and the subsequent positive and negative pressure testing (insufficient cement curing time) could have led to

²⁵ BP, *Deepwater Horizon Accident Investigation Report*, Op. ct 12, p56.

serious disturbance of the unset cement with consequence loss of its integrity. Additional testing of the cement used in the bottom of the Macondo well has been proposed. Further testing may shed additional light on the stability and strength characteristics of the cement.

Other factors that may have influenced the integrity of the cement in the annulus at the bottom of the Macondo well are associated with the limited amount of cement used in this portion of the well (62 bbl) and the number of centralizers (6) used in this section of the well. There was a very small annulus between the formations at the bottom of the well and the outside of the well casing. This required a relatively small volume of cement. Use of a larger volume of cement to accommodate potential mixture of the cement with the fluids and solids below the bottom of the shoe track or an enlarged section at the bottom of the well could result in development of a cement seal above the intended top of cement and thereby increase the potential for annular pressure build-up. There is a significant possibility the cement did not end up where it was intended.

The centralizers in this part of the well had particular importance because of the relatively small annular clearance between the 7 in diameter casing and the diameter of the well—8½ in diameter (Figure 2.1). Even though this portion of the well was relatively vertical and straight, if the casing was not accurately centralized, the ¾ in width annulus could be compromised. If the casing was allowed to contact the side of the well, then cement could not properly seal the annulus; channels could be developed in the cement annulus seal. In engineering of this part of the Macondo well, Halliburton had paid particular attention to the number and placement of centralizers. Halliburton issued a report to BP indicating a high likelihood of significant channeling if less than 21 centralizers were used. The long string casing originally was supplied with 6 centralizers. To comply with the Halliburton *low-risk* design, BP supplied an additional 15 centralizers from its inventory. Concerns arose among the BP well team members onboard the *Deepwater Horizon* that the supplied centralizers were not the right ones and there was a significant risk that the supplied centralizers could fail. The BP well team made the decision to install the casing with 6 centralizers. After the production casing was placed, it was discovered that the 15 centralizers were the right ones and should have been used. The use of 6 centralizers together with the nitrogen-infused, foamed cement in this critical part of the well indicate a high potential for channeling and lack of sufficient integrity in this barrier.

Consequently, for a variety of reasons, these analyses indicate it is plausible that the cement in the annulus and in the shoe track of the production string did not have the required barrier properties. The BP and National Commission investigations arrived at similar conclusions.

As summarized in Chapter 1, it took nine tries to convert the float collar. There were anomalous flow-pressure conditions during and following the conversion attempts. Analysis of the available information indicates it is plausible that the float collar failed to convert (Figure 2.6). In this condition, hydrocarbons would be able to migrate through the flow tube and open back-flow valves and into the open well bore above. The BP investigations identified three failure modes for the double-valve float collar in the shoe track: 1) it was damaged by the high load conditions required to establish circulation, 2) it failed to convert due to insufficient flow rate, and 3) the check valves failed to seal. The BP analyses were not able to determine which of these failure modes occurred. Similar conclusions were reached by the National Commission. Consequently, as for the annulus and shoe track cement barriers, there are multiple plausible failure modes that can explain how hydrocarbons were able to breach the float collar assembly.

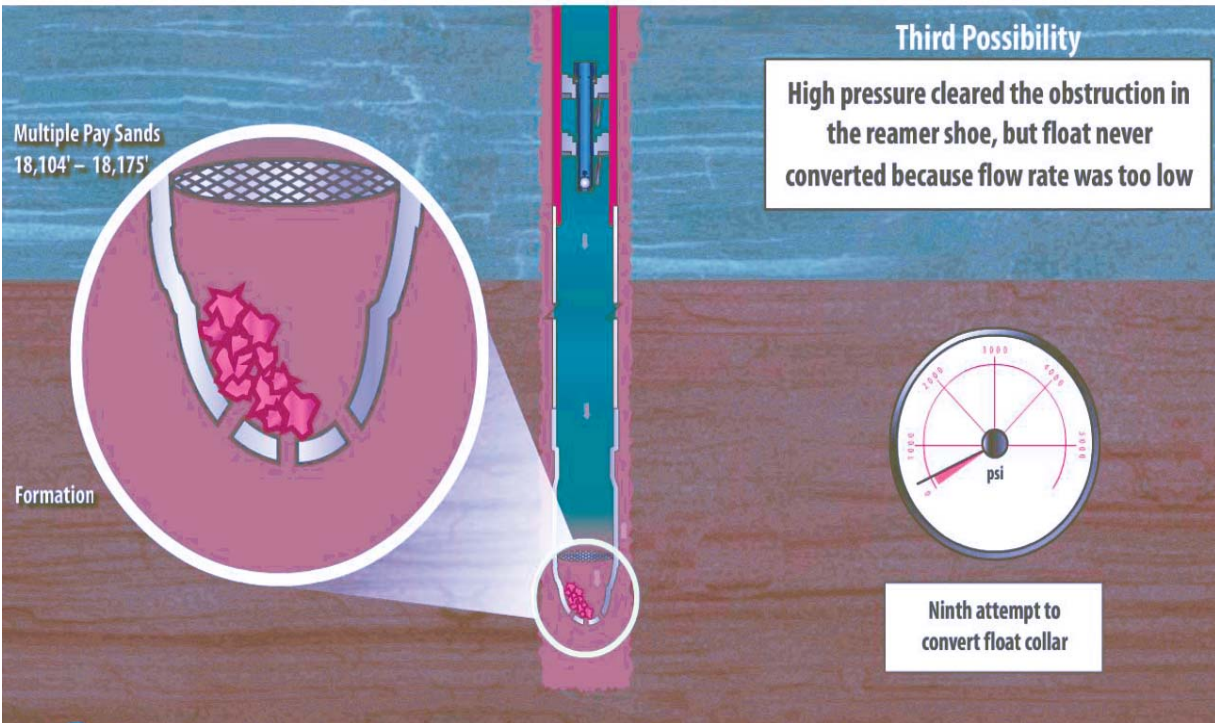

Figure 2.6 – Float collar conversion failure.²⁶

Flow Path 1 with flow from the production zone through channels or micro-annuli upward into the open-hole annular space, into annular space between the production casing string and the innermost casing strings used in drilling the well, and into one or more partings in the production casing could have resulted in hydrocarbons entering the well bore. Gas (nitrogen or gassy oil) could have entered the annulus behind the production casing and migrated upward. The gas could have come from separation of the nitrogen mixed into the cement slurry. Pressure in the closed annular space would rise and could have resulted in the loss-prone zone below the thick pay starting to take fluid. Alternately, as fluid was lost to the permeable pay zone from the high-water-loss, cement slurry, pressure in the annular space could have dropped and hydrocarbons near the top of the thick pay zone might have commenced to flow. When the pressure under-balances were imposed during the temporary abandonment process, a casing connection could have leaked due to undetected mechanical damage to it while making it up on the rig floor during deployment. The casing plan called for the casing connections to be lubricated at the shore base and only the boxes wiped out during running²⁷—hence shipping or stabbing damage to the metal to metal seal surfaces of the connections could have easily escaped notice. The approved casing-running plan makes no note of using an elastomeric stabbing guide.

The design and construction of the production casing—the long string—resulted in development of two plausible flow paths for hydrocarbons to enter the Macondo well. Credible explanations have been advanced for development of these flow paths. Both flow paths required multiple failures of the well barriers. These analyses of currently available data do not permit definitive identification of the modes of failure that would allow hydrocarbons to enter the Macondo well during Phase 2—the temporary abandonment phase.

²⁶ Image Source: National Commission Master Presentation, p119-120.

²⁷ MC 252 #1 STOOBP01 - Macondo Prospect 7" x 9-7/8" Interval as submitted to Congressional hearing records.

Phase 2 – Temporary Abandonment

As noted in Chapter 1, in early April BP submitted a plan for temporary abandonment of the Macondo well to the MMS for approval. The proposed plan was approved. The plan called for BP to confirm the location of the Top of Cement (TOC) based on an evaluation of lift pressures and full returns during the cementing operation. Purportedly, as a contingency measure, BP requested that Schlumberger provide a logging crew and instrumentation to confirm the location of the TOC and integrity of the cement to the shoe. No cement had been placed above the top wiper plug of the shoe so the location of TOC in the annulus could probably have been meaningfully confirmed. If TOC had been found substantially above that calculated, severe channeling could have been inferred and the associated risks could have therefore been assessed. The sensor recordings during the placement indicated that the cement had been placed as per the proposed and approved plans with the required lift pressures and measurement of full returns. The well team concluded that Phase 1 has been successful and that no Schlumberger logging services were needed. Early the morning of April 20, 2010, the Schlumberger logging crew reportedly departed from the *Deepwater Horizon* via a regularly scheduled helicopter without running a cement bond log.

A unique part of the temporary abandonment plan developed by BP was the plan to place a second barrier in the well located approximately 3,300 ft below the seafloor—rather than the 300 ft. required by the MMS. Purportedly, this plan was developed because of concerns for sufficient weight from the drill string to set a lock-down sleeve on the top of the production casing. The plan called for setting this lock-down sleeve in seawater rather than drill mud purportedly because of concerns for the integrity of the seal due to debris in the drill mud. Originally, the temporary abandonment plan called for placement of the cement plug in drill mud before displacement with seawater to perform the negative test. The temporary abandonment procedure approved on April 16, 2010, was to set the cement plug in seawater after displacement of the drill mud. This procedure resulted in the second barrier inside of the production casing not being placed until after there had been complete displacement of the heavy drill mud above the planned location of the barrier—some 8,300 ft below the drill deck. This procedure could save some rig time.

On April 20, 2010, at 10:43 a.m., BP sent an 11-step procedure for the temporary abandonment to the well team onboard the *Deepwater Horizon*.²⁸ The plan called for positive and negative testing of the well to confirm the integrity of its structure. While the MMS had requirements for positive pressure testing of the casing, the MMS did not have any specific requirements or guidelines for the negative pressure testing. Both BP and Transocean had general requirements for positive and negative testing, but neither provided specific guidelines for how the tests were to be performed or how the results from the tests were to be interpreted.

The negative test was intended to simulate the condition where the drill riser was removed and seawater occupied the portion of the well above the to-be-placed cement barrier inside the production casing at 3,300 ft below the mud line. Due the presence of the upper wiper plugs above the top of the shoe track (Figure 2.5), the positive pressure tests could not determine the pressure integrity of the shoe track and cement in the annulus outside the shoe track. Only the negative test would test the integrity of this important part of the well. However, as noted earlier the BP negative test procedure called for removal of the heavy drill mud before the second barrier inside the production casing would be placed. This meant that during the negative test, there would be only

²⁸ E-mail from Brian Morel (BP) to the BP well team, April 20, 2010, 10:43 AM.

one barrier at the bottom of the well—the shoe track and cement in the annulus outside the shoe track—and the heavy drill mud above the shoe track. Available testimony indicates this procedure was deliberated onboard the drill rig during the morning meeting. Agreement was reached to proceed with the approved BP procedure. Testimony indicates that part of the thinking that led to the agreement was a feeling that if there was trouble during this part of the operation, that the well could be controlled.²⁹

The BP plan called for a positive test of the casing to 250 psi and then 2,500 psi. These tests were performed and produced satisfactory results.

With seawater in the well above 8,367 ft to above the BOP at the seafloor, the next step in the procedure was to close the BOP annular and perform a negative test with approximately 2,350 psi differential pressure. The criteria for a successful negative test would be no build up in pressure when the well was closed or flow from the well when the well was open.

This step required running the drill pipe to 8,367 ft below the drill deck, then displacing the well above to seawater—including the BOP boost, choke, and kill lines that would be used to perform the negative test. This step required placement of a high viscosity *spacer* to separate the Synthetic Oil Based Mud (SOBM) from the seawater. The decision was made to use a spacer comprised of Lost Circulation Material (LCM) that remained in the mud pits. If the LCM was used as a spacer, regulations permitted pumping this material overboard. If the LCM was not used as a spacer, regulations required the LCM to be transported to *the beach* and disposed of as a hazardous material.

The BP investigation analysis of the real-time data from the rig indicated 424 bbl of spacer followed with 30 bbl of fresh water and 352 bbl of seawater were pumped into the well. The BP analyses indicate that this procedure would have placed the seawater—spacer interface about 12 ft above the BOP.

During the first attempt to perform the negative test, the BOP annular preventer was closed and pressure in the drill pipe was reduced. During this step, the real-time data indicated that the annular preventer was leaking (Figure 2.7). To correct the leak, the annular preventer closing pressure was increased to develop an effective seal with the drill pipe. The real-time data indicated that during this process approximately 50 bbl of spacer leaked downward past the annular preventer. This would have placed the spacer across the BOP kill line that would be used to perform the next negative test.³⁰ There is no information available to indicate the rig crew recognized that spacer was across the BOP kill line inlet at the BOP. Some of the heavy, viscous spacer could therefore have been pulled into the kill line bore running to surface as fluid was bled from it at surface, and could partially or completely block the kill line that was being used to conduct the negative pressure test.

²⁹ U.S. Coast Guard – Bureau of Ocean Energy Management, Regulation, and Enforcement hearing transcripts May—October 2010. BP Deepwater Horizon Accident Investigation Report, September 8, 2010.

³⁰ BP, “Washington Briefing – Deepwater Horizon Incident Investigation,” (Draft), May 24, 2010, p16-27, <http://energycommerce.house.gov/documents/20100527/BP.Presentation.pdf>.

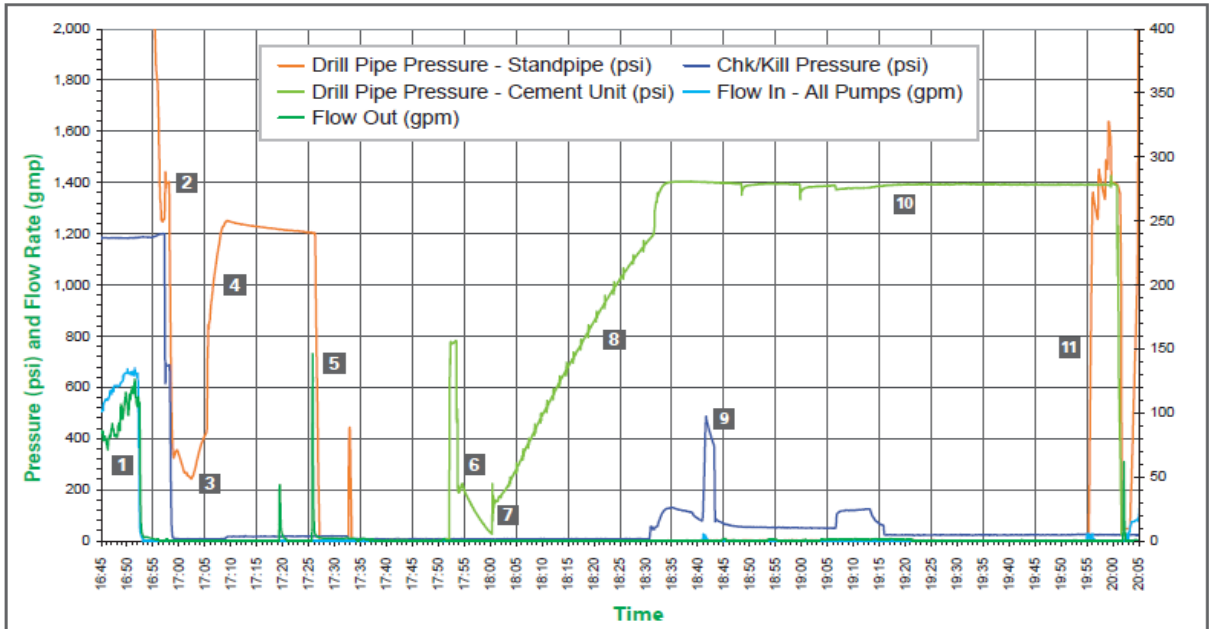

- | | |
|---|--|
| <p>1 Spacer displacement complete; mud pumps stopped.</p> <p>2 Annular preventer closed; attempt to bleed drill pipe pressure to zero.</p> <p>3 Drill pipe pressure decreases to only 273 psi; annular preventer leaking.</p> <p>4 Drill pipe pressure increases as annular preventer leaks; hydraulic closing pressure increased to seal annulus.</p> <p>5 Drill pipe pressure bled to zero for negative-pressure test.</p> <p>6 Decision made to conduct negative-pressure test via kill line; kill line opened; 3 bbls to 15 bbls bled to cement unit.</p> | <p>7 Shut in kill line at cement unit, drill pipe pressure starts to increase.</p> <p>8 Drill pipe pressure slowly increases to 1,400 psi.</p> <p>9 Fluid pumped into kill line to confirm full; kill line opened to mini trip tank for monitoring.</p> <p>10 Discussion ongoing about 'annular compression' and 'bladder effect' while monitoring kill line; drill pipe pressure static at 1,400 psi.</p> <p>11 Negative-pressure test concluded, declared a success; preparation made to continue displacement.</p> |
|---|--|

Figure 2.7 – Real-Time data (April 20, 2010) during negative pressure tests.³¹

After the annular preventer pressure was increased to produce a seal with the drill pipe, using their regular practice on prior wells, the drill crew reduced the pressure in the drill pipe to develop the required differential pressure. About 2,000 psi under balanced pressure referenced to the estimated production zone pore pressure of about 13,000 psi at the bottom was developed. During this process, the available information indicates that approximately 15 bbl of seawater flowed from the drill pipe.³² Due to the reduced pressure, less than 5 bbl should have flowed from the well.³³ In addition, less than 4 minutes after the pressure in the drill pipe was reduced to near atmospheric pressure it rose unexpectedly to more than 400 psi (Figure 2.7). These were the first indications that

³¹ BP, *Deepwater Horizon Accident Investigation Report*, Op. ct 12, p56.

³² U.S. Coast Guard – Bureau of Ocean Energy Management, Regulation, and Enforcement hearing transcripts May – Oct. 2010. BP Deepwater Horizon Accident Investigation Report, September 8, 2010.

³³ It is not possible to determine a more precise amount because of the complex well conditions including gas absorption by the SOBM.

the well did not have the desired integrity. It is also very likely this was the first time (about 5:30 p.m.) that hydrocarbons were able to enter the well bore.

The negative testing procedure supplied by BP did not specify how the negative test was to be performed. The BP MMS-approved Application for Permit to Modify for the Macondo well temporary abandonment specified that the test should be conducted by monitoring flow from the BOP kill line. The BP well site leader brought this specification to the attention of the Transocean well team, and the negative testing was resumed by closing the drill pipe and creating a flow path from the BOP kill line to the cement unit which would monitor the pressures and flows from the BOP kill line.

The BOP kill line was opened. There is no real-time data available to indicate the flow that came from the kill line after it was opened. Witness testimony indicates that opening the kill line resulted in the flow of between 3 to 15 bbl of seawater; one witness testified that the sea water flow did not stop.³⁴

The BOP kill line was closed. During the next 40 minutes, the drill pipe pressure built to 1,400 psi (Figure 2.7). Testimony indicates the rig crew discussed this build-up in pressure in the drill pipe. After discussion of different mechanisms that could account for this build-up in pressure, the crew decided that build up in pressure was “normal.”

At this point, the rig crew decided to resume the negative pressure test on the kill line by verifying that the kill line was full of seawater and connecting the kill line to a *mini trip tank* so that any flow could be accurately determined. The rig crew confirmed that the kill line was full. The kill line was then opened to the mini trip tank. A small volume of fluid flowed from the kill line and stopped (Figure 2.7).

With no flow coming from the open kill line, the well crew concluded that the negative test was successful. The anomaly of the 1,400 psi pressure on the drill pipe with no flow exiting the kill line was not explained. The well crew did not recognize it was likely that the viscous spacer had blocked the kill line—or that the flow path to the mini trip tank might not have been correctly established. The well crew and the BP well site leaders incorrectly concluded that the no flow coming from the open kill line was a demonstration of well integrity. Given the previous test results and the anomalous drill pipe pressure, both negative tests had in fact failed to demonstrate the integrity of the well.

After the negative pressure tests were completed, the annular preventer was opened and the fluids in the well returned it to an overbalanced condition (about 8:05 p.m.). Displacement of the remaining drill mud above 8,360 ft was resumed. During this time, a large number of simultaneously occurring *end-of-well* activities were being carried out that may have impaired the effectiveness of monitoring drilling fluid (mud) levels and well status. Additional *distractions* were provided due to activities associated with visiting VIPs from BP and Transocean.

Drilling mud was being offloaded to the supply vessel M/V *Damon Bankston*. Some of the mud pits and the trip tank on the *Deepwater Horizon* were being emptied and cleaned during offloading.

³⁴ U.S. Coast Guard – Bureau of Ocean Energy Management, Regulation, and Enforcement hearing transcripts May – Oct. 2010. BP Deepwater Horizon Accident Investigation Report, September 8, 2010.

Preparations were also underway to set a cement plug in the well following completion of the displacement operations. Available information and testimony indicates there was no effective monitoring of well flow conditions between about 5:30 p.m. when offloading the mud to the supply vessel began to about 9:00 p.m. (Figure 2.8). The available records indicate the first indication of significant flow from the well would have been shortly before 9:00 p.m. when the well again reached an under balanced condition—the pressures in the reservoir exceeded the pressures in the well bore. The real-time data show the drill pipe pressures were continuing to increase and the flow out exceeded the flow in after the pumps were shut down at 9:08 p.m. Available testimony does not indicate that anyone on the *Deepwater Horizon* recognized these *early warning* signals or took appropriate action to shut in the well.

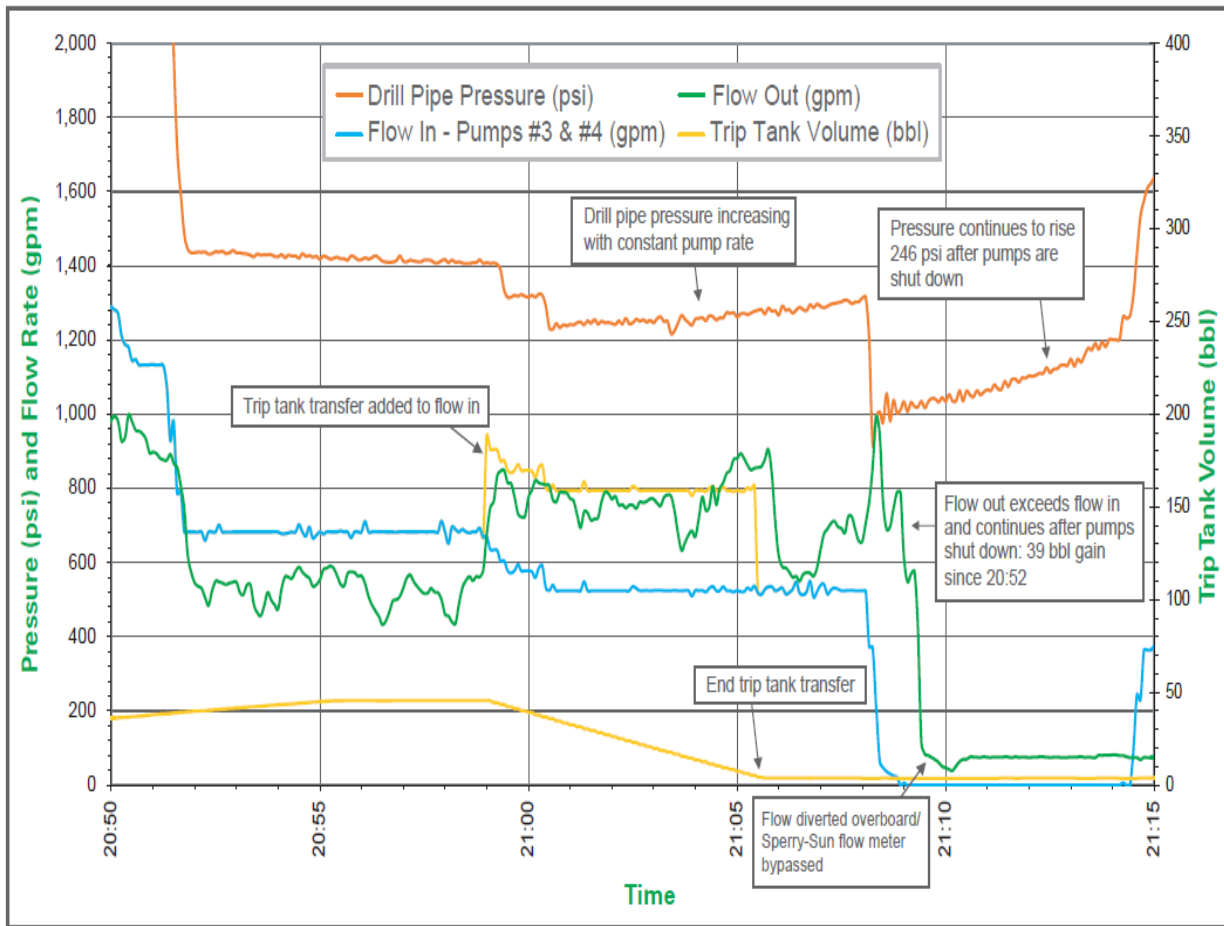

Figure 2.8 – Real-Time data (April 20, 2010) during last portion of mud transfer operations.³⁵

About 9:08 p.m., the spacer in the well arrived at the drill deck. The rig crew shut down the pumps to perform a *sheen test*. The well permit required a sheen test to verify that no oil from the oil based mud was present in the spacer before discharging the spacer overboard. A sample of the spacer was collected. The test confirmed that the spacer met the test requirements.

³⁵ BP, *Deepwater Horizon Accident Investigation Report*, Op. ct 12, p56.

Preparations for the discharge operation required that the flow path be re-configured. During this operation, the pumps were shut off (9:08 p.m.). The real-time data (Figure 2.8) showed the well was continuing to flow and pressure was continuing to increase in the drill pipe. By 9:15 p.m. the pressure in the drill pipe had increased to more than 1,600 psi.

Once the flow was routed overboard (about 9:14 p.m.), real-time data from the Sperry-Sun flow meter was no longer available. The *Deepwater Horizon* had another flow meter on the discharge line whose recordings should have been available to the driller. Flowline flowmeter recordings are available,⁸ but they show that the calibration of that meter was very poor. The riser outflow (flow line sensor as contrasted to the mud room pressure-volume-temperature (PVT) outflow sensor discussed above) registered no flow at all until about 260 bbl had been pumped, then registered less than half of the pump rate from there on. The indication of this trace that there was zero flow with the pump shut down at various times is adjudged meaningless since it was under-reporting the flow with the pumps on so badly. However, note that from 9:18 p.m. to 9:20 p.m. with the pumps shut down, the under-reporting flow line indicator showed something in the order of 4 bbl/min of flow, whereas it had consistently shown zero flow with pumps off previously. Previous zero indications may have been spurious and 4 bbl/min indication may have been from a much stronger flow.

There is no information on what the driller was able to do or did to monitor the well during this period of time. However, there is no testimony to indicate that during this period of time the drill crew was aware the well was in a major loss-of-control event and needed to be shut in immediately.

Testimony and the available real-time data indicate that about 9:17 p.m. the rig crew was working to start mud pump #2. The pump was erroneously started with a closed discharge valve. This actuated a pressure relief valve (Figure 2.9). With the exception of pump #1, the other three pumps were shut down until about 9:20 p.m. when pumps #3 and #4 were brought online. The crew continued to work to start pump #2. Testimony indicates the off-duty senior tool pusher called the on-duty tool pusher about 9:20 p.m. to inquire about the results of the negative pressure test. The on-duty tool pusher advised the senior toolpusher that the test results were satisfactory and that the operations were “going fine.”³⁶ The evidence indicates the drill crew was still unaware the well was in a major control event was in process and the well needed to be shut in.

³⁶ U.S. Coast Guard – Bureau of Ocean Energy Management, Regulation, and Enforcement hearing transcripts May – Oct. 2010. BP Deepwater Horizon Accident Investigation Report, September. 8, 2010.

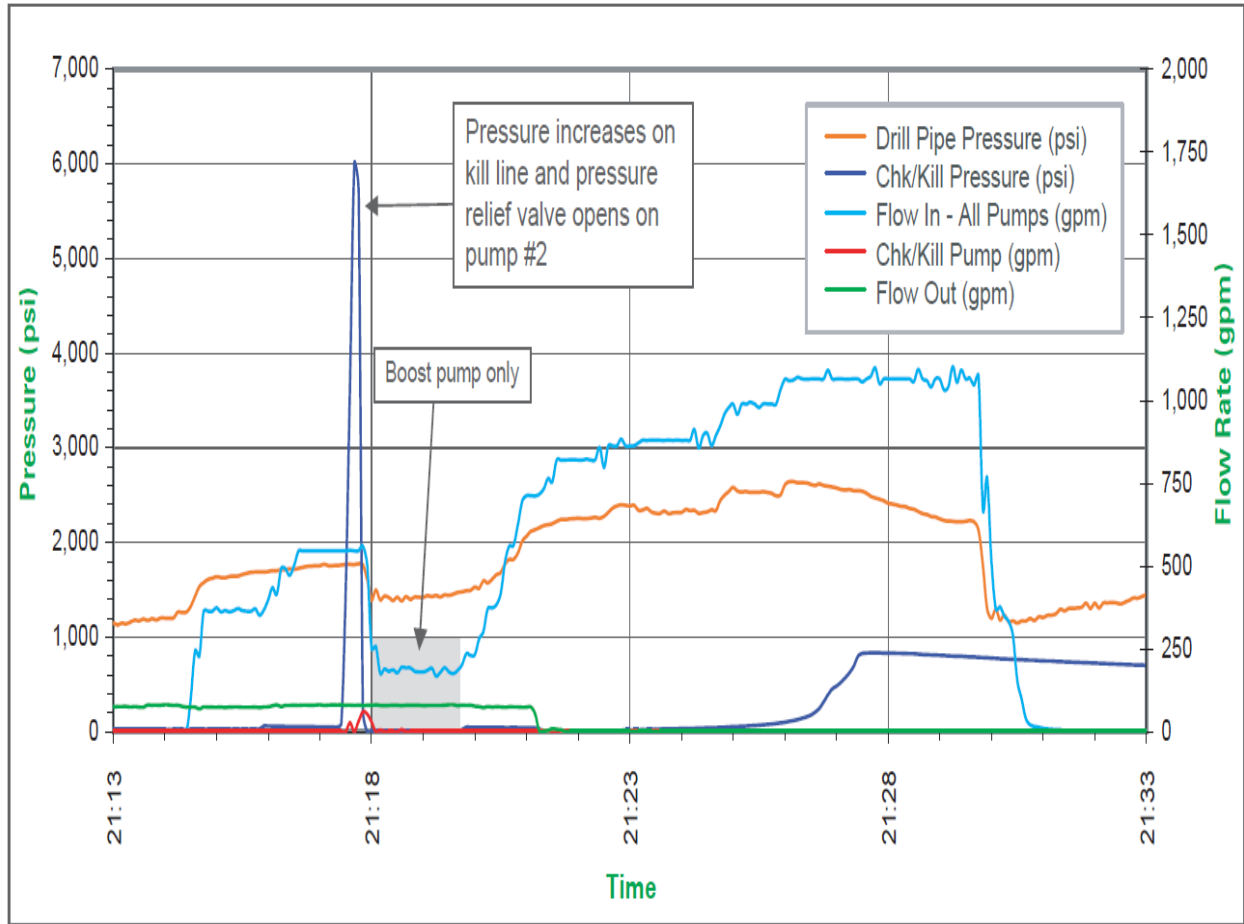
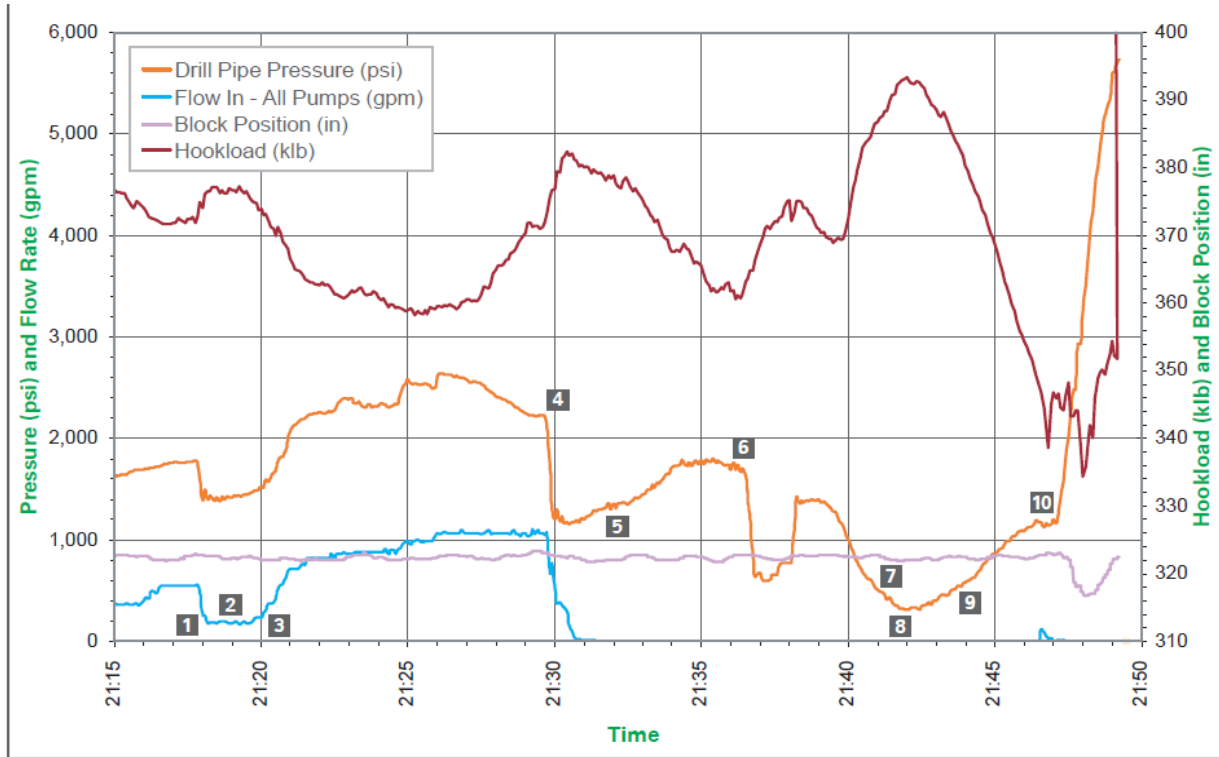

Figure 2.9 – Real-Time data (April 20, 2010) during overboard discharge operations.³⁷

About 9:30 p.m., the mud pumps were shut down (Figure 2.9). Testimony has not disclosed why the pumps were shut down. Testimony provided by the chief mate indicate that about this time the toolpusher and driller were concerned with the *differential pressure* on the drill pipe.²⁸ The real-time data indicates that the pressure on the drill pipe was continuing to increase (Figure 2.10). The drill pipe pressure rose from 1,240 psi to 1,750 psi followed by a sudden pressure decrease to 750 psi and then another pressure increase to 1,400 psi then another decrease to 340 psi. Analyses indicate these changes were due to additional influx of hydrocarbons into the well bore, displacement of the fluids in the well bore, and actions taken by the crew to reduce pressure in the drill pipe.^{1, 28}

³⁷ BP, *Deepwater Horizon Accident Investigation Report*, Op. ct 12, p56.

Deepwater Horizon Study Group
Investigation of the Macondo Well Blowout Disaster



- | | |
|---|---|
| <p>1 Pressure relief valve on pump #2 opens; toolpusher called to rig floor.</p> <p>2 All pumps shut down except boost pump.</p> <p>3 Assistant driller called to pump room.</p> <p>4 Pumps shut off.</p> <p>5 Toolpusher and driller discuss 'differential pressure.'</p> <p>6 Opening of 4" surface line to bleed pressure.</p> | <p>7 Mud/water flows onto rig floor and then unloads through the derrick.</p> <p>8 Diverter and annular preventer activated; diverted to mud gas separator.</p> <p>9 Well site leader and senior toolpusher receive calls from rig floor; annular preventer attempting to close.</p> <p>10 BOP sealing.</p> |
|---|---|

Figure 2.10 – Real-Time data (April 20, 2010) after mud pump shutdown.³⁸

Testimony indicates that about 9:47 p.m., the well site leader was notified that the well was being shut in, the senior toolpusher was notified of uncontrolled flow from the well, and that seawater and drill mud had started to flow out of the riser onto the rig floor. Note that the well site leader said his alarm clock showed 9:50 p.m. when he received the news, but his clock or the real time clock could easily have been different by a few minutes. The real time data,⁸ as partially duplicated in Figure 2.10 above, shows a sharp increase in drill pipe pressure starting at 9:47 p.m.

More than 4 hours had elapsed between the first signs the well did not have the required integrity and the attempts to shut in the well. There had been multiple indications of flow from the well and increasing pressures in the drill pipe. By 9:00 p.m., there were definitive indications the well was flowing—the drill pipe pressures were steadily increasing. The established requirements and procedures for shutting the well in were not followed. Prior to 9:40 p.m., there had not been any attempts to shut-in the well. Analyses show that hydrocarbons at that time were above the BOP.

³⁸ BP, *Deepwater Horizon Accident Investigation Report*, Op. ct 12, p56.

Due to reductions in pressure in the well above the BOP, the gases in the well bore and marine riser were expanding rapidly pushing seawater and drill mud to the drill deck. It was too late to stop the hydrocarbons from reaching the rig drill floor. The stage was set for Phase 3—‘last minute’ attempts to control the well and prevent a blowout.

Phase 3 – Attempts to Control the Well

After about 9:40 p.m., the drill pipe pressure increased from about 340 psi and reached 1,200 psi about 9:47 p.m. (Figure 2.10). Testimony indicates that by about 9:47 p.m. seawater and mud were shooting up through the derrick, and shortly thereafter the diverter was closed and flow from the riser was routed to the mud gas separator (MGS) (Figure 2.11 and Figure 2.12).

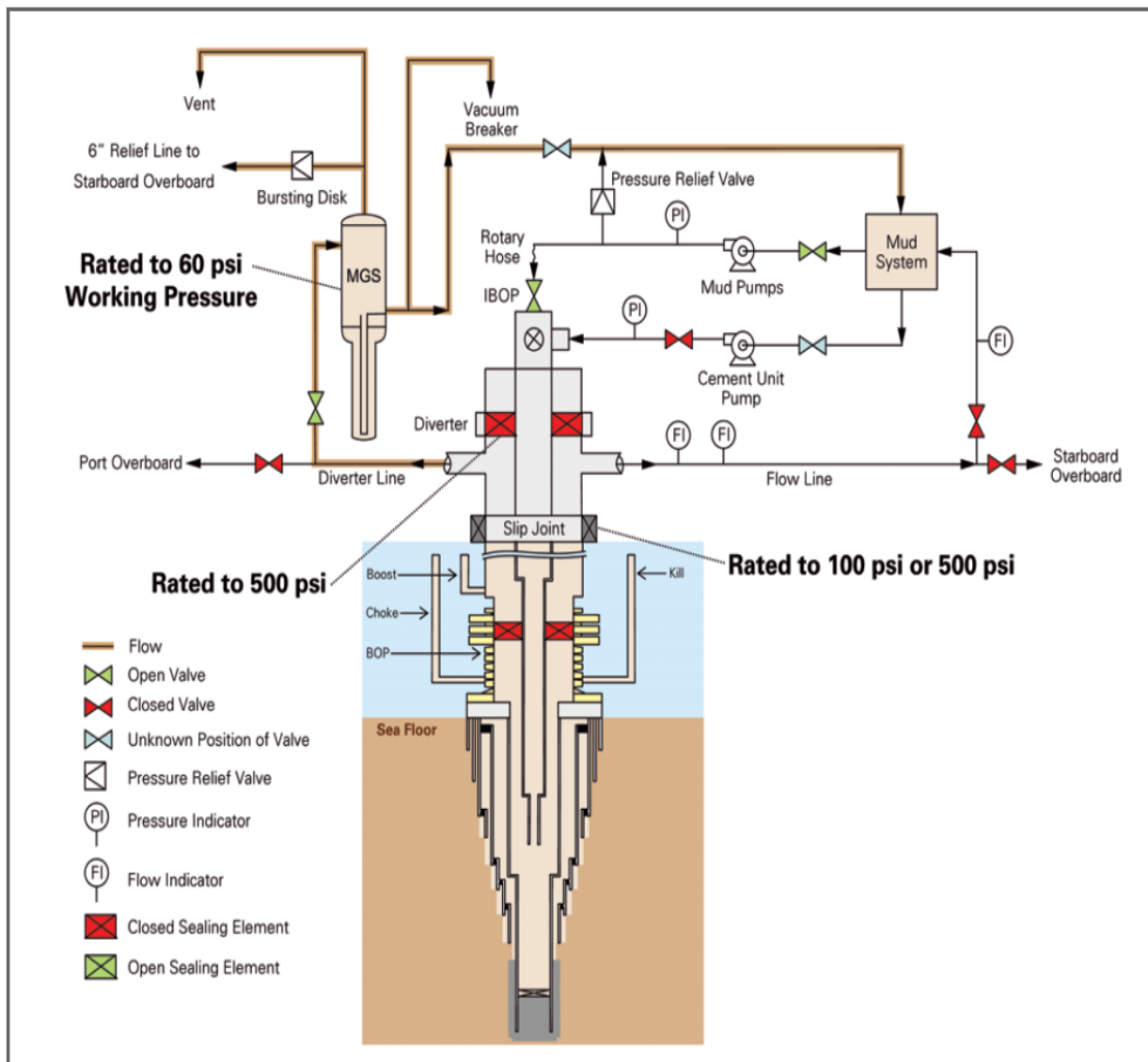

Figure 2.11 – Schematic of *Deepwater Horizon* surface equipment.³⁹

³⁹ BP, *Deepwater Horizon Accident Investigation Report*, Op. ct 12, p56.

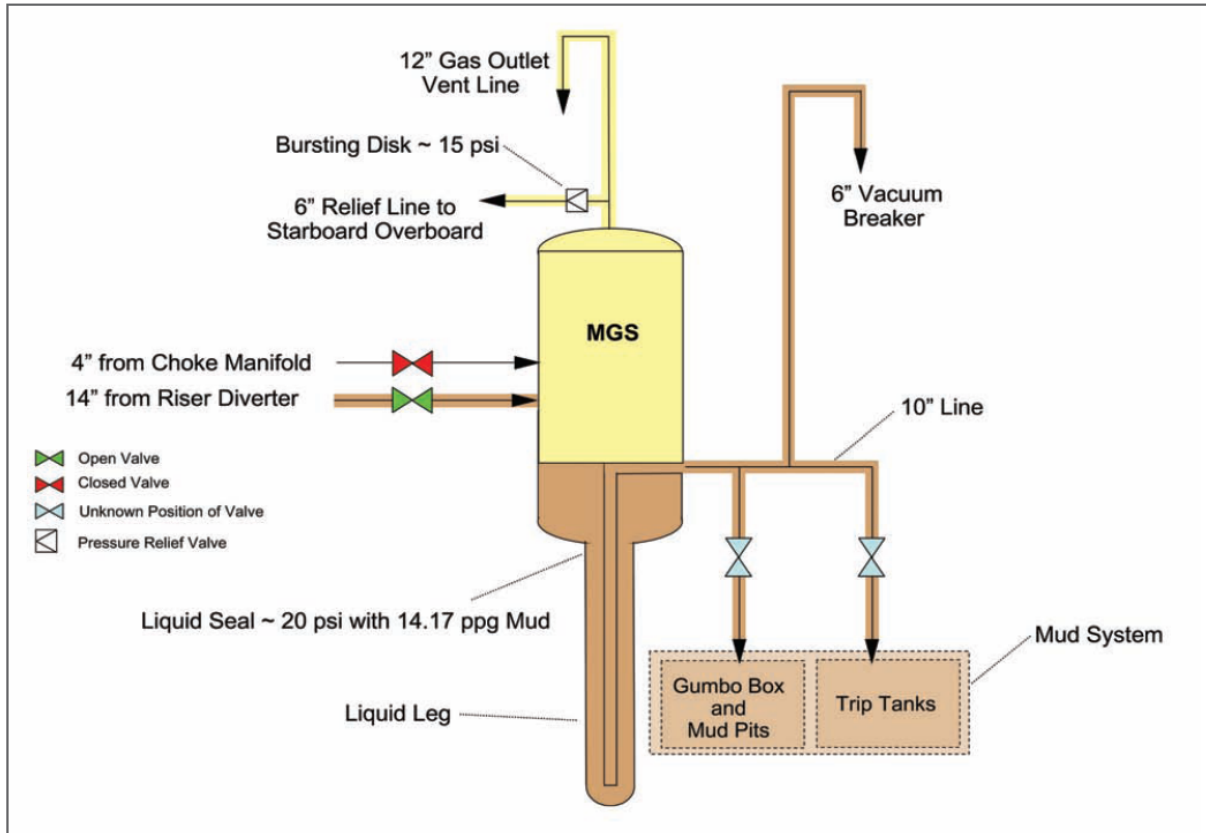

Figure 2.12 – Schematic of *Deepwater Horizon* Mud Gas Separator.⁴⁰

The Transocean operating procedures require the diverter to be closed with flow directed overboard if there is rapid gas expansion in the riser. If the expansion is slow, then the flow would be directed through the Mud-Gas Separator (MGS) unit. The MGS was used successfully during the March 8, 2010, well control event that resulted in stuck drill pipe that caused the necessity to sidetrack the well.

Returns blowing strongly from the riser were routed to the MGS unit rather than directly overboard through one of the 14 in diverter lines.⁴¹ As a consequence, MGS unit was quickly over-pressured and its capacity overwhelmed. That resulted in dispersion of gas and liquids over a large area of the vessel, including into electrically unclassified spaces where ignition sources may be present, i.e., spaces not classified as “explosion-proof” such as engine rooms. Although there is no record or testimony to prove it, it appears that the sealing packer on the riser slip joint leaked massively under the impetus of back pressure applied. First, there was active fire under the rig floor after the explosions according to testimony, and second, there was testimony of hearing a high pressure gas release from that direction preceding the first explosion.³²

Routing of returns from the riser diverter are pre-selected on the control system panels to reflect the operators’ judgment of where fluids ought to go for best rig and personnel safety in the event of a rapidly developing blow from the riser bore.³² Ordinarily, with water-based mud in use, the settings

⁴⁰ BP, *Deepwater Horizon Accident Investigation Report*, Op. ct 12, p56.

⁴¹ Gary Marsh, “Final Fateful Flaws,” Working Paper, Deepwater Horizon Study Group, January 2011.

are pre-selected to route the fluids overboard to the prevailing leeward side of the vessel. Obviously, with weather or vessel heading changes, the pre-selection might need to be changed. On this occasion, the pre-selections were obviously made which would route the riser returns to the MGS as soon as the diverter packer was closed. When and how this pre-selection was done prior to the blowout, and how often this judgment may have been reviewed if at all, is not known.

Analysis of the available information indicates the BOP lower annular was closed at 9:50 p.m. and the pressure in the drill pipe began to increase. As the BOP annular pressure increased there was a very rapid increase in drill pipe pressure to approximately 5,700 psi at 9:49 p.m. (Figure 2.10). The increase in drill pipe pressure is thought to be due to pressurization and sealing of the lower annular.

Testimony indicates that about 9:45 p.m. water, mud, and gas exited the MGS vents—indicating failure of the low pressure, low capacity MGS unit. Once the MGS failed, high pressure flammable hydrocarbon gas and condensate vapor/mist (aerosol) was released to the rig decks. Gas-hissing noises were reported coming from different parts of the rig. The first gas alarm sounded about 9:47 p.m. accompanied by roaring noises and vibrations. About 9:50 p.m., the main power generation engines started over speeding followed by the loss of rig power and the first and second explosions. Testimony indicates the first explosion happened very close to the MGS—ignition caused by vapor ingestion in one or more of the power generation engines is deemed to be very likely based on the record and the historical database.⁴²

All of the critical protective systems failed. The systems did not stop the hydrocarbons from reaching ignition sources. The engine room fans did not shut down automatically upon gas detection. The engine over speed controls did not function. Testimony indicates that many of the protective systems had been placed on *inhibited* mode that required activation by the crew, including the platform's general alarm. With the multiplicity of alarms and systems, the suddenness of the crisis, and the rapidly developing sequence of events, crew members were not able to manually activate all of the protective systems in time to prevent the explosions and fires.

Given that the BOP annular had been fully closed at about 9:47 p.m., then flow to the surface through the riser should have stopped shortly thereafter. However, testimony and photographic evidence, as well as the ultimate outcome, clearly indicates that the flow did not stop. Hydrocarbon-fueled fires continued to surround the rig after the initial explosions. The fires fed with hydrocarbons from the Macondo well continued to burn until the rig sank on April 22, 2010, leaving only the surface spill burning.

Subsequent hydrocarbon flow could have developed through the drill pipe inside the riser. There are a number of pieces of equipment that could have failed and allowed hydrocarbons to flow to the surface through the drill pipe (Figure 2.11) thereafter. Also, flow could have developed outside of the drill pipe (Figure 2.13). Following loss of power, the rig dynamic positioning system was inoperable. Rig drift-off following the loss of power could have caused the drill pipe to be pulled through the BOP destroying the annular seal and allowing resumption of flow up the riser. Analysis

⁴² According to Bly, after the well-flow reached the rig it was routed to a mud-gas separator, causing gas to be vented directly on to the rig rather than being diverted overboard. The flow of gas into the engine rooms through the ventilation system created a potential for ignition which the rig's fire and gas system did not prevent. If the fluids had been diverted overboard rather than to the MGS, there may have been more time to respond [due to delayed or prevented ignition]. Ref. BP's *Deepwater Horizon Accident Investigation Report*, September 8, 2010, p11.

of the available testimony and evidence indicates it is likely that a combination of these flow paths developed resulting in continuing hydrocarbon flow through the riser and drill pipe.

There are many unresolved issues and questions associated with performance of the BOP during this critical period of time. The BOP was the last line of defense to help prevent an uncontrolled blowout. It is palpably clear that the inimically dysfunctional BOP was not able to perform its intended functions and regrettably proved not to live up to its “fail-safe” namesake.

Currently, detailed inspections and analyses are being performed to determine how and why the BOP assembly failed, and to better characterize its many possible failure modes. The BOP had six different ways to actuate the Blind Shear Rams (BSR) and stop the uncontrolled flow of fluids.⁴³ Three of these could be initiated from the surface; three could be initiated by a Remote Operated Vehicle (ROV) from below the surface. None of the activation modes that were tried worked.

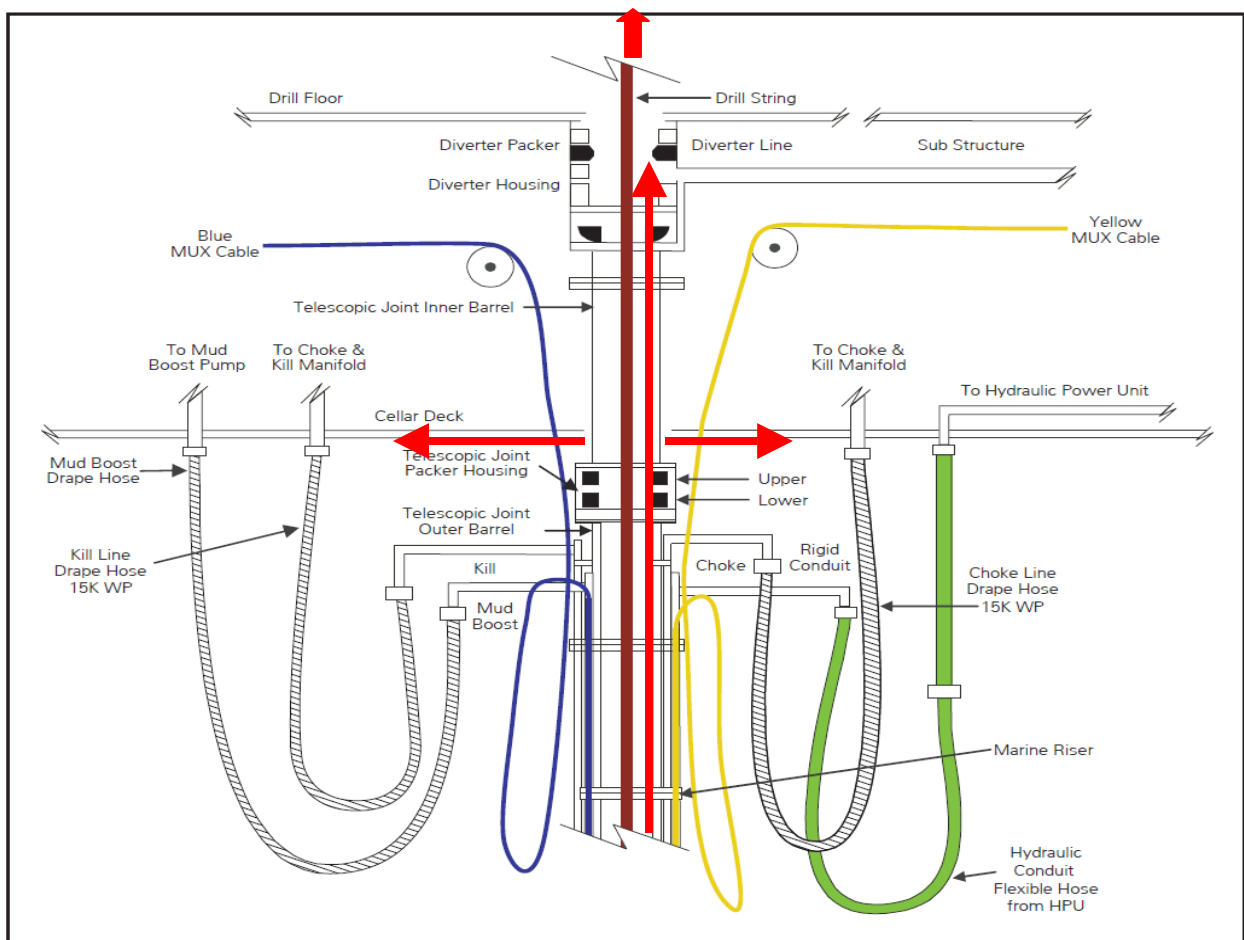

Figure 2.13 – Configuration of drilling riser, drill pipe, and other equipment in Moonpool area.⁴⁴

⁴³ An acoustical means of actuating the BOP was not provided for the *Deepwater Horizon's* BOP stack. Cameron advertises the NASMUX as an acoustical system providing full control for subsea Blow Out Preventer (BOP) equipment and offers an alternative to traditional multiplexed (MUX) control systems. NASMUX replaces the command, control and monitoring aspects of a control umbilical with an acoustical system which requires very little topside equipment. Ref. http://www.otcnet.org/2009/pages/spotlight/Cameron_Nautronix.html.

⁴⁴ BP, *Deepwater Horizon Accident Investigation Report*, Op. ct 12, p56.

Available information indicates that only two of the surface initiated modes of BOP BSR activation were implemented. Testimony indicates one or more attempts were made to activate the rig's Emergency Disconnect System (EDS) function. The EDS primary function is to allow the rig to be able to disconnect from the BOP in the event of a loss of the dynamic positioning system that held the rig on location. The EDS function is also capable of activating the BOP high pressure BSR. The available testimony indicates that the EDS function was initiated from the BOP control panel on the bridge following the initial explosions and fires, but it failed to function. The EDS function requires at least one operational control pod and a MUX (multiplex) cable connecting the control panel with the BOP. The rig could not be disconnected from the BOP nor could the BOP high-pressure BSR be activated. Given the location of the MUX control cables (Figure 2.13) in the rig *moon pool* and their connection to the marine riser, it is very likely these control cables were non-functional following the initial explosions and fires. In addition, there is evidence and testimony indicating that the BOP control pods might not have been functional.

The second surface initiated mode of BOP BSR activation was the BOP Automatic Mode Function (AMF). The AMF provided an automatic means of closing the high-pressure BSR when electrical power, electronic communication, and hydraulic pressure from the surface were lost. The AMF had to be manually *armed* by the crew from the BOP control panel and required at least one operational control pod and sufficient hydraulic power provided by the accumulators on the BOP. Testimony indicates that the AMF had been armed. Other testimony and evidence indicates that both control pods may have not been functional and that due to hydraulic leaks in the system that the accumulators may have not been able to supply the necessary power to close the high-pressure BSR.

The third surface initiated mode of BOP BSR activation was the BOP high pressure BSR function on the BOP control panel. This mode required at least one operational control pod, an associated MUX cable, and the hydraulic pressure accumulators to provide sufficient closing power. There is no evidence to indicate that this third mode was activated.

Three subsurface ROV modes of activating the BOP high pressure BSR were tried. The first was tried a few hours before the *Deepwater Horizon* sank. The first method was an ROV initiated AMF that used the ROV to cut the MUX and hydraulic lines on the BOP. This method was not successful. As noted earlier, deficiencies in the control pods and hydraulic pressure accumulator system provide plausible reasons why this method did not work.

The second method also was tried a few hours before the rig sank. This was an ROV initiated *autoshear* function. This function was incorporated into the BOP to provide for an emergency or inadvertent disconnection of the Lower Marine Riser Package (LMRP) from the BOP. The autoshear function is initiated by severing the autoshear activation rod that connects the LMRP to the BOP stack. In this case, the hydraulic accumulators on the BOP were the only source of hydraulic power for this function. Potential deficiencies in the stack-mounted hydraulic pressure accumulator system combined with a leak in the hydraulic circuit feeding the BSR *close and lock* function provide a plausible reason why this method did not work.

The third method was tried several times before and after the rig sank. The BSR is activated by an ROV *hot stab* connection with the BOP hydraulic lines. Hydraulic power to close the BSR is provided by a pump on the ROV or from a bank of hydraulic accumulators. Both sources of power were tried and both failed to close and seal off the well using the high pressure BSR.

Six *redundant* means of activating the BOP high pressure BSR failed. There were similar redundant systems and processes to assure that the BOP was properly maintained and functional. All of these systems and processes failed.

Summary

Currently available information and analysis of that data indicates the three phases that led to the uncontrolled Macondo well blowout each involved a series of compounding failures in the Macondo well development project *system*.⁴⁵

The Phase 1 preparation of the well for production resulted in development of a series of critical flaws and deficiencies in the well system. These critical flaws and deficiencies were founded during the concept and design phases of the Macondo well project. They were made real and embedded in the system during the Phase 1 construction operations.

The Phase 2 temporary abandonment procedures and processes exposed the critical flaws and deficiencies to the well system to high pressure high temperature (HPHT) hydrocarbon reservoir conditions. These very hazardous conditions exposed and exploited critical flaws and deficiencies in the well system. The well structure failed at one or more points allowing hydrocarbons to enter undetected into the well bore. Tests performed on the well failed to disclose the presence of the flaws and defects in the well structure. Subsequent operations did not result in detection of the entry of hydrocarbons into the well and their propagation upward through the well toward the drill floor of the *Deepwater Horizon*.

The Phase 3 well control processes were initiated when the rapidly evolving hydrocarbon liquids and expanding gases were approaching the drill floor. No effective actions were taken to shut-in the well before the hydrocarbons arrived unexpectedly at the drill floor. As the well fluids, hydrocarbons, and gases suddenly erupted on the drill floor, a series of deficiencies and defects in the Macondo well system were again exposed and exploited. All rig emergency and well control systems failed to prevent the hydrocarbons from igniting with disastrous effects. The explosions and fires further damaged rig emergency and well control systems. Due to multiple BOP failures, the last line of defense failed. The uncontrolled Macondo well blowout was underway and unstoppable.

For more background on analysis of factors involved in development of the Macondo well blowout, the reader is referred to the series of DHSG Working Papers authored by Gary Marsh and David Pritchard and co-authors (Appendix B).

⁴⁵ In this context, a *system* is taken to be comprised by seven inter-related, interactive, inter-dependent parts: 1) operating groups on the rig and *onshore*, 2) organizations that provide and determine incentives, resources, means and methods, 3) hardware and equipment, 4) formal and informal procedures and processes, 5) structures, 6) internal and external social environments, and 7) interfaces among the foregoing.

Chapter 3 – Insights

Introduction

The study of how and why major failures can develop and propagate in complex engineered systems is inextricably entwined with the data available and the methods and means used in the analysis. Using multiple approaches and alternative methodologies can shed additional light on causal and contributing factors, and yield different perspectives of understanding why such failures develop and describe how they unfold. That is why it is important to examine an artifact, evidence remnant, or the sequence of events from all sides and from all angles, exercising unbiased scientific and engineering judgment based on facts and tested hypothesis to deduce meaningful conclusions.

In the Macondo well disaster, it is known that important information and key data has not been made publicly available at this time. It may take several more years, if ever, before many parts of the whole story are produced during the course of pending litigation. Some information may never see the light of day due to protective orders imposed by the court.¹ And some of the desired data or information may simply not be recoverable. If experience with prior major system failures is any guide, even when the major investigations have been completed, there will be important missing gaps of information.

Needless to say, in the pursuit of further knowledge about how and why the Macondo incident occurred, all currently available information and data must be carefully evaluated and validated in so far as possible. All pieces of important evidence, including physical evidence, documentary evidence, testimonial evidence, circumstantial evidence, and anecdotal evidence must be compiled, collated, corroborated, and verified. In addition, interpretation of evidence needs to be similarly corroborated and validated. Parsing and validation of interpretation is particularly important because of the wide variety and diversity of cognitive (thinking) *biases* and subjectivity that can influence those interpretations. All practical measures need to be employed to identify and account for possible bias-influences in assimilating and interpreting the available evidence with an ever present awareness of “knowing what we don’t know” in the process of investigation.

As stated in the Background section of this report, the DHSG did its best to identify and neutralize both cognitive and expectation bias² in developing its report proposals and to corroborate the informational data base and evidence as far as possible. Perfection in *looking back*—how and why

¹ Court-Ordered Confidentiality In Discovery by Howard M. Erichson, Seaton Hall Law School: Some version of the following exchange happens regularly in state and federal courts around the United States. A party seeks discovery; the request includes a demand for documents or other information that the responding party considers sensitive. The responding party agrees to turn over the documents or other information only if given an assurance of confidentiality. The lawyers hammer out a confidentiality agreement that both sides find acceptable, and they present it to the judge as a stipulated protective order.

² As used in this report, the term *Cognitive Bias* is defined as a pattern of deviation in judgment that occurs in particular situations. Such biases can drastically affect the reliability of anecdotal and legal evidence. These are thought to be based upon heuristics, or rules of thumb, which people employ out of habit or evolutionary necessity. The term *Expectation Bias* is meant to describe the tendency for investigators and researchers to believe, look for, and collect evidence and data that agrees with their expectations for the outcome of an incident or experiment, and to disbelieve, discard, or downgrade the corresponding importance of evidence or data that appears to conflict with those expectations. The expectations may be assumed by or imposed on the investigator, often unwittingly, by preconceived desires or by suggestion.

the failures developed in this specific case—is not possible however, nor necessary, in order for the *looking forward* analysis as described herein to arrive at sensible and effective proposals and recommendations to reduce the likelihoods and consequences of similar failures. In the same way, the specific objective of this chapter is to make sense of how and why the Macondo well disaster unfolded so that a firm foundational basis is established for proposals aimed at effectively reducing the associated risks of similar types of complex major system failures to desirable and acceptable levels and that hopefully, will serve as a template for future project development risk assessment.

Organizational Accidents Perspectives

A useful metaphorical perspective that can be applied to the Macondo well disaster has been developed by James Reason. Reason’s *Managing the Risks of Organizational Accidents Theory* (OAT)³ describes major system *organizational* accidents as penetration of hazards through the system’s defenses or *barriers*. In Reason’s ‘Swiss Cheese’ model (Figure 3.1), an accident develops when the major hazards confronting a system are able to successfully penetrate the barriers through aligned *holes* (defects, deficiencies) in the barriers formed by the Risk Control System (RCS).

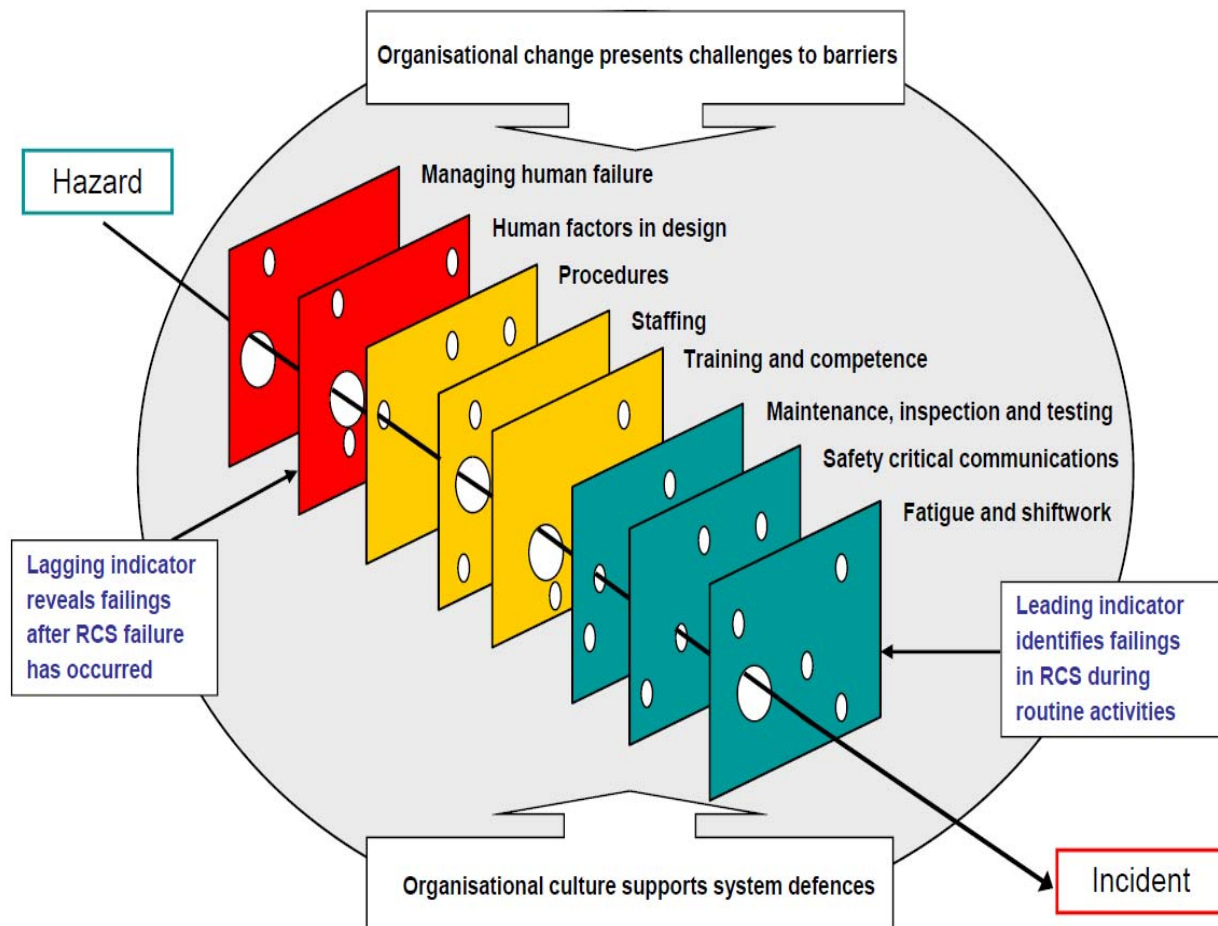

Figure 3.1 – Accident resulting from successful penetration of multiple defensive barriers.⁴

³ “Managing The Risks of Organizational Accidents,” by James Reason, Ashgate Publishers, 1997.

⁴ “Human Factors Performance Indicators for the Energy and Related Process Industries,” Energy Institute, London, UK, December 2010.

Reasons's barrier defenses are designed to serve one or more of the following functions:

- 1) create understanding and awareness of the local hazards,
- 2) give clear guidance on how to operate safely,
- 3) provide alarms and warnings when danger is imminent,
- 4) restore the system to safe state in an off-normal situation,
- 5) interpose safety barrier between the hazards and the potential losses contain and eliminate the hazards should they escape this barrier, and
- 6) provide the means of escape and rescue should hazard containment fail.

The barrier *holes* are created by active activities, such as unsafe acts, and by latent activities, such as undetected or otherwise embedded defects. Active holes are developed by operators at the *sharp end* of the system, that is, when the system is actually operating. Latent conditions are embedded in the system by organizations along the *blunt end* of the system, e.g., during the system design or construction. These conditions may be present for many years before they combine with the local active failures to allow hazards to penetrate the system's layers of defenses.

The size and alignment of the holes in the defenses are determined in large measure by the balance maintained by the involved organizations between *production* and *protection*. Multiple defenses are effective only when there are no other factors at work to help defeat these barriers. When insufficient resources are devoted to protection, the increased hazards associated with increased production act to enable the system to fail. If the imbalance is very high (high production, low protection), catastrophes resulting from multiple failures develop. The organization's *safety culture* has major effects on maintenance of appropriate balances between production and protection, and consequently, on the effectiveness of barriers to prevent failures.

OAT makes clear distinctions between prevention of individual worker accidents and organizational—or system—accidents. Prevention of individual worker accidents can be focused on local elements—primarily people performing the activities. Prevention of system accidents must be focused on a much broader set of issues covering the entire organizational *complex* (industrial, governmental, and inter-organizational) involved in development and performance of the system.

Application of Reason's OAT to the Macondo well disaster renders useful insights into both the causes of this disaster and into how the risks associated with such systems can be better *managed* in the future.⁵ It is obvious that multiple proactive, reactive, and interactive barriers were penetrated to develop the blowout (Figure 3.2). A critical proactive protective barrier that was penetrated was the plan for temporary abandonment of the Macondo well—specifically the plan for the negative pressure test and displacement of the mud from the well before a second barrier was in place. During the negative pressure test, interactive barriers were penetrated. Critical *signals* (e.g., drill pipe pressures, well fluid volumes) were not properly detected, analyzed, or appropriate action taken.⁶ After the well began blowing out, multiple reactive barriers were breached including diversion of the well effluents to the low capacity mud-gas separator rather than overboard.

⁵ BP, *Deepwater Horizon Accident Investigation Report*, Houston, Texas, September 8, 2010, p32, Figure 1.

⁶ "Deepwater Horizon Macondo Blowout – Analysis of Negative Pressure Test Anomalies Understanding The Origin of the Blowout," by Phil Rae, InTuition Energy Associates Pte. Ltd., December 1, 2010.

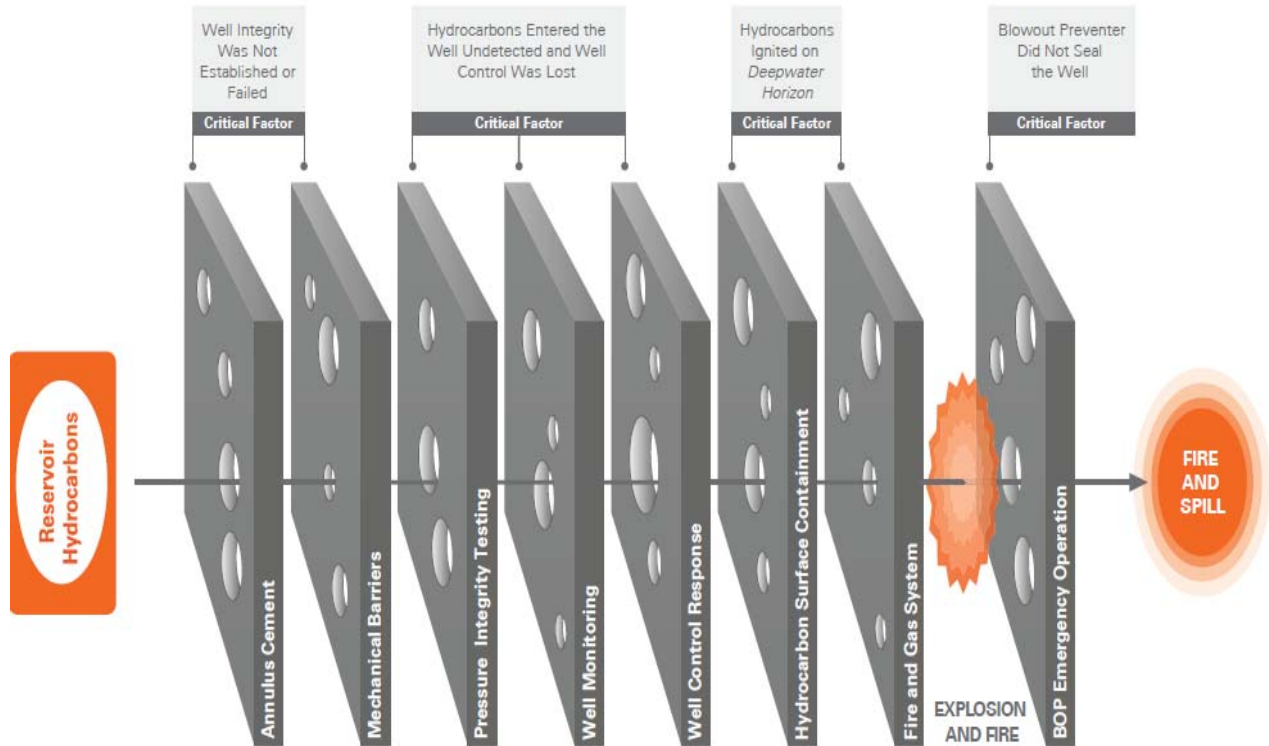

Figure 3.2 – BP’s analysis of defensive barrier penetration leading to the Macondo blowout.⁷

There were critical defects embedded in BP’s defensive barrier system prior to the initiation of the failures including those associated with the design and construction of the long-string completion system with the *iffy* barriers.⁸ Another example is related to the *sketchy* negative test procedure sent by BP to the *Deepwater Horizon* on the morning of April 20, 2010. The procedure was a high hazard process in which a critical test was performed with minimal passive and active barriers. No definitive guidance, however, was designed or provided for interpretation of data derived from the negative tests or prescribed the corrective action required if the negative tests did not provide assurance that the well *pressure vessel* was intact. Evidence indicates that the drilling crew had not received any formal training in performing this critical test.

Active deficiencies and defects developed by the operating team onboard the *Deepwater Horizon* activated the defects embedded in the system enabling penetration of the multiple barriers. A prime instance are the significant distractions and diversions of attention that developed during the multiple ongoing operations that were being performed during temporary abandonment operations that prevented accurate monitoring of drilling fluid flow into and out of the mud pits and prevented detecting subtle tendencies in well pressures and flows (*weak signals in a strong noise environment*). Another example was the confusion and uncertainty in the offshore teams’ thinking caused by the sequence of multiple *last-minute* (last-days) changes in BP’s plans and personnel used for preparation of the well’s future production and temporary abandonment.

⁷ BP, *Deepwater Horizon Accident Investigation Report*, Houston, Texas, September 8, 2010.

⁸ “Causative Technical and Operational Elements of the Deepwater Horizon Blowout,” “Cementing 7” x 9-7/8” Production Casing at the MC252 #1 Well,” “Final Fateful Flaws,” by Gary Marsh, DHSG Working Papers, January 2011.

In reviewing the Macondo well development project, clear indications have been identified of inappropriate imbalances between production and protection. As would be expected, there were significant pressures to complete this *well-from-hell* as quickly as possible. However, there is no clear evidence of corresponding pressures to provide appropriate *protections* to counter-balance and mitigate the multiple effects of these production pressures. Much like a pressure gauge on a steam boiler, real-time *risk-meter* was moving higher and higher during this period and there was no safety valve to relieve the building pressure.⁹

OAT underscores why the Macondo system's good record of *lost time* accidents could not provide effective precursors for the major impending *system accident*. Efforts to prevent system accidents must address a broader set of *organizational* issues and hazards associated with all of the elements that comprise a given system. The good record of lost time accidents plausibly led to complacency that contributed to the disaster. In addition, the exceptional success associated with the previous world record setting Tiber Well project may have contributed to this complacency.

A key element of organizational accidents theory is the *Safety Culture*¹⁰ of a given system. OAT characterizes a System Safety Culture as one resulting from seven elements, each of which commands attention:

- 1) "...the engine that continues to propel the system towards the goal of maximum safety health, regardless of the leadership's personality or current commercial success."
- 2) "...continuing respect for the many entities that can penetrate and breach the defenses...its power is derived from not forgetting to be afraid." "...creating a safety information system that collects, analyses and disseminates information from incidents and near-misses as well as from regular proactive checks on the system's vital signs....an informed culture."
- 3) "...it is necessary to engineer a reporting culture—an organizational climate in which people are prepared to report their errors and near-misses."
- 4) "...a just culture, an atmosphere of trust in which people are encouraged, even rewarded, for providing essential safety-related information—but in which they are also clear about where the line must be drawn between acceptable and unacceptable behaviour."
- 5) "...high reliability organizations—domain leaders in health, safety and environmental issues—possess the ability to reconfigure themselves in the face of high-tempo

⁹ The overall level of [platform] risk at a particular point in time, e.g., real-time risk or *effective risk*, R at time 't' varies from a normalized baseline risk, R_b , or residual risk, in accordance with nature of the change taking place. Changes of a temporal nature, such as conducting a high risk activity for a finite time period, will cause an aberration of the level of effective risk, R_t . The goal of risk management programs is to manage how risk may change over the operational lifetime of a platform, e.g., the key to successful risk management is successfully management of change. *FLAIM*©, *Fire and Life Safety Assessment and Indexing Methodology for Offshore Production Platforms*, MMS Report 170AB, January, 1994, William E. Gale, Jr., Robert G. Bea and Robert Brady Williamson, University of California, Berkeley, p110 & 214.

¹⁰ *Ibid.*, p207: The overall "safety culture" or attitude that permeates throughout the organization, from upper management to shift foremen, is crucial to safe operations. The safety culture of an organization can be expressed in terms of its commitment to safety and the resources that are made available to meet this commitment. This in turn affects all other aspects of safety management...

operations or certain kinds of danger. A flexible culture takes a number of forms, but in many cases it involves shifting from the conventional hierarchical model to a flatter professional structure, where control passes to task experts on the spot, and then reverts back to the traditional bureaucratic mode once the emergency has passed. Such adaptability is an essential feature of the crisis-prepared organization and, as before, depends crucially on respect—in this case, respect for the skills, experience and abilities of the workforce and, post particularly, the first-line supervisors. But respect must be earned, and this requires major training investment on the part of the organization.”

- 6) “...must possess a learning culture—the willingness and competence to draw the right conclusions from its safety information system, and the will to implement major reforms when their need is indicated.”
- 7) “...must possess a learning culture – the willingness and competence to draw the right conclusions from its safety information system, and the will to implement major reforms when their need is indicated.”

Review of available information indicates that this system’s (BP’s) organizations and operating teams did not possess a functional Safety Culture. Their system was not propelled toward the goal of maximum safety in all of its manifestations but was rather geared toward a trip-and-fall compliance mentality rather than being focused on the Big-Picture. It has been observed that BP’s system “forgot to be afraid.” The system was not reflective of one having well-informed, reporting, or just cultures. The system showed little evidence of being a high-reliability organization possessing a rapid learning culture that had the willingness and competence to draw the right conclusions from the system’s safety signals. OAT clearly indicates the Macondo well disaster was an organizational accident whose roots were deeply embedded in gross imbalances between the system’s provisions for production and those for protection.

Early studies of High Reliability Organizations (HRO)^{11, 12} shed important light on factors that contribute to system failures developed by organizations. HROs are those organizations in hazardous environments and with complex technologies that have operated nearly error free over long periods of time. A variety of HRO ranging from the U. S. Navy nuclear aircraft carriers to the Federal Aviation Administration Air Traffic Control System have been studied. These organizations are notable, because, *inter alia*, existing theory suggests that the more complex the technology and environment, the greater the chances of failure and the greater the consequences of that failure.¹³

HRO research has been directed towards identifying what these organizations do to reduce the probabilities of serious errors. Reduction in error occurrence (and by implication consequence occurrence) is accomplished by the following: 1) command by exception, 2) redundancy (robustness), 3) procedures and rules, 4) selection and training, 5) appropriate rewards and punishment, and 6) ability of management to *see the big picture*. As with a safety culture, there is no recipe there.

¹¹ Roberts K H, 1989. *New Challenges in Organizational Research: High Reliability Organizations*, Industrial Crisis Quarterly, Vol. 3, Elsevier Science Publishers, Amsterdam, the Netherlands.

¹² Weick, KE & Sutcliffe, KM, 2001. *Managing the Unexpected*, Jossey-Bass, San Francisco, CA.

¹³ Perrow, C. 1999 [1984]. *Normal Accidents: Living with High-Risk Technologies*. Princeton University Press, Princeton, NJ.

Command by exception (management by exception) refers to management activity in which authority is pushed to the lower levels of the organization by managers who constantly monitor the behavior of their subordinates. Decision making responsibility is allowed to migrate to the persons with the most expertise to make the decision when unfamiliar situations arise. Positive redundancy (robustness) involves people, procedures, and hardware. Multiple components with respect to each permit the system to function when one of the components fails.

Procedures that are correct, accurate, complete, well organized, well documented, and are not excessively complex are an important part of HRO. Adherence to the rules is emphasized as a way to prevent errors, unless the rules themselves contribute to error. Procedures are core to an HRO's safety culture, but more than procedures are needed. HROs also develop constant and high quality programs of selection and training. Selection is difficult but essential given that the goal is to match the talents and capabilities of people with the tasks that have to be performed. To reflect the conduct of normal and abnormal activities a wide range of training (including the use of highly sophisticated simulators) is mandatory to avoid errors and understand the risks involved. Training prepares people for not just the inevitable surprise but also those *unbelievable* unraveling "knock-on" events that threaten the survival of a system. Establishment of appropriate rewards and punishment that are consistent with the organizational goals is also critical aspect of training and safety culture indoctrination.

Lastly, HRO organizational structure is one that allows key decision makers to understand the big picture. Decision makers with a big picture perception can recognize the importance of developing situations, properly integrate this data, and then develop high reliability responses—another way of saying that those in charge can rapidly adapt to and successfully manage change on a real-time basis. Team situational awareness is crucial for the level at which decisions are made to prevent *all-those-accidents-waiting-to-happen* in high-risk technologies which would develop if "production and protection" were not balanced both on a local level as well as elsewhere in the organization.¹⁴ Sustained team situational awareness has been recognized as especially important for the high reliability management of real-time operations by control rooms responsible for major critical infrastructures, including those for water, nuclear power, electricity, and elsewhere.¹⁵

Weick, Sutcliffe, and Obstfeld¹⁶ extended this and other research (e.g., Roberts and Libuser¹⁷) to characterize *how* organizations can organize for high reliability. Their extensive review of the literature and studies of HRO indicate that organizing in effective HRO's has several important features that merit close attention:

- 1) *Preoccupation with failure* – any and all failures are regarded as insights on the health of a system, thorough analyses of near-failures, generalize (not localize) failures, encourage self-reporting of errors, and understand the liabilities of successes.

¹⁴ Garbis, C. and H. Artman, 2004. Team situational awareness as communication practice. In *A Cognitive Approach to Situation Awareness: Theory and Application*, edited by S. Banbury and S. Tremblay, Ashgate Publishing, Great Britain.

¹⁵ Roe, E. and P. Schulman. 2008. *High Reliability Management*. Stanford University Press, Stanford, CA.

¹⁶ Weick, KE, Sutcliffe, KM, and Obstfeld, D, 1999. Organizing for High Reliability: Processes of Collective Mindfulness, *Research in Organizational Behavior*, Staw and Sutton (Eds.), Research in Organizational Behavior, JAI Press, Vol 21, Greenwich, CT.

¹⁷ Roberts, K. H., and Libuster, C. (1993): "From Bhopal to Banking: Organizational Design Can Mitigate Risk," *Organizational Dynamics*, Spring, Academy of Management, New York.

- 2) *Reluctance to simplify interpretations* – regard simplifications as potentially dangerous because they limit both the precautions people take and the number of undesired consequences they envision, respect what they do not know, match external complexities with internal complexities (requisite variety), diverse checks and balances, encourage a divergence in analytical perspectives among members of an organization (it is the divergence, not the commonalities, that hold the key to detecting anomalies).
- 3) *Sensitivity to operations* – construct and maintain a cognitive map that allows them to integrate diverse inputs into a single picture of the overall situation and status (situational awareness, *having the bubble*), people act thoughtfully and with heed, redundancy involving cross checks, doubts that precautions are sufficient, and wariness about claimed levels of competence, exhibit extraordinary sensitivity to the incipient overloading of any one of its members, and sense-making.
- 4) *Commitment to resilience* – capacity to cope with unanticipated dangers after they have become manifest, continuous management of fluctuations, prepare for inevitable surprises by expanding the general knowledge, technical facility, and command over resources, formal support for improvisation (capability to recombine actions in repertoire into novel successful combinations), and simultaneously believe and doubt their past experience.
- 5) *Under-specification of structures* – avoid the adoption of flawed procedures to reduce error that often spreads them around, avoid higher level errors that tend to pick up and combine with lower level errors that make them harder to comprehend and more interactively complex, gain flexibility by enacting moments of organized anarchy, loosen specification of who is the important decision maker in order to allow decision making to migrate along with problems (migrating decision making), move in the direction of a garbage can structure in which problems, solutions, decision makers, and choice opportunities are independent streams flowing through a system that become linked by their arrival and departure times and by any structural constraints that affect which problems, solutions and decision makers have access to which opportunities.

Conversely, in the case of LROs (Lower Reliability Organizations), Weick, Sutcliffe, and Obstfeld observed that these non-HROs are characterized by a focus on success rather than failure, and production rather than protection. In LROs the cognitive infrastructure so critical to team situational awareness and decision-making is underdeveloped. In-place processes propagate inertial blind spots, thereby enabling risks and failures to accumulate and produce catastrophic outcomes. In LROs, expensive and “inefficient” learning and diversity in problem solving are not welcomed. Information, particularly *bad* or *useless* information, is not actively sought, failures are not taken as learning lessons, and new ideas or divergent views are discouraged. Communications are regarded as wasteful and hence the sharing of information and interpretations between individuals is stymied.

In LROs the “failure-to-fail” is treated as success, which, in turn, breeds overconfidence and fantasy. Executives and managers end up attributing success to themselves and any failure to factors outside their control, i.e., as *Acts-of-God*. Under these illusions, the non-HRO drifts into complacency, inattention, and habituated routines that they often justify with the argument that they are eliminating unnecessary effort and redundancy. Often down-sizing and out-sourcing are used to

further the drives of efficiency, and an insensitivity is developed to overloading and its effects on judgment and performance. Positive redundancy is recast as “excess capacity” and eliminated or reduced in the same drive resulting in elimination of cross checks, assumption that established precautions and existing levels of training and experience are sufficient, and dependence on claimed (but unproven) levels of competence. These are the indicators and telltale signs of the insidious devolution process in which HROs turn into LROs.

Analysis of currently available information pertaining to the Macondo well failures in the context of HRO theory clearly indicates that the primary organizations involved directly in the well drilling and completion operations (Appendix C) did not perform as HROs. Rather, they performed in the context of LROs. The organizations were not preoccupied with failure; they were preoccupied with success and seemingly lost their ability to manage risk, i.e., they forgot to be afraid. The organizations were not reluctant to simplify interpretations such as those associated with results from the critical negative pressure tests. The organizations lost situational awareness, did not make proper sense of the situations, and did not act thoughtfully (“thinkingly”). The organizations were *brittle* rather than robust. Proper selection, training, and support systems for the operating teams were not present. Effective damage and defect tolerance in the organizations and in the system they created was defeated by the organizations themselves. All of this is even more telling, when one considers that a key organization—BP—insisted it was instilling a safety culture with high reliability attributes.¹⁸

Production versus Protection Insights

Imbalances that develop between production and protection have been *driving forces* in causation of many previous system disasters such as those of the Occidental Piper Alpha platform, the Exxon Valdez tanker, the Petrobras P36 platform, and the NASA Columbia shuttle. The DHSG analyses of the available evidence indicate the Macondo project disaster is no exception. *The question is why and how do such imbalances develop?* Answers to this key question provide important insights into causation of the Macondo well project and hence provide important insights into how to reduce the likelihoods and consequences of such disasters in the future.

Protection costs resources. Monetary, human, and material options are needed to provide protection. More protection costs more resources. If the protection is effective, accidents and failures decrease. With such decreases, costs associated with accidents and failures are reduced. Thus, effective protection can be *good business*.

In the case of frequently occurring *worker accidents*, if the protection is not effective, there is an active *feedback* process to help indicate how the protection can be improved. Also, there are regulatory-legislative-legal processes to help define how much protection should be provided by industry.

In the case of very infrequently occurring *system accidents*, however, there is often little or no effective *feedback* process to help indicate how protection can be improved or demonstrate why it is needed. This is because catastrophic accidents do not happen frequently and their probability (risk) is often rationalized by fearless risk-prone management focused on the bottom line rather than on the big picture. *Near-miss* frequency and severity indicators can provide early warnings of developing

¹⁸ “After the Dust Settles ...”, by Karlene Roberts, DHSG Working Papers, Draft, June 2010.

problem organizational environments that promote system accident causation IF such incidents are sufficiently understood by management and otherwise not *localized* or *normalized*.

Unlike frequently occurring worker accidents, generally there is not an effective regulatory-legislative-legal process to help define how much protection should be provided by industry to prevent major system failures. This is most often left to the perception of the operator to ensure self-regulation based on industry standards. It is only after system disasters that processes are activated to help define the system's *revised* reliability requirements. The process is reactive, not proactive. Further, it is rare that the system's reliability requirements are sufficiently defined or detailed to allow adequate protection to be developed to meet the reliability requirements. It is difficult to tell when the *line* between safe and unsafe has been crossed when that line is *fuzzy* or not defined.

Another problem arises when there is no accounting for system accidents and failures that do not happen. Investments are made with no apparent or perceived benefits. There are economic pressures to reduce investments when there are no professed benefits in the eyes of management. If these pressures prevail, investments to provide protection are reduced and the occurrence of system accidents and failures can be expected to increase. Yet when it comes to reliability, a fire prevented is as much an event as a fire that has not been prevented. The problem has been to tie the measurement of both to the perception of benefits.

Production and associated profitability provide resources to achieve desirable and acceptable protection. Without sufficient production and profitability, the resources required to achieve desirable and acceptable protection cannot be provided and sustained. Generally, it is much easier to measure production and profitability than protection. There are many important monetary metrics of production and profitability. Some of these metrics are *leading* (e.g., forecast Return on Investment) and some are *lagging* (e.g., profit). While there are *lagging* metrics for system protection (e.g., costs of failures), there are much less obvious *leading* metrics.¹⁹ Future accidents and failures that don't happen—that are prevented—are, it deserves repeating, not easy to measure. Reason observes:²⁰

“All rational managers accept the need for some degree of protection. Many are committed to the view that production and protection necessarily go hand-in-hand in the long term. It is in the short term that conflicts occur. Almost every day, line managers and supervisors have to choose whether or not to cut safety corners in order to meet deadlines or other operational demands. For the most part, such short-cuts bring no bad effects and so can become an habitual part of routine work practices. Unfortunately, this gradual reduction the system's safety margins renders it increasingly vulnerable to particular combinations of accident-causing factors.”

Thus, long periods without major system failures and disasters can result in gradual erosion or removal of protection. In some cases, system managers have arrived at decisions that as there were no major system failures or disasters then protective measures could be reduced or removed. HRO theorists call this phenomenon, the *normalization of deviance*. In other cases, the protective measures

¹⁹ “Human Factors Performance Indicators for the Energy and Related Process Industries,” Energy Institute, London, UK, December 2010.

²⁰ Op. cit.

that have led to substantial increases in production have not been accompanied by commensurate increases in protection.

The DHSG analysis of the available evidence concerning the Macondo disaster indicates that when given the opportunity to save time and money—and make money—tradeoffs were made by the system operator for the certainty of the measurable thing—production. The perception was that there were no downsides associated with the uncertain, difficult-to-measure thing—failure caused by the lack of sufficient protection. As a result of a concatenation of deeply flawed failure and signal analysis, decision-making, communication, and organizational-managerial processes performed by the primary organizations involved in the Macondo well project, safety was compromised to the point that the blowout occurred with catastrophic effects. The regulatory-governance processes (Federal, State, and local) charged with oversight of these operations did not provide the necessary checks and balances to prevent the disaster.

The DHSG investigation has concluded that those who worked on the Macondo well project did not make conscious, *well-informed*, deliberated decisions to trade safety for money. The analyses of the available evidence indicate they were trading something that was in their estimation unlikely for something that was sure. They were trading sure savings in time and money—and perhaps quicker returns on investments—for what they took to be the unlikely possibility of a blowout and its unimagined severe consequences. The risks were erroneously judged to be insignificant. Thus, erroneous tradeoffs between risks (safety) and costs were made and set into place.

Available evidence indicates this crew, the onshore support staffs, and the regulatory agency staffs had never experienced a major accident such as that which unfolded on the *Deepwater Horizon*. This failure was beyond their experience—a “failure of imagination.” If so, then it is reasonable to conclude that they were operating in conditions at the Macondo site that they had not fully studied or appreciated.

Instead, the Macondo well-permitting documentation clearly shows that both BP and the MMS believed the likelihood of a catastrophic blowout were not significant. Blowout prevention plans were not required (waived). Procedures, processes, and equipment for containment and cleanup of the *worst case* blowout were deemed to be readily available and would prevent significant negative environmental impacts.

There was significant off-site experience to bolster this over confidence in success. This very complex system (managers, men, and machines) had just completed a world record setting operation to the west of the Macondo well—the Tiber well. The Tiber well was drilled to 35,000 ft below the drill deck in more than 4,000 ft of water. The Tiber well led to discovery of more than 3 billion barrels of recoverable hydrocarbon reserves. In addition, this system had completed 7 years without a reportable-recordable lost time accident. This system was confident in its abilities to cope with the challenges posed by the Macondo well—whose risks again were judged to be *insignificant*.

Available evidence and testimony indicates there were multiple (20 or more, Table 3.1) key decisions and subsequent actions that developed in the days before the blowout that in hindsight (hindsight does not equal foresight) led to the blowout. There were conscious deliberations about each of the primary decisions and action sequences—on the rig and *on the beach* (the office staffs). The well permitting documentation contains many detailed flow charts and decision points that were

used in parts of this operation. In each instance, the deliberations addressed the likelihoods and consequences of failure (a blowout)—implicitly or explicitly—but ultimately unsuccessfully.

Table 3.1 – Decisions made during the Macondo well drilling and completion that increased risks.^{21,22,23}

to leave well drilling liner overlaps uncemented
to delay installation of the lock-down for the production casing hanger seal assembly until after the riser mud was circulated out
to use single long string casing instead of liner and tieback
to use minimum positive pressure test on cemented production casing
to not use recommended casing centralizers
to not confirm proper conversion of float equipment
to perform only partial bottoms-up circulation to remove well debris before cementing
to run underbalance test with most of the drill pipe out of the well instead of running a full string to total depth
to not perform cement bond log on basis of cement lift pressures and absence of fluid losses during cementing
to not cement the annulus between production casing and drilling liner
to place sole reliance on float equipment and shoetrack cement to isolate bottom of production casing
to displace drilling mud from riser before setting plug in production casing
to set temporary abandonment plug at 3,300 ft below the seafloor
to use nitrogen in cement mix to lighten the slurry density rather than non-gaseous additives
to not perform proof tests of cement slurry mix to be used in cementing the production casing
to not use MMS approved plan for negative testing
to perform negative testing before cement could have fully cured (based on laboratory test data)
to not verify location of spacer before negative pressure test
to not verify functionality of negative pressure test system before and during negative tests
to perform multiple simultaneous operations preventing accurate determination of mud volumes
to not properly monitor mud pit volumes and flow out meter during displacement of drill mud with seawater during temporary abandonment
to not perform required maintenance of the blowout preventer
to not resolve conflicting information developed during the negative pressure testing
to use lost circulation material as spacer during drill mud—sea water displacement negative testing temporary abandonment operations
to place emergency alarms and response systems on <i>inhibit</i> —manual mode of operation
to divert well to the mud gas separator rather than overboard

²¹ “Causative Technical and Operational Elements in the Deepwater Horizon Blowout,” “Final Fateful Flaws,” and “Mistakes – Omissions on Macondo Well,” by Gary L. Marsh, DHSG Working Paper, January 2011.

²² “Risk Assessment & Management: Challenges of the Macondo Well Blowout Disaster,” by Robert G. Bea, DHSG Working Paper, January 2011.

²³ “Looking Back and Forward: Could Safety Indicators Have Given Early Warnings About the Deepwater Horizon Accident,” by Jon Espen Skogdalen, Ingrid B. Utne, and Jan Erik Vinnem, DHSG Working Paper, January 2011.

This system also had proactive, interactive, and reactive risk management processes that were in place and implemented (effectively or poorly) before the blowout. The proactive processes included provisions for inspections, maintenance, and repairs of critical pieces of hardware such as the blowout preventer. Interactive processes included formal Management of Change (MOC) processes. There were interactive quality assurance and control procedures to address risks during operations such as the procedures for negative pressure testing and setting a barrier 3,300 ft below the seafloor. There were procedures, processes, and hardware for reactive risk assessment and management; automatic shut-in systems, blowout preventers, emergency disconnect systems, emergency evacuation systems, and environmental protection systems. This system had a suite of risk assessment and management processes intended to enhance prevention, interception, and reaction to a catastrophic blowout.

When each of the primary decisions and subsequent actions concerning the production well design and temporary abandonment was developed, the available evidence indicates risk assessments found no significant likelihoods or consequences associated with failure. The available evidence does not indicate that any one person or group was keeping tabs on the accumulation of risks that accompanied the individual decisions and subsequent actions or inactions. Apparently it was concluded by those involved in this operation (BP, MMS, Transocean, Halliburton) that there were no significant challenges to *safety*. A realistic, rigorous Risk Analysis and Management (RAM) process and Management of Change (MOC) process (for changing modes from drilling to completion) appears not to have been performed. The result was a serious compromise of process safety.

In contrast, those involved could easily understand the potential savings in time and money associated with expedited *efficient* operations. They could easily understand this project was seriously behind schedule (more than 50 days) and over budget (approaching \$100 millions). What was significant were those incentives to *wrap this job up* as quickly as possible. In addition, there were significant incentives to get this productive well on stream as quickly as possible – the *last day's* decisions and actions to prepare the permitted exploratory well for production.

The available documentation does not provide any references to guidelines on how the risk assessments developed onboard and *on the beach* were developed and validated. In the majority of cases, judgments of the likelihoods and consequences of failures (e.g., blowout) appear to have been based on unsubstantiated *feelings*. The available documentation does not indicate any of the participants had major formal training or qualifications in risk assessment and management of complex systems. Experience has adequately demonstrated that a few hours of training with a *risk matrix* (plot of likelihoods versus consequences) does not qualify people to perform risk assessments of complex systems. The power of this extensive branch of technology is critically dependent on the knowledge, qualifications, training, experience, and motivations of the people who use it. *Gut feelings*, like tacit knowledge, do matter, but they too need to be substantiated by appropriate risk assessment and management methods.

Hence it is not surprising that the assessments that were undertaken found no significant risks by what assessments were undertaken is, thus, not surprising. The likelihoods and consequences were incorrectly judged by those involved not to be significant. Deeply flawed and deficient risk assessment and management processes were in place and were being used. Protective barriers were in place and were incorrectly thought to be adequate and functional. The failures that developed before, during, and after the Macondo well project clearly show these risk assessment and management processes—barriers—were deeply deficient and pervasively flawed. Important things that were supposed to have been done correctly were either not done or were done incorrectly. When the system was *tested* before, during, and after the blowout, it performed miserably.

As described by Exxon-Mobil CEO Rex Tillerson in response to questions before the National Commission, an organization’s safety culture takes time (several decades) to develop and has to be grown from within—you can’t buy or import a recipe—it has to be nurtured from within the organization. Exxon-Mobil has been at it now for more than twenty years, after learning the hard way and paying for its complacency and risk management failures that led to the Valdez spill. Since that time, Exxon-Mobil has introduced many positive innovations to improve safety culture, such as their Operations Integrity Management System (OIMS), introduced in 1992 as an integral part of their overall safety management system.

In contrast, at the time of the Macondo blowout, BP’s corporate culture remained one that was embedded in risk-taking and cost-cutting – much like was found to be its case in 2005 (Texas City), in 2006 (Alaska North Slope Spill), and in 2010 (“The Spill”). Whether or not there is “evidence” that someone in the Macondo well project made a conscious decision to put costs before safety misses the more important point. It is the underlying safety culture, much of it so ingrained as to be unconscious, that governs the actions of an organization and its personnel. Cultural influences that permeate an organization and an industry and manifest in actions that can either promote and nurture a high reliability organization with high reliability systems, or actions reflective of complacency, excessive risk-taking, and a loss of team situational awareness.²⁴

Summary

The DHSG analyses of currently available information indicates this disaster was preventable if existing progressive guidelines and practices been followed—the Best Available and Safest Technology (BAST).

The multiple failures (to contain, control, mitigate, plan, and clean-up) that unfolded and ultimately drove this disaster appear to be deeply rooted in a multi-decade history of organizational malfunction and shortsightedness. There were multiple opportunities to properly assess the likelihoods and consequences of organizational decisions (i.e., Risk Assessment and Management) that were ostensibly driven by BP management’s desire to “close the competitive gap” and improve bottom-line performance. Consequently, although there were multiple chances to do the right things in the right ways at the right times, management’s perspective failed to recognize and accept its own fallibilities despite a record of recent accidents in the U.S. and a series of promises to change BP’s safety culture.

²⁴ W.E. Gale, Jr., “Perspectives on Changing Safety Culture and Managing Risk,” R.G. Bea, “Understanding the Macondo Well Failures,” K. Roberts, “After the Dust Settles,” E. Roe and P. Schulman, “A High Reliability Management Perspective on the Deepwater Horizon Spill, Including Research Implications,” DHSG Working Papers, 2010.

Analyses of currently available evidence indicates that the single critical element precipitating this blowout was the undetected entry of high pressure-high temperature *highly charged* hydrocarbons into the Macondo well. This important change in the *environment* was then allowed to exploit multiple inherent weaknesses in the system's barriers and defenses to develop a blowout. Once the blowout occurred, additional weaknesses in the system's barriers and defenses were exposed and exploited to develop the Macondo well disaster.

Analysis of the available evidence indicates that when given the opportunity to save time and money—and make money—poor decision making played a key role in accident causation. The tradeoffs that were made were perceived as safe in a normalized framework of business-as-usual. Conscience recognition of possible failure consequences seemingly never surfaced as the needle on the real-time risk-meter continued to climb. There was not any effective industry or regulatory *checks and balances* in place to counter act the increasingly deteriorating and dangerous situation on *Deepwater Horizon*. Thus, as a result of a cascade of deeply flawed failure and signal analysis, decision-making, communication, and organizational-managerial processes, safety was compromised to the point that the blowout occurred with catastrophic effects.

Chapter 4 – Going Forward

Introduction

The Department of Interior’s newly created Bureau of Offshore Energy Management, Regulation and Enforcement (BOEMRE) has issued updated rules and permitting requirements following the lessons learned and shortcomings revealed by Macondo that seek to harden the regulatory régime and enforce compliance to a much greater degree of scrutiny for all offshore well drilling activity on the OCS. As this report goes to press, the first post-Macondo deepwater drilling permit has been issued to Noble Energy to resume drilling in the Mississippi Canyon, some ten months following the blowout. BOEMRE Director Bromwich reported that “The application has met our new standards for well design, casing and cementing,” and more permit approvals are expected in the “coming weeks or months,” the bureau said in a statement.

The National Commission on the BP *Deepwater Horizon* Oil Spill and Offshore Drilling has addressed both short-term and long-term industry and government regulatory technical and organizational reforms associated with drilling and production operations in high hazard environments—including those of ultra-deep water and in the arctic. U.S. offshore oil and gas exploration and production operators—including BP, contractors, and trade organizations (e.g., American Petroleum Institute, International Association of Drilling Contractors, Society of Petroleum Engineers) also have responded with recommendations to address a variety of technical and organizational reforms for implementation in future deepwater drilling and production operations.

In its study of the Macondo incident the DHSG elected to address developments recommended for industry and government consideration that are focused on advanced Risk Assessment and Management (RAM) for hydrocarbon drilling and production operations in high hazard—high risk environments such as those of ultra-deepwater in the northern Gulf of Mexico. Chapter 4 – Going Forward addresses the DHSG’s finding and recommendations based on the Group’s unique perspective and interdisciplinary assessment of what went wrong.

Observations

As summarized in Chapter 3, the DHSG analyses of currently available information concludes that the Macondo well disaster was preventable if BP and its contractors consistently and rigorously applied and put to use the current Best Available and Safest Technology (BAST).¹ In going forward with comparable high hazard – high risk exploration and production projects, the key challenge for industry and government is to identify, implement, and verify consistent application of current BAST.

During the DHSG work several important insights emerged. One was that industry and government had embarked on development of petroleum resources in areas that presented significant increased risks—the likelihoods and consequences of system failures—while in some cases employing systems that had not kept pace with these higher risk operations. There were signs that in some cases drilling systems used in ultra-deep water projects were severely challenged by the ultra deepwater and the geologic conditions specific to the well location. In the case of the Macondo

¹ BAST and other advanced risk mitigating regulations and processes are summarized in Appendix D.

prospect, there was ample evidence that operating teams lacked the depth of knowledge, rules, skills, and teamwork required to properly address the increased hazards and risks. There was evidence of a lack of sufficient resources devoted to development, operation, and maintenance of the hardware systems employed in the Macondo well project. Procedures—formal and informal—did not adequately address the increased hazards and risk challenges. The industry knew that there were no recognized methods for stopping a deepwater blow-out other than drilling a relief well. However, the risk of a deepwater blow-out was considered by many in industry and the MMS to be very small and hence acceptable. BP’s top management and MMS had a persistent lack of awareness of these risk challenges.

These observations indicate that if the risks associated with future high-hazard hydrocarbon exploration and production projects are to be properly addressed, then the systems² used in these projects must be upgraded to consistently utilize the BAST developed by industry and government in its global activities. The most important parts of this upgraded technology is associated with the operating teams and organizations responsible for the developments—the capabilities of the human resources and how they are deployed, motivated and utilized. To mitigate current risks, high priority attention must be given by industry and government to selection, training, qualification, mentoring, and adequate compensation of operations personnel and teams. The actions required to achieve and maintain the *right stuff* will be of critical importance to enable realization of the required BAST in future high hazard hydrocarbon offshore exploration and production projects.

Findings

Finding 1 – The oil and gas industry has embarked on an important ‘next generation’ series of high hazard exploration and production operations in the ultra-deep waters of the northern Gulf of Mexico. These operations pose risks (likelihoods and consequences of major system failures) much greater than heretofore generally recognized. The significant increases in risks are due to: 1) complexities of hardware and human systems and emergent technologies used in these operations, 2) increased hazards posed by the ultra-deep water marine environment (geologic, oceanographic), 3) increased hazards posed by the hydrocarbon reservoirs^{3,4} (very high potential productivities, pressures, temperatures, gas-oil ratios, and low strength formations with very narrow *drilling windows*), and 4) the sensitivity of the marine environment to introduction of very large quantities of hydrocarbons.

Finding 2 – The Macondo well project failures demonstrated that the consequences of major offshore oil and gas system failures in ultra-deepwater in the northern Gulf of Mexico can be several orders of magnitude greater than those associated with previous generations of well drilling activities. If the risks of major system failures are to be As Low As Reasonably Practicable

² Consisting of operating teams, organizations, hardware and equipment, structures, procedures (formal, informal, standard operations, emergency, computer software), environments (external, internal, social), and interfaces among the foregoing.

³ “Lessons Learned from the Golden Zone Concept for Understanding Overpressure Development and Drilling Safety in Energy Exploration,” by Paul H. Nadeau, DHSG Working Paper, February 2011.

⁴ “A megascale view of reservoir quality in producing sandstones from the offshore Gulf of Mexico,” by R.N. Anderson and A. Boulangeur, American Association of Petroleum Geologists Bulletin, V. 92, No. 2, 2009, New York.

(ALARP),⁵ the likelihoods of major failures (e.g., uncontrolled blowouts, production operations explosions and fires) must be orders of magnitude lower than in the BP Macondo well project and those that may prevail in other similar projects planned or underway.⁶ In addition, major developments are needed to address the consequences of major system failures. Reliable systems need to be developed to enable effective and reliable containment and recovery of large releases of hydrocarbons in the marine environment.^{7, 8}

Finding 3 – The Macondo well project failures provide important opportunities to re-examine the strategies and timing for development of important non-renewable product and energy resource. This *final frontier* in the ultra-deep waters of the northern Gulf of Mexico and other similar areas provides access to an important public resource that has significant implications for the future generations and energy security of the United States.⁹ These social, economic, and national security interests, as well as safety and environmental considerations, dictate a measured pace of development consistent with sustainable supplies and development and application of BAST.

Finding 4 – Major *step change* improvements that consistently utilize BAST are required by industry and government to enable high hazard offshore exploration and production operations to develop acceptable risks and benefits. Future development of these important public resources require an advanced high competency collaborative industrial-governmental-institutional enterprise based on use of high reliability technical, organization, management, governance, and institutional systems.

Commentary

Current developments have shown there are significant challenges that need to be addressed if the recommendations that follow are to be effectively implemented. There are important developments that must be undertaken to enable realization of an effective Technology Delivery System (TDS) that will unite industry and government capabilities to deliver BAST for ultra hazardous hydrocarbon exploration and production projects. These challenges must be addressed by Federal, State, and local government agencies with responsibilities to the public and environment for these projects.

A capable and productive industry needs equally capable and productive government—governance. It is clear that the predecessor of the BOEMRE, the U.S. Minerals Management Service (MMS) was not able to keep abreast of developments associated with ultra hazardous hydrocarbon exploration and production projects. The agency was chronically under staffed and funded. The MMS was confronted with significant internal conflicts with its responsibilities for leasing, revenue, energy management, and enforcement. These conflicts have been recognized and the BOEMRE reorganized into two new, independent agencies responsible for carrying out BOEMRE's offshore

⁵ “Legal framework considerations in the development of risk acceptance criteria,” by D.N.D. Hartford, *Structural Safety*, Vol. 31, 2009.

⁶ “Risk Assessment & Management: Challenges of the Macondo Well Blowout Disaster.” by Robert G. Bea, DHSG Working Paper, January 2011.

⁷ “The Macondo Blowout Environmental Report,” by Thomas Azwell, Michael J. Blum, Anthony Hare, Samantha Joye, Sindhu Kubendran, Artin Laleian, George Lane, Douglas J. Meffert, Edward B. Overton, John Thomas III, and LuAnn E. White, DHSG Working Paper, January 2011.

⁸ “A Perspective From Within Deepwater Horizon’s Unified Command Post Houma,” by Charles Epperson.

⁹ “World Energy Outlook 2010,” International Energy Agency, Paris Cedex, France.

energy management and enforcement functions: The Bureau of Safety and Environmental Enforcement (BSEE) and The Bureau of Ocean Energy Management (BOEM).

Currently, these BOEMRE developments are confronted with simultaneous needs to reorganize, increase staff, develop capabilities, and maintain a reasonable pace of developments in offshore hydrocarbon exploration and production activities; and at the same time, develop advanced capabilities to address proposals for new high risk exploration and production projects. At this time, Congressional approval of proposed funding and staff additions required to develop the required capabilities has not been obtained. The rapid pace of developments and the resulting *stalemates* in provision of the necessary resources have inhibited the necessary organizational developments by the BOEMRE. This has led to undesirable delays in development of plans and processes to enable continuation of both conventional and unconventional offshore exploration and production projects. As a result, industry activities have experienced and continue to experience significant delays and disruptions.

If the BOEMRE is to be able to realize its short and long term goals and responsibilities, then it is mandatory that Congress approve and authorize as soon as possible the required funding and staff additions. However, even with the required funding and staff additions, it will take significant time for the BOEMRE to develop the capabilities to address the *system risks* associated with ultra hazardous hydrocarbon exploration and production projects. In the interim, it is suggested that BOEMRE employ experienced and qualified non-government consultants, contractors, classification societies, and individuals (e.g., retired industry managers, engineers, operations personnel) having demonstrated capabilities to properly evaluate the BAST required to address system risks associated with high risk hydrocarbon exploration and production projects. This would be similar to the Certified Verification Agent program previously utilized by the MMS for offshore projects that presented exceptional hazards and risks.

The BOEMRE has taken significant steps to engage other Federal agencies that have important capabilities that need to be employed to help address the challenges represented in ultra hazardous hydrocarbon exploration and production projects including the U.S. Coast Guard, The Department of Energy, the National Oceanic and Atmospheric Administration, and the U.S. Geological Survey. Additional Federal interagency collaborations are encouraged with organizations that have developed advanced capabilities to assess and manage the system risks associated with high hazard-high technology systems such as the Nuclear Regulatory Agency and the Federal Aviation Agency. The Department of Interior, in coordination with the Department of Energy, the United States Coast Guard and the National Oceanic and Atmospheric Administration has initiated creation of an Ocean Energy Safety Institute—representing a collaboration among government, industry, academia and outside experts to develop advanced RAM technology and required containment and oil spill response capabilities. These cooperative engagements are extremely important to help insure that the BAST is developed and employed in realization of the Federal government’s responsibilities for future offshore oil and gas projects.

State and local government agencies with responsibilities for offshore oil and gas operations also face challenges similar to, and in some cases, more difficult than those faced by the BOEMRE. Such State and local government challenges were particularly evident during the post-blowout phase of the Macondo well project. State and local government agencies must be adequately developed, funded, and staffed to enable them to do their parts to assure that the interests of the public and

environment are properly addressed in offshore oil and gas exploration and production developments.

Industry also faces needs to further develop its capabilities to consistently apply the BAST in ultra hazardous hydrocarbon exploration and production projects offshore the U.S. Many of the major operators working offshore the U.S. already have developed and demonstrated capabilities to apply the BAST in ultra hazardous hydrocarbon exploration and production projects in their U.S. and international offshore operations. Many of these major operators are very familiar with full-scope life-cycle Safety Cases, RAM, High Reliability Organizations, High Reliability Governance, High Reliability Systems and other advanced processes required to properly address the *system risks* associated with ultra hazardous hydrocarbon exploration and production projects. These operators should take a leadership position to demonstrate that BAST can be consistently and properly applied in U.S. offshore operations—including those performed for the operators by offshore contractors and service companies.

At the same time, it is evident that industry also must address important challenges to upgrade selection (people with the right talents for the tasks to be performed), training (for normal, emergency, and abnormal activities)¹⁰, mentoring, collaboration, and teamwork of management, engineering, and operations personnel (operators, contractors, service companies) who do the work associated with ultra hazardous hydrocarbon exploration and production projects. There are important needs to make design, process, equipment and materials upgrades that will enable consistent realization of BAST in these operations including those in blowout prevention and emergency response systems, well design and construction (e.g., cement and cementing processes), well drilling and completion systems, and oil spill containment and recovery.¹¹

These developments should be fostered by permitting a series of *demonstration projects* that would engage highly qualified operators, contractors, service companies, classification societies, and consultants to demonstrate that ultra hazardous exploration and production projects can be developed and performed while properly addressing the system risks associated with these projects.

¹⁰ “Managing the Unpredictable,” Robert Bea, *Engineering Management, Mechanical Engineering*, American Society of Mechanical Engineers, March 2008.

¹¹ Suggested design, process, equipment and material upgrades are provided in Appendix E.

Recommendations

Recommendation 1 – Develop and maintain an effective Technology Delivery System (TDS) fostering industry and government (Federal, State, Local) collaboration in exploration for and development of high hazard environment hydrocarbon resources in reliable and sustainable ways.

Background on development and implementation of an effective TDS is provided in the DHSG Working Papers by:

- Ed Wenk, Jr. titled “How Safe is Safe?” and
- Robert Bea titled “Risk Assessment & Management: Challenges of the Macondo Well Blowout Disaster.”

Recommendation 2 – Develop and maintain industrial-governmental institutions responsible for development, validation, advancement, and implementation of Risk Assessment and Management (RAM) technology including definition of RAM goals and objectives for exploration and production of high hazard environment hydrocarbon resources.

Background on development of industrial-governmental institutions responsible for RAM technology for exploration and production of high hazard hydrocarbon resources is provided in the DHSG Working Papers by:

- Earl Carnes titled “Highly Reliable Governance of Complex Socio-technical Systems,”
- Michael Baram and Florian Buchler titled “Institutional Governance of Offshore Oil and Gas Developments,” and
- Michael Baram titled “Institutional Recommendations.”

Key elements included in Recommendation 2 Working Papers include development, implementation, and maintenance of:

- New government regulation model with:
 - Independent government regulatory agency with clarified regulatory roles and integrated functions coordinated with other Federal government agencies (e.g., U.S. Coast Guard, Occupational Safety and Health Administration, Environmental Protection Agency, National Oceanic and Oceanographic Administration, U.S. Geological Survey) and State agencies established under the Coastal Zone Management Act with improved oil spill response capabilities provided by the National Response Framework and applicable legislation such as the Oil Pollution Act and the Stafford Act,
 - A systems safety regulatory model clearly establishing that system safety is necessary to prevent major events; that worker protection models, while essential and mandatory, alone are not sufficient,
 - Compliance by regulatory authorities and permit applications with the National Environmental Policy Act based on context-specific and activity-

specific information and assessments of the foreseeable impacts of routine operations, accidents, and other non-routine incidents on the human and natural environments,

- Risk-informed regulation (a combination of traditional engineering requirements for technical systems and components informed by probabilistic risk assessment to focus on safety critical systems and components, combined with performance regulations for management and organizational systems and processes),
 - Intense advanced training and qualification programs for inspectors who has had “Hands on Experience,”
 - Defined Management of Change systems with clear responsibilities,
 - Operating experience monitoring together with inspectors and promotion of organizational learning from anomalies, near misses and accidents, and
 - Industry-wide operations reporting system with “whistle blower” protection.
- A competent independent organization, established by industry and government, to perform evaluations of drilling programs and production operations.
 - Independent standards and training to promote excellence.
 - Industry-funded accident insurance pool to supply a guaranteed source of funds to pay for compensation for loss of life and injuries, environmental cleanup, and economic damages.
 - Research on petroleum industry management excellence and risk awareness.
 - Research and investment in developing new safer and cheaper technologies.
 - Safety equipment standardization and qualification.
 - Industry-wide emergency response capability to include a industry-funded network of oil spill response operators and response equipment.

Recommendation 3 – Implement proven RAM technology within industrial and governmental organizations to create and maintain High Reliability Organizations, Highly Reliable Governance, and High Reliability Systems used in exploration and development of high hazard environment hydrocarbon resources.

Recommendation 3.1 – Develop and maintain industrial and governmental High Reliability Organizations (operators, contractors, regulators) that maintain adequate and acceptable balances of protection and production. These are organizations that have strong core *System Safety Cultures*.

Background on development of High Reliability Organizations having High Reliability Management and cultures that provide adequate and acceptable balances of protection and production is provided in Chapter 3 of this report and the DHSG Working Papers by:

- William E. Gale, Jr., titled “Perspectives on Changing Safety Culture and Managing Risk,”
- Karlene Roberts titled “After the Dust Settles...,” and
- Emery Roe and Paul Schulman titled “A High Reliability Management Perspective on the *Deepwater Horizon* Spill, Including Research Implications.”

Recommendation 3.2 – Develop and maintain advanced RAM technology in life-cycle full-scope system *Safety Cases* that engage operators, contractors, and regulators in collaborative development and maintenance of high reliability exploration and production systems.

Background on RAM technology for high hazard exploration and production systems is provided in the DHSG Working Papers by:

- Gary Marsh titled “Generalized Temporary Abandonment Procedure for Pull of Subsea BOP for Repair,” and “What Might Have Been – Risk Assessment and Management Analysis (RAM) of BP Tapered Production Casing Plan,”
- David Pritchard and Kevin Lacy titled “Deepwater Well Complexity – The New Domain,”
- Emery Roe titled “An Industry Stress Test for Deepwater Drilling and Exploration Companies?”
- David Pritchard titled “Drilling Hazards Management – Excellence in Drilling Performance Begins with Planning,” “The Value of the Risk Assessment Process,” and “Mitigating Drilling Hazards with Technologies,”
- Yngvar Duesund and Ove Gudmestad titled “Deepwater Well Design, Competency – Management of Risks,”
- Ove Gudmestad and Marriane Tiffany titled “Issue Management, Treatment of ‘Bad News’,”
- Jon Espen Skogdalen, Ingrid Utne, and Jan Erik Vinnem titled “Looking Back and Forward: Could Safety Indicators Have Given Early Warnings About the *Deepwater Horizon* Accident?”
- Robert Bea titled “Risk Assessment & Management: Challenges of the Macondo Well Blowout Disaster,” and “Managing Rapidly Developing Crises: Real-Time Prevention of Failures,”
- David Pritchard and Kenneth Kotow titled “The New Domain in Deepwater Drilling: Applied Engineering and Organizational Impacts on Uncertainties and Risk,”
- Jon Espen Skogdalen and Oyvind Smogeli titled “Looking Forward – Reliability of Safety Critical Control Systems on Offshore Drilling Vessels,”
- Paul Donley titled “This is Not About Mystics: Or Why a Little Science Would Help A Lot,”
- Michael Baram titled “Preventing Accidents in Offshore Oil and Gas Operations: The U.S. Approach and Some Contrasting Features of the Norwegian Approach,” and
- Jahon Khorsandi titled “Summary of Various Risk-Mitigating Regulations and Practices Applied to Offshore Operations.”

Key elements included in the Recommendation 3.2 Working Papers include development, implementation, and maintenance of:

- Shared operator, contractor, regulator, real-time electronic operations and well monitoring, analysis, management of change, decision support, and communications and alert systems;
- Industry and government field operations system safety barriers (leading, lagging) reporting, analysis, e-learning, and communications systems with stop work authority and whistle blower anonymity and protection;
- Risk assessment and management training systems (classroom, simulators, e-learning, on-the-job) including drilling and completion hazards awareness and management programs;
- Robust risk assessment and management requirements—including organizational responsibilities and authorities and formal Management of Change Requirements—in all design and crucial execution phases;
- Operations personnel selection, training, and certification programs for high hazard operations (normal, abnormal, crisis) involving classroom instruction, simulation training, field training, on-the-job training, and career mentoring;
- Competency selection, training, and career development programs for operator – contractor operations teams and regulators;
- Requirements for third-party testing (onshore and offshore), maintenance, verification and upgrading programs for all safety critical control systems including electronic control system software;
- Stress—risk assessment and management training, testing and verification for operators and contractors; and
- Requirements full-scope life-cycle RAM Safety Cases based on SEMP and BAST including integrated Proactive (before important operations initiated), Interactive (during important operations), and Reactive (after operations completed to improve understanding and control—mitigate consequences) approaches with coordinated strategies to reduce the likelihoods and consequences of failures and to increase proper detection, analysis and correction of malfunctions before failures develop.

Recommendation 3.3 – Develop and maintain effective and reliable oil spill and blowout response containment and recovery systems capable of operating in high hazard hydrocarbon exploration and production environments.

Background on environmental impacts from the Macondo well blowout and development and maintenance of reliable oil spill response containment and recovery systems capable of operating in high hazard hydrocarbon exploration and production environments of is provided in the DHSG Working Papers by:

- Thomas Azwell, Michael J. Blum, Anthony Hare, Samantha Joye, Sindhu Kubendran, Artin Laleian, George Lane, Douglas J. Meffert, Edward B. Overton, John Thomas III, and LuAnn E. White titled “The Macondo Blowout Environmental Report,”
- Charles Epperson titled “A Perspective From Within *Deepwater Horizon’s* Unified Command Post Houma,”

- George Lane titled “Air Quality Issues – Air Monitoring Needed for Workers on Vessels,”
- Luann White titled “Human Health,”
- Artin Laleian and Thomas Azwell titled “The Tradeoffs of Chemical Dispersant Use in Marine Oil Spills,” and
- Sindhu Kubendran titled “Waste Management and the Gulf Oil Spill.”

Key elements included in Recommendation 3.3 Working Papers include:

- Development, testing, maintenance and deployment of an effective containment and recovery protocol that removes oil from the environment,
- Development of trade-offs of technology choices such that environmental protection is prioritized,
- Inclusion of natural gas in measures of total petroleum - hydrocarbon discharges,
- Inclusion of waste generated by cleanup response as a component of cumulative environmental impact,
- Expansion of research into the oil’s pathways and half-life, e.g. naturally dispersed, recovered, evaporated, etc.,
- Minimization of occupational risks associated with cleanup efforts through adequate water toxicity testing and air quality monitoring, and
- Inclusion of a mechanism for participation from academic researchers in the response plan of the Incident Command System

Recommendation 3.4 – These recommendations should be fostered by permitting a series of *validation projects* that would engage highly qualified operators, contractors, service companies, classification societies, and consultants in field demonstrations that ultra hazardous high-risk exploration and production projects can be performed while properly addressing the system risks associated with such projects.

Summary

The background developed by the DHSG clearly indicates that required BAST already exists for performing offshore high-hazard high-risk exploration and production projects with an acceptable level of residual risk. The major challenge facing the industry and governments is identification, application, maintenance, and validation that BAST is diligently applied to all of the components that comprise the complex systems utilized in these projects and that changing real-time risk levels are recognized and properly managed during the course of operations. Particular attention must be given to the operating team and organizational components of these complex systems so they are able to realize the benefits from application of BAST and achieve safe operations through developing and maintaining diligent HROs having core System Safety Cultures.

Appendix A – Deepwater Horizon Study Group Members and Affiliations

Thomas Azwell, Doctoral Student, Researcher, Department of Environmental Science, Policy, and Management, University of California, Berkeley.

Michael Baram, LL.B., Professor Emeritus, Boston University Law School, Boston, Massachusetts.

Robert G. Bea, Ph.D., P.E., Professor, Department of Civil and Environmental Engineering, University of California, Berkeley.

Michael J. Blum, Ph.D., Arnold Early Career Professor in Earth and Ecological Science, Department of Ecology and Evolutionary Biology, Tulane University, New Orleans, Louisiana.

K. Florian Buchler, LL.M., ESQ., New Orleans, Louisiana.

W. E. Carnes, M.A., B.S., Practitioner Associate, Center for Catastrophic Risk Management, Haas School of Business, University of California, Berkeley.

Paul Donley, Corporate Trainer, Programmer, Web Developer, Relevant Training, Melbourne, VIC Australia.

Yngvar Duesund, Special Advisor to the Center for Information Technology Research in the Interest of Society, The Banatao Institute—CITRIS, University of California, Berkeley.

R.Charles Epperson, Civilian, Reserve Lieutenant, Senior Planner, United States Coast Guard.

Howard Foster, Ph.D., Analyst, Geographic Information Science Center, University of California, Berkeley.

William E. Gale Jr., Ph.D., P.E., CSP, CFEI, CFII, Forensic Engineering Consultant, President, William E. Gale, Jr., Inc.; Principal, Bundy, Gale & Shields LLC, Novato, California.

Ove T. Gudmestad, Ph.D., Professor, Faculty of Science and Technology, University of Stavanger, Stavanger, Norway.

Anthony Hare, Psy.D., Executive Director, Center for Catastrophic Risk Management, University of California Berkeley.

Samantha Joye, Ph.D., Professor, Department of Marine Sciences, University of Georgia

Jahon D. Khorsandi, M.S.E., Graduate Student Researcher, Center for Catastrophic Risk Management, University of California, Berkeley.

Trevor A. Kletz, D.Sc., Visiting (Adjunct) Professor, University of Loughborough, United Kingdom.

Kenneth Kotow, P.E., Senior Associate, Successful Energy Practices International, San Antonio, Texas.

Sindhu Kubendran, B.S., Research Associate, University of California, Berkeley.

Kevin Lacy, B.S., Petroleum Engineering, M.B.A., Senior Vice President, Global Drilling and Completions, Talisman Energy, Calgary Alberta, Canada.

George Lane, Ph.D., Director R&D, Emergency Response Technology, Baton Rouge, Louisiana.

Artin Laleian, Student, Research Associate, University of California, Berkeley.

Gary Marsh, B.S.M.E., Retired, Shell Drilling Engineering Advisor, Houston, Texas.

Paul H. Nadeau, Geologist, Center for Catastrophic Risk Management, University of California, Berkeley.

Wayne Needoba, B.S., P.E., Consultant on Drilling, Project Coordination, Learning, Competence Assessment, Labrador Holdings WA, Perth, Western Australia; Managing Director, LIS Thailand Co., Chiang Mai, Thailand.

Scott Nicholson, MSCE, MCP, MLA, Doctoral Graduate Student Researcher, University of California, Berkeley.

Michael L. Olson, Ph.D., P.E., Innovation, Sustainability, and Change Management Consultant, Walnut Creek, California.

David M. Pritchard, B.S, P.E., Owner, Successful Energy Practices International LLC, San Antonio, TX

John D. Radke, Ph.D., Associate Professor of City & Regional Planning and Landscape Architecture & Environmental Planning; Director, Geographic Information Science Center.

Karlene Roberts, Ph.D., Professor Emeritus, Haas School of Business, Director, Center for Catastrophic Risk Management, University of California, Berkeley.

Emery Roe, Ph.D., Research Associate, Center for Catastrophic Risk Management, Haas School of Business, University of California, Berkeley.

David Rosenberg, Civil & Ocean Engineering, Commercial Diving and Salvage, New Orleans, Louisiana.

Paul Schulman, Ph.D., Research Associate, Center for Catastrophic Risk Management, Haas School of Business, University of California, Berkeley.

Jon Espen Skogdalen, M.S.E., Research Fellow, Visiting Fulbright Scholar, Department of Civil and Environmental Engineering, University of California, Berkeley; Research Fellow, Doctoral Student, Faculty of Science and Technology, University of Stavanger, Norway.

Liz Taylor, President, DOER Marine, Alameda, California.

John Thomas III., Law Student, Golden Gate University School of Law, San Francisco, California

Marianne Tiffany, B.Sc., School of Psychology, the University of Aberdeen, Aberdeen, Grampian, United Kingdom.

Ingrid B. Utne, Ph.D., Visiting Scholar, Department of Mechanical Engineering, University of California, Berkeley; Professor (Qualification Fellowship), Department of Marine Technology, Norwegian University of Science and Technology, Trondheim, Norway.

Jan-Erik Vinnem, Ph.D., Professor II, Faculty of Science and Technology, University of Stavanger, Norway.

Ed Wenk Jr., Ph.D., Emeritus Professor of Engineering, Public Administration and Social Management of Technology, University of Washington at Seattle, Washington.

LuAnn E. White, Ph.D., DABT, Tulane University School of Public Health and Tropical Medicine, New Orleans. LA

Appendix B – List of DHSG Working Papers

Causative Technical and Operational Elements of the Deepwater Horizon Blowout by Gary L. Marsh

Cementing 7” X 9-7/8” Production Casing at MC 252#1 Well by Gary L. Marsh

Deepwater Well Complexity - The New Domain by David M. Pritchard, Kevin Lacy

Final Fateful Flaws by Gary L. Marsh

Generalized Temporary Abandonment Procedure for Pull of Subsea BOP for Repair by Gary L. Marsh

Looking forward - Reliability of safety critical control systems on offshore drilling vessels by Jon Espen Skogdalen, Øyvind Smogeli

Mistakes – Omissions on Macondo Well by Gary L. Marsh

What Might Have Been - Risk Assessment and Management Analysis (RAM) Of BP Tapered Production Casing Plan by Gary L. Marsh

Why B/S Rams May Not Have Sealed On ROV Deadman Command by Gary L. Marsh

Considerations for Underwater Investigation and Salvage of Deepwater Horizon by David Rosenberg

A High Reliability Management Perspective on the Deepwater Horizon Spill, Including Research Implications by Emery Roe, Paul Schulman

After the Dust Settles...., by Karlene Roberts

An Industry Stress Test for Deepwater Drilling & Exploration Companies? by Emery Roe

Drilling Hazards Management - Excellence in Drilling Performance Begins with Planning (Part 1), by David M. Pritchard

The Value of the Risk Assessment Process (Part 2) by David M. Pritchard

Mitigating Drilling Hazards with Technologies (Part 3) by David M. Pritchard

This Is Not About Mystics: Or Why a Little Science Would Help a Lot, by Paul Donley

Lessons Learned From the Golden Zone Concept for Understanding Overpressure Development and Drilling Safety in energy Exploration by Paul H. Nadeau

Deepwater Well Design, Competency – Management of Risks by Yngvar Duesund, Ove T. Gudmestad

Evacuation, Escape, and Rescue (EER) from the Deepwater Horizon by Jon Espen Skogdalen, Jahon D. Khorsandi, Jan Erik Vinnem

Highly Reliable Governance of Complex Socio-technical Systems by W.E. Carnes

How Safe is Safe? Coping with Mother Nature, Human Nature and Technology’s Unintended Consequences by Edward Wenk, Jr.

Issue Management, Treatment of “Bad News” by Ove T. Gudmestad, Marriane Tiffany

Looking Back and Forward: Could Safety Indicators Have Given Early Warnings About the Deepwater Horizon Accident? By Jon Espen Skogdalen, Ingrid B. Utne, Jan Erik Vinnem

Managing Rapidly Developing Crises: Real-Time Prevention of failures, by Robert G. Bea

Perspectives on Changing Safety Culture and Managing Risk, by William E. Gale, Jr.

Risk Assessment & Management: Challenges of the Macondo Well Blowout Disaster, by Robert G. Bea

The New Domain in Deepwater Drilling: Applied Engineering and Organizational Impacts on Uncertainties and Risk by David M. Pritchard, Kenneth J. Kotow

Understanding the Macondo Disasters, by Robert G. Bea

Preventing Accidents in Offshore Oil and Gas Operations: The US Approach and Some Contrasting Features of the Norwegian Approach, by Michael Baram

Institutional Recommendations, by Michael Baram

Institutional Governance of Offshore Oil and Gas Development, by Michael Baram, Florian Buchler

Summary of Various Risk-Mitigating Regulations and Practices Applied to Offshore Operations, by Jahon Khorsandi

The Macondo Blowout Environmental Report, by Thomas Azwell, Michael J. Blum, Anthony Hare, Samantha Joye, Sindhu Kubendran, Artin Laleian, George Lane, Douglas J. Meffert, Edward Bl. Overton, John Thomas III, and LuAnn E. White

A Perspective from within Deepwater Horizon’s Unified Command Post Houma, by R. Charles Epperson

Air Quality Issues - Air Monitoring Needed for Cleanup Workers in Vessels, by George Lane

Human Health, by Luann White

The Tradeoffs of Chemical Dispersant Use in Marine Oil Spills, by Artin Laleian, Thomas Azwell

Waste Management and the Gulf Oil Spill, by Sindhu Kubendran

Appendix C – Primary Organizations Involved in the Macondo Well Project

Deepwater drilling operations are large and complex, requiring the knowledge and services of several parties and organizations. Such organizations include the operators (in this case, BP), partners, contractors, and subcontractors, as well as the governmental agencies which provide regulatory oversight. Based on currently available information and testimony, the following provides a summary of the primary organizations involved in the Macondo well project.

Minerals Management Service (MMS), under the authority of the Department of Interior, was the regulating body in charge of leasing activities and overseeing offshore operations for the Outer Continental Shelf (OCS). Since June 18, 2010, the MMS was renamed the Bureau of Ocean Energy Management, Regulation and Enforcement (BOEMRE).

Before exploratory drilling began on the Mississippi Canyon Block 252 which BP had leased, BP submitted an exploration plan to the MMS that specified the details of where and how exploratory drilling activities would take place. BP also submitted an *Application for Permit to Drill* (APD) to the MMS for the drilling of the Macondo well. The MMS approved the plan and issued the permits for BP to begin drilling. If modifications were to be made during the drilling operations, BP was required to notify the MMS obtain permits for the proposed changes. BP had submitted *Applications for Permit to Modify* (APM) to the MMS for approval of such changes. Inspectors from the MMS had visited the *Deepwater Horizon* to monitor and inspect the drilling activities on the Macondo well.

As the operator, BP leased the offshore parcel of land from the U.S. government in order to drill and explore for natural resources. The Macondo well was a joint venture including BP (65%), Anadarko (25%), and MOEX Offshore 2007 (10%). As the major shareholder, BP was the operator, in charge of overseeing operations of the well.

BP as the operator was responsible for obtaining seismic data and assessing the subsurface formation, engineering design of the well, and submitting detailed plans of the intended operations to the government (MMS) in order to obtain the permits required to drill and construct the well. Once the plans were approved and permits were issued, BP served as the general contractor, in the sense that it was responsible for hiring and overseeing the work of various contractors needed to support the drilling operations and the design and construction of the well. BP personnel were present on board the *Deepwater Horizon* floating dynamically positioned drilling unit leased from Transocean overseeing the operations and activities.

Transocean was selected by BP selected to provide the drilling rig *Deepwater Horizon*, including the personnel required to operate it. Transocean was responsible for operations and maintenance of the rig, including subsea equipment such as the BOP. Transocean carried out the drilling activities based on the well plan provided by BP. As the operator, BP held the right to approve and inspect the work carried out on its behalf by Transocean. Transocean was responsible for the actual performance and supervision of the work.

Halliburton was the cementing contractor which provided engineering services, materials, testing, mixing, and pumping for the cementing of the Macondo well. The purpose of cementing is to seal the well so that hydrocarbons cannot enter the wellbore and rise to the surface. Once cement is in place, drilling mud is no longer needed to control the reservoir pressures. Halliburton provided advice regarding the design, modeling, testing, and placement of the cement.

Sperry-Sun, which is a Halliburton company, provided mud logging equipment and personnel to assist the driller with monitoring the well, in addition to services including assistance with mud logging, monitoring the mud pit changes and the flow to and from the well, and pressure fluctuations.

Schlumberger provided well logging services to measure formation properties in the well including resistivity, conductivity, and formation pressures, as well as sonic properties and wellbore dimensions.

M-I SWACO was contracted to provide drilling mud products, as well as personnel (mud engineer) to perform engineering services and supervise the mud operations. In drilling operations, heavy mud is used to control the pressures inside the reservoir to avoid hydrocarbons from moving up the well onto the rig. M-I SWACO monitored the mud properties and specified additives to be mixed, and reported on the conditions and effectiveness of the mud to BP. M-I SWACO's mud engineer on board the rig supervised mud handling operations carried out by the Transocean crew.

Weatherford provided the casing components used in the Macondo well, which included the float collar, shoe, and centralizers, as well as the personnel and equipment necessary for installing the casing and components. Casings are large pipes installed in the drilled hole in a telescopic manner to maintain the integrity of the wellbore, and are the primary barrier to fluids entering the well. The types of casings to be installed were specified by BP.

Dril-Quip was contracted to provide wellhead equipment and the personnel necessary to supervise the installation and maintenance of the equipment which included the casing hangers, seal assembly, and the lockdown sleeve.

Oceaneering was contracted to provide remote operated vehicle (ROV) equipment and the personnel required for its operations in order to inspect the subsea equipment used for the Macondo well, including the wellhead, BOP, and riser, as well as the seafloor. For deepwater operations, divers cannot reach the depths necessary to perform such tasks, for which ROVs can provide valuable assistance.

Appendix D – Summary of Risk Mitigating Regulations

Regulations in the UK

Safety Case Regulations

Quantitative Risk Analysis (QRA), also known as *Quantified Risk Assessment* is a type of risk assessment frequently applied to offshore operations. Following the tragic Piper Alpha incident in 1988, the UK regulations experienced major changes based on the recommendations from the official inquiry led by Lord Cullen. Lord Cullen recommended that risk assessment practices be implemented into the UK legislation similar to those implemented earlier in Norway. The following regulations have been issued as a result:

- Safety Case Regulations (SCR)
- Prevention of Fire and Explosion, and Emergency Response Regulations (PFEER)
- Management and Administration Regulations
- Design and Construction Regulation

A safety case is a document which provides evidence of a duty holder's ability and means to control the risks of major accidents effectively. According to the HSE, "The Offshore Installations (Safety Case) Regulations 2005 (SCR05) aims to reduce the risks from major accident hazards to the health and safety of the workforce employed on offshore installations or in connected activities."¹ The principle purpose for producing a safety case is to present how the system will be deemed safe in a given context. Therefore, in order to prepare a safety case, it is necessary to understand the levels of risks involved with a system, and whether they satisfy the legal requirements.

In the UK, it is required that all installations must have a safety case in order to operate. The requirements for safety cases differ depending on the type of installation, such as those for production facilities, and those used for drilling, exploration, or accommodation. Submitting a safety case is generally the responsibility of an operator of a production installation and the owner of a non-production installation.

For new installations, operators are required to notify the Health and Safety Executive early in the design phase. This is because incorporating safety in design is an important role of QRA in an effort to reduce accidents rooted in the design of offshore facilities. The notification must be followed by the submission of the safety case, for which the HSE must grant approval before the installation can be operated. Notifications are also required if a production installation is planned to move to a different location, or if a non-production installation is converted to a production installation. Similarly, for an installation with an approved safety case, in the case of change of location, they must submit a revision of the safety case for approval by the HSE. Dismantling of a fixed platform also requires an approved safety case.

¹ The Offshore Installations (Safety Case) Regulations 2005, Retrieved September 9, 2010, ref: <http://www.legislation.gov.uk/uksi/2005/3117/contents/made>.

In general, safety case regulations require the duty holder to identify hazards, evaluate levels of risk, and demonstrate that the appropriate measures are or will be in place to control the risks to an extent that the residual risk level is *As Low As Reasonably Practicable* (ALARP). According to Vinnem, “The Safety Case should also demonstrate that the operator has a HES (health, environment, safety) management system which is adequate in order to ensure compliance with all health and safety regulatory requirements.”²

A safety case is assessed under three principal adequacy criteria³:

- Management systems to ensure compliance with statutory health and safety requirements
- Arrangements for auditing and reporting
- Major hazards identification, risk assessment, and control

Further information can be found in the Offshore Installations (Safety Case) Regulations 2005 (SCR05).

Purpose of a Safety Case Report

The purpose of the safety case as stated by the Lord Cullen Inquiry⁴ is:

“Primarily the safety case is a matter of ensuring that every company produces a formal safety assessment to assure itself that its operations are safe.”

The safety case report is essentially a document that can be used to ensure the duty holder and HSE that the necessary risk control measures and health and safety management systems are in place, and can operate as intended.

The Safety Case Report, which previously lasted 3 years (before being required to be resubmitted for assessment), now lasts the life of the installation. However, the duty holder is still required to revise and review the safety case at least every five years, or as directed by the HSE as a demonstration of safety to reflect changing knowledge and operational conditions. It is required that HSE accepts the safety case before an installation is permitted to operate. In order to assess the safety case, HSE’s offshore division (OSD) uses the principles outlined in the Assessment Principles for Offshore Safety Cases (APOSC).⁵ According to the APOSC, “The principles should be widely known by industry managers, technical experts and employees, enabling a common understanding of the process.” It is important to understand that the safety case report does not contain any quantitative criteria or formulae for the design of oil and gas installations. A Qualitative Risk Assessment

² Vinnem, Jan Erik. *Offshore Risk Assessment: Principles, Modeling and Applications of QRA Studies*. 2nd Ed. London, Springer series in reliability engineering, Limited 2007. p10.

³ Bureau Veritas Website, Retrieved September 9, 2010, ref: http://bureauveritas.com/wps/wcm/connect/bv_com/Group/Home/bv_com_serviceSheetDetails?serviceSheetId=1102&serviceSheetName=Offshore+Safety+Case+Management+and+Review.

⁴ Maguire, Richard. *Safety Cases and Safety Reports: Meaning, Motivation and Management*. Abingdon, Oxon, GBR: Ashgate Publishing, Limited, 2008. p46.

⁵ Health and Safety Executive (HSE) 2006, *Assessment Principles for Offshore safety Cases (APOSC)*, Retrieved September 9, 2010, ref: <http://www.hse.gov.uk/offshore/aposc190306.pdf>.

(QRA) approach should be used to demonstrate the level of risk to personnel on the installation is As Low As Reasonably Practicable. Further information and guidance on the application of QRA methods can be found in the HSE Offshore information sheet No. 3/2006⁶ titled: “Guidance for Risk Assessment for Offshore Installations.”

Every system of regulations however, has its own set of challenges and difficulties in its implementation and effectiveness; hence it is important to understand those challenges in order to optimize the effectiveness. According to the HSE Offshore Health and Safety Strategy to 2010,⁷ such challenges/barriers for improving safety performance on the UKCS are as follows:

“A number of barriers appear to inhibit improvements in the safety performance on the UKCS. The UKCS has developed relatively sophisticated safety policies and procedures, which have served to improve the technical integrity of installations, yet have failed to instill, at all levels, personal accountability and responsibility for safety. More importantly visible safety leadership from senior players in the oil and gas industry is not consistent. As a result many workers do not believe it to be the high priority that duty holders claim it to be.”

PFEER Regulations

The Prevention of Fire and Explosion, and Emergency Response (PFEER)⁸ Regulations, according to the HSE, outlines the requirements necessary to:

- Prevent fires and explosions, and provide protection to persons from the effects of those which occur;
- Secure effective arrangements for emergency response.

The purpose of the PFEER regulations is to ensure that the residual risk levels are As Low As Reasonably Practicable (ALARP) in the case of a fire or explosion, and to ensure effective emergency response arrangements that would allow for the safe rescue of personnel, for all possible scenarios. The regulations apply to both fixed and mobile installations (however for mobile installations it does not apply when they are in transit). Also important in these regulations is that according to the HSE “The duty holder has a responsibility to all people on the installation—not just their own employees.”⁸ According to PFEER Regulation 5⁸:

“The regulation requires the duty holder to repeat the assessment as often as may be appropriate. This would include, for example, taking account of changes to the installation or to working activities, and the introduction of new equipment or systems.”

⁶ Health and Safety Executive (HSE) 2006, *Guidance on Risk Assessment for Offshore Installations, Offshore Information Sheet No. 3/2006*, Retrieved September 9, 2010, ref: <http://www.hse.gov.uk/offshore/sheet32006.pdf>

⁷ Health and Safety Executive, *HSE Offshore Health and Safety Strategy to 2010*, Retrieved September 10, 2010, ref: <http://www.hse.gov.uk/consult/disdocs/offshore2010.pdf> (pg8).

⁸ Health and Safety Executive, *HSE Offshore Installations (Prevention of Fire and Explosion, and Emergency Response) Regulations 1995. Approved Code of Practice and Guidance*, Retrieved October 10, 2010, ref: <http://www.hse.gov.uk/pubns/priced/l65.pdf>.

“The regulation does not itself stipulate the measures to be taken and the arrangements to be made as a result of the assessment. But the assessment should be used as the basis for determining the detailed measures and arrangements to be made to comply with the other PFEER Regulations.”

Reducing risks to personnel to ALARP requires the application of risk-based design practices and the use of QRA for fire and explosion evaluations.

ALARP (As Low As Reasonably Practicable)

Duty holders use various methods to reduce the levels of risk to a system, however as it is not possible to completely eliminate all risks involved, there will always be a certain level of risk remaining known as residual risk. ALARP is a term used to express an expected level of residual risk involved with a system or set of operations.⁹ What this means, is that the duty holder, overseen by the regulatory authorities, is responsible for exercising good practice and judgment to ensure the necessary measures have been taken in order to reduce the levels of risk, such that the residual risk levels are as low as reasonably practicable.

ALARP fundamentally has the same meaning as So Far As Is Reasonably Practicable (SFAIRP). The meaning of the two terms involves weighing the risk against time, effort and the money required to control it. Thus, ALARP is a term used to describe the level for which risks are controlled. Figure D.1, and Figure D.2 show how the level of risk assessment applied should be proportionate to the magnitude of the risk.

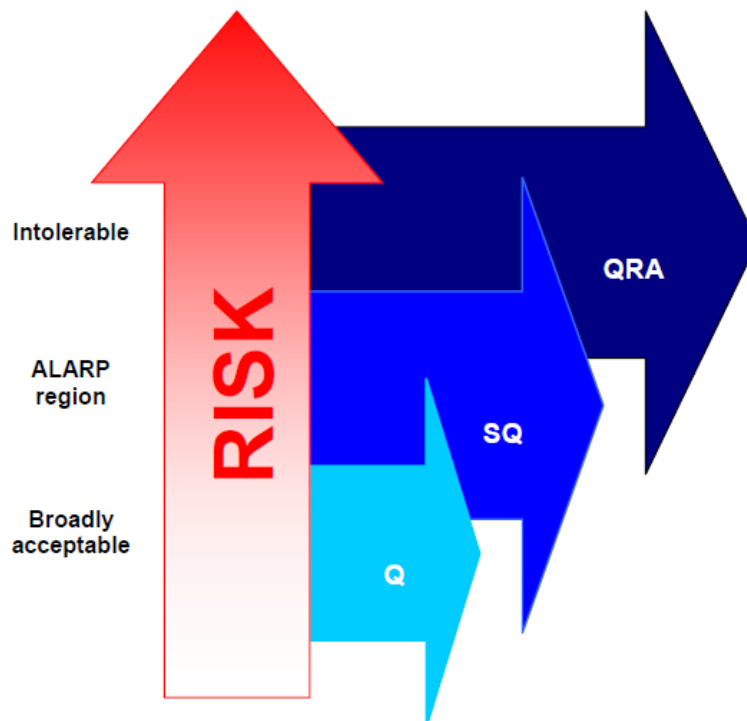

Figure D.1 – Proportionate Risk Assessment.⁶

⁹ Health and Safety Executive (HSE), *Principles and Guidelines to assist HSE in its judgments: that dutyholders have reduced risk as low as reasonably practicable*, Retrieved September 12, 2010, ref: <http://www.hse.gov.uk/risk/theory/alarp1.htm>.

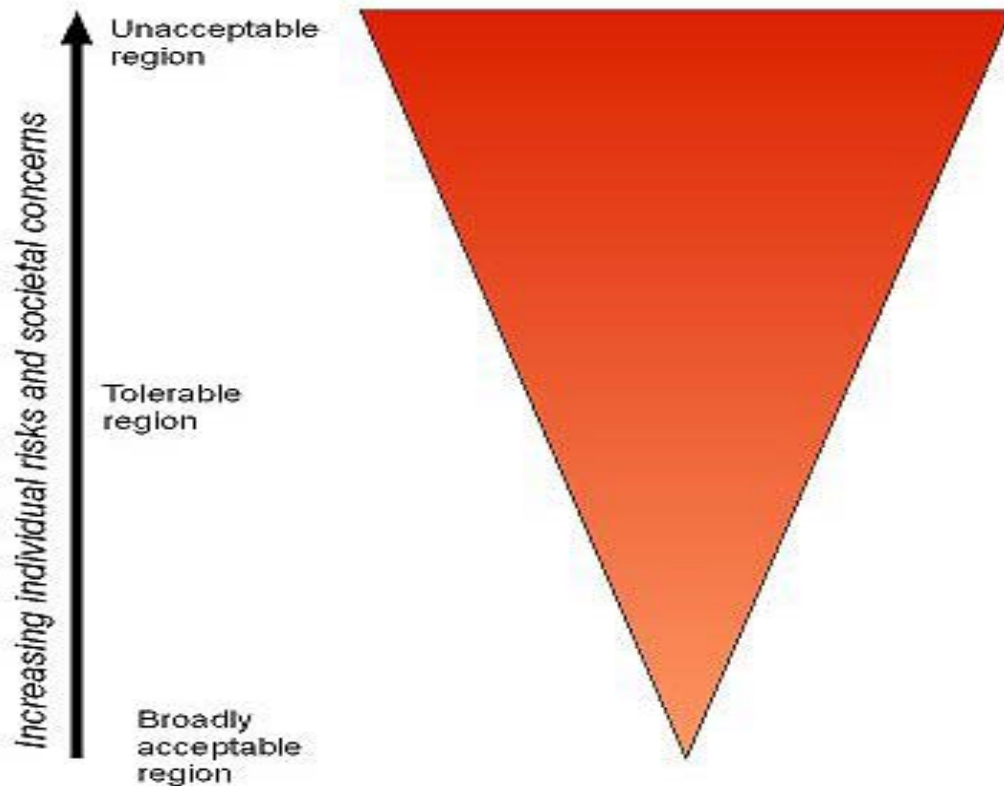

Figure D.2 – ALARP Diagram.⁶

The definition of “reasonably practicable” as stated by the UK’s Court of Appeal in its judgment in *Edwards v. National Coal Board*, is¹⁰:

“ ‘Reasonably practicable’ is a narrower term than ‘physically possible’ ... a computation must be made by the owner in which the quantum of risk is placed on one scale and the sacrifice involved in the measures necessary for averting the risk (whether in money, time or trouble) is placed in the other, and that, if it be shown that there is a gross disproportion between them—the risk being insignificant in relation to the sacrifice—the defendants discharge the onus on them.”

There are three documents which provide guidance on what constitutes good practice or demonstrates that risks have been reduced ALARP, which are “Principles and Guidelines to assist HSE in its judgments that dutyholders have reduced risk as low as reasonably practicable,”⁹ “Assessing compliance with the law in individual cases and the use of good practice,”¹¹ and “Policy and guidance on reducing risks as low as reasonably practicable in Design.”¹²

¹⁰ Health and Safety Executive (HSE), *ALARP at a glance*, Retrieved September 12, 2010, ref: <http://www.hse.gov.uk/risk/theory/alarpglance.htm>.

¹¹ *Assessing compliance with the law in individual cases and the use of good practice*, Health and Safety Executive website, Retrieved September 12, 2010, ref: <http://www.hse.gov.uk/risk/theory/alarp2.htm>.

¹² *Policy and guidance on reducing risks as low as reasonably practicable in Design*, HSE website, Retrieved September 12, 2010, ref: <http://www.hse.gov.uk/risk/theory/alarp3.htm>.

How ALARP is Applied

The Health and Safety Executive of the UK, is ultimately responsible for enforcing that duty holders reduce risks ALARP. The term ALARP is used to set goals for the duty holders, rather than providing prescriptive outlines. HSE admits that “There is little guidance from the courts as to what reducing risks ‘as low as is reasonably practicable’ means.”⁹ Because ALARP is not outlined explicitly in regulations, the challenge with determining whether a risk is ALARP relies on the judgment of both the duty holders and regulators. As stated by the HSE¹⁰:

“...in ALARP judgments, the rule is that the measure must be adopted unless the sacrifice is grossly disproportionate to the risk. So, the costs can outweigh benefits and the measure could still be reasonably practicable to introduce.”

Principles 8 and 9 of the “Principles and guidelines to assist HSE in its judgments that dutyholders have reduced risk as low as reasonably practicable,” outline how it is to be determined whether a risk has been reduced ALARP. According to the HSE, the principles are as follows⁹:

8. Thus, determining that risks have been reduced ALARP involves an assessment of the **risk** to be avoided, of the **sacrifice** (in money, time and trouble) involved in taking measures to avoid that risk, and a **comparison** of the two.
9. This process can involve varying degrees of rigor which will depend on the nature of the hazard, the extent of the risk and the control measures to be adopted. The more systematic the approach, the more rigorous and more transparent it is to the regulator and other interested parties. However, dutyholders (and the regulator) should not be overburdened if such rigor is not warranted. The greater the initial level of risk under consideration, the greater the degree of rigor HSE requires of the arguments purporting to show that those risks have been reduced ALARP.

In most cases, risks that are ALARP can be determined by comparing the duty holder’s existing or proposed control measures, with those of which the regulators expect to see, based on experience and *good practice*. The ‘General ALARP Guidance’ defines good practice as¹⁰:

“...those standards for controlling risk that HSE has judged and recognized as satisfying the law, when applied to a particular relevant case, in an appropriate manner.”

The decision on whether the control measures are good practice is then made by the HSE regulators through a process of discussion involving various stakeholders, such as employers, trade associations, other governmental departments, safety professionals, etc.

Principles 40–45 of the “Principles and guidelines to assist HSE in its judgments that dutyholders have reduced risk as low as reasonably practicable” make clear what should be expected from dutyholders relating to the application of good practice. According to the HSE, sources of written, recognized good practice include the HSC Approved Codes of Practice, as well as HSE guidance documents. Other acceptable written sources can include guidance produced by other governmental departments, standards produced by standard-making organizations, or guidance

agreed by a body representing and industrial or occupational sector.¹¹ Other unwritten sources may be used if they fulfill the necessary requirements as stated in the “Identifying Good Practice” section of the HSE’s “Assessing compliance with the law in individual cases and the use of good practice” website.¹¹

If duty holders would like to propose different methods other than those decided as good practice, they must convince the regulators by demonstrating that the proposed methods are at least as effective (if not better) in controlling the risks.

In the case of major hazard systems or installations, as well as new complex systems, additional methods are used such as cost-benefit analysis to assist regulators with their judgment. When using these methods, health and safety is favored over cost, and therefore in order to avoid further sacrifices, a duty holder must show that the efforts and sacrifices (time, money, etc) required to reduce a risk is grossly disproportionate to the level of safety gained as a result (i.e., extremely high cost is required, and the benefits of risk reduction are only marginal).¹⁰

The following table adapted from the HSE12 shows how ALARP can be applied to the design of new major hazard facilities, and also how it can influence significant modifications to them.

Table D.1 – Application of ALARP to Design.

Project Stage	Elements in demonstration that risks are as low as is reasonably practicable
Choosing Between Options or Concepts	<ul style="list-style-type: none"> • Risk assessment and management according to good design principles • Demonstration that dutyholder's design safety principles meet legal requirements • Demonstration that chosen option is the lowest risk or justification if not • Comparison of option with best practice, and confirmation that residual risks are no greater than the best of existing installations for comparable functions. Risk considered over life of facility and all affected groups considered • Societal concerns met, if required to consider.
Detailed Design	<ul style="list-style-type: none"> • Risk assessment and management according to good design principles • Risk considered over life of facility and all affected groups considered • Use of appropriate standards, codes, good practice etc. and any deviations justified • Identification of practicable risk reduction measures and their implementation unless demonstrated not reasonably practicable.

As mentioned previously, it is not possible to completely eliminate all risks involved, and there will always be a certain level of risk remaining, known as residual risk. Principles 12 and 13 of the “Principles and guidelines to assist HSE in its judgments that duty holders have reduced risk as low as reasonably practicable,” further explain this matter. The principles are as follows:⁹

- The risks must be only those over which dutyholders can exercise control or mitigate the consequences through the conduct of their undertaking. Some risks arise from external events or circumstances over which the duty-holder has no control, but whose consequences duty-holder can mitigate. Such risks should be included in the assessment.
- In any given workplace there would be a large number of hazards which dutyholders could address. However, requiring dutyholders formally to address them all would place an excessive and largely useless burden on them. So as not to impose unnecessary burdens on dutyholders, HSE will not expect them to take account of hazards other than those which are a reasonably foreseeable cause of harm, taking account of reasonably foreseeable events and behavior.

In conclusion, bearing in mind the information provided, a duty holder must understand the responsibilities placed upon him by regulatory authorities to ensure that the required safety levels achieved, reducing the risks As Low AS Reasonably Practical. Because ALARP is not outlined explicitly in regulations the duty holder, overseen by the regulatory authorities, must exercise good practice and judgment to ensure that the necessary measures have been taken in order to reduce the levels of risk as low as reasonably practicable, to an extent that the sacrifices burdened by the duty holder do not disproportionately outweigh the benefits to do so.

Norwegian Regulations

The use of safety cases in Norway is very similar to those in the UK. Overall, the Norwegian regulations are mainly performance-based with supplementary prescriptive requirements.¹³ This is different than in the US, where OCS regulations are primarily prescriptive. Further information on the differences between the Norwegian and US regulations can be found in the report issued by the DNV.¹³

According to Vinnem,² the Norwegian Petroleum Directorate (NPD) issued guidelines in 1981 for safety evaluation of platform conceptual designs. The regulations required QRA to be performed during the conceptual design phase for all new installations, and required a 10^{-4} cutoff frequency per platform per year as the limit of accidents relevant to define design basis accidents, also known as Design Accidental Events. However, notable changes and improvements have been made since the 1981 regulations. In January of 2004, the Petroleum Safety Authority (PSA) was created, which serves as the authority for technical and operational safety, emergency preparedness, and the environment. Currently, there are five regulations relevant to safety for the design and operation of offshore installations as defined by the Petroleum Safety Authority of Norway. These regulations which pertain to the continental shelf are¹⁴:

- Framework HSE Regulations (PSA, 2002a)
- Management Regulations (PSA, 2002b)
- Information Duty Regulations (PSA, 2002e)
- Facilities Regulations (PSA, 2002c)
- Activities Regulations (PSA, 2002d)

¹³ Det Norske Veritas (DNV) 2010, *OLF/NOFO - Summary of differences between offshore drilling regulations in Norway and U.S. Gulf of Mexico*, Report no/DNV Reg No.: 2010-1220/ 12P3WF5-9

¹⁴ Petroleum Safety Authority Norway, Regulations, Retrieved September 8, 2010, ref: <http://www.ptil.no/regulations/category216.html>.

Framework Regulations

Framework regulations contain the overall principles which are described further in other regulations. The purpose of the framework regulations is to develop and further improve health, environment and safety for petroleum activities. Of particular importance in these regulations, is the mention of the Norwegian equivalent of As Low As Reasonably Practical as outlined in Section 9 of these regulations.

Management Regulations

Management regulations cover various aspects relating to the management of health, environment, and safety (HES) for petroleum activities. Vinnem outlines the importance of this section by referring to Sections 14 and 15 which are of particular importance relating to major accident risk and QRA. In addition Section 2 covers barriers or defenses and pertains to the design and operation of installations. Section 6 of the regulations, covers risk acceptance criteria, including personnel, main safety functions, pollution and damage to third party groups and facilities.²

Information Duty Regulations

Information duty regulations are regulations pertaining to material and information in petroleum activities. Examples of such regulations are regulations on the preparation of materials and information, as well as the material required to be submitted among others.

Facilities Regulations

These set of regulations govern the design and outfitting of petroleum facilities. ALARP is referred to in Section 4 of these regulations, which state that facilities must be designed such that the major accident risk becomes as low as practically possible. In addition, Sections 6 and 10 of these regulations which govern the main safety functions and the loads and load effects respectively, necessitate the need for risk assessment.

Activities Regulations

Activities regulations do not contain any relevant requirements relating to risk assessment and management.² However, the use of QRA is implicitly mentioned in the emergency preparedness requirements¹⁴:

“The emergency preparedness shall be established on the basis of results from risk and preparedness analyses as mentioned in the Management Regulations Section 15 on quantitative risk analyses and emergency preparedness analyses and Section 16 on environmentally oriented risk and emergency preparedness analyses, the defined situations of hazard and accident and the performance criteria applicable to the barriers, cf. the Management Regulations Section 2 on barriers.”

There is also mention of the use of ALARP as to the content of oil in water that is discharged. This is mentioned in section 55a *Discharge of oil-contaminated water*.

As mentioned previously, the Norwegian Regulations take a performance based approach towards offshore regulations rather than a prescriptive approach. According to the DNV,¹³ performance based regulation gives the industry a relatively high degree of freedom to selecting the right solutions that will fulfill regulatory requirements.

The Norwegian Petroleum Safety Authority expresses its views of the two methods by favoring the performance based method in the following statement¹⁵:

“A trend has existed among safety regulators worldwide over the past 20-30 years to move their regimes towards a greater degree of functional-based regulation. This is because the prescriptive approach has often turned out to encourage a passive attitude among the companies. They wait for the regulator to inspect, identify errors or deficiencies and explain how these are to be corrected. As a result, the authorities become in some sense a guarantor that safety in the industry is adequate and take on a responsibility which should actually rest with the companies.”

Regulations in the U.S.

Best Available and Safest Technologies (BAST)

Oil and gas operations conducted on the Outer Continental Shelf (OCS) are managed by the Bureau of Ocean Energy Management, Regulation and Enforcement (BOEMRE), a bureau within the United States Department of the Interior (DOI). However, prior to the DOI and BOEMRE, the Outer Continental Shelf Lands Act passed in 1953 placed the responsibility on the U.S. Geological Survey (USGS) to develop, administer and enforce regulations pertaining to safe and environmentally sound drilling operations. The OCS Lands Act Amendments on September 18, 1978, were a result of an effort to increase OCS leasing following the 1973 oil embargo. Congress reviewed the OCS lands act of 1953 and the regulations pertaining to drilling operations, in order to determine their effectiveness and adequacy addressing the technical, environmental, and political issues of drilling operations. One of the noticeable additions to the regulations was recognition of the need for a system to constantly update and review OCS technologies through the use of BAST in OCS operations.

Section 21(a) of the regulations provides.¹⁶

“Upon the date of enactment of this section, the Secretary and the Secretary of the Department in which the Coast Guard is operating shall, in consultation with each other and, as appropriate, with the heads of other Federal departments and agencies, promptly commence a joint study of the adequacy of existing safety and health regulations and of the technology, equipment, and techniques available for the exploration, development, and production of the minerals of the outer Continental Shelf. The results of such study shall be submitted to the President who shall submit a plan to the Congress of his proposals to promote safety and health in the exploration, development, and production of the minerals of the outer Continental Shelf.”

The requirement for the use of BAST is stated in Section 21(b) of the regulations, which states:

¹⁵ Petroleum Safety Authority (PSA), *From Prescription to Performance In Petroleum Supervision*, Retrieved September 18, 2010, ref: <http://www.ptil.no/news/from-prescription-to-performance-in-petroleum-supervisionarticle6696-79.html>.

¹⁶ U.S. Senate Committee on Environment & Public Works, *Outer Continental Shelf Lands Act*, Retrieved September 18, 2010, ref: <http://epw.senate.gov/ocsla.pdf>.

“In exercising their respective responsibilities for the artificial islands, installations, and other devices referred to in section 4(a)(1) of this Act, the Secretary, and the Secretary of the Department in which the Coast Guard is operating, shall require, on all new drilling and production operations and, wherever practicable, on existing operations, the use of the best available and safest technologies which the Secretary determines to be economically feasible, wherever failure of equipment would have a significant effect on safety, health, or the environment, except where the Secretary determines that the incremental benefits are clearly insufficient to justify the incremental costs of utilizing such technologies.”

Definition of BAST

Best Available and Safest Technologies (BAST) is a term used to describe a program or system to be implemented into drilling and production operations in the OCS, in order to ensure operations which are safe and environmentally conscious. Rather than providing an exact meaning, the term is used to encourage a program which constantly evolves and takes advantage of the advancements in technology.

Because the BAST program was developed under the authority of the USGS, the fundamental definitions as outlined by the USGS are mentioned in this report, with the addition of updated material as provided by the BOEMRE. According to the USGS¹⁷, the BAST program consists of the following components:

1. Documentation of the BAST requirement.
2. Application of BAST to OCS operations.
3. Development of Information for BAST determinations.
4. Organization and procedures for the BAST program.

The concept of BAST is broad, and therefore it is necessary to understand what the individual terms mean, and how BAST can be applied. The USGS provides the following definitions for BAST¹⁷:

Best: It may be expected that “best” means that which would most completely fulfill the composite purpose of the legislation, not necessarily the most expensive or sophisticated.

Available: Discussion concerning the term “available control technology” found in the Federal Water Pollution Control Act Amendments of 1977 indicates that the technology does not have to be in actual use somewhere, but the technology must be available at a cost and at a time which the Administrator determined to be reasonable.

¹⁷ U.S. Geological Survey (USGS), *The Use Of Best Available And Safest Technologies (BAST) During Drilling And Producing Operations Of The Outer Continental Shelf (OCS): Program for Implementing Section 21 (B) OCS Lands Act Amendments of 1978*, Reston, Virginia, April 1980.

Safest: the foregoing comments about the term “best” also apply to the term “safest”. The legislative record indicates only that it means something more than “safe” and the exact meaning would be left to administrative discretion.

Technology (and “Technologies”): It was emphasized that more than one technology may be applicable as the best way to achieve a particular objective or to do a particular job. Hence, the word “technologies” was inserted. There was substantial concern about the anticompetitive and innovation-stifling impacts of designating a single technology, technique, or product as “best” and banning the use of any other.

Further definitions of terms used in section 21(b) of the regulations can be found in the USGS document titled *The Use Of Best Available And Safest Technologies (BAST) During Drilling And Producing Operations Of The Outer Continental Shelf (OCS): Program for Implementing Section 21 (B) OCS Lands Act Amendments of 1978*.

The BAST requirement applies to technology, and was not created with the goal of mitigating human errors. The goal of designing and implementing BAST is to ensure a reasonable balance between the economic sacrifices required to achieve the “highest degree” of safety, and the benefits gained as a result. In addition, BAST specifications are intended to target industry operations as a whole or classes of operations, and not individual operations, as stated by the USGS¹⁷:

“BAST was not to be applied installation-by-installation, company-by-company, or lessee-by-lessee. Instead, Agencies were to implement the requirement in a reasonable, discreet manner on an industry wide basis or with respect to classes or categories of operation.”

Given the overall definition of BAST, the USGS documents certain overall principles relating to the BAST requirement. Among these principles, it is included that drilling and production operations in the OCS should use technologies that allow for the safest and most reliable operations, which are cost-effective. The USGS also specifies that the application of technologies refers to the equipment, for which “the government should take the initiative in assuring that new technologies are developed, when deficiencies are detected.”¹⁷ Additionally, BAST requirements should be applied such that it recognizes the availability of a technology, as well as the consequences of including or omitting it from the requirements. Finally, public participation should be encouraged in the development of BAST requirements.

Implementing BAST in OCS Operations

As mentioned previously, according to Section 21(b) of the OCS Lands act, the BOEMRE on behalf of the Secretary of Interior requires the use of BAST in offshore drilling and production operations. The BOEMRE has the responsibility of determining the Best Available and Safest Technologies, and ensuring that they are applied to offshore drilling and production operations. BOEMRE regulations are largely prescriptive, and many of the regulations are based on the use of safe equipment which can meet the BAST requirement.

In order to continually improve the safety to offshore personnel and the environment, the BOEMRE heavily relies on technologies developed by industry. As the BOEMRE is continually

seeking to determine the BAST, the bureau has implemented a Technology Assessment and Research (TA&R) Program as part of their safety program in which universities, private firms, and government laboratories are awarded contracts to perform such research. According to the BOEMRE¹⁸: “the TA&R Program was established in the 1970's to ensure that industry operations on the Outer Continental Shelf incorporated the use of the best available and safest technologies (BAST) subsequently required through the 1978 OCSLA amendments.” The Technology Assessment and Research Program (TA&R) is a research and development program implemented by the BOEMRE regulatory program to promote research which mainly concentrates on the safety and pollution aspects of drilling operations, including oil spill response and cleanup capabilities. The TA&R Program has two branches of research activities:

- Operational Safety and Engineering Research (OSER)
- Oil Spill Response Research (OSRR)

The BOEMRE outlines the primary objectives of the TA&R Program as follows¹⁸:

- **Technical Support:** Providing engineering support to the Bureau decision makers in evaluating industry operational proposals and related technical issues and ensuring that these proposals comply with applicable regulations, rules, and operational guidelines and standards.
- **Technology Assessment:** Investigating and assessing industry applications of technological innovations and ensuring that governing the Bureau regulations, rules and operational guidelines encompass the use of the Best Available and Safest Technologies.
- **Research Catalyst:** Promoting leadership in the fields of operational safety and engineering research and oil spill response and cleanup research activities.
- **International Regulatory:** Providing international cooperation for Research and Development initiatives to enhance the safety of offshore oil and natural gas activities and the development of appropriate regulatory program elements worldwide.

Given the prescriptive nature of BOEMRE regulations, in addition to the BOEMRE's responsibility and efforts to determine the Best Available and Safest Technologies, it can be concluded that by following the rules and guidelines set forth by the BOEMRE, BAST can be implemented in OCS operations.

Safety and Environmental Management Plan (SEMP)

In 1991, the MMS (now BOEMRE) introduced the Safety and Environmental Management Plan, also known as SEM, as a result of the National Research Council's Marine Board findings, which concluded that that the MMS's approach to regulating offshore operations was too

¹⁸ Bureau of Ocean Energy Management, Regulation and Enforcement (BOEMRE) website, *Technology Research and Assessment Program: Introduction*, retrieved September 25, 2010, ref: <http://www.boemre.gov/tarsafety/>.

prescriptive, and as a result industry had developed a compliance mentality. Having such a mentality where safety improvement efforts stopped at the lower limit of compliance with regulations was unfavorable. Therefore to effectively identify potential operational risks, and encourage industry to develop more effective and comprehensive accident mitigation methods and systems, it was decided that the MMS needed a more systematic approach to manage and regulate offshore operations. As a result, SEMP was developed by the API in cooperation with the BOEMRE which is known as *Recommended Practice 75 - Development of a Safety and Environmental Management Program for Outer Continental Shelf Operations and Facilities*. The application of SEMP is not mandatory and the BOEMRE has asked operators in the OCS to voluntarily make use of SEMP for their operations as a compliment to their compliance with regulations.

The BOEMRE describes SEMP as “a nontraditional, performance-focused tool for integrating and managing offshore operations. The purpose of SEMP is to enhance the safety and cleanliness of operations by reducing the frequency and severity of accidents.”

There are four principle SEMP objectives for the BOEMRE, as stated on their website¹⁹:

- Focus attention on the influences that human error and poor organizations have on accidents;
- Continuous improvement in the offshore industry's safety and environmental records;
- Encourage the use of performance-based operating practices; and
- Collaborate with industry in efforts that promote the public interests of offshore worker safety and environmental protection.

Finally, SEMP should include methods on how to perform the following tasks²⁰:

- Operate and maintain facility equipment;
- Identify and mitigate safety and environmental hazards;
- Change operating equipment, processes, and personnel;
- Respond to and investigate accidents, upsets, and "near misses;"
- Purchase equipment and supplies;
- Work with contractors;
- Train personnel; and
- Review the SEMP to ensure it works and make it better.

Note: On June 17, 2009, the MMS published a set of proposed rules, which would require operators to develop and implement a Safety and Environmental Management System (SEMS) for their operations in the Outer Continental Shelf (OCS).²¹ The proposed SEMS system would replace SEMP, and would consist of four elements:

¹⁹ Bureau of Ocean Energy Management, Regulation and Enforcement (BOEMRE), *SEMP*, Retrieved September 16, 2010, ref: <http://www.boemre.gov/sempl/>.

²⁰ Bureau of Ocean Energy Management, Regulation and Enforcement (BOEMRE), *What is SEMP?*, Retrieved September 16, 2010, ref: <http://www.boemre.gov/sempl/what.htm>.

²¹ Bureau of Ocean Energy Management, Regulation and Enforcement (BOEMRE), *Proposed Rules*, Federal Register Vol. 74, No. 115 June 17, 2009, Retrieved September 16, 2010, ref: <http://www.boemre.gov/federalregister/PDFs/74FR28639.pdf>

- Hazards Analysis,
- Management of Change,
- Operating Procedures, and
- Mechanical Integrity

MMS proposed that each offshore lessee/operator would be required to develop, implement, maintain, and operate under a SEMS program which included all four elements listed above.²¹

Most recently, the SEMS program became mandatory under the Workplace Safety Rule issued by the U.S. Department of interior on September 30, 2010. Further details of the new regulations are mentioned below.

Recent Regulations

Following the *Deepwater Horizon* accident, the U.S. Department of Interior issued two new safety regulations known as the Drilling Safety Rule and the Workplace Safety Rule, to improve the safety of drilling operations and the workplace.

According to the U.S. Department of the Interior²²:

“The Drilling Safety Rule, effective immediately upon publication, makes mandatory several requirements for the drilling process that were laid out in Secretary Salazar’s May 27th Safety Report to President Obama. The regulation prescribes proper cementing and casing practices and the appropriate use of drilling fluids in order to maintain well bore integrity, the first line of defense against a blowout. The regulation also strengthens oversight of mechanisms designed to shut off the flow of oil and gas, primarily the Blowout Preventer (BOP) and its components, including Remotely Operated Vehicles (ROVs), shear rams and pipe rams. Operators must also secure independent and expert reviews of their well design, construction and flow intervention mechanisms.”

“The second regulation, known as the Workplace Safety Rule, requires offshore operators to have clear programs in place to identify potential hazards when they drill, clear protocol for addressing those hazards, and strong procedures and risk-reduction strategies for all phases of activity, from well design and construction to operation, maintenance, and decommissioning.”

“The Workplace Safety Rule requires operators to have a Safety and Environmental Management System (SEMS), which is a comprehensive safety and environmental impact program designed to reduce human and organizational errors as the root cause of work-related accidents and offshore oil spills. The Workplace Safety Rule makes mandatory American Petroleum Institute (API) Recommended

²² U.S. Department of the Interior Press Release, *Salazar Announces Regulations to Strengthen Drilling Safety, Reduce Risk of Human Error on Offshore Oil and Gas Operations*, retrieved October 11, 2010, ref: <http://www.doi.gov/news/pressreleases/Salazar-Announces-Regulations-to-Strengthen-Drilling-Safety-Reduce-Risk-of-Human-Error-on-Offshore-Oil-and-Gas-Operations.cfm>

Practice 75, which was previously a voluntary program to identify, address and manage safety hazards and environmental impacts in their operations.”

From the descriptions above, it can be seen that the Drilling Safety Requirement implicitly indicates the use of Best Available and Safest Technology (BAST), while the Workplace Safety Case now makes it mandatory for operators to implement SEMS. The BOEM is said to issue additional workplace safety regulations, such as the requirement for third party verification of an operator’s SEMS program, in the near future.

Appendix E – BAST Well Design, Processes, Equipment and Materials Upgrades

Well Design

1. Casing design data and depths should be accompanied by wellbore stability models which at the minimum depict the anticipated overburden fracture gradient, pore pressure and method used to generate the data.
2. The highest formation pore pressures shall govern design of the casing.
3. All shallow casing strings installed shall be protected with a full string of intermediate casing or liner and or tied back to the wellhead and tested.
4. Any real time change while drilling in the anticipated section depth requires a Management of Change (MOC) document before drilling progresses with an explanation of the reason and risk assessment for the change. The governing factor requiring the change should be the lesser of:
 - a. A + 10% hole section tolerance of the total depth of the hole section from the base of the prior casing seat to current or new depth, or
 - b. Any time real time data suggesting hole section Equivalent Circulating Density (ECD) will exceed the kick tolerance of the prior casing string.
5. Any MOC generated shall assure that casing design criteria related to burst or collapse is not exceeded.
6. The base of production casing shoe track must provide sufficient protection below the reservoir to at a minimum must not be set in porous and permeable media and assure protection of the shoe from reservoir fluids vertical transmissibility.

Well Cementation, Barrier Building, and Barrier Testing

1. If Equivalent Circulating Density requires that neat cement mixes need to be lightened, consideration should be given to use of glass beads (or other friction reducers) rather than Nitrogen for the lightening medium. For prolific production zones, this shall be observed in all cases.
2. For casing off deep, prolific production zones, a liner and tieback should be run in preference to an all-in-one casing string to provide more certainty of obtaining annular barriers.
3. A float shoe or collar should not be depended on as an effective wellbore barrier. If wellbore barriers are in doubt at any point, a mechanical packer plug should be set above the float collar and a cement plug spotted above that and given time to develop at least 1,000 psi compressive strength.

4. Negative testing of wellbore barrier(s) should be performed with the drill pipe shoe near to the float shoe and only after waiting on cement time is well beyond that needed to obtain 2,000 psi compressive strength in laboratory testing of the actual materials from the rig. Negative testing intensity should be set to provide underbalance at least equivalent to replacement of the mud column length equal to water depth plus 1,000 ft with seawater. With drill pipe set deep for the test, seawater or base oil in the drill pipe bore should be used to induce the underbalance.
5. Surplus fluids on the rig shall not be used for unintended purposes with the goal of circulating them through the well to qualify for overboard dumping.
6. BOEMRE-approved plans for the negative test should provide calculated bleed back volumes to obtain zero surface pressure during the test. The approved plan should include sufficient detail of fluids and volumes, pump rates and paths to obviate gross modifications (only amplifications if any) at the rig site. Amplifications should be sent to the originating office engineer for approval.
7. Regardless of negative testing outcome, process safety during displacement of the upper well and riser with seawater shall include closed system volume monitoring of all fluids being pumped and recovered. Any need to transfer fluids into or out of the control volume pits shall be done with the pumps shut down and the well monitored on the trip tank during the shut-down and transfer(s). The trip tank should be kept full during the entire process for this purpose. Process safety procedures shall be written and require regulatory approval. Periodic flow checks to ensure and verify correct material balance shall be included.
8. Since the production casing is one of the key barriers, each connection thereof should be carefully inspected during deployment. If metal-to-metal seals are incorporated in the design, they should be cleaned and inspected for damage just before stabbing and make-up on the rig floor. An elastomer stabbing guide should be used to reduce risk of seal damage during stabbing. Production casing shall be internally and externally (connections) hydrostatically tested while running in the hole
9. For any production full string or tieback to the wellhead at the mud line, the well should be monitored for annular flow for one hour before the seal assembly is installed, set, and tested. The lock down, if any should be installed immediately after the seal assembly is in place and tested.

Diverter and Gas Separation Systems

1. Separate mud/gas separators should be used for the output from the diverter system and for the output from the choke and kill manifold.
2. The mud/gas separator serving the diverter should be rated for a minimum of 100 psi and equipped with both gas outlet pressure control and a positive liquid outlet level control (not a U-tube). It should be similar in size and general capability to Swaco Super gas separator having these type controls.
3. A smaller but similarly equipped 100 psi rated separator should be used to handle the choke and kill manifold output.

4. Pressure burst plate protection for the diverter separator should be at not less than 60 psi. Outlet piping from the overpressure protection burst plate should be tied back through check valves to the overboard diverter line selected for the day's operation.
5. Slip joint inner barrel packer operating pressure should automatically be increased to a (operator-selected) maximum if the diverter is closed. If a high and a low pressure packer are both available, control should automatically shift to the higher pressure rated packer. An automatic lubricant deluge system should be available for the slip joint inner barrel packer top to minimize wear and sticking when higher pressure sealing is invoked—this might be especially important under high heave conditions.
6. Initial selection of routing for discharge from the diverter should always be *overboard* regardless of mud type being used until such time as it can be confirmed that flow or blow from the riser is or will for certain be manageable through the mud/gas separator.
7. Controls for outlets of both mud/gas separator should be tested in conjunction with every other BOP test, i.e., approximately monthly using nitrogen and mud injected simultaneously. Liquid level in the separators shall be maintained simultaneously with gas pressure exerted by the gas outlet control valve, which should be set to maintain not less than 30 psig.

Blowout Preventers (BOP)

1. Equip LBOP (Lower BOP Package) with two blind/shear rams. Retain two variable pipe rams as well.
2. Provide LBOP with newest style (hydrostatic driven) subsea accumulators sufficient to operate two LBOP functions with 50% margin and with residual pressure of 3,000 psi plus seawater hydrostatic pressure after closing both with the hydraulic conduit blocked.
3. Equip LBOP with dedicated accumulator packages with non-defeatable isolation from common hydraulic power system. Charge automatically through double-ranked check valves. Discharge to sea for recovery when needed through double-ranked pilot operated check valves. Serve *close* side of selected functions through double-ranked SPM valves. Serve *open* side of same functions from dedicated system, but with only one SPM serving but serving through a carefully choked discharge (to minimize SPM deterioration).
4. Monitor leakages in all of the LBOP control system functions and pull stack for repairs if any exceed 0.1 gallon per minute. This includes continuous leakage through dedicated accumulator circuit.
5. Test dedicated accumulator capacity every other BOP test with the hydraulic conduit temporarily blocked at surface. Pull stack for repairs if excess capacity drops below 50% or closed pressure is below specified pressure after closing two functions.
6. Equip LMRP (Lower Marine Riser Package) with newest style (hydrostatic driven) subsea accumulators sufficient to close one annular BOP function and outlet valve operators (for both LBOP and LMRP) with 50% margin independent of hydraulic conduit, and with residual pressure of 2,000 psi plus seawater hydrostatic pressure after closing. Rig for isolation of LMRP accumulators by charging only through double check valves and

discharging to sea through double pilot operated check valves. Serve all functions through pods at single SPM valves or two single SPM valves in parallel.

7. Sufficient time and staff should be allotted to BOP preparations at surface to achieve all refurbishment and testing by qualified laborers and supervisors. System records should be fully updated and reviewed by the rig manager before the stack is deployed.
8. All Original Equipment Manufacturer (OEM) recommendations for in-service inspections, replacements, or refurbishments shall be followed. All OEM parts shall be used when reasonably available. Any non-OEM parts shall be replaced with OEM parts at the next opportunity for access.
9. Both annular BOP's should be equipped with sealing elements equivalent to the working pressure rating of the body.