

Jazz Theory I

5th edition

by

Hiroaki Honshuku

Index

Notation	2
Class Restrictions	4
Key Signature (the Circle of the 5th)	5
Intervals	6
How to get the Interval	7
Chord	
Chord Structure	8
Chord Tone & Tension	9
Inversion	10
Mode	
Church Mode	12
How to get the correct mode scale	13
Tension & Avoid Note	14
Tritone	15
Tritone Substitution Chord (Altered Mixo)	16
Melody Analysis	18
Exercise	19
Summary	20
Diatonic Functioning Chord	21
Analysis	22
Harmonic Rhythm	23
Secondary Dominant	24
Extended Dominant	26
Related II minor	27
Example (Peace)	28
Summary	31
Project	32
About the author	33

Theory II Subject

Diminished Scales

Minor Key

Modal Interchange

Special Dominant

#IV-7(b5)

Deceptive Resolution

Compound Chords

Notation

- Notation is the most profound communication tool between the composer and the performer. If the music is not notated clearly, the performer will fail to sight read. The composer, most likely, has to be present at the rehearsal, and the performer will demand more payment for the over work. On the other hand, if the music is written perfectly clear, the performer will be blamed for a bad performance. As most of the college assignments will not accept hand written paper, this class requires basic notation skill by hand. The assignments done by unreadable hand writing or notated by computer will not be graded.
- Basically, a right up angle of 30° should be kept in mind. This angle is the maximum and/or comfortable angle to the sight reader's eyes.

TIP Unlike written language, music notation is very psychological to the sight reader. You must pretend to be a performer reading the music for the first time, trying to get all the necessary information (tempo, dynamics, articulations, etc.) as quick as possible.

- **Note Head**

30° right up angle.

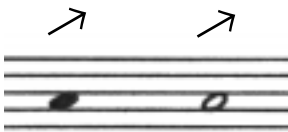

- **Quarter Rest**

Starts from the bottom. Note that the starting circle is on the 2nd line.

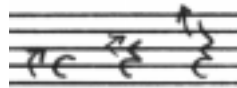

- **8th Rest**

Should fit between the 2nd and the 4th line.

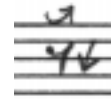

- **Treble Clef (G Clef)**

Starts from the bottom, should make a sharp top, and circle the note G.

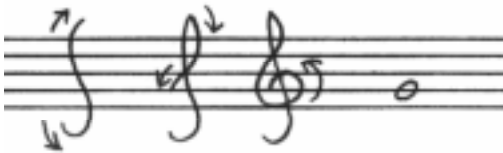

- **Bass Clef (F Clef)**

Starts from circling the note F (4th line).

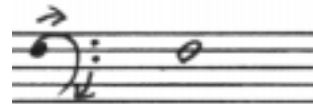

- **Stem**

The length of the stem is an 8va. The direction of the stem switches at the 3rd line.



- **Flag**

The direction of the flag is the same side of the note head, going down, and up.



- **Important:** Each ledger must be the same size as the staff space. If the ledger lines are more than two, the length of the stem is extended to the 3rd line.

- **The Beam Angle**
Should not exceed 30°.



- The direction of the beam is decided by the first and the last note. However, it is better to use a leveled one when many notes in the beam are distant.

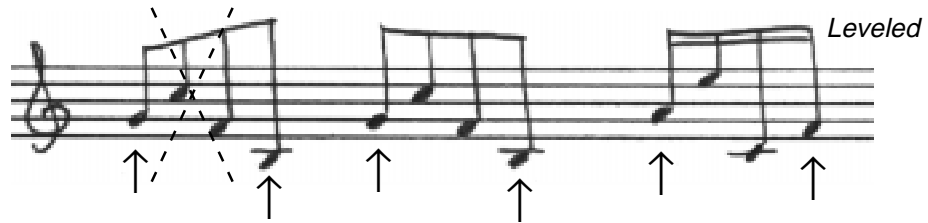

- **Imaginary Bar Line**
An imaginary bar line is a line drawn in the middle of a measure that has a time signature in even beats (2/4, 4/4, 6/8, 12/8 etc.). It is a sub-division of a bar.

The dotted quarter on the 2nd beat crosses the Imaginary bar line which makes it harder to read. The sight reader will not be able to tell the time signature of the piece without going back to the top of the piece. Therefore, it must be written as shown in the 2nd bar.

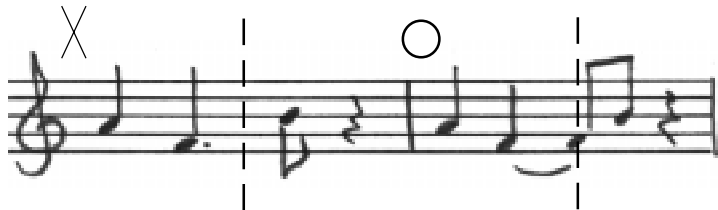

Exception to this rule is when the note value is bigger than 2 beats (half note in this case), because it is not as difficult to identify the imaginary bar line in sight reading.

- **Space**
Spacing is one of the biggest issues. If each note is not spaced in relation to the others, the sight reading will not be easy.



The example on the first measure here makes sight reading almost impossible. You have to rewrite it as in the 2nd measure.



Class Restriction (the big rules)

- * The neat manuscript skill is required as described in page 2 and 3.
- * When the Interval is asked verbally, the prefix must always be said along with the number. For example, 7th will not have any meaning if Major, minor or other prefixes are not attached.
- * "-" sign must be used for chord tones, -3rd and -7th, while "b" sign is used for tensions, ^b9th and ^b13th.
"Aug" and "dim" sign must be used for chord tones, Aug5th and dim5th, while "#" sign is used for tensions, #9th and #11th.
- * The Chord spelling must follow the class rule as shown below:

	Never in this class	Prefered very much in this class
Major	X CM7 X CΔ7	CMaj7
minor	X Cm7	C-7
minor 7th with flatted 5th <i>Never "Half Diminished"! There is no diminish function.</i>	X Cø7	C-7(^b 5)
Augumented	X C+7	CAug7
diminished	X Co7	Cdim7
Chord with tensions	X C7 ^b 9, ^b 13	C7(^b 9 ^b 13)

Key Signature

Circle of the 5th

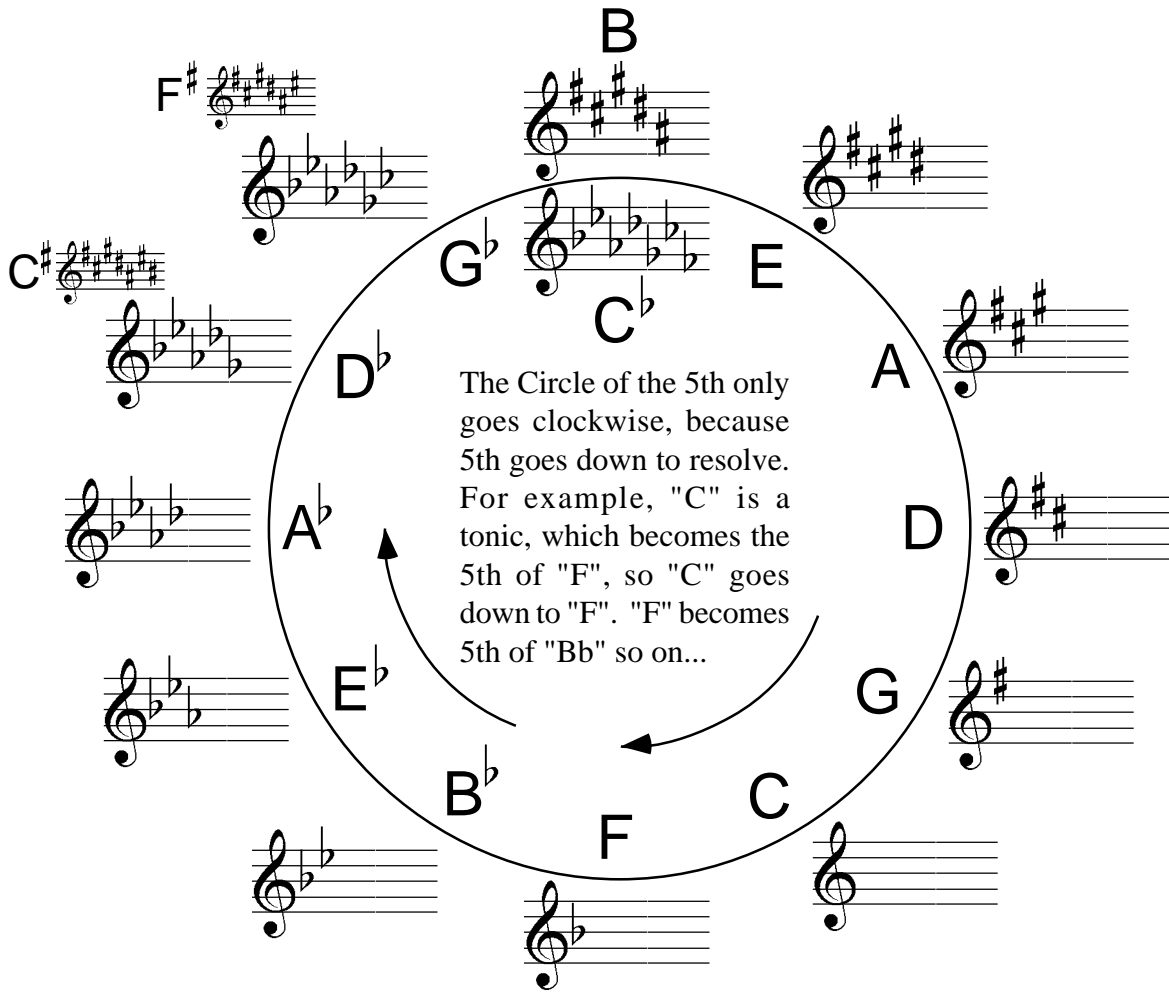

b	<p>P5th Down</p> <p>B^b — E^b — A^b — D^b — G^b — C^b — F^b</p>
#	<p>P5th Up</p> <p>F[#] — C[#] — G[#] — D[#] — A[#] — E[#] — B[#]</p>

Intervals

Intervals

	C Major Scale Starting from the Tonic
Major 2nd	No Spot
Major 3rd	No Spot
Perfect 4th	1 Spot
Perfect 5th	1 Spot
Major 6th	1 Spot
Major 7th	1 Spot
Perfect 8th	2 Spots

If the interval is 2nd, 3rd, 6th, and 7th, use this chart.

One level = Half Step

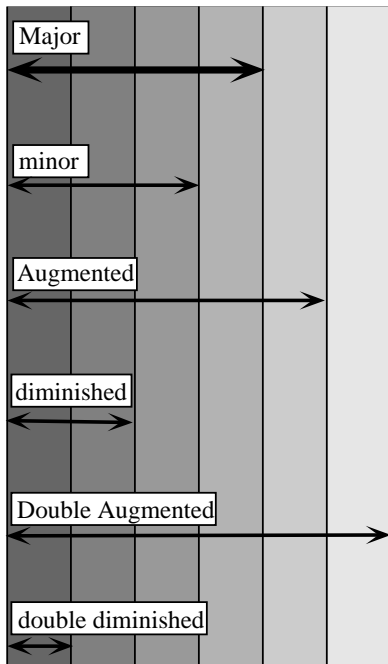

If the interval is 4th, 5th, and 8th, use this chart.

One level = Half Step

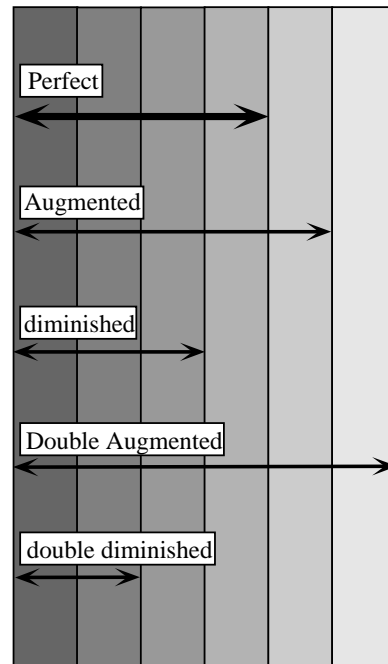

• **How to get the correct interval with no screw-ups**



Lets find the interval shown here, step by step as shown below.



1. Hide any accidentals.



2. Use your fingers to count the distance.

E	F	G	A	B	C	D	E	F	G
1	2	3	4	5	6	7	8	9	10

Now you know the interval is some kind of 10th. When you count, do not forget to include the first note.



Write down the number **NOW**.

(10th)

3. Since this is more than an octave away (the number is greater than 8), you have to take the top note down an octave in order to find the kind (Major, Perfect, etc.) or it will not fit with the chart shown on page 6.



Now this is a 3rd that will fit in the chart. The third is the Major-minor group, not the Perfect group. So, is this Major or minor?

Lets use the keyboard chart.

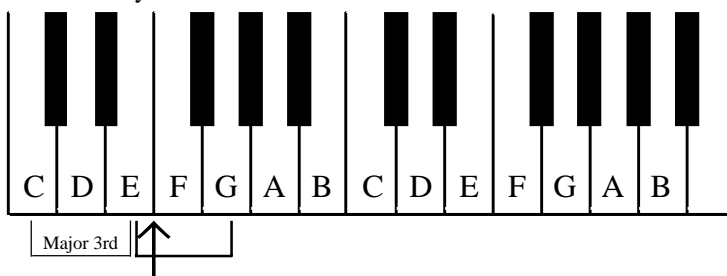

According to the chart on page 6, C to E is a Major 3rd and does not have the Spot (where the black key is missing). But E to G has the Spot, which tells you the interval is a step shorter than Major 3rd. Therefore, it is a minor 3rd.

4. Put the accidental back in.

From here on, forget the keyboard.



Use both of your hands vertically, and add the accidental.

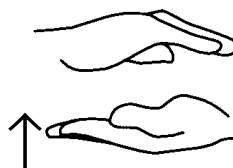
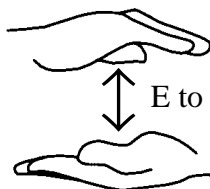

Adding a # on the bottom note makes the distance shorter by a step.

• Now you know the answer is a diminished 10th. Easy!.

**** The MORE Spots, the SMALLER the Interval. The Fewer Spots, the BIGGER the interval.***

Chord

The definition of a chord is two or more notes in a certain interval away vertically. To be a tonal harmonic chord, the root and the 3rd are essential.

Diatonic Triads

Major Triad (CMaj): Shows intervals of M3rd and P5th.

minor Triad (A-): Shows intervals of -3rd and P5th.

Augmented Triad (Eaug): Shows intervals of M3rd and Aug5th.

diminished Triad (C#dim): Shows intervals of -3rd and dim5th.

Seventh Chord

Major Seventh (CMaj7): Shows intervals of M3rd, P5th, and M7th.

minor Seventh (A-7): Shows intervals of -3rd, P5th, and -7th.

Dominant Seventh (G7): Shows intervals of M3rd, P5th, and -7th.

minor Seventh (b5) (B-7(b5)): Shows intervals of -3rd, dim5th, and -7th.

Chord Tone & Tension (references)

C Major Scale

Root (1) T9th 3rd (4) 5th 13th M7th

A minor Scale

Root (1) T9th -3rd T11th 5th b6th -7th

G Dominant Scale

Root (1) T9th 3rd (4) 5th T13th -7th

CMaj7(#5)	Cdim7	CMaj6	C ⁹ ₆	C-6	C-(b6)
M7th	dim7th	M6th	M9th	M6th	-6th
Aug5th	dim5th	P5th	M6th	P5th	P5th
M3rd	-3rd	M3rd	P5th	-3rd	-3rd
Root	Root	Root	M3rd	Root	Root
			Root		

CMaj9	C-9	G7(b9)	G7(b13)	G7(#9)	C-(11)
M7th	-7th	Root	M3rd	T.Aug9th	-3rd
P5th	P5th	P5th	M3rd	-7th	-7th
M3rd	-3rd	M3rd	Root	P5th	T.P11th
T.M9th	T.M9th	T.-9th	T.-13th	M3rd	Root

Inversion

- **Chord: Root Position and Inversion**

Almost every type of chord is formed with a rule. That is, if the root is on the staff line, the rest of the chord tones above it will also be on the line. Similarly, if the root is in the staff space, the rest of the chord tones above it will also be in the space. Therefore, whenever you see a chord formed with notes that are a mix of on the line and in the space, you should assume the chord is an Inversion.

- Examples shown below contains C^b , F^b , and B^\sharp . Those spellings are necessary to find the root of the chord.

- Likewise, all the tension notes must be written in the same rule to be a root positioned chord.

- Diminished chords are the ones you need to spell correctly, or you may never find the right scale.



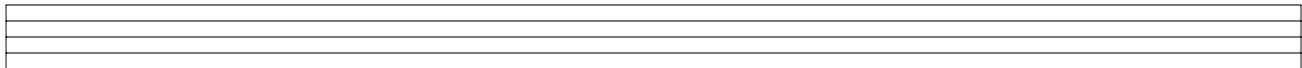
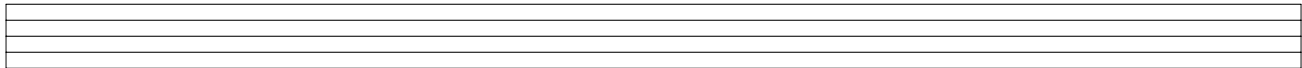
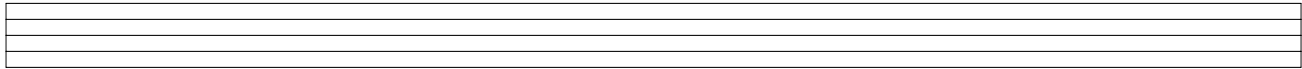
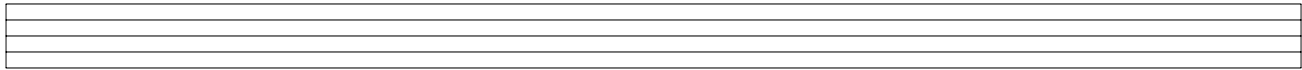
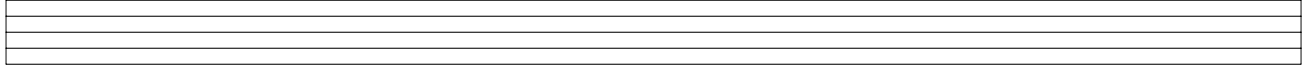
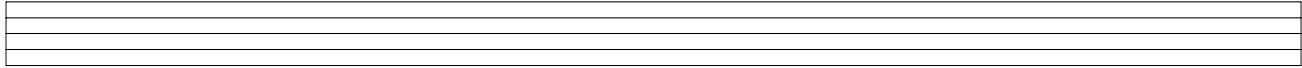



- **Exception** is Six and/or Six Nine chords. Though usually, the Six chords are regarded as a type of inversion.

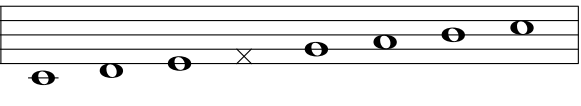

Church Mode

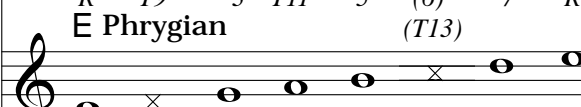
Parent Key: C Major

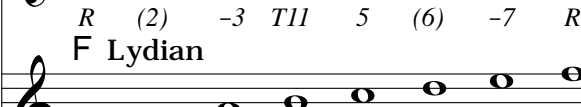
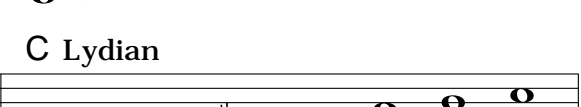
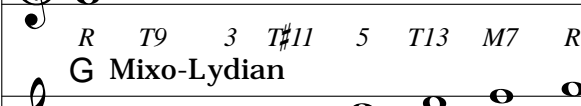
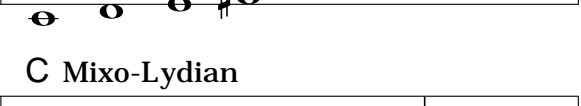
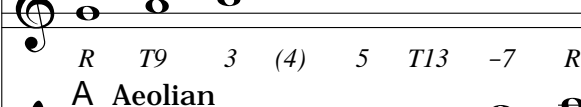
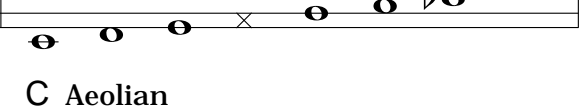
Transposed to C Root

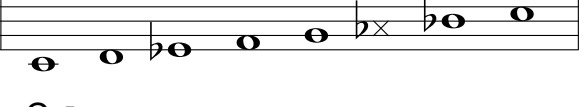





	C Ionian	C Ionian
I Maj7 Ionian	 R T9 3 (4) 5 T13 M7 R	
II-7 Dorian	 R T9 -3 T11 5 (6)* -7 R (T13)	
III-7 Phrygian	 R (2) -3 T11 5 (6) -7 R	
IV Maj7 Lydian	 R T9 3 T#11 5 T13 M7 R	
V7 Mixolydian	 R T9 3 (4) 5 T13 -7 R	
VI-7 Aeolian	 R T9 -3 T11 5 (6) -7 R	
VII-7(b5) Locrian	 R (2) -3 T11 b5 T#13 -7 R	

[x=Avoid Note]

*Note: The 6th note of Dorian becomes Avoid Note only when it is followed by V7 chord of the key, because the note will create Tritone with the -3rd, which will be a duplicate of the Tritone following V7 has.

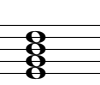
C Major Diatonic Chords

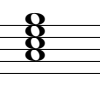
Diatonic Chords are chords built on each of the scale notes within the same key. Therefore, no note will have accidentals except melodic and harmonic minor scale.

C Maj7	D-7	E-7	F Maj7	G7	A-7	B-7(b5)
						
Ionian	Dorian	Phrygian	Lydian	Mixolydian	Aeolian	Locrian

- **How to get the correct mode scale with no screw-ups**

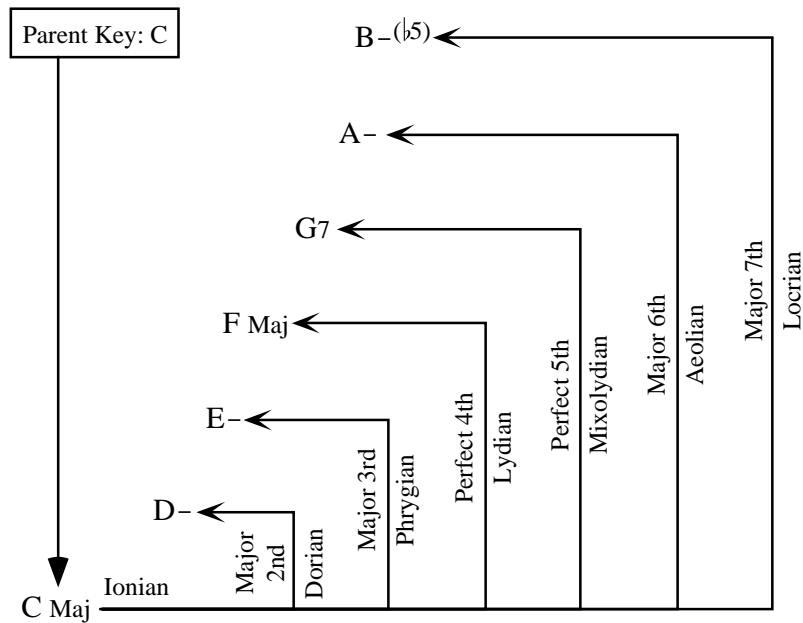

- Lets find the correct scale for $E\flat$ Aeolian using the chart above. First, write out the notes across an octave from E to D (ignore the \flat at this point).



- Next, using the chart above, find the Parent key for $E\flat$ Aeolian. The Aeolian is located at the Major 6th above the Parent key. You will get $G\flat$ Major going down a Major 6th from $E\flat$ as the Parent key.
- Apply the key signature of $G\flat$ Major to the scale above. The key signature for $G\flat$ Major is $B\flat-E\flat-A\flat-D\flat-G\flat-C\flat$.



- This is the $E\flat$ Aeolian scale. Easy, Isn't it?!

Tension

- * Tension notes are notes other than chord tones that can be placed 8va above the chord, yet will not create $\flat 9$ th interval from one of the chord tones. If the note creates the $\flat 9$ th interval from one of the chord tones, the note becomes a scale note rather than a tension note.

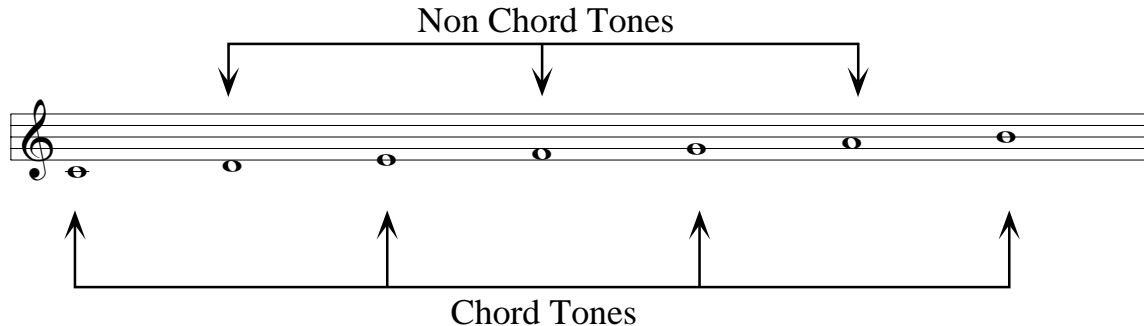

Avoid Note

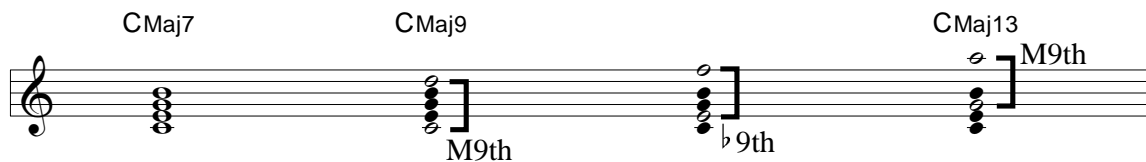

- * The example above shows that each one of the non chord tones from the C Ionian scale can be placed above the chord, except the 4th note. The scale note 2nd (D) becomes Tension 9th, and the scale note 6th (A) becomes Tension 13th. The scale note 4th (F), however, will create $\flat 9$ th interval from the chord tone 3rd (E). Therefore, the 4th note in a Ionian scale becomes an Avoid Note, which is identified by writing with a parenthesis, like (4), and is called "The scale note 4".
- * The $\flat 9$ th interval is the most dissonant interval that will destroy a sense of quality of the chord. In the example above, as soon as the note F is played over C Maj chord, it destroys a sense of Major harmony.
- * The definition of the Avoid Note is;
 - 1) Do not start with.
 - 2) Do not hold with.
 - 3) Do not end with.

Note that in general, passing the Avoid Note with a value smaller than an 8th note will not create any effect. Occasionally, even the beat value (i.e., quarter note in 4/4) is acceptable if the note is placed on the weak beat (i.e., 2nd and 4th beat in 4/4).

Tritone

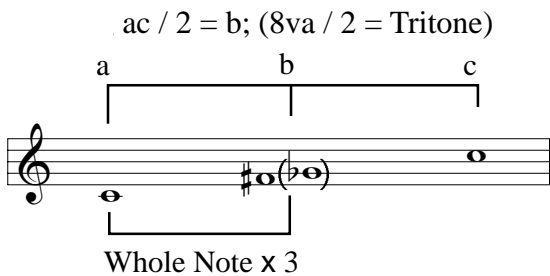

* The word Tritone originally came from the interval built with three whole tones. However, it is often talked about as the three points within an Octave: the bottom note (a), the top note (c) and the very mid point note (b). Since the Medieval Era, this interval was often called "The Devil's interval" because of the difficulty in performance. Since this interval must be exact mid point of an Octave, the enharmonic spelling will not matter.

* The real importance of the Tritone interval is as follows:
 The Tritone interval is the most unstable interval to the human ear, and it wants to be resolved. In other words, this interval will not create a stable sound for use as a stand-alone chord. If this interval is used in the end of a music, it will never sound a sense of complete release. Note that it became more popular to purposely use the Tritone to make an unstable impression in this century.

The Primary Resolution (Inward resolution)

Tritone goes inward to resolve to the root and the third of the target chord. The chord itself resolves down from G7 to C by Perfect 5th.

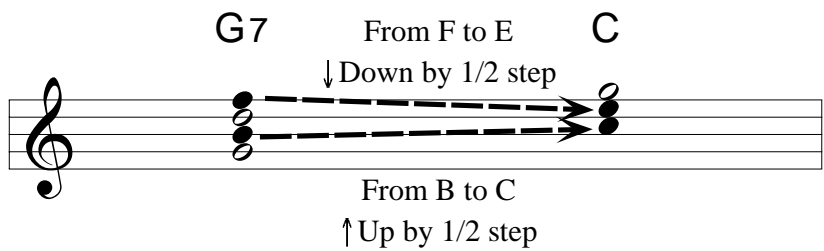

The Secondary Resolution (Outward resolution)

Tritone goes outward to resolve to the root and the third of the target chord. The chord itself resolves down from G7 to G^b by minor 2nd.

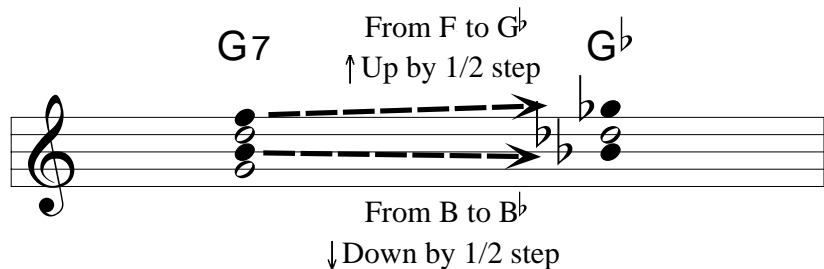

Tritone Substitution Chord (Substituted Dominant, or subV7)

- * As shown before, a dominant chord can resolve to 2 targets, one by going down Perfect 5th as a primary dominant motion, the other by going down minor second. This is called Substituted Dominant Motion.
- * The example bellow shows that there are two dominant chords that can be resolved to a target chord, C Maj. Note that G7 (Primary Dominant) and D \flat 7 (Substituted Dominant) have the same Tritone, F and B(C \flat). This means that D \flat 7 can substitute G7. Thus, this function of the dominant resolution is called Tritone Substitution. Coincidentally, the distance from the root of G7 to the root of D \flat 7 is a Tritone away.

G7
D \flat 7 From C \flat to C C

B = C \flat
↑ Up by 1/2 step

F = F
From F to E

↓ Down by 1/2 step

- * This is an example of a Be-Bop line over a Substituted Dominant chord.

D \flat 7
CMaj7

3rd T \sharp 11th T9th R
b7th R T13th T9th

- * When the same line is played over the Primary Dominant, the natural tensions, 9th, 13th, and a least important chord tone, 5th becomes Altered Tensions.

G7
CMaj7

b7th R T \flat 13th b5th
3rd b5th T \sharp 9th T \flat 9th

* As seen in the example, an Altered Mixolydian scale is a result of a superimposed Substituted Dominant scale.

G Mixolydian (parent Key: C)



D \flat Mixolydian (parent Key: G \flat)

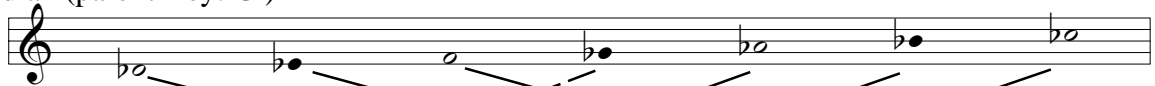

G Altered Mixolydian
(D \flat Mixolydian Superimposed
over G Mixolydian)



D \flat Lydian \flat 7th
(Raised 11th in order to maintain
the substitute function)



- There are few important points that must be remembered:
 - 1) ONLY on a Dominant chord is a \flat 9th interval allowed for the non-chord tones, because Tritone is stronger than the \flat 9th dissonance effect.
 - 2) The 4th note of the Mixolydian (includes any kind of tension notes) is ALWAYS the Avoid Note, because the 4th note is the root of the target chord. Tritone must maintain the wanting to resolve, so it cannot anticipate the target.
 - 3) Note that the tension 9th splits to \flat 9th and \sharp 9th as a result of superimposing the Substituted Mixolydian.

V to I motion

G7 C Altered Mixolydian (Commonly called; Altered Scale)

R(1) T \flat 9th T \sharp 9th 3rd (4) \flat 5th T \flat 13th \flat 7th

subV to I motion

D \flat 7 CMaj7 Lydian \flat 7th (Mixolydian with \sharp 11th)

R(1) T9th 3rd T \sharp 11th 5th T13th \flat 7th

Melody Analysis

* This is jazz specific, while classical music theory explains further.

C7

T9th R 3rd $b7th$ T9th R 5th

C7

5th (4) 3rd $b7th$ T9th R 5th

C7

1/2 step \uparrow
C7 1/2 step \uparrow
T9th Pass. 3rd $b7th$ T9th R 5th

C7

1/2 step \uparrow
5th App. 3rd $b7th$ T9th R 5th

C7

1/2 step \uparrow 1/2 step \downarrow
T9th R 3rd W.App. R 5th
App.

C7

B7
 $b7th$ $b7th$ T $b13th$

C7

B7
 $b7th$ $b7th$ T $b13th$ $b5th$

* Analyzing melody is done by numbering each note according to the mode (C Mixolydian, in this example).

An Avoid Note

An Avoid Note is one of the Scale Notes as explained before, so it will be marked accordingly. In this example, the 4th note is the Avoid Note to the Mixolydian. Therefore, it will be marked as (4), which indicates it is one of the Scale Notes.

A Passing Note

Passing Note is a note located between the notes from the mode. A Passing Note must be preceded by a 1/2 step, and followed by a 1/2 step as well. Note that D# in this example is not T#9th because the Passing Note function is obvious.

An Approach Note

An Approach Note, unlike a Passing Note, is a note that is followed by a note from the mode by a 1/2 step. Note that D# in this example is not T#9th because the Approach Note function is obvious.

An Double Approach Note

An Double Approach Note is a note that is followed by an Approach Note. Note that a Double Approach note must have the opposite direction of an Approach Note by a whole step.

Anticipation

Anticipation is defined by a value smaller than the beat value (i.e., Quarter Note in 4/4). In this first example, if the note A is a quarter note placed on 2 instead of an 8th note on the end of 2, it becomes T13th against C7, and will be changed to $b7th$ on beat 3 even though the note is tied over.

The second example shows that the Anticipation appears followed by a rest. It is easier if the imagination is used to hear the ring of the note over the rest.

Melody Analysis Exercise

* Number each note according to the chord.

A

Yardbird Suite by Charlie Parker

B

A'

Summary of Chord and Tension

- The definition of a Chord is any combination of more than one note piled up vertically.
- The definition of Tension is one of the non-chord tones from the scale (including the church mode scales), and can be placed an octave above the chord and yet does not create $\flat 9$ th interval with any one of the chord tones. However, the $\flat 9$ th violation will not affect the dominant chord which Avoid Note is always (4).

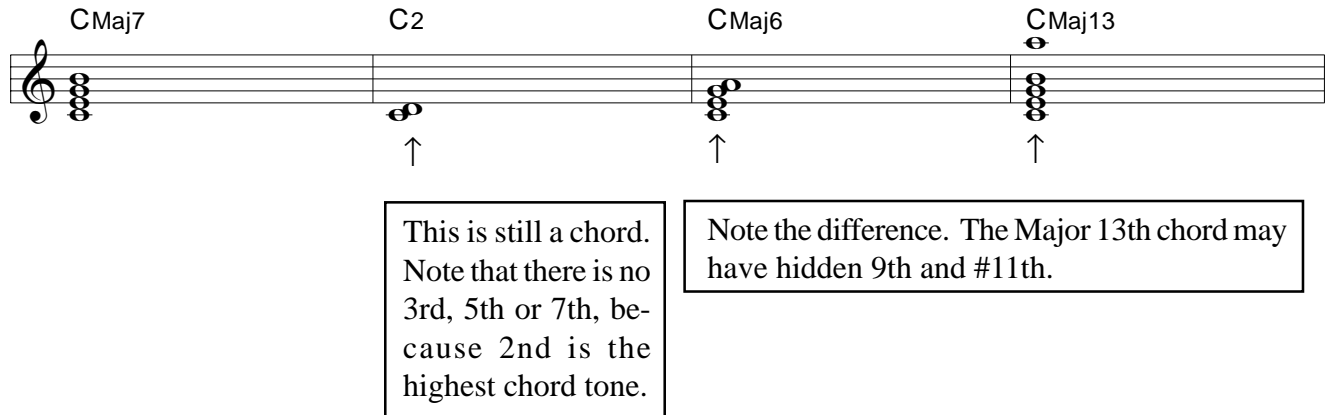

CMaj7 C2 CMaj6 CMaj13

This is still a chord. Note that there is no 3rd, 5th or 7th, because 2nd is the highest chord tone.

Note the difference. The Major 13th chord may have hidden 9th and #11th.



C-7 C-6 C-($\flat 6$) C-7(13)

- As shown above, the number attached to the chord name indicates the available tensions. In 6 chord, because 6 is the highest number, 7th, 9th, 11th, and 13th will not be available in the strict sense in theory. However, composers often write 6 chord to prohibit only 7th. Especially in Major chord, Major 7th chord cannot be used if the melody is the root. Because the melody always sounds an 8va above the chord no matter what the actual range of the note is, it will sound the violation with the $\flat 9$ th interval. Even though the melody is played in a close range on the same harmony instrument, it will still be weak sounding by a 1/2 step above the M7th of the chord. Thus, when the melody is the root of the chord, M6th or 6/9th chord must be used to maintain the integrity of the melody.
- The minor $\flat 6$ th chord in the example above may be easier if treated as an inversion of $A\flat$ Maj7 chord. However, spelling this chord this way maintains minor quality which affects the performance, and indicates Aeolian mode as well.
- Important Chord spelling rule:
If a number appears with no prefix (i.e., C9, C13), it is a dominant chord; while the Maj sign must be used to indicate a Major chord (i.e., CMaj9, CMaj13), except on 6 chord, which does not need any prefix to identify whether Dominant or Major because 6 chord is prohibited to have 7th note which is needed to create Tritone in the dominant chord, and therefore it will never be a dominant chord.

Diatonic Functioning Chord

Basic Cadence

T - SD - T

CMaj7 FMaj7 CMaj7

T - D - T

CMaj7 G7 CMaj7

T - SD - D - T

CMaj7 FMaj7 G7 CMaj7

CMaj7 D-7 E-7 FMaj7 G7 A-7 B-7^(b5)
T SD T SD D T D

T = Tonic Function SD = Subdominant Function D = Dominant Function

Tonic Functioning Chords

III- (E-7) is I Maj9 without the Root.
VI- (A-7) is Inverted I Maj6

CMaj⁽¹³⁾ E-7 A-7

Subdominant Functioning Chords

II- (D-7) is Inverted IV Maj⁽¹³⁾.

FMaj⁽¹³⁾ D-9

Dominant Functioning Chords

VII- (B-7^(b5)) is V7 without the Root.

G7⁽⁹⁾ B-7^(b5)

Note: In jazz theory, -7^(b5) will not substitute the dominant even though it contains Tritone. This chord is a member of minor chords, instead (i.e., II degree in a minor key).

Analysis

Find all the Dominant Chords first

- When you see a set of progression: $_7$ (any Dominant 7th, including altered tension(s)) going **down Perfect 5th** to any kind of chord, draw an arrow.

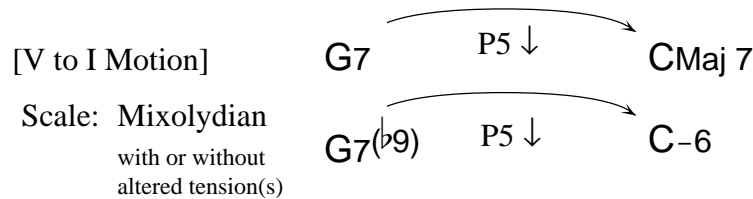

- When you see a set of progression: $_7$ (any Dominant 7th, including altered tension $\#11$ th) going **down minor 2nd** to any kind of chord, draw a dotted arrow. (See page 13 for the scale)



- When you see a set of progression: $_ -7$ (any minor, including $_ -7(\flat 5)$) going **up Perfect 4th** to $_7$ (any Dominant 7th, including altered tension(s)), draw a bracket.

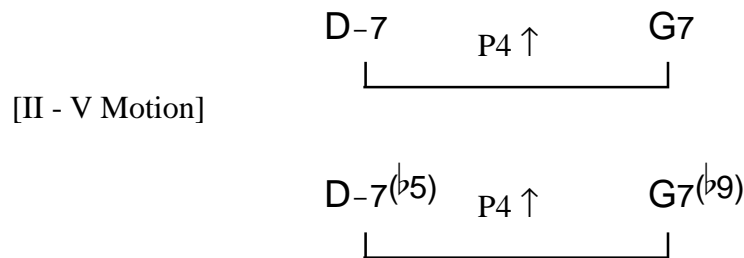

Complete Major II - V - I



Complete minor II - V - I

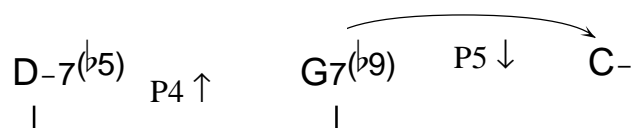

Harmonic Rhythm

- Harmonic Rhythm is a division line in music that evenly divides the section. I.e., a 32 bars music form is divided in 16 bars x 2, the 16 bars section will be divided in 8 bars x 2, the 8 bars section....., a measure in 4/4 is divided in 2 beats x 2...., and so on.
- Harmonic Rhythm creates a sense of section which affect melody as well as chord changes.
- Note that the Blues form differs in division. The 12 bars form could have been divided into 6 bars each, but the 6 bars section cannot be divided into 3 bars each because it is an odd number. Therefore, the Harmonic Rhythm in a 12 bars Blues form is 4 bars x 3.
- In most of the standard jazz music, which written in a 32 bars form, the Harmonic Rhythm subdivision is 8 bars x 4, because most common form styles are "A-A-B-A" and "A-B-A-C".

32 bars form	A(A)	4	4
	A(B)	4	4
	B(A)	4	4
	A(C)	4	4

- * **IMPORTANT:** Note that any of the dominant functions are not affected when it appears within Harmonic Rhythm; However, II - V motion are affected. As shown in the examples , if the II - V motion is seen across the Harmonic Rhythm division, it will never sound II - V motion.

In both examples, E-7 will sound an extension of CMaj7 because E-7 is a tonic functioning diatonic chord. Therefore, it will not be analyzed with a bracket.

Secondary Dominant

- Secondary Dominant Chords are non-diatonic dominant chords that resolve to a diatonic chord. V7 chord is already a diatonic chord, so it is called primary dominant chord. IV7 is not a Secondary Dominant Chord, because expected destination (Perfect 5th down) is a \flat VII, which is not a diatonic chord. However, it may be considered as a SubV7 chord which resolved to III-7 (minor 2nd down), so it could be analyzed as SubV7/III .

C

CMaj7 D-7 E-7 FMaj7 G7 A-7 B-7(\flat 5)

V7/II II-7 V7/III III-7
 A7 D-7 B7 E-7

V7/IV IVMaj7 V7/V V7
 C7 FMaj7 D7 G7

V7/VI VI-7 V7/VII $\text{VI-7}(\flat 5)$
 E7 A-7 F#7 B-7(\flat 5)

- Available Scale for Secondary Dominant Chords.

V⁷/II A7 Mixolydian $\flat 13$ (see the option below)

R T9 3 (4) 5 Tb13 b7

V⁷/III B7 Mixolydian $\flat 5, \flat 9, \flat 13$ (Can be Altered Mixo with $\sharp 9$ added)

R Tb9 3 (4) b5 Tb13 b7

V⁷/IV C7 Mixolydian

R T9 3 (4) 5 T13 b7

V⁷/V D7 Mixolydian

R T9 3 (4) 5 T13 b7

V⁷/VI E7 Mixolydian $\flat 9, \flat 13$

R Tb9 3 (4) 5 Tb13 b7

V⁷/VII F \sharp 7 Mixolydian $\flat 5, \flat 9, \flat 13$ (Can be Altered Mixo with $\sharp 9$ added)

R Tb9 3 (4) b5 Tb13 b7

- It is very common to see V⁷/II with Tb9. This is because II-7 is assumed as a I-7 momentary, so the key signature of that assumed minor will apply, which is $\flat 9$ to V⁷/II. This option will not occur with any other Secondary Dominant Chord.

V⁷/II A7 Mixolydian $\flat 9, \flat 13$

R Tb9 3 (4) 5 Tb13 b7

Extended Dominant

Scale: Mixolydian

- Extended Dominant Chords are dominant chords in a pattern of Circle of 5th which eventually reaches to a target. The changes shown below are typical Rhythm Changes bridge in B \flat . The target chord after this section is B \flat Maj7, which is I Maj7.

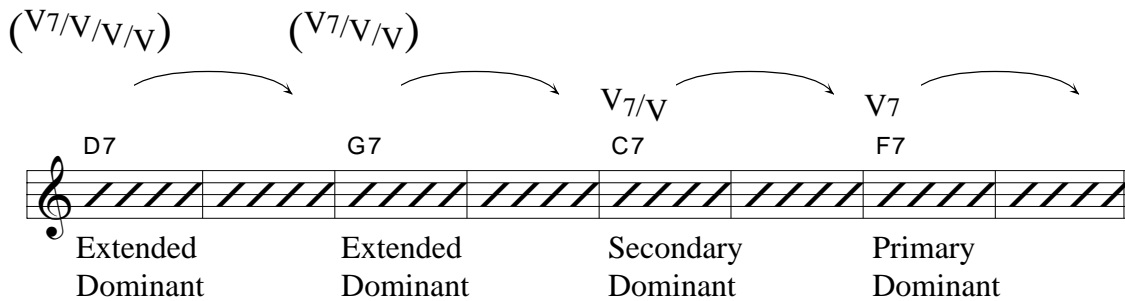

- Note that the Roman Numeral Analysis is usually not applicable to the Extended Dominant Chords. However, this class will apply them with Parentheses as shown.



Left: **Hiro Honshuku** with **Dave Liebman** and **Tiger Okoshi** at Live House RAG.

Bottom: **Honshuku** with his Boston Blazing Orchestra and **Mike Stern**.



Related II-

- Any dominant chord can be preceded by a minor chord, which is a P4th below the dominant chord. This is because the dominant chord is assumed as a V7 no matter where it is resolving to, so the added minor chord becomes a II- chord as the relationship. Therefore, the Roman numeral analysis are not applied, but brackets are needed.
 - Shown below is the bridge of Rhythm Changes and an arrangement applied with related II- chords. This kind of re-harmonization was common during the Be-Bop Era.

Original progression: D7, G7, C7, F7

Re-harmonized progression: A-7, D7, D-7, G7, G-7, C7, C-7, F7

Relationships: D7 → A-7 (II-7), G7 → D-7 (II-7), C7 → G-7 (II-7), F7 → C-7 (II-7). Also, C7 → V7/V, F7 → V7.

- The example shown below is Autumn Leaves, and its arrangement. Note that the target is completely ignored and replaced with a sequence of ^{sub}V7 and its related II-7.

Original progression: C-7, F7, B^bMaj7, E^bMaj7, A-7(^b5)

Re-harmonized progression: C-7, F7, B-7, E7, B^b-7, E^b7, A-7(^b5), D7(^b9)

Relationships: C-7 → IV-7, F7 → ^bVII7, B^bMaj7 → ^bIII Maj7, E^bMaj7 → ^bVI Maj7, A-7(^b5) → II-7(^b5). Re-harmonized chords are described as subV7/V and II-7(^b5).

PEACE

Horace Silver

G- II-7(b5) V7(b9) F II-7 V7
 A-7(b5) D7(b9) G-7 C7

1 2

Bb ^bII Maj7 II-7(b5) V7(#9) I Maj7 A II-7 V7
 B Maj7 C-7(b5) F7(#9) Bb Maj7 B-7 E7

3 4 5

I Maj7 (I Maj7) VI-7 (VI-7) Db II-7(b5) SubV7 I Maj7
 A Maj7 A/G# F#-7 F#-/E Eb-7(b5) D7(#11) Db Maj7

6 7 8

Bb n/a SubV7 I Maj7
 C7(#11) B7(#11) Bb Maj7

9 10

PEACE

Horace Silver

The musical score for "PEACE" by Horace Silver is presented in B \flat major, 4/4 time. The analysis shows the following chord progressions and their corresponding chord symbols:

- Bar 1: $\boxed{\text{B}\flat}$ VII-7($\flat 5$) A-7($\flat 5$)
- Bar 2: V7($\flat 9$)/VI D7($\flat 9$)
- Bar 3: VI-7 G-7
- Bar 4: V7/V C7
- Bar 5: \flat II Maj7 BMaj7
- Bar 6: II-7($\flat 5$) C-7($\flat 5$)
- Bar 7: V7($\sharp 9$) F7($\sharp 9$)
- Bar 8: I Maj7 B \flat Maj7
- Bar 9: B-7
- Bar 10: E7

The melodic line consists of eighth-note patterns with triplet markings. Bar numbers 1 through 5 are indicated below the staff.

- The analysis shown on page 22 is a way for improvisation, which is not quite correct in the sense of strict theory. These complicated changes in the beginning are landing on bar 4. One reason is that the 4th bar will sound strong as a target to the human sense. Another reason is that all of the changes will not sound too far away from key in B \flat Major. Therefore, if all of the progressions of the first 4 bars are analyzed as in key in B \flat Major, it will be shown above. This analysis is done using a technique called Modal Interchange, which will be explained later in this book. When you are improvising, it is necessary to see the quick momentary key changes in order to make effective solo line. When you are composing, it is necessary to use a related change to get to a landing key.

Analysis (cont.)

- Available Scale for "PEACE".

A-7(^b5) Loc
 D7(^b9) Mixo ^b9
 G-7 Dori
 C7 Mixo

Note: When this is analyzed as VI-7 as theory suggests, Aeolian should be used instead. As matter of fact, if this piece is played slow using Aeolian rather than Dorian, it will sound more effectively.

BMaj7 Lyd
 C-7(^b5) Loc
 F7([#]9) Mixo [#]9
 B^bMaj7 Ion

B-7 Dori
 E7 Mixo
 AMaj7 Ion
 F[#]-7 Aeol

E^b-7 Dori
 D7([#]11) Lyd ^b7
 D^bMaj7 Ion
 C7([#]11) Lyd ^b7

B7([#]11) Lyd ^b7
 B^bMaj7 Ion

Summary of Analysis

- When you are asked to analyze a tune in the class, the steps shown below are required

1. Arrow and Bracket Analysis, and the Key of the Moment indication with the box.

C CMaj7 A-7 D7 G7 CMaj7 FMaj7 G7 E-7 A7 D-7

2. Roman Numeral Analysis and Mode (Scale) Analysis.

I Maj7 VI-7 V7/V V7 I Maj7 IV Maj7 V7 III-7 V7/II II-7
 Ion Aeo Mixo Mixo Ion Lyd Mixo Phry Mixo Dori
 b9, b13

C CMaj7 A-7 D7 G7 CMaj7 FMaj7 G7 E-7 A7 D-7

3. Indication for M.I.(Modal Interchange) and/or D.R.(Deceptive Resolution) if applicable.

I Maj7 VI-7 V7/V V7 I Maj7 IV Maj7 V7 III-7 V7/II II-7
 Ion Aeo Mixo Mixo Ion Lyd Mixo Phry Mixo Dori
 b9, b13

C CMaj7 A-7 D7 G7 CMaj7 FMaj7 G7 E-7 A7 D-7

D.R.

4. Scale Degree Analysis.

I Maj7 VI-7 V7/V V7 I Maj7 IV Maj7 V7 III-7 V7/II II-7
 Ion Aeo Mixo Mixo Ion Lyd Mixo Phry Mixo Dori
 b9, b13
D.R.

C CMaj7 A-7 D7 G7 CMaj7 FMaj7 G7 E-7 A7 D-7

Project

- **Write a piece using the technique you have learned**

- 32 bars form recommended.
- Two types of the conventional forms are recommended.
 - 1) A - A - B - A
i.e.; "Take The A Train"
 - 2) A - B - A - C
i.e.; "The Days Of Wine And Roses"

If you are sure you can make unconventional form musically, it is acceptable as long as you know what you are doing.

I.e.; "Peace", "Blue In Green"

No Blues please.

- **Check Points**

- **Notation**
Neatness, Imaginary bar line, Beats positioning, Accidentals, Ending bar line, Beaming, Clef and so on.
- **Scale notes**
Notes must fit in the chord scales, unless otherwise it is an passing/approach note. Therefore, **you must analyze** with Roman numeral and name of the scale (mode) for your piece referring to the page 31.

- **Extra Points**

- Musical Phrasing.
- Intro and TAG (Outro).
- Recording of the piece.



Hiroaki Honshuku (F l u t e , E W I) and A-NO-NE BAND

Hiroaki Honshuku was first introduced to jazz in 1985 while teaching music at the US Naval Base in Yokosuka, Japan. Two years later, Hiro came to the Boston area. He started at Berklee College of music as a scholarship student in January 1987. By the fall, he was also accepted to the New England Conservatory as a scholarship graduate student. He has studied with George Russell, Thomas McKinley, Dave Holland, Bob Moses, George Garzone, and Matthew Marvuglio. Hiro was chosen as leader of the 1990 New England Conservatory Honors Jazz Quintet, which performed throughout Massachusetts.

In May 1990, Hiro graduated simultaneously from Berklee College of Music and the New England Conservatory. He received Summa Cum Laude for his Diploma of Music at Berklee as a performance major. He received Academic Honors and Distinction in Performance for his Master of Music at the New England Conservatory as a Jazz Composition major. Besides being very active playing in Boston jazz clubs, he has been busy teaching in the Boston area. Since graduation, he has taught at the New England Conservatory.

Hiro has also played with Mike Stern, Dave Liebman, Mick Goodrick, Dave Weckl, Tiger Okoshi, George Russell, George Garzone, Bob Moses, and Tom McKinley. Hiro has recorded two CDs with the Ken Schaphorst Big Band as well as performing at jazz clubs. He also recorded “Are You Blue” with his own group A-NO-NE Band in 1994.

The nature of the A-NO-NE Band varies according to the performance. This concept was started by Hiro at the end of 1987 when he realized he wanted to be a strong composer. He made a list of good musicians around the Boston area and tried to organize different size bands and different types of music for several concerts. The A-NO-NE Band can be a small Jazz group, Avant-garde, Funk Fusion and even a Big Band. All of the selections of the A-NO-NE Band are written by Hiro. Because of the success of four A-NO-NE Big Band concerts, he was invited to Paris as a guest conductor in June 1990, and his newly formed big band “Boston Blazing Jazz Orchestra” was invited to the Jazz Festival in Kyoto ‘94 for a week long performance.

December, 1994