

# BASIC MUSIC THEORY

HOW TO READ, WRITE, AND UNDERSTAND  
WRITTEN MUSIC



Sol-Ut Press

[www.sol-ut.com](http://www.sol-ut.com)

Published by Sol-Ut Press  
A Music Education Business  
**www.sol-ut.com**

Copyright © 2001 Questions, Ink. All rights reserved. No part of this book, including interior design, cover design, and icons, may be reproduced or transmitted in any form, by any means (electronic, photocopying, recording, or otherwise) without the prior written permission of the publisher.

Questions, Ink and the Q.I. logo are trademarks of Sol-Ut Press.

send E-mail regarding this book to [BMT@QuestionsInk.com](mailto:BMT@QuestionsInk.com)

**LCCN: 2001086279**

**ISBN: 0-9707512-9-X**

For general information about this book or Sol-Ut Press, visit our web site at [www.QuestionsInk.com](http://www.QuestionsInk.com) or [www.sol-ut.com](http://www.sol-ut.com).

**Publisher's Cataloging-in-Publication**  
*(Provided by Quality Books, Inc.)*

Harnum, Jonathan.

Basic music theory : how to read, write, and  
understand written music / Jonathan Harnum. -- 1st ed.

p. cm.

Includes index.

LCCN 2001086279

ISBN 0-9707512-9-X

1. Music Theory. 2. Conducting. 3. Musical  
notation. I. Title.

MT6.H37 2001

781

QBI01-700378

# What's New in *Basic Music Theory 2nd ed.*



- New Chapter on the Guitar Fingerboard
- Change in sequence of material. Rhythm before pitch.
- Larger format (8.5 x 11) for easier reading
- Updated web references
- More scales included
- More *Practical Use* exercises
- More blank staves to practice on
- Revised *Chapter* and *Part Reviews*
- Links to helpful information on Sol-Ut.com
- Fully hyperlinked TOC, Index, cross-references, and web addresses

\$14.95

[Click to order](#)

**Read what folks have to say about the Music Theory book versatile enough to be used by middle schools, universities, and adults!**

“Fun and engaging. A real winner!”

—Terrie Lyons, PhD, P.C.

“Jonathan Harnum has taken an overly complicated subject matter and made it learnable for anyone. And I do mean anyone! Harnum de-cryptifies all that is involved with music theory for the non-musician. But this book is not just for the non-musician. I have been a student of music for more than 13 years and a teacher for 3 and I found myself finding new and interesting (and humorous) facts about music theory. This book can teach anyone music theory and keep a smile on their face the entire time.”

—Robin Gibelhausen, music teacher, Illinois

“Basic Music Theory by Jonathan Harnum is an excellent book for people of all levels. I have played various instruments over 24 years and because of Harnum's matter of fact, conversational tone, this book has lent more to my understanding of basic music theory than all my private instructors combined.”

—Solstice 1221, Anon. reader in LA

“I appreciate the clever and humorous ways that you introduce many of the concepts. The illustrations and pictures are very helpful. Can't wait to get to the bookstore to get a copy for myself.”

—Dave Larsen, elementary teacher, Hawarden, IA

“Basic Music Theory is an ideal and highly recommended text for anyone of any background wanting to become proficient in the reading, composing, and performance of written and notated music.”

—Midwest Book Review (5 stars, highest rating)

“This is a book that covers lots of ground without ever appearing "difficult." It is written in a breezy, conversational manner, so one "talk" naturally drifts into the next.”

—KLIATT Library Review Service

## **EVEN LISTENING TO MUSIC IS PROVEN TO MAKE YOU SMARTER! NO JOKE.**

One important center of this research has been the University of California at Irvine, where Drs. Gordon Shaw and Fran Rauscher have found that active music making improves children's math skills. Shaw is a physicist who found that the inner working of the human brain operates in patterns that resemble musical structures, and he suspects that music may be the key to understanding intelligence.

Other research supports similar conclusions: at McGill University in Canada, researchers found that kids who take piano lessons showed improved general and spatial cognitive development, and studies at a Miami Veterans Administration hospital indicate that music making may improve the brain's natural production of regulatory hormones like melatonin. And most amazingly, an experiment by Rauscher showed that listening to the first ten minutes of the Mozart Concerto for Two Pianos in D Major (K. 448) improved the listeners' spatial-temporal reasoning!

In the days of the New England singing-schools, people believed in teaching and learning music because it was good for the soul. We've learned a lot since then.

If music really can make a person better at math, science and engineering, and if just *listening* to music can make you smarter, why wouldn't anyone want to benefit from music?

As we begin a new century, there is proof about the power of music education.

And it's still good for your soul.

For more information about music and the brain visit:

**[www.QuestionsInk.com/brain](http://www.QuestionsInk.com/brain)**



**JUST AS THERE CAN BE NO MUSIC  
WITHOUT LEARNING, NO EDUCATION IS  
COMPLETE WITHOUT MUSIC.**

**THIS BOOK IS DEDICATED  
TO ALL MY TEACHERS, AND  
TO MY STUDENTS, WHO ARE  
ALSO MY TEACHERS.**

**THANK YOU.**





Click on a subject to jump to its corresponding page

# **Basic Music Theory**

## Table of Contents

|   |   |
|---|---|
| 0 The Chapter Everyone Skips . . . . .          | 1 |
| Welcome to <i>Basic Music Theory!</i> . . . . . | 2 |
| Why Basic Music Theory? . . . . .               | 3 |
| What's Inside. . . . .                          | 3 |
| The Icons. . . . .                              | 5 |
| <i>Basic Music Theory: Overview</i> . . . . .   | 6 |
| How to Use the Special Features . . . . .       | 9 |
| Moving On . . . . .                             | 9 |

### **PART ONE: START ME UP**

|   |    |
|---|----|
| 1 An Ultra-brief History of Musical Notation . . . . .    | 13 |
| Hear, There, Everywhere . . . . .                         | 14 |
| Music Performed . . . . .                                 | 15 |
| The Future . . . . .                                      | 20 |
| Moving On . . . . .                                       | 21 |
| 2 Lines, Lines, Everywhere There's Lines . . . . .        | 23 |
| The Staff. . . . .  | 24 |
| Moving On . . . . .                                       | 25 |
| Chapter 2 Study Guide. . . . .                            | 25 |
| 3 More Lines. . . . .                                     | 27 |
| No Holds Barred. . . . .                                  | 28 |
| What? More Lines? . . . . .                               | 28 |
| Moving On . . . . .                                       | 29 |
| Chapter 3 Study Guide . . . . .                           | 30 |
| 4 The Wind-up and the Pitch . . . . .                     | 31 |
| Spaced Out and Lined Up . . . . .                         | 32 |
| The High and the Lowly . . . . .                          | 33 |
| Moving On . . . . .                                       | 34 |
| Chapter 4 Study Guide . . . . .                           | 34 |
| Home, Home on the Ranges . . . . .                        | 36 |
| 5 A Note by Any Other Name Would Sound as Sweet . . . . . | 37 |
| What's in a Name? . . . . .                               | 38 |
| Moving On . . . . .                                       | 39 |

|                                 |           |
|---------------------------------|-----------|
| Chapter 5 Study Guide . . . . . | 40        |
| <b>Part I Review . . . . .</b>  | <b>41</b> |
| Whew! You Made It. . . . .      | 41        |
| The Review . . . . .            | 41        |
| Moving On . . . . .             | 44        |

**PART TWO: CLEF NOTES**

|   |           |
|---|-----------|
| <b>6 Going Over the Clef . . . . .</b>        | <b>47</b> |
| What's a Clef? . . . . .                      | 48        |
| The Clefs . . . . .                           | 49        |
| Moving On . . . . .                           | 52        |
| Chapter 6 Study Guide . . . . .               | 52        |
| <b>7 No Trouble with Treble . . . . .</b>     | <b>55</b> |
| Golly G . . . . .                             | 56        |
| Moving On . . . . .                           | 58        |
| Chapter 7 Study Guide . . . . .               | 58        |
| <b>8 The Bass of the Clef . . . . .</b>       | <b>61</b> |
| This Clef is Not a Fish! . . . . .            | 62        |
| Nmore Mnemonics . . . . .                     | 63        |
| Moving On . . . . .                           | 64        |
| Chapter 8 Study Guide . . . . .               | 65        |
| <b>9 To Fathom the Rhythm Clef . . . . .</b>  | <b>67</b> |
| No Letters With this Staf. . . . .            | 68        |
| Why No Note Names? . . . . .                  | 68        |
| The One-Line Staff with Rhythm Clef . . . . . | 68        |
| Instruments, not Pitches . . . . .            | 69        |
| The 5-Line Staff with Rhythm Clef . . . . .   | 69        |
| Moving On . . . . .                           | 71        |
| Chapter 9 Review . . . . .                    | 71        |
| <b>Part II Review . . . . .</b>               | <b>73</b> |
| Whew! You Made It. . . . .                    | 73        |
| The Review . . . . .                          | 73        |
| Moving On . . . . .                           | 77        |

## **INTERLUDE: COMING TO TERMS**

|  |           |
|--|-----------|
| <b>10 Musical Terms . . . . .</b>      | <b>79</b> |
| Musical Terms are Directions . . . . . | 80        |
| Tempo . . . . .                        | 80        |
| Dynamics. . . . .                      | 81        |
| Articulations . . . . .                | 82        |
| General Musical Terms. . . . .         | 84        |
| Pete and Repeat . . . . .              | 85        |
| Moving On . . . . .                    | 87        |

## **PART THREE: YOU GOT RHYTHM**

|  |            |
|--|------------|
| <b>11 Where's the Beat? . . . . .</b>    | <b>91</b>  |
| The Beat Goes On . . . . .               | 92         |
| The Notes . . . . .                      | 92         |
| Note Anatomy 101 . . . . .               | 93         |
| The Stem . . . . .                       | 94         |
| Moving On . . . . .                      | 95         |
| Chapter 11 Review. . . . .               | 95         |
| <b>12 The Sound of Silence . . . . .</b> | <b>97</b>  |
| Take a Rest . . . . .                    | 98         |
| The Rests of the Story . . . . .         | 98         |
| Moving On . . . . .                      | 99         |
| Chapter 12 Review. . . . .               | 99         |
| <b>13 Meter. . . . .</b>                 | <b>101</b> |
| Not the Metric System. . . . .           | 102        |
| 4/4 Time . . . . .                       | 103        |
| 2/4 Time . . . . .                       | 104        |
| 3/4 Time . . . . .                       | 104        |
| Moving On . . . . .                      | 104        |
| Chapter 13 Review. . . . .               | 105        |
| <b>14 Down With the Count . . . . .</b>  | <b>107</b> |
| Can You Count to 4? . . . . .            | 108        |
| Tap Your Foot . . . . .                  | 108        |
| Quarter Note Count . . . . .             | 109        |
| Half Note Count . . . . .                | 109        |
| Whole Note Count . . . . .               | 110        |
| Count the Rest . . . . .                 | 111        |
| All Together Now . . . . .               | 111        |
| Moving On . . . . .                      | 112        |

|  |            |
|--|------------|
| Chapter 14 Review . . . . .                | 112        |
| <b>15 New Notes . . . . .</b>              | <b>113</b> |
| Eighth Notes and Rests . . . . .           | 114        |
| Sweet Sixteenth Notes . . . . .            | 116        |
| How to Figure out a Tough Rhythm . . . . . | 118        |
| Moving On . . . . .                        | 118        |
| Chapter 15 Review . . . . .                | 119        |
| <b>16 Seeing Dots . . . . .</b>            | <b>121</b> |
| You Are Not Seeing Things . . . . .        | 122        |
| The Dotted Whole Note . . . . .            | 122        |
| The Dotted Half Note . . . . .             | 123        |
| The Dotted Quarter Note . . . . .          | 123        |
| Dotted Eighth Note . . . . .               | 124        |
| Dotted Rests . . . . .                     | 125        |
| Moving On . . . . .                        | 126        |
| Chapter 16 Review . . . . .                | 126        |
| <b>17 Triplets! . . . . .</b>              | <b>127</b> |
| General Triplet Information . . . . .      | 128        |
| Eighth Note Triplet . . . . .              | 128        |
| Sixteenth Note Triplets . . . . .          | 129        |
| Quarter Note Triplets . . . . .            | 130        |
| Moving On . . . . .                        | 131        |
| Chapter 17 Review . . . . .                | 131        |
| <b>Part III Review . . . . .</b>           | <b>133</b> |
| Whew! You Made It . . . . .                | 133        |
| The Review . . . . .                       | 133        |

**INTERLUDE: TO PLAY OR NOT TO PLAY**

|   |            |
|---|------------|
| <b>18 Don't Say Practice. . . . .</b>   | <b>141</b> |
| Don't Say the P Word . . . . .          | 142        |
| Come on Baby, Light my Desire . . . . . | 144        |
| How to Get Better . . . . .             | 145        |
| Start a New Habit . . . . .             | 146        |
| Where to Do It . . . . .                | 147        |
| How to Do It . . . . .                  | 148        |
| The Ideal Session . . . . .             | 150        |
| Other Ways to Play . . . . .            | 154        |
| Some Instruments . . . . .              | 156        |

## **PART FOUR: SEE SHARP OR BE FLAT**

|   |            |
|---|------------|
| <b>19 Accidentals On Purpose . . . . .</b>              | <b>159</b> |
| Accidentals Are No Accident . . . . .                   | 160        |
| General Accidental Information . . . . .                | 160        |
| Flats . . . . .   | 161        |
| Sharps . . . . .  | 161        |
| Naturals . . . . .                                      | 162        |
| More Accidental Rules . . . . .                         | 162        |
| Moving On . . . . .                                     | 163        |
| Chapter 19 Review . . . . .                             | 163        |
| <br>  |            |
| <b>20 The Piano Keyboard . . . . .</b>                  | <b>165</b> |
| Why Learn the Keyboard? . . . . .                       | 166        |
| Note Names on the Keyboard . . . . .                    | 166        |
| Flat Notes on the Keyboard . . . . .                    | 167        |
| Sharp Notes on the Keyboard . . . . .                   | 168        |
| Enharmonic Notes . . . . .                              | 168        |
| Half Steps and Whole Steps . . . . .                    | 169        |
| The Chromatic Scale . . . . .                           | 169        |
| Moving On . . . . .                                     | 170        |
| Chapter 20 Review . . . . .                             | 170        |
| <br>  |            |
| <b>21 Major Scales . . . . .</b>                        | <b>173</b> |
| The Major Scale . . . . .                               | 174        |
| The C Major Scale . . . . .                             | 174        |
| Octave . . . . .  | 175        |
| Scales with Accidentals . . . . .                       | 176        |
| Major Scales with Many Accidentals . . . . .            | 177        |
| Moving On . . . . .                                     | 178        |
| Chapter 21 Review . . . . .                             | 178        |
| <br>  |            |
| <b>22 Unlock the Secret of Key Signatures . . . . .</b> | <b>179</b> |
| Key Signatures . . . . .                                | 180        |
| Flat Key Signatures . . . . .                           | 181        |
| Find the Name of a Flat Key . . . . .                   | 181        |
| Construct a Flat Key . . . . .                          | 182        |
| Sharp Key Signatures . . . . .                          | 183        |
| Find the Name of a Sharp Key . . . . .                  | 183        |
| Construct a Sharp Key . . . . .                         | 184        |
| The Key of C . . . . .                                  | 184        |
| The Keys to the Kingdom . . . . .                       | 185        |
| Moving On . . . . .                                     | 186        |
| Chapter 22 Review . . . . .                             | 187        |

|                                 |            |
|---------------------------------|------------|
| <b>Part IV Review</b> . . . . . | <b>189</b> |
| Whew! You Made It. . . . .      | 189        |
| The Review . . . . .            | 189        |

**PART FIVE: INTERVAL TRAINING**

|  |            |
|--|------------|
| <b>23 Intervals</b> . . . . .          | <b>197</b> |
| Intervals by the Number . . . . .      | 198        |
| Interval Quality . . . . .             | 199        |
| Altering Perfect Intervals . . . . .   | 200        |
| Altering Major Intervals. . . . .      | 201        |
| Finding an Interval . . . . .          | 202        |
| A Brief Note on Ear Training . . . . . | 204        |
| Moving On . . . . .                    | 204        |
| Chapter 23 Review. . . . .             | 205        |

|                                    |            |
|------------------------------------|------------|
| <b>24 Minor Scales</b> . . . . .   | <b>207</b> |
| General Minor Scale Info . . . . . | 208        |
| The Natural Minor Scale . . . . .  | 208        |
| The Harmonic Minor Scale. . . . .  | 211        |
| The Melodic Minor Scale. . . . .   | 212        |
| Moving On . . . . .                | 213        |
| Chapter 24 Review. . . . .         | 213        |

|                                       |            |
|---------------------------------------|------------|
| <b>25 Scales a la Mode</b> . . . . .  | <b>215</b> |
| What is a Mode? . . . . .             | 216        |
| The Modes . . . . .                   | 216        |
| Finding Modes in Other Keys . . . . . | 219        |
| Moving On . . . . .                   | 220        |
| Chapter 25 Review. . . . .            | 220        |

|   |            |
|---|------------|
| <b>26 Blues To Bebop and Beyond</b> . . . . . | <b>221</b> |
| General Blues Scale Info . . . . .            | 222        |
| The Blues Scale . . . . .                     | 222        |
| Other Crazy Scales . . . . .                  | 224        |
| Moving On . . . . .                           | 226        |
| Chapter 26 Review. . . . .                    | 226        |
| How to Sing the Blues (Not Really) . . . . .  | 227        |

|                                 |            |
|---------------------------------|------------|
| <b>Part V Review.</b> . . . . . | <b>229</b> |
| Whew! You Made It. . . . .      | 229        |
| The Review . . . . .            | 229        |

## **INTERLUDE: CONDUCTING YOURSELF**

|  |            |
|--|------------|
| <b>27 Conducting</b> . . . . .           | <b>235</b> |
| General Conducting Information . . . . . | 236        |
| Conducting Patterns . . . . .            | 238        |
| The Left Hand . . . . .                  | 240        |
| Moving On . . . . .                      | 242        |

## **PART SIX: STRIKE A CHORD**

|                              |            |
|------------------------------|------------|
| <b>28 Triads</b> . . . . .   | <b>245</b> |
| General Chord Info . . . . . | 246        |
| The Triad . . . . .          | 247        |
| Major Triads . . . . .       | 248        |
| Minor Triads . . . . .       | 249        |
| Diminished Triads . . . . .  | 249        |
| Augmented Triads . . . . .   | 250        |
| Moving On . . . . .          | 250        |
| Chapter 28 Review . . . . .  | 251        |

|  |            |
|--|------------|
| <b>29 Chord Extensions</b> . . . . .   | <b>253</b> |
| General Chord Extension Info . . . . . | 254        |
| Seventh Chords . . . . .               | 254        |
| Ninth Chords . . . . .                 | 256        |
| Other Chords . . . . .                 | 256        |
| Moving On . . . . .                    | 257        |
| Chapter 29 Review . . . . .            | 257        |

|                                      |            |
|--------------------------------------|------------|
| <b>30 Chord Inversions</b> . . . . . | <b>259</b> |
| More General Chord Info . . . . .    | 260        |
| First Inversion . . . . .            | 261        |
| Second Inversion . . . . .           | 262        |
| Inverting Seventh Chords . . . . .   | 263        |
| How to Find a Chord's Name . . . . . | 263        |
| Moving On . . . . .                  | 263        |
| Chapter 30 Review . . . . .          | 264        |

|  |            |
|--|------------|
| <b>31 Chord Progressions</b> . . . . .               | <b>267</b> |
| What is a Chord Progression? . . . . .               | 268        |
| Chord Progression General Guidelines . . . . .       | 268        |
| The I IV V <sup>7</sup> I Progression . . . . .      | 270        |
| The ii V <sup>7</sup> I Progression . . . . .        | 272        |
| The iii vi ii V <sup>7</sup> I Progression . . . . . | 273        |
| The 12 Bar Blues . . . . .                           | 273        |

|                             |     |
|-----------------------------|-----|
| Moving On . . . . .         | 274 |
| Chapter 31 Review . . . . . | 275 |

|                                 |            |
|---------------------------------|------------|
| <b>Part VI Review . . . . .</b> | <b>277</b> |
| Whew! You Made It . . . . .     | 277        |
| The Review . . . . .            | 277        |

## **PART SEVEN: MORE OF THE SAME**

|  |            |
|--|------------|
| <b>32 Faster Notes and Double Dots . . . . .</b> | <b>287</b> |
| Shorter Notes . . . . .                          | 288        |
| Double Dotted Notes . . . . .                    | 289        |
| Moving On . . . . .                              | 289        |
| Chapter 32 Review . . . . .                      | 290        |

|   |            |
|---|------------|
| <b>33 Double Flats, Double Sharps . . . . .</b> | <b>291</b> |
| Double Your Fun . . . . .                       | 292        |
| Double Flats . . . . .                          | 292        |
| Double Sharps . . . . .                         | 292        |
| A Werd on Spelling Kords . . . . .              | 293        |
| Moving On . . . . .                             | 294        |
| Chapter 33 Review . . . . .                     | 294        |

|                                 |            |
|---------------------------------|------------|
| <b>34 More Meters . . . . .</b> | <b>295</b> |
| Beyond 4/4 Time . . . . .       | 296        |
| Cut Time, or 2/2 Time . . . . . | 296        |
| 6/8 Time . . . . .              | 296        |
| Odd Meters . . . . .            | 298        |
| Moving On . . . . .             | 299        |
| Chapter 34 Review . . . . .     | 299        |

|                             |     |
|-----------------------------|-----|
| <b>Part VII Review 301</b>  |     |
| Whew! You Made It . . . . . | 301 |
| The Review . . . . .        | 301 |

|                                    |            |
|------------------------------------|------------|
| <b>35 What Comes Next. . . . .</b> | <b>305</b> |
| So Much More . . . . .             | 306        |
| Theory Ain't Everything . . . . .  | 306        |
| Drop Me An E-mail . . . . .        | 306        |



# THE CHAPTER EVERYONE SKIPS



*A journey of one thousand miles  
must begin with a single footstep.*

— Lao Tzu c531 B.C.

## In This Chapter

- Welcome to *Basic Music Theory!*
- Why this book?
- Book Overview
- How to Use the Special Features
- Moving On

# Welcome to *Basic Music Theory*!

---

If you never thought you would pick up a book on music theory, you're not alone. I never thought I'd write one. But in my experience as a student, a player, and a teacher, I have searched for and used many different methods of learning music theory. Some methods were good, most were okay, and a few were bad, but none of them satisfied me.

I've tried to take all the positive things about teaching theory, thrown in many of the tricks I've used with hundreds of students, and tossed in a little humor, in an effort to make learning music theory both easier and more enjoyable. These methods and suggestions have worked well with all students of all sizes. I hope they'll work for you too.

## What It's All About

*Basic Music Theory* is your introduction to another language—the rich and often strange language of music. By the time you've completed even two lessons in this book, you'll have made big steps down the path toward understanding how to read music.

With this language you'll be able to reproduce sounds from nearly a thousand years ago by someone like Guillaume de Machaut. And with this same language you can play music by someone like Alannis Morissette, or Limp Bizkit, or Dave Matthews, or Garth Brooks. Name your favorite artist. If it's written down, you'll be able to understand and interpret it!

But let's not get too carried away. Those musicians you look up to (some of whom have earned millions upon millions of dollars) have spent thousands of hours learning both their instrument and their music theory. Learning theory will take some focus and some work, but that work will be clearly explained, and you'll be surprised to find how easy it can be.

Nobody likes to work on a task endlessly. For that reason, the theory lessons are broken up by Interludes every few chapters. These interludes cover things like practice, conducting, Italian terms, and a brief history of musical notation.

So, if you're interested in the music of Mozart or Metallica, Beethoven or B.B. King, Dizzie Gillespie or Vince Gill, you've finally found the right book.

# Why *Basic Music Theory*?

---

Learning music theory doesn't have to be a long and difficult process. It does take some work, but with this book, you can make that work much easier. I've suffered through some of the most boring music courses a person should be forced to suffer, and have had experience *inflicting* such boredom on others as well. Believe me, it's not fun on either side! Whether you're a teacher or a student, I'd like to spare you any of that frustration and difficulty.

Music theory is a language that is used by all Western instruments. Whether you play the kazoo or the krumhorn, voice or vibraphone, French horn or nose flute, pignout psaltery or percussion, trombone or triangle, bagpipes or bass fiddle, Sousaphone or Saxophone.... You get the idea. Whatever instrument you play, reading music will be a useful tool in your studies, and this book will teach it to you.

## What's Inside

---

*Basic Music Theory* is divided in seven Parts, and in each Part are several chapters.

Between some of the Parts are Interludes, stand-alone sections giving information on aspects of music other than theory.

The Codicil (stuff at the back of the book) contains a musical terms glossary, a book index, the keyboard template, and blank staff paper for photocopying (please don't tear it out of the book so others may use it, too).

## Chapters

Each chapter is fairly short and contains detailed information on one or two topics. When an important term appears for the first time, it is in ***bold and italics*** so that when you do the review at the end of the chapter you can find the information easily.

## Chapter Reviews

At the end of each chapter is a brief review covering the material in the chapter. The reviews are generally very short, the longest being around fifteen questions.

## Practical Use

Also at the end of each chapter is a short list (often only one item) of written exercises to hone your music-writing/reading ability.

## Parts

Each Part is made up of four to seven Chapters. The division isn't arbitrary. Information in each Part is related and the reviews come at a point where a review will do the most good.

### Part Review

At the end of each Part is a comprehensive review in the same format as the chapter reviews. Cross-references below the questions allow you to quickly find and re-read any section that you haven't quite remembered yet.

## About the End-of-Section Reviews

After each Chapter and Part is a section which contains questions on the information presented. The reviews are arranged as quizzes, but with one important difference. *The answers are in the margin!* That's right, the answers are right there. How is that supposed to help you? Read on...

The best way to learn is to get immediate feedback. There is no better way to get feedback than to have the answer right there with the question. Of course, this does you no good if you can see the answer before reading the question, so you have to cover up the answers while you give yourself the quiz. In the back of this book is a cut-out bookmark with a piano keyboard on it (if this is a library book, please photocopy the keyboard and leave the original for others to copy as well). Use the keyboard to cover up the answers while you test yourself.

After you answer the question, simply uncover the answer in the margin and kiss yourself on the elbow for giving the correct answer. If you didn't

get the answer correct, at least you have the answer right there to remind you.

Voila. Instant feedback, and your memory of the material is sped right along.

Once you're confident you know the information, you can either go on to the next chapter or take the written quiz. You can find the quizzes and a whole lot more in the *Basic Music Theory Teaching Packet*. For more information go to **[www.QuestionsInk.com/classroom1](http://www.QuestionsInk.com/classroom1)**, (that's the number one, not the letter "1" at the end of the web address).

*Basic Music Theory* is meant to be used as a textbook and study guide, with written work taking place on the blank staff paper photocopied from the back of the book. That way the book may be used over and over again. Of course, if you've bought this book for your own personal use, mark it up!

## The Icons

---

### Memory Tip

This icon is placed near methods to improve your memory of terms, notes, and other fun stuff. These little memory tricks will save you a lot of brain strain.



## Take Notice

This icon is placed near information that is particularly useful to know. Heed this information and you'll avoid common mistakes.



## Theory Geek Alert

This icon is placed near information that isn't especially necessary, but might be interesting.



# *Basic Music Theory: Overview*

---

## Chapter 0: General Information

In addition to what you've already read, this part will give you an overview about the book as well as tips on how to study the information.

## Part I: Start Me Up

Chapter 1. This section is where the fun begins. And what better way to start than with something other than music theory! The first chapter is an ultra-ultra-brief history of written music. It'll be painless, I promise.

In Chapters 2-5 you'll learn the basic terms and symbols of written music, how they look, what they mean, and what they do; also in this section are note names, pitches, and of course the review. You'll be able to read music in only one or two lessons.

## **Part II: The Clefs**

Chapters 6-9. The party continues. In this section you'll find more symbols (no, not cymbals) used in written music. Chapter 6 covers general information about clefs, and Chapters 7-9 give you the specifics of the bass, treble and percussion clefs. In four easy lessons you'll understand what these signs tell you.

## **Interlude: Musical Terms**

Chapter 10. Time for a break. This Interlude is all about musical terms, most of which are in Italian. You'll learn the terms, what they mean, and what they tell you to do.

## **Part III: You Got Rhythm**

Chapters 11-17. This is the longest Part with 7 chapters, in which you'll learn about note lengths and how they're related to each other, several different rests, time signatures, a method for counting rhythms, what a dot does to a note, and triplets.

## **Interlude: To Play or Not to Play**

Because that last part was so long, we'll take another short break. This Interlude is all about practice. How to go about it, how to structure it, how to record it in a journal and on a tape recorder, equipment you'll need and how to use it, and how to do what must be done to become a better player.

## **Part IV: See Sharp or Be Flat**

Chapters 18-21. Once you've got the basics of reading music down, we go into more advanced concepts. This section shows you how to use the piano keyboard, covers whole steps and half steps, sharps, flats, and naturals, the chromatic scale, enharmonic notes, and key signatures.

## **Part V: Intervals and Minor Scales**

Chapters 23-26. In this section you'll learn how to measure the interval from one note to another, and using that information you'll learn how to

construct a minor scale beginning on any note. From there you'll move on to modes, and finally to several other types of scales.

## Interlude: Conducting Yourself

Chapter 27. The final interlude. In this Interlude you'll learn the basics of conducting, conducting patterns, body and facial language, and the work it takes to become a good conductor. Also learn how to use conducting patterns to enable you to write down what you hear.

## Part VI: Chords

Chapters 27-30. Here you'll learn about how chords are constructed and the many different types of chords. You'll also learn about chord extensions and the symbols they use, chord inversions, and several basic chord progressions.

## Part VII: More of the Same

In this final short section are some concepts which go further than when they were originally introduced. Included are double dots, double sharps and double flats, faster notes, 6/8 time and odd meters.

## Codicils

Teacher Information: A quick summation of the *Basic Music Theory Classroom Packet*.

Glossary of Musical Terms: Here they are. A quick reference and not exhaustive by any means, but you'll find most of what you might be looking for.

Index: This is a cross-reference to all the terms and concepts presented in the book, so you can find any topic covered quickly and easily.

Blank Staff Paper: To be used for the Practical Use sections at the end of the Chapter Reviews. Please leave the staff paper in the book so others may use them later. Feel free to make as many copies as you need. Make extras. Give them to your friends.



Piano Keyboard: One side with the note names, one side for you to fill in later. Also used with the End-of-Section Reviews as mentioned next.

## How to Use the Special Features

---

### The End-of-Section Reviews

What's different about these reviews is that the answers are right there with the questions. Also, in case you want to go back to review the information, there's a reference (in itty bitty writing) to the page where you can look at the information again.

The answers are on the right side of the page, and the questions on the left. While reviewing the chapter, to cover up the answer, you'll use . . .

### The Keyboard

In the back of the book is a piano keyboard template, double-sided with the keys named on one side and blank on the other. The keyboard is used as a bookmark, as a cover for the study guide answers and—can you believe it?—also as a keyboard. To keep the book useful for everyone, please photocopy the keyboard if this book is borrowed.

### Practical Use

After the Chapter Reviews are Practical Use exercises, most of which will be done on the staff paper you've copied from the back of the book. There may be as many as four exercises, or as few as one.

## Moving On

---

Okay, enough details. If you've read them, good job! You'll have a better handle on how to get the most out of this book and you won't be at all surprised or confused about what's next.

Part I: Start Me Up is next, and the first chapter is about how written music came to be. Hope you like it!

The Table of Contents in the eBook version of  
*Basic Music Theory 1st ed.* is hyperlinked.  
Navigate the entire book quickly and easily  
using the Table of Contents, Book Index and all  
Cross-References.

\$4.95

Learn faster and smarter when  
information you need is just a click away.

If you're online, click anywhere in this message to order

# PART ONE

## Start Me Up

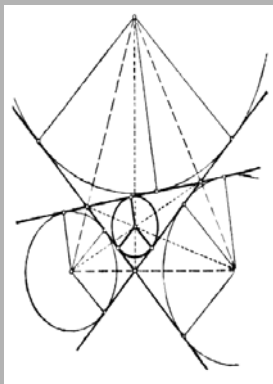
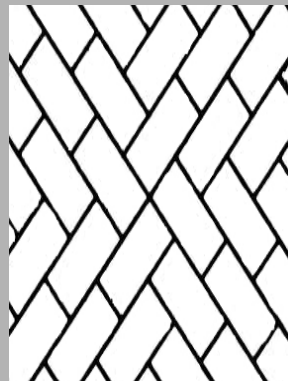

### In This Section You Will Learn:

- A Brief History of Notation
- The Staff
- Bar Lines
- Measures
- High and Low
- Pitch Names
- Leger Lines

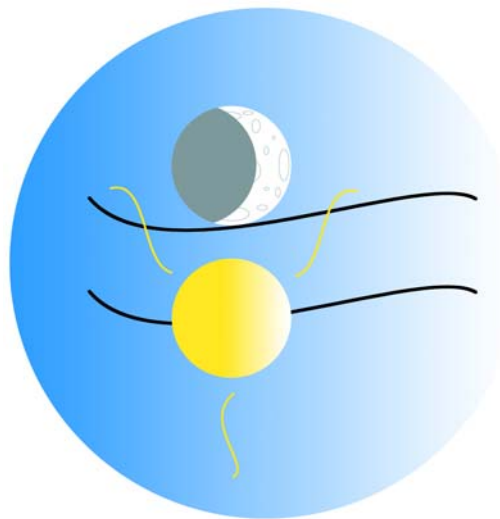

**SolUt Press**

[www.Sol-Ut.com](http://www.Sol-Ut.com)

# CHAPTER 1

# Prelude



## AN ULTRA-BRIEF HISTORY OF MUSICAL NOTATION

History doesn't repeat itself,  
but it does rhyme.

— Mark Twain

### In This Chapter

- The Origin of Hearing
- The Origin of Music
- Music Performed
- The Origin of Written Music

# Hear, There, Everywhere

---



When you hear something you like, thank a fish. About five hundred million years ago fish began to develop the ability to sense vibrations, but not with anything we would call an ear. Amphibians improved on the fishy system with sack-like organs containing clumps of neurons devoted only to sensing vibrations, much like the ears frogs have today. Birds improved the design even further.

The ear reached its peak with mammals and the appearance of *pinna*, the fleshy outer ear which funnels sound to the *cochlea*, one of the many tiny pieces of the inner ear. The cochlea takes sound vibrations, converts them into nerve impulses and sends them to the brain.

**Figure 1.1** Cutaway of the ear showing the pinna (outer ear) and the cochlea within the inner ear.

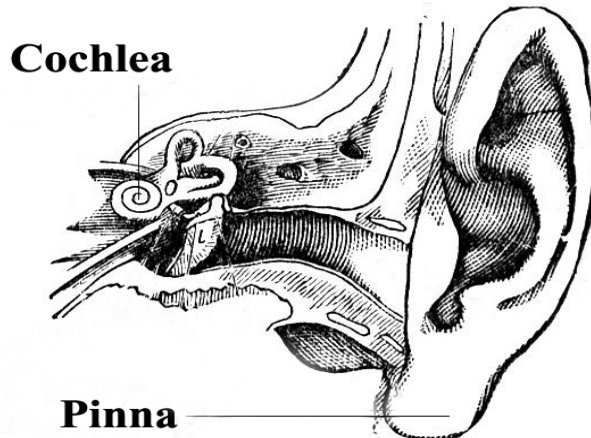

It took over one hundred million generations of critters to evolve an ear capable of hearing the ecstasy of the *B Minor Mass*, the groove of *Enter Sandman*, or the blistering Bebop of Charlie Parker.

With this wonderful ability to hear, it's no surprise that we humans began to organize sounds into patterns of rhythm and pitch. That's music. A question that will remain unanswered forever is what the first instrument was. Some say drum, some say voice, but we'll never know for sure. Maybe it was something completely different.

# Music Performed

---

From the very beginning, music was linked with magic and shamanism, and still is. Wherever you find a shaman, you'll probably find a drum.

Music has magical powers. It can transport you into an altered state, heal sickness, purify the body and mind, and work miracles in nature. In the Old Testament David cures Saul's madness with a harp, and the walls of Jericho were brought tumbling down by horns.

**Figure 1.2** Rembrandt's painting, *David and Saul*, c. 1658.

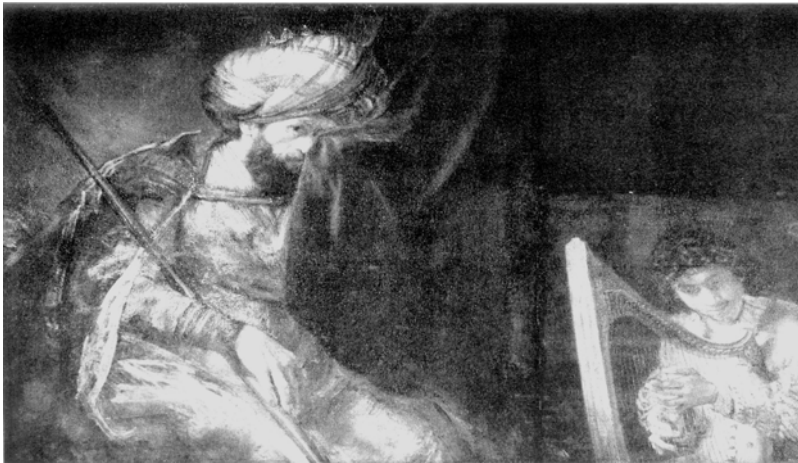

You may scoff at such primitivism, but do it softly and don't let anyone hear you. Recent discoveries are showing that such ideas are not so cracked as you might think. Don't believe me? Okay, here are some examples:

Imagine. It's night. A cavern begins to fill with creatures which normally keep distance between themselves and the others of their kind. They rarely touch. Tonight, because of sound, they will experience an altered state of being.

Soon there will be ten thousand of them. Then twenty thousand. Thirty. More. Tonight they will crush together and dance to the music. On a raised platform, anywhere from three to a dozen people stroke or bang on or breathe into instruments which produce complex rhythms and pitches. The sound causes us humans to behave in a way that's different from the everyday norm, especially if we really like the band.

Here's another scenario.

You've had a long hard day and you arrive home exhausted. At home loud and annoying music plays—something you really hate, like your dad's vinyl Barry Manilow, or your kid's Megadeth Live! CD—and it grates and grinds on your nerves.

Once it's turned off, you heave a deep sigh and a peacefulness settles over you. You put on some of your favorite music—say that Barry Manilow record, or maybe that rockin' Megadeth Live! CD—and the relaxation deepens.

Music therapy has shown positive results in those undergoing cardiac rehabilitation, and drug rehabilitation. Music has also helped sufferers of asthma, depression, high blood pressure, migraines and ulcers. Music can help with the production of melatonin, an important chemical in the body. The use of music therapy in healing has gained much credibility and its use is increasing.

Or how about this:

You listen to the Mozart piano sonata in D, and when it's over your spatial reasoning intelligence has jumped up several points. You're temporarily smarter! Music does affect the brain.

There's more:

A trained singer breathes deeply, begins a note and holds it. She sings with power and confidence and clarity. The note is high and clear and like a laser beam. A tall empty champagne glass sits on a stool nearby and begins to vibrate with the voice. The voice grows louder. The glass begins to tremble. Then it explodes in a shimmering cascade of shards.

Jane Goodall, the famous chimpanzee expert, relates a story about a chimp who discovered that banging two empty gasoline cans together makes a terribly wonderful racket. In a few days of banging the chimp had become the dominant male of the group. A percussionist's dream.

There is power in sound.

These are only a very few examples of the strange power of music. There are many, many more which you can learn about by reading Don Campbell's book, *The Mozart Effect* or take a gander at [www.amc-music.com/brain.html](http://www.amc-music.com/brain.html)





How long has music been around? Nobody really knows, but we all suspect it's been with us from the beginning.

**Figure 1.3** LEFT: 35,000 year old mastodon bones with markings for resonance points (places where it sounds really good to hit). This bone xylophone was found with two bone flutes. RIGHT: A figure from North Africa playing the talking drum, one of the oldest forms of communication.



Use your imagination to think about what the very first musical experience was. You have about as much chance being correct as anyone, and it's fun to imagine.

Sound and music have been with us from the beginning. And, being the creatures that we are, it was only a matter of time until we developed a written language which could record these rhythms and pitches so that others could make them too.

Just like with language, music existed for a long, long time before it was written down, and some think music existed *before* spoken language. Music was taught by rote, which means copying what another has played or sung. No need to read music, just copy the sounds, the fingerings, or whatever. It's a method that takes a lot of time but works well and many, many people still learn this way.

But with a system of writing, a song could be shared with an audience far away, played by a musician who could read the lines and squiggles created by someone she has never met.

## Writing Down the Bones

Our western tradition of written music—what you’re about to learn—has only been around a thousand years or so, not very long at all in the grand scheme of things.

There are older traditions of written music. Ancient Hindus and then the Greeks made use of the letters of their alphabet to write out music; the Persians used numbers and a kind of staff with nine lines between which the numbers were written; the Chinese used special signs for their pentatonic scales.

But it wasn’t until around 500 AD that we see the first glimmer of written western music.

Around this time lived *Boethius*, a Roman poet and philosopher who wrote a famous Latin treatise on music which was studied throughout the Middle Ages. In it was the first use of Latin letters to represent musical sounds.

Monks in the monasteries of the Catholic Church studied this treatise by Boethius and improved upon his ideas for their own system.

After a few hundred years, in addition to letter names for notes, a system of *neumes* (pronounced *nooms*, from the Greek word for *sign*) were invented. Neumes are signs written above the text of a song which show note length, pitch, and movement from one note to the next.

After a while, neumes began to be written on, above, or below a single line. The line represented a specific pitch. A neume written above the line was higher in pitch than a neume written below the line.

Around 1,000 AD many innovations in written music came to be. Though it isn’t clear who invented them, *Guido di Arezzo* is given most of the credit. He was a Benedictine monk who was thrown out of his monastery for his radical innovations in music. It’s believed that he didn’t actually invent the staff, but increased the lines from two to four.

We’re lucky he got kicked out of the monastery because it caused his ideas to be spread more widely. After he had an audience with the Pope who recognized Guido’s skill, his monastery wanted him back.

**Figure 1.4** LEFT: 9th Century manuscript with neumes written above text. RIGHT: 12th Century manuscript with two lines, neumes, and text.

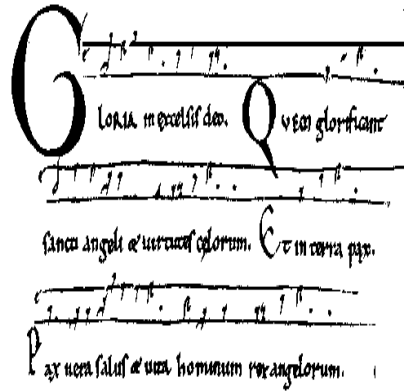
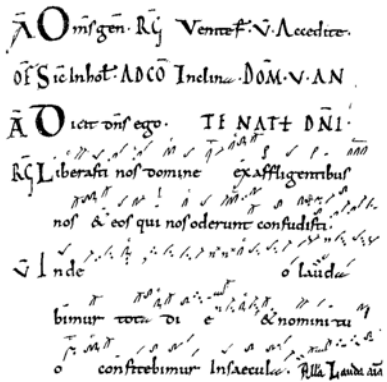

Guido di Arezzo was definitely responsible for adding more lines to the staff, and he was also thought to have invented the *Guidonian Hand*, a system for singing together. He would point to specific places on his upraised hand which indicated a specific note. This allowed a large number of monks to sing together. The following example on the right shows the notes from low to high, starting with the thumb.

**Figure 1.5** Two versions of the Guidonian Hand. Notice the 4-line staffs on the left example.

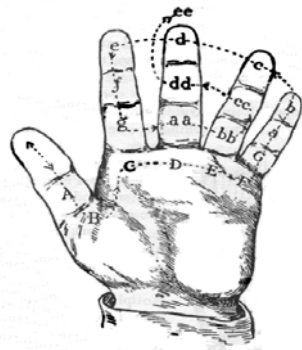

Up until this time most music was *monophonic*, which means it had only one part, usually vocal. All of the musical examples which survive from this time come from the church. There were popular secular (non-religious) musicians around at the time, but they weren't writing down what they played and so there is almost no record of it.

An example of monophonic music is a type of song called a *plain chant*. Some of the first examples of written western music are plain chants. They sound more like inflection than singing and are still used in Roman Catholic churches today. Eventually all those monks got bored with singing one-line music and began to add other parts. Music was becoming more complex.

Music with more than one part is called *polyphonic* music. Polyphonic music soon became popular in the monasteries, but was difficult to write out.

Because polyphonic music is more complex than monophonic music, it was necessary to add more lines to show the other voices. This is where *Guido d'Arezzo* comes in. He expanded the staff to four lines. Soon after that a fifth line was added.

Over the next five hundred years, composers experimented with different systems of writing music. It was written in elaborate shapes and some times with a six-line staff. By about 1500 we arrived at a system which has remained nearly unchanged until today.

**Figure 1.6** LEFT: 4-line staff. MIDDLE: Heart-shaped staff. RIGHT: 6-line staff.



## The Future

---

The spirit of experimentation with written music still exists. Modern composers like John Cage or Stephen Reich use notation which is radically different from what you'll learn in this book.

**Figure 1.7** LEFT: Part of John Cage's *Piano Concerto*. RIGHT: *Extension No. 1* by William R. Maginnis, 1964.

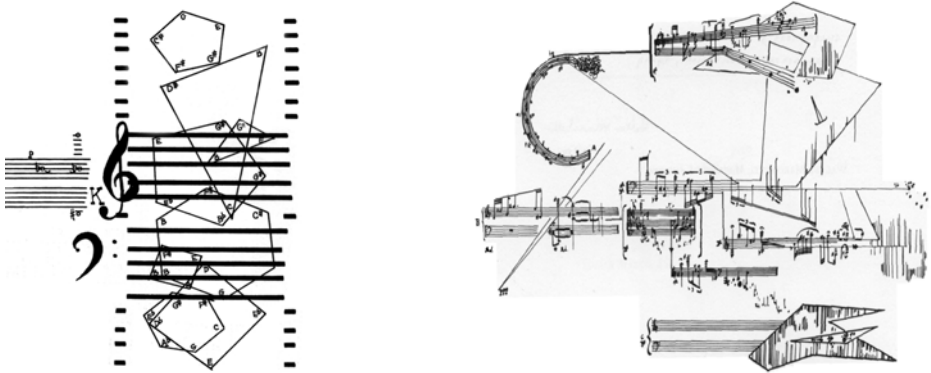

Music, like any language, evolves over time. Maybe in another thousand years we'll be reading music based on smells. Who knows? What do *you* think music will look like and sound like in another thousand years?

## Moving On

---

Now that you have a general idea of the origins of written music, it's time to get down to some specifics.

In Chapter Two you'll learn about the staff: how it's made and what it's used for in music.





## LINES, LINES, EVERYWHERE THERE'S LINES

*All music is folk music. I ain't never  
heard no horse sing a song.*

— Louis Armstrong

### In This Chapter

- The Staff
- Lines
- Spaces
- Study Guide

# The Staff

---

Music is written on a *staff* (plural *staves*) which is five horizontal parallel lines. The five lines create four spaces between them.

**Example 2.1** Blank staff.

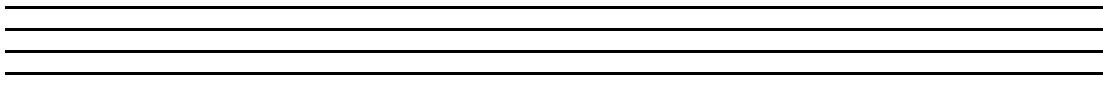

Lines and spaces are numbered from bottom to top.

**Example 2.2** Staff with lines and spaces numbered.

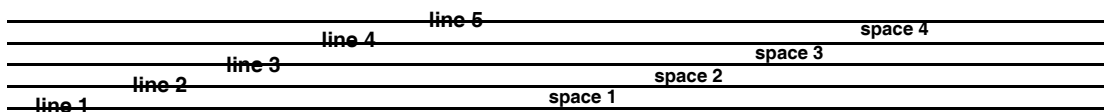

## Theory Geek Alert



When things are counted in music—staff lines, degrees of a scale, intervals, even the strings of a guitar (don't worry if you have no idea what some of these things are)—they're *always* counted from the bottom up.

## Memory Tip

The following exercise works. It may feel a little silly, but kinesthetic learning—learning with your body—works.



Take your hand—left or right—and put it up in front of your face *with the palm toward you*. Pretend your fingers are the lines of the staff. The spaces between your fingers are the spaces of the staff. Pinky is line one, ring finger line two, middle finger line three, index finger line four, and thumb line five. Between your pinky and ring finger is space one, etc., etc. Touch each finger and say the number of the line. Do the same with the spaces.



The example below shows a right hand. The only difference between this example and *your* hand is that you might use your left hand, and your hand will probably have more skin on it.

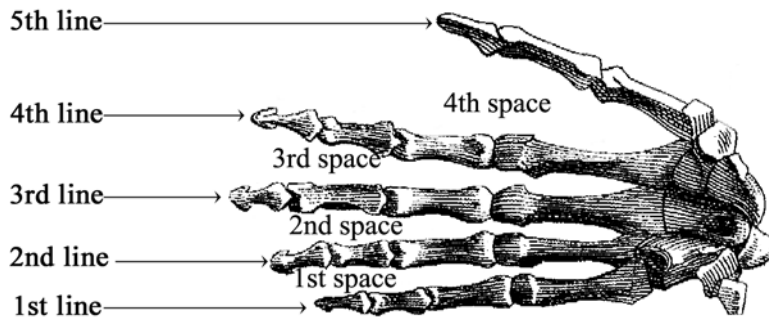

## Moving On

---

So much for the staff. Pretty simple so far, right? Stick with it, because most of music theory is pretty easy to understand as long as you've mastered previous chapters.

Coming up next is Chapter 3 in which you'll learn about more lines that are used in written music: bar lines, double bar lines, and leger lines. It's all pretty easy stuff, but you probably guessed that.

## Chapter 2 Study Guide

---

1. How many lines make up the musical staff? 1. 5
2. How many spaces in the musical staff? 2. 4

3. Using a separate sheet of paper and a pencil, draw a musical staff like the one below.  
Hint: use a straight edge if you want it to be neat.

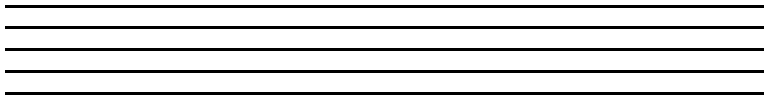

4. What is the number of the bottom line? *4. One*
5. What is the number of the top line? *5. Five*
6. What is the number of the bottom space? *6. One*
7. What is the number of the top space? *7. Four*

## Practical Use

---

1. Hold your right hand up in front of your face. Use the other hand to count the lines (your fingertips) starting with the finger closest to the floor as “1.” Count the spaces between your fingers the same way.
2. Draw three five-line staves, each one a different size. Draw in your own type of notes and be as creative as you want to be. Try to discover which size staff works best for you.
3. Photocopy the staff paper in the back of this book (make at least 20 double-sided copies), and use the magnification button on the copier to make the staves bigger or smaller as you see fit.
4. Hole-punch the copied blank staves and make a folder for yourself. You will use it to keep track of your progress. For less effort, blank manuscript and guitar tablature notebooks are available commercially.

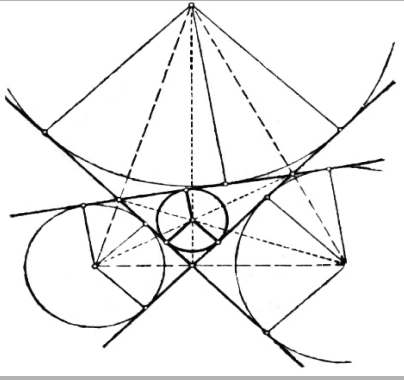

*Can we ever have too much of a good thing?*

— Cervantes, *Don Quixote*

### **In This Chapter**

- Bar Lines
- Double Bar Lines
- Measures
- Leger Lines

# No Holds Barred

---

## Bar Lines and Double Bar Lines

To make music easier to read, the staff is divided into sections by vertical lines called **bar lines**. There are two types of bar lines. The single bar line is a single thin line from the top line to the bottom line. Bar lines simply divide up the staff into small sections which are easier to read. Think of bar lines as punctuation: you don't hear them, they're there to help with the reading.

The **double bar line** marks the end of a section, or the end of a song. It has a regular-sized line in addition to a thicker line close by to the right.

## Measure

The area between two bar lines is called a **measure**, or a bar. To avoid confusion, from here on, I'll call them measures. The staff below is divided into four measures. Because some measures may have more notes in them than others, the space between bar lines doesn't have to be equal (notice the first measure is a bit longer).

**Staff 3.1** Staff with bar lines, double bar, and measures marked.

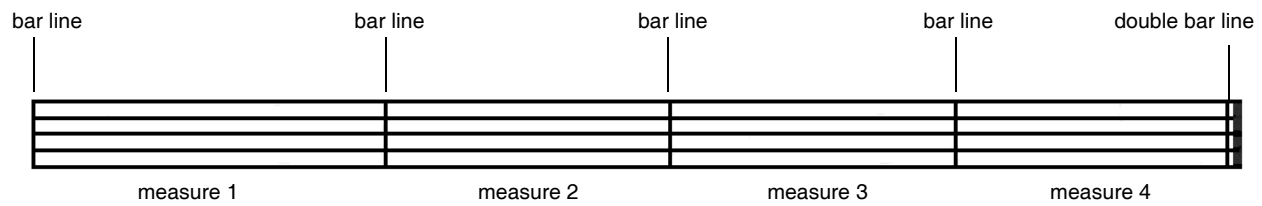

# What? *More* Lines?

---

## Learning Leger Lines

Most notes are written on the staff, but some notes are higher or lower than the staff can show. When a note goes beyond the range of the staff (higher or lower), small horizontal lines are used to show where the staff would be if it had more than five lines and four spaces. These are called **leger lines** (sometimes spelled “ledger lines”).

The words “leger line” appeared around 1700, though the practice of writing leger lines is older. To keep music from looking cluttered, leger lines are never used unless they're with a note. Below are some examples which use three different kinds of notes, but don't worry about them—you'll learn what they are soon.

The last two measures show extreme examples which you'll rarely see, but give you an idea of what's possible.

**Staff 3.2** Four measures of leger line examples



## Moving On

---

Not too tough, was it? When talking about music, you'll often hear the terms you learned in this chapter: bar lines, double bar lines, measures, and leger lines. Be sure you know the information in the Chapter Review before you go on.

Coming up in Chapter 4 you'll learn about space and line notes and how the highness or lowness of a note is shown on a staff.

If you keep at it, you'll find all the chapters are this easy.

# Chapter 3 Study Guide

---

1. What is a bar line used for?
2. Where is a double bar used?
3. On another piece of paper draw a staff. Make it a fairly long one.
4. Divide the staff into four measures (they don't have to be equal length). The bar line should touch the upper and lower lines of the staff without going over.
5. What are leger lines?
6. What are leger lines used for?
7. Draw in some leger lines both above and below your staff. Draw some notes on your leger lines. Use any kind of note.

*0. Divides the staff into measures. Makes music easier to read.*

*0. The end of a section and/or the end of a song.*

*5. Small lines above and below the staff*

*5. Used for notes that are higher or lower than the staff*

## Practical Use

---

1. Divide a staff into 4 equal measures. Use an entire line of staff paper for these 4 measures. Do the same thing 2 more times (you should have 12 measures total), and put a double-bar line at the end of the last measure.
2. Draw in some leger lines. Use real notes like the ones in example 3.2, or invent your own. Better yet, do both!



## THE WIND-UP AND THE PITCH

*You can't think and hit at the same time.*

— Yogi Berra

### In This Chapter

- Space notes
- Line notes
- High and Low

# Spaced Out and Lined Up

---

Notes on the staff will be either *space notes* or *line notes*. A space note is any note which rests within a space of the staff *without crossing over a line*. A line note is any note split through the middle by a line. Notice in the examples that I've included leger notes.

## Practice on the Blank Staff

In the back of the book are two pages of blank staff lines. Please don't tear them out so that others may also use them. Photocopy the blank staves and practice writing out the techniques and symbols you're learning. If you write them down you'll be more likely to remember them.

## Space Notes

A space note fits within a space on the staff (or between leger lines). At first, it might be tough to draw a note exactly in the space, but keep at it. If you go over the line, your space note may look more like a line note.

**Staff 4.1** Space notes, low to high.



## Line Notes

Line notes have a line going through their middle. When you draw a line note be sure the line goes through the middle of the note, otherwise it might look more like a space note, and that can be confusing.

**Staff 4.2** Line notes, low to high.

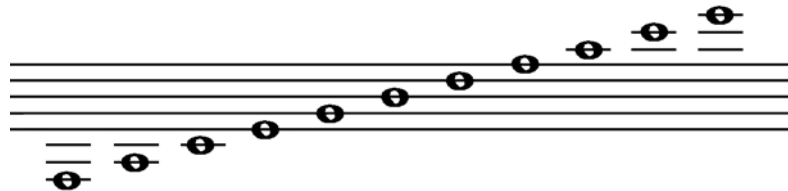

## Ah, Togetherness

Line and space notes alternate, one after the other. After a line note comes a space note, and after a space note comes a line note. I know that's redundant, and I said it twice, but it's important. Here's what it looks like:



**Staff 4.3** Line and space notes combined, low to high (there are notes both higher and lower than those shown here).



## The High and the Lowly

---

**Pitch** is not only something you find in a tree and at a baseball game. As it relates to sound, Webster's definition of pitch is: *the property of a sound and especially a musical tone that is determined by the frequency of the waves producing it.* Don't you sometimes just hate dictionaries?

What pitch means in music is the highness or lowness of a sound or note.

If the pitch of one note is higher than another, it will be written higher up on the staff. And if one note's pitch is lower than another's, it will be written lower down on the staff.

**Staff 4.4** Examples of low and high.

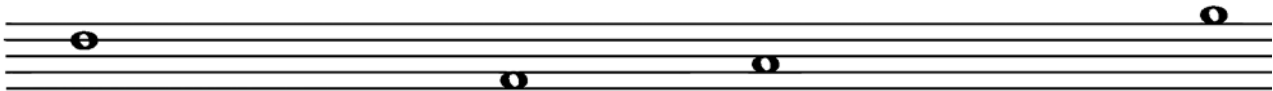

This note is higher than ..... this one.

This note is lower than ..... this one.

## Moving On

---

Okay. You should now have a good handle on line and space notes and how pitch is shown in written music. Is it all clear? Be sure you've got it before you move on.

Coming up in Chapter 5 you'll learn the musical alphabet and how these letter names are applied to the lines and spaces and leger lines of the staff.

## Chapter 4 Study Guide

---

1. What is a line note?
2. What is a space note?
3. What does pitch mean in music?
4. If one note's pitch is higher than another, it will be written \_\_\_\_\_ on the staff.

1. Any note with a line through it
2. Any note lying in a space
3. The highness or lowness of a note
4. Higher

5. If one note's pitch is lower than another, it will be written \_\_\_\_\_ on the staff.

5. Lower

6. In the examples below:

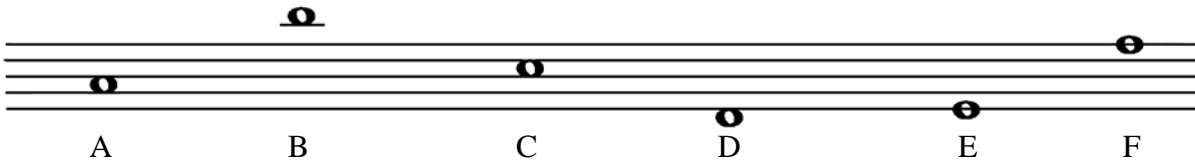

Note A is \_\_\_\_\_ than note B.  
Note C is \_\_\_\_\_ than note D.  
Note E is \_\_\_\_\_ than note F.

7. In the examples below:

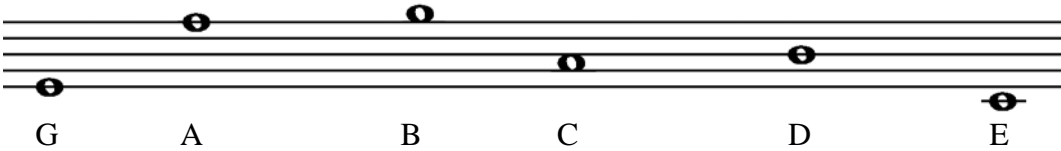

6. lower  
higher  
lower

Note G is \_\_\_\_\_ than note A.  
Note B is \_\_\_\_\_ than note C.  
Note D is \_\_\_\_\_ than note E.

7. lower  
higher  
higher

## Practical Use

1. In the 12 measures you made in the last chapter, draw in several notes per measure. Vary the highness and lowness. Use leger lines. Go through your example and identify lower and higher from note to note.
2. On a blank staff, draw in all the line and space notes from one leger line below the staff all the way up to one leger line above the staff.

# Home, Home on the Ranges



Range refers to the notes an instrument is able to play, from lowest to highest. Each example below shows the range of an instrument from its lowest note to its highest note. There are some exceptions, like pedal tones (very low notes) for brass, a low B foot for a flute, you can put your foot into the bell of a baritone sax and get a half step lower, and other such tricks, but for now don't worry about those unless you want to.

There are many symbols below which you don't know yet, but don't worry about that for now. You'll learn them soon.

Since voice *is* an instrument, I'll show vocal ranges first. I'm doing this mostly to show you that all instruments use leger lines. You didn't believe me, did you?

While you look at these examples, compare the ranges of the instruments. Notice that the highest note for a soprano is higher than the highest note for an alto; or notice the guitar is able to play lower than the violin.

**Staff 4.5** Ranges for Voice: Soprano, Alto, Tenor, Bass



**Staff 4.6** Ranges for: Violin, Guitar, Bass.

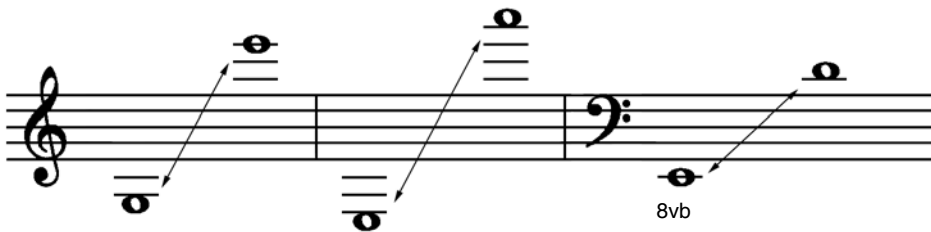

**Staff 4.7** Ranges for: Trumpet, Alto Sax, Flute, Bb Soprano Clarinet.

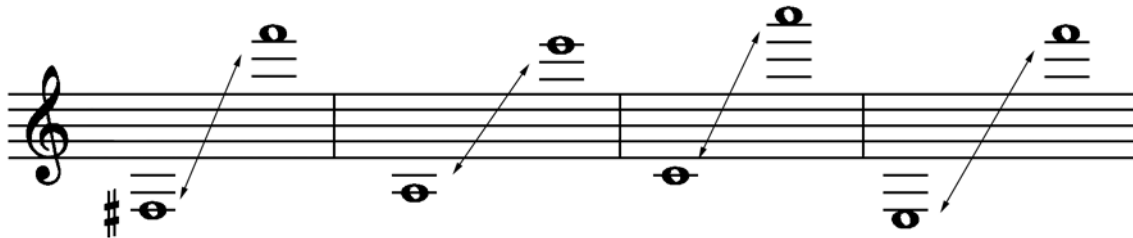





## A NOTE BY ANY OTHER NAME WOULD SOUND AS SWEET

*Sweetest melodies  
Are those that are by  
distance made more sweet.*

— Wordsworth, *Personal Talk*.

### In This Chapter

- The Musical Alphabet
- Note Names
- Naming Leger Line Notes

# What's in a Name?

---

You'll be happy to find you only need the first seven letters of the alphabet for music.

The music alphabet uses **A, B, C, D, E, F,** and **G**. You'll never find an "H" in music, or a "Q", or anything other than **A through G**. This is one of those few rules that has *no exceptions!*

Remember when we talked about line and space notes coming one after the other? If not, see "Ah, Togetherness" on page 32. The notes are named alphabetically when the notes are written one after the other (line-space-line-space, etc.).

## Round and Round

But wait a minute, you're saying, *I know* there are more than seven notes in music. There are at least 88 on piano keyboard. What are *their* names?

Good question. After **G**, the pattern begins again with **A**. Below is an example showing this.

Don't worry about the things you see that you don't know yet, like the funny-looking symbol at the beginning of the staff; you'll learn it in the next chapter. Focus on the letter names and how they work.

**Example 5.1** Note names in the treble clef. Notice the letter change from the 3rd note to the 4th note.

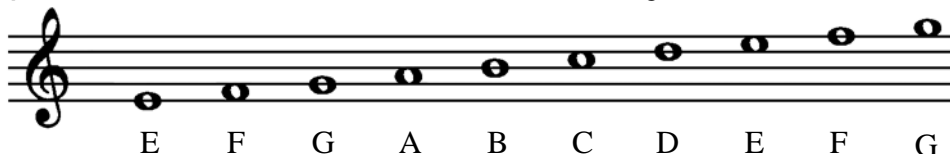

## Remember Leger Lines?

Notes on leger lines or spaces are named the same way. Following is an example with leger lines below the staff. These are the first 8 notes for both guitar and clarinet. Again, don't worry about the things we haven't gone over yet. Focus on the note names only.

**Example 5.2** Leger line note names below the treble clef staff.

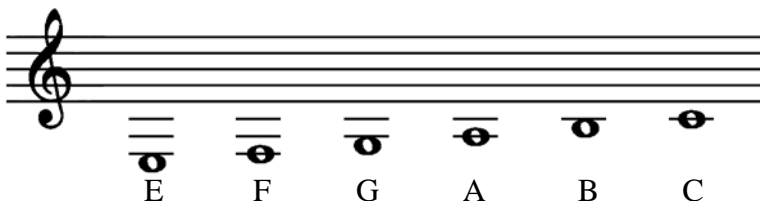

And here are some examples of leger line note names above the staff. Notice there is a different loopy symbol at the beginning of this music. Not to fear, you'll learn what that is soon. For now you can ignore it. These are notes you might find in trombone music, electric bass music, or bassoon music.

**Example 5.3** Leger line note names above the bass clef staff.

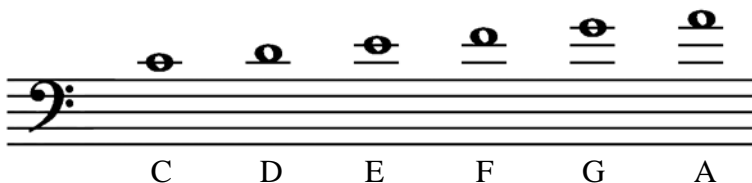

## Moving On

---

Not much to note names, is there? Just remember that A-G repeats over and over and that's all you need. Make sure you know the information in the Chapter Review before you go on. Shouldn't be too hard.

This is the end of Part I, so after the review for this Chapter there is a big fat study guide for all of Part I. Once you've got that info learned, go on to Part II, which is all about clefs (those odd-looking symbols at the beginning of the staff). Good luck!

# Chapter 5 Study Guide

---

1. What letters are used to name notes in music? 1. *A B C D E F G*
2. What letter comes after G? 2. *A*
3. What kind of note comes right before or after a space note? 3. *A line note*
4. What kind of note comes right before or after a line note? 4. *A space note*
5. Write out five times, "After G comes A."
6. Can you think of a better system for naming notes?  
How about using colors? Shapes? Textures?  
Tastes? Smells? Numbers?

## Practical Use

---

1. Say the letters A-G in a repeated loop as fast as you can. Do the same thing backwards. Say every other letter: A, C, E, G, B etc. Think up another way to say these seven letters.
2. Write the 7 letters out in as many patterns as you can think of. Make shapes with the letters. Be creative with them.



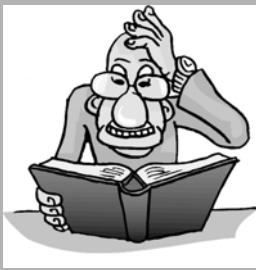

# PART I REVIEW

## Whew! You Made It.

---

These pages can be used to test your memory on what you've learned in Part I, and if some of the information hasn't stuck, you can go back and check it out on the page indicated below the question.

As with the chapter reviews, use your keyboard to cover up the answers while you test yourself.

When you think you've got it all down, either take the test in *Basic Music Theory Quiz Book*, or go on.

## The Review

---

1. How many lines make up the musical staff?

*page 24*

1. 5

2. How many spaces in the musical staff?

*page 24*

2. 4

3. Using a separate sheet of paper and a pencil, draw a musical staff like the one below.

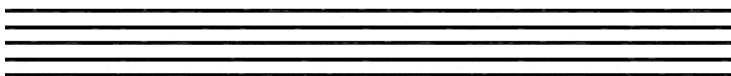

4. What is the number of the bottom line?

*page 24*

4. 1

5. What is the number of the top line?

*page 24*

5. 5

6. What is the number of the bottom space?  
*page 24*
6. 1
7. What is the number of the top space?  
*page 24*
7. 4
8. What is a bar line used for?  
*page 28*
8. *Divides the staff into measures*
9. Where is a double bar used?  
*page 28*
9. *The end of a section or song*
10. On another piece of paper draw a staff. Make it a fairly long one.
11. Divide the staff into four measures.
12. What is a leger line?  
*page 28*
12. *A small line above or below the staff*
13. What are ledger lines used for?  
*page 28*
13. *Notes that are higher or lower than the staff shows*
14. Draw in some ledger lines both above and below your staff.
15. What is a line note?  
*page 32*
15. *Any note with a line through it*
16. What is a space note?  
*page 32*

17. In the example below:

Note A is \_\_\_\_\_ than note B.

Note C is \_\_\_\_\_ than note D.

Note E is \_\_\_\_\_ than note F.

*page 33*



16. Any note in a  
space

18. What letters are used to name notes in music?

*page 38*

17. lower  
higher  
lower

19. In the musical alphabet, what letter comes after

G?

*page 38*

18. A B C D E F G

19. A

20. In the example below:

Note G is \_\_\_\_\_ than note A.

Note B is \_\_\_\_\_ than note C.

Note D is \_\_\_\_\_ than note E.

*page 33*

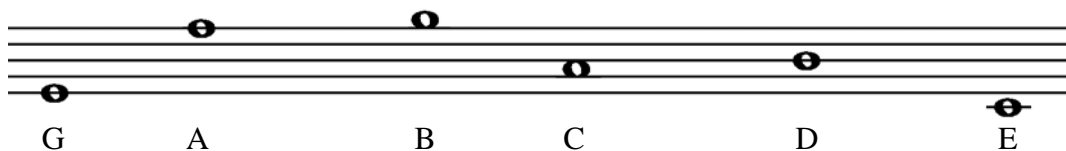

20. *lower*  
*higher*  
*higher*

21. What kind of note comes right before or after a space note?

*page 32*

21. *A line note*

22. What kind of note comes right before or after a line note?

*page 32*

22. *A space note*

## Moving On

---

Okay. That was pretty painless, I hope. Once you have this information stored in your little gray cells, take the quiz or move on to Part II, *Clef Notes*.

Part II is the shortest Part of the book in which you'll learn about clefs, the odd-looking symbols you've been seeing at the beginning of a staff.

# PART TWO

## Clef Notes

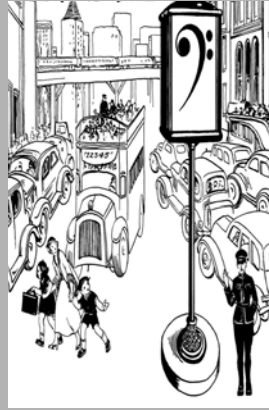

### In This Section You Will Learn:

- Clefs in General
- Treble Clef
- Bass Clef
- Rhythm Clef

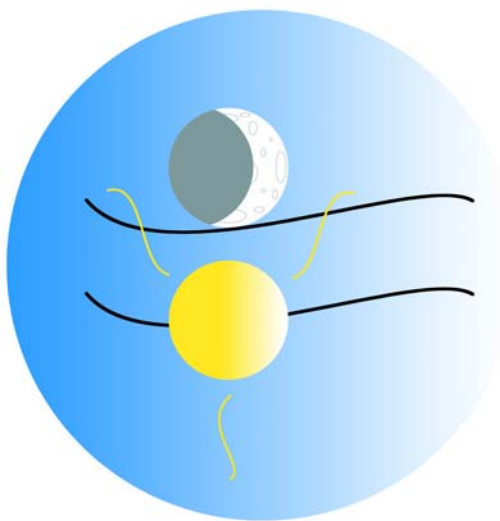

**SolUt Press**

[www.Sol-Ut.com](http://www.Sol-Ut.com)

## GOING OVER THE CLEF

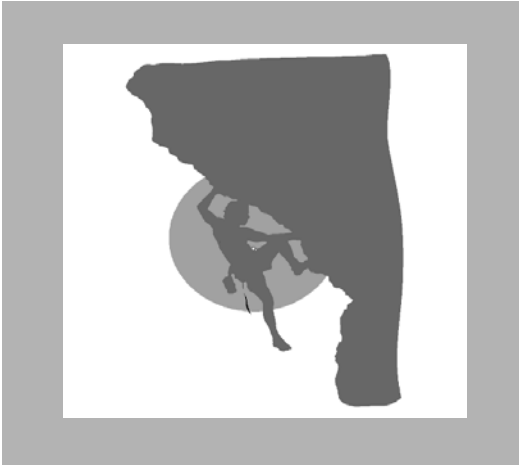

*Sometimes it takes a long time to play  
like yourself.*

— Miles Davis

### In This Chapter

- What is a Clef?
- What a Clef does
- Types of Clefs

# What's a Clef?

---

A *clef* is a symbol used at the beginning of a musical staff to tell the reader which letter name goes with which line or space. The word *clef* didn't show up until around the middle 1500s. Clef is a French word that means *key*, as in, "Hey man, what *key* are we in?"

In early music, a letter was written at the beginning of the text of a plainchant (remember monophonic music on page 19?). The letter told the singer which note to start on.

Around 1000 AD some bright soul thought to draw a line from the letter all the way across the page. Then Guido di Arezzo added more lines and we had our staff. Over time, composers made that beginning letter more and more fancy until it no longer looked like a letter at all. That was probably when somebody in France in the middle of the 1500s decided to call them clefs.

There are several different kinds of clefs: *C clefs*, *treble clef*, *bass clef*, and *rhythm clef* (also called the *percussion clef*). We'll only be learning the three most common ones: treble clef, bass clef, and the rhythm clef.

## Example 6.1 The Clefs.



C Clef



Treble Clef



Bass Clef

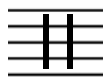

Rhythm Clef

Each clef has something which shows the letter name of one line. Because you now know how letter names are used in music (A through G, right?), you can figure out what all the other letters are for that staff once you know the name of one line. I'll show you how when we look at each clef in its own chapter.



For now, just remember a clef points to and names one line of the staff. I'll show you all the gory details when we go over each clef in its own chapter.

## The Clefs

---

Some clefs are used more frequently than others. We'll get the odd ones out of the way first so you can forget them more quickly. You'll rarely (if ever) need them, unless you're a viola player.

### C Clefs



The *C clef* isn't used much any more, except by viola players and occasionally trombone and bassoon players.

It's pretty easy to imagine the symbol looks like the letter *C*, which is what it used to be. It's also obvious which line is being indicated. That big arrow pointer in the middle is what tells you which line or space is *C*.

The *C clef* is different than other clefs and can be confusing at first because it's a *moveable clef*. Depending on which line the clef indicates, the name of the clef is different. Confused? Don't worry about it. You don't really need to know much about these clefs, but you should be able to generally identify them and know what they do. In case you already forgot, they're *C clefs*.



I couldn't resist, so here are the names of the different *C clefs*. Feel free to forget them immediately. Except maybe you should remember that the alto clef is used by viola players.

**Example 6.2** The four types of *C Clefs*.



**Soprano  
Clef**



**Alto  
Clef**



**Tenor  
Clef**



**Vocal Tenor  
Clef**

## Treble Clef



This is the most common clef. Remember up above when I said each clef has something about it which tells the letter name of a line? Well, with treble clef, it's the inner loop which circles the second line and gives it a name.

What name, you ask? All in good time. No need to rush. You'll find out soon.

What letter does the treble clef look like? Take a guess now and see if you're right. You'll find out all these niggling details in the next chapter.

**Example 6.3** The treble clef. Notice how the inner loop circles the second line.

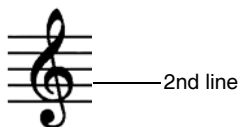

Treble clef is used for instruments with a high pitch. Some of them are: piccolo, flute, clarinet, oboe, guitar, violin, French horn, saxophone, trumpet, and piano.

## Bass Clef



The second most common clef. The bass clef uses both the head (that bulbous part) and those two dots to indicate which line it names.

The bass clef was also once a letter. Which one do you think it was? We'll go over the details in Chapter 9. The only thing to remember at the moment is that both the head of the bass clef and the dots indicate the fourth line.

**Example 6.4** The Bass Clef. The bass clef indicates the fourth line.

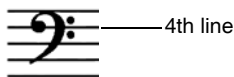

Bass clef is used for instruments with a low sound. Some of them are: tuba, cello, double bass, trombone, bassoon, electric bass, and piano.

Because of their large range between high and low, keyboard instruments like piano, organ, and synthesizer use *both* the treble and bass clefs.

## Rhythm Clef



This is a clef which shows rhythms, not pitches like the other clefs.

The real name for this clef is the *neutral clef*. It's also called the *percussion clef* because it's used by percussionists and drummers and other instruments that produce a sound that isn't a clear pitch. These types of instruments are called non-pitched instruments.

For clarity's sake, from here on I'll call it a rhythm clef.

**Example 6.5** The Rhythm Clef. Notice how this clef carefully avoids indicating any one line?



All the other clefs show the letter name of a line except the rhythm clef. Because the instruments that use this clef have no clear pitch, there's no need for letter names. The rhythm clef was never a letter. Sound simple? Well, it is and it isn't. We'll go over the details of this clef in Chapter 10.

Some instruments that use rhythm clef are: drum set, small percussion (tambourine, maracas, claves, triangle, vibra-slap, guiro, etc.—the list is nearly endless), snare drum, bass drum, and anything you can hit to make a sound. A percussionist's instruments are everywhere!

## Moving On

---

Okay, once you've got the general details of clefs down, you'll be ready to chew more deeply into the juicy specifics of each clef. We'll start with treble clef in Chapter 8.

## Chapter 6 Study Guide

---

1. What did clefs used to be?
  1. *A letter at the beginning of a piece of music indicating a specific note.*
2. About when and where was the word *clef* first used?
  2. *Mid-1500s, France*
3. What does a clef do?
  3. *Names a line of the staff, thereby setting the names of the other lines and spaces.*
4. What are the three most common clefs?
  4. *Treble clef, bass clef, rhythm clef.*
5. Which line does the treble clef name?
  5. *2<sup>nd</sup>*
6. Which line does the bass clef name?
  6. *4<sup>th</sup>*

7. Which instruments use the rhythm clef?
8. Which line does the rhythm clef name?
9. On any scrap of paper, draw five treble clefs.
10. On the same piece of paper, draw five bass clefs.
11. On the same piece of paper, draw five rhythm clefs.
12. Name two instruments which use treble clef.
13. Name two instruments which use bass clef.
14. Go make yourself a snack.
7. *Drums and other non-pitched instruments.*
8. *None.*
12. *Some possibilities: flute, piano, guitar, trumpet, sax, piccolo, violin, F horn, oboe, clarinet, accordion*
13. *Some possibilities: trombone, tuba, piano, bass guitar, acoustic bass, electric bass, bassoon, baritone, euphonium, timpani/kettle drum, double tenor steel drum...*
14. *Something with cheese in it*

# Practical Use

---

1. On your copied staff paper draw a line of treble clefs, a line of bass clefs and a line of rhythm clefs. Experiment. See how fast you can make each one and still have it look like a clef.
2. If the 4th line is F, name all the other lines and spaces.
3. If the 2nd line is G, name all the other lines and spaces.
4. Invent your own clef.



## NO TROUBLE WITH TREBLE

*The flute is not an instrument which has a good moral effect; it is too exciting.*

— Aristotle, *Politics*

### In This Chapter

- The Treble Clef
- The Letter *G*
- Notes on the Treble Clef Staff
- Mnemonic Devices for Lines and Spaces

# Golly G

---

Okay, I'm sure you're dying of suspense. The *treble clef* used to be the letter **G**

You can kind of see its “g-ness” if you use some imagination. The treble clef is also called the *G clef* because it shows where the note G is on the staff.

The inner loop of the treble clef circles the second line and thus names it G.

**Example 7.1** The treble clef, languidly looping line two.



Once you know where “G” is, use the musical alphabet (A-G) to fill in the rest of the notes. Remember that when naming notes in order, the notes go: line, space, line, space, line, space, etc. Like so:

**Example 7.2** The treble clef note names, alphabetically from the bottom line to the top of the staff.

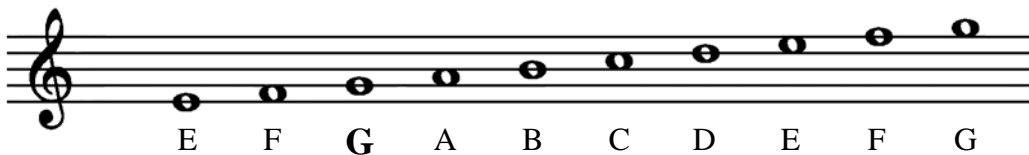

## What? You Want it Easier? Okay.

Instead of memorizing that long string of letters above, you can memorize two short strings of letters. Five letters for the lines, and four letters for the spaces.

A *mnemonic device* will make it even easier.



## A *What* Device?

Mnemonic (the first m is silent) came from a Greek word meaning *to remember*. A mnemonic device is a trick you can use to remember a long series of things—grocery lists, test answers or, in this case, note names.

Use a mnemonic device to learn the names of the lines and spaces. Usually the sillier, crazier or weirder the sentence you make up, the easier it is to remember.

## Mnemonics for Treble Clef Lines

**Example 7.3** The treble clef line-names.

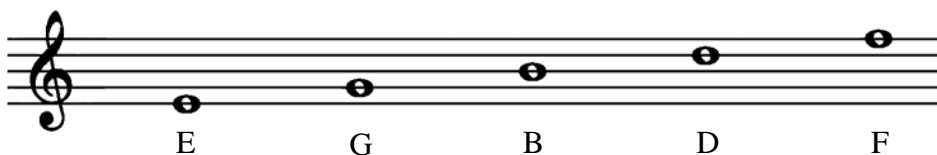

|                 |                   |                  |
|-----------------|-------------------|------------------|
| <b>E</b> mpy    | <b>E</b> lephants | <b>E</b> very    |
| <b>G</b> arbage | <b>G</b> o        | <b>G</b> ood     |
| <b>B</b> efore  | <b>B</b> ackwards | <b>B</b> oy      |
| <b>D</b> ad     | <b>D</b> own      | <b>D</b> eserves |
| <b>F</b> lips   | <b>F</b> reeways  | <b>F</b> udge    |

# Mnemonics for Treble Clef Spaces

**Example 7.4** The treble clef spaces.

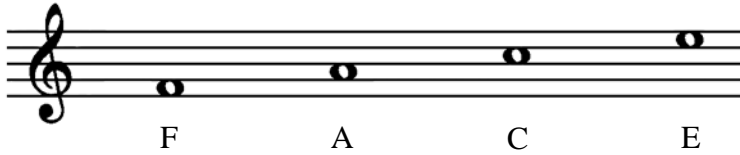

|          |                 |                   |
|----------|-----------------|-------------------|
| <b>F</b> | <b>F</b> arting | <b>F</b> requent  |
| <b>A</b> | <b>A</b> lways  | <b>A</b> sking    |
| <b>C</b> | <b>C</b> auses  | <b>C</b> an       |
| <b>E</b> | <b>E</b> nemies | <b>E</b> nlighten |

Take a couple minutes to come up with your own mnemonic device. If you make up your own, you're more likely to remember it. But, if nothing comes to you, memorize one from above that you like.

If you come up with some good ones, send them to me: [jonathan@QuestionsInk.com](mailto:jonathan@QuestionsInk.com) and I'll put the best ones in the next edition of *Basic Music Theory* and give you credit for your ideas.

## Moving On

---

Because so many instruments use treble clef, it's important to learn this clef even if your instrument uses another type of clef. Once you understand this clef and how it names the second line, you'll be ready for Chapter 8, which shows you all the fascinating details of the bass clef.

## Chapter 7 Study Guide

---

1. What letter did the treble clef used to be? 1. G
2. The inner loop of the treble clef circles which line? 2. 2nd

3. What is a mnemonic device? 3. *A trick to improve memory*
4. What letter name does the treble clef give to the 2<sup>nd</sup> line? 4. *G*
5. On a piece of blank staff paper, draw a dozen treble clefs. Try them in different sizes. Try to loop the second line of the staff.
6. What is another name for the treble clef? 6. *G clef*
7. What are the names of the treble clef lines? 7. *E G B D F*
8. What are the names of the treble clef spaces? 8. *F A C E*
9. What is your mnemonic device for remembering the lines of the treble clef staff?
10. What is your mnemonic device for remembering the spaces of the treble clef staff?

## Practical Use

---

1. Put your *right* hand up in front of your face, palm outward. Use your left hand to point to the fingertips and “valleys” of the right hand fingers. Say each line/space name as you touch it.
2. In your notebook of staff paper, write in the line and space numbers. Draw a treble clef and then write the correct letter names in the lines and spaces. Also name two leger lines above the staff, and two leger lines below the staff.





## THE BASS OF THE CLEF

*Never look at the trombones. You'll only encourage them.*

— Richard Strauss

### In This Chapter

- The Bass Clef
- The Letter *F*
- Names of Bass Clef Lines and Spaces
- Nmore Mnemonics for the Lines and Spaces

# This Clef is Not a Fish!

---

Remember clefs used to be letters way back when? Well, *bass clef* is no exception (by the way, this bass is not a fish. This kind of bass is pronounced *base*).

The bass clef used to be the letter *F* until those nutty artistic-type composers kept messing with it, making it fancier and fancier until we got what we have today, something that looks nothing like an *F*. And even though it looks nothing like an *F*, it's called the *F clef* because it shows us where the note *F* is on the staff.

**Example 8.1** The bass clef in all its bulbousness.



The bass clef tells us that the fourth line is an *F* in two ways. The first way is the head of the clef, the round part at the top left of the clef. It's smack-dab on the fourth line. In case that isn't enough, there are also two little dots which straddle the fourth line as if they're saying, "Hey! Hey You! This is an F!"

**Example 8.2** The bass clef as it sits on the staff. Notice the 4th line?

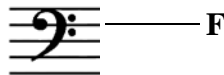

Okay, you know the drill. Now that you know the name of that one line, you can apply the musical alphabet to all the spaces above and below it.

**Example 8.3** Note names on the bass clef staff.

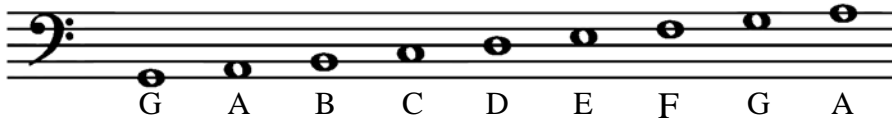

## More Mnemonics

Here are some more memory tricks to remember the bass clef line and space names.

### Mnemonics for Bass Clef Lines

**Example 8.4** The bass clef lines.

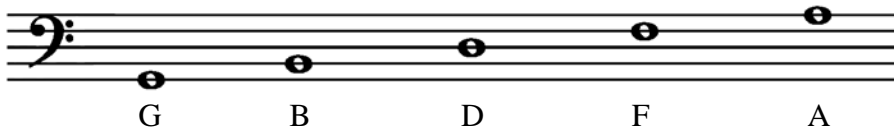

|                |                  |               |
|----------------|------------------|---------------|
| <b>Good</b>    | <b>Great</b>     | <b>Goofy</b>  |
| <b>Bubbles</b> | <b>Big</b>       | <b>Babies</b> |
| <b>Do</b>      | <b>Dinosaurs</b> | <b>Do</b>     |
| <b>Fizz</b>    | <b>Fight</b>     | <b>Funny</b>  |
| <b>Always</b>  | <b>Always</b>    | <b>Acts</b>   |

# Mnemonics for Bass Clef Spaces

**Example 8.5** The **bass clef** space names.

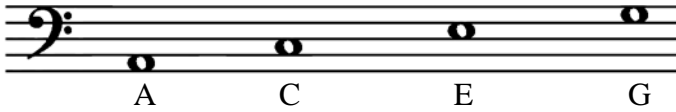

|              |              |             |
|--------------|--------------|-------------|
| <b>A</b>     | <b>All</b>   | <b>All</b>  |
| <b>Cat's</b> | <b>Cows</b>  | <b>Cars</b> |
| <b>Eyes</b>  | <b>Eat</b>   | <b>Eat</b>  |
| <b>Glow*</b> | <b>Grass</b> | <b>Gas</b>  |

\*Created by Erin Downey of Big Lake, Alaska.

## Make Up Your Own

Take a couple minutes to make up your own mnemonic device for the bass clef lines and spaces. If you make your own, and make it wacky, it'll be easier to remember.

Send good ones to me: [jonathan@QuestionsInk.com](mailto:jonathan@QuestionsInk.com). I'll put the best ones in the next edition of this book and give you credit for them.

## Moving On

---

Even if you're instrument uses a different clef, it's still good to know bass clef. Once you've got it memorized, you're ready for Chapter 9 in which you'll learn about the rhythm clef.



# Chapter 8 Study Guide

---

1. What letter did the bass clef used to be? 1. *F*
2. Which staff line goes between the two dots of the bass clef? 2. *4<sup>th</sup>*
3. Which line is the bass clef head on? 3. *4<sup>th</sup>*
4. What letter name does the bass clef give to the fourth line? 4. *F*
5. On a scratch piece of paper, draw a dozen bass clefs. Don't forget the dots!
6. What are the names of the bass clef lines? 6. *G B D F A*
7. What are the names of the bass clef spaces? 7. *A C E G*
8. What is another name for the bass clef? 8. *F clef*
9. What is your mnemonic device for remembering the bass clef lines?
10. What is your mnemonic device for remembering the bass clef spaces?

# Practical Use

---

1. Draw a bass clef upside down. Backwards. Sideways. Inside out. Correctly. After the correct bass clef, write in the letter names for the lines and spaces. Name two high leger lines, and two low ones.



**Meet Harry Pitts, champion Armpit Player. Says Harry, “Shoot. Ain’t no problem learning bass clef. I been readin’ it for years.” Harry is currently at work writing out Gershwin show tunes in bass clef for his instrument.**

## TO FATHOM THE RHYTHM CLEF

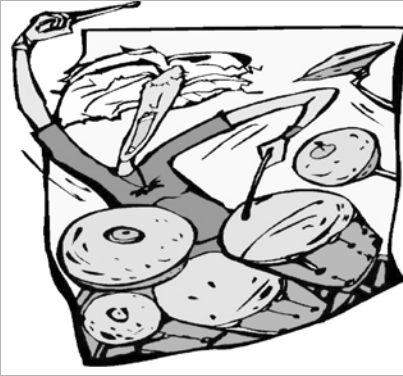

*I like to see you move with the rhythm;  
I like to see when you're dancin' from  
within.*

— Bob Marley

### In This Chapter

- The Rhythm Clef
- The Single Line Rhythm Clef
- The 5-Line Rhythm Clef
- The Drum Set
- Mno mnemonics!

# No Letters With this Staff

---

Unlike the other clefs, the *rhythm clef* doesn't show pitch (the high and low of notes), so there is no need for letter names. The rhythm clef shows rhythms. Go figure.

This clef didn't start out as another letter, because no letters are used with the rhythm clef. Doesn't this sound like this should be easier than treble or bass clef? Well, guess again....

**Example 9.1** The **rhythm clef** in all its neutral-ness.



## Why No Note Names?

---

Remember that note names show what pitch a note is? If not, take a look at “The High and the Lowly” on page 33 for information about pitch, and look at example 5.1 on page 38.

Percussion instruments, most of them, don't have definite pitches like other instruments do. Compare the sound of a flute to the sound of a drum. Flute is an instrument with high notes and low notes and everything in between. A drum has only one pitch.

## The One-Line Staff with Rhythm Clef

---

If only one pitch, why not only one line? Great question. Some single-instrument percussion music *is* written on one line. The line looks something like this:

**Example 9.2** Single staff line with rhythm clef.

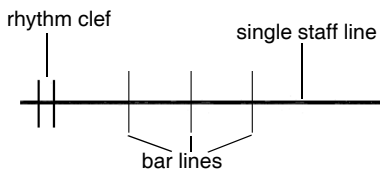

# Instruments, not Pitches

---

You might be wondering, “Why not *always* use just one line?”

Beginners often use one line when playing snare drum, or bass drum because it’s easier to read. But soon one line isn’t enough. Percussionists have dozens of instruments to learn, and there are usually many more than two instruments used in a song, and they all need a place on the staff.

## Some Percussion Instruments

These are just a few percussion instruments which use the rhythm clef:

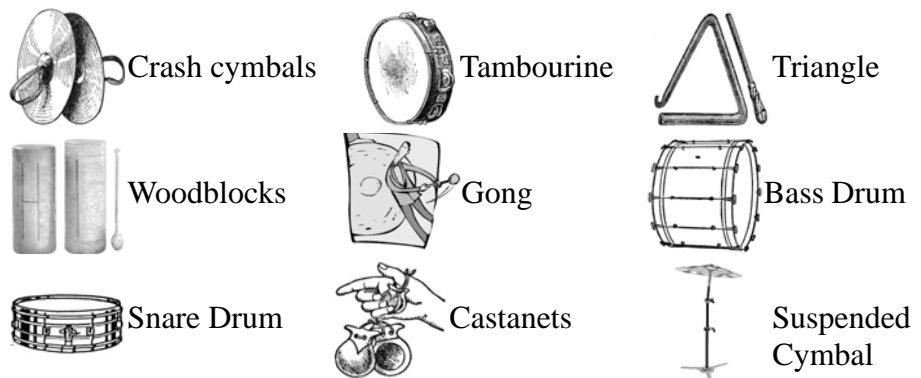

## The 5-Line Staff with Rhythm Clef

---

The drum set has at least three instruments, and usually many more. We’ll use the drum set as a focus to learn the 5-line staff with rhythm clef.

Though many people play with less, the typical drum set has 8 or 9 instruments: snare drum, bass drum, hi-hat, suspended/crash cymbal(s), ride cymbal, high tom-tom, middle tom-tom, and low tom-tom. Most

people know what a drum set looks like. If not, here you go (extra points if you can name the parts that are missing in the drum set below...).

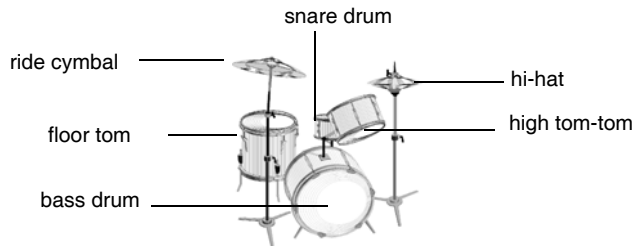

In order to read music for the drum set, the drummer has to know where each instrument is written on the rhythm staff. Curious about what that might look like? Well, here it is, but don't worry about the kinds of notes you see—they get explained in the next Part.:

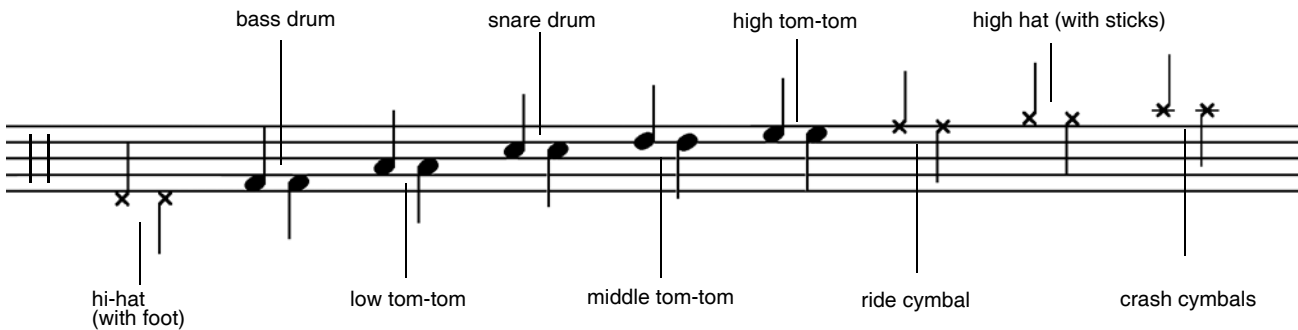

For example, rhythms for the bass drum will *always* be written on that first space. Rhythms for snare drum will *always* be written on the third space. Etcetera, etcetera.

### X Marks the Cymbal Spot, Maybe

The *x* notes in a rhythm clef usually show the cymbal part, but they can also be used to show the triangle part, or the cowbell part, or any other small percussion instrument.

Instruments and where they are on the staff are usually defined at the beginning of a piece of music, and what shows a triangle in one piece may be used for cowbell in a different song. It's always best to check the beginning directions to be sure.

# Moving On

---

We won't be seeing much of the rhythm clef in this book, but it's important to know, especially if you're interested in drums and percussion instruments.

That's the end of this Part. It was a short one, but the information is essential to everything which follows, so if there's something you don't understand, go back and review until you've got it.

After the review for this chapter is the big fat review for the entire Part.

The next part is called *You Got Rhythm*, and goes over the notes you've been seeing: their names, their anatomy, and their length.

## Chapter 9 Review

---

1. What does the rhythm clef show?  
*1. Rhythm only. No pitches*
2. Why doesn't the rhythm clef show pitch?  
*2. Drums/percussion are non-pitched instruments*
3. Why use a one-line rhythm clef?  
*3. One line is all that's needed for a single percussion instrument.*
4. If the 5-line rhythm clef staff doesn't show pitches, why is it used?  
*4. The 5-line clef can show rhythm for several instruments at once.*
5. If a note-head is an x, what instrument is used?  
*5. Options: cymbals, cowbell, triangle, guiro, any small percussion instrument*

6. If you're reading say, a bass drum part, and it's on the first space, will it ever change to another line or space within that piece?

6. *NO!*

7. Did you hear about the drummer who locked her keys in her car?

7. *It took an hour to get the bass player out.*

## Practical Use

---

1. In your staff-paper notebook, write a percussion clef. Write out the correct name of the instrument in the appropriate line/space of your staff. If necessary, look at page 70 to get it right.

2. Get on the "throne" of a drum set. Play each instrument of the set while looking at the appropriate space in your music from example 1. Try two instruments/drums at once. Then three. Then all four.



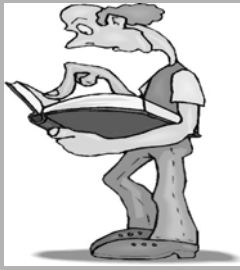

# PART II REVIEW

Whew! You Made It.

---

These pages can be used to test your memory about what you've learned in Part II, and if some of the information hasn't stuck, you can go back and check it out on the page indicated below the question.

As with the chapter study guides, use your keyboard to cover up the answers while you test yourself.

When you think you've got it all down, either take the test in *Basic Music Theory Quiz Book*, or go on.

## The Review

---

1. What did clefs used to be?  
page 48

1. *A letter at the beginning of a piece of music*

2. About when and where was the word *clef* first used?  
page 48

2. *Mid-1500s, France*

- |  |   |
|--|---|
| <p>3. What does a clef do?<br/>page 48</p>   | <p>3. Shows the letter name of a staff line</p>                                       |
| <p>4. What are the three most common clefs?<br/>page 48</p>  | <p>4. Treble clef, bass clef, rhythm clef</p>   |
| <p>5. What does the rhythm clef show?<br/>page 51</p>  | <p>5. Rhythm only. No pitches</p>   |
| <p>6. Why doesn't the rhythm clef show pitch?<br/>page 51</p>  | <p>6. Drums/percussion are non-pitched instruments</p>                                |
| <p>7. Why use a one-line rhythm clef?<br/>page 68</p>  | <p>7. One line is all that's needed for a single percussion instrument.</p>           |
| <p>8. If the 5-line rhythm clef staff doesn't show pitch, why is it used?<br/>page 69</p>  | <p>8. To show the rhythm for several instruments at once</p>                          |
| <p>9. If a note-head is an x, what instrument is used?<br/>page 70</p>   | <p>9. Options: cymbals, cowbell, triangle, guiro, any small percussion instrument</p> |
| <p>10. If you're reading a bass drum part and it's on the first space, will it ever change to another line or space within that piece?<br/>page 69</p> | <p>10. No</p>   |
| <p>11. Which line does the treble clef name?<br/>page 50, page 56</p>  | <p>11. 2<sup>nd</sup></p>   |
| <p>12. Which line does the bass clef name?<br/>page 50, page 62</p>  | <p>12. 4<sup>th</sup></p>   |

13. What letter did the bass clef used to be?  
page 62

13. *F*

14. What instruments use the rhythm clef?  
page 51 page 69

14. *Drums and other  
non-pitched  
instruments*

15. Which line does the rhythm clef name?  
page 68

15. *It doesn't show  
letter names*

16. On a scratch piece of paper, draw five treble clefs.  
page 56

17. On the same piece of paper, draw five bass clefs.  
page 50

18. On the same piece of paper, draw five rhythm  
clefs.  
page 68

19. What letter did the treble clef used to be?  
page 56

19. *G*

20. The inner loop of the treble clef circles which line?  
page 56

20. *2nd*

21. What is a mnemonic device?  
page 56

21. *A trick to improve  
memory*

22. What letter name does the treble clef give to the  
2<sup>nd</sup> line?  
page 56

22. *G*

23. What is another name for the treble clef?  
page 56

23. *G clef*

24. What are the names of the treble clef lines?  
page 57

24. *E G B D F*

25. What are the names of the treble clef spaces?  
page 58

25. *F A C E*

26. What is your mnemonic device for remembering  
the lines of the treble clef staff?  
page 57

27. What is your mnemonic device for remembering  
the spaces of the treble clef staff?  
page 58

28. Name two instruments that use treble clef.  
page 50

28. *Possibilities: flute,  
piano, guitar,  
trumpet, sax,  
piccolo, violin, F  
horn, oboe, clarinet,  
accordion...*

29. Which staff line goes between the two dots of the  
bass clef?  
page 50 page 62

29. *4<sup>th</sup>*

30. Which line is the head of the bass clef on?  
page 50 page 62

30. *4<sup>th</sup>*

31. What letter name does the bass clef give to the  
fourth line?  
page 62

31. *F*

32. What are the names of the bass clef lines?  
page 63
33. What are the names of the bass clef spaces?  
page 64
34. What is another name for the bass clef?  
page 62
35. What is your mnemonic device for remembering the bass clef lines?  
page 63
36. What is your mnemonic device for remembering the bass clef spaces?  
page 64
37. Name two instruments that use bass clef.  
page 50
32. *G B D F A*
33. *A C E G*
34. *F clef*
37. *Possibilities:  
trombone, tuba,  
piano, bass guitar,  
acoustic bass,  
electric bass,  
bassoon, baritone,  
euphonium,  
timpani/kettle  
drum, double  
tenor steel drum...*

## Moving On

---

The info in the past Part is very important, so I hope you've got it down. If you're taking the Quiz for this part, good luck!

Coming up next we'll begin to learn note types and how long they are. You'll learn whole notes, half notes, and quarter notes, time signatures, and more.



# Interlude



## MUSICAL TERMS

*The mind is a musical instrument  
with a certain range of tones, beyond  
which in both directions we have an  
infinite silence.*

— John Tyndall (1820 - 1893)

### In This Interlude

- Musical Terms
- Tempo Markings
- Dynamic Markings
- Articulation Markings

# Musical Terms are Directions

---

Music can be loud or soft; notes can be short or long or anywhere in between; a musical phrase can be played sweetly or crassly, smoothly or choppy; and music can be played at many different speeds from sleepily slow to furiously fast.

The performer needs to know this information, and in most music the information is written in Italian.

## Why Italian?

Way back when, beginning in the late 1500's, there was a lot of music-making going on in Italy, and at the time, some bright soul thought to write these detailed instructions on the music. Because the composers were Italian, the instructions were written in, you guessed it, Italian.

You'll occasionally see some terms in German and French and even English (especially if you play a piece by Percy Grainger), but the vast majority of musical terms are in Italian.

Following are many Italian terms that are applied to music. They're grouped by category: *tempos* (how fast to go), *dynamics* (how loud or soft to play, *articulations* (how short or long a note is), general terms, and terms for special types of repeats.

## Tempo

---

Tempo is an Italian word which comes from the Latin *tempus* which means *time*.

In order to understand these tempos (some people say *tempi* for the plural), we'll refer to the metronome and how many beats per minute each tempo is. To review the metronome, see "The Metronome (or: The Torture Device)" on page 152. Most metronomes have these markings listed somewhere on them.



Here are the most common tempos, from slowest to fastest:

| TEMPO NAME         | BEATS PER MINUTE |
|--------------------|------------------|
| <b>Largo</b>       | 40-60            |
| <b>Larghetto</b>   | 60-66            |
| <b>Adagio</b>      | 66-76            |
| <b>Andante</b>     | 76-108           |
| <b>Moderato</b>    | 108-120          |
| <b>Allegro</b>     | 120-168          |
| <b>Presto</b>      | 168-200          |
| <b>Prestissimo</b> | 200-208          |

## Tempo-related Terms

There are other terms that affect the tempo of a piece. They are:

accelerando (accel.) = speed up gradually.

allargando (allarg.) = slow down and grow louder.

ritardando (rit.) = slow down gradually.

rallentando (rall.) = slow down gradually.

## Dynamics

---

Dynamics is another word for how loud or soft to play. The base words to remember for dynamics are *piano* (quiet) and *forte* (loud). All of the dynamic markings are variations of these two words. You'll see what I mean. Often in music, you'll see an abbreviation of the dynamic, shown in the following chart in parentheses.

| DYNAMIC MARKING                 | MEANING    |
|---------------------------------|------------|
| <i>pianissimo</i> ( <i>pp</i> ) | very quiet |
| <i>piano</i> ( <i>p</i> )       | quiet      |

| DYNAMIC MARKING         | MEANING      |
|-------------------------|--------------|
| <i>mezzo piano (mp)</i> | medium quiet |
| <i>mezzo forte (mf)</i> | medium loud  |
| <i>forte (f)</i>        | loud         |
| <i>fortissimo (ff)</i>  | very loud    |

### *Grow Gradually*

In the Romantic era—around 1800—composers began writing music which contained sections that would grow gradually louder or softer. Up until this time, dynamic changes were usually abrupt. This new technique needed a name. What did they do? They used Italian of course.

To grow gradually louder is to *crescendo* (kra-SHEN-doe), and to grow gradually softer is to *decrescendo* (DEE-kra-SHEN-doe). Below are the symbols used to show this:

You may also see the abbreviations *cresc.* or *decresc.*

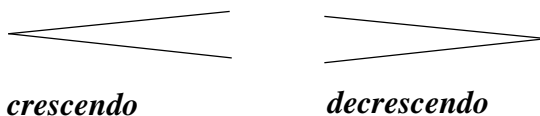

Another term for becoming gradually quieter is *diminuendo (dim.)*.

## Articulations

---

Articulation is a fancy way to say *note length*. Depending on your instrument, there are many ways to change the length of a note. For example, with wind instruments the breath and the tongue are used; for bowed instruments like violin, viola, cello and double bass, the bow is used; for piano (the instrument, not the dynamic) articulation is controlled by how long the keys are held down.

Articulations are indicated with a symbol which appears either above or below the note head. Articulations can also be shown by simply writing out the whole word under the notes to be affected.

Articulations may also be combined. For example, an accent with a legato would be a very short accent.

| ARTICULATIONS (SYMBOL) | MEANING                  |
|------------------------|--------------------------|
| <b>accent</b> (>, ^)   | note given more emphasis |
| <b>legato</b> (—)      | play the note full value |
| <b>staccato</b> (.)    | short                    |

**Example 10.1** Notes with various articulations.



## Of Ties and Slurs

Two more types of articulations seen quite frequently are *ties* and *slurs*.

Technically, ties aren't really a form of articulation, but because they look exactly like slurs but for one important difference, I'm introducing them together.

*A tie is a curved line connecting two or more notes of the same pitch.*

*A slur is a curved line connecting two or more notes of different pitches.*

### The Tie

Just like tying one piece of string to another gives you a longer piece of string, so tying two notes together makes a longer note. There is no break between tied notes. Ties are often used to join notes over the bar line.

**Example 10.2** Some tied notes.

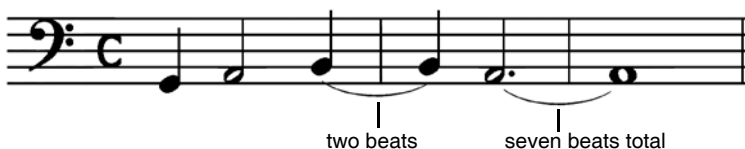

## The Slur

Notes of different pitches with the curvy line over or under them are articulated as smoothly as possible. For wind players, this means no tonguing; for piano players it means you hold the keys down for each note down as long as possible; for guitar players it means hammer-ons and pull-offs; for bowed instruments, the notes happen in the same bow stroke. Whatever your instrument, the idea is to make a slur as smooth as possible.

**Example 10.3** Some slurred notes.



## General Musical Terms

---

The terms you've been introduced to in the last few pages are often paired with other Italian words, giving you more specific directions. Below are the most common ones.

| TERM                      | MEANING    |
|---------------------------|------------|
| al                        | to the     |
| con                       | with       |
| fine (pronounced FEE-nay) | the end    |
| molto                     | very, much |
| poco                      | little     |
| sempre                    | always     |

For example, *molto ritardando* means slow down a lot; *sempre staccato* means notes are always short.

If you find a term you don't know, you can look it up in the glossary of terms at the back of this book. It's a good idea to have a pocket dictionary of terms in your instrument case. Hal Leonard Publishing makes a good small one.

# Pete and Repeat

---

Almost all music has repetition. A single measure may be repeated, a small section, or a large section. There are several ways to indicate these repeats in a piece of music.

## Repeat a Single Measure

The following sign is used to show that a specific measure is to be repeated:  $\frac{2}{\%}$ . If there is a number with this sign, say a “2”, then the previous two measures are to be repeated.

**Example 10.4** A two-measure repeat.



## Section Repeat

A section repeat is shown with two sets of dots at the beginning and end of the measures to be repeated. The second set of dots tell you to go back to the previous two dots. If there are no previous dots, then the repeat goes back to the beginning of the piece.

**Example 10.5** A section repeat.



## First and Second Endings



Sometimes a section is repeated, but has a different ending the second time around. The first time through the section, play to the repeat sign and return to the previous repeat sign (or the beginning, as in the example below). The second time through, skip the first ending which begins under the bracket with the number “1”, and play the second ending.



**Example 10.6** First and second endings. In this example the first ending repeat returns to the beginning.

The image shows two staves of musical notation in C major, common time. The first staff contains a sequence of eighth notes with triplets indicated by a '3' above the notes. The second staff shows a first ending bracket labeled '1' and a second ending bracket labeled '2'. A repeat sign is placed at the end of the first ending, with a double bar line and repeat dots. The second ending concludes with a final cadence.

## More Complex Repeats

The following terms and symbols show more complicated types of repeats.

| TERM  | MEANING  |
|---|--|
| <b>Da Capo al Fine</b><br>(D.C. al Fine)  | Go back to the beginning and play to the <i>fine</i> .   |
| <b>Del Segno al Fine</b><br>(D.S. al Fine)  | Return to the sign (  ) and play to the <i>fine</i> . |
| <b>Coda</b> (  ) | A closing section of a piece of music.   |

| TERM  | MEANING   |
|---|---|
| <b>Da Capo al Coda<br/>(D.C. al Coda)</b>   | Go back to the beginning and jump to the coda section at the coda sign (  ).   |
| <b>Del Segno al Coda<br/>(D.S. al Coda)</b> | Return to the sign(  ) and jump to the coda section at the coda sign  . |

## Moving On

---

As you can tell, there are many, many terms to know. If you look in the glossary in the back of this book, you'll find even more. While I was researching terms for the glossary, I learned several that I hadn't known before, and I've been playing music for over twenty years.

Unless you have a photographic memory, it's a good idea to keep a pocket dictionary around in case you come across terms like, *grave*, *con moto*, *leggerio*, *senza sordino*, or other strange utterances.





# PART THREE

## You Got Rhythm

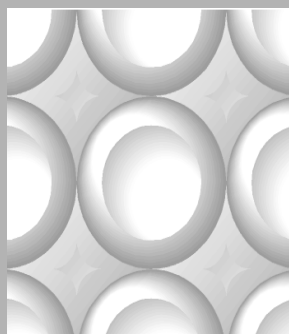

### In This Section You Will Learn:

- The Beat
- Whole Notes
- Half Notes
- Quarter Notes
- Eighth Notes
- Sixteenth Notes
- Rests
- Time Signatures
- Counting System
- Dotted Notes

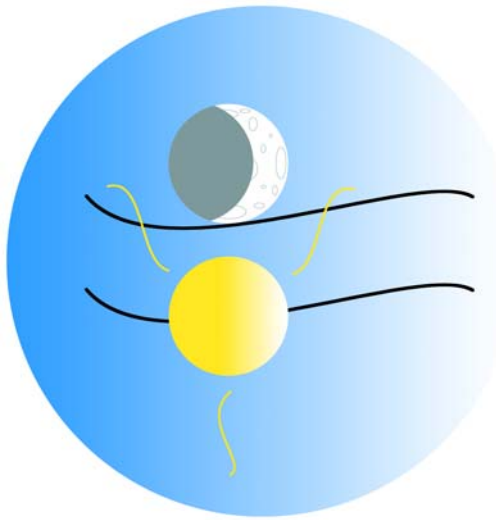

**SolUt Press**

[www.Sol-Ut.com](http://www.Sol-Ut.com)



## WHERE'S THE BEAT?

*Days full of wanting.  
Let them go by without  
worrying that they do.  
Stay where you are inside  
such a pure, hollow note.*

— Rumi

### In This Chapter

- The Beat
- Whole Note
- Half Note
- Quarter Note
- Note Anatomy 101
- Note Stems: Up or Down?

# The Beat Goes On

---

The *beat* of nearly any piece of music is easy to feel. It's what sets your toe tapping, it's what makes you dance. The beat is a regular pulse, like your heartbeat, which lasts throughout a piece of music.



Speaking of pulse, did you know that music with a fast beat makes your heart beat faster and speeds up your breathing? And music with a slow beat makes your heart and breathing slow down? It's true.

The beat is music's pulse, and like yours, it doesn't stop until the performance is over.

## The Notes

---

There are only three different note lengths you have to know at first. You'll notice that the half notes and quarter notes have two examples. Keep reading to find out why. From longest to shortest the notes are:

*whole note*, 4 beats each:

*half notes*, 2 beats each:



*quarter notes*, 1 beat each:



**All notes are named from their relationship to the *whole note*.**

**A *half note* is half as long as a whole note. (two half notes = 1 whole)**

**A *quarter note* is one fourth as long as a whole note (4 quarters = 1 whole).**

# Note Anatomy 101

---

Let's dissect a note. You'll need to know the parts so that later in the book, when I say, "Make sure the note head is in the space and flip the stem," you'll know exactly what I'm talking about.

No notes were harmed for this dissection.

## The Note Head

Not a tough one. Just like with people, the **head** is the round part where almost everything is happening. It's the position of the note head which gives us the pitch we need. Or—in the case of the rhythm clef—the type of instrument.

The whole note is the  
Braniac of notes. It's all  
head.



Note heads.



Note heads.

Notice how the shapes of the note heads are similar? Good. Some might have holes in the middle, and some might be filled in, but they're all the same basic shape.

## Size Doesn't Matter

A whole note the size of my house and a whole note the size of a house fly would each get the same number of beats.

# The Stem

---

Whole notes don't have stems. Half notes and quarter notes do have stems. So do eighth notes, but we'll get to them later. The stem is the part that sticks up or down from the note head.

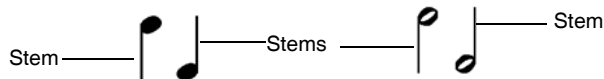

## Put Your Stems Up, Put Your Stems Down

The stem can go either up or down. When a note is on the third line of the staff or below, the stems grow up from the right side of the note head.

Putting the stem on the wrong side of the note head is one of the most common mistakes made. Be sure your notes look like the following:



**Example 11.1** Half notes and quarter notes, 3rd line and below, with their stems up.



If the notes are on the third line or above, the stems go down on the left side.

**Example 11.2** Half notes and quarter notes, 3rd line and above, with their stems down.



## Third Line Notes Are Conformists

The stem will be up for a note on the third line if it's with other notes whose stems are up.

The stem will be down for a third line note if it's with other notes whose stems are down.

Here's an easy way to remember what the stems look like:



A note **u** high on the staff looks like this.



A note **down** low on the staff looks like this.

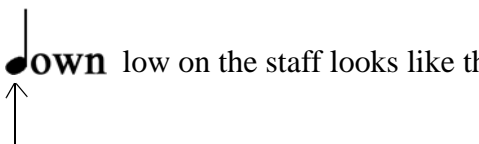

## Moving On

---

This was a very important Chapter because if you don't recognize and know the lengths of notes, reading music will be impossible. Stay with this Chapter until you've understood it, and read it over again if you think it'll help.

So you've got pitch, you've got note lengths. Now you're ready for time signatures, or meters. Study the review until you know all the questions, then read on!

## Chapter 11 Review

---

1. What is the beat, in music?
  1. A steady pulse; what makes your toe tap
2. Name the notes you learned from shortest to longest.
  2. quarter, half, whole

3. Which notes have stems? *3. Quarter and half notes*
4. The stems of notes above the third line go \_\_\_\_\_ . *4. Down*
5. The stems of notes below the third line go \_\_\_\_\_ . *5. Up*
6. Notes on the third line have stems which go \_\_\_\_\_ . *6. Either up or down*
7. When will a note on the 3rd line have its stem up? *7. When it is with other notes with their stems up*
8. How many beats does a whole note get? *8. 4*
9. How many beats does a half note get? *9. 2*
10. How many beats does a quarter note get? *10. 1*

## Practical Use

---

1. Draw a treble clef at the beginning of a blank staff. Fill up the line with different types of notes on different spaces and lines. Get in all three types: whole, half and quarter.
2. Go back through the notes in number 1 and write in the correct letter name underneath each note.





CHAPTER  
12

## THE SOUND OF SILENCE

*The rest is silence.*

— Shakespeare, *Hamlet*, Act v, sc.2

### In This Chapter

- Rests in General
- Whole rest
- Half rest
- Quarter rest

# Take a Rest

---

Ovid said that silence is strength. If that's true, you'll be much stronger after this chapter because it's all about silence.

Silence in music is as important as sound, and of course we crafty humans have invented a way to show this silence in music. **Rests**.

Rest lengths and rest names are the same as the note lengths you learned in the last chapter. The three you'll learn in this chapter are **whole rests**, **half rests**, and **quarter rests**.

## The Rests of the Story

---

Whole rests are 4 beats long, and look like this: 

Half rests are 2 beats long, and look like this: 

Quarter rests are one beat long and look like this: 

### Whole or Half, Hole or Hat

Whole rests and half rests look very much the same, and they can be easily confused with each other. Here's a way to remember which is which.



The whole rest, looks like a *hole* in the ground, like so:

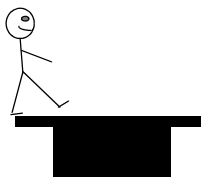

The half rest, looks like a *hat* (I know, *half* and *hat* don't sound the same, but work with me here):

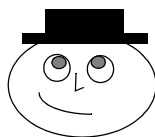

## Making a Quarter Rest

This is probably one of the trickiest symbols to make in written music, but it certainly isn't tough. Make a letter 'Z', then put a letter 'C' right below it. It won't look exactly like the quarter rest above, but anyone who reads music will know what it is (as long as you aren't too sloppy with it).

$$Z + C = \text{♩}$$

## Rests On The Staff

Whole rests hang from the 4th line of the staff, half rests sit on the third line, and quarter rests are plastered over the middle 3 lines. Notice the brim of the "hat" and the edges of the "hole" are gone when the half and whole rests are written on their proper line.

**Example 12.1** Whole rest, half rest, and quarter rest on the staff.

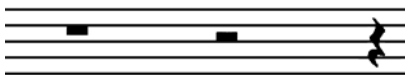

## Moving On

---

Without silence there can be no sound; without sound there can be no silence. And silence is an important part of music, and now you know how to show silence in music using whole, half and quarter rests. Make sure you can answer all of the study guide questions before you move on.

Coming up next is meter or time signature, a device at the beginning of a piece of music which tells you which note gets one beat and how many beats are in each measure.

## Chapter 12 Review

---

1. What does a rest show? *1. Silence*
2. Which three rests did you learn? *2. Whole rest, half rest, quarter rest*

3. How many beats does a quarter rest get? 3. 1
  
4. How many beats does a half rest get? 4. 2
  
5. How many beats does a whole rest get? 5. 4
  
6. Which line does the whole rest hang from? 6. 4th
  
7. Which line does the half rest sit on? 7. 3rd
  
8. On a scratch piece of staff paper, draw 5 whole rests, 5 half rests, and 5 quarter rests.

## Practical Use

---

- 1.** Fill up a line of staff paper alternating whole and half rests. Put an *h* below the half rests and a *w* under the whole rests.
- 2.** Draw a bass clef at the beginning of a blank staff. Write in as many notes and rests as you can comfortably fit. Include all notes and rests you've learned. Though the rests must go in specific places, use many different notes from high to low.
- 3.** Go back through these notes and rests and name them. Letter names for the notes (A-G) and *h, w, q* for rests.

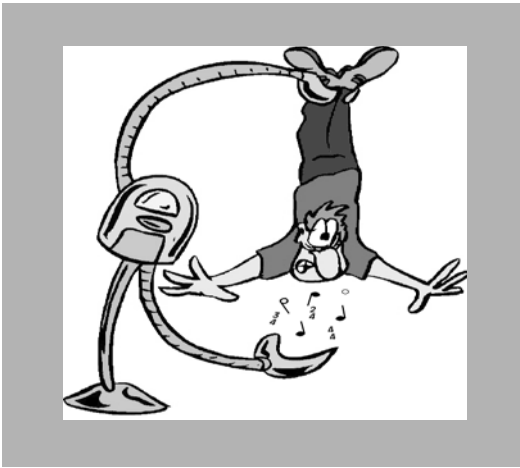

CHAPTER  
13

**METER**

*All times are not alike.*

— Cervantes, *Don Quixote*

**In This Chapter**

- Meter/Time Signature
- 4/4 Time
- 2/4 Time
- 3/4 Time

# Not the Metric System

---

At the beginning of every piece of music is what is called the *time signature* or *meter* which gives you information about the piece of music you're about to play.

The time signature or meter tells you how many beats are in each measure. To review measures, see “Measure” on page 28. The time signature also tells you what kind of note gets one beat. To review the notes, see “The Notes” on page 92.

**Example 13.1** The most common time signatures, or meters: 4/4, 3/4, and 2/4.

|          |          |          |
|----------|----------|----------|
| <u>4</u> | <u>3</u> | <u>2</u> |
| <u>4</u> | <u>4</u> | <u>4</u> |

## The Top Number

*The top number tells you how many beats will be in each measure.*

So, in the examples above, in 4/4 time, there will be 4 beats in each measure; in 3/4 time there will be three beats in each measure, and in 2/4 time there will be two beats in each measure.

The top number in the meter can be almost anything, but the most common ones are 4, 3, 2, and 6, in that order.

## The Bottom Number

The bottom number tells you which note gets one beat. Remember fractions? Another way of saying 1/4 is *one quarter*, right? And so, with a 4 in the bottom of the time signature, you know that the quarter note receives one beat.

There are several possible numbers for the bottom of the time signature. The most common are 4, 2, and 8, with 4 being by *far* the most common. And because it's the most common (and the easiest to understand), we'll stick with 4 as the bottom number until Chapter 33 More Meters, in which you'll learn about time signatures in which a note other than the quarter receives the beat.

## Why One Meter and Not Another?

Why have different meters? When you look at the following examples you'll see how the words and the music fall in certain patterns. The pattern might be shaped by the words, or the music. If there is a 4-beat pattern, it'll be in 4/4 time. A 2-beat pattern is in 2/4 time, and a 3-beat pattern is in 3/4 time.

### 4/4 Time

---

This meter is more common than all of the other meters by a long way. If you're a beginner, you'll most likely be working with this time signature for quite a while before moving on to others.

You can see from the example how the song falls easily into the 4 beat-per-measure pattern.

**Example 13.2** A few measures of *Mary Had a Little Lamb* in 4/4 time.

Top number tells you there are 4 beats per measure.

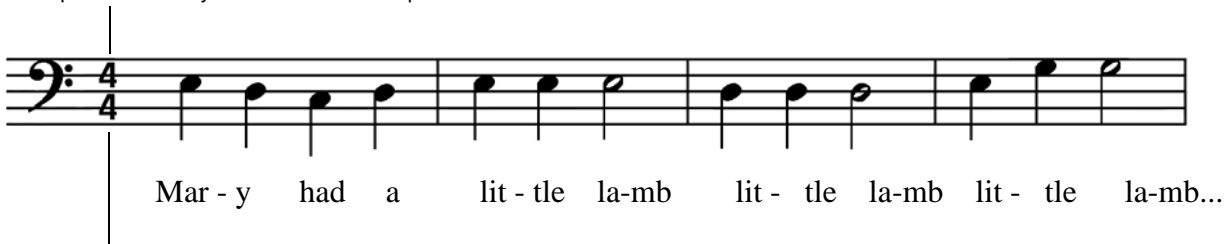

The image shows a musical staff in bass clef with a 4/4 time signature. The melody consists of quarter notes: G2, A2, B2, C3, D3, E3, F3, G3, A3, B3, C4, D4, E4, F4, G4, A4, B4, C5. The lyrics are: Mar - y had a lit - tle la-mb lit - tle la-mb lit - tle la-mb...

Bottom number tells you the quarter note gets one beat.

### Common Time

Because 4/4 time is so common, you'll often see a letter "C" in the place of the time signature. The "C" stands for "common," and looks like this:



The image shows a musical staff in bass clef with a common time signature (C). The melody consists of quarter notes: G2, A2, B2, C3, D3, E3, F3, G3, A3, B3, C4, D4, E4, F4, G4, A4, B4, C5.

## 2/4 Time

---

Another fairly common time signature, though not as common as 4/4. Again, notice how easily this example falls into the pattern of 2 beats per measure.

**Example 13.3** A few measures of *Twinkle, twinkle* in 2/4 time.

2 beats per measure.

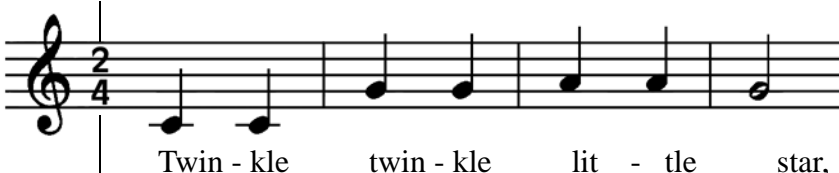

Quarter note gets one beat.

Twin - kle      twin - kle      lit - tle      star,

## 3/4 Time

---

If you've ever heard a waltz, or danced a waltz, you've heard the 3/4 pattern. It has a strong pulse on the first beat of each measure.

**Example 13.4** A few measures of *My Country, 'Tis of Thee* in 3/4 time.

3 beats per measure.



Quarter note gets one beat.

My coun - try      'tis of thee,

## Moving On

---

Now that you've learned meters, and what the numbers mean, it's now time to learn a system for counting notes and rests so that you can figure out how rhythms in a piece of music sound.

But first, the chapter review.



# Chapter 13 Review

---

1. What is another name for meter?  
*1. Time signature*
2. Where does the time signature appear?  
*2. At the beginning of a piece of music, directly after the clef*
3. What information does the time signature give?  
*3. How many beats in each measure, and what type of note gets one beat*
4. Which are the three most common time signatures?  
*4. 4/4, 2/4, 3/4*
5. What does the top number tell us?  
*5. How many beats in one measure*
6. What does the bottom number tell us?  
*6. What type of note gets one beat*
7. Why are different meters used?  
*7. Each song has a pattern. The meter depends on the pattern of each song.*

## Practical Use

---

1. Write any meter you have learned at the beginning of a staff. Choose a clef also, and place the two correctly. Are you using a pencil? Do. It saves time and is much neater when mistakes are made.
2. Fill up a line with notes and rests. Feel free (and do) change clef and meter when you want. Simply write the meter/clef where you want it to change.





CHAPTER  
14

## DOWN WITH THE COUNT

*Music is nothing else but wild sounds  
civilized into time and tune.*

— Thomas Fuller, *History of the  
Worthies of England.*

### In This Chapter

- Tap Your Foot
- Counting Quarter Notes
- Counting Half Notes
- Counting Whole Notes
- Counting Rests

## Can You Count to 4?

---

Now that you know the note lengths and time signatures, we can move on to the counting system.

The counting system is *very* helpful, especially for difficult rhythms. *Every* time I have a student count a difficult passage out loud, it becomes much easier. When you count, do it rhythmically, and tap your foot with a steady beat at the same time.

The rhythms we'll be using at first won't be tough, so you can get a good idea of how the system works. Gradually I'll introduce more and more difficult rhythms on which to practice this counting system.

The good news is that you only have to know how to count to 4, the length of a measure of 4/4 time. And because we don't really need a specific pitch for this exercise, we'll use the one-line rhythm clef for the examples.

## Tap Your Foot

---



It's one thing that both beginning musicians and masters have in common. It's what keeps your rhythms the right length, and it keeps you synchronized with others you may be playing with. It's the foot tap.

Over the last few days I watched Eric Clapton, then B.B. King, then Wynton Marsalis, then Leo Kottke, then Metallica, and all of them, almost the entire time they played, were tapping their feet. And if they didn't tap their foot (which was seldom), their bodies moved in some other way to keep time steady.

If you're in a large group in which 20 or more people tapping their feet sounds like a marching army, tap your toe inside your shoe, or tap your heel softly instead. If you're playing solo guitar, maybe a blues tune, you can stomp your foot on beats 2 and 4 to add a little percussion to your song. Either way, if you tap your foot your performance will be better for it.

If you're not used to tapping, it'll take a little concentration and a little coordination but keep with it even if it's difficult at first. Soon you'll be tapping your foot without thinking about it.

If you don't tap, or keep some rhythmic movement going, you're pretty much guessing where the beat is. What you're after is precision.

On to the counting system.

## Quarter Note Count

---

The count is basically the same as the beat, so in 4/4 time, or any time signature with a 4 as the bottom number, the beat is the same as the quarter note. Here's what a measure of quarter notes looks like with the proper counting:

**Example 14.1** Two measures of quarter notes with counting.

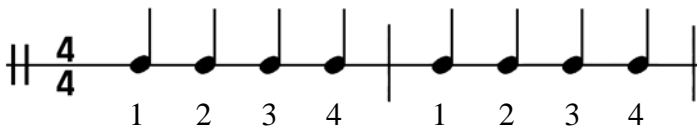

Simple and straightforward. At the beginning of the measure, the count begins again at “1”.

Don't forget to tap your foot. As you say the numbers out loud, say them rhythmically, so you can feel the beat. If you're doing it correctly, each number is said as the foot hits the floor.

This will come in handy later. Trust me.

## Half Note Count

---

Half notes, because they're two beats, are treated a little differently. It's easier to show than to explain. Remember the sound of a half note in 4/4 time is sustained for two beats each. Here you go:

**Example 14.2** Two measures of half notes with counting.

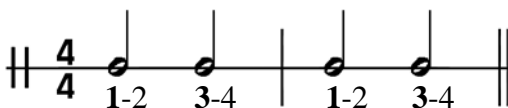

You probably guessed the count would look something like that, right? The dash shows that the sound is continuous. When you say this rhythm, say it rhythmically, and say the 1 and 3 louder than the 2 and 4. Each half note will have two foot taps.

For these two measures, you would say (rhythmically), “ONE-two, THREE-four, ONE-two, THREE-four.”

## Whole Note Count

---

I’m sure you could figure out the whole note counts for yourself, but I’ll give them to you anyway.

**Example 14.3** 2 measures of whole notes with counting.

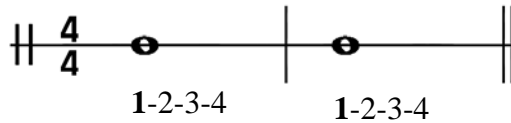

For these two measures, you’d say, “ONE-two-three-four, ONE-two-three-four.”

## Mix ‘Em Up

Any combination of notes will be counted similarly. I won’t include whole notes in the example because, in 4/4 time whole notes get the entire measure to themselves.

**Example 14.4** Counting for mixed quarter and half notes.

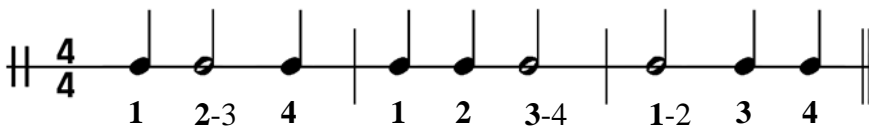

## Other Meters

Other meters, like 2/4 and 3/4 would be treated the same, the only difference being there would be less counts in each measure. An added bonus is that in those meters, whole notes aren't used.

## Count the Rest

---

Counting rests is very similar to counting notes. Because rests are silent, parentheses ( ) are used to indicate the silence. Here are three measures with whole, half, and quarter rests. And just for kicks, we'll use the 5-line treble clef staff.

An added help when you count rests out loud is to count them softly, with a whisper.

**Example 14.5** Whole, half, and quarter rests with counting.

Musical notation for Example 14.5 in 4/4 time, using a treble clef staff. The first measure contains a whole rest with the count (1-2-3-4) below it. The second measure contains a half rest with the count (1-2) below it, followed by another half rest with the count (3-4) below it. The third measure contains four quarter rests, each with its own count (1), (2), (3), and (4) below it.

## All Together Now

---

I'd rather be guilty of overkill than guilty of not being thorough, so here's an example with notes and rests of several different values. Knock yourself out.

Count out loud and rhythmically, and don't forget to tap your foot.

**Example 14.6** Notes, rests, and their counts in 4/4 time.

Musical notation for Example 14.6 in 4/4 time, using a bass clef staff. The first measure contains a quarter note with count 1-2, a quarter rest with count (3), and a quarter note with count 4. The second measure contains a quarter note with count 1, a quarter note with count 2, and a half rest with count (3-4). The third measure contains a quarter rest with count (1), a quarter note with count 2-3, and a quarter note with count 4.

# Moving On

---

Being able to read rhythms is one of the most valuable skills you can have as a musician, and this counting system (combined with a foot tap) will help you figure out how a rhythm sounds.

Coming up next you'll learn what a tiny little dot (.) can do to the length of a note.

## Chapter 14 Review

---

1. The count of any measure, in any time signature/  
meter, begins with what number? 1. 1
2. How is a measure of quarter notes in 3/4 time  
counted? 2. 1 2 3
3. How is a measure of half notes in 4/4 time counted? 3. 1-2, 3-4
4. How is a whole note counted in 4/4 time? 4. 1-2-3-4
5. When writing out the counting, what is used to  
indicate a rest? 5. parentheses ( )
6. When counting out loud, how should you count a  
rest? 6. softly

## Practical Use

---

1. Write out 8 measures of each meter: 2/3, 3/4, and 4/4. Use notes and rests randomly. Get as many in as you can. Go back through and do the counting. Say it out loud (remember the rests are whispered) while you tap your foot.



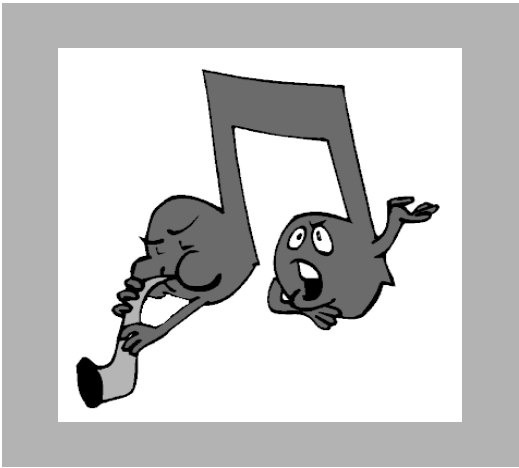

CHAPTER  
15

**NEW NOTES**

*Indeed, what is there that does not  
appear marvellous when it comes to our  
knowledge for the first time?*

— Pliny the Elder

**In This Chapter**

- Eighth Notes, Eighth Rests
- Counting Eighth Notes and Rests
- Sixteenth Notes, Sixteenth Rests
- Counting Sixteenth Notes and Rests

# Eighth Notes and Rests

---

Remember when I said all notes get their name because of their relationship to the whole note? If you don't remember, check out "The Notes" on page 92 for a refresher.

**Eighth notes** are no different. You can tell by their name that they're  $1/8$  as long as a whole note (which I'm sure you remember gets 4 beats). What is one eighth of 4 beats? It's one half of a beat.

**An eighth note gets half of a beat in 4/4 time.**

It might be easier to say that there are 8 eighth notes in one whole note.

Or that there are 4 eighth notes in one half note.

Or that there are 2 eighth notes in one quarter note.

Or that there are 2 eighth notes per beat.

"Okay, Okay, I get it," you say. "Just show me the notes!" Well, before I do, there's something you should know about. They're called **flags**, and we're not talking about the stars and stripes.

A flag is a doohickey which hangs from the end of the stem of an eighth note, and it has two forms. The first type can be seen dangling from the eighth notes on the left below. The second version on the right is used for two or more eighth notes. When there are two or more eighth notes, the flags are connected with a **beam** to make the notes easier to read.



When you add a flag or beam to a note, it cuts the note's value in half.

**Example 15.1** LEFT: Single eighth notes. RIGHT: Eighth notes grouped by twos and fours with beams (flags connected).

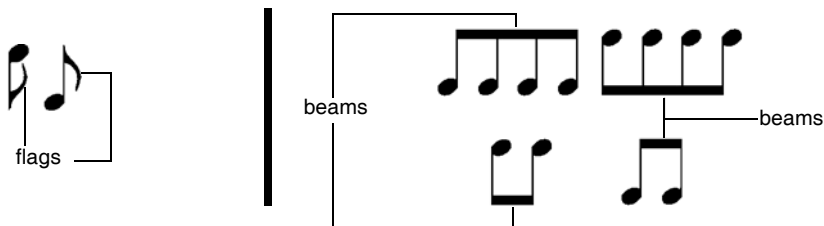

## Counting Eighths

Because there are two eighth notes for every beat, the count is a little different than what you've learned already. With eighth notes, the beat is *subdivided*, which means chopped up (but evenly chopped up).

Here are two measures of eighth notes in 2/4 time. And just so you know, when said out loud, the “+” sign is pronounced “and.”

Be sure when you count these, that your foot comes down firmly on each number. Your foot will be in the “up” position for the “+.” And by the way, when a note falls on an “+,” it's called an *upbeat*. Coincidence? I don't think so.

**Example 15.2** 8th note count in 2/4 time.

The image shows a musical staff in 2/4 time. The first measure contains four eighth notes: quarter, quarter, eighth, eighth. The second measure contains four eighth notes: quarter, quarter, eighth, eighth. Brackets above the notes indicate 'upbeats' on the '+' signs. The count '1 + 2 +' is written below the notes.

In 4/4 time the count would be “One And Two And Three And Four And (said rhythmically with your foot tapping away like a machine).

## Eighth Rests

The eighth rest also gets only 1/2 of a beat, but is silent. The eighth rest looks like a seven with a strange growth at its tip and it lies in the middle of the staff, like so:

**Example 15.3** One little bitty eighth rest, all by its lonesome.

The image shows a bass clef staff with a single eighth rest in the middle of the staff.

## Counting Eighth Rests

The count for eighth rests is the same as the count for eighth notes, only there is a parentheses ( ) around either the number or the +. When counting the eighth rest, be sure you know which part of the beat the

rest falls on, the upbeat (when your foot is up), or the downbeat (when your foot hits the floor).

Here are a few measures of eighth notes and eighth rests with the counting. Be sure to count it rhythmically, and say the rests more quietly than the notes.

**Example 15.4** A whole mess of eighth rests and eighth notes, with counting.

(1) + 2 + 3 + (4) + 1 + 2 (+) 3 (+) 4 (+)

## Sweet Sixteenth Notes

---

Why sweet? Because *sixteenth notes* are the last type of note you'll learn in this book. Yippee!

You've probably already figured out that, because of the name, there are 16 of these babies in each whole note. Okay, time for a little math. If you divide up 4 beats (the whole note) sixteen ways, how long is each sixteenth note?

The answer is...1/4 of a beat.

So there are 16 sixteenth notes in one whole note,

or 8 sixteenth notes in one half note,

or 4 sixteenth notes in one quarter note,

or 4 sixteenth notes in one beat of 4/4 time,

or 2 sixteenth notes in one eighth note.

So what do they look like? Coming up. Sixteenth notes also have flags, with one added bonus: there are two of them.

When a flag is added to a note, it cuts the note length in half.



**Example 15.5** LEFT: Single sixteenth notes. RIGHT: Sixteenth notes in groups of 4 and 2.



## Counting Sixteenths

I love counting sixteenth notes. Just like with eighth notes, the beat is subdivided, but even more so than with eighths. Each beat is split up into 4 parts, and each part has a name.

Again, when you're counting, make sure your foot is tapping down on each number (each beat), and up with each "+" symbol, just like with eighth notes. The "e" occurs halfway up and the "a" occurs halfway down.

Practice this count with your foot VERY SLOWLY until you've got it down enough to do it more quickly.

**Example 15.6** A measure of sixteenth notes with counting.



## Sixteenth Rests

They look like eighth rests but with an extra little flag on them:

**Example 15.7** A single sixteenth rest, all by its lonesome.



## Counting Sixteenth Rests

The same count is used (1 e + a) but as before, there are parentheses around the rests.

Here are some measures with the sixteenth rest in different positions in the measure.

**Example 15.8** Sixteenth rests scattered around the measures.

The image shows a musical staff in 4/4 time with sixteenth notes and rests. Below the staff, the counting for each measure is provided: 1 e (+) a, 2 e +(a), 3 (e) + a, (4) e + a, (1) e (+), (2) (3-4). The rests are placed at different points in the measures to illustrate their placement.

## How to Figure out a Tough Rhythm

---

- 1 Write out the counting under the notes. Triple check to make sure you've written it out correctly.
- 2 Practice saying it rhythmically VERY SLOWLY, and be sure to tap your foot down on each number, and up on each "+."
- 3 If there are rests, say them more quietly than the notes.
- 4 Repeat from step two, and as your brain becomes used to the rhythm, gradually increase speed. If it's frustrating or you're making mistakes, slow it down and try it again.
- 5 If all else fails, find someone who reads music better than you and ask them for help.

## Moving On

---

I'm sure you're discovering that the notes and counting system don't stick in your brain with just one reading. Not to worry, this is normal. It takes a while living with these new concepts before they seem familiar and easy. You may have to refer back to these chapters often, and that's okay too. Stick with it.

You've now been introduced to all the types of notes and rests that you'll probably ever need for reading music. However, these notes you've learned can be treated in such a way as to change their length.

One of these is a small dot following a note. In the next chapter you'll learn all about these dots and what they do to the length of a note.

## Chapter 15 Review

---

1. How long is an eighth note? 1.  $1/2$  beat
  2. How long is an eighth rest? 2.  $1/2$  beat
  3. How many eighth notes in one quarter note or one beat of 4/4 time? 3. 2
  4. How are eighth notes counted in 4/4 time? 4. 1 + 2 + 3 + 4 +
  5. How are eighth rests counted in 2/4 time? 5. (1) (+) (2) (+)
  6. What is the count for this example? 6. 1 + 2 (+)  
3 (+) 4 (+)
- 
7. How long are sixteenth notes in 4/4 time? 7.  $1/4$  beat
  8. How many sixteenth notes are in one quarter note or one beat of 4/4 time? 8. 4
  9. How do you count sixteenth notes in 4/4 time? 9. 1 e + a 2 e + a  
3 e + a 4 e + a

10. What is the count for this example?



10. 1 e (+) a  
2 e + (a)  
3 (e) + a  
(4) e + a

11. What is an upbeat?

11. *The part of the beat when your foot is in the "up" position; the "+" of a beat.*

## Practical Use

---

1. On a blank staff, write out eight single eighth notes, four stem up and four stem down. Write out another eight barred in groups of 2 with stems up and down, then nine barred in groups of 3, and a final eight grouped in fours.
2. Go back through and name each note in exercise number one. Do at least 4 in each group. Write in the counting under the notes you've written. Use a 4/4 time signature and place the bar lines correctly.
3. On a blank staff write out sixteen single sixteenth notes, 8 stem up and 8 stem down. Another 8 barred in groups of 2, then 9 sixteenths barred in groups of three, and finally 8 barred in groups of 4.
4. Write the count under the sixteenth notes you've written. Use a 3/4 time signature and place the bar lines correctly.



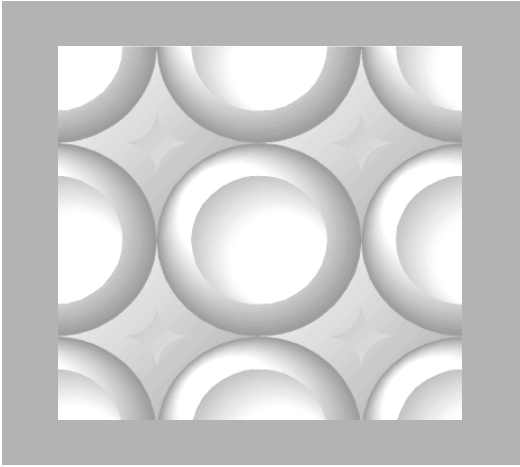

CHAPTER  
**16**  
**SEEING DOTS**

*We see things not as they are, but as we are.*

— H.M. Tomlinson,  
*Out of Soundings*

### **In This Chapter**

- The Effect of a Dot
- Dotted Whole Note
- Dotted Half Note
- Dotted Quarter Note
- Dotted Eighth Note

# You Are Not Seeing Things

---

Those dots you see behind some notes are supposed to be there. A dot just to the right of a note makes the note longer. How much longer? Well it depends on what note the dot follows. Let me explain.

A dot adds half the amount of the note it follows. Another, perhaps simpler, way of saying it, is that a dotted note is 1.5 times the length of the same kind of note without a dot.

Sounds weird doesn't it? An example might throw more light on this peculiar practice. Let's use a whole note as our first example.

## The Dotted Whole Note

---

A whole note (  ), as you know, gets 4 beats. Half of that is two, for a total of six.

Or,  $4 \times 1 \frac{1}{2} = 6$ ; or  $4 + 2 = 6$

*A dotted whole note (  ) has six beats.*

But wait a minute, you might be saying, there are only 4 beats in a measure. Well, for 4/4 time, you're right. But with dotted whole notes we need a new meter, 6/4 time. Remember the top number tells us there are six beats per measure; the bottom number tells us that the quarter note gets one beat. Here are a couple measures of 6/4 time:

**Example 16.1** Three measures of dotted whole notes.

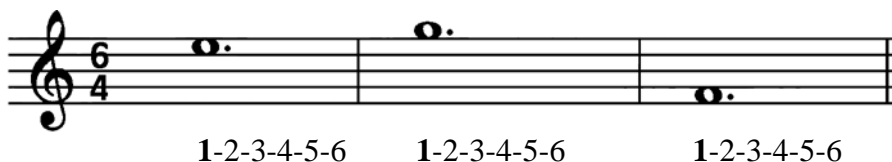

The image shows a musical staff in 6/4 time, indicated by a treble clef and the time signature '6/4'. The staff is divided into three measures. Each measure contains a single dotted whole note. Below each measure, the beat counts '1-2-3-4-5-6' are written, showing that each dotted whole note spans the entire six-beat measure.

# The Dotted Half Note

---

A more common type of dotted note is the *dotted half note*. How long is a dotted half note? Use the formula. The half note gets two beats, and half of that is one. Two plus one is three.

Or,  $2 \times 1 \frac{1}{2} = 3$ .

*The dotted half note gets three beats.*

Though a dotted half note could happen in any time signature with more than three beats in the measure, in the example, I've used 3/4 time.

**Example 16.2** Three measures of dotted half notes.



# The Dotted Quarter Note

---

Here's where things get a little tricky, but it's still not too tough. A quarter note gets one beat. Half of that is half of a beat.

Or  $1 \frac{1}{2} \times 1 = 1 \frac{1}{2}$

*A dotted quarter note gets 1 1/2 beats in 4/4 time.*

To make the counting easier, think of the dotted quarter note in terms of how many eighth notes are in it. Because it's 1 1/2 beats, that comes out to be 3 eighth notes.

Notice that when counting dotted quarters, you use a count similar to eighth notes. This is so that you can keep track of exactly how long each dotted quarter note is. Say the bold items in a normal voice, and the rest in a softer voice, as always with a steady foot-tap.

**Example 16.3** Two measures of dotted quarter notes in 4/4 time.

1--2 + 3--4 + 1 +2-+ 3 +-4-+

## Musical Example

Because this rhythm is a little trickier, below is an example which you should recognize (be sure to tap your foot):

**Example 16.4** First two measures of *My Country, 'Tis of Thee*.

1 2 3 1--2 + 3  
My coun- try 'tis of thee

## Dotted Eighth Note

---

This is the last type of dotted note we'll discuss. Find the length with the same process as the other dotted notes.

An eighth note is half of a beat. There are two sixteenth notes in one eighth note. So half of an eighth note is  $1/4$  of a beat, or 1 sixteenth note. When we add that to the eighth note, we get  $3/4$  of a beat, or 3 sixteenths.

Or,  $1 \frac{1}{2} \times \frac{1}{2} = \frac{3}{4}$ .

You'll rarely see a dotted eighth note without a sixteenth note following it to round out the beat. In fact, it's so common, that the figure has a name. Dotted eighth-sixteenth. Go figure.

Here is a measure of dotted 8th-16ths. Notice that a sixteenth note count is used so that you can keep track of exactly how long the dotted eighth is. Be sure your foot hits the floor on the numbers.

**Example 16.5** The dotted 8th-16th figure.

1-e-+ a    2-e-+ a    3-e-+ a    4

## Musical Example

Here's a musical example you'll recognize which uses the dotted 8th-16th figure.

**Example 16.6** First few notes of *The Star Spangled Banner*

(1) (2) 3-e-+ a    1    2    3    1-2    3-e-+ a    1  
 O - h    say    can    you    see,    by    the    dawn's

## Dotted Rests

Dotted rests are treated exactly the same as dotted notes, the only difference being that the count will be in parentheses.

This example has dots like a sickness, and that's for the sake of illustration. You won't normally see a musical passage with that many dots.

**Example 16.7** Dotted notes and rests with counting.

1-+-2 (+) (3-4-5) 6 (1-+-2) + 3-e-+ a 4 (e-+-a) 5 6 (1-2-3-4-5-6) 1-2-3-4-5-6

# Moving On

---

The concepts you're learning are becoming more complex, and you'll probably find it will take some time living with these ideas before they really stick, so come back and review as much as you want.

Now that you understand that a dot increases the length of a note by half its original value, you can decipher the length of any dotted note.

Coming up next is another treatment of the notes you already know, called *triplets*, which is a grouping of three notes. Find out what it all means in the next chapter.

## Chapter 16 Review

---

- |   |   |
|---|---|
| 1. What does a dot do to a note?                            | 1. <i>Makes the note it follows 1 1/2 times as long</i> |
| 2. How long is a dotted half note?                          | 2. <i>Three beats</i>                                   |
| 3. How long is a dotted quarter note?                       | 3. <i>1 1/2 beats</i>                                   |
| 4. How long is a dotted eighth note?                        | 4. <i>3/4 of a beat</i>                                 |
| 5. Which type of note usually follows a dotted eighth note? | 5. <i>Sixteenth note</i>                                |
| 6. Why?   | 6. <i>To round out the beat</i>                         |

## Practical Use

---

1. In any clef, using as few measures as possible in 6/4 time, include every dotted note you've learned. Write in the counting and the letter names of the notes. Check your work with a friend.

CHAPTER  
17

**TRIPLETS!**

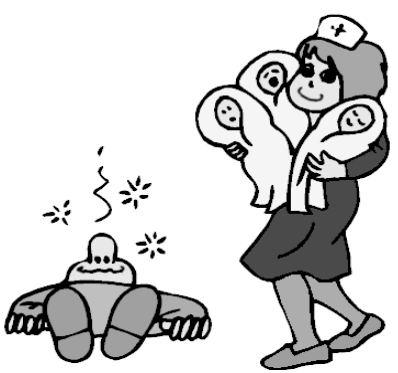

*A composer is someone who goes around forcing their will on unsuspecting air molecules. Often with the assistance of unsuspecting musicians.*

— Frank Zappa

## **In This Chapter**

- General Triplet Information
- Eighth Note Triplets
- Sixteenth Note Triplets
- Quarter Note Triplets

# General Triplet Information

---

The notes you're about to learn are called *triplets*, and they belong to a group of notes known as triplets.

A triplet is a group of notes that doesn't follow the normal rules of counting. Some examples would be duplets (2 notes), *triplets (three notes)*, quintuplets (5 notes), and sextuplets (6 notes). Of course there are also septuplets, octuplets and on and on, but you get the idea, right? In this chapter you'll learn triplets because they're the most common, and the easiest to understand.

The rule you'll want to remember for triplets, is that a *triplet (three notes) takes place in the amount of time it would normally take to play two of the triplet notes at their regular length*. Sound confusing? A concrete example will help explain.

## Eighth Note Triplet

---

Eighth note triplets are the most common triplet and the easiest to count and to feel. The three notes of the triplet are beamed together, and there is a small three over the beam telling you the figure is a triplet. They look like this:



*All triplets are played in the time of two notes of equal value.* What this means for the eighth note triplet is that the eighth note triplet is played in the amount of time it normally takes to play two eighth notes, which is one beat.

*An eighth note triplet is one beat long.*

In the next example you can see how eighth note triplets are counted. Be sure to tap your foot as you count so that your foot hits the floor on all the numbers.



**Example 17.1** A few measures of eighth note triplets with counting.



The image shows a musical staff in common time (C) with a treble clef. It contains eight measures of music. Measures 1, 2, 3, and 4 each contain a triplet of eighth notes. Measures 5, 6, 7, and 8 each contain a triplet of eighth notes. Below the staff, the counting is written as: 1 tri ple, 2 tri ple, 3 tri ple, 4 tri ple, 1 tri ple, 2 tri ple, 3 tri ple, 4. The word 'ple' is written below the 'tri' in each measure.

## Sixteenth Note Triplets

To find the length of a sixteenth note triplet, we use the same rule: a triplet's length is the same length as two notes of equal value. That means a sixteenth note triplet happens in the time it takes to play two sixteenth notes, which is half of a beat.

*A sixteenth note triplet is a half beat long.*

Sixteenth note triplets look like this:  .

The image shows a musical staff with a treble clef. It contains a triplet of sixteenth notes. The notes are beamed together, and a '3' is written above them. Below the staff, there is a period.

The counting for sixteenth note triplets is a little trickier than most other rhythms, but with a couple tries and some foot coordination, you shouldn't have any trouble.

The count for two beats of sixteenth note triplets is 1 la li + la li, 2 la li + la li. The "1" and "2" occur when your foot hits the floor, the "+" is the upbeat, or the second half of the beat, when the foot is in the "up" position. The "la" and "li" should fit between the number and the "+", while your foot is either going up or coming down.

Sixteenth note triplets are fast, even at a slow tempo, so you have to spit out that "la-li" quickly. It'll probably take a few tries to get it right, so keep at it until you've got it.

In the example which follows, notice that in measure two and three the sixteenth note triplet is connected to an eighth note. Sixteenth note triplets are often paired with eighth notes to round out the beat.

**Example 17.2** Sixteenth note triplets and their count.

The image shows a musical staff in 2/4 time with a treble clef. It contains three measures of music. The first measure has a triplet of eighth notes followed by a quarter note. The second measure has a quarter note followed by a triplet of eighth notes. The third measure has a triplet of eighth notes followed by a quarter note. Below the staff, the counts are: 1 la li + la li 2 + for the first measure; 1 + la li 2 + la li for the second measure; and 1 + la li 2 for the third measure. Each triplet is marked with a '3' above it.

## Quarter Note Triplets

---

Quarter note triplets are difficult to count accurately, so I've saved them for last.

Using the triplet rule for quarter note triplets means that the quarter note triplet takes place over the length of two quarter notes, or two beats.

***Quarter note triplets are two beats long.***

Quarter note triplets have a curvy line over them, with the three in the middle. This curvy line simply groups the notes together so you can tell which three notes are in the triplet. Here's what they look like.



The reason quarter note triplets are difficult to count is that you have to divide two beats three ways, and we don't easily think in thirds. If we divide 2 by three, we get  $2/3$ , so ***each note of the quarter note triplet is  $2/3$  of a beat long.***

This makes regulating the length of a quarter note triplet with the foot tap difficult, but not impossible. Let's break it down.

The first note of the triplet is easy because it starts right on the beat, or when the foot hits the floor.

The second note of the triplet happens  $2/3$  of a beat after the first, so your foot will have gone up and will just be coming down when the second note starts.

The third note of the triplet happens  $\frac{4}{3}$  of a beat after the first (or  $1\frac{1}{3}$  beats), so the third note starts just after the foot taps down on the second beat of the triplet.

This is a confusing concept, and I would highly suggest you get someone familiar with quarter note triplets to show you some. It will be worth your time.

When you hear quarter note triplets, they feel as though they are dragging, and that's why you see "drag it" in the count. The word *drag* is split up so that the *g* goes with the *it*.

**Example 17.3** Quarter note triplets with the count.

The image shows a musical staff in bass clef with a 4/4 time signature. The first measure contains a quarter note triplet of G4, A4, and B4, followed by a quarter note G4 and a quarter note F4. The second measure contains a quarter note G4, a quarter note A4, and a quarter note triplet of B4, C4, and D4. The third measure contains a quarter note G4, a quarter note F4, and a quarter note E4. The fourth measure contains a quarter note D4, a quarter note C4, and a quarter note B3. The fifth measure contains a quarter note A3, a quarter note G3, and a quarter note F3. The sixth measure contains a quarter note E3, a quarter note D3, and a quarter note C3. The seventh measure contains a quarter note B2, a quarter note A2, and a quarter note G2. The eighth measure contains a quarter note F2, a quarter note E2, and a quarter note D2. The counts below the staff are: 1 dra git 3 4 | 1 2 3 dra git | 1-2-3-4. Brackets above the first and third measures indicate the triplet groups.

## Moving On

---

In a week or two you may find your memory of triplets fuzzy. This is pretty normal. Just like with learning a language, learning to read music takes time and a lot of exposure. If the information about triplets is tough to remember, keep coming back to it until you've got it.

Well, it was a long section, the longest in the book, but now it's over! After the review for this chapter is the big review for the entire section.

Coming up in the next section, you'll learn about flats, sharps and naturals, the piano keyboard, the Major scale, and key signatures.

## Chapter 17 Review

---

1. How long is an eighth note triplet in 4/4 time? 1. *One beat*
  
2. How is a measure of eighth note triplets counted in 4/4 time? 2. *1 tri ple 2 tri ple 3 tri ple 4 tri ple.*

- |  |  |
|--|--|
| 3. How long is a sixteenth note triplet?   | 3. <i>1/2 beat</i>                                 |
| 4. What is the count for a measure of sixteenth note triplets in 2/4 time?           | 4. <i>1 la li + la li<br/>2 la li + la li</i>      |
| 5. Where is your foot positioned on “+” part of the beat?                            | 5. <i>Up</i>                                       |
| 6. How long is a quarter note triplet?   | 6. <i>Two beats</i>                                |
| 7. How long is each note in the quarter note triplet?                                | 7. <i>2/3 beat</i>                                 |
| 8. On which part of the foot tap does the 2nd note of the quarter note triplet fall? | 8. <i>Just after the “+”<br/>of the first tap.</i> |
| 9. On which part of the foot tap does the 3rd note of the quarter note triplet fall? | 9. <i>Just after the<br/>second tap.</i>           |
| 10. Ask a teacher or musician to demonstrate quarter note triplets to you.           |  |

## Practical Use

---

1. In any clef write out three measures of 4/4 time using all the triplet figures you’ve learned. Write in the count underneath them.
2. Play or sing what you’ve written. If it is too difficult, simplify it as much as possible until you *can* sing or play it.
3. Have someone demonstrate quarter note triplets for you. Imitate what you hear.

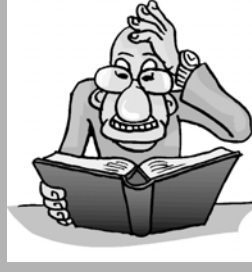

# PART III REVIEW

## Whew! You Made It

---

These pages can be used to test your memory on what you've learned in Part III, and if some of the information hasn't stuck, you can go back and check it out on the page indicated below the question.

As with the chapter reviews, use your keyboard to cover up the answers while you test yourself.

When you think you've got it all down, either take the test in *Basic Music Theory: Teacher's Edition*, or go on.

## The Review

---

1. What is the beat, in music?  
page 92  
*1. A steady pulse;  
what makes your  
toe tap*
2. Name the notes you learned from shortest to  
longest.  
page 92  
*2. Quarter note,  
half note,  
whole note*

3. Which notes have stems?

page 93

3. *Quarter half,  
eighth and  
sixteenth notes*

4. The stem of notes above the third

line go \_\_\_\_\_.

page 94

4. *Down*

5. The stems of notes below the third

line go \_\_\_\_\_.

page 94

5. *Up*

6. Notes on the third line have stems

which go \_\_\_\_\_.

page 94

6. *Either up or down*

7. How many beats does a whole note get in 4/4

time?

page 92

7. *4*

8. How many beats does a half note get in 4/4 time?

page 92

8. *2*

9. How many beats does a quarter note get in 2/4

time?

page 92

9. *1*

10. What does a rest show?

page 98

10. *Silence*

11. Which five rests did you learn?

page 98, page 115, page 117

11. *Whole rest, half  
rest, quarter  
rest, eighth rest,  
sixteenth rest*

12. How many beats does a quarter rest get in  $2/4$  time?  
page 98 12. 1
13. How many beats does a half rest get in  $3/4$  time?  
page 98 13. 2
14. How many beats does a whole rest get in  $4/4$  time?  
page 98 14. 4
15. Which line does the whole rest hang from?  
page 98 15. 4th
16. Which line does the half rest sit on?  
page 98 16. 3rd
17. On a scratch piece of staff paper, draw 2 whole rests, 2 half rests, and 2 quarter rests.
18. What is another name for meter?  
page 102 18. *Time signature*
19. Where does the time signature appear?  
page 102 19. *At the beginning of a piece of music, directly after the clef*

20. What information does the time signature give?  
page 102
21. What are the three most common time signatures?  
page 103
22. What does the top number tell you?  
page 102
23. What does the bottom number tell you?  
page 102
24. Why are different meters used?  
page 103
25. The count of any measure, in any time signature/ meter, begins with what number?  
page 108
26. How is a measure of quarter notes in 3/4 time counted?  
page 109
27. How is a measure of half notes in 4/4 time counted?  
page 109
28. How is a whole note counted in 4/4 time?  
page 110
20. *How many beats in each measure, and what type of note gets one beat*
21. *4/4, 2/4, 3/4*
22. *How many beats in one measure*
23. *What type of note gets one beat*
24. *The meter depends on the rhythmic pattern of the song.*
25. *1*
26. *1, 2, 3*
27. *1-2, 3-4*
28. *1-2-3-4*



29. When writing out the counting, what is used to indicate a rest?  
page 111
29. *Parentheses ( )*
30. When counting out loud, how should you count a rest?  
page 111
30. *Softly*
31. When counting out loud in 4/4 time, how would you say a measure of half notes?  
page 109
31. *ONE-two,  
THREE-four*
32. How long is an eighth note in common time (4/4)?  
page 114
32. *1/2 beat.*
33. How long is an eighth rest in 2/4 time?  
page 115
33. *1/2 beat.*
34. How many eighth notes in one quarter note or one beat of 3/4 time?  
page 114
34. *2.*
35. How are eighth notes counted in 4/4 time?  
page 114
35. *1 + 2 + 3 + 4 +*
36. How is a measure of eighth rests counted in 2/4 time?  
page 115
36. *(1) (+) (2) (+)*
37. How long is one sixteenth note in 4/4 time?  
page 117
37. *1/4 beat.*

38. How many sixteenth notes are in one quarter note or one beat of 4/4 time?  
page 117
39. How do you count sixteenth notes in 4/4 time?  
page 117
40. What does a dot do to a note?  
page 122
41. How long is a dotted whole note?  
page 122
42. How long is a dotted half note?  
page 123
43. How long is a dotted quarter note?  
page 123
44. How long is a dotted eighth note?  
page 124
45. Which type of note usually follows a dotted eighth note?  
page 124
46. How long is an eighth note triplet in 4/4 time?  
page 128
47. How is a measure of eighth note triplets counted in 4/4 time?  
page 128
38. 4
39. *1 e + a 2 e + a  
3 e + a 4 e + a*
40. *Makes it longer  
by half its original  
value*
41. *Six beats*
42. *Three beats*
43. *1 1/2 beats*
44. *3/4 of a beat*
45. *Sixteenth note*
46. *One beat*
47. *1 tri ple  
2 tri ple  
3 tri ple  
4 tri ple*

48. How long is a sixteenth note triplet?  
page 129
49. What is the count for a measure of sixteenth note triplets in 2/4 time?  
page 129
50. Where is your foot positioned on “+” part of the beat?  
page 129
51. How long is a quarter note triplet?  
page 130
52. How long is each note in the quarter note triplet?  
page 130
53. On which part of the foot tap does the 2nd note of the quarter note triplet fall?  
page 130
54. On which part of the foot tap does the 3rd note of the quarter note triplet fall?  
page 130
48. *1/2 beat*
49. *1 la li  
+ la li  
2 la li  
+ la li*
50. *Up*
51. *Two beats*
52. *2/3 beat*
53. *Just after the “+”  
of the first tap*
54. *Just after the  
second tap*



# Interlude



## DON'T SAY *PRACTICE*

*I never practice; I always play.*

— Wanda Landowska, 1952

### In This Interlude

- Don't Say the *P* Word
- A Note on Private Teachers
- How Much to Play
- When, Where, How
- The Ideal Practice Session

# Don't Say the *P* Word

---

Johann Sebastian Bach said, “There’s nothing remarkable about it. All one has to do is hit the right keys at the right time and the instrument plays itself.”

That quote was probably delivered with a heavy dose of sarcasm. If only old Bach was right and playing an instrument was that easy.

If playing an instrument well or singing well could happen only by wanting it badly enough, there would be many more great musicians in the world than there are. But that’s not how it works. To learn an instrument you’ve got to practice. Oops, I said a bad word.

I don’t like to say the p-word. When I think of the word “practice,” what usually comes to mind is a boring task, one which I’m forced to do. So let’s do away with that word.

I prefer a friendlier p-word. Play. Which would you prefer saying, “I’ve got to go practice.” or “I’ve got to go play.” I don’t know about you, but I like the second much better. If you think you have to say the *p* word, try *rehearse* instead.

What does *play* mean? You play music. It’s *supposed* to be fun. If it’s not, something might be wrong. I say *might be wrong* because no matter what you do in this life, if you do it often enough, no matter how much you like it, there will be times when it doesn’t seem so pleasant. Especially when you push yourself toward improvement. It’s bound to get frustrating once in a while. Not to worry. Those feelings pass.

In order to do something well, you have to spend a lot of time doing it. This may seem obvious but you would be surprised by how many students—especially the younger ones—don’t quite understand this. Whether it’s sports or art or business or any old thing you care to name, to become something more than a beginner takes focused effort and time.

Now, keep in mind there are some people out there who are so naturally gifted that they need little time to master a skill. They’re the type of people who can pick something up—art, sports, music, dance, mathematics, Spanish—and start doing it well almost immediately. They’re the kind of people we admire and envy. They’re the kind of people we secretly want to strangle.

**Why did Mozart have to get rid of his chickens?**

**They ran around the yard saying, “Bach, Bach, Bach.”**

What this section is geared towards is you and me. People with average abilities, average intelligence and average coordination. And even so, if you *are* one of those rare and gifted individuals, this section will help you too, so don't skip it.

## A Note on Private Teachers



No book can teach you everything, or teach it as well as a good private teacher can. The fastest way to learn anything is one-on-one, just you and the teacher in a room. Half an hour each week is pretty standard for beginners, but an hour is better.

A good teacher can save you years of time and show you tricks that make playing much easier, and more fun. A good teacher knows what songs you can handle, knows which ones are fun, and will show you things you aren't doing quite right as well as how to do them better.

A good teacher is invaluable. Find one. Study with him or her until you've soaked up all you can (usually 2-4 years), then find another and do it all over again. You'll learn the most this way, the fastest this way, and you'll never regret the money you spend. It's well worth it.

Good teachers aren't cheap though, and if you can't afford one you have several options. One good alternative, especially if you're a beginner, is to find someone who plays your instrument and is further along than you are (high school and college students work well). Another way is to find musicians that will let you hang out with them while they play. You can pick up a lot of free tips this way.

## How Much is Enough?

This is one of the most often-asked questions, and it's a lot like asking how much you should pay for a pair of shoes. The answer depends on many things: what do you want to spend, what *can* you spend, what do you need, what quality do you want, what style, etc., etc.

As far as playing music is concerned, you should be aware of a few things: your desire to play, your ability on the instrument, and how much time you can *make* to play (I purposefully didn't say, "how much time you can *spare*," because nobody can spare time—everyone is always busy).

The very best answer is: play as much as you feel like. That may seem like a cop-out answer, but let me explain. Playing is supposed to be enjoyable, first and foremost, never forget that. When you learn something new, there is a very high possibility of frustration. Avoid this like the plague. If you begin to feel frustrated, keep at it another couple minutes to see if the frustration goes away, and if it doesn't, stop. It's that easy. Pick it up again later in the day or tomorrow.

## Come on Baby, Light my Desire

---

The single most valuable thing you can have is your desire. Foster it. Imagine yourself playing somewhere. Anywhere. You could be on stage in front of 10,000 screaming fans, you could be at Carnegie Hall, you could be at the local coffee shop, you could be playing a song for a loved one, or even in a room alone playing for yourself. There are many excellent players in the world who play only for personal enjoyment. Use your imagination to see yourself performing, keep with it and you'll get to experience it!

Desire will keep you motivated through exercises and repetitions and slumps in mood. The only problem with desire is that it's not like a metronome. You can't bop down to the local music store and pick some up, so you've got to foster it, be aware of it, let it grow. You can't buy it, but there are ways to increase it.

**Take a music bath once or twice a week for a few seasons, and you will find that it is to the soul what the water bath is to the body.**

**Oliver Wendell Holmes, Jr.**

### Live Music is Best

The single most beneficial thing to your development as a musician is to go see music performed live. It will increase your desire to play more than any other thing. There are many places to hear live music: coffee shops, concerts, even just sitting around in a friend's living room and listening to her play. Somehow, seeing music being done right in front of you makes it more real, more within reach. Recordings are great, but live is better.

### Your Stereo is Next Best

Listening to good music is important and can be very inspiring, especially if you realize the musicians you listen to were once as clueless as you may be right now. So listen as much as you can.



If you like grunge rock, get the best there is and listen to it. If you like speed metal, find the best and listen to it. If you like classical music, find the best symphony orchestras under the best conductors and listen to them. I could go on, but I'm sure you get the idea. Find the best.

And the best is simply what you *like* best. Don't give up. There is so much music out there that most of it will do nothing for you. But on the other hand, there is so much music out there, you're bound to find something you love to hear. And you'll love to play it, too. Keep your ears out and wide open.

## How to Get Better

---

### Beginnings are Delicate Times

If you're a beginner, it's essential to take things slowly. As a beginner you're trying to get the hang of a very complex task that involves many different and difficult skills, and it takes time. Stick with it. You'll get it. I have *never* run into someone who has said, "Gee, I'm sure glad I quit playing my guitar/clarinet/trumpet/piano." It's always the opposite.

Tack up encouraging notes to yourself. On my desk I have a fortune cookie message which says, "Be persistent and you will win."

As a beginner, your playing sessions might be ten to fifteen minutes, three or four times a week. The less you play, the longer it will take to get better. Remember this. It seems very common sense, but I see it all the time with new students—playing is difficult and unfamiliar at first so they don't play much or not at all and it *remains* difficult and unfamiliar and frustrating.

**The less you play, the longer it will take to get better.** There is no getting around this. Once a week will simply not cut it. Of course it's better than nothing, but it's too easy to forget all that information over a week's time and when you get back to your instrument, very little will have changed. This will be very frustrating. Avoid frustration by playing more often.

Play as long as you can, but don't push it too hard. Remember that the best indication of when it's time to stop is your frustration/boredom

level. You have your whole life to work on this. Don't be lazy, but don't overdo it either.

## Improvement

As you continue to play, you'll become better and better and the amount of time you spend on your instrument will naturally increase. This will happen for several reasons: you'll be able to play more songs, your understanding of what you need to do will increase, your skill exercises will take longer to go through, and the very best part is that it will become more and more fun!

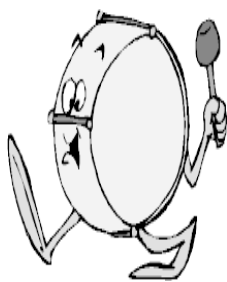

## Don't Beat Yourself Up

Remember that it usually takes a long time to sound really good, and the progress is gradual. Anyone who plays an instrument has been a beginner at one point. And let's be honest. Beginners make some really funny noises: squeaks, blats, bellows and bleats. We've all done it. It's part of the process of becoming better. Have the patience to wait out your frustrations and the funny sounds you might make. Things will get better. I promise, but only if you stick with it.

## Start a New Habit

---

We are creatures of habit. Starting new ones is easy enough, and breaking old ones is sometimes painful. If you can make playing music an old habit, you'll never have to worry. It's a habit you'll never want to break.

One way to grow this habit is to choose a specific time every day to play. Have a routine. This will take some time to figure out and will change as you discover what works for you. Try different times of the day. Some people like early mornings and sit in a quiet house with a latté and strum their guitar, some play right after dinner or after school, some like to play just before going to bed (this option doesn't work well for brass players, unless they live far from others).

Take at least one day off a week, two at most, to give yourself a rest—take a hike, read a book, take a swim, a nap, anything. Of course, if you don't *want* to take a break, that's also a good option. There are no rules.

## Television

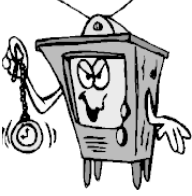

My first piece of advice is to throw the time-bandit out. No? You're unwilling to do that? Okay then, use it to your advantage. During one hour of prime time television there are over twenty minutes of advertisements. That's twenty minutes you could use to play. And besides, you don't need to buy all that stuff people are trying to sell you. Save your money and buy a nicer instrument instead. Press the mute button and play! (This technique works best for single people...)

## When in Doubt, Leave it Out

I leave all my instruments out and ready to play. I have to be careful when I pick one up because once I do, often it's at least an hour before I can put it down again. By leaving your instrument out you can pick it up at a random moment and toss off an exercise or a song. Five minutes later you're back to what you were doing before.

## Where to Do It

---

### A Garage of One's Own

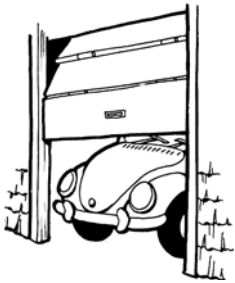

When I was a kid and had to practice trumpet (I use the *p* word on purpose—back then I didn't know the difference), my parents finally ended up sending me to the garage. It sounds cruel, but it was an excellent thing. They didn't have to hear my squawks and blats, and I didn't have to feel self-conscious about making so much noise.

When you start to play an instrument as a beginner, your self-image as a musician is very fragile. You'll feel self-conscious, maybe a little silly, and you'll be very aware of how bad you sound.

Yes, it's true. You *will* sound bad at first. That's part of it. For some it can feel embarrassing, and for others simply uncomfortable. Only a rare few don't care. If you're one of these, consider yourself lucky. If you do feel uncomfortable playing with others around, the solution is to play when you have lots of privacy, either when nobody else is home, or in a separate building. Even a closed door is better than nothing.

## Repetition is the Mother of Success, and the Father of Irritation

Charles Reynolds, a master teacher and man of great enthusiasm coined the first part of that phrase, and I added the second. When you're learning to play a song, you must play it over, and over, and over, and over, often hundreds if not thousands of times. And not the whole song at once, but measure by measure until you've got the whole thing. Then you get to play the whole thing over and over and over.

It's a lot like jet skis—plenty of fun for the one doing it but not fun at all for anyone who has to listen to it. Even if you're Yo Yo Ma or James Hetfield, the same phrase or scale or exercise played over and over and over again will drive even the most patient person bug-nuts.

Get a private place to play if you can. Those you live with will love you for it and will enjoy your music more when you're ready to perform it for them.

## How to Do It

---









There are as many ways to play as there are people who play, but all of them share some similar characteristics. There are certain tools which can make your progress on an instrument or voice much faster.

Some of these tools are crucial, some are less so, but all of them will put you further down the road toward musical mastery if you use them correctly.

### Equipment

Arturo Sandoval, a world-renown trumpet player, grew up very poor in Cuba. He wanted to play very badly. He would walk miles to the next village where someone had a copy of *Arban's Complete Conservatory Method for Trumpet*, a book that is hundreds of pages long, crammed full of thousands of exercises and songs; the trumpet player's bible. Because he couldn't afford the book, Sandoval kept returning to the distant village until he had the whole book memorized.

All you really need is your instrument and desire. The rest will come. However, here are some things which will make your experience much more pleasant and more successful in a shorter time. In order of importance they are:

-  **instrument:** If you're a singer, you won't have any problems with forgetting it somewhere. Get the best instrument you can afford and treat it well.
-  **metronome:** Apart from your instrument, this is the most useful tool you can own as a musician. Get one early on and use it often. I'll discuss its use later in this chapter.
-  **music:** This may be method books, sheet music, or both. Not every practice session will require music. There are many things that can be done without it.
-  **music stand:** There are many different types, from inexpensive fifteen dollar wire stands which fit in an instrument case to beautiful and expensive hardwood stands which aren't so portable.
-  **pencil:** This will be used to mark up your music with notes to yourself and also to record your sessions if you choose to do so. Keep several in your case so you'll have one when needed.
-  **practice journal:** A spiral notebook in which to keep a record of what you play, how long you play, and how you feel about your playing. This is a valuable tool to look back on. Not a requirement, but a good idea.
-  **tape/CD player:** A very useful tool. Not only to provide good music to listen to, but also something you can try playing along with. Trying to figure out a favorite song is good training for your hand-ear coordination.
-  **tuner:** A tuner can tell you exactly what pitch you play, and whether it's in tune or not. You're now in the world of sound and a small change of pitch is audible to most listeners.

- **Tape recorder:** Not essential, but very helpful. Hearing yourself recorded is much different than hearing yourself while playing, and you'll be surprised how many mistakes you hear that you weren't aware of while you recorded. The tape recorder tells no lies.
- **Instrument stand:** Not essential, but useful. If you leave your instrument out you'll pick it up and play more often. My guitars, trumpet and flute are always out on their stands.

## The Ideal Session

---

### The Best Time

Directly after a lesson is the very best time to practice. When all that new information is fresh in your head, take the time to go over it again on your own. If there is something you don't understand, write down any questions or problems you may have so your teacher can explain them in your next lesson.

### Warm-up

This is a short part. Use it to make sure your instrument works properly, is tuned, and you have all you need for the coming session (valve oil, music, extra strings, reeds, pencil, etc.).

Depending on your instrument, there are several things you want to keep in mind. Generally speaking, keep things in the low register of your instrument and do exercises to get you fingers, your wind, and your brain warmed up.

### Exercises

If a playing session is a meal, this section is the broccoli. It may not taste very good (unless you like lots of cheese), but it's good for you. Do the exercises for your instrument religiously—it will pay off. Dessert is coming up.

This is when you do your scales, finger-stretching exercises, long tones, interval studies, chord progressions... whatever your teacher assigns you. The list is nearly endless, but your time is limited. Keep time spent on exercises down to about 1/3 of the session time you'll spend playing.

If you're a beginner and none of the above makes sense to you, don't worry, it will soon.

## Long Tones

When I was a beginner in middle school, my mom made me practice for half an hour every day, five days a week. Some of the time I hated it, but I'm very grateful now. On the days I really didn't want to be at it, I would choose one note and play it for the entire half hour. Well, I *did* stop to breathe now and then. If I got daring and a little less stubborn, I *might* switch to another note. I didn't know it, but I had stumbled upon an essential ingredient to creating a good sound on *any* instrument.

When you play long tones, take a huge breath (if you're a wind player) and play a note that is comfortable for you. Don't let your mind wander, though. Listen closely to the sound. Make it as perfectly clear and clean as you are able. You'll be surprised at the wavering and crackles and hitches in your sound.

Experiment with different qualities of sound (bright, dark, open, pinched, soft, loud, etc.)

If you're a string player, long tones are equally important but done differently. It's a good way to improve your bowing, or to check your finger position all the way up the neck on each string.

I take the time to mention long tones because they're often neglected and are important to achieve a good sound. And they're so easy to do! Especially for beginners. Three or four minutes is long enough. Do them every day and you'll soon have a great sound on your instrument.

## The Heart of the Session

Here is where you will do most of your work. This is the longest part of your playing session. This is where you work on the song you're learning to perform. Use the *tuner*, the *metronome* and the *tape recorder*.

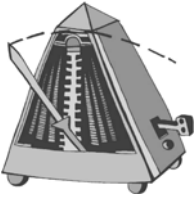

Close your eyes and repeat three times, “The metronome is my friend.”

## The Metronome (or: The Torture Device)

There is a legend about Chinese Water Torture. I have no idea if it’s true, but it makes for a good story. You’re strapped down to a table and above you is a barrel full of water. The barrel has a small hole in it through which a tiny drop of water falls every minute or so down onto your forehead. This goes on for a long time, finally driving you mad. The metronome is kind of like that, only it’s actually *good* for you.

A metronome is a mechanical foot-tap which keeps perfect time. Each metronome has a series of gradations on it, usually from around 40-200 *beats per minute (bpm)*. The higher the number, the faster the clicks. You set the metronome on the tempo you need and away you go.

Metronomes come in many different shapes and sizes. There are electronic varieties with different beeps and dings, or the simpler wind-up pendulum variety like the one pictured. Loudness of your instrument and the metronome is a consideration when buying one. Some have an earplug that will send the clicks right to your ear, a good option for loud instruments, like drums and brass.

Nobody likes being wrong. That’s one of the reasons metronomes are so neglected. They keep perfect time and we humans do not. But if you think about it, we learn the most when we’re wrong, as long as we’re paying attention. So really, being wrong can turn into a good thing.

Of course *staying* wrong is *not* a good thing. You use a metronome to fix mistakes in rhythm.

### How to Use the Metronome

When you’re learning a song, use the metronome on only a short section at one time—several measures at the most, two notes at the least. It’s important to *start slowly*. Whatever you learn is what you will play, so ***if you set it at a speed which is too difficult, you will learn mistakes.***

- 1 Set the metronome to a tempo that is slow enough so your playing feels comfortable and easy. Play the short section through a few times at this tempo. If you’re making mistakes, the tempo is too fast. Slow it down



some more until you find an easy tempo. Play 5-10 times correctly before going on.

- 2 Click up to the next fastest tempo. One click only. The clicks may not *sound* any faster, but when you play the passage you'll notice the difference. Play at this tempo until it's easy. Play 5-10 times perfectly.
- 3 Click up to the next fastest tempo. One click only. Play the section several times at the new tempo. It may take more repetitions to get the passage perfect. Keep at it. If it's too hard at the new tempo, go back one click until it's perfect again. Play 5-10 times perfectly.
- 4 Continue with this process until the correct tempo of the song is reached. This may take several days, weeks or months.

Remember, you're in this for the long haul. Don't bash your head against something for too long. If you become very frustrated or discouraged, go back to a slower tempo and play it a few times correctly before you quit.



The first song I learned on guitar was much too difficult for my abilities and I probably shouldn't have chosen it, but I did. At first, the song was so incredibly slow it was unrecognizable. It took about three or four days (of two hours a day) to get each 4-measure passage up to a decent speed. Using the metronome as mentioned above, I learned the song, but it took me six months.

You may not be so foolish as to choose such a hard piece at first, but if you do, using the metronome works very, very well. Try it. Play with it. Come up with your own variations. There are no rules.

## The Tape Recorder Tells No Lies

I got my first stereo when I was eleven. It had a tape deck with a microphone attachment. During my enforced *practice* sessions, I came up with a plan to get away with not practicing. I'd record something on the tape deck, then turn up the volume and play it back, sometimes twice. That way everyone in the house would think I was still playing. *Ha! That'll show them*, I must have thought. *I'm not actually practicing*.

But I was. Listening to yourself play an instrument on a recording is a lot like listening to your *voice* on a recording. It doesn't sound anything like what you thought it sounded like. Every little wobble and flub and

mistake is painfully obvious. Again, we learn the most from making mistakes.

But as with the metronome, don't let those mistakes stand. Fix 'em.

Try recording yourself. You'll be surprised, and you might like doing it. You will definitely improve!



## You Can Tune a Trumpet but You Can't Tuna Fish

A **tuner** is a valuable tool. If you play a fretted instrument like guitar or electric bass, you'll probably need a tuner only to tune your strings.

The rest of us benefit a lot by using a tuner. With a tuner, you can become more aware of how your instrument plays, where it's out of tune, and what you need to do with your mouth or your finger placement to correct the pitch. Every wind instrument has certain notes which are out of tune. With a tuner you can find these out-of-tune notes on your instrument.

The best type of tuner for this sort of thing is an analog tuner, one which has a little arm that swings back and forth to show how sharp or flat you are. If the little arm is straight up at "0," you're in tune.

There are many types of tuners. Visit your local music store for a demonstration and decide which will work best for you.

## Other Ways to Play

---

You aren't limited to playing only during your daily session. There are opportunities throughout the day to hone your skills, and you don't even need your instrument.

For brass players, there's always buzzing (if you don't know what this is, ask a brass player to demonstrate for you). This can be done either with or without a mouthpiece. For other wind players there are other lip-strengthening exercises.

Using only your lips (no teeth), hold a pencil out parallel to the ground for as long as you can. This will strengthen your pucker muscles.

For fingerings, woodwind players can practice on a pencil. Valve players can get an old valve casing from an instrument at the pawn shop and carry that around instead of the whole instrument; or simply do fingerings on your thumb or palm. String players can find an old instrument, saw off a five-fret section of the fingerboard and use that to practice fingering.

These are just a few suggestions. Use your noggin to think up some other options. There is a lot of “down” time in a day that you can use to improve yourself.

## Another Instrument

Don’t be afraid to switch instruments. If an instrument just isn’t working, give it a fair chance for two or three months. Then, if you still want to play, try something else.

I have a wonderful guitar student who began on the trombone. After a couple months, she decided the trombone wasn’t for her and switched to guitar. She’s playing very well and is progressing quickly. She was not good on trombone. She’s becoming an excellent guitar player.

Even if you’re doing well on an instrument you can always pick up another. Another of my students, a good beginning trumpet player expressed interest in the flute, so we had a flute lesson and he has decided to play that as well.

Many famous musicians started on a different instrument and continued on to learn many others. Stevie Wonder, Prince, and Beck play *all* the instruments on their early albums. Beck still does it. Those three are only a few. There are many more. Nowhere is there a rule that says you can only play one instrument. Heck, learn ‘em all if you want to. A new instrument can light the fire inside you again.

And if you can read music, learning songs on a new instrument is much much easier.

Speaking of reading music, let’s get back to it!

# Some Instruments

---

Ever wonder what all those instruments are? Ever call a trombone a trumpet, or other embarrassing *faux pas*? Now some of your problems are over. Below are many instruments and their names.



Accordion



Bass Clarinet



Bassoon



Banjo



Oboe



Tenor Flute



Piccolo



French Horn



Flugel Horn



Trombone



Alp Horn



Baritone Horn



Baritone



Tuba



Timpani



Castanets



Sitar

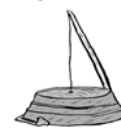

Washtub Bass



English horn



Cello



Double Bass



The saxes

For loads of information about your instrument, visit the Questions, Ink web site: [www.QuestionsInk.com/instruments](http://www.QuestionsInk.com/instruments)

# PART FOUR

## See Sharp or Be Flat

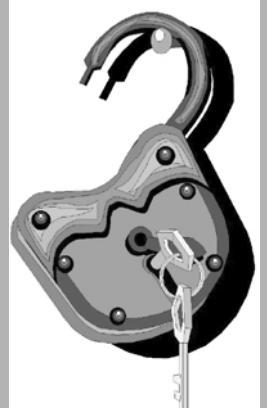
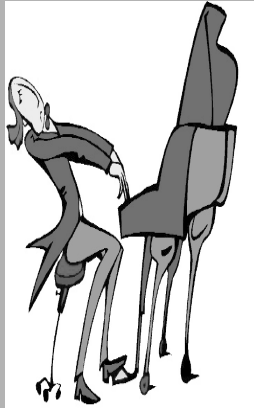

### In This Section You Will Learn:

- Sharps, Flats, and Naturals
- The Piano Keyboard
- Whole Steps and Half Steps
- Major Scales
- Key Signatures

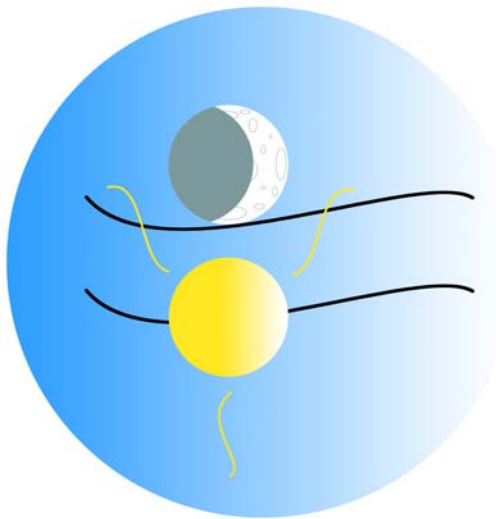

**SolUt Press**

[www.Sol-Ut.com](http://www.Sol-Ut.com)



## ACCIDENTALS ON PURPOSE

*Roaming through the jungle of "oohs" and "ahs,"  
searching for a more agreeable noise, I live a life  
of primitivity with the mind of a child and an  
unquenchable thirst for sharps and flats.*

— Duke Ellington (1899 - 1974)

### In This Chapter

- General Accidental Information
- Flats
- Sharps
- Naturals
- More Accidental Rules

# Accidentals Are No Accident

---

The pitch of a note can be altered in two ways—slightly lowered, or slightly raised. This is shown by symbols which appear in front of the note on the staff, and they're called *accidentals*. Though I know the use of the word *accidental* began around 1651, I'm not really sure why, because these changes are made on purpose. They should be called *onpurposes*. But we're stuck with accidentals, so that's what I'll call them.

There are three types of accidentals: *flats*, *sharps*, and *naturals*. Each has its own sign, shown below.

**Example 19.1** The Accidentals.



Flat



Sharp



Natural

## General Accidental Information

---



Accidentals appear in front of the note they alter. This is so that when you're reading music, you see the accidental *before* you get to the note. If the accidental was placed after the note, it would be too late. Putting the accidental after the note is a very common mistake that a lot of people make who are unfamiliar with writing music.

However, there is a good reason for this mistake. When written, the accidental comes before the note, but when spoken, the accidental comes *after* the letter name of the note. For example, even though you say *B flat*, the actual note in the treble clef is on the third line with a flat sign in *front* of the note, like so:







Another common mistake is to write the accidental just anywhere in front of the note it is supposed to alter, but actually, ***the accidental should be written on the same line or space as the note it alters***. Each accidental has an open spot in the center which is placed on the line or space. You'll see what I mean in the examples to follow.

Remember that when notes are above or below the range of the staff they need leger lines. Accidentals don't need a leger line; they simply hang in front of the note which uses the leger line.

## Flats

---

A flat ***lowers*** the pitch of a note by a small amount (a half step, a term you'll learn in the next chapter). One way to remember a flat lowers a note's pitch is that when something is flattened, it's lower than it was before it was flattened.

Flats look a little like a squashed letter *b* (or maybe I should say flattened letter *b*), and the open part in the center of the flat is the part which will be on the line or the space. Although I've only shown you six notes below, a flat can be used with *any* note.

**Example 19.2** From left to right: B flat, D flat, E flat, A flat, B flat, D flat, and A flat.



## Sharps

---

A sharp ***raises*** the pitch of a note by a small amount (also a half step) and looks like a number symbol. The center of that little grid is where the sharp should be centered on the line or space. Just like with flats, a sharp can go in front of *any* note.

**Example 19.3** From left to right: D sharp, G sharp, C sharp, F sharp, A sharp, C sharp, F sharp.

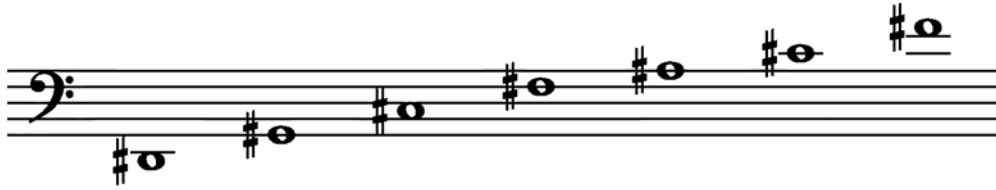

## Naturals

---

Naturals are a little different from sharps and flats. *A natural sign cancels the effect of a sharp or flat*, and is used for this purpose only. Any note which isn't affected by an accidental is already a natural note. In fact, *all* the notes you've seen before this chapter have been natural notes. When there aren't any sharped or flatted notes to be changed, the natural sign isn't used.

So *a natural can either raise or lower* the pitch of a note. If a natural cancels a flat, it raises the pitch of a note by a half step. If a natural cancels a sharp, it lowers the pitch of the note by a half step. And you've already guessed that a natural can be used with *any* note.

**Example 19.4** From left to right: B natural, D natural, E natural, D natural, A natural, C natural.



## More Accidental Rules

---

When an accidental is used at the beginning of a measure, *it's effect lasts for the entire measure*. For example, if at the beginning of a measure we have a B flat, and then at the end of the measure there is another B, it is *also* a B flat unless there is a natural sign in front of it.

An accidental can't have an effect over a bar line.

**Example 19.5** The effect of an accidental lasts for the entire measure and is canceled by the bar line.

The image shows two musical staves. The top staff is in bass clef, 4/4 time, and contains a sequence of notes: B-flat, B-flat, B-flat, B-flat, B-flat, B-flat, B-flat, and B-natural. The bottom staff is in treble clef, 4/4 time, and contains a sequence of notes: F-sharp, F-sharp, F-sharp, F-sharp, F-sharp, F-sharp, F-sharp, and F-natural. Labels with arrows point to the accidentals: 'B flats' for the first six notes of the bass staff, 'B natural' for the seventh note, 'F sharps' for the first six notes of the treble staff, and 'F natural' for the seventh note.

## Moving On

---

That's it for accidentals: sharps raise, flats lower, and naturals cancel. Once you're able to answer the review questions about accidentals, you can move on to the concepts of whole steps and half steps.

But before we do that you'll get a quick lesson on the piano keyboard in the next chapter. Knowing the keyboard will make whole and half steps much easier to understand.

## Chapter 19 Review

---

1. What does an accidental do?  
*1. Slightly alters the pitch of a note*
2. What are the names of the accidentals?  
*2. Flat, sharp, natural*
3. Where are accidentals written?  
*3. In front of the note and on the same line or space as the note*
4. What does a flat do to a note?  
*4. Lowers the pitch by one half step*

5. Draw five flats.
6. Draw five sharps.
7. What does a sharp do to a note?  
*7. Raises the pitch by one half step*
8. Draw five naturals.
9. What does a natural do?  
*9. Cancels a sharp or a flat*
10. How many notes can accidentals be used with?  
*10. All of them*
11. How long does the effect of an accidental last?  
*11. For an entire measure*
12. Can an accidental have an effect across a bar line?  
*12. No*

## Practical Use

---

**1.** Write out the following whole notes: B-flat, E-flat, A-flat, B-flat. Find these notes on your instrument and play them. Sing them. Now write out these notes: D-flat, G-flat, C-flat, and D-flat. Find them on your instrument and play them. Sing them. Sound familiar?

**2.** Do the same thing as you did in number one with these notes: F-sharp, A-sharp, C-sharp, F-sharp. Find them on your instrument and play them. Sing them. Now write out C-sharp, E-sharp, G-sharp, C-sharp. Find and play these notes. Sing them.

CHAPTER  
20

## THE PIANO KEYBOARD



*Music is perpetual, and only the hearing  
is intermittent.*

— Henry David Thoreau (1817 - 1862)

### In This Chapter

- Note Names on the Piano Keyboard
- Flats and Sharps on the Keyboard
- Half Steps
- Enharmonic Notes
- Natural Half Steps
- Whole Steps
- Chromatic Scale

# Why Learn the Keyboard?

---

Notes are laid out on the keyboard in a very simple way which is easy to comprehend, and the visual aid is a great help when trying to understand nearly all of the concepts you'll find in this and other sections.

In fact, one of the definitions of a half step is two adjacent keys on the piano, so there you go.

If you've been using your keyboard template on the Reviews, you've already become familiar with the keyboard, and maybe even some notes on it.

I don't want to insult your intelligence, but I've got to say it. Lower notes are toward the left of the keyboard and higher notes are to the right.

## Note Names on the Keyboard

---

All of the white keys are natural notes, (A-G). All of the black keys are notes with accidentals (sharps or flats). Notice in the keyboard below how the black keys are grouped: two black, then three black, then two black, etcetera, etcetera, all the way up and down the keyboard.

Any white key to the left of a group of *two* black keys is the note *C*. Any white key directly to the left of *three* black keys is *F*. If you'd rather find the *A* because it's the beginning of the alphabet, it's between the second and third black keys.

**Example 20.1** A short chunk of the piano keyboard.

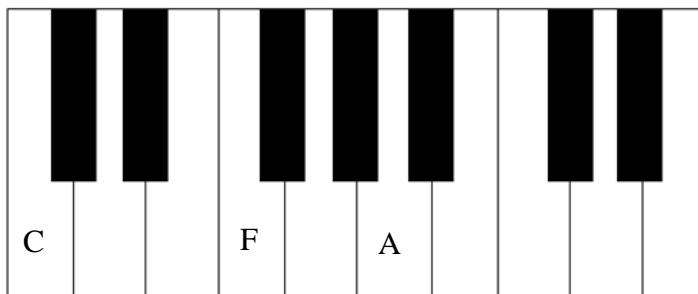

From there it's easy to fill in the rest of the note names, like so:

**Example 20.2** Piano keyboard with natural notes named.

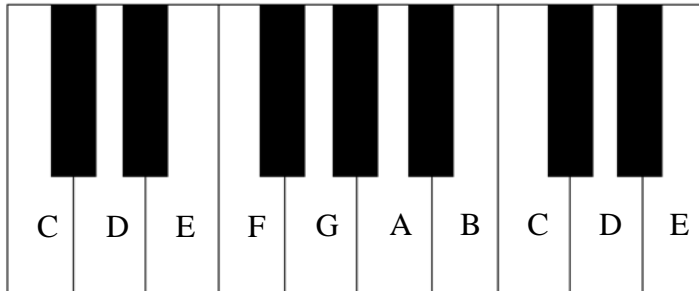

## Flat Notes on the Keyboard

---

Any black key directly to the left of a white key is a flat note (remember to the left is lower). The note's name is derived from the natural note. So the black key just to the left of the A, is A flat. The black key directly to the left of the D is D flat. And so on.

Due to the limited space, I'll use the symbol for flat (*b*) next to the letter name instead of the word *flat*.

**Example 20.3** Piano keyboard with natural notes and flat notes.

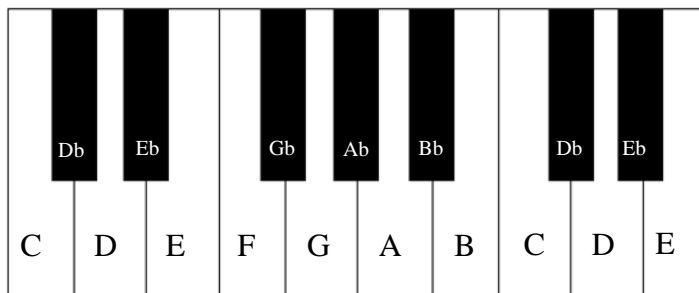

# Sharp Notes on the Keyboard

---

A sharp note is any black key to the right of a white key (remember to the right is higher). The sharp note names are derived from the key directly to the left of the black key. For example, the black key directly to the right of the C is C sharp. The black key directly to the right of the F is F sharp.

**Example 20.4** Piano Keyboard with natural notes and sharp notes.

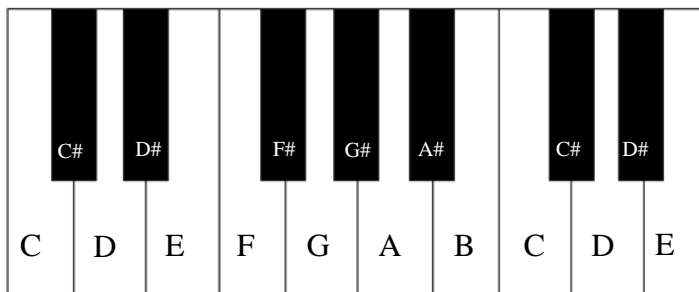

# Enharmonic Notes

---

You probably noticed that each black key has both a sharp name and a flat name. When notes have the same pitch but different names, they're called *enharmonic notes*.

Enharmonic notes are a lot like homonyms, words that sound alike but mean different things, like the words to, too, and two. Enharmonic notes are the same pitch but have different meanings.

A common question is, "Why bother? Doesn't that make things confusing?" Well, yes, it does make things a bit confusing but there are several good reasons for enharmonic notes. The first I'll show you later in this chapter; others will have to wait until we get to scales and chords in Parts V and VI.



# Half Steps and Whole Steps

---

A *half step*, as it's defined by Webster's, is *one twelfth of an octave*, but that definition doesn't help us much. A better definition for a half step is *the difference in pitch between any two adjacent keys on a piano*. Or, if you're more familiar with the guitar or electric bass, a half step would be the difference in pitch between any two adjacent frets on the same string.

## Natural Half Steps

This is a *really* important concept and will cause you no end of confusion if you don't understand it, so put your thinking cap on.



Most half steps involve some kind of accidental, like B to B $\flat$ , or F $\sharp$  to G, or C $\sharp$  to C natural. But if you look at the keyboard, you can see that there are two places where there is no black key between two white keys. Go ahead. Look right now and see if you can name them. I'll wait.

Remember our definition of a half step? Any two adjacent keys on the piano, right? So those notes—E to F, and B to C—are also half steps, but without the need of any accidentals. These are called *natural half steps* and if you memorize them now, you won't have to memorize them later.

## Whole Steps

Two half steps make a whole step.

# The Chromatic Scale

---

I guess first we have to define what a scale is in music. According to Webster's it's a *graduated series of musical tones ascending or descending in order of pitch according to a specific scheme of their intervals*. And actually, that's a pretty good definition, so we'll use it.

The *chromatic scale* is the first reason for the existence of enharmonic notes. The scheme of intervals in the chromatic scale is half steps.

If you were to play a chromatic scale from C to C, you would begin at C and play every single note going up until you got to the next C, and then

you'd come back down doing the same thing. Here's where the enharmonic notes come in:

As you go up the scale, sharps are used. As you come down, flats are used. An example is worth a hundred words. For this example, follow along with your keyboard.

Notice the example is two lines of music. When a song is long, the staves below the first do not need the time signature, only the clef.

**Example 20.5** Chromatic scale from C to shining C in 12/4 time. Ascending and descending. Notice the natural half steps between E-F and B-C.



## Moving On

---

The piano keyboard will be a valuable tool in the chapters which follow, so be sure you've understood it before going on. Not only will it help you in the next chapters, it will also be valuable in your life as a musician.

Coming up next is the major scale, the basis for nearly everything in Western music. A small and simple scale, but very important.

## Chapter 20 Review

---

1. What is the definition of a half step?
  1. *The difference in pitch between two adjacent keys on a piano keyboard*
2. What is an enharmonic note? Give a couple examples.
  2. *A pitch with two different names, like C# and Db, or F# and Gb*

- |   |                             |
|---|-----------------------------|
| 3. What is a whole step?  | 3. <i>Two half steps</i>    |
| 4. What are the two natural half steps?                           | 4. <i>B-C</i><br><i>E-F</i> |
| 5. Which accidentals are used when going up a chromatic scale?    | 5. <i>Sharps</i>            |
| 6. Which accidentals are used when coming down a chromatic scale? | 6. <i>Flats</i>             |

## Practical Use

---

1. Write out the chromatic scale from A to A in either clef. Refer to example 20.5 if you must.
2. Identify the notes on the keyboard (use the side with no note names :-).
3. From the note C, count up three half steps. What note did you get? It should be *E<sub>b</sub>*. Start on *F<sub>#</sub>* and count down two whole steps. What note did you get? Should be a D.
4. Get in front of a real piano/keyboard. Find all of the E-sharps on the piano. Find all of the C-flats on the keyboard. Find the F-flats. The B-sharps (hint: enharmonic notes).
5. Mess around with the piano and find sounds you like. Write out the sounds you most like. To get you oriented, the C in the middle of the piano is called *Middle C*, and it's written as a line note, one leger line *below* the treble clef staff. Middle C in bass clef is written as a line note one leger line *above* the bass clef staff.



CHAPTER  
21

**MAJOR SCALES**

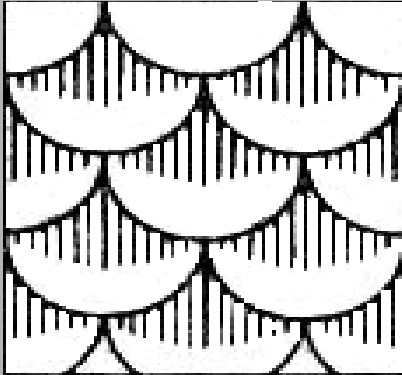

*Without music, life would be a mistake.*

— Nietzsche

**In This Chapter:**

- The Major Scale
- C Major Scale
- The Octave
- The F Major Scale
- The G Major Scale
- The Db Major Scale
- The F# Major Scale

# The Major Scale

---

I read on the Internet that if Western music were genetic material, the *major scale* would be its DNA. A more perfect analogy I have never heard.

The major scale is the basis for nearly all music you're familiar with, from country to hip-hop, classical to jazz, grunge to punk.

Other scales are described based on their relationships to the major scale. Intervals—the measurement of distance between two notes—are based on the major scale. Chord symbols are derived from the major scale.

Remember our definition of a scale. It's kind of wordy, and you don't need to memorize it, so here it is again: *a graduated series of musical tones ascending or descending in order of pitch according to a specific scheme of their intervals.*

With the chromatic scale, the scheme of intervals was half steps. With the major scale, the scheme of intervals is a series of whole and half steps. Remember that a whole step consists of two half steps.

Every scale has a letter name and a descriptive name. The letter is the bottom note of the scale and also the top note of the scale. The descriptive name tells you what kind of scale it is, like major, minor, blues, pentatonic, etc. For example, the D Major scale would start on D and end on D and have the necessary whole and half steps which make up a major scale.

Enough words. An example will show you the pattern of whole and half steps for a major scale. The scale we'll use will be the C Major scale, because it has no sharps or flats in it.

If you have your keyboard out and use it to follow along, you'll understand these concepts more quickly and more thoroughly.

## The C Major Scale

---

Before I show you the scale, I've got to define a couple images which are used to show half and whole steps. They're simple, and a good visual reference.

half step: 

whole step: 

If you have access to an actual keyboard, play the scale below. It will be all white notes from C to C. You'll probably recognize the way it sounds.

**Example 21.1** The C Major Scale. Ascending whole and half steps shown.



## Whole and Half Steps for the Major Scale

Remember the natural half steps between E-F and B-C? In the C Major scale, these natural half steps give us the pattern of whole and half steps without the bother of accidentals.

As you can see above, the pattern for the C major scale: ***whole, whole, half, whole, whole, whole, half*** (***wwhwwwh***). You'll need to memorize this, because this pattern of whole and half steps is the same for *every* major scale.

## Octave

---

This is as good a place as any to introduce you to the ***octave***, a type of interval which contains a certain amount of notes. Like octopus and octagon, the octave also has an 8 in it.

Look at the scale above, and count the notes from C to C. There are 8 of them. That's an octave. From one letter name to the next, either up or down, is an octave.

So, to be more specific, the above scale is the C Major scale, one octave, ascending.

# Scales with Accidentals

---

Now we can take that pattern of whole and half steps and apply it to another scale. Let's start on F this time.

## F Major Scale

**Example 21.2** The F major scale, ascending, with whole and half steps shown.



In order for our series of whole and half steps to be correct (wwhwwwh), we have to alter a note. Look at your keyboard while you examine the whole and half steps in the F major scale to see where those half and whole steps fall. That Bb is necessary to get the half step between the third and fourth *degrees* of the scale. The Bb also gives us the whole step between the fourth and fifth degrees of the scale.

A degree is a name for a scale tone, and is usually associated with a number. For example the 4th degree of a scale is the fourth note from the bottom.

In the above scale, because E to F is a natural half step, we don't need to alter either of those degrees of the scale to have the half step between the seventh and eighth degrees of the scale.

## G Major Scale

**Example 21.3** The G major scale, ascending, with whole and half steps shown.



Follow along with your keyboard and you can see where the whole and half steps should be for the Major scale starting on G.

Between the third and fourth degree of the scale we have the natural half step from B-C, and between the seventh and eighth degree of the scale, in



order to have a half step, we need an F#. And it just so happens that between the sixth and seventh degree of this scale we need a whole step; E to F# is a whole step.

## Major Scales with Many Accidentals

---

This same technique can be applied to a scale with any starting note. Just for kicks, we'll do one with lots of flats and one with lots of sharps. You'll need to follow along with your keyboard for this one, so have it ready.

### A Major Scale with Lots of Flats

**Example 21.4** The Db major scale, ascending, whole and half steps shown.



### A Major Scale with Lots of Sharps

**Example 21.5** The F# major scale, ascending, whole and half steps shown.

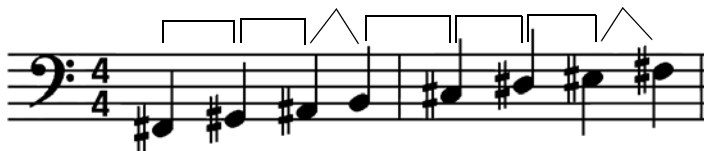

### More Enharmonics

Use your keyboard to understand the following concept.

Take a look at the seventh degree of the F# major scale above. An E#, right? The enharmonic note that is the same pitch as E# is F. It's that natural half step between E and F that causes this. Similarly, B# is the same pitch as C.

And going the other way, Fb is the same pitch as E, and Cb is the same pitch as B.

# Moving On



---

If you understand the major scale, you've got a powerful tool to unlock the intricacies of much of music theory. Be sure you know the ins and outs of this scale before you move on.

Coming up in the next chapter are key signatures, devices at the beginning of a piece of music that tell you which notes are sharp or flat for the entire piece.

## Chapter 21 Review

---

1. What is an octave?  
1. *The distance from one note to the next note with the same letter name. Twelve half steps or 6 whole steps.*
2. What is the series of whole and half steps for the major scale?  
2. *wwhwww*
3. What is the symbol for a half step?  
3. 
4. What is the symbol for a whole step?  
4. 
5. Between which degrees of the major scale do the half steps occur?  
5. *3-4, 7-8*

## Practical Use

---

1. On a blank staff using the clef of your instrument, write in an E-flat low on the staff. Use your keyboard to figure out the E-flat major scale. Write it down, then play it on your instrument. Does it sound right? Sing it.
2. Do the same thing, starting on A this time. Be sure to play and sing the scale until it's memorized.
3. Write out all 12 Major scales. Learn them on your instrument. They are of immense value in your progress as a musician!



CHAPTER  
22

## UNLOCK THE SECRET OF KEY SIGNATURES

*Servant and master am I: servant of those  
dead, and master of those living. Through  
my spirit immortals speak the message that  
makes the world weep and laugh, and won-  
der, and love, and worship.  
I am Music.*

— Anonymous

### In This Chapter

- What is a Key Signature?
- The key of C
- Mnemonics Revisited
- Flat Keys
- Sharp Keys

# Key Signatures

---

Any piece of music has a certain feel which comes from several things, like the meter, the types of notes used, and the *key signature*. The key signature is a device which contains sharps and flats and tells the performer many things: the type of scale the piece is based on, the most likely starting and ending notes. If there is improvising in the song (spontaneously making the melody), the key signature will tell the performer which notes can be used. If a song is too high for a singer, the whole song can be lowered, and this will give you a different key signature.

Just like time signatures, key signatures come at the beginning of a piece of music. The key signature fits between the clef and the time signature. I have included a time signature in all of the examples so you can see where the key signature should be placed. Most of the time signatures will be familiar, but some are odd, so don't let that throw you.

A key signature is a device that tells you which notes have flats or sharps for an entire piece of music. This saves the composer from having to write in *all* the accidentals for an entire piece. The good news is that a key signature will *never* have mixed sharps and flats. It will be either all sharps, all flats, or no accidentals at all.

Another piece of good news is that the order of the flats and the order of the sharps will *always* be the same. That is, if you have only one sharp in a key signature, as long as you've memorized the order of sharps, you'll know what that sharp is. If you have seven flats in a key signature, as long as you've memorized the order of flats you'll know exactly which seven flats to use and what order to put them in.

More good news. The order of the sharps is the reverse order of the flats, or vice versa, so you only have to memorize them one way.

## Why Key Signatures?

When you constructed major scales in the last chapter, you had to alter some of the notes with sharps or flats to make the whole and half step pattern correct. Each key signature is also the name of the major scale of the same name. For example, the key signature of G will give you the correct accidentals for the G Major scale. A key signature at the

beginning of a song affects all the notes throughout the song, so the composer doesn't have to write out all the accidentals for every single note in the song. They key signature takes care of it.

## Flat Key Signatures

---

There are only seven flats, and they'll *always* be in the same order in a key signature. This is one of the few rules that has no exceptions.



### More Mnemonics

The order of flats is **B-E-A-D-G-C-F**. An easy way to remember this is the word BEAD followed by Greatest Common Factor. Or you can make up your own saying which uses all the letters in the proper order. Something like, “Being Ethereal After Death, Ghosts Can Fly.”

As with other mnemonic devices, if you make up your own and make it silly or funny or weird, you'll be more likely to remember it.

Here is a key signature with all of the flats in it. Notice the order (from left to right) and where the flats are placed on the staff.

**Example 22.1** A key signature in both treble and bass clef with all seven flats.

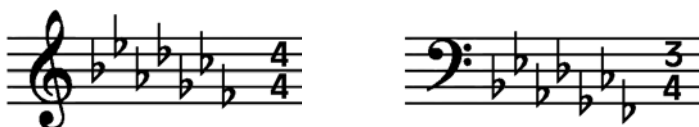





## Find the Name of a Flat Key

---

If you're faced with a piece of music with a bunch of flats in the key signature, there is an easy way to find out what key it's in. The name of the key is the same name as the second-to-last flat in the key signature.

An example will show this better than words can:

**Example 22.2** The keys of Bb and Eb.

|                       |   |   |
|-----------------------|---|---|
|                       | Second-to-last flat is Bb   | Second-to-last flat is Bb   |
| The Key of<br>B flat: |  |  |
|                       | Second to last flat is Eb   | Second to last flat is Eb   |
| The Key of<br>E flat: |  |  |

## Construct a Flat Key

---

To create a flat key, there are three easy steps:

- 1 Find the name of the key you want in the order of flats. For example, if we're looking for the key signature for A flat, we'd find where the letter A is in the order of flats: B E **A** D G C F.
- 2 Add one more flat beyond the key signature name, and use all of the flats up to that point for the key signature. In our example, one flat beyond Ab would be Db, for a total of 4 flats.
- 3 Construct the key signature, putting the flats in the correct order, and on the right line or space.



And that's all there is to it.

## The Key of F

There is one flat key which is a little different than the others, and that's the key with only one flat in it. Because there's only one flat, there can't be a second-to-the-last flat.

You can sort of use the same procedure above to find the name of the key with one flat. If you look at the order of flats, B is the first one. Before the B is the one at the end of the line—F, which is the name of the 1-flat key.

Here's a more visual representation of what I'm talking about.

Here's the B flat in the key signature

B E A D G C F

And here's the name of  
the key with one flat: F.

Or you could just memorize that one flat is the key of F. Whatever works best.

## Sharp Key Signatures

---

Hopefully you've already got the toughest part learned, which is the order of sharps. It's the order of flats backwards, or: F C G D A E B. If you want, make a mnemonic device for the order of sharps, or simply reverse the order of flats.

In the following key signature, which uses all the sharps, notice the order and the placement of the sharps.

**Example 22.3** Key signatures in bass and treble clef with all seven sharps.



## Find the Name of a Sharp Key

---

Finding the name of a key with sharps in it is much less involved than finding a flat key.

That very last sharp in a sharp key signature is the one responsible for making the half step from the seventh to the eighth degree of the major scale. Simply go up half a step from that last sharp and you have the name of the key.

**Example 22.4** The keys of G and B.

1/2 step up from F# is G.

The Key of G: 

1/2 step up from A# is B

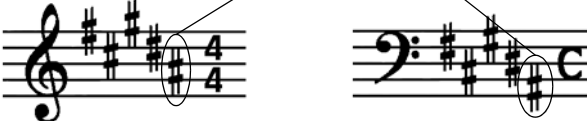
The Key of B: 

## Construct a Sharp Key

---

If you reverse the process, you can construct a sharp key. Again, three easy steps.

- 1 Take the name of the key you want and go to the sharp note a half step below the key note. For example, if you want to find the key of D, go down a half step to C#.
- 2 Find out where that note is in the order of sharps. In our example, C# is the second sharp (F C G D A E B), so there are two sharps in the key of D.
- 3 Put the sharps in the correct order on the right line or space and you've got it.



## The Key of C

---

This is the only key signature you have to memorize. Because there are no sharps or flats with this key, there is no quick way to figure out what the key signature is. But if you know the C major scale, you know that there are no sharps or flats in the scale. You can see the key of C on the next page













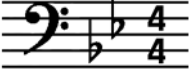

# The Keys to the Kingdom

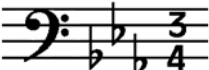
---

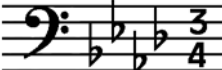

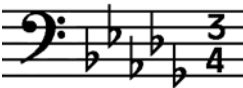

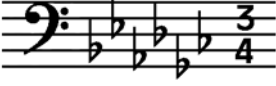

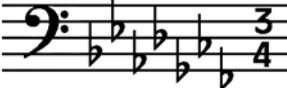



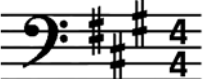

The Key of C:  

---

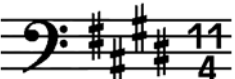
## Flat Keys

|    |   |  |
|----|---|--|
| F  |    |    |
| Bb |    |    |
| Eb |    |    |
| Ab |    |    |
| Db |  |  |
| Gb |  |  |
| Cb |  |  |

## Sharp Keys

|    |   |  |
|----|---|--|
| G  |    |     |
| D  |    |     |
| A  |    |    |
| E  |    |    |
| B  |    |    |
| F# |   |   |
| C# |  |  |

## Moving On

---

The concept of key signatures can be difficult to understand, but I hope you've got it. If not, spend some more time with this chapter until you do. Key signatures are important.

After the review for this chapter is the review for the entire section. This has been an important section, and most of what follows builds on what you've learned in this section, so be sure you understand all of it before moving on.

After the section review, you get to take a break from music theory with another Interlude. In this one you get to learn a little bit about conducting.

## Chapter 22 Review

---

1. How are key signatures and the major scale related?
  1. *A key signature gives the correct whole and half steps for a major scale of the same name.*
2. What is the order of flats?
  2. *BEADGCF*
3. How do you find the name of a flat key?
  3. *The second -to-the-last flat in the key signature is the name of the key.*
4. Which key has only one flat in it?
  4. *F*
5. Which flat is that?
  5. *Bb*
6. Which key has four flats?
  6. *Ab Major*
7. How many flats in the key of Eb Major, and what are they?
  7. *Three: Bb, Eb, Ab*
8. How many flats are in the key of C Major?
  8. *None*
9. Which key has seven flats?
  9. *Cb Major*

10. What is the order of sharps? 10. *FCGDAEB*
11. How do you find the name of a sharp key? 11. *Go up 1/2 step from the last sharp in the key signature*
12. How many sharps are in the key of D and what are they? 12. *Two: F#, C#*
13. What is the name of the key signature with 4 sharps in it? 13. *E*
14. How many sharps in the key of C? 14. *None*
15. Where do you find key signatures (be specific)? *At the beginning of a piece of music, between the clef and the time signature.*

## Practical Use

---

1. On a low line/space of a blank bass or treble clef staff, write an F. Now put a note on each line and space above the F until you reach the F an octave above (you should end up with 8 notes). Now, just after the clef, put in the key signature for F# Major. Look at the sharp key examples for help with this if you must. Play and sing the F# Major scale you just made (have a fingering chart for your instrument handy).
2. Create a 4-measure melody in the key of Ab. Choose your own clef and meter. Play and sing what you've written. Change it if you don't like it. Do the same in two more keys of your choice.
3. From now on, whenever you see a piece of music, look at it and identify its key signature.



# PART IV REVIEW

Whew! You Made It.

---

These pages can be used to test your memory on what you've learned in Part IV, and if some of the information hasn't stuck, you can go back and check it out on the page indicated below the question.

As with the chapter reviews, use your keyboard to cover up the answers while you test yourself.

## The Review

---

- |   |   |
|---|---|
| 1. What does an accidental do?<br>page 160            | 1. <i>Slightly alters the pitch of a note</i> |
| 2. What are the names of the accidentals?<br>page 160 | 2. <i>Flat, sharp, natural</i>                |

3. Where are accidentals written?

page 160

3. *In front of the note  
and on the same  
line or space as  
the note*

4. What does a flat do to a note?

page 161

4. *Lowers the pitch  
by one half step*

5. Draw five flats.

page 161

6. Draw five sharps.

page 161

7. What does a sharp do to a note?

page 161

7. *Raises the pitch  
by one half step*

8. Draw five naturals.

page 162

9. What does a natural do?

page 162

9. *Cancels a sharp  
or a flat*

10. How many notes can accidentals be used with?

page 161, page 161, page 162

10. *All of them*

11. How long does the effect of an accidental last?

page 162

11. *For an entire  
measure*

12. Can an accidental have an effect across a bar line?

page 162

12. *No*

13. What is the definition of a half step?

page 169

13. *The difference in pitch between two adjacent keys on a piano keyboard*

14. What is an enharmonic note? Give a couple examples.

page 168

14. *A pitch with two different names, like C# and Db, or F# and Gb*

15. What is a whole step?

page 169

15. *Two half steps*

16. What are the two natural half steps?

page 169

16. *B-C, E-F*

17. Which accidentals are used when going up a chromatic scale?

page 169

17. *Sharps*

18. Which accidentals are used when coming down a chromatic scale?

page 169

18. *Flats*

19. What is an octave?

page 175

19. *The distance from one letter name to the next letter of the same name. 12 half steps, or 6 whole steps*

20. What is the series of whole and half steps for the major scale?

page 174

20. *wwhwww*

21. What is the symbol for a half step?

page 175

21.



22. What is the symbol for a whole step?  
page 175
22. 
23. Between which degrees of the major scale do the half steps occur?  
page 174
23. 3-4, 7-8
24. Use your keyboard to figure out the following scales: A Major, Ab Major, D Major, and Db Major.  
page 177
25. How are key signatures and the major scale related?  
page 180
25. *A key signature gives the correct whole and half steps for a major scale of the same name.*
26. What is the order of flats?  
page 181
26. *BEADGCF*
27. How do you find the name of a flat key?  
page 181
27. *The second -to-the-last flat in the key signature is the name of the key.*
28. Which key has only one flat in it?  
page 182
28. *F*
29. Which flat is that?  
page 182
29. *Bb*
30. Which key has four flats?  
page 181
30. *Ab*



31. How many flats in the key of Eb, and what are they?  
page 182
32. How many flats are in the key of C?  
page 181
33. Which key has seven flats?  
page 181
34. What is the order of sharps?  
page 183
35. How do you find the name of a sharp key?  
page 183
36. How many sharps are in the key of D and what are they?  
page 184
37. What is the name of the key signature with 4 sharps in it?  
page 183
38. In a piece of music, where will you find the key signature (be specific)?  
page 180
31. *Three: Bb, Eb, Ab*
32. *None*
33. *Cb*
34. *FCGDAEB*
35. *Go up 1/2 step from the last sharp in the key signature.*
36. *Two: F#, C#*
37. *E*
38. *At the beginning of a piece of music, between the clef and the time signature*



# PART FIVE

## Interval Training

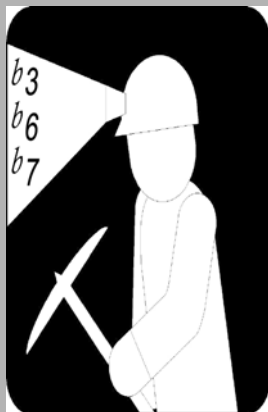

### In This Section You Will Learn:

- General Interval Info
- Major and Minor Intervals
- Diminished and Augmented Intervals
- Natural, Harmonic and Melodic Minor Scales
- Modes

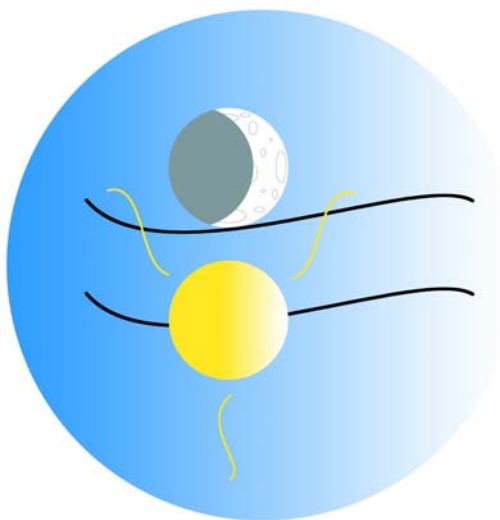

**SolUt Press**

[www.Sol-Ut.com](http://www.Sol-Ut.com)

CHAPTER  
23

**INTERVALS**

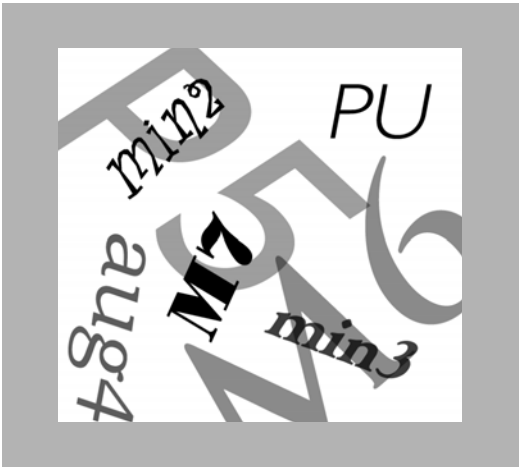

*My idea is that there is music in the air,  
music all around us; the world is full of  
it, and you simply take as much as you  
require.*

— Sir Edward Elgar

**In This Chapter**

- Basic Intervals
- Major and Perfect Intervals
- Minor Intervals
- Diminished Intervals
- Augmented Intervals

# Intervals by the Number

---

An *interval* is the distance between two pitches. An interval is expressed as a number from 1 to 13. It is possible to have a number greater than 13, but it's so rare that we'll forget about it.

There are two types of basic intervals, harmonic and melodic.

A *harmonic interval* is when two notes are sounded simultaneously.

A *melodic interval* is when two notes are sounded one after the other.



Harmonic Interval



Melodic Interval



*When measuring the interval between two notes (both harmonic and melodic), the interval is always measured from the lower note to the higher.*

## A Simple Way to Find an Interval

To find the number of an interval, simply count every line and space from the bottom note to the top note. ***Be sure to count the line/space of the bottom note as 1.*** This is the most common mistake when figuring out an interval. If you don't count the bottom note as 1, you'll end up with the wrong interval.

**Example 23.1** The melodic interval of a fifth and a sixth. Notice in the second example that the count starts with the *lower note* even though it comes after the higher one.

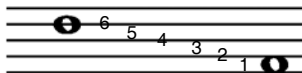
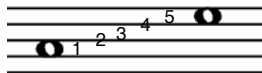

**Example 23.2** The harmonic intervals of a third and a seventh.



## Interval Quality

---

In addition to having a number, each interval will also have a quality of *perfect, major, minor, diminished, or augmented*.

In order to understand these qualities, we've got to take a look at the major scale again. We'll use the key of C Major because it's the least complicated, but these principles can be applied to any key signature.

### Perfect Intervals

The *Perfect* intervals are: *Unison* (the same note, also called *prime*), *4ths*, *5ths*, and *octaves* (8ths). They're called perfect because their sound quality, which is a function of their vibration, which is mathematically elegant. But let's not get into the *Golden Mean* right now. For excellent information on this subject, get *Hearing and Written Music* by Ron Gorow.

The symbol for a perfect interval is "P". So the intervals, when written look like so:

|                     |                              |
|---------------------|------------------------------|
| <b><i>PU/PP</i></b> | perfect unison/perfect prime |
| <b><i>P4</i></b>    | perfect fourth               |
| <b><i>P5</i></b>    | perfect fifth                |
| <b><i>P8</i></b>    | perfect octave               |

See example 23.3 on page 200 for the perfect intervals in the C major scale.

# Major Intervals

All other intervals in a major scale are called major intervals. That leaves us with seconds, thirds, sixths, and sevenths. The letter used for a major interval is a *capital “M”*. These intervals would be written like so:

|           |               |
|-----------|---------------|
| <b>M2</b> | major second  |
| <b>M3</b> | major third   |
| <b>M6</b> | major sixth   |
| <b>M7</b> | major seventh |

See example 23.3 below for Major intervals in the key of C major.

It takes two notes to have an interval, so in the example that follows I’ve put a C below each note, which gives us harmonic intervals up the major scale. Any of these intervals spread out one after the other would be a melodic interval.

**Example 23.3** Intervals in the key of C Major.

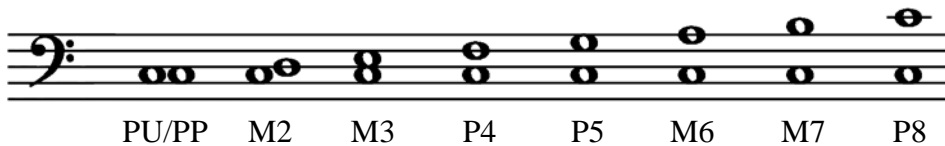

PU/PP   M2   M3   P4   P5   M6   M7   P8

## Altering Perfect Intervals

---

A perfect interval can be raised or lowered, and this changes the quality of the interval.

*A perfect interval lowered a half step becomes a diminished interval.*

*A perfect interval raised a half step becomes an augmented interval.*

Here’s a little diagram to help remember this. The *aug* is above the P because an augmented interval is higher than a Perfect interval. The *dim*





is below the P because a diminished interval is lower than a Perfect interval.

aug  
P  
dim

**Example 23.4** Altered Perfect intervals in C major.

dimU      augU      dim4      aug4      dim5      aug5

dim8      aug8

## Altering Major Intervals

---

Major intervals can also be altered by raising or lowering them.

*A Major interval lowered a half step becomes a minor interval.*

*A Major interval raised a half step becomes an augmented interval.*

Here's another little diagram. Just like before, the *aug* is above because it's higher than the Major, and the *min* is below because it's a lower than the Major:



aug  
M  
min

**Example 23.5** Altered Major intervals in the key of C.

The image shows two musical staves in bass clef with a 4/8 time signature. The first staff contains six pairs of notes: C2-B1 (min2), C2-B#1 (aug2), C2-Bb2 (min3), C2-B#2 (aug3), C2-Bb3 (min6), and C2-B#3 (aug6). The second staff contains two pairs: C2-Bb3 (min7) and C2-B#3 (aug7).



And just to mess with your mind a little, a minor interval lowered a half step becomes a diminished interval.

## Finding an Interval

In a few easy steps you can find an interval. It's easiest with the key of C so we'll stick with that for now, but you should be able to find an interval from any note to any other note.

- 1 Count the lines and spaces up from the lower of the two notes. Be sure to count the lowest note as 1.
- 2 Determine if the number of the interval is Major or Perfect. (M = 2, 3, 6, 7; P = U, 4, 5, 8).
- 3 Determine if the interval is lowered or raised from what it would be in the Major scale. Use the Major scale which starts on the lower of the two notes.

For example, let's take a C and a Bb, with C being the lower of the two notes. For the first step, we count the lines and spaces to get the number of the interval.

A musical staff in treble clef showing the interval from C4 to Bb4. The notes are on the lines C, D, E, F, G, A, B. The B is flat. The interval is labeled with numbers 1 through 7 above the notes.

For step 2, we need to know if a 7th is a Perfect or Major interval. It's a Major interval if unaltered. But this one is altered, so....

For step 3 we determine that the 7th has been lowered a half step, which would make it a minor 7th.

## Finding Intervals in Keys Other than C

The best way to find intervals in other keys is to have all the Major scales memorized. There are only 12 of them, so it shouldn't take too long. Because I'm originally a trumpet player, I still figure out intervals by running up the major scales with trumpet fingerings. It's sort of like counting on your fingers. Very handy.

Another way is to memorize how many whole and half steps are in each interval. This takes a lot of brain space, but it's possible. Here's a little table with the number of whole and half steps for each interval.

| INTERVAL    | NUMBER OF STEPS |
|-------------|-----------------|
| <i>dimU</i> | -1/2            |
| <i>PU</i>   | 0               |
| <i>augU</i> | 1/2             |
| <i>min2</i> | 1/2             |
| <i>M2</i>   | 1               |
| <i>a2</i>   | 1 1/2           |
| <i>min3</i> | 1 1/2           |
| <i>M3</i>   | 2               |
| <i>a3</i>   | 2 1/2           |
| <i>dim4</i> | 2               |
| <i>P4</i>   | 2 1/2           |
| <i>a4</i>   | 3               |
| <i>dim5</i> | 3               |
| <i>P5</i>   | 3 1/2           |
| <i>a5</i>   | 4               |
| <i>min6</i> | 4               |

| INTERVAL    | NUMBER OF STEPS |
|-------------|-----------------|
| <i>M6</i>   | 4 1/2           |
| <i>a6</i>   | 5               |
| <i>min7</i> | 5               |
| <i>M7</i>   | 5 1/2           |
| <i>a7</i>   | 6               |
| <i>dim8</i> | 5 1/2           |
| <i>P8</i>   | 6               |
| <i>a8</i>   | 6 1/2           |

## A Brief Note on Ear Training

---

Knowing these intervals intellectually is valuable, but knowing them by hearing them is priceless. If you've ever struggled with learning a song by ear, you'll appreciate knowing intervals by the way they sound.

The trick is to sing or play each interval over and over and over until you can sing any interval from any note. There are many ways to do this. One way is to pick an interval a week and sing/play that interval from every note you can sing/play until you've memorized the difference in pitch.

Do this everywhere you won't be looked at strangely (or if you don't mind looking strange, do it everywhere): in the car, in the shower, hum them under your breath at a boring lecture or meeting, use your imagination. Knowing these intervals by ear is a valuable skill for any musician of any level. If you can hear an interval correctly, writing it out is a cinch.

## Moving On

---

It may take some time living with these intervals before they really stick in your head. Keep at it until you've got them. Knowing your intervals will be necessary when we get to building chords, which is coming up in a few chapters.

Coming up in the next chapter are minor scales.

# Chapter 23 Review

---

1. What is the definition of an interval?
  1. *The distance between two pitches*
2. What is a harmonic interval?
  2. *The distance between two pitches sounded simultaneously*
3. What is a melodic interval?
  3. *The distance between two pitches sounded consecutively*
4. How do you find the number of an interval?
  4. *Count each line and space up from the lower of the two notes*
5. What will always be the number of the lower note?
  5. *1*
6. What are the qualities of intervals?
  6. *Perfect, Major, minor, diminished, augmented*
7. What does a Perfect interval become when lowered a half step?
  7. *diminished (dim)*
8. What does a Perfect interval become when raised a half step?
  8. *augmented (aug)*
9. What does a Major interval become when raised a half step?
  9. *augmented (aug)*
10. What does a Major interval become when lowered a half step?
  10. *minor*

11. What is this interval?

11. *min 6*



12. What is this interval?

12. *aug 4*



## Practical Use

---

1. Draw a whole note C on the treble clef (any octave is fine). Draw another note a fifth above the C. What is the name of the note a fifth above C? Sing or play the interval of a fifth until you can do it from any pitch (this may take some time...keep at it).
2. On the first three lines and two spaces of the treble staff, draw whole notes on E, F, G, and A. Next you'll make a harmonic interval (one note directly over another) above each note you've already written. Write in the note an octave above the E, F, G, and the A. What are the names of these notes an octave above? Now, in between the note and the octave, write in a fifth. Play and sing these intervals.
3. On a piece of music you are currently studying, identify at least two intervals. Sing and play the interval out of the context of the piece. When you play the piece from now on, try to be aware of the sound of the intervals you've chosen. When you can identify them by their sound, pick a couple more and repeat the process.

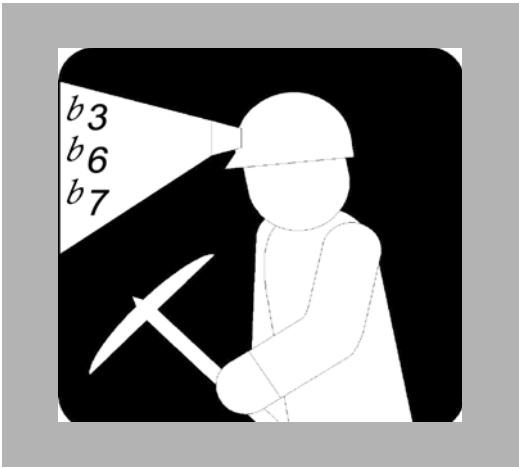

CHAPTER  
24

**MINOR SCALES**

*A painter paints pictures on canvas, but  
a musician paints pictures on silence.*

— Leopold Stokowski

**In This Chapter**

- General Minor Scale Information
- Natural Minor Scales
- Parallel and Relative Minor
- Harmonic Minor Scales
- Melodic Minor Scales

# General Minor Scale Info

---

If you hear music which evokes a feeling of sadness or melancholy, you can bet it's in a minor key.

This change in emotion is brought about by lowering a few degrees of the major scale by half a step.

There are three types of minor scale: *natural minor*, *harmonic minor*, and *melodic minor*. Just like the Major scale, each minor scale has a different scheme of whole and half steps.

The good news is that you don't have to memorize those schemes, we'll just alter the Major scale to get the minor scales.

Even better news is that the only minor scale that gets a lot of use is the harmonic minor scale. But the others are important too, especially the natural minor.

## The Natural Minor Scale

---

It's easy to get a key signature for a *natural minor scale*: *simply add three flats to the key signature of a Major scale*.

Which three flats? Well, it depends on the major scale. You add the next three flats in the key signature. For example, the key of F Major has one flat, a Bb. If we wanted to get F minor, we'd add the next three flats in the order of flats, which are Eb, Ab, and Db.

**Example 24.1** The key signatures of F Major and f minor.



F Major



f minor

I'm sure you're saying, "But wait a minute, that's also the key of Ab Major, isn't it?" Yes it is. What's different is the starting note of the scale.



In this case, we'll be starting on F, so the key signature of f minor will give us a specific series of whole and half steps from F to F with the key signature of 4 flats. In example 24.2 you'll see that adding the next three flats in the key signature will lower the 3rd, 6th, and 7th degrees of the major scale by half a step. Though the key signature takes care of the flat notes, I've put the flats in parentheses in front of the notes to illustrate which have been lowered.

**Example 24.2** The f minor scale with whole and half steps shown.

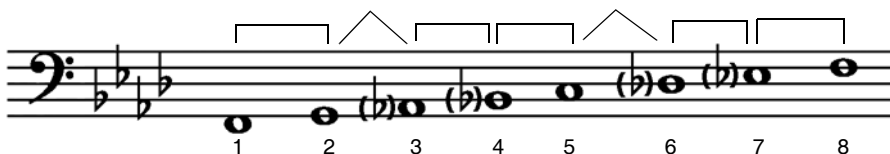

With this example, you can see the series of whole and half steps for *any natural minor scale is: whole, half, whole, whole, half, whole, whole* (*whwwhww*). Memorize this if you want, but it's easier to simply add three flats to the major key of the starting note.

## What About Sharp Keys?

The process for making a minor key is the same for sharp keys. Add three flats. What's different is that the flats will cancel out the sharps.

For example, if we take the key of E with 4 sharps and add 3 flats, those three flats cancel out three of the sharps, leaving us with one sharp, which is the key of e minor.

**Example 24.3** The keys of E Major and e minor.



E Major



e minor

You'll notice that the key of e minor is the same as the key of G, but what is different is the starting note, which will of course be E. I'm not going

to write it out but I guarantee that if you checked the whole and half step pattern from e to e with one sharp, it'll also be whwhww.

If you have a sharp key with only one or two sharps (keys of G and D Major), adding three flats will cancel out the sharps and you'll be left with two or one flat, respectively (keys of g and d minor).

## How Do You Tell the Difference?

You may be wondering that a key signature can be either Major or minor (as in the example above: e minor, or G Major). There is an easy way to tell. Your first signal should be the beginning and ending note, especially the ending one. It is almost always the tonic, or the note which gives the key its name. For example, in a song with one sharp, if it's in G Major, the last note (and likely the first note, too) will be G. If the piece is in e minor, the last note (and likely the first note, too) will be e. If you actually hear the song, you can tell by the way it sounds: sad is minor, happy is Major.

## Parallel and Relative Minor Scales

You may hear the above terms. They aren't different types of minor scales but are different ways of finding out which notes to play in the minor scale.

### Parallel Minor

The way you have just learned—adding 3 flats to the key—is how to find the *parallel minor* scale. It's called parallel because it begins on the same note as the Major scale equivalent.

### Relative Minor

I pointed out above that a minor key signature can also be a major key signature, but what makes it minor is the starting note.

Take a look at example 24.3 above, the key signatures for E Major and e minor. The key of e minor has only one sharp, right? This is also the key signature for G Major. These two keys are related (hence the term “relative minor”). The key signatures are exactly the same, but the difference is the starting note.

If you go up the G Major scale, what is the 6th note? I'll wait while you figure it out ....

It's E, isn't it? Play or sing a scale with the key of G, but play it from E to E and you've got the E natural minor scale.

If you take any major scale and play it from the sixth note to the next sixth note an octave higher, you'll have played the relative minor scale of the major key.

So e minor is the relative minor of G Major; A minor is the relative minor of C Major; G minor is the relative minor of Bb Major; B minor is the relative minor of D Major; and so on.

The cool thing about this is that when learning natural minor scales, you don't really have to memorize a whole new set of scales, simply start on the sixth degree of the Major scale, play the notes of that major scale from the 6th degree to the 6th an octave higher, and you've got a natural minor scale.

## The Harmonic Minor Scale

---

This is the minor scale which gets the most use. *The harmonic minor scale is a slightly altered natural minor scale. The seventh degree is raised one half step.*

The harmonic minor scale gets its name from how it's used. The harmonic minor scale is used in order to get the harmony correct when using chords.

When constructing chords (which are harmony—two or more notes at once), in order for the chord progressions to sound right to our ears, we need a half step between the 7th and 8th degree of the scale, and that's what the harmonic minor scale does.

This seventh degree, when it's a half step away from the tonic, is called a *leading tone*. It's called a leading tone because it leads our ear to the tonic. Try this: play a major scale and stop on the seventh degree. It feels unresolved, unfinished, and leaves us slightly unsettled.

If you remember, in the natural minor scale, there is a whole step between the 7th and 8th degrees of the scale. To change this to a half step, you must raise the 7th degree a half step.

You find the key signature of a harmonic minor scale exactly the same way as a natural minor scale: add three flats to the Major key signature of the starting note, then simply raise the seventh degree one half step.

In the example below, I took the C Major key signature (no sharps or flats), added three flats (Bb, Eb, Ab), then wrote out the scale and raised the seventh degree (Bb) a half step with a natural sign.

**Example 24.4** The C harmonic minor scale.

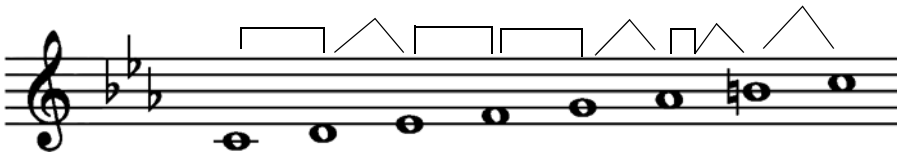

There is no key signature for the harmonic minor scale, so you have to alter the 7th degree in order to get the scale. If you tried to alter the key signature to do this, you'd have to take out the first flat, the Bb. You can't take it out without also taking out the others because the order of flats must always remain the same. It isn't just a good idea, it's the law.

Notice that between the 6th and 7th degree of this scale we have 1 1/2 steps. This is part of what gives the harmonic minor scale its distinctive sound.

Play the scale in example 24.4 above. Many people think it sounds "Arabian" or "exotic". It's a cool sound, and if you're memorizing scales, after you get your majors down, start with the harmonic minors.

## The Melodic Minor Scale

---

This is an oddball scale, one which you'll rarely see, and rarely use, but here it is.

The melodic minor scale is also based on the natural minor key signature with some alterations to the notes in the scale, but not to the key signature itself.

One weird thing about this scale is that it's different going up than it is coming down.

On the way up, the 6th and 7th degrees of the natural minor scale are raised a half step, and on the way down they're lowered again. Pretty strange, isn't it?

In the example, I took the A Major scale (3 sharps), added three flats (they cancel the sharps) and got a key signature with no sharps or flats (the key of a minor). Then I raised the sixth and seventh degrees ascending, and lowered them again descending.

**Example 24.5** The a melodic minor scale.

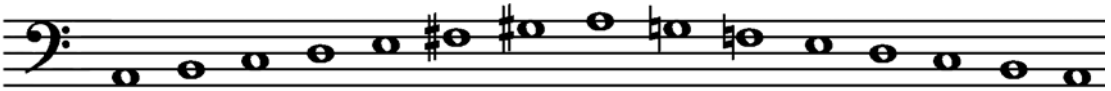

## Moving On

---

The information in this chapter can be confusing, and many students find it a little challenging to wrap their brain around these concepts, so don't be surprised if you have to go back through it several times before it makes sense. Keep at it.

Coming up in the next chapter are modes, two of which you already know: the Major and minor scale.

1. What are the three types of minor scale?

1. *Natural, harmonic, melodic*

2. How do you make a natural minor scale?

2. *Add 3 flats to the key signature of a Major scale and use the same starting note*

3. Which notes of the major scale are lowered to make the natural minor scale?

3. *3rd, 6th, 7th*

---

## Chapter 24 Review

---

- |  |  |
|--|--|
| <p>4. The key of D Major has 2 sharps (F# and C#).<br/>What is the key of d minor?</p>                       | <p>4. <i>One flat (Bb)</i></p>   |
| <p>5. How do you make a harmonic minor scale?</p>  | <p>5. <i>Raise the 7th degree of the natural minor scale a half step</i></p>   |
| <p>6. What is a leading tone?</p>  | <p>6. <i>One half step between the 7th and 8th degree of a scale</i></p>   |
| <p>7. Do Major scales have leading tones?</p>  | <p>7. <i>Yes</i></p>   |
| <p>8. Can you alter the natural minor key signature to get a key signature for the harmonic minor scale?</p> | <p>8. <i>No</i></p>  |
| <p>9. How is a melodic minor scale different from the natural minor scale?</p>                               | <p>9. <i>6th and 7th degrees are raised a half step going up; lowered again going down</i></p>   |
| <p>10. What's the difference between a parallel minor scale and a relative minor scale?</p>                  | <p>10. <i>Parallel minor scales start on the same note as the major but the key signature has 3 extra flats. Relative minor scales begin on the 6th note of a Major scale and have the same key signature.</i></p> |

## Practical Use

---

1. Write out harmonic minor scale starting on the following notes: C, B-flat, D, and F. Play them and sing them until memorized. Learn all 12 harmonic minor scales (keep at it no matter how long it takes!).
2. Write out all the key signatures and identify the major and minor for at least three of them. Example: 1 sharp is G Major, and e minor.
3. Persistence is the mother of success. Repetition is the father of success. Keep at it!



CHAPTER  
25

## SCALES A LA MODE

*Musical innovation is full of danger to the State, for when modes of music change, the laws of the State always change with them.*

— Plato, *The Republic*

### In This Chapter

- What is a Mode?
- Ionic Mode
- Dorian Mode
- Phrygian Mode
- Lydian Mode
- Mixolydian Mode
- Aeolian Mode
- Locrian Mode

# What is a Mode?

---

A mode is a type of scale. Modes are used in certain types of music, like salsa, jazz, country, rock, fusion, speed metal, and more. To find out the details, read on.

The reason the Theory Geek appears on the title page of this chapter is that this information isn't crucial to understanding music theory, but it does come in handy for things like improvisation in different styles of music.

These are also called “church modes” because they were first used in the Catholic Church back in Medieval times (remember good old Guido d' Arezzo?). The names of the modes were taken from the Greek modes, but other than the names, they have no relation to the Greek modes.

The two modes which have been used the most, and the only two most people know, are now called the Major and natural minor scales. Their original names were the *Ionian mode* (Major), and the *Aeolian mode* (minor). The other modes are: *dorian*, *phrygian*, *lydian*, *mixolydian*, and *locrian*.

Modes are easy to understand. We'll map out each mode's series of whole and half steps and use the key of C so there aren't any sharps or flats to bother with.

## The Modes

---

### Ionian

As you already know, the Ionian mode is the same as the C Major scale. All the white keys on the piano from C to C. And I'm sure you remember the whole-half step pattern of WWHWWWH

Ionian is used in nearly all Western music, from Classical to Hip-hop.

**Example 25.1** The Ionian mode, also known as the Major scale.





## Dorian

The Dorian mode begins on the second degree of the Major scale and in the key of C goes from D to D on the white keys of the piano. The pattern of whole and half steps is WHWWWHW.

There are 12 Dorian scales, corresponding to the 12 key signatures. The Dorian mode is a minor-sounding scale used in rock, jazz, blues, and fusion.

**Example 25.2** Dorian mode ascending.



## Phrygian

You've probably caught on to the pattern by now. Phrygian begins on the third degree of the Major scale and in the key of C is E to E on the white keys of the piano. The whole-half step pattern is HWWWHWW.

This mode has a Spanish flavor and is used in flamenco music, fusion, and speed metal. Twelve of these, too. In fact, 12 of all of them.

**Example 25.3** Phrygian mode ascending.



## Lydian

Lydian begins on the 4th degree of the Major scale and in the key of C is from F to F on the white keys of the piano. Whole-half step pattern is WWWWWH.

You might see this mode in jazz, fusion, rock, or country music.

**Example 25.4** Lydian mode ascending.



## Mixolydian

Mixolydian begins on the fifth degree of the Major scale, and in the key of C is G to G on the white keys. Whole-half step pattern is WWHWWHW.

This mode shows up in rockabilly, country, blues, and rock.

**Example 25.5** Mixolydian mode ascending.



## Aeolian

Also known as the natural minor scale, the aeolian mode begins on the sixth degree of the Major scale. In the key of C it's from A to A on the white keys. WHWWHWW.

This mode appears in all kinds of music: pop, country, Rock, blues, heavy metal, classical, and on and on.

**Example 25.6** Aeolian mode ascending.



## Locrian

This is the strangest sounding mode, and the least used, though you'll probably find it in some fusion and in jazz.

The locrian mode begins on the seventh degree of the Major scale, and is B to B in the key of C.

**Example 25.7** Locrian mode ascending.



## Finding Modes in Other Keys

---

There are two ways to find a mode in another key. You can find a mode within a certain key signature, or find a mode starting on a specific note.

To find a mode in a certain key is easiest. Just a couple steps.

- 1 Play the Major scale in the key you'll be using. For an example, let's say you wanted to find the Dorian mode which uses the key of Ab. First step is to play the Ab Major scale.
- 2 Depending on what mode you want, start on the appropriate note in the Major scale, and play an octave in the key of the Major scale. For our example, you want the Dorian mode, which begins on the second degree of the Major scale. So you'd play from Bb to Bb using the key of Ab. Or think of D Dorian as D Major with a flatted third and a flatted seventh.

To find a mode beginning on a specific note, the process is a little different but still pretty simple.

- 1 Depending on the mode you want, find out which major scale has that note in the appropriate place. Let's stick with Dorian for an example.

You want to find the Dorian mode which begins on F. So you'd find out which Major scale has F as its second note. The answer is Eb.

- 2 Then use the key signature you found in step 1 for the Dorian mode. In our example, you'd play F to F using the key of Eb.

## Moving On

---

Again, modes aren't particularly necessary to understand music theory, but can be useful. Now we get to move on to the blues scales, which are fun and sound cool.

## Chapter 25 Review

---

1. What are the names of the modes?  
*1. Ionian, Dorian, Phrygian, Lydian, Mixolydian, Aeolian, Locrian*
2. Which mode is the same as the major scale?  
*2. Ionian*
3. Which mode is the same as the natural minor scale?  
*3. Aeolian*
4. What is the starting note for the Dorian mode which uses the key of D Major?  
*4. E*
5. What key signature would be used for the Dorian mode beginning on an A?  
*5. Key of G. One sharp*

## Practical Use

---

1. Write out all of the modes in the key of C. Learn them on your instrument/voice. Know where the half steps are in each. Then learn all of the modes in the key of F, then G, etc. Keep adding a sharp or flat each time. Another option is to learn only one mode at a time in every key, for example, the D Ionian, D Dorian, D Phrygian, etc.

CHAPTER  
26

**BLUES TO BEBOP  
AND BEYOND**



*Jazz isn't dead, it just smells funny.*

— Frank Zappa

**In This Chapter**

- General Blues Scale Information
- The Blues Scale
- 12 Bar Blues
- Other Crazy Scales

# General Blues Scale Info

---

Most people like blues scales. They sound cool, are fun to play and easy to learn. They also come in handy if you're improvising in blues, rock and roll, country, jazz, and many other styles of music.

Just like all the other scales, the blues scale can be made by altering notes of the major scale.

These altered notes are called *blue* notes, and their use originated with Africans who were brought to this country as slaves. A blue note was originally a bending of the pitch with the voice.

It's thought that the use of "the blues" as a term for feeling down came from a Native American tribe in the south who would cover their bodies with a blue dye when they were in mourning. Slaves in the area saw the practice and invented the term "feeling blue." Maybe it's just legend, but it's a story I like.

## The Blues Scale

---

### Standard Blues Scale

The *standard blues scale* is also called the minor blues scale.

As usual, we'll start with the key of C to avoid the confusion of lots of accidentals.

The 3rd, 5th and 7th degrees are lowered a half step, but the P5th is also needed so we'll have to slap a natural on the G to get that one in.

**Example 26.1** C blues scale.



## Recipe for Any Standard Blues Scale

- 1 Take one Major scale of your choice
- 2 Use the tonic of the Major scale as the first note of the blues scale.
- 3 Lower the third degree of the Major scale a half step to get the second degree of the blues scale.
- 4 Use the P4 of the Major scale as the 3rd note of the blues scale.
- 5 Lower the P5 by a half step to get the 4th note of the blues scale.
- 6 Put the needed accidental in front of the 5th to get a P5 for the 5th note of the blues scale.
- 7 Take the seventh degree of the Major scale and lower it a half step for the 6th degree of the blues scale.
- 8 Use the P8 for the seventh note of the blues scale.
- 9 Turn lightly over and over in your brain and under your fingers until memorized.
- 10 Repeat from step one with a new scale until all 12 are memorized.

## The Major Blues Scale

The Major blues scale is a slight alteration of the standard blues scale. See if you can spot the difference. There is a M2, a M3, and a M6, but no P4, and no m7.

**Example 26.2** The C Major blues scale.



If you were talking to a “jazzzer”, and asked her what the Major blues scale was, she’d say, “Tonic, two, flat three, three, five, six, eight,” or something similar. This a shorthand version of describing each degree of the Major blues scale as it relates to the Major scale.

# Other Crazy Scales

---



In this little section I'll show you: bebop scales, pentatonic scales, whole tone scales, and the super-locrian scale.

I'll only give you the version of each scale starting on C, and from there you can figure out the rest. If you're really gung-ho, you can take a look at [www.QuestionsInk.com/student](http://www.QuestionsInk.com/student), where you'll find a link for "Scales Galore". Go there and be amazed.

## Pentatonic Scales

This is a type of *gapped scale*, which means a regular scale with some notes missing. In this case, we take out the 4th and 7th degrees of the major scale.

The pentatonic scale is another scale used a lot in jazz improvisation. As the name implies, there are only 5 notes in this scale. Though you see six, the bottom and top notes (tonic) count as one because they have the same name.

**Example 26.3** C Major pentatonic scale.

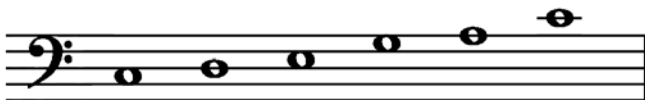

**Example 26.4** C minor pentatonic scale.



## Bebop Scales

Bebop is a form of jazz begun by Dizzy Gillespie and Charlie "Bird" Parker. It features blinding speed and virtuosic improvisational solos. Some great bebop performers include Dizzy and Bird, Miles Davis, Stan Getz, Sonny Rollins, Sonny Stitt, and that's only a few.



There are three types of bebop scales: Major bebop, minor bebop, and dominant bebop.

**Example 26.5** C Major bebop scale.



**Example 26.6** C minor bebop scale.



**Example 26.7** C dominant bebop scale.



## Whole Tone Scale and the Super Locrian

Here are a couple of the strangest sounding scales you'll ever hear. The whole tone scale consists entirely of whole tones (whole steps), no half steps allowed.

The second scale has several names: diminished whole tone, altered, and my personal favorite, the super locrian.

**Example 26.8** C whole tone scale.



**Example 26.9** The Super Locrian scale (aka: diminished whole tone; altered).



## Moving On

---

Now that you've gotten a taste of several other scales that are out there, you can never say, "But there's nothing to practice."

Coming up is the chapter review, then the hefty Section review. After that it's on to the next Part, which is all about chords: what they are, how to build them, chord extensions, and basic chord progressions.

## Chapter 26 Review

---

1. What is a blue note?
  1. An altered note (usu. lowered) of the major scale
2. As compared to the major scale, what are the notes of a standard blues scale?
  2. Tonic, flat 3, 4, flat 5, natural 5, flat 7, 8.
3. What is a gapped scale?
  3. A scale with some notes removed.
4. Name at least three other types of scales.
  4. Super Locrian, Major pentatonic, minor pentatonic, Major bebop, minor bebop, dominant bebop, whole tone.

## Practical Use

---

1. Write out the C, F, and G blues scales. Memorize them on your instrument. Sing them. Improvise melodies and sounds with these three scales.

# How to Sing the Blues (Not Really)

---

1. Most blues begin with “woke up this mornin.”
2. “I got a good woman” is a bad way to begin the blues unless you stick something nasty in the next line: “I got a good woman, with the meanest dog in town...”
3. Blues are simple. After you’ve got the first line, repeat it. Then find something that sort of rhymes:  
Got a good woman with the meanest dog in town,  
Got a good woman with the meanest dog in town,  
He gots teeth like Mick Jagger  
And he weigh 500 pounds.
4. The blues aren’t about limitless choice.
5. Blues cars are Chevys and Cadillacs. Other acceptable blues transportation: a Greyhound bus or a southbound train. Not acceptable: BMW, hot air balloons, an R.V.
6. Walkin’ always plays a major part in the blues, as does fixin’ to die.
7. The best places to get the blues are Chicago, St. Louis, and Kansas City.
8. The following colors don’t belong in the blues: beige, mauve, violet, periwinkle.
9. You can’t have the blues in an office or mall. The lighting is wrong.
10. Good places for the blues: the highway (crossroads are best), the jail house, an empty bed.
11. Bad places for the blues: an ashram, gallery openings, wine tastings.
12. No one will believe it’s the blues if you wear a suit unless you’re an old African-American man.
13. Do you have a right to sing the blues?  
Yes if:  
your first name is a state, like Georgia;  
you’re blind;  
you shot a man in Memphis;  
you can’t be satisfied;  
“the man” doesn’t like you.  
No if:  
you were once blind but now can see;  
you ski in Tahoe each year  
you have an IRA.
14. If you ask for water and yo’ baby gives you gasoline, it’s the blues.

15. Other blues liquids:

wine from a bottle in a sack;  
Irish whiskey from a dirty glass;  
muddy water (usually not for drinking).

16. Not blues beverages:

any mixed drink, or drink with an umbrella in it;  
any kosher wine;  
Yoo Hoo (all flavors).

17. If it occurs in a fleabag motel or in a shotgun shack, it's a blues death. Other blues deaths: being stabbed in the back by a jealous lover, being pushed down an old mine shaft, crying yourself to death. You cannot die a blues death during a tennis match or during a liposuction treatment.

18. Some blues names for women:

Sadie  
Big Mama  
Bessie  
Billie

19. Some blues names for men:

Joe (including "Big", "Old", or "Blind" in any combination, but not Little Willie (Little Willie could work)  
Lightnin'  
Almost anything with Howlin' in front of it  
Other possibilities include physical infirmities: Blind, Cripple, Wheezin'  
Fruit names: lemon, lime, (not pomegranate)  
Presidents: Jefferson, Johnson, Fillmore, (not Bush)

20. Persons with names like Sierra, Sequoia, or Chauncey will not be permitted to sing the blues no matter how many men they kill in Memphis.



# PART V REVIEW

## Whew! You Made It.

---

These pages can be used to test your memory about what you've learned in Part V, and if some of the information hasn't stuck, you can go back and check it out on the page indicated below the question.

As with the chapter reviews, use your keyboard to cover up the answers while you test yourself.

## The Review

---

1. What is the definition of an interval?

page 198

1. *The distance between two pitches*

2. What is a harmonic interval?

page 198

2. *The distance between two pitches sounded simultaneously*

3. What is a melodic interval?

page 198

3. *The distance between two pitches sounded consecutively*

4. How do you find the number of an interval?

page 198

4. *Count each line and space up from the lower of the two notes*

5. When figuring an interval, what will always be the number of the lower note?

page 198

5. *1*

6. What are the qualities of intervals?

page 199

6. *Perfect, Major, minor, diminished, augmented*

7. What does a Perfect interval become when lowered a half step?

page 200

7. *diminished (dim)*

8. What does a Perfect interval become when raised a half step?

page 200

8. *augmented (aug)*

9. What does a Major interval become when raised a half step?

page 201

9. *augmented (aug)*

10. What does a Major interval become when lowered a half step?

page 201

10. *minor*

11. What is this interval?



page 200

11. *min 6*

12. What is this interval?



page 201

12. *aug 4*

13. What are the three types of minor scale?

page 208

13. *natural,  
harmonic, melodic*

14. How do you make a natural minor scale?

page 208

14. *Add 3 flats to the  
key signature of a  
Major scale and  
use the same  
starting note*

15. Which notes of the major scale are lowered to make the natural minor scale?

page 208

15. *3rd, 6th, 7th*

16. What is the key of B minor?

page 209

16. *Two sharps (F#,  
C#)*

17. What is the key of Ab minor?

page 209

17. *Seven flats (Bb,  
Eb, Ab, Db, Gb,  
Cb, Fb)*

18. How do you make a harmonic minor scale?

page 211

18. *Raise the 7th  
degree of the  
natural minor  
scale a half step.*

19. What is a leading tone?

page 211

19. *One half step  
between the 7th  
and 8th degree of  
a scale.*

20. Do Major scales have leading tones?

page 211

20. *Yes.*

21. Can you alter the natural minor key signature to get a key signature for the harmonic minor scale?  
page 211
22. How is a melodic minor scale different from the natural minor scale?  
page 212
23. What's the difference between a parallel minor scale and a relative minor scale?  
page 210
24. What are the names of the modes?  
page 216
25. Which mode became known as the major scale?  
page 216
26. Which mode became known as the natural minor scale?  
page 218
27. What is the starting note for the Dorian mode which uses the key of D Major?  
page 219
21. No
22. *6th and 7th degrees are raised a half step going up; lowered again going down*
23. *Parallel minor scales start on the same note as the major but the key signature has 3 extra flats. Relative minor scales begin on the 6th note of a Major scale and have the same key signature.*
24. *Ionian, Dorian, Phrygian, Lydian, Mixolydian, Aeolian, Locrian*
25. *Ionian*
26. *Aeolian*
27. *E*



28. What key signature would be used for the Dorian mode beginning on an A?

page 219

*28. Key of G. One sharp*

29. What is a blue note?

page 222

*29. An altered note (usu. lowered) of the major scale*

30. Using the major scale intervals, what are the notes of a standard blues scale?

page 222

*30. Tonic, flat 3, 4, flat 5, natural 5, flat 7, 8*

31. Name at least three other types of scale.

page 224

*31. Super Locrian, Major pentatonic, minor pentatonic, Major bebop, minor bebop, dominant bebop whole tone*



# Interlude



## CONDUCTING

*Conductors must give unmistakable and suggestive signals to the orchestra, not choreography to the audience.*

— George Szell

### In This Interlude

- General Conducting Info
- Conducting Patterns
- Body Language

# General Conducting Information

---

A conductor is a musician whose instrument is a large group of singers or instrumentalists. These musicians are guided either with a baton (also called a stick) or by the conductor's hands alone.

An audience only sees a very small part of what a conductor does, because all they see is the conductor's back. The audience doesn't get to see the frowns and grimaces, the stern looks and the kind, the oh-so-rare smiles, and all the subtle nuances of body language and facial gesture. The audience sees only the wilder gesticulations of the arms and part of the body language.

Most of a conductor's work in shaping a piece of music comes during rehearsals, though a good conductor with a good group of musicians can shape a piece of music spontaneously during a performance.

A conductor's arm moves in a specific pattern which depends upon the time signature of the piece being played. It's usually the right hand and arm which beat out this pattern while the left hand controls dynamics and phrases and expressiveness. This is only a general rule.

The roles of a conductor change depending upon the level of musician in the group. Let's compare conductors at the two ends of the spectrum: the professional symphony conductor and the elementary school music teacher.

Imagine being responsible for forty students and their knowledge of their instrument and music, fingerings, posture, embouchure, breathing, reading music, and how to clean their instrument. These are just a few things a musician should know. There are thousands of school teachers who are responsible for teaching this every day of every school year, and in addition to all that, they conduct these musicians in rehearsals and concerts. Then of course there is grading, and faculty meetings, and hall duty, and on and on. We should be in awe of them. If you know one, thank him or her.

A professional orchestra conductor's focus is more on his or her aural vision of the piece, on the subtle nuances of the music. He or she is not concerned with teaching the clarinets an alternate fingering for low F. A professional conductor might be interested with a certain passage being

more marcato, a little quieter, and with less trombone. A conductor may however, fire the clarinetist who doesn't know the alternate fingering for low F.

Whatever the level, a conductor is responsible for many more things than the individual musician. First of all, the music a conductor reads is much more complex than the music of any player in the group. This is because the conductor reads from a score, which is a large, multi-paged piece of music with *all* the parts in it, from the piccolo to the percussion, from the violin to the bass voice parts.

Conductors are also musical scholars, and should know about performance practices (how a certain piece should be performed), about chord structure and chord progressions, about the intonation tendencies of every instrument, about movement and how musicians react to it, about rehearsal technique and how to get what is needed from musicians, about music history and theory, and on and on. A good conductor is always learning.

## Stance

How a conductor stands will change based upon the music, and we'll get to some specifics later in the chapter, but generally, a conductor should have good posture, feet about shoulder width apart, and a relaxed stance.

At first, the left arm will simply hang relaxed at your side—you'll use it later, but for now you won't need it. The right arm will be extended, slightly bent, and will move around in an area a foot or two in front of you, from the top of your head to the middle of your chest, and from shoulder to shoulder.

If you're using a baton (a pencil will work), grip it with the thumb and index finger and wrap the other fingers lightly around it without grasping.

## Eye Contact

Probably one of the most important aspects of conducting is eye contact. If a conductor's face is buried in the music, he or she won't be able to look a section of altos or a section of trumpets right in the face to be sure they understand what is being asked for.

Eye contact is a double-edged sword. It won't matter *how* fiercely the conductor looks at the musicians, or how flamboyantly his or her arms wave if the musicians don't look up from their music. Ever wonder why choirs memorize their music?

## Conducting Patterns

---

The right arm gives each beat in each measure. Each meter has a different pattern for the right arm. The first one you'll learn is the most common pattern, the one for 4/4 time.

Each diagram that you see is given from the conductor's point of view. You'll get the right movement if you simply trace the pattern in the air.

With *all* patterns, beat one is always given straight down. Your arm is out in front of you and travels from the level of your head down to the level of your chest.

Be sure to make each beat obvious. Do this by giving a small sharp bounce with the hand on each beat.

It takes a little practice to make each pattern look natural, so keep at it. You can learn a lot by watching other conductors, and you might notice that the more accomplished the conductor, the more difficult it will be to determine exactly which pattern he or she is using. Call it creative license.

**Example 27.1** The conducting pattern for 4/4 time.

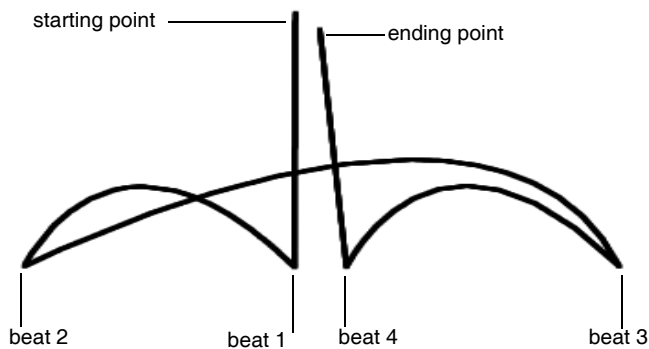

**Example 27.2** The conducting pattern for 3/4 time.

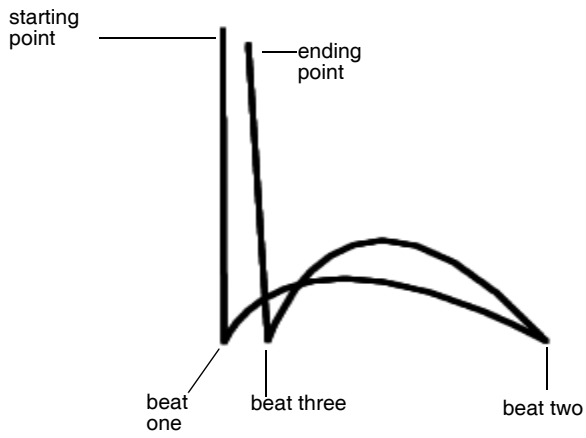

**Example 27.3** Two conducting patterns for 2/4 time.

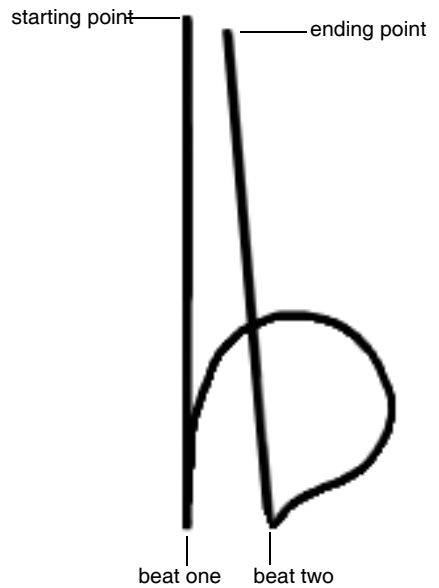
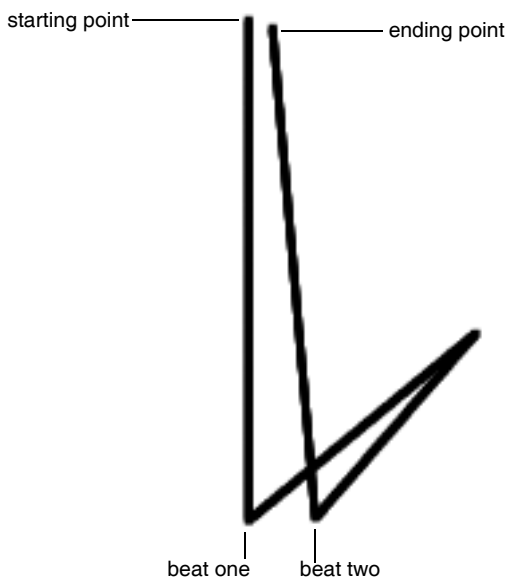

## Showing Style with the Right Hand

Much of the style of a piece of music can be shown with the right hand alone: short, choppy strokes for a piece like a march; long flowing strokes for a more lyric song; a small pattern for quiet sections; a larger pattern for loud sections.

## The Left Hand

---

Though the left hand may also beat out the patterns you just learned, the left normally shows dynamics, articulations, cues (telling instruments or soloists when to come in), and cut-offs.

The independence of each hand takes some effort to master. It's a lot like rubbing your head and patting your stomach at the same time. Try not to beat out the pattern simultaneously with both hands (called *mirroring*). It's generally considered bad conducting form.

While you're conducting, if you're having trouble getting your left hand to act independently, just let it hang at your side.

### Dynamics

There are several ways to show dynamics while conducting: body position, facial expression, and hand position. Let's start with hand position.

### Hand Position

If you conduct with a very small pattern (say two square inches in front of you), players—if they're watching you—will play more quietly. In contrast, very large motions will cause a group to play or sing more loudly.

To show crescendos (gradually louden), start with the left hand down near your gut with the palm up and gradually raise it where the crescendo in the music should happen. By the time your hand reaches a position above the height of your shoulder, the crescendo should be at its peak. At the same time, the pattern in the right hand should start small and grow larger. It's easier to say than it is to do. Try it.



Decrescendos (gradually soften) are shown in the opposite way. The left hand begins above the shoulder, palm *down* this time, and gradually lowers down to the middle of your torso. While doing this, make the right hand pattern become gradually smaller.

If the saxes or the sopranos are too loud, you can “give them the hand”, which means holding your left hand out with the palm facing the loud group. This works well accompanied by a stern look.

## Body Position

If you step forward on the podium and lean towards the group or even crouch down, this will cause them to become quieter, especially if you combine these movements with the above-mentioned technique of making the conducting pattern smaller.

Also effective is to show the group a *quiet face*, whatever you think that is for you. Pursing your lips in a “shush” works pretty well. Practice in a mirror.

In contrast, to get a group to play louder, stand tall as you step back on the podium and lean away from the group. Combine this with making all of your gestures bigger and a group should get louder if they’re watching you.

For this technique, use a *loud face*, usually something that looks stern or even angry. An upraised fist shaken in the air is also quite effective.

## Practicing Conducting

Perhaps the best way, when you’re just beginning to learn, is to get some recordings of music you like which require a conductor and, in the privacy of your own home, give it a try.

The next step, once you’ve got the patterns down, is to get the score for that piece of music and try to follow along while you conduct.

The best advice I can give you for practicing *anything* is to be persistent. Persistence is way more important than talent. Keep at it.

If you’re serious about becoming better, videotaping yourself is a necessity.

This is only the briefest introduction to the art of conducting. If you'd like to learn more, take a look at the following books:

*The Grammar of Conducting: A Comprehensive Guide to Baton Technique and Interpretation* by Max Rudolf and Michael Stern.

*Preparatory Exercises in Score Reading* by Reginald O. Morris and Howard Ferguson.

*Conducting Technique for Beginners and Professionals* by Brock McElheran and Lukas Foss.

## Moving On

---

Conducting is a discipline much like playing an instrument, and the more you know about it, the better able you'll be to play in a group and follow a conductor, if one is even necessary.

Hope you liked this little break from learning music. Let's jump back into it. Up next are intervals, a way to measure the distance between two notes.

# PART SIX

## Strike a Chord

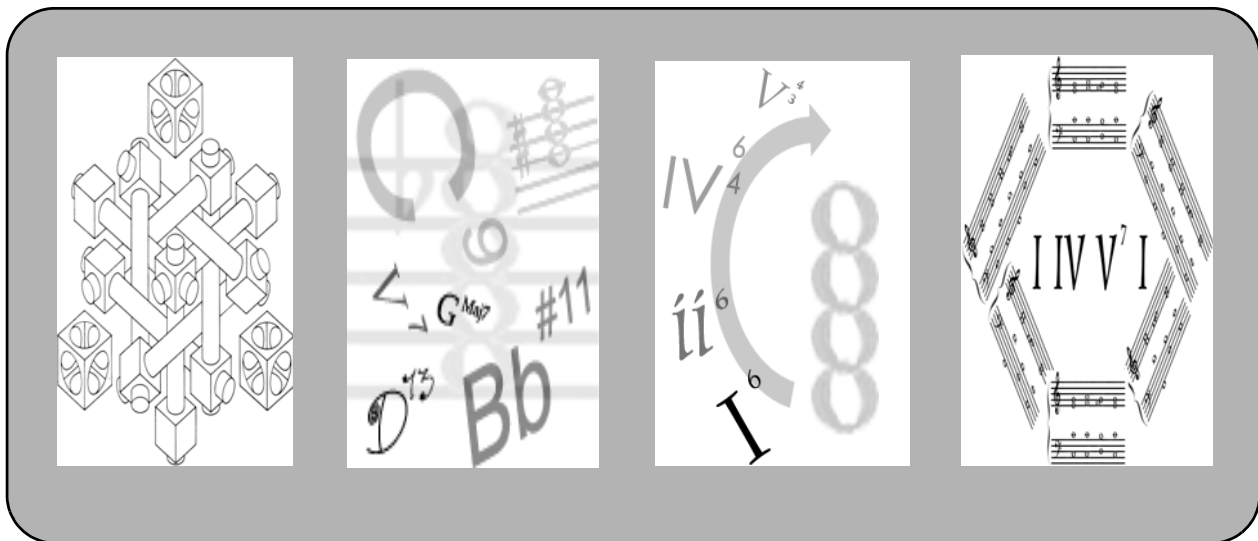

### In This Section You Will Learn:

- Triads
- Chord Extensions
- Chord Inversions
- Chord Progressions

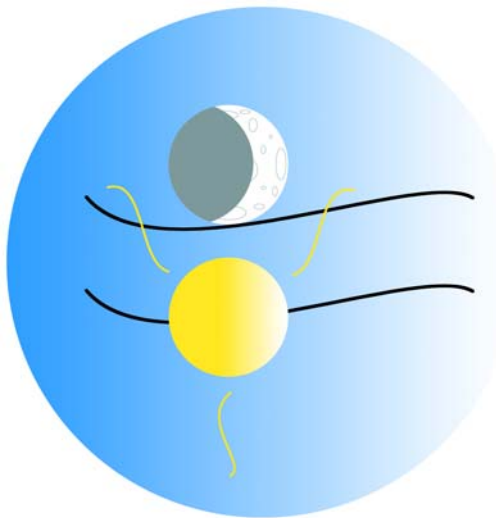

**SolUt Press**

[www.Sol-Ut.com](http://www.Sol-Ut.com)

CHAPTER  
28

TRIADS

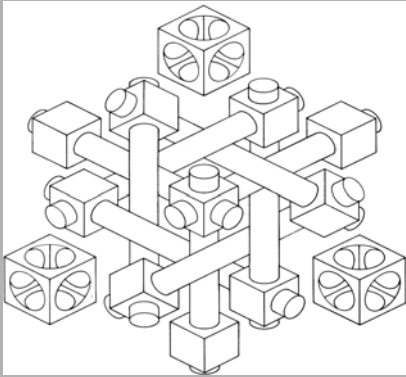

*Music*

*Which can be made anywhere, is invisible  
And does not smell.*

— W.H. Auden

## In This Chapter

- General Chord Information
- The Triad
- Major Triad
- Minor Triad
- Diminished Triad
- Augmented Triad

# General Chord Info

---

The use of the word chord began, according to Webster's, around 1608, and is short for *accord*, which means to be in harmony, as in agreeing. It's a good word for a musical chord, because the notes in most chords tend to agree with each other. They sound good together.

***A chord is three or more notes sounded simultaneously.*** A chord can be played on one instrument like guitar or piano, or a chord can be played by many instruments at once, like a woodwind quintet, or a brass quartet, or a choir. As long as there are three or more notes sounding simultaneously, it's a chord.

There are many types of chords, and many different chord symbols that tell you which notes to use in a chord. Just like with scales, there are Major chords, minor chords, but unlike scales, there are also diminished chords and augmented chords. ***The quality of a chord is determined by the intervals within the chord.***

There are also other types of chords with more than three notes and several different treatments of chords, but I'll save those for the next two chapters.

While you're learning these chords, if you have access to a keyboard, you really should try playing them to hear what they sound like.

## Naming Chords

***A chord has two names. One is a number, a Roman numeral. The other is a letter name.*** Both the letter name and the Roman numeral have with them abbreviations or symbols to show the chord qualities of Major, minor, diminished, and augmented.

### Roman Numerals

***Each chord has a Roman numeral which corresponds to the degree of the scale on which the chord is built.*** Take a look at example 28.2 on page 248 to see this. The upper case Roman numerals denote Major triads, and lower case denotes minor triads.

In addition, there are other symbols to show diminished and augmented triads. You'll see those soon.

## Letter Names

Chords also have a letter name which comes from the root (the bottom note) of the chord. Example 27.1 shows you what a root is.

***If a chord is named with only a capital letter, this means the chord is Major. A minor chord will have “min” written next to the letter.***

Another method for showing minor is to use lower case letters, though it's more common to use the “min” next to the letter.

In addition, the symbols for augmented and diminished are also used with the letter. We'll get to diminished and augmented chords in a few more pages.

When you say the notes in a chord, you're *spelling the chord*. For example, to spell the C chord I'd say, “C, E, G.”

## The Triad

---

A triad consists of three notes stacked in a specific order, ***a root (or bottom note and usually the letter name of the chord), a third, and a fifth***. As you'll see in the examples, each triad is built on all lines or all spaces.

The parts of a triad get their name from their interval above the root note.

**Example 28.1** Triads in various positions on the staff.

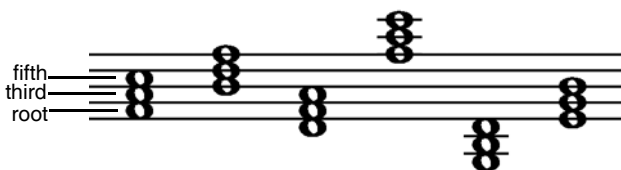

## Triads in a Major Key

In the following example, you'll see a triad stacked on each degree of the C Major scale. Triads stacked in this way will have a quality of either Major, minor, or diminished (there's only one naturally occurring diminished chord in a Major scale).

Notice the little circle to the right of the vii. This symbol tells you the chord is a diminished chord. I'll show you why it's diminished coming up.

**Example 28.2** Triads built upon the degrees of the C Major scale, with Roman numerals.

C    Dmin    Emin    F    G    Amin    B°    C

I    ii    iii    IV    V    vi    vii<sup>o</sup>    I

C    Dmin    Emin    F    G    Amin    B°    C

I    ii    iii    IV    V    vi    vii<sup>o</sup>    I

## Major Triads

Major triads have a happy, bright sound quality.

*A Major triad consists of a note a Major third above the root and another note a Perfect fifth above the root.*

In a Major key, there are three naturally occurring Major triads, those built upon the first, fourth, and fifth degrees of the scale, or the I, IV, and V chords.

**Example 28.3** Breakdown of the Major triads in the key of C.

C                    F                    G

min3    M3    min3    M3    min3    M3    P5

I                    IV                    V



# Minor Triads

---

Minor triads have a dark, sad sound quality.

*A minor triad consists of a note a minor 3rd above the root and another note a Perfect 5th above the root.*

In a Major key, there are three naturally occurring minor triads, those built upon the second, third, and sixth degrees of the Major scale, or the ii, iii, and vi chords.

**Example 28.4** Breakdown of the minor triads in the key of C.

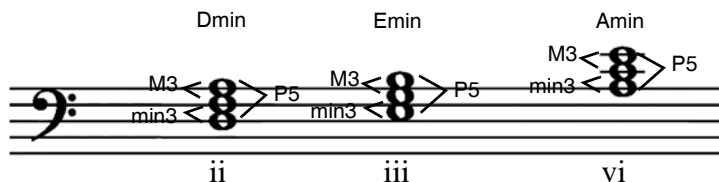

# Diminished Triads

---

Diminished triads are less common than the Major or minor triads and have a suspenseful sound quality. This is the chord you hear when the damsel in distress is tied to the railroad tracks by Dastardly Dan as an approaching train hoots in the near distance.

*A diminished triad consists of a note a minor 3rd above the root and another note a diminished 5th above the root.*

In a Major key, there is only one naturally occurring diminished triad, the one built on the seventh degree of the Major scale.

Don't forget to put the little circle next to the lowercase Roman numeral. We'll get into more chord symbols in the next chapter.

**Example 28.5** Breakdown of the diminished triad on the 7th degree of the Major scale.

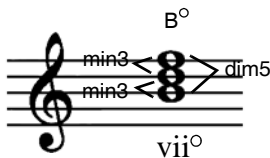

# Augmented Triads

---

There aren't any naturally occurring augmented triads in the key of C, or in any major key, so we'll have to throw in an accidental to get one. The augmented triad has a vaguely unsettling sound, and is usually the type of chord played just before the knife-wielding psycho jumps out from behind the couch and scares the cooties off your head.

***An augmented triad consists of a note a Major 3rd above the root and another note an augmented 5th above the root.***

Since there aren't any augmented triads occurring naturally in the key of C, I'll just make a couple up.

The chord symbol for an augmented chord is a plus symbol (+), or the abbreviation "aug."

**Example 28.6** Breakdown of two augmented triads in the key of C.

The diagram shows two augmented triads on a bass clef staff. The first triad, labeled F<sup>+</sup> and IV<sup>+</sup>, consists of notes F, A, and C#. The interval between F and A is marked as M3, and the interval between F and C# is marked as aug5. The second triad, labeled G<sup>+</sup> and V<sup>+</sup>, consists of notes G, B, and D#. The interval between G and B is marked as M3, and the interval between G and D# is marked as aug5.

## Moving On

---

Triads are the most basic chord form and it's important to know the difference between Major, minor, diminished and augmented triads, so don't go on until you've got it.

In the next Chapter we'll add another note on top of the chord to make the triad a seventh chord, a type of chord extension. We'll also discuss other chord extensions. But first, the review.

# Chapter 28 Review

---

1. What is the definition of a chord?
  1. *Three or more notes played simultaneously*
2. What determines the quality of a chord?
  2. *The intervals within the chord*
3. How are chords named?
  3. *With a Roman numeral, a letter, and a quality of Major, minor, diminished or augmented*
4. What are the parts of a triad?
  4. *Root, third, fifth*
5. Why are they called this?
  5. *Root is the bottom note of the chord; the third is a 3rd above the root; the fifth is a 5th above the root*
6. How do you tell if a triad is Major?
  6. *Capital Roman numeral, or a capital letter only*
7. How do you tell if a triad is minor?
  7. *Lowercase Roman numeral, lowercase letter, or "min" next to the letter name*
8. What are the intervals in a Major triad?
  8. *A note a Major 3rd above the root and another a Perfect 5th above the root*

9. What are the intervals in a minor triad?
9. *A note a minor 3rd above the root, and another a Perfect 5th above the root*
10. What are the intervals in a diminished triad?
10. *A note a minor 3rd above the root and another a diminished 5th above the root*
11. What are the intervals in an augmented triad?
11. *A note a Major 3rd above the root and another an augmented 5th above the root*
12. What are the sound qualities of the different types of triads?
12. *Major = happy; minor = sad; diminished = suspenseful; augmented = unsettling*

## Practical Use

---

1. Write out triads above the notes C, D, E, F and G. Sing or play these chords in an arpeggio (look this word up in the glossary if you don't know it) until you can hear each note in the chord easily. Play these notes as a chord on a piano or guitar. Identify which chords are Major and which chords are minor. Identify by singing or playing the minor thirds and Major thirds within these triads.

CHAPTER  
29

**CHORD EXTENSIONS**



*I don't care too much about music. What I like is sounds.*

— Dizzy Gillespie (1917 - 1993)

**In This Chapter**

- General Chord Extension Information
- The Seventh Chord
- The Ninth Chord
- The 11th and 13th Chords
- Other Chords

# General Chord Extension Info

---

*A chord extension is a note that isn't in the triad.* It's extra. Notes are added to triads to change their flavor, their feel, and in many cases the extension changes how the chord is used.

Some notes added to triads are: 7ths, 9ths, 11ths, and 13ths. We haven't talked about intervals higher than octaves (called *compound intervals*), so now's the time.

If you look at a scale, the 8th note is the same letter as the bottom note. Therefore, the 9th note is the same letter as the 2nd note of the scale, only it's an octave higher. The 11th is like a 4th, but an octave higher; the 13th is like a 6th, but an octave higher.

Chords with extensions are written with the number of the extension above and to the right of the chord letter, like so: A<sup>7</sup>, G<sup>9</sup>, C<sup>#11</sup>, F<sup>13</sup>, D<sup>Maj7</sup>, and so on. Extensions can also be used with Roman numerals, like V<sup>7</sup>, IV<sup>9</sup>, etc.

The number tells you which note you're adding to the triad. The number represents the interval from the root of the chord to the extension.

An extension can be altered a half step up or down to give yet another type of chord. In the examples I gave you above, there was a #11, and a Maj7. In these two cases you would raise the 11th a half step or use a Major 7th above the root, respectively.

On to some specifics.

## Seventh Chords

---

Seventh chords are an important type of chord in Western music. They are essential to most chord progressions, and give progressions the quality our ears are used to hearing. But we'll get more into chord progressions in Chapter 31.

The seventh chords have a property that other extensions don't have. When you see *a seven next to a chord symbol, it's always a minor 7th above the root.*

If you want a Major seventh above the root, you have to specify it in the extension by putting an “M” or a “Maj” or a small triangle “ $\triangle$ ” in front of the extension number.

**Example 29.1** Some seventh chords.

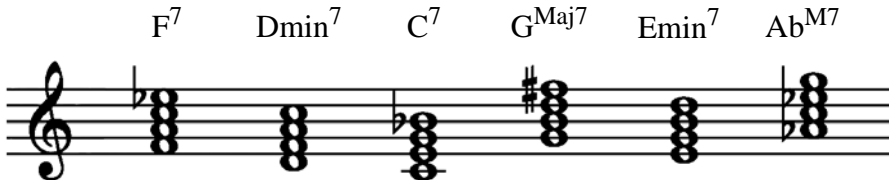

As you can see in the above examples, the quality of the chord itself is written in larger letters next to the letter of the chord (except for Major chords which are just the letter), and any alterations to the 7th are written in small letters before the 7.

## The Dominant Seventh Chord

There is a special kind of seventh chord which appears in a huge majority of chord progressions and it's called the *dominant seventh chord*.

The dominant seventh chord symbol looks like this: V<sup>7</sup>.

Because you know how Roman numerals are used, you know that the above symbol means that the chord is built on the 5th degree of the scale and it's got a minor seventh in it.

I didn't tell you each scale degree had a name when we went over scales because you had enough to worry about without me giving you more information than was necessary, but now it's necessary.

Each scale degree has a name, and it just so happens that the name of the 5th degree of the scale is “dominant.” So there you go. That's why a chord built on the 5th is called a dominant chord, and one with a seventh is called a dominant seventh chord.

The dominant seventh chord is an important chord because it pulls our ears back toward the tonic chord, or the I chord. But more on that in Chapter 30.

**Example 29.2** Dominant seventh chords in the keys of C, G, Bb, and F.

$G^7$        $D^7$        $F^7$        $C^7$   
 $V^7$        $V^7$        $V^7$        $V^7$

Notice above that each measure is in a different key signature. When you build a chord on the 5th degree of the scale in any Major key, the seventh of  $V^7$  will automatically be a minor seventh because of the key signature.

## Ninth Chords

---

*Ninth chords have 5 chord tones: Root, third, fifth, seventh, and ninth.*

As before, the quality of the chord is written in larger letters next to the chord letter, and the extensions are written in smaller letters above and to the right. If all you see is a “9”, the 7 is assumed. However, if you want a *Major 7th* in there (remember the 7th is always minor), you must specify it, as in the  $G^{M7,9}$  and the  $A^{b+7,9}$  below.

**Example 29.3** Some ninth chords.

$F^9$        $D^{min^9}$        $C^{7,9}$        $G^{Maj7,9}$        $E^{min^9}$        $A^{b+7,9}$

## Other Chords

---

### Eleventh and Thirteenth Chords

The process for these chords is very similar to what you already know. An eleventh chord will have a root, third, fifth, seventh, ninth and eleventh.



A thirteenth chord will have a root, third, fifth, seventh, ninth, eleventh, and thirteenth.

## Chords Not Covered

There are several other types of chord which this book won't cover, though I'll tell you what some are and you can discover them on your own if you'd like.

There are suspended fourth chords, Neapolitan sixth chords, German sixth chords, half diminished seventh chords, fully diminished seventh chords, and many more.

## Moving On

---

This chapter should allow you to understand and spell most chords you'll come across. Again, the concepts you're now learning are more complex than previous ones and they may take some time before they're understood well, so keep at it.

All the chords in this chapter have been in root position, the most basic form of a chord. In the next chapter, you'll learn about chord inversions, which is a chord with a note other than the tonic as the bottom note.

## Chapter 29 Review

---

1. What is a chord extension?
  1. *A note that doesn't appear in the triad*
2. How are chord extensions notated?
  2. *With a number equal to the note's interval above the root*
3. What is a compound interval?
  3. *An interval greater than an octave*
4. When you see a <sup>7</sup> to the right of a chord letter, what kind of a 7th is it?
  4. *A minor 7th above the root*

- |   |   |
|---|---|
| 5. How would you indicate a Major 7 above the root? | 5. <i>With a small triangle, a small "M", or a small "Maj" before the 7</i>                     |
| 6. What kind of chord is a V <sup>7</sup> ?         | 6. <i>A dominant seventh chord</i>  |
| 7. Why are V <sup>7</sup> chords so important?      | 7. <i>They draw the ear to the tonic (I) chord, and appear in nearly all chord progressions</i> |
| 8. Spell the V <sup>7</sup> chord in the key of G.  | 8. <i>D, F#, A, C</i>   |
| 9. Which chord tones are in a 9th chord?            | 9. <i>Root, 3rd, 5th, 7th, 9th</i>  |
| 10. Which chord tones are in an 11th chord?         | 10. <i>Root, 3rd, 5th, 7th, 9th, 11th</i>   |

## Practical Use

---

1. Write out the triads above C, A, B-flat, and A-flat. Put the chord name underneath (don't forget Major/minor distinctions). Place the seventh in each of the chords and alter the chord symbol as necessary to make it correct. Place the ninth in each chord and again correct the chord symbol.
2. Sing or play (both is best) a Major triad. Any starting note will do but try to make it in a comfortable range. As you are singing one note of the chord, try to hear the others simultaneously. Once the Major triad is in your ear, add the seventh until you can sing or play a seventh easily. Do the same with the ninth chord.
3. Spend some time messing around with triads and extensions on the piano. It's fun and will help your understanding.

CHAPTER  
30

**CHORD INVERSIONS**

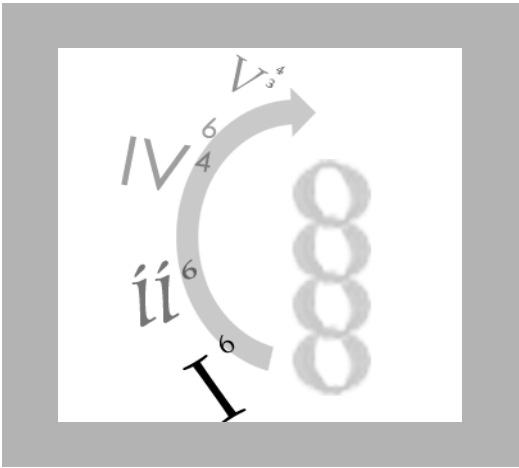

*See deep enough, and you see musically;  
the heart of nature being everywhere  
music, if you can only reach it.*

— Thomas Carlyle, *Heroes and  
Hero Worship*

**In This Chapter**

- More General Chord Information
- Close and Open Harmony
- First Inversion
- Second Inversion
- Third Inversion

## More General Chord Info

---

We've been working with chords which have been in what is called **root position**, which is the most basic form of a chord. In root position the notes are stacked neatly together as close as they can be.

There is a broader definition of root position. ***If the lowest note of a chord is also the letter name of the chord, then that chord can be said to be in root position.***

For instance, with a C chord, as long as the C is the lowest note, it doesn't matter where the 3rds and 5ths are above that C; the chord will still be in root position.

**Example 30.1** Three versions of a C chord in root position.

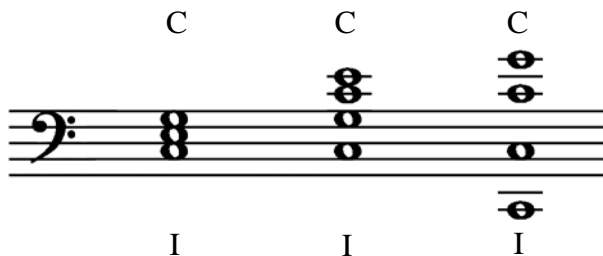

In the chords above, you'll find a C in the root, and above that root somewhere an E and a G. There could be three Es and seven Gs but as long as that C stays in the root position, it's a root position C chord. *Any doubling of chord tones doesn't affect the quality of the chord.*

### Voice

***Any note of a chord can be said to be a voice of the chord.*** For example, in a triad there are three voices: the bottom voice, the middle voice and the top voice. The term *voice* is used even for music in which there is no vocal part.

### Open and Close Harmony

What is different about the chords above is how they are spaced. When a chord's tones are written as closely together as possible, as in the first

example above, that chord is said to be in *close harmony*, or *close position*, and this is usually within an octave.

When a chord is spread out over more than an octave, or if there is a gap between chord tones where another could be but isn't, as in the second and third examples above, that chord is said to be in *open harmony*, or *open position*.

## First Inversion

---

*A first inversion chord has the third of the chord as its bottom note.* To make a first inversion chord, take the tonic of a root position chord and move it above the fifth. This will leave the third of the chord in the bottom voice.

You'll often see chord letters marked in music, especially music with lyrics. The letter name won't tell you anything about inversions or the Roman numeral for that chord; you have to figure these out for yourself. This is called *harmonic analysis*. Inversions and Roman numerals are shown in harmonic analysis, which you'll see under the chords in the examples below.

To mark the first inversion in harmonic analysis, a 6 is written above and to the right of the Roman numeral. This is because the interval from the bottom note (3rd of the chord, remember) to the tonic is now a 6th. If you don't believe me, count it out in the examples below.

**Example 30.2** First inversion chords in the key of C in close and open harmony.

The image shows three first inversion C major chords on a treble clef staff. The first chord is in close harmony with notes G4, E4, and C4. The second is in open harmony with notes G4, E4, and C3. The third is in very open harmony with notes G4, E4, and C2. Each chord is labeled with 'C' above and 'I<sup>6</sup>' below. An arrow points to the interval between the bottom note (G4) and the tonic (C4) in the first chord, labeled '6th'.

## Second Inversion

---

*A second inversion chord has the fifth of the chord as the bottom note.* To make a second inversion chord from a first inversion chord, simply move the third up an octave. This leaves the fifth in the bottom voice.

In harmonic analysis, this inversion is shown by a 6 over a 4 next to the Roman numeral. Again, these numbers represent the intervals above the bottom note. In the second inversion C chord, it's a 6th from G to E, and a 4th from G to C.

Because the 6 and 4 are only used in a harmonic analysis, when you see a chord, you have to figure for yourself which inversion it's in. Not to fear; at the end of the chapter is a step-by-step process to find out what any type of chord is.

**Example 30.3** Second inversion chords in the key of C in close and open harmony.

The image shows three C major chords in second inversion on a treble clef staff. The first chord is in close harmony with notes G4, E4, and C5. The second is in open harmony with notes G4, C5, and E5. The third is in open harmony with notes G4, C5, and E5, with the E5 note on a ledger line above the staff. Roman numerals 'C' are placed above each chord, and 'I 6/4' are placed below. Arrows indicate the 6th interval between G and E, and the 4th interval between G and C.

To keep things simple, I've only used the I chord, but these inversions can be applied to any chord, the IV, the ii, the vi<sup>0</sup>, anything.

If chords are stacked in close harmony, it's pretty easy to tell at a glance whether it's a root position triad (three notes stacked one atop the other), a first inversion (two stacked on the bottom), or a second inversion (two stacked on the top).

Keep in mind that I've used simple chords in only one clef, and chords are often spread out over two clefs, but the same rules apply.

# Inverting Seventh Chords

---

Seventh chords may also be inverted, and the symbols used for this in harmonic analysis are a little different but the concept is the same; the numbers tell you chord tone intervals above the bottom note.

With the extra note of the seventh chord, we get another inversion, called a third inversion.

**Example 30.4** The dominant seventh chord in the key of C; root position and inversions.

The image shows a treble clef staff with four chords. Above each chord is the label G<sup>7</sup>. Below each chord is a Roman numeral with a superscript: V<sup>7</sup>, V<sup>6</sup>/<sub>5</sub>, V<sup>4</sup>/<sub>3</sub>, and V<sup>4</sup>/<sub>2</sub>. The chords are: 1. Root position (G-B-D-F), 2. First inversion (B-D-F-G), 3. Second inversion (D-F-G-B), and 4. Third inversion (F-G-B-D).

## How to Find a Chord's Name

---

- 1 Know the key signature you are working in.
- 2 Spell the chord using the letters in the chord. Ignore duplicate letters.
- 3 Stack the chord in close harmony, with the **same root as the original chord**. This is important because if you don't use the same root note you won't know if the chord is an inversion or not.
- 4 Determine what the tonic of the chord is. This will tell you the chord's letter name and Roman numeral in relation to the key you are in.
- 5 Determine if the chord is a first, second, or third (for 7th chords only) inversion.
- 6 Use the correct letters, Roman numerals and symbols to name the chord.

## Moving On

---

Now that you can identify a chord and its inversion, you're ready for information about chord progressions, or how one chord moves to another chord.

The next chapter covers some of the most common chord progressions.

# Chapter 30 Review

---

1. What is a root position chord?
  1. A chord with the tonic of the chord as the lowest voice of the chord.
2. What is close harmony?
  2. When the notes of a chord are placed as close together as possible.
3. What is open harmony?
  3. A chord spread over more than an octave with space between chord tones.
4. What is harmonic analysis?
  4. A technique of identifying chord names and types, using Roman numerals and the symbols for chord inversions.
5. What is a first inversion chord?
  5. A chord with the 3rd of the chord as the lowest voice.
6. What is the symbol for a first inversion chord?
  6. A small <sup>6</sup> to the right of the letter or Roman numeral.
7. Why is this symbol used?
  7. It tells the interval between the third and the tonic, a 6th.
8. What is a second inversion chord?
  8. A chord with the 5th of the chord as the lowest voice.



9. What is the symbol for a second inversion chord?

9.  $\overset{6}{4}$  above and to the right of the letter or Roman numeral

10. Why is this symbol used?

10. It tells the interval between the fifth and tonic (a 4th), and between the fifth and third (a 6th).

11. What is the name and Roman numeral for this chord in the key of C?



11. F, IV<sup>6</sup>

12. What is the name and Roman numeral for this chord in the key of B flat?



12. Dmin, iii<sup>6</sup><sub>4</sub>

13. What is the name and Roman numeral for this chord in the key of G?



13. G, I

# Practical Use

---

1. Write out all the inversions for  $Bb^{M7}$ . Don't forget root position. Sing/play each inverted chord until it feels comfortable.
2. Identify at least 3 chords. Piano music, guitar music, and band or orchestra scores are excellent sources for many chords. Once you identify the chord name and quality of the chord, identify how that chord fits into the key signature of the song. Give the chord its Roman Numeral.
3. Mess around on the piano with inverted triads, and inverted chords with extensions.

# CHORD PROGRESSIONS

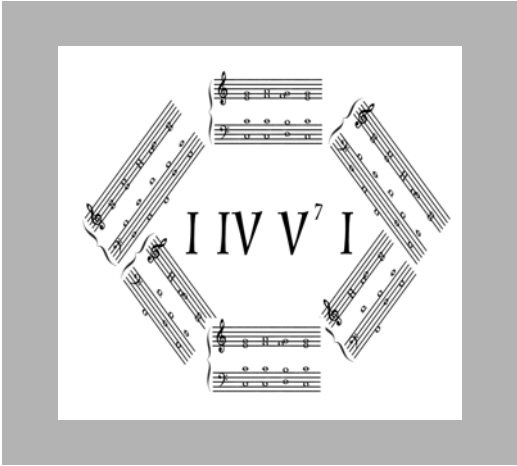

*Do you know that our soul is composed  
of harmony?*

— Leonardo da Vinci

## In This Chapter

- What is a Chord Progression?
- General Chord Progression Guidelines
- The I IV V<sup>7</sup> I Progression
- The ii V<sup>7</sup> I Progression
- The iii vi ii V<sup>7</sup> I Progression
- The 12 Bar Blues Progression

# What is a Chord Progression?

---

***A chord progression is a pattern of movement from one chord to another.***

Any piece of music has a chord progression. And even if it's a melody without chords at all, there is still a chord progression implied by that melody.

Chord progressions are often very simple, involving only a few chords, but they can also be quite complex. The chord progressions we'll be going over will be of the simple variety.

Chord progressions, especially the ones we'll be looking at, are repeated often many times throughout a piece of music. All of the progressions we'll be going over, with the exception of the 12 Bar Blues, can be found most often at the end of sections or songs.

## Chord Progression General Guidelines

---

### Voice Leading

Remember all those pesky details about chord inversions you learned in Chapter 30? Well, now you get to put that information to work, because inversions can make chord progressions sound more smooth.

***Voice leading is how one chord tone (or voice) moves to another.*** There are certain general rules which, if you follow them, will give you a clean, clear chord progression. These aren't laws, but general guidelines. Feel free to experiment with them.

### Doubling

***Chord tones may be doubled*** without affecting the general quality of the chord. Voices which are usually doubled are tonics and fifths. Thirds are doubled less often, and extensions are rarely doubled. For our examples, I'll keep doubling to a minimum.

## No Leaps

One of the first general rules is to *avoid large interval skips from one chord tone to the next*. This is called *disjunct motion*.

The bass, or lowest part, can pretty much ignore this rule without harming the sound of the chord progression.

For the purpose of a clear example, we'll ignore this rule for the introduction of each chord progression.

## Keep the Common Tone

There will often be notes which two chords have in common. If at all possible, you'll want to *keep these similar notes in the same voice from one chord to the next*.

For example, from a C chord (C-E-G) to an F chord (F-A-C), there is a C which the chords have in common. If this C is in the top voice of the first chord, it should also be in the top voice of the second chord. This makes the chord change sound smooth, and is also much easier to sing or play.

## Resolve Toward the Half Step

An essential component of chord progressions is the movement of half steps between chords. These are called leading tones and lead our ear from one note to another. You'll see these most—and they're most important—from the V<sup>7</sup> to the I chord.

*If there is a half step from one chord to the next, move the appropriate voice toward the half step.*

For example, in the key of C, the V<sup>7</sup> chord (G-B-D-F) moves to the I chord (C-E-G). The third and seventh (B and F) in the V<sup>7</sup> chord should move to the tonic and third (C and E) in the I chord, because they are a half step apart.

## Similar Motion

*Similar motion is when two or more parts move in the same direction.*

## Parallel Motion

Parallel motion is a special type of similar motion in which *the interval between the two parts remains the same from one chord to another*. An example of parallel motion would be a Major third between the upper two voices in one chord moving down (or up) to a Major third in the top two voices of the following chord.

Most parallel motion sounds fine, but parallel fifths, fourths, and octaves are usually frowned upon by our ears and by those who adhere to the strict rules of counterpoint. Experiment with them to hear for yourself what they sound like.

## Contrary Motion

*Contrary motion is when two or more voices move in opposite directions.*

## A Word on the Examples

Again, to keep things simple and uncluttered, we'll use the key of C for all our examples, but these progressions can (and do!) happen in any key.

The first examples you'll see will be simple chords in root position in the treble clef. Once you've been exposed to the basic chord progression I'll then subject you to a more complex version with both treble and bass clef, and chords in inverted positions.

Now you know all you need to know, for the moment anyway, about chord progressions, so let's get to some actual examples.

## The I IV V<sup>7</sup> I Progression

---

This progression is probably the most common of all progressions in Western music. When you hear it, you'll most likely recognize it. It can be found in nearly every style of music, and though it will appear in other parts of a piece, it's most common at the end of a song or section.

Even if you don't consider yourself a piano player, sit down at one and play through these progressions. It might take some effort (and perhaps a review of the bass or treble clef), but it'll be worth it.

**Example 31.1** The I IV V<sup>7</sup> I progression in C with chords in root positions.

The image shows a single treble clef staff with four chords in root positions: C, F, G<sup>7</sup>, and C. Above each chord is its name, and below each chord is its Roman numeral: I, IV, V<sup>7</sup>, and I. The notes are: C (C4, E4, G4), F (C4, E4, F4), G<sup>7</sup> (B3, D4, F4, G4), and C (C4, E4, G4).

The above example follows few rules of voice leading, but is simple and clear so you can see what the basic chord progression looks like. In the following example, you'll see bass and treble clef staves connected with a bracket. This is called the *grand staff* and is what piano music looks like.

The example which follows has the same notes as example 31.1, though often in different octaves, or in a different clef, and some chord tones are doubled.

**Example 31.2** I IV V<sup>7</sup> I in the key of C.

The image shows a grand staff (treble and bass clefs) with four chords: C, F, G<sup>7</sup>, and C. The bass clef has two staves, and the treble clef has one. The chords are: C (C4, E4, G4), F (C4, E4, F4), G<sup>7</sup> (B3, D4, F4, G4), and C (C4, E4, G4). Annotations include: 'common tones' pointing to the C and F notes between the first two chords; 'voice doubling' pointing to the two bass clef staves; and 'half step motion' pointing to the F4 note moving down to E4 and the B3 note moving up to C4.

Notice that the IV chord is in the second inversion so that the common tone—the C—remains in the bottom voice; the F remains in the same voice from the IV to the V<sup>7</sup>. The V<sup>7</sup> chord is also in the second inversion so that the bottom voice only moves a whole step from chord to chord.

And from the V<sup>7</sup> to the I, the leading tones resolve toward the half step. The F goes down to the E, and the B in the bass clef goes up to the C.

See if you can pick out some of the parallel motion, and some of the contrary motion. It's in there.

This progression is in relatively close harmony, and is only one of many, many, many possibilities.

# The ii V<sup>7</sup> I Progression

This is another very common chord progression, used in everything from pop songs, to country to jazz and beyond.

**Example 31.3** The ii V<sup>7</sup> I progression in the key of C, root position, treble clef.

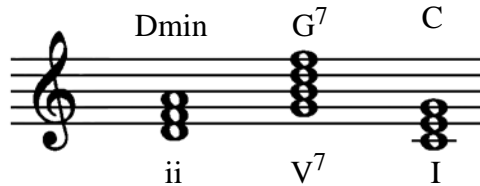

Musical notation for Example 31.3 showing the ii V<sup>7</sup> I progression in the key of C, root position, treble clef. The chords are Dmin (ii), G<sup>7</sup> (V<sup>7</sup>), and C (I).

And now for the same progression, but following more of the guidelines for voice leading.

This time, see if you can spot the voice doublings, the common chord tones, and the half step motion.

As I began to write out the example below, a tune came on my stereo and it caught my ear because it used the ii V I progression over and over for several measures, and it sounded good, so I swiped it and put it below.

**Example 31.4** ii V<sup>7</sup> I in the key of C.

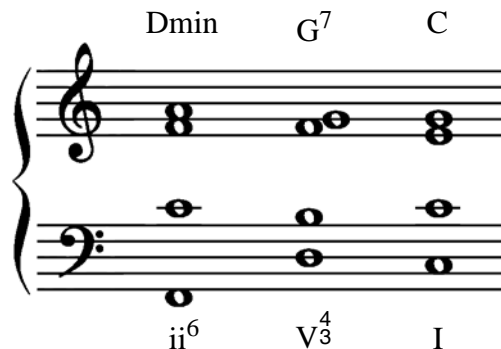

Musical notation for Example 31.4 showing the ii V<sup>7</sup> I progression in the key of C, with voice leading. The chords are Dmin (ii<sup>6</sup>), G<sup>7</sup> (V<sup>3</sup>), and C (I).

Play this one on the piano too, and try it in other keys as well as with other voicings and other inversions. Once you get the sound in your head, you'll recognize this progression all over the place.



## The iii vi ii V<sup>7</sup> I Progression

---

This is another very common chord progression which is simply a variation on the ii V<sup>7</sup> I progression. The difference of course is the added iii and vi chords before the ii V<sup>7</sup> I.

Because I'm sure you get how this works, this time I'm going to skip the basic chords in root position and go right to the good stuff.

See if you can pick out the chord tones of the iii and vi chords, and all the other stuff: voice doubling, parallel and contrary motion, half step motion, and common chord tones.

**Example 31.5** iii vi ii V<sup>7</sup> I progression in C.

The musical notation shows a progression of five chords in C major: Emin, Amin, Dmin, G<sup>7</sup>, and C. The chords are written in a grand staff with a treble clef and a bass clef. The bass clef part shows a significant stretch in the ii chord (Dmin), with the bass note on the second line (F) and the root note on the second space (D). Below the staff, the chords are labeled as iii<sup>6</sup>, vi, ii<sup>6</sup>, V<sup>4</sup>, and I.

Always be aware of what instrument(s) you're writing for. The bass clef part in the example above has quite a stretch in the ii chord, something only a big-handed piano player would be capable of.

## The 12 Bar Blues

---

Remember the blues scale? If not, take a look back at “The Blues Scale” on page 222. It's the scale that is associated with the 12 bar blues form.

There have been volumes and volumes written on the blues, and if you're looking for in-depth coverage, this ain't the place. This section will give you the vanilla version of the 12 bar blues.

Some artists, dead and living, who play and/or sing the blues are: Buddy Guy, Muddy Waters, Robert Johnson, Stevie Ray Vaughn, B.B. King,

John Lee Hooker... The list is nearly endless and these are just a few of the big names of the blues. Many many other artists also dabble in the blues forms, from Eric Clapton to James Taylor.

The 12 bar blues is basically a 12 measure chord progression repeated over and over for the entire song. There are variations, but 12 bars is so standard that it's safe to say 95% of blues songs follow this format.

Each Roman numeral represents one measure, and if you count them, there are 12. Try playing these chords in this order, and you'll most likely recognize the sound.

**Example 31.6** The basic pattern of the 12 bar blues.

|                 |  |                 |  |                |  |                |
|-----------------|--|-----------------|--|----------------|--|----------------|
| I <sup>7</sup>  |  | I <sup>7</sup>  |  | I <sup>7</sup> |  | I <sup>7</sup> |
| IV <sup>7</sup> |  | IV <sup>7</sup> |  | I <sup>7</sup> |  | I <sup>7</sup> |
| V <sup>7</sup>  |  | IV <sup>7</sup> |  | I <sup>7</sup> |  | I <sup>7</sup> |

To find the right chord, simply put the chord letter in place of the Roman numeral. In the below example, if we did it in the key of C, the chords would be I<sup>7</sup> = C<sup>7</sup>, IV<sup>7</sup> = F<sup>7</sup>, V<sup>7</sup> = G<sup>7</sup>.

## Moving On

---

So there you have it: four of the most common chord progressions in one easy chapter. Be sure to try all of these chord changes in as many keys as you can stomach, in as many different ways as you can think of. You'll be a much better musician for it if you do.

Coming up next, after the review for this chapter, is the review for all of Part VI.

The next Part (and the last one!) covers more information on subjects you already know, like dots after a note, faster types of notes, more accidentals, and some different meters.

# Chapter 31 Review

---

1. What is a chord progression?
  1. *The movement from one chord to another*
2. What is the rule about doubling chord tones?
  2. *Doubling the octave and fifth is common; doubling the 3rd less so; and doubling the extensions is rare*
3. What is disjunct motion?
  3. *A leap of more than a second*
4. What is the rule about disjunct motion?
  4. *Keep it to a minimum. Okay in the bass voice*
5. What is the rule about common tones from one chord to another?
  5. *Keep the common tones in the same voice*
6. What is contrary motion?
  6. *One voice goes up, the other goes down, or vice-versa*
7. What is parallel motion?
  7. *Both voices moving in the same direction with the same interval*
8. Which types of parallel motion should be avoided?
  8. *Parallel fourths, fifths and octaves*
9. Which chords are used for the I IV V<sup>7</sup> I progression in the key of Bb?
  9. *Bb Eb, F<sup>7</sup>, Bb*
10. Where would you be likely to find this progression?
  10. *At the end of a section or song*

11. Which chords are used for the ii V<sup>7</sup> I progression in the key of G? 11. Amin, D<sup>7</sup>, G
12. Which chords are used for the iii vi ii V<sup>7</sup> I progression the key of F? 12. Amin, Dmin, Gmin C<sup>7</sup>, F
13. What is the basic progression for the 12 Bar Blues? 13. I I I I  
IV IV I I  
V<sup>7</sup> IV I I
14. Did you sit down at the piano and try to play these chords? 14. Please say yes.

## Practical Use

---

1. In the key of F Major, write out an arrangement for piano, guitar, multiple voices, or instruments using the I, IV, V<sup>7</sup>, I chord progression. Play or sing the progression as a group until it feels comfortable. Use the correct accidentals to change the progression to i, iv, V<sup>7</sup>, i. Play the minor progression until it feels comfortable. Switch chord voicings.
2. Write out a chord progression in the key of C Major and try to break every rule of motion talked about in this Chapter. Play the example (if it's playable), and listen carefully to it. Why are certain changes of sound frowned upon?
3. Pick your favorite key signature. Outline the I chord by either playing or singing each chord tone. Try to hear the whole chord in your head as you do this. Do the same for the IV chord, and then the V<sup>7</sup>. Try to do this exercise with two or more people at once. Be sure to specify a meter/beat and the length of each chord so you can change chords together.



# PART VI REVIEW

## Whew! You Made It.

---

These pages can be used to test your memory about what you've learned in Part VI, and if some of the information hasn't stuck, you can go back and check it out on the page indicated below the question.

As with the chapter reviews, use your keyboard to cover up the answers while you test yourself.

## The Review

---

1. What is the definition of a chord?

page 246

1. *Three or more notes played simultaneously*

2. What determines the quality of a chord?

page 246

2. *The intervals within the chord*

3. How are chords named?

page 246

4. What are the parts of a triad?

page 247

5. Why are they called this?

page 247

6. How do you show a triad is Major?

page 248

7. How do you show a triad is minor?

page 249

8. What are the intervals in a Major triad?

page 248

9. What are the intervals in a minor triad?

page 249

3. *With a Roman numeral, a letter, and a quality of Major, minor, diminished or augmented*

4. *Root, third, fifth*

5. *Root is the bottom note of the chord; the third is a 3rd above the root; the fifth is a 5th above the root*

6. *Capital Roman numeral, or a capital letter only*

7. *Lower case Roman numeral, lowercase letter, or the abbreviation "min" next to the letter name*

8. *A note a Major 3rd above the root and another a Perfect 5th above the root*

9. *A note a minor 3rd above the root, and another a Perfect 5th above the root*

10. What are the intervals in a diminished triad?

page 249

*10. A note a minor 3rd above the root and another a diminished 5th above the root*

11. What are the intervals in an augmented triad?

page 250

*11. A note a Major 3rd above the root and another an augmented 5th above the root*

12. What are the qualities of the different types of triads?

page 248, page 249, page 249, page 250

*12. Major = happy;  
minor = sad;  
dim = suspenseful  
aug = unsettling*

13. What is a root position chord?

page 260

*13. A chord with the tonic of the chord as the lowest voice of the chord*

14. What is close harmony?

page 260

*14. When the notes of a chord are placed as close together as possible*

15. What is open harmony?

page 260

*15. A chord spread over more than an octave with space between chord tones*

16. What is a first inversion chord?

page 261

17. What is the symbol for a first inversion chord?

page 261

18. Why is this symbol used?

page 261

19. What is a second inversion chord?

page 262

20. What is the symbol for a second inversion chord?

page 262

21. Why is this symbol used?

page 262

22. What is the name and Roman numeral for this chord in the key of C Major?



page 263

16. A chord with the 3rd of the chord as the lowest voice

17. A small <sup>6</sup> to the right of the letter or Roman numeral

18. It tells the interval between the third and the tonic, a 6th

19. A chord with the 5th of the chord as the lowest note

20. <sup>6</sup>/<sub>4</sub> above and to the right of the letter or Roman numeral

21. It tells the interval between the fifth and tonic (a 4th), and between the fifth and third (a 6th)

22. F, IV<sup>6</sup>



23. What is the name and Roman numeral for this chord in the key of B flat Major?



page 263

23. *Dmin, iii<sup>6</sup><sub>4</sub>*

24. What is the name of this chord?



page 263

24. *G, I*

25. What is a chord progression?

page 268

25. *The movement from one chord to another*

26. What is the rule about doubling chord tones?

page 268

26. *Doubling the octave and fifth is common; doubling the 3rd less so; and doubling the extensions is rare*

27. What is disjunct motion?

page 269

27. *A leap of more than a second*

28. What is the rule about disjunct motion?

page 269

28. *Keep it to a minimum. Okay in the bass voice*

29. What is the rule about common tones from one chord to another?  
page 269
29. *Keep the common tones in the same voice*
30. What is contrary motion?  
page 270
30. *One voice goes up, the other goes down, or vice-versa*
31. What is similar motion?  
page 269
31. *Two or more voices moving in the same direction*
32. What is parallel motion?  
page 269
32. *Both voices moving in the same direction with the same interval between them*
33. Which types of parallel motion should be avoided?  
page 270
33. *Parallel fourths, fifths and octaves*
34. What are the chord names for the I IV V<sup>7</sup> I progression in Bb?  
page 270
34. *Bb Eb, F<sup>7</sup>, Bb*
35. Where would you be likely to find this progression?  
page 270
35. *At the end of a section or song*
36. What are the chord names for the ii V<sup>7</sup> I progression in G?  
page 272
36. *Amin, D<sup>7</sup>, G*

37. What are the chord names for the iii vi ii V<sup>7</sup> I progression in F?  
page 273

37. *Amin, Dmin,  
Gmin C<sup>7</sup>, F*

38. What is the basic progression for the 12 Bar Blues?  
page 273

38. *I I I I  
IV IV II  
V<sup>7</sup> IV II*



# PART SEVEN

## More of the Same

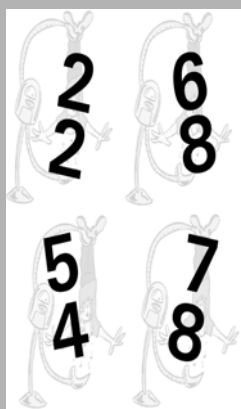
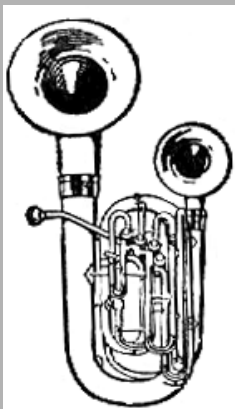

### In This Section You Will Learn:

- Thirty-second and Sixty-fourth Notes
- Double-dotted Notes
- Double Flats, Double Sharps
- 6/8 Time
- 2/2 Time
- Odd Meters

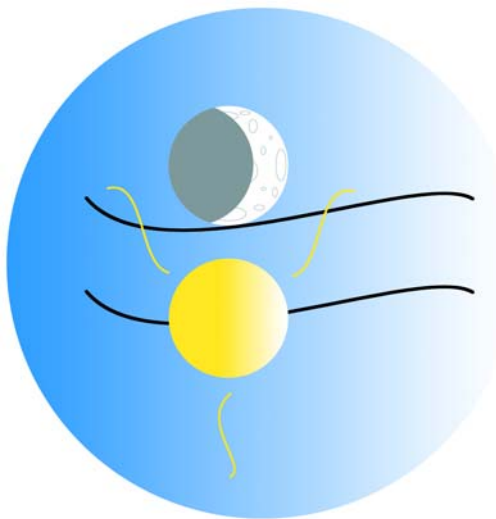

**SolUt Press**

[www.Sol-Ut.com](http://www.Sol-Ut.com)

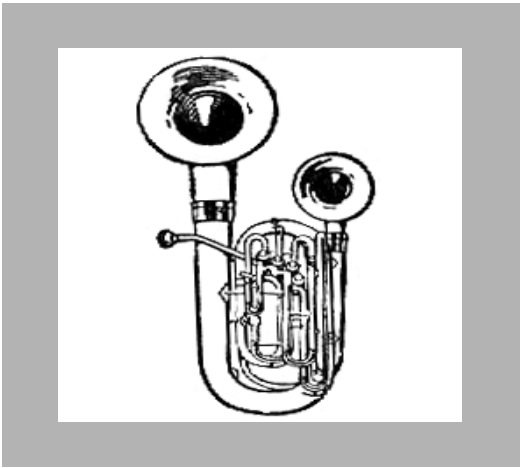

CHAPTER  
32

**FASTER NOTES AND  
DOUBLE DOTS**

*You are the music while the music lasts.*

— T. S. Eliot

**In This Chapter**

- Thirty-second Notes
- Sixty-fourth Notes
- Double Dots

# Shorter Notes

---

There are shorter notes than sixteenths.

*Each time a beam or flag is added to a note, it's value is cut in half.*

Remember when we added a flag to a quarter note? It became an eighth note. Remember when we added another flag to the eighth? It became a sixteenth. As with the other notes, when there is more than one of them, the flags are connected and become a beam.

## Thirty-second Notes

And so, we're going to add a flag to the sixteenth and cut its value in half, making it a thirty-second note. Just like the name implies, there are thirty two of them in a whole note; sixteen of them in a half note; eight of them in a quarter note or a beat (in 4/4 time); four of them in an eighth note; two of them in a sixteenth note.

Thirty-second notes are fairly rare, but you'll probably run into them now and then, often as grace notes (quick notes just before the main note).

**Example 32.1** Two single 32nd notes with flags, and a beat of barred 32nd notes with stems up and down.



## Sixty-fourth Notes

These are even more rare, and it's likely that you'll never see them, but I thought I'd throw them down on the page for your enjoyment.

Same deal with the flag/beam. Add another beam to the 32nd note and it cuts the length in half. So, for sixty-fourth notes there are: 64 in a whole note, 32 in a half note, 16 in a quarter note or one beat (in 4/4 time), 8 in an eighth note, 4 in a sixteenth note, and two in a thirty-second note.



**Example 32.2** Two single 64th notes, and 1/2 beat of barred 64ths with stems up and stems down.



## Double Dotted Notes

---

You already know that a dot lengthens the note it follows by half the amount of the original note.

Another dot after that first dot also lengthens the note, but by half the amount of the first dot.

An easier way to say this is that *a double dot increases the length of a note or rest by 3/4 of its original value.*

So a double-dotted whole note or rest is 7 beats. A double-dotted half note or rest is  $3 \frac{1}{2}$  beats, a double-dotted quarter note or rest is  $1 \frac{3}{4}$  beats, and a double-dotted eighth note or rest is  $\frac{7}{8}$  of a beat.

We could continue the process, but it's pretty safe to say you'll probably never see a double-dotted sixteenth, thirty-second, or sixty-fourth note.

Because and it sounds right and is easier to read and play, a double-dotted note will usually be paired with whatever note finishes out the beat or measure. Take a look at the examples below and you'll see what I mean.

**Example 32.3** Double-dotted whole, half, quarter, and eighth notes.



## Moving On

---

Okay, only a few more chapters to go in the book! Use the review to make sure you've understood the details of faster notes and double dots.

Coming up is a very short chapter on double sharps and double flats.

# Chapter 32 Review

---

1. How do you cut the length of a note in half? *1. Add a flag or beam*
2. What note is half the length of a sixteenth note? *2. 32nd note*
3. What note is one fourth the length of a sixteenth note? *3. 64th note*
4. How many 32nd notes in one beat of 4/4 time? *4. 8*
5. What does a double dot do to a note? *5. Increases its length by 3/4 of the note's original value*
6. How long is a double-dotted quarter rest? *6. 1 3/4 beat*
7. Which note is usually paired with a double-dotted quarter note? Why? *7. 16th note. It finishes out the beat. Sounds better and is easier to read and play.*

## Practical Use

---

1. Write out 4 measures of 8/4 time. Use at least two double-dotted notes per measure, but see if you can use them all. Play and sing what you've written.
2. Write out another 4 measures of 8/4 time. This 4 measures is meant to be a harmony part to what you composed in exercise 1, so don't choose the same notes, though you may use the same rhythms (hint: 3rds, 4ths, 9ths and 5ths sound good). Find a friend and sing or play both parts together.

CHAPTER  
33

**DOUBLE FLATS,  
DOUBLE SHARPS**



*If I were to begin life again, I would  
devote it to music. It is the only cheap  
and unpunished rapture upon earth.*

— Sydney Smith, 1814

**In This Chapter**

- Double Flats
- Double Sharps
- A Werd on Speling Kords

# Double Your Fun

---

Welcome to the shortest chapter of the book. You're about to learn double sharps and double flats, but before you do, I'd like to tell you why.

There are several ways to say the sound to, two, too. Even though each sounds exactly the same, they have different meanings. Just as you wouldn't write, "I went two the store," so you wouldn't spell a Dbdim chord with a G. I'll show you this in detail in just a moment. First the details about how to write double flats and sharps.

## Double Flats

---

*A double flat lowers a note by one whole step.* It looks like this  $\flat\flat$ .

You won't see them very often, but now and then double flats are necessary in order to spell a chord or an interval correctly, and it will often be a minor or diminished interval in a flat key. An example follows.

Double flats are easy. Just put two flats close together before the note they are to alter.

**Example 33.1** B double-flat, E double-flat, and A double-flat.

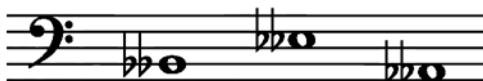

## Double Sharps

---

A double sharp raises a note by one whole step. It looks like this  $\sharp\sharp$ .

You'll see a double sharp about as often as you'll see a double flat. These will usually pop up when augmented intervals are needed in a sharp key.

**Example 33.2** G double-sharp, C double-sharp, and F double sharp.



You'll be glad to hear there are no such things as double naturals, triple sharps or triple flats.

## A Word on Spelling Kords

---

Here's why such pesky things as double sharps and flats exist.

Stay with me here. The Db Major triad is spelled Db, F, Ab, right? Well, for a diminished chord, the third and fifth of the chord have to be lowered a half step. A half step down from F is E, and a half step down from Ab is G, right? But even though those pitches would *sound* correct, you can't write them that way and still have a Db diminished triad. Take a look below. On the left is the Db Major triad. In the middle is a chord that will sound exactly like the Db diminished triad, but the way it's written, the chord is actually an inverted e minor<sup>dim7</sup>. The correct spelling of Db dim. is on the right.

**Example 33.3**



Even though it makes things a little crowded, for the Db dim chord to be spelled correctly, we have to use an Fb, and a double-flatted A.

I know it's weird, but I didn't make up the rules. Don't kill the messenger.

# Moving On

---

Double sharps and double flats are pesky things that you probably will see if you continue long enough with music, so even though you won't use them often, it's good to know what they are, and now you do.

Only one lesson left! It's on meters we haven't covered yet which include 6/8 time, cut time, and some odd meters, like 7/4.

## Chapter 33 Review

---

- |   |   |
|---|---|
| 1. Why are double flats and double sharps used? | 1. <i>To spell certain chords and intervals correctly</i> |
| 2. What does a double flat do to a note?        | 2. <i>Lowers it one whole step</i>                        |
| 3. What does a double flat look like?           | 3. <i>Two flats close together in front of a note</i>     |
| 4. What does a double sharp do to a note?       | 4. <i>Raises it one whole step</i>                        |
| 5. What does a double sharp look like?          | 5. <i>An X</i>  |
| 6. What does a triple flat look like?           | 6. <i>No such thing</i>                                   |

## Practical Use

---

1. Write out the following key signatures with their Major scale: Eb, Ab, B, and E. One line below these scales, write the following intervals: a diminished fifth above Eb, a diminished fourth above Ab, an augmented fifth above B, and an augmented sixth above E.

CHAPTER  
34

**MORE METERS**

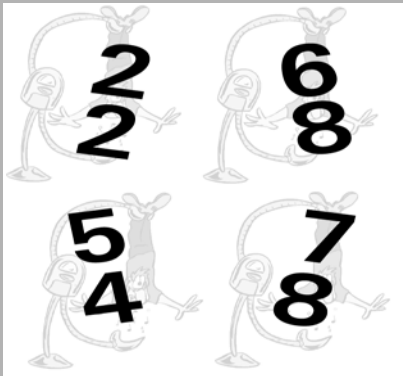

*After playing violin for the cellist Gregor Piatagorsky, Einstein asked, “Did I play well?”*

*Piatagorsky replied, “You played relatively well.”*

**In This Chapter**

- Cut Time
- Slow 6/8 Time
- Fast 6/8 Time
- Odd Meters

## Beyond 4/4 Time

---

The majority of music has the quarter note as its pulse and is in a duple meter (the top number is divisible by 2), but there is a whole lot of great music out there that has a different pulse, and even some with an odd meter.

Remember way back in Chapter 13 when we went over meters for the first time? The top number tells you how many beats in a measure and the bottom number tells you which note gets one beat. For a refresher, see Chapter 13 “Meter” on page 101.

## Cut Time, or 2/2 Time

---

This is a very common meter. It’s typically shown with the symbol “ $\text{C}$ ,” but may also be written 2/2. The top number tells you there are two beats in each measure, and the bottom number tells you that the half note gets one beat.

Essentially, all note lengths in cut time are cut in half. Half notes act like quarters; quarters act like eighths, etc. Because of this, the counting is a little different, but the foot tap is the same. In the example below your foot hits the floor on the numbers.

**Example 34.1** A few measures of cut time with the counting.



The image shows a musical staff in cut time (C) with four measures. The notes and their corresponding counts are as follows:

| Measure | Notes                              | Count       |
|---------|------------------------------------|-------------|
| 1       | Quarter, Quarter, Quarter, Quarter | 1 + 2 + a   |
| 2       | Half, Quarter, Quarter, Quarter    | 1 2 e + a   |
| 3       | Quarter, Quarter, Quarter, Quarter | (1) + (2) + |
| 4       | Half, Half                         | 1-2         |

## 6/8 Time

---

Six-Eight time is fairly common and one of the more confusing basic time signatures, but I’ll break it down for you so it’s easy to understand.



First of all, from the top number, you know that there will be six beats per measure. And the bottom number tells you that the eighth note gets one beat.

It's the eighth note getting the beat which is confusing. This throws everything out of whack from what you're used to. Eighth notes get one beat, quarter notes get two beats, dotted quarters get three, half notes get four, and dotted halves get six. No whole notes in this time signature; they're too long.

As with other meters, the strong beats are the numbers. Tap your foot with the numbers as you count out the following example at a fairly slow tempo. Sing it. Play it.

**Example 34.2** A few measures of slow 6/8 time with counting.

The image shows a musical staff in treble clef with a 6/8 time signature. The staff contains six measures of music. Below the staff, the following counts are written: 1 2 3 4 5 6, 1-2 3 4-5-6, (1-2-3) 4 (5) 6, and 1-2-3-4-5-6. The music consists of eighth notes, quarter notes, and dotted quarter notes.

## Simple 6/8 versus Compound 6/8

If that's all there was to 6/8 time, it would be much easier to understand, but there's more. The example above is in simple 6/8 time, also called slow 6/8 time. What you see in simple 6/8 is what you get, the 8th note gets one beat and there are six beats per measure.

Compound 6/8, or fast 6/8, is counted differently and has a different feel. ***In compound 6/8, the pulse is the dotted quarter note.*** To get this feel, try the following: say the numbers 1-6 quickly, but give emphasis to the numbers 1 and 4. Like this: **1 2 3 4 5 6, 1 2 3 4 5 6**, etc.

***So in fast or compound 6/8 time, there are only two pulses per measure***, each beat subdivided into three. This is counted with the following syllables: **1 an da 2 an da, 1 an da 2 an da**, etc. Your foot hits the floor on the numbers. Dotted quarter notes get one beat each.

Let's use our same example, but this time it will go much more quickly, and will also be counted differently.

Compound 6/8 has a triplet feel. Your foot taps down with the numbers, and remember that the pulse is now a dotted quarter note. Try counting it out loud, first at a comfortable tempo, then speed it up. Sing it. Play it.

**Example 34.3** An example in fast 6/8 time with counting.



1 an da 2 an da 1-an da 2-an-da (1-an-da) 2 (an) da 1-an-da-2-an-da

## Odd Meters

---

Occasionally you'll hear or see music in an odd meter. When you listen to it, the clue is that it's difficult to find the pulse, and when you do find the pulse, it changes. Odd meter pieces can be difficult to tap your foot with unless you know the meter.

An odd meter has an odd number greater than 3 as the top number of the time signature. Some examples might be 5/4, 7/4, 5/8, or 7/8. These are the most common odd meters, but that shouldn't stop you budding composers from trying a piece in 11/8 or 13/4.

The counting for odd meters is the same as more familiar meters, but with a different number of beats per measure.

Most odd meters are grouped in 2s and 3s, and often there will be directions above the meter (or in the meter itself) telling you what this grouping is.

For example: a meter with a 5 on top—5/4 or 5/8—can be 2 + 3 (counted **1 2 3 4 5**), or 3 + 2 (counted **1 2 3 4 5**).

A meter with a 7 on top—7/4 or 7/8—can be 2 + 2 + 3 (counted **1 2 3 4 5 6 7**) or 3 + 2 + 2 (counted **1 2 3 4 5 6 7**), or even 2 + 3 + 2 (counted **1 2 3 4 5 6 7**), though this last version I've never seen.

If you'd like to hear a master of odd meters, listen to some Dave Brubek, especially the tunes *Take 5*, in 5/4 time, and *Blue Rondo alla Turk*, in 7/8.

## Moving On

---

Congratulations! After you are able to complete the final reviews, you're done! It's been a long haul, and don't be surprised if you forget a lot of what you learned—that's perfectly normal. If you do forget, now you know where to go to find the answers you need. The more you use this information, the more it will stick in your memory.

The only thing left is the final review for this Part. It's a short one.

If you can answer the questions on all the study guides for all the Parts, you now have an excellent foundation in music theory. Good job!

## Chapter 34 Review

---

1. What is the numerical time signature for cut time? 1. 2/2
2. How many beats does a whole note get in cut time? 2. 2
3. How many eighth notes in one beat of cut time? 3. 4
4. How would 4 quarter notes be counted in cut time? 4. 1 + 2 + 3 + 4 +
5. What note gets one beat in slow 6/8 time? 5. 8th note
6. How many beats are in each measure of slow 6/8 time? 6. 6
7. How many beats do quarter notes get in slow 6/8? 7. 2

8. How many beats do dotted half rests get in slow 6/8? 8. 6
9. How many pulses are in a measure of complex, or fast 6/8 time? 9. 2
10. What note gets one beat in fast 6/8 time? 10. dotted quarter
11. What is the counting for a measure of 8th notes in fast 6/8? 11. 1 an da 2 an da
12. How do you tell if a song is in an odd meter? 12. *Can't easily tap your foot to it, or there is an odd number greater than 3 as the top number of the time signature.*
13. How are the beats in 5/4 time grouped? 13. 2+3 or 3+2
14. How are the beats in 7/8 time grouped? 14. 2+2+3 or 3+2+2 or 2+3+2

## Practical Use

---

1. Write out an 8 measure melody in 5/4 time.
2. Charles Ives, an American composer, often used two meters at once in a piece of music. Write a 10 measure harmony part to number one, but use 4/4 time (10 measures of 4/4 = 8 measures of 5/4). Find a friend and sing/play what you've written.



# PART VII REVIEW

## Whew! You Made It.

---

These pages can be used to test your memory about what you've learned in Part VII, and if some of the information hasn't stuck, you can go back and check it out on the page indicated below the question.

As with the chapter reviews, use your keyboard to cover up the answers while you test yourself.

## The Review

---

1. How do you cut the length of a note in half?

page 288

1. *Add a flag or beam*

2. What note is half the length of a sixteenth note?

page 288

2. *32nd note*

3. What note is one fourth the length of a sixteenth note?

page 288

3. *64th note*

4. How many 32nd notes in one beat of 4/4 time?  
page 288
4. 8
5. What does a double dot do?  
page 289
5. *Adds 3/4 the length of the rest/ note it follows*
6. How long is a double-dotted quarter rest?  
page 289
6. *1 3/4 beat*
7. What note is usually paired with a double-dotted quarter note? Why?  
page 289
7. *16th note. It finishes out the beat, is easier to read and play.*
8. Why are double flats and double sharps used?  
page 292
8. *To spell certain chords and intervals correctly*
9. What does a double flat do to a note?  
page 292
9. *Lowers it one whole step*
10. What does a double flat look like?  
page 292
10. *Two flats close together in front of a note*
11. What does a double sharp do to a note?  
page 292
11. *Raises it one whole step*
12. What does a double sharp look like?  
page 292
12. *An X*
13. What does a triple flat look like?  
page 292
13. *No such thing*

14. What is the numerical time signature for cut time?  
page 296
14.  $2/2$
15. How many beats does a whole note get in cut time?  
page 296
15. 2
16. How many eighth notes in one beat of cut time?  
page 296
16. 4
17. How would 4 quarter notes be counted in cut time?  
page 296
17.  $1 + 2 + 3 + 4 +$
18. What note gets one beat in 6/8 time?  
page 296
18. *8th note*
19. How many beats are in each measure of slow 6/8 time?  
page 297
19. 6
20. How many beats do quarter notes get in simple, or slow 6/8 time?  
page 297
20. 2
21. How many beats do dotted half rests get in slow 6/8?  
page 297
21. 6
22. How many pulses are in a measure of complex, or fast 6/8 time?  
page 297
22. 2

23. What is the counting for a measure of 8th notes in fast 6/8?  
page 297
24. Which note gets one beat in fast 6/8 time?  
page 297
25. How do you tell if a song is in an odd meter?  
page 298
26. How are the beats in 5/4 time grouped?  
page 298
27. How are the beats in 7/8 time grouped?  
page 298
23. *1 an da 2 an da*
24. *dotted quarter*
25. *Can't easily tap your foot to it, or there is an odd number greater than 3 as the top number of the time signature.*
26. *2+3 or 3+2*
27. *2+2+3 or 3+2+2 or 2+3+2*



# Postlude



## WHAT COMES NEXT

*Too many pieces finish too long after  
the end.*

— Igor Stravinsky

### In This Postlude

- More To Learn
- Theory Ain't Everything
- Drop Me an e-mail

## So Much More

---

Congratulations for getting through a huge load of information. Because there is so much that you've learned, don't be surprised if you forget parts of it, and feel free to go back and review anything you need to review. It's normal.

Even though you've taken in a great deal of information, there is much, much more left to be learned, if you're willing to learn it. Things like more advanced chord progressions, more chord extensions, transposing from one part to another, arranging music, composing music, and on and on and on.

It's exciting how much there is to learn; a lifetime's worth, really.

## Theory Ain't Everything

---

Keep in mind that music theory is only one of many tools to be used to become a better musician. The music is the master, and the quest for a better performance of the music is the reason for this factual, rule-based method of writing down the sounds.

With so many rules and regulations in music theory, it can be easy to get away from the ultimate goal of music theory, which is to enable you to produce and perform better music.

So keep making music, with all your heart and all your brains.

## Drop Me An E-mail

---

If you notice problems or inconsistencies or downright mistakes, please let me know so I can make this a better book in future editions.

And of course, if you liked the book and it helped you, I'd love to hear about it. You can reach me at [harnum@questionsink.com](mailto:harnum@questionsink.com)

Due to limited time, and the volume of e-mails I receive, it's tough to answer music theory-related questions, but feel free to give it a try anyway.

Thanks.

# APPENDIX

**Teacher Information**  
**Musical Terms Glossary**  
**Index**  
**Blank Staff Paper**  
**Order Forms**  
**Piano Keyboard**

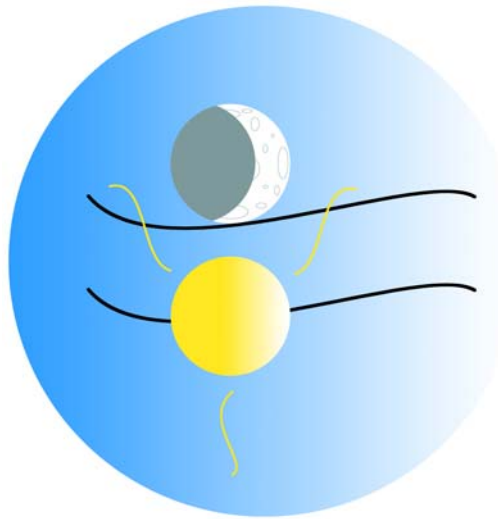

**SolUt Press**

[www.Sol-Ut.com](http://www.Sol-Ut.com)

# TEACHERS!

# FREE TEACH-AIDS

## Get The Most out of *Basic Music Theory*

It's okay, we can admit it. Everyone would rather play music than study music theory, teachers and students alike. No big surprise there, right? Yet we all know the important role theory plays in communicating a musical idea. Despite this knowledge, music theory isn't taught for several reasons: no good methods students enjoy, no time, and no money to buy books, are only a few reasons.

So what's the answer? Theory in small, enjoyable doses from a program designed as a cost- and time- effective teaching tool. This book.

Though it works well for individuals, *Basic Music Theory* was written specifically for use in the classroom. Its clear explanations, short chapters, and reviews make it a low-maintenance option for teachers with limited time (and we all have limited time, right?).

### **The Classroom Packet**

The Classroom Packet is an addition which complements *Basic Music Theory*. In it are Chapter and Part quizzes, student tracking forms, book tracking forms, and additional information like how to schedule time for theory, how to pay for books, and fun yet productive rehearsal suggestions.

Combined with the Classroom Packet, *Basic Music Theory* is the best method for teaching music theory to be found anywhere, and it works with classes of all sizes.

### **Quizzes**

Though I'm aware that multiple-choice tests are a poor way to determine comprehension, they are very efficient. With our limited time, and class sizes that exist only in other teachers' nightmares, efficiency is a must.

All quizzes are in a multiple choice format with a quick-correct key to make correcting an easy task for an aide.

Each Chapter and Part Quiz has 4 different versions to curb cheating. These can be rotated in a 4-year period, or month-to-month, or any way you think most effective.

## **Student Tracking Form**

Also included in the Classroom Packet is a Student Information Form which includes class name, period/time, semester/year, student name, year, and condition of their book (new, good, used). There are spaces for over 100 students.

The form is shaded so students (and you) can find their information quickly and easily. Each chapter has one column to indicate date begun and date passed. Grades can be entered here also if you choose to use a grading system. More about assessment in the *Extra* Section below.

## **Student Fee Forms**

A set of books is a significant investment of your program's resources, and just as a student is charged for damage to a borrowed instrument, so they are also responsible for damaged books.

The Student Fee Form has dollar values for books in conditions from new to damaged and is also shaded for convenient location of information. There are several more columns for other fees the student may owe, including a column for funds the student may have through fund raising.

## **Extras**

All sections of the Classroom Packet are clearly explained with suggestions to make their use easy and productive. Included in the Classroom Packet are suggestions for scheduling time for theory and systems of grading. Also included are some special rehearsal techniques which students and directors alike enjoy and benefit from.

# To Order

---

The Classroom Packet is entirely free at [www.QuestionsInk.com/Books/packet.html](http://www.QuestionsInk.com/Books/packet.html)

You can make as many copies of the forms, quizzes and tools as you need, without limit. If you can't get a copy online, simply fill out one of the order forms in the back of this book (slight shipping fee for CD) and send it to us with your information, especially E-mail. To learn more or to request a copy go to <http://sol-ut.com> and follow the links.

You can also order or request information by [E-mail](#) or snail-mail:

Questions, Ink  
Sol-Ut Press  
PO Box 140452  
Anchorage, AK 99514-0452





# Musical Terms

## A

a, á (It): At, by, for, with.

A 440: The note A above middle C, with frequency of 440 vibrations per second. The note which orchestras and music ensembles universally tune with.

a cappella (It): Without accompaniment.

accelerando: Becoming faster.

accent (Eng): To emphasize or stress a note, indicated by the symbol “>”. The three main kinds of accents are agogic, dynamic, and tonic.

accidental: Sharps, flats or natural signs; used to raise, lower or return a note to its normal pitch.

accompaniment: Secondary musical material, supports more important material.

acoustic: An instrument that produces sound without the use of electronic amplification.

acoustics **1**: The science of sound. **2**: The physical properties of an instrument or room as related to sound.

adagietto (It): A little faster than adagio.

adagio (It): “At ease.” A slow tempo between *largo* and *andante*.

à demi-voix (Fr): With half the voice, whispered.

à deux, a due (Fr, It): For two instruments or voices (to be played or sung in unison).

ad libitum, ad lib. (Lat.): “At will.” the performer improvises freely and may vary the tempo.

Aeolian: A medieval mode whose half- and whole-step pattern is that of playing A to A on the white keys of the piano (same as the natural minor scale).

affrettando (It): Hurrying.

agitato (It): Agitated, excited, hurried, restless.

agogic accent: Emphasis is given to a note by making it longer than normal.

air: A song or melody.

al, all', alla, alle (It) **1**: “To the.” **2**: In the style of (e.g., *alla valse*, “in a waltz style”).

al coda (It): “To the coda.”

al Fine (It): To the end.

alla breve (It): A duple time signature, usually 2/2.

allargando (It): Growing broader and slower.

allegretto (It): A cheerful fast tempo, a little slower than *allegro*.

allegro (It): “cheerful.” A lively, fast tempo: *allegro assai*, very fast; *allegro di bravura*, fast, bright and spirited; *allegro moderato*, moderately fast.

alphorn: A wooden horn up to 10 feet long, curved slightly at the end with an upturned bell; from Switzerland.

al segno (It): Return to the sign (see *dal segno*).

alt (It): “High.” the notes from G to F that fall above the fifth line of the *treble clef*.

alteration: The raising or lowering of a note with an *accidental*.

altered chord: A chord in which a note(s) has been raised or lowered chromatically.

altissimo (It): “Most high.” The highest notes; the octave above the *alt*.

alto (It): “High.” the highest male singing voice and lowest female singing voice.

alto clef: The C clef on the third line of the staff. Used by the viola.

alto flute: See *flute*.

alto saxophone: See *saxophone*.

amabile (It): Amiable, gentle.

anacrusis (Gr.): *Pickup* or upbeat or preparatory beat.

andante (It): “Going.” A moderate tempo between *allegretto* and *adagio*.

andantino (It): Originally a tempo a little slower than *andante*, but now indicates a tempo a bit faster than *andante*.

animato, animoso (It): Animated, energetic or spirited.

anticipation: Nonharmonic note or notes played before the chord in which it belongs.

antiphonal: Alternating singing or playing by separate groups of performers; originally separated also by distance.

appassionato (It): Passionately.

appoggiatura (It): An accented nonharmonic note that resolves stepwise to a harmonic note.

arco (It): “Bowed.” For string instruments, indicates to use the bow.

archet, archetto (Fr): For string instruments, the bow; to bow.

arco (It): “Bow”. For string instruments, indicates to use the bow.

arpeggio (It): The notes of a chord played in succession; a broken chord.

arraché (Fr): Strong pizzicato.

arrangement: A different version of a composition.

arsis (Gr.): The upbeat.

articulation: The degree to which notes are separated or connected, such as *staccato* or *legato*.

assai (It): Very, extremely.

a tempo (It): Return to the original tempo.

atonal: Music lacking a tonal or key center.

attacca (It): Go on, proceed immediately to next section. *Segue*.

attack: The beginning of a note or phrase.

a 2: For 2 instruments or voices.

augmentation: A lengthening of the duration of notes in a *theme*.

augmented: Raised, enlarged.

augmented chord: A triad composed of a root, major third, and augmented fifth.

augmented sixth chord: A chord with the interval of an augmented sixth resolving upward to an octave.

augmented interval: A major or perfect interval raised by a *half step*.

authentic cadence: A cadence with a progression from the dominant (V) chord to the tonic (I) chord.

## B

back beat: Used with drums, emphasis on beats 2 and 4.

balance: the harmonious adjustment of volume and sound quality between instruments and/or voices.

bar: A *measure*; the space between two bar lines. Also, the *bar line* itself.

baritone: A male singing voice higher than bass but lower than tenor.

baritone horn: A brass instrument similar to the *euphonium*, but with 3 valves and smaller bore.

baritone saxophone: see *saxophone*.

bar line: Vertical line through a staff to separate measures or bars.

barre (Fr): Used for guitars; playing sever strings with a single finger across the fretboard.

bass **1**: The lowest male singing voice. **2** The lowest part in music. **3** Electric bass, bass viol, upright bass.

bassa (It): Low.

bass clef: The clef which names the 4th line of the staff as *F*.

basso continuo (It): Used in the baroque era; an accompaniment usu.

improvised with numbers indicating the harmony.

bassoon: A double-reed instrument with low pitch.

baton: Conductor's wand.

beam: A horizontal line used in place of flags to connect short notes.

beat **1**: A rhythmic unit of time. **2**: To mark time.

beats: pulses caused by sound waves of slightly different frequency.

bebop: A form of jazz invented by Dizzy Gillespie and Charlie Parker; uses improvisation, complex rhythms and harmonies.

bend: A change in pitch, usu. a half or whole step. Used with voice, guitar, harmonica and other instruments.

big band: Jazz band playing dance music. Popular in '30's and 40's, experienced a renaissance in late '90's.

bitonal: A composition using two keys at the same time.

bluegrass: Folk music, usu. fast tempo with banjo, fiddle, bass, mandolin, and other instruments.

blue notes: Notes played/sung below intended pitch (usu 3rd, 7th, 5th). Used in blues music.

blues: the basis of jazz. Originated from African vocal music; minor 3rd and 7th of scale. Form is 12 bars long.

Boehm system: System of keys used with woodwind instruments perfected by Theobald Boehm.

bones **1**: Percussion instrument of African origin, a pair of sticks/bones held between the fingers and clicked in rhythm. **2**: Slang for trombones.

bore: The diameter and shape of the tube of a wind instrument.

bow: The device drawn across the strings of string instruments like violin, cello, etc. A stick ~3 ft. long with horsehair stretched between the ends.

brace: A curved line which connects the staves for instruments which use more than one staff.

bracket: A straight line with curved ends which connects staves for different instruments playing simultaneously.

break **1**: The point at which a voice shifts from the chest register to the head (falsetto) register. **2**: The change in woodwind instruments (esp. clarinet) from the lower register to the higher register.

breve: Originally a short note, has come to mean a long note equalling two whole notes.

bridge **1**: A transitional section in a piece of music. **2**: A piece of wood that supports the strings and holds them away from the body of the instrument.

brillante (It): Brilliant.

brio (It): Vigor, spirit. *Con brio*.

broken chord: Notes of a chord played in succession rather than simultaneously.

brushes: Thin wire brushes used on percussion instruments, esp. in jazz.

bull roarer: An instrument originating in aboriginal Australia consisting of a thin piece of bone or wood of special shape tied to rope and whirled vigorously about one's head. Makes a very loud roaring sound.

BWV (abbr.): "Bach-Werke Verzeichnis." A method of cataloguing Bach's work.

## C

cabasa (Sp): Percussion instrument. A gourd covered with beads; a cylinder of metal covered with beads of metal.

cacophony: Dissonant sound. Usu. loud and unpleasant.

cadence: The ending of a piece or section, usu. applied to chord progression (e.g. *deceptive cadence*, *perfect cadence*, etc.).

cadenza: An unaccompanied solo passage usually near the end of a piece. Either ad lib or written by composer.

caesura: A sudden pause or break, shown by the symbol //.

calma, calmando (It): Calming, quiet, tranquil.

calypso: A type of rhythm or song originating in Trinidad.

cancel: Another name for the natural sign used to remove the affect of an accidental.

canción (Sp): Song.

cantabile (It): In a singing style.

capo **1**: The head, beginning, or top. **2**: A device placed across the strings of an instrument to raise the pitch.

capriccio: A piece played in a free, playful style.

castrato (It): An adult male singer with a soprano or alto voice.

catgut: Formerly used as material for string instruments. Actually sheep or goat intestines.

C clef: A moveable clef indicating middle C.

celere (It): Quick, rapid.

chalumeau (Fr): The low register of a clarinet.

changes: Slang for chord changes.

chanson (Fr): Song.

chart: The score or parts of an instrumental ensemble, usu. pop or jazz.

chest voice: the low register of the voice.

choir: A group of singers of sacred music.

choke cymbal: **1**: The hi-hat cymbals on the drum set. **2**: Verb meaning to silence a cymbal quickly.

chops: Slang for a player's ability.

chord: Three or more tones sounding simultaneously.

chorus: **1**: The *refrain* of a song. **2**: A group of singers of secular music.

chromatic: Moving by half steps.

chromaticism: Melodic or harmonic use of tones other than those of the diatonic scale.

chromatic scale: A scale made up of 12 half steps in succession.

circle of fifths: The succession of keys progressing by fifths.

circular breathing: A technique used by wind players in which air is expelled from the mouth while inhaling through the nose.

clam: Slang for a wrong note.

classical **1**: Music of a "serious" (non-pop) nature. **2**: The time period from the late 1700's to the early 1800's.

claves: Percussion instrument from Cuba; round hardwood sticks hit against each other.

clef: A symbol at the beginning of a piece of music which shows the names of the lines and spaces of the staff.

close harmony: Harmony with the chord tones as close together as possible.

cluster: group of notes with the interval of a second.

coda (It): Closing section of a piece. In written music a separate section to after repeating a previous section (e.g. D.C. al Coda; D.S. al Coda). Indicated by the symbol .

col legno (It): Playing with the wood part of the bow.

combo (abbr.): Short for combination. A small group of instrumentalists, used in jazz.

comma: Breath mark (‘).

common chord: Triad. Chord with root, third and fifth.

common time: Four beats to a measure, quarter note gets one beat. 4/4.

common tone: A note that remains the same between two chords.

còmodo (It): Comfortable.

complete cadence: I-IV-V-I.

compound interval: An interval larger than an octave (9th, 11th, 13th).

compound meter: A time signature in which the basic beat is divisible by 3 (6/8, 9/8, etc.).

con (It): With.

con anima (It): With spirit.

con brio: With animation.

concertmaster: First-chair violinist in an orchestra.

concerto: a composition for soloist and orchestra.

concert pitch **1**: The pitch for C instruments (e.g. flute, oboe, trombone, violin, etc.). **2**: International tuning pitch of A440 or A442.

con fuoco (It): With fire.

con gusto (It): With gusto.

consonance: Sounds pleasing to the ear.

con sordini (It): With mutes.

con sordino (It): With mute.

contra (It): In the octave below normal (e.g. contra bassoon).

contralto: The lowest female voice, a.k.a. *alto*.

contrary motion: Term used in *counterpoint* for two voices moving in opposite directions.

cor (Fr): Horn.

corona: *Fermata*.

count: The pulse or beat.

counterpoint: The combination of two or more melodic lines occurring simultaneously.

countertenor: The highest male singing voice.

cover: Slang for the performance of a song written by someone other than the performer.

cowbell: A metal bell struck with a drumstick.

crescendo: Gradually becoming louder.

cross rhythm: Different rhythms played at the same time.

crotchet: British name for quarter note.

cue **1**: A gesture made by a conductor for a performer to make an entrance. **2**:

Small notes indicating another instrument’s part.

cut time: 2/2 time signature.

cymbals: Percussion instruments of circular brass plates. May be struck together (crash cymbals), with a mallet (suspended cymbal), or mechanically (hi-hat).

## D

da capo, D.C. (It): Direction in a piece of music to return to the beginning.

da capo al coda, D.C. al Coda (It): Direction to return to the beginning, play to the Coda sign, then to skip to the Coda and finish the piece.

da capo al fine, D.C. al Fine (It): Direction to return to the beginning of a piece and play to the “Fine” sign.

dal (It): “From the,” or “by the.”

dal segno, D.S. (It): Direction to return to the point marked by the sign  $\text{S}$ .

dal segno al coda, D.S. al Coda (It): Direction to return to the sign  $\text{S}$ , play to the coda sign  $\text{C}$ , then skip to the coda.

dal segno al fine: Direction to return to the D.S. sign and play to the “Fine” sign.

dB (abbr.): Decibel. Measurement of loudness.

decrescendo: Gradually becoming softer.

degree: a note of a scale.

delicato (It): Delicately.

demiquaver: British term for sixteenth note.

demisiquaver: British term for thirty-second note.

détaché (Fr): Short, detached bowing strokes.

di (It): Of, with.

diatonic: The tones of any major or minor scale.

didgeridoo: Australian aboriginal horn made of wood hollowed by termites, played with the lips and breath.

diminished: Lowered.

diminished interval: A minor or perfect interval lowered a half step.

diminished seventh chord: A chord with root, minor third, diminished fifth, and diminished seventh.

diminished triad: A triad with root, minor third, and diminished fifth.

diminuendo (It): Growing gradually softer.

diminution: Shortening the length of notes in a *theme*.

discord: Dissonant sounds or sounds unpleasant to the ear.

disjunct: Moving by intervals larger than a second.

dissonance: Sounds unpleasant to the ear.

divisi, div. (It): Indication for separate parts written on one staff. To be played by two or more performers.

do: The first note (*tonic*) of a diatonic scale.

dodecaphonic: Twelve-tone music.

doit: A jazz technique used on brass instruments where a note is bent upwards.

dominant: Fifth degree of a major or minor scale.

doppio (It): Double.

Dorian: A medieval mode with the half-whole-step pattern from D to D on the white keys of the piano.

dot **1**: Written above or below a note indicates *staccato*. **2**: Written after a note, the dot increases the length by half its original value.

double bar: Two bar lines on a staff that show the end of a section or piece.

double bass: Lowest member of the violin family, tuned E, A, D, G.

double concerto: A concerto for two instruments.

double dot: Increases a note’s length by 3/4 of its original value.

double flat: Written before a note, it lowers the note a whole step.

double horn: A French horn comprised of two different horns (one in F, one in Bb), with valve to switch between the two. Better intonation and greater range.

double reed: Two thin pieces of cane bound together at one end which vibrate to produce sound for *oboe*, *English horn*, and *bassoon*.

double sharp: Written before a note, it raises the pitch of the note a whole step.

double stop: For violin family instruments, playing two notes at once.

double time: Twice as fast.

double tonguing: On brass and flute instruments, a method of rapidly articulating notes, alternating with the front and back of the tongue (ta-ka-ta-ka).

downbeat: the first beat of a measure given with downward stroke by the conductor.

drone: A note of the same pitch which continues for a long time. Used by instruments like bagpipes, 5-string banjo and hurdy-gurdy.

drum kit, drum set: A set of drums several drums, usu. consisting of: snare drum, bass drum, hi-hat, ride cymbal, crash cymbal, hi- middle- and low tom toms.

duet or duo: Musical composition for two performers.

duple meter: A time signature with two beats to a measure (e.g. 2/4 or fast 6/8).

duration: The length of a note or rest.

dynamic accent: Emphasis given a note by louder articulation than normal.

dynamic markings: Symbols which indicate different levels of loudness or softness (e.g. *p*, *mp*, *mf*, *f*).

dynamics **1**: The level of loudness or softness. **2**: They symbols for dynamics.

## E

8va: Ottava altus. One octave higher.

8vb: Ottava bassus. One octave lower.

ear training: A technique of learning to hear music and write it down.

eighth: An octave.

eighth note, eighth rest: A note/rest with one eighth the length of a whole note, and half the length of a quarter note. Half of a beat in 4/4 time.

eleventh: Diatonic interval from the first to the eleventh note. Same letter name as the 4th.

embellishment: An *ornament* added to music.

embouchure: The position and use of lips, tongue, and teeth when playing a wind instrument.

English horn: An alto *oboe* with a pitch a fifth lower. Same conical shape but with a bulbous bell.

enharmonic: Two notes of the same pitch with different names (e.g. Ab and G#).

ensemble: A group of performers.

entr'acte (Fr): A piece played between acts of an opera, ballet, or musical.

equal temperament: A tuning system which divides the octave into equal intervals.

espressivo (It): Expressive, with emotion.

estinto (It): Very soft, almost inaudible.

-etto (It): A suffix meaning "little."

étude: A piece of music studied to improve technique.

euphonium: A brass instrument similar to the *baritone horn* but with a larger bore.

eurhythmics: A system which teaches rhythm by using body movement.

expression marks: Directions or symbols for musical expression and interpretation, like *dynamics*, *tempo*, *articulation*, and mood.

## F

f (abbr.): Forte. Loud dynamic.

fa: 4th Degree of a *diatonic* scale.

fake: Slang for improvisation. "If you can't make it, fake it."

fake book: A song book containing chord changes, lyrics, and melodies for many songs.

false cadence: see *deceptive cadence*.

falsetto (It): A high voice used for notes above the normal vocal range.

fanfare: A short piece of music for brass to attract attention.

F clef: The bass clef centered on the 4th line of the staff and naming that 4th line as F below middle C.

feminine cadence: A *cadence* ending on a weak beat.

fermata (It): A symbol indicating a hold or pause. 

festoso (It): Happy or merry.

ff (abbr.): *Fortissimo*.

fff (abbr.): *Fortississimo*.

f-hole: On violin family instruments it's the *f*-shaped sound holes on top of the instrument. Also on some guitars.

fiddle: A violin used for folk- or bluegrass music; it usu. has a flatter *bridge*, uses metal strings and a *tuner* on each string.

fiero (It): Bold.

fife: A high, keyless flute.

fifth: The interval of 5 diatonic scale degrees.

fine: The end.

fingerboard: The surface of the neck on string instruments where the fingers press down on the strings.

fixed do: A singing system in which the note C is always do. Compare to *moveable do*.

flag: A curved line extending from the right side of the stem of a note. Used on eighth notes and smaller notes.

flam: A drum rudiment. Small grace note before the main note.

flamenco: A Spanish dance/song usu. played on guitar and including rhythmic clapping and stomping of the dancer.

flat **1**: The symbol used to lower a note by one half step. **2**: To be below normal pitch.

flip: A jazz technique, usu performed on brass instruments. Note is raised in pitch and then glissed down to the next note.

flugelhorn: A brass instrument in the trumpet family with a wider bell than trumpet, a conical bore, and more mellow tone.

flute: A woodwind instrument of wood or metal in the shape of a cylinder closed at one end. Sound is produced by blowing across a hole near the closed end (see also: *alto flute*, *bass flute*).

flutter tonguing: A wind instrument technique of very rapid tonguing, produced by rolling the tongue saying trrrrrr.

form: The structure or organization of a piece of music.

forte (It): Loud.

fortissimo (It): Very loud.

fortississimo (It): Very very loud. Officially the loudest dynamic marking.

forzando, forzato (It): Forced. Strongly accented.

fourth: An interval of 4 diatonic degrees.

fourth chord: A chord with intervals of a fourth.

French horn: A brass instrument with a conical bore, valves, highly flared bell, and many coils of tubing.

French sixth: A type of *augmented sixth chord* with a major third, augmented fourth, and augmented sixth above the root.

fret **1**: On many string instruments, a strip usu of metal placed across the fingerboard to give a specific note when fretted. **2**: The act of pressing the fingers down on the fingerboard.

fretboard: The *fingerboard* of instruments with frets.

frog: The end of the *bow* which is held in the hand.

fugue: A piece in which two or more parts are built upon a recurring theme.

full score: An instrumental score in which appear all the parts for the instruments.

fundamental: The lowest note in a *harmonic series*.

funk: A rhythmic style with much syncopation.

furioso (It): Furiously, wildly.

fusion: A combination of rock and jazz beginning in the early '70s.

fz (abbr.): *Forzando*, *sforzando*.

## G

gapped scale: A scale made from a complete scale by leaving out some notes. The pentatonic scale is a gapped scale.

G clef: The treble clef, centered on the second line of the staff, giving that line the pitch G above middle C.

German flute: The standard flute.

German sixth: A type of *augmented sixth chord* with a major third, perfect fifth, and augmented sixth above the root.

Gestopft (Ger.): Muting a horn with the hand.

ghost bend: A guitar technique in which a note is pre-bent before sounding the string.

ghost note: A jazz technique in which the note indicated by parentheses is barely played.

gig: A musician's slang for a job.

giocoso (It): Humorous.

glass harmonica: An instrument invented in the 1700s made of various sizes of glass bowls played by rubbing around the rim with a wet finger.

glee: Unaccompanied vocal music for three or four parts.

glee club: A group that sings glees.

glide: A smooth change in pitch from one note to another.

glissando: A fast scale produced by sliding the hand finger rapidly from one note to another.

gong: A percussion instrument from Asia made up of a heavy circular metal plate and struck with a soft mallet.

G.P. (abbr.): Grand Pause. A pause in a piece of music.

grace note: An ornamental note played quickly before the main note.

grandioso (It): Grand, grandiose.

grand pause: A pause for the entire group of musicians.

grand staff: Both the treble and bass clef staves. Piano music is written on a grand staff.

grave (It): Slow. Solemn.

grazia, grazioso (It): Grace, graceful.

groove: Slang for when music is perfectly in synch.

grosso (It): Great, large.

growl: A rough sound produced by growling in the back of the throat. Often used in jazz.

gruppetto (It): An ornamental group of notes like a *turn*, *shake*, or *trill*.

gusto (It): Enjoyment, gusto.

## H

**H 1:** German for B natural. **2:** Letter used with a number for the works of Haydn, after the cataloguer "Hoboken."

half cadence: see *imperfect cadence*.

half note, half rest: A note/rest equal to half the length of a whole note/rest or two quarter notes/rests. Two beats in 4/4 time.

half step: The smallest *interval* in Western music. One twelfth of an *octave*.

harmonic minor: A *natural minor* scale with a half step between the 7th and 8th degrees of the scale.

harmonic progression: Movement from one chord to another.

harmonics **1:** The pure individual tones which make up a complex tone. **2:** On string instruments, a tone produced by touching the strings at the harmonic nodes.

harmonic series: A series of notes produced above a *fundamental* and having a specific order.

head voice: The upper *register* of the voice.

heidimisemiquaver: British name for a sixty-fourth note.

hexachord: A six-note scale.

hi-hat cymbals: Used in the drum kit; a pair of cymbals facing each other and struck together with a mechanical device operated by the foot.

hold: A *fermata* or pause.

horn **1:** The brass instrument with conical tube wound round itself. Another name for French horn. **2:** Musician's slang for his or her instrument.

Hungarian minor scale: A harmonic minor scale with a raised 4th.

hyper-: Prefix meaning above or over.

hypo-: Prefix meaning below.

## I

ictus (Lat.): Stress, or an accent.

imitation: The restatement of a musical idea in another part. Used in counterpoint.

improvisation: Music composed on the spot.

incomplete cadence: A cadence in which a note other than the *key note* is in the top voice of the I chord.

interlude: A short piece used to bridge the acts of a play.

interrupted cadence: A cadence in which the dominant chord (V) moves to a chord other than the tonic (I).

interval: The distance between two notes.

Intonation: The accuracy of pitch.

inversion, chordal: A chord with a bass tone other than its root.

inversion, melodic: The change of an ascending interval to its corresponding descending interval.

Ionian: A medieval mode whose whole and half steps correspond to the major scale. C to C on the white keys of the piano.

istesso (It): The same. *l'istesso tempo*.

Italian sixth: A type of *augmented sixth chord* containing a major third and an augmented sixth above the bass.

## J-K-L

jam: Slang for a gathering of musicians to play or improvise.

jazz: A style of music with African-American roots and using *blue notes*, *improvisation*, and strong rhythms.

jazz combo: A small jazz group usu consisting of piano, drums, bass, and a solo instrument.

jazz ensemble: A group of musicians (usu rhythm section, brass, and woodwinds) who play various styles of *jazz*.

K: Used to catalogue Mozart's works; represents Köchel. (e.g. K 201)

kettledrum: A percussion instrument with a tunable head. Also called *timpani*.

key **1:** The tonal center of a composition, based on the tonic of the scale. **2:** A lever pressed by the finger on an instrument (e.g. piano, flute).

keynote: The first note of the scale of a *key*. Also called the *tonic*.

key signature - accidentals at the left side of the staff between the clef and the time signature which indicate what key the piece is in.

kick: In jazz, a rhythmic accent or cue applied by the rhythm section.

la: The sixth degree of a diatonic scale.

lacrimoso (It): Tearful, mournful.

largamente (It): Broadly.

largando (It): Slowing down.

largetto (It): A little faster than *largo*.

Largo (It): Broad. A very slow tempo.

leading note/tonic: The seventh degree of a diatonic scale; leads the ear to the *tonic* note.

lead sheet: Melody line, lyrics and chord for a song. A *fake book* is made up of lead sheets.

leap: A skip of more than a 2nd.

ledger line, leger line: A short line drawn for a note above or below the staff.

legato (It): Smooth.

leggero, leggiero (It): Lightly.

leno (It): Faint.

lento (It): slow.

lesto (It): Lively.

licks: Slang for a short musical idea or phrase.

ligature **1**: A metal device used by woodwind instruments to secure the reed to the mouthpiece. **2**: A curved line over a group of notes to be sung on the same syllable.

lip: A verb meaning to adjust the pitch of a note slightly up or down.

lip trill: A technique used by brass players; an upward trill without use of valves.

l'istesso (It): The same.

loco (It): Return to the normal place. Used after playing 8va or 8vb.

Locrian: a medieval mode which starts on the seventh degree of a diatonic scale. B to B on the white keys of a piano.

lungo (It): Long.

Lydian: A medieval mode beginning on the 4th degree of a diatonic scale. F to F on the white keys of a piano.

## M

ma (It): But. Allegro ma non troppo.

maestoso (It): Majestically.

maggiore (It): Major.

major: Used in music theory to describe *intervals, chords, and scales*.

major chord: A triad consisting of a root, major third, and perfect fifth.

major scale: A diatonic scale with half steps between from the third to fourth degrees and seventh to eighth degrees.

marcato (It): Stressed or accented.

marcia (It): March.

mariachi (Sp): A Mexican folk group with 2 violins, guitar, guitarron and maybe rhythm instruments.

martelé, martellato (Fr): Play with short detached bow strokes without lifting the bow from the strings.

masculine cadence: A *cadence* in which the last chord is on the strong beat.

measure: The space between two bar lines.

mediant: The third degree of a scale.

melisma: Several notes sung on the same syllable.

melismatic: Song that uses melismas.

melodic minor: A natural minor scale with the sixth and seventh degrees raised ascending, and lowered descending.

melody: A sequence of single notes.

meno (It): Less.

meter: The rhythmic structure of a piece determined by number of beats, time values and accents. *Simple meters* are divisible by two; *compound meters* are divisible by 3.

metronome: A mechanical or electronic device used for sounding beats per minute. Invented c. 1812.

mezza voce (It): Half voice. Quiet.

mezzo (It): Half or medium (e.g. mezzo forte).

mezzo forte (It): Medium loud.

mezzo piano (It): Medium soft.

mezzo soprano (It): A female voice between soprano and alto.

*mf* (abbr.): Mezzo forte.

mi: The 3rd degree of a *diatonic* scale.

middle C: The note C in the middle of the *grand staff* and near the middle of the keyboard.

minim: British name for the *half note*.

minim rest: Half rest.

minor: Used to describe *intervals, chords, and scales*. Means lesser.

minor scale (natural): A *diatonic* scale in which the 3rd, 6th and 7th degrees are lowered a half step from the *major scale*. See also *harmonic minor*, and *melodic minor*.

misterioso (It): Mysteriously.

mit (Ger.): With.

Mixolydian: A Medieval mode starting on the 5th degree of a diatonic scale. G to G on the white keys of a piano.

M.M. (abbr.): Stands for Maelzel's *metronome*, the man who invented the device.

mode: A type of scale with a certain arrangement of intervals. See *Ionian, Dorian, Phrygian, Lydian, Mixolydian, Aeolian, and Locrian*.

moderato (It): A moderate tempo.

modulate: To change from one key to another.

moll (Ger.): Minor.

molto (It): Very.

monotone: An unvaried pitch.

mordent: A melodic ornament consisting of the alteration of the written note with the note directly below (lower ~) or above (upper ~) it.

mouthpiece: On a brass or woodwind instrument, the part responsible for making the vibrations, placed on the player's lips or in the mouth.

moveable do: A system of singing using syllables in which the first note of any diatonic scale is *do*. See *fixed do*.

movement: A self-contained piece of music within a larger piece of music.

mp (abbr.): *Mezzo piano*.

music theory: The study of how music is written down and put together.

music therapy: The use of music as a healing agent for physical and psychological problems.

muta (It): Direction to change keys, usually found in timpani and horn parts.

mutes: Devices used to muffle, soften, or change the sound of an instrument.

## N

natural: The symbol which indicates a note is neither sharp nor flat, and when the symbol is in front of the note, it cancels any previous accidental.

natural horn: A horn with no valves or slides.

natural minor: A diatonic scale with the whole-half step pattern of WHWWHWW. A to A on the white keys of the piano.

Neopolitan sixth: A chord constructed on the fourth degree of a *diatonic* scale with a minor third and a minor sixth above the bass.

neck: The long slender part on a string instrument to which the fingerboard is attached.

neumes: The signs and symbols used for musical notation in the Middle Ages.

ninth: The interval of nine *diatonic* notes. An octave and a second.

ninth chord: Root, third, fifth, seventh, and ninth.

node: A point of lowest amplitude in the wavelength of a string. These points are where *harmonics* are produced on a string instrument.

non (Fr): No or not.

nonet: A piece for 9 musicians.

nonharmonic notes: Notes not a part of the chord structures around them.

non-transposing: instruments pitched in the key of C (e.g. flute, trombone, bells).

notehead: The main, bulbous part of a note.

## O

**O 1:** The symbol for diminished. **2:** The symbol for an open string.

obligato (It): An optional part contrasting the melody. Originally meant an obligatory part.

oblique motion: Two melodic lines, one of which moves while the other remains stationary.

oboe: A *double-reed* woodwind instrument with a conical bore.

oboe d'amore: Slightly larger than the normal oboe and with a more bulbous bell. Pitched a minor third lower.

octave - the interval between the first and eighth degrees of a *diatonic* scale.

octet **1:** Eight performers. **2:** A piece of music for eight performers.

odd meter: A meter with an odd number grouped with an even number of beats per measure, like 7/4 (3+4) and 5/8 (2+3).

oliphant: A medieval horn made from an elephant's tusk.

Op. (abbr.): Opus.

open: Not stopped or muted.

open fifth: A triad with no third.

open harmony: When notes of a chord aren't played as closely together as possible. See *close harmony*.

open notes **1:** On string instruments, the open, unfretted strings. **2:** Notes on wind instruments played without the use of valves or keys.

open triad: Triad without the third.

Opus (Lat.): Means "work"; used with a number which shows the order in which a composer's work were composed.

ornamentation: The addition of *ornaments* to a melody.

ornaments: Melodic embellishments. May be written in or improvised. Some ornaments: acciaccatura, appoggiatura, arpeggio, grace notes, mordent, trill, turn.

ossia (It): Indicates a passage which is an alternative version.

ostinato (It): A repeated musical phrase, rhythmic pattern, or motive, usu. occurring in the bass.

ottava (It): Octave.

ottava alta (8va) (It): An octave higher.

ottava bassa (8vb) (It): An octave lower.

overblow: A technique of blowing harder used in brass instruments when *harmonics* are produced above the *fundamental*.

overtone series: The same thing as the *harmonic series*, but without the fundamental.

## P

**p 1:** (It) *Piano*; soft dynamic. **2:** (Sp) Pulgar, which is the thumb of the right hand in guitar music.

parallel chords: The movement of specific chords up and down the scale.

parallel fifths, fourths, octaves: Two parts moving in the same direction at the same time a fifth, fourth or octave apart.

parallel intervals: Movement of two or more parts of the same interval in the same direction.

parallel keys: Major and minor keys which have the same *tonic*.

parallel motion: The movement in two or more parts in the same direction with the same intervals.

passing notes: Scalewise notes which connect two notes of the harmony, but are not part of the harmony themselves.

pause: A rest of variable length. A fermata.

pedal point: An organ term used for a note, usu. in the bass, around which other notes move.

pedal tone: A "false" note below the fundamental on a brass instrument.

pentachord: The first five notes of a diatonic scale.

pentatonic scale **1:** Any scale with five notes. **2:** The major scale without the 4th and 7th degrees. The black keys on a piano.

percussion family: Instruments of indefinite pitch which resonate when

struck or shaken. Drums, maracas, bells, gongs, and xylophones.

perfect cadence: A cadence moving from the dominant chord (V) to the tonic chord (I).

perfect interval: Octave, fifth, and fourth without alterations.

perfect pitch: The ability to identify any note by ear.

period: A segment of music consisting of two or more phrases and a cadence.

pesante (It): Heavy.

pf (abbr.): Soft then loud.

phrase: A musical "sentence" or idea.

Phrygian: A medieval mode beginning on the third degree of a diatonic scale. E to E on the white keys of a piano.

pianissimo (It): Very soft.

pianissimo (It): Very, very soft.

piano (It) **1:** Soft. **2:** Short for "pianoforte," a keyboard instrument.

piano quartet: Violin, viola, cello, and piano.

piano trio: Violin, viola, and piano.

Picardy third: A minor piece ending on a chord with a major third.

piccolo (It): A member of the flute family which sounds an octave higher than written. Smaller than the normal flute.

pitch: The highness or lowness of a tone.

pitch pipe: A small wind instrument used for tuning.

pivot chord: A chord used when modulating which is the same for both keys.

pizzicato: Plucking the strings of an instrument that uses a bow.

placido (It): Calm, placid.

plagal cadence: A cadence which moves from the subdominant chord (IV) to the tonic chord (I).

poco a poco (It): Little by little.

polychords: Chords resulting from two triadic units.

polymetric: The simultaneous use of different meters.

polyphony: Music which combines two or more melodic lines.

polytonal: The simultaneous use of different key signatures.

pomposo (It): Pompous.

ponticello (It): The bridge of a string instrument.

portamento: A smooth glide from one note to another.

portado (It): An articulation halfway between staccato and legato.

pp (abbr.): pianissimo.

ppp (abbr.): pianississimo.

prebend: To bend a string before playing on a string instrument, esp. guitar.

preciso (It): Exact.

prélude (Fr): An introductory piece or movement.

preparation: The use of a consonant note before playing that same note as part of a discord.

prestissimo (It): Very, very fast. The fastest tempo.

presto (It): Very fast.

prima donna (It): The most important woman in an opera.

primary chords: The tonic (I), subdominant (IV), and dominant (V) chords of a key.

prime **1**: Unison. **2**: The first note of a scale.

principal: The section leader.

program music: Music that tells a story or paints a picture. As opposed to absolute music.

progression: Movement from one chord to another.

pronto (It): Prompt.

pulgar (Sp): Thumb. Used specifically in guitar music for the thumb of the right hand.

pull-off: A technique used by string players in which a fretted note is plucked while it's released which sounds the note below.

pulse: The beat.

Pythagorean scale: The earliest known scale comprising an octave. Whole and half step arrangements are the same as the major scale, but the ratio of whole and half steps is different.

## Q

Quadrat (Ger.): A natural sign.

quadruple meter: A time signature with four beats in a measure.

quadruplet: Four notes to be played in the space of three notes of equal value.

quarter note, quarter rest: A note/rest one fourth the length of a whole note and half the length of a half note. Equal to one beat in 4/4 time.

quartet **1**: A composition for four performers. **2**: Four performers.

quasi (It): Almost, as if.

quaver: British term for an eighth note.

quintet **1**: A composition for five performers. **2**: Five performers.

quintuple meter: A time signature with five beats per measure (e.g. 5/4 time).

quintuplet: five notes to be played in the time of four notes of equal value.

## R

racket: **1**: A double-reed instrument of the Renaissance period. **2**: The sound a beginning alto saxophone player makes.

ragtime: The earliest form of jazz from the early 1900s.

rallentando (It): Decreasing speed gradually.

range: The notes from lowest to highest that an instrument or voice is capable of producing.

rattenuato (It): Slowing down.

re: The second note of a diatonic scale.

reduction: The arrangement of a piece for a smaller number of parts.

reed: A vibrating strip of cane which vibrates at high frequency when blown.

refrain: A section of a composition that occurs several times.

register: A certain range of an instrument or voice.

relative keys: Major and minor keys with the same key signature (e.g. A minor and C major).

Renaissance (Fr): Meaning "rebirth." The musical era from the mid 1400s through the end of the 1500s.

resolution: A progression of chords or notes from dissonance to consonance.

rest: A period of silence. Types of rests: whole rest, half rest, quarter rest, eighth rest, sixteenth rest, thirty-second rest.

retardation: Gradually slowing.

retrograde: Playing a melody line backwards.

rhythm: A pattern of long and short in music.

rhythm section: In jazz and pop music, the piano, bass, guitar and drums. Provides the harmony and rhythm.

riff: Repeated melodic idea.

ritardando (It): Gradually decreasing speed.

ritenuto (It): Immediately slower.

rolled chord: A chord in which the notes are played in rapid succession, much like an arpeggio.

romantic: The musical era from ~1820 to 1900.

root: The fundamental note of a chord or scale.

rubato (It): A free tempo which speeds up and slows down at the conductor's or performer's discretion, but without changing the basic pulse.

rudiments: Basic sticking patterns used for drums.

run: A fast scale passage.

## S

S. (abbr.): Segno, senza, sign, sol, solo, soprano, sordini, subito.

SA (abbr.): Used in choral music to indicate soprano, alto.

SAB (abbr.): Used in choral music to indicate soprano, alto, baritone.

sackbut (Ger.): The ancestor of the trombone. German for push-pull.

saltato, saltando (It): a bow technique in which the bow is bounced lightly on the string.

SATB: Used in choral music to indicate soprano, alto, tenor, bass.

saxhorn: Brass family instruments consisting of valved bugles invented by Adolphe Sax.

saxophone: A woodwind family instrument of keyed brass, conical bore, and single reed. Types of saxophones: Eb soprano; Bb soprano; Eb alto; Bb tenor; Eb baritone; Bb bass.

scale: An ascending or descending series of tones related to a certain chosen fundamental tone.

scale degrees: The names and numbers for notes in a scale.

scat singing: A form of vocal jazz improvisation in which the performer makes up the melody with nonsense syllables.

scherzando (It): Playful and light-hearted.

scherzo (It): Literally "joke." A piece with a lively tempo.

schmaltz (Yid): Excessively sentimental.

score: The notation of a composition which shows all its parts arranged horizontally and aligned rhythmically.

secco (It): Means "dry." Unornamented.

second: The interval between two consecutive degrees of a diatonic scale.



secondary dominant: A dominant chord (V) built upon the fifth degree of a chord other than the tonic.

secular music: Any music not sacred.

segno (It): Sign. 

segue: To continue without a break.

semibreve: British name for whole note.

semiquaver: British name for a sixteenth note.

semitone: One half step.

sempre (It): Always.

senza (It): Without. Senza sordino.

septet **1**: A composition for seven performers. **2**: Seven performers.

septuplet: Seven notes played in the time of four or six notes of equal value.

seventh: The interval between the first and seventh degrees of a diatonic scale.

seventh chord: A chord containing a root, third, fifth, and seventh.

sextet **1**: A composition for six performers. **2**: Six performers.

sextuplet: Six notes played in the time of four notes of equal value.

sharp **1**: The symbol indicating to raise a note one half step. **2**: To be slightly above normal pitch.

sightreading: Playing a piece of music without studying it.

sightsinging: Singing a piece of music without studying it.

signs: Symbols which tell a performer articulation, bowing, breathing, dynamics, fingering, ornamentation and other musical effects.

similar motion: The movement of two or more parts in the same direction.

simile, sim. (It): To continue in a similar style.

simple meter: A time signature whose pulse is divisible by 2 (e.g. 2/4, 3/4, 4/4). See compound meter.

sin' al fine (It): To the end.

single reed instruments: Instruments which use only one reed attached to a mouthpiece of some sort.

six-four chord: A triad in the second inversion with a sixth and a fourth above the bass note.

sixteenth note, sixteenth rest: A note/rest one sixteenth as long as a whole note and half the length of an eighth note. In 4/4 time, 1/4 of a beat.

sixth chord **1**: A triad in the first inversion, with a sixth and a third above the root. **2**: A chord with an added sixth.

skip: Melodic movement of more than a whole step.

slide **1**: To move smoothly from one note to another with a constant sound. **2**: The movable part on a trombone which is used to change the pitch by lengthening the instrument.

slur: A curved line connecting two notes of different pitch; to be played as legato as possible.

smorzando (It): Fading away.

so, sol: A solfege syllable for the fifth degree of the diatonic scale.

solfege: A system used for eartraining which uses syllables (do, re, mi, etc.) for the degrees of the scale.

solo (It): Means "alone." To perform alone or as the most important part.

sopra (It): Over, above.

soprano: The highest female singing voice.

soprano clef: The C clef that puts middle C on the first line of the staff.

sordino (It): Mute.

sostenuto (It): Sustained.

sotto voce (It): Quietly, beneath the voice.

Sousaphone: A tuba made for John Phillip Sousa's band which encircles the player.

spacing: The vertical placement of the notes of a chord.

spezzato (It): Divided.

spiccato (It): A bow technique in which the middle of the bow is bounced on the string at a moderate speed.

SSA: Used in choral music to indicate soprano, soprano, alto.

SSAA: Used in choral music to indicate two sopranos, two altos.

staccato (It): Means "detached." Short separated notes indicated by a small dot over or under the note head.

staff, staves: The horizontal lines on which music is written.

stem: A vertical line extending from a note head.

step: Movement melodically of one or two semitones.

stesso (It): Same. L' stesso tempo.

stick **1**: The wooden part of the bow. **2**: A conductor's baton.

sticking: The hand pattern for drums.

stringendo (It): Hurrying the tempo to increase tension.

string quartet: Two violins, viola, and cello.

string quintet: Two violins, two violas, and cello.

string trio: Violin, viola, cello.

subdominant: The fourth degree of a diatonic scale.

subito (It): Suddenly.

submediant: The sixth degree of a diatonic scale.

subtonic: A flatted seventh degree of a diatonic scale, one whole step below the tonic.

suite: A collection of short instrumental movements.

sul (It): On the.

sul ponticello (It): Bowing on or next to the bridge to produce a high-pitched eerie sound.

sul tasto: On the fingerboard.

superdominant: The sixth degree of the diatonic scale. Same as submediant.

supertonic: The second degree of a diatonic scale.

sur (Fr): On, over.

suspension: A counterpoint technique in which a consonant note is sustained while the other voices move which results in a dissonance which is then resolved.

sussurando (It): Sussurating, whispering.

swing **1**: A style of jazz featuring big band dance music. **2**: A treatment of the eighth note which gives it a lilting triplet feel of long-short.

symphony **1**: A large orchestra. **2**: A piece composed for an orchestra, usu. in 4 movements.

syncopation: Rhythmic accents on weak beats, or weak parts of the beat.

system: Two or more staves connected.

## T

t. (abbr.): Tempo, trill, tre, tutti.

T. (abbr.): Tenor, tonic.

TAB (abbr.): Tablature. A method of notation developed for lute and guitar in which the lines of the staff represent the strings and numbers represent the frets. Developed in 1500s.

tacet (Lat.): Means "be silent."

Direction in a part to not play or sing.

tactus (Lat.): Used in the 1400s to measure the length of a beat. Precursor to bar lines.

tag: The end of a piece, the *coda*.

taking 4s/8s: A jazz term. Player takes a solo, usu. improvised, 4 or 8 bars long.

talking drum: Ancient drum of western Africa, beaten with a curved stick. A waisted drum, the pitch controlled by squeezing at the waist which tightens the skin membrane thereby raising the pitch.

tardo, tardando: Become slower.

tanto (It): Much.

temperament: A system of tuning, esp. of pianos, in which pure intervals are altered slightly to enable playing in different keys.

tempestoso (It): Tempestuous, stormy.

tempo: Means "time." The speed of music.

tenor: A high male voice, the range between alto and baritone.

tenor clef: A C clef falling on the fourth line of the staff.

tenor saxophone: Of the saxophone family, in the key of Bb.

tenor trombone: The regular trombone.

tenth: An interval of an octave and a third.

tertian harmony: Usual harmony, based on thirds.

tessitura (It) **1**: The average highness and lowness of a piece. **2**: The usable range of a voice or instrument.

tetrachord: The first four notes of a scale.

texture: The number of voices in a piece: *monophonic*, *homophonic*, and *polyphonic*.

theme: The musical subject of a piece, the main idea.

thesis (Gk): The strong beat, usu. the downbeat.

third: An interval of three diatonic scale degrees.

thirty-second note, thirty-second rest: A note/rest one thirty-second as long as a whole note, and half as long as a sixteenth note.

ti: The seventh degree of a diatonic scale. The leading tone.

tie: A curved line which connects notes of the same pitch indicating they are to be played as one continuous note.

timbre: Sound quality or color.

time: A synonym for meter.

time signature: The meter. Numbers at the beginning of a piece of music, after the clef. Top number is beats per measure, bottom number is which note receives one beat.

tonal: Relating to key.

tone: A sound of particular quality. The basis of music.

tone row: Used in serial and twelve-tone music. The order of twelve notes chosen by a composer which appear in the composition in that specific order.

tonguing: A technique on wind instruments of articulating notes with the tongue.

tonic: The first degree of a scale (I), or the root of a chord.

tonic accent: A type of accent in which the accented note is significantly higher than those around it.

tr (abbr.): Trill.

trading 4s/8s: Jazz term. Players take turns playing solos, usu. improvised, of 4 or 8 bars.

train wreck: Slang for when an ensemble's playing contains so many mistakes that it breaks down to the point of stopping.

tranquillo (It): Calm, tranquil.

transcription: The writing down of a piece from a recording.

transpose, transposing: Changing a piece from one key to another.

transposing instruments: Instruments whose notes sound at a different pitch than written.

treble clef: The G clef which centers on the second line of the staff, naming it G.

tremolo (It): **1**: A bow technique in which short up and down bow strokes are used on a single note. **2**: The rapid alteration between two or more notes, usu. more than a step apart.

triad: A chord of three notes: a root, third, and fifth.

trill: An ornament. The rapid alteration of one note with another note usu. a step or half step higher than the written note. Indicated by the symbols *tr* or *tr* with a wavy line.

trio **1**: A composition for three performers. **2**: Three performers. **3**: The middle section of a march.

triple meter: Meters with three beats per measure, or meters with beats divisible by three.

triple-tonguing: Technique of rapid articulation which uses the front and back of the tongue (t-k-t, or t-t-k, or t-k-t, k-t-k).

tritone: The interval of an augmented fourth or diminished fifth. Considered the most dissonant interval.

tromba (It): Trumpet.

trombone: Member of the brass family. Uses a slide to change pitch. Also called 'bone. Types of 'bones: soprano (also called slide trumpet), tenor, bass.

troppo (It): Too much. (e.g. Allegro non troppo).

troubadour: A wandering minstrel in the Middle Ages of Western Europe.

trumpet: A member of the brass family with cylindrical bore and high pitch and brilliant sound. Types of trumpets: Bb, C, Eb, Bb piccolo.

TTB (abbr.): Used in choral music to indicate tenor, tenor, bass.

TTBB (abbr.): Used in choral music to indicate two tenors, two basses.

tuba: Lowest member of the brass family, conical bore, very large. May be in BB-flat, Eb, or F bass.

tune **1**: A song or melody. **2**: To put an instrument at the correct pitch (in tune).

tuner **1**: A mechanical device which reads pitches and tells the player where it falls in relation to standard intonation. **2**: A small screw near the bridge which allows fine tuning of string instruments.

tuning fork: A device with two tines that, when struck, vibrates to produce a pure single note.

turn: An ornament which "turns" around the principal note, going above it and below it. Indicated by the symbol .

tutti (It): Means "all." Used as an indication for all players to play, usu. comes after a solo or soli section.

twelve-bar blues: A musical form using three chords (I, IV, V) in a specific pattern which is twelve bars long. Characterized by many *blue notes* and improvisation.

twelve-tone scale: A scale using all 12 half steps in an octave organized in a certain order called a *tone row*.

## U

ukulele (HI): A Hawaiian instrument in the string family, small with four strings.

unequal temperament: A system of tuning, esp. of piano which allows an instrument to play in several keys.

unison: Two or more voices sounding the same pitch.

un poco (It): A little.

upbeat **1**: The "and" of the beat, the second half of the beat. **2**: A pick-up note or *anacrusis*. **3**: Denotes a fast or happy tune.

up bow: Stroking the bow upward.  
up-tempo: Fast.  
ut (Lat.): Another name for *do* or C.

## V

valve: A device on brass instruments which redirects the air column to produce a different pitch, may be piston or rotary.  
vamp: A short, usu. introductory section, which repeats until a performer is ready to enter.  
vibrato: A type of ornament which is a fluctuation of pitch. Used almost constantly in violin, flute and voice.  
viola: Instrument in the violin family, uses alto and treble clef, sounding lower than violin.  
violin family: Instrument of the violin family (imagine that), which uses treble clef, has four strings and a high pitch.  
violoncello: A member of the violin family of the tenor range. Held between the knees and uses the bass and treble clefs. Also called cello.  
virtuoso: An instrumental performer of exceptional skill.  
vivace (It): A very quick tempo.  
Vl., Vln (abbr.): Violin.  
Vla. (abbr.): Viola.  
Vlc. (abbr.): Violoncello.  
vocalise: A vocal warm-up exercise using different vowels.  
vocal tenor clef: A G clef used for tenor parts in vocal music and pitched an octave below regular treble clef.  
voice 1: An instrumental or vocal part.  
2: The sound of the human voice.  
voice leading: The movement of an individual part in *polyphonic* music.  
voicing: The arrangement of pitches horizontally in a chord.  
voix (Fr): Voice.  
volti (It): Turn the page.  
volti subito (It): Turn the page quickly.  
volume: Loudness.  
vox (Lat.): Voice.  
V.S. (abbr.): Volti subito.

## W

Wagner tuba: Five-valved horns designed by Richard Wagner for use in his opera *The Ring of the Nibelung*.  
wah: A brass instrument sound produced when a device (stem of harmon mute or plunger mute) is removed from the bell.

walking bass: A bass line, usu. moving stepwise, in a steady pattern of quarter or eighth notes.

well-tempered: A tuning system in which an instrument, usu. piano, can play in all twelve keys.  
whole note, whole rest: A note equal to two half notes/rests, or four quarter notes/rests. Four beats in 4/4 time.  
whole step: Two half steps, or a major second.  
wind instrument: An instrument on which the sound is produced by the vibration of an air column.  
woodwind: An instrument made of wood or using a reed to create vibrations. Also the flute.  
woodwind quintet: Flute, clarinet, oboe, French horn, and bassoon.

## X-Y-Z

xylophone: A barred pitched percussion instrument, often with resonator tubes extending down from the bars.  
yodel: A style of singing in which the voice centers around the break between the normal voice and falsetto. Originated in Switzerland.  
Zink (Ger.): Cornett.  
zydeco: A style of music mixing Cajun, Afro-Caribbean, and rhythm and blues.



Feel free to photocopy these pages, but please don't write on them. If they're left blank, others may also use them. If the book is yours however, go for it.

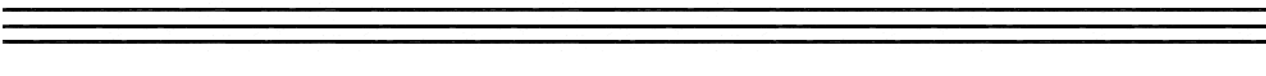
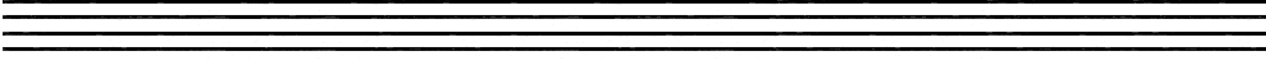
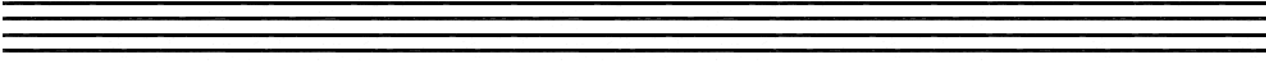
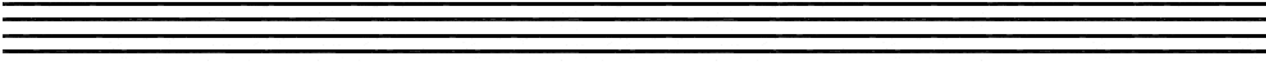
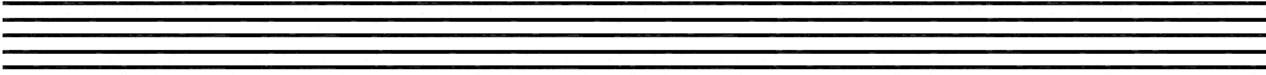
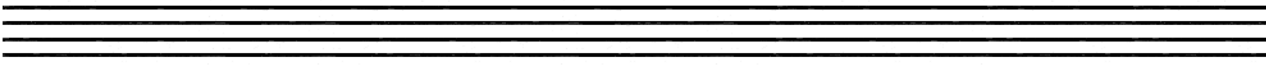
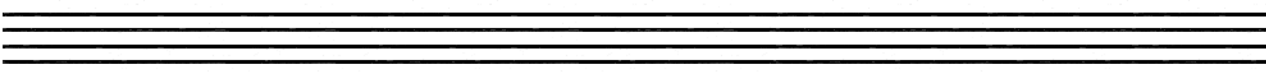
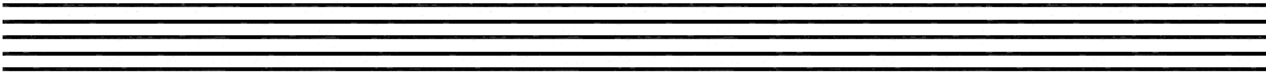
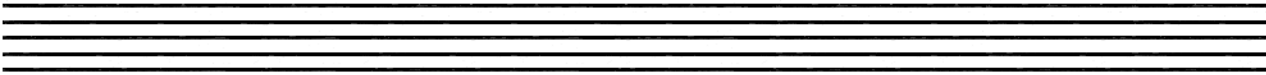
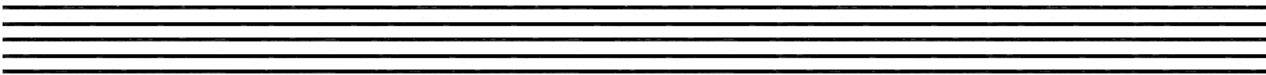
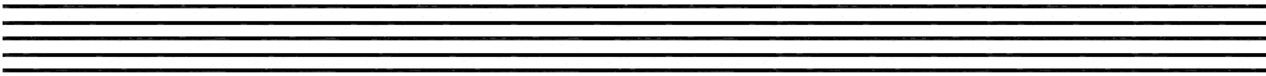

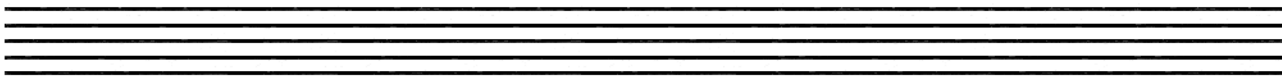
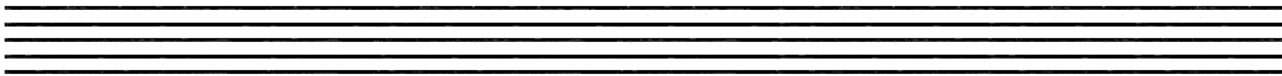
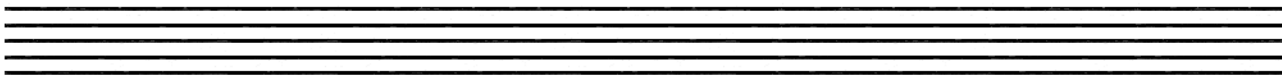
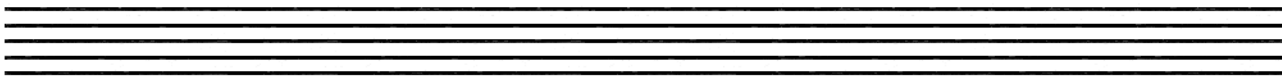
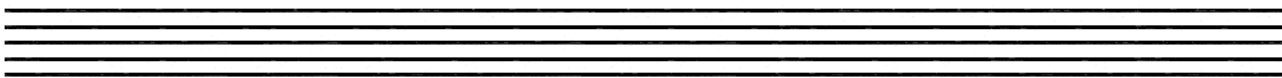
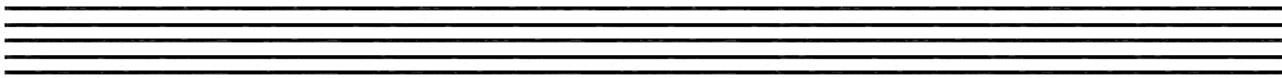
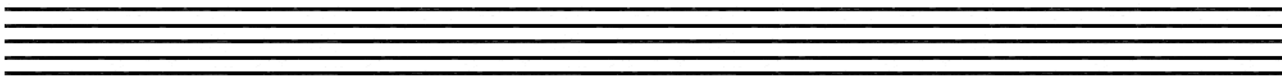
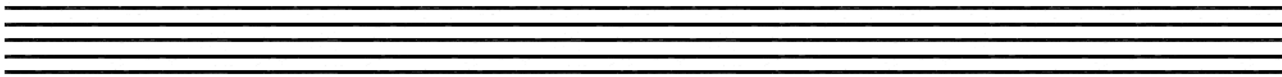
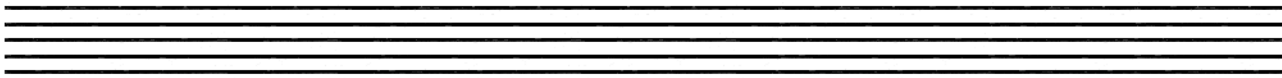
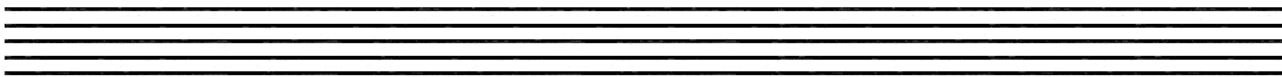
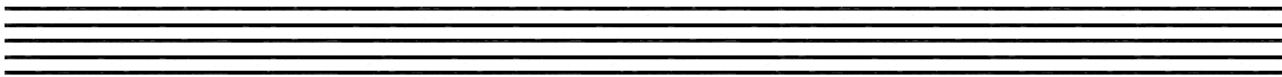
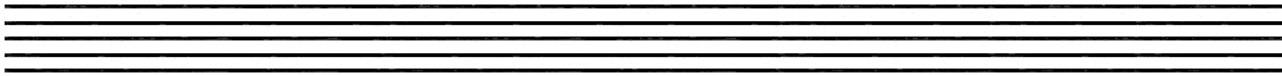
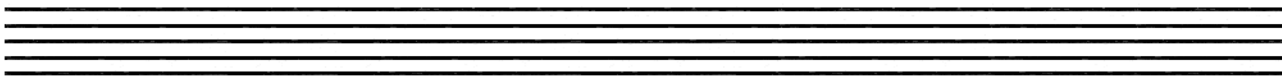

Please fold here.

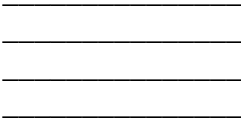

Affix  
1st class  
postage  
here

Questions, Ink  
Sol-Ut Press  
PO Box 140452  
Anchorage, AK 99514-0452

Telephone Orders: (907)830-5887

E-mail Orders: order@QuestionsInk.com

## Sol-Ut Press Books

*Sound the Trumpet: How to Blow Your Own Horn (eBook as hyperlinked PDF)*

# of copies

price ea.

\_\_\_\_\_

\$14.95

*Basic Music Theory: How to Read, Write and Understand Written Music  
2nd edition (eBook as hyperlinked PDF)*

\_\_\_\_\_

\$14.95

*Sound the Trumpet: How to Blow Your Own Horn  
(hardcopy available Fall 2004)*

\_\_\_\_\_

\$24.95

*Basic Music Theory: How to Read, Write and Understand Written Music, 2nd edition  
(hard copy available January '05)*

\_\_\_\_\_

\$24.95

*Basic Music Theory: How to Read, Write and Understand Written Music, 1st edition  
**FREE SHIPPING, CONTINENTAL US***

\_\_\_\_\_

\$19.95

Sub Total: \$ \_\_\_\_\_

*Priority: add \$3 for 1st, \$1 for additional;  
Book Rate: add \$2 for 1st, \$.50 additional*

Shipping: \$ \_\_\_\_\_

\$

Total: \$ \_\_\_\_\_

Payment: \_\_\_\_\_ Check enclosed

\_\_\_\_\_ Purchase Order #

\_\_\_\_\_ Bill Me

Credit Card (circle one): Visa    Mastercard    Am. Ex.    Discover

Card number: \_\_\_\_\_

Name on Card: \_\_\_\_\_ Exp. Date: \_\_\_\_\_

Name: \_\_\_\_\_

Address: \_\_\_\_\_

City: \_\_\_\_\_ State: \_\_\_\_\_ Zip: \_\_\_\_\_



CUT ALONG DOTTED LINE

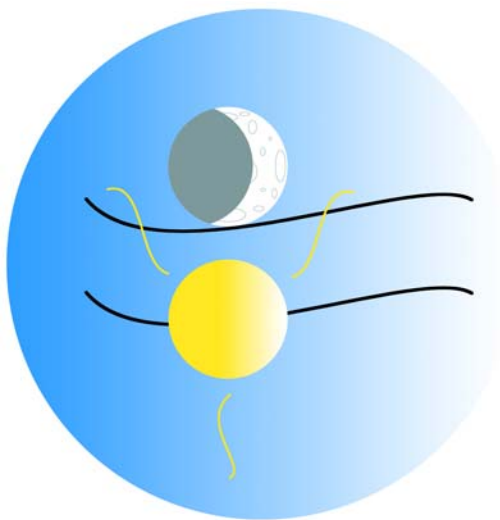

SolUt Press

[www.Sol-Ut.com](http://www.Sol-Ut.com)

|          |          |
|----------|----------|
| <b>A</b> | A#<br>Bb |
| <b>B</b> |          |
| <b>C</b> | C#<br>Db |
| <b>D</b> | D#<br>Eb |
| <b>E</b> |          |
| <b>F</b> | F#<br>Gb |
| <b>G</b> | G#<br>Ab |
| <b>A</b> | A#<br>Bb |
| <b>B</b> |          |
| <b>C</b> | C#<br>Db |
| <b>D</b> | D#<br>Eb |
| <b>E</b> |          |
| <b>F</b> | F#<br>Gb |
| <b>G</b> | G#<br>Ab |
| <b>A</b> | A#<br>Bb |
| <b>B</b> |          |

|                   |  |
|-------------------|--|
|                   |  |
| <b>[REDACTED]</b> |  |
|                   |  |
| <b>[REDACTED]</b> |  |
|                   |  |
| <b>[REDACTED]</b> |  |
|                   |  |
|                   |  |
| <b>[REDACTED]</b> |  |
|                   |  |
| <b>[REDACTED]</b> |  |
|                   |  |
|                   |  |
| <b>[REDACTED]</b> |  |
|                   |  |
| <b>[REDACTED]</b> |  |
|                   |  |
|                   |  |
| <b>[REDACTED]</b> |  |
|                   |  |

# INDEX

- A**  
accidentals  
    general info, 160  
    sharp, 161  
    double sharp, 294  
    double flat, 294  
Aeolian mode, 218  
augmented triads, 250
- B**  
bar, 28  
bar line, 28  
bass clef, 50, 62  
beam, 114, 288  
beat, 92  
bebop scales, 225  
blues scale  
    standard, 222  
    major blues, 223  
    minor, 222  
    recipe for one, 223
- C**  
C clef, 49  
chord, 246  
Chord Extensions  
    general info, 254  
    seventh chord, 254  
    ninth chord, 256  
    seventh chord  
        dominant seventh chord, 255  
Chord Inversions  
    general info, 260  
    first, 261  
    second, 262  
    third, 263  
    seventh chords, 263  
Chord Progression  
    general info, 268  
    parallel motion, 270  
    rules of, 268  
    similar motion, 269  
    I IV V I, 270  
    ii V I, 272  
    iii vi ii V I, 273  
    12 bar blues, 273  
chord progression, 268  
chord quality, 246  
Chords  
    Finding name of, 263  
    general info, 246  
    triads, 247  
    close harmony, 260  
    open harmony, 260  
    seventh chord  
        dominant seventh chord, 255  
    triads  
        augmented, 250  
        diminished, 249  
        major, 248  
        minor, 249  
        using Roman numerals with, 246  
    11th and 13th chords, 256  
    seventh chord, 254  
    ninth chord, 256  
chromatic scale, 169  
Clef  
    general info, 48  
    alto clef, 49  
    bass, 50  
    bass clef, 62  
    C clef, 49  
    rhythm clef, 51, 68  
        one line, 68  
        5 lines, 69  
        drum set notes, 70  
    soprano clef, 49  
    tenor clef, 49  
    treble clef, 50  
    vocal tenor clef, 49  
close harmony, 260  
common tone, 269  
compound interval, 254  
Conducting  
    general info, 236  
    left hand, 240  
    right hand, 240  
Patterns  
    2/4 time, 239  
    3/4 time, 239  
    4/4 time, 238  
    right arm, 238  
conducting, 236  
Counting System  
    whole note, 110  
    half note, 109  
    quarter note, 109  
    eighth notes, 115  
    rests, 111  
cut time, 298
- D**  
diminished triads, 249
- directing, see *Conducting*  
dominant seventh chord, 255  
Dorian mode, 217  
dotted half note, 123  
dotted whole note, 122  
double bar lines, 28  
double dotted notes, 289  
double dotted rests, 289  
double flat, 294  
double sharp, 294  
doubling, 268
- E**  
ear training, 204  
eighth note, 114  
eighth note triplet, 128  
eighth rest, 115  
Extensions  
    11th and 13th chords, 256  
Extensions, see *Chord Extensions*
- F**  
fifth, 247  
first inversion, 261  
flag, 114, 288  
flat, 167  
    double flat, 294  
    order of, 181  
foot tap, 108
- H**  
half note, 92, 109  
half rest, 111  
half step, 169, 175  
harmonic  
    harmonic, 198  
harmonic interval, 198  
harmonic minor scale, 211  
head, 93
- I**  
interval, 198  
    finding an interval, 198  
    augmented, 200, 201  
    diminished, 200, 201  
    finding, 201  
    harmonic, 198  
    major, 200, 201  
    melodic, 198  
    minor, 201

perfect, 199, 200  
Inversions, see *Chord Inversions*  
Ionian mode, 216

## K

Key Signatures  
all keys, 185 to 186  
general info, 180  
flat keys, 181  
construct a sharp key, 184  
construct flat keys, 182  
key of C, 184  
naming flat keys, 181  
sharp keys, 183  
keyboard, 166

## L

leap, 269  
leger line, 28  
line note, 32  
Locrian, 219  
long tones, 151  
Lydian mode, 218

## M

major intervals, 200  
major scale, 174, 216  
major triads, 248  
measure, 28  
melodic interval, 198  
melodic minor scale, 212  
meter, 102  
Meters  
2/2, 298  
2/4, 104  
3/4, 104  
4/4, 103  
5/4, 5/8, 300  
6/8  
simple, 298  
compound, 299  
7/4, 7/8, 300  
cut time, 298  
odd, 300  
metronome, 152  
minor scale  
general info, 208  
natural minor, 208  
harmonic minor, 211  
melodic minor, 212  
natural minor  
parallel, 210

relative, 210  
minor triads, 249  
Mixolydian mode, 218  
Mnemonic Device  
bass clef lines, 63  
bass clef spaces, 64  
order of flats, 181  
treble clef lines, 57  
treble clef spaces, 58  
mnemonic device, 57  
Modes  
general info, 216  
finding or creating, 219  
Aeolian, 218  
Dorian, 217  
Ionian, 216  
Locrian, 219  
Lydian, 218  
Mixolydian, 218  
Phrygian, 217

## N

naming sharp keys, 183  
natural, 162  
natural half step, 169  
natural minor scale, 208, 218  
neutral clef, 51, 68  
ninth chords, 256  
Note  
anatomy  
stems up or down, 94

### Notes

whole, 92  
half, 92  
quarter, 92  
eighth note, 114  
sixteenth, 116  
thirty-second, 288  
sixty-fourth, 288  
anatomy, 93  
anatomy, 94  
eighth  
dotted 8th, 124  
eighth note triplet, 128  
enharmonic, 168  
half note  
dotted half, 123  
letter names, 38  
line note, 32  
sixteenth note  
16th note triplet, 129  
space note, 32  
whole note

dotted whole, 122  
double-dotted notes, 289

## O

octave, 175  
open harmony, 260  
order of flats, 181

## P

parallel minor scale, 210  
parallel motion, 270  
pentatonic scale, 224  
percussion clef, 51, 68  
perfect fifth, 199  
perfect fourth, 199  
perfect intervals  
fifth, 199  
fourth, 199  
octave, 199  
prime, 199  
unison, 199  
perfect octave, 199  
perfect prime, 199  
Phrygian mode, 217  
pitch, 33  
Practice  
beginning, 145  
equipment, 149  
how much to, 143  
how to, 148, 150  
using the metronome, 151  
where, 147  
private teachers, 143  
pulse, 92

## Q

quarter, 109  
quarter note, 92, 109  
quarter note triplet, 130  
quarter rest, 111

## R

relative minor scale, 210  
Rests  
dotted rests, 125  
eighth, 115  
half, 98  
quarter, 98  
whole, 98  
Reviews  
Part I, 41  
Part II, 73

Part III, 133  
Part IV, 189  
Part V, 229  
Part VI, 277  
Part VII, 303  
rhythm clef, 68  
root, 247  
root position, 260

## S

### Scales

bebop, 225  
blues, 222  
chromatic, 169  
harmonic minor, 211  
major, 174, 216  
melodic minor, 212  
natural minor, 218  
parallel minor, 210  
pentatonic, 224  
relative minor, 210  
super Locrian, 226

whole tone, 225  
second inversion, 262  
seventh chord, 254  
sharp, 161, 168  
similar motion, 269  
sixteenth note, 116  
sixteenth note triplet, 129  
sixty-fourth note, 288  
space, 24  
space note, 32  
staff, 24  
staff lines, 24  
stem, 94  
super Locrian scale, 226

## T

tap, 108  
third, 247  
thirty-second note, 288  
time signature, see *meter*  
triad, 247  
Triplets

eighth, 128  
sixteenth, 129  
tuner, 154  
tuplet, 128

## U

unison, 199

## V

voice leading, 268

## W

warm-up, 150  
washtub bass, 156  
whole note, 92, 110  
whole rest, 111  
whole step, 169, 175  
whole tone scale, 225

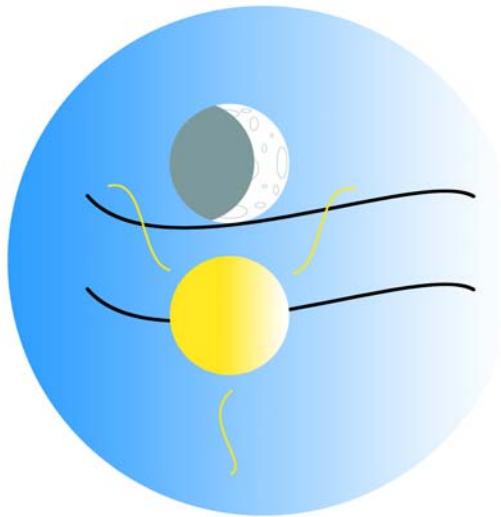

**SolUt Press**

[www.Sol-Ut.com](http://www.Sol-Ut.com)

# INDEX

This page (and many others) are hyperlinked in the eBook version of *Basic Music Theory*. (\$4.95)

click this notice to buy or go to

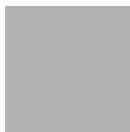

[www.sol-ut.com](http://www.sol-ut.com).

## A

accidentals  
  general info, 160  
  sharp, 161  
  double sharp, 294  
  double flat, 294  
Aeolian mode, 218  
augmented triads, 250

## B

bar, 28  
bar line, 28  
bass clef, 50, 62  
beam, 114, 288  
beat, 92  
bebop scales, 225  
blues scale  
  standard, 222  
  major blues, 223  
  minor, 222  
  recipe for one, 223

## C

C clef, 49  
chord, 246  
Chord Extensions  
  general info, 254  
  seventh chord, 254  
  ninth chord, 256  
  seventh chord  
    dominant seventh chord, 255  
Chord Inversions  
  general info, 260  
  first, 261  
  second, 262  
  third, 263

  seventh chords, 263  
Chord Progression  
  general info, 268  
  parallel motion, 270  
  rules of, 268  
  similar motion, 269  
  I IV V I, 270  
  ii V I, 272  
  iii vi ii V I, 273  
  12 bar blues, 273  
chord progression, 268  
chord quality, 246  
Chords  
  Finding name of, 263  
  general info, 246  
  triads, 247  
  close harmony, 260  
  open harmony, 260  
  seventh chord  
    dominant seventh chord, 255  
  triads  
    augmented, 250  
    diminished, 249  
    major, 248  
    minor, 249  
  using Roman numerals with, 246  
  11th and 13th chords, 256  
  seventh chord, 254  
  ninth chord, 256  
chromatic scale, 169  
Clef  
  general info, 48  
  alto clef, 49  
  bass, 50  
  bass clef, 62  
  C clef, 49  
  rhythm clef, 51, 68

  one line, 68  
  5 lines, 69  
  drum set notes, 70  
  soprano clef, 49  
  tenor clef, 49  
  treble clef, 50  
  vocal tenor clef, 49  
close harmony, 260  
common tone, 269  
compound interval, 254  
Conducting  
  general info, 236  
  left hand, 240  
  right hand, 240  
Patterns  
  2/4 time, 239  
  3/4 time, 239  
  4/4 time, 238  
  right arm, 238  
conducting, 236  
Counting System  
  whole note, 110  
  half note, 109  
  quarter note, 109  
  eighth notes, 115  
  rests, 111  
cut time, 298  
  
**D**  
diminished triads, 249  
directing, see *Conducting*  
dominant seventh chord, 255  
Dorian mode, 217  
dotted half note, 123  
dotted whole note, 122  
double bar lines, 28  
double dotted notes, 289

double dotted rests, 289  
double flat, 294  
double sharp, 294  
doubling, 268

## E

ear training, 204  
eighth note, 114  
eighth note triplet, 128  
eighth rest, 115  
Extensions  
    11th and 13th chords, 256  
Extensions, see *Chord Extensions*

## F

fifth, 247  
first inversion, 261  
flag, 114, 288  
flat, 167  
    double flat, 294  
    order of, 181  
foot tap, 108

## H

half note, 92, 109  
half rest, 111  
half step, 169, 175  
harmonic  
    harmonic, 198  
harmonic interval, 198  
harmonic minor scale, 211  
head, 93

## I

interval, 198  
    finding an interval, 198  
    augmented, 200, 201  
    diminished, 200, 201  
    finding, 201  
    harmonic, 198  
    major, 200, 201  
    melodic, 198  
    minor, 201  
    perfect, 199, 200  
Inversions, see *Chord Inversions*  
Ionian mode, 216

## K

Key Signatures  
    all keys, 185 to 186  
    general info, 180

flat keys, 181  
    construct a sharp key, 184  
    construct flat keys, 182  
    key of C, 184  
    naming flat keys, 181  
    sharp keys, 183  
keyboard, 166

## L

leap, 269  
leger line, 28  
line note, 32  
Locrian, 219  
long tones, 151  
Lydian mode, 218

## M

major intervals, 200  
major scale, 174, 216  
major triads, 248  
measure, 28  
melodic interval, 198  
melodic minor scale, 212  
meter, 102  
Meters  
    2/2, 298  
    2/4, 104  
    3/4, 104  
    4/4, 103  
    5/4, 5/8, 300  
    6/8  
        simple, 298  
        compound, 299  
    7/4, 7/8, 300  
cut time, 298  
odd, 300

metronome, 152  
minor scale  
    general info, 208  
    natural minor, 208  
    harmonic minor, 211  
    melodic minor, 212  
    natural minor  
        parallel, 210  
        relative, 210

minor triads, 249  
Mixolydian mode, 218  
Mnemonic Device  
    bass clef lines, 63  
    open harmony, 260  
    order of flats, 181  
    treble clef lines, 57  
    treble clef spaces, 58

mnemonic device, 57

## Modes

    general info, 216  
    finding or creating, 219  
    Aeolian, 218  
    Dorian, 217  
    Ionian, 216  
    Locrian, 219  
    Lydian, 218  
    Mixolydian, 218  
    Phrygian, 217

## N

naming sharp keys, 183  
natural, 162  
natural half step, 169  
natural minor scale, 208, 218  
neutral clef, 51, 68  
ninth chords, 256

## Note

    anatomy  
        stems up or down, 94

## Notes

    whole, 92  
    half, 92  
    quarter, 92  
    eighth note, 114  
    sixteenth, 116  
    thirty-second, 288  
    sixty-fourth, 288  
    anatomy, 93  
    anatomy, 94  
    eighth  
        dotted 8th, 124  
    eighth note triplet, 128  
    enharmonic, 168  
    half note  
        dotted half, 123  
    letter names, 38  
    line note, 32  
    sixteenth note  
        16th note triplet, 129  
    space note, 32  
    whole note  
        dotted whole, 122  
    double-dotted notes, 289

## O

octave, 175  
open harmony, 260  
order of flats, 181



## P

parallel minor scale, 210  
parallel motion, 270  
pentatonic scale, 224  
percussion clef, 51, 68  
perfect fifth, 199  
perfect fourth, 199  
perfect intervals  
  fifth, 199  
  fourth, 199  
  octave, 199  
  prime, 199  
  unison, 199  
perfect octave, 199  
perfect prime, 199  
Phrygian mode, 217  
pitch, 33  
Practice  
  beginning, 145  
  equipment, 149  
  how much to, 143  
  how to, 148, 150  
  using the metronome, 151  
  where, 147  
private teachers, 143  
pulse, 92

## Q

quarter, 109  
quarter note, 92, 109  
quarter note triplet, 130  
quarter rest, 111

## R

relative minor scale, 210  
Rests

dotted rests, 125  
eighth, 115  
half, 98  
quarter, 98  
whole, 98  
Reviews  
  Part I, 41  
  Part II, 73  
  Part III, 133  
  Part IV, 189  
  Part V, 229  
  Part VI, 277  
  Part VII, 303  
rhythm clef, 68  
root, 247  
root position, 260

## S

Scales  
  bebop, 225  
  blues, 222  
  chromatic, 169  
  harmonic minor, 211  
  major, 174, 216  
  melodic minor, 212  
  natural minor, 218  
  parallel minor, 210  
  pentatonic, 224  
  relative minor, 210  
  super Locrian, 226  
  whole tone, 225  
second inversion, 262  
seventh chord, 254  
sharp, 161, 168  
similar motion, 269  
sixteenth note, 116  
sixteenth note triplet, 129

sixty-fourth note, 288  
space, 24  
space note, 32  
staff, 24  
staff lines, 24  
stem, 94  
super Locrian scale, 226

## T

tap, 108  
third, 247  
thirty-second note, 288  
time signature, see *meter*  
triad, 247  
Triplets  
  eighth, 128  
  sixteenth, 129  
tuner, 154  
tuplet, 128

## U

unison, 199

## V

voice leading, 268

## W

warm-up, 150  
washtub bass, 156  
whole note, 92, 110  
whole rest, 111  
whole step, 169, 175  
whole tone scale, 225



**SolUt Press**

[www.Sol-Ut.com](http://www.Sol-Ut.com)