

# THE ROSWELL REPORT

FACT VS FICTION  
IN THE  
NEW MEXICO  
DESERT



HEADQUARTERS UNITED STATES AIR FORCE

# THE ROSWELL REPORT

Fact versus Fiction  
in the  
New Mexico Desert

Headquarters United States Air Force  
1995

---

For sale by the U.S. Government Printing Office  
Superintendent of Documents, Mail Stop SSOP, Washington, DC 20412-9328  
ISBN 0-16-048023-X

## FOREWORD

This report represents a joint effort by Col. Richard L. Weaver and 1st Lt. James McAndrew to address the request made by Representative Steven H. Schiff (R-NM) for information regarding an alleged crash of an unidentified flying object (UFO) that occurred in the state in 1947. This publication duplicates the information provided to the Secretary of the Air Force and to the General Accounting Office (GAO). It was written as a result of Colonel Weaver's and Lieutenant McAndrew's efforts to locate the records that explain the events of July 1947 leading to what is popularly known as the Roswell Incident. The only information presented here that was not in the report delivered to the Secretary of the Air Force and the GAO is the photograph section. It appears after Colonel Weaver's final attachment, at the very end of this book.

The importance of attachment 32, Lieutenant McAndrew's synopsis, derives from his description of Project MOGUL, the top-priority classified project of balloon-borne experiments, which provides the explanation for the "Roswell Incident." Interest abounds surrounding the UFO wave of 1947 which began in the spring and did not dissipate until fall. Interest in UFOs climaxed during the summer, when multiple sightings of such objects occurred.

RICHARD P. HALLION  
Air Force Historian



## ACKNOWLEDGMENTS

This report and publication would not have been possible without the expert assistance and outstanding cooperation of many persons and organizations. Appreciation is extended to the Administrative Assistant to the Secretary of the Air Force, Mr. William Davidson, and to his predecessor, Mr. Robert McCormick. The Air Force Historian, Dr. Richard P. Hallion, generously offered the services of his staff and facilities. Col. Jeffrey Butler, of the Secretary of the Air Force Office of Security and Special Program Oversight, made signal contributions to both the research and writing of this report.

The primary research conducted for this report was provided by the Secretary of the Air Force's Declassification and Review Team (SAF/AAZD), headed by Col. Linda Smith. Lt. Col. Dale Freeman and Maj. Len Shoemaker initiated the project. Maj. Bill Coburn, CMSgt. Owen Costello, and MSgt. Jean Hardin provided invaluable assistance throughout. SSgt. Jim Bruns acquainted himself with the numerous research facilities available in the Washington, DC, area, and contributed mightily to the effort. Grace Rowe, the Records Manager for the Secretary of the Air Force, provided unparalleled guidance and counsel to help sort through fifty years of records amassed by the U.S. Air Force.

At Bolling AFB, we are indebted to Col. George Williams, Commander of the Air Force History Support Office, and to his staff for their expert advice, guidance, and kind use of facilities. Our foremost debt is owed to historian Sheldon Goldberg, who greatly assisted our efforts. Additionally, historians Alfred Beck, William Heimdahl, Roger Miller, Eduard Mark, and Jacob Neufeld shared with us their wide knowledge of Air Force history. Also, Robert "Gus" Bell contributed with his attractive art work; Richard Wolf provided invaluable computer expertise; and Maj. Myrt Wilson, SSgt. Steve Rapp, SRA Francis Noel, and Debra Moss supplied essential administrative assistance. Thanks go to editor Barbara Wittig for her efforts in this undertaking.

A special thank-you goes to Bruce Ashcroft, chief historian at the National Air Intelligence Center, Wright Patterson AFB, OH. Mr. Ashcroft gave freely of his official and personal time to provide assistance whenever we asked. Moreover, his unique previous experience, as a historian in the State of New Mexico, added a wealth of detail that would otherwise have been missed.

We must also express our sincerest gratitude to the staff of the USAF Phillips Laboratory, Geophysics Directorate at Hanscom AFB, MA, especially to Lisa Duffeck, of the Research Library, whose research talents contributed significantly to this report. We thank John Armstrong, also of the Research Library, for having the foresight to preserve the

balloon files; Neal Stark and Jack Griffin, of the Geophysical Directorate's Aerospace Engineering Group, whose corporate knowledge of Air Force ballooning answered many difficult questions; and to historian Ruth Liebowitz for sharing her files and photographs. Many thanks also to Sheilagh Banacos in Information Management and Evelyn Kindler of the Public Affairs Office.

At the National Archives and Records Administration in Washington, DC, it was a pleasure to collaborate with archivist Edward Reese of the Military Reference Branch. Mr. Reese, who retired in October 1994 after more than fifty-three years of faithful civil service, provided a much-welcomed professional logic and calm to our endeavors. Also at the Military Reference Branch, Wil Mahoney's knowledge of Air Force records proved invaluable. At the Washington National Records Center in Suitland, MD, we thank Reference Section archivist Carry Conn, who patiently led us through the stacks, and Richard Boylan, Reference Branch Assistant Chief, for his truly prodigious memory. At the National Personnel Records Center, in St. Louis, MO, archivists Bill Siebert and Eric Voltz helped to map out a search plan, while Carl Paulson capably guided us through it. Pearline Foster shared her time, personnel, and an all-important photocopier. At National Archives II in College Park, MD, Allen Lewis graciously provided access to their excellent facilities.

Numerous individuals agreed to be interviewed for this publication. We would like to express our sincerest thanks to them and their spouses for helping guide us through the complex maze of names, projects, and places that had been shrouded in secrecy by the passing of nearly fifty years. Special thanks go to Athelstan and Kathy Spilhaus, Charles and Wilma Moore, Col. Albert and Jean Trakowski, Lt. Col. Sheridan and Mary Cavitt, and Maj. Irving Newton, USAF (Ret). Also sincerest thanks to Mrs. Emily Duffy and Mrs. Mildred Cray for sharing their recollections and photographs of their distinguished husbands.

We also put to good use the fine reference facilities at the Naval Research Laboratory in Washington, DC, and thank Eileen Pickenpaugh, the Deputy Librarian, Murray Bradley, head of Research Reports Section, and Ralph Peterson, the Research Report Librarian, all of whom helped immeasurably to make our searches easier.

Our thanks go also to the men and women of the 913th Airlift Wing (AFRES) at Willow Grove ARS, PA, especially to Col. Richard Moss, the 913th Airlift Wing Commander, and Lt. Col. (Col. Select) Robert Hunter, the 913th Logistics Group Commander, for providing end-of-year assistance. And we are grateful to CMSgt. Michael Breitenbach, for sharing his very useful experiences and insights.

We are most grateful to the members of Air Force Publishing—Ray Del Villar, Linda Garmon, and Jack Fischer—who brought this publication into print, and to SRA Garrety Wood of the 11th Communication Squadron Photo Lab for excellent photo reproduction services.

In the course of researching and writing this report, numerous other individuals contributed to the success of the project. Among them were Col. Gerald Merritt, Director,

Clinical Investigations and Life Sciences Division, Headquarters Air Force Medical Operating Agency, Bolling AFB, DC; John Jenkins, Freedom of Information Act Manager, USAF Phillips Laboratory, Kirtland AFB, NM; George Horn, Technical Publications Editor, Air Force Environmental Technical Applications Centers, Scott AFB, IL; Steve Dean, Computer Specialist, Office of the Secretary of the Air Force, Pentagon; George Cully, Historian, 81st Training Wing, Keesler AFB, MS; Gene Schreiner, Technical Publications Editor, USAF Rome Laboratory, Griffiss AFB, NY; MSgt. Al Mack, Historian, 49th Fighter Wing, Holloman AFB, NM; Lois Walker, Historian, Air Force Matériel Command, Wright-Patterson AFB, OH; TSgt. Donald Valentine, Administrative Specialist, 89th Airlift Wing, Andrews AFB, MD; Maj. David Thurston, Secretary of the Air Force Public Affairs Office; Dr. Saxson and Betsy Hudon of the University of Texas at Arlington Library; Col. Joseph Fletcher, USAF (Ret); Robert Todd; Frank Press; Vance Mitchell; Lt. Col. Joseph Rogan; Maj. Kevin Stubbs; SRA Donald Crissman; Francis Whedon; Richard Hassard; Joseph Worzel; John Peterson; Martin Koenig; Eileen Ulrich Farnochi; and the late Vivian Bushnell. To all, we extend our sincerest gratitude.

RICHARD L. WEAVER, COL, USAF  
Director of Security and Special Program Oversight  
SAF/AAZ

JAMES McANDREW, 1ST LT, USAFR  
Declassification and Review Officer  
SAF/AAZD





## GUIDE FOR READERS

This publication contains two narratives: The *Report of the Air Force Research Regarding the "Roswell Incident"* by Col. Richard L. Weaver and the *Synopsis of Balloon Research Findings* by 1st Lt. James McAndrew. These are the same narratives and supporting documents that went to the Secretary of the Air Force and to the Government Accounting Office, except that a photograph section has been appended. It appears at the end of the book, after Attachment 33.

Thirty-three attachments support Colonel Weaver's *Report*. Attachment 32 consists of Lieutenant McAndrew's *Synopsis*, itself followed by eleven attachments and twenty-five appendices. McAndrew's appendices reproduce the actual sources cited in his report.

The attachments to the Weaver *Report* are located by black tabs printed at the lower right-hand corner of their cover pages, whereas the attachments to McAndrew's *Synopsis* are located by black tabs printed midway up the page. Appendices to the McAndrew *Synopsis* are identified by gray tabs which appear at the top right-hand corners of their respective cover pages (*see below*).

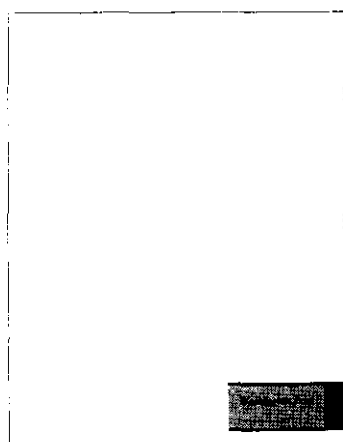

Weaver Attachments

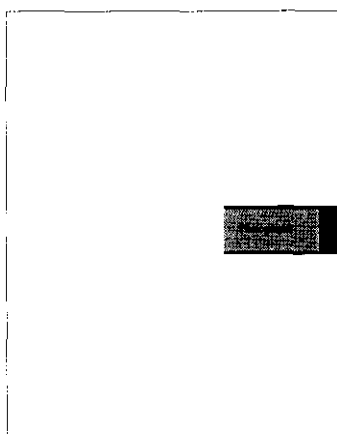

McAndrew Attachments

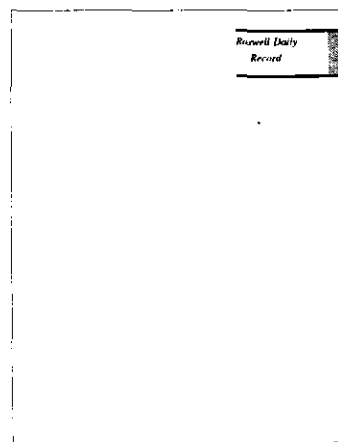

McAndrew Appendices

Choosing to distinguish attachments and appendices from each other by using separate colors and placements for the tabs has been done to avoid creating ambiguity in repaginating the original source material reproduced here. Because many of the attachments and appendices appeared in previous publications and were integrally numbered there, their original pagination has not been changed for the purposes of this report. Additionally, any blank pages appearing in these source documents, though

numbered there, were not printed as pages in the present document. This accounts for any discontinuity present in the page numbering of the source material reprinted here.

Security markings have been deleted from previously classified documents. The reader is advised that blacked-out areas noted in the top and bottom margins of pages printed in this document indicate pages that originally contained classified information. These pages have since been declassified, and so can be printed here.

Also, privacy act restrictions apply to witnesses whose statements and interviews are reproduced for the purposes of this report. The reader will see that the addresses of such individuals have been deleted. Such witnesses are identified by name only.

# TABLE OF CONTENTS

Foreword .....	iii
Acknowledgments .....	v
Guide for Readers .....	ix
Introduction .....	1
<b>“Report of Air Force Research Regarding the ‘Roswell Incident’,” with Memorandum for the Secretary of the Air Force, by Richard L. Weaver, Col, USAF, July 27, 1994 .....</b>	<b>5</b>

## **Attachments to Colonel Weaver’s Report of Air Force Research:**

1. *Washington Post*, “GAO Turns to Alien Turf in Probe,” January 14, 1994
2. Letter and GAO Code 701034, Richard Davis, GAO, to William J. Perry, DOD, February 15, 1994
3. Memo, Marcia J. Van Note, DOD/IG, for Distribution, subj: General Accounting Office (GAO) Letter Dated February 9, 1994 . . . , February 23, 1994
4. Memo with Indorsement, Vaughn E. Schlunz, SAF/FMPF, for Distribution, subj: GAO Review Letter Dated February 15, 1994, “Records Management Procedures . . . , February 24, 1994
5. Memo with Addendum, Robert J. McCormick, SAF/AA, for Distribution, subj: GAO Review on Records Management Procedures Dealing with Weather Balloons, Unknown Aircraft, and Similar Crash Incidents . . . , March 1, 1994
6. Memo with Attachments, AF/IN for SAF/AA, Subj: GAO Inquiry into Records Management Procedures Dealing with Weather Balloons, Unknown Aircraft, and Similar Crash Incidents, March 14, 1994

7. Memo, Brig Gen James L. Cole, Jr., AF/SE, for SAF/AAZ, subj: GAO Review on Records Management Procedures with Weather Balloons, Unidentified Aircraft, and Similar Crash Incidents . . ., March 14, 1994
8. Memo, Col Michael W. Schoenfeld, SAF/AQL, for SAF/AA, subj: GAO Review on Records Management Procedures Dealing with Weather Balloons, Unknown Aircraft, and Similar Crash Incidents . . ., March 22, 1994
9. Memo, Col Steve O. Ouzts, AF/XOWP, for SAF/AAZ, subj: GAO Review on Records Management Procedures Dealing with Weather Balloons, Unknown Aircraft, and Similar Crash Incidents . . ., March 9, 1994
10. Memo, Grace T. Rowe, SAF/AIQ, for SAF/AAI, SAF/AAZ, subj: GAO Review of Records Management Procedures Dealing with Weather Balloons, Unknown Aircraft, and Similar Crash Incidents . . ., March 10, 1994
11. Memo with Attachment, Richard S. Rauschkolb, AFHRA/CC, for AF/HO, SAF/AAZ, subj: GAO Review on Records Management Procedures Dealing with Weather Balloons, Unknown Aircraft, and Similar Crash Incidents . . ., March 8, 1994
12. Memo, with Attachments, Edward C. Mishler, HQ AFOSI/HO, for SAF/AAZ, subj: GAO Review on Records Management Procedures . . ., May 11, 1994
13. Records Searched
14. Letter, Lt Col Thomas Badger, Jr., HQ/AAF, to Commanding General, AMC, subj: Issuance of Orders, June 5, 1947
15. Appointment Book and Diary, Lt Gen Hoyt S. Vandenberg, July 7-9, [1947], and July 5-9, 1947
16. *Fort Worth Star-Telegram*, Photographs of Balloon Debris, [July 9, 1947]
17. Statement, Lt. Col. Sheridan D. Cavitt, USAF (Ret), May 24, 1994
18. Interview, Col Richard L. Weaver with Lt Col Sheridan D. Cavitt, USAF (Ret), [May 24, 1994]
19. Letters, Brig Gen E. O'Donnell to Commanding General AAF, July 8, 1946; Lt Col W.H. Congdon and Col D.P. Graul to Commanding General AMC, September 9, 1947; and Brig Gen Tom C. Rives to Commanding General AAF, September 10, 1947
20. Statement, Athelstan F. Spilhaus, June 3, 1994
21. Statement, Charles B. Moore, June 8, 1994, and Hieroglyphic and Balloon Train Drawings, August 28, 1992
22. Statement, Albert C. Trakowski, June 29, 1994
23. Interview, Col Jeffrey Butler and 1st Lt James McAndrew with Professor Charles B. Moore, June 8, 1994
24. Interview, [Col Jeffrey Butler and 1st Lt James McAndrew with] Col Albert C. Trakowski, USAF (Ret), June 29, 1994
25. Drawing, NYU Cluster Flight No. 2

26. Photographs, Project MOGUL Balloon Trains
27. Table No. 7, Summary of NYU Constant-Level Balloon Flights, November 20, 1946–July 5, 1947
28. Museums Contacted
29. Blueprint, Corner Reflector, ML–307C/AP Assembly
30. Statement, Irving Newton, July 21, 1994
31. Photographs, ML–307C/AP Device with Vintage Neoprene Balloons and Debris
- 32. Synopsis of Balloon Research Findings, with Memorandum for SAF/AAZ, Att: Colonel Richard L. Weaver, by James McAndrew, 1st Lt, USAFR**

**Attachments to the McAndrew Synopsis:**

1. *Fort Worth Star-Telegram*, Photographs of Balloon Debris, [July 9, 1947]
2. Organizational Chart, Watson Laboratories, January 20, 1947
3. Drawing, NYU Cluster Flight No. 2
4. Illustrations, AN/CRT–1 Sonabuoy
5. Blueprint, Corner Reflector, ML–307C/AP Assembly
6. Table No. 7, Summary of NYU Constant-Level Balloon Flights, November 20, 1946–September 9, 1947
7. Map of New Mexico
8. Illustration, Weather Balloon and Corner Reflector
9. Letter, Brig Gen E. O'Donnell to Commanding General AAF, July 8, 1946
10. Hieroglyphic Drawing, Charles B. Moore, August 28, 1992
11. *Alamogordo News*, "Fantasy of 'Flying Disc' Is Explained Here: News Men Watch Army Radar Crew Launch 'Disc'," July 10, 1947

**Appendices to the McAndrew Synopsis:**

1. *Roswell Daily Record*, July 9, 1947
2. Interview, Col Richard L. Weaver with Lt Col Sheridan D. Cavitt, USAF (Ret), [May 24, 1994]
3. Statement, Irving Newton, July 21, 1994
4. Letter, Lt Col Edward A. Doty to Mr David Bushnell, March 3, 1959
5. Letter, Brig Gen E. O'Donnell to Commanding General AAF, July 8, 1946
6. Report, Maurice Ewing for General Carl Spaatz, "Long Range Sound Transmission in the Atmosphere," n.d.
7. Report, HQ Fitzwilliam Fwd, "Sonic Balloon Test Kwajalein," May 17, 1948

8. Memo, Brig Gen Tom C. Rives to Maj Gen Curtis LeMay, subj: Relief of Major R.T. Crane as Project Officer for MOGUL and TORRID, June 18, 1946
9. Memo, Maj Gen Curtis E. LeMay to Maj Gen L.C. Craigie, April 16, 1947
10. New York University, *Constant Level Balloons, Final Report*, March 1, 1951
11. New York University, *Constant Level Balloons, Section 1, General*, November 15, 1949
12. New York University, *Constant Level Balloons, Section 3, Summary of Flights*, July 15, 1949
13. New York University, *Technical Report No. 1, Constant Level Balloon*, April 1, 1948
14. Athelstan F. Spilhaus, C.S. Schneider, C.B. Moore, "Controlled-Altitude Free Balloons," *Journal of Meteorology*, Vol. 5, August 1948
15. New York University, *Progress Report No. 6, Constant Level Balloon, Section II*, June 1947
16. New York University, *Special Report No. 1, Constant Level Balloon*, May 1947
17. Personal Journal of Albert P. Crary
18. New York University, *Progress Report [No. 7], Constant Level Balloon, Section II*, July 1947
19. New York University, *Progress Report No. 4, Radio Transmitting, Receiving and Recording System for Constant Level Balloon*, [Section I], April 2, 1947
20. Interview, Col Jeffrey Butler and 1st Lt James McAndrew with Professor Charles B. Moore, June 8, 1994
21. Report, Holloman AFB, "Progress Summary Report on U.S.A.F. Guided Missile Test Activities," August 1, 1948
22. Interview, [Col Jeffrey Butler and 1st Lt James McAndrew with] Col Albert C. Trakowski, USAF (Ret.), June 29, 1994
23. Report, Cambridge Field Station, Air Materiel Command, "Review of Air Materiel Command Geophysical Activities by Brigadier General D.N. Yates, and Staff, of the Air Weather Service," February 10, 1949
24. New York University, *Constant Level Balloons, Section 2, Operations*, January 31, 1949
25. Combined History, 509th Bomb Group and Roswell Army Airfield, September 1-30, 1947

**Attachment to Colonel Weaver's Report of Air Force Research:**

33. Mensuration Working Paper, with Drawing and Photo

## Photograph Section

General Carl A. Spaatz  
Lt Gen Hoyt S. Vandenberg  
General Nathan F. Twining  
Maj Gen Curtis E. LeMay and Brig Gen Roger M. Ramey  
Col William H. Blanchard  
Maj Gen Clements McMullen  
Brig Gen Donald N. Yates  
Albert P. Crary and Phil Chantz  
Dr. W. Maurice Ewing and Albert P. Crary  
Dr. Althelstan F. Spilhaus and Col Marcellus Duffy  
Capt Albert C. Trakowski and Dr. James Peoples  
Charles B. Moore  
U.S. Army GR-3 Sound Ranging Set, TNT Detonation, and Project MOGUL PT Boat  
Project MOGUL Neoprene Balloons and Standard Meteorological Weather Balloons  
MOGUL Balloon Train, AN/FMQ-1 Radiosonde Receiver/Recorder, and Project MOGUL  
Microphones  
Polyethylene Balloons  
Project MOGUL Balloons  
Seyfang Laboratory Balloons  
Project MOGUL Balloon Train Components and Debris Recovered  
Heights of Familiar Architectural Structures Relative to the Length of a Project MOGUL  
Balloon Train  
Map of New Mexico





## INTRODUCTION

Throughout the latter half of the twentieth century the subject of Unidentified Flying Objects (UFOs) has evoked strong opinions and emotions. For some, the belief in or study of UFOs has assumed the dimensions of a religious quest. Others remain nonbelievers or at least skeptical of the existence of alien beings and elusive vehicles which never quite seem to manifest themselves. Regardless of one's conviction, nowhere has the debate about UFOs been more spirited than over the events that unfolded near the small New Mexico city of Roswell in the summer of 1947. Popularly known as the Roswell Incident, this event has become the most celebrated UFO encounter of all time and has stimulated enthusiasts like none other. Numerous witnesses, including former military personnel and respectable members of the local community, have come forward with tales of humanoid beings, alien technologies, and government cover-ups that have caused even the most skeptical observer to pause and take notice. Inevitably these stories coming from the desert have spawned countless articles, books, films, and even museums claiming to have proof that visitors had come from outer space.

In February 1994, the Air Force was informed that the General Accounting Office (GAO), an investigative agency of Congress, planned a formal audit to ascertain "the facts regarding the reported crash of an UFO in 1949 [1947] at Roswell, New Mexico."<sup>1</sup> This task was delegated to numerous agencies, but the focus was on the U.S. Air Force, the agency most often accused of hiding information and records on Roswell. The Presidential Science Advisor had also expressed an interest in the investigation. Thereupon, the Secretary of the Air Force directed that a complete records search identify, locate, and examine any and all information available on this subject. From the outset there was no predisposition to refute or overlook any information. Moreover, if any of the information discovered was under security classification, it was to be declassified, and if active or former Air Force officials had been sworn to a secrecy oath, they were to be freed from it. In short, the objective was to tell the Congress, and the American people, *everything* the Air Force knew about the Roswell claims.

Subsequently, researchers conducted an extensive search of Air Force archives, record centers, and scientific facilities. Seeking information that might help to explain peculiar tales of odd wreckage and alien bodies, the researchers reviewed a monumental number

---

1. Memo, Marcia J. Van Note, DOD/IG, for Distribution, subj: General Accounting Office (GAO) Letter Dated February 9, 1944 . . . , Feb 23, 1994.

of documents concerning a variety of events, including aircraft crashes, errant missile tests, and nuclear mishaps.

The researchers reported to the Administrative Assistant to the Secretary of the Air Force (SAF/AA), the office responsible for both Air Force records and security policy oversight. Within SAF/AA, the tasking fell to the Director of Security and Special Program Oversight and its specialized subunit, the Declassification and Review Team. This team, comprised entirely of Reservists, was well versed in the Air Force's records system and its complex declassification procedures. Previously, Declassification and Review Team members demonstrated their expertise and effectiveness by declassifying millions of pages of Southeast Asian War and Prisoner of War—Missing in Action records.

As this study makes abundantly clear, the Declassification and Review Team found no evidence of any extraterrestrial craft or alien flight crew. In fact, what they did find had been declassified for more than twenty years—a shadowy, formerly Top Secret project, code-named MOGUL.

Project MOGUL resulted from two important post-World War II priorities set by the Commanding General of the Army Air Forces, Henry H. "Hap" Arnold. These were to continue the cooperative wartime relationship between civilian research institutions and the military, and to maintain America's technological superiority, especially with respect to guarding against a bolt from the blue—in other words, a devastating surprise attack. MOGUL addressed both of these concerns. Developed partly under contract with leading scientific institutions—such as New York University (NYU), Woods Hole Oceanographic Institution, Columbia University, and the University of California at Los Angeles—MOGUL's objective was to develop a long-range system capable of detecting Soviet nuclear detonations and ballistic missile launches.

Army Air Forces officials assembled an expert group of military and civilian scientists to carry out the project. The group included Dr. W. Maurice Ewing of Columbia University, a preeminent geophysicist and oceanographer; Dr. Athelstan F. Spilhaus, the Director of Research at NYU who later advised five presidents on scientific and cultural matters; Dr. James Peoples, the Air Force's civilian project scientist and later editor of the *Journal of Geophysical Research*; Albert P. Crary, also a civilian Air Force scientist, known for significant contributions to Antarctic research; and Charles B. Moore, Project Engineer at NYU and an atmospheric physicist who pioneered the use of giant plastic research balloons still widely used today. Col. Marcellus Duffy, a respected Air Force pilot and scientific administrator, led the project. Capt. Albert C. Trakowski, a young Massachusetts Institute of Technology graduate, followed Duffy in the leadership role.

Determining whether the Soviets were testing nuclear devices was of the highest national priority; it demanded the utmost secrecy if the information gained was to be useful. When the Soviets exploded their first atomic device in August 1949, the experimental Project MOGUL was not in operation. However, the explosion was detected by a specially equipped Air Force B-29 aircraft. Accordingly, MOGUL was conducted under stringent security—secluded laboratories, code words, maximum security clearances, and strictest enforcement of need-to-know rules. Nevertheless, while the nature of the project remained

shrouded in secrecy, some of its operations obviously could not. The deployment of giant trains of balloons—over thirty research balloons and experimental sensors strung together and stretching more than 600 feet—could be neither disguised nor hidden from the public. Moreover, operational necessity required that these balloons be launched during daylight hours. It was therefore not surprising that these balloons were often mistaken for UFOs. In fact, MOGUL recovery crews often listened to broadcasts of UFO reports to assist them in their tracking operations. Additionally, the balloons were unsteerable, leading to such amusing events as the one reported by the *New York Times* in which a secret MOGUL balloon “floated blithely over the rooftops of Flatbush . . . causing general public excitement . . . before it came to rest on top of a [Brooklyn] tavern.”<sup>2</sup> In another episode, MOGUL balloon recovery technicians directed a B-17 bomber, which was tracking one of the tests, to buzz and scare off a curious oil rig crew that was about to “capture” a balloon train that had fallen near Roswell. The ruse worked. However, too much activity was going on for the project to remain completely hidden. A MOGUL project officer later noted, “It was like having an elephant in your backyard . . . and hoping no one would notice.”<sup>3</sup> These occurrences were typical, leading the recovery crews to describe themselves as *Balloonatics*, due to the predicaments in which the wandering balloons sometimes placed them, but the information the balloons were attempting to obtain was vital.

To attempt to limit unauthorized disclosure, the Air Force employed a security mechanism known as compartmentation. Compartmentation controlled access to classified information by dispersing portions of the research among several facilities and institutions. Each participating entity received only enough information necessary to accomplish its assigned tasks. In the case of MOGUL, only a small circle of Air Force officers received the intimate details that linked together these unrelated research projects. The use of compartmentation along with strict enforcement of the need to know enabled MOGUL to remain a secret—despite its obvious security difficulties—and to remain unevaluated for many years as the cause of the Roswell Incident.

The issue of compartmentation was significant because some UFO researchers assert that the persons who recovered the MOGUL equipment, members of the 509th Bombardment Group stationed at Roswell Army Airfield, should have been able to recognize the debris collected at the crash site as that of a research balloon. Although members of the 509th possessed high-level clearances, they were not privy to the existence of MOGUL; their job was to deliver nuclear weapons, not to detect them. The unusual combination of experimental equipment did not encourage easy identification that undoubtedly left some members of the 509th with unanswered questions. Some UFO enthusiasts have manipulated these unanswered questions to support their flying-saucer recovery scenario, while eagerly supplying unfounded explanations of extraterrestrial visitation and cosmic conspiracy. Additionally, many claims of a flying saucer crash at Roswell rest on the description of debris collected at the Foster ranch site. UFO researchers, including those

---

2. *New York Times*, “Balloon Staggers Down to Brooklyn Tavern, Hooks Itself to Roof and Upsets Decorum,” Oct 1, 1948.

3. *New York Times*, “Wreckage of a ‘Spaceship’: Of This Earth (and U.S.),” Sep 18, 1994.



OFFICE OF THE SECRETARY OF DEFENSE

who are said to have known *all about* MOGUL, apparently did not compare the descriptions of the suspect debris with that of the components of a Project MOGUL balloon train. MOGUL reports and documents that contain descriptions, illustrations, and photographs have been publicly available for at least twenty years. Had the researchers completed even a cursory comparison, they would have found that the materials were suspiciously similar; detailed examination would have shown them to be one and the same. In the final analysis, it appears these individuals have pursued the convenient red herring provided by Roswell Army Airfield, while the real explanation lay just over the Sacramento Mountains at the MOGUL launch site in Alamogordo.

This report explains the events that transpired in and near Roswell, New Mexico, in the summer of 1947. It is based on written documentation and first-hand accounts of participants, all of which are provided here in their entirety. While these answers are not as titillating as tales of unearthly craft and creatures, it is a fascinating story nonetheless.

JAMES McANDREW, 1ST LT, USAFR  
Declassification and Review Officer  
SAF/AAZD

MEN

FRO

SUE

is se  
con

typ  
up"  
obj  
"cc  
any  
sur

A  
R  
th



DEPARTMENT OF THE AIR FORCE  
WASHINGTON DC 20330-1000



OFFICE OF THE SECRETARY

JUL 27 1994

MEMORANDUM FOR THE SECRETARY OF THE AIR FORCE

FROM: SAF/AAZ  
1720 Air Force Pentagon  
Washington, DC 20330-1720

SUBJECT: Report of Air Force Research Regarding the "Roswell Incident"

Attached is a report prepared in support of a General Accounting Office (GAO) audit that is seeking to identify information concerning the "Roswell Incident." The report documents the considerable effort expended by numerous Air Force offices and personnel in this matter.

The Air Force efforts did not identify any indication that the "Roswell Incident" was any type of extraterrestrial event or that the Air Force has engaged in a 47 year conspiracy or "cover-up" of information relating to it. Therefore, it is assumed that pro-UFO groups will strongly object to the attached report and denounce it as either shortsighted or a continuation of the "cover-up" conspiracy. Nevertheless, the attached report is a good faith effort and the first time any agency of the government has positively responded officially to the ever-escalating claims surrounding the Roswell matter.

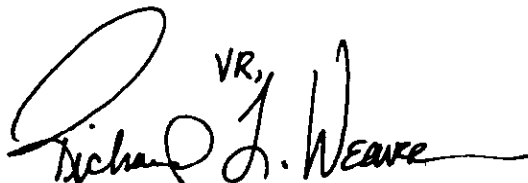
VR,  

RICHARD L. WEAVER, Col, USAF  
Director, Security and Special  
Program Oversight

Attachment:  
Report of Research Regarding  
the "Roswell Incident", 27 Jul 94

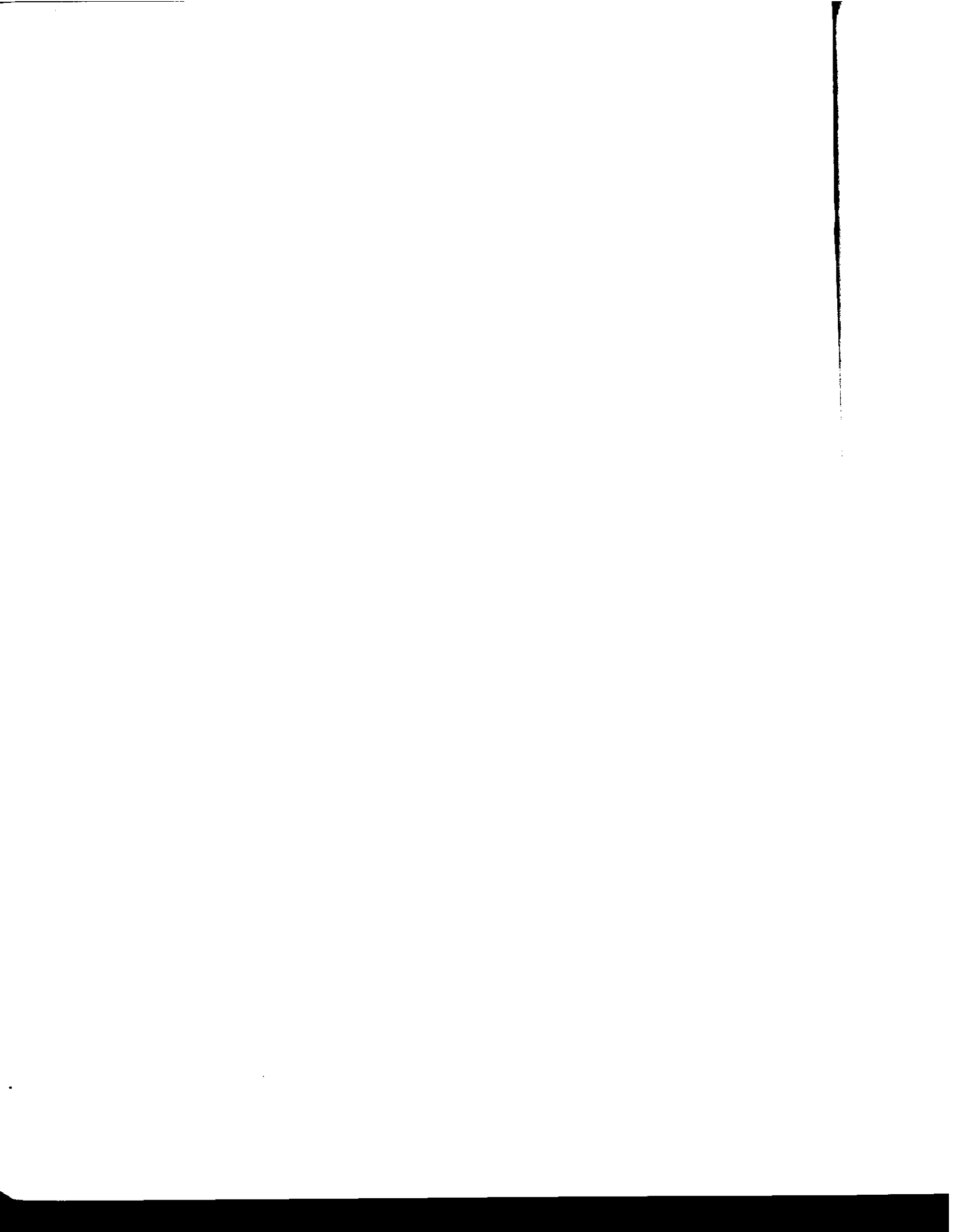

**REPORT OF AIR FORCE RESEARCH  
REGARDING THE  
"ROSWELL INCIDENT"**



**JULY 1994**



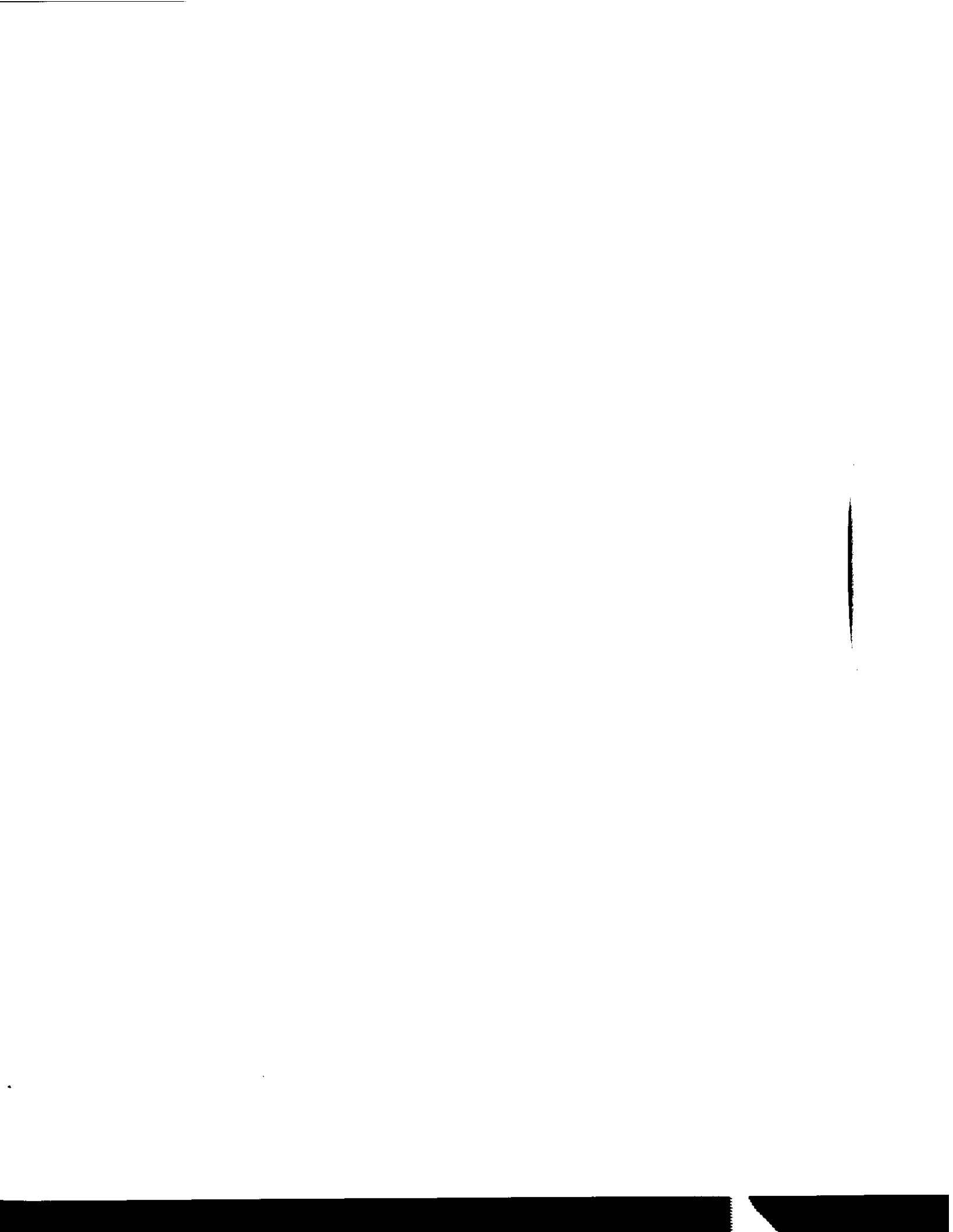

## REPORT OF AIR FORCE RESEARCH REGARDING THE "ROSWELL INCIDENT"

### EXECUTIVE SUMMARY

The "Roswell Incident" refers to an event that supposedly happened in July, 1947, wherein the Army Air Forces (AAF) allegedly recovered remains of a crashed "flying disc" near Roswell, New Mexico. In February, 1994, the General Accounting Office (GAO), acting on the request of a New Mexico Congressman, initiated an audit to attempt to locate records of such an incident and to determine if records regarding it were properly handled. Although the GAO effort was to look at a number of government agencies, the apparent focus was on the United States Air Force (USAF). SAF/AAZ, as the Central Point of Contact for the GAO in this matter, initiated a systematic search of current Air Force offices as well as numerous archives and records centers that might help explain this matter. Research revealed that the "Roswell Incident" was not even considered a UFO event until the 1978-1980 time frame. Prior to that, the incident was dismissed because the AAF originally identified the debris recovered as being that of a weather balloon. Subsequently, various authors wrote a number of books claiming that not only was debris from an alien spacecraft recovered, but also the bodies of the craft's alien occupants. These claims continue to evolve today and the Air Force is now routinely accused of engaging in a "cover-up" of this supposed event.

The research located no records at existing Air Force offices that indicated any "cover-up" by the USAF or any indication of such a recovery. Consequently, efforts were intensified by Air Force researchers at numerous locations where records for the period in question were stored. The records reviewed did not reveal any increase in operations, security, or any other activity in July, 1947, that indicated any such unusual event may have occurred. Records were located and thoroughly explored concerning a then-Top Secret balloon project, designed to attempt to monitor Soviet nuclear tests, known as Project MOGUL. Additionally, several surviving project personnel were located and interviewed, as was the only surviving person who recovered debris from the original Roswell site in 1947 and the former officer who initially identified the wreckage as a balloon. Comparison of all information developed or obtained indicated that the material recovered near Roswell was consistent with a balloon device and most likely from one of the MOGUL balloons that had not been previously recovered. Air Force research efforts did not disclose any records of the recovery of any "alien" bodies or extraterrestrial materials.

## INTRODUCTION

Air Force involvement in the alleged UFO-related incident popularly known as the "Roswell Incident" began as the result of a January 14, 1994, *Washington Post* article (Atch 1) which announced Congressman Steven Schiff's intent to initiate a GAO effort to resolve this controversial matter. Having previously been involved in numerous Freedom of Information Act (FOIA) and Congressional requests on "unusual aircraft," to include Unidentified Flying Objects (UFOs), The Director, Security and Special Program Oversight, Office of the Secretary of the Air Force (SAF/AAZ), believed the Air Force would become involved in any GAO effort involving this subject.

Thus, in late January, 1994, SAF/AAZ directed its research/declassification team, SAF/AAZD, to attempt to locate any official records relative to this matter. These initial research efforts focused on records at the Air Force Historical Research Agency (AFHRA), Maxwell Air Force Base (AFB), AL, the Air Force Safety Agency (AFSA) at Kirtland AFB, NM, and the National Archives and Records Administration (NARA).

On February 15, 1994, the GAO officially notified Secretary of Defense William J. Perry that it was initiating an audit of the Department of Defense (DoD) policies and procedures for acquiring, classifying, retaining, and disposing of official government documents dealing with weather balloon, aircraft, and similar crash incidents (Atch 2). This notification was subsequently passed to the Department of Defense Inspector General who in turn officially notified the Secretaries of the Services and other affected parties of the audit in a February 23, 1994, memo (Atch 3). This memorandum indicated that the "GAO is anxious to respond to Representative Schiff's request and to dispel any concerns that the DoD is being unresponsive." These were the first official US Government documents that indicated that the purpose of the GAO was to review "crash incidents involving weather balloons and unknown aircraft, such as UFOs and foreign aircraft, and (2) the facts involving the reported crash of an UFO in 1949 [sic, 1947] at Roswell, New Mexico . . . [and an] alleged DoD cover-up."

An entrance meeting of potentially concerned parties was held in the offices of the DoD Inspector General on February 28, 1994. During this meeting it was learned that, while the audit officially would be reviewing the records of a number of DoD (and possibly other Executive Branch entities), the bulk of the effort would be focused on Air Force records and systems. The audit was officially given the GAO code 701034 and entitled "Records Management Procedures Dealing With Weather Balloon, Unknown Aircraft, and Similar Crash Incidents." Although this official title appeared rather broad, there was no misunderstanding that the real purpose was to attempt to locate records and/or information on the "Roswell Incident." This incident, explained later in more detail, generally dealt with the claim that in July of 1947, the US Army Air Forces (USAAF) recovered a flying saucer and /or its alien occupants which supposedly crashed near Roswell, New Mexico. When the USAAF ultimately became the

USAF in September, 1947, the USAF inherited equipment, personnel, records, policies, and procedures from the AAF. In this particular case, the Air Force also inherited the allegation that it had "covered up" the "Roswell Incident" and has continued to do so for the next 47 years.

Within the Air Force, the Office of the Administrative Assistant to the Secretary of the Air Force (SAF/AA) is responsible both for information management procedures (SAF/AAI) and security policy and oversight (SAF/AAZ). Because of this organization, SAF/AA was the logical entity to assist the GAO in its audit, and SAF/AAZ was officially named as the Central Point of Contact for this endeavor (Atch 4). Subsequently, the then-Administrative Assistant, Mr. Robert J. McCormick, issued a tasking memorandum dated March 1, 1994 (Atch 5), to a number of current Air Staff and Secretariat offices that might possibly have records related to such an incident if, indeed, something had actually occurred. This search for records was purposely limited to Air Force records and systems since:

- (a) The Air Force had no authority to compel other agencies to review their records;
- (b) The Air Force would have no way to monitor the completeness of their efforts if they did; and
- (c) the overall effort was the task and responsibility of the GAO—not the Air Force.

During the in-briefing process with GAO, it was learned that this audit was, indeed, generated at the specific request of Congressman Steven Schiff of New Mexico. Earlier, Congressman Schiff had written to the Department of Defense Legislative Liaison Office for information on the "Roswell Incident" and had been advised that it was part of the former UFO "Project Bluebook" that had previously been turned over to NARA by the Air Force. Congressman Schiff subsequently learned from NARA that, although they did, indeed, have the "Bluebook" materials, the "Roswell Incident" was not part of that report. Congressman Schiff, apparently perceiving that he had been "stonewalled" by the DoD, then generated the request for the aforementioned audit.

It is within this context that the following research and assistance efforts were conducted in support of the GAO. This report is intended to stand as the final official Air Force response regarding this matter.

#### THE "ROSWELL INCIDENT"—WHAT WAS ORIGINALLY REPORTED IN 1947

The modern preoccupation with what ultimately came to be called Unidentified Flying Objects (UFOs) actually began in June, 1947. Although some pro-UFO researchers argue that sightings of UFOs go back to Biblical times, most researchers will not dispute that anything in UFO history can compare with the phenomenon that began in 1947. What was later characterized as "the UFO Wave of 1947" began with 16 alleged sightings that occurred between May 17 and July 12, 1947

(although some researchers claim there were as many as 800 sightings during that period). Interestingly, the "Roswell Incident" was not considered one of these 1947 events until the 1978–1980 time frame. There is no dispute, however, that something happened near Roswell in July, 1947, since it was reported in a number of contemporary newspaper articles, the most famous of which were the July 8 and July 9 editions of the *Roswell Daily Record*. The July 8 edition reported "RAAF Captures Flying Saucer On Ranch In Roswell Region," while the next day's edition reported, "Ramey Empties Roswell Saucer" and "Harassed Rancher Who Located 'Saucer' Sorry He Told About It."

The first story reported that the Intelligence Officer of the 509th Bomb Group, stationed at Roswell Army Air Field, Major Jesse A. Marcel, had recovered a "flying disc" from the range lands of an unidentified rancher in the vicinity of Roswell and that the disc had been "flown to higher headquarters." That same story also reported that a Roswell couple claimed to have seen a large unidentified object fly by their home on July 2, 1947.

The July 9 edition of the paper noted that Brigadier General Roger Ramey, Commander of the Eighth Air Force at Fort Worth, Texas, stated that upon examination the debris recovered by Marcel was determined to be a weather balloon. The wreckage was described as a ". . . bundle of tinfoil, broken wood beams, and rubber remnants of a balloon. . . ." The additional story of the "harassed rancher" identified him as W.W. Brazel of Lincoln County, New Mexico. He claimed that he and his son, Vernon, found the material on June 14, 1947, when they "came upon a large area of bright wreckage made up of rubber strips, tinfoil, a rather tough paper, and sticks." He picked up some of the debris on July 4 and ". . . the next day he first heard about the flying discs and wondered if what he had found might have been the remnants of one of these." Brazel subsequently went to Roswell on July 7 and contacted the Sheriff, who apparently notified Major Marcel. Major Marcel and "a man in plain clothes" then accompanied Brazel home to pick up the rest of the pieces. The article further related that Brazel thought that the material:

. . . might have been as large as a table top. The balloon which held it up, if that is how it worked, must have been about 12 feet long, he felt, measuring the distance by the size of the room in which he sat. The rubber was smoky gray in color and scattered over an area about 200 yards in diameter. When the debris was gathered up the tinfoil, paper, tape, and sticks made a bundle about three feet long and 7 or 8 inches thick, while the rubber made a bundle about 18 or 20 inches long and about 8 inches thick. In all, he estimated, the entire lot would have weighed maybe five pounds. There was no sign of any metal in the area which might have been used for an engine and no sign of any propellers of any kind. Although at least one paper fin had been glued onto some of the tinfoil. There were no words to be found anywhere on the instrument although there were letters on some of the parts. Considerable scotch tape and

some tape with flowers printed upon it had been used in the construction. No string or wire were to be found but there were some eyelets in the paper to indicate that some sort of attachment may have been used. Brazel said that he had previously found two weather balloons on the ranch, but that what he found this time did not in any way resemble either of these.

## EVOLUTION OF THE EVENT FROM 1947 TO THE PRESENT

General Ramey's press conference and rancher Brazel's statement effectively ended this as a UFO-related matter until 1978, although some UFO researchers argue that there were several obtuse references to it in 1950's-era literature. Roswell, for example, is not referred to in the official USAF investigation of UFOs reported in Project Bluebook or its predecessors, Project Sign and Project Grudge, which ran from 1948-1969 (which Congressman Schiff subsequently learned when he made his original inquiry).

In 1978, an article appeared in a tabloid newspaper, the *National Enquirer*, which reported the former intelligence officer, Marcel, claimed that he had recovered UFO debris near Roswell in 1947. Also in 1978, a UFO researcher, Stanton Friedman, met with Marcel and began investigating the claims that the material Marcel handled was from a crashed UFO. Similarly, two authors, William L. Moore and Charles Berlitz, also engaged in research which led them to publish a book, *The Roswell Incident*, in 1980. In this book they reported they interviewed a number of persons who claimed to have been present at Roswell in 1947 and professed to be either firsthand or secondhand witnesses to strange events that supposedly occurred. Since 1978-1980, other UFO researchers, most notably Donald Schmitt and Kevin Randle, claim to have located and interviewed even more persons with supposed knowledge of unusual happenings at Roswell. These included both civilian and former military persons.

Additionally, the Robert Stack-hosted television show "Unsolved Mysteries" devoted a large portion of one show to a "re-creation" of the supposed Roswell events. Numerous other television shows have done likewise, particularly during the last several years, and a made-for-TV movie on the subject is due to be released this summer. The overall thrust of these articles, books, and shows is that the "Roswell Incident" was actually the crash of a craft from another world, the US Government recovered it, and has been "covering up" this fact from the American public since 1947, using a combination of disinformation, ridicule, and threats of bodily harm, to do so. Generally, the USAF bears the brunt of these accusations.

From the rather benign description of the "event" and the recovery of some material as described in the original newspaper accounts, the "Roswell Incident" has since grown to mythical (if not mystical) proportions in the eyes and minds of some researchers, portions of the media and at least part of the American public. There are also now several major variations of the "Roswell story." For

example, it was originally reported that there was only recovery of debris from one site. This has since grown from a minimal amount of debris recovered from a small area to airplane loads of debris from multiple huge "debris fields." Likewise, the relatively simple description of sticks, paper, tape and tinfoil has since grown to exotic metals with hieroglyphics and fiber optic-like materials. Most versions now claim that there were two crash sites where debris was recovered, and at the second site, alleged bodies of extraterrestrial aliens were supposedly retrieved. The number of these "alien bodies" recovered also varied. These claims are further complicated by the fact that UFO researchers are not in agreement among themselves as to exactly where these recovery sites were located or even the dates of the alleged crash(es). Consistently, however, the AAF was accused of securing these sites, recovering all the material therefrom, keeping locals away, and returning the recovered wreckage (and bodies) to Roswell under extremely tight security for further processing and later exploitation.

Once back at Roswell Army Air Field, it is generally alleged that special measures were taken to notify higher headquarters and arrangements made to have recovered materials shipped to other locations for analysis. These locations include Fort Worth, Texas, the home of the Eighth Air Force Headquarters; possibly Sandia Base (now Kirtland AFB), New Mexico; possibly Andrews Army Air Field, Maryland; and always to Wright Field, now known as Wright-Patterson AFB, Ohio. The latter location was the home of "T-2" which later became known as the Air Technical Intelligence Center (ATIC) and the Air Materiel Command (AMC), and would, in fact, be a logical location to study unknown materials from whatever origin. Most of the Roswell stories that contain the recovery of alien bodies also show them being shipped to Wright Field. Once the material and bodies were dispersed for further analysis and/or exploitation, the government in general, and the Army Air Forces in particular, engaged in covering up all information relating to the alleged crash and recovery, including the use of security oaths to military persons and the use of coercion (including alleged death threats) to others. This, as theorized by some UFO researchers, has allowed the government to keep the fact that there is intelligent extraterrestrial life from the American public for 47 years. It also supposedly allowed the US Government to exploit recovered extraterrestrial materials by reverse engineering them, ultimately providing such things as fiber optic and stealth technology. The "death threats," oaths, and other forms of coercion alleged to have been meted out by the AAF personnel to keep people from talking have apparently not been very effective, as several hundred people are claimed to have come forward (without harm) with some knowledge of the "Roswell Incident" during interviews with nongovernment researchers and the media.

Adding some measure of credibility to the claims that have arisen since 1978 is the apparent depth of research of some of the authors and the extent of their efforts. Their claims are lessened somewhat, however, by the fact that almost all their information came from verbal reports many years after the alleged incident occurred. Many of the persons interviewed were, in fact, stationed at, or lived near Roswell during the time in question, and a number of them claim military

service. Most, however, related their stories in their older years, well after the fact. In other cases, the information provided is second or thirdhand, having been passed through a friend or relative after the principal had died. What is uniquely lacking in the entire exploration and exploitation of the "Roswell Incident" is official positive documentary or physical evidence of any kind that supports the claims of those who allege that something unusual happened. Conversely, there has never been any previous documentary evidence produced by those who would debunk the incident to show that something did not happen; although logic dictates that bureaucracies do not spend time documenting nonevents.

## SEARCH STRATEGY AND METHODOLOGY

To insure senior Air Force leadership that there were no hidden or overlooked files that might relate to the "Roswell Incident," and to provide the GAO with the best and most complete information available, SAF/AAZ constructed a strategy based on direct tasking from the Office of the Secretary, to elicit information from those functional offices and organizations where such information might logically be contained. This included directing searches at current offices where special or unusual projects might be carried out, as well as historical organizations, archives, and records centers over which the Air Force exerted some degree of control. Researchers did not, however, go to the US Army to review historical records in areas such as missile launches from White Sands, or to the Department of Energy to determine if its forerunner, the Atomic Energy Commission, had any records of nuclear-related incidents that might have occurred at or near Roswell in 1947. To do so would have encroached on GAO's charter in this matter. What Air Force researchers did do, however, was to search for records still under Air Force control pertaining to these subject areas.

In order to determine parameters for the most productive search of records, a review was first conducted of the major works regarding the "Roswell Incident" available in the popular literature. These works included: *The Roswell Incident* (1980) by William Moore and Charles Berlitz; "Crashed Saucers: Evidence in Search of Proof" (1985) by Moore; *The UFO Crash at Roswell* (1991) by Kevin Randle and Donald Schmitt; *The Truth About the UFO Crash at Roswell* (1994), also by Randle and Schmitt; *The Roswell Report: A Historical Perspective* (1991), George M. Eberhart, editor; "The Roswell Events" (1993) compiled by Fred Whiting; *Crash at Corona* (1992) by Stanton T. Friedman and Don Berliner; and numerous other articles written by a combination of the above and other researchers. Collectively, the above represent the "pro" UFO writers who allege that the government is engaged in a conspiracy. There are no specific books written entirely on the theme that nothing happened at Roswell. However, Curtis Peebles in *Watch the Skies!* (1994) discussed the development of the UFO story and growth of subsequent claims as a phenomenon. There has also been serious research as well as a number of detailed articles written by so-called "debunkers" of Roswell and other incidents, most notably Philip J. Klass, who writes *The Skeptic's UFO Newsletter*, and Robert Todd, a private researcher. The concerns and claims of all the above authors and others were considered in conducting the USAF records search.



It was also decided, particularly after a review of the above popular literature, that no specific attempt would be made to try to refute, point by point, the numerous claims made in the various publications. Many of these claims appear to be hearsay, undocumented, taken out of context, self-serving, or otherwise dubious. Additionally, many of the above authors are not even in agreement over various claims. Most notable of the confusing and now ever-changing claims is the controversy over the date(s) of the alleged incident, the exact location(s) of the purported debris, and the extent of the wreckage. Such discrepancies in claims made the search much more difficult by greatly expanding the volume of records that had to be searched.

An example of trying to deal with questionable claims is illustrated by the following example: One of the popular books mentioned that was reviewed claimed that the writers had submitted the names and serial numbers of "over two dozen" personnel stationed at Roswell in July, 1947, to the Veterans Administration and the Defense Department to confirm their military service. They then listed eleven of these persons by name and asked the question: "Why does neither the Defense Department nor the Veteran's Administration have records of any of these men when we can document that each served at Roswell Army Air Field." That claim sounded serious so SAF/AAZD was tasked to check these eleven names in the Personnel Records Center in St. Louis. Using only the names (since the authors did not list the serial numbers) the researcher quickly found records readily identifiable with eight of these persons. The other three had such common names that there could have been multiple possibilities. Interestingly, one of the listed "missing" persons had a casualty report in his records reflecting that he died in 1951, while the writers claimed to have interviewed him (or a person of the exact same name) in 1990.

While the historical document search was in progress, it was decided to attempt to locate and interview several persons identified as still living who could possibly answer questions generated by the research. This had never been officially done before, although most of the persons contacted reported that they had also been contacted in the past by some of the listed authors or other private researchers. In order to counter possible future arguments that the persons interviewed were still "covering up" material because of prior security oaths, the interviewees were provided with authorization from either the Secretary of the Air Force or the Senior Security Official of the Air Force that would officially allow discussion of classified information, if applicable, or free them from any prior restriction in discussing the matter, if such existed. Again, the focus was on interviewing persons that could address specific issues raised by research and no consideration was given to try and locate every alleged witness claimed to have been contacted by the various authors. For example, one of the interviewees thought vital to obtain an official signed, sworn statement from was Sheridan Cavitt, Lt Col, USAF (Retired), who is the last living member of the three persons universally acknowledged to have recovered material from the Foster Ranch. Others were also interviewed as information developed (discussed in detail later). Additionally, in some cases survivors of deceased persons were also contacted in

an attempt to locate various records thought to have been in the custody of the deceased.

Even though Air Force research originally started in January, 1994, the first official Air Force-wide tasking was directed by the March 1, 1994, memorandum from SAF/AA (Atch 5) and was addressed to those current Air Staff elements that would be the likely repository for any records, particularly if there was anything of an extraordinary nature involved. This meant that the search was not limited to unclassified materials, but also would include records of the highest classification and compartmentation.

The specific Air Staff/Secretariat offices queried included the following:

- (a) SAF/AAI, Directorate of Information Management
- (b) SAF/AQL, Directorate of Electronics and Special Programs
- (c) AF/SE, Air Force Safety
- (d) AF/HO, Air Force Historian
- (e) AF/IN, Air Force Intelligence [including the Air Force Intelligence Agency (AFIA) and the National Air Intelligence Center (NAIC)]
- (f) AF/XOW, Directorate of Weather
- (g) [added later] The Air Force Office of Special Investigations (AFOSI)

In addition to the above Air Staff and Secretariat offices, SAF/AAZ also reviewed appropriate classified records for any tie-in to this matter. With regards to highly classified records, it should be noted that any programs that employ enhanced security measures or controls are known as a Special Access Programs (SAPs). The authority for such programs comes from Executive Order 12356 and flows from the Department of Defense to the Services via DoD Directive 5205.7. These programs are implemented in the Air Force by Policy Directive 16-7 and Air Force Instruction 16-701. These directives contain detailed requirements for controlling and reporting, in a very strict manner, all SAPs. This includes a report from the Secretary of the Air Force to the Secretary of Defense (and ultimately to Congress) on all SAPs submitted for approval, and a certification that there are no "SAP-like" programs being operated. These reporting requirements are stipulated in public law.

It followed that if the Air Force had recovered some type of extraterrestrial spacecraft and/or bodies and was exploiting this for scientific and technology purposes, then such a program would be operated as a Special Access Program (SAP). SAF/AAZ, the Central Office for all Air Force SAPs, has knowledge of, and security oversight over, all SAPs. SAF/AAZ categorically stated that no such SAP or SAPs exist that pertain to extraterrestrial spacecraft/aliens.

Likewise, the Secretary of the Air Force and the Chief of Staff, who head the Special Program Oversight Committee which oversees all sensitive programs in the Air Force, had no knowledge of the existence of any such program involving, or relating to, the events at Roswell or the alleged technology that supposedly

resulted therefrom. Besides the obvious irregularity and illegality of keeping such information from the most senior Air Force officials, it would also be illogical, since these officials are responsible for obtaining funding for operations, research, development, and security. Without funding, such a program, operation, or organization could not exist. Even to keep such a fact "covered-up" in some sort of passive "caretaker status" would involve money. More importantly, it would involve people and create paperwork.

The aforementioned March 1, 1994, SAF/AA tasking generated negative responses (Atchs 6-12) from all recipients; i.e., all offices reported that they had no information that would explain the incident. Consequently, these negative responses led to an increase in the already ongoing historical research at records centers and archives.

The extensive archival and records center search was systematically carried out by the SAF/AAZD Declassification Review Team. This team is composed entirely of Air Force Reserve personnel who have extensive training and experience in large scale review of records. (Previous efforts include the Southeast Asia Declassification Review, declassification of POW/MIA records, and the review of the Gulf War Air Power Survey records.) The team members all had the requisite security clearances for classified information and had the authority of the Secretary of the Air Force to declassify any classified record they found that might be related to Roswell. SAF/AAZD conducted reviews at a number of locations, including the National Archives in Washington, DC; the National Personnel Records Center, St. Louis, MO; the National Archives, Suitland MD; the National Records Center, Suitland, MD; Naval Research Laboratory, Washington, DC; Federal Records Center, Ft Worth, TX; the INSCOM Archives, Fort Meade, MD; National Air and Space Museum, Washington, DC; Air Force Historical Research Agency, Maxwell AFB, AL; Center for Air Force History, Bolling AFB, DC; Phillips Laboratory, Hanscom AFB, MA and Kirtland AFB, NM; Rome Laboratory, Griffiss AFB, NY; and the Library of Congress, Washington, DC.

A listing of the specific record areas searched is appended as Atch 13. The areas included all those subject areas logically believed to possibly contain any reference to activities at Roswell Army Air Field during the period of time in question. It is anticipated that detractors from this effort will complain that "they did not search record group *x*, box *y*, or reel *z*, etc.; that's where the real records are!" Such complaints are unavoidable and there is no possible way that the millions of records under Air Force control could be searched page by page. The team endeavored to make logical searches in those places where records would likely be found. They were assisted in this task by archivists, historians, and records management specialists, including experienced persons who have continually worked in Army and Air Force records systems since 1943. The team also searched some record areas that were recommended by serious private researchers such as Robert Todd, who had independently obtained almost encyclopedic knowledge of the complexities of Air Force records systems, particularly those related to this subject area.

Not surprisingly, the research team found the usual number of problems in many of the records centers (particularly St. Louis) with misfiling, lost or misplaced documents, mismarking of documents, or the breaking up of record groups over the years and refileing in different systems. This included, for example, a small amount of missing "decimal files" from the 509th Bomb Group at Roswell that covered the years 1945-1949, that were marked on the index as "destroyed." The researchers noted that there was no pattern to any anomalies found and that most discrepancies were minor and consistent with what they had found in the past on similar projects.

## WHAT THE ROSWELL INCIDENT WAS NOT

Before discussing specific positive results that these efforts revealed, it is first appropriate to discuss those things, as indicated by information available to the Air Force, that the "Roswell Incident" *was not*:

### *An Airplane Crash*

Of all the things that are documented and tracked within the Air Force, among the most detailed and scrupulous are airplane crashes. In fact, records of air crashes go back to the first years of military flight. Safety records and reports are available for all crashes that involved serious damage, injury, death, or a combination of these factors. These records also include incidents involving experimental or classified aircraft. USAF records showed that between June 24, 1947, and July 28, 1947, there were five crashes in New Mexico alone, involving A-26C, P-51N, C-82A, P-80A, and PQ-14B aircraft; however, none of these occurred on the date(s) in question nor in the area(s) in question.

One of the additional areas specifically set forth by GAO in its efforts was to deal with how the Air Force (and others) specifically documented "... weather balloon ... and other crash incidents." In this area, the search efforts revealed that there are no *air* safety records pertaining to weather balloon crashes (all weather balloons "crash" sooner or later); however, there are provisions for generating reports of "crashes" as ground safety incidents in the unlikely chance that a balloon injures someone or causes damage. Such records are only maintained for five years.

### *A Missile Crash*

A crashed or errant missile, usually described as a captured German V-2 or one of its variants, is sometimes set forth as a possible explanation for the debris recovered near Roswell. Since much of this testing done at nearby White Sands was secret at the time, it would be logical to assume that the government would handle any missile mishap under tight security, particularly if the mishap occurred on private land. From the records reviewed by the Air Force, however, there was nothing located to suggest that this was the case. Although the bulk of remaining testing records are under the control of the US Army, the subject has also been very well documented over the years within Air Force records. There would be no reason to keep such information classified today. The USAF found

no indicators or even hints that a missile was involved in this matter.

#### *A Nuclear Accident*

One of the areas considered was that whatever happened near Roswell may have involved nuclear weapons. This was a logical area of concern since the 509th Bomb Group was the only military unit in the world at the time that had access to nuclear weapons. Again, reviews of available records gave no indication that this was the case. A number of records still classified Top Secret and Secret—Restricted Data having to do with nuclear weapons were located in the Federal Records Center in St. Louis, MO. These records, which pertained to the 509th, had nothing to do with any activities that could have been misinterpreted as the "Roswell Incident." Also, any records of a nuclear-related incident would have been inherited by the Department of Energy (DOE), and, had one occurred, it is likely DOE would have publicly reported it as part of its recent declassification and public release efforts. There were no ancillary records in Air Force files to indicate the potential existence of such records within DOE channels, however.

#### *An Extraterrestrial Craft*

The Air Force research found absolutely no indication that what happened near Roswell in 1947, involved any type of extraterrestrial spacecraft. This, of course, is the crux of this entire matter. "Pro-UFO" persons who obtain a copy of this report, at this point, most probably begin the "cover-up is still on" claims. Nevertheless, the research indicated absolutely no evidence of *any kind* that a spaceship crashed near Roswell or that any alien occupants were recovered therefrom, in some secret military operation or otherwise. This does not mean, however, that the early Air Force was not concerned about UFOs. However, in the early days, "UFO" meant Unidentified Flying Object, which literally translated as some object in the air that was not readily identifiable. It did not mean, as the term has evolved in today's language, to equate to alien spaceships. Records from the period reviewed by Air Force researchers, as well as those cited by the authors mentioned before, do indicate that the USAF *was* seriously concerned about the inability to adequately identify unknown flying objects reported in American airspace. All the records, however, indicated that the focus of concern was not on aliens, hostile or otherwise, but on the Soviet Union. Many documents from that period speak to the possibility of developmental secret Soviet aircraft overflying US airspace. This, of course, was of major concern to the fledgling USAF, whose job it was to protect these same skies.

The research revealed only one official AAF document that indicated that there was any activity of any type that pertained to UFOs and Roswell in July, 1947. This was a small section of the July Historical Report for the 509th Bomb Group and Roswell Army Air Field that stated: "The Office of Public Information was quite busy during the month answering inquiries on the 'flying disc,' which was reported to be in possession of the 509th Bomb Group. The object turned out to be a radar tracking balloon" (included with Atch 11). Additionally, this history showed that the 509th Commander, Colonel Blanchard, went on leave on July 8, 1947, which would be a somewhat unusual maneuver for a person involved in

the supposed first ever recovery of extraterrestrial materials. (Detractors claim Blanchard did this as a ploy to elude the press and go to the scene to direct the recovery operations.) The history and the morning reports also showed that the subsequent activities at Roswell during the month were mostly mundane and not indicative of any unusual high-level activity, expenditure of manpower, resources or security.

Likewise, the researchers found no indication of heightened activity anywhere else in the military hierarchy in the July, 1947, message traffic or orders (to include classified traffic). There were no indications and warnings, notice of alerts, or a higher tempo of operational activity reported that would be logically generated if an alien craft, whose intentions were unknown, entered US territory. To believe that such operational and high-level security activity could be conducted solely by relying on unsecured telecommunications or personal contact without creating any records of such activity certainly stretches the imagination of those who have served in the military who know that paperwork of some kind is necessary to accomplish even emergency, highly classified, or sensitive tasks.

An example of activity sometimes cited by pro-UFO writers to illustrate the point that something unusual was going on was the travel of Lt Gen Nathan Twining, Commander of the Air Materiel Command, to New Mexico in July, 1947. Actually, records were located indicating that Twining went to the Bomb Commanders' Course on July 8, along with a number of other general officers, and requested orders to do so a month before, on June 5, 1947 (Atch 14).

Similarly, it has also been alleged that General Hoyt Vandenberg, Deputy Chief of Staff at the time, had been involved directing activity regarding events at Roswell. Activity reports (Atch 15), located in General Vandenberg's personal papers stored in the Library of Congress, did indicate that on July 7, he was busy with a "flying disc" incident; however this particular incident involved Ellington Field, Texas and the Spokane (Washington) Depot. After much discussion and information gathering on this incident, it was learned to be a hoax. There is no similar mention of his personal interest or involvement in Roswell events except in the newspapers.

The above are but two small examples that indicate that if some event happened that was one of the "watershed happenings" in human history, the US military certainly reacted in an unconcerned and cavalier manner. In an actual case, the military would have had to order thousands of soldiers and airman, not only at Roswell but throughout the US, to act nonchalantly, pretend to conduct and report business as usual, and generate absolutely no paperwork of a suspicious nature, while simultaneously anticipating that twenty years or more into the future people would have available a comprehensive Freedom of Information Act that would give them great leeway to review and explore government documents. The records indicate that none of this happened (or if it did, it was controlled by a security system so efficient and tight that no one, US or otherwise, has been able to duplicate it since. If such a system had been in effect at the time, it would

have also been used to protect our atomic secrets from the Soviets, which history has showed obviously was not the case). The records reviewed confirmed that no such sophisticated and efficient security system existed.

#### WHAT THE "ROSWELL INCIDENT" WAS

As previously discussed, what was originally reported to have been recovered was a balloon of some sort, usually described as a "weather balloon," although the majority of the wreckage that was ultimately displayed by General Ramey and Major Marcel in the famous photos (Atch 16) in Fort Worth was that of a radar target normally suspended from balloons. This radar target, discussed in more detail later, was certainly consistent with the description of July 9 newspaper article which discussed "tin foil, paper, tape, and sticks." Additionally, the description of the "flying disc" was consistent with a document routinely used by most pro-UFO writers to indicate a conspiracy in progress—the telegram from the Dallas FBI office of July 8, 1947. This document quoted in part states: ". . . The disc is hexagonal in shape and was suspended from a balloon by a cable, which balloon was approximately twenty feet in diameter. . . . the object found resembles a high altitude weather balloon with a radar reflector. . . . disc and balloon being transported . . . ."

Similarly, while conducting the popular literature review, one of the documents reviewed was a paper entitled "The Roswell Events" edited by Fred Whiting and sponsored by the Fund for UFO Research (FUFOR). Although it was not the original intention to comment on what commercial authors interpreted or claimed that other persons supposedly said, this particular document was different because it contained actual copies of apparently authentic sworn affidavits received from a number of persons who claimed to have some knowledge of the Roswell event. Although many of the persons who provided these affidavits to the FUFOR researchers also expressed opinions that they thought there was something extraterrestrial about this incident, a number of them actually described materials that sounded suspiciously like wreckage from balloons. These included the following:

Jesse A. Marcel, MD (son of the late Major Jesse Marcel; 11 years old at the time of the incident). Affidavit dated May 6, 1991. ". . . There were three categories of debris: a thick, foil like metallic gray substance; a brittle, brownish-black plastic-like material, like Bakelite; and there were fragments of what appeared to be I-beams. On the inner surface of the I-beam, there appeared to be a type of writing. This writing was a purple-violet hue, and it had an embossed appearance. The figures were composed of curved, geometric shapes. It had no resemblance to Russian, Japanese or any other foreign language. It resembled hieroglyphics, but it had no animal-like characters. . . ."

Loretta Proctor (former neighbor of rancher W.W. Brazel). Affidavit dated May 5, 1991. ". . . Brazel came to my ranch and showed my husband and me a piece of material he said came from a large pile of debris on the property he managed.

The piece he brought was brown in color, similar to plastic . . . . 'Mac' said the other material on the property looked like aluminum foil. It was very flexible and wouldn't crush or burn. There was also something he described as tape which had printing on it. The color of the printing was a kind of purple . . . ."

Bessie Brazel Schreiber (daughter of W.W. Brazel; 14 years old at the time of the incident). Affidavit dated September 22, 1993. ". . . The debris looked like pieces of a large balloon which had burst. The pieces were small, the largest I remember measuring about the same as the diameter of a basketball. Most of it was a kind of double-sided material, foil-like on one side and rubber-like on the other. Both sides were grayish silver in color, the foil more silvery than the rubber. Sticks, like kite sticks, were attached to some of the pieces with a whitish tape. The tape was about two or three inches wide and had flower-like designs on it. The 'flowers' were faint, a variety of pastel colors, and reminded me of Japanese paintings in which the flowers are not all connected. I do not recall any other types of material or markings, nor do I remember seeing gouges in the ground or any other signs that anything may have hit the ground hard. The foil-rubber material could not be torn like ordinary aluminum foil can be torn.."

Sally Strickland Tadolini (neighbor of W.W. Brazel; nine years old in 1947). Affidavit dated September 27, 1993. ". . . What Bill showed us was a piece of what I still think as fabric. It was something like aluminum foil, something like satin, something like well-tanned leather in its toughness, yet was not precisely like any one of those materials. . . . It was about the thickness of very fine kidskin glove leather and a dull metallic grayish silver, one side slightly darker than the other. I do not remember it having any design or embossing on it . . . ."

Robert R. Porter (B-29 flight Engineer stationed at Roswell in 1947). Affidavit dated June 7, 1991. ". . . On this occasion, I was a member of the crew which flew parts of what we were told was a flying saucer to Fort Worth. The people on board included...and Maj Jesse Marcel. Capt. William E. Anderson said it was from a flying saucer. After we arrived, the material was transferred to a B-25. I was told they were going to Wright Field in Dayton, Ohio. I was involved in loading the B-29 with the material, which was wrapped in packages with wrapping paper. One of the pieces was triangle-shaped, about 2 1/2 feet across the bottom. The rest were in small packages, about the size of a shoe box. The brown paper was held with tape. The material was extremely lightweight. When I picked it up, it was just like picking up an empty package. We loaded the triangle shaped package and three shoe box-sized packages into the plane. All of the packages could have fit into the trunk of a car. . . . When we came back from lunch, they told us they had transferred the material to a B-25. They told us the material was a weather balloon, but I'm certain it wasn't a weather balloon. . . ."

In addition to those persons above still living who claim to have seen or examined the original material found on the Brazel Ranch, there is one additional person who was universally acknowledged to have been involved in its recovery, Sheridan Cavitt, Lt Col, USAF (Ret). Cavitt is credited in all claims of having



accompanied Major Marcel to the ranch to recover the debris, sometimes along with his Counter Intelligence Corps (CIC) subordinate, Lewis Rickett, who, like Marcel, is deceased. Although there does not appear to be much dispute that Cavitt was involved in the material recovery, other claims about him prevail in the popular literature. He is sometimes portrayed as a closed-mouth (or sometimes even sinister) conspirator who was one of the early individuals who kept the "secret of Roswell" from getting out. Other things about him have been alleged, including the claim that he wrote a report of the incident at the time that has never surfaced.

Since Lt Col Cavitt, who had firsthand knowledge, was still alive, a decision was made to interview him and get a signed sworn statement from him about his version of the events. Prior to the interview, the Secretary of the Air Force provided him with a written authorization and waiver to discuss classified information with the interviewer and release him from any security oath he may have taken. Subsequently, Cavitt was interviewed on May 24, 1994, at his home. Cavitt provided a signed, sworn statement (Atch 17) of his recollections in this matter. He also consented to having the interview tape-recorded. A transcript of that recording is at Atch 18. In this interview, Cavitt related that he had been contacted on numerous occasions by UFO researchers and had willingly talked with many of them; however, he felt that he had oftentimes been misrepresented or had his comments taken out of context so that their true meaning was changed. He stated unequivocally, however, that the material he recovered consisted of a reflective sort of material like aluminum foil, and some thin, bamboo-like sticks. He thought at the time, and continued to do so today, that what he found was a weather balloon and has told other private researchers that. He also remembered finding a small "black box" type of instrument, which he thought at the time was probably a radiosonde. Lt Col Cavitt also reviewed the famous Ramey/Marcel photographs (Atch 16) of the wreckage taken to Fort Worth (often claimed by UFO researchers to have been switched and the remnants of a balloon substituted for it), and he identified the materials depicted in those photos as consistent with the materials that he recovered from the ranch. Lt Col Cavitt also stated that he had never taken any oath or signed any agreement not to talk about this incident and had never been threatened by anyone in the government because of it. He did not even know the "incident" was claimed to be anything unusual until he was interviewed in the early 1980's.

Similarly, Irving Newton, Major, USAF (Ret), was located and interviewed. Newton was a weather officer assigned to Fort Worth, who was on duty when the Roswell debris was sent there in July, 1947. He was told that he was to report to General Ramey's office to view the material. In a signed, sworn statement (Atch 30) Newton related that ". . . I walked into the General's office where this supposed flying saucer was lying all over the floor. As soon as I saw it, I giggled and asked if that was the flying saucer . . . I told them that this was a balloon and a RAWIN target. . . ." Newton also stated that ". . . while I was examining the debris, Major Marcel was picking up pieces of the target sticks and trying to convince me that some notations on the sticks were alien writings. There were

figures on the sticks, lavender or pink in color, appeared to be weather faded markings, with no rhyme or reason [sic]. He did not convince me that these were alien writings." Newton concluded his statement by relating that ". . . During the ensuing years I have been interviewed by many authors, I have been quoted and misquoted. The facts remain as indicated above. I was not influenced during the original interview, nor today, to provide anything but what I know to be true, that is, the material I saw in General Ramey's office was the remains of a balloon and a RAWIN target."

#### *Balloon Research*

The original tasking from GAO noted that the search for information included "weather balloons." Comments about balloons and safety reports have already been made; however the SAF/AAZ research efforts also focused on reviewing historical records involving balloons, since, among other reasons, that was what was officially claimed by the AAF to have been found and recovered in 1947.

As early as February 28, 1994, the AAZD research team found references to balloon tests taking place at Alamogordo Army Air Field (now Holloman AFB) and White Sands during June and July 1947, testing "constant level balloons" and a New York University (NYU)/Watson Labs effort that used ". . . meteorological devices . . . suspected for detecting shock waves generated by Soviet nuclear explosions"—a possible indication of a cover story associated with the NYU balloon project. Subsequently, a 1946 HQ AMC memorandum surfaced, describing the constant altitude balloon project and specified that the scientific data be classified Top Secret Priority 1A. Its name was Project MOGUL (Atch 19).

Project MOGUL was a then-sensitive, classified project, whose purpose was to determine the state of Soviet nuclear weapons research. This was the early Cold War period and there was serious concern within the US government about the Soviets' developing a weaponized atomic device. Because the Soviet Union's borders were closed, the US Government sought to develop a long range nuclear explosion detection capability. Long range, balloon-borne, low frequency acoustic detection was posed to General Spaatz in 1945 by Dr. Maurice Ewing of Columbia University as a potential solution (atmospheric ducting of low frequency pressure waves had been studied as early as 1900).

As part of the research into this matter, AAZD personnel located and obtained the original study papers and reports of the New York University project. Their efforts also revealed that some of the individuals involved in Project MOGUL were still living. These persons included the NYU constant altitude balloon Director of Research, Dr. Athelstan F. Spilhaus; the Project Engineer, Professor Charles B. Moore; and the military Project Officer, Colonel Albert C. Trakowski .

All of these persons were subsequently interviewed and signed sworn statements about their activities. A copy of these statements are appended at Atchs 20–22. Additionally, transcripts of the interview with Moore and Trakowski are also included (equipment malfunctioned during the interview of Spilhaus) (Atchs

23-24). These interviews confirmed that Project MOGUL was a compartmented, sensitive effort. The NYU group was responsible for developing constant level balloons and telemetering equipment that would remain at specified altitudes (within the acoustic duct) while a group from Columbia was to develop acoustic sensors. Doctor Spilhaus, Professor Moore, and certain others of the group were aware of the actual purpose of the project, but they did not know of the project nickname at the time. They handled casual inquiries and/or scientific inquiries/papers in terms of "unclassified meteorological or balloon research." Newly hired employees were not made aware that there was anything special or classified about their work; they were told only that their work dealt with meteorological equipment.

An advance ground team, led by Albert P. Crary, preceded the NYU group to Alamogordo Army Air Field, New Mexico, setting up ground sensors and obtaining facilities for the NYU group. Upon their arrival, Professor Moore and his team experimented with various configurations of neoprene balloons; development of balloon "trains" (see illustration, Atch 25); automatic ballast systems; and use of Naval sonobuoys (as the Watson Lab acoustical sensors had not yet arrived). They also launched what they called "service flights." These "service flights" were not logged nor fully accounted for in the published Technical Reports generated as a result of the contract between NYU and Watson Labs. According to Professor Moore, the "service flights" were composed of balloons, radar reflectors, and payloads specifically designed to test acoustic sensors (both early sonobuoys and the later Watson Labs devices). The "payload equipment" was expendable, and some carried no "Reward" or "Return to . . ." tags because there was to be no association between these flights and the logged constant altitude flights which were fully acknowledged. The NYU balloon flights were listed sequentially in their reports (i.e., A, B, or 1, 5, 6, 7, 8, 10 . . .), yet gaps existed for Flights 2-4 and Flight 9. The interview with Professor Moore indicated that these gaps were the unlogged "service flights."

Professor Moore, the on-scene Project Engineer, gave detailed information concerning his team's efforts. He recalled that radar targets were used for tracking balloons because they did not have all the necessary equipment when they first arrived in New Mexico. Some of the early developmental radar targets were manufactured by a toy or novelty company. These targets were made up of aluminum "foil" or foil-backed paper, balsa wood beams that were coated in an "Elmer's-type" glue to enhance their durability, acetate and/or cloth reinforcing tape, single strand and braided nylon twine, brass eyelets and swivels to form a multi-faced reflector somewhat similar in construction to a box kite (see photographs, Atch 26). Some of these targets were also assembled with purplish-pink tape with symbols on it (see drawing by Moore with Atch 21).

According to the log summary (Atch 27) of the NYU group, Flight A through Flight 7 (November 20, 1946-July 2, 1947) were made with neoprene meteorological balloons (as opposed to the later flights made with polyethylene balloons). Professor Moore stated that the neoprene balloons were susceptible to degrada-

tion in the sunlight, turning from a milky white to a dark brown. He described finding remains of balloon trains with reflectors and payloads that had landed in the desert: the ruptured and shredded neoprene would "almost look like dark gray or black flakes or ashes after exposure to the sun for only a few days. The plasticizers and antioxidants in the neoprene would emit a peculiar acrid odor and the balloon material and radar target material would be scattered after returning to earth depending on the surface winds." Upon review of the local newspaper photographs from General Ramey's press conference in 1947 and descriptions in popular books by individuals who supposedly handled the debris recovered on the ranch, Professor Moore opined that the material was most likely the shredded remains of a multi-neoprene balloon train with multiple radar reflectors. The material and a "black box," described by Cavitt, was, in Moore's scientific opinion, most probably from Flight 4, a "service flight" that included a cylindrical metal sonobuoy and portions of a weather instrument housed in a box, which was unlike typical weather radiosondes which were made of cardboard. Additionally, a copy of a professional journal maintained at the time by A.P. Crary, provided to the Air Force by his widow, showed that Flight 4 was launched on June 4, 1947, but was not recovered by the NYU group. It is very probable that this Top Secret project balloon train (Flight 4), made up of unclassified components, came to rest some miles northwest of Roswell, NM, became shredded in the surface winds, and was ultimately found by the rancher, Brazel, ten days later. This possibility was supported by the observations of Lt Col Cavitt (Atchs 17-18), the only living eyewitness to the actual debris field and the material found. Lt Col Cavitt described a small area of debris which appeared, "to resemble bamboo type square sticks one quarter to one half inch square, that were very light, as well as some sort of metallic reflecting material that was also very light . . . . I remember recognizing this material as being consistent with a weather balloon."

Concerning the initial announcement, "RAAF Captures Flying Disc," research failed to locate any documented evidence as to why that statement was made. However, on July 10, 1947, following the Ramey press conference, the *Alamogordo News* published an article with photographs demonstrating multiple balloons and targets at the same location as the NYU group operated from at Alamogordo Army Air Field. Professor Moore expressed surprise at seeing this since his was the only balloon test group in the area. He stated, "It appears that there was some type of umbrella cover story to protect our work with MOGUL." Although the Air Force did not find documented evidence that Gen. Ramey was directed to espouse a weather balloon in his press conference, he may have done so because he was either aware of Project MOGUL and was trying to deflect interest from it, or he readily perceived the material to be a weather balloon based on the identification from his weather officer, Irving Newton. In either case, the materials recovered by the AAF in July, 1947, were not readily recognizable as anything special (only the purpose was special), and the recovered debris itself was unclassified. Additionally, the press dropped its interest in the matter as quickly as they had jumped on it. Hence, there would be no particular reason to further document what quickly became a "non-event."

The interview with Colonel Trakowski (Atchs 23-24) also proved valuable information. Trakowski provided specific details on Project MOGUL and described how the security for the program was set up, as he was formerly the Top Secret Control Officer for the program. He further related that many of the original radar targets that were produced around the end of World War II were fabricated by toy or novelty companies using a purplish-pink tape with flower and heart symbols on it. Trakowski also recounted a conversation that he had with his friend, and superior military officer in his chain of command, Colonel Marcellus Duffy, in July, 1947. Duffy, formerly had Trakowski's position on MOGUL, but had subsequently been transferred to Wright Field. He stated: ". . . Colonel Duffy called me on the telephone from Wright Field and gave me a story about a fellow that had come in from New Mexico, woke him up in the middle of the night or some such thing with a handful of debris, and wanted him, Colonel Duffy, to identify it. . . . He just said 'it sure looks like some of the stuff you've been launching at Alamogordo' and he described it, and I said 'yes, I think it is.' Certainly Colonel Duffy knew enough about radar targets, radiosondes, balloon-borne weather devices. He was intimately familiar with all that apparatus."

Attempts were made to locate Colonel Duffy but it was ascertained that he had died. His widow explained that, although he had amassed a large amount of personal papers relating to his Air Force activities, she had recently disposed of these items. Likewise, it was learned that A.P. Crary was also deceased; however his surviving spouse had a number of his papers from his balloon testing days, including his professional journal from the period in question. She provided the Air Force researchers with this material. It is discussed in more detail within Atch 32. Overall, it helps fill in gaps of the MOGUL story.

During the period the Air Force conducted this research, it was discovered that several others had also discovered the possibility that the "Roswell Incident" may have been generated by the recovery of a Project MOGUL balloon device. These persons included Professor Charles B. Moore, Robert Todd, and coincidentally, Karl Pflock, a researcher who is married to a staffer who works for Congressman Schiff. Some of these persons provided suggestions as to where documentation might be located in various archives, histories and libraries. A review of FOIA requests revealed that Robert Todd, particularly, had become aware of Project MOGUL several years ago and had doggedly obtained from the Air Force, through the FOIA, a large amount of material pertaining to it; long before the AAZD researchers independently seized on the same possibility.

Most interestingly, as this report was being written, Pflock published his own report of this matter under the auspices of FUFOR, entitled *Roswell in Perspective* (1994). Pflock concluded from his research that the Brazel Ranch debris originally reported as a "flying disc" was probably debris from a MOGUL balloon; however, there was a simultaneous incident that occurred not far away, which caused an alien craft to crash and which the AAF subsequently recovered three alien bodies therefrom. Air Force research did not locate any information to corroborate that this incredible coincidence occurred, however.

In order to provide a more detailed discussion of the specifics of Project MOGUL and how it appeared to be directly responsible for the "Roswell Incident," a SAF/AAZD researcher prepared a more detailed discussion on the balloon project which is appended to this report as Atch 32.

#### *Other Research*

In the attempt to develop additional information that could help explain this matter, a number of other steps were taken. First, assistance was requested from various museums and other archives (Atch 28) to obtain information and/or examples of the actual balloons and radar targets used in connection with Project MOGUL and to correlate them with the various descriptions of wreckage and materials recovered. The blueprints for the "Pilot Balloon Target ML307C/AP Assembly" (generically, the radar target assembly) were located at the Army Signal Corps Museum at Fort Monmouth and were obtained. A copy is appended as Atch 29. This blueprint provides the specification for the foil material, tape, wood, eyelets, and string used and the assembly instructions thereto. An actual device was also obtained for study with the assistance of Professor Moore. (The example actually procured was a 1953-manufactured model "C" as compared to the Model B which was in use in 1947. Professor Moore related the differences were minor.) An examination of this device revealed it to be simply made of aluminum-colored foil-like material over a stronger paper-like material, attached to balsa wood sticks, affixed with tape, glue, and twine. When opened, the device appears as depicted in Atch 31 (contemporary photo) and Atch 25 (1947 photo, in a "balloon train"). When folded, the device is in a series of triangles, the largest being 4 feet by 2 feet 10 inches. The smallest triangle section measures 2 feet by 2 feet 10 inches. (Compare with descriptions provided by Lt Col Cavitt and others, as well as photos of wreckage.)

Additionally, the researchers obtained from the Archives of the University of Texas-Arlington (UTA), a set of original (i.e., first generation) prints of the photographs taken at the time by the *Fort Worth Star-Telegram*, that depicted Ramey and Marcel with the wreckage. A close review of these photos (and a set of first-generation negatives also subsequently obtained from UTA) revealed several interesting observations. First, although in some of the literature cited above, Marcel allegedly stated that he had his photo taken with the "real" UFO wreckage and then it was subsequently removed and the weather balloon wreckage substituted for it, a comparison shows that the same wreckage appeared in the photos of Marcel and Ramey. The photos also depicted that this material was lying on what appeared to be some sort of wrapping paper (consistent with affidavit excerpt of crew chief Porter, above). It was also noted that in the two photos of Ramey he had a piece of paper in his hand. In one, it was folded over so nothing could be seen. In the second, however, there appears to be text printed on the paper. In an attempt to read this text to determine if it could shed any further light on locating documents relating to this matter, the photo was sent to a national-level organization for digitizing and subsequent photo interpretation and analysis. This organization was also asked to scrutinize the digitized photos for any indication of the flowered tape (or "hieroglyphics," depending on the

point of view) that were reputed to be visible to some of the persons who observed the wreckage prior to its getting to Fort Worth. This organization reported on July 20, 1994, that even after digitizing, the photos were of insufficient quality to visualize either of the details sought for analysis. This organization was able to obtain measurements from the "sticks" visible in the debris after it was ascertained by an interview of the original photographer what kind of camera he used. The results of this process are provided in Atch 33, along with a reference diagram and the photo from which the measurements were made. All these measurements are compatible with the wooden materials used in the radar target previously described.

## CONCLUSION

The Air Force research did not locate or develop any information that the "Roswell Incident" was a UFO event. All available official materials, although they do not directly address Roswell *per se*, indicate that the most likely source of the wreckage recovered from the Brazel Ranch was from one of the Project MOGUL balloon trains. Although that project was Top Secret at the time, there was also no specific indication found to indicate an official preplanned cover story was in place to explain an event such as that which ultimately happened. It appears that the identification of the wreckage as being part of a weather balloon device, as reported in the newspapers at the time, was based on the fact that there was no physical difference in the radar targets and the neoprene balloons (other than the numbers and configuration) between MOGUL balloons and normal weather balloons. Additionally, it seems that there was overreaction by Colonel Blanchard and Major Marcel in originally reporting that a "flying disc" had been recovered when, at that time, nobody knew for sure what that term even meant, since it had only been in use for a couple of weeks.

Likewise, there was no indication in official records from the period that there was heightened military operational or security activity which should have been generated if this was, in fact, the first recovery of materials and/or persons from another world. The postwar US military (or today's for that matter) did not have the capability to rapidly identify, recover, coordinate, cover up, and quickly minimize public scrutiny of such an event. The claim that they did so without leaving even a little bit of a suspicious paper trail for 47 years is incredible.

It should also be noted here that there was little mentioned in this report about the recovery of the so-called "alien bodies." This is for several reasons: First, the recovered wreckage was from a Project MOGUL balloon. There were no "alien" passengers therein. Secondly, the pro-UFO groups who espouse the alien bodies theories cannot even agree among themselves as to what, how many, and where such bodies were supposedly recovered. Additionally, some of these claims have been shown to be hoaxes, even by other UFO researchers. Thirdly, when such claims are made, they are often attributed to people using pseudonyms or who otherwise do not want to be publicly identified, presumably so that some sort of retribution cannot be taken against them (notwithstanding that nobody has been

shown to have died, disappeared, or otherwise suffered at the hands of the government during the last 47 years). Fourth, many of the persons making the biggest claims of "alien bodies" make their living from the "Roswell Incident." While having a commercial interest in something does not automatically make it suspect, it does raise interesting questions related to authenticity. Such persons should be encouraged to present their evidence (not speculation) directly to the government and provide all pertinent details and evidence to support their claims if honest fact-finding is what is wanted. Lastly, persons who have come forward and provided their names and made claims may have, in good faith but in the "fog of time," misinterpreted past events. The review of Air Force records did not locate even one piece of evidence to indicate that the Air Force has had any part in an "alien" body recovery operation or continuing cover-up.

During the course of this effort, the Air Force has kept in close touch with the GAO and responded to their various queries and requests for assistance. This report was generated as an official response to the GAO, and to document the considerable effort expended by the Air Force on their behalf. It is anticipated that that the GAO will request a copy of this report to help formulate the formal report of their efforts. It is recommended that this document serve as the final Air Force report related to the Roswell matter, for the GAO, or any other inquiries.

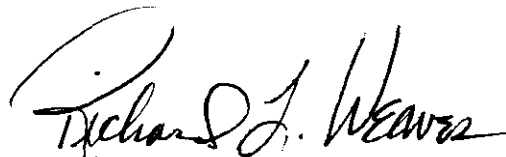

RICHARD L. WEAVER, COL, USAF  
DIRECTOR, SECURITY AND SPECIAL  
PROGRAM OVERSIGHT

#### Attachments

1. *Washington Post* Article, "GAO Turns to Alien Turf in New Probe," January 14, 1994
2. GAO Memo, February 15, 1994
3. DoD/IG Memo, February 23, 1994
4. SAF/FM Memo, February 24, 1994, w/Indorsement
5. SAF/AA Memo, March 1, 1994, w/ March 16, 1994 Addendum
6. AF/IN Memo, March 14, 1994
7. AF/SE Memo, March 14, 1994
8. SAF/AQL Memo, March 22, 1994
9. AF/XOWP Memo, March 9, 1994
10. SAF/AAI Memo, March 10, 1994
11. AFHRA/CC Memo, March 8, 1994
12. AFOSI/HO Memo, May 11, 1994



13. List of Locations and Records Searched
14. HQ AAF "Issuance of Orders," June 5, 1947
15. Copy of Vandenberg's Appointment Book and Diary, July 7-9, 1947
16. July 9, 1947 Photos of Balloon Wreckage, *Ft Worth Star Telegram*
17. Signed Sworn Statement of Cavitt, May 24, 1994
18. Transcript of Cavitt Interview, May 24, 1994
19. Letter, July 8, 1946, Project MOGUL
20. Signed Sworn Statement of Spilhaus, June 3, 1994
21. Signed Sworn Statement of Moore, June 8, 1994
22. Signed Sworn Statement of Trakowski, June 29, 1994
23. Transcript of Interview with Moore, June 8, 1994
24. Transcript of Interview with Trakowski, June 29, 1994
25. Illustration of Project MOGUL "Balloon Trains"
26. Two Photos of Project MOGUL "Balloon Trains"
27. Log Summary, NYU Constant Level Balloon Flights
28. List of Museums Contacted
29. Copy of Blueprint for "Pilot Balloon Target, ML-307C/AP Assembly"
30. Signed Sworn Statement of Newton, July 21, 1994
31. Photos of ML-307C/AP Device, With Vintage Neoprene Balloon and Debris
32. Synopsis of Balloon Research Findings by 1st Lt James McAndrew
33. "Mensuration Working Paper," With Drawing and Photo

1

*Washington Post*  
"GAO Turns to Alien Turf in Probe"  
January 14, 1994

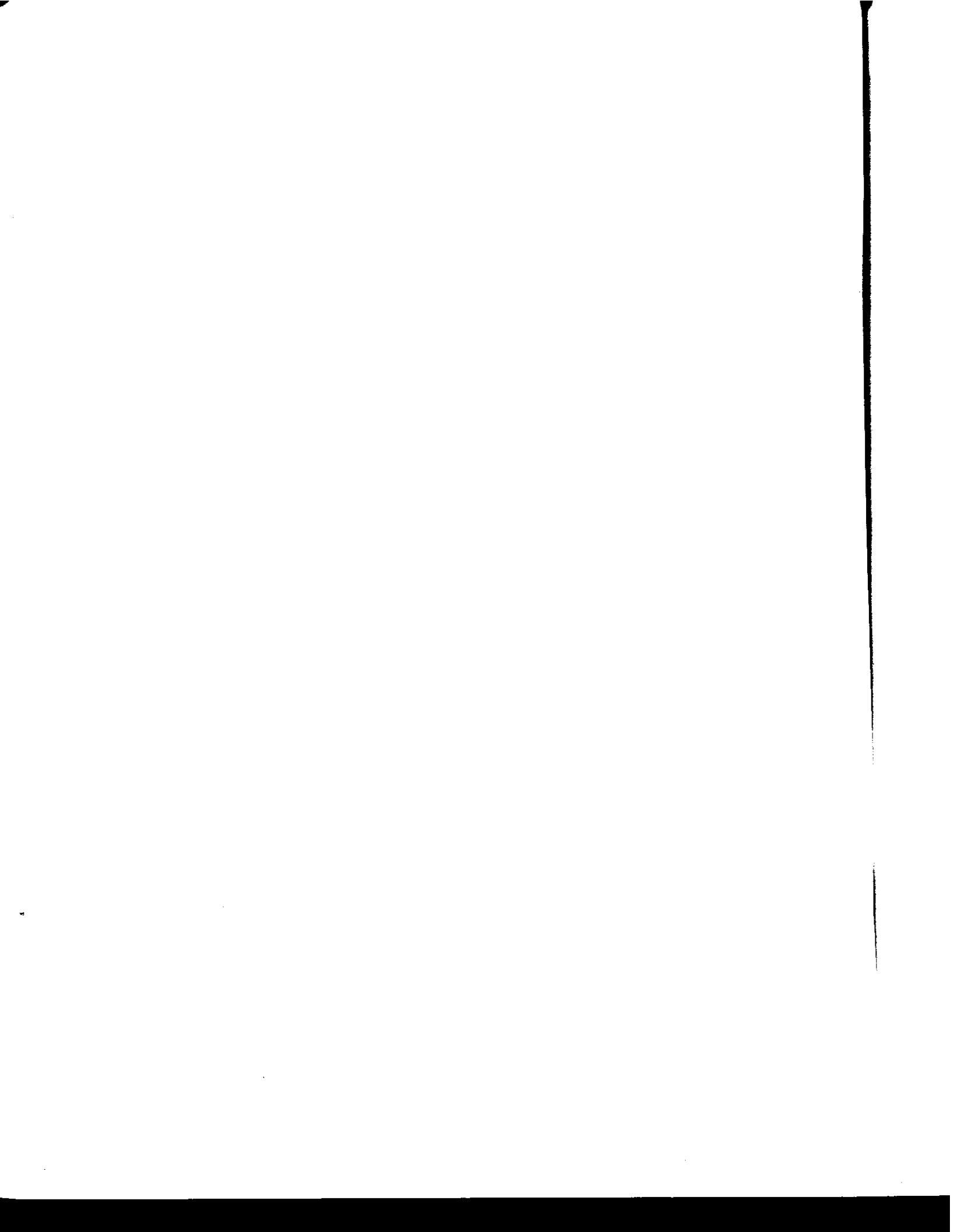

# GAO Turns to Alien Turf in Probe

## Bodies of Space Voyagers Said to Have Disappeared in 1947

By William Claiborne  
Washington Post Staff Writer

Where television's "Unsolved Mysteries" has tried and failed, the General Accounting Office is unafraid to venture.

At the request of Rep. Steven Schiff (R-N.M.), Congress's investigative branch has launched a study to determine whether the government covered up a story alleging that the bodies of alien space voyagers were removed from a crashed flying saucer found near Roswell, N.M., in 1947.

After the purported crash of the spacecraft, the bodies of the extraterrestrial visitors were said by a local undertaker and other conspiracy theorists to have been autopsied and secretly flown to an Air Force base in Ohio.

Even though the "Roswell Incident" has been repeatedly dismissed by the Defense Department as nothing more than UFO fantasizing triggered by the discovery of a downed weather balloon, the GAO has begun searching for documents to prove allegations that the Air Force "suppressed" information sought by Schiff.

Schiff is a member of the House Government Operations Committee, which oversees the GAO.

GAO spokeswoman Laura A. Kopelson said the office's investigation, first reported in the Albuquerque Journal yesterday, stemmed from a meeting in October between Schiff and GAO Controller General Charles A. Bowsher. Schiff complained then that the Defense Department had been "unresponsive" to his inquiries about the 1947 incident.

Kopelson said "as far as I know only one investigator had been assigned" to the case, and that not enough work had been done to report any results to Schiff. At another point, Kopelson said "the people doing it are either on sick leave or are unavailable."

She said there was no way of estimating how much the investigation would cost, and that the GAO does not release such information anyway.

GAO conducted 1,380 inquiries into government operations in 1992. Its budget has risen from \$46.9 million in 1965 to \$490 million last year. The agency has been criticized, especially by Republicans, as the "lap dog of the requesters," producing reports that tend to support whatever conclusion the requesting member of Congress suggests.

Kopelson said Schiff had asked the GAO "to see if there is any evidence that information regarding UFOs had been suppressed" following the Roswell incident.

Schiff, however, said that at a routine October meeting he had merely complained about the Defense Department's lack of responsiveness but a GAO official said, "We're willing to take a stab at it."

Schiff, in a telephone interview from Albuquerque, said that last March, after receiving inquiries from "UFO believers" and some Roswell residents who were in the military in 1947, he wrote Defense Secretary Les Aspin asking for more information about the reported spacecraft crash and the alleged disappearance of the aliens' bodies.

The crash of a mysterious object 75 miles northwest of Roswell, which the Air Force later claimed was a weather balloon equipped with a radar-reflecting device, was the subject of several books and remains many UFO buffs' greatest riddle.

A privately owned museum in Roswell contains a number of documents and photographs purporting to prove existence of the aliens. It also displays a re-creation of the spacecraft surrounded by figures portraying the dead extraterrestrials.

UFO buffs contend the incident marked the beginning of a government conspiracy to suppress evidence of alien life.

Much of the speculation stems from claims by William Haut, a former Air Force public affairs officer, who said that on July 2, 1947, he was told to prepare a news release reporting the Air Force had recovered parts of a flying saucer and then was told to change the story to report a weather balloon.

Also, a nurse reportedly told a local funeral home director that she witnessed the autopsies of the spacemen, whom she described as having oversized heads and beetle-like features. The nurse subsequently died in a plane crash.

After the autopsies, conspiracy theorists said the bodies were flown to Fort Worth and then to what is now Wright-Patterson Air Force Base in Ohio.

In 1989, NBC's "Unsolved Mysteries" investigated the controversy, which the program's host, Robert Stack, concluded remained unsolved.

Schiff said after calling Aspin last March to request a Defense Department briefing on the Roswell incident, he received a call from an Air Force lieutenant colonel, who brusquely told him the documents had been turned over to the National Archives.

However, Schiff said, Archives officials told him they did not have the records on Roswell, even though they did have records of "Project Blue Book," a 1969 Air Force study of reported



An "alien" depicted on NBC's "Unsolved Mysteries," which concluded case is unsolved.

UFO sightings. That study, Schiff said, did not deal with the Roswell case.

"I was getting pretty upset at all the running around," Schiff said, adding that at his meeting with GAO officials, "they made an offer to help."

"Generally, I'm a skeptic on UFOs and alien beings, but there are indications from the run-around that I got that whatever it was, it wasn't a balloon. Apparently, it's another government coverup," Schiff said.

He called the Defense Department's lack of response "astounding," and said government accountability was an issue "even larger than UFOs."

Asked if the GAO might not be extending itself, Schiff acknowledged that the agency "usually does fiscal investigations and at present I can't find a fiscal impact" in the Roswell incident.

Had the agency said, "This is beyond our realm of expertise," Schiff said, "I wouldn't insist on it." He added, "If the Defense Department had been responsive, it wouldn't have come to this."

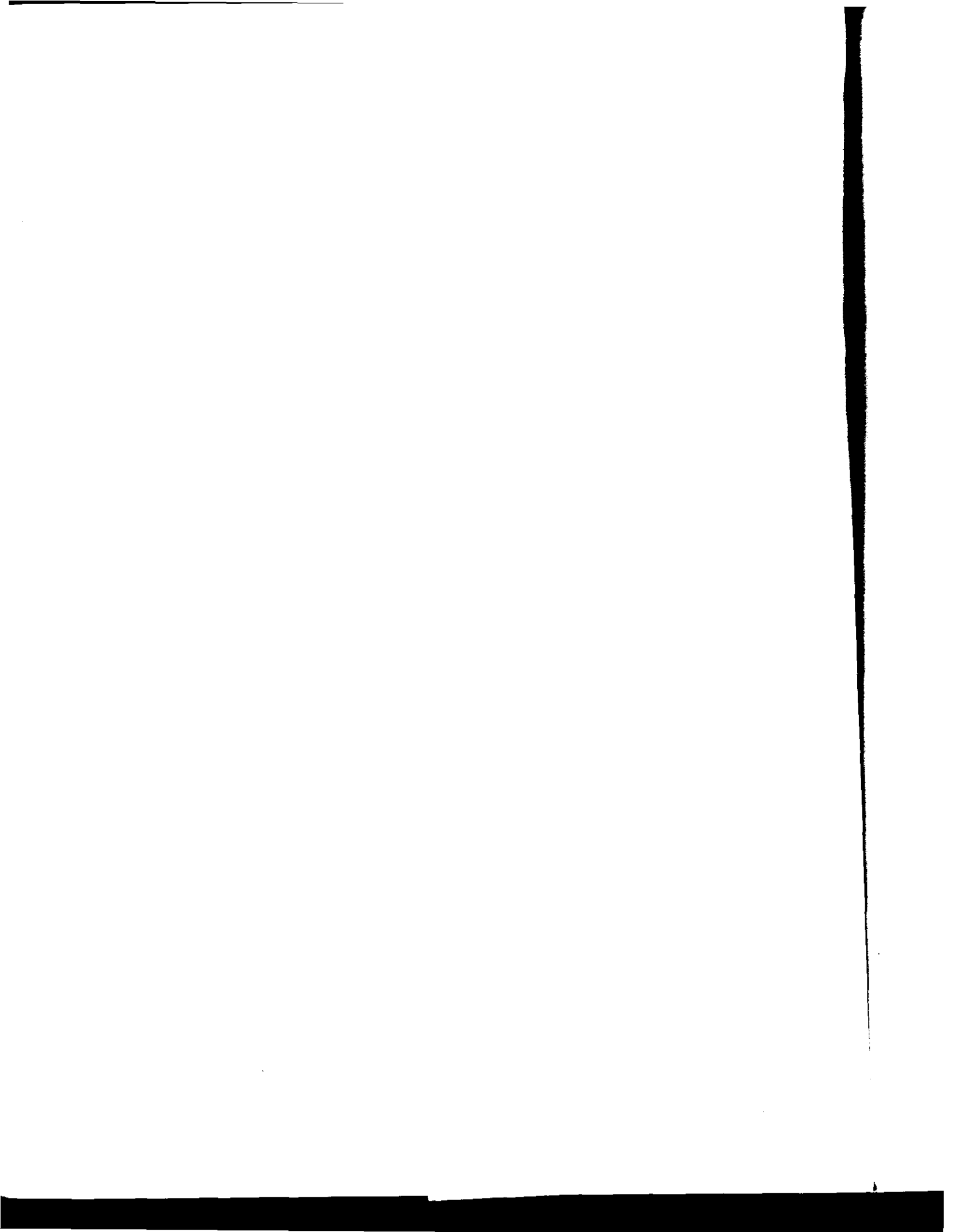

2

Letter, with GAO Code 701034  
Richard Davis, GAO, to William J.  
Perry, DOD  
February 9, 1994



**GAO**

United States  
General Accounting Office  
Washington, D.C. 20548

REC'D GAO(SFU)  
GAO SURVEYS/REVIEWS

National Security and  
International Affairs Division

FEB 15 1994

FEB 9 1994

The Honorable William J. Perry  
The Secretary of Defense

Attention: DOD Office of the Inspector General  
Director for GAO Surveys and Reviews

Dear Mr. Secretary:

In response to a congressional request, the General Accounting Office is initiating a review of DOD's policies and procedures for acquiring, classifying, retaining, and disposing of official government documents dealing with weather balloon, aircraft, and similar crash incidents. The review will involve testing whether DOD, the military services, specialized defense agencies, and others such as the National Archives, have systematically followed the proper procedures to ensure government accountability over such records.

The work will be performed under GAO code 701034 by staff from our National Security Analysis group in Washington, D.C. If you have any questions concerning this assignment, please contact either Mr. Gary Weeter, Assistant Director, at (202) 512-4603 or Mr. Jack Kriethe, Evaluator-in-Charge at (202) 512-4567. This review has been coordinated with Dan Chambers of the Inspector General's Office.

Sincerely yours,

*Richard Davis*

Richard Davis  
Director, National Security  
Analysis

ENCL TO ATCL 4



GAO ENTRANCE CONFERENCE FOR  
ASSIGNMENT CODE 701034

ISSUE:

Has the Government met its responsibility in the handling, retention, and subsequent disposition of official records concerning the investigation and reporting of air vehicle and other crash incidents similar to the reported crash of a weather balloon near Roswell, New Mexico in July 1947.

SCOPE:

Initial work will be performed at the Department of Defense, the Services, specialized defense agencies, and other executive branch agencies as required.

APPROACH:

- (1) Interview responsible officials and review pertinent directives and regulations to determine the executive branch policies and procedures governing the reporting of air vehicle and similar crash incidents.
- (2) Select a sample of crash incidents covering different time periods (1947 to present) to determine whether proper procedures were followed.
- (3) For the incidents selected, determine whether proper records management procedures were followed in the retention and subsequent disposition of those records.
- (4) Determine the "OFFICIAL" explanation of what has become known as the "Roswell Incident".

3

Memo  
Marcia J. Van Note, DOD/IG, for  
Distribution  
Subj: General Accounting Office  
(GAO) Letter Dated February 9,  
1994 . . .  
February 23, 1994



Anal  
and



INSPECTOR GENERAL  
DEPARTMENT OF DEFENSE  
400 ARMY NAVY DRIVE  
ARLINGTON, VIRGINIA 22202-2984



Analysis  
and Followup

FEB 23 1994

MEMORANDUM FOR: SEE DISTRIBUTION

SUBJECT: General Accounting Office (GAO) Letter Dated  
February 9, 1994, "Records Management Procedures  
Dealing with Weather Balloon, Unknown Aircraft, and  
Similar Crash Incidents" (GAO Code 701034)--  
NOTIFICATION OF GAO REVIEW

The DoD Directive 7650.2 designates this office as the central DoD liaison for tasking, controlling, and monitoring GAO survey, review, and report activities. The enclosed Information Sheet describes the specific DoD procedures for tasking GAO surveys/reviews and the DoD primary action office (PAO) responsibilities.

On February 15, 1994, we received the enclosed official GAO notification letter on the subject effort. The GAO National Security and International Affairs Division (National Security Analysis) is doing the work. The review is at the request of Representative Steven H. Schiff (R-NM).

Representative Schiff requested the GAO review two issues of concern (1) the DoD records management procedures for crash incidents involving weather balloons and unknown aircraft, such as UFOs and foreign aircraft, and (2) the facts regarding the reported crash of an UFO in 1949 at Roswell, New Mexico. Since the UFO story appeared in an episode of the television program "Unsolved Mysteries," Representative Schiff has received many requests for an investigation into the alleged "DoD cover-up." Apparently, reports on the incident were attributed to a weather balloon crash.

The GAO is anxious to respond to Representative Schiff's request and to dispel any concerns that the DoD is being unresponsive. For that reason, it is important that we identify the correct DoD representatives so that the GAO can begin its work. Since the enclosed GAO notification letter did not mention the Roswell incident or specifically site unknown aircraft as the area of interest, we have been unable to determine the appropriate DoD primary and collateral action offices.

We have scheduled an entrance meeting with the GAO for February 28, 1994, 10:00 a.m., 400 Army Navy Drive, Room 730, Arlington, VA. The entrance meeting should clarify the issues to the extent that a DoD primary action office can be identified.

Please provide the name and telephone number of your representative(s) for the entrance meeting as soon as possible to my action officer, Pattie Cirino, (703) 693-0214. If she is not available, I can be reached on the same number.

*Marcia J. Van Note*

Marcia J. Van Note  
Director  
GAO Surveys and Reviews

Enclosures:  
As stated

DISTRIBUTION:	SEC ARMY	USD(P&R)
	SEC NAVY	ASD(C3I)
	SEC AIR FORCE	DIR, JS
	CMDT, USMC	DIR, A&M
	USD(P)	DIR, NSA
	ATSD(LA)	USCINCSpace
	ATSD(PA)	USCINCTrans
	GC	

4

Memo, with Indorsement  
Vaughn E. Schlunz, SAF/FMPF, for  
Distribution  
Subj: GAO Review Letter Dated  
February 15 [*sic*], 1994, "Records  
Management Procedures . . .  
February 24, 1994





DEPARTMENT OF THE AIR FORCE  
WASHINGTON DC



OFFICE OF THE ASSISTANT SECRETARY

24 FEB 1994

MEMORANDUM FOR

<input type="checkbox"/> SAF/FM	<input checked="" type="checkbox"/> AF/INR	<input checked="" type="checkbox"/> AFAA/DO	<input type="checkbox"/> AETC/FMFM
<input type="checkbox"/> SAF/AQXA	<input checked="" type="checkbox"/> AF/SPO	<input checked="" type="checkbox"/> AFIA/CVS	<input type="checkbox"/> AMC/FMAP
<input checked="" type="checkbox"/> SAF/LLR	<input checked="" type="checkbox"/> AF/HO	<input type="checkbox"/> AFOTEC/RMR	<input type="checkbox"/> PACAF/IGIX
<input checked="" type="checkbox"/> SAF/PA	<input checked="" type="checkbox"/> AF/JAG	<input type="checkbox"/> AFSPACECOM/FMP	<input type="checkbox"/> ACC/FMP
<input type="checkbox"/> SAF/IA	<input type="checkbox"/> AF/SCXX	<input type="checkbox"/> AFCC/FMFA	<input type="checkbox"/> USAFE/FMEP
<input checked="" type="checkbox"/> SAF/AAX (OPR)	<input checked="" type="checkbox"/> AF/XOS	<input type="checkbox"/> AFMC/IGQ	<input type="checkbox"/> AFMPC/RMM
<input type="checkbox"/> SAF/FMBMD	<input checked="" type="checkbox"/> AF/SE	<input type="checkbox"/> ANGRG/FMP	

\*

FROM: SAF/FMPF

SUBJECT: GAO Review Letter Dated February 15, 1994, "Records Management Procedures Dealing With Weather Balloon, Unknown Aircraft, and Similar Crash Incidents", (GAO Code 701034) -- ACTION MEMORANDUM

This memo is to advise you of the subject review and to request each organization indicated as OPR or OCR above to designate a Central Point of Contact (CPC). The CPC should return the indorsement immediately. This package is provided to other listed organizations as information. Air Force Regulation 11-8 applies.

The CPC should further assess the potential impact of the GAO review on the Air Force. If the assessment indicates the need, the CPC should brief the Deputy Chief of Staff and other officials, as appropriate.

An entrance meeting is scheduled for February 28, 1994, at 1000, in Room 730 at 400 Army Navy Drive, Arlington VA. The SAF/FMPF point of contact is Mrs. Ann Cook, Room 4C228, extension 76051.

*Vaughn E. Schlunz*  
VAUGHN E. SCHLUNZ  
Director for Audit  
Liaison and Followup  
(Financial Management)

- 3 Atch
- 1. DoD(IG) Memo, February 23, 1994
- 1. Indorsement



1 MAR 1994

1st Indorsement

TO: SAF/FMPF, Room 4C228, Pentagon

SUBJECT: Central Point of Contact, GAO Code 701034

1. CPC Richard L. Weaver , Col SAF/AAZ , 5D972 , 3-2013  
NAME GRADE OFC SYMBOL ROOM EXT.

Alt Jeff Butler , Lt Col SAF/AAZ , 5D972 , 3-2013  
NAME GRADE OFC SYMBOL ROOM EXT.

FAX Number 693-2059 .

2. You will be notified of any changes in the above designees.  
SAF/AA focal point for all audits and inspections is Ms. Carolyn  
Lunsford, SAF/AAX, 697-9057, FAX 693-9763.

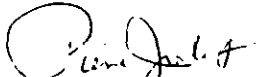

PIERRE JOUBERT, Colonel, USAF  
Director, Plans, Programs, & Budget  
Office of the Administrative Ass't

cc: SAF/AAZ  
SAF/AAIQ

Memo, with Addendum  
Robert J. McCormick, SAF/AA, for  
Distribution  
Subj: GAO Review on Records  
Management Procedures Dealing  
with Weather Balloons, Unknown  
Aircraft, and Similar Crash  
Incidents . . .  
March 1, 1994





DEPARTMENT OF THE AIR FORCE  
WASHINGTON DC 20330-1000



OFFICE OF THE SECRETARY

1 March 1994

MEMORANDUM FOR DISTRIBUTION

SUBJECT: GAO Review on Records Management Procedures Dealing with  
Weather Balloons, Unknown Aircraft, and Similar Crash Incidents (GAO  
Code 701034) - ACTION MEMORANDUM

References: (a) 23 Feb 94 DoD/IG Memorandum, Subj, same as above  
(b) 15 Feb 94 GAO Memorandum of Review Notification

The Department of Defense and other executive branch agencies are undergoing a review by the GAO concerning whether the US government has "met its responsibility in the handling, retention, and subsequent disposition of official records concerning the investigation and reporting of air vehicle and other crash incidents similar to the reported crash of a weather balloon near Roswell, New Mexico in July 1947". To fulfill the Air Force portion of this review, addressees, as applicable, are requested to:

- (a) identify pertinent directives concerning records retention and disposition;
- (b) identify pertinent directives concerning reporting air vehicle crashes, investigations, and wreckage/debris retention and disposition;
- (c) identify any records (unclassified or classified) related to air vehicle (aircraft, lighter-than-aircraft, rocket/missile, or other) impacts or crashes in New Mexico from 20 June to 31 July 1947; identify record groups and/or other indexes associated with these records for further review; and
- (d) provide copies of pertinent directives (including any changes of policies on retention and disposition) and records (i.e., item c above) to SAF/AAZ, 1720 Air Force Pentagon, Washington DC 20330-1720.

Please provide your responses (interim or final) by 14 Mar 94. Contact Col Weaver or Lt Col Butler at DSN 223-2013/7 or commercial (703) 693-2013/7 if there are any questions.

ROBERT J. McCORMICK  
Administrative Assistant

2 Attachments:

1. 23 Feb 94 DoD/IG Memo w/encl
2. GAO Issue/Scope/Approach

DISTRIBUTION:

SAF/AAI  
SAF/AQL  
AF/SE  
AF/HO  
AF/IN  
AF/XOW



DEPARTMENT OF THE AIR FORCE  
WASHINGTON DC 20330-1000



OFFICE OF THE SECRETARY

16 March 1994

MEMORANDUM FOR AFOSI/HO

FROM: SAF/AAZ  
1720 Air Force Pentagon  
Washington DC 20330-1720

SUBJECT: GAO Review on Records Management Procedures Dealing with  
Weather Balloons, Unknown Aircraft, and Similar Crash Incidents (GAO  
Code 701034) - ACTION MEMORANDUM

Reference: SAF/AA 1 Mar 94 Memorandum w/atch, Subj, same as above

SAF/AAZ has taken the lead for the Air Force in providing the GAO with all pertinent records and information related to the above subject. Part of this review will involve retrieving records, histories, reports of investigations, etc. related to sightings of unknown aerial objects/phenomena.

To insure that we have searched all applicable document holdings, request you research AFOSI histories for any records that might be relevant to the GAO review. Such records might have been created prior to the formal establishment of AFOSI, e.g., AAF/CIC or USA/CID records. Request you limit your search to holdings within your purview for the period Jan 1947 through Dec 1953.

Please contact me or Lt Col Butler at (703) 693-2013 if there are any questions on this subject.

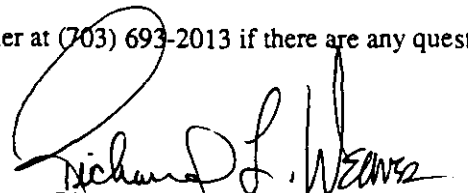
  
RICHARD L. WEAVER, Col, USAF  
Director for Security and Special  
Program Oversight  
SAF/AAZ

1 Attachment:  
SAF/AA 1 Mar Memorandum

AFOSI  
(ADDENDUM TO SAF/AA-  
1 MAR 94 TASKER)

6

Memo, with Attachments  
AF/IN for SAF/AA  
Subj: GAO Inquiry into Records  
Management Procedures Dealing  
with Weather Balloons, Unknown  
Aircraft, and Similar Crash  
Incidents

March 14, 1994

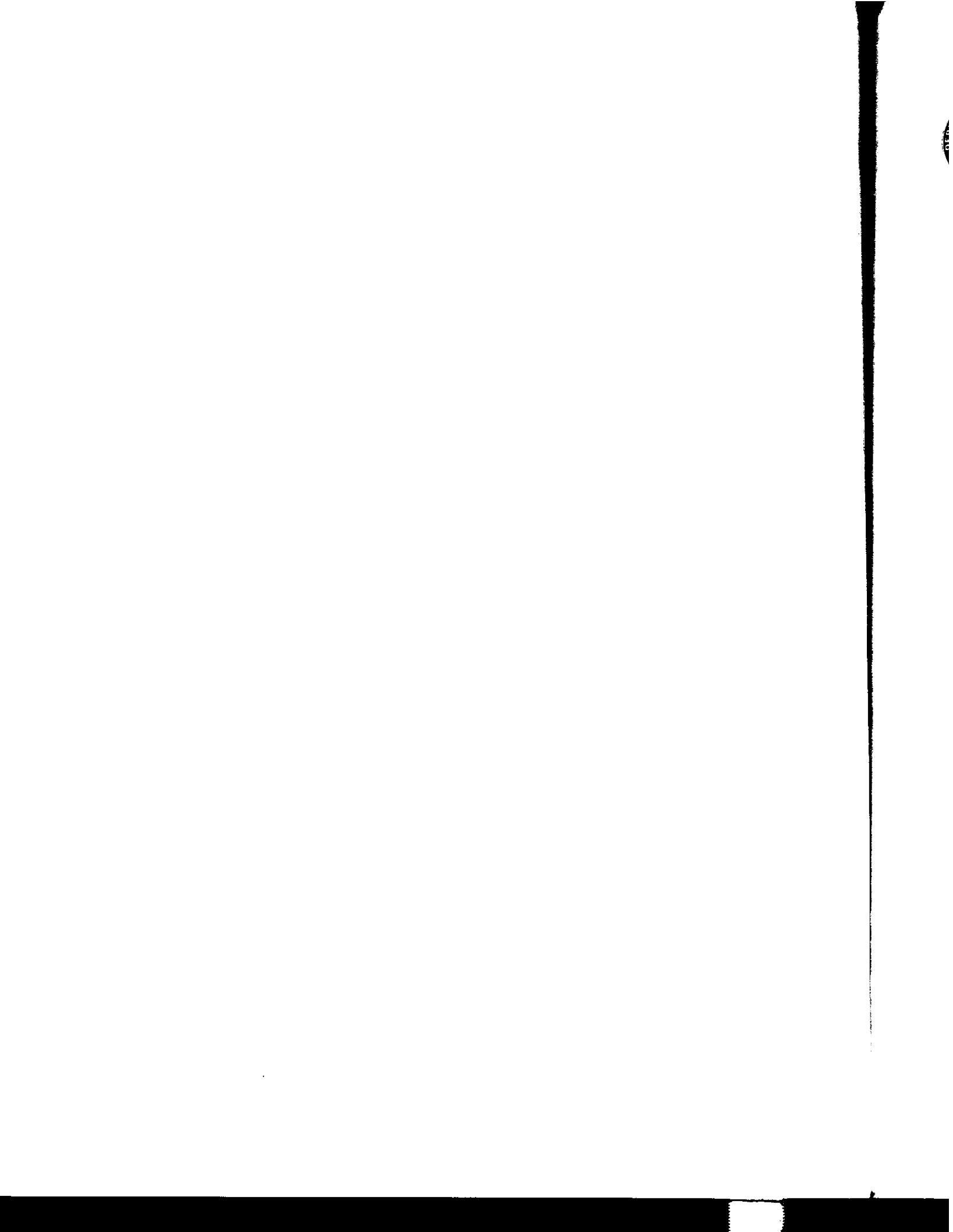



DEPARTMENT OF THE AIR FORCE  
HEADQUARTERS UNITED STATES AIR FORCE



MEMORANDUM FOR SAF/AA *W. J. Foley 16 Mar 94*

FROM: AF/IN

SUBJECT: GAO Inquiry into Records Management Procedures Dealing with Weather  
Balloons, Unknown Aircraft, and Similar Crash Incidents -  
INFORMATION MEMORANDUM

References: (a) SAF/AA Memorandum, 1 Mar 94  
(b) Telecon: Lt Col Butler/AAZ - Mr. Foley/INXA, 3 Mar 94

In response to references, the following information is provided--with answers keyed to ref a:

- a. None.
- b. None.
- c. None, but see below for related material.
- d. None.

Ref para c above. Although we possess no official records related to the subject matter, we do possess documents received from FOIA requesters that discuss the Roswell Incident which we think may be pertinent to the GAO inquiry:

a. One is a FOIA request from Dr. Neal in California. It is of particular interest in that he claims to know of a physician in California who allegedly participated in the hands-on pathological examination of four alien bodies. (Atch 1). Dr. Neal does not identify the individual.

b. There is a second document called "Synopsis of Roswell Incident." (Atch 2). In its recapitulation of the events that allegedly transpired on that day in Roswell, the synopsis cites several people who relate stories told to them by alleged eyewitnesses to the event.

We also attach a report from the National Air Intelligence Center (NAIC) at Wright-Patterson AFB OH, which summarizes its research, and that of others at WPAFB, into UFOs and the Roswell Incident (Atch 3). The NAIC report concludes that after exhaustive research there is no evidence of the existence of any relevant documents, flying saucer debris, or space aliens on WPAFB.

AF/IN's POC is Mr. M. J. Foley, x31664.

Attachments:

- 1. Dr. Neal's FOIA Letter
- 2. Synopsis of Roswell Incident
- 3. Summary of NAIC Research

*W. J. Foley*  
16 Mar 94  
Mr. M. J. Foley  
AF/IN



RICHARD M. NEAL, JR., M.D., INC.  
OBSTETRICS, GYNECOLOGY & INFERTILITY



February 5, 1993

Freedom of Information Act Request  
(5 U.S.C. 552)  
Department of the Air Force  
HQ USAF/DADF  
Washington, DC 20380

RE: ALIEN HUMANOIDS/UFO'S

Dear Sirs:

As a physician I have done personal/private research in the field of Ufology for the past twenty years. Of great interest to me is the July 2, 1947 crash of an extra-terrestrial object in New Mexico.

Also of greater interest is the recovery of 4 alien bodies from this crash - a separate portion of the compartment/control room/crew cabin area was found several miles from the rest of the UFO debris. There has been rumors of post-mortem examinations being performed on these bodies.

The bodies were described as the body of a small humanoid, tan (or sunburned) in color, approximately the size of a ten year old boy, was examined at a laboratory of the Guggenheim Foundation then on 23rd Street in New York City. The pathological examination disclosed a human with a skeleton having two extra ribs on each side, whose flesh had a somewhat higher mineral content than we would consider normal and somewhat denser bones.

Reportedly, shortly after the discovery of this vehicle and its occupants - it prompted then President Harry S. Truman to appoint (on Sept. 18, 1947) a committee of twelve individuals - called the "Majestic-12" or MJ-12 to secure and study the crashed UFO debris and its occupants.

An important person - one of the MJ-12, was an individual named Dr. Detlev W. Bronk, a neurophysiologist. In June 1947 he was named a member of the Scientific Advisory Committee of the Brookhaven National Laboratory; he subsequently became the sixth President of John Hopkins University in 1949. It is believed that Dr. Bronk was the medical director of a team that performed these pathological examinations of the aliens; his medical team would be restricted to a limited number of physicians - such as the following:

93-0252

F  
F  
P  
  
P  
C  
P  
r  
  
t  
d  
w  
a  
  
t  
o  
i  
  
b  
"  
b  
g  
a  
t  
  
a  
w  
w  
f  
R  
  
Y  
s  
t  
o  
u  
t  
U  
A

- 1). Pathologist
- 2). Radiologist
- 3). Neurophysiologist (Dr. Bronk)
- 4). Cardiovascular-Thoracic Surgeon

Presently living in Southern California is one of the physicians who participated in this project. I must respect his confidentiality and anonymity. He is in his mid to late 70's and is probably the last link (firsthand) to have experienced this research on the alien bodies in 1947.

In regards to any release of this subject matter, existence of this material/past research would not be exempt from mandatory disclosures under the FOIA because it would not/does not interfere with our national security nor knowledge of the above would give any other foreign country a military advantage.

Serious UFO researchers believe that the Air Force now wishes the American public, to know the truth, of the extra-terrestrial origin of the UFO phenomena, and thus are "leaking" some information out to various researchers.

Nationwide polls revealed that over 70% of our population believes in the extra-terrestrial theory; movies such as "E.T.", "Close Encounter of the Third Kind", "Hanger 18" and "Cocoon" are being released to cushion the public to the truth. Could the government/private corporation use subliminal suggestions in the above movies or possibly TV - To prepare this country eventually to the truth that UFO's and aliens exist.

Being in this field of research - specifically physiological and psychological effects suffered secondary to individuals who were allegedly abducted by aliens has increased my knowledge that we are definitely being visited by an alien race. I have enclosed for your review a brief synopsis of what occurred in and around Roswell, New Mexico in July 1947. Please review this information.

Why have I decided to write at this time This is the 45th year anniversary of UFO's - many lectures and seminars will be scheduled around the country to herald this event. Because of this, it is hopeful that through the FOIA someone sympathetic to our research efforts will release some "shocking" information for us to relay to the general public. It seems coincidental/ironic that the most prominent seminar was the MUFON 1992 International UFO Symposium on July 11-12, 1992 at the Convention Center in Albuquerque, New Mexico.

PROJECT SIGMA

The project was originally established in 1954. Its mission was to establish communications with aliens. This project met with positive success (SIC) when in 1959, the United States established primitive communications with the aliens. On April 25, 1964, a USAF intelligence officer met two aliens at a pre-arranged location in the desert of New Mexico. The contact lasted for approximately three hours. The Air Force officer managed to exchange basic information with the two aliens. The project is believed to be continuing at an Air Force base in New Mexico.

I am respectfully requesting the following information:

- 1). An authentic photocopy of the "Majestic-12" (MJ-12) groups information - a 9 page document (1947).
- 2). Any photocopies of pathological reports (post-mortem) performed on the aliens in 1947 (comparative anatomy).
- 3). Any authentic photocopies of aliens - full body exposures; close-up photos, etc.
- 4). Project Whirlwind - a UFO study done at M.I.T. in 1949, then referred back to the Dept. of Defense.

Although I realize that the government is reluctant in giving out information, particularly to civilian researchers, my approach will continue to be positive and will have a optimistic outlook. While I might accurately anticipate some negative reactions to all this information (continued debunking) in the letter, I would nevertheless value your response.

Sincerely,

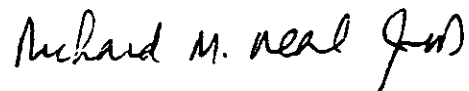

Richard M. Neal, Jr., M.D.

/rnm

Enclosures

## SYNOPSIS OF ROSWELL INCIDENT

I am writing to request a clarification of the U.S. Government's *current* position concerning events which occurred in and around Roswell, New Mexico, in July 1947.

According to newspaper accounts and eyewitness reports, a local rancher, William W. Brazel, discovered pieces of debris from an object which crashed on the property he managed outside Corona, on or about July 2, 1947. He brought some of this material to the attention of Chaves County Sheriff George Wilcox, who called the Roswell Army Air Field. The base Intelligence Officer, Jesse A. Marcel, and a Counter Intelligence Corps Officer, Sheridan Cavitt, went to the ranch to inspect the material.

They discovered a great deal of lightweight debris which couldn't be cut, burned, or even dented with a sledgehammer. On orders from the base commander, Col. William Blanchard, the Public Information Officer, Walter G. Haut, issued a news release that the Army Air Force had recovered "flying disc." Some of the debris was flown to Fort Worth, Texas where the Commander of the Eighth Air Force, Gen. Roger Ramey, identified the material for the press as the remains of a weather balloon and its radar target.

However, subsequent investigation has raised considerable doubt about the weather balloon explanation. For example:

■ According to his son and neighbors, Brazel was held incommunicado by officials at the Roswell base for nearly a week, questioned extensively and ordered not to say anything about his experience; however, in a newspaper interview, he said that the material he recovered "did not in any way resemble a weather balloon," many of which he had recovered on his property.

■ Sheriff Wilcox, to whom Brazel initially reported finding the debris, also was ordered by the military not to say anything, but members of his family say that not only did he see debris at the crash site — he also saw four "space" beings, one of whom was alive. Moreover, his granddaughter, Barbara Dugger, was told by her grandmother, Inez Wilcox, that the entire family was threatened with death by the military if they discussed the incident.

■ The former manager of KGFL Radio in Roswell, Jud Roberts, says the station was threatened with loss of its license by government officials in Washington, DC, if it broadcast the story about the "flying saucer." In addition, according to Lydia Sleppy, a secretary at KOAT Radio in Albuquerque, a wire transmission of the news story on the event was interrupted by a message something like: "CEASE TRANSMISSION. NATIONAL SECURITY ITEM."

■ According to Brig. Gen. Thomas J. DuBose (USAF, ret.), who was Gen. Ramey's Chief of Staff, Maj. Gen. Clements McMullen, the Deputy and Acting Commander, Strategic Air Command, at Andrews Army Air Field, ordered that some of the debris recovered on the ranch be brought directly to him in Washington. Gen. DuBose says officials at the Headquarters of the Eighth Air Force were directed to tell the press that the material was from a weather balloon radar target, and that the weather balloon explanation was a "cover story" to divert the attention of the press.

■ The pilot who transported some of the wreckage, Oliver W. Henderson, said he saw the bodies of alien beings at the Roswell base, according to his widow, Sappho Henderson, his daughter, Mary Kathryn Groode, and his friend, John Kromschroeder.

■ A mortician who worked for the funeral home in Roswell, Glenn Dennis, says an Army nurse friend told him about participating in the autopsies of three alien bodies at the base.

Therefore, I am formally requesting that you seek to determine whether the highly unusual material recovered near Corona was from a "flying disc," a weather balloon, or something else.

Please advise me, at your earliest opportunity, of the United States Government's *current* position on the nature of the material recovered outside Roswell, New Mexico, in July 1947, and its current explanation for all official actions taken with respect to this event.

Sincerely,

SUMMARY OF HQ NAIC RESEARCH INTO THE ROSWELL INCIDENT,  
UNIDENTIFIED FLYING SAUCERS, AND PROJECT BLUE BOOK

**PURPOSE.** To summarize sources of information used in the HQ NAIC study of the 1947 Roswell incident. Allegations are that a flying saucer(s) and/or alien(s) were found at the crash site and transported to Wright-Patterson AFB, Ohio.

**BACKGROUND.** In 1993, Congressman Steven Schiff from New Mexico began an investigation of the Roswell incident. Pursuant to that, a General Accounting Office auditor visited the HQ NAIC History Office to see what records were available within the center. Also, a local television station picked up the story. In addition to HQ NAIC records, the Historian visited other base archives to search for material.

**FINDINGS.**

1. A review of the HQ NAIC History Office and CIRC holdings, plus other base and USAF Museum archives, encompassing several million pages of documents, did not turn up any reference to the Roswell incident or the presence of flying saucer(s) and/or alien(s) at the base.

2. An electronic search of the Air Force Historical Research Agency archives, again, several million pages of documents, did not turn up any reference to the Roswell incident or the presence of flying saucer(s) and/or alien(s) at Wright-Patterson AFB.

3. A review of the Dayton Daily News for July 1947, all of the UFO-related material available in the Dayton, Centerville, and Woodbourne Public Libraries, as well as information in the Wright State University holdings and material in the AFIT, Base Technical Library, and Base Library did not turn up any conclusive evidence that flying saucer(s) and/or alien(s) had ever been at Wright-Patterson.

4. Conversations with a dozen people who had worked in the Project Blue Book office or with Blue Book materials did not turn up any evidence that there had ever been a flying saucer(s) and/or alien(s) at Wright-Patterson.

5. Over the years, there have been several congressional investigations of this organizations study of UFO reports. None has ever turned up evidence of a flying saucer(s) and/or alien(s) at Wright-Patterson.

6. All of this organization's UFO study files were transferred to the National Archives and made available to the public.

Atch 1

## CONCLUSIONS.

1. Concerted research has failed to turn up any evidence relating to the Roswell incident or of a flying saucer(s) and/or alien(s) at Wright-Patterson. Because this conclusion is based on the absence of documentation, the issue can never be definitively resolved. There will always be those who say "You didn't search hard enough" or "We know you really do have the records/saucer(s)/alien(s), but you are just not revealing them to us." It would almost be a physical impossibility to search every desk drawer in every building on Wright-Patterson looking for the report, if it ever existed, on Roswell-related material. HQ NAIC is convinced that no such record currently exists.

2. Because no document has ever been found, however, leads center researchers to the conclusion that the Roswell material, if it came to Wright-Patterson for analysis, was nothing remarkable, certainly nothing extraterrestrial. The standard procedure for any government record is that it is kept for some period of time, then retired or destroyed according to a general schedule established by regulation. One might assume that a document purporting to be the true analysis of extraterrestrial material would always be needed and, thus, would have been preserved.

3. Because the Roswell incident occurred so long ago, now nearly 50 years ago, there may be no record trail to follow to absolutely determine if a study had ever been conducted.

4. Despite the best efforts of UFO researchers over the years, not one scrap of physical evidence or one incontestable photograph of either a flying saucer or an alien has ever been found relating to the Roswell incident. Some researchers have devoted years of their lives to this effort. Again, using an argument based on the absence of evidence, the fact that several hundred man-years of effort have followed all of the research trails imaginable leads HQ NAIC to believe that nothing extraterrestrial was found at Roswell.

5. The earliest UFO literature, books by Ruppelt, Keyhoe, and Menzel do not mention the Roswell incident. Also, the Blue Book records and the Condon report do not mention the Roswell incident, though many sightings from 1947 were investigated by this organization's predecessors.

6. HQ NAIC realizes that the absence of evidence is not evidence of absence, but every reasonable avenue of research has been exhausted without finding evidence that a flying saucer(s) and/or alien(s) have ever been at Wright-Patterson AFB.

7. Because the GAO will have searched the records of many federal agencies, HQ NAIC suggests that they be contacted, or Congressman Schiff be contacted, for a comprehensive report of their findings relating to the Roswell incident.

## SUGGESTED READING.

Blue Book Special Report 14 and the Project Sign and Project Grudge reports. These primary documents should have been part of this organization's UFO study files and currently available through the National Archives.

The UFO Controversy in America, David Michael Jacobs. Contains a comprehensive review of documents belonging to this organization's UFO study files.

The Report on Unidentified Flying Objects, Edward Ruppelt. Ruppelt was the UFO study project officer from 1951-1953 and he investigated a series of reports from 1947. He found nothing, apparently, about the Roswell incident.

The UFO Experience, J. Allen Hynek. Written by the chief scientific advisor to this organization for UFO studies. Associated with Sign/Grudge/Blue Book from 1948-1969, he found nothing, apparently, about the Roswell incident.

Flying Saucers: Top Secret, Donald Keyhoe. Keyhoe helped establish NICAP and was one of the earliest to allege that the government was withholding UFO "secrets" from the public. He found nothing, apparently, about the Roswell incident.

Flying Saucers and the U.S. Air Force, Lawrence Tacker. States the official Air Force position as of 1960 and includes earlier Air Force statements about UFOs.

7

**Memo**  
**Brig Gen James L. Cole, Jr., AF/SE,**  
**for SAF/AAZ**

**Subj: GAO Review on Records**  
**Management Procedures with**  
**Weather Balloons, Unidentified**  
**Aircraft, and Similar Crash**  
**Incidents . . . .**

**March 14, 1994**







DEPARTMENT OF THE AIR FORCE  
HEADQUARTERS UNITED STATES AIR FORCE  
WASHINGTON DC

14 MAR 1994

MEMORANDUM FOR SAF/AAZ  
ATTENTION: LT COL BUTLER

FROM: AF/SE

SUBJECT: GAO Review on Records Management Procedures Dealing with Weather Balloons, Unknown Aircraft, and Similar Crash Incidents (GAO Code 701034) - INFORMATION MEMORANDUM

In response to your memorandum dated 1 Mar 94, same subject, Air Force Safety has identified 2 directives concerning the investigating and reporting of air vehicle crashes. One is within our purview, while the other is managed by the Office of the Judge Advocate General.

AFR 127-4, *Investigating and Reporting US Air Force Mishaps* (attached), provides guidance for Air Force safety investigations, to include "air vehicle mishaps." The mishap report is used for mishap prevention purposes only and is not normally released outside Air Force channels. It does not cover the investigation of air vehicle crashes belonging to other branches of government or civilian crashes.

AFR 110-14, *Investigations of Aircraft, Missile, and Nuclear and Space Accidents*, provides guidance for Accident Investigation Boards, which are convened primarily to obtain and preserve available evidence for claims, litigation, disciplinary and administrative actions, and for all other purposes. The accident report is normally releasable to the public.

Normally, the safety investigation is done first, after which the wreckage/debris retention and disposition becomes the responsibility of the Accident Investigation Board. AFR 110-14, paragraph 10, *Disposition of Wreckage and Other Evidentiary Materials*, states "HQ USAF/JACC [now AFLSA/JACT] manages the retention of aircraft wreckage for anticipated litigation or in cases where there is a high degree of publicity. The Air Force is not under any general requirement to retain wreckage for long periods of time, but in some cases, it is advantageous to do while in others the wreckage can be disposed of quickly."

The Air Force Safety Agency searched the microfilm records (classified and unclassified) for air vehicle mishaps for the period 20 June through 31 July 1947. The only mishaps reported in New Mexico during that periods are as follows:

AIRCRAFT	DATE	TIME*	LOCATION
A-26C	24 June 1947	0809	7 miles northwest of Hobbs NM
P-51N	10 July 1947	1252	7 miles northwest of Hobbs NM
C-82A	12 July 1947	1206	7 miles southeast of Albuquerque NM
P-80A	18 July 1947	1200	Carrizozo NM
PQ-14B	28 July 1947	0935	15 miles southwest of Alamogordo NM

\* all times are Mountain Standard Time

We have no information regarding mishaps of air vehicles belonging to civilian or other government agencies. Please note that mishaps involving unmanned air vehicles (which during the 1940s included remotely piloted aircraft, low-speed "cruise missiles" like the V-1, and most balloons) are considered "ground mishaps." Reports on such occurrences are not retained for an extended period; AFR 4-20, vol II, Table 127-2, rule 4 directs the Air Force Safety Agency to destroy them after 5 years.

*James L. Cole, Jr.*

JAMES L. COLE, JR., Brig Gen, USAF  
Chief of Safety

Attachment:

AFR 127-4 *w/d*

cc:

AFLSA/JACT (atch w/d)

Memo  
Col Michael W. Schoenfeld,  
SAF/AQL, for SAF/AA  
Subj: GAO Review on Records  
Management Procedures Dealing  
with Weather Balloons, Unknown  
Aircraft, and Similar Crash  
Incidents . . .  
March 22, 1994





DEPARTMENT OF THE AIR FORCE  
WASHINGTON DC



OFFICE OF THE ASSISTANT SECRETARY

MAR 1994

**MEMORANDUM FOR SAF/AA**

**FROM: SAF/AQL**

**SUBJECT: GAO Review on Records Management Procedures Dealing with  
Weather Balloons, Unknown Aircraft, and Similar Crash Incidents (GAO  
Code 701034) (Your memorandum, 1 Mar 1994)  
-- INFORMATION MEMORANDUM**

SAF/AQL is not the OPR for: 1) directives concerning records retention and disposition or for 2) directives concerning reporting air vehicle crashes, investigations, and wreckage/debris retention and disposition. Additionally, we do not possess any records related to air vehicle impacts or crashes in New Mexico.

**MICHAEL W. SCHOENFELD, Col, USAF**  
Director, Electronic & Special Programs  
Assistant Secretary  
of the Air Force (Acquisition)

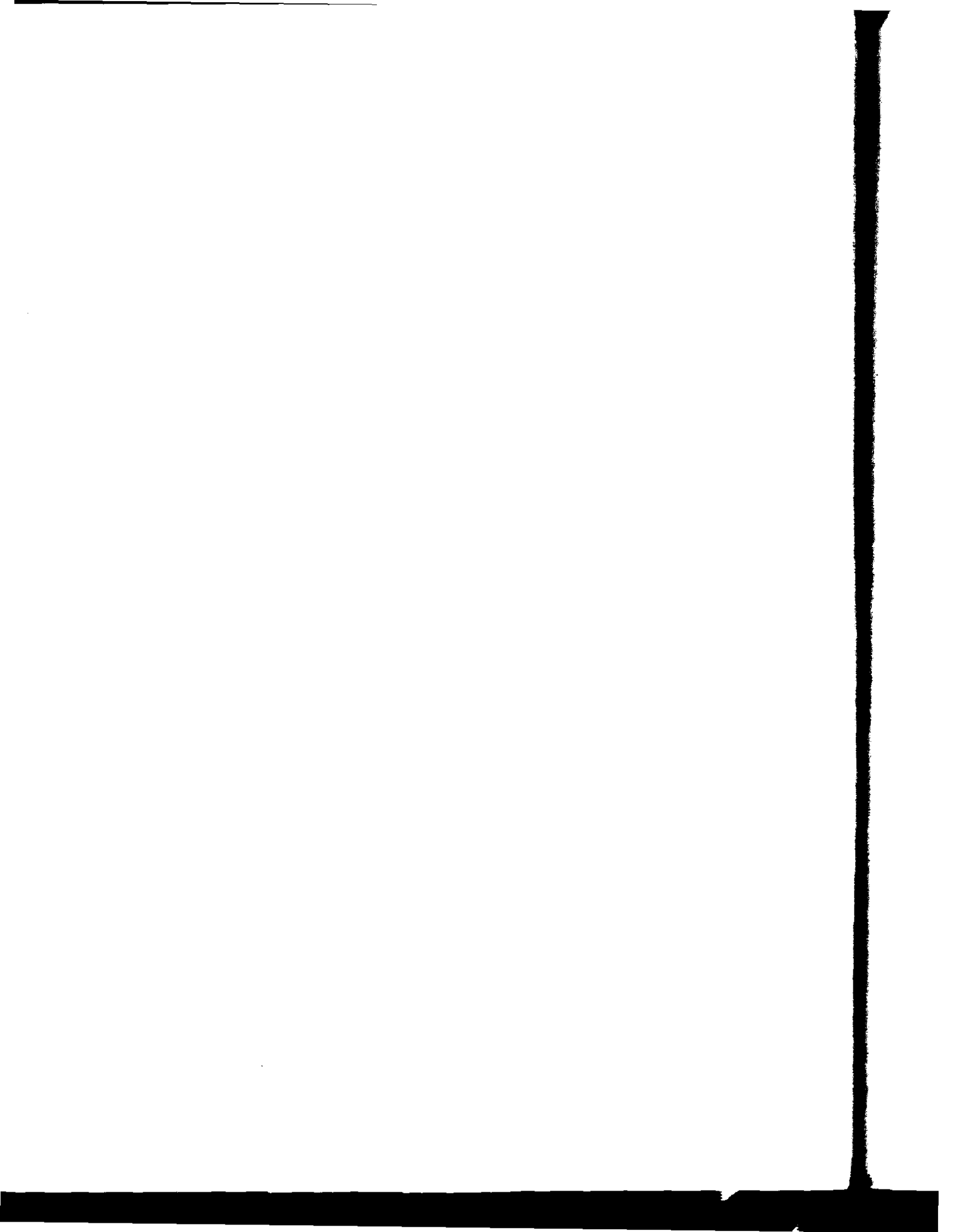

Memo  
Col Steve O. Ouzts, AF/XOWP, for  
SAF/AAZ  
Subj: GAO Review on Records  
Management Procedures Dealing  
with Weather Balloons, Unknown  
Aircraft, and Similar Crash  
Incidents . . .  
March 9, 1994







DEPARTMENT OF THE AIR FORCE  
HEADQUARTERS UNITED STATES AIR FORCE



09 Mar 94

MEMORANDUM FOR SAF/AAZ  
ATTENTION: Lt Col Bulter

FROM: HQ USAF/XOWP  
1490 Air Force Pentagon  
Washington DC 20330-1490

SUBJECT: GAO Review on Records Management Procedures Dealing with Weather  
Balloons, Unknown Aircraft, and Similar Crash Incidents (GAO Code  
701034)- INFORMATION MEMORANDUM

Reference: 1 Mar 94 SAF Memorandum, Subj, same as above

There is no requirement for weather personnel to record weather balloon landings.  
Only meteorological data are retained.

We did not find any records in the Air Force weather archives of a weather balloon  
crash near Roswell, New Mexico from 20 June to 31 July 1947. If you have any  
questions, my point of contact is Lt Col Jim Near DSN224-5163.

STEVE O. OUZTS, Col, USAF  
Chief, Policy Division  
Directorate of Weather  
DCS, Plans and Operations



Memo  
Grace T. Rowe, SAF/AAIQ, for  
SAF/AAI, SAF/AAZ  
Subj: GAO Review of Records  
Management Procedures Dealing  
with Weather Balloons, Unknown  
Aircraft, and Similar Crash  
Incidents . . .  
March 10, 1994

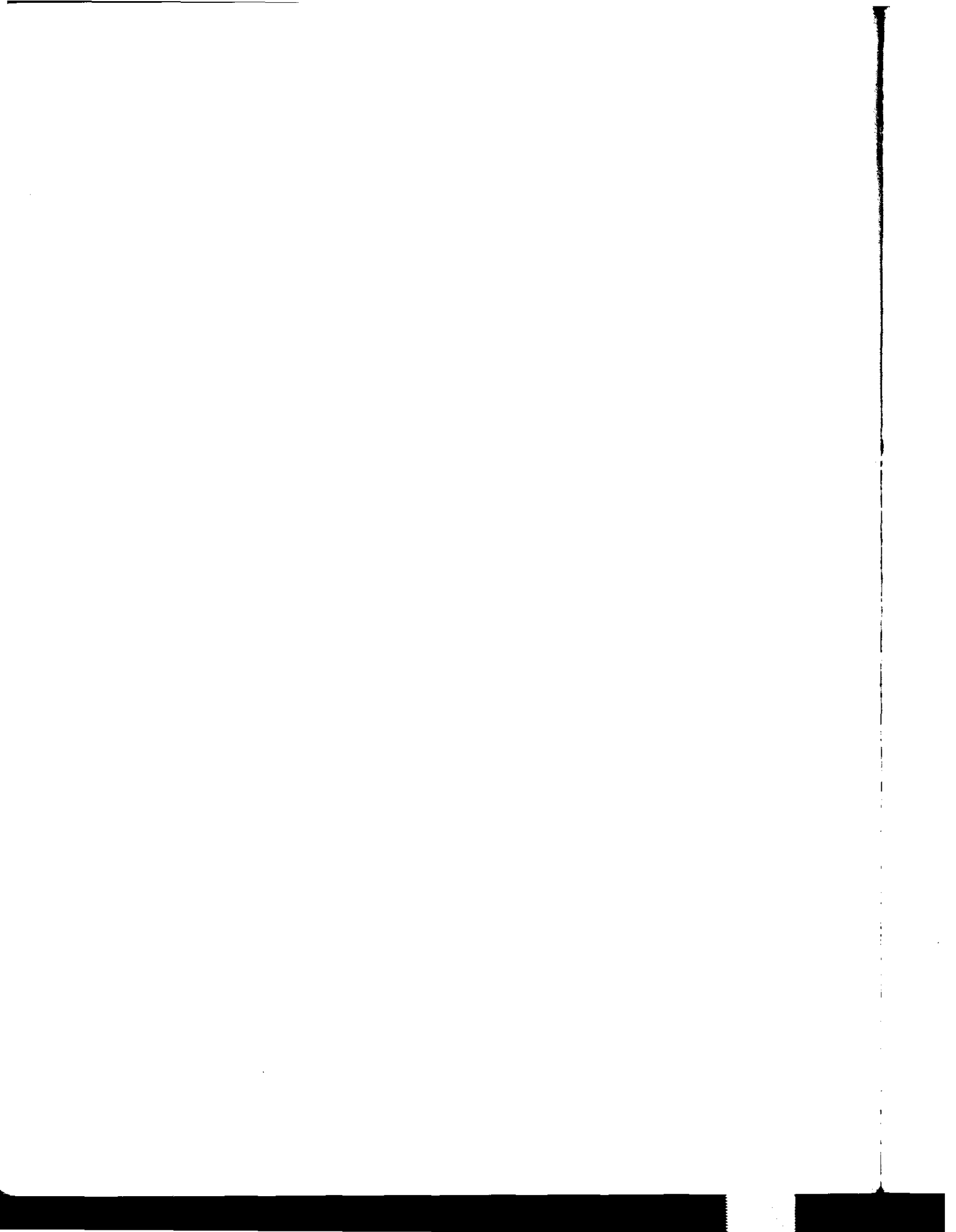



DEPARTMENT OF THE AIR FORCE  
WASHINGTON DC 20330-1000



OFFICE OF THE SECRETARY

10 March 1994

SAF/AAIQ  
1610 Air Force Pentagon  
Washington, DC 20330-1610

MEMORANDUM FOR SAF/AAI

SAF/AAZ  
IN TURN

*Fairman  
14 Mar 94  
15 Mar 94*

SUBJECT: GAO Review of Records Management Procedures Dealing with  
Weather Balloons, Unknown Aircraft, and Similar Crash  
Incidents (GAO Code 701034) - INFORMATION MEMORANDUM

Reference your memorandum, 1 March 1994, request items:

- (a) Identify pertinent directives concerning records retention and disposition.

The Air Force current regulation is AFR 4-20, Volume 2, Disposition of Air Force Records, Records Disposition Schedule, dated 1 May 1992.

Earlier schedules were:

AFR 12-50 volume II, Disposition of Air Force Records, Records Disposition Standards, 30 October 1987; 31 January 1986; 14 May 1984.

AFM 12-50 Volume II, Disposition of Air Force Documentation; 1 October 1969.

AFM 181-5, Records Management, Evaluation and Disposition of Records, 1 December 1966; 1 July 1963; and 10 November 1958.

AFM 181-5, Records Management, Disposition of Records, 1 July 1956; and 1 August 1954.

AFM 181-5, Administration of Records, 1950.

- (b) Identify pertinent directives concerning reporting Air vehicle crashes, investigations, and wreckage/debris retention and disposition.

AFR 110-14, Investigations of Aircraft, Missile, and Nuclear and Space Accidents (AF/JACC).

AFP 127-1 Volume 1, US Air Force Guide to Mishap Investigation (AFSA/SEP)

AFP 127, Volume 3, Safety Investigation Workbook (AFSA/SEP)

AFR 127-4, Investigating and Reporting US Air Force Mishaps (AFSA/SEP)

AFR 127-11, Participation in a Military Civil Aircraft Accident Safety Investigation (AFSA/SEP)

(c) Identify any records (unclassified or classified) related to air vehicle (aircraft, lighter-than-aircraft, rocket/missile, or other) impacts or crashes in New Mexico from 20 June to 31 July 1947; identify record groups and/or other indexes associated with these records for further review.

We asked the National Personnel Records Center to see if they have any files for Roswell Air Force Base for the 1947 time frame in their holdings. They noted that the histories for the 509th Bomb Group and Wing for Roswell Army Air Base for period of November-December 1947 was transferred to Air University in 1953. The regular 1947 records have been destroyed. They do have a packet of Top Secret for 509th Bomb Wing, Walker Air Force Base, Roswell, NM for 1949-1950. They said we would need to look through this for any records.

(d) provide copies of pertinent directives (including any changes of policies on retention and disposition) and records (i.e., item c above) to SAF/AAZ, 1720 Air Force Pentagon, Washington, DC 20330-1720.

We are attaching appropriate extract from our disposition schedule since 1950. This is our earliest schedule.

*Grace T. Rowe*  
GRACE T. ROWE  
Chief, Records Management Branch  
Directorate of Information Management

1 Atch  
Extracts from AF *W/D*  
Records Schedules

Memo, with Attachment  
Richard S. Rauschkolb, AFHRA/CC,  
for AF/HO, SAF/AAZ  
Subj: GAO Review on Records  
Management Procedures Dealing  
with Weather Balloons, Unknown  
Aircraft, and Similar Crash  
Incidents . . .  
March 8, 1994



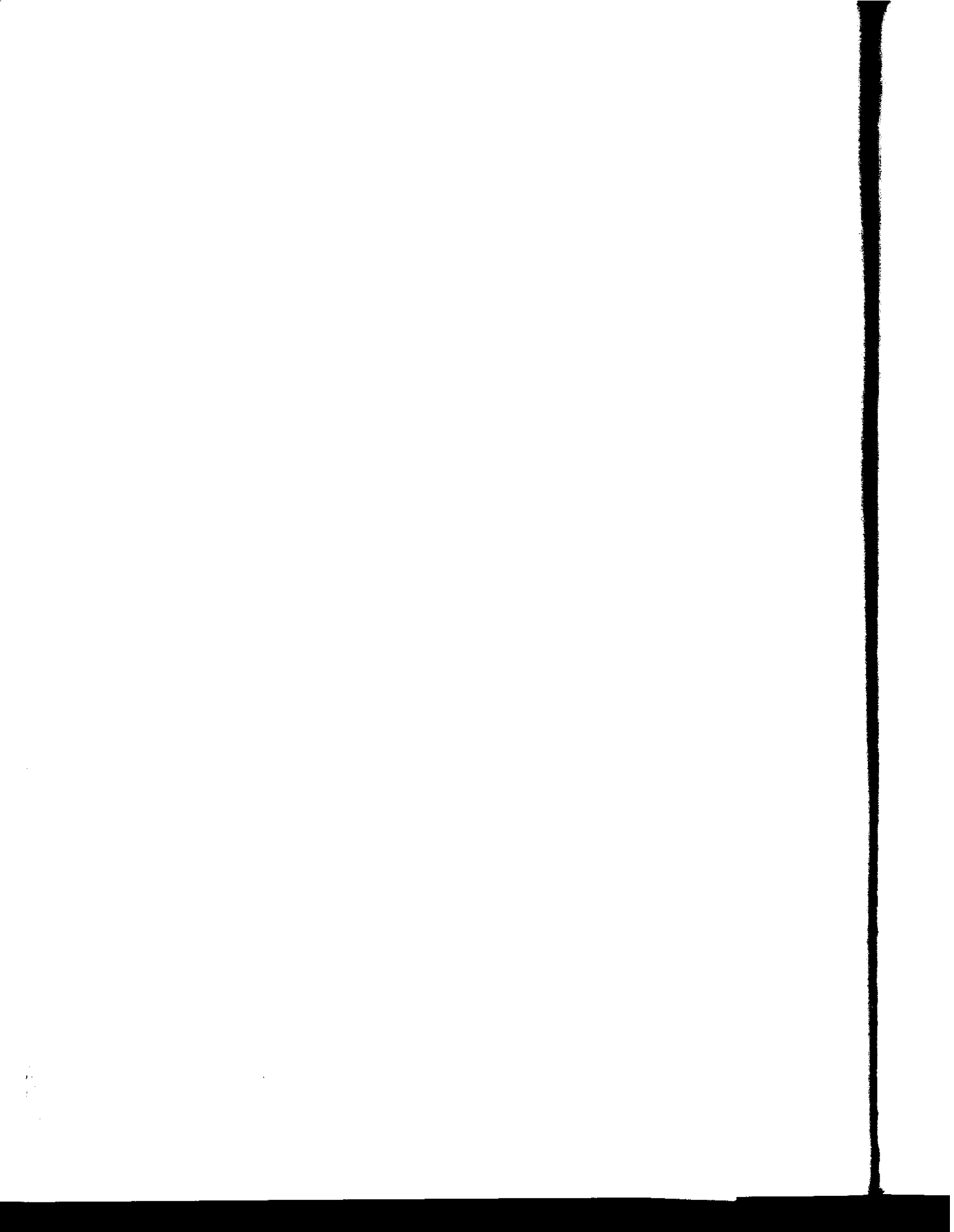



DEPARTMENT OF THE AIR FORCE  
AIR FORCE HISTORICAL RESEARCH AGENCY  
MAXWELL AIR FORCE BASE, ALABAMA



8 Mar 94

MEMORANDUM FOR AF/HO <sup>PLS</sup>  
SAF/AAZ <sup>Wheeler Col</sup>  
IN TURN <sup>10 MAR 94</sup>

FROM: AFHRA/CC  
600 Chennault Circle  
Maxwell AFB AL 36112-6424

SUBJECT: GAO Review on Records Management Procedures Dealing with  
Weather Balloons, Unknown Aircraft, and Similar Crash Incidents

Reference: SAF/AAZ Ltr, 1 Mar 94

Attached are the results of the records search conducted at the Agency pursuant to the instructions of referenced letter. Point of contact at this Agency is Dr James Kitchens, DSN 493-5068 or commercial (205) 953-5068.

*Richard S. Rauschkolb*  
RICHARD S. RAUSCHKOLB  
Colonel, USAF  
Commander

Attachment:  
AFHRA's Report

## REPORT

### GAO INVESTIGATION OF "THE ROSWELL INCIDENT": RELEVANT HOLDINGS AT THE AFHRA

8 March 1994

#### Preface

On 1 March 1994 a facsimile transmission from the Secretary of the Air Force, Office of Administrative Assistant (SAF/AA) directed the Historical Research Agency to support the General Accounting Office's investigation of "the Roswell incident." Specifically, the Agency was directed to identify any records in its possession concerning the investigation and reporting of air vehicle and other crash incidents similar to the reported crash of a weather balloon near Roswell, New Mexico, in July 1947 ("the Roswell incident"). This report presents the search procedure and results and indicates some possible additional locations for Air Force files on the Roswell incident.

#### Definition of a Search Strategy

The AFHRA/RSQ (Inquiries Branch) was assigned the task of responding to the SAF/AAZ directive. On 2 March 1994, Inquiries Branch staff developed a list of possible file locations which might contain relevant documents. Primary items on this list were Roswell AAFld installation histories, together with unit histories of the Air Force organizations stationed at Roswell in June-July 1947. In addition, the following rubrics were identified for insertion into the Agency's finding aids:

- Roswell
- Roswell Army Air Field
- Unidentified Flying Objects
- UFO(s)
- Weather Balloon(s)

#### Results of the Search - Unit Histories

In June/July 1947, the principal Air Force unit stationed at Roswell was the 509th Bomb Group (H). This group, its constituent squadrons, and support organizations were therefore indicated as the most likely locations for any reporting about the Roswell incident in Agency files. On 3 March 1994, the unit histories of Air Force organizations stationed at Roswell AAFld were retrieved and examined page-by-page for any entries

related to unidentified flying objects and/or the crash of a weather balloon near the base in the June/July 1947 time frame. The results of this search were as follows:

- 509th Bomb Group (H) - June/July 1947 - One brief passage mentioning the Office of Public Affairs and "flying disc" activities in GP-509-HI, July 1947, p. 39 (see Appendix I).
- 393rd Bomb Sqdn - No AFHRA files for June/July 1947.
- 715th Bomb Sqdn - No AFHRA files for June/July 1947.
- 830th Bomb Sqdn - Nothing in unit history for 24 May 1946-23 June 1947 (SQ-BOMB-830-HI, 24 May 1946-23 June 1947).
- 1027th Air Materiel Sqdn - Nothing in unit history for 17 Dec 1944-Nov 1947 (SQ-SV-1027-HI, 17 Dec 1944-Nov 1947).
- 427th AAF Base Unit - This unit's historical reports are included in Roswell AAFld installation histories (AFHRA series 288.17-28, 1947). No mention of Roswell incident found.
- 390th Air Service Sqdn - No AFHRA files for June/July 1947.
- 1395th Military Police Company (Aviation) - No AFHRA files for June/July 1947.
- 603rd Air Engineering Sqdn - Nothing in unit history for Feb-Nov 1947 (SQ-ENGR-603-HI, Feb-Nov 1947).

It should be noted that the period from approximately 1946 to 1950 is the least well documented era in the Air Force's unit history program. During this time of drastically reduced forces and peacetime concerns, major unit histories were frequently thin and their content sketchy at best. Small units, especially support units, frequently did not submit histories at all during the 1946-1947 period. Although we cannot be absolutely sure that the histories marked "no holding" in the above list were never written, it appears virtually certain that they were not, in fact, ever created. If written, there is good evidence through accessioning and microfilming records that the Agency never received those indicated as absent from the AFHRA collection.

#### **Result of the Search - Base Histories**

On 3 March 1994 the Agency's files of Roswell AAFld histories for June/July 1947 were examined. These base or installation histories are designated AFHRA 288.17-28, Roswell AAFld Histories, Jan 1946-Dec 1947 (3 vols). These histories amount to approximately two linear inches and are largely concerned with administrative matters (number of

personnel, transfers, routine administrative actions, etc.). No mention of the Roswell incident was found in them.

### Result of the Search - Card Catalog and IRIS

On 3 March 1994 appropriate rubrics in the Agency's card catalog such as "Roswell," "Roswell AAFld," "UFO(s)," "Unidentified Flying Objects," "Weather Balloon(s)," were examined. No entries were found which identified information remotely related to the Roswell incident.

The Agency's IRIS electronic data base was also queried for potential entries. The following key words or phrases were entered:

ROSWELL  
UFO  
UFOS  
UNIDENTIFIED FLYING OBJECT  
UNIDENTIFIED FLYING OBJECTS  
WEATHER BALLOON  
WEATHER BALLOONS

The IRIS search produced no documents concerned with a flying disc and/or weather balloon crash at Roswell AAFld. The IRIS search, however, did reveal a substantial file in AFHRA microfilm roll 33,764, beginning frame 562, which is concerned with flying disk reports in the western United States during the summer and fall of 1947. This file was apparently maintained by the Air Force Missile Development Command. It reveals contemporary investigative agencies, methods, and personalities both Air Force and civilian, thus it provides archival clues for further investigation of the Roswell incident. Extracts from microfilm roll 33,764 are attached as Appendix II.

Finally, a passage mentioning balloon operations from Holloman AFB during June-July 1947 was located in AFHRA K280.10-54G, 1947-1958, *Contributions of Balloon Operations to Research and Development at the Air Force Missile Development Center, Holloman Air Force Base, N. Mex., 1947-1950* (Holloman AFB, NM: AFMDC, n.d.), pp. 1-2 (Appendix III). This passage indicates that a cluster of "rubber-type weather balloons" was launched at Holloman AFB on 5 June 1947, the equipment from which was recovered. A second launch of polyethylene balloons was made on 3 July, the equipment for which was not recovered.

### Aircraft or "Vehicle" Crash Reports

The AFHRA does not hold aircraft accident reports. The office of record for such reports is the Air Force Safety Agency/SERR, Kirtland AFB, NM.

## Summary and Conclusions

The Historical Research Agency is primarily a repository for unit histories and supporting documents, and it has never routinely received the kind of records which might provide details of the Roswell incident. If such records survive today, they will undoubtedly be held by the National Archives and Records Administration (NARA), either at the Washington National Records Center (WNRC) or the Southwest Regional Depository (Fort Worth, Texas).

## Recommendations

Because the records management policy of the federal government requires that obsolete office files be retired to the NARA, the WNRC and the NARA Southwest Regional Depository might be searched for files related to the Roswell incident.

AFHRA microfilm roll 33,764 indicates that the Fourth Air Force and its A-2 intelligence section apparently carried out investigations of flying disks in the western US in 1947. Research in the NARA, therefore, might reasonably include a search for surviving HQ Fourth AF and Fourth AF A-2 Section files in the NARA.

*James H. Kitchens, III*  
JAMES H. KITCHENS, III, PhD  
Archivist  
Inquiries Branch

*Richard S. Rauschkolb*  
RICHARD S. RAUSCHKOLB  
Colonel, USAF  
Commander

## Appendix

1. 509 BG History, Jun/Jul 47
2. Extract from "Flying Disks 1947" w/o
3. Ballon Operations at AFMDC, 1947-1950, pp 1-2 w/o

COMBINED HISTORY  
509<sup>TH</sup> BOMB GROUP  
AND  
ROSWELL ARMY AIRFIELD  
1 JULY 1947 THROUGH 31 JULY 1947



00095394

U.S. AIR FORCE  
HISTORICAL RECORDS  
APR 29 1953

See Chap. #3 (Organization)

HEADQUARTERS  
509TH BOMB GP (WH)  
ROSWELL ARMY AIR FIELD  
ROSWELL, NEW MEXICO

GENERAL ORDERS)  
NUMBER 9)

8 July 1947

1. Pursuant to authority contained in Hqs. 8th Air Force TEX number 41 1593 dated 6 July 1947, the undersigned hereby assumes command of the Roswell Army Air Field, Roswell, New Mexico. Effective this date.

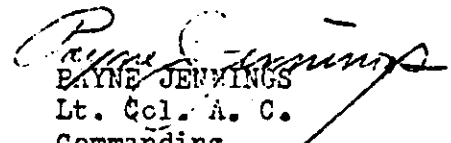
  
PAYNE JENNINGS  
Lt. Col. A. C.  
Commanding

DISTRIBUTION:

"A" & Post	(325)
Personnel	(6)
Classification	(5)
Hqs. 8th AF	(5)
Hqs. SAC	(2)
Col. Jennings	(1)



[REDACTED]

CHAPTER III

ORGANIZATION

Any significant changes in organization as activation or de-activation of units, or change of command, will be dealt with in this chapter.

Lt Colonel Payne Jennings, Deputy Commander, assumed command of Roswell Army Air Field on 8 July 1947. Colonel W. H. Blanchard, Commanding Officer went on leave. <sup>1/</sup>

Lt Colonel Charles W. Horton, Jr., was assigned as Commanding Officer of Squadron "A", vice Lt Colonel Richard F. Schumacher on 14 July 1947. The Squadron Adjutant, Captain Bowman, was transferred overseas and was replaced by Captain Joseph A. Jones.

Command of the 3rd Photo Laboratory Unit (VH), was assumed by 1st Lt Harold W. Arner per Paragraph 3, Special Order, #139, Headquarters, Roswell Army Air Field, dated 18 July 1947. He relieved 1st Lt Lewis C. Bohanan who was transferred to the 701st AAF BU, Hamilton Field, California.

The 390th Air Service Squadron received a new commanding officer in the person of Lt Colonel Walter Y. Lucas, who assumed command on 1 July 1947. Colonel Lucas relieved Lt Colonel William C. Kingsbury who then assumed command of the 715th Bomb Squadron (VH), formerly commanded by Colonel Lucas.

1st Lt W. G. Hilburn, former Assistant Base Adjutant, transferred from Squadron "A", 427th AAF BU to 603rd Air Engineering Squadron as Squadron Adjutant. He replaces Captain Earl O. Casey, who is on orders for an overseas assignment to Project PAC

<sup>1/</sup> G.O. #9, paragraph 1 - RAAF, Roswell, New Mexico

[REDACTED]

The other three briefings were those which were given to the VIP and a simulated briefing to a large group of Air Scouts representing all of the troops in New Mexico which was given on 15 July 1947.

Several small projects were completed during the month including signs on all the office doors, a building directory, and a world situation map which is maintained on a day-to-day basis.

The Historical Section of S-2 has been seriously handicapped by the removal of the regular stenographer with the reduction in force.

Due to the fact that the quality of the department reports has in general been so inadequate, lectures are being prepared to be given early in August to properly train the liaison representatives of each department.

The Office of Public Information was kept quite busy during the month answering inquiries on the "flying disc", which was reported to be in possession of the 509th Bomb Group. The object turned out to be a radar tracking balloon.

The main project of the month was making all arrangements for a successful Air Force Day. Lt. Colonel Oliver LaFarge, Air Reserve Corps, at Santa Fe, made arrangements for Colonel Blanchard to visit the Governor of New Mexico and ask him to declare Air Force Day in New Mexico on 1 August.

[REDACTED]

The Public Information Office was host during the month to the Senior Air Scouts of New Mexico, and to the several groups of visiting VIP's. Several easy chairs and couches have been procured to make the Public Information Office a more comfortable place in which to entertain.

The Public Information Officer and the Commanding Officer were guests of the Kiwanis Club of Roswell at a luncheon, for which Colonel W. H. Blanchard was the guest speaker. Colonel Blanchard spoke on the future of the Air Force, and the talk was very well received.

Arrangements have now been made to have the P.I.O. called on all crash calls in accordance with AAF Regulation. In the past, the P.I.O. has been called too late to get to the scene in time to do any good.

The 3rd Photo Laboratory Unit (VII) is now commanded by 1st Lt Harold W. Arner per paragraph 3, SO #139, Headquarters, this station, dated 18 July 1947. 1st Lt. Lewis C. Bohanan, former commanding officer of the 3rd Photo Lab Unit, was transferred to the 701st AAF BU, Hamilton Field, California.

The principal difficulty reported is a critical lack of photostat paper. This has caused a large back log of important work to pile up.

The following is a breakdown of work performed during the month ending 31 July 1947;

Contact Prints.....	3058	Projection Prints.....	403
Photostats.....	0	Ground Negatives.....	285
Copy Negatives.....	158	Aerial Roll Film.....	741 feet
		35 mm Film.....	454 feet

[REDACTED]

CHAPTER XIII

VISITORS

- 1 July 1947 - Lt Colonel R. Hamilton Martin and Lt. Colonel Loberg, Headquarters, Eighth Air Force, arrived this date to coordinate with S-3 and check inventory of printing and reproduction equipment.
- 2 July 1947 - Colonel Brown, Colonel Dubose, and others from Headquarters, Eighth Air Force, arrived on official visit and inspection. Others included Lt Colonel Raymond R. Spurgeon, to coordinate with Adjutant's Section; Lt Colonel Ray C. Milton, to coordinate with Engineering; and Lt Colonel Donald S. Dundas, to coordinate with the Legal Section (Judge Advocate).
- 2 July 1947 - Major O'Neal J. T. Archer, Headquarters, Eighth Air Force, arrived to coordinate with S-3 on flying safety.
- 2 July 1947 - Mr. M. E. Sudt, Engineering Depot, St. Louis, Missouri, visited to coordinate with Theater Officer.
- 3 July 1947 - Mr. Giles, Fire Prevention Inspector from Strategic Air Command, departed this station after completing his inspection of the Fire Departments.
- 3 July 1947 - Eighth Air Force Group Competition Inspection Team, under the supervision of Lt Colonel Burns, arrived to make the competition inspection. Major L. J. Seibert and Major Rogers L. Pearson were among those present.
- 8 July 1947 - Mr. John H. Kawka, Eighth Air Force, arrived on an ammunition inspection.
- 9 July 1947 - S-4 was inspected by Major K. D. Thompson and Captain J. W. Brady.
- 10 July 1947 - Mr. E. S. Rupp and Mr. C. D. Hall, SAGD, visited Base Supply regarding Quartermaster Stock Control.
- 11 July 1947 - Captain Billy M. Seargeant, 70th AAF BU, 103rd Weather Group, arrived on Weather Station Inspection.
- 11 July 1947 - Captain Edward G. Retartyk, Eighth Air Force, arrived to coordinate with Budget and Fiscal Officer.

- [REDACTED]
- 11 July 1947 - Mr. R. W. Truitt, Cost Analyst, Eighth Air Force, coordinated with Budget and Fiscal Officer on cost analysis.
  - 11 July 1947 - Colonel Sager, Surgeon, Eighth Air Force, arrived to coordinate with Station Hospital and Base Commanding Officer.
  - 14 July 1947 - Captain R. R. Showalter, Jr., and Major L. A. Boatright, Headquarters, Eighth Air Force, arrived to coordinate with Statistical Control on cost analysis.
  - 16 July 1947 - Brigadier General Roger M. Ramey arrived from Ft Worth on an official visit.
  - 16 July 1947 - Lt Colonel J. P. Hines, Major Louis R. Fimian, Major Howard A. Beck, and Lt Colonel John H. Bell arrived from Headquarters, Strategic Air Command, for inspection and coordination of S-4 Section.
  - 17 July 1947 - Brigadier General Roger M. Ramey departed this station enroute to Tucson, Arizona.
  - 21 July 1947 - Mr. W. L. Wilson, SAAMA, arrived to coordinate with the Air Installation Officer and AACS, regarding Headquarters AMC projects.
  - 22 July 1947 - Dr. E. M. Townsend, PHS, Ft Stanton, New Mexico, arrived for a visit with the Commanding Officer or Executive Officer. He is Chief Surgeon, Public Health Service, Ft Stanton.
  - 23 July 1947 - 19 VIP consisting of several college presidents and deans, also CAP and National Guard notables from the western states arrived from Hamilton Field to spend the night. They were enroute to Eglin Field, Florida, to witness demonstration of latest army air force equipment.
  - 24 July 1947 - The above mentioned VIP departed this base after a short courtesy tour, including a sample briefing.
  - 24 July 1947 - Major R. J. D. Johnson and Captain W. A. Hartzop, Jr., Army Air Forces, Washington, D. C., arrived for investigation of the B-29 crash which occurred 20 May 1947.
  - 25 July 1947 - Governor Thomas J. Mabry of New Mexico, and party, were the guests of honor of Roswell Army Air Field. Brigadier General Roger M. Ramey, Commanding General, Eighth Air Force, was one of the visiting dignitaries to welcome the Governor.

[REDACTED]

BIBLIOGRAPHY

1. Historical Liaison Officer's Reports
2. Mission Reports, filed in Intelligence Office
3. Operations Reports, filed in 3-3 Office
4. Commanding Officers Daily Diary, filed in Base Adjutants Office
5. Transcript of Staff Meetings



12

Memo, with Attachments  
Edward C. Mishler, HQ AFOSI/HO,  
for SAF/AAZ  
Subj: GAO Review on Records  
Management Procedures . . .  
May 11, 1994







DEPARTMENT OF THE AIR FORCE  
AIR FORCE OFFICE OF SPECIAL INVESTIGATIONS

11 May 1994

MEMORANDUM FOR SAF/AAZ

FROM: HQ AFOSI/HO  
226 Duncan Ave Suite 2100  
Bolling AFB, DC 20332-0001

SUBJECT: GAO Review on Records Management Procedures (Your memo 16 Mar 94)

1. This is to inform you that on 19 December 1975, the HQ AFOSI History office transferred two cubic feet of documents consisting of directives and policy guidance relating to the conduct of investigations of the type GAO is reviewing and all investigative files covering the period of 1948 to 1968 to the National Archives. You will find attached a copy of the Standard Form 135, Record Transmittal and Receipt, signed by the Assistant Chief, Military Projects Branch, National Archives, on that date (atch 1). My predecessor, who was instrumental in transferring these records informed me that these were the only records that AFOSI held. Currently, anyone who requests information on the subject from HQ AFOSI/Information Release is directed to the National Archives. Further, you will find attached a copy of my input to a staff meeting of 8 February 1989 in which I noted that 40 years earlier a meeting was held in the Southwest U.S. concerning subject (atch 2). At that time, District 17, Kirtland AFB, NM, was designated to be responsible for collection and reporting on aerial phenomena. That is about the only reference I've found in AFOSI historical files relating to the subject for the period of 1948 to 1953. AFOSI did not become operational until 1 August 1948, so we have no histories dealing with events before that time.

2. If you have any further questions, please contact me at DSN 297-5725 or Commercial (202)767-5725.

Handwritten signature of Edward C. Mishler in cursive.

EDWARD C. MISHLER  
Historian

Attachments:

1. Copy of SF 135, 19 Dec 75
2. Copy of HO Input, 8 Feb 89 Staff Meeting

STANDARD FORM 135 JULY 1961 EDITION GENERAL SERVICES ADMIN. FPMR '41 CFR, 101-11.4		RECORDS TRANSMITTAL AND RECEIPT		TO BE COMPLETED AT FEDERAL RECORDS CENTER			
		ACCESSION NO NN-375-209		RECORD GROUP NO			
INSTRUCTIONS Send original and two copies to appropriate Federal Records Center. EXCEPTION—Send original and three copies to the Alexandria, Virginia, Center		SIGNATURE <i>Francis J. Heppner</i>		DATE RECORDS RECEIVED 12-19-75			
FROM: (Name and address of Agency transferring records) HQ AFOSI/HO Rm 1-H-053, Forrestal Bldg 1000 Independence Ave., SW Wash, DC 20314		TITLE Assistant Chief Military Projects Branch, National Arch		TO: Federal Records Center, GSA The Archivist of the United States National Archives & Records Service General Services Administration Wash, DC 20408			
1 CITE SECURITY CLASSIFICATION AND/OR RESTRICTION ON USE OF RECORDS, IF ANY UNCLASSIFIED							
2 SQUARE FEET OF SPACE CLEARED		3. FILING EQUIPMENT EMPTIED			4. CUBIC FEET OF RECORDS TRANSFERRED		
A. OFFICE	B. STORAGE	A. FILE CABINETS (No.)	B. TRANS. FILES (No.)	C. SHELVING (Lin. Ft.)		2	
5 NAME OF AGENCY CUSTODIAN OF RECORDS Kurt K. Kunze, Capt, USAF, Historian				6 BUILDING AND ROOM NO. Forrestal Bldg, Rm 1H-053		7. TELEPHONE NO. 695-5997	
8 MAY THE RECORDS BE DESTROYED AS SCHEDULED WITHOUT FURTHER AGENCY CONCURRENCE? <input type="checkbox"/> YES <input type="checkbox"/> NO							
9 AGENCY OFFICIAL SIGNATURE <i>David H. Ferguson, Maj, USAF</i>				10 TITLE Chief, Documenta- tion Div, Directorate of Administration, HQ AFOSI		11. DATE 19 Dec 75	
12 BOX NUMBERS FRC ONLY		13 DESCRIPTION OF RECORDS WITH INCLUSIVE DATES (Show organizational component creating records)				14 DISPOSAL AUTHORITY (Schedule and Item No.)	
		Source documents dating from 1948 to 1968 concerning the USAF investigation of Un-identified Flying Objects (UFOs). These records contain documents on investigative policy and Air Force Office of Special Investigation reports of investigations on UFO sightings.					
		SOURCE DOCUMENTS					
		1 File folders 24-185-1 through 24-185-27 (Note: There is no file for 24-185-3; there are two files under the number 24-185-17; and there is no file for 24-185-26) These files contain policy guidance and AFOSI District reports of investigation concerning UFOs (filed primarily by district).					
		2 File folders 24-185-001 through 24-185-008 containing policy guidance and AFOSI District reports of investigation concerning UFOs (filed primarily in chronological order.).					

HO Input for 8 Feb 89 Staff Meeting

The following are two old items from the APOSI archives. Forty years ago, representatives of US investigative and intelligence agencies met in the southwestern United States. They decided District 17, Kirtland AFB, NM, would be responsible for the overall collection and reporting on aerial phenomena. These phenomena, later termed unidentified flying objects or UFOs, had been sighted with some frequency in the New Mexico area. This program was initially called Project Sign, then Project Grudge, and was renamed Project Blue Book in 1951. NOTE: APOSI turned over all its investigative files pertaining to this project to the National Archives in 1976. Twenty years ago, in response to the increasing drug problem in the Air Force, OSI took steps to provide additional training. District 17 sponsored a narcotics seminar at Kirtland AFB, NM, which 225 people from state and local law enforcement agencies as well as OSI agents attended. OSI also developed an advanced Narcotics Investigations Course designed to teach the latest technics in combatting drug abuse.

\* Actually, on 19 Dec 1975.



Records Searched

13

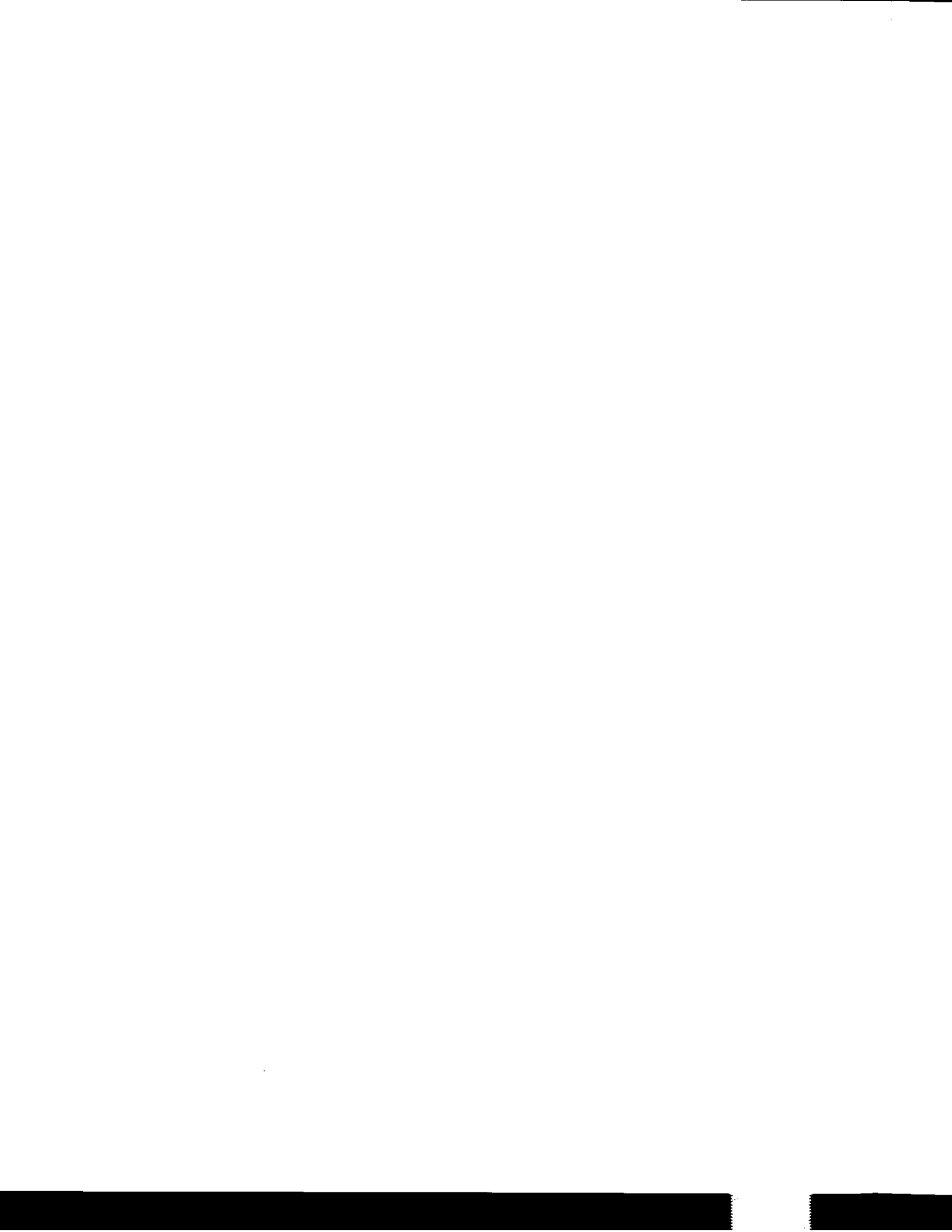

# ARCHIVES/ LIBRARY OF CONGRESS

NOTE: RECORD GROUP 319, RECORDS OF THE ARMY STAFF MESSAGE CENTER, WERE SEARCHED FOR 1947.

RECORD GROUP	ENTRY	BOX	REEL #	TITLE	LOCATION
N/A	N/A	N/A		LeMay Papers	LIB OF CONGRESS
N/A	N/A	N/A		SPAATZ PAPERS	LIB OF CONGRESS
N/A	N/A	N/A		TWINING PAPERS	LIB OF CONGRESS
N/A	N/A	N/A		VANDENBERG PAPERS	LIB OF CONGRESS
18	1	556		AIR ADJUTANT GENERAL	NARA DC
18	1	557		AIR ADJUTANT GENERAL	NARA DC
18	1	558		AIR ADJUTANT GENERAL	NARA DC
18	1	559		AIR ADJUTANT GENERAL	NARA DC
18	1	560		AIR ADJUTANT GENERAL	NARA DC
18	1	561		AIR ADJUTANT GENERAL	NARA DC
18	1	562		AIR ADJUTANT GENERAL	NARA DC
18	1	563		AIR ADJUTANT GENERAL	NARA DC
18	1	564		AIR ADJUTANT GENERAL	NARA DC
18	1	565		AIR ADJUTANT GENERAL	NARA DC
18	1	566		AIR ADJUTANT GENERAL	NARA DC
18	1	567		AIR ADJUTANT GENERAL	NARA DC
18	1	568		AIR ADJUTANT GENERAL	NARA DC
18	1	569		AIR ADJUTANT GENERAL	NARA DC
18	1	570		AIR ADJUTANT GENERAL	NARA DC
18	1	571		AIR ADJUTANT GENERAL	NARA DC
18	1	572		AIR ADJUTANT GENERAL	NARA DC
18	1	573		AIR ADJUTANT GENERAL	NARA DC
18	1	574		AIR ADJUTANT GENERAL	NARA DC
18	1	575		AIR ADJUTANT GENERAL	NARA DC
18	1	576		AIR ADJUTANT GENERAL	NARA DC
18	1	576		AIR ADJUTANT GENERAL	NARA DC
18	1	577		AIR ADJUTANT GENERAL	NARA DC
18	1	578		AIR ADJUTANT GENERAL	NARA DC
18	1	580		AIR ADJUTANT GENERAL	NARA DC



18	1	581	AIR ADJUTANT GENERAL NARA DC
18	1	582	AIR ADJUTANT GENERAL NARA DC
18	1	583	AIR ADJUTANT GENERAL NARA DC
18	1	584	AIR ADJUTANT GENERAL NARA DC
18	1	585	AIR ADJUTANT GENERAL NARA DC
18	1	586	AIR ADJUTANT GENERAL NARA DC
18	1	587	AIR ADJUTANT GENERAL NARA DC
18	1	588	AIR ADJUTANT GENERAL NARA DC
18	1	589	AIR ADJUTANT GENERAL NARA DC
18	1	590	AIR ADJUTANT GENERAL NARA DC
18	1	591	AIR ADJUTANT GENERAL NARA DC
18	1	592	AIR ADJUTANT GENERAL NARA DC
18	1	593	AIR ADJUTANT GENERAL NARA DC
18	1	594	AIR ADJUTANT GENERAL NARA DC
18	1	595	AIR ADJUTANT GENERAL NARA DC
18	1	596	AIR ADJUTANT GENERAL NARA DC
18	1	597	AIR ADJUTANT GENERAL NARA DC
18	1	598	AIR ADJUTANT GENERAL NARA DC
18	1	599	AIR ADJUTANT GENERAL NARA DC
18	1	600	AIR ADJUTANT GENERAL NARA DC
18	1	602	AIR ADJUTANT GENERAL NARA DC
18	1	601	AIR ADJUTANT NARA DC
18	1	603	AIR ADJUTANT GENERAL NARA DC
18	1	604	AIR ADJUTANT GENERAL NARA DC
18	1	605	AIR ADJUTANT GENERAL NARA DC
18	1	606	AIR ADJUTANT GENERAL NARA DC
18	1	607	AIR ADJUTANT GENERAL NARA DC
18	1	608	AIR ADJUTANT GENERAL NARA DC
18	1	609	AIR ADJUTANT GENERAL NARA DC
18	1	610	AIR ADJUTANT GENERAL NARA DC
18	1	611	AIR ADJUTANT GENERAL NARA DC
18	1	612	AIR ADJUTANT GENERAL NARA DC

18	1	613	AIR ADJUTANT GENERAL NARA DC
18	1	614	AIR ADJUTANT GENERAL NARA DC
18	1	615	AIR ADJUTANT GENERAL NARA DC
18	1	616	AIR ADJUTANT GENERAL NARA DC
18	1	617	AIR ADJUTANT GENERAL NARA DC
18	1	619	AIR ADJUTANT GENERAL NARA DC
18	1	620	AIR ADJUTANT GENERAL NARA DC
18	1	620	AIR ADJUTANT GENERAL NARA DC
18	1	621	AIR ADJUTANT GENERAL NARA DC
18	1	622	AIR ADJUTANT GENERAL NARA DC
18	1	623	AIR ADJUTANT GENERAL NARA DC
18	1	624	AIR ADJUTANT GENERAL NARA DC
18	1	625	AIR ADJUTANT GENERAL NARA DC
18	1	626	AIR ADJUTANT GENERAL NARA DC
18	1	627	AIR ADJUTANT GENERAL NARA DC
18	4	178	RECORDS OF ARMY AIR SUITLAND
18	4	179	RECORDS OF ARMY AIR SUITLAND
18	4	392	RECORDS OF ARMY AIR SUITLAND
18	4	393	RECORDS OF ARMY AIR SUITLAND
18	4	394	RECORDS OF ARMY AIR SUITLAND
18	4	395	RECORDS OF ARMY AIR SUITLAND
18	4	396	RECORDS OF ARMY AIR SUITLAND
18	4	397	RECORDS OF ARMY AIR SUITLAND
159			IG REPORT- INDIVIDUALS NARA SUITLAND
159			IG CORRESPONDENCE NARA SUITLAND
319			G2 INTEL RECORDS OF NARA SUITLAND
319		2889	RECORDS OF THE ARMY ARCHIVES-SUITLAND
319		2930	RECORDS OF THE ARMY ARCHIVES-SUITLAND
319		2933	RECORDS OF THE ARMY ARCHIVES-SUITLAND
319		2934	RECORDS OF THE ARMY ARCHIVES-SUITLAND
319		2941	RECORDS OF THE ARMY ARCHIVES-SUITLAND
319		2947	RECORDS OF THE ARMY ARCHIVES-SUITLAND

319	2950	RECORDS OF THE ARMY ARCHIVES-SUITLAND
319	3053	RECORDS OF THE ARMY ARCHIVES-SUITLAND
319	3054	RECORDS OF THE ARMY ARCHIVES-SUITLAND
319	3056	RECORDS OF THE ARMY ARCHIVES-SUITLAND
319	3058	RECORDS OF THE ARMY ARCHIVES-SUITLAND
319	3057	RECORDS OF THE ARMY ARCHIVES-SUITLAND
319	3102	RECORDS OF THE ARMY ARCHIVES-SUITLAND
319	3102	RECORDS OF THE ARMY ARCHIVES-SUITLAND
319	3103	RECORDS OF THE ARMY ARCHIVES-SUITLAND
319	3114	RECORDS OF THE ARMY ARCHIVES-SUITLAND
319	3115	RECORDS OF THE ARMY ARCHIVES-SUITLAND
319	3116	RECORDS OF THE ARMY ARCHIVES-SUITLAND
319	3117	RECORDS OF THE ARMY ARCHIVES-SUITLAND
319	3118	RECORDS OF THE ARMY ARCHIVES-SUITLAND
319	3119	RECORDS OF THE ARMY ARCHIVES-SUITLAND
319	3120	RECORDS OF THE ARMY ARCHIVES-SUITLAND
319	3121	RECORDS OF THE ARMY ARCHIVES-SUITLAND
319	3122	RECORDS OF THE ARMY ARCHIVES-SUITLAND
319	3123	RECORDS OF THE ARMY ARCHIVES-SUITLAND
319	3124	RECORDS OF THE ARMY ARCHIVES-SUITLAND
319	3125	RECORDS OF THE ARMY ARCHIVES-SUITLAND
319	3126	RECORDS OF THE ARMY ARCHIVES-SUITLAND
319	3127	RECORDS OF THE ARMY ARCHIVES-SUITLAND
319	3128	RECORDS OF THE ARMY ARCHIVES-SUITLAND
319	3129	RECORDS OF THE ARMY ARCHIVES-SUITLAND
319	3130	RECORDS OF THE ARMY ARCHIVES-SUITLAND
319	3131	RECORDS OF THE ARMY ARCHIVES-SUITLAND
319	3132	RECORDS OF THE ARMY ARCHIVES-SUITLAND
319	3133	RECORDS OF THE ARMY ARCHIVES-SUITLAND
319	3134	RECORDS OF THE ARMY ARCHIVES-SUITLAND
319	3136	RECORDS OF THE ARMY ARCHIVES-SUITLAND
319	3143	RECORDS OF THE ARMY ARCHIVES-SUITLAND

319			3145	RECORDS OF THE ARMY	ARCHIVES-SUITLAND
319			3146	RECORDS OF THE ARMY	ARCHIVES-SUITLAND
319			3957	RECORDS OF THE ARMY	ARCHIVES-SUITLAND
341				CORRESPONDENCE	NARA SUITLAND
341				HQ USAF MESSAGES	NARA SUITLAND
341	23	1		TOP SECRET MSGS	NARA SUITLAND
341	213	1		OFFICE OF DIRECTOR	NARA SUITLAND
341	213	2		OFFICE OF DIRECTOR	NARA SUITLAND
341	213	3		OFFICE OF DIRECTOR	NARA SUITLAND
341	213	5		OFFICE OF DIRECTOR	NARA SUITLAND
341	213	6		OFFICE OF DIRECTOR	NARA SUITLAND
341	213	7		OFFICE OF DIRECTOR	NARA SUITLAND
341	213	8		OFFICE OF DIRECTOR	NARA SUITLAND
341	213	9		OFFICE OF DIRECTOR	NARA SUITLAND
341	213	10		OFFICE OF DIRECTOR	NARA SUITLAND
341	213	11		OFFICE OF DIRECTOR	NARA SUITLAND
341	213	12		OFFICE OF DIRECTOR	NARA SUITLAND
341	213	13		OFFICE OF DIRECTOR	NARA SUITLAND
341	213	14		OFFICE OF DIRECTOR	NARA SUITLAND
341	213	16		OFFICE OF DIRECTOR	NARA SUITLAND
341	213	17		OFFICE OF DIRECTOR	NARA SUITLAND
341	213	18		OFFICE OF DIRECTOR	NARA SUITLAND
341	213	19		OFFICE OF DIRECTOR	NARA SUITLAND
341	213	20		OFFICE OF DIRECTOR	NARA SUITLAND
341	213	21		OFFICE OF DIRECTOR	NARA SUITLAND
341	213	22		OFFICE OF DIRECTOR	NARA SUITLAND
341	213	23		OFFICE OF DIRECTOR	NARA SUITLAND
341	213	24		OFFICE OF DIRECTOR	NARA SUITLAND
341	213	25		OFFICE OF DIRECTOR	NARA SUITLAND
341	213	26		OFFICE OF DIRECTOR	NARA SUITLAND
341	213	27		OFFICE OF DIRECTOR	NARA SUITLAND
341	213	28		OFFICE OF DIRECTOR	NARA SUITLAND

341	213	29	OFFICE OF DIRECTOR	NARA SUITLAND
341	213	30	OFFICE OF DIRECTOR	NARA SUITLAND
341	213	31	OFFICE OF DIRECTOR	NARA SUITLAND
341	213	32	OFFICE OF DIRECTOR	NARA SUITLAND
341	213	33	OFFICE OF DIRECTOR	NARS SUITLAND
341	213	33	OFFICE OF DIRECTOR	NARA SUITLAND
341	213	34	OFFICE OF DIRECTOR	NARA SUITLAND
341	213	35	OFFICE OF DIRECTOR	NARA SUITLAND
341	213	37	OFFICE OF DIRECTOR	NARA SUITLAND
341	213	38	OFFICE OF DIRECTOR	NARA SUITLAND
341	213	39	OFFICE OF DIRECTOR	NARA SUITLAND
341	213	40	OFFICE OF DIRECTOR	NARA SUITLAND
341	213	41	OFFICE OF DIRECTOR	NARA SUITLAND
341	213	42	OFFICE OF DIRECTOR	NARA SUITLAND
341	213	43	OFFICE OF DIRECTOR	NARA SUITLAND
341	213	44	OFFICE OF DIRECTOR	NARA SUITLAND
341	213	45	OFFICE OF DIRECTOR	NARA SUITLAND
341	213	46	OFFICE OF DIRECTOR	NARA SUITLAND
341	213	47	OFFICE OF DIRECTOR	NARA SUITLAND
341	213	48	OFFICE OF DIRECTOR	NARA SUITLAND
341	213	49	OFFICE OF DIRECTOR	NARA SUITLAND
341	213	50	OFFICE OF DIRECTOR	NARA SUITLAND
341	213	51	OFFICE OF DIRECTOR	NARA SUITLAND
341	213	52	OFFICE OF DIRECTOR	NARA SUITLAND
341	213	53	OFFICE OF DIRECTOR	NARA SUITLAND
341	213	54	OFFICE OF DIRECTOR	NARA SUITLAND
341	213	55	OFFICE OF DIRECTOR	NARA SUITLAND
341	213	56	OFFICE OF DIRECTOR	NARA SUITLAND
341	213	57	OFFICE OF DIRECTOR	NARA SUITLAND
341	213	58	OFFICE OF DIRECTOR	NARA SUITLAND
341	337	18	HQ USAF RECORDS	NARA DC
341	337	1 OF 18	HQ USAF RECORDS	NARA DC

341	337	2 OF 18	HQ USAF RECORDS	NARA DC
341	337	3 OF 18	HQ USAF RECORDS	NARA DC
341	337	4 OF 18	HQ USAF RECORDS	NARA DC
341	337	5 OF 18	HQ USAF RECORDS	NARA DC
341	337	6 OF 18	HQ USAF RECORDS	NARA DC
341	337	7 OF 18	HQ USAF RECORDS	NARA DC
341	337	8 OF 18	HQ USAF RECORDS	NARA DC
341	337	9 OF 18	HQ USAF RECORDS	NARA DC
341	337	10 OF 18	HQ USAF RECORDS	NARA DC
341	337	11 OF 18	HQ USAF RECORDS	NARA DC
341	337	12 OF 18	HQ USAF RECORDS	NARA DC
341	337	13 OF 18	HQ USAF RECORDS	NARA DC
341	337	14 OF 18	HQ USAF RECORDS	NARA DC
341	337	15 OF 18	HQ USAF RECORDS	NARA DC
341	337	16 OF 18	HQ USAF RECORDS	NARA DC
341	337	17 OF 18	HQ USAF RECORDS	NARA DC
401	124	1	A.P. CRARY PAPERS	NARA DC

## RECORDS CENTERS

ACCESSION #	BOX #	UNIT BASE
338-78-0260	1	WHITE SANDS - ARMY
338-78-0261	14	WHITE SANDS - ARMY
338-78-0262	14	WHITE SANDS - ARMY
338-78-0262	4 OF 4	WHITE SANDS - ARMY
338-78-0643	2 OF 2	AIR DEFENSE SCHOOL FT BLISS
341-69A-1262	1	BOLLING AFB
341-69A-1262	15	BOLLING AFB
341-69A-1262	30	BOLLING AFB
341-71A-6170	27	PENTAGON
341-71A-6170	29	PENTAGON
341-71A-6170	30	PENTAGON
341-71A-6170	32	PENTAGON
341-71A-6170	36	PENTAGON
341-71A-6170	67	PENTAGON
342-48A-5049	1	WATSON LABS
342-49-A-5025	1	8TH AF
342-49A-5025	1 OF 20	8th AF
342-49A-5025	10 OF 20	8th AF
342-49A-5025	11 OF 20	8th AF
342-49A-5025	12 OF 20	8th AF
342-49A-5025	13 OF 20	8th AF
342-49A-5025	14 OF 20	8th AF
342-49A-5025	2 OF 20	8th AF
342-49A-5025	3 OF 20	8th AF
342-49A-5025	4 OF 20	8th AF
342-49A-5025	5 OF 20	8th AF
342-49A-5025	6 OF 20	8th AF
342-49A-5025	7 OF 20	8th AF
342-49A-5025	8 OF 20	8th AF
342-49A-5025	9 OF 20	8th AF
342-49B-6004	1	12th AF
342-49C-5025	1 OF 2	8th AF
342-49C-5025	2 OF 2	8th AF
342-49D-5025	1	8th AF
342-49D-6015	1 OF 3	SAC

342-49D-6015	2 OF 3	SAC
342-49D-6015	3	SAC
342-49E-5025	1	8th AF
342-49E-6015	1	SAC
342-49H-5025	1	8th AF
342-50-7029	1	10 th AF BROOKS AFB
342-51-7012	1	HQ BOLLING AFB
342-51-7110	1	428 AAFBU KIRTLAND AFB
342-51-7111	1	KIRTLAND AFB
342-51-7112	1	KIRTLAND AFB
342-51A-5071	1	BOLLING FLD COMMAND
342-51B-0614	1	BOLLING FLD
342-51C-5071	1	BOLLING FLD
342-52-7089	1 OF 8	3151 ELEC GRP WATSON LABS
342-52-7089	2 OF 8	3151 ELEC GRP WATSON LABS
342-52-7089	3 OF 8	3151 ELEC GRP WATSON LABS
342-52-7089	4 OF 8	3151 ELEC GRP WATSON LABS
342-52-7089	5 OF 8	3151 ELEC GRP WATSON LABS
342-52-7089	6 OF 8	3151 ELEC GRP WATSON LABS
342-52-7089	7 OF 8	3151 ELEC GRP WATSON LABS
342-52-7089	8	3151 ELEC GRP WATSON LABS
342-52-7091	1	WRIGHT PAT
342-52-7096	1	JOINT LONG RANGE PROV GRD
342-52-7103	1	AIR WEATHER SERV ADW
342-52-B-6067	1 OF 2	HQ AMC WRIGHT PAT
342-52A-5033	23	10TH AF
342-52A-5099	1	10th AF
342-52A-6117	1	CAMBRIDGE LABS
342-52B-4003	1 OF 7	8th AF
342-52B-4003	2 OF 7	8th AF
342-52B-4003	3 OF 7	8th AF
342-52B-4003	4 OF 7	8th AF
342-52B-4003	5 OF 7	8th AF
342-52B-4003	6 OF 7	8th AF
342-52B-4003	7	8th AF
342-52B-6067	2 OF 2	HQ AMC WRIGHT PAT
342-52G-4002	1	8th AF
342-52Q-4002	1	8th AF
342-53-7026	1 OF 25	8th AF



342-53-7026	11 OF 25	8th AF
342-53-7028	12 OF 25	8th AF
342-53-7026	13 OF 25	8th AF
342-53-7077	2 OF 6	3089 EXP TEST GP HOLLOMAN AFB
342-53-7077	3 OF 6	3089 EXP TEST GP HOLLOMAN AFB
342-53-7077	4 OF 6	3089 EXP TEST GP HOLLOMAN AFB
342-53-7077	6 OF 6	3089 EXP GP HAFB
342-53-7078	1	3089 MSC EXP GP HOLLOMAN AFB
342-53-7106	1 OF 2	CONAF MITCHEL FLD
342-53-7106	2	CONAF MITCHEL FLD
342-53A-6074	1 OF 2	WRIGHT PAT
342-53A-6074	2	WRIGHT PAT
342-53A-6078	1 OF 18	HQ AMC WRIGHT PAT
342-53A-6078	2 OF 18	HQ AMC WRIGHT PAT
342-53A-6078	3 OF 18	HQ AMC WRIGHT PAT
342-53A-6078	4 OF 18	HQ AMC WRIGHT PAT
342-53A-6079	1	HQ AMC WRIGHT PAT
342-53A-6079	1	HQ AMC WRIGHT PAT
342-53A-6079	10	HQ AMC WRIGHT PAT
342-53A-6079	11	HQ AMC WRIGHT PAT
342-53A-6079	12	HQ AMC WRIGHT PAT
342-53A-6079	3	HQ AMC WRIGHT PAT
342-53A-6079	4	HQ AMC WRIGHT PAT
342-53A-6079	5	HQ AMC WRIGHT PAT
342-53A-6079	6	HQ AMC WRIGHT PAT
342-53A-6079	7	HQ AMC WRIGHT PAT
342-53A-6079	8	HQ AMC WRIGHT PAT
342-53A-6079	9	HQ AMC WRIGHT PAT
342-53A-6081	1	HQ AMC WRIGHT PAT
342-53A-6081	2	HQ AMC WRIGHT PAT
342-53A-6081	2	HQ AMC WRIGHT PAT
342-53A-6081	3	HQ AMC WRIGHT PAT
342-53A-6081	3	HQ AMC WRIGHT PAT
342-53A-6081	4	HQ AMC WRIGHT PAT
342-53A-6087	1	AMC HQ WRIGHT PAT
342-53A-6087	2	AMC HQ WRIGHT PAT
342-53A-6087	3	AMC HQ WRIGHT PAT
342-53A-6087	4	HQ AMC WRIGHT PAT
342-53B-6079	1	HQ AMC WRIGHT PAT

342-53C-6079	1	HQ AMC WRIGHT PAT
342-54-E-6128	1	HQ AMC WRIGHT PAT
342-54-F-6128	1	HQ AM WRIGHT-PAT
342-54-F-6128	1	HQ AMC WRIGHT PAT
342-54-F-6128	2	HQ AM WRIGHT-PAT
342-54-F-6128	3	HQ AM WRIGHT-PAT
342-54-F-6128	4	HQ AM WRIGHT-PAT
342-54B-6097	1	HQ AMC WRIGHT PAT
342-54B-6097	2	HQ AMC WRIGHT PAT
342-54B-6097	2	HQ AMC WRIGHT PAT
342-54B-6097	2	HQ AMC WRIGHT PAT
342-54F-4022	1	12th AF
342-54J-4045	9 OF 48	HQ AMC WRIGHT PAT
342-55A-6099	1	HQ AMC WRIGHT PAT
342-55A-6099	2	HQ AMC WRIGHT PAT
342-55A-6099	2	HQ AMC WRIGHT PAT
342-56A-6191	1	CAMBRIDGE LABS
342-A-6067	1	AMC HQ WRIGHT PAT
342-G-4002	1 OF 3	8 th AF
342-G-4002	2 OF 3	8th AF
509th BG ORDERS		509th BOMB GROUP
MORNING REPORT	JULY 1947	509th BOMB GROUP
MORNING REPORTS	JULY 1947	427 AAFBU



14

Letter

Lt Col Thomas Badger, Jr., HQ/AAF,  
to Commanding General, AMC

Subj: Issuance of Orders

June 5, 1947



HEADQUARTERS, ARMY AIR FORCES  
WASHINGTON

TO:

JUN 5 1947

SUBJECT: Issuance of Orders

TO: Commanding General  
Air Materiel Command  
Wright Field, Ohio.

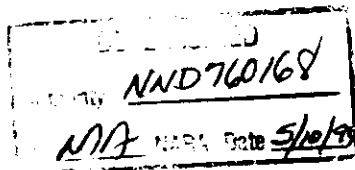

1. Request confidential orders be issued placing the following named officers on three (3) days temporary duty at Sandia Base, Albuquerque, New Mexico, for purpose of pursuing Bomb Commanders Course, reporting not later than date indicated:

8 July 1947 Class

Lt. General Nathan F. Twining, O-12366, AC  
Major General Benjamin W. Ghidlaw, O-14936, AC  
Brigadier General Arthur Thomas, O-10376, AC  
Brigadier General Samuel C. Brentnall, O-17132, AC

5 August 1947 Class

Brigadier General Donald L. Putt, O-17875, AC  
Brigadier General John C. Gordon, O-18571, AC  
Colonel Leighton I. Davis, O-19721, AC

2. Copies of orders should be forwarded to Commanding Officer, Kirtland Field. Additional copies of orders should be furnished to the Commanding Officer, The Armed Forces Special Weapons Project, Washington, 25, D. C.

BY COMMAND OF GENERAL SPAATZ:

THOMAS BADGER, JR.  
Lt. Colonel, Air Corps  
Executive, Military Personnel Division  
Office of AD, 25-A



15

Appointment Book; Diary  
Lt Gen Hoyt S. Vandenberg  
July 7-9 [1947]; July 7-9, 1947





5520

MANUSCRIPT



DIVISION

THE PAPERS OF  
HOYT S. VANDENBERG

Diaries & Appointment Books

DECLASSIFIED

Box 1

*Gen. Vandenberg*  
**APPOINTMENTS**

YEAR 19 47

*Secretary's desk calendar*



No. 845/5

**NATIONAL BLANK BOOK COMPANY**  
Holyoke, Massachusetts

MADE IN U. S. A.

A  
B  
C  
D  
E  
F  
G  
H  
I  
J  
K  
L  
M  
N  
O  
P  
Q  
R  
S  
T  
U  
V  
W  
X  
Y  
Z

THE MANUFACTURER'S DIRECTOR'S OFFICE HOLYOKE MASSACHUSETTS

*Monday*

JULY 7

8:00

2:00

8:30

2:30

9:00

3:00

9:30

3:30

10:00

4:00 *Dental Appt.*

10:30

4:30

11:00

*NOTE.*  
*Mr. Price Lathrop*  
*Co.*

5:00

11:30

5:30

12:00

*War Council*

6:00

12:30

6:30

1:00

7:00

1:30

7:30

JULY 8

*Memorandum*

8:00	2:00	
8:30	2:30	
9:00	3:00	AIR MARSH GODDARD 4 SUBJECTS
9:30	3:30	
10:00	4:00	Recruiting Pres. to S/W + C/S 3E 869... See Weston Memphis (20/47)
10:30	4:30	Cong. W. C. Coker on Lincoln (1947) (Ch. P. ...)
11:00	5:00	
11:30	5:30	
12:00	6:00	
12:30	6:30 - 8:00	Carroll Gen. ... - 2520 34th Floor
1:00	7:00	
1:30	7:30	

REPRODUCED FROM THE COLLECTIONS OF THE MANUSCRIPT DIVISION, LIBRARY OF CONGRESS

JULY 9

8:00	2:00
8:30	2:30
9:00	3:00
9:30 BEN PEARCE	3:30
10:00	4:00 St. Wendt. Rev. 1015 Gravelly 6582
10:30	4:30
11:00 O/S Meeting Cancelled	5:00/p - Mr. Petrick & Mr Lawrence - Reaction Motors
11:30	5:30
12:00 Home Kiser new Building 7th 432 W 15th	6:00 Amy Smith - ... John Hubbard
12:30	6:30
1:00 O/S ...	7:00
1:30	7:30

REPRODUCED FROM THE COLLECTIONS OF THE MANUSCRIPT DIVISION, LIBRARY OF CONGRESS

DECLASSIFIED

DOD ltr.

8 Jan. & 20 June 1989

By: *[Signature]* Date: *[Signature]*

*[Redacted]*  
OFFICE OF  
DAILY DEWY WEPY OF, DEPUTY CONSIDER  
*[Redacted]*

July 5, 1947

1:00 P.M. Returned from Wichita Falls, Texas.

July 7, 1947

9:15 A.M. Arrive Office.

9:15 A.M. Gen. Rawlings

9:40 A.M. Gen. Boatner with mail.

9:43 A.M. Colonel Garland on phone with reference to memorandum from General Kenney on how to have more groups and fewer people. Was that approved. Approved to extent instructions given that SAC units be left alone until September and at that time make a decision as to approval of Kenney's organization and how extensively it will be used in the Air Force. Find out if Kenney has been advised and let me know.

9:45 A.M. Colonel Galloway thanking General Vandenberg for what he put on for CIC

9:50 A.M. Colonel Garland advised that General Hood had handled the matter of SAC units and would be right down to brief Gen. Vandenberg.

9:55 A.M. Gen Chauncey on phone from Pocatello, Idaho to state that Gen Cannon doesn't want Moody or Turner in Georgia. Doesn't want Columbus at all - wants to substitute San Marcos. Wants to concentrate all expansion in a little bunch in Texas and take over fields that belong to <sup>8000</sup>Colombians like Brooks and Bergstrom. General Chauncey says that it is possible we will have to give up the two in Georgia. Gen Chauncey stated he advised Gen Cannon to put his wants in writing and not to telephone as Gen Chauncey feels Gen Cannon is not too sure of himself, as two months ago he wanted to get out of San Marcos and now he wants it and also Brooks & Bergstrom.

10:00 A.M. Gen Hood & Col Hobson —briefing on SAC units.

10:55A.M. Mr. Zuckert re civilian personnel and limitations and personnel at inactive installations or installations which we are not planning to retain in our permanent structure.

11:05 A.M. Mr. Robert Gross and Mr. Maher of Lockheed

11:55 A.M. Gen. Sam Anderson

12:00 To War Council in absence of Gen. Spaatz

12:20 P.M. Returned and then to lunch



July 7, 1947 (Cont'd)

- 1:10 P.M. Mr. Hicks of the Toronto Star, Toronto, Canada on phone - He spoke in regard to the "flying discs". They understand these discs are a U.S. plane that is still on the secret list. He asked Gen. Van what he thought they were and Gen. Van was quite noncommittal. Gen. Van said that some National Guard Planes were on duty on their own volition to search for the discs, but that no planes have been put on duty from Hq, AAF.
- 1:20 P.M. General Tommy Power
- 1:40 P.M. Cong. Drewry of Va. on phone requesting a B-29 be sent to Blackstone, Va. for a celebration by the CAF and volunteer fire organizations in the vicinity. Date - July 27. May be able to do some recruiting on that day. Gen. Van said he would look into the matter and advise Mr. Drewry's office.
- 1:50 P.M. Mr. Leo on phone re article on "Saucers". Said one had been found with instructions on it to get in touch with Colonel Frank Hackett in Spokane. Mr. Leo reported the matter to General Schulgen, G-2.
- 1:52 P.M. Mr. Zuckert on phone informing him with reference to National Guard that all planes where we haven't squadron or group headquarters should take their people away.
- 1:55 P.M. Mr. Leo and General LeMay with reference to discs.
- 2:00 P.M. Colonel Frank Hackett, Spokane, Washington on phone - General Van informed Colonel Hackett that we had gotten a call from the Houston Chronicle saying that a flying disc had landed there with his (Colonel Hackett's) name on it. Gen. Van asked if he knew anything about it. Colonel Hackett stated that he knew nothing at all about it. Gen. Van told Col. H. that it was reported here that Col. H. said that his people knew all about it and that a statement was coming out from Washington. Col. H. said, "I have said nothing". Col. H. had the Chronicle called and told to get in touch with the F.B.I. - get photographic proof - and then get in touch with Gen. Twining.
- 2:20 P.M. Colonel Bob Warren, Ellington Field, Tex on phone. - Gen. Van informed Col. Warren that the Houston Chronicle had found a disc about 20" in diameter and 5 or 6" thick. It is supposed to have Col. Frank Hackett's name on it. We are most anxious to explode this thing. I would appreciate it if you would get in touch with the Chronicle, ask them where it is, go out and see the thing and then call me back. The line of approach is that we have nothing like that, we don't understand what it is, but we are leaving no stone unturned to be sure. Colonel Warren said it would be a couple of hours before he could call back.

July 7, 1947 (Cont'd)

- 2:30 P.M. To airport to meet Mr. Symington and then to Mr. Symington's office.
- 4:10 P.M. Returned.
- 4:15 P.M. General O'Donnell
- 4:20 P.M. General LeMay
- 4:20 P.M. Col. Warren called back re Gen. Vandenberg's directive that he run down the story about the flying discs. Col. W. finally located the reporter who picked up the story from another man. This man lives in Goose Creek. He now says that it was entirely a figment of his imagination and that he just made it up. Col. W. talked to a Mr. Evans who is handling this thing at the Chronicle — and they took it up with somebody up at the Air Depot at Spokane. - - - He said to them that he just made the thing up. Col. Warren said that the Chronicle seemed to be satisfied that the thing was just a cock and bull story. Col. W. is going to check with the local F.B.I. and possibly drive over to see the man at Goose Creek. If anything further develops he will call Gen. Vandenberg.
- 4:30 P.M. Mr. Leo on phone - Gen. Van told him the above story. A civilian, Joe Shipman, who works with Col. Hackett is reported to have told the Chronicle to contact Gen. Twining.
- 5:00 P.M. To see Mr. Symington
- 5:15 P.M. Departed for office of Congressman Hoffman.

July 8, 1947

- 9:20 A.M. Arrive office.
- 9:25 A.M. General Gardner and General Power - approved restrictions on flying due to gasoline shortage so that the Air Force would be in a tenable position if it became necessary to curtail civ. gas consumption.
- 9:30 A.M. Gen. LeMay & Dr. Bowles - briefing for JRDB meeting.
- 9:50 A.M. JRDB Meeting with General LeMay.
- 12:15 P.M. Returned - then to Mr. Symington with reference to personnel for the President's Air Board.
- 12:45 P.M. Lunch.
- 1:30 P.M. Returned.
- 1:50 P.M. Colonel Moore on phone who stated Senator Guerney stopped him in the hall and said they were starting hearings on the three million six hundred thousand dollar cut in flying pay.
- 2:10 P.M. Gen. Rawlings advised Colonel Moore that the cut was okay as we had reduced the number of people on flying status. Also advised Colonel Moore that Sen. Guerney had been sent the letter of June 20 that went to the rest of the members of the committee with reference to flying pay.
- 2:30 P.M. Mr. Chalmers Hall on phone with reference to a study he is going to present to Senator Vandenberg with reference to the security of this country. Read his plans in detail to Gen. Vandenberg and the General advised him that all the things contained in his study were in the new bill on unification - that it had all the elements he was plugging for.
- 3:00 P.M. General Lyon on phone with reference to the cases of Major John M. White and Gerald R. Johnson for transfer to the Air Forces. All transfers by War Department direction have been cancelled as of 31 March. In the case of Major White there will be no trouble in event of the merger goes through and recommend this case be held until then. Johnson was recommended against by General Fairchild.
- 3:10 P.M. Air Marshal Goddard
- 3:25 P.M. Senator Cabot Lodge on the phone with reference to increased appropriation to call for 70 Groups. (1) Was the 70 Group Program cleared by the Budget or not? Gen Van said no--were cut down to 55 Groups. (2) Can you have someone in your office write an argument as to why it should be 70 Groups? Gen Van advised him

- 3:25 p.m. (Cont'd)      Wants a statement prepared ~~about~~ he can use as coming from him — not an Air Force or General Vandenberg statement — for the 70 Group Program instead of 55. He wants this in a day or two.
- 3:35 p.m.      Briefing by Gen Kauch, Mr. Zuckert, A-3, A-5 on Alaskan Air Base
- 3:45 p.m.      To Office of Congressman Wolverton with Mr. Zuckert on the subject of Alaskan Air Bases. Took up matter of starting hearing at this session of this committee. Will give us an answer tomorrow. Any hearings to be held will be started next week.
- 5:07 p.m.      Returned from Congressman Wolverton's office.
- 5:08 p.m.      To Mr. Symington with reference to personnel for the President's Air Board.
- 5:12 p.m.      Gen. Rawlings on the box reference request of Senator Cabot Lodge mentioned above (3:25 p.m.)
- 5:14 p.m.      To Mr. Symington - re personnel for the President's Air Board.
- 6:15 p.m.      Gen. Kissner on phone re request of Senator Lodge for statement in connection with appropriations. General Kissner will have this ready by Noon tomorrow.
- 6:20 p.m.      To Mr. Leo's office and then home.

July 9, 1947

- 8:30 A.M. Arrive Office.
- 8:50 A.M. General Chauncey
- 9:13 A.M. General Stearley re letter in connection with motion picture personnel. Gen. Van advised it would not get by Secretary Patterson. Have to take a reading on exactly how we can get by with 8 reserve officers and 2 regulars and still spend that money on them. (\$500,000 each) Gen. Van advised him to look into the matter of reserve officers and that his office should write the letter.
- 9:17 A.M. General Gardner, General Power, Col. Peterson
- 9:33 A.M. Cong. Harness of Ind. re Capt. Roger Smith O-744641 who has had 5 years overseas with B-29's and is now on terminal leave. He wants reassignment - regular or otherwise, and is willing to be placed on foreign service. Gen. Van asked that he come over to see Major White and we would get him the information. Cong. Harness advised he thought we were getting the Merger Bill worked out pretty fine.
- 9:35 A.M. General Doolittle on phone. To come in at 10:30.
- 9:38 A.M. Mr. Ben Pearse with reference to two stories he is writing - one about the Anglo-American Oil Agreement and the other about CIG.
- 9:25 A.M. Harry Bruno of New York - Gen. Van advised he would let him know as soon as he could with reference to an engagement for week-end either 18 July, 25 July, 1 August or 8 August.
- 10:30 A.M. To Mr. Symington
- 10:50 A.M. To Gen. Eisenhower's office with General Norstad
- 11:45 A.M. Mrs. Bowers of the White House called Major White to advise that Gen. Vandenberg should be in the President's office at 12:15 tomorrow for signing of Air Force proclamation.
- 12:15 P.M. Returned from Chief of Staff's office.
- 12:50 P.M. To Mr. Symington

July 9, 1947 (Cont'd)

2:15 p.m. Returned from JCS

2:30 p.m. To Mr. Syzington

3:10 p.m. Returned

3:30 p.m. Mr. Leo on phone re "This recruiting matter". Gen. Streett's office recommends against it on the ground that that is a small enterprize down there and they don't want to set a precedent. Mr. Leo will check further and call back. Also, General Streett has been concerned in the event of unification about recruitment funds and wanted Mr. Leo to express to Gen. Vandenberg his opinion that it ought to be a gradual shift if there was not going to be a central recruitment.

3:40 P.M. General Anderson - General Van informed Gen. Anderson that he was definitely against his leaving Washington at the present time and plans to recommend to Gen. Spaatz that it not be done.

5:05 p.m. Mr. Pethick and Mr. Lawrence. Mr. Pethick (Navy), Mr. Lawrence (President of the Reaction Motors) and General LeMay. Presented to General LeMay and General Vandenberg problem of their monetary position which was bad and they were afraid of being refused contracts which would set back the jet rocket motor development several years. General LeMay stated that they were to take it up with Wright Field and present their case out there where the contracts are let.

5:35 P.M. Home.



16

*Fort Worth Star-Telegram*  
Photographs of Balloon Debris  
[July 9, 1947]













Statement  
Lt. Col. Sheridan Cavitt, USAF (Ret)  
May 24, 1994

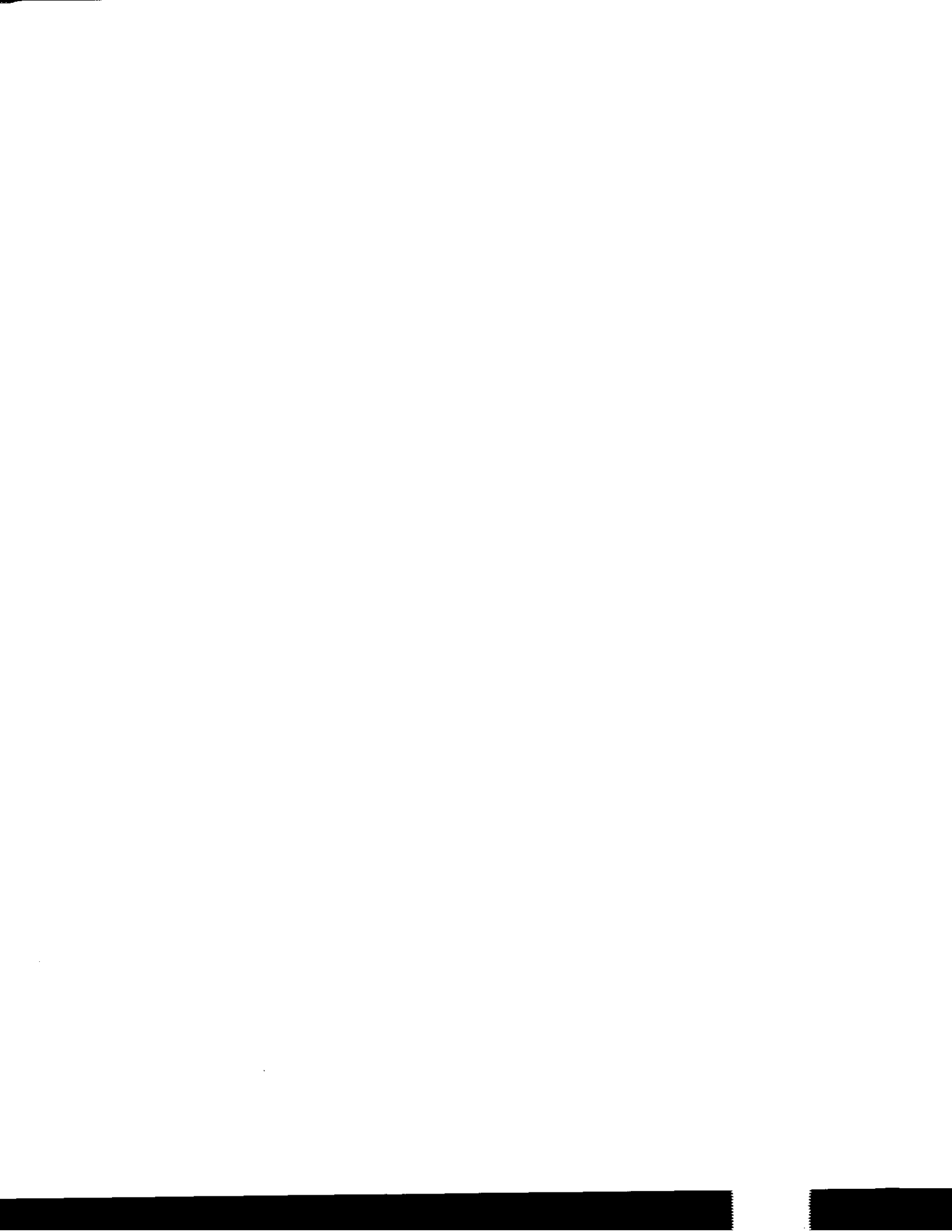

STATEMENT OF WITNESS

Date: 24 May 94

Place: Washington

*SW* I Sheridan W. Cavitt, hereby state that Richard L. Weaver was identified to me as a Colonel, USAF. I do hereby voluntarily and of my own free will make the following statement without having been subjected to any coercion, unlawful influence or unlawful inducement. *SW*

*SW* I was a Counterintelligence Corps (CIC) Special Agent for the US Army Air Force who was initially assigned to Roswell AAF following my graduation from CIC school at Ft. Holabird, MD, in late June or Early July, 1947. Shortly after arriving at Roswell, New Mexico in that time frame I had occasion to accompany one of my subordinates, MSGT Bill Rickett, CIC, and Major Jesse Marcel, Intelligence Officer the 509th Bomb Group, to a ranchland area outside of Roswell to help recover some material. I think that this request may have come directly from Major Marcel. I do not know who may have made the report to him. To the best of my knowledge, the three of us traveled to the aforementioned ranch land area by ourselves (that is, no other persons, civilian or military, were with us). I believe we had a military jeep that Marcel checked out to make this trip. When we got to this location we subsequently located some debris which appeared to me to resemble bamboo type square sticks one quarter to one half inch square, that were very light, as well as some sort of metallic reflecting material that was also very light. I also vaguely recall some sort of black box (like a weather instrument). The area of this debris was very small, about 20 feet square, and the material was spread on the ground, but there was no gouge or crater or other obvious sign of impact. I remember recognizing this material as being consistent with a weather balloon. We gathered up some of this material, which would easily fit into one vehicle. there certainly wasn't a lot of this material, or enough to make up crates of it for multiple airplane flights. What Marcel did with this material at the time was unknown to me, although I know now from reading about this incident in numerous books that it was taken to Eighth Air Force Headquarters in Fort Worth where it was subsequently identified as a weather balloon, which I thought it was all along. I have reviewed the pictures in the 1991 Book by Randle and Schmitt on the UFO Crash at Roswell wherein Marcel and Ramey are holding up this material and it appears to be the same type of material that we picked up from the ranch land. I did not make a report of this incident to my headquarters since I felt that the recovery of a weather balloon was not a big deal that did not merit a written report. In the same referenced book by Randle and Schmitt I was reputed to have told Rickett ( on Page 63) that we were never there and this incident never happened. The book seems to imply this was in some sort of conspiratorial tone; however it is more likely I told him not to mention it to our headquarters because we had wasted our time recovering a balloon. I only went to this area once and recovered debris once and to the best of my knowledge there were no other efforts to go back there. If there were, they did not involve me. There was no secretive effort or heightened security regarding this incident or any unusual expenditure of manpower at the base to deal with it. In fact, I do not recall the incident being mentioned again as being any big deal and I never even thought about it again until well after I retired from the military when I began to be contacted by UFO researchers. Many of the things I have mentioned to these people have either been taken out of context, misrepresented, or just plain made up. I did know both Jesse Marcel and Bill Rickett very well (both are now deceased). I considered them to be good men, however both did tend to exaggerate things on occasion. With regards to claims that we tested this material by hitting it with sledgehammers without damaging it, I do not recall any of us doing so. I also did not test this material for radioactivity with a Geiger counter (or anything else). I do not recall attempting to burn any of this debris but my wife tells me she recalled that Jesse Marcel, his wife and son did have a small piece that they held over the fire when we had a cookout. In short, I did help recover some debris near Roswell, New Mexico in the summer of 1947. I thought at the time and think so now, that this debris was from a crashed balloon. I am not part of any conspiracy to withhold information from anyone, either the US Government or the American public. I have never been sworn to any form of secrecy by anyone concerning this matter and I have received authorization from the Secretary of the Air Force to discuss with Colonel Weaver any information of a classified nature that I may have concerning it. There is no classified information that I am withholding. I have never been threatened by the US Government or any of its subdivisions, or by any persons, not to talk about this incident with anyone, and in fact I have talked to a number of private researchers. My bottom line is that this whole incident was no big deal and it certainly did not involve anything extraterrestrial. *SW*

*Sheridan W. Cavitt*

*page 1 of 2 SW*



CONTINUATION SHEET FOR AF FORM 1168 AND 1169

THIS PAGE  
USED  
FOR  
SIGNATURES  
ONLY

I further state that I have read this entire statement, initialed all pages and corrections, and signed this statement, and that it is correct and true as written.

WITNESSES:

[Signature]  
(Signature)

Mary D. Carth  
(Signature)

[Redacted] MA  
(Address)

[Redacted]  
(Address)

Subscribed and sworn to before me, a person authorized by law to administer oaths, this

\_\_\_\_\_  
(Signature)

34 day of MAY 19 94

\_\_\_\_\_  
(Address)

at [Redacted]  
[Signature]  
(Signature of Person Administering Oath)

RICHARD L. WEAVER COL, USAF  
(Type Name, Grade & Title of Person Administering Oath)

18

Interview  
Col Richard L. Weaver with Lt Col  
Sheridan D. Cavitt, USAF (Ret)  
May 24, 1994



TRANSCRIPT OF INTERVIEW OF SHERIDAN CAVITT

(Note: RW = Col Richard L. Weaver; SC = Sheridan Cavitt; MC = Mary Cavitt)

RW: Today is the 24th of May 1994. I am in \_\_\_\_\_ I am Colonel Richard L. Weaver and I am talking to Lt Col Sheridan Cavitt, US Air Force, Retired. Also present in the room is his wife, Mary. Colonel, you don't mind that I tape record this do you?

SC: Go right ahead.

RW: O.K. thank you. What I would like to ask you is to confirm you were with the Counter Intelligence Corps (CIC) (at that time of the US Army) in 1947?

SC: Yes...the Army Air Corps...right.

RW: When did you get transferred to Roswell, Sir?

SC: I went to Roswell after going to the CIC School in Baltimore, Maryland, at Camp Holabird...in 1946. I do not remember the month. My wife might. It was in the Fall was it not?

MC: June of 47.

SC: June?

RW: I think on your records you graduated in June of 47.

SC: From Holabird?

RW: Yeah, Holabird.

SC: O.K...I told you my dates are slipping my mind.

RW: That's O.K...I have the same problem.

SC: It's hard to remember July 47. I hadn't been there very long.

RW: Did you know a Major Jesse Marcel who was the Intelligence Officer during Roswell at that time?

SC: Oh yes. I knew Jesse, his wife, and his son. We were very close friends. We were in the same building in the CIC office, which was next to the intelligence office. We associated socially as well as business.

RW: Sir, you were the senior officer and the commander at the detachment there at Roswell?

SC: Yes, I guess you could say that. I was the only commissioned officer. I had two enlisted agents "working for me" quote end quote.

RW: Who were the enlisted agents that worked for you?

SC: The senior was a Master Sergeant by the name of Rickett and the young agent, Jack Williams. I later had some other people working for me after CIC deceased and OSI took over for the Air Force...the investigative agency.

RW: That actually came, I think, in September when the Air Force first stated. You were one of the charter members of OSI, as I understand?

SC: Yeah, over from CIC and OSI; and then I went to OSI school later.

RW: You reported through your chain of command? You didn't report to General Blanchard, the Base Commander? You reported like we did in OSI through the separate chain of command, as I understand it; is that right?

SC: Yeah, our parent organization was 700 CIC and I believe that there...they had sort of a branch up in Colorado at that time, but I think most of our work was sent directly back to Bolling at that time. I am a little fuzzy on that because I wasn't in the organization very long, you know.

RW: OK. General Blanchard was the Base Commander and everyone else in the 509th basically reported to him then?

SC: Oh yeah. Colonel Blanchard.

RW: Oh yeah. Excuse me, Colonel Blanchard.

SC: He was the Wing Commander of the 509th, right. I didn't report to anybody on the base.

RW: Just like in OSI?

SC: Yeah, I associated and coordinated stuff with Marcel and I had no responsibility to Blanchard or Marcel.

RW: Do you recall an incident that happened during the early part of July when you were asked to accompany Major Marcel to go recover some wreckage of anything?

SC: Well, there again I couldn't swear to the dates, but in that time, which must have been July, we heard that someone had found some debris out not too far from Roswell and it looked suspicious; it was unidentified. So, I went out and I do not recall whether Marcel went with Rickett and me; I had Rickett with me. We went out to this site. There were no, as I understand, check points or anything like that (going through guards and that sort of garbage) we went out there and we found it. It was a small amount of, as I recall, bamboo sticks, reflective sort of

material that would, well at first glance, you would probably think it was aluminum foil, something of that type. And we gathered up some of it. I don't know whether we even tried to get all of it. It wasn't scattered; well, what I call, you know, extensively. Like, it didn't go along the ground and splatter off some here and some there. We gathered up some of it and took it back to the base and I remember I had turned it over to Marcel. As I say, I do not remember whether Marcel was there or not on the site. He could have been. We took it back to the intelligence room...in the CIC office.

RW: What did you think it was when you recovered it?

SC: I thought a weather balloon.

RW: O.K. Were you familiar with weather balloons at the time?

SC: I had seen them. I had seen them. As I recall, I am really reaching back, I think they were equipped with a radio sonde or something like that, that transmitted data from, when it got up to altitude (what altitude I have no idea) and somebody on the ground received it and that way they got some information on what was happening up there.

RW: O.K.

SC: This is all over my head. When I saw it it was too flimsy to be anything to carry people or anything of that sort. It never crossed my mind that it could be anything but a radio sonde.

RW: How did you get the report that the material was out there?

SC: That I don't recall. Looking back on it, I imagine somebody called the 509th. The 509th called Marcel and said there is something over here, wherever. and then...more and more thinking back on it now he must have been...I must have been with him...."lets go out look and see what the hell..."

RW: Did you just make one trip out to the area?

SC: I can't recall ever making more than just that one trip.

RW: And you think it was you, Marcel, and Rickett?

SC: Well, I not sure it was Marcel but I know Rickett was...

RW: Rickett was there? When you got back with this stuff you turned it over to the Intelligence Office. What happened then?

SC: Nothing, as far as I'm concerned. I don't think I even made a report. Our CIC had gone by... 700 CIC was the CIC Headquarters.

RW: 700 CIC was the Headquarters?

SC: Yes, I don't think I even made a report to them, which I normally would if there was anything at all unusual.

RW: Do you remember the newspaper? It actually was, I think, July 7, 1947, where this now famous newspaper says they found a "flying disc" in Roswell? That was actually the Roswell paper, that was the first one. How about you, Mary, do you remember that at all?

SC: I don't remember it. We took the local paper to get some weather reports.

MC: We were so new there. In fact, I think I had just been there just maybe just a few days because I had been up to my sister's wedding and I don't think at that time we might not even been taking the paper. We heard no...

SC: I don't remember anything in the paper.

MC: We heard nothing. Of course, we didn't associate with people on the base, either.

RW: Yeah, I understand.

MC: We were brand new. Jesse and Salazar were best friends. At that...starting about the first of July on.

RW: After you found this, Sir, do you remember any sort unusual activity occurring? Like a big military alert, or people going out to the base and large numbers of high security?

SC: No. The reason I wouldn't have been involved in anything like that, if there was any activity like that, I was Counter Intelligence Corps, this didn't have anything to do with counter-intelligence. It looked to me, somebody lost a weather balloon. I couldn't care less...tough luck.

RW: But when you went out and saw this material, there was no doubt in your mind that it was some sort of man made material? And, you though at the time was a weather balloon, some sort of balloon?

SC: When I first saw it.

RW: When you said the wreckage wasn't very much, could you, was it as long as your house here, or just a small little clump?

SC: Maybe as long as this room is wide.

RW: So, twenty feet maybe?

SC: Some here, some here, some here. No concentration of it. No marks in the ground, dug up, anything hidden, or anything like that, just out on the territory around the bottom of New Mexico, just good for growing sheep - they don't eat too well.

RW: Yeah, I don't imagine. They probably have to eat on the run out there. Do you remember at the time the article or the photo of General Ramey and Marcel holding up a piece of material? Have you seen that since that time?

SC: Oh yeah, I have seen it, yeah, but at the time I don't recall seeing anything like that.

RW: In that photo, actually there are four separate photos there, Marcel, I think in two of them, is holding up material. Does that look like the material that you picked up out in the desert? Actually it's in this book if you don't mind...

MC: I was going to say that I think it's in there.

SC: I don't remember...Yeah, Yeah, that's...

RW: The first picture is actually with Jesse Marcel and that's General Blanchard and...

SC: I think this was taken at the Headquarters at Carswell.

RW: Yeah, that's right. That's correct.

SC: And I obviously...Marcel took it to Fort Worth. Yeah that's the...

RW: Yeah. That doesn't look like they substituted anything from what you found?

SC: No, No.

RW: Is this about the extent of the material? I realize you can't see all of it in any of the pictures. Or was there large...could you fill up an airplane with it?

SC: Oh, good God! You couldn't fill up (unintelligible) with it. Yeah, I can't tell what those sticks look like. But, as I recall, to me they look like bamboo or some sort of very small lav type material ripped out.

RW: Could you break them or bend them, or...

SC: I didn't try.

RW: O.K.

SC: It was someone else's balloon as far as I was concerned. I didn't want to fool around with it.



RW: After you picked that up and you turned it over to Marcel, did you ever hear anything more about this? Did people from Washington come and talk to you about it? Did you have to swear any security oaths or debriefing statements?

SC: I don't remember anybody from Washington coming there. It's possible that somebody came over to talk to Marcel that I didn't even know about. To my knowledge, no. Certainly nobody from Washington. I would have, I think, remembered that. Someone from the headshed coming down and talking to me. Certainly, I would have. And I was not sworn into any secrecy ever about any of this stuff.

RW: So, as far as you are concerned, none of this was ever classified? There was no attempt to, I use the word, "cover up" this information or to classify it?

SC: Well let's put it this way: as far as I knew, I never heard anyone say, "Don't talk about this and its hot stuff." I think Marcel, would...I'm sure he would have told me something.

RW: Would he have? Did he ever say anything to you after this incident occurred until the time he left? Or, anywhere up until the time he died?

SW: Oh, Rich, dealing with him there in the office or the next office to him so he probably said something about it. That he had taken it down to Ramey or something. But, nothing that would, you know, stick in my mind of importance. Do you understand what I mean? If he had said something like, "I took it to 8th Air Force Headquarters, General Ramey was excited; they were going to take it to Wright-Pat" (or wherever they allegedly took it). Oh, I'm sure I would have remembered that.

RW: It had been alleged in a number of books, including the one by Randle and Schmitt, that there were a number of airplane flights back and forth of C54's and B29's going into Wright-Pat and Kirtland, or to Fort Worth. Back and forth, loaded up, with very tight security, hauling this wreckage. Do you recall any of that going on?

SC: None...Nothing.

RW: And then its indicated (and not directly quoting ) Some counterintelligence people from Washington or Andrews (as they said in the book) had come out there and apparently done photographs or crime scene searches or whatever. There was nobody else out there from CIC or Counter Intelligence Corps that you knew of? Other than Rickett?

SC: Not to my knowledge. Not to my knowledge. I made a booboo. I said it was 700 C at Bolling. I believe now that you mentioned Andrews, it could have been Andrews. But no nobody came out. Maybe they did, maybe they didn't talk to me. CIC did some crazy things in those days, shuttling some people around.

RW: But it would have been likely, had you been involved in recovering something kind of special that they would have talked to you?

SC: Yeah, I think they would have asked me, "Cav, what did you see" ...right.

RW: Did Rickett ever talk to you about this again?

SC: No...I don't think so. I don't think so. Right about that time just before OSI was formed and we all were absorbed into OSI. I think he went on a special undercover job up to...maybe somewhere to an Air Force Base up here in Washington.

MC: Fort Lewis, I think he...

SC: Was it Lewis or McChord? I don't remember. Anyway, he went on to an undercover assignment, and that's what I said about CIC doing some crazy things. They didn't even tell me. I was his boss locally and they didn't even tell me that he had gone up. He use to be a mechanic at one time, Rick did, in the Air Force; the Air Corps. I think they wanted to...they were having some trouble with their planes being what they thought were sabotaged and they asked him to go up there and try out the machine...like an airplane mechanic, which he could do pretty good. Outside of that, I don't know of anything that Rick did.

RW: One of the things that was mentioned in this book...and I don't know how much you read it, is that Rickett some time later that Fall apparently went with a scientist by the name of Doctor LaPaz, and he accompanied him and they went around to various places. Dr. LaPaz was a well known person...

SC: I knew of him. I never met LaPaz personally, but I knew what he was.

RW: Did Rickett go with him that you recall; accompany him around?

SC: He could have, but it certainly didn't stick to my mind. It wouldn't be for any extended time I don't think, because we needed him around the office.

MC: The Ricketts were friends of ours too; and his wife and I. I don't remember Mack ever saying anything.

SC: Mack was his wife.

MC: ...that he was gone for a long time.

SC: He could have, but Rickett would go off the deep end every once in a while. He was a fantastic story teller. He worked for an insane asylum up in the Washington DC area. I think his wife worked there, also. He would sit around and tell some of the most hilarious, ridiculous stories about things that happened in this nut house, so to speak.

RW: Was that St. Elizabeth's? That's the big government mental institution.

SC: I don't know. It's in the Washington DC area. I forget since I was there in the Washington area for awhile but I never did get acquainted with the insane asylum.

RW: It's always best to keep it that way.

SC: No, well I put it again, he might have gone off with LaPaz for a few days, but I can't imagine what excuse I would have been given as to why he'd be out goofing around with an astronomer. LaPaz was a well thought of individual in New Mexico and, I imagine, all over the United States. He had quite a reputation.

RW: He did quite a bit of work for the Air Force, as I found through research.

SC: Contract work or something... Yeah.

RW: But there was nothing that you knew of that he did as a direct result of this incident on the stuff that you recovered out there?

SC: No. Of course, I could have been held in the dark about it; but as far as I know, no.

RW: O.K. I went through and pulled out wherever, in this book UFO Crash at Roswell by Randle and Schmitt, this is a 1991...I pulled out wherever you were identified. They never identified you by name except in the credits when they interviewed you, but they always referred to you as the "Senior CIC man" and "Senior CIC agent". They identified Rickett and Marcel, of course, by name. There are many things that are in the book that people said that you said or implied that you said, without directly saying that "Colonel Cavitt told me such and such."

SC: Yeah.

RW: I pulled a couple of these out and just ask you if you can comment on it to see how they ring with your memory of the incident. "The second fellow we interviewed" (this right from the front on page six) "was an agent in the counterintelligence corps. He accompanied another intelligence officer on the initial trip to the crash site and we believe wrote a report of the incident for his superiors in Washington"...implying that was you, since you were the senior guy.

SC: I'm just reading this end quote "book." No, No. I assume...I assume when I read this thing for the first time that they sent me a big deal, you know...

RW: An autographed copy?

SC: An autographed copy and all that. No, I didn't say all like that.

RW: On the next page, on seven, again referring to you: "At first this intelligence agent refused to admit that the event had occurred at all. There had been no newspaper story, no fuss, not even the recovery of a weather balloon. After much prodding, that he was going to admit that something came down and was recovered, and but that was as far as he would go. He admits no

personal involvement even though other reliable sources gave him a central role. That kind of sums up everything in...

SC: No. No. From the very start, when these clowns started hounding me, Randle and Schmitt, I told they accused me of covering up and having signed a security...

RW: Berlitz and Moore?

MC: Now, you see, he was here at the house. I've heard numerous deals on the radio when I'm listening at night and all this, all of this, has been...

SC: I told these guys when they first talked to me, I said: "I have taken no security oath. I'm under no obligation to not tell you anything, because, as far as I was concerned, it wasn't anything other than a weather balloon." And, I said: "I want you to quit inferring that I am staying silent under an oath of security." And, finally, I think about two years, later Randle told me: "Hey, we believe you." It was getting ridiculous. I was getting so sick and tired of this garbage.

RW: Yeah. I sensed a little of reluctance when I first called up and..."like, Oh no, here we go again" type of thing.

SC: I did, really.

MC: He gets so many phone calls. I usually answer the phone and say: "Who's calling please?" And then, I don't know whether...come and write a book...

SC: You've hear of Pflock?

RW: I know who he is, yeah.

SC: He's our chief debunker. I lean toward him.

MC: Rich, have you got, read, Randle and Schmitt's latest book?

RW: I've not. I've tried to find it and I haven't been able to find it.

MC: It just came out in April.

SC: They haven't sent me a copy yet. I think they are mad at me.

MC: Didn't they tell us that they found some new information and it wasn't at the spot that...

SC: Right. Right.

RW: Yeah. As I understand it, the new information (and this may not be quite right, since I haven't read it, this is hearsay) is that there was this crash...what they call the crash site,

apparently, where you were at and picked up this material, and then there is another one 120 miles or so away.

SC: A ricochet.

RW: Yeah. Which at one time was on the Plains of San Augustin and now it has apparently in this new book been changed to a location closer to Roswell. And, that's where these bodies were supposedly recovered. I think their new research has to do with that aspect of it.

MC: Well we haven't seen it, but I know it came out in April.

RW: O.K. Lets see; also on the same page it said: "The CIC responded to the phone call. Jesse Marcel was one. "The intelligence and the CIC responded to the phone call. Jesse Marcel was one of them. Colonel William Blanchard and the other officer suggested that Marcel and CIC agent accompanied Brazel to the ranch to see what was there." Brazel, of course, was the farmer who apparently came in and made the original report.

SC: Yeah. To the best of my recollection, I never met the rancher, Brazel.

RW: O.K., because as I go through here you'll see that you're accused, I say "accused"; claimed, to have been with him on a number of occasions and basically, it was alleged that the Army Air Corps had imprisoned him, if you will, for about a week and kept him away from everybody. Not that you personally did, but the Army Air Corps in general: "The trip to the ranch took the rest of the afternoon...they were forced to stay in a small cabin with no electricity no running water...the next morning they headed out into a field where Brazel had found the debris." So, this would have been you and whoever else accompanied you.

SC: Totally, made up, or fabricated, or whatever. I didn't have any experiences like that of spending the night out on the ranch.

MC: Eating a can of beans...

RW: Eating beans...yeah, that is, in fact, mentioned in one of the...

SC: Yeah.

RW: O.K. Now this: "Marcel would later say that the material was like nothing he had ever seen and the metal was as thin as newsprint and as light as a feather. It was flexible but very strong. He tried to dent it with a sledge hammer but Marcel and the CIC agent tried to burn it but it would not burn. It was lighter, stronger and more fire resistant than any of them had ever seen. Marcel, along with the counterintelligence agent picked up as much as they could and begun loading it up in Marcel's convertible and the counterintelligence agent's Jeep Carryall vehicle with a rear box." So, apparently, according to Marcel's version of the story (and I don't know when this was given, sometime after 1978) you hammered on it and tried to rip it and did other stuff with it and it was like nothing you had ever seen.

SC: No.

MC: I remember we were at the Marcel's house and I can remember Jesse had something had something on the pad...and then went out to...and took it out onto the back porch. And, I remember that (unintelligible)

RW: Was it some sort of material, metal material or...

MC: And it's in one of these books and then they...and as little Jesse said, they cemented over that...

RW: Oh yeah...O.K. I remember that.

MC: I can still visualize the stove of where they were and we were out there.

SC: No, he could have had some there at the house.

MC: I honestly do remember that.

RW: O.K. Was it like tinfoil type stuff or do you recall...

MC: I don't remember.

SC: I remember. He could have had some there at the house and it was, and it looked like a foil of some sort, and he could have tried to burn that and it didn't burn very well, I don't know. I don't remember that. I can't why imagine he'd be beating on it with a hammer for, but it doesn't make sense.

RW: One of the other things that I'll just jump to real quick was that you had tested the material with a Geiger counter. Did you ever have a Geiger counter?

SC: No.

RW: Now that's not standard OSI/CIC issue that I was aware of.

SC: Honest to God, no!

RW: I've never seen a Geiger counter myself, but I didn't know if you knew what one was.

SC: I had never seen one...what CIC would...No, absolutely.

RW: That comes a little further...did you have a Jeep Carryall, was that...?

SC: No.

RW: When you went out to the site, do you remember how you got out there?

SC: I don't. It was a possibility we could have taken a Jeep. Marcel had gotten a Jeep...Marcel had gotten a Jeep.

RW: Just a regular Jeep?

SC: Yeah. out of the motor pool, but certainly no Carryall.

RW: O.K. Then it said: "After Marcel had gone to Fort Worth and came back Marcel challenged the CIC man who had remained at the base asking to see (your) report. Marcel was told that the report was now classified and he wasn't authorized to see it and it was on its way to the Pentagon if he had a problem with that he could take it up with the Pentagon."

SC: Negative.

RW: O.K. "Blanchard, who was still at the base...ordered Marcel to accompany the rancher back to Corona," You said you never saw...and then you said you were going to...you never saw the rancher from what you told me previously?

SC: No.

RW: Or dealt with him personally?

SC: I certainly don't remember ever meeting Mr. Brazel or Brazzel, whatever his name was.

RW: O.K. Here is where they talk about the Geiger counter. You have already said that you didn't test anything for radioactivity because you didn't have anything to test it with.

SC: No.

RW: Oh. Then Marcel said there was a wire-like material that looked like monofilament fishing line. Do you recall any of that?

SC: Oh, no. It sort of tickles a little bit of remembrance of, you know, of all this junk foil, I would call it, and the sticks and so forth. There probably was some line of some sort there to hold it together, I guess.

RW: What they...

SC: What was supposed to have been with that I...

RW: Well where they go with that, later on, is that this is where we developed fiber optics from. That this is, was, in fact, fiber optic cable which was, of course, unheard of in 1947.

SC: Yeah.

RW: Yeah. We were still dealing with copper wire. You can bend light with fiber optics, and that's where we got...we (the world) got fiber optics from that material which we reverse engineered. That's the implication.

SC: O.K...I didn't see any of that, but there could have been some wire or nylon or something.

RW: O.K. "Together Marcel and the Counterintelligence agent walked around the entire perimeter looking at clues. It took them most of the morning to do it because of the size of the field they started collecting material at the outer edge of the field and moved in toward the center." So, this implies that this was a pretty major undertaking that you and Marcel - in order to examine all of this stuff took a long time because of the volume of the material. This is what I imply from that.

SC: If it were true, you know, the size of the rancher's field they are sometimes a section that are miles square, maybe larger. No.

RW: But there wasn't material all over?

SC: No.

RW: You are right. You could walk into New Mexico forever with...

SC: Oh Lord! Ranches are big out and down in New Mexico. No,...I didn't spend any extended time down there at the site.

RW: O.K. Then, on page 55, it talks about there was discussion that this may have been a foil parachute from a V-2. Were you aware that they were testing, we were testing, V-2's at that time out of White Sands?

SC: Oh yeah. I went down to a couple of launches. One abort and one launch.

RW: O.K. But there was no doubt in your mind that this was not part of V-2 or any other type of rocket when you saw the debris in the field?

SC: No. No. I never had any idea that it was anything with the V-2. They told us down at the V-2 site that they weren't shooting them toward Roswell, anyway. Of course the sent up a few of them and they had an awful lot of aborts. They had to detonate them or pull the trigger...shortly after they got off the launch pad because they went awry, shall we say.

RW: Yeah. Apparently one went awry and went into Mexico, too. They already found that later.



SC: No, I had no idea, no suspicion, that it came from Holloman. Holloman is that...

RW: It was White Sands.

SC: It was White Sands. Holloman base. Alamagordo.

RW: O.K. "Marcel would take some of the sample to Fort Worth to show Ramey. In the mean time, the CIC man would head back to the crash sit with some MP's showing them exactly where this field was and to round up the rancher. There were now additional questions for him." This implies that after you came back you took some MP's and went back up there.

SC: I went back down there? No. No.

RW: So you were just there the one original time and you didn't go back with any MP's, the rancher or anybody else?

SC: No.

RW: O.K. "Marcel would go to Fort Worth and the CIC man would stay behind to lead the clean up detail at the site another reason they send Marcel was the CIC had there own chain of command that reported to Kirtland in Albuquerque rather than Fort Worth and although Blanchard outranked the CIC agent (meaning yourself) a phone call to Kirtland could have gotten his orders overturned." So, this implied that you reported to Kirtland, which I know, of course, we did later when District 17 was formed.

SC: Yeah, OSI.

RW: Yeah, but at that time you didn't necessarily - the CIC did not report to Kirtland?

SC: No. No. Kirtland was just another Air Base as far as we were concerned down at Roswell. They weren't part of SAC. They weren't anything to do with us CIC - wise or nothing.

RW: O.K...Here is where Rickett comes into the picture, and Rickett makes a number of claims that basically...I don't know if Rickett is still alive or not.

SC: No, Rick is dead now.

RW: O.K. Because I...(Unintelligible)

SC: No, he is dead and I think now maybe his wife might be now. We use to exchange Christmas cards up until a couple of years ago when he died. Two or three years ago.

RW: So, he died two or three years ago? OK. He makes a number of claims that, at least Randle and Schmitt; and when I say "Randle and Schmitt I'm not trying to pick on them or to imply that

they're doing anything different than any of these other people...they just happen to have the most current stuff on the street.

SC: Trying to write a book.

RW: "Rickett, the Provost Marshal"...excuse me...page 61. "According to Lewis Rickett, one of the CIC Agents, he, with the commander of the CIC shop, drove a staff car from the motor pool and returned to the crash site. They were followed by a second car carrying several MP's. An MP did ask for identification because neither of the counterintelligence men were in uniform." So this would have been the second trip, which you said you did not take. But, he did apparently go with you on the first trip?

SC: Rickett?

RW: Rickett...Yeah.

SC: Yeah.

RW: And I assume at that time, just like in OSI, you did not wear uniforms for the most part?

SC: I didn't even have any uniforms.

RW: Yeah. I know the feeling. For the first eight years in OSI, I think, the only uniform I had was my mess dress. "But Rickett, the Provost Marshal and the senior intelligence officer walked into the debris field, examined the wreckage. Rickett said it looked like metal and asked if it was radioactive"...and you said it wasn't. That was page 62. This is on the, you would have been on this now second trip again, O.K.? On page 63: as they prepared to leave the crash site the CIC agent told Rickett: "You and I were never out here. You and I never saw this. You don't see any military people or military vehicles out here. Rickett agreed saying yeah, we never even left the office." Now that's the little quote they have out also in the..

SC: Now what page is that on?

RW: That's on page 63.

SC: 63? No. Now I could have said something facetious like that after we got back to the office, after I was convinced that it was a weather balloon, or some such contraption. I didn't know, naturally. I could have said after we got back to the office: "Rickett, this has been a big boondoggle. I don't even want 700 CIC Headquarters to know we wasted our time on it. Forget we ever did it." I mean I could have...

RW: O.K.

SC: said in a facetious way: "Lets make out like it never existed, because we're wasting our time." But I didn't say it in such a way that it would be this is so highly classified we won't have anything to do with it.

RW: O.K. On page 86, it said: "The counterintelligence people came into Roswell on a special flight from Andrews Army Air Field on July 8.". So that, to me, implies that this would have been your CIC Headquarters also sent some other people out there.

SC: Yeah. Right. That's what it sounds like.

RW: Yeah, but you said you would have known if anybody from Washington had come into your area, sort to speak. More than likely.

SC: Well I certainly hope so. We were secretive and so forth, but I think they would have touched base with me, since obviously if they talked to Marcel he would have probably said something to begin with, but they would have wanted to know what I knew. No, I...

MC: Of course Jack Williams was there. Jack could have been on some of these...

SC: No Jack was young and sort of scatterbrained, as you well know. And I never relied much on him for anything. He's the type that would read a book while he was on a road trip driving his car. He'd finish a book while driving...

RW: While he was actually driving?

SC: Oh sure.

RW: Sounds like the people driving on 95 in Washington there in the traffic jam.

MC: There weren't many people on the road.

SC: Jack rabbits. No. No disrespect to Jack, but he just wasn't a solid citizen as far as I'm concerned. And if anybody from headquarters CIC came in I'm positive they would have checked in with me.

RW: O.K. The page that's kind of devoted to you, if you will, is on 171 and it said that "Schmitt suggested the possibility that the crash had been a V-2 or A-9, (which is one of derivatives of the V-2, that we were playing with at that time). Schmitt asked if there had ever...if they had ever retrieved anything like that anywhere in New Mexico. Never, he said any rocket going off course would be destroyed by the range officer and they wouldn't have wanted to risk injury to civilians on the ground. Randle asked if he remembered any talk at all about a flying saucer. He (meaning you) insisted that nothing at all happened. The former CIC man hadn't heard any rumors about a crash. All this, including the story shown on "Unsolved Mysteries", was a bunch of garbage. Schmitt and Randall spent two hours with the man, he told them that any reports he wrote in the

normal course of his duty was sent to Washington not 8th Air Force in Fort Worth. He was attached to the 509th, but his chain of command was different than the 8th Air Force, that's..."

SC: That's one of the few true stories they had in this book.

RW: "In fact he talked about many things willingly. He said the ranks of CIC agents were all classified at the time" (I know that's the way it was in OSI for years) "It didn't look right to have a Master Sergeant investigating a Colonel so no one on the base, except for a few clear to know, had any idea of what he or any of the others were. (Of course, that's the way we did business.)

SC: True.

RW: "He provided names of others who might be able to help and he described his normal unclassified duties at Roswell, but according to him the crash and recovery had never happened. There was no investigation on the Foster ranch, no mystery flight, and no discovery of alien bodies, nothing." Now we are getting to the part where they make you sound like somewhat of a conspirator. It said, "Randall said he and Schmitt had literally two dozen witness' to the special flights out of Roswell and the special clean up operation on the ranch. Something must have happened, the CIC man finally conceded, but I don't know what it was. As they left, the CIC man asked them, if you boys found something that affected national security would you keep it to your self? The former CIC man grins, and said 'very good'." So, somehow, by that remark, I imply that this was kind of, "I know something that you guys don't and if affects national security so we're not going to tell you." That's the way that I interpret what they wrote. Because, the rest of it just kind of recounts the way we did business, even when I came into OSI twenty years after that.

SC: You think they're talking about me there, "the former CIC man?"

RW: Yeah.

SC: If I said that, I probably said it really meaning that if these guys trying to make a buck writing their sensational book run into to something that really affected national security, I meant don't put it in a book.

RW: Yeah. OK.

SC: Turn it over to somebody.

RW: But you weren't implying that this incident affected national security and you weren't going talk about it?

SC: Oh, no! No way.

RW: OK. I see you have some materials you brought out here. That looks like one of your basic agent classes. Is that one of your basic agent classes there?

SC: No, that was the old District Office 17, OSI.

RW: Oh. OK.

SC: So this is after. Dr. Pflock sent me that. I got it out when Pflock sent it to me. This is Rickett.

RW: OK.

SC: And that is Jack Williams and that's old Cavitt. Down on the lower left.

RW: Oh. OK.

SC: That's me, and these are the two boys that were with me there at Roswell. I have them all identified and who's no longer with us. This thing that Pflock sent me, this picture. It says that Jack Williams is deceased. No wonder why somebody didn't contact him. I didn't even know he was dead. We were not friends. He was a Staff Sergeant, and a good honest kid, I think.

MC: A smart guy.

SC: What?

MC: Really, he was quite intelligent.

SC: Oh, yeah. He read. Read books while he was on road trips.

RW: Well the names I recognize from here that were still: are Doyle Rees and John Stahl.

SC: Doyle is still alive. I have a letter from him.

RW: I think he's in the Association of Former OSI Agents.

SC: Yeah. Right.

RW: And I am also a member of that so I see a lot of that. So, I see a lot of their letters and stuff, pictures that they send.

MC: We get correspondence from Doyle. Chris' son called him not long ago. He had a hole in one on his eightieth birthday.

RW: Oh, is that right. Was it his first one?

SC: I'm sure it was.

MC: Nice, nice man.

SC: He is a nice man. And a nice family. I don't know what the date on that is. Letter from Doyle, it says: "When you call the press conference to tell the world, let me know, because I want to be there." So, I just got reams of this stuff from books.

RW: Do you mind if I look through that real quick?

SC: Oh, heavens no. I got it (Unintelligible)

RW: Stanton T. Freidman?

SC: Freidman or whatever.

RW: Yeah, he doesn't like me a lot. He writes me nasty letters.

SC: He called me a couple of times. I could hear him a little bit, but it wasn't good enough for me to try to strain my brain. He apologized a little later. He wrote me back and said sorry we had a bad telephone connection. On your end!

RW: O.K. Here is the stuff about Schiff that I referenced earlier. Asking the GAO to look at this. Karl Pflock...

SC: You know, you can look at any of that. You can have copies. As a matter of fact I don't know what I'm going to do with it.

MC: Oh, your sons want it.

SC: Oh, I don't know.

MC: Oh, yes they do. Joey said last night maybe Dad could make a fortune out of being a hero.

SC: Well, if I wanted to make a little money I could have imagined a lot of things and cooperated more.

MC: Well, that's what Doyle said.

SC: With these authors and so forth I could be given royalties for a long time.

RW: Oh, this was out of the Global Reliance. I don't remember seeing this in there. Oh, Karl Pflock wrote this for the Global Reliance.

SC: Have you ever seen that clipping?

RW: This one on Rickett here?

SC: Yeah.

RW: No, I never saw this.

SC: I don't know what that is from.

RW: "But at least one surviving member of the recovery team actually handled the material, (Unintelligible). Eighty two year old Lewis Rickett. 'Cavitt had been there the day before, but he wouldn't tell me what was going on until we got there.' With armed troops standing guard Rickett wandered through the security phalanx and saw metallic debris scattered in an outer circle with a diameter of 25, 30, or 40 feet."

SC: It must have been Rickett sort a flipped of little bit. See this was something that he...an interview he had shortly before he died, I think.

MC: Well, when they interview Rick he was older and trying to make people remember things that happened umpteen years ago is pretty hard.

SC: I have probably received an awfully lot more than that, Rich, and threw it away. Sorry.

RW: So these people have been pretty much tracking you down on a regular basis then?

SC: Oh, yes! Mary can verify that. She said she had been home when she got telephone calls.

MC: I have talked to some of these fellows myself.

SC: Yeah, if I'm not here she talks to them. Blabber away, and she gives it right down the line. "Have they ever tried to influence you to say that I am lying or holding anything out?"

MC: No. I just tell them that you are telling the truth.

SC: They don't believe you when you tell the truth.

RW: I guess they don't. That's the problem we have with this whole line of inquiry and attempt to look this. It is very hard to prove the negative. It is hard to prove that something didn't happen, because you don't document stuff that doesn't happen.

SC: No, it is pretty hard to, difficult, but a good imagination can. These boys have it.

MC: The picture that was in the Roswell paper, as I said, we had just gotten there so we probably had to start subscribing to it. But nobody passed it around.

RW: Well let me tell you what's in the official records that we found so far. So you will have feel.

SC: Please, do.

RW: We did this, as investigators would, logically. We figured, "where would this stuff be"? So we went to all the different records. Working for me I have a group of reservists who are declassification experts. They are excellent researchers. They spend their whole time dealing with records, so these people know where all this stuff is buried. So, we have been to all the major record centers. The Archives and nuclear records (ranging from unclassified to TS nuclear stuff because the 509th was the only nuclear unit in the world at that time. So, some of these records were TS and still are.) That is because they have never been declassified. Anyway, we found that there was no airplane crash that could account for this. Just to show you how unsafe it was to fly at that time, there were six airplane crashes in less than a month in New Mexico alone in 1947, and that doesn't include the rest of the United States. We were lucky to have six.

SC: Remind me to double back on that. Go ahead with your story and I'll tell you another little story.

RW: We found no indication of a V-2 launch that is not accounted for. There was one scheduled on the 3rd of July and that was scrubbed. There was no indication that there was some sort of nuclear accident at that time where we either dropped a weapon or did something stupid, which we had to consider during that period of time, but there is no indication of any of that happening. Weather balloons themselves are; (although they have a "return to" type of thing on them) supposed to crash. I mean, they go up and then sooner or later they're going to come down. Right? Now what we did find, however (and I not implying what you saw up there), but its a possibility. There was a project run by New York University, out of Holloman at that time. It was a balloon experiment that lasted for years. But at the time a portion of it was Top Secret. It has since then be declassified. It was called Project Mogul.

SC: Never heard of it.

RW: Mogul was designed to run balloons at very high altitudes with extremely sensitive acoustic sensors (what we were looking for were nuclear test on the part of the Russians, because we thought the Russians had gotten the bomb) so you needed high enough and far enough so, and at a constant altitude, we could see...because there were no satellite (Unintelligible) they had a couple Mogul balloons and several of those are unaccounted for during that period of time. They are very large in the sense that some of them were up to 600 feet long, not one gigantic balloon, but a series of balloons, because as they went up to altitude some of them broke off, and some of them dropped ballast and they were very sophisticated. They had a lot of tin foil on them and a lot of different things. Mogul is a possibility. We found a couple of researchers from New Mexico that we are in contact with now because they kept private records in some regards. But, of course that was a Top Secret project at the time and we don't know if Blanchard knew about that or not: (we don't have any indication that he did). And that they used the weather balloon in an attempt to cover the other balloon which was a classified project.



SC: Yeah, that is possible. I didn't know about that particular thing. I just knew weather balloons went up and measured. This was my first impression. I didn't know anything else, so O.K., that's it, forget it. The thing that disturbed me is why they cannot shoot down this story about the little bodies and so forth that were allegedly taken to Wright-Pat or some place.

RW: Wright-Pat, right.

SC: And put in a sealed (unintelligible) or so forth. And the only thing, Rick might have gotten confused about something. You mentioned crashes. We had one there at Roswell. They practiced this air to air refueling, which was just, I think, getting into real high-tech stuff as far as I knew.

RW: B-29's?

SC: Yeah. And they were refueling them. We had one rather, rather hell! Where the plane that was being refueled for some reason or other pitched up when they were either getting to attach the cord, or the other one came down, which doesn't sound logical, I think it's more apt to have went up. One or both of those planes crashed. I forget what direction it was up from Roswell, but I went out to that crash at the request of Marcel, maybe Blanchard, and I probably took Rickett with me. We had bodies all over the place, and it was a sad thing. We recovered some fingers, of course, there was one hell of a big fire after it happened. I collected a bunch of hands, fingers and so forth, trying to identify them. At the time I thought this was sort of stupid. They had a list back at the Operation Office. Other than identifying body parts so that some guy's wife would know that she had part of her, used to be, former husband. And I don't remember where we sent those things for identification. I remember going into the office after that trying to get prints off of these old shriveled up fingers and so forth. What good it would do, I don't know. I didn't know then, but I was wonder if maybe Rick got confused that maybe this was some of the bodies. I doubt it, but it is just a possibility. But I don't know why they can't trace down those bodies.

RW: Well, that is the ultimate part of the quote "cover up" that we're involved in. You and I would probably think as OSI agents if you recovered a body that is unusual, that would generate a whole bunch of paperwork. We are a paperwork society. I mean, it may be classified with a bazillion stamps on it, but it would generate a lot of study and things. And we have not been able to locate one piece of anything to indicate that is so.

SC: It boggles my mind that we would not be able to find anything. The Air Force having the...I mean we were close knit and it seemed that there had to be a trail and pick up and eventually end there in that grip, or whatever they put these bodies in.

RW: But did you ever hear of any talk of that type of stuff when you were at Roswell?

SC: Down there. No.

RW: When did all of this first surface, in your life? After you picked up the original stuff and you went on to your career. When did the UFO part first surface in your life?

SC: You mean this sort of stuff?

RW: Yes. Was it with Berlitz and Moore?

SC: Our son sent this book to us.

RW: This is 1980, I think. Yeah 1980.

MC: A lot of that has been debunked by the other two guys.

SC: Well, I don't remember where Joey got this book.

MC: They bought it, they bought it. And he came by to see us and we had just back from fishing and you had one of your cluster headaches. And I did most of the talking here, because Cav was having his cluster headaches.

SC: I had another cycle of cluster headaches. Similar to migraine.

RW: I understand those are really painful.

SC: I am about to come out of it, although I had one last night, and I was awake all night long.

MC: Don't you think that is it. I never even gave it a thought.

RW: Until Mr. Moore and company showed up, around 1980 time frame?

SC: Yeah.

MC: 16 September 82 that he was here.

RW: O.K. Now from my research (not of AF records, but of popular literature records) Friedman is the guy who ran into Marcel down in Louisiana in 1978, because Friedman had been a UFO researcher for years. He ran into Marcel and from his interview of Marcel it got Berlitz and Moore interested, and that's when Marcel then started talking to all of these different people. And then it has kind of grown since then.

MC: And then of course, it's too bad apparently, you see little Jesse was about 11. Cav never told me anything. He said I'll never tell you anything then you won't spread anything. We always wondered how little Jesse knew so much. To us it should have been business. Neol (Marcel's wife) apparently was not able to give any information after Jesse died.

RW: Yeah. The son is mentioned in a number of publication, because he claimed his dad brought this stuff to his house and they hammered on it and...

MC: Which I remember seeing.

SC: He was a smart little devil, his son.

RW: He is a doctor, I think.

SC: Is he is a PHD type of doctor or a Medical doctor?

RW: Yeah, I though he was a medical doctor.

MC: He is an MD, but his brother was medical type technician.

SC: They were a smart family. I always thought Marcel was just a little on the outer scale.

RW: Since you were friends with both Marcel and Rickett, is there any explanation that they would (in your mind, since you knew them) tell these stories and get this interest generated?

SC: No.

MC: I wouldn't think purposely, would you darling?

SC: Not purposely, no. I gave you a little insight on Rick, he could sit and tell stories that last hours.

MC: They were visited by a lot of people, more than we were. Handier to some people, being in Florida where they were. She would write on cards, so and so has been here, but I don't think purposely they would try to make up tales for being heroes or glorifying anything.

RW: Let me ask you officially for the record. Did you take any kind of security oath, promise, sign anything, or verbally agree to anything not to talk about any of this, that occurred in New Mexico?

SC: No. I told you that awhile ago. I'll take an oath on that. I swear.

RW: O.K. Has anybody in the US Government, the Air Force, or anyone connected with the Government, ever threatened you if you said anything about any of these incidents that something would happen to you, your family or anybody else?

SC: No. No way.

RW: O.K.

SC: I am telling the truth, and I have told all of these other people the truth. That, I don't know anymore than what I told them, and I don't know anything about any "little men", or anything. I am a pretty stupid person, when I say "I don't know anything."

RW: Well, I appreciate having to ask you some of these questions, even after you told me that...

SC: I know you have to.

RW: But, we want to do this officially, because as near as we can tell nobody ever has before.

SC: I certainly wish you good luck. I hope you can convince these people.

RW: Well, it is going to be difficult, because like I say we have nothing other than this one formerly classified project that was occurring out there at the same time that was even a little bit "funny", if you will...

SC: Yeah. Had I known about that, Rich, at that time I would have probably hooked it up with that instead of a weather balloon.

RW: But, a balloon is basically a balloon. Some of them are bigger and some of them are smaller.

SC: Some do some things, some of them do others.

RW: One of the things that they mentioned, going back to the balloons for a minute, was what Marcel called "hieroglyphics". It was something that was written or printed on some of the debris. Do you recall any of that?

SC: No. But in reading over some of my other garbage here, I have seen some hieroglyphics. I don't think there were any claims that these were the Roswell deal. Were there?

RW: Marcel claims.

SC: Marcel says so?

RW: However, the day after the original flying saucer article in the Roswell paper, there was a follow up article where they interview Brazel (the rancher), and he described this stuff almost similar to what you did, almost like basal wood type of sticks and tin foil type of things. Then he said some had what appeared to be Scotch tape with little purple flowers stamped on it. Apparently at that time, as near as we can tell, one of the balloon manufactures did use some type of tape that had some sort of flowers on it. It is possible, I guess, that somebody could mistake...

SC: I don't remember anything like that.

MC: I think there is a picture in one of these...

SC: Well, some of these authors, Mary, you got to remember, they will skip from the Roswell incident to something that happened someplace else in the United States and they get a little confusing. You just read through it. I remember something about some hieroglyphics, not on that one. I didn't see anything. I do not remember any writing at all on the thing. But if Marcel saw something, maybe he did.

RW: Did you know Haut, Lt. Haut? The public affairs guy at the time?

SC: Just vaguely. What was he, base information, or something of that sort?

RW: Yes.

SC: Not close at all. As a matter of fact I couldn't even describe him. I got a picture with a tall fellow and I didn't know much about him, at all.

RW: Is there anything else that you can recall or like to add?

SC: I have been thinking about it ever since you called, and said you were coming out.

MC: It is a shame that Don Yeager was in the office with Jess.

SC: Yeah. Is he dead now?

MC: I don't know.

SC: But he won't know a thing, Mary. He wouldn't know a thing.

MC: He wouldn't have known anything with Jesse?

SC: No. No. Jesse didn't trust Don very much. I wouldn't want (unintelligible). He was trying to keep up, but couldn't. He just wasn't a reliable sort of individual.

MC: So Jess probably wouldn't have...

SC: No. No. I don't even think he even talked to Don about it. There was another Captain in the Intelligence office at the time who I always thought was a very sharp individual, his name I don't remember his first name...Carl was his first name, Macamer. He ended up as a full Colonel.

MC: Now we gave Randall their names. We gave them everything we could think of.

SC: Yeah. Carl might be dead now. I always thought he was a pretty smart individual.

MC: Carl was the last we knew.

SC: Somewhere up in the North, wasn't he?

MC: He is our generation. He would have retired.

RW: Did he switch over to the Air Force too, when he...

MC: Who Macamer?

RW: Yeah.

MC: Oh, yeah. He was in the 8th Air Force.

RW: So when you all just went over to the USAF when it formed in September?

SC: He went right along with the 8th Air Force, becoming USAF. We being OSI, well...

MC: He was always Air Force. He was always Army CIC, or was he?

SC: Who, me?

MC: No. No. Carl.

SC: Carl wasn't even in the CIC. He was in intelligence. He was just in the intelligence office there at...He was under Marcel. He was under Blanchard. He was under Ramey. Wasn't that the General's name over at the 8th Air Force, Roger Ramey?

RW: Yeah, that's right. In fact, they named a SAC base in Puerto Rico after him.

SC: The things that Ramey and Blanchard used to! Blanchard came over to the Philippines. I think he was IG in 1963 or 4 and I was District Commander of the OSI District 42 in the Philippines. We had a few chuckles together and...

MC: Do you recall once when we were some place and Roger, and Ramey and I were dinner partners. I think it was Greece. You were on one of your many trips.

RW: Blanchard was the IG, you're right.

SC: He and Ramey, I don't know what he was after the commander of the Eight Air Force, but he and Blanchard use to have some...(unintelligible). Oh Lord! I knew these guys pretty well. No. I don't know anything about any crashed space ships. I don't know anything about any little men.

MC: I am quite sure that we never gave it a thought until that book.

RW: I'll tell you what, if you can indulge me for a few minutes and let me set up my computer. Do you mind signing a statement. I'll make it very short. (unintelligible).

SC: Sure. You bet. Yeah.

RW: And we'll just make a kind of quick summary statement if you can bare with my computer skills here.

SC: I'll prick my finger and sign it in blood.

RW: I don't think we'll require that.

MC: Rich, it always seems funny to us with all these, if these things happened. How can 30 or even 3 people keep something a secret?

RW: Well, I would kind of like to know how they did it, because in my real job we handle all the Special Programs that do keep all the secrets. And we would like to figure out how they do it so we can duplicate it. Because it is very hard to keep secrets, as you well know.

MC: But you see, I am talking about civilians and other people who were in on these bodies going to the morgue and all that. (unintelligible) some grave digger from the funeral home or whatever...

RW: Well, of course, Randle and Schmitt do claim that those people are out there and that they have interviewed them. They list a whole bunch of them. Now, we're not trying to go after them and undo every interview they had done. That is not our point. In fact, you are the only person we have gone out and interviewed, because you're always reputed to be the guy...one of the two or three people that was there picking up the stuff...

MC: And he is the only one that is still living.

RW: That is right.

MC: That is what Doyle Rees said on his post card. He said you better keep this going. If anybody likes publicity as he...(unintelligible)

SC: But what he was saying, all of these guards...

RW: He claims that he had interviewed a number of these people and said that they did guard something and there were a number flights. Now, we have never found the flight records to substantiate that, so I don't know where they have. If they have.

SC: The crew chiefs on the airplane that are making these flights. They went with them. Flight Engineers?

MC: It will be interesting for you to get Randle and Schmitts last book.

SC: Their latest book? They promised they're going to take it easy on me.

RW: Well, I have tried to find a copy, because, among other things, that have happened, is that people keep changing the dates of when things happened.

MC: And sites!

RW: Yeah. And that makes it very difficult when you are try to track down records. If you are looking between this period of time and all of a sudden they change the period of time.

MC: Well, when they came here about 14 months ago they sat right there and we became good friends down in Sierra Vista and we would tell them everything we know, honestly. We gave them gobs of names. They sat down and said we have something new, something different. Something happened at this site and it was not on the same date. So, you could have one of your researchers get that book, and research that.

SC: You are very well aware of the good guy bad guy approach of when they interrogation.

RW: Oh, yes.

SC: Well, I got a perfect example of this with Randle and Schmitt. Randle is the outgoing, buddy-buddy type and this Schmitt he'd sit over their and he'd look over at me like this (while Randall is asking me a question), "you lying Cur." Particularly down in Sierra Vista. They just grated on me.

RW: You probably had done that a time or two yourself. You would know what he was doing.

SC: Not really. Let him type up this deal that I...

RW: Yeah, I don't want to take up all of your time.

MC: We have all day. I'll go down and get a hamburger or...

RW: If you don't mind, if you got a plug in over by the table. I need two plug ins to make this thing work.

SC: You need two?

RW: One for the computer and one for the power supply.

SC: O.K.



RW: If that is possible. Although the cords are a lot longer than this one, hopefully

SC: Where would be the best place?

RW: In fact, I can probably...

MC: (unintelligible)

SC: Your cord is not all that long.

RW: (unintelligible)

SC: Is that tape recorder still running?

RW: Yeah, let me shut the tape recorder off. Its about 12:30 here on the 24th.

SC: Well, you're not interrupting anything here.

RW: O.K. We'll just do this. I'll make it a short one which just kind of summarizes what we have already talked about.

SC: Good.

END RECORDING

## Letters

Brig Gen E. O'Donnell to  
Commanding General AAF; Lt Col  
W.H. Congdon and Col D.P. Graul  
to Commanding General AMC;  
Brig Gen Tom C. Rives to  
Commanding General AAF  
July 8, 1946; September 9, 1947;  
September 10, 1947

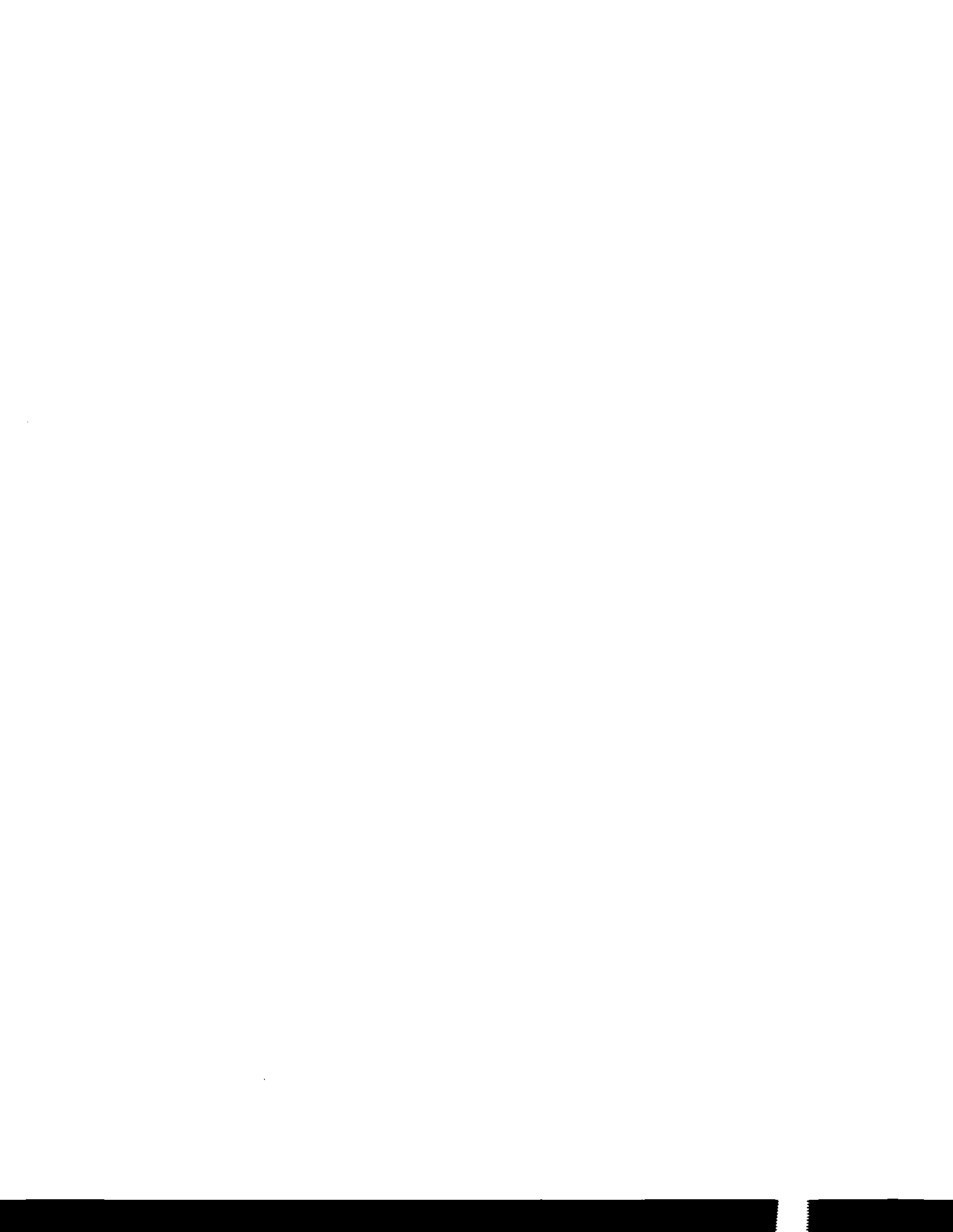

Ltr Watson Labs. 14 Jun 46, subj: "Change in Class. of 'Mogul,' Item 188-5."

1st Ind.

TSELT-2/WHD/mch

Hq., Air Materiel Command, Wright Field, Dayton, Ohio. 8 July 1946.

TO: Commanding General, Army Air Forces, Washington 25, D.C.

THRU: (AC/AS-4)

1. To amplify the information given in the basic letter it is desired by Electronic Subdivision that the following information and scientific data pertaining to project "Mogul" be classified "TOP SECRET:"

a. Precise data as to the exact placement of measuring instruments.

b. Scientific observations and measurements that have military application.

c. Detailed methods of measuring results.

2. Engineering preparations for the final test that are not in conflict with the above will be classified "Confidential."

3. Contractual documents will be classified the same as the security classification of the equipments involved. Equipments used in project "Mogul" are common to other systems or sets that are now classified "Confidential," "Restricted," or "Unclassified;" contractual documents should be classified accordingly.

4. Authorization is requested to observe the security classifications proposed herein.

FOR THE COMMANDING GENERAL:

E. O'DONNELL  
Brig.Gen., U.S.A.  
Deputy Chief  
Engineering Division

AIR MATERIEL COMMAND  
WATSON LABORATORIES  
Red Bank, New Jersey

188-5

ACT/m

WLEAT

SUBJECT: Research Operations in Alaska

TO: Commanding General  
Air Materiel Command  
Wright Field  
Dayton 2, Ohio  
ATTN: TSELT

1. Plans for research on Project "Magul," E. O. 158-11, priority 1A, include determination of compressional wave velocity in the upper atmosphere in regions of high latitude. This information is vital to the completion of the project and as far as is known, no previous work has been done in this field. These Laboratories are now planning to begin the first phase of this research in Alaska between 15 October and 15 December 1947. Completion of this first phase will require about six weeks at the test site.

2. The method of determining acoustic velocity fields in the upper atmosphere will be similar to that which has been done off the New Jersey coast and in New Mexico throughout this year. Explosives are set off at or near the earth's surface and the resulting compressional waves refracted through the upper atmosphere are recorded at sites up to 300 miles distant. One method consists of cropping airburst bombs from airplanes flying a course in various directions from the recording sites, 50 to 300 miles away. Another method involves firing charges of explosives on the ground at fixed distances from the recording sites. Whichever method is used will depend upon available conditions and the granting of clearances to do the work. Both methods have been successfully used for over a year. Techniques are well established and the engineering personnel are well experienced on all phases of the operations.

3. A previous survey of facilities in Alaska by personnel of these Laboratories indicates that all requirements may be fulfilled at Ladd Field, Fairbanks. The following requirements are necessary to conduct either or both types of tests:

a. Facilities for landing and servicing a C-54 airplane and either a B-17 or a B-29 airplane.

b. Housing and messing facilities for three civilian technicians from the Watson Laboratories and the military aircraft crews for a period of six weeks.

U-37827

[REDACTED]

Air, WASH, to CG, AEC, Subj: Research Operations in Alaska 7 Sep 1947

c. Heated and lighted storage and workshop space for scientific equipment (approximately 400 sq. ft.).

d. Upper air meteorological data from the surface to maximum obtainable altitudes for establishing test conditions and evaluating test data.

e. Ground vehicles for transporting test crew and up to one ton of test equipment to recording stations, up to 50 miles from the base.

f. Storage of explosives, bombs and/or TNT demolition charges, is required conveniently available to the base and aircraft.

g. Six thousand (6000) pounds of tetratol (2-1/2 lb. demolition charges) or one hundred (100) each 100-lb. to 500-lb. bombs are required to carry out the experimental work.

4. It is requested that the Watson Laboratories be granted permission to conduct the above outlined tests within the Territory of Alaska, preferably in the vicinity of Fairbanks, beginning between the dates of 15 October and 15 December 1947 for a period of six weeks. In addition, it is requested that the following clearances and authorities be established in connection with the carrying out of this work.

a. Permission to install and operate recording stations at convenient points between Fairbanks and Point Barrow.

b. Permission to drop airburst bombs over at least a 150 mile straight-line course from Fairbanks.

c. If airburst bombing is not possible or proves unsatisfactory, it will be necessary to obtain permission to detonate up to 500 lbs. of TNT on the ground within 50 miles of the operating base. A vehicle will be required for carrying up to 1000 lbs. of explosives, and the assistance of two Corps of Engineers or Ordnance Department enlisted personnel will be required in firing the charges.

d. Authority is required for these Laboratories to draw upon any available supply of explosives in Alaska, requirements as indicated in paragraph 3 (g). If explosives are unavailable in Alaska, these Laboratories will make arrangements for obtaining explosives within the United States and transporting them to the point of the test.

5. If overall approval is granted to conduct this work as outlined, it is requested that these Laboratories be notified immediately, even though detailed arrangements are incomplete, so that aircraft clearances and personnel orders may be initiated.

/s/ W. H. Congdon, Lt. Col., AC

[REDACTED]

D. P. GRAUL  
Colonel, Air Corps  
Commanding

C  
O  
P  
Y

[REDACTED]

Basic ltr WLAMC, 9 Sep 47, to CG AMC, subj: "Research Oprs in Alaska."

1st Ind TSELT(TSELO)/JGR/1a

Hq AMC, Wright Field, Dayton, Ohio. 10 Sept 47

To: Commanding General, Army Air Forces, Washington 25, D. C.  
ATTN: AC/AS-4

1. The proposed operation outlined in the basic correspondence is concurred in by this command.

2. In view of the high priority carried by this project, request that necessary action be taken to have the Alaskan Department provide the necessary facilities.

FOR THE COMMANDING GENERAL:

/s/ Tom C. Rives

TOM C. RIVES, Brig Gen, USA  
Chief, Electronic Subdivision  
Engineering Division

C  
O  
P  
Y

Statement  
Athelstan F. Spilhaus  
June 3, 1994





STATEMENT OF WITNESS

Date: 3 Jun 94

Place: VA

*CSJ* I Athelstan F Spilhaus, hereby state that Jeffrey Butler, was identified as a Colonel, USAF and Jim McAndrew, was identified as a Lieutenant, USAF on this date at my home and do hereby, voluntarily and of my own free will, make the following statement. This is done without having been subjected to any coercion, unlawful influence or unlawful inducement. *CSJ*

*CSJ* I was the Director of the NYU Balloon Project and also involved with many other sensitive activities. Until these discussions, I had no indication of what the "Roswell incident" was. I was involved in numerous unusual activities such as reconstruction of captured German rockets, development of drone planes and the like--such as long range balloons. The Army Air Force had seen what the Japanese had done with long range balloons; although not effective as weapons, they did initiate the long-range balloon research which led to use of balloons for the detection and collection of debris from atomic explosion. Although I was involved in sensitive classified programs, I completed secrecy agreements for various projects, and I understand that this activity (Mogul, etc. is now declassified) and I did enforce "need to know". In part, I left NYU because the administration wanted to know too much about the various projects I was involved in (the Bikini test). At one time I was sent by the US government to assist the South Africa meteorological efforts and I worked numerous other special missions. Even though the war was over the Cold War had just started and certain things were sensitive. I recall that it was Col Duffy who brought me from the Reserves to active duty. It was during this period that I did become involved in a "UFO case". Some bush pilot had found some pock marks in dry snow in Alaska in 1950. So we flew up and saw peculiar round holes in the snow. We landed and took dog sleds to the site and found craters with a hole in the center. We cored one out of the snow and found a center of frozen conical ice. I began to think of something I had seen in the desert where glass had been formed similarly after a lightening strike (the "fumoroles"). I took one back to the university in dry ice and wrote a classified report. We even simulated a small lightning strike over dry snow (just from the snow blowing over the surface) and came up with conical ice formations. This was the Stony River Incident and it wasn't a UFO. On the December 1947 balloon project reports the "service flights" probably refer to the then Top Security project AFOAT 1 (related to MOGUL) which was to produce a report to the President when the Russians exploded an atomic device and were ready to produce a droppable atomic bomb. We coordinated all the listening posts to determine what stage the Russians were at. Concerning the Watson Laboratory gear, I don't remember the specifics of what that gear was. I recommend you check with Charlie Moore for those details. Many of the projects I just new about in general--these were sensitive times--it was sometimes better not to know too much--I knew about the collection of debris with special planes daily from Eilson AFB to the North Pole and back, PTARMIGAN flights, that lasted through the 50's. Concerning the Japanese balloons, I don't recall any specifics. Nor do I recall whether we had REWARD tags on all the balloons. I went many times to Alomogordo AAF and White Sands--not necessarily for balloon flights. I worked on naval activity such as the thermal affects on SONAR. Concerning actual balloon construction, Winzen of St Paul Minnesota, in association with General Mills, did most of the balloons. General Mills also did some balloon projects. Winzen made the first polyethelene (non-stretchable balloons). Flight #5, I really did not get into the details of the individual flights or experiments. The polyethelene material was very durable--it was designed not to burst--you could push a sharp thing through it but it would be difficult to tear *CSJ*

*Athelstan Spilhaus*

400p

it with your hands. There was also debris collection on sticky paper. Most of the balloon projects were not concerned with weather--that's why there weren't radiosondes on all the balloons. The "cosmic ray train" was probably just a cosmic ray experiment on one of our balloons. The balloons were made of sections and had tape reinforcements but I recall any specifics on the tape material. Mylar was not called that originally--it may have originated as polyethelene. All the polyethelene we use was of a translucent material. Neoprene was used during the war, generally for meteorological and artillery firing ballons. The artillery radar tracked the balloons with corner reflectors--this gave the winds aloft to assist the gunners. The radar reflectors were sheets of reflective material and they changed over time but I don't recall the details of the changes. On reviewing Charlie Moore's letter, the acoustic detection relates with the atomic debris collection. The reflectors were for tracking and was made up of a metalized paper or fabric. Charlie explains the flowers--I'd heard about the flowers before, don't remember where--we used whatever we had in the experimental realm. The targets were throw-aways--we didn't put a tag on them, maybe a radiosonde, but not a target. Such a train would make gouges (shallow) as it was dragging the ground. We used meteorology as a cover story--it was a natural. It had a purpose beyond the project--we could use the constant level analysis of the constant pressure (isobaric) vs constant altitude to study atmospheric mathematically--therefore using it was natural. Ramey's press conference--the Air Force position makes sense for the mistake that the PIO made in his statements. (All the NYU personnel had left Alomogordo when the "material" was brought in--someone stated that it may have been Col Duffy's and therefore sent it to him at Wright Patterson--not because it was extraterrestrial) It is a logical reason to send it (the debris from the desert) there--not because it was special--Col Duffy was a fine officer and I'm sure he'd recognize it. I was not aware of any association between our balloon projects and the alleged "Roswell incident" until this interview. I am not part of any conspiracy to withhold information from either the US government or American public. There is no classified information that I am withholding related to this inquiry and I have never been threatened by US Government persons concerning not talking about this situation.

Box

SIGNED:

*Arthur Spiller*

WITNESS(s):

*Arthur Spiller*

Subscribed and sworn to before me, a person authorized to administer oaths this 3rd day of June 1994 VA

*Jeffrey Butler*  
 JEFFREY BUTLER, COL, USAF

*James McAndrew*  
 JAMES MCANDREW, 1LT, USAF

21

Statement, with Hieroglyphic and  
Balloon Train Drawings

Charles B. Moore

June 8, 1994



STATEMENT OF WITNESS

Date: 8 Jun 94

Place: NM

*CBM*  
I, Charles B Moore, hereby state that Jeffrey Butler, was identified as a Colonel, USAF and Jim McAndrew, was identified as a Lieutenant, USAF on this date at my home and do hereby, voluntarily and of my own free will, make the following statement. This is done without having been subjected to any coercion, unlawful influence or unlawful inducement. *CBM*

*CBM*  
I was the Project Engineer for the NYU balloon project during the 1947 time frame. I was not aware that the project had the name MOGUL until 1992 when I was contacted by an individual who was working on some research related to the "Roswell Incident" and the relationship to the NYU balloon project. Our only purpose for the NYU group was to develop constant level balloons. In the early flights at Alomorgodo, starting in June, 1947, we used radar targets to track the balloons (not all the balloons had targets). Some of the targets were apparently manufactured by a toy or novelty company. Ed Istvan was the procurement officer and he had contacted some company that extruded toothpaste tubes as well as radar chaff. The early balloons were made of neoprene and manufactured primarily by the Dewey Almy company in Cambridge and the Kaysam company. Dewey balloons were dip type and the Kaysam ones were cast in a mold. The neoprene balloons were susceptible to degradation in sunlight turning from a translucent milky white to a dark brown. Some of the material would almost look like dark gray or black flakes or ashes after exposure to the sun for only a few days. The balloon material and radar target material would be scattered after returning to the earth depending on the surface winds. The balloon material also had a peculiar acrid odor due to plasticizers and anti-oxidants. There is a recollection from another procurement person (Peterson) that he had obtained radar reflectors from a toy manufacturer. I have a specific recollection of reinforcing tape applied to the seams of the reflectors that had some symbols such as arcs, flowers, circles and diamonds. These were pinkish in color. To my knowledge, there were no radar reflectors in New Mexico in 1947 like the ones we used until the NYU group arrived. The Columbia group was primarily involved in developing low frequency microphones for long range detection of explosions. There was intense pressure for these developments, the constant altitude balloons and the microphone gear. I was involved in 1945 in China-Burma-India for the installation and maintaining of weather equipment in the war against Japan. Our subsequent work with the balloons and microphones was highly classified and we didn't know that there was a project name until 1992. Concerning the make up of the balloon trains, we used braided or twisted nylon lines--there were no monofilament lines during the 1947 time frame. Some of the balloons in early June carried radar targets for tracking purposes since we did not have radiosonde receivers with us. Some also carried sonobouys for detecting the pressure waves where we didn't have the Watson Lab microphone gear. All the radiosondes were covered in white painted cardboard; I don't recall the color of the sonobouys but I believe they were covered in metal. On review of the photos in the Randle/Schmitt book, the material looks like one of our balloon and target assemblies. The wooden beams were made of a balsa wood that had been coated in an Elmers-like glue. The targets had eyelets where the various strings were attached. The 307(B) model was more of an aluminum foil material than the 307(C) model, which was more of an aluminized paper. The targets we used appeared more fragile than the later

*CBM*

C.B.M

model. I think that Flight #4 was the flight that was launched out of Alamogordo on June 4, 1947. This is based on Dr. Crary's actual diary of the launch and other events. This is also one of those events where we went to multiple radar targets because we were not having good success with single targets. This flight was with multiple balloons and targets and may have had a sonobouy (black box?). The Watson Lab gear was the microphone equipment specifically for MOGUL. The idea was proposed in a 1945 letter from Dr Ewing (Woods Hole and Columbia) to Gen Spaatz that we might be able to detect nuclear blasts via pressure waves and low frequency microphones. This was developed from a study of the 1883 Krakatoa explosion where the pressure waves circled the earth seven times. Dr Crary was sent to Ascension island (the antipodol) to attempt to detect the Crossroads shot for Operation Crossroads on Kiloheua or Bikini. He didn't get anything. In December, 1946, Dr Crary was sent to Alamogordo to run the field stations for MOGUL. There were several ground microphone sites for detecting blasts (bombs) detonated off the New Jersey coast. He also initiated activities off Bermuda and Panama. Dr Crary and Dr Peoples were the advance people and scientific monitors for our project. Dr Peoples told us to use the cover story of meteorology and to enforce the need-to-know--in fact I had been reluctant to discuss any of this until only a few years ago. Your letter (SAF/AA) is the first official document I've seen that says this is declassified. Concerning the Japanese balloons, we did not use any of them for MOGUL. We didn't pattern our work after the Japanese balloons. We were very secretive of our work, but the cover story was not a detailed developed cover story. Our new hires were not even aware of the purpose. They thought they were just handling meteorological equipment. Any of the flights that had "tags" would have stated, "Research Balloon Flight, Request Return to NYU". The "service flights" for Dr Peoples were specific ones carrying the microphone gear. The radar test flights were not recorded. There was a lot of pressure to develop the constant level balloons. The tracking was to be done by the Watson Labs radar for the V-2 launches, etc. Starting in early June, 1947 the 307(B) targets came from NYU. We also launched TNT on some of the balloons to simulate airbursts for detection. All of these balloons were accounted for. These and the radar test flights had no tags--we did not want these to be associated with our project and the explosive ones would all be destroyed with pressure switches. To my knowledge, the NYU group were the only ones using balloons in New Mexico during this time but others were involved in other activities so debris from rockets, aircraft dropsondes, etc. may have been found throughout this area. Initially we did not coordinate any of our balloon launches with the Civil Aeronautics Administration. We had no contact with any of the Roswell personnel-- although Crary or Peoples may have. There were two July 8th press releases: in the earlier release, Col J D Ryan stated that radar reflectors were being used to track balloons for wind information. July 8th is the same day the NYU group returned to NYU, so we had no contact with the Roswell personnel when the announcement was made concerning having found the "discs". When we heard the news back in New York, we joked that they probably found one of our balloons. From that time up until about 1980, no one, officially or otherwise made any contact with me concerning the possible association between MOGUL and the "Roswell incident" ( it was in about 1980 that William Moore contacted me and asked questions about balloons making "gouges" in the earth). The July 10th Alamogordo News article shows a demonstration of some of our multiple balloons and target trains. We had no one there so it was surprising to see this. It almost appears that there was some type of "umbrella cover story" to protect our work with MOGUL.

C.B.M

C.B.M.

I can think of no other explanation for Roswell than one of our early June service flight balloons. If one of our balloons went down there was no shroud of secrecy about it. We would attempt to recover the flight gear when possible, but the reflectors, balloons, and microphone equipment was expendable. We went to no great effort to recover the equipment and we certainly would not cordon off an area where one of our balloons went down. We would sometimes send out 3-4 men to recover the equipment if we knew where it went down. The July 10th Alamogordo News report was a good cover--it does not appear to be a coincidence--I don't know who may have initiated it. Trakowski does not recall being involved in a cover story in one of my conversations with him. In New Mexico during 1947, all of our balloon operations were launched from Alamogordo AAF. C.B.M.

C.B.M.

I am not part of any conspiracy to withhold information from either the US government or American public. There is no classified information that I am withholding related to this inquiry and I have never been threatened by US Government persons concerning refraining from talking about this situation. C.B.M.

SIGNED:

Charles B. Moore

WITNESS(s):

Subscribed and sworn to before me, a person authorized to administer oaths this

8th day of June 1994 , NM

  
JEFFREY C BUTLER, COL, USAF

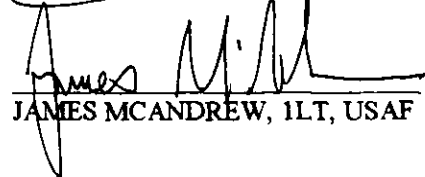
  
JAMES MCANDREW, 1LT, USAF



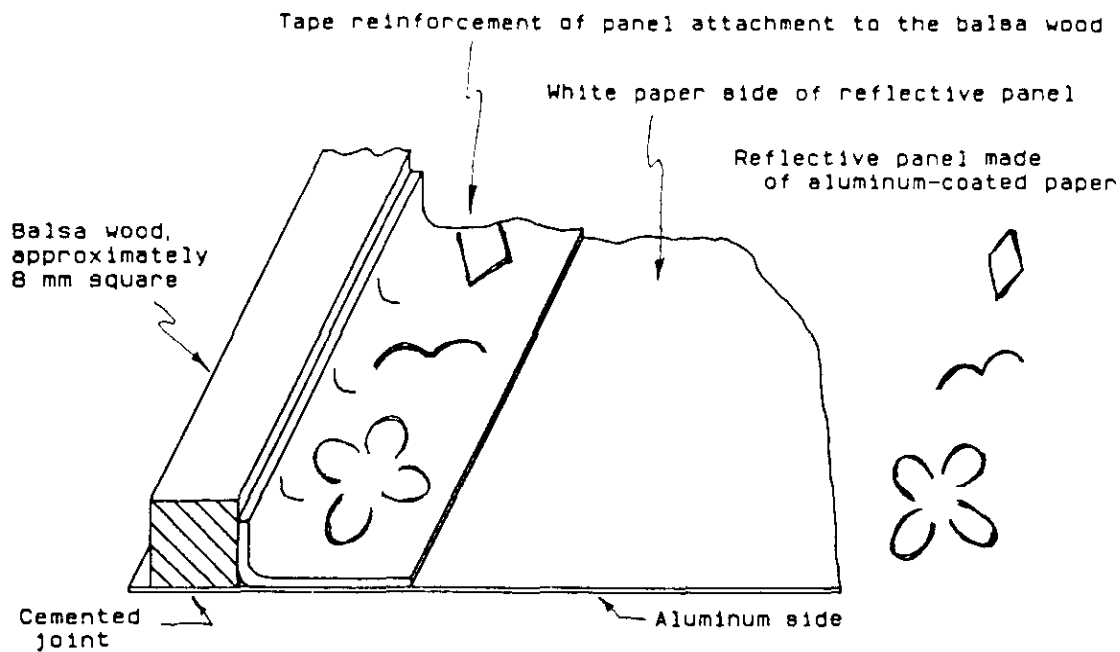

MY RECOLLECTION OF THE REFLECTOR MATERIAL ATTACHMENT TO THE Balsa WOOD PIECES ON THE ML-307/AP PILOT BALLOON RADAR TARGETS IN 1947.

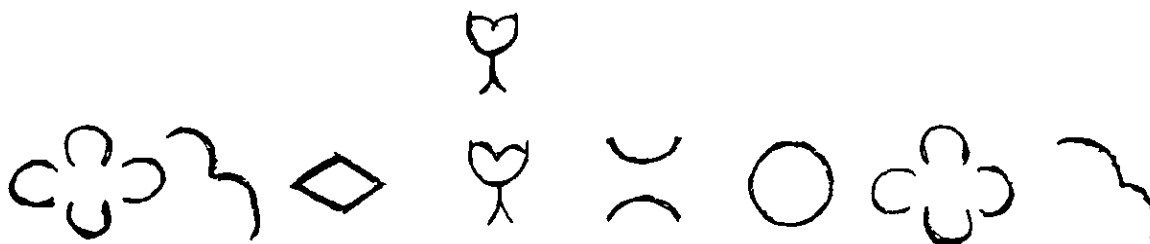

AN APPROXIMATE REPRODUCTION OF THE FIGURES PRINTED ON THE TARGET-REINFORCING TAPE (This is not authoritative since I last saw one of these targets more than 20 years ago.)

*C. B. Moore*

C.B. Moore  
August 28, 1992

Three to five sounding balloons.  
350 gram size, each inflated  
to about 4 feet in diameter

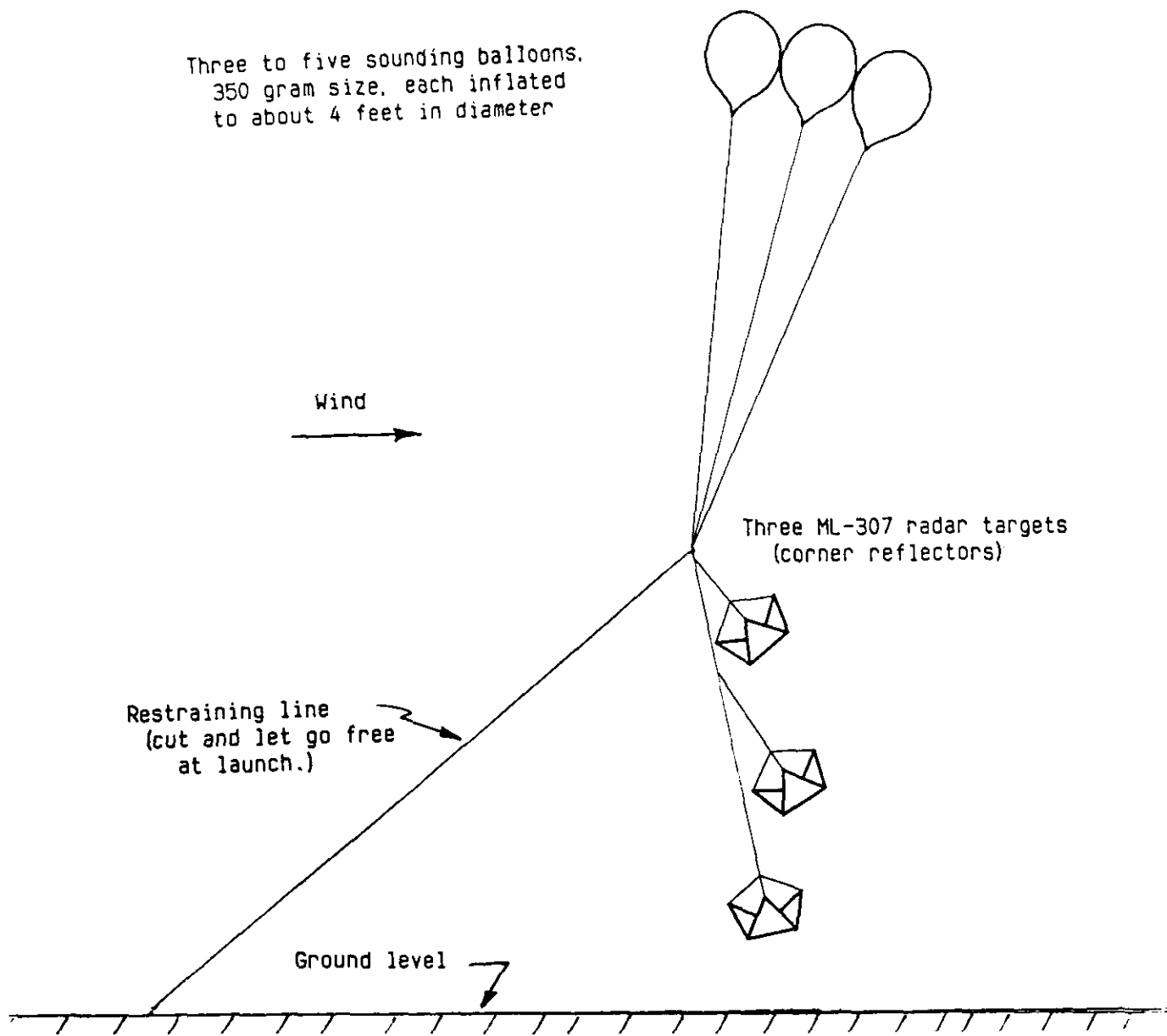

TYPICAL RADAR TARGET FLIGHT TRAIN USED BY THE NYU BALLOON GROUP IN 1947



Statement  
Albert C. Trakowski  
June 29, 1994



## STATEMENT OF WITNESS

Date: 29 Jun 94

Place:

VA

I, Albert C. Trakowski, hereby state that Jeffrey Butler, was identified as a Colonel, USAF and Jim McAndrew, was identified as a Lieutenant, USAF on this date at my home and do hereby, voluntarily and of my own free will, make the following statement. This is done without having been subjected to any coercion, unlawful influence or unlawful inducement.

I was provided a background on the Air Force efforts related to the GAO audit and it's association with the "Roswell Incident" and project Mogul. I personally know all the persons that Col Butler identified to me as having been contacted in this effort (Spilhaus, Moore, Istvan, Fletcher, Ms Duffy). I have also been contacted by several researchers and writers and discussed project Mogul and provided some documents to some of them. Robert Todd, I'm not sure whether he was a believer or not. Charles Ziegler was working on the history of nuclear weapons detection capability. He had some letters/papers that I did not have such as the letters the Gen Spaatz directed the establishment of project Mogul. Carl Pflock apparently wanted to establish the "incident" of Roswell as a UFO incident. Charlie Moore was primarily responsible for development of the constant level balloons for lifting the instrument packages. Concerning a cover story for the project Mogul, there was no planned cover story. I do not recall any documentation nor any efforts to develop a cover story even though the security for Mogul was of great concern. Charlie Moore and Athel Spilhaus used meteorological research as a cover but this was a spur of the moment effort--it was an obvious answer to a query--there was no documentation for using meteorology. We never considered a planned cover story; we were concerned with security.

I was the project officer succeeding Col Duffy in approximately November 1946. My primary purpose was nuclear weapons and guided missiles detection programs. Previously, I was appointed as the laboratory chief in the Signal Corps as an Air Force officer in charge of the Spherics program and later for the development of weather radar. Since my background was in physics, I took over project Mogul. It was the only Top Secret project at Watson Labs and I was the Top Secret Control Officer, so I knew the impacts with security associated with the project. We moved from Watson Labs to Cambridge Me which combined became the Air Force Cambridge Research Center, and I became the Director of the Air Force Geophysics Lab (and remained so until 1949). Through 1949, I was the director of both MX968 and Mogul. As the Mogul director, I went to Alamogordo Army Air Field in early July 1947, to observe the New York University balloon group. The "Roswell Incident" occurred after we had returned to Red Bank (Watson lab) NJ. I became aware of this only after Col Duffy called me from Wright Field from his home. This was just an informational call, he just wanted to let me know that someone had come to him with some debris from New Mexico and he said, "this sure looked like some of the stuff that you launched from Alamogordo." Duffy was very familiar with the various

apparatus and materials for the project, so if he said that it was debris from the project, I'm sure that's what it was. He was not concerned with a breach of security for the project.

Concerning the name Maj Pritchard, he may have worked for me but I don't recall him. I have no knowledge of any counterintelligence, or intelligence persons on the project or associated with my directorate at Watson or Cambridge Labs. When we took over the project, we were aware of the sensitivity of the project—we were aware that we were working in the open—it was a weakness of security because the activity could be observed. I never observed any of the balloon "trains" but I did see some of the early reflectors. Some of the reflectors were procured from sources out of normal channels. Some of the contractors lined up were not quite in concert with typical Signal Corps practices and procedures. Jack Peterson was very energetic and could make procurement actions take place. Ed Itsvan, who I believe actually arranged for production for some of the reflectors, actually went to a toy manufacturer in New York city to get some. It was kind of a standing joke. I remember that some of the prototype and preproduction targets had this pink or purplish tape holding the material to the balsa beam. This tape had flowers and other designs on it. The reflectors were probably made starting in late 1944 but I do not recall how long the production run was. I do not recall any other specific attributes but they were geometrically and structurally simple.

I am not part of any conspiracy to withhold information from either the US government or American public. There is no classified information that I am withholding related to this inquiry and I have never been threatened by US Government persons concerning refraining from talking about this situation .

SIGNED:

Albert C. Trabovich

WITNESS(s):

\_\_\_\_\_

Subscribed and sworn to before me, a person authorized to administer oaths

this <sup>28th</sup> day of June 1994 at \_\_\_\_\_, VA

Jeffrey C. Butler  
JEFFREY C. BUTLER, COL, USAF

James M. Andrew  
JAMES MCANDREW, 1LT, USAF

23

Interview

Col Jeffrey Butler and 1st Lt James  
McAndrew with Professor Charles  
B. Moore

June 8, 1994





Transcript from 8 June 94, Interview with  
Professor Charles Moore

(A) Professor Charles Moore  
Project Engineer - Project Mogul  
(Q) Colonel Jeff Butler  
(Q) Lieutenant Jim McAndrew  
8 June 1994

A: ...Dr. Spilhaus, who you may have met, was really the Director of the project.

Q: We talked with him last week. He sends you his regards. He's a very interesting man to chat with.

A: But I was essentially the project engineer and a graduate student, whereas he was Director of Research at New York University at that time.

Q: We have gone through many of the various technical documents related to Project Mogul and some of the other work that you and Dr. Spilhaus and others have done with the Constant Altitude balloon projects. According to Dr. Spilhaus, he said you would be the technical expert as it related to those types of projects in terms of the materials involved, the instrumentation, that sort of thing. Is that a pretty accurate statement?

A: I think that's correct.

Q: What we're really here for is to discuss this that came out in the newspaper and the General Accounting Office's investigation of how we deal with records, the acquisition, and ultimately disposition. There is an allegation that the Government is involved in a conspiracy and coverup of something that occurred in 1947, which is the allegation of their being some sort of flying disk, flying saucer, UFO, what have you.

A: That's correct.

Q: Of course the people who put out things such as this journal, MUFON, Mutual UFO Network, the books that have been written by William Moore, and Randall Schmidt, and others, a lot of the popular television shows, they've just exacerbated the situation where a lot of things, quotations, some of your quotations taken out of context. One of the individuals, Sheridan Cavitt, who at that time was a Counter-Intelligence Corps officer at [Roswell] Army Airfield who actually went out with Jesse Marcel to recover some material that has been alleged to be the results of a UFO which Colonel Cavitt specifically states looked like a weather balloon to him.

A: I'm aware that he had been there, but I'd understood that other quotations had been attributed to him.

Q: Yes, sir. As we go through this, I believe I've got a copy of essentially a statement he made to Colonel Weaver, whom

you've talked with also. Colonel Weaver talked with Sheridan Cavitt two weeks ago. So a lot of the statements that have been attributed to Sheridan Cavitt, he says they're taken out of context. He refutes a lot of the information that appears in these various books.

What I'd like to do, even though this is out of a popular UFO type of magazine, is there are some statements attributed to individuals concerning the material that was found, supposedly by Mac Brazel, somewhere northwest of Roswell, New Mexico. They talk in terms of materials that look like metallic foil, and specifically that "could not be bent or broken."

As we've gone through the various research, what we believe to be Project Mogul was probably involved in this incident. The materials that were being used in Mogul included, of course, not only the polyethylene balloons, but included the neoprene balloons at some point, the various types of radar reflectors, the instrumentation that was being used. Is there any type of material from that project that you can think of that would be pliable, would be bendable, but could not be torn? Could any of the polyethylene or the foil-like radar reflectors, could that be the case?

A: Let me get a picture for you. This is a radar reflector manufactured in 1953. It's the ML-307C.

Q: Which is a little different from the B model that was used in 1947?

A: Where this looks like a pine stick, the material on the ones we had, this was all balsa and somewhat smaller in diameter, but the configuration, with one exception... This configuration of corners, these corners were the same thing. Here's a picture of this sort of target being used in 1948, and you can see we are launching multiple targets beneath this balloon.

Q: Is this the same type of target as this, or is this the B model?

A: This is the B model we flew in 1947 and 1948. Those are pictures of the B model. If you look, faintly along here you can see a sort of a discoloration, and that's where my memory of the reinforcing tape was that they talked about. The B models, as I remember, did not have these three vanes up here. You don't see particularly any suggestion in other photographs I have, I don't remember these which would make the thing rotate in flight.

But this, in the B models was more like an aluminum foil with a heavy laminated paper. So the material they talk about, I think, was derived from some version of this.

Q: They talk in terms of the material, being able to crumple it and releasing it, and it would unfold by itself and

not leave any creases. This material looks like it would almost be like aluminum foil, would crease and remain creased.

A: It does have this paper laminate, and the paper, I think, was maybe a bit tougher on the earlier thing. But I have no explanation for the fact that it couldn't be bent with a sledge hammer, as one of the people said, and couldn't be...

Q: Burned?

A: I think some of the balsa wood was dipped in something like Elmer's glue, and as a result had some sort of a glue coating on it which would make it somewhat resistant to burning.

Q: I know in Colonel Weaver's discussions with Sheridan Cavitt, they talked about the aspect of burning. He did not recall burning anything, but then his wife indicated that there had been one night they'd been out and had a barbecue and had a few beers and that Jesse Marcel just took a piece and stuck it in the barbecue and then pulled it back out. So if that's what they're using to say it wouldn't burn, that's what we consider typically testing a material for burning or not.

A: I need to say here, you need to qualify everything I say with the memory of almost 50 years ago. I will say things that are to the best of my memory, but on the other hand, should other evidence indicate my memory is faulty, I readily accept that. So I'll state things to the best of my memory, but...

I have a memory that there was something like Elmer's glue... There was a problem in attaching this to the paper behind.

Q: Going back to the reinforcing tape and things, there were discussions concerning unusual symbols and almost like hieroglyphics -- purple, pinkish in nature, that sort of thing.

A: I don't know if I sent Colonel Weaver a copy of the sketch.

Q: No, we did not see that.

A: Robert Todd, who has been a person very interested in trying to get to the truth of this, asked me to make a sketch of what I remember. A couple of years ago, or a year or so ago, I made this sketch, and this is my memory of what was there.

I do remember every time I prepared one of these targets for flight, I always wondered why these figures were on the tape. There was always a question of why they were there. When this purplish-pink marking on the debris came up, I immediately remembered this sort of marking. Other people, I have a letter here from one of my technicians, who says oddly he remembers the same marking. You, perhaps, have talked to Albert Trakowski...

Q: We have tried to reach Colonel Trakowski, and he has not returned our calls. We've left messages on his answering machine, and there's been no response.

A: He may be out of town. I did visit him last October, and he made the point that... He was our project officer. He and I served together under Colonel Duffy in the Air Force Liaison Office in 1943 to... Well, I went overseas in '44 but Trakowski stayed and took a commission in the Air Force when it was offered and was the project officer on Mogul. I have some paperwork here from General LeMay's files in which after the war a number of people were to be sent overseas because they had not had overseas duty. There is a history of Colonel Trakowski. Perhaps you have it from the Pentagon files already, from the AG files.

Q: We have some records, yes.

A: Anyway, Albert Trakowski was the Watson Laboratory project officer on this. When I raised this question to him he said he had talked to John Peterson, one of Colonel Duffy's procurement men, and they were joking about these markings on the tape. I have a letter that I can give you a copy of in which I quote Trakowski in saying, "What do you expect when you have your targets made by a toy factory in Manhattan?"

Q: So essentially, the original targets were made by a toy company?

A: Well, it's either a toy company or a garment manufacturer in the garment district in Manhattan, or it was by a novelty company. I talked to Ed Istvan who was another one of the Air Force liaison office people who stayed in. Istvan lives in your area. I can give you documentation on these things. Istvan says that it was some outfit that extruded toothpaste tubes and he got involved with them because they made radar chaff. In the early days of this effort, there were a number of different targets made. I don't have them here, I have them downstairs, there were a number of different forms the targets were made. One idea was just the inside of a meteorological balloon, to put radar chaff and adhere it with glycerine. Just wet the inside of the balloon with glycerine and then shake in dipoles cut to the proper half wave length. When the balloons were inflated, these would be all on the inside, coating the inside of the balloon. This didn't give nearly the sort of target that the corner reflector gave.

But anyway, Istvan initially went to New York hunting for a source of supply and came across a company.

(Pause)

A: ...much of which we can copy and make it easier for you. These are balloon fragments, things that held balloons [up] after they'd been exposed to the sun.

Q: Is this the neoprene type or the...

A: That's the neoprene type. I have the polyethylene type...

Q: Is this from the '47 era?

A: That's a balloon probably from the '50s. That's a K-San balloon. The kind of balloons we used then were the (inaudible) derricks balloons, and that's the way they look after they've been out in the sun. That's about three weeks' exposure to sunlight here in New Mexico.

Q: So the polyethylene really is degraded by sunlight.

A: That's neoprene. All that's neoprene.

Q: This almost looks like ashes of paper.

A: That's right. And there's a big point in some of the recovery that the material was black...

Here is the list of the people who were assigned under Colonel Duffy in the Air Force liaison office. Istvan's name you'll find in there. He ended up being in the Titan program and, I think, retired as a lieutenant colonel maybe back in the '70s.

Schneider was the administrative director of our project. He and I worked together. He was in Maine, and was not really technically involved. I have letters from him if you're interested in seeing them. He says he has no memory of this.

A person who was heavily involved in developing this whole radar thing was Colonel Joe Fletcher. I wrote him a letter asking for his help and he essentially says he doesn't remember much.

Q: He's also been hounded by some of these UFO...

A: And by Todd and by me.

Q: So it appears as though you, yourself, have done some extensive research into this particular incident.

A: Until two years ago, I was quite convinced one of our polyethylene balloons we didn't recover caused it. Then I got this newspaper, Todd sent me this, and I immediately saw there's no way that could be a polyethylene balloon.

Q: W.W. Brazel mentions eyelets which appear in the reflectors. There's also, on the polyethylene balloons, the shroud however you had it hooked on there. There's eyelets around the base. There was a ring at the neck of the balloon and then there were attach points to that ring, were there not?

A: But there were no eyelets.

Q: I believe there were. I've reviewed the New York University documents and there's a very clear depiction in one of them of eyelets.

A: Okay, I was thinking of the later... Here are the NYU reports, the originals of them.

Q: In one of the configurations they clearly show eyelets in the drawing.

Q: Going back to Brazel, you state that you think it could not be one of the polyethylene balloons. He indicates in this newspaper article that he actually found the debris in mid-June, however it didn't subsequently come out until July.

A: You're right. That is in one of the polyethylene balloons, you're correct. I fall back on my plea that my memory isn't...

Q: It comes into depending on what Brazel was speaking about.

A: There are clearly eyelets here. In fact there's a little swivel.

He talks about the smoky gray rubber...

Q: Which these samples here, as you say, if they'd only been out for a short time, a matter of days, smoky gray, that's a very good description of what they looked like.

A: And when you first retrieve it has a bad odor. And people talked about there being a burned odor.

We need to talk about these neoprene balloons because they came in different... There were two manufacturers -- one, Dewey & Olney in Cambridge manufactured with a dip process and they had very much the appearance, if you will, of a condom. They were an ivory colored jell. The Kaysam company in Patterson made a cast neoprene emulsion into a mold, and then they inflated the mold. They had to put a lot of plasticizers so they could take this wet jell and inflate it and make it into a meteorologic balloon. This is a Kaysam balloon here, which I think is not a good candidate.

Q: Kaysam?

A: A guy named Sam Kay formed a company and it was called Kaysam. In fact I have, and you're welcome to them...

(Pause)

A: Kaysam balloons because of the way they were made, and this jell that had to be inflated had this ring, cardboard ring put in them. That's the neck of a Kaysam balloon, and here are more modern Kaysam balloons, the sort that are still being flown.

Q: These are just used for the typical meteorological type balloons.

A: Carry radio (inaudible), that's correct.

Dewey & Olney have gone out of the business and Kaysam bought them out. Here's a Kaysam balloon that is made by a dip mold. This is somewhat indicative, I think, of the way one of those balloons of the type we're using. As you can see on exposure just to ordinary light, they discolor. But these are balloons that were made probably in the '70s. As they change with plasticizer and anti-oxidants for ozone, they certainly change in appearance. The balloons we...

I have pictures here, pictures in the hangar. There, as you can see, these are the ivory colored balloons of the sort we were flying. This is the balloon you just found the eyelets on in the hangar. These are pictures from the 1947 era where we're getting ready to fly the 15 foot H.A. Smith balloon.

Q: The reinforcing tape on these balloons, these polyethylene balloons, we were told is a type of acetate. It had none of this symbology, is that correct?

A: None at all.

Q: So the symbology on the tape was only related to the radar reflectors.

A: That's correct. Here is a later model polyethylene balloon, and it's a little thinner than the ones we were flying, but there's a polyethylene balloon.

Q: It looks like polyethylene sheeting that I would use to cover up...

Q: I've also heard the early balloons described as carrot bag quality. Material they would use in a carrot bag. Dry cleaner bags.

Q: Dry cleaner bags. We think of them as being very fragile, but materials from this time frame have been described as durable -- something you couldn't tear with your hands.



A: That's about two mil polyethylene here.

Q: Obviously, you could tear this.

A: This was four mil. These balloons that we had... That's Flight 8. These are the little balloons here that are seen from the air.

Q: From a B-17?

A: I think this was a C-45. We did, indeed, have B-17's attached to us, and C-54's. But I think this was trying to chase Flight 8 down. This was one of the candidate flights that I thought might have been, until two years ago, I thought might have been an explanation for what occurred.

Q: Why did you change your mind at that point?

A: Because of that newspaper report right there.

Q: Because of him saying that he actually found the material in mid-June?

A: No, because he said it was balsa sticks and smoky rubber and had those curious markings on that. That's a very vivid memory I have of these markings on the radar targets we flew.

Q: You said you often wondered why those markings were on there. Had you ever resolved that for yourself?

A: Only what Albert Trakowski told me, that our friend John Peterson, the procurement man, was just joking, "What else do you expect when you have your targets made by a toy factory?"

Let me go back, if I may. Colonel Duffy was assigned to extract meteorological equipment out of the Signal Corps in 1943. There was a great argument that went on between the Army Air Force and the Signal Corps. The Signal Corps didn't want to let any meteorological equipment out until he thought it was perfect. At the same time, General Arnold was expanding for a global war, and was trying to get meteorological equipment all around the earth. So Colonel Duffy got assigned to expedite the equipment. As various of us graduated from the meteorological cadet schools, he took those of us with engineering backgrounds and assigned us to bird dog various things within the Signal Corps engineering laboratories. I got assigned to... I ended up with some appendicitis and got pulled off of an overseas shipment, and while I was recovering I got assigned to prepare this manual that Colonel Duffy, he was unhappy with the rate at which Signal manuals were coming out so he wanted a loose leaf arrangement to send things out. So I got assigned to prepare this manual.

At the same time, then Captain Fletcher was assigned... Duffy had heard that weather was giving trouble to radar, so Colonel Duffy just turned around and said, "Gee, you mean radar can pick up weather?" And ended up with Captain Fletcher being assigned to both convert this for looking at storm clouds and also to make wind measurements. There was a big problem, the Weather Bureau prior to World War II determined upper winds merely by releasing a pilot balloon, following with the (inaudible), and estimating the rate of rise, and then from the elevation and azimuth angles and the assumed height after a certain time, to calculate what the winds were.

Q: Is that the Boford Scale?

A: Well, Boford was Navy, that was the Navy...

Q: Like taking a Pi Ball reading now.

A: Exactly. It was called a Pi Ball then and it is now. Colonel Duffy pushed very heavily to get electronic means for measuring winds aloft. There were two approaches. One, use a radar target, and the SCR-584 with which you may be familiar -- the early gun-laying radar. Colonel Duffy talked to the field artillery that was procuring through the Signal Corps, gun-laying radar, the SCR-584, which is, that's this radar right here.

Q: We've seen that photo before.

A: This is Spilhaus's book. So Fletcher ended up with a whole bunch of his own 2nd lieutenants around. There was a Jud Tibbett from whom I have a photograph showing an earlier model target, the A Model target. Istvan was one. There are a bunch of them listed. This listing is for you if you'd like to have it.

Tibbetts ended up being the big installer of radar and, in fact, was assigned down to the Tulerosa Range Camp to make wind measurements for the Trinity shot, the test in 1945. As far as I know, that was the first time these targets had been used in New Mexico. Tibbetts, who until recently lived in Albuquerque, he's now moved to Scottsdale, Arizona. Tibbetts says that he did not ever fly this kind of target in New Mexico, which will be of interest with you when they talk about, that people should have known what a target looked like.

Q: Right. There were discussions concerning having radar targets, but supposedly the B Model and subsequent models were brand new, had never flown anything like that in this area.

A: According to Tibbetts, the A Model had bit aerodynamic drag. It was a flat plane of aluminum foil and had two triangles coming down that made a corner reflector. The A Model looked like... Then across here was that. This is one surface, this is another surface, and this is yet another, and they were held by

strings from these four corners. Obviously, trying to take something that's almost a meter in cross section, a meter on a side, take it sideways up through, gave a lot of drag, and it took a lot of lift to make the balloons rise very rapidly.

So instead, somebody came up with this smart idea of this other arrangement of a corner reflector that had much less drag. These, according to Tibbetts, weren't distributed until something like November of 1945. As far as I know, as you will see in the various correspondence, there were no SCR-584s which were required to track them, issued to the weather services here in New Mexico. Obviously, after the Trinity shot, there was no bit military operation that required wind determination in New Mexico.

Q: So essentially you'd say there were no radar reflectors in New Mexico until 1947 until this appeared?

A: That's my opinion.

Q: Was Major Pritchard doing any kind of balloon project?

A: No. He and Dyvad and others were at Watson Laboratories. I understand from Trakowski that Alamogordo Army Air Field was about to be closed down as surplus. The people at Watson Laboratories seized on it and were able to keep it on active status for two projects -- one, the radar project from Watson Laboratories that was set to track the V-2 being flown from the proving ground across the Tulerosa Valley; and Project Mogul.

I joined the NYU group in January of '47, and while I was finishing up at Georgia Tech I had talked to my chemical engineering professors, I'd already been recruited by Duffy and Spilhaus, and I asked if you wanted to make a balloon of non-extensible material, what plastic would you use. My professor named Grubb told me you ought to consider polyethylene. It's a new plastic just now becoming available. You can heat seal it. It has a lot of desirable properties.

So as soon as I got to NYU, I began talking to everybody I could find in Manhattan -- DuPont, all the sales offices...

Q: We saw your listing.

A: I was concerned with where we could get the plastic and who we could get to manufacture the balloons. I was in my 20's, just a recent graduate. I knew nothing about manufacturing. But we did try to get a manufacturing company that would fabricate balloons for us.

During that period we heard of the Navy project that was going on at General Mills where Jean Get was planning to make a flight to 100,000 feet. General Mills at that time was making

balloons out of a Goodyear film called pliofilm. It was a vinyl chloride that just went to hell when exposed to sunlight. It really came apart. So I'm very proud that we began pushing them for polyethylene balloons. With some difficulty we got Otto Winzen who was the entrepreneur and promoter, working with Get, and we got him to make these balloons you see here in the design that was being planned for Project Helios, with the pliofilm balloons. At the same time we got an entrepreneur who was even faster acting, and that was this fellow A.J. Smith. A one-man shop. He would do anything for money. He, indeed, did. With no great technical background, he made a number of these balloons for us.

Q: Kind of a garage type of affair where he would sit down and make them one by one and...

A: I don't know. He got some girls and got some assembly workers, for a contract from us. Anyway, we got these balloons going, made visits to Minneapolis to push General Mills. The pressure from the Air Force was enormous. There was a similar problem, of course, in developing microphones that would pick up low frequency sound waves with Columbia. There was much enthusiasm, in testing these microphones.

Q: How did you come to join the Army Air Force?

A: When World War II broke out I applied for pilot training, and so did everybody else. Because I was a senior at Georgia Tech in a chemical engineering course with a fair amount of thermodynamics and other things, I got diverted into the meteorological cadet program. I still wanted to be a pilot but I got diverted into the meteorological cadet program, and the next class that I could join didn't start until December of '42. I joined up sometime in '42. So I went through the meteorological cadet program and found I was a lousy forecaster, but I did end up, when Spilhaus came recruiting for people with engineering background, I got recruited into Colonel Duffy's liaison office.

Q: Was that directly for General Arnold's staff?

A: I was assigned, believe it or not, to Headquarters, Air Force... I still have the Headquarters Air Force [rondelles]. I ended up being assigned to Headquarters, Army Air Force. I was a second lieutenant.

Q: So you got recruited by, at that time, Captain Spilhaus.

A: Right, and I got sent to the Weather Equipment Technician School in Spring Lake, New Jersey, essentially Fort Monmouth. When I finished the training course for radiosonde and for maintenance of equipment, I was headed for North Africa, and I had a medical problem. When I got out of the hospital, I was assigned back to Colonel Duffy. I remained there. I finished

this manual in '44. I was commissioned in September of '43, finally, and then finished the school in November, was assigned to write this manual which was finished in the summer of '44, and then I got an assignment to China.

Q: With Dr. Spilhaus?

A: No. I ended up being the weather equipment officer for CBI and the Spilhaus came over later. At that time the war was going very much better. Spilhaus and Duffy had a long range storm detection system, the spheric system, the predecessor of what's used now for lightning detection, the storm scopes, and the LLP. If you're familiar with LLP, the lightning location system...

Q: Used by the Weather Service.

A: We have one of the stations here on campus. And we actually have, if you're interested later on we'll go over and show you, we have a map of the lightning strokes over the entire U.S. as they occur. We have a read-out right here in our laboratory.

Q: So you're doing that work from China?

A: Spilhaus came over with the spherics net, it was called, and got a station installed in Chianting, China to work, of course, for the bombing of Japan. So Spilhaus came over I think the summer of '45 is when he came over. We had the radio wind, the ra-win, the SCR-658s, we had a number of them that were being installed. We had one up in Yunan in the communist area; we had several of them in China for getting good wind measurements. Spilhaus had been involved in that. I think by '45 it was clear that things would be over relatively soon. We thought we'd be back in '48. In any event, he got an assignment over to 10th Weather in the summer of '45 and came over.

Q: At what point did you ever hear the term long range detection?

A: That's a good question. I didn't know the name Mogul until Robert Todd told me two years ago. I'd never heard the name Mogul -- the classification was that high. I knew what we were doing. When "Helgoland" was exploded in April of '47, we had balloons in the air. We launched balloons out of the Watson Laboratory, actually Eatontown, what had been the Eatontown Signal Laboratory, but I think it was now Watson Laboratory. In any event, we launched a string of balloons, even though we didn't have [constant-level] balloons, we still carried microphones aloft and a C-54 orbited overhead and followed the balloons out to sea. I have no idea about the results that they got.

Q: Did you number that balloon flight?

A: No, we didn't.

Q: Not a letter or a number?

A: Wait a minute. The answer is, I don't know.

Q: If you did give it a letter or a number would it be on... There are some of these flights that appeared to have no sequence number and they were talking in terms of being service flights and the impression that we got was that the service flights were either test flights just to check the balloons out or they were the highly classified flights where the information was not being logged into essentially an unclassified document.

A: You notice that Flight 1 was made from Bethlehem, Pennsylvania.

Q: The football field there?

A: LeHigh, exactly. That's where we did it, from the football field. And we did this because a professor at NYU had just gone to head up the physics department at LeHigh and he invited us over. His name was Frank, Butler keeps coming to mind, but I'm not sure that's the right name. Anyway, we went there and that was for an early, early attempt for Helgoland. I think the Helgoland explosion got scrubbed, but we had balloons in the air from this and we were woefully not ready. We had all sorts of problems. We adopted the balloon technique that a cosmic ray investigator at NYU, a fellow named Sergei Korf, we adopted his technique and we had a lot to learn. We got our hands torn up with nylon line being pulled through it as we couldn't hold the balloons down in the wind...

Q: Speaking of nylon line, were these braided type lines or were they monofilament type lines?

A: Neither. I think initially we used either parachute cord, which was braided. I don't remember the details of what we used, but we rapidly used that the radiosonde cord we used was not strong enough at all to hold the forces that came, so we went to what was called lobster twine. We used a lot of lobster twine that was twisted, a laid line that was used in lobster nets.

Q: Do you recall there ever having been some sort of monofilament similar to the monofilament fishing line in any of the projects?

A: I think there was none available at that time. My memory, the answer is yes, we've used an awful lot of monofilament and we use it now all the time.

Q: But at that time you don't think it was available?

A: I think it was not available.

Q: The early nylon line, would it have degraded, such as the balloon material degraded, and maybe fused in the hot sun?

A: I doubt it. If we had any it would have been white, which would have been a high (inaudible), would not have absorbed a lot of sunlight.

Q: There were discussions about what appeared to be unbraided or unstranded fiber type lines. It's been alluded to that was the precursors to what we use for fiber optics today. The materials that were found. That's why I asked about the monofilament line.

A: A lot of what we used early was a linen cord, not twisted, and it was indeed, a brown, a dull brown color. But because it was designed just for radiosonde balloons, and we rapidly exceeded its strength. So very quickly, and I don't know when, but we very quickly went over to this twisted lobster twine.

To answer your question, there are three flights that are missing here -- two, three, and four. I've identified Flight 4. Flight 4 was a flight we made, and you don't have it there, but Flight 4 we made in Alamogordo something like June 2nd or 3rd of 1947. The reason I have it identified is I have Albert Crary's diary. The scientific end of the group was heavily based from Columbia University. It was Dr. James Peoples who was an employee of Watson Laboratory, and there was an Albert Crary who had been a graduate student under Dr. Ewing.

Q: Who later also was an employee of...

A: Who was then an employee of Watson Laboratory. I have Crary's diary. Here is a translation...

(END OF SIDE)

A: ...Here is the diary starting May 24, '47, and on May 28 he has "B-17 from Watson with Mirs, Hackman, NYU and Alden, they plan to test fly balloons tomorrow. Other gang with recording equipment due to leave Watson Laboratories Saturday. Got everything ready for Hermes Rocket today."

May 29th. "Mirs and Hackman got balloon ascension off at 1:00 p.m. today without plane to follow it. Don and Godby out to Donyo. Bill and I out to E. White Sands to record Hermes."

I've marked the key things here with red, and then I've given you a page without my red if you have any need for that.

June 1st, "C-47 with Moore, Schneider and others from NYU, also Irewin, Minton, Olson, NYU men worked on balloons, north hangar."

June 4th, "Out to Tulerosa Range and fired charges between 0-0 and 0-6" something. "No balloon flight again on account of clouds. Flew regular sonobuoy mike with cluster balloons and had good luck with receiver on ground but poor on plane." I think that's Flight 4 right there.

Q: So that's June 4th.

A: As to that flight made by Mirs and Hackman earlier, we have no record of it here in the NYU summary.

Q: If he flew that on June 4th and it carried the microphones, the radar reflectors, that would have been with a neoprene type balloon.

A: There were no plastic balloons delivered until the 28th or 29th of June that year. So everything as evidenced on the Helgeland flight that we made and the other flight, they were all meteorological balloons prior to late June.

Q: That would have also had the B Model reflector, this type of reflector, but the B Model?

A: My memory is that Jim Peoples, because we were being sent down by B-17 and by air, didn't let us take the radiosonde receiving equipment which at that time was very heavy. It was like a 500 pound rack with a receiver, frequency meter, recorder, etc., and we weren't allowed to use that. Instead, the idea was that Peoples would provide tracking on the balloons with radar targets and so on. So this is where I think the radar targets come in. If you look in these reports you'll find here statements, radiosonde reception, and you'll see 60 percent with recorder, 50 percent without recorder, 100 percent without recorder for June 5th. A hundred percent without recorder.

So I think we tried the radar targets, as I remember, our contact who was a Captain Larry Dyvad found that they weren't able to track our flights at all. They had a radar that was entirely aimed at looking at the missiles. To look at slow moving balloons with poor signal return was difficult for them. So we started off with making single target flights. I think we went to multiple target flights, and still didn't have any success, so I began putting radiosondes and then just audibly, as the tones would change, I would log it on a piece of paper. I'd count the pressure... Are you familiar with radiosondes?

Q: Somewhat.

A: The commutator with the pressure contacts, etc. I would count contacts and record it and you'll see in some of these flight reports, there's two different interpretations possible, depending on what the contact sequence was. An ordinary radiosonde is very good for something that's going one way. But for something that's going to go up and float, you can



have ambiguities. You don't know if it went up or down when you get the next pressure contact switch. You'll find that sort of uncertainty in describing the report.

So I'm quite sure that as a result of the failure of the radar tracking, I went back and started using radiosondes even though I didn't have the right equipment.

Q: You mentioned a few moments ago the Watson Laboratory gear, the microphones, and it was also Columbia that was developing the low frequency microphones. You had all of that gear on these balloons, is that correct?

A: No, not on all of them. That mention of a sonobuoy microphone, in the early... While the improved low frequency microphones were being designed and built, we flew on balloons, believe it or not, sonobuoy used to detect submarines. We were flying sonobuoy microphones on the balloons.

Q: But the material that's been identified as Watson Lab gear shows up as very generic in all of these reports and things. That was all part of Mogul also, is that correct?

A: That's correct. I think what happened is because the Watson Laboratory radar wasn't very successful, I think we made a number of flights like this. I think I sent a sketch like that to you. We made a number of flights like that which was an unorthodox use of radar targets, and it's my opinion that the thing that caused the debris that was picked up was probably from a cluster of meteorological balloons carrying a cluster of targets.

When something like the idea of a cluster balloon was not only to carry the weight, but was also to keep the target in the air for a long time. If one balloon burst, we still would have enough buoyancy for awhile to keep the thing airborne. When it would come to the ground this would drag along the ground and get shredded, but this would still be carried downwind until another balloon would burst, whereupon this one would start getting shredded. So I think the explanation of why things were over such a large area was, indeed, because it was a cluster, it was multiple targets and cluster balloons.

Q: Of course the issue of the large area has been different in different reports. Different people have stated the 200 yards, Cavitt in his description, described it in terms of his living room which was not that large.

A: Even a single target, if it came down, wouldn't have filled a single living room, but a multiple target, begins dragged sideways and then blown transversally by any later winds, could have filled a reasonable area.

Q: And left pieces of debris everywhere. Depending on...

A: What the wind did.

The description that Brazel gives here that everything would weigh about five pounds when it was all together, is more than you would have gotten from a single balloon.

Q: Those were measured in terms of 300 to 500 grams or something like that?

A: Three hundred and fifty only. At that time we didn't have any bigger balloons than 350 grams, so the balloons would have been 350 grams.

Q: About one pound.

A: Correct. And the targets are nominally maybe a quarter of a pound.

Q: Those targets are only four to five ounces?

A: Here was the specification spelled out for it. Approximate weight, 100 grams. These, as I say, are somewhat heavier than the ones we had.

Q: You indicated that the balsa wood was coated with some sort of glue such as Elmer's glue.

A: That's my memory. It wasn't completely coated. Some of it was and some of it wasn't.

Q: Some of the balsa wood is fairly dense, as far as being durable, and one of the descriptions concerning this "wood-like" material was that you couldn't dent it with your fingernail. So if you have a fairly dense balsa wood coated with a glue, it may be quite possible that a person would not be able to put their fingernail in it.

A: That's correct. It's my memory that the reflective material was more aluminum foil than here. These are second or third iteration targets, as evidenced by this picture, wherever that picture is down in here of the 1948 flight. It certainly looks more aluminum-foil like.

Q: What year were you discharged from active duty?

A: '46.

Q: Before you left active duty, while you were still working with Duffy and Spilhaus, did they invite you to join the staff at New York University, or to continue your studies there?

A: I came back from overseas and was assigned to Colonel Duffy's, he had a little flight detachment assigned to him with a B-29 and a B-25 and some other aircraft. I ended up being the

executive officer of a flight detachment at Newark Airport. I got back from overseas in February of '46, I think. After getting out of the replacement depot, I got assigned back to Colonel Duffy and was assigned at Newark. I went on terminal leave something like July of '46 and went back to Georgia Tech and finished two quarters. I had two quarters to finish at Georgia Tech. While I was at Georgia Tech I began working with a microwave, an anonymous propagation research group that turned out, oddly enough, was under Colonel Duffy's direction. I didn't know it. It had nothing to do with my getting deployed there, but I had a student assistanceship working on that.

I made some report, and my name came back in front of Colonel Duffy in September, I think, of '46, and I got asked to come up to his office. I think he was still at Bradley Beach, Sharp River Hills Hotel there near Belmar, New Jersey. When I was there, who should come in but Spilhaus. They told me they had a problem involving balloons and asked if I would be interested in working with them, and they offered me a graduate assistanceship at NYU, and I wanted to go to graduate school in physics, so I was delighted to have that opportunity. That was either September or October of '46.

Q: So Spilhaus, since he was on the staff there, he invited you to come to New York University.

A: Yes, he did.

Q: So you went to New York University when?

A: Right after Christmas. January 1, 1947. The program had already started. I presume you have all the details. I have a copy of (inaudible) letter to General Spaatz. I presume you have all of that.

Q: I believe we do, but I'd still like to review it and make sure it's the same letter.

A: In any event, there was a big push. I guess after Operation Crossroads the first nuclear test in the Pacific was in July of '46, and Crary, because of the long range detection concept, Crary was sent to Ascension Island which is the antipode for, as close as they could get to the antipode for Bikini, and failed to detect any signal from Operation Crossroads, from the nuclear explosion.

Q: You mentioned detection. What drove the aspect of detection? Was it because of our test?

A: Yes, our test was being used as a signal source. The question was in order to detect any Soviet test, could we detect our own tests. So Crary was essentially sent to Ascension to see if he could detect the nuclear explosion.

Q: He was unsuccessful?

A: He was unsuccessful.

Q: What method did he employ?

A: Low frequency microphones on the ground. Are you familiar with the Krakatou measurements?

Q: No.

A: In 1883, Krakatou, near Java, made an enormous explosion and the pressure wave from that went around the world seven times, and was picked up and... There was a report, a big analysis by Lord Railey and others...

Q: A volcanic eruption?

A: Volcanic eruption. Here are the isocomes of the pressure waves from Krakatou as it went out. From the time it took the signal to go out and come back, he went to the antipode which is around Colombia or Venezuela, and came back as a big spherical wave. It went back and forth around the earth. The British investigators were able to show that there was a duct up around the tropopause, and the speed of sound, as I remember, was something like 310 meters per second instead of the regular 334 that we had at sea level. From that they could deduce the temperature of the medium in which the sound was propagating and it was something like minus 25.

Q: How was this detected as a pressure wave in that time frame?

A: Barograph.

Q: What year?

A: 1883. This is what prompted Ewing.

Q: I'm familiar with barometer-type measurements being used to measure that pressure wave and the fact that it traversed the earth, you said seven times.

A: Maurice Ewing had been an oceanographer at Woods Hole and had found a similar acoustic duct in the ocean. You may be familiar with what's called Sofar. In 1945 he wrote a letter to Spaatz suggesting this might be useful in detection of Soviet activity.

Q: The 1945 letter was kind of the initiative as a means of detection.

A: That's correct. That caused the Army Air Force to begin this research.

Q: How did you come in possession of it?

A: Todd. Todd does everything.

Q: Did he say where he got these documents?

A: Freedom of Information, I think.

Q: It looks like National Archives. I believe I have this letter.

So Ewing was at Woods Hole...

A: And was going to head up the geophysics department at Columbia. These are subsequent documents of people in the Air Force considering the desirability of it.

After Crossroads there seemed to be an enormous push to try to put microphones into the sound channel. During WWII, the Signal Corps had laid on them the requirement to develop a constant level balloon. It had not been very successful. I knew a bunch of people in the balloon branch.

The reason I got into balloons is that while I was working on this manual there was a great problem in the winter of '43 with the supply of gum rubber cut off, meteorological sounding balloons weren't flying very well. In the summer time, the balloons would go through the depth of the troposphere, but in the winter time, the balloons began bursting down at levels of 15,000 feet or so because the neoprene wouldn't stretch at low temperatures. Somewhere Spilhaus came up with the idea, talked to somebody in the Weather Bureau, that maybe you ought to heat the balloons. He told a couple of us second lieutenants, that I wonder if that would work. We got a blow torch and a mop bucket and we had a radiosonde, and he was in charge of the Air Force push on radiosonde technology. I was his leg man on that. We put a blow torch on a mop bucket and heated the water to boiling and flew the balloon. Much to our surprise, the balloon went to about 60,000 feet.

Q: So it stretched without rupturing.

A: It turns out that neoprene crystallizes and you can make it back into an amorphous state with high elasticity. Elasticity changes as a function of the degree of crystallinity. By heating, we removed that.

In any event, there was a group in Spilhaus's detachment known as the balloon [boilers]. The Signal Corps, it turned out, was very unhappy with this idea. They wanted no interest in it at all, and their manual doesn't use it. But that was my introduction, that's how I got attached to ballooning, as a result of doing this simple thing for Spilhaus.

It's of interest, in the Holloman report there's a big talk about boiling balloons. That's certainly a heritage of the association from our early balloon boiling days. When you look at the instructions on the modern balloon, you see that it is really a physical effect that can be controlled.

Q: You went on board at New York University, and you immediately set out, as documented in the reports, acquiring the various materials, [putting out bids], things of this nature. At that point you were working at New York University under the direction...

A: Spilhaus was the nominal principal investigator and director of the project, but he just turned us loose.

Q: So you were the project engineer?

A: I was the project engineer, and Schneider was the project administrator. We employed a lot of students, a lot of people that we could, and were a mixture of trying to develop a constant level balloon and providing service flights for Peoples. Peoples was entirely our contact.

Q: He would come to New York University?

A: He would go down to Red Bank. He'd call and say he wanted certain things, can you do it, so we made this flight out at Lehigh and then we made the Helgoland flight down at Red Bank, and he wasn't really happy. There were all sorts of constraints flying balloons in the New York City area even then.

Q: All the problems with air traffic and getting FAA, or their equivalent at that time, approval, etc.

A: So up in the stratosphere above my level, a decision was made that we go to Alamogordo, and there would be a big flight. We had balloons promised, but even ahead of that time people wanted to test microphones. He had Crary already, about from December of '46, I think Crary went to Alamogordo and ran a field station and...

Q: That field station was for ballooning in general?

A: For Mogul. It was more than that. Crary was operating sound-ranging microphones on the ground there. He was having bombs dropped off the New Jersey coast and trying to pick up the acoustic signals in New Mexico.

Q: He was having the bombs dropped in New Jersey, off the coast, and trying to detect them in New Mexico?

A: That's correct.

Q: What technique? Balloon borne?

A: No. We were the balloonists. This was all ground-based stuff. There was also an operation in Bermuda. Then later you'll find...

Q: Crary also initiated that?

A: He was in charge of it. He was running it. They went and got a whole bunch of 500 pound bombs out of the Earl Ammunition Depot in New Jersey. Later you'll find that they did a bunch down in the Canal zone. Then eventually they went to Alaska.

Q: This was prior to '47?

A: The New Jersey, and I think the Bermuda operation, you'll find a hint in this diary I gave you, you'll find a hint about Bermuda and so on in there. He was talking about trying to measure the sky waves coming in.

If you're interested, we can go extract, there's a paper in the Journal of Meteorology in something like '47.

Q: I believe I have that. Is that the same one?

A: No, this is by Crary.

Q: Crary did quite a few publications for Red Bank and then for Cambridge Labs.

A: Correct. But you'll find one, I think it's either '74 or '49. If you want we can go over to our library and make you a xerox of it.

Q: I'm familiar with that one.

A: It's very circumspect as far as classified matter.

Q: So Peoples and Crary had Columbia University affiliation?

A: Well, Watson. They were derived from Columbia. Both of them were derived... I think Peoples got his PhD under Ewing at Columbia, and Crary didn't get his doctorate until later.

Q: You said Crary's ground station was Alamagordo, but he was actually doing explosions in Alaska, off Bermuda, Panama, the Jersey coast.

A: In the late '46, early '47 era, he was in Alamagordo, in and around Alamagordo. He was very concerned about explosions off the Jersey coast and I think off Bermuda. The Panama Canal operation I think was not associated with Alamagordo at that time.

Here's a nice paper that came through courtesy of Todd. In '48 there was a big operation in the Pacific for Operation Sandstone, and we were heavily involved in that. Here's the Fitzwilliam... Schneider and J.R. Smith... My chief associate technically was a fellow named Dick Smith, James Richard Smith, who unfortunately, died two years ago. Smith and Schneider and some other of my associates went out on Sandstone to Kwajelin, Guam, and then Oahu.

Q: I've seen that in publication. I have to acquire it.

A: You can xerox it.

Q: Moving chronologically, Professor Ewing had affiliation with Woods Hole, and he was a meteorologist by trade?

A: No, oceanographer. He was a physicist, a geophysicist.

Q: What was he doing at Columbia?

A: I think he ended up head of the Department of Geophysics. I don't know the details.

Q: For the AMC contract he was developing...

A: He, as we, were contractors.

Q: He was developing the acoustical...

A: That's correct.

Q: That acoustical gear, this is a later flight but it's a fairly good depiction. It shows payload here, and payload is mentioned in a lot of the reports without any further elaboration, what the payload was. That was primarily the low frequency microphones...

A: That was their euphemism for...

Q: So as not to be able to talk about what was then a classified payload.

A: Here are the sort of instruments. A chamber with a leak in it, and then a method of sensing the pressure inside the chamber. That affected the frequency of an oscillator that came to ground. That's the sort of thing that was developed at Columbia.

Q: Dr. Spilhaus also mentioned about trying to detect particulate matter.

A: That was another operation. A Tracer lab, have you come across Charlie Ziegler at Brandeis?



Q: No.

A: He worked for a Tracer lab and is just bringing out a book on the early detection system.

Q: That was Project Center. MX-968.

A: There was another one that followed on this to measure krypton. It was called Grab Bag in our lexicon.

Q: Did you ever hear of the project Bequeath?

A: No. Being a civilian and outside, I was more knowledgeable, essentially, of the intent and what was required rather than the project names.

Q: What type of clearance did you hold?

A: At various times I had Top Secret and Q and I don't remember exactly when I got various clearances. I also had a clearance with the CIA.

Q: So at this time in New York University you were cleared but you had no need to know.

A: I knew exactly what we were doing. I knew about Helgoland. I knew, just being an atmospheric physicist, I knew about the sound duct channel and I knew what we were doing, but I just didn't know any of the operational details and I wasn't concerned with them.

Q: From a security standpoint, did anyone ever discuss with you, other than the letter that I showed you stating that this is now unclassified, did anyone ever tell you never to discuss any of this with anyone?

A: I can't say they did.

Q: It was just a matter of enforcing the need to know what classified project...

A: I guess I was aware this was highly classified, and having been in the military was aware this wasn't something to be discussed lightly. But no, I can't say that...

Q: The reason I ask the question is there are some statements made in the various publications and books -- the popular press, about people being threatened not to talk about things they had seen or that sort of thing. I just wanted to see if there had been anything stated to you never to discuss any of the activities either related to this project or any other project.

A: There's a gray area here. I was certainly aware that what we were doing in Alamogordo was highly classified and was well aware, and I guess had been perhaps encouraged to have a suitable cover story to explain what we were doing.

Q: So you were encouraged by whom to have a cover story?

A: Probably by James Peoples, who was our scientific monitoring... As you may be aware, there is a former colonel, later General DuBose, who makes a statement that something was a cover story. When I read this, I was not at all surprised. I interpreted that as saying someone was covering up on Mogul. That was my interpretation when I read what was attributable to General DuBose. So from his point of view, there were certainly no threats, but we were aware we weren't supposed to be talking.

Q: So was it Dr. Peoples then who actually actively said use meteorology as a cover story, or...

A: I don't remember the details, to be truthful...

Q: But it was kind of a natural thing to think of in terms of meteorology?

A: We were careful around NYU with the various technicians we hired. We kept our knowledge of what we were doing to ourselves. It's certainly my memory that we were aware that this was classified, but we weren't threatened. We were just instructed that this sort of information was not to be passed out, even though the technical aspects we understood. So the answer is yes, we very well understood this was classified; and second, there was no physical threat or anything like that. We were instructed not to talk about it, and until Todd told me that Mogul had been declassified I was very reluctant to say anything about it.

Q: Anywhere in the early days were you ever aware of involvement by General LeMay?

A: Not at all.

Q: Not at your level. How about the [AFOAT-1] study group?

A: I became involved with them later on Project Grab Bag and others, and I knew a bunch of people in [AFOAT-1] -- Doyle Northrop... I knew that, but later ballooning got even more heavily involved in various classified things.

Q: Where were your duty locations involved with [AFOAT-1]?

A: Probably at General Mills.

Q: Not ever in Washington?

A: Oh, yeah. I visited people in Washington.

Q: Just for the record, Major Marcel later worked at [AFOAT-1]. Do you recognize him at all?

A: Not at all. The people I was involved with were civilian scientists. If we looked at a list of people at Northrop, Doyle Northrop sort of sticks in my mind, and there are other names I've seen related to that. Yeah, I knew that guy, but I never knew Marcel.

Q: So you went, moving into Mogul, you did go on the June and July field trips.

A: I ran them.

Q: How many did you go on? All of them?

A: I didn't go to the one in the Pacific. If you look at the planning on the Project Fitzwilliam, my name was listed as the person as being there. Then suddenly, I'm not. What happened, my people got taken away from me and I had to recruit brand new people to help me fly balloons into Alamogordo during the April and May 1948 operations. So I had new personnel, and we went up and down the Rio Grande Valley trying to launch balloons so they would pass over the ground stations at Alamogordo.

Q: During that early period, before you had your full complement of various types of balloons, did you ever use any of the Japanese balloons? We were given the impression there were at least a few of the Japanese balloons made available.

A: I got very interested in the Japanese balloons and communicate, and I have pieces of the Japanese balloon downstairs if you're interested in seeing a piece of it. And I've got translations. I met the chief of the Central Meteorological Office, a Dr. Wadati, and he put me in contact, so I have extensive files on the Japanese balloons.

Q: But were any of those used as precursors to Mogul or...

A: None whatsoever. That was part of a promotion that... When I went to General Mills, Winzen who had been the great entrepreneur, had gotten fired. He'd gotten caught in a prevarication about whether or not the Navy was going to provide money. He was replaced by a fellow named Frank Jewitt. Jewitt recruited me out of graduate school. We really promoted balloons. That's part of the balloon promotion.

Q: None of the Japanese balloons were actually used as far as a precursor to Mogul or anything like that.

A: That is absolutely correct.

Q: But you had them available for study, but you didn't launch them.

A: No, they didn't have any.

Q: In the New York University report it says that you were provided two Japanese balloons.

A: That's interesting, because I have no memory of them whatsoever. Spilhaus may have. But I have no memory that I ever saw them. In the spirit of being given proper scientific credit, in the paper that you have, the Journal of Meteorology Paper, we, heavily written by Spilhaus, credited the Japanese with doing, with their trans-Pacific flights. So what we were doing certainly was based, came after what they had done, and we didn't want to take credit away from them. But I'm told that on my own, completely free from this, I talked with Wadati and others on a Japanese balloon. I've never seen a Japanese balloon that I know of, I've never seen the payload, but I do have fragments of the Mulberry Favor.

Frankly, we did not depend on the Japanese balloons. The Japanese just preceded us. But we didn't pattern what we were trying to do on what the Japanese did. After all, they had opaque balloons, and my belief from the beginning is balloons ought to be transparent so they don't absorb sunlight so at sunset you don't have the cooling and the ballasting. So we owe nothing to the Japanese other than the fact they were ahead of us.

Q: You went on these field trips. When you left, getting back to the cover story, you were the project engineer. Did people come to you and say you need to put something together in case one of these things falls in somebody's hands?

You didn't.

Did you brief your people, your personnel, when they were there, that they if should go into town for food or something if someone says "Why are you there?"...

A: We were certainly secretive and not talkative, but at the same time...

Q: In other words, was there a developed cover story where everyone got together, discussed what you were going to say or not say concerning the various activities that were going on at Alamagordo and other locations?

A: That's a good question. I have no memory of such a thing. I'm just aware that we were under very strong stricture not to encourage speculation on what we were doing.

Q: So is that pretty much maybe a condition of hiring? I notice you used a lot of former military people. Did you just tell them at the outset, "This is a classified project for AMC?" Or were they not read on to the project at all?

A: By and large, people thought we were flying balloons for the Air Force.

Q: As far as they were concerned they were just launching meteorological balloons?

A: That's correct.

Q: They didn't particularly quiz you about the microphone you hung in there or...

A: No.

Q: The balloons that you did launch for Project Mogul and some of the other test balloons, without the actual instrument packages, did they have reward tags, "Return to New York University," or "Return to Roswell Army Air Field," or to Alamogordo Army Air Field or anything like that?

A: The ones that we wanted to get back, which were the test constant level balloons and the ones that had microphones on them, by and large, they did have NYU reward tags on them.

Q: Dr. Peoples, whoever was directing you, was there ever any concern voiced that this is a top secret object we're sending into the atmosphere and we're not sure where it's going to come to earth. Did they ever express any problem with that, that wherever it came down, it came down?

A: I think the argument was that when it came down, it would be mixed in with our other gear, and it was just part of a flight that was to be recovered by NYU. He thought nobody would interpret what those sorts of instruments would be.

Q: So the tags were kind of generic, like a meteorological tag, say. "This consists of meteorological instruments..."

A: "This is a research balloon flown by New York University..."

Q: Were you doing other research? When you went to New Mexico was there another agenda other than the top secret project?

A: None whatsoever. Our whole life revolved around the NYU constant level balloon project. We were developing constant level balloons, and the service flights for Peoples just sort of got hidden in that.

Q: The service flights were which ones?

A: The ones carrying the microphones.

Q: So specifically that term was used for the microphone flights from...

A: That's right. You'll notice when you look at this, that the flights out in the Pacific don't even get mentioned. There's just no report on the flights in the Pacific, and the flights in '48 that we made for Sandstone, there are some flight numbers recorded, but there are no details at all provided.

Q: That was Grab Bag?

A: No, Grab Bag was to grab stratospheric air to measure the krypton 85...

Q: Essentially particulate detection and gaseous...

A: That was gaseous. The particulate was, I think we were less involved in grabbing particulates. There have been thousands of flights made, and certain people did carry cascade impactors and other things, but that was a minor part of what we did, whereas Grab Bag was a very measure effort.

Q: That was in '48?

A: That was more '50 odd.

Q: Was that Fitzwilliam?

A: No, Fitzwilliam was entirely acoustic detection. Again, very long range detection. Fitzwilliam was spring of '48. There were various code names, and thanks to our friend Todd, I've learned about the code name got termed Black Heart and a whole bunch of odd names...

Q: Black Heart, Rock Fish. He may be wrong on that part. He may be right, but...

A: I heard Mogul got converted into Rock Fish. But I heard the detection part of Fitzwilliam ended up being called Black Heart.

Q: He may be in error on that.

A: As I say, I'd been much more concerned with the technical aspects than the military operations.

Q: This is one of the technical reports and it's talking about the various flights, and this is the report that lists all of the numbered flights and it talks about, it says, "Excluded are the flights made to test," it's technical report number one,

"Excluded are those two tests' special gear in launches which were not successful."

A: Right.

Q: So the special gear that's referred to here is the microphone gear?

A: Yes, sir.

Q: There's another passage that talks about the intelligence gear. Was that considered also...

A: Did we make such a faux pas as that?

Q: It's in there.

Q: I have the classification letter from July of '46. You might want to review this. Maybe your friend has shown that to you.

A: No, I've never seen this.

Trakowski argued that even the name Mogul was classified, and he said it had the same classification as the Manhattan Project had, which surprises me, because in various reports that Todd has sent me, such as the monthly progress reports from the people at later Holloman Air Force Base, Mogul appears in things that are no higher classification than confidential, but Trakowski insists that Mogul was super classified.

(END OF SIDE)

Q: This is a copy of the letter you wrote to Colonel Weaver. One of the things that you talk about in this letter was that the radar test flights were not reported, which is exactly what we were discussing a moment ago in your kitchen. Would you go over again what you just described as far as this particular test flight that occurred? What we just went through in there.

A: As I said initially, the essence in trying to develop constant level balloons, we needed to know what the altitude was. At the same time, we were under a lot of pressure to carry the test microphones for the Watson Laboratory and Columbia people. We got into an operation at Alamogordo in early June of 1947, in which we were required to make flights in which the tracking of the flights would be provided by the Watson Laboratory Radar that was already in place at Alamogordo for tracking the V-2s and other rockets the Ordnance Corps people were flying over at White Sands. So we came down to fly balloons in early June, in which the tracking of the flights was to be done by radar, tracking corner reflector targets, which I think we brought with us. I don't have any evidence of this.

Q: So you made your plan in New York to fly... Your primary research was the acoustical detect...

A: That's correct.

Q: Secondary was refining the technique of constant level balloons.

A: And that was on hold until we got the delivery of the polyethylene balloon that was scheduled for the end of June. So the first of June we came, really, just for the test flight of microphones, doing service flights for Watson Laboratories.

Q: To fly the balloons in association with...

A: To fly meteorological balloons, tracked by a Watson Lab radar on the ML-307B targets that I think we brought with us.

Q: And you launched these balloons in conjunction with V-2 firings?

A: Those went independently. Albert Crary was monitoring the V-2 firings.

Q: That was with the ground microphones?

A: You're right, I beg your pardon. As you'll find in the diary, that we launched Flight 8, these cluster balloons, we launched those at 3:00 o'clock in the morning for a V-2 firing. You're quite right. I'd forgotten that. We launched those in the morning, then the rocket got scrubbed while Flight 8 was in the air, and we were out of plastic balloons that day in early July -- this is jumping ahead to early July -- and we inflated meteorological balloons for the delayed firing of the V-2 rocket on the afternoon of July 3rd, you'll see. Then there was an accident over at White Sands and the V-2 got scrubbed a second time. What was Flight 9, we launched Flight 9, as you will see in here, as a dummy flight, and it probably had radar targets on it.

Let me just read this. This is Crary's summary for the week of 30 June-5 July 1947. "Balloon tests 7, 8, 9, and 10 off this week. Test 7 slated for July 1 postponed to July 2nd because equipment not ready. A hundred tanks with helium obtained from Amarillo Monday evening. Trakowski went over in a C-54 and picked them up. Also radiosonde receivers set up by NYU but sonobuoy not operable. Test 7 at dawn, July 2nd, with Pi Ball. One hour, first falling with the autolights. Winds were very light, and balloons up between base and mountains most of the time. Included a cluster of met balloons, followed by C-54 several hours, and finally landed in mountains near road, south cloudcroft. Before gear could be recovered, most of it had been stolen. Station operating in north hangar, Cloudcroft and Roswell. Shots made repeatedly at Site 4 and picked up goods



from north hangar and from Cloudcroft for awhile. Nothing from Roswell.

"On Thursday morning, July 3rd, a cluster of GM plastic balloons sent up for V-2 recording, but V-2 not fired. No shots fired. Balloons up for some time."

Q: What is a shot?

A: Explosive on the ground.

Q: You were doing explosives on the ground in New Mexico too?

A: Crary.

Q: So Crary would give you the signal, he'd say at 0400 I'm going to launch a balloon, and at 0500 I'm going to...

A: No, he wouldn't launch a balloon. I'd launch a balloon. What Peoples would do is say I want a flight up tomorrow morning. So the NYU group would get ready to make a flight, and then Crary would go out with his crew and fire explosives up and down the Tulerosa Basin while our balloons were in the air.

Q: So you had multiple explosions on the ground, the V-2...

A: And explosions on the East Coast.

Q: On the East Coast, Caribbean, and you had those timed so you knew when those were going to take place and you were simply waiting for...

A: They had them timed and we balloon types just fit into the schedule. But the master, the timing, bringing all this together, we knew nothing about. We were just scheduled to fly balloons.

Q: But you did want to launch early morning for the light winds.

A: We did want to launch early in the morning for light wind. We had freedom to tell them what we could do and what we couldn't do. We actually on this, in addition to everything else, we actually flew blocks of TNT on free balloons and fired them while we had other balloons in the air.

Q: Did those have radar targets on them also?

A: Probably.

Q: Were those detonated by...

A: By a pressure switch.

Q: Were those tracked? Was there some sort of log that would tell you where those particular balloons were? You wouldn't want to just release TNT to float anywhere, would you?

A: They wouldn't float. The balloons would just go up until they burst. And we were on the edge of the restricted area. So the answer is yes, we did.

I'll have to get back to this. The radar tracking turned out to be abysmally poor. I don't know why, but they were abysmally poor. That's why I got off onto this part of it. And when you asked me the V-2 question...

Let me finish this, and then we'll get back to what you asked.

"Thursday morning, cluster of GM balloons sent out, V-2 not fired, no shots fired. Balloons up for some time, no recording. Pi Ball showed no West winds. Balloons picked up by radar, WS." I presume that means White Sands. You'll find this hard... and hunted by somebody's name I couldn't get. It looks like Maryalls' "C-54, located on Tulerosa Range by air. Out PM with several NYU men by weapons carrier, but we never located it. Rocket postponed until 7:30 p.m. Thursday night," which was the third. "But on last minute before balloon went up, V-2 was called off on of accident at White Sands. Sent up cluster balloons with dummy load. Balloon Flight 10 on dawn, July 5th, had gone out with C-54, again with Moses and Dufeld to hunt for Flight 8 but not sure was found then."

Then I added a note here, "Flight 8 was never recovered."

"C-54 went to El Paso July 4th and picked up single smith plastic balloon and GM cluster plastic balloons."

So the answer is yes. We did try to coordinate the balloon launchings for the V-2 firings, and Crary would also take that as a time of opportunity to go out on the desert and fire TNT. He had vast stocks of explosives available to him.

Q: Was that primarily on the White Sands range, or did he go out into other areas, say Northwest of Roswell? Did he contract with any of the ranchers to use these locales, other than the actual missile range itself?

A: I think all the explosions he made were coordinated with the White Sands Proving Ground people. Alamagordo Airfield, later Holloman, was just on the fringe of the proving ground at that time. Crary sent his men to all sorts of places -- over to Roswell, to Artesia, to Hagerman, up and down the Pecos River area. He had a place you'll read about, Fabians, Texas, which turns out to be just down the Rio Grande from El Paso, maybe 50

miles. Then he had Don Edmondson went to Silver City frequently. Then he had some place he called Donna, Las Cruces is in Donna Anna County, but I don't know where his Donna site was. But I think he had microphones scattered all around in central New Mexico and West Texas. But the explosions were all created either on the White Sands Proving Ground, or there were V-2 rockets, or they were things coming from...

I won't take the time now, but he talks about cruises, which apparently are, maybe they were cruisers firing off the Jersey coast.

We got off into this, we were talking about tracking, and we went down to, in early June, to make service flights which were to be tracked by radar, and the radar was unsuccessful. It's my memory that we made a number of flights just to test out the radar. These would not have had a reward tag on them. These were throw away flights. Once a target like this comes down from high altitude or drag, you don't want it back. It's my memory we didn't want to have anything traced back to us, if we weren't going to go out and pick it up.

Q: So you just kind of let the material lie wherever it fell?

A: We shot a balloon into the air and didn't want to do any more. There are some pictures of our going out to recover things. On one of the early flights we went out east of Roswell, and I remember beyond the Bottomless Lakes, going out in oil well country, picking up one of our flights that had come down. We aggressively tried to recover our own flights.

Q: So were you directed to that location by aircraft?

A: By the aircraft.

Q: Did they give you a lat and long, landmark?

A: We talked to them by radio. The transmitters on these microphones were so low powered that, believe it or not, they had B-17s just orbiting under our balloons with receivers aboard the aircraft, and we, of course, would talk to the aircraft, and they'd tell us when things would come down. So it was a coordinated operation.

Q: So you had explosions or V-2 going through. So the aircraft had recording devices. You had the acoustical pickup on the balloon and the aircraft had the recording device that would record the sounds.

A: That's correct. Would record the signal from the balloon.

Q: In what media was it recorded on?

A: Brush recorders. [Strip charge] recorders feeding out at high speed. You'll see in here, you'll see the sort of records.

Q: The graphic representation.

A: The recorders looked like that.

Q: So that was recorded on the aircraft and then...

A: That's correct. As you'll see, they said they had receivers at Roswell, at Alamogordo, and they had them on the airplane.

Q: But most of the detection was via the aircraft because of the low power receivers.

A: Most of the reception, the detection, was really... The balloon received the acoustics, and sent it down by radio to the aircraft. It often didn't work. That was the reason why for Operation Sandstone in April and May of '48, we went up and down the Rio Grande Valley... Here are some of the pictures. There's a ground cloth for the balloon to be laid out. There's a balloon being inflated, just getting ready. So we tried to get up wind.

That's a device from White Sands that was picked up around Carazoso and was reported in to us, and we thought it was one of ours. So I took a weapons carrier and drove up there. We were aggressively trying to recover our equipment and that just happened to be something that was on the ground. The technician that had been in that group, remember the [Marginal] tape, Herbert Crow. That's a picture he took when we were aggressively trying to recover a load. That turned out not to be ours.

Q: What is it, and who did it belong to?

A: It probably was flown on a rocket or by Marcus O'Day who was the chief scientist at Watson Laboratory. Dr. O'Day. You'll see, when you read the Duffy thing, where Duffy thinks maybe there were things that were flown by Dr. O'Day. Anyway, that just happens to be a picture in the collection of NYU photographs.

Q: So there were a lot of other people flying balloons or launching...

A: Not balloons. We were the only balloon flyers. That came down by parachute. But there were a lot of rockets being flown in the early days there, and a lot of high altitude aircraft. Duffy says there were dropsondes.

Q: So it could be that some of the material found may not have been associated with a balloon. It is possible it could have been some other type of material. But the description that

Brazel gives the impression that it is the smoky rubber of a balloon that's been in the sunlight.

A: That's circumstantial. That fits exactly with what would have been done, and orthodox use of radar targets would not have produced what he found. But you're quite right, there's debris that was reported to us that...

Q: ...some sort of cylindrical instrument, though, that's obviously an instrument package of some sort.

A: It had a plexiglass, it looked like maybe it had a UV sensor. There was some optical equipment under the plexiglass dome that was shattered...

Q: You're familiar with the popular literature about the various crash sites. There's one crash site, two crash sites, three crash sites and all that craziness?

A: Yes.

Q: What I'm thinking is we may have two incidents here, where they collected your debris from your radar targets, and then there may have been another something else not related to a balloon.

A: There could have been other things from White Sands. This was on the edge of the proving ground. There's a story behind this, and that is that a rancher, whose land had been taken from him to form the proving ground, had cattle that were still on what had been his land. He had found this while he was looking for his cattle, I can show you on the map if you're interested. Anyway, he called in to Alamogordo about this. So I went up to see if it was one of our missing balloons. While we were there, a range security guard came on the rancher and really castigated him for breaking the law, coming back onto the range. So this was really on the range. It would be hard for me to understand how the sort of operations, which I knew, could have fallen as far away as these other sites you talk about. This was really on the northeast corner of the range, just west of the town of Carazoso.

Q: So that's not too far from here.

A: Here's the northeast corner. [Looking on map] Right on this road, right about there is where that load there was found. Here is where the Brazel finding was, just north of this bend of the road here, and there's Roswell.

Q: You're talking in terms of sites around Corona and in that vicinity. So it's quite possible that there had been other types of debris from the proving ground or...

A: As I say, I find it hard to think that something... While we may have been flying TNT on balloons and being very carefree about it, I really doubt that a thing of any military significance would have fallen this far away from the proving ground. It could have, but...

Q: Other than your balloons.

A: Oh yeah, those first flights we didn't even coordinate with CAA. Peoples was so eager to go get those measurements, that these were going to be flown from a restricted area and he didn't worry about it. We later, before the Civil Air Board in El Paso, but that was two or three months later.

Q: When you went on the field trips, what was the chain of command at that point when you arrived? Who did you report to?

A: We were somewhat self contained, but we got housing provided by, I guess Crary was our contact, if you will. Some way or another, barracks were made available for us to live in at Alamogordo.

Q: Would anyone at Roswell Army Air Field have known about your activities, what your purpose was?

A: Not at all. In fact, we went over and tried to get into the weather station at Roswell and because of the atomic bomb security of the 509th, as I remember, we couldn't even get on the base. We drove up in a weapons carrier to the Roswell Army Air Field, and tried to get on the base because we wanted to go to the weather station, wanted to see if we could put a radiosonde receiver there. As I remember we got turned away.

Q: But you ultimately did put a radiosonde receiver there.

A: In a motel. We just worked out of motels in Roswell.

Q: I thought I saw you had a radiosonde receiver on Roswell Army Air Field.

A: Again, forgive my memory, but I do remember being turned away. But if you can find it, I'd be glad to have my memory refreshed.

Q: I saw that you had a copy of the 509th Bomb Group history. In the 509th Bomb Group history from September I saw a meeting where Dr. Peoples met with LTC Joe Briley, 830th Bomb Squadron Commander, 509th Air Group Roswell. Do you know why Dr. Peoples would meet with the squadron commander of a B-29 outfit?

A: Only if he wanted to get in to put a receiver on the base there. That would be my guess. We had a big operation. We went back to Alamogordo in September. We had our first 20 foot

diameter General Mills balloons. We had a very successful set of balloon launches in Alamogordo in September of '47. My only guess is trying to have a down-wind receiving station.

Q: There are some other names mentioned that I can't recall.

Q: What about then Colonel Blanchard and General Ramey? Do you think they may have had any knowledge of what your ultimate purpose was?

A: I think not. I want to say something about Colonel J.D. Ryan. He was Chief of Staff of the Air Force later, but "Dr. Peoples, Murray Hackman, and First Lieutenant Thompson from Air Material Command, were out at the field to inspect Air Material Command installations and to confer with LTC Briley."

Well, well. Hackman was one of our radiosonde operators. There's Colonel John D. Ryan right there. That's interesting.

On the morning of this famous press release, July 8th, in The Roswell Daily Dispatch, there is a statement about a flying disc being identified, and Colonel J.D. Ryan who is on the staff of 8th Air Force said that the Air Force was now using radar targets to measure winds aloft in some stations.

I find that of interest because apparently in reading some of the various things that happened in General Ramey's office, apparently someone that afternoon did think this was a radar target that had been brought in. But the Roswell morning paper clearly showed that there was a knowledgeable person in Fort Worth.

Q: Is that in the article, the 8 July article, that Ryan made the statement?

A: Yes. Maybe not the article you're talking about.

Q: Is this the one that William Haut...

A: No, this is that morning, not that afternoon. (Pause to look for clipping) There's Newt Goldenberg, you mentioned him earlier in one of our conversations. That's one of our altitude controls.

Here's the morning paper, "Report flying disc found." Down here is about Colonel J.D. Ryan, and he mentioned the existence of radar wind measuring equipment in the Air Force. If you want a copy of that...

Q: Then there's, subsequently, no mention of the radar targets until General Ramey discusses it on the 9th, talking about the material being a balloon.

A: On the afternoon of the 8th. It may have been published on the 9th, but...

Q: You're right. Evening of the 8th. Examination by the Army revealed last night, a high altitude weather balloon. General Ramey, Commander, 8th Air Forces, cleared up the mystery.

A: In these pictures here, don't show these flaps. This, I think, is my step ladder that I used to reach high targets, when we have these big balloon trains going way up in the air. Here again, is an unorthodox use of radar targets. We did that, and as far as I know, other people didn't.

Q: Did you ever use radar targets with the polyethylene balloons?

A: Yes, sir. In fact somewhere I have a picture where we flew a missile, we launched a missile for O&R Special Devices Center in 1949. I have a picture showing the targets up and down the balloon train there.

Q: Do you remember trying to pin down some of these flights that could possibly cause this misunderstanding? You talk about putting a target with the neoprene balloons, but at that time you also launched them with the polyethylene?

A: This picture I showed you right here. This is a polyethylene balloon.

Q: So you used a visual by the aircraft to watch the balloon? It would circle underneath.

A: The aircraft circling underneath were really to pick up the microphone signals. That was part of the Watson Lab operation. Our operation, we depended on radiosons and where we could get radar tracking for tracking air balloons. But the aircraft operation here was entirely to support Project Mogul. We didn't consider ourselves Mogul because I didn't even know the name.

Q: The summary of flights...

A: That's one of the flights with the mixed interpretations because of the radiosondes.

Q: In one column it says "tracking percent." Then sometimes it will say by aircraft.

A: That's true.

Q: So "aircraft observation", was that a visual observation or an electronic?



A: That's really saying did we have aircraft on it or not, and what percentage. Here the B-17 was on it for 40 percent of the time. Indeed, that was the aircraft tracking for the Mogul operation.

Q: That was for the electronic data gathering.

A: That's correct.

Q: Not observing the balloon to tell you where it went down.

A: That's right. Well, we did have the aircraft stay as long as we could. As long as we could end up with that very expensive aircraft chasing an air balloon, we were happy. On the flight that came down east of Roswell on one of these, Flight 5 or so on came down east of Roswell, the aircraft spotted it on the ground for us and told us where to go to look for it.

Q: About 17 miles east of Roswell.

A: Then we had another one, Flight 11...

Q: That's the one that appears to come down northwest of Roswell.

A: Correct.

Q: It appears to have almost come down exactly where they're talking about.

A: That's right.

Q: That's the one where you provided a depiction to Colonel Weaver.

Q: No, that's another one.

Q: That's an earlier one, that's right.

A: Where is that old NYU report? (Pause)

Here it is right here. More or less due west of Walker, Roswell Army Air Field.

Q: Then this graphic conflicts with this graphic, which shows Number 11 coming down... Is that circle the Roswell reporting station?

A: That's about right.

Q: Is this circle a weather reporting station which would be Roswell?

A: You're right.

Q: This has it coming down northwest.

A: What's the origin of this?

Q: It's in the back of one of the reports.

A: It looks to me like it may have been out of this report.

Q: Not every report had this graphic depiction like this which was number eight.

(Pause to look through documents)

A: With those numbers it wouldn't have been in that first report because these flights were much later.

Q: Technical Report No. 1.

A: Right. And Flight 58 and 55 aren't going to be in that early report. They occurred after that report was written.

(Pause)

A: I would say what was in that first report is more accurate than this. This, I think, occurred after I left NYU. It's a general summary. Flight 11 was a very important flight. They got very important data on it -- Crary and Peoples.

Q: Spilhaus based his article from Journal of Meteorology on it.

A: Right, and he wrote a paper in the bulletin. The fact that the balloon trajectory has this hook in it when it went over the mountain ridge...

Q: That's obviously the [ano-cyclonic] winds aloft.

A: Exactly. So he and Bernard Harwitz were very excited about the fact that the balloon at nominal constant level, had a change in direction when the air was forced over the mountain barrier, and they published a special paper on that. So everybody was happy with this flight.

As soon as that flight was made, that was the 7th, and we went home on the 8th.

Q: That would be the reason why there would be no one there in the area who could explain this debris that was brought in. There were no experts there who dealt with this particular type of material or radar reflectors.

A: There was really no contact, at that time, as far as I know, between Peoples and Roswell, and there's no way Roswell, other than my memory of getting turned away by the MPs at the gate, there's no way that the people at Roswell would have known what was going on over at Alamagordo. When we sent people to Roswell, Hackman worked out of a motel to receive.

So the more puzzling thing in line with what you say comes from Crary's diary. Here's what Crary's diary says: "Alamagordo. Balloon Flight 11A, off at 5:07. Big plastic balloon with small auxiliary plastics," etc. "Watson Lab and gear." "Followed" (inaudible) "receiver until about 11. Picked up on radiosonde receiver at Roswell then followed. Then came down. At 10,000 feet, cap should have punctured plastic. Then it came down near Highway 70, between Roswell and Tulerosa.

"Second balloon, met balloons with radiosonde up about 6:30. Third balloon with two and a half pound stick of TNT and cap set by pressure element set to fire at 35,000 feet, up at 6:20."

Q: What day is that again?

A: July 7th.

"Surface bombing at Site 4 from 5:45 to 8:45 at 15 minute intervals. (Inaudible) followed main receiver only three-quarters of an hour, but followed radiosonde about three hours. Thirty-five thousand food implosion? off about 6:55. Vivian got instructions for completing work on Flights 1 to 30 and packed all records and photo. Sent off TWX regarding Bermuda flight and wrote up memo on it. Worked with Eileen on April 1st rocket plotting HD5 HT SST, whatever [that is]."

July 8th. "C-54 off about 10:30 with 23 people, all NYU, Watson Lab including Vivian, Eileen," and somebody else. I can't tell. "Lieutenant Thompson, Edmondson, Reynolds and myself left. Wrote a report on East Coast flights for Peoples."

Here's 9 July, the time this occurred at Alamagordo. "Worked today on balloon flight. Studied Watson Lab records of them briefly and wrote memorandum to Peoples about results. Left in car this PM later. Flat tire between Roswell and Tulerosa, and stayed there."

July 10th. "Changed tire and went into Roswell. Bought new tire. Off to El Rino, Oklahoma today. Stopped in cafe in Hereford, Texas and met Danny Hard from UGC. Went up to office and saw Bob Cowden, somebody in charge, and supervisor."

That's the end of it. So there's no hint that Crary was involved in any coverup such as this clearly is. This is a coverup right here because they talk about our operations, they talk about our balloons we thought went to Colorado, and they all claim it to be part of Pritchard's radar operation.

Q: But he wasn't launching balloons.

A: He wasn't launching balloons.

Q: So where did they get the equipment to take this picture? Did you leave equipment behind?

A: This is right outside of the hangar.

Q: Those are your people?

A: It's our equipment and my stepladder.

Q: Did you leave equipment there?

A: Yes. Everything

Q: Because you expected to return.

A: We were just going back...

Q: It looked pretty tricky. How did they know how to do that?

A: I just don't know anything about the hierarchy above us. I do know that I worked carefully with a guy named Larry Dyvad, a pilot, who later became a private pilot, running a fixed base operation in Alamogordo, and got killed 20 years ago. But I know I worked with Larry Dyvad whose name you'll see here. I don't remember Pritchard at all, but Dyvad was my contact with the radar. I know they didn't have balloons or anything else, yet they talk about boiling balloons there.

Q: So when you returned in September, did you see that somebody had tampered with your equipment and used up some of your balloons?

A: If it did, it didn't ring a bell.

Q: And no one mentioned it to you. No one said hey, look, we had to do something while you were gone.

A: I think we were just some ignorant, little innocent graduate student contractors on a military base, and things were going on that we didn't know anything about.

Q: So no one approached you to say they had used some of your equipment?

A: Not at all.

Q: This photo that's depicted here in the July 10th Alamogordo News, this could have been taken during one of your actual launches versus...

A: I think not, because they say, the whole article is this was a demonstration. I would have thought, since Crary was a senior person and he and Peoples, Peoples was our contact with the base. But other than Dyvad, we had no real contact with anyone I remember. I do remember being very disappointed with the radar.

Q: If this were a demonstration sometime on the 9th or 10th of July, prior to this being published, they talk in terms here of these radar reflectors. These particular radar reflectors, as having labels on them. The radar reflectors you were using, did they have any type of labels talking about being property of U.S. Army, or Watson Laboratories?

A: None that I know of. We were strongly encouraged not to mix in the Air Force with what we did. Everything we did had an NYU label. I may be able to dig back in my file somewhere...

Q: So they may have had an NYU label on it. Even the service ones.

A: On service, but on radar test flights, there's no way we would have put a label on.

Q: Those were just shakedown flights. You were just saying hey, what's going to work best to get the data, so let's use some of the equipment we have and see what works, so you'd have someone on the radar and say yeah, this configuration works, this one doesn't. That's what you were doing. Then later on you refined your technique...

A: What we would do is we would put up things and they'd come back and say it didn't work. So we'd scratch our heads and do something else. But we were running that end of the balloon end of the operation. Nobody else was flying balloons around us. There may have been a radiosonde operation out over White Sands, but there was not one, as far as I know, at either Roswell or Alamogordo. If there had, I would have used them because we were using standard AMQ-1...

Q: But you did coordinate with Big Spring, Texas.

A: Did we?

Q: It's in the report, saying you guys, when you came back to New Jersey, you were sending thank you letters to various organizations that helped you while you were in the field. Big Springs, Texas; some other places that you had coordinated with.

A: Thank you...

Q: The New York University reports are very voluminous. There are three big bound volumes. I have the originals with your signature.

A: You're making my point, that there probably wasn't any other nearby radiosonde station for us to receive things. I'd forgotten all about Big Springs, but I'm sure we made every effort we could to get radiosonde reception.

Q: Can you think of, just in general, any other explanation for what became the so-called Roswell incident, other than what we've discussed here as far as potentially your balloon project, which at that time was a very secretive project. Is there any other explanation you can think of?

A: No, and the particulars of this case are sufficiently nearly unique, that I think no one else had anything that could have fit into providing these results. No, we were doing something that was unorthodox, using targets that, as far as I know, had not been flown before in New Mexico. There's no way that the rancher could have ever seen one. And there's no way that either Major Marcel nor General Ramey or General Ramey's people could have come up with providing a radar to substitute for the real debris. I think there's a very high likelihood that the unusual things we were doing provided this debris.

However, all the other stuff that's in, and a lot of the material, I can't explain bodies or material that can't be [folded] by a sledge hammer.

Q: Let's dwell on the bodies just for a second here. It turns out that during this time frame, 1947, 1948, 1949, there were numerous aircraft accidents, a lot of fatal aircraft accidents, in this general vicinity. Did you all ever come across any of those?

A: No, sir.

(END OF SIDE)

Q: There was an accident that took place right out of Roswell, a B-29, two B-29 accidents that resulted in fatal crashes. We were wondering if maybe over time people were beginning to think in terms of those fatal accidents, which essentially scattered body parts, small parts, over areas, where people were getting confused with what occurred in those aircraft accidents with the sensationalism of this UFO story.

A: As I said in my letter, all of us went back to NYU on the 8th of July and we heard about that afternoon, and we just thought it was one of our balloons. All of us that were in that group have held onto that view for a long time. I do have Crow's letter here. He apparently joined us for that Operation Sandstone pickup crew in '48, but he knew that we knew that we

thought the Roswell incident, so-called, was caused by one of our balloons.

Q: Did anyone ever mention it to you once you returned? Did any of the Red Bank folks mention it to you, or even in passing, or told you that maybe you'd better tighten up your procedures or anything of that nature, or a memo?

A: I have no memory. I do think that Peoples had the idea that it was one of our balloons, and it wasn't a matter of tightening up our procedures, it was just one of our balloons we couldn't recover. As you'll see looking at Crary's diary, there was no frantic effort to recover the earlier flights, even though they had microphones on them. I read to you one about some equipment had been stolen by the time we got there. As you can see in the diary, there's no record that there was any major problem.

Q: So even though the equipment was taken, there was no shroud of secrecy, the MPs didn't come out and close down the area or anything of this sort.

A: No, not at all.

Q: It was just expected in the normal course of research. Expendable equipment.

A: Expendable equipment.

Q: And you had no fear that it was going to be taken by enemy agents or...

A: No, the biggest fear was the thought of loose talking, and we just didn't talk about the purpose of this. We certainly did talk a lot about our balloons, and there was just no security or no concern. We were flying constant level balloons.

Q: For pressure and temperature...

A: For meteorological trajectories. A lot of interest in trajectories.

One thing I should mention is that after I had visited from William Moore around '80 or '81, I wrote Ro Peoples and at that time Jim Peoples was in the Geology Department at the University of Kansas. I wrote him and got a letter back from Ro Peoples saying that he had died. So I wrote her back and said there was considerable interest still in this Roswell incident, and did he ever get called out... I do know that on occasion he got involved in classified things and left us. I asked her did he ever talk to her about anything regarding this debris that had been recovered. Her letter, which I perhaps can find somewhere, was the fact that no, he thought that flying saucers were a bunch of hoey, and he had a very low opinion of people who believed in

flying saucers. I did get a letter back from Ro to the response that he had not been, as far as she knew, he had not been involved in any classified identification of something. That had occurred to me that things could have gone on that I had no need to know. I tried to extract that.

Q: So you had no recollection or strong recollection of him, when you got back to New Jersey, discussing it. It caused a lot of fuss.

A: I'm really surprised at this newspaper story because implicit in this is the idea that someone provided a good cover for us, and yet Crary's diary doesn't show that he was involved in it, and I wasn't aware that my contact, Dyvad, was privy enough to our operations to have carried this out. So this is a bit of a mystery to me.

Q: What would you speculate, how would someone, just circumstances, coincidences, or intentional?

A: It's very clear that it was intentional, and there was a better security operation going on than I appreciated at the time. That would be my assessment.

Q: So you believe that someone was privy to your activities...

A: Trakowski was there. I had forgotten, but he reminded me that he had gone on the C-54 to pick up the helium at Amarillo. I asked Trakowski had he been involved in manufacturing a cover story. He kept saying how important Mogul was, how highly classified it was, and how he was really wheeling and dealing. He apparently went down to Fort Bliss, to the commanding general there -- I guess he was a captain at the time -- and had no trouble talking the general into releasing something like maybe several hundred 500 pound bombs for this. At the same time, Trakowski has no memory of a coverup.

Q: He didn't have participation.

A: Whether he was on that C-54 that had 23 people on it or not, I don't know. Crary's list of the people left, there was only one military type, a Lieutenant Thompson, in what you have here.

Q: Who did you report to?

A: Peoples.

Q: Then getting back to talking about quarters and things like that, did you have to go introduce yourself to the commanding officer at the base, or...



A: That's the surprising thing. As far as I know we just never interfaced with the military.

Q: Where were you actually operating from?

A: We operated out of the north area of Alamagordo Army Air Field. This hangar right here, which was a big wooden hangar, on the south side of the ramp in the north area.

Q: That was arranged by Peoples?

A: Crary was already resident there when we had arrived.

Q: That's right. He arrived first to establish the ground stations first.

A: Correct. As you'll see in this, he was already firing explosive for the GR-6, the various sound-ranging microphones.

Q: Did he have a cover story for those ground explosions and the microphones?

A: I don't know. There were very few enlisted men on the airfield. As Trakowski said, it was about to be closed. There was a motor pool, because in the stuff Todd has dug up, there were a bunch of weapons carriers being requisitioned. We certainly had some brand new, good ground transportation that was just turned over to us. We civilians were driving weapons carriers to carry helium around, and to go into town to get meals, etc.

Q: So you operated from Alamagordo Army Air Field. You did not operate out of White Sands.

A: That is correct.

Q: There is a difference.

A: A very strong schism between the ordnance people across the valley 50-odd miles at the proving ground, and the skeleton group at Alamagordo Army Air Field.

Q: So there weren't many people at Alamagordo.

A: Correct. The main people I have a memory of were the people operating what sticks in my mind as either C-5 or an M-5 radar. I knew the Signal Corps designation, the SCR-584s and 270-s, etc., but this was some new radar that had a bigger dish on it and was on the north side of the ramp. It would have been... This is looking toward the south. You can see here, those are some old abandoned, those were barracks used to handle air crew during training of World War II. They were all closed and dusty and we didn't use them. We were in barracks down somewhere on the main base. But we were just in an enlisted

men's barracks down on the main base and there was a mess hall that we ate lunch in, ate our meals. We were up at odd hours, as you can see, these 3:00 o'clock launchings.

Q: Who did Alamagordo report to? You indicated it was Fort Bliss?

A: No. There was a commanding officer, and I'm not sure which command he was in, but the people in the north area were all, if you will, tenants. We didn't use that word, but we were all associated, one way or another with Watson Labs.

Q: So Trakowski then, his reporting chain was...

A: His reporting chain was Watson Lab to Colonel Duffy.

Q: There was no real interface, Trakowski had no real interface with the Alamagordo people or anyone else around 8th Air Force.

A: There were some fancy orders that gave him a position to talk to the commanding officer and get what he wanted, to arrange what he wanted on the basis of orders out of Headquarters Army Air Force.

Q: While you were operating, doing your procedure, did it take a security monitor type person or security officer to come by and just say I wanted to see how you were...

A: No interface at all.

Q: You don't remember any strangers poking around or....

A: No, just absolutely nothing. We were just a little bunch of civilians there on an almost deserted base, doing what we wanted.

Q: Going back to the orders that you mentioned, were these some sort of special orders different from what we would typically see as military orders?

A: You'll have to talk to Trakowski on it, but my opinion is that he had orders that came from a fairly high level that introduced him and let him do what he wanted to. As the research changed, he didn't have to go back and get new orders. He was in the position of doing what Cray and Peoples wanted.

Q: Like Jim and I have blanket orders that say we're authorized to go anywhere, essentially, in the world; but was there anything specific in those orders that said provide all assistance requested...

A: I suspect so. I too, have had such general orders -- do as someone may deem necessary. In fact I have a copy of my

1944 orders that say such things here. But you'll have to talk to Trakowski. My feeling is that he and Peoples provided the interface to the base and we just weren't bothered. We never saw anybody in security. There was certainly nobody keeping us secure. If anything, we were keeping ourselves secure.

Q: These are the pictures taken in General Ramey's office, 8th Air Force Headquarters by a news photographer of the Fort Worth Star Telegram. It's four pictures that show various people with some equipment, and I'd just like to know what you believe that equipment to be.

A: Joe Fletcher has written your friend Todd, and said there's no question that's a target. The only question is that there are people who allege this is a target that's been substituted for the real debris, and there are also stories where Marchelle said the picture in which he appears are the real stuff, etc. That looks very much like our radar targets. And you'll notice that this does look more aluminum foilish than what I have here. It's my memory that there was good, bright, aluminum metal foil, not painted stuff on the targets we were using. That looks like more than one target to me in the various pictures. That looks like the stuff we were flying.

Q: I think they talked in terms of being a rawin target in this book.

A: It's just radio wind. There are two kinds of radio winds -- the 400 megacycle transmitters tracked by the SCR-658, the old bed springs; and then the radar wind. Ray Win is the right way to say it.

Q: So the rawin would be a radar target that most of the officers and the weather people there would have been associated with, they would have some knowledge of?

A: Not really. As I say, these came out right at the end of the war. The warrant officer, I have a letter that he wrote Todd, I don't know if you've seen it...

(Pause)

Q: We've got this thing narrowed down to just a few flights. There couldn't have been... Due to your time frame, when you were there, the rancher went on the record of saying he picked it up the 14th or the 15th.

A: The 14th.

Q: So it would have to be in the June field trip, early in June. You had several service flights but you also had, you called them experimental flights. The experimental flights with the testing...

A: The ones in early June were all service flights. In other words, all flights we were making for Peoples, and we had some radar test flights.

Q: So to go with the June 14th date, what type of flight do you think would have...

A: All the balloons launched in that period would have been meteorological balloons, 350 gram meteorological balloons, some of them with radar targets just to test the radar out and some of them, I'd forgotten all about it, but Crary's diary says we had sonobuoy microphones on some of them. So that black box that Cavitt had really began to get my attention.

Q: That would not be a radiosonde.

A: That would not be a radiosonde.

Q: What would a radiosonde look like?

A: It would be a white, usually a cardboard or a plastic box, and the fact that we were involved in radar is because we weren't allowed to have our radiosonde equipment. We weren't all set up for that.

Q: You said you didn't bring it with you.

A: We didn't bring the receiver. I have to correct myself, we did attach radiosondes to them, to the flights carrying microphones because there's a statement in this summary here of radiosonde reception. Radiosonde recording. So I take that back. Yes, we had radiosonde. But we did fly this one mentioned here, on June 4th, out to Tulerosa range, no balloon flight, again, on account of clouds. By that he means none of their flights. Then "Flew regular sonobuoy mike on a cluster of balloons and had good (inaudible) receiver on ground but poor on plane."

Q: I notice early on you were going ahead with the Navy stocked sonobuoy while Professor Ewing was trying to perfect his technique of the low range frequency microphone.

A: Oh, the low frequency microphone, right. That's correct.

Q: He was experimenting with both AM and FM, is that your recollection?

A: In the laboratory, devices for measuring low frequency acoustic waves were well known, but what he was attempting to do was to modify these and devise something to be a throw-away microphone and radio transmitter, so this was to build an instrument for a certain purpose. He actually had a fellow named

Joe Johnston, the electrical engineer at Columbia, whose name will come up as the person who did these.

Q: But you think in these early service flights you did have sonobouys?

A: Initially we had sonobouy, according to Crary. We initially were flying radar targets on the balloons only. Then by about Flight 5, we'd had sufficient lack of results that we began putting radiosondes on.

(Pause)

Q: The end report we're going to write is going to be based on official records, and essentially, transcripts such as this. So there will be a lot of things, Cavitt's tape, the transcript will not be part of that. This statement will be.

A: If you remember, there's a note in there from Dave Atlas to Colonel Duffy, a copy of a letter. Dave mentioned somewhere or another that Colonel Duffy took him down in the basement and Colonel Duffy had trunkfulls of documents that were unclassified. I wonder if it would be possible for you to contact Mrs. Duffy...

Q: I was wondering about what she might have.

A: She may have a great deal. Maybe in the Duffy file I have the address and phone number. I think it's Barrington, Rhode Island.

(Looking for name and phone number)

A: Here's a letter Todd got having to do with chasing down modern targets, the people who now make targets, who know nothing about this earlier affair.

Q: We talked with the Signal Corps up at Fort Monmouth and that's where we got the copy of the engineering drawing, which is a copy for you. They said these targets are no longer made. They have a national stock number and they can be made, but they would have to go out and write a new contract for them.

A: This is the C Model. It doesn't show the reinforcements.

Q: The young lady I talked with at Fort Monmouth indicated this drawing pre-dated that time frame. June of '44.

A: I'll be darned.

Q: I found that unusual when she said that was June of '44, and I didn't pick up on the designation being printed on the

side. I thought the B Model was a 1947 vintage and assumed, wrongly so, that the C Model would have come later.

A: This, then, is really... So they didn't change the numbers. It does show the little swivel there, in '44. Well, as always, my memory can be improved.

Tibbetts, the radar lieutenant working for Fletcher, said that when they got these in '44 there was a lot of trouble with breakage in the air and they had to go back for reinforcement.

Q: That's where maybe the tape came in?

A: He said that's where the tape came in. Because it certainly doesn't show this. There's just no question in my memory, bad as it may be, that there was a tape there. That impelled me to drag out Herbert Crow's letter. While I'm finding that, here is a communication between Todd and a Warrant Officer Newton, who identified things in General Ramey's office.

(Pause)

Q: It says a material like mylar. Do you have any knowledge of when that term came into use? mylar is a polyethylene, it's a metalized polyethylene.

A: It's not really a polyethylene, it's a polyturpoline...

Q: I'm not a chemist.

A: It's really quite a different thing. We certainly got involved with mylar balloons in General Mills around 1950 or 1951.

Q: Nothing that early, though.

A: I think not. It was really quite a new plastic. This is mylar. As you can see from the appearance, it's really quite different than polyethylene. It's non-extensible, where this really stretches. This scatters light and this doesn't. We have flown mylar balloons and mylar balloons vacuum coated with aluminum, but I think we didn't fly any in this era. It would be my guess that someone is sort of confusing this with later things. There were a lot of mylar balloons carried on rockets, and it was called Jim's sphere. Someone named Jim came up with the idea of increasing the turbulence around a following sphere by putting a little protuberance, little combs out on it. That was Jim's sphere. A lot of them were flown to measure winds in the low ionosphere, flown on rockets, from White Sands. They could well have fallen, but to my memory, it would have been anachronistic, out of times.

Here's a letter to me from Herbert Crow who was one of my technicians in the 1948 operation. These pictures you saw,

including that debris, are pictures that he sent to me with that letter and a subsequent letter. These are pictures taken by Crow.

Q: When did Alamagordo become Holloman?

A: Probably about September of '47.

Q: It says HAFB on the back of the truck.

A: Those pictures were taken during the Sandstone operation in April of '48.

Q: I take it the side arm was for protection against rattle snakes?

A: Good question.

Q: Some of the popular writers have alleged that certain persons were turned away by armed guards, etc.

A: Not in our area.

Q: I mean as far as the so-called...

A: Oh, out at the ranch.

(END)

24

Interview

[Col Jeffrey Butler and 1st Lt James  
McAndrew with] Col Albert C.  
Trakowski, USAF (Ret)

June 29, 1994





Colonel Albert Trakowski  
29 June 1994

Q: We have [concluded] independently from several other researchers the fact that MOGUL is probably responsible for the so-called Roswell incident... The Air Force position on that is that it was a misidentified balloon. The balloon was not a weather balloon, but was then a classified project, Project MOGUL, which has since been declassified.

What we have not found is any documented evidence that there was a planned cover story related to Project MOGUL. Jim has culled through literally millions of pages in various archives and repositories trying to find some sort of documented evidence where somebody at some level has stated that a cover story of weather research or weather-related activities would be used for Project MOGUL, the real purpose of which was nuclear detection...

(Pause)

A: ...All of that is to say that I know these people, and I know of what their involvement was, so I can at least give credibility and corroboration to what it was they did and where they fit in the picture.

There have been several writers who have been interested in this story, and they have been in touch with me. I have given them a lot of words, and in some cases documents that I had in my personal files. They were at first a Charles [Robert] Todd, from Ardmore, Pennsylvania, who was writing a story, and I never quite could determine whether he was on the side of the believers in UFOs or was writing to refute the believers. That I really was unsure of. One thing, he did appear to be sincere in getting the facts that surrounded the matter.

Another was a Charles Ziegler, a professor of physics at Brandeis University who was writing a monograph or perhaps a book on the history of nuclear weapons detection. It figured, of course, that Project MOGUL would come into view. So he had done a great deal of documentary searching and had found some documents that I did not have. For example, the original letter from Maurice Ewing to Carl Spaatz, then Chief of Staff of the Air Force. And some of the original letters of General Spaatz directing the establishment of Project MOGUL. All of this Charles Ziegler apparently found, and I did not have them at all.

Another fellow recently came into view, a Carl Pflock from Albuquerque, New Mexico. He appeared to want to substantiate the existence of the UFO incident as a UFO. I have a tape here, a one-sided tape, my half of the conversation only, with him. You're welcome to listen to that.

Charlie Moore has been in it since the beginning. Charlie was not a general project scientist or engineer on Project MOGUL. His efforts were confined to the development of the constant level balloons which were the instrument carriers for the devices that we hoped would pick up the sound waves operating in the sound channel in the stratosphere. The constant level balloon was the lifting mechanism, and Charlie was the principal in the development of that.

All of these things I have recorded on this tape to Mr. Pflock and also on the tapes that I made for Ruth Liebowitz, the historian at the Air Force Cambridge Research Center.

Maybe the best thing to do before plowing over all this old ground would be to consider some specific questions you may have. In the course of that, the history may come out.

Q: Were there any documents, or were there any directions either from yourself or from someone else up the chain to develop a cover story for MOGUL?

A: Not to my knowledge, no. I have never seen such a document nor have I ever heard of any effort to develop a cover story for MOGUL. The security of MOGUL was a great concern of mine from the very beginning, because it was like trying to hide an elephant in an open farmyard—almost ludicrous.

Q: Both Dr. Spilhaus and Professor Moore have indicated that they did use weather research as essentially a cover story when asked questions about what they were doing.

A: Correct. That we did. I'm aware of that. But it was not a policy. It was, if anything, a lash-up idea on the spur of the moment. And indeed, it was obvious. I may have been involved in using such a story myself, but to the best of my recollection there was no official stimulation [sic] or documentation of doing that. If you find such a document I, indeed, would be surprised.

Q: In the course of the research projects you worked on, in that time frame—the postwar period—would they give you a cover story on any particular project, even other than this one? Would they say, this is what you do, say this? Or would they kind of leave it to you, that it was a classified project and you just didn't discuss it and you just avoided questions?

A: The latter. I have no recollection of a cover story being used on any project that I was involved in, nor that a prefabricated cover story existed. No. I never encountered any such thing. We simply treated the security classification straight and did all we could to adhere to it.

Q: So you, as the project officer, you knew that MOGUL was a Top Secret...

A: Did I know that? There was no way to avoid it. I was the project officer, succeeding Colonel Duffy, and all that history is in the tapes that I made for Ruth Liebowitz. I came into being as the project officer on Project MOGUL about November of 1946. I had considerable background in nuclear weapons detection, using devices that I had developed in the Signal Corps. I was an Air Force officer assigned to the Signal Corps as part of Colonel Duffy's office. Much to the chagrin of the Signal Corps hierarchy, I was appointed a laboratory chief in the Signal Corps for purposes of developing instrumentation that the Air Force required, and I did that. In connection with that instrumentation, I conceived of an application of that instrumentation for use in detection of nuclear weapons. We conducted field experiments which at best were controversial, and at worst showed no positive result.

So my studies took me into the nuclear weapons problem. I had a background in physics—in nuclear physics and high-energy physics and modern physics—so I had some understanding of what was going on. I then took over the development of the original weather radar prototypes that the Air Force required in 1946. I did that in 1946. From that position, I was transferred to Colonel Duffy's new position as project officer for Project MOGUL in the Air Force, Watson Laboratories. I took up that task, I believe, around November. Those dates I think are specific in the tapes I made for Ruth Liebowitz— November of 1946. Colonel Duffy was reassigned to Wright Field, and I was the project officer. I was Top Secret control officer in addition to other duties, it being the only Top Secret project at Watson Laboratories at

the time, and probably ever. I remained project officer of Project MOGUL through our move of the laboratory from Watson Laboratories at Eatontown, New Jersey, to Cambridge, Massachusetts, and combined my laboratory, which was then known as the Geophysical Research Directorate, with that of John Marchetti's Electronics Research Directorate, and these two components made up the Air Force Cambridge Research Center.

I continued in my position of the Director of the geophysics component until May of 1949, when I was relieved of the duty at my own request and returned to school at MIT.

Q: Until '49, were you still on Project MOGUL?

A: Yes, indeed. And Project MX-968.

Q: You were on-site in New Mexico when Charlie Moore was doing most of his work, some of the early launches out of Alamogordo.

A: Yes. Jim Peoples and I went down to Alamogordo in early July 1947 to assist and observe the prototype launches being done by Charlie Moore and his crew from New York University.

Q: You said you went in July of '47, so you were there only in July. Was that early in July?

A: Yes, it was early in July. Again, I think those dates are in this tape of my conversation with Mr. Pflock. It was early in July. The Roswell incident occurred after I returned to Watson Laboratories. I wasn't involved in it at all. Really, the only thing that I knew about it, after it happened, was that Colonel Duffy called me on the telephone from Wright Field and gave me a story about a fellow that had come in from New Mexico, woke him up in the middle of the night, or some such thing, with a handful of debris, and wanted him, Colonel Duffy, to identify it.

Q: Did he identify who the person was?

A: No, I don't remember the person at all. I don't remember who came from New Mexico, no.

Q: Someone came from New Mexico with this debris?

A: Yes, I believe that's correct.

Q: They came to his quarters?

A: Yes, at Wright Field, yes. He had quarters on the base at Wright Field.

Q: Was his family there?

A: Yes.

Q: Did he identify the type of debris?

A: He just said it sure looks like some of the stuff you've been launching at Alamagordo, and he described it, and I said yes, I think it is. Certainly Colonel Duffy knew enough about radar targets, radiosondes, and balloon-borne weather devices. He was intimately familiar with all that apparatus.

Q: What was his position at Wright Field?

A: He was on the staff of General Tom Rives who was Director of the Electronic Subdivision of the Air Materiel Command, and under whose purview the Watson Laboratories was run.

Q: Why did they bring this debris to Colonel Duffy? Why didn't they bring it to someone else?

A: Probably because of questions about who knows about this project put to people at Alamagordo. I'm not sure. I can't answer that with any firm knowledge at all.

Q: So you had no idea there was an "incident" until Colonel Duffy called you, and you were back in Massachusetts at this time?

A: At that time we were at Eatontown, New Jersey. But what you said is correct. I had no knowledge of the so-called "incident" until Colonel Duffy called me.

Q: Do you recall what day you actually departed Alamagordo?

A: No. No, I don't. I have a full file of my TDY orders upstairs. Right offhand I can't tell you, but I was back in Watson Laboratories for several days before Colonel Duffy called me.

Q: Do you recall there being a Major Pritchard on-site?

A: I remember the name, yes.

Q: Did he work for you at Watson Laboratories?

A: No. He didn't work for me. I don't recall him working for me. I only had one major working for me, and I was a captain. He was a dull fellow... Right offhand I can't remember.

Q: You were the Chief of the Applied Propagation Subdivision.

A: Yes.

Q: I've seen the organizational chart, the way those things go...

A: I was.

Q: You were at the top, and then down below, as a technical adviser, below your name on the chart, is Major Pritchard.

A: Is that so? I don't remember. I simply don't remember. But if the chart says that, I'll go along with the chart.

Q: Major W. D. Pritchard. On July 10th in the Alamogordo newspaper, there's an article where it shows, it doesn't say when this was taken, but it says a Major Pritchard and his balloon group are demonstrating to reporters what these balloons and the various radar reflectors look like. Now, Charlie Moore took a look at that and said, "I don't recall there being any other balloon group in New Mexico or in that area at the same time we were there."

A: I think Charlie's right. I don't recall any either.

Q: So we were trying to figure out whether Major Pritchard was maybe a counterintelligence-type person or whether he was there reviewing the security procedures, or maybe he was there for promulgating the cover story of weather balloon and weather research so that MOGUL would not come out in the open. The article in the paper talks about the use of reflectors for tracking purposes—the radar reflectors for tracking purposes—but it never comes out talking about MOGUL and the instrumentation that you all were using for nuclear detection or the tests that were being conducted.

A: Could Major Pritchard have been attached to or some way connected with the base weather station at Alamogordo?

Q: Well, sir, we don't know, but he is identified in that newspaper article as being a public information officer. When we traced that name back to your organization, we thought he may have been essentially undercover himself. We don't know if that's the same person, even though it's the same name.

A: I'm afraid I can't offer any positive knowledge here.

Q: Were you associated with any counterintelligence people in Watson Labs or...

A: Not to my knowledge. If some were around, they were spoofing me because I didn't know it.

Q: Were there any other types of intelligence persons on your staff or the staff of Watson Laboratories?

A: Not to my knowledge.

Q: So the only people you had were actually civilian researchers...

A: And a few military officers, yes.

Q: Signal Corps and Army Air Force?

A: All the officers that I had on my staff were Air Force. I had no Signal Corps people at all.

Q: A few more names came off that news article where they're displaying the balloon launch—Maj. W. D. Pritchard, Maj. C. W. Mangum, Lieutenant Siegal, and a Capt. L. H. Dyvad.

A: None of those names are in my memory, firm in my memory, at all.

Q: You were aware of the previous Colonel Duffy's predecessor, Major Crane...

A: I never met Richard [Robert] Crane. I knew him only by the path of debris he left behind. I never met him.

Q: When you took over, was there any worry about security on the project, that security was possibly a problem, or that there was a problem or that there could be a potential problem that might warrant scrutiny by Air Force intelligence or security people?

A: We were aware of the delicacy of security on the project, and the reason was obvious. You could not conduct field operations of the size that we had to without somebody asking questions. Anybody with a pair of 8x50 binoculars on the side of the mountain could look down and see what was going on, and that, of course, would prompt questions. We were aware of all that, and we didn't really know what to do about it except to go on doing our job and taking care of things as they occurred. But we were aware of the sensitivity and of the weakness of security in Project MOGUL. Not from the people in the project, not disclosure by them, but simply the obvious activity that could be observed.

You can't fill a balloon that's give-or-take 60 feet high without somebody seeing it.

Q: When you were at Alamogordo and some of the various balloons were being launched, what was the largest array that you saw out there?

A: You mean payload?

Q: No, the entire assembly. The balloons, payloads, reflectors...

A: I didn't observe any of the reflectors, and if I did, they were so commonplace that it wouldn't have stuck in my memory. The neoprene balloons bearing reflectors were just common occurrences. I wouldn't have lodged any of those observations in memory because they were just too common.

Q: Charlie Moore has indicated that some of the balloons they tried during the early experiments were the relatively new types of reflectors that probably had never been used in New Mexico before, the M307B model, and that Ed Istvan had gone to several essentially toy manufacturers, to try to get some of these reflectors made.

A: That's correct. I don't know [about] that Ed Istvan... Ed Istvan got out of line. Charlie may have told you this, and I don't mean to tell tales about Ed, but Ed was a very...indeed, every man on Colonel Duffy's staff was very energetic. It was the Signal Corps' responsibility to procure those targets; it was not the responsibility of our and Colonel Duffy's office. However, to accelerate the activity of the Signal Corps and spur them to action, our Air Force officers in Colonel Duffy's office were literally on the backs of the Signal Corps people who did the job, and oftentimes did things they shouldn't have and

were out of channel, so to speak. It was on such an occasion that Ed Istvan acted to line up contractors for these targets. He got into a considerable amount of, shall we say, controversy with the Signal Corps because he was out of line.

Q: Do you recall any of the contractors he may have worked with?

A: No, I don't remember them by name. They were not within my purview at the time. As I have told others, including Mr. Pflock, we had an outstanding expeditor on our staff, on Colonel Duffy's staff, by the name of John E. Peterson. Jack Peterson was a major at the time. He was a prewar graduate of Harvard Business School, and he knew business operations inside and out. Again, he was an extremely energetic fellow. He was very, very valuable and successful at breaking loose stuck contracts and stuck production and things that weren't moving as fast as they should. During the war that was very important.

Jack monitored the procurement of these radar targets, and I believe Ed Istvan either worked for or alongside Jack Peterson, and I remember when they finally... Now this was all not under my purview, but I worked in the same building with them, and I knew Jack very well, he was a very good friend and we talked and joked with each other a lot. I remember so clearly when the contractor for these targets was selected, and Jack thought it was the biggest joke in the world that they had to go to a toy manufacturer to make these radar targets. Then it was even a bigger joke when it turned out that because of wartime scarcities of materials, the tape that they used to assemble these targets, the reflecting material on the balsa frames, was some kind of a pinkish purple tape with a heart and flower design on it. This was, again, a big flap.

Q: Did you ever see any of those?

A: Yeah, I saw some of them. Not in connection with my work, but they were around the office. The prototypes were around the office, and the first production runs were there.

Q: So you would say it's a limited number of a few runs maybe.

A: I have no idea how many hundreds were made, or even thousands. But like everything else that goes into production, the contractors have a limited production to begin with until they work out the bugs, and then they go full blower in the high production.

Q: Do you remember a rough span of times when you saw these: when you saw the first one, and when you saw the last?

A: It was probably 1944 or 1945. It was probably late in 1944 when the first ones were produced.

Q: Where did you see those? What part of the country?

A: Right there at Signal Corps. We were all working at that time, and John Peterson had his offices at the Toms River Signal Laboratory, which was actually located on the jurisdictional lines between Sea Girt and Springlake, New Jersey. It was an old night club that the Signal Corps had rented for the purposes of doing remote experimentation.



Q: The Sea Girt Inn?

A: Exactly. That's where John had his office, and I was there for a time doing work on developing the operational procedures of the SCR-658, the radio direction of wind— meteorological data. Rawinsonde—I did most all the work on developing how to use that instrument, and it was done there at the Sea Girt Inn.

Q: Do you recall any other physical attributes about the radar reflectors, the balsa wood? Charlie Moore indicated that the material had been coated in something like Elmer's glue which made it much more durable. Do you recall anything like that?

A: No, I don't. I didn't concern myself with that except as an observation to the side. The radar targets were geometrically elementary. There were three intersecting planes: X, Y, and Z. Their geometry was such, as you well know, that any incident wave would be reflected exactly, precisely, in the direction from which it came. So they were simple. I don't recall any of the details of how they were made, what the materials were, what coatings were used, or anything. At the time it wasn't within the range of my job.

Q: Did Colonel Duffy inform you officially? When he said he called you, was this like an official...

A: No. It was just an informative call. There wasn't any official transmission of knowledge nor expected action to result from it.

Q: Did Colonel Duffy consider this to be some sort of security violation?

A: No. Not to my knowledge, no. It was part of doing business.

Q: So he wasn't particularly upset, and he didn't require a formal explanation.

A: No.

Q: So that's the first you were aware, when he called you. None of your technicians had mentioned it to you?

A: No. Not to my knowledge.

Q: Did you have any interaction with the people at Eighth Air Force such as General Ramey or anyone else who may have been at Roswell Army Air Field?

A: No. I don't recall any interaction with them, no.

Q: What about Dr. Crary or Dr. Peoples? Do you know if they had interaction with the [Eighth Air Force] folks?

A: I don't recall any, no.

Q: At some point in Project MOGUL did you utilize equipment based at Roswell Army Air Field?

A: No, we had our own aircraft based at Fort Dix, New Jersey.

Q: Did you ever have a rawinsonde receiver at Roswell?

A: Not to my memory. No. We may have, but the specifics on that, I don't recall.

Q: Can you think of any reason why Dr. Peoples would meet with one of the bomb squadron commanders at Roswell in September of 1947?

A: Probably to arrange air drops of bombs as signal sources for testing the MOGUL sound receivers. We had a fellow who was assigned to the electronics test squadron at Fort Dix by the name of Duff, Eugene Duff, an ordnance expert, and he may have been involved in arranging for bombs to be exploded in the air as sound signal sources for testing the MOGUL receivers.

Q: Did you also procure aircraft from Middletown, Pennsylvania?

A: Yes. I believe our electronic squadron was moved from Fort Dix to Middletown—to Olmstead Air Force Base. When that was, I can't exactly pinpoint, but it was probably some time in 1947. Gene Duff, our ordnance man, was a part of that group. I don't know whether Gene Duff still lives or not, but he is a name that you might look into. Eugene Duff.

Q: Has anyone asked you to explain what happened at Roswell? In your opinion, what happened?

A: Until these recent inquiries, I don't recall anyone asking me to explain. I don't recall it ever coming up for me to answer in connection with the MOGUL tests. I don't recall that. You know, things happen every day, and you treat crises from moment to moment as though they were so much cordwood. They aren't all worthy of memory. But I don't recall it.

Q: Other than our conversation here today, has anyone ever discussed with you not talking about MOGUL? It's essentially declassified—it is no longer a classified project—but has anyone in the government—the Air Force, the Army, the Department of Energy, or anyone else—ever said don't discuss this?

A: Absolutely not. No such thing.

Q: What we're trying to do is make sure we are open to the General Accounting Office and to the American public as a whole when we publish our reports. So to all the people we've discussed this with, we want to make absolutely certain that someone has not come to them and said, you're going to get in the cover story. We want this to be as open as possible and get this thing resolved once and for all. There are going to be those individuals—as you have stated, the true believers—who may not accept what we have to say, but we just want to try to get everything out in the open.

A: It's about 45 years since all of this happened. Even at the time, as I mentioned a moment ago, one gets very busy in a project of this sort, and you treat rather large events as they come; you give them action, and then you go on to the next. All of these events don't stay in memory.

Q: We understand that you've been contacted by various people such as Mr. Pflock and Mr. Todd, and we do appreciate your spending some time with us in this endeavor. We think it's very valuable for people who were actually on the scene to provide their accounts of what occurred. It is valuable to us, and we do appreciate that.

A: I wish I could be of more help on this thing. Apparently, things like this die very hard.  
(Laughter)

Q: Did you ever hear of any intelligence people getting involved in this thing? Colonel Duffy mentioned that some of the people at AMC maybe wanted...

A: No, I don't. Certainly no intelligence people... Certainly I was not involved with any intelligence people in this matter. If I was, I don't recall it. Colonel Duffy and the group at Wright Field protected me greatly, I know that. They never said it, but I know they did because they left me free to do the project. And if anything would interfere with getting the project done as quickly as possible, they would try to steer that away from me. I know they did. Again, they never said it, but their actions were obvious.

(Pause)

A: ...I was assigned for about two months to AFOAT-1. Then Colonel Benjamin Holtzman, later General Holtzman, pulled me out of AFOAT-1 and sent me to Baltimore because the Air Research and Development Command had just been organized, and I arrived on the scene while they were still trying to find chairs and desks. We worked in the old *Sun* newspaper building in downtown Baltimore.

Q: They had intelligence personnel there, didn't they?

A: They may have. I'm not aware of that. Then after I left the headquarters of ARDC in Baltimore, I spent four years at the Air Force Research and Development Command Office in Brussels, Belgium. Following that, I spent more than three years on the Air Staff in the Pentagon.

Q: What year did you retire?

A: On my birthday in 1963. I then went into industry, and I worked for EG&G, a high-technology company based near Boston, and I became a Vice President of one of their subsidiaries. I became the project manager and developer of the National Space Science Data Center at Goddard, in Greenbelt, Maryland. I built that and set it up.

Then when the EPA, the Environmental Protection Agency, was formed in December of 1970, I was invited to join the newly formed EPA, and I did. I accepted the position. I went into the EPA as a Deputy Assistant Administrator in the Office of Research and Development. Then in 1973 and 1974 I served as Assistant Administrator for Research and Development in the EPA, the position from which I retired in 1982.

Q: Did you have interaction with Spilhaus in your civil service career?

A: No. Oh, I met with him. Spilly was a consultant, and even in his advancing age he was still an enormous source of ideas. If you brought him into a meeting as a consultant, surely somewhere along the line he would offer an idea that was useful. So he found a lot of contact throughout many organizations, particularly in those related to geophysics...meteorology, geology. I know he worked with the U.S. Geological Survey, a very, very fine organization, and with NOAA. Those are two that I know he continued relationships with. But I had very little contact with him.

Spilly was a very intimidating character. I lived with him for awhile.

Q: Were you involved in his exploits in North Africa, out there in the desert with him?

A: No. Nor in China.

Q: He had quite some stories about some of his past exploits.

A: No matter where he went, he gathered stories.

(END)



25

Drawing  
Cluster Flight No. 2



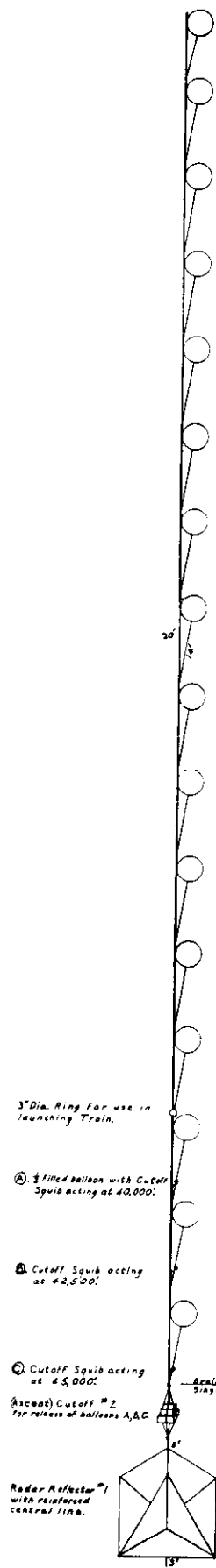
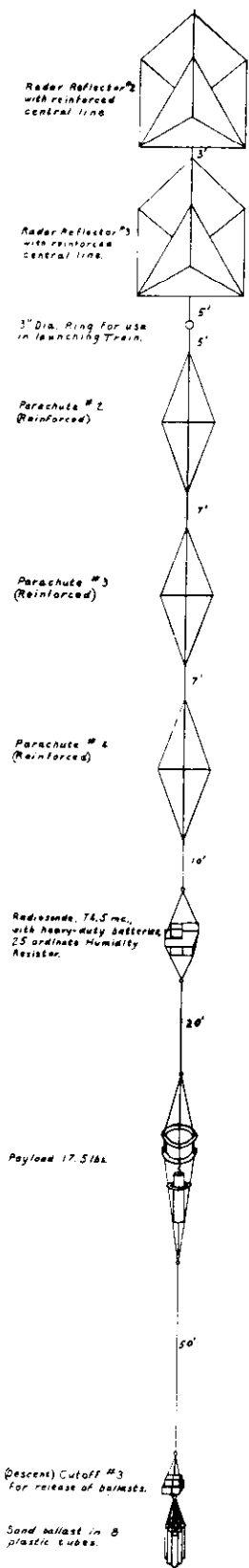

**TRAIN FOR CLUSTER FLIGHT NO.2**  
TO BE FLOWN AT BETHLEHEM, PENNSYLVANIA

SCALE: BALLOONS AND ALL LINES — 1" = 15' 0"  
ALL EQUIPMENT — 1" = 2' 0"

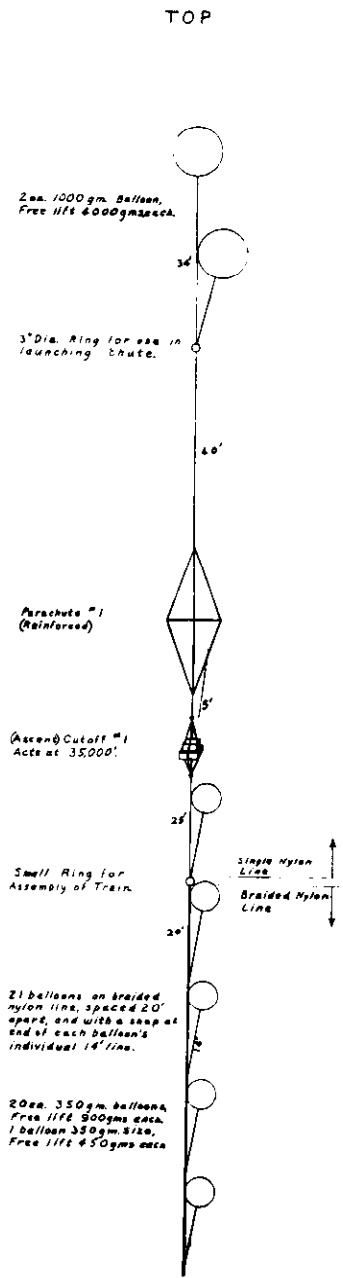



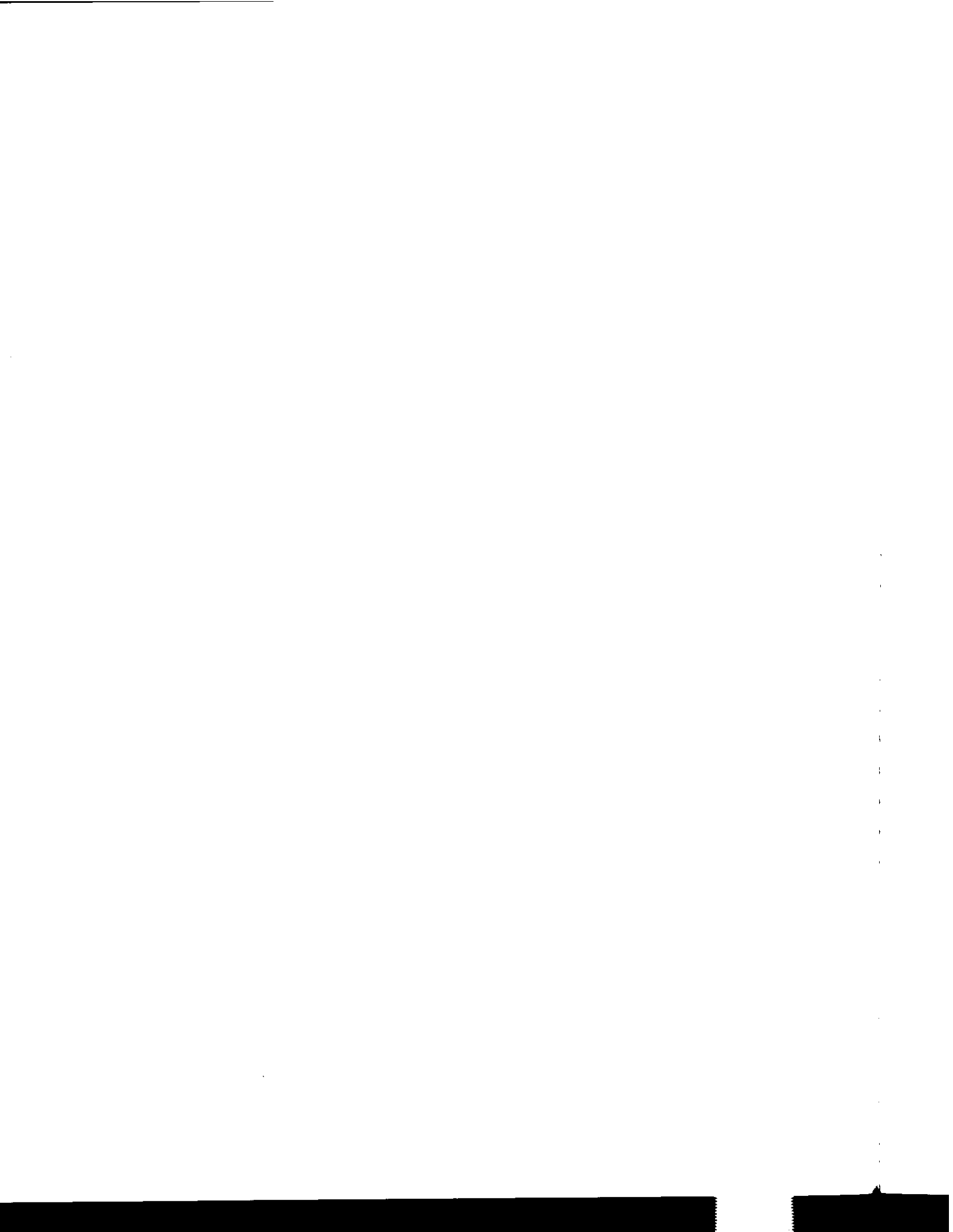





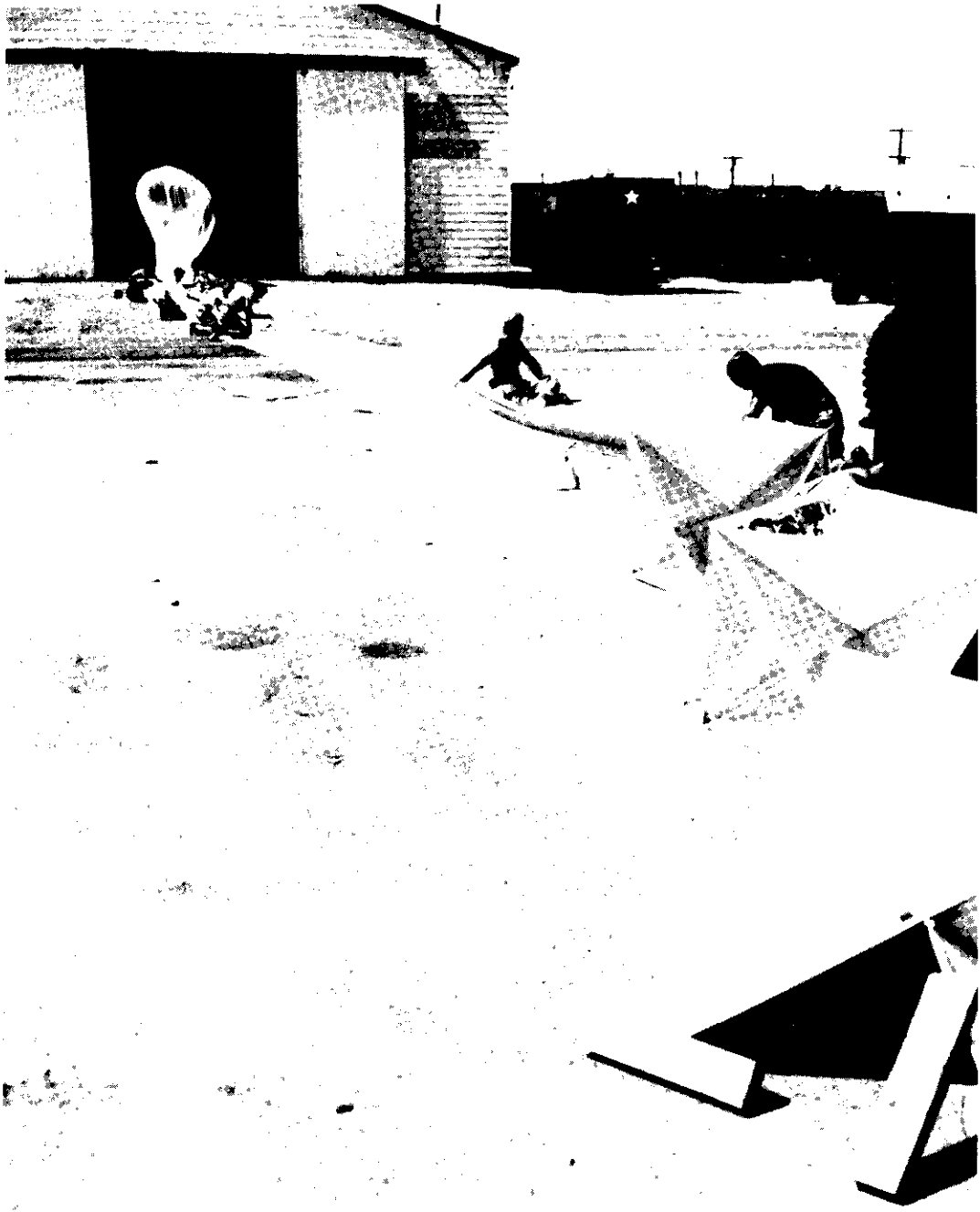

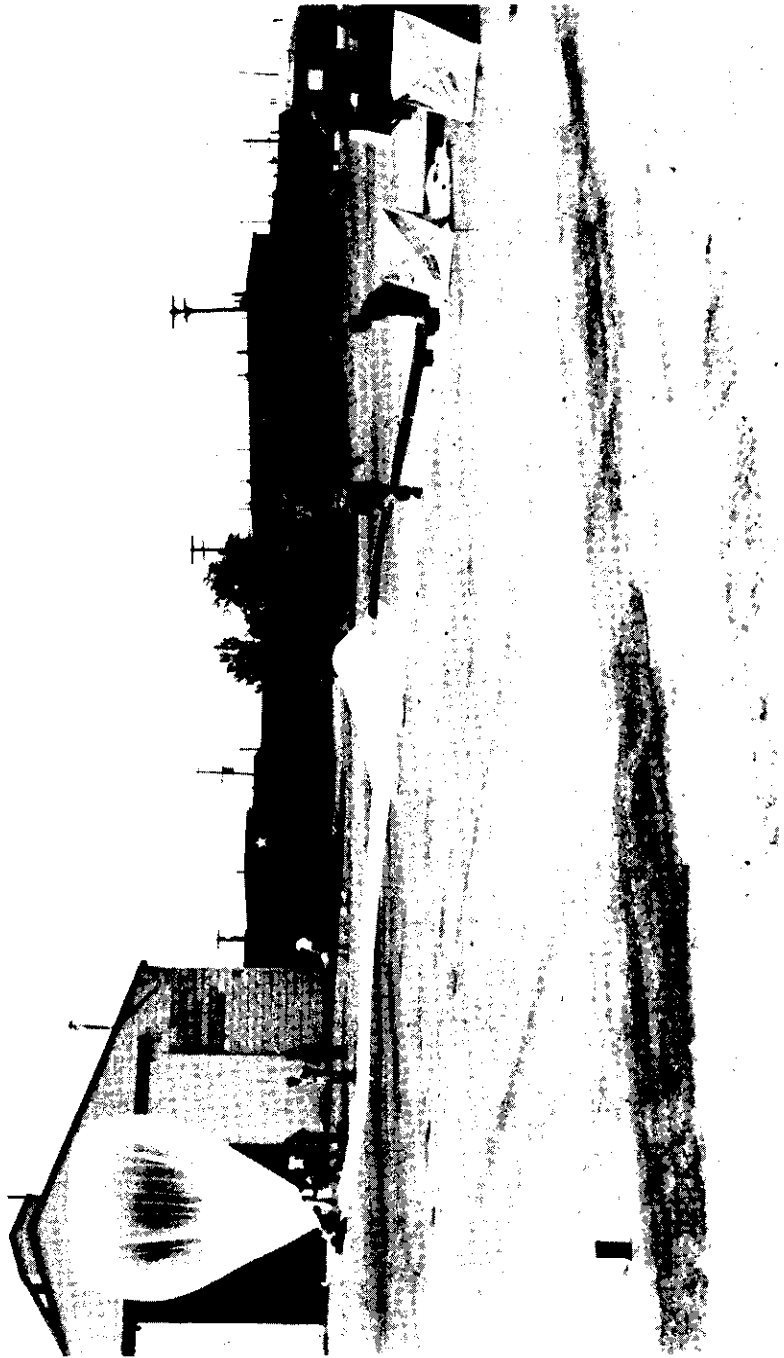

Summary Table  
NYU Constant-Level Balloon Flights  
November 20, 1946–July 5, 1947



FORM 111

SUMMARY OF HIGH CONSTANT-LEVEL BALLOON FLIGHTS

FLIGHT NUMBER	DATE AND RELEASE TIME	ORIGIN AND LAUNCH SITE	NUMBER OF BALLOONS	WEIGHT OF BALLOONS	WEIGHT OF BALLAST	WEIGHT OF INSTRUMENTS	TOTAL WEIGHT ON BALLOON INCLUDING BALLAST	DESCRIPTION OF ALTITUDE CONTROL	BALLOON WEIGHT	INSTRUMENT WEIGHT	BALLOON LIFT	RADIOSONDE DESCRIPTION	THEODOLITE	ALIGNMENT OBSERVATION	FLIGHT DURATION	D. TIME CONSTANT	BALLOON CONSTANT	MAXIMUM ALTITUDE	ACCURACY	CRITICISM
4	20 Nov. 1948 1438 ZST	RTU, N.T.	2 - 350 gram meteorological	0.7 kg	74.2 mc Radiosonde	1.6 kg	None	None	0	Not known	Not known	80%	OK	OK	4 min. ± 1000'	Max. 37000' Const. 37000'	OK	OK	Balloon balancing load. Free lift from 350 gram meteorological balloon. Successful cutting free of lifter balloon. Balloon did not level off.	
5	14 Dec. 1948 1219 ZST	RTU, N.T.	2 - 350 gram meteorological	0.7 kg	74.2 mc Radiosonde	1.6 kg	None	None	0	Not known	Not known	80%	Thodo-lite 50%	OK	4 min. ± 1000'	Max. 15000' Const. 15000'	OK	OK	Balloon balancing load. Free lift from 350 gram meteorological balloon. Successful cutting free of lifter balloon. Balloon did not level off.	
6	3 April 1949 1412 ZST	Methuen Pennsylvania	14 - 350 gram meteorological balloons, long cosmic ray trails	6.9 kg	74.2 mc Radiosonde Lead ballast	13.0 kg	2 seas of 5 kg sand and 5 kg liquid to be dropped on descent	2 seas of 5 kg sand and 5 kg liquid to be dropped on descent	6.8 kg	Not known	Not known	80% with 50% out recorder	Thodo-lite 60%	OK	None	None	Max. 44000' Const.	OK	OK	Failure due to poor rigging, poor launching technique. 2 lifter balloons damaged. Some balloons burst then descended rapidly.
7	3 June 1949 1317 ZST	Almogordo New Mexico	29 - 350 gram meteorological balloons, long cosmic ray trails	10.2 kg	74.2 mc Radiosonde Lead ballast Liquid ballast	26.4 kg	Balloons to cut off above 40000'	Balloons to cut off above 40000'	10.0 kg	9.9 kg	34.3 kg	10% with out recorder	Thodo-lite 90% B-17	90%	34 min. ± 100'	Max. 58000' Const. 51000'	100%	OK	First successful flight carrying a heavy load. 3 lifter balloons, 26 main balloons.	
8	7 June 1949 0909 ZST	Almogordo New Mexico	28 - 350 gram meteorological balloons, long cosmic ray trails	9.8 kg	74.5 mc Radiosonde Lead ballast Ballast assembly	28.3 kg	Balloons to cut off above 40000'	Balloons to cut off above 40000'	10 kg	1.9 kg	30.2 kg	95% with out recorder	Thodo-lite 87% B-17	40%	None	None	Max. 72000' Const.	50%	OK	Flight unsuccessful. Altitude control damaged on launching. 4 lifter balloons, 26 main balloons.
9	8 July 1949 0541 ZST	Almogordo New Mexico	20 - 350 gram meteorological balloons in 2 Balice clusters	7.0 kg	74.5 mc Radiosonde Ballast assembly	23.7 kg	4 over inflated balloons, 10 kg lead shot to fall under 30000'	4 over inflated balloons, 10 kg lead shot to fall under 30000'	10 kg	10.5 kg	36.2 kg	60% with out recorder	Thodo-lite 100%	100%	147 min. ± 500'	Max. 48300' Const. 39000'	15%	OK	Best flight thought possible with flabby neoprene balloons. 4 lifter balloons, 16 main balloons.	
10	3 July 1949 0303 ZST	Almogordo New Mexico	10 General Mills '001' polyethylene	6.6 kg	74.5 mc Radiosonde Ballast assembly	26.7 kg	Driftler, compass fluid Fixed lead 140 gphr	Driftler, compass fluid Fixed lead 140 gphr	3 kg	3.5 kg	30.2 kg	100% with recorder	Thodo-lite 33% A-45 last 55%	Last C-45	42 min. ± 1500'	Max. 18500' Const. 18000'	OK	OK	First non-extendible balloon flight. Due to lack of information on altitude the altitude control was not actuated. However, flight shows excellent stability of non-extendible balloons. Rate of lift due to helium leakage 1040 gphr.	
10	3 July 1949 0501 ZST	Almogordo New Mexico	1 H.I. Smith 15' .000" polyethylene	14.2 kg	74.5 mc Radiosonde Ballast assembly	16.2 kg	Driftler Compass fluid	Driftler Compass fluid	3 kg	5.4 kg	21.8 kg	33% with recorder	Thodo-lite 88 min.	OK	Over 130 min. ± 900' 512 min. ± 2000' ± 2700'	Max. 13100' Const. 9000'	OK	OK	Successful flight with altitude control working. Balloon reported over Albuquerque after 11 hours; Pueblo, Colorado after 28 hours; Flagstaff, Arizona after 48 hours; Flagstaff, Arizona after 72 hours; Flagstaff, Arizona after 96 hours over desert. Balloon diffusion 10 gphr.	







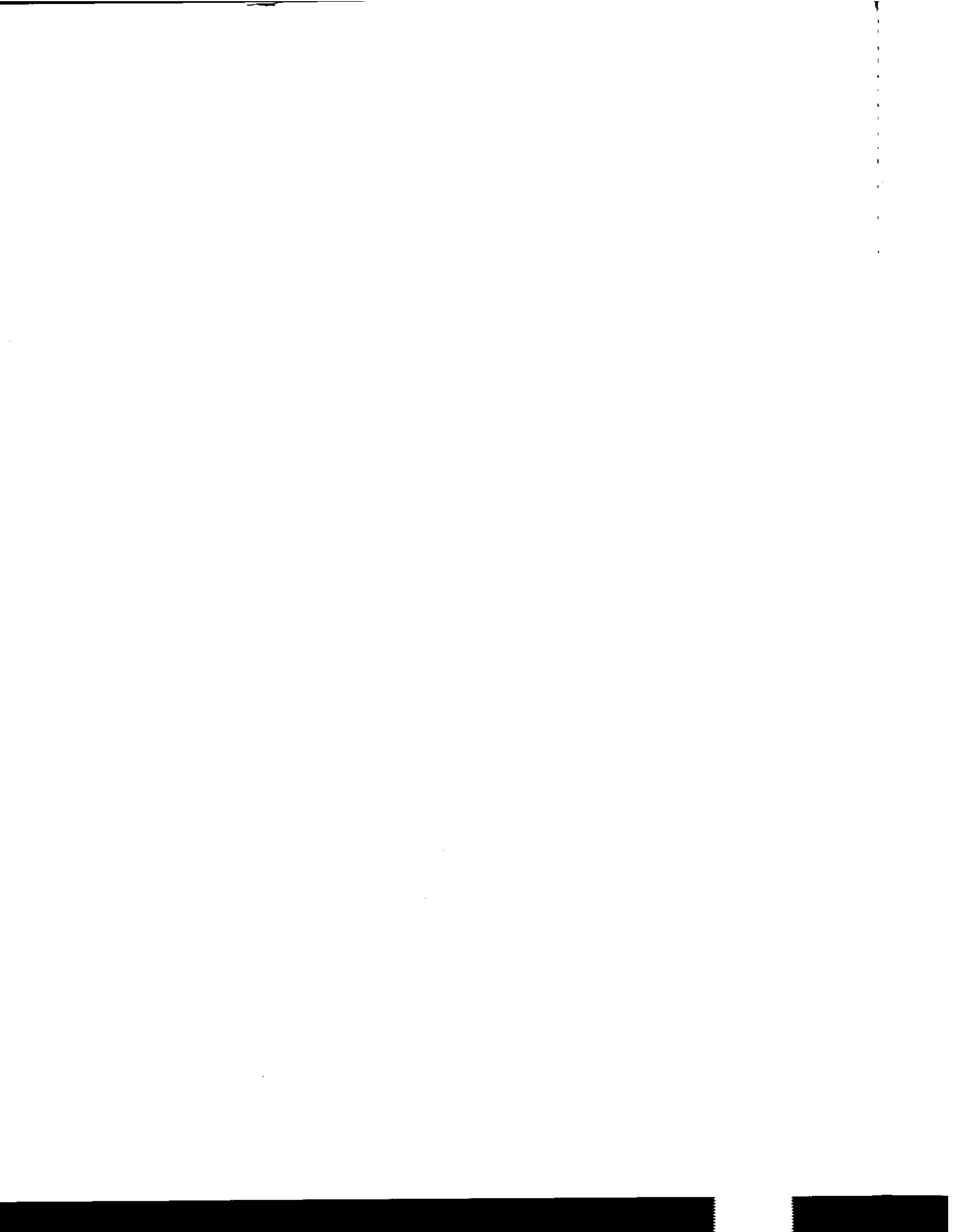

27 MAY 94

MFR

SUBJECT; OTHER CONTACTS ON BALLOON ACTIVITY OR AVIATION  
MISHAPS THAT MAY BE RELATED TO THE "ROSWELL INCIDENT"

The following organizations and individuals have been contacted during the period 23-27 May, concerning information on balloon activity and types of balloons being used for various purposes in New Mexico during 1947.

- a) US Army Signal Corps Museum, Ft Gordon GA  
Mr Ted Wise, Director, DSN 780-2818  
"no actual balloons but will take a look for photographs, or descriptions, etc.  
ref Mogul"  
Ms Carol Stokes, Historian
- b) US Army Communications and Electronics Command Museum, Ft Monmouth NJ  
Ms Mindy Rosewitz, Curator, DSN 992-2440  
"no examples or photos of balloons but did find a mechanical drawing (9 Jun 44) for an Air Pilot Balloon radar reflector" for which a copy was provided  
Mr Richard Bingham, Command Historian, DSN 992-1675  
Ms Ruth Fiornarto DSN 992-5781
- c) Westinghouse Electronics History Museum, Baltimore MD  
Mr Robert Dwitzbe, President  
"no balloon activity or balloon-borne electronics packages in the 1940's;  
Westinghouse became involved in balloon "TCOM" and dirigibles in the 50's and 60's; we have no reference to Project MOGUL"  
Ms Betsy XXXXXXXXXX
- d) Sperry Hagley Museum  
Ms Gail Dietzyk, Curator, (304) 658-2400 ext 330  
no contact as of 31 May--no information as to the manufacturer of the instrument packages associated with MOGUL
- e) AF/SE  
Lt Col Lineberger, 3-7280  
AAZ requested information related to B-29 and/or B-50 accidents in New Mexico in 1947 and 1948--response: B-29 crashed on T/O from Albuquerque in Jan 1947 and a B-29 crashed on T/O from Walker AAF (Roswell) in Aug 1948; both had multiple fatalities; no refueling mishaps between B-29 and B-50 in 1947/48  
On 26 May AAZ requested information on all B-29 mishaps in the "New Mexico" area (ie, NM and surrounding states) for the period 1947-50; information to include specific date, crash location and number of fatalities: Lt Col Lineberger said they were on microfilm, that all mishaps were filed chronologically and that there were 7,000 mishap files; a manual review will take at least 60 days; I requested an update in two weeks and a followup after the first year's entries had been reviewed
- f) Smithsonian Air and Space Museum 20 May 94  
Mr Tom Crouch, Aeronautics Curator, (202) 357-2515/3133  
"no examples of 1947 vintage balloons; have photographs but are taken at such a distance that no details of the balloon construction are evident; recommend

contacting Mr James Rand (Jim) of Winzen Balloons, Sioux Falls, SD; Jim Rand is the President and his office is at 12061 Network Blvd, Suite 200, San Antonio TX 78249 (512) 690-3400

Requested Lt Col Hachida at AIA to attempt to contact Mr Rand and determine if he had any information relative to the construction of these early balloons

g) Center for Military History, 14th St NW Washington DC

Dr Bennett, Curator

Dr Drea

Ms Hannah Zeidlik, Archivist (202) 504-5416

"no records of Project Mogul; recommend checking with DOE historian or the US Army Military Institute"

h) Dr Benjamin Cooling, DOE Historian (301) 903-5431

Dr Marie Hallion (202) 586-5238 @ Forrestal Bldg

"the AEC collection from the 1947-late 50's era has been transferred to NARA; might check the 'Military Liaison Committee' (MLC), the military organization associated with AEC during that time; recommend discussing this with the AEC POC at NARA, Mr Jimmy Rush (301) 713-7250; check to see if there are any references to AEC people/correspondence with the MLC

i) US Army Military History Institute, Carlisle Barracks PA

Mr John Slonaker, Librarian DSN 242-3611

Jeffrey Butler, Col, USAF

**29**

**Blueprint  
Corner Reflector of the ML-307C/AP  
Assembly**









**30**

Statement  
Irving Newton  
July 21, 1994



**STATEMENT OF SUSPECT/WITNESS/COMPLAINANT**  
(THIS FORM IS SUBJECT TO THE PRIVACY ACT OF 1974 - SEE REVERSE)

SUSPECT  
 WITNESS/COMPLAINANT

SECTION I. STATEMENT INFORMATION			
DATE 21 Jul 94	TIME 1630	LOCATION (Bldg/Room No.) AND INSTALLATION AFOSI Detachment 401 Randolph AFB TX	UNIT TAKING STATEMENT AFOSI Detachment 409
			REPEAT (If Known) OFFENSE COMPLAINT

SECTION II. PERSONAL IDENTIFICATION (Print or Type)		
NAME (Last, First, Middle Initial) NEWTON, IRVING	SSN	STATUS/GRADE USAF(RET) O-4
LOCAL ADDRESS (Include Zip Code)	DATE AND PLACE OF BIRTH (If Required)	TELEPHONE HOME DUTY:
PERMANENT ADDRESS OR HOME OF RECORD (Include Zip Code) Same as Above	MILITARY ORGANIZATION/EMPLOYER USAF Retired	DEROS N/A
SPONSOR INFORMATION (Name, Grade, SSN, Organization, Duty Phone) N/A		

**SECTION III. ACKNOWLEDGEMENT OF OFFENSES AND 5TH AMENDMENT/ARTICLE 31 RIGHTS ADVISEMENT (Suspect Only)**

1. I have been advised that I am suspected of the following offenses: \_\_\_\_\_  
 \_\_\_\_\_  
 by \_\_\_\_\_ (Rank and Full Name) who identified himself/herself as a \_\_\_\_\_  
 (SP, special agent, etc.) and advised me that I have the following rights according to the 5th Amendment of the US Constitution/Article 31 of the Uniform Code of Military Justice (suspect initials on line next to each statement).

\_\_\_ a. I have the right to remain silent - that is to say nothing at all.  
 \_\_\_ b. Any statement I make, oral or written, may be used as evidence against me in a trial or in other judicial, non-judicial, or administrative proceedings.  
 \_\_\_ c. I have the right to consult with a lawyer.  
 \_\_\_ d. I have the right to have a lawyer present during this interview.  
 \_\_\_ e. I may obtain a civilian lawyer of my own choice at no expense to the government.  
 \_\_\_ f. I may request a lawyer any time during this interview.  
 \_\_\_ g. If I decide to answer questions with or without a lawyer present, I may stop the questioning at any time.  
 \_\_\_ h. MILITARY ONLY: If I want a military lawyer, one will be appointed for me free of charge.  
 \_\_\_ i. CIVILIANS ONLY: If I cannot afford a lawyer and want one, a lawyer will be appointed for me by civilian authorities.

2. I have read my rights as listed above and I fully understand my rights. No promises, threats, or inducements of any kind have been made to me. No pressure or coercion has been used against me. I make the following choice (suspect initials on line next to appropriate statement):

\_\_\_ a. I do not want a lawyer. I am willing to answer questions or make a statement or both, about the offense(s) under investigation.  
 \_\_\_ b. I do not want a lawyer and I do not wish to make a statement or answer any questions.  
 \_\_\_ c. I want a lawyer. I will not make any statement or answer any questions until I talk to a lawyer.

3. I fully understand my rights and that my signature alone does not constitute an admission of guilt.

\_\_\_\_\_  
 (Signature of Suspect)

\_\_\_\_\_  
 (Signature of Witness/Interviewer)

**PRIVACY ACT STATEMENT**

**AUTHORITY:** 10 U.S.C. 8013, 44 U.S.C. 3101, and EO 9397

**PRINCIPAL PURPOSES:** Used to record information and details of criminal activity which may require investigative action by commanders, supervisor, security police, AFOSI special agents, etc. Used to provide information to the appropriate individuals within DOD organizations who ensure that proper legal and administrative action is taken

**ROUTINE USES:** Information may be disclosed to local, county, state and federal law enforcement or investigatory authorities for investigation and possible criminal prosecution or civil court action. Information extracted from this form may be used in other related criminal and/or civil proceedings.

**DISCLOSURE IS VOLUNTARY:** SSN is used to positively identify the individual making the statement and as a conduit to check past criminal activity records.

**SECTION IV. STATEMENT**

THIS PAGE USED FOR SIGNATURE ONLY. TEXT OF STATEMENT BEGINS ON PAGE 3

*JS*

**SECTION V. SIGNATURE/OATH**

"I hereby voluntarily and of my own free will make this statement without having been subjected to any coercion, unlawful influence, or unlawful inducement. I swear (or affirm) I have read this statement, initialed all pages and corrections, and it is true and correct to the best of my knowledge."

*[Signature]*  
(Signature of Person Making Statement)

*[Signature]*  
(Signature of Witness/Interviewer)

Subscribed and sworn to before me, a person authorized by law to administer oaths, this 21st day of July 1994

*[Signature]*  
(Signature of Person Administering Oath)

**SECTION VI. INSTRUCTIONS FOR CONTINUATION PAGE(S)**

Use plain bond paper (both sides optional). At the top right of each page, print or type: "(Last Name of individual making the Statement) on (Date)". At the bottom of each page, print or type: "Page \_\_\_ of \_\_\_ Pages". The individual must initial the top and bottom entries and sign his/her name at the bottom of each page.

*JS*

I was asked to provide this statement, by Lt. Col. Joseph V. Rogan who advised me, he was assisting in an investigation at the behest of the Secretary of the Air Force, for the GAO, to look into facts concerning what has become to be known as "The Roswell Incident".

As I recall it was July 1947, I was then a Warrant Officer with seven years service. I was the only weather forecaster on duty in the Fort Worth base weather and flight service center. The base weather covered only the base the flight service center covered most of the southwest states. I received a call from some one in General Ramey's office who asked that I go to the General's office. I informed him that I was the only forecaster on duty and could not leave. Several minutes later General Ramey Himself called and said "get your ass over here If you don't have a car take the first one with a key".

I was met at the General's office by a Lt Col or Col who told me that some one had found a flying saucer in New Mexico and they had it in the General's Office. And that a flight had been set up to send it to Wright Patterson AFB OH., but the General suspicioned that it might be meteorological equipment or something of that nature and wanted it examined by qualified meteorological personnel.

The Col and I walked into the General's office where this supposed flying saucer was lying all over the floor. As soon as I saw it, I giggled and asked if that was the flying saucer. I was told it was.

Several people were in the room when I went in, among them, General Ramey, a couple of press people, a Major, I learned to be Major Marcel and some other folks. Someone introduced Major Marcel as the person who found this material.

I told them that this was a balloon and a RAWIN target. I believed this because I had seen many of these before. They were normally launched by a special crew and followed by a ground radar unit. They provided a higher altitude winds aloft. We did not use them at Fort Worth. However, I was familiar with them because we used them and their products on various projects in which I was involved. These were used mostly on special projects and overseas. The balloon was made out of a rubber type expandable material and when launched was about six to eight feet across. When the balloons got to altitude they expanded to twenty feet or more. The target was used for radar reflections and I believe each leg of the target was approximately 48 inches. It resembled a child's Jack (like a child's ball and jacks set) with a metallic material between the legs. The legs were made of material appearing to be like balsa wood kite sticks but much tougher.

While I was examining the debris, Major Marcel was picking up pieces of the target sticks and trying to convince me that some notations on the sticks were alien writings. There were figures on the sticks lavender or pink in color, appeared to be weather faded markings, with no rhyme or reason. He did not convince me these were alien writings.

I was convinced at the time that this was a balloon with a RAWIN target and remain convinced.

I remember hearing the General tell someone to cancel the flight the flight to Wright Patterson.

While in the office several pictures were taken of Major Marcel, General Ramey, myself and others.

I was dismissed and went to my office to resume my normal duties.

During the ensuing years I have been interviewed by many authors, I have been quoted and misquoted. The facts remain as indicated above. I was not influenced during the original interview, nor today, to provide anything but what I know to be true, that is, the material I saw in General Ramey's office was the remains of a balloon and a RAWIN target.



31

Photographs  
ML-307C/AP Device with Vintage  
Neoprene Balloons and Debris





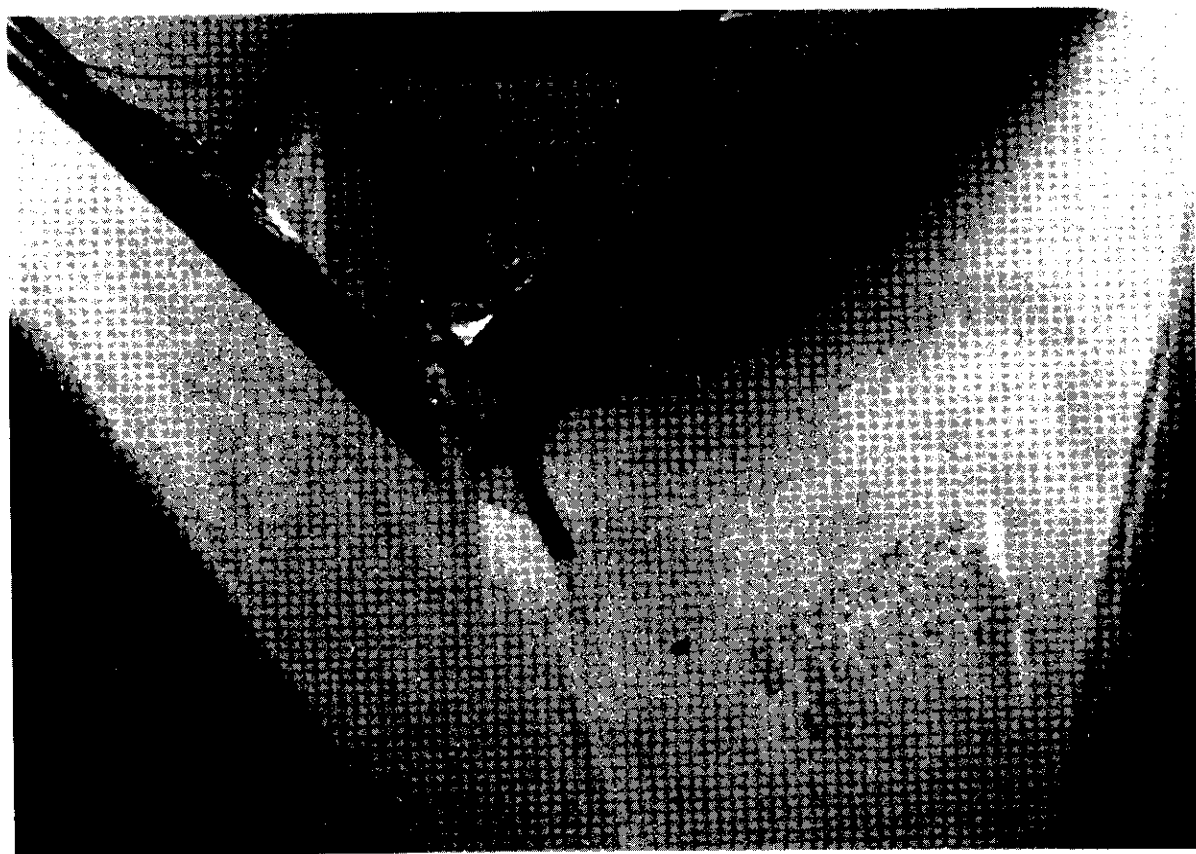
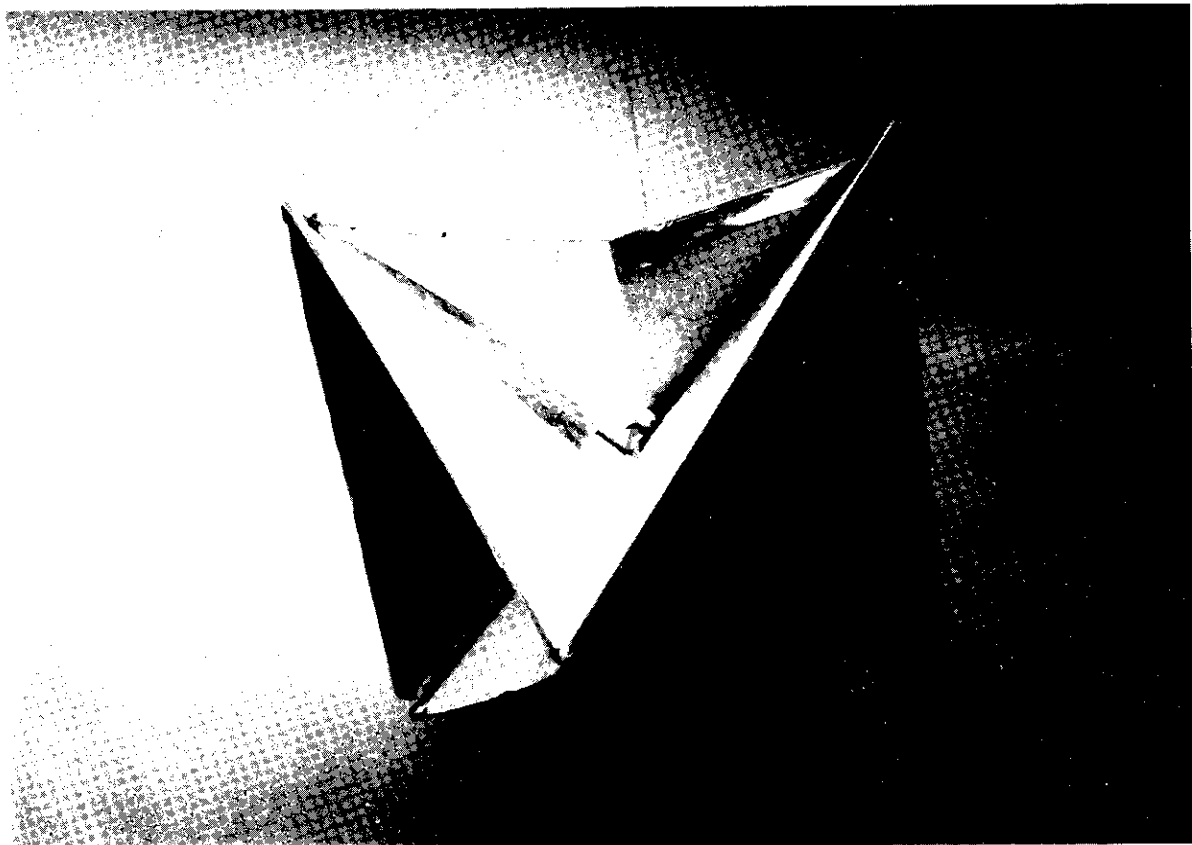

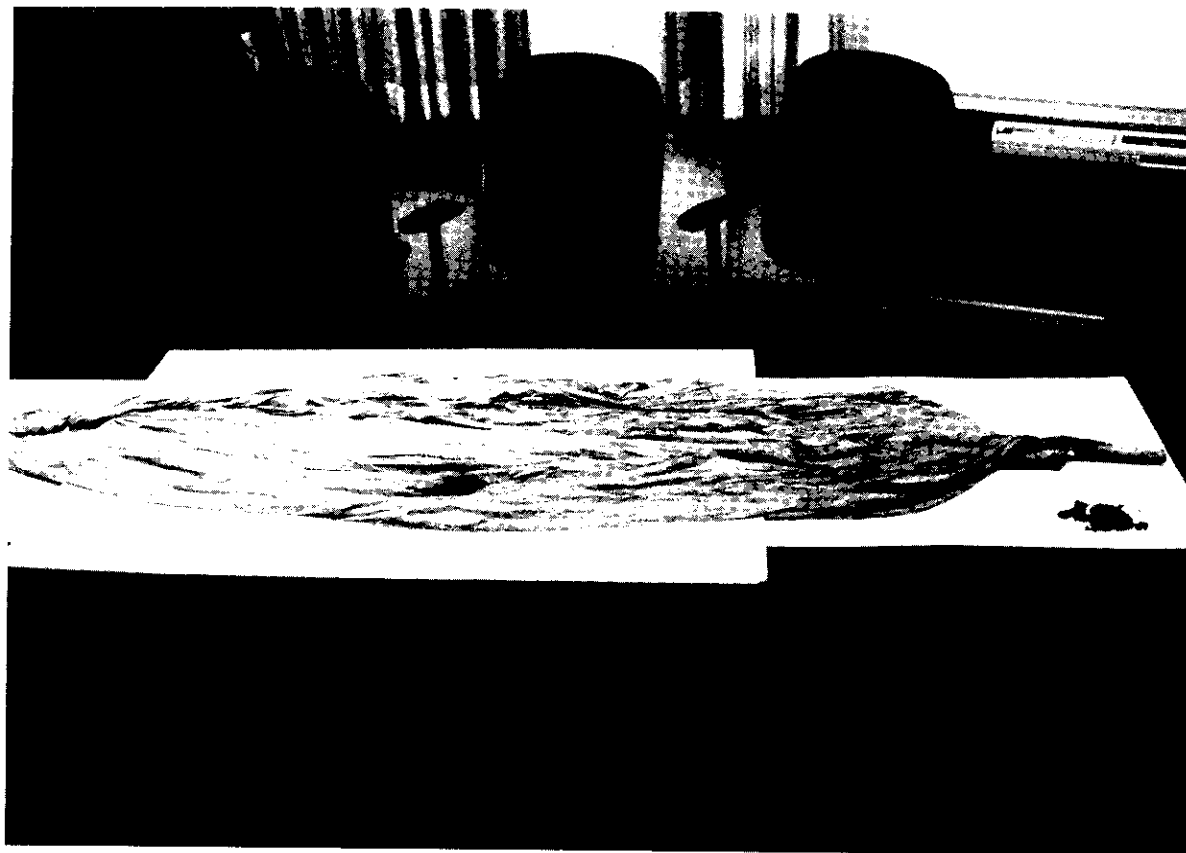

Synopsis of Balloon Research  
Findings  
1st Lt James McAndrew





DEPARTMENT OF THE AIR FORCE  
WASHINGTON DC 20330-1000



OFFICE OF THE SECRETARY

JUL 27 1994

MEMORANDUM FOR SAF/AAZ

ATTENTION: Colonel Richard L. Weaver

FROM: SAF/AAZD  
1720 Air Force Pentagon  
Washington, DC 20330-1720

SUBJECT: *Report of Findings on Balloon Research*

The following report is submitted in support of findings developed as a result of research efforts conducted at your request in support of the General Accounting Office (GAO) audit that focused on obtaining information relative to the so-called "Roswell Incident."

Previously you were separately provided a list of the locations and records searched in regard to that endeavor. This is in addition to other materials and briefings previously provided. The focus of this paper is to concentrate on those findings developed regarding balloon operations that were taking place in New Mexico during the time frame in question.

The following was compiled from records reviews and in some case, interviews with participants. Where appropriate, copies of the source documents used are provided as attachments. In the case of interviews or other references that are attached to the main report, these will be reflected in the footnotes, but not attached here.

  
JAMES MCANDREW, 1LT, USAFR  
Declassification and Review Officer  
SAF/AAZD

## THE ROSWELL INCIDENT

On July 7, 1947, W.W. (Mac) Brazel, a rancher from approximately 75 miles northwest of Roswell, NM, contacted the local sheriff and reported that some metallic debris had come to rest on the ranch on which he worked near the town of Corona, NM. This was during the "UFO Wave of 1947," and he told the sheriff that he thought this debris may be part of a "flying disc."<sup>1</sup> The sheriff contacted Roswell (Army Air Field) AAF, which in turn sent intelligence officer, Maj Jesse Marcel, and two Counterintelligence Corps Agents, Capt Sheridan Cavitt and MSgt Lewis Rickett, to evaluate the debris. The officers collected a portion of the material and brought it back to Roswell AAF on the evening of July 7.<sup>2</sup> The following day, the Public Information Office released a statement saying that the Army Air Forces had recovered a flying disc. This press release was provided to local newspapers who sent it out to wire services. Meanwhile, Brig Gen Roger Ramey, Eighth Air Force Commander, ordered that the debris be flown to Eighth Air Force Headquarters at Fort Worth AAF, TX, for his personal inspection. Upon viewing the debris, he and his staff recognized parts which looked similar to a weather balloon. He then summoned the base weather officer, who identified the debris as the remnants of a weather balloon and its attached metallic radar target.<sup>3</sup> General Ramey then invited the local press to view and take photographs of the materials and he declared the episode to be a misunderstanding (Atch 1).

The above summarizes the previously reported information of what happened on July 7 and 8, 1947. Before now, however, a larger portion of the story was never told. Recent research indicates that the debris recovered from the ranch on July 7, 1947, *was* a weather balloon—but it was not being used strictly for weather purposes; its real purpose was to carry classified payloads for a Top Secret US Army Air Forces project. The project's classified code name was MOGUL.

The current investigation discovered that an experimental balloon project was being conducted at nearby Alamogordo Army Airfield (now Holloman AFB, NM) during the summer of 1947.<sup>4</sup> An examination of unclassified technical and progress reports prepared by the balloon project revealed that a highly classified program, Project MOGUL was the ultimate reason for the balloon experiments. Project MOGUL was classified Top Secret and carried a priority level of 1A.<sup>5</sup> *It is Project MOGUL that provides the ultimate explanation for the "Roswell Incident."*

---

1. *Roswell Daily Record*, Jul 9, 1947, p. 1.

2. Intvw, Col Richard L. Weaver with Lt Col Sheridan Cavitt, USAF (Ret), May 24, 1994.

3. Intvw, Lt Col Joseph V. Rogan with Irving Newton, Jul 21, 1994.

4. Ltr, Lt Col Edward A. Doty to Mr David Bushnell, Mar 3, 1959.

5. Ltr, Brig Gen E. O'Donnell, Deputy Chief, Engineering Division, HQ AMC, to Commanding General, USAAF, subj: Change in Classification of MOGUL, Item 188-5, Jul 8, 1946.

## PROJECT MOGUL

Project MOGUL was first conceived by Dr. Maurice Ewing of Columbia University, NY, and Woods Hole Oceanographic Institution, MA. Dr. Ewing had conducted considerable research for the Navy during World War II, studying, among other things, the "sound channel" in the ocean. He proved that explosions could be heard thousands of miles away with underwater microphones placed at a predetermined depth within the sound channel. He theorized that since sound waves generated by explosions could be carried by currents deep within the ocean, they might be similarly transmitted within a sound channel in the upper atmosphere. The military application of this theory was the long-range detection of sound waves generated by Soviet nuclear detonations and the acoustical signatures of ballistic missiles as they traversed the upper atmosphere. He presented his theory to General Carl Spaatz, Chief of Staff of the Army Air Forces, in the fall of 1945.<sup>6</sup> The project was approved, and research was begun by the scientific research agency of the US Army Air Forces (USAAF), the Air Materiel Command (AMC), early in 1946. The project was assigned to HQ AMC, Engineering Division, Electronics Subdivision, which in turn assigned the project to AMC's Watson Laboratories, Engineering Division, Applied Propagation Subdivision, located in Red Bank, NJ.

### SCOPE

Project MOGUL initially focused on three areas of technology: (1) an expendable microphone, capable of detecting, at long range, low-frequency sound transmissions generated by explosions and missiles; (2) a means of telemetering these sounds to a ground or airborne receiver; and (3) a system from which to suspend the microphone and telemetering device in the upper atmosphere for an extended period of time. To meet these criteria, contracts were awarded by AMC to Columbia University (AMC contract no. W28-099-ac-82) for the acoustical equipment, and to New York University (NYU) for the development of constant-level balloons (AMC contract no. W28-099-ac-241). After the initial contracts were awarded, Project MOGUL branched out into many areas related to the geophysical properties of the upper atmosphere, including radiowave propagation, radar propagation, ionospheric physics, solar physics, terrestrial magnetism, meteorological physics, and weather forecasting. Considerable resources were devoted to Project MOGUL which included numerous bomber and transport aircraft and two oceangoing vessels. At one point the staff, exclusive of contractors, numbered over 100 persons. To accommodate this sensitive, high-priority project, facilities of the secluded Oakhurst Field Station of Watson Laboratories were used. Balloon operations associated with Project Mogul were conducted at various locations throughout the United States and the Pacific, the latter in reference to acoustical detection research associated with the Sandstone atomic tests at Entiwetok Atoll in April and May 1948.<sup>7</sup>

---

6. Rprt, Maurice Ewing for General Carl Spaatz, "Long Range Sound Transmission in the Atmosphere," n.d.

7. Rprt, HQ Fitzwilliam Fwd, "Sonic Balloon Test Kwajalein," May 17, 1948 (hereafter "Sonic



By December 1948, serious concerns had arisen regarding the feasibility of the project as first conceived. Even though the principle on which the project was based was determined to be sound, questions concerning cost, security, and practicality were discussed that ultimately led to the disbandment of the project, and Project MOGUL as first conceived was never put into operational use. However, MOGUL did serve as the foundation for a comprehensive program in geophysical research from which the USAF and the scientific community have benefited to the present time. These benefits included constant-level balloon technology, first developed by NYU for Project MOGUL.

## WATSON LABORATORIES

The organizational structure of Watson Laboratories Applied Propagation Subdivision, which was established primarily for MOGUL, as it appeared in January 1947, is shown in Attachment 2. Over the course of the project, MOGUL had three military project officers, or "chiefs": Maj Robert T. Crane, spring 1946–July 1946; Col Marcellus Duffy, August 1946–January, 1947; and Capt Albert C. Trakowski, January 1947–May 1949. Major Crane had been personally recommended by Dr. Ewing, originator of the project, but by June of 1947, MOGUL had not met the expectations of HQ USAAF, and Colonel Duffy replaced Major Crane.<sup>8</sup> Colonel Duffy was a respected, highly capable career Army Air Forces officer. During World War II, Colonel Duffy had reported directly to General Hap Arnold, Chief of Staff USAAF, as the Army Air Forces Liaison Officer to the US Army Signal Corps, with primary duties for securing meteorological equipment from the Army for use by the USAAF. Colonel Duffy had a reputation for accomplishing difficult assignments by getting the most out of his personnel—exactly what was desired by HQ USAAF to solve the numerous administrative and personnel problems that had arisen in Project MOGUL under Major Crane. In a short period, Colonel Duffy was able to make the necessary corrections and was reassigned to become the Assistant Chief, Electronics Plans Section, Electronics Subdivision, HQ AMC, at Wright Field, OH. Colonel Duffy also continued to monitor "the upper air research program" (i.e., Project MOGUL) in addition to his duties as the Assistant Chief of the Electronics Plans Section.<sup>9</sup> The primary scientist for MOGUL was Dr. James Peoples, assisted by Albert P. Crary, the Field Operations Director. Both scientists had previous associations with Dr. Ewing: Dr. Peoples at Columbia, and A.P. Crary at Woods Hole. Both scientists were assigned to MOGUL for the entire length of the project.

## NEW YORK UNIVERSITY "BALLOON GROUP"

From September 30, 1946, until December 31, 1950, the Research Division of the College of Engineering of NYU conducted research under contract for the Army

---

Balloon Test Kwajalein").

8. Memo, Brig Gen Tom C. Rives, Chief, Electronic Subdivision, Engineering Division, AMC, to Maj Gen Curtis LeMay, subj: Relief of Major Crane as Project Officer MOGUL and TORRID, Jun 18, 1946.

9. Memo, Maj Gen Curtis E. LeMay, Deputy Chief of Air Staff for Research and Development, to Maj Gen L.C. Craigie, Chief Engineering Division, AMC, Apr 16, 1947.

Air Forces, in conjunction with Project MOGUL.<sup>10</sup> The NYU "balloon group" was to develop and fly constant-level balloons while simultaneously developing telemetering equipment to transmit data obtained in the upper atmosphere.<sup>11</sup> Group members launched, tracked, and recorded data only in regard to constant-level balloon flight and telemetering of information. They did not have access to observations and measurements that had military applications. MOGUL, in other words, was conducted as a compartmented, classified project in which participants knew only what they needed to know, and no more. Due to the compartmentation, balloon flights made by NYU were divided into two categories, "research" and "service."<sup>12</sup> Research flights tested balloon controls and telemetering systems and were fully reported in the unclassified NYU reports.<sup>13</sup> A total of 110 research flights were flown during the contract. Service flights were flown at the direction of Watson Laboratory personnel, but the military purpose was Top Secret. These flights carried classified equipment, which could not be fully reported in the unclassified NYU documents. Further evidence of the exclusion of classified information from the reports is the lack of data for balloons flown in association with the Sandstone nuclear tests held in April and May of 1948.<sup>14</sup> In recent interviews with former NYU personnel, Dr. Athelstan F. Spilhaus, NYU Director of Research, and Professor Charles B. Moore, NYU Constant-Level Balloon Project Engineer, stated that they were never informed of the classified name, MOGUL, nor did they ever have access to the scientific data that was obtained by the USAAF as a result of their efforts. In response to inquiries, professional or casual, project personnel simply said that they were engaged in balloon research.<sup>15</sup>

The first balloon launches associated with Project MOGUL were carried out at several locations on the east coast of the United States.<sup>16</sup> However, unfavorable winds, conflicts with commercial air traffic, and the need to gather data on the V-2 flights currently being conducted at White Sands Proving Ground, NM, led the NYU group to conduct further tests from Alamogordo AAF.<sup>17</sup> The NYU group would make three "field trips" during the summer of 1947 for test and evaluation, labeling them Alamogordo I, II, and III. The majority of the balloon flights over the next four years originated from Alamogordo AAF.

---

10. Research Division, College of Engineering, NYU, *Technical Report No. 93.03, Constant Level Balloons, Final Report*, Mar 1, 1951 (hereafter NYU, *Final Report*), p. 3.

11. Research Division, College of Engineering, NYU, *Technical Report 93-02, Constant Level Balloons*, Sect 1, *General*, Nov 15, 1949, p. 5.

12. NYU, *Final Report*, p. 13.

13. Research Division, College of Engineering, NYU, *Technical Report No. 1, Constant Level Balloon*, Apr 1, 1948, Table VII, "Summary of NYU Constant-Level Balloon Flights" (hereafter NYU, *Technical Report No. 1, Table VII*); *ibid.*, *Technical Report No. 93.02, Constant Level Balloons*, Sect 3, *Summary of Flights*.

14. "Sonic Balloon Test Kwajalein."

15. Athelstan F. Spilhaus, C.S. Schneider, C.B. Moore, "Controlled-Altitude Free Balloons," *Journal of Meteorology*, 5 (Aug 1948): 130-137.

16. NYU, *Technical Report No. 1, Table VII*.

17. Research Division, College of Engineering, NYU, *Progress Report No. 6, Constant Level Balloon*, Sect II, June 1947 (hereafter *Progress Report No. 6, Sect II*), p. 4.

New York University, in accordance with contractual requirements, produced monthly progress reports, technical reports, and final reports detailing the various aspects of the balloon and telemetering research. In addition, Crary maintained a detailed journal of his work throughout his professional career to include the summer of 1947. The following discussion is based on these two documents and interviews with Moore, who was present on all three of the Alamogordo field trips, and, with Trakowski, who was present at the Alamogordo II and III field trips.

**NOTE:** *Technical Report No. 1, Table VII, "Summary of NYU Constant-Level Balloon Flights,"* and *Technical Report No. 93.02, Constant Level Balloons, Section 3, "Summary of Flights,"* do not fully account for all balloons flown during the initial stages of the contract to include the Alamogordo I field trip. Absent from the reports are service flight nos. 2, 3, and 4. Flight no. 2 was flown on April 18, 1947, at Bethlehem, PA, in an attempt to obtain acoustical data from the explosion of 5,000 tons of TNT by the British on the German island of Helgoland.<sup>18</sup> NYU flight no. 3 was flown on May 29, followed by NYU flight no. 4 on June 4. Both launched from Alamogordo AAF.

#### ALAMOGORDO I (May 28, 1947–June 7, 1947)

The first NYU "field trip" departed Olmstead Field, Middletown, PA, by C-47 for Alamogordo AAF on May 31, 1947, arriving on June 1, 1947.<sup>19</sup> Present on this flight was C.B. Moore, NYU Project Engineer, Charles S. Schneider, NYU Project Director, and other supporting staff members from both NYU and Watson Laboratories. A.P. Crary, along with other personnel from Watson Laboratory, were already present in Alamogordo, but they did not conduct any balloon operations. During this time, Crary and several technicians detonated ground explosives, or "shots," for sound-wave generation purposes, on the nearby White Sands Proving Ground. These detonations were monitored by ground-based GR3 and GR8 sound ranging equipment at locations in New Mexico and West Texas.<sup>20</sup> On May 28, the advance party of the balloon group arrived by B-17.<sup>21</sup> On May 29, the advance team made the first launch for Project MOGUL from Alamogordo (NYU flight no. 3). The equipment carried on this flight was identified as essentially the same as that carried on NYU flight no. 2 (Atch 3).<sup>22</sup> NYU flight no. 4 was launched on June 4, with a configuration the same as on flight nos. 2 and 3. Crary's diary indicated that flight no. 4 consisted of a "cluster of (meteorological) balloons" and a "regular sonobuoy."<sup>23</sup> Presumably, flight no. 3 was configured the same.

---

18. Research Division, College of Engineering, NYU, *Special Report No. 1, Constant Level Balloon*, May 1947 (hereafter NYU, *Special Report No. 1*), p. 27.

19. Personal journal of Albert P. Crary, p. 13.

20. *Ibid.*, pp. 4–16.

21. *Ibid.*, p. 13.

22. NYU, *Progress Report No. 6, Sect II*, p. 5.

23. Crary personal journal, p. 12.

The objective of this trip, so far as NYU was concerned, was to perfect the handling of large flight trains of meteorological balloons and to evaluate the operations of altitude controlling and telemetering devices.<sup>24</sup> Already established before the trips to Alamogordo was that the use of the standard, 350-gram meteorological balloons, constructed of neoprene, was, at best, a "stop gap" method of achieving constant-level flight.<sup>25</sup> Balloons most suitable for this type of work were made of polyethylene, a very thin, translucent plastic. These balloons, however, had just been developed, and, although the NYU group had contracted for some of them, the balloons had not been received until after the group departed for Alamogordo.<sup>26</sup> For Watson Laboratory scientists Peoples and Crary, the purpose of this trip was to experiment with different types of equipment to collect and transmit sound waves in the upper atmosphere. Therefore, just as the "balloon group" was using meteorological balloons as a stopgap method in attaining constant-level flight, the Watson Laboratory scientists utilized an AN/CRT-1A Sonabuoy while awaiting the delivery of acoustical equipment specifically designed for Project MOGUL.<sup>27</sup> The NYU personnel developing the telemetering equipment experimented with components of the sonabuoy, which was cylindrical, nearly 3 feet long and 4 3/4 inches wide, and weighing 13 pounds (Atch 4). The sonabuoy contained both the acoustical pickups, known as hydrophones, and the means of telemetering the sounds by use of a FM transmitter, the T-1B/CRT-1.

Soon after arriving at Alamogordo AAF, a problem developed. Dr Peoples, Project Scientist, decided not to bring the radiosonde recorder (an AN/FMQ1 weighing approximately 500 pounds), due to the weight and space limitations of the B-17 aircraft originally scheduled to transport the equipment from Olmstead Field. Radiosondes were a widely used and accurate method of tracking weather balloons consisting of a transmitter, which was carried aloft by the balloon, and a ground-based receiver/ recorder. Radiosondes, along with aircraft, were to be the primary method to track the Project MOGUL balloons.<sup>28</sup> Dr. Peoples, however, believed that the radar currently in place at Alamogordo for tracking V-2 firings would be sufficient for tracking the balloons trains. However, this radar did not work well and often lost contact with the balloon while it was still within visual range. Accordingly, Moore, the project engineer, experimented with an "unorthodox" method, in the absence of a radiosonde recorder. He tried to track the balloons using multiple radar targets.<sup>29</sup> A radar target was a multisided object, which, in appearance, resembles a box kite constructed of balsa wood and metallicized paper (Atch 5). Moore and his technicians conducted test flights, attempting to obtain a better radar return by attaching additional targets. They

---

24. Research Division, College of Engineering, NYU, *Progress Report No. 7, Constant Level Balloon*, Sect II, Jul 1947 (hereafter NYU, *Progress Report No. 7, Sect II*), p. 5.

25. NYU, *Special Report No. 1*, p. 26.

26. NYU, *Progress Report No. 7, Sect II*, p. 6.

27. Research Division, College of Engineering, NYU, *Progress Report No. 4, Radio Transmitting, Receiving and Recording System for Constant Level Balloon*, Sect I, Apr 2, 1947, p. 1.

28. Intvw, Col Jeffrey Butler and 1st Lt James McAndrew with Professor Charles B. Moore, Jun 8, 1994.

29. Moore intvw, Jun 8, 1994.

received satisfactory results when the number of targets was increased to between 3 and 5.<sup>30</sup> Interestingly, during July of 1948, a similar test would be made at Alamogordo AAF by another organization.<sup>31</sup> This test confirmed Moore's theory that when targets were increased to at least three, satisfactory returns were received by the radar. This procedure, according to Moore, was employed on flight nos. 3 and 4, but it was only marginally successful. This prompted Moore and his associates to configure the two remaining flights of Alamogordo I, flights #5 and #6, with radiosonde transmitters.

For these two final flights, Moore devised a method of manually determining azimuth and elevation, in the absence of a radiosonde recorder, by counting clicks as pressure-sensitive contacts closed. NYU Technical Report No. 1 shows two "interpretations" of the data which confirm that manual calculations were used. In regard to flight no. 5, it appears there was a typographical error in Technical Report No. 1, Table VII, for the time of launch which is erroneously listed as 1517 MST, contrary to figures 32 and 33 in Technical Report No.1 and Crary's diary (Atch 6). The correct time of launch for flight no. 5 appears to be 0516 MST. With the launching of flight no. 6 at approximately 0530 on June 7, the NYU group departed Alamogordo via a B-17 for Newark AAF, NJ. NYU flight nos. 1-6 are summarized below:

#### SUMMARY OF FLIGHTS 1-6

Flight no.	Date	Launch Site	Configuration	Landing Site
1	4/3/47	Bethlehem, PA	See NYU <i>Tech. Report No. 1</i> , Table VII	Sandy Hook, NJ
2	4/18/47	Bethlehem, PA	See Appendix NYU <i>Special Report No. 1</i>	Unknown
3	5/29/47	Alamogordo, NM	Same as flight no. 2*	Unknown
4	6/4/47	Alamogordo, NM	Same as flight no. 2*	Unknown
5	6/5/47	Alamogordo, NM	See NYU <i>Tech. Report No. 1</i> , Table VII	East of Roswell, NM
6	6/7/47	Alamogordo, NM	See NYU <i>Tech. Report No. 1</i> , Table VII	South of Highrolls, NM

\* Depictions of flight nos. 3 and 4 are not provided in the NYU reports. According to NYU *Progress Report No. 6*, Section II, p. 5, the equipment to be used for the Alamogordo field trip in June was consistent with the depiction of flight no. 2. This information also concurred with Crary's partial description of flight no. 4 in his diary.

Note: An attempt to launch a balloon-train assembly which would have been NYU flight no. 3 was made on May 8, 1947, but due to strong winds, restraining lines failed before the acoustical payload was attached. Since the launch was unsuccessful, no flight number was assigned.

30. Ibid.

31. Rprt, Holloman AFB, "Progress Summary Report on U.S.A.F. Guided Missile Test Activities," Vol 1, Aug 1, 1948.

## ALAMOGORDO II (June 27, 1947–July 8, 1947)

On the morning of June 28, 1947, personnel from NYU and Watson Laboratories arrived at Alamogordo AAF to resume balloon flights. Present during this field trip were Dr. Peoples, A.P. Crary, Captain Trakowski, C.B. Moore, and Charles Schneider. The objective during this trip was to experiment with the newly developed polyethylene balloons which replaced the neoprene meteorological balloons used on the previous field trip. Also tested was an improved aluminum ballast reservoir that had been developed to replace the plastic tubes used during the June field trip.<sup>32</sup> Another improvement that resulted from the experiences in June was the presence of a radiosonde receiver/recorder for improved balloon tracking and plotting. This eliminated the need for radar "corner reflectors" on the balloon train since radar was not to be used as a primary method of tracking the flights. This is confirmed by Technical Report No. 1, Table VII, "Radiosonde Reception %," which indicates the use of the radiosonde recorder on all flights except for no. 7. Flight no. 7 was not recorded by radiosonde because the equipment was not operable.<sup>33</sup> Also Figures 36, 39, 42, and 44 in Technical Report No. 1, corresponding to the July flights, do not depict corner reflectors. All numbered flights (except for no. 9) flown during the July field trip were summarized in NYU Technical Report No 1, Table VII. Flight no. 9 appeared to have been launched on July 3.<sup>34</sup> On July 8, their work completed, 23 members of the combined NYU and Watson Laboratory group boarded a C-54 aircraft at 1030 AM and returned to the east coast.<sup>35</sup>

Based on the above, it appeared likely that the debris found by the rancher and was subsequently identified as a "flying disc" by personnel from Roswell AAF was, with a great degree of certainty, MOGUL flight no. 4, launched on June 4, 1947. This conclusion was based on the following:

1. Descriptions of the debris provided by Brazel, Cavitt, Crary's diary, and the photos of the material displayed in General Ramey's office. These materials were consistent with the components of a MOGUL service flight, with neoprene balloons, parchment parachutes, plastic ballast tubes, corner reflectors, a sona-buoy, and a black electronics box that housed the pressure cutoff switch (Atch 3).
2. According to Brazel's July 8 statement, the debris was recovered on June 14, obviously eliminating any balloons launched in July.
3. Only two flights launched in June were unaccounted for, i.e., flight nos. 3 and 4.
4. Flight no. 3, most likely would not have had the "unorthodox" configuration of corner reflectors devised by Moore, who did not arrive until June 1, three days after flight no. 3 was launched.

---

32. NYU, *Progress Report No. 7*, Sect II, p. 5.

33. Crary personal journal, p. 15.

34. *Ibid.*

35. *Ibid.*, p. 16.

On July 7, as the NYU group members were winding down their work and preparing to return to New York City, a train of events began to unfold at Roswell AAF, 60 miles away. Roswell AAF was home of the 509th Bomb Group of the Strategic Air Command's Eighth Air Force, the only unit in the world capable of delivering nuclear weapons. It now appears that the debris from MOGUL flight no. 4 had come to earth on the plains east of the Sacramento Mountains, about 70 miles from the launch point at Alamogordo AAF (Atch 7). The fact it descended there was not unusual. Over the course of Project MOGUL, several balloons had landed and been recovered from that area. In fact, in August 1947, the NYU group had to receive special permission from the Civil Aeronautics Administration to continue to launch balloons from Alamogordo AAF since "balloons have been descending outside of the area [White Sands Proving Ground] in the vicinity of Roswell, New Mexico."<sup>36</sup> According to the sole living participant in the recovery, Sheridan Cavitt, he, Major Marcel, and MSgt William Rickett gathered some of the material, which appeared to resemble "bamboo type square sticks, one quarter to one half inch square," that was "very light"—reflecting material—and a "black box, like a weather instrument." Cavitt believed this material to be consistent with what he knew to be a weather balloon. This debris, would soon become, for a short time, the focus of national and even worldwide attention when it was thought to be a "flying disc."

On July 8, the same day that the NYU/Watson Laboratory group departed Alamogordo, the Public Information Office of Roswell AAF announced the recovery of a "flying disc" and that it would be flown to Fort Worth AAF for further examination. How could experienced military personnel have confused a weather balloon for a "flying disc"? The answer was this was not an ordinary "weather balloon." Typical weather balloons employed a single, 350-gram neoprene balloon and a radiosonde for measuring temperature, atmospheric pressure, and humidity, housed in a cardboard box. If it was to be tracked by radar for wind-speed measurement, a single corner reflector was added (Atch 8). The balloon that was found on the Foster Ranch consisted of as many as 23 350-gram balloons spaced at 20 foot intervals, several radar targets (3 to 5), plastic ballast tubes, parchment parachutes, a black "cutoff" box containing portions of a weather instrument, and a sonobuoy (Atch 3). After striking the ground, the radar reflectors, constructed of very light materials for minimum weight, would tear and break apart, spreading out over a large area when pulled across the ground by balloons that still possessed some buoyancy. It should also be understood that the term "flying disc" was not at this time synonymous with "space ship," It denoted a disc-shaped flying object of unknown (or suspected Soviet) origin.

Before the announcement was made, the "disc" was flown to Fort Worth AAF, at the direction of Brig Gen Roger Ramey, Commander, Eighth Air Force. General Ramey personally inspected the "disc," became skeptical, and summoned the base

---

36. NYU, *Technical Report No. 1*, Table VII, p. 43.

weather officer, Warrant Officer Irving Newton, to make an identification. Newton positively identified the debris as the remnants of a balloon and RAWIN target.<sup>37</sup> With this identification, the incident officially closed.

## THE "COVER STORY"

From research, it appears that the wreckage displayed on July 8 consisted of unclassified components of a MOGUL balloon assembly. Possibly withheld, if it was indeed recovered, was the AN/CRT-1 Sonabuoy, which could have compromised Project MOGUL. Although the Sonabuoy was not itself classified, its association with a balloon would have exposed a specific military purpose, an obvious violation of project classification guidelines (Atch 9). A device described in "crashed disc" publications as "a giant thermos jug" was allegedly transported from Fort Worth AAF to Wright Field.<sup>38</sup> This description is consistent with the appearance of an AN/CRT-1 Sonabuoy such as was used on flight no. 4 (Atch 4). At some point General Ramey decided to forward the material to Wright Field, home of AMC, the appropriate agency to identify one of its own research devices or a device of unknown origin. If the debris was determined to be from an unknown source, the AMC, T-2, Intelligence or Analysis Division, would conduct scientific and/or intelligence analysis in an attempt to discover its origin. But since the balloons, reflectors, and Sonabuoy were from an AMC research project, the debris was forwarded to the appropriate division or subdivision, in this case the Electronics Subdivision of the Engineering Division. There, it was identified by Colonel Duffy, under whose purview Project MOGUL operated. Colonel Duffy, a former project officer of MOGUL with specific directions to "continue to monitor upper air programs," was the appropriate headquarters officer to make an identification, which he apparently did. According to Captain (now Colonel) Trakowski, the officer who succeeded Colonel Duffy as project officer on MOGUL, after returning from the Alamogordo II field trip, Colonel Duffy contacted him by phone at Watson Laboratories and informed him that the "stuff you've been launching at Alamogordo," had been sent to him for identification. He described the debris to Captain Trakowski, and Trakowski agreed that it was part of his project (MOGUL).<sup>39</sup>

Another occurrence sometimes said to "prove" that General Ramey was part of a cover story is that portions of the debris were flown to Andrews AAF, MD. Andrews would have been a probable location to send the debris since it had components of weather observation equipment. Andrews AAF was headquarters of the Army Air Forces Weather Service. It is also interesting to note that the commanding general of the Weather Service, Brig Gen Donald N. Yates, was quoted in wire service newspaper articles on July 9, providing his opinion of the

---

37. Rawin is short for radar wind, a technique in which a single corner reflector is towed aloft by a single neoprene balloon to measure wind speed by radar.

38. Kevin Randall and Donald Schmitt, *UFO Crash at Roswell* (New York, 1991), p. 103.

39. Intvw, Col Jeffrey Butler and 1st Lt James McAndrew with Col Albert C. Trakowski, USAF (Ret), Jun 29, 1994, p. 4.



incident. Additionally, in 1949, General Yates received a full briefing of the projects, including constant-level balloons, that made up Project MOGUL.<sup>40</sup> While crashed disc proponents claim that General Ramey ordered a "colonel courier" to transport portions of the debris in a briefcase handcuffed to his wrist for the inspection of his superior, Maj Gen Clement McMullen, Deputy Commander of Strategic Air Command, it is more likely that any forwarding of such debris was another attempt to identify the research agency to which it belonged. If it did go to General McMullen, it would not have been difficult for him to have obtained the opinion of the Weather Service, since SAC and the Weather Service were located in the same building (no. 1535) at Andrews AAF.

### "HIEROGLYPHICS"

One of the most puzzling aspects of the reports that a "UFO" crashed near Corona in 1947 were the later descriptions of "hieroglyphic-like" characters by seemingly reliable, firsthand witnesses. Research has revealed that the debris found on the ranch and displayed in General Ramey's office probably did have strange characters. These, however, were not hieroglyphics, but figures printed on the pinkish-purple tape used to construct the radar targets used by the NYU group.

The witnesses have recalled small pink/purple "flowers" that appeared to be some sort of writing that couldn't be deciphered. These figures were printed on tape that sealed the seams of the of the radar target. The radar targets, sometimes called corner reflectors, had been manufactured during or shortly after World War II, and due to shortages, the manufacturer, a toy company, used whatever resources were available. This toy company used plastic tape with pink/purple flowers and geometric designs in the construction of its toys and, in a time of shortage, used it on the government contract for the corner reflectors. A depiction of these figures, as described by C.B. Moore, is shown in Attachment 10.

Allegations have also been made that the debris displayed to the press on July 8 and subsequently photographed was not the original wreckage; i.e., a switch had occurred sometime after the debris left Roswell AAF. However, statements made by Moore and Trakowski attested that the corner reflectors they launched during that period had the same flowers and figures that were later reported by Marcel, Cavitt, and Brazel as being on the debris found on the Foster ranch in Corona. In fact, Trakowski distinctly remembered the figures on the tape because, when the targets first were produced, much fanfare was made over the use of a toy manufacturer for production. He related that a fellow USAAF officer, John E. Peterson, monitored the procurement of the targets and "thought it was the biggest joke in the world that they had to go to a toy manufacturer" to make the radar targets and an "even a bigger joke when . . . the reflecting material on the balsa frames was some kind of a pinkish purple tape with hearts and flowers

---

40. Rprt, Cambridge Field Sta, AMC, "Review of Air Materiel Command Geophysical Activities by Brigadier General D.N. Yates, and Staff, of the Air Weather Service," Feb 10, 1949.

designs on it."<sup>41</sup> Furthermore, the Fort Worth Army Airfield Weather Officer, Irving Newton, who was called in to identify the wreckage, also remembers the purple/pink marks. Newton stated that when he was called to General Ramey's office he remembers meeting Marcel, who attempted to convince him that the wreckage on the floor of the office was a crashed "flying disc." Newton, having seen many weather balloons and targets, positively identified the debris as a weather device.<sup>42</sup> In short, descriptions of the wreckage found on the ranch near Corona and of the wreckage displayed in General Ramey's office are entirely consistent with each other.

## THE REAL COVER STORY

On July 10, 1947, a newspaper article appeared in the *Alamogordo Daily News* displaying for the press the devices, neoprene balloons, and corner reflectors which had been misidentified as the "flying disc" two days earlier at Roswell AAF (Atch 11). The photographs and accompanying article quoted Maj Wilbur D. Pritchard, a Watson Laboratory Project Officer (not assigned to MOGUL) stationed at Alamogordo AAF. This article appeared to have been an attempt to deflect attention from the Top Secret MOGUL project by publicly displaying a portion of the equipment and offering misleading information. If there was a "cover story" involved in this incident, it is this article, not the actions or statements of Ramey.

The article in the *Alamogordo Daily News* stated that the balloons and radar targets had been used for the last fifteen months for the training of long-range radar personnel and the gathering of meteorological data. The article lists four officers—Maj W.D. Pritchard, Lieut S.W. Seigel, Capt L.H. Dyvad, and Maj C.W. Mangum—as being involved with the balloon project, which was false. Moore and Trakowski could not recall any of the officers in the photograph, with the exception of Dyvad, whom Moore identified as a pilot who coordinated radar activities.<sup>43</sup> Additionally, some of the details discussed (balloon sighting in Colorado, tracking by B-17s, recovery of equipment, launching balloons at 5-6 AM, and balloon altitudes of 30,000-40,000 feet) relate directly to the NYU balloon project, indicating that the four officers had detailed knowledge of MOGUL.<sup>44</sup> Moore's unorthodox technique of employing several balloons and several radar targets was shown in one of the photographs. Other techniques unique to Moore,

---

41. Trakowski intvw, Jun 29, 1994.

42. Newton intvw, Jul 21, 1994.

43. Moore intvw, Jun 8, 1994.

44. NYU, *Technical Report No. 1*, Table VII.

including the boiling of balloons before launch (which he personally developed during World War II) and a stepladder used to launch balloons, could not all have coincidentally been used by other organizations.<sup>45</sup>

The details may have been provided to the radar officers by Crary, Project MOGUL Field Operations Director, who did not depart by C-54 with the rest of the NYU/Watson Laboratory group on July 8, but who later left by car on July 9, the day the staged launch took place. Additionally, three of Crary's staff, Don Reynolds, Sol Oliva, and Bill Edmonston, resided permanently in Alamogordo. It was apparent from Crary's diary that he had worked very closely with Major Pritchard and reported to him on occasion (twelve documented meetings from December 1946–April 1947). One instance, on April 7, 1947, Crary gave Pritchard a "progress report for MOGUL project to date," indicating that Major Pritchard had access to MOGUL information.<sup>46</sup> Another statement which appeared to confirm a cover story appeared in the caption below the balloon picture and described a typewritten tag stapled to the target identifying it as having come from Alamogordo AAF. Moore believed this not to be true because any equipment found was not to be associated with the USAAF, only with NYU; therefore flights carried "return to" tags identifying NYU as the responsible agency.<sup>47</sup>

## CONCLUSION

Many of the claims surrounding the events of July 1947 could be neither proved nor disproved. Attempts were not made to investigate every allegation, but rather to start with what was known and work toward the unknown. To complicate the situation, events described here took place nearly 50 years ago and were highly classified. This Top Secret project appeared to have utilized the concept of compartmentalization very well. Interviews with individuals and review of documents of organizations revealed that the ultimate objective of the work, or even the name of the project, in many instances was not known. It was unlikely, therefore, that personnel from Roswell AAF, even though they possessed the appropriate clearances, would have known about project MOGUL. In fact, when the NYU/AMC group returned to Alamogordo in September, their first trip since the "incident" occurred, one of the first activities of the project scientists, Peoples and Crary, who were accompanied by Major Pritchard and Captain Dyvad, was to brief the commanding officer of Alamogordo AAF and the 509th Bomb Group Operations Officer, Lt Col Joseph Briley, on MOGUL.<sup>48</sup>

---

45. Moore intvw, Jun 8, 1994.

46. Crary personal journal, p. 10.

47. Moore intvw, Jun 8, 1994; Research Division, College of Engineering, NYU, *Technical Report No. 93.02, Constant Level Balloons*, Sect 2, *Operations*, Jan 31, 1949, pp. 36–38.

48. Combined Hist, 509th Bomb Grp and Roswell AAF, Sep 1–30, 1947, p. 79; Untranscribed journal of Albert P. Crary, p. 64.

When the civilians and personnel from Roswell AAF (Marcel, Cavitt, and Rickett) "stumbled" upon the highly classified project and collected the debris, no one at Roswell had a "need to know" about information concerning MOGUL. This fact, along with the initial misidentification and subsequent rumors that the "capture" of a "flying disc" occurred, ultimately left many people with unanswered questions that have endured to this day.

JAMES McANDREW, 1st Lt, USAFR  
Declassification and Review Officer  
SAF/AAZD

Attachments:

1. 4 Photographs of Balloon Debris
2. Organizational Chart—Watson Laboratories
3. Drawing—New York University Flight No. 2
4. 2 Depictions of AN/CRT-1 Sonabuoy
5. Drawing of Corner Reflector
6. New York University *Technical Report No. 1*, Table VII
7. Map of New Mexico
8. Typical Employment of Weather Balloon and Corner Reflector
9. Project MOGUL Classification Letter
10. Drawing of "Hieroglyphics" by Prof. C.B. Moore
11. *Alamogordo Daily News* Article



1

*Fort Worth Star-Telegram*  
Photographs of Balloon Debris  
[July 9, 1947]



Same as  
Weaver Attachment 16





2

Organizational Chart  
Watson Laboratories  
January 20, 1947



WLETS  
 MR. REG. 20-11 (P. 10-11)  
 MR. DOUGLAS RIGNEY (ASST)  
 CAPT A C TRAKOWSKI, JR  
 CHIEF

WLETS  
 ELECTROMAGNETIC  
 WAVE LABORATORY  
 DR PHILIP HERMAN

WLETS  
 MICROWAVE AND VHF  
 BRANCH  
 MR SAR PURE

WLETS  
 IONOSPHERIC  
 BRANCH  
 MR SAR PURE

WLETS  
 COMPRESSIONAL WAVE  
 LABORATORY  
 DR JAMES PEOPLES

WLETS  
 ATMOSPHERIC  
 BRANCH  
 DR ALBERT GRANT

WLETS  
 OCEANOGRAPHIC  
 BRANCH  
 DR CHARLES MELLAND

WLETS  
 TERRESTRIAL  
 BRANCH  
 DR ALBERT GRANT

WLETS  
 TECHNICAL SERVICES SECTION  
 LT H G BALL  
 LT H F STEENS (ASST)

WLETS  
 REQUIREMENTS AND  
 SCHEDULING BRANCH  
 LT H F STEENS

WLETS  
 FACILITIES  
 BRANCH  
 LT VAN D THOMPSON, JR

WLETS  
 FIELD TEST BRANCH  
 LT VAN D THOMPSON JR

APPLIED PROPAGATION SUBDIVISION  
 AIR NATIONAL GUARD  
 WATSON LABORATORIES  
 20 JAN 1947



3

Drawing  
Cluster Flight No. 2



Same as  
Weaver Attachment 25





Illustrations  
AN/CRT-1 Sonabuoy

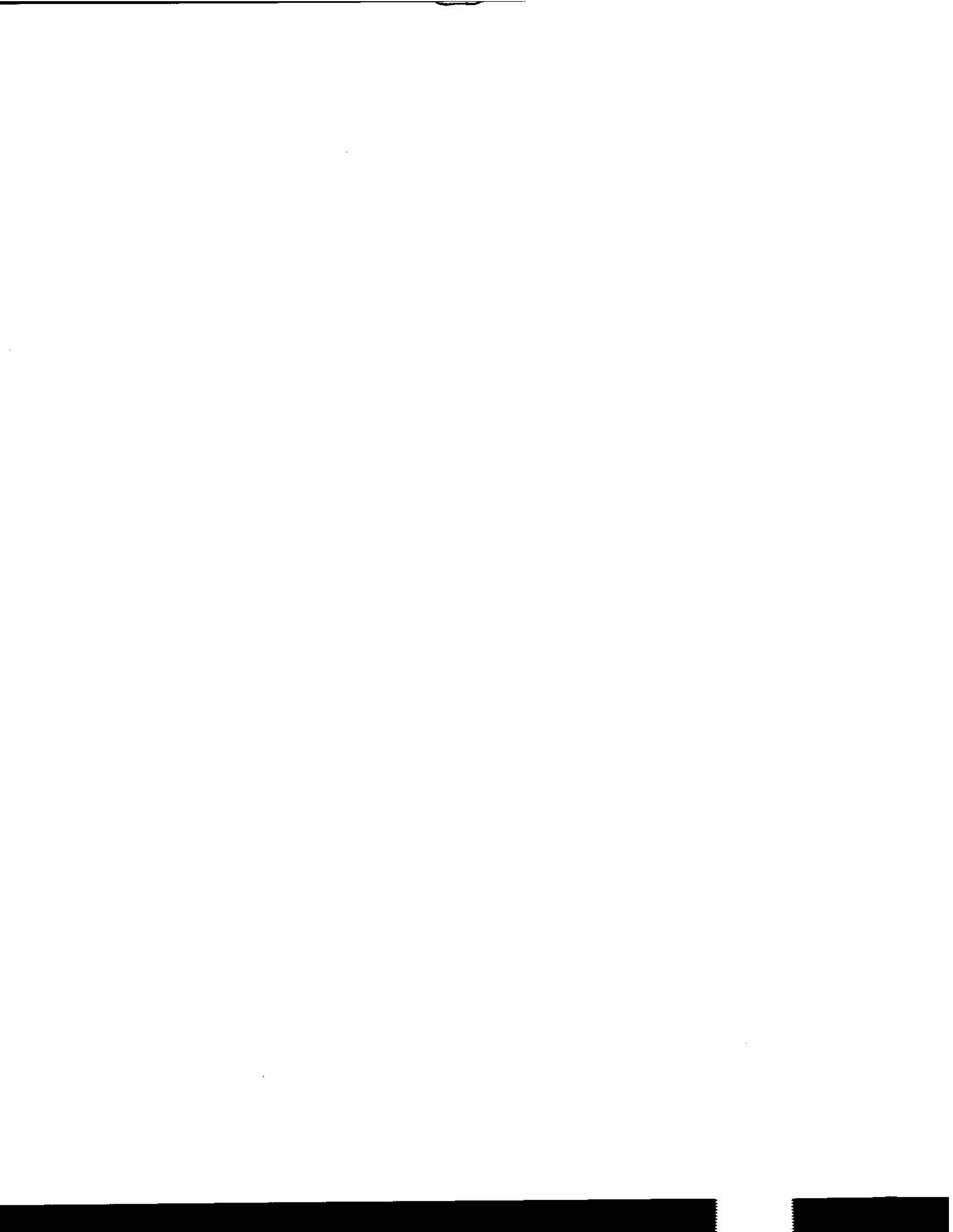

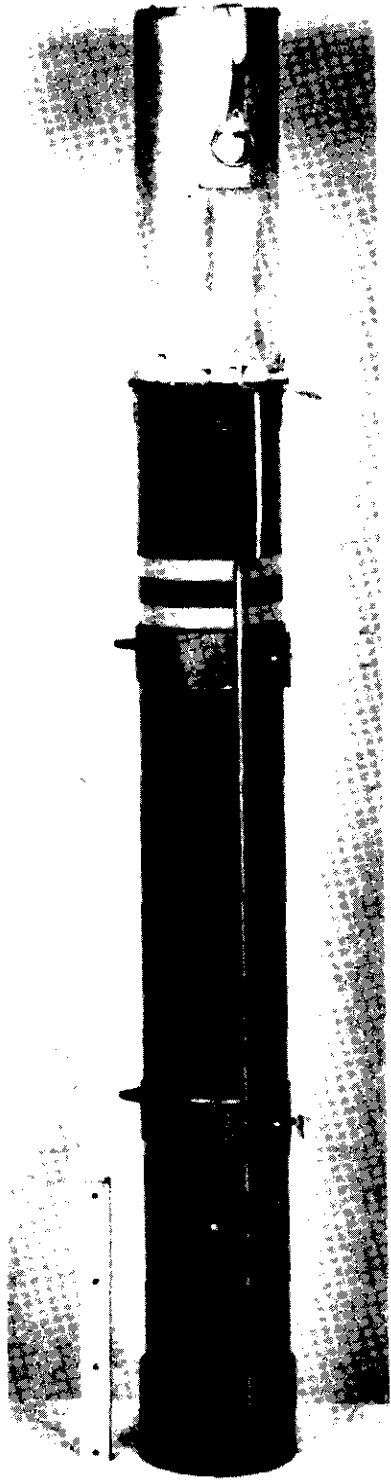

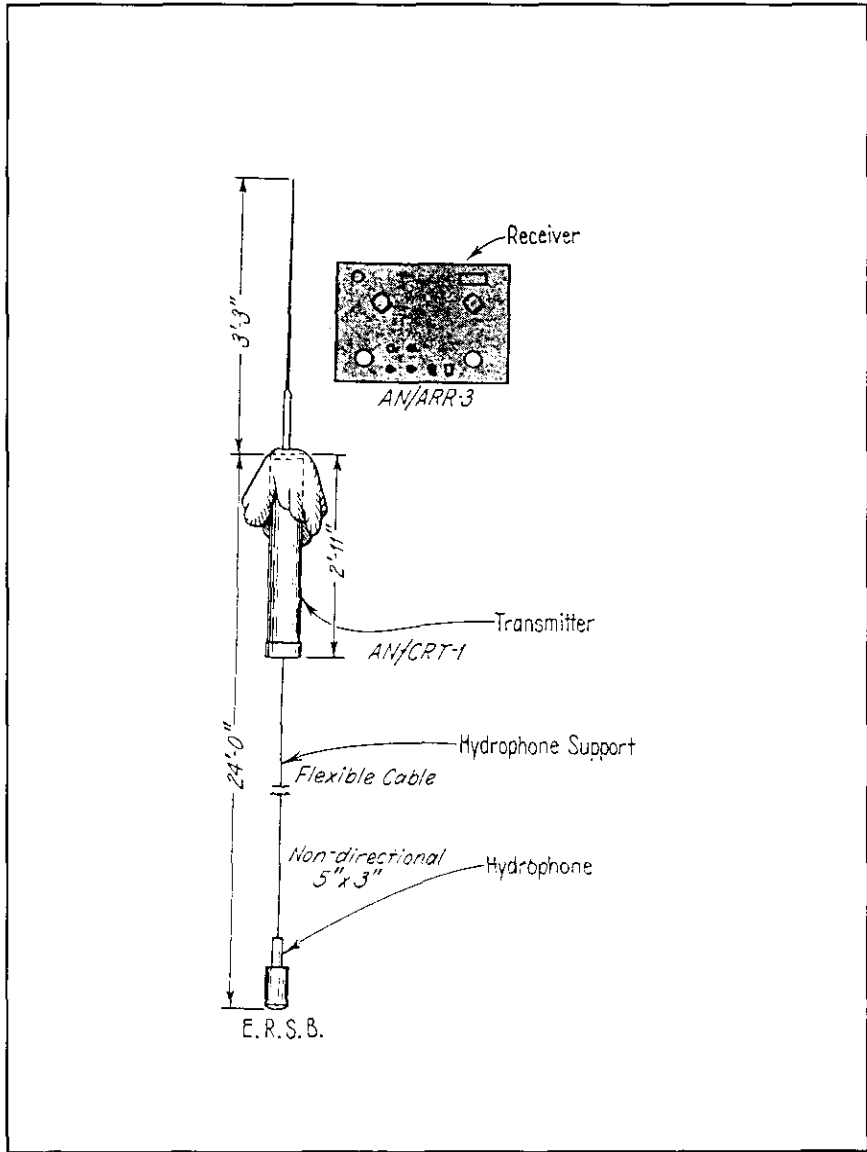

5

Blueprint  
Corner Reflector, ML-307C/AP  
Assembly



Same as  
Weaver Attachment 29





Summary Table  
NYU Constant-Level Balloon Flights  
November 20, 1946–September 9,  
1947



See also  
Weaver Attachment 27

SUMMARY OF HYDRO-COAST-T...VAL-BALLOON FLIGHTS

FLIGHT NUMBER	DATE AND TIME	LAUNCHING SITE	DESCRIPTION OF CHALLENGE	BALLOON WEIGHT	WEIGHTS OF APPARATUS	AVERAGE WEIGHT OF BALLOON ASSEMBLY	DESCRIPTION OF ALTITUDE CONTROL	BALLOON WEIGHT	FREE WEIGHT	BALLOON WEIGHT	ADDITIONAL INFORMATION	TRACKING	ALTIMETER	FLIGHT DURATION	OPTIMUM ALTITUDE	MAXIMUM CONSTANT LEVELS	BALLOON & LAUNCHING SITE	REMARKS
11	7 July 1949 0900 MST	Alamogordo New Mexico	7 - General Mills 1 - 15' .000" Poly-ethylene 6 - 5' .001" Poly-ethylene in balloon 15' Balloon	17.1 kg	74.5 mc Adionoms ballast assembly	15.9 kg	Oxiblar Compress Fluid Fixed Leak 300 gm/hr	31.3 kg	3.3 kg	37.3 kg	87.6 mib recorder	Theodo-111e 1500-458 100%	100% C-34	510 min.	423 min. 1300'	Max. 4800' Const. 16000'	0.5	Balloons used in cluster to obtain higher altitudes in high wind at launching site. Balloons did not rise high enough to restore altitude control. Driftballer leak and balloon diffusion both 300 gm/hr. Therefore balloon remained at ceiling until ballast was expended.
12	8 Aug 1949 0715 MST	Lakewood New Mexico	1 - General Mills 20' .001" Poly-ethylene	4.1 kg	1 mc Trans-187.5 mc Adionoms 12.2 mc Adionoms Ballast assembly	28.0 kg	Automatic and valve ballast valve and altitude pressure switch	31.8 kg	3.8 kg	35.6 kg	100% Millman	Theodo-111e 1500-458 100%	95%	407 min.	40 min. 400'	Max. 14100'	95%	First flight with large thin balloon. Open appendix caused ballast diffusion with air-burst. Over appendix thought to have caused burst. Flight not resumed as balloon test or altitude control test.
13	5 Sept. 1949 0647 MST	Alamogordo New Mexico	2 General Mills 20' .001" Poly-ethylene, 10' appendix inside around lines	8.4 kg	387 mc Adionoms Data User Ballast release	24.2 kg	Automatic Ballast release assembly	31.8 kg	3.8 kg	28.0 kg	100%	Theodo-111e 1500-458 100%	Not required	58 min.	None (burst)	Max. 4760'	0%	Appendix tested around around lines, preventing release of gas at altitude. Both balloons burst within 2 minutes and gear fell free to desert. Recovery not attempted.
14	6 Sept. 1949 0613 MST	Alamogordo New Mexico	1 General Mills 20' .001" Poly-ethylene, 10' appendix inside around lines	6.0 kg	397 mc Adionoms Banner Ballast release	15.1 kg	Automatic Ballast release assembly	5.0 kg	2.2 kg	17.3 kg	100%	Theodo-111e 1500-458 100%	Least 10%	55 min.	None (burst)	Max. 49000'	100%	Appendix again tested around around lines, preventing release of gas at pressure altitude, where balloon burst. Success retarded by banner.
15	6 Sept. 1949 1153 MST	Alamogordo New Mexico	1 General Mills 20' .001" Poly-ethylene, 10' appendix outside around lines	6.0 kg	397 mc Adionoms Banner Ballast release	15.1 kg	Normal ballast valve. Fixed rate of leak 1000 gm/hr	3.0 kg	2.6 kg	17.7 kg	344 min.	Theodo-111e 175 min. 1500-458 100%	Not required	More than 364 min.	71 min. 5000'	Max. 45800' Const. 34000'	0%	First flight with large G. M. balloons which did not burst due to appendix. Minor holes in balloon due to high wind at launch height caused slow descent after pressure altitude was reached. Banner used of short appendix and automatic ballast valve.
16	8 Sept. 1949 0828 MST	Alamogordo New Mexico	1 General Mills 20' .001" Poly-ethylene, 10' appendix outside around lines	6.4 kg	397 mc Adionoms Data User Ballast release	16.1 kg	Automatic Ballast release assembly	3.2 kg	2.4 kg	18.5 kg	100%	Theodo-111e 1500-458 100%	Not required	30 min.	None (burst)	Max. 31700'	0%	Heavily loaded balloon with too much free lift (inflated by volume estimate in wind). High oscillations observed after release. Balloon burst due to blowing off top wall when pressure altitude. Balloon came down with free falling gear but was not found.
17	9 Sept. 1949 1447 MST	Alamogordo New Mexico	1 M. A. Smith 15' .004" Poly-ethylene with 18 lead points	6.4 kg	397 mc Adionoms Banner Ballast release	11.3 kg	Automatic Ballast release assembly 100 gm/hr fixed leak	4.0 kg	2.1 kg	13.4 kg	201 min.	201 min.	Not required	10 min.	18 min. 2000'	Max. 29700' Const. 29100'	0%	Successful controlled altitude flight demonstrating altitude control maintaining height through a burst. Balloons descended near Craft. Banner long after gear had reached the reception range. Need for a barograph shown.

7

Map of New Mexico



See  
Map of New Mexico  
in  
Photograph Section





8

Illustration  
Weather Balloon and Corner Reflector

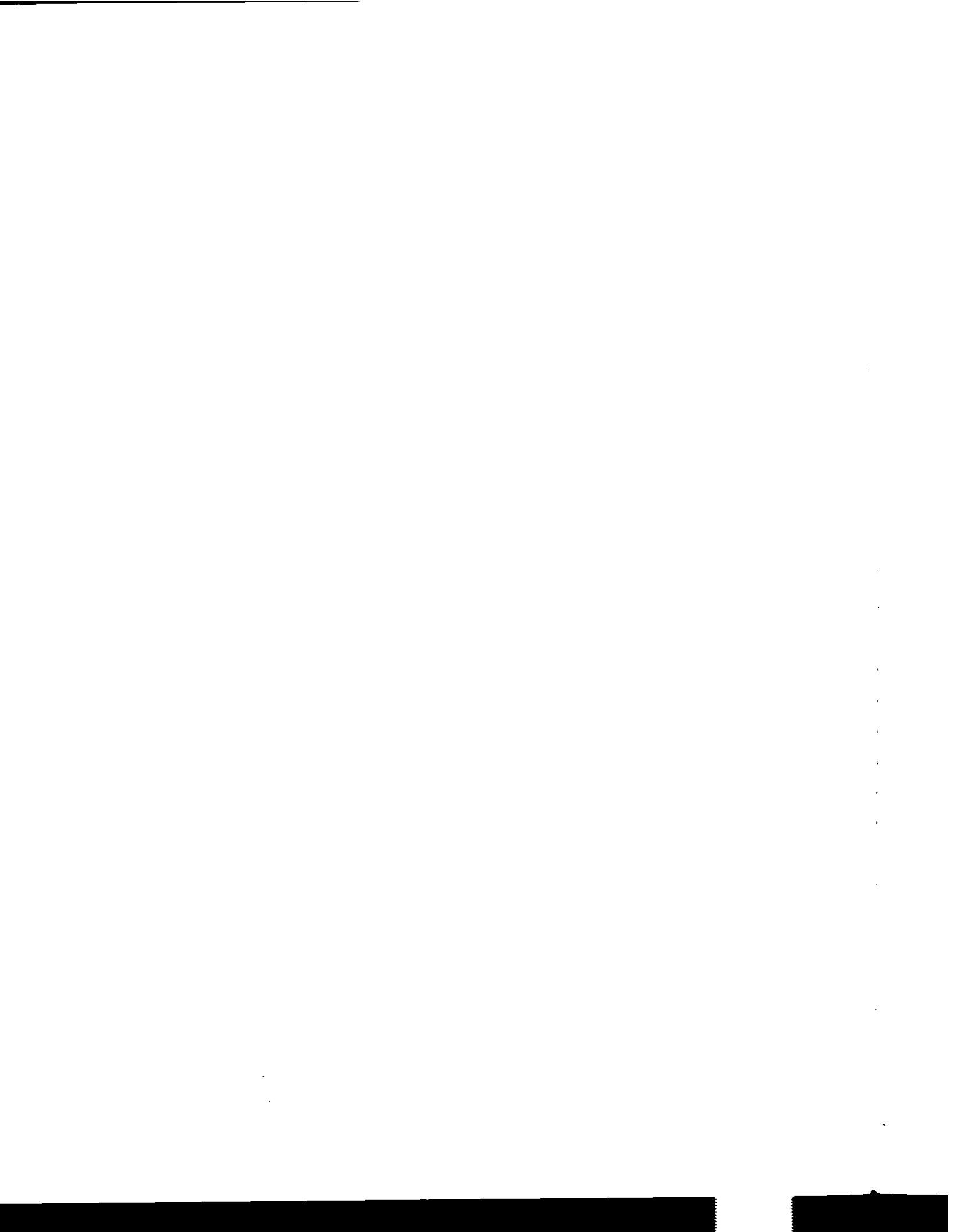

ML-307(\*)/AP



Figure 50. Pilot Balloon Target ML-307/AP or ML-307A/AP ready for flight.

*Status:* Standard. *Stock No.:* 7A1237. *Reference:* TM 1-235.

Pilot Balloon Target ML-307(\*)/AP represents Pilot Balloon Targets ML-307/AP, ML-307A/AP, and ML-307B/AP. Pilot Balloon Target ML-307(\*)/AP is a reflector which is attached to a 100- or 350-gram pilot balloon to assist in tracking it by radar. It is composed of a combination of triangular-shaped surfaces constructed of light, paper-backed aluminum foil supported by balsa sticks; it weighs approximately 100 grams. The target folds into a flat triangle for shipment. Pilot Balloon Target ML-307(\*)/AP is designed to function best with Radio Sets SCR-584 (any model), SCR-545 (tracking components), and SCR-614 (any model). The targets are packed 24 to a shipping container.



9

Letter  
Brig Gen E. O'Donnell to  
Commanding General AAF  
July 8, 1946



Included in  
Weaver Attachment 19





10

Hieroglyphs  
Charles B. Moore  
August 28, 1992



Included in  
Weaver Attachment 21

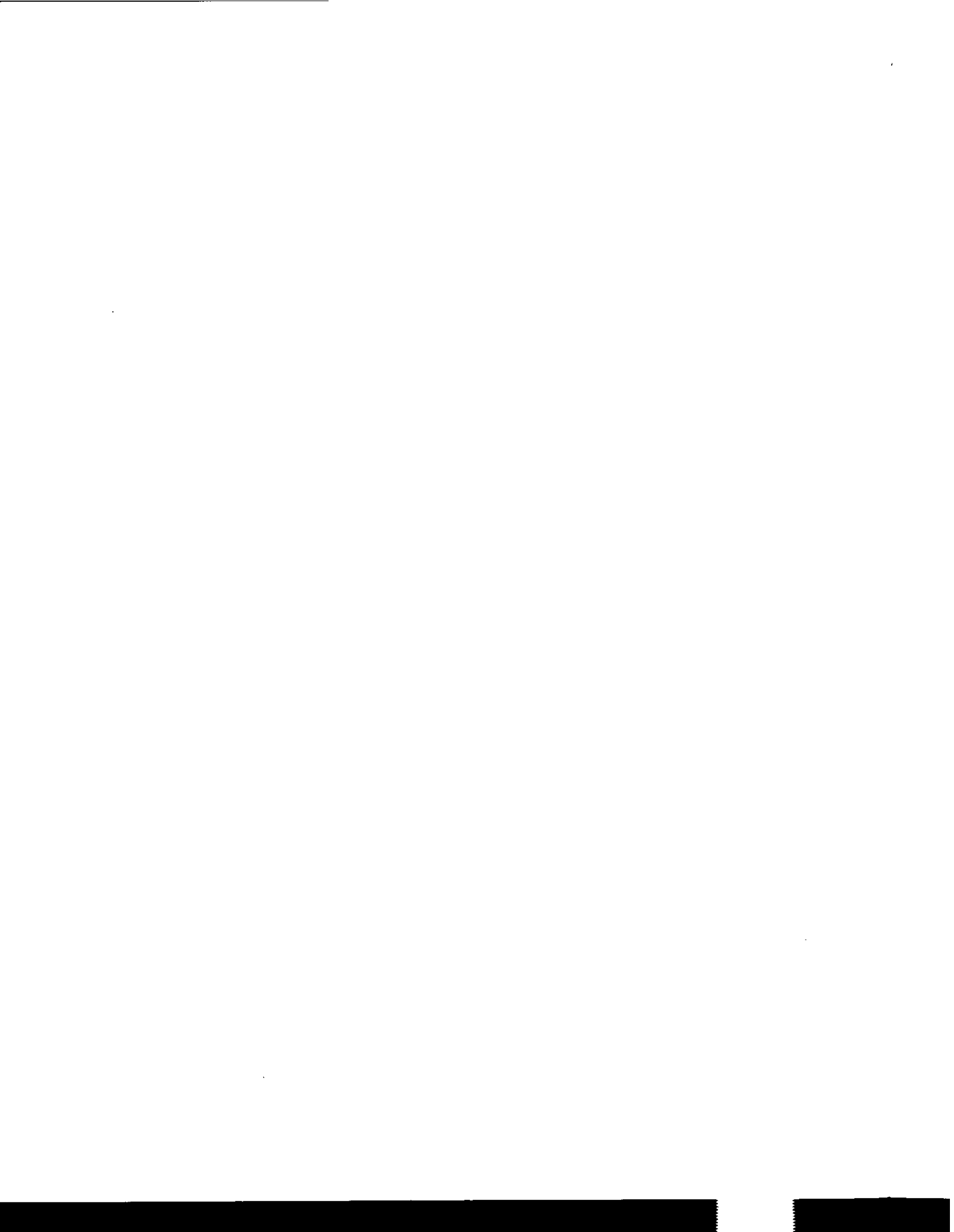

11

*Alamogordo News*

“Fantasy of ‘Flying Disc’ Is  
Explained Here: News Men Watch  
Army Radar Crew Launch ‘Disc’”  
July 10, 1947









*Roswell Daily Record*  
"Harassed Rancher Who Located  
'Saucer' Sorry He Told About It"  
[July 9, 1947]

---



# Harassed Rancher who Located 'Saucer' Sorry He Told About It

W. W. Brazel, 48, Lincoln county rancher living 30 miles south east of Corona, today told his story of finding what the army at first described as a flying disk, but the publicity which attended his find caused him to add that if he ever found anything else short of a bomb he sure wasn't going to say anything about it.

Brazel was brought here late yesterday by W. E. Whitmore, of radio station KGFL, had his picture taken and gave an interview to the Record and Jason Kellahin, sent here from the Albuquerque bureau of the Associated Press to cover the story. The picture he posed for was sent out over AP telephoto wire sending machine specially set up in the Record office by R. D. Adair, AP wire chief sent here from Albuquerque for the sole purpose of getting out his picture and that of sheriff George Wilcox, to whom Brazel originally gave the information of his find.

Brazel related that on June 14 he and an 8-year old son, Vernon were about 7 or 8 miles from the ranch house of the J. B. Foster ranch, which he operates, when

they came upon a large area of bright wreckage made up on rubber strips, tinfoil, a rather tough paper and sticks.

At the time Brazel was in a hurry to get his round made and he did not pay much attention to it. But he did remark about what he had seen and on July 4 he, his wife, Vernon and a daughter Betty, age 14, went back to the spot and gathered up quite a bit of the debris.

The next day he first heard about the flying disks, and he wondered if what he had found might be the remnants of one of these.

Monday he came to town to sell some wool and while here he went to see sheriff George Wilcox and "whispered kinda confidential like" that he might have found a flying disk.

Wilcox got in touch with the Roswell Army Air Field and Maj. Jesse A. Marcel and a man in plain clothes accompanied him home, where they picked up the rest of the pieces of the "disk" and went to his home to try to reconstruct it.

According to Brazel they simply

could not reconstruct it at all. They tried to make a kite out of it, but could not do that and could not find any way to put it back together so that it would fit.

Then Major Marcel brought it to Roswell and that was the last he heard of it until the story broke that he had found a flying disk.

Brazel said that he did not see it fall from the sky and did not see it before it was torn up, so he did not know the size or shape it might have been, but he thought it might have been about as large as a table top. The balloon which held it up, if that was how it worked, must have been about 12 feet long, he felt, measuring the distance by the size of the room in which he sat. The rubber was smoky gray in color and scattered over an area about 200 yards in diameter.

When the debris was gathered up the tinfoil, paper, tape, and sticks made a bundle about three feet long and 7 or 8 inches thick, while the rubber made a bundle about 18 or 20 inches long and about 8 inches thick. In all, he estimated, the entire lot would

have weighed maybe five pounds. There was no sign of any metal in the area which might have been used for an engine and no sign of any propellers of any kind, although at least one paper fin had been glued onto some of the tinfoil.

There were no words to be found anywhere on the instrument, although there were letters on some of the parts. Considerable scotch tape and some tape with flowers printed upon it had been used in the construction.

No strings or wire were to be found but there were some eyelets in the paper to indicate that some sort of attachment may have been used.

Brazel said that he had previously found two weather observation balloons on the ranch, but that what he found this time did not in any way resemble either of these.

"I am sure what I found was not any weather observation balloon," he said. "But if I find anything else, besides a bomb they are going to have a hard time getting me to say anything about it."



Interview  
Col Richard L. Weaver with Lt Col  
Sheridan Cavitt, USAF (Ret)  
May 24, 1994

---

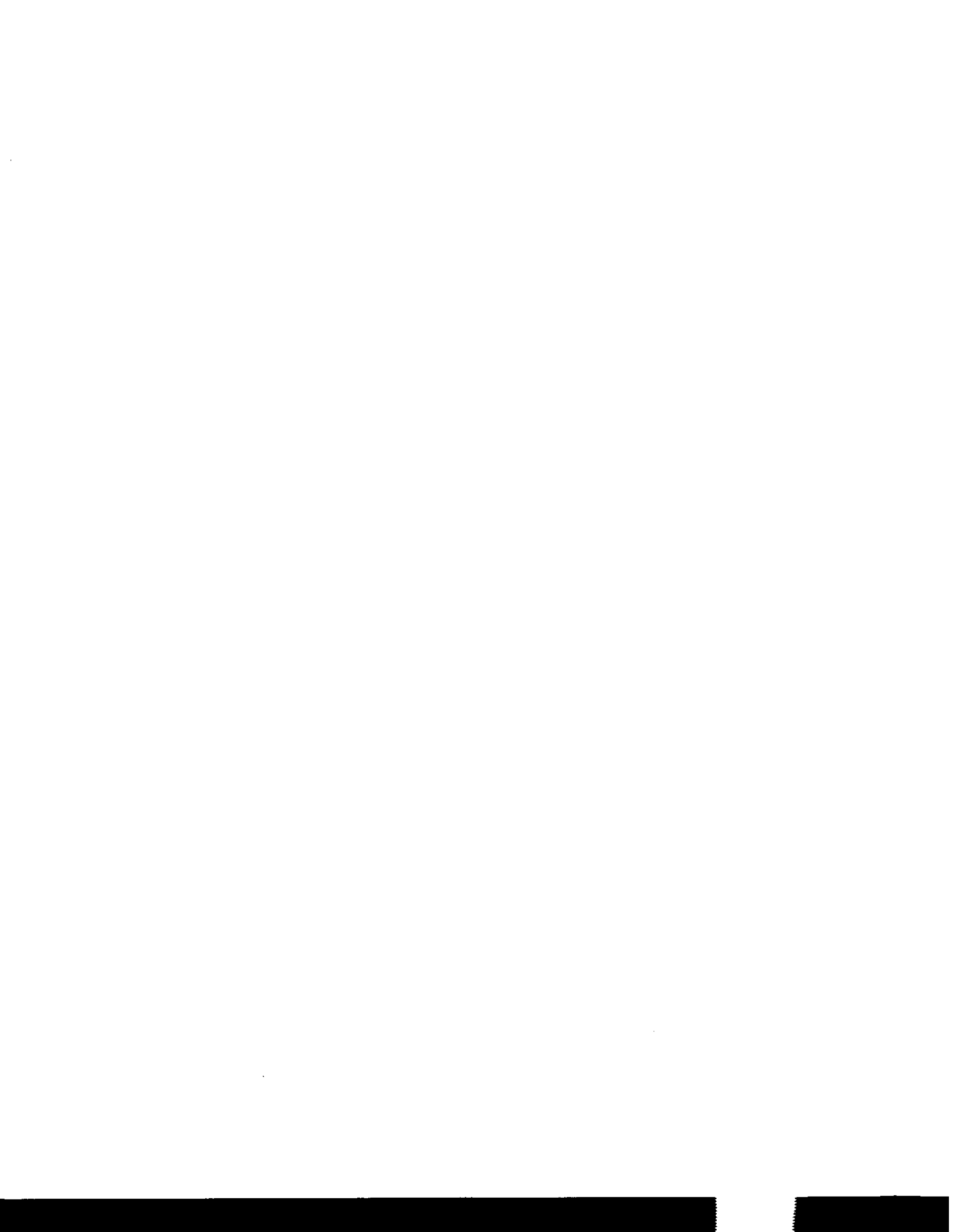

Same as  
Weaver Attachment 18





Interview  
Lt Col Joseph V. Rogan with Irving  
Newton  
July 21, 1994

---

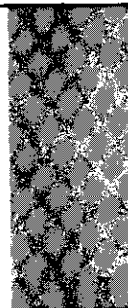



Same as  
Weaver Attachment 30



Letter  
Lt Col Edward A. Doty to Mr David  
Bushnell  
March 3, 1959

---



3 March 1959

Mr. David Bushnell  
MDNH  
Air Force Missile Development Center  
Holloman Air Force Base, New Mexico

Dear Mr. Bushnell:

It has taken me much too long in answering your inquiries of 9 October 1958 but I hope this information will be of some value to you in preparing a history of balloon operations at Holloman. Thanks also for the three reports which you sent me.

Answering your specific questions, my EDCMR to Holloman was 20 January 1948. I reported in about 1 February 1948. I immediately joined the Electronic and Atmospheric Projects Section and remained in this same basic organization through its various name changes for my entire tour at Holloman.

I attended the January 1950 Class at the Air Tactical School, Tryndall Air Force Base, Florida for sixteen (16) weeks and returned to Holloman by 15 May.

On 31 July 1950 I was assigned Chief, Geophysical Research Unit, (Balloon) Electronics and Atmospheric Branch, Technical Operations Section, O&P on Special Orders No. 152, par 24. This, I believe, was the first balloon organization. On 29 May 1951, S.O. No. 111, par 8 redesignated me without change of assignment as Chief, Balloon Atmospheric Unit, Electronics and Atmospheric Branch; Development and Test Section Base Directorate, Technical Operations. Then in S.O. No. 98, 13 November 1951, par 11, I was Chief, Balloon Sonde Sub-Unit, Electronics and Atmospheric Unit, Development and Test Section, Operations.

I was never the Holloman Base Weather Officer. Lt Colonel Maas was assigned as Base Weather Officer and as head of the E&A organization as a dual assignment for a while.

There was a continuity of organization from the earliest balloon activities up to the present. The name changed but the group continued. The radar research activities, the Aerobee rocket atmospheric investigations and the balloon activities were sponsored originally



by the Air Force Cambridge Research Center and were administered in a single organization up through the time I left Holloman.

When I first arrived at Holloman, a New York University group under Mr. C. B. Moore with a AFRCR contract had been launching 20 foot plastic balloons since June 1947 from the North area. I began as their project officer.

I hope this has been of some use to you.

Sincerely,

EDWARD A. DOTY  
Lt Colonel, USAF

H7 6801 AFDRD-ER

Letter  
Brig Gen E. O'Donnell to  
Commanding General, USAAF  
Subj: Change in Classification of  
MOGUL, Item 188-5  
July 8, 1946

---

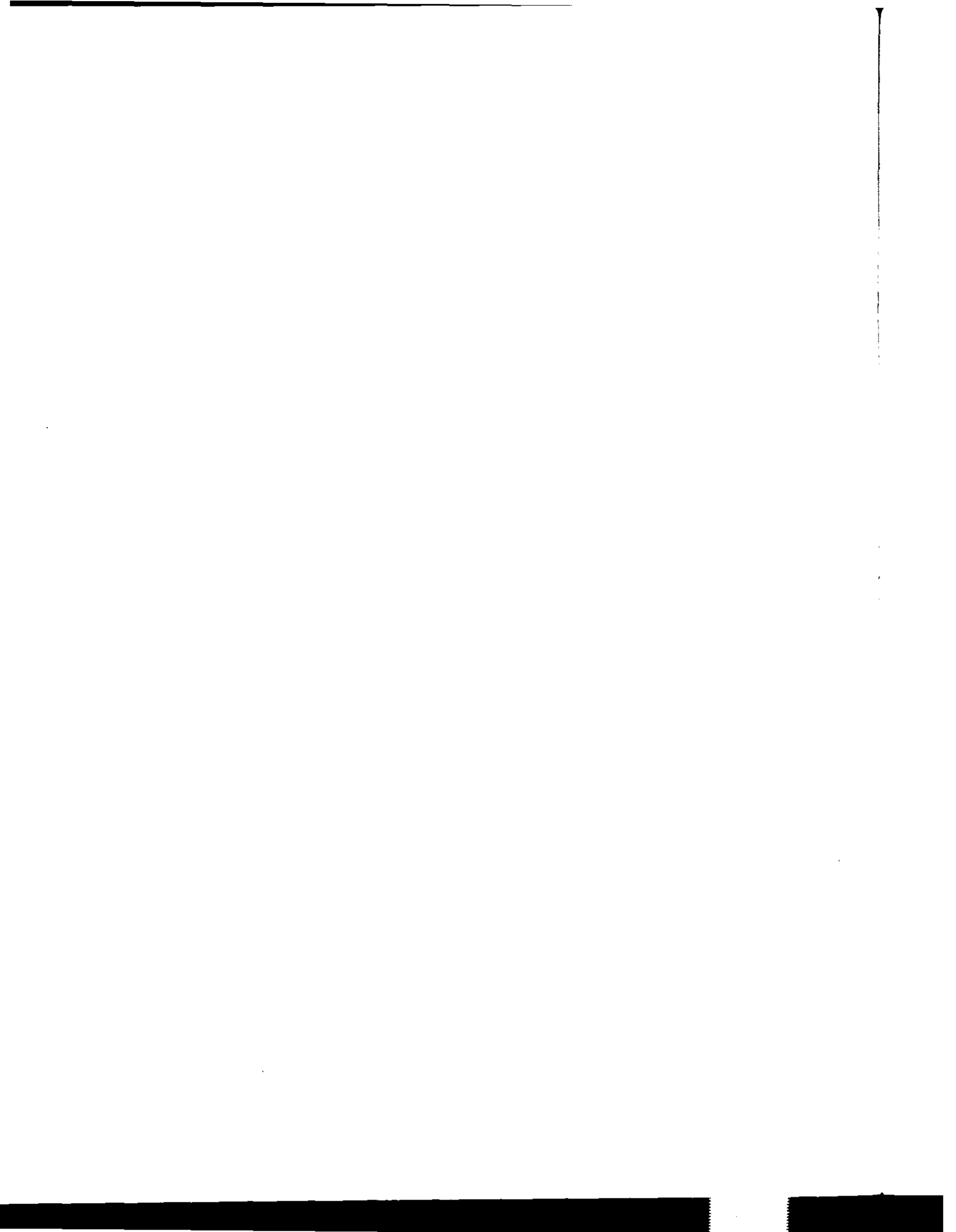

Included in  
Weaver Attachment 19



Report  
Maurice Ewing for General Carl  
Spatz  
“Long Range Sound Transmission in  
the Atmosphere”  
n.d.

---

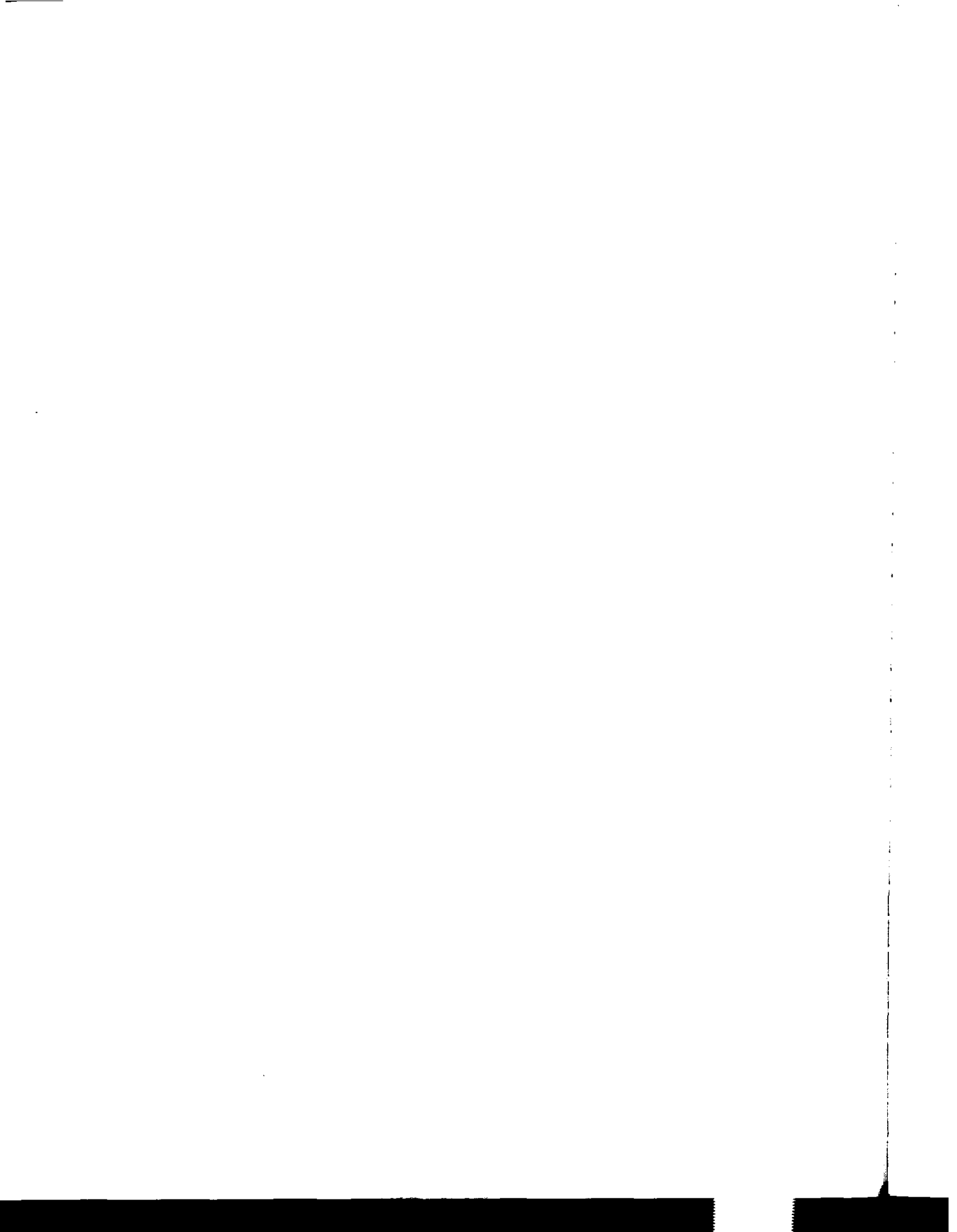

~~SECRET~~

LONG RANGE SOUND TRANSMISSION IN THE ATMOSPHERE

A Report for General Carl Spaatz

prepared by Maurice Ewing

I THE SOUND CHANNEL IN THE OCEAN

Under a contract with the Bureau of Ships, we have proved that there is a sound channel in the ocean with its axis at a depth of about 4000 feet. Confirming a prediction made by the writer, a four pound bomb fired at this depth has been heard at a distance of 2300 miles, using a hydrophone at the same depth as a receiver. This range enormously exceeds anything before achieved, and is possible primarily because the source and the receiver are placed at the most advantageous depth. The signal strength indicates that far greater ranges can be obtained without change of equipment.

At a typical place in the ocean, the speed of sound at the surface is 5001 ft/sec. It decreases to 4888 ft/sec at a depth of 4000 feet, and then increases to 5065 ft/sec at a depth of 16,200 feet. This situation is described as a sound channel with its axis at 4000 feet, because all sound rays are deflected downward at points above the axis and upward at points below it. Detailed calculation of the bending of the ray paths due to pressure and temperature shows that all rays leaving a sound source on the axis in directions within  $12^\circ$  of the horizontal are refracted back and forth across the axis and can travel unlimited distances without contact with surface or bottom, hence the long ranges. A similar calculation for a sound source near the surface shows that all rays must be reflected at surface and bottom many times in the course of a few hundred miles, hence the limited range of detection of ordinary shallow explosions, and the occurrence of skip distances.

The sound from an explosion at the axis of the sound channel has a duration of about 12 seconds per thousand miles of travel, and an unmistakable pattern of a gradual building up to maximum intensity with a very sharp out-off. This last feature is of great importance because it permits accurate triangulation with a network of three listening stations, the rate of transmission being about one mile per second.

(Reference 1)



~~SECRET~~

## II EXISTENCE OF A SOUND CHANNEL IN THE ATMOSPHERE

In September, 1944, it occurred to me that there is a similar sound channel in the atmosphere with the axis at a height of about 45,000 feet, and that, with source and receiver placed at this height, we might exceed the accepted ranges as enormously as we had in the ocean. In other words, it might be possible to detect sound half way around the world.

The fundamental data on this subject as revealed during a hurried search of the literature (mostly prior to 1930), show that, for a typical large explosion, there is audibility from 0 to 25 miles and from 90 to 125 miles, with a zone of silence from 25 to 90 miles. The accepted explanation of the total collection of these data is that the speed of sound decreases from about 1090 ft/sec at the surface to about 970 ft/sec at about 45,000 feet, and then increases to about 1165 ft/sec at about 130,000 feet. (Reference 2)

Thus there is a sound channel in the atmosphere with its axis at a height of about 45,000 feet, and if both sound source and receiver are located at this height, we may expect extraordinary ranges and all the other useful phenomena which have been found in the sound channel in the ocean. This means that the signals will have highly characteristic identifying features and that they will permit accurate triangulation.

## III PROBABLE MAXIMUM RANGE

The maximum range for sonic signalling in the atmospheric sound channel will depend primarily on the absorption coefficient, which is the rate at which the acoustical energy is converted into heat by frictional losses. Following Rayleigh (Reference 3, p. 316), it may be calculated that the distance at which sound of frequency 50 cycles per second would be reduced in intensity by the factor 7.5 by the effect of friction alone is about 24,000 miles at sea level, and about 4500 miles at 45,000 feet. As these distances are inversely proportional to the square of the frequency, they would be one hundred times greater for sounds of frequency 5 cycles per second, which have often been observed when large explosions were studied.

~~SECRET~~

It is impossible to make really detailed calculations of the maximum range without better information about temperature and sound velocity in locations from 45,000 to 90,000 feet, for it is there that the greatest frictional losses will occur. However, it is safe to predict that a bomb containing a few pounds of TNT can be heard from 4000 to 5000 miles. The chance that it could be heard to the farthest point on earth is worth consideration.

#### IV PROPOSED MILITARY USE OF ATMOSPHERIC SOUND CHANNEL

It is my belief that a large rocket or jet propulsion motor passing the axis of the sound channel would also be detectable by listening at several thousand miles, and subject to location by triangulation if heard by three suitably chosen stations. In time of war this triangulation could locate the launching sites of the enemy, and in peace time it is conceivable that suitably chosen listening stations could monitor the entire world to detect and locate any unusual rocket or jet propulsion experiments, thus minimizing the danger of surprise attacks with secret weapons.

#### V TYPES OF LISTENING STATION

The most promising types of listening station according to my present knowledge would make use either of the higher mountains of the world or of free balloons to gain adequate height. It is unknown at present by how far the receiver may be removed from the preferred height without prohibitive sacrifice of sound channel properties. However, in the submarine sound channel we have had fairly good reception with the hydrophone at 2000 feet when the axis of the channel was at 4000 feet. Hence, it is not beyond reason that the taller mountains might provide sufficient altitude of themselves.

Small stratosphere balloons provided with radio means for transmission of sound impulses to a receiving station either fixed or mobile, probably provide the most readily available listening arrangement.

## VI PRELIMINARY INVESTIGATIONS RECOMMENDED

a) Canvas published literature for such further information as can be gleaned from sound transmission between source and receiver at the earth's surface about variation of sound velocity and sound absorption with altitude. Also canvas meteorological literature for better information about the stratosphere.

b) Assign an officer to search confidential publications on sound ranging and other related subjects for relevant information. This officer should also collect data on sound ranging equipment and personnel in the army which could be assembled for a preliminary test.

c) Make a preliminary measurement using about three sound ranging units on ground as receivers, and bombs dropped or rockets fired upward from a high flying plane, or anti-aircraft shells sent as high as possible as sources. This will not be true sound channel transmission, but rather a refinement of the data collected from audibility of large explosions. By proper interpretation of records from bombs exploded at intervals of a few miles out to 400 or 500 miles, all of the basic information will be made available. By use of techniques which I have used for years on sound transmission through ground and through water, it is possible to calculate the path followed by each sound ray, to find its highest ascent into the stratosphere, and to determine the coefficient of sound absorption.

d) A study of existing publications should be made to determine the sound production of typical rocket and jet propulsion units in order to have data about the intensity and the frequency distribution of these sources for ultimate estimates of sound channel range.

If these data do not exist, experiments should be made to produce them, for they would certainly be of use in other connections.

e) An estimate of the background noise to be expected at the axis of the sound channel should be made. In my opinion, the principal contributors will be meteors, possibly high-flying normal air traffic, lightning, and anti-aircraft type artillery fire. A considerable body of information could be collected on this subject without experimentation.

My opinion is that the background noise will not be seriously high unless normal traffic begins to reach such heights that it will create the same type of disturbance as the projectiles which we are considering.

f) Measurements of actual sound channel transmission using a small stratosphere balloon carrying sound receivers and a radio for transmission of sound signals to a recording station should be the next step in this investigation.

## VII CONCLUSIONS

It is my opinion that the stratosphere sound channel should be investigated, for it has the potentiality of military importance. I believe that its military importance depends greatly upon secrecy and that the investigation should be started in a quiet way, restricting knowledge of the purpose of the work to the smallest possible group.

## VIII REFERENCES

1. Interim Report No. 1 Long Range Sound Transmission, by Maurice Ewing and J. L. Worzel, Contract NObS-2083, Bureau of Ships, Navy Department, 1948.
2. Handbuch der Experimentalphysik, by C. Meisser, pp 211-251, XIV, 3 Teil Luftseismik, Wien & Harms, Leipzig, 1930.
3. Theory of Sound, by Lord Rayleigh, vol. II, pp. 316-17, Macmillan & Co., London, 1928.



---

Report  
HQ Fitzwilliam Fwd  
"Sonic Balloon Test, Kwajalein"  
May 17, 1948

---



HEADQUARTERS FITZWILLIAM FORWARD  
c/o Commander, Task Group 7.2  
APO 187, c/o Postmaster  
San Francisco, Calif.

17 May 1948

SONIC BALLOON TEST, KWAJALEIN

Inclosure G to FITZWILLIAM FORWARD Report

The Watson Laboratories of Air Materiel Command arranged for one (1) of its sonic balloon teams to participate in the FITZWILLIAM project as a mobile team to operate in the Central Pacific, at KWAJALEIN, GUAM and HICKAM FIELD, HAWAII, in that order, changing location for each of the three (3) explosions.

The purpose of this exploratory test was as follows: first, to determine if an atomic explosion's compressional waves are generated in the sound channel existing between 50,000 and 70,000 feet (such waves would conceivably travel unimpeded for long distances in this channel without touching the earth's surface); second, to determine whether a sound pick-up unit suspended from a floating balloon could detect compressional waves (possibly undetected by similar sound units at the earth's surface) by virtue of the decreased background noise in the high-level sound channel.

Balloons were made of high grade plastic, were of tear-drop shape, and were twenty-five (25) feet at their largest sea-level diameter. The sonic unit was a combination microphone-transmitter which was suspended from the balloon and picked up sound waves, transmitting them to a ground directional antenna connected to a radiosonde receiver (standard SCR 658 air weather radio receiver). The transmitted sound impulses were recorded on two (2) Esterline-Angus recorders.

A dribble constructed of a five (5) gallon tin incorporating a metered jet to allow a predetermined spillage rate of high grade kerosene-ethylene-glycol mixture was attached to the balloon. This was designed to counteract the helium gas seepage thru the surface pores of the plastic balloon. This metered loss of ballast and controlled the rising rate of the balloon at 500 to 600 feet a minute.

Ground sonic equipment consisted of World War II sound ranging devices utilized to pick up sound waves from an explosion traveling along the earth's surface.

A radio receiver was used to obtain explosion time notification code signals from the ENIWETOK radio station.

The balloon launching site had to have a down-wind clearance of about 1000 feet to lay out the 100 feet risers and cables to which were attached the microphone-transmitter and dribbler units. Also the site had to be sheltered from the wind to prevent damage to the balloon while it was being



inflated. At KWAJALEIN a wind-break was constructed through the courtesy of the island commander, Captain Vest, USN. At a predetermined time, the balloon was inflated with a fixed amount of helium gas to raise it to an altitude of from 50,000 to 60,000 feet where it floated at a constant level. The balloon was cautiously launched and guided until it cleared all ground obstacles. Electrical power for the microphone-transmitter was provided through wet-cell batteries, especially constructed to prevent freezing. The balloon was tracked visually by use of theodolites. Prior to the actual test on KWAJALEIN on X-day (15 April 1948) two (2) practice runs were made to minimize chance of failure and to improve operating techniques.

The transportation requirement was for air lift to transport the team of six (6) scientists and twelve (12) thousand pounds of equipment from BELMAR, NEW JERSEY to KWAJALEIN, GUAM, HAWAII and then back to BELMAR, NEW JERSEY. The Air Materiel Command provided three (3) aircraft, a C-54, a B-29, and a B-17, and crews, under the direction of Captain Stanley C. Lewis, from the 4149th AFBW, MIDDLETOWN, PENNSYLVANIA. The C-54 was also utilized in carrying Tracerlab personnel and equipment to KWAJALEIN and GUAM. Maintenance assistance was afforded by the local base and tactical organizations.

The mobile team personnel was assembled and partially trained at Watson Laboratories. The team arrived at KWAJALEIN 31 March 1948; departed for NORTH FIELD, GUAM, on 16 April 1948; for HICKAM FIELD on 3 May 1948; and was scheduled to depart from HAWAII for its home station on Z plus one (1) day.

The balloon team and aircraft crew personnel were as follows:

BALLOON TEAM:

Dr. Albert P. Crary	"Q" clearance	Physicist
Mr. Charles S. Schneider	"Q" clearance	Meteorological Engineer
Mr. John W. Alden	"P" clearance	Radio Engineer
Mr. John A. Moulden	"P" clearance	Radio Repairman
Mr. Murry Hackman	"P" clearance	Meteorological Engineer
Mr. James Smith	"P" clearance	Meteorological Engineer

B-29 CREW

Captain Stanley C. Lewis	Pilot (Flight Commander)
1st Lieutenant Randall S. Kane	Co-Pilot
1st Lieutenant Wm. L. Adams	Navigator
M/Sergeant W. L. Halliday	Engineer
M/Sergeant R. A. Kabaste	Radio Operator
T/Sergeant R. A. Cox	Ass't Radio Operator
T/Sergeant L. D. Moon	Ass't Engineer

C-54 CREW

Captain John P. Clowry	Pilot
1st Lieutenant Richard Mesher	Co-Pilot
1st Lieutenant Chas. A. Lamana	Navigator
S/Sergeant James Brau	Engineer
S/Sergeant L. H. Campbell	Radio Operator
Sergeant George L. Fratwell	Ass't Engineer

B-17 CREW

1st Lieutenant Owen B. Dubell	Pilot
1st Lieutenant Thomas F. Carroll	Co-Pilot
1st Lieutenant John Mertzzen	Navigator
Sergeant W. R. Rice	Engineer

Time notification signals were required and provided in order to afford sufficient time to make necessary launching preparations, and to position the balloons just a few minutes prior to the predetermined arrival of the explosion sound wave. Headquarters FITZWILLIAM FORWARD furnished ARPACAS 3-1 and 3-2 by officer courier. The team experienced no difficulty in obtaining the time signals.

Reports required of the team were a brief statement as to positive or negative results of the tests, and notification of team movement to its several locations. Reports of results were made to Headquarters FITZWILLIAM FORWARD and to AFMSW-1.

Results of the KWAJALEIN test were as follows: balloon-borne equipment results were positive and ground equipment results were questionable. An accurate final analysis and evaluation report will be submitted upon Dr. Crary's return to Watson Laboratories, including an accurate determination of results.

Due to time limitation and pending a thorough evaluation of results, the following recommendations, of necessity, should be considered tentative:

1. Before departing for field locations, a survey should be made to determine the best balloon launching sites, giving due consideration to shelter from high velocity and gusty winds, and sufficient clear space to lay-out shroud lines and control cables thus affording clear passage of the instruments which are suspended about one hundred (100) feet below the balloon.

2. That an SCR 658, radiosonde receiver be included in the team equipment list. For these tests, a receiver had to be borrowed from the air weather station at each location. This presented a problem because each station had only one (1) receiver and it was needed by the station personnel for upper air sounding operations. This necessitated selecting the best possible launching site adjacent to the weather station. Also, this precluded selection of a site without a weather station.



Memo  
Brig Gen Tom C. Rives to Maj Gen  
Curtis LeMay  
Subj: Relief of Major R.T. Crane as  
Project Officer for MOGUL and  
TORRID  
June 18, 1946

---

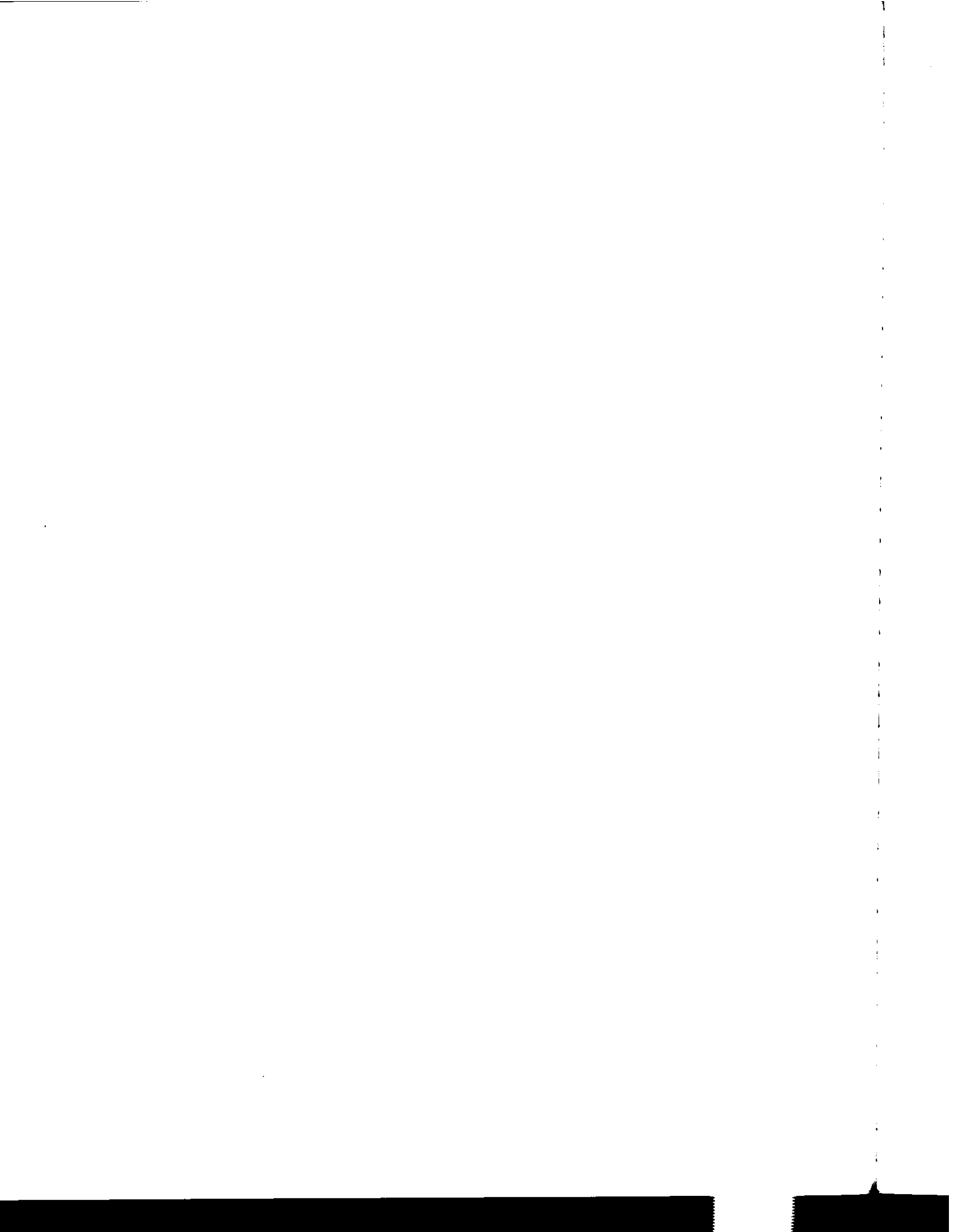

~~XXXXXXXXXXXXXXXXXXXX~~  
MATERIEL

TSELT/TCR/gen

18 June 1946

TSELT

MEMORANDUM FOR: Major General Curtis LeMay

SUBJECT: Relief of Major R. T. Crane as Project Officer for  
MOGUL and TORRID

1. In compliance with General Spaatz' directive, I contacted Dr. M. Ewing at Columbia University on 15 June 1946 and discussed the proposed relief of Major R. T. Crane as project officer on projects MOGUL and TORRID.
2. Dr. Ewing was exceedingly pleasant and agreed to the relief of Major Crane, asking only that it be done in such a way as to cause as little embarrassment to any of the parties concerned as possible. I advised him that the matter would be handled diplomatically.
3. I then discussed with Dr. Ewing the subject of a successor to Major Crane and suggested to him that Colonel Marcellus Duffy, a Regular Army officer and well-qualified on meteorological research and development work, might be made available for this duty. Dr. Ewing advised that he believed that he could work well with Colonel Duffy if he is assigned to this work. It was further agreed that as soon as a project officer is finally selected, a conference would be held with Dr. Ewing and the new project officer and Colonel Maier and Colonel Graul in order that there will be a clear understanding as to the objectives to be accomplished.

TOM C. RIVES  
Brig. General, USA  
Chief, Electronic Subdivision  
Engineering Division

*Noted by General Spaatz.*



Memo  
Maj Gen Curtis E. LeMay to Maj Gen  
L.C. Craigie  
April 16, 1947

---



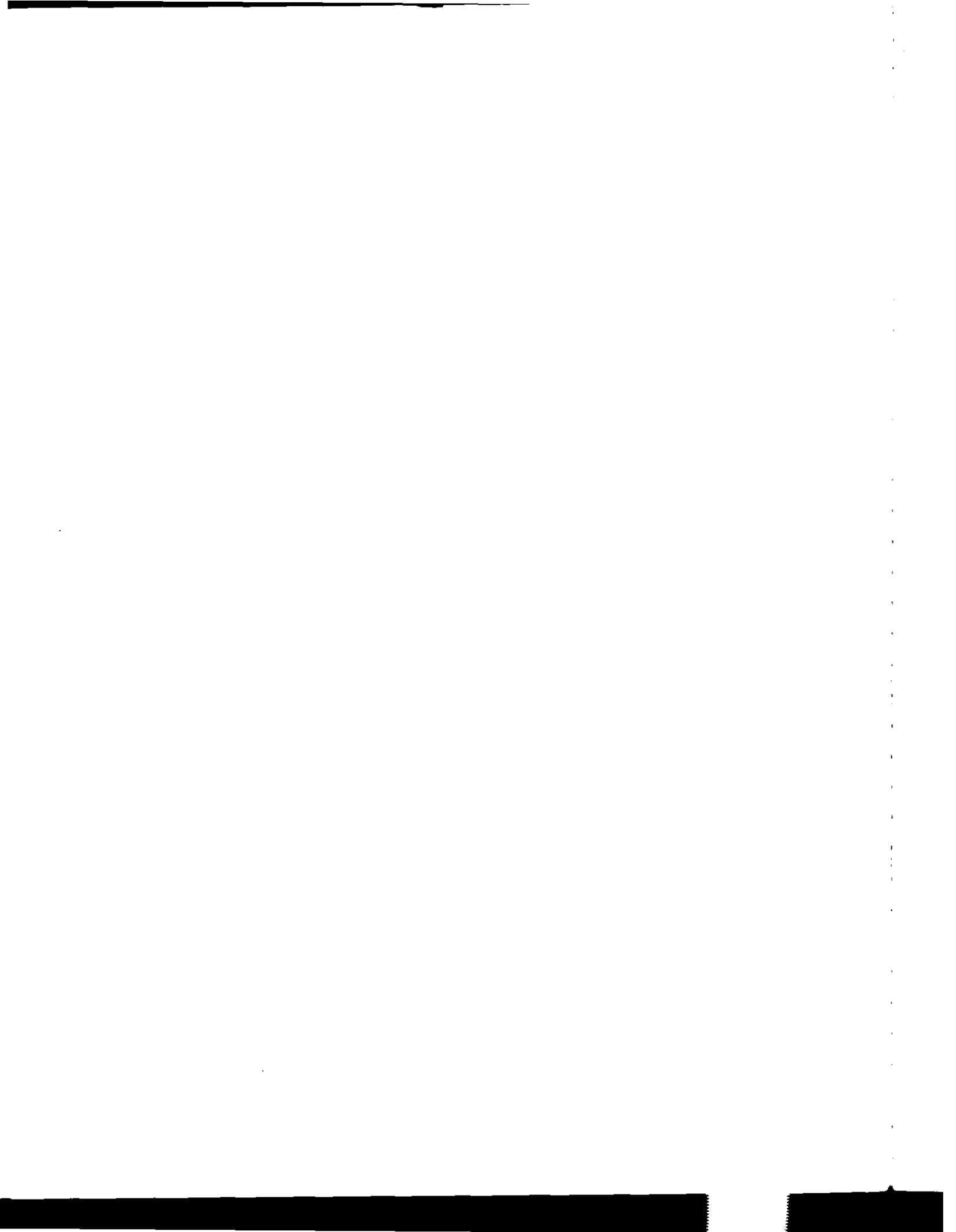

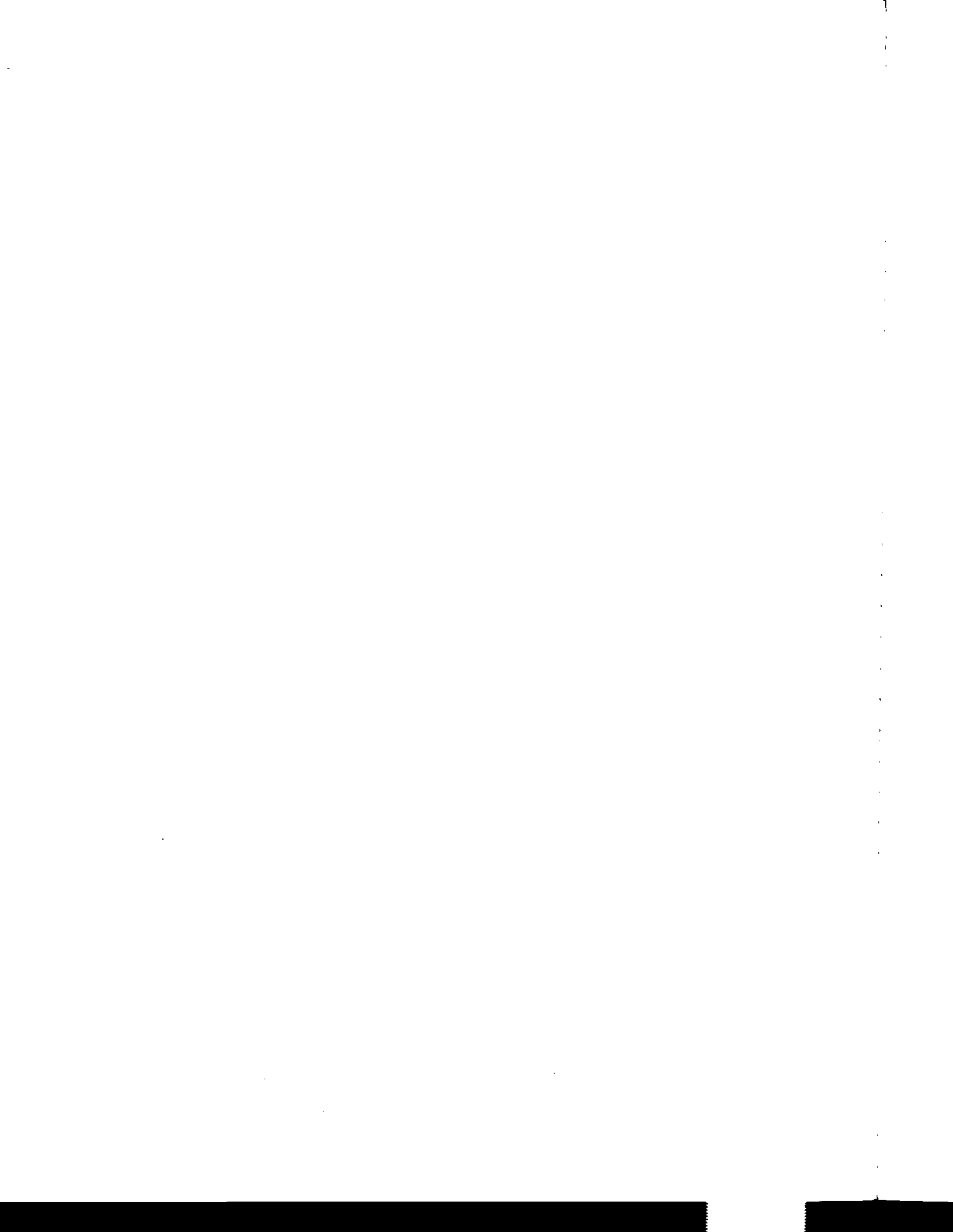

16 April 1947

Major General L. C. Craigie  
Chief, Engineering Division  
Air Materiel Command  
Wright Field, Dayton, Ohio

Dear Bill,

Attached is the action on your letter requesting deferment of foreign service for some of your people. I hope this solves your personnel problem for the time being. I am still waiting for the study on Wright Field people ordered to school this fall.

Sincerely,

CURTIS E. LEMAY  
Major General, U. S. Army  
Deputy Chief of Air Staff for  
Research and Development

Incl.

Memo fr. A-1, 14 Apr 47

Colonel Oscar C. Maier, O-16096

Retention: Indefinite. No known replacement in the AAF.

Duties: Chief, Electronic Plans Section, Electronic Subdivision. This officer should be retained in his present assignment due to the background of knowledge and experience which he has with reference to electronic research and development as well as meteorological research and development and the physics of the upper air. Colonel Maier has completed all requirements for a Ph. D. degree from the California Institute of Technology except for six months residency. During the period 1 February 1945 to 1 January 1946, Colonel Maier had been Commanding Officer of Watson Laboratories in charge of research and development of ground radar, radio and electronics equipment peculiar to the Army Air Forces, previous to which he was in command of various Signal Corps laboratories. Furthermore, he has complete technical knowledge and understanding of the projects being carried on by Watson Laboratories and Cambridge Field Station, which can only be achieved by years of active participation in the actual research and development of that particular type of electronic ground equipment.

Colonel Marcellus G. Duffy, O-18373

Retention: Indefinite. No known replacement in the AAF.

Duties: Assistant Chief, Electronic Plans Section, Electronic Subdivision. This officer has an extensive background and knowledge in meteorological and electronic research and development. He is a graduate of M.I.T. in meteorology. Colonel Duffy was liaison officer from the Commanding General, AAF, to the Chief Signal Officer for duty in connection with meteorological equipment for the period 1942-1946. During this period he set up AAF requirements, standards and training programs for weather equipment and personally followed this equipment from the laboratories to its introduction in all combat theaters. From September 1946 to January 1947, Colonel Duffy was in charge of applied propagation of compressional and magnetic waves at Watson Laboratories. At the present time, Colonel Duffy is monitoring the upper air research program for the AAF in addition to his duties as Assistant Chief of the Electronic Plans Section. With the Air Force competing against other services in the upper air research program, guided missiles and meteorological research, a competent, practical and theoretical officer is considered essential in the Plans Section, Electronic Subdivision.

Colonel Ralph L. Wassell, O-22329

Retention: Indefinite. No known replacement in the AAF.

Duties: Chief of Operations for Power Plant Laboratory. In this capacity he is responsible directly to the Laboratory Chief for the planning and execution of the entire engine development program. Specifically, he is responsible for supervision of the Rotating Engine Branch and the Non-Rotating Engine Branch. In order to successfully execute his responsibilities, Colonel Wassell must coordinate and approve the initiation of all research and development projects for

New York University  
*Constant Level Balloons Final Report*  
March 1, 1951

---

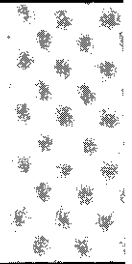



Technical Report No. 93.03

CONSTANT LEVEL BALLOONS

FINAL REPORT

Constant Level Balloon Project  
New York University

Prepared in Accordance with provisions of Contract  
W28-099-ac-241, between  
Watson Laboratories, Red Bank, New Jersey  
and  
New York University

The research reported in this document has been made possible through support and sponsorship extended by the Geophysical Research Directorate of the Cambridge Research Laboratories, AMC, U. S. Air Force, under Contract No. W28-099-ac-241. It is published for technical information only and does not represent recommendations or conclusions of the sponsoring agency.



Prepared by: William D. Murray, Project Director



Approved by: Harold K. Work,  
Director of the Research Division

College of Engineering  
New York University  
1 March 1951  
New York 53, New York

TABLE OF CONTENTS

	<u>Page Number</u>
A. Introduction and Statement of Problem.....	1
B. Constant Altitude Balloon Systems.....	3
C. Telemetering from Balloon Systems.....	7
D. Launching Services.....	13
E. Meteorological Analysis.....	19
F. Flights Utilizing the Constant Level Balloon System.....	21
High Altitude Balloon Trajectory Study (Contract AF 19(122)-45).....	21
High Neutron Intensity Study (Contract AF 28(099)-10).....	22
List of Flights.....	24
References.....	27



LIST OF ILLUSTRATIONS

<u>Figure Number</u>	<u>Page Number</u>
1. Pressure Displacement Switch for Ballast Control	4
2. Ballast Control Circuit	5
3. Constant Level Balloon Flight Using Ballast Control	6
4. FM-1 Transmitter	8
5. FM-2 Transmitter	8
6. AM-1 Transmitter	10
7. AM-2 Transmitter	12
8. Balloon Flight Using Fixed Ballast Flow	13
9. Balloon Flight Without Ballast	14
10. Flight Train, Service Flight	14
11. Inflation of a 20 ft. Plastic Balloon	15
12. Flight Termination Switch	17
13. Balloon Rip Assembly	18
14. Rip Assembly Cannon	19
15. "Two Level" Stepped Flight	23

## ABSTRACT

Systems of constant altitude balloons have been designed, developed, tested and used in various types of atmospheric research. After investigation and testing of several methods, a system comprising of a plastic fixed-volume balloon, electrically operated control instrumentation, and liquid ballast was developed.

This system has been used on several series of flights for carrying instruments at constant altitudes, studying winds over long periods at the 200 mb level, and investigation of neutron maxima.

Balloon launchings were carried out at various sites in the United States by members of the project in coordination with representatives of the sponsoring agency. Meteorological analysis of conditions over selected stations in the Western Hemisphere as requested by the sponsor was carried out by members of the Department of Meteorology of New York University.

A. Introduction and Statement of Problem

Contract W-28-099-ac-241 between Watson Laboratories AMC was entered into on 1 November 1946 to be carried out from 30 September 1946 to 1 October 1948.

Services to be furnished were as follows:

Research, investigation and engineering services in connection with obtaining and furnishing experimental data on pressure and temperature in the upper atmosphere, to involve the following:

- a. The securing of constant level balloons under the following conditions:
  - (1) Initially a six to eight hour minimum time for the balloon in air; eventually a forty-eight hour time for balloon in air.
  - (2) The altitude to be attained by the balloon will be 10 to 20 km, adjustable at 2 km intervals.
  - (3) Maintain elevation within 500 meters and the frequency of oscillation to be such that it will not interfere with operation of balloon borne radio equipment.

- b. The construction by the contractor of an experimental air borne radio and associated air borne or ground receiving equipment which will transmit and receive information from a mechanical movement introduced into the radio circuit. The weight of the pick up device and any required power supply to be carried in the balloon will not be over 2 lbs.
- c. The contractor will fly the balloons, track them, and collect the data on pressure and temperature to be transmitted as the balloon goes up and at periodic intervals at flight altitude. These intervals to be determined by consultation. The accuracy is to be comparable to that of the standard Army Radiosonde.
- d. Interpretation of Meteorological data in connection with project.

Five copies of reports of design and development phases were to be delivered at monthly intervals. Results of meteorological studies were to be transmitted as completed to the sponsoring agency for use of Air Force scientific personnel.

On 27 February 1948, Modification #1 revised the number of copies of reports to be furnished to 25. Modification #2, of 2 April 1948, added the requirement of "Research Investigation, and Engineering services leading to the determination of the dependance of the propagation of sound on atmospheric conditions", to the contract. Contract funds were increased to cover this additional requirement.

Under Modification #3 of 23 April 1948, it was agreed that a separate final report on telemetering from Balloon Systems would be completed and transmitted to the sponsor. The time of performance was extended to 1 February 1949 and contract funds increased to cover the increased period of performance by Modification #4 to the contract on 29 September 1948.

On 28 October, 1948, the number of reports required was increased to fifty (50) and the place for final inspection and acceptance changed to Cambridge Field Station, AMC by Modification #5. Modification #6 changed the allotment for funds to be used on the project. The period of performance of the project was extended to 50 March 1949, by Modification #7 of 26 January 1949.

Modification #8 of 8 April 1949, modified the requirement to that of maintenance of one trained person in the field to carry out balloon launching and tracking services in conjunction with Air Force scientific personnel. Funds were increased to extend the

period of performance to 15 March 1950. A final report on development and testing of constant altitude balloon systems was to be submitted to the Air Force. Modification #9 revised the delivery address for reports.

Modification #10 of 1 May 1950, increased contract funds to continue field service and meteorological analysis work to 15 June 1950.

Modification #11 subsequently extended the period of performance to the termination date of 31 December 1950 and increased funds accordingly.

#### B. Constant Altitude Balloon Systems

Development of a system to maintain balloons at constant altitudes for long periods of time was completed on 15 March 1949. This development has been completely reported in "Technical Report 93.02"(1) by this Research Division under "Section 1, General".

Essentially the system as developed at New York University consists of a constant volume balloon of thin polyethylene which, when filled with hydrogen or helium, furnishes the lift for the system. (Because of the increased safety to personnel and equipment, use of helium is to be recommended). The balloon is inflated with enough gas to balance the weight of the suspended equipment, plus a certain amount of "free lift" which will cause the system to ascend. When the balloon nears floating altitude and becomes full, the gas comprising the "free lift" will be expelled through an open appendix at the bottom of the balloon. The system is then at equilibrium at an altitude fixed by the balloon volume. The ratio of molecular weights of the lifting gas and air, density of the surrounding air, and the total balloon load are as follows:

$$V_b \left(1 - \frac{M_g}{M_a}\right) d_a = L$$

This state of equilibrium is broken, however, by changes in any of the above variables. Basically, losses of lift due to leakage and diffusion of gas, and changes of temperature of the lifting gas cause a change from equilibrium conditions.

Any variations causing an increase in altitude will result merely in a valving of gas from the fixed volume balloon and a slight increase in altitude. Changes in the reverse direction, however,

must be compensated for by decreasing the load on the system to prevent descent to the ground.

This decrease of load is carried out by dropping liquid ballast as demanded by a pressure activated ballast control switch. This switch completes a circuit through a relay operated ballast valve whenever the balloon system descends to a region of pressure greater than that of its selected floating altitude. Ballast is thus dropped and the system returned to floating altitude.

On flights made on another project since the termination of the development phase of this project, the ballast control system was standardized to include a pressure displacement switch and an electrically operated ballast valve. The displacement switch (Fig. 1) consists of a standard temperature compensated aneroid cell and pen arm from a radiosonde modulator

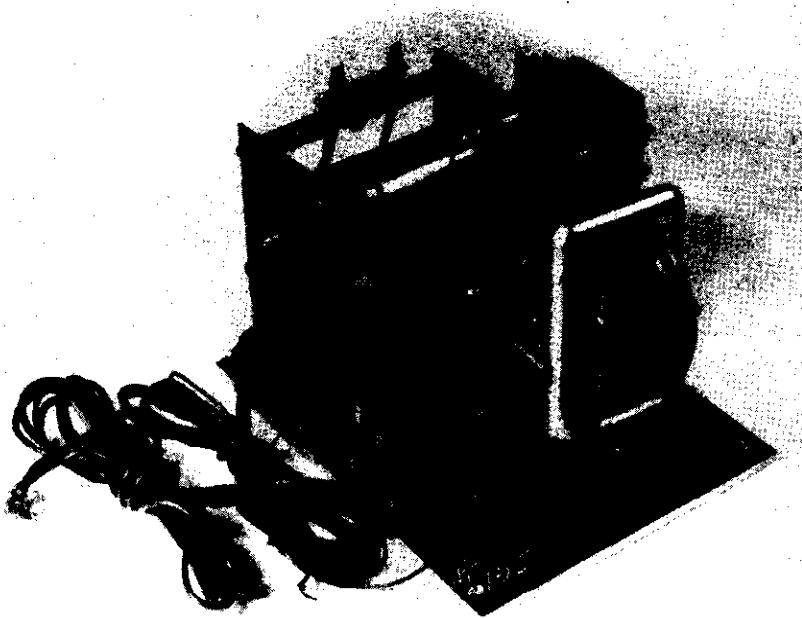

Fig. 1  
Pressure Displacement Switch for Ballast Control

(Type E preferred); a rotating commutator of two segments, an insulator and a conductor; a six volt 1 rpm motor; and a shelf for the pen arm. In calibration, the aneroid cell is moved across the base by means of a screw which allows selection of various altitudes for control.

Initially the pen arm rides on the shelf during ascent so that the circuit to the valve remains open until the balloon approaches floating altitude. Several thousand feet before ascent is completed the pen arm falls off the shelf closing the ballast circuit (Fig. 2) and causing ballast flow during the final period of ascent. When the balloon reaches control

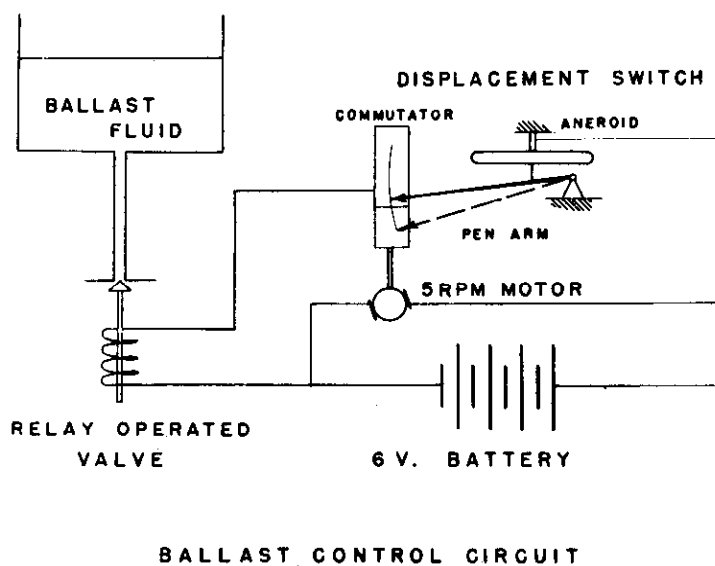

Fig. 2  
Ballast Control Circuit

altitude the pen passes to the insulator portion of the commutator and ballast flow ceases. Whenever the balloon system subsequently descends past control altitude, ballast is made to flow, maintaining the balloon altitude at control level. This system has been used successfully on over twenty constant level flights maintaining altitude to close limits for periods up to 60 hours. An example of a flight made with this control is shown as Fig. 3.

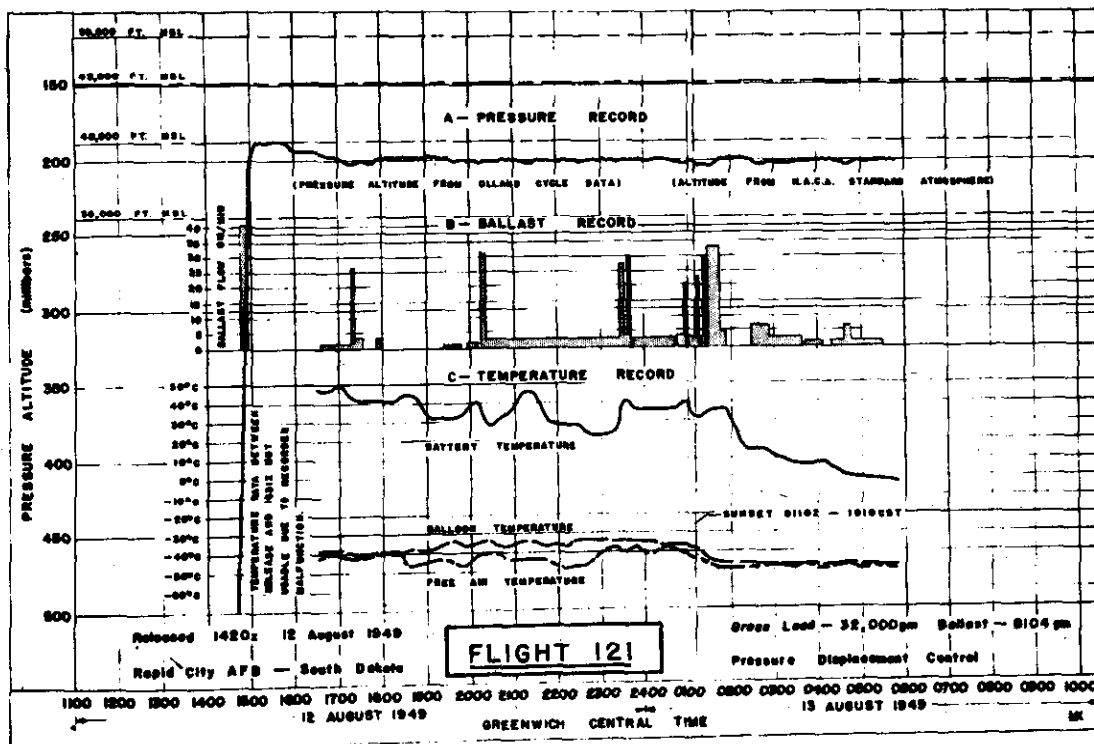

Fig. 3  
Constant Level Balloon Flight Using Ballast Control

A review of this system by members of the University staff has been published in "Transactions of the American Geophysical Union<sup>(2)</sup>". Earlier work on this development has been reported by members of this Research Division in "Technical Report 93.01"<sup>(3)</sup> and in the "Journal of the American Meteorological Society"<sup>(4)</sup>.

A manual for those interested in making use of balloon systems of this type has also been published as "Section II, Operations" of our "Technical Report 93.02"<sup>(1)</sup>. This report consists of a discussion of instrumentation for balloon systems, techniques for launching and tracking, and telemetering from balloons as developed and tested at New York University.

### C. Telemetering From Balloon Systems

The second requirement of this project was the investigation, development, and testing of balloon borne telemetering systems. The development was completed in June of 1948 and a final report<sup>(7)</sup> of work accomplished and recommendations made to the sponsor at that time.

Two types of transmitter units were suggested as a means of accomplishing the telemetering of data from a balloon to ground station receivers. A high frequency system, making use of line-of-sight transmission allows for accurate positioning of the balloon system from two ground stations. The line-of-sight characteristic, however, limits the range of this type transmitter, and ranges in excess of 250 miles are not to be expected with a balloon system floating at 40,000 ft.

Three line of sight transmitters were designed for use in balloon work. The first, the FM-1, was designed to operate at 72 mc, using a conventional reactance tube modulator. Several stages were included to deliver 1 watt output at the design frequency. The unit was quite complicated and the required input power large due to the requirement for several stages to transmit at the high frequency. Fig. 4 is a schematic of the FM-1 transmitter.

In order to overcome this limitation of FM sets, a two tube transmitter was developed (Fig. 5). Variation in vacuum tube resistance is used to modulate the oscillator plate voltage of a self-excited oscillator in accordance with the audio signal. This provides the frequency modulation desired. In order to maintain a stable center frequency and render the oscillator insensitive to changes in supply voltage, a neon tube voltage regulator was included.



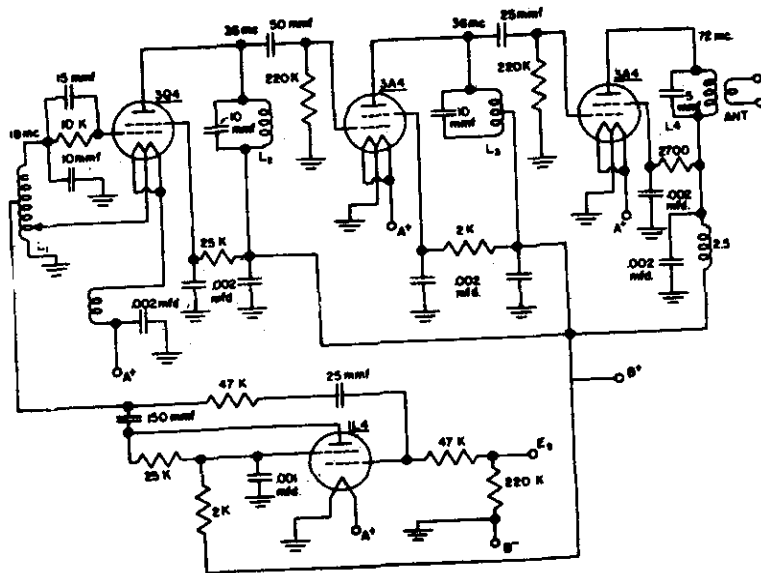

Fig. 4  
FM-1 Transmitter

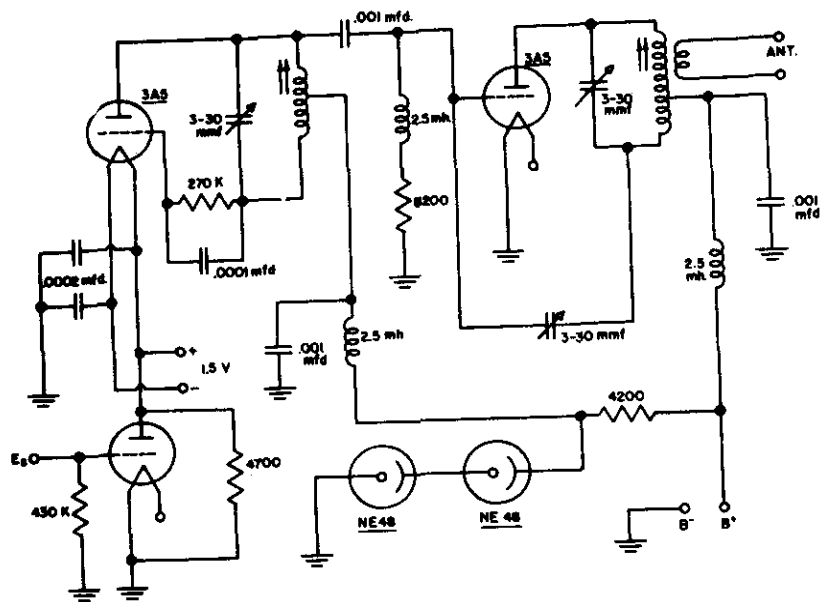

Fig. 5  
FM-2 Transmitter

Output of the oscillator is both amplitude and frequency modulated, the amplitude modulation being limited by a class "C" RF amplifier. This unit weighed six ounces, was fed by a plate voltage of 270 volts with a filament drain of 400ma. at 1.5 volts. The output was one watt at frequencies from 25 to 100mc.

Before procurement of a receiver with automatic frequency control an attempt was made to develop a crystal controlled oscillator to overcome the frequency drift inherent in FM systems. This work was abandoned when the controlled receiver was obtained. The crystal control unit which was developed required extreme care in tuning in order that modulation be linear.

A miniature power amplifier, using one dual triode as a push-pull amplifier was constructed for use at 25 to 100mc with any of the above mentioned transmitters. The antennae for these transmitters was a half-wave vertical dipole.

The receiver found satisfactory for these systems was the R-2A/ARR-3 Sonobuoy receiver. This unit employs Automatic frequency control and will tolerate a drift - .35mc before retuning is required.

When SCR-658 radio direction finding equipment became available work on these transmitters was abandoned and a 400mc transmitter used. This system allows for accurate positioning of the balloon systems by use of crossed azimuths from several receiving stations.

A transmitter using pulse time modulation was designed for use with this receiving equipment. The advantages here are high peak power with relatively low input power (and thus a high signal to noise ratio) and simultaneous transmission of several data channels at one frequency. This project was abandoned before tests could be completed due to a modification of project requirements, but preliminary results indicated that this system would be advantageous in AM or FM transmission. This system makes use of short duration pulses ( .5 micro second) at a repetition rate of approximately 10 kc.

For long range transmission of information an amplitude-modulated transmitter was developed. (Fig. 6) This unit, the AM-1, is crystal controlled, employing a 3A4 miniature tube in a Pierce oscillator circuit as the crystal oscillator. This circuit does not require an LC tank circuit and eliminates the tuning of this additional stage. The RF amplifier is a 3A5 miniature dual triode tube. The unit was designed to give 1.5 watt output with a 270 volt plate supply and can be used with 380 volts to give 3 watt output.

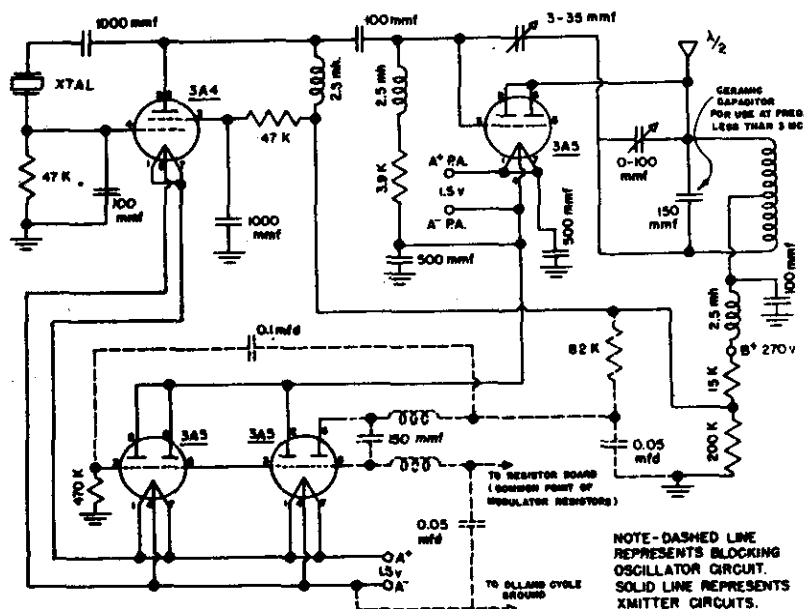

Fig. 6  
AM-1 Transmitter

Frequency ranges from 1.5 to 9mc can be employed with the AM-1. The modulation of the AM-1 is effected by use of a triode modulator (2-3A5) tubes) connected in series with the plate supply of a class "C" RF amplifier. Variation of the plate supply voltage of the RF amplifier caused by change in tube resistance gives amplitude modulation linear with plate voltage of the amplifier. By use of this system modulation from DC to several hundred cycles is obtained.

The receiver for this transmitter was a Hammerlund SP 400X with several modifications. In order to increase the signal to noise ratio a crystal filter was introduced into the IF amplifier circuit to narrow the bandwidth. Bandwidth was also reduced by

decreasing the coefficient of coupling between the primary and secondary of the IF transformers. By this reduction of bandwidth to 3kc a 3 microvolt signal produced a 15.5 DB signal to noise ratio, where at 16 kc bandwidth only 7 DB was obtained.

In order to obtain accurate reproduction of the amplitude of the audio frequency the AVC circuit was modified by adding a fixed bias to the AVC diode of the receiver. This flattened the characteristic of the AVC circuit and no change in amplitude of recorded audio signal was detected over a six hour flight using a constant amplitude audio signal from the transmitter. The signal was tapped off at the output of the second detector of the receiver and fed to a Brush BL 905 AC amplifier for recording. The recorder used was a Brush BL-202 double channel oscillograph. A quarter wave vertical receiving antennae was employed with a counter poise ground. The transmitting antennae was a vertical half wave dipole.

In order to use the AM-1 for transmission of information from pressure and temperature sensors a relaxation oscillator circuit was incorporated in the system. (dotted section - Fig. 6). This oscillator used one half of one of the 3A5 modulator tubes and produced a blocking rate approximately proportional to resistance of the sensor instruments. This information could be superimposed on the regular modulated signal and two types of information could be transmitted simultaneously; one as an amplitude and frequency change of the basic signal, the other as a frequency of pulses superimposed on the basic signal.

The AM-1 has been used in balloon control research to transmit information on pressure, temperature and ballast requirements. It was also employed to give information on Neutron intensities in another Air Force project<sup>(5)</sup>. In order to obtain information on balloon position on a wind study project the AM-1 was used as a beacon to be "homed in" on by the radio compass of aircraft<sup>(6)</sup>.

A system of diversity reception was considered for use with a dual channel AM-1 transmitter in order to increase reliability despite atmospheric noise. In the dual channel unit a common modulator was connected to two separate crystal oscillators and RF amplifiers. In preliminary tests two receiver and recording units were used.

For short range balloon flights the AM-1 was modified for use with subminiature and acorn type tubes. In this, the AM-2, two 2E27 tubes in parallel provide excitation for the type 958A RF amplifier. A circuit diagram of this unit is shown as Fig. 7.

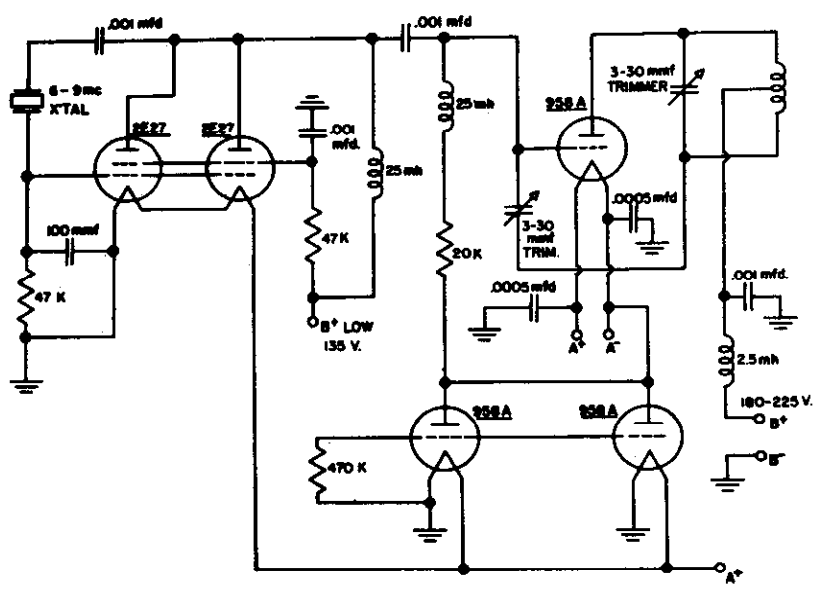

Fig. 7  
AM-2 Transmitter

In addition to radio direction finding with the SCR658 and beacon transmission with radio compass, several other methods of balloon positioning were evaluated. Radar positioning was successful only if a target was attached to the balloon train. Generally, the ranges possible with radar are not as great as those possible by radio direction finding. For direction finding on the low frequency AM transmitter some value was found in use of loop antennae. Accuracy of this method is between .5 and 2 degrees and is generally hindered by sky wave reflection.

A pulse time modulated transponder beacon at high frequencies was found to be advantageous for obtaining accurate slant range to the balloon. Preliminary investigation of use of Doppler effect for positioning indicated that this method is not feasible due to difficulty in measuring the low frequency differences involved.

#### D. Launching Services

During the course of the project balloon flights were split into two general classifications, (a) research and (b) service.

Research flights were made to test balloon controls and telemetering systems developed under the contract. A full report of these research flights has been made in "Technical Report 93.02 (1), Section III, Summary of Flights"

Service flights were carried out by New York University personnel in conjunction with technical personnel from the sponsoring agency to test geophysical equipment developed in Air Force laboratories. The requirements for these flights were launching and tracking of balloons to float at specified altitudes for short periods of time (6 to 8 hours). Because of this short flight duration, simplified plastic balloon systems were used. Balloons were maintained aloft by use of constant fixed ballast flow, or ballast was excluded entirely from the system. A typical flight using constant ballast flow at a rate slightly exceeding leakage losses is shown as Fig. 8.

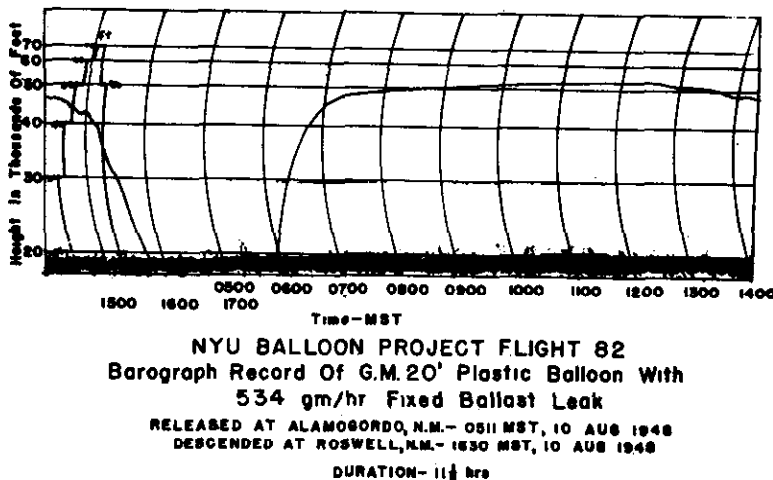
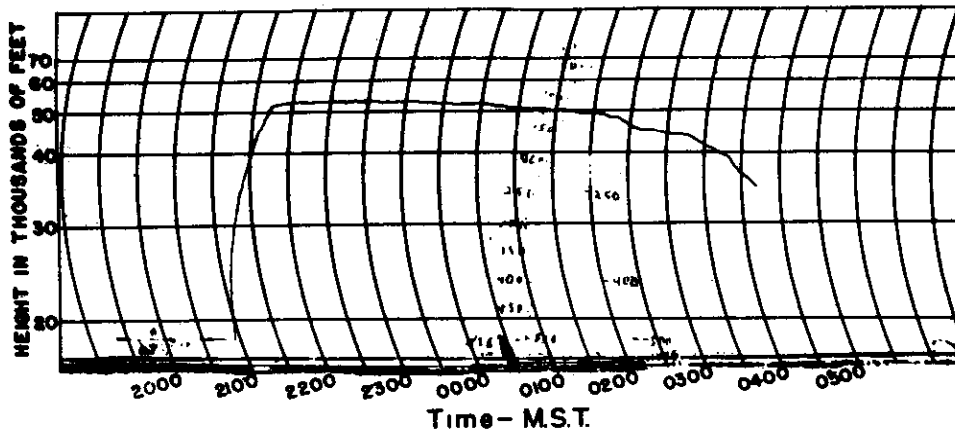

Fig. 8  
 Balloon Flight Using Fixed Ballast Flow

Fig. 9 is a typical flight with no ballast. The flight train for these flights is shown as Fig. 10.



NYU BALLOON PROJECT FLIGHT 71  
Barograph Record Of GM 20 Ft. Plastic Balloon Showing  
Balloon Performance When No Ballast Was Dropped  
RELEASED AT ALAMOGORDO N.M., 2042 MST-9 JULY, 1948  
RECOVERED AT VALENTINE TEXAS, 10 JULY, 1948  
ESTIMATED DURATION 10 HOURS

Fig. 9  
Balloon Flight Without Ballast

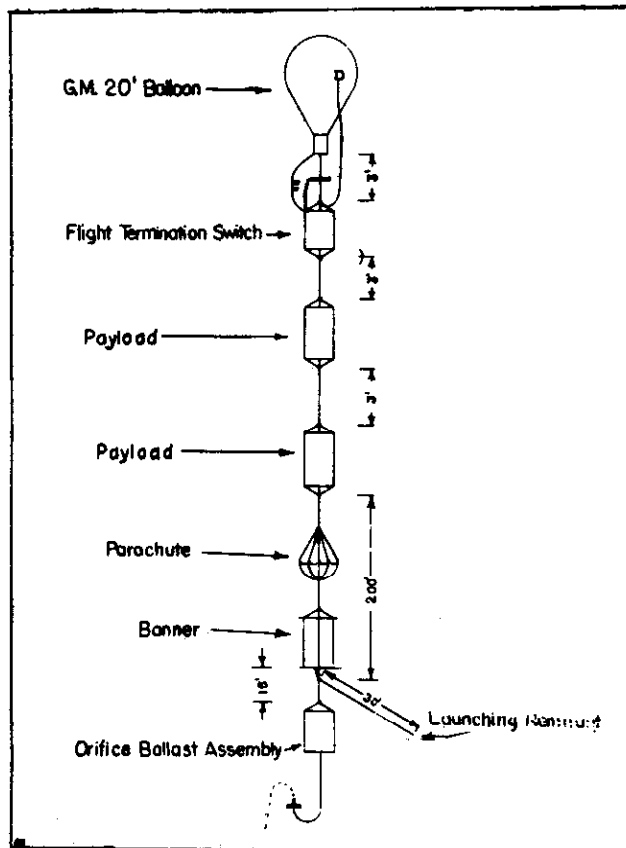

Fig. 10  
Flight Train, Service Flight

With light weight payloads, balloon systems of this type can be launched by two or three experienced balloon men. The launching is carried out in a manner similar to that explained in Section II, Operations, of "Technical Report 93.02<sup>(1)</sup>", in that the balloon is inflated in the lee side of a building or wind screen, (or in an aircraft hangar if one is available, or in the open when winds are light) with the equipment train laid out downwind of the balloon. The amount of gas lift is equal to balloon weight plus approximately 10% to cause ascent at 800 to 1000ft. min. A picture of inflation of a 20 ft. diameter plastic balloon is shown as Fig. 11.

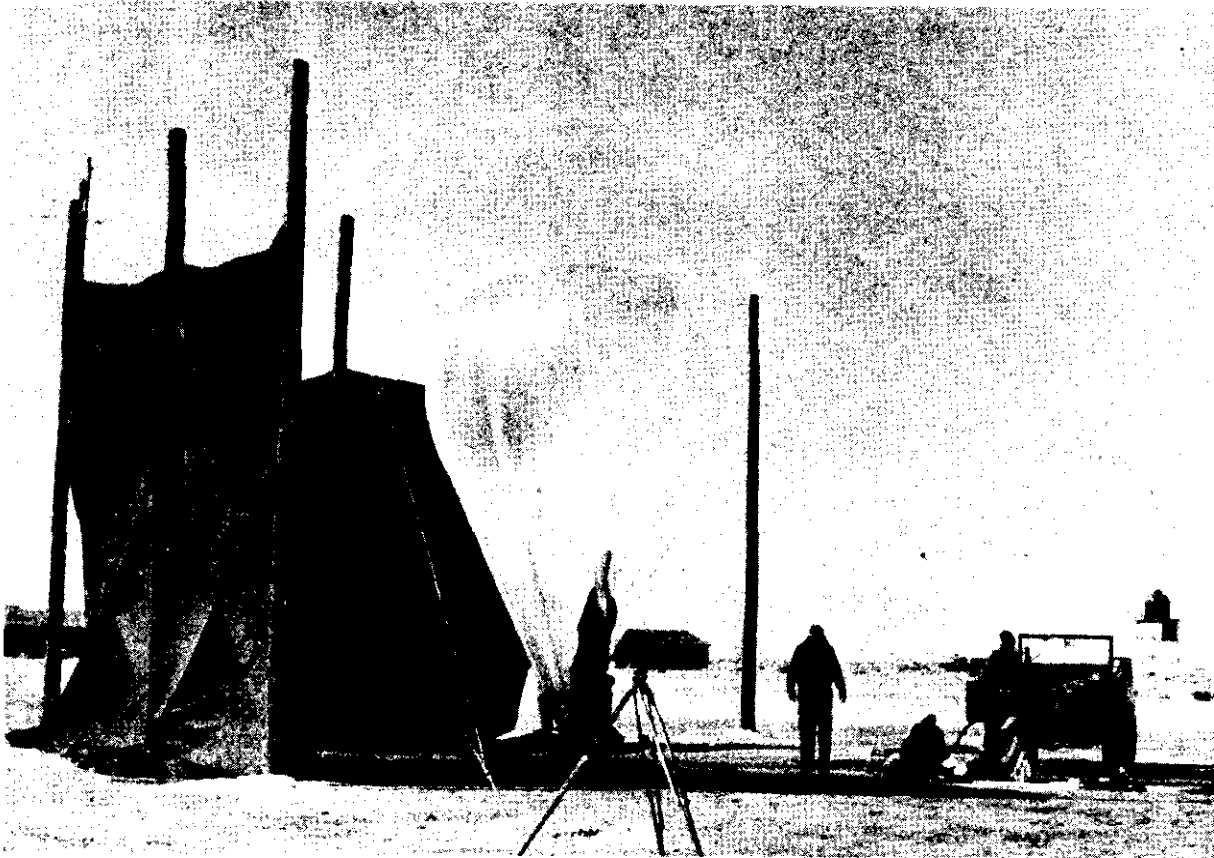

Fig. 11  
Inflation of a 20 ft. Plastic Balloon



The following is a list of equipment needed for launching of a single flight of this type:

(a) Launching Equipment:

- 1 ea. set instructions (Operations Manual)
- 2 ea. elliptical shot bags (each filled with 100# of shot)
- 1 ea. 40' x 6' Ground Cloth
- 4 ea. sheets polyethylene, .001" to .004", 4' x 4'
- 1 ea. gas tank manifold with pressure gages and valve
- 1 ea. rubber hose, 1" I.D., 10' long with diffuser
- 1 ea. rubber tubing 1/2" bore, 1/8" wall, 8' long
- 1 ea. solution balance
- 1 ea. inflation nozzle, ML-196 for rubber balloons
  
- 1 ea. tool kit complete with 2 sheath knives, 50' cloth measuring tape, brass wire, 1" Mystic tape, volt ohmmeter, pliers, screwdrivers, inflation tools, flashlights, crescent wrenches, soldering iron, compass, 2 open-end wrenches, 1-1/8" x 1-1/4" openings, 14" pipe wrench, spanner for helium tank valves, etc.
  
- 1 ea. theodolite ML-247 with tripod ML-78 (optional)
- 1 ea. recorder, brush oscillograph or other with amplifier.
- 1 ea. SCR-658 radio direction finder
- 1 ea. chronometer

(b) Flight Equipment:

- 2 to 5 tanks helium
- 1 ea. balloon
- 2 ea. rolls acetate fiber scotch tape
- 1 ea. appendix stiffeners (if appendix is to be used)
- 500# test nylon line
- 75# test linen twine
- 2 ea. 350 gram balloon ML-131A (for wind sock)
- 5 to 10 toggles or hooks
- 1 ea. radio transmitter
- 1 ea. pressure sensor (and temperature if desired)
- Payload instrumentation
- 1 ea. banner, 3' x 6'
- Data sheets
- Weight sheets
- Reward tags (English, Spanish or other language)

(c) Termination Equipment

- 1 ea. flight termination switch
- 1 ea. set rip rigging
- 2 ea. cannons
- 2 ea. squibs (treated for high altitude)

(d) Fixed Rate Ballast Equipment:(optional)

- 1 ea. orifice spinnerette, to give proper ballast flow
- 1 gallon ballast, compass fluid AN-C-116
- 1 ea. ballast reservoir (1 gallon capacity)
- 1 ea. filter 3' diameter, 325 x 325, phosphor bronze mesh
- 6 inches tubing (Tygon) 3/16" bore

Tracking of these flights was maintained by use of an SCR 658 radio receiver with a 400mc transmitter telemetering information from the balloon system. Information received through the telemetering circuit can be recorded on a standard weather station recorder, a recording oscilloscope of the Brush Development type or by any other convenient means.

Altitude of the service flights was determined by use of a modified radiosonde modulator, an olland cycle modulator (see p.68 , Section I, General, Technical Report 93.02<sup>(1)</sup>), or by computation from knowledge of the weight of the balloon system and volume of the balloon.

In order to keep balloon systems from floating in the air lanes, a flight termination switch was included in the circuit. This switch is a radiosonde modulator modified so that all contacts above 25,000 ft. are disconnected from the circuit. The pen arm rides on a shelf during ascent to about 30,000 ft. and then falls to the commutator (See Fig. 12).

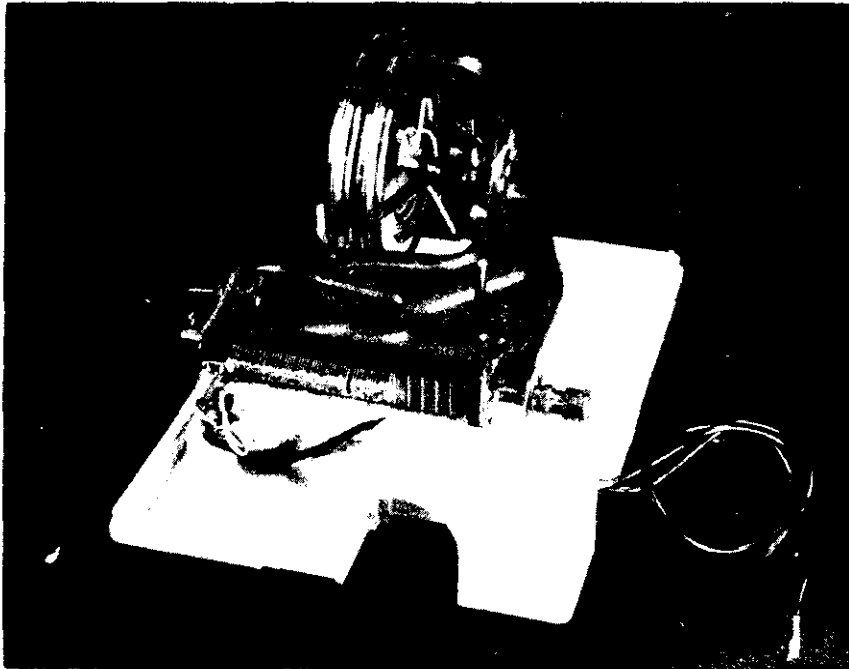

Fig. 12  
Flight Termination Switch

When the system again descends to 25,000, the pen arm comes into contact with the commutator contact and an electrical circuit is closed through a squib in the load line. The load line is cut and the load on the system falls six to eight feet before being caught by a supplementary load line. During this fall a rip line pulls a hole one foot long in the side of the balloon and the system descends using the partially inflated balloon to hold the rate of descent to approximately 1200 ft/minute. This system has been used successfully in over 100 flights.

A drawing of the rip assembly is shown as Fig. 13. The cannon and squib to cut the load line are shown as Fig. 14.

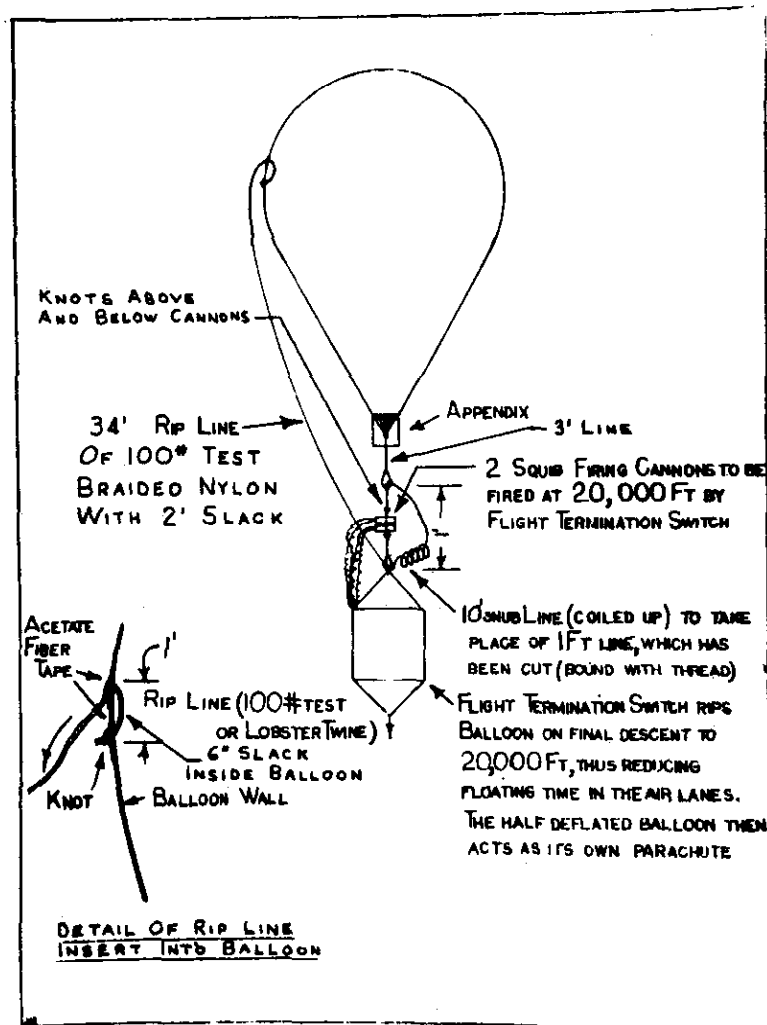

Fig. 13  
Balloon Rip Assembly

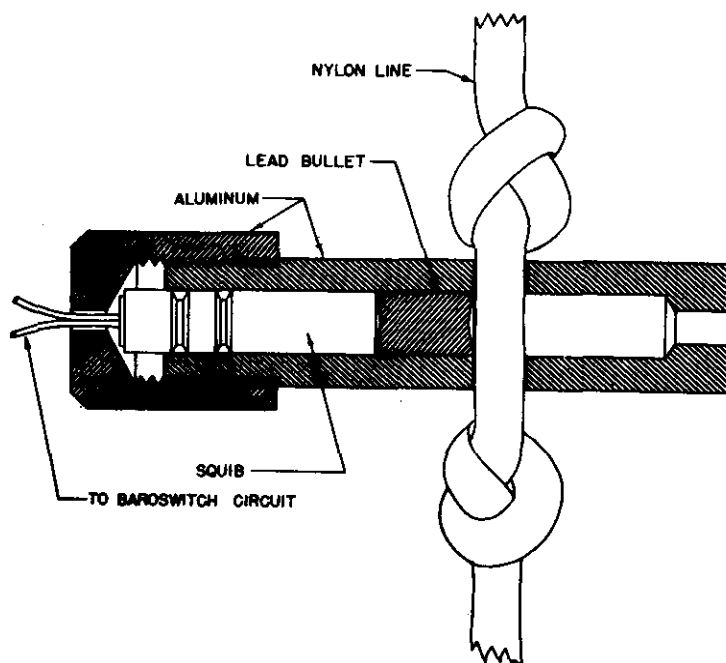

Fig. 14  
Rip Assembly Cannon

In all, 115 service flights were made under this contract from various government installations throughout the country. A summary of these flights is listed in Table I (see end of text).

#### E. Meteorological Analysis

As one phase of this project, New York University agreed to prepare analyses of winds and temperatures in the troposphere for dates and localities specified by Watson Laboratories.

The vertical distribution of temperature from the ground up to heights of about 15 km at the time of any particular experiment was estimated from the routine radiosonde ascents which were nearest in respect to both time and space, to the site of the experiment. If the time of the experiment was within three hours of one of the twice-daily, standard hours of radiosonde observation, the temperature distribution given by such observation was assumed to have existed (within the limits of error in the method of measurement) at the time of the experiment. If the time difference was greater than three hours, a linear interpolation was made between radiosonde observations preceding and following the time of the experiment. Interpolation in space was accomplished ordinarily by assuming a linear horizontal variation of temperature.

However, when weather conditions indicated a markedly discontinuous variation of temperature (i.e. a "front"), appropriate subjective modification of the objective linear interpolation technique was applied.

The vertical distribution of wind was determined mainly from direct observations (pilot-balloon and radio wind-sounding measurements) of free-air winds at weather stations in the area of each experiment. However, actual measurements of winds in the upper half of the troposphere often are scarce or completely lacking, and it was frequently necessary to make use of an indirect method of estimating the wind at elevations greater than 5 km. Charts of the distribution of atmospheric pressure (as given by radiosonde observations) at selected levels between 5 km and 15 km were constructed, and the wind direction and speeds at these levels were computed from the well-known geostrophic wind equation, which relates the wind to the horizontal distribution of pressure.

For the experiments carried out off the east coast of the U.S.A. between 1 August 1946 and 1 August 1947, it seemed feasible to show the distributions of both temperature and wind in vertical cross-section. This was due to the fact that these experiments were made, and the results of same recorded, within a fairly narrow band centered close to a line between Lakehurst, N. J., and Nantucket, Mass., at which points radiosonde and upper-wind observations are taken regularly. However, vertical cross-sections of temperature and wind were abandoned as a method of representation of the distribution pertaining to all subsequent experiments.

There were several reasons for this decision. In the first place, the sites and character of later experiments did not fit into the existing weather-observing network in a manner favorable to cross-sectional representation. In the second place, experience brought about the conclusion that the horizontal gradient of temperature is usually so small that, within the area encompassed by an experiment, the difference in temperature at a given level between points at the ends of a cross-section is no greater than the average error of the radiosonde measurements. Thirdly, it was soon realized that the variability of the wind in space and time is such that an individual pilot-balloon or rawinsonde ascent is not representative of the average vertical distribution of velocity during the interval occupied by a single experiment. Furthermore, as mentioned above, the wind at high levels in the troposphere often had to be inferred by indirect means. Since the true wind usually deviates somewhat from the theoretical geostrophic wind (the latter being derived under certain simplifying assumptions) and since the geometry of the pressure field is subject to some uncertainty owing to inaccuracies in the radiosonde observations, it became apparent that the assignment of a single velocity value at any

given point in a cross-section through the atmosphere was misleading.

In order to avoid the suggestion of greater precision than was warranted by the character of the information available, it was decided, during the autumn of 1947 to present the meteorological diagnoses in a different form. Since that time, graphs (in lieu of cross-sections) have been constructed to show the vertical distributions of the estimated ranges, that is to say, the estimated extremes of temperature and wind on the whole or over a part of the area involved in each experiment.

Since August, 1950, the principal task has been the preparation of diagnoses of conditions existing during experiments being conducted regularly in eastern Colorado, western Nebraska and western Kansas by the Industrial Research Institute of the University of Denver. The design of these experiments necessitates a particularly careful study of the available weather data and the exercise of a considerable amount of synoptic meteorological judgment in the preparation of the wind and temperature diagnoses.

#### F. Flights Utilizing the Constant Level Balloon System

After completion of the balloon control and telemetering development phases of the project, the balloon systems were utilized under Contracts AF 19(122)-45 and AF 28(099)-10, between this University and the Air Force Cambridge Research Laboratories. A brief review of these projects is as follows:

##### 1. High Altitude Balloon Trajectory Study (Contract AF 19(122)-45)

Under the terms of this contract the Research Division was commissioned to launch and track constant level balloon systems in order to study wind conditions at the 200 mb level of the atmosphere. Flights were to remain afloat until they had traveled approximately 1000 miles.

In order to track the balloon systems, the AM-1 transmitter was operated at 1746 kc, using the radio compass from an aircraft to "home in" on the balloon and position it at specified time intervals. Information on pressure altitude, ballast flow data and balloon, free air and transmitter battery pack temperatures was transmitted through the AM-1 to receivers mounted in the aircraft and recorded on brush recorders for analysis at New York University.

A total of 22 flights (two of which crossed the Atlantic Ocean and were recovered in Norway and Algeria) were

made on this project. A complete report of these flights and the equipment used is included in "Technical Report 121.01"<sup>(6)</sup> by this Research Division.

2. High Neutron Intensity Study (Contract AF 28(099)-10)

In conjunction with a study to determine the altitude of maximum neutron density a modification was made on the Constant Altitude balloon system developed under this contract. In order to study neutron densities at two different altitudes with the same set of instruments, it was desirable to carry these instruments through a "stepped flight". The balloon system in this case was to ascend to a selected altitude (say 45,000 ft.) float there for one hour and then ascend to a higher altitude (for example 65,000 ft.) to float for another hour before descending.

The advantages of this type flight for Cosmic Ray studies are that a given altitude may be sampled for a long enough period of time to obtain statistically valid results, and such statistical sampling can be made at several levels without the necessity of releasing another balloon system and other set of neutron sensing instruments. By proper design of equipment a fairly wide range of altitudes can be sampled with "altitude steps" of almost any desired size.

The step effect is attained by release of a fairly large amount of ballast at a fast rate set off by a pre-set clock timer or a radio release activated by a transmitter on the ground. The amount of ballast to be released is determined from the standard altitude-volume load relationships used for constant-level balloon flight. As a part of the final ballast release, the ballast tank and its controls may be dropped from the system.

If the level positions of the flight must be controlled to fine limits, or if they must be of long duration (more than two hours) it is necessary to employ constant-level ballast control over these portions of the flight. However, if the level portions of the flight are to be in the neighborhood of 1 hour duration, ballast control during these floating periods can be eliminated, making use of the inherent stability of the plastic balloon systems for short range constant level flights. It is this latter method which was used by the New York University group in the study of Neutron Maxima.

In this study four flights were made to study conditions at altitudes of 45,000 and 60,000 ft. A clock timer was set to cause release of ballast after the system had floated at the lower level for one hour. After ballast was expended the timer caused release of the ballast tank to further reduce the load on the systems. A typical flight of this series is shown as Fig. 15. Further details on this study have been given in reports on "Neutron Intensity Study"<sup>(5)</sup> by this Research Division.

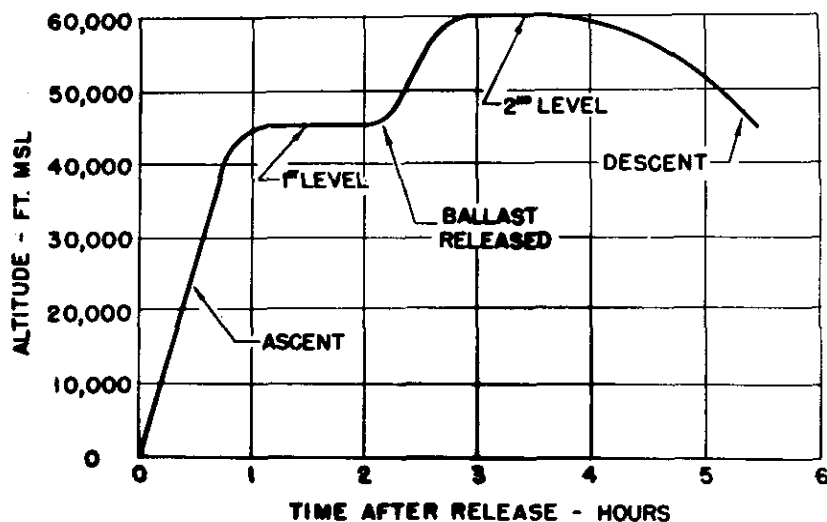

Fig. 15  
"Two Level" Stepped Flight



<u>Flight No.</u>	<u>Date</u>	<u>Release Point</u>	<u>Altitude in ft.</u>	<u>Recovery</u>
MXF-1	5/13/48	Maxwell Field, Ala.	60,000	
" -2	5/14/48	" " "	55,000	
" -3	5/14/48	" " "	did not reach Tyler, Ala.	
" -4	5/14/48	" " "	55,000	
E-CW-400-2	7/23/48	Eglin AFB, Fla.	45,000	
" " " -3	8/23/48	" " "	45,000	
" " " -4	8/24/48	" " "	45,000	
" " " -5	8/25/48	" " "	45,000	
" " " -6	8/25/48	" " "	45,000	
" " " -7	8/26/48	" " "	45,000	
" " " -8	8/30/48	" " "	45,000	
" " " -9	8/31/48	" " "	45,000	
" " " -10	9/2/48	" " "	45,000	
" " " -11	9/2/48	" " "	45,000	
" " " -12	9/8/48	" " "	45,000	
" " " -13	9/10/48	" " "	45,000	
" " " -14	9/13/48	" " "	45,000	
" " " -15	9/29/48	" " "	45,000	
" " " -16	9/30/48	" " "	45,000	
" " " -17	11/1/48	" " "	45,000	
" " " -18	11/4/48	" " "	45,000	
" " " -19	11/4/48	" " "	45,000	
" " " -20	11/8/48	" " "	45,000	30° 26' N 86° 29' W
" " " -21	11/8/48	" " "	45,000	
" " " -22	11/9/48	" " "	45,000	
" " " -23	11/15/48	" " "	45,000	
" " " -24	11/15/48	" " "	45,000	
" " " -25	11/16/48	" " "	45,000	
" " " -26	11/17/48	" " "	45,000	
" " " -27	11/18/48	" " "	45,000	12 mi.W., Fitzgerald, Ga. 3:30 P.M. 11/18/48
" " " -28	11/18/48	" " "	45,000	
" " " -29	12/1/48	" " "	45,000	
" " " -30	12/9/48	" " "	45,000	
" " " -31	12/11/48	" " "	60,000	
" " " -32	12/12/48	" " "	62,000	
" " " -33	12/14/48	" " "	65,000	
" " " -34	12/16/48	" " "	65,000	
" " " -35	12/17/48	" " "	65,000	
" " " -36	1/13/49	" " "	Test	
" " " -37	1/13/49	" " "	50,000	
" " " -38	1/14/49	" " "	50,000	
" " " -39	1/15/49	" " "	50,000	
" " " -40	1/28/49	" " "	No release	

<u>Flight No.</u>	<u>Date</u>	<u>Release Point</u>	<u>Altitude in ft.</u>	<u>Recovery</u>
E-CW-400-41	1/28/49	Eglin AFB, Fla.	60,000	
" " " -42	1/28/49	McDill AFB, Fla.	50,000	
" " " -43	2/16/49	Avon Park, Fla.	48,000	
" " " -44	2/17/49	" " "	50,000	
" " " -45	2/18/49	" " "	48,000	
" " " -46	2/21/49	" " "	55,000	
" " " -47	2/22/49	" " "	50,000	
" " " -48	2/22/49	" " "	40,000	
" " " -49	2/23/49	" " "	42,000	
" " " -50	2/23/49	" " "	Equipment failure	
" " " -52	2/24/49	" " "	50,000	
" " " -53	3/2/49	" " "	45,000	
" " " -54	3/3/49	" " "	Instrument failure	
" " " -55	3/3/49	" " "	50,000	
" " " -56	3/4/49	" " "	50,000	
CL-1	6/7/49	Clovis AFB, N.M.	45,000	
" -2	6/10/49	" " "	45,000	
" -3	6/10/49	" " "	45,000	
" -4	6/14/49	" " "	45,000	Graham, Texas
" -5	6/14/49	" " "	45,000	
" -6	6/16/49	" " "	50,000	
" -7	6/23/49	" " "	50,000	Sayre, Okla.
" -8	6/23/49	" " "	55,000	
" -9	7/19/49	" " "	50,000	Portales, N.M.
" -10	7/21/49	" " "	50,000	
" -11	7/21/49	" " "	50,000	
" -12	9/26/49	" " "	50,000	Marlow, Okla.
" -13	10/6/49	" " "	50,000	La Mont, Okla.
" -14	11/18/49	" " "	50,000	Frankel City, Texas
" -15	11/30/49	" " "	50,000	
" -16	12/2/49	" " "	50,000	
" -17	12/6/49	" " "	50,000	Boonville, Miss.
" -18	12/8/49	" " "	50,000	Fort Douglas, Ark.
EN-1	1/23/50	Vance AFB, Okla.	50,000	Centralia, Ill.
" -2	1/31/50	" " "	50,000	Nevada, Mo.
" -3	2/2/50	" " "	50,000	Moore's Hill, Ind.
" -4	2/9/50	" " "	50,000	Sheridan, Ky.
" -5	2/9/50	" " "	50,000	Pt. Hillford, Nova Scotia, Can.
" -6	2/9/50	" " "	50,000	Jonesboro, Me.
" -7	2/14/50	" " "	50,000	Perkins, Okla.
" -8	2/14/50	" " "	50,000	Winchester, Ontario, Can.

<u>Flight No.</u>	<u>Date.</u>	<u>Release Point</u>	<u>Altitude in ft.</u>	<u>Recovery</u>
EN-9	2/17/50	Vance AFB, Okla.	55,000	Washburn, Mo.
" -10	3/3/50	" " "	50,000	
KN-1	4/25/50	Sedalia AFB, Mo.	50,000	
" -2	5/12/50	" " "	55,000	Booneville, Mo.
" -3	5/26/50	" " "	55,000	Warrensburg, Mo.
" -4	5/26/50	" " "	40,000	Concordia, Mo.
" -5 Hi.	6/2/50	" " "	50,000	Wapella, Ill.
" -5 Lo.	6/2/50	" " "	40,000	
" -6 Hi.	6/20/50	" " "	50,000	Ashtabula, Ohio
" -6 Lo.	6/20/50	" " "	40,000	
" -7 Lo.	7/11/50	" " "	40,000	Springdale, Ark.
" -7 Hi.	7/11/50	" " "	50,000	
" -8	7/14/50	" " "	40,000	Loysville, Pa.
" -9	7/24/50	" " "	50,000	California, Mo.
" -10	8/31/50	" " "	50,000	
" -11	9/14/50	" " "	48,000	Shelbyville, Tenn.
" -12	9/14/50	" " "	45,000	La Monte, Mo.
" -13	9/22/50	" " "	52,000	
" -14	9/28/50	" " "	48,000	Louisiana, Mo.
" -15	10/5/50	" " "	48,000	
" -16	10/10/50	" " "	45,000	
" -17	10/12/50	" " "	45,000	Marshall, Mo.
" -18	10/17/50	" " "	45,000	
" -19	10/26/50	" " "	50,000	Dickson, Tenn.

In addition service flights were made from Watson Laboratories, AMC Eatontown, N.J., for testing of items of geophysical equipment during the course of the project.

During June, 1949, service flights were made from Luke AFB, Arizona, simultaneously with those made from Clovis AFB, New Mexico.

REFERENCES

1. Research Division, College of Engineering, New York University, Technical Report 93.02, Constant Level Balloons  
Section I - General - November, 1949  
Section II- Operations - January, 1949  
Section III- Summary of Flights - July, 1949
2. Murray, W. D.; Schneider, C. S.; Smith, J. R. - Development and Utilization of Constant Level Balloons - "Transactions of the American Geophysical Union", Dec. 1950.
3. Research Division, College of Engineering, New York University, Technical Report #1, Constant Level Balloon Project #93 - April, 1948.
4. Spilhaus, A. F.; Schneider, C. S.; Moore, C. B. - Controlled Altitude Free Balloons - "Journal of Meteorology" - August, 1948.
5. Research Division, College of Engineering, New York University, Determination of Neutron Maximum at High Altitudes - Progress Reports and Technical Report #118.5, March, 1949 to March, 1950.
6. Research Division, College of Engineering, New York University, Technical Report 121.05 - High Altitude Balloon Trajectory Study, June, 1950.
7. Research Division, College of Engineering, New York University, Final Report 93.17, Radio Transmitter, Receiver and Recording Systems for Constant Level Balloons - June, 1948.

New York University  
*Constant Level Balloons*  
Section 1, *General*  
November 15, 1949

---



Technical Report No. 93.02

CONSTANT LEVEL BALLOONS  
Section 1

GENERAL

Constant Level Balloon Project  
New York University

Prepared in accordance with provisions of contract  
W28-099-ac-241, between  
Watson Laboratories, Red Bank, New Jersey  
and  
New York University

The research reported in this document has been made possible through support and sponsorship extended by the Geophysical Research Directorate of the Cambridge Field Station, AMC, U. S. Air Force, under Contract No. W28-099-ac-241. It is published for technical information only and does not represent recommendations or conclusions of the sponsoring agency.

Prepared by: James R. Smith  
and  
William D. Murray

Approved by:

*Harold K Work*

Dr. Harold K. Work  
Director of the Research Division

College of Engineering  
New York University  
15 November 1949  
New York 53, New York

TABLE OF CONTENTS

	<u>Page Number</u>
I. <u>Introduction</u> .....	5
Contract Requirements .....	5
Project Facilities .....	6
II. <u>Principles of Balloon Control</u> .....	6
III. <u>Methods of Attack</u> .....	8
Rubber Balloons .....	8
Plastic Balloons .....	9
Internal-Pressure Balloons .....	14
Altitude Controls .....	16
Flight Simulation .....	25
Flight Termination Gear .....	29
IV. <u>Equations and Theoretical Considerations</u> .....	30
Floating Altitude and Altitude Sensitivity .....	30
Rate of Rise .....	33
Superheat and its Effects .....	34
Adiabatic Lapse Rate .....	38
Diffusion and Leakage of Lifting Gas .....	40
Bursting Pressure and Appendix Considerations .....	47
A General Equation of Motion .....	56
V. <u>Telemetering</u> .....	62
Information Transmitted .....	62
Transmitters Used .....	63
Receivers and Recorders Used .....	65
Batteries Used .....	65
Radio Direction-Finding .....	66
Radar and Optical Tracking .....	67
VI. <u>Instrumentation</u> .....	67
Altitude Determination .....	67
Temperature Measurements .....	74
Ballast Metering .....	76
VII. <u>Conclusions</u> .....	79



## I. INTRODUCTION

### A. Contract Requirements

On November 1, 1946 the Research Division of the College of Engineering of New York University entered into Contract W28-099-ac-241 with Watson Laboratories of the Air Materiel Command. Under this contract the University was commissioned to design, develop and fly constant-level balloons to carry instruments to altitudes from 10 to 20 kilometers, adjustable at 2-kilometer intervals.

The following performance was specified:

1. Altitude to be maintained within 500 meters.
2. Duration of constant level flight to be initially 6 to 8 hours minimum, eventually 48 hours.
3. The accuracy of pressure observation to be comparable to that obtainable with the standard Army radiosonde ( $\pm 3-5$  mb).

In addition to this balloon performance it was desired that:

4. A balloon-borne transmitter be developed for telemetering of information from the balloon to suitable ground receivers.
5. Positioning of balloon during flight be determined by ground tracking such as radar or radio direction-finding or theodolite.
6. Appropriate meteorological data be collected and interpreted.

Following the first year of work the contract was renewed for a 1-year period, and in addition to the provisions of the original contract it was agreed that a total of 100 test flights would be launched by the University.

In September, 1948 a second renewal of the contract was effected. With this renewal, which expires in March, 1949, it is expected that the development of equipment will be concluded. Further extensions are under consideration whereby New York University will supply standardized flight gear and flight service personnel for routine test flights.

## B. Project Facilities

To meet the requirements of the contract, a research group was built up and the following facilities were made available:

1. Administrative section.
2. Engineering personnel were assigned to one or more of the following groups:
  - (a) Balloon section
  - (b) Performance control section
  - (c) Telemetering section
  - (d) Analysis section (including meteorological and performance data analysis)
3. A small machine shop was provided to manufacture experimental models of equipment which was flown.
4. A field crew for launching, tracking and recovery of balloons was established.

Work-shop, laboratory, office and storage space was provided by New York University (Figures 1 and 2). Field work was largely conducted at Army bases and Air Forces installations. At one time the number of full-time employees reached 26 with 17 part-time men on the staff at that time. Most individuals were called upon to work in several departments depending upon the urgency of field work, equipment preparation or development work.

## II. PRINCIPLES OF BALLOON CONTROL

Following preliminary investigations, two distinct principles of achieving constant-pressure altitude for free balloons were studied in detail. The first of these is the maintenance of the balloon at floating level by the use of a servo-mechanism or other control which causes the supported load to vary with the buoyancy of the balloon. The second principle embodies the use of a non-extensible balloon capable of withstanding a high internal pressure. With a fixed volume and a given load, such balloons remain at a constant pressure level as long as the internal pressure of the balloon is equal to or greater than that of the air at floating level. A surplus of buoyancy causes super-pressure, but when the gas is cooled relative to the air environment such a surplus is needed to prevent excessive reductions in balloon pressure. Whenever the balloon's internal pressure becomes less than that of the air, it falls to earth. Such a balloon was used by the Japanese for the fire bombing of the western United States during World War II.

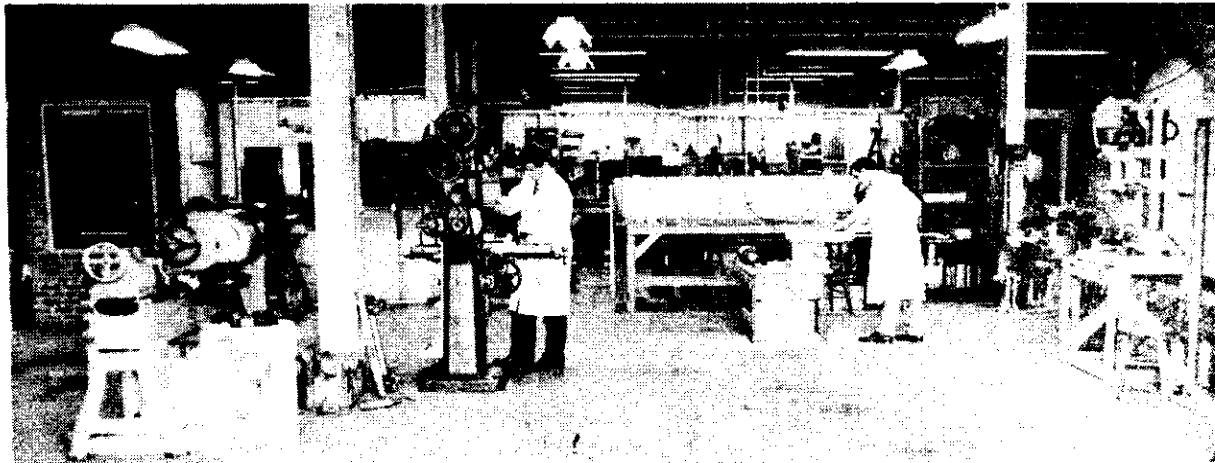

Figures 1 and 2. Interior views, Research Division Shop.

To use the first of these principles it is possible to maintain a condition of buoyancy by at least the following two methods: (1) dropping a part of the load, as ballast, to match the loss of lifting gas which occurs as a result of diffusion and leakage; (2) replacement of the lifting gas by evaporation from a reservoir of liquified helium or hydrogen. Of these two methods, ballast dropping is most satisfactory from the consideration of simplicity of control and safety of personnel. While the use of liquid helium is theoretically more efficient, the amount and complexity of control equipment adds much to the cost and also the weight of air-borne equipment.

The development of non-elastic balloons which can withstand high internal pressure was investigated. Two designs which compromise extreme cost (required for balloons of high internal pressure) with small wall strength, hence small super pressure, were tested.

At first, attempts were made to control balloon performance by using buoyancy-load balance techniques with elastic balloons, but the difficulties which were experienced resulted in the development of a third principle of operation combining a non-extensible balloon with a system of controls which can be applied either to a freely expanding balloon or to a balloon of fixed volume.

### III. METHODS OF ATTACK

The work on the development of controlled-altitude balloons may be divided into three phases, each one identified by the type of balloon which was used. Concurrent with the balloon development was the design and testing of control equipment required to maintain the balloon at specific altitudes. Some of the equipment instrumentation was used on more than one kind of balloon, but in general the problems and methods of attack are identified with one of the three types of balloons.

#### A. Rubber Balloons

Following the example of Clarke and Korff, assemblies of neoprene rubber balloons were first considered. Using these freely expanding balloons it was necessary to balance the load to be lifted with the buoyancy given by an integral number of balloons. One or more accessory balloons were attached to the assembly to provide lifting force to carry the train aloft. With the gear at a predetermined altitude, the lifting balloons were cut loose from the train by a pressure-activated switch, leaving the equipment at floating level, more or less exactly balanced. Since there is no inherent stability in an extensible balloon, any existing unbalance will cause the train to rise or fall indefinitely until the balloon reaches

its bursting diameter, the gear strikes the ground, or corrective action is taken. Even if the extremely critical balance is initially achieved, there will be unbalance occasioned by (1) bursting of balloons due to deterioration in the sunlight, (2) diffusion of lifting gas from the balloons, (3) loss or gain of buoyancy when temperature inside the balloon changes with respect to the ambient air temperature. This will result initially from radiative differences, and after an amount of difference (superheat) has been established, changes in ventilation will cause changes in buoyancy.

Two methods of attaching the payload to the clusters of rubber balloons were tried. In the first of these (Figure 3) a long load line was used, and short lines led from it to the individual balloons. The length of such arrays was as much as 800 feet, and this size made them difficult to launch. The single load ring array, seen in Figure 4, proved to be much easier to handle and is recommended for cluster launchings. During ascent each of the balloons in such an array ride separated from each other and no rubbing or chafing has been observed.

The controls which were associated with this balloon system were crude and, in general, ineffective. They included (1) cutting off balloons as the buoyancy became excessive and a preset altitude extreme was passed, and (2) releasing part of the load in the form of solid or liquid ballast whenever descent occurred. The sensitivity of these elastic balloons makes it difficult to control their altitude with any system of controls, and as controls were developed it was found more practical to change from freely expanding balloons to non-extensible cells not made of neoprene. The tendency of neoprene to decay within a few hours when exposed to sunlight was the most cogent argument against doing more work on altitude controls to be used with such a system.

#### B. Plastic Balloons

The next attempts to control the altitude of a balloon vehicle were made using non-extensible plastic cells, with an open bottom to prevent rupture when expansion of the lifting gas is excessive. With a fixed maximum volume, such a system has inherent vertical instability in only one direction. When full, there is a pressure altitude above which a given load will not be carried. The instability of such a system is found only when an unbalanced downward force exists. The development of controls and films for balloon material proceeded concurrently, but the choice of a non-extensible plastic film was made before the system of control was perfected.

The properties which were given most consideration in the selection of fabric include (1) availability and cost, (2) ease of fabrication and (3) satisfactory chemical and physical properties. Pri-

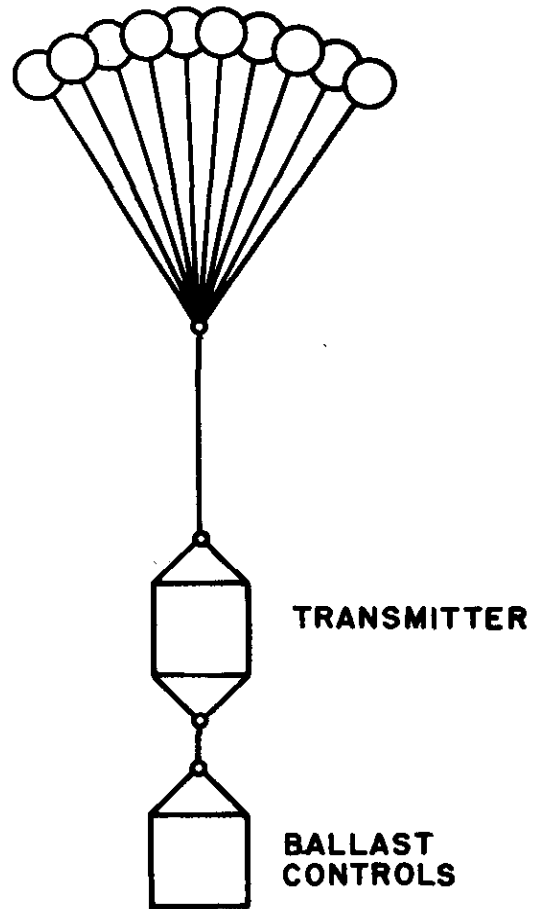
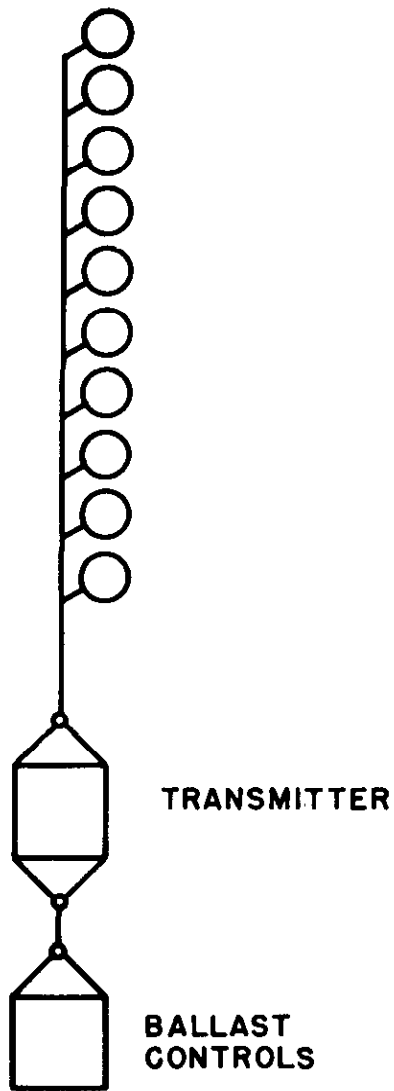

Figures 3 and 4. Typical rubber balloon arrays.

marily on the cost basis, an extruded film of plastic was found to be superior to fabrics such as silk or nylon with the various coatings.

The physical and chemical properties needed in a balloon material are: (1) chemical stability, (2) low permeability, (3) high tensile strength, (4) low brittle temperature, (5) high tear resistance, (6) high transparency to heat radiation and (7) light weight.

In Table 1 the properties of 7 plastics and 2 coated materials are given. From this data polyethylene and saran appear to be the most suitable films.

Table 1

Fabric	Low Temperature Properties	Permeability	Tensile Strength	Tear Resistance	Ease of Fabrication	Stability to Ultraviolet
Polyethylene	Good	Medium	Low	Good	Good	Good
Saran	Fair	Low	High	Poor	Fair	Fair
Nylon	Good	Low	High	Low	Good	Good
Vinylite	Very poor	Medium	Medium	Good	Good	Good
Teflon	Believed good	Low	High	Good	Cannot be fabricated	Good
Ethocellulose	Good	Very high	Low	Fair	Good	Good
Pliofilm	Poor	High	Poor	Fair	Good	Poor
Nylon or silk fabric coated with:						
Neoprene	Fair	Low	High	Fair	Fair	Fair
Butyl rubber	Good	Low	High	Fair	Fair	Good

Having decided upon the proper fabric to be used, an effort was made to interest a number of companies in the fabrication and production of balloons. The first supplier of balloons made of polyethylene was Harold A. Smith, Inc., Mamaroneck, New York. In these balloons, 4 and 8 mil sheets were heat sealed to form a spherical cell open at the bottom. Load attachment tabs were set into the fabric and loading lines ran from these tabs to a load ring. This method of supporting the load proved to be unsatisfactory.

Subsequently, other companies produced balloons of one type or another for us; the total number and type of balloons purchased is given in Table 2.

Table 2  
Plastic Balloons

Company	Film Type, Thickness Diameter, Shape	Special Features	Unit Cost	No. Delivered to Date
Harold A. Smith, Inc.	.004 polyethylene 3-ft.diam., spherical	Prototype	\$150.00	4
" " " "	.008 polyethylene 15-ft.diam., spherical	Low permeability	530.00	5
" " " "	.004 polyethylene 15-ft.diam., spherical	Low permeability	530.00	5
General Mills Inc.	.001 polyethylene 7-ft.diam., tear-drop	Stressed tape type seam	20.00	25
" " "	.001 polyethylene 20-ft.diam., tear-drop	Stressed tape type seam	125.00	175
" " "	.001 polyethylene 30-ft.diam., tear-drop	Stressed tape type seam	250.00	15
" " "	.001 polyethylene 70-ft.diam., tear-drop	Stressed tape type seam	900.00	5
The Goodyear Tire & Rubber Company, Inc.	.004 polyethylene 20-ft.diam., egg-plant	Stressed tape type seam and low permeability	475.00	10
Winzen Research, Inc.	.015 polyethylene 20-ft.diam., tear-drop	Low permeability	115.00	20
<u>Non-Plastic Balloons</u>				
Dewey and Almy Chemical Co.	J-2000 neoprene balloon with nylon shroud of 15-ft. diam., spherical	Internal pressure	325.00	3
Seyfang Laboratories	Neoprene-coated nylon 22.5-ft. diam., spherical	Internal pressure	550.00	10



Teardrop shaped polyethylene balloons were produced by General Mills Inc. and Winzen Research, Inc., both of Minneapolis, Minnesota. The General Mills cells were supplied in four sizes with the diameters of 7, 20, 30 and 70 feet to carry loads to varying altitudes. A 20-foot balloon is shown in Figure 5.

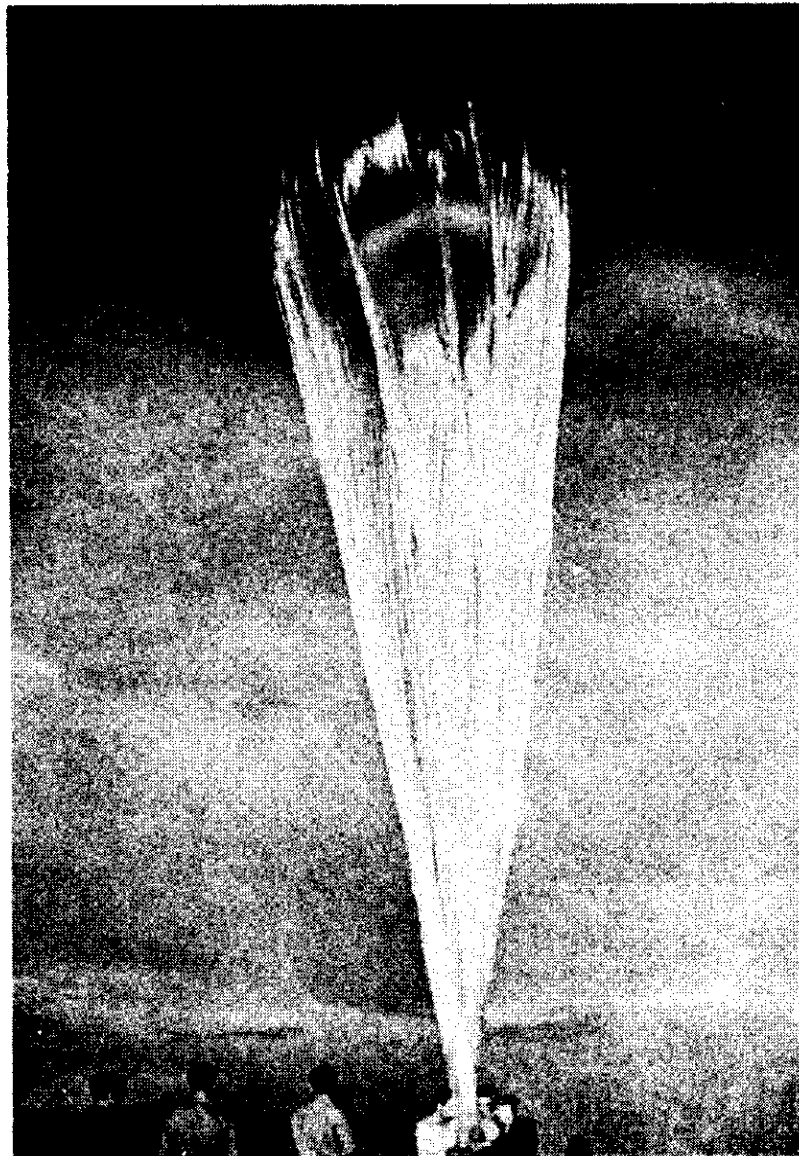

Figure 5. 20'-Diameter, teardrop polyethylene balloon. In all of these, film is .001" polyethylene, butt welded with fiber tape laid along the seams to reinforce the seal, and to carry

and distribute the load. These tapes, which converge to the load ring at the bottom, actually support the load (Figure 6). An open bottom permits the escape of excess lifting gas and thus prevents rupture.

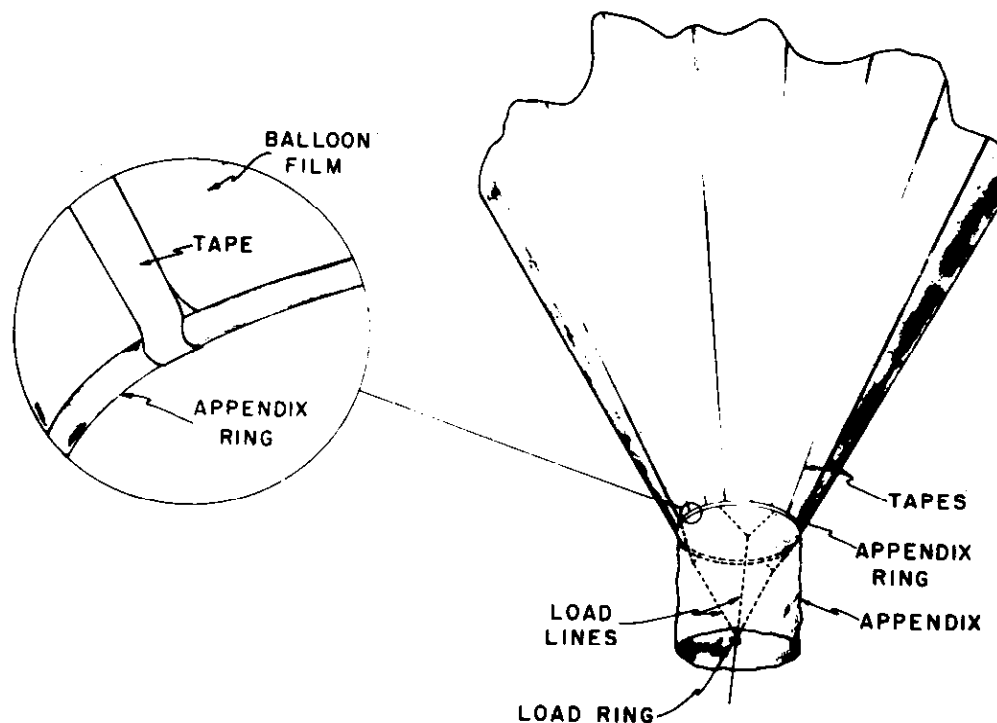

Figure 6. Appendix detail, polyethylene balloon.

On the Winzen balloons, which are made from .015" polyethylene, all but two of the balloons were made with similar fiber tape reinforcements; these two were produced without tapes and both of them have been flown with no evidences of unsatisfactory performance.

The eggplant shaped balloon produced by The Goodyear Tire & Rubber Company, Inc. has been flown with satisfaction, but the exact amount of diffusion, which is expected to be low from this balloon, is not yet known.

#### C. Internal-Pressure Balloons

From a theoretical standpoint the most satisfactory means of keeping a balloon at constant pressure-altitude is to use a non-extensible

cell with very low diffusion through the walls and one capable of maintaining super-pressure in excess of that lost with reductions of gas temperature. Such a balloon could be sealed off completely or a pressure-activated valve could be used to permit efflux of the gas when the bursting pressure is approached. The neoprene-coated nylon balloon built by Seyfang Laboratories (Figure 7) has been used with a valve set to prevent rupturing.

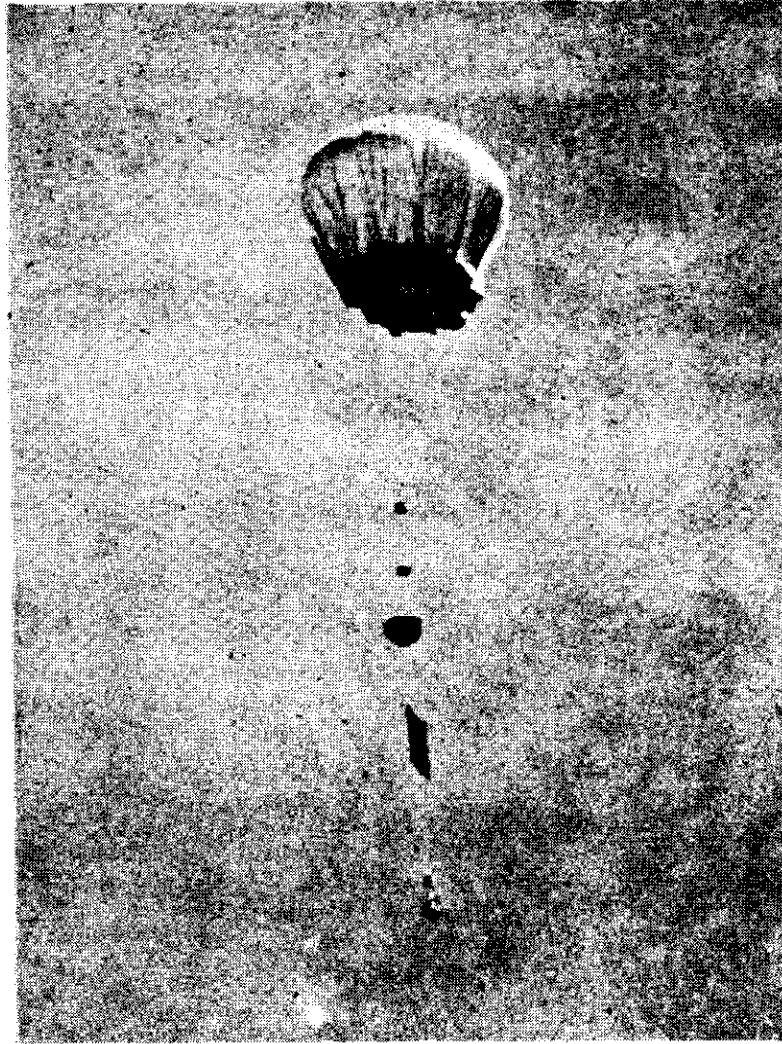

Figure 7. Neoprene-coated nylon balloon,  
two-thirds inflated.

The fabric has been coated with a metallic paint to minimize the effects of radiation. However, the values of superheat obtained by the gas when the balloon is in the sun have been of the order of 30°C. The amount of buoyancy lost when circulation

or sunset cuts off the superheat is so large that it is not possible to carry enough ballast to sustain the system under these conditions. On the other hand, the loss of buoyancy through a sealed-off Seyfang balloon at 4100 feet MSL is of the order of 50 grams per hour which is significantly less than the loss expected from a 20-foot, 1 mil polyethylene cell in flight conditions. (With the appendix aperture sealed, such a cell shows a loss of lift of about 40 grams per hour when one-fifth inflated at sea level).

One other type of balloon which has been used as a super-pressure balloon is the neoprene J2000 balloon of Dewey and Almy, surrounded by nylon cloth shroud. The rubber balloon normally would expand until it reached bursting diameter, but when enshrouded, it is limited to the volume of the shroud. The difficulties in launching and flying this balloon are not unusually great, but on each of the several tests which have been made to date improper handling has been a possible cause of the early rupture of the balloon. It is believed, however, that such a balloon is not especially suitable for long flights because of the deterioration which occurs in the neoprene in the presence of sunlight. Perhaps a shroud of material which would filter out the ultraviolet rays would protect and lengthen the life of such a balloon.

Despite the success of the Japanese silk or rice-paper balloons, which were constructed on a super-pressure principle, it is not believed practical at this time to develop a balloon of such strength that it would successfully withstand and retain pressure increases corresponding to the temperature changes from night to day as the superheat of absorbed sunlight is gained. The super-pressure with a neoprene-coated nylon balloon, for example, would be approximately 0.5 psi. That such a balloon could be built is unquestioned. The cost of production, however, appears at this time to be unwarranted.

#### D. Altitude Controls

Beginning with the arrays of rubber balloons which were first used, various systems of dropping ballast, both solid and liquid, have been attempted with the aim of exactly compensating for the loss of buoyancy which is occasioned as the lifting gas diffuses or leaks through the balloon. On the early rubber balloons only rough incremental ballast dropping was employed. At that time it was decided not to use sand as ballast since most sand contains some water which may freeze while aloft. Further, it is easier to control the flow of a liquid ballast than it is to control sand particles. In the investigations for a suitable liquid ballast the petroleum product known commercially as Mobil Aero compass fluid was finally settled upon. These investigations included tests of cloud point, freezing point, and also density and viscosity over a large range of temperatures. The compass fluid is especially suitable for ballast work

in high altitudes, since it freezes below  $-80^{\circ}\text{C}$  and will flow readily at low temperatures. Also, this fluid will absorb only a very slight amount of water which might freeze aloft.

Basically three different principles have been used in the control of ballast flow. The first of these is calculated constant flow; the second is displacement-switch control; and the third is rate-of-ascent switch control.

#### (1) Constant Flow

In the simplest of the control systems, liquid ballast is allowed to flow continuously through an orifice (Figure 8) at a pre-determined rate. This rate is set to slightly exceed the ex-

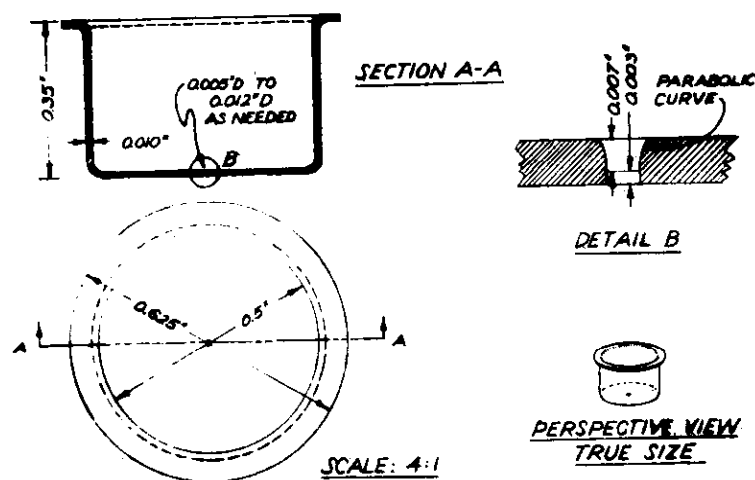

Figure 8. Orifice for fixed-rate ballast flow.

pected loss of lift of the balloon due to leakage and diffusion. If this method is successfully used, the balloon stays full because the gas remaining in it has less load to support. Therefore, the balloon will rise slowly as ballast is dropped, maintaining equilibrium between the buoyancy and the load. In the General Mills 20-foot balloon, for example, diffusion losses are about 200 grams per hour at altitudes near 40,000 feet. The balloon at its ceiling of 40,000 feet with a 26-kilogram payload rises about 700 feet with each kilogram of ballast dropped. This means that such a balloon using this constant-flow type control will float at a "ceiling" which rises at the rate of about 140 feet per hour. Constant flow was first obtained by use of the manual ballast valve shown in Figure 9. Due to excessive clogging of this valve, caused by its annular ring opening, gate-type valves were tested, and finally the use of

simple orifices of various sizes replaced the manual ballast valve.

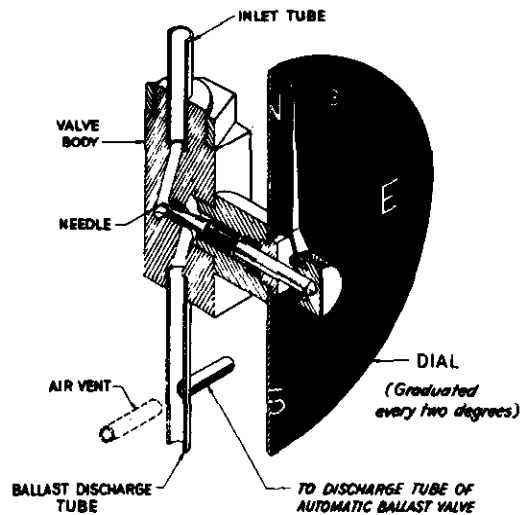

Figure 9. Manual ballast valve.

## (2) Displacement Switch

The displacement principle in ballast control has been used in two different types of valves. The first of these, called the "automatic ballast valve," used a needle valve, controlling ballast flow by an aneroid capsule to which the needle was attached (Figure 10). The aneroid capsule was open to the atmosphere on ascent; as the balloon began to descend to a region of higher pressure, a minimum pressure switch was used to seal off the capsule and further descent caused ballast flow. (For details see Technical Report No. 1, Constant Level Balloon Project, Research Division, College of Engineering, New York University, New York, N.Y., 1948.)

There are three undesirable features of this system. Greatest is the effect of temperature changes on the air sealed in the capsule. Seal-off pressure acts as a datum plane. Any increase from this pressure causes compression of the aneroid, and ballast flows proportionally to the difference from seal-off pressure. However, with changes of temperature of the entrapped air, the activation pressure of the valve changes, the floating level is thus also a function of temperature of the gas in the aneroid.

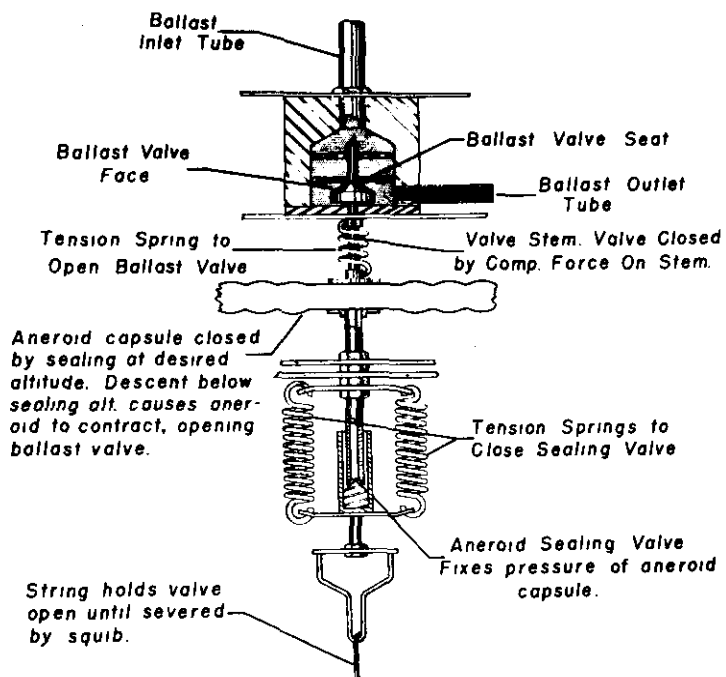

Figure 10. Automatic ballast valve.

The second undesirable feature of the automatic ballast valve system is the lag induced by the use of a minimum pressure switch to seal off the aneroid capsule. This is in addition to the lag of the aneroid itself. If a mercury switch is used, the differential between minimum and seal-off pressure is about 8 millibars; with a less dense liquid, the operation will still require about a 2-millibar difference. If the sealing is done by a fixed pressure switch, it is then necessary to predict the altitude to which the balloon will rise. Failure to reach this height would leave the aneroid open and useless. Deliberate under-estimation of the ceiling causes a relatively long period of uncontrolled slow descent before control begins.

The third unwanted feature is the waste of ballast which flows during both descent and ascent of a balloon whenever it is below the seal-off elevation. Since the balloon is no longer "heavy" when its downward motion has been arrested, flow during the return to the datum plane is needless and indeed

will cause an overshoot, hence the unnecessary exhaust of some lifting gas.

The effects of temperature on the aneroid capsule of the automatic ballast valving system were eliminated by the use of a ballast switch which uses a vacuum-sealed aneroid, set to permit ballast flow through a valve whenever the balloon is below a given pressure altitude. In this system the minimum pressure switch and the lag caused by its use are eliminated. This displacement-switch control has the disadvantage that the flow which it permits is not proportional to the displacement of the balloon below a datum plane but is constant through the valve. Normally this flow is large to permit rapid restoration of equilibrium. A second disadvantage is the requirement of batteries to supply power to the electrically operated valve. However, the advantage of eliminating the temperature effects on the aneroid compensate for these two comparatively minor disadvantages.

In practice, the displacement switch has consisted of a modified radiosonde modulator in which the standard commutator is replaced by a special bar which is an insulator above a certain point and a conductor at lower levels (higher pressures). When the aneroid pen arm is on the conducting section of the commutator, a relay opens the ballast valve. To prevent excessive flow on ascent, the pen arm rides on an insulated shelf above most of the contact segment of the commutator (Figure 11).

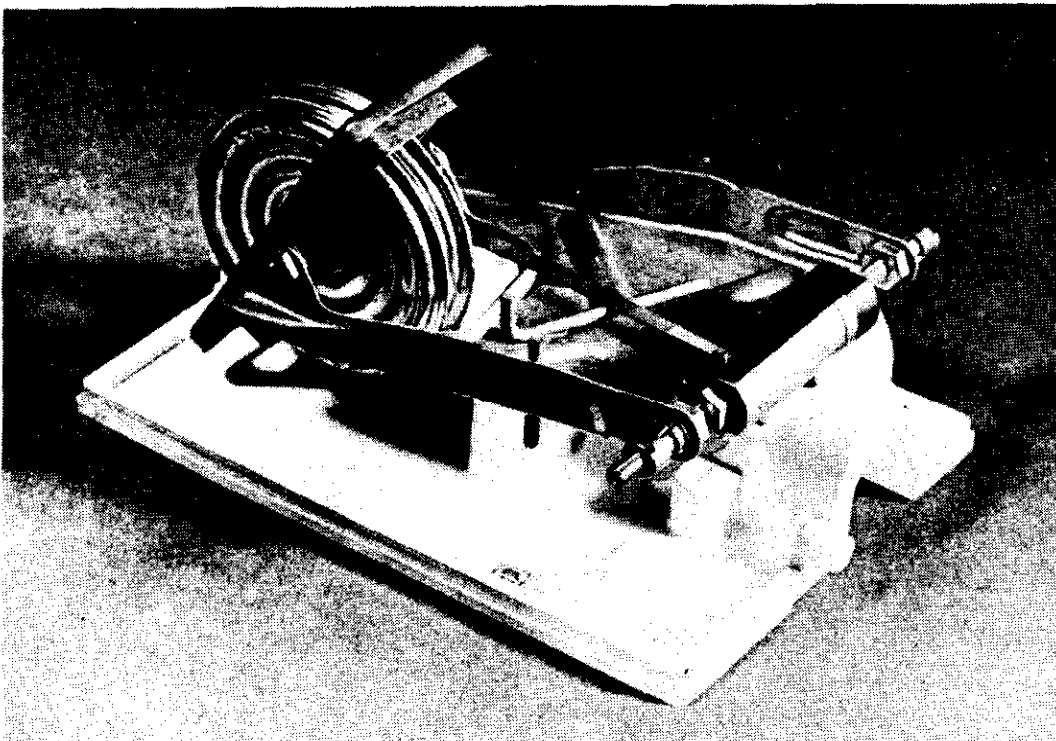

Figure 11. Pressure displacement switch.



The pen drops off the shelf at a safe distance below the expected pressure altitude and ballast then flows until the pressure pen reaches the insulating section of the commutator. In order to prevent the overshoot mentioned as one undesirable feature of the automatic ballast system, the high pressure end of the insulator may correspond to the expected maximum altitude of the balloon, any loss of lift due to impurities or escape of lifting gas will cause the balloon to level off at a ceiling within the ballast-dropping range. Continued ballast dropping will result in the rise of the balloon. Thus, an over-estimation of the ceiling is not as critical as in the case of the previous system.

### (3) Rate-of-Ascent Switch

With the displacement-switch control just described there remain the problems of ballast waste and balloon oscillation resulting from discharge of ballast during rises of the balloon after a descent has been checked. To eliminate this, a ballast-control switch acting on the rate of rise of the balloon is put in series with the displacement switch to close the ballast flow circuit only when the balloon is coming down or floating below pressure altitude. When it is rising, no ballast flow is permitted. This "rate-switch" is seen in Figure 12.

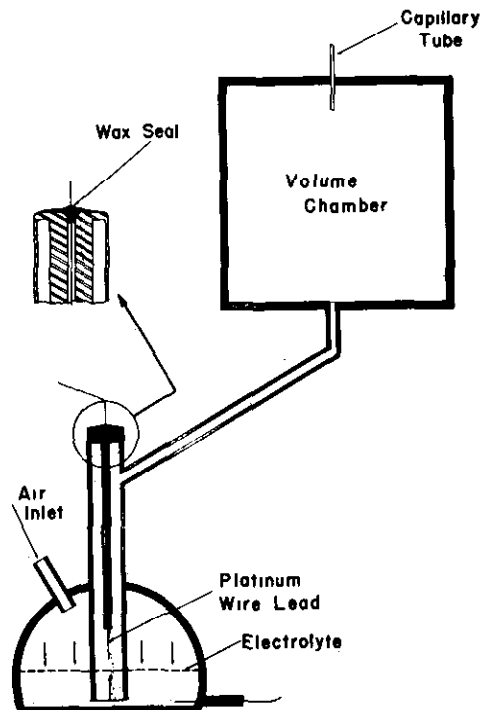

Figure 12. Rate-of-ascent switch.

A glass flask is open to atmospheric pressure through a fine capillary tube. With various rates of change of pressure, various differential pressures exist between the air in the flask and the outside air. This pressure difference controls the level of liquid in a manometer switch, filled with 24% hydrochloric acid. When the internal pressure is 0.2 mb more than the ambient pressure, the switch opens and ballast flow is stopped even though the balloon may be below the floating level. (The switch is set so that a rate of change of .1 mb/minute acting for three or more minutes will open the switch.) By thus restricting flow when the balloon is rising, balloon oscillations are minimized and ballast is conserved. A sketch of this operation is shown as Figure 13.

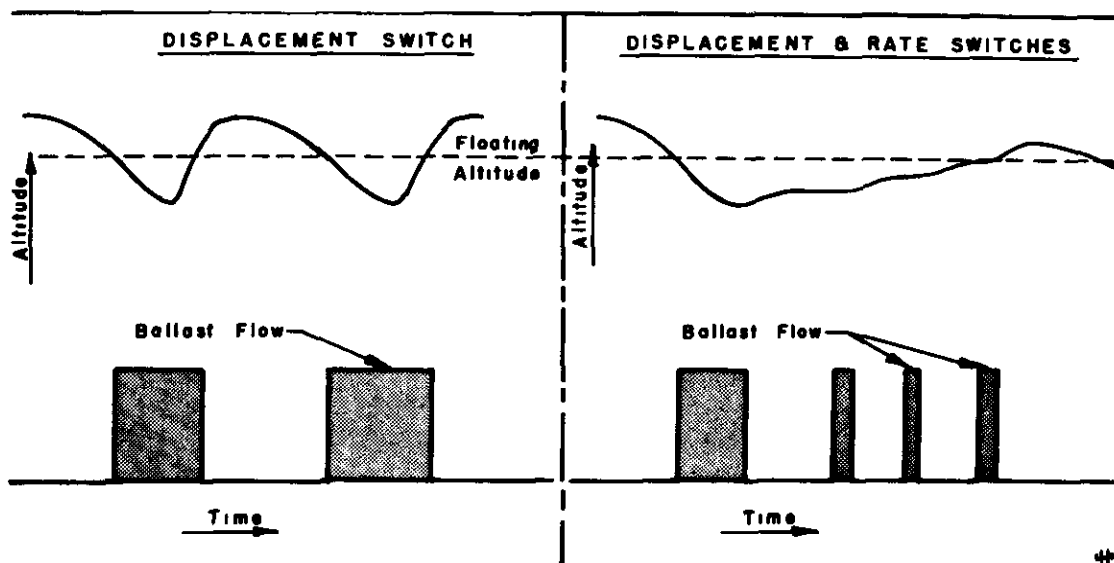

Figure 13. Height-time curve, showing ballast control action.

Since the rate switch is much more delicate than the displacement switch, safety considerations have caused the combined control to be supplemented by a pure displacement switch control. In this, the conducting segment of the pressure modulator is divided, and only a limited pressure height range (set for desired floating level) is controlled by both switches in series. If the rate switch is damaged at launching (by spilling some of its electrolyte, for instance) or in flight (perhaps by evaporation of the electrolyte) and the balloon descends, simple displacement control becomes effect when the high pressure (lower altitude) segment of the conductor is touched by the pres-

sure pen. The switch circuit is seen in Figure 14.

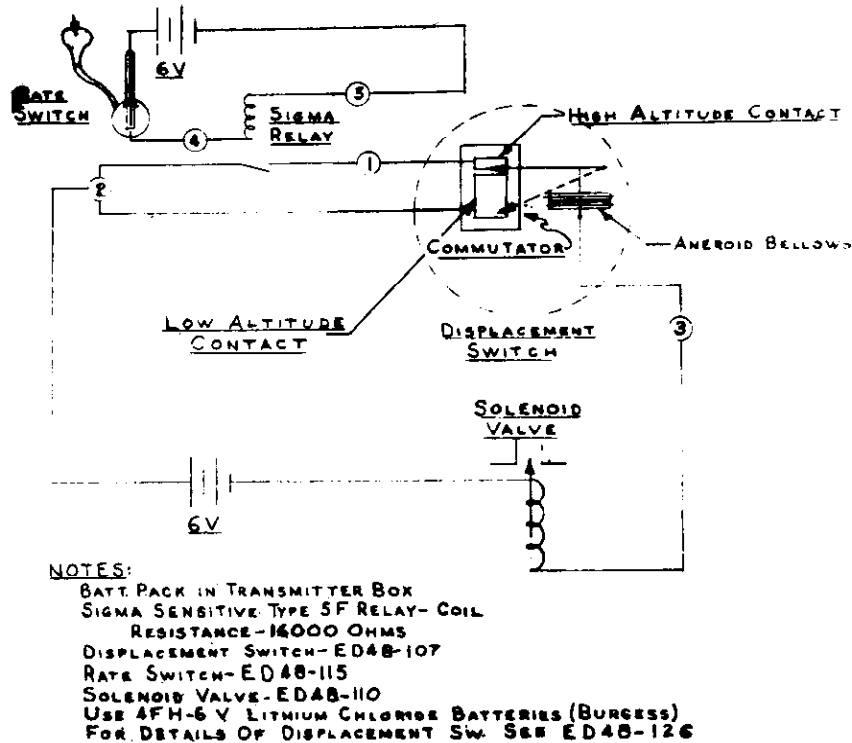

Figure 14. Circuit for ballast control with combined displacement and rate-of-ascent switches.

Figure 15 is a theoretical height-time curve, showing when ballast would be dropped using such a control and the resulting balloon behavior. During ascent the pressure pen is kept off the commutator bar until Point 1 where it falls onto the low-altitude conducting segment. (The shelf has been set so that the pen will fall onto the low-altitude segment in order that a ballast signal will be received for a short period of time, indicating that the system is working properly. The balloon rises and ballast flows until the pressure pen reaches Point 2, the beginning of the region where both switches in series control the ballast. As long as the balloon continues to rise, no flow occurs. Should the maximum altitude be above the control level, no ballast will flow until the balloon descends to that point. Then, with both controls operating, ballast will flow only on the descending and floating portions of the flight below control level. A second course is illustrated, wherein the rate-switch has failed. There the balloon descends to Point 2 and oscillates about this level, as a result

of displacement switch actions alone.

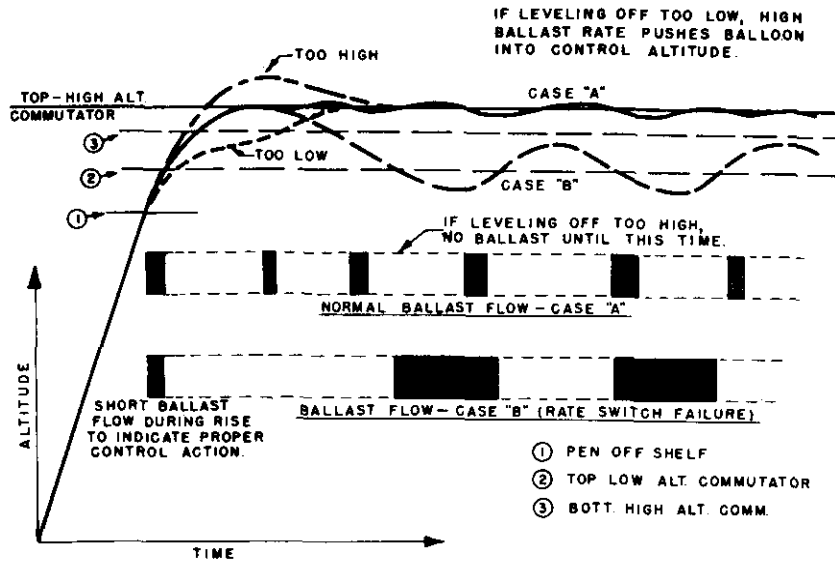

Figure 15. Theoretical height-time curve.

(4) Rate-of-Descent Switch

It may at times be desirable to control a balloon merely by a switch activated at any given rate of descent. This could be accomplished merely by "reversing" the rate-of-ascent switch. This type of control would prove to be quite difficult, however, for a constant level flight. One flight, No. 97, was made using a type of rate-of-descent switch as shown in Figure 16. In

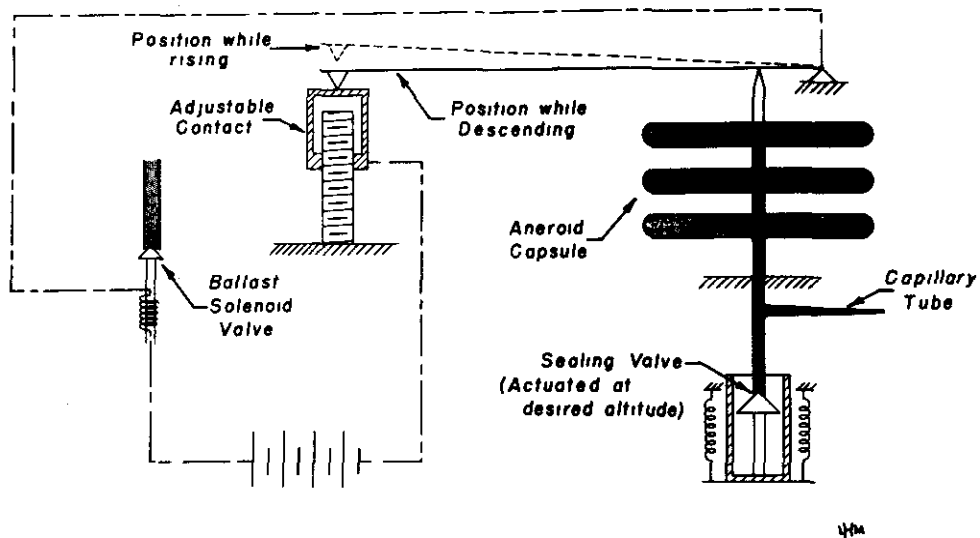
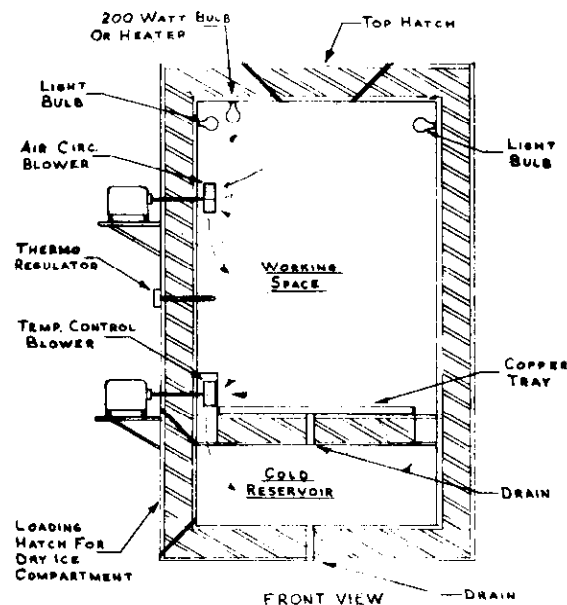

Figure 16. Rate-of-descent switch.

this switch a circuit is closed when the rate of descent exceeds 1/5 mb/minute, allowing ballast to flow. The record of Flight 97 indicates that good control was obtained for a four-hour period using this switch. However, the instrument is so delicate and susceptible to temperature effects that its use is not advised.

### E. Flight Simulation

To make laboratory tests on the control equipment just described, a flight-simulation chamber has been built combining a bell jar and a temperature chamber. A drawing of the temperature chamber designed and built at New York University is shown in Figure 17. (Investi-



LOWEST WORKING TEMP. -65° To -75°C  
ACCURACY OF TEMP CONTROL 0.5°C

Figure 17. Temperature control chamber.

gation of commercially sold chambers showed that the cost of purchasing a temperature chamber of the size desired would be prohibitive.) First designs called for the use of a freon refrigerating system; however, use of dry ice as a coolant proved to be more advantageous. This chamber, with its automatic control, can hold temperatures as high as +100°F and as low as -90°F within 5° for a period of several hours. Dry ice consumption at -60°F is approximately 150 pounds for a 24-hour period.

It is possible, using a bell jar for flight-similitude studies, to arrange switches so that the vacuum pump is turned off and on at

the same time that ballast is normally required in flight. This system simulates the effect of rising and falling in the atmosphere and indicates the effectiveness of the controls which have been applied.

In order to simulate flight, it is necessary that three conditions be maintained within the system. The first is that a leak of air into the bell jar is permitted at a rate of pressure increase which has been observed during balloon descent. A large lag chamber is connected into the bell jar to supply the second condition which is a delay similar to that inherent in the control action on an actual balloon flight. It is necessary to properly adjust the volume of such a lag chamber to obtain the desired magnitude of control action.

A third requirement is that the response of the vacuum pump must correspond to that response which has been observed when a balloon system drops ballast. In order to measure this, the control mechanism has been allowed not only to switch the vacuum pump on and off but also to actuate the standard ballast-flow equipment. This system may be adjusted so that the amount of pressure change which a single period of pumping produces accurately represents the amount of ballast thrown off during flight.

The barogram shown in Figure 18 is an example of such a test. On this test the rate-of-ascent ballast switch was added to the displace-

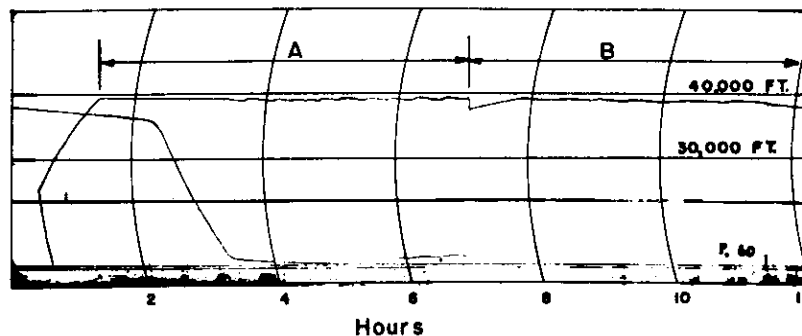

Flight Similitude Record Of Pressure

- A- Displacement Switch Operating.
- B- Displ. & Rate Of Ascent Switches Operating.

Figure 18. Sample barograph record.

ment switch after the latter had operated for a period of six hours. The combination of the two is seen to have effected a reduction in

the amplitude and frequency of oscillations induced by the servo system. In fact, under the influence of both controls, oscillation is almost undetectable.

As a consequence of such tests, it is possible to predict the type, size and frequency of oscillations which the servo-control equipment will introduce into the balloon flight. This is especially significant since it is known from flights on which no control equipment was included that oscillations do occur naturally within the atmosphere, apparently as a result of vertical cellular convection currents. By knowledge of the frequency of oscillation caused by a given control system it is possible to analyze oscillations and determine which are caused by control and which are atmospheric. The wiring diagram of the flight-similitude system is shown in Figure 19.

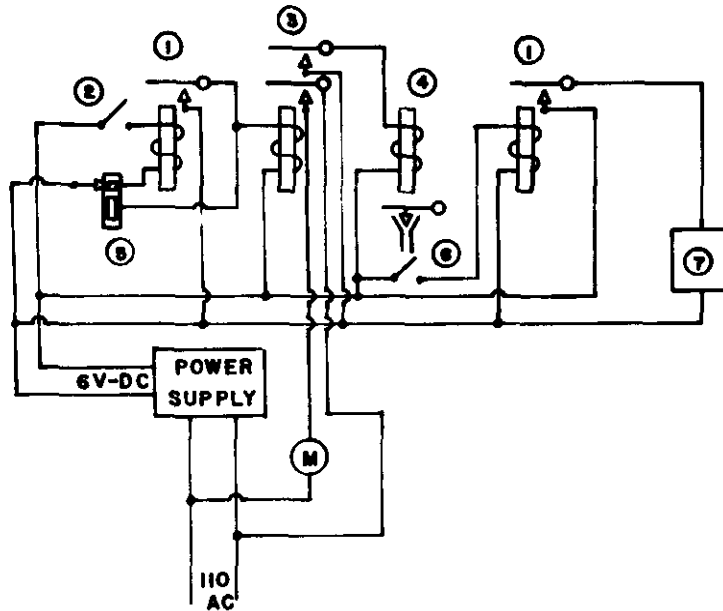

#### NOTES

- ① Sigma Relay Type 5F
- ② Rate Switch - ED 48-115
- ③ Heavy Duty Relay, Guardian Series 200dpst
- ④ Ballast Solenoid Valve - ED 49-2
- ⑤ Displacement Switch - ED 48-107
- ⑥ Auto Syphon
- ⑦ Counter
- (M) Pump Motor

Figure 19. Wiring diagram, flight-similitude system.

The vacuum system is shown in Figure 20.

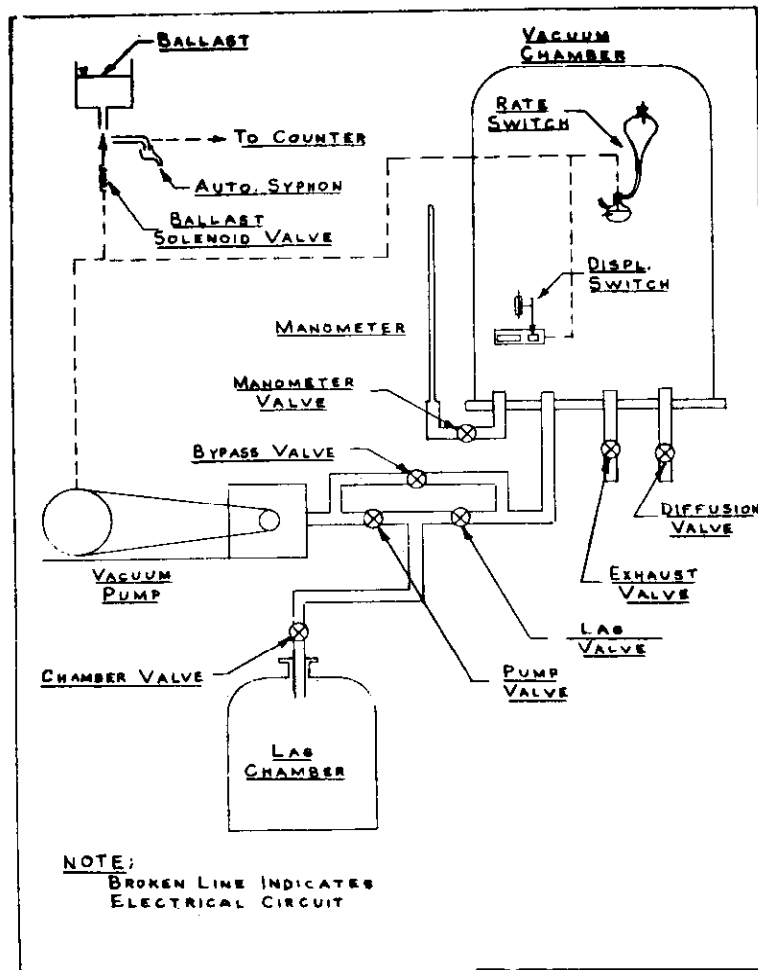

Figure 20. Physical layout, flight-similitude system.

This equipment has been used in testing instruments to be flown and also equipment which is used in the launching and preparation before release. For example, the Du Pont S64 squibs, which have been used in conjunction with the flight-termination switches and also for severing launching lines, were tested in this chamber and found to fail when subjected simultaneously to cold temperature ( $-50^{\circ}\text{C}$ ) and low pressures (10 millibars) although tests at either low temperature or low pressures alone produced no failures. As a result of these tests, a new squib, the S59, has been produced by Du Pont and is used in current flights. Other equipment which has been tested in the bell jar and the cold chamber includes the Lange barographs and the Olland-cycle pressure-measuring instruments.



F. Flight Termination Gear

The rate of descent when controlled balloons are falling after exhausting all ballast is sometimes as slow as 50 feet per minute. This means that several hours might be required to fall through the lanes of aircraft traffic, increasing considerably the hazard to aircraft (admittedly very small). To minimize this possibility, units have been added to the flight train to cause a rapid descent after the balloon system has descended to some critical value, say 20,000 feet. One such destruction system, using a flight-termination switch, is shown in Figure 21. It consists of a pressure-activated switch, triggered on descent only, an explosive charge used to sever

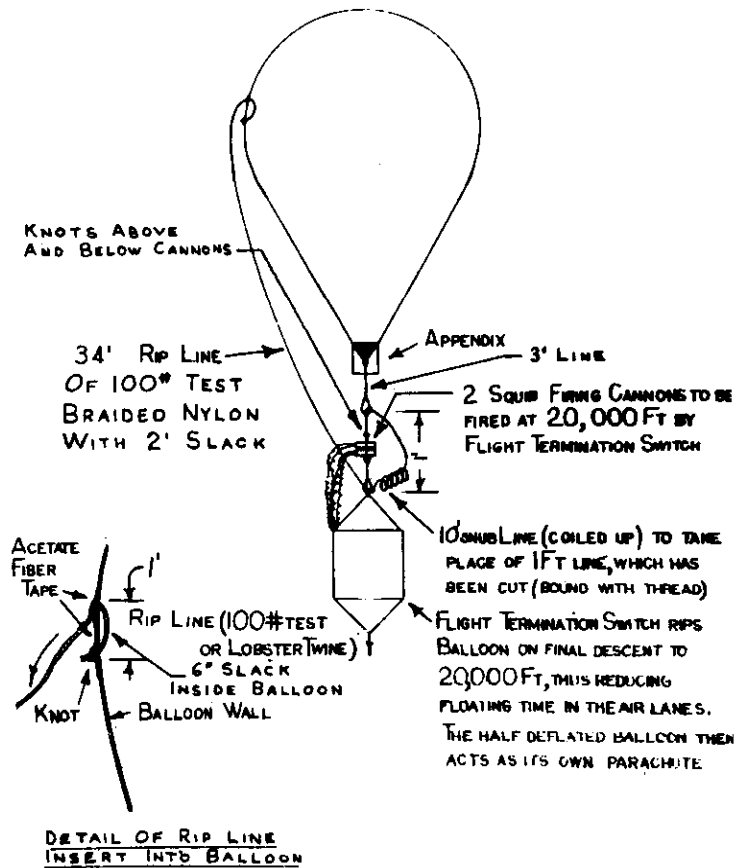

Figure 21. Flight termination equipment.

the main load line, a rip line attached to the balloon near the equator and a snub line which takes up the strain after the load has fallen a few feet.

When the contact is made, the load line is cut and the entire weight of the dependent equipment is used to pull out a section of the balloon wall. Through this rupture, the lifting gas can escape, and the balloon descends, using the upper portion as a parachute. The rate of descent has been observed to vary from 600 to 1500 feet per minute when this system is employed.

For some special applications it has been desirable to cause the balloon to descend after some predetermined time, instead of waiting for the descent to air traffic lanes. In these cases, a clockwork switch has been used instead of the pressure-activation unit. When docks are used they are kept free of lubricants which will freeze. The best results have been obtained from the use of a Dow Corning Silicone (DC 701) diluted with 30% kerosene. If this is not available, it is better to send up a clock without any lubrication. Given relatively loose mechanism (a cheap alarm clock) the differential expansion of parts which is encountered at low temperatures is apt to cause less trouble than does the congealing of standard lubricants.

#### IV. EQUATIONS AND THEORETICAL CONSIDERATIONS

Development of a controlled altitude balloon has led to investigation of many theoretical considerations applicable both directly and indirectly to the description of variables encountered in balloon control. Some of these relationships have been derived directly from standard hydrodynamic or thermodynamic principles; others come from an empirical study of results of laboratory tests and actual balloon flights. In this section we will investigate these theoretical considerations and endeavor to correlate them with actual flight results. A more simple investigation of the equations necessary for the launching and tracking of a controlled altitude balloon is contained in Part II of this report, "Operations."

We shall first consider the relationships which aid in evaluating the elementary characteristics of non-extensible balloon flight and those which are helpful in carrying out inflation and launching operations of such balloons. Next, we shall discuss more complex considerations involved in balloon flights.

##### A. Floating Altitude and Altitude Sensitivity

To determine the altitude at which a non-extensible balloon will float we must consider the weight of the balloon system, the volume of the balloon, and the densities of the lifting gas and the air. [If the lifting gas is 98% helium (molecular weight 4.50 lb./lb. mol), the lift of a unit of gas will be 24.4 lb./lb. mol. Similarly, if 98% hydrogen were the lifting gas, the lift would be 26.6 lb./lb. mol.] By using these three basic parameters, we can obtain an expression for the molar volume at which the balloon will float:

$$(1) \quad MV = \frac{\text{Balloon Volume} \times \text{Gas Lift}}{\text{Gross Load}}$$

[It may be noted from this equation that a balloon can float at molar volumes less than that computed for maximum balloon volume (i.e., when it is not full). However, under these conditions the balloon would be in neutral equilibrium, since any vertical force would cause it to rise or fall until a force in the opposite direction stopped it. This is also the case with floating extensible balloons.]

To convert from molar volume to equivalent altitude we must know the pressure-temperature distribution of the atmosphere in which the balloon will float. Since it is difficult to obtain an accurate distribution for each flight, the atmospheric model as drawn up by NACA standards has been used. In general the error obtained in using the NACA standard is not great, but if greater refinement is desired, data obtained from averaged radiosonde observations over a given launching site can be used.

From such knowledge of the distribution of pressure and temperature, we may plot a curve of molar volume vs. altitude by use of the following equation:

$$(2) \quad MV_z = 359 \frac{\text{ft}^3}{\text{lb mol}} \times \frac{T_z}{273^\circ \text{K}} \times \frac{1013.3 \text{ mb}}{p_z} \frac{\text{ft}^3}{\text{lb mol}}$$

By use of such a plot we easily find the floating altitude of a full non-extensible balloon by use of equation (1) to find molar volume, and then of the plot of equation (2) to find altitude.

The two equations have been combined and graphed in the form of an altitude vs. gross load chart with helium as the lifting gas for various balloon sizes and various release sites in the "Operations" section of this technical report (Part II, page 108).

For the NACA standard atmosphere we may derive an equation for altitude sensitivity by use of the molar volume-altitude relationship. This is most easily done by plotting molar volume vs. altitude on semi-logarithmic paper, since the curve of molar volume vs. altitude from 40,000 to 105,000 feet (where a constant lapse rate of zero is assumed) is approximately a straight line on semi-log paper. The general form of the equation for this portion of the atmosphere is  $y = ae^{bz}$  where  $y$  is the molar volume and  $z$  the altitude.

It is possible to determine empirically the constants  $a$  and  $b$ . For example, using the molar volume at 50,000 feet, we find from

\*359 ft<sup>3</sup> = Molar volume of air at standard conditions (273°K, 1 atm. pressure)

the equation  $2500 \text{ ft.}^3/\text{lb. mol} = ae^{50b}$  where 50 is the expression for altitude in thousands of feet. Similarly, at 70,000 feet,  $6450 = ae^{70b}$ , and by solving to eliminate a, we find  $2.58 = e^{20b}$  or  $20b = .95$ , and the constant b is equal to .0475. Thus, the equation may be written:

$$(3) \quad y = ae^{.0475z}$$

y was originally defined as the molar volume, equal (for 98% helium) to:

$$\frac{\text{Balloon Volume} \times 24.4}{\text{Gross Load}} = \frac{K}{W}$$

In turn,  $\frac{K}{W} = ae^{.0475z}$ , where z is the expression for altitude in thousands of feet. From this relationship, we may solve for W, the gross load.

$$(4) \quad W = \frac{K}{a} e^{-.0475z}$$

$$(5) \quad \ln\left(\frac{Wa}{K}\right) = -.0475z$$

or:

$$(6) \quad \ln W + \ln \frac{a}{K} = -.0475z$$

Differentiating with respect to W:

$$(7) \quad \frac{dz}{dW} = -\frac{21.052}{W} \frac{\text{ft}}{\text{lb}} \quad \text{where W is gross load in lb.}$$

We see that the value of the constant a is unimportant here, and the expression is independent of balloon volume, as long as it does not vary with time. Included is the assumption that over a short period of time buoyancy of lifting gas does not change.

Thus, we have an expression for A, the altitude sensitivity, which is valid between 40,000 and 105,000 feet. Similarly, it is possible to evaluate altitude sensitivity for operation between 0 and 30,000 feet. A in this range is equal to  $\frac{31,400 \text{ ft.}}{W}$  lb.

A plot of altitude sensitivity against load is shown on page 109 of the "Operations" section (Part II of this technical report).

We may use this equation to approximate the rise of a full balloon system when controlled by overcompensated constant ballast flow:

$$(8) \quad \frac{dz}{dt} = \frac{dW}{dt} \times A$$

where  $z$  is the balloon ceiling,  $t$  is time, and  $W$  is total weight of the balloon system.

#### B. Rate of Rise

The equation of Clarke and Korff:

$$(1) \quad \frac{dz}{dt} = 272 \frac{F^{1/2}}{G^{1/3}} \frac{\text{cm}}{\text{sec}}$$

has been used to obtain the relationship between rate of rise and free lift (or excess buoyancy) for a balloon system of any given weight. For practical use, the equation has been modified to:

$$(2) \quad \frac{dz}{dt} = 1486 \frac{F^{1/2}}{G^{1/3}} \quad \text{where } F \text{ is free lift in pounds} \\ \text{and } G \text{ is gross lift in pounds.}$$

Although this equation was derived for use with extensible spherical balloons, it predicts closely the performance of non-extensible balloons while they are rising to floating level. An average value for the constant in equation (2) from actual flights is  $1600 \text{ ft./min}(\text{lb.})^{1/6}$

The deviation from this relationship, evidenced in several flights, may be due to several variations from the assumptions upon which the equation is based. This deviation has in general been an increase of rate of rise of from 0 to 25% at higher altitudes.

To explain this increase, let us first investigate the changes which may occur in the free lift. If any gas leaves the balloon because of leakage through the balloon or the appendix, the free lift will be reduced and the rate of rise will decrease (as it does after the balloon is full and "levels off"). Therefore, this variation may be ruled out when considering rise before the balloon becomes full.

Free lift will vary with changes of temperature of the lifting gas with respect to the free-air temperature. A change of this sort can be caused by acquisition of superheat of the lifting gas, or by temperature decrease or increase caused by adiabatic expansion or compression of the lifting gas. (These items will be discussed later in this report.) Actual temperature measurements during rising portions of flights indicate that there is no appreciable tempera-

ture difference between the lifting gas and free air. Evidently the effect of ventilation as the balloon moves through the air causes the lifting gas to remain at a temperature approximating that of the air, and the increase of lift due to temperature variation is small in magnitude.

Since changes in the value of free lift appear incapable of causing any appreciable increase in rate of rise, other possible variations such as a change of the drag, or fluid friction, effect must be considered.

The equation of Korff is based upon the assumption that the effect of the change in Reynolds number and the change in size are of equal magnitude, but in opposite directions. Therefore, these variables are eliminated to obtain the simple engineering formula of Korff. With a non-extensible balloon, however, the change of drag effect is probably less than the effect of change of Reynolds number. Therefore, it is likely that the rate of rise would increase with altitude. The change in drag effect may be realized by a decrease of relative size of the flabby, unfilled portion of the balloon. Thus there will be a decrease of the drag caused by flow of air past this flabby portion as the shape of the balloon changes; the result will be an increase in the rate of rise of the system.

### C. Superheat and Its Effects

The effect of the heating of lifting gas by the sun's rays has long been of interest to those using balloons for atmospheric investigation. In cosmic-ray studies using freely extensible balloons, this heating effect was used to advantage in extending the length of flights. These flights were often released at night using the heat added at sunrise to replenish lift lost during the night by diffusion and leakage.

In constant-level balloon work, using non-extensible balloons, the effect of superheat of the lifting gas is more often a disadvantage than an advantage. The disturbance of the flight is not great when the gas acquires this superheat but may be disastrous when the superheat is lost. It is at this time that a large amount of ballast is required to keep the balloon system afloat.

Let us investigate the effects of gain and loss of superheat on a full, non-extensible balloon. We shall try to explain these effects in terms of percentage loss or gain of lift of the balloon system by use of simplified engineering formulas. First, the general formulas:

$$(1) \text{ Lift: } L = V_b(d_a - d_g) \quad , \text{ where}$$

$V_b$  = balloon volume

$d_a, d_g$  = density of air and lifting gas, respectively

(2) Density:  $d = \frac{p}{RT}$

$p, R, T$  = pressure, specific gas constant, and temperature of the air or lifting gas

(3) Let:  $B = \frac{R_a}{R_g} \left( = \frac{M_g}{M_a} \right)$

At any two positions:

$$L_1 = V_1 (d_{a1} - d_{g1})$$

$$L_2 = V_1 (d_{a2} - d_{g2})$$

Investigating the gain of superheat, since there is no change of volume  $V_1 = V_2$  and:

(4)  $\Delta L = L_2 - L_1 = V_1 (d_{a2} - d_{a1} - d_{g2} + d_{g1})$

Assume now that the balloon carries no internal pressure and that the difference in lift does not cause the balloon system to pass through any appreciable atmospheric pressure difference (in the case where the balloon is floating at 40,000 ft. MSL a change of 1000 ft. would be only 9 mb, or a 5% change).

Therefore:

$$p_{a1} = p_{a2} = p_{g1} = p_{g2} = p$$

Assume also that initially the air and lifting gas are at the same temperature and that the air passes through no appreciable temperature change. Then:

$$T_{a1} = T_{a2} = T_{g1} = T_1$$

Then, making use of our two assumptions and substituting equation (2) into equation (4), we have:

$$\begin{aligned} \Delta L &= Vp \left( \frac{1}{R_a T_1} - \frac{1}{R_a T_1} - \frac{1}{R_g T_{g2}} + \frac{1}{R_g T_1} \right) \\ &= \frac{Vp}{R_g} \left( \frac{1}{T_1} - \frac{1}{T_{g2}} \right) \end{aligned}$$

and:

$$\frac{\Delta L}{L_1} = \frac{\frac{1}{R_g} \left( \frac{1}{T_1} - \frac{1}{T_{g2}} \right)}{\frac{1}{T_1} \left( \frac{1}{R_a} - \frac{1}{R_g} \right)}$$

CHARLES E. H. 2120

$$(5) \quad \frac{\Delta L}{L_1} = \frac{B}{1-B} \left( \frac{T_{g2} - T_1}{T_{g2}} \right)$$

or, for small temperature differences, we have:

$$(6) \quad \frac{\Delta L}{L} = \frac{B}{1-B} \left( \frac{\Delta T}{T} \right)$$

With increasing temperatures, there will be an unbalance in the direction of greater altitude. While climbing to a greater altitude the balloon will valve gas and come to equilibrium at a new level. Thus the effect of gain of superheat with a full non-extensible balloon will be a slight increase of altitude.

Investigating the case where an initial amount of superheat is lost:

$$(7) \quad \Delta L = V_2 (d_{a2} - d_{g2}) - V_1 (d_{a1} - d_{g1})$$

and since the balloon volume will decrease with cooling of the lifting gas:

$$V_1 = V_2 \frac{T_{g2}}{T_{g1}} \quad (\text{assuming constant } p)$$

Therefore, again making use of the assumptions that:

$$p_{a1} = p_{a2} = p_{g1} = p_{g2} = p$$

and:

$$T_{g2} = T_{a1} = T_{a2} = T_2$$

Combining equation (2) and equation (7), we have:

$$\begin{aligned} \Delta L &= V_1 \left[ \frac{T_2}{T_{g1}} \left( \frac{p}{R_a T_2} - \frac{p}{R_g T_2} \right) - \left( \frac{p}{R_a T_2} - \frac{p}{R_g T_{g1}} \right) \right] \\ &= V_1 \left( \frac{p}{R_a T_{g1}} - \frac{p}{R_g T_{g1}} - \frac{p}{R_a T_2} + \frac{p}{R_g T_{g1}} \right) \end{aligned}$$



$$(8) \quad = \frac{pV_1}{R_a} \left( \frac{1}{T_{g_1}} - \frac{1}{T_2} \right)$$

Then:

$$\frac{\Delta L}{L_2} = \frac{\frac{1}{R_a} \left( \frac{1}{T_{g_1}} - \frac{1}{T_2} \right)}{\frac{1}{T_2} \left( \frac{1}{R_a} - \frac{1}{R_g} \right)}$$

$$(9) \quad = \frac{1}{1-B} \left( \frac{T_2 - T_{g_1}}{T_{g_1}} \right)$$

or for small temperature differences:

$$(10) \quad \frac{\Delta L}{L} = - \frac{1}{1-B} \left( \frac{\Delta T}{T} \right)$$

the negative sign indicating a loss of lift.

From this equation we may approximate the amount of ballast required to compensate for the loss of superheat of the lifting gas. It is apparent, then, that the amount of superheat gained or lost by a balloon's gas is of extreme importance to the control of the flight.

For this reason a transparent film has a definite advantage over a reflecting fabric. For example, aluminum-coated fabric balloons floating at 40,000 feet have exhibited lifting gas superheat in the neighborhood of 40°C.\* Polyethylene balloons, on the other hand, show superheat of approximately 10°C under the same conditions.

Assuming a total weight of 30 kilograms in the balloon system, with helium as the lifting gas ( $B \approx \frac{1}{7}$ ), the following compensation at sunset, or when superheat is lost, will be necessary:

Aluminized fabric:

$$\frac{\Delta L}{L} = \frac{1}{1-\frac{1}{7}} \left( \frac{40^\circ}{250^\circ} \right) = 18.7\%$$

Polyethylene:

$$\frac{\Delta L}{L} = \frac{1}{1-\frac{1}{7}} \left( \frac{10^\circ}{250^\circ} \right) = 4.7\%$$

\*This will explain the rapid descent of flight with fabric balloons and will show the need for high rates of ballast flow at sunset with polyethylene balloon flights (see Part III, "Summary of Flights," of this report).

This relationship between loss of lift and loss of superheat is substantiated by analysis of Flight 94. From the rate of descent the unbalance (using the equation of Clarke and Korff, see page 33) is in the neighborhood of 5 kilograms. Although there was no temperature measurement on this flight, a previous flight of this type indicated a superheat of approximately 40°C. By equation (10), with a gross load of 52 kg., the unbalance caused by loss of all of this superheat would be 9.7 kg. It is believed that ventilation past the balloon during a low velocity descent before operation of the ballast mechanism caused loss of superheat. Since this loss caused greater descent, and thus more ventilation, superheat was lost. An enormous rate of ballast flow would have been required to check descent.

#### D. Adiabatic Lapse Rate

One of the causes of temperature difference between the lifting gas and free air during rise or descent of balloon systems is the difference in lapse rates of air and the lifting gas. The adiabatic lapse rate is that temperature change caused by adiabatic expansion or compression of a gas during ascent or descent through a given vertical distance. The actual lapse rate of the lifting gas is the adiabatic lapse rate plus the effects of conduction and radiation. The adiabatic lapse rate is defined as:

$$(1) \quad LR = \frac{A g}{C_p}$$

where:

$$A = 2.39 \times 10^{-8} \text{ cal / erg}$$

$$C_p = \text{specific heat at constant pressure}$$

$$g = \text{acceleration caused by gravity}$$

In the metric system for helium, (  $C_p = 1.25 \frac{\text{cal}}{^\circ\text{C/gm}}$  ):

$$LR = -\frac{980 \times 239 \times 10^{-3}}{1.25} = -1.87^\circ\text{C / km}$$

or:

$$LR = -.57^\circ\text{C / 1000 ft}$$

The adiabatic lapse rate for air, (  $C_p = 0.239 \frac{\text{cal}}{^\circ\text{C/gm}}$  ):

$$LR = -\frac{980 \times 239 \times 10^{-3}}{0.239} = -9.8^\circ\text{C / km}$$

or:

$$LR = -2.98^\circ\text{C / 1000 ft}$$

The actual atmospheric distribution, however, does not indicate an adiabatic lapse rate for air but rather a lapse rate which varies with altitude. For the troposphere the lapse rate of the atmosphere averages  $-1.98^{\circ}\text{C}/1000\text{ ft.}$  It may be shown then that in the troposphere a rising balloon will get warm with respect to the air (neglecting ventilation and radiation effects) at a rate of  $1.98 - .57 = 1.41^{\circ}\text{C}/1000\text{ ft.}$  In the tropopause the lapse rate of the atmosphere is zero. Thus the lifting gas (if helium) will cool relative to the air at a rate of  $.57^{\circ}\text{C}/1000\text{ ft.}$

Similarly, in the stratosphere, the lifting gas will cool relative to the air at a rate of  $2.24 + .57 = 2.81^{\circ}\text{C}/1000\text{ ft.}$  This effect is plotted as Figure 22.

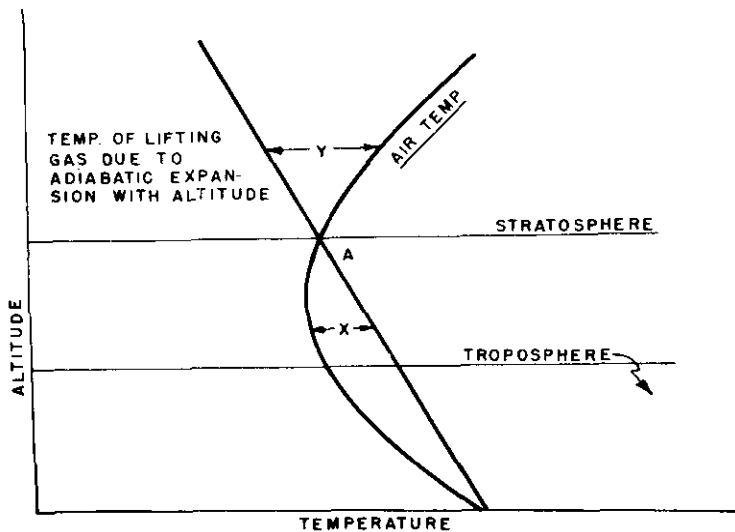

Figure 22. Lapse rate of air and helium.

Here, below point A, the lifting gas will be warmer than the air. Above point A, the lifting gas will be cooler than the air. The effect of this temperature difference on the lift (as shown in the previous section) is approximately  $\Delta L = L \frac{\Delta T}{T} \frac{1}{(1-B)}$

Thus, as a balloon system passes through point A, it will have less lift than at release. This effect has been observed on several flights, where a balloon system slowed down during ascent through a temperature inversion.

Since the effect of the sun in heating the lifting gas decreases the effect of different lapse rates, the effect is not as noticeable during the day as at night. At night the balloon system may pass through an inversion, lose its lift, and remain at an altitude much below its estimated floating altitude until warmed by the sun's rays at sunrise.

This effect adds to the stability of stratospheric balloon flights. If a system in equilibrium in the stratosphere were to lose lift and descend, the compression of the gas would cause an increase of the lifting gas temperature relative to the air temperature, causing a decrease in unbalance.

Similarly, an initial unbalance causing rise of the system would cause relative cooling of the lifting gas and thus again decrease the unbalance. Hence, the rate of rise or descent in the stratosphere will be limited by the rate of heat exchange due to conduction and radiation, which will counteract this effect of adiabatic heating or cooling.

Empirical evidence indicates that there is a great deal more stability in a stratospheric balloon system than in a similar system floating in the troposphere. This "adiabatic stability" is a principal reason for better performance of stratosphere flights.

#### E. Diffusion and Leakage of Lifting Gas

The lifting gas of a balloon can be lost by:

leakage through small holes in the fabric or film;  
solution, migration and evaporation through fabric or film;  
true molecular diffusion through openings, such as the  
appendix opening.

##### (1) Leakage

Volumetric flow,  $Q$ , of a gas through any given opening in the balloon surface may be evaluated as a function of the area of the opening,  $A$ ; the pressure head causing the flow,  $h$ , and a coefficient of leakage,  $C_d$ .

$$(1) \quad Q = C_d A \sqrt{2gh} \quad \text{where } g \text{ is the acceleration due to gravity}$$

It would be difficult to evaluate the amount and area of holes in the balloon surface. Let us, then, compare the rate of leakage at any given altitude with leakage at sea level, rather than attempting to evaluate the leakage at a given altitude.

First we shall compare the rate of leakage of a full balloon at any given altitude with leakage of a full balloon at sea level. Let us assume that the area of any opening in the surface of the balloon does not vary with altitude and that the coefficient of leakage is constant. Thus:

$$(2) \quad Q = \sqrt{h} \quad \text{where } h \text{ is pressure head in feet of lifting gas}$$

However:

$$(3) \quad h = \frac{\Delta p}{d_g} \times 144$$

where  $\Delta p$  is the pressure difference across the opening (psi) and  $d_g$  is density of lifting gas (lb./ft.<sup>3</sup>). Combining equation (2) and equation (3):

$$(4) \quad Q \propto \sqrt{\frac{\Delta p}{d_g}}$$

The pressure difference across any given opening can be evaluated in terms of: height above a known point of zero pressure difference; rate of pressure change with altitude of the atmosphere (which, for any small section of altitude is assumed to be constant); and ratio of the densities of air and the lifting gas. Since the pressure difference across the appendix opening is zero this is our reference point for evaluating height. Figure 23 shows this pressure relationship in graphic form.

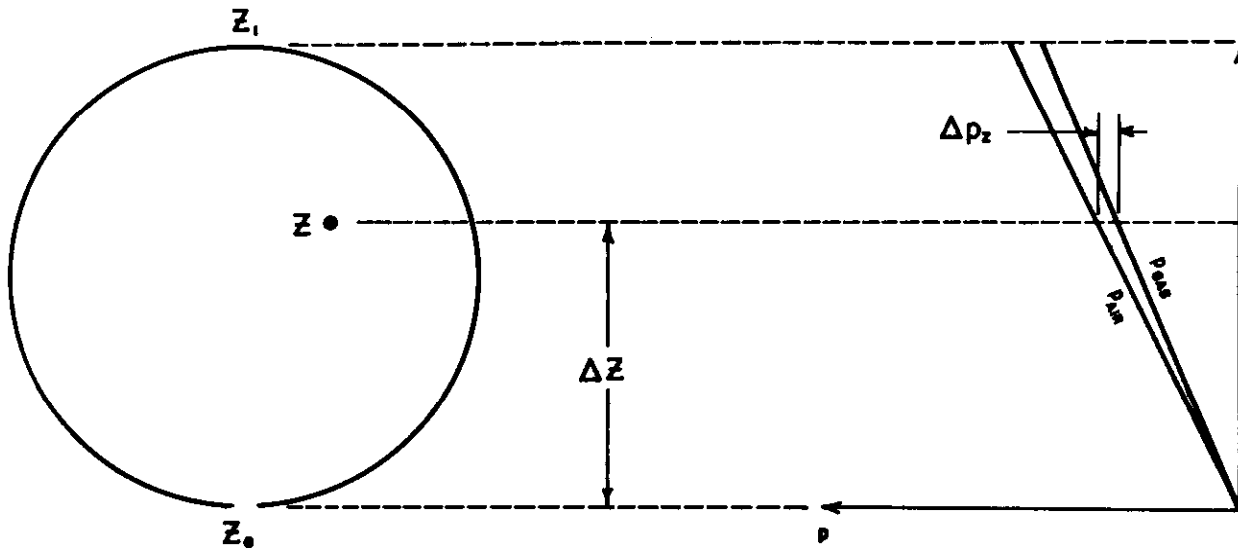

Figure 23. Pressure difference across balloon.

This relationship is expressed as:

$$(5) \quad \Delta p = \Delta z \left( \frac{dp}{dz} \right)_{\text{air}} (1-B)$$

where  $B = \frac{M_g}{M_a}$ ,  $M_g$  &  $M_a$  are molecular weights of lifting gas and air, respectively.

Since, for a full balloon,  $\Delta z$  is constant at any altitude, and B (for our discussion) is a constant:

$$(6) \quad Q \propto \sqrt{\frac{\left( \frac{dp}{dz} \right)_{\text{air}}}{d_g}}$$

The mass rate of flow is equal to the density of the lifting gas multiplied by the volumetric rate of flow:

$$(7) \quad L = Q d_g \propto \sqrt{\left( \frac{dp}{dz} \right)_{\text{air}} d_g}$$

Since the number of openings will not change with altitude, equation (7) expresses the relationship for mass rate of flow from a full balloon for any altitude. The leakage at any altitude may be expressed as a function of leakage at sea level:

$$\frac{L_z}{L_0} = \left( \frac{\left( \frac{dp}{dz} \right)_{\text{air}-z}}{\left( \frac{dp}{dz} \right)_{\text{air}-0}} \frac{d_{g_z}}{d_{g_0}} \right)^{\frac{1}{2}}$$

As an example, let us compare the leakage rates of a lifting gas through a full balloon at sea level, at 40,000 feet and at 100,000 feet.

Altitude	$(dp/dz)_{\text{air}}$	$d_g$
0	$\frac{1}{27}$	$\frac{1013}{288R}$
40,000	$\frac{1}{112}$	$\frac{188}{218R}$
100,000	$\frac{1}{1880}$	$\frac{10.9}{218R}$

Comparing rate of leakage at 40,000 feet with leakage at sea level:

$$\frac{L_{40}}{L_0} = \sqrt{\frac{27}{112} \cdot \frac{188}{1013} \cdot \frac{288}{218}} = 0.243$$

Comparing rate of leakage at 100,000 feet with leakage at sea level:

$$\frac{L_{100}}{L_0} = \sqrt{\frac{27}{1880} \cdot \frac{10.9}{1013} \cdot \frac{288}{218}} = 0.044$$

Therefore, if leakage of a full balloon at sea level is known, it is possible to compute theoretical leakage at any altitude. However, if it is not possible to completely inflate a balloon on the ground in order to make a sea level test (if lift would be great enough to rupture balloon or load lines), a method of comparing full balloon leakage with partially full balloon leakage must be found.

Let us assume that it is possible to obtain results of a leakage test for a balloon inflated to a volume  $\frac{1}{x}$  of full balloon volume. Again starting with equation (1):

$$Q = C_d A \sqrt{2gh}$$

We see that in this case the total area of openings, A is not constant but is a function of volume. Therefore, we have:

$$(8) \quad Q \propto A\sqrt{h}$$

We have shown that:

$$h = \frac{\Delta p}{d_g} \cdot 144 = \frac{\Delta z \left( \frac{dp}{dz} \right)_{\text{air}} (1-B)}{d_g} \cdot 144$$

Since we are comparing partially inflated balloon leakage at sea level with full balloon leakage at sea level the variable in the above expression is  $\Delta z$ . This is graphically illustrated in Figure 24.

CHARLES E. H. HARRIS

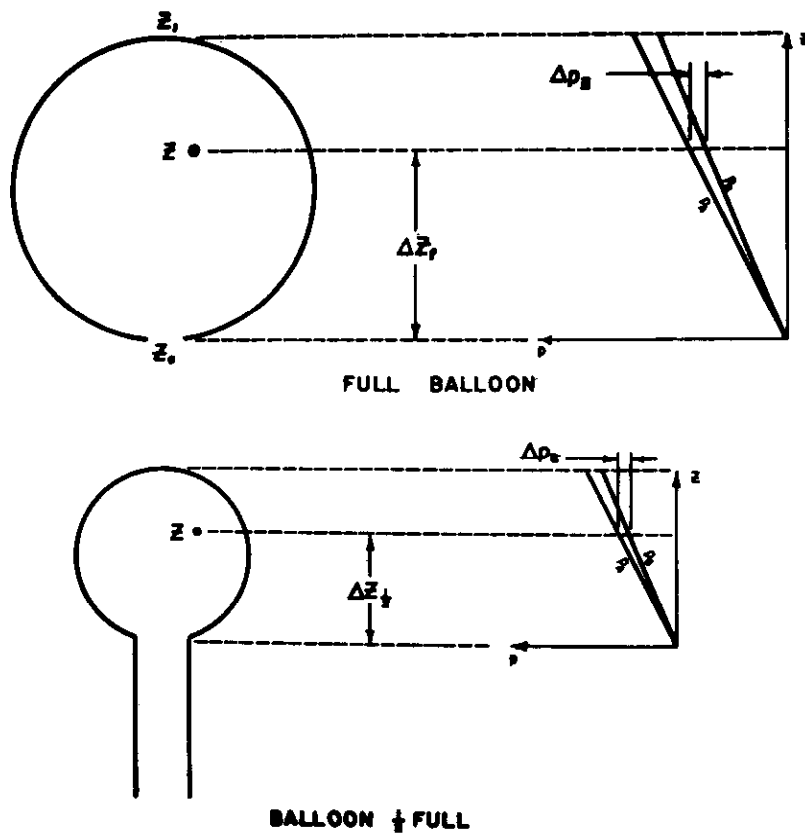

Figure 24. Comparison of pressure head across partially and fully inflated balloons.

Thus, the relationship is:

$$(9) \quad Q \propto A \sqrt{\Delta Z}$$

$$(10) \quad Q \propto V^{\frac{2}{3}} \sqrt{V^{\frac{1}{3}}} \propto V^{\frac{5}{6}}$$

Since the density of the lifting gas is constant, we may then express mass leakage as:

$$(11) \quad L \propto V^{\frac{5}{6}}$$

And then, to compare leakage of a full balloon with leakage of a balloon  $\frac{1}{x}$  full:

$$(12) \quad L_F = L_{\frac{1}{x}} (x)^{\frac{5}{6}}$$



Example: If a 20-foot diameter balloon  $\frac{1}{10}$  full were tested at sea level and found to have a leakage rate of 50 gm/hr. the leakage rate of a full 20-foot balloon at sea level would be:

$$L_f = 50 \frac{\text{GM}}{\text{HR}} (10)^{\frac{5}{6}} = 340 \frac{\text{GM}}{\text{HR}}$$

The leakage of a full 70-foot diameter balloon at sea level in this case would be:

$$L_f = 50 \frac{\text{GM}}{\text{HR}} \left[ 10 \left( \frac{70}{20} \right)^3 \right]^{\frac{5}{6}} = 7820 \text{ GM/HR}$$

Values for leakage at several different altitudes for 20-foot and 70-foot diameter balloons, assuming a leakage of 50 gm/hr. for a 20-foot balloon  $\frac{1}{10}$  full at sea level are:

Altitude (MSL)	0	40,000 ft.	100,000 ft.
20-ft. diam.	340 gm/hr.	83.2 gm/hr.	15 gm/hr.
70-ft. diam.	7820 gm/hr.	1912 gm/hr.	345 gm/hr.

Another consideration is that relationship expressed by the kinetic theory of gases regarding gases at low pressures. The kinetic theory states that there is a molecular type of flow across a thin diaphragm through openings whose dimensions are of the order of the length of the mean free path of the molecules involved. Mass flow of the gas is then:

$$L = \Delta p \cdot A \sqrt{\frac{d_g}{2\pi}}$$

where:

$\Delta p$  = is the pressure difference across the film

$A$  = area of the opening

$d_g$  = density of the gas in question

This relationship, however, becomes valid only at extremely low pressures, and when considering balloon systems at normal floating levels the more common fluid-flow relationship will control the rate of loss of lift through openings in the film. It would be of little use then to investigate further the leakage of gas through openings by means of the relationships involved in the kinetic theory.

CHARLES W. H. 01520

(2) Solution, Migration and Evaporation through Film

A very slight amount of lift is lost through solution of the gas into the balloon film, migration through the film and evaporation into the atmosphere. The rate of this type of diffusion is a function of the characteristics of the lifting gas and the partial pressure involved. Since the lifting gas is assumed to be very nearly pure, the partial pressure is merely the pressure of the atmosphere in which the balloon is floating. This method of diffusion need not be considered when examining the loss of a balloon's lifting gas since it is of a low enough value to be insignificant as compared with the loss of gas by leakage through openings in the film.

Tests have indicated that this type of diffusion through .001" polyethylene has a value of approximately 4 liters/meter<sup>2</sup>/day. At sea level this is equivalent to 5.32 gm/hr. for a 20-foot diameter balloon. At 40,000 feet MSL the value would be approximately 1 gm/hr.

(3) Diffusion through Appendix

We have seen that there is no pressure difference across the open appendix of the balloon during floating. Therefore, the loss of lifting gas through this appendix (except when the balloon is rising and gas is being valved out of the appendix) can be only by true intermolecular diffusion of the gas into the atmosphere and air into the lifting gas. The expression for loss of lifting gas by diffusion is similar in form to the expression for transfer of heat through a given distance by conduction:

$$(13) \quad \frac{dN}{dt} = -D \frac{dN}{dz} dy dx$$

where:

$$\frac{dN}{dt} = \text{time rate of transfer of molecules of gas across the area } dy dx \text{ in direction } z$$

$$D = \text{a coefficient of diffusion, dependent upon viscosity and density of the gas involved } (D = c \frac{\eta}{\rho})$$

$$\frac{dN}{dz} = \text{variation of molecular concentration with variation in direction } z$$

$$dy dx = \text{the differential term for area.}$$

Then, since a molecule of lifting gas has a given weight, we may state that:

$$(14) \quad \frac{dw}{dt} = K \frac{dN}{dt}$$

where K is a constant.

We may state the relationship (13) in terms of rate of transfer and area of the opening, assuming  $\frac{dN}{dz}$  to be constant across the opening:

$$(15) \quad \frac{dw}{dt} = -K_1 D \frac{dc}{dz} A$$

where:

$\frac{dw}{dt}$  = mass transfer of lifting gas

$\frac{dc}{dz}$  = variation of concentration of lifting gas  
in direction z

A = area of opening

In order, then, to determine the rate of loss of lifting gas by diffusion through the open appendix we must:

- (a) determine the relationship between the coefficient of diffusion, D, and altitude (or pressure and temperature)
- (b) determine the loss of lift by diffusion through the appendix at any convenient altitude (i.e. at the ground)
- (c) derive a relationship between loss at the ground and loss at any altitude.

However, determination of valid relationships to find diffusion through the appendix opening would require large scale laboratory testing and then tedious derivation of mathematical equations, a study in research in itself. It was deemed more practical to reduce or eliminate this type of loss of lift by reduction of the area of the opening by use of a relief valve system as explained in Part II of this report, "Operations," pp. 8-14.

#### F. Bursting Pressure and Appendix Considerations

Bursting pressure of a balloon can be computed from the equation:

$$(1) \quad \Delta p = \frac{4S\sigma t}{D} \quad \text{for failure of the fabric or film,}$$

where:

CHARLES W. H. DAVIS

$\Delta p$  = bursting pressure (psi)

$S_f$  = maximum allowable tensile stress of fabric or film (psi) (for safety  $S_f = 1/2 S_{max}$  where  $S_{max}$  = maximum stress in tension)

$t$  = thickness of fabric or film (in.)

$D$  = balloon diameter (in.)

or:

$$(2) \quad \Delta p = \frac{4 S_s}{D} \quad \text{for failure of seams}$$

where:

$S_s$  = maximum allowable tensile strength of seams (lb./in.)

$D$  = balloon diameter (in.)

In general, a balloon should be manufactured so that any failure should occur first in the fabric or film and thus the tensile stress of this fabric or film will be the factor in determining bursting pressure.

Since the non-extensible balloons used in constant-level work by the N.Y.U. group have been of the open-appendix type, bursting due to excessive super-pressure has not been a problem. Strength of the balloon must be considered, however, from the standpoints of back pressure induced during rise of a full balloon and pressure distribution of the lifting gas itself inside of the balloon.

#### (1) Pressure Distribution of Lifting Gas

It was shown in the previous section that the pressure difference across any portion of the balloon surface may be equated:

$$(3) \quad \Delta p_z = \Delta z \frac{dp}{dz} (1-B)$$

A plot of  $\Delta p$  against  $\Delta z$  would then be a straight line at any given altitude. Maximum allowable balloon pressure-- equation (1)--may be plotted as a function of  $\Delta z$ , rather than diameter for any given horizontal plane of the balloon surface,  $z$ . Using this relationship, cutting any horizontal plane  $z-z$  across the balloon (Figure 25), the diameter of the

balloon at any point  $z$  may be expressed as:

$$d_z = 2 \left[ \left( \frac{D}{2} \right)^2 - \left( \Delta z - \frac{D}{2} \right)^2 \right]^{1/2}$$

$$(4) \quad = 2 \left[ D \Delta z - \Delta z^2 \right]^{1/2}$$

Therefore, maximum allowable balloon pressure at any plane  $z-z$  will be:

$$(5) \quad \Delta p_z = \frac{4 S_f t}{2(D \Delta z - \Delta z^2)^{1/2}} \text{ psi}$$

Equation (5) may be plotted in terms of bursting pressure and  $\Delta z$  for any given diameter balloon. A straight line through the origin and tangent to the plot of Equation (5) will indicate the maximum allowable  $(dp/dz)_{\text{air}} (1-B)$  for any given diameter balloon. Comparing the maximum allowable  $(dp/dz)_{\text{air}}$  with a chart of altitude vs. pressure in the atmosphere will indicate the minimum altitude at which the balloon can be allowed to be full. From an altitude-buoyancy table for any given diameter balloon, the maximum allowable buoyancy, or maximum allowable gas inflation can be obtained.

Figure 26 is a plot of equations (3) and (5) for .001" polyethylene ( $S_f = \frac{900}{2}$  psi) balloons of 20', 30' and 70' diameters.

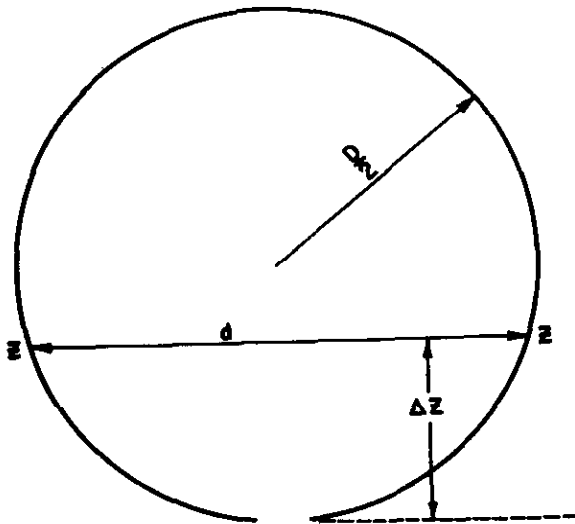

Fig. 25.  
Relationship  $d/\Delta z$ , for balloon.

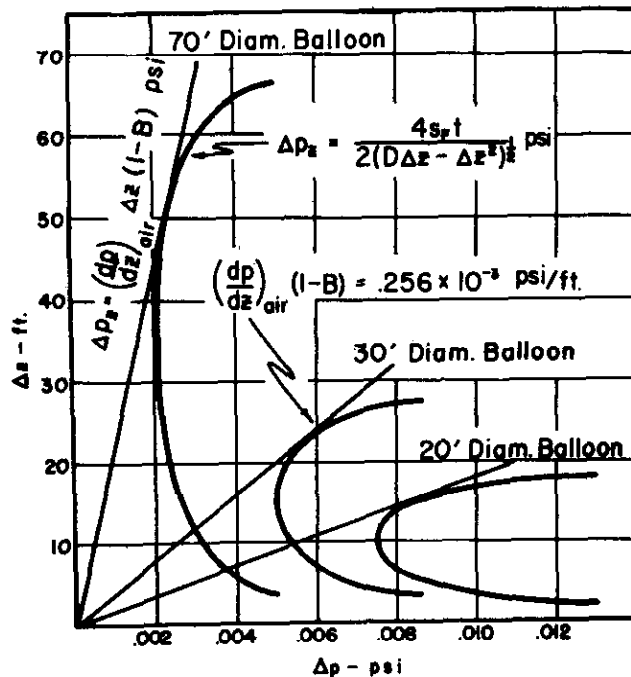

Fig. 26.  
Graph of equations (3) and (5).

We see that the maximum allowable  $(dp/dz)_0(1-B)$  for a 30' diameter, .001" thick polyethylene balloon is  $256 \times 10^{-3}$  psi/ft. Dividing by  $(1-B)$  we have the maximum allowable:

$$\begin{aligned} (dp/dz)_0 &= \frac{256 \times 10^{-3}}{1-.138} = .300 \times 10 \text{ psi/ft}^{-3} \\ &= 20.7 \times 10^{-3} \text{ mb/ft} \end{aligned}$$

This is comparable to an altitude of 18,300 ft. or a gross buoyancy of 450 lb., the maximum allowable inflation of a 30' diameter, .001" thick polyethylene balloon from the stand-point of pressure distribution.

In order to determine mathematically the point of failure due to pressure distribution we may use equations (3) and (5) and their derivatives:

$$\begin{aligned} \Delta p_z &= \Delta z \left( \frac{dp}{dz} \right)_{air} (1-B) \\ \Delta p_z &= \frac{4Sft}{2(D\Delta z - \Delta z^2)^{1/2}} \end{aligned}$$

at the point of tangency of these curves (T in Figure 26):

$$\Delta p_{T3} = \Delta p_{T5} \quad \text{and} \quad \left( \frac{dp}{dz} \right)_{T3} = \left( \frac{dp}{dz} \right)_{T5}$$

in equation (5), making  $\frac{4Sft}{2} = K$  and in equation (3), making  $(dp/dz)_0(1-B) = m$ , the slope of the line  $\Delta p_z = \Delta z \cdot m$  we have:

$$(5a) \quad \Delta p_z = \frac{K}{(D\Delta z - \Delta z^2)^{1/2}}$$

and:

$$(3a) \quad \Delta p_z = m \Delta z$$

differentiating with respect to  $z$  :

$$(5b) \quad \frac{dp}{dz} = - \frac{K(D-2\Delta z)}{2(D\Delta z - \Delta z^2)^{3/2}}$$

$$(3b) \quad \frac{dp}{dz} = m$$

Since at T,  $\left(\frac{dp}{dz}\right)_3 = \left(\frac{dp}{dz}\right)_5$  :

$$m = -\frac{K}{2} \frac{(D - 2\Delta Z)}{(D\Delta Z - \Delta Z^2)^{3/2}}$$

and, since at T,  $\Delta p_{z3} = \Delta p_{z5}$  :

$$m \Delta Z_T = -\frac{K \Delta Z_T}{2} \frac{(D - 2\Delta Z_T)}{(D\Delta Z_T - \Delta Z_T^2)^{3/2}} = \frac{K}{(D\Delta Z_T - \Delta Z_T^2)^{1/2}}$$

and:  $\Delta Z_T (2\Delta Z_T - D) = 2(D\Delta Z_T - \Delta Z_T^2)$

$$\Delta Z = \frac{3}{4} D$$

Then:

$$\Delta p_T = \frac{K}{\left(\frac{3}{4}D^2 - \frac{9}{16}D^2\right)^{1/2}} = \frac{K}{\sqrt{\frac{3}{4}}D}$$

$$m = \left(\frac{dp}{dz}\right)_{air} (1-B) = \frac{K(2 \cdot \frac{3}{4}D - D)}{2\left(\frac{3}{4}D^2 - \frac{9}{16}D^2\right)^{3/2}} = \frac{16K}{3\sqrt{3}D^2}$$

Allowable:

$$\left(\frac{dp}{dz}\right)_{air} = \frac{16K}{3\sqrt{3}D^2} \cdot \frac{1}{1-B}$$

For the example above,

Then:  $D = 30'$ ,  $S_f = \frac{900}{2}$ ,  $t = .001$  in.,  $B = \frac{53.3}{386} = 0.138$  (helium)

$$\left(\frac{dp}{dz}\right)_{air} = \frac{16}{3\sqrt{3}} \cdot \frac{4}{2} \cdot \frac{900}{2} \cdot \frac{.001}{(30)^2 \cdot 12} \cdot \frac{1}{(1-0.138)} \text{ psi/ft}$$

$$\begin{aligned} \text{Allowable } \left(\frac{dp}{dz}\right)_{air} &= 0.298 \cdot 10^{-3} \text{ psi / ft} \\ &= 20.55 \text{ mb/ft} \end{aligned}$$

This is comparable to an altitude of approximately 18,200 ft. Thus the maximum allowable buoyancy for a 30' diameter, .001" thick polyethylene balloon filled with helium is 440 lb.

## (2) Appendix-Opening Considerations

As an open-appendix, constant-volume balloon ascends the lifting gas will expand due to the decrease in the pressure

of the surrounding atmosphere. Upon reaching the altitude at which it is full it will still have an unbalance in the direction of increase of altitude due to the excess buoyancy causing ascent. This unbalance is gradually decreased as the balloon rises (with a fixed volume) into less dense air. Meanwhile excess gas pressure is relieved by valving gas through the appendix until the balloon system is in a condition of equilibrium. The portion of the ascent after the balloon has become full is known as the "leveling-off" period.

The lifting gas which is valved out through the appendix will cause a "back pressure" inside of the balloon which must be transferred to the balloon fabric or film. In other words, there must be a pressure difference across the appendix opening during this period to force the excess lifting gas out of the balloon. Let us analyze this back pressure by the method used by Picard. Using the rules of subsonic aerodynamics, Picard suggests that air at sea level escaping at 1333 ft./sec. produces a back pressure of 1 atmosphere and that back pressure induced is proportional to the square of escape velocity of the gas and inversely proportional to the density of the gas escaping. Volume of gas lost in ascent through 1 foot is, within a reasonable degree of accuracy:

$$(6) \quad \frac{\Delta V}{\Delta Z} = \frac{V}{P} \frac{dp}{dz} \cdot \frac{T + \Delta T}{T}$$

$\frac{\Delta V}{\Delta Z}$  = volume lost per foot of ascent (ft.<sup>3</sup>/ft.)  
 $V$  = balloon volume (ft.<sup>3</sup>)  
 $P$  = pressure of free air (psi)  
 $\frac{dp}{dz}$  = pressure change with increase of  $Z$  (psi/ft)  
 $T$  = temperature of air (°C abs.)  
 $\Delta T$  = change in air temperature during rise (°C)

For ascent in the troposphere this relationship will reduce to:

$$(7) \quad \frac{\Delta V}{\Delta Z} = \frac{V}{27,800} \cdot \frac{V^2}{FT}$$

The velocity of escape of gas, then:

$$(8) \quad V = \frac{dz}{dt} \cdot \frac{V}{27,800} \cdot \frac{1}{A_0}$$

$V$  = velocity of escape of lifting gas (ft./sec.)



$$\frac{dz}{dt} = \text{ascent velocity of balloon (ft./sec.)}$$

$$\frac{V}{27800} = \text{volume of gas lost per foot of ascent (ft.}^3\text{/ft.)}$$

$$A_a = \text{area of appendix opening (ft.}^2\text{)}$$

The back pressure caused by this velocity:

$$(9) \quad \Delta p = \left( \frac{V}{1333} \right)^2 \cdot 14.7 \frac{d_g}{d_{a0}}$$

$\Delta p =$  back pressure induced (psi)  
 $V =$  velocity of escape of gas (ft./sec.)  
 $d_g =$  density of lifting gas at altitude of balloon (lb./ft.<sup>3</sup>)  
 $d_{a0} =$  density of air at sea level (lb./ft.<sup>3</sup>)  
 $14.7 =$  pressure of air at sea level (psi)  
 $1333 =$  escape velocity of air to produce back pressure of 1 atmosphere at sea level (ft/sec)

or, combining equation (8) and (9):

$$(10) \quad \Delta p = \frac{\left( \frac{dz}{dt} \cdot \frac{V}{27800} \cdot \frac{1}{A_a} \right)^2}{(1333)^2} \cdot 14.7 \frac{d_g}{d_{a0}} \quad \text{psi}$$

As an example, let us find the back pressure induced in a 20' diameter balloon with a 1' diameter opening ascending at 800 ft./minute, as it becomes full at 30,000 ft. (density of helium @ 30,000 ft. =  $\frac{300 \cdot 290}{1015 \cdot 232} \cdot 0.138 d_{a0}$ )

$$\Delta p_{10} = \frac{\left( \frac{800}{60} \cdot \frac{\pi \cdot 20^3}{6 \cdot 27800} \cdot \frac{1}{\pi} \right)^2}{1333^2} \cdot 14.7 \cdot 0.051 = .275 \times 10^{-4} \text{ psi}$$

It is to be noted that equation (5) can be arrived at by more simple reconstruction of the standard equation for fluid flow:

$$(11) \quad \frac{dV}{dt} = C_d A_a \sqrt{2gh}$$

$\frac{dV}{dt} =$  volume rate of flow (ft.<sup>3</sup>/sec.)  
 $C_d =$  a constant of flow

$g$  = the acceleration of gravity (ft./sec.<sup>2</sup>)

$A_d$  = area of the opening (ft.<sup>2</sup>)

$h$  = head of fluid causing flow (ft.)

since  $h = \frac{144 \Delta p}{d_g}$ , we have:

$$(12) \quad \Delta p = \frac{d_g}{288g} \left( \frac{l}{C_d A_d} \cdot \frac{dV}{dt} \right)^2 \text{ psi}$$

where  $d_g$  is density of the lifting gas (lb./ft.<sup>3</sup>).

From equation (7) we have:

$$\frac{dV}{dt} = \frac{dz}{dt} \frac{V}{27800} \text{ ft}^3/\text{sec}$$

therefore:

$$(13) \quad \Delta p = \frac{d_g}{288g} \left( \frac{l}{C_d A_d} \cdot \frac{dz}{dt} \cdot \frac{V}{27800} \right)^2 \text{ psi}$$

Comparing equations (10) and (13) we see that if the equations are equal:

$$\frac{l}{288g C_d^2} = \frac{14.7}{1333^2 d_{g0}}$$

If we let  $C_d = .975$ , a reasonable value for the relatively low velocity flow of gas through the appendix, we have:

$$\frac{l}{288g C_d^2} = 113.5 \times 10^{-6} \text{ ft-sec}^2/\text{in}^2$$

$$\frac{14.7}{1333^2 d_{g0}} = 114.8 \times 10^{-6} \text{ ft-sec}^2/\text{in}^2$$

Therefore, the equations (10) and (13) are equal and interchangeable.

It may be noted from equations (10) and (13) that for any given balloon, appendix area and balloon volume are fixed, and the related variables are lifting gas density, rate of rise, and allowable back pressure. For any given allowable back pressure greater rates of rise are allowable at higher altitudes (where  $d_g$  is lower).

Once a floating altitude has been decided upon or it has been decided to carry a given load as part of the balloon system, we can find a maximum allowable rate of rise. We must consider

the pressure distribution of the lifting gas and the internal back pressure due to valving gas. To find maximum rates of ascent for various balloons would necessitate a complicated series of trial and error solution. In general, it has been more practical to determine a maximum rate of rise for normal operating conditions for any given size balloon by finding the maximum allowable rate for the balloon rising to its lowest normal operating level (i.e., we will find the maximum allowable rate for the worst normal operating conditions and consider it a maximum for all normal operating conditions.)

Let us take the case of a 20-foot diameter polyethylene balloon of .001" thickness. Lowest normal floating altitude is 20,000 ft. MSL. Let us assume that the balloon will be full and begin valving gas at 15,000 ft. MSL. Assume the appendix diameter to be  $\frac{1}{2}$  foot. Using equation (1) to find maximum allowable internal pressure and assuming the critical x-y plane to be that of maximum diameter  $\Delta Z = D/2$ , we have:

$$\Delta P_{all} = \frac{4 S_f t}{D} = \frac{4(900/2) \cdot .001}{12 \cdot 20} = .0075 \text{ psi}$$

(Here we have introduced a factor of safety by saying  $S_f = 900/2$  instead of 900 psi, the ultimate strength in tension of polyethylene.) Pressure distribution:

$$\Delta P_{D/2} = \Delta Z \frac{dp}{dz} (1-B) = \frac{20}{2} \cdot 3.38 \cdot 10^{-4} \cdot .862 = .00291 \text{ psi}$$

Allowable back pressure:

$$\Delta P_{bp} = \Delta P_{all} - \Delta P_{D/2} = .0046 \text{ psi}$$

Maximum rate of rise using equation (13);

$$\frac{dz}{dt} = \sqrt{\frac{288 \Delta P_{bp} g}{d_g}} \left( \frac{27800}{V} C_d A_a \right) \text{ ft/sec}$$

$$= 100.7 \text{ ft/sec}$$

$$= 6000 \text{ ft/min}$$

It is evident from this calculation that the rate of rise of the 20-ft. diameter polyethylene balloon is not a critical factor in bursting unless the open appendix becomes snarled and gas is not allowed to escape.

Rate of rise and appendix openings are important from the standpoint of balloon design. For operational reasons it is important to have a rapid rate of rise. In order to make most efficient use of weight, the balloon film should be thin. As mentioned

in the preceding section on diffusion and leakage the appendix opening should be small. It can be seen that as we make one of our conditions better, we must sacrifice at least one of the others. Therefore, balloons must be designed compromising rate of rise, balloon thickness, and appendix opening. Methods of decreasing the appendix opening, except during the valving of lifting gas, are discussed in other sections of this technical report. In general they consist of means of applying a delicate relief valve, capable of opening to a large area with application of only slight internal pressure, and also closing tight upon release of this internal pressure.

#### G. A General Equation of Motion

If we collect and relate the variables incidental to balloon flight, we may form a general equation of motion. This is most easily expressed in terms of forces acting upon the balloon system. We may equate an acceleration term plus a drag or friction term against  $F$  term to include all other forces:

$$(1) \quad m D^2 z + n (Dz)^2 = \Sigma F$$

This is a differential equation of a type common in mechanical vibration problems, and solution for the variable  $z$  would not be difficult if relationships of the many variables included in the terms  $n$  and  $\Sigma F$  were simple. However, the complexity of the balloon system introduces many terms as parts of  $n$  and  $\Sigma F$ .

We shall first state the more complex form of equation (1) above and then attempt to explain the variables included in each part of the equation. As will be shown, it is extremely difficult to find a complete solution of the equation since many of the variables are in themselves extremely complex and at this time incapable of accurate solution. Therefore, our discussion will be more of a qualitative rather than a quantitative nature.

The general force equation is:

$$(2) \quad \frac{W}{g} D^2 z + C \frac{\rho}{2} A (Dz)^2 = V_b (\rho_a - \rho_g) - W \pm F_{otm}$$

The force due to acceleration  $F_A = \frac{W}{g} D^2 z$   
where:

- $W$  = weight of the balloon system
- $g$  = acceleration of gravity
- $D^2 z$  = acceleration of the balloon system (An acceleration in the direction of greater altitude is considered positive.)

The force due to friction or drag  $F_D = C_D \frac{\rho}{2} A Dz$  (This assumes that there is no vertical motion of the air in which the balloon system is floating. We shall later consider the case where an atmospheric force is causing vertical motion of the air.)

Where:

$\rho$  = mass density of the air surrounding the balloon system

$A$  = projected area of the balloon on a plane perpendicular to the relative velocity

$Dz$  = vertical velocity of the balloon system (Velocity in the direction of greater altitude is considered positive.)

$C_D$  = a coefficient of drag, dependent on Reynolds number  $N_R = \frac{Dz d \rho}{\mu}$  where:

$d$  = diameter of sphere (ft.)

$\rho$  = mass density of surrounding fluid  $(\frac{\text{lb. sec.}^2}{\text{ft.}^4})$

$\mu$  = viscosity of surrounding fluid  $(\frac{\text{lb. sec.}}{\text{ft.}^2})$

A plot of drag coefficient against Reynolds number for a sphere is shown in Figure 27.

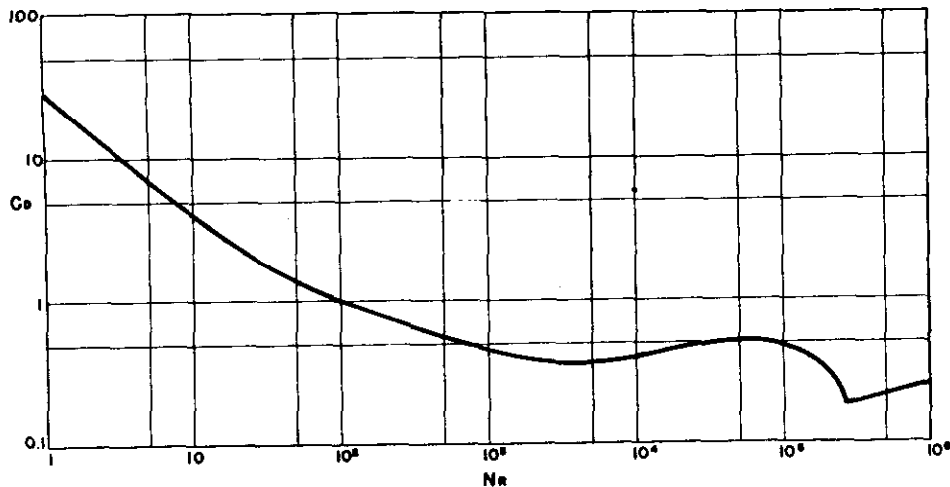

Figure 27. Drag coefficient vs. Reynolds Number, for sphere.

If a balloon is teardrop in shape rather than spherical, the curve would be modified so that the value of  $C_D$ , for a given Reynolds number would be lower. In this case the sudden drop in  $C_D$  as Reynolds number increases (the change from viscous to turbulent flow) would occur at a lower Reynolds number.

We have thus far in our discussion assumed that there is no vertical motion of the air surrounding the balloon system relative to the coordinate  $z$ . However, this is not necessarily the case under actual conditions. In many instances vertical air movement is found in the atmosphere. Therefore, we must introduce a term to allow for this vertical air movement. In equation (2) this term was indicated as  $\pm F_A$ , the external atmospheric force.

We may consider this vertical air movement in terms of a velocity  $D\zeta$ . Then the vertical velocity of the balloon system relative to the air surrounding the system will be the difference between the velocity of the balloon relative to the absolute altitude  $Dz$  and the velocity of the surrounding air relative to the absolute altitude  $D\zeta$ . This may be equated as  $Dz - D\zeta$ , where  $Dz$  and  $D\zeta$  are both considered positive in the direction of increase of altitude.

The total force due to the drag, or friction will be:

$$F_D + F_{ATM} = C_D \frac{\rho}{2} A (Dz - D\zeta)^2$$

where the notations are those used previously, except that now  $N_R = \frac{(Dz - D\zeta) d\rho}{\mu}$ . The relationship between  $N_R$  and  $C_D$  will be those used previously.

The force due to buoyancy of the lifting gas  $F_b = V_b (\rho_a - \rho_g)$  where:

$$V_b = \text{balloon volume (ft.}^3\text{)}$$

$$\rho_a, \rho_g \quad \text{density of the air and lifting gas, respectively (lb./ft.}^3\text{)}$$

This term may also be stated as:  $F = V_b \left( \frac{\rho_a}{R_a T_a} - \frac{\rho_g}{R_g T_g} \right)$  where:

$$P_a, P_g = \text{pressure of air and lifting gas}$$

$$R_a, R_g = \text{specific gas constant of air and lifting gas}$$

$$T_a, T_g = \text{temperature of air and lifting gas}$$

The changes that will take place in this expression are those due to a temperature difference between the lifting gas and the free air, change in volume of the balloon due to loss of lifting gas, change of the gas constant of the lifting gas due to dilution with air, and (in the case of a balloon that will hold an internal pressure) pressure difference between lifting gas and surrounding air.

Temperature effects were discussed previously in this report. Those discussions on superheat and adiabatic temperature change will apply to the general equation. In general, temperature of the free air and lifting gas can be measured to a fair degree of accuracy.

Balloon volume at any time is a function of original full balloon volume plus the summation of all the changes in volume due to pressure and temperature changes and loss of lifting gas. It will also be affected by loss or gain of air by the balloon through diffusion and intake of air through the appendix. The non-extensible balloon will have a maximum volume and thus any changes tending to increase the gas volume to a value greater than the balloon volume will result in a valving of the excess lifting gas into the air, or (in the case of a balloon which will carry internal pressure) a pressure increase of the lifting gas.

It is for this reason that a non-extensible balloon is said to be in a state of stable equilibrium in a direction of greater altitude when it is full. However, in a direction of lesser altitude, and with the case of a partially full floating balloon, the system is in a state of neutral equilibrium.

Composition of the lifting gas will change due to contamination of the lifting gas by the entry of air into the balloon, either by the flow of air through the appendix opening or by diffusion of air into the balloon. We may then modify our term for density of the lifting gas to include a term for the pure gas and a term for the contaminating air. Using the method of partial volumes, we may equate the density of the lifting gas at any time by:

where: 
$$\rho_g = \frac{P_g}{V_b T_g} \left( \frac{V_p}{R_p} + \frac{V_a}{R_a} \right)$$

$P_g$  = pressure of the lifting gas

$V_b$  = total lifting gas volume

$V_p$  = volume of pure lifting gas in balloon

$V_a$  = volume of air in balloon

$R_g$  = specific gas constant of pure lifting gas

$R_a$  = specific gas constant of air

Then, calling  $\frac{V_p}{V_b} = x_p$  and  $\frac{V_a}{V_b} = x_a$  (here we see that since

$V_p + V_a = V_b$ ,  $x_p + x_a = 1$ ) we may equate:

$$\rho_g = \frac{P_g}{T_g} \left( \frac{x_p}{R_p} + \frac{x_a}{R_a} \right)$$

The equation for the force due to buoyancy will then become:

$$F_b = V_b \left[ \frac{p_a}{R_a T_a} - \frac{p_g}{T_g} \left( \frac{x_p}{R_p} + \frac{x_a}{R_a} \right) \right]$$

If the balloon is of the type that will carry no internal pressure  $p_a = p_g$ , and we may state that:

$$F_b = V_b p_0 \left[ \frac{1}{R_a T_a} - \frac{1}{T_g} \left( \frac{x_p}{R_p} + \frac{x_a}{R_a} \right) \right]$$

Discussions of the contamination of the lifting gas are included under the section on "Diffusion and Leakage of Lifting Gas" of this report.

The force due to the weight of the system  $F_w = W$  The weight of the balloon system at any time is a function of the original weight of the system plus the change of weight of the system. This change in the weight of the system is caused by the loss of ballast and the weight of the system at any time ( $t$ ):

$$W_t = W_0 - \sum_{t=0}^t \Delta W_b$$

where:

$$W_0 = \text{the original weight of the system}$$

$$\sum_{t=0}^t \Delta W_b = \text{the sum of all the losses of ballast from time at which } W = W_0 \text{ until the time } t$$

The value of the term  $\sum_{t=0}^t \Delta W_b$  depends on the type of ballast control. With no ballast:

$$\sum_{t=0}^t \Delta W_b = 0 \quad \text{and} \quad W_t = W_0$$

If a constant ballast flow is used:

$$\sum_{t=0}^t \Delta W_b = \frac{dW}{dt} t$$

where:

$$\frac{dW}{dt} = \text{rate of ballast flow}$$

$$t = \text{elapsed time from } t=0 \text{ to } t=t$$

If a practical fixed opening type of ballast control is used:

$$\text{where:} \quad \sum_{t=0}^t \Delta W_b = f(t, h, \mu_b, \rho_b, A)$$

$$t = \text{time}$$

$$h = \text{head of ballast above opening}$$

$$\mu_b = \text{viscosity of ballast fluid}$$

$$\rho_b = \text{density of ballast fluid}$$

$$A = \text{area of opening}$$



The ballast flow at any time, t:

$$\frac{dW}{dt} = C_F \rho_b A \sqrt{2gh}$$

so that:

$$\sum_{t=0}^t \Delta W_b = \int_0^t C_F \rho_b A \sqrt{2gh} dt$$

where:

$C_F$  is a coefficient of discharge, dependent upon Reynolds number of the flow through the opening

In this equation only  $\sqrt{2g}$  and  $A$  are constants (if temperature effect on the opening  $A$  is neglected),  $\rho_b$  is dependent upon temperature of the fluid and  $h$  is dependent upon the shape of the vessel containing the fluid and time  $t$ .

If ballast flow is controlled by atmospheric pressure:

$$\sum_{t=0}^t \Delta W_b = \sum_{t=0}^t \frac{dW}{dt} t_{p > p_c} \quad , \text{ with a fixed valve opening (open-or-closed valve)}$$

where  $t_{p > p_c}$  represents the time when atmospheric pressure is greater than the pressure of control. Here, again,  $\frac{dW}{dt} = C_F \rho_b A \sqrt{2gh}$

With ballast flow proportional to  $p - p_c$  :

$$\sum_{t=0}^t \Delta W_b = \sum_{t=0}^t \frac{d\left(\frac{dW}{dt}\right)}{d\Delta p} (p - p_c) t_{p > p_c}$$

where:

$$\frac{d\left(\frac{dW}{dt}\right)}{d\Delta p} \quad \text{relationship between rate of flow and pressure difference } (p - p_c) \text{ where } p > p_c$$

If we include a rate of pressure change control or a rate of ascent control such that there is no ballast flow if rate of pressure change is less than some value  $-\left(\frac{dp}{dt}\right)_c$  or rate of ascent is greater than some value  $\left(\frac{dz}{dt}\right)_c$ , we impose the condition for ballast flow in the above two cases that for flow to occur  $p > p_c$ , and  $\frac{dp}{dt} > \left(\frac{dp}{dt}\right)_c$  or  $\frac{dz}{dt} < \left(\frac{dz}{dt}\right)_c$

We might also have a control that will open or close a valve on rate of pressure change such that:

$$\sum_{t=0}^t \Delta W_b = \sum_{t=0}^t \frac{dW}{dt} t_{\frac{dp}{dt} > \left(\frac{dp}{dt}\right)_c}$$

where  $\frac{dp}{dt} > \left(\frac{dp}{dt}\right)_c$  is the time during which pressure change of the air surrounding the balloon is greater than a design value of pressure change causing ballast flow.

The general equation, then, indicates the relationships between the variables involved in balloon flight. The discussions in this section of the report, "Equations and Theoretical Considerations," attempt to qualitatively organize the relationships between these variables in order that a complete overall picture of the aspects of balloon flight can be formulated.

It should be stressed that the theoretical relationships as stated here do not lend themselves to simple insertion into an overall equation which is easily solved. Rather, solutions of many of the variables are in themselves complex. At this time it appears impractical to delve too deeply into such matters as "the variation of diffusion and leakage through various types of balloons under different conditions" or "a study in the change of coefficient of drag on a balloon system at all points during its flight." It has been more practical to generally state the relationships in unsolved form and concentrate the experimental portion of the research problem on such matters as actual development of balloon controls.

## V. TELEMETERING

### A. Information Transmitted

The need for a balloon-borne transmitter and some system of ground receiving and recording was recognized early in the work of the project. The primary objective of such telemetering was to collect data to evaluate the altitude controls applied to the balloon system. Pressure, perhaps the most important data, was measured by the use of radiosonde-type aneroid capsules. A discussion of the pressure modulators used is given in the following section.

A second use of air-borne transmitters was to provide a beacon for radio direction-finding. With proper equipment a balloon-borne transmitter can provide a signal to guide an aircraft, homing with a radio compass, or provide a position "fix" by the crossed azimuths of ground receiving stations.

In addition to these two very important functions of altitude determination and positioning, telemetering systems were used to detect and transmit temperature data and ballast flow data. The equipment used for these purposes is described below.

## B. Transmitters Used

### (1) 72-Megacycle Radiosonde Transmitter (T-49)

The standard T-49 transmitter of the Army Weather Service was first used in project work, with a modified commutator bar switching specially coded resistors into the circuit as the balloon passed from one critical pressure to another. The operating characteristics of this transmitter may be found in the following publications: T.B. Sig. 165, T.M. 11-2403, T.M. 11-2404 and the Weather Equipment Technician's Manual.

The defects which were encountered in the use of this transmitter were principally (1) relatively short range and (2) unfitness for direction-finding using available equipment. Our experience has been that reception from the T-49 transmitter by standard equipment is not much above 80 miles under good conditions. When flights were made which traveled many times this distances, the inadequacy of this transmitter was clearly demonstrated.

The problem of direction-finding is of major importance when attempts are made to position and track the balloon and its equipment train. Since no standard directional receiver equipment is available for this use with the T-49, this transmitter is of limited value.

### (2) 400-Megacycle FM Transmitter (T-69)

The T-49 transmitter was abandoned in favor of the T-69 400-mc system as soon as ground receiving equipment for the latter was available. By using the directional receiving set SCR-658 with the T-69 transmitter, the problem of direction-finding and positioning was attacked. A second advantage enjoyed by this system is the improved range attainable.

Our experience has been that an SCR-658 set in good condition can receive a signal up to a range of 150 miles, providing that the line-of-sight transmitter is high enough to preclude blocking by intervening terrain. The use of two or more sets to increase the area of a tracking net is discussed under "Radio Direction-Finding" below.

The operating characteristics of the T-69 system and the SCR-658 may be found in these publications: T.B. Sig. 165, T.M. 11-1158A.

Pressure indicators were obtained, as with the T-49, by use of the modified commutator bar switching specially coded resistors into the circuit as the balloon passed from one fixed pressure to another. A few special tests were made of a chronometric system of pressure modulation. For a complete discussion of pressure modulation methods, see Section VI, A.

(3) Low-Frequency Transmitter (AM-1)

A low-frequency transmitter developed by the Electrical Engineering Department of New York University was adapted to replace or supplement the T-49 and T-69 transmitters. The carrier frequencies used have been in the region 1 mc to 3 mc. The schematic of this set is shown in Figure 28, as operated at 3135 kc. The output is approximately 2 watts, and a typical air-to-ground range is 300 miles, although reception of more than 450 miles has been attained by both ground and air-borne receivers.

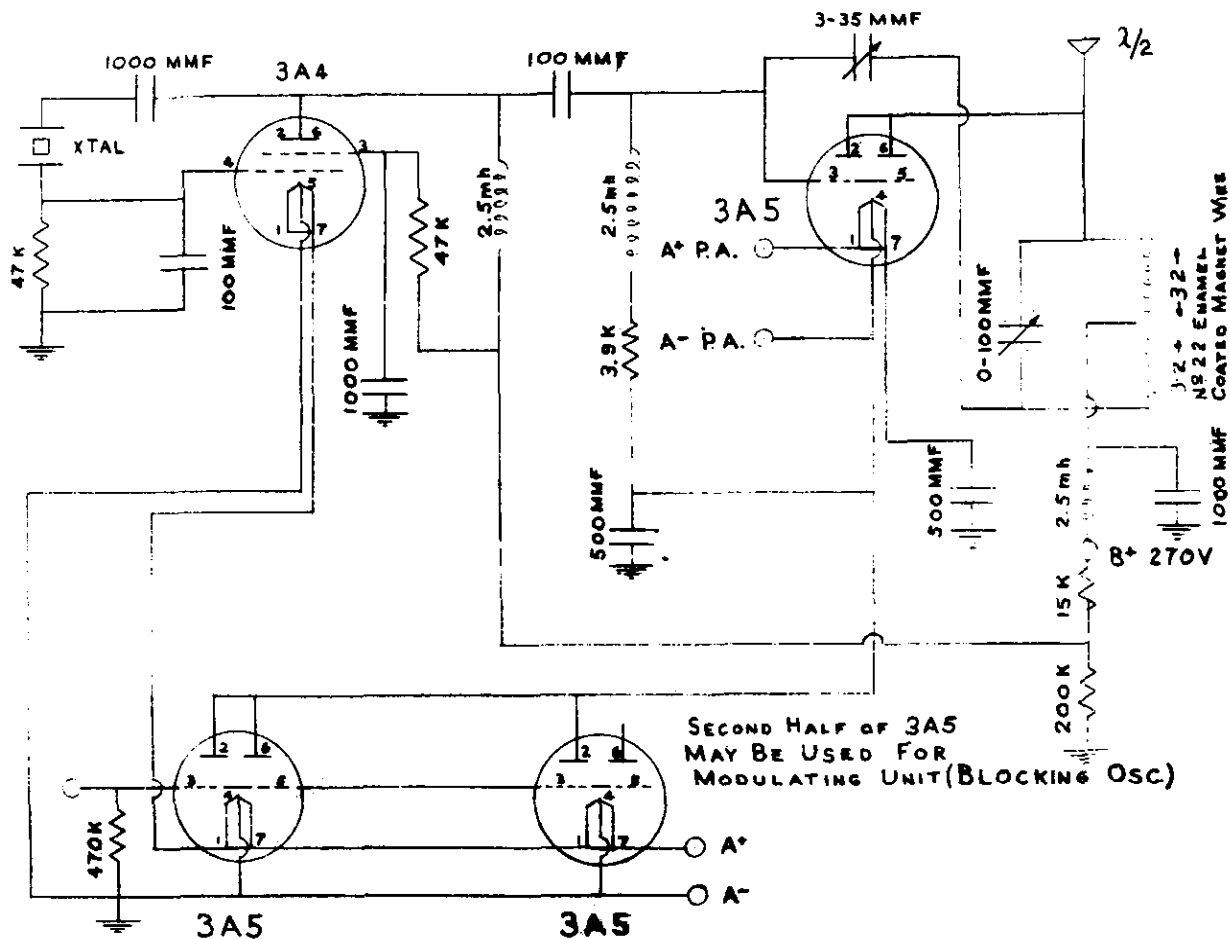

Figure 28. Schematic diagram, AM-1 transmitter.

Information is introduced in a manner similar to that employed in conventional radiosonde transmitters: resistances are switched into the blocking-oscillator grid circuit. In the case of pressure or ballast-count, fixed resistors causing distinct blocking frequencies are used; for temperature, the switch introduces the thermistor resistances.

When this transmitter operates at a lower frequency, say 1746 kc, the standard aircraft radio compass can be used to find the direction to the transmitter. No suitable standard equipment for ground direction-finding has been available to the project.

#### C. Receivers and Recorders Used

For the T-49 and T-69 radiosonde transmitters, standard ground-station equipment was used to receive and record the signal. An appropriate receiver (National 110 for the T-49 and SCR-658 for the T-69) feeds the signal through a frequency meter and into a Friez recorder, model AN/FMQ-1(). With this system, frequencies between 10 and 200 cycles per second can be recorded.

When the Olland-Cycle pressure modulator is used, (see Section VI, A,3) with low-frequency pulses indicating the completion of the pressure or reference circuit, a recorder made by the Brush Development Co. (Model BL 212) replaces the Friez recorder and frequency meter. With the AM-1 transmitter, the usual ground receiver has been the Hammarlund Super-Pro Model SP-400-X. For aircraft operation, an aircraft radio compass such as AN/ARN-7 is used.

#### D. Batteries Used

To extend the life of the batteries used with the T-49 and T-69 transmitters, experimental packs were developed using both dry and wet cells. A typical "12-hour" dry-cell pack for the T-69 was composed of:

B supply: 135V--1 ea. B90FL (especially assembled for N.Y.U. by Burgess Battery Co.) or 6 ea. Burgess XX30 in series--parallel

A supply: 6V--1 ea. Burgess 2F4 or 2 ea. F4H in parallel

C bias supply: 45V tap of B90FL or XX30 assembly

With an AM-1 transmitter, the input power required is as follows: "B" supply, 270 volts at about 300 milliamperes; main "A" supply,  $1\frac{1}{2}$  volts at 600 milliamperes; and a separate "A" supply for the power amplifier,  $1\frac{1}{2}$  volts at 200 milliamperes. The battery pack includes 8 Burgess XX45 or Eveready 467 in series--parallel; 2 Burgess 4FH batteries in parallel; and one 4FH, respectively. This pack lasts about 20 hours in flight. Also included in the battery container were batteries for auxiliary functions such as Olland-Cycle or program-switch motors, ballast-control relays, and bring-down mechanisms.

The problem of operating at cold temperature was given much consideration. Special cold temperature batteries were tried with insufficient difference in performance to justify the added expense and difficulty of procurement. In addition, it was felt that

mass-production methods and quality control associated with standard dry batteries gave greater assurance of satisfactory performance.

Subsequent measurements made of the temperature inside the transmitter battery pack showed that the temperature can be maintained above  $-10^{\circ}\text{C}$  if the transmitter and batteries are housed in a box insulated with one- to two-inch walls of Styrofoam. This insulation is effective even through long nighttime periods when no solar heating is added.

One type of battery tested in flight was a light-weight wet cell (Burgess Type AM) of the "dunk" type, (magnesium + silver chloride). These cells were vacuum-packed to provide indefinite shelf-life. Activated by immersion in water just before release, they were expected to produce a constant voltage over a period of 6 hours to overcome cold temperature effects. Those units used proved to be rather unsatisfactory and subject to erratic behavior. Furthermore the cost of the cells was very great compared with ordinary cells.

#### E. Radio Direction-Finding

For ground stations, when the balloon-borne transmitter is a T-69, the SCR-658 RDF set has been used. With such a set the radio signal can be picked up at distances up to 150 miles and good azimuth bearing may be obtained (accurate to less than one degree). Although the elevation angle may be obtained with equal accuracy when free from distortion, angles of less than 13 degrees are usually affected by ground reflection to such an extent as to render them valueless.

To extend the range over which such sets were effective, two or more usually were used, positioned along the expected track of the balloon at intervals of about 100 miles. With two sets giving crossed azimuth "fixes" the position may be determined. If the elevation angle is above 13 degrees, it is possible to fix the balloon with one SCR-658 (assuming the pressure altitude is known).

For details of the maintenance and use of the SCR-658, see War Department publication T.M. 11-1158A.

When aircraft are used to follow and position the balloon, the use of a radio-compass is found to be feasible, using the AM-1 transmitter at a frequency that is within the limits of the compass receiver. By homing on the signal and flying along the indicated bearing until the compass needle reverses, the balloon's position may be found from initial distances of up to 500 miles. No appreciable cone of silence has been observed in recent flights which used a transmitter operating at 1746 kc.

Radio compass equipment, AN/ARN-7, is described in U. S. A. A. F. publication T. O. 68-10.

## F. Radar and Optical Tracking

Because of their limited range, ground radar sets and theodolites were only of minor value in tracking balloons. Sets such as the SCR-584, the SPM-1, and MPS-6 are suggested when the balloon is expected to remain within the 60 to 80 mile range.

## VI. INSTRUMENTATION

### A. Altitude Determination

To provide accurate, sensitive and readable records of the pressure (altitude) encountered by the balloon, various systems have been tried. A modified radiosonde-type aneroid pressure capsule (Signal Corps ML 310-/) has been the basic sensing element, but three different systems of modulation of the radio signal as a function of pressure have been used.

#### (1) Standard Diamond-Hinman Radiosonde Pressure Modulator

Seen in Figure 29, the standard Diamond-Hinman radiosonde system provided first pressure sensor used. As the pen arm is pushed

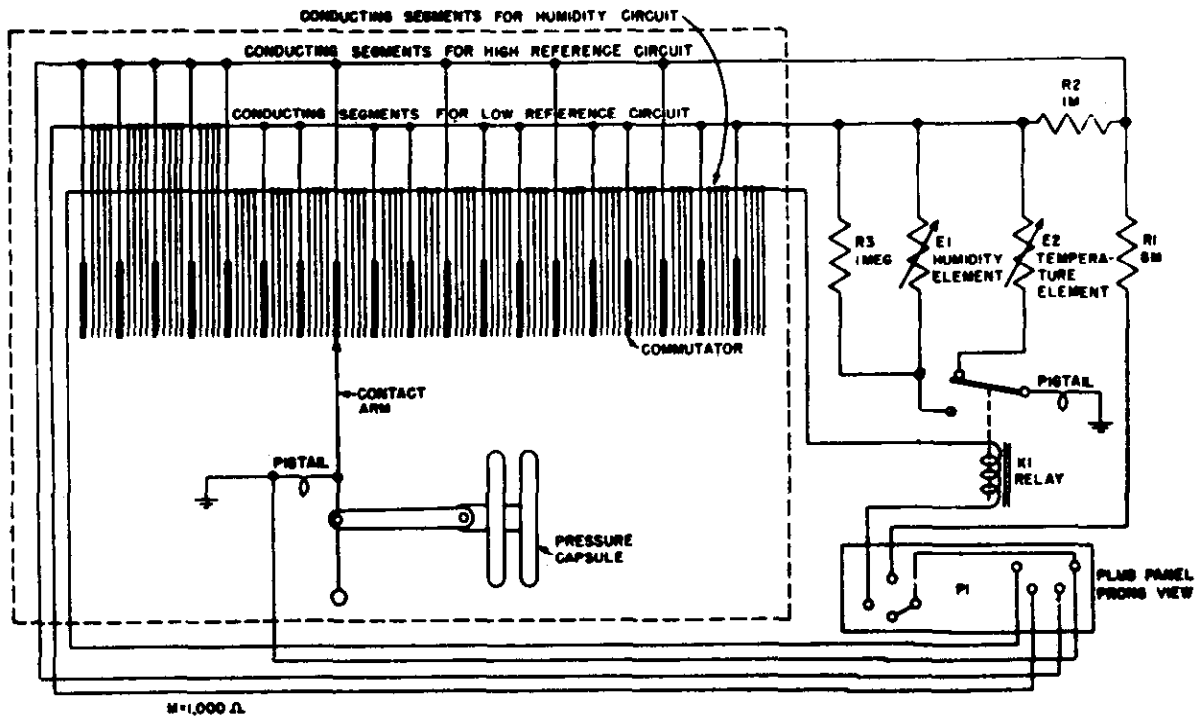

Figure 29. Schematic diagram, Diamond-Hinman radiosonde system.

across the commutator by the aneroid capsule, it falls on alternating insulators and conductors attached to three circuits.

By knowing the altitude of release and counting the number of switches from conductor to insulator, the position along the the commutator is known. This in turn is calibrated to give pressure values, from which the altitude may be computed.

This system was not suitable for floating balloons because (1) only 70 to 90 discrete contacts are provided to cover the entire atmospheric pressure range; this means that the best readability obtainable with this system is about  $\pm 10$  millibars. (2) When the balloon oscillates about a floating level, the frequent changes from one contact to another give ambiguous readings, since the number of discrete resistances used is limited.

For circuit details of this unit, see T.B. Sig. 165 and the Weather Equipment Technician's Manual.

### (2) Specially Coded Radiosonde Modulators

To remove the ambiguity of altitudes reported by the system above, extra resistances were introduced into the circuits of those contacts near the floating level; thus, each contact gives a distinctive frequency and each pressure (altitude) can be clearly distinguished.

In this system, there still remains the lack of resolution or sensitivity inherent in the modulator with 70 to 90 contacts.

### (3) Olland-Cycle Modulator

To improve the sensitivity of the pressure measurements, an Olland-Cycle (chronometric) pressure modulator was developed. Seen in Figure 30, the modulator contains a standard Signal

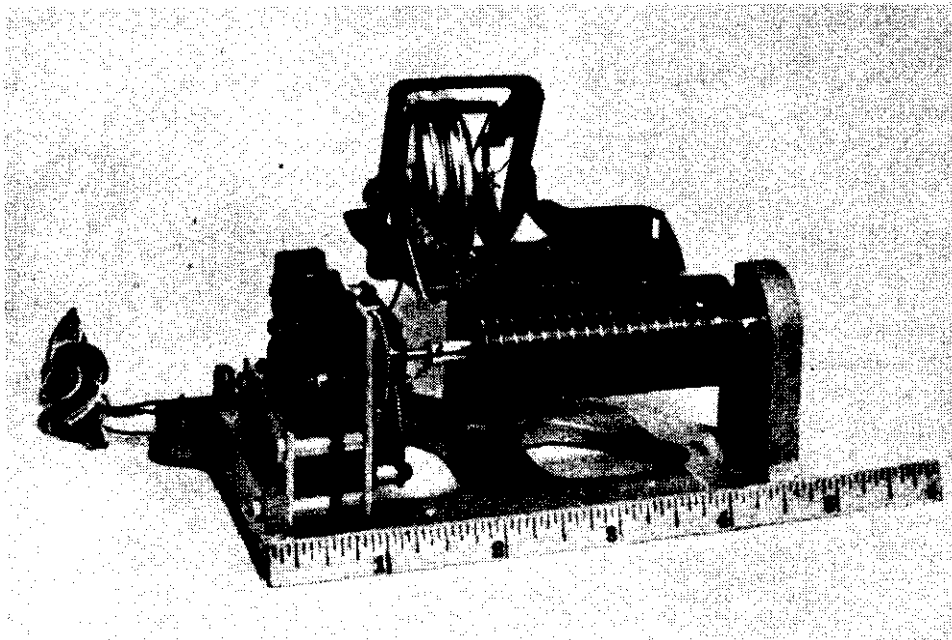

Figure 30. Olland-Cycle pressure modulator.



Corps ML-310/ radiosonde aneroid unit, a metal helix on a rotating cylinder of insulating material, and a 6-volt electric motor which rotates the cylinder.

There are two contacting pens which ride on the cylinder and complete the modulator circuit of the transmitter when they touch the helix. One pen is fixed in position and makes a contact at the same time in each revolution of the helix. This contact is used as a reference point for measuring the speed of rotation of the cylinder. The time that the second pen (which is linked directly to the aneroid cell) makes contact with the spiral, is dependent on the cylinder speed and on the pen position which is determined by the pressure. By an evaluation chart, the atmospheric pressure can be determined as a function of the relative position of the pressure contact as compared to the reference, thus eliminating all rotation effects except short-term motor speed fluctuations.

The operation of this unit is described in detail in Section II, "Operations," of this report, pages 54-63.

Some of the units flown have been made in the shops of the project, while others have been commercially supplied. The following specifications have been set up for performance of the Olland-Cycle:

Pressure range: 1050 to 5 mb.  
Temperature range: +30°C to -30°C  
Accuracy: ±0.2 mb.  
Readability: ±0.1 mb.

A number of tests have been made on the accuracy of the Olland-Cycle modulator. The tests were of two types. The first was made running the unit at room temperature while the pressure remained constant. In the second, the pressure was varied from surface pressure to about 20 millibars several times at different temperatures. In tests of the first type, the maximum variation of pressure for a given contact pen position was 1.3 millibars in a series of 182 revolutions.

The most comprehensive tests of this type were made with two Olland-Cycles in the same bell jar running for three hours and ten minutes. Due to differences in speed of revolution, different numbers of revolutions were recorded in the time interval, 138 being made by instrument No. L-416 and 181 by instrument No. B-501. No. L-416 was made in the shops of the Research Division and used a Brailsford 6-volt (1 rpm nominal speed) motor, hard-rubber cylinder with 8 turns per inch of .010" nickel wire on a  $\frac{1}{4}$ " aluminum plate base. No. B-501 was made by Brailsford and Co. to Balloon Project specifications. It had the same 6-volt motor, a paper base bakelite cylinder with 8 turns per inch of .010" nickel wire and was mounted on a 1/16" sheet aluminum frame.

The following statistics for a given pressure (1001.8 millibars) were computed:

	N.Y.U. Shop Model L-416	Brailsford Model B-501
on the mean	12.5%	34 %
within 0.1% of mean	25 %	50 %
" 0.2% " "	41.5%	70.5%
" 0.3% " "	62.5%	85.5%
" 0.4% " "	75 %	91 %
" 0.5% " "	95.6%	100 %

Other conclusions arrived at as a result of this test were:

- (a) Since changes of speed of the motors did not occur simultaneously in the two instruments, the speed changes probably are not due to slight changes in pressure or temperature.
- (b) Sensitivity varied from 0.1 to 0.9 millibars.
- (c) Sensitivity increased with increase of rate of pressure change.

It was recommended as a result of these tests that the records of flights when the balloon is floating be read to the nearest two-tenths of a percent of a cycle, or approximately two-tenths of a millibar, for high accuracy. When using the instruments manufactured by Brailsford and Co., satisfactory accuracy will be attained, if necessary, when the record is read to the nearest one-tenth of a percent of a cycle.

In the second group of tests the pressure was reduced slowly to about 20 millibars and increased to sea-level pressure at different temperatures.

The most comprehensive series of calibrations was made with the first instrument made by Brailsford and Co. Two runs were made at room temperature (22°C), one at -10°C, one at -30 to 37°C and one at -56 to -62°C. On the last test at the lowest temperature, the unit was found to be completely unreliable. The cause of failure was the erratic motor operation at extremely low temperatures. This had been observed previously during flights when the Olland-Cycle was not thermally insulated.

The other curves were plotted on a single chart in order to study their spread (see Figure 31). The envelope of curves thus obtained showed no regular temperature effect over the range +22°C to -37°C. In general, the envelope was less than 10 millibars wide although at some higher pressures it was as much as 12 millibars wide. The curves at low pressures fell closest together and were all within 3 to 4 millibars apart between 50 and 150 millibars and 6 millibars apart between 150 to 200 millibars.

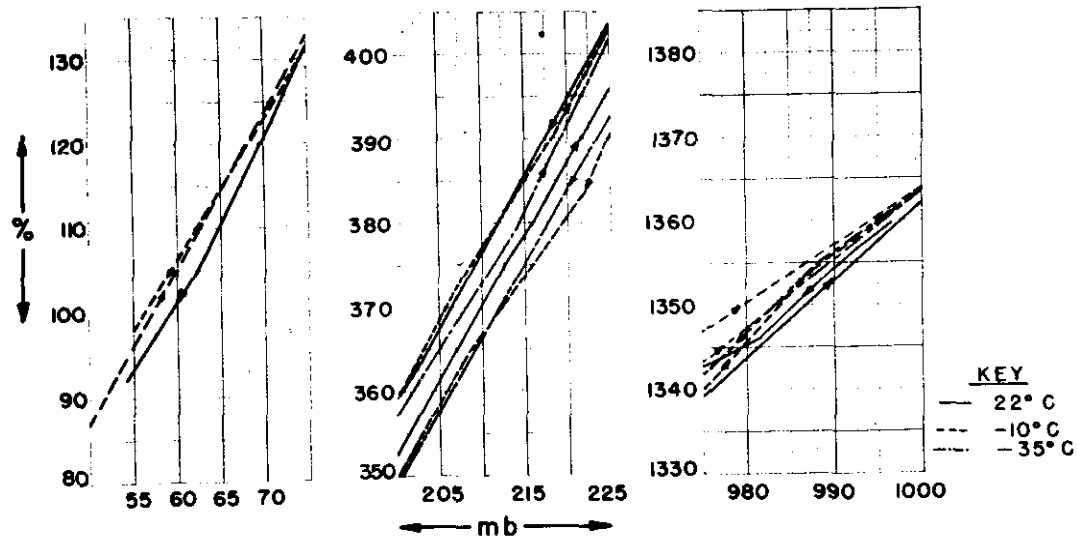

Figure 31. Tests of Olland-Cycle performance.

Hysteresis at any one temperature was the worst serious cause of the width of the envelope of curves. However, this error was minimized by the smoothness of the rotating cylinder and the continuous motion of the cylinder under the contact pen. Probably the necessary looseness of the bearings and the joining to the motor gear train had a great deal to do with the spread between different calibrations.

The maximum variation of any one calibration curve from the mean was about  $\pm 3$  millibars.

The following recommendations are made for the use of the Olland-Cycle modulator:

- (a) The modulator should be mounted inside the battery box and insulated so as to keep its temperature above  $-30^{\circ}\text{C}$ .
- (b) During the rapid-rising portion of the flight the accuracy of the data warrants reading only to the nearest one percent of a cycle, or about one millibar of pressure.

Tests on the sensitivity of Olland-Cycle modulators indicate that although the accuracy is limited as indicated above, small variations may be detected with the result that it is valid to read the pressure record to the nearest tenth of one percent of one revolution.

When the Olland-Cycle principle was originally adopted, both clocks and electric motors were considered for the power supply. In addition to the tendency of clocks to stop at cold temperatures due to freezing of lubricants and unequal expansion of the parts, the movement of the clockwork in discrete steps limits the accuracy of sampling. For these reasons, electric motors are preferred.

The motor now in use has been built to meet the following specifications:

- (a) 6 to 7.5 volt operation.
- (b) 1 RPM gear train.
- (c) 20 to 40 milliamperes drain.
- (d) Speed change at low temperature to be no more than 20%.
- (e) Constancy of speed during any single revolution not to deviate by more than 0.3%.

To check the performance of these motors at cold temperatures, a series of tests was run on the motors now in use with the average case seen in Figure 32. The loss in RPM was more than

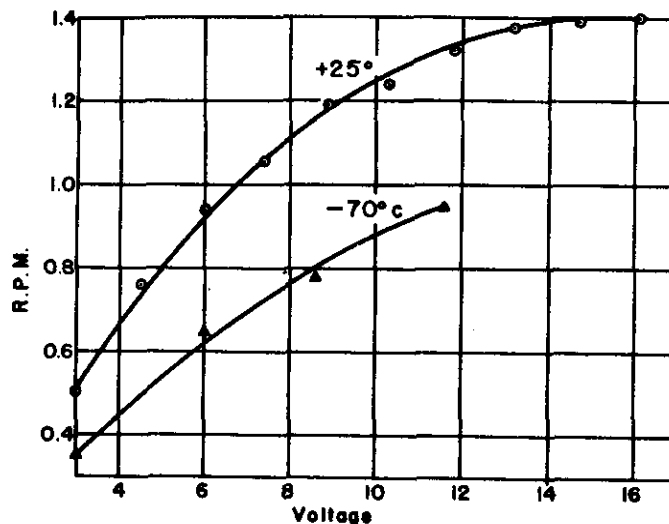

Figure 32. Speed tests of Olland-Cycle motors.

desired, but the motors continued to operate at a steady rate. As long as the speed of revolution does not vary markedly within a single revolution, the error is not serious. In early flights made at prolonged cold temperature, erratic performance

of the motor-driven units was observed; current practice is to provide adequate temperature insulation.

(4) Barograph

As a secondary pressure unit, a clock-driven barograph has been included on many flights. The instrument (shown in Figure 33)

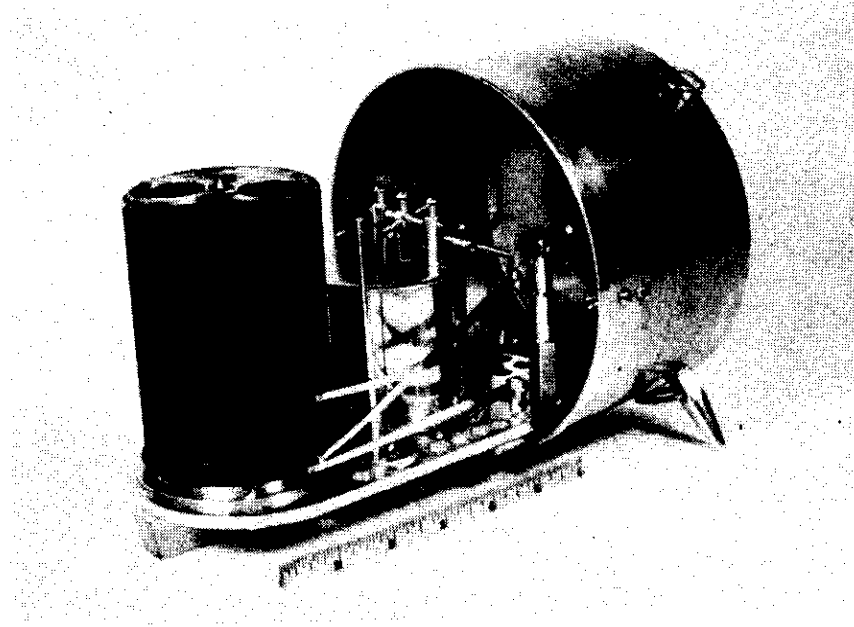

Figure 33. Smoked drum barograph.

will provide up to 40 hours of pressure data if recovered. About 70% of all those units flown to date have been recovered. The performance specifications are as follows:

- (a) Rotation: one revolution every 12 hours
- (b) Duration: 36 hours running time
- (c) Pressure range: 500 to 5 mb.
- (d) Accuracy:  $\pm 5$  mb.
- (e) Readability: 1.0 mb. or approximately .22 mm on the drum
- (f) Weight: 1000 grams
- (g) Time accuracy: 10%
- (h) Temperature compensation between 30°C and -70°C

Instruments have been built by Lange Laboratories to meet these requirements (the time accuracy figure is questionable).

A description of the use of this barograph is given in Part II, "Operations," of this report.

## B. Temperature Measurement

To interpret some of the observed balloon behavior, a knowledge of the temperature of the gas and the outside air temperature was required. The evaluation of "superheat" effects was accomplished primarily by exposing a conventional radiosonde thermistor inside the balloon with a control thermistor measuring the free-air temperature. Similarly, a thermistor was sometimes installed inside the battery-pack housing to measure the temperature of the batteries.

While this system was in use it was general practice to use the standard government service thermistors ML 378/AM (brown) and ML 395/FMQ-1 (white). The white elements were needed when the external temperature was measured, since no adequate protection from the sun was available. Also, at floating level there is no ventilation to be had since the balloon is stationary with respect to the air.

The resistance of the thermistors was switched into the grid circuit of the blocking oscillator of the AM-1 transmitter, and by comparison with pre-flight calibrations the audio frequency transmitted could be interpreted in terms of temperature. To record the signal after it was received, a fast-speed Brush Co. Oscillograph Model BL212 is used. (Due to the frequency response of the Brush recording system, the circuit was arranged to give lower frequencies than a standard radiosonde for the same temperature range.) A sample calibration chart is shown in Figure 34.

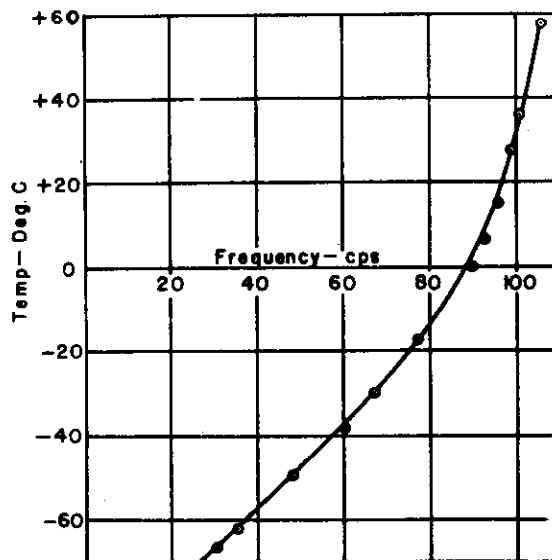

Figure 34. Sample calibration chart for temperature measurements.

The temperature data obtained was of considerable value, especially to determine the effect of insulation of the battery pack. It was found on most flights where reasonable thermal insulation was applied that the temperature of the pack remained above 0°C after several hours of exposure at nighttime. The extreme observed was -10°C. Daytime flights had the added advantage of heating from the sun.

The temperature of the lifting gas at the ground was ordinarily found to be somewhat below the temperature of the air. This is due to the extreme cooling encountered in the expansion of the compressed gas as it was fed from the tanks into the balloon. During the rising period, in daytime, the gas gained heat, since it cools adiabatically less rapidly than does air (also less than the normal tropospheric lapse rate); at the floating level a differential of about 10°C was common. A typical temperature trace is shown in Figure 35.

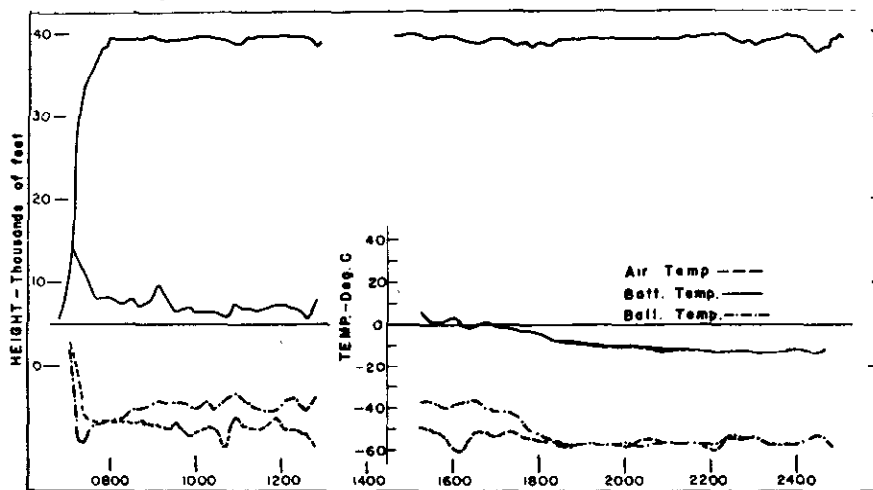

Figure 35. Typical temperature record.

To permit the transmission of both temperature and pressure data by one radio channel, a pair of programming switches have been designed and flight tested. The first is the temperature switch (Figure 36).

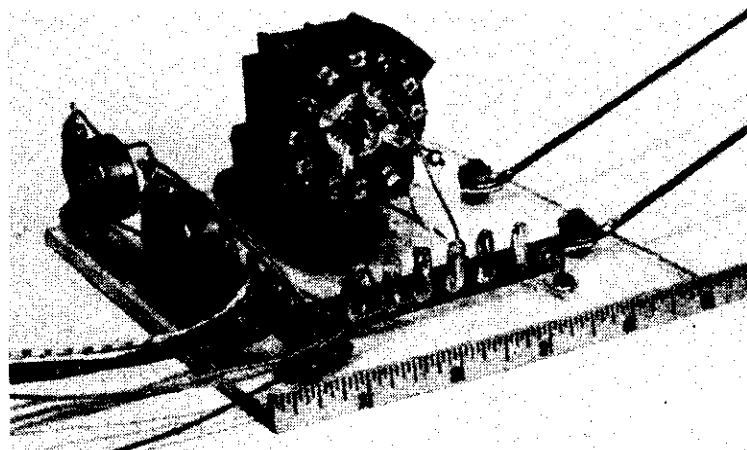

Figure 36. Temperature programming switch.

which switches four elements into the transmitter circuit in turn. Recently a motor making five revolutions per minute was used so that each temperature is transmitted for three seconds. The four elements are the free-air temperature, the gas temperature, battery-pack temperature and a reference signal. This switch is supplemented by a master program switch which alternately places the temperature switch and the pressure modulator into the transmitter circuit. The present arrangement is to permit the temperature data to be transmitted for about one minute in every fifteen. In this way representative temperature sampling may be obtained, without materially destroying the continuity of the pressure and ballast data.

A second system of determining temperature makes use of the smoked drum of the barograph. By adding a temperature-activated pen, this unit makes a record of the temperature encountered. Since it is not the free-air temperature nor the temperature of the lifting gas but rather the temperature of the barograph itself, the data obtained has been of little value. Following the development of suitable temperature telemetering apparatus, this method was not used.

#### C. Ballast Metering

It is often very desirable to know whether or not ballast control equipment is operating properly during flight tests. For this purpose, two systems of ballast metering have been devised. It is possible (1) to record on an instrument which is balloon-borne or (2) to detect and telemeter information to the ground concerning ballast flow.

Figure 37 shows the automatic siphon which has been used in the AM-1 transmitter circuit for the telemetering of such information. A series of pulses of fixed frequency is transmitted whenever the contact arm of the automatic siphon is filled above a critical level. The electrolyte used is non-miscible with the ballast and rises and falls in proportion to the rise and fall of the main arm of the siphon. This main arm empties when approximately 3.5 grams of ballast have been allowed to flow into it. As a consequence of this intermittent filling and emptying of the lines of the siphon, an intermittent signal of fixed frequency is transmitted whenever ballast is flowing steadily. It is important that an electrolyte be used which will not freeze at low atmospheric temperatures and will not boil at the low pressures encountered. After a series of tests it was decided that a 24% solution of hydrochloric acid be used for altitudes up to 85,000 feet. It is necessary to use platinum wire for the contact points.

In order to record in flight the functioning of the ballast control system a ballast recording mechanism has been developed in conjunction with the Lange Laboratories of Lexington, Kentucky. This



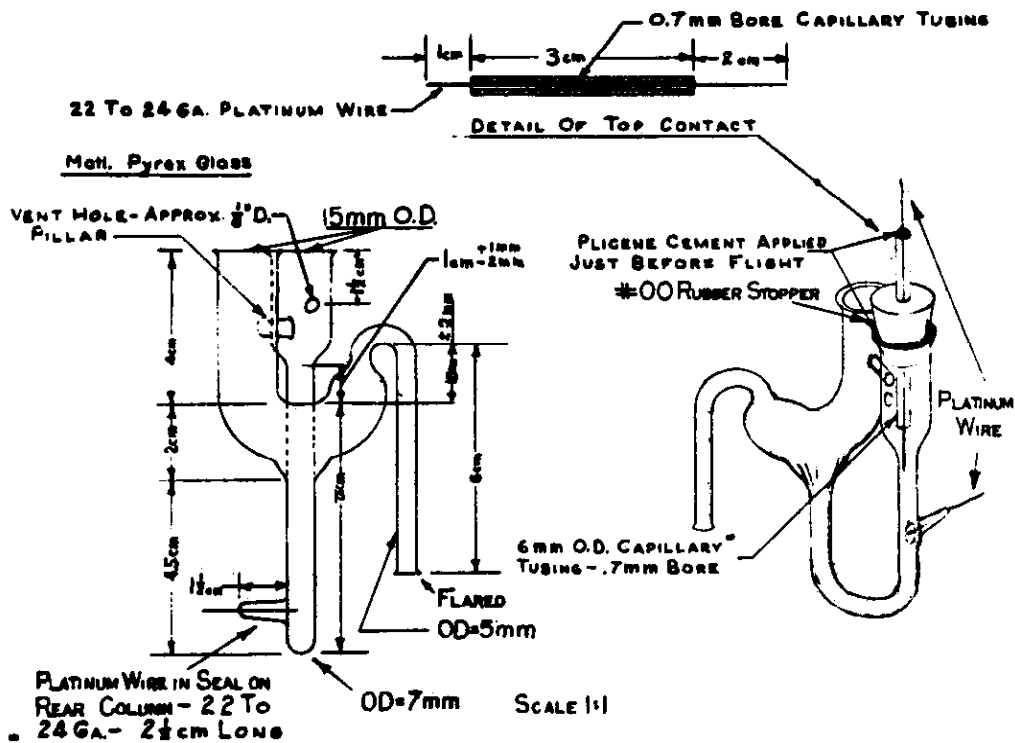

Figure 37. Automatic siphon.

instrument has been added as a part of the baro-thermograph. A cutaway sketch of this ballast-recording instrument is shown as Figure 38.

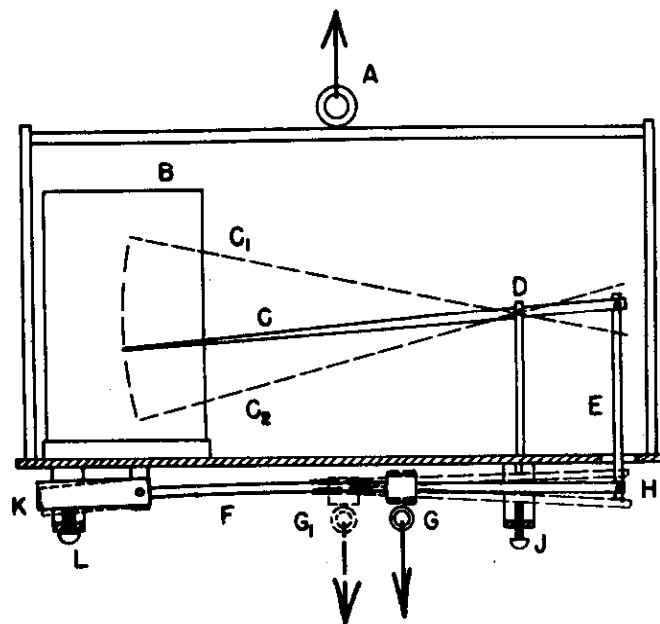

Figure 38. Ballast-recording meter.

Operation of the instrument may be described as follows: The instrument is inserted in the load line just above the ballast assembly by attaching the load line to the upper ring (A) and the rigging from the ballast assembly to the lower ring (B). A cantilever spring (F) is set into an adjustable base (K), which may be adjusted for various empty ballast-assembly weights by changing the setting of the adjusting screw (L). The lower ring is attached to the cantilever spring, but can be adjusted for different ballast weights by sliding along the spring (from G to G<sub>1</sub>, for instance). For light ballast weights the lower ring is moved away from the base (K) (to the right on the diagram), and for heavy ballast weights it is moved toward the base. Adjustments are made on the adjusting screw (L) and the lower ring (G) before each flight according to the weights of the ballast assembly and the ballast.

The cantilever spring is attached to the connecting bar (E) at (H). Thus the deflection of the lower ring is transferred through the cantilever spring to the connecting bar and then to the pen arm (C), which is pivoted about a fixed point (D). The deflection is recorded by the pen on a rotating smoked drum (B). In order to prevent the pen from going off the drum, an adjustable stop is set at (J).

The unit should be calibrated for maximum load (pen arm at C<sub>1</sub>), a medium load (pen arm at C) and minimum load (pen arm at C<sub>2</sub>) before each flight. A trace of ballast function will start at the top of the drum and as ballast is discarded will fall toward the bottom of the drum. By measuring the deflection at any time and comparing with the calibration, the amount of ballast left in the assembly at any time can be determined. Since this instrument is a part of the baro-thermograph, the trace obtained upon recovery will contain information concerning altitude, temperature, and ballast functioning over the complete flight. After proper correction for time displacement of the three pens has been made, the three types of information can be correlated to give a fairly complete picture of the balloon flight, including reasons for various types of motion.

It is expected that this instrument will be extremely valuable in determining ballast control operation over a long period of time, especially after the balloon system is out of radio reception range. It also will give information that could not be obtained if there were any failure of the automatic siphon meter or the transmitter during launching or flight. The chief drawback of the instrument is that information is dependent on recovery.

At the time of writing of this report the instrument has not been flight tested. Preliminary laboratory tests indicate that the instrument will live up to the high expectations placed upon it. Since the instrument actually records the tensile force in the load line during flight, it may also be valuable in analysis of the acceleration forces induced during periods of balloon oscillation in the atmosphere.

## VII. CONCLUSIONS

Considerable experimental work has been done in conjunction with the study of balloons and controls. The description of operating procedures and the use of specially developed equipment is included in Part II of this report, "Operations," (bound separately).

A summary of the results of flights made to test equipment and controls is given in Part III, "Summary of Flights." At this time the use of thin polyethylene balloons with pressure-activated ballast controls has been demonstrated effectively to meet the contract requirements. Tests made on another contract have found controls consistently active over 24 hours with an average pressure constancy of  $\pm 2$  mb. at 200 mb. Even greater ballast efficiency has been found at higher altitudes using the same pressure-activated controls.

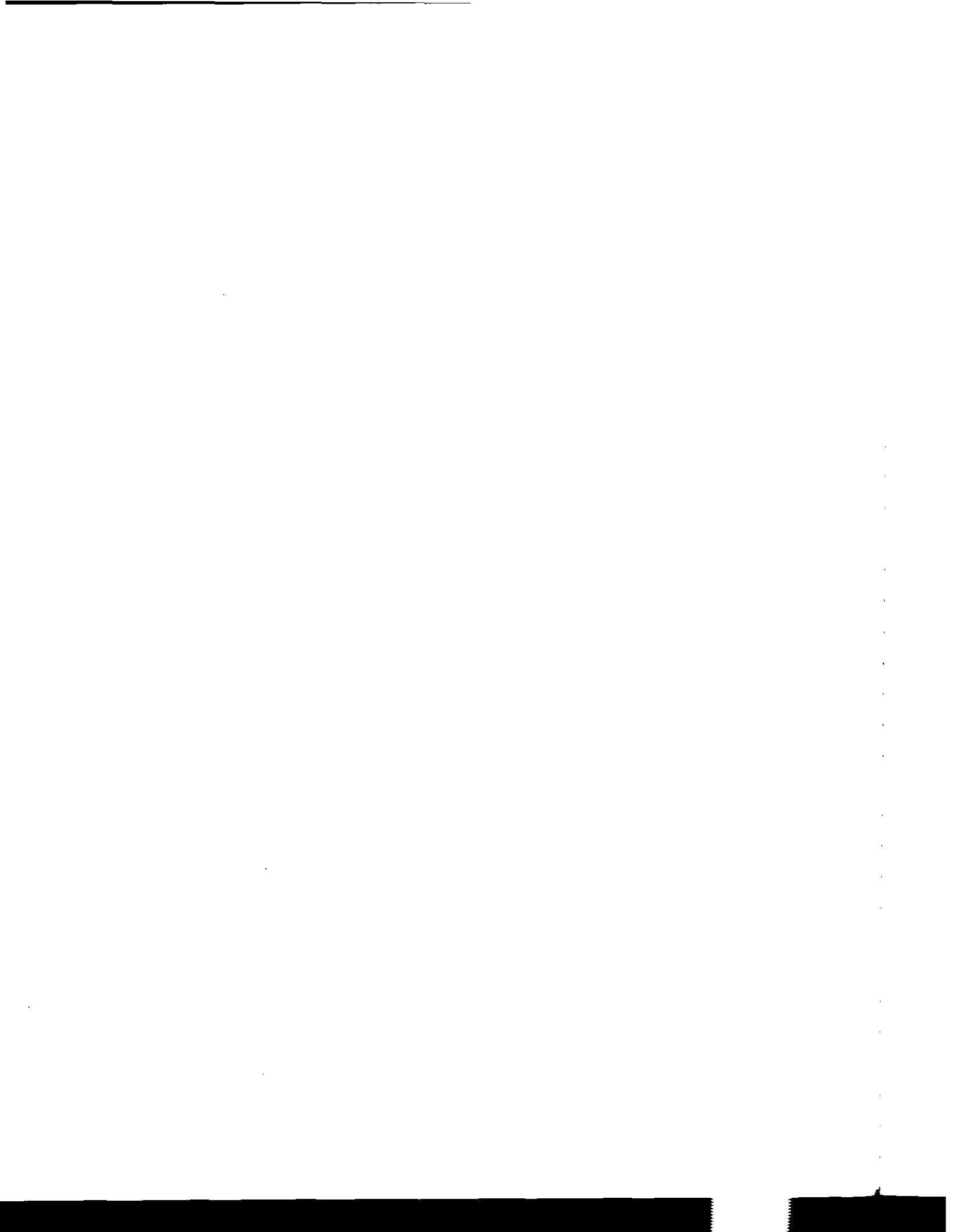

New York University  
*Constant Level Balloons*  
Section 3, *Summary of Flights*  
July 15, 1949

---

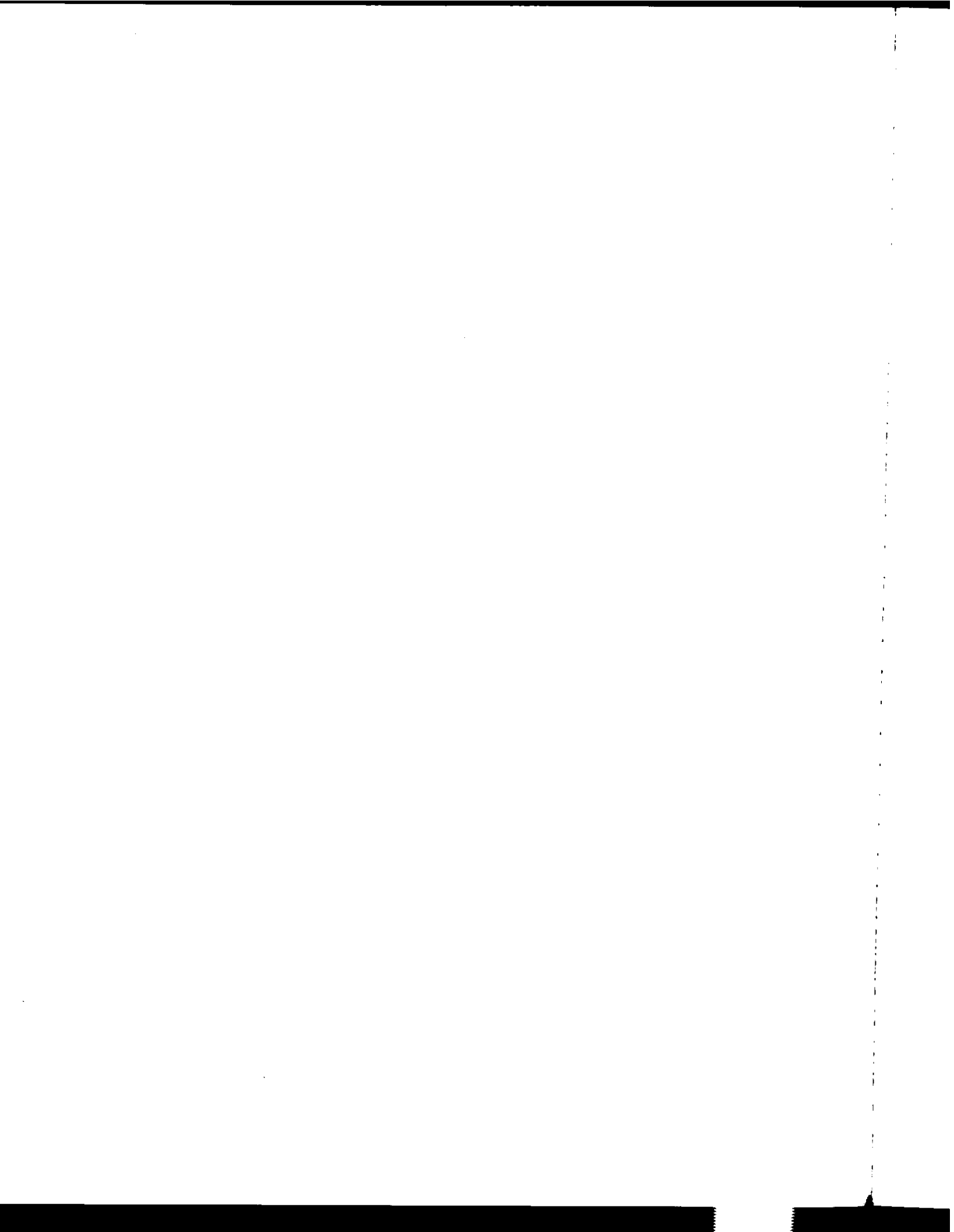

Technical Report No. 93.02

CONSTANT LEVEL BALLOONS  
Section 3

SUMMARY OF FLIGHTS

Constant Level Balloon Project  
New York University

Prepared in Accordance with provisions of Contract  
W28-099-ac-241, between  
Watson Laboratories, Red Bank, New Jersey  
and  
New York University

The research reported in this document has been made possible through support and sponsorship extended by the Geophysical Research Directorate of the Cambridge Field Station, AMC, U. S. Air Force, under Contract No. W28-099 ac-241. It is published for technical information only and does not represent recommendations or conclusions of the sponsoring agency.

Prepared by:

*James R. Smith*

James R. Smith

Approved by:

*Harold K Work*

Dr. Harold K. Work  
Director of the Research Division

College of Engineering  
New York University  
15 July 1949  
New York 53, New York

Table of Contents

	<u>Page Number</u>
I. <u>Introduction</u> . . . . .	5
II. <u>Flights</u>	
Number 5. . . . .	6
7. . . . .	8
10. . . . .	10
11. . . . .	12
12. . . . .	14
13 - 16 . . . . .	16
17. . . . .	17
20. . . . .	16
23. . . . .	18
29 - 39 . . . . .	19
41. . . . .	20
43 - 51 . . . . .	22
52. . . . .	24
54. . . . .	26
55. . . . .	28
56. . . . .	26
58. . . . .	30
60. . . . .	26
63. . . . .	32
68 - 72 . . . . .	33
73. . . . .	34
74. . . . .	35
75. . . . .	36
78. . . . .	38
79. . . . .	39
80. . . . .	40
81. . . . .	42
82. . . . .	43
85. . . . .	44
86. . . . .	45
88. . . . .	46
89. . . . .	47
90. . . . .	48
92. . . . .	50
93. . . . .	52
94. . . . .	53
96. . . . .	54
97. . . . .	55
98. . . . .	56
102. . . . .	58
103 - 111. . . . .	60
104. . . . .	63
106. . . . .	64
110. . . . .	66
III. <u>Index</u> .....	68



## Introduction

In November, 1946 the Research Division of the College of Engineering of New York University contracted with Watson Laboratories, AMC, to develop and fly constant-level instrument-carrying balloons. This is the third part of the final report on the work accomplished and describes the experimental balloon flights which were made.

In reviewing the flights a number of analytical comments may be made. In most flights one objective was the maintenance of the balloon at a constant pressure level for as long as possible. On many flights, balloon behavior was affected by instrumental controls of one kind or another while on some flights no controls at all were used.

Balloons of varying sizes and of different principles of construction have been launched singly, in tandem and in clusters. On some, temperatures were measured and on others the flight path was an object of special study. To explain certain observed flight data a careful analysis of atmospheric stability has been made, while other flights have special significance because they demonstrate the effect of superheat on the lifting gas or some other feature of analytical importance.

Since over 100 flights have been made, it is difficult to tabulate the important results obtained on each specific flight. To present the data which has been collected each significant flight is presented chronologically, with drawings and details where necessary, and a summary of the flight results is given.

To render this information useful, an index has been prepared with reference made to flights which show typical or important results in each category.

Flight 5: Released from Alamogordo, New Mexico, 0517 MST, June 5, 1947  
 Recovered at Roswell, New Mexico

In this flight, a 55-pound load was lifted with a linear array of 28 350-gram rubber balloons. By attaching the balloons at 20-foot intervals along the load line, a total length of about 600 feet was required. The train is shown in Figure 1. For altitude control, three lifting balloons

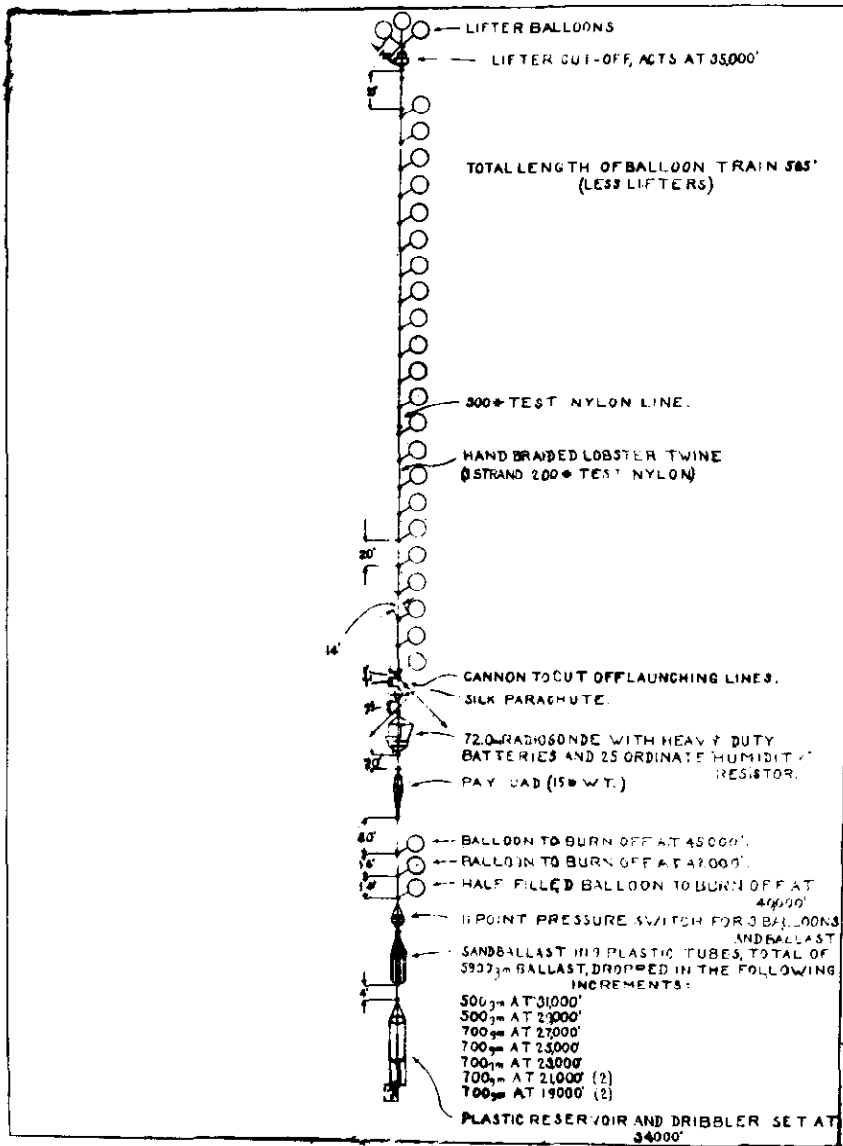

Figure 1: Train, Flight 5

were cut free at 35,000 feet, and the remaining load was weighted to balance at that point. As a precaution against over-buoyancy, three more balloons

were to be freed at 40,000, 42,000 and 45,000 feet. The use of sand ballast, to be dropped in increments upon descent to altitudes below 31,000 feet, was supplemented by an early model of the automatic ballast valve set to expend liquid ballast at 34,000 feet.

From the height-time curve of the flight (Figure 2), it will be seen that the maximum altitude reached was much above the predicted 35,000 feet. Also

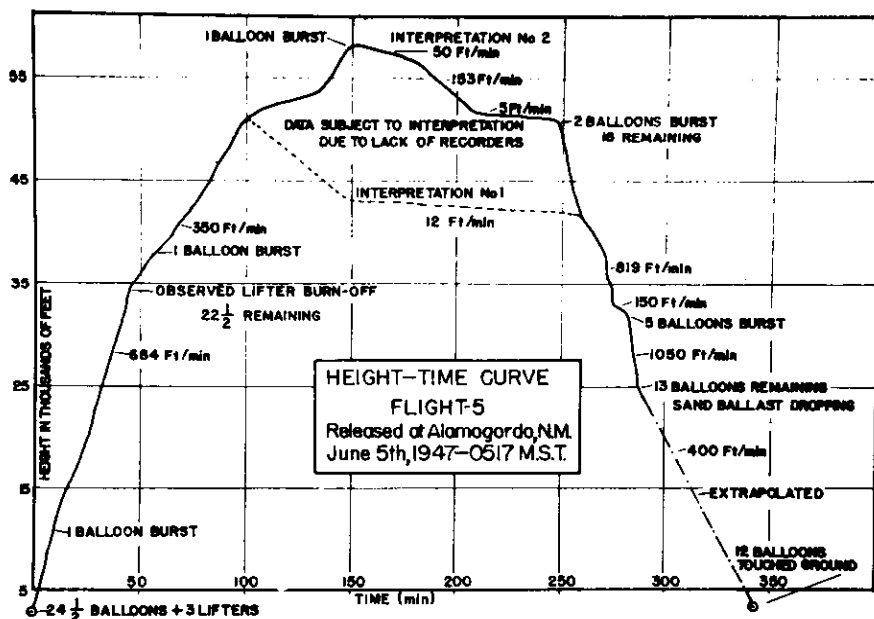

Figure 2

the rate of rise was greater than expected. Both of these evidences of excess buoyancy are attributed to superheating of the balloon by sunshine. The real height is somewhat in doubt because the conventional radiosonde baro-switch (Army type ML-310/) was used, and the pressure signal which was transmitted was ambiguous at some points.

On this flight theodolite readings were taken until the balloon was 90 miles away from release point after 260 minutes of flight. In addition, visual observations were taken from a B-17 aircraft which circled the balloon for most of the flight.

Flight 7: Released from Alamogordo, New Mexico, 0509 MST, July 2, 1947  
 Descended at Cloudercroft, New Mexico

Using a cluster array (Figure 3) of 13 350-gram rubber balloons and four larger lifting balloons, a 53-pound load was carried aloft on this flight. At 35,000 feet, the desired floating level, the lifter balloons were cut free.

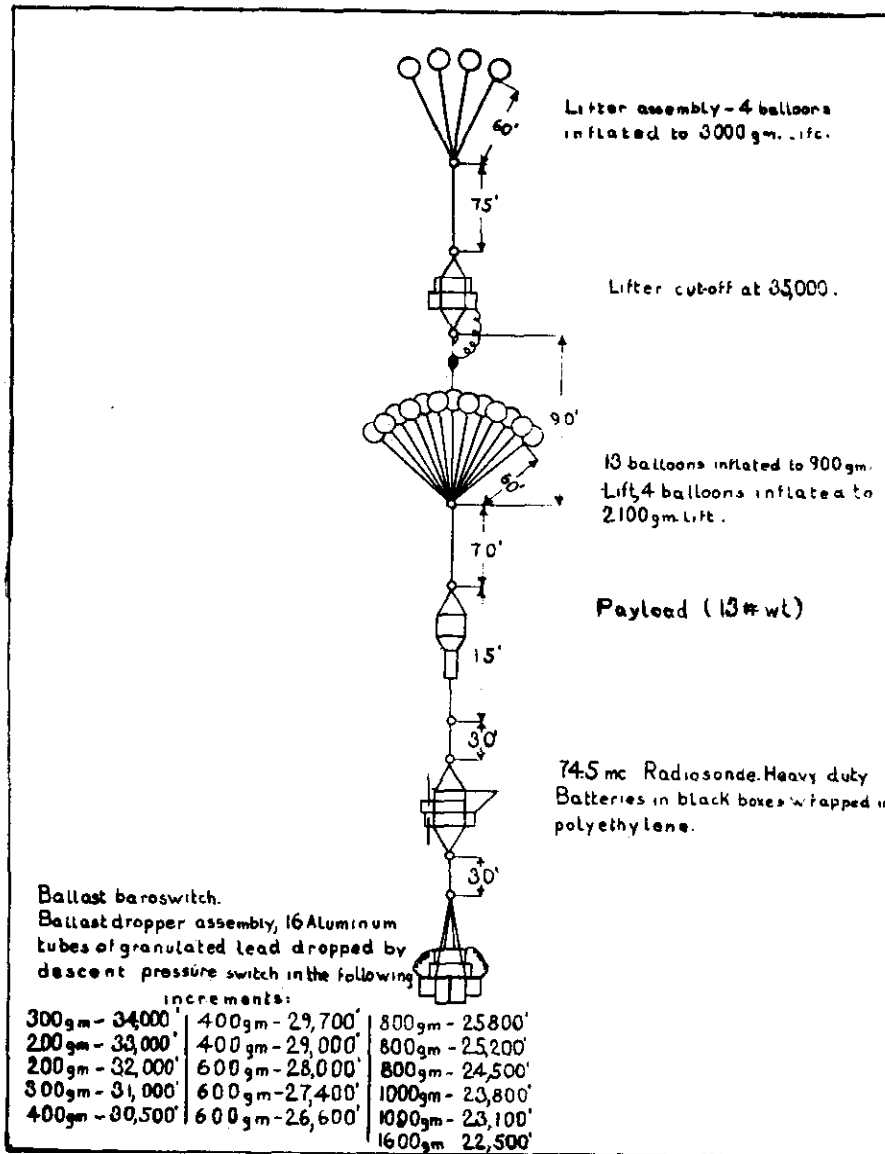

Figure 3: Train, Flight 7

When the train began to descend below 34,000 feet, lead shot was dropped in increments to maintain buoyancy.

This altitude-control system operated well enough to produce a height-time curve (Figure 4) with one descent checked by ballast dropping. Too much weight was lost in this action, and the train rose until some of the balloons were burst. Subsequent descent was not checked.

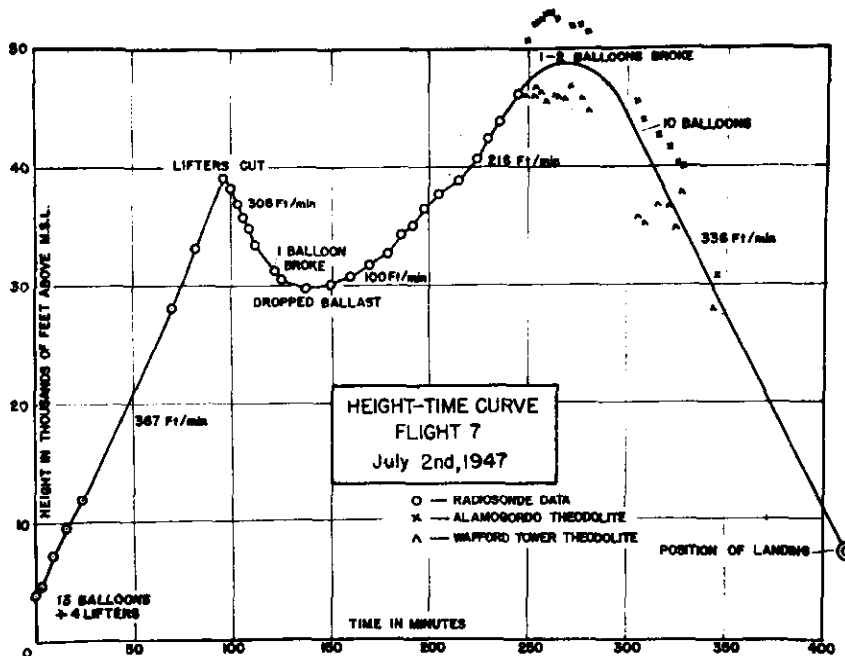

Figure 4

From this flight it appears that the inherent instability of freely extensible balloons is so great that no simple control will cause them to remain at one pressure level.

Tracking for the entire flight period was accomplished with a C-54 aircraft. Two theodolite stations were operated, one at the launching site and one at Wafford Lookout, a fire tower about 20 miles northeast of the release point.

Flight 10: Released from Alamogordo, New Mexico, 0501 MST, July 5, 1947  
 Not recovered

This flight was the first to use a large plastic balloon as the lifting vehicle. The cell was spherical, 15 feet in diameter, and the walls were .008" polyethylene heat sealed at the seams (made by Harold A. Smith, Inc.). The altitude control was an automatic ballast valve, pressure-triggered to throw off liquid ballast. The equipment train used on this flight is shown in Figure 5.

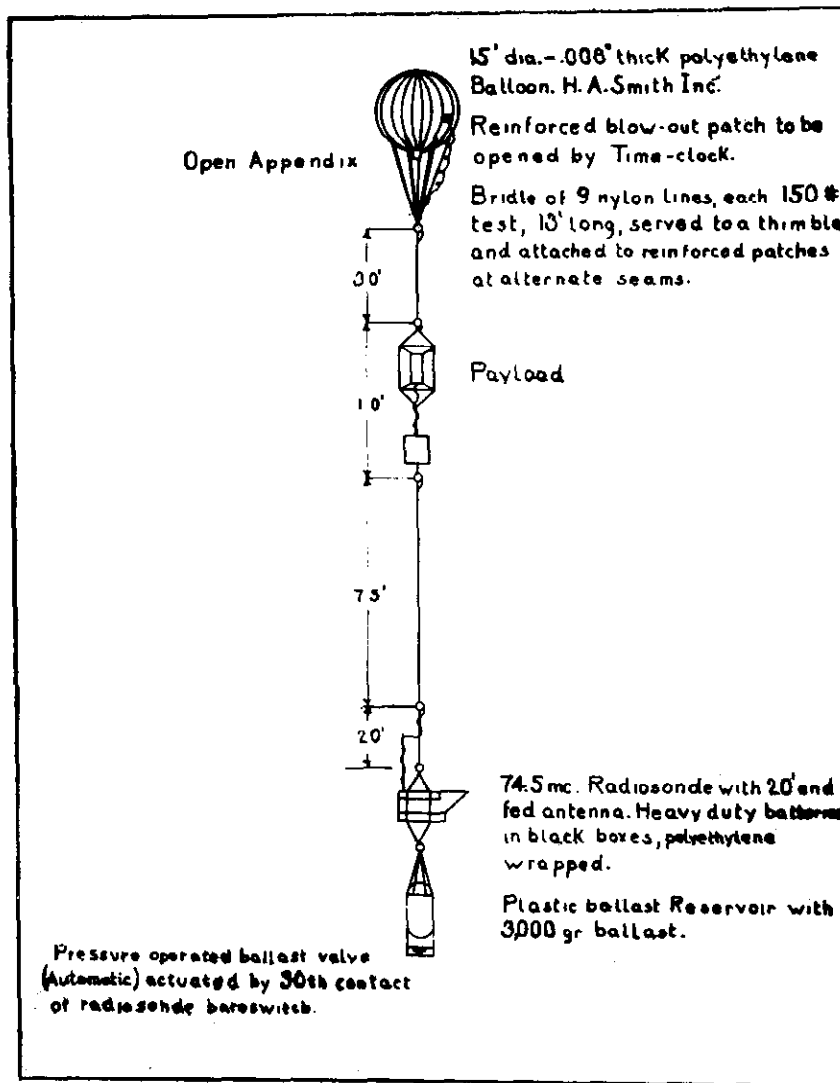

Figure 5: Train, Flight 10

The balloon rose to about 16,000 feet MSL and dropped back to 9000 feet MSL where it "floated" for at least 4 hours, at which time radiosonde reception failed. It is believed that the automatic ballast valve sealed off

properly at 12,000 feet, but the air entrapped in its aneroid was heated and caused the operating level to be at the lower value. This would correspond to a superheat of 30°C above the air temperature.

Later flights showed that the type of load attachment used on this balloon was unsatisfactory; however, with proper rigging, cells of .008" thickness were good vehicles as they usually showed very low diffusion and gas leakage.

Near the end of the recorded data, the height-time curve shows large oscillations about a pressure plane (Figure 6). Three factors which probably

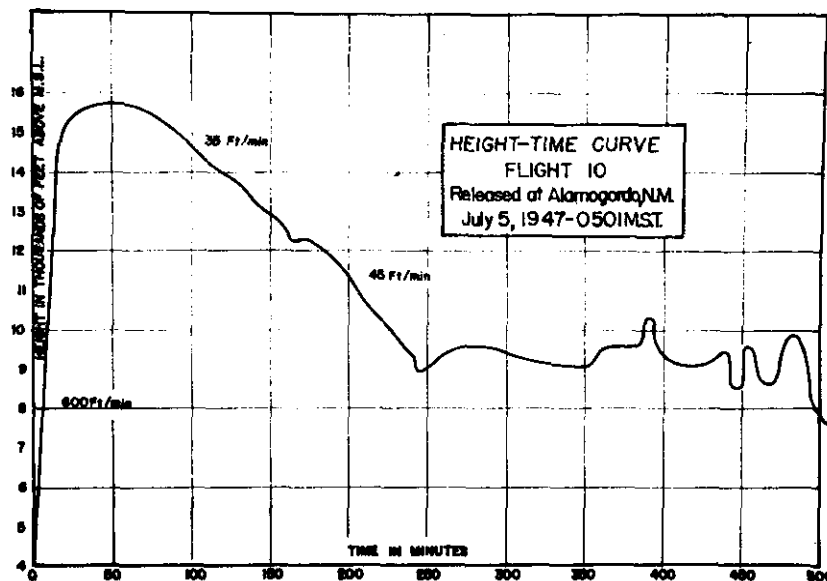

Figure 6

contributed to this instability were: (1) the turbulent motion of the heated air over the desert, (2) the changes in temperature of air in the aneroid valve as intermittent clouds shut off the sun, and (3) the overcompensation caused by the valve-controlled ballast flow.

On this flight the first "destruction device" was used for the purpose of bringing down the balloon after a fixed time to prevent excessive interference in air-traffic lanes. This particular model was a clock-driven device which failed to operate, probably because of low temperatures causing unequal contraction within the movement. Its action was to consist of detonating an inflammable compound taped to the balloon, rupturing its side and permitting a rapid escape of the lifting gas.

Flight 11: Released from Alamogordo, New Mexico, 0508 MST, July 7, 1947  
 Not recovered

On this flight a 15-foot, .008" wall, polyethylene balloon was combined with a cluster of six small plastic cells (7-foot diameter, .001" wall) to lift a total load of 35 pounds as high as possible (Figure 7). The small

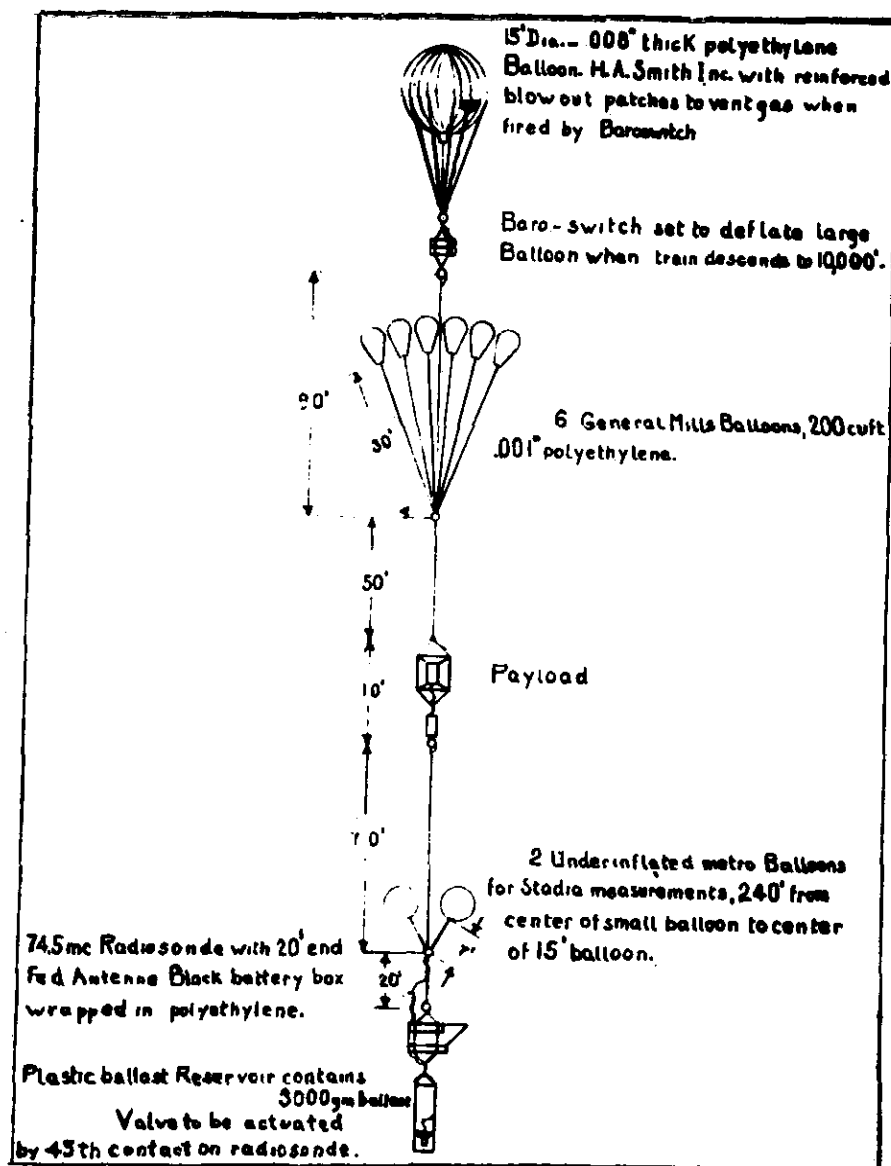

Figure 7: Train, Flight 11

cells did not rise as fast as the large balloon; consequently, three of them were inverted and filled with air.

With this loss of lift, the altitude reached was only about 17,000 feet MSL, and the automatic ballast valve (set to operate at 45,000 feet) was not activated. This flight demonstrated the need for a minimum-pressure switch



to activate the ballast valve. A fixed ballast leak of about 400 grams per hour was caused by a defective valve fitting and this was sufficient to maintain the balloon at nearly constant level until all the ballast was exhausted. Following this experience, the use of a preset fixed leak was employed on many flights.

The very unstable "floating" seen on Flight 10, when the automatic ballast valve controlled the flight, is not found on this flight where the vehicle used only a fixed-leak control. This eliminates both the over-compensation and the serious effects of temperature changes on the aneroid capsule, which are found when the automatic ballast valve is used.

The trajectory of this balloon (Figure 8) shows a very interesting deformation at the transit of the Sacramento Mountains. The anti-cyclonic

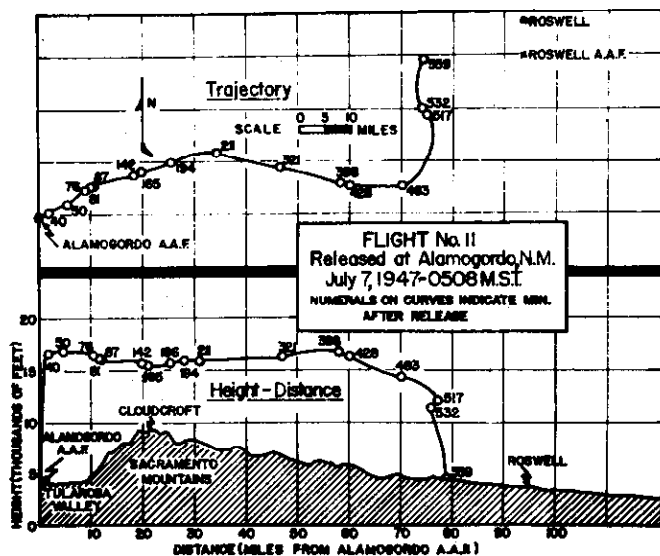

Figure 8

curvature over the eastern slope suggests that the air stream at the floating level was distributed by the terrain, and the deformation predicted by dynamic theory may thus be given a physical illustration. The trajectory was determined by aircraft and theodolite observation.

Another striking feature of the flight is the disagreement between the actual flight path and the trajectory which might have been estimated from routine upper-wind reports. Reports from El Paso, Roswell, Albuquerque and White Sands were used for comparison with the observed trajectory. Except for White Sands, none of these stations reported any wind from the WSW at or near the floating level during the 12-hour period covered by the flight. At White Sands a very shallow current was detected moving in the direction indicated by the balloon flight. This clearly demonstrates the non-representiveness of the ordinary pilot balloon observation.

Flight 12: Released from Lakehurst, New Jersey, 0714 EST, August 5, 1947  
Recovered at Smyrna, Delaware

This flight saw the first use of several new items. The balloon was the first .001<sup>m</sup> polyethylene cell flown; a 397 mc (T-69) transmitter was flown, with radio direction-finding equipment used to track the balloon; a 3 mc (AM-1) transmitter was tested for the first time and the first model of a minimum-pressure switch was provided to activate the automatic ballast valve. The equipment train for this flight is illustrated in Figure 9.

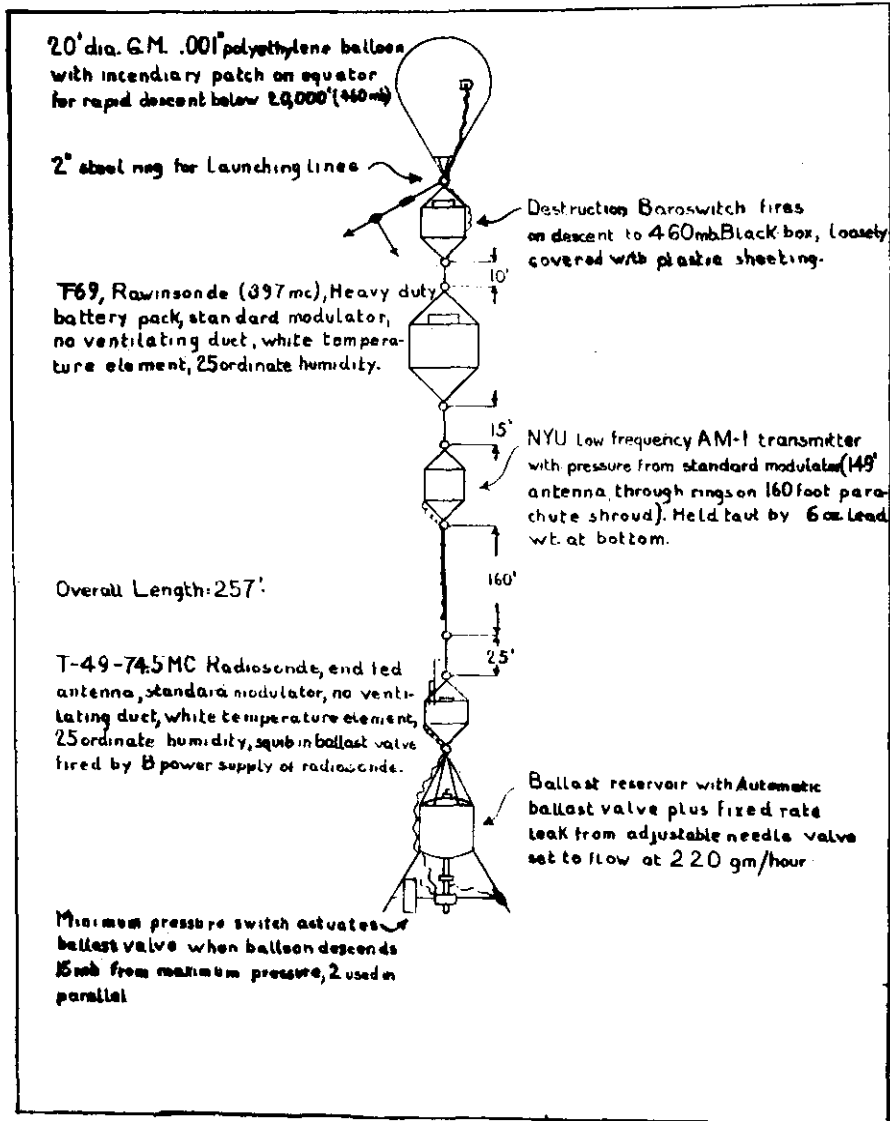

Figure 9: Train, Flight 12

Measurements in the hangar prior to release indicated that lift losses from leakage and diffusion were about 200 grams per hour, and in addition

to the automatic ballast valve system, a fixed-flow needle valve was set to discharge ballast slightly in excess of the expected loss. Both systems failed to keep the balloon afloat, and a slow descent from its maximum altitude of 14,000 feet MSL resulted. The expected altitude of 38,000 feet was not reached, and this is believed to be due to mixing of the air with the lifting gas during rising. The bottom of the balloon was open with no protecting skirt or valve to keep out air. Since the thin fabric would rupture with an internal pressure of 0.017 psi, some form of skirt or external appendix was suggested for future flights.

Radio reception with the 3 mc transmitter was excellent and far surpassed the performance of either the 72 mc or 394 mc transmitters which were also flown.

Because of the low elevation angle of the transmitter, the single SCR-658 radio direction-finding equipment was not of much use for positioning. Tracking by aircraft was satisfactory throughout the flight.

Flights 13, 14, 15, 16 and 20: Made in September, 1947, they had as their primary purpose the testing of external balloon appendices to prevent excessive dilution of the lifting gas with air.

On three of these flights the loose polyethylene tubes twisted shut during the balloons' ascent and caused the cell to burst as it became full. The unsatisfactory models tried are seen in Figure 10, as well as the skirt

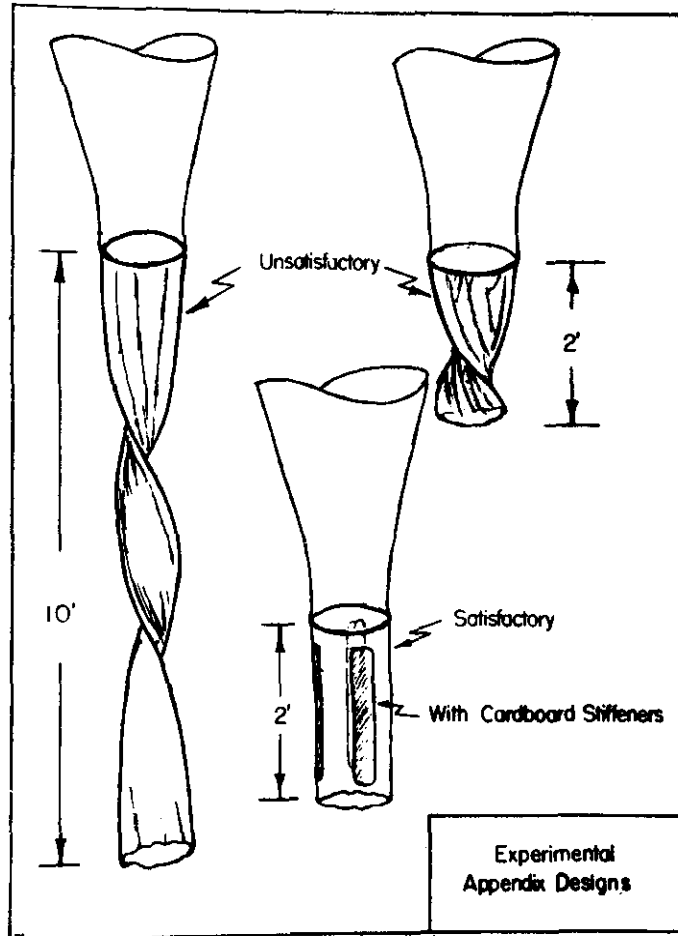

Figure 10

stiffened with external battens which was developed on Flight 20 and used successfully thereafter.

On most of these flights, radio direction-finding equipment (SCR-658) was used, as well as theodolite and aircraft for tracking and positioning the balloons. A system of air reconnaissance and ground recovery was developed using a radio-equipped jeep to move cross-country at the direction of the aircraft observer. Several satisfactory recovery missions were made on these and later flights using this technique.

Flight 17: Released from Alamogordo, New Mexico, 1647 MST, September 9, 1947  
Recovered at Croft, Kansas

On this flight the first balloon made of .004" polyethylene was launched. The altitude controls were a fixed-flow needle valve orifice set to leak at 100 grams per hour and an automatic ballast valve activated by a minimum-pressure switch.

This flight reached floating level shortly before sunset, and the balloon took on superheat which was lost when the sun went down. This cooling necessitated the rapid discharge of ballast to maintain buoyancy. The operation of the automatic ballast valve at this time was satisfactory and restored the balloon to a floating level within one hour. Following restoration a satisfactory floating performance was indicated for as long as radio contact was maintained (Figure 11). The need for a balloon-borne

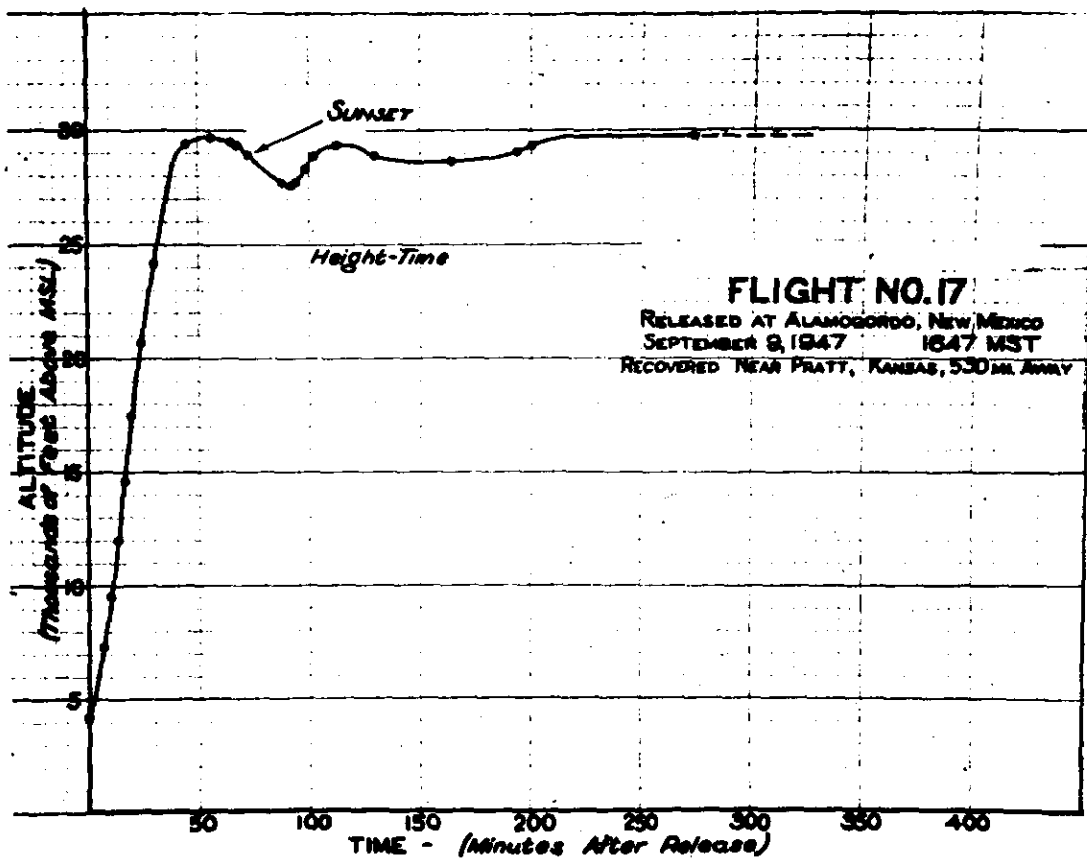

Figure 11: Height-time curve, Flight 17

barograph was demonstrated by this flight which traveled more than 500 miles from the release point.

Flight 23: Released from Alamogordo, New Mexico, 0918 MST, September 12, 1947  
Not recovered

A J-2000 neoprene balloon was encased with a nylon shroud and provided with a valve to permit gas to escape after a small superpressure ( $\frac{1}{4}$ " of water) was exceeded. The balloon in its shroud is shown in Figure 12.



Figure 12: Neoprene balloon encased in a nylon shroud

If a "superpressure" balloon is used, much less ballast is required since, during minor oscillations, the reduction of buoyancy will not cause the balloon to descend as long as the remaining buoyancy is equal to or greater than the load supported.

This balloon, and three similar ones (Flights 38, 66, 87), failed to achieve any constancy of altitude. All four failed during the rising period or soon after the shroud became full. (The balloons were heated prior to release to restore elasticity.)

Flights 29 through 39: They were made from Alamogordo, New Mexico during November and December, 1947 to test ballast controls and to develop a launching technique satisfactory for high winds. The period of data reception by radio was too short in all of these flights to permit much evaluation of the altitude controls. On three flights (33, 35 and 39) a Ferguson meteorograph was added to the train to record flight pressure; of 11 balloons released, only these three were not recovered.

On seven flights the pressure signals received by radiosonde were lost while the balloon was still rising; Flight 38 was a shrouded neoprene balloon which burst as it became full; and Flight 39 was a polyethylene balloon which burst at or near its ceiling following a very rapid rise. (This was the first balloon to burst using a short external appendix with stiffeners.)

On the other two flights (30 and 35) a very short period of level flight was recorded before the balloon-borne radio transmitter passed out of range.

Besides these two, several other .001" polyethylene balloons probably were maintained at constant or near-constant levels for several hours, as can be seen from their points of recovery (Figure 13). One balloon was seen descending 18 hours after release.

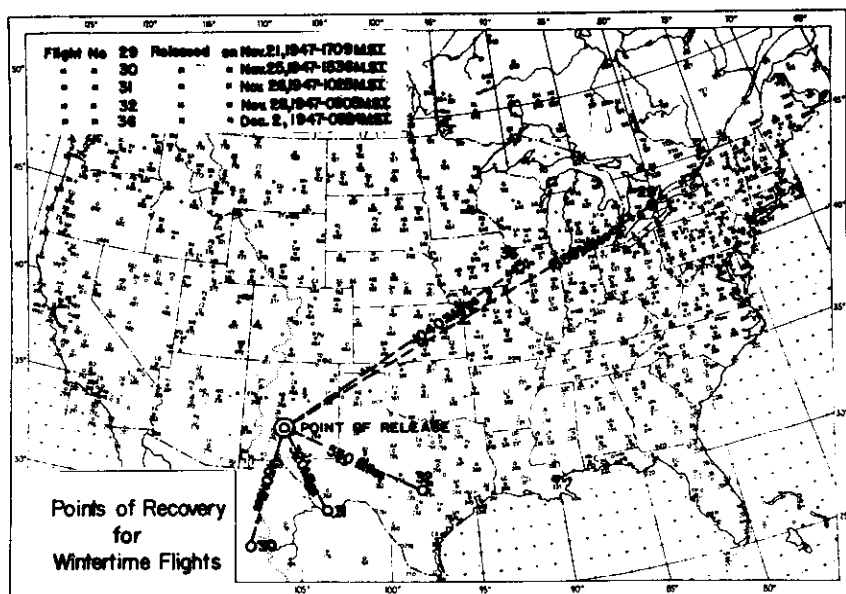

Figure 13

On Flights 29 through 33 only a fixed ballast leak was used, set for flows of from 300 to 600 grams per hour. Other flights used automatic ballast controls. Although these fixed leaks seemed to be sufficient to keep the balloons aloft, there was no clear evidence as to what amount would be needed for most efficient operation. The need for a system of ballast metering was indicated in this series of flights.

Flight 41: Released from Indiantown Gap Military Reservation, Pennsylvania,  
0956 EST, February 16, 1948  
Not recovered

The balloon was of .001" polyethylene and had a fixed-leak ballast control set to provide a constant flow of 650 grams per hour. The principle objective of this flight was to test aircraft reception from a balloon-borne transmitter. Using RDF equipment, two B-17 planes were able to receive clear signals from the transmitter at least 150 miles away from it and were able to home in on the signal by using the radio compass. There was a questionable zone of about a 15-mile radius beneath the balloon, and it is probable that this represented a cone of silence from the vertical antenna. The balloon was near 40,000 feet with the planes at about 10,000 feet.

On later flights, using a frequency of 1746 kc, reception range was extended to over 400 miles and no cone of silence was encountered. By flying along the bearing indicated by the compass until it abruptly reverses, the position of the balloon may be determined. Visual observations confirmed the presence of the balloon overhead.

On service flights made from this same base during this week, two new pieces of flight gear were added to the train. The first of these was a cloth parachute, mounted upside down in the line to serve as a drag, acting against excessive rates of rise. When mounted above the cloth identification banner, this chute also acts to minimize sway and lateral oscillation of the equipment.

The second unit was a new type of destruction device--a pressure-activated mechanism by which a large hole is ripped in the balloon upon descent into the lanes of air traffic. In this device (Figure 14) the equipment is permitted to fall freely for a few feet, jerking a length of line through the balloon side. After this fall, the equipment again is carried by the main load line, and the ruptured balloon acts as a parachute to lower the gear to the ground at about 1000 feet per minute.



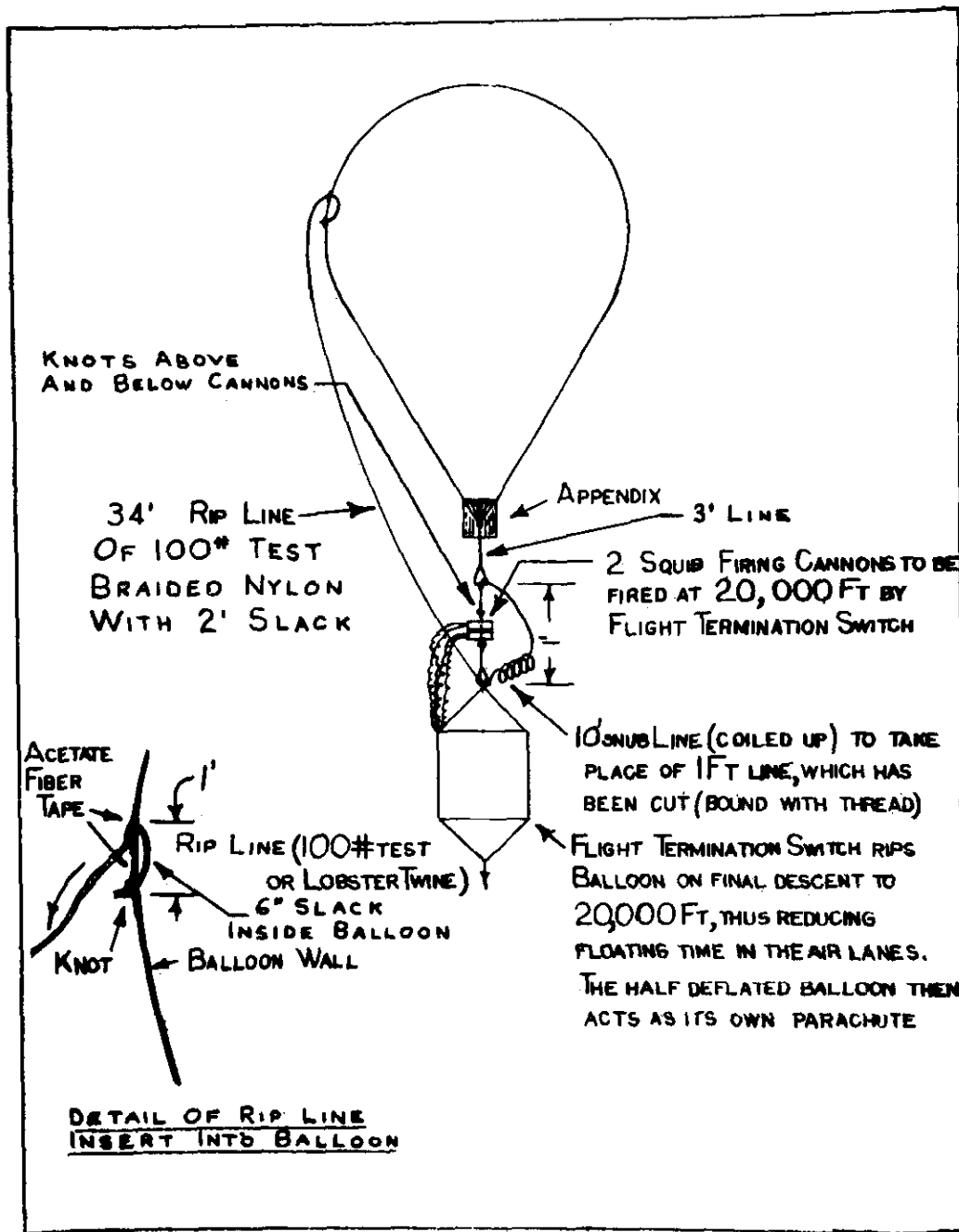

Figure 14: Rip-out line in place on balloon

Flight 43 through 51: In April, 1948 a number of flights were made using .001" polyethylene balloons and fixed-leak ballast controls. Only four of these flights were recovered. The landing points of these are shown in Figure 15.

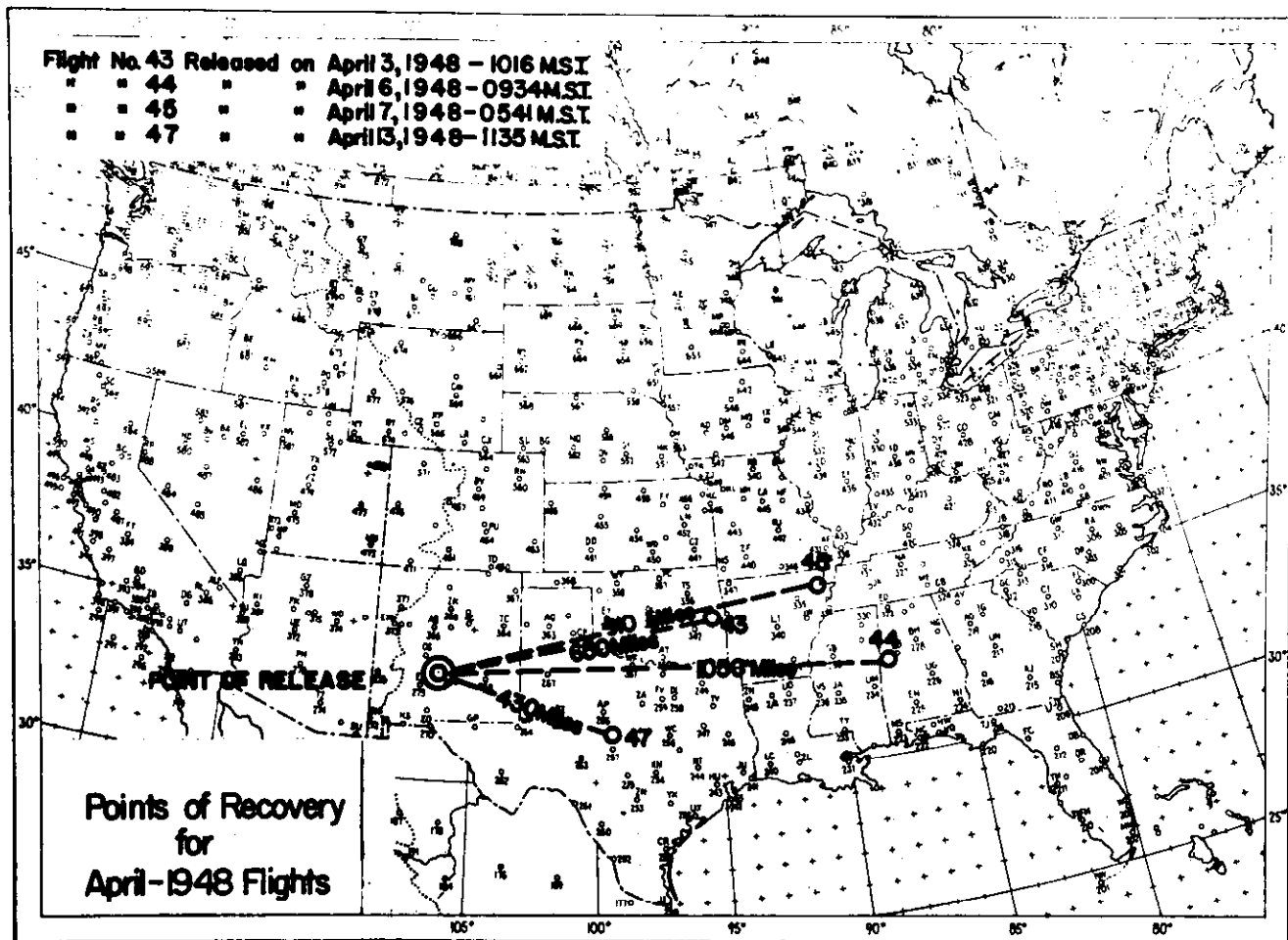

Figure 15

Little is known positively about the floating levels since radiosonde data was not obtained on most flights, and no barographs were available. Three receiving stations at Alamogordo, Roswell and Carlsbad, New Mexico were used to position the balloon with radio direction-finding equipment. By assuming a floating level corresponding to the load, several flight patterns were derived. No aircraft tracking was provided to check these computed trajectories.

On these flights fixed ballast leaks of from 250 to 600 grams per hour were used. These leaks were provided through round orifices rather than through needle valves which had been in use previously. This improvement reduced the possibility of clogging.

On Flight 43 the first model of an Olland-cycle pressure modulator was flown with a modified T-69 (400 mc) radiosonde transmitter. The results obtained on this flight were not satisfactory, but later test proved successful.

The train seen in Figure 16 is typical of those flown during this period. Note the presence of the device to rip the balloon when descending into air lanes and thus speed up its fall.

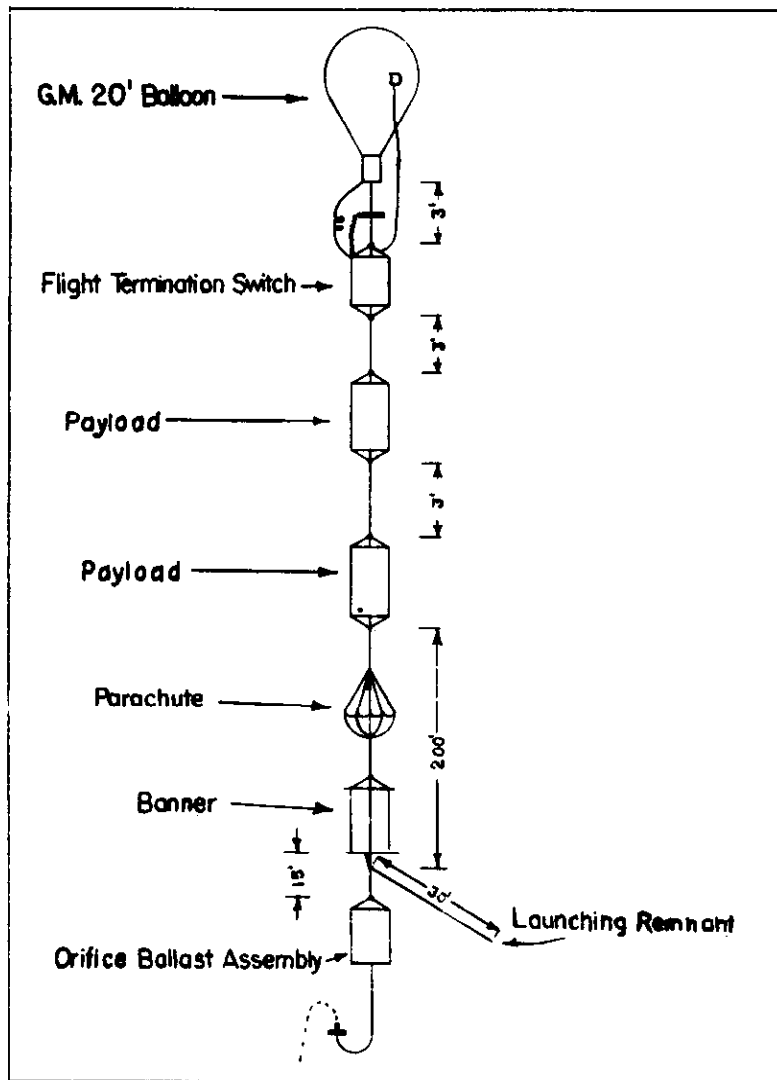

Flight 16: Train, typical of those flown in April, 1948

Flight 52: Released from Alamogordo, New Mexico, 0958 MST, April 23, 1948  
Recovered at Galseburg, Kansas

On this flight a .001" polyethylene balloon carried the first model of the Lange Barograph and an improved Olland-cycle pressure modulator to give improved radiosonde pressure data. The signal from the radiosonde was lost soon after the release, but the barograph was recovered and the altitude record is shown in Figure 17. It will be seen that the balloon rose to a

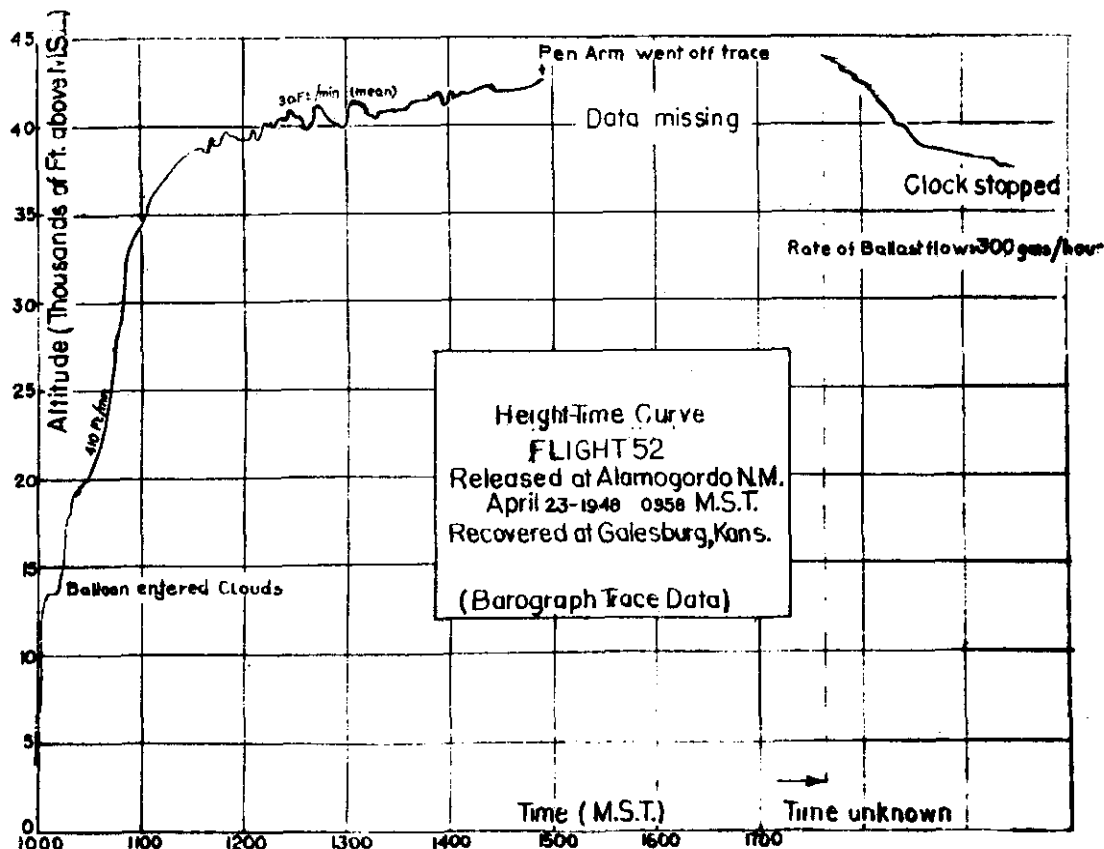

Figure 17

pressure such that the barograph pen passed off the chart, and several hours of flight were not recorded. The slowly rising ceiling seen here was the first long-period confirmation of the expected behavior of a balloon controlled by a constant ballast loss. The flow in this case was set for about 250 grams per hour, and the altitude change was about 400 feet per hour. This rise of "ceiling" is somewhat larger than predicted and heightened the interest in obtaining temperature measurements so that the buoyancy behavior could be more exactly determined.

Three other points of interest may be seen on this barotrace: (1) The two very pronounced step effects found on the rising portion of the flight at about 625 mb and 480 mb correspond to stable layers in the atmosphere as seen from the El Paso radiosonde sounding taken at 0800 MST (Figure 18).

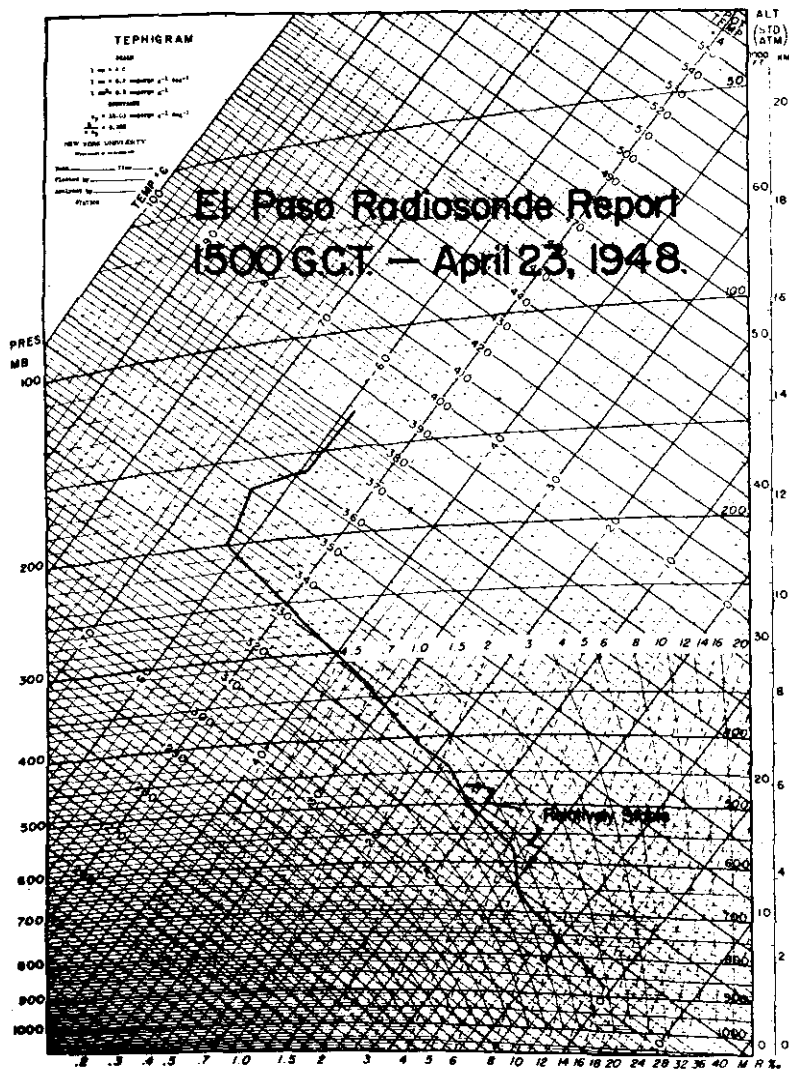

Figure 18

(2) The clock of the barograph stopped after being exposed about 10 hours at cold temperature. (3) During the floating period many small oscillations are seen on the pressure record. Neglecting superheat changes, there is no variation in the forces of the balloon system except the constantly decreasing weight of ballast and the monotonic loss of lifting gas, and these oscillations must, therefore, be attributed to some force in the atmosphere.

Flights 54, 56 and 60: On these three flights, made in April and May, 1948, fixed-leak ballast losses were used to keep a .001" polyethylene balloon aloft, but no barograph record of pressure is available. From the descent points (Figure 19) and the radiosonde data which was received it is believed that the ballast flows of about 300 grams per hour were adequate.

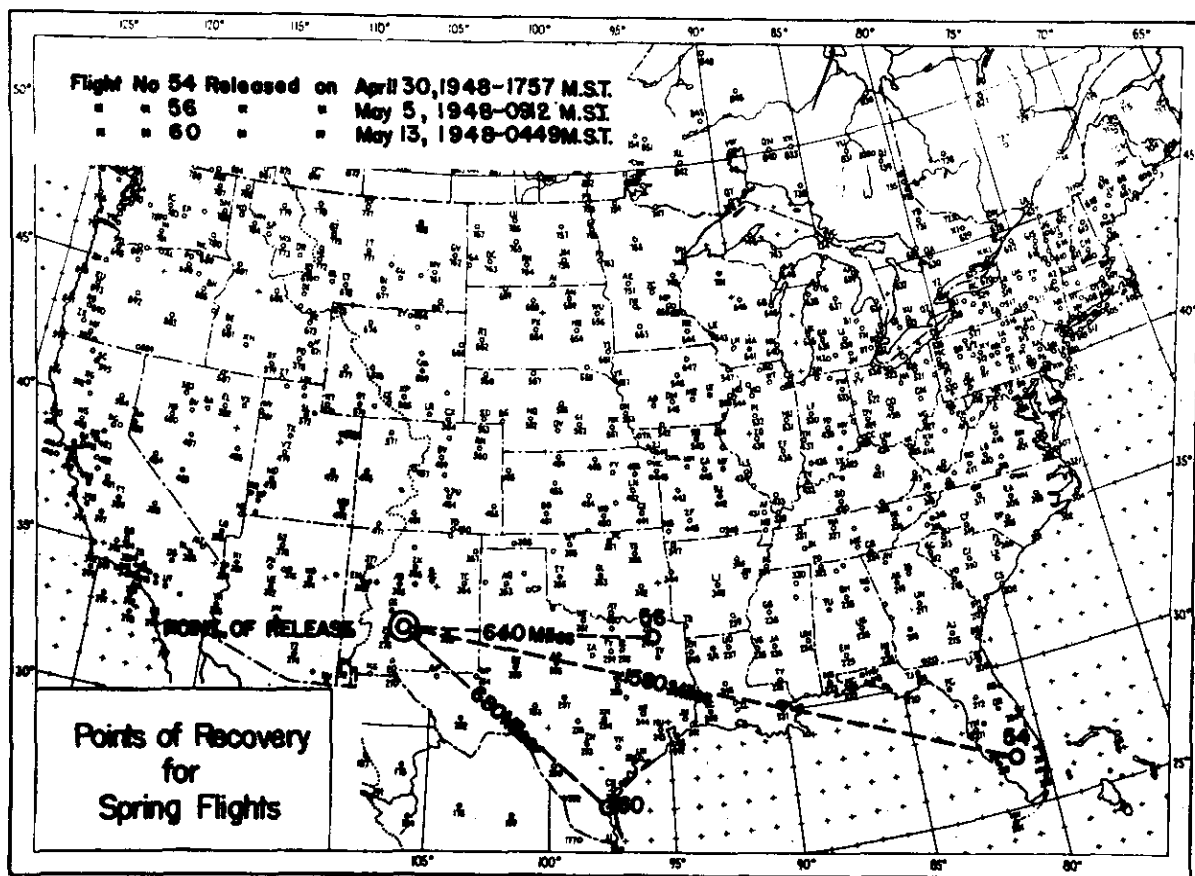

Figure 19

On both Flights 56 and 60 a very light load was lifted, and the floating level in each case was over 60,000 feet MSL. Light winds were encountered in both cases, and a reversal from Westerlies to Easterlies was experienced

near the floating level on Flight 60. With a relatively slight change in elevation, the balloon passed from Westerlies (below) to Easterlies (above) with the result that the balloon was still visible from the launching site (Alamogordo, New Mexico) at sunset,  $14\frac{1}{2}$  hours after released. The finder reported seeing the balloon descend 35 hours after release.

Since the ballast flowing to maintain buoyancy would have been exhausted in only 5 hours, this flight provided the first evidence that such a balloon in the stratosphere maintains buoyancy much longer than at lower levels. The two factors which contribute to this are the heat added to the helium by adiabatic compression when descending and the diminished diffusion of lifting gas at a low pressure.

On Flights 56 and 60, a three-station network was set up to receive pressure signals on radio direction-finding (SCR-658) equipment. In addition, theodolites were used for several hours in each case.

Flight 55: Released from Alamogordo, New Mexico, 1907 MST, May 3, 1948  
Recovered at Northeast, Pennsylvania

On this flight a barograph was flown, and a satisfactory Olland-cycle pressure modulator was also used for over 5 hours to give height data. The length of time of signalreception is significant, since the battery box of the transmitter was not insulated, and there was no heat to be gained from the sun during this nighttime flight. The .001" polyethylene balloon was observed descending 22 hours later after traveling more than 1500 miles.

The altitude control used on this flight was an automatic ballast valve, activated by a minimum-pressure switch, and as evidenced by the barogram in Figure 20 (12-hour rotation), the balloon maintained its altitude for over

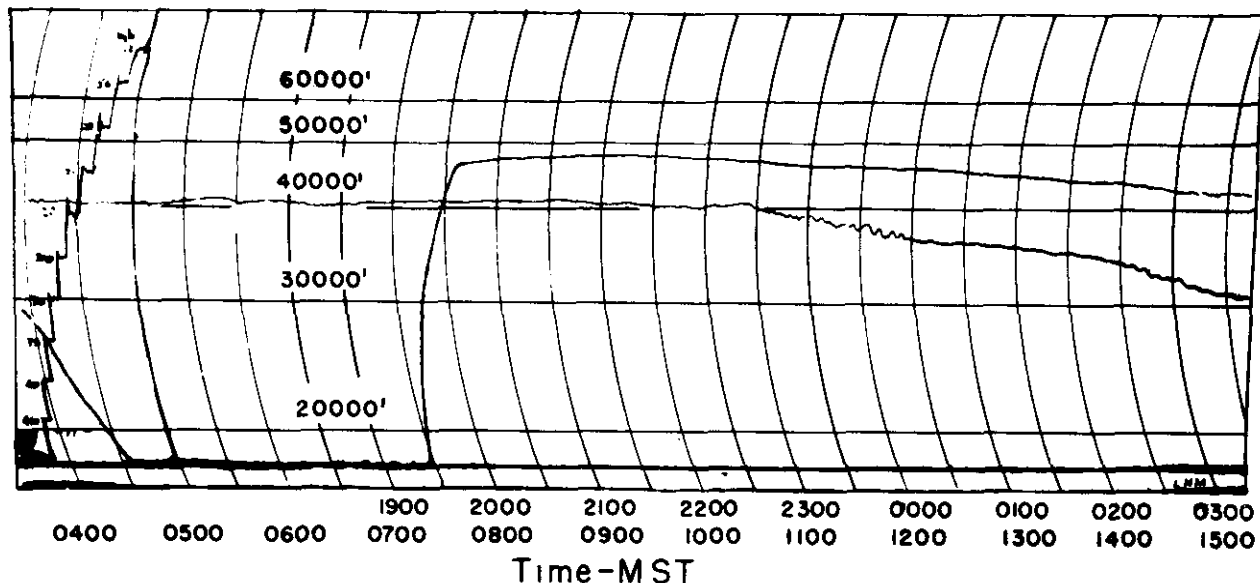

NYU BALLOON PROJECT FLIGHT 55  
Barograph Record Of G.M. 20 Ft. Balloon With  
Automatic Ballast Valve  
RELEASED AT ALAMOGORDO, N.M., 1907 MST- 3 MAY, 1948  
RECOVERED AT NORTHEAST, PA., 4 MAY, 1948  
DURATION 23 HOURS

Figure 20

15 hours before beginning its accelerating descent. On this flight record, marked oscillations are observed at three points. Despite the presence of automatic ballast controls which might cause oscillatory motion, these rises and falls must be attributed to atmospheric disturbances since the magnitude of the forces required to produce such accelerations is far greater than any which could be supplied by the control equipment.



A check against the trajectory and end point of the balloon flight was made by a group of graduate students of meteorology at New York University. By constructing constant-pressure maps from the appropriate radiosonde data, the expected trajectory was computed assuming the balloon would move with the geostrophic wind. The results of this comparison (Figure 21) show that the balloon tends to move across the isobars toward lower pressure.

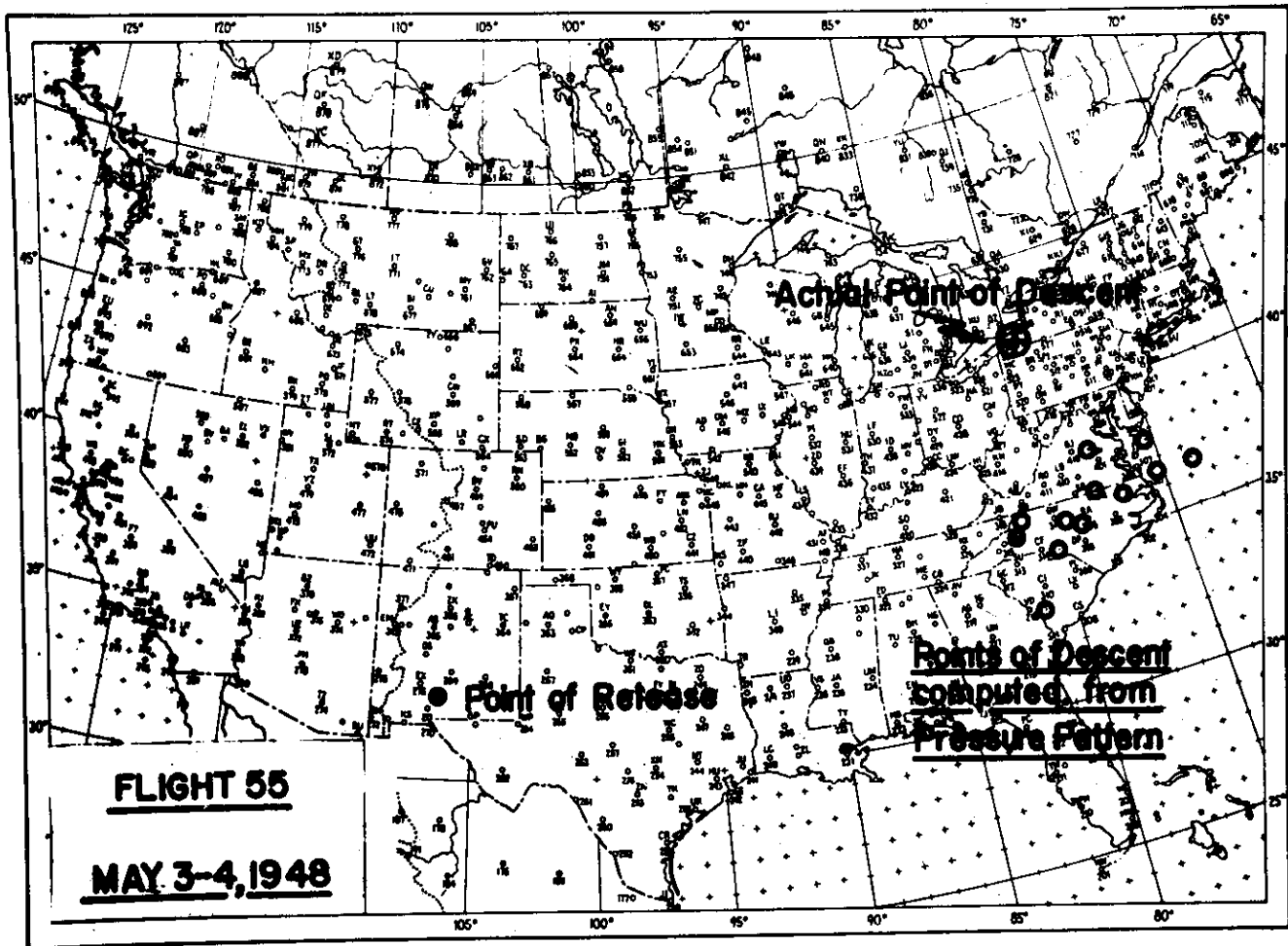
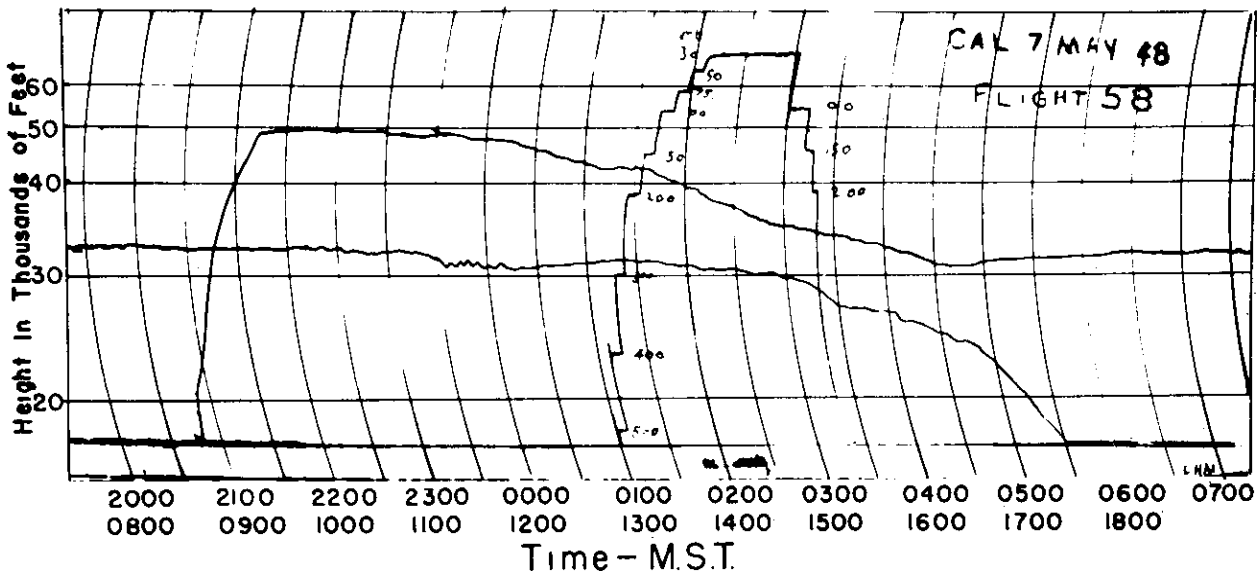

Figure 21

Flight 58: Released from Alamogordo, New Mexico, 2033 MST, May 10, 1948  
Recovered at Val D'Or, Quebec

A .001" polyethylene balloon was the vehicle on this flight carrying a barograph as well as an early model of the Olland-cycle pressure modulator. This flight was released at night with a fixed ballast flow of about 300 grams per hour expected to keep the balloon afloat. From the barogram (Figure 22) (12-hour rotation) it appears that the orifice did not permit sufficient (if any) flow to maintain buoyancy during the first several hours (perhaps the orifice was clogged or frozen). After a descent to about 33,000 feet at sunrise a floating level was maintained with 4 kilograms of ballast available. The full flow rate could not have been maintained much more than the 11 hours during which the balloon was at this pressure.



NYU BALLOON PROJECT FLIGHT 58  
Barograph Record Of G.M. 20 ft. Plastic Balloon With  
300 gm/hr Fixed Ballast Leak  
RELEASED AT ALAMOGORDO, N.M. - 2033 MST, 10 MAY, 1948  
RECOVERED AT VAL D'OR, QUEBEC, CANADA - 24 MAY, 1948  
ESTIMATED DURATION - 24 1/2 hrs.

Figure 22

On this flight, oscillations in the pressure record were seen. With no control system which could cause such behavior, they must be attributed to atmospheric motion.

The descent point was compared with that expected from analyses of the pressure field. The results of a number of such analyses are shown in

Figure 23. As on Flight 55, the balloon appears to have moved across the isobars, toward lower pressure.

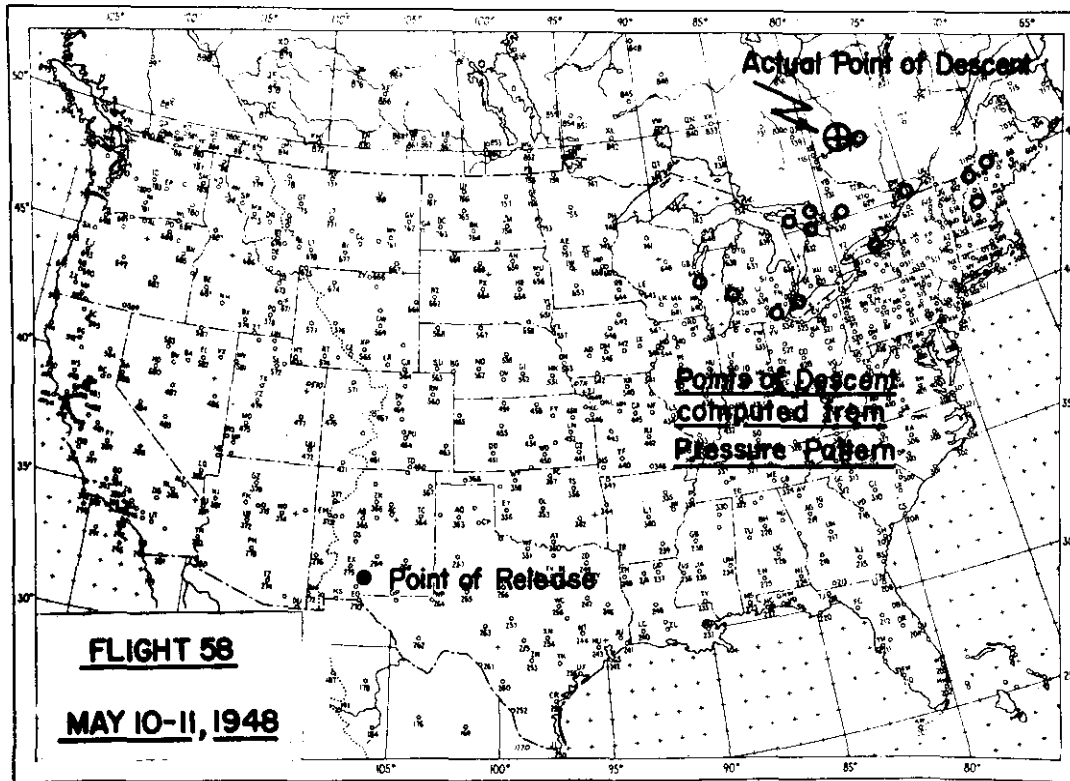

Figure 23

Radio direction-finding tracking (SCR-658) was used during the first 367 minutes of this flight. This was made possible by a strong output from the battery, indicating that no harmful effects were experienced in the cold atmosphere despite the absence of solar radiation. The need for measurements of the temperature of the batteries was suggested by this flight.

Flight 63: Released from Alamogordo, New Mexico, 1116 MST, May 13, 1948  
Descended at Alamogordo, New Mexico

On this flight a Seyfang Laboratories balloon, made of neoprene-coated nylon, was flown with a valve in the appendix set to open after an internal pressure of 0.02 psi was built up. On an earlier flight (59) such a balloon was flown with no valve but an appendix held closed with a rubber band; it ruptured upon becoming full.

Both a constant ballast-flow orifice and an automatic ballast control were used to keep this balloon buoyant. In addition to the ballast, a surplus of buoyancy might have been acquired when superpressure was built up inside the cell. Despite these controls, the balloon began to descend after a short period of floating, and its descent was not checked (Figure 24).

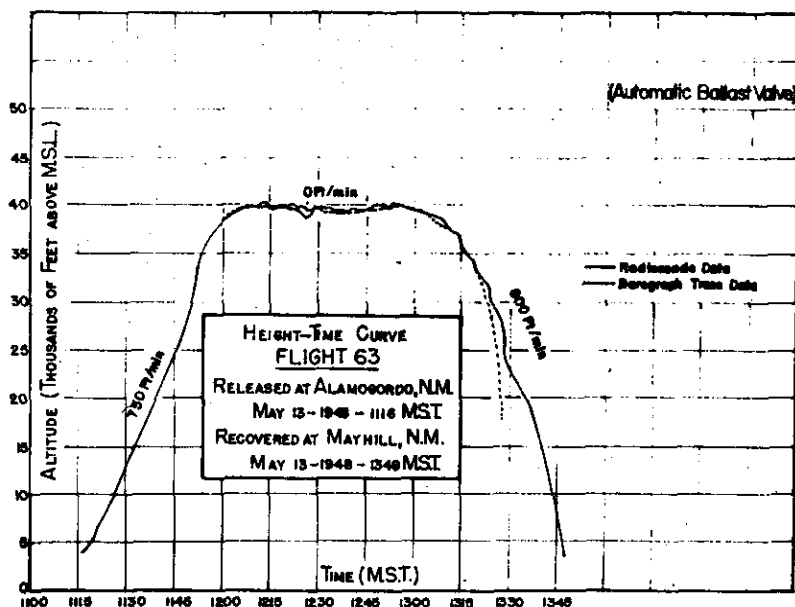
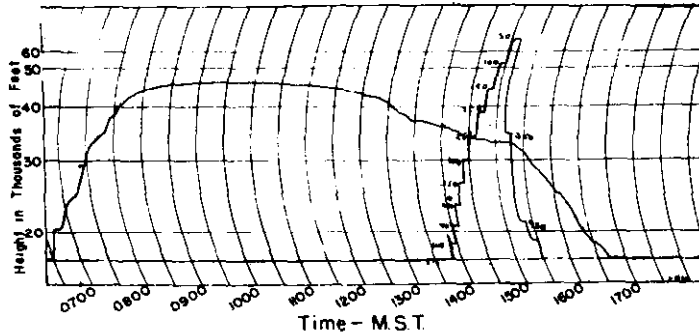

Figure 24

An analysis of the acceleration which could be gained from a loss of superheat indicated that if the coated fabric had absorbed radiation and gained  $50^{\circ}\text{C}$  over the outside air, the superheat thus obtained would be so great that its subsequent rapid loss (as by ventilation) could not be compensated for even with the ballast flowing at full rate. To improve the analysis of balloon flights, a measure of the temperature difference between lifting gas and air temperature was suggested.

Flights 68 through 72: In July, 1948 this series of flights was made without ballast controls to determine the natural buoyancy of the General Mills, Inc. 20-foot .001" polyethylene balloons. Of five such flights, only two good barograph records were obtained, one daytime flight (70) and one night flight (71). In both cases a nearly constant level was maintained for about four hours at the highest altitude reached.

On the barogram of Flight 70 (Figure 25) a section of arrested descent may be noticed, preceded and followed by a nearly constant fall. The cause of this step is not apparent, although a check has been made of the atmospheric structure of that day.



NYU BALLOON PROJECT FLIGHT 70  
Showing 20' General Mills Balloon  
Performance When No Ballast Was  
Dropped

RELEASED AT HOLLOWAN AFB, N.M. - JULY 8, 1948  
0833 MST - RECOVERED AT KENT, TEXAS

Figure 25

On Flight 71 marked oscillations are seen at the floating level and also during the descent portion of the barogram (Figure 26). Clearly these must represent atmospheric motions since no controls of any sort were in use. There is no reason to believe that rapid changes in superheat occurred, since the floating level was far above the cloud level. Also the flight was made at night and no sunshine was encountered.

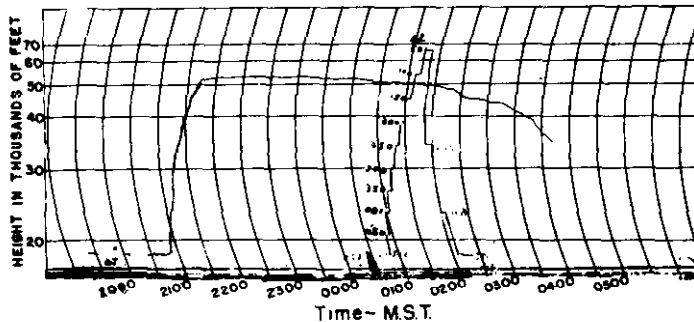

NYU BALLOON PROJECT FLIGHT 71  
Barograph Record Of GM 20 Ft. Plastic Balloon Showing  
Balloon Performance When No Ballast Was Dropped.

RELEASED AT ALAMOGORDO N.M., 2042 MST - 9 JULY, 1948  
RECOVERED AT VALENTINE TEXAS, 10 JULY, 1948  
ESTIMATED DURATION 10 HOURS

Figure 26

Flight 73: Released from Alamogordo, New Mexico, 1948 MST, July 14, 1948  
Recovered at Lincoln National Forest, New Mexico

The objective of this nighttime flight was to determine whether a fixed ballast leak of 100 grams per hour would sustain a 20-foot, .001" polyethylene balloon at floating levels near 50,000 feet. From the Olland-cycle pressure record (Figure 27) it appears that loss of buoyancy due to

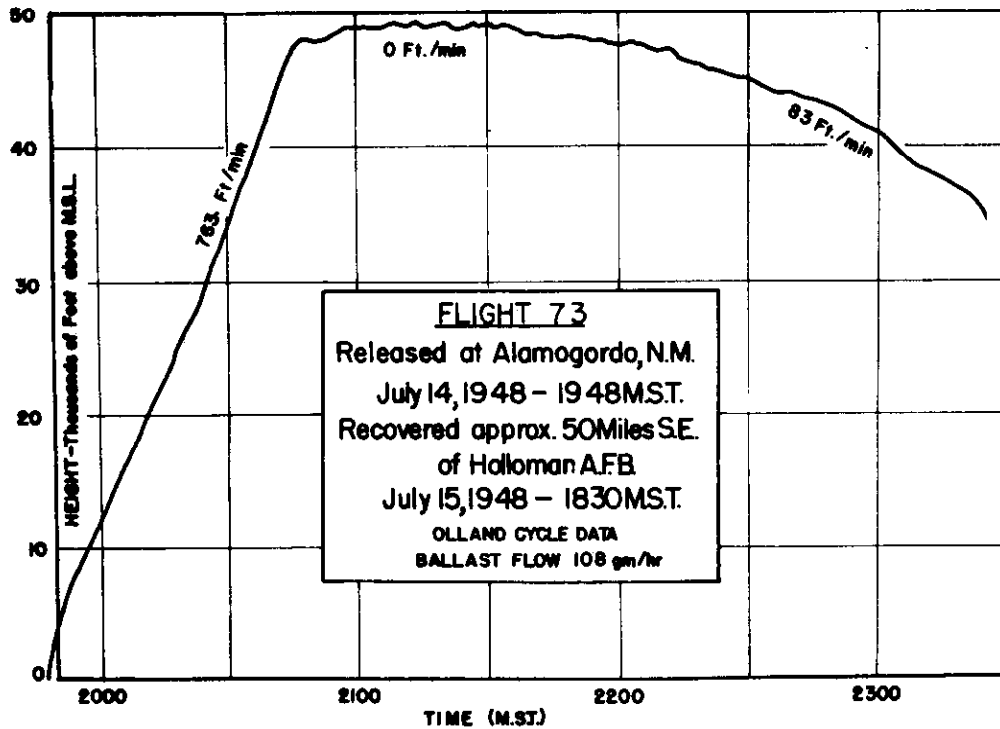

Figure 27

diffusion and leakage is more than this. Indeed, the balloon with this ballast flow did not remain at altitude as long as either Flight 70 and 71 which were without altitude controls.

Flight 74: Released from Alamogordo, New Mexico, 1040 MST, July 19, 1948  
Not recovered

This was a test of a single 7-foot balloon made of .001" polyethylene, carrying a 4-kilogram payload. One part of the load was the first model of an automatic ballast siphon used to detect and telemeter the amount of ballast being discharged through an automatic ballast valve.

The balloon flew at 7000 feet MSL across a heated desert area and into a mountain pass whose elevation was about 6000 feet MSL. During the first two hours its behavior was reported by radio, and the accompanying time-height curve (Figure 28) shows how the ballast valve operated successfully

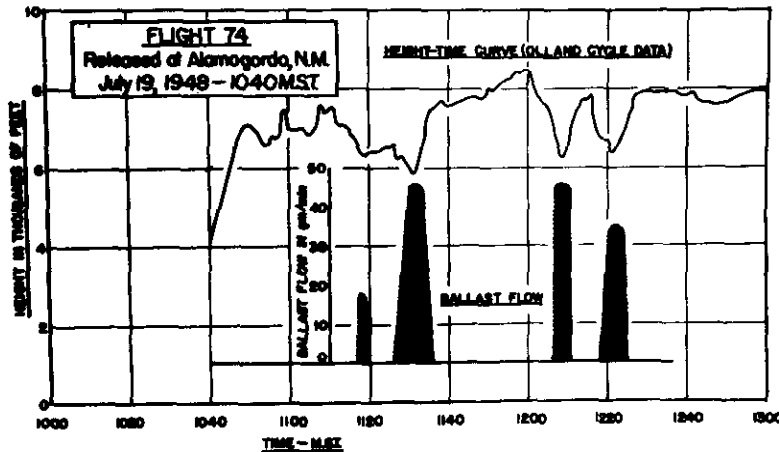

Figure 28

to sustain the balloon. During this turbulent flight about 200 grams of ballast were expended per hour, but the pronounced orographic and convective currents probably necessitated more control than would be required in a more stable atmosphere.

The very useful information about ballast flow was reported clearly, and the principle of the auto-siphon was used repeatedly on later flights. Small variations are seen in the pressure at which the ballast flow began. Since the balloon was floating below the base of clouds, this represents the changes of activation pressure which resulted from changes of superheat of the air entrapped in the aneroid.

Flight 75: Released from Alamogordo, New Mexico, 1010 MST, July 20, 1948  
Recovered at Hollister, California

In order to reach higher altitudes than was possible when 20-foot plastic balloons were used, a 70-foot, .001" polyethylene cell was flown on Flight 75. To determine the duration of buoyancy of this type of balloon no controls were used. Despite this, the balloon remained aloft for more than 60 hours and successfully withstood the loss of superheat occasioned by at least two sunsets. From the height-time curve of this flight (Figure 29) the very marked effect of superheat is apparent.

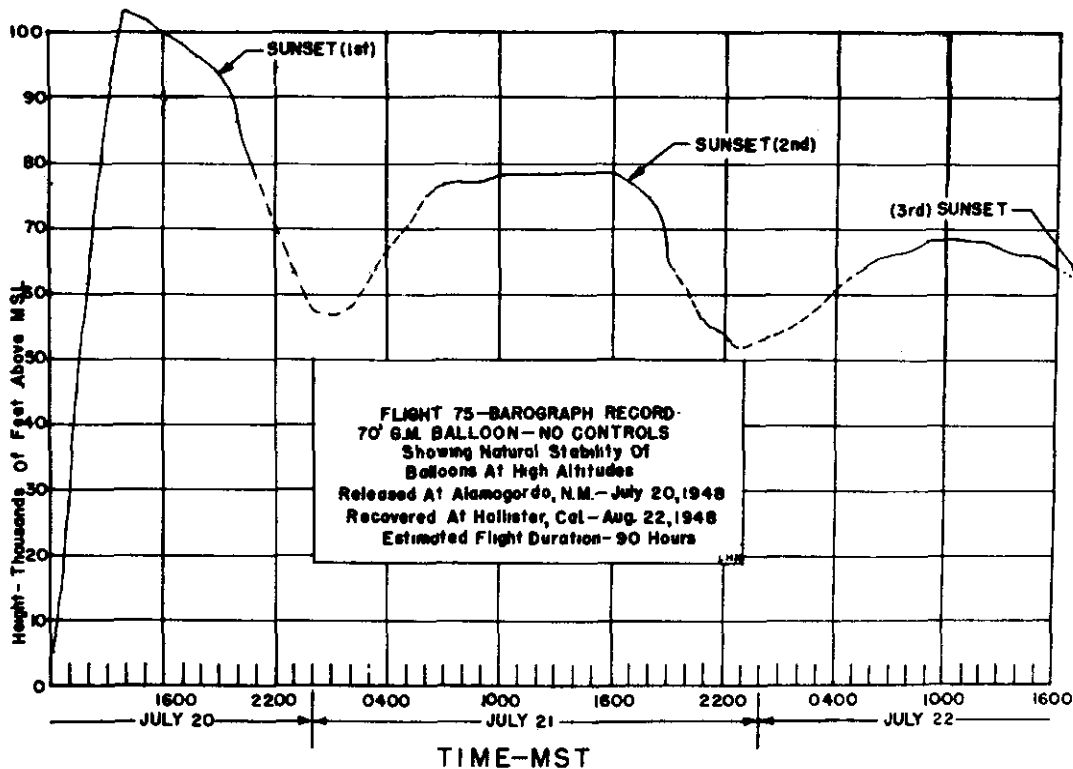

Figure 29

The record of the barograph was not complete since the clock stopped each night (clearly recording the lowest elevation reached, however) and ran down completely after 56 hours.

Since the small external appendix with cardboard stiffeners was not suitable for the large balloon, a new design with aluminum formed stiffeners (Figure 30) was used. This type of appendix closer worked well on later flights, and it is likely that the long duration of this flight may be attributed in part to satisfactory closing off of the aperture. In addition to



maintenance of the purity of the lifting gas, this balloon floated in a region of very low pressure, thus reducing the loss of buoyancy by diffusion.

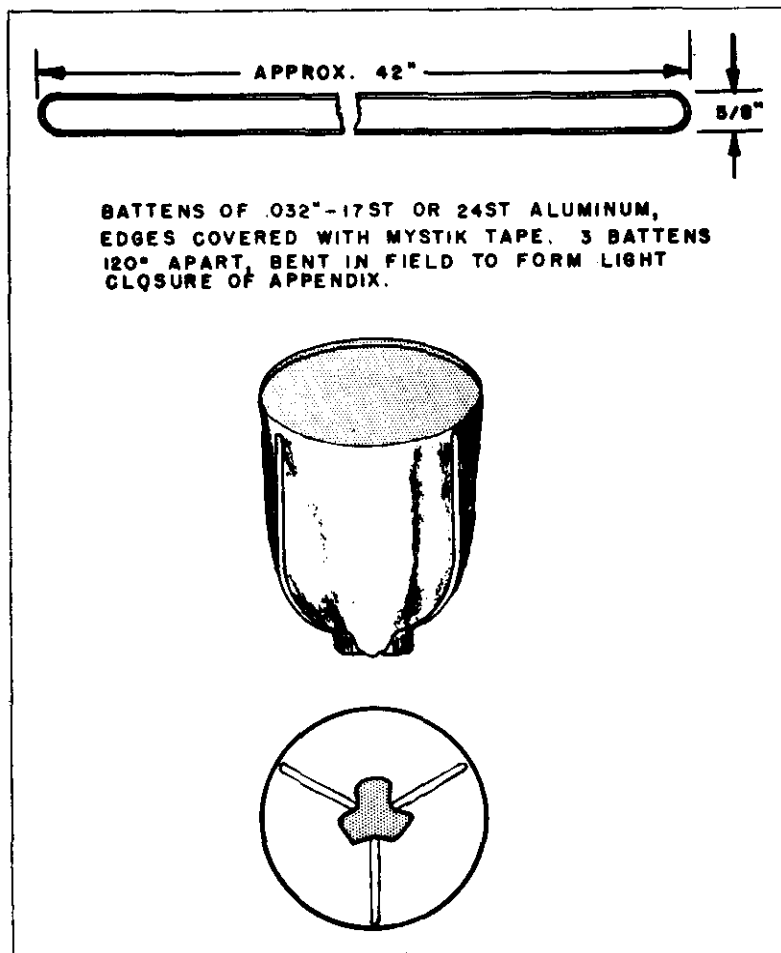

Figure 30: Aluminum battens for balloon appendix

A third factor contributing to the long flight was the heat gained by adiabatic compression of the helium during descent. In the temperature inversion of the stratosphere this adiabatic heating would add to the buoyancy by superheating the lifting gas.

From this flight it becomes apparent that the control required to maintain buoyancy at high levels is much smaller than that at low levels. On the next day, before Flight 75 had ended, a second 70-foot balloon was flown with standard automatic ballast controls, and this flight was never recovered. Presumably the marked easterly flow then observed above 60,000 feet carried this second flight into the Pacific Ocean.

Radar, RDF and theodolite were used to track the balloon.

Flight 78: Released from Alamogordo, New Mexico, 2038 MST, July 22, 1948  
Not recovered

This flight was the first to be made with (white) thermistors exposed inside the .001" polyethylene balloon, inside the battery box and exposed to the air. The flight was at night and the balloon temperature was colder than the air temperature by about 5°C during the short period of time that the temperature values were telemetered. The standard SCR-658 receiver and Friez radiosonde ground station were used to record this data which was transmitted by a T-69 radiosonde. A New York University AM-1 transmitter was used to send out pressure data.

An automatic ballast valve, activated by a mercury minimum-pressure switch, was used to control ballast flow but the cold temperature presumably caused the mercury to freeze and no ballast flow was evidenced. (A ballast-metering siphon was part of the equipment.)

On subsequent flights, the minimum-pressure switch used an electrolyte which can withstand the cold nighttime temperatures of the upper air.

The evidence of the thermistor in the battery box is very encouraging, since after four hours of flight the temperature remained above 10°C. This was the first measurement obtained on the cooling of batteries and indicated that no special cold temperature batteries were needed if insulation is carefully made. The temperature data and the height-time curve of Flight 78 are shown in Figure 31.

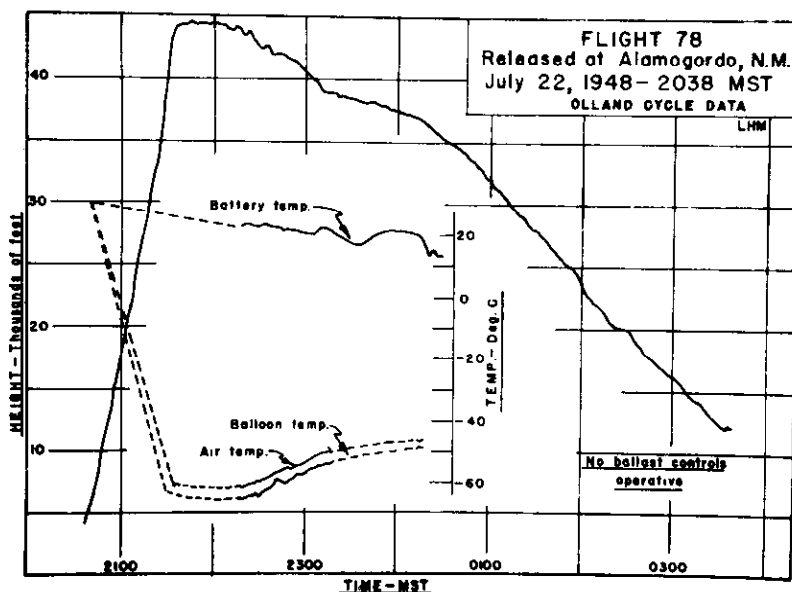

Figure 31

Flight 79: Released from Alamogordo, New Mexico, 1614 MST, July 23, 1948  
Recovered at Alamogordo, New Mexico

This was the third attempt to use a coated nylon balloon, sealed off with a valve in the bottom. From Figure 32, the height-time curve, it may be seen

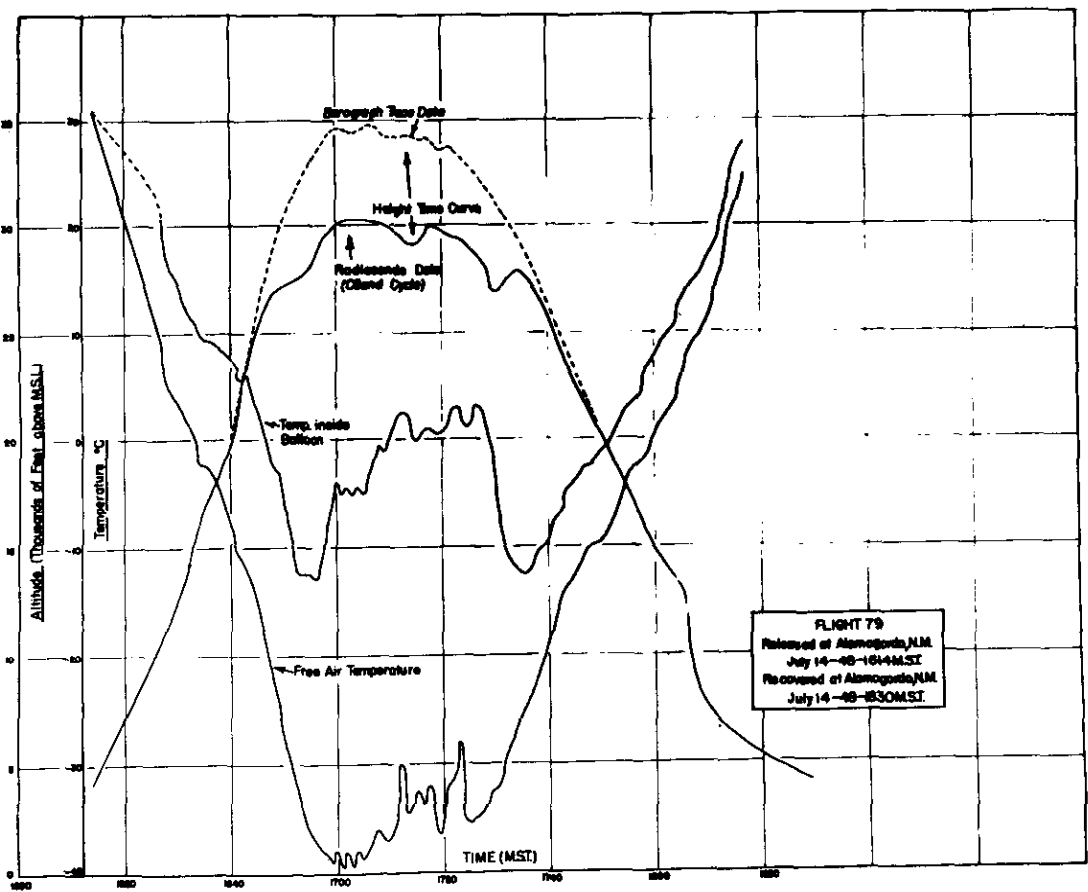

Figure 32

that this balloon did not remain aloft very long but that a high degree of superheat was generated in the lifting gas, despite the aluminum coating of the balloon.

The automatic ballast controls included in the flight equipment were inoperative, and as soon as the balloon lost its initial excess buoyancy (corresponding to the super-pressure maintained behind the safety valve) it descended. From the speed of the descent it was computed that an accelerating force equal to 5% of the gross load (52 kg) was acting to bring the balloon down. This force was in turn derived from the loss of lift encountered when over 300C of superheat was lost by ventilation.

Flight 80: Released at Alamogordo, New Mexico, 1126 MST, July 24, 1948  
Recovered at Rincon, New Mexico

On this flight an automatic ballast valve activated by a minimum-pressure switch was used to support a .001", 20-foot polyethylene balloon. From the height-time curve (Figure 33) it may be seen that the balloon remained at its maximum height for two hours, then began to descend slowly. A ballast meter was in use, and no ballast flow was recorded until the balloon descended to about 30,000 feet. It is likely that the mercury minimum-pressure switch was frozen at the higher levels, or that the squib which the switch controlled failed to detonate until a higher pressure was reached.

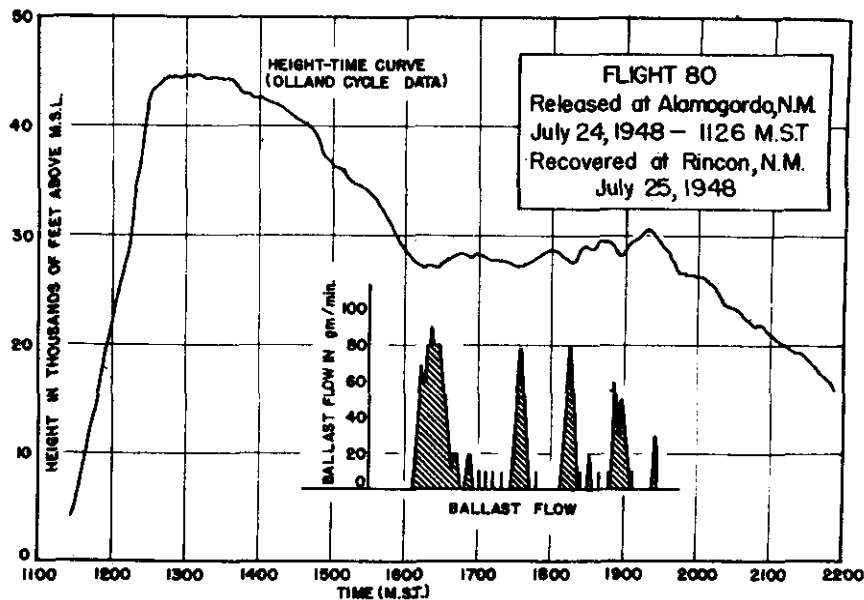

Figure 33

Following the activation of the aneroid capsule of the automatic ballast valve, ballast was released in four separate blocks. With each flow of ballast except the fourth, the balloon was returned to the seal-off pressure of the aneroid with no change in this pressure (321 mb=28,500 feet). The fourth ballast-flow period lasted until the balloon had risen to 300 mb (30,000 feet) and ballast cut off there. Since the sun had set between the third and

fourth ballast-flow periods, this rise in "ceiling" is attributed to the cooling of the air entrapped in the aneroid of the automatic ballast valve. This decrease of pressure of 21 mb corresponds to a loss of 8°C of superheat. In each of the four periods of ballast flow, there was enough unnecessary ballast lost to cause an overshoot when the balloon returned to its floating level. This excess ballast was that used during the period when the balloon had begun to rise but was still below activation altitude of the automatic ballast valve. The inefficient use of ballast was one of the major objections to such a control system.

On this flight the ballast load of 3 kilograms was exhausted in only three hours, indicating a large loss of gas from this particular balloon. It is believed that the large initial acceleration provided by the rapid descent of the balloon caused the restoring force, and the subsequent overshoot, to be very large, and the high ballast flow is probably much greater than was the loss of buoyancy on this flight.

Flight 81: Released from Alamogordo, New Mexico, 0548 MST, August 6, 1948  
Not recovered

The balloon flown on this flight was made of .004" polyethylene, and it was eggplant shape about 20 feet in diameter and 25 feet long. The first of its kind, this balloon was made by Goodyear Tire & Rubber Company, Inc.

Only a short period of radio reception was obtained, but during this time the balloon rose with predicted speed (500 feet per minute) nearly to its predicted altitude (40,000 feet) and floated within 1500 feet of the 37,000-foot level. Figure 34 is the height-time curve for this flight.

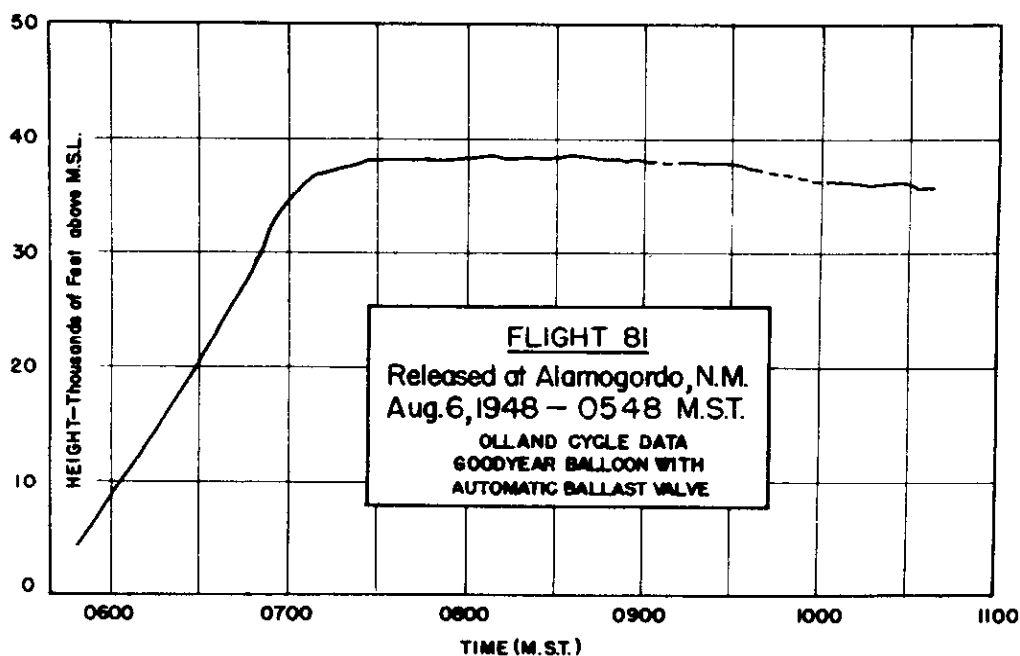
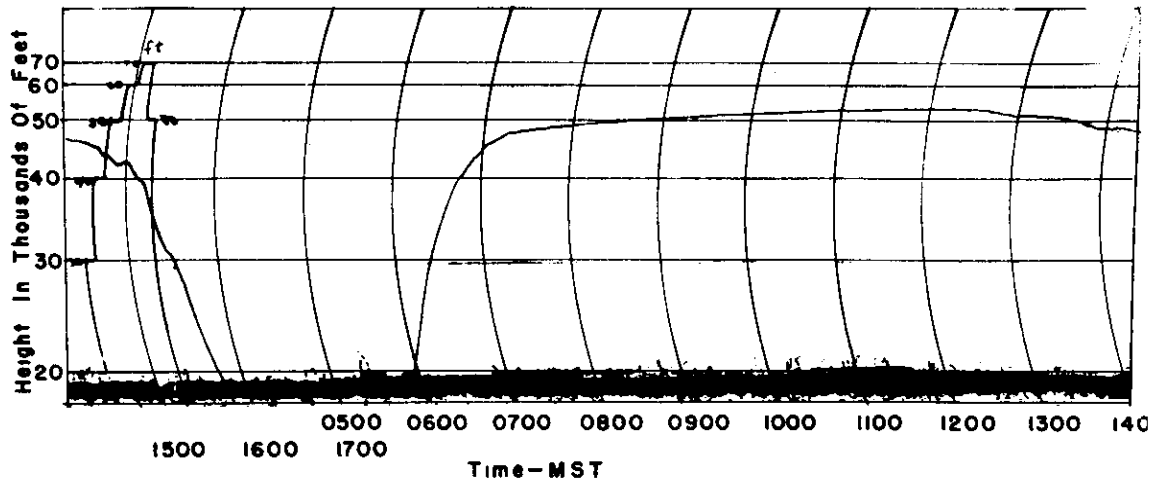

Figure 34

Since the balloon did not descend far enough below its maximum altitude to activate the minimum-pressure switch and the automatic ballast valve, no ballast flow data was telemetered while the balloon was within the radio range. This indicates a very low rate of gas loss through the walls of this balloon.

Flight 82: Released from Alamogordo, New Mexico, 0515 MST, August 10, 1948  
Recovered at Roswell, New Mexico

This flight was made with a 20-foot, .001" polyethylene balloon carrying a load to 54,000 feet and sustained by a fixed-leak orifice control, expending ballast at about 525 grams per hour. With 4500 grams of ballast aboard the balloon should have been increasingly buoyant for  $8\frac{1}{2}$  hours after release. From the barogram (Figure 35) it may be seen that the "ceiling" did rise, at



NYU BALLOON PROJECT FLIGHT 82  
Barograph Record Of G.M. 20' Plastic Balloon With  
534 gm/hr Fixed Ballast Leak

RELEASED AT ALAMOGORDO, N.M. - 0511 MST, 10 AUG 1948  
DESCENDED AT ROSWELL, N.M. - 1630 MST, 10 AUG 1948

DURATION -  $11\frac{1}{2}$  hrs

Figure 35

a rate of 700 feet per hour (525 grams of ballast was lost each hour), for about  $7\frac{1}{2}$  hours, and then generally accelerating descent was experienced.

On this flight, radio reception was maintained for the entire air-borne period of 11 hours. Flight 82 is a good example of flight using a single fixed-leak orifice for altitude control by ballast dropping.

Flight 85: Released at Alamogordo, New Mexico, 1542 MST, August 17, 1948  
Not recovered

The objective of this flight was to carry a standard radiosonde to a high level; there it was to be released on a parachute and, at the moment of release, the batteries for the transmitter were to be activated. To accomplish this a pressure-triggered switch was rigged on a .001", 20-foot polyethylene balloon. Below the baroswitch a standard T-69 radiosonde was supported with a parachute stuffed into a case also hanging from the parent balloon (Figure 36). Two plugs were set to keep the transmitter circuit

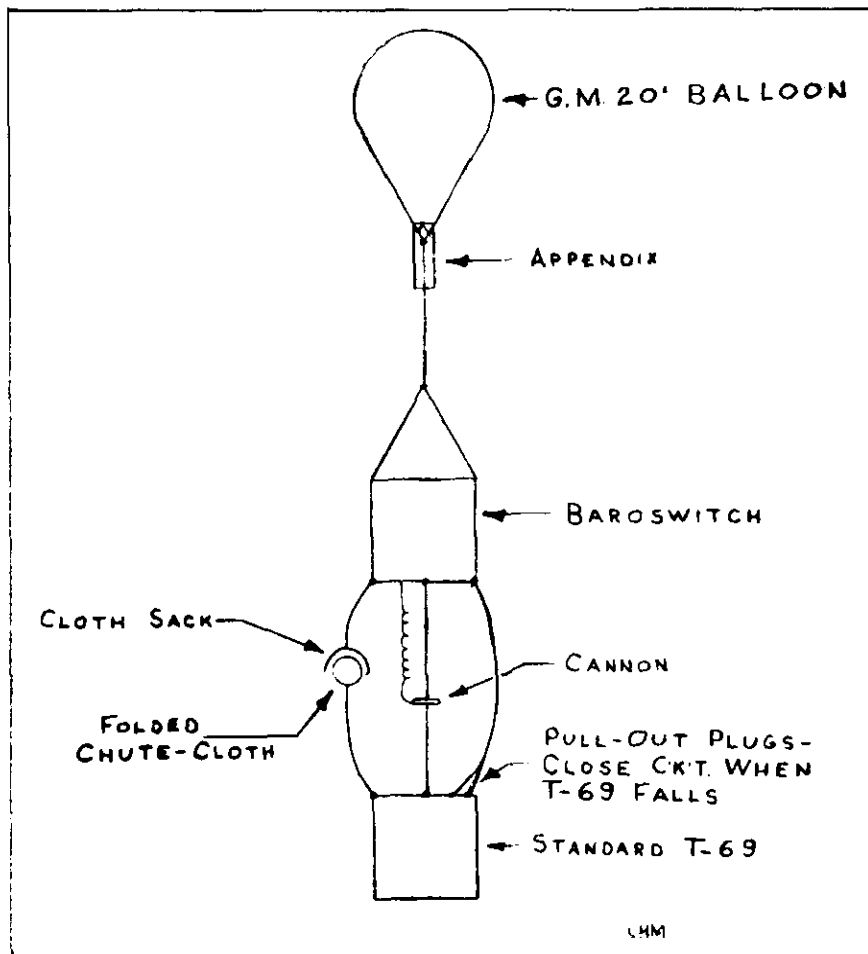

Figure 36: Equipment train, Flight 85

open until the baroswitch fired the "cannon" which severed the supporting line. Then the circuit plugs were to be pulled from their stops, and the parachute was to be pulled from its sock, supporting the radiosonde on its descent.

The failure of this system to act may be attributed to the use of a squib to fire the line-cutter cannon. Subsequent tests at lower levels (where the squibs work better) were made with a satisfactory release and activation of the "dropsonde."



Flight 86: Released from Alamogordo, New Mexico, 0941 MST, August 19, 1948  
Recovered at Valmont, New Mexico

This was the fourth flight made with a single, 7-foot, .001" polyethylene balloon (Figure 37), carrying a light load to relatively low altitudes.

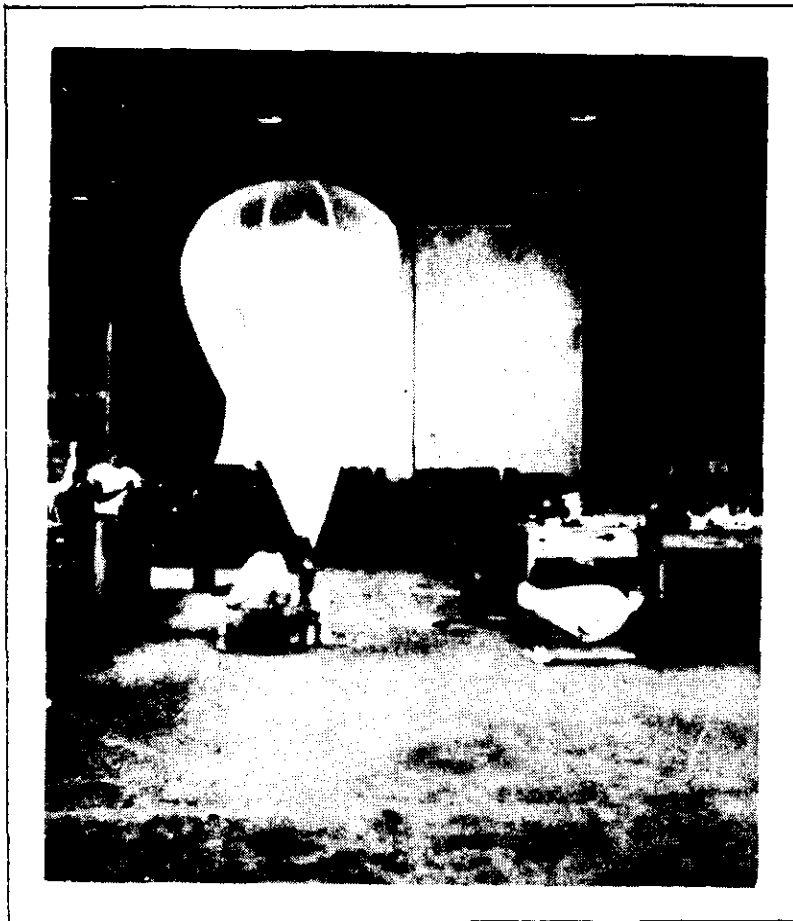

Figure 37: 7-Foot polyethylene balloon

On Flight 74, the automatic ballast meter showed that a ballast flow of 200 grams per hour was required by an automatic ballast valve on such a balloon. Flight 84 was launched in August, 1948 with a low-altitude barograph and no altitude controls to ascertain how long such a balloon would stay up. Using radar and helicopter that balloon was tracked for nearly 2 hours at an altitude of 12,500 feet with a load of 3 kilograms. It was still floating when lost.

On Flight 86, a fixed ballast leak was used, set at 170 grams per hour. After an early failure of the radiosonde transmitter, this balloon was followed with a plane; a floating level of about 14,500 feet was maintained for 4 hours, with a rise of "ceiling" of about 1200 feet per hour.

This balloon was observed during descent and was still distended, indicating that the lifting gas had been replaced by air both before and during descent.

Flight 88: Released from Alamogordo, New Mexico, 1241 MST, August 25, 1948  
Recovered at Lovington, Texas

This flight was planned to measure the diffusion and leakage of lifting gas through a 20-foot, .001" polyethylene balloon at 40,000 feet. A fixed-leak orifice was set to flow at 100 grams per hour, and an automatic ballast valve was included to supply more ballast as demanded. This automatic valve broke on release, and the flow of 100 grams per hour was not sufficient to keep the balloon and equipment up.

Temperature data on this flight was obtained from thermistors inside the balloon, inside the battery and in the free air. These data and the height-time curve are shown in Figure 38. During the period from 1400 to 1530 when

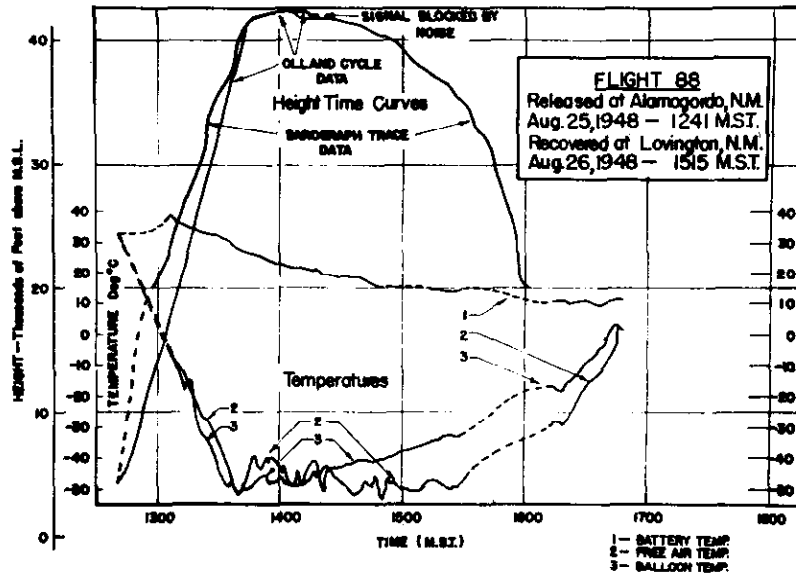

Figure 38

the balloon was slowly descending, the temperature of the gas increased with respect to the free air temperature, and a differential of 15°C was recorded at 1530. With subsequent, more rapid descent, this differential was reduced, presumably by ventilation. The battery box temperature remained above 10°C after four hours aloft.

Flight 89: Released from Alamogordo, New Mexico, 1005 MST, August 26, 1948  
Not recovered

On this flight a .001", 20-foot polyethylene balloon was used to carry a ballast meter to about 45,000 feet to determine the ballast requirements at that altitude, using an automatic ballast valve. No record of ballast flow was telemetered during this flight, but it is not known whether the ballast meter was inoperative or the ballast valve itself failed--possibly due to failure of a squib to detonate at the combined low pressure and cold temperatures aloft.

From the height-time curve, Figure 39, it will be noted that the balloon was in a near floating condition for about five hours after reaching its maximum altitude. The total weight available on this flight was 2 kg, so a loss of 400 grams per hour would have been required if the ballast was used during this period.

From Flights 70 and 71 we know that a balloon has remained for about four hours at slightly higher altitudes with no ballast flow to support it; Flight 89, therefore, is not necessarily an example of the action of the automatic ballast valve control.

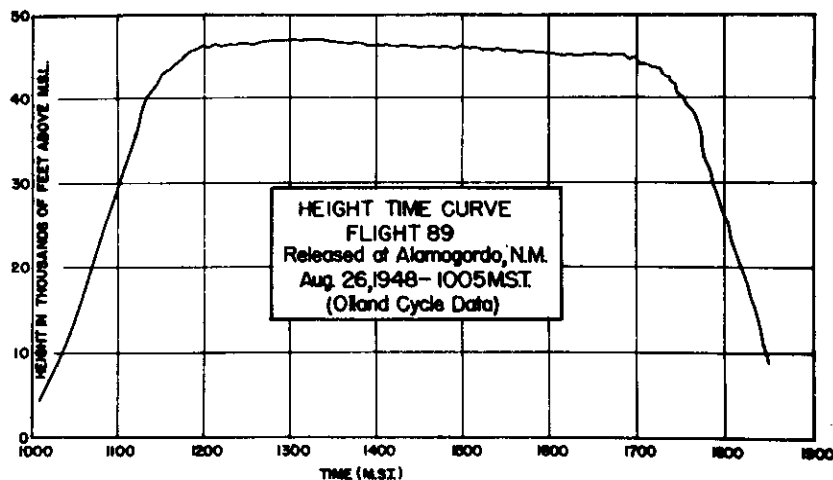

Figure 39

Flight 90: Released from Alamogordo, New Mexico, 1502 MST, August 27, 1948  
Recovered at Roswell, New Mexico

The .001", 20-foot polyethylene balloon used on this flight was released in mid-afternoon to provide a test of the sunset effect on a balloon supported by the automatic ballast valve.

From the height-time curve, Figure 40, it may be seen that the balloon had attained a floating altitude shortly before the sunset and that the action of the automatic ballast valve was sufficient to restore the buoyancy

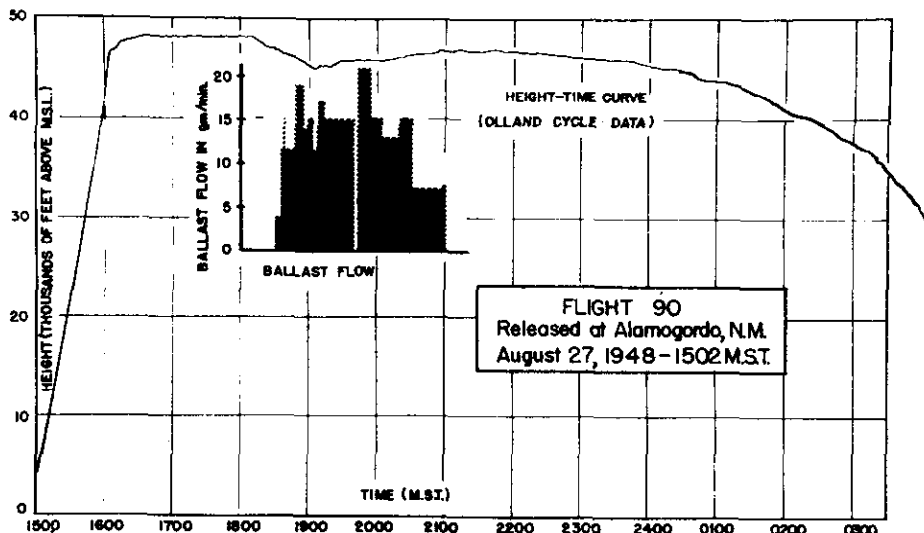

Figure 40

and cause the balloon to again reach a floating condition. The difference between the two floating levels may be explained by a consideration of the automatic ballast valve and the minimum-pressure switch which was used to seal off its aneroid capsule. Since the balloon had not fallen far enough to permit the switch to seal off the valve before sunset, this action was accomplished

during the sunset descent (caused when the superheated helium lost the sun's heating effect). A further descent of 5 mb (500 feet at this level) was required to start the flow of ballast. By this time, the balloon had lost considerable lift and in exchange had acquired a downward velocity of about 120 feet per minute. To check this descent a ballast flow was required for about 40 minutes. During the next hour the balloon was buoyant and climbing back to the seal-off pressure of the automatic ballast valve. The inefficiency of this valve system is demonstrated by the ballast which was lost after the balloon had regained its buoyancy and had begun to rise. More ballast was wasted than was required to check the descent. Indeed, the entire 3000 grams available was expended at this time, according to the evidence of the ballast meter.

On this flight there was no apparent change in the activation pressure of the automatic ballast aneroid between the times when ballast flow began and ended. This indicates that the entrapped air had not experienced any significant temperature change during the two hours of ballast operation.

Flight 92: Released from Alamogordo, New Mexico, 0911 MST, August 31, 1948  
Recovered at Ft. Stockton, Texas

On this flight an automatic ballast valve (with ballast meter) was used to support a 20-foot, .001" polyethylene balloon. The automatic ballast valve operated properly for about six hours, and 3000 grams of ballast was exhausted soon after sunset. In this case (Figure 41) the floating level of the

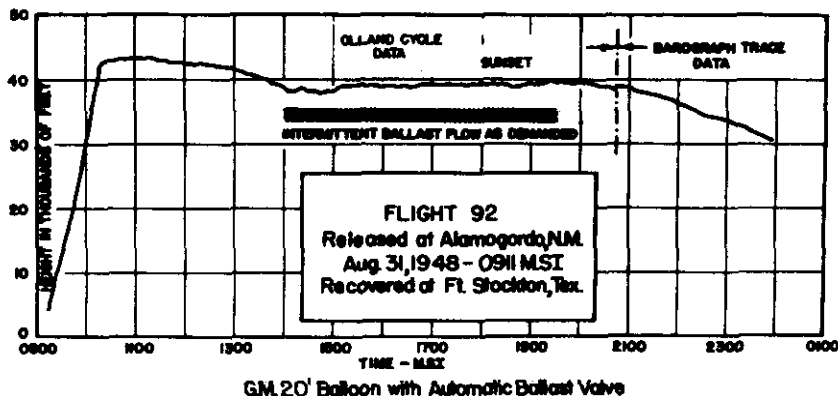

Figure 41

balloon was not seriously affected by sunset as was the case in Flight 90, since the balloon had already descended to the activation level of the automatic ballast valve. This descent followed about three hours of relatively stable flight during which time no ballast was released. The 5000-foot descent represents the delay in operation caused by the activation of the aneroid capsule by a minimum-pressure switch, added to the lag of the aneroid itself. Following the initial activation at about 38,500 feet, small oscillations were introduced into the flight pattern by the action of the automatic ballast valve.

Flight 92 provides a good example of the control of a balloon's altitude by the use of a pressure-set automatic ballast valve. In such a flight there is no tendency to rise to higher and higher levels. The adulteration of the lifting gas with air reduces the buoyancy of the balloon, and through the ballast-valve control, the load is diminished to the same extent so that equilibrium is maintained at the activation pressure of the automatic ballast valve's aneroid. In this flight the altitude constancy achieved was the best of all flights made to date. For seven hours and 35 minutes this balloon was held within 1000 feet at 38,000 feet MSL. (At this altitude 1000 feet corresponds to a pressure difference of 10 millibars.)

The sunset effect resulted in a rise of about 500 feet (5 mb) in the floating level of the balloon at 1830 MST. This seems to be due to a change in the effective seal-off pressure of the aneroid capsule of the automatic ballast valve which was the consequence of a decrease in the temperature of the trapped air inside. The rise in altitude experienced corresponds to a decrease of temperature of about 6°C, the superheat of the aneroid, which was lost at sunset. This valve may be compared with the 30°C found on Flight 10. On the earlier flight a black valve was used while on this flight the equipment was polished aluminum, with a highly reflective surface.

Flight 93: Released from Alamogordo, New Mexico, 0712 MST, September 1, 1948  
Recovered at Nevas Casas Grandes, Chihuahua, Mexico

This daytime flight with a 20-foot, .001" polyethylene balloon went up with defective ballast controls; consequently the flight's main value is in showing the natural stability of such a balloon without any altitude controls. As with Flight 88, which went to about the same height (40,000 feet), this balloon remained at a near-floating level for less than two hours (Figure 42). It is interesting to compare this duration at 40,000 feet with the four-hour duration at 50,000 feet shown on Flight 70 and 71. Probably the effect of reduced pressure on diffusion of the lifting gas is a major factor contributing to the longer floating period at the lower pressure.

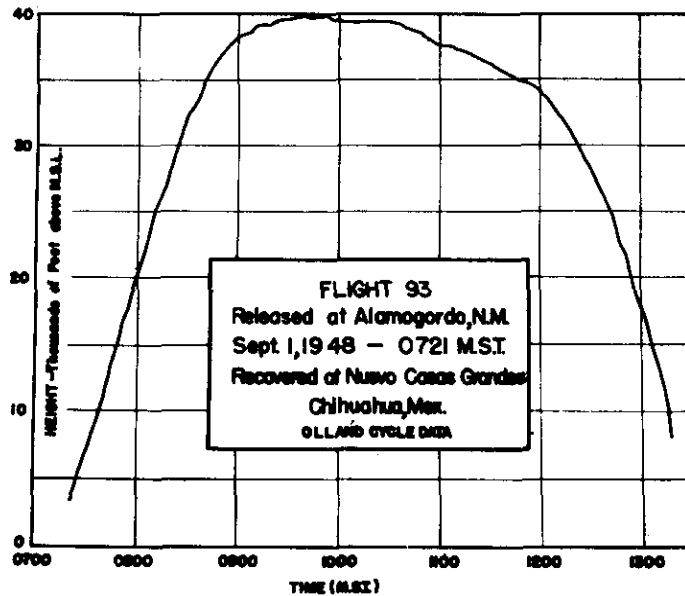

Figure 42



Flight 94: Released from Alamogordo, New Mexico, 1208 MST, September 3, 1948  
Recovered At Villa Ahumada, Chihuahua, Mexico

On this flight, a fourth attempt was made to sustain a Seyfang, neoprene-coated nylon balloon. On Flight 79, a previous Seyfang flight, no ballast equipment had been in operation, and so a careful record of ballast flow on Flight 94 was desired. This was provided by a ballast meter. In addition to this and the barograph and Olland pressure-measuring instruments, a thermograph was also part of the equipment train.

The height-time curve (Figure 43) shows that the initial buoyancy surplus of this balloon (for the most part due to superpressure held behind

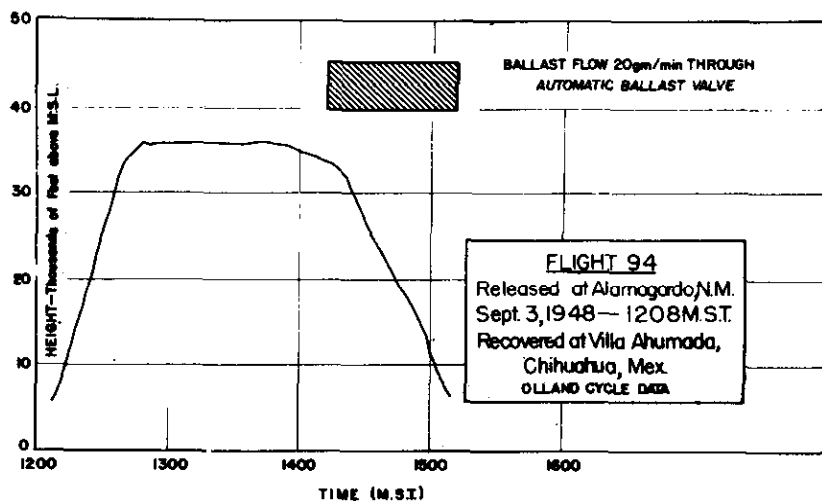

Figure 43

the safety valve) was reduced by diffusion so that after one hour of floating it began to descend at an accelerating rate. After falling about 2000 feet, the automatic ballast valve began to operate, and ballast was discharged at the rate of 20 grams per minute. During the descent, however, the strong superheat which the balloon had acquired was reduced by ventilation.

The adiabatic lapse rate of helium is 2°C per kilometer, whereas air in the troposphere warms up about 6°C with each kilometer of descent. This means that with each kilometer of fall, the lifting gas was cooled relative to the air by an additional 4°C. The combination of inertia, loss of superheat through ventilation, and adiabatic cooling of the gas as it was compressed, proved too great for the limited flow of ballast through the automatic valve, and the balloon fell unchecked to the ground.

From Flight 79, it was determined that superheat of nearly 40°C is built up when Seyfang balloons are flown in the sunshine. If this were lost, the buoyancy of the balloon would be reduced by one-sixth, and no satisfactory control could be achieved by ballast dropping.

Flight 96: Released from Alamogordo, New Mexico, 0733 MST, September 8, 1948  
Not recovered

On Flight 96 a .001", 20-foot polyethylene balloon was used to carry a ballast meter to about 45,000 feet to determine the flow required at that altitude using an automatic ballast valve. No record of ballast flow was telemetered during this flight, but it is not known whether the meter was inoperative, or the valve itself failed--possibly due to failure of a squib to detonate at the combined low pressure and cold temperature aloft.

From the height-time curve, Figure 44, it will be noted that the balloon was in a near-floating condition for about four hours when the transmitter

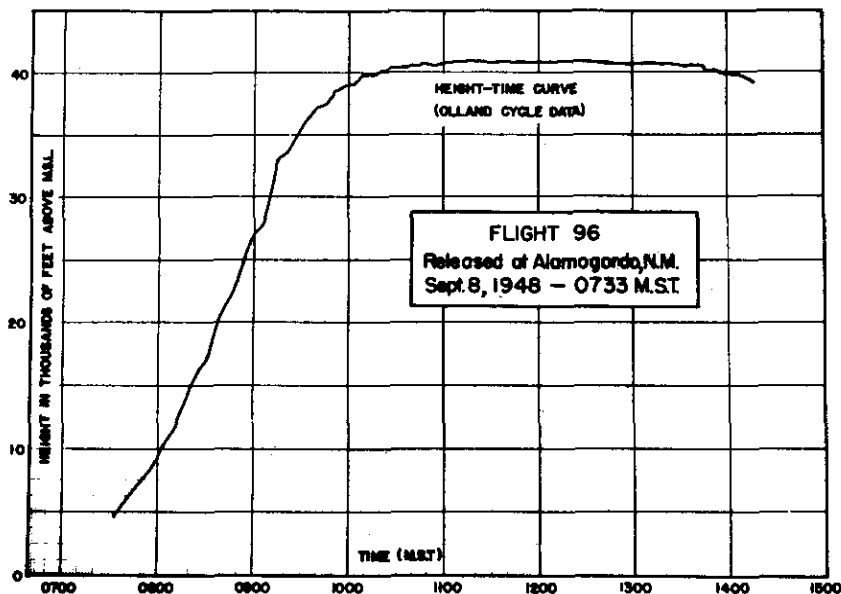

Figure 44

signal gave out. There is no way of telling whether the constant-level flight obtained was due to the natural buoyancy of the balloon or the action of the automatic ballast valve.

Flight 97: Released from Alamogordo, New Mexico, 0856 MST, September 10, 1948  
Recovered at Duncan, Oklahoma

On this flight a .001", 20-foot polyethylene balloon was used to test a new type of ballast control. In this system, ballast flow was excited at any altitude if the balloon descended at a rate equal to or greater than 1 milli-bar in five minutes.

The buoyancy record and the Olland-cycle pressure data obtained from this flight show a disagreement of about 10,000 feet (Figure 45). No explanation has been provided for this difference and the following evidence has been considered. The predicted floating level was about 45,000 feet, in agreement with the Olland-cycle radiosonde data. On the other hand, the balloon rose extremely slowly and may have taken in air to dilute the lifting gas. In this event, the floating level might easily have been reduced by 10,000 feet.

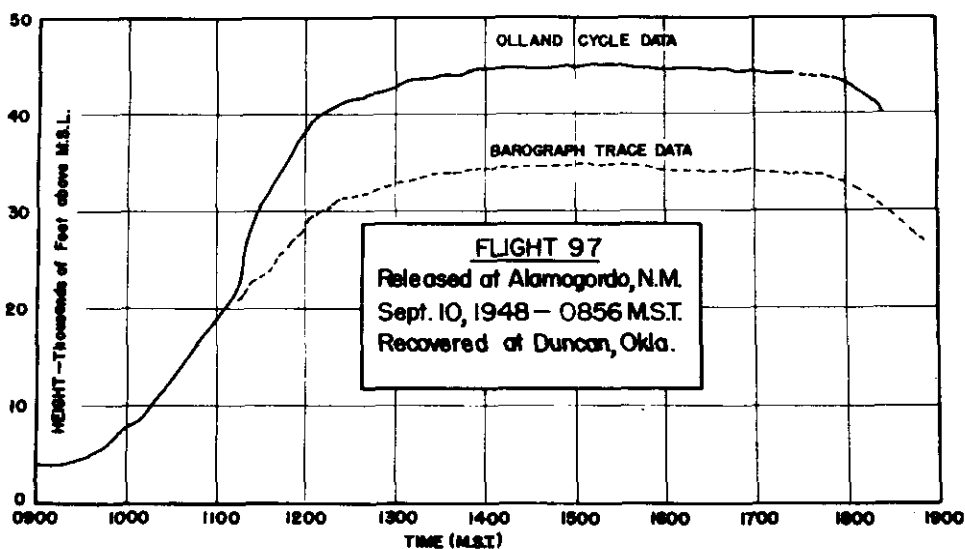

Figure 45

Once at the floating level, however, the balloon was maintained within 1000 feet (or 1200 feet) of a constant level for over four hours. This indicated that the control system was in operation since previous flights (88 and 93) at this altitude descended after about two hours of flight without ballast.

Flight 98: Released from Red Bank, New Jersey, 0948 EST, October 28, 1948  
Not recovered

On Flight 98 a 20-foot, .001" polyethylene balloon was used to test radio reception using a new model of the Olland-cycle modulator and a T-69 radiosonde transmitter. Three receiving stations were used, with elevation and azimuth angles as well as the pressure altitude recorded by RDF (SCR-659) equipment. The trajectory of this flight (Figure 46), reconstructed from the data received at the ground station, indicates that the balloon was more than

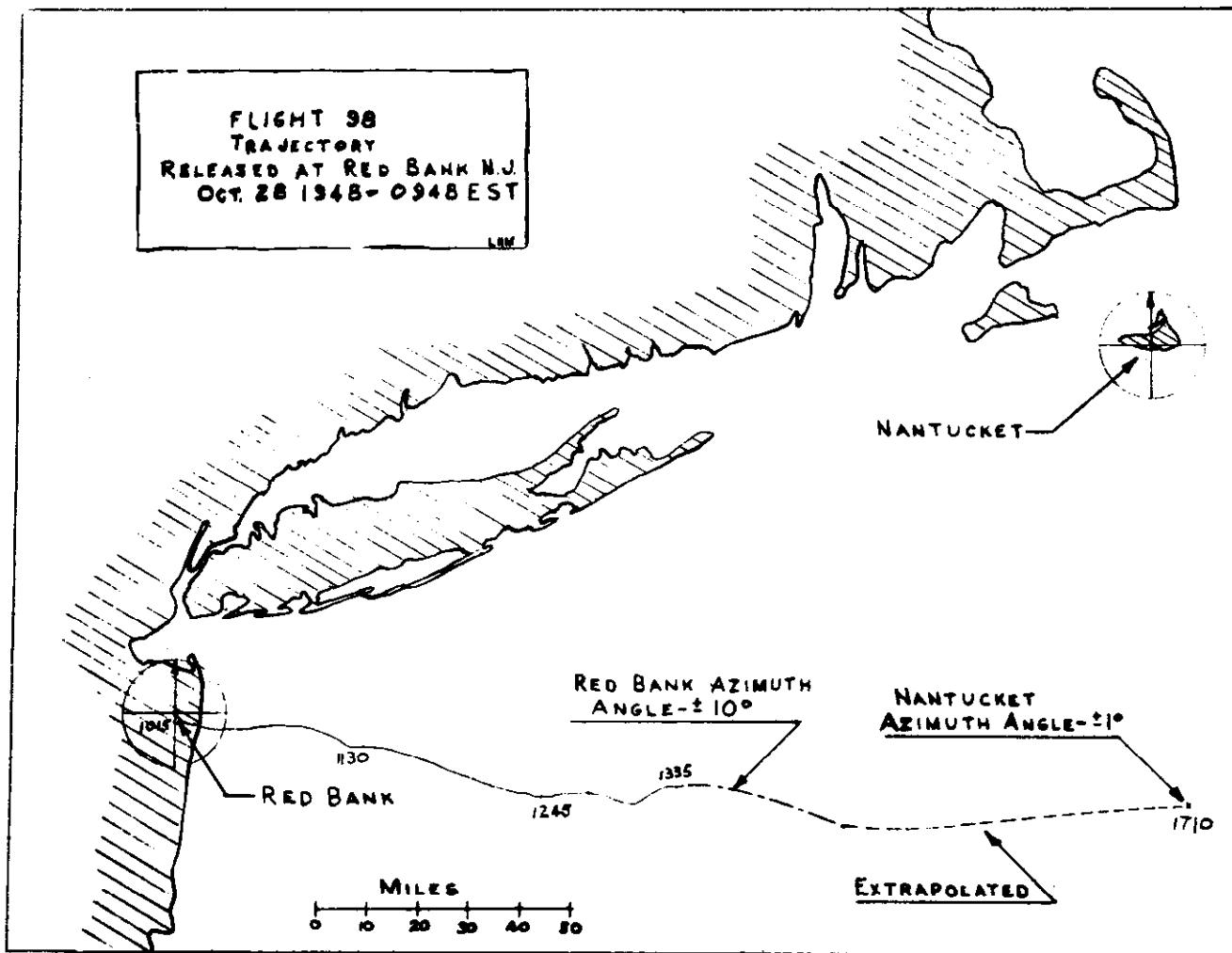

Figure 46

175 miles from the Nantucket station at the time the signal was first received. This reception is much greater than may be expected from most

SCR-658 ground sets when the T-69 transmitter is used. The signals obtained were not very strong, and there was only an interrupted record of the pressure height. From the height-time curve (Figure 47) it will be seen that a three- to four-hour period of floating was recorded, at an altitude near 50,000 feet MSL. This is in good agreement with the results obtained from earlier flights (70 and 71) at this level when no control apparatus was included.

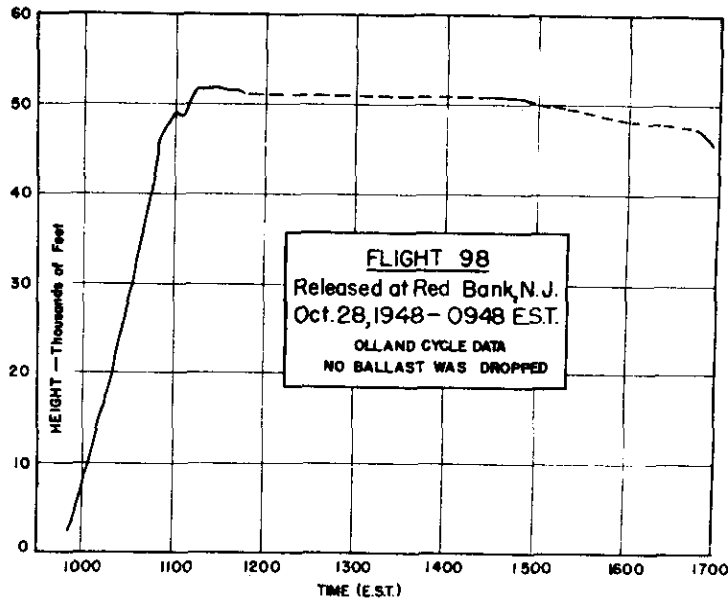

Figure 47

Flight 102: Released from Red Bank, New Jersey, 1023 EST, December 9, 1948  
Not recovered

Flight 102 was the first test given to a 30-foot, .001" polyethylene balloon manufactured by General Mills, Inc.; with this balloon a 30-kilogram payload was successfully lifted to 58,000 feet. A combination rate-of-ascent switch and displacement switch was used to control ballast flow, but no record of ballast was made since the ballast meter was broken at launching.

Flight data was received by three ground stations, and the signal from the AM-1 transmitter (with about 10 pounds of batteries) was received for about 400 miles. This was a good test of the distance to which a signal may be transmitted by the AM-1 (N.Y.U) transmitter under daytime conditions. The trajectory of this flight is Figure 48.

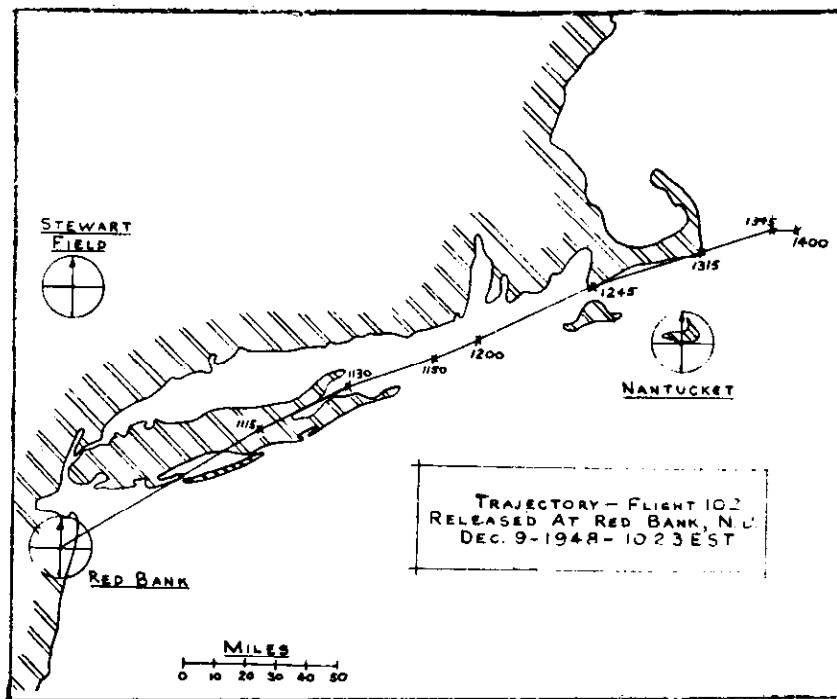

Figure 48

In the height-time curve (Figure 49) it is interesting to note the descent which began shortly before sunset. There is reason to believe that this fall was being checked by ballast flow. The normal descent after a balloon

begins to fall is accelerating, while on this flight acceleration is evident. With a loss of 10°C superheat, and a limited flow (900 grams per hours), it would require two hours of flow to restore the buoyancy of the balloon. This is a demonstration that more rapid compensation is required.

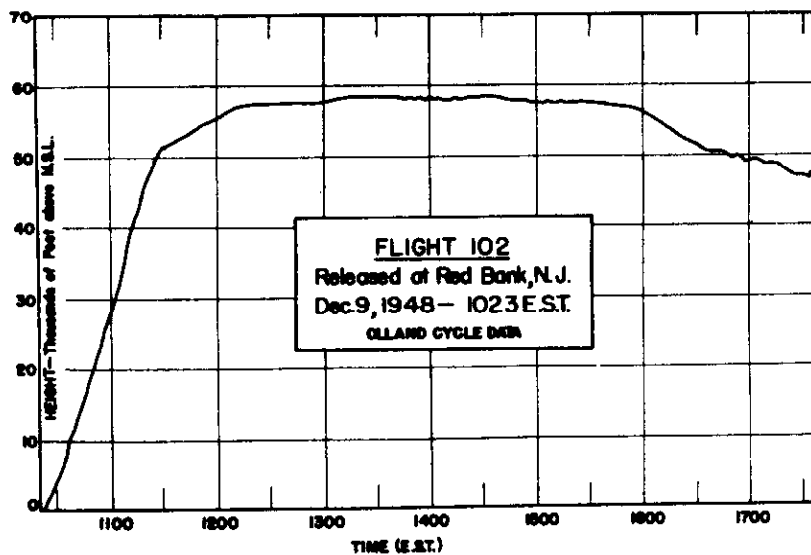

Figure 49

Flight 103 through 111: These flights were released in January and February, 1949 from Alamogordo, New Mexico to test the action of the combined ballast controls (displacement switch and rate-of-ascent switch). Receiving units were stationed at Alamogordo; at Miami, Oklahoma and at Nashville, Tennessee; aircraft were used both to receive the signal and also to track and position the balloon by the use of the radio compass.

For the first time on these flights, a program switch was used to permit a single transmitter to transmit three temperature signals as well as ballast-flow data and pressure information. By interrupting the pressure and ballast data for short intervals of temperature data, all of this information was telemetered with the AM-1 (N.Y.U.) transmitter.

Aircraft reception of 500 miles was reported on these flights, but ground reception was limited to about 250 miles, perhaps due to mountains surrounding the receiving station.

No significant data was obtained on four of these flights, and on two more the principal objective of the flight was defeated by the excessive gas loss from the balloons.

From the height-time curves of Flights 103 and 107 (Figures 50 and 51) may be seen that even with constant ballast flow (at 2400 grams per hour)

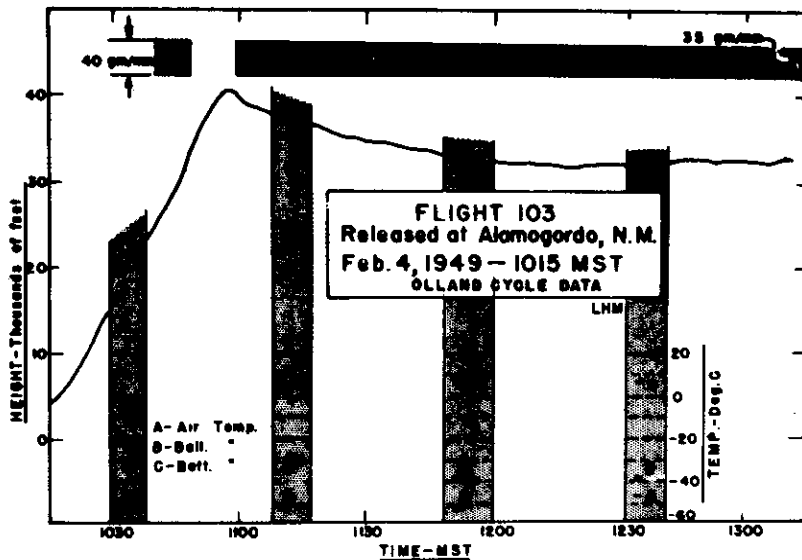

Figure 50



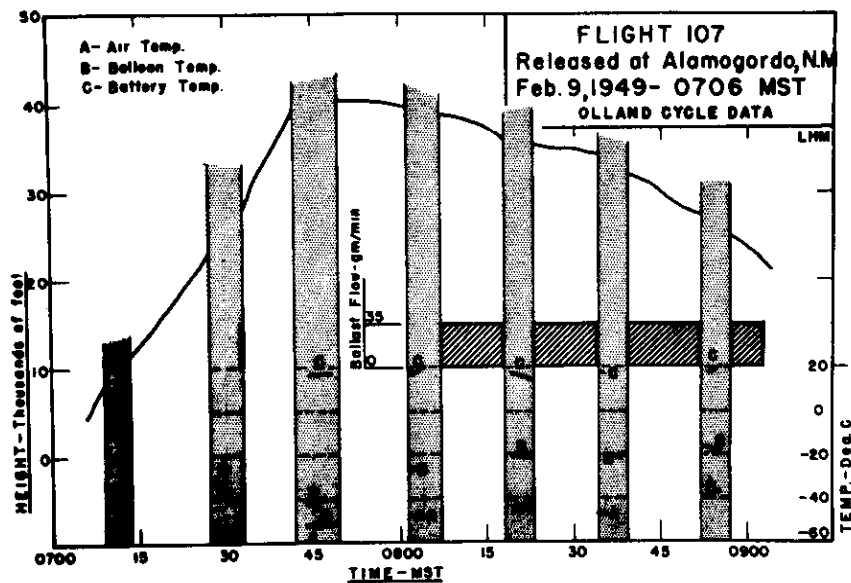

Figure 51

the balloon continued to descend. In both cases the token ballast flow on the ascent portion of the flight indicates that the controls were operative, but there was no test of efficiency since on-off operation was never permitted.

The temperature data of these flights is in generally good agreement with that seen earlier with the balloon gas being warmed by the sun to acquire a superheat of 10° to 20°C.

Flight 103: Released from Alamogordo, New Mexico, 1015 MST, February 4, 1949  
 Recovered at Mountain View, Oklahoma

On Flight 103 a B-17 airplane was used to follow the balloon, homing in on the signal from the AM-1 transmitter with the radio compass. There were few clouds over the first section of the balloon's path, and very exact positioning was obtainable. The compass needle reversed almost immediately, and no cone of silence was found when the plane passed beneath the balloon. The fixes indicated on the trajectory (Figure 52) show how exactly the path of the balloon may be determined when tracked in such a manner.

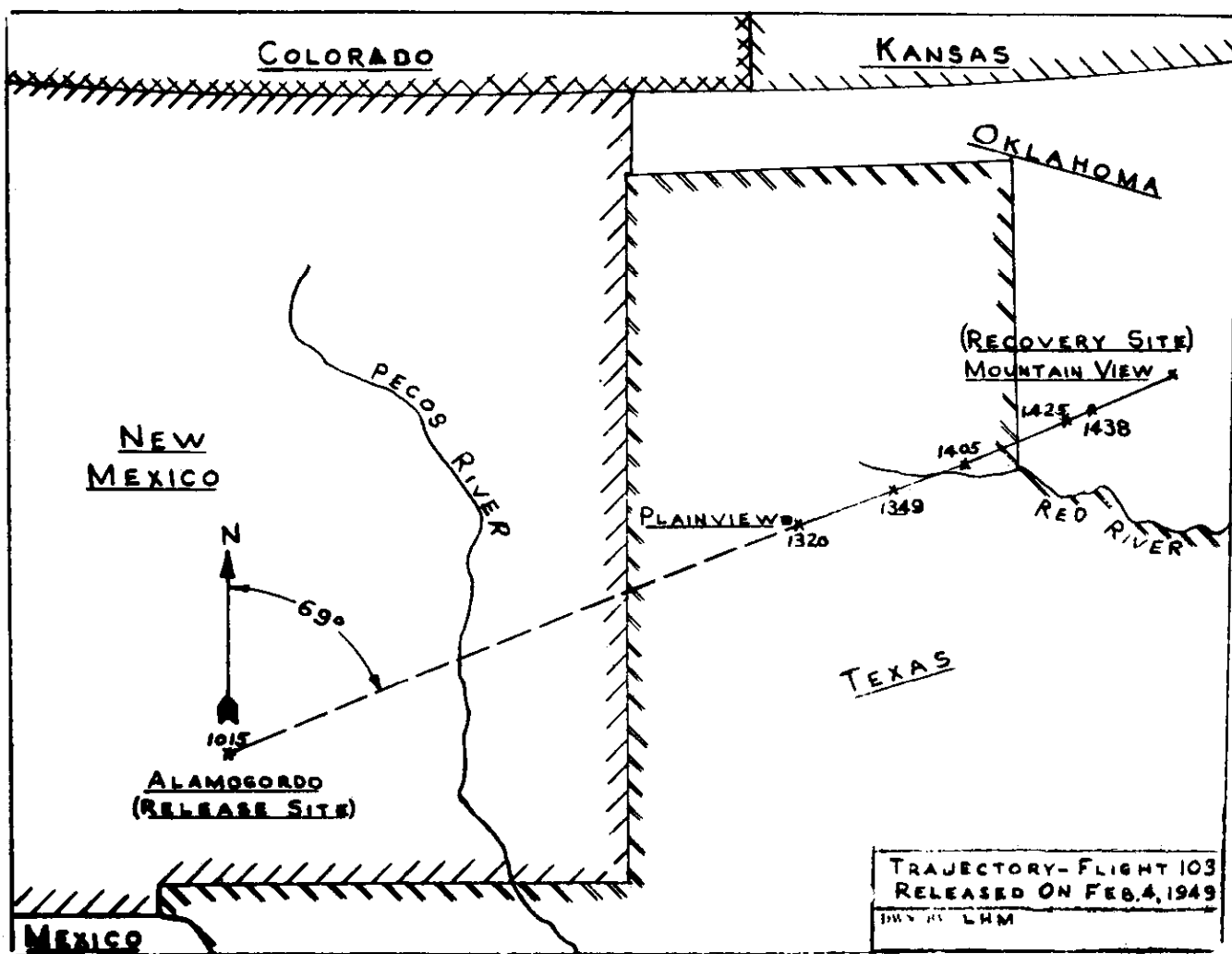

Figure 52

Flight 104: Released from Alamogordo, New Mexico, 1123 MST, February 5, 1949  
Recovered at Hale Center, Texas

On this flight a stepwise floating level was achieved by the dropping of weight from the 20-foot, .001" polyethylene balloon. From the height-time curve (Figure 53) the climb from 35,000 feet MSL to 47,000 MSL can be seen. A time clock was used to start the rapid flow of ballast after about one hour at the first level. Following the exhaustion of all ballast, the ballast reservoir itself was released to cause the final rise of the balloon.

By the use of this technique, atmospheric sampling of any kind may be conducted with two or more levels sampled on a single flight. Without using any control to keep the balloon constantly at a given altitude for a long time, the sampling steps should not be expected to be much longer than one hour apiece.

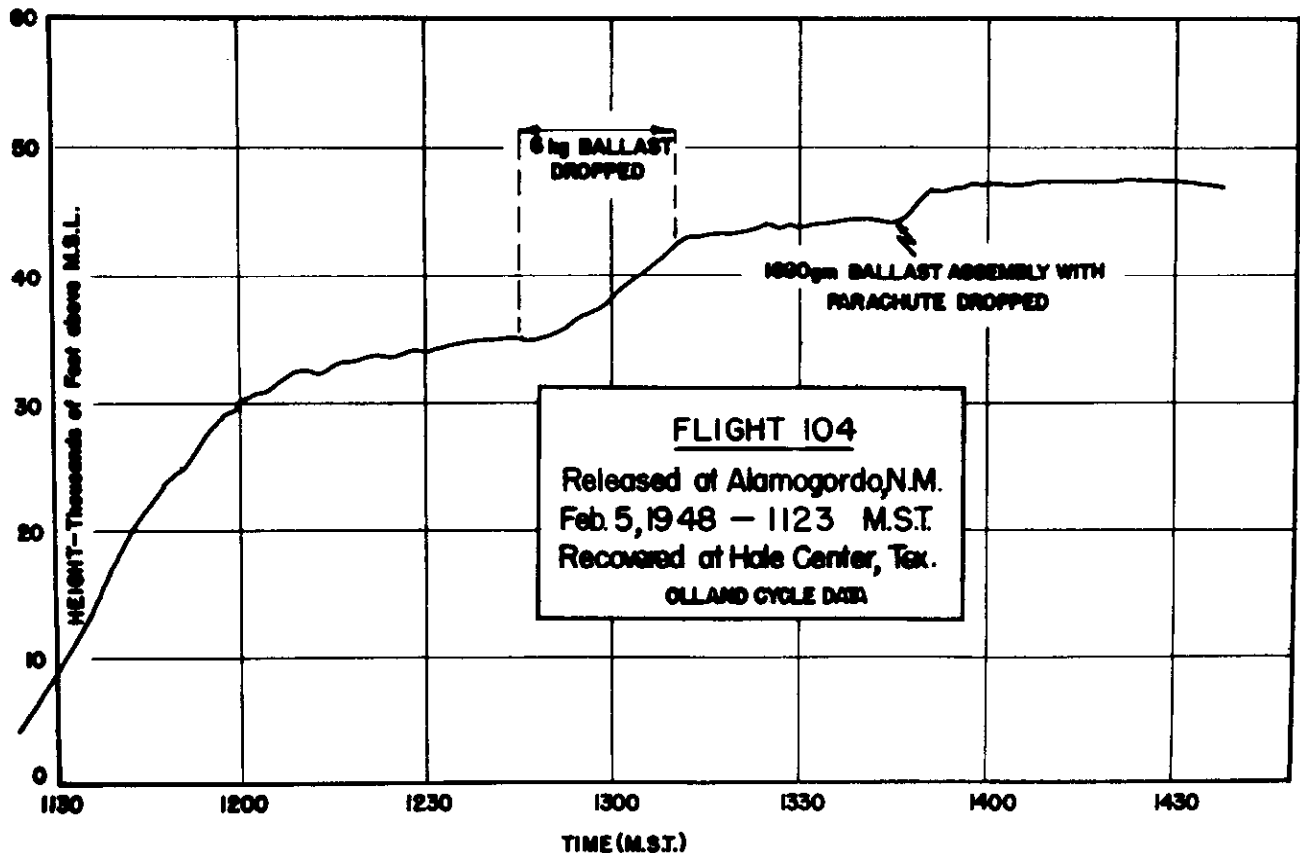

Figure 53

Flight 106: Released from Alamogordo, New Mexico, 0657 MST, February 8, 1949  
Recovered at Ellsmore, Kansas

This was the first flight to clearly demonstrate the efficient action of a combination ballast control--displacement switch and rate-of-ascent switch--on a 20-foot, .001<sup>m</sup> polyethylene balloon. From the height-time curve and ballast-flow record (Figure 54), it will be seen that the ballast control was operating at 41,000 feet MSL during the period of radio reception from Alamogordo, New Mexico. By the time the second receiving station picked up the signal, all of the ballast had been exhausted and the balloon was falling. On this flight a high loss of lifting gas caused the total ballast load of 600 grams to be exhausted in less than five hours. (Average used in first two hours was 1700 grams per hour.)

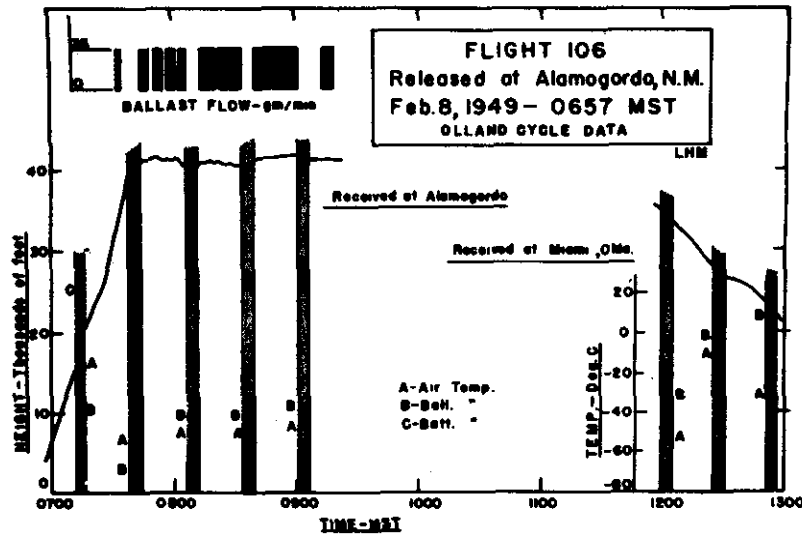

Figure 54

The descent point of this balloon was compared with that predicted from a study of the atmospheric pressure patterns at floating level. Assuming geostrophic flow, members of a graduate class in meteorology at New York

University computed the points of descent seen in Figure 55. As in the cases of Flights 55 and 58, the balloon appears to have moved across the isobars toward lower pressure.

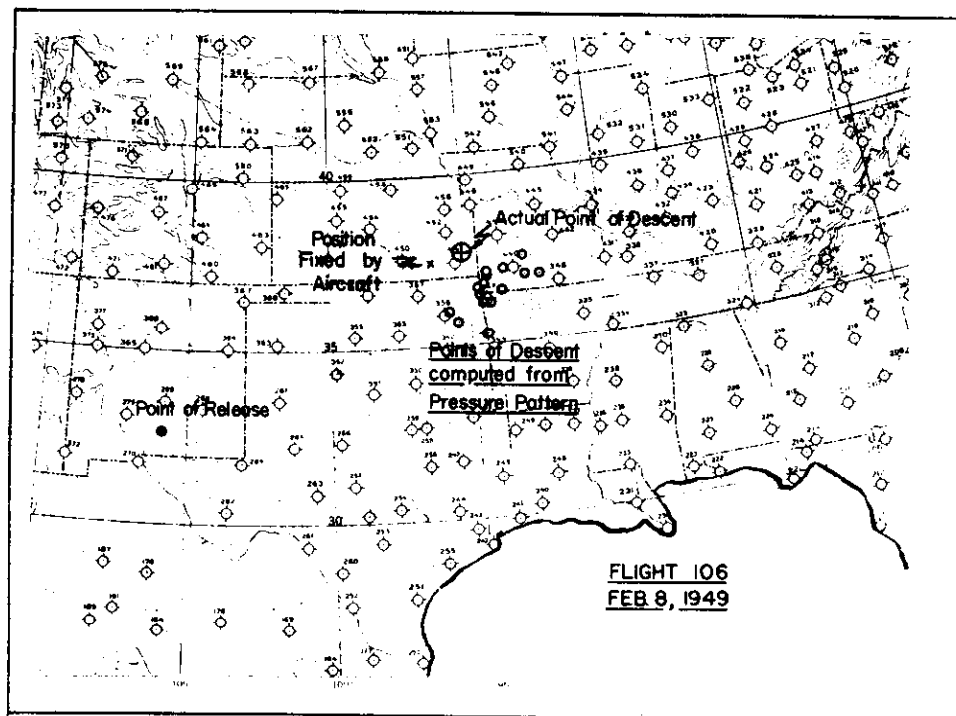

Figure 55

Flight 110: Released from Alamogordo, New Mexico, 0649 MST, February 11, 1949  
 Recovered at Kershaw, South Carolina

This flight had as its main objectives the testing of a Winzen Research Inc. .0015", 20-foot polyethylene balloon, and further testing of the combination ballast control--displacement switch and rate-of-ascent switch. Following the initial ascent of this flight, a slow descent resulted from loss of lifting gas. Three hours were required for a descent of 2000 feet to the pressure where ballast flow was begun. This and the general flight pattern indicate the satisfactory nature of this Winzen Research Inc. balloon. After ballast started, the valve stuck and a constant flow at 1800 grams per hour followed. The rising ceiling seen in Figure 56 is the typical flight pattern for a balloon whose load is being steadily decreased at a rate in excess of the loss of buoyancy.

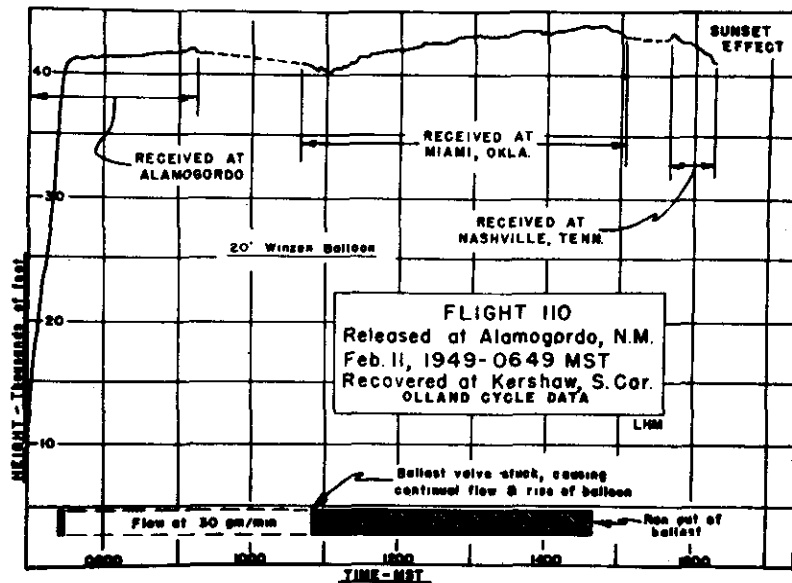

Figure 56

On this flight all three of the receiving stations positioned along the expected path were able to receive and record the pressure and ballast signal. No temperature equipment was flown.

A comparison of the point of descent predicted from geostrophic flow and that actually observed was made by members of a graduate class of meteorology at New York University (Figure 57). Using an airplane fix

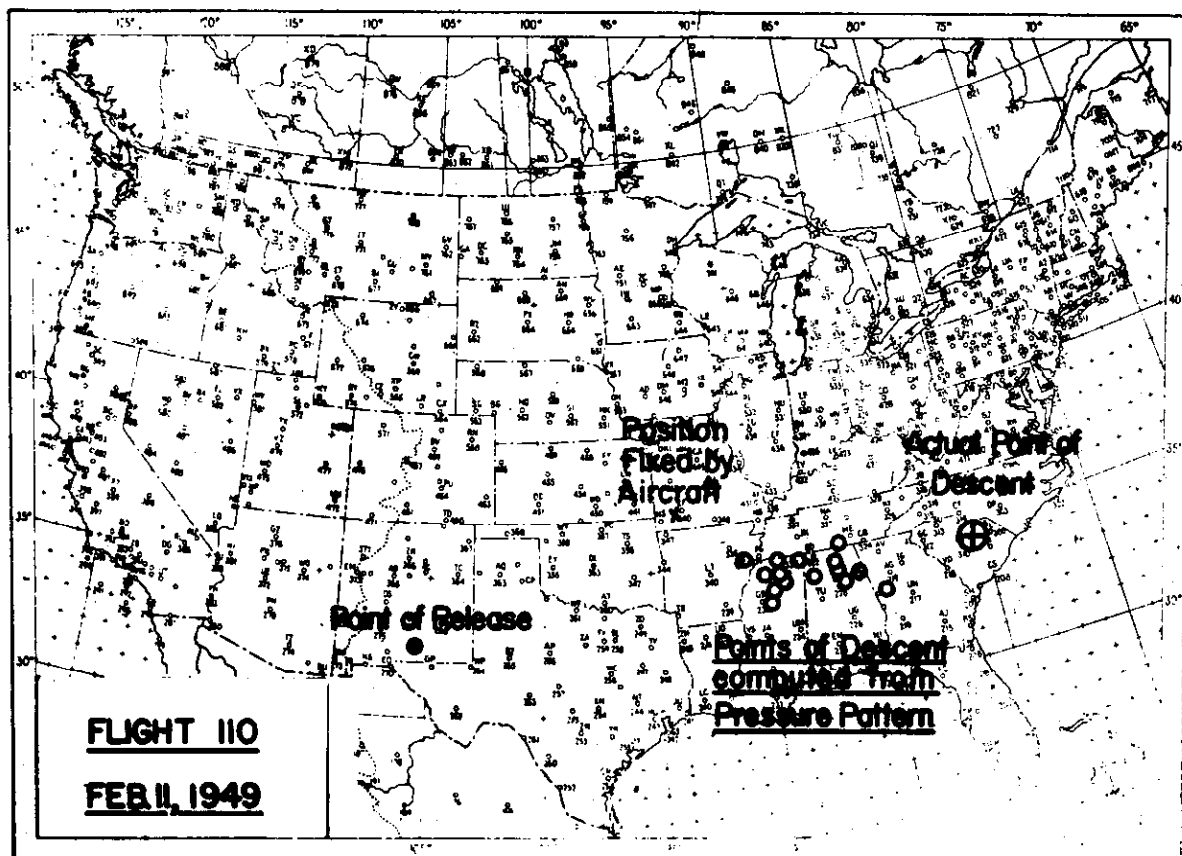

Figure 57

made during the flight the actual trajectory seems to have been well to the north of the "center of gravity" of predicted points of descent, and the actual flight path was considerably longer than that predicted. Since the pressure pattern at the eastern end of the flight was anticyclonic, this seems to be in accordance with the idea of super-geostrophic flow associated with anticyclonic systems. As in all the earlier cases where such a study was made, the balloon apparently moved across the isobars toward lower pressure.

## Index

(All references are to flight numbers. The number of the flight on which a particular instrument or principle was first demonstrated is underlined. For example, airborne radio direction finding was first used on Flight 41.)

- Adiabatic temperature changes, 60, 75, 94
- Airborne radio direction-finding, 41, 103, 110
- Aircraft tracking, 5, 7, 11, 12, 13-20, 86, 103
- Air flow  
deformation of, over mountain range, 11  
geostrophic, compared with balloon trajectories, 55, 58, 106, 110
- Altitude sensitivity, 52, 82, 86, 110
- Appendices (external) on polyethylene balloons  
first use of, 13  
need for, demonstrated, 12  
stiffened with cardboard, 20, 39  
stiffened with metal, 75
- Arrays of rubber balloons  
cluster, 7  
linear, 5
- Atmospheric oscillations, 10, 52, 55, 58, 63, 71
- Automatic ballast valve  
effect of superheat on, 10, 74, 80, 92  
first activated by minimum-pressure switch, 12  
first use of, 5  
sunset effect on, 80, 90, 92  
typical flight with, 92
- Ballast meter  
need for, demonstrated, 29-39  
use of, 74, 78, 80, 86, 89, 90, 92, 94, 96, 102
- Ballast requirements  
with .001", 7'-diameter polyethylene balloons, 74  
with .001", 20'-diameter polyethylene balloons, 54, 56, 60, 80, 92, 106
- Ballast requirements (cont'd.)  
with .008", 15'-diameter polyethylene balloon, 11  
with Seyfang balloon, 94
- Balloons  
flights using other than polyethylene neoprene-coated nylon (Seyfang), 59, 63, 79, 94  
rubber, 5, 7  
shrouded rubber (Dewey and Almy), 23, 38, 66, 87  
flights using polyethylene  
.001", 7'-diameter, 74  
.001", 20'-diameter, 12  
.001", 70'-diameter, 75  
.001", 30'-diameter, 102  
.004", 20'-diameter, 17  
.008", 15'-diameter, 10
- Barograph  
longest record of, 75  
need for, demonstrated, 17, 29, 30, 32  
use of (Fergusson), 33, 35, 39  
use of new model (Lange), 52
- Buoyancy  
changes in, due to sunset, 75, 90  
natural  
Seyfang balloons in the troposphere, 79  
7'-diameter polyethylene balloons  
in the troposphere, 86  
20'-diameter polyethylene balloons  
in the stratosphere, 60, 96  
20'-diameter polyethylene balloons  
in the troposphere, 70, 71, 88, 93, 98  
70'-diameter polyethylene balloons  
in the stratosphere, 75
- Combination control (rate of ascent ballast switch with displacement switch)  
first use of, 102  
typical flight with, 106
- Controls  
first use of  
automatic ballast valve, 5



- Controls, first use of (cont'd.)  
 fixed needle-valve ballast leak, 11  
 fixed orifice ballast leak, 43  
 minimum-pressure switch with auto-  
 matic ballast valve, 12  
 rate-of-ascent ballast switch, 97  
 rate-of-ascent ballast switch  
 combined with displacement  
 switch, 102  
 superpressure, 23  
 lifter balloons, 5, 7  
 solid ballast, 5, 7  
 superpressure, 23, 38, 59, 63, 66,  
 79, 87, 94  
 typical flight with  
 automatic ballast valve, 92  
 fixed ballast leak, 82  
 rate-of-ascent ballast switch  
 combined with displacement  
 switch, 102
- Deformation of air flow over mountain  
 range, 11
- Destruction device  
 first use of, 10  
 first use of new design (rip-out  
 principle), 41, (Fig. 16)
- Dewey and Almy, shrouded rubber  
 balloons, 23, 38, 66, 87
- Dropsonde, 85
- Easterly winds at high levels, 60, 75
- Fixed-leak ballast control  
 first use of, 11  
 typical flight with, 82
- Flight patterns, typical  
 with polyethylene balloons and  
 automatic ballast-valve control,  
 92  
 with polyethylene balloons and auto-  
 matic ballast-valve control  
 thru a sunset, 90, 92  
 with polyethylene balloons and  
 fixed flow of ballast, 82
- Flight patterns, typical (cont'd.)  
 with rubber balloons and increment  
 ballast loss, 5, 7
- Geostrophic air flow, compared with  
 balloon trajectories, 55, 58, 106, 110
- Lange barograph  
 first use of, 52  
 longest record of, 75
- Lifter balloons for altitude control, 5, 7
- Meteorograph, Fergusson, 33, 35, 39
- Minimum-pressure switch  
 failures due to freezing of, 78, 80  
 first use of, 12  
 need for, demonstrated, 11
- Olland-cycle pressure modulator, use of,  
43, 52, 55, 58, 73, 97, 98
- Oscillations in the atmosphere, 10, 52,  
 55, 58, 63, 71
- Polyethylene balloons  
 7'-diameter, 74, 76, 84, 86  
 30'-diameter, 102  
 15'-diameter, 10  
 20'-diameter, 12, 17  
 70'-diameter, 75
- Pressure-measuring instruments  
 barograph, 33  
 Lange barograph, 52  
 Olland-cycle modulator, 43, 52, 55, 58,  
 73, 97, 98
- Program switch, use of, 103
- Radar tracking, 75, 86
- Radio direction-finding  
 airborne, 41, 103, 110

Radio direction-finding (cont'd.)  
SCR-658, 12, 13-20, 56, 58, 60, 75,  
78, 81, 98

Rate of rise, excessive, 13, 14, 16, 39

Rubber balloons, 5, 7

Seyfang, neoprene-coated nylon bal-  
loons, 59, 63, 79, 94

Solid ballast for altitude control,  
5, 7

Stepwise pattern of floating, 104

Sunset effect  
on automatic ballast valve, 80, 90,  
92  
on buoyancy, 5, 75, 90

Superheat  
effect on automatic ballast valve,  
10, 74, 80, 92  
effect on buoyancy, 75, 79  
effect on Seyfang balloon, 59, 63,  
79, 94

Superpressure balloons  
Dewey and Almy, shrouded rubber,  
23, 38, 66, 87  
Seyfang, neoprene-coated nylon,  
59, 63, 79, 94

Temperature measurements, need for  
shown, 58, 63, 73, 78, 88, 103,  
106, 107

Theodolite observation, 5, 7, 11, 13-  
20, 56, 60, 75

Tracking  
aircraft, 5, 7, 11, 12, 13-20, 86,  
103  
radar, 86, 75  
radio direction-finding  
airborne, 41, 103, 110  
SCR-658, 12, 13-20, 56, 58, 60,  
75, 78, 81, 98

Tracking (cont'd.)  
theodolite, 5, 7, 11, 13-20, 56, 60,  
75

Trajectories, 11, 55, 58, 103, 106, 110

Transmitters  
3 mc (AM-1)  
first use of, 12  
longest reception distance with, 102  
longest reception time with, 92  
397 mc (T-69)  
first use of, 12,  
longest reception distance with, 82  
longest reception time with, 82

Typical flight patterns, see Flight patterns,  
typical

---

New York University  
*Technical Report No. 1*  
*Constant Level Balloon*  
April 1, 1948

---

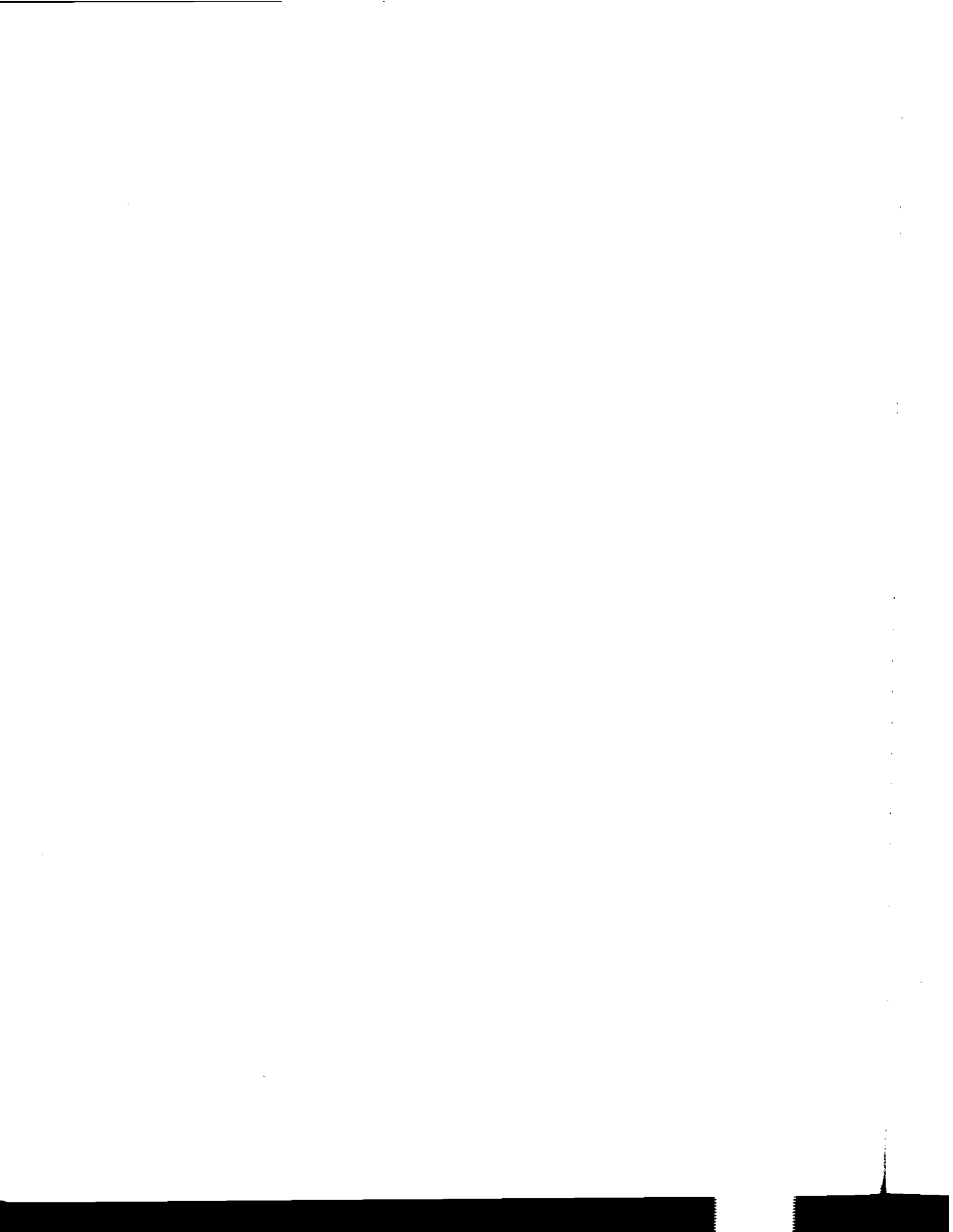

TECHNICAL REPORT NO. 1

Balloon Group, Constant Level Balloon Project

New York University

Covering the period Nov. 1, 1946 to Jan. 1, 1948

CONSTANT LEVEL BALLOON

Research Division, Project No. 93

Prepared in Accordance with Provisions of Contract  
W28-099-ac-241, between  
Watson Laboratories, Red Bank, New Jersey  
and  
New York University

Prepared by: Charles B. Moore, James R. Smith, and  
Seymour Goldstein

Approved by: Charles S. Schneider, Project Director  
and  
Prof. Athelstan F. Spilhaus  
Director of Research

Research Division, College of Engineering, New York University.

April 1, 1948

New York 63, New York

## CONTENTS

	<u>Page</u>
Section 1. Introduction to Problem.....	1
Section 2. Method of Attack.....	1
A. Balloons.....	1
B. Altitude Controls.....	6
C. Altitude Determination.....	10
D. Horizontal Position Determination.....	13
E. Flight Termination Control.....	14
Section 3. Theoretical Relationships and Computations.....	15
A. Altitude-Density Relationships.....	15
B. Load-Diameter-Maximum Altitude Relationships.....	16
C. Balloon Diameter-Weight Relationships.....	18
D. Rate of Rise.....	18
E. Ballast Requirements.....	19
F. Internal Pressure.....	20
Section. 4. Flight Techniques.....	22
A. Inflation.....	22
B. Release.....	23
C. Recovery.....	26
Section 5. Flight Summary.....	26
Section 6. Current Objectives.....	32
Section 7. Appendix	
1. Flight Summary Data.....	36
2. Correspondence.....	37
3. Flight forms and tables.....	47
Section 8. Reference Notes.....	61

## List of Figures

	Following Page
Fig. 1. Plastic Balloon for Constant Level Balloon Project.....	4
Fig. 2. Thin, tear-drop, polyethylene balloon.....	5
Fig. 3. General Mills twenty-foot balloon.....	5
Fig. 4. Ten-foot appendix attached to a General Mills balloon.....	5
Fig. 5. Two-foot appendix, stiffened, shown on a General Mills balloon.....	5
Fig. 6. General Mills twenty-foot balloon in flight.....	5
Fig. 7. Idealized time-altitude curves for various balloon control systems.....	7
Fig. 8. Manual ballast valve.....	7
Fig. 9. Components of Manual Ballast release assembly.....	7
Fig. 10. Manual ballast release assembly.....	7
Fig. 11. Automatic ballast valve.....	7
Fig. 12. Automatic ballast valve, showing loaded diaphragm.....	7
Fig. 13. Automatic ballast valve.....	7
Fig. 14. Minimum Pressure switch.....	8
Fig. 15. Ballast reservoir.....	10
Fig. 16. Ballast release assembly.....	10
Fig. 17. Complete ballast release assembly.....	10
Fig. 18. Coverage of probable balloon paths with four-station. SCR-658 net.....	12
Fig. 19. Buoyancy vs. altitude for various diameter balloons (helium).....	17
Fig. 20. Buoyancy vs. altitude for various diameter balloons (hydrogen).....	17
Fig. 21. Calculated net lift for General Mills Inc., balloons.....	18

List of Figures (cont'd)

	Following Page
Fig. 22. Polyethylene balloon weights.....	18
Fig. 23. Balloon weights for various fabric weights.....	18
Fig. 24. Free lift of balloons vs. rate of rise.....	19
Fig. 25. General Mills twenty-foot balloon billowing in a 5- knot wind.....	23
Fig. 26. Heavy elliptical shot bag.....	23
Fig. 27. Aluminum "cannon" in position.....	24
Fig. 28. Plan view of balloon launching layout.....	25
Fig. 29. Balloon shapes during launching.....	25
Fig. 30. General Mills twenty-foot balloon in flight.....	26

APPENDIX I

Fig. 31. Train Assembly, flight 5, (meteorological cluster)....	36
Fig. 32. Trajectory, flight 5.....	36
Fig. 33. Height-time curve, flight 5.....	36
Fig. 34. Trajectory, flight 6.....	36
Fig. 35. Height-time curve, flight 6.....	36
Fig. 36. Train assembly, flight 7, (meteorological cluster)....	36
Fig. 37. Trajectory, flight 7.....	36
Fig. 38. Height-time curve, flight 7.....	36
Fig. 39. Train assembly, flight 8, (General Mills Cluster)....	36
Fig. 40. Trajectory, flight 8.....	36
Fig. 41. Height-time curve, flight 8.....	36
Fig. 42. Train assembly, flight 10.....	36
Fig. 43. Height-time curve, flight 10.....	36
Fig. 44. Train assembly, flight 11.....	36
Fig. 45. Trajectory and height-time curve, flight 11.....	36
Fig. 46. Train assembly, flight 12.....	36
Fig. 47. Height-time curve, flight 12.....	36



List of Figures (cont'd)

	Following Page
Fig. 48. Height-time curves, flights 13, 14, 16, and 23....	36
Fig. 49. Height-time curve, flight 15.....	36
Fig. 50. Height-time curve, flight 20.....	36
Fig. 51. Height-time curve, flight 24.....	36
Fig. 52. Height-time curve, flight 27.....	36
Fig. 53. Height-time curves, flights 29, 30 and 32.....	36
Fig. 54. Height-time curves, flights 33, 34, 35 and 36.....	36
Fig. 55. Height-time curves, flights 37, 38 and 39.....	36
Fig. 56. Trajectory, flight 17.....	36
Fig. 57. Height-time curve, flight 17.....	36

List of Tables

	<u>Page</u>
I. Properties of Fabrics used for balloon manufacture.....	3
II. Types and number of balloons ordered.....	4
III. Average wind values above selected stations in the Southwest.....	12
IV. Buoyancy per Pound Mol of Gas.....	16
V. Glossary of Terms.....	21
VII. Summary of Flight Data.....	Appendix I Following Page 36

## THE BALLOON PROJECT TECHNICAL REPORT

### Section 1. Introduction to Problem

On 1 November 1946, the Research Division of the College of Engineering of New York University entered into Contract No. W28-099-ac-241 with Watson Laboratories, Air Materiel Command. Under this contract, the University was commissioned to design, develop and fly constant-level balloons to carry instruments to altitudes from 10 to 20 km, adjustable at 2 km intervals.

The following performance was specified:

- a. Altitude shall be maintained within 500 meters
- b. Duration of constant-level flight to be initially 6 to 8 hours minimum; eventually 48 hours
- c. The accuracy of pressure observations shall be comparable to that obtainable with the standard Army radiosonde ( $\pm$  3 to 5 mb)

Monthly reports have been submitted to describe the progress of the project, however, much data and details of technical nature were given only in a qualitative way. It is intended to collect these data in this technical report and to review at the same time the total achievement of this phase of the project.

### Section 2. Method of Attack

#### A. Balloons

A survey was made of previous attempts to produce a constant-level balloon; such as, the experiments by Meisinger<sup>1</sup> with manned balloons, the shrouded meteorological balloon developed by Dewey and Almy<sup>2</sup>, the Japanese balloon bombs<sup>3</sup>, and the clusters of meteorological balloons which have been used in cosmic ray investigations by Compton, Korff and others<sup>4</sup>.

From this survey and a study of aerostatics,<sup>10, 15, 16</sup> it appeared that a non-extensible balloon is highly desirable due to the vertical stability exhibited when such a balloon is full of the lifting gas: A non-extensible balloon with no diffusion or leakage through the walls, which could withstand a high internal pressure, would automatically remain at the density where the buoyancy of the full balloon equaled the load. In practice, control devices are needed to offset the leakage and diffusion of the lifting gas and to correct for the motion of the balloon due to diurnal changes of the balloon's temperature and to correct for vertical wind currents in the atmosphere. It was decided to use a plastic as the balloon fabric, since available plastics have suitable characteristics, and are also relatively inexpensive as compared to coated fabrics.

The desirable properties to be considered in the selection of a plastic balloon material are:

- a. Ease of fabrication
- b. High tear resistance
- c. Light weight
- d. High tensile strength
- e. Chemical stability
- f. Low permeability
- g. Low brittle temperature
- h. High transparency to heat radiation

Table I is a qualitative-characteristics catalog of the film and fabrics investigated. The data in the table are presented as approximations because of the great variations of a given property with choice of samples and test methods. From this study, polyethylene, nylon, saran, and neoprene-

coated nylon seem to be most generally satisfactory. Eighteen plastics and balloon fabrication companies were contacted in an attempt to secure fabricators.

Table I

<u>Fabric</u>	<u>Low Temp. Properties</u>	<u>Permeability</u>	<u>Tensile Strength</u>	<u>Tear Resistance</u>	<u>Ease of Fabrication</u>	<u>Stability to Ultraviolet</u>
Polyethylene	Good	Medium	Low	Good	Good	Good
Saran	Fair	Low	High	Poor	Fair	Fair
Nylon	Good	Low	High	Low	Good	Good
Vynylite	Very poor	Medium	Medium	Good	Good	Good
Teflon	Believed good	Low	High	Good	Cannot be fabricated	Good
Ethocellulose	Good	Very high	Low	Fair	Good	Good
Pliofilm	Poor	High	Poor	Fair	Good	Poor
Nylon or silk fabric coated with:						
1. Neoprene	Fair	Low	High	Fair	Fair	Fair
2. Butyl rubber	Good	Low	High	Fair	Fair	Good
3. Polyethylene	Unknown	--				
4. Saran	Unknown	--				

Table II shows the balloons which have been purchased from those manufacturers who expressed an interest in the problem.

Table II

<u>Company</u>	<u>Film type, thickness, diameter, shape</u>	<u>Special Features</u>	<u>Unit Cost</u>	<u>Delivered to date</u>
H. A. Smith Coatings, Inc.	.004 Polyethylene 3 feet diameter spherical	Proto-type	\$150.00	4
H. A. Smith Coatings, Inc.	.008 Polyethylene 15 feet diameter spherical	Low Permeability	\$530.00	5
H.A. Smith Coatings, Inc.	.004 Polyethylene 15 feet diameter spherical	Low Permeability	\$530.00	5
General Mills, Inc.	.001 Polyethylene 7 feet diameter Teardrop.	Stressed tape type seam	\$20.00	25
General Mills, Inc.	.001 Polyethylene 20 feet diameter Teardrop.	Stressed tape type seam	\$125.00	47
Dewey & Almy Chemical Co.	A spherical nylon cloth shroud around a neoprene balloon.		\$339.00	2

Table II is based upon final or modified orders in those cases where the rapid progress of flight technique rendered certain features obsolete before the balloons on order were delivered.

Figure 1 shows the spherical balloon as originally designed. This type of balloon was made of .004 and .008 inch, heat-sealed, polyethylene. It had several good characteristics, such as very low leakage, but the method of load attachment furnished by H.A. Smith, Inc., was not satisfactory. Of the six balloons of this type which were used, two ripped free from the shroud lines during launching.

Spherical Balloon  
15' Diameter.

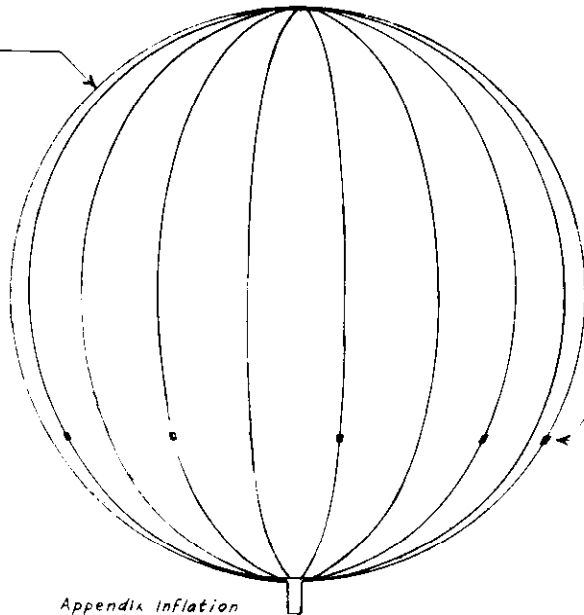

9 eyelets in reinforced  
seams for attaching bridle  
rigging to balloon at 30°  
below balloon's equator.

Appendix Inflation  
4" Dia. X 10" Long.

Balloon with rigging

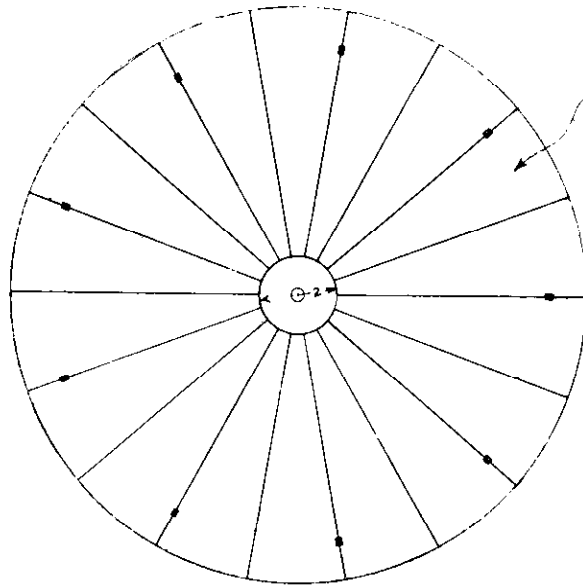
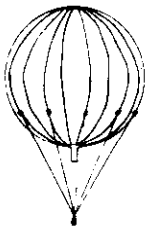

18 blunes of flat film  
cemented together to  
make sphere.

PLASTIC BALLOON  
FOR CONSTANT LEVEL BALLOON PROJECT AT NYU  
APRIL 27, 1947  
SCALE: 1" = 3' 0"

FIG. 1

Figures 2 and 3 show the tear-drop cell of the stressed tape design developed by General Mills, Inc. The film is .001 inch polyethylene, butt-welded, with scotch tape laid along the seam to reinforce the seal and to carry and distribute the load. These strips, which converge to the load ring at the bottom, actually support the load.

The overloading of a General Mills 20-foot balloon on Flight 12 at Lakehurst kept the lower end of the balloon open during ascent. The ceiling was greatly reduced by the resulting dilution of the helium with air. On later flights an unsuccessful attempt to minimize this mixing was made, using a 10-foot external appendix passing through the shroud lines. This appendix fouled in the rigging and twisted completely shut, causing the balloon to burst at pressure-altitude. A modification with a 10-foot appendix outside the shroud lines also failed in actual flight. Figure 4 shows this appendix construction on a General Mills balloon which is being inflated. The final style is shown in Figures 5 and 6. It consists of a 2-foot external appendix stiffened with cardboard battens. This is taped on the outside of the load ring. It serves as a one-way valve which excludes air during ascent but allows the extra helium to valve freely when the balloon is full. No external appendix can be used whenever the rate of rise exceeds 600 feet per minute. For optimum balloon performance, it has been determined that: 1) the equipment load for the General Mills 20-foot balloon should be held under 30 pounds; 2) rates of rise should be less than 900 feet per minute; and 3) for maximum altitudes an external appendix is needed; hence the limiting rate of rise is about 600 feet per minute in this case.

Several experimental flights have been made using shrouded Dewey and Almy neoprene balloons, as well as small and large experimental cells in



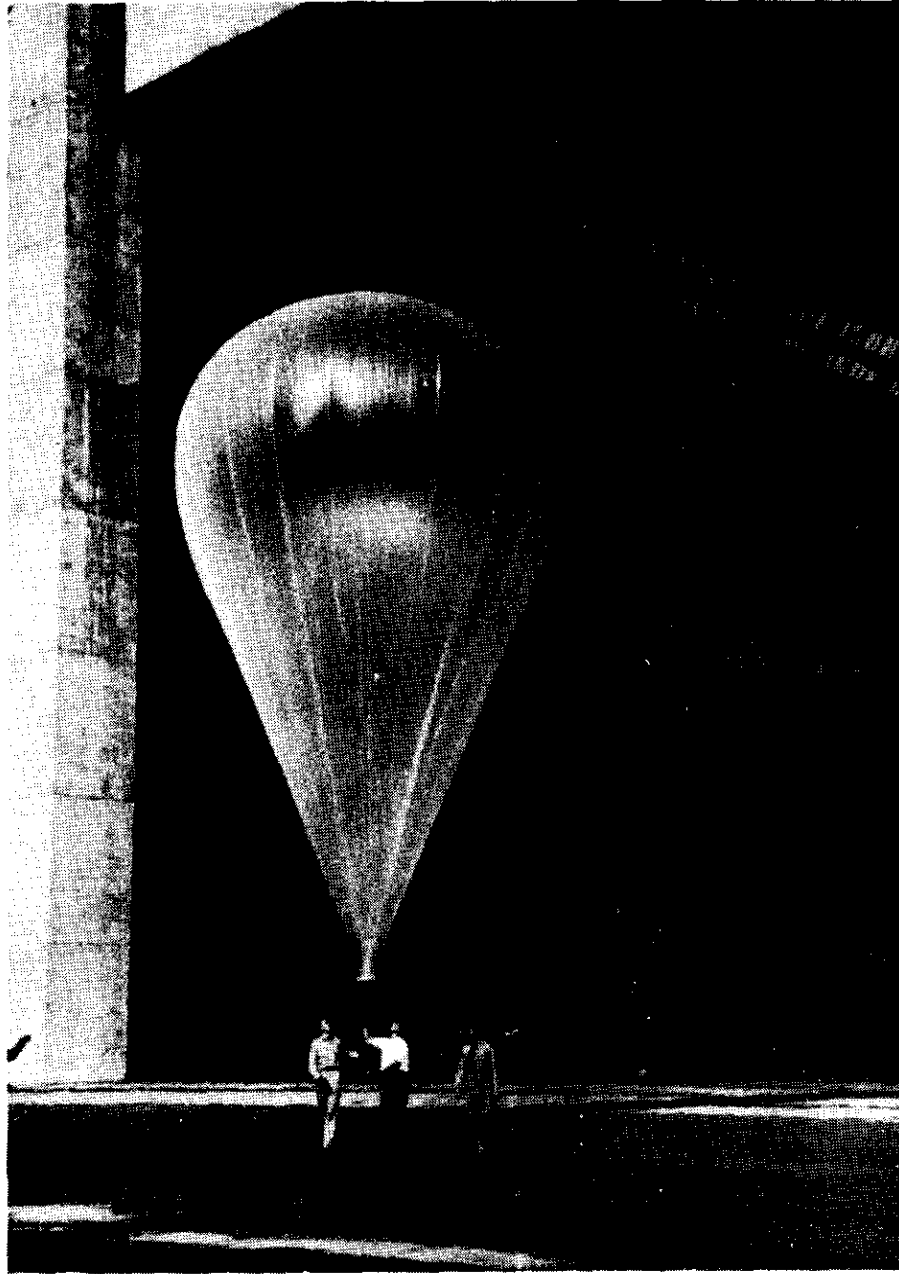

Figure 2  
Teardrop, .001" polyethylene  
balloon, 20 foot in diameter,  
designed by General Mills, Inc.

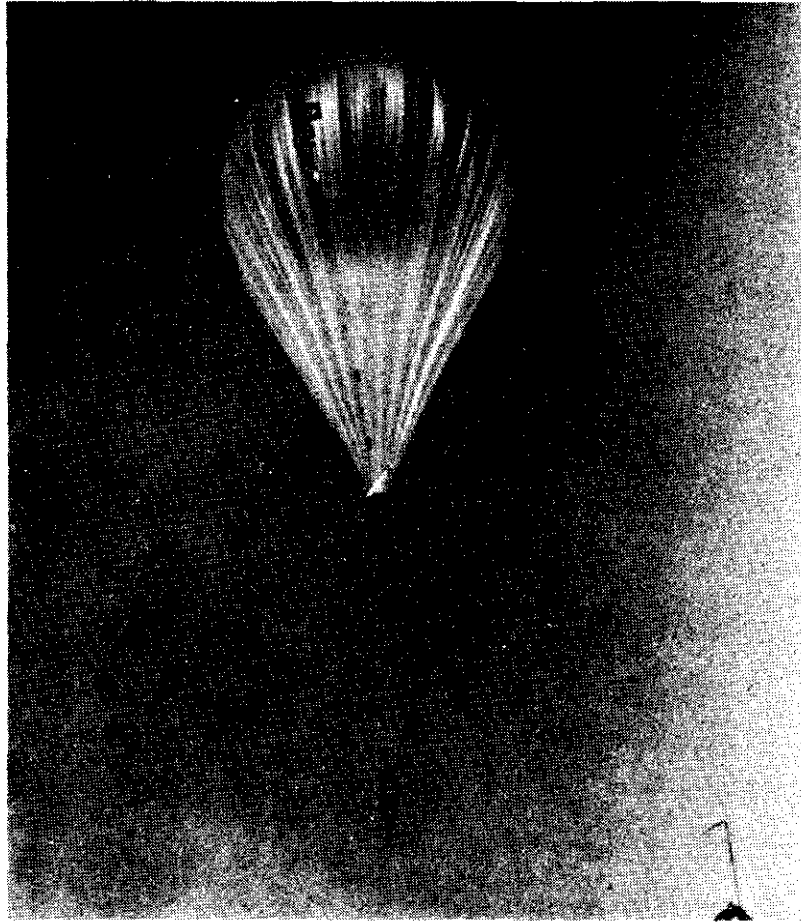

Figure 3  
Twenty ft. balloon, showing  
burn-out patch in place.

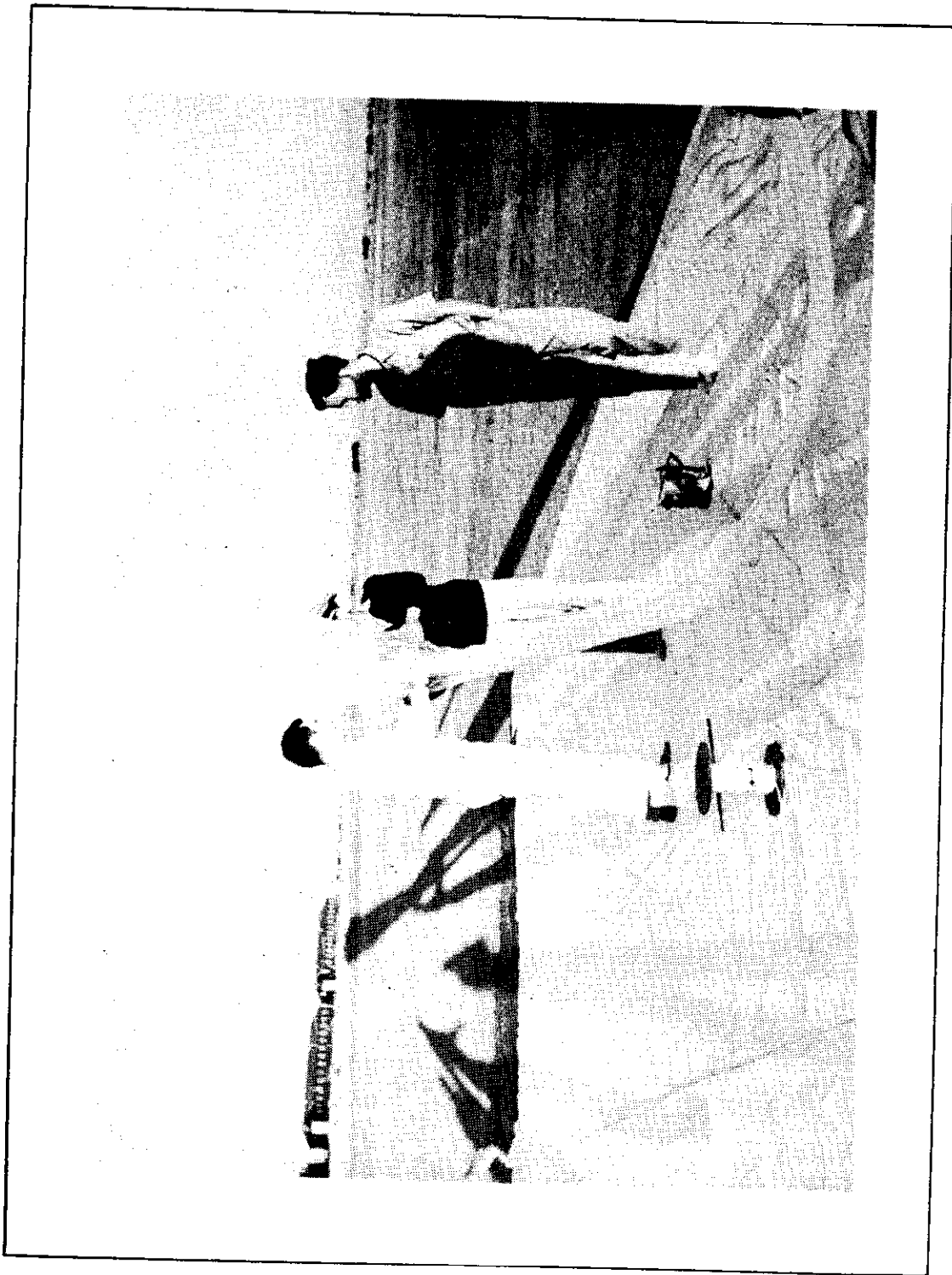

Figure 4  
General Mills 20 foot balloon with 10 foot appendix.



Figure 5

Two foot appendix, stiffened, shown on a General Mills balloon. The swollen inflation tube indicates that the balloon is being filled.

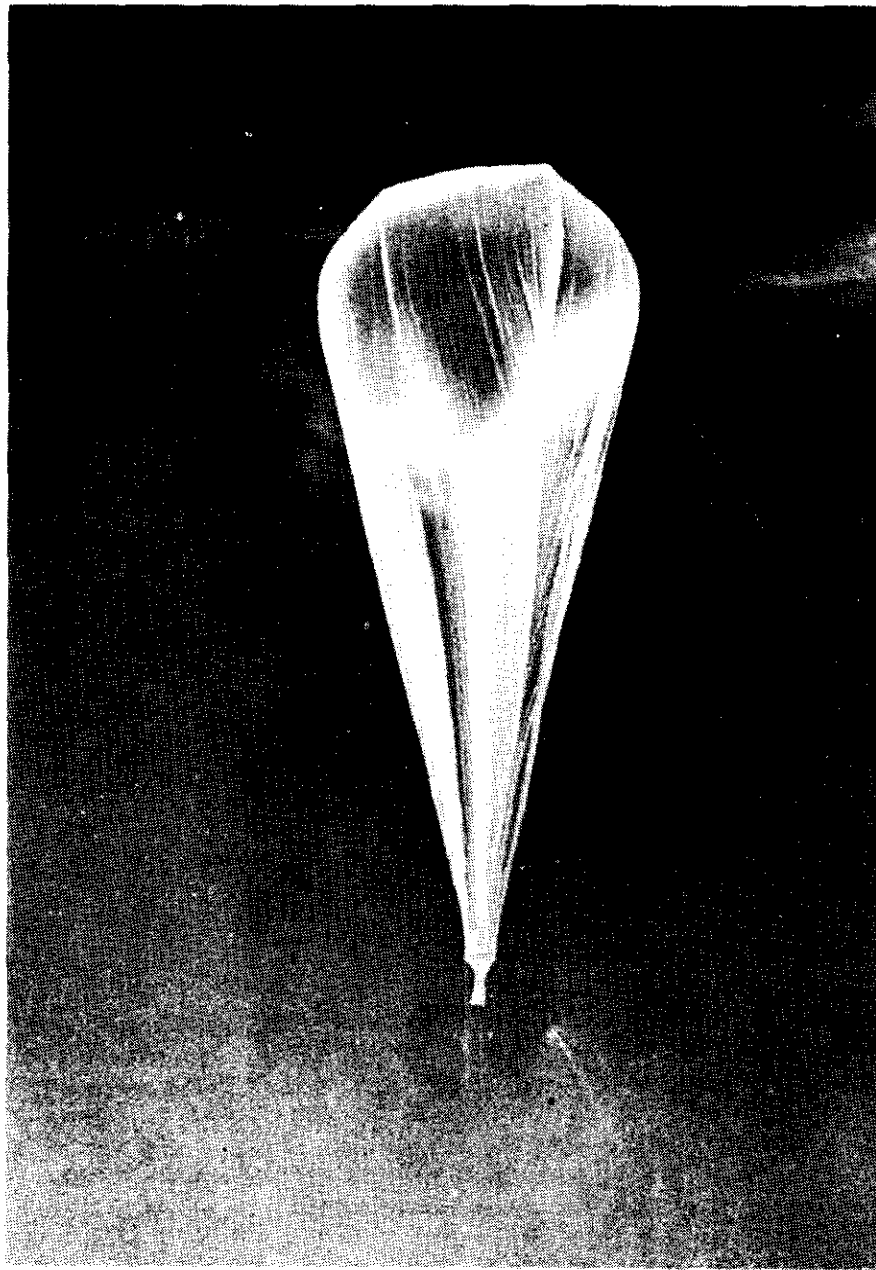

Figure 6  
General Mills 20 foot balloon in  
flight with 2 foot stiffened appendix.

various cluster arrangements. None of these have been too satisfactory but further investigation will be made in the field of shrouded or coated films.

### B. Altitude Controls

Given a balloon capable of carrying the instruments to a desired altitude (the theory and computations involved are discussed in Section 3), there remains the problem of maintaining the cell at a constant level. The buoyancy of a gas-filled cell will decrease as the gas leaks or diffuses through the balloon wall. To hold an absolutely constant altitude, the volume of lifting gas entrapped must be maintained in an atmosphere of unvarying horizontal density, with no change in the total weight supported by the balloon and with no fluctuations of the temperature of the gas with respect to the air. The best approximation to these conditions may possibly be achieved through the use of liquified hydrogen, which would be permitted to evaporate at a rate in excess of gas leakage. The weight of equipment required to control this evaporation rate appears to be prohibitive. Liquid hydrogen, also, is not safe to handle.

Two practical methods of keeping a balloon at nominally constant altitude have been devised, both using the liquid ballast dropping technique. (Solid ballast, such as sand, does not flow well and is liable to absorb moisture which will freeze at the temperatures experienced at high altitudes. Although a few preliminary flights were made with desiccated sand, a highly refined water-free kerosene-type petroleum product, compass fluid, was found to be more satisfactory).

In the simpler control system, ballast is dropped at a pre-determined rate, aimed to slightly exceed the loss of lift of the balloon due to leakage and diffusion. If this method is successfully used, the balloon stays full because the remaining gas in the balloon has less load to support; therefore,

the balloon can rise slowly until the balloon is again full and the equilibrium is again reached between the buoyancy and the load. In the General Mills 20-foot balloon, for example, diffusion losses equal about 300 grams per hour; the balloon at its ceiling of 50,000 feet, with a 30-pound payload, rises about 900 feet with each kilogram of ballast dropped. This means that a balloon, using the simple ballast-dropping technique, will float at a ceiling which rises at the rate of about 360 feet per hour. An idealized flight of this type is shown in the solid curve of Fig. 7., neglecting the oscillation shown at sunset.

The "manual ballast valve" which was developed for this simple control system is shown in Fig. 8. This valve can be adjusted prior to balloon release to allow any predetermined flow of compass fluid up to 2000 grams per hour. The filter housing and ballast reservoir used with this valve are shown in Figures 9 and 10. This method is good where 1) a slowly rising ceiling can be tolerated, and 2) the flight does not have to go through a sunset while at its ceiling.

For economy of ballast, hence longer flight duration, it is desirable to keep the constant flow as close as possible to the total loss of buoyancy resulting from diffusion and leakage. This means that whenever rapid loss of buoyancy occurs, due to changes in solar radiation, the manual ballast valve alone will not sustain the balloon. When the balloon is suddenly cooled, due to sunset or clouds cutting off insolation (loss of superheat), the heavy loss will start the balloon downward and only a rapid expenditure of ballast will check its fall and restore its stability.

The second type of ballast dropping control has been devised to operate on a demand basis, when such a descent occurs. This control is called the automatic ballast valve. Figures 11, 12 and 13 show the appearance and design of this pressure-actuated needle valve.

FIG. 7

IDEALIZED TIME ALTITUDE CURVES FOR  
VARIOUS BALLOON CONTROL SYSTEMS

NYU - 27 AUG 47

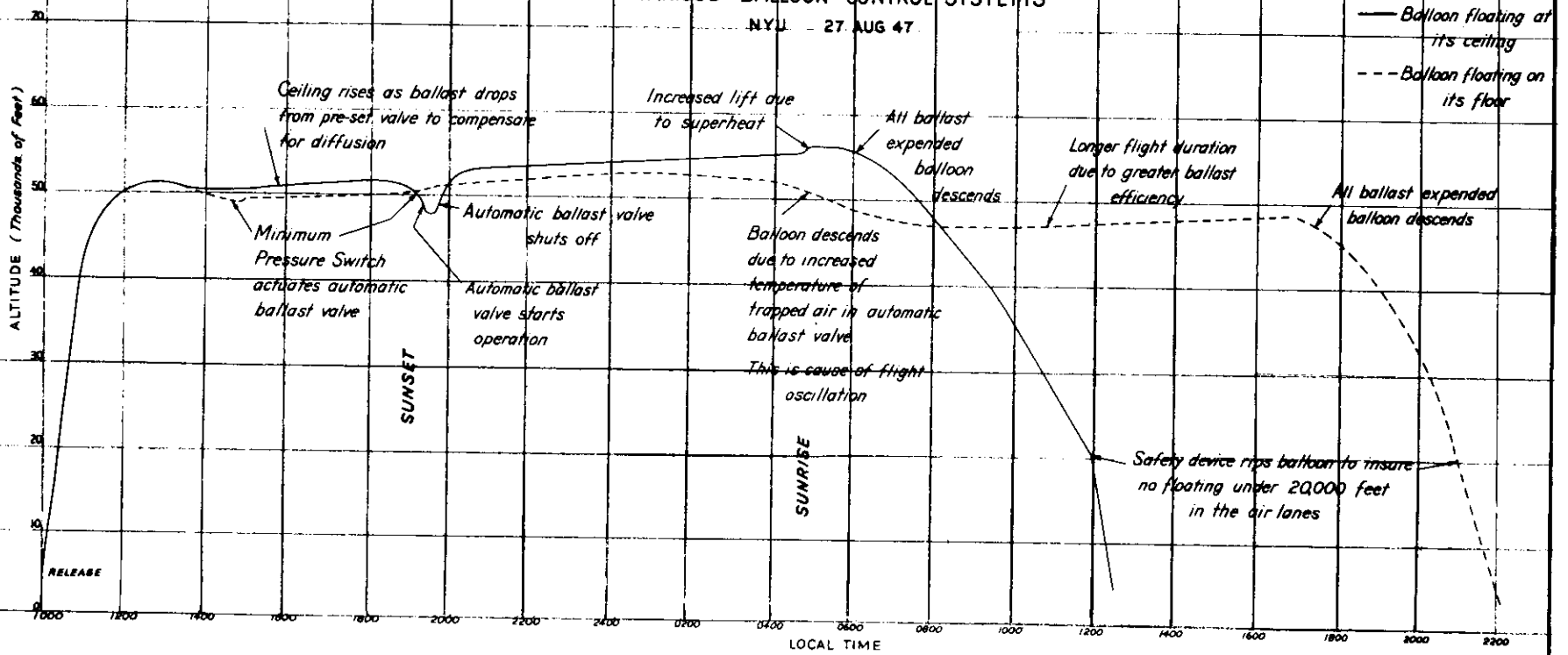



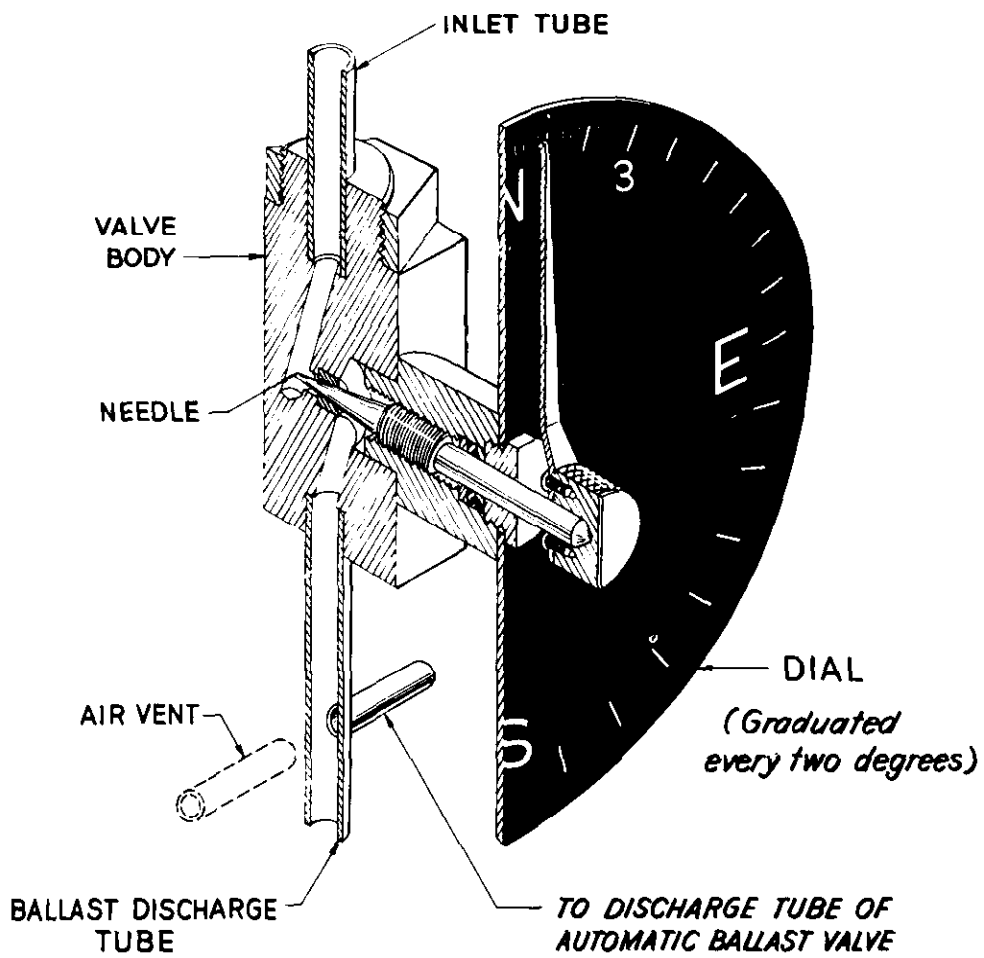

**MANUAL BALLAST VALVE**

**FIG. 8**

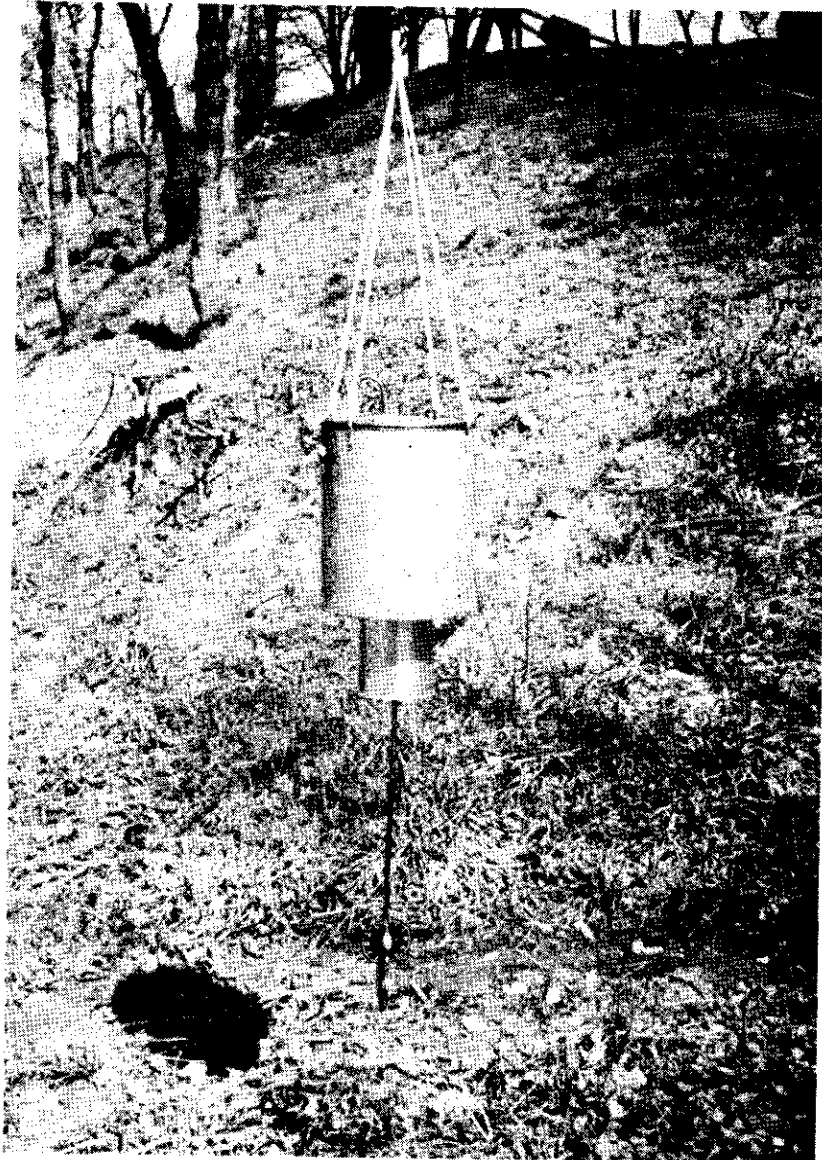

Figure 9  
Fixed rate, manually operated  
ballast release assembly.

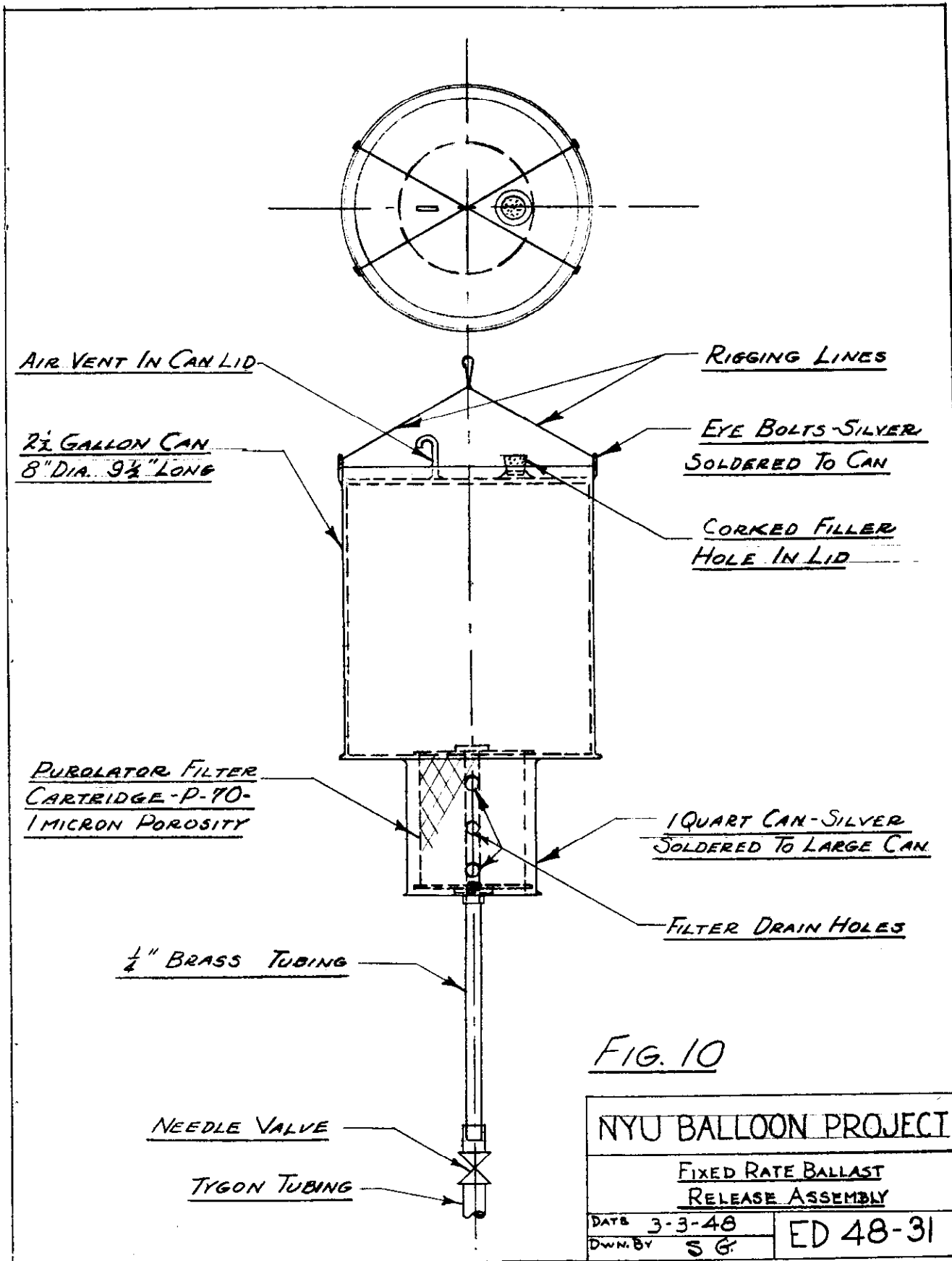

FIG. 10

NYU BALLOON PROJECT	
FIXED RATE BALLAST RELEASE ASSEMBLY	
DATE 3-3-48	ED 48-31
DWN. BY S G	

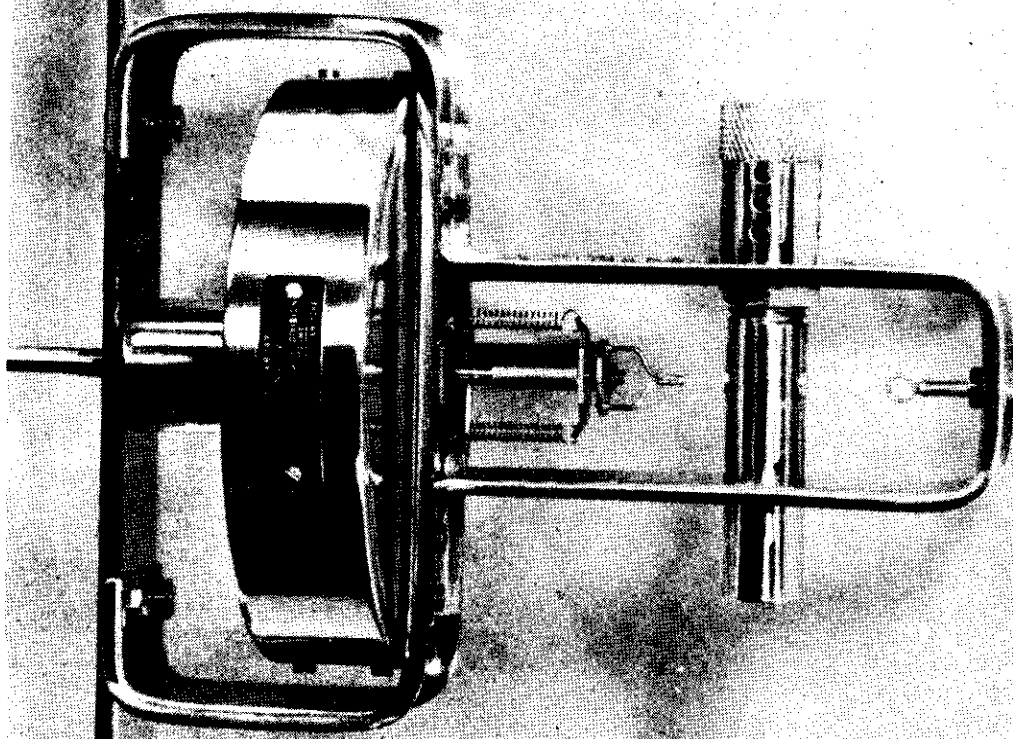

Figure 11  
Automatic ballast valve.

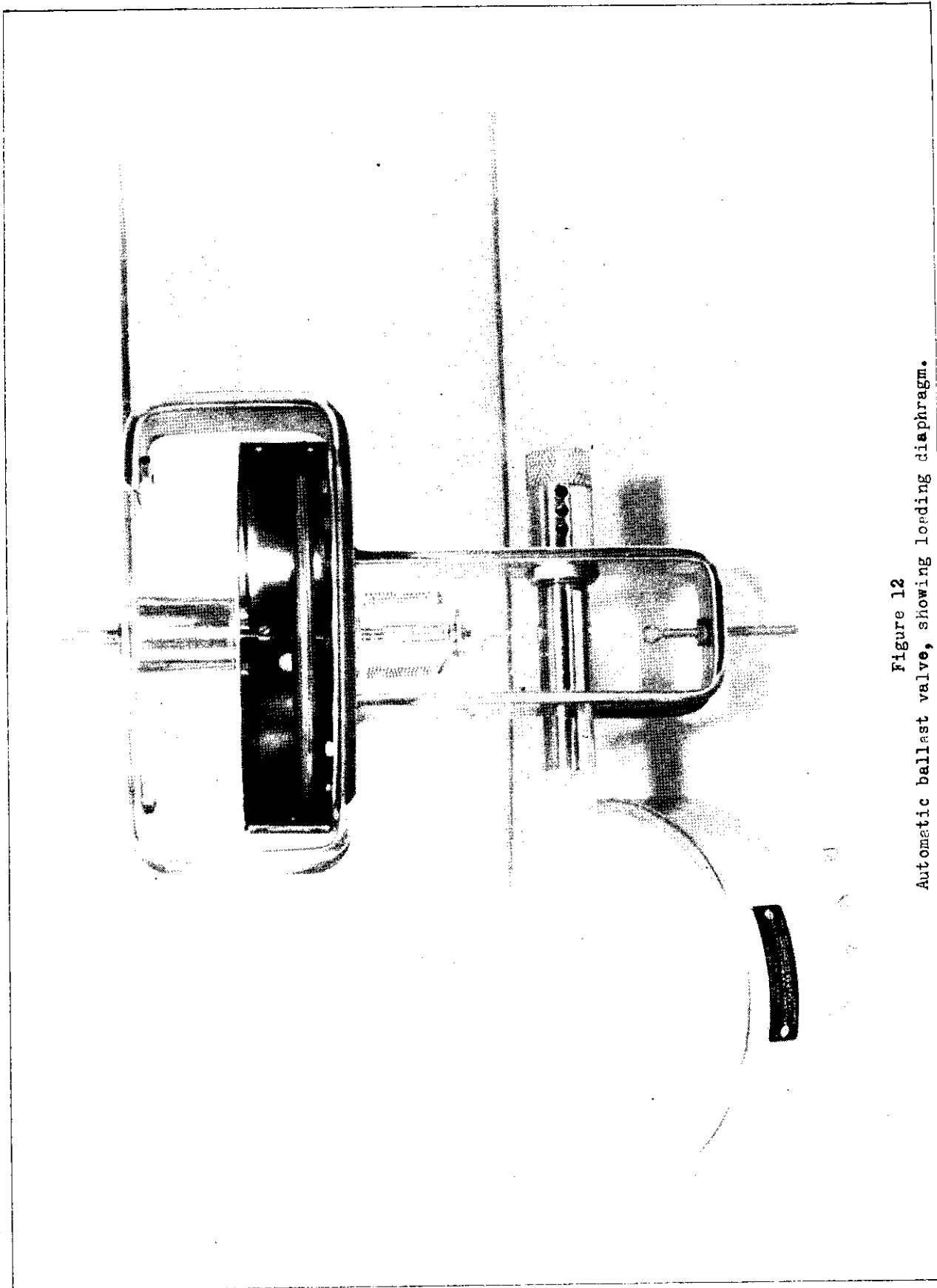

Figure 12  
Automatic ballast valve, showing loading diaphragm.

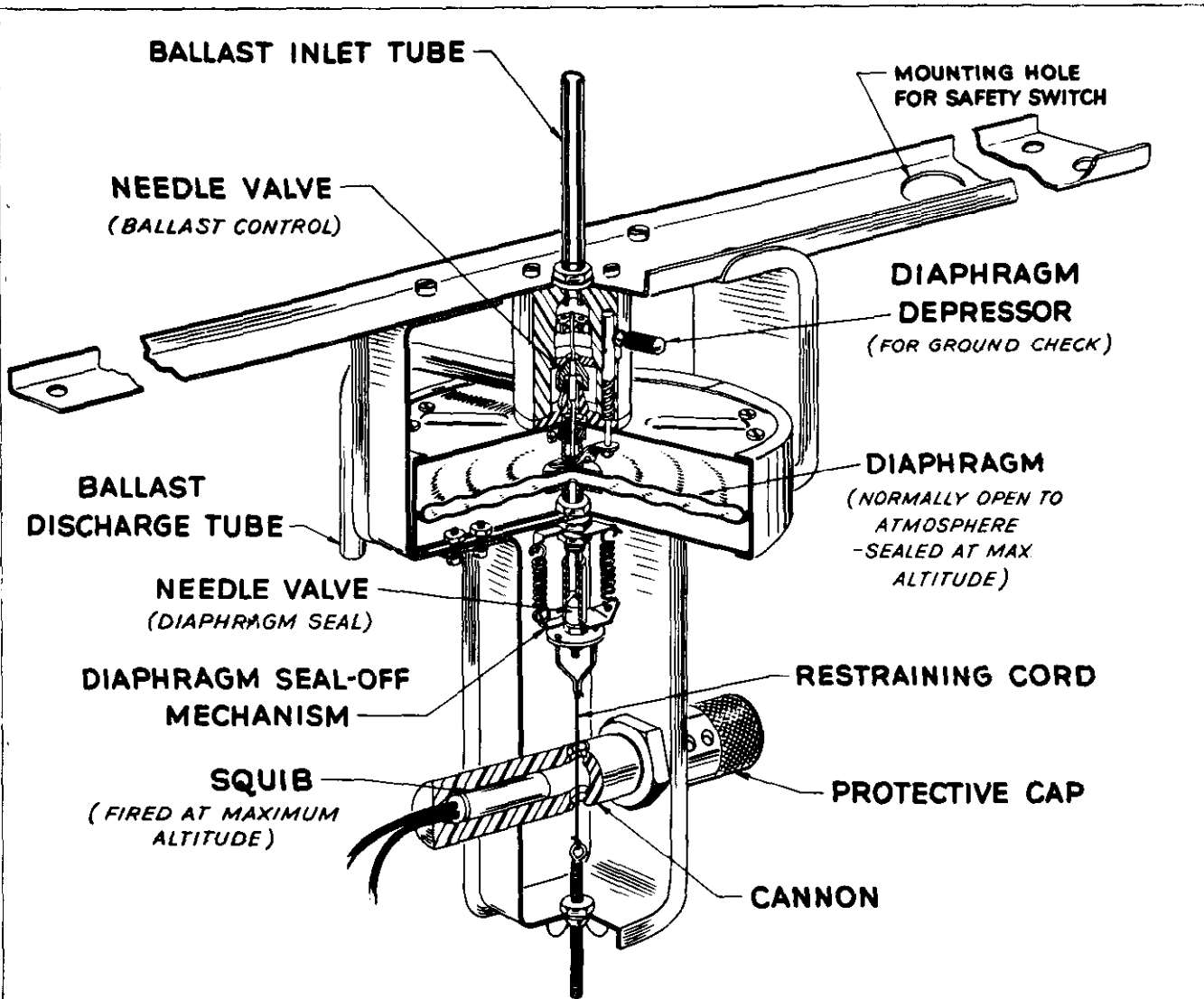

FIG. 13

AUTOMATIC BALLAST VALVE

When the atmospheric pressure outside the diaphragm increases to 5 mb. above the internal pressure, compass fluid will be discharged at the rate of 160 grams per minute under a 1-foot head. When the automatic ballast valve is completely open (at 6.5 mb. pressure differential), 300 grams per minute will flow.

The automatically operated needle valve is held closed by a loaded diaphragm until the balloon reaches altitude. This diaphragm is open to the atmosphere until the balloon descends from the minimum atmospheric pressure attained. At that time, an electrical contact is made, firing a squib which seals the diaphragm mechanically from any further access to the external air. Thereafter, the capsule contains a volume of air which has been trapped at the pressure and temperature existing at the time of operation of the sealing switch. When the ambient pressure increases to the point where the entrapped air is compressed below this original volume, the diaphragm will withdraw the ballast control needle valve allowing ballast discharge to occur.

Figure 14 shows the minimum pressure switch which makes the electrical contact at the time of seal-off. It consists of a trapped volume of air that is allowed to escape through a mercury pool as long as the outside pressure is decreasing. As soon as the exterior pressure increases, mercury is drawn into the tube making the seal off contact between two electrodes.

The dimensions of the air chamber and capillary tubing are chosen so that during operation the change in the volume of the air would be less than one one-thousandth of the original volume. The distance between the two electrodes (one under mercury, the other within the capillary tubing) was influenced by considerations of safety and sensitivity. If the distance is less than 6 mm., shaking during launching is likely to move the mercury

MATERIAL - BLOWN PYREX GLASS

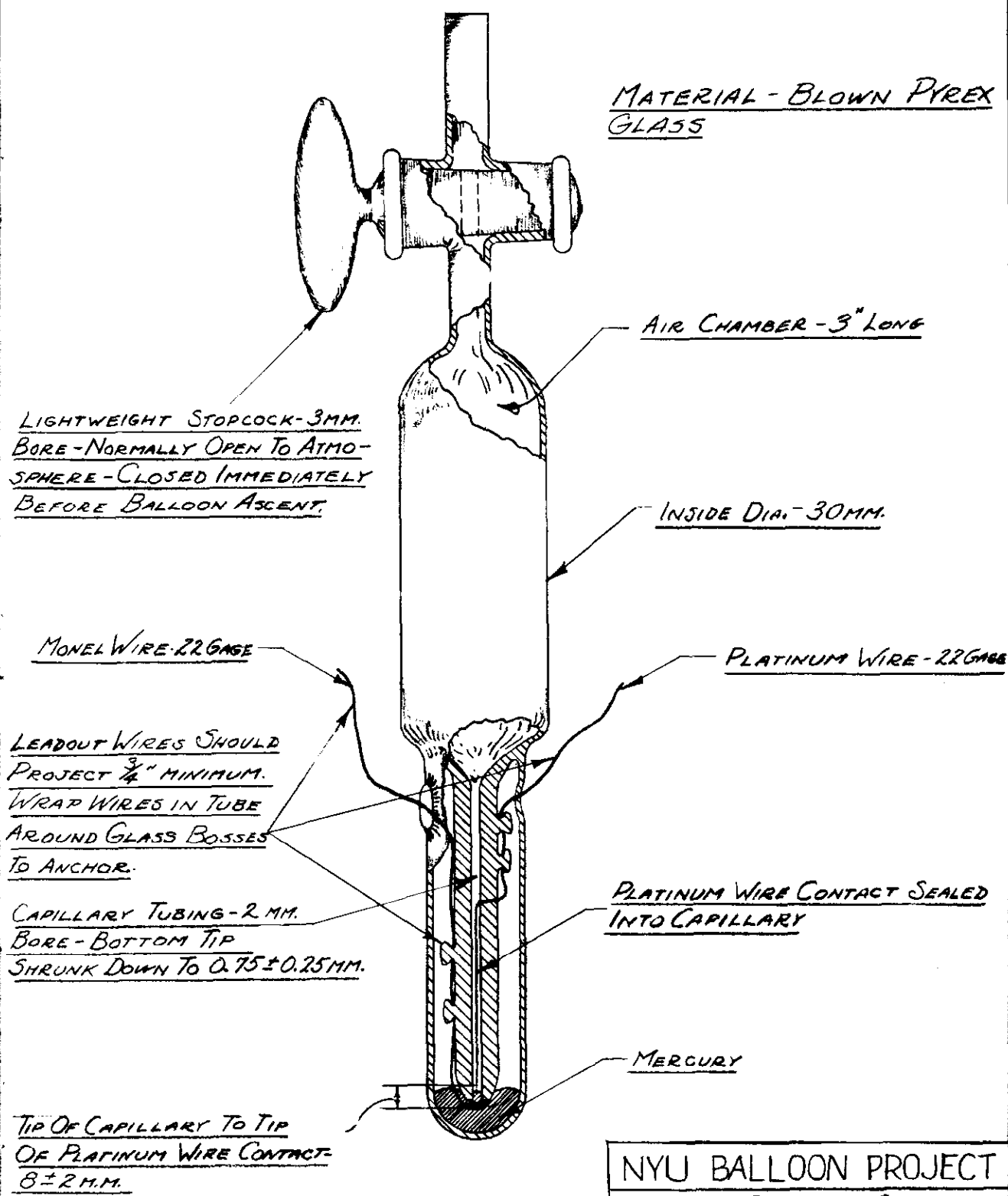

FIG. 14

NYU BALLOON PROJECT	
MINIMUM PRESSURE SWITCH (MERCURIAL)	
DATE: 3-9-48	ED 48-33
SCALE: FULL	
DWN. BY: S.G.	



sufficiently to cause a short between the electrodes, firing the squib prematurely. If the distance is too large, however, there will be too great a height difference between the time of minimum pressure and the time the electrodes are shorted. For instance, a spacing of 10 mm. would delay the firing of the squib until the pressure reached 13.3 mb. above the minimum pressure. At an altitude of 50,000 feet, the equivalent height (standard atmosphere) would be about 2300 feet. It is obvious that for high level flights, a less dense and lower freezing electrolyte for the minimum pressure switch will be needed to obtain the desired sensitivity of 2000 feet.

By adding the pressure-activated automatic ballast valve to the manual ballast valve, the complete pattern of the solid curve in Figure 7 may be achieved ideally. At sunset the rapid cooling causes descent which cannot be compensated for by the manual ballast valve. As soon as the seal-off pressure of the automatic ballast valve is exceeded by the atmospheric pressure, ballast flow is begun, which restores the balloon to its ceiling.

The dashed curve in Figure 7 shows the action of a balloon when the automatic ballast valve alone is used for control purposes. In this case the balloon will sink slowly from its ceiling (where full buoyancy just equals the load) to the level where the automatic ballast valve drops ballast at a rate equal to the diffusion (the floor). It will be noted that a flight which is controlled in this manner is less wasteful of ballast and results in a correspondingly longer flight. The "floor" determined by this valve varies diurnally as the temperature (hence pressure) of the air entrapped in the diaphragm is affected by solar radiation. The amplitude of this diurnal oscillation may be as much as 6000 feet, the night level being higher than the day level.

To reduce the effect of varying fluid heads and a corresponding variation in valve calibration, a ballast reservoir mounting was devised to limit the head values. This ballast reservoir, after several modifications, consists of a spun aluminum tank with filter, mounted on 18-inch legs. It is shown in Figure 15. The legs serve as supports for the other control units and a head of at least one foot is provided by tubing to the automatic ballast valve. The capacity of the reservoir is approximately five gallons. Figures 16 and 17 show the complete ballast release assembly.

One other system of altitude control may be mentioned. This is the method used by Korff and others<sup>4</sup> to roughly approximate constant level flights for cosmic ray investigations. A number of meteorological balloons are inflated until they will just support the flight load. A few other balloons are added to the train to give a free lift appropriate for the desired rate of rise (see Computations, Section 3). At some time after release these "lifter" balloons burst due to over-inflation, or are released by a pressure or time-activated mechanism. If the original balance was correct, and the effects of superheat and diffusion cancel each other, the cluster of cells may float. When one or more of the balloons breaks, or leaks excessively, the train will descend. Although this method was used in early experimental flights it proved to be useful only as a stop-gap method of carrying gear aloft for test purposes. No modification of this basic technique seems likely to produce even a consistent flight pattern due to the uncertainty of properties and behavior of these inherently unstable balloons.

#### C. Altitude Determination

In order to evaluate the performance of the basic control apparatus, an investigation of pressure-measuring equipment and telemetering gear has been made. The problems of measuring upper-air conditions in general

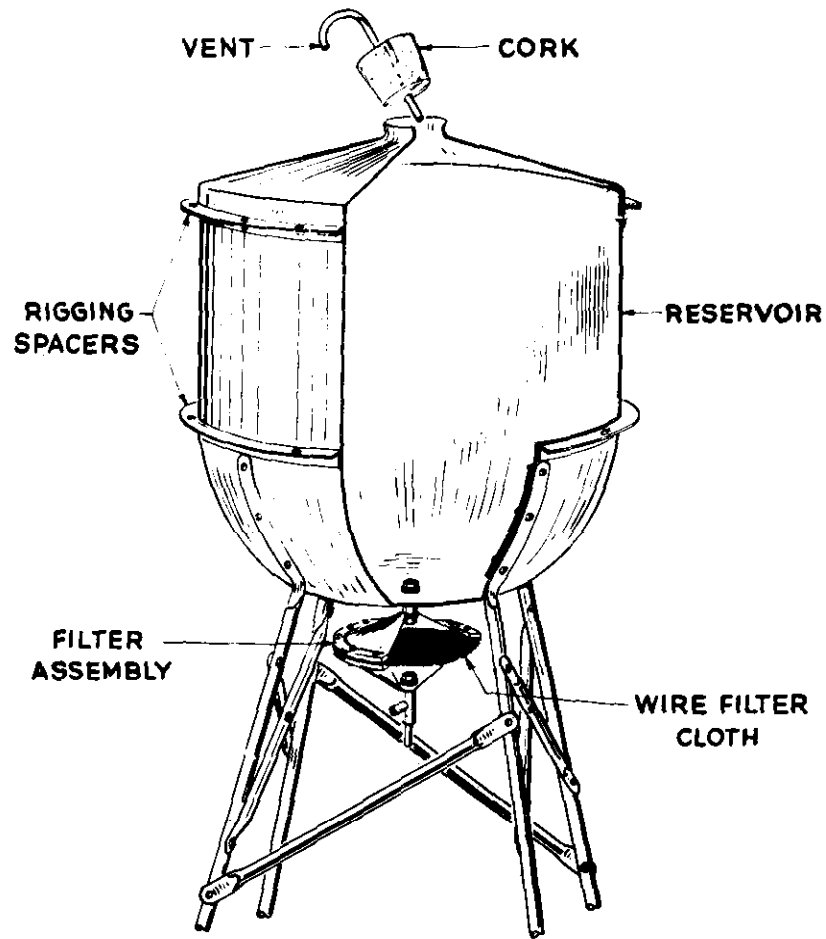

**BALLAST RESERVOIR**

FIG. 15

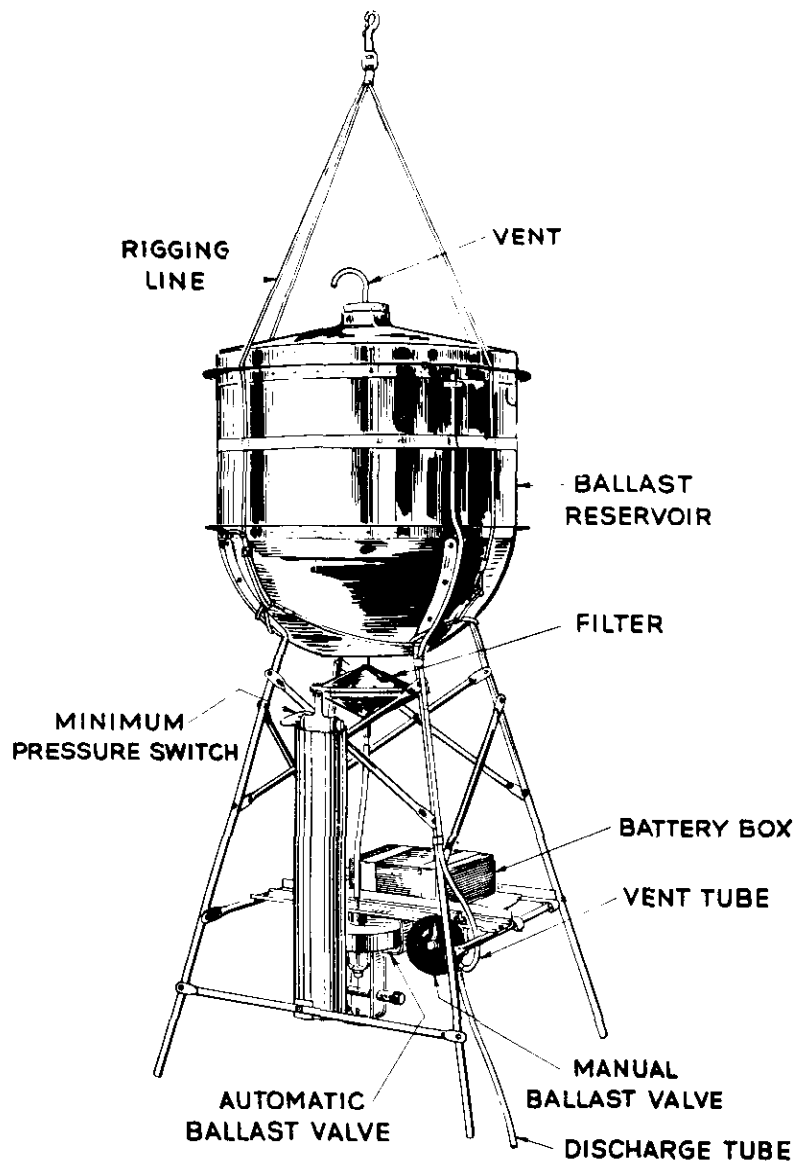

BALLAST RELEASE ASSEMBLY

FIG. 16

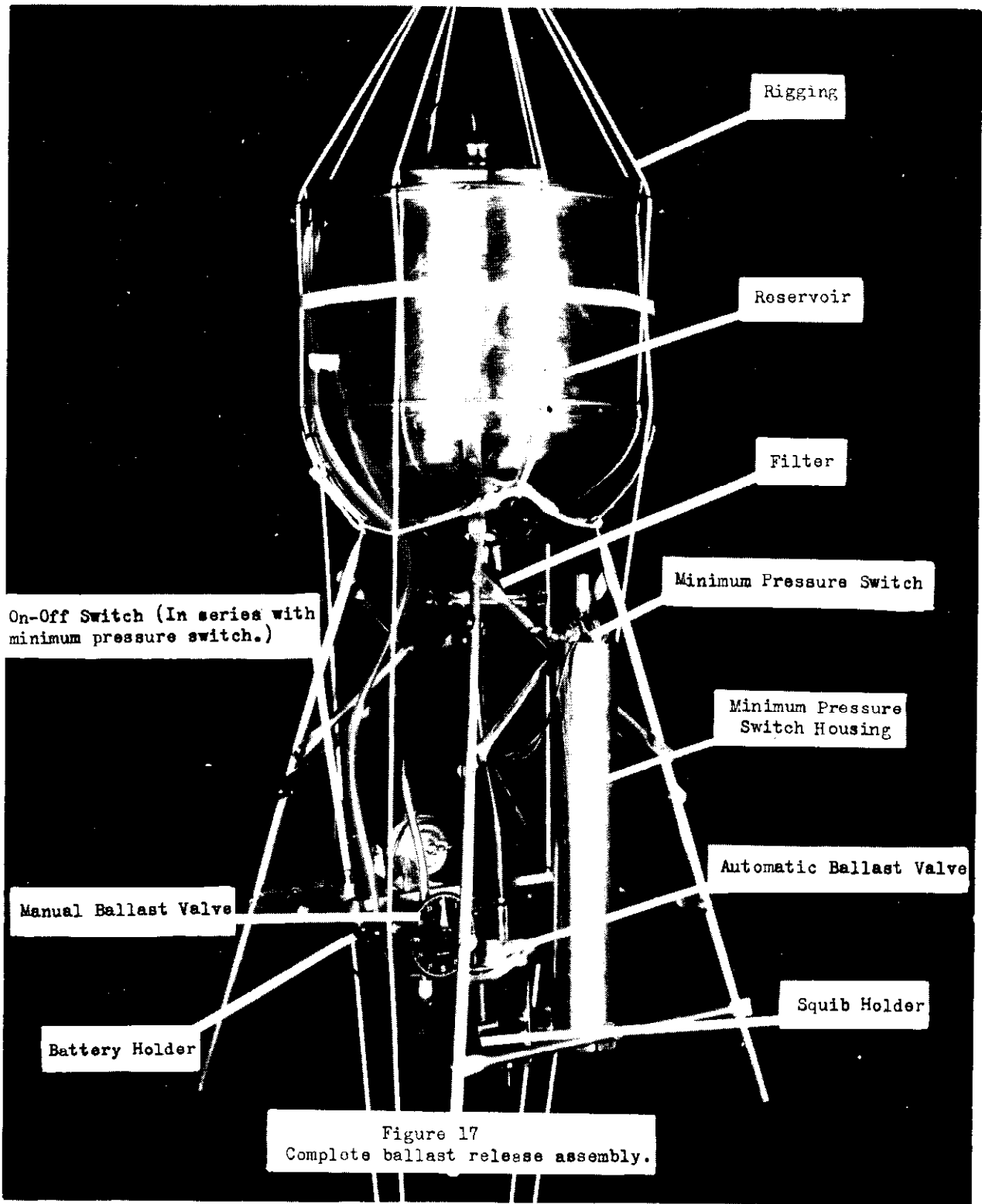

Rigging

Reservoir

Filter

Minimum Pressure Switch

On-Off Switch (In series with minimum pressure switch.)

Minimum Pressure Switch Housing

Automatic Ballast Valve

Manual Ballast Valve

Squib Holder

Battery Holder

Figure 17  
Complete ballast release assembly.

may differ markedly from the problems of surface measurement. For example; for any instrument used on a floating balloon, some consideration must be given to the effect of solar radiation on its behavior. As mentioned in the discussion of the automatic ballast valve, this effect is especially important in the action of any aneroid or other capsule which is not completely temperature compensated. Since the floating balloon will remain within one parcel of air, rising and falling and moving sidewise as the air does, temperature extremes will result from radiation effects and lack of ventilation. One investigator<sup>9</sup> has estimated that the temperatures to be experienced by such a body range from  $-60^{\circ}\text{C}$  after a night of radiation to a maximum of  $+50^{\circ}\text{C}$  in direct sunlight. Two ways of partially circumventing the undesirable results of this feature are:

1. Temperature compensation of the pressure capsule for some pre-set pressure. This compensation is only complete at one pressure.<sup>5</sup>
2. A second method of reducing insolation effects is the use of highly reflective shields.

The methods of height determination used so far are not completely satisfactory. Pressure-heights have been obtained by 72 mc. and 397 mc. radiosonde transmitters with long-life battery packs. Difficulties have been experienced in all long flights due to:

1. Signals being lost due to excessive range or to power failure.
2. When the balloon begins to float and height oscillations result from the action of the automatic ballast valve, it is impossible to identify the radiosonde contact (hence the pressure) using the conventional baroswitch of the Diamond-Hinman type radiosonde.

These steps are now being taken to improve height measurements:

1. The addition to the flight train of a light-weight barograph.

This could provide up to 40 hours of pressure-time data if recovered. At present, about 60 percent of the flights have been recovered.

2. The adoption of a time-interval or Olland-cycle radiosonde system for telemetering pressure data.
3. Expansion of the network of ground tracking stations equipped with SCR-658 direction finding sets to increase reception of data telemetered. Figure 18 shows the area to the east of Alamogordo, New Mexico, and the probable boundaries of flight paths following release from the Alamogordo Army Air Base.

Table III shows the prevailing wind data on which these probable boundaries are based. Also shown in Figure 18 are the desirable locations for SCR-658 sets and the overlap of reception ranges which could be expected, using stations at Alamogordo, Roswell, New Mexico; Hobbs, N.Mex.; and Big Springs, Texas.

TABLE III

AVERAGE WIND INTENSITIES IN BEAUFORT SCALE  
AND WIND DIRECTIONS AT ELEVATIONS TO 10,000  
METERS FOR NOVEMBER AND DECEMBER 1944 AND 1945

		<u>NOVEMBER</u>				
	<u>Year</u>	<u>Surface</u>	<u>1,500 M</u>	<u>3,000 M</u>	<u>5,000 M</u>	<u>10,000 M</u>
El Paso	1944	N-3	NE-1	WSW-5	W-7	--
	1945	N-3	WSW-3	WSW-5	W-7	--
Roswell	1944	S-1	WNW-3	W-4	--	--
	1945	S-3	SW-1	WNW-5	W-7	--
Albuquerque	1944	SE-3	--	W-3	W-6	W-9
	1945	N-3	--	WNW-5	W-8	W-9
Amarillo	1944	SSW-4	W-4	WSW-5	W-7	WSW-11
	1945	SW-4	SW-4	W-6	WNW-9	--
Big Spring	1944	--	WSW-4	WNW-4	W-7	WSW-9
	1945	--	SW-3	W-6	WNW-7	--
Abilene	1944	--	--	--	--	--
	1945	--	--	--	--	W-10

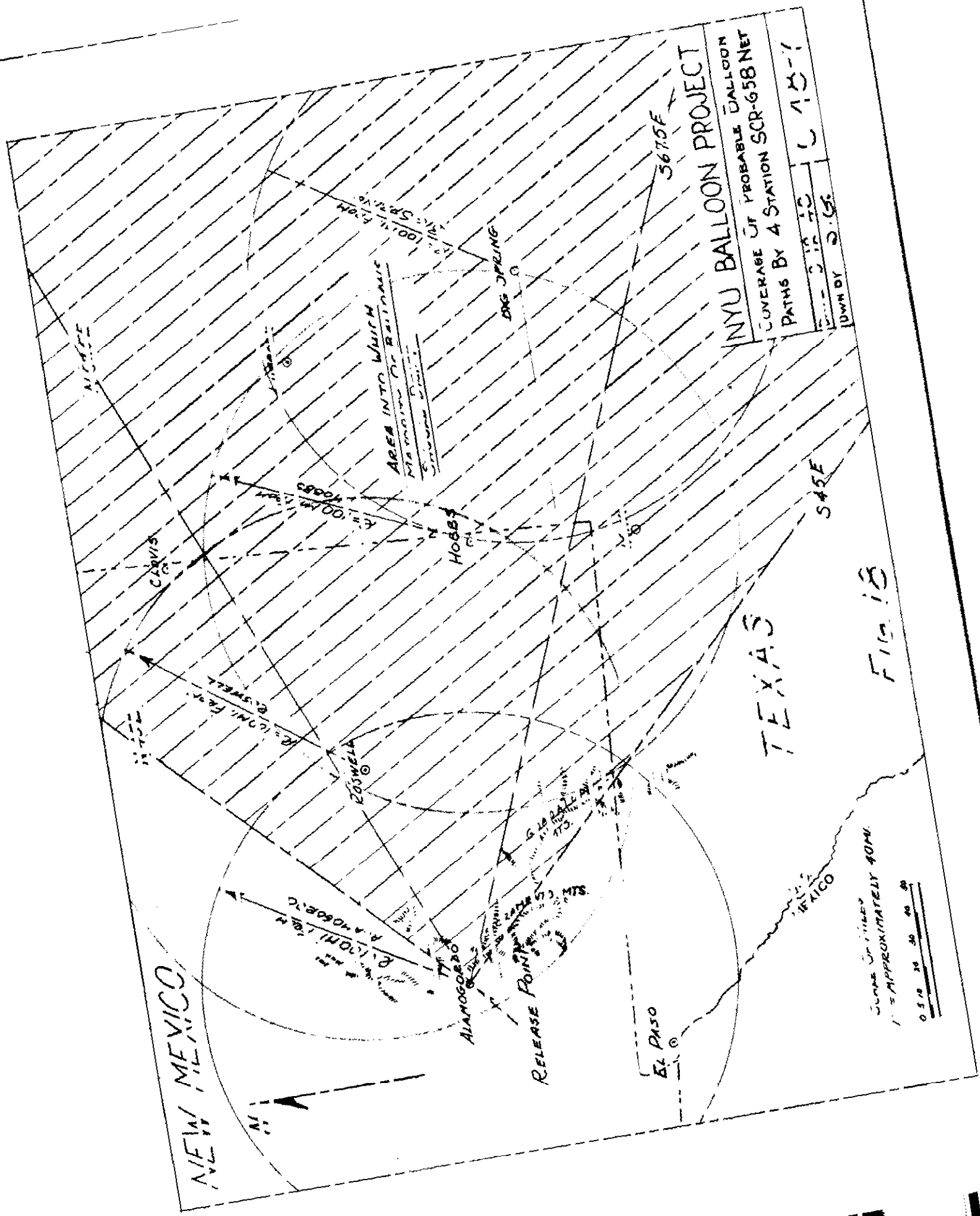

NYU BALLOON PROJECT  
 COVERAGE OF PROBABLE BALLOON  
 PATHS BY 4 STATION SCR-658 NET

DOWN BY 200  
 100  
 50  
 0  
 100-1

Scale of Miles  
 1" = APPROXIMATELY 40MI  
 0 10 20 30 40 50

FIG 18



DECEMBER

	<u>Year</u>	<u>Surface</u>	<u>1,500 M</u>	<u>3,000 M</u>	<u>5,000 M</u>	<u>10,000 M</u>
El Paso	1944	N-3	NNE-1	W-2	NW-1	--
	1945	NNE-3	W-3	WNW-6	WNW-6	--
Roswell	1944	S-1	NW-3	NW-4	WNW-6	--
	1945	SSE-3	WSW-2	WNW-5	WNW-8	--
Albuquerque	1944	N-3	--	WNW-4	WNW-6	W-10
	1945	N-3	--	NW-6	WNW-8	WNW-9
Amarillo	1944	NW-4	NW-4	WNW-5	WNW-6	WNW-8
	1945	SW-3	W-2	WNW-5	WNW-9	--
Big Spring	1944	--	NW-4	NW-5	WNW-6	--
	1945	--	WSW-3	W-6	WNW-7	--

D. Tracking Devices: Horizontal

The flights made in the early part of this program were tracked optically with theodolites. Coupled with the height data, theodolite readings provide a fairly reliable horizontal locus of the balloon. However, even in the clear air of New Mexico, this method is useful for not more than 100 miles and, unless accurate height data are available, theodolite stations provide useful data for not more than 40 miles.

Aircraft observations have been used with some success when the ceiling of the balloon is not too great. It is expected that an inverted AN/APQ-13 radar, mounted atop a B-17, will greatly augment the horizontal tracking and will be of some value in determining height.

The most useful equipment for determining horizontal movement of the balloons has been the SCR-658 radio direction finding set. Long after the vertical angles registered by this gear are questionable (due to reflections off intervening terrain), the horizontal angles are useable. Used in sets of two or more, or coupled with height data, these observations give good positions with distances up to 150 miles. Figure 18 shows the coverage a network of four of these sets would provide. In contrast to the theodolites and aircraft observations, these instruments are perfectly operative when

the balloon is not visible due to haze, cloud cover, etc. Ground radar has been used, when available, with fair results, particularly when radar targets are added to the flight train.

#### E. Flight Termination Control

Due to the size and weight of the balloons and the flight gear, the Civil Aeronautics Authority was advised of the testing program. At a meeting in New York on 20 March 1947, the New York Air Space Sub-Committee prescribed a procedure which was designed to minimize the hazard to air traffic. Similarly, the Fort Worth Sub-Committee established a procedure for flights made within the Fort Worth region of the CAA. Pertinent correspondence with the CAA is included in the Appendix, Part 2. Owing to the size of these cells, a very slow rate of descent should be expected after all ballast has been expended and the flight control devices have ceased to operate. Thus a large balloon and several heavy pieces of equipment might take an hour or more to descend through the levels of air travel. Despite the extreme improbability of midair collision, it is obviously desirable to take all possible precautions against such mishap and current flights have the following safeguards: (1) Flights are released on days when cloud cover is forecast to be light, thus permitting visual contact. (2) Notices to airmen are to be issued if the balloon is descending within designated regions of dense air traffic. (3) To reduce the time involved in a final descent, a special device called the "blowout patch" has been developed. This is an igniting squib which is fastened to the side of the cell, on the equator. Sealed in with the squib, which is fired electrically when the cell descends below 20,000 feet, is a quantity of gunpowder and magnesium. When the squib is fired, the incendiary patch blows out, allowing a rapid escape of gas through the opening. Since the

patch is on the equator, the cell does not collapse but serves as a parachute to prevent extremely rapid fall and damage to the instruments. Figure 3 shows this patch in position on a balloon. Due to premature firings, a time switch has been built into the circuit to prevent misfiring in launching. A rip device will be developed to replace the incendiary on all future flights.

### Section 3. Theoretical Relationships and Computations

#### A. Altitude-Density Relationships

An investigation into the relationship between density of the atmosphere and altitude, with the seasonal and geographical variations experienced, was made. The basic data, mean aerological soundings, were taken from the Monthly Weather Review, 1943<sup>6</sup>. These basic data consisted of observed temperatures, pressures, and humidities for altitudes from the surface up to the bursting height of balloons, normally 50,000 to 60,000 feet. For altitude above this height, the highest reported temperatures for the stations under consideration were used and the pressure data were taken for the remaining altitudes up to 100,000 feet, from the N.A.C.A. Standard Atmosphere<sup>7</sup>.

Density was expressed inversely in terms of pound molar volumes, as this relates volume in cubic feet to buoyancies of gases of varying purity, using fundamental data. Using the simple gas laws, the molar volume of dry air at each altitude was computed in the following manner:

Given: (1) The pound molar volume of any gas at standard conditions=359 ft.<sup>3</sup>

(2) From the mean sounding data at 49,200 ft. (15 km.)

over Lakehurst, N.J. (Jan. 1943).

Temperature = -59.5°C.

Pressure = 120 mb.

$$\text{Molar volume (standard)} \times \frac{\text{Temperature (observed)}}{\text{Temperature (standard)}} \times \frac{\text{Pressure (standard)}}{\text{Pressure (observed)}}$$

= Molar volume at observed conditions.

$$359 \times \frac{273.2 - 59.5}{273.2} \times \frac{1013.3}{120} = 2370 \text{ ft.}^3$$

This is the mean pound molar volume at 15 km for Jan. 1943 over Lakehurst, N. J. This volume data was computed for levels up to 100,000 ft. over several stations and may be found in Appendix 3, plotted on the left hand side of figures 19 and 20.

#### B. Load-Diameter Maximum Altitude Relationships

Molar volume is related to buoyancy in the following fashion. Using 98% hydrogen of molecular weight, 2.11 lb./mol. and dry air of molecular weight 28.76 lb./mol., a buoyancy equal to the difference, 26.65 lb/mol. (See Table IV) is available whenever one pound molecular weight of hydrogen displaces one pound molecular weight of dry air under the same conditions of temperature and pressure.

TABLE IV

Buoyancy per Pound-Mol.	
Helium (98%)	24.6 #/#mol, or 11.1 kg/#mol
Hydrogen (98%)	26.6#/#mol, or 12.1 kg/#mol

The number of mols in a balloon volume may be readily computed by dividing the air density, expressed in molar volume, at a given altitude into the balloon volume. The lift of the gas filling the balloon at any altitude is then equal to the number of mols multiplied by the buoyancy per mol. For example: To find the lift of the gas in a completely inflated (hydrogen filled) balloon of 20-foot diameter, at an altitude where the pound molar volume is 1000 ft.<sup>3</sup> (This is equivalent to about 30,000 ft.):

$$\text{Volume of a 20-foot diameter sphere} = 4190 \text{ ft}^3.$$

$$\text{Number of mols in sphere at this altitude} = \frac{4190}{1000} = 4.19 \text{ mols}$$

$$\text{Buoyancy} = 4.19 \text{ mols} \times 26.65 \text{ #buoyancy/mol} = 111.7 \text{ # lift given by the gas at 30,000 feet.}$$

In one step, this becomes:

$$\text{Gross Lift/Balloon} = \frac{(\text{Balloon Volume}) \times (\text{Difference in molecular weights of air and lifting gas})}{\text{Molar Volume at a given altitude}}$$

Conversely, the maximum altitude to which a given size balloon will carry itself and a specified load can be determined, as a molar volume, which may be evaluated from a graph of altitude versus molar volume. Such graphs, computed as in Part A of this Section, are given in Figures 19 and 20, at the left hand edge.

Hydrogen and helium lifts were computed for various molar volumes for spheres of lifting gas with diameters from 7.5 to 75 feet. Figures 19 and 20 were plotted using the values computed. To use these figures to determine the maximum altitude of a balloon with a specified pay load, enter the table with required buoyancy (balloon weight plus payload). Go vertically to the diagonal line representing the balloon's size, and then read horizontally on the left hand edge, either the molar volume or the equivalent altitude over

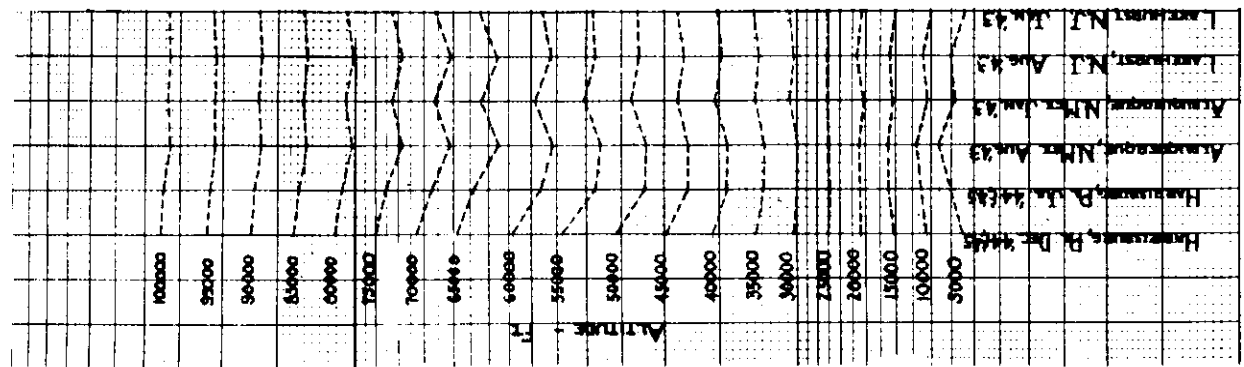
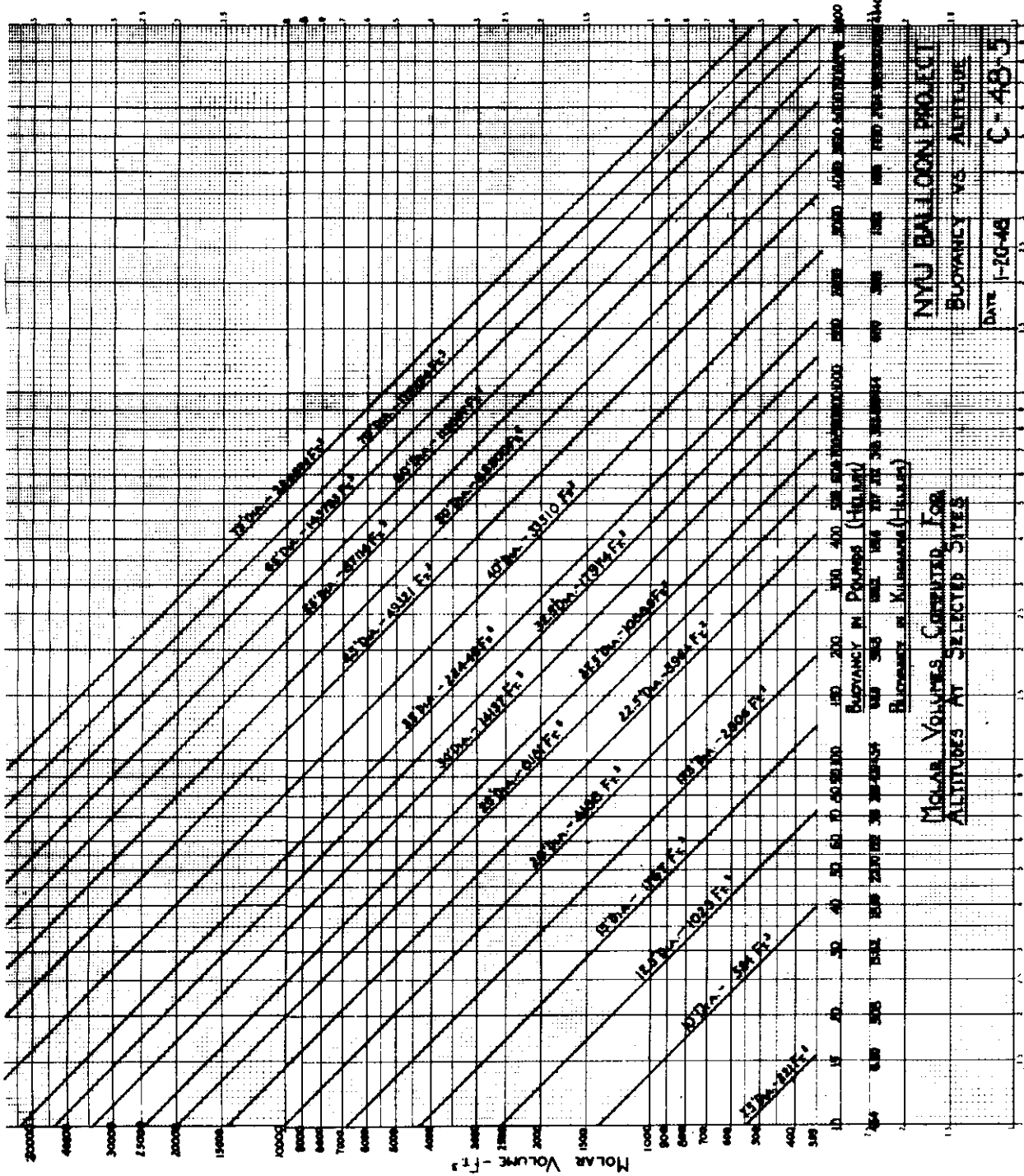

FIG. 19

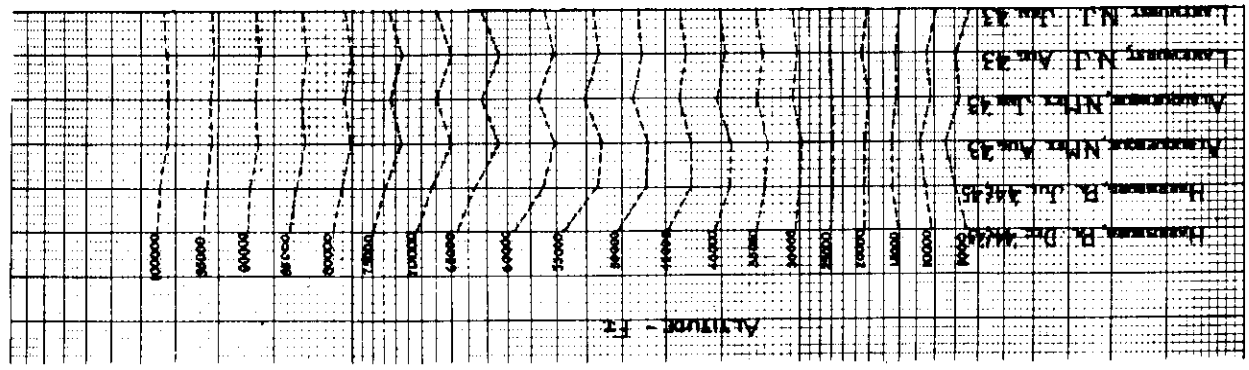
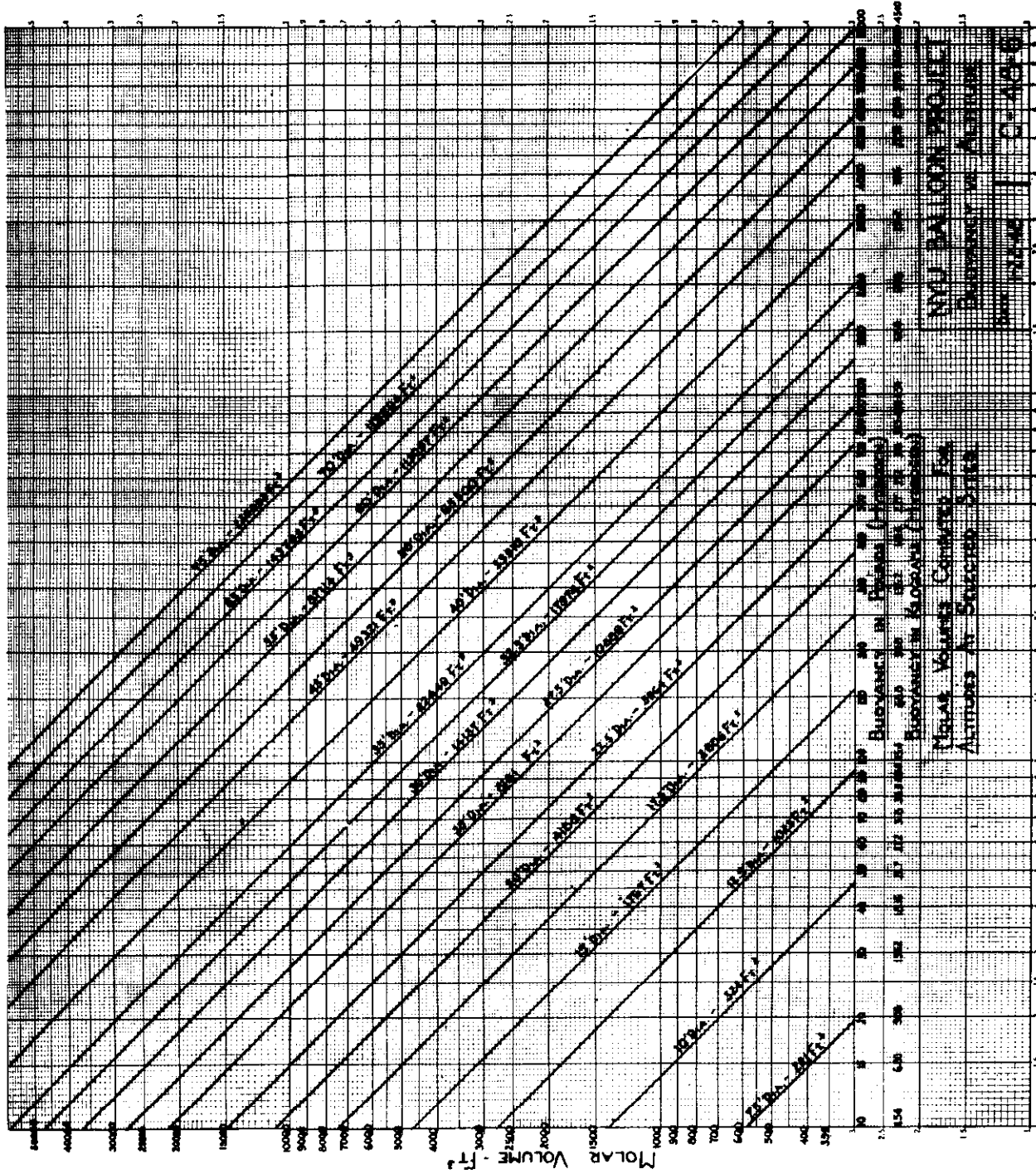

FIG. 20

NAVY BALLOON BUREAU  
 BUREAU OF AERONAUTICS  
 WASHINGTON, D. C.

MEAS. VOLUMES CORRECTED FOR  
 AIRBORNE AIR STATISTICS SERIES

sample stations. Figure 21 shows the calculated net lift of the General Mills balloons.

C. Balloon Diameter-Weight Relationships

To facilitate design discussions, charts have been drawn up relating the approximate weight of a balloon to its size and the unit weight of the balloon fabric. A ten percent increase is added to the weight over that determined from the surface area to account for seams and shroud lines. Figures 22 and 23 are these charts.

D. Rate of Rise

It is important that the rate of rise of a balloon be neither too fast nor too slow. For example, if a General Mills' 20-foot balloon rises faster than 900 feet per minute, there is danger of rupturing the balloon when pressure altitude is reached. On the other hand, if rates of rise under 400 feet per minute are chosen, since the free lift will be quite low, there is danger of: 1) a slight error in inflation resulting in the balloon's being unable to lift the equipment, or 2) with a wind much in excess of the rate of rise, the up-wind release failing due to the dragging of the equipment prior to its being lifted by the balloon.

To compute the free lift necessary for a given rate of rise, the equation developed by Korff<sup>4</sup> is used. This equation is:

$$V = 412 \frac{(F)^{\frac{1}{2}}}{(G)^{\frac{1}{3}}}$$

where F = free lift in grams

V = rate of rise in feet per minute

G = gross lift in grams

For our purposes, we wish to find F and have modified the equation to read:



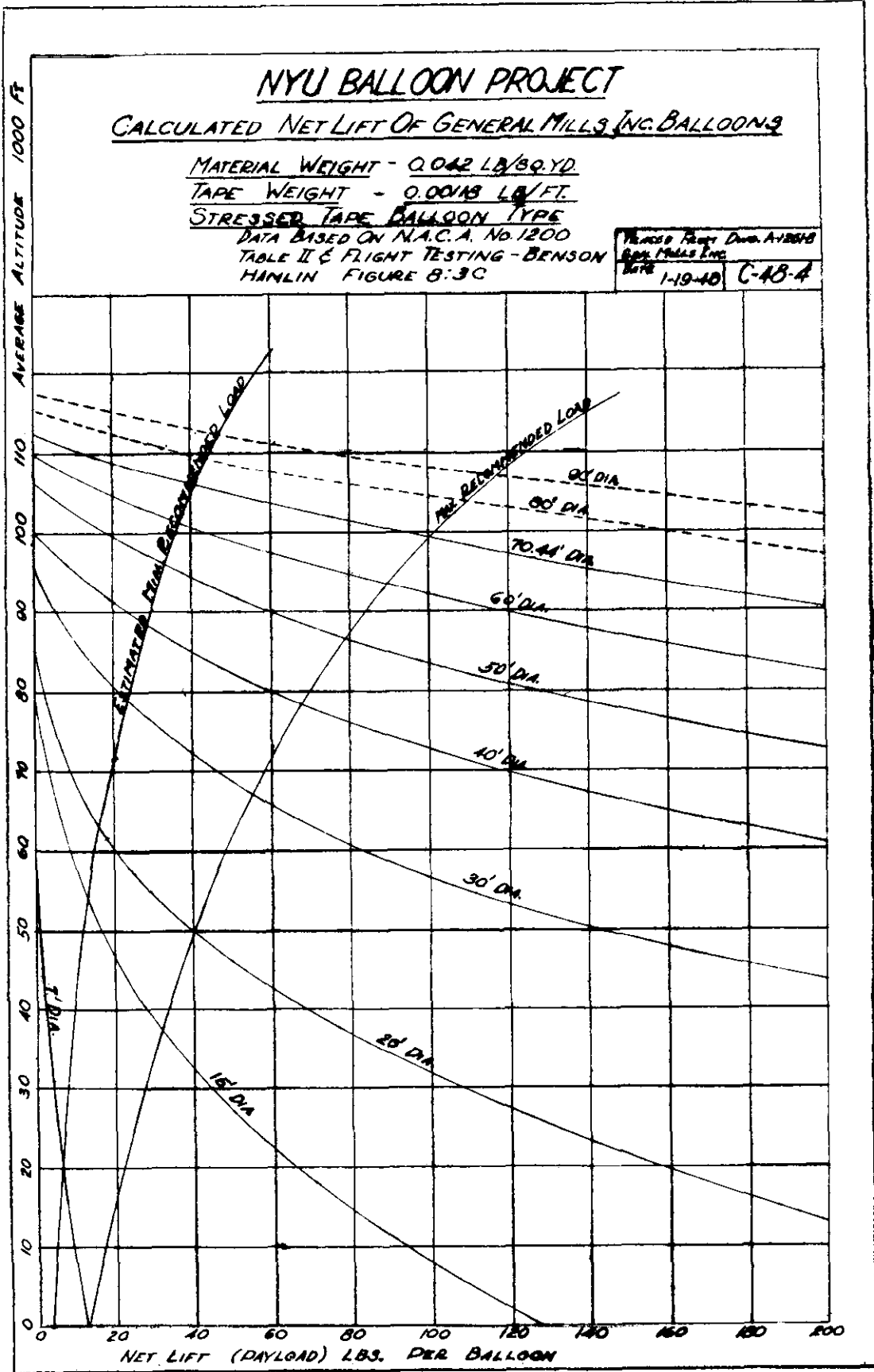
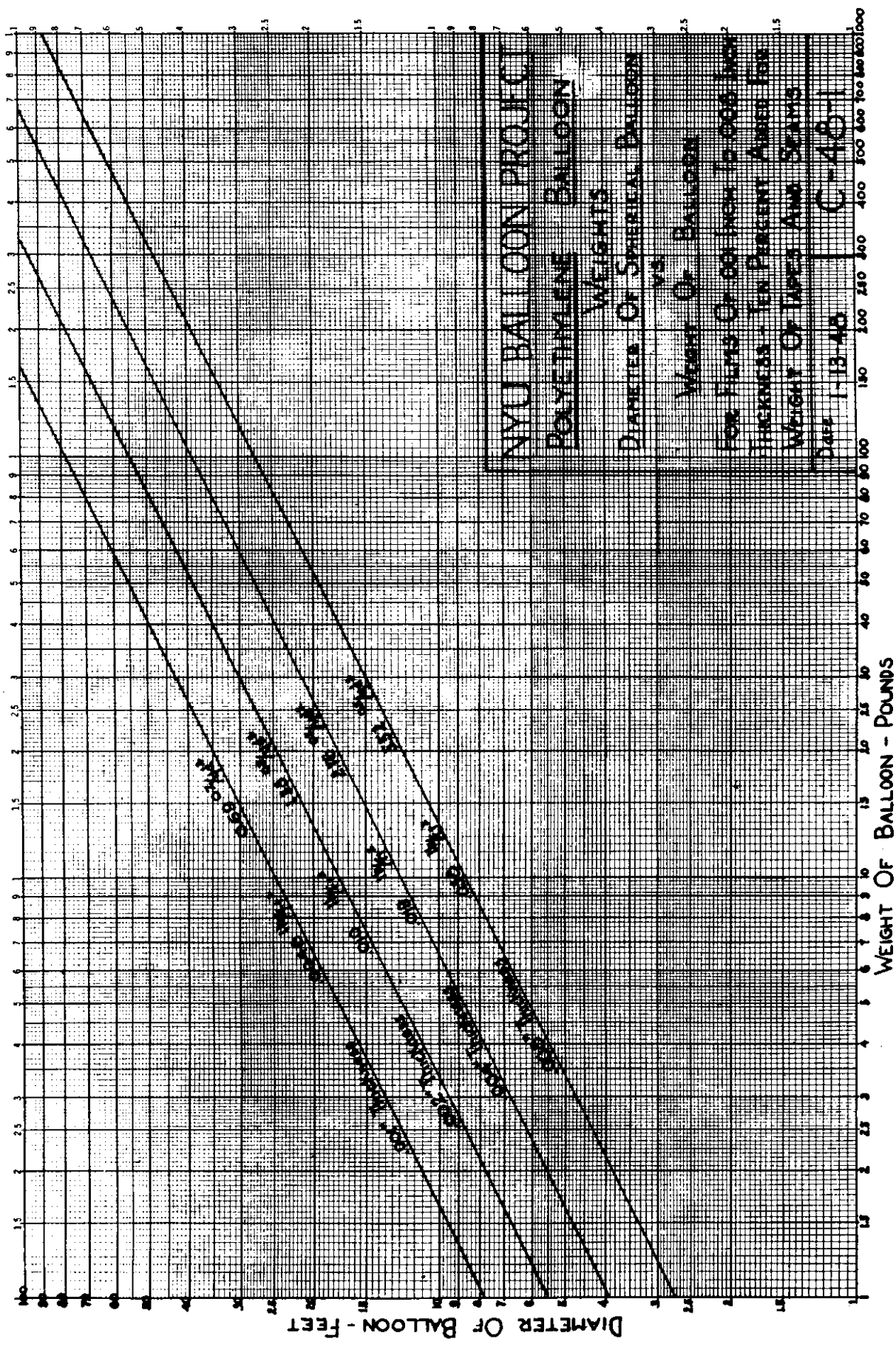

FIG. 21



WEIGHT OF BALLOON - POUNDS

FIG 22

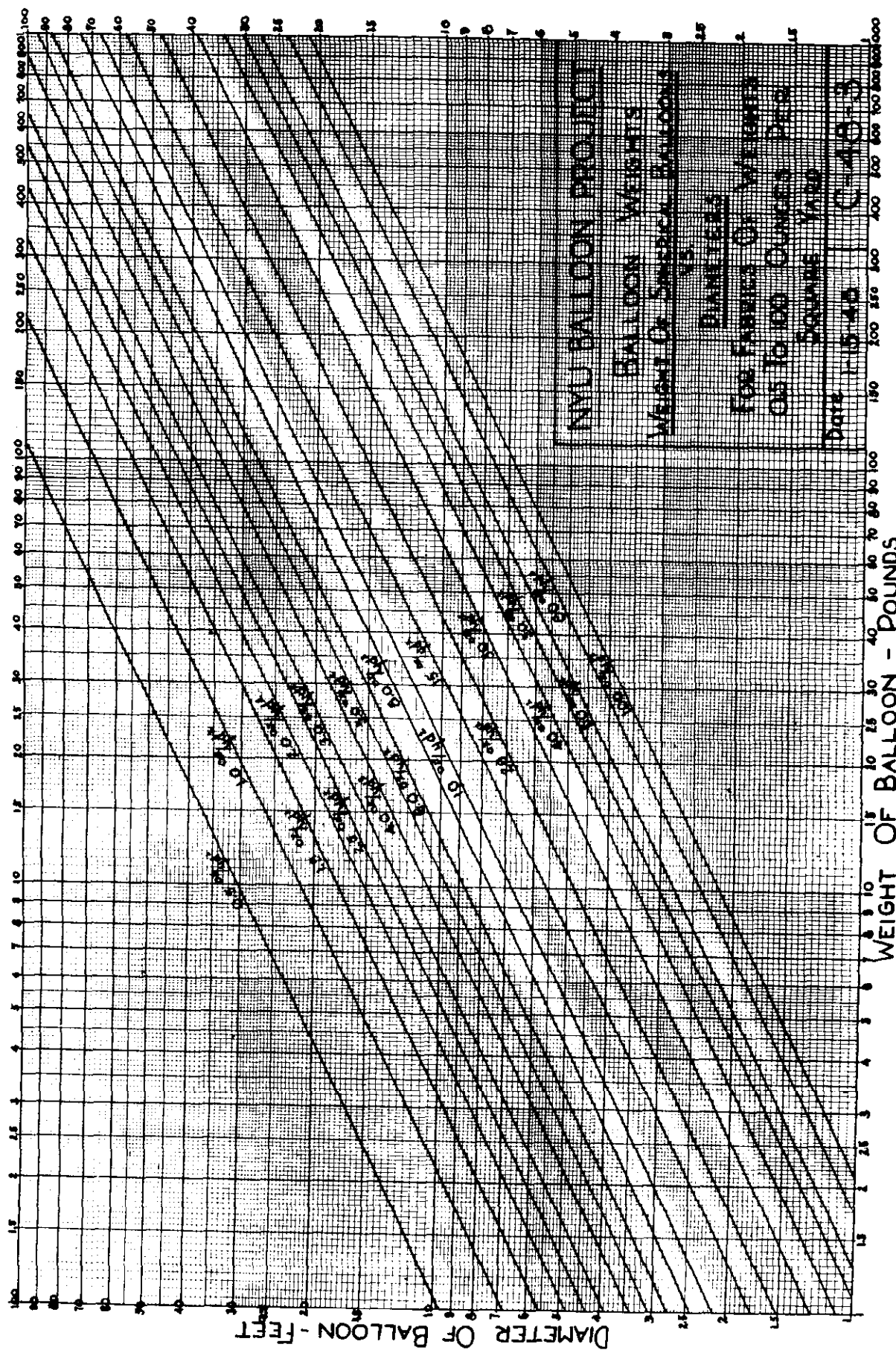

FIG 23

$$F = \left( \frac{V}{412} \right)^2 \times (G)^{\frac{2}{3}} \quad (\text{Approximate})$$

where G = gross load

A chart, Figure 24, has been drawn up, based on this equation, expressing free lift as a percentage of gross load, allowing the rate of rise to be approximately predetermined.

#### E. Ballast Requirements

The amount of ballast which must be dropped through the manual ballast valve to keep the balloon at its ceiling, can be approximately determined by the following measurements: a balloon of similar size and construction is inflated and its loss of lift with time is measured with correction for variation of temperature. This inflation is not complete, but is of the same magnitude as that of a balloon ready for release, approximately 14% of full inflation in the case of a General Mills balloon. The loss of lift per hour, multiplied by a factor representing the increase of the surface which results from total inflation, is thus obtained. This factor is the reciprocal of the fraction of inflation raised to the two-thirds power for a spherical balloon, and is approximately the same for the tear-drop shaped General Mills balloons.

Field experience has shown that ballast leak pre-set to slightly exceed the computed loss of lift is insufficient. A ballast leak of double the computed loss of lift has usually been adequate. It is believed that increased liquid viscosity and valve closure caused by the colder temperatures of the high atmosphere are responsible for the need for this higher ballast setting. An investigation into temperature effects on the ballast release systems has been started.

The amount of ballast which must be released at sunset to compensate for the loss of superheat, may be computed as follows:

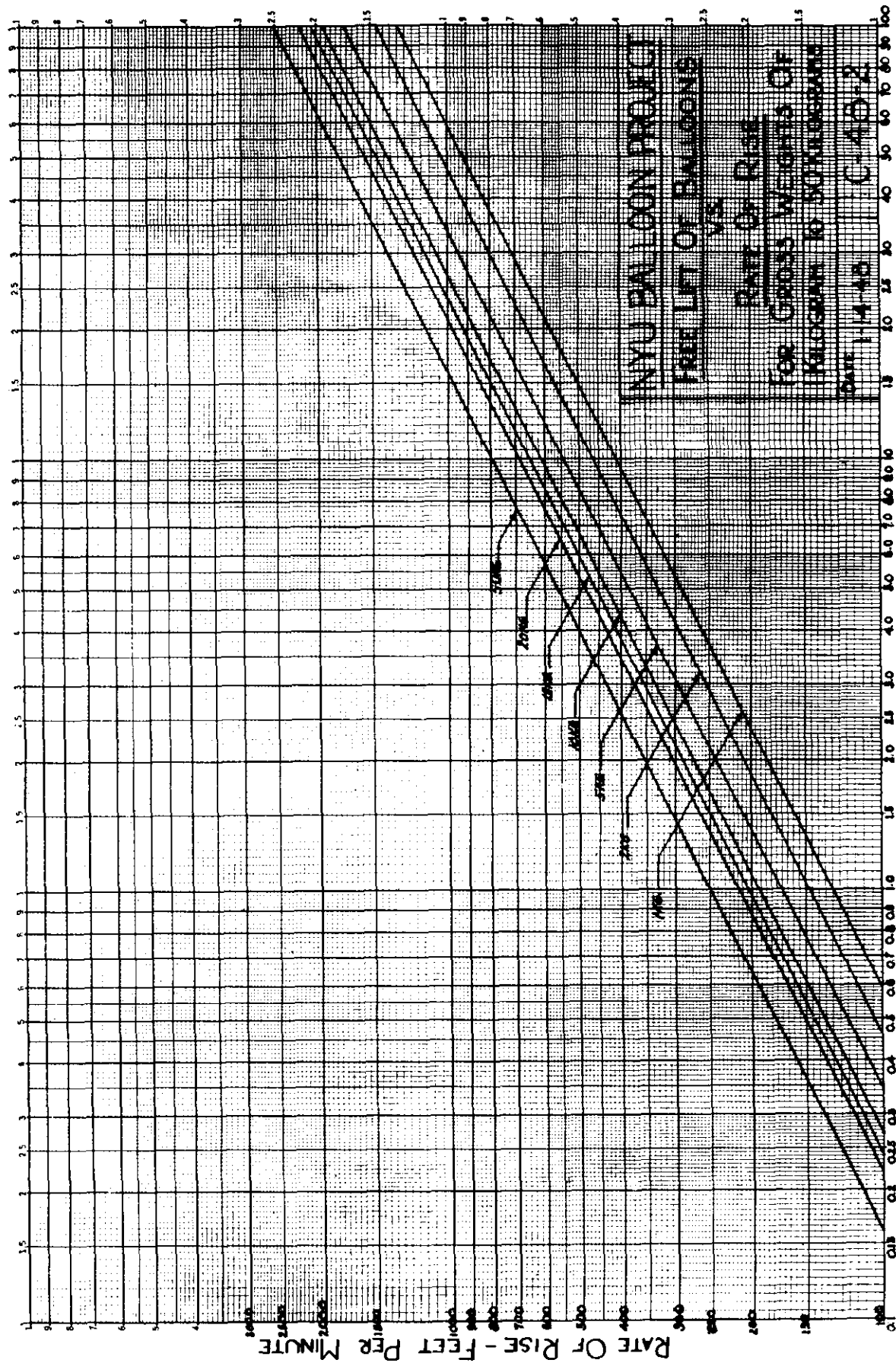

FREE LIFT - PERCENT OF GROSS WEIGHT

FIG 24

$$\Delta G = G \times \frac{\Delta T}{T} \times (1 + K) K$$

where  $\Delta G$  = loss of lift

$G$  = gross load (balloon weight plus  
equipment load)

$\Delta T$  = mean temperature difference in  
lifting gas before and after sunset

$T$  = free air temperature

$K$  = specific gravity of lifting gas,  
relative to air

The specific gravity of 98% helium, diluted with air, and with respect to air, is 0.157. It may be noted that with a lower specific gravity of a gas, lower ballast corrections are required. Hydrogen, for example, requires half the ballast which helium requires for the same temperature differential. At high altitudes, a difference of 40°C may be expected in the temperature of the lifting helium from day to night. This would correspond to a loss of lift at sunset, on a General Mills 20-foot balloon, of about 550 grams.

#### F. Internal Pressure

The maximum internal pressure which can be held within a spherical container is given by Timoshenko<sup>8</sup>:

$$P = \frac{2S_u \times t}{r}$$

where  $S_u$  is the ultimate strength of the material in tension,  $t$  is thickness of the material and  $r$  is the radius of the spherical shape. Applying this equation to a polyethylene film, such as used in the General Mills 20-foot balloons,  $S_u$  at room temperature = 1900 psi.,  $t = 0.001"$ , and  $r = 10$  ft., giving the maximum pressure,  $P = 0.032$  psi. This pressure is equivalent to about 1.1 inches of water, or 2.5 mb. This small bursting pressure necessitates proper inflation and load values to prevent the balloon's

bursting at pressure altitude.

A series of forms which have been used to facilitate computations have been drawn up. They are included in Appendix 3, together with a table of altitudes based on the N.A.C.A. Standard Atmosphere<sup>6</sup>, and other useful reference tables.

TABLE V

Glossary

Equipment load: Weight of all equipment, rigging, and ballast hung from the balloon shrouds not including balloon or its integral parts.

Gross load: Load on the gas at release (Balloon plus equipment load weight).

Free lift: Net lift of the balloon with the equipment load attached.

Gross lift: Lift of all of the gas in the balloon at release (Equals weight of the balloon, equipment load plus the free lift).

Balloon inflation: Gas inflation to be given the balloon in terms of initial lift of the balloon (equals weight of equipment load plus free lift plus allowance for gas losses before launching).

Floor: The locus of altitudes at which a balloon will float when lift losses are exactly compensated for on a demand basis by ballast dropping. In practice, this is determined by the operation of the automatic ballast release and is some altitude below the ceiling.

Ceiling: The locus of pressure altitudes at which a non-extensible balloon will float when gas losses are slightly over-compensated for by ballast losses.

Pressure Altitude: The altitude at which a non-extensible balloon becomes fully inflated.

Pressure Height: The height above mean sea level as determined from pressure measurements used in this work with the N.A.C.A. Standard Atmosphere.

#### Section 4. Flight Techniques

The general techniques of preparing and launching controlled altitude balloons are patterned after those of the smaller radiosonde balloons. The treatment of large, manned balloons has been studied, however, and information of considerable value has been gleaned; as from the National Geographic Society reports of the flights of Explorer I and Explorer II<sup>11,12</sup>, and from the book by Upson and Chandler<sup>15</sup>. From these and other studies<sup>13, 14</sup>, and from original experimentation with General Mills advice, a satisfactory technique of handling controlled-altitude balloons has been developed.

##### A. Inflation

The lifting gas used for these large balloons has been helium. The choice of gas was made on safety considerations. Hydrogen, however, has several advantages over helium. It will lift 9% more than helium and, due to its lower specific gravity, requires but 50% of the ballast release that helium requires to correct for disappearance of superheat at sunset. Helium, on the other hand, leaks and diffuses at a rate but 70% that of hydrogen. However, for long flights, hydrogen would probably have more over-all economy of ballast.

Inflation has been made through a low-pressure, diffusing manifold, feeding from a number of helium tanks simultaneously to the balloon. The smaller balloons have been inflated inside a hangar, permitting very exact weigh-off of the balloon's free lift, thus predetermining the rate of rise fairly well. The plastic balloons larger than 15 feet in diameter have generally been inflated out-of-doors, as no hangar large enough for interior



inflation has been available.

The 20-foot General Mills balloons are inflated through a tube in such a fashion that the gas collects in a bubble at the top of the balloon. The tube is inserted by the manufacturer and is shown in Figure 5. If this bubble is restricted, the wind cannot catch and make a sail of it. (See figure 25 for the sail effect.) The actual technique of inflation is as follows:

In actual inflation the balloon is spread out on a ground cloth which covers the launching table and a balance. The balloon is arranged so the upper 18 feet projects beyond the balance. Two heavy (80#) elliptical shot bags (see Figure 26) are covered with polyethylene and placed on top of the balloon on either side of the inflation tube. The platform is then made to balance. The lower end of the balloon is weighed and then stretched out again down wind, held down with sand bags and polyethylene strips. A weight equal to the weight of the lower half of the balloon, plus the equipment weight and the desired free lift is placed on the balance. Inflation is started, taking care to get all twists out of the inflation tube before allowing full gas flow. When the balance beam falls, inflation is complete (care must be exercised to guard against underinflation due to wind moving the balloon on the balance). The inflation tube is carefully removed, and the helium truck is moved clear. All personnel are now positioned for release.

#### B. Release

During the early portion of the experimental period, flights of meteorological balloons in clusters were launched. The first flights were made with balloons hitched one above another along a single strong load line.

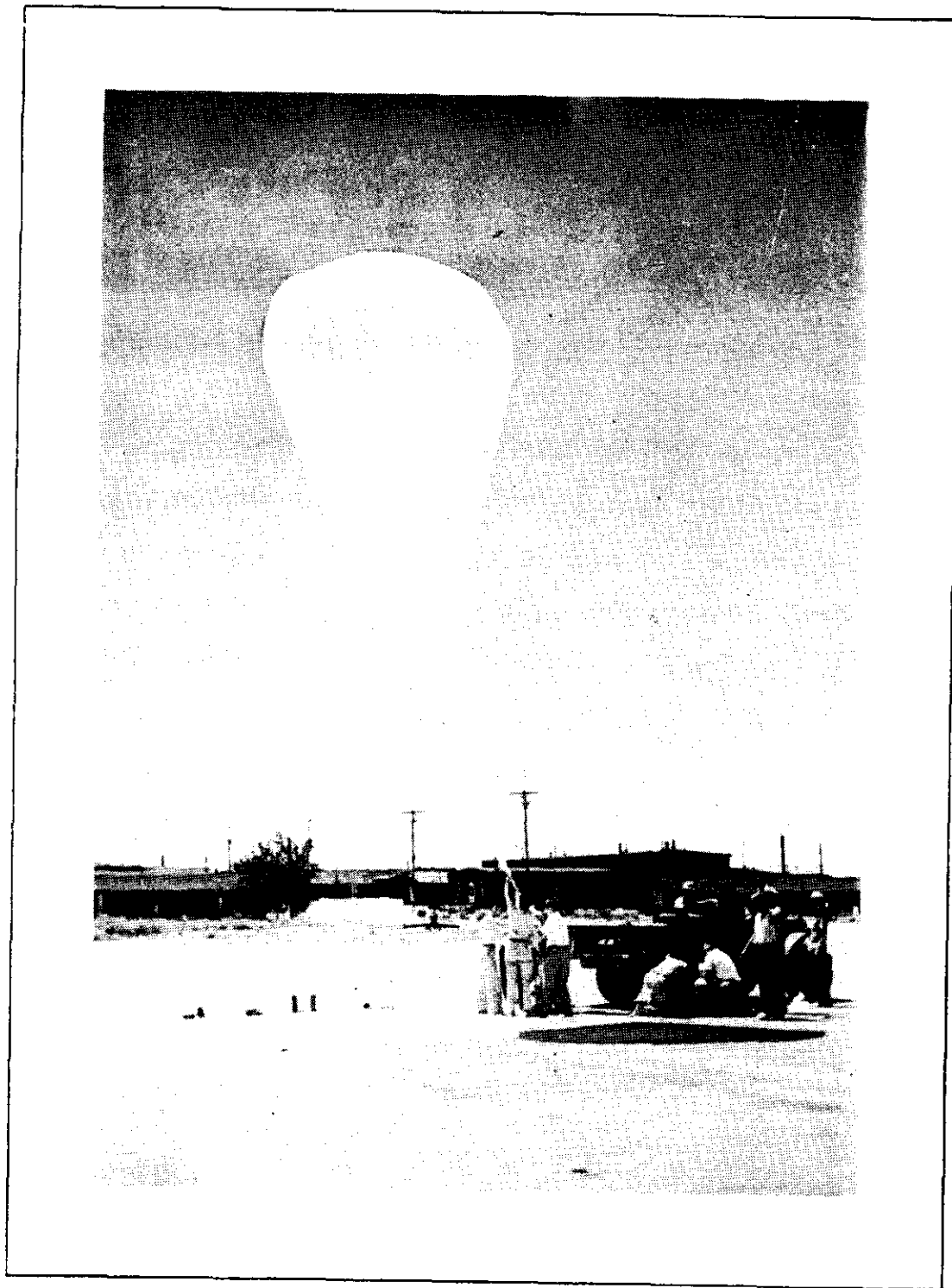

Figure 25  
General Mills 20 foot balloon  
billowing in a five knot wind.

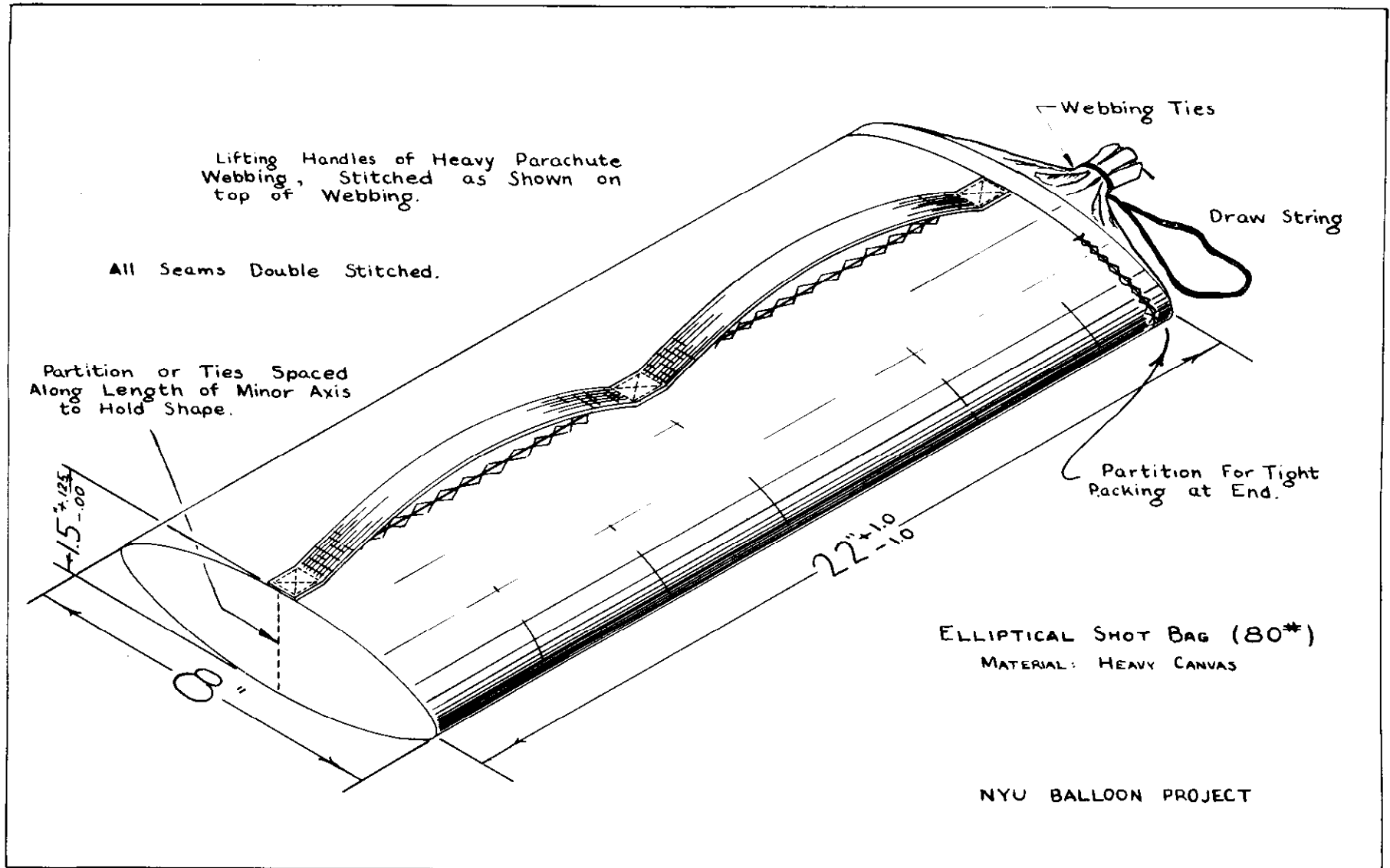

FIG. 26

With these and subsequent rigging lines the following technique was used: on all lines a strength test was made and a safety factor of at least ten to one was demanded. Most of the lines used are of braided or woven nylon, chosen for its low weight-strength ratio. To facilitate handling of the line segments each length is prepared with a small hook on either end. The knots employed are double carrick bends.

The total length of the early trains reached as much as eight hundred feet, making them extremely difficult to release. A system of restraining the load line was evolved with two winches paying out restraining lines while balloons and equipment were added to the load line. In this way the pull of the balloons themselves and the much greater strain caused by even light winds was held by winches. When the final piece of equipment was clear of the ground (or when the entire flight line was under tension with the lowest element being held back) a gunpowder squib was electrically fired to sever the restraining lines near the bottom of the balloon. Figure 27 shows the aluminum "cannon" holding the gunpowder, the two winch lines and a light line used to pull the restraining lines away from the load line after firing. The load line has not yet been attached in Figure 27, but will be fixed just above the "cannon".

When the restraining line is severed, there is danger of a pendulum swing of the train causing the lower components to be dashed into the ground. To avoid this action, the lowest piece of equipment is usually held by a member of the crew on the back of a truck. By driving downwind faster than the surface wind speed, the pull of the balloon can be resolved into only a vertical component and the equipment may be safely released when the truck gets under the balloon.

With later plastic cell flights, this method of launching was also used in cases of light wind. When winds of about 5 knots are encountered,



Figure 27  
Aluminum "cannon" and launching  
lines used to restrain balloon while  
load is being attached.

the total strain on rigging lines and even on the balloon itself becomes excessive. With the thin polyethylene film of the General Mills' balloons, such a wind force causes the balloon first to billow, sail-like, as in Figure 25, then to tear.

To eliminate surface failures on days when the wind is not calm, the following release technique is employed: The equipment train is laid out parallel to the wind direction, with the balloon in the lee of a large building and the other components stretched out downwind. The central portion of the balloon rests on a platform balance and the lower portion rests on a sloping eleven-foot table whose top is level with the platform and whose bottom rests upon the ground. The upper portion of the balloon usually lies on another table, level with the platform. Except for this upper portion, the balloon is held down on the scales and sloping table by bags of sand and lead shot. In addition, one sand bag is fastened to the lead thimble of the balloon by a short line which is kept taut during inflation. This layout is shown in Figure 28.

When the balloon is inflated, it is held down at the weighing-off scales by the shot bags. Personnel required for the launching consist of two men at the hold-down shot bags (who lift the bags at the release signal), one man near the large sand bag (who cuts the line to the load thimble when the balloon rises above him), one man at each piece of sensitive equipment on the train (to support and protect the equipment until it is airborne), one man at the lower end of the hold down line (who fires the cannon severing the last line when the gear is all safely lifted).

If each operation is performed when the balloon is directly overhead and if the train has been accurately laid out downwind, the entire train is sent off with a minimum of oscillation of the load. Figure 29 shows successive positions of the balloon and gear during release.

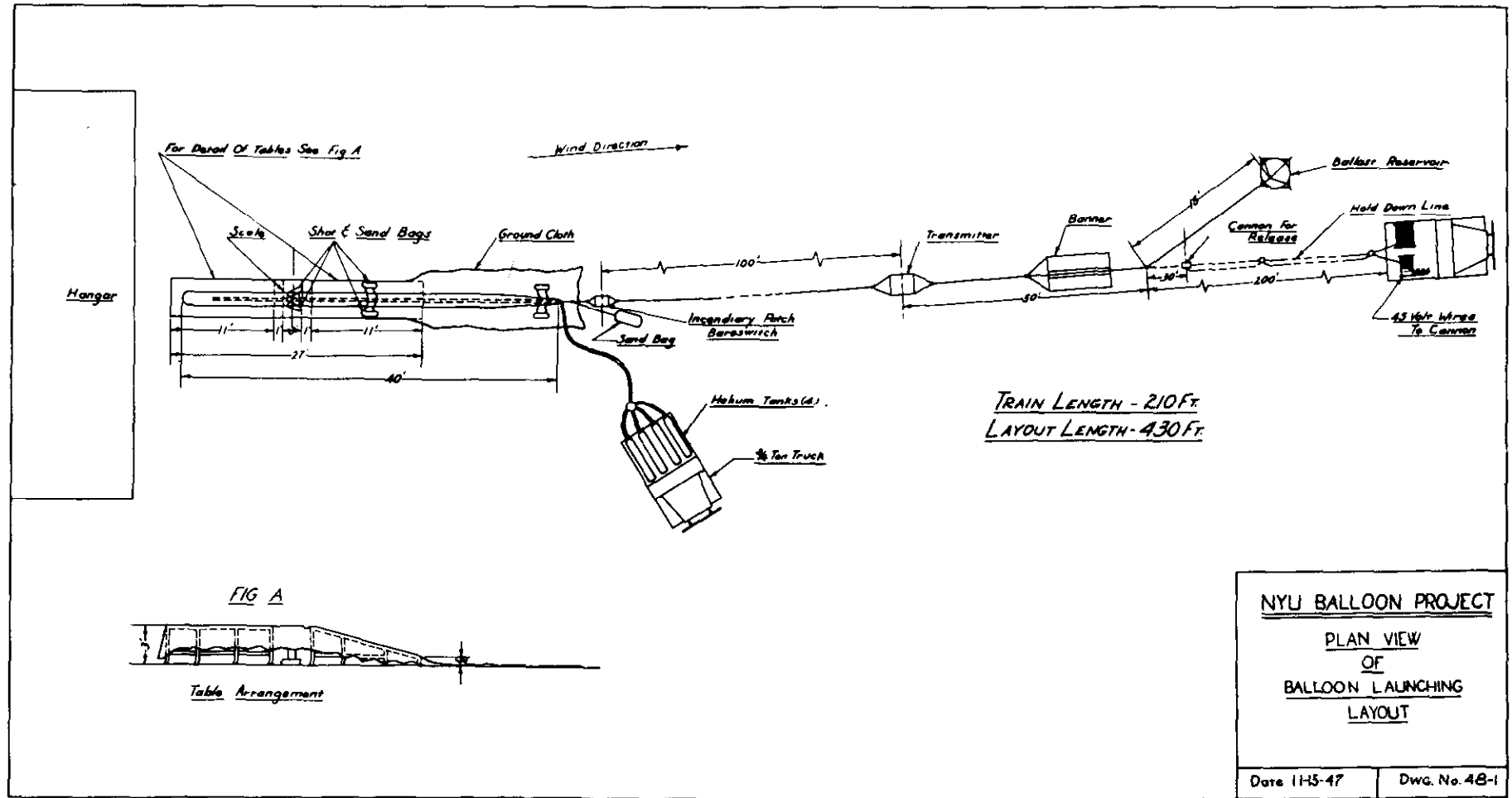

FIG 28

ED-48-3

DATE 1-16-48

BALLOON SHAPES  
DURING LAUNCHING

NYU BALLOON PROJECT

Fig. 29

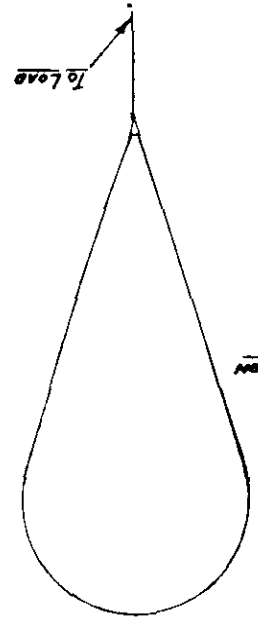

IN FLIGHT, THE BALLOON  
ASSUMES A VERTICAL POSITION  
WITHOUT DISTORTION.

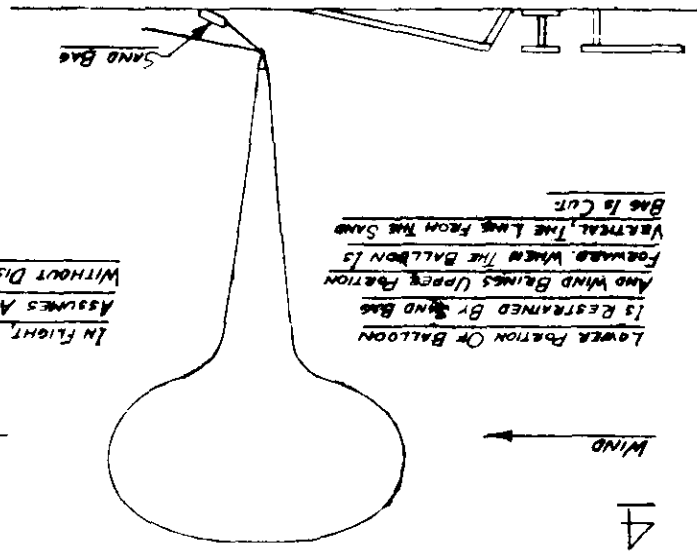

LOWER PORTION OF BALLOON  
IS RESTRAINED BY SAND BAG  
AND WIND BLENDS UPPER PORTION  
FORWARD WHEN THE BALLOON IS  
VERTICAL, THE LINE FROM THE SAND  
BAG IS CUT

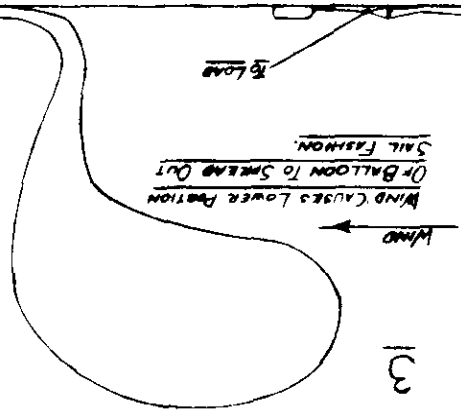

WIND CAUSES LOWER PORTION  
OF BALLOON TO SWEEP OUT  
IN SAIL FASHION.

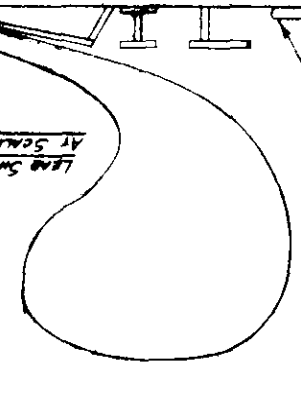

LEAD SAND BAG  
AT SCALE LIFTED

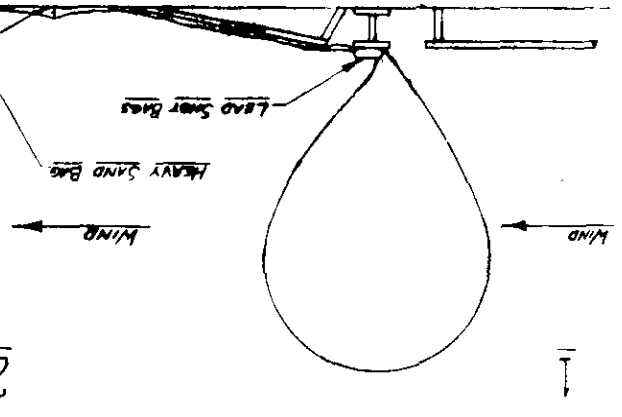

HEAVY SAND BAG  
LEAD SAND BAG



This method of release is a development of the upwind release used in radiosonde flights in the U.S. Weather Bureau, with refinements first used by General Mills Aeronautical Research Laboratories and necessitated by the larger balloon size and the number of components on each flight.

Using this method, successful releases were made at Alamogordo in winds of 20 miles per hour with gusts up to 30 miles per hour.

### C. Recovery

Much additional information on the behavior of the train components can be gained if they are recovered. Two methods of recovery are employed: 1) reward tags and 2) recovery by the balloon crew tracking the flight.

Reward tags attached to several components have encouraged the finders to protect the equipment and report its location. The tag and associated questionnaire are included in Appendix 3. Total recovery of flights to date is about 60% of those released.

When the location of the balloon is known by visual observation from an airplane, or the landing area is indicated by direction-finding gear, recovery is attempted by truck by the balloon crew or the crew at one of the downwind stations. Several successful recoveries have been made of flights of relatively short range. It was found in earlier attempts that the balloon equipment was a difficult target both in the air and on the ground. Consequently a colored cheesecloth banner (6 by 12 ft., stiffened top and bottom) was added to the train. It also is a convenient marker for theodolite stadia measurements. A banner may be seen in Figure 30. White banners seem to be the most generally useful.

### Section 5. Flight Summary

A summary of pertinent information on all flights made to date is included in Appendix 1 as table VII. Also shown there are flight train

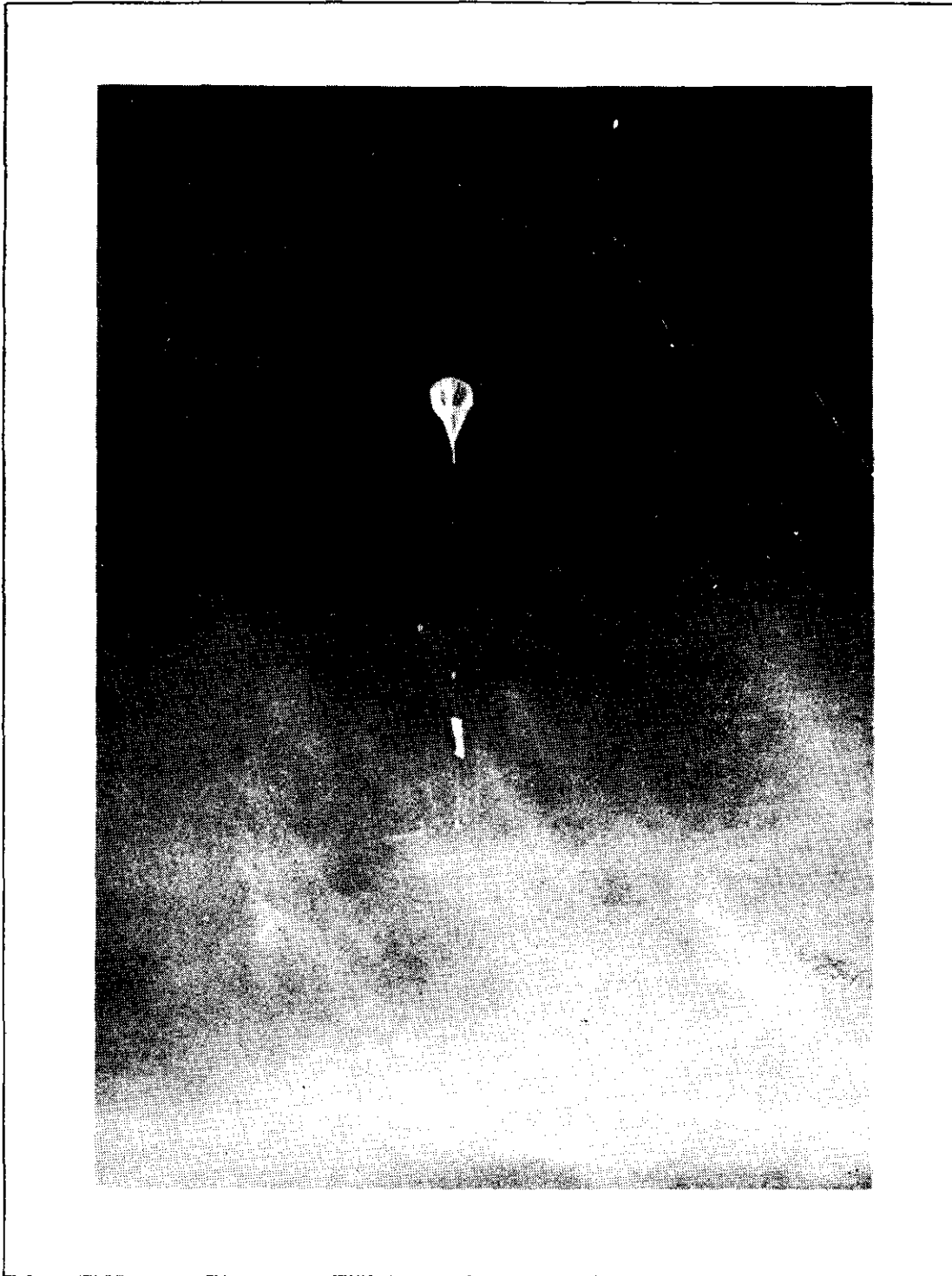

Figure 30  
General Mills 20 foot balloon  
in flight, showing banner and other  
flight train components.

diagrams, time-height curves, trajectories and photographs of significant flights, grouped by flight numbers. The flight numbering system has been revised since its inception and now only those flights in which an attempt was made to control the altitude of the balloon are included in the summary. Excluded are flights made to test special gear and launchings which were not successful.

Flights A, B, 1, 5, 6 and 7 all made use of meteorological balloons in various arrangements and combinations. Each flight included one or more "lifting balloons" which were to be released from the train when the desired altitude was reached, the other balloons then theoretically supporting the load at the constant altitude.

Figures 31 and 36 show the two methods used to group the balloons in clusters. Figure 31 shows the linear array borrowed from cosmic ray flight techniques; figure 36 shows the modified "Helios Cluster" in which lines from the balloons are joined at a central ring at the top of the load line.

The Helios cluster was by far the easier to handle because of the simpler rigging and the reduced launching strains.

Flight 7 was the only one of this group in which anything approaching a controlled altitude was attained. The previous flights failed to level off when the lifting balloons broke loose. In flights 1, 5 and 6, where ballast dropping devices were included, the ballast either did not drop, or the dropping did not have the desired effect. In flight 7, however, the cluster rose till the lifters were cut off, descended until sufficient ballast was dropped to cause the cluster to rise to a still higher altitude. There several balloons burst, resulting in a final descent. The time-height curve for this flight is shown as figure 38.

This flight pattern represents the best approximation to constant level flight that we have obtained with meteorological clusters.

Flights 8 and 11 each employed more than one polyethylene balloon in an attempt to reach higher altitude than possible with the single balloons then available. Figure 39, 40, 41, 44 and 45 show the type and arrangement of balloons and their flight behavior. In both flights, the maximum altitude was not high enough to cause activation of the automatic ballast valve. Consequently, there was no compensation for diffusion other than the steady leakage of ballast through the imperfect seating of the valve. In flight 8, after one hour, this leak was not sufficient to maintain a constant altitude, so the flight terminated. However, in flight 11, constant altitude was maintained at 16,000 ft. † 1500 feet for 7 hours until all of the ballast was expended.

Flight 10, in contrast to flights 8 and 11, did reach an altitude at which the automatic ballast control was actuated, resulting in a flight of perhaps more than 26 hours. Although the maximum altitude reached by this heavy spherical cell was 15,000 feet, the ballast control was effective at a level of 9000 feet. The expected difference between activation level and operation level was probably exceeded because of the temperature effect of the air entrapped in the pressure capsule.

Figure 42 shows the train, and figure 43 shows the time-altitude curve for the 512 minutes of radiosonde data.

The oscillations around 9000 feet during the last two hours of data may be attributed to the changing buoyancy of the balloon as cloud masses intermittently shielded it from the sun's rays. An unconfirmed report was received to the effect that this balloon was still floating 26 hours later over Pueblo, Colorado.

Flight 12 was designed to overcome the difficulties encountered in flights 8 and 11, and, by the use of a thin tear-drop balloon (General Mills balloon) to carry the load to a higher altitude than flight 10. To guarantee a predetermined constant ballast flow, the manual ballast valve was added to the flight train. The minimum pressure switch replaced the fixed pressure switch to activate the automatic ballast valve, whether or not a predetermined activation altitude was reached. Figure 46 shows the train; figure 47 shows the time-altitude curve, which exhibits a marked departure from the ideal. The minimum pressure switch failed to operate or operated near surface pressure, effectively preventing the operation of the automatic ballast valve. The manual ballast valve did not provide sufficient flow to prevent the gradual descent of the balloon. Finally, the heavy load necessitated almost complete inflation of the balloon at the surface. This distention permitted continual mixing of air through the open bottom of the balloon. Instead of reaching the pre-calculated 38,000 feet maximum altitude, this flight had a peak of 14,000 feet from which it slowly descended. Since the blowout patch was set to act upon descent to 20,000 feet, it also failed to operate.

Five of the succeeding flights (nos. 13, 14, 15, 16 and 20) had as a prime objective the development of a satisfactory appendix to overcome the loss of buoyancy due to mixing during launching and ascent. The types considered have been discussed in Section II, Part A of this report and the (two foot) appendix stiffened with battens, which was finally evolved, is shown in figure 5. Figures 48, 49 and 50 show the time-altitude curves for these flights. Either short flight or limited radio reception curtailed the trajectory data.

In flight 19, the danger to personnel of the blowout patch was

dramatically demonstrated by its firing 30 seconds after release. Launching shocks caused the baroswitch pen-arm to fall off its shelf, completing contact prematurely. In later flights, a time delay switch was placed in series with the baroswitch to prevent a recurrence of this action.

Flights 21, 22, 24, 26 and 27, although carrying altitude control devices, were flown to test gear for associated projects. Either no pressure reporting gear was carried or the data from modified gear proved unreliable. Hence few performance data charts are presented.

Flight 21, using a late-model General Mills 20 foot thin cell and an automatic ballast valve, is known to have lasted for ten hours, descending at Marietta, Oklahoma.

Flight 22, included an earlier model General Mills balloon with a high rate of gas leakage, and an automatic ballast valve. The ballast control kept the balloon aloft, but for only six hours.

Flight 24, including an automatic ballast valve, is believed to have maintained constant level,  $\pm$  1,000 feet, for 122 minutes. It stayed aloft for at least  $3\frac{1}{2}$  hours, when transmission ceased. The time-altitude curve is shown in figure 51.

Flight 27 employed a fixed rate of leak rather than an automatic ballast valve. The manual control did not provide sufficient ballast flow, accounting for the time-altitude curve shown in figure 52.

Flights 29 through 37 and flight 39 were undertaken to test the downwind launching procedure, to try for higher constant level altitudes, and to determine the feasibility of using the General Mills thin cells for frequent service flights. Flights 37 and 39 burst early. The former was released during a rainstorm and balloon failure occurred at the seams.

Flight 29, with a manual ballast valve, was released just before sunset on 22 November. It was observed descending 50 miles north of Toronto, Ontario, Canada, 14 hours later. The average wind was 130 mph. Radio reception was for 69 minutes.

Of the other recent flights, satisfactory radio performance was enjoyed only on flight 36. Before any more flights are made, a better transmitter and battery pack will be needed. Even on this flight the signal was lost after 135 minutes, due to excessive range. The last plotted position was northeast of Tucumcari, N.M. This flight was recovered from Burlington, Iowa.

Time-height curves of this series are included in figures 53, 54 and 55. Despite the limited data, some results can be determined. For example, flight 32 is believed to have floated for at least 70 minutes within 1,000 feet of a constant level above 40,000 feet MSL.

Flight 35 also exhibited 32 minutes of constant-level flight before the radio signal was lost. From the remarkable distances that some of the others traveled (See flight summary Table VI, Appendix I) it is almost certain that they floated for long periods.

These flights included a simple-filter manual ballast valve assembly (Figure 9) designed to reduce equipment weight and cost. The performance of this equipment justifies its continued use for relatively short flights.

Considerable difficulty was experienced with the type of filter used. Experiments are now being conducted to improve the filter.

Because of limited data received from earlier flights, modified Fergusson meteorographs were added to the equipment train on flights 33, 35 and 39. As of January 1, 1948 none of these instruments have been recovered.

Flight 17, using a fifteen-foot balloon of .004 Polyethylene is worthy of special consideration. The thickness of this type of cell eliminates much of the problem of appendix design since more internal pressure can be withstood. Despite this factor, and the low permeability of the fabric, balloons of this type are too heavy and costly to be used for high altitude flights.

The trajectory and time-altitude curve of this flight are shown in figure 56 and 57. This controlled-altitude flight demonstrates that the automatic ballast valve combined with a fixed leak, will successfully maintain constant altitude through a sunset. The balloon floated at 29,000 feet  $\pm$  500 feet for at least three hours, after which the excessive range prevented further radio reception. Here again the necessity of a barograph was demonstrated as the balloon was recovered from Pratt, Kansas, 530 miles away. Two flights, 23 and 38, were made using the shrouded Dewey and Almy J-2000 Neoprene balloon. Both of these flights were failures. Flight 23 (see figure 48) attained a maximum altitude at 50,700 feet and began to descend immediately. Flight 38 (see figure 55) was observed from a B-25, and the balloon was seen to burst within the shroud.

#### Section 6. Current Objectives

In order to meet the requirements for future flights, improvement must be made in three phases:

1. Performance data for too many flights have been either uncertain or of too short duration. Before more flights are undertaken, altitude-measuring instruments must be improved and increased. To this end, four specific improvements are being undertaken:
  - A. To supplement the pressure data received by radio, a lightweight barograph will be added to those flight trains in the future when flights of more than a few hours' duration are attempted.



B. The improvement of radio transmitter gear; it is planned to utilize the three megacycle transmitter developed in the Electrical Engineering Laboratories at New York University. In previous tests, this has provided clearer reception and a longer range for comparable weight than either the 72 megacycle or 397 megacycle units previously used. To provide direction finding, 397 megacycle carrier signal will also be transmitted which will be tracked by SCR-658 sets. It is also hoped that a better light weight battery pack can be developed for airborne use.

C. The Olland cycle time-interval method of pressure measuring and data presentation is being adapted, with the following advantages anticipated:

(1) The direct interpretation of pressure data in terms of the time interval eliminates the ambiguities inherent in counting pressure contacts in the Diamond-Hinman system. Used in conjunction with the Brush recorder operating at medium speed, and with four turns on a helix rotating once a minute, the pressure readability of this system will be better than one millibar.

(2) Under noisy conditions the recorded data obtained with this system will be more readable than the audio signal now being employed. When only pressure data is being transmitted, this system can be more economical of power than is a system of modulated audio frequencies.

(3) In cases where data other than pressure is also to be transmitted on the same radio channel, the pressure

signals may be arranged so as to consume a very small portion of transmission time.

- D. The duration of radio reception and of positioning data may be greatly extended by appropriately equipped aircraft. It is intended to utilize a B-17 with top-mounted radar to search above the plane for tracking. Depending upon the noise-level encountered, it may be possible to acquire pressure data with a receiver in the plane. It may be necessary to provide at least two aircraft for continuous reception over long periods.
2. It is very desirable that the simplified light-weight ballast control system for flights of less than 24 hours' duration be perfected. The elaborate ballast assembly with the automatic ballast valve will not be needed for the many contemplated flights which will be made with a useful life of less than eight hours. A lower-capacity reservoir with manual ballast valve and filter provides a light-weight, inexpensive unit. Tests are now being conducted to find the best design for these components.
3. In order to float a balloon at a pre-selected maximum altitude it is necessary to supplement the variation-of-ballast with a new height control system.
- A. With a given balloon, and given total load, it is possible to forecast the maximum height. (See Section III for the computation.) If various maximum heights are desired, this maximum height may be varied by varying the total load, or varying the bouyancy of the balloon through variation in balloon volume.

The method used heretofore is variation of balloon load through changes in the amount of ballast used. However, there are upper and lower limits on the amount of ballast that can be used, due to the strength limitations of the fabric. Also, the "height sensitivity"; that is, the ratio of change in altitude to change in load, is not great enough to provide suitable choice of heights.

- B. Another attack is to effect a change of volume by making openings below the equator of the balloon. The volume of gas contained in the balloon envelope is then obviously limited.
- C. If this method of height control proves to be unsatisfactory, still other control mechanisms will be sought.

The three objectives, with their indicated subdivisions, will be pursued to better effect control of the balloon altitude. A parallel pursuit will be the investigation of other balloon types and sizes, in addition to the satisfactory General Mills Polyethylene models now in use. Thus, plans for the future include both the development of control devices currently under test and also a broad, general study of the basic components of constant-level balloon trains from the theoretical as well as the operational viewpoint.

APPENDIX 1

Train Assembly, flight 5, (meteorological cluster)..... Fig. 31

Trajectory, flight 5..... Fig. 32

Height-time curve, flight 5..... Fig. 33

Trajectory, flight 6..... Fig. 34

Height-time curve, flight 6..... Fig. 35

Train assembly, flight 7, (meteorological cluster)..... Fig. 36

Trajectory, flight 7..... Fig. 37

Height-time curve, flight 7..... Fig. 38

Train assembly, flight 8, (General Mills Cluster)..... Fig. 39

Trajectory, flight 8,..... Fig. 40

Height-time curve, flight 8..... Fig. 41

Train assembly, flight 10..... Fig. 42

Height-time curve, flight 10..... Fig. 43

Train assembly, flight 11..... Fig. 44

Trajectory and height-time curve, flight 11..... Fig. 45

Train assembly, flight 12..... Fig. 46

Height time curve, flight 12..... Fig. 47

Height-time curves, flights 13, 14, 16, and 23..... Fig. 48

Height-time curve, flight 15..... Fig. 49

Height-time curve, flight 20..... Fig. 50

Height-time curve, flight 24..... Fig. 51

Height-time curve, flight 27..... Fig. 52

Height-time curves, flights 29, 30 and 32..... Fig. 53

Height-time curves, flights 33, 34, 35 and 36..... Fig. 54

Height-time curves, flights 37, 38 and 39..... Fig. 55

Trajectory, flight 17..... Fig. 56

Height-time curve, flight 17..... Fig. 57

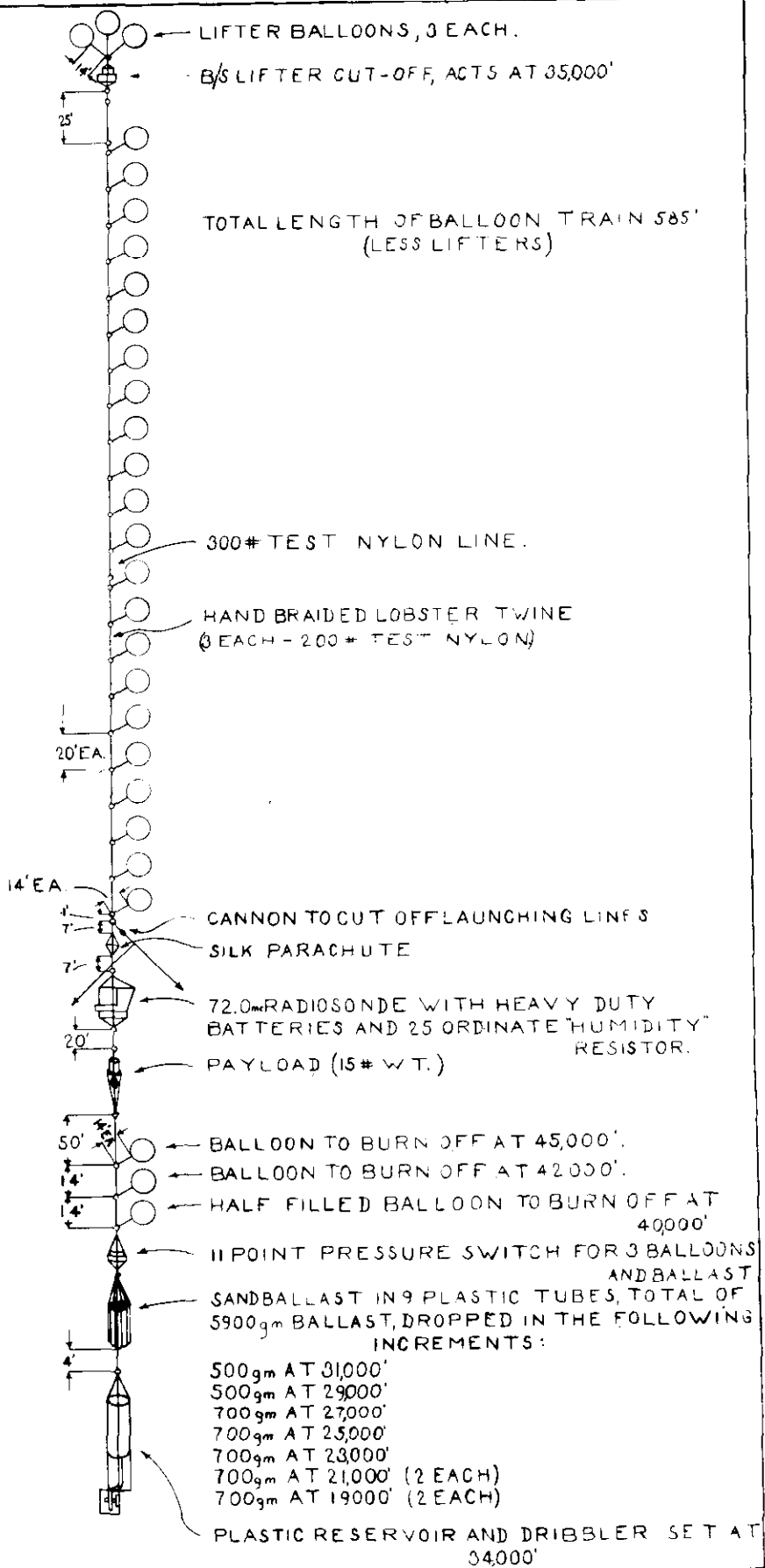

FIG 31

NYU BALLOON PROJECT

Flight 5

DATE 6-5-47

ED 48-39

# FIG 32

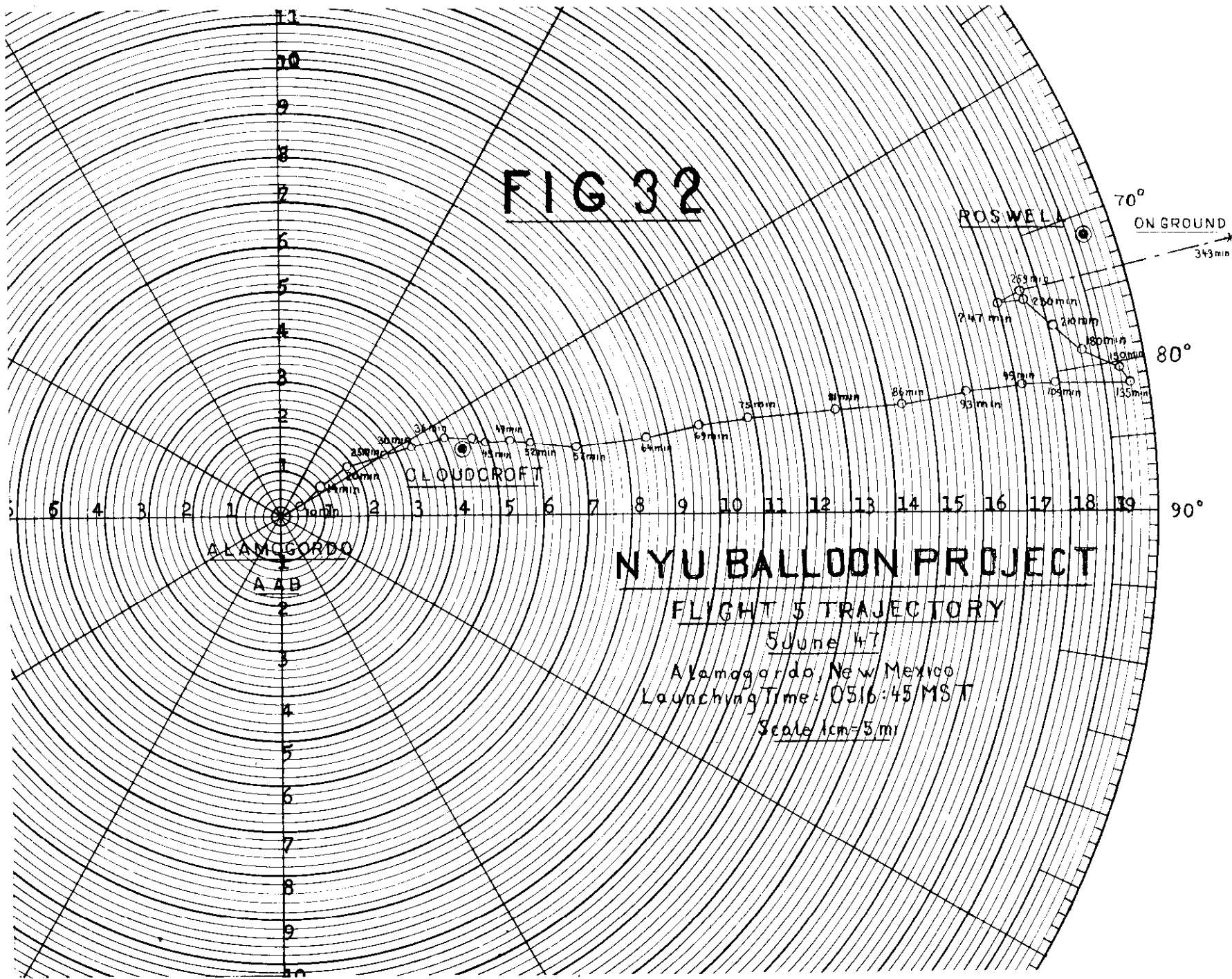

## NYU BALLOON PROJECT

### FLIGHT 5 TRAJECTORY

5 June 47

Alamogordo, New Mexico

Launching Time: 0516:45 MST

Scale 1cm = 5 mi

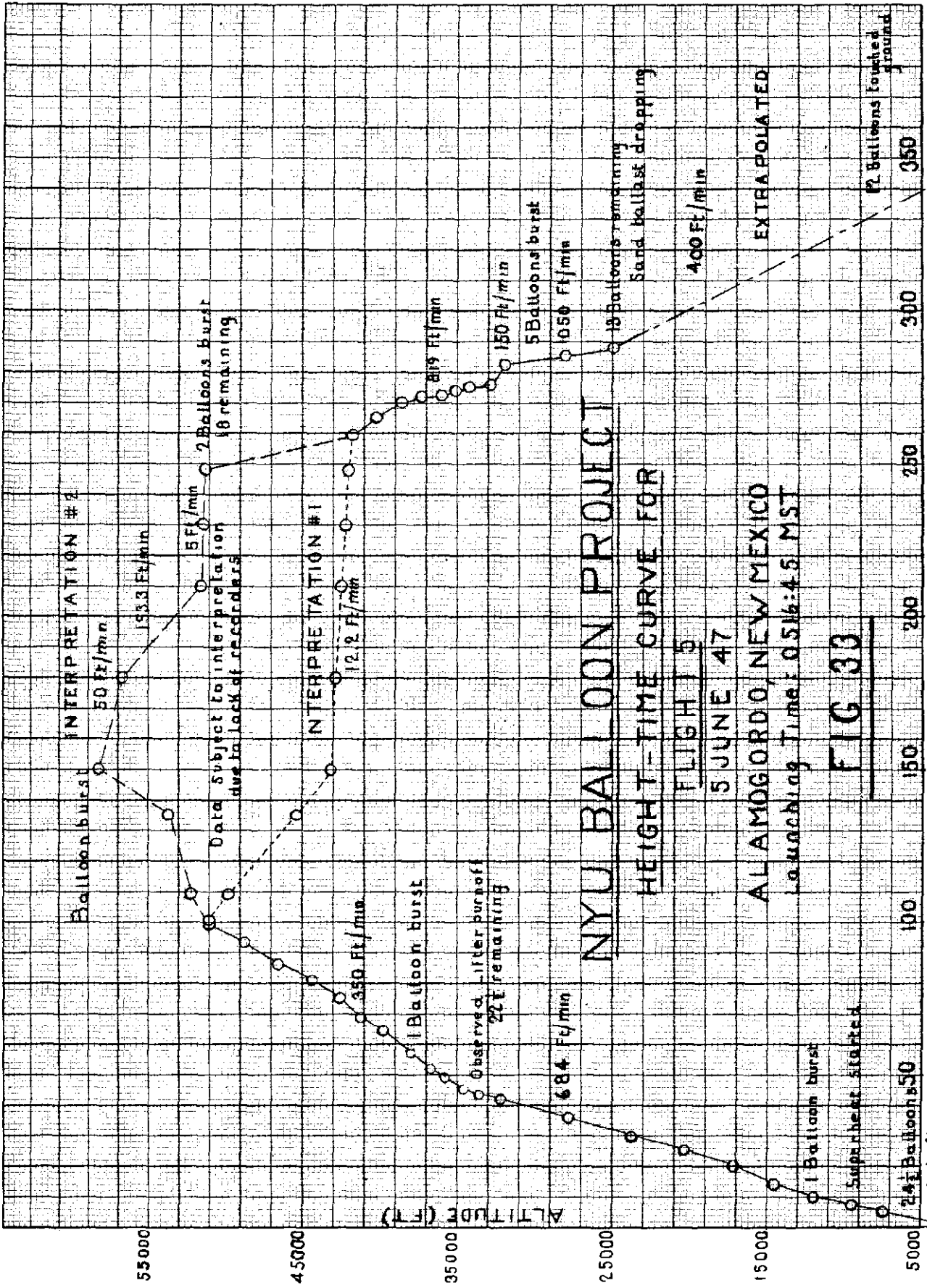

3600 3343 min  
 RUFFEL & ESSER CO. N. Y.

FIG 34

# NYU BALLOON PROJECT FLIGHT TRAJECTORY

1 June 47  
Atamigordo, New Mexico  
Launching Time: 0321:00 MST  
Scale: 1 cm = 1 hr

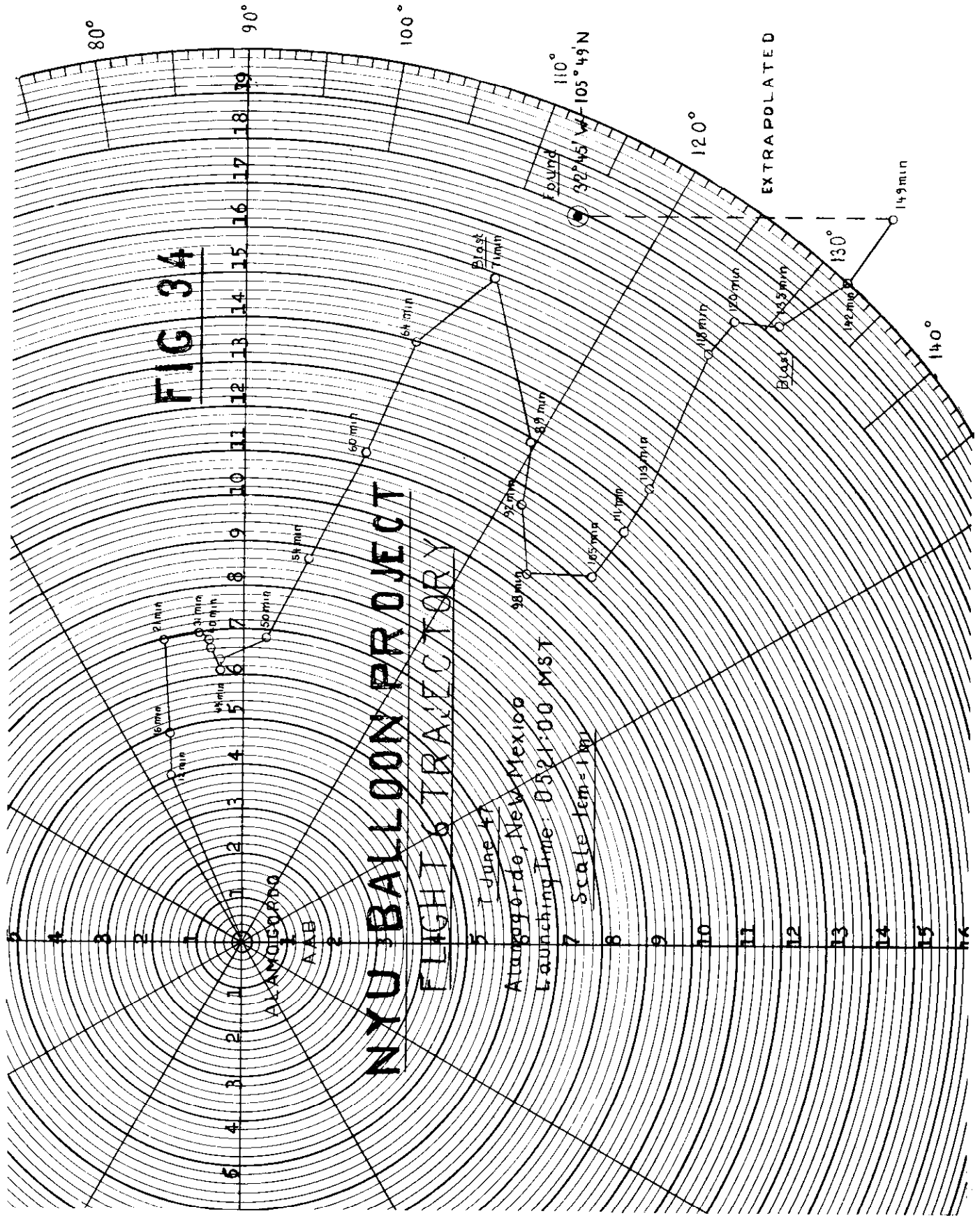



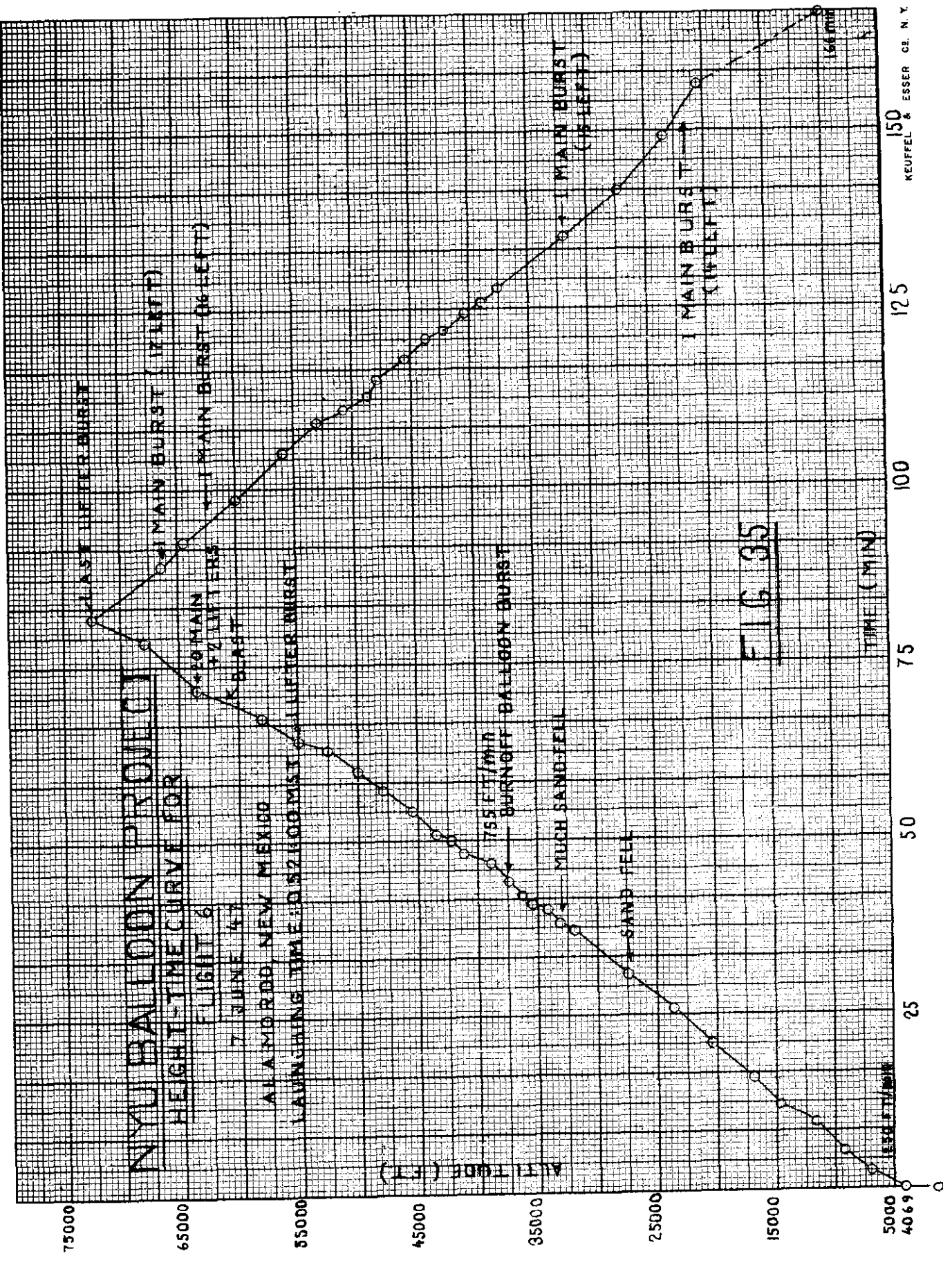

**FIG 35**

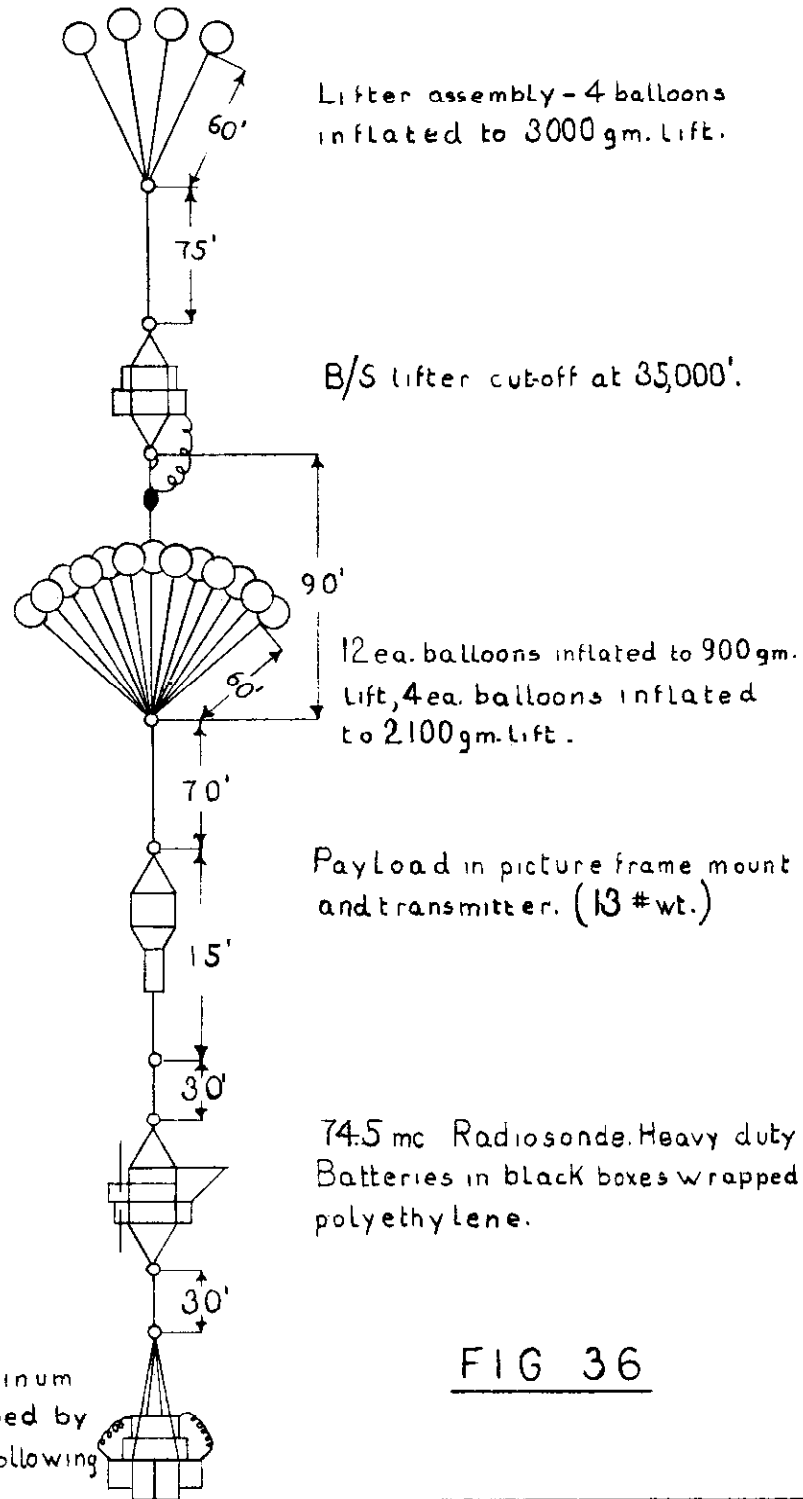

Lifter assembly - 4 balloons inflated to 3000 gm. lift.

B/S lifter cut-off at 35,000'.

12 ea. balloons inflated to 900 gm. lift, 4 ea. balloons inflated to 2100 gm. lift.

Payload in picture frame mount and transmitter. (13 #wt.)

74.5 mc Radiosonde. Heavy duty Batteries in black boxes wrapped in polyethylene.

Ballast baroswitch.

Ballast dropper assembly, 16 Aluminum tubes of granulated lead dropped by descent pressure switch in the following increments:

300 gm - 34,000'	400 gm - 29,700'	800 gm - 25,800'
200 gm - 33,000'	400 gm - 29,000'	800 gm - 25,200'
200 gm - 32,000'	600 gm - 28,000'	800 gm - 24,500'
300 gm - 31,000'	600 gm - 27,400'	1000 gm - 23,800'
400 gm - 30,500'	600 gm - 26,600'	1000 gm - 23,100'
		1600 gm - 22,500'

FIG 36

NYU BALLOON PROJECT

FLIGHT 7

Date: 7-2-47 | ED-48-44

# NWU BALLOON PROJECT

## FLIGHT 7 TRAJECTORY

July 2, 1947

Aramogordo AAB, New Mexico

Launching Time: 0509 $\frac{1}{2}$  M.S.T.

Scale: 1cm = 1 M.

FIG 37

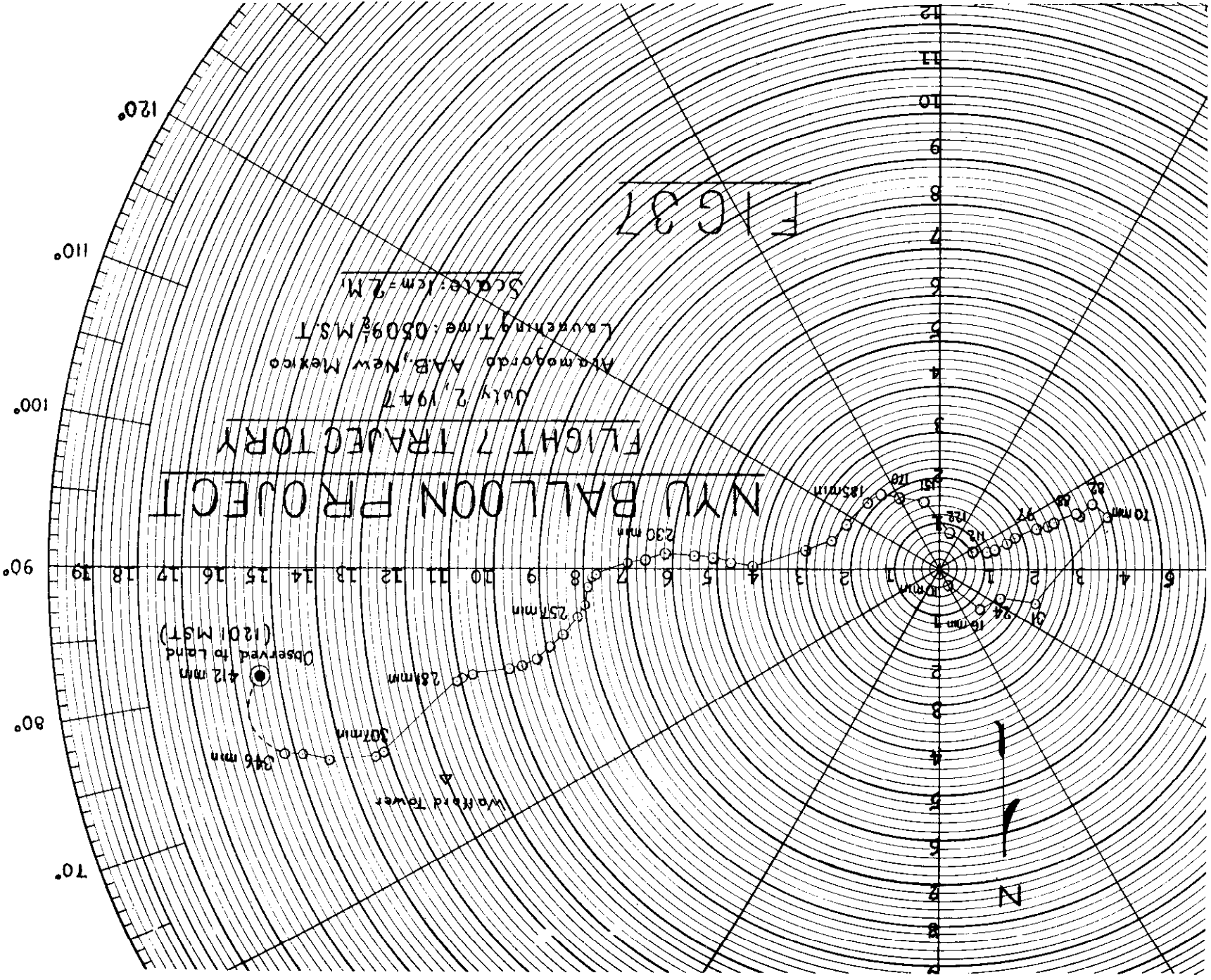

x x x  
x x x  
x x x

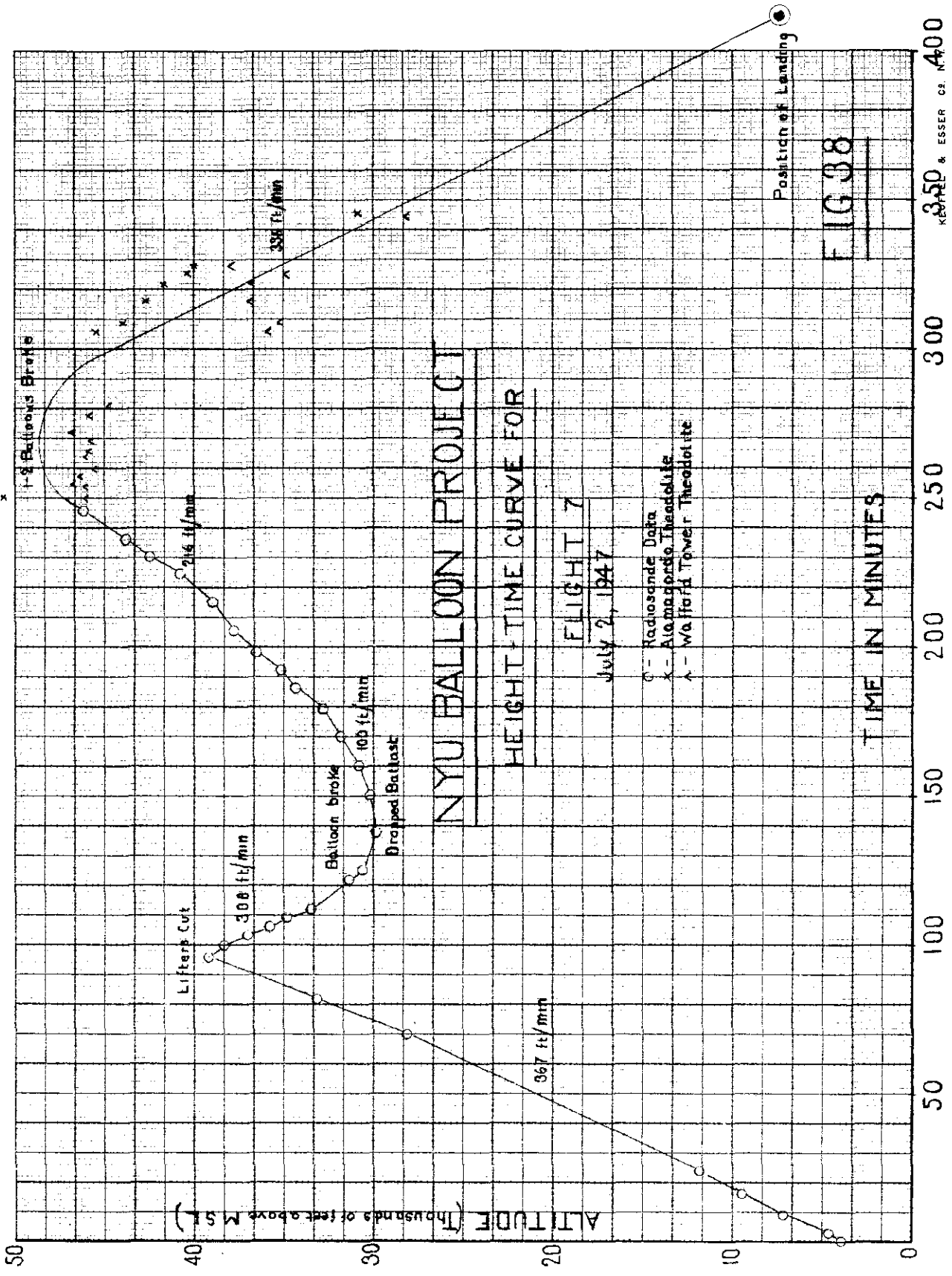
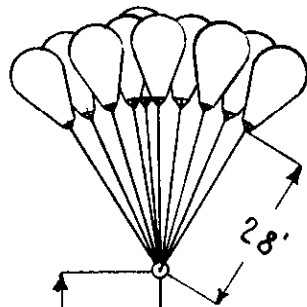

FIG 38



10 Each - Conical General Mills  
Balloons, .001" polyethylene, 7' long

50'

Payload and Transmitter

10'

70'

20'

74.5 mc. - Radio sonde, Standard  
Modulator, 20' End fed Antenna

Plastic Ballast Reservoir and  
Dribbler, 5,000 gm. of ballast.

FIG. 39

NYU BALLOON PROJECT

FLIGHT 8

Date 7-3-47 ED-48-40

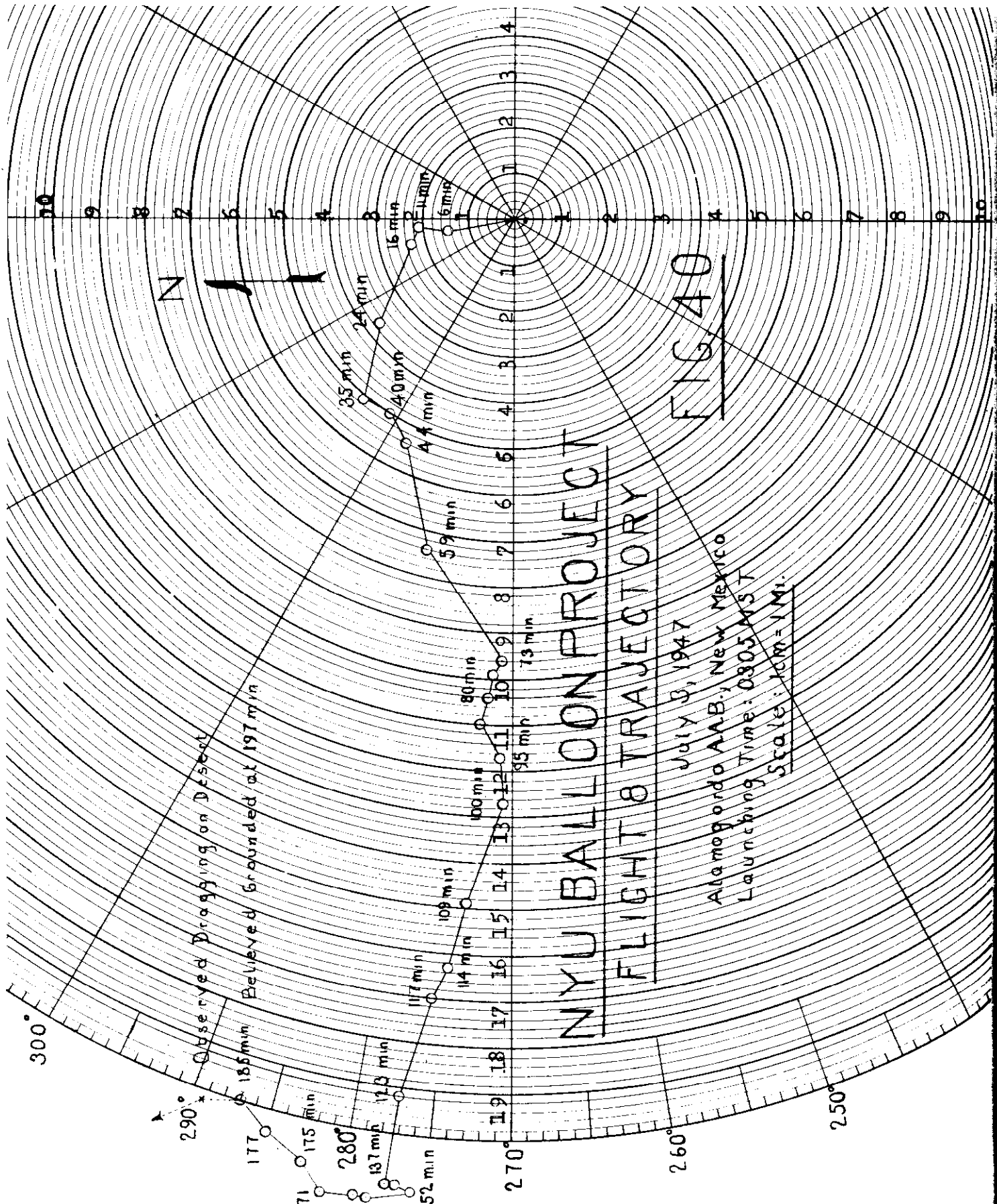

Observed Drifting on Desert

Believed Grounded at 197 min

# NYU BALLOON PROJECT FLIGHT 8 TRAJECTORY

ENG 40

July 3, 1947  
Alamogordo A.A.B., New Mexico  
Launching Time: 0805 MST  
Scale: 1cm = 1 Mi.

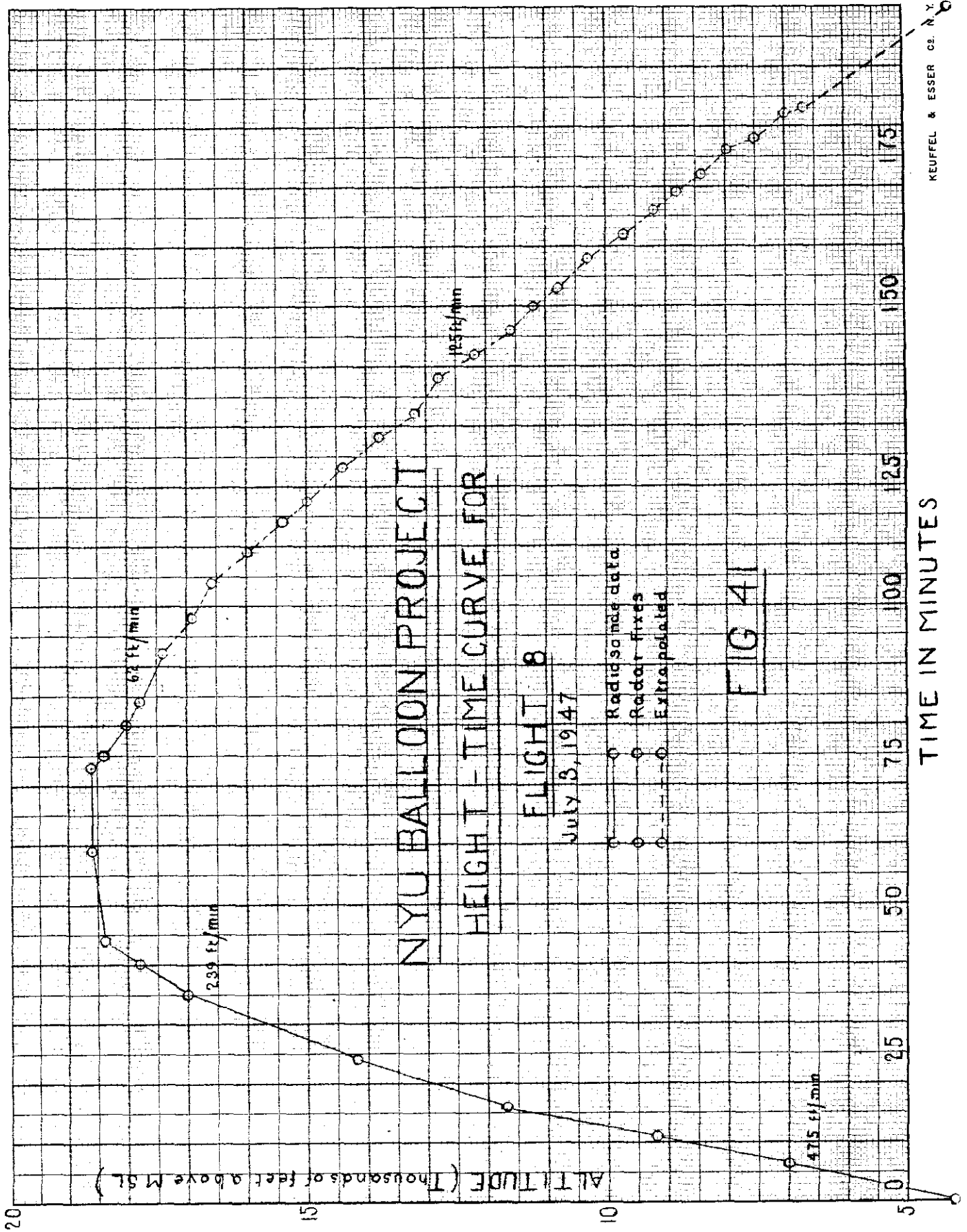
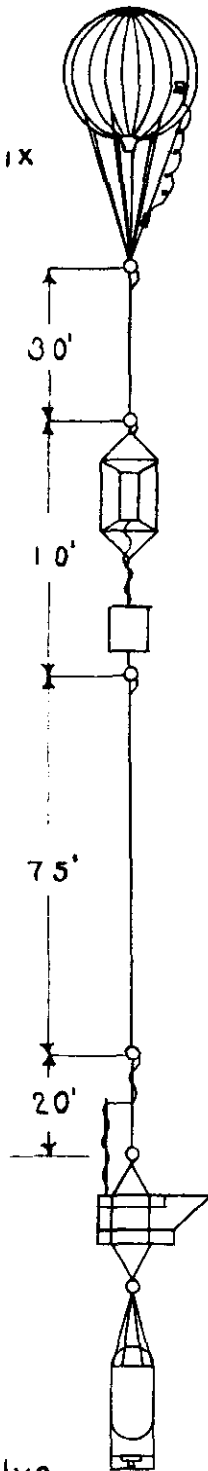

FIG 41  
 TIME IN MINUTES

Open Appendix



15' dia. - .008" thick polyethylene Balloon. H. A. Smith Inc.

Reinforced blow-out patch to be opened by Time-clock.

Bridle of 9 nylon lines, each 150# test, 13' long, served to a thimble and attached to reinforced patches at alternate seams.

Payload in picture frame mount, and payload transmitter

FIG. 42

74.5 mc. Radiosonde with 20' end fed antenna. Heavy duty batteries in black boxes, polyethylene wrapped.

Plastic ballast Reservoir with 3000 gr ballast.

Pressure operated ballast valve (Dribbler) actuated by 30th contact of radiosonde baroswitch.

NYU BALLOON PROJECT

FLIGHT 10

Date 7-5-47 ED-48-42



# NYU BALLOON PROJECT

## HEIGHT-TIME CURVE FOR

FLIGHT 10  
July 5, 1947  
05011-MST

Alamogordo, New Mexico

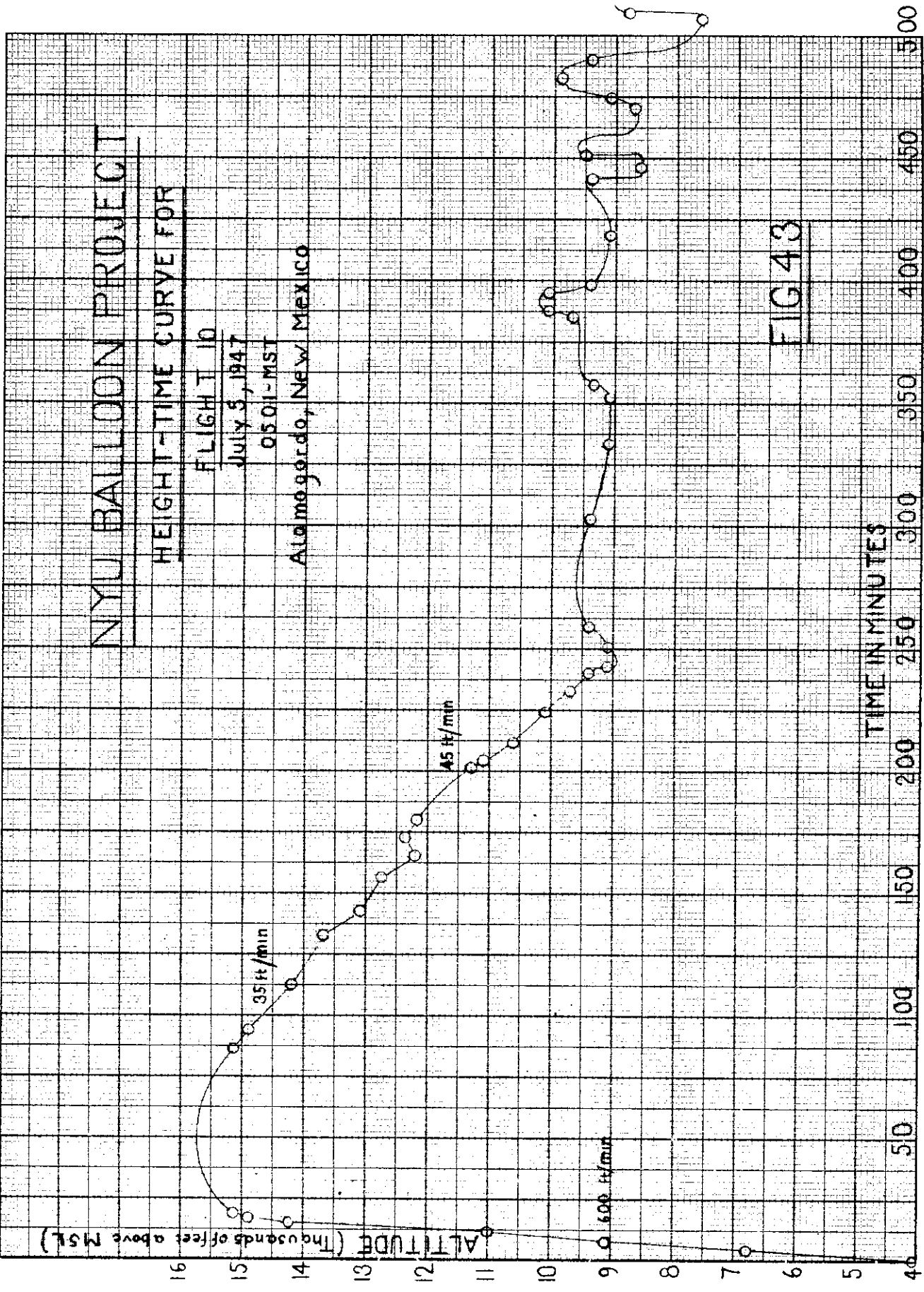
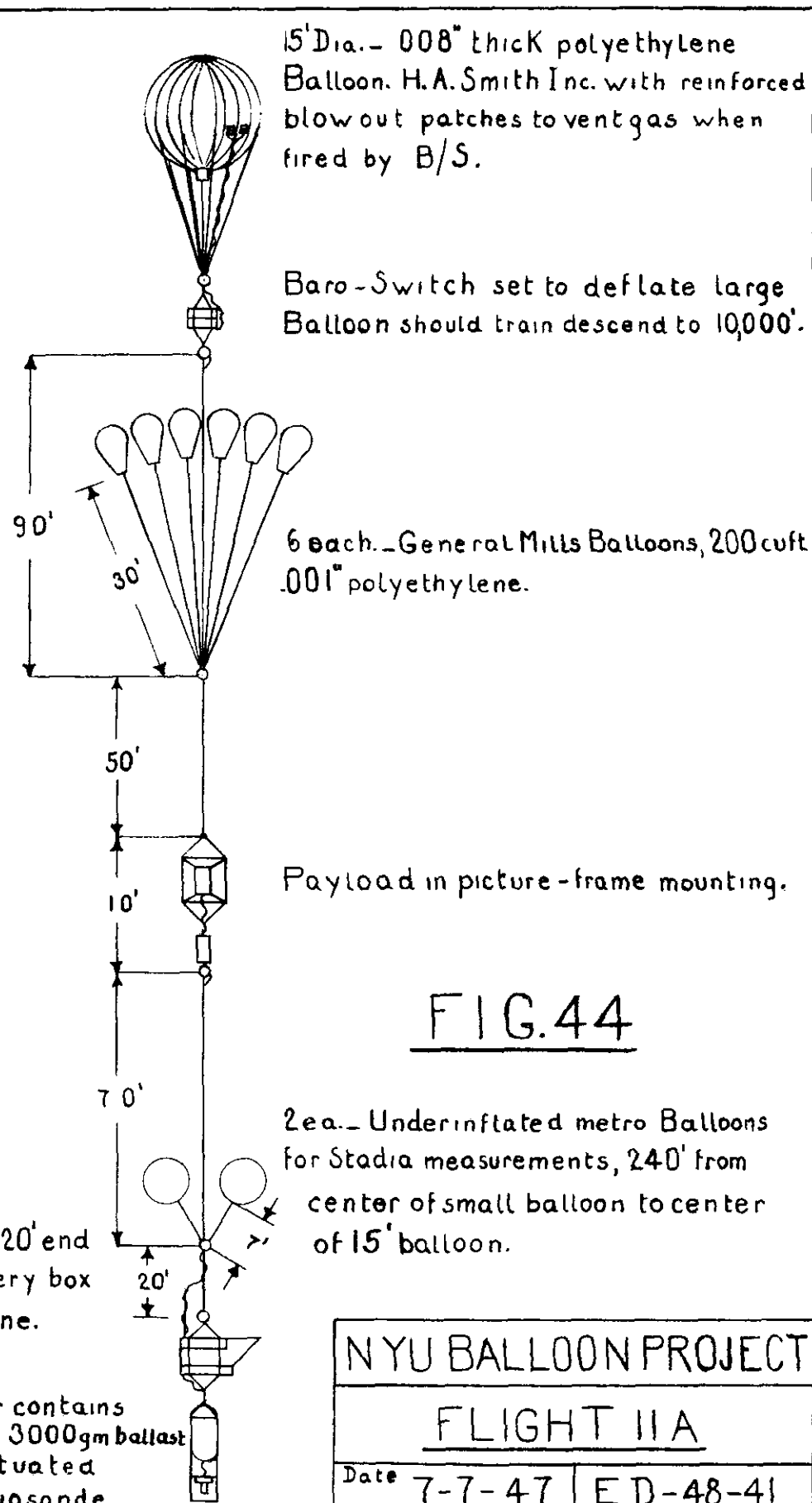

FIG 43



15' Dia. - .008" thick polyethylene Balloon. H.A. Smith Inc. with reinforced blow out patches to vent gas when fired by B/S.

Baro-Switch set to deflate large Balloon should train descend to 10,000'.

6 each. - General Mills Balloons, 200 cuft .001" polyethylene.

Payload in picture-frame mounting.

2 ea. - Underinflated metro Balloons for Stadia measurements, 240' from center of small balloon to center of 15' balloon.

74.5mc Radiosonde with 20' end fed Antenna. Black battery box wrapped in polyethylene.

Plastic ballast Reservoir contains 3000gm ballast  
Dribbler to have been actuated by 45th contact on radiosonde.

FIG. 44

NYU BALLOON PROJECT	
<u>FLIGHT IIA</u>	
Date 7-7-47	ED-48-41

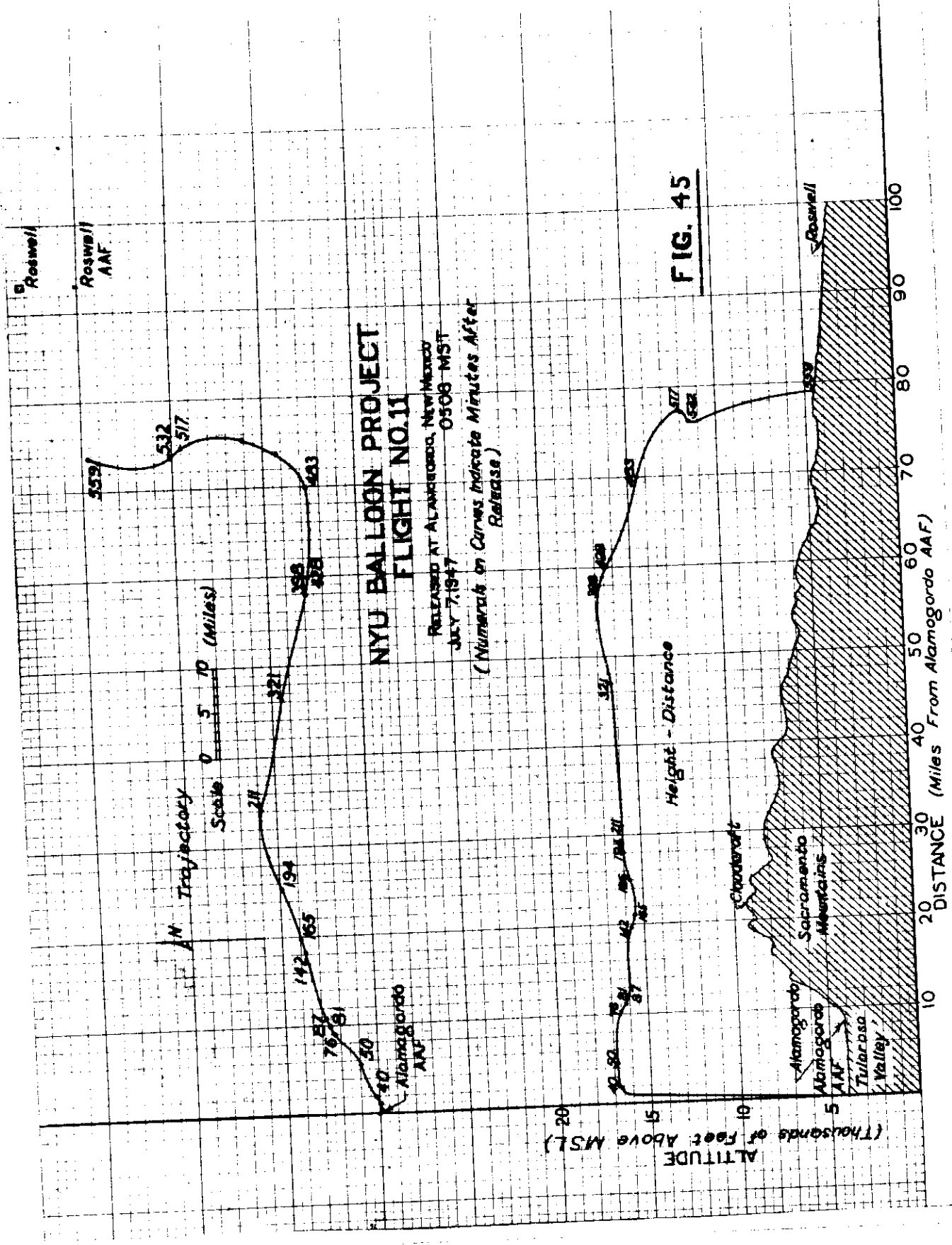

**NYU BALLOON PROJECT  
FLIGHT NO. 11**

RELEASED AT ALAMOGORDO, NEW MEXICO  
JULY 7, 1947 0508 MST

(Numbers on Curves Indicate Minutes After Release)

AN Trajectory

Scale 0 5 10 (Miles)

Height - Distance

ALTITUDE  
(Thousands of Feet Above MSL)

DISTANCE (Miles From Alamogordo AAF)

Rosewell

Rosewell  
AAF

Alamogordo  
AAF

Alamogordo

AAF

Tularosa  
Valley

Sacramento  
Mountains

Choodcraft

**FIG. 45**

20' dia. G.M. .001" polyethylene balloon with incendiary patch on equator for rapid descent below 20,000' (460 mb)

2" steel ring for launching lines

Heavily reinforced baroswitch fires on descent to 460 mb. Uses 2 ea. 45 volt batteries in parallel. Black box, loosely covered with plastic sheeting.

F69, Rawinsonde (397 mc), Heavy duty battery pack, standard modulator, no ventilating duct, white temperature element, 25 ordinate humidity.

Hillman's transmitter w/pressure from standard modulator. 3.135 MC (149' antenna through rings on 160 foot parachute shroud). Held taut by 6 oz. lead wt. at bottom.

Estimated length overall: 257'

T-49-74.5 MC Radiosonde, end fed antenna, standard modulator, no ventilating duct, white temperature element, 25 ordinate humidity, squib in ballast valve fired by B power supply of radiosonde. HEAVY DUTY BATTERY PACK

Ballast reservoir with Kollmann ballast valve plus fixed rate leak from adjustable needle valve set to over-compensate diffusion by 10%

Minimum pressure switch actuates ballast valve when balloon descends 15 mb from maximum pressure, 2 each used in parallel.

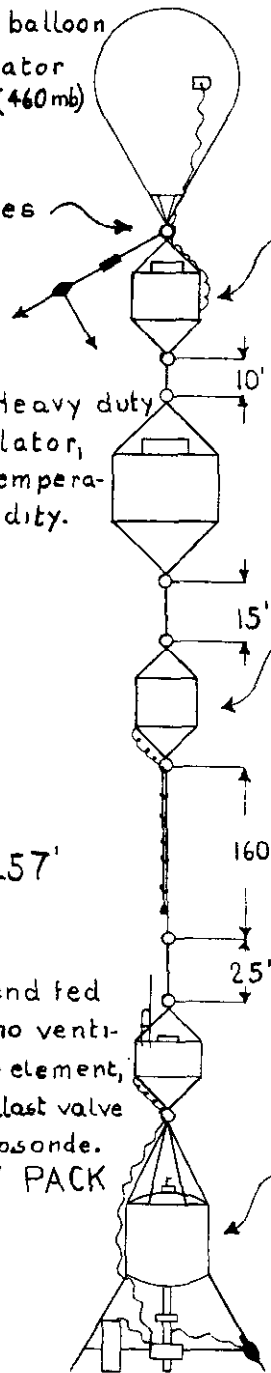

FIG. 46

NYU BALLOON PROJECT

FLIGHT 12

Date 8-5-47 ED-48-43

# NIYU BALLOON PROJECT

## HEIGHT-TIME CURVE FOR

FLIGHT #12  
LAKEHURST N.A.S.  
NEW JERSEY 5 AUGUST 1947

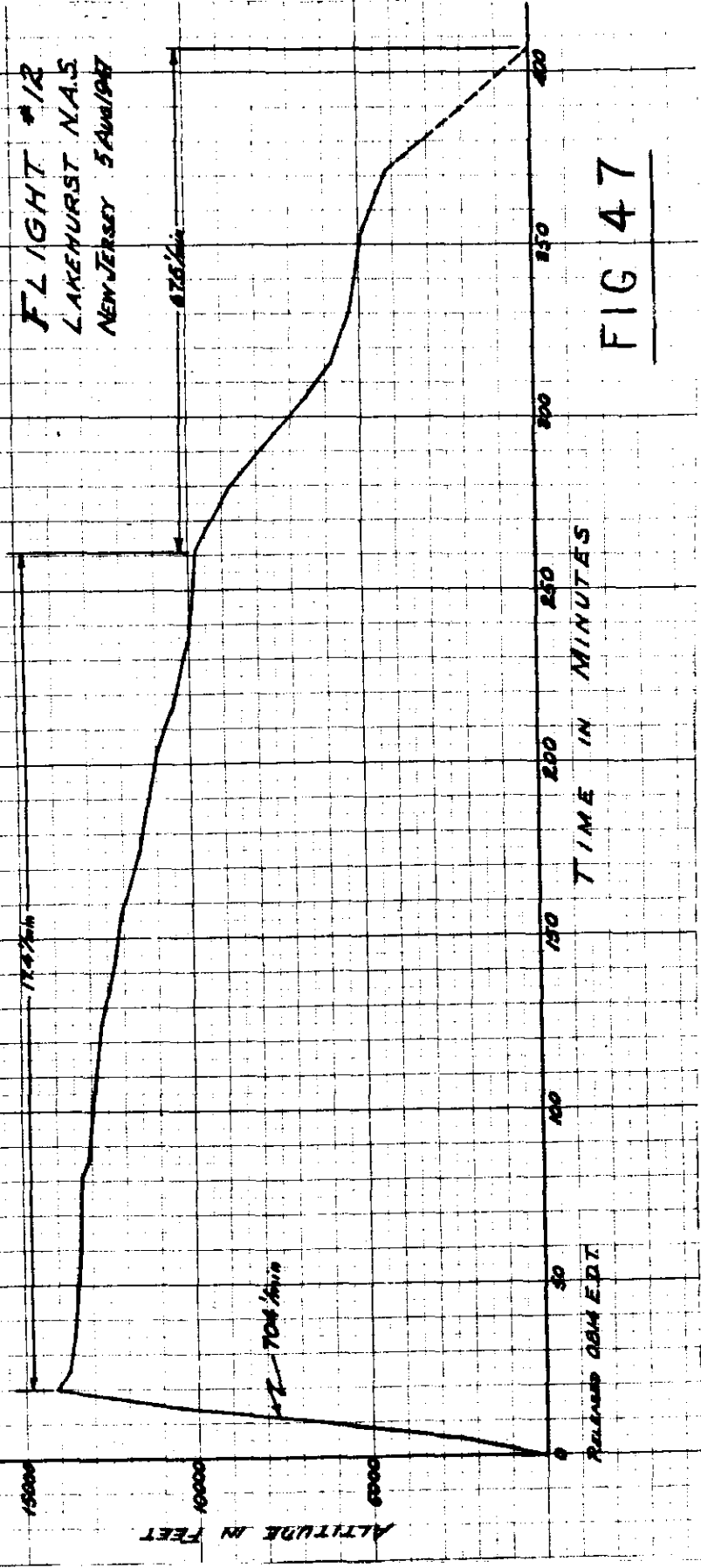
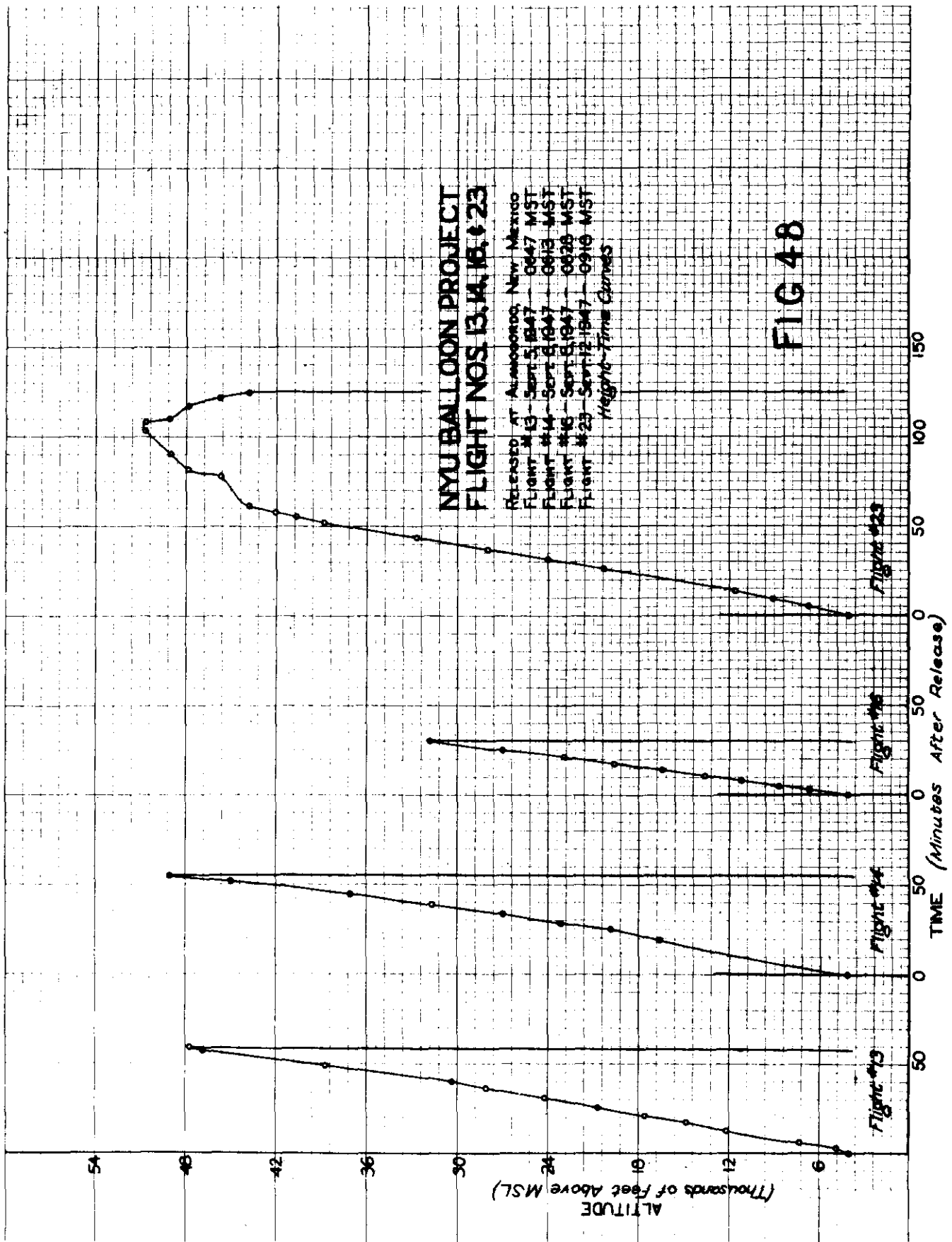
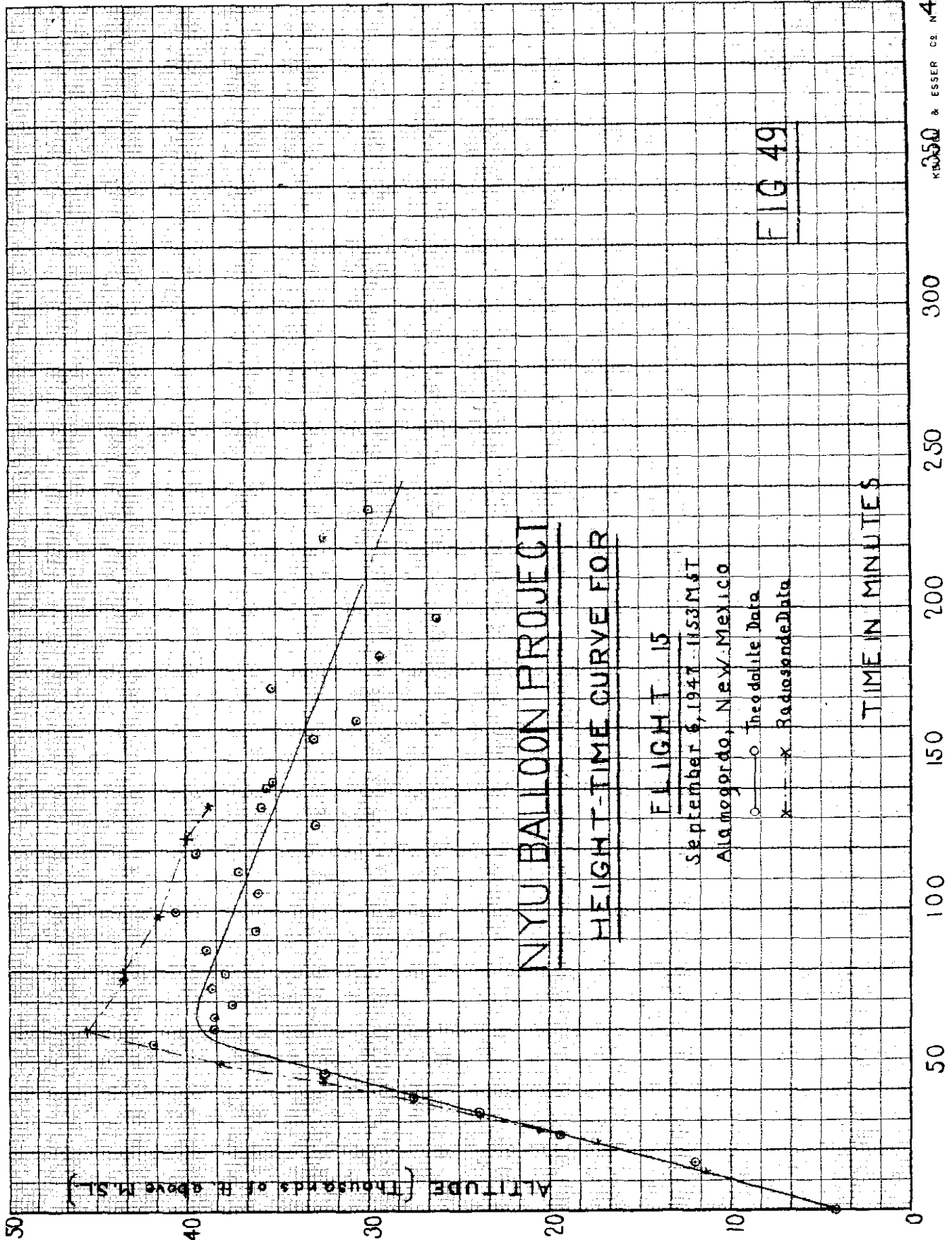

FIG 47



**FIG 48**

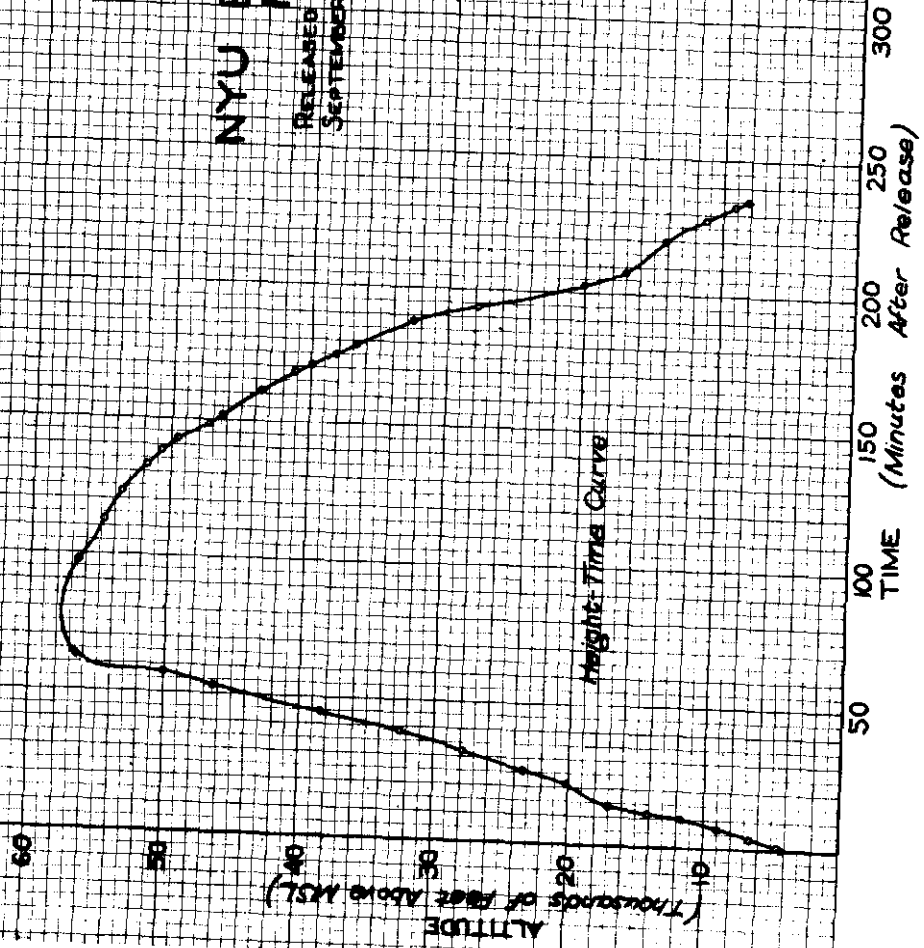

**FIG 49**

NYU BALLOON PROJECT  
FLIGHT NO. 20

RELEASED AT ALAMOGORDO, NEW MEXICO  
SEPTEMBER 10, 1947 1300 MST

FIG 50





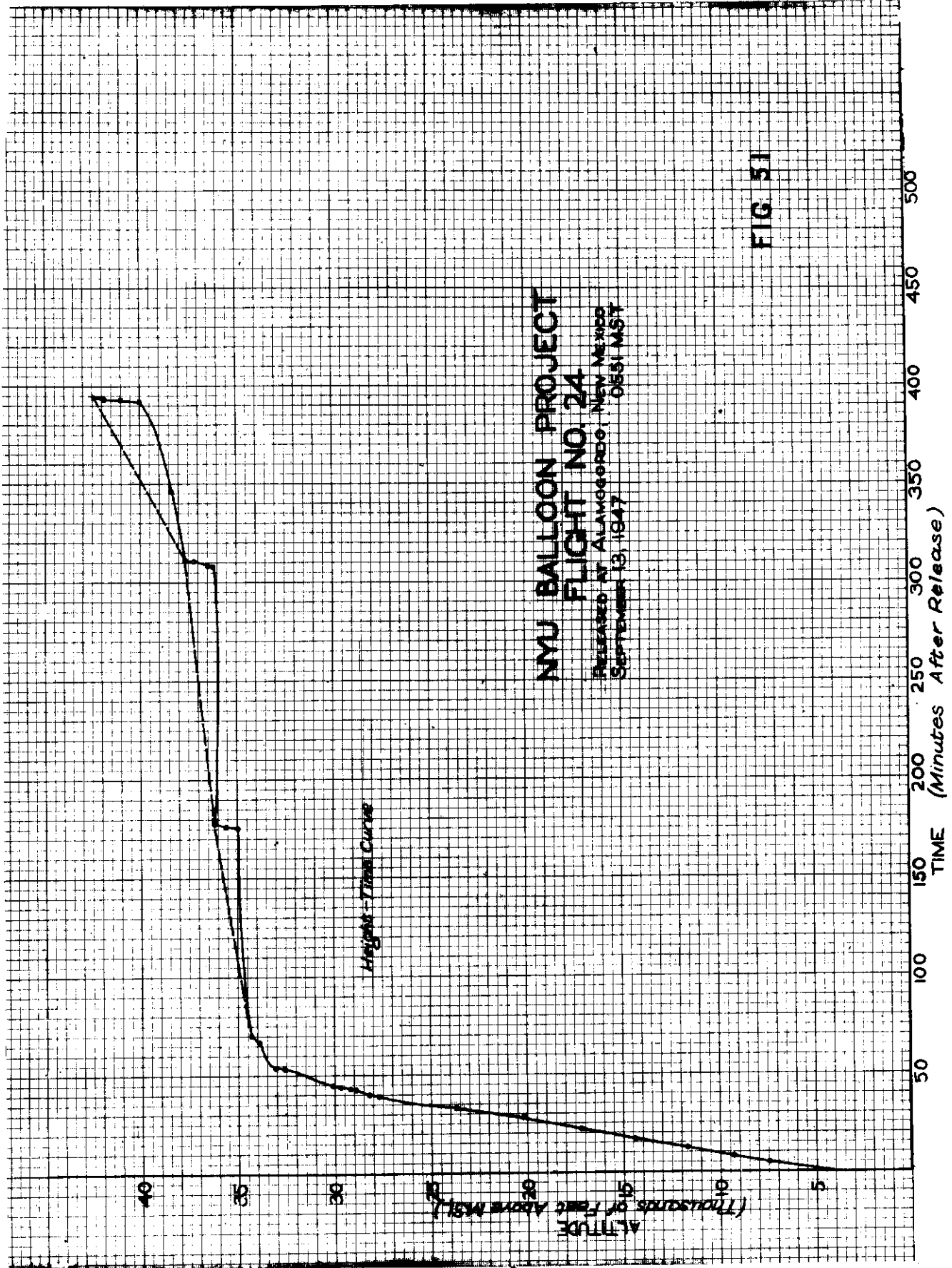

NMU BALLOON PROJECT  
 FLIGHT NO. 24  
 RELEASED AT ALAMOGORDO, NEW MEXICO  
 SEPTEMBER 13, 1947 0551 MST

FIG 51

**NYU BALLOON PROJECT  
FLIGHT NO. 27**

RELEASED AT ALBUQUERQUE, NEW MEXICO  
SEPTEMBER 16, 1947 0521 MST

ALTITUDE  
(Thousands of Feet Above MSL)

Height-Time Curve

TIME (Minutes After Release)

**FIG 52**

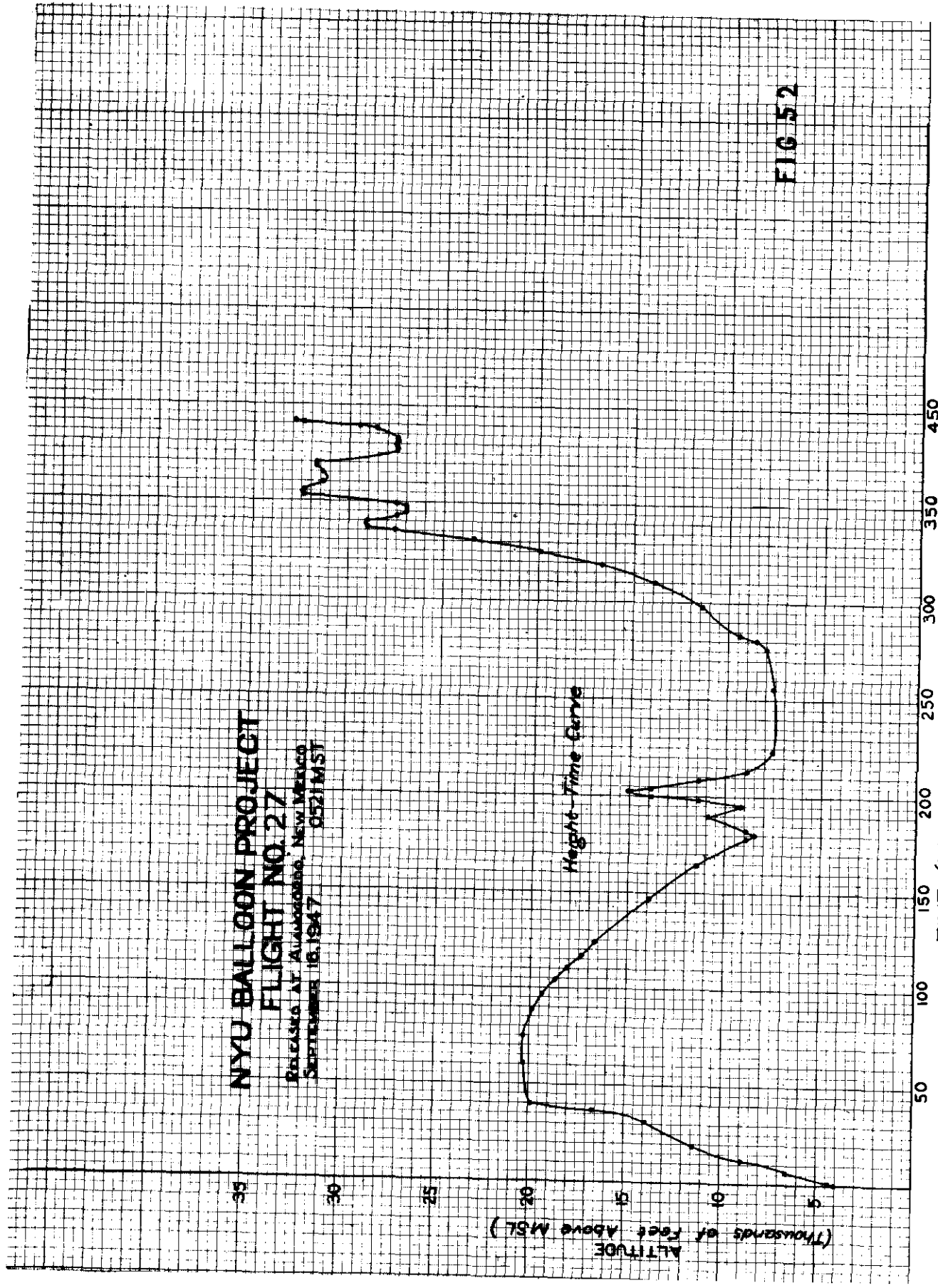

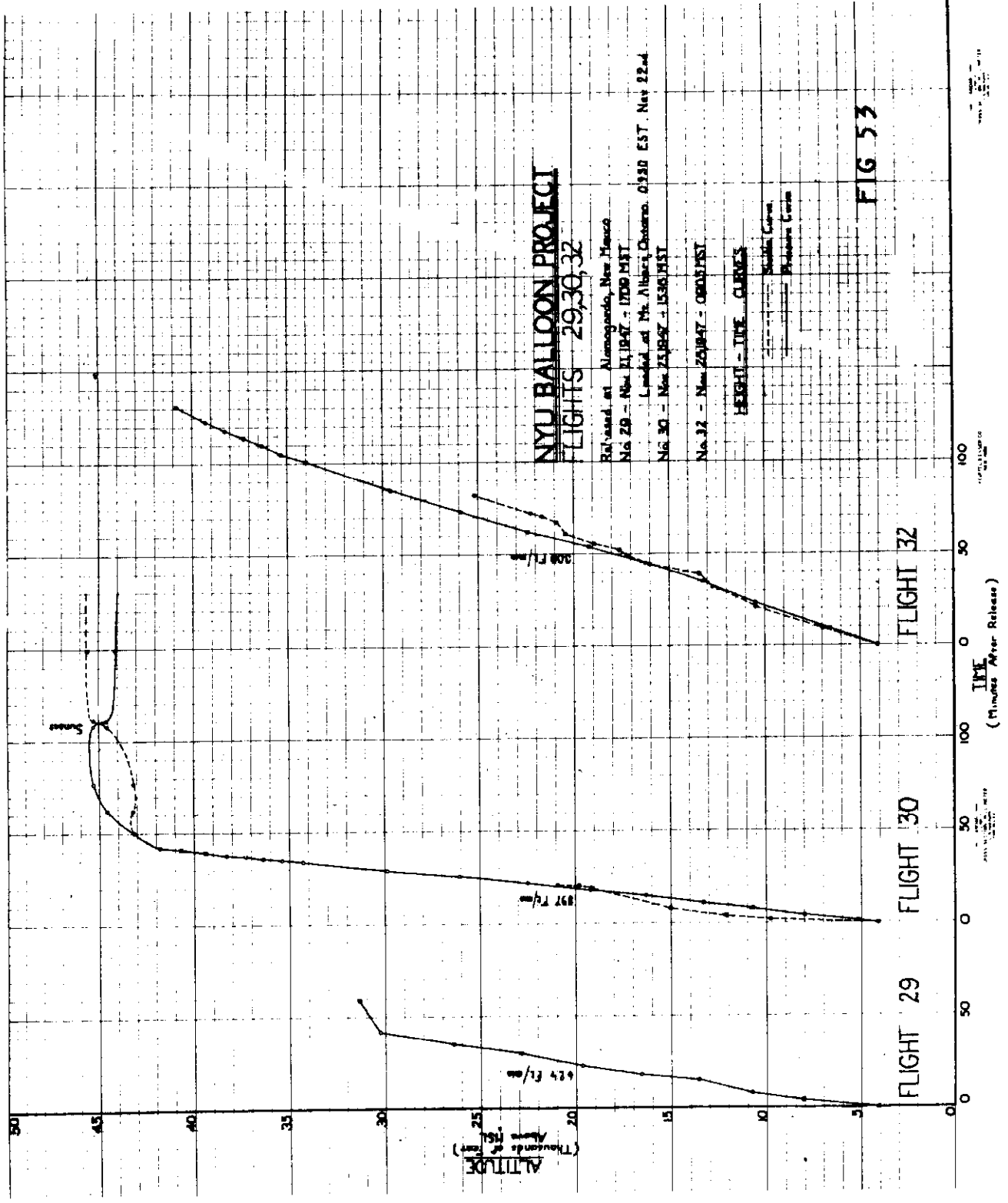
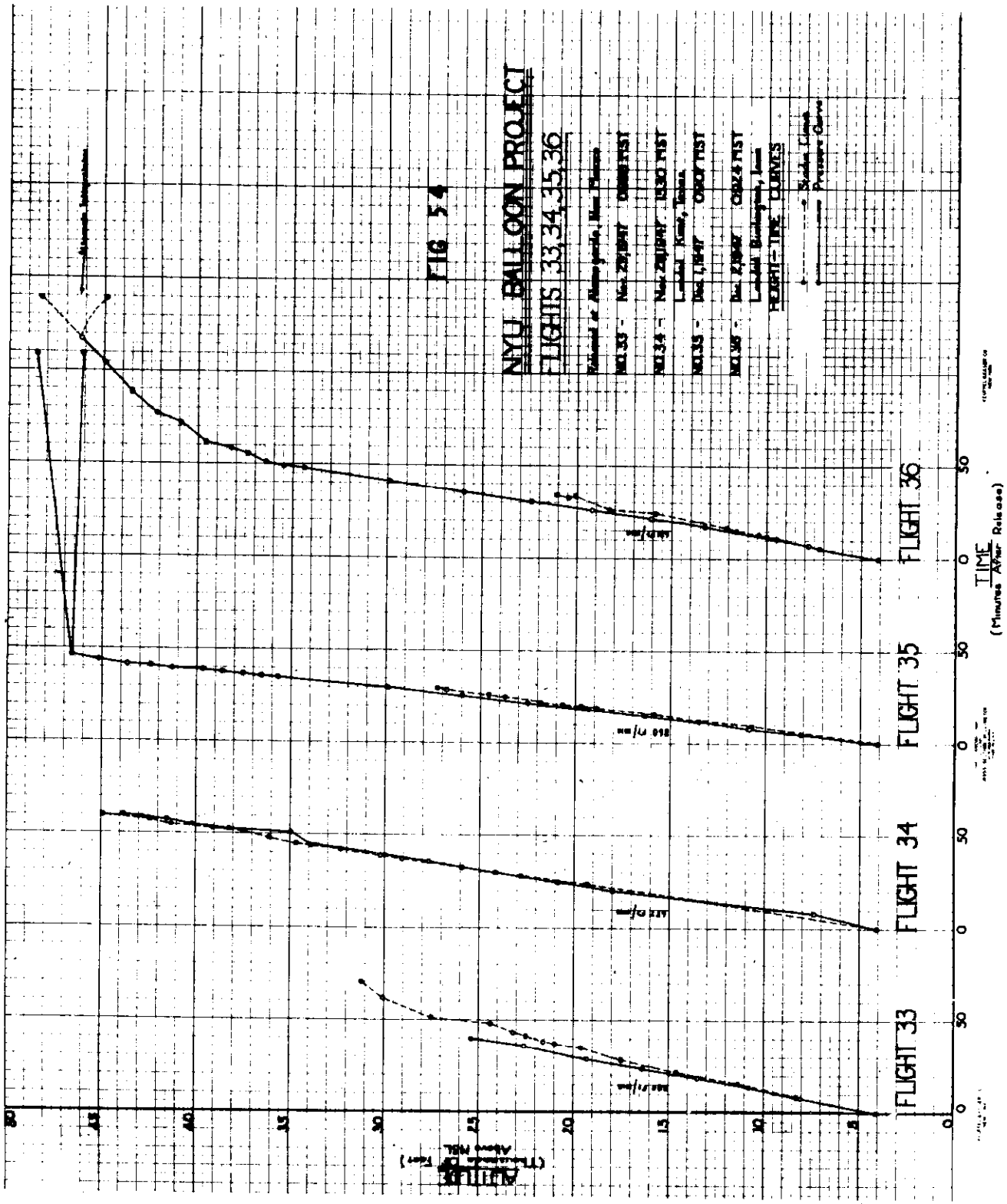

FIG 53



**N Y U BALLOON PROJECT**  
**FLIGHTS 37, 38, 39**

Released at Alamojordo, New Mexico  
 No. 37 - Dec. 3, 1947 - 1542 MST  
 Landed Alamojordo, New Mexico  
 No. 38 - Dec. 4, 1947 - 0850 MST  
 Landed 50 M. N. of Roswell AAF 1047 MST  
 No. 39 - Dec. 4, 1947 - 1624 MST  
 Landed 3 M. N. E. of Cloudcroft, N. Mexico

**HEIGHT - TIME CURVES**  
 ○ --- ○ Static Curve  
 ○ --- ○ Pressure Curve  
 ○ --- ○ Extrapolated

**FIG 55**

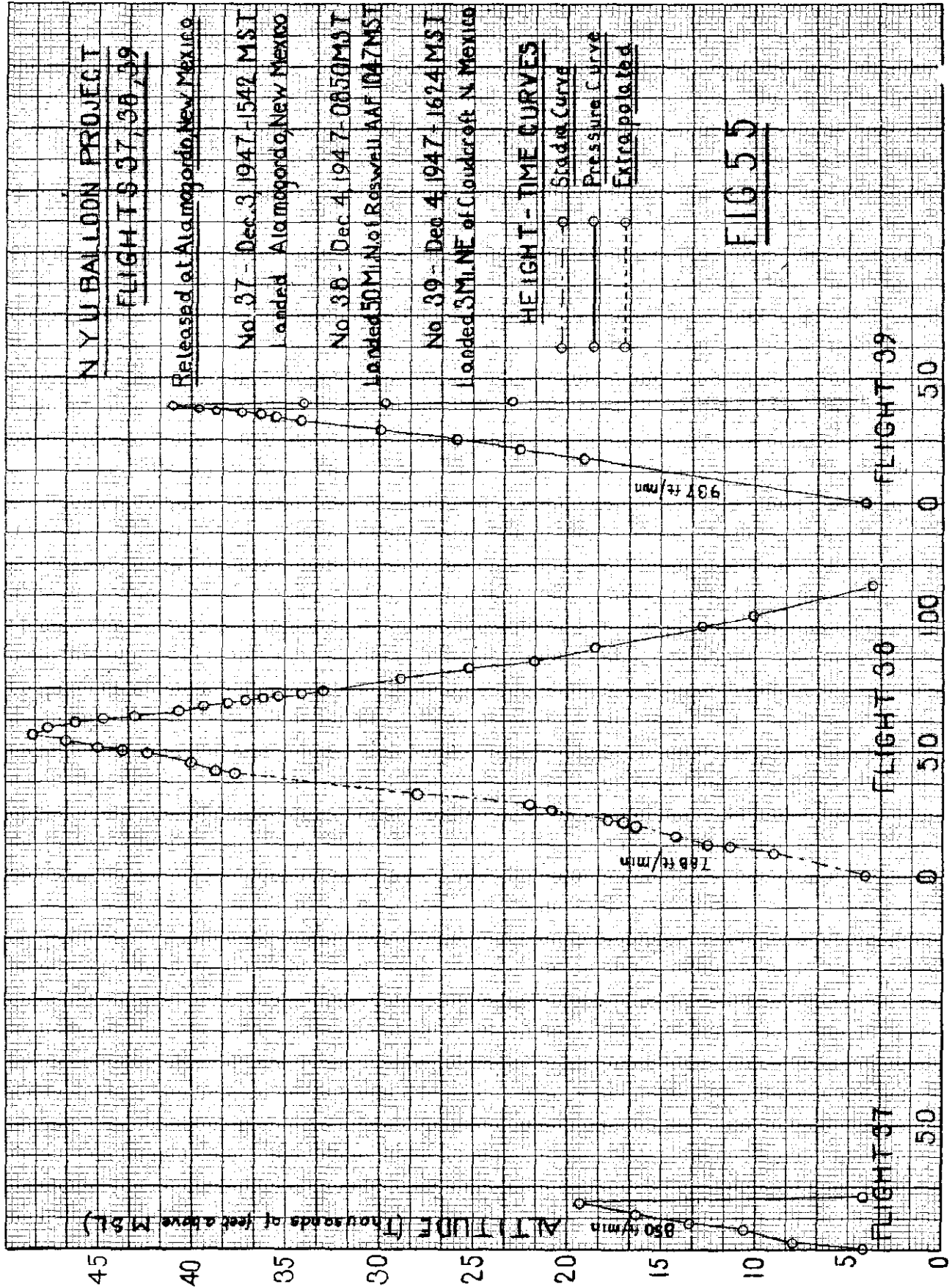

TIME (minutes after release)

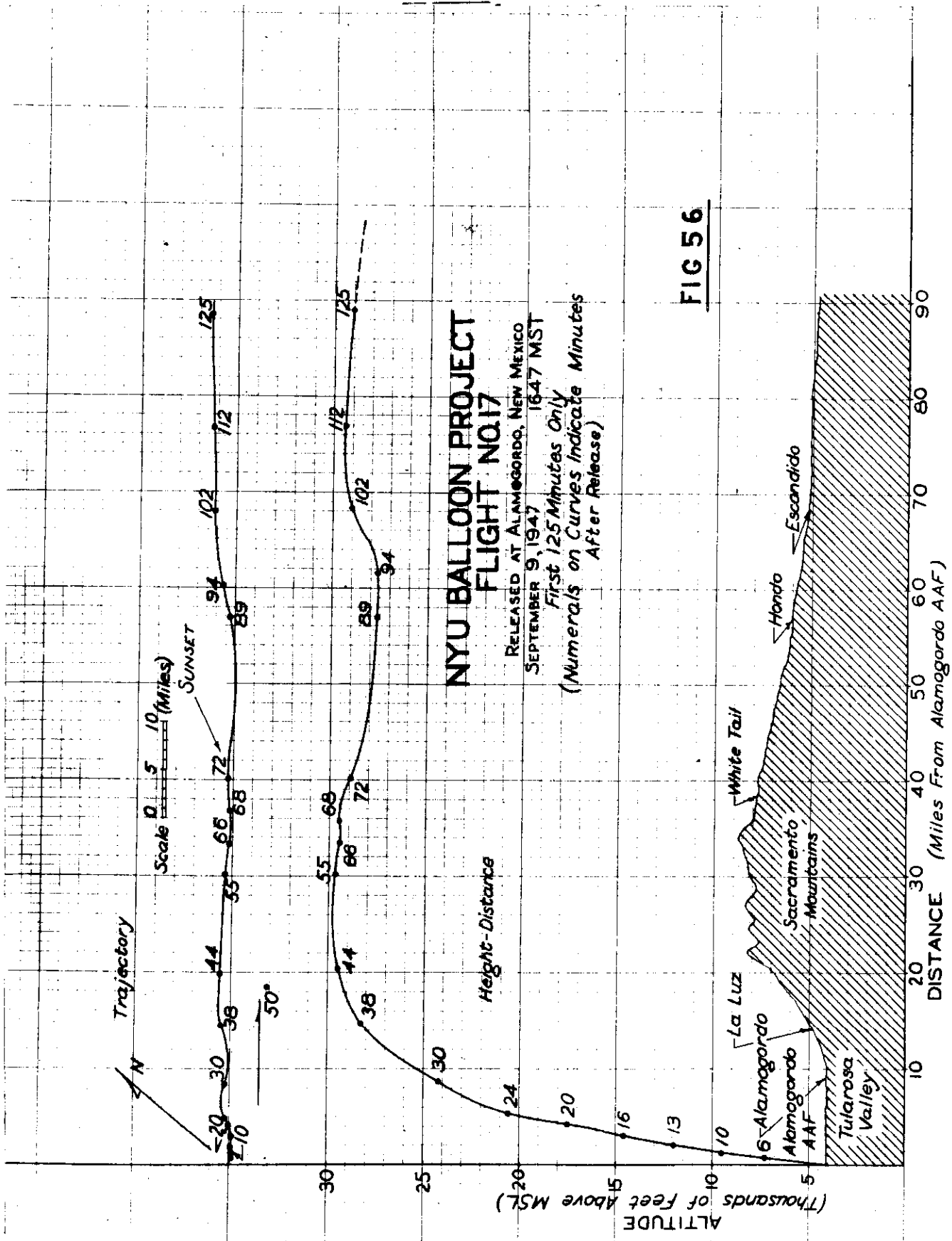

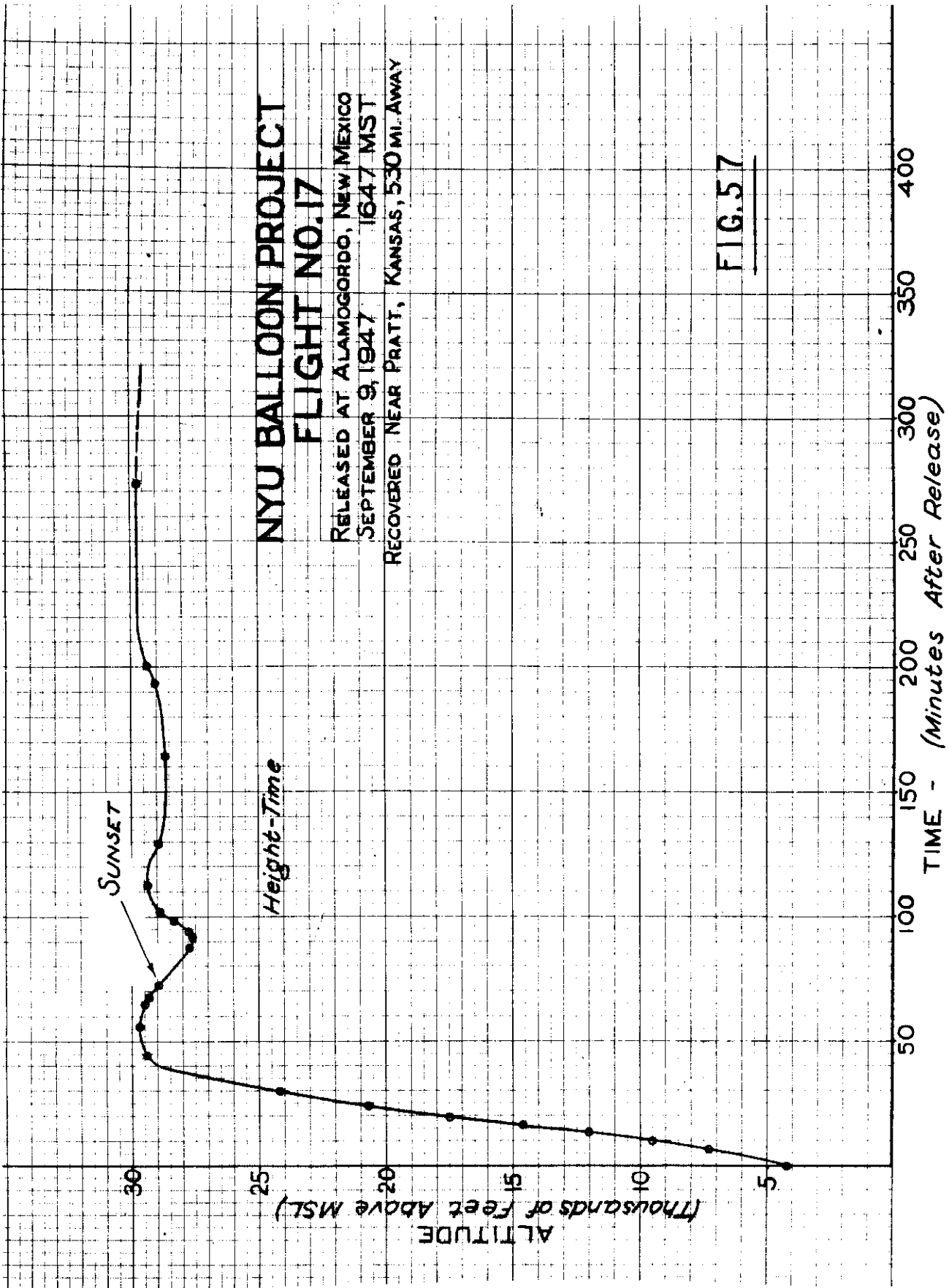

**NYU BALLOON PROJECT  
FLIGHT NO. 17**

RELEASED AT ALAMOGORDO, NEW MEXICO  
 SEPTEMBER 9, 1947 1647 MST  
 RECOVERED NEAR PRATT, KANSAS, 530 MI. AWAY

FIG. 57





TABLE III  
SUMMARY OF NYU CONSTANT-LEVEL BALLOON FLIGHTS

FLIGHT NUMBER	DATE AND AIRCRAFT TIME	LAUNCHING SITE	DESCRIPTION OF CARRIER	BALLOON WEIGHT	APPROXIMATE WEIGHT OF BALLAST ASSEMBLY	TOTAL WEIGHT INCLUDING BALLAST	DESCRIPTION OF ALTITUDE CONTROL	BALLOON WEIGHT	FRESH WEIGHT	BALLOON WEIGHT	RADIOSONDE RECAPTION %	TRACKING X	AIRCRAFT OBSERVATION %	FLIGHT DURATION	OPTIMUM ALTITUDE	MAXIMUM ALTITUDE	RECOVERY & LANDING SITE	CRITICISMS
11	7 July 1947 0908 MST	Alamogordo New Mexico	7 - General Mills 1 - 15' .008" Polyethylene 6 - 7' .001" Polyethylene in balloon cluster below 15' balloon	17.1 kg	74.5 mc Radiosonde Ballast assembly	15.9 kg	Dribbler Copiers fluid Fixed leak 300 gm/hr	3 kg	11.3 kg	27.2 kg	97% with recorder	Theodolite 384	100% C-54	350 min.	423 min. ± 1500'	Max. 14800' Const. 14000'	OK	Balloons used in cluster to obtain higher altitude. In high wind at launching 3 small balloons deflated. Therefore cluster did not rise high enough to actuate altitude control. Dribbler leak and balloon diffusion both 300 gm/hr. Therefore balloon remained at ceiling until ballast was expended.
12	5 Aug. 1947 0714 MST	Lakehurst New Jersey	1 - General Mills - 20' .001 Polyethylene	4.1 kg	3 mc transmitters 39.7 mc Radiosonde 72.2 mc Radiosonde Ballast assembly	28.0 kg	Automatic and manual ballast valves and minimum pressure switch	5 kg	3.8 kg	31.8 kg	100% Millman	Theodolite 15% SCR-658 80%	85%	407 min.	40 min. ± 400'	Max. 14100'	95% Smyrna, Delaware 85 mi.	First flight with large thin balloon. Open appendix caused helium diffusion with air-corer over appendix thought to have caused balloon rupture, terminating flight early and low. Flight not successful as balloon test or altitude control test.
13	5 Sept. 1947 0647 MST	Alamogordo New Mexico	2 General Mills 20' .001" Polyethylene. 10' appendix inside shroud lines	8.4 kg	397 mc Radiosonde Data Gear Ballast release	24.2 kg	Automatic Ballast release assembly	10.0 kg	3.8 kg	28.0 kg	100%	Theodolite 100% SCR-658 100%	Not required Burst over desert	58 min.	None (burst)	Max. 4760'	OK White Sands, N. M.	Appendices twisted around shroud lines, preventing valving of gas at pressure altitude. Both balloons burst within 2 minutes and gear fell free to desert. Recovery not attempted.
14	6 Sept. 1947 0613 MST	Alamogordo New Mexico	1 General Mills 20' .001" Polyethylene. 10' appendix outside shroud lines	4.0 kg	397 mc Radiosonde Banner. Ballast release	15.1 kg	Automatic Ballast release assembly	5.0 kg	2.2 kg	17.3 kg	100%	Theodolite 100% SCR-658 100%	Last 10% (L-3)	55 min.	None (burst)	Max. 49600'	100% 6 mi. north of Alamogordo AAF	Appendix again twisted around shroud lines, preventing valving of gas at pressure altitude, where balloon burst. Descent retarded by banner.
15	6 Sept. 1947 1353 MST	Alamogordo New Mexico	1 General Mills 20' .001" Polyethylene. 1' appendix outside shroud lines.	4.0 kg	397 mc Radiosonde Banner. Ballast release	15.1 kg	Manual ballast valve. Fixed rate of leak 1000 gm/hr	5.0 kg	2.6 kg	17.7 kg	364 min.	Theodolite 175 min. SCR-658 364 min.	Not required accurate data not required	More than 364 min.	71 min. ± 900'	Max. 45800' Const. 34000'	OK	First flight with large G. M. balloon which did not burst due to appendix. Believe holes in balloon due to high wind at launching caused slow descent after pressure height was reached. Shows need of short appendix and automatic ballast valve.
16	6 Sept. 1947 0828 MST	Alamogordo New Mexico	1 General Mills 20' .001" Polyethylene. 2' appendix outside shroud lines	4.4 kg	397 mc Radiosonde Data gear Banner. Ballast release	16.1 kg	Automatic Ballast Release assembly	3.2 kg	2.4 kg	18.5 kg	100%	Theodolite 100% SCR-658 100%	Not required a/c used to search for gear	30 min.	None (burst)	Max. 31700'	OK 6 miles NE Alamogordo AAF	Heavily loaded balloon with too much free lift (inflated by volume estimate in wind). High oscillations observed after release. Balloon burst due to blowing off top well below pressure altitude. Balloon came down with free falling gear but was not found.
17	9 Sept. 1947 1647 MST	Alamogordo New Mexico	1 H. A. Smith 15' .004" Polyethylene with 18 lead points	6.4 kg	397 mc Radiosonde Banner. Ballast release	11.3 kg	Automatic Ballast release assembly 100 gm/hr fixed leak	4.0 kg	2.1 kg	13.4 kg	281 min.	281 min.	Not required night flight	20 hrs.	181 min. ± 500'	Max. 29700' Const. 29100'	Croft, Kansas 555 miles	Successful controlled altitude flight demonstrating altitude controls maintaining height through a sunset. Balloon descended near Croft, Kansas long after passing out of Roswell's reception range. Need for a barograph shown.

TABLE VII  
SUMMARY OF NYU CONSTANT-LEVEL BALLOON FLIGHTS

FLIGHT NUMBER	DATE AND RELEASE TIME	LAUNCHING SITE	DESCRIPTION OF BALLOONS	BALLOON WEIGHT	DESCRIPTION OF EQUIPMENT	TOTAL WEIGHT ON BALLOON INCLUDING BALLAST	DESCRIPTION OF ALTITUDE CONTROL	BALLOON WEIGHT	FINE LIFT	BALLOON LIFT	RADIOSONDE RECEPTION	TRACKING	AIRCRAFT SEARCH TIME	FLIGHT DURATION	OPTIMUM ALTITUDE	BAROMETRIC ALTITUDE	RECOVERY	CAUSE
19	10 Sept. 1947 0655 MST	Almogordo New Mexico	1 R. A. Smith 15' .004" Poly- ethylene with 18 long points	4.3 kg	Data gear Ballast release	13.2 kg	Automatic Ballast re- lease as- sembly	2.4 kg	2.3 kg	15.5 kg	100%	Theodo- lite 500-650 100%	Used on search for 300-450 gear	20 min.	None	100% Atmos- pheric 6000'	Pressure retention of burnoff berostitch, caused by jerking in high altitude. Hole in the balloon caused by sharp point. Balloon descended slowly, landing 2 miles away. Excellent demonstration of blowout patch and that only. Two hour delay with patch in burnout circuit.	
20	10 Sept. 1947 1308 MST	Almogordo New Mexico	1 General Mills 20' .001" Poly- ethylene 2' ap- pendix with bat- tens outside shrouds	4.1 kg	397 mc Medionda Buzzer Ballast as- sembly	9.0 kg	Manual bal- list release Pined rate of leak 1000 g/hr	4.5 kg	1.5 kg	10.5 kg	225 min.	Theodo- lite 115 500-650 100%	Not re- quired date not essential	Over 235 min.	10 min. ± 1000'	Max. 54400' Const. 55000'	Successful using design (M type). Success- ful appendix design shown. Need of auto- matic ballast valve demonstrated as high fired rate of ballast leak did not keep ball on floating after reaching ceiling.	
21	12 Sept. 1947 0718 MST	Almogordo New Mexico	1 General Mills 20' .001" Poly- ethylene 2' ap- pendix with bat- tens outside shrouds	4.1 kg	Data gear Buzzer Ballast as- sembly	12.8 kg	Automatic Ballast re- lease assembly	5.0 kg	0.2 kg	13.0 kg	Not pro- vided for	Theodo- lite 115 37 min. 10%	Not avail- able	About 400 min.	No data	Max. 58000' Max. esti- mated 58000' Const. 55000'	Flight for Watson. No pressure reporting gear due to weight limitations. Very suc- cessful flight due to improved low leakage General Mills balloon, in spite of complete failure of ballast release mechanism. Gas leakage not observed. Descent observed by finder.	
22	14 Sept. 1947 0638 MST	Almogordo New Mexico	1 General Mills 20' .001" Poly- ethylene 2' ap- pendix with bat- tens outside shrouds	4.1 kg	Data gear Buzzer Ballast as- sembly	12.8 kg	Automatic Ballast re- lease assembly	4.8 kg	1.2 kg	13.9 kg	Not pro- vided for	Theodo- lite 115 37 min. 10%	1 hour Balloon climbed range of plane	About 382 min.	No data	Max. 54000' Const. 55000' Max. esti- mated 55000'	Flight for Watson. No pressure reporting gear due to weight limitations. Successful flight due to improved low leakage General Mills balloon, in spite of complete failure of ballast release mechanism. Gas leakage not observed. Descent observed by finder.	
23	15 Sept. 1947 0918 MST	Almogordo New Mexico	1 shrouded Devey & Almy	4.0 kg	397 mc Medionda Buzzer, ball- ist assembly	9.8 kg	Automatic Ballast re- lease assembly	2.1 kg	0.99 kg	10.8 kg	125 min.	Theodo- lite 115 500-650 100%	Not re- quired 125 min. available	Over 125 min.	20 min. ± 1000'	Max. 50000' Const. 48000'	Foot ropes of shrouded balloon believed to be broken during sailing. Perhaps the reason certain parts of balloon failed and remaining balloon burst inside of shroud due to friction.	
24	15 Sept. 1947 0551 MST	Almogordo New Mexico	1 General Mills 20' .001" Poly- ethylene 2' ap- pendix with bat- tens, outside shrouds	4.1 kg	3 mc trans- mitter, buz- zer, ballist assembly	12.7 kg	Automatic Ballast re- lease assembly	2.2 kg	1.1 kg	12.8 kg	394 min.	Theodo- lite 115 230 min.	Middle 2 hours	Over 234 min.	122 min. ± 1000'	Max. Un- known Const. 48000' 440 MI.	Medionda indicator defective. Good balloon burst inside of shroud and remaining shrouds until transmitter failed.	
25	15 Sept. 1947 0407 MST	Almogordo New Mexico	11 Meteorological balloons 350 gm each	3.9 kg	Data gear Buzzer	7.3 kg	None	None	1.8 kg	9.3 kg	210 min.	Theodo- lite 115 500-650 210 min.	Not re- quired	Over 210 min.	20 min. ± 1000'	Max. Un- known Const. 27000'	Cluster of meteorological balloons for Watson. No altitude control or radiosonde provided.	
26	15 Sept. 1947 1008 MST	Almogordo New Mexico	1 General Mills 20' .001" Poly- ethylene 2' ap- pendix with bat- tens outside shrouds	4.2 kg	3 mc trans- mitter, buz- zer, ballist assembly	12.4 kg	Automatic Ballast re- lease assembly	5.0 kg	0.2 kg	13.8 kg	508 min.	Theodo- lite 115 94 min.	2 hours	Over 508 min.	Un- known	Unknown	Operational flight for NYU transmitter test. Pressure data which was received proved to be incorrect when gear was retrieved.	

Table VII  
SUMMARY OF MYD CONSTANT-LEVEL BALLOON FLIGHTS

FLIGHT NUMBER	DATE AND BALLOON TIME	LAUNCHING SITE	DESCRIPTION OF BALLOONS	BALLOON WEIGHT	DESCRIPTION OF EQUIPMENT	TOTAL WEIGHT ON BALLOON INCLUDING BALLAST	DESCRIPTION OF ALTITUDE CONTROL	BALLAST WEIGHT	FAN WEIGHT	BALLOON WEIGHT	RADIOSONE RECEPTION	TRACKING	AIRCRAFT OBSERVATION	FLIGHT DURATION	U-TIME CONSTANT	MAXIMUM ALTITUDE	RECOVERY TIME SITE	CRITIQUE
27	16 Sept. 1947 0521 MST	Alamogordo New Mexico	1 N. A. with 15' 10" 1/2 styrene with 18 lead points	12.5 kg	3 m. burner, 3 m. wiper, burner, ballast assembly	12.1 kg	Manual ballast valve. Fixed rate of leak 200 gm/hr	4.1 kg	2.5 kg	14.6 kg	392 min.	None	None required	Over 392 min.		Max. 12900'	OK	Another flight showing necessity of automatic ballast valve. Burner assembly on some gear was dropped. Balloon then ascended between ground and successively higher ceilings. Radiosonde modulator believed defective.
28	16 Sept. 1947 0542 MST	Alamogordo New Mexico	11 meteorological balloons	3.9 kg	Data gear banner	7.1 kg	None	None	2.0 kg	9.1 kg	Not provided	Theodolite, Alamo, Gordo 52 min. Tolerman sea level 225 min.	None required	Over 225 min.	No data	No data	OK	Cluster of meteorological balloons for Watson Labs. No altitude control or radiosonde provided.
29	25 Nov. 1947 1709 MST	Alamogordo New Mexico	1 OM 2' appendix with bottom	4.1 kg	1.49 burner, out barometric banner, ballast assembly	13.1 kg	2 1/2 gal. can pressure filler. Manual ballast valve	5.5 kg	857 g	14.4 kg	69 min.	530 - 84 theodolite 12 min. 37	None	1 1/2 hours 21 min.	Rise time when lost	51,000'	W. Albert, Ontario	Excellent flight presumed from duration and distance. Manual ballast valve kept flight in air. Observed landing 9:30 AM, Nov. 22, 1947. Again stations downed not in operation. Tracking only for 1000 ft. Altitude above 1000 ft. less than 300 ft. Flight above read of barograph.
30	25 Nov. 1947 1535 MST	Alamogordo New Mexico	1 OM, no appendix	3.7 kg	1.49 burner, out barometric ballast assembly, 817, banner	13.1 kg	2 1/2 gal. can pressure filler. Manual ballast valve	5.5 kg	2900 g	14.1 kg	146 min.	650-148 min. theodolite 26 min.	Not found by tracking plane 1-2	Over 70 min. at 1000 ft	Over 70 min. at 1000 ft	45,000'	Chihuahua Mexico	Good flight presumed though data not optimum available. Maximum altitude 6000 feet lower than computed due to lack of appendix.
31	26 Nov. 1947 1055 MST	Alamogordo New Mexico	1 OM	4.1 kg	1.49 burner, out barometric ballast assembly, 817, banner	13.4 kg	2 1/2 gal. can pressure filler. Manual ballast valve	5.0 kg	1460 g	14.1 kg	148 min.	650 theodolite by tracking plane 1-2 200 min.	Not found by tracking plane 1-2	Unknown	Rise time when lost	Unknown	Freddie Texas	Transmitter failed shortly after release.
32	28 Nov. 1947 0905 MST	Alamogordo New Mexico	1 OM 3' appendix w/watena	4.0 kg	1.49 burner, out barometric ballast assembly, 817, banner	12.7 kg	2 1/2 gal. can pressure filler. Manual ballast valve	5.0 kg	1480 g	14.3 kg	148 min.	650-148 min. theodolite 146 min. Roswell 155 min	None	Unknown	Rise time when lost	Unknown	Blanco, Texas	650 tracking 83 miles from Alamogordo, about 70 miles from Roswell. Transmitter apparently failed after 155 min. Flight 200 miles from Alamogordo 155 min.
33	29 Nov. 1947 0934 MST	Alamogordo New Mexico	1 OM 3' appendix	4.0 kg	1.49 Watson banner, 817, banner, meteorograph, barometric ballast assembly, 817, banner	14.2 kg	Manual ballast valve	5.0 kg	2160 g	16.5 kg	38 min.	650-38 min. theodolite 115 min	None	Unknown	Rise time when lost	Unknown	Not recovered	Transmitter failure. Altivation made 13 when lost. Distance about 15 miles.

TABLE VII  
SUMMARY OF HYDROCONSTANT-BALLOON FLIGHTS

FLIGHT NUMBER	DATE AND TIME	LAUNCHING SITE	DESCRIPTION OF BALLOON	BALLOON WEIGHT	DESCRIPTION OF BURSTING ASSEMBLY	TOTAL WEIGHT AT BURSTING	DESCRIPTION OF BURSTING	BALLOON WEIGHT AT BURSTING	WIND VELOCITY AT BURSTING	HEIGHT AT BURSTING	ASCENT RATE	FLIGHT DURATION	OUTLINE OF INCIDENT	MATHIAS' COMMENTS	REMARKS	CAUSE
34	29 Dec. 1947 1530 MST	Alamogordo New Mexico	1 OM 3' appendix	4.1 kg	Cool water, burst barometer, ballast assembly burner	15.8 kg	Cool water, burst barometer, ballast assembly burner	5.0 kg	16.3 kg	Unknown	None	Unknown	Barometer activated before release. New balloon filled and flight released with difficulty due to wind shift. Signal strength reduced when balloon moved behind hangar. Cause for end of tracking.	Unknown	East, Texas	Barometer activated before release. New balloon filled and flight released with difficulty due to wind shift. Signal strength reduced when balloon moved behind hangar. Cause for end of tracking.
35	1 Dec. 1947 0937 MST	Alamogordo New Mexico	1 OM 3' appendix	4.0 kg	Cool water, barometer, ballast assembly, burner	15.7 kg	Cool water, barometer, ballast assembly, burner	5.0 kg	16.9 min.	Unknown	None	Unknown	Released in rain shower. Burst and fell 8 miles NE of field due to embolic and failure of tapes holding balloon fabric.	48,700' const.	Not recovered	A constant level flight. No data due to transmitter or battery failure over Maxwell.
36	2 Dec. 1947 0934 MST	Alamogordo New Mexico	1 OM 3' appendix	4.3 kg	T-69 Weston battery, burst barometer, automatic ballast assembly, burner	12.7 kg	T-69 Weston battery, burst barometer, automatic ballast assembly, burner	5.8 kg	13.5 min.	Unknown	None	Unknown	Flight with General Mills automatic ballast assembly. Signal strength rapidly to OM. Signal lost over Tucuman.	Unknown	Bladwinville, Ill.	Flight with General Mills automatic ballast assembly. Signal strength rapidly to OM. Signal lost over Tucuman.
37	3 Dec. 1947 1542 MST	Alamogordo New Mexico	1 OM no appendix	4.0 kg	T-69 Weston battery, ballast assembly, burner	13.8 kg	T-69 Weston battery, ballast assembly, burner	5.0 kg	38 min. 100%	None	None	38 min. 100%	Released in rain shower. Burst and fell 8 miles NE of field due to embolic and failure of tapes holding balloon fabric.	19,300' maximum	Alamogordo New Mexico	Released in rain shower. Burst and fell 8 miles NE of field due to embolic and failure of tapes holding balloon fabric.
38	4 Dec. 1947 0850 MST	Alamogordo New Mexico	1 MA J.R.000 with nylon stream	5.6 kg	Cool water, ballast assembly, burner	10.8 kg	Cool water, ballast assembly, burner	3.0 kg	80 min. 87%	117 min.	last 75' 8-25	117 min.	None	48,570' maximum	50 mi. N of Roswell AAF, 1007 AM, 12/4/47	None
39	4 Dec. 1947 1842 MST	Alamogordo New Mexico	1 OM 3' appendix	4.0 kg	T-69 Weston battery, burst barometer, automatic ballast assembly	13.6 kg	T-69 Weston battery, burst barometer, automatic ballast assembly	5.0 kg	80 min. 100%	60 min.	None	60 min.	Released in rain shower. Burst and fell 8 miles NE of field due to embolic and failure of tapes holding balloon fabric.	41,100' maximum	5 mi. NE of Alamogordo N.M.	Deflation error due to resulting high (700 ft) wind velocity (1000 ft/min) and resulting ground speed at burst altitude. Fall in mountain near Cloud Creek. Recovery not attempted. Strong signals received by 650's at Alamogordo, Roswell and Hobbs.

APPENDIX 2

Correspondence

	<u>Page</u>
1. Abstract from: Air Coordinating Committee, New York Subcommittee on Airspace, Rules of the Air and Air Traffic Control. Subject: Approval to release free balloons from Allentown, Pa. and Lakehurst, N. J.....	38
2. Letter to the Secretary, New York Subcommittee on Airspace. Subject: Request for interpretation of agreement on conditions of release of free balloons from Allentown, Pa. and Lakehurst, N.J.....	41
3. Reply from the Secretary, New York Subcommittee on Airspace. Subject: Same as above.....	42
4. Extract from: Air Coordinating Committee, Fort Worth Regional Airspace Subcommittee. Subject: Obstructions to air navigation.....	43
5. Memorandum from the Chairman, Fort Worth Regional Airspace Subcommittee. Subject: Procedure for Release of free balloons in the White Sands Danger Area.....	45

C O P Y

Abstract from:

AIR COORDINATING COMMITTEE  
NEW YORK SUBCOMMITTEE ON AIRSPACE  
RULES OF THE AIR AND AIR TRAFFIC CONTROL  
385 Madison Avenue  
New York 17, N. Y.

20 March 1947

N. Y. Meeting No. 12

PROBLEM:

1. The Secretary of the Subcommittee presented a request from the War Department member in behalf of New York University for approval to release free balloons from Allentown, Pa. and Lakehurst, N. J.

DISCUSSION

2. The subject project is broken down into two phases as described below:

A. PHASE I.

- (1) The type balloon to be used in this phase of the project will be 6 ft. in diameter, hydrogen filled, encompassed by a nylon shroud with black and white panels 24" wide. Radio instruments weighing approximately 3 lbs. will be suspended approximately 50 ft. below the balloon and equipped with parachute device so that upon separation from the balloon, the attached equipment will float down towards the earth rather than become a freely falling body.
- (2) It is anticipated that two flights will be required in this phase of operation, the release to be made during weather conditions in which the sky is free of clouds and the visibility at least three miles at all altitudes up to 20,000 feet., within a four hour cruising radius from Allentown, Pa.
- (3) The balloon, during these flights, shall be conveyed by suitable aircraft to maintain air-ground communications on the balloon trajectory and equipped to effect destruction of the balloon at the termination of four hours flight or at such time that the balloon may become hazardous either to aircraft flight operations or the persons or property of others on the surface.
- (4) New York University will file a Notice to Airmen at least twelve (12) hours in advance of balloon release and a second notice will be filed at the time of release with the Allentown, Pa. Airways Communications Station.

B. PHASE II.

- (1) The type balloon to be used in this phase of the project will be a 15 to 40 ft. diameter plastic balloon, hydrogen filled. Radio equipment weighing approximately 25 lbs., will be suspended approximately 100 ft. below the balloon. The balloon will be towed to high altitude levels (above 20,000 feet) by three auxilliary lifting balloons fastened together with a 4 lb. weight. All equipment attached to the balloon will be equipped with parachute device so that upon separation from the balloon, the attached equipment will float down towards the earth rather than become a freely falling body. Upon attaining the desired altitude, the auxilliary lifting balloons will be released from the main balloon.
- (2) It is anticipated that a maximum of ten flights will be required in this phase of operation, 2 to 5 releases to be made from Allentown, Pa. and 2 to 5 releases to be made from Lakehurst, N. J. Release will be made during weather conditions in which the sky is free of clouds and the visibility at least three miles at all altitudes up to 20,000 feet.
- (3) The range of flight during this phase of operation will be between 30,000 and 60,000 feet. A period of six hours will be the maximum duration of flight.
- (4) New York University will provide an operator for tracking of the balloon during period of flight and will furnish information on its position to the N.Y. Air Traffic Control Center during period of flight.
- (5) New York University will file a Notice to Airmen at least twelve (12) hours in advance of balloon release and a second notice will be filed at time of release with either the Allentown, Pa. or Lakehurst, N.J. Communications Stations.
- (6) Destruction of the balloon will be predetermined to be effected over water where hazards are not present. Aerial convoy will not be effected during this phase of operation inasmuch as balloon flights will be conducted in excess of 20,000 feet.

3. The War Department member requests that balloon operations along the lines of Phase II be presented to the Washington Subcommittee for clearance with all other Regional Airspace Subcommittees, in consideration of War Department plans to continue the Phase II type of operation from White Sands, New Mexico, upon completion of the 12 proposed releases described herein. The type of balloon releases proposed out of White Sands, N. Mex., will involve flight through other regions.

RECOMMENDED ACTION

4. That the release of free balloons by New York University as described above in Paragraph 2-A (Phase I), Subparagraphs (1) - (4) inclusive, be approved.

5. That the release of free balloons by New York University as described above in Paragraph 2-B (Phase II), Subparagraphs (1) - (6) inclusive, be approved.

6. That the Washington Airspace Subcommittee present the Phase II operation to other Regional Airspace Subcommittees for clearance, in view of War Department plans to continue the Phase II type of operation from White Sands, New Mexico.



April 17, 1947

Mr. C. J. Stock, Secretary  
New York Subcommittee on Air Space  
385 Madison Avenue  
New York 17, N. Y.

Reference: New York Meeting No. 12 Subject No. 26, New York Case #156

Dear Sir:

Receipt of the minutes of the above meeting are acknowledged with thanks. However, on reading them, a discrepancy was noted. We believe the weather conditions agreed upon for Phase 2 operations were not a cloudless sky, but no ceiling under 20,000 ft.

We realize that there might be occasions when the clouds present would not constitute a ceiling. Yet, due to chaotic or unstable sky conditions, our balloons might be considered an unseen hazard to aircraft.

It is therefore requested that we be permitted to fly these rapidly rising, high altitude balloons after obtaining clearance on days when there are no more than scattered clouds in thin layers up to 20,000 ft. and visibility greater than three miles.

This is an important point, as the phenomena which we hope to measure is not a frequent one and our chances to investigate the remote phenomena are markedly reduced if we have to wait for cloudless skies and the phenomena to coincide.

This would have been brought to your attention earlier. However, we are unable, until yesterday, to confirm our impressions with the representatives of the Army Air Forces who were present at the meeting.

Yours very truly,

C. S. Schneider  
Research Assistant

CSS:gm

DEPARTMENT OF COMMERCE  
CIVIL AERONAUTICS ADMINISTRATION

385 Madison Ave.  
New York 17, N. Y.

New York University  
College of Engineering  
Research Division  
University Heights  
New York 53, N. Y.

Attention: Mr. C. S. Schneider, Research Assistant

Dear Mr. Schneider:

This is in reply to your letter of April 17th.

It is true that at N.Y. Airspace Subcommittee Meeting #12, we advised you that the Phase II operations would be restricted to weather conditions in which the sky was clear of clouds below 20,000 feet and the visibility at least three miles at all altitudes up to and including 20,000 ft. However, it was indicated that these conditions were subject to concurrence and approval by the Washington Airspace Subcommittee.

In order to expedite final approval of this case, coordination was effected with the Washington Airspace Subcommittee immediately subsequent to our Meeting #12. It was revealed as a result of such coordination that the Washington Committee felt that the ceiling restriction was inadequate in the interests of air safety and required that a cloudless sky condition be specified.

This information was relayed to the members of the N.Y. Airspace Subcommittee and they in turn concurred with this amendment in the interest of air safety. The minutes of New York Meeting #12 were amended accordingly.

Yours very truly,

C. J. Stoek  
Secretary, N. Y. Airspace Subcommittee

AIR COORDINATING COMMITTEE  
FORT WORTH REGIONAL AIRSPACE SUBCOMMITTEE  
P. O. BOX 1689  
FORT WORTH 1, TEXAS

August 21, 1947

Meeting No. 30

Time: August 21, 1947 - 10:00 a.m. to 1:30 p.m.

Place: Regional Office, CAA, Ft. Worth, Texas

Members Present: L. C. Elliott, Chairman  
Lt. Col. Hall F. Smith, War Dept. Member  
Major Williams, War Dept. Alternate Member  
Perry Hodgden, CAB Member  
Commander James Douglas Arbes, Navy Dept. Member  
Tracy Walsh, ATA Coordinator

Secretary: Paul H. Boatman

EXTRACT COPY

SUBJECT

PAGE NUMBER

III. OBSTRUCTIONS TO AIR NAVIGATION

A. WHITE SANDS, NEW MEXICO, PROVING GROUND - NEW YORK UNIVERSITY - RELEASE  
OF FREE BALLOONS - CASE #111.:..... 3

PROBLEM

1. The Secretary of the Subcommittee presented a request received from the New York University through the Department of Commerce Member for approval of releases of free balloons at the White Sands Proving Ground in Phase II operation as outlined in New York Subcommittee Meeting No. 12, dated March 20, 1947.

DISCUSSION

2. It was first thought that balloons would ascend and descend within the confines of the White Sands presently assigned danger area and that no further authorization would be required; however the Subcommittee was advised by the University that balloons have been descending outside of the area in the vicinity of Roswell, New Mexico. It, therefore, appeared that there was a certain amount of hazard to aircraft encountered in the descent of this equipment.

3. The Subcommittee did not have full information on the number of releases anticipated and other pertinent details; however it appeared the chances of collision of aircraft with this equipment was very remote and due to the fact prevailing winds in this area would ordinarily carry the equipment eastward, which would tend to carry it away from heavy travelled already established civil airways, that this activity might not be too objectionable.

4. The Department of Commerce Member stated that he felt it may be necessary to effect some coordination with air traffic in the local El Paso area but that due to the meager information available, this could not be determined without a discussion of methods and procedures with the people who were actually going to do the work.

5. The War Department Member stated that he felt it desirable to stipulate that local coordination should be effected with the Commanding Officer at Biggs Field.

(NOTE: At a meeting held in El Paso, Texas, on August 27, 1947, between representatives of the CAA and the New York University, procedures satisfactory to the Commerce Member and the Commanding Officer at Biggs Field were established).

RECOMMENDED ACTION

6. That release of free balloons by the New York University within the confines of the White Sands Proving area be approved provided that:

(a) Local coordination be effected to the satisfaction of the Department of Commerce Member and the Commanding Officer at Biggs Field to assure all precautions are taken to prevent collision of aircraft with this airborne equipment.

COPY

AIR COORDINATING COMMITTEE  
FORT WORTH REGIONAL AIRSPACE SUBCOMMITTEE  
P. O. BOX 1689  
FORT WORTH 1, TEXAS

September 2, 1947

MEMORANDUM

TO: L. C. Elliott  
Chairman, Ft. Worth Regional Airspace Subcommittee  
  
Lt. Col. Hall F. Smith, War Dept. Member, Ft. Worth  
Regional Airspace Subcommittee

FROM: Secretary, Ft. Worth Regional Airspace Subcommittee

SUBJECT: Procedure for Release of Free Balloons in the White Sands Danger  
Area

The writer met with Mr. James R. Smith of New York University and Lt. V. D. Thompson of Alamogordo AAF, at El Paso, Texas, on August 27 to discuss procedures to be followed during the descent of free balloons released within the White Sands Danger Area.

Mr. Smith advised that he had met with the Commanding Officer at Biggs Field who had stated he desired no further coordination other than what the Civil Aeronautics Administration might require and that he would write a letter to Mr. Smith to this effect. Mr. Smith will forward this to the Chairman of the Subcommittee for the record.

Mr. Smith outlined their program, which consists for the most part of testing various types of balloons. Their program will probably be of 5 flights per month for the next 6 months, the first flight to be released on Sept. 6, weather permitting. Weather minimums were agreed on as not more than 4/10 of the sky covered or forecasted to be covered within the expected descent area (60 mile radius).

Balloons are tracked by VHF DF stations at Alamogordo and Roswell for the present plus an aircraft. When the balloon descends to 20,000 feet, if not in the clear, positions will be given every hour or so and will be put out as notams on Schedule "A" from the Roswell AAF. This will serve to advise the Army Fields, the airlines, and some itinerant traffic. In any case if the balloon is outside the assigned danger area, notams will be issued when the balloons descend below 15,000 feet.

The balloons are for the most part 15 feet in diameter and plastic. Suspended from the balloon is a 100 foot one thousand pound test nylon line which carries the airborne equipment. Releases are usually made at dawn and the flight terminates in an average of 8 hours time; it may be from 6 to 12 hours duration.

It is believed the notam procedure will serve to advise pilots of this activity effectively enough to provide the desired amount of caution. It is understood

the airlines have some instrument flights through this area at 20,000 feet; however these are for the most part at night and to the north of the expected balloon track.

/s/ Paul H. Boatman  
PAUL H. BOATMAN  
Secretary, Ft. Worth Regional Airspace  
Subcommittee

C  
O  
P  
Y

APPENDIX 3

Flight Forms and Tables

	<u>Page</u>
1. Pressure in Standard Atmosphere.....	48
2. Mathematical tables for diameters, volumes, and surfaces of spheres.....	50
3. Table of basic data for computation of molar volume.....	51
4. Data for molar volume-altitude graph.....	53
5. Notice to finder (one copy in Spanish, one in English).....	54
6. Questionnaire.....	55
7. Preflight data sheets and computation forms.....	56

PRESSURE IN STANDARD ATMOSPHERE

(Accurate to .001 mm of Hg, .0001 in. of Hg and .002 of millibar)

<u>Thermal Layer</u>				<u>Isothermal Layer</u>					
Altitude	Pressure			ft. per	Altitude	ft per			
(feet)	(mm Hg)	(In. Hg)*	(mb)	(mb)	(feet)	(mm Hg)*	(In. Hg)*	(mb)	
-5,000	907.809	35.7404	1210.312		35,332	175.899	6.9251	234.513	
-4,000	876.533	34.5091	1168.615		36,000	170.375	6.7077	227.148	
-3,000	846.130	33.3121	1128.081		37,000	162.430	6.3949	216.556	
-2,000	816.582	32.1488	1088.686		38,000	154.854	6.0966	206.455	
-1,000	787.879	31.0188	1050.419		39,000	147.632	5.8123	196.826	
0	760.000	29.9212	1013.250	27	40,000	140.747	5.5412	187.647	110
1,000	732.923	28.8552	977.150		41,000	134.183	5.2828	178.896	
2,000	706.634	27.8202	942.101		42,000	127.925	5.0364	170.553	
3,000	681.114	26.8155	908.077		43,000	121.959	4.8015	162.599	
4,000	656.344	25.8403	875.053		44,000	116.271	4.5776	155.015	
5,000	632.308	24.8940	843.008	31	45,000	110.848	4.3641	147.785	140
6,000	608.991	23.9760	811.921		46,000	105.678	4.1605	140.892	
7,000	586.375	23.0856	781.769		47,000	100.750	3.9665	134.322	
8,000	564.444	22.2222	752.530		48,000	96.051	3.7815	128.057	
9,000	543.180	21.3850	724.180		49,000	91.571	3.6052	122.085	
10,000	522.571	20.5736	696.704	36	50,000	87.301	3.4370	116.392	175
11,000	502.600	19.7874	670.078		51,000	83.229	3.2767	110.963	
12,000	483.251	19.0256	644.282		52,000	79.348	3.1239	105.789	
13,000	464.511	18.2878	619.297		53,000	75.647	2.9782	100.854	
14,000	446.362	17.5733	595.100		54,000	72.119	2.8393	96.151	
15,000	428.793	16.8816	571.677	43	55,000	68.755	2.7069	91.666	225
16,000	411.786	16.2120	549.003		56,000	65.549	2.5807	87.391	
17,000	395.332	15.5642	527.066		57,000	62.492	2.4603	83.316	
18,000	379.412	14.9375	505.841		58,000	59.577	2.3455	79.429	
19,000	364.018	14.3314	485.317		59,000	56.799	2.2362	75.726	
20,000	349.132	13.7453	465.471	50	60,000	54.150	2.1319	72.194	285
21,000	334.742	13.1788	446.286		61,000	51.624	2.0324	68.826	
22,000	320.836	12.6313	427.746		62,000	49.217	1.9377	65.617	
23,000	307.403	12.1025	409.837		63,000	46.921	1.8473	62.556	
24,000	294.429	11.5917	392.540		64,000	44.733	1.7611	59.639	
25,000	281.901	11.0984	375.837	60	65,000	42.647	1.6790	56.858	360
26,000	269.808	10.6223	359.714		66,000	40.658	1.6007	54.206	
27,000	258.140	10.1630	344.158		67,000	38.762	1.5261	51.678	
28,000	246.883	9.7198	329.150		68,000	36.954	1.4549	49.268	
29,000	236.027	9.2924	314.677		69,000	35.230	1.3870	46.969	
30,000	225.561	8.8803	300.723	72	70,000	33.587	1.3223	44.779	455
31,000	215.473	8.4832	287.274		71,000	32.021	1.2607	42.691	
32,000	205.754	8.1005	274.316		72,000	30.528	1.2019	40.701	
33,000	196.394	7.7320	261.837		73,000	29.104	1.1458	38.802	
34,000	187.381	7.3772	249.821		74,000	27.746	1.0924	36.992	
35,000	178.705	7.0353	238.254	86	75,000	26.452	1.0414	35.266	580
					76,000	25.219	.9929	33.623	
					77,000	24.043	.9466	32.055	

\* Mercury column at 0° C.



PRESSURE IN STANDARD ATMOSPHERE

(Accurate to .001 mm of Hg, .0001 in. of Hg and .002 of millibar)

Altitude (feet)	<u>Isothermal Layer</u>			Ft. per (mb)
	Pressure (mm Hg)*	Pressure (in.Hg)*	Pressure (mb)	
78,000	22.921	.9024	30.559	
79,000	21.852	.8603	29.134	
80,000	20.833	.8202	27.775	735
81,000	19.862	.7820	26.480	
82,000	18.935	.7455	25.245	
83,000	18.052	.7107	24.067	
84,000	17.210	.6776	22.945	
85,000	16.408	.6460	21.876	935
86,000	15.642	.6158	20.854	
87,000	14.913	.5871	19.882	
88,000	14.217	.5597	18.954	
89,000	13.554	.5336	18.071	
90,000	12.922	.5087	17.228	1190
91,000	12.319	.4850	16.424	
92,000	11.745	.4624	15.659	
93,000	11.197	.4408	14.928	
94,000	10.675	.4203	14.232	
95,000	10.177	.4007	13.568	1510
96,000	9.702	.3820	12.935	
97,000	9.250	.3642	12.332	
98,000	8.819	.3472	11.758	
99,000	8.407	.3310	11.208	
100,000	8.015	.3156	10.686	1920

Diam.	Volume	Surface	Diam.	Volume	Surface	Diam.	Volume	Surface	Diam.	Volume	Surface	Diam.	Volume	Surface	Diam.	Volume	Surface							
1/4	0.0002	0.0006	7	179.594	151.979	14	1436.75	615.7516	26	9202.76	2123.71	41	36086.9	5281.01	65	143793	13273	77	219040	18626	89	349120	24885	
3/8	0.0013	0.0272	8	189.368	165.4646	15	1596.25	660.5193	27	9710.76	2174.52	43	37122.3	5410.96	66	150531	13869	78	244727	18849	91	375377	25165	
1/2	0.0102	0.0406	9	199.532	179.8532	16	1680.25	683.4922	28	10022.3	2248.00	45	40194.3	5674.50	67	153960	13995	80	253284	19340	93	380100	25770	
5/8	0.0200	0.0699	10	210.893	196.527	17	1852.14	706.9578	29	10290.0	2320.22	47	41629.7	5808.00	68	157679	14131	81	258114	19607	95	394458	26016	
3/4	0.0345	0.1047	11	223.125	212.6540	18	1949.81	734.1620	30	10580.0	2399.22	49	42972.2	5936.00	69	161603	14263	82	263082	19876	97	401718	26302	
7/8	0.0516	0.1489	12	235.711	231.217	19	2045.69	762.9107	31	10869.0	2471.22	51	44340.0	6064.00	70	165394	14406	83	268050	20156	99	409218	26580	
1	0.0816	0.2171	13	248.002	251.466	20	2144.66	791.3670	32	11158.0	2545.22	53	45710.0	6192.00	71	169207	14547	84	273140	20358	100	414403	26880	
1 1/8	0.1165	0.2850	14	260.846	272.331	21	2246.61	820.3200	33	11447.0	2619.22	55	47080.0	6320.00	72	172954	14689	85	278290	20646				
1 1/4	0.1598	0.3976	15	273.280	293.846	22	2352.07	849.3790	34	11736.0	2693.22	57	48450.0	6448.00	73	176807	14831	86	283440	20934				
1 1/2	0.2261	0.5476	16	286.346	315.910	23	2460.61	878.3300	35	12025.0	2767.22	59	49820.0	6576.00	74	180664	14973	87	288590	21222				
1 3/4	0.3211	0.7603	17	299.999	338.531	24	2572.44	907.3800	36	12314.0	2841.22	61	51190.0	6704.00	75	184521	15115	88	293740	21510				
2	0.4545	1.0655	18	313.825	361.716	25	2686.16	936.4300	37	12603.0	2915.22	63	52580.0	6832.00	76	188382	15257	89	298890	21800				
2 1/8	0.6219	1.4609	19	327.925	385.468	26	2802.61	965.4800	38	12892.0	2989.22	65	53970.0	6960.00	77	192243	15405	90	304040	22090				
2 1/4	0.8289	2.0007	20	342.280	409.740	27	2922.15	994.5300	39	13181.0	3063.22	67	55360.0	7088.00	78	196094	15553	91	309190	22380				
2 3/8	1.0705	2.7014	21	356.890	434.550	28	3045.45	1023.5800	40	13470.0	3137.22	69	56750.0	7216.00	79	200000	15701	92	314340	22670				
2 1/2	1.3525	3.5805	22	371.655	459.900	29	3172.44	1052.6300	41	13759.0	3211.22	71	58140.0	7344.00	80	203910	15850	93	319590	22960				
2 3/4	1.6805	4.7505	23	386.575	485.810	30	3303.62	1081.6800	42	14048.0	3285.22	73	59530.0	7472.00	81	207820	16000	94	324840	23250				
3	2.0605	6.3205	24	401.560	512.280	31	3436.61	1110.7300	43	14337.0	3359.22	75	60920.0	7600.00	82	211730	16150	95	330000	23540				
3 1/8	2.4985	8.5005	25	416.655	539.400	32	3574.61	1140.7800	44	14626.0	3433.22	77	62310.0	7728.00	83	215640	16300	96	335060	23830				
3 1/4	3.0005	11.3005	26	431.860	566.570	33	3716.61	1170.8300	45	14915.0	3507.22	79	63700.0	7856.00	84	219550	16450	97	340120	24120				
3 3/8	3.5705	14.8505	27	447.175	593.800	34	3862.61	1200.8800	46	15204.0	3581.22	81	65090.0	7984.00	85	223460	16600	98	345180	24410				
3 1/2	4.2105	19.2005	28	462.600	621.090	35	4012.61	1230.9300	47	15493.0	3655.22	83	66480.0	8112.00	86	227370	16750	99	350240	24700				
3 3/4	4.9305	25.4505	29	478.135	648.440	36	4166.61	1260.9800	48	15782.0	3729.22	85	67870.0	8240.00	87	231280	16900	100	355300	24990				
4	5.7405	33.6005	30	493.780	675.850	37	4324.61	1290.9300	49	16071.0	3803.22	87	69260.0	8368.00	88	235190	17050							
4 1/8	6.6405	43.8505	31	509.535	703.320	38	4486.61	1320.9800	50	16360.0	3877.22	89	70650.0	8496.00	89	239100	17200							
4 1/4	7.6305	56.2005	32	525.390	730.850	39	4652.61	1350.9300	51	16649.0	3951.22	91	72040.0	8624.00	90	243010	17350							
4 3/8	8.7105	70.6505	33	541.355	758.440	40	4822.61	1380.9800	52	16938.0	4025.22	93	73430.0	8752.00	91	246920	17500							
4 1/2	9.8805	87.2005	34	557.420	786.080	41	5006.61	1410.9300	53	17227.0	4100.22	95	74820.0	8880.00	92	250830	17650							
4 3/4	11.1405	105.8505	35	573.585	813.780	42	5194.61	1440.9800	54	17516.0	4174.22	97	76210.0	9008.00	93	254740	17800							
5	12.5005	126.6005	36	589.850	841.540	43	5386.61	1470.9300	55	17805.0	4248.22	99	77600.0	9136.00	94	258650	17950							
5 1/8	13.9605	149.4505	37	606.215	869.350	44	5582.61	1500.9800	56	18094.0	4322.22	100	78990.0	9264.00	95	262560	18100							
5 1/4	15.5305	194.4005	38	622.680	897.210	45	5782.61	1530.9300	57	18383.0	4396.22													
5 3/8	17.2105	251.5505	39	639.245	925.120	46	5986.61	1560.9800	58	18672.0	4470.22													
5 1/2	19.0005	320.8005	40	655.910	953.080	47	6194.61	1590.9300	59	18961.0	4544.22													
5 3/4	20.9105	403.1505	41	672.675	981.090	48	6406.61	1620.9800	60	19250.0	4618.22													
6	22.9405	508.5005	42	689.540	1009.150	49	6622.61	1650.9300	61	19539.0	4692.22													
6 1/8	25.0905	636.8505	43	706.505	1037.260	50	6842.61	1680.9800	62	19828.0	4766.22													
6 1/4	27.3605	789.2005	44	723.570	1065.420	51	7066.61	1710.9300	63	20117.0	4840.22													
6 3/8	29.7505	966.5505	45	740.735	1093.630	52	7294.61	1740.9800	64	20406.0	4914.22													
6 1/2	32.2605	1170.0005	46	758.000	1121.890	53	7526.61	1770.9300	65	20695.0	4988.22													
6 3/4	34.8905	1414.5505	47	775.365	1150.200	54	7762.61	1800.9800	66	20984.0	5062.22													
7	37.6405	1691.0005	48	792.830	1178.560	55	8002.61	1830.9300	67	21273.0	5136.22													
7 1/8	40.5105	1999.5505	49	810.395	1207.070	56	8246.61	1860.9800	68	21562.0	5210.22													
7 1/4	43.5005	2341.0005	50	828.060	1235.740	57	8494.61	1890.9300	69	21851.0	5284.22													
7 3/8	46.6105	2816.5505	51	845.825	1264.560	58	8746.61	1920.9800	70	22140.0	5358.22													
7 1/2	49.8405	3436.0005	52	863.690	1293.530	59	9002.61	1950.9300	71	22429.0	5432.22													
7 3/4	53.1905	4200.5505	53	881.655	1322.660	60	9262.61	1980.9800	72	22718.0	5506.22													
8	56.6605	5121.0005	54	899.720	1351.950	61	9526.61	2010.9300	73	23007.0	5580.22													
8 1/8	60.2505	6206.5505	55	917.885	1381.390	62	9794.61	2040.9800	74	23296.0	5654.22													
8 1/4	63.9605	7467.0005	56	936.150	1410.980	63	10066.61	2070.9300	75	23585.0	5728.22													
8 3/8	67.7905	8902.5505	57	954.515	1440.720	64	10342.61	2100.9800	76	23874.0	5802.22													
8 1/2	71.7405	10523.0005	58	972.980	1470.610	65	10622.61	2130																

Basic Data for Computation of Molar Volume

ALBUQUERQUE, NEW MEXICO

January 1943

(Mean Sounding)

<u>Altitude</u> (KM)	<u>Temp.</u> (°C)	<u>Pressure</u> (Mb)	<u>Humidity</u> %	<u>Molar</u> <u>Volume</u> ft. <sup>3</sup>
1.620 (Surface)	+ 3.8	838	45	449
2	3.4	800	46	463
2.5	.6	752	45	486
3	- 2.6	706	48	522
4	- 8.3	622	51	567
5	-14.6	546	50	631
6	-21.2	477	48	704
7	-28.3	416	46	786
8	-35.7	332	39	872
9	-43.0	312	-	983
10	-49.7	269	-	1140
11	-54.7	230	-	1250
12	-57.2	197	-	1450
13	-58.1	168	-	1690
14	-60.2	143	-	1990
15	-61.6	122	-	2320
16	-63.0	104	-	2700
17	-64.3	88	-	3170
18	-65.1	75	-	3700

PHOENIX, ARIZONA

20	-63	54	-	5410
----	-----	----	---	------

## Basic Data for Computation of Molar Volume

ALBUQUERQUE, NEW MEXICO

(Mean Sounding)

August 1943

<u>Altitude</u> (KM)	<u>Temp.</u> (°C)	<u>Pressure</u> (Mb)	<u>Humidity</u> %	<u>Molar</u> <u>Volume</u> <u>ft.<sup>3</sup></u>
1.620 (Surface)	25.2	838	44	480
2	23.3	803	39	492
2.5	20.4	758	42	517
3	16.6	715	48	541
4	8.8	634	66	594
5	1.1	562	79	652
6	- 5.6	495	72	715
7	-11.0	436	56	803
8	-17.1	382	45	895
9	-24.2	333	45	980
10	-31.6	290	-	1110
11	-39.4	251	-	1250
12	-47.0	217	-	1390
13	- 54.7	186	-	1560
14	-61.6	158	-	1780
15	-66.4	134	-	2060
16	-69.8	114	-	2460
17	-70.0	96	-	2830

SANTA MARIA, CALIFORNIA

20	-58.1	58	-	4960
----	-------	----	---	------

Data for Molar Volume-Altitude Graph

Altitude, ft.	Molar Volume, ft. <sup>3</sup>	Altitude, ft.	Molar Volume, ft. <sup>3</sup>
5,000	420	50,000	2200
10,000	490	55,000	2850
15,000	590	60,000	3700
20,000	680	65,000	4900
25,000	820	70,000	6200
30,000	980	75,000	7800
35,000	1230	80,000	10,000
40,000	1410	85,000	12,600
45,000	1750	90,000	15,900
		95,000	20,200
		100,000	25,600

This data assumes a constant temperature ( $-60^{\circ}\text{C}$ ) above 65,000 ft., and below that altitude is based on representative pressures and temperatures taken from Washington, Albuquerque, Pittsburgh and Lakehurst soundings.

Individual variations from season to season, and from station to station may be noted in the graphs at the left of Figures 19 and 20. These variations are at most about 10%.

Remuneracion

La materia ha volado con este globo desde la New York University para hacer investigaciones meteorologicas. Se desea que esta materia se vuelva para estudiarle nuevamente.

Con este motivo, se dara una remuneracion de \_\_\_\_\_ dolares norteamericanos y una suma proporcional para devolver todos los aparatos en buen estado. Para recibir instrucciones de embarque, comuniquense con la persona siguiente por telegrafo, gastos pagados por el recipiente, refiriendo al numero del globo \_\_\_\_\_.

CUIDADO!

PELIGRO DE FLAMA. HAY KEROSEN EN EL TANQUE.

C.S. Schneider  
Research Division  
New York University  
University Heights  
Bronx 53, N. Y.

NOTICE

This is special weather equipment sent aloft on research by New York University. It is important that the equipment be recovered. The finder is requested to protect the equipment from damage or theft, and to telegraph collect to: Mr. C. S. Schneider, New York University, 181st St. & University Heights, West Hall, New York City, U.S.A. Phone: LUdlow 4-0700, Extension 63 or 27. REFER TO FLIGHT #

A \_\_\_\_\_ dollar (\$) reward and reasonable reimbursement for recovery expenses will be paid if the above instructions are followed before September 1948.

KEEP AWAY FROM FIRE. THERE IS KEROSENE IN THE TANK.

### CUESTIONARIO

Tenga la bondad de contestar lo siguiente y enviarnos para que podamos mandarle a Ud. la remuneracion.

1. En que fecha y a que hora se descubrio el globo?
  2. Donde se descubrio? Indique la distancia y direccion aproximada del pueblo mas cercano que se encuentra en el mapa del sitio de descubrimiento.
  3. Se observo bajar? Cuando?
  4. Se bajo despacio o se cayo rapidamente?
- 

### QUESTIONNAIRE

Please answer this and send to us so that we may pay you the reward.

1. On what date and at what hour was the balloon discovered?
2. Where was it discovered? (Approximate distance and direction from nearest town on map?)
3. Was it observed descending? If so, when?
4. Did it float down slowly or fall rapidly?

WEIGHT SHEET

Flight No. \_\_\_\_\_

Date \_\_\_\_\_  
Time \_\_\_\_\_

Balloon Manufacturer \_\_\_\_\_  
Number \_\_\_\_\_ Quantity \_\_\_\_\_

Burnout Patch and Wires. . . . . \_\_\_\_\_

Shrouds . . . . . \_\_\_\_\_

Total Balloon Weight . . . . . \_\_\_\_\_

Launching Remnant . . . . . \_\_\_\_\_

1st Unit. Serial No. \_\_\_\_\_

description \_\_\_\_\_

Line length \_\_\_\_\_

2nd Unit. Serial No. \_\_\_\_\_

description \_\_\_\_\_

Line length \_\_\_\_\_

3d Unit Serial No. \_\_\_\_\_

description \_\_\_\_\_

Line length \_\_\_\_\_

4th Unit Serial No. \_\_\_\_\_

description \_\_\_\_\_

Line length \_\_\_\_\_

Banner description \_\_\_\_\_

Ballast assembly - description \_\_\_\_\_

\_\_\_\_\_

\_\_\_\_\_

Ballast . . . . . \_\_\_\_\_

Total Equipment Weight. . . . . \_\_\_\_\_

Gross Load . . . . . \_\_\_\_\_



RATE OF RISE AND MAXIMUM ALTITUDE COMPUTATIONS

Flight No. \_\_\_\_\_ Date \_\_\_\_\_  
 \_\_\_\_\_ Time \_\_\_\_\_

BALLOON INFLATION

Desired Rate of Rise . . . . . \_\_\_\_\_ ft./min.  
 Gross Load . . . . . \_\_\_\_\_  
 Assumed Gross Lift (Gross Load + 10%) G \_\_\_\_\_  
 G 2/3 \_\_\_\_\_  
 Free Lift -  $F = \left(\frac{V}{412}\right)^2 G^{2/3}$  . . . . . \_\_\_\_\_  
 Equipment Weight. . . . . \_\_\_\_\_  
 Desired Balloon Inflation = Free Lift + Equipment Total \_\_\_\_\_ grams  
 Allowance for Leakage @ \_\_\_\_\_ gm/hr, \_\_\_\_\_ hrs. waiting \_\_\_\_\_ "  
 Actual Balloon Inflation . . . . . \_\_\_\_\_ "

MAXIMUM ALTITUDE

Balloon Volume. . . . . \_\_\_\_\_ cu. ft.  
 Gas Lift/mol . . . . . \_\_\_\_\_ kg/mol  
 Helium 11.1  
 Hydrogen 12.0  
 Molar Volume =  $\frac{\text{Balloon volume} \times \text{gas lift/mol}}{\text{gross load}}$  \_\_\_\_\_ cu. ft.  
 Maximum Altitude . . . . . \_\_\_\_\_ ft. m.s.l.  
 Altitude Sensitivity . . . . . \_\_\_\_\_ ft./kg.

BALLAST COMPUTATIONS

Flight No. \_\_\_\_\_

Date \_\_\_\_\_

Time \_\_\_\_\_

Surface Balloon Diffusion (measured) . . . \_\_\_\_\_ gms/hr  
(estimated) . . . \_\_\_\_\_

Percent Inflation. . . . . \_\_\_\_\_

Full Balloon Diffusion: Surface Diffusion x  $\left(\frac{1}{\% \text{ inflation}}\right)^{2/3}$   
\_\_\_\_\_

Ballast Leak (120% Full Balloon Diffusion). . . \_\_\_\_\_

Automatic Ballast Valve Calibration  
\_\_\_\_\_

Estimated Ballast Duration. . . . . \_\_\_\_\_

New York University  
Research Division  
Balloon Project

4.

Supplementary Information for Flight No. \_\_\_\_\_

Release: Site \_\_\_\_\_ date \_\_\_\_\_ time \_\_\_\_\_

Encoded Sounding Data:

---

Encoded Upper Winds.

---

Release Weather

---

In-Flight Hourly Weather

---

Train Sketch in Folder \_\_\_\_\_ Films Sent Out \_\_\_\_\_

List Flight Records in Folder:

---

Remarks

Checked by \_\_\_\_\_

Transmitter Performance for Flight No. \_\_\_\_\_.

Release: Date \_\_\_\_\_ Time \_\_\_\_\_ Site \_\_\_\_\_.

Transmitter Type and Serial No. \_\_\_\_\_.

Batteries: ' Type and Number \_\_\_\_\_.

Open Circuit Voltages:

Voltages Under Load:

Reception at Station #1

Reception at Station #2

Reception at Station #3

Critique

#### REFERENCES

1. Meisinger, C. L. "Constant Elevation Free-balloon Flights from Fort Omaha," Monthly Weather Review, Vol. 47, pp. 535-538, 1919.
2. "Progress in Developing a Constant-Level Balloon", Report by Dewey and Almy Chemical Company, Cambridge, Massachusetts, June 15, 1944.
3. "Analysis of Japanese Weather Service", Air Weather Service Technical Report 45-1, Langley Field, Virginia, May, 1946.
4. Clarke, E.T., Korff, S.A., "The Radiosonde: The Stratosphere Laboratory", Journal of the Franklin Institute, Vol. 232, No. 3, September, and No. 4, October, 1941.
5. Middleton, W.G.K., Meteorological Instruments, Toronto, Canada, 1941, p. 46.
6. "Aerological Observations", Monthly Weather Review, Vol. 71, pp. 202-3, 1943.
7. Brombacher, W. G., "Altitude-Pressure Tables Based on the United States Standard Atmosphere", Report No. 538, National Advisory Committee for Aeronautics, Washington, D. C. September, 1935.
8. Timoshenko, MacCullough, Elements of Strength of Materials, Vol. 1, p. 51.
9. Lange, K. C., Unpublished Report, Lexington, Kentucky, 1947.
10. Warner, E. P., Aerostatics, The Roland Press Co., New York, 1926.
11. "The National Geographic Society - "U.S. Army Air Corps Stratosphere Flight of 1934 in the Balloon 'Explorer'", Contributed Technical Papers of the National Geographic Society, Washington, 1935.
12. The National Geographic Society - "U.S. Army Air Corps Stratosphere Flight in the Balloon 'Explorer II'", Contributed Technical Papers of the National Geographic Society, Washington, 1936.

13. Lugeon, Jean, "Le Poste Aerologique de la Station Centrale de Meteorologie a Payerne et les nouvelles methodes suisses de radiosondage", Extrait des Annales de la Station Centrale Suisse de Meteorologie, 1941; Zurich, 1942
14. Lugeon, Jean, "Quelques Innovations aux Methodes Suisses de Radiosondage," Tirage a part des Annales de la Station Centrale Suisse de Meteorologie, 1942, Zurich, 1943.
15. Upson, R., Chandler, C. Free and Captive Balloons, The Roland Press Co., New York 1926.
16. Prandtl, L., Tietjens, O.G., Fundamentals of Hydro-and Aeromechanics, the Maple Press Co., York, Pa.

Athelstan F. Spilhaus, C.S. Schneider,  
and C.B. Moore

“Controlled-Altitude Free Balloons”

*Journal of Meteorology*

Vol. 5, August 1948

---

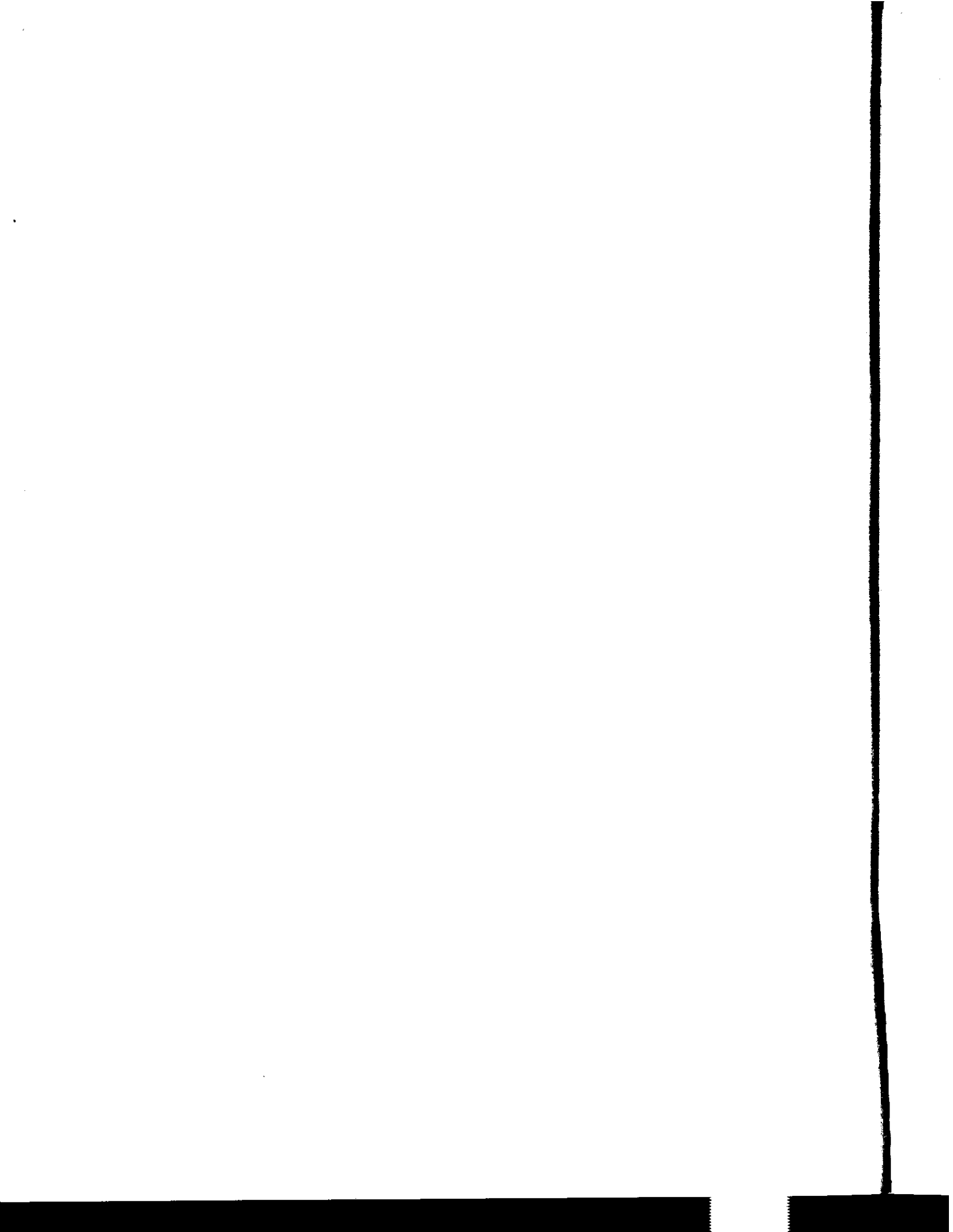



# JOURNAL OF METEOROLOGY

---

VOLUME 5, 1948

---



40871

Published bimonthly by the  
AMERICAN METEOROLOGICAL SOCIETY

## CONTROLLED-ALTITUDE FREE BALLOONS

By *Athelstan F. Spilhaus, C. S. Schneider, and C. B. Moore*

College of Engineering, New York University

(Manuscript received 4 December 1947)

### ABSTRACT

The results of an experimental program to develop balloons with associated control devices, which will float at constant pressure in the atmosphere, are given.

Newly developed plastic balloons and automatic ballast equipment are described. Examples of successful controlled-altitude flights are shown, together with a preliminary analysis of their trajectories.

The constant-level balloon may provide data not obtainable from an ordinary pilot-balloon network. Future possibilities and plans for its use are indicated.

### 1. Purpose

Drift bottles have been used for many years in the study of ocean currents and have provided interesting data. In meteorology, no corresponding device has been available. It is evident, however, that a balloon which is free to move with the air currents, and yet whose altitude can be controlled, has many important applications in meteorology, as well as in other fields, where it may be desired to keep instruments at altitude for considerable lengths of time. An example is in the investigation of cosmic rays; here, clusters of ordinary extensible meteorological balloons have been used, but the constancy of altitude obtained is not sufficient for many meteorological applications. The purpose of the present investigation<sup>1</sup> was to develop a balloon with a control system which would fly at a predetermined constant level for periods of many hours. Such a balloon has wider application than the ocean drift bottle, because, whereas the latter is limited to surface (or near surface) currents, controlled free balloons may be set to drift at any pressure elevation desired, or along other thermodynamically defined surfaces, as long as the element defining the surface changes in a monotone fashion in the vertical.

In addition to the uses for maintaining instruments at high elevations, there are numerous potential applications of these balloons. Direct measurements of air trajectories and of lateral diffusion become possible. The balloons may also be used as vehicles to convey and drop radiosondes over ocean areas. One problem in this application is to obtain an absolute altitude tie-in point, as it will be difficult to identify the point at which the radiosonde reaches the sea surface.

### 2. Earlier attempts

There have been numerous attempts for various purposes to get a balloon or group of balloons to stay at a fairly constant altitude. Meisinger was interested

in the meteorological aspects of this, using a manned balloon. In the investigation of cosmic rays, as for example, by Clarke and Korff (1941), clusters of ordinary meteorological balloons, 350-gram or 700-gram size, numbering anywhere from twenty to nearly seventy, were utilized. No altitude-control devices were used; the balloons were merely given different amounts of inflation. Thus the whole train ascended to an altitude where certain of the more highly inflated balloons burst until the remainder just balanced the load; thereafter, the assembly descended slowly due to loss of lift by the diffusion of gas. The only provision for having the system regain altitude if it descended too low was by arranging the launching before dawn, so that after the bursting of the first balloon and the subsequent descent, superheating of the balloons by the rising sun would cause the whole assembly to rise again, thereby increasing the duration of the flight. The system does not have sufficient control for many purposes.

The much-publicized use of balloons by the Japanese in the last war represents an attempt which must be considered highly successful from the point of view of the length of time which the balloons stayed in the air. Here the objective was not to obtain any critical altitude control, but rather to insure that the balloons remained floating. The Japanese nonextensible balloons were of two types. One type was of heavy paper, coated to minimize diffusion, of spherical shape, about 25 to 30 ft in diameter, and containing about 19,000 cubic feet of gas. A solid-ballast control system was utilized and gas was valved at a low internal pressure (about two inches of water) to prevent the balloons from rupturing due to the increase of the internal pressure by altitude fluctuations or radiation changes. Such a valve tends to conserve the lifting gas but acts as a safety device to prevent damage of the envelope due to too great an internal pressure.

The solid-ballast system was complex; approximately 900 pounds of sand was used on each balloon, distributed in thirty-six bags. The dropping of ballast

<sup>1</sup> Sponsored by, and in cooperation with the Watson Laboratories of the Air Materiel Command.

was controlled by a baroswitch arrangement which dropped a bag by igniting a fuse when the altitude fell below any one of four different levels between 25,000 and 5000 ft. In addition, a delay mechanism consisting of a two-minute fuse was arranged between successive switches so that after ballast was dropped, two minutes would be allowed for the balloon to regain its altitude; if it did not regain in this time another bag of ballast would be dropped. The system was inefficient because if any one of the thirty-six fuse arrangements failed, no more ballast was dropped.

The second type of Japanese balloon was similar, in general, but slightly larger; it was made of oiled silk and therefore would stand a greater internal pressure (approximately six inches of water). The higher the internal pressure that the balloon can stand, the less gas need be valved under conditions of superheating or altitude fluctuations. The Japanese released many balloons of these types from their islands and estimated five to seven per cent of those released reached the west coast of this country. The balloons floated between the surface and 30,000 ft above sea level; those which reached the west coast must have remained aloft from four to ten days. While the altitude maintained was not constant, these balloons were highly successful for the time they remained in the air.

An attempt in this country was made in 1943 by the Dewey and Almy Company, to obtain constant-level balloons which would float at altitudes up to 15,000 ft. An ordinary 350-gram meteorological balloon was used but its volume was controlled by a nonextensible shroud around it. With this method a flight at about 5000 ft was obtained at fairly constant altitude for about an hour and a half.

### 3. Design of controlled-altitude balloons

As a result of the Japanese and other experiments, the use of a nonextensible envelope for the balloons was indicated. If a perfectly nonextensible balloon could be built with no diffusion through the walls, and which could withstand a high internal pressure, it would automatically stay at a constant density where the buoyancy of the full balloon equaled the load. In practice, control devices are needed to offset the leakage and diffusion of gas, to compensate for vertical currents in the atmosphere, to correct for the motion of the balloon due to diurnal changes of the balloon's temperature, and to compensate for the valving of gas which is necessary to prevent rupture of the envelope. It was decided to use a plastic as the balloon fabric, as some modern plastics are quite transparent to radiation, strong, easily fabricated, and relatively inexpensive as compared with coated fabrics.

*A. Choice of plastics.*—In the selection of a plastic material of which to make the balloons, the desirable

properties are: (a) low brittle temperature, (b) low permeability, (c) high tensile strength, (d) high tear resistance, (e) chemical stability, (f) high radiation transmission or reflection. *Polyethylene* soon recommended itself for use, with its brittle temperature of below  $-80^{\circ}\text{F}$ . It is apparently unaffected by ultraviolet and ozone. The permeability through one mil of thickness and one square meter of area for 24 hours is ten liters for hydrogen and seven liters for helium, at normal atmospheric temperature and pressure.

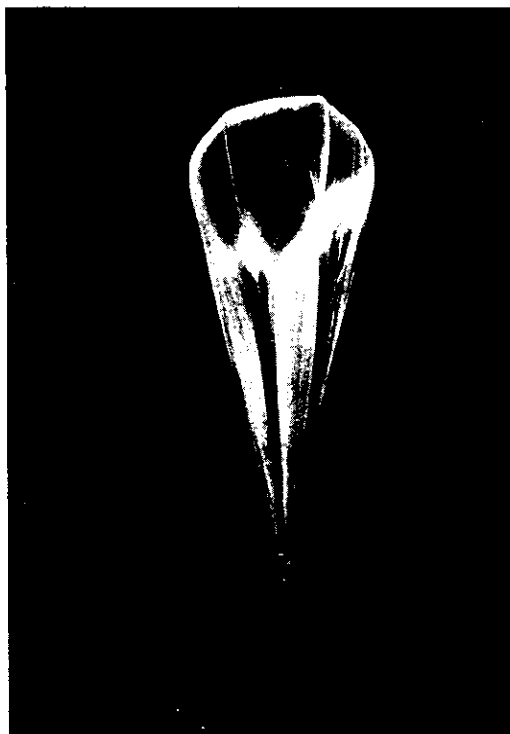

FIG. 1. Polyethylene balloon, 20-ft diameter.

Polyethylene is also relatively easy to fabricate. It has an ultimate tensile strength of 1,900 pounds per square inch at  $25^{\circ}\text{C}$ , which, in a 15-ft balloon made out of four-mil fabric, represents a working pressure of about 2.3 inches of water. The tensile strength at the temperatures at which the balloon flies at high altitude may be more than three times the value quoted above.

Fig. 1 shows a polyethylene balloon<sup>2</sup> flown successfully in Flight 26 described below. Another film investigated is *Saran*, which has ten times the tensile strength of polyethylene—three times the strength across the seams. *Saran* has a higher transparency and one-thirtieth the permeability of polyethylene. The effective brittle temperature of *Saran* for this work is not known reliably.

*B. Ballast valve.*—The altitude control is an automatic ballast-dropping device<sup>3</sup> consisting essentially of

<sup>2</sup> Made by General Mills, Inc.

<sup>3</sup> Made by Kollsman Instrument Division of Square D Company.

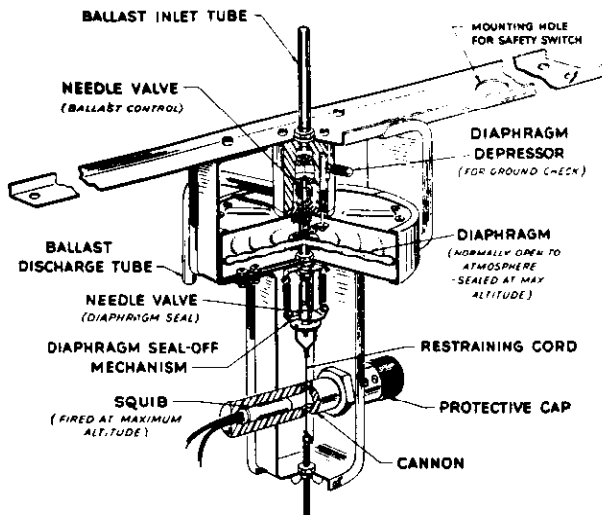

FIG. 2. Automatic ballast valve.

a diaphragm-operated needle valve which jettisons liquid ballast whenever the balloon is below the altitude at which the control is actuated. This is shown in fig. 2. The ballast reservoir (fig. 3), in general, can hold 15 kilograms of the liquid ballast—usually compass fluid, a highly refined kerosene-type petroleum product. When the atmospheric pressure outside the diaphragm is 5 millibars above the internal pressure, 160 grams of ballast per minute flow under a one-foot head. When the automatic ballast valve is wide open, which is after 6.5 millibars increase over the internal pressure, 300 grams per minute flow. These values may be compared with a diffusion loss of lift of the order of magnitude of 10 grams per hour from the thicker 15-ft balloon described below. Quite positive altitude control can be obtained.

Efforts are made to cause the static rate of leakage, *i.e.*, the leakage which proceeds when the automatic ballast valve is closed, to exceed slightly the rate of loss of lift due to the diffusion of the lifting gas from the balloon. To facilitate setting the fixed leak, a manually operated ballast valve, consisting of a leak adjustable by means of a fine needle valve, is added to the ballast-release assembly.<sup>4</sup>

*C. Minimum pressure switch.*—Obviously, the automatic ballast valve must not be in operation while the balloon is rising, as this would be a waste of ballast. Therefore the automatically operated needle valve is closed until the balloon reaches altitude. This is accomplished by having the loaded diaphragm of the altitude control open to the atmosphere until the balloon descends from a minimum pressure. At this time, an electrical contact is made and a squib<sup>5</sup> cuts a

<sup>4</sup> Since this manuscript was written, the procedure has been simplified. Only a simple fixed leak is used for daytime flights. The automatic ballast valve is used alone for flights through sunset or sunrise.

<sup>5</sup> A small electrically detonated charge.

restraining cord and allows a needle valve to seal off the diaphragm from any further access to the air (fig. 2). The capsule then contains a volume of air which has been trapped at the existing pressure and temperature, at the time of operation of the sealing switch. Thereafter the aneroid will withdraw the ballast-control needle valve when the ambient pressure increases to the point where the entrapped air is compressed below this volume.

Fig. 4 shows the minimum pressure switch which makes the electrical contact at the time of seal-off. It consists of a trapped volume of air that is allowed to escape through a mercury pool as long as the outside pressure is decreasing. As soon as the exterior pressure increases once more, however, mercury is drawn into the tube, making the seal-off contact between two electrodes.

#### 4. Height determination

Up to the present time, the standard radiosonde has been used in order to determine the altitude at which the balloon is flying. This permits a regular radiosonde ascent to be obtained during the period that the balloon is rising. Thereafter, as the balloon remains at approximately the same altitude, it becomes somewhat difficult to identify the radiosonde contact, but utilizing both the temperature and pressure indication, this is possible. A special radiosonde modulator of the Olland type has been designed (fig. 5). The pressure

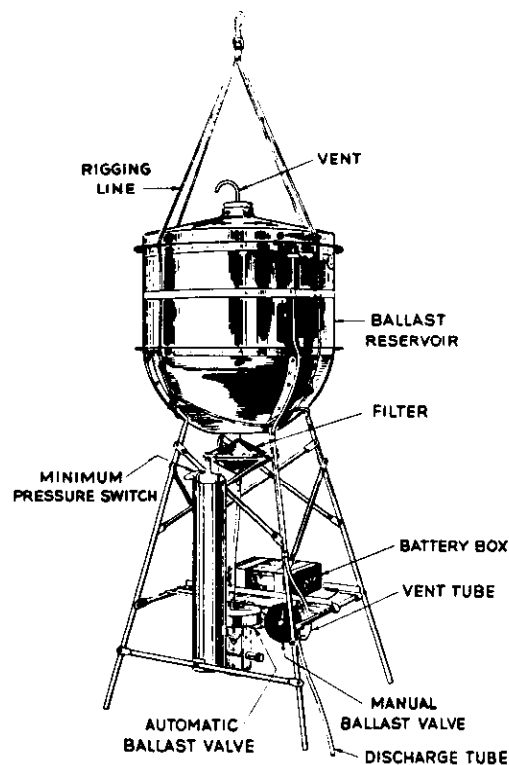

FIG. 3. Ballast-release assembly.

capsule and linkage is of conventional design but in place of the commutator bar, a motor driven helix is employed. This system permits the determination of

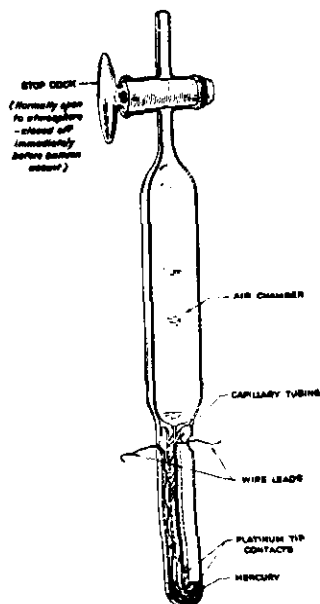

FIG. 4. Minimum pressure switch (mercurial).

pressure data without knowledge of the history of contact sequence or of the ascent or descent of the balloon, as is required in the conventional radiosonde.

### 5. Tracking of the balloon

The balloons that have been flown by the writers usually have been tracked by theodolites. Airplanes have also been used, to extend the observations. These two methods require the balloon to be visible and not obscured by cloud cover. When available, ground radar has been used in tracking the balloons, with good results.

A series of SCR 658 radio direction-finders is also used, arranged in a net along the expected trajectory of the balloon. In addition, aircraft equipped with inverted search radar have been employed to extend the tracking net.

### 6. Flight results

While the characteristics of various plastics were being investigated, four preliminary flights were made with clusters of ordinary meteorological balloons, from 16 to 26 in number, to which two to four towing balloons were attached. The towing balloons were cut free by a baroswitch at a predetermined altitude. The remainder of the balloons were inflated so that they exactly balanced the load hung from the cluster. To offset diffusion, sand was dropped from an arrangement of tubes, 9 to 16 in number, each containing about 200 to 1500 grams of sand ballast. This ballast was dropped by a baroswitch mechanism on descent

only. Some of these flights were relatively successful as a beginning method but the dropping of discrete quantities of sand caused too great fluctuation of altitude and therefore was abandoned later. The first successful flight stayed at 51,000 ft, plus or minus 100 ft, for 38 minutes; another remained between 30,000 and 40,000 ft for 147 minutes. The latter shows the same characteristic time-altitude curve as the cosmic-ray clusters, although its altitude control is superior. It is not believed that much improved altitude control can be obtained, utilizing ordinary meteorological balloons. Flight termination was usually due to deterioration of the balloon caused by the sun.

In the first flight utilizing plastic balloons, a cluster of ten seven-foot diameter balloons<sup>6</sup> was used. The load on the cluster was 16.5 kilograms. An altitude control was used. Unfortunately, the maximum altitude reached was not as high as the predetermined altitude which was selected to seal the diaphragm of the automatic ballast valve. As a result, the cluster rose to ceiling and stayed at this altitude for a short while. Diffusion and leakage of helium produced a loss of lift at the rate of 125 feet per minute.

The next flight was made with a single polyethylene balloon, 15 ft in diameter. To insure sealing-off, the ballast-release diaphragm was set to operate at an altitude of 12,000 ft, considerably below the calculated ceiling of the balloon. After a dawn release the balloon continued to ascend to 15,100 ft where it leveled off, then slowly descended to 9000 ft due to diffusion losses. At this altitude the ballast release began to operate and thereafter the balloon maintained its altitude within  $\pm 1300$  ft for a period of 4½ hours before the radio signal was lost. However, in the first two hours of this period, before the convection currents

<sup>6</sup> Made by General Mills, Inc.

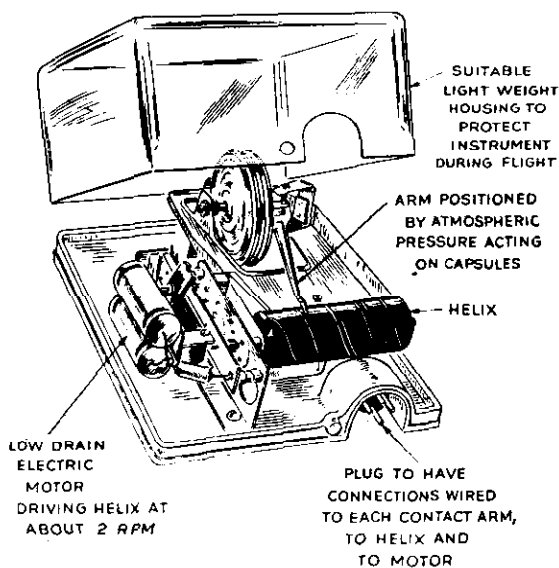

FIG. 5. Off-and-cycle pressure modulator.

from the desert set in, the balloon maintained an altitude of  $9200 \pm 150$  ft.

An explanation as to why the ballast release functioned at 9000 ft, although it was set to operate at 12,000 ft, is plain from the following data. The air in the diaphragm was sealed off on the dawn ascent at 12,000 ft, where the pressure was 657 mb and the temperature 9C. However, by the time the balloon passed through this level during the slow descent, the instrument temperature was 19C. This means that the pressure of the air trapped inside the diaphragm was higher than it was at time of seal-off.

For the ballast valve to function, the balloon had to descend to a pressure which would be greater by about 3 mb than the pressure of the trapped air at its now higher temperature. Of course, there was little ventilation past the instrument, and therefore the instrument temperature was about 25C above the ambient temperature after the sun had risen.

The automatic ballast valve operates when the volume inside the sealed diaphragm becomes slightly less than the volume at seal-off. Denoting the altitude at which it can operate by the subscript  $h$ , the pressure divided by the temperature at this altitude will equal the pressure at the seal-off altitude divided by the trapped-air temperature at the time of seal-off; in this case

$$\begin{aligned} p_s &= 657 \text{ mb} \\ T_s &= 9\text{C} = 282\text{A} \\ T_h &= 39\text{C} = 312\text{A}, \end{aligned}$$

where the subscript  $s$  refers to seal-off. Thus the pressure at altitude  $h$  is given by

$$p_h = p_s T_h / T_s = 727 \text{ mb.}$$

This pressure, at which ballast release will begin, corresponds to an altitude of 9000 ft, which is the observed altitude maintained by the balloon for nearly  $4\frac{1}{2}$  hours, until the radiosonde tracking signal was lost.

The theodolite lost the balloon in clouds earlier and the airplane observer never succeeded in seeing it, so the balloon may have remained for a considerably longer period at this altitude. Eleven hours after beginning the ascent, the balloon was reported to have been seen over Albuquerque, New Mexico, and about 26 hours later a report was made from Pueblo, Colorado, which seemed to indicate that the balloon was still in the air at that time. The meteorological situation and wind data for that area at the time of flight support the contention that the latter observations were of the same balloon.

The next flight consisted of an assembly of various balloons, as follows:

- One 15-ft diameter 0.008-inch polyethylene balloon,
- Six 7-ft diameter General Mills 0.001-inch polythene balloons,
- Two 350-gm meteorological balloons for stadia measurements.

The single balloon had a measured diffusion loss of lift of 4 grams per hour. The General Mills balloons were observed to lose lift at the rate of about 100 grams per hour per balloon.

Three of the 7-ft balloons were inverted and deflated shortly after launching, due to differences in the rates of rise of the various balloons in the cluster. Therefore, the altitude reached was not high enough to effect seal-off. (It is for this reason that the minimum pressure switch was developed for use in later flights.)

Fig. 9 shows the elevation and plan views of the track of this flight. The train leveled off at 16,500 ft. The diffusion loss of lift of the remaining balloons was approximately 300 grams per hour. The ballast valve used had an unusually high rate of static leakage which had been measured before release and found to be 310 grams per hour. Thus fortuitously, the loss of lift was compensated by ballast leakage. This nearly

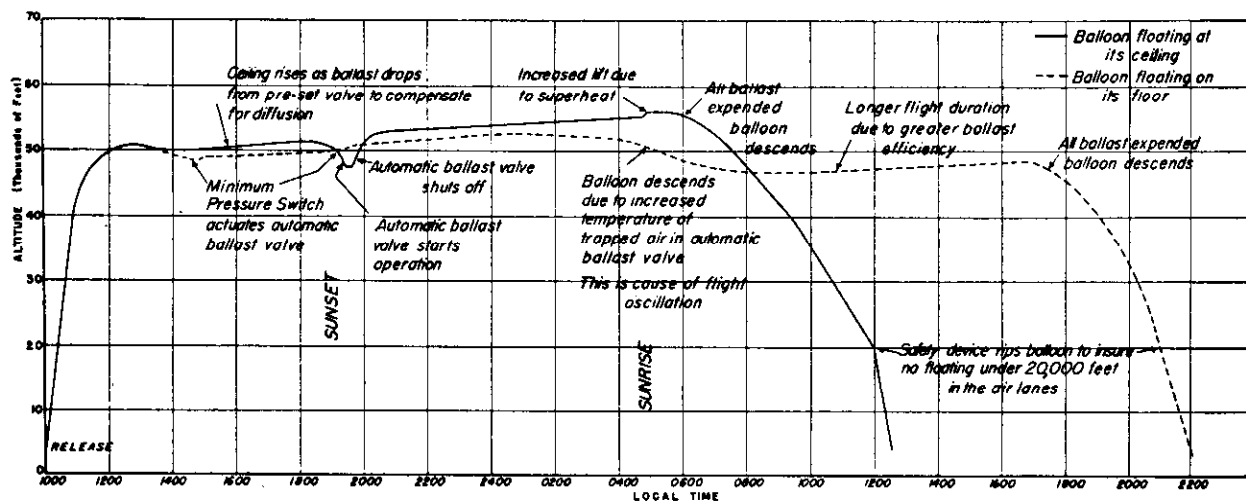

FIG. 6. Idealized time-altitude curves for various balloon-control systems.

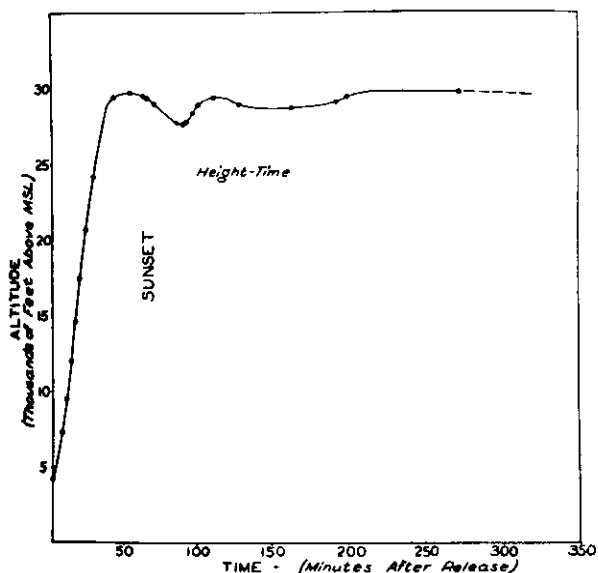

FIG. 7. Height-time curve of balloon Flight 17. Released at Alamogordo, New Mexico, on 9 September 1947 at 1647 MST (105th meridian). Recovered near Pratt, Kansas, 530 miles distant.

constant leakage held the balloon at  $16,800 \pm 700$  ft for 7 hours. The duration of the flight was  $9\frac{1}{4}$  hours. When the original 2700-gram ballast was expended, the balloon descended rapidly. Even had the automatic ballast valve been functioning, the constancy of altitude would have been the same. This seems to indicate that only a minimum of automatic control is needed, provided that diffusion losses are slightly overcompensated by a constant ballast leak.

Other flights also indicate the importance of a check valve in the balloon appendix to prevent dilution of the lifting gas with air. If this is not done, the altitude reached is far under the theoretical altitude determined by the displacement and gross load.

### 7. Control systems

Two systems of control are possible with the equipment as described. The balloon is controlled between an upper level (ceiling), where the full balloon buoyancy just equals the load, and a lower level (floor), below which the automatic ballast valve operates. Schematic curves for these two systems of control are shown in fig. 6.

In the first system of control the rate of static ballast leakage is greater than the diffusion loss of lift, and the balloon will stay at the ceiling. If it is displaced above the ceiling the buoyancy is insufficient to balance the load and it will descend again. Provided the rate of ballast discharge is greater than the rate of lift by loss of gas this ceiling will slowly rise by valving of gas, and as gas is lost by diffusion. The less the amount of gas the lower the pressure (higher ceiling) must be for the gas to fully distend the envelope. Unnecessary

valving is undesirable and may, in part, be minimized by use of a restraining safety valve set in the appendix, which will allow some slight pressure to be carried in the balloon, preventing gas loss at the peaks of minor oscillations but still valving gas before the balloon ruptures due to too great an internal pressure.

In this system of control, the automatic valve is not sealed off until the balloon starts a descent due to cooling or other changes in lift, as when night falls. Upon descent the valve is activated and starts dropping ballast immediately; this continues until the balloon is no longer losing lift at a rate greater than the diffusion losses. The balloon will then rise above its former ceiling to a height determined by the weight of ballast dropped, and remain there as long as there is ballast to compensate for lift losses. Flight 17, reproduced in fig. 7, used a low-leakage balloon and is an actual case of ceiling control. It may be compared with the idealized time-altitude curves in fig. 6.

In the second system of control the static rate of leakage is less than the diffusion loss of lift. In this case the balloon will descend to the floor, where the automatic control operates and the balloon floats at an equilibrium altitude where the rate of ballast release exactly balances the rate of loss of lift. Floor control conserves ballast, since only that needed for altitude control is released. However, the altitude of the floor varies diurnally as the temperature of the entrapped air in the automatic ballast valve is affected by solar radiation. Two methods are being investigated to circumvent this undesirable feature. One is to

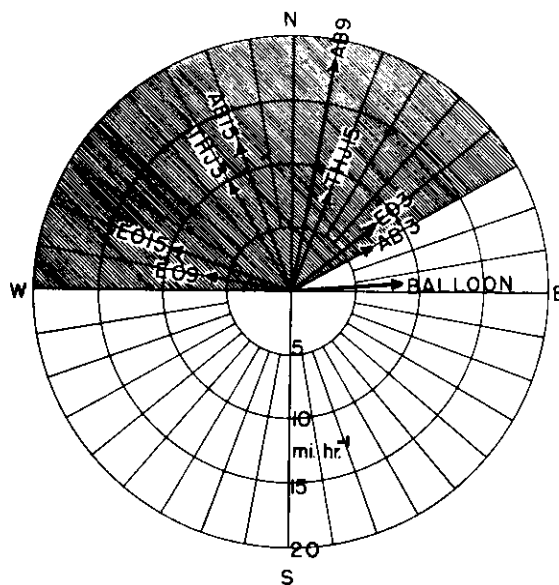

FIG. 8. Wind vectors at 16,000 feet for El Paso (EO), Albuquerque (AB), and Roswell (THJ), at 03<sup>h</sup>, 09<sup>h</sup> and 15<sup>h</sup> (MST) on 7 July 1947, in connection with balloon Flight 11, mean motion of which is shown by the balloon vector. Cross-hatched sector contains all wind vectors at these three stations for the three observation hours and for the three levels, 14,000, 16,000, and 18,000 feet.

temperature-compensate the diaphragm, the other to insulate and shield the valve from radiation.

Using the ceiling-control system, flights of less than 24 hours not passing through sunset, may be held at ceiling by use of a nonextensible balloon and a simple fixed rate of leak to over-compensate diffusion losses. The constancy of level will be better the lower the diffusion and the lower, therefore, the rate of rise of the ceiling. The automatic control is needed for flights lasting through a period in which day changes to night.

#### 8. Preliminary trajectory analysis of two constant-level balloon flights, 7 July 1947<sup>7</sup>

The most striking feature of the constant-level balloon flight (Flight 11, fig. 9) originating at Alamogordo Army Air Base at 05<sup>h</sup>08<sup>m</sup> MST<sup>8</sup> on 7 July 1947 is the disagreement between the actual trajectory and the trajectory that might have been estimated from routine upper-wind reports. In this connection the observations from the Weather Bureau stations at El Paso, Roswell, and Albuquerque have been examined, since the path of the balloon was contained within the triangle formed

by these stations. Over El Paso, the wind direction at 16,000 ft (the approximate average altitude of the balloon during the greater part of the flight) was approximately SW at 03<sup>h</sup>, ESE at 09<sup>h</sup>, and ESE at 15<sup>h</sup>. Over Roswell, the apparent average wind direction at 16,000 ft was S during this period. Over Albuquerque, which was considerably farther from the path of the balloon than the other two stations, the wind direction at 16,000 ft was variable between WSW and SSE during the interval from 03<sup>h</sup> to 15<sup>h</sup>. In contrast with these observations is the fact that the constant-level balloon floated in an essentially steady WSW current between 06<sup>h</sup> and 09<sup>h</sup>.

In fig. 8 the wind observations at 16,000 ft have been plotted for El Paso, Roswell, and Albuquerque for 03<sup>h</sup>, 09<sup>h</sup>, and 15<sup>h</sup>. The wind directions at 14,000 ft, 16,000 ft, and 18,000 ft (only the intermediate level is shown in the figure) are all contained in the 150-degree sector between directions 90° and 240°; yet the mean motion of the balloon (approximately 265°) between 05<sup>h</sup>48<sup>m</sup> and 13<sup>h</sup>11<sup>m</sup> falls entirely outside this sector.

An indication that this local WSW current was of small depth is given by a special upper-wind observation made at White Sands at about 13<sup>h</sup>. The observation in question recorded a wind direction of 250° at 16,000 ft, which is in excellent agreement with the first

<sup>7</sup> The authors are indebted to Prof. G. Emmons for contributing the major part of this section.

<sup>8</sup> Mountain Standard Time—105th meridian civil time. All further time references will be tacitly MST.

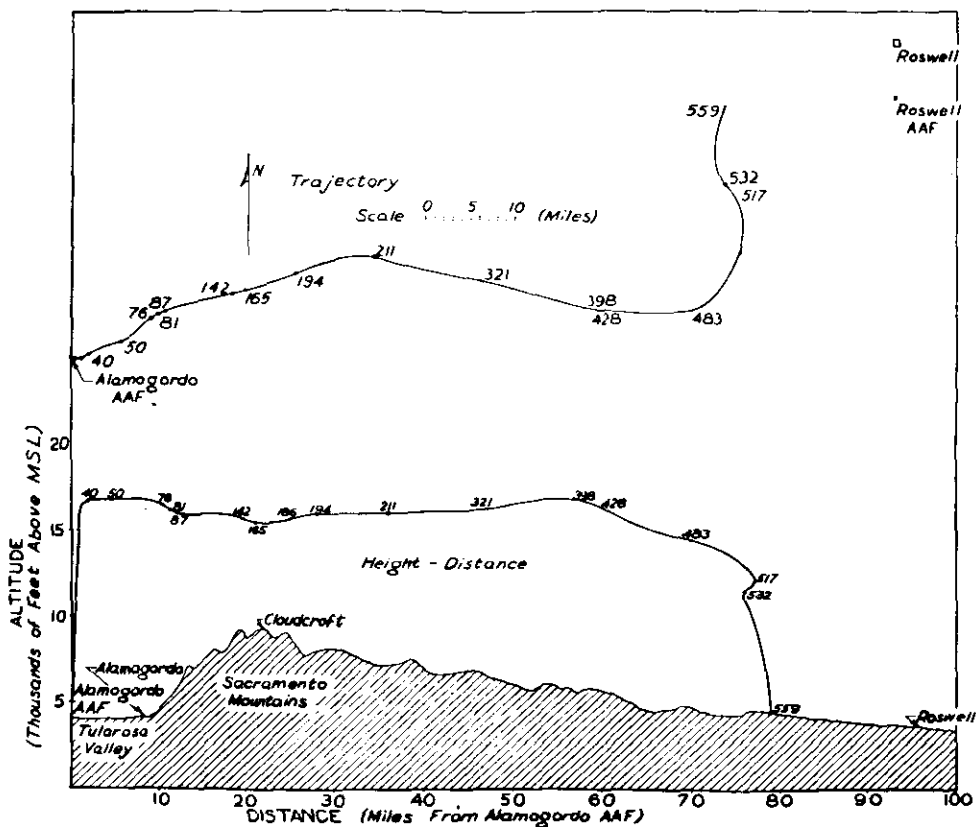

FIG. 9. Height-distance curve and planned trajectory of balloon Flight 11. Released at Alamogordo, New Mexico, 7 July 1947, at 0508 MST. (Numerals on curves indicate minutes after release.)



part of the trajectory of the constant-level balloon. The interesting fact about the White Sands observation is that *at all but one of the other reported altitudes between the ground and 20,000 ft, the wind directions were from either the NE or SE quadrants.*

The trajectory of the balloon curved slightly anticyclonically over the eastern slopes of the Sacramento Mountains. This characteristic is suggestive of the well-known deforming effect of a mountain range on an air current directed toward the axis of the range. In this case, however, the validity of invoking the aforementioned effect to explain the anticyclonic curvature, when the wind at levels below the mountain summits appears to have been blowing approximately parallel to the range, depends on assuming that the air currents parallel to the range themselves constitute a barrier deforming a higher current blowing in a different direction across the mountains. The sharp cyclonic bend that occurred after the balloon had come over relatively flat country occurred at the time that the balloon began its final descent and is due to the fact that the course of the balloon turned toward the north as a result of descent to levels where the wind had maintained a southerly direction throughout the day.

It is of interest to compare this flight with Flight 17 (fig. 10). It may be observed on fig. 10 that no deform-

ing effect of the mountain barrier is apparent. This, however, is to be expected, as the altitude of the balloon above the mountain top is three times that of Flight 11, where this anticyclonic deformation of the trajectory was observed. The balloon was ultimately recovered from Croft, Kansas, a distance of 530 miles from the release point; on the basis of the observed wind speeds a 12-hour flight duration is estimated.

9. Conclusion

Within the coming year it is hoped that a number of meteorological investigations may be attempted, utilizing constant-level balloons. Release of three or more from a single point to float at the same level, release at a number of points to obtain a synoptic presentation of the trajectories in a chosen level, and the dropping of radiosondes from balloons are some of the operations to be attempted. Efforts will be made to simplify the arrangement so that a constant-level flight may be made in a routine fashion and at no greater cost than the ordinary radiosonde flight.

REFERENCE

Clarke, E. T., and S. A. Korff, 1941: The radiosonde: the stratosphere laboratory. *J. Franklin Inst.*, 232, 217-355.

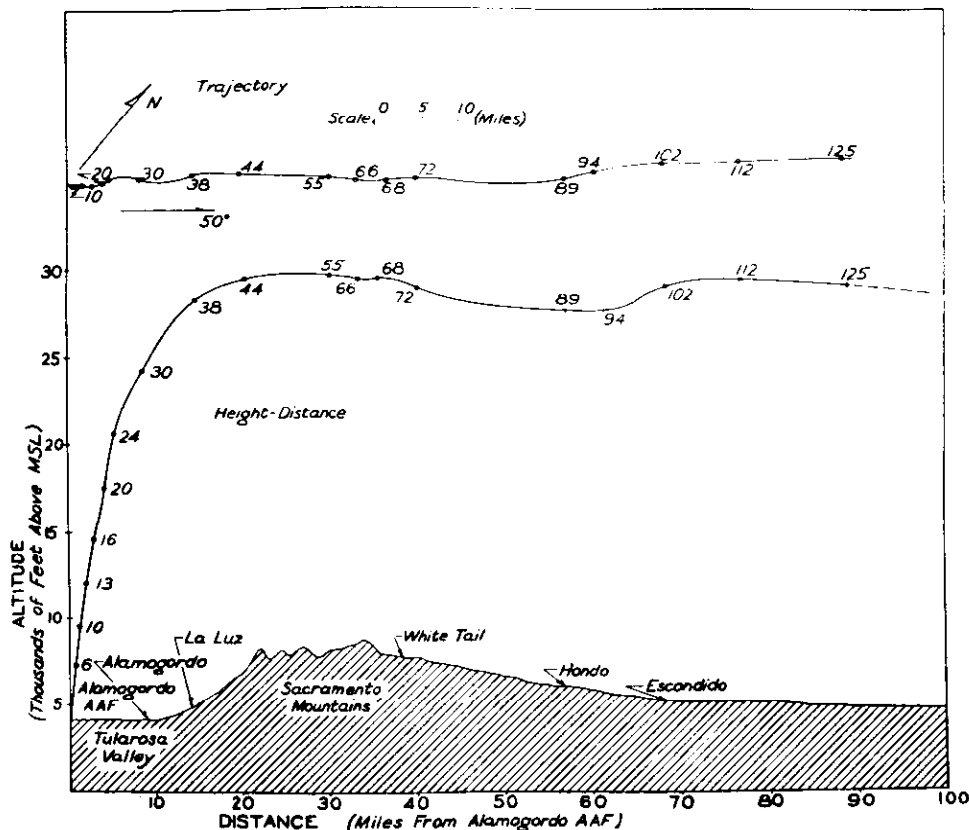
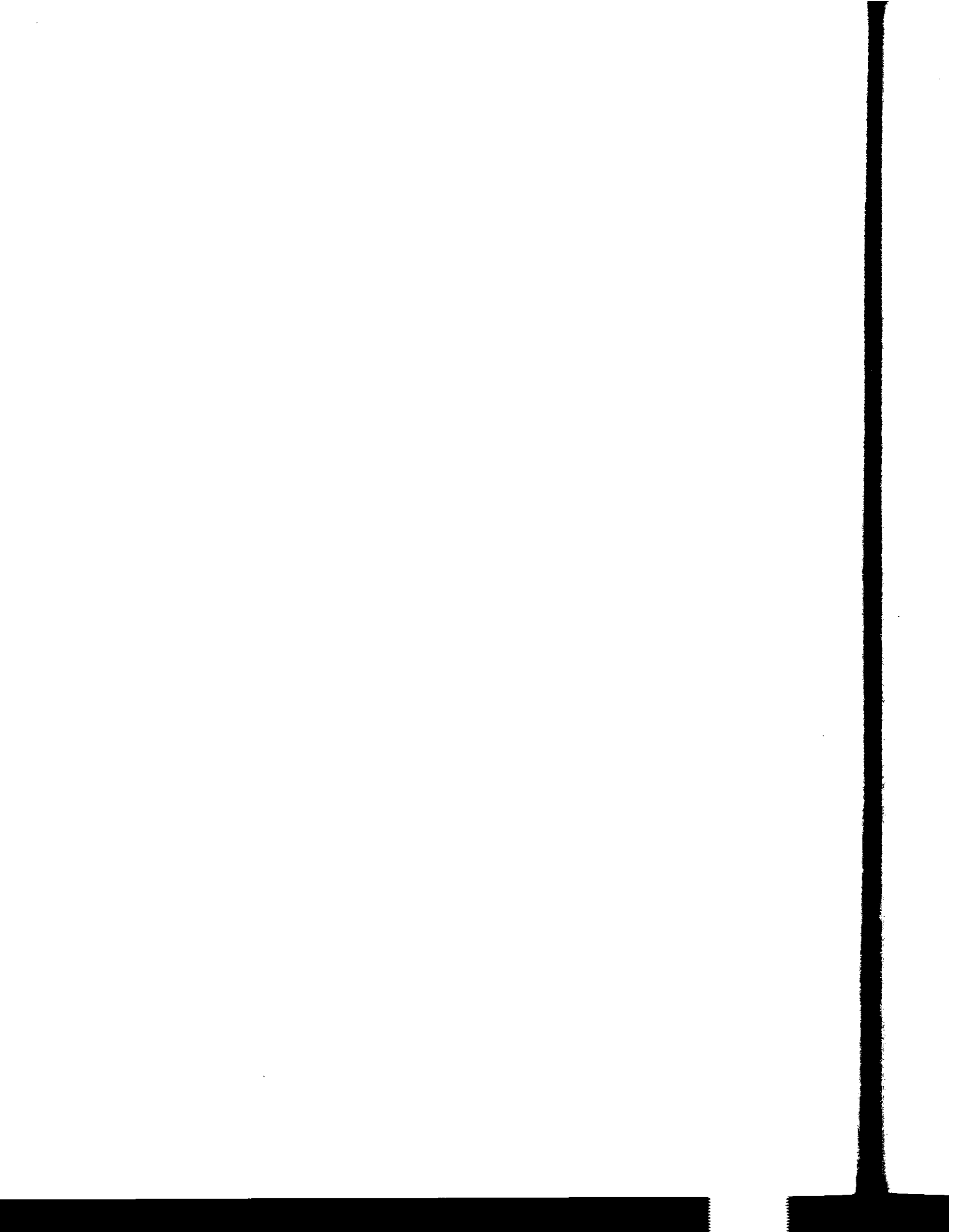
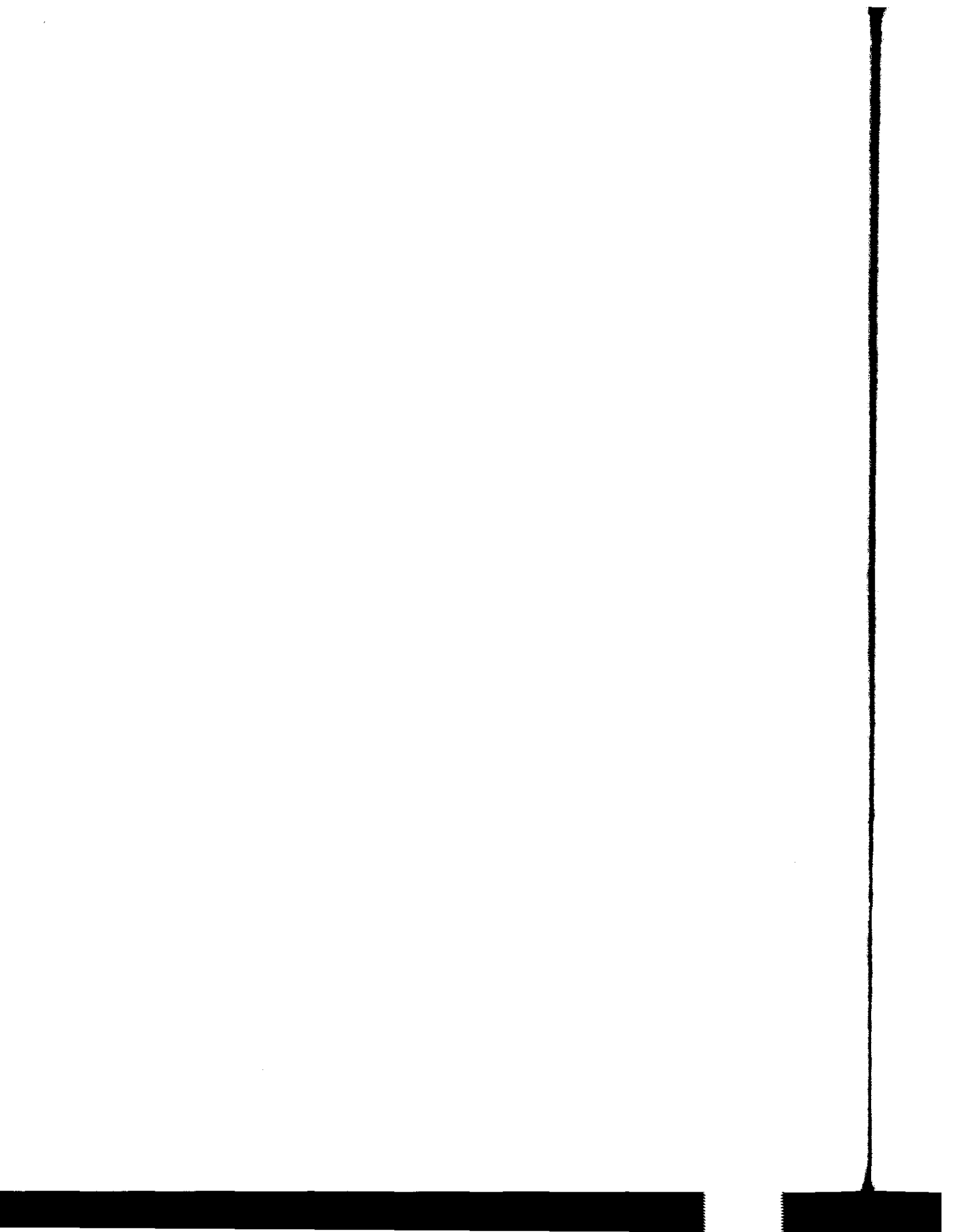

FIG. 10. Height-distance curve and planned trajectory of balloon Flight 17. Released at Alamogordo, New Mexico, 9 September 1947, at 1647 MST. First 125 minutes only are shown. (Numerals on curves indicate minutes after release.)



New York University  
*Progress Report No. 6*  
*Constant Level Balloon*  
Section II  
June 1947

---



PROGRESS REPORT *Fb*

Covering Period from May 1, 1947 to  
May 31, 1947

CONSTANT LEVEL BALLOON

Section II

Research Division, Project No. 93

Prepared in Accordance with Provisions of Contract  
W28-099 ac-241, between  
Watson Laboratories, Red Bank, New Jersey  
and  
New York University

Prepared by

Charles S. Schneider

Approved by

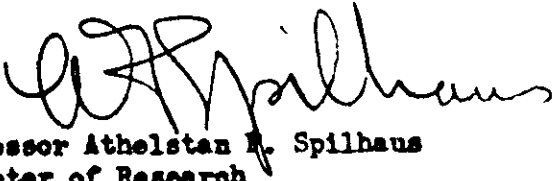
  
Professor Athelstan M. Spilhaus  
Director of Research

Research Division  
College of Engineering  
June, 1947

I. The following new men were employed on the Balloon Project during May:

<u>Name</u>	<u>Duties</u>	<u>Qualifications</u>
J. Richard Smith	Meteorologist (full time)	Former Weather Bureau and Army forecaster. Taught weather equipment at New York University, M.S. in Physics-Meteorology, NYU.
William O. Davis	Balloon Performance Analyst (part time)	B.A. Physics, New York University. Former AAF pilot. Graduate student in Physics.
Fred Barker (rehired)	Equipment Construction (part time)	Undergraduate Aeronautical Engineering Student.

II. The following administrative action was taken during the month of May:

A bid was obtained from Skinner, Cook, & Babcock, Contractors, at 60 E. 42d Street, New York City, for the erection of a prefabricated building for the Balloon Project. The quotation of \$4,000 was forwarded to Watson Laboratories.

Correspondence during this period was as follows:

<u>Date of Corres- pondence</u>	<u>Address</u>	<u>Abstract</u>	<u>Answer</u>
5/2/47	WIRE Dr. Frank Myers Lehigh University Bethlehem, Pa.	Use of football field requested for balloon launching on 6 May.	Granted.
5/5/47	WIRE Same	Bad weather postponed flight until 9 May.	None needed.
5/6/47	Kelleman Instrument Div. Square D Co. Elmhurst, L.I. Attn: Paul Gowdy	Request for quotation on diaphragm seal-off for dribbler and for increased quantity of modified dribblers.	Furnished.

5/7/47	WIBB Barney Frank Hightstown, N.J.	Samples of parachute shroud lines requested.	Furnished.
5/6/47	General Mills Minneapolis, Minn. Atts: Mr. O. C. Winsen	Request for quotation on sample balloons shown to C.B. Moore on visit.	Awaiting Navy clearance.
5/13/47	Dewey & Almy Chem. Co. Cambridge, Mass. Atts: Mr. Isaac	Request delivery date on 1000 gm balloons.	Given.
5/14/47	Mr. G.P. Clare 4719 W. Sunnyside Ave. Chicago, 30, Ill.	Request for information and catalogues on rot- ary switches.	Furnished.
5/14/47	Goodyear Tire & Rubber Akron, Ohio Atts: Leonard M. Harb	Delaying action in Goodyear's quotation for balloons.	
5/15/47	Office of the Secretary Fort Worth Sub-Committee on Air Space Civil Aeronautics Auth- erity, (4th Region) Fort Worth, Texas	Request clearance for flight of Balloons from Alamogordo.	Given.
5/27/47	General Mills Minneapolis, Minn. Atts: Mr. O.C. Winsen	Repeat request for quotation on plastic balloons.	Awaiting Navy clearance.

#### IV. Conferences

The following conferences were held during the month of May:

<u>Date</u>	<u>People Present</u>	<u>Where Held</u>	<u>Discussed</u>	<u>Conclusions</u>
5/1/47	O. C. Winsen of General Mills	General Mills Minneapolis, Minn.	Manufacture of balloons by General Mills for this project.	Obtain Navy clearance General Mills bal- loons look good for our work.
5/8/47	Dr. Peoples, Mr. Ireland, of Watson Laboratories. C.S. Schneider, C.B. Moore	Watson Laboratories Red Bank, N.J.	Bethlehem flight for May 9.	Final details.
5/10/47	Same	Same	New flights at Alamo- gordo, N.M., where lower winds can be found.	Set up trip to Alamo- gordo for May 29.
5/13/47	Paul Goudy of Kollsman Instrument C.B. Moore	Kollsman Instrument Div. Square D Co. Elmhurst, L.I., N.Y.	New dribbler design.	
5/14/47	Representative of Vulcan Proofing Co. C.S. Schneider, C.B. Moore	Vulcan Proofing Co. Brooklyn, N.Y.	Testing of balloon fabrics and films.	Vulcan proofing would make tests.
5/22/47	Dr. Peoples, Messrs: A.H.Mears, John Alden, Charles Ireland, C.S.Schneider, C.B. Moore	Watson Laboratories, Red Bank, N.J.	Final arrangements for Alamogordo trip.	



### III C 1. General Work Accomplished

A conference was held on May 1 at Minneapolis with Mr. O. C. Winsen of General Mills concerning the manufacture of balloons by General Mills for this project. At the present time this company cannot supply us with balloons until Navy clearance is obtained, but it is hoped that arrangements can be completed in the near future. The type of balloons manufactured by General Mills seems to be well suited to the needs of this project.

On May 8 a trip was made to Lehigh University, Bethlehem, Pa., to fly a cluster of meteorological balloons carrying Watson Laboratories equipment. Winds developed during launching and the balloons escaped when the restraining lines snapped under the strain, carrying balloons aloft without payload.

As a result of this incident, two conclusions were drawn: first, that a new launching technique was needed; second, that another launching site must be selected offering consistently calm winds during launching. It was decided to make the next flights at Alamogordo, New Mexico, early in June.

On May 14 a conference was held at the Vulcan Proofing Co., in Brooklyn, N.Y. to discuss the possibility of this company testing various types of fabric and film used in the manufacture of balloons. It was agreed that the company would make the desired tests when ordered by us.

The high point of the month's activities was the departure for Alamogordo on May 31, and the balance of the month was spent in the preparation of equipment for the flights to be made there. Departure was made from Olmstead Field, Middletown, Pa. in a C-47 furnished by the Watson Laboratories.

### 2. Specific Problems

In general, problems remain the same as those discussed in the previous report, namely: the determination of the relative merits of various balloon films and fabrics available; the analysis of the altitude control devices to be used; and the flight testing of the equipment to be used in preliminary work. All of these problems now await further flights and delivery of equipment ordered before solution can be attempted.

### 3. Limitations

The greatest hindering factor in the progress of work is the lack of available space. The prefabricated building to be furnished by the government under the terms of the contract is now more urgently

needed than before, due to the hiring of more personnel. The joint laboratory and office which this project shares with another is highly inadequate for six men of theirs and eleven of ours -- a total of 17 men in a space approximately 15x15 feet.

d. Methods of Attack

Until plastic balloons can be obtained, we will continue to fly clusters of meteorological balloons.

e. Apparatus and Equipment

The only substantial change in equipment during the period covered by this report, other than general strengthening of flying lines, is the addition of a new main sand ballast dropping device to the equipment train of the flights to be made at Alamogordo.

The device consists of a nest of eight plastic tubes each filled with dry sand and sealed on the bottom with a sturdy paper membrane. At the bottom of each tube, resting against the membrane, is a small detonating squib of sufficient force to rupture the paper and permit the sand to fall. Each squib is connected to a different lead on the baro-switch of a radio-sonde modulator, so that a predetermined weight of sand may be released at eight predetermined altitudes. A small wire "shelf" is placed over the commutator of the modulator in such a way that the pin arm is lifted clear of the contacts during ascent and permitted to drop into place at an altitude above that of the highest firing contact. This is designed to prevent the firing of squibs and consequent dropping of ballast during ascent.

f. Conclusions and Recommendations

It is felt that the use of freely extensible meteorological balloons is unsatisfactory for any final solution of our problem because of their inherent instability and the rapid deterioration of neoprene rubber under the rays of the sun. It is felt that cluster flights of these balloons are a purely stop-gap method of floating Watson Laboratories equipment until plastic non-extensible balloons can be obtained and tested.

The need for greater work space is becoming increasingly urgent as new personnel are added to the project and the extent of the work grows.

It is believed that with present equipment the Alamogordo, New Mexico, area is the most suitable available for launching purposes, since calm winds are consistently present at dawn, and there are a minimum of clouds to impair ground observation of the balloons in flight.

#### Future Work

It is hoped that in the immediate future satisfactory techniques for the launching and floating of cluster flights may be developed under optimum conditions, and tests made on small plastic balloons to be furnished by H.A. Smith, Coatings, Inc., of Mamaroneck, New York.

Arrangements have been completed with the Vulcan Proofing Co. of Brooklyn, N.Y. to test various balloon fabrics and films available. These tests will probably be conducted in the near future.

As soon as arrangements can be completed to obtain Navy clearance we plan to obtain non-extensible balloons from General Mills in sufficient quantity to make flight tests and commence work on the ultimate objective of this project.

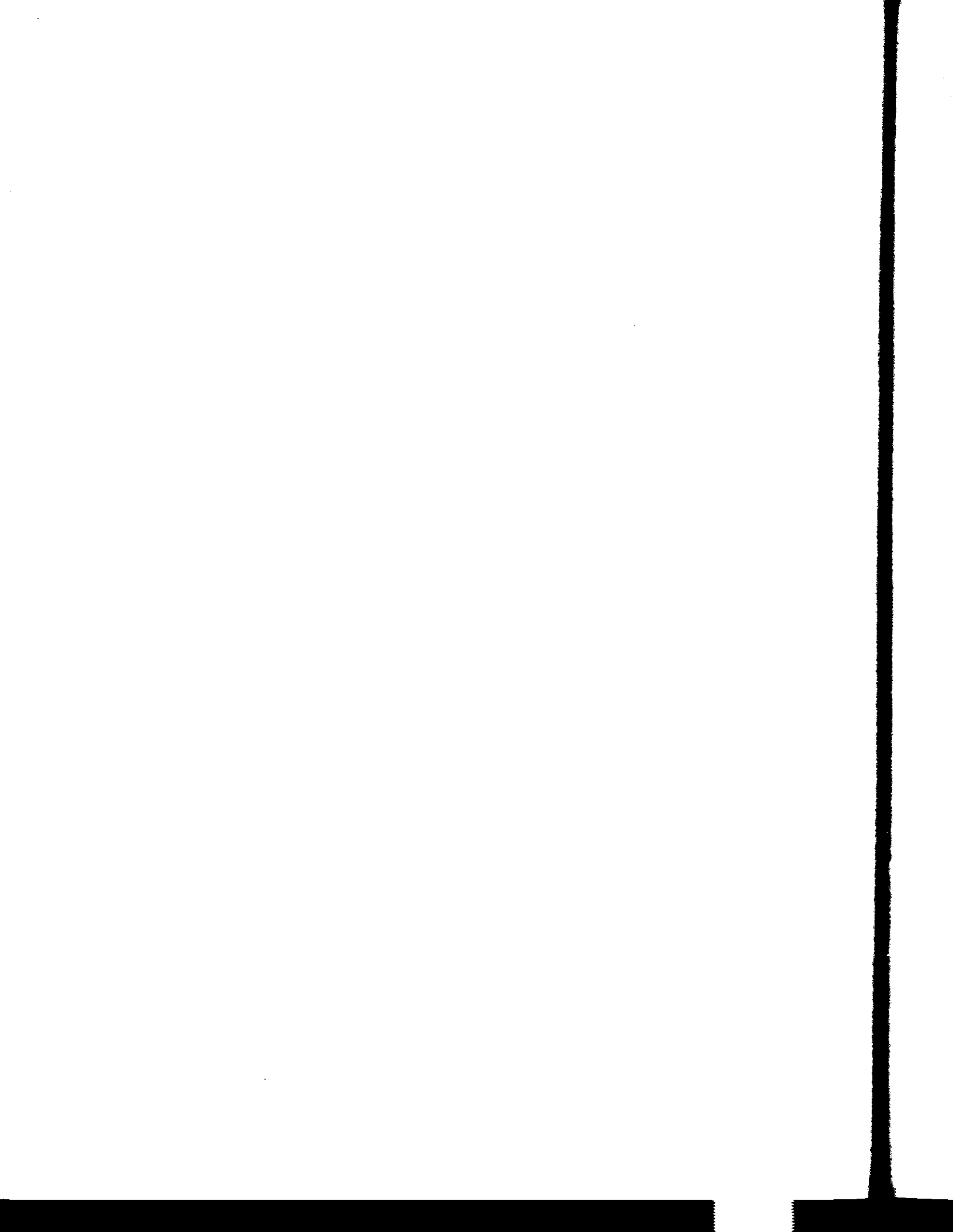

New York University  
*Special Report No. 1*  
*Constant Level Balloon*  
May 1947

---

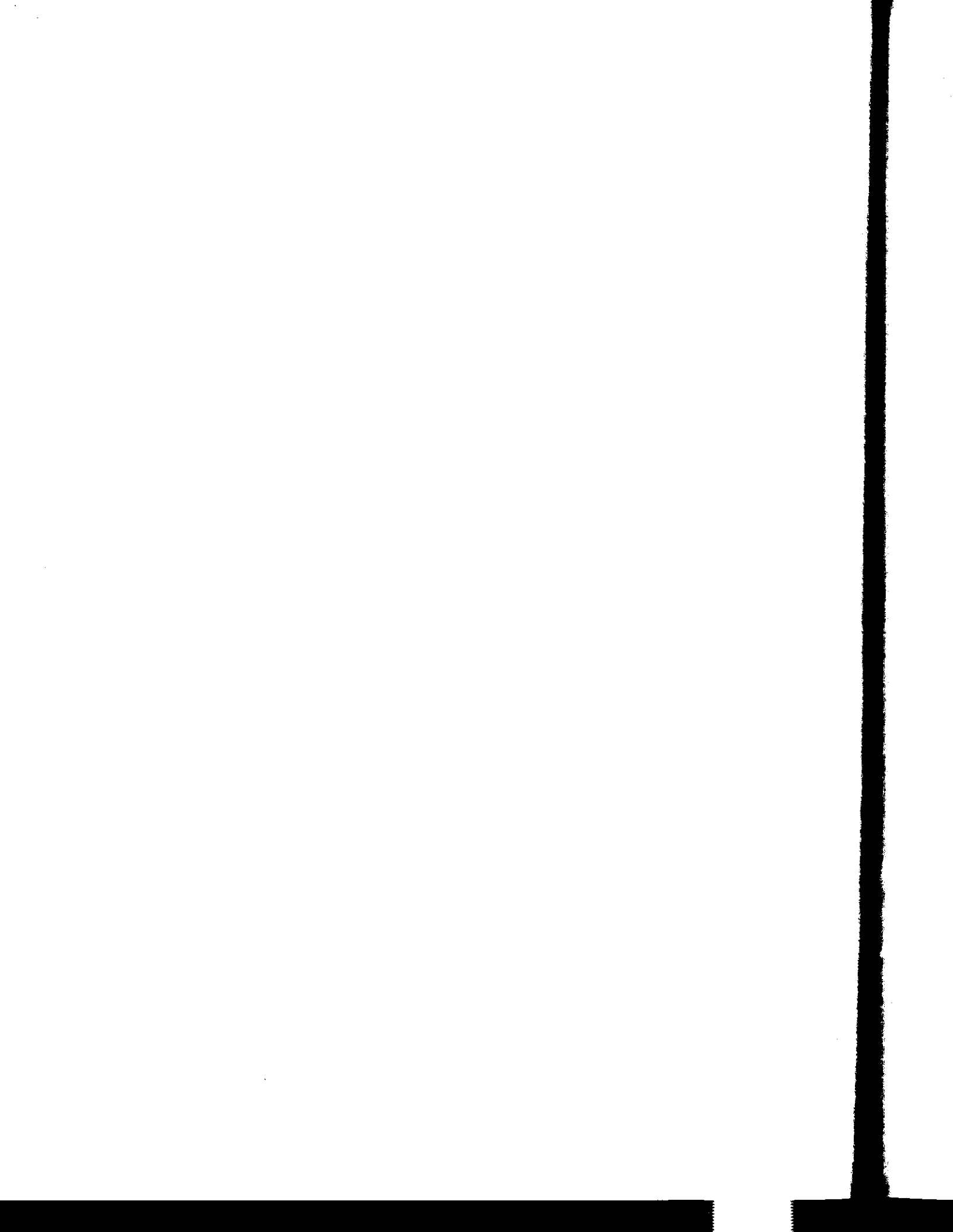

See also  
Weaver Attachment 25

SPECIAL REPORT #1

Covering Period from January 1, 1947  
to April 30, 1947

CONSTANT LEVEL BALLOON

Research Division, Project No. 93

Prepared in Accordance with Provisions of Contract  
W28-099 ac-241, between  
Watson Laboratories, Red Bank, New Jersey  
and  
New York University

Prepared by: *Charles S. Schneider*  
Charles S. Schneider  
Assistant Project Director

Approved by: *Renato Contini*  
Renato Contini  
Acting Director of Research

Research Division  
College of Engineering  
May, 1947



### ABSTRACT

A preliminary survey was made of the problem. Specifications were drawn up for the equipment needed and manufacturers were contacted to construct experimental balloons and altitude controls.

A balloon crew was assembled.

While awaiting delivery on the NYU designed equipment, clusters of meteorological balloons have been flown for experience and as a stop-gap method of carrying a payload to altitude. In addition, two salvaged, racing-type, man-carrying balloons of 35,000 cubic foot size have been procured and are being prepared for flight. Two 19,000 cubic foot Japanese balloons have been made available by the Navy.

Preliminary calculations have been made on balloon buoyancies and families of curves plotting altitude vs. lift for various balloon sizes have been prepared for planning and flight purposes.

Civil Aeronautics Authority has given clearance for flight of large balloons from Lakehurst, New Jersey, and Bethlehem, Pennsylvania, with certain restrictions.

REPORT

I. The personnel working on this project consists of the following full-time employees:

<u>Name</u>	<u>Duties</u>	<u>Qualifications</u>
Charles S. Schneider	Asst. Proj. Director	Former weather equipment officer, Army Air Forces doing similar work during the war. Elec. Engineering, Brooklyn Polytechnic & NYU
Charles B. Moore Jr.	Research Engineer	Former weather equipment officer, Army Air Forces doing similar work during the war. Graduate of Georgia School of Technology in Chemical Engineering.
Richard Hassard	Chief of Flight Detail	Former Signal Corps Officer, Elec. Engineering at NYU.
Murry Hackman	In charge of the Electronic Weather Equipment.	Former weather equipment Technician, Degree in Mathematics and Statistics City College of New York.

In addition to the above full-time employees, the following part-time personnel are now working on the project:

<u>Name</u>	<u>Duties</u>	<u>Qualifications</u>
Henry Kammenzind	Computations & Equipment Construction	Undergraduate Elec. Engineering Student.
Ralph Morrell	Equipment Construction	Undergraduate Admin. Engineering Student.
James Smith	Weather Observer and Draftsman	Former Weather Observer in Army and Undergraduate Engineering Student.
William Kneer	Machinist	Undergraduate Engineering Student.

The following personnel were hired but later resigned:

<u>Name</u>	<u>Duties</u>	<u>Qualifications</u>
Robert Wisnieff	Equipment Construction	Undergraduate Physicist Student.
Robert Ferris	Equipment Construction	Undergraduate Physics Student.
Fred Barker	Equipment Construction	Undergraduate Aeronautics Engineering Student.

II. The following administrative action has been taken in connection with this contract:

Personnel

1. The assignment of Charles S. Schneider to act as Assistant Project Director.
2. The employment of Charles B. Moore Jr. of Georgia Tech. as a Research Assistant with duties as Engineer.
3. Murry Hackman was engaged to take charge of the Electronic weather equipment due to his past experience as a weather equipment technician and as an instructor of the AAF classes in the maintenance of radiosonde receptor AN/FMQ-1 and radio directional finder SCR-658 at Chanute Field, Illinois.
4. Richard Hassard, a former Signal Corps Officer was hired because of his general knowledge of electrical and radio circuits to handle the construction of special flight equipment.

Equipment

5. As New York University did not possess all the necessary equipment a list of equipment was prepared and submitted to the Government with the request that this equipment be loaned or furnished

by the government. To date most of this equipment has been received with the exception of the AN/FM-1, SCR-653 and the prefabricated buildings needed for office and storage space.

6. The list of equipment that was submitted to the government consisted of the major items that were necessary. However, because many small hand tools and radio parts and other equipment were needed periodically a petty cash fund of \$100 was set up to facilitate purchase of small items. A further request has been submitted to the Chancellor of the University requesting that this petty cash be increased to \$200 and that a travel fund of \$100 be established.

#### Housing

7. The existing inflation shelter at the school for the Meteorological Department's use was not adequate to handle the large diameter plastic balloons that we plan to use. Therefore a request was submitted and approved by the Contracting Officer for the construction of a 27 ft. cube inflation shelter on the campus of New York University. Due to restrictions placed on us by the Air Space Sub-Committee of the Civil Aeronautics Authority, New York Office, it has since been decided not to erect this inflation shelter in the New York area, but rather to use existing facilities at Lakehurst, New Jersey or Olmstead Field, Middletown, New Jersey.

#### Sub-Contracts

8. Permission was secured from the Contracting Officer of the Watson Laboratories to place two sub-contracts. One was for the fabrication of plastic balloons and was placed with Harold A. Smith Inc., of Mamaroneck, New York. This sub-contract amounted to \$7,565. The second sub-contract was placed with Kollsman Instrument Division of

Square D Incorporated at Elmhurst, Long Island, New York. This sub-contract was for the construction of model altitude controls and amounted to \$7,446.

Correspondence written during this period is as follows:

<u>Date of Correspondence</u>	<u>Address</u>	<u>Abstract</u>	<u>Answer</u>
11/7/46	Plax Corp Hartford, Conn. Att: Mr. Griffith	Forwarding P.O.#5983 & Requesting price quotation and delivery schedule for 4 diff. thicknesses of 36" wide polyethylene sheet (.001" .00225" .004" and .008".	Not furnished.
11/7/46	Visking Corp. Chicago, Ill. Mr. Cahn	Request to know what <u>maximum</u> width Polyethylene could be supplied in, and what the cost and delivery date would be.	
12/4/46	Visking Corp. Chicago, Ill. E. B. Cahn	Advising interest in securing 300 ft. of 72" circumference polyethylene tubing request information on thickness and price.	72" circumference Polyethylene tube could be furnished. Request to know quantity and thickness .002 mil thick \$1.40/lb. estimate and would need 19 lbs.
12/10/46	Dewey & Almy Chem. Co. Cambridge, Mass. Att: Mr. Langley W. Isom	Acknowledging receipt of material used by Mr. Isom in his constant level balloon work. Also advising that order for single and double neck 1000 gram balloons had been placed.	None required.

12/16/46 Celanese Celluloid Corp. 180 Madison Avenue New York, N. Y.	Advising this company of our desire to fabricate a balloon from plastic film and our interest in ethyl cellulose as a possible plastic film to be used for this construction. Request that literature be supplied showing low temperature characteristics, tensile strength, etc.	Advising they do not believe ethyl cellulose would work secondly that they do not make film only molding powder - no literature available.
12/17/46 Nixon Nitrogen Works Nixon, New Jersey	Same request made of this company as with Celanese Celluloid Corp.	Advising they only make molding powder.
12/17/46 Plax Corp. Hartford, Conn. Att: Mr. Griffith	Advising that E. L. Courmand Co., recommended by Plax, had declined the contract for fabrication of balloons. That Unexcelled Chem. Corp. of New Brunswick had agreed to this fabrication and supplied the necessary shipping address for the polyethylene.	None required.
12/17/46 Dewey & Almy Chem. Co. Cambridge, Mass. Att: Mr. Isom	Acknowledging receipt of single and double neck balloons. Double neck balloons were received with a single neck plus a nub on the top of the balloon. Request to know whether shipment was in error and if so what disposition to be made.	Advising that nub must be cut with scissors in order to get double neck.
12/17/46 Dow Chem. Co. Midland, Mich.	Same request made of this company as that made with Celanese Celluloid Corp.	Not received.

12/24/46 Unexcelled Chem. Corp.  
Harold A. Smith

Advising the Plax Corp. Advising that .002  
had been supplied with mil thickness too  
his shipping address thin. Suggested  
and also requesting endeavoring to  
his technical advice obtain 72" width  
on the feasibility of in .006 mil.  
using a 72" wide strip  
of polyethylene, 2 mil.  
thickness that Visking  
Corp. of Chicago could  
supply.

1/3/47 Harold A. Smith

Acknowledge receipt of New quotation  
letter of December 26th furnished.  
containing estimated  
cost of fabrication of  
balloon. Advising that  
the bid could not be  
accepted on a cost plus  
basis. Requesting that  
their quote be resub-  
mitted.

1/3/47 Visking Corp.  
Chicago, Ill.  
Att: J. L. Lane

Advising that fabri- Advising that  
cation of balloons at they only have  
a 2 mil. thickness .004 and .006  
polyethylene film would 15 18" flat width.  
be extremely difficult The 36" width  
to handle. Request request could be  
made that information made but price  
be supplied on a 72" would be prohi-  
circumference film 4-6 bitive.  
mils in thickness.

1/8/47 Watson Laboratories  
Red Bank, N. J.  
Mr. A. H. Mears

Advising need of radio- Advising part ship-  
sonde receptor SCR658 ment would be made  
by NYU plus power units Feb. 13th.  
and technical publi-  
cations.

1/8/47 Watson Laboratories  
Red Bank, N. J.  
Mr. A. H. Mears

Returning list of Advising government  
equipment to the records changed and  
government loaned or that catalogues  
government furnished will be sent under  
with request that separate cover.  
certain corrections,  
additions and deletions  
be made.

1/14/47 Bland Charnas Inc. Yonkers, N. Y.	Requesting to know whether this company would consider fabrication of 15 ft. diameter plastic balloon.	Advising that they could not assist us in fabrication.
1/21/47 Shellmar Projects Corp. Mt. Vernon, Ohio	Request that they quote on delivery and cost of fabrication of 10 ea. 15 ft. balloons. Five to be fabricated from Saran (Type M.00225" thick and 5 from polyethylene made from PM-1.004" thick.	Advising plant could not cope with problem at this time.
1/21/47 Milprint Inc. Milwaukee, Wisc. Mr. Paul B. Hultkrans	Same request as letter to Shellmar 1/21/47.	Verbally informed. Not interested.
1/21/47 Rowe Packaging Co. Ltd. Toronto, Canada	Same request as letter to Shellmar 1/21/47.	Wish to make model and submit same before quoting. Never heard anything.
1/21/47 Western Products Inc. Newark, Ohio	Same request as letter to Shellmar 1/21/47.	Acknowledged receipt of letter and advising quotation would follow. Did not arrive.
1/23/47 Kennedy Car Liner & Bag Co., Inc. Shelbyville, Ind.	Same request as letter to Shellmar 1/21/47.	Verbally informed. Not interested.
1/23/47 Unexcelled Chem. Corp. Harold A. Smith	Request for quote on 15-15 ft. diameter balloons and 6-3 ft. diameter balloons to be fabricated from various thicknesses of Saran and Polyethylene.	New quotation furnished.
1/23/47 Watson Laboratories Red Bank, N. J. Mr. A. H. Mears	Advising that tool equipment TE-50A was short a 6" ruler a pr. of tweezers, and a socket wrench. No request for replacement for these items made.	None required.



1/28/47 Kollsman Instrument Co. Elmhurst, L. I. Att: Paul Goudy	Request for quotation Quotation supplied. of 3 ea. of the follow- ing altitude control equipment: 1. Motor switched modulators. 2. Elec. controlled dribblers. 3. Mech. controlled dribblers.
2/3/47 Contracting Officer Watson Laboratories Red Bank, New Jersey	Forwarding quote from Not approved. Unexcelled & requesting approval.
2/7/47 Watson Laboratories Red Bank, New Jersey Att: Mr. D. Rigney	Requesting permission Permission granted. to build a 27 cubic foot inflation shelter.
2/10/47 Contracting Officer Watson Laboratories Red Bank, New Jersey	Forwarding quotation Permission granted received from Kollsman to place subcontract Instrument Co. for the necessary control de- vices for the constant level balloon.
2/11/47 Patterson Bros. New York City Att: Mr. H. Carey	Advising that one Ungar Replacement made. electric soldering pencil is being returned under separate cover as it was received in unusable con- dition. Request for re- placement made. Quotation enclosed.
2/18/47 Contracting Officer Watson Laboratories Red Bank, N. J.	Requesting permission to Permission withheld. place subcontract with Unexcelled Chem. Corp. for the fabrication of balloons.
2/24/47 General Mills Minneapolis, Minn. Mr. O. C. Winzen	Request that quotation Declining to quote be supplied for the until after confer- fabrication of 15-15 ft. ence with NYU diameter balloons and representatives. 6-3 ft. diameter balloons made of various thick- nesses of polyethylene and Saren.

2/24/47	Bland Charnas Co. Inc. New York City	Same request as letter No reply received. to General Mills 2/24/47.
2/24/47	Leonard M. Harb Goodyear Tire & Rubber Akron, Ohio	Same request as letter Quotation supplied to General Mills 15 April 1947. 2/24/47.
3/6/47	Watson Laboratories Red Bank, N. J. Mr. Brophy	Forwarding copy of letter of request that had been sent to Mr. H. A. Smith for the fabrication of balloons.  No answer received.
3/7/47	Contracting Officer Watson Laboratories Red Bank, N. J.	Advising that Unexcelled Permission granted. Chem. Corp. did not wish to proceed with the con- tract and that instead H. A. Smith of Mamaro- neck, N. Y. was willing to undertake the fabri- cation. Quotation from Mr. Smith enclosed. Re- quest that approval be granted.
3/7/47	Goodyear Tire & Rubber Akron, Ohio Mr. L. M. Harb	Request a quote on the Quotation supplied fabrication of 5 ea. 15 April 1947. balloons made from Nylon covered with suitable neoprene and 5 ea. balloons made from fortisan covered in a similar fashion. Advising that any recommendations con- cerning balloon fabrics would be appreciated.
3/7/47	Seyfang Laboratories 1300 Mediterranean Ave. Atlantic City, N. J.	Same request as letter Advised interest. to General Mills 2/24. Ask for conference.
3/7/47	Unexcelled Chem. Corp. New Brunswick, N. J.	Requesting that poly- No action taken. ethylene film that had been shipped to them from Plax Corp. be returned to NYU.
3/7/47	Plax Corp. Hartford, Conn. Mr. R. E. Ames	Request that shipping ad- No answer required dress for polyethylene film be changed from Unexcelled Chem. Corp., New Brunswick, N.J. to H. A. Smith, 490 Bleecker Ave., Mamaroneck, N.Y.

3/19/47 Unexcelled Chem. Corp. New Brunswick, N. J. Att: Mr. Tegen	Confirming telephone conversation in which authorization was given to ship polyethylene film to NYU and advising once again of correct shipping address.	Film shipped. Quotation supplied.
3/21/47 Manne-Knollton Insul. Co., N. Y. C.	Requesting quote and delivery date on fibre screws 1 $\frac{1}{2}$ " long, fillister head and 8-32 thread.	Quotation supplied.
3/24/47 General Mills Minneapolis, Minn. Mr. O. C. Winzen	Acknowledge letter of 3/11 and advising that our representatives would be pleased to discuss construction details of the balloons.	Asked for conference in April.
3/24/47 Mr. R. S. Hassard 5 Hollywood Ave. Tuckahoe, N. Y.	Advising him of possibility of full-time position in Research Div. of NYU. Requesting that he make appointment for interview.	Hassard employed.
3/25/47 Mr. George E. Weidner Engineer Board Barrage Balloon Branch Ft. Belvoir, Va.	Requesting permission for NYU representatives to visit with him to discuss constant level balloons and safety valves and control devices.	Invited to visit Mr. Weidner.
3/27/47 H. A. Smith Mamaroneck, N. Y.	Requesting quote on valves.	Supplied
3/29/47 H. A. Smith Mamaroneck, N. Y.	Request for quote on balloons fabricated from nylon and fortisan film coated with butyl rubber.	Not received.
3/29/47 Seyfange Laboratories 1300 Mediterranean Ave. Atlantic City, N. J.	Requesting quote on 3 sets of stabilizer fins.	Received.

3/31/47	J. R. Garvin Douglas Leigh Sky Advertising Co. Lakehurst, N. J.	Requesting quote for the Acknowledged. 30,000 cu. ft. balloons Asked for definite that this company re- express ion of ceived from surplus. interest.	
3/31/47	Seyfang Laboratories 1300 Mediterranean Ave. Atlantic City, N. J.	Requesting quote on one Furnished. to five each 15 ft. diameter balloons made of 3 oz. silk cloth coated with neoprene and 2 each 3 ft. dia- meter balloons made from the same material.	
4/1/47	Mr. J. Boyle Air Cruisers Inc. Clifton, N. J.	Requesting quote on 25-15 ft. diameter balloons and 10-3 ft. diameter balloons made from polyethylene .004" polyethylene .008" saran .00225" and a fortisan fabric coated with butyl rubber and from nylon film.	Quote furnished on nylon fabric coated with butyl rubber. Interested but want cost plus basis.
4/1/47	Molded Latex Products Inc. Paterson, N. J.	Identical letter as above request to Air Cruisers Inc.	Furnished.
4/8/47	WIRE H. J. Brailsford & Co. Inc. Rye, N. Y.	Requesting price and delivery date of 3 volt price type relays.	
4/8/47	Capt. Albert C. Trakowski Watson Laboratories Red Bank, N. J.	Forwarding minutes of Air Space Sub-Committee Meeting.	None required.
4/8/47	General Mills Minneapolis, Minn. Mr. O. C. Winzen	Acknowledging receipt of March 31st letter and notifying this company that our re- presentatives would be pleased to come at their convenience.	April date set.
4/10/47	WIRE H. G. Brailsford Rye, N. Y.	Requesting to know how relays ordered were shipped.	Answered.
4/10/47	WIRE Lehigh University Bethlehem, Pa. Prof. Frank Myers	Requesting permission to make balloon re- lease from Lehigh Uni- versity on 15 April.	Given.

			Date Given.
4/10/47	WIRE Seyfang Laboratories 1300 Mediterranean Ave. Atlantic City, N. J.	Requesting to know whether April 17th or 13th would be satisfactory to Mr. Frank C. Seyfang to meet NYU representatives to inspect 30,000 cu. ft. and 2-35,000 cu. ft. in Heightstown, N. J.	
4/11/47	WIRE Dewey & Almy Cambridge, Mass. Mr. W. L. Dawbarn	Advising that single neck N1000 gram balloons should be furnished on our order 148-48.	None needed.
4/14/47	WIRE Frank Seyfang Seyfang Laboratories Atlantic City, N. J.	Advising NYU representative could not keep engagement for April 17th to inspect balloons and requesting that next best suitable date be furnished.	Furnished.
4/15/47	WIRE Mr. Barney Frank 27 Rochdale Ave. Roosevelt City, N. J.	Advising NYU still interested in purchase of balloons. Requesting that inspection date be changed from 17 Apr. to 23 Apr.	Satisfactory
4/17/47	WIRE Lehigh University Bethlehem, Pa.	Advising time of arrival at Lehigh to release balloons.	None needed.
4/17/47	N. Y. Sub-Committee on Air Space 385 Madison Ave., NYC Att: C. J. Stock	Advising that discrepancies observed in minutes of CAA meeting and requesting that conditions for more suitable flights be granted.	Request refused.
4/21/47	WIRE General Mills Minneapolis, Minn. Mr. O. C. Winzen	Advising that NYU representatives would make definite date for arrival later in week.	

4/21/47	WIRE Barney Frank 27 Rochdale Ave. Roosevelt City, N. J.	Confirming date of Apr. 23 for date inspection of bal- loons.	None needed.
4/21/47	Seyfang Laboratories Atlantic City, N. J.	Confirming date of 23 Apr. for date in- spection of balloons.	Answered.
4/23/47	Kollsman Instrument Division 80-08 45th Avenue Elmhurst, L. I.	Changing details in altitude control purchase order.	None needed.
4/28/47	WIRE Seyfang Laboratories Atlantic City, N. J.	Advising that 2 - 35,000 cu. ft. bal- loons were purchased from Barney Frank and that these bal- loons were being shipped to him for repair.	Acknowledged.
4/28/47	Barney Frank 27 Rochdale Ave. Roosevelt City, N. J.	advising that Univer- sity would buy 2 - 35,000 cu. ft. balloons and that these balloons should be shipped to Seyfang Laboratories.	Acknowledged.

#### IV. Conferences

Preliminary conferences were held with plastic packaging companies. However, as trained personnel were not always available at the time of these conferences with the various companies it was necessary to write followup letters. Reference to these letters can be found under communications of this report.

In addition to these preliminary conferences regarding plastics the following conferences were also held:

<u>Date</u>	<u>People Present</u>	<u>Where Held</u>	<u>Discussed</u>	<u>Conclusions</u>
2/11/47	Dr. J. Peoples, C. Ireland, D. Rigney, Capt. Trakowski, Hackman, Moore, Schneider	Watson Laboratories Red Bank, N. J.	Government furnished equipment.	Equipment would be expedited by Watson.
2/21/47	R. Brophy, Dr. J. Peoples, Capt. Trakowski, D. Rigney, Schneider, Moore	Watson Laboratories Red Bank, N. J.	Placement of sub-contracts for balloons with H. A. Smith, Inc.	NYU should visit Goodyear before placing contract.
2/25/47	Lt. Comdr. Harrison, Dr. Peoples, Schneider, Moore, Hackman	Lakehurst Naval Air Station Lakehurst, N. J.	Jap Balloons.	Jap balloons were available for projecture.
2/27/47	J. Sturtevant, L. Harb, Schneider, Moore	Goodyear Tire & Rubber Co. Akron, Ohio	Fabrication of large balloons	Goodyear was interested and would prepare a quote.
3/3/47	Dr. Peoples, D. Rigney, Moore, Schneider	Watson Laboratories Red Bank, N. J.	Placement of sub-contracts for balloons and altitude controls.	Permission granted to place sub-contract.
3/21/47	Mr. Hagen, Dr. Prendergast, Moore	Molded Latex Paterson, N. J.	Fabrication of large balloons.	Await preparation of a quote.

3/25/47	Lt. Gunther, Comdr. Harrison, C. Ireland, Moore	Lakehurst Air Naval Station Lakehurst, N. J.	Use of Lakehurst as a launching site.	Lakehurst would be available to Watson.
3/26/47	F. Seyfang, Mrs. F. Seyfang, Moore, Schneider	Atlantic City, N. J. Seyfang Laboratories	Fabrication of large balloons.	A quotation would be prepared.
4/4/47	Dr. Peoples, D. Rigney, Moore, Schneider	Watson Laboratories Red Bank, N. J.	1st Cluster Flight	Prepare for Second Flight
4/11/47	R. Brophy, Mr. Cambridge R. Contini, M. Giannini Schneider, Moore	New York University	Contract Administration	Housing would be provided by govt.
4/30/47	P. Goudy, Moore	Kollsman Instrument Co. Elmhurst, L. I.	Ballast valve construc- tion.	Change indetails.

- 10 -

During the period covered by this report, Messrs. Moore and Schneider made repeated trips to Kollsman Instrument Co. and discussed the fabrication of the modulators and other equipment that Kollsman was designing for our use. These meetings have not been considered conferences but for the benefit of this report the same individuals were always present, Messrs. Schneider and Moore of New York University and Paul Goudy, Engineer for Kollsman Instrument Co. The material discussed was methods of improving the construction of the modulators and other equipment.



### III C 1. General Work Accomplished.

The period was spent in preparatory work which consisted of the following phases:

Phase 1. The designing of a balloon and of altitude controls to be used as tentative solutions to the main problem.

2. The contacting of plastic film fabricators to obtain several sources of supply for large non-extensible balloons. To date, one sub-contract has been let for 15 ft. diameter balloons.

3. The contacting of an instrument company which would construct the altitude control devices. A subcontract has also been let for altitude controls.

4. The designing of a large balloon inflation shelter at N. Y. U. Materials have been procured for it. Due to change in plans the shelter will not be built at N. Y. U. therefore the materials are being held for the government until termination of contract.

5. The repairing and testing of the radiosonde receptor in Department of Meteorology for preliminary flights pending the arrival of Government-loaned equipment.

6. The preliminary flights with clusters of Meteorological balloons as stop-gap methods to attempt constant level balloon flights while awaiting the delivery of N. Y. U. designed equipment.

7. The making of preliminary calculations and requirements on constant level balloon performance.

### 2. Specific Problems.

Yet to be determined is the relative merits of various balloon films and fabrics available. This is to be handled by test work done by

the General Mills and perhaps by the Bureau of Standards in Washington.

The altitude control devices need to be analyzed for determination of optimum settings for initial action and rates of release of the ballast. This problem is awaiting some flights before a full scale, mathematical study is undertaken.

The main problem is the flight testing of the equipment planned as a tentative solution to the desired flight path. This awaits receipt of some large lightweight balloon envelopes and more of the altitude controls.

### 3. Limitations.

More work would have been accomplished had the equipment to be furnished by the Government arrived. The prefabricated building that is to be supplied by the Government according to the contract is urgently needed, as there is no housing available for the project at N. Y. U. The project personnel has been using work benches occupied by other projects. The project has been using the office space of another research group. This has not been satisfactory as six of their men and four of ours attempt to work in a joint laboratory and office 15 x 15.

Restriction on the project is the Civil Aeronautics Authority requirement that balloon flights be made only on days that are cloudless up to 20,000 feet. This is difficult to meet in the eastern United States but appears less difficult in the New Mexico area.

The pertinent abstract from minutes of the meeting with the Air Space Sub-Committee of CAA on 17 March 1947 are included in the appendix.

d. Methods of Attack

(1) After a survey of available literature in aerostatics and after conferences with various balloon manufacturers and authorities it is believed that the basic problem of maintaining the 15 lbs. of payload at constant altitude can best be solved by using a non-extensible balloon and a device operated by pressure which drops ballast whenever the balloon descends below a preset altitude.

The specifications for the equipment are as follows:

The balloon should be of large known volume, light in weight, non-extensible, either transparent or highly reflective to solar radiation. Rigging should be used to distribute the load evenly about the balloon.

A safety valve should be used to hold the inflation appendix of the balloon normally closed (as any hydrogen lost decreases the time possible at nominal constant altitude). The valve would act as a safety vent if the balloon should rise appreciably above the altitude where it is fully inflated, as there is danger of rupturing the envelope unless the excess pressure is relieved. The safety valve should be set to release pressure before the limit of the working stress of the balloon fabric is reached. If the exact volume of the balloon is known and the air density vs. altitude relationship is determined on the day of flight, it is possible to compute the total lift of the gas in the balloon at any altitude. By adjusting the gross load to be supported by the gas to equal the total lift at the desired altitude of flight, the balloon will level off at the desired

altitude as it has no further buoyancy. This altitude stability exists only as long as the balloon is in the fully inflated or "taut" state. Once the balloon starts descending (due to loss of hydrogen by diffusion or by other loss) it becomes flabby and is no longer stable. It will continue descending until corrective action is taken or until it reaches the earth.

The altitude control to be used is the ballast valve. When correctly set it will determine the lower limit of the balloon's oscillation as it would release a free flowing liquid ballast from a reservoir whenever the balloon descends a short distance below a preset altitude.

To test this tentative solution to the basic problem, intermediate sizes of balloon made of suitable fabric or films are needed in addition to the altitude controls.

### Balloons

Balloon manufacturers and fabricators of plastic films were contacted to locate a suitable balloon material. The following materials were suggested:

<u>Material</u>	<u>Advantages</u>	<u>Disadvantages</u>	<u>Disposition</u>
<u>Plastic Film</u>			
Polyethylene	Good low temperature properties (Gen.Mills desires to fabricate Picard's balloons from this).	Low tensile strength, Milky-translucent, Medium permeability.	10 ea. 15 ft. balloons being fabricated from it.
Saran	Transparent, low permeability, high tensile strength.	Tears easily, fair low temperature properties (?), weak at seams if heat sealed.	5 large balloons being fabricated.

Nylon	Good low temperature properties, easily fabricated, strong.	Not available, low tear resistance (?)	Awaiting sample.
Vynylite	Easily fabricated. Almost transparent.	Very poor low temperature properties.	Discarded.
Teflon	Strong	Can not be fabricated.	Discarded.
Ethoceil	Easily fabricated. Good low temperature characteristics.	Very high permeability.	Discarded.
Pliofilm	Easily fabricated.	Poor ultra violet properties, poor low temperature properties.	Discarded.

Coated Fabrics

Nylon coated with neoprene butyl rubber polyethylene saran	Strong, easily fabricated.	Heavy, expensive opaque, nylon cloth has relative high elongation.	Awaiting Investigation.
Fortasin (regenerated cellulose rayon) coated with neoprene butyl rubber polyethylene saran			Awaiting Investigation.
Silk coated with neoprene butyl rubber			Awaiting Investigation.

As a result of this preliminary study a sub-contract was given to H. A. Smith, Coatings Inc. of Mamaroneck, New York, to fabricate balloons with the following specifications for test purposes:

3 foot diameter balloons, no attachments excepting an inflation tube or appendix made of the balloon film about 10 inches long and 1.4" diameter.

- 2 each made from Polyethylene PM-1 film .004" thick
- 2 each made from Polyethylene PM-1 film .008" thick
- 2 each made from Saran type M film .00225" thick

15 foot diameter balloons with inflation tube 4" in diameter and 12" long, also means for attaching rigging lines supporting a 25-pound load to bottom of balloon and means for attaching auxiliary lifting balloons to top of balloon. If possible, balloon should be capable of withstanding internal pressure equivalent to 2" water.

- 5 each made from Polyethylene PM-1 film .004" thick
- 5 each made from Polyethylene PM-1 film .008" thick
- 5 each made from Saran Type M film .00225" thick

(1) The balloon film should be treated before or after manufacture in such a way as to seal all pinholes.

(2) A patching kit should be furnished for use of the balloon flight personnel.

(3) It is desired that either the volume of the 15 foot balloons be known to within 10 to 20 cubic feet when fully inflated or that the volume, though unknown, be nearly the same for each of the balloons of this size (differences in volume should not exceed  $\pm 1\%$  of the total volume of a mean balloon).

Delivery was made 20 April 1947 on the first 3 foot balloons, two 15 foot balloons are expected by the end of May.

In an attempt to interest another manufacturer in the problem, the following companies were contacted.

<u>Company</u>	<u>Type of Company</u>	<u>Interested?</u>	<u>Disposition</u>
Dobeckman Co. 500 Fifth Avenue, NYC	Plastics & Packaging	No	None
Kennedy Car Liner & Bag Co., Shelbyville, Ind.	Plastics & Packaging	No	None

Plextron Inc. 55 Tremont Ave., Bx 57	Beach Balls	No	None
DuPage Plastics Co. 475 Fifth Ave., NYC	Beach Balls	No	None
Shellmar Products Inc. Empire State Bldg., NYC	Plastics & Packaging	No	None
Millprint Inc. Milwaukee 1, Wisconsin	Plastics & Packaging	No	None
Celanese Plastics Corp. 180 Madison Ave., NYC	Plastics & Packaging	No	None
E. L. Cournand Co. 2835 9th Ave., NYC	Plastics & Packaging	No	None
Bland Charnas Co. 24 Ashburton Ave, Yonkers	Toys, Beach Balls	No	None
Western Products Inc. Newark, Ohio	Plastics & Packaging	No	None
Rowe Packaging Co. 26 Queens St. E. Toronto 1, Ontario Canada	Plastics & Packaging	No	None
Goodyear Tire & Rubber Co., Akron 16, Ohio	Blimps & Balloons	Yes	Awaiting final decision.
Molded Latex Products Inc., 27 Kentucky Ave. Paterson 3, N. J.	Balloons (Meteorological)	Not very.	None
Air Cruisers Inc. Clifton, N. J.	Balloons (Meteorological)	Yes	Awaiting final decision.
General Mills Inc. 1837 Pierce St. N.E. Minneapolis 13, Minn.	Balloons (Picard's)	Yes	Awaiting visit.
Seyfang Laboratories 1300 Mediterranean Ave. Atlantic City, N. J.	Barrage Captive & Other Balloons	Yes	Awaiting final decision.
Dewey & Almy Company Cambridge 40, Mass.	Meteorological Balloons	No	None

On completion of the survey of balloon materials other orders will be placed for experimental intermediate balloons.

As soon as a series of successful flights are obtained, it is planned to procure balloons of about 8 times the displacement of the intermediate size for tests as the model to solve the problem. These larger balloons would be about 30 feet in diameter.

#### Altitude Control

Mr. Goudy of the Kollsman Instrument Division of Square D Corporation was contacted to determine the feasibility of:

- (1) An accurate pressure-actuated liquid ballast dropping device.
- (2) A motor-switched modulator for the standard Army radiosonde AN/SMT-1. The standard pressure-switched modulator would be of little value in determining the height of the constant level balloon after it leveled off on a constant pressure surface.

On a subcontract Kollsman undertook to build a pressure actuated "dribbler" or ballast dropping device as follows:

#### Mechanically Controlled Dribbler

To consist of a diaphragm operated needle valve which will allow no flow for a 2 mb. increase in pressure on the diaphragm over pressure of which diaphragm is sealed but will allow a flow of 40 grams/minute under 1 foot of lead for a 5 mb. increase in pressure. Petroleum ballast with a density of about .775 gm/cc is to be used.

Diaphragm to be open to the atmosphere until it is sealed off by the radiosonde pressure switch at a preset altitude.



An electrically operated needle valve was included in the order, however it is to be cancelled as the mechanical valve appears more feasible to the manufacturer.

As the motor switched modulator was already in experimental state of manufacture for the Signal Corps and Evans Signal Laboratories an order was placed for 3 of them with these characteristics:

To have a motor-driven commutator to contain 4 contacts alternately switching two different temperatures, pressure and a reference. Rate of switching will complete one cycle per minute. To report pressure accurately between 150 and 500 mb. with a pressure resistor to be of such a value that with a large radiosonde frequency variation for a small change in pressure.

To have an adjustable contact variable between 250 mb and 400 mb with a factory adjustment of 300 mb. When the pressure arm reached this contact, a squib will cut a thread that holds the ballast diaphragm open.

The first mechanical dribbler was received on 20 April 1947 and is undergoing modification and tests before being flown on Cluster Flight #2. If it is successful, an order for improved models will be placed.

Another method maintaining a balloon at constant altitude is by replenishing the hydrogen in the non-extensible envelope as it is valved or as it diffuses. This might be accomplished by use of liquid hydrogen but not by use of chemicals due to their great weight relative to the small volume of hydrogen generated. The liquid hydrogen method is being investigated with a long range view. It does not seem too feasible, however, due to the difficulties of keeping the rate of evaporation of the liquid hydrogen low at the high altitudes, without extensive and heavy guard flasks of liquid air.

A third method of holding the equipment at a nominal constant altitude is to fly a cluster of standard meteorological balloons equipped with ballast dropping devices and a device for releasing lifting balloons should the cluster depart from the altitude limits desired. This method is inherently unstable, as there are no proportional restoring forces which will act on the flabby, freely extensible meteorological balloons. The success of this procedure depends on very careful balancing of the load against the variable lift of the balloons.

This cluster method is of use and interest only as a stop-gap method of lifting the Army equipment to altitude now, and has been the method used while awaiting delivery of the non-extensible plastic balloons.

III d) e. A flight was made on 3 April 1947 using this method. A cluster of 12 balloons meteorological carrying a radiosonde, a 15 lb. dummy load and a series of ballast dropping devices was released from the football field at Lehigh University, Bethlehem, Pa. The train was to be towed to 30,000 ft. by 2 lifting balloons which would then be cut loose. The weight of the equipment was adjusted to equal the lift of the balloons and presumably the train should have floated after the towing balloons were cut off. Actually, due to lack of experience in the difficulty of handling long balloon trains, auxiliary rigging lines were needed to take up launching stresses. These lines fouled the main flying line and the ballast which was to be dropped on parachutes. As a result, the balloon train went to 50,000 ft. where the tow balloons worked themselves free. The remaining train thereupon descended as fast as it had climbed (1,000 ft. per minute), landing in the ocean near Sandy Hook,

N. J. The flight was of value in training personnel, establishing a net for reception of the 74 megacycle radiosonde data, and in obtaining familiarity with the type of operation peculiar to all large balloon flights. The actual layout of the train used is sketched in the appendix.

Using the lessons learned on the dummy flight, improved equipment was built for a flight with a payload. Release was attempted on 18 April. Due to the high wind at 0830 EST, the time of release, and due to malfunctioning of the Army receiver in the plane that was to follow the balloons, release was not made. The already-inflated balloons were cut free and the equipment was brought back to New York University. It is expected that this equipment will be flown about 8 May. A description of the final flight equipment will be given in the report for May. A sketch of the layout of equipment built for the second cluster flight is given in the appendix. As this is a stop-gap method using modified standard components, no detailed report is being prepared on the equipment. Preliminary altitude controls used in both flights consist of standard radiosonde modulators ML-310 which have had leads taken off of the desired contacts of the commutator. The modulator thus acts as a pressure actuated control that releases ballast or balloons. In the first flight small radiosonde relays were used to close circuits to burn off cans filled with ballast. In the improved, second flight, a nest of plastic tubes were filled with dried sand. The bottom of the tube was covered with paper and a DuPont type S64 Squib was placed on the paper under the sand. On firing the squib, a hole is torn in the paper, permitting the sand to trickle out. This method permits dropping of more ballast and yet, in smaller increments. In the

second cluster flight, provision was also made to release balloons if the train rose above 40,000 ft. The flying line in the second train was approximately 500 ft. long.

This cluster flight is tedious to prepare and difficult to launch, and is a greater hazard to aircraft than the plastic balloons will be because of the great length of the cluster train.

### III e) Apparatus and Equipment.

A detailed explanation is not given on the equipment of the Cluster Flight. However, a layout sketch is enclosed in the appendix. An important piece of new apparatus for this project is the ballast valve or dribbler, a photograph and drawings of which appears in the appendix. It consists of a special diaphragm which operates a needle valve. Normally the valve is closed as the diaphragm is open to the air before the balloon reaches the desired altitude. This allows the pressure inside the diaphragm to be the same as the outside pressure. The diaphragm is sealed electrically by the baroswitch of the flight radiosonde when the balloon train passes a predetermined altitude. Whenever the balloon train descends below this preset altitude, the increase of pressure on the sealed diaphragm causes the needle valve to be opened. The greater the excess in pressure on the diaphragm the more ballast there is released through the valve. Thus a proportional restoring force is applied to the train. The ballast that is to be used is a petroleum cut boiling from 300° to 400°F with a density of about .78 and a minimum change of viscosity with temperature. Two different type fluids that may meet this specification are the Army type compass fluid

and a Sinclair paint solvent. The ballast valve or dribbler essentially perform the same function as the Japanese altitude control on the balloon bombs yet it is simpler and permits use of a liquid ballast for better control.

Another piece of equipment that is under construction by Kollsman Instrument Company is a motor-switched radiosonde modulator. It presents pressure data to the radiosonde transmitter as a variable resistance. The meteorological data is programmed by a small Brailsford Electric motor. This modulator will provide the contact that seals off the diaphragm in the ballast valve. A complete discussion of this equipment will be furnished upon its delivery.

Sketches of balloon and rigging of the balloon to be used on to the main problem are given in the appendix and are self-explanatory.

#### Computations

A chart showing the relation between altitude, gross lift, and balloon size has been found necessary.

Data for it was computed using mean aerological soundings as reported in the Monthly Weather review for 1943.

A chemical term, molar volume (in cubic feet) was used as a term relating the sounding data with buoyancies of the balloons at various altitudes.

Using the simple gas laws, the molar volume of dry air was computed thus:

- I. (1) Molar volume of any gas at standard conditions is 359 ft.<sup>3</sup>
- (2) From Monthly Weather Review Jan. 1943, the mean sounding data at 15 km for Lakehurst, N. J. is: Temperature -59.5°C  
Pressure 120 mb.

$$359 \times \frac{273.2 - 59.5}{273.2} \times \frac{1013.3}{120} = 2370 \text{ ft.}^3 \text{ (the mean molar volume at 15 km for Jan. 1943 over Lakehurst, N.J.)}$$

This volume data was computed for all levels given. Data was "borrowed" from other stations in the same latitude to piece out the 20 km soundings as needed.

II. Lifts were computed for various molar volumes for balloons between 7.5 and 75 feet diameter in the following manner:

Given

purity of Hydrogen 99.7%  
 impurity as oxygen 0.3%  
 computed molecular wt. 2.11 #/mol  
 Molecular weight of dry air as computed from data reported at 10 km. in Handbook of Chemistry and Physics. 28.764 #/mol

To find the lift of a 20' D balloon at an altitude where the molar volume is 1000 ft.<sup>3</sup>:  
 Volume 20 ft. D Balloon = 4190 ft.<sup>3</sup>

$$\text{Lift/Balloon} = \frac{\text{Balloon Volume} \times (\text{Difference in molecular wghts. of air \# / mol})}{\text{Molar Volume at a given altitude}}$$

or

$$\text{Total Lift of gas in \#/Balloon} = \frac{\text{ft.}^3/\text{Balloon} \times (\text{\#/mol})}{\text{ft.}^3/\text{mol}}$$

for the 20 foot diameter balloon:

$$\text{Lift} = \frac{4190 (28.76 - 2.11)}{1000} = 111.7 \# \text{ lift from a 20 foot diameter sphere of hydrogen at an altitude where the molar volume is 1000 ft.}^3.$$

The lifts were plotted against molar volume for each size balloon. The altitudes corresponding to various molar volumes for Lakehurst and Albuquerque in January and in August 1943 as computed above were plotted on the left margin of the chart.

The family of curves was plotted on log paper and is included in the appendix with the basic sounding data.

### III g) Conclusions and Recommendations.

It is believed that a balloon can be kept at nominal constant altitude between 10 and 20 km. for six hours using a non-extensible envelope with the addition of a ballast valve to keep the balloon near its pressure altitude. The flying of a balloon thus equipped is our main objective. The work to date has been primarily preparatory but it is believed that plastic balloons can be flown in the early summer with a payload.

Additional work space is urgently needed at New York University if significant work is to come from this group.

It is believed that the ideal launching area for balloons of this type is Lehigh University, Bethlehem, Pa. as long as this is feasible, For large balloons it is believed that the Navy people at Lakehurst can best facilitate the launching. Calm winds are essential for actual launching.

#### Future Work

General Mills is making large balloons from lightweight films that would meet our specifications with the exception that they cannot take any internal pressure. It is believed that their balloons should be investigated as General Mills appear to be the best source of supply for large balloons. An order will be placed with them as soon as they furnish a quotation.

As a stop-gap device before these might arrive it is planned to fly two 35,000 cu.ft. racing type as well as the 2 Japanese balloons from Lakehurst, N. J. carrying payloads with heavy duty power supplies for the radio transmitters.

In the meantime, improved clusters of meteorological balloons will be flown until larger balloons are available.

C O P Y

Abstract from:

AIR COORDINATING COMMITTEE  
NEW YORK SUBCOMMITTEE ON AIRSPACE  
RULES OF THE AIR AND AIR TRAFFIC CONTROL  
385 Madison Avenue  
New York, 17, N. Y.

N.Y. Meeting No. 12

20 March 1947

PROBLEM:

1. The Secretary of the Subcommittee presented a request from the War Department member in behalf of New York University for approval to release free balloons from Allentown, Pa. and Lakehurst, N. J.

DISCUSSION

2. The subject project is broken down into two phases as described below:

A. PHASE I.

- (1) The type balloon to be used in this phase of the project will be 6 ft. in diameter, hydrogen filled, encompassed by a nylon shroud with black and white panels 24" wide. Radio instruments weighing approximately 3 lbs. will be suspended approximately 50 ft. below the balloon and equipped with parachute device so that upon separation from the balloon, the attached equipment will float down towards the earth rather than become a freely falling body.
- (2) It is anticipated that two flights will be required in this phase of operation, the release to be made during weather conditions in which the sky is free of clouds and the visibility at least three miles at all altitudes up to 20,000 feet., within a four hour cruising radius from Allentown, Pa.
- (3) The balloon, during these flights, shall be convoyed by suitable aircraft to maintain air-ground communications on the balloon trajectory and equipped to effect destruction of the balloon at the termination of four hours flight or at such time that the balloon may become hazardous either to aircraft flight operations or the persons or property of others on the surface.
- (4) New York University will file a Notice to Airmen at least twelve (12) hours in advance of balloon release and a second notice will be filed at the time of release with the Allentown, Pa. Airways Communications Station.



B. PHASE II.

- (1) The type balloon to be used in this phase of the project will be a 15 to 40 ft. diameter plastic balloon, hydrogen filled. Radio equipment weighing approximately 25 lbs., will be suspended approximately 100 ft. below the balloon. The balloon will be towed to high altitude levels (above 20,000 feet) by three auxiliary lifting balloons fastened together with a 4 lb. weight. All equipment attached to the balloon will be equipped with parachute device so that upon separation from the balloon, the attached equipment will float down towards the earth rather than become a freely falling body. Upon attaining the desired altitude, the auxiliary lifting balloons will be released from the main balloon.
- (2) It is anticipated that a maximum of ten flights will be required in this phase of operation, 2 to 5 releases to be made from Allentown, Pa. and 2 to 5 releases to be made from Lakehurst, N. J. Release will be made during weather conditions in which the sky is free of clouds and the visibility at least three miles at all altitudes up to 20,000 feet.
- (3) The range of flight during this phase of operation will be between 30,000 and 60,000 feet. A period of six hours will be the maximum duration of flight.
- (4) New York University will provide an operator for tracking of the balloon during period of flight and will furnish information on its position to the N. Y. Air Traffic Control Center during period of flight.
- (5) New York University will file a Notice to Airmen at least twelve (12) hours in advance of balloon release and a second notice will be filed at time of release with either the Allentown, Pa. or Lakehurst, N. J. Communications Stations.
- (6) Destruction of the balloon will be predetermined to be effected over water where hazards are not present. Aerial convoy will not be effected during this phase of operation inasmuch as balloon flights will be conducted in excess of 20,000 feet.

3. The War Department member requests that balloon operations along the lines of Phase II be presented to the Washington Subcommittee for clearance with all other Regional Airspace Subcommittees, in consideration of War Department plans to continue the Phase II type of operation from White Sands, New Mexico, upon completion of the 12 proposed releases described herein. The type of balloon releases proposed out of White Sands, N. Mex., will involve flight through other regions.

RECOMMENDED ACTION

4. That the release of free balloons by New York University as described above in Paragraph 2-A (Phase I), Subparagraphs (1) - (4) inclusive, be approved.

5. That the release of free balloons by New York University as described above in Paragraph 2-B (Phase II), Subparagraphs (1) - (6) inclusive, be approved.

6. That the Washington Airspace Subcommittee present the Phase II operation to other Regional Airspace Subcommittees for clearance, in view of War Department plans to continue the Phase II type of operation from White Sands, New Mexico.

2 ea. 1000 gm. Balloons on  
Single 30' Nylon Line.  
5000 gms. Lift each.

Parachute #1

Ascent Cutoff #1  
Acts at 283 mbs.

10 equally spaced balloons  
in break.

Parachute #2

Descent Cutoff #1  
Acts at 472 mbs.

Parachute #3

Parachute #4

Parachute #5

Dummy Payload  
15 lbs.

Radiosonde  
with antenna

Descent Cutoff #2  
Acts at 370 mbs.

Parachute #6

Ballast Can #1

Descent Cutoff #3  
Acts at 338 mbs.

Parachute #7

Ballast Can #2

All individual balloons on  
single 15' Nylon lines and  
tied onto Main Line at  
20' intervals.

Flying line from Cutoff #1 to  
Parachute #2 is braided for  
added strength.

There is a distance of 5' between  
each piece of equipment, except  
the 20' between balloons on the  
Main Flying Line.

The 12 balloons on the braided  
line are each 350 gm. balloons  
with a lift of 1550 gms. each.

BALLOON TRAIN FOR  
CLUSTER FLIGHT NO. 1  
BETHLEHEM, PENNA.  
3 APRIL 47.

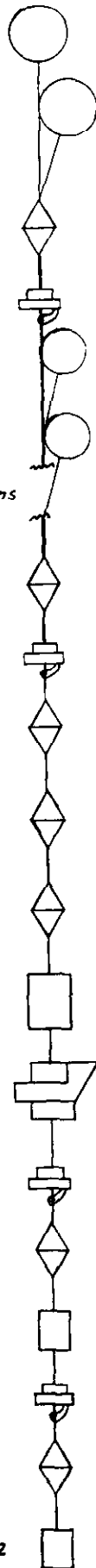

Spherical Balloon  
15' Diameter.

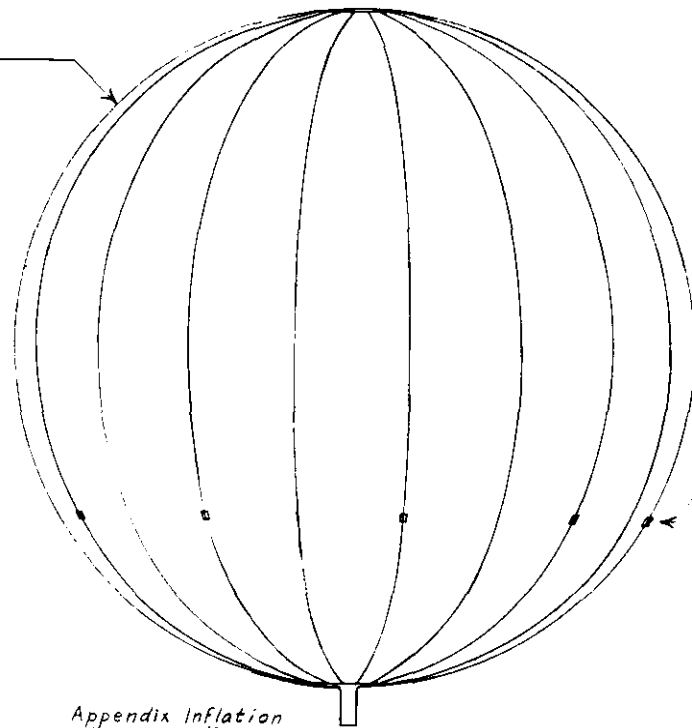

9 eyelets in reinforced  
seams for attaching bridle  
rigging to balloon at 30°  
below balloon's equator.

Appendix Inflation  
4" Dia. X 10" Long.

Balloon with rigging

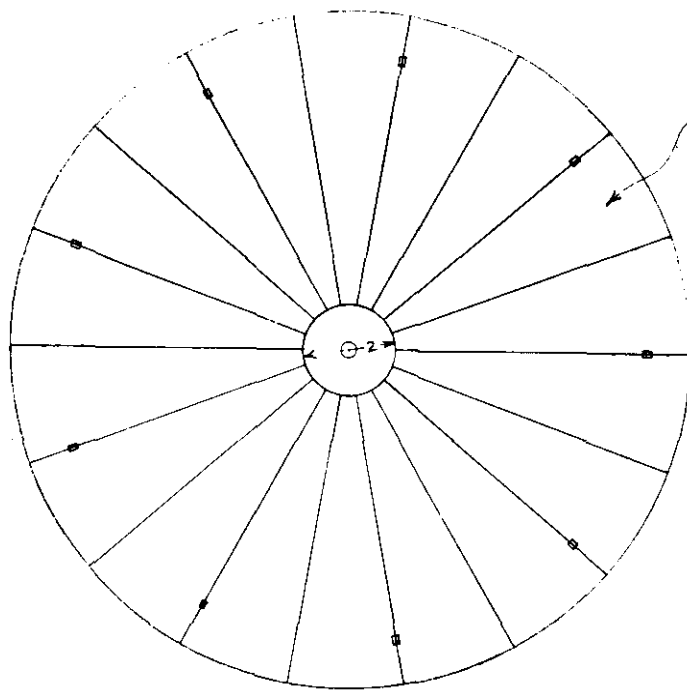
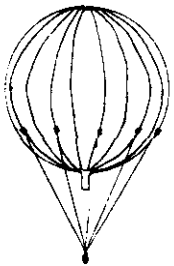

18 lunes of flat film  
cemented together to  
make sphere.

### PLASTIC BALLOON

FOR CONSTANT LEVEL BALLOON PROJECT AT NYU  
APRIL 27, 1947

SCALE: 1" = 3'0"

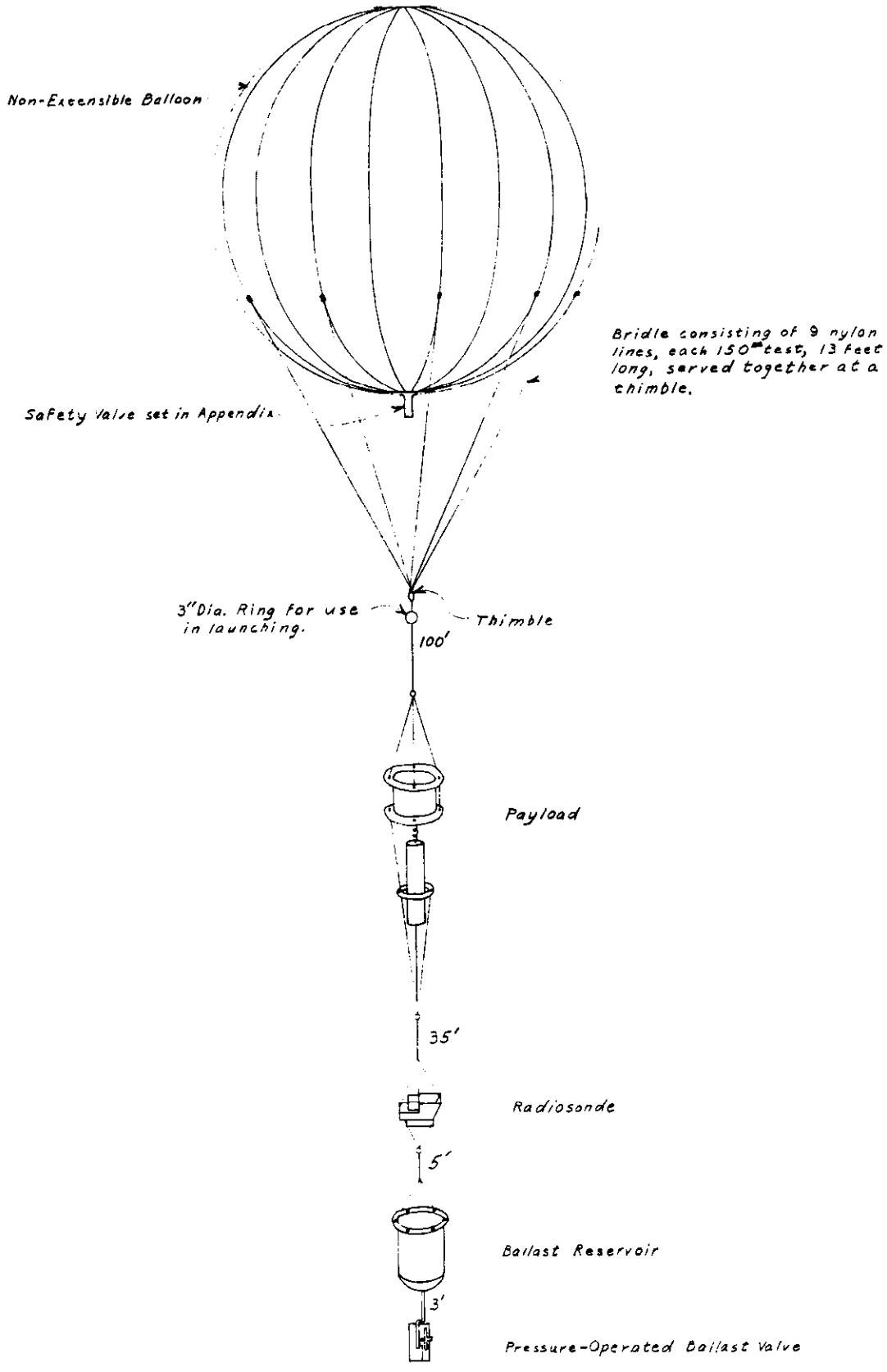

PROPOSED ASSEMBLY OF  
TRAIN FOR CONSTANT LEVEL BALLOON

LAKEHURST (39 meters)

JANUARY 43

AUGUST 43 -

<u>Alt. Ft.</u>	<u>Temp. °C</u>	<u>Press mb</u>	<u>Humidity%</u>	<u>Molar Vol. ft.<sup>3</sup></u>	<u>Temp. °C</u>	<u>Press mb</u>	<u>Humidity%</u>	<u>Molar Vol. ft.<sup>3</sup></u>	<u>Alt. Ft.</u>
65,617	-58	53	--	5410	- 64	58	--	4850	65,617
62,336	--	--	--	--	--	--	--	--	62,336
59,055	--	--	--	--	212.0 - 61.2	79	--	3585	59,055
55,774	--	--	--	--	337.2 - 64.2	94	--	2962	55,774
52,493	--	--	--	--	338.6 - 65.6	110	--	2370	52,493
49,212	213.7 -59.5	120	--	2370	337.1 - 64.1	130	--	2150	49,212
45,931	215.8 -57.4	140	--	2050	333.7 - 60.7	153	--	1845	45,931
42,651	216.3 -56.9	164	--	1808	329.4 - 56.9	179	--	1630	42,651
39,370	217.2 -56.0	192	--	1506	304.0 - 51.2	209	--	1440	39,370
36,089	-54.1	224	--	1339	318.0 - 45.3	243	--	1250	36,089
32,808	-51.0	262	--	1130	311.2 - 38.2	282	--	1115	32,808
28,527	-45.5	304	--	995	303.4 - 30.4	325	--	1000	28,527
26,247	-38.8	352	--	888	296.0 - 23.8	374	--	890	26,247
22,966	1 -32.1	408	--	788	290.0 - 17.0	428	--	800	22,966
19,685	248.2 -25.0	469	--	705	283.1 - 17.1	488	31	718	19,685
16,409	254.3 -18.9	536	60	632	276.9 - 3.9	555	28	650	16,409
13,123	-13.0	611	59	566	1.5	629	38	582	13,123
9,843	- 8.5	696	60	507	6.4	711	49	513	9,853
8,202	- 6.4	742	61	478	9.0	756	51	499	8,202
6,561	- 4.5	791	65	453	11.9	802	55	474	6,561
4,921	- 3.2	843	69	427	15.0	852	63	452	4,921
3,281	- 2.5	898	68	401	13.6	903	68	432	3,281
1,640	- 1.7	956	69	378	21.7	956	60	413	1,640
0	- 1.0	1013	76	359	21.5	1008	76	388.9	0

ALBUQUERQUE (1620 meters)

- JANUARY 43

- AUGUST 43 -

<u>Alt.Ft.</u>	<u>Temp.°C</u>	<u>Press mb</u>	<u>Humidity%</u>	<u>Molar Vol.ft.<sup>3</sup></u>	<u>Temp.°C</u>	<u>Press mb</u>	<u>Humidity%</u>	<u>Molar Vol.ft.<sup>3</sup></u>	<u>Alt.Ft</u>
65,617	-63	54	--	5410	-58.1	58	--	4960	65,617
62,336	--	--	--	--	--	--	--	--	62,336
59,055	-65.1	75	--	3701	--	--	--	--	59,055
55,774	-64.3	88	--	3170	-70.0	96	--	2830	55,774
52,493	-63.0	104	--	2700	-69.8	114	--	2430	52,493
49,212	-61.6	122	--	2320	-66.4	134	--	2060	49,212
45,932	-60.2	143	--	1990	-61.5	138	--	1780	45,932
47,651	-54.1	168	--	1690	-54.7	186	--	1560	47,641
39,370	-57.2	197	--	1450	-47.0	217	--	1390	39,370
36,089	-54.7	230	--	1250	-39.4	251	--	1250	36,089
32,808	-49.7	269	--	1140	-31.6	290	--	1110	32,808
29,527	-43.0	312	--	983	-24.2	333	45	980	29,527
26,247	-35.7	362	39	872	-17.1	382	45	895	26,247
22,966	-28.3	416	45	786	-11.0	436	56	803	22,966
19,685	-21.2	477	48	704	- 5.6	495	72	715	19,685
16,404	-14.6	546	50	631	1.1	562	79	652	16,404
13,123	- 8.3	622	51	567	3.8	634	66	594	13,123
9,843	- 2.6	706	48	522	16.6	715	48	541	9,843
8,202	.6	752	45	486	20.4	758	42	517	8,202
6,562	3.4	800	46	463	23.3	803	39	492	6,562
0	3.8	838	45	449	25.2	838	44	430	0

5fc 1620 meters = 5315 feet

Fiscal Report As of April 30th, 1947

Total amount expended	\$20,067.96
Available Balance	<u>97,632.04</u>
Total	\$117,700.00



Journal Transcriptions

Albert P. Crary

April 2, 1946–May 8, 1946, *and*

December 2, 1946–August 16, 1947

---

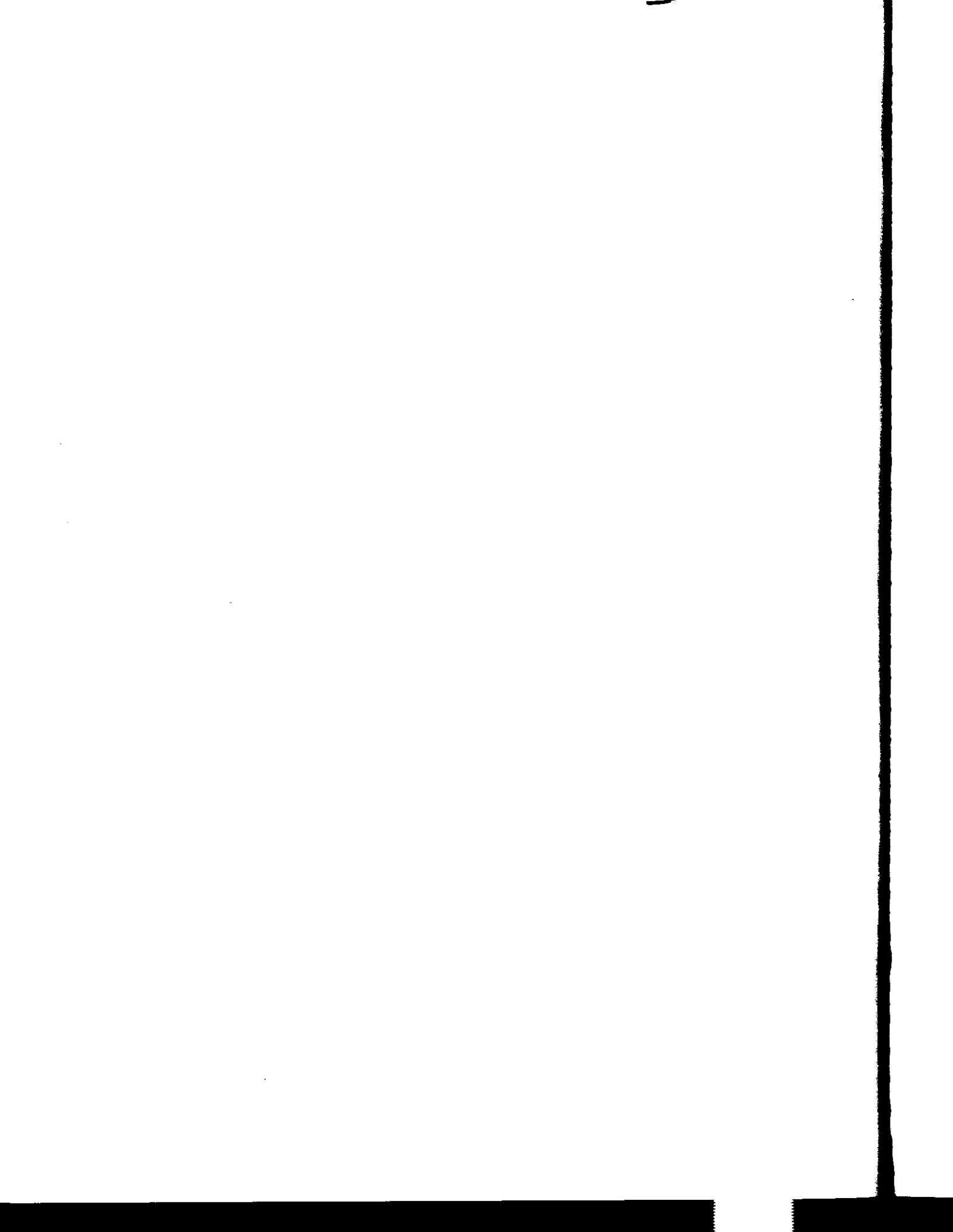

1946

1

April 2 Tues D & I left Caracas Pan Am bus 9 pm. Arrived Miami 10 pm on Pan Am. through customs and caught 1 am National Airlines plane for Newark

April 3 Wed Arrived Newark 730 am and took airline bus to NYC. D left for Providence 9 am. Called up Ewing but he was in Chicago - due back tomorrow. Left on 1040 sleeper for Canton tonight.

April 6 Sat At home. Over to Ogdensburg to see Steve this pm

April 7 Sun. Left Canton on 805 sleeper. Saw Bob Foster '31, also on way to NYC

April 8 Mon. Arrived NYC 730 am. Up to Columbia University to see Ewing 130 pm. Nyckoff and Dove on way to Los Angeles by plane this pm. Crane and Morrison in also from Watson Labs. Went back to Red Bank with them in AVUS car to Officer's Club near Watson Lab. Crane, Morrison and I went up tonight to see Reinagle at office. Met Gifford who has 20' sea rescue boat this project is planning to use. Stayed at Officer's Club tonight

April 9 Tues. At Watson Labs all day. Went through all processes necessary for employment under Civil Service. Warrant Officer Gifford transferred to WLRL-4 today. McCurdy already in and started work. Talked with Reinagle and Gallo re Columbia contract. Gifford left pm for Washington, Major Crane for Camp Dix and Morrison for NYC. Reinagle and I went down to CO this pm to meet group from Cornell extension at Buffalo - Aeronautical research wanting to get contracts. Stayed at Molly Pitcher Hotel in Red Bank tonight

April 10 Wed Checked out of Molly Pitcher Hotel and caught 730 am train out of Red Bank to NYC. Checked in at Hotel Webster and then up to Ewings at Columbia University. Mr Gallo of Watson Labs in at 10 am and we went over contract questions regarding Watson Lab contract with Columbia until 1 PM. Went over all parts of work with Doc from 2 to 530 pm. John Ewing in from Missouri.

April 11 Thurs. Worked on rough outline of Eglin Field and SOFAR project Am. Up to see Ewing at Columbia PM. Doc and I went over contract with Watson Lab & Columbia tonight. Caught 1205 sleeper to Boston.

April 12 Fri. Arrived Woods Hole about 11. Joe Worzel went over all sound transmission work at WHOI this pm.

April 13 Sat. Talked with Columbus Iselin this Am regarding Watson Lab work and needs. Crane and Gifford up pm and Joe and I went up to lab with them.

April 14 Sun. Down to lab this am with Joe looking for G9A files. Jim Peoples over about noon for awhile. Joe and I went golfing pm. Took 600 pm train to Boston and 1230 sleeper to NYC. Up to Boston with Lt Frank Ryder with Navy and WHOI

April 15 Mon. Contacted Doc Ewing in NYC and rode down to Red Bank with him. Talked over instrumentation of upper atmosphere investigations. Out to Oakhurst this pm. Conference with Col. Cole and Col. Grough re Project 188-5 and regarding microseisms. Doc and I went back to Molly Pitcher Hotel in Red Bank tonight.

April 16 Tues. Rode out to Watson Labs with Ewing. Went over to Evans Labs with Harry Davis Watson Lab navigation man, and saw newly developed ranging apparatus and talked to Lt Rydetor? re Spherics, location of lightning and thunderstorm data collected during past few years. Saw Col. Duffy of Meteorological Division AAF and back to Watson Labs. Doc went on through to NYC. Went over program with Dove and Crane this pm. Back to lab tonight with Crane and Gifford, discussing Project 185-7-1. Back to Myrtle Hotel at 1045 pm.

April 17 Wed. Rode out to Watson Labs with McCurdy. Worked with Major Crane on report regarding underwater work, Eglin Field and deep water. Took this in to Colonel Cole this pm. Acceptance probable. Got room in private house in Red Bank. Moved out of Molly Pitcher Hotel.

April 18 Thurs. Caught bus out to Watson Lab. Col Cole up this am and advised writing new Cost Expenditure for and revising the R. & R. Major Crane left about noon for trip Phila and Woods Hole. Made arrangements to meet him in NYC Monday. Wrote out new R & R and Cost Expenditure ready to take to Col Cole.

April 19, Fri. Talked over work with Dove and we wrote up 2nd EO covering all ocean work. Talked to Ewing on phone this am. Dove and I went down to see Col Cole and then wrote up new EO for deep water work. Saw Hincke? regarding this EO and A for P processed this pm and ready to go out to Wright Field.

April 20 Sat. Caught 710 train to NYC, cashed check at Chase Natl Bank, talked to Ewing on phone. Back to Red Bank about 4 pm.

April 22 Mon. At Watson Labs this am. Got final physical exams. Down to Supply to see Major Morris with Reinagle re getting equipment out that came from WHOI without paper coverage. Got travel order back and authority to use it. Caught 342 pm out of Red Bank and arrived

in Newark about 430. Reservations to Dayton on Spirit of St. Louis had been cancelled. Called Watson Labs. Got roomette on Spirit about 530. Called Mrs Ewing in NYC. Left Newark on Spirit of St Louis at 620 pm.

April 23 Tues. Arrived Dayton, Ohio about 830 am. Tried to get return ticket for tonight but coach car only open. Took bus out to Wright Field, Bldg 28. Saw Mr Drexler and turned over 2 of the A for P to him. Colonel Maier on leave. Went down to Colonel Winter's office and found Major Crane there. He talked to Colonel Winters regarding the need for planes and about new EO on extended long ranges of the 189-7-1 program which he approved and marked up to 1-P & sent on for higher approval. Went over with Crane & saw Colonel Lindgard in the plane assignment division and talked about planes. Had lunch with him and then went back to talk to Colonel Eaton regarding planes to 189-9-1. Went over to look at C-97, converted B-29 for transport. Back to Bldg 28 & talked with General Rives. Request for planes agreed upon and B-29 will be available near the 1st of June. 189-7-1 required by Rives. A for Ps in Drexler's office not yet signed. - will be sent on to Watson Labs later. Crane had reservations for me on the Spirit of St Louis and we left Dayton at 8 pm.

April 24 Wed. Discussed with Crane possibilities of getting sound through the ground part of the ocean sound channel and about the possibilities of a balloon such as Piccards. Arrived in NYC about 1030. Called Watson Labs and then we took a taxi up to Ewing's office at Columbia. After Ewing 1-2 class we discussed plans for 188-5 and 189-7-1, both Eglin Field and long range channel program. Left Ewing's office about 6. Crane registered at Hotel Lexington and I caught 740 out of Penn Station and arrived at Red Bank at 845 pm

April 25 Thurs. Up to Watson Labs. Worked over notes of conference with Ewing yesterday. Wrote up both travel blanks and sent them down to Travel Order Section. Talked with Palmer about HQ travel forms. Wrote up letter to Wright Field requesting use of second crash boat. Wrote RFR for Mark 2 hydrophone. Talked to Lt. Hungerford regarding request of this. Stepanoff, new physicist for WLERL in this pm. Crane left for Wright Field tonight.

April 26 Fri. Up to Watson Labs. Went over purchases already applied for with Reinagle. Wyckoff in this am. McCurdy in pm for radio parts. Went back to Oakhurst with McCurdy this PM

April 27 Sat. Left Red Bank about 730 AM with McCurdy in his car. Drove through NJ at Trenton & down to Philadelphia. Mac left me off at Olney at subway station. Contacted Marion at Bankers Security and went by train with her to Newton, Pa at 100 PM. Stayed with Flaggs.

Apr 28 Sun. Wayne & Marion drove me over to Trenton, NJ & I caught 1030 am train into NYC. Went up to Ewing's about 1215. Joe Worzel there & Hilly Barbour. They left for Woods Hole about 2 PM. I caught 550 train out of Penn Station to Red Bank, NJ

April 29 Mon. Up to Watson Labs. Checked over at library to have some periodicals obtained. Went over water work with McCurdy regarding what is needed in way of purchases. Went over to Oakhurst with Roke, new engineer, former Lt. Commander in Navy. Talked to Charlie Ireland regarding Eglin Field work.

April 30, Tues. Up to Oakhurst. Went over equipment that would be left there and what we might do when rest of people gone to Whitesands with Wyckoff. Wyckoff and I took car to Watson Labs to conference with Col Duffy of Weather Bureau, Capt Kellogg and Col Gault. Discussed weather problems - on eqpt? and S658s & aerography needs in coming work. Discussed equipment with McCurdy pm and tried to find where demolition cable could be located.

May 1 Wed. Up to Watson Labs. Talked with Stepanoff and Wyckoff regarding work to be done while crew was recording White Sands in New Mexico. Commander Navy arrived about 1130 am and we held a conference - Gault, Compton?, Dove Crane, Wyckoff, Hungerfield, Vaux and myself regarding Navy participation with us in Crossroads. Captain Kellogg of Weather Service over pm and talked with Crane and I regarding 658s, airgraphs, etc. Got travel orders etc to Columbia tomorrow. Wyckoff and about 11 others leaving for White Sands by plane tomorrow morning. Up to lab tonight with Crane.

May 2 Thursday. Left Red Bank on 8 am train, off at Elizabeth and took ferry to NYC. Up to GCT and then up to Docs. Too late for talk with Kellogg but in time for conference with Ewing, Lane of Columbia, Gallo, Bradford, Dove and Crane of Watson Labs. Conference went over contracts with Columbia and WL. Crane and I talked to Dove for short time after dinner. Caught 1130 sleeper to Boston tonight.

May 3 Fri. Arrived Woods Hole 1045 am. Went over to Falmouth with Dorothy. Up to lab pm with Joe W. Talked to Jim Peoples re his amplifier and level recorder. Bump and Kit over tonight. Saw Columbus PM.

May 4 Sat

1946

3

May 4 Sat. Up at WHOI this am. Out with John Ewing taking bottom shots in water. Worked with Joe on his boat this pm. Over to Jim and Rows tonight and to Buzzards Bay bowling.

May 5 Sun. Up to WHOI about 11. Went over deep water equipment with Joe Worzel and Jim Peoples. Jim and I caught 600 pm train to Boston tonight, got 1130 pm Owl to NYC

May 6 Mon. Caught 625 train out of Penn Station to Red Bank. Arrived Red Bank 730 and caught bus out to Watson Labs. Checked at library for caps?military info. Called up Morris of Supply and wrote supply request. Stepanoff in fm Oakhurst. Wrote up weekly report to Watson Labs for 189-7-1. Arranged truck to take fathometer to Nyack, N.Y. for 104' boat and bring back microbarograph from Columbia. Went out to Oakhurst and saw Rooke who is working on flux-meter, and got fathometer NPE-1 ready to send to Nyack. Went over list of parts needed 189-7-1 with Peoples. Peoples signed in at Watson Labs today. Capt Kellogg in from Evans Labs re how they can help- rough draft of letter of request to be written by Col Graul. Got travel orders to NYC tomorrow and to Nyack.

May 7 Tues. Jim Peoples and I caught 608 train out of Red Bank and arrived Ewing's office about 850 am. Conference at Ewing's office Gallo, Bradley, Crane, Peoples and I from Watson Labs, Lane and Ewing of Columbia and Iselin and McCrory? of WHOI regarding 189-7-1 contract of WHOI with Columbia. Conference later Iselin, Crane, Ewing, Peoples and myself regarding technical procedure and plan for Atlantis, Anton Dohrn and two boats of Watson Lab for summer and next winter. Crane, Peoples and I left about 240 pm for Nyack, NY in Army car. Arrived in Nyack at Peterson's Shipbuilding Co, new 104' boat P778 docked about the same time. Went over all changes and additions to the boat with Gifford and made plans for conversion to our needs. Left Nyack about 6. Jim Peoples and I caught 740 train out of Penn Station and arrived in Red Bank 9 pm.

May 8 Wed. Jim Peoples and I went up to Watson Labs this am

1946

1

Dec 2 Mon. Cakhurst. Cold wave hit about midnight - temperature down to 15° - strong wind. Started preparations for Alamogordo trip; getting Rubicon drums and galvanometers ready.

Dec 3 Tues. Cakhurst. Worked on Rubicon drums and galvanometers for Alamogordo trip - Stepanoff on August 9 data - Vivian working up cruise tabulations. Cliva setting up new GR3 for Alamogordo. Got oscillograph operating with 3 T-21 microphones.

Dec 4 Wed. Cakhurst. Set up 20 sec galvos and operated for several hours. In with McCurdy to safety meeting, W. Chantz set up Rubicon in dark box and took several records with 1 sec galv. Made up list for Alamogordo.

Dec 5 Thurs Cakhurst. Worked on relays for setup at Alamogordo. McCurdy & his group on T-21 operations. Woodruff and Chantz getting motors, etc ready for trip. Went over work at Cakhurst with Vivian.

Dec 6 Fri. Cakhurst. Worked on equipment for Alamogordo. Left at noon, caught 135 to New York City. Contacted Carl Gerdes and Ed Schempf at United Geophysical office. Curtin also in NY office. Went out to eat with Carl and Ed and discussed future work. They have job open for me in Alaska and also later possibilities in Turkey. Ed caught plane out about 745. Left on 1215 tonight for Asbury Park.

Dec 7 Sat. Went to Cakhurst 10 - 3. Woody and Phil there getting ready for Alamogordo. Peoples up for awhile pm.

Dec 8 Sun. Worked about 7 - 8 hours at Cakhurst. Chantz and Peoples there - getting realys, etc ready for Alamogordo. Went over all theoretical work on flights, etc with Peoples.

Dec 9 Mon. Cakhurst. Finished getting all equipment ready for Alamogordo. Chantz, Woody and I went to Watson Labs. Got checks and travel orders. All equipment loaded on trucks and taken to Watson late pm. Talked to Colonel Duffy a while about future plans.

Dec 10 Tues. Woody, Chantz and I left Cakhurst in staff car about 9 am. Arrived at Newark airport 10. C-54 in from Middletown about 11, bringing Ball and Cakes from Wright Field. Loaded up all equipment on C-54 and left Newark about 145 pm. Lewis, pilot; Clowry, co-pilot. Arrived Oklahoma City about 945 pm EST. Got rooms at Air Base Hotel. Went into Oklahoma City for dinner tonight.

Dec 11 Wed. Oklahoma City. Waited for weather to lift. Unable to leave in time to reach Alamogordo before dark. At Air Base hotel tonight. Equipment from Johns Hopkins University transferred to MOGUL plane, including warhead of W-2. 4 scientists & crew, including Delgado? . Called Jimmie at Fairview, Okla.

Dec 12 Thurs. Left Oklahoma City in C-54 at 0800 CST. Arrived at Alamogordo about 11 RMT. Met Major Pritchard at air base. C-54 unloaded warhead material first then all MOGUL eqpt which went to North Hanger. Went over to Pritchard's office, met Major Maguire? and talked over prospects of serups. Woody and Phil worked on equipment pm. Went up in L-3 with Sgt Mack looking over country of proposed sites. WAC corporal launched at 4 pm. Worked on equipment tonight. Staying at BOQ.

Dec 13 Fri. Woody and I left Alamogordo Air Base in weapon carrier and scouted out area south of White Sands and Turoro Lake. Got lost on ordnance map we had. Located Tower and K station. Went to Proving Ground. Saw Karsh and Major Grant and got good locations and one of good maps. Left Proving Grounds about 2 and went up west side of sand area to site A3. Arrived there at 4 but over very rough roads. Back to Alamogordo Air Base at 620. Chantz in Alamogordo working on T-21s, BST and Brush equipment.

Dec 14 Sat. Went out Hwy 70 this am toward Proving Grounds. Turned off at White Sands Nat'l Monument and drove to end of 9 mile road in park, about half in white sand area. Found location for #2 site which is about 30 miles north and a little east of launching site. Back to Air Base at noon. Went out north looking for Site 3. Tried to get through Ordnance Gate but needed key. Went back and around by Alamogordo and Tularosa but couldn't get in there. Back to base, got key from Provost Marshal and went out to Ordnance Gate. Found it did not lead in right. Came back to North Hanger and took road out from there, finally landing at bombing area about 35 mi from base. Left all Rubicon equipment there. Back at Base 645

Dec 15 Sun. Got all GR3 recording units and went up to site 3. Set up both Rubicon in tent and GR3 in small building. Got recordings on both. Back through Tularosa and Alamogordo.

Dec 16 Mon. Signal Corps people, Dr Kane and Dr Crenshaw in this am. They are planning to measure time interval between bursts of meteorites at 60, 70, 80 seconds after launching. Went over our plan with them. Packed eqpt for Site #2 in White Sands. Chantz and I stayed setting up apparatus and Woody went back for equipment for Site #1. Left Site 2 about 3 pm and went to site 1. Set up equipment there. Finished about 7. To Alamogordo for dinner.

1946

2

Dec 17 Tues. Got Chantz a Jeep to use on Station 3. Went out to #3 made final checks - Chantz stayed there. Woodruff and I went to Station 1 and made final checks there. Woodruff drove me to Station 2 and then went back to 1. V-2 rocket went up at about 1015<sup>PM</sup>. Got Brush recording - 1 trace & Rubicon at 2. Woodruff got EST & Rubicon at 1 - though had interference with other group. Chantz got GR 3 & Rubicon record at #3. Back to BOQ about 12. Rubicon & EST recordings not yet developed.

Dec 18 Wed. Chantz and I went out to Sta 3 and got all equipment together and back to camp about 1 - went in borrowed weapon carrier. Woody and Jeff Fowler took other weapon carrier and collected all equipment from Sites 1 and 2. Packed all equipment at north hanger and loaded it into truck, which was then put on plane. Got data from V-2 firings from Fritchard's office. Left Alamogordo about 730 pm in C-54 and went to El Paso Biggs Field.

Dec 19 Thurs. Went down to El Paso this morning and then across to Juarez. Back to Biggs Field about 230 pm. C-54 left El Paso 400 pm, landed in Patterson Field, Dayton, Ohio 110am

Dec 20 Fri. Left Dayton about 9 am & arrived in Elmsted Field near Harrisburg, Pa about noon. Lt Carroll and Clowry drove us down to Pa RR station. Got 150 out of Harrisburg and arrived in Newark 6 pm. Caught train to Asbury Park.

Dec 21 Sat. Chantz went down to Oakhurst and developed 3 Rubicon recordings from White Sands and EST recording at Site # 1. Site #1 recording poor, possibly NG. Looked over recordings obtained at Oakhurst on bombing run of 19 Dec.

Dec 22 Sun. Out to Peoples this evening in Marlboro.

Dec 23 Mon. Oakhurst. Worked on Alamogordo and Flight 13. Had flight # 14 this pm. - 24 bombs starting at 2 pm. Ran GR-3, Brush and Rubicon at lab. Woodruff went out to Farmingdale with van and Rubicon but results NG. No shots apparent on recordings.

Dec 24 Tues. Oakhurst. Closed down about 1130. Worked on Flight# 14 and work from NYU.

Started Stepanoff on extension of Aug 8 flight. Into NYC PM and caught 1045 sleeper to NNY

Dec 28 Sat. Cold NE winds and storms all day. Unable to get roads cleared out. Cancelled reservations for this evening to NYC.

Dec 29 Sun. Caught 805 sleeper to NYC this evening.

Dec 30 Mon. Arrived NYC about 915 am - caught 1040 out of Penn Sta, arrived Asbury Park about 1 pm. Worked on Alamogordo results. Went over work with McCurdy who proposed new type instrument and wants authority to go ahead with it.

Dec 31 Tues. Oakhurst. Flight # 15 this morning at 1040 - 1105. Woody went out to Farmingdale and recorded on Rubicon drum. Recorded also on Rubicon drum T-9- Brush and GR3-T-8. Set up sonobuoy 1000 ft \* west of T-8-0. Times Square tonight.

1947

Jan 1 Wed Asbury Park. Snowstorm pm

Jan 2 Thurs. Oakhurst. Worked with V on flights 12, 13 and part of 14. Got Alamogordo results together. Conference this pm with Colonel Duffy and showed him my results with flights and with Alamogordo.

Jan 3 Fri. Oakhurst. Worked with V on Flights 14 and 15 and started NYU data of Sept 12. Stepanoff on extension of August 9 results. Conference pm: Dr. Ewing, Spilhaus, Dr Ference of Evans, Duffy. Discussed Evans program and air flight and Alaomgordo results. Made arrangements for cooperation with Evans in coming tests.

Jan 4 Sat. At Oakhurst about 3 hours. Finished getting velocities for Sept 17 flight and started work on data of Oct 4 cruise.

Jan 6 Mon. Oakhurst. Finished velocity data for Oct 4 and Oct 16 from NYU meteorological studies. Stepanoff finished Aug 9 data and started on # 1 of Sept 12. Moved into new building next to T-8-0 today.

Jan 7 Tues. Oakhurst. Vivian worked up ray paths, time and distance for Vel #2 of Sept 12. Started on Aug 8 data to get Stepanoff's figures together for study above 15 kms. Went scouting for location of sono buoy west of Oakhurst Arm about 3000 ft. Chantz and Woodruff on calibration of Alamogordo instruments and fixing up of equipment for field uses.

Jan 8 Wed. Oakhurst. Worked on Aug 8 cruise, making final calculations for sky wave. " on Vel #3, Sept 12 cruise. Woody and I went over to high ridge 2900 ft west of Oakhurst with sonobuoy which worked into GR3.

Jan 9 Thurs. Oakhurst. Worked on sky wave data. Vivian and Stepanoff on Sept 12 ray paths. Flight # 16 at 1200 to 1220 pm. No noticeable results. Used sonobuoy at 160' hill back of labs.

Jan 10 Fri. Oakhurst. Into Watson Labs at 9 to take supervisor's test. Trakowski, Peoples and I went to Camp Evans and discussed results of "2 rocket recordings informally. Flight #17 this PM 1600 to 1620. Worked on sky wave data

1947

3

Jan 11 Sat. Oakhurst. Worked on sky wave data of Aug<sup>8</sup>. Drew up curves for lower and upper stratosphere. Regung? brought in calculator from Wright Field.

Jan 12 Sun. Oakhurst. Worked on sky waves Aug 8th and 9th. Got out letter to Gutenberg pertaining to those two days.

Jan 13 Mon. Oakhurst. Working on sky wave curves. Made plans for Alamogordo this Thursday

Jan 14 Tues. Oakhurst. Calibrated instruments A-21 to take to Alamogordo. Raining

Jan 15 Wed. Oakhurst. Started writeup of V-2 rocket work. Dr O'Day in from Watson and we went over V-2 rocket program with him. Finished calibration of T-21s on GR<sup>8</sup>. Vivian finished sky wave curves. Worked on Dec 31 Woods Hole recordings.

Jan 16 Thurs. Oakhurst. All equipment for Alamogordo packed and loaded on truck pm. Worked with Vivian on sky waves of Aug 8th and 9th.

Jan 17 Fri. Oakhurst. Conference with Cpts Lewis, Clowry and Duff of Clmstead Field and MCCU at 1230 regarding bombs, future flights, etc. Mathematician from Newman's group started work this noon - for two weeks. - working with Vivian. Woodruff and Chantz went up to Newark with equipment and loaded on P-47. Went up at 2 pm by staff car. P-47 left Newark 333 pm, landed at Patterson for fuel, landed at Tinker Field, Okla City 120 am. Stayed there overnight, Officers Manjak and Layden.

Jan 18 Sat. Left Oklahoma City about noon and went as far as Amarillo. Stayed at Amarillo - at Clinton Hotel

Jan 19 Sun Left Amarillo about 1130 CST - arrived Alamogordo 1230 pm RMST. Unloaded equipment off plane and put in north hanger. Unpacked GR-8s, T-21 galvanometers. 3 T-21s and 2 galvanometers broken. Repairing tonight

Jan 20 Mon Alamogordo. Tested out T-21s at north hanger with GR-8s. Loaded up all equipment for GR-3 and Rubicon drum and went out to A1 tower. Set up house along road about 3/4 mi southeast of the tower. Ran out 3 1000' lines for the at 120° radii. Set up dark room tent and 2 galv L&N broken suspensions. Worked on timing circuits, T-21s and galv at Alamogordo Air Base.

Jan 21 Tues Alamogordo. Tried out more T-21s with GR-8. All OK but one. Set out Site 2 near Hwy 70, C&GS marker 'Dona'. Laid out 1000' cables, set up Rubicon. Went out to end of Doppler line to station G but could not find C&GS marker 'Town'. Went back along line toward blockhouse & set up site #1, cables and Rubicon drum at intersection of G line and O line. Sites now set up 6, 13, 19 mi from blockhouse, all about 2 mi east of N line from boundary? site

Jan 22 Wed Alamogordo. Made rounds of all 3 sites. Set up L&N at Site #3, & surveyed to tower. Took T-21s and GR-8s to Sites 1 and 2 and set them up ready to operate. Took Rubicon recordings at Site 1 and 3 to check galvanometers.

Jan 23 Thurs. Alamogordo. Left air base about 900am. Bombing postponed from 11 am to 3 pm. Went out to Site 3, surveyed to tower. Got GR-3 recordings. Left Chantz at Site 3 and went to Site 2. Woody left Site 2 and went to site 1. Bombing delayed by 15-30 minute intervals from 3 pm to 519 pm. Got good recordings at Site 2. Both other stations lost to triangulation acc't radio communication though Woody had GR-8 operating but without directional instrumnets.

Jan 24 Fri. Alamogordo. Checked with Major Pritchard at base. Left about 830 and picked up all equipment from 3 sites. Surveyed Site #2 and made rough survey of Site #1

Jan 25 Sat. Alamogordo. Sorted out all equipment at north hanger. Left GR3, Rubicons and Sprengnethers. Packed up GR8's and other equipment and loaded in C-47. Carroll and Short in C-47 from Middletown. ready to leave tomorrow. Worked on Site 2 recordings pm. got azimuths and angles of ascent for 2 main explosions. Have high angle of ascent.

Jan 26 Sun. Left Alamogordo about 830 am in C-47, Lt Sherry of Alamogordo pilot. Landed at Scott Field, St Louis for gas & eats, and then to Patterson Field, Dayton, Ohio where we stayed overnight acct bad weather east of Pittsburg.

Jan 27 Mon. Left Patterson Field about 930 am, arrived in Newark near noon. Chantz and Woodruff left by train. I went to Oakhurst with truck and equipment. Arrived about 330 pm. Peoples going to Washington tomorrow to V-2 panel meeting with Trakowski.

Jan 28 Tues. Oakhurst. Worked up diagrams for azimuth and offset distances, also angle of descent from Site 2, Alamogordo. Went over recording, got about 20 recordings on first part but only 2 on down part.

Jan 29 Wed. Oakhurst. Worked on latter part of V-2 recording of Alamogordo. Got 2 recordings besides 2 large ones, but very poor. Worked up possible trajectory of V-2 rocket. Worked up future program for Alamogordo - Chantz & Oliva leaving about 10 February for semi-permanent work there. We are passing up Feb 6 rocket but starting on definite program following that.



Jan 30 Thurs. Plotted up angle of azimuth against angle of descent for V-2 recordings. Set aside this work for bombing runs. Worked on Flight 18 with Vivian. Started Eileen on calculations with Aug 8 and 9 data, reworking calculations done before. Checked picks on Flight 18 - they appear to be sky waves though angle of descent is not regular.

Jan 31 Fri Oakhurst. Worked with Eileen on Aug 8 calculations. Finished up for both direct and reflected possibilities. Went over Flight 19 records. Found that all of these are sky waves.

Feb 1 Sat. Left A.P. for Philly on 940 bus, arrived at Marions apt about 1. Wayne back from work about 5. After dinner we went out to Newtown and stayed overnight.

Feb 2 Sun. Drove up to Sparta NJ with Marion and Wayne. Saw Dorothy, Joe and family. Nelson Steenland & family living there with them. Saw Worzels pm. Ed Douglas in tonight for few minutes. Joe took me over to Dover & caught 958 train, then 1120 out of Penn Station, Newark. Arrived AP about 1230

Feb 3 Mon Oakhurst. Peoples in Washington regarding balloon ascension in June. Made plans for flight 20 which was made this pm 1300 to 1320 in conjunction with instruments in blimp. Route just south of east, no results. Worked on sky waves from Flights 18-19.

Feb 4-5-6, Tues, Wed, Thurs. Oakhurst. Checked over all sky wave picks on Flights 18 - 19. Went over Loran data and plotted up to get accurate plane speed. Plotted T - X curve using these figures. Worked up Oakhurst corrections for elevations and replotted all values for velocity - Flights 18 - 19. Received Gutenberg letter in which he had worked out Aug 8,9 data. Went over this method and worked over thae data again. Unique solution not obtainable. Went over possible experiments in 'Helios' balloon June with Peoples.

Feb 7 Fri Oakhurst. Worked on 23, 24 Jan T-X curves. V files 23,24 Jan forms, started on NYU data. Eileen worked on least squares-Va, then on Gutenberg's method applied to Aug 9 data.

Feb 8 Sat Oakhurst. Worked on V-2 rocket information 23 Jan. Used meteorological information for 2 explosions. Tried to get  $\bar{V}$  at height of explosions but seems too low.

Feb 9 Sun Asbury Park - worked on calculations of flights, setup? and calculations for rockets.

Feb 10 Mon Oakhurst. Worked over Alamogordo Radar Hueco stations for 23 Jan 1947 records and made plot of V-2 rocket D - H using all radar data. Went over all equipment to go to Alamogordo. Made plans for departure Thurs. Set up 8 sec galv in T-9. Vivian checked velocity from caps with temperatures and continued on Oct 22-23, Flights 12-13, Cruises, NYU data. Eileen in pm - worked on formulas of seismic refraction using straight line for line - Aug 8 - 9. Finished this and went back to least square solutions of Jan 23 -24 data.

Feb 11 Tues Oakhurst. Flight 21 scheduled for 8 tonight postponed until tomorrow. Worked on Oct 22 data with sky waves to Highland Lights. Went over all records. Have 2? consecutive shots to H.L. Oliva left by train tonight for Alamogordo.

Feb 12 Wed Oakhurst. Vivian & Eileen worked on temperatures and winds Oct 22 & 23 and worked up ray paths for sky waves to Highland Lights. All equipment for Alamogordo assembled and loaded on trucks for Watson Labs this pm. Flight 21 at midnight tonight. McCurdy, Chantz, Woodruff, Ball, Hom?, Rigny present. Dropped 20 bombs 1200 to 1237. No signals received, either sky or direct waves.

Feb 13 Thurs. Got special instruments for 1 cycle from McCurdy this AM. Drove up to Newark in staff car- Chantz & myself. Loaded B-25 this pm but could not get all equipment on -left 5 reels and box of equipment ? . Left Newark about 330, stopped in Middletown, Pa - Clnsted Field for 1 1/2 hrs to eat and gas plane, then left and landed at Godman Field outside Fort Knox, Louisville, Ky. Stayed at Officers Club tonight.

Feb 14 Fri Left Louisville about 930 am. Stopped at Tinker Field, Ok City for eats and refuel then to Alamogordo. Arrived Alamogordo 430 pm - contacted Watson Lab and got truck. Unloaded all equipment from B-25 & took part of it to North hanger. B-25 crew: It Mosher, It Alberts, Sgt ? Oliva arrived Alamo. by train this am

Feb 15 Sat. Moved eqpt from north hanger across runway to stowage building. Checked T-21s on GR 8, Checked galvanometers, etc

Feb 16 Sun Alamogordo. Out to Tower and Dona sites & surveyed in instrument locations - 5 to be station(ed) in shape. Ran out field wire at Dona station.

Feb 17 Mon Alamogordo. Went out to Tower site and set up Springnether and GR3 equipment. Rubicon 500 ft from GR3. Took trial recordings on both equipments

Feb 18 Tues Alamogordo. Went out to Dona Site this morning. Set up GR8 then Phil took truck and went over to GR3 Tower site. WAC corporal shot off about 215 but with little slipstream. Recorded at Dona but Phil at Tower site never saw rocket. Waited at Dona until 6 pm. Phil had

not come so got ride into Army base. Phil in later. Very windy for recording.

Feb 19 Wed. Alamogordo. Got radios from Watrus of Signal Corps and got trip tickets for tomorrow. Ran test records on Rubicon at both sites and checked everything ready for tomorrow.

Feb 20 Thurs. Alamogordo. Out early to station at Tower. Left Phil off there and went over to Dona Site. Rocket delayed from 10 to 1119. Both stations got good recordings except 1 9T-NS on both WC. Worked on GR8 records tonight.

Feb 21 Fri. Alamogordo. Went to White Sands Proving Grounds with Fritchard, Magnir?, Sol & Phil this morning for V-2 critiques, 0930 to 1100. Canister from rocket unpacked? about 40 miles up and finally found this pm between El Paso and Alamogordo. No transportation back to NJ yet. Worked on GR-3 records today

Feb 22 Sat. Alamogordo. Worked on data all day today. Correlated between the Tower and Dona sites for several sources. Worked total travel times for ascents both Dona and Tower and got average velocities up to about 65 kms, velocity increases from about 40 kms up to 60. Average velocity at 65 kms is about 320 meters per sec.

Feb 23 Sun. Worked on detailing record from GR3. Added more and made T-D move up to 75 kms, giving velocity of about 420 m/sec at top. Phil and Sal went out and picked up equipment - T-791s and GR8 and checked all pickups.

Feb 24 Mon. Alamogordo. Waited for air transportation today but none available and may not be any until Thurs at latest. Worked on V-2 recordings, frequency and characteristic analysis - T-3. Sal and Phil out to Site at Dona and recorded WAC Corporal at 1400. Got some waves in, about 7 minutes after it had left ground.

Feb 25 Tues. Alamogordo. Went out to Tower Site, surveyed in #6, took down shelter. To Dona Site, set up GR3 in shelter, surveyed in #6, went to launching site, about 2 -3 miles NW launching area. Phil went in to WSPR and got permission, Sal and I surveyed 1 site for use with WAC Corporal.

Feb 26 Wed. Alamogordo. Worked on GR8 records of 20 Feb V-2 rocket. This am Phil and Sal set up Sounding? site for tomorrow's W.A.C. I left 7 pm - C-47 Hoffman, Missinger: Pilot, co-pilot. arrived in Newark 9am.

Feb 27 Thurs. Arrived Newark 9 am. Lewis, Duff, Mosher a request? in from Middletown - on way to WL to conference and I rode in with them. Conference re future missions. Conference PM Trakowski, Peoples, Rying & myself regarding future operations

Feb 28 Fri. Oakhurst. Ewing in from NYC. Went over Alamogordo results with Ewing, Peoples and Trakowski. Out to Peoples tonight

March 1 Saturday. Asbury Park

March 2 Sunday Oakhurst. worked on calculations for wind translations.

March 3 Monday. Oakhurst. Postponed Alamogordo trip, until tomorrow, getting together equipment for Alamogordo. Thompson going also to get information on bombing runs? there, Worked on calculations from V-2

March 4 Tuesday. Thompson and I left staff car about 930, arrived at Newark 1040. Loaded up B-25 with equipment and left about 1230. Stopped at Middletown and picked up radio. Stopped at Scott Field & Tinker Field for gas. Arrived at Alamogordo 2 am. Crew B-25: Hoffman, DeTurk, Hancock

March 6 Thursday. Alamogordo. Snowing - rocket flight called off until tomorrow. Chantz out to Tower Site and brought in batteries. Sal and I checked low frequency equipment and went out to Tularosa site with it this pm. Ready to use on 1 sec galv on Rubicon drum

March 5 Wednesday. Alamogordo. Chantz, Thompson and myself out to Tularosa site and surveyed out X setup and ran out wires. Back about 2. Oliva working on check of T21s. Worked on radio and T21s until tonight

March 7 Friday. Alamogordo. At 8 am Fritchard got word rocket would go off between 1034 and 1200. Phil and Sal went out to Dona and Launching Sites with weapon carrier. Hoffman, DeTurk and Thompson out with them in staff car. I took Jeep and went out to Tularosa site. Rocket off at 1123. Got recording on GR8 but not time for Rubicon record. Phil and Sal got OK records from their sites. Thompson reported on bombing sites for runs and met and talked with Ordnance Officer. Left Alamogordo 845 pm, B-25 with Hoffman, DeTurck. Motor trouble on way and reached? Tinker Field 1200 with cylinder broken.

March 8 Sat. Hoffman wired Alamogordo and caught Manjak & Schneider (P4)? before leaving for Florida. They changed their route and landed at Tinker Field, O.C. 535. Trouble with their oil gauge and the trouble not repaired until 10 am. Left Tinker Field 10 and landed at Patterson. Off from Patterson to Olmsted, Olmsted at 9pm. I stayed there overnight.

1947

6

March 9 Sun. Left Olmsted 09<sup>34</sup> am - 047, Manjak and Schneider and landed at Newark 1130  
Thompson and I took train to Asbury Park from Pa station. In Asbury Park 3 pm

March 10 Mon Oakhurst. Vivian and I worked on Flight 25, Parts 1 and 2. Started Eileen  
on V-2 rocket recordings.

March 11 Tues Oakhurst. Vivian and I worked on Flights 25, 24. Flight 26 off today, Part  
1 at 9, part 2 at 2 pm. Good results! Eileen on V2 rocket March 7, Dona Site.

March 12 Wed Oakhurst. Vivian and I worked on records - Flight 26, and started Flight 23.  
Eileen worked on Dona site, V-2. Thompson and I went over Alamogordo plans.

March 13 Thurs Oakhurst. Worked with Vivian some on Flight 23 and 22. Worked on Tularosa  
site of V2 - 7 March. Eileen worked on Launching Site, V-2. Flight 27 today - at 12 noon  
and at 4 pm. Probably last of flights.

March 14 Fri Oakhurst. Vivian worked on identification of returns, last 4-5 cruises. gave  
good sky waves. Trakowski, Peoples and myself wrote up report for General Reves on overall  
program to be hand carried by Thompson to Washington. Eileen worked on V-2 records, #21

March 15 Sat Oakhurst. Worked up survey of Launching Area and Tularosa sites & plotted all  
sites on air map. Worked on V2 rocket March 7 records.

March 16 Sun Oakhurst. Worked on formula for sound correction until 2 pm - went over to  
McCurdys tonight.

March 17 Mon Oakhurst. Vivian plotted up all last sky waves. Worked on eqpt list for Alamo-  
gordo. Worked on formulas for wind correction.

March 18 Tues Oakhurst. Worked with V. Checked through all March 13 records. Worked on  
Woods Hole recordings pm. Eileen working on V-2 rockets.

March 19 Wed Oakhurst. Reviewed Flight 24A trying to get some azimuths from Oakhurst but  
records very poor. Reviewed records of Jan 23rd and started on stratosphere calculations.  
Eileen working on corrections Jan 20 V2 rocket from meteorological data. Baten? in from  
Florida Field Station, ready to go to Alamogordo next Tuesday.

March 20 Thursday, Oakhurst. Went over final calculations for stratosphere data using  
seismic methods, of Jan 23 data with Vivian. Got  $V=325$  at 3 kms. Studied azimuths on that  
data and got  $w = 10$  m/sec coming from south on June 23rd. Worked with Eileen on rocket  
Jan 20th correcting for met data and plotting final H against X in kms from surface for  
up data.

March 21 Friday Oakhurst. Worked on Alamogordo plans - Lewis & Clowry over this pm and we  
went over all future plans including bombing for Alamogordo. Worked on rocket data with  
Eileen and on flight data with V, Stepanoff on ray paths of Dec 13

March 22 Saturday Oakhurst. Went over all V2 rocket data. Studied azimuth - elevation  
graphs & studied WAC Corporal of 3 March. Caught 5<sup>34</sup> train from Asbury Park - 1045  
sleeper out of NYC

March 23 Sunday. At home. Arrived Canton about 9. Left on sleeper tonight about 8 pm

March 24 Monday. Arrived NYC about 7. At 0930 went up to Math Department at NYU - Washington  
Square. Met Mr Bennett of WL. Found that Dr. Courant would not be in until late and decided  
not to wait but caught 1040 train to Asbury Park. Went over shipment ready for Alamogordo  
and over work for Vivian and Eileen. Packing tonight.

March 25 Tuesday Truck at Oakhurst at 9 with scales - all equipment weighed - about 3500#  
total including TORRID. Edmonton, Reynolds, Thompson, Porter, Godbie? and I left about 10  
and went through to Mitchell Field in staff car. B-17, Carroll, pilot -- co-pilot. Left  
Mitchell Field about 3 pm. High level winds - went southern route - stayed at Maxwell Field  
Alabama tonight. Thompson stayed behind waiting for B-45

March 26 Wednesday. Left Maxwell Field, Ala. about 9 and landed in Alamogordo 3 pm

March 27 Thursday Alamogordo. Phil, Reynolds and I went out to Tower site, took in all wires,  
Pulled down tent and Rubicon equipment and took it over to new site west of Lake Lucero.  
Strung out wire, surveyed in site & set up Rubicon tent. Sal, Edmondson, Godbie?, Porter  
weighing in equipment in Alamogordo air base.

March 28 Friday. Alamogordo. Went out with Godlers, Porter to White Sands west of air base.  
Located site and surveyed it, put up shelter and set up GR3. Phil and Reynolds went up to  
Tularosa site, Sal and Edmondson worked on GR8 and low frequency equipment. Thompson in  
with B-45 from Newark.

March 29 Sat Alamogordo

March 30 Sun Alamogordo. Phil and I went out to Dona site and picked up some equipment and  
then out to Lucero site. Set up Rubicon and took a record. Tried to get through to Tularosa  
site west of White Sands but couldn't find road.

1947

7

March 31 Monday. Alamogordo. Chantz, Bill Godbee and Ace went out to E. White Sands and Tularosa sites to make final setups. Sal, Edmondson, Peoples and I went out to Dona site this pm and moved tent and Rubicon to #3 position and set up low frequency apparatus

April 1 Tues V2 Rocket #22 went off at 1310 this pm. Chantz and Don at Tularosa, Godbee and Peoples at East White Sands, Sal and Edmondson at Dona, Porter and I at Lucero. All 4 stations got good recordings though low frequency instrument at Dona did not work out.

April 2 Wed. Peoples, Major Magnur?, Thompson and myself went over to Lt Col McKenson's office this am regarding bombing puns. There are many difficulties with the bombing here, mostly that so many new groups have moved in and are setting up on the northern? range. Thompson and I went over to see Major Mitchell this pm regarding same matter. Wrote memo regarding proposed work to take to CO tomorrow. Peoples left on B-17 today. Don and Bill G went to Dona and Launching Area sites am and got all loose wires. Don and Bill E went to East White Sands and Tularosa pm and got inventory and brought back Rubicon and tent from Tularosa. Worked on East White Sands record. V2 made 85 peaks - down course. Porter worked on calculations pm. Sal and Edmondson took complete inventory and this pm worked on low frequency equipment.

April 3 Thurs. Oliva and Edmondson on low frequency equipment. All T-21s changed over to Stds. Edmondson and Bill G went out to Lucero and Dona, got inventory and brought back tent from Lucero.

April 4 Fri. Reynolds and I went out to Osurso? Range and located PB1 bombing range. Set up wires and did surveying. Chantz and Porter on computations April 1

April 5 Sat Alamogordo.

April 6 Sun. Checked clocks. Cleaned out hanger and emptied trash out at East White Sands

April 7 Mon Talked to Pritchard re 3rd car for tomorrow. Gave him memo of progress report for MOGUL project to date, talked to Lt Dyer of Signal Corps regarding for tomorrow firing. Chantz and Bill went out to Tularosa and got that site ready. All equipment checked for tomorrow. Edmondson and Reynolds ran drum recording of McCurdy low frequency equipment at base. Porter and I worked on amplitudes and frequencies of all recordings April 1 firing and started calculations. Olive worked on calibration of GR8 recorder attenuation. Got 3rd vehicle and all trip tickets for tomorrow.

April 8 Tues. Ace and I went out 7 am to Osarco site. Arrived 9 and set up radio and T-21s. Rocket due at 11, delayed until 1710. Very windy then, all settings at 8. Ran 3 rolls but nothing came in. Chantz at Tularosa alone - Godbee and Reynolds at East White Sands - Oliva and Edmondson at Dona - all sites windy but 3 closest ones got some signals.

April 9 Wed. Worked on yesterday's records. Made picks on Dona, East White Sands and Tularosa. Found nothing on Oscuro site recordings. Don and Bill G went out to East White Sands site and took recordings with pistonphone to get GR3 attenuation calibration. Sal Olive left this pm for San Diego. Wrote letters to Vivian and Jim P tonight.

April 10 Thurs. Ace and Phil worked on rocket recordings. - azimuths vs elevation angles. Don and I went out to Tularosa Range and checked bombing sites - bombing range just north of Range Camp and another site between that and our Tularosa site. Triangulated in with Tularosa Peak, etc. Thompson left in 45 for East. Godbee and Edmondson went with him.

April 11 Fri. Don and I went out past Tularosa Site looking for bombing sites. Went back to Air to Ground Range and to air strip. Chantz and Porter working on calculations V2 23 and T-21 calibrations.

April 12 Sat. Alamogordo Air Base

April 13 Sun. Worked on formula for triangulation without using compass - Alamogordo Air Base

April 14 Mon. Porter, Chantz and I worked on GR3 and GR8 calibration curves for frequency and attenuation settings. Don worked around equipment - Don, Ace and Bill got apartments at air base. Wrote letters to Vivian and Eileen tonight.

April 15 Tues Alamogordo. B-29 arrived today - Lt Ball, McCurdy, Woodruff and MOGUL personnel - 41493; Lewis, Wolk, Burnhoff, Adams, Duff. Worked some on instrument calibrations. Lewis, Ball and I checked with Major Pritchard, then to Major Mitchell's office regarding bombing sites. Mitchell said CO had turned down bombing from air, but we could have surface charges along Tularosa road. Went up in AT-6, light plane with Capt Runcraft and looked over area west of Tularosa as far as the mountains, where bombing sites are to be located.

April 16 Wed. Alamogordo. Chantz and Reynolds out to East White Sands and Tularosa sites to check GR3 equipment for tomorrow. Porter and McCurdy working on low frequency equipment for V2 tomorrow. Woodruff, Ball, Work and I went out to Dona site then to Launching Area site. Strung out wires and left equipment for tomorrow's firing. McCurdy working tonight on low freq. Oliva in from San Diego this pm

April 17 Thurs. V2 firing #24 scheduled for 11 am. Chantz - Porter at Tularosa Range; Reynolds - Woodruff at East White Sands, Woodruff with low frequency equipment for 1 trace GR3; Oliva - Kabassa?, radio operator on B-29 at Dona Site, Bill Edmonston arrived by car from Florida about 11 and went out to Dona -- Captain Lewis and myself at Launching Area site. V-2 postponed from 11 to 1610. 9 explosives supposed to go off, SCEL, only 1 worked. Tularosa site - had bad instruments - had 3 working but in line; East White Sands - one short roll, then paper jammed; Dona Site OK; Launching Area site - OK for first 2 rolls, paper jammed on third roll. McDurdy set up low frequency in hanger, north side, and on Rubicon drum but recordings questionable - as SCEL radio transmitter interfered.

April 18 Fri. B-29 took off for Middletown and Newark about 730 from Alamogordo with all personnel that came down with it. Wrote Peoples a letter regarding split-up of equipment so that bombing runs could be continued on East Coast. Plans are to have Edmonston, Reynolds here with 2 sets and take Oliva, Chantz w 2 sites for the East. Set up equipments - Sprengnether & L&N galvanometers for Helgoland experiment & run equipment 1030 to 3 Pm. Checked over all recordings. Oliva and Reynolds out to Dona and brought in all equipment except wire.

April 19 Sat. Into El Paso with Bill E this am. Got reservations to Houston next weekend.

April 20 Sun. Worked on plans for bombing runs and V2 monitoring.

April 21 Mon. Alamogordo Air Base. Bill Edmonston and I went out to Tularosa Range and checked 2 bombing targets, and located third bombing site 7-8 miles west of A1, near alkali flats. Chantz and Porter worked on calculations V2 -#24. Sal worked on equipment. Don off today.

April 22 Tues. Alamogordo. Reynolds - Oliva out to East White Sands. Brought GR3 there in for overhaul. Worked up calibration of GR 8. Got curves for settings of 8 and for changes in attenuation. Talked to St. James, Ordnance Supply, re 500# bombs. Wire from Peoples - Godbee ready to come back - plane ready to come down this week. Sent return wire to hold plane off until after 1 May.

April 23 Wed. Alamogordo. Bill E. and I left Air Base at 0930 and drove to Roswell. Scouted out area between Roswell and Donali? but all irrigated farm lands. Finally back with finding suitable site, 129 miles from Air Base to Roswell. Chantz went Tularosa range GR3 back, Oliva and Reynolds checking GR3 in base, Datn? on calculations April 1 rocket

April 24 Thurs. Phil and Ace working on V-2 recordings April 1 and 8 getting and amplitudes. Sal and Don on GR3, Bill E. on clock checks. Saw Pritchard about Roswell trips, bombing. Saw Post Engineers and Major Mitchell.

April 25 Fri. Sal and I went to Motor Pool and got our driving licenses. Worked up sunshots for Tower and Dona sites, OK within 10 minutes. Bill E and Phil got timbers from scrap pile and went out on Tularosa Bombing Range to build shelters. Sal and Don working on GR3. Left Air Base 130 and left Alamogordo 3 pm. Got room in El Paso at Hotel McCoy.

April 26 Sat. Left El Paso on Continental Air Lines about 0930, went by way of Hobbs, Midland, Odessa, San Angelo to San Antonio. Waited there about 2 hrs and caught Eastern Air Lines out to Houston. Got in about 0630, took bus to Houston and taxi to see Donnie.

April 27 Sun. Houston with Donnie and family

April 28 Mon. Down to Sohio Geophysical office with Donnie and Roy Bennett. Went up to Abbott and Stansell about a car. Caught bus out to airfield 1020 and caught Eastern Air Lines to San Antonio, and Continental Air Lines to El Paso. Arrived El Paso 730 and caught train to Alamogordo, then bus to Air Base. Chantz, Oliva and Bill E. checked over L&Ns, got driving licenses and worked on calibration curves.

April 29 Tues. Alamogordo Air Base. Delayed trip to Silver City to talk over Signal Corps Communication with Peoples, Ball this PM. Went out with Don to East White Sands to set up GR3 and get it working. Lt Thompson in pm. Lt Stevens in on vacation trip. Sal and Bill E got low frequency equipment together and ran test with it at hanger. Possibility rocket will not be fired until Monday acct weather

April 30 Wed. Alamogordo. Phil and Don out to East White Sands and Tularosa sites to get equipment ready for test tomorrow. Set up Rubicon at Tularosa. Sal and Bill E. went to Dona and Launching Area sites to set up equipment. All mikes got out ready for firing.

May 1 Thurs. Out at 2 am. Put up equipment for low frequency run at the north hanger. Out to stations in field - Thompson with Phil at Tularosa - Don and Ace to East White Sands, Sal and Bill E. to Dona and I went to Launching Area site. Rocket misfired at 050009 and all equipment of Signal Corps 'explosions' lost. Picked up equipment from Dona, Launching Area and East White Sands this pm. C-47 in this pm: Dubell, Mosher and Duff. Duff brought in 2 100# bombs with some TNT charges. Bill Godbee in from R.B.

May 2 Friday. Alamogordo. Assembled apparatus to go back to Watson Labs. Phil and Bill Godbee out to Tularosa and picked up all GR3 equipment. Duff, Mosher, Dubell and I went out to Tularosa Bombing Site #2 and shot off 2 100# bombs, using the TNT blocks alongside. All went off OK. Duff got box caps for use. Will cancel 500# bomb order and use just TNT blocks if possible. All equipment loaded on plane this pm.

May 3-4 Sat, Sun. Left Alamogordo about 9 am, Chantz, Porter and myself, 2 Signal Corps men along. Stopped at El Paso and went over to Juarez for pm. Left El Paso about 8 pm. Landed in Scott Field about 4 and found weather bad in East. Stayed at BOQ until 10. Left about 11 and arrived in Middletown, Olmsted Field, about 6. Weather bad in Newark. Stayed in Olmsted Field BOQ

May 5 Mon. Left Olmsted Field at 7 am. In Newark about 8. Trucks in about 11. Loaded equipment and sent to Oakhurst. Arrived Oakhurst about 230. Chantz left for Frenchtown fm Newark

May 6 Tues. Oakhurst. Worked with Vivian and Eileen on their calculations. Eileen working on several? Feb 20 rocket and Vivian on last flights from Oakhurst.

May 7 Wed Oakhurst. Conference am - Dr Delassos? and Leonard from UCLA. Went over T-21 calibration they had - also the results from Alamogordo. Conference pm with Mr--- from AMC Wright Field. Flight scheduled for tomorrow, balloons with instruments going up at Bethlehem - B-17 following balloons with recording equipment and B-29 dropping bombs eastward from Atlantic City.

May 8 Thurs. Oakhurst. Scheduled balloon flight this morning at 730. Mears and men from NYU at Bethlehem with balloons. Trouble with winds and instruments did not go up. Peoples, Moulton over to Middletown with recording equipment on B-17 following balloons. Had no trouble following them. B-29 started dropping bombs near Atlantic City about 8. Trouble with oil leak in a motor and B-29 had to jettison the bombs and return. Recorded at Oakhurst with Brush and GR3. Working today with Eileen on Feb 20 rocket - final ave velocity data

May 9 Fri Oakhurst. Worked on calculations - bombing runs and V2 tests Feb 20. Took sleeper out of NYC for Canton tonight.

May 10 Sat. Canton. Steve and Esther up from Syracuse for weekend.

May 11 Sun. At home. Took sleeper out of Canton for NYC

May 12 Mon. Arrived NYC and caught 0940 out to Asbury Park - then to Oakhurst. Saw Mr Emmons of NYU this pm regarding future flights both here and in Alamogordo.

May 13 Tues. Chantz and I went down to Cape May today with staff car and driver. Located suitable site for bomb recordings on road between Cape May Court House and Goshen. Surveyed out 5 pickup locations and took solar observations. Back in AP about 0800 pm

May 14 Wed - Finished checking up with Chantz and Oliva in regard to bombing runs on east coast. Run scheduled for 9 and 12 on Friday. Packed up all equipment from computing office to go to Alamogordo. Checked transit and rod to go to Alamogordo. Jappett?, new computer, in today. Started him out on work Stepanoff was doing.

May 15 Thurs Oakes, Stevens?, Oliva and myself to Fort Dix this am early. Loaded up C-54 when it arrived, with 229 boxes of TNT, about 12,000#. Carroll - pilot and Hoffman- copilot. Mears, Vivian and Eileen arrived later and we took off Fort Dix about 1130, EDST. Arrived in Fort Worth about 9 EDST. Off again to Big Springs, Texas, where forced to stop account of weather conditions. Stayed overnight at Hotel Supples.

May 16 Fri C-54 arrived at Alamogordo from Big Spring about 930 MST. All TNT unloaded and put in dump. Vivian and Eileen got rooms at girls dorm, Mears and I at BOQ 25. Went over future program with Edmondson, Reynolds and Godbee. Vivian and Eileen in office this pm. Have office in Watson Lab Bldg. Checked out ready to go to Silver City Monday. Got car ready and gas for car. Checked transit and made from field wire chain for 125 meters. Mears and Thompson down to critique at White Sands and to see Capt Smith of Weather Service.

May 17 Sta. Alamogordo. Vivian, Eileen and I worked on May 15 rocket data. Plotted up azimuth angle against elevation angle for Dona and White Sands stations. Plotted azimuth against time for Dona site.

May 18 Sun. Alamogordo. Worked on Dona record, May 15 rocket. Checked through picks - plotted elevation angle against time, calculated elevation and distance from bombing site using straight line plane between launching site and point of impact.

May 19 Mon Reynolds and I left about 0745 in weapon carrier for Silver City. Arrived at Giles National Forest Station about 1230. Got permission for site there and went along valley 16 miles, then back 5 and located site. Surveyed location, dug holes and strung wire. Back to ranger station and located ourselves on range map. Left Bayard about 630 pm. Back at Alamogordo about 1045 pm. Edmondson and Godbee out to record WAC Corporal at Dona site

but it was postponed until Thursday.

May 20 Tues. Edmondson and I left about 0845 in weapon carrier for Roswell. Arrived at Hagerman about 12. Went across Pecos R and found site. Surveyed in locations, dug holes and strung wires. Went over to Roswell Army Air Field, filled up with gas. Checked for room for Bill for Wed and Thurs. Back to Alamogordo about 730 pm. Godbee and Reynolds loaded up one weapon carrier, ready to leave tomorrow. Vivian working on weather data to send back to Watson. Eileen working on March 7 azimuth - elevation plots and checking picks.

May 21 Wed. Reynolds and Godbee left about 800 in loaded weapon carrier. Stopped at gate by SC Lt and had to unload on motor pool weapon carrier acc't bad tires and heavy load on other one. Left about noon for Silver City. Bill Edmondson picked up GR8 and left for Roswell in weapon carrier SC about noon. Got all equipment together for shooting tomorrow. Worked with V and E this pm. Eileen finished checking original data 7 March and started checking April 1 azimuths and elevation angles. V finished azimuths direct waves and started extension of weather data to 288, 18 kms fm sky wave data.

May 22 Thurs. Thompson and I out at 0730 to Ordnance dump. Sgt Rand met us there and let us in area. Picked up 17 boxes of TNT. Shot 1000 at Site 1, 1100 at Site 3, 1200 at Site 3 and 1300 at Site 1 again. Thompson left for El Paso to meet his family, in from Corpus Christi. Worked a little in office PM. Called up Silver City and Roswell tonight, changed schedule of tomorrow from 1100 last one to 1115. Checked AAF clocks over telephone.

May 23 Fri. Went out at 0530 and got sgt Rand. We went out to ammunition dump, picked up 16 boxes of TNT. Sgt Rand to field with me. Shot 0800 Site 1, 0900 Site 2, 1000 Site 3 and 1115 Site 1. Worked on theoretical calculations pm. Bill E in from Roswell about 5 and and Reynolds & Godbee in about 800

May 24 Sat. Went over with Godbee and unloaded his truck, hung his recordings to dry. Went over GR8 records too but didn't see any signals there. GR3 from Silver City has some good sky waves.

May 25 Sun. Tried to get into El Paso to catch train to Houston but Alamogordo train too late to make connections. Back to Alamogordo Air Base.

May 26 Mon. Worked on Tests 1 and 2 records today. No signals from Roswell - some thunder on 2 shots. 5 sky waves from Silver City. Vivian worked on records, Eileen on thunder recordings. Godbee worked am, Bill and Don off today.

May 27 Tues. Worked with V on tests 1 and 2, E back on rocket of April 1. Bill Godbee and Don out to Dona and set up GR3 for Thursday firing.

May 28 Wed. B-17 in from Watson with Mears, Hackman, NYU and Alden. They plan to fly test balloon tomorrow. Other gang with recording equipment, due to leave Watson Sat. Got everything ready for HERMES rocket tomorrow, Dona & White Sands. Finished theoretical calculations of T-X solution of sky waves.

May 29 Thurs. Mears and Hackman got balloon ascension off about 1 PM today with B-17 plane to follow it. Don and Godbee out to Dona, Bill and I to East White Sands to record HERMES. Set for 1100 am, postponed repeatedly, finally fired at 0730 PM. Rocket off course, landed near Juarez, Mexico.

May 30 Fri. Memorial Day. Got 330 bus out of Alamogordo, 1030 train out of El Paso to Houston.

May 31 Sat. Arrived Houston 715, went up to bank 900, then to Abbott - Stansell and picked up car - '42 Chrysler. Went up to Sohio and talked to Donnie and Roy Bennett for an hour. Left Houston about 1145, stayed overnight past Post, Texas.

June 1 Sun. Left 0400, arrived in Alamogordo about 0930 - 800 miles to base from Houston. C-47 with Moore, Schneider and others from NYU. Also Ireland, Minton, Olsen. NYU men worked on balloons today in north hanger.

June 2 Mon. Changed shooting plans to coordinate with balloon flights. Balloon all ready to go. Receiver in plane and receiver on ground. Edmondson with GR8 to Roswell pm, Godbee and Reynolds with GR3 to Silver City. Vivian working on amplitudes of flights - Eileen on April 7 rocket.

Jun 3 Tues. Up at 0230 am ready to fly balloon but abandoned due to cloudy skies. I went out to Tularosa Range and fired charges from 6 on to 12, missed 530 shot - trouble getting ordnance man.

Jun 4 Wed. Out to Tularosa Range and fired charges between 00 and 06 this am. No balloon flights again on account of clouds. Flew regular sono buoy up in cluster of balloons and had good luck on receiver on ground but poor on plane. Out with Thompson pm. Shot charges from 1800 to 2400.

June 5 Thurs. Up at 4 to shoot 2 charges for balloon flight. Whole assembly of constant-altitude balloons set up at 0500. Fired charges at 0537 and 0552, then soon buzzed by plane

to return. Receiver at plane did not work at all. Ground receiver worked for a short time but did not receive explosions. B-17 and most of personnel out to Roswell - recovered equipment some 25 mi east of Roswell. Out at 10 this morning, got TNT and went out to range. Fired shots 12 to 18 every hour. Last of bombing tests this week.

June 6 Fri. NYU personnel getting ready for flight tomorrow. Conference about noon, Hackman with radiosonde, Olsen and Godbee with receiver to Roswell - also Smith on theodolite. Regular equipment in plane. Edmundson and Reynolds to operate equipment at labs - receiver with GR8. Worked on adopting GR8 this pm and this evening. Fired some shots pm at site #4 but no transmitter for sonobuoy. This pm put McCurdy low frequency amplifier in circuit before GR8 and have plenty of signal.

June 7 Sat. Balloon flight off about 530. Dribbler? broken on takeoff. Balloon was to 60,000', broke left balloons then train came down somewhere in mountains. Recordings at north hanger, and at Roswell but plane did not receive. Shot at 6, 630, 7, 730, 8 and 830 at site #4. Plane out to find balloons but no luck. All NYU personnel and John Adden off on B-17 - Lewis, Gallagher. Went over to Alamogordo with Ireland, Minton, Olsen and Mears but no train today - making reservations for tomorrow.

June 8, Sun. Rancher, Sid West, found balloon train 25 mi south of High Rolls in mountains. Contacted him and made arrangements to recover equipment Monday. Got all recordings of balloon flights. Took Ireland, Mears, Winton, Olsen to Alamogordo to catch train this pm

June 9 Mon. Bill Godbee and Don Reynolds went out to Sid West's ranch south of High Rolls and brought back recovered balloons - clock, 2 radiosondes, sonobuoy and microphone and lower part of dribbler. Bill Edmondson cleaning up hanger and sorting out equipment of NYU. Worked today on balloon records (GR8) from north hanger. No definite signals obtained. Took inventory MRs.

June 10 Tues. Bill G, Bill E and Don worked on equipment, repairing GR8, T21 mikes, etc. Getting ready for rocket Thursday. Worked on GR8 recordings from Hagerman, Tests 3,4,5,6. No signals obtained. Worked on balloon tests from Roswell - no signals. V on Gila R tests 3,4,5,6, Eileen on V2 amplitudes.

June 11 Wed. Bill Godbee and I went out to Tularosa Range and located Site #5 for bombing, 24 mi N of Site #3 - roads bad. Laid out wire for shooting, Don and Bill E getting ready for rocket. Checked Rubicon records, all 3 sites.

June 12 Thurs. All rockets postponed until July 3 rocket of S.C.E.L. Bill E, Don, Bill G went down to El Paso and then SE along Rio Grande. Located listening site south of Clint, Texas and layed out wires and dug holes. Worked on bombing flights from Oakhurst.

June 13 Fri. Men off today. V worked on tests 3,4,5,6 Tularosa bombing. E on V-2 rocket amplitudes. I plotted T-X all sky waves and started reviewing March 11 and 17 records.

June 14 Sat. Bill E and family, Don R and family, V, E and I to Carlsbad.

June 15 Sun. Through Carlsbad Caverns and back to Alamogordo.

June 16 Mon. Men off today. Worked on eastern shore cruises, plotting T-X corrected to 68 kms & worked on apparent velocities and differences in azimuth.

June 17 Tues. Men left for Silver City and Febrero? near El Paso for bombing tests. Worked on Cruises.

June 18 Wed. Test 7 of Tularosa Bombing Program, Shots at 7, 930 and 1230. Men called in from field to check clocks. Weather poor - raining at all sites. E on V2 rockets, V Cruises.

June 19 Thurs. Test 8 of Tularosa bombing program, shots at 1600, 1830, 2100, 2400. Weather poor - rainy at Alamogordo.

June 20 Fri Finish of Test 8. Shots at 0000 and 0230, Sites 1,3,5. Men back today. Godbee, Reynolds at Silver City got all shots, Edmondson at El Paso got 1 possibly 2. Looked over all Fabens records today. E on weather data, rocket firings, V on Tests 3,4,7 and Flights.

June 21 Sat Worked on GR8 records from Fabens - calculated azimuth and elevation angles - Fabens recordings and some of Silver City.

June 22 Sun. On trip with V & E - San Cruzes, Hot Springs, Carizzo

Week of Jan 23-28 Alamogordo Air Base. Men worked on equipment for sound ranging Monday and made arrangements for off base transportation, had to get some from Base Motor Pool; Bill G, Don R left am for Gila Valley and Bill E went to Fabens. Tests 9, 10 Wednesday 25 and Thurs, Fri 26-27. Test 9: 7-10-13-16-18 Sites 1-3-5-3-1. Went out with Sgt Rand. Contacted by telephone Wed night and Thursday. Shot 10 Thurs, Fri at 18-21-00-03-05. Out with Sgt Rand again. Men in Fri pm. Good results from west, but poor or nothing from Fabens. Looked over some of Fabens records Sat. V worked on Tests 7-8 getting all data, including amplitudes, then worked on Flights 1-27. Got met data for all flights up to 18 kms except Oct ones. Found one whole minute error in timing on 24A flight which now checks with others



in March. E on new weather calculations 20 Feb. Found adding wind directly to velocity from temp gives accurate enough results. Changed 20 Feb rocket and plotted up altitudes against signal strength - shows nothing significant & started on 1 April rocket. Have all 4 station azimuths about finished. Phil Chantz and Wiggett in by train Friday night. They brought in records of Flights 28, 29 and 30 on east coast - 1 of May and 2 in June. Went over records Saturday and identified signals of 28 -29. Balloon expedition personnel arrived Saturday evening - Peoples, Trakowski, Mears, Ireland, Olsen, Moulton, Alden from AMS and Moore, Schneider, Hackman, Smith, Hazzard, 2 others and a Lt Smith from Navy NYU. 29 June (Sun) NYU personnel and some of Watson Lab men working today with equipment in north hanger. Went to Ruidoso with Mears, Trakowski, Godbee, V & E. Week of 30 June - 5 July '47 Alamogordo. Vivian worked on Tests 9 and 10, finishing all upward data on GR3 recordings. Eileen worked on 1 April rocket, getting signal strengths vs altitude (corrected for weather data) and started on time calculations to get time of signal for correlation purposes. Appears likely that strength of signal is dependent on station factors rather than anything about rocket.

Balloon tests? 7, 8, 9, and 10 off this week. Test 7, slated for 1 July postponed until 2 July as equipment was not ready. 100 tanks Helium obtained from Amarillo Monday evening. Also radiosonde receivers set up by NYU personnel Monday but were not operable. Test 7 at dawn on July 2 with pibal 1 hr first following with theodolite. Winds were very light and balloons up between A air base and mountains most of time. Included cluster of met balloons. Followed by C-54? for several hours & finally landed in mountains near road to Cloudcroft. Before gear could be recovered, most of it had been stolen. Stations operating at north hanger, Cloudcroft and Roswell. Shots made unfortunately at Site #4 and picked up good from north hanger and from Cloudcroft for awhile. Nothing from Roswell. On Thursday morning 3 July, a cluster of GM plastic balloons sent up for V2 recording but V2 was not fired. No shots fired. Balloons up for some time. No recordings from Roswell as pibal showed no W winds. Balloons picked up by radar WL and hunted by Manjak C-45. Located on Tularosa Range by air. Out pm with several NYU by weapon carrier but we never located it. Rocket postponed until 730 Thursday night but at last minute before balloon went up, V2 was called off on account of accident at White Sands. Sent up cluster balloons with dummy load. Balloon flight #10 at dawn on July 5th. Had gone out in C-45 again with Moser and Dubell to hunt for balloon from Flight 8 but not since? we found them. C-54 went to El Paso and picked up single Smith plastic balloon and GM cluster plastic balloons. Flight 10 with single plastic followed from Alamogordo and Cloudcroft. Shot 8 shots from Site 4. Picked up most and lost signal at 845. Balloons ? more than 6 hrs although time clock had been put in to bring them down after 5 hrs. ? were picked up by ? C-45 as first flight out was delayed. Had special balloon at 7 with explosive charge which went off at 35,000 ft and at 745 but by that time the receiver had lost the signal. Followed by radiosonde series until after 1300. Cloudcroft off at 8 and doubtful about signals received.

Peoples and Trakowski up 4 July with Dr. O'Day of CFS to Alamo Tower ---- ? Solar Observatory the SCEL station. Schneider up with O'Day to check use as NYU station.

Alamogordo crew helped get helium, and did ground shooting of 2 July. Out July 3 at Dona and Launching sites at 2 pm and later at night.

Finished identification on Flights 28, 29 and 30 on east coast and made plans for Bermuda flights.

Unable to leave for home on 3 July as was planned and wired Donnie first part of week if he could change his schedule and go home following week. Got wire back that he had decided not to make the trip.

July 6 (Sun). Worked at office on flights and rocket data. Started on plans for speech 17 July meeting NYU - Getting ready for Flight 11. Plans are to put up Smith balloon with GM ? plastics + simple met balloon sonobuoy + balloon bomb.

July 7 (Mon) Alamogordo. Balloon Flight 11 A off at 0503. Big plastic with small auxiliary plastics. WL gear - radiosonde and dribbler. Followed with theodolite and receiver until about 11. Picked up on radiosonde receiver at Roswell and followed them. Finally came down (at 10,000' cap should have punctured plastic) near Hwy 70 between Roswell and Tularosa. Second balloon - met balloons with radio sonde up about 630. Third balloon with 2 1/2 # stick TNT and caps set by pressure element to fire at 35,000' up at 0630. Surface bombing at Site 4 from 545 to 845 at 15 min intervals. Ireland followed main receiver only about 3/4 hr but followed radio sonde about 3 hrs. 35,000' explosion off about 655.

Vivian got all instructions for completing work on Flights 1-30 and picked all records and filed. Sent off TWX re Bermuda Flight and wrote up memo on it. Worked with Eileen on

April 1 rocket plotting H-SS, H-T, SS-T.

July 8(Tues) Alamogordo. C-54 off about 1030 with 23 people - all NYU, WL including J, E, Godbee. Lt Thompson, Edmondson, Reynolds and myself left. Wrote up report on East Coast Flights for Peoples.

July 9(Wed) Alamogordo. Worked today on balloon flights. Studied WL records of them briefly and wrote a memorandum to Peoples about results. Left in car this PM late. Flat tire between Roswell and Tularosa and stayed there.

July 10 Thurs. Changed tire and went into Roswell. Bought new tire. On to El Reno, Okla today. Stopped in cafe in Hereford, Texas and met Dannie Harns from UGC. Went up to office and saw Bob Cowder?, PC and Gene Conant, supervisor.

July 11 Fri. From El Rosa to Cherokee. Got note at Cherokee that Jimmie was at Tonkawa and went over there. Stayed tonight with J & family.

July 12 Sat. Jim, Pat, Vanessa along with me on way home. Got to Doolittle, Ark tonight.

July 13 Sun. to cabins in Ohio just out of Springfield.

July 14 Mon. To cabins near Geneva, N.Y.

July 15 Tues. Stopped at Syracuse. Got home about 230. Marion & her baby there.

July 16, 17, 18 At home. Drew in 4 or 5 loads of hay but land very wet and rains intermittently.

July 19 Sat. Marion and I left in Chrysler for Woods Hole to see Dorothy & family. Through Albany, Springfield, Providence. 463 miles 12 hours. Doc Ewing on Atlantic cruise. Worzel working on gravity at sea. Saw Geo Woollard and the Ryders. Woollard after Guggenheim fellowship for next year - positions at WHOI and Princeton are ? very satisfactory.

July 20 Sun. Saw men working with Worzel at WHOI, Pollak, went over to Vine's new house, saw Kit and Bump at their house, then out to Ewings, saw Midge & children, Anne and Mikey.

July 21 Mon. Went down to WHOI, saw Pollak, Bumpus, Worthington. Up 3rd floor and saw Emmons of NYU, who is finishing up some research work there under Ray Montgomery. Talked with Columbus Iselin for short time. Saw Gil Oakley. Marion & I left about 11 am. Went through Providence, Hartford. Crossed river at Hudson. Met rain last part of trip, not home until 130. Jim & family spent weekend with Steve and Esther in Syracuse.

July 22, 23, 24 At home. Drew in a little more hay from lot in front of barn but still raining quite often. Jimmie & family took Thursday PM train to Syracuse to catch tomorrow's plane to Wichita, Kansas.

July 25, 26, 27 At home. Steve and Esther came up Sat night. Marion and I went to Watertown to pick them up at bus station at midnight. They left again Sun pm on bus from Canton. Chas Crary up from Canton Sunday PM

July 28, 29, 30, 31, Aug 1. At home. Chrysler to Canton, change plugs, reline wheels - Rained hard first part of week then clear. Got in lots in back of barn, north of road and front of house.

Aug 2 Sat. Marion - Bunny and I left 1230 PM, arrived Marcellus about 5 PM. Ate dinner with Steve and Esther, left Marcellus 730 PM. Through Binghamton, Scranton, Stroudsburg, Easton. Arrived in Newtown about 245 am.

Aug 3 Sun. In Newton with Flagg for dinner. Left Newtown about 5 PM. Arrived Jersey Coast. Got room on Hwy 35 near White Bite Shop.

Aug 4 Mon. Up to Oakhurst. Went over developments to date with Jim Peoples. Out to lunch with Lt Ball. This PM Chantz and I surveyed to Sonobuoy site.

Aug 5 Tues. Oakhurst. Worked on Aberdeen results - 2 failures - 1 direct wave. - Worked on Bermuda run # 2 - Oakhurst and started Bermuda #2 C.N.C.H., Peoples on vacation starting today.

Aug 6, 7, 8 Wed, Thurs, Fri. Oakhurst. Worked on Cruises 1 -28 with Vivian and Epstein. Checked over all recordings of Bermuda #2, Flight 32. Got sonobuoy survey calculated and worked up results of Flight 25 B which depended on sonobuoy signal. Started Epstein on weather data which Wiggett is working on. Wrote letter to Emmons with remaining work to be done there. Conference Wed pm with Clowry, Carroll, Dubell, Bernhoff of Olmsted regarding Bermuda and Alamogordo plans. Mr Mears put up balloons with equipment on here at Oakhurst. Reynolds and Edmondson in and working around lab. Worked some with Eileen on rockets.

Aug 9, 10 Asbury Park

Aug 11, 12, 13, 14, 15, 16 Oakhurst. Wrote memo regarding Alaskan work and had copies typed up. Worked most of week on rockets. Plotted altitude against time of origin for April 1, 8 rockets but did not get identical graphs. Tried to vary distance to obtain similar curves but this was not possible. Made plots of time vs SS and altitude vs SS in effort to correlate signals between stations. Correlated fairly good on 1 April but poor on 8 April.

New York University  
*Progress Report* [No. 7]  
*Constant Level Balloon*, Section II  
July 1947

---

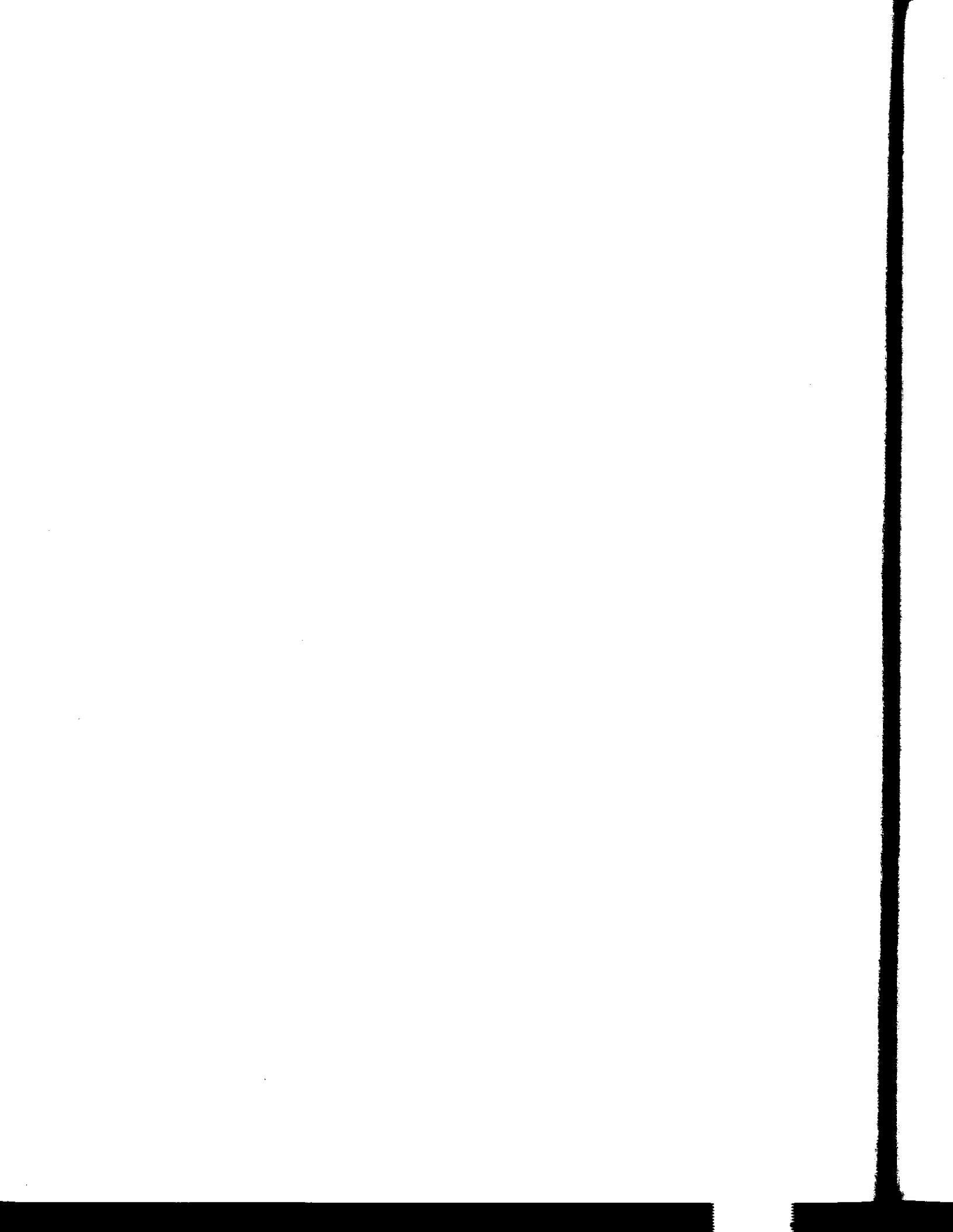

PROGRESS REPORT

Covering Period from June 1, 1947 to  
June 31, 1947

CONSTANT LEVEL BALLOON

Section II

Research Division, Project No. 93

Prepared in Accordance with Provisions of Contract  
W23-099 ac-241, between  
Watson Laboratories, Red Bank, New Jersey  
and  
New York University

Prepared by  
Charles S. Schneider

Approved by  
Professor Athelstan F. Spilhaus  
Director of Research

Research Division  
College of Engineering  
July, 1947

II. ABSTRACT

The first successful, though nominal, constant level flight was made in a series of launchings at Alamogordo, New Mexico. Navy permission was given for New York University to purchase the Navy-sponsored polyethylene balloons from General Mills. This opens up the first source of large, light-weight plastic balloons. First delivery was made on the subcontract with H. A. Smith Coatings, Inc. for the 15-foot diameter heavy polyethylene balloons. Improved type ballast reservoir was designed and procurement started. Equipment was prepared for a second series of flights at Alamogordo in July.

III. a. PERSONNEL

The following men were hired:

<u>Name</u>	<u>Duties</u>	<u>Qualifications</u>
Dorion, Richard	Navigator, Draftsman	Former B-17 Radar Navigator. Undergraduate Mechanical Engineering Student.
Higgins, Robert L.	Equipment Construction	Undergraduate Mechanical Engineering Student. Army Instrument Mechanic at Oak Ridge.
Morrell, Paul	Equipment Construction	Undergraduate Engineering Student. Merchant Marine Engineer.

ADMINISTRATIVE ACTION

Clearance was obtained from the U. S. Navy for the purchase of plastic balloons from General Mills, Inc., Minneapolis, Minnesota.

b. COMMUNICATIONS

6/18(1) Correspondence during this period was as follows:

<u>Date of Correspondence</u>	<u>Address</u>	<u>Abstract</u>	<u>Answer</u>
6/18/47	Mr. A. P. Crary, Watson Labs., AMO, Alamogordo AAF, N.M.	Forwarding check for equipment recovery reward	None required

<u>Date of Correspondence</u>	<u>Address</u>	<u>Abstract</u>	<u>Answer</u>
6/16/47	Mr. F. M. Cooper 959 Whittier Ave. Akron 2, Ohio	Specification of large balloon sent and appointment requested to discuss manufacture	Considering problem before mailing bid.
6/19/47	Contracting Officer, Watson Laboratories Red Bank, N. J.	Enclosing copies of Special Report #1	None required.
6/19/47	Mr. Douglas Rigney Watson Laboratories Red Bank, N. J.	Request for additional Army weather equipment	Being procured.
6/23/47	Chief of U. S. Weather Bureau Washington 25, D. C. Atts: Mr. B. C. Haynes	Request for Big Springs radio-sonde station to monitor Alamo-gordo flights	Active cooperation received.
6/23/47	Kollman Instrument Div. Square D Company Elmhurst, N. Y. Atts: Mr. Paul Goudy	Order to modify dribble mounting and rate of flow.	Complied with.
6/24/47	WIRE Mr. O. C. Winsen General Mills Minneapolis, Minn.	Request 7 foot balloons have means of attaching shroud lines to carry load.	Complied with.
6/26/47	Mr. O. C. Winsen General Mills Minneapolis, Minn.	Order to ship remaining 7-foot balloons to El Paso. Request for estimate on ballast gripping devices.	Complied with. General Mills awaiting ballast sample.

(2) Conferences

The following conferences were held during the month of June:

<u>Date</u>	<u>People Present</u>	<u>Where Held</u>	<u>Discussed</u>	<u>Conclusions</u>
6/12/47	H. A. Smith, Messrs. Schneider, Moore	New York University	Manufacture of Poly- ethylene balloons for this project.	2 each 15 ft. dia- meter balloons would be completed by 1 July.
6/15/47	Dr. Peoples, Messrs. Ireland, Mears, of Watson Laboratories, Messrs. Schneider, Moore, J. K. Smith, Hackman of N.Y.U.	Watson Laboratories Red Bank, N. J.	Results of Alamogordo flights	Communications will be improved, next flight's set- up accomplished.
6/17/47	Mr. Paul Goudy, G. B. Moore	Kollman Instrument Co.	Modification of the Ballast valve	
6/20/47	H. A. Smith, Messrs. Moore, J. K. Smith	New York University	Different types of solid ballast	Granular lead is better than sand or various powders.
6/25/47	Mr. Gordon Vaeth, Commander G. W. Hoover, J. K. Smith, G. B. Moore	Sands Point Office of Naval Research, Port Washington, L. I., N. Y.	Request for clearance on General Mills Bal- loons. Request for Lt. H. F. Smith (USNR) to accompany project to Alamogordo.	Granted.



c. 1. GENERAL WORK ACCOMPLISHED

Field tests were conducted at Alamogordo Army Air Base during the week of June 1, using clusters of meteorological balloons. The primary object of these tests was to perfect handling and launching techniques for large flights and to check the operation of the various altitude controlling devices developed for this project. At the same time, the tests afforded the opportunity to carry aloft payloads of Watson Laboratories equipment. In general, while the flights were successful in the sense of carrying Watson Laboratory gear aloft for an extended period of time, difficulties and materiel failures encountered served to emphasize the unsatisfactory characteristics of meteorological balloon clusters. A technical report under preparation will contain discussion of the flights.

After the return from Alamogordo, the remainder of the month was occupied with preparations for a second field trip to Alamogordo Army Air Base for tests to be conducted in July.

Twenty-five seven-foot diameter 1 mil. thick polyethylene balloons were received from General Mills. One each fifteen-foot diameter 8 mil. thick polyethylene balloons was received from H. A. Smith, Inc.

A seven-man balloon crew departed for Alamogordo Army Air Base on June 27 to make the second series of launchings there.

The plastic ballast reservoir used for the first flights in New Mexico was too fragile to take launching stresses. An aluminum reservoir, mounted on legs containing a built-in filter was designed and a supplier was located. The capacity of the new reservoir is 5 gallons (30#) though it will weigh only 2 pounds. It is believed that the aluminum reservoirs if recovered may be used repeatedly.

2. Specific Problems

The greatest problem encountered during the field tests at Alamogordo was the unpredictable and highly variable effect of superheat on meteorological balloons. The unpredictable increase in lift of the cluster under the rays of the sun was as much as 25% higher than the initial lift. This in several instances resulted in the inability of altitude control balloon cut-offs to stop the ascent of the balloon train at the desired altitude.

The extreme low temperatures encountered at high altitudes apparently has considerable effect on the operation of electrical equipment used in altitude control.

In several cases squibs used for altitude control failed to fire at extremely high altitudes. It is believed that placing a small load on batteries may help keep cells warm enough to produce the necessary voltage at high altitude on future flights.

### 3. Limitations

The greatest factor hindering the progress of work is still the lack of available space at New York University.

#### d. METHODS OF ATTACK

Field tests at Alamogordo indicated that a Helios-type cluster is much superior to a long cosmic-ray type flying line in case of fabrication, handling and launching when it is necessary to use clusters. Therefore, this type of cluster where the balloons are all at the same level, will be used on all future multiple balloon flights.

Large plastic balloons have been obtained and will be flown at Alamogordo during the tests to be conducted in July.

#### e. APPARATUS AND EQUIPMENT

The main sand ballast-dropping device was improved as a result of experiments at Alamogordo by constructing the ballast tubes of aluminum rather than plastic, and by using stronger paper diaphragms as the frangible support for the ballast.

#### f. CONCLUSIONS AND RECOMMENDATIONS

Opinion has been strengthened that clusters of meteorological balloons will never be a satisfactory method of achieving constant altitude for long period flights. Various factors which weigh against the success of such flights are: the inherent vertical instability of extensible balloons; the rapid deterioration of neoprene under the rays of the sun (average 6 hour life); the complex set of ballast and lifting equipment required; the variable and indeterminate effects of superheat; and the difficulty of launching a long train assembly, even under the best conditions.

In general, equipment must be strengthened and higher safety factors must be used to withstand the strains of launching and the oscillations of the balloon train in flight.

One or more observation posts, downwind, are needed for Alamogordo releases; each post should have theodolite and radiosonde observers and equipment. Better communications between, and coordination of observation posts is vital for satisfactory

tracking of balloons in flight. Aerial observation of the balloons greatly assists interpretation of performance data. Better radio transmission of data is needed from the balloon.

#### IV. FUTURE WORK

Plastic balloons have been obtained from both General Mills and H. A. Smith, Inc. and will be flown on the next field trip to Alamogordo in July. Arrangements have been completed to obtain as large a supply as is necessary of these balloons and tests will be conducted frequently to perfect a technique of maintaining a balloon at nominal constant altitude.

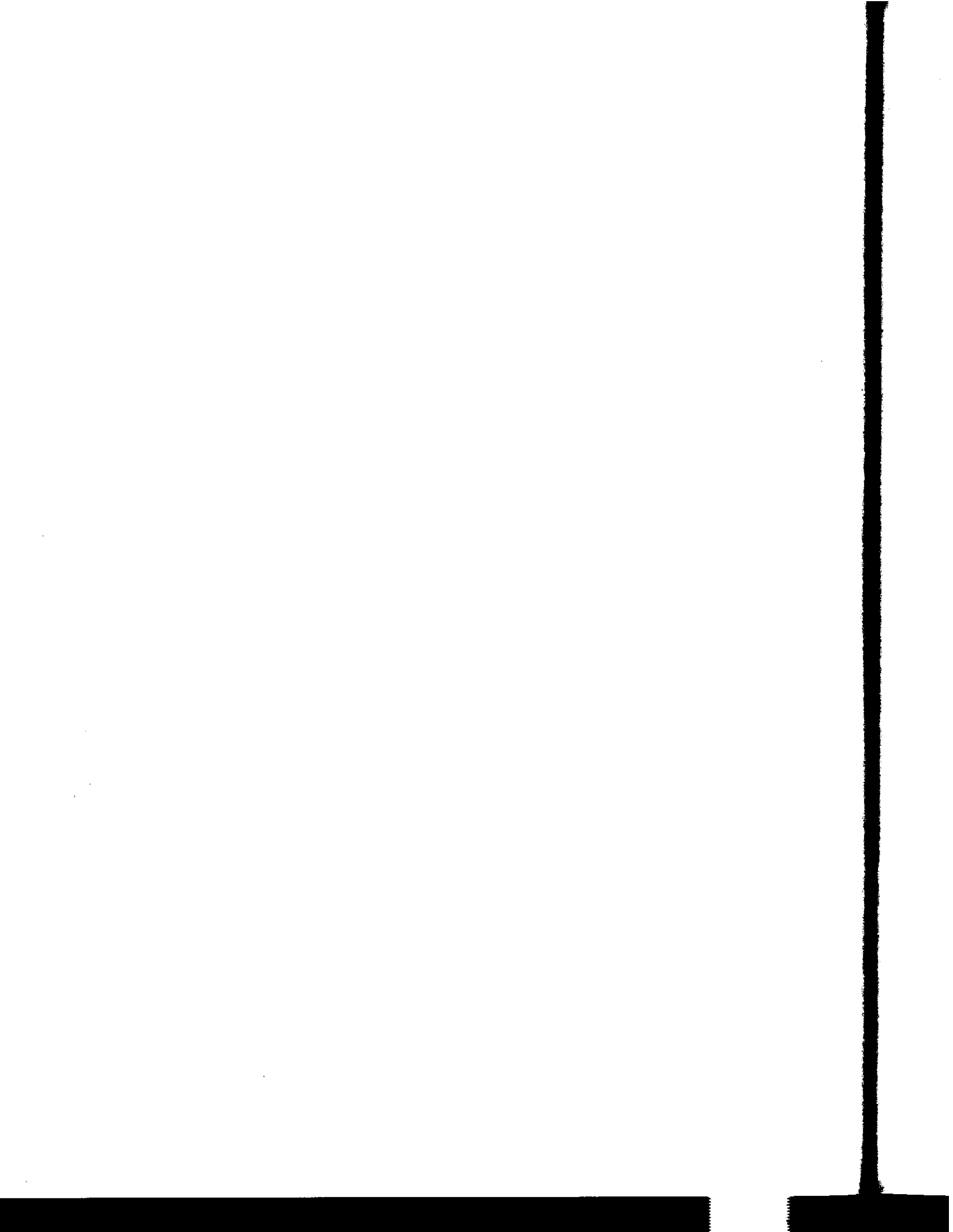

New York University  
*Progress Report No. 4*  
*Radio Transmitting Receiving and*  
*Recording System for Constant*  
*Level Balloon*

[Section I]  
April 2, 1947

---

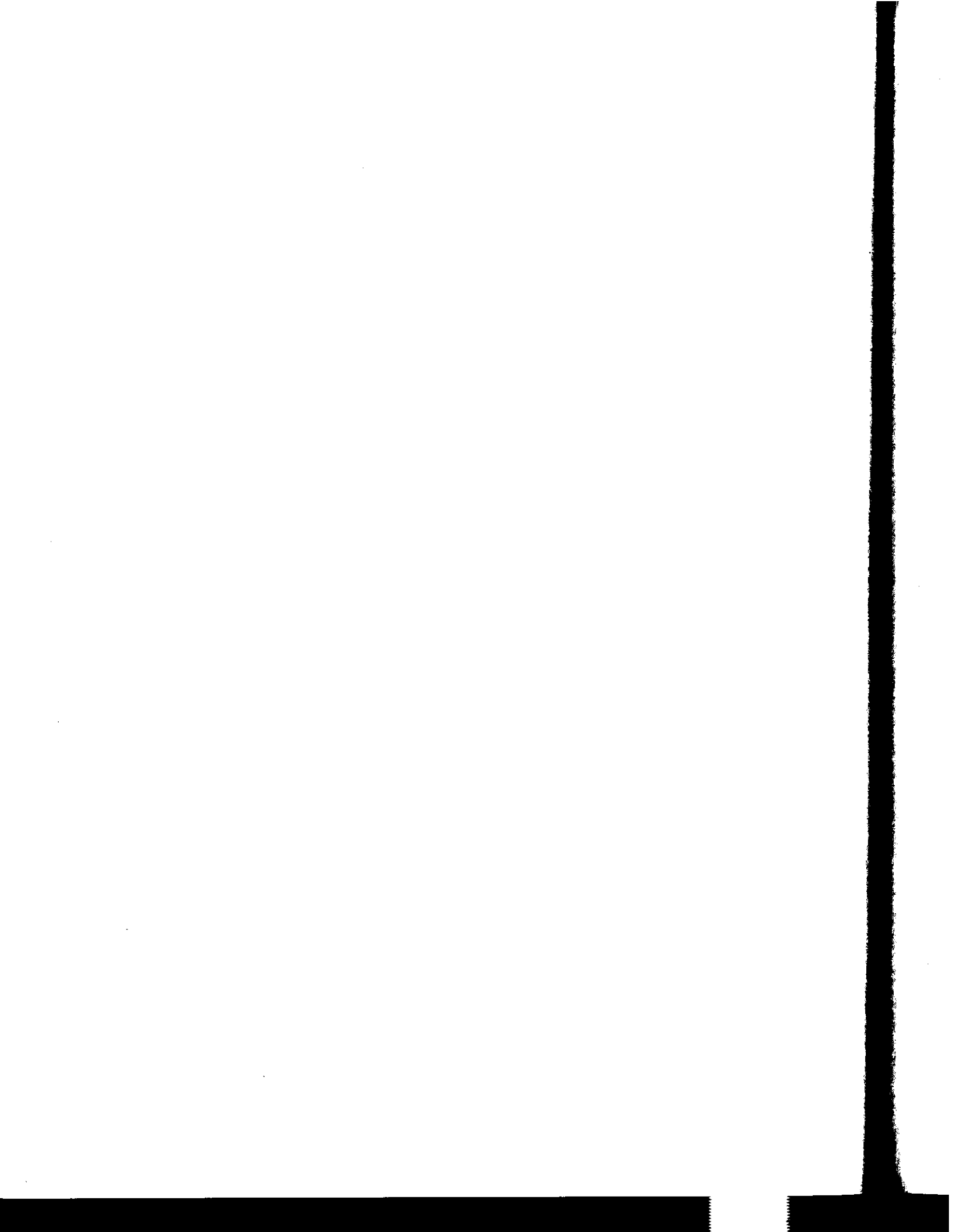

Rot 3 (rev 4)

# COLLEGE OF ENGINEERING NEW YORK UNIVERSITY



LIBRARY OF THE  
COLLEGE OF ENGINEERING  
NEW YORK UNIVERSITY

REPORT BY THE  
ENGINEERING RESEARCH DIVISION

4  
PROGRESS REPORT NO. 8 ~~8~~

Covering Period from March 1, 1947 to  
March 31, 1947

**RADIO TRANSMITTING, RECEIVING AND RECORDING SYSTEM  
FOR CONSTANT LEVEL BALLOON**

Research Division, Project No. 95

Prepared in Accordance with Provisions of Contract  
W28-099 ac-241, between  
Watson Laboratories, Red Bank, New Jersey  
and  
New York University

Prepared by

Prof. Philip Greenstein  
Project Director  
Department of Electrical Engineering

Approved by

  
Renato Contini  
Acting Director of Research

Research Division  
College of Engineering  
April 2, 1947



## ABSTRACT

During the period covered by this report, work was continued on developing an FM transmitter. Tests were made on FM Radio Receiver R-2a/ARR-5 and Radio Transmitter T-1B/CRT-1 to determine their performance characteristics, and compare the results with the transmitter system under development.

Necessary field equipment was constructed and an antenna was erected in preparation for field testing of the completed AM transmitter. A duplicate model of the AM transmitter was constructed and built into a container with a battery pack and simulated signal circuit.

### a. PERSONNEL AND ADMINISTRATION

No change

### b. COMMUNICATIONS

None

### c. GENERAL WORK UNDERTAKEN DURING THIS PERIOD

It was called to our attention by the Watson Laboratories, Oakhurst Field Station, that the FM radio transmitter T 1-b/CRT, which is a unit of Eonobuoy equipment AM/CRT-1, might have application in this project. Five of these transmitters were purchased from a surplus radio supply house. These units were tested for frequency stability under conditions of variation in plate and filament voltages. Deviation measurements were made at several values of plate voltage. These tests indicated that this transmitter would probably be unsatisfactory without a system of automatic frequency control. The receiver used with transmitter, R-2a/ARR-5, has an a.f.c. circuit incorporated. A receiver of this type was borrowed from the Oakhurst Field Station. Tests were conducted to determine the overall frequency drift which could be tolerated in the transmitter before retuning became necessary. It was observed that as great as a  $\pm 0.35$  mc shift could be tolerated at the transmitter. Further tests on the transmitter showed that the frequency deviation varied with input plate voltage and that as the battery depreciated, an error would be introduced in any amplitude measurement. For a plate voltage change from 135 to 90 volts, a variation in detected amplitude of over 20% was observed.

Further tests on the FM transmitter being developed at this laboratory showed that the deviation was likewise a function of the applied plate supply voltage. This problem will have to be solved by improved circuit design before a suitable FM transmitter can be evolved.

In addition to the AM transmitter model already constructed, a second unit was built. This duplicate was installed in a cardboard container which also houses the storage battery supply and a blocking oscillator to supply an audio-frequency which modulates the carrier at 50 c.p.s. Plans and arrangements were made for testing this unit on a captive balloon.

d. APPARATUS

A battery box containing a metered circuit for constant monitoring of transmitter currents were constructed for field or blimp transmission tests.

An antenna approximately 150 ft. in length was erected on poles twenty feet above the roof of the Electrical Engineering Building for use in receiving signals during test flights.

e. FUTURE WORK

In view of the excellent characteristics of the automatic frequency control of the Radio Receiver R-2a/ARR-5, an attempt will be made to secure the circuit diagram of this equipment and employ its use in any FM receiver which might be used.

Further circuit investigation will be carried out to develop an FM transmitter which is free of the undesirable effects introduced by input voltage variations.

Field tests will be carried out on the AM transmitter using a tethered balloon and a blimp, if available. It is desired to obtain information about the operating range and difficulties which might develop with this transmitter.

  
Philip Greenstein  
Project Director

Interview  
Col Jeffrey Butler and 1st Lt James  
McAndrew with Professor Charles  
B. Moore  
June 8, 1994

---

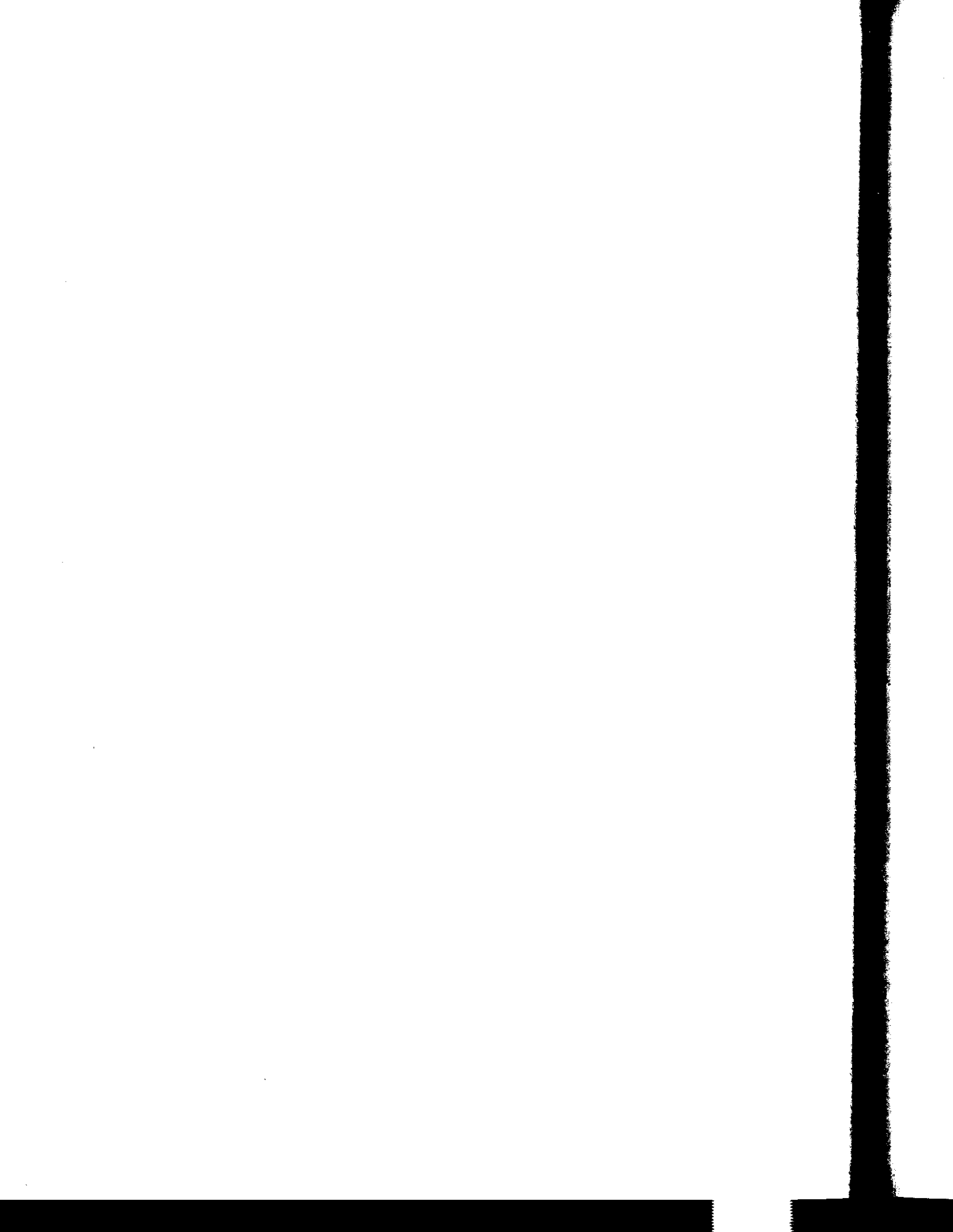

Same as  
Weaver Attachment 23

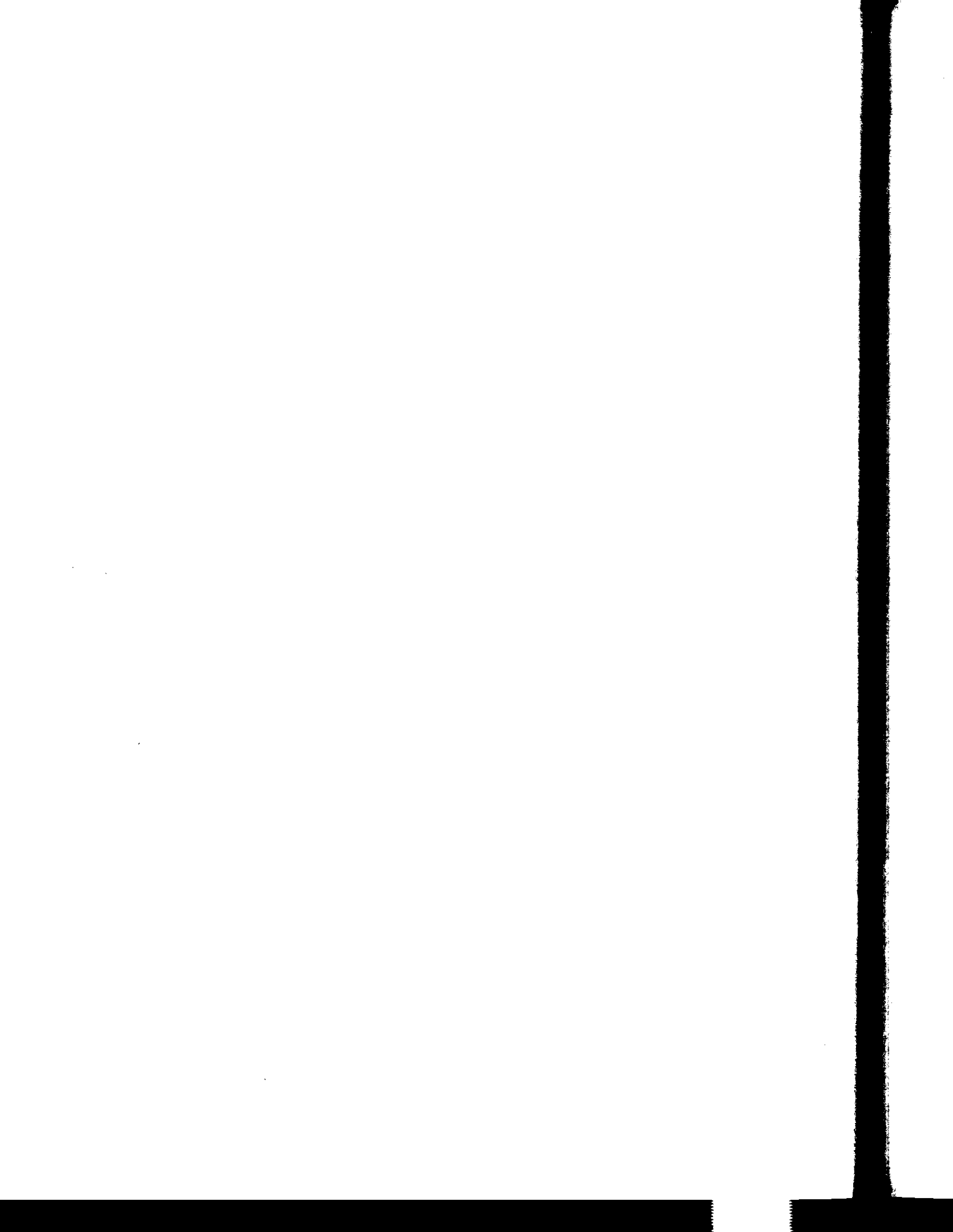

Report [Selected Pages]  
Holloman AFB  
"Progress Summary Report on  
U.S.A.F. Guided Missile Test  
Activities"  
August 1, 1948

---

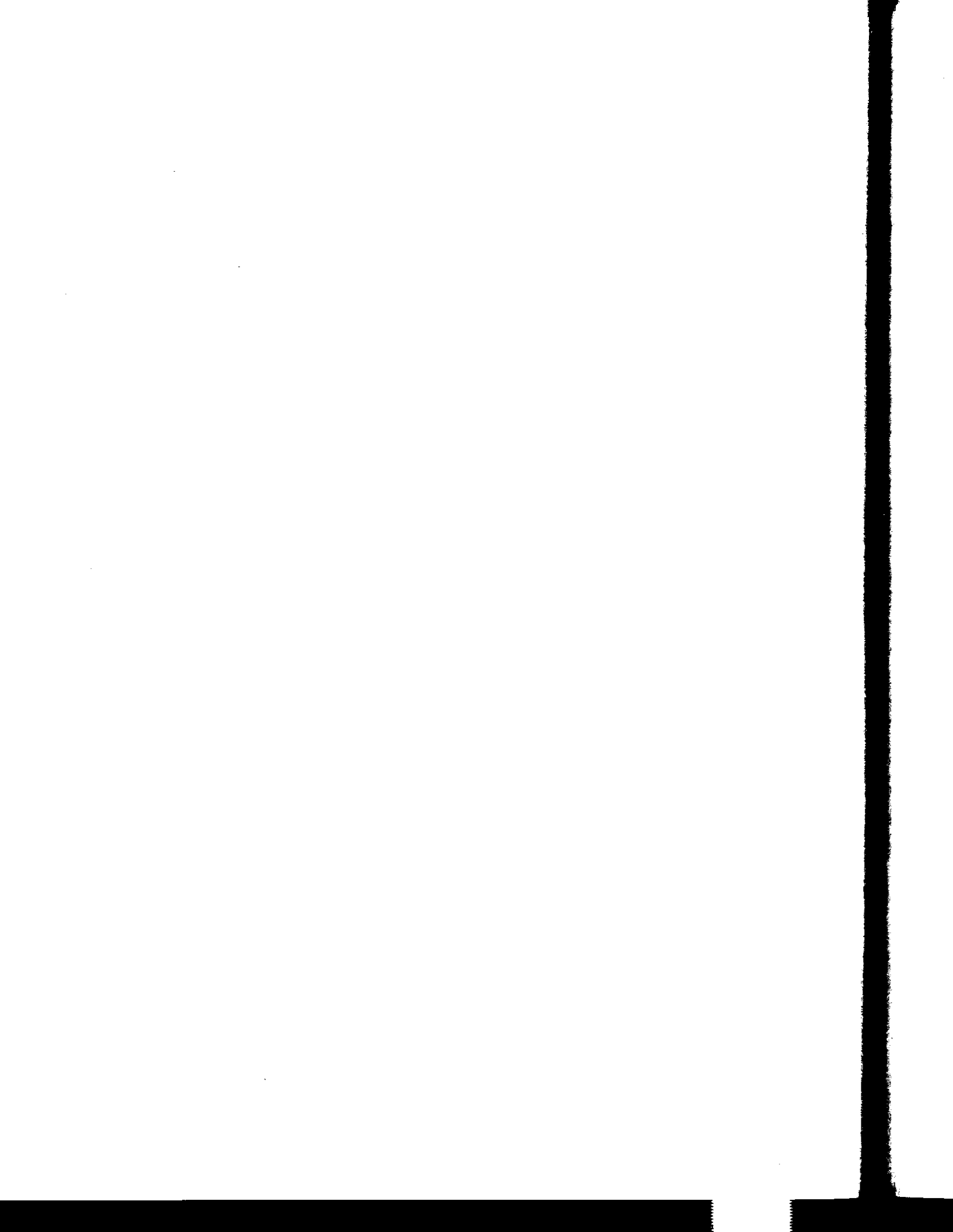





47-539

*Follow*

AIR FORCE BASE  
ALAMOGORDO, NEW MEXICO

SUPER MISSILE  
ES —

VOL. 1 1 AUG. '48 NO. 10

COPY # 10

HOLLOMAN AIR FORCE BASE  
Alamogordo, New Mexico

PROGRESS SUMMARY REPORT

on

U. S. A. F

GUIDED MISSILE TEST ACTIVITIES

Compiled by:



D. M. BROWN,  
Major, USAF,  
Director of Technical  
Information Division

Reviewed by:



THOMAS R. WADDLETON,  
Lt. Colonel, U S A F  
Deputy for Operations  
and Projects

Approved by:

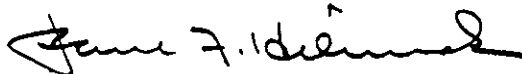

PAUL F. HELMICK,  
Colonel, U S A F  
Commanding

~~SECRET~~

S-E-C-R-E-T

MAN COPY  
NONRECORD

Vol I

1 August 1948

No. 10

Copy \* 50

PERMANENT  
RECORD

This document contains information affecting the National Defense of the United States within the meaning of the Espionage Act, 50, U. S. C. 31 and 32. Its transmission or the revelation of its contents in any manner to an unauthorized person is prohibited by law.

**DOWNGRADED AT 3 YEAR INTERVALS:  
DECLASSIFIED AFTER 12 YEARS  
DOD DIR 8100.10**

radar station was not troubled by this phenomenon due to its antenna directivity and elevation orientation of 60 degrees. It is believed that the intermediate loss of signal by the radar station is normal because of elevation pattern lobing produced by ground-reflection interference which is initiated by secondary antenna lobe transmission. Since this condition exists in the transmitting pattern, it affects both the radar station and its remote receiving station. Current effort is concentrated on improvement of photography and antenna orientation in preparation for additional tests.

b. Tracking Projects:

- (1) Radar Tracking Set AN/MPS-6 - A letter was received from Watson Laboratories authorizing changes and modifications of the range circuits necessary for conditions as encountered at this location. The fore part of July was spent in achieving these betterments, and in the installation and orientation of an M-2 optical tracker to be used in conjunction with the MPS-6 and as a tracking aid.

Experimental tracking of three balloons furnished and flown by the Atmospheric Group was performed for the dual purpose of checking the signal return of the radar with various reflecting targets, and for precise position data of the balloon equipment for use by the Atmospheric Group. On 19 July, a 130 foot balloon carrying no radar reflector was tracked. Radar contact was made at a range of about 3K yards with signal return being above saturation on the scopes of the MPS-6. Tracking was automatic in Azimuth and Elevation and aided in range. Signal return remained above saturation until a range of 7K yards was read, at which point grass appeared on the scopes and signal to noise averaged about 4 to 1 out to a range of 23K yards where too frequent radar losses necessitated that automatic tracking be abandoned. This balloon was then tracked manually to a maximum range of 27K yards.

On 20 July 1948, a weather balloon carrying one kite type reflector was flown and tracked. Contact was made at a range of 3K yards, and signal return was above saturation at all times until a range of 10K was exceeded and grass showed only occasionally out to 24,360 yards. This balloon was obscured by clouds at a range of 33K yards, but tracking was continuous in automatic Azimuth and Elevation throughout its flight, and the maximum range read was 34K yards.

On 21 July, a 130 foot balloon, identical with the one flown on 19 July except for three kite reflectors being carried, was flown and tracked. Radar contact was made at a range of 1,510 yards. Grass first appeared on scopes at a range of 24.5K yards, and signal was above saturation to 30K yards. Tracking was continuous and automatic throughout the flight, and a maximum range of 121K yards was reached.

Permission to use the MPS-6 in tracking further V-2 missiles having been received, plans were formulated for operation in conjunction with the missile scheduled to be fired Thursday, 22 July and postponed until Monday, 26 July at 1100. Plans contemplated that the crew on the M-2 Optical Tracker would track visually at all times during the flight with their elevation and azimuth readings repeated on the antenna. The MPS-6 antenna was initially positioned in azimuth on the calculated bearing to the launcher and raised slightly above the horizon in elevation, with the correct range gated on the scopes and with a velocity of about 300 MPH set in the aided range motor and the motor initially stopped. It was further planned that when target echo would bloom on the scopes, the echo should be trued up in Azimuth, Elevation, and Range; and antenna control would be thrown to automatic with range followed manually until speed of the missile approximated the 300 MPH as set on the motors, at which time the video motor would be activated and range tracking thrown to "Aided." It was planned to throw antenna control to the M-2 Tracker only if target failed to show or if extended "loss" subsequently occurred.

During the half-hour period prior to the take-off, several random aircraft were noted in the vicinity of the launcher; and at X-5 minutes, one low flying aircraft was observed on the scopes at a range beyond the launcher directly in line with it and flying in towards the launcher.

Timing signals and the zero signal were received, and at about X plus 2 seconds the target "bloomed" on the J Scopes at the calculated range to the launcher (62,800 yards). This pip went almost instantly to far beyond saturation, and all grass disappeared from the scopes. The Azimuth and Elevation, and Range controls were centered on the target, and antenna control was thrown to automatic. Range started to slowly increase as did elevation with azimuth being stationary. The echo remained beyond saturation for about two seconds after automatic control was thrown in, at which time grass appeared on the scopes and the signal fell rapidly to zero and the antenna whirled off target at about X plus 6 seconds. Upon returning antenna to position manually, a strong target appeared at a range of about 2K yards outside the range gate, and believing this to be the rocket, this pip was trued up and antenna locked in "Automatic" and this target was tracked for a period of about 10 seconds or until it was noted that range was decreasing and elevation was stationary at the horizon while the M-2 Elevation repeater showed the optical tracker to be looking at approximately 50 degrees. Realizing that the target being followed was the aircraft noticed before take-off, antenna control was transferred to the optical tracker and left in its control until the M-2 crew lost the missile. During this time, no target was visible at any time and no further radar contact was made with the missile. However, slightly before the missile impact was heard, a cluster of small echoes were found at a

Interview

[Col Jeffrey Butler and 1st Lt James  
McAndrew with] Col Albert  
Trakowski, USAF (Ret)

June 29, 1994

---

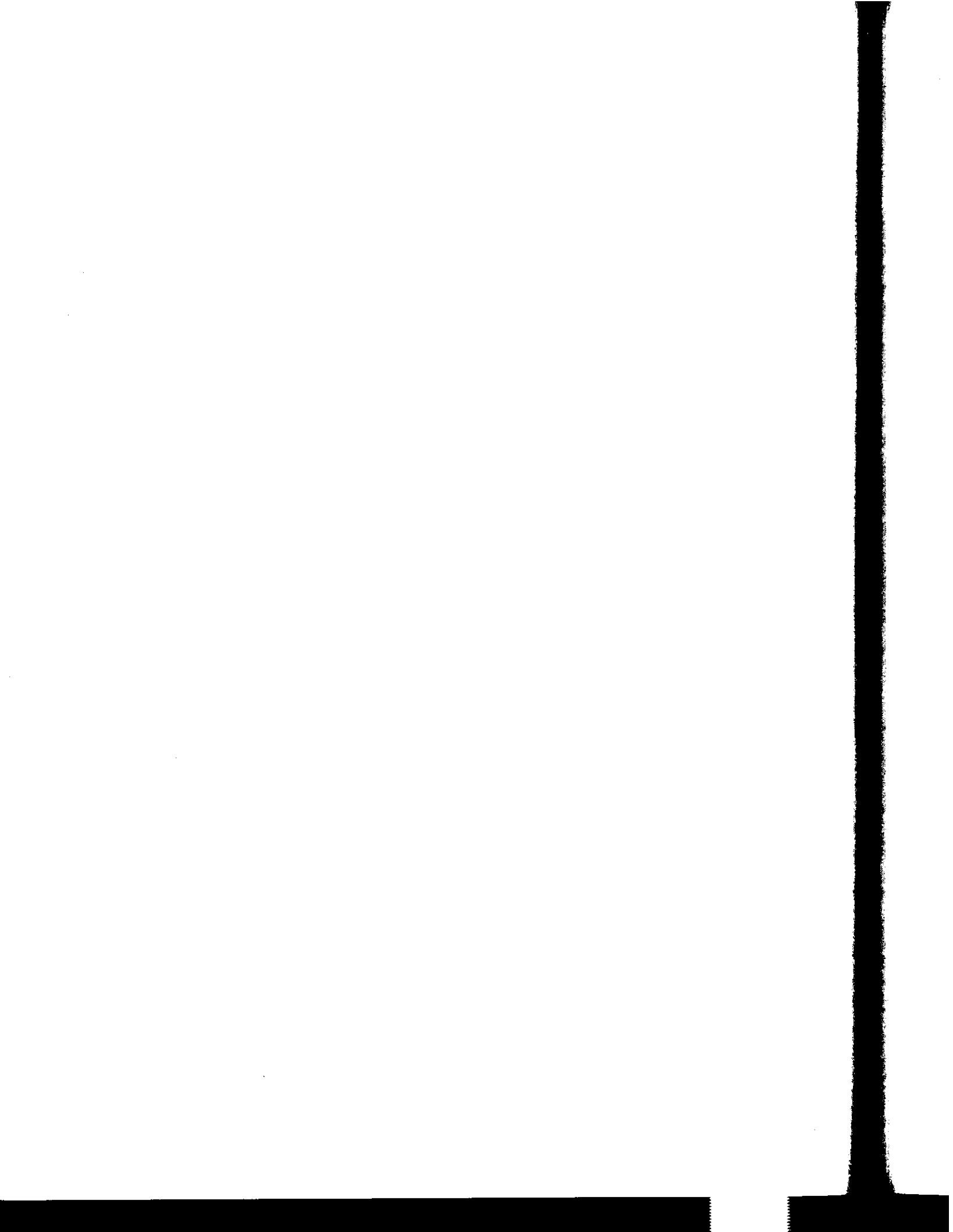

Same as  
Weaver Attachment 24

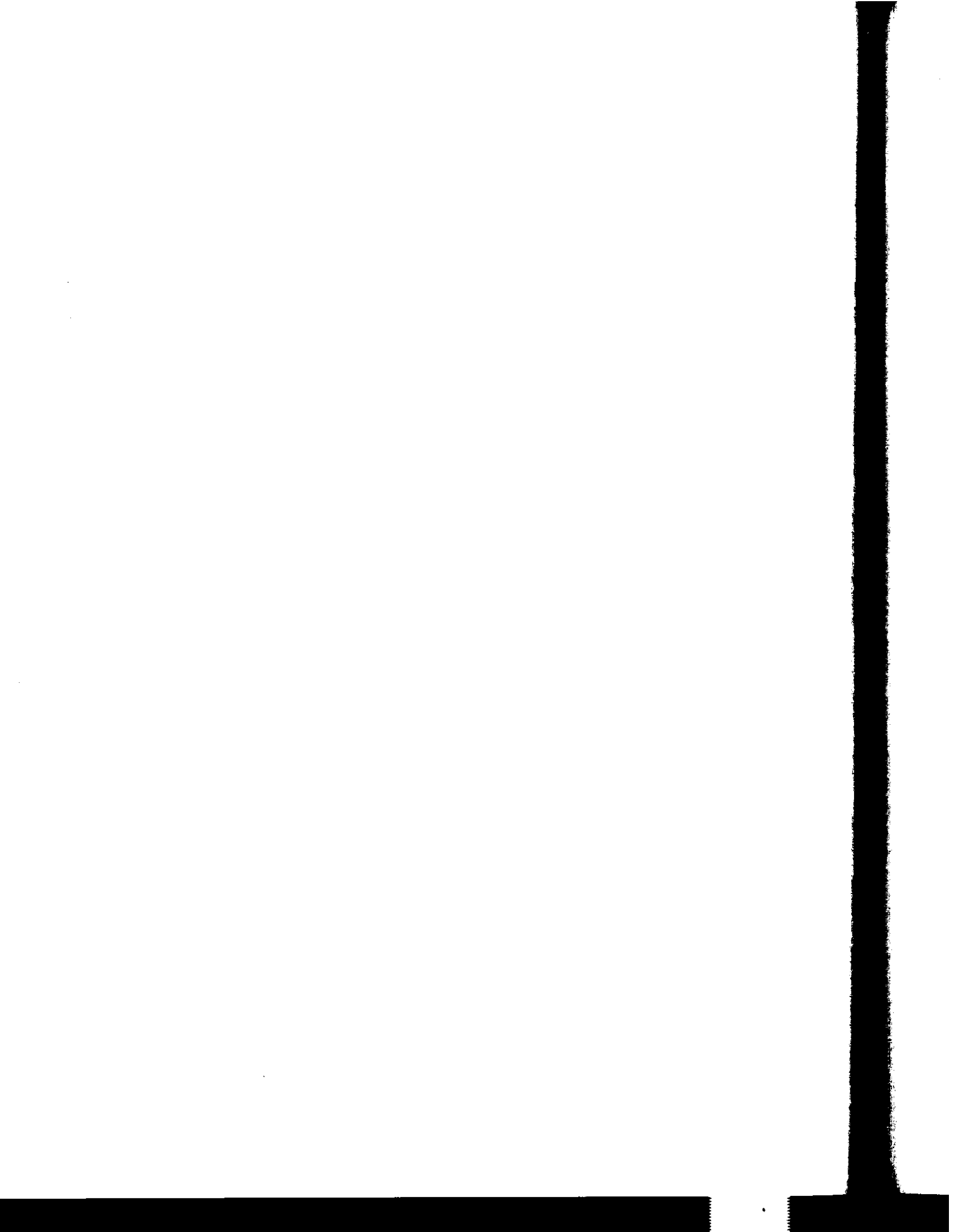



Report  
Cambridge Field Station, Air Materiel  
Command

“Review of Air Materiel Command  
Geophysical Activities by  
Brigadier General D.N.Yates, and  
Staff, of the Air Weather Service”

February 10, 1949

---

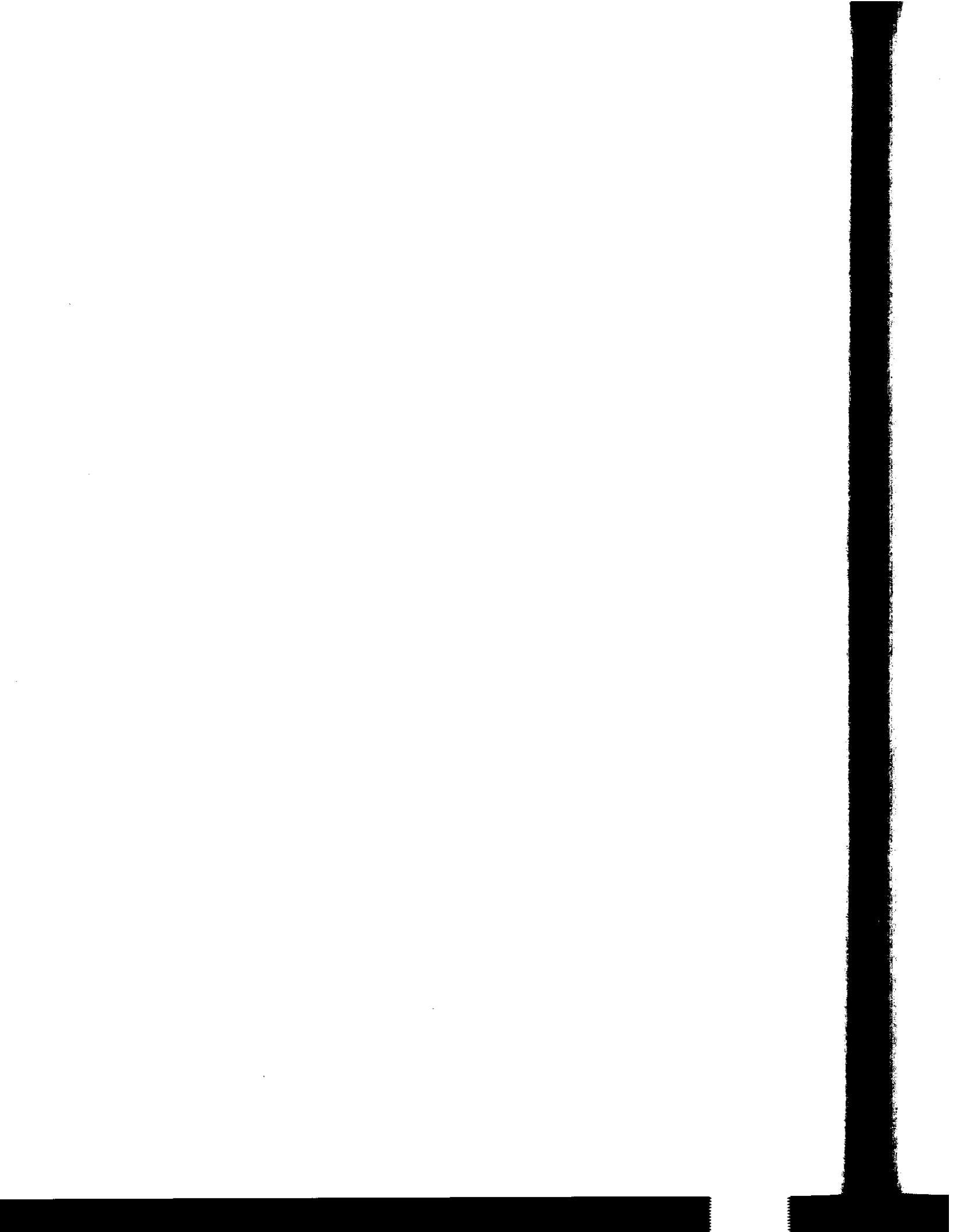

~~SECRET~~

~~CONFIDENTIAL~~

47

copy 3

Review of Air Materiel Command Geophysical Activities by  
Brigadier General D. N. Yates, and Staff, of the Air Weather Service

Cambridge Field Station  
Air Materiel Command  
Cambridge 39 Massachusetts

~~23~~

FACTS

10 Feb. 1949

- I. Introduction
- II. Tour of Geophysical Research Laboratories
  - a. Review of facilities
  - b. Project presentations
- III. Discussion

DOWNgraded AT 12 YEAR  
INTERVALS NOT AUTOMATICALLY  
DECLASSIFIED. DOD DIR. 5200.10

~~EXCLUDED FROM GENERAL DECLASSIFICATION SCHEDULE~~

~~SECRET~~

~~CONFIDENTIAL~~

[REDACTED]  
PROJECT ABSTRACTS

I. TERRESTRIAL SCIENCES LABORATORY

Chief: Dr. James A. Peoples, Jr.

1. Project title: Acoustic sounding of the Atmosphere

Project scientists: Dr. J. A. Peoples, Jr., Dr. Norman Haskell

Summary of In-Laboratory work:

When large explosions have occurred, it has been observed that the sound was heard locally, say up to 25 miles, and also at distances of 100 to 200 miles, but that nothing was heard at intermediate distances. This phenomenon can only be explained by assuming that the sound is refracted into the atmosphere over the intermediate observers and then is bent back down to the more distant areas. For this to occur the velocity of propagation must first decrease with altitude and then increase again to a value at least as large as ground velocity. This is due to a decrease of temperature up to the tropopause followed by an increase in temperature above that level. Winds also have an appreciable effect which can be determined from asymmetrical propagation.

Up to about 1946 most data on this phenomenon had been obtained by taking polls after accidental explosions had occurred. Zones of audibility were mapped out and general conclusions then drawn. Very little systematic work was done in which accurate travel times and other factors were obtained. Beginning in 1946 at these laboratories, a systematic study of these propagation anomalies were started. Sound ranging detectors were set up in arrays, so that the direction and time of arrival of compressional waves could be determined. Explosions were set off on or near the ground at ranges varying from 25 to 200 miles. Data has been taken which has resulted in the indirect determination of the temperature (sound velocity) structure of the atmosphere up to the stratospheric level. East-west propagation was first studied off the New Jersey coast. These tests show there is little or no regular diurnal variation, and that some annual variation in the temperature structure exists. High level winds are shown to be generally easterly. Additional tests have been made in New Mexico to determine the diurnal and annual variations of the temperature structure at that latitude. Some accurate observations of wind velocity are indicated by observations taken along a north-south line as well as an east-west line. Winter observations have been taken in the vicinity of Fairbanks, Alaska for information at very high latitudes. Observations have been taken near the Panama Canal Zone for additional information in the tropics.

The sounds produced by rockets launched at Alamogordo have been recorded with acoustic detector arrays located on the ground near the rocket trajectory. From data gathered in this manner, some indications of upper air temperature and winds have been obtained and much more accurate determinations could be made if the rocket trajectories were more accurately known.

[REDACTED]

Additional details of the atmospheric temperature and wind structure can be obtained by placing microphones near the tropopause where the velocity of sound is at a minimum. To our knowledge, no one has ever tried such an experiment, and in order to do this new equipment had to be developed, since wind produces strong noise in any microphone it was obvious that the detectors could not be used on an aircraft. It was further believed that the noise level of an instrument placed on a constant level balloon would be far below that generally observed on ground equipment. Both a satisfactory constant level balloon and a light weight microphone and telemetering system has been developed in this laboratory.

Basic acoustic propagation information is now being accumulated from equipments launched at Eglin Field Florida. The sound for these experiments is obtained from high altitude (20,000 to 25,000 feet) bomb bursts. Sufficient data have not yet been obtained to justify complete analysis, but it can be stated that observed results generally agree with predictions based upon theory.

Observations of the travel times of waves from an explosive source has yielded a considerable amount of data on the temperature and wind structure of the atmosphere up to altitude of about 50 km (160,000 feet). The interpretation of the data has so far been based on geometrical wave theory, and leads to a variation of propagation velocity with altitude which is in reasonable agreement with other lines of evidence. There are, however, several observed facts which cannot be explained on the basis of the elementary geometrical ray theory, and require a more complete analysis in terms of wave theory. They are: --(1) the "zones of silence", that follow according to geometrical ray theory from the initial decrease of velocity with altitude, which do not have sharply defined boundaries; (2) the same apparent angle of arrival is often observed over a considerable range of distance from the source, whereas on the ray theory a given angle of arrival was associated with one particular distance only; (3) at large distances, the total duration of the signals received is very much greater than can be explained by ray theory, and the character of the signal received is that of a long train of waves of varying amplitude and frequency rather than a limited number of well defined transient pulses.

Preliminary studies indicate that all of these facts may be explained qualitatively by more complete wave theoretical analysis of the diffraction of wave energy into the regions that are zones of silence in the elementary ray theory, and further work, aimed at quantitative treatment is in progress. Until an analysis of this kind has been carried through, one can not feel too much confidence in attempts that have been made to use long distance sonic and microbarometric wave propagation data to deduce atmospheric temperatures at levels above the second inversion.

In addition to the theoretical approach to this problem, consideration is being given to the use of surface waves on shallow water as a model of wave propagation in the atmosphere. The velocity of surface waves whose wave length is greater than the depth of the water is a function of the depth, so that the variation of velocity with altitude in the atmosphere can be simulated on a thin sheet of water by suitable contouring of the bottom. Surface tension and viscosity set at a lower limit of about 4 cm. to the wave lengths that can be used in such a model. With a water table about four feet wide simulating the atmosphere up to 50 km. a four centimeter wave length would represent a wave length in the atmosphere of about 1 mile, or a period of about five seconds.

Complementary Contracts:

- a. Columbia University  
No. W28-099-ac-82
- b. University of California at Los Angeles  
No. W28-099-ac-228
- c. Woods Hole Oceanographic Institution  
No. W28-099-ac-227  
All contracts on: "Consultation and Assistance in Research  
on Atmospheric Acoustical Wave Propagation."

2. Project title: Development of Constant Level Balloons

Project scientist: Dr. James A. Peoples, Jr.

Summary of In-Laboratory Work:

The development of a constant level balloon was at first motivated by the needs of the acoustic upper air sounding program. As it has developed, this balloon is now a principal atmospheric probing tool in its own right. In order to develop this balloon several special devices have been invented. An Olland cycle pressure indicator, accurate to better than one millibar, has been developed. A device has been constructed which will deflate and bring down balloons in flight either by timing or by pressure activated mechanisms. A balanced flow control valve has been made which gives a constant flow of ballast material proportional to pressure change. Other accessories include a telemetering device to indicate the rate of ballast flow, minimum ballast flow, minimum pressure switches, barographs, and balloon tracking radio transmitters which can be picked up by an aircraft radio compass at a range of 100 miles or more. A sensitive integrating vertical anemometer is now being developed which will aid in the interpretation of atmospheric oscillations.

A thorough investigation of balloon materials and fabrication methods has been conducted, and balloons have been designed suitable for use with the ballasting mechanisms developed. Launching and operational techniques have been developed which permit the launching of balloons in winds up to 20 per hour. Good control of ascent rate and ceiling altitude has been obtained. Constant level flights of several hours duration are now routine and flights lasting up to 5 hours with pressure variations not greater than one or two millibars have been obtained. Simplified control which operate satisfactorily during the day or night are not adequate when sunset occurs during a flight. A system for maintaining constant level thru sunset has been devised and tested in a bell jar, but in actual flight tests have not yet been made. Temperature measurements have been made both inside and outside of balloons to show the affects of super-heat. Temperature measurements have also been made in instrument and battery cases during flight. Measurements to show the actual characteristics of control devices have been made on balloons in flight and simulated in the laboratory. This

includes rate of ballast expenditure, diffusion, leakage, and stability of control.

By-product information of importance to meteorology or balloon flying techniques includes the following: Observation, measurement and theoretical analysis of high altitude atmospheric oscillations has been accomplished. These oscillations are several millibars in amplitude (as indicated on balloon barograph traces) and the period of oscillation varies between 4 and 10 minutes. Air mass trajectories have been measured over ranges up to about 400 miles and have been indicated by the recovery of gear up to 2,000 miles from the launching point. Additional field tests on air mass trajectories are now being made.

Complementary Contracts:

- a. New York University  
No. W28-099-ac-241  
"Development of Constant Level Balloon"
- b. Melpar, Inc.  
No. W28-099-ac-429  
"Development of Balloon Telemetering System"

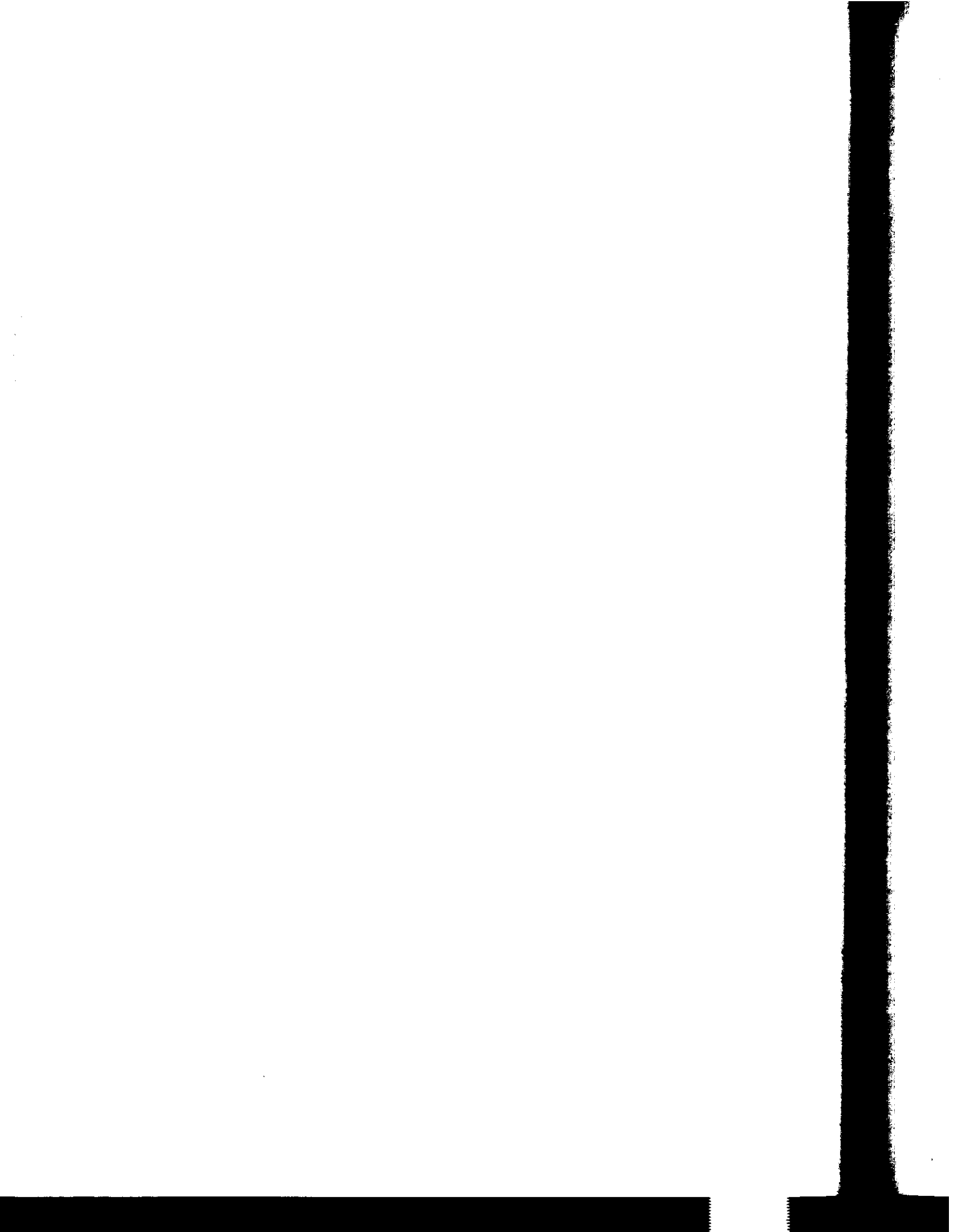



New York University  
*Constant Level Balloons*  
Section 2, *Operations*  
January 31, 1949

---

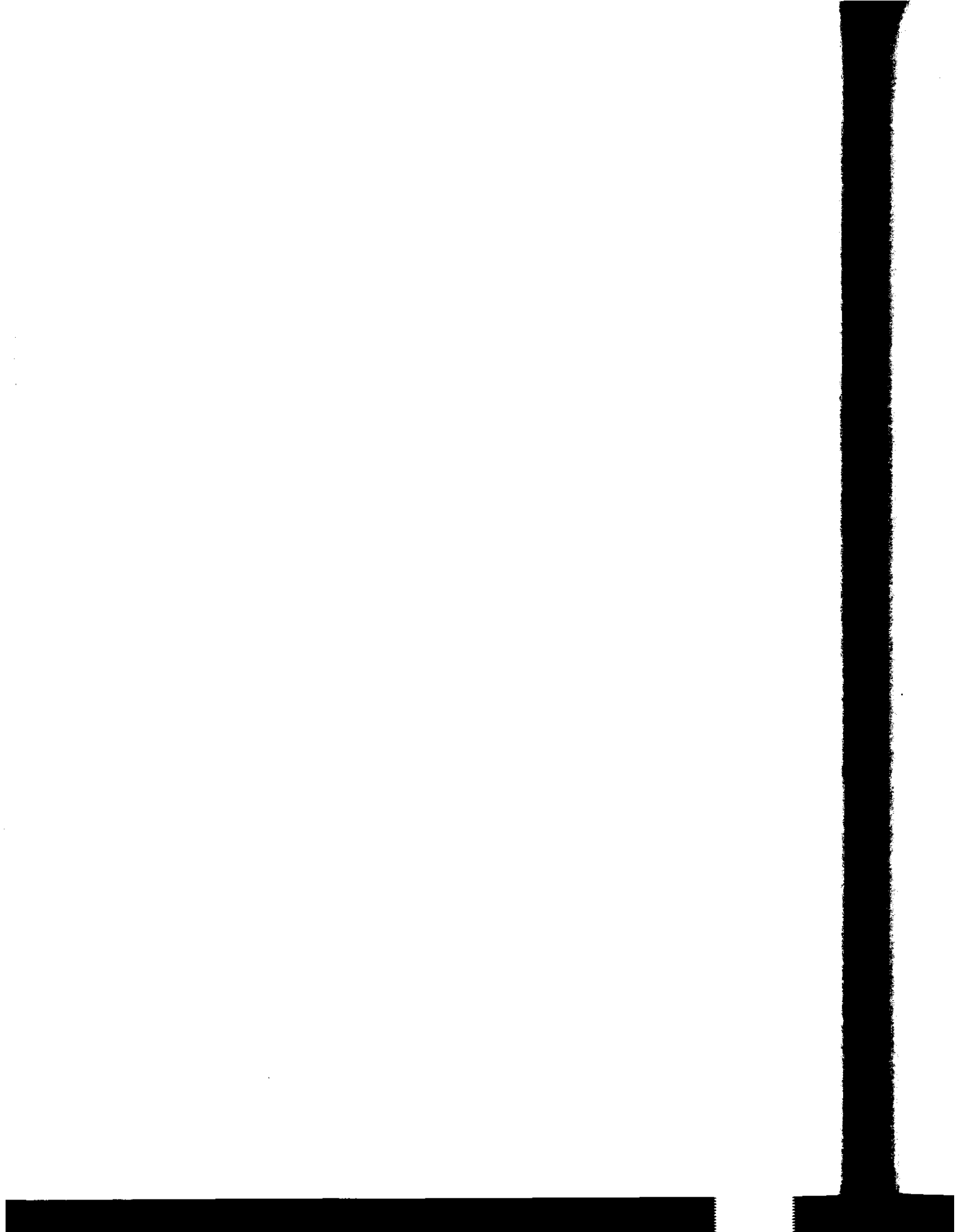

Technical Report No. 93.02

CONSTANT LEVEL BALLOONS  
Section 2

OPERATIONS

Constant Level Balloon Project  
New York University

Prepared in Accordance with provisions of Contract  
W28-099-ac-241, between  
Watson Laboratories, Red Bank, New Jersey  
and  
New York University

The research reported in this document has been made possible through support and sponsorship extended by the Geophysical Research Directorate of the Cambridge Field Station, AMC, U. S. Air Force, under Contract No. W28-099 ac-241. It is published for technical information only and does not represent recommendations or conclusions of the sponsoring agency.

Prepared by: Charles B. Moore, Project Engineer  
and  
James R. Smith, Project Meteorologist

Approved by: *William D. Murray for*  
Professor E. N. Kemler  
Acting Director of the Research Division

College of Engineering  
New York University  
31 January 1949  
New York 53, New York

TABLE OF CONTENTS

	<u>Page Number</u>
I. <u>Introduction</u> . . . . .	7
Purpose of Manual . . . . .	7
Principles of Altitude Control . . . . .	7
II. <u>General Mills 20-Foot Balloons</u> . . . . .	7
Description . . . . .	7
Load Limits . . . . .	8
Appendices . . . . .	8
III. <u>Equipment Train</u> . . . . .	14
Lines and Rigging . . . . .	14
Altitude Control Equipment . . . . .	16
Flight Termination Gear . . . . .	20
Accessory Flight Equipment . . . . .	27
Tracking and Recording Instruments . . . . .	27
Flight Tools and Equipment . . . . .	29
IV. <u>Pre-Flight Computations</u> . . . . .	29
Lifting Gas and Rate of Rise . . . . .	29
Length of Balloon Bubble . . . . .	33
Expected Altitude . . . . .	33
Ballast Requirements . . . . .	36
Altitude Sensitivity . . . . .	36
Forms and Records . . . . .	36
V. <u>Balloon Inflation</u> . . . . .	36
Preparation of Balloon . . . . .	36
Use of Shot Bags and Releasing Device . . . . .	39
Inflation Techniques . . . . .	39
VI. <u>Balloon Launching</u> . . . . .	47
VII. <u>Tracking and Altitude Determination</u> . . . . .	51
Positioning Equipment . . . . .	52
SCR-658 . . . . .	52
Theodolite . . . . .	52
Aircraft Radio Compass . . . . .	53
Radar . . . . .	53
Altitude Determination . . . . .	53
Olland Cycle Pressure Measuring Instrument . . . . .	54
Codesonde . . . . .	64
Barograph . . . . .	64

	<u>Page Number</u>
VIII. <u>Analysis</u> . . . . .	.71
IX. <u>General Mills 7-, 30-, and 70-Foot Balloons</u> . . . . .	.71
Glossary . . . . .	.79
Appendix I. Equipment List and Flight Forms . . . . .	.81
Appendix II. Tables and Charts for 20-Foot Balloon Flights . . . . .	.91

LIST OF ILLUSTRATIONS

<u>Figure Number</u>	<u>Page Number</u>
1. General Mills 20-foot balloon . . . . .	9
2. Balloon appendix stiffened with cardboard battens . . . . .	11
3. Detail drawing for balloon battens. . . . .	12
4. Balloon appendix with spring bow stiffener. . . . .	13
5. Carrick bend knot . . . . .	15
6. Detail drawing of fixed rate ballast assembly . . . . .	17
7. Detail drawing of orifice assembly . . . . .	18
8. Detail drawing of filter. . . . .	19
9. Ballast control circuit . . . . .	21
10. Ballast reservoir assembly . . . . .	22
11. Detail drawing of flight termination rip rigging . . . . .	23
12. Detail drawing of flight termination switch . . . . .	24
13. Detail drawing of line cutter cannon . . . . .	25
14. Schematic drawing of line cutter cannon . . . . .	26
15. Detail drawing of banner . . . . .	28
16. Typical service flight train (complete) . . . . .	30
17. Typical service flight train (simple) . . . . .	31
18. Typical research flight train . . . . .	32
19. Sample calibration curve for helium gage . . . . .	34
20. Sample warning and reward tags . . . . .	37
21. Sample reward notice and questionnaire. . . . .	38
22. Detail drawing of elliptical shot bag . . . . .	40
23. Detail drawing of sand and shot bag . . . . .	41
24. Launching platform with arms open . . . . .	42
25. Launching platform with balloon fixed in place. . . . .	43
26. Five tank helium manifold . . . . .	45
27. Detail drawing of diffuser. . . . .	46
28. Detail drawing of Y-shaped wind screen. . . . .	48
29. Plan view of balloon launching layout . . . . .	49
30. Balloon shapes during launching . . . . .	50
31. Olland cycle pressure modulator . . . . .	55
32. Sample record of Olland cycle pressure modulator signal . . . . .	58
33. Olland cycle test oscillator circuit. . . . .	59
34. Calibration curve for Olland cycle pressure modulator . . . . .	60
35. Lange barograph-thermograph . . . . .	65
36. Sample barograph record . . . . .	67
37. Correction curve for Lange barograph. . . . .	70
38. Sample height-time curve. . . . .	72
39. Sample trajectory . . . . .	73
40. General Mills 7-foot balloon . . . . .	74
41. General Mills 70-foot balloon being inflated. . . . .	76
42. General Mills 70-foot balloon being launched. . . . .	77
43. Detail drawing of helium heater . . . . .	78

## OPERATIONS MANUAL

### I. INTRODUCTION

#### A. Purpose of Manual

This manual is designed to serve as a guide in the preparation, launching, and tracking operations of constant-level balloons. In the body of this manual, most of the discussion applies specifically to the 20-foot diameter balloon developed by General Mills, Inc. In Section IX, a brief description is given of the other sizes of balloons used for constant-level flight. The manual is based upon the experiences and investigations of the Constant Level Balloon Project, Research Division of the College of Engineering, New York University. The charts and tables which were developed to use for this work are included in Appendix II of the manual.

#### B. Principles of Altitude Control

For constant-level work, non-extensible balloons are used for three reasons:

- (1) With a given weight of equipment, it is possible to determine before the release of the balloon, the maximum altitude which will be attained.
- (2) Without special control equipment, it is possible to maintain a nearly constant altitude for periods from one to six hours, depending upon atmospheric conditions and floating level. Generally, it is not possible to extend such flights through a sunset.
- (3) By adding altitude control equipment, it is possible to maintain the balloon at various nearly constant, predetermined levels for periods of much more than six hours regardless of the time of day.

### II. GENERAL MILLS 20-FOOT BALLOONS

#### A. Description

General Mills, Inc. of Minneapolis, Minnesota, has developed a series of non-extensible, plastic balloons. These balloons are tear-drop in shape, made from extruded polyethylene sheet, 0.001" thick. Cells are currently produced with a diameter of 7, 20, 30 and 70 feet. The

volume of the 20-foot cell is about 4300 cubic feet and its uninflated length is 38 feet. It is made up of 20 goras, heat sealed together in a butt weld. Along the seams thus formed, a special acetate-fiber scotch type tape (Minnesota Mining and Mfg. Co.,) is laid to reinforce the weld and to carry and distribute the load. These tapes converge to an appendix ring at the balloon bottom, to which the load harness is attached. By using this stressed tape design, much larger loads may be carried than the thin polyethylene alone could hold. To exclude air entering through the bottom, which is left open, an external skirt or appendix is added.

Figure 1 shows a 20-foot balloon ready to be released, with an external appendix in position. As the balloon rises, the lifting gas inside will expand until the balloon is full, whereupon the excess gas which was needed to make the balloon rise will be valved out. The full balloon will then float at a level where the buoyancy just balances the load. It will remain there until buoyancy is lost by diffusion of the lifting gas, or by cooling, as at sunset.

Neglecting minor effects, the amount of gas which is needed to just balance the load at the maximum or floating elevation would also just balance the load at any lower level, including the surface, although the balloon would be less than completely full at such a lower level.

#### B. Load Limits

For a given lifting gas, the altitude to which a balloon will rise is determined principally by the load it bears. With a 20-foot General Mills balloon, using helium, a payload of 40 pounds will reach approximately 46,000 feet and an 18-pound load will go to about 58,000 feet. Although the manufacturers recommend keeping the payload between 18 and 40 pounds, no trouble has been found in launching loads of as much as 70 pounds (37,000 feet) or as small as 4 pounds (67,000 feet).

#### C. Appendices

For highest altitudes and smallest sunset effects on a balloon, it is necessary to keep air from diluting the helium. To accomplish this, a check valve is required in order that helium may be valved when the balloon is full, yet air not be permitted to enter at any time. An appendix, consisting of a tube of balloon material, whose length is about 2 to  $2\frac{1}{2}$  times its diameter is used for this purpose, and is supplied as part of the General Mills balloon.



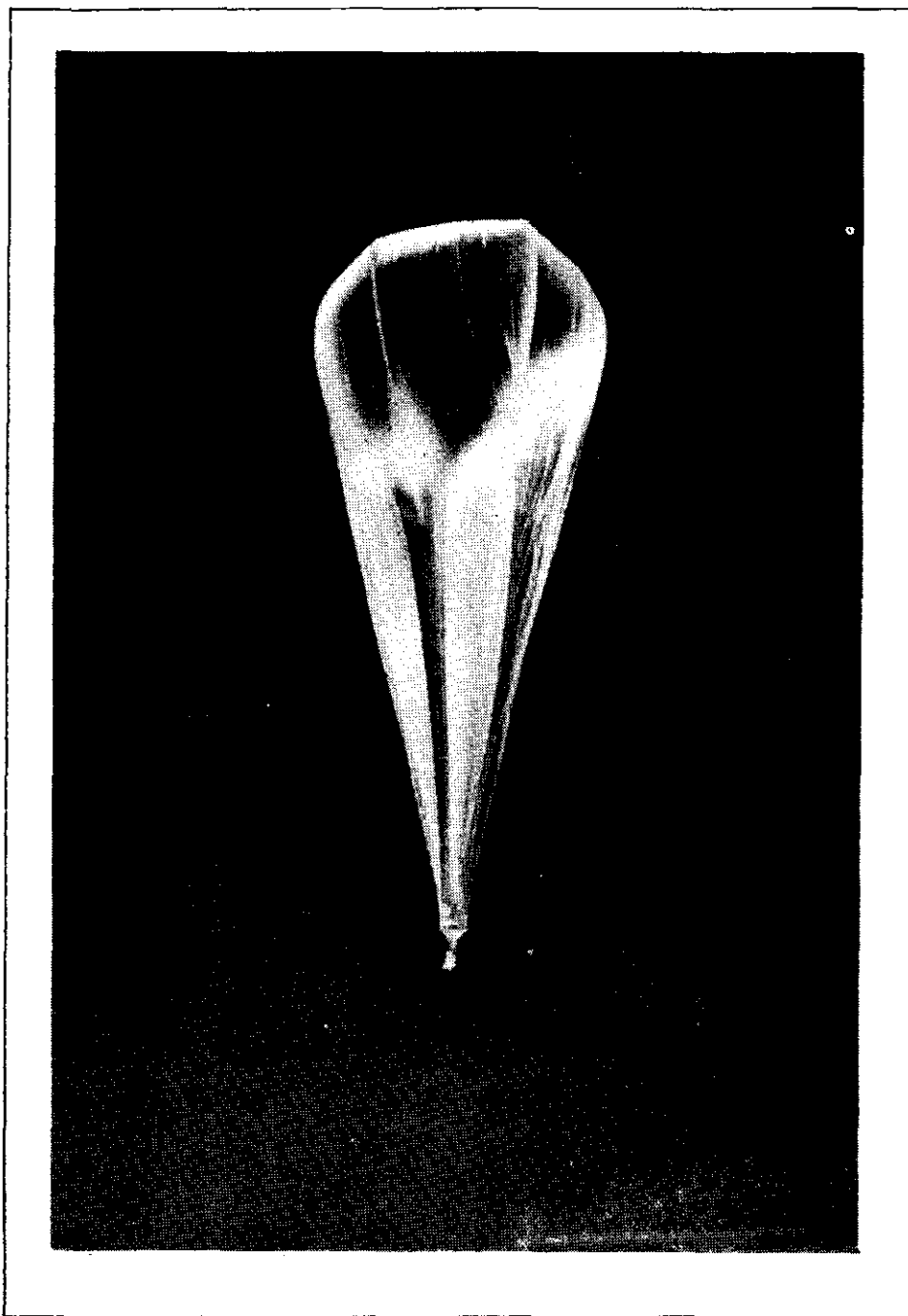

Figure 1  
General Mills 20 foot balloon in flight with 2  
foot appendix, stiffened with cardboard battens.

Stiffeners are added so that the appendix will not foul in the rigging. With a fouled appendix the helium cannot be valved, and the balloon after becoming full at its ceiling will burst. These stiffeners are taped to the outside of the appendix just before inflation.

The various appendix types which have been used are given in the following table:

Appendix Data

<u>Appendix Type</u>	<u>Stiffeners</u>	<u>Effect on Altitude Attained</u>	<u>Effect on Descent</u>
None	None	Ceiling is 10,000 to 20,000 feet lower than computed.	Balloon remains full at all times after ceiling is reached by taking on air. Greatly complicates control.
Standard	3 corrugated cardboard battens, $2\frac{1}{2}$ " by 15"	Computed ceilings attained.	Balloon remains full at all times after ceiling is reached by taking on air. Greatly complicates control.
Standard	4 aluminum battens 15 x $\frac{1}{2}$ " x .030" 24 ST	Computed ceiling attained if balloon does not burst due to restriction on appendix.	Air excluded during any descent fairly well.
Flattened Tube	Metal spring bow to hold appendix flat, like pressed trousers	Not yet flight tested. Similitude tests indicate computed ceiling would be reached with no bursts due to appendix at 1000 ft/min rate of rise.	Not yet flight tested. Similitude tests indicate almost complete exclusion of air.

Figures 2, 3, and 4 show the various appendices described in the above table.

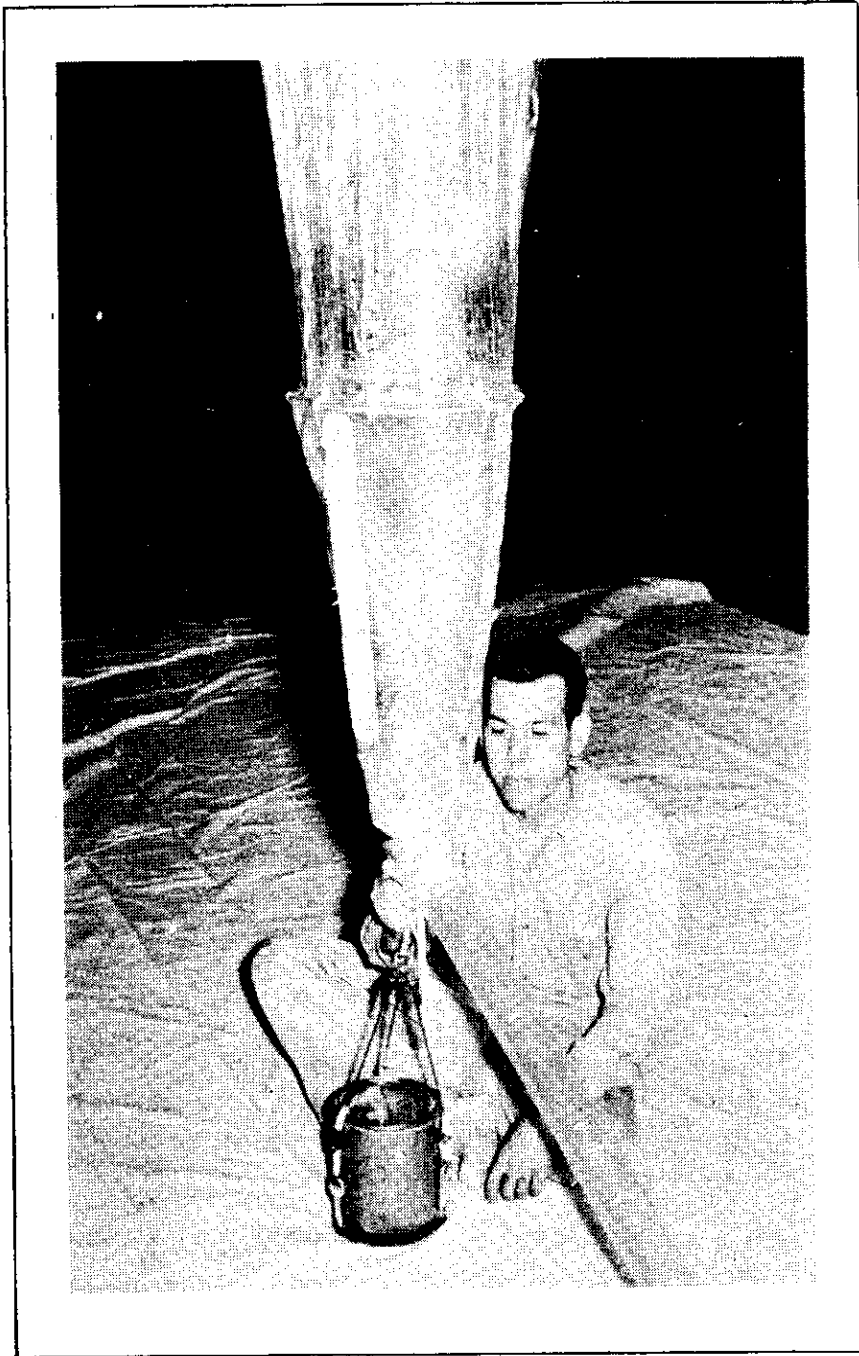
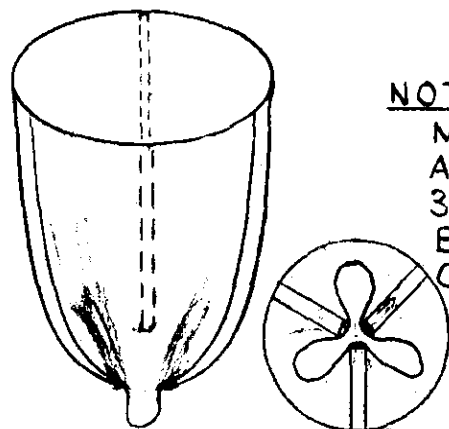
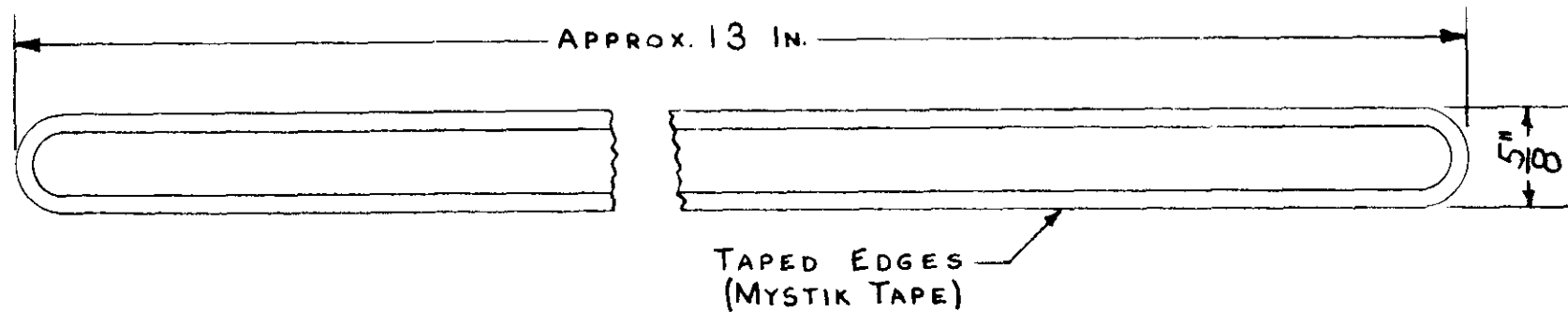

Figure 2

Two foot appendix, stiffened with cardboard battens, shown on a General Mills balloon. The swollen inflation tube indicates that the balloon is being filled.



NOTE:

MAT'L: 17ST OR 24ST. AL. SHEET-.032 THK.  
 ALL EDGES TO BE COVERED WITH TAPE  
 3 BATTENS, 120° APART  
 BENT IN FIELD TO FORM LIGHT  
 CLOSURE OF APPENDIX

FIG. 3

BATTENS FOR G.M.	
20 FT. BALLOON	
DWG. BY LHM	ED48-95A
DATE 10-14-48	



Figure 4  
Two foot appendix, showing  
metal spring bow in position.  
-13-

Since the back pressure forcing the helium out of a full balloon when it is rising is 4 times as great at 1000 feet per minute as at 500 feet per minute, the rate of rise is critical when an appendix is used. It has been found necessary to limit the rate of rise to 700 feet per minute to prevent bursting at ceiling when using General Mills 20-foot balloons with standard appendix. It is believed, from laboratory tests, that use of the spring bow stiffeners on the new appendix will permit rates of rise up to 1000 feet per minute. Flutter in the balloon fabric while rising is apt to cause failure due to ripping at speeds of more than 1000 feet per minute. A 20-foot General Mills balloon will burst with an internal pressure of 0.014 psi., which is about 1 mb., equivalent to a 200-foot rise at ceiling with a closed appendix.

### III. EQUIPMENT TRAIN

#### A. Lines and Rigging

Following rigging failures early in the testing program, careful study was given to the lines and rigging methods used to attach flight instruments to the balloon. For safety in launching, a factor of 10 to 1 is used on all loads. Thus, if a 40-pound load is to be lifted, it is not safe to use less than a 400-pound tested line. The line strength should be determined independently if possible, since the actual breaking point of lines runs between 50 and 70% of the manufacturer's rated strength.

Braided or woven nylon is recommended for all rigging. A stranded or laid line is subject to untwisting in flight, twirling the suspended instruments and reducing line strength. The nylon material is weather resistant to a high degree and tends to stretch under shock rather than to snap. For some purposes it may be desirable to use a line of constant length, in which case the nylon may be pre-stretched. Only a few of the common knots are useful in tying nylon. Bowlines and square knots have been found to slip and are hard to untie. The carrick bend, shown in Figure 5, is recommended. In addition to this, a safety knot is made in the loose end, and the entire tie secured by a final taping. For convenience in assembly, the individual pieces of line and equipment are rigged with harness snaps at each end. This permits unit replacements or removal at the last minute with a minimum of delay. For extremely light-weight rigging, wooden toggles and loops in the nylon may be used instead of the heavier metal snaps.

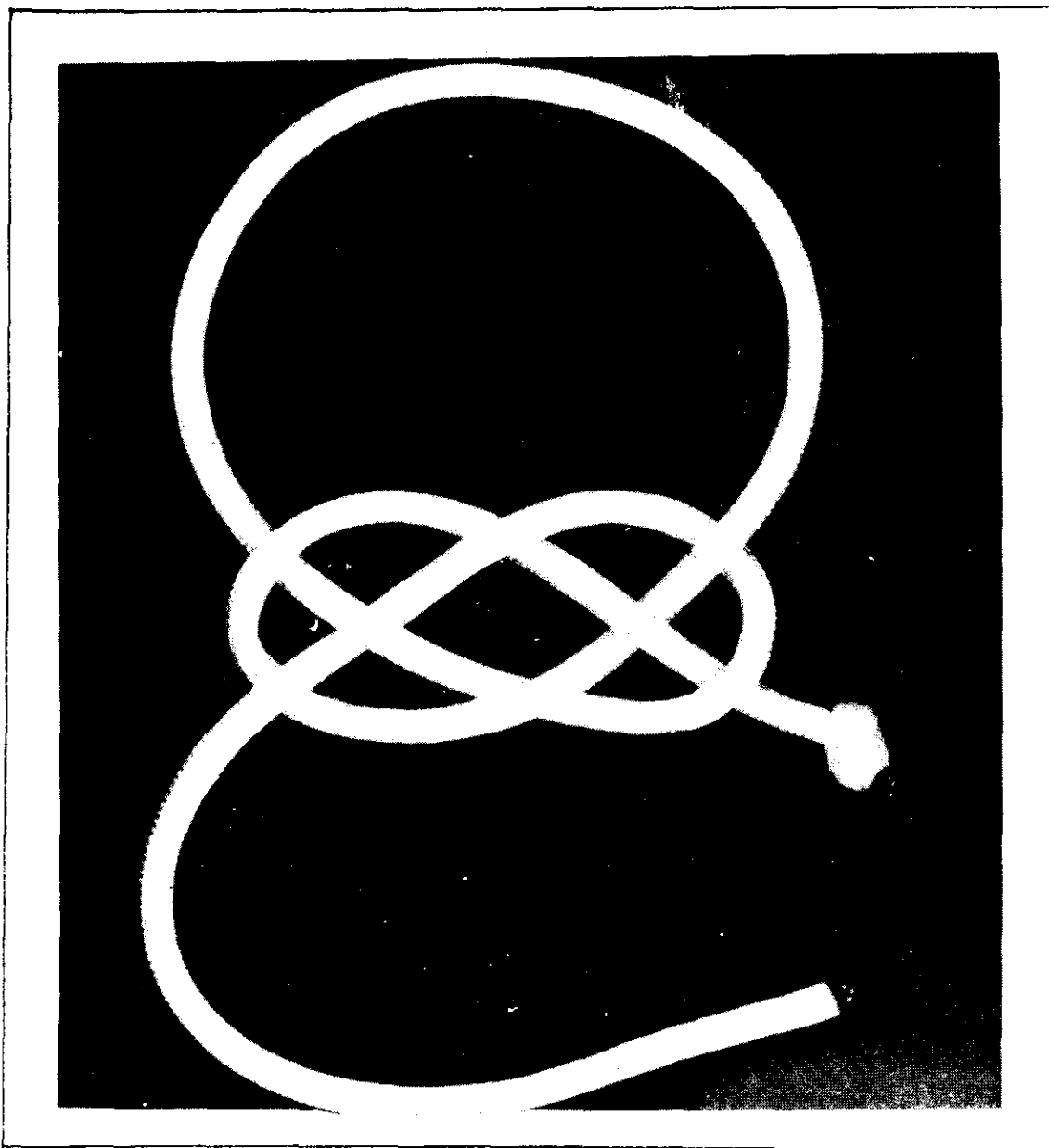

Figure 5  
Carrick Bend

## B. Altitude Control Equipment

Flights of 20-foot General Mills balloons, using no control equipment, have been sent to altitudes of about 50,000 feet. After reaching maximum altitude, the balloons all exhibit a tendency to float then descend at an increasing rate for periods of from 2 to 6 hours. In stable layers of air such as the stratosphere the descent of a balloon is retarded by the helium, on compression, getting warmer than the surrounding air. This results in much longer duration flights requiring no external control though, strictly speaking, the altitude is not constant. This concept is in good general agreement with the observed data; balloons have remained in a semi-floating state much longer (up to 30 hours) when in the stratospheric inversion than when in less stable lower atmospheric layers.

When it is desired to maintain a balloon at constant level for a guaranteed period of time in excess of two hours, a ballast system of altitude control should be added to the flight gear. The level at which the balloon is to float must be the maximum altitude to which it can carry the payload. To compensate for loss in buoyancy occasioned by loss of lifting gas through diffusion and leakage, a continual lightening of the load is required. To effect this in a simple fashion, liquid ballast is permitted to flow through an orifice at a predetermined rate which exceeds the expected loss of lift. (See Section IV, D) The reservoir and ballast assembly which has been developed for this use is shown in Figure 6. A detail sketch of the orifice in its mounting is shown as Figure 7, and Figure 8 shows a suitable filter which must be used to protect the orifice from clogging. The liquid ballast must (1) not freeze, but flow well at cold temperature ( $-80^{\circ}\text{C}$ ); (2) not absorb water, which would freeze; and (3) be relatively inexpensive. A recommended liquid is Aeromobil Compass Fluid, made by Socony-Vacuum Co. (Air Force Spec. AN-C-116).

There are three possible objections to the use of this simple control system. First, a continued lessening of the total weight on the balloon--with no change in volume--must result in a constantly rising ceiling. For a 20-foot balloon at 45,000 feet, this change is approximately 1000 feet with each kilogram of ballast dropped (see Section IV, E). Second, only a prefixed ballast flow is permitted, and excessive loss of lift, as might come when the gas is cooled at sunset (when the balloon loses superheat,



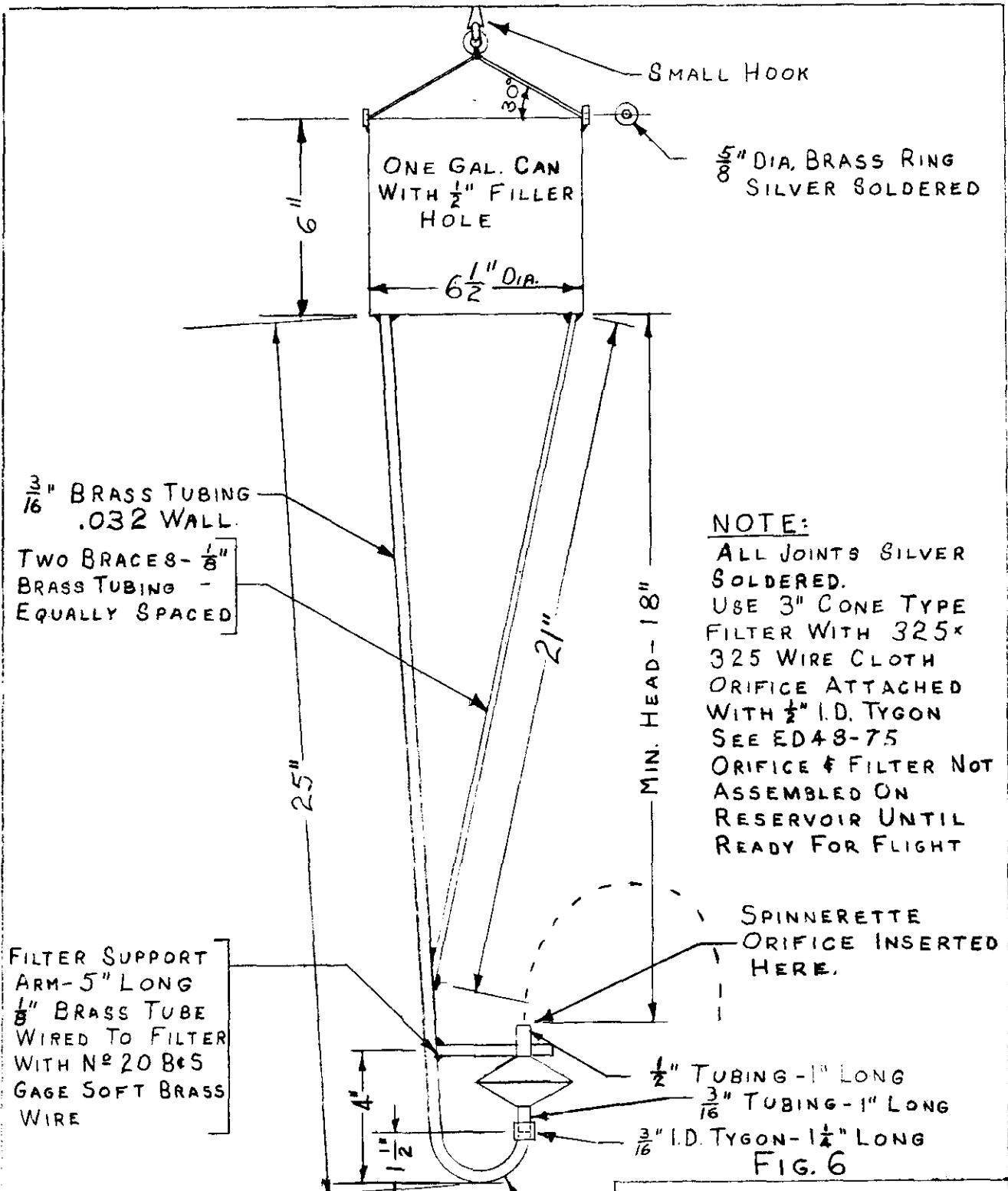

**NOTE:**  
 ALL JOINTS SILVER SOLDERED.  
 USE 3" CONE TYPE FILTER WITH 325x325 WIRE CLOTH ORIFICE ATTACHED WITH 1/2" I.D. TYGON SEE ED48-75 ORIFICE & FILTER NOT ASSEMBLED ON RESERVOIR UNTIL READY FOR FLIGHT

3/16" BRASS TUBING  
 .032 WALL  
 TWO BRACES - 1/8" BRASS TUBING - EQUALLY SPACED

FILTER SUPPORT ARM - 5" LONG  
 1/8" BRASS TUBE WIRED TO FILTER WITH NO. 20 B&S GAGE SOFT BRASS WIRE

SPINNERETTE ORIFICE INSERTED HERE.

1/2" TUBING - 1" LONG  
 3/16" TUBING - 1" LONG  
 3/16" I.D. TYGON - 1 1/4" LONG  
 FIG. 6

RATE OF FLOW 200 TO 250 GM./HR. WITH .008" SPINNERETTE.  
 WEIGHT APPROX. 575 GM. COMPLETE LESS BALLAST.  
 CAPACITY - APPROX. 2800 GM. OF BALLAST

**NYU BALLOON PROJECT**  
 1 GAL. CAP. LT WGT. FIXED RATE BALLAST RESERVOIR  
 DWN BY: LHM  
 DATE: 9-2-48  
 ED48-79A

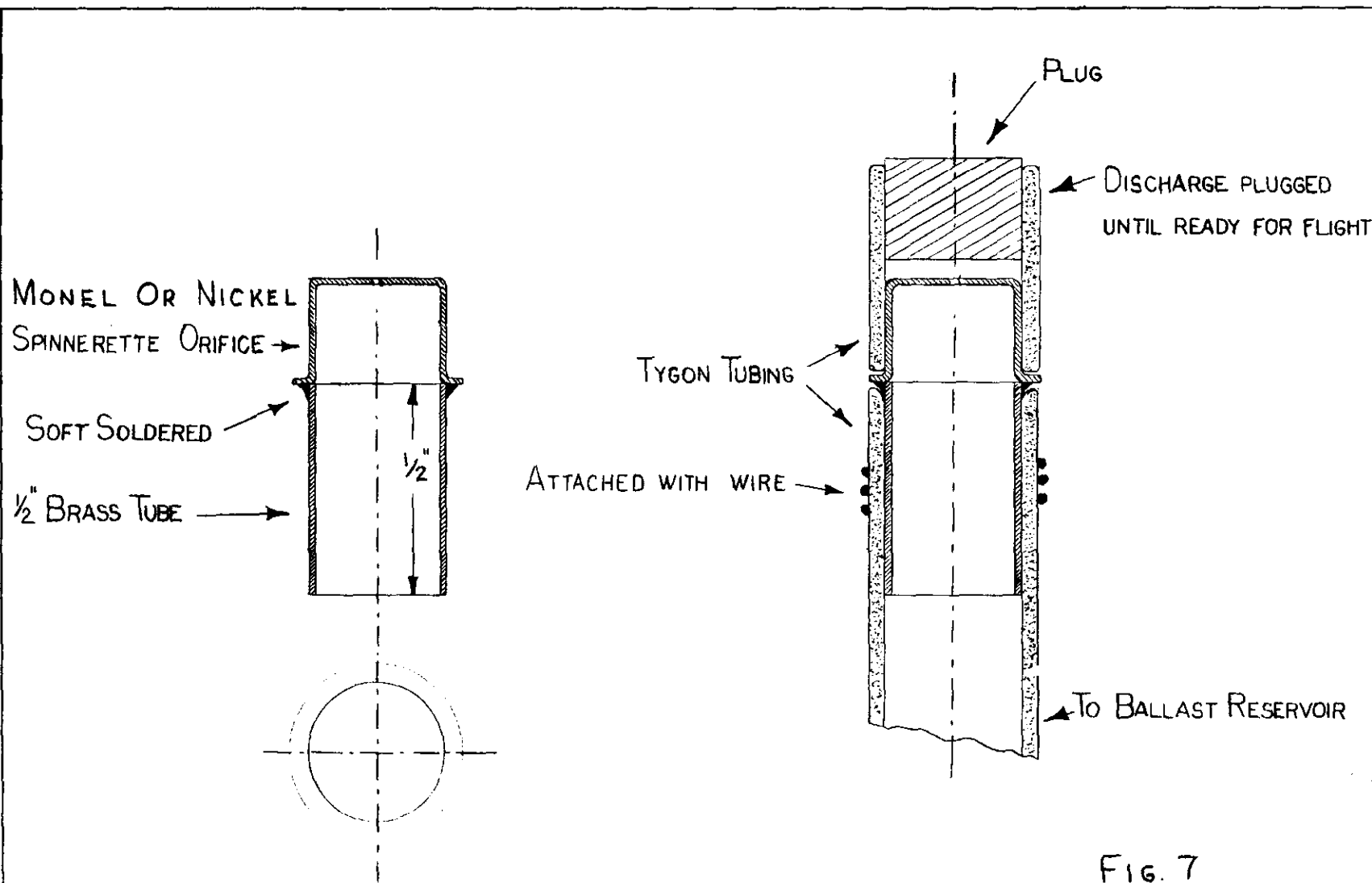

NOTE  
 SPINNERETTE ORIFICE MFD. BY J. BISHOP  
 Co., MALVERN, PA.

FIG. 7	
NYU BALLOON PROJECT	
ORIFICE ASSEMBLY	
DATE	8-25-48   ED48-75A

SECTION A-A

BRASS TUBING  
 $\frac{1}{2}$ " OR  $\frac{3}{16}$ " O.D.  
 CUT  $1\frac{1}{8}$ " AND  
 FLARE ONE END

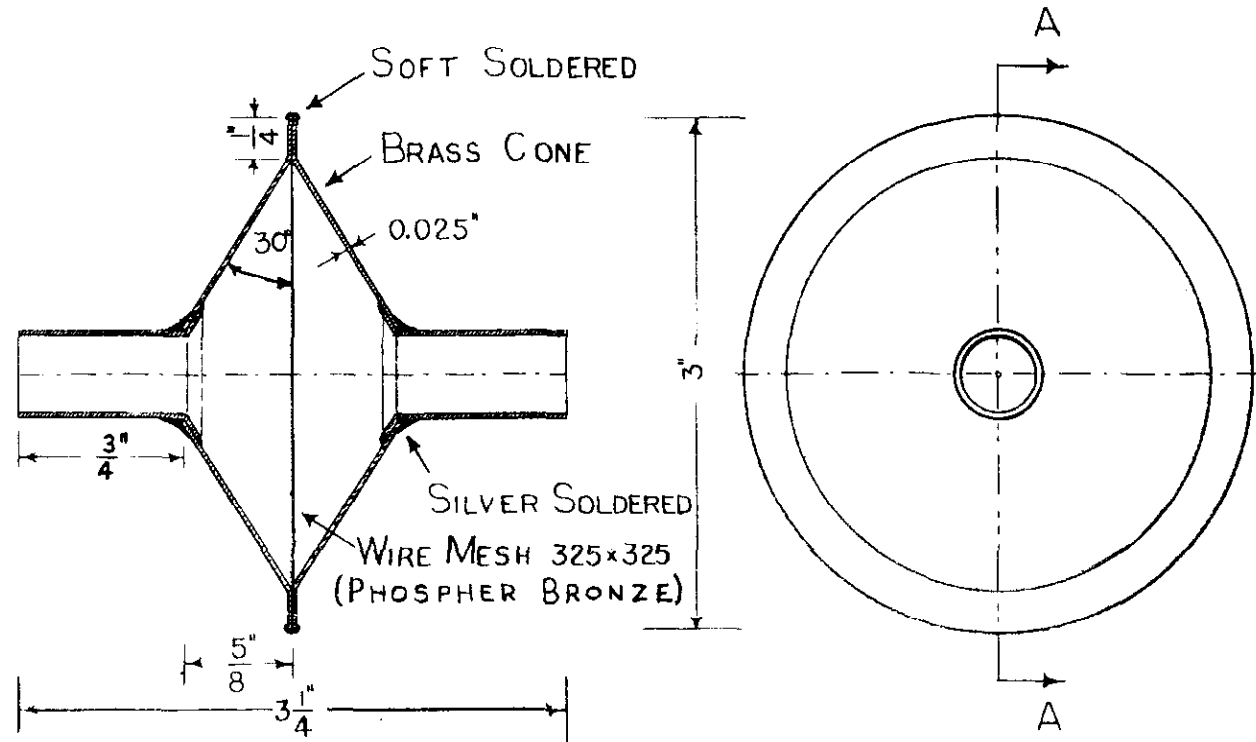

SCALE 1:1

NOTE

WIRE MESH FROM NEWARK WIRE CLOTH  
 CO., TWILLED WEAVE CODE PYA, OR  
 EQUIVALENT.

FIG. 8

NYU BALLOON PROJECT	
TYPE "C" FILTER	
Date: 5-18-48	ED 48-54A

will cause the balloon to descend. Third, as a consequence of the previous limitation, the maximum floating period of a balloon with this control system is 24 hours, achieved when launching is at sunset.

When any or all of the above objections prohibit the use of this simple control system, more complex ballast dropping devices may be used. Figure 9 shows in schematic form the servo or demand type control which has been used to maintain balloons at a constant pressure level, with high ballast efficiency and without harmful sunset effects. Figure 10 is the ballast reservoir assembly which is used with this type control. A more detailed discussion of this servo-control is given in Technical Report Number 2 of the Balloon Project, New York University.

### C. Flight Termination Gear

When a balloon loses buoyancy by the loss of lifting gas, it sinks slowly to earth. To prevent the balloon from remaining in airplane traffic lanes for a long period of time, a flight termination device is added to the equipment train. This device, shown in Figure 11, consists of a pressure-actuated switch and rigging to tear a large hole in the balloon when it descends to some predetermined height. A pressure pen is held above its commutator by a short shelf (see Figure 12). After passing an altitude corresponding to the end of the shelf, the pen falls onto the commutator. Upon subsequent descent to 20,000 feet, it closes an electrical circuit. When this circuit is closed, a squib is detonated in an aluminum "cannon" (see Figures 13 and 14) driving a pellet through the main load line. As the line is severed, the weight of the load is suddenly taken by a rip line which extends nearly taut (about 2 feet slack) up the side of the balloon to a point about 10 feet below the balloon crown. At this point, two small holes about 18" apart have been made, and the rip line is passed from the outside into the balloon through the top hole, then down the inside and out the bottom hole. Both holes are securely taped with acetate fiber tape. About 6 inches of slack line is left inside the balloon. When the main line is cut, a large hole is made in the fabric by this rip line as it pulls out of the balloon. After the instruments have fallen about 10 feet and the rip is made, they are caught up by a snub line and the load is again taken to the load ring. The ruptured balloon then acts as a parachute for the load, descending at about 1000 to 1500 feet per minute.

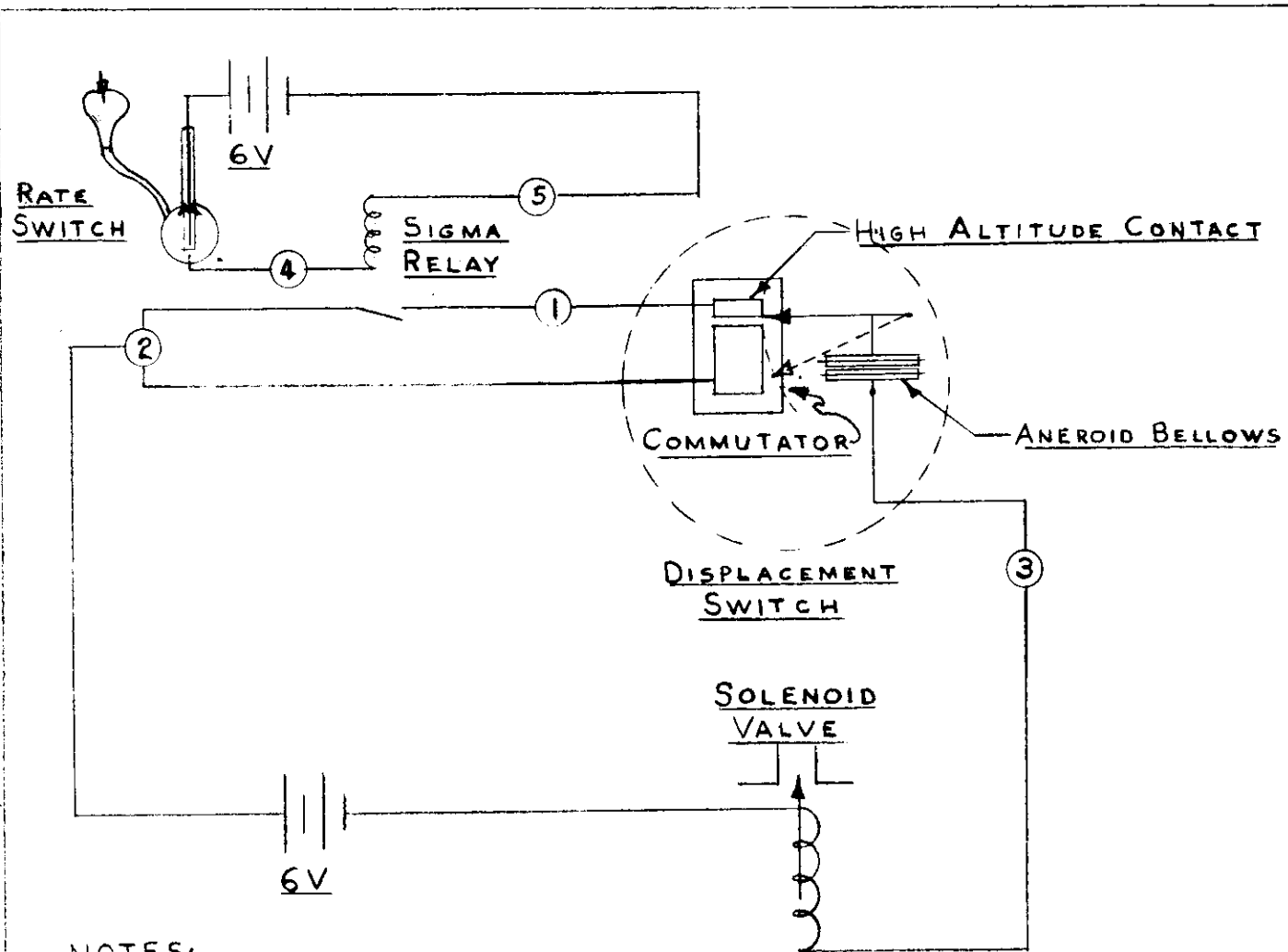

NOTES:  
 BATT. PACK IN TRANSMITTER BOX  
 SIGMA SENSITIVE TYPE 5F RELAY- COIL  
 RESISTANCE-16000 OHMS  
 DISPLACEMENT SWITCH-ED48-107  
 RATE SWITCH-ED48-115  
 SOLENOID VALVE-ED48-110  
 USE 4FH-6 V LITHIUM CHLORIDE BATTERIES (BURGESS)  
 FOR DETAILS OF DISPLACEMENT SW. SEE ED48-126

FIG. 9

W. J. ...  
 BALLAST CONTROL  
 CIRCUIT  
 LHM  
 11-12-48 ED48-114B

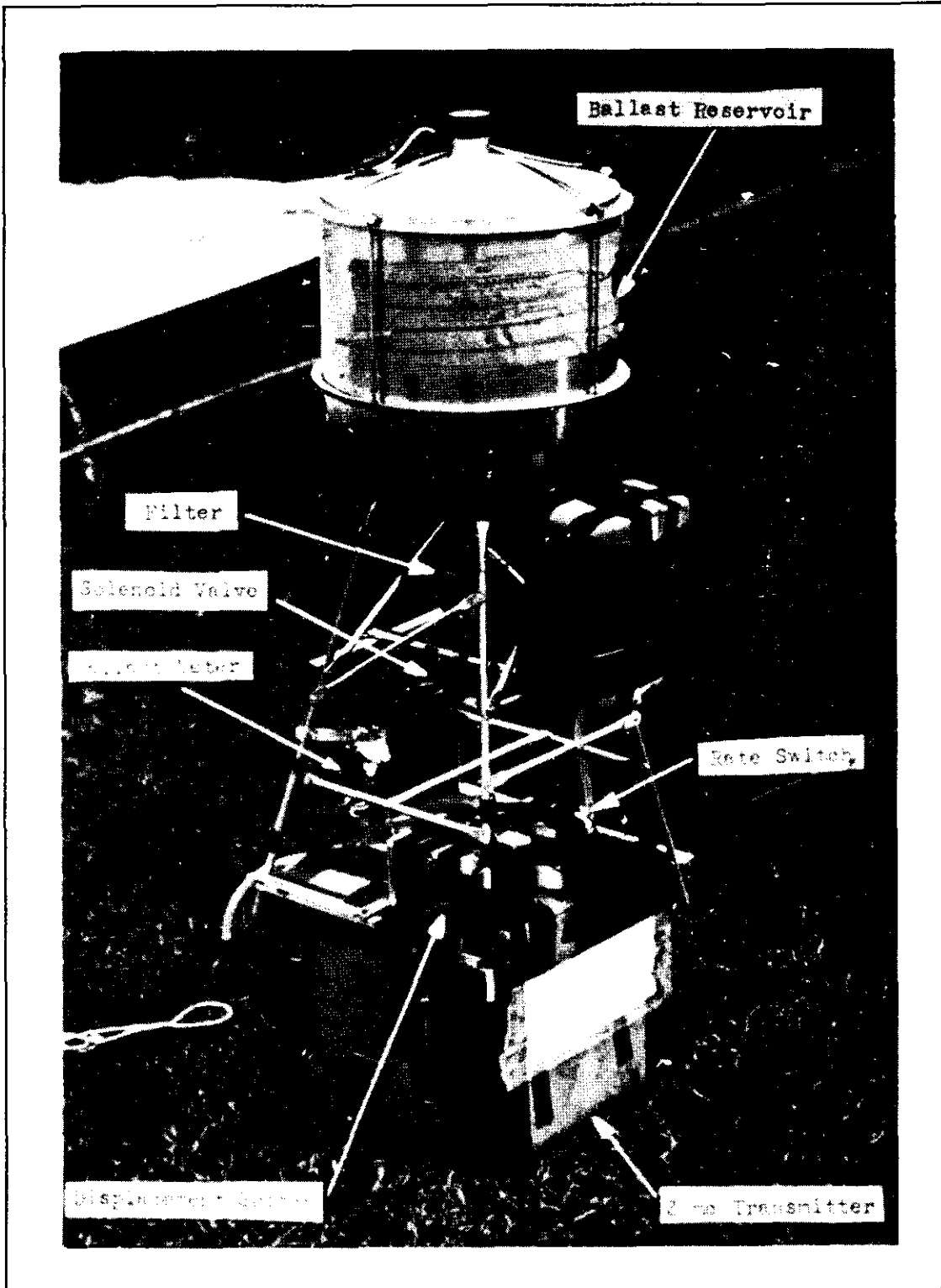

Figure 10  
Ballast reservoir assembly  
showing component parts

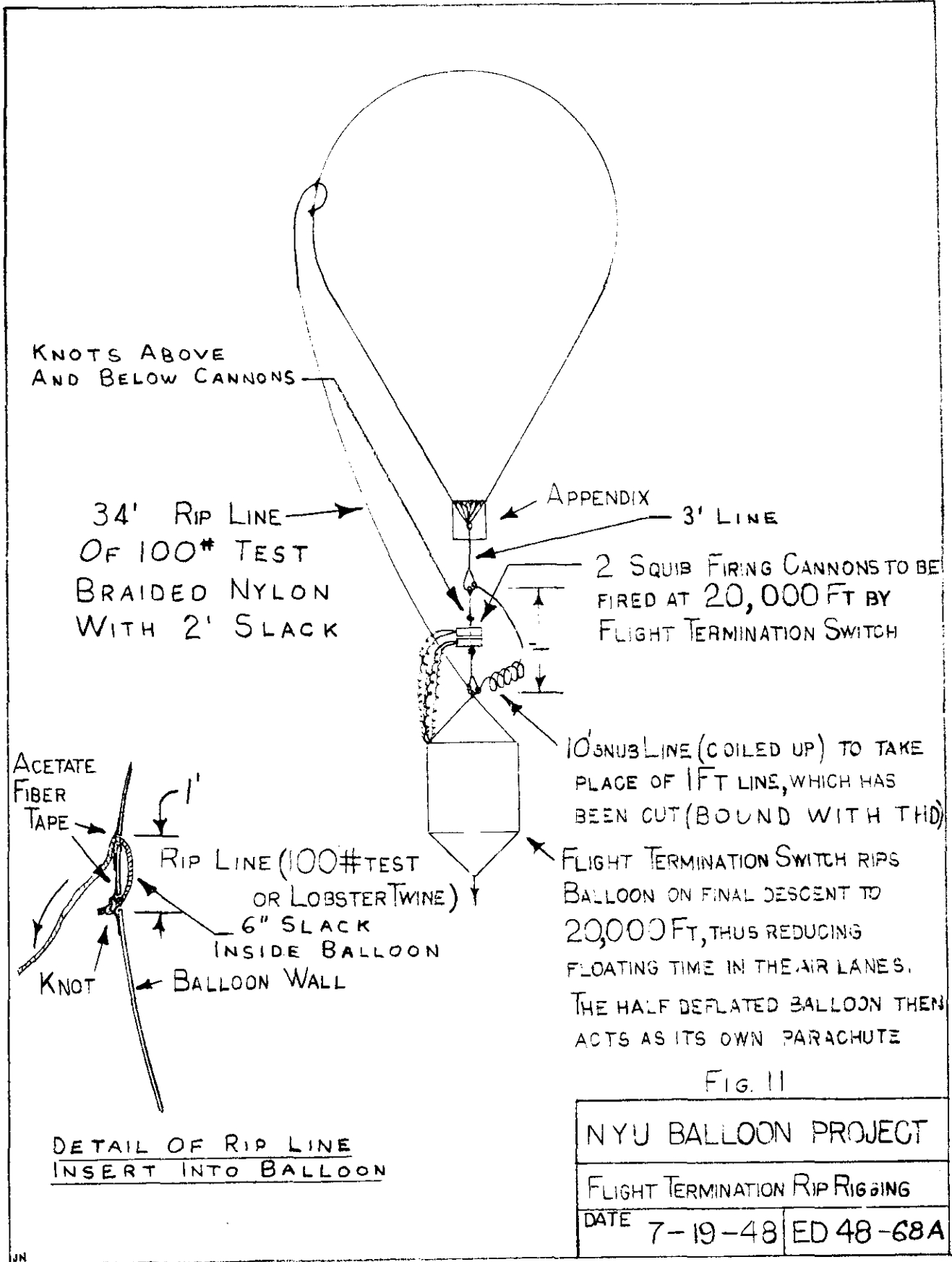

Fig. 11

NYU BALLOON PROJECT	
FLIGHT TERMINATION RIP RIGGING	
DATE	7-19-48 ED 48-68A

PEN ARM IS ON SHELF UNTIL BALLOON RISES ABOVE 25,000 FT. WHERE IT FALLS ON TO THE COMMUTATOR. WHEN THE BALLOON DESCENDS THE PEN ARM RIDES DOWN ON COMMUTATOR UNDER THE SHELF, CLOSING THE CIRCUIT AT 20,000 FT.

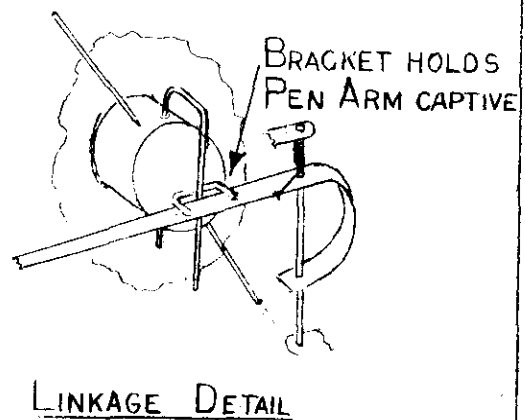
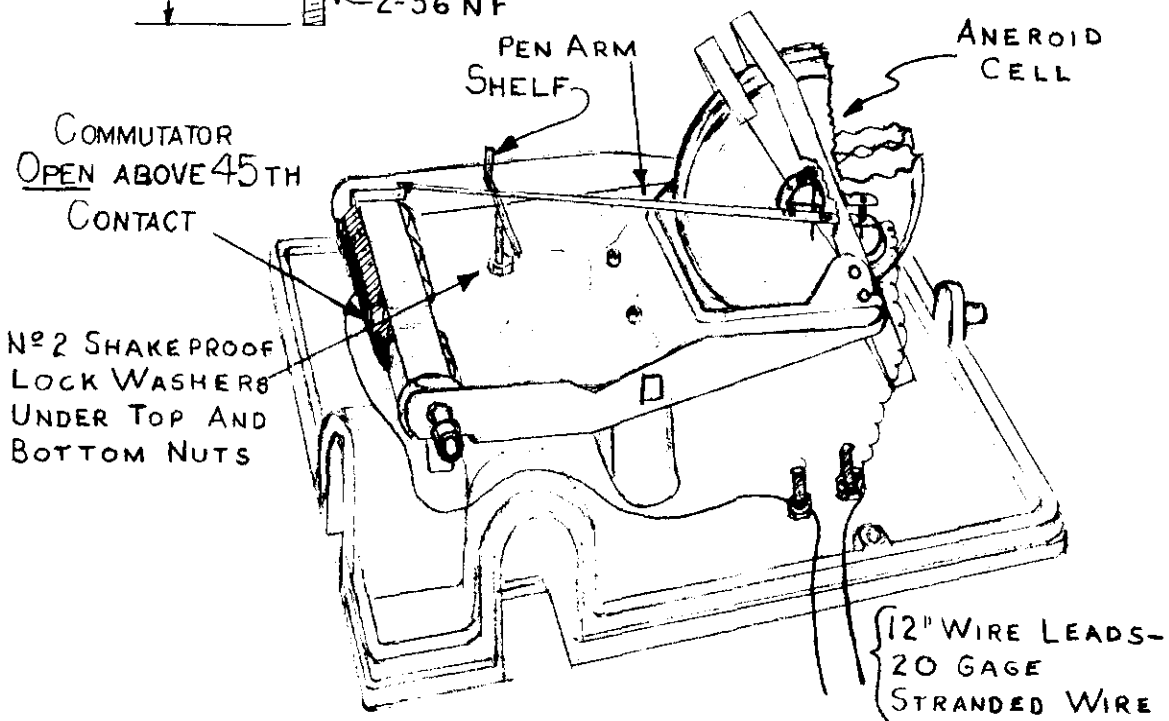
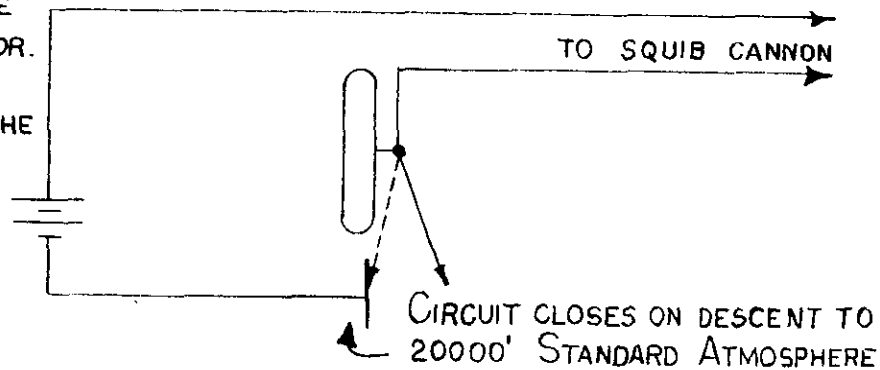
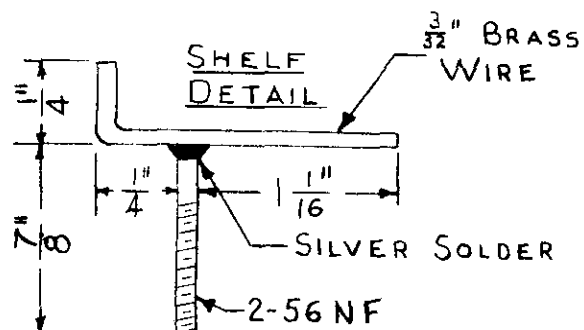

FIG. 12

NYU BALLOON PROJECT

FLIGHT TERMINATION SWITCH

DATE 7-27-48 ED48-70A

NOTE: MFD BY KOLLSMAN



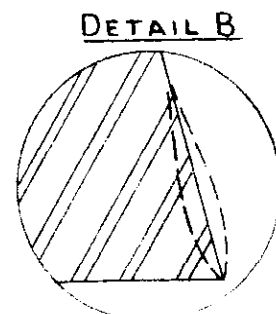
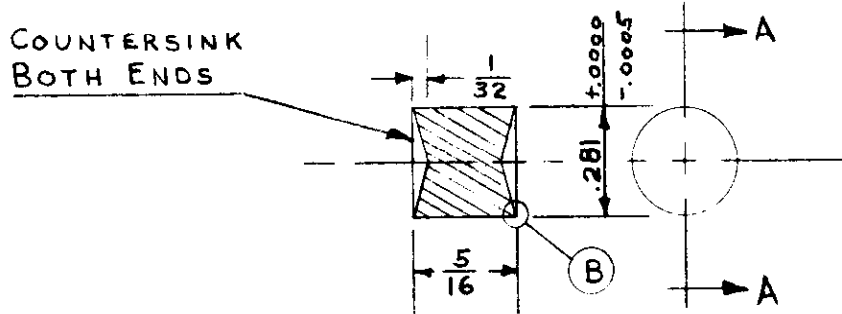
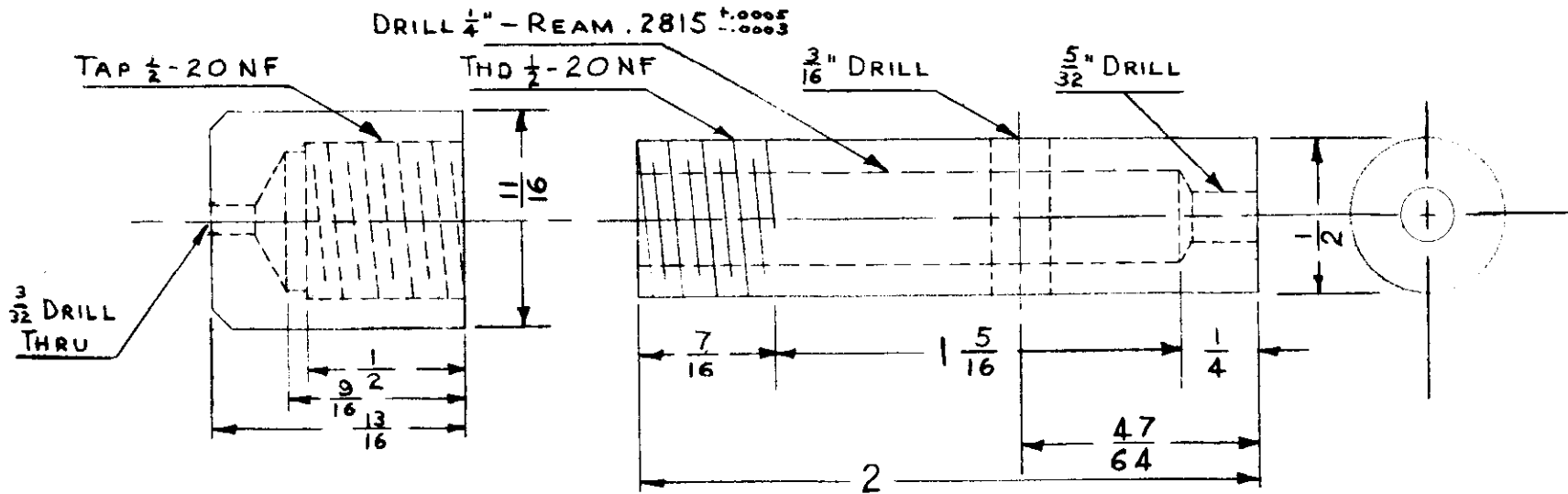

SECTION A-A  
 HARDEN DRILL ROD BULLET

NOTES:  
 FOR USE WITH:-  
 1. DuPont S-64 Squib (3' WIRES)  
 2. 500\* TEST PARACHUTE SHROUD LINE

PART	MATERIAL
CANNON	24 OR 61 STAL
CAP	24 OR 61 STAL
BULLET	DRILL ROD OR CAST LEAD

NYU BALLOON PROJECT  
 LINE CUTTER  
 CANNON  
 LHM  
 11-15-48  
 ED48-117A

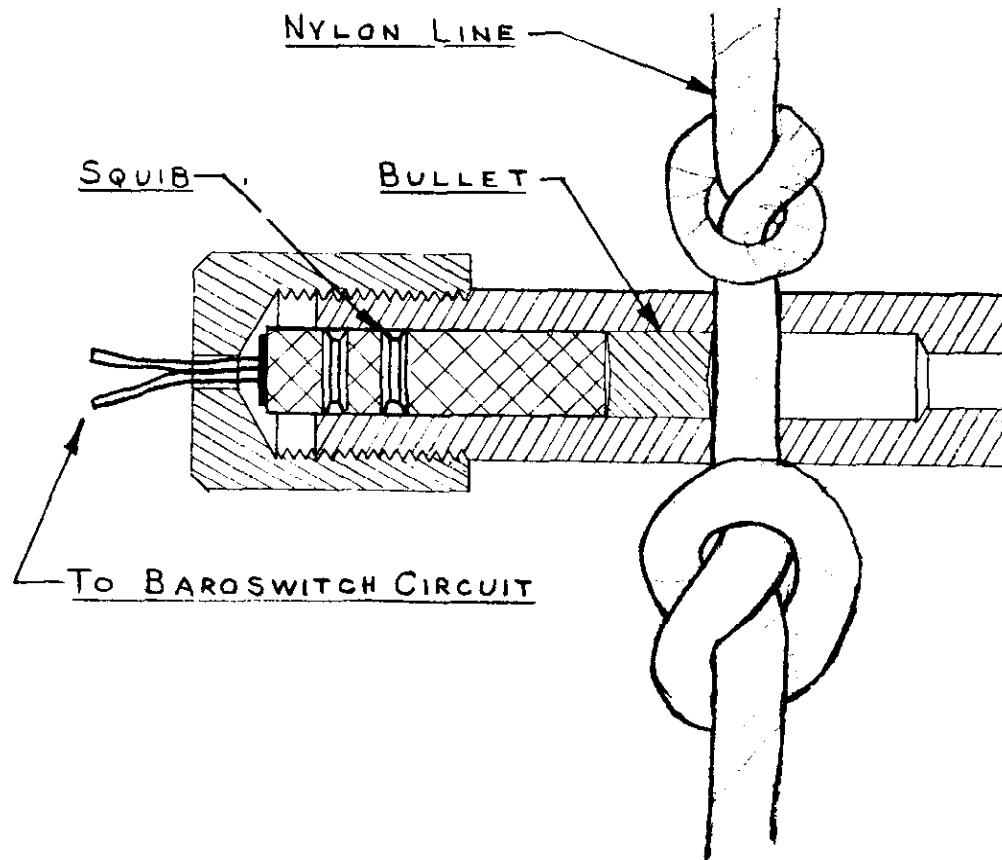

NOTES

FOR CANNON DETAILS SEE ED 48-117A  
 USE KNOTS ABOVE AND  
 BELOW CANNON  
 SQUIB- DUPONT S-64

FIG. 14

N.Y.U. BOLDWIN PROJECT	
ASSEMBLY OF LINE CUTTER CANNON	
DESIGNED BY LHM	ED49-5A
DATE: 2-1-49	

#### D. Accessory Flight Equipment

On most flights, three pieces of equipment are added to the train for special purposes. These are: (1) a banner, (2) a drag parachute, and (3) safety weights.

The banner is a red or yellow cheesecloth rectangle, 3 x 6 or 6 x 12 feet, with aluminum spreaders at top and bottom. Shown in Figure 15, the banner is tied taut to the load line, and serves to reduce sidewise swaying as the balloon rises. Due to the bright color, it is useful in locating the balloon after being grounded and acts as a warning to air craft during descent and ascent. If theodolite stadia determinations are being made, the banner can be used as one of the check points on the train.

The drag parachute is inserted into the train above the banner in inverted position and serves to retard the ascending balloon somewhat, thus reducing the probability of bursting due to excessive rates of rise.

To correct a too slow rate of rise, (which may result from under inflation due to gage errors, freezing of valves, or excessive adiabatic cooling of the gas during inflation) two small bags of sand or shot are added to the bottom of the restraining line. If it appears that the balloon is not rising with the desired velocity as it picks up the equipment, one or both of these safety weights are cut free. The weight of each bag is equal to the desired free lift, so that if the computed free lift is not available, this lift may be supplied. Prior to the adoption of this practice, it was necessary to sacrifice equipment or the balloon in such cases.

#### E. Tracking and Recording Instruments

Depending upon the nature of the flight, the weather conditions, and the equipment available, gear may be added to the flight train to aid in horizontal position determination and altitude measurement. The discussion of suitable equipment for such work is given in Section VII. In general, the equipment added may be either radio transmitters or gear of other assorted types. Each unit is rigged separately, with hooks at each end of the line segment. Prior to the inflation of the balloon a thorough check of all such equipment, especially radio gear, is made. It is necessary to have spare equipment tested, calibrated, and assembled for last minute replacement if failure is detected at this time.

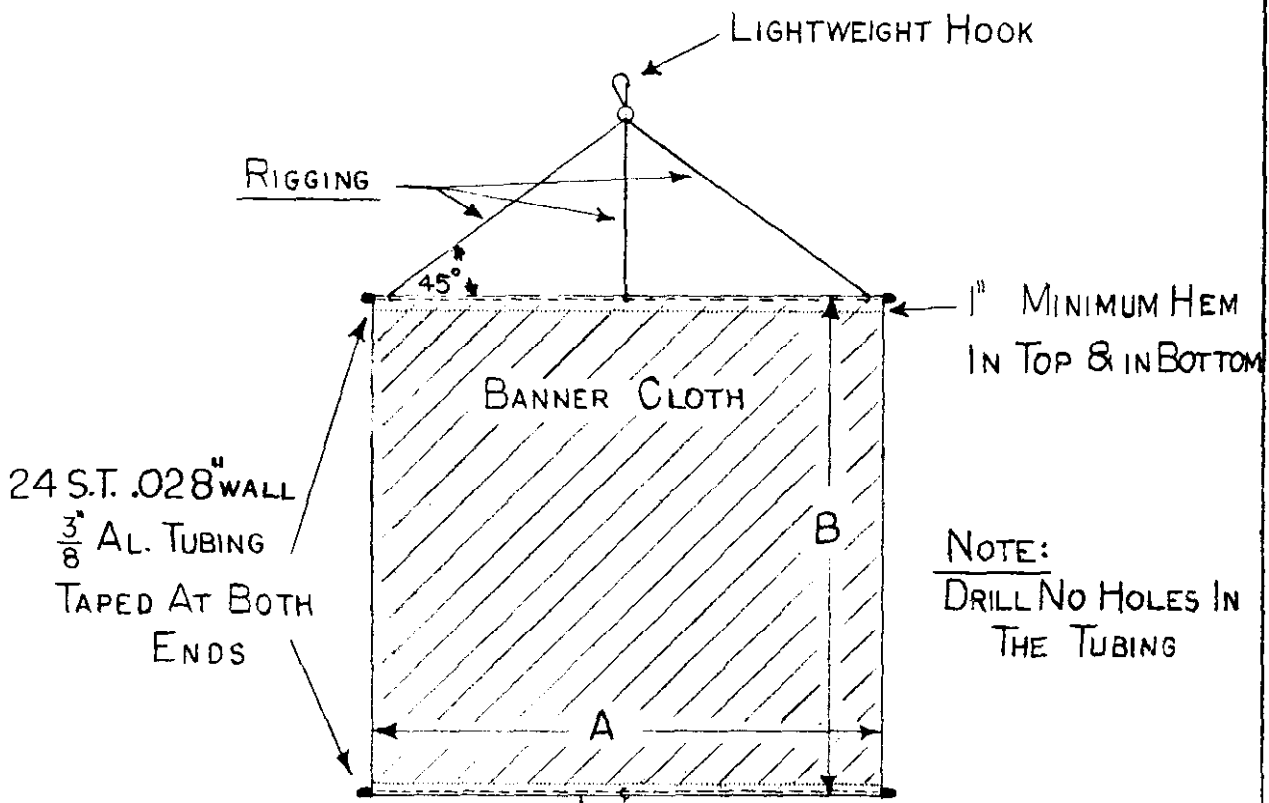

24 S.T. .028" WALL  
 $\frac{3}{8}$ " AL. TUBING  
 TAPED AT BOTH  
 ENDS

NOTE:  
 DRILL NO HOLES IN  
 THE TUBING

CLOTH: CHEEEECLOTH  
 20 THREADS x 20 THREADS PER INCH

SIZES:

A	B
3'	3'
6'	6'
6'	12'
3'	6'

COLOURS:  
 WHITE  
 YELLOW  
 RED

FIG. 15

NYU BALLOON PROJECT	
BANNER	
Date: 5-19-48	ED 48-56

Position of recording and radio instruments in the flight train is in some cases dictated by the size and shape of antennae or other special part. In general this type of gear is not placed below the altitude control equipment because of possible damage which might result from ballast being dropped upon them. Typical trains are shown in Figures 16, 17, and 18.

#### F. Flight Tools and Equipment

A list of tools and equipment and facilities which should be provided for any launching site is given in Appendix II.

### IV. PRE-FLIGHT COMPUTATIONS

#### A. Lifting Gas and Rate of Rise

When the equipment for a flight is in readiness and the inflation procedure is to be begun, the total weight to be lifted must be determined. A weight sheet (shown in Appendix I) is filled in, with the final weight of each piece of gear with its rigging. In this work the weights of the equipment are measured in grams and kilograms for ease of computation. The gross load reported should be accurate to the nearest 200 grams. The amount of lifting gas to be used must be carefully figured to prevent incorrect inflation which might result either in the balloon failing to rise, or perhaps rising too fast and rupturing at its ceiling. After the total weight to be lifted is found, a percentage of this total is added to provide for lifting the load at some specified rate. With a given excess of buoyancy, a balloon will lift its load at an almost constant predictable speed. (The rate of rise will increase by about 25% at higher altitudes, due to the changes in balloon shape and decrease of air density.) Graph 1 of Appendix II shows the relationship between the free lift and the rate of rise, with free lift expressed as a percentage of the total or gross load (which includes the weight of the balloon itself). For example, if a gross load of 10.0 kilograms is to be lifted at a desired ascent rate of 600 feet per minute, 9.2% of the gross load should be added, giving a gross lift of  $10.0 + .920 = 10.920$  kilograms. (The rate of rise should not exceed 700 feet per minute if a standard appendix is used.)

It should be noted that this graph, derived from equations for spherical balloons, applies also to the tear-drop cells of General Mills, Inc., without regard for the balloon diameter.

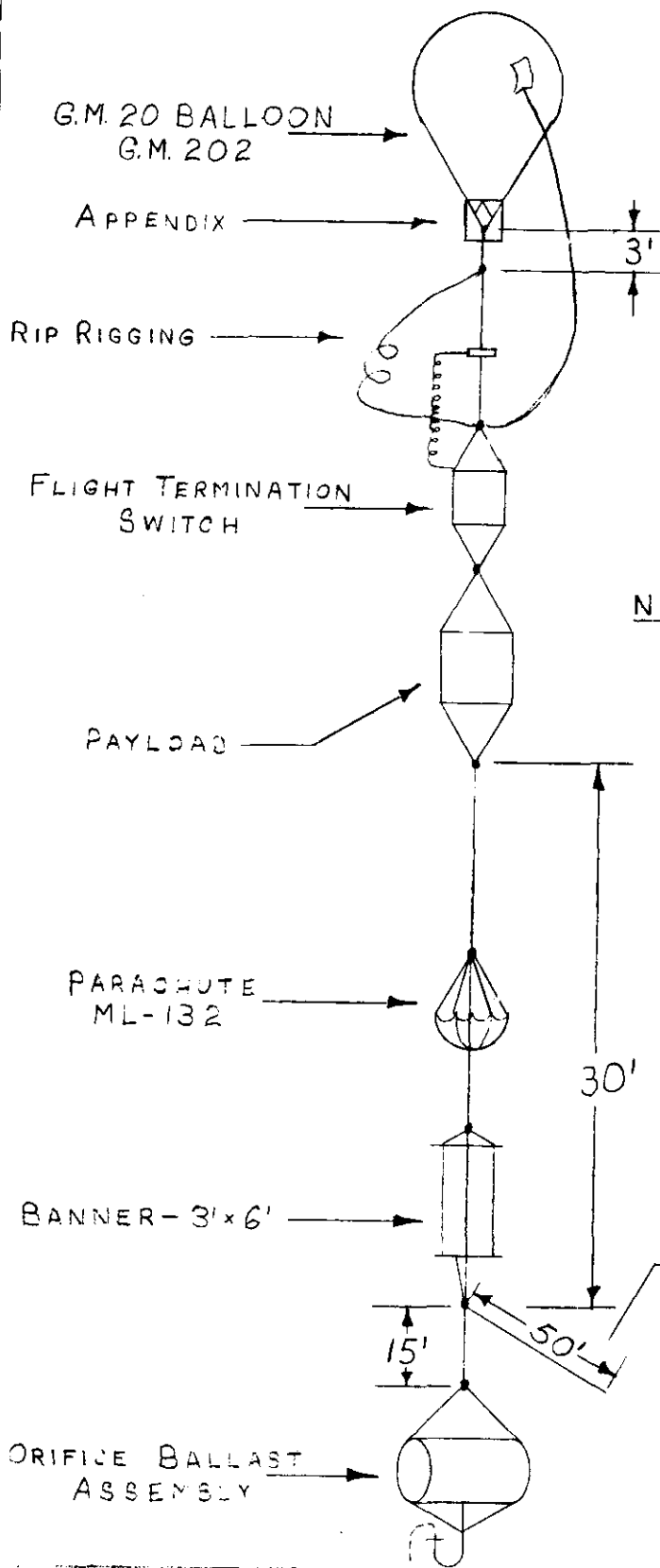

1500 gm FT. SWITCH  
 500 » RIGGING  
 2500 » PAYLOAD  
 500 » DRAG & BANNER  
 500 » RESERVOIR  
1500 » BALLAST  
 7000 gm NET  
4500 » BALLOON  
 11500 gm Gross

NOTE:  
 CEILING - 59000 to 63000 ft.  
 All rigging 500 lb. test Nylon  
 2 Full Tanks Helium Req'd  
 Prob. Flight Dur. - 10 hrs.

Fig. 16

NYU BALLOON PROJECT	
PROPOSED FLIGHT TRAINS FOR SERVICE FLIGHTS (COMPLETE)	
DWN. BY: L.H.M.	FT 48-XI
DATE: 8-31-48	

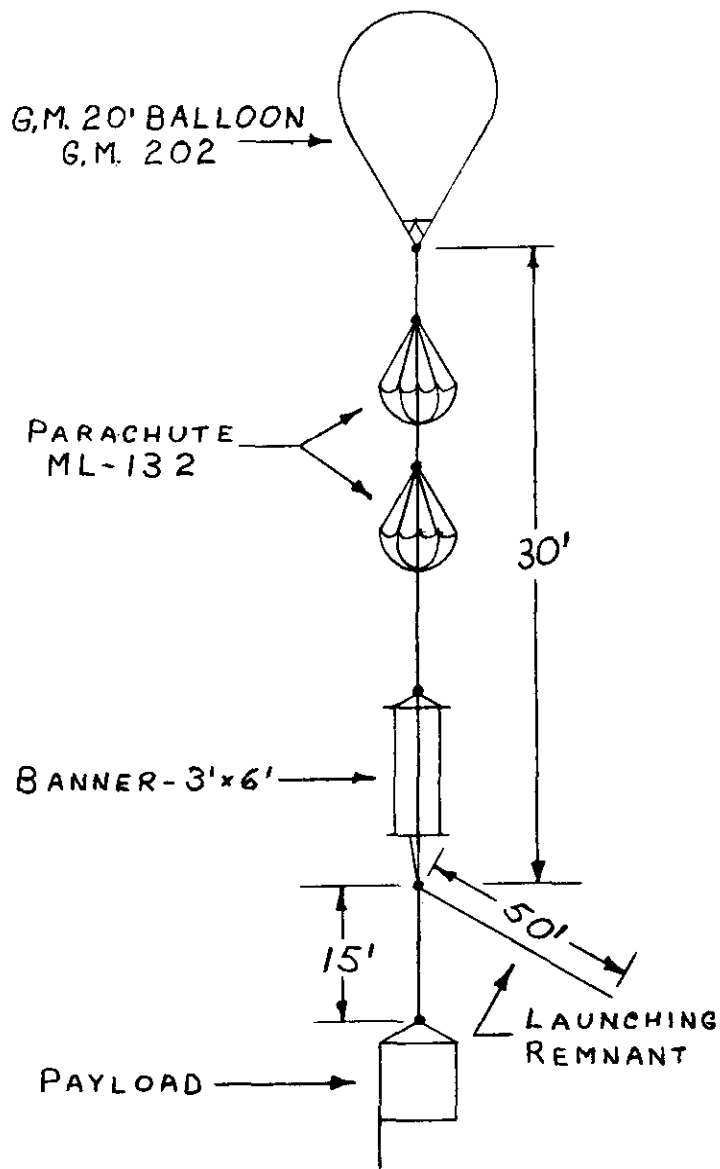

500 gm	DRAG CHUTES
300 "	BANNER
2000 "	PAYLOAD
4500 "	BALLOON
<u>7300 "</u>	GROSS LOAD

**NOTE:**

Use low rates of rise (500 ft per min) to prevent balloon failure during ascent.  
 All rigging 500 lb. test Nylon.  
Max. Ceiling with this load:  
 67000 to 70000 ft.  
Probable Ceiling: 45000 ft.  
 since no appendix is used.  
Prob. Flight Duration- 3 hrs.  
 1/4 FULL TANKS HELIUM REQ'D.

FIG. 17

NYU BALLOON PROJECT	
PROPOSED FLIGHT TRAINS FOR SERVICE FLIGHTS (SIMPLE GEAR)	
DWN. BY: L.H.M.	FT 48-X 2
DATE: 8-30-48	

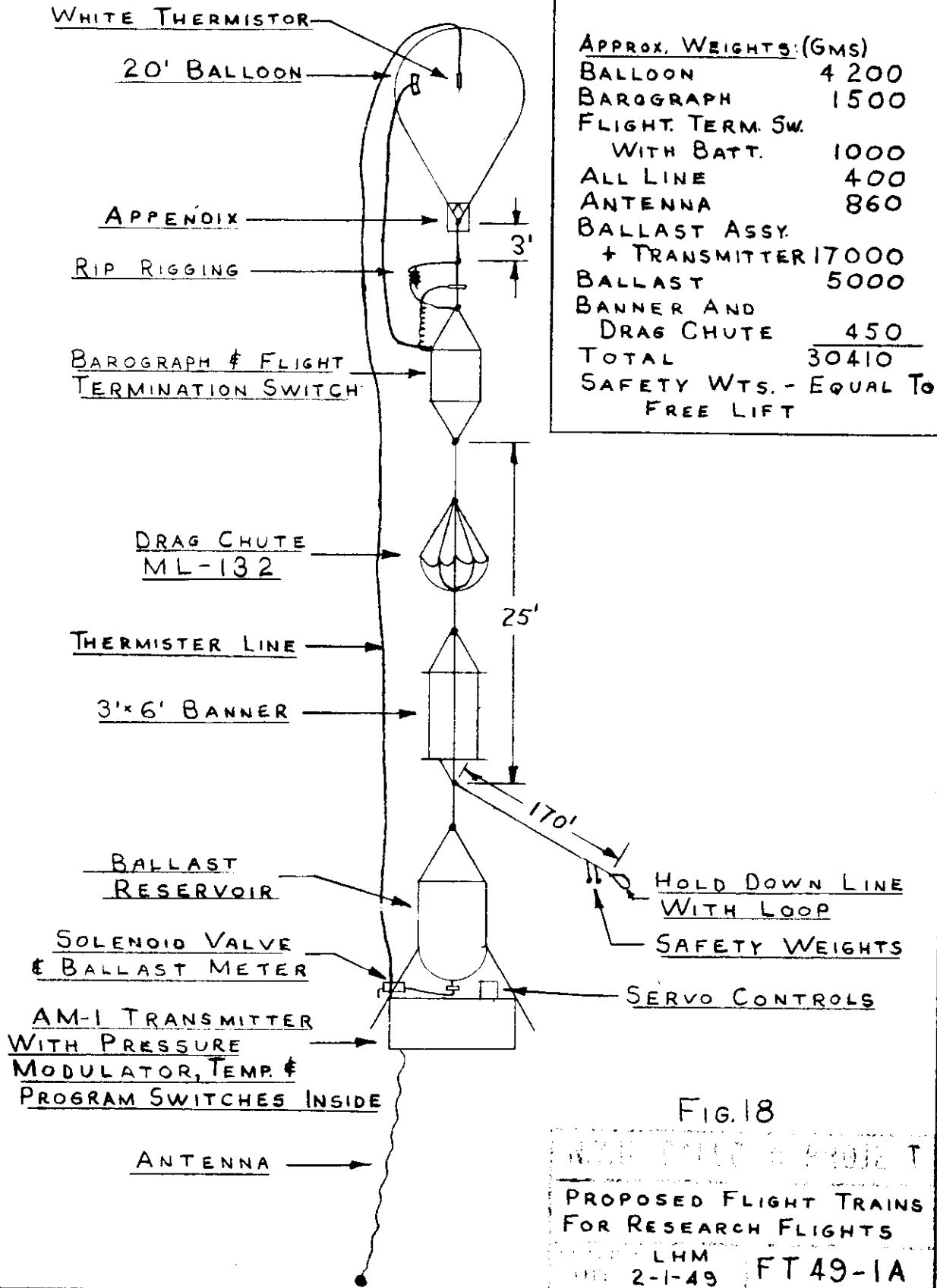

APPROX. WEIGHTS: (GMS)	
BALLOON	4 200
BAROGRAPH	1 500
FLIGHT TERM. SW.	
WITH BATT.	1 000
ALL LINE	400
ANTENNA	860
BALLAST ASSY.	
+ TRANSMITTER	17 000
BALLAST	5 000
BANNER AND DRAG CHUTE	450
TOTAL	30 410
SAFETY WTS. - EQUAL TO FREE LIFT	

FIG. 18

PROPOSED FLIGHT TRAINS FOR RESEARCH FLIGHTS

LHM

2-1-49 FT 49-1A



When the total quantity of gas needed has been computed, the lift requirement may be expressed in terms of the pressure of a number of cylinders of gas. It is not possible to assume that each tank of gas will give the same amount of lift, nor is it possible to use a gage which has not been experimentally calibrated to relate lift to pressure. For calibration of a gage it is sufficient to valve gas from an observed equilibrium temperature and pressure in a cylinder into a rubber balloon and then measure the total lifting capacity of the gas from the tank. Check points should be made with tanks under varying amounts of pressure. Figure 19 shows a sample gage calibration worked up for varying temperatures assuming the simple gas law

$$\text{Lift}_2 = \frac{P_2}{P_1} \times \frac{T_1}{T_2} \text{Lift}_1$$

This law applies to within 1%. Note: Do not use Graph 6 without checking calibration of gage to be used. Ordinarily a whole number of full tanks of gas will not exactly supply the desired lift, which should be figured with not more than one-tenth full tank tolerance in excess (permit no under inflation). It is thus necessary to prepare partially full tanks and by combining full and partially full cylinders get the required total. It is necessary to allow the cylinders to attain equilibrium temperature after valving them before taking final pressure readings.

#### B. Length of Balloon Bubble

The volume of gas required for a given balloon may be expressed as the length of an uninflated bubble at the crown of the balloon. Graph 2 of Appendix II gives the relationship between bubble length and resultant inflated volume, using gross lift as an expression of volume. It will be noted that when the elevation of the launching site is markedly different from sea level, a shift in this curve is needed to accommodate varying densities of the atmosphere. The inflation of this bubble, which is pinched off by launching equipment or shot bags, will serve as a good check of the final amount of gas in the balloon, thus warning if the balloon is underinflated.

#### C. Expected Altitude

To predict the altitude to which a balloon will rise it is necessary to know the volume of the balloon, the total

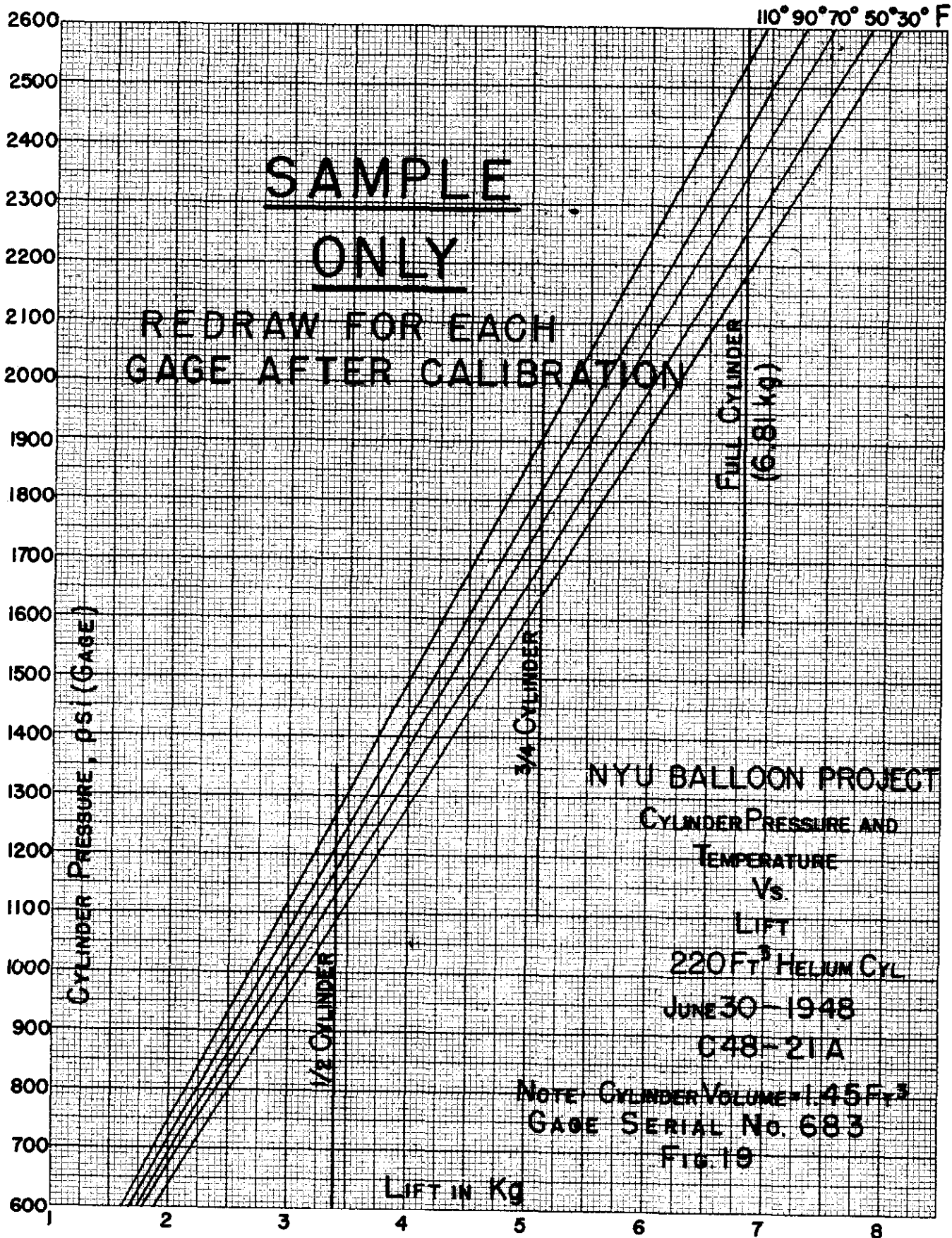

weight of equipment and balloon, the distribution of density in the atmosphere and the buoyancy of the lifting gas. Assuming that the lifting gas is helium, Graph 3 in Appendix II summarizes the relationship between gross load and floating level for balloons of several diameters. To use this graph to find the floating level of a balloon of given size and load, enter with the required buoyancy (equal to the gross load). Go vertically to the diagonal line corresponding to the balloon size and then horizontally to the extreme left-hand edge and read the altitude. The volume of the balloon is related to density by the use of the molar volume in this chart. Assuming observed pressure and temperature distributions over selected stations and the N. A. C. A. standard atmosphere, the molar volume is given as well as the altitudes. Table 1 of Appendix II gives the N. A. C. A. Standard Atmosphere relating pressure with altitude, and Table 2 gives the variation of temperature with altitude. For local conditions more exact measurements may be made using the temperature and pressure distribution indicated by a sounding rather than the standard. To do this, it is necessary to compute the molar volume from this relationship

$$\text{molar volume}_z = 359 \text{ ft.}^3 \times \frac{T_z}{273^\circ\text{C}} \times \frac{1013.3 \text{ mb}}{P_z}$$

Example: Find the molar volume at 30,000 feet MSL where the reported temperature is  $-30^\circ\text{C}$ , and the reported pressure is 300 mb.

$$\text{molar volume}_{30,000} = 359 \text{ ft.}^3 \times \frac{(273-30)^\circ\text{C}}{273^\circ\text{C}} \times \frac{1013 \text{ mb.}}{300 \text{ mb.}} = 1080 \text{ ft.}^3$$

This is the volume of a pound mol of any gas at those conditions.

By plotting several points of this curve of molar volume versus altitude, it is possible to locate very exactly the altitude which corresponds to the molar volume to which the balloon will go (found from Graph 3 or as follows). This density or molar volume to which a balloon will rise is given by the following formula:

$$\text{Molar volume} = \frac{\text{Balloon volume}}{\text{Gross load}} \text{ Gas Lift/mol}$$

$$\text{Gas lift/mol} = 11.1 \text{ kg/mol (using Helium)}$$

#### D. Ballast Requirements

For a 20-foot General Mills balloon, a flow of ballast of at least 200 grams per hour is needed to keep the balloon aloft. Flow of the compass fluid used varies (through a sharp-edged orifice) with the head, or vertical distance between the free surface of the liquid and the orifice. It is not affected by the temperature or pressure, so long as the reservoir is properly vented.

Flow also varies with the size and shape of the orifice. Using round spinnerette orifices, the flow of various heads has been computed and is shown in Table 3, Appendix II. From a knowledge of the minimum head to be expected (depending on the construction of the ballast reservoir and its connection to the orifice), the desired rate of flow can be obtained by proper selection of orifice size. While 200 grams per hour has been used successfully for the usual floating altitudes of the General Mills 20-foot cells, this figure should be considered as an absolute minimum. A short period check of the flow rate through each ballast assembly prior to flight is recommended.

#### E. Altitude Sensitivity

The altitude gained by a balloon when its load is reduced by one kilogram is called its altitude sensitivity. This amount is affected by the density of the atmosphere at the floating level; for 20-foot balloons between 40,000 and 53,000 feet, it is roughly 1000 feet per kilogram of weight lost. This weight is normally lost by ballast dropping. The altitude sensitivity and the ballast drop control the rate of rise of the ceiling. Graph 4, Appendix II gives more exact values for this figure at various altitudes.

#### F. Forms and Records

For the purpose of making standard pre-flight computations, a series of computation sheets have been drawn up. These are shown in Appendix I. Reward tags attached to components of the flight train have encouraged the finders to protect the equipment and report its location for recovery. The tags, questionnaires, and the warning notices which are used on appropriate gear where squibs or acid are used are shown in Figures 20 and 21.

### V. BALLOON INFLATION

#### A. Preparation of Balloon

From the moment the protective packing of the balloon is removed, great care must be exercised to prevent tears

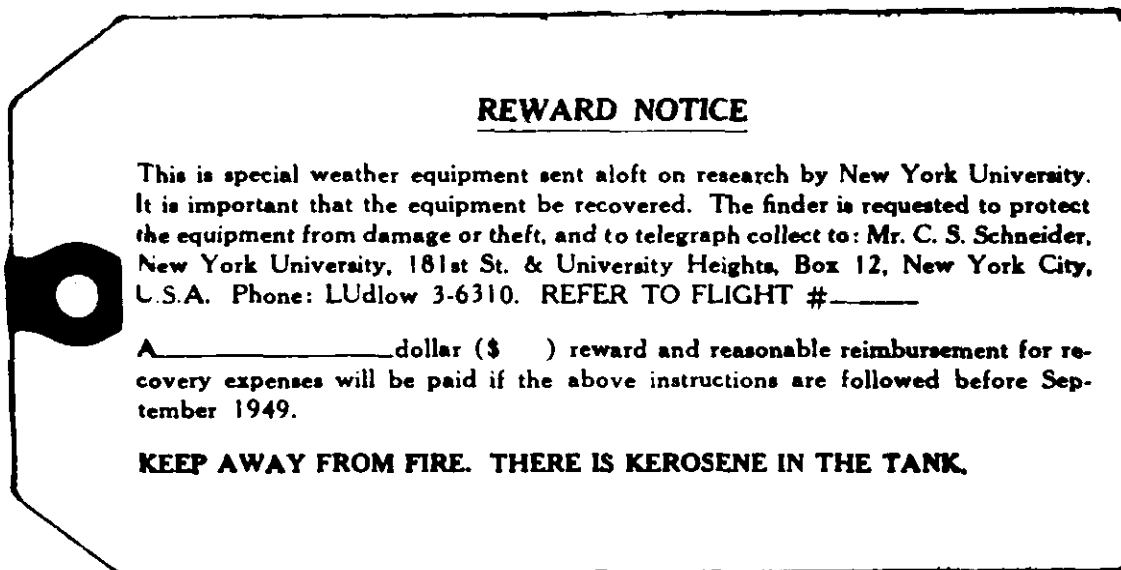

Figure 20  
Sample warning and reward tags

### QUESTIONNAIRE

Please answer this and send to us so that we may pay you the reward.

1. On what date and at what hour was the balloon discovered?
2. Where was it discovered? (Approximate distance and direction from nearest town on map?)
3. Was it observed descending? If so, at what time?
4. Did it float down slowly or fall rapidly?
5. How much kerosene was there in the tank?

### Remuneracion

La materia ha volado con este globo desde la Nueva York University para hacer investigaciones meteorologicas. Se desea que esta material se vuelva para estudiarle nuevament.

Con este motivo, se dara una remuneracion de \_\_\_\_\_ dolares norteamericanos y una suma proporcional para devolver todos los apartos en buen estado. Para recibir instrucciones de embarque, comuniquense con la persona siguiente por telegrafo, gastos pagados por el recipiente, refirriendo al numero del globo \_\_\_\_\_.

**CUIDADO!**

**PELIGRO DE FLAMA, HAY KEROSEN EN EL TANQUE.**

C. S. Schneider  
Research Division  
New York University  
University Heights  
Bronx 53, New York

Figure 21  
Sample Spanish reward notice and English questionnaire.

and pin holes from being made in the fabric. For example, the film is so easily injured that it is not safe to lay a folded-up balloon on a bare table-top or other hard surface on which sand or splinters might be found. For this reason a clean ground cloth of canvas should always be used for the lay-out of the balloon. Once the balloon has been laid out on the ground cloth, it is made ready for inflation and the rip line of the flight-termination gear is inserted into the cell (see Section III, C).

#### B. Use of Shot Bags and Releasing Device

While the balloon is being inflated it is necessary to hold it in position. Under conditions of calm wind, this may be accomplished by simple fastening heavy weights to the loading ring and allowing the entire balloon envelope to rise freely above its anchor.

Since only 10 to 20% of the balloon is full at the surface when the inflation is complete, it is possible to restrict the volume filled and so cut down the area exposed to the wind on days which are not calm. The volume required can be expressed as the length of the bubble collected at the head or top of the balloon. Having determined the desired length (see Section IV, B), the remainder of the balloon may be held down on the ground cloth by weighted bags wrapped in protective sheets of polyethylene (see Figures 22 and 23). Elliptical shot bags, weighing 100 pounds, are used to hold the base of the bubble to be inflated. Twenty-pound sand bags are used to keep the appendix closed to prevent filling of the balloon with air and to restrict the uninflated folds of the balloon. A more elaborate system of holding the gas in the upper section of the bubble makes use of the General Mills releasing device shown in Figures 24 and 25. Mounted on wheels, this mechanism is rolled into position with the head of the balloon lying across the platform. The protective roller arms lock into position holding the bubble until launching. This device is used with large loads when shot bags might roll or slide off the balloon. As the arms open outward as well as upward when the locking pins are removed, it is necessary to position the platform with the arms opening away from the bubble.

#### C. Inflation Techniques

When the balloon is manufactured, a polyethylene inflation tube about 4" in diameter is inserted. This tube extends from a few feet outside the appendix to near the top of

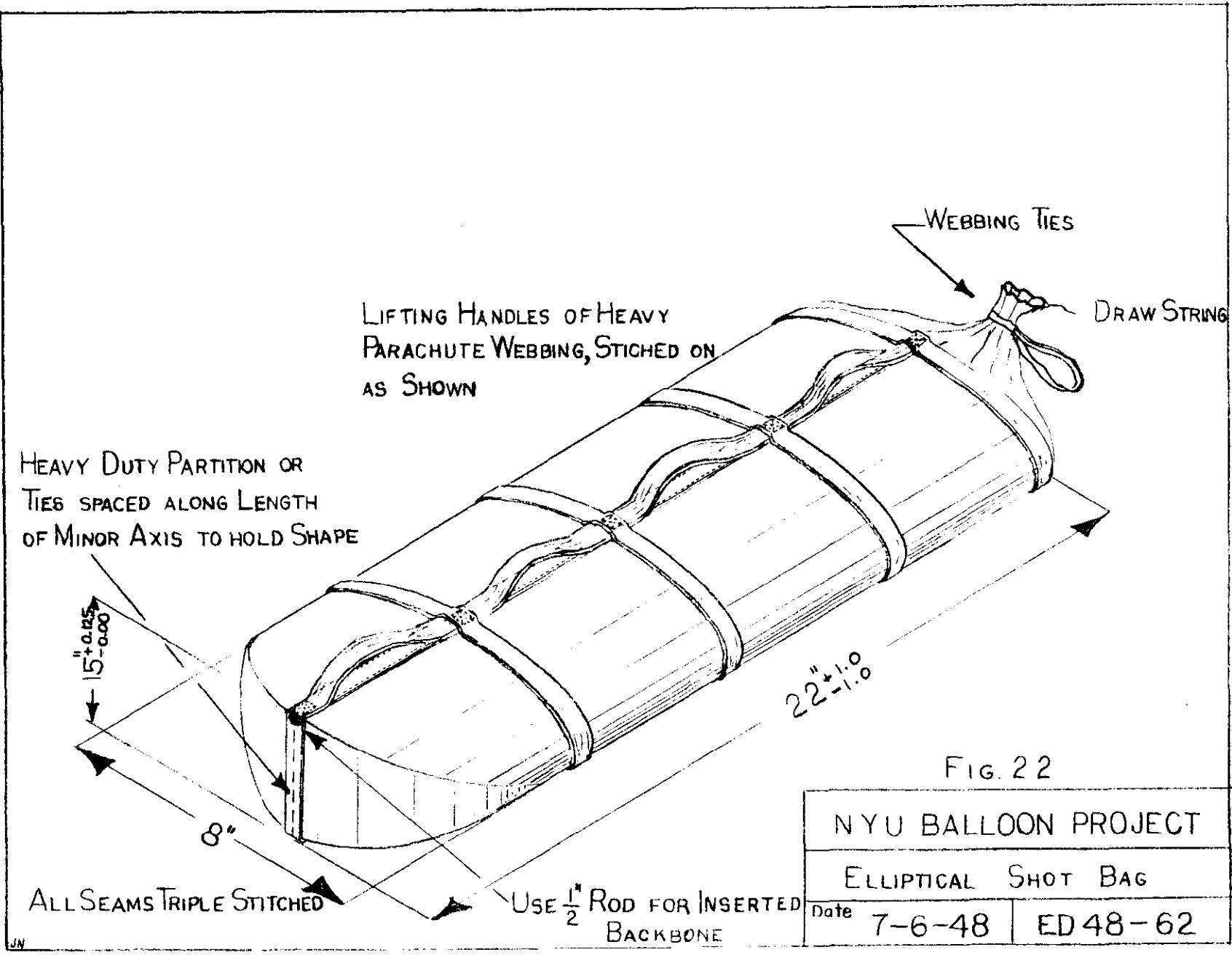
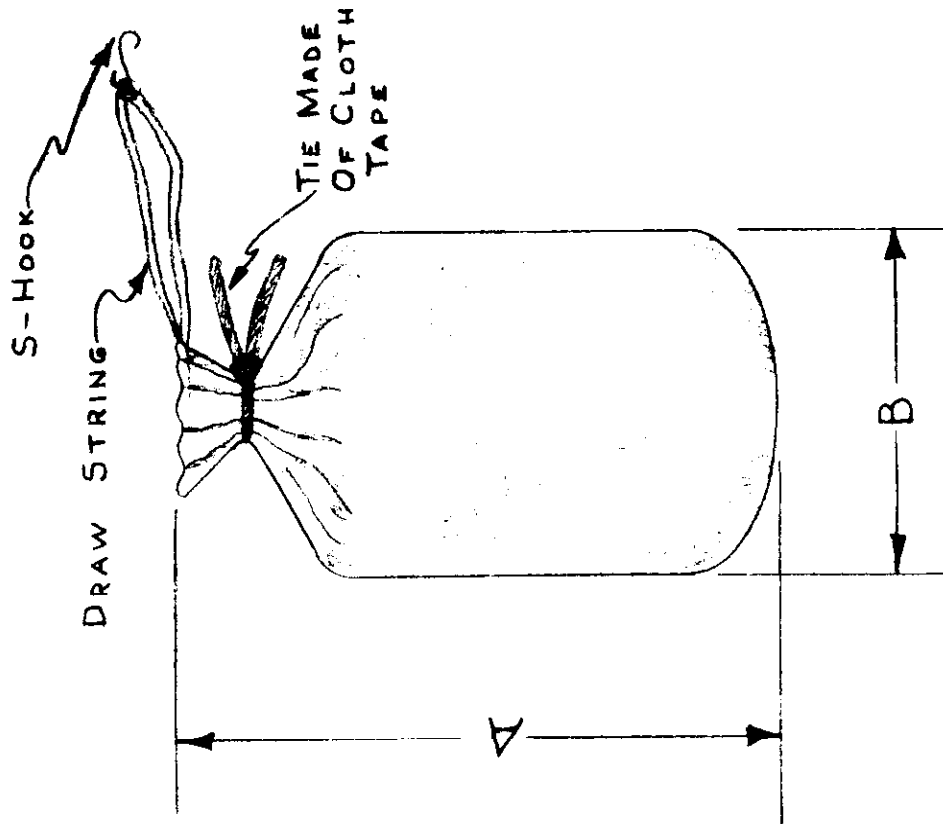

FIG. 22

NYU BALLOON PROJECT	
ELLIPTICAL SHOT BAG	
Date	7-6-48   ED 48-62





BAG SPECIFICATIONS			
TYPE	A	B	BOTTOM
40* SAND	12"	10"	DOUBLE
40* SHOT	7"	6"	DOUBLE
SAFETY WT.	5"	3"	SINGLE

MATERIAL-HEAVY CANVAS DUCK

FIG. 23

WATER BOMBING PROJECT

SAND AND SHOT BAG  
SPECIFICATIONS

PROJECT LHM

DA 5-11-23-48

ED48-122A

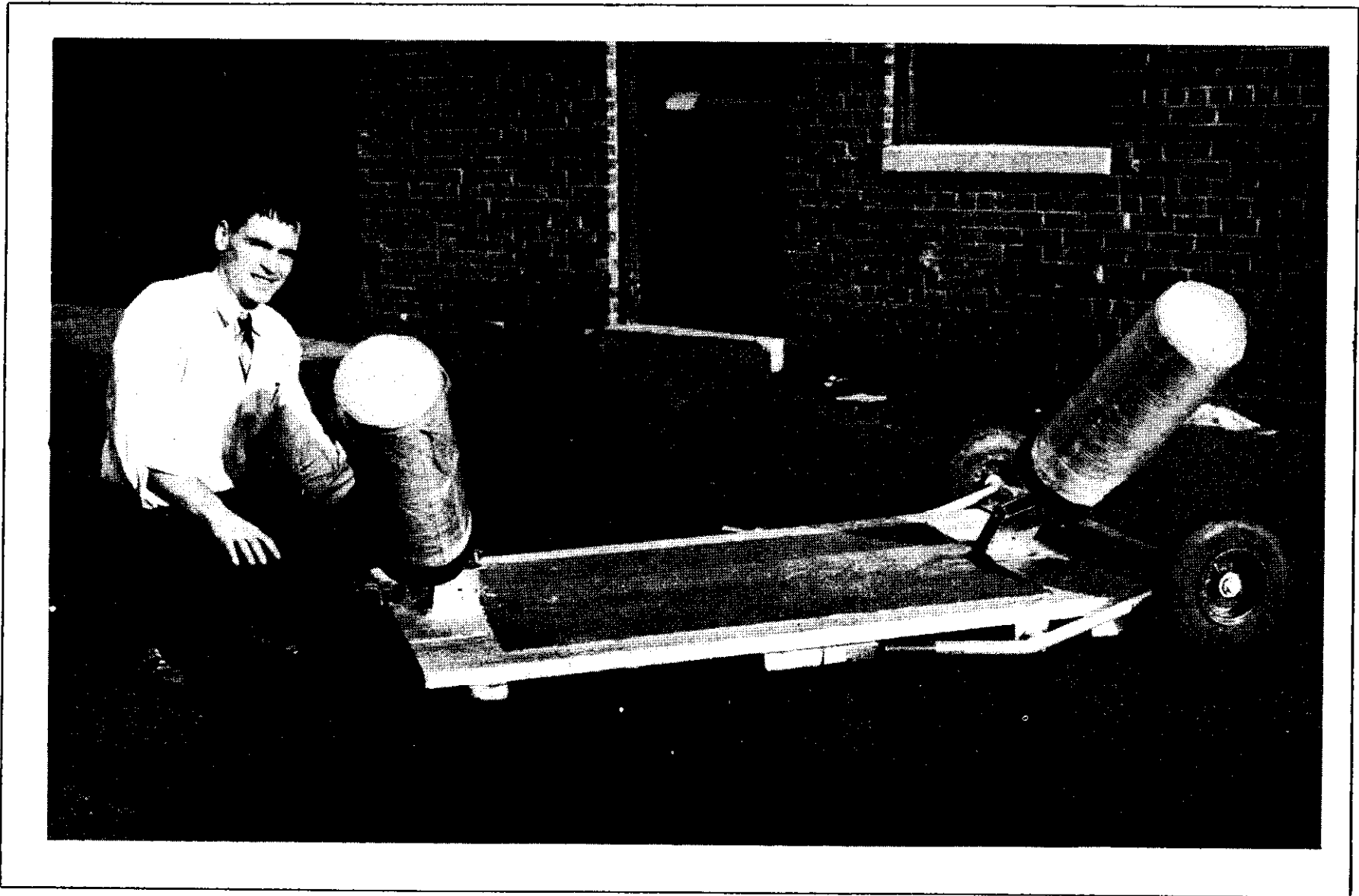

Figure 24  
General Mills launching platform for large balloons.

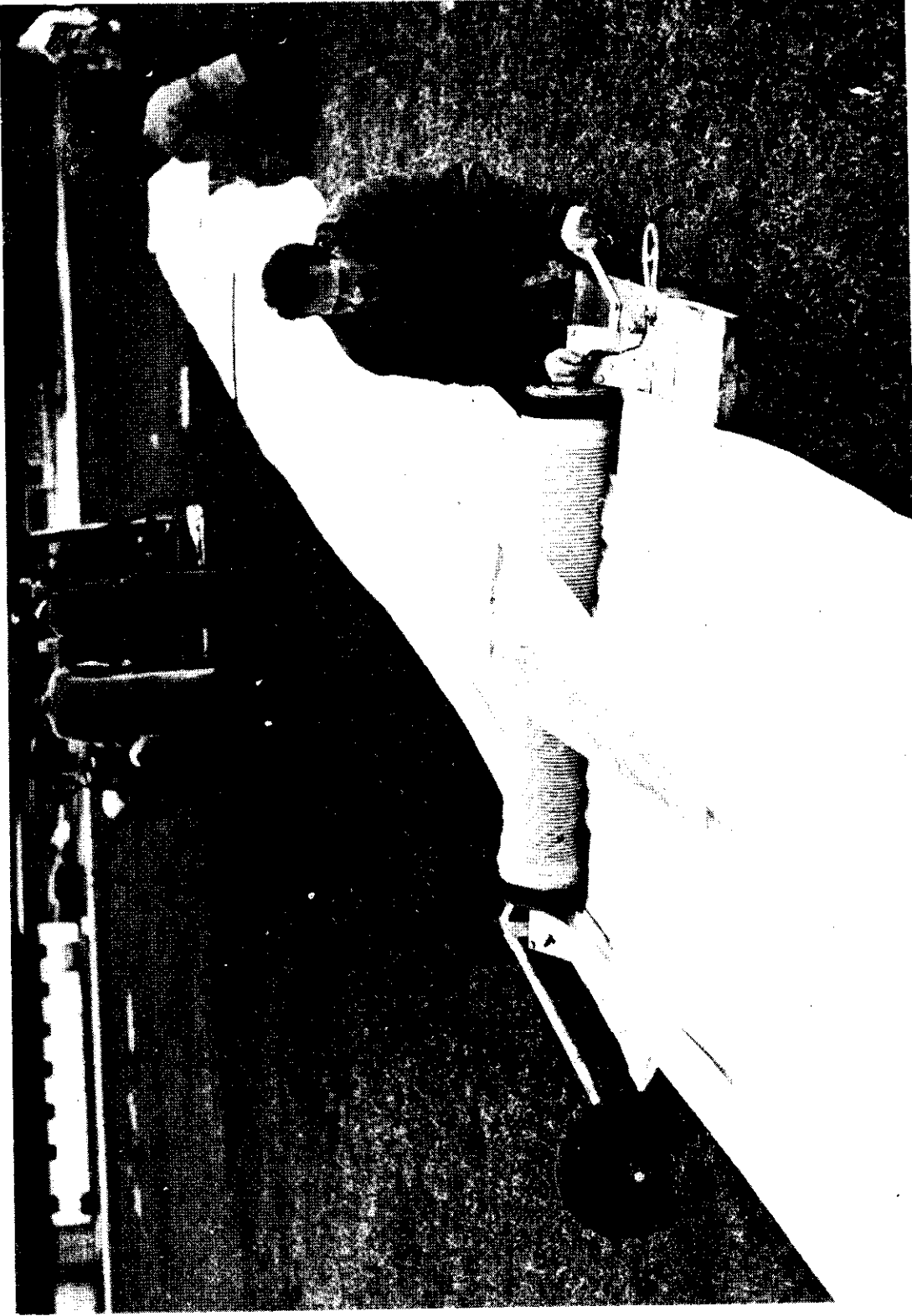

Figure 25  
Launching platform with balloon fixed in place  
for inflation.

the balloon and permits gas to be introduced into the top of the cell first. As the balloon is laid out and shotbags are positioned, this tube must be kept clear. At the point where the bubble is pinched off the folds of the balloon are carefully divided; the inflation tube is made as free as possible with only one layer of polyethylene above and one below it. The tube is then pulled up above and between the arms of the releasing device or the heavy shot bags, and the remainder of the fabric is pinned down so that no shifting will permit premature release.

Depending upon the load to be lifted and the rate of rise desired, a pre-computed amount of helium is fed into the balloon (see Section IV, A). This amount is determined by noting the equilibrium pressure and temperature of the gas in each cylinder. A manifold is used to feed the gas from the tanks to the inflation tube in the balloon. Shown in Figures 26 and 27 this manifold system consists of an adjustable number of flexible pigtailed leading into a main line of heavy copper tubing. This main line and the fittings are capable of withstanding the full tank pressure of about 2500 feet psi. Two pressure gages are included in the main line and it is thus possible to make last-minute checks of the amount of gas (pressure) in each tank. (Due to variable gage-calibrations, it has been found necessary to establish the lift-pressure ratio of each gage before using it.) In the main line of the manifold, two valves control the gas flow. The inflation tube is often initially twisted when the balloon is first laid out. A small amount of gas at very low pressure should be valved into the tube to strengthen it. In addition to the fine valve control required for this preliminary gas feed, it is also necessary for a manifold valve to permit high gas flow from the tanks even when the pressure is greatly reduced. For this, the coarse globe valve is used.

Once the tube has been checked, inflation should proceed as rapidly as possible. The balloon is outdoors and so subject to buffeting by the wind. The limiting factor of speed of inflation is the vibration of the fabric near the open end of the inflation tube.

As a result of the extreme cooling of the rapidly expanding gas, the manifold and the tank valve generally become coated with frost. Too rapid cooling may actually cause the valve to freeze shut.

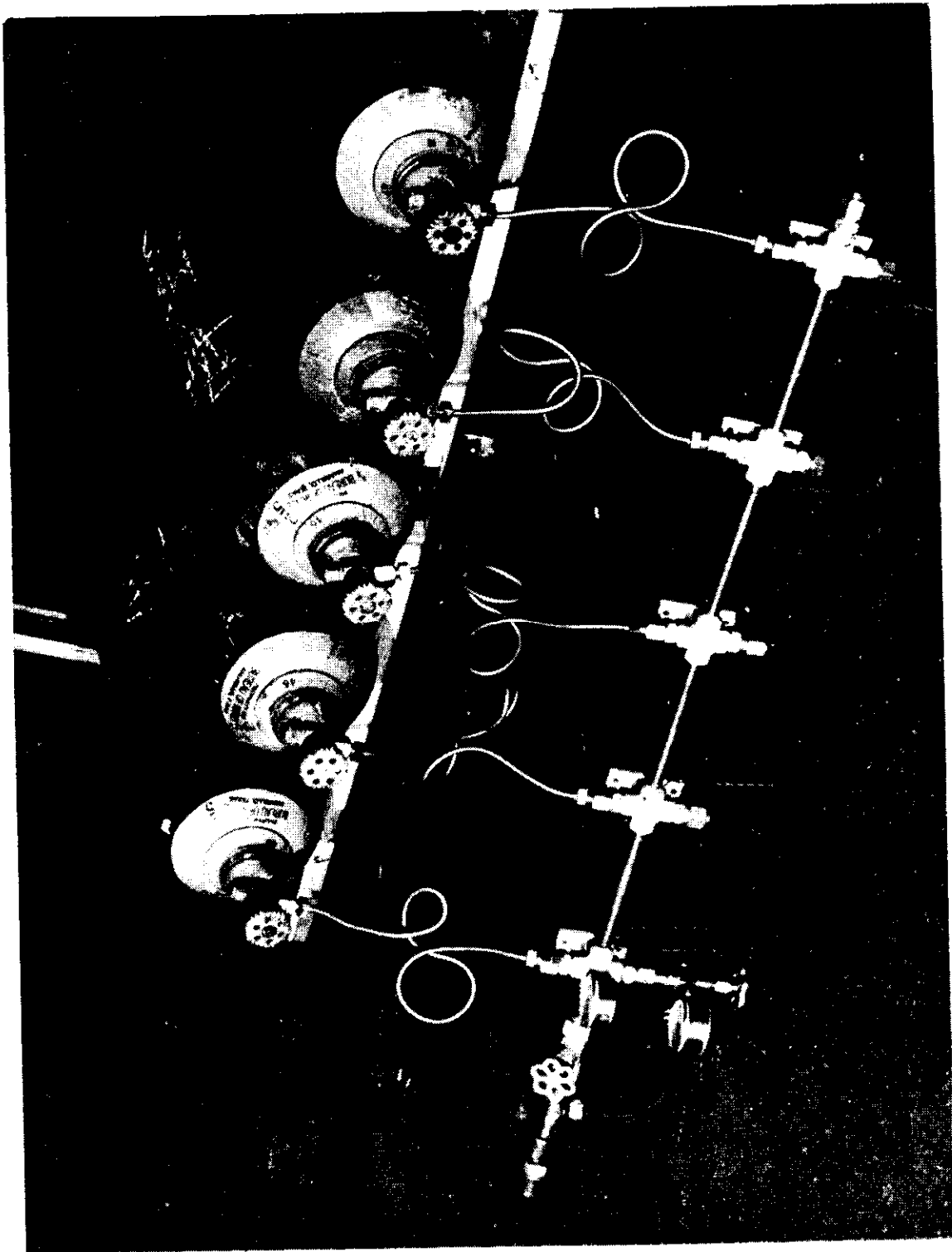
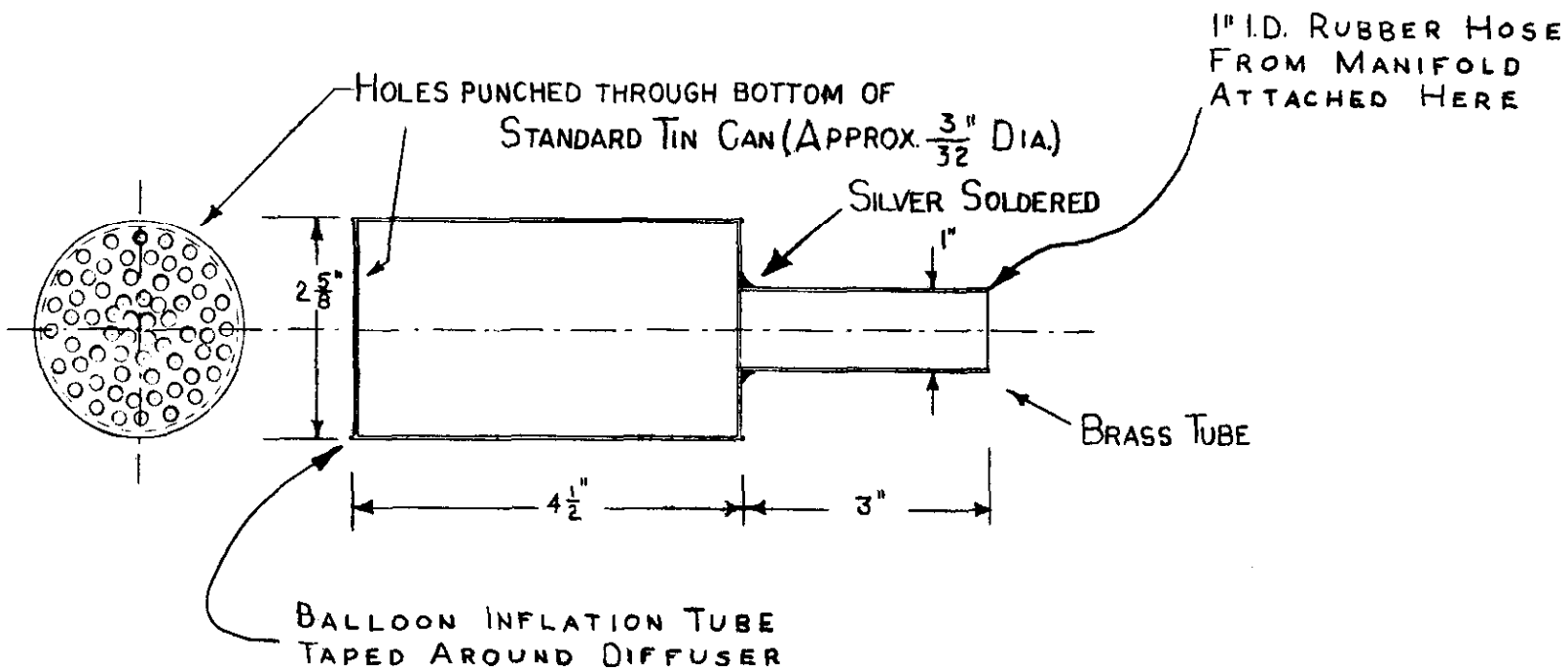

Figure 26  
Five Tank Helium Manifold



SCALE 1:2

FIG. 27

NYU BALLOON PROJECT

TYPE 2 DIFFUSER

DATE 8-25-48 ED48-76A

The effect of this cooling is evidenced in the lifting power of the gas. When a rapidly filled balloon is launched immediately after inflation, it has less lift than desired and may even be "heavy" rather than buoyant. 20°C cooling will make balloon 1% heavier. This may be 25% of free lift. In the inflation of the 70-foot balloons where more gas is used, and the cooling effect is more often harmful, a heating unit is added to the inflation equipment. The gas passes from the manifold through a coil which is centrally warmed by a blow torch and on into the inflation tube. The gas should arrive in balloon no more than 20°C cooler than the air.

## VI. BALLOON LAUNCHING

When the balloon inflation is complete, the inflation tube is removed from the balloon as gently as possible. There is apt to be constriction at the point where the bubble is formed by the launching arms or the shot bags. If the tube does stick at this point, great care must be given to freeing without ripping the balloon.

Should the balloon be torn in this or any other manner, it may be possible to patch the fabric and salvage the flight. The acetate-fiber scotch tape, used to attach the batten is used for patching. Transverse tapes are laid across the tear and the entire region is covered with a matting of tape.

When the inflation tube is freed and the restrained bubble is ready for launching, the lower portion of it is laid out down wind, as is all of the gear on the load line. The inflation is generally done in the lee of the hangar or "Y"-shaped wind screen (see Figures 28 and 29) with the bubble as close to the wall as possible. It is imperative that the wind direction be noted prior to launching and that the equipment be directly downwind from the head of the bubble. It is strongly recommended that a standard meteorological rubber balloon be inflated and tethered on a 150-foot line near the point of release to serve as a wind indicator. This balloon is much more effective than a standard wind vane.

All pieces of equipment and all on-lookers must be removed from the immediate vicinity to prevent accidental entanglement of the load line when the balloon begins to rise. Each piece of delicate gear to be carried aloft should be cradled by one man. As a signal given by the flight director (after checking to see everyone is ready and that the balloon will go in the desired direction), the bubble is released (see Figure 30). If "launching arms" are used, this is not

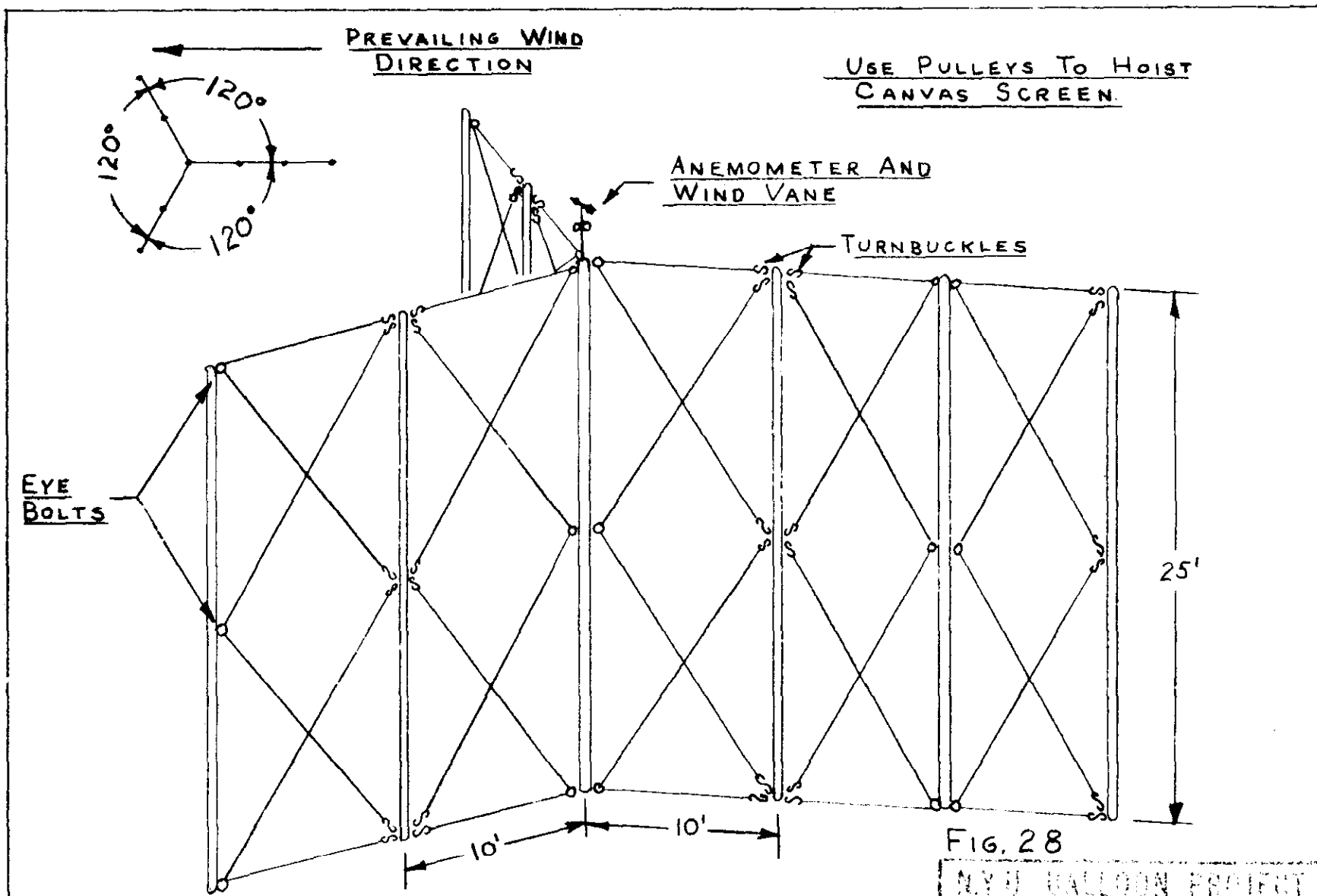

TELEPHONE POLES CROSS BRACED WITH STEEL CABLE TO SUPPORT CANVAS WIND SCREEN. CANVAS REMOVED AFTER USE. PERMANENT WIND SCREEN MAY BE ERECTED USING WOODEN SIDES.

FIG. 28

NAVY BALLOON PROJECT	
Y-SHAPED WIND SCREEN	
DR. BILLHM	ED49-3A
NOV 1-25-49	



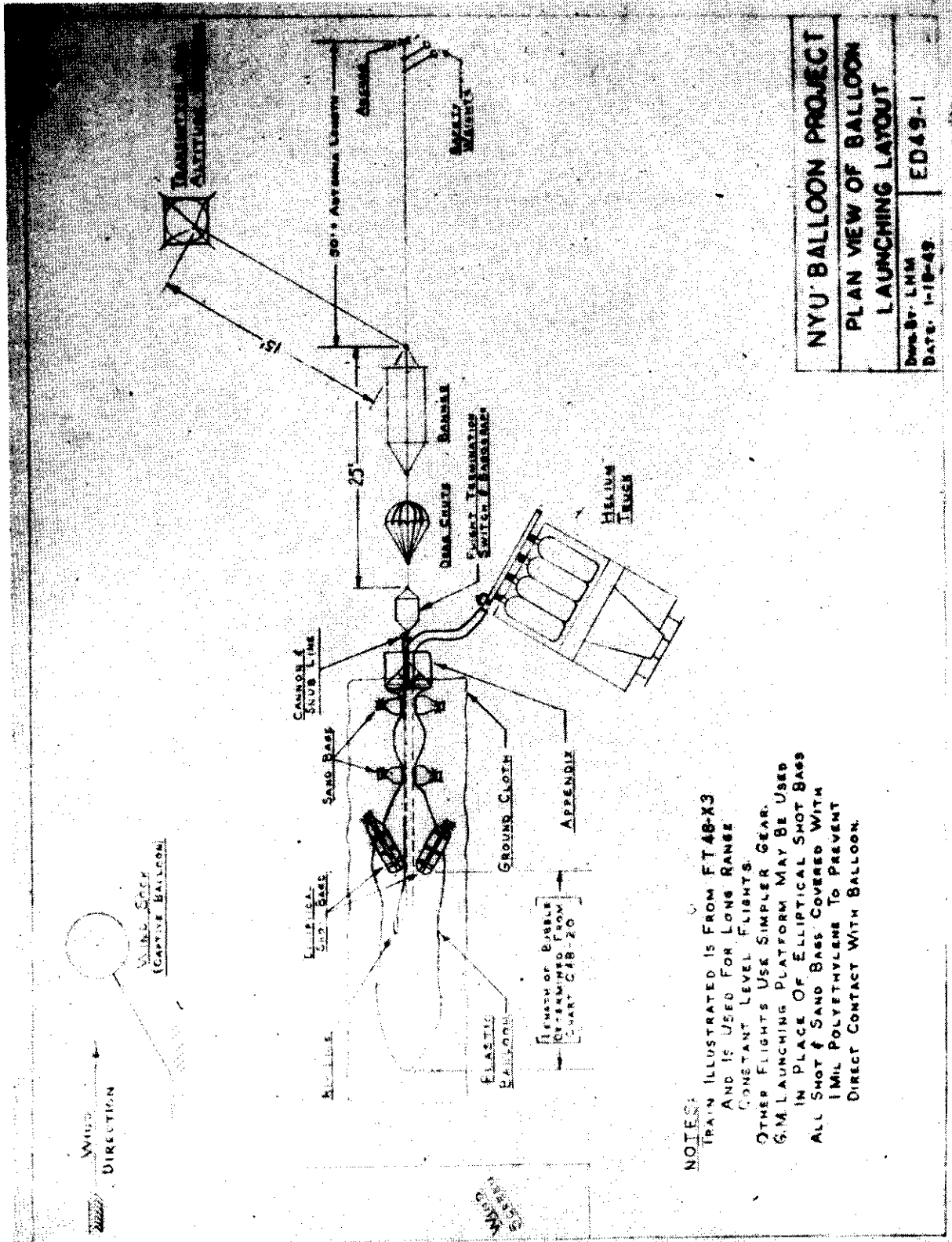

**NYU BALLOON PROJECT**  
**PLAN VIEW OF BALLOON**  
**LAUNCHING LAYOUT**  
 Dev. By: LHM  
 Date: 1-18-49  
 ED 49-1

**NOTES:**  
 TRAIN ILLUSTRATED IS FROM FT 48-X3  
 AND IS USED FOR LONG RANGE  
 CONSTANT LEVEL FLIGHTS.  
 OTHER FLIGHTS USE SIMPLER GEAR.  
 6" M. LAUNCHING PLATFORM MAY BE USED  
 IN PLACE OF ELLIPTICAL SHOT BAGS  
 ALL SHOT & SAND BAGS COVERED WITH  
 1 MIL POLYETHYLENE TO PREVENT  
 DIRECT CONTACT WITH BALLOON.

Figure 29

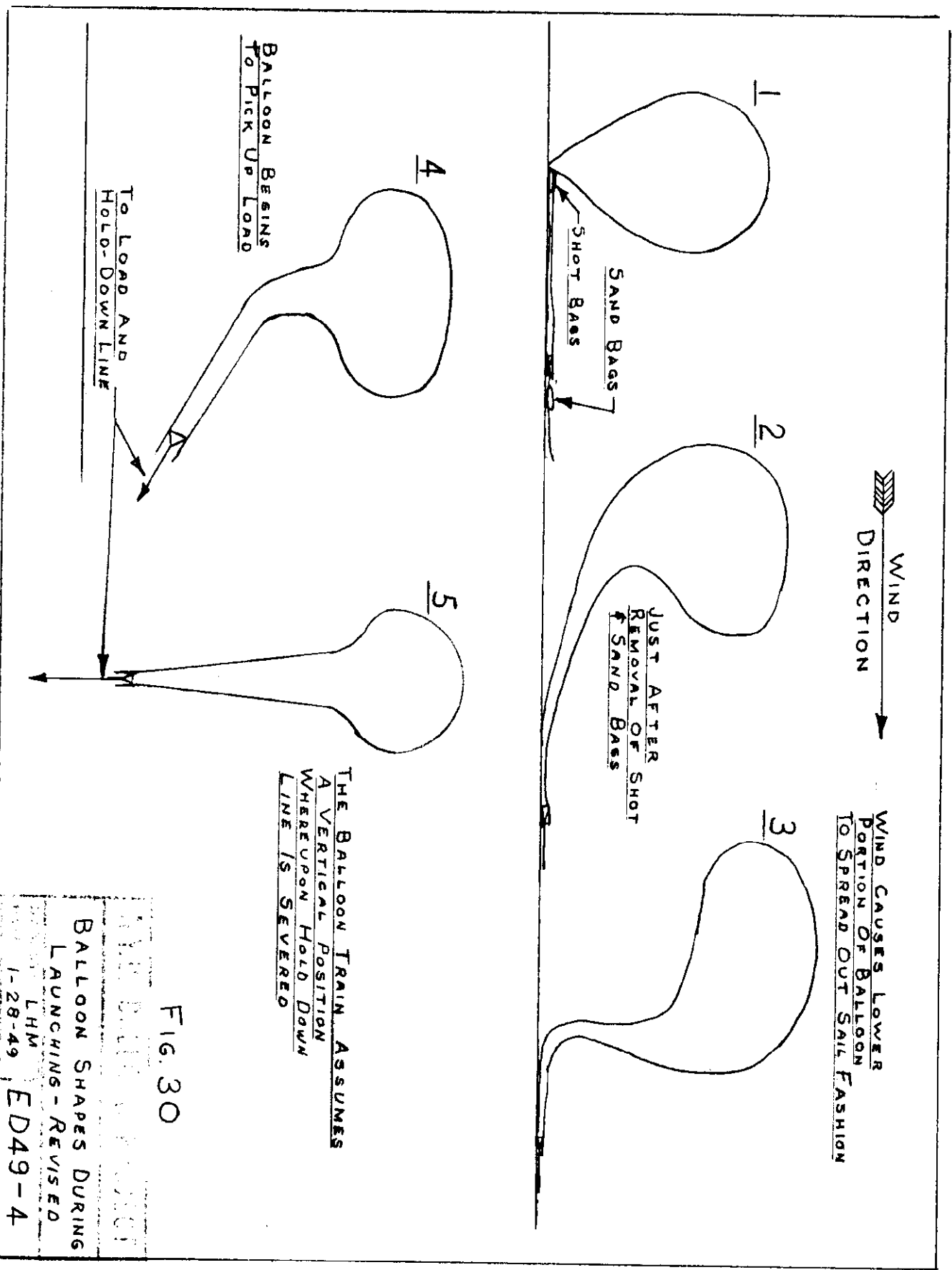

FIG. 30

NAVY DEPARTMENT  
 BALLOON SHAPES DURING  
 LAUNCHING - REVISED  
 LHM  
 1-28-49 ED49-4

difficult, but if the two elliptical shot bags are employed, they must be lifted simultaneously upward and outward away from the balloon. As the cell rises, each piece of gear must be cradled by its bearer allowing it to be lifted vertically when the balloon passes overhead. In many instances where the wind direction is not constant at the surface or changes as the balloon goes upward, and exact downwind positioning of launching personnel will be difficult. It is often necessary for these men to run to one side or forward or backward to get directly beneath the balloon. In cases of extreme wind speed, it has been found necessary to load the lower pieces of equipment on to a truck bed before release of balloon and launch it by driving underneath the balloon.

It is possible to estimate the space required to launch a train of given length if the wind speed is known. By using the computed figure for rate of rise, the length of time required to lift the entire train is found. The distance the bubble will travel during this time is proportionate to the wind speed. For example, if a train 250 feet long is launched with the rate of rise at 500 feet per minute, a bubble will move downwind at 660 feet if the wind is 15 miles per hour (22 feet per second), and the man at the end of the equipment train must cover 410 feet in 30 seconds carrying the gear with him.

The use of a restraining line attached to the load line above any heavy gear or delicate gear is recommended. A loop in this restraining line is attached to a winch mounted on a track a few hundred feet downwind of the lowest piece of gear, or is held by a well-gloved man. The safety weights are attached near the end of this line. The balloon tends to pull the gear in beneath itself in calm or light winds, and may pull sidewise if the train alignment is not perfectly downwind; the restraining line withstands this pull. Thus tethered, the balloon is forced to come overhead of the equipment bearers, and they are able to launch with less difficulty and danger of equipment damage. If the apparent ascent rate is too slow, the restraining line is cut between the safety weights and the other pieces of equipment. If the rate of rise appears to be high enough, the restraining line is severed below the safety weights and they rise, completing the launching.

## VII. TRACKING AND ALTITUDE DETERMINATION

Following release, it is often necessary to know the position of the balloon and its height as long as possible. Several methods of position and height determination have been found useful. Advantages and limitations of each system are given.

## A. Positioning Equipment

### (1) SCR-658

The radio direction finding set SCR-658 has been found to be the most useful unit to track a balloon-borne transmitter, within its limited range. If the set is in good condition and the transmitter signal is good, it is possible to receive from a transmitter which is 150 miles away at an altitude of 50,000 feet. At this distance, the elevation angle is usually not high enough to be reliable, since below angles of  $13^{\circ}$ , ground reflection of signals makes them nearly meaningless. The azimuth angle and the elevation angle, when above  $15^{\circ}$ , are accurate to about  $0.5^{\circ}$ . It is thus necessary to use two such sets on about a 100-mile base line to give a position fix. If the elevation of the balloon is determined independently, and the elevation angle is above  $13^{\circ}$ , it is possible to locate the balloon-borne transmitter with one SCR-658.

The installation and maintenance of SCR-658 requires the services of a specially trained man, while the operation procedure may be made by relatively unskilled personnel, with limited training. For details of the use of the SCR-658, see War Department publication TM11-1158A.

### (2) Theodolite

The meteorological theodolite is useful on daytime flights when skies are clear for ranges up to 100 miles. If radio data are available to give height, the additional information obtained from this instrument--elevation and azimuth angle--will completely fix the balloon's position in three dimensions.

When pressure data are known, two theodolites with a base line several miles in length will also uniquely locate the balloon. A third method, less accurate but still useful, is the method of stadia measurements. By carefully measuring, prior to release, the distance between two distinctive portions of the train and then noting the angular distance subtended during flight by these instruments, the altitude and hence all coordinates of the balloon may be determined.

Regular and frequent checks must be made of the scale adjustments of the instruments and of the base plate

levels when the instrument is located out of doors. For details of the use and care of theodolites, see either the War Department publication TM-11-423 or the U. S. Weather Bureau Circular "O".

(3) Aircraft Radio Compass

It has been found feasible to determine the position of the balloon by following the signal from a balloon-borne transmitter, using an aircraft radio compass as receiving unit. In this way it is possible to fly along a path toward the balloon, usually at a much lower altitude, and, by noting the plane's position where the compass reading is reversed, the position of the transmitter is found. The main disadvantage of using this system is that aircraft is needed, but there is no other method which will so readily position the balloon over great distances and periods of time. With this system, the limit of transmission time is a function of the weight of transmitter batteries which can be carried rather than distance. It is possible to power a transmitter to supply 2 watts, for about 15 hours, using 15 pounds (7 kilograms) of batteries. Longer periods of transmission may be achieved by intermittent operation of the transmitters or use of heavier batteries.

(4) Radar

If ground radar is available, accurate positioning over a limited range can be made. It is helpful but not strictly required to add radar targets (corner reflectors) to the flight train for such tracking. Using radar, the elevation angle, azimuth angle and slant distance out are obtained, giving a complete fix on the balloon with one set. The maximum distance to which appropriate sets can reach is about 65 miles; such sets are the SCR-584, the SPM-1 and the MPS-6. With good orientation and leveling such sets have an accuracy of 1.00 and about 500 feet of slant range. Because of the limited range, radar sets are not generally useful. Attempts to use radar mounted atop aircraft for aerial observation have been abandoned in favor of the radio compass.

B. Altitude Determination

In early attempts to utilize standard radiosonde pressure modulators they were found to be unsatisfactory. The Diamond-Hinman system of counting signal changes

is not useful when the changes occur at a nearly constant altitude due to the width of the steps and the ambiguity of direction of vertical motion. Two pressure measuring systems have been found satisfactory for use in constant-level work and are discussed below. For a discussion of the radio transmitters which have been used (the standard T-69 and the NYU AM-1), see Technical Report No. 2, Balloon Project, New York University Research Division.

(1) Olland Cycle Pressure Measuring Instrument

This instrument, shown in Figure 31, is used in balloon flights as the primary pressure measuring unit, as it will continuously measure pressure without ambiguity. It modulates the transmitted radio signal at intervals whose timing is determined by the pressure of the air at the balloon's position.

As presently designed, the modulator contains a standard Signal Corps ML-310E radiosonde aneroid unit, a rotating cyclinder of insulating material with a metal helix wound around the cylinder, and a 6-volt electric motor which rotates the cylinder.

There are two contacting pens which ride on the cylinder and conduct electrical current when they touch the helix. One pen is fixed in position and makes a contact at the same time in each revolution of the helix. This contact is used as a reference point for measuring the speed of rotation of the cylinder. The time that the second one, which is linked directly to the aneroid cell, makes contact with the spiral, is dependent on the cylinder speed and on the pen position which is determined by the pressure. By an evaluation chart, the atmospheric pressure can be determined as a function of the relative position of the pressure contact as compared to the reference thus eliminating all rotation effects but short term motor speed fluctuations.

Preparation of the modulator for flight consists of the following steps:

- (a) Test the motor operation. When a 6-volt battery is inserted in the motor circuit with the proper polarity, the motor should run smoothly at one revolution per 60 to 80 seconds. Noisy operation is probably a sign of dirty or corroded

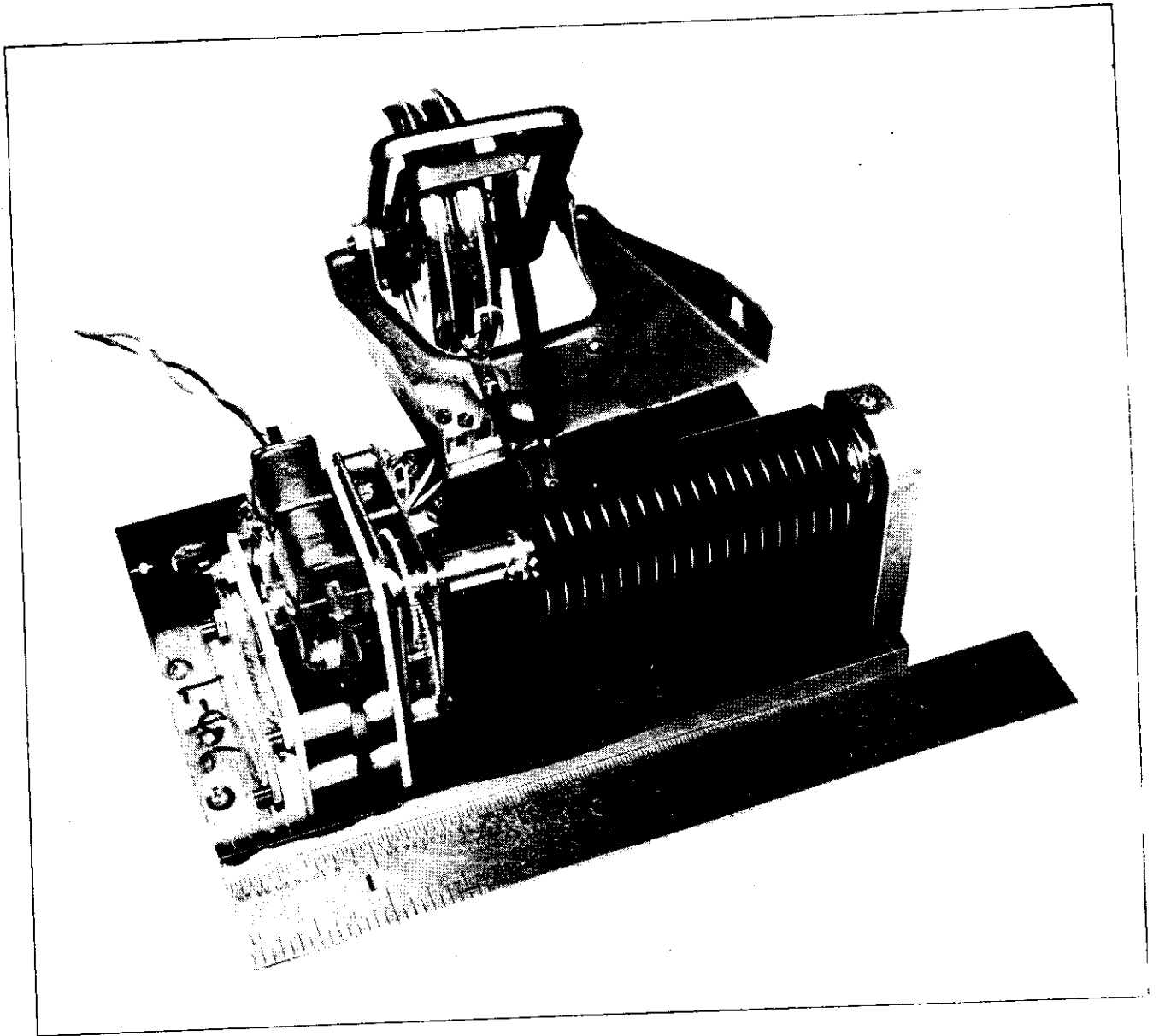

Figure 31  
Olland Cycle Pressure Modulator

gears or poor alignment of the rotating cylinder. The motor gears may be cleaned with carbon tetrachloride and a small clean brush. If the trouble is due to misalignment, the instrument should not be used since this will affect the rotation at a non-uniform rate and thus destroy the entire accuracy of the record.

- (b) Calibrate the instrument. The following equipment is required for the calibration:

Vacuum pump  
Bell jar  
Base plate with at least 4 electrical leads  
Manometer  
Tape recorder

The vacuum pump should be capable of evacuating the bell jar to a pressure lower than that to be reached by the balloon in flight. A pressure of ten millibars, corresponding to about 100,000 feet elevation is usually a good minimum.

Four wires are necessary to conduct the six volts to the motor and to transmit the reference and pressure signals. The wires must pass out of the bell jar through an air-tight seal in the base plate. The base plate also needs a tube leading to the manometer and a tube to the vacuum pump. It is advisable to use two separate tubes rather than placing the manometer lead in the same line as the pump lead in order to obtain the pressure in the bell jar rather than that in the pumping line.

In operation the negative line of the battery leads is used as the ground connection of the output signal.

A tape recorder such as the Brush Development Co. model BL-902 oscillograph and amplifier BL-905, is needed to record the signal both during calibration and during the balloon flight. The Brush recorder is used at present and the discussion of the operation will be made in terms of the characteristics of this instrument. When using the slow speed of the recorder, which feeds the paper at the rate of 30 centimeters per minute, the distance between successive reference marks will be 30 to 40 centimeters de-



pending upon the speed of rotation of the modulator motor. The pressure signal appears at any point along the record between or overlapping the references depending upon the pressure. A sample record of this sort is shown in Figure 32.

The Olland cycle acts as a switching unit for the test oscillator (see Figure 33) whose signal is fed into the Brush amplifier and finally to the recorder. By adjusting the resistors in the test circuit, the frequency of oscillation may be adjusted. Since within the usual range, the frequency of oscillation is approximately additive when the two signals overlap, the suggested frequencies are about 4 cycles per second for pressure and 8 cycles per second for reference. When overlapping signals are being recorded the frequency will be about 12 cycles per second which is easily recognizable on the record.

The calibration of the modulator unit should be in steps of 25 to 30 millibars in order to have at least three points within each turn of the helix.

Evaluation of the record is accomplished with the aid of a nomogram divided into 100 equal parts. The record is laid on the nomogram with the leading edge of the first reference on the zero line and the leading edge of the second reference on the 100th line. The position of the leading edge of the pressure signal is then read to the nearest third of a division on the nomogram. If one complete turn of the spiral represents 75 millibars, it is thus possible to read the pressure to an accuracy of one-three-hundreth of 75 or about one-quarter millibar.

In evaluating the record the tape should be kept parallel to the horizontal lines on the nomogram or perpendicular to the zero line in order to avoid errors in interpretation.

The total motion of the pen arm of the modulator is normally 12 to 14 turns of the spiral. Therefore, there will be the same number of points at which the pressure and reference signals overlap. The calibration curve (Figure 34) is drawn to show pressure from zero to surface pressure (about

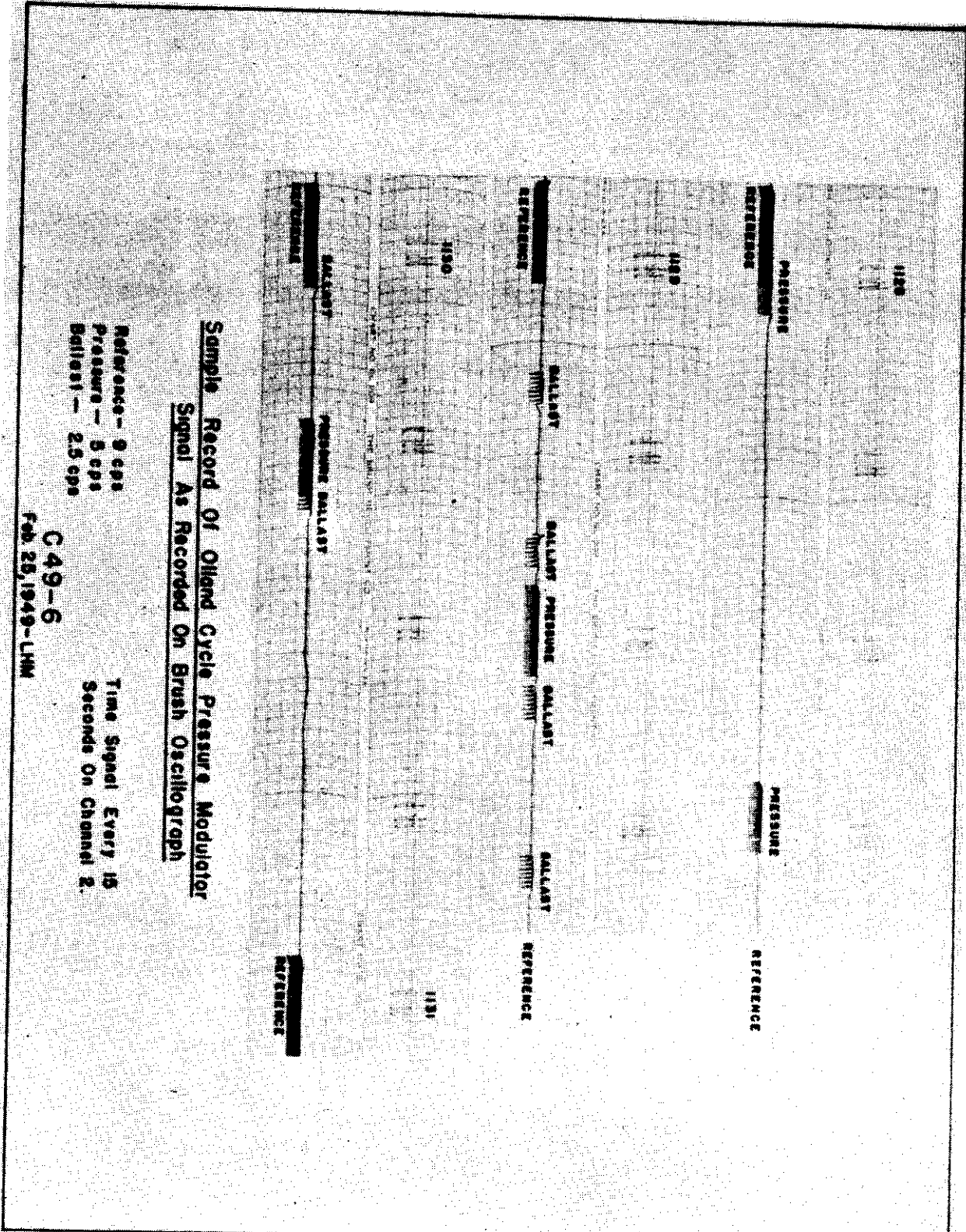

**Sample Record Of Oiland Cycle Pressure Modulator  
Signal As Recorded On Brush Oscillograph**

Reference - 9 cps  
Pressure - 5 cps  
Ballast - 2.5 cps

Time Signal Every 15  
Seconds On Channel 2

**C 49-6**  
Feb 28, 1949-LHM

Figure 32

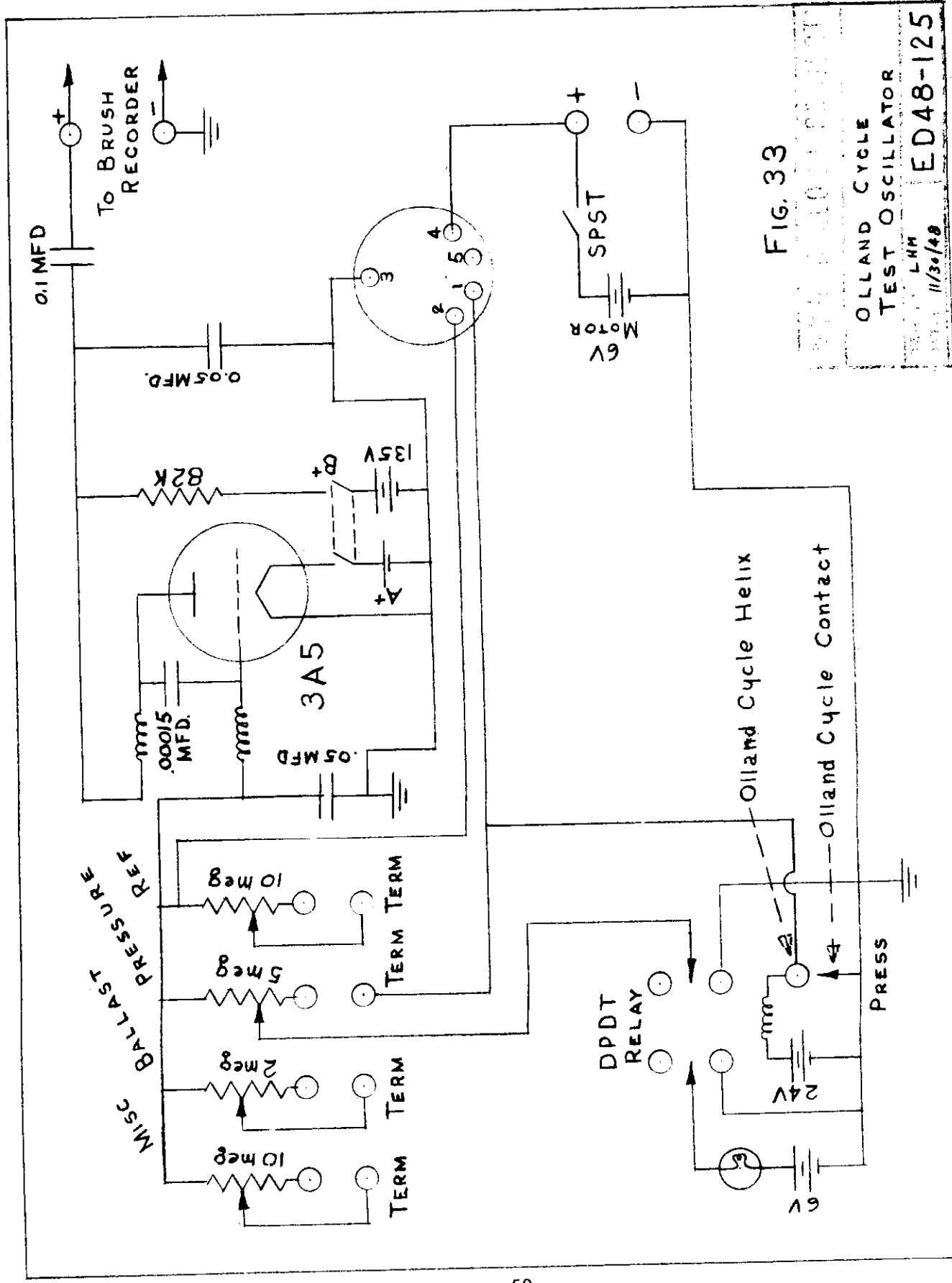
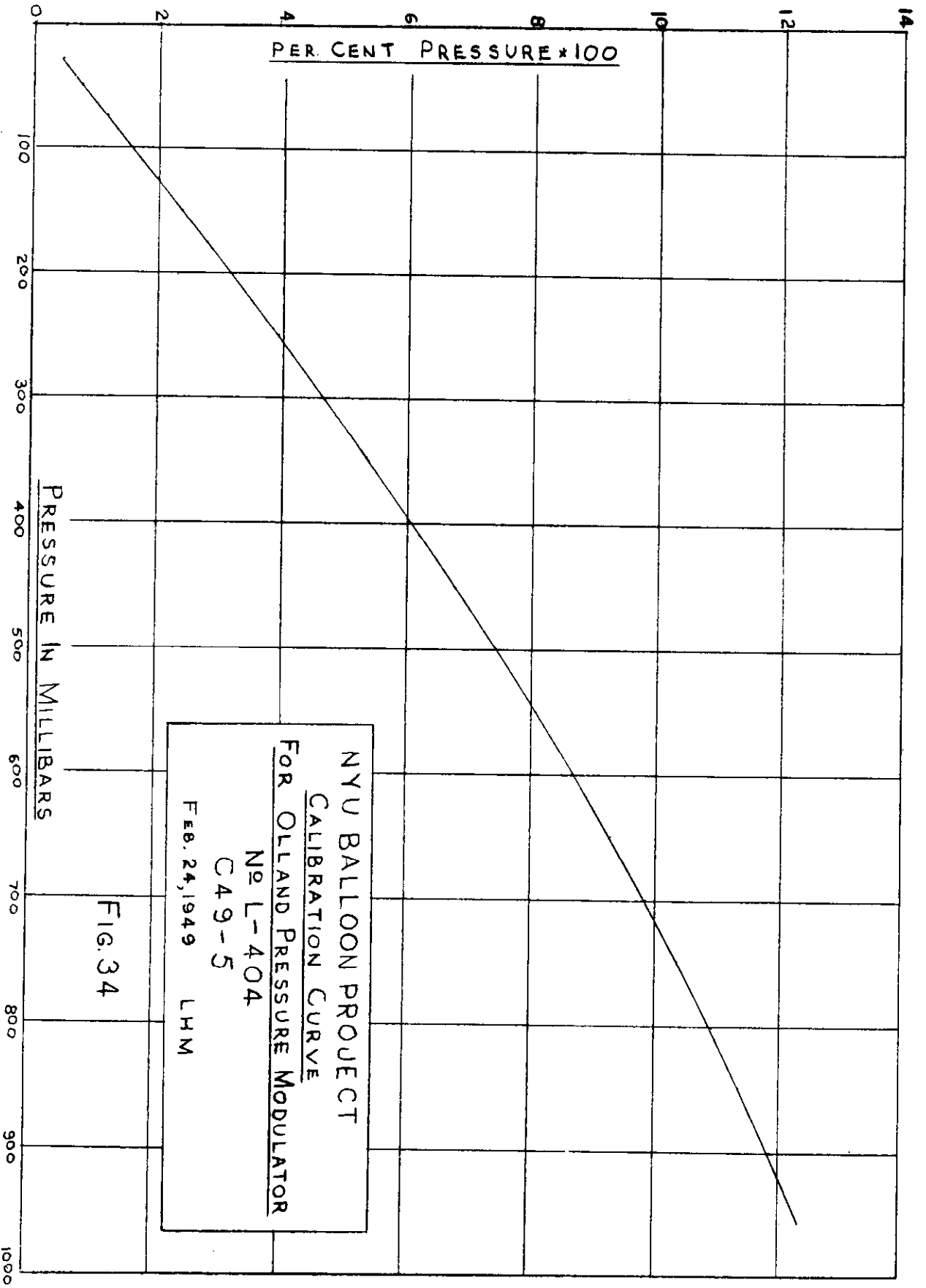

FIG. 33

OLLAND CYCLE  
TEST OSCILLATOR  
LHM  
11/30/48  
ED48-125



NYU BALLOON PROJECT  
 CALIBRATION CURVE  
 FOR OLLAND PRESSURE MODULATOR  
 No L-404  
 C49-5  
 FEB. 24, 1949 LHM

FIG. 34

1020 millibars) against percentage of the turns as read on the nomogram. The lowest pressure reading is numbered as read and succeeding pressures are plotted in a continuous ascending series. When the pressure reading reached the first overlap on the reference, it is called 100 percent; the second overlap is 200 percent and so on until the last overlap which may be 1200 or 1300 percent.

- (c) Pack the modulator and insert it inside the transmitter box. The modulator should be protected from extreme cold since the motor operation becomes erratic when the temperature reached 30° to 40°C below zero. A box or paper cover over the modulator will keep particles of insulation and dirt from the moving parts.
- (d) When the entire assembly has been made and inflation of the balloon is about to begin, the transmitter and motor should be turned on and reception of the signal tested. If any serious trouble appears, the modulator should be replaced by another calibrated modulator since any work on the instrument will probably change the calibration.

During the flight, radio static and noise will appear on the Brush record as pips which may resemble the transmitted signals and with increasing distance or weakening transmitter the noise will finally completely obscure the pressure record. Careful tuning of the receiver will prolong the record as long as possible. When tuning the receiver, the sensitivity control of the Brush amplifier should be turned to the least sensitive position since any sudden change in the tuning may throw the pen off its supports and damage its glass tip.

When the flight reception is completed the record is evaluated exactly as in the evaluation of the calibration record--using the same nomogram. However, since the instrument is subjected to different atmospheric conditions, the motor speed may vary suddenly, giving false values for the pressure. These values may be detected by carefully observing the rate of rotation of the motor, which is measurable by the distance between the reference marks. If there is a sudden

change in motor speed of five percent or more from the preceding rotation, the pressure value should be rejected. A slow, continuous change in speed from minute to minute may be neglected since it is probably a uniform change throughout the rotation period. The motor speed will decrease during the flight, as a result of the low temperatures and the drop in battery voltage. This of itself does not decrease the value of the record, as long as the speed does not change suddenly.

(e) Olland-Cycle Pressure Element Specifications

- (1) Pressure range: 1050 to 5 mb.
- (2) Desired accuracy: Surface to 300 mb  $\pm 5$  mb.  
300 mb to 50 mb  $\pm 2$  mb.  
50 mb to 5 mb less than  $\pm 2$  mb,  $\pm 1$  mb if possible.

Highest accuracy and readability desired on low pressure end. Temperature compensation, as required to meet pressure accuracy requirements for temperature, range  $+30^{\circ}$  to  $-70^{\circ}\text{C}$  or equivalent for medium and high altitude flights. Mean operating temperature required more than  $0^{\circ}\text{C}$ .

(3) Helix:

Cylinder--made of insulating material with low temperature coefficient.  
Diameter  $3/4$  inch to 1 inch, length  $2\frac{1}{4}$  inch.

Spiral--made of nickel or other metal which does not corrode in the atmosphere, .010 inch or less in diameter.  
Eight turns per inch on cylinder.

Check-points--Six points located between turns of spiral, starting with 9th turn, 60 degrees apart.  
Made of the same material as the spiral.  
In the electrical circuit of the pressure signal.  
Suggested shape  $1/16$  inch diameter, round pin, flush with surface of helix.

General--Helix mounted in a rigid frame to prevent lengthwise movement or springing out through bending of a frame. Joined to motor drive by a pin through both drive shaft and helix shaft. When rotating at about 1 rpm duration of signals not over 3 to 4 seconds. Surface of helix to be polished with rouge or crocus cloth. Loading edge of the metal spiral will be true and smooth to within .0005 inch.

(4) Motor:

6 to 7.5 volts  
1 rpm gear train  
20 to 40 milliamperes drain  
Constant speed--change of speed during any single revolution not more than 0.3%  
Speed change at low temperature not more than  $\pm 20\%$

(5) Mounting of Unit:

Mounting in such manner that temperature changes and stresses will not change the relative positions of the aneroid and the helix. This may be done by mounting all elements on a  $\frac{1}{4}$ " metal plate or by mounting all parts in a frame supported on a single pedestal.

Mount unit in an easily opened, stiff single thickness cardboard or plastic box to protect it from other units in flight trains.

External terminal strip with four terminals connected to ground, motor, reference, and pressure.

Total weight not over 500 grams.

Overall dimension not over 5 x 5 x 4 inches.

To be mounted in transmitter, where insulation will prevent cooling below 0°C within 6 hours at air temperature of -40° to -50°C.

## (2) Codesonde

The modified radiosonde built by Brailsford and Co., Rye, New York, called the codesonde, has been found valuable when knowledge of small variations in the height of the balloon is not required. Using this system, a radio transmitter is modulated by a Morse code signal which is a function of pressure (and temperature if desired). This system is useful for tracking a balloon with aircraft since no recording equipment is necessary for data interpretation.

Each combination of dots or dashes may be identified by ear, and with a calibration chart, the pressure which corresponds to the balloon's height may be thus determined by anyone who can read Morse code with a suitable radio receiver. The advantages of using this system for a balloon which is to be followed by aircraft include the fact that it is necessary to receive only one complete code group to completely identify the pressure level of the balloon. It is thus possible to interrupt the period of reception without permanently losing the altitude record. It is expected that a balloon transmitter which can be followed with an aircraft radio compass will be used in conjunction with this pressure modulator, giving three-dimensional position data.

## (3) Barograph

Many balloon flights pass out of the range of even a network of receiving stations. When it is not possible, because of weather or other considerations, to follow the balloon with aircraft, a clock-driven meteorograph may be added to the flight train to record data, such as pressure and temperature. It is necessary to recover the balloon equipment to evaluate this sort of record. With inland release points, it has been possible to recover about 75% of all flights.

The model U-48 Lange barograph, shown in Figure 35, is designed to give a record of atmospheric pressure and the temperature of the barograph case. In order to obtain a maximum spread of the pressure record in the range at which the data is most useful, the linkages are arranged so that recording begins at about 500 millibars or around 19,000 feet, and may be continued as high as the balloon rises. The



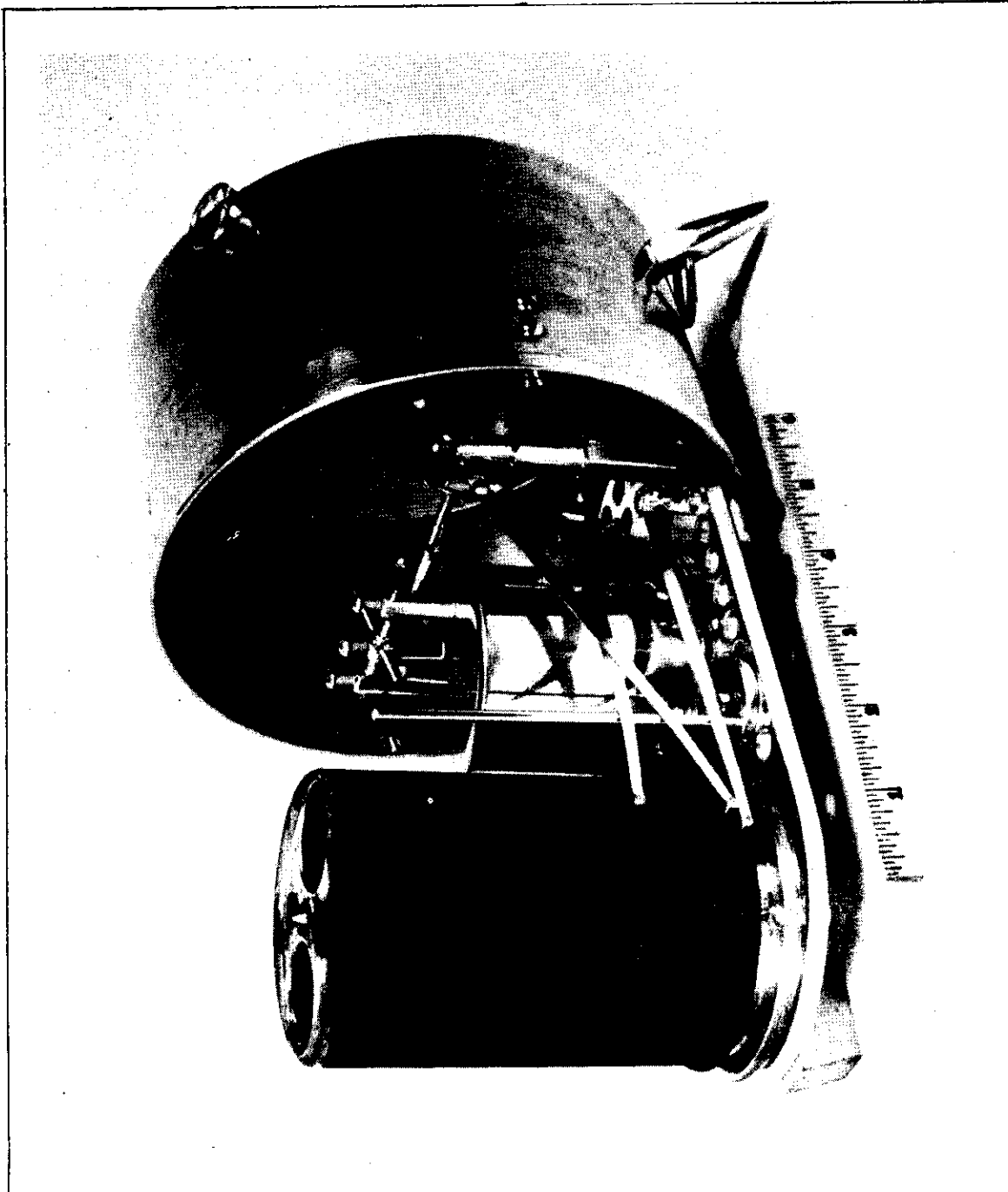

Figure 35  
Large Barograph Thermograph With  
Smaller Pen on Recording Drum

temperature recording is confined to the lower 2 inches of the drum so as to interfere as little as possible with the pressure record when the balloon floats above 30,000 feet.

Recording is accomplished by three pens which scratch carbon from a smoked aluminum foil. This method eliminates the need for liquid ink and applies a minimum of pressure to the recording drum.

The recording drum rotates once in twelve hours. Therefore, if a flight lasts over twelve hours, the trace will overlap. Such a record is shown in Figure 36. The clock runs for 36 to 40 hours on one winding.

Preparation of the barograph for use on a balloon ascension requires the following:

- (a) Place an aluminum foil about 10 inches long by  $3 \frac{3}{4}$ " , .002" thick on the drum. Care should be taken to have the overlapping edge of the foil face in the direction of rotation of the drum so that the stylus slides off the edge instead of catching and tearing the foil. A few drops of rubber cement along each edge of the foil are sufficient to fasten the foil to the drum and will not interfere with removal of the foil after recovery of the barograph.
- (b) Wind the clock. The clock should not be wound tightly since at the low temperatures encountered in the upper atmosphere the clock spring may snap. However, if the clock is wound an hour or so before release, it will be sufficiently relaxed by the time the low temperatures are reached.
- (c) Check pressure of the marking pens. Too much pressure of the pens on the drum will introduce an error due to the frictional lag. When the drum is removed from the clock mechanism, and the pen lifter released, the stylus points should touch the clock housing lightly.
- (d) Smoke the drum. A very thin, fine-grained carbon film should be deposited on the aluminum foil. The best result will be obtained by use of a bright yellow gas flame, although a kerosene flame gives a satisfactory coating. Solid or liquid

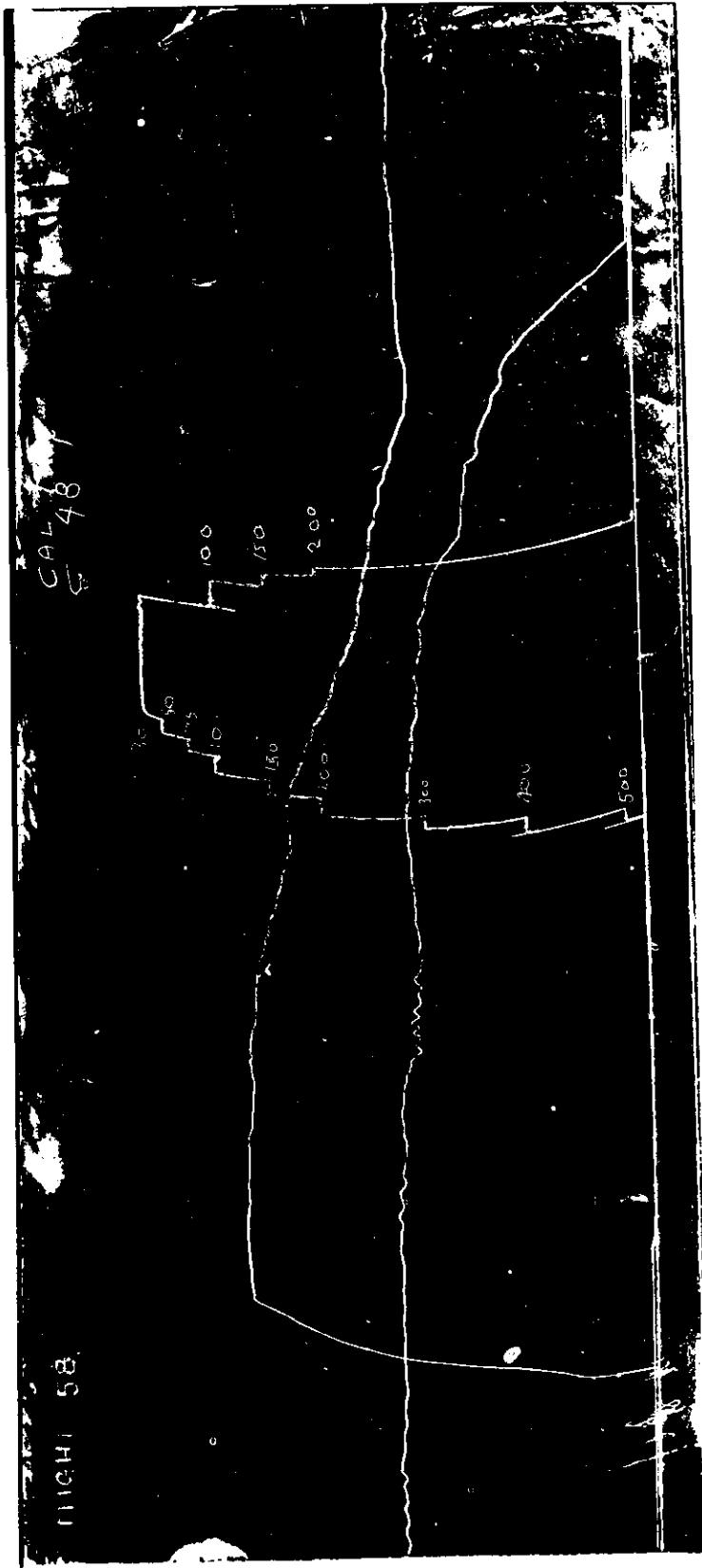

NYU BALLOON PROJECT  
 Barograph Record

FLIGHT 58

Released at Alamogordo, N.M. May 10-1948 2033 M.S.T., Recovered at  
 Val D'or, Quebec, Canada  
 (Orifice Ballast-Leak 300gm/hour)  
 Duration 24½ hours

Figure 36

fuels usually give a coating which is too coarse grained and heavy. In smoking the drum a long rod is used as a rotating axis. The drum is rotated rapidly in the flame so as to prevent overheating and oxidizing of the foil. The carbon should not be so thick as to obscure the metallic appearance of the aluminum foil.

- (e) Calibrate the barograph for pressure. The instrument is placed in a bell jar and the air evacuated. The pressure is kept constant at a number of pressures so that as the drum turns a step, record is made on the smoked foil. Pressure recording starts at about 500 millibars so the first level in the calibration should be at that value. At each level the pressure should be kept constant for three to five minutes in order to obtain a measurable line. Great care and considerable practise are required to control the valves of the vacuum system so that the pressure does not change noticeably during each step.

The pressure steps at which the barograph is calibrated may be either at regular pressure intervals or at the pressure values corresponding to regular height intervals according to the standard atmosphere figures. The recommended steps are listed below. If the balloon is not expected to go to the higher altitudes, the calibration may be stopped at correspondingly higher pressures.

<u>Pressures</u>	<u>Standard Atmosphere Heights</u>		
500 mb	466	mb corresponding to	20,000 ft.
400 mb	300	mb	" 30,000 ft.
300 mb	188.5	mb	" 40,000 ft.
200 mb	117	mb	" 50,000 ft.
150 mb	72.8	mb	" 60,000 ft.
100 mb	45.3	mb	" 70,000 ft.
50 mb	28.2	mb	" 80,000 ft.
10 mb	17.5	mb	" 90,000 ft.
	10.9	mb	" 100,000 ft.

The temperature calibration may be made by recording two widely spaced temperatures, such as room temperature and the temperature of dry ice (-78°C). This calibration will be approximately a straight line and, therefore, two points are sufficient to plot the curve.

Immediately before the balloon release, when the clock is wound and the pens lowered against the drum, the pressure and temperature pens should be tapped lightly so as to make short marks and the time noted.

When the barograph is recovered the smoked foil should be treated to preserve the record. A solution of clear shellac diluted with about ten times its volume of alcohol may be used. The drum is immersed in the shellac and allowed to dry thoroughly before further handling.

- (f) Evaluation of the record. In evaluating, the record heights of significant points are measured vertically from the reference line. The pressure calibration steps are measured first and plotted on graph paper, vertical distance versus pressure or altitude. Each significant point on the flight trace is then measured and the corresponding altitude determined from the calibration curve.

The same procedure is followed in evaluating the temperature record, measuring from the reference line.

The curvature of the record due to the motion of the pens must be corrected for. Since the temperature record covers a short vertical range, the time correction may be neglected. Corrections for curvature of the pressure record may be read directly from Figure 37, which gives the correction in inches as a function of the distance of the point in question from the center of the record.

The final time correction is made to correlate the temperature and pressure records. This may be done by measuring the horizontal distance between the temperature and pressure marks as made before release and correcting this amount for vertical position. The rotation of the drum is once in 12 hours and, therefore, the time-distance relation may be computed by noting the total length of record obtained in one revolution.

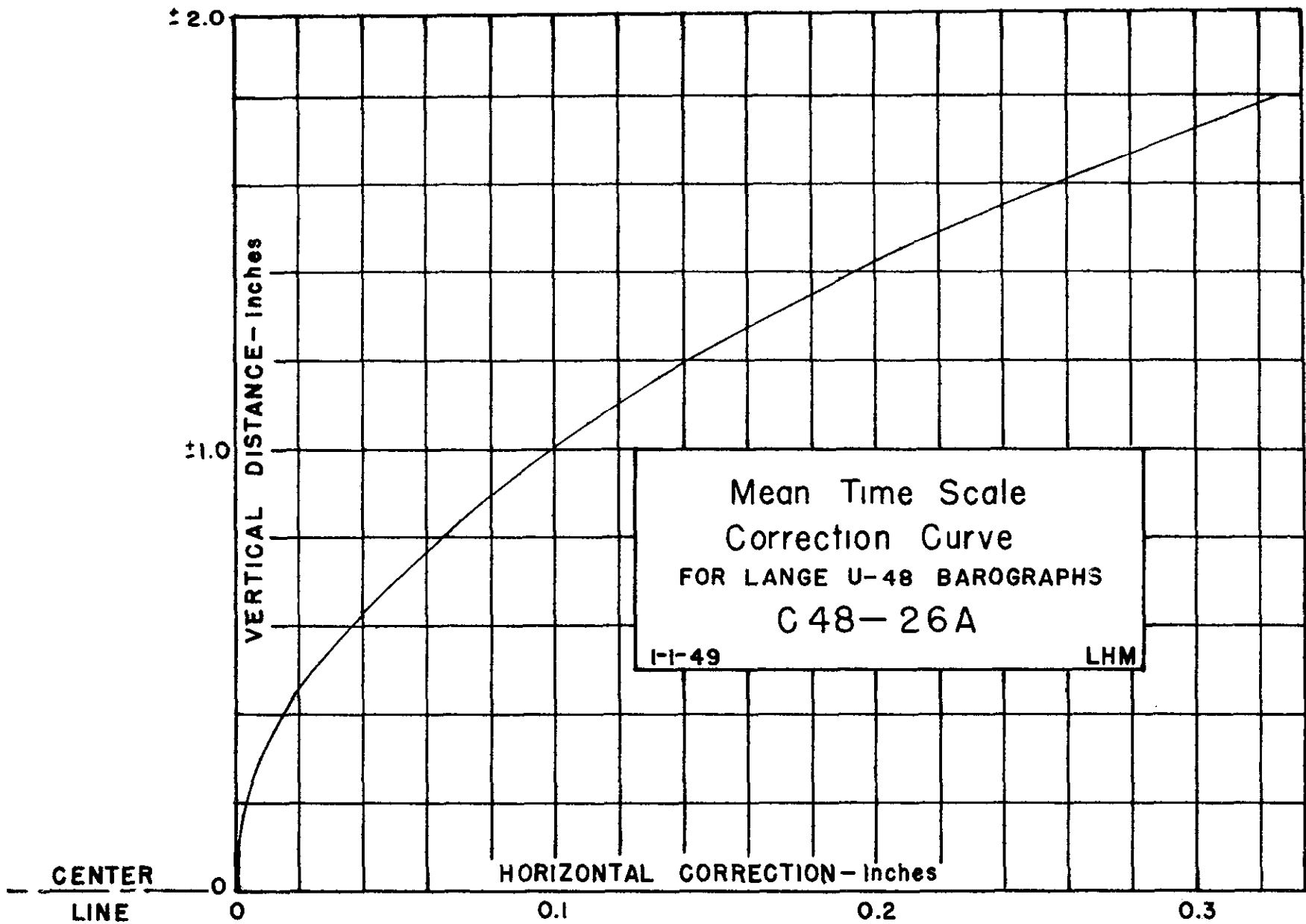

FIG. 37

## VIII. ANALYSIS

During and following the flight it is customary to analyze the behavior of the balloon. Two curves are usually drawn when data is available for their preparation. The first of these is a time-height curve which gives the altitude of the balloon at all times with respect to sea level. On this curve also it is customary to plot the temperature data and ballast flow data when such has been recorded. In some cases it has been found useful to plot a profile of the terrain over which the balloon is passing. The second diagram usually prepared is the trajectory of the balloon, and again it may be prepared with respect to the terrain over which the balloon was passing. That is to say, it is plotted on an aircraft map of the area, with positions and heights plotted every ten minutes. Figures 38 and 39 show sample plots.

## IX. GENERAL MILLS 7-, 30-, AND 70-FOOT BALLOONS

The altitudes reached and loads which may be carried by the General Mills balloons other than the 20-foot cell are shown in Table 4, Appendix II. Graph 3, Appendix II may be used for interpolation of the tabulated values to give the relationship between floating altitude and gross load, and Graph 4 shows the altitude sensitivity at various heights. It has been assumed that helium is the lifting gas. Graph 1, Appendix II is useable for all of these balloons to determine the amount of free lift which is needed to give a desired rate of rise.

To launch a 7-foot balloon, it is not necessary to utilize the elaborate technique of the larger balloons. A can of sand is made to weigh the same amount as the required gross lift (equipment weight plus free lift), and attached to the load ring. Inflation from a single tank may be made inside any building with relatively large doors and when the balloon just lifts the inflation weights it may be attached to the equipment line, carried outdoors and released. In light winds the equipment may be released with a hand-over-hand paying out of the line. If there is too much wind for this method, the equipment is laid out downwind and the balloon released so as to pass over the pieces of gear and pick them up while rising.

A 7-foot balloon being inflated is seen in Figure 40. The appendix which is shown is made of a flattened 2-foot length of inflation tube, from a 20-foot balloon, without stiffeners. Such a balloon has been sustained with a fixed ballast leak

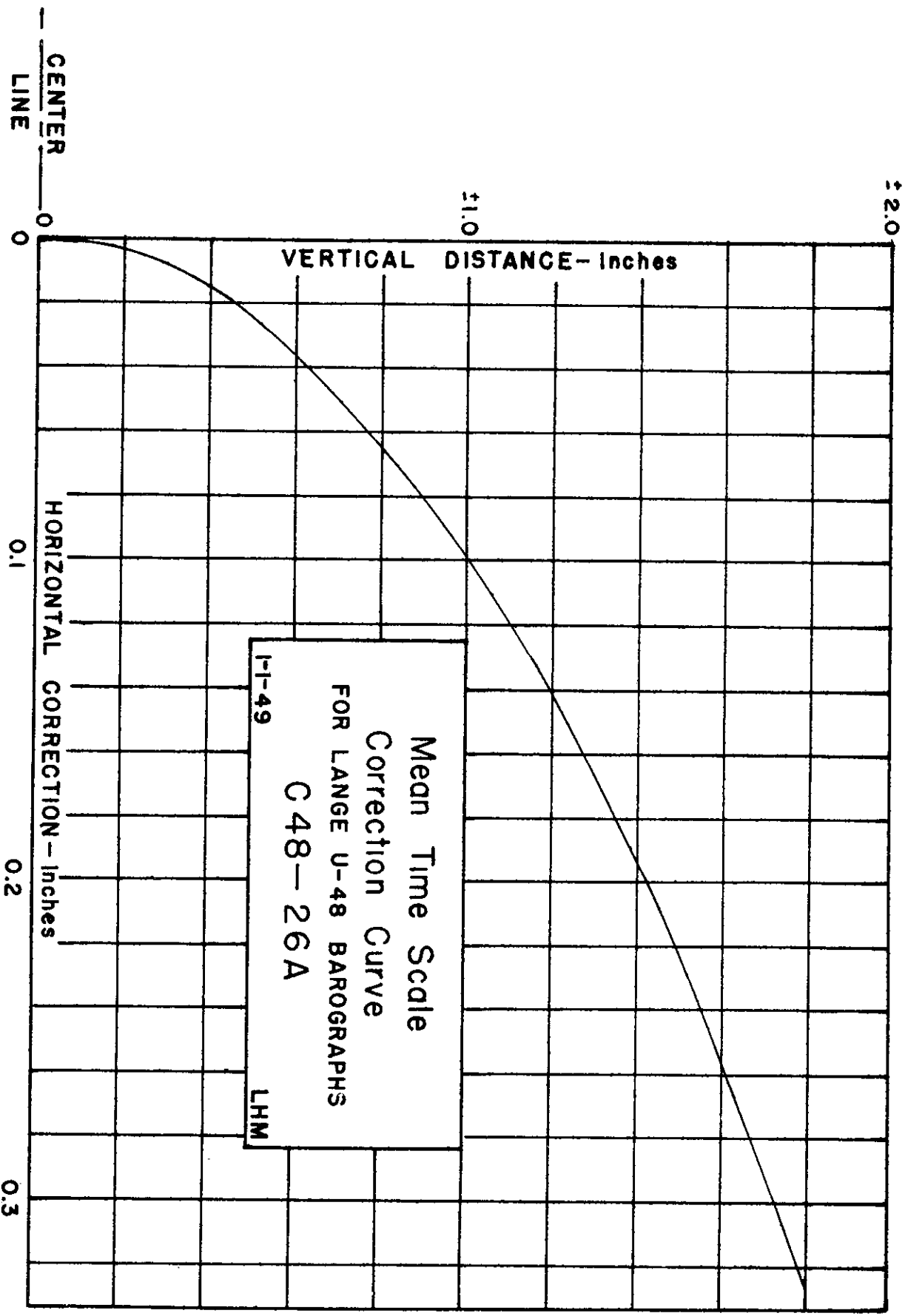

FIG. 37



## VIII. ANALYSIS

During and following the flight it is customary to analyze the behavior of the balloon. Two curves are usually drawn when data is available for their preparation. The first of these is a time-height curve which gives the altitude of the balloon at all times with respect to sea level. On this curve also it is customary to plot the temperature data and ballast flow data when such has been recorded. In some cases it has been found useful to plot a profile of the terrain over which the balloon is passing. The second diagram usually prepared is the trajectory of the balloon, and again it may be prepared with respect to the terrain over which the balloon was passing. That is to say, it is plotted on an aircraft map of the area, with positions and heights plotted every ten minutes. Figures 38 and 39 show sample plots.

## IX. GENERAL MILLS 7-, 30-, AND 70-FOOT BALLOONS

The altitudes reached and loads which may be carried by the General Mills balloons other than the 20-foot cell are shown in Table 4, Appendix II. Graph 3, Appendix II may be used for interpolation of the tabulated values to give the relationship between floating altitude and gross load, and Graph 4 shows the altitude sensitivity at various heights. It has been assumed that helium is the lifting gas. Graph 1, Appendix II is useable for all of these balloons to determine the amount of free lift which is needed to give a desired rate of rise.

To launch a 7-foot balloon, it is not necessary to utilize the elaborate technique of the larger balloons. A can of sand is made to weigh the same amount as the required gross lift (equipment weight plus free lift), and attached to the load ring. Inflation from a single tank may be made inside any building with relatively large doors and when the balloon just lifts the inflation weights it may be attached to the equipment line, carried outdoors and released. In light winds the equipment may be released with a hand-over-hand paying out of the line. If there is too much wind for this method, the equipment is laid out downwind and the balloon released so as to pass over the pieces of gear and pick them up while rising.

A 7-foot balloon being inflated is seen in Figure 40. The appendix which is shown is made of a flattened 2-foot length of inflation tube, from a 20-foot balloon, without stiffeners. Such a balloon has been sustained with a fixed ballast leak



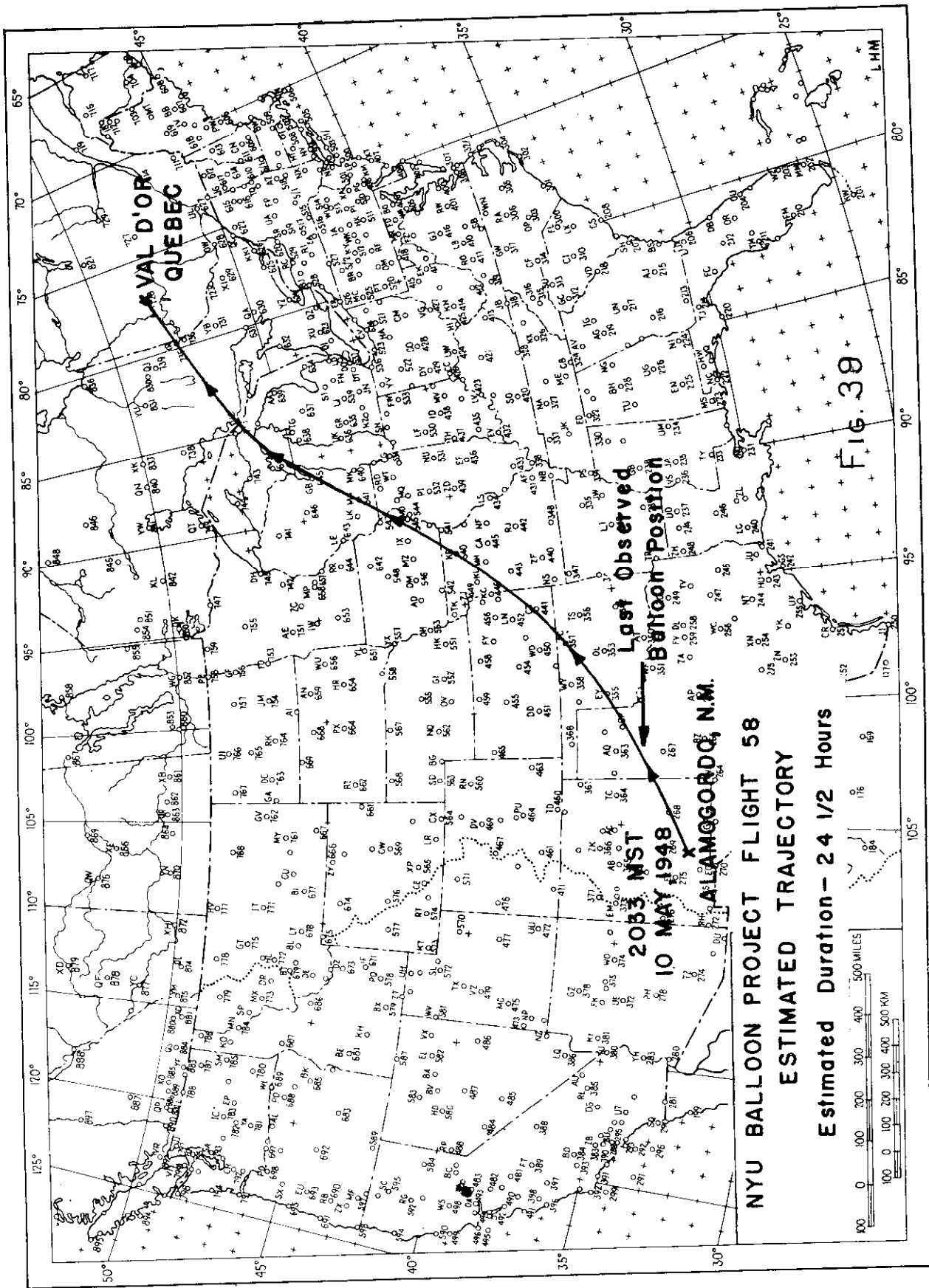

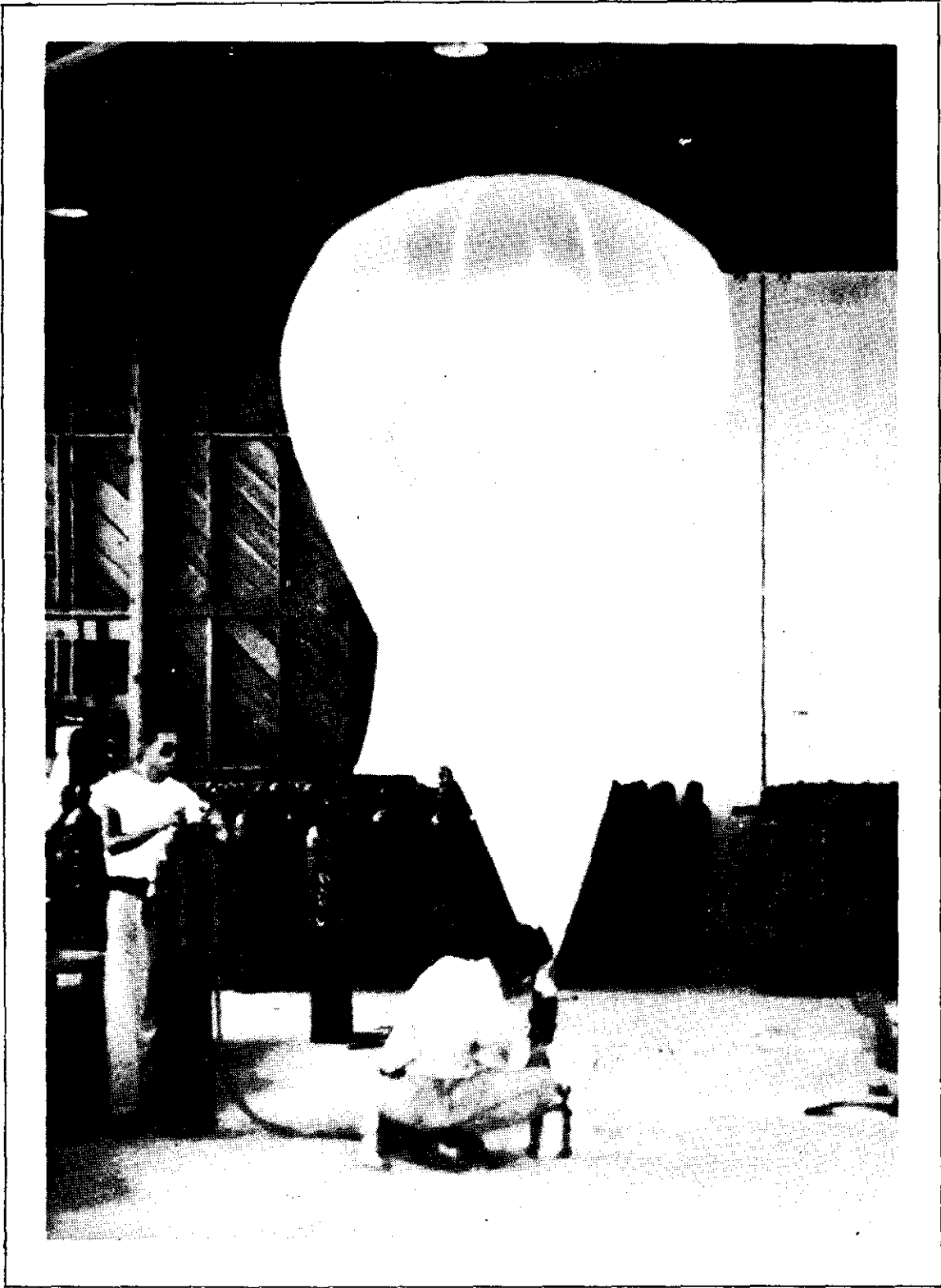

Figure 40  
General Mills 7 foot  
balloon being inflated.

of 170 grams per hour. A balloon of this type with no altitude control stayed aloft for more than two hours and after reaching ceiling, the altitude did not vary by more than 1500 feet while the balloon was within range of the observing station.

The preparation and launching techniques discussed for the 20-foot balloon apply also to the 30-foot cell. No further discussion is required for the 30-foot balloon.

The 70-foot balloon seen in Figures 41 and 42 is launched in the same manner as the 20-foot cell. A much larger amount of gas is required and since it is valved rapidly into the balloon, it has been found necessary to pass the gas through a heating coil to prevent it from reaching the balloon so adiabatically cooled as to be incapable of lifting the load. This heater is shown in Figure 43. Due to the large lift and area exposed to the wind at launching, the large cell may be dangerous if personnel attempt to hold the gear or act as anchors. If possible, all gear should be laid out downwind to be picked up from the ground by the balloon. The anchor should be a winch mounted on a truck which can move around the balloon so as to be downwind at launching.

Since the altitudes where the 70-foot balloons normally float are high in the stratosphere, the natural stability of the balloon in the temperature inversion keeps these cells up for a long period of time without ballast or other controls. One such flight fell slowly during a period of 75 hours and was still above 65,000 feet when the barograph record ended.

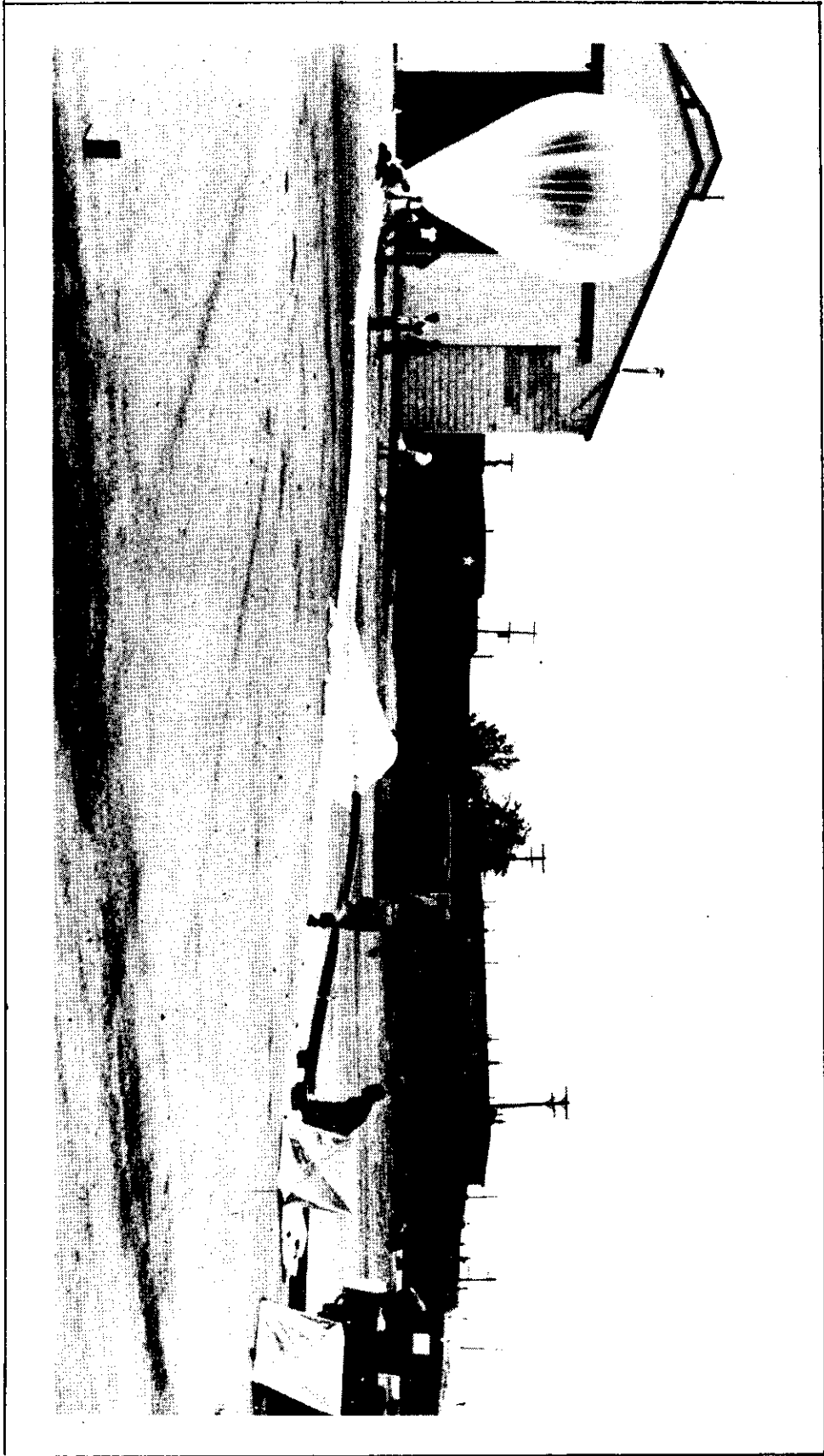
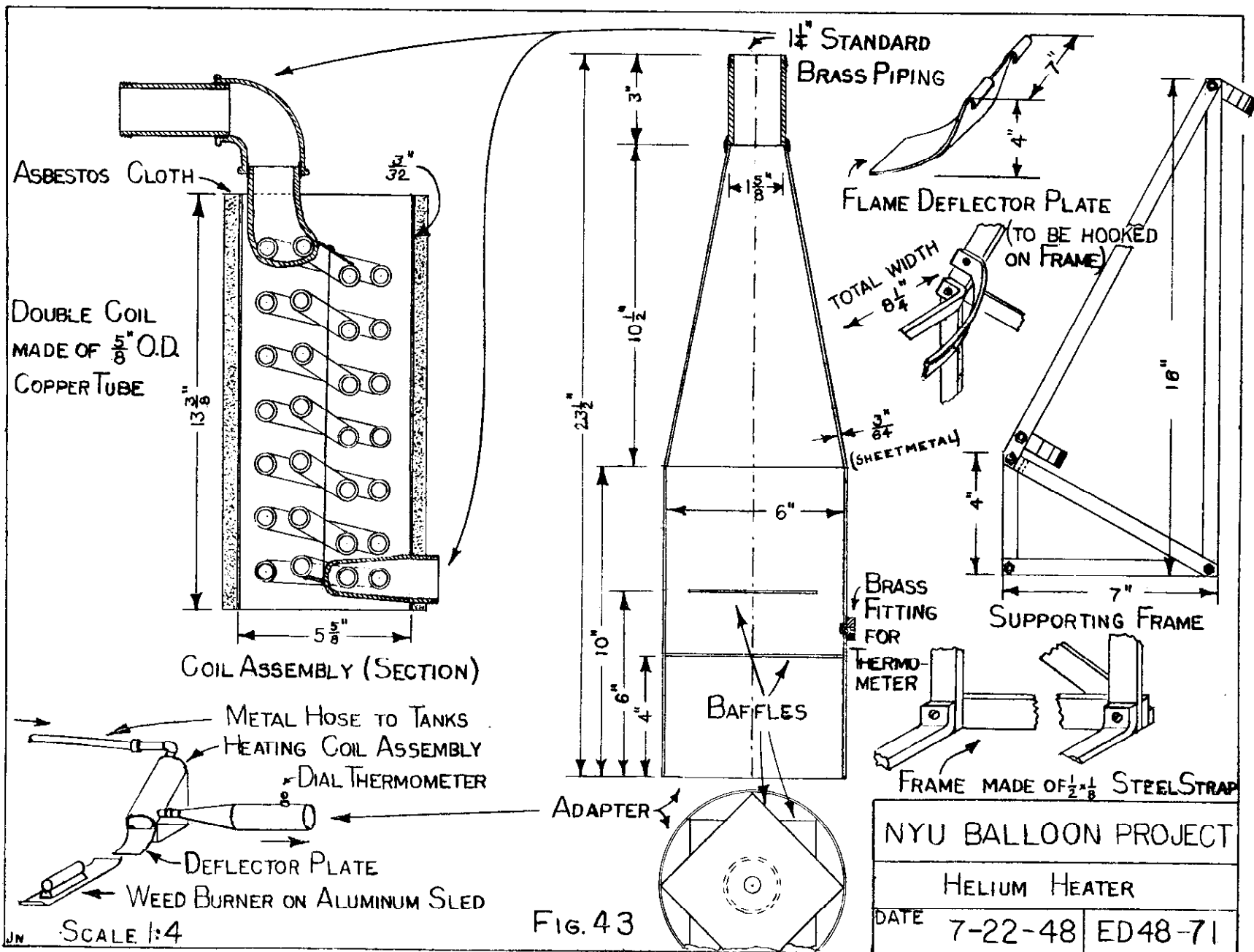

Figure 41  
Inflation of 70 foot diameter  
General Mills balloon.



Figure 42  
General Mills 70 foot balloon  
being launched in a 5 knot wind.



NYU BALLOON PROJECT  
 HELIUM HEATER  
 DATE 7-22-48 ED48-71



## GLOSSARY

- Altitude Sensitivity:** The altitude gained by a balloon when its load is reduced by one kilogram.
- Balloon Inflation:** Gas inflation to be given the balloon in terms of initial lift of the balloon (equals weight of equipment load plus free lift plus allowance for gas losses before launching).
- Ceiling:** The locus of pressure altitudes at which a non-extensible balloon will float when gas losses are slightly over-compensated for by ballast losses.
- Equipment Load:** Weight of all equipment, rigging, and ballast hung from the balloon shrouds not including balloon or its integral parts.
- Floor:** The locus of altitudes at which a balloon will float when lift losses are exactly compensated for on a demand basis by ballast dropping. In practice, this is determined by the operation of the automatic ballast release and is some altitude below the ceiling.
- Free Lift:** Net lift of the balloon with the equipment load attached.
- Gross Lift:** Lift of all of the gas in the balloon at release (equals weight of the balloon, equipment load plus the free lift).
- Gross Load:** Load on the gas at release (balloon plus equipment load weight).
- Pressure Altitude:** The altitude at which a non-extensible balloon becomes fully inflated.
- Pressure Height:** The height above mean sea level as determined from pressure measurements used in this work with the N. A. C. A. Standard Atmosphere.

Appendix I

<u>Table Number</u>	<u>Page Number</u>
Table 1: Equipment List. . . . .	.83
Table 2: Flight Forms. . . . .	.86

Table 1

BASIC EQUIPMENT FOR FIELD TRIPS  
LAUNCHING OF 20' BALLOONS  
WITH SIMPLE CONTROL GEAR

GROUND EQUIPMENT:

NYU Balloon Pro-  
ject Drawing No. or  
Figure No. in Opera-  
tions Manual

---

1 ea. Set instructions (Operations Manual)	
2 ea. Elliptical shot bags (each filled with 100 # of shot)	ED-48-62
2 ea. 40 # Sand bags	ED-48-122A
4 ea. 40 # Sand bags	
1 ea. 40' x 6' Ground Cloth	
4 ea. Sheets polyethylene, .001" to .004", 4' x 4'	
1 ea. 5 Tank manifold with pressure gages and valve	Figure 26
1 ea. Rubber hose, 1" I.D., 10' long	
1 ea. Gas diffuser	ED-48-76A
2 ea. Rubber tubing $\frac{1}{2}$ " bore, $\frac{1}{8}$ " wall, 8' long	
2 ea. Hose clamps, arooseal, $1\frac{1}{4}$ " I.D.	
3 ea. Hose ends for helium tanks	ED-48-80
1 ea. Box white chalk	
1 ea. Solution balance Fisher #2-100	
1 ea. Inflation nozzle, ML-196	
3 ea. Weems plotters	
1 ea. Set aircraft maps of area	
1 ea. Tool kit complete with 2 sheath knives, 50' cloth measuring tape, brass wire, 1" Mystic tape, volt ohmmeter, pliers, screwdrivers, inflation tools, flashlights, crescent wrenches,	

(Tool kit, cont'd.) soldering iron,  
compass, 2 open-end wrenches 1-1/8"  
x 1-1/4" openings, 14" pipe wrench,  
spanner for helium tank valves

2 ea. Theodolite ML-247 with tripod ML-78

2 ea. Recorder, Brush oscillograph or  
other

2 ea. Standby power units

2 ea. SCR-658 Radio direction finder

or

2 ea. Hammerlund Super-Pro receiver

2 ea. Kytoon with spare bladders  
for antenna support

2 ea. Captive balloon, Dewey & Almy N4

4 ea. Chronometers

4 ea. Clip boards

2 ea. Complete set of communication equip-  
ment

Telephone account

Wind screen, 30' x 20', Y-shaped,  
equipped with flood lights and  
anemometer

ED-49-3

FLIGHT GEAR:

2 to 5 Tanks helium

1 ea. General Mills 20' balloon (or other  
balloon to be used) plus spare

24 ea. Rolls acetate fiber scotch tape

3 ea. Appendix stiffeners (if appendix is  
to be used)

ED-48-95A

1 ea. 200' 500 # Test nylon line

1 ea. 100' 75 # Test linen twine

2 ea. 350 Gram balloon ML-131A (for wind  
sock)

5 to 10 Toggles or hooks

2 ea. Parachutes ML-132	
1 ea. Banner, 3' x 6'	ED-48-56
4 ea. Data sheets	
4 ea. Weight sheets	
4 ea. Reward tags (English, Spanish or other language)	Figure 21
2 ea. "Danger Fire" tags	Figure 20
2 ea. Other Danger tags as required	

If Flight Termination gear is to be used:

1 ea. Flight termination switch	ED-48-70A
1 ea. Set rip rigging	ED-48-68A
2 ea. Cannons	ED-49-5
2 ea. Squibs Du Pont S-64 (treated for high altitude)	

If fixed rate ballast release is to be used:

1 ea. Orifice spinnerette, to give ballast flow of 250 gm/hr (.008" D.)	ED-48-75A
1 Gallon ballast, compass fluid AN-C-116	
1 ea. Ballast reservoir (1 gallon capacity)	ED-48-79A
1 ea. Filter 3" diameter, 325 x 325, phosphor bronze mesh	ED-48-54A
4 feet Tubing (Tygon) $\frac{1}{2}$ " bore	
6 inches Tubing (Tygon) $\frac{3}{16}$ " bore	
Metal beakers or rimless 1 qt. tin cans	
Metal funnel	

Table 2  
WEIGHT SHEET

Flight No. \_\_\_\_\_ Date \_\_\_\_\_  
Time \_\_\_\_\_

Balloon Manufacturer \_\_\_\_\_ Weight \_\_\_\_\_  
Number \_\_\_\_\_

Appendix or valve \_\_\_\_\_

Shrouds . . . . . \_\_\_\_\_

Total Balloon Weight . . . . . \_\_\_\_\_

Launching Remnant . . . . . \_\_\_\_\_

Line Length . . . . . \_\_\_\_\_

1st Unit. Serial No. \_\_\_\_\_

description \_\_\_\_\_

Line length \_\_\_\_\_

2nd Unit. Serial No. \_\_\_\_\_

description \_\_\_\_\_

Line length \_\_\_\_\_

3d Unit. Serial No. \_\_\_\_\_

description \_\_\_\_\_

Line length \_\_\_\_\_

4th Unit. Serial No. \_\_\_\_\_

description \_\_\_\_\_

Drag chute \_\_\_\_\_

Banner description \_\_\_\_\_

Ballast assembly - description \_\_\_\_\_

\_\_\_\_\_

\_\_\_\_\_

\_\_\_\_\_

Ballast . . . . . \_\_\_\_\_

Total Equipment Weight . . . . . \_\_\_\_\_

Gross Load . . . . . \_\_\_\_\_



BALLAST COMPUTATIONS FLIGHT # \_\_\_\_\_

Balloon Surface Diffusion {measured } gm/hr. o/o Inflation \_\_\_\_\_ o/o  
{estimated}

Full balloon surface diffusion - balloon surface diffusion  
(o/o Inflation)  $2/3$  \_\_\_\_\_ gm/hr.

Estimated full Balloon ceiling diffusion - F. B. Surface Diffusion  
 $\times \frac{\text{Ceiling Pr.}}{\text{Surface Pr.}}$  \_\_\_\_\_ gr/hr.

Description of Ballast Unit: (components, serial nos. Dimensions)

Amount of Ballast \_\_\_\_\_ gm.

Initial flow, maximum head \_\_\_\_\_ gm./min.

Maximum flow, maximum head \_\_\_\_\_ gm./min.

Estimated Ballast duration  $\frac{\text{Amount of ballast}}{\text{Full balloon ceiling diffusion}}$  \_\_\_\_\_ hrs.

Size Orifice used \_\_\_\_\_ in. Waiting time before release \_\_\_\_\_ min.

Size Limiting Orifice used \_\_\_\_\_ in.

Size filter used \_\_\_\_\_ in.

Initial Head to valve or orifice \_\_\_\_\_ in.

Final " " " " " \_\_\_\_\_ in.



New York University  
Research Division  
Balloon Project

Supplementary Information for Flight No. \_\_\_\_\_

Release: Site \_\_\_\_\_ date \_\_\_\_\_ time \_\_\_\_\_

Encoded Sounding Data:

\_\_\_\_\_  
Encoded Upper Winds

\_\_\_\_\_  
Release Weather

\_\_\_\_\_  
In-Flight Hourly Weather

\_\_\_\_\_  
Train Sketch in Folder \_\_\_\_\_ Films Sent Out \_\_\_\_\_

List Flight Records in Folder:

\_\_\_\_\_  
Remarks

Checked by \_\_\_\_\_

Transmitter Performance for Flight No. \_\_\_\_\_

Release: Date \_\_\_\_\_ Time \_\_\_\_\_ Site \_\_\_\_\_

Transmitter Type and Serial No. \_\_\_\_\_

Batteries: Type and Number \_\_\_\_\_

Open Circuit Voltages:

Voltages Under Load:

Description of Pressure Unit

Description of Special Equipment

Reception at Station #2

Reception at Station #3

Critique

Appendix II

<u>Table Number</u>	<u>Page Number</u>
Table 1: N. A. C. A. Pressure-Altitude. . . . .	96
Table 2: N. A. C. A. Temperature-Altitude . . . . .	.103
Table 3: Ballast Flow. . . . .	.104
Table 4: Balloon Data . . . . .	.105

<u>Graph Number</u>	
Graph 1: Free Lift vs. Rate of Rise . . . . .	.106
Graph 2: Gross Lift vs. Bubble Length . . . . .	.107
Graph 3: Buoyancy vs. Altitude . . . . .	.108
Graph 4: Gross Load vs. Altitude Sensitivity. . .	.109

PRESSURE AND TEMPERATURE  
IN THE N.A.C.A. STANDARD ATMOSPHERE

December 1948

Prepared by

Irwin Brill  
Research Assistant

Balloon Project  
Research Division  
New York University

Under Contract W28-099-ac-241 with  
Watson Laboratories, A.M.C., U.S. Air Forces

Source

Pressure from surface (0 feet) to 65,000 feet: taken from National Advisory Committee for Aeronautics Report #538, and corrected as noted below.

Pressure from 65,000 feet to 163,538 feet: taken from National Advisory Committee for Aeronautics Report #1200.

Temperatures at 1000-foot intervals, taken from National Advisory Committee for Aeronautics Reports #538 and 1200.

Geopotential Assumptions for pressure corrections:

0 feet to 30,000 feet based upon assumed constant geopotential.

30,000 feet to 65,000 feet corrected for geopotential, by approximate correction factors. (Taken from extrapolated curve of difference in feet, from 65,000 to 100,000 feet, between N.A.C.A. table #538 (uncorrected) and N.A.C.A. Technical Note #1200 (corrected).

65,000 feet to 163,538 feet, corrected for geopotential by National Advisory Committee for Aeronautics, Note #1200.

Accuracy

Surface to 30,000 feet = 15 feet, assuming constant geopotential.

30,000 feet to 65,000 feet	± 30 feet
65,000 feet to 100,000 feet	± 50 feet
100,000 feet to 120,000 feet	± 100 feet
120,000 feet to 135,000 feet	± 150 feet
135,000 feet to 163,538 feet	± 250 feet

Table 1

PRESSURE (MB) VERSUS HEIGHT (FEET)

<u>MB</u>	<u>ALT.</u>	<u>DIF.</u>	<u>MB</u>	<u>ALT.</u>	<u>DIF.</u>	<u>MB</u>	<u>ALT.</u>	<u>DIF.</u>	<u>MB</u>	<u>ALT.</u>	<u>DIF.</u>
.015	-47	27	969	1228	28	922	2593	29	878	4002	31
.014	-20	27	968	1256	28	921	2622	29	874	4033	31
.013.25	0	27	967	1284	28	920	2651	29	873	4064	31
.013	7	27	966	1312	28	919	2680	29	872	4095	31
.012	34	27	965	1340	28	918	2709	29	871	4126	31
.011	61	27	964	1368	28	917	2738	29	870	4157	31
.010	88	27	963	1396	28	916	2767	29	869	4188	31
.009	115	27	962	1424	28	915	2796	29	868	4219	31
.008	142	27	961	1452	28	914	2825	29	867	4250	31
.007	169	27	960	1481	29	913	2854	29	866	4281	31
.006	198	27	959	1510	29	912	2883	29	865	4312	31
.005	223	27	958	1539	29	911	2912	29	864	4343	31
.004	250	27	957	1568	29	910	2942	30	863	4374	31
.003	277	27	956	1597	29	909	2972	30	862	4405	31
.002	304	27	955	1626	29	908	3002	30	861	4436	31
.001	332	28	954	1655	29	907	3032	30	860	4467	31
.000	360	28	953	1684	29	906	3062	30	859	4498	31
999	388	28	952	1713	29	905	3092	30	858	4529	31
998	416	28	951	1742	29	904	3122	30	857	4560	31
997	444	28	950	1771	29	903	3152	30	856	4591	31
996	472	28	949	1790	29	902	3182	30	855	4622	31
995	500	28	948	1829	29	901	3212	30	854	4653	31
994	528	28	947	1858	29	900	3242	30	853	4684	31
993	556	28	946	1887	29	899	3272	30	852	4715	31
992	584	28	945	1916	29	898	3302	30	851	4746	31
991	612	28	944	1945	29	897	3332	30	850	4777	31
990	640	28	943	1974	29	896	3362	30	849	4808	31
989	668	28	942	2003	29	895	3392	30	848	4840	32
988	696	28	941	2032	29	894	3422	30	847	4872	32
987	724	28	940	2061	29	893	3452	30	846	4904	32
986	752	28	939	2090	29	892	3482	30	845	4936	32
985	780	28	938	2129	29	891	3512	30	844	4968	32
984	808	28	937	2158	29	890	3542	30	843	5000	32
983	836	28	936	2187	29	889	3572	30	842	5032	32
982	864	28	935	2216	29	888	3602	30	841	5064	32
981	892	28	934	2245	29	887	3632	30	840	5096	32
980	920	28	933	2274	29	886	3662	30	839	5128	32
979	948	28	932	2303	29	885	3692	30	838	5160	32
978	976	28	931	2332	29	884	3723	31	837	5192	32
977	1004	28	930	2361	29	883	3754	31	836	5224	32
976	1032	28	929	2390	29	882	3785	31	835	5256	32
975	1060	28	928	2419	29	881	3816	31	834	5288	32
974	1088	28	927	2448	29	880	3847	31	833	5320	32
973	1116	28	926	2477	29	879	3878	31	832	5352	32
972	1144	28	925	2506	29	878	3909	31	831	5384	32
971	1172	28	924	2535	29	877	3940	31	830	5416	32
970	1200	28	923	2564	29	876	3971	31	829	5448	32

<u>MB</u>	<u>ALT.</u>	<u>DIF.</u>	<u>MB</u>	<u>ALT.</u>	<u>DIF.</u>	<u>MB</u>	<u>ALT.</u>	<u>DIF.</u>	<u>MB</u>	<u>ALT.</u>	<u>DIF.</u>
828	5480	32	781	7026	34	734	8648	35	687	10358	37
827	5512	32	780	7060	34	733	8683	35	686	10395	37
826	5544	32	779	7094	34	732	8718	35	685	10433	38
825	5576	32	778	7128	34	731	8754	36	684	10471	38
824	5608	32	777	7162	34	730	8790	36	683	10509	38
823	5640	32	776	7196	34	729	8826	36	682	10547	38
822	5672	32	775	7230	34	728	8862	36	681	10585	38
821	5704	32	774	7264	34	727	8898	36	680	10623	38
820	5736	32	773	7298	34	726	8934	36	679	10661	38
819	5768	32	772	7332	34	725	8970	36	678	10699	38
818	5800	32	771	7366	34	724	9006	36	677	10737	38
817	5833	33	770	7400	34	723	9042	36	676	10775	38
816	5866	33	769	7434	34	722	9078	36	675	10813	38
815	5909	33	768	7468	34	721	9114	36	674	10851	38
814	5932	33	767	7502	34	720	9150	36	673	10889	38
813	5965	33	766	7536	34	719	9186	36	672	10927	38
812	5998	33	765	7570	34	718	9222	36	671	10965	38
811	6031	33	764	7604	34	717	9258	36	670	11003	38
810	6064	33	763	7638	34	716	9294	36	669	11041	38
809	6097	33	762	7672	34	715	9330	36	668	11079	38
808	6130	33	761	7706	34	714	9366	36	667	11117	38
807	6163	33	760	7740	34	713	9402	36	666	11155	38
806	6196	33	759	7774	34	712	9438	36	665	11193	38
805	6229	33	758	7808	34	711	9474	36	664	11231	38
804	6262	33	757	7843	35	710	9510	36	663	11270	39
803	6295	33	756	7878	35	709	9546	36	662	11309	39
802	6328	33	755	7913	35	708	9582	36	661	11348	39
801	6361	33	754	7948	35	707	9618	36	660	11387	39
800	6394	33	753	7983	35	706	9655	37	659	11426	39
799	6427	33	752	8018	35	705	9692	37	658	11465	39
798	6460	33	751	8053	35	704	9729	37	657	11504	39
797	6493	33	750	8088	35	703	9766	37	656	11543	39
796	6526	33	749	8123	35	702	9803	37	655	11582	39
795	6559	33	748	8158	35	701	9840	37	654	11621	39
794	6592	33	747	8193	35	700	9877	37	653	11660	39
793	6625	33	746	8228	35	699	9914	37	652	11699	39
792	6658	33	745	8263	35	698	9951	37	651	11738	39
791	6691	33	744	8298	35	697	9988	37	650	11777	39
790	6724	33	743	8333	35	696	10025	37	649	11816	39
789	6757	33	742	8368	35	695	10062	37	648	11855	39
788	6790	33	741	8403	35	694	10099	37	647	11894	39
787	6823	33	740	8438	35	693	10136	37	646	11933	39
786	6856	33	739	8473	35	692	10173	37	645	11972	39
785	6890	33	738	8508	35	691	10210	37	644	12011	39
784	6924	34	737	8543	35	690	10247	37	643	12051	40
783	6958	34	736	8578	35	689	10284	37	642	12091	40
782	6992	34	735	8613	35	688	10321	37	641	12131	40

MB	ALT.	DIF.	MB	ALT.	DIF.	MB	ALT.	DIF.	MB	ALT.	DIF.
640	12171	40	592	14130	42	543	16270	45	494	18574	49
639	12211	40	591	14172	42	542	16315	45	493	18623	49
638	12251	40	590	14214	42	541	16360	45	492	18672	49
637	12291	40	589	14256	42	540	16405	45	491	18721	49
636	12331	40	588	14298	42	539	16451	46	490	18770	49
635	12371	40	587	14341	43	538	16497	46	489	18819	49
634	12411	40	586	14384	43	537	16543	46	488	18868	49
633	12451	40	585	14427	43	536	16589	46	487	18917	49
632	12491	40	584	14470	43	535	16635	46	486	18966	49
631	12531	40	583	14513	43	534	16681	46	485	19015	49
630	12571	40	582	14556	43	533	16727	46	484	19065	50
629	12611	40	581	14599	43	532	16773	46	483	19115	50
628	12651	40	589	14642	43	531	16819	46	482	19165	50
627	12691	40	579	14685	43	530	16865	46	481	19215	50
626	12731	40	578	14728	43	529	16911	46	480	19265	50
625	12771	40	577	14771	43	528	16957	46	479	19315	50
624	12811	40	576	14814	43	527	17003	46	478	19365	50
623	12851	40	575	14857	43	526	17049	46	477	19415	50
622	12891	40	574	14900	43	525	17095	46	476	19465	50
621	12931	40	573	14943	43	524	17141	46	475	19515	50
620	12971	40	572	14986	43	523	17188	47	474	19565	50
619	13012	40	571	15029	43	522	17235	47	473	19616	51
618	13053	41	570	15072	43	521	17282	47	472	19667	51
617	13094	41	569	15115	43	520	17329	47	471	19718	51
616	13135	41	568	15158	43	519	17376	47	470	19769	51
615	13176	41	567	15202	44	518	17423	47	469	19820	51
614	13217	41	566	15246	44	517	17470	47	468	19871	51
613	13258	41	565	15290	44	516	17517	47	467	19922	51
612	13299	41	564	15334	44	515	17564	47	466	19973	51
611	13340	41	563	15378	44	514	17611	47	465	20024	51
610	13381	41	562	15422	44	513	17658	47	464	20075	51
609	13422	41	561	15466	44	512	17705	47	463	20127	52
608	13463	41	560	15510	44	511	17752	47	462	20179	52
607	13504	41	559	15554	44	510	17800	48	461	20231	52
606	13545	41	558	15598	44	509	17848	48	460	20283	52
605	13586	41	557	15642	44	508	17896	48	459	20335	52
604	13627	41	556	15686	44	507	17944	48	458	20387	52
603	13668	41	555	15730	45	506	17992	48	457	20439	52
602	13710	42	554	15775	45	505	18040	48	456	20491	52
601	13752	42	553	15820	45	504	18088	48	455	20543	52
600	13794	42	552	15865	45	503	18136	48	454	20595	52
599	13836	42	551	15910	45	502	18184	48	453	20647	52
598	13878	42	550	15955	45	501	18232	48	452	20699	52
597	13920	42	549	16000	45	500	18280	48	451	20751	52
596	13962	42	548	16045	45	499	18329	49	450	20803	52
595	14004	42	547	16090	45	498	18378	49	449	20856	53
594	14046	42	546	16135	45	497	18427	49	448	20909	53
593	14088	42	545	16180	45	496	18476	49	447	20962	53
			544	16225	45	495	18525	49	446	21015	53



MB	ALT.	DIF.	MB	ALT.	DIF.	MB.	ALT.	DIF.	MB	ALT.	DIF.
445	20543	53	397	23741	58	349	26684	64	301	29989	74
444	21122	54	396	23799	58	348	26748	64	300	30061	74
443	21176	54	395	23857	58	347	26812	64	299	30139	76
442	21230	54	394	23915	58	346	26878	66	298	30217	76
441	21284	54	393	23973	58	345	26944	66	297	30295	76
440	21338	54	392	24031	58	344	27010	66	296	30373	76
439	21392	54	391	24090	60	343	27076	66	295	30451	76
438	21446	54	390	24150	60	342	27142	66	294	30529	78
437	21500	54	389	24210	60	341	27208	66	293	30607	78
436	21554	54	388	24270	60	340	27274	66	292	30685	78
435	21608	54	387	24330	60	339	27340	66	291	30763	78
434	21662	54	386	24390	60	338	27406	66	290	30841	78
433	21716	54	385	24450	60	337	27472	66	289	30919	78
432	21770	54	384	24510	60	336	27538	66	288	30977	78
431	21824	54	383	24570	60	335	27604	66	287	31075	78
430	21878	54	382	24630	60	334	27670	66	286	31153	78
429	21932	54	381	24690	60	333	27738	68	285	31231	78
428	21986	54	380	24750	60	332	27806	68	284	31309	78
427	22040	54	379	24810	60	331	27874	68	283	31387	78
426	22095	55	378	24870	60	330	27942	68	282	31465	78
425	22151	56	377	24930	60	329	28010	68	281	31544	80
424	22207	56	376	24990	60	328	28078	68	280	31624	80
423	22263	56	375	25050	60	327	28146	68	279	31704	80
422	22319	56	374	25112	62	326	28214	68	278	31784	80
421	22375	56	373	25174	62	325	28282	68	277	31864	80
420	22431	56	372	25236	62	324	28350	68	276	31944	80
419	22487	56	371	25298	62	323	28418	68	275	32024	80
418	22543	56	370	25360	62	322	28487	69	274	32104	80
417	22599	56	369	25422	62	321	28557	70	273	32184	80
416	22655	56	368	25484	62	320	28627	70	272	32264	80
415	22711	56	367	25546	62	319	28697	70	271	32344	80
414	22767	56	366	25608	62	318	28767	70	270	32424	80
413	22823	56	365	25670	62	317	28837	70	269	32504	80
412	22879	56	364	25732	62	316	28909	72	268	32584	80
411	22935	56	363	25794	62	315	28981	72	267	32664	80
410	22991	56	362	25856	62	314	29053	72	266	32744	80
409	23047	56	361	25918	62	313	29125	72	265	32824	80
408	23103	56	360	25980	62	312	29197	72	264	32904	80
407	23161	58	359	26044	64	311	29269	72	263	32984	80
406	23219	58	358	26108	64	310	29341	72	262	32064	80
405	23277	58	357	26172	64	309	29413	72	261	33144	80
404	23335	58	356	26236	64	308	29485	72	260	33226	82
403	23393	58	355	26300	64	307	29557	74	259	33308	82
402	23451	58	354	26364	64	306	29629	74	258	33390	82
401	23509	58	353	26428	64	305	29701	74	257	33472	82
400	23567	58	352	26492	64	304	29773	74	256	33554	82
399	23625	58	351	26556	64	303	29845	74	255	33638	84
398	23683	58	350	26620	64	302	29917	74	254	33722	84

MB	ALT.	DIF.	MB	ALT.	DIF.	MB	ALT.	DIF.	MB	ALT.	DIF.
253	33806	84	204	38338	102	155	44110	136	106	52099	196
252	33890	84	203	38440	102	154	44246	136	105	52299	200
251	33974	84	202	38544	104	153	44382	136	104	52499	200
250	34060	86	201	38648	104	152	44520	138	103	52701	204
249	34146	86	200	38752	104	151	44660	140	102	52905	204
248	34232	86	199	38858	106	150	44800	140	100	53316	208
247	34318	86	198	38964	106	149	44940	140	$\Delta MB = .50$		
246	34404	86	197	39070	106	148	45081	142	99.50	53421	105
245	34490	86	196	39178	108	147	45225	144	99.00	53526	105
244	34576	86	195	39286	108	146	45369	144	98.50	53631	105
243	34662	86	194	39394	108	145	45513	144	98.00	53741	110
242	34749	88	193	39502	108	144	45657	144	97.50	53851	110
241	34837	88	192	39612	110	143	45804	146	97.00	53961	110
240	34925	88	191	39721	110	142	45952	148	96.50	54071	110
239	35013	88	190	39832	112	141	46100	148	96.00	54181	110
238	35101	88	189	39944	112	140	46248	148	95.50	54291	110
237	35189	88	188	40056	112	139	46400	150	95.00	54401	110
236	35277	88	187	40168	112	138	46552	152	94.50	54511	110
235	35367	90	186	40280	112	137	46704	152	94.00	54621	110
234	35457	90	185	40392	112	136	46856	152	93.50	54733	115
233	35547	90	184	40506	116	135	47012	156	93.00	54848	115
232	35637	90	183	40622	116	134	47168	156	92.50	54963	115
231	35727	90	182	40738	116	133	47324	156	92.00	55078	115
230	35819	90	181	40854	116	132	47484	160	91.50	55433	115
229	35911	92	180	40970	116	131	47644	160	90.00	55548	115
228	36003	92	179	41086	116	130	47804	160	89.50	55653	115
227	36095	92	178	41202	118	129	47968	164	89.00	55770	120
226	36187	92	177	41321	120	128	48132	164	88.50	55890	120
225	36281	94	176	41441	120	127	48296	164	88.00	56010	120
224	36375	94	175	41561	120	126	48464	168	87.50	56130	120
223	36469	94	174	41681	120	125	48632	168	87.00	56250	120
222	36563	94	173	41801	120	124	48800	168	86.50	56370	120
221	36658	96	172	41921	120	123	48969	172	86.00	56491	120
220	36754	96	171	42044	124	122	49141	172	85.50	56616	125
219	36850	96	170	42168	124	121	49313	172	85.00	56741	125
218	36946	96	169	42292	124	120	49488	176	84.50	56866	125
217	37042	96	168	42416	124	119	49664	176	84.00	56991	125
216	37138	98	167	42541	128	118	49840	176	83.50	57116	125
215	37236	98	166	42669	128	117	50018	180	83.00	57241	125
214	37334	98	165	42797	128	116	50198	180	82.50	57366	125
213	37432	98	164	42925	128	115	50381	184	82.00	57495	130
212	37530	98	163	43053	128	114	50565	184	81.50	57625	130
211	37630	100	162	43181	128	113	50752	188	81.00	57755	130
210	37730	100	161	43311	132	112	50940	188	80.50	57885	130
209	37830	100	160	43443	132	111	51129	190	80.00	58015	130
208	37930	100	159	43575	132	110	51321	192	79.50	58145	130
207	38032	100	158	43707	132	109	51513	192	79.00	58279	135
206	38134	102	157	43839	132	108	51707	196	78.50	58414	135
205	38236	102	156	43974	134	107	51903	196	78.00	58549	135

MB	ALT.	DIF.	MB	ALT.	DIF.	MB	ALT.	DIF.	MB	ALT.	DIF.
77.50	58684	135	52.50	66884	200	27.50	80502	380	20.60	86606	102
77.00	58819	135	52.00	67086	205	27.00	80892	390	20.50	86708	102
76.50	58959	140	51.50	67291	205	26.50	81284	400	20.40	86812	104
76.00	59099	140	51.00	67499	210	26.00	81684	410	20.30	86916	104
75.50	59239	140	50.50	67709	210	25.50	82090	420	20.20	87020	104
75.00	59379	140	50.00	67922	215	$\Delta P = .1mb$			20.10	87124	104
74.50	59519	140	49.50	68137	215	25.00	82510	84	20.00	87228	104
74.00	59659	140	49.00	68352	215	24.90	82596	86	19.90	87334	106
73.50	59799	140	48.50	68567	215	24.80	82682	86	19.80	87440	106
73.00	59943	145	48.00	68782	215	24.70	82768	86	19.70	87546	106
72.50	60088	145	47.50	68997	220	24.60	82854	86	19.60	87654	108
72.00	60233	145	47.00	69207	220	24.50	82940	86	19.50	87762	108
71.50	60378	145	46.50	69432	225	24.40	83026	86	19.40	87870	108
71.00	60527	150	46.00	69669	230	24.30	83112	86	19.30	87978	108
70.50	60677	150	45.50	69899	230	24.20	83200	88	19.20	88088	110
70.00	60827	150	45.00	70132	235	24.10	83288	88	19.10	88198	110
69.50	60977	150	44.50	70367	240	24.00	83376	88	19.00	88308	110
69.00	61131	155	44.00	70607	240	23.90	83464	88	18.90	88418	110
68.50	61286	155	43.50	70848	245	23.80	83552	88	18.80	88532	114
68.00	61441	155	43.00	71093	245	23.70	83640	88	18.70	88646	114
67.50	61596	155	42.50	71338	250	23.60	83730	90	18.60	88760	114
67.00	61751	155	42.00	71585	250	23.50	83820	90	18.50	88874	114
66.50	61908	160	41.50	71835	255	23.40	83910	90	18.40	88988	114
66.00	62068	160	41.00	72087	255	23.30	84000	90	18.30	89102	114
65.50	62228	160	40.50	72346	260	23.20	84092	92	18.20	89216	114
65.00	62388	160	40.00	72608	265	23.10	84184	92	18.10	89330	114
64.50	62551	165	39.50	72873	270	23.00	84276	92	18.00	89448	118
64.00	62716	165	39.00	73141	270	22.90	84368	92	17.90	89566	118
63.50	62881	165	38.50	73411	275	22.80	84462	94	17.80	89684	118
63.00	63047	170	38.00	73685	275	22.70	84556	94	17.70	89802	118
62.50	63217	170	37.50	73966	280	22.60	84650	94	17.60	89920	118
62.00	63387	170	37.00	74243	285	22.50	84744	94	17.50	90039	118
61.50	63557	170	36.50	74531	290	22.40	84838	94	17.40	90160	122
61.00	63727	170	36.00	74823	295	22.30	84932	94	17.30	90282	122
60.50	63899	175	35.50	75120	300	22.20	84028	96	17.20	90404	122
60.00	64074	175	35.00	75420	305	22.10	84124	96	17.10	90526	122
59.50	64249	175	34.50	75725	310	22.00	85220	96	17.00	90648	122
59.00	64429	180	34.00	76032	310	21.90	85316	96	16.90	90774	126
58.50	64609	180	33.50	76344	315	21.80	85412	96	16.80	90900	126
58.00	64789	180	33.00	76660	320	21.70	85508	96	16.70	91026	126
57.50	64970	185	32.50	76980	325	21.60	85606	98	16.60	91152	126
57.00	65155	185	32.00	77304	330	21.50	85704	98	16.50	91278	126
56.50	65340	185	31.50	77634	335	21.40	85802	98	16.40	91408	130
56.00	65525	190	31.00	77972	340	21.30	85900	98	16.30	91538	130
55.50	65715	190	30.50	78314	350	21.20	86000	100	16.20	91668	130
55.00	65905	190	30.00	78664	360	21.10	86100	100	16.10	91798	130
54.50	66095	195	29.50	79022	360	21.00	86200	100	16.00	91928	130
54.00	66290	195	29.00	79382	365	20.90	86300	100	15.90	92064	136
53.50	66485	200	28.50	79748	370	20.80	86402	102	15.80	92200	136
53.00	66684	200	28.00	80122	380	20.70	86504	102	15.70	92336	136

<u>MB</u>	<u>ALT.</u>	<u>DIF.</u>	<u>MB</u>	<u>ALT.</u>	<u>DIF.</u>	<u>MB</u>	<u>ALT.</u>	<u>DIF.</u>
15.60	92472	136	10.60	100634	198	5.60	114578	432
15.50	92608	136	10.50	100832	198	5.50	115010	432
15.40	92744	136	10.40	101030	198	5.40	115442	432
15.30	92886	142	10.30	101240	210	5.30	115874	432
15.20	93028	142	10.20	101450	210	5.20	116338	464
15.10	93170	142	10.10	101660	210	5.10	116802	464
15.00	93312	142	10.00	101870	210	5.00	117266	464
14.90	93454	142	9.90	102080	210	4.90	117730	464
14.80	93596	142	9.80	102304	224	4.80	118194	464
14.70	93738	142	9.70	102528	224	4.70	118724	530
14.60	93880	142	9.60	102752	224	4.60	119254	530
14.50	94022	142	9.50	102976	224	4.50	119784	530
14.40	94164	142	9.40	103200	224	4.40	120352	568
14.30	94306	142	9.30	103424	224	4.30	120920	568
14.20	94454	148	9.20	103648	224	4.20	121488	568
14.10	94602	148	9.10	103872	224	4.10	122056	568
14.00	94750	148	9.00	104096	224	4.00	122696	640
13.90	94898	148	8.90	104342	246	3.90	123336	640
13.80	95046	148	8.80	104588	246	3.80	123976	640
13.70	95200	154	8.70	104834	246	3.70	124672	696
13.60	95360	160	8.60	105080	246	3.60	125368	696
13.50	95520	160	8.50	105326	246	3.50	126064	696
13.40	95680	160	8.40	105572	246	3.40	126858	794
13.30	95840	160	8.30	105818	246	3.30	127652	794
13.20	96000	160	8.20	106064	246	3.20	128444	812
13.10	96160	160	8.10	106339	275	3.10	129276	812
13.00	96320	160	8.00	106614	275	3.00	130088	812
12.90	96480	160	7.90	106889	275	2.90	131032	944
12.80	96648	168	7.80	107164	275	2.80	131976	944
12.70	96816	168	7.70	107439	275	2.70	132984	1008
12.60	96984	168	7.60	107714	275	2.60	133992	1008
12.50	97152	168	7.50	107989	275	2.50	135074	1082
12.40	97320	168	7.40	108296	307	2.40	136156	1082
12.30	97498	178	7.30	108603	307	2.30	137438	1282
12.20	97676	178	7.20	108910	307	2.20	138720	1282
12.10	97854	178	7.10	109217	307	2.10	140002	1282
12.00	98032	178	7.00	109524	307	2.00	141462	1460
11.90	98210	178	6.90	109831	307	1.90	142922	1460
11.80	98388	178	6.80	110138	307	1.80	144382	1460
11.70	98566	178	6.70	110482	344	1.70	146182	1800
11.60	98744	178	6.60	110828	346	1.60	148062	1880
11.50	98922	178	6.50	111174	346	1.50	150040	1978
11.40	99100	178	6.40	111520	346	1.40	152176	2136
11.30	99288	188	6.30	111866	346	1.30	154384	2208
11.20	99476	188	6.20	112246	380	1.20	156792	2408
11.10	99664	188	6.10	112626	380	1.10	160040	3248
11.00	99852	188	6.00	113006	380	1.00	163538	3498
10.90	100040	188	5.90	113386	380			
10.80	100238	198	5.80	113766	380			
10.70	100436	198	5.70	114146	380			

Table 2

TEMPERATURE IN N.A.C.A. STANDARD ATMOSPHERE

Altitude	Temp.(°C)	Altitude	Temp.(°C)	Altitude	Temp.(°C)
0	15			96,000	-55
1,000	13	48,000	-55	97,000	-55
2,000	11	49,000	-55	98,000	-55
3,000	9.1	50,000	-55	99,000	-55
4,000	7.1	51,000	-55	100,000	-55
5,000	5.1	52,000	-55	102,000	-55
6,000	3.1	53,000	-55	104,000	-55
7,000	1.1	54,000	-55	104,987	-55
8,000	- 0.8	55,000	-55	106,000	-52.9
9,000	- 2.8	56,000	-55	108,000	-48.5
10,000	- 4.8	57,000	-55	110,000	-43.9
11,000	- 6.8	58,000	-55	112,000	-39.5
12,000	- 8.8	59,000	-55	114,000	-35.0
13,000	-10.8	60,000	-55	116,000	-30.6
14,000	-12.7	61,000	-55	118,000	-26.1
15,000	-14.7	62,000	-55	120,000	-21.6
16,000	-16.7	63,000	-55	122,000	-17.1
17,000	-18.7	64,000	-55	124,000	-12.7
18,000	-20.7	65,000	-55	126,000	- 8.2
19,000	-22.6	66,000	-55	128,000	- 3.7
20,000	-24.6	67,000	-55	130,000	+ .72
21,000	-26.6	68,000	-55	132,000	+ 5.2
22,000	-28.6	69,000	-55	134,000	+ 9.7
23,000	-30.6	70,000	-55	136,000	+14.2
24,000	-32.5	71,000	-55	138,000	+18.6
25,000	-34.5	72,000	-55	140,000	+23.1
26,000	-36.5	73,000	-55	142,000	+27.6
27,000	-38.5	74,000	-55	144,000	+32.1
28,000	-40.5	75,000	-55	146,000	+36.5
29,000	-42.5	76,000	-55	148,000	+41.0
30,000	-44.4	77,000	-55	150,000	+45.5
31,000	-46.4	78,000	-55	152,000	+50.0
32,000	-48.4	79,000	-55	154,000	+54.4
33,000	-50.4	80,000	-55	156,000	+58.9
34,000	-52.4	81,000	-55	158,000	+63.4
35,000	-54.3	82,000	-55	160,000	+67.8
35,332	-55	83,000	-55	162,000	+72.3
36,000	-55	84,000	-55	164,000	+76.8
37,000	-55	85,000	-55		
38,000	-55	86,000	-55		
39,000	-55	87,000	-55		
40,000	-55	88,000	-55		
41,000	-55	89,000	-55		
42,000	-55	90,000	-55		
43,000	-55	91,000	-55		
44,000	-55	92,000	-55		
45,000	-55	93,000	-55		
46,000	-55	94,000	-55		
47,000	-55	95,000	-55		

Table 3

Table of flows in gm/hr. from "Spinnerette Orifices"

dia. (in inches)	Q (actual) in gm/hr.			
	at 24 Hd.	at 22" Hd.	at 20" Hd.	at 18" Hd.
.003	35	33.5	32	30.5
.004	62.8	60	57	54.5
.005	97.5	93.5	88.8	84.5
.006	141	134	128	122
.007	192	184	175	166
.008	251	241	229	217
.009	317	303	289	274
.010	392	375	358	340
.011	474	453	433	410
.012	564	540	515	488

$$Q \text{ (actual) gm/hr.} = C_d (\text{dia.}^{\prime\prime})^2 (\text{hd.}^{\prime\prime})^{\frac{1}{2}} \times 1.003 \times 10^6$$

( $C_d$  varies from .78 to .82)

$C_d$  (mean) = .80 (used above)

$$\frac{Q_1}{Q_2} = \left( \frac{\text{hd.}_1}{\text{hd.}_2} \right)^{\frac{1}{2}}$$

Table 4

## BALLOON DATA

General Mills Nominal Diameter ft.	Actual Volume cu.ft.	Balloon Weight kg.	Estimated Gross Load Limit kg.	Altitude Range ft.
7	200	0.6	1.5 to 5	38,000 to 0
20	4300	3.8 to 5.0	7 to 36	68,000 to 37,000
30	12,700	8.9	12 to 60	82,000 to 50,000
70	200,000	41 to 54	50 to 175	110,000 to 84,000

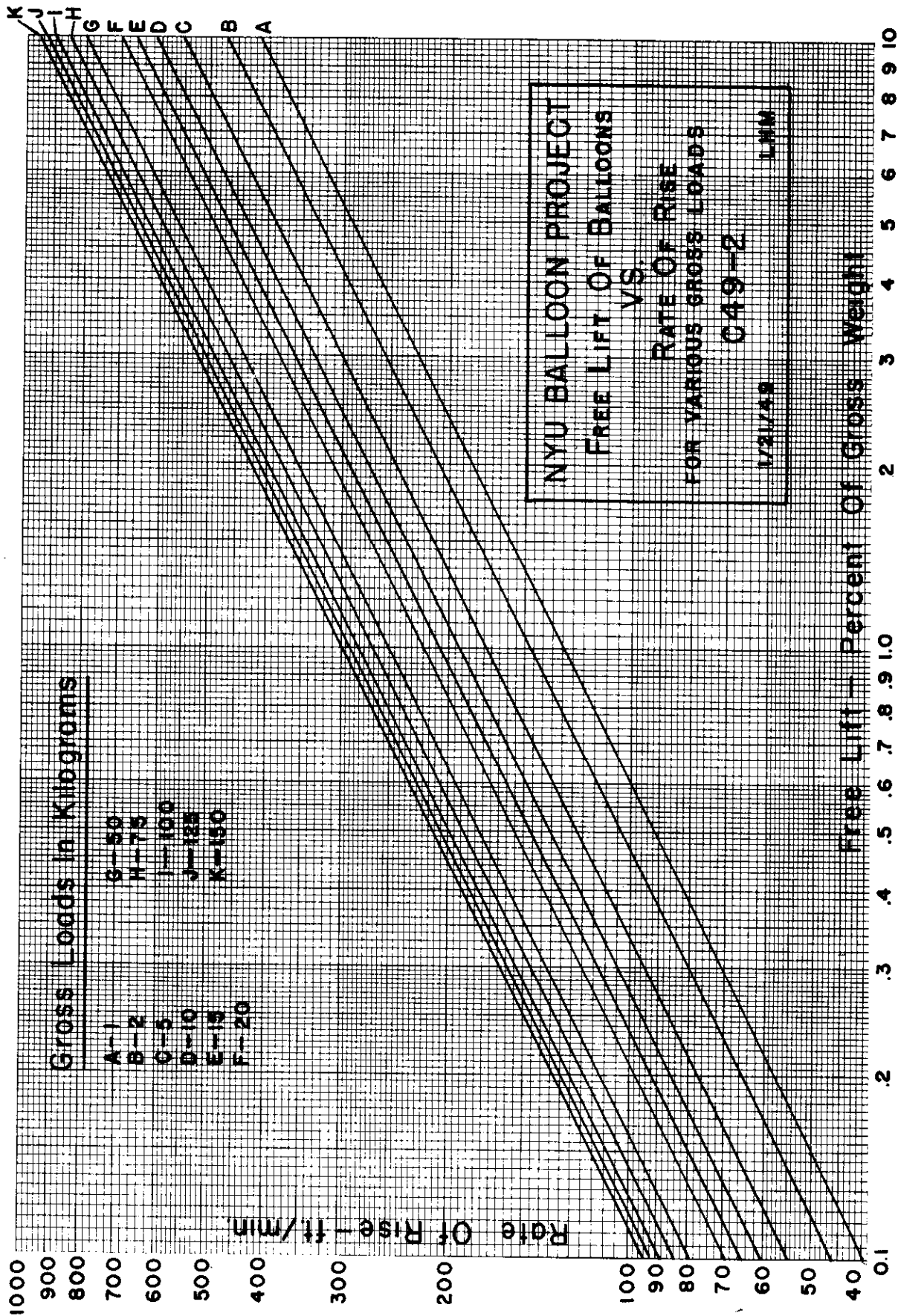



MINIMUM LENGTH OF GM BALLOON ABOVE SHOT BAG IN FEET

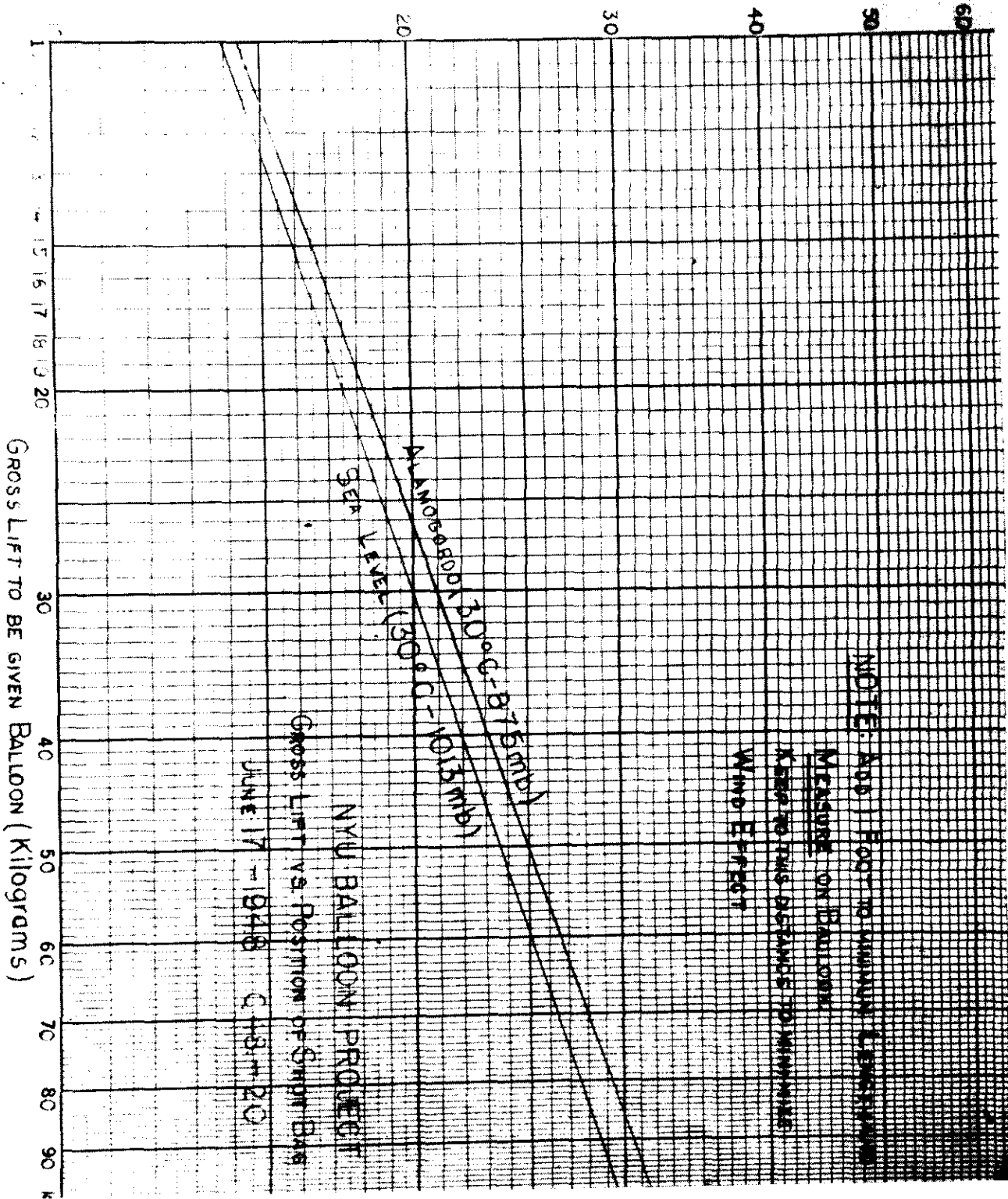

Graph 2

NYU BALLOON PROJECT  
 Buoyancy Vs. Altitude  
 2/27/48 LHM C49-4

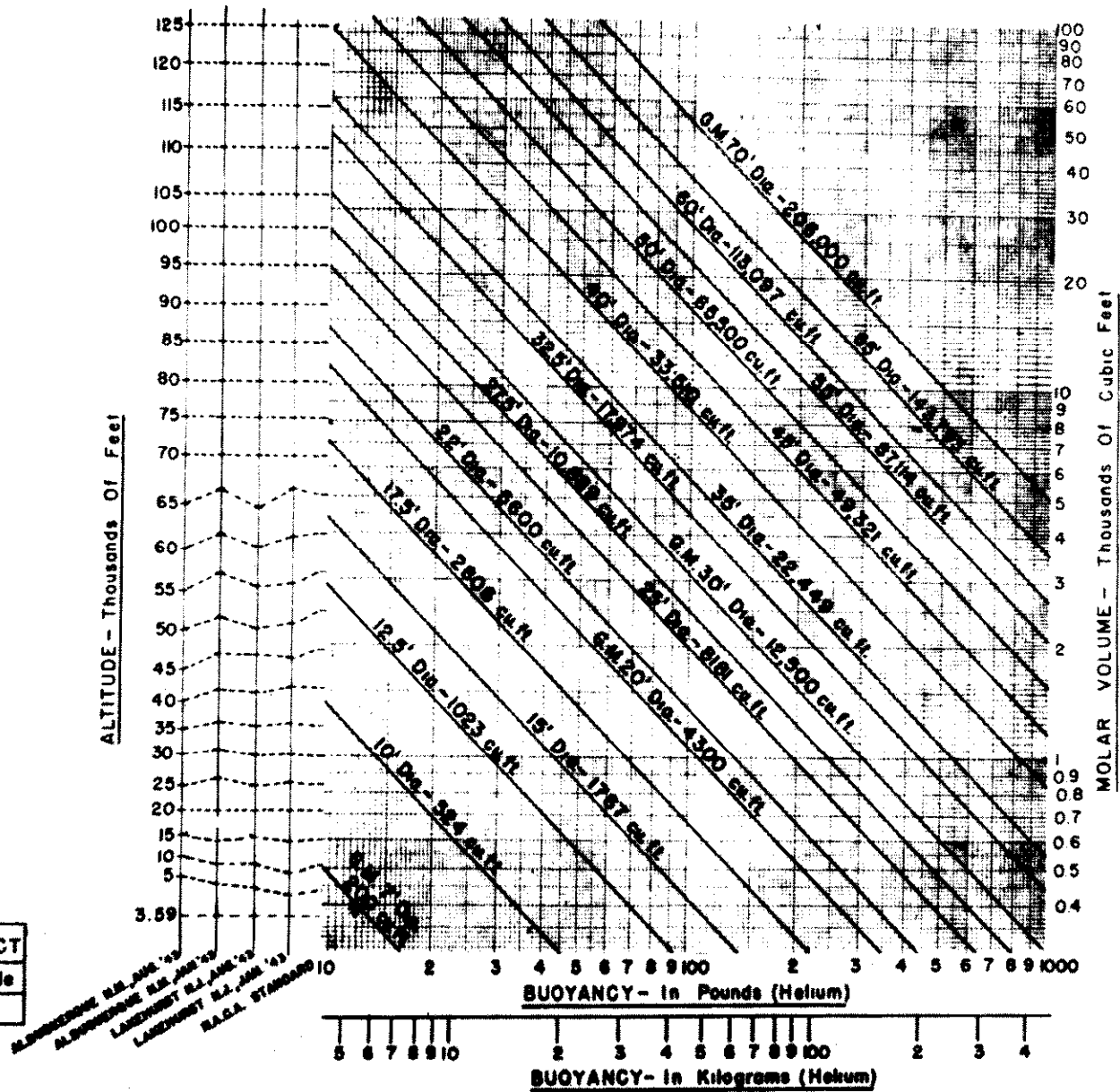

Graph 3

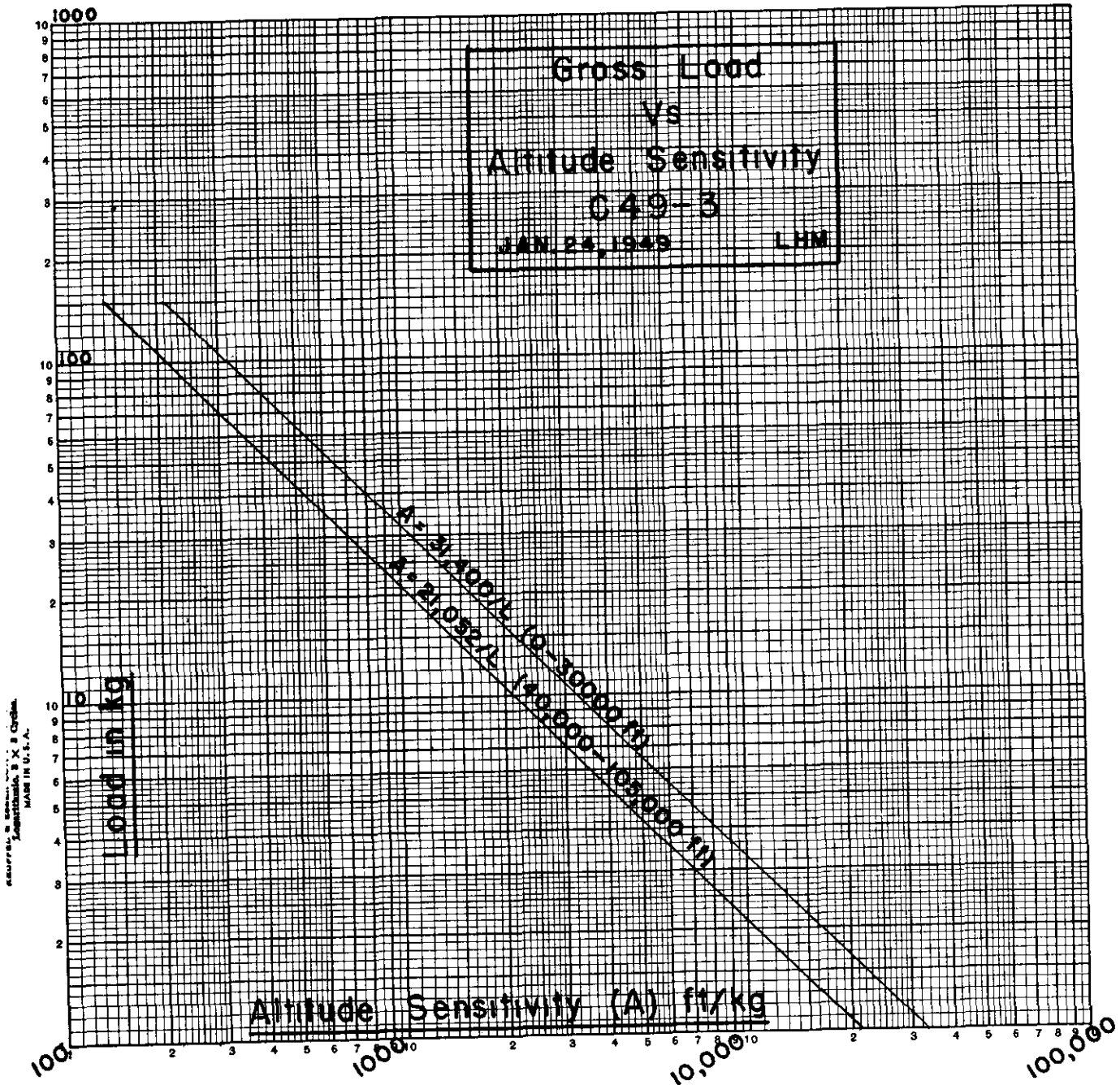

Graph 4

Note: On flights made in February, 1949, spring bow appendix closers were used successfully with rates of rise exceeding 1000 feet per minute. Of those described on page 10, this type of appendix stiffener is now recommended.

Combined History [Selected Pages]  
509th Bomb Group and Roswell  
Army Airfield  
September 1947

---

A

[Redacted text block]



[REDACTED]

CHAPTER XIII

VISITORS  
and  
EXECUTIVE CALENDAR

- 3 September 1947 - Colonel Blanchard and Lt. Haut went to Artesia where Colonel Blanchard was guest speaker at the Artesia Woman's Club luncheon.
- 3 September 1947 - Colonel Pelham D. Glasford, Eighth Air Force Air Inspector's Office and Lt. Colonel John A. Roberts, Assistant Chief of Staff, arrived for general familiarization with various activities on the field as pertains to their respective jobs.
- 3 September 1947 - Col. John D. Ryan, A-3; Lt. Colonel Calvin W. Fite, Jr., Lt. Colonel Carl V. Ekstrand, Lt. Colonel Ray C. Milton, Major Leroy S. English, Captain Floyd R. Creasman, Captain James W. Brady, all from Headquarters Eighth Air Force, arrived here for a conference and inspecting and coordination with various sections on the base. Lt. Colonels Harman and Ord arrived from Albuquerque for the conference.
- 4 September 1947 - The above-named group departed for Forth Worth and Tucson.
- 5 September 1947 - Mr. Lawrence A. Deason, Sr., liason representative from San Antonio, called on Colonel Blanchard.
- 10 September 1947 - Mr. Peoples, Mr. Mackman and First Lieutenant Thompson from Air Material Command arrived on the field to inspect Air Material Command installations and to confer with Lt. Colonel Briley.
- 11 September 1947 - Captain J. F. Morgan, from Headquarters Eighth Air Force, was here to confer with the Engineering Officer, Captain Peterson, in regard to the de-icer boot on C-54 aircraft.
- 12 September 1947 - Inspection teams from this Base inspected various Base activities, organizations, and installations.
- 15 September 1947 - Troops from Roswell Army Airfield marched in a parade in the City of Roswell at 1030 for the benefit of the Chavez County Memorial Youth Center.
- 15 September 1947 - A meeting of S-1, S-2, S-3, S-4, DCC, Executive, Air Inspector, Adjutant and Commanding Officers of the 393rd, 830th, and 715th Bomb Squadrons was held in the Control Room to discuss the reorganization.



33

“Mensuration Working Paper,” with  
Photo and Drawing  
February 15, 1994

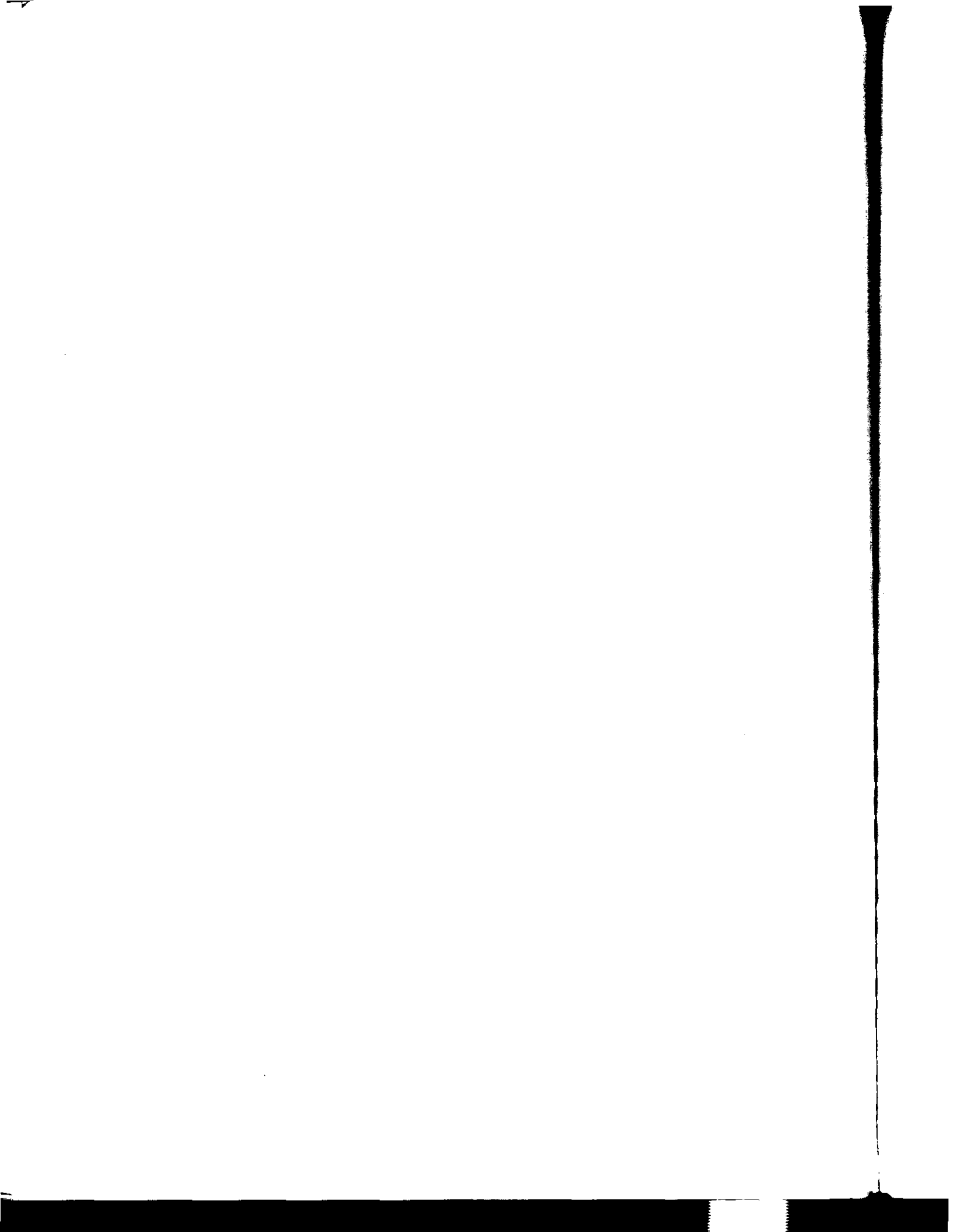

## Mensuration Working Paper

TARGET NAME		ROSWELL, N.MX.		DATE RETURNED		26-JUL-94	
IMAGE ID		FWST(UTA) NEG. ENV. #2026, NEG #1		PHONE		703-693-2013	
IMAGERY ANALYST		LT. MCANDREW		DIVISION		DOD	
IMAGERY SCIENTIST				PHONE			

COMPARATOR	N/A	MEASUREMENTS		HOURS		STEREO	<input type="checkbox"/>
INTERGRAPH	MSB2	MEASUREMENTS	17	HOURS	7	TERRESTRIAL	<input checked="" type="checkbox"/>
						RUSH JOB	<input checked="" type="checkbox"/>
						Q-JOB	<input type="checkbox"/>
						IA ASSISTED	<input type="checkbox"/>
						CABLE/PUBLICATION ITEM	<input type="checkbox"/>

SIGNATURE	DATE
-----------	------

**MENSURATION RESULTS:**

**PHOTOGRAPH AND CAMERA INFORMATION:**

GROUND PHOTOGRAPHS- FWST(UTA) NEG. ENV. #2026, NEG #1- #4. TAKEN JULY 8, 1947.  
 CAMERA TYPE- SPEED GRAPHIC ( 4" X 5" FORMAT)  
 NOMINAL FOCAL LENGTHS- 127mm, 135mm and 150mm(MOST COMMON).

THE FOCAL LENGTH CALCULATED FOR THE CAMERA USED TO TAKE PHOTOGRAPH NEG #1 IS EQUAL TO 121mm.

**ASSUMPTIONS:**

BROWN WRAPPING PAPER ON FLOOR UNDER OBJECT OF INTEREST IS ASSUMED TO HAVE A WIDTH OF 35.5 ± 3".  
 RADIATOR ON LEFT SIDE OF THE PHOTOGRAPH IS ASSUMED TO HAVE A TOTAL HEIGHT OF 28 ± 2".

**MEASUREMENTS:**

STICK MEASUREMENTS:

ID.	LENGTH		WIDTH	
	(M)	(IN)	(M)	(IN)
A	0.7	27.6"	0.01	0.4"
B	0.6	23.6"	0.01	0.4"
C	0.9	35.4"	0.02	0.8"
D	0.5	19.7"	---	---
E	0.5	19.7"	0.02	0.8"
F	0.4	15.7"	0.01	0.4"
G	0.4	15.7"	0.01	0.4"
H	0.6	23.6	---	---
BASE BOARD	0.1	3.9"	---	---

NOTE: THE ACCURACY STATEMENT IS 10% OF THE REPORTED LENGTHS AND WIDTHS.



Radiator

Rug Edge

Brown Edge



.H

.G

.D

.E

.F

.B

.C

7/29/54  
MAP VIEW  
NES. #1 PHOTOGRAPH

rug edge

brown paper

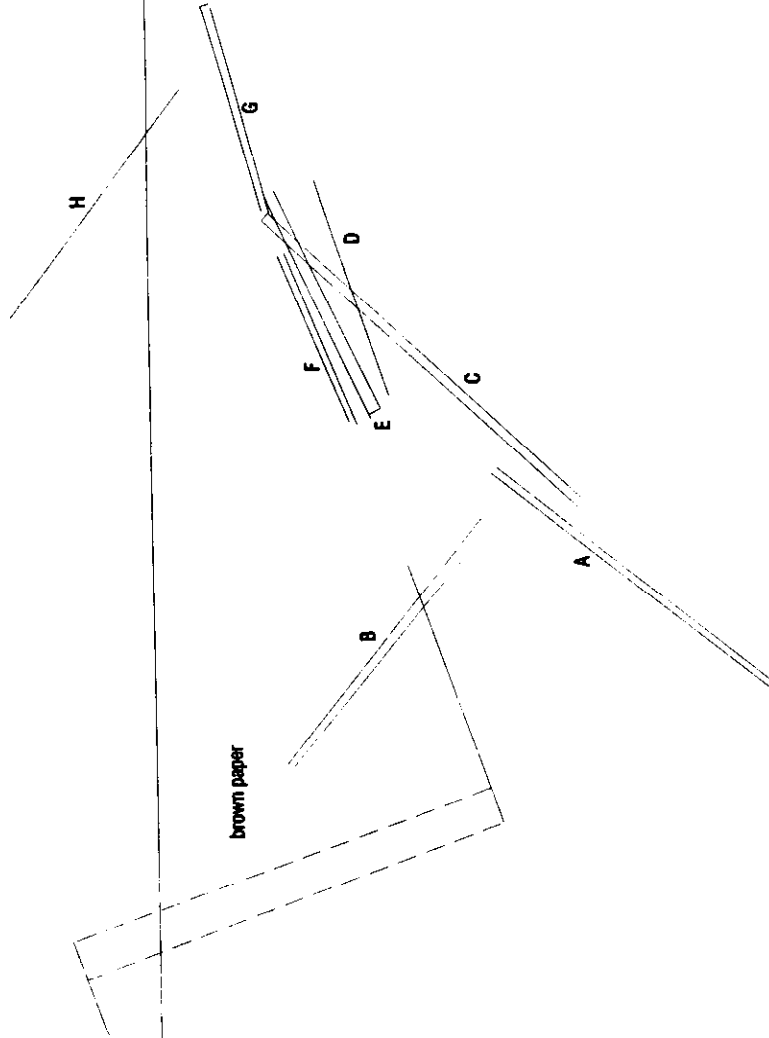

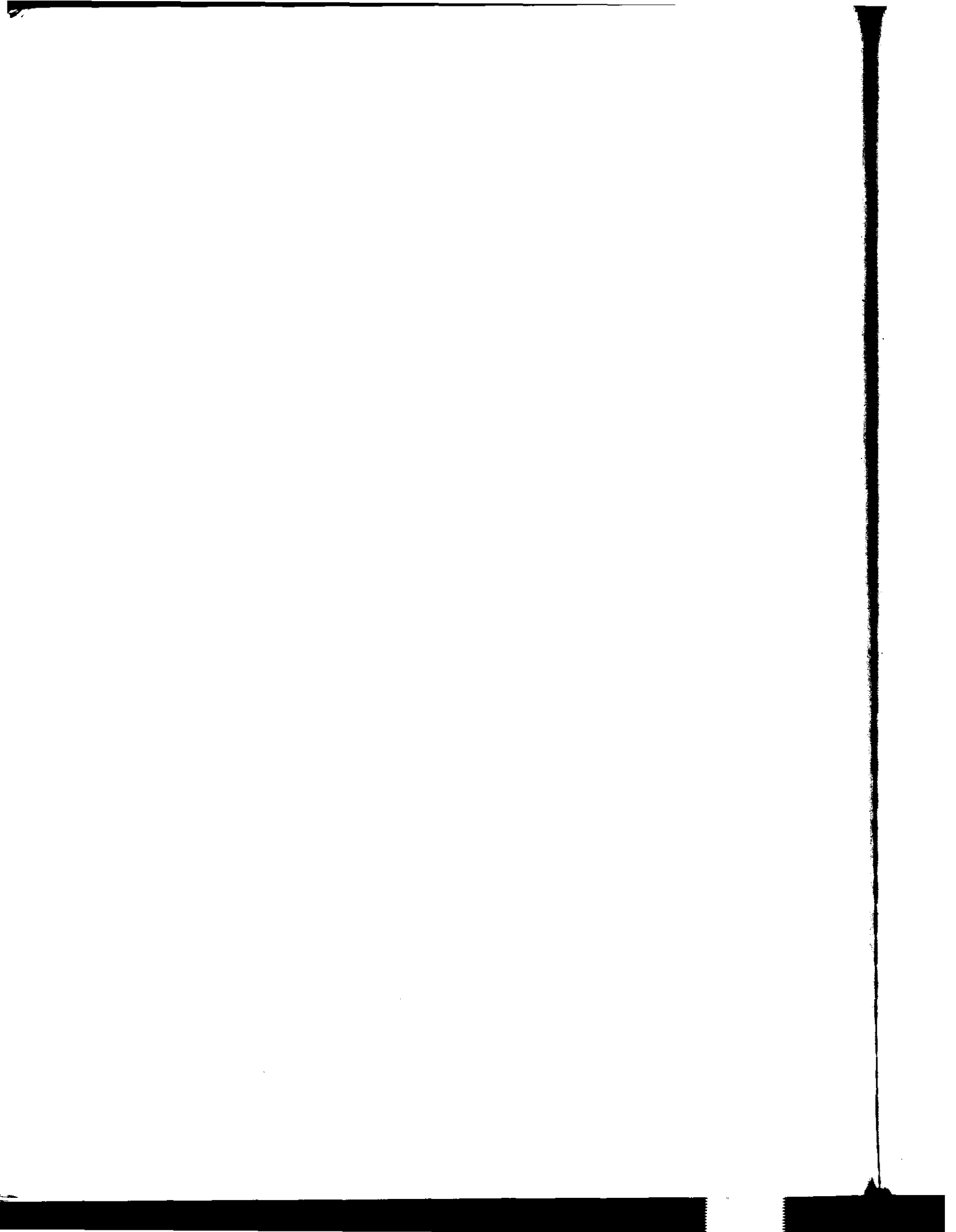

# PHOTOGRAPH SECTION



**General Carl A. Spaatz**, Commanding General, U.S. Army Air Forces, 1947. Gen Spaatz was the Chief of Staff, United States Air Force, 1947–1948. A review of his personal and official documents, including highly classified daily briefings for the summer of 1947, do not in any way suggest that U.S. Army Air Forces recovered a flying saucer or its alien occupants. *U.S. Air Force Photo.*





**Lt. Gen. Hoyt S. Vandenberg**, Deputy Commander, U.S. Army Air Forces, 1947. General Vandenberg served as Chief of Staff, United States Air Force 1947–1953. He is alleged to have directed the recovery of a flying saucer at Roswell Army Air Field on July 8, 1947. A review of his official daily activities calendar revealed his knowledge of a reported flying saucer recovery on July 7 in Texas, an incident that he later determined to be a hoax. Records do not support the claim that he had any similar involvement on July 8, as charged by crashed saucer conspiracy theorists (*see Atch 15*).  
*U.S. Air Force Photo.*



**General Nathan F. Twining**, Commanding General, Air Matériel Command, 1947. General Twining was Chief of Staff, United States Air Force, 1953–1957. UFO theorists allege that General Twining altered his plans unexpectedly in July 1947 to go to New Mexico to oversee the recovery of a flying saucer. However, records indicate that Twining went to New Mexico in July 1947, along with several other general officers, to attend the Nuclear Bomb Commanders Course. He received orders to attend this course more than a month *before* the alleged “incident” occurred (see *Atch 14*). *U.S. Air Force Photo.*



**Maj. Gen. Curtis E. LeMay** (*left*) and **Brig. Gen. Roger M. Ramey** are shown here while serving in Kharagpur, India, during World War II. *U.S. Air Force Photo.*

**General Curtis E. LeMay** was Deputy Chief of Air Staff for Research and Development, U.S. Army Air Forces, in 1947, and later Chief of Staff, United States Air Force, 1961–1965. As Deputy Chief of Air Staff for Research and Development, LeMay had a strong influence on the high-priority Project MOGUL (*see Apps 8 and 9*). He also maintained close associations throughout his career with former subordinates from World War II bombing campaigns, including Brig. Gen. Roger M. Ramey and Col. William H. Blanchard.

**Brig. Gen. Roger M. Ramey** was the Commanding General, Eighth Air Force, in 1947. He is alleged to have participated in the cover-up of the recovery of an extraterrestrial vehicle by substituting debris from an ordinary weather balloon for that of an alien spacecraft. In fact, General Ramey displayed the original debris recovered from the ranch, which came from a MOGUL balloon train. Ramey withheld only the components that would have compromised the highly sensitive project (*see Atch 16*).



**Col. William H. Blanchard**, Commander 509th Bomb Group, 1947, and later, Vice Chief of Staff, United States Air Force, 1965–1966. As commander of Roswell Army Airfield and the 509th Bomb Group, Blanchard is alleged to have secretly directed the recovery of a flying saucer while pretending to be on leave. Records indicate that Blanchard was on leave, departing Roswell on July 8 and returning on July 23, 1947 (see Atch 11). *U.S. Air Force Photo.*



**Maj. Gen. Clements McMullen**, Deputy Chief of Staff, Strategic Air Command, 1947. General McMullen is alleged to have directed General Ramey to cover up the recovery of an extraterrestrial craft and crew. After an extensive search, the "Command Correspondence" file for the period was located. This file contained privileged and classified information of the highest order between McMullen and Ramey—it contained no information to support the outrageous claim.



**Brig. Gen. Donald N. Yates**, Chief, Air Weather Service, 1947, and later, Deputy Director of Defense for Research and Engineering. Crashed saucer theorists contend Yates participated in a conspiracy by confirming the weather balloon explanation for the mysterious debris. They also contend that the debris recovered by the rancher was transported to Andrews AAF, MD (near Washington, DC), to be examined by high government officials including the President. In reality, Andrews AAF was the home of the Army Air Forces Air Weather Service and would be a probable location for debris, which contained components of weather equipment, to be identified. *U.S. Air Force Photo.*



Project MOGUL Field Operations Director **Albert P. Crary** maintained a journal of his professional activities including Project MOGUL research in the summer of 1947. Portions of his journal provided details necessary to reconstruct events not available from published MOGUL reports (*see App 17*). In addition to his work for the Air Force, this world-renowned scientist is credited with significant contributions to the study of Polar regions; a research center at McMurdo Station, Antarctica was recently named in his honor.

**Albert P. Crary** (*left*) and technician **Phil Chantz** taking a break during Project MOGUL operations at White Sands Proving Ground, NM, July 1947.





**Dr. W. Maurice Ewing**, preeminent geophysicist and oceanographer. It was Ewing who first conceptualized the military significance of the atmospheric sound channel. His proposal, made directly to the Commanding General U.S. Army Air Forces, General Carl Spaatz, was well received and resulted in the initiation of Project MOGUL (*see App 6*). *Photo Courtesy of Woods Hole Oceanographic Institution.*

The distinguished scientists **Albert P. Crary** (*left*) and **Dr. W. Maurice Ewing** collaborated at various scientific research institutions throughout their careers, in addition to performing their work for the U.S. Air Force. In the course of their collaborations, these men had affiliations with Lehigh University, Columbia University, and Woods Hole Oceanographic Institution.

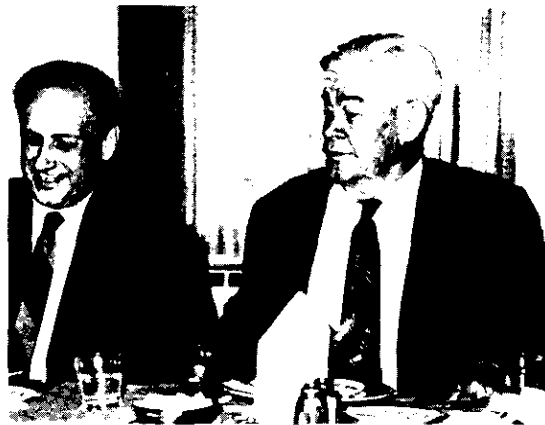





**Dr. Athelstan F. Spilhaus** (*left*) and **Col. Marcellus Duffy** appear here serving as members of HQ USAAF Liaison Group to the U.S. Army Signal Corps, Saipan, in 1944. *Photo Courtesy of Mrs. Emily Duffy.*

**Dr. Athelstan F. Spilhaus**, Director of Research at New York University, oversaw but had no direct involvement in the activities of the NYU Balloon Group or the alleged incident. He did, however, serve on various high-level panels which set military and national policy, including the USAF Scientific Advisory Board (1953–1957). When asked, for the purpose of this report—and released from any security oaths he may have taken—if he ever had knowledge of a recovery of an extraterrestrial vehicle or its occupants by the U.S. Government, his unqualified response was “no.”

**Col. Marcellus Duffy**, a highly capable scientific research officer, was a MOGUL project officer. Maj. Gen. Curtis LeMay, Deputy Chief of Air Staff for Research and Development, turned to Colonel Duffy to make adjustments to MOGUL after the project's progress was determined to be inadequate (*see App 8*).



**Capt. Albert C. Trakowski** who succeeded Colonel Duffy as MOGUL Project Officer, confirmed in a recent interview that the debris mistaken for part of a flying saucer was flown to Wright Field (now Wright-Patterson AFB) OH, not for scientific analysis as alleged by UFO theorists, but for Colonel Duffy's personal identification. *Photo Courtesy of Col. Albert Trakowski.*

**MOGUL Project Scientist Dr. James Peoples.** Peoples's decision not to bring the radiosonde tracking equipment for the NYU field trip in June 1947 prompted Project Engineer C.B. Moore to attach additional radar targets to the MOGUL balloon trains. The targets, seldom used in the continental United States, were recovered by the rancher and mistaken to be part of a flying saucer.





**Charles B. Moore, NYU Constant-Level Balloon Project Engineer.** Moore pioneered the use of polyethylene balloons for upper atmospheric research. He launched NYU flight No. 4 on June 4, 1947, which was the balloon train most likely to have caused what is known today as the "Roswell Incident." Moore is presently Professor Emeritus of Atmospheric Physics at New Mexico Institute of Mining and Technology, Socorro, NM. *Photo Courtesy of C.B. Moore.*

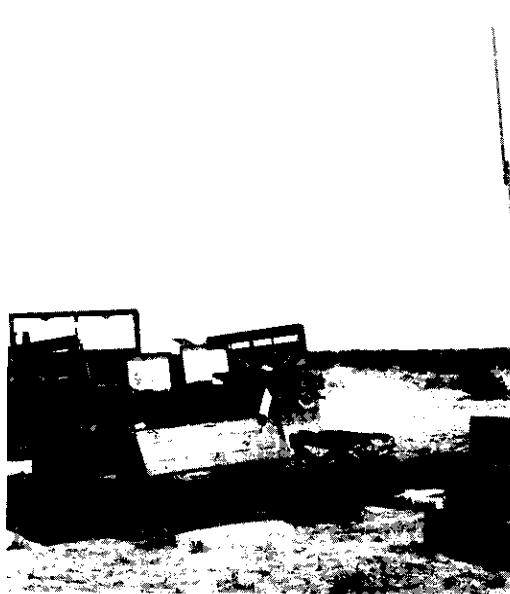

**Sitting in the back of the truck** (*left*) is a U.S. Army GR-3 Sound Ranging Set, normally used by field artillery observation units but adapted for use in Project MOGUL. The set was employed for the MOGUL operations at White Sands Proving Ground in July 1947. **The detonation, or “shot”** (*right*), of 500 pounds of TNT was monitored at White Sands Proving Ground, NM, in July 1947, by Project MOGUL balloon and ground-based sensors. *Photo Collection of Albert P. Crary.*



**This modified PT boat** that was assigned to Project MOGUL is shown here off Block Island, RI. Col. Marcellus Duffy eliminated it and several others from the project when Headquarters U.S. Army Air Forces expressed concerns over the progress of MOGUL under the previous project officer. *Photo collection of Albert P. Crary.*

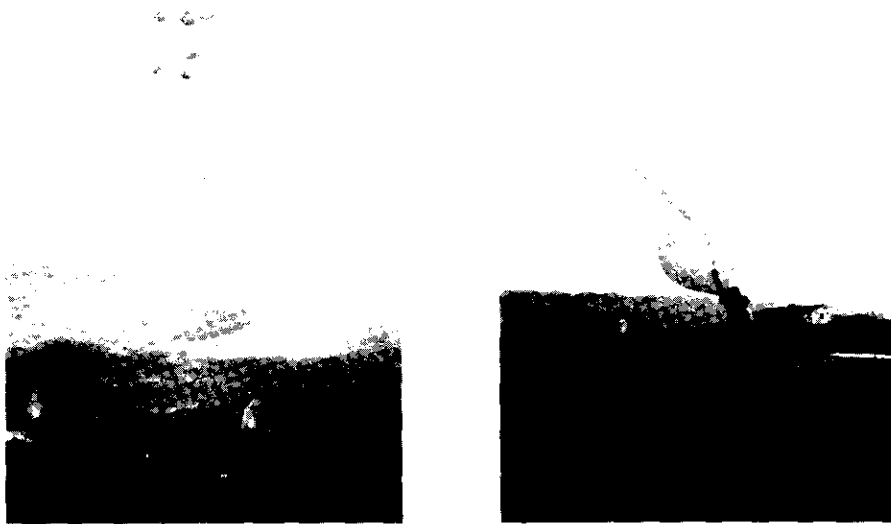

**Launch of Project MOGUL neoprene balloons, Alamogordo AAF, NM, June 1947.** While awaiting the experimental polyethylene balloons, NYU engineers utilized long trains of the smaller neoprene balloons as a stopgap method of placing their acoustic sensors in the upper atmosphere. These balloon trains consisted of a variety of equipment and measured more than 600 feet long (*see Atch 25*). *Photo Collection of Albert P. Crary.*

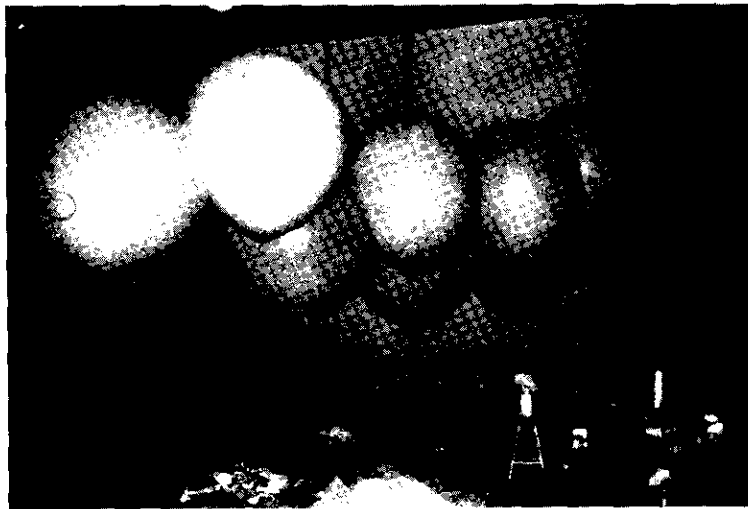

**Standard 350-gram meteorological weather balloons in the North Hangar at Alamogordo AAF for use by Project MOGUL in June 1947.** Although the balloons themselves were common, the remainder of the equipment on the MOGUL trains was experimental or had been recently placed in service (*see Atch 25*). It would not be unusual for individuals uninvolved in the development of these devices not to recognize them. *Photo Courtesy of C.B. Moore.*



A New York University launch crew prepares a MOGUL balloon train for flight (Holloman AFB, NM, 1948). The three ML-307C/AP corner reflectors (*left*) are of the type that W.W. "Mac" Brazel recovered on a ranch near Corona, NM, in June 1947.



C.B. Moore, New York University Constant Level Balloon Project Engineer (*left and standing*), adjusts an AN/FMQ-1 radiosonde receiver/recorder. The absence of this equipment on the first NYU field trip in June 1947 (it was left behind in New York due to space limitations of the B-17 aircraft) prompted Moore to attach additional ML-307C/AP corner reflectors to MOGUL flights. The addition of the oddly constructed reflectors, intended to enhance radar returns, contributed to the confusion when Mogul Flight No. 4 returned to earth and was mistaken for a part of a flying saucer. Moore (*right and reaching down*) prepares experimental Project MOGUL microphones for launch (Holloman AFB, Alamogordo, NM, July 1948).

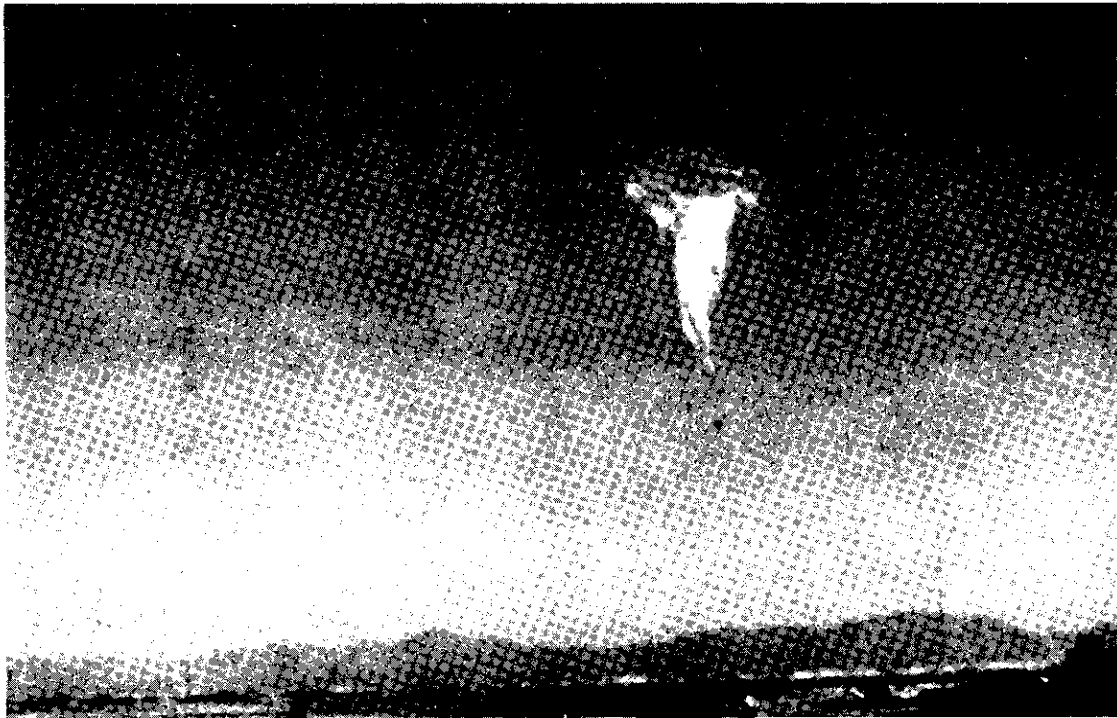

**This 15-foot polyethylene balloon** (*left*) and **70-foot polyethylene balloon** (*above*) are representative of the type used extensively by Project MOGUL. It is this variety of balloon that caused many UFO sightings due to their flat, spherical appearance when viewed from the ground.

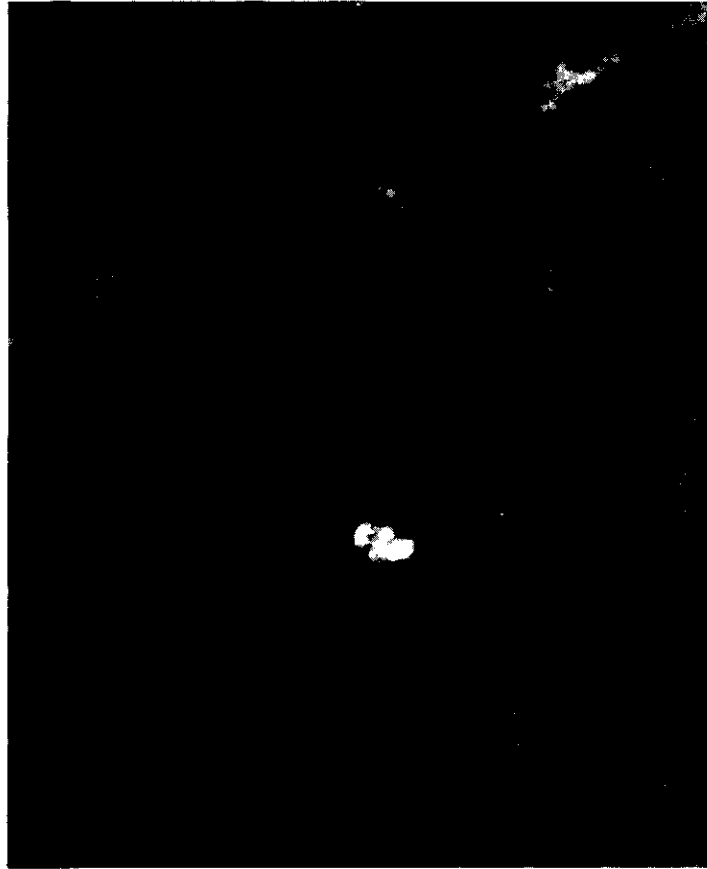

**A blimp hangar at Lakehurst Naval Air Station, NJ (left), contains a Project MUGUL balloon during its preparation for flight. Lying on the desert floor near Roswell, NM, in July 1948 (right) is a Project MUGUL balloon.** Due to the prevailing westerlies, MUGUL balloons often descended in the vicinity of Roswell after launch from Alamogordo. The unpredictability and hazards to aircraft presented by the balloons prompted the Civil Aviation Administration (now the Federal Aviation Administration) to conduct a hearing addressing safety concerns of balloons landing in the Roswell area (*see App 13, pp. 43-44*).



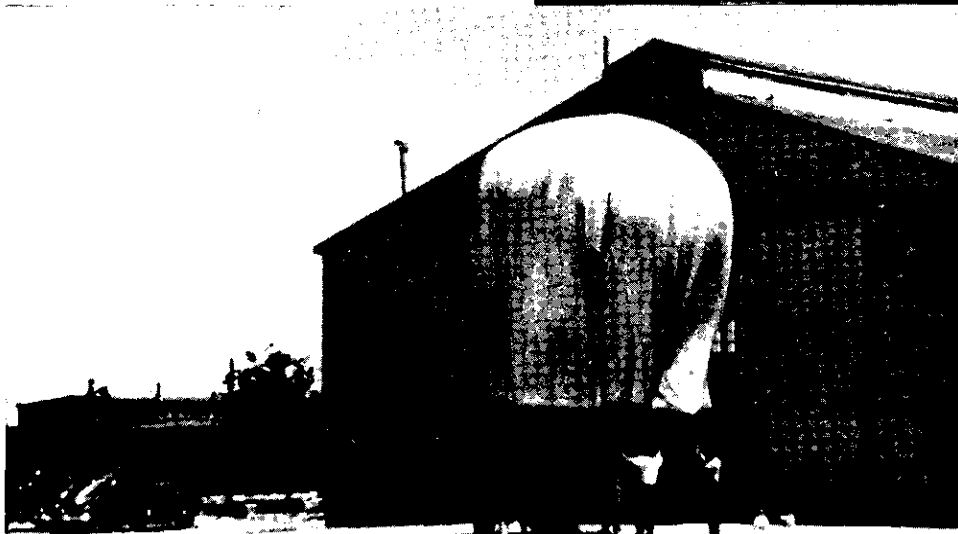
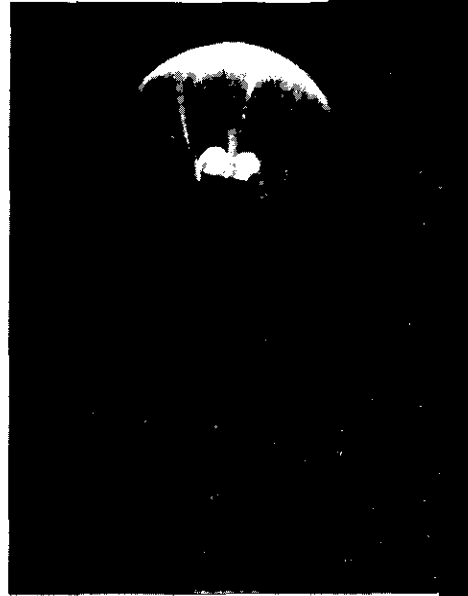
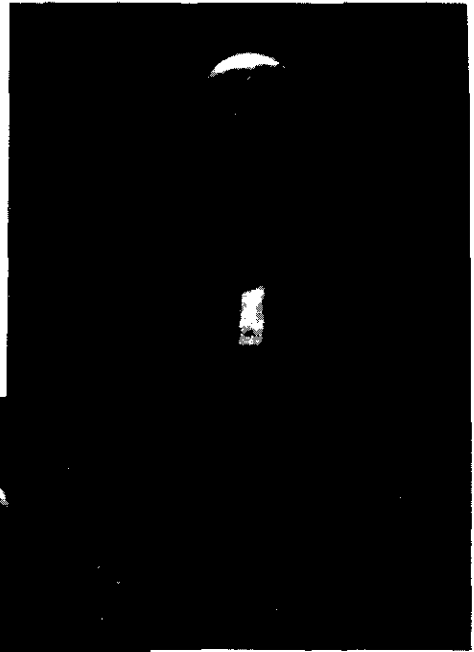

Also used during Project MOGUL were balloons developed by Seyfang Laboratories, the inventors of the first Macy's Thanksgiving Day Parade balloons. These balloons were easily mistaken for flying saucers due to their shape and metallic exterior coating.



**Project MOGUL balloon train components** (*above*) can be compared with the debris recovered from the Foster ranch and shown at Forth Worth Army Airfield with Maj. Jesse Marcel. Crashed saucer theorists allege that the debris depicted with Major Marcel is not the original debris collected from the Foster ranch. A switch is alleged to have taken place after the material arrived from Roswell AAF. However, detailed analysis and interviews with individuals who viewed and handled the debris verify it to be completely consistent with the materials launched by Project MOGUL and subsequently recovered at the Foster ranch.



Eiffel Tower  
PARIS  
1056ft

Project MOGUL  
Balloon Train  
ALAMOGORDO, NEW MEXICO

657ft

Washington Monument  
WASHINGTON, D.C.

555ft

Statue  
of Liberty  
NEW YORK HARBOR

305ft

Relative  
heights and  
balloon  
elements  
shown  
are to  
scale

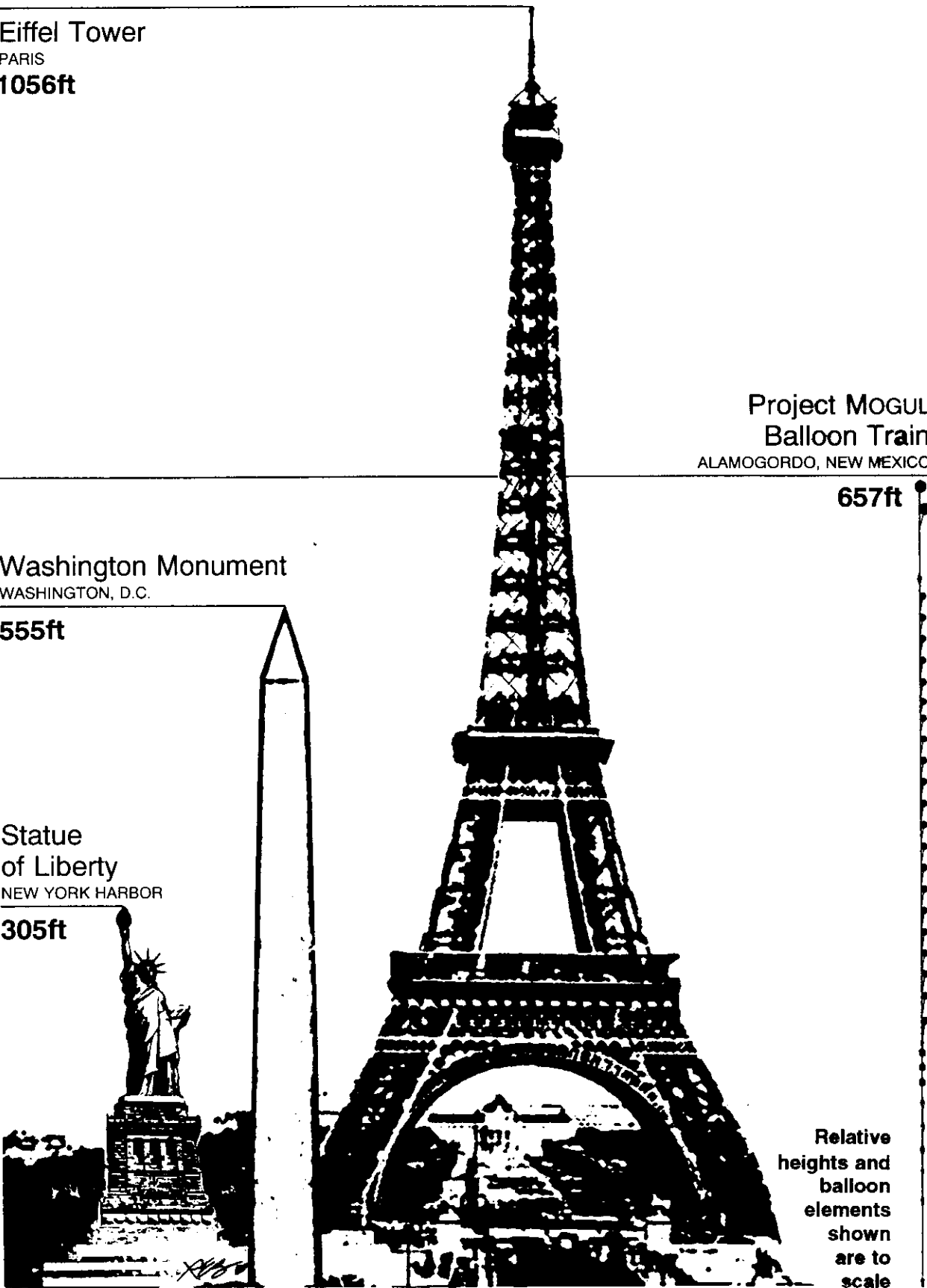

# NEW MEXICO

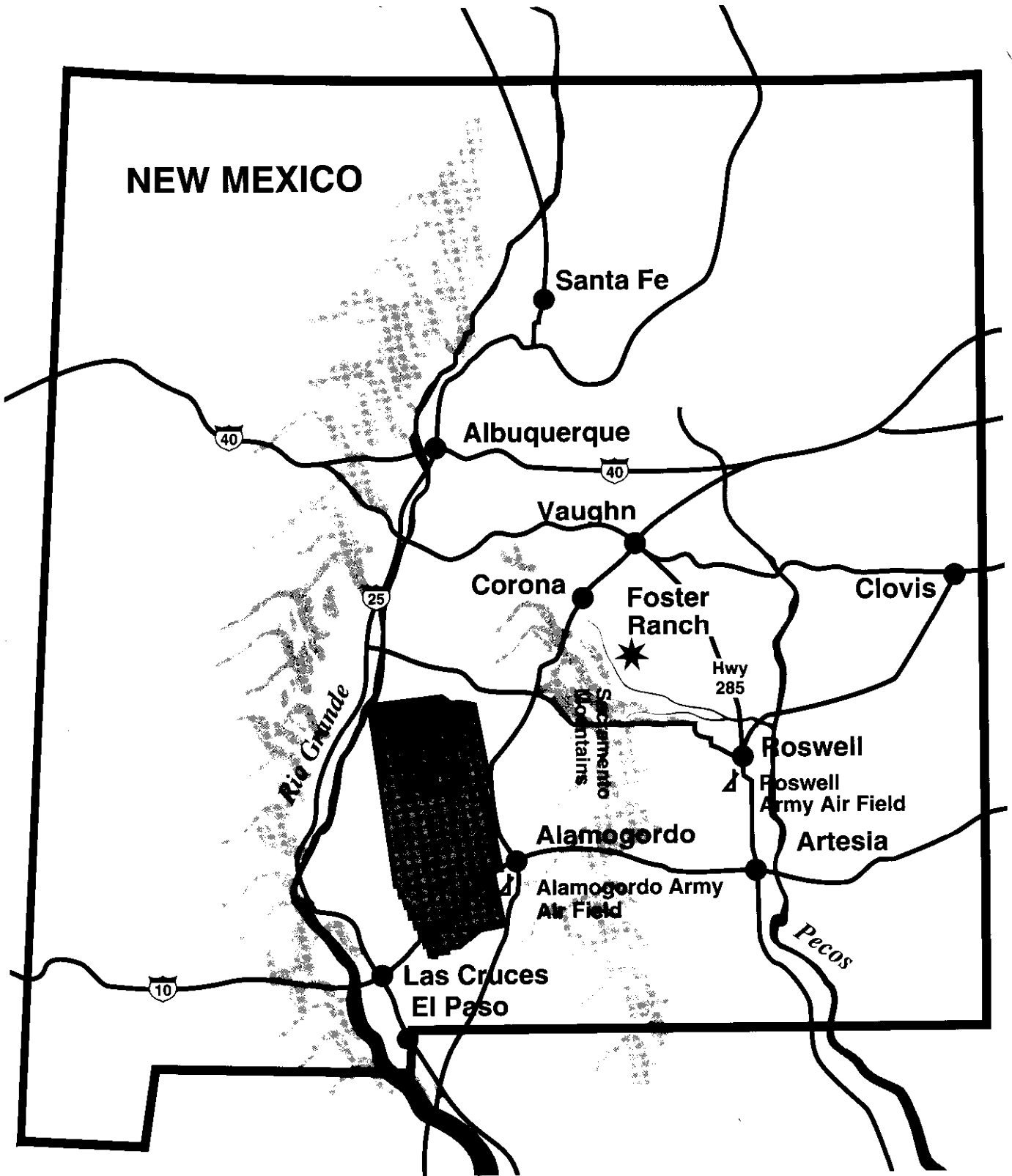

Santa Fe

Albuquerque

Vaughn

Corona

Foster Ranch

Clovis

Rio Grande

Sacramento Mountains

Hwy 285

Roswell

Roswell Army Air Field

Artesia

Alamogordo

Alamogordo Army Air Field

Las Cruces  
El Paso

Pecos

40

40

25

10

