

FLYING SAUCERS

**FACT OR
FICTION?**

By Max B. Miller

TWELVE YEAR RESEARCH OF U.F.O.'S
IN OUR SKIES REVEALED BY THE TOP
SCIENTISTS, ASTRONOMERS, AIRFORCE
PERSONNEL AND TECHNICAL OBSERVER





These are considered to be among the finest still pictures ever taken of Unidentified Flying Objects. Taken over South Africa in late 1956, they are reproduced here through courtesy of Edgar Sievers who authored book called "Flying Saucers Uber Suid Afrika."

FLYING SAUCERS

FACT OR FICTION?

By Max B. Miller

Acknowledgements

The author wishes to express his extreme gratitude to the following persons for their cooperation in the compilation of material for this volume:

Orfeo Angelucci, Joseph Barbieri, Robert C. Beck, Truman Bethurum, Borden Publishing Company, British Book Centre, Al Chop, The Citadel Press, Fay M. Clark, Criterion Books, Manon Darlaine, DeVorss & Co., Frank Edwards, Mrs. Idabelle E. Epperson, Marilyn Epperson, Fawcett Publications, The Fortean Society, Dewey J. Fournet, Jr., Frederick Miller Ltd., Daniel W. Fry, Harold H. Fulton (Editor, *Flying Saucers*), Mrs. H. V. Goodell, Hart T. Goodman, Clarence Greene (Greene-Rouse Productions), Walter H. Haas (Editor, *The Strolling Astronomer*), Harper & Brothers, R. W. Harvey (Office of Public Information, Department of Defense), Henry Holt and Company, Richard Hughes, Major Donald E. Keyhoe, USMC, ret., Kjell Lynau (Editor, *NA*), McGraw-Hill Book Co., William Brenton Nash, National Investigations Committee on Aerial Phenomena, *The Observatory Magazine*, John Otto, Bud Pecaro, Joseph W. Penton (Department of Army Ordnance), Commander F. M. Richardson (Pictorial Branch, Department of the Navy), George M. Rideout (President, Gravity Research Foundation), August C. Roberts, The Ronald Press Company, Edward J. Ruppelt, Science Service, Ben Shirley, Ray Stanford, Fred Stone (Editor, *Australian Saucer Record*), Leonard H. Stringfield, Toronto Star Syndicate, The Hon. Brinsley le Poer Trench, United Press Assns., H. P. Wilkins, Betty McGovney, Jack Waer of Las Vegas for originating the idea for this book, and countless fine people and organizations who have expended considerable effort and cooperation to further the author's objectives.



EDITORIAL AND PRODUCTION STAFF

PUBLISHER R. E. PETERSEN
EDITORIAL DIRECTOR WALTER A. WORON
EDITOR KENNETH M. BAYLESS
MANAGING EDITOR WILLIAM H. MARTIN
ART DIRECTOR ALBERT ISAACS
ART EDITOR GEORGE FUKUDA
PRODUCTION MANAGER YVONNE HULL
GENERAL MANAGER LEE RYAN
BUSINESS MANAGER TED JOHNSON
CIRCULATION MANAGER GORDON BEHN

FLYING SAUCERS, Fact or Fiction, by Max B. Miller, Trend Book 145.
U. S. Copyright 1957 by Trend Books, Incorporated, 5959 Hollywood
Boulevard, Los Angeles, 28, California. Phone HOLLYWOOD 2-3261. No
part of this book may be reproduced without written information. Printed
in the U. S. A. by Pacific Press Inc., Los Angeles, Calif.

Library of Congress Catalog Card No. 57-7210

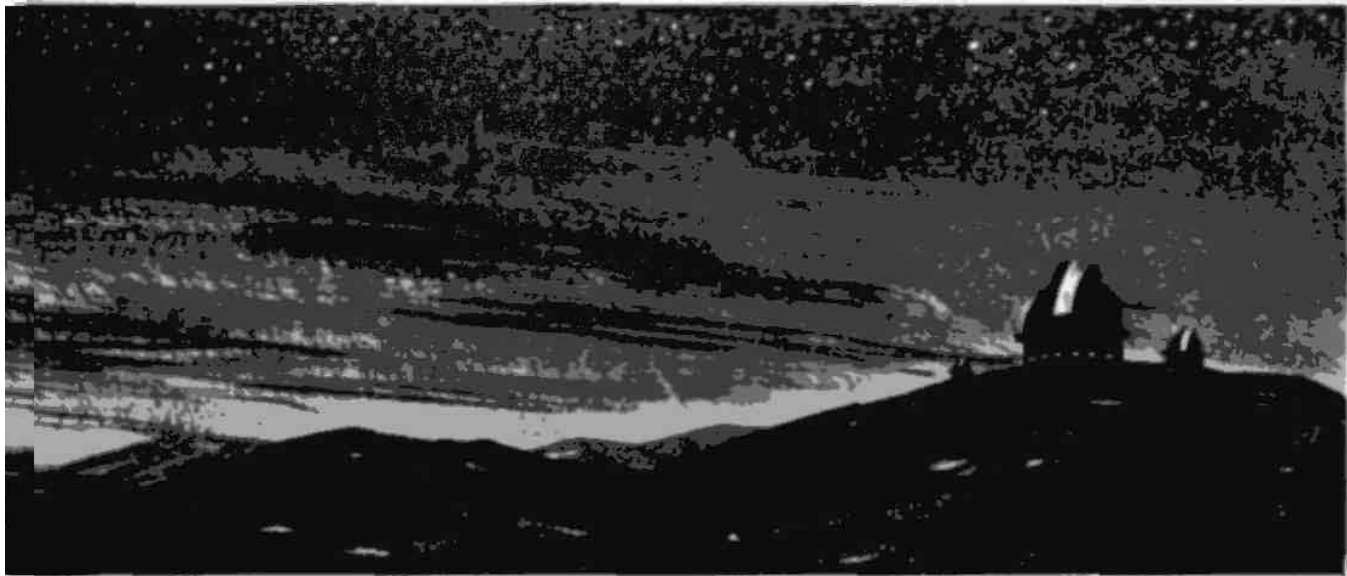

CONTENTS

I	FLYING SAUCER HISTORY	4-13
II	WORLD OPINION	14-27
III	SPACE TRAVEL AND THE UFO	28-39
IV	SPACE COMMUNICATION AND DETECTION	40-51
V	MARS—THE MYSTERY PLANET	52-61
VI	THE WORLDWIDE ENIGMA	62-87
VII	CONTACT STORIES	88-111
VIII	NEW LIGHT ON THE UFO	112-117
IX	THE PROBLEMS TODAY	118-127
	GLOSSARY	128

THE COVER

The outstanding color rendition of flying saucers and space was drawn by artist Sol Dember of Rocketdyne Corporation, Van Nuys, California. With 20 years of science art behind him, Dember is an outstanding artist in the field of rockets, satellites and space travel drawing and illustration.



chapter 1

Flying Saucer History

SINCE THE 24TH OF JUNE, 1947—when pilot Kenneth Arnold reported observing nine shining, “saucer-like” objects flying at 1,200 miles per hour over the Cascade mountain range of Western Washington—the controversy of the *flying saucers* has been raging.

But many do not know that Arnold's report was not the beginning. No one can say when the phenomena of unidentifiable aerial objects began any more than one can say when history began.

The U.S. Air Force has admitted investigating several UFO reports in late 1946 and early '47, prior to the Arnold sighting. Their official investigation, however, did not actually begin until mid-1947.

During the latter years of World War II, both Allied and Axis Intelligence records were overlaid with reports of glowing, almost ghost-like phenomena. The objects were termed “foo-fighters.” Both sides thought they were newly developed and secret weapons of the enemy.

For the UFO accounts in the years prior to the Second World War, all such researchers are indebted to such intensive investigators as Charles Fort and Desmond Leslie.

Fort collected these enigmatic data from libraries on two continents until his untimely death in 1932. Fort's four primary books on the unusual and the unknown are *The Book of the Damned* (originally published 1919), *New Lands* (1923), *Lo!* (1931), and *Wild Talents* (1932). These volumes now comprise the 1125 pages of *The Books of Charles Fort*, published in 1941 for the Fortean Society by Henry Holt and Co. These books are now classics in literature, as well as UFO research. Perhaps many feel as New York *Times* reviewer Maynard Shipley must have when he wrote, “Reading Fort is a ride on a comet.”

Desmond Leslie, who co-authored *Flying Saucers Have Landed* with George Adamski, has researched far into archaic records and has come up with a monumental work.



Leslie, a young Briton, has broached such unconventional fields as the purported history of Atlantis and the occult sciences with interesting results.

For example, in the year 1290 A.D., according to an account related in an antiquated manuscript found at Ampleforth Abbey, England, in early 1953, "a large round silver thing like a disk flew slowly over" the town of Byland Abbey, Yorkshire.

In the pre-Christian era, one curious report was recorded in the Royal Annals of Thuthmosis III (*circa* 1504-1450 B.C.) of ancient Egypt. The datum was discovered by Boris de Rachewiltz among the papers of the late Professor Alberto Tulli, formerly of the Vatican Museum.

The objects in this case—be what they may—were described as "a circle of fire that was coming in the sky . . . had no head . . . It had no voice." Several days thereafter, the Annals continued, "they were more numerous than anything. They were shin-

ing in the sky . . . to the limits of . . . heaven . . . After supper . . . they went up higher directed towards the South."

When does a conventional topic become unconventional? Or when does an unconventional subject become conventional? The author does not know, nor does he know where to divide the borderline which separates the strictly objective from the subjective. This largely applies to the so-called legends of old.

An undying controversy has raged over the reality or fancy of Plato's *Atlantis*. But it is, admittedly, difficult for a legend to persist for some thousands of years without having been drowned by the waters of truth and enlightenment.

Such is the case for the ancient real or mythical lands of Atlantis and Lemuria. *The Story of Atlantis*, written in 1895 by W. Scott Elliott, is one of a number of older books which purportedly describes aerial vehicles—called *vimanas*—resembling the UFO's of today.

These "vimanas," according to Elliott, were "apparently seamless and perfectly smooth, and they shone in the dark as if coated with luminous paint."

This phenomenon of luminosity has been closely allied to reports of unidentified aerial phenomena, many of which are contained in the files of Air Technical Intelligence Center, Ohio.

The *Ramayana*, classic of ancient India, describes another type of fabled aerial device—the "Car Celestial," or *Puspaka*.

"The Puspaka Car," relates the *Ramayana*, "that resembles the sun and belongs to my brother, was brought by the powerful Ravan; that aerial and excellent car, going everywhere at will, is ready for thee (Rama). That car, resembling a bright cloud in the sky, is in the city of Lanka."

The ancient classic continues:

"Beholding the car coming by force of will Rama attained to an excess of astonishment. And the king got in, and the excellent car, at the command of Raghira, rose up into the higher atmosphere. And in that car, coursing at will, Rama greatly delighted."

Protap Chandra Roy's *Maha-Bharata* (of 1889) contains "descriptions" of such heavenly wonders, during the legendary time of Atlantis, as—

"The beautiful car-celestial possessed the radiance of fire . . .

"Blazing with a mighty radiance, like a flame on a summer night . . .



Ancient Egyptian concept of the "boat of the sun traveling in the sky."

YERKES OBSERVATORY PHOTO

"Like a comet in the sky . . . Like a meteor encircled by a mighty cloud . . ."

The same author's *Samsaptakabadha* told of a "vimana" that "proceeded through that region of the sky firmament which is above the regions of the winds," and a celestial chariot which "could move in a circular course, or move forwards, backwards, and divers kinds of movement."

It looks as though the saucer phenomena was with us throughout ancient as well as modern eras. In the archaic language of Sanskrit, the volume *Samarangana Sutradhara* attempted to describe the transportation of its day:

"Four strong mercury containers must be built into the interior structure. When these have been heated by controlled fire from iron containers, the vimana develops thunder-power through the mercury. And at once becomes like a pearl in the sky."

In this defunct Indian language, writings were always defined as mythical (*Daiva*) or factual (*Manusa*). The *Samarangana Sutradhara* was designated as *Manusa*. In addition to the above passages, this fascinating work also recounts the following sentence, of possible noteworthy interest:

"By means of these machines, human beings can fly in the air and heavenly beings can come down to Earth."

Such other volumes of early history as the Tibetan *Tantjua* and *Kantjua*, P. C. Roy's *Drona Parva*, the 3,000 years old

Mababbarata, the *Vishnu Purana*, A. Bailey's *A Treatise on Cosmic Fire*, the *Emperor's Capitularies* and others, all relate phenomena nearly paralleling current reports and characteristics.

Phylos "the Tibetan," in *A Dweller on Two Planets* (completed in 1886), is another to describe skyward contrivances purportedly utilized during the Atlantean era—and this work may bear further investigation.

According to Phylos, these airships—"round, hollow needles of aluminum"—came in four sizes: 25, 80, 155, and about 250 feet in diameter.

"Long as was our silver-white spindle," described "The Tiberan," "we had soon risen so high as to make us seem a mere speck to people on the earth beneath."

"Windows of crystal, of enormous resistant strength," he later continued, "were in rows like portholes along the sides, a few on top, and others set in the floor, thus affording a view in all directions." As for their source of power, this was supposedly derived from the "Night-Side of Nature"—whatever that may be.

Writing in the *Australian Saucer Record*, Andrew Tomas—who lived in the Far East for some 25 years—asks, "Do Saucers Have Bases on Earth?"

He answers his own query by many references. One is the mythical city of "Shamballa, the City of Cosmic Men . . . known in Asia far and wide."

Tomas quotes the noted painter, Profes-

sor Nicholas Roerich, one who has spent many years in Central Asia, as asking a "learned lama" if it is true "that very soon new energies shall be given to humanity"?

The lama is quoted as having replied: "Innumerable are the great things predestined and prepared. Through the Holy Scriptures we know of the Teachings of the Blessed One about the *inhabitants of the distant stars*. From the same source we have heard of the *flying steel bird*, about *iron serpents* which devour space with fire and smoke."

Chinese Taoist records relate that *Chen Jen*—the "Perfect Man"—was "borne on the wings of the wind, seated on the clouds of Heaven, (and) he travels from one planet to another and fixes his habitation in the stars."

"Shen Ye (Divine Archer)," wrote Tomas, "is depicted in Chinese lore riding on a celestial bird. It is said that when he was carried into the center of an immense horizon 'he could not perceive the rotary motion of the sun.' Our future spacemen will not be able to see that either."

Bringing ourselves into biblical times, we may possibly find the greatest proof of written accounts of the UFO in the *Holy Bible*.

Ezekiel records a rather spectacular phenomenon in the first chapter of his book:

Verse 4—"And I looked, and, behold, a whirlwind came out of the north, a great cloud, and a fire unfolding itself, and a brightness was about it, and out of the midst thereof as the colour of amber, out of the midst of the fire."

Verse 7—" . . . And they sparkled like the colour of burnished brass."

Verse 12—"And they went . . . straight forward . . . and they turned not as they went."

Verse 13—" . . . Their appearance was like burning coals of fire, and like the appearance of lamps . . . and the fire was bright, and out of the fire went forth lightning."

Here, the reference to *like burning coals of fire* could not help but to remind the author of a particularly interesting sighting report made by airline pilots 1st Officer William B. Nash and 2nd Officer William H. Fortenberry, both of whom witnessed eight UFO's traveling beneath them near Norfolk, Virginia, on July 14, 1952. (See Chapter VI.) The Nash-Fortenberry report was classified by the Air Technical Intelligence Center as "Conclusion: Unknown."

The paralleled description in this case was contained in a passage of their report. "They (the objects) had the fiery aspect of *hot coals*, but of much greater glow." Could this be another way of describing "burning coals of fire"?

But to continue with Ezekiel:

Verse 16—"The appearance of the wheels and their work was like unto the colour of a beryl . . . and their appearance and their work was as it were *a wheel in the middle of a wheel*."

The similarity between Ezekiel's description of "a wheel in the middle of a wheel" and current reports of unidentified flying objects is striking. One such simile was related by the *Boston Traveler* of May 5, 1952. On the prior 30th of March, the

Fireball, flying saucer or possibly Halley's Comet? This scene is depicted on the Bayeux Tapestry in year 1066.
YERKES OBSERVATORY PHOTO



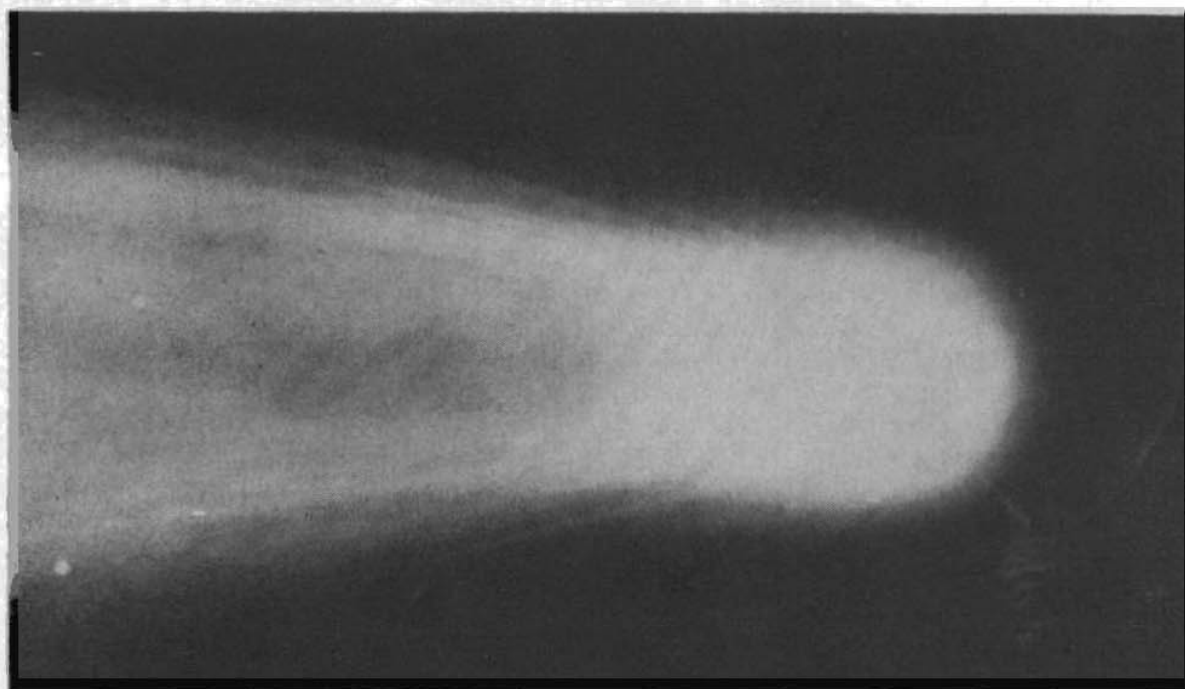

The "head" of Halley's Comet photographed in 1910. Comet won't reappear until 1985-1986.

account stated, a whining sound was noticed and "a bright silvery object . . . descended at great speed," then hovered in midair.

"It appeared to be a large *rotating ring* . . . with the sky visible through the center."

Ibid. Verse 18—"As for their rings, they were so high that they were dreadful; and their rings were full of eyes round about them four."

This sounds strangely like a description of portholes—perhaps in four rows—by one who had never before encountered such things.

One wonders if Jeremiah's advice to "be not dismayed at the signs in the heaven" (10:2) might not have referred to our current aerial phenomena. The same may likewise hold true for the words of Joel: "And I will shew wonders in the heavens . . ." (2:30).

Few things are more anomalous in the light of present-day knowledge and occurrence than the innumerable biblical references to "flying clouds."

"Who are these," asked Isaiah, "that fly as a cloud, and as the doves to their windows?" (60:8).

Nothing, to the author's imagination, could more aptly describe a circular-shaped

object in the days before Christ than to say a *flying cloud*. Isaiah is believed to have lived early in the eighth century, B.C.

A "fiery flying serpent" was mentioned by Isaiah in chapter 14, verse 29.

II Kings, 2:11, tells us: ". . . there appeared a chariot of fire . . . and Elijah went up by a whirlwind into heaven."

Psalms, 104:3: "Who layeth the beams of his chambers in the waters: who maketh the clouds his chariot: who walketh upon the wings of the wind."

Revelation, 10:1: "And I saw another mighty angel come from heaven clothed with a cloud: and a rainbow was upon his head, and his face was as it were the sun, and his feet as pillars of fire."

Psalms, 68:17: "The chariots of God are twenty thousand, even thousands of angels: the Lord is among them, as in Sinai, in the holy place."

Revelation, 11:12: "And they heard a great voice from heaven saying unto them, Come up hither. And they ascended up to heaven in a cloud; and their enemies beheld them."

Bringing the account of the UFO in world history additionally up to date, no book would be complete without mention-

ing the researches of Harold T. Wilkins as contained in his book, *Flying Saucers on the Attack*. Wilkins has authored two volumes on ancient South America prior to his UFO research.

The following are some representative cases from Wilkins' collection of early UFO sighting reports.

In 1893 the officer on watch on the H.M.S. *Caroline*, according to the British scientific periodical, *Nature*, reported sighting a number of "unusual lights, sometimes in a mass." They were described as occasionally taking "the form of a crescent of diamonds."

Jumping back into time, we find that Roman historian, Julius Obsequens, recorded the appearance of "a globe of fire (*aurea globis*), at sunrise, appeared in the sky with terrific noise, and burning" over the town of Spoleterum, Umbria, in 90 B.C. This "globe . . . golden in color," continued the historian, "fell to earth from the sky, and was seen to gyrate." Then it rose "from the earth, was borne east, and obscured the disc of the sun with its magnitude."

And still farther back, in 222 B.C., "there shone a great light, like . . . three moons (that) appeared in quarters of the sky distant from each other" over the township of Ariminum.

In all of these cases of such antiquated reports it is oft-times difficult to separate apparently enigmatic occurrences from reasonably simple misinterpretations of meteorological phenomena. However, objectivity must prevail, and only those incidents (assuming them to be accurately recounted) that will withstand easy discounting are herein included.

One such curious report was of "a round shield" over Arpi, 180 miles east of Rome, in 216 B.C. Possibly a current report could easily discount such a phenomenon—but a *round shield* closely equates present-day reports about as much as could be expected from such an era of early recorded history.

"Small globes . . . circling round the sun" were recorded over England in 796 A.D. by Roger of Wendover.

On the 18th of August, 1783, Tiberius Cavallo, F.R.S.—according to the data collected by Wilkins—witnessed:

"Northeast of the terrace, in clear sky and warm weather, I saw appear suddenly an oblong cloud nearly parallel to the horizon. Below the cloud was seen a luminous body . . . It soon became a roundish body, brightly lit up and almost stationary. It was about 9:25

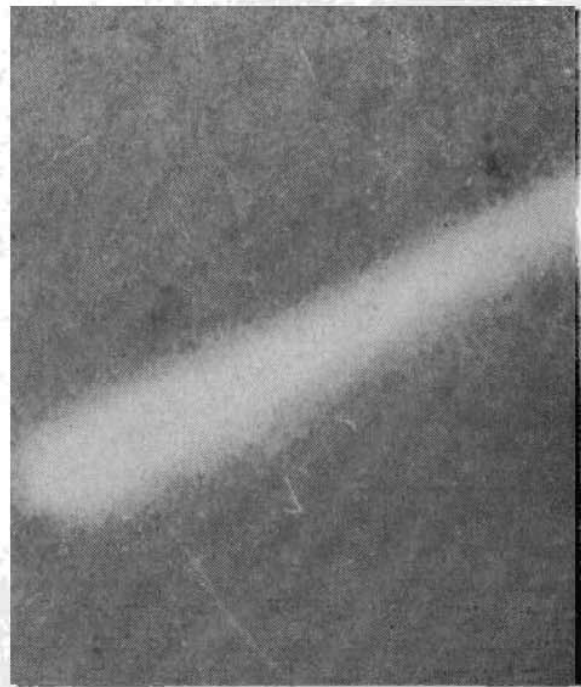

Reported photo of one of the so-called "ghost rockets" that plagued Scandinavian skies shortly after World War II. This photo was published by the London Daily Telegraph in 1946. COURTESY RICHARD HUGHES

p.m. This strange ball at first appeared bluish and faint, but its light increased, and it soon began to move. At first, it ascended above the horizon, obliquely towards the east. Then it changed its direction and moved parallel to the horizon. It vanished in the S.E. I saw it for half a minute, and the light it gave out was prodigious. It lit up every object on the face of the country. It changed shape to oblong, acquired a tail, and seemed to split up into two bodies of small size. About two minutes later came a rumble like an explosion."

Here the possibility of a meteoroid may be suggested. This can easily be discounted, however, by the facts that the object was relatively "stationary" and "oblong" or "roundish"—none of which are indigenous to meteor reports. And meteors are never visible for a duration of nearly "half a minute."

Leaving the researches of Wilkins we find—just prior to the turn of the century—nearly a year of good UFO reports, rivaling the current avalanche of reports, or "flap" as termed by the Air Force.

"In Air Force terminology," defined Edward J. Ruppelt, former USAF director of its official UFO investigatory body—Project Blue Book—in his *The Report on Unidenti-*

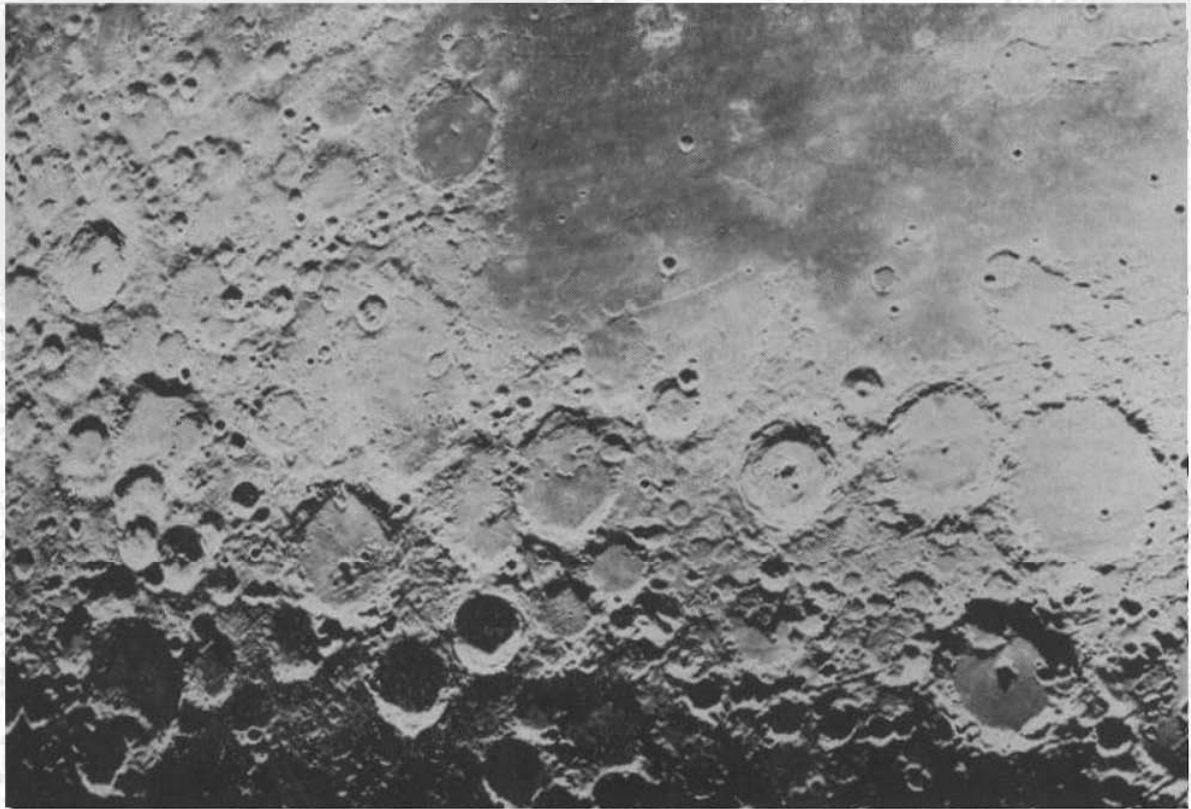

An astronomical photograph showing small portion of the moon.

fied Flying Objects, "a 'flap' is a condition, or situation, or state of being of a group of people characterized by an advanced degree of confusion that has not quite yet reached panic proportions. It can be brought on by any number of things, including the unexpected visit of an inspecting general, a major administrative reorganization, the arrival of a hot piece of intelligence information, or the dramatic entrance of a well-stacked female into an officers' club bar."

On the 22nd and 30th of November, 1896, a "cigar-shaped object with stubby wings"—apparently a reasonably static description—appeared and was viewed by thousands of residents over the areas of Oakland, San Francisco, Santa Rosa, Sacramento, Chico, and other cities of Central California. But not until the following year did the phenomena receive nation-wide import and renown.

On March 29, 1897, Omaha reported a similar object, and Denver on the 30th.

Kansas City reported a "mysterious light" on April 1. "It was directed toward the

earth, traveling east at a rate of sixty miles an hour," reported the *New York Sun*.

By April 9, newspaper accounts had been dispatched from Illinois, Indiana, Missouri, Iowa and Wisconsin.

During the night of April 9-10, at Chicago until 2 a.m., "thousands of amazed spectators," said the *New York Herald* on the 14th, "declared that the lights seen in the northwest were those of an airship, or some floating object . . . Some declare they saw two cigar-shaped objects and great wings." And this was five years before the Wright Brothers made their historic flight in a heavier-than-air craft. The *Herald*, of April 12, reported the "cigar-shaped" object and framework had been photographed by a Chicagoan.

On the afternoon of the 10th, an object of cigar shape and "with wings, and a canopy on top" had reportedly landed on a farm at Carlensville, Ill. When approached, however, it is supposed to have taken off and disappeared.

A "dark object" is reported, by the New

York *Sun*, to have passed over the face of the moon on April 16 at Benton, Texas.

A bright object with flashing red, white and green lights was sighted at Sisterville, W. Va., at about 9 p.m. on April 19. "An examination with strong glasses," related the New York *Sun*, "left an impression of a huge cone-shaped arrangement 180 feet long, with large fins on either side."

Some months later, in early August of 1897, J. B. Robson and Mrs. William Sullivan in a "calm and cloudless" sky "noticed a round, grayish-looking object in the sky, to the right of the sun" in British Columbia. "As she watched," reported *The National Geographic Magazine*, "it grew larger and was descending." For lack of a better explanation, the mystery object was assumed to be a free—and unaccounted-for—balloon.

A remarkable phenomenon was seen from the Eastern half of Canada and the United States, at sea, and from several islands in the Atlantic in 1913.

On February 9, a glowing object was observed as traveling from Central Canada toward Bermuda, although "observers," according to a Professor Chant in the *Journal of the Royal Astronomical Society of Canada*, of Nov.-Dec. 1913, "differ as to whether the body was single, or was composed of three or four parts, with a tail to each part."

But that glowing body was not of a singular variety. "It disappeared in the distance, and another group emerged from its place of origin. Onward they moved, at the same deliberate pace, in twos or threes or fours."

In all, about fifty of the aerial bodies were observed, and in a total of three or four groups. The only possible explanation, in this case, would be to assume the phenomena's origin as being meteoric. This, however, seems illogical if not ridiculous.

Streams and swarms of meteors are not uncommon, there being several "streams" per year; swarms are a spectacular rarity that occur only several times per century. But rarely if ever are there groups of meteors, and certainly not with such apparent regularity.

As most of us know, the glow of a meteor—or "shooting star"—results from the fantastic atmospheric pressure built up in front of the unusually minute meteoroid. The meteor's incandescence is generally observable for only a fraction of a second, to

perhaps three seconds for the so-called "fireballs." It is stretching the imagination to believe that these objects traveled for well over one thousand miles before being disintegrated by atmospheric friction, or else being slowed down to the extent of initiating a collision between the meteoroids and the surface of the earth. In actuality, there is no indication that either occurred, as no reports, to the author's knowledge, are on record which would tend to indicate a disintegration or collision.

Charles Fort, the master of writers concerning the unexplainable and inexplicable, quoted one observer as relating, "the peculiar thing about" the aerial objects "was their moving in fours and threes and twos, abreast to one another; and so perfect was the lining up that you would have thought it was an aerial fleet maneuvering after rigid drilling."

Perhaps one of the most enigmatic among phenomena recorded in the past several centuries are so-called "skyquakes." They are oftentimes associated with unusual aerial displays.

Florence, Italy, for example, experienced an earth shock preceded by a "luminous cloud, moving at high velocity, disappearing behind the horizon," on December 9, 1731. And on May 22 of the following year, "several weeks before the shock, globes of light had been seen in the air."

With the 1816 earthquake in Great Britain, according to Sir David Milne in the *Edinburgh New Philosophical Journal*, "a large luminous body, bent like a crescent" was seen.

These phenomena go on virtually without cessation.

Luminous objects were sighted over Pignerol, Piedmont, Italy, on April 2, 1808, and were followed by "explosive"-like sounds. The Illinois "earthquake" of October 8, 1857, was preceded by "a luminous appearance, described by some as a meteor and by others as vivid flashes of lightning." This strange phenomenon is related by Ponton in his book, *Earthquakes*.

Perhaps a good representative case occurred during the Worcester, England, earthquake—possibly the severest of that century for the British Isles—on December 17, 1896. (This was also the year, it may be recalled, when the "flap" of the late 19th Century began State-side.)



This spiral galaxy in Ursa Major is designated Messier 81. The billions of stars, or suns, within such a galaxy are conjectured by scientists to have thousands, if not millions, of satellite planets which like our own Earth are capable of supporting some form of life like ours.

According to the British scientific journal, *Nature*, "a great blaze" was observed at the time of the quake (5:30 a.m.), and was termed "a strange coincidence" by Dr. Charles Davison.

In his volume, *The Hertford Earthquake of 1896*, Dr. Davison recounts that luminous object "traversed a large part of the disturbed area" of the earthquake. The phenomenon was so bright, he related, that a person could have picked up a pin from the ground.

But such anomalies cannot be relegated to just antiquity; nor are the "earthquake" variety any more inexplicable than the now-designated "skyquakes."

One such more recent account occurred over Dieppe, France, January 7, 1954, and was reported by the Reuters news service. Termed a "mysterious explosion," the phenomenon broke windows, blasted doors open, and roused residents early that morning. Several minutes preceding that explosion, a flash was observed skyward up to a distance of fifty miles.

"A railwayman at Orchies, near the Belgian border," related the news dispatch,

"said he saw a fiery disc in the sky moving at great speed at the time of the Dieppe explosion."

Our current and common nuisance—the sonic "booms" or "blasts"—cannot help but be thought of in a parallel light. If UFO's exist, and as physical objects exhibiting great speed, sonic phenomena may occasionally account for such occurrences—but not necessarily. Utilizing an advanced field theory of propulsion, it is quite conceivable that such could be (and ultimately will be by our own technological advances) eliminated.

Arthur C. Clarke, noted British authority on rocketry and space travel, questioned the existence of the non-terrestrial saucer in an article appearing in the *Journal* of the British Interplanetary Society (May, 1953), by opining that, from atmospheric pressure building up ahead of the object, "some of the U.A.O.'s (Unidentified Aerial Objects) reported would have caused nothing less than concussions that would have blasted hundreds of square miles."

"Or if they are solid," he added, "they must be above the atmosphere."

Perhaps the countless "sonic-blast" reports

ending with "source unknown" or "no explanation available" should be re-examined in the light of the UFO.

But we have digressed from the history of the aerial enigma. A somewhat different but extremely intriguing incident took place in a vast wilderness area in Central Siberia on June 30, 1908.

Sometime on that early morning an object—possibly a meteoroid, but the like of which cannot be accounted for in scientific historical records—struck the earth.

The force of this impact is almost impossible to estimate. Seismographs around the world registered the vibration of this collision.

The thunderous impact was noted over 600 miles distant. Nearly 400 miles away humans and animals alike were thrown to the ground; rivers overflowed their banks, farm workers were knocked unconscious and suffered from shock. Thermal radiation was felt for a radius of fifty miles. The apparent molten metal—or whatever composed the object—rose in a column to some 60,000 feet.

Best estimates of the object's approximate weight varied from 50,000 tons to ten times that figure.

Unfortunately for the West, the area of impact is far behind the Iron Curtain. And the point of collision in itself is so inaccessible as to make any intensive scientific investigation virtually impossible. The only known expedition into the region—that of Professor Kulik's in 1927—found thousands of burnt tree trunks. Farther away from impact, the trees of the forest domain were fanned-out for many miles around. Fragments were not found—a frustrating bit of news to the meteoritical as well as UFO researcher. One possibility for this suggests that the tremendous impact may have vaporized the body to steam and dust.

But what makes this phenomenon distinct from a meteor or fire-ball, in the usual sense of the definitions, are its unique characteristics.

According to the Soviet Professor Liapunov, as related in an article by M. X. Velathcourt in the French periodical, *Semaine du Monde*, of June 5, 1953, the meteoroid (for lack of a better designation) was "cylindrical" or "shuttle" in shape, of gigantic proportions, and traveled with relative slowness for that type of object.

For several nights following the explosion, the Russian scientist said, "clouds" at an

altitude of 250,000 feet "lit up from the inside" and were so intense that it was possible to read or photograph by the light they emitted.

Professor Liapunov suggests we "abandon the concept of a meteorite" and term the object "a cosmic ship" of extra-terrestrial origin.

Apparently the professor's hypothesis has achieved some support, for another Russian scientist, by the name of Kasanzew, has indicated his belief that "inhabitants of another" world "came into the atmosphere of the Earth" in 1908. This latter account was published in a West German magazine, believed to be *Der Stern*, sometime in late 1952 or early 1953.

It must be emphasized, however that the above entails only two opinions. The scientists named have no great renown and their exact titles and positions remain obscure. But it still should be remembered that the phenomenal occurrence did happen inside Soviet territory, and presumably their research and knowledge on the impact and resultant data are probably superior to that of any other country or scientific body.

As possibly throughout history, reports of UFO's were not a rarity to the early 20th Century, nor could they have been considered commonplace.

Artist and explorer Nicholas Roerich, while traveling in Mongolia, was one of such few to observe the virtually ever-prevalent circular-airfoil—the *flying saucer*.

At 9:30 a.m., on August 5, 1920, several of his expedition were watching a "remarkable bird," when suddenly one of the group spotted "something far above the bird."

"We all saw," wrote Roerich in *Altai Himalaya* in 1921, ". . . something big and shining, reflecting the sun like a huge oval moving at great speed. Crossing our camp, this thing changed direction from south to south-west."

Through binoculars, he continued, they "saw quite distinctly an oval form with shining surface, one side of which was brilliant in the sun."

Thirteen years later, in 1933, F. S. Smythe headed the 1933 Mount Everest expedition.

Writing in his book, *Camp Six*, he relates, "Chancing to glance upwards my attention was caught by a tiny silvery object in the sky apparently very high, moving from West to East."

And thus we have the background and history—to the present—of the UFO. ■

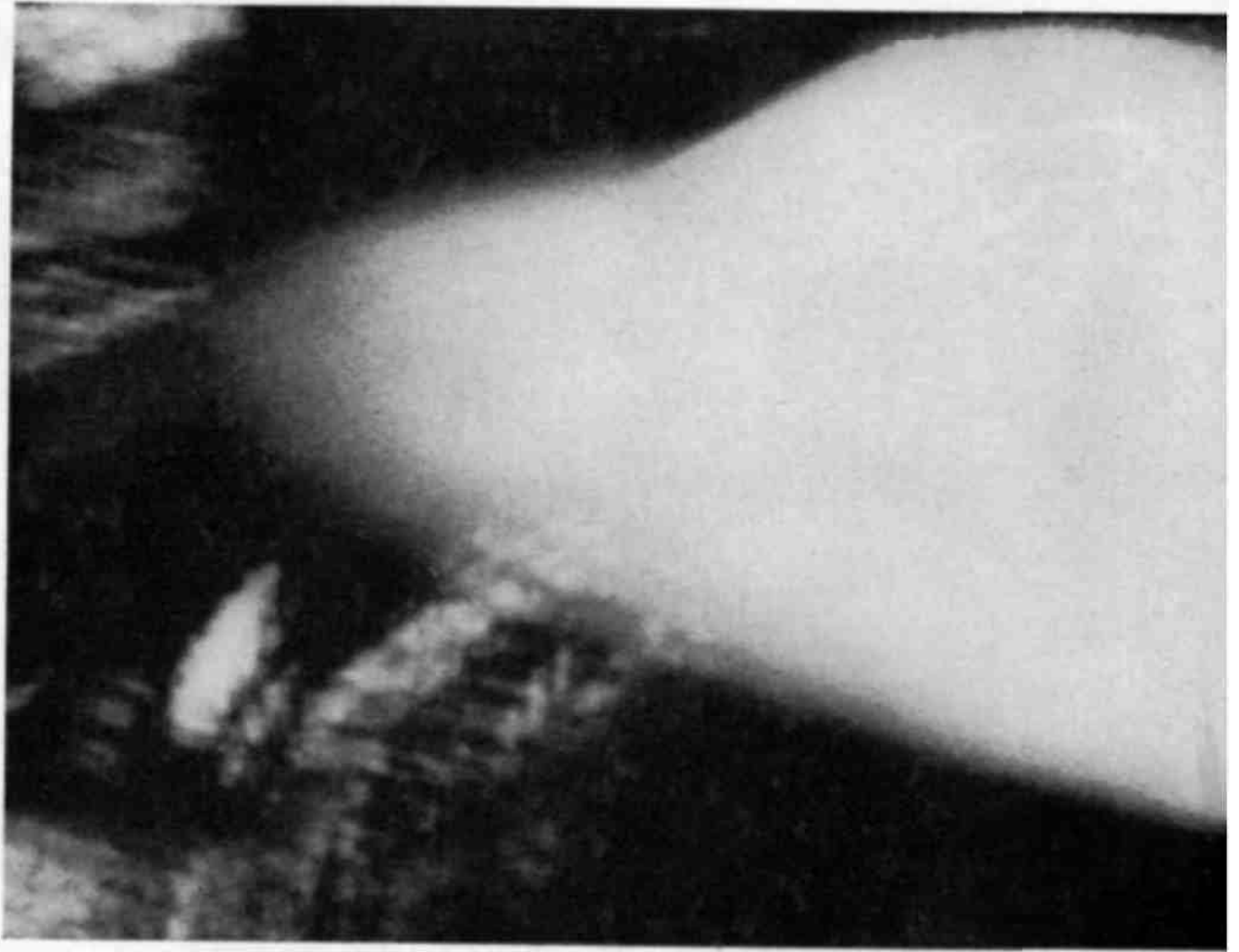

chapter 2

World Opinion

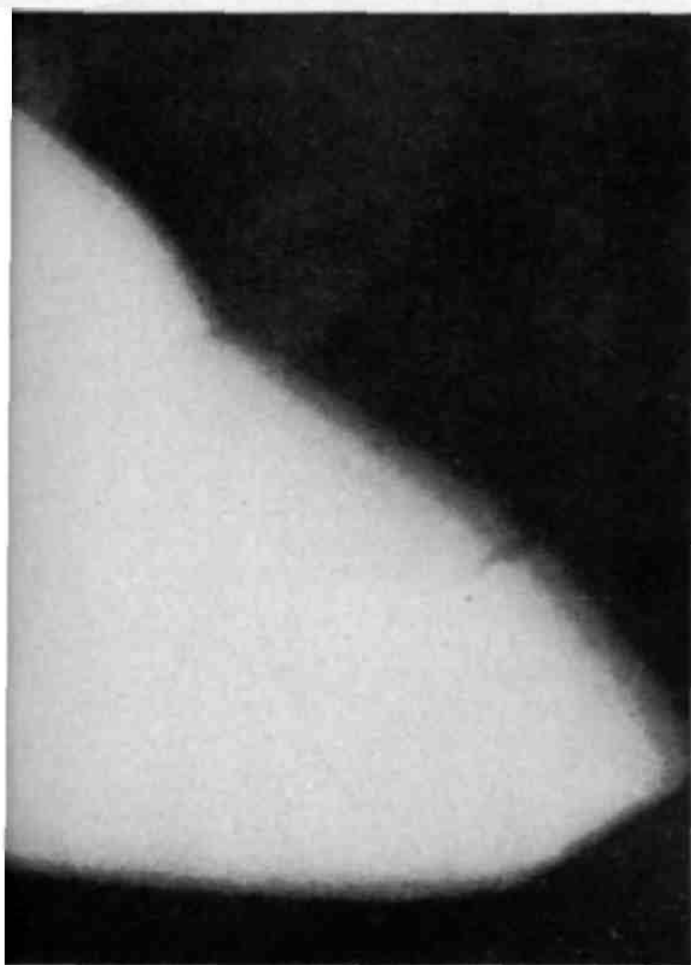

COURTESY AUGUST C. ROBERTS

IT IS difficult to say when world opinion on the UFO began. And perhaps it should not merely be limited to the current enigma but also include the belief in extra-terrestrial intelligences.

That discussion of other-worldly life was of deep interest in the late seventeenth and early eighteenth centuries was indicated by the two noted classics of the era, *Entretiens sur la Pluralite des Mondes* (Discussions on the Plurality of Worlds") by M. Bernard de Fontenelle (1686) and *The Celestial Worlds Discover'd* 1722 by the renowned Dutch mathematician and astronomer, Christianus Huygens. A later British edition of Fontenelle's work, *Conversations With a Lady on the Plurality of Worlds*, went through several printings in London in the late 1710's.

Physicist Huygens felt "it is plain that under the general Name of *Stars or Earth* at the Creation, are comprehended all the Heavenly Bodies, even the Attendants upon

Jupiter and Saturn, why must all Multitude of Beings which the Almighty Created has been pleased to place upon them, be excluded the Privilege, and not Suffered to have a Share in the Expression?"

The great scientist philosophizes that there is probably not only life on other planets but that this life may even resemble that to which we are familiar. "Who doubts but that God, if he had pleased," wrote Huygens, "might have made the Animals in *America* and other distant Countries nothing like ours? yet we see he has not done it."

Philosopher Voltaire, in 1752, wrote one of the earliest fictional books on the possibility of outer space journeying and theory. This fantasy, called *Micromegas*, described the interplanetary travels of two space men.

Considerable interest was evidenced in the possibility of intelligent life on the planet Mars around the turn of the century. This stems largely from the canal phenomenon reported by Schiaparelli and the Martian satellites discovered by Asaph Hall—both in 1877.

Some years later, the famed Lowell Observatory was established—primarily for the study of our planetary neighbors—at Flagstaff, Arizona. And Percival Lowell, founder of the Observatory, had his four classic contributions to the astronomical bookshelf published about that time. They were *Mars, Mars and Its Canals, Mars as the Abode of Life*, and *The Evolution of Worlds*.

Lowell's pronouncements did much to encourage liberal thought regarding extra-terrestrial existence. It is unlikely that there was a time in history more open-minded to outer-spatial life than the aforementioned period.

The Air Force has probably played the predominant role in forming World Opinion on the UFO. Many feel their reports have been misleading and contradictory; having periodically accepted and discounted objective existence of the phenomenon. But more unfortunately, they have afforded little or no cooperation and data to the private researcher nor to the non-profit organization.

For example, the author directed two letters to the Air Force Press Desk, Office of Public Information, Department of Defense, Washington 25, D. C., requesting some recent and non-restricted information.

(The letters were airmailed on July 27 and August 30, 1956.) Yet neither has been so much as acknowledged at this writing (October 15, 1956).

It must be pointed out, however, that this is not standard procedure. Up to 1956 the Air Force has virtually always replied to such missives. The questions this time were relatively simple: What is the present status of Project Blue Book? Who comprise the Project? And approximately how many UFO reports have been received by Blue Book (as of that date) so far in 1956?

Such is official "cooperation." And such may be why we are so little nearer to *the answer*.

Dropping the recounting of the early Air Force UFO investigative bodies, Project Sign and Project Grudge, we find the most intensive flying saucer investigation effort to date: Project Blue Book. To convey an accurate picture of the general *official* Air Force policy relevant to UFO, the following is condensed from their summary of a report issued in late 1952:

"The majority of sightings could be accounted for as misrepresentations of conventional objects, such as balloons and aircraft. Others could be explained as meteorological phenomena or light reflections from crystallized particles in the upper atmosphere. Some were determined to be hoaxes. However, there still remained a few unexplained sightings.

"The Air Force has stated in the past, and reaffirms at the present time, the unexplained aerial phenomena are not a secret weapon, missile, or aircraft developed by the United States. None of the three military departments nor any other agency in the Government is conducting experiments, classified or otherwise, with flying objects which could be a basis for the reported phenomena. "By the same token, no authentic physical evidence has been received establishing the existence of space ships from other planets."

As conservative as the 1952 report was, it decidedly shows a more liberal viewpoint and approach than the latest statement of October 25, 1955. In prefacing a news release, the Office of Public Information quotes Air Secretary Donald A. Quarles:

"On the basis of this study we believe

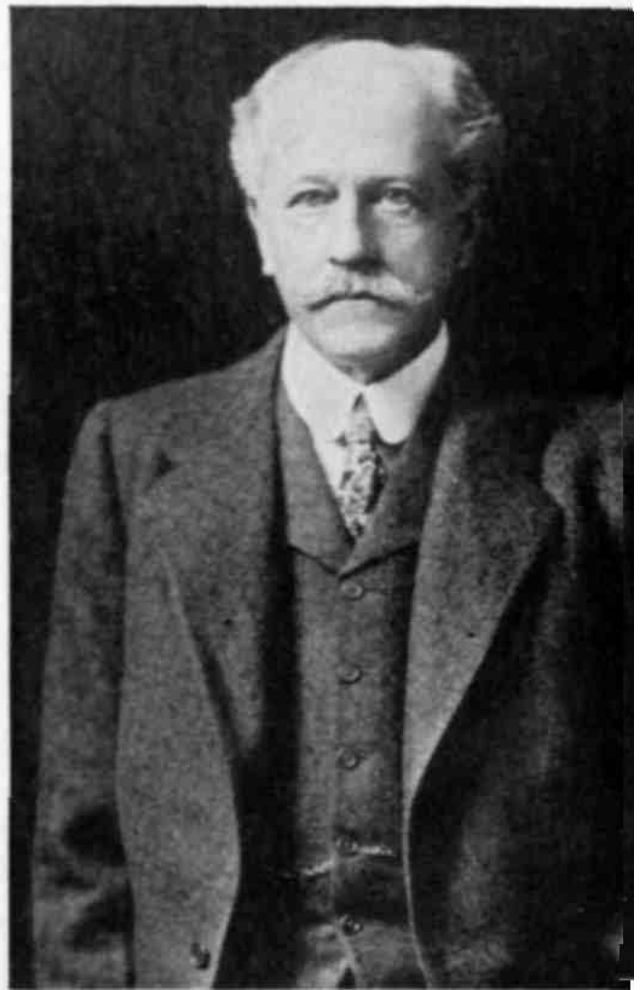

Percival Lowell, founder of Lowell Observatory in Arizona is renowned as foremost observer of the enigmatic details surrounding the planet Mars. YERKES OBSERVATORY PHOTO

that no objects such as those popularly described as flying saucers have overflowed the United States. I feel certain that even the unknown three percent could have been explained as conventional phenomena or illusions if more complete observational data had been available."

(Author's Note—The "unknown three percent" is a rather curious figure, at least as viewed by the UFO researcher. Edward J. Ruppelt, the former chief of Project Blue Book and probably the top authority on these phenomena in the United States today, has repeatedly stated that nearly 27 percent of the reports in the files of Blue Book defy all possible known explanations.)

The meat of the actual report is contained in its concluding paragraphs:

"All available data were included in this study [of UFO's] which was prepared by a panel of scientists both in and out of the Air Force. On the basis of this study it is believed that all the unidentified aerial objects could have been explained if more complete observational data had been available. Insofar as the reported aerial objects which still remain unexplained are concerned, there exists little information other than the impressions and interpretations of their observers. As these impressions and interpretations have been replaced by the use of improved methods of investigation and reporting, and by scientific analysis, the number of unexplained cases has decreased rapidly towards the vanishing point. "Therefore, on the basis of this evaluation of the information, it is considered to be highly improbable that reports of unidentified aerial objects examined in this study represent observations of technological developments outside of the range of present-day scientific knowledge. It is emphasized that there has been a complete lack of any valid evidence of physical matter in any case of a reported unidentified aerial object."

The so-called "study" mentioned in the preceding paragraphs refers to a purported 316-page summary of their current evaluation. (It is current to the extent that the last sighting report contained therein was made in 1953. Some authoritative comments on this "study" can be found in chapters VIII and IX.) It may be significant to note that the enlarged report was not published by the Air Force, although a "limited number" of copies can be read *at the Pentagon*. Nor will they grant permission for an outside source to reproduce them.

Understandably it takes many years for such an unconventional and controversial subject as "flying saucers" to build up to the proportion where it will deserve—and receive—general public and world attention. For this reason it was not until approximately 1952 when the phenomenon did receive a world-wide audience—and it has been growing relevant to its import ever since.

All was relatively quiet in the sultry month of July, 1952. Then—

Twice, in the period of one week, Unidentified Flying Objects "buzzed" the nation's capital—Washington, D. C. (July 20 morning and night of July 26-27, 1952).

Visual and radar contacts were made.

The "objects" hovered over the White House and Capitol Building. Jet interceptors were hurried aloft.

Three UFO's outmaneuvered the jets at every turn.

As our fastest interceptors were sent into a "critical area," the objects would vanish. When the planes were gone, the objects reappeared!

Careful, reliable radar operators—whose reputations must be of the highest to man the Air Control towers of the Capital and surrounding area—calculated the UFO's to have a velocity of two miles per second—7200 miles per hour!

Several days after this "crisis"—following a deluge of demands from citizens, organizations and the press for "the answer"—the Air Force held a press conference at the Pentagon.

Major General John A. Samford, Chief of U.S. Air Force Intelligence, with several aides discussed the varied aspects of the UFO reports, including the Washington sightings. Maj. Gen. Samford generally discredited the "saucers-are-real" theory, laying to blame the temperature inversion refraction phenomenon. (This is extremely rare. When it does occur, the "unknowns"—either visual or radar—are generally nebulous and poorly-defined. And, because of the phenomenon's ambiguity, these "mirages" are virtually never—if ever—sighted simultaneously as in the aforesaid case.—*Author.*)

The so-called light-reflection or mirage hypothesis for the UFO has been expounded primarily by Dr. Donald H. Menzel, astrophysicist and Director of the Harvard College Observatory. In 1952 he authored the expostulation, *Flying Saucers*.

Temperature inversions strong enough to give a radar return—or "echo"—would have to have been eight to ten degrees in Fahrenheit.

Major Donald E. Keyhoe, USMC, ret., author of the best-seller *Flying Saucers from Outer Space*, checked official Weather Bureau figures. The records show a one-degree inversion for the first night; two degrees on the second.

Major Keyhoe was allowed to question Major Lewis S. Norman, Jr.—an authority on atmospheric inversions—as an official Air Force spokesman. Norman said that temperature inversions could not possibly have accounted for the Washington sightings.

Albert M. Chop, former Chief of Press Section for the Air Materiel Command, Wright-Patterson Air Force Base, Ohio, later told Columnist Matt Weinstock of the now-defunct *Los Angeles Daily News*:

"How can you write off as a mirage an object that appears on a radar screen, then is being chased by a jet interceptor equipped with radar, then maneuvers at speeds up to 5,000 miles per hour, making sharp angle turns that are impossible in any craft that engineers conceive?"

And early in 1953, Major General Samford was quoted by a national magazine as saying of the Menzel inversion-hypothesis:

"The theory is appealing, but has not yet been proved. Therefore the Air Force cannot yet accept it as a satisfactory explanation. Furthermore, it would not account for all reports, by any means."

Subsequent statements by Project Blue Book have virtually eliminated this explanation as a satisfactory solution to the saucer enigma. To clinch the matter, Captain Walter Karig, Special Deputy to Chief of Information, U.S. Navy, said in 1954:

"Reflected lights, mirror images and the like, do not send back a radar return."

Gradually it appeared that all solutions to the UFO puzzle had dwindled to practically nothing. On Armed Forces Day, May 16, 1954, General Nathan Twining, Air Force Chief of Staff, told a press conference at Amarillo, Texas:

"Ninety percent of the reports we receive are baseless, but about the other 10 percent . . . we don't know."

"Flying saucer reports are mostly received from people in the United States," the general continued. "They run in cycles and are tricks of the mind. But some very reliable people have made reports—they aren't all screwballs by any means."

Such a statement is considerably more extensive than those issued during both the earlier and latter parts of the Air Force's investigation. It used to be intimated that such things as flying saucers "just ain't so."

Interestingly enough, it now appears that the more open-minded and far-sighted foreign countries will take the lead over

the United States in the UFO investigations.

Britain's Air Chief Marshal Lord Dowding, who commanded the Home Fighter Plane Forces during World War II, told an audience just 10 days following General Twining's press conference:

"I believe there are people on other planets who are operating—through flying saucers—to help our world in its present crisis."

He argued, apparently in rebuttal to those who say they won't believe in the phenomenon until they see one, that although he had never seen the continent of Australia, he still believes it exists.

And speaking in Bogota, Columbia, early in 1955 American William P. Lear, Chairman of the Board of Lear, Inc., and a recipient of the Collier's Annual Aviation Award, told the press that he not only believed in the existence of the interplanetary saucers but felt they originate from planets outside the range of observation from the earth. (See also Chapter IV.) He added that he believes the UFO's are piloted by beings of "superior intelligence."

One of the most intensive projects to resolve the anomaly of unidentified aerial phenomena was begun in 1953 by Ohio Northern University. Known as "Project A," it united all areas of study at the University (psychology, physics, astronomy, etc.) in a combined analytical staff.

Unfortunately, for lack of cooperation and insufficient data, the Project disbanded. But it did add some rather interesting comments in its notice of disbandment.

"The information received by Project A," the statement said, "indicated that a sizable fraction of the total sightings throughout the country were sightings made of material objects. These material objects were not standard aircraft. Having concluded that a proportion of the sightings were of material objects, possessing ability to maneuver at extremely high speeds and (under varying) climatic conditions. An investigation was begun of the relationship of sighting dates to magnetic storms."

Here, unfortunately, the study was dropped because lack of information made it "impossible for the Project to continue with its study of the relationship of magnetic storms to sightings of phenomena known as flying saucers. We had hoped such a study might be indicative of the possibility of the use of electro-magnetic energy as a means of propulsion."

Noted science and aviation writer, Mar-



Major Donald E. Keyboe, USMC retired, wrote three books on UFO enigma. "The Flying Saucers Are Real," "Flying Saucers From Outer Space," "The Flying Saucer Conspiracy." He's considered outstanding civilian authority on the subject of UFO's.

tin Caidin, declared his belief in *Mr. America Magazine* 1953 that "spaceships" offer the "least implausible of all possible explanations" as a solution to the UFO mystery. He added that "there is no other possible answer to the incidents that have occurred" than to accept as extra-terrestrial the objects' origin.

Another savant declared his views on the controversial topic in mid-1952. ("Saucers," Dec. 1953). In early July the Reverend Louis A. Gardner of Los Angeles directed a questionnaire to the late Dr. Albert Einstein. His reply, dated July 23, 1952, was brief and to the point. He wrote:

Dear Sir:

Those people have seen something.
What they saw I do not know and I

am not curious to know.

Sincerely yours,
Albert Einstein

(The word *something*, incidentally, was underlined by Dr. Einstein—Au.)

Canada got into the act November 11th, 1953, when it established the "world's first official flying saucer sighting station" at Shirley's Bay, 10 miles northwest of Ottawa.

Harold Greer, courtesy of the *Toronto Daily Star*, gave probably the best account of the project.

"The world's first scientific flying saucer sighting station is being constructed by Canadian electronic engineers at Shirley's Bay.

"The work of 'Project Magnet'—code name for the secret development of a flying disc powered by electro-magnetic propulsion—the station is being equipped with every conceivable type of recording device in the hope of obtaining the scientific measurement necessary to prove or disprove the existence of flying saucers.

"When completed, the station will be manned 24 hours a day. It will contain the various types of radar, an ionosphere recorder, a magnetometer to measure electrical charge, a recording gravometer to measure gravity and a radio set running full volume at 530 kilocycles to pick up any radio noise."

Greer continued:

"'Project Magnet' researchers have found that flying saucer reports have come in flurries about two years and two months apart. It may or may not be significant that they have occurred when the planet Mars has been in opposition to the earth and that reports are more frequent when Mars reaches its closest point to the earth . . .

"Since the board began systematic investigation of flying saucer sightings early in 1952, heavy secrecy has surrounded the work. It is known, however, that a considerable number of reports have been received on the special forms printed in order to obtain as much precise observation as possible from the person or instrument making the sighting. While not called classified material, these forms are held to be 'for official use only.' The board has never published any analysis of them or made any report of the investigation . . .

"The department has meteorological

officers and radio operators from coast to coast and sea captains beyond that, all under standing instruction to report strange phenomena; it supplies by far the bulk of the sighting reports."

Wilbert B. Smith is engineer in charge of Project Magnet of the telecommunications division of the Canadian Department of Transport. He voiced the opinion to the Canadian Press news service that "There is a high degree of probability that they [the flying saucers] do exist and are interplanetary."

Smith claims that there is a 90 to 95 percent probability that flying saucers do exist; a 60 percent probability that they are "alien vehicles;" a 10 percent probability they originate here on Earth and a 30 percent probability that they are inconceivable to man—such as some form of time travel involving a form of life other than protoplasm.

The article in the *Daily Star* concludes:

"... It is generally agreed that the average layman would conclude from the more dramatic sighting reports that flying saucers do indeed exist.

"One of the Canadian sightings, for example, took place over an airport at night. Several persons saw a disc-like object moving at low altitude over the field at about 60 miles an hour. A searchlight caught the object in its beam for a moment at which point it zipped skyward at an incredible speed. Sightings of this kind, it is believed, are by no means rare..."

Australia also figures prominently in the UFO picture. First, on June 1, 1953, the Australian Flying Saucer Investigation Committee, which is composed of 12 members, including two industrial chemists, an electronic engineer, a civil engineer and five astronomers, announced that "some so-called flying saucers are real objects, and are not caused by meteors, hallucinations, or any atmospheric freaks."

Later, on January 9, 1954, a news dispatch from Melbourne quoted an RAAF officer as saying that the Royal Australian Air Force was keeping an open mind on the source of the objects. Adding:

"I believe, from the information we have received, that the objects could have an interplanetary source. People on earth should be able to fly into outer space within about 40 years. Why shouldn't people on other planets have already reached this stage?"

However, foreign activity in this field

did not really begin until late 1954 when many European and South American countries were deluged with reports. In France, for example, things got so hectic that the French National Assembly was asked to study the defenses against a flying saucer invasion. The Mayor of Chateau Neuf-du-Pape issued a decree forbidding flying saucers to land in his territory.

At Belgrade, the Director of the Ljubljana Meteorological Institute reported sighting a "very bright flying object moving at high speed from southeast to northwest," which could not have been a plane, balloon or any recognizable object.

Tito's government announced it was going to make a "serious investigation of the subject as these things acted like nothing known to aviators or meteorologists."

Over on the South American continent, flying saucers sighted in Brazil were described as "round, luminous, and silvery flying objects *obviously not on an involuntary course.*" The Brazilian Air Base Command announced that the UFO's were observed "at great height and speed," and were witnessed by "enlisted men, officers and civilians." A Brazilian Government-authorized statement said:

"The sighting of flying saucers in the skies of Porto Alegre has been officially confirmed."

On December 15, 1954, the Honduras Air Force reported that a large luminous object flew over the city of Tegucigalpa that morning at an altitude of about 25,000 feet. The Air Force promptly broadcast the report over the radio. Many persons rushed to the streets to view the phenomenon.

One eye-witness described it as a "glowing body of considerable size which seemed to change shape slightly as it moved through space, giving the impression it was made of or surrounded by a gaseous substance."

Germany has had its share of UFO sightings, too. An example of this is contained in a letter dated May 1, 1955, from an Army Private (then at Grafenwohr, Germany) to the author:

"Tonight I saw a flying saucer. I observed this UFO for about 10 minutes. At first I saw a bright light almost due north at about 500 ft. elevation. If you would hold your hand at arm's length, three fingers' span would just cover it. "The only form that I could observe was spherical. It made no noise that I could hear and had no tail or exhaust that was visible to me.

"The UFO made about four horizontal passes at a slow (100 m.p.h.) speed. It hovered occasionally. Finally it slowly started up in a north-east direction. It picked up speed and soon was traveling up and away from me at a great speed. Soon it looked like a star. However, if you observed closely you could see it getting smaller and smaller and traveling in a very slight, almost minute, spiraling motion. If it ever changed color from its bright white, I did not observe it.

"I have two reliable witnesses besides myself, and they were not believers in UFO's. They are not talking about it. It seems as though they do not want to believe what they saw. But they *did* see it.

"There is no chance of it being an airplane or helicopter, because we are only a few miles from the Russian sector and there can be no flying at night over this area.

"This all happened about one hour after sunset. The town of Grafenwohr is not too far from Weiden, a larger town than Grafenwohr.

"*I can say now that I believe there are Unidentified Flying Objects.*"

Such reports are certainly not uncommon.

Back to the United States, we find flying saucers again in the news. Frank Edwards, former Mutual Broadcasting System news commentator for the American Federation of Labor, announced one night:

"Top scientists, whose identity I am not at liberty to reveal, have been investigating the phenomena of unidentified aerial objects since 1947; analyzing samples of various types; inspecting every bit of evidence, for whatever could be learned from it. With their permission I can read this one significant paragraph from their statement to me, dated September 8, 1953:

"Our research in this matter leads us to believe that these unidentified flying objects are observation vehicles from another planet and further that this information is being kept from the people. A statistical analysis of the evidence collected thus far proves without doubt that we are dealing with extra-terrestrial influences from an unknown source."

Writing in the March 1954 issue of *Saucers*, Arthur Louis Joquel II, noted authority on rocketry and space travel and author

of *The Challenge of Space*, opined:

"For hundreds, or even thousands, of years, observations and reports have been made regarding these objects. Accurate, well-trained, impartial witnesses have described them, using almost the same terms in all ages and times. There have been sufficient reports concerning these objects made by scientists, military personnel, and trained civilians, to have removed any doubts as to their existence.

"No country on Earth could have built such vehicles hundreds of years ago. It would strain the ability of any country today to develop such flying objects, and to construct, test, and launch them, and furthermore keep their place of origin a secret. It seems much more logical, under the circumstances, that flying disks have their place of origin somewhere in space, and visit the earth for some reason or purpose."

As late as July 19, 1956, Civil Aeronautics Administration flight instructor Irwin Ross Vermillion confirmed a report that the Air Force has issued instructions to "shoot down" UFO's. (Santa Ana, Calif. *Independent*, July 20, 1956).

"It is imperative," Vermillion was quoted as saying, "that the Air Force get a tangible fragment of a flying saucer, from which to detect its possible origin and construction."

He added that he thought the interplanetary objects "are radar ships, designed to observe our planet and forms of life." And, "I don't believe they mean any impending invasion."

Will Air Force pilots be able to shoot down a UFO?

Vermillion, a former USAF bomber pilot, doubts it. "They travel awfully fast," he said.

The UFO found itself in good company by early 1955. The famed Hermann Oberth is recognized throughout the world as one of the great pioneers of rocketry, and is noted for his many impressive contributions to the German V-1 and V-2 missiles. He has come out in favor of the UFO.

His opinions—perhaps representative of European countries insofar as personal conjecture and philosophy are concerned—follows. It is reproduced from the excellent British bi-monthly, *Flying Saucer Review*, 1 Doughty Street, London W.C. 1, England.

Professor Hermann Oberth:

"For centuries strange luminous objects



Stephen Darbishire and cousin Adrian Myers were photographing bird life near Torver, England when they spotted and recorded the above on February 15, 1954. So called "ionization" and "force fields" make all UFO photos indistinct, experts declare. COURTESY RICHARD HUGHES

have been observed in the sky. The earliest mention is found in the Latin of Pliny who called them "Shining Shields." Up to the second World War about 50 reports were available. Then the phenomena became more frequent; the Allies thought they were a German secret weapon, and the Germans thought they were a weapon of the Allies. From 1947 onwards eye-witness reports have been increasing by leaps and bounds; according to Air Marshal Lord Dowding there were already more than 10,000 reports in 1953.

"The phenomena are usually described as discs, sometimes as balls or ellipsoids. Occasionally reports say that several of the discs appear to bunch together, the largest in the centre, the smallest at the ends, so that a cigar-shaped body is formed, which flies away at great speed. It has also been observed that occasionally a cigar stops and breaks up into single discs.

"In the sunlight, which appears to be stronger than the illuminating power of the discs themselves, the discs seem to have a metallic gleam. By night they appear dark orange or cherry-red. When hovering they do not glow very much, but as more driving power is needed the brightness increases and appears to be yellow, then greenish-

yellow, then green like a copper flame and, at highest speeds, a blinding white. Sometimes they seem suddenly to light up or blot out.

"Reports claim that the speed of UFO's can be enormous; up to 40 ft./sec. have been measured on radar. The reliability of these reports has been questioned; and I agree that it would be foolish to form any conclusions from just one or two reports, without waiting for further confirmation. On the other hand, I do not think that radar sets would be part of the equipment of U.S. Fleet Air Arm planes if they were not reliable.

"So far there has been no proof of landings by Flying Saucers, and all such reports should be carefully considered. Stories like that of George Adamski have not yet been authentically corroborated; and many reports of alleged meetings with occupants of Flying Saucers have since been proved false.

"We should also be critical of photographic evidence. It is quite possible to fake background; to mount a picture of an UFO on to a landscape background showing a human figure.

"But, although a photograph could be faked, it does not necessarily follow that it

is faked. When the Edison gramophone was shown for the first time before the Paris Academy, one member angrily declared that the engineer was a ventriloquist and a swindler. Certainly a ventriloquist could have produced the voice, but in fact it was a machine which made the sounds!

"In 1952 a retired American, Major Donald E. Keyhoe, published the book *Flying Saucers from Outer Space*. Keyhoe is a journalist and he used a colloquial style, broken up with dialogue, to make his book light and readable. But, unfortunately, in using this style he failed to make clear the distinction between objective observation and his subjective opinion.

"The U.S. Navy, which he occasionally mentions, refused to recognize him and dismissed the official who had confirmed the authenticity of his material with an officially stamped letter. However, I do not believe that Keyhoe invented all these reports."

Note: The majority of UFO sighting reports found in Major Keyhoe's book have been paraphrased from official U.S. Air Force records, and were cleared through the Air Force Press Desk, Department of Defense.

"It seems much more likely that he managed to get the addresses of people who had reported UFO's, and that he went to them privately and questioned them. As he went to them in a friendly, informal way he probably learned more than a stranger and an official would have done. The official was dismissed *only because he had no authority* to give Keyhoe these addresses and such a confirmation, not because his facts were untrue.

"Various official explanations have been given for reports of UFO's. Here are some of them: (a) *Unsubstantiated rumor*, or uncorroborated report, as in the case of George Adamski. (b) *Hoaxes*, as in the case of the French farmer who let loose

Aime Michel authored "*The Truth About Flying Saucers*," published by *Criterion*.

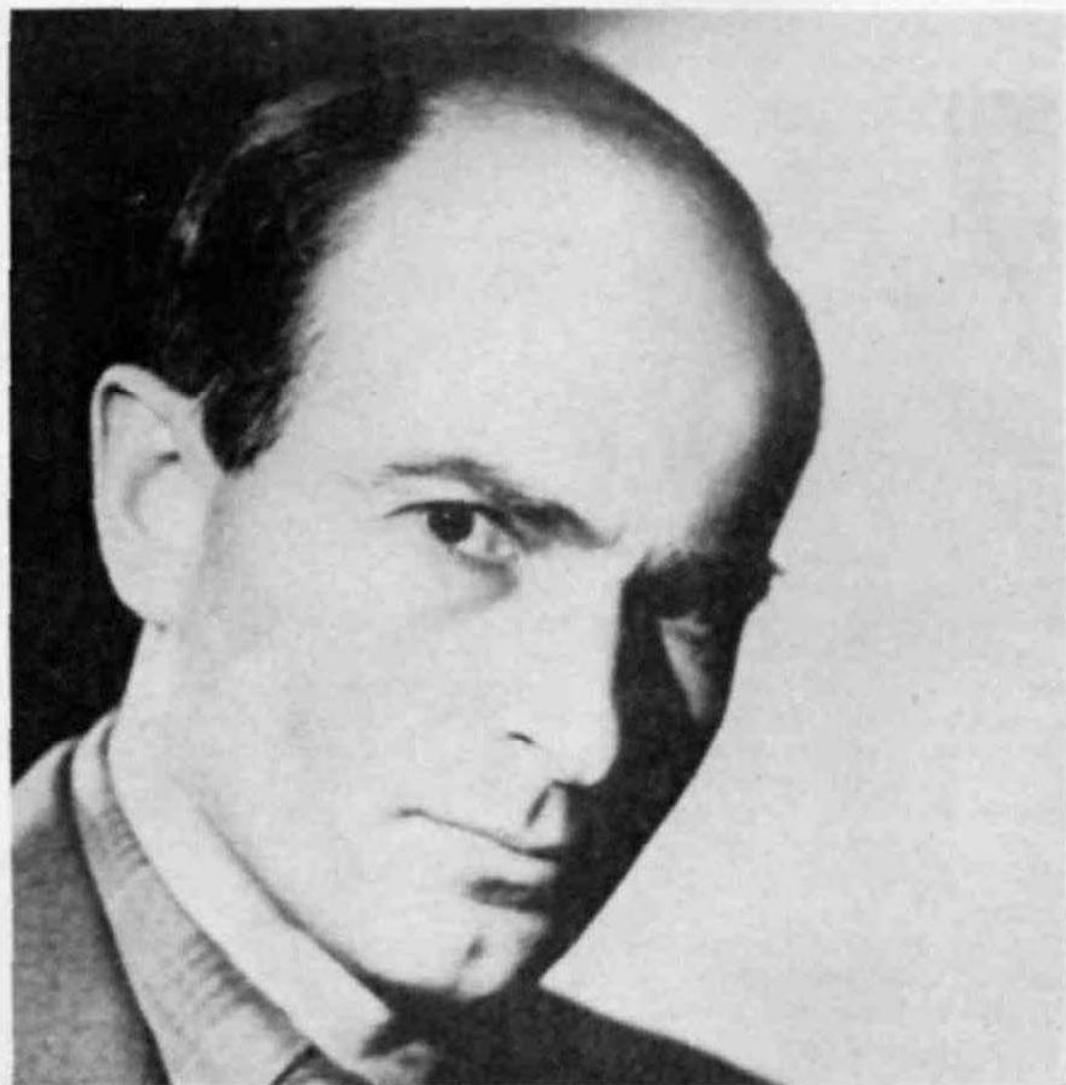

paper balloons filled with hot air. Later he said he had only wanted the name of his home town to get into the papers. (c) *Hallucinations or mistakes*, like the gleaming dots that were seen in the beam of a searchlight. They obviously did not like being caught in the beam; and when a second searchlight was directed on to them they were recognized as the light-coloured breasts of wild geese.

"*Reflections* have also been suggested, but I cannot accept this explanation. I cannot believe that an experienced pilot is unable to distinguish between a light on the ground, reflected in the glass of his cockpit, and a luminous object flying above him.

"*Mirages* also seem to me to be an invalid explanation. They are very rare in our latitudes—I doubt if one of you has ever seen one. And often UFO's appear under conditions in which a mirage is impossible on the evidence of the weather charts. Apart from that, mirages don't look like flying discs, but like static pictures such as lakes, palms and castles.

"*Other Objects Mistaken for UFO's:* (a) *Weather balloons*. (b) *Aircraft*. Occasionally low flying aeroplanes which reflected the light have been reported as UFO's. So also have meteors . . .

"*And I think that a German machine, the V7, and various modifications have been responsible for many UFO reports.* At the end of the war we developed first in Prague, then in Vienna, the V7 helicopter—this could easily have been mistaken for a Flying Saucer. Instead of having rotor blades like an ordinary helicopter, the V7 had rotating tubes which released an "exhaust" of flame. As the tubes rotated the helicopter appeared to have a circle of flame round it, and at a distance it looked like a shining disc.

"When it hovered the flame was dark red and dim. At higher speeds the disc appeared lighter and the flame looked yellowish, then white. At its highest speed 4000 ft./sec. to 4600 ft./sec. the V7 tipped over and flew on its side. A significant feature is that it was extremely noisy in flight, and produced a thick trail in the stratosphere.

"The V7 certainly does not explain UFO reports before the end of the war. This behaviour corresponds with many reports of UFO's. There have been a number of sightings of objects which change colour as they increase speed, and leave condensation trails.



Noted amateur rocket authority Arthur Louis Joquel II wrote THE CHALLENGE OF SPACE and believes "flying saucers to be intelligently directed [outer] space ships."

"Russia has now obtained the plans and a model of the V7, and has built some models of her own which could account for some UFO reports. France is also building a similar machine. America denies flying a V7-type machine, but a number of American reports of UFO's correspond with descriptions of V7s.

"Air Technical Intelligence Commission, the American official department for UFO reports, had collected 3200 reports up to 1952 (after this time their work became secret). Of this number just over 50 percent could be explained by the things I have mentioned—wild geese, hoaxes, weather balloons, the V7, etc. A further 40 percent, though not identified, were so similar to the first group that they, too, were probably hallucinations or terrestrial objects.

"But just over 9 percent remained unanswered by any of the above explanations.

"The Swedish physicist Prof. Benedicks suggested that this small percentage was due to ball lightning, but his theory postulates characteristics of ball lightning most of

which are quite contrary to observations of its normal behaviour, duration and size. Naturally anyone in attempting to explain such phenomena is entitled to make such assumptions as he feels necessary. But in that case it is really up to him to prove that his assumptions are justified. In the absence of such proof I do not personally accept these assumptions.

"My own explanation of the unsolved percentage of UFO's is that they are machines built in some place other than Russia and countries on the Earth. (This is my personal opinion; it is not made in any official capacity.) Just as mankind is preparing for space travel, there may well be beings on other planets who have already discovered a means of doing so.

"I do not, in fact, think that Russia is building any UFO's at all; on the contrary, I believe they originated exclusively from outside the Earth, for these reasons:

"(a) Observations suggest that Flying Saucers are able to suppress the force of gravity, and I do not think that anyone on Earth has yet found the means to do so.

"(b) If they were a Russian secret weapon, it is hardly likely that the risk would be taken of allowing one to be shot down and captured by the Americans. The possession of such machines would make it possible for the Russians to build gigantic telescopes in the universe which would magnify a millionfold. Placed at a height of 26,400 miles above the centre of the Earth, they would take exactly one day to circle the Earth once. They could bring the Earth's surface as near as some 40 miles and entirely replace reconnaissance flights over large U. S. towns and arms centers.

"(c) Not one single crash or crash-landing of UFO's has so far been officially reported. This would be the first time in history a new machine had such a record. At Peenemunde in 1942 only one rocket out of four flew as desired, and even in 1944 only 80 percent of all V2s reached their objective. Twenty percent did not ignite, or exploded on the way, or did not follow the desired route.

"The safe working of the UFO's—in conjunction with the long history of reports—seem to suggest a very old invention which has long since disposed of its teething troubles.

"Having weighed all the pros and cons, I find the explanation of flying discs from outer space the most likely one. I call this the "Uraniden" hypothesis, because from

our viewpoint the hypothetical beings appear to come from the sky (Greek—"Uranos").

"There seems to me to be so far only two worthwhile objections to this theory.

"(a) It is true that within our solar system perhaps only Mars, apart from Earth, supports life as we know it. But it has been said that if Mars had highly intelligent inhabitants, there would not be desert over two-thirds of its surface. This need not necessarily be true. Perhaps these deserts could be more valuable than pasture land. A hundred years ago, when a farmer came to town for the first time, he said he would like to know what the townspeople lived on, as he had not seen a heap of manure in front of a single house!

"On the other hand, our solar system is not the only one in the universe. The Milky Way alone has 50,000 suns like ours, and 40 percent of these, according to latest astrophysical information, are surrounded by planets, as our sun is. And there are 500,000,000 Milky Way systems!

"The problem here is the length of time it would take the Uraniden to travel from one Milky Way system to another. But modern physics claim that Time is a relative conception, so that it could be possible for a space-ship to dash for centuries through space without its passengers becoming noticeably older!

"(b) The second objection which has been made is that the passengers of Flying Saucers do not appear to emerge and say "Good-day" to us. My answer to that is that they probably don't think it is worth bothering to do so!

"These then are my conclusions on Flying Saucers. But you must remember that a scientist works in a special way. First he collects observations. Then he sets up a hypothesis. He says if we assume this and this is so and so, then this would explain the phenomena under discussion. Whether a hypothesis is really true can naturally be determined only by further research. Other scientists may certainly set up other hypotheses as explanations of the phenomena, which they feel more probable.

"These conclusions of mine are based on present reported observations. But tomorrow my opinion may be changed by some new report. I can only say: based on what I know today, I believe the Uraniden hypothesis to be the most probable answer to the unexplained percentage of UFO reports." ■



Second Annual Spacecraft Convention, near Palm Springs, California

PHOTOS BY ROBERT C. BECK



(Above) By plane and auto, flying saucer enthusiasts arrived at Giant Rock Airport on Southern California desert from everywhere.

(Right) Giant rock on desert floor was focal point for Spacecraft Conventioneers who gathered to hear latest on Flying Saucers.





Part of great throng (above) waits eagerly for newest UFO facts to be revealed for all.



Orfeo Angelucci is author of "The Secret Of The Saucers," also attended space convention.



George W. Van Tassel, owner of Giant Rock, authored "I Rode A Flying Saucer."

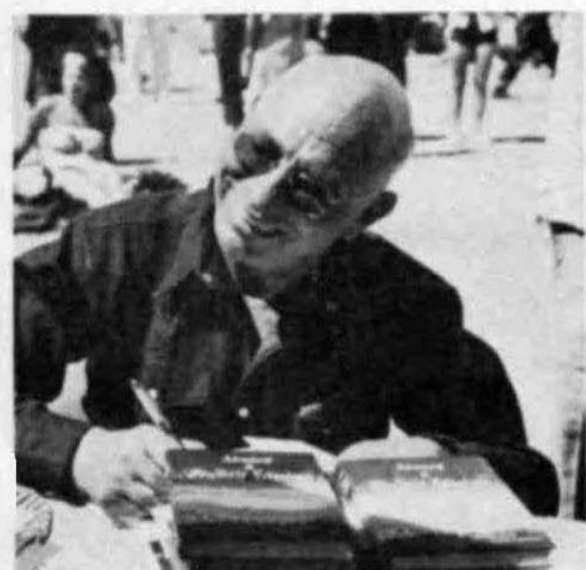

Truman Bethurum autographs his book "Aboard A Flying Saucer" at Giant Rock.

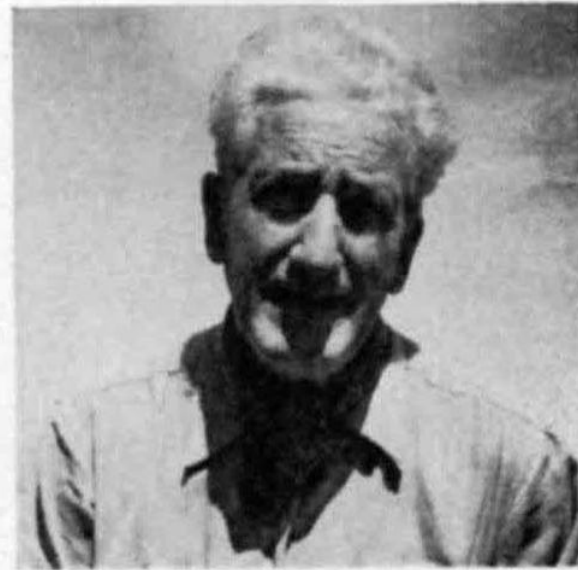

Frank Scully was early flying saucer writer, produced book "Behind The Flying Saucers."

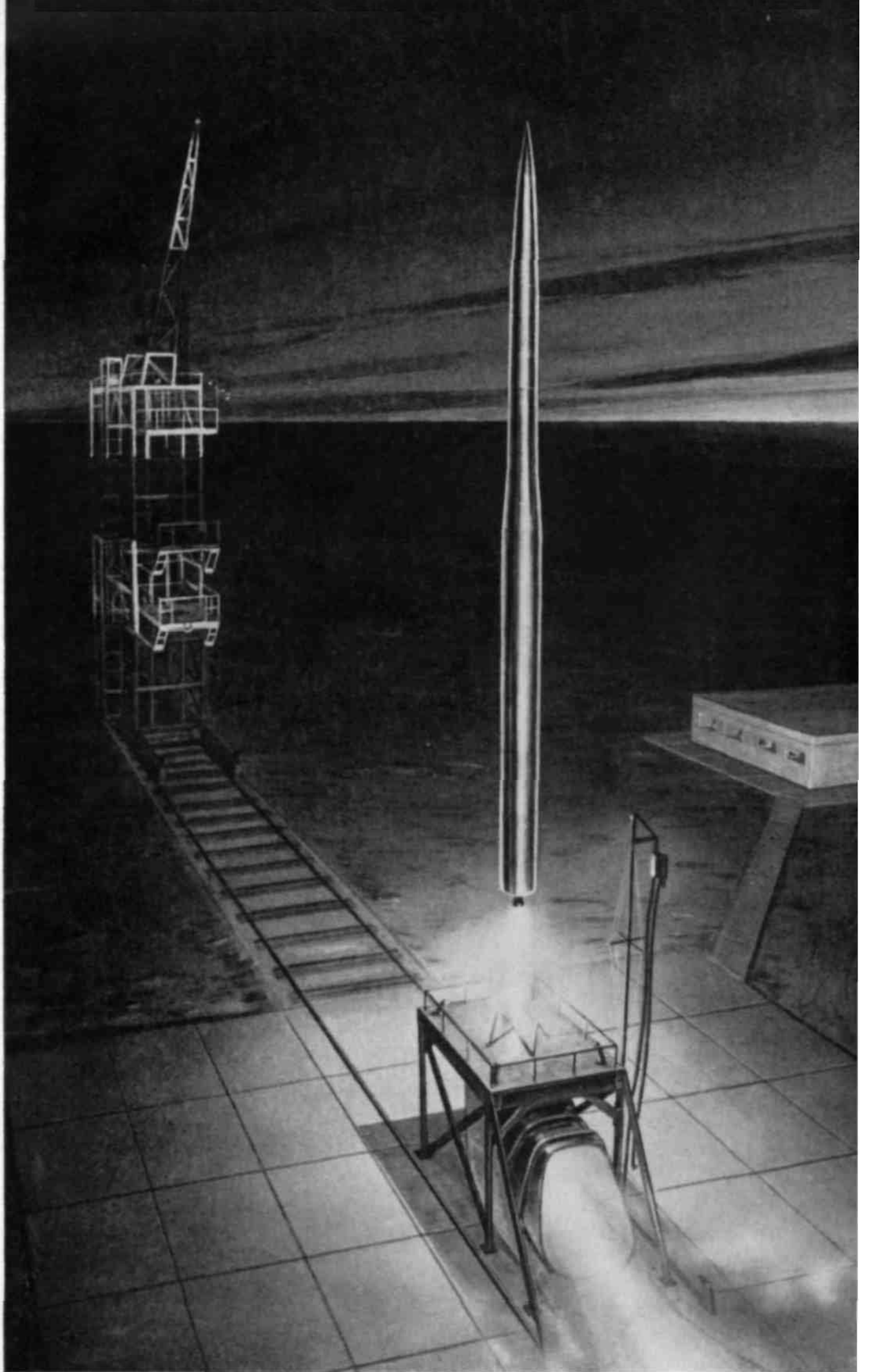

chapter 3

Space Travel and the UFO

FROM THE INCEPTION of the UFO enigma in recent years, scientists, researchers and laymen alike have pondered a prize question: *What powers the saucers?*

Possibly it has been our never-ending quest for better and cheaper travel and transportation; possibly it represents our search for a link between the finite and infinite. Or maybe it is merely our thirst-driven curiosity—the kind of curiosity which has developed the automobile and the airplane, which has discovered electricity and nuclear energy.

But whatever the cause, the effect is there; we search for the answer as to what propels the UFO in so infinitely superior a manner than anything yet developed—or at least known—on earth.

Interest in space flight, as most of us know, is not new. It probably began when the first philosopher theorized that there was a *space* and that the earth wasn't "all."

With space travel the ultimate goal, the field of rocketry—in a state of advancement over the pyrotechnic variety and the crude type developed by the Orientals over five hundred years ago—apparently got under way when the paper entitled "A Method of Reaching Extreme Altitudes" by Dr. Robert H. Goddard was published in 1919. Dr. God-

dard, regarded as the father of rocketry, launched his, and the world's, first liquid-fuel experimental rocket on March 16, 1926, at Auburn, Massachusetts.

The rocket reached a disappointing altitude in two and one-half seconds of 184 feet. But by enlarging and improving his experimentation, Dr. Goddard's rocket had by 1930 achieved a height of nearly one-half mile, and a velocity of 500 miles per hour.

About this time, Germany entered the field of rocketry and led in research and development until the close of World War II.

In 1923 Mathematics Professor Hermann Oberth's classic work, *The Rocket into Interplanetary Space*, was published at Munich. From perhaps that day on, the rocket and space travel objective had its niche in world, and more directly European, history and acceptance. That volume instigated the formation of the Verein für Raumschiffahrt—Germany's Society for Space Travel.

After the Second World War the confiscated V-2 rockets—like those which plagued the skies over Britain in the last days of the war—were brought to the White Sands Proving Ground, New Mexico, for assembly and testing. The White Sands V-2 proj-

SATELLITE PROGRAM

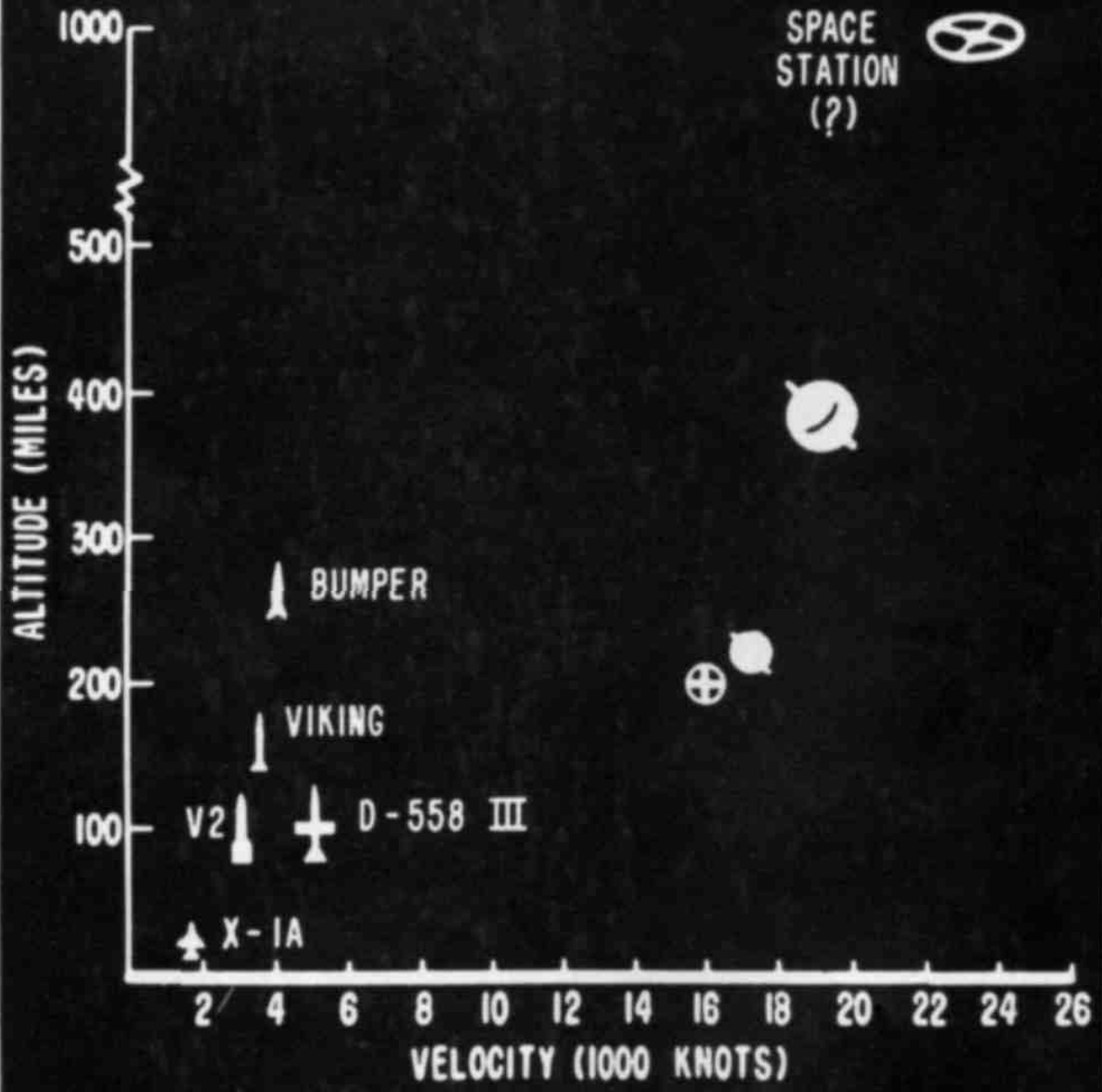

Above chart shows progress being made with rockets and illustrates tremendous speed which must be attained to establish a space station which would orbit the earth. A three-stage Redstone rocket was fired over Atlantic in late 1956. It traveled 3000 miles, went 400 miles up.

ect was concluded in 1952, by which time a total of 47 of the rockets had been launched.

An important development in the area of rocket engineering took place in 1949 at the White Sands rocket center, when a double or two-stage rocket was launched on February 24. These two stages consisted of a V-2 as the first, or lower rocket, and an Army Ordnance WAC corporal as the second, or upper, stage.

The V-2, in this case, was actually a "booster" rocket; when it consumed its fuel supply, the Corporal separated and continued on in its outer space voyage.

The firing was a success. And the V-2/WAC Corporal combination today holds the official world altitude record for a multi-stage rocket. The Corporal climbed to a height of 252 miles and attained a maximum velocity of 5200 miles per hour.

Three years prior to the termination of the V-2 project, the Viking Rocket Program began. This strictly research projectile of the Glenn L. Martin Company holds the record at this writing for the one-stage rocket—158 miles on May 24, 1954.

The admirable Viking has served its purpose, and the Aerobee-Hi is presently the nation's number one active research missile. With a payload of 120 pounds, the Aerobee-Hi has a theoretical potential to reach 202 miles. It will be used as the second stage of the forthcoming Vanguard multi-stage satellite rocket, while a Viking of larger construction and advanced design will be the first stage in the history-making attempt.

The hopes and dreams for eventual space flight received their greatest boost on July 29, 1955, when The White House announced the establishment, under the National Science Foundation and to be coordinated by the Naval Research Laboratories, of Project Vanguard during the International Geophysical Year, (IGY for short) which will be active from July 1957 to December 1958.

During IGY, the White House announcement and subsequent bulletins have stated, approximately 15 three-stage rockets will attempt to launch miniature, unmanned, and orbital sateloids from Patrick Air Force Base, Florida. Best estimates place the starting date sometime in early 1958.

The first two stages will utilize a liquid chemical bi-fuel system (consistent of a primary propellant—i.e., alcohol, aniline,

hydrazine—and an oxidizing agent, such as the relatively common liquid oxygen or nitric acid). The third or principal stage will use a solid propellant (composition unknown).

Although on a much smaller scale, the Vanguard program closely parallels the objectives of Dr. Wernher von Braun—German rocket authority noted for his contribution to the Nazi V-2 Project—on the establishment of an orbital satellite of the earth. Unlike the Vanguard, however, Dr. von Braun and the Collier's Symposium on Space Travel advocate a plan whereby a number of three- or four-stage rockets will carry equipment to some 1075 miles into outer space to construct a permanent and manned "space station." The cost of the project was estimated to run about four billion dollars.

While not nearly so spectacular or massive in scale, the Vanguard program should effect vital information on the upper atmosphere, on cosmic and varied outer-spatial radiation, and on gravity and magnetic forces that play on the earth. Scientists believe that the data unveiled will be worth many times the approximate expenditure of thirty million dollars to launch the tiny, 21-pound sateloids.

The majority of these small satellites will be launched into elliptical orbits of from 200 to 300 miles and extending into space as far as 800 miles. This ellipsoid should permit the sateloids to stay in their orbits far longer than the previously estimated week, for the more rarefied atmosphere will not as rapidly slow down the 18,000 m.p.h. projectile. Also, the higher the orbit the greater the data will be on the varying effects of outer space. Dr. Milton W. Rosen, director of the Vanguard Program and former head of the Viking project, has recently announced the intention of the Naval Research Laboratory to attempt to launch one of the sateloids into an orbit at an altitude of up to 1500 miles at its farthest point. This latter mark would surpass the von Braun plan.

Even those in charge of the Vanguard Program are not as optimistic as the press and public seem to be, and foresee the disappointing possibility that the whole project may prove unsuccessful. One reason for this is our extremely limited knowledge of the relatively new science of rocketry—at least

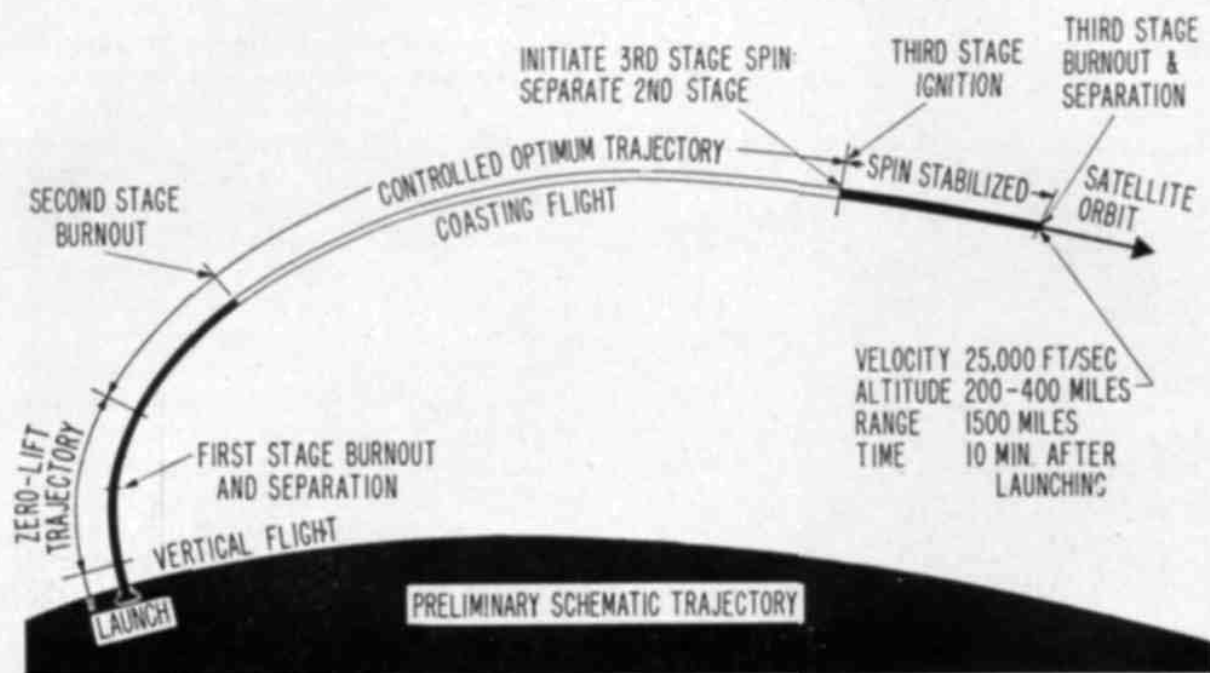

Artist's concept of satellite preliminary schematic trajectory. OFFICIAL U.S. NAVY PHOTOGRAPH

outside the field of ballistic guided missiles. Vanguard will utilize only recognized research missiles.

The Viking Program is a good example of this pessimism. It took nearly five years from the inception of the project—through designing and initial testing—to where it could begin on a full and satisfactory scale. And yet of the approximate 13 Vikings fired, only about half could be considered successful or fruitful. Not only that but the Viking was a one-stage rocket while *Vanguard* combines three individually complex stages. (The timing problems alone in separating the stages are enough to discourage any but the most enthusiastic engineers.) And with only three years for designing and completion.

At this writing, it looks as though the Aerobee-Hi—the *Vanguard* second stage—is plagued with as many setbacks as the Viking. No data on the third solid-fuel stage are available.

Astrophysicists estimate that it may be another 10 to 15 years yet before the United States is capable of establishing a manned space station. The construction of this artificial satellite is expected to be the last

stepping stone to the moon, the planets, and eventually . . . to the stars.

But the drawbacks to such a concept are limitless.

The following are a few of the obstacles to be overcome:

1. The heavy strain of enormous G-forces upon the human body during acceleration to reach escape velocity. (G designates the pressure of gravity on earth. Therefore, 10 G's would equal 10 times earth's normal gravity as we know it.) Minimum escape velocity must be about 18,000 miles per hour, to reach a 1000-mile altitude satellite orbit and approximately 25,000 m.p.h. to make a direct flight into outer space, with G-factors of close to nine.

2. The constant danger from ultra-violet and cosmic radiations. The ship must be specially shielded from ultra-violet rays, but nothing has as yet been found to halt the heavier cosmic particles.

3. The *probability* that the rocket or satellite will be struck by a meteoroid. Such could prove disastrous and rupture the hull of the craft. Again, extra shielding would be required.

4. The apparently insurmountable limita-

tions of the chemical-reaction engine. A trip to earth's nearest planetary neighbor, Venus, would take many months or years. Traveling at the fastest known velocity—that of light, or 186,280 miles per second—it would take such an interstellar vehicle more than four years to reach the nearest star, and some 1,700,000 years to reach our closest galactic neighbor, the so-called "island universe" of Andromeda.

The group exploiting the chemical bi-fuel method toward interplanetary flight feel that nuclear energy may ultimately be harnessed in this direction. To date, however, there is little indication as to how this can be accomplished, although the Atomic Energy Commission announced the establishment of such a project at White Sands last September (1956).

In their recent book, *Space Travel*, authors Kenneth W. Gatland and Anthony M. Kunesch relate that even the stars are considered as possible destinations for future space ships. It would require more than 130,000 years to reach the nearest star with a chemical rocket, they declare, but an atomically driven missile might need only 350 years.

All of which finally brings us back to the UFO.

Electro-magnetic or electro-gravitational force-fields, according to most scientists and researchers in this field, have the greatest potential for future space travel, and seem to indicate that this area of propulsion is now directly related to the various characteristics of unidentified aerial objects.

This *field theory*, as it is commonly designated, is known by several names—all of which tend to add to the confusion. Electro-gravitic, G-field, and electro-static are several of the names by which this area of propulsive mechanics are known.

The UFO reports that purport color changes, tremendous velocities, the general shape of a circular airfoil, lack of visible means of propulsion, rapid accelerations, and right-angle changes in direction all but prove the G-field hypothesis.

Hermann Oberth, mentioned previously relevant to the development of rocketry in Germany, declared his belief in the extraterrestrial saucer before the International Astronautical Congress at Innsbruck, Germany, in 1954. The behavior of the UFO, he explained, discounts any means of propul-

sion—including the reaction rocket—known to us. The savant told the gathering that the principle of an "anti-gravity device" was a possible exception.

The Canadian Government in 1953 established Project Magnet. Headed by Wilbert B. Smith, this project was initiated for the development of a disc-shape aircraft to be powered by electro-magnetic energy. Smith professes his acceptance of UFO's, stating there is a 91 percent probability that they do, indeed, exist as material objects, and only about a 10 percent possibility that they are of earthly origin.

The advantages of the field-theory vs. the reaction, bi-fuel concept are manifold. A few are as follows:

1. Low cost of energy. Not the billions of dollars for fuel as required by the rocket system. Theoretically, the outer-spatial vehicle need only be started and then will continue in its acceleration until the desired velocity is reached.

2. There is but one form of acceleration known to us which will not result in the uncomfortable G-load. This is the force ("push" or "pull"—varying upon the theorist) of gravity the earth exerts upon every particle and atom in its mass, and on into outer space, *ad infinitum*.

Falling towards earth, a body accelerates at the speed of 32.2 feet per second, per second. And yet there is a feeling of "weightlessness." Therefore, we may be able to look for no danger nor apparent discomfort from the electro-magnetic or electro-gravitic principle.

3. The airfoil should be capable of enormous velocities within the earth's atmosphere. (Neither the rocket nor any other type of known projectile can now withstand the tremendous atmospheric friction. At a critical speed—designated by some as the Thermal Barrier—the aircraft melts or disintegrates.)

There are several, rather involved hypotheses relating to frictionless characteristics apparently exhibited by the UFO during high speed flight.

The general concept is that the energy field—be it magnetic or gravitational—influences and "captures" the air within its immediate vicinity and its effect diminishing by the square of the distance. The only result, in this case, would possibly be an aureole-effect surrounding the UFO. Such

a resultant "glow"—if that it be—has oft-times been included in such reports, particularly those made at night. In fact, the color of the "glow" has been reported to change in direct relationship to the acceleration and/or velocity of the object.

Such phenomenon as the above can scarcely be relegated into the subjective category, and may ultimately not only prove the physical existence of the phenomena but also may be a link in our stepping-stones to the stars.

This same energy field may also prohibit—possibly by a new concept of a frequency "block" or refraction—ultra-violet and cosmic radiations from penetrating the craft.

4. Again theoretically, velocities near to and of the speed of light should be achieved easily, as it may conceivably be possible to travel along magnetic lines of force or kindred radiation. Possibly a better analogy would be to picture a radio tuning to a certain frequency. Let us assume that the UFO can "tune-in" on the radiation: to a slight degree at first, thereby gradually increasing ascension and/or acceleration. As the "tuning" nears its peak or the frequency emanation amplified, the acceleration would become more pronounced, and almost limitless. In this respect the term "absorption" can possibly be used to describe the principle.

Of course the process would just be reversed for deceleration and landing. To hover it should be simple to "tune" or to inversely amplify the radiation with a neutral result.

Still it may be argued that even by traveling at the speed of light it would take us some four-years-plus to reach our nearest interstellar neighbor, Proxima Centauri. This field of cosmology is pure conjecture and, in the author's opinion, cannot be treated objectively. Some cosmologists feel that space is curved—or "warped." Therefore, conceivably—by this unique method—it may be possible not to "warp" space but to directly approach our destination. But this is delving into inter-dimensional concepts—something far too complex and too limited in present-day knowledge to dwell upon here.

One interesting sidelight, however, is the effect of near-speed-of-light travel upon the occupants of an interstellar craft. Traveling well over 99 percent of, but still slightly under, the velocity of light, and with a destination of say Andromeda, the space ship—in a round trip—would arrive

back on earth more than three million years later. But those inside would not only be still alive, according to postulations by professors George Gamow and the late Albert Einstein, *but only a few hours older.*

Known as the Lorentz Transformation (or Contraction), as elaborated by Einstein, matter and time unite at the velocity of light. Therefore, a contraction occurs in both as that speed is approached, although it is not prominent until the 186,280 miles per second is relatively neared. Of course nothing, outside of electrons in a cyclotron has yet approached such an inconceivable velocity. Even traveling at the somewhat *slow* speed of 167,000 m.p.s., the occupants of such a vehicle—and even such physical devices as clocks—age only half their expected norm, as viewed from a stationary point. Actually if travel near the speed of light were possible today, and almost ageless humans returned from a trip several million years later, they would in reality be their expected age—but as related only to themselves. This, in an extremely vague analogy, follows Einstein's theory on Relativity: that matter, space and times are directly proportional to one another. So what would *apparently* be only a few hours to our space travelers would be millenia to their point of origin, or any other nearly stationary body.

A vastly increasing interest in the anti-gravity thesis has been indicated over the past several years. The research manufacturing concerns of Glenn L. Martin, General Electric, Hughes Aircraft, Lear, Inc., Gluhareff Helicopter Airplane Corp., Clarke Electronics, and Sperry-Rand are a *few of those* now actively engaged in gravity research projects.

The Gravity Research Foundation is a non-profit organization founded for the study and dissemination of data and new concepts as related to anti-gravitational theory.

In a bulletin titled "Gravity and Metallurgy," the Foundation's President, George M. Rideout, states:

"For six years this Foundation has been busy interesting scientists to seek means of 'harnessing' gravity. From the first, it was believed that a *differential* must be discovered in order to make a gravity motor. Furthermore—with the possible exception of the automobile—we insisted that no outside power be used. In other words, any acceptable motor must operate as 'perpetual motion' using only gravity or some supernatural force as power.

The record making V-2/WAC Corporal rocket, believed to be the world's first two-stage missile. When the V-2, or lower stage, exhausted its fuel, the smaller WAC Corporal separated from its big brother and set an altitude mark of 252 miles on February 24, 1949. U.S. ARMY PHOTOGRAPH

"So far as we now know, the above requires and awaits the discovery of an insulator, deflector or absorber of gravity in order to bring about such a differential. This thought has been the basis of 485 essays which have been submitted to the Foundation during the past six years. For the most original of these it has given awards amounting to \$10,800.

"... The history of aviation from [the Wright Brothers] . . . to the present is well known. The famous Zeppelins, which were then being duplicated in the United States by the Goodyear Company at the expense of the U. S. Government, were soon discarded. Gradually all interest was directed to the heavier-than-air machines. The only unbeliever was Thomas A. Edison, who insisted that some means must be discovered to reduce the danger involved from falling. He insisted that the *proposed* helicopters, then on the drawing boards and in Aeronautical laboratories, would be discarded as were the Zeppelins."

At the Gravity Day Meeting, New Boston, N. H., on August 18, 1956, President Rideout told the gathering "how the attitude toward the Foundation had changed over the years from open scoffing to serious interest, the most marked change having taken place in the past year and a half."

He related the Foundation's "three purposes which still govern its activities:

"1. To stimulate interest in the field of gravity through awards for essays.

"2. To serve as a free clearing house for everyone seriously interested in the application of gravity to practical uses.

"3. To have the best library and files on Gravity in the country, open freely to anyone."

In a paper titled "Why I Think the Force of Gravity Is Controllable," Charles Tilger, Jr., of the Grumman Aircraft Engineering Corporation, told the Gravity Day Meeting

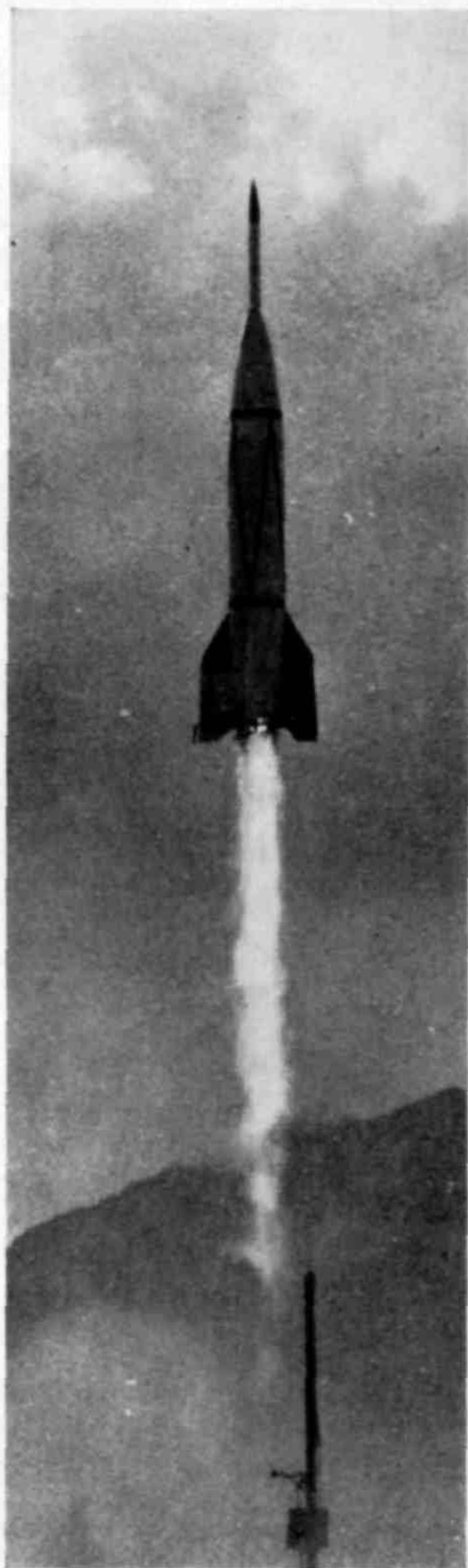

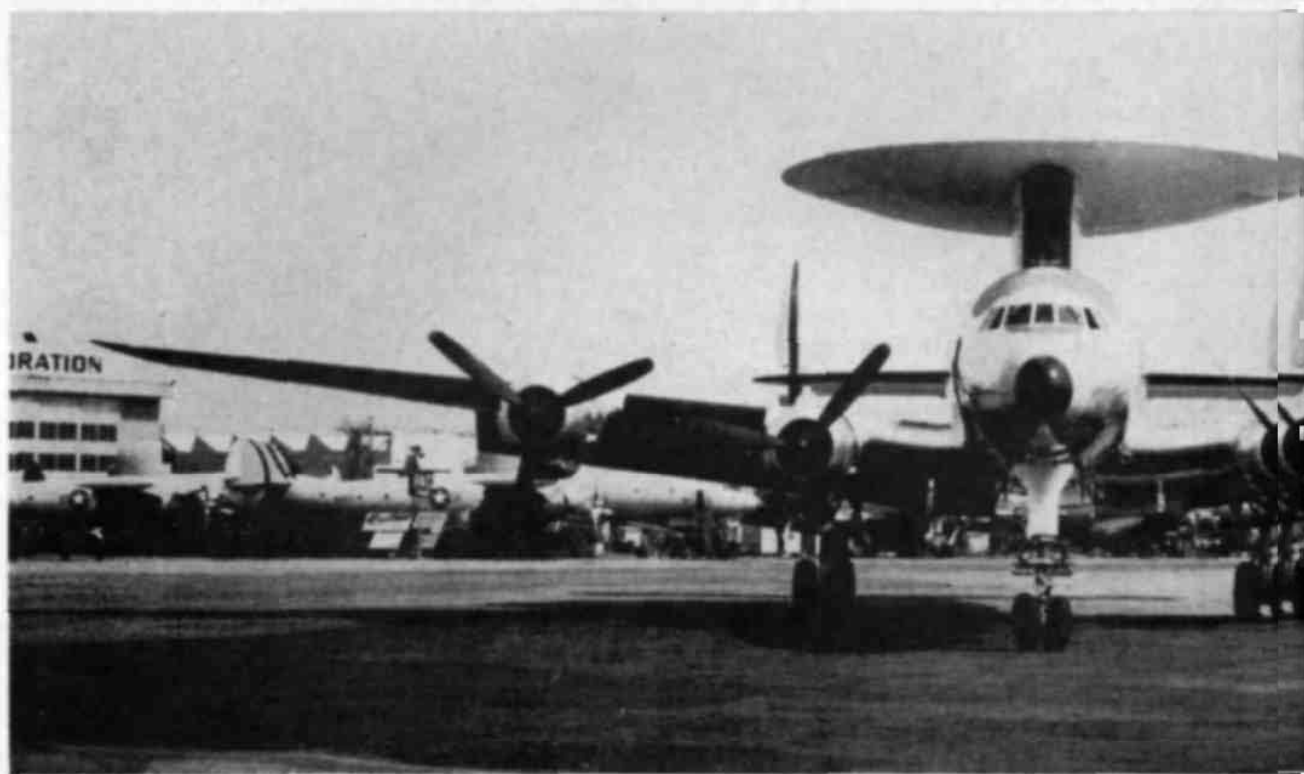

Disc-shaped radome atop this U.S. Navy WV-2 Super Constellation measures thirty feet across. When seen from certain angles, this plane could give rise to saucer stories.

that he felt "when we finally discover the means for control, it will very likely . . . be something which we have encountered frequently and failed to recognize."

Additional support for the anti-gravitic theory, and the extra-terrestrial saucer, comes from William P. Lear, renowned for his development of the F-5 electronic automatic pilot, now in strategic use by the U. S. Air Force and winner of the Collier's Annual Aviation Award. On February 2, 1955, Lear elaborated upon his beliefs in an Associated Press story on why he accepted the reality of the UFO:

1. "Numerous manifestations have been made over long periods of time.
2. "Many observations have been made simultaneously by reliable observers.
3. "There are great possibilities of scientific reality if the latest theory of electro-gravitation field is proved.
4. "Actual serious efforts are now in progress to prove the existence of anti-gravitational forces . . ."

One research project to attempt to propel a discoid airfoil by an electro-static force-field is headed by T. Townsend Brown, an American with 30 years experience in the field.

According to recent information, "security" supposedly prevents the researcher from divulging any specifics on the performance of their latest experimentation. But it has been reported that, utilizing a "localized

gravity field," circular airfoils two feet in diameter have flown around an area 20 feet, across, with a speed of 17 feet per second (about 12 m.p.h.). Induced with 50 kilovolts and 50 watts of "continuous energy," an electrical condenser coordinates the power and mechanical function.

According to one report in *Interavia* (May 1956), the Swiss Review of World Aviation, a three-foot airfoil using 150 kilovolts of power on a 50 foot aircourse, indicated "results so impressive as to be highly classified." Work is reported to be presently under way to develop a power supply of up to fifteen million volts.

Brown seems to feel, contrary to Dr. Einstein, that this area of electro-static-field propulsion may not be limited to the boundaries of the velocity of light. He adds, however, that this is yet to be proved.

"Gravity isotopes," Brown relates, may ultimately create contra-gravity fields for varied uses—both on earth and for outer-spatial travel. Also, says *Interavia*, some materials have been reduced in weight by energizing them. This was not—for "security" reasons—defined, and can mean almost anything.

Another American project on theoretical energy fields is being conducted at the University of North Carolina, and apparently in association with the Institute of Field Physics, Winston-Salem. Dr. Bryce S. DeWitt directs this program, which is

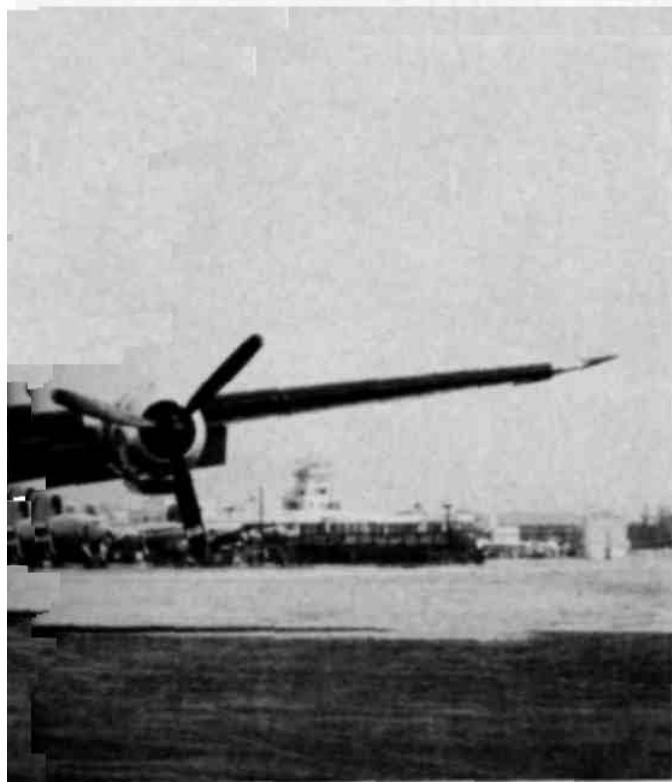

known as the North Carolina Project.

And in England, the Aviation Studies (International), Ltd., has established a Gravity Research Group. Their *Aviation Report* of 12 October 1954 stated that a "combat type disc" was under development to achieve a speed of three times the speed of sound (Mach 3).

"Tentative targets now being set," the report stated, "anticipate that the first disc should be completed before 1960 . . ."

A confidential summary of this and other projects is contained in the report on *Electrogravitics Systems*, published by Aviation Studies.

Many of these projects were actually brought into existence through Einstein's noted *Unified Field Theory*. As early as 1919, this great scientist concluded a paper before the Prussian Academy of Sciences by saying, "The preceding reflections indicate the possibility of theoretical construction of matter from gravitational field and electro-magnetic field . . ."

The *Unified Field Theory* proposes to resolve one of science's greatest anomalies—the basic differences of electro-gravity and electro-magnetism, the two fundamental forces of nature. This hypothesis as set forth by Dr. Einstein is the cosmological attempt to bridge the microcosm with the macrocosm—from the smallest atomic particle to the largest interstellar super-galaxy. In this respect, the gravitational effect of a star or planet, the macrocosm, may be paralleled to the magnetic attraction of an invisible electron, the microcosm.

Einstein, who spent a quarter-century in

culminating this hypothesis, once said that it "is intolerable to the theoretical spirit" to believe "there are two structures of space independent of each other . . ."

To demonstrate the import of such a postulation, the noted Briton, Bertrand Russell, once observed: "When we have told how things behave when they are electrified, and under what circumstances they are electrified, we have told all there is to know."

The reported flight characteristics of the UFO have presented some unique problems for the researcher. One such researcher is Leonard G. Cramp, M.S.I.A., and Member of the British Interplanetary Society. He has attempted to apply a practical solution to the enigma in his book, *Space, Gravity and the Flying Saucer* (The British Book Centre, New York, 1955). He theorizes, like so many before him, that the craft utilize a gravity-field principle.

"The theory," says Cramp in his foreword, ". . . was originally conceived prior to the second world war, and certainly long before the term 'Flying Saucer' came into general use. Can it be wondered therefore that the author took more than a casual interest in the significance of the many sightings? Indeed, the more he sifted the available information, the greater became his conviction that such a craft actually existed, and that there was more than a little justification for his theory. The reports coming in from ordinary people all over the world provided evidence of a phenomenon that he had hitherto only dreamt of.

"Rocket enthusiasts may naturally be reluctant to admit an entirely different conception of space travel, and may therefore adopt a sceptical attitude towards the interplanetary flying saucer hypothesis. However, it is hoped that . . . the flying saucer reports do suggest an alternative and more attractive method of space travel. Neither need we await further developments in physical science; the pioneer never has waited, and never will, upon others when he has become inspired by a new idea.

". . . It may well be, even in our own time," he continues, "that men will discover the key with which to unlock a force that is all about us and so enable us to use it for all our industries, transport, and finally, space travel."

The author goes on to say:

"Left to its natural conclusions, the



This photograph, taken in 1949 by August C. Roberts shows something of an enigmatic object believed to be an optical phenomenon in camera shutter effected by the brilliant street lamp.

development of the rocket as a space vehicle will obviously go through several stages. First, there is the bi-fuel step rocket principle that is being explored today. Secondly, the more advanced nuclear reaction rocket at present only dreamed of. Finally, as a result of findings brought out by atomic research, an entirely different and far more efficient means of anti-gravity will be discovered.

"Left to itself, the evolution of the rocket to this stage will take a long time, perhaps as long as did the evolution of the internal combustion engine . . .

"Must we persevere with the rocket as a means of interplanetary flight? Is there not another way to hasten the process? Yes, I am convinced that there is a better way to the stars . . . In some respects it may be a disquieting thought

to us who are rocket technicians and enthusiasts that the rocket may never be employed as an interplanetary machine. It is perhaps a discouraging thought and will not be well received by many, but if we are truly determined in our efforts to get to the stars we should welcome the possibility of a better means of doing so and be glad to examine any theory without prejudice."

Concluding, Author Cramp cautions, ". . . To cling to the rocket as a means of interplanetary transport and to deny the possibility of a better means is to exhibit a bias not worthy of scientific thought."

Another who disparages the rocket concept is former astronomer, M. K. Jessup. In 1926-27 Jessup served as a temporary instructor in astronomy at the University of Michigan, and later assisted Professor R. A. Rossiter in completing the erection of the University's 27-inch refracting tele-

scope at Bloemfontein, South Africa. As observing assistant to Professor Rossiter, Jessup discovered 803 physical double stars during his stay of three to four years.

In presenting *The Case For the UFO* (The Citadel Press, New York, 1955), Jessup writes: "It should be obvious to all engineers and scientists that rocket propulsion will never solve the problems of space travel, not only because of the unavoidable problems of acceleration, but because of the impossibility of transporting the necessary fuel and carrying the heavy reactance motors."

He adds, rather strongly:

"If the money, thought, time, and energy now being poured uselessly into the development of rocket propulsion were invested in a basic study of gravity, it is altogether likely that we could have effective and economical space travel, at a small fraction of the ultimate cost which we are now incurring, within one decade."

One of the characteristics displayed by the UFO which has often been mentioned by the skeptic as unlikely to impossible are abrupt stops and sudden right-angle turns so many times included in sighting reports. Jessup sums up the general precept of the gravitic engineer and UFO researcher as relevant to the mystery—

"Any force which would simultaneously accelerate every molecule of either the living body or the mechanical structure would avoid all such stresses, and both the living and the mechanical could undergo any amount of acceleration without the slightest damage or discomfort!"

Possibly the most recent contribution to the G-field principle has come from the noted French pilot, Lt. Jean Plantier.

This concept does not basically differ from the many others as herein expounded. But instead of traveling along magnetic or kindred radiation, or using an electro-static condenser, Plantier proposes the force-field theory should be applied to cosmic energy (or radiation).

In his excellent book, *The Truth about Flying Saucers* (Criterion Books, New York, 1956), Author and science writer Aimé Michel explains: "A way exists to liberate this energy, by transforming it into energy of a more degraded kind, in the same way, for example, as the stroke of a hammer against an anvil transforms kinetic into thermal energy."

The "liberation of this cosmic energy," Michel continues, "makes it possible to create, at the point where it operates, a local field of force that can be varied and directed at will. This local field may be likened to the magnetic field existing in a solenoid, or between the poles of a magnet or of the earth itself."

And that just about brings us up to date on the experimentation, research and theory which has so far evolved on the force-field concepts of electro-magnetic or -gravitic propulsion. As can be seen, the theory is not new, nor is it limited to any one precept or mode of operation. This field of endeavor, as was strongly intimated, is rapidly gaining momentum. With governmental support and foundation and private research, the simple, long-awaited answer is eventually forthcoming. When that will be—no one knows.

Perhaps a general reaction to this area of thought was expressed recently by Ward Kimball, Director of the "Tomorrowland" TV series for Walt Disney Productions. In a statement to Leonard H. Stringfield, Director of Civilian Research, Interplanetary Flying Objects and Editor of *Orbit*, Kimball wrote:

"The most interesting aspect of creating the factual space travel television shows for Disneyland has been the exciting contacts we've made with the scientists, engineers and physicists connected directly or remotely with the government guided missile and artificial satellite program. The one question that seems to start the fur flying, good-naturedly and otherwise, is when we ask, 'What do you think about flying saucers?' The answers run from, 'It's very absurd!' all the way down to 'If a flying saucer landed on my lawn tomorrow, I wouldn't be at all surprised!'

"Even though we have to be factually conservative on our television shows, we try to present the subject of space travel with an open mind, hoping the audience will be stimulated to receive the program the same way. However, where there's smoke, there's fire, I think your readers would be quite surprised and gratified to know that there are many young engineers reported to be secretly working overtime on the big important key to future space travel—the anti-gravitational drive!"

All of which points to our future progress and travel—Onward . . . and upward! ■



chapter 4

Space Communication and Detection



bove are shown Dr. Walter S. Huxford of Northwestern University and A. H. Nethercot, Jr., testing a German "Lichtsprecher" telephonic communication device. The instrument provides telephonic communication on rays of invisible light, a principle expounded by researcher John Otto of Chicago who has done considerable work in space craft and extra-terrestrial communications. The transmission of sound by light rays may hold the secret of communication in space. Radio signals have been received from several different planets in our solar system.

EVER since it has been theorized that planets other than the Earth may be the habitations of intelligent life, mind and mechanics alike have combined in efforts to detect or communicate with this intelligence.

One of the earliest known efforts in this direction was announced by the *London Fortnightly Review* in 1896. The first issue for 1897 of *The Electrical Engineer* summarized the account, which was later dispatched around the country.

The British scientist, Sir Francis Gaulton—according to the *Review*—stated the belief that we on earth are the recipients of definite signals from the planet Mars.

"It is said," related a condensed report in the Providence, Rhode Island, *Evening Bulletin* of January 1, 1897, "that one of the

great European observatories has prepared a recording apparatus, which is found to perform its mission effectively." A piece of paper, the dispatch recounted, "is slowly drawn by clockwork, upon a hinged pencil, on which the observer rests his finger. When the scintillation or flash is on, he presses his finger and the pencil leaves a mark. When the flash is off, he ceases to press, a spring lifts the pencil and a blank is left on the traveling slip of paper.

"Three, and only three different signals are employed," according to the story. "These signals differ only in their lengths, and resemble the dots and dashes of the telegraphic code. The dot lasts one second and a quarter. The dash lasts two seconds and one half. The line, or longest dash, lasts five seconds."

The interval between letters is reported to be one and one-half seconds, three seconds for words, and six seconds for paragraphs.

"As there are only three varieties of signals," the Providence *Evening Bulletin* continues, "the total number of different words of one letter is three, of two letters nine, of three letters 27, of four letters 81, of five letters 243, and so on in geometrical progression. The average time occupied in signaling these words, including the three seconds pause at the end of each, are 6, 10, 15, 20 and 24 seconds respectively.

"The Mars folk evidently intend to speak to us in very terse and pointed language," the dispatch concluded.

To the author's knowledge, nothing has subsequently been published on this "communication." Perhaps it was a hoax. (The *Evening Bulletin* felt, however, that "the name of the distinguished English scientist gives it a sober aspect.") And why haven't these signals—or "scintillations"—been reported since? It is unfortunate that the name of the observatory, if it exists, was not included for some credence.

But in any event, it was an interesting story. And it illustrated the interest in such communication attempts.

Several years later a famous inventor got into the act. Yugoslav born Nikola Tesla, who created the first device utilizing—and to some degree discovered—alternating current, said in 1900 that he had received signals, or "vibrations," in series of triplets with his wireless set. He believed they emanated from Mars.

Harry Walker while at sea on May 19, 1919, reported that he picked up strange

wireless messages—"meaningless in the languages of this Earth." These signals were translated into the letters *K U J* and *V K A J*.

In 1921 Signor Guglielmo Marconi—"father of the wireless"—conducted some electronic experiments in the Mediterranean aboard his yacht *Electra*. In September 1921 J. C. H. Macbeth, London Manager of the Marconi Wireless Telegraph Company, announced that Signor Marconi believed he had intercepted messages from Mars.

"The regularity of the signals," Macbeth declared, "disposed of any assumption that the waves might have been caused by electrical disturbance. The signals were unintelligible, consisting apparently of a code. The only signal recognized was one resembling the letter 'V' in the Marconi code."

Marconi said he received these emanations at 150,000 meter wave-lengths. The maximum magnetic wave-length transmitted at the time was about 14,000 meters.

Tesla and Marconi weren't crackpots. Without the vast knowledge and discoveries they gave the world, it is questionable if we would now have radar, television and other recent electronic innovations.

Mars swung close to earth in 1924—so close, in fact, that this proximity will not again be duplicated until sometime in the 21st century.

Apparently feeling that such an opportunity should not go by unchallenged, Dr. David Todd, then Professor Emeritus of Astronomy at Amherst College, organized an International Listening Post to intercept any signals from Mars. He requested, under this program, all high-wattage radio stations to silence their transmitters for five minutes every hour from 11:30 p.m. on August 21 to 11:30 p.m. August 23.

R. I. Potelle, Chief Engineer of WOR (Newark, N.J.) later told a press conference that he had received a series of "dots" and "dashes," that were neither of the Morse nor Continental codes, between 7:30 and 10 p.m. on August 22. These signals, he said, were steadily repeated.

After hours of intensive investigation, Engineer Potelle decided that *Eunza* was the word he had received. *Eunza*, needless to say, has no meaning in any of earth's languages.

C. Francis Jenkins, a Washington, D.C. inventor, had perfected a radio-photo-recording device shortly before the Mars opposition. He was requested, and agreed, to cooperate in the listening program. His



UFO researcher John Otto uses "Light Beam" transmitter for contact experiments with outer space intelligences in the midwest.

invention was attached to a receiving set "tuned" to 6000 meters.

(Jenkins' device converted radio signals into light patterns. These patterns were then exposed to a roll of film tape 30 feet long and six inches wide.)

A total of about 30 hours was recorded during the many "silence periods." When the film (now locked safely away at the Bureau of Standards) was developed, it disclosed a series of "dots" and "dashes."

Another phenomenon was recorded which turned out to be just as great an anomaly. Said Inventor Jenkins:

"The film shows a repetition at intervals of about a half hour of what appears to be a man's face, and it's a freak we can't explain."

Organizer Dr. Todd said of the film, "We now have a permanent record which can be

studied, and who knows until we have studied it, just what these signals may have been?"

At Dulwich Village, England, extremely clear signals resembling "dots" in the Morse code, and arranged in groups of fours and fives, were received by a "24-valve wireless" during the early morning hours of the opposition. They could not be pin-pointed as originating upon earth.

British lawyer Mansfield Robinson in 1928 attempted to contact the Mystery Planet by transmitting a message on the 18,700 meter band. As he anxiously awaited some type of response, Professor A. M. Low, a British scientist, reported he had received something at that wave-length.

"It was a mysterious message," he said. "It is hardly likely that it could have come from Mars. However, I must confess that I do not know who sent it. It was a series of dots and dashes."

In 1930 Harry Price, Director of the National Laboratory of Psychical Research, London, postulated the idea of igniting some 10 tons of magnesium, combined with oxygen, at the 11,000 foot level of the Bernese Oberland. He felt that Martians could easily perceive such a brilliant beam if directed toward the planet by huge reflectors. For lack of funds, however, the project collapsed.

Interest, apparently wasn't dwindling in extra-terrestrial communication. The Congress of the British Association for the Advancement of Science met in September 1931 at Westminster, London. On the 29th of the month, the late Bishop Barnes told the gathering:

"There are many other inhabited worlds . . . and on some of them beings exist who are immeasurably beyond our mental level. We should be rash to deny that they can use radiation so penetrating as to convey messages to earth. Probably, such messages come now. When they are first made intelligible a new era in the history of humanity dawns. At the beginning of the new era, the opposition between those who welcome the new knowledge and those who deem it dangerously subversive may lead to a world war . . . But I should like to be living then, when we begin this new era. We might get a true understanding of the beginning of the universe."

In 1937, at the age of 81, Nikola Tesla predicted communication between the earth

and other planetary bodies within the foreseeable future.

The war years, as always, brought to a temporary close the thoughts of other worlds and other beings. We reverted back to our mundane way of life; to our constricted thinking and expression. Imagination was stifled.

Then came the Foo-Fighters, the Ghost-Rockets (plaguing the skies of the Scandinavian countries and the Baltic area)—and the Flying Saucers . . .

Minds were becoming unburdened—and uncluttered.

We were free again.

Talk of space travel began to permeate the air.

And a New Age was born.

Few things are more difficult than to convey an accurate or even slightly complete picture of the work and research being done in attempted extra-terrestrial communications. This is largely because of the few group efforts in this direction; most of the attempts are on a completely individual basis. As to just how extensive these programs are, few can guess except to estimate that it extends far beyond most expectations.

Amateur radio communication is unquestionably the prime means of attempting to establish this type of contact. Yet it is extremely confined. Except for the novice license, it takes months and sometimes years to become a licensed Amateur Radio Operator—a "Ham."

But even this might not seem so formidable if it were the only obstacle. Section 12.101, Part 12, of the Federal Communications Commissions Rules Governing Amateur Radio Service, generally stipulates that amateurs can only contact other licensed stations, and what outer-spatial vehicle or body is licensed?

So as far as radio is concerned, it has usually been a matter of patient "listening."

Chicagoan John Otto has probably been responsible for more interest and activity in the field of electronic communication in recent years than any other UFO researcher.

"Without claiming 'firsts' in any effort, for we find wherever we turn there is nothing new under the sun," says Otto, "it was nevertheless the sighting of a large cigar-shaped craft near Needles, California, several years ago that spurred me into thinking of a radical

new means of a communication attempt. Feeling rather stupid after shining a flashlight skyward while snuggled in a bedroll on the desert that night, the idea of light-beam communication was born for interplanetary spacecraft use."

Light-beam communicators, according to Otto, are relatively simple in principle, and offer additional advantages over the ham rigs. Basically, the transmitter electronically converts sound—or voice—waves into light radiation, and, by focusing reflector, sends it in any desired direction. The receiver merely reverses the principle.

But the light-beam units achieve their greatest advantage insofar as the FCC is concerned—no license required. Likewise, it is highly directional and relatively "private." Unless the broadcaster's exact procedure were known in advance, it would be impossible for an outside source to monitor the transmissions.

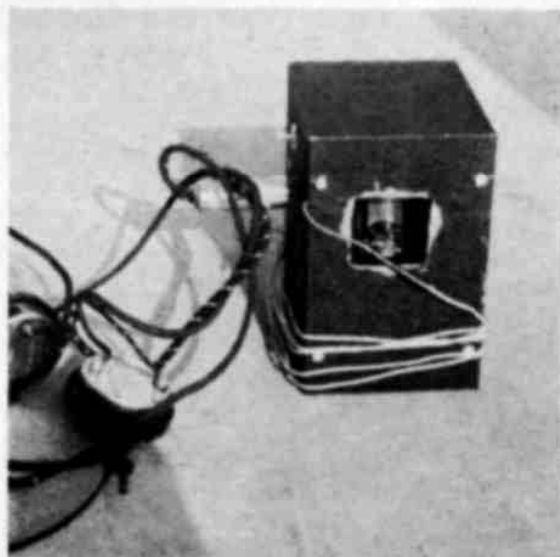

This is a portable and inexpensive "light beam" receiver unit; is very easy to operate.

John Otto and a group of mid-west electronic engineers and communication specialists feel that these light-beam units are far more practical and portable than the rather heavy and expensive amateur radio equipment. Their maximum potentials, however, are still unknown. Until recently these units were unavailable to the public, but late modifications and recent manufacturing applications have brought out a few models on a limited scale.

Some patient researchers have claimed the interception of signals, or messages, via these units. Such data needs intensive processing, and it may be quite some time before anything conclusive is known. Many have admitted no receptions whatsoever.

John Otto, a patent development engineer who has extensively investigated and lectured on the UFO enigma in recent years, relates one interesting result via light beam communication. The incident, involving a radio ham, is recorded as follows:

"An amateur radio operator continuously modulated some 'canned' music and sent out a jumbled jargon of words, always closing with 'How is my readability?'"

"After two weeks he had a reception of the same type of material, jumbled, unintelligible words, and then some music. Finally came, 'How is my readability? Go ahead—'"

"The ham did not have anything of importance ready to converse with his unseen communicator, so it floored him somewhat.

"This," advises Otto, "should be considered and planned before any transmitting efforts."

The early 1950's saw the establishment of several ham saucer networks (called "nets"). These groups, however, have followed the laws under the Federal Communications Commission, and have specifically not attempted non-terrestrial communication.

One exception was an Arizona group in 1952-53 who claimed to have received several messages (by rapid telegraphy and coupled with many meaningless letters and phrases) from the occupants of flying saucers on 405 and 450 kilocycles. These frequencies are extremely close to air traffic and weather forecast bands.

One of the first attempts at space craft communication by a commercial and public media was initiated over WGN, Chicago, on Sunday, November 28, 1954.

Disc-jockey Jim Mills announced a 15-second "listening period" for 11:25 a.m. His program began at 11:05, and this time was steadily repeated. John Otto and several associates simultaneously transmitted the Mills' appeal to outer space inhabitants by light-beam.

At 11:15—10 minutes before zero—the disc jockey requested:

Outer space inhabitants, this is Jim Mills. I invite you and those in flying discs listening to this program—and it is understood you can understand English—to stand by for a message from the friendly people of Earth. We desire to communicate with you, if this is within the scope of your current operational plans.

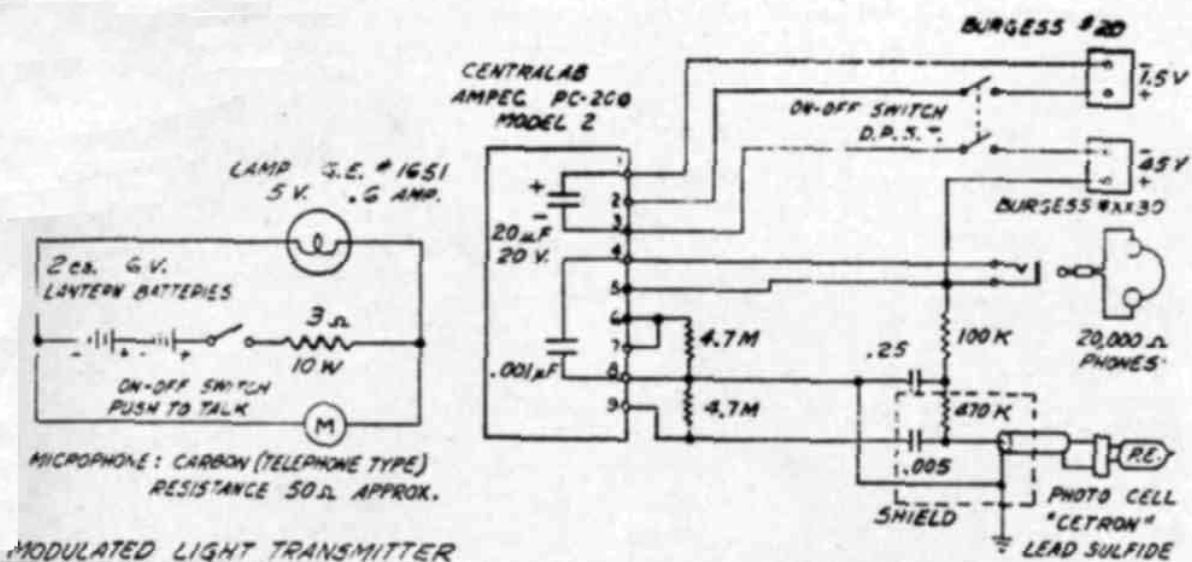

NOTE: THE AMPEC PC-200 SHOULD BE PURCHASED, LESS REGULAR TUBES & SUPPLIED WITH TUBES AS FOLLOWS:

V_1 & V_2 = CK 512 AX
 V_3 = CK 506 AX

Shown above are schematic diagrams of the light beam transmitter and receiver units. DRAWINGS COURTESY OF JOHN OTTO

Our sincerity, coupled with your cooperation, I feel sure will open the door to a new way of life for we, the people of Earth.

We earnestly desire to join hands now. Such a relationship will benefit mankind throughout the entire planet. Therefore, at exactly 11:25 a.m., today—Chicago, Earth time—we will hold a 15 second period of silence, for you to cut in and speak to us through the WGN transmitter.

There were several additional prior breaks and announcements. Then—

Three seconds. Two—one—zero!

Come in outer space!

If outer space came in, few people heard it. Varied interference was reported by listeners unevenly distributed within range of the WGN transmitter. But there was one report which John Otto feels may be of value.

Two Chicagoans had wire-recorded the listening segment of the broadcast. Several seconds after the silence period began, "a terrific blast of code" came over the 720 kilocycle AM frequency—and it lasted exactly 15 seconds, running over into the disc jockey's return to the regularly scheduled program.

The "code" closely resembles short wave teletype transmissions and was, according to Otto, almost immediately discarded for this reason. But short wave code does not come through an AM frequency. Otto feels assured that the recording was not faked.

The next step was to run the high speed, multiplex-type code into a teletype receiver, and determine if its coherency indicated fraud on the part of the recipients.

At the completion of the rest, no words or phrases of any familiar languages were noted. The code remains a mystery to this day, despite the fact that many electronics and communications experts and cryptographers have studied it with no apparent results.

In breaking down the recording by greatly reducing its playback speed, the code was found to greatly resemble a series of unusual musical notes, comparable to indistinct combinations of Oriental windpipes and Scottish bagpipes.

Another commercial radio attempt at space craft communication was instigated just eleven months later. John Otto, who had temporarily dropped his engineering development vocation to pursue the elusive UFO, had toured the country on a lecture tour and new media interview circuit.



John Otto (right) is shown with Announcer Ben Hunter on radio KFI Los Angeles on the morning of October 28, 1955 during space communication attempt. PHOTO BY G. S. COLLINGS

One of these personal interviews took place during the early morning hours of October 28, 1955. In Los Angeles for the purpose of a lecture engagement, John Otto guested on the Ben Hunter Nite-Owl show, which is broadcast over 50,000 watt, clear-channel station KFI (an NBC affiliate at 640 k.c.) from one a.m. to 5:30 a.m. Ben Hunter is a well-liked and respected Southern California radio personality, and had been publicly chosen as the "Honorary Mayor of Hollywood" several days prior to Otto's appearance.

Writing in *Saucers*, John Otto prefaced: "Lecturing date being the very same night, I had accepted with the feeling that I would be on Ben Hunter's program for a short visit and get out of the studio by at least two o'clock and acquire some needed sleep."

Apparently someone—or something—else had other ideas.

At two a.m. Otto read the same introduction employed by Jim Mills nearly one year earlier. The "silence period" was set for 2:15.

But nothing happened at 2:15.

However—

"One of the first to call," related Otto, "was a chap in San Diego who had made a recording in which he heard some high speed code, but instead of hearing it during the specific listening period of 15 seconds at 2:15 a.m. he had heard it at 2:10—fully five minutes preceding the allotted period.

"This seemed to be the entire pattern of the response; just preceding the actual listening period. And I suspect very much that the data coming in at the 2:10 period was highly authentic and a true answer to our request. I was personally keen to acquire this 2:10 material and partially convinced that data following, at 2:15, would have to be rejected on the grounds that tampering was evident."

That was only the beginning.

"The telephones at KFI were on a rampage," says Otto. "The switchboard lit up like a Christmas tree. People were calling from far into Northern California and the Pacific Northwest, as far east as Arizona and New Mexico. Many tape recordings were being reported by the many and various returns of an extra-terrestrial answer to our request."

These isolated reports, unfortunately, are too numerous to include here. These and other data on communication attempts and personal investigations will be published in a book by John Otto, which is now in preparation.

Ben Hunter found that hectic morning suspenseful and interesting but inconclusive. Of the two or three tapes received by KFI, "We got quite excited about tape number two," Hunter later said. "It definitely did have some kind of code on it and it definitely did occur at what would have been 2:10 a.m." However, the radio M.C. concludes, several of the station's engineers felt that the signals originated from the LORAN station at San Rafael, California.

Obviously, even at this late date, a definite conclusion cannot be acknowledged superficially. The vague possibility that the LORAN transmissions did so dramatically interfere with the 50,000 watts of KFI could not account for many of the other reports directly called into the station. The author later heard, from a friend in Tacoma, Washington, that KFI was completely blocked out by interference in that area on the morning of October 28. Normally, since it is one of the most powerful stations on the West Coast, KFI is received "loud and clear" up and down the Pacific Coast. Apparently, only time will tell what actually occurred.

John Otto emphasizes that these and other "returns" are ostensible responses to "requested data and not freak interceptions (or interferences), such as the strange unintelligible signals acquired through radio astronomy."

And this brings us to the radio astronomer.

If one wants to see interesting shades of green, red and purple, it is suggested one just ask a radio astronomer if he has received any "interesting messages" from outer space of late. The reaction will be interesting, if not violent.

The science of radio astronomy began in Australia in June 1947; the same month and year, incidentally, that Kenneth Arnold saw the aerial objects which he described as "saucers," and thereby began current ter-

minology. John G. Bolton, then 25 years of age, picked up strange signals from an "object" which is now designated Cygnus A. It took him and his associates four years to realize what they had found.

This area of astronomy has grown rapidly from that meager beginning. Bolton is now working at Caltech, where he will establish the two largest radio telescopes in this country. (A 250-foot parabolic, or "dish," reflector will soon be completed at Cambridge, England.)

The objectives of this science are manifold, none of which include *attempted* interceptions of intelligently created messages or signals originating in space. These scientists hope to eventually determine the point of origin of various extra-terrestrial emanations, the composition of invisible gases and areas of the universe, and the climatic and temperature conditions on the neighboring planets.

But if there are signals from planetary neighbors radiated in our direction—intentionally or otherwise—it is quite conceivable that they could be received via the telescopes' antennas.

From the summer of 1954, to illustrate a possibility of the above conjecture, radio noise has been detected as emanating from the planet Jupiter. This declaration was contained in a report by Drs. B. F. Burke and K. L. Franklin, of the Carnegie Institute of Washington, to the 92nd meeting of the American Astronomical Society at Princeton, N.J., in April, 1955.

The radiation was detected at 13.5 meters (22 megacycles), and similar bursts have been received "at 10 meters using a simple antenna." But they are not detectable at or below 7.8 meters. During nine of the 30 transits of Jupiter over the Institute's radio telescope at Seneca, Md., in early 1955, "very intense, irregular bursts were observed."

No satisfactory explanation has been evolved for the phenomenon, according to the "American Astronomers Reports" in the June 1955 issue of *Sky and Telescope*. It added that climatic conditions on the planet's surface would have to be on an "enormously greater scale" than terrestrial electrical discharges to create the reported intensities.

Australian radio astronomers told the Jodrell Bank, England, Symposium on Radio Astronomy that the emanations coincided with the positions of certain "spots" on Jovian surface as relevant to the earth.

And Astronomer Bart J. Bok, in the November 1955 *Sky and Telescope* (p. 27), relates that the signals from the 12-mooned

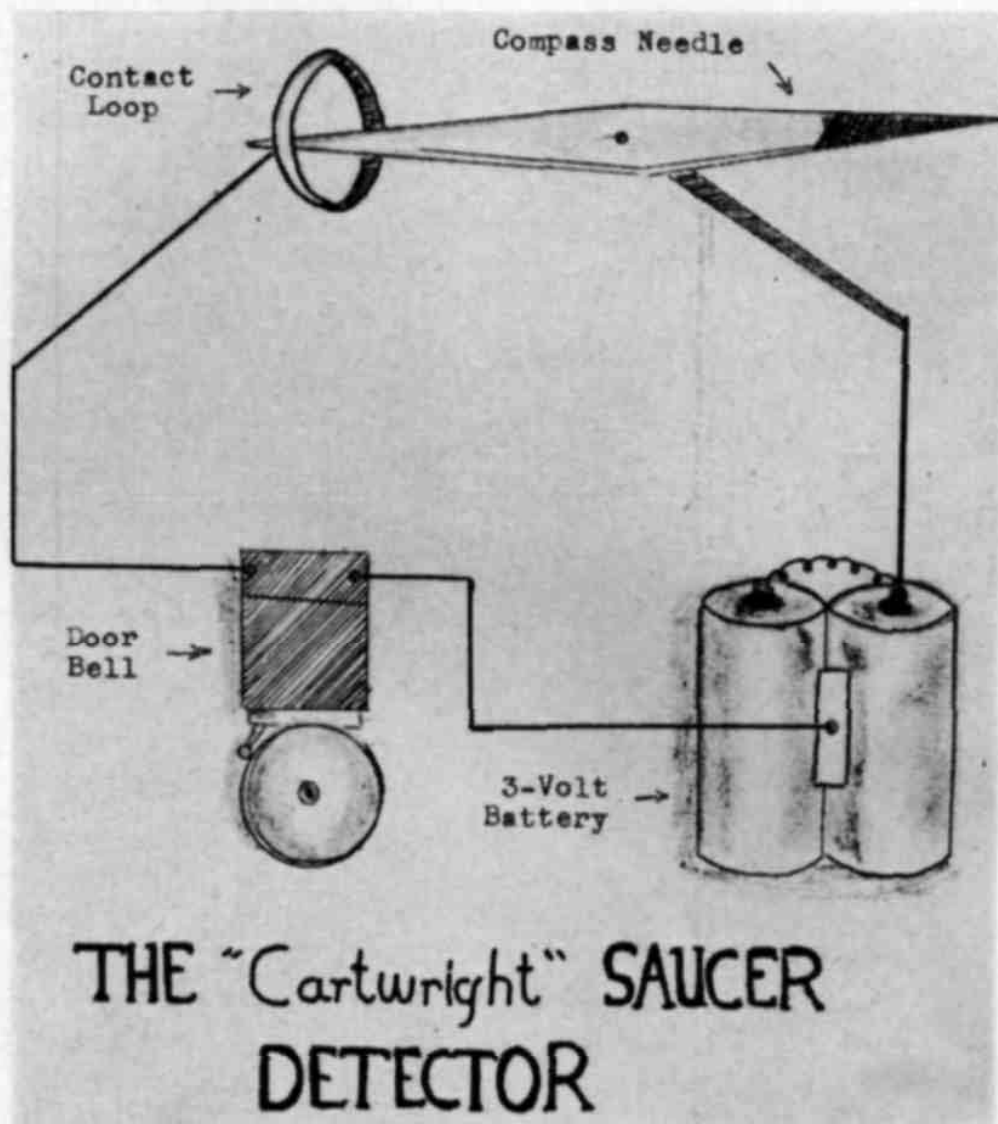

This illustration by Bud Pecaro shows the "Cartwright Saucer Detector" for research.

planet are no less than "a billion times" stronger than terrestrial thunderstorms radiations.

Then came Venus.

Reported the Associated Press August, 1956, (significant words have been italicized by the author):

"BERKELEY, Aug. 27—(AP)—The planet Venus has been broadcasting some astronomically interesting radio signals, says an Ohio State University scientist.

"The signals come in pulses often lasting one second or more and sometimes there is a long string of them, with more or less *uniform intervals between*, said Dr. John D. Kraus in a paper prepared for the American Astronomical Society. "Frequency of the signals ranges from 2,000,000 to 4,000,000 cycles per second. Those at

higher frequency arrive as much as two seconds ahead of those on the lower side of the band. This suggests, Dr. Kraus said, that the electrified atmosphere of Venus and the earth and the space between have an anomalous way of dispersing radio waves.

"The impulses appear to be modulated to an audio frequency of about 117 cycles per second, the scientist reported. This frequency, when heard through a speaker, sounds something like the key of B flat next to C below middle C on a piano.

"The distant planet also sends out another class of radio signals which might be the product of lightning storms, Dr. Kraus said. Sometimes they sizzle away for as long as 12 hours. They fluctuate greatly in intensity, with peaks occurring 20, 39,

63 and 90 minutes, 6 hours 25 minutes, and 11 days apart."

Science News Letter reported the former signals, designated as Class II, "sound as though they are coming from a radio telegraph station somewhere on earth . . ." Dr. Kraus indicated the same thing late last June, when Associated Press said "the new signals, of a distinctly different type, resemble radio telegraphy in many ways."

And Dr. John D. Kraus is considered to be one of the country's leading authorities on this phase of scientific research. As such, he is a conservative astronomer.

"Whatever phenomenon is responsible for the signals must be of a rather complex type," he was quoted by AP. And these signals, Dr. Kraus added, have "many of the characteristics of signals from a terrestrial transmitting station."

Thus a whole new science and a relatively new phenomena has sprung up within the past 10 years. With vast improvements in all areas of research, with more accredited authorities in kindred fields evaluating these phenomena, with newly devised means of detection set up and, finally, *with time*, the answers will ultimately be ours.

Attempts at UFO detection have come into their own within only recent years. One ingeniously simple device has been perfected by Keith Cartwright, a member of the Australian Flying Saucer Research Society. His first mechanism "was not sensitive enough to give the required results," and was therefore modified.

In a letter to the *Australasian Post*, Cartwright said "it has been noted that magnetic compasses seem to go hay-wire when UFO's are in the vicinity, so why not connect up an electrical circuit with the compass needle, so that when the needle is deflected from magnetic north it completes a circuit in which is included an electric bell?" (See diagram on page 48).

"Care should be taken," Cartwright adds, "to fasten the wire to the battery only after orienting the equipment so that the compass needle is nicely balanced inside the loop. This contact loop should be made of a material like silver which will minimize arcing. The contact loop hole should be about $\frac{3}{16}$ " in diameter. A further improvement to prevent arcing is to connect a .05 radio condenser between the needle pivot and the contact loop."

Some elaboration was contained in the *Australian Saucer Record*:

"The tip of the needle and the pivot on which the needle rests should be

cleaned with emery paper so that good electrical contact with the loop can be made. Silver wire is ideal for the contact loop, but if this is not available a loop of tinned copper or clean bare copper may be used. The Mark 2 detector is so sensitive that the bell may be set ringing by iron or steel objects being moved in the vicinity. Therefore it should be set up in a quiet corner, away from electrical equipment, steel furniture, etc.

"Another member, Mr. A. J. Millikan, of Robertstown," continues the *Record*, "has made himself a Mark 2 detector. Here is his own report of an experience with it:

"On the night of Dec. 27th, 1955, at about 10:15 p.m. the bell rang. I thought I had jolted the needle and didn't take much notice for a few moments. Then I thought "It won't hurt to have a look," so I went outside and was looking up when a very bright blue-white object shot across the sky. It seemed to be very low, and headed for the Earth in a slight curve like a meteor, yet it seemed to flutter, like so' (Mr. Millikan drew a zig-zag line). 'It was more or less like a medium-sized skyrocket, with a glowing tail. It traveled at a speed comparable with a toy rocket. Just before it burned out it turned a decided greenish colour. There was no sound, and it was visible for perhaps 2-3 seconds. The sky was clear except for an odd cloud or two.'

"Coincidence?" asks the *Australian Saucer Record*. "Perhaps so. But we must stretch the coincidence a little further. Fifteen minutes later, some people in Adelaide saw a cigar-shaped object 'giving off a reddish glow,' which cannot be accounted for. A few more such cases would forge a valuable link in the chain of evidence."

The *Adelaide Advertiser* reported the aforementioned sighting on December 28, 1955. This account was paraphrased by the *Record*, as follows:

"A cigar-shaped object giving off a reddish glow was seen in the Northern sky over Adelaide last night. Mr. L. E. Grant of Percy Street, Cheltenham, said he and a friend had seen the object about 10:30 p.m. and watched it for several minutes. A smaller similarly shaped object had detached itself from the main body while they were watching, he added. The object was also reported by a man who had



World's first space clock developed by the Hamilton Watch Company records hour, date, month and year on Earth and planet Mars, is symbolic of man's destinies in outer space.

seen it from Port Road, Kilkenny."

From the simple unit of the now-called Cartwright Saucer Detector, we find the opposite extreme—*Project Magnet*.

In late 1953, the Canadian Project Magnet UFO sighting station was established at Shirley's Bay, near Ottawa. This station—"manned twenty-four hours a day," according to Harold Greer in the *Toronto Daily Star*—contains "the various types of radar, an ionosphere recorder, a magnetometer to measure electrical charge, a recording gravimeter to measure gravity and a radio set

running full volume at 530 kilocycles to pick up any radio noise."

In late August 1954, operators at the sighting station believed they had detected their first UFO. On August 31, the Assistant Minister of Transport announced that the Project Magnet station had been officially terminated.

The most frustrating part of the Project Magnet story is that no official public reports, conclusions or sightings were ever released by the Project itself or the Canadian government. This policy would seem to

largely parallel the American investigation of these phenomena.

Early in 1956, the author had occasion to be in brief correspondence with Wilbert B. Smith, the Director of Project Magnet for the Canadian Department of Transport. At my request, Mr. Smith granted the following undated statement.

PROJECT MAGNET THE CANADIAN FLYING SAUCER STUDY

Project Magnet was authorized in December, 1950, following a request made to the Canadian Department of Transport by W. B. Smith, for permission to make use of the Department's laboratory and field facilities in a study of unidentified flying objects and physical principles which might appear to be involved.

The program consisted of two parts. The first part was the collecting of as much high quality data as possible, analyzing it, and where possible drawing conclusions from it. The second part consisted of a systematic questioning of all our basic concepts in the hopes of turning up a discrepancy which might prove to be the key to a new technology.

Unfortunately, the program was plagued by well-meaning but misguided journalists who were looking for spectacular copy, or copy which could be turned to political account, to such an extent that both those who were working on the project and the Department of Transport found themselves in an embarrassed position. Consequently, when the Project Magnet Report was made and permission sought to extend the scope, the decision was finally made in 1954 that this would not be advisable in the face of the publicity from which the whole project had suffered.

Project Magnet was officially dropped by the Department of Transport in October 1954, although the Department indicated its willingness to permit the continued use of laboratory facilities, provided this could be done at no cost to the public treasury. The project has been continuing under these conditions, and to this extent may be said to have gone underground. The Government of Canada are not participants in the Project and not in any way responsible for its conclusions.

The conclusions reached by Project Magnet and contained in the official report were based on a rigid statistical analysis of sighting reports and were as follows: There is a 91% probability that at least some of the sightings are of real objects of unknown origin. There is about 60% probability that these objects are alien vehicles. (Alien meaning not of earthly fabrication.)

The Conclusions based on studies of the basic physical concepts were as follows: Many of our fundamental concepts are inherently ambiguous and quite a different philosophy can be built up on the alternatives. Several of these alternatives lead to much simpler arithmetic and presentations which do not have to resort to patchwork corrections to make them all embracing. Furthermore, some of our ideas with respect to fields and their behaviour are wrong.

Recent Project Magnet activities have dealt with following up any and all leads. Many of these leads were dead ends, but a few were quite significant and well worth the overall effort. At the present time a definite pattern is emerging, and the groundwork is being laid for a new technology which may literally lead us to the stars.

W. B. Smith

We have seen that a small, inexpensive device called the Cartwright Saucer Detector has been devised to detect UFO's. And we have seen that such an extensive program as Project Magnet has been created for the like purpose. Finally, we find that there have been continual endeavors to forget the restrictions of earthly thought; we have seen that men have and shall continue to attempt to project above our constricting theory that there is only one world—the globe we live on.

The unfettered minds and individuals with encompassing foresight shall not be shackled to conform their being to a humdrum consciousness.

True, we may not be ready for the coming challenge—let alone the infinite. But this realization will not keep us from trying and striving to probe the secrets of Space.

"... the pioneer never has waited, and never will," wrote Leonard G. Cramp in *Space, Gravity and the Flying Saucer*, "upon others when he has become inspired by a new idea."

Our destiny is before us:

Need we more than ever to look up! ■



chapter 5

Mars-- the Mystery Planet

ON SEPTEMBER 6, 1956 the Planet Mars made its closest approach to Earth since 1924. Not until August 1971 will it again be in such close proximity.

From the inception of the science of Astronomy, this feature-ridden disc has, through the telescope, offered no satisfaction to the inquiring mind. It is probably regarded as the most unsolved riddle in the annals of historical astronomy.

Mars, like the other eight planets comprising our solar system, orbits around the sun in an eccentric or elliptical manner. And unlike Venus, the closest of earth's planetary neighbors, Mars is the first planet describing an orbit outside of the earth's. The 4200 mile diameter planet is roughly 35 million miles distant during its favorable opposition.

Although Earth-Mars oppositions occur



Mars photographed in blue light, left, and red light, at right. Blue light shows the Mars atmosphere; red light its solid mass.

about every two years and two months apart, only once in 15 to 17 years does an especially favorable, or "peak," approach come about. This is simply because of the planet's orbital eccentricity—sometimes bringing it closer to earth, at other times seemingly pushing it away.

While Mars was a "mere" (astronomically speaking) 35,120,000 miles away early in September, 1956, it will be ten million miles farther distant from earth during the next opposition in November 1958. This outward movement will continue until 1963, when the planet will be at a distance of 62.3 million miles. Then it will begin its inward motion again, until the inception of a new cycle.

But let's not get ahead of ourselves. Let's go back to when astronomers first intensively studied the gleaming orange-colored disc of the planet Mars—and wondered . . .

Let's start with the Mars that has enticed the imaginations of young and old alike.

Perhaps it all began when Giovanni V. Schiaparelli focussed his 8.75-inch reflecting

telescope on the planet one night during the opposition of 1877. Suddenly the renowned astronomer glimpsed several long and narrow lines.

These lines he called *canali*. In his native language, Signor Schiaparelli's *canali* meant "channels." But in the translation, much to the everlasting horror of astronomers, this word was defined as "canals," or artificial waterways. By the time of his death in 1910, Schiaparelli had recorded a total of 113 *canali*.

Although the astronomical profession exhibited a dim view of the canal-phenomenon being created by intelligent direction, Schiaparelli is reported to have said he was careful not to "combat this supposition" that the canals were the "work of intelligent beings." But that was only the beginning.

Unquestionably the foremost observer of the continually changing surface of Mars was Percival Lowell. In 1894, Professor Lowell built the quite adequate Lowell Observatory at Flagstaff, Arizona—a region un-



In 1877 Italian astronomer G. V. Schiaparelli detected several straight and narrow lines on the surface of Mars. These he called "canali," which fostered great interest in the so-called Martian "canals." YERKES OBSERVATORY PHOTO

surpassed for the quality of the never-too-important "seeing" conditions, astronomy's prime requisite. This observatory today is still equipped with its excellent 24-inch Alvan Clark refracting telescope.

The professor's findings were dramatic to say the least. He charted a total of nearly 700 canals on the face of Mars, some as much as 3000 miles in length. They intersected, he said. Where they intersected, the astronomer believed, were the "cities"—called oases—where the inhabitants gathered together to be near that ever-precious, and apparently dwindling, water supply.

Lowell believed that Mars was a dying planet. The "Martians," he theorized, were forced to construct these canals to retard the water-vaporation process, and consequently to preserve their civilization.

Perhaps it was just wishful thinking, but 700 "charted canals" cannot easily be discarded. From 1894 to 1915 Prof. Lowell and his staff carefully studied the planet.

"Mars is inhabited," Lowell finally concluded. "We have absolute proof."

The famed French astronomer Eugene M. Antoniadi—using the 33-inch Meudon telescope where, perhaps significantly, "seeing" is not so favorable—claimed Lowell was mistaken, and had misinterpreted a series of "dots and dashes" for continuous lines.

Another observer, American John E. Mellish at the Yerkes 40-inch refractor, said that the Martian canals were nothing more than water-filled cracks and the oases merely volcanic crater-pits on the planet's surface. All three theories, to some degree, are accepted today.

During the opposition of 1877, Asaph Hall, of the Washington Naval Observatory, announced the discovery of two Martian satellites, or "moons."

The inner moon—named Phobos—is possibly five to ten miles in diameter and transits the Martian sky about three times per 24-hour period. Deimos—the outer moon—is slightly larger and circles the planet once every six days.

At the time these "moonlets" were first observed, such things as "artificial satellites" and "space stations" were not even dreamed of. However, the possibility that these satellites are some type of "way station to space" cannot be denied. Their minute size and proximity to the planet, as is evidenced by their rapid velocities, give them an appearance quite similar to the artificial satelloids our scientists hope to establish during the International Geophysical Year of 1957-58.

The noted British scholar, Gerald Heard, in his *Is Another World Watching?* (Harper and Brothers, New York, 1951) suggested:

"For the flash they [the satellites] give—by which their size is gauged—could come more brightly from a far smaller body, if that body were for instance a gleaming globe or disk."

Other puzzling phenomena of our close planetary neighbor include the many reported observations of mysterious clouds (or "cloud-like" formations), and lights or flares.

Astronomers at Lowell Observatory viewed, for 70 minutes upon the night of December 7th, 1900, a long series of blinking lights on Mars.

Professor Lowell believed they could have been signals, while the eminent Professor W. B. Pickering described them as "absolutely inexplicable."

A "dust-cloud-like" object was observed near the terminator of Mars by Lowell on May 20th, 1903. It remained visible for several days. Several changes in the surface

features of Mars were noted in mid-1909.

French observers Antoniadi and Jerry-Desloges found that the wedge-shaped *Syrtis Major* had a pointed tip in that year. And the *Phison Canal* appeared "doubled" on the 14th and 16th of September, but was its usual single feature on the 15th.

A new complicated canal system radiated from the unusually elongated *Lake of the Sun*. A month earlier, August 23 to 27, a "vast yellow cloud" covered much of the region near *Trivium Charontis*.

December 1911, another "yellow cloud" appeared, this time south-southeast of *Syrtis Major*. It "changed in shape and size" from November 3 to December 23. Martian clouds are generally white and dissipate rapidly.

If there are Martians, they must have felt conspicuous in August of 1924. For that was the year when Mars swung around in its orbit to a distance of only 34.5 million miles—nearly one million miles closer than the 1956 approach.

From the 10th to the 12th of October, 1924, clouds appeared to project from the Martian surface and covered the large region known as *Hellas*. The dark areas of Mars appeared unusually dark. And the northern polar cap began to break up.

An extremely heavy cloud layer spread over Mars in 1926. Few *canali* were reported during this opposition.

June 4, 1937, Japanese astronomer, Sizuo Mayeda, observed an "intense flare spot" near *Sithonius Lacus* on Mars. At 500 magnifications through his 8-inch reflecting telescope, observer Mayeda viewed this phenomenon for a full five minutes. He declared it to be far brighter than the white clouds or polar caps.

At a meeting of the American Philosophical Society in April, 1938, Dr. V. M. Slipher, then Director of the Lowell Observatory, told the gathering that he had found "evidence of changes in the canal system of Mars, as if their pattern had been altered by design."

Little was heard of Mars for the next few years, as it slipped away from us. The planet gradually extended outward in its eccentric orbit during the war years.

For several years Tsuneo Saheki, of the Japanese Osaka Planetarium, was destined to observe one of Mars' oddest phenomena: the "flare" anomaly. The noted Saheki has specialized in studying the Red Planet since 1933. Saheki's initial sighting was on the night of December 9, 1949, when he observed a luminous yellow cloud, 700 miles



Asaph Hall is the man who discovered Mars' two miniature moons in 1877. These satellites bear a strange resemblance to the artificial satelloids being proposed for use today. PHOTOGRAPH COURTESY OF YERKES OBSERVATORY

in diameter and 40 miles above the planet's surface. It was followed by a "brilliant glow" lasting several minutes.

His next observation came on December 8, 1951. This time he saw "a sharp, glaring spot suddenly appear on *Tithonius Lacus*." Saheki described it as being as bright as a 6th magnitude star (about the faintest dot the human eye can pick out on an exceptionally clear night), and "decidedly brighter" than the northern polar cap. Although gradually changing into the appearance of a large cloud, the "flare" scintillated for about five minutes.

The third and final "flare" was viewed in July, 1954, when the Mars observer saw *Edom Promontorium* suddenly brighten for about five seconds. Although another astronomer, Ichiro Tosaka, missed the "flare," he did record the apparent extra brightness of the region. To this date there has been no satisfactory explanation for the mysterious "flares."

Saheki has suggested the phenomena may be of volcanic origin. But Dr. Dean B.

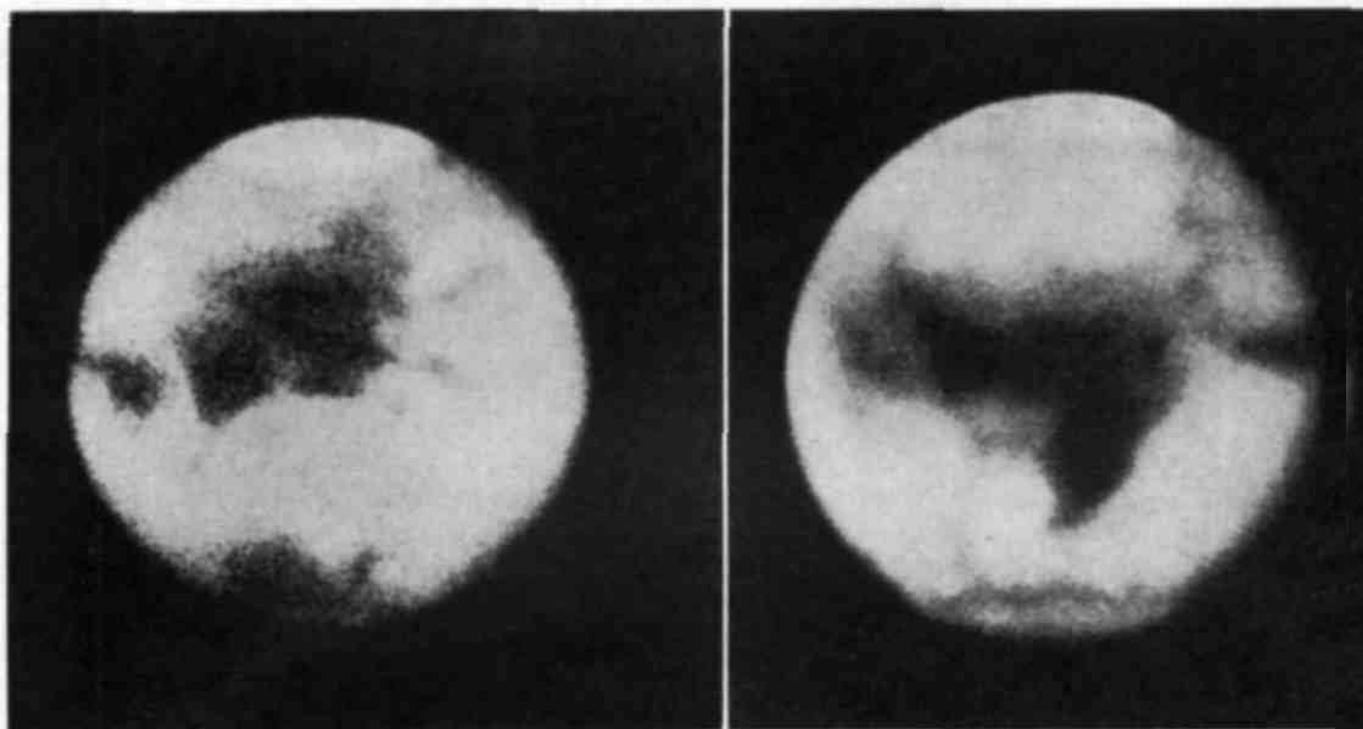

These photos of Mars were taken in South Africa in 1939 by Dr. E. C. Slipher. Pictures show intricate surface detail as well as Martian white polar caps. YERKES OBSERVATORY PHOTO

McLaughlin, of the University of Michigan, attempted to discredit this theory by noting that if the great Mount Vesuvius eruption of 1779 had occurred on Mars, it would have only had a brightness in the 16th or 17th magnitude range—when observed from Earth—almost inconspicuous to the largest telescope. Dr. McLaughlin suggests exploring the possibility that these “flares” may be only sunlight reflected from ice-crystals in the planet’s upper atmosphere.

A far more daring explanation involves the theory of the phenomena being created by the detonations of atomic or hydrogen devices.

The late John J. O’Neill, former amateur astronomer and science editor of the *New York Herald Tribune*, analyzed Saheki’s earlier report. *Had* the phenomenon been of artificial nuclear reaction, he reasoned, we are faced with two possibilities. The first is that it was the detonation of an atomic war-head on an experimental guided missile directed from the earth. (This is, at present, considered highly unlikely. According to latest indications, the Intercontinental Ballistics Missile has yet to be developed.) And, secondly, the possibility that intelligent beings on Mars discharged the device (or devices).

The science editor concluded that the phenomenon “remains a mystery.”

In 1953 the International Mars Committee was organized to develop a program for the forthcoming 1954 and 1956 oppositions. It consisted of an informal group of astronomers, meteorologists, astro-physicists, and other experts.

The Lowell Observatory at Flagstaff was designated as the co-ordinating center for the project. The observatories of Bosscha (Java), Kodaikanal (India), Helwan (Egypt), Lamont-Hussey (South Africa), Pic du Midi (France), and Eva Peron (Argentina) were officially active in the program.

An additional 10 observatories—five in the United States, two in Japan, and one each in South Africa, New Zealand and Australia—cooperated unofficially. The American stations included Mount Wilson and Palomar.

A Lowell Observatory expedition to the University of Michigan’s Lamont-Hussey Observatory at Bloemfontein, South Africa, was sponsored by The National Geographic Society in 1954. It was headed by Dr. E. C. Slipher, brother of the previously mentioned V. M. Slipher.

Their objective was to obtain as much information as possible on both the atmosphere and surface features. To do this, the “Mars Patrol”—as the group was officially known—distributed special lenses, filters and film plates to its members. The filters con-

sisted of the colors light-blue, yellow, and red. The blue filters enabled photographs to be taken of only the planet's atmospheric belts, while the yellow and red filters penetrated the atmosphere to show surface detail.

It is difficult to estimate to what extent the cooperating observatories were successful in their programs. The findings of many of the foreign projects are still unknown.

However, it is known that Dr. E. C. Slipher did take some 20,000 photographs of the mysterious planet—many in full color—through the 27-inch Lamont-Hussey refractor at South Africa. Of these 20,000 photos, 50 percent are of a very high quality, and about 70 percent were described as "extremely useful."

On the other side of the world, the Mount Wilson Observatory, near Pasadena, Calif., focused both its 60 and 100-inch reflectors at the mystery planet. Astronomers Robert S. Richardson and Edison Pettit logged about two hours observing time on each of 20 different "good" nights. (*Good*, of course, referring to the so-called "good" seeing conditions.)

Using a Mitchell motion picture camera, the pair took a total of 4700 yellow-filter and 3200 blue-filter pictures utilizing both large telescopes. A one-third-inch image of Mars was recorded on the motion picture film. However, probably because of the proximity of the planet to the horizon, only 40 percent of the pictures were rated as "above fair" to "good."

The Drs. Richardson and Pettit may have been the first to record a new and rather odd type of Martian phenomenon. Appearing only in the blue filter pictures—as it was strictly an atmospheric phenomenon—a peculiar "W-shaped cloud" covered an area on the edge of Mars of nearly 1100 miles.

But the mysterious object was in still another way unusual. First photographed at Mount Wilson on June 2nd of 1954, it was later photographed (the same W-shape) by Dr. Slipher at Bloemfontein from June 20 to July 4, an unheard of length of time for a cloud to stay in existence. Dr. Slipher voiced the belief that the cloud may have "reformed" every afternoon and dissipated each evening.

The Mount Wilson astronomers discovered that bright spots, or "knobs" were centered at the three intersections of the W. They were found to generally correspond to the oases of *Hebes Lacus*, *Titbonius Lacus*, *Asraeus Lacus* and *Arsia Silva*. Stems of the W-shape seemed to connect to the canals of *Ulysses* and *Fortunae*.

Undoubtedly the most dramatic change of any Martian surface feature was in the canal of *Tboth*, or *Tboth-Nepenthes*. Here, in the relatively short period of one Martian year (687 days), this canal-like feature changed into an area twice the size of our isle of Madagascar, rivaling almost any outstanding feature on Earth.

Good "seeing" conditions prevailed at Bloemfontein, South Africa, where the National Geographic-Lowell Observatory expedition had been sent. An unusual number of the canals stood out to the eyes of observers. Dr. Slipher, regarded as one of the world's foremost authorities on Mars, reported that one canal ran for 1500 miles without a bend. Occasionally one canal would run directly through another—"something no sensible river would do."

Early in 1956, the author called Dr. Slipher at the Lowell Observatory. (As the year's opposition was not due until the coming September, the astronomer was scheduled to remain at Lowell until late spring or early summer.)

"Do you believe the expanded scope of the 1956 'Mars Program' will prove, with some degree of finality, if Mars is inhabited?" the author asked.

"Not directly," Dr. Slipher replied.

The reason for this, he told me, was that the primary function of the International Mars Committee is to obtain the best possible measurements of the planet's atmospheric composition, temperature readings and variations, details of surface features and a myriad of other objectives too numerous to mention. When all of the final data is in and correlation and analyses have taken place, then we may have "the answer."

Mentioning the *canali* enigma, Dr. Slipher told me that many astronomers hold the view that the canals are definitely not of intelligent construction. "But," he added, "it is equally difficult to explain them as natural features."

The author injected a rather touchy question by asking the astronomer to estimate the percentage probability of the canals being intelligently constructed.

"Under fifty percent," was the reply.

In attempting to pin him down to a more specific answer, I suggested a 25 percent probability. Dr. Slipher responded in the affirmative.

Contacting Dr. Robert S. Richardson, at the Mount Wilson Observatory office in Pasadena, I put the same question to him.

He took the conservative viewpoint, by saying there was no "proof" that the Martian

canals were anything but a natural phenomena. He did say, however, that he had seen three canals—describing them as “streaks”—during one of his observations in July, 1954.

In his book, *Exploring Mars* (McGraw-Hill Book Co., Inc., New York, 1954), Dr. Richardson commented upon the intriguing W-shaped cloud.

Mars, he pointed out, is named after—unfortunately!—the god of war. And the letter W “immediately suggests the word *War*...” But that wasn't all.

The astronomical telescope, as most of us know, *inverts* the image. Therefore the object would actually, if viewed correctly, be the letter M—for *Mars*?

“We shudder,” added Astronomer Richardson, “when we think of the impact this information will have on that part of the population of the United States who write letters to astronomers!”

Still writing on the Martian cloud, the author commented regarding the W-shape:

“White clouds have been photographed on Mars many times before, but so far as I can discover they have been of irregular form and have lasted for only a few days. What conditions on Mars could have produced line-like markings a thousand miles in length that remain fixed in position for a month or more?”

Elsewhere in his fine book, Dr. Robert S. Richardson deplors the *lack* of acceptable photographs of the canal-phenomenon. But he added that since such relatively long durations are required to photograph the planet, usually from one to five seconds, these intricate lines would expectedly be blurred on photographic plates. The eye, of course, can catch such fleeting objects in a fraction of a second.

But while rummaging through some lantern slides at Mount Wilson after writing the foregoing and yet prior to its publication, Dr. Richardson said in addendum, he found a faded envelope containing four lantern slides from Dr. E. C. Slipher at Lowell. The photographs were taken in 1909 and 1916. Several of the 1916 photographs showed definite “streaks.”

An opinion had apparently changed.

“One doesn't have to imagine these streaks,” wrote Dr. Richardson. “They are in plain sight for all to see.”

What about 1956?

It takes years to thoroughly examine and collate astronomical data. For this reason

only an extremely minute percentage of information is available at the writing, and this is probably incomplete. Undoubtedly the most promising new developments for 1956 are the three newly unveiled devices to simultaneously view and photograph the planetary phenomena.

These devices employ a TV-like system, of great light-gathering ability and resolution. The light from an astronomical body is focused upon an image-orthicon tube and then is photo-amplified and projected on a kinescope screen.

The greatest advantage of such a system is its tremendous light amplification. It can, for example, “make” a 200-inch telescope out of the Yerkes' 40-inch refractor.

For something like Mars, it will mean that photographic exposure time can be cut to about $\frac{1}{25}$ th to $\frac{1}{50}$ th of a second, a fraction of the time now used for direct-plate photography. And that is only the beginning. It is difficult to estimate at this time how far the system may be perfected even in the near future.

This “Lumicon” and kindred devices, many astronomers feel, are the only hope of resolving the *canali*-mystery without first going to Mars. The extremely brief exposure durations may easily “catch” the brief periods of super-seeing, when the intricate lines of Mars' surface stagger some astronomical imaginations.

These TV-like systems were used during the peak 1956 opposition, and are in use at this writing. If these devices are as satisfactory as now believed, much new knowledge of the mystery planet may be revealed at any moment.

In 1956, as in 1954, Dr. E. C. Slipher again headed the Lowell Observatory-National Geographic expedition to the South African observatory. It is unlikely that there will be an announcement of any findings prior to this book's publication.

Thousands of amateur astronomers and amateur astronomer groups throughout the world spent endless hours observing the Red Planet. Unlike other hobbyists, most amateurs are recognized as accurate and valuable observers, and have contributed much over the years to the study of our planetary neighbors. Their instruments are not usually large, ranging from 6- to 12-inches in diameter, but of unexcelled quality for their size of aperture. The larger telescopes of the professional observatories magnify the atmospheric turbulence and “poor seeing” as

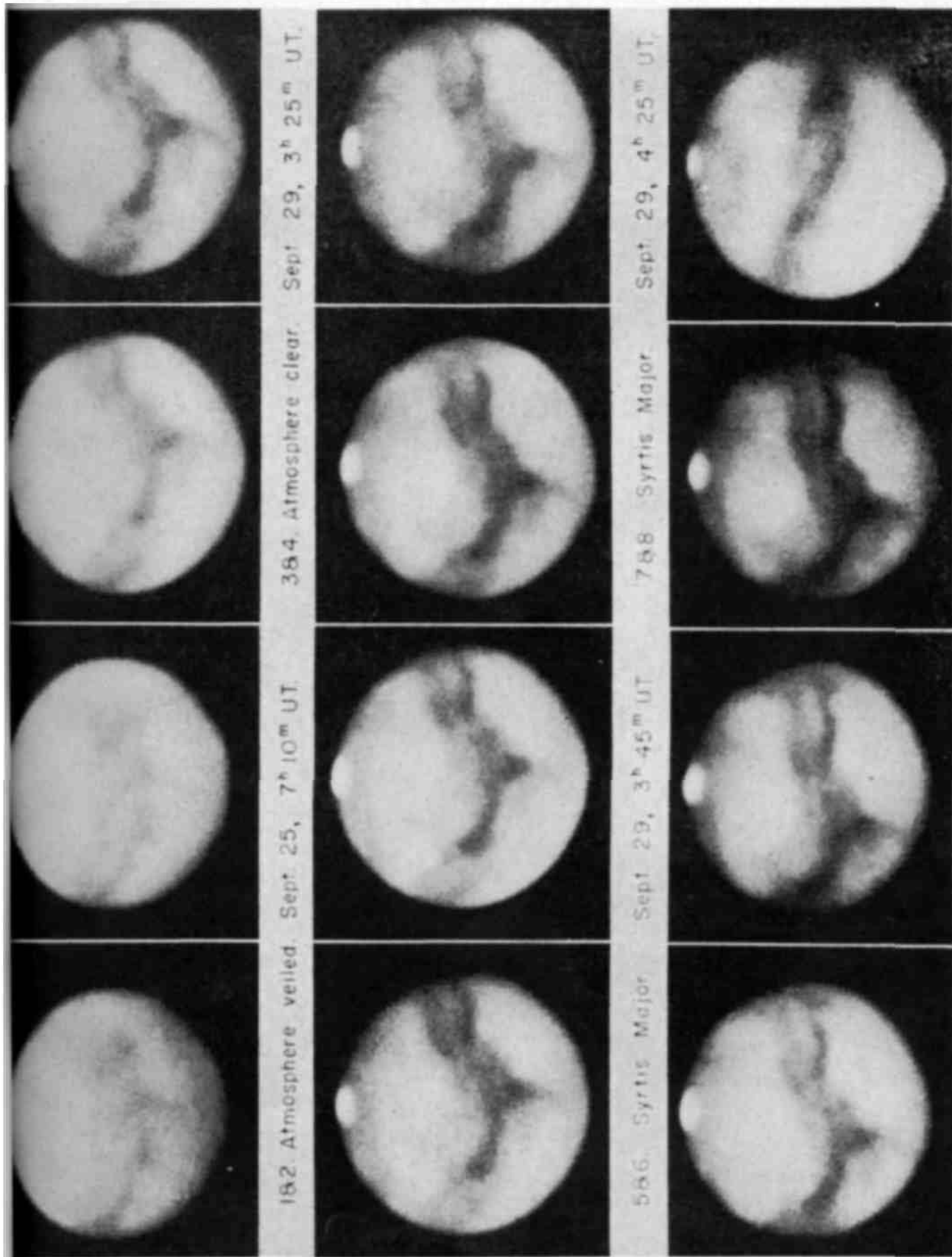

A series of photos of the planet Mars taken by Astronomer Gerard Kuiper. Many times photographs are obscure due to "dust storms" which disturb the planet. YERKES OBSERVATORY PHOTO

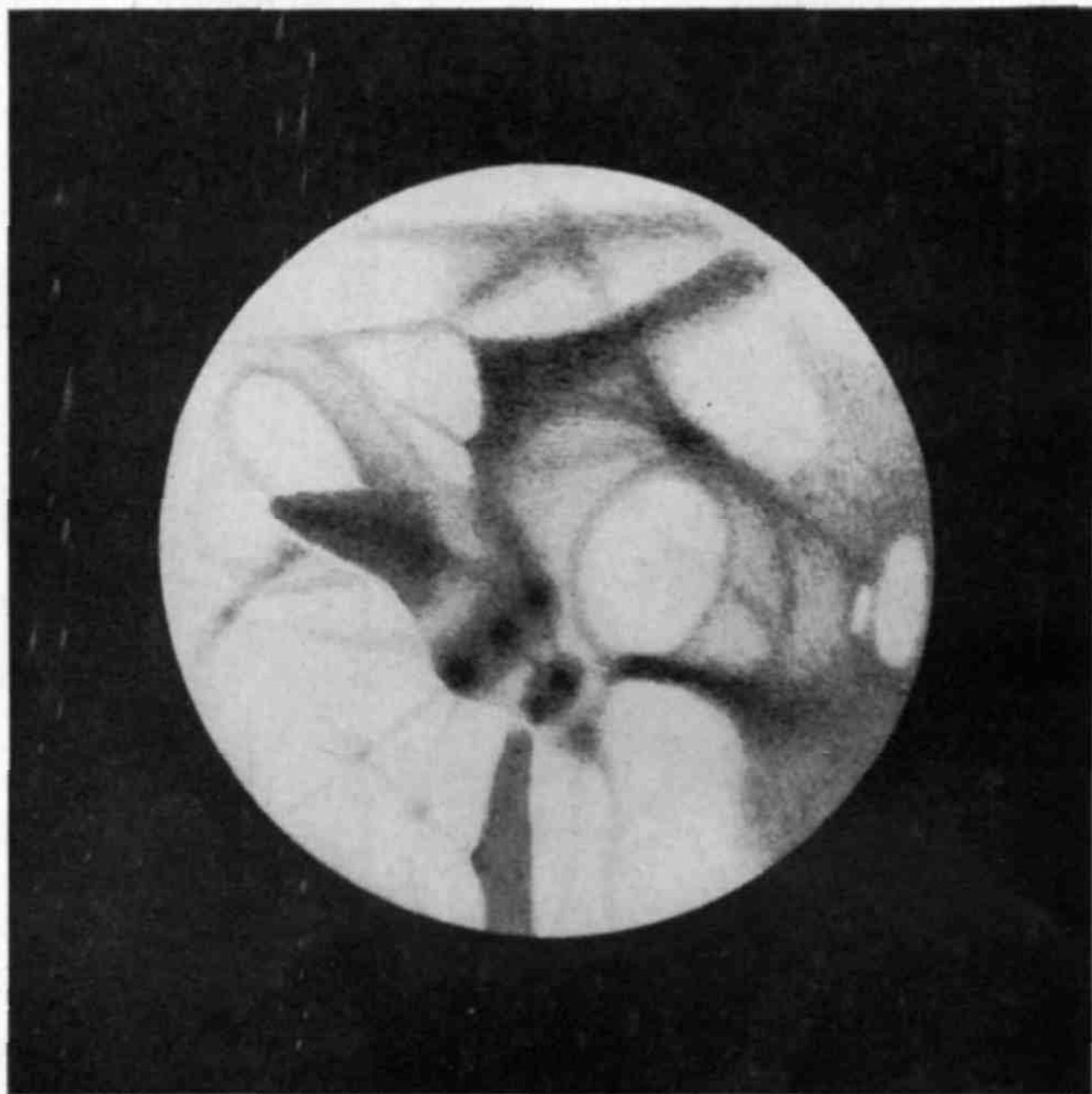

Drawing of Mars in 1924 by Astronomer R. J. Trumpler clearly shows the network of "canals."

well as the Martian disc itself, so their usefulness is extremely limited. For this reason, the 200-inch Hale telescope atop Mount Palomar is virtually never turned towards the enigmatic planet.

One group comprising professional and amateur astronomers alike is known as the Association of Lunar and Planetary Observers. Their bi-monthly journal, *The Strolling Astronomer*, publishes the reports and observations as they are communicated to the association.

So far, these are the findings for 1956 concerning Mars:

From mid-August, a gigantic yellow dust cloud spread over nearly half the planet's visible surface, obscuring much intricate detail. It has been described as the most violent dust-storm in astronomical annals of obser-

vations of Mars. Dr. Sadao Murayama, of the Tokyo National Science Museum, first observed the cloud when 1400 miles long and 300 miles wide, on August 16.

A one-second "flash of white light" was spotted on the eastern edge of the Martian disc (near Ausonia) on August 25 by amateur astronomer R. R. Richardson, Jr. After the flash, the astronomer said, a white spot extended "beyond the limb," and remained visible for a total of 30 minutes.

On August 30, University of Chicago astronomer, Dr. Gerard P. Kuiper, reported that a "dust cloud," invisible the night before, took a form 1000 miles in length and 30 miles wide. He observed this "unusual phenomenon" from the McDonald Observatory of the University of Texas.

The following day, he said, the cloud

elongated to a length of 3000 miles and had a width of 250 miles in the strange shape of the letter "W."

From Auckland, New Zealand, amateur astronomer R. A. McIntosh reported the Martian ice cap melted three months earlier than usual in 1956. He said this would "create some excitement."

In Japan, Dr. Michikazu Onishi sighted several of the elusive "canals" in the planet's northern hemisphere, at Kobe. He also observed several "white clouds" near the polar regions.

Tsuneo Saheki of the Osaka Observatory described a comet-like object near Mars.

of accidental or intelligent creation: spider-webs, mud-crack fissures, communications patterns, and the ilk.

Mud crack fissures intersected in threes, spider web strands in fours. But, Webb said, only man-made arteries, such as railroad patterns, gathered in higher numbers like the canals. All of which brings this rather meager information as much up to date as possible.

When all the data is in; when the new observations are correlated and placed in their proper perspective; then the information unveiled by recent scientific approaches to resolving the Martian mysteries are ex-

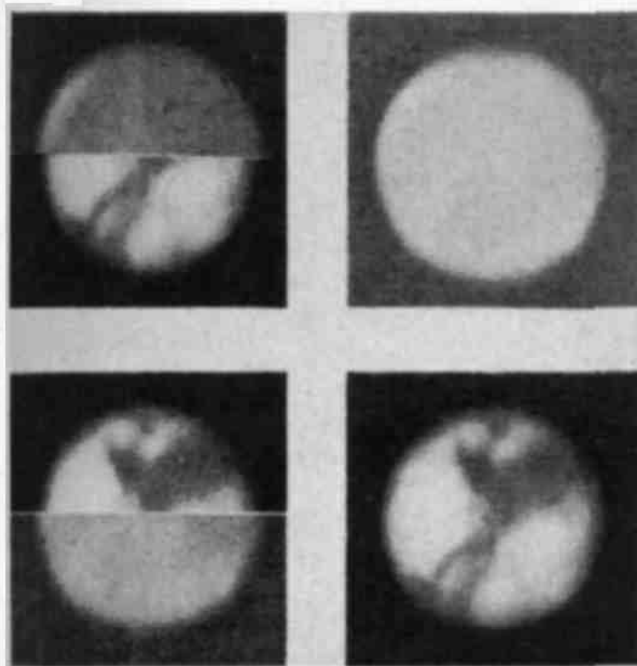

1926 photos of Mars taken in ultra-violet and infra-red light. The halved images show apparent density of Martian atmosphere.



Several astronomers have reported seeing strange lights at certain times on Mars. As yet, no one knows what causes the lights.

Other astronomers voiced doubt that the phenomenon may have been a comet.

Drs. Robert S. Richardson and Robert Leighton took several thousand color photographs of Mars through the Mount Wilson Observatory's 60- and 100-inch telescopes. One project was the hope of discovering if Mars had a third satellite. No data has so far been revealed.

At the Western Amateur Astronomers convention Aug. 30, 1956, at Flagstaff, Arizona, the site of the Lowell Observatory, Research Chemist Wells A. Webb told the gathering that he believed the Martian canals were created by life on the planet.

He related how he compared the reported canal-pattern of Mars to known phenomena

amined, re-examined, and placed in the light of the latest knowledge on the subject—then the world may learn for the first time if Mars is inhabited by intelligent life. But more likely we shall have to await newer knowledge and further discoveries in this fascinating field.

Soon we may learn if the canals are only optical illusions, misinterpretations of natural surface markings and fissures, lichen, or cobwebs before tired eyes . . .

Soon we may learn if Percival Lowell, the pioneer, was right when he told the world: "Mars is inhabited. We have absolute proof."

Or we may have to wait until we get there. ■

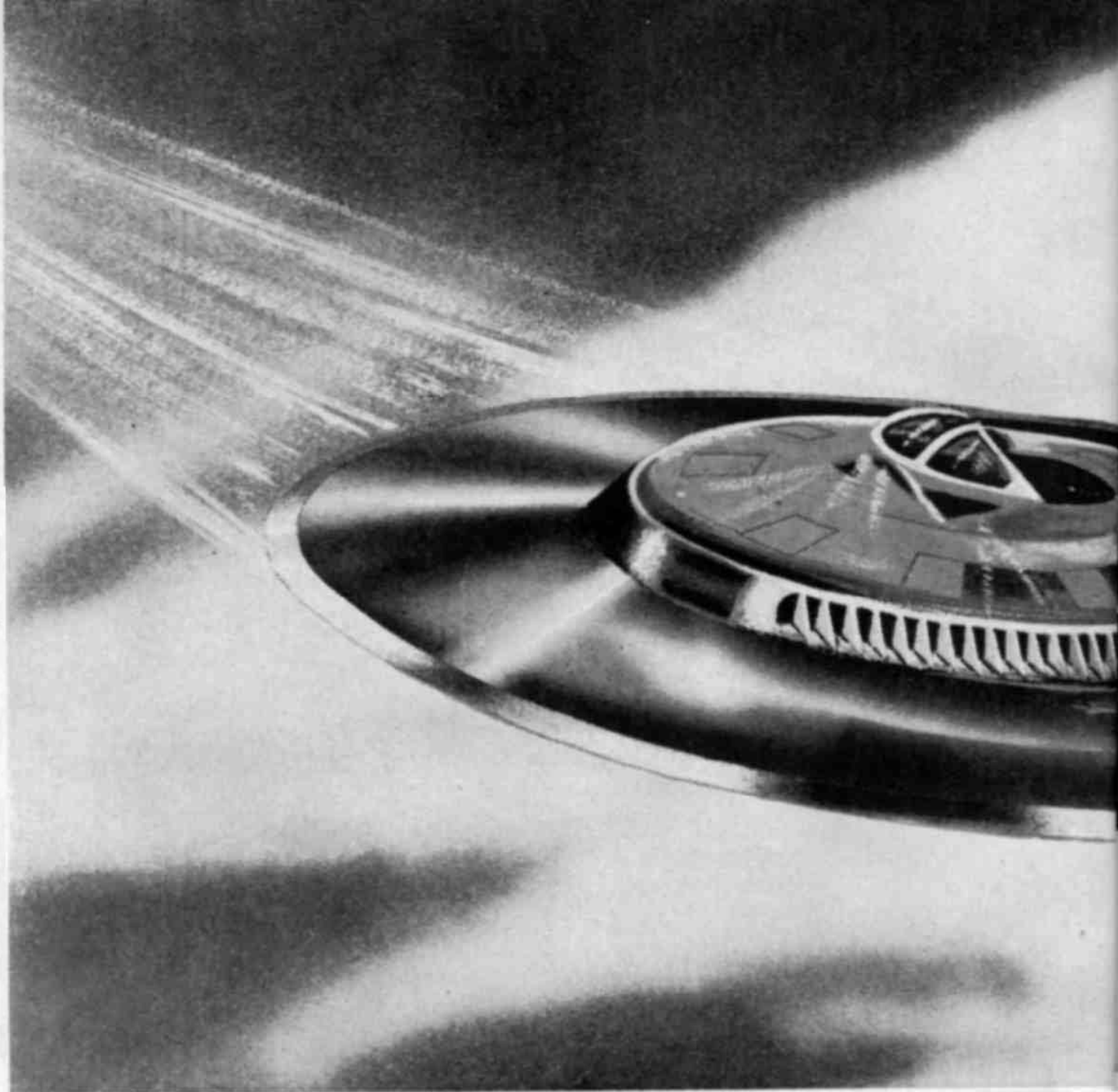

chapter 6

The Worldwide Enigma

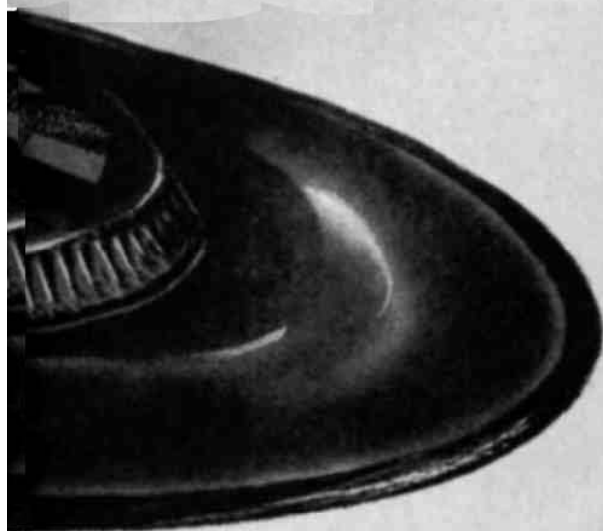

Artist's conception of a disc-shaped airfoil the Air Force is reputed to have on the drawing board. If practical, this "flying saucer" may soon be seen traversing our skies.

U.S. AIR FORCE PHOTO

THE FLYING saucer investigation agency of the United States Air Force—Project Blue Book—states that it has received less than ten thousand UFO reports since the inception of the first such investigative unit—Project Sign—back in 1947. These reports, however, are from *qualified* observers and of *unconventional* objects. Or, in the words of Major General John A. Samford, Director of Intelligence for the Air Force: "Credible observers have sighted relatively incredible objects."

But just how accurate is the "less than ten thousand" figure? Not very, by any means. The hundreds of thousands of newspaper reports, for example, are not included in this list. And unless UFO's happen to be reasonably "hot" at the time, most news media will play down the reports. A leading news service—the Associated Press—has repeatedly declared that it will not dispatch reports without the availability of several reliable witnesses or additional substantiation. Some of the world's leading dailies—the *New York Times* and *London Times* for examples—have adopted a virtual "hands off" policy almost without exception.

One wonders what becomes of the countless UFO reports made by citizens to Ground Observer Posts and Air Defense Filter Centers. They obviously are not *officially*—or at least *publicly*—recorded at Air Technical Intelligence Center, Ohio, where Blue Book is located; nor are they apparently listed by the Office of Public Information at the Pentagon.

An indication of the unofficial—and not public—activity ultimately reaching ATIC was related by the *Los Angeles Times* on September 13, 1956.

It told of a Hollywood resident who received strange telephone calls during the night. When this person would get up to answer his recently installed telephone an excited "I want to report a flying saucer!" usually blasted in his ear.

And the calls continued.

"It began to drive me nuts," he told the *Times*. "It went on for a week. I was seeing flying saucers in my sleep—what sleep I got."

The perturbed and exhausted recipient of the nerve-shattering calls—a television writer by profession—finally queried the telephone company. He got his answer.



Five photos of a UFO snapped by George J. Stock as the object reportedly passed slowly over his home in Passaic, N.J., on July 29, 1952. Intensive research failed to indicate that the photos may have been faked.

PHOTOS COURTESY AUGUST C. ROBERTS, 443 OGDEN AVE., JERSEY CITY

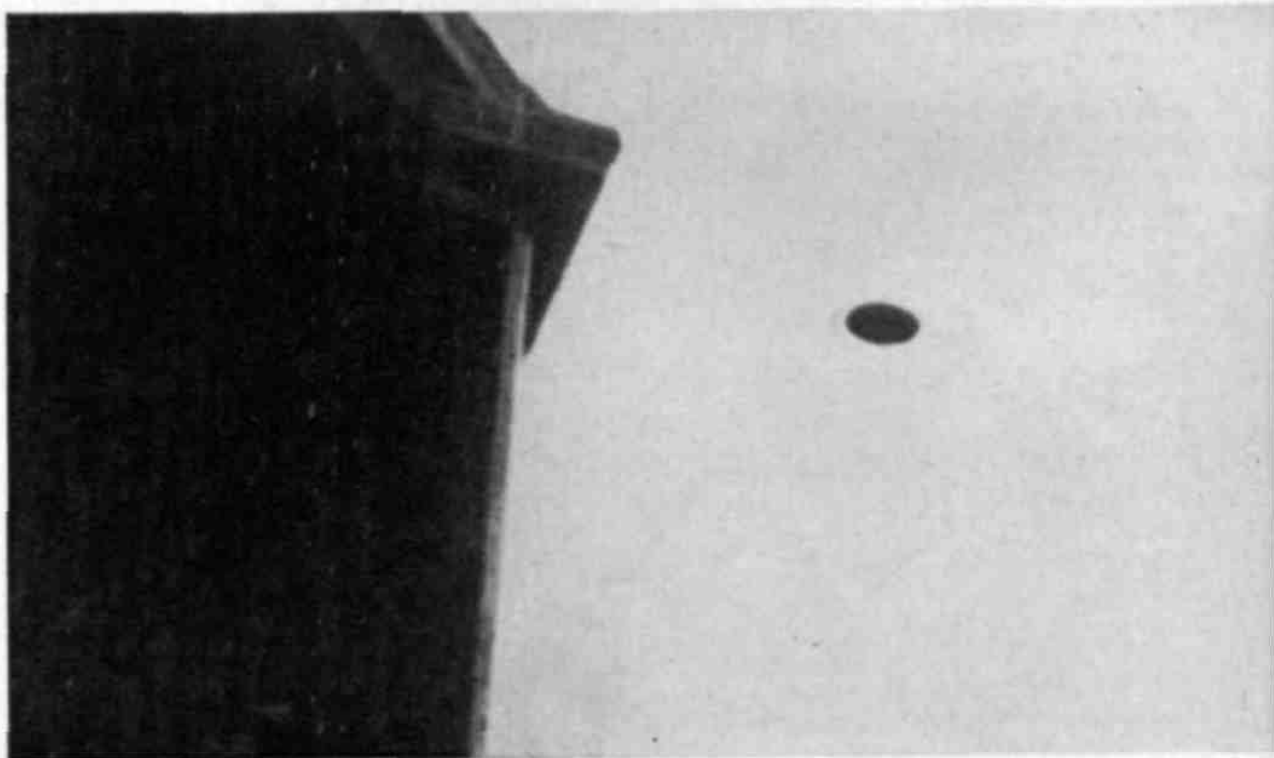



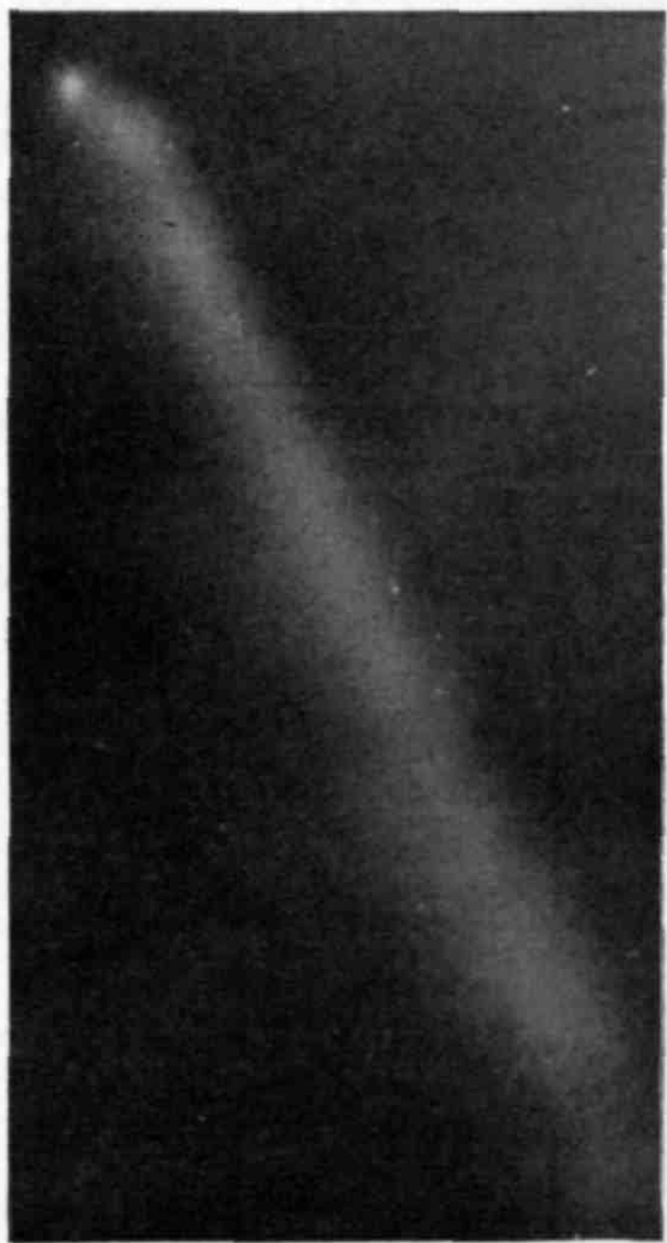

*Cropped photos of 16 mm
frames showing search-
light beam striking UFO
over Cincinnati in 1949.*
PHOTOS COURTESY JOHN OTTO.
PERMISSION TO REPRODUCE
FROM LEONARD STRINGFIELD

The number was still listed in the telephone directory as the Ground Observer Corps of Hollywood. It had recently been discontinued and reassigned to the sleepless writer.

"So if you see a flying saucer," cautioned the *Los Angeles Times*. "Call the Pasadena Air Defense Filter Center. They're used to it."

Yes—they're used to it.

So are all Filter Centers. And Ground Observer Posts. And newspapers. And the Air Force.

But they won't admit it. Not publicly. Nineteen-hundred and fifty-four proved to be a good example in question.

By mid-year, the Pentagon told the press that the Air Force was receiving an average of less than 18 UFO reports per month.

Then Leonard H. Stringfield called ATIC at Dayton. (Len Stringfield is a noted Cincinnati UFO researcher and advertising executive. He served with Air Force Intelligence during the Second World War.)

He talked with Colonel John O'Mara, Deputy Commander of Intelligence for the Air Technical Intelligence Center. Colonel O'Mara confirmed that the ATIC was still receiving UFO reports. Quite a few, in fact.

Seven hundred per week, Stringfield was told.

And it must be emphasized that ATIC is the prime center for UFO reporting. The entire investigation and correlation of unidentified aerial phenomena reports come within its jurisdiction.

Who should have the facts—ATIC or someone at the Pentagon?

It is impossible to estimate as to what percentage of Americans believe they have sighted a UFO (or UFO's) at one time or another during their lives. But whatever it is, that percentage is believed to be large. Most of us find it uncommon to discuss the topic among a small group and not discover someone who has spotted a UFO. Even discounting ninety-nine per cent of these sighting reports, a fantastic residual of unexplained sightings remain. •

Professional astronomers are a bloc often believed to be vehemently anti-UFO. This has been largely because only those who impetuously consider the subject preposterous have commented to any degree on it. The greatest majority of these astronomers prefer to follow the general conserva-

tive precept of not entangling with such a conjectural and controversial phenomena.

But the pro-ranks are growing.

Clyde W. Tombaugh is the only living astronomer to have discovered a planet—Pluto. And he has witnessed an unexplainable aerial event.

At about 10:45 p.m. on August 20, 1949, the astronomer was gazing skyward outside his home at Las Cruces, New Mexico, with his wife and mother-in-law, when they unexpectedly caught sight of six or eight rectangular, greenish lights. They were traversing the sky, he later recounted, at a steady velocity. And there was "no sound whatever."

Professor Tombaugh said some type of object, apparently cigar in shape, was *silhouetted against the dark sky*. Several accounts have indicated that he believed the pattern of lights were two rows of windows.

"In all of my several thousand hours of sky-watching," the astronomer is quoted by Aimé Michel in *The Truth About Flying Saucers*, "I have never seen anything so strange as this . . ."

Except for amateurs, astronomers are not notorious sky gazers. Most of their work is done at the end of a large telescope tube, and in dome-capped buildings. Even visual observations no longer account for the majority of an astronomer's time. Photographic surveys and spectroscopy comprise the bulk of his present activity.

The field of view of the larger telescopic-instruments is extremely limited. And if by some sheer piece of a chance a UFO should transit this narrow field it would, in all likelihood, be either too out of focus or its apparent velocity too greatly magnified to be *even noticeable*.

Nevertheless, a superficial study was undertaken several years back by Project Blue Book to determine the approximate number of professional and noted astronomers who believed they had sighted UFO's.

The answer, according to Edward J. Ruppelt in *The Reports on Unidentified Flying Objects*, was that some eleven per cent fell into the category of UFO spotters.

But the object of this chapter is not to estimate the number of people—or astronomers, although many believe they are people—who have sighted, or believe they have sighted, unidentified aerial objects.

Its purpose rather is to summarize a num-

ber of the better, more conclusive, and representative UFO sighting reports.

These selections haven't been easy. And it should be remembered that the bulk of the sighting reports collected by the varied world governmental investigating agencies are locked securely away from prying eyes and public acceptance.

Therefore, the twofold prime requisites the author has followed in compiling the few reports are as follows:

1. The competency, experience and number of observers to the respective phenomena.

2. And accuracy of the reports. Wherever possible, the descriptive narratives will be expressed directly by the observer. Otherwise, the reliability and objectivity of the source is taken heavily into consideration. And where newspaper accounts are reproduced, superficial research at least has taken place to verify accuracy of the reports. In some cases the incidents and data are condensed from published paraphrased Project Blue Book reports and files.

These selected reports have been gleaned by the author from hundreds of sources. They represent some of the most comprehensive available. They deserve intensive reflection. Read them . . . And wonder!

It's news when a lot of people see a flying saucer. It's news when an astronomer sights an unidentified airborne object. And it's news when a relatively spectacular phenomenon takes place. But what happens when all these occur *before* we had such aerial contraptions as airplanes, dirigibles and the ilk?

We shall soon see. For they did happen—in 1882!

The noted astronomer Walter Maunder—Secretary of the Royal Astronomical Society from 1892 to 1897—took a position on the roof of the Greenwich Observatory at dusk on November 17 to watch for the commencement of an auroral display, which he believed would accrue from a magnetic storm of that day.

He saw the expected display. And he saw something else.

For their 500th anniversary issue of *The Observatory* for May 1916, the editors asked Maunder to describe the most remarkable experience or sight that he could remember.

He told of November 17, 1882:

The auroral glow spread over the north-

west that evening, he recalled. Nothing of the unusual was noted.

"Then, when the display seemed to be quieting down," Astronomer Maunder recounted in *The Observatory*, "a great circular disc of greenish light suddenly appeared low down in the E. N. E., as though it had just risen, and moved across the sky, as smoothly and steadily as the Sun, Moon, stars and planets move, but nearly a thousand times as quickly. The circularity of its shape when first seen was merely the effect of fore-shortening, for as it moved it lengthened out, and when it crossed the meridian and passed just above the Moon its form was almost that of a very elongated ellipse, and various observers spoke of it as 'cigar-shaped,' 'like a torpedo,' or a 'spindle' or 'shuttle.' Had the incident occurred a third of a century later, beyond doubt everyone would have selected the simile—it would have been 'just like a Zeppelin.' After crossing the meridian its length seemed to contract, and it disappeared somewhat to the south of the west point. Its entire passage took less than two minutes to complete.

"I watched for several hours longer, but no repetition of the phenomenon occurred. A pale greenish glow fringing the upper edge of the great London smoke cloud in the north was observed but showed little, if any, structure or movement.

"The 'torpedo,' on the other hand," he continued, "was many times brighter than this northern glow . . . and it had a most clearly defined outline, but a plain and uniform surface. The greatest length which it presented was about 30°; its breadth was from 2° to 3° . . . (about 65 times the size of the moon).

"This 'torpedo-shaped' beam of light was unlike any other celestial object I have ever seen . . .

"It appeared to be a definite body, and the inference which some observers drew from this was that it was a meteor . . . But nothing could well be more unlike the rush of a great meteor or fireball with its intense radiance and fiery train than the steady—though fairly swift—advance of the 'torpedo.' There was no hint of the compression of the atmosphere before it, no hint that the matter composing its front part was in any way more strongly heated than the rest of its substance . . ."

In all objectivity, it must be stated that

Maunder felt the phenomenon might have been the effect of the auroral display. But could anything else have been hypothetically advanced at that time?

If the object was, in fact, of physical existence—and such descriptions as “it had a *clearly defined* outline” and “appeared to be a *definite body*” would seem to indicate thusly—the craft may have followed the electro-magnetic influence, as would have resulted from the aurora, with possibly the objective of scientific research.

And whatever it was, it was huge.

The *Philosophical Magazine* for 1883 summarized and correlated 26 “reliable” observational reports. It concluded that the object maintained altitude at 133 miles, and had a velocity of 10 miles per second—36,000 miles an hour!

In an earlier issue of *The Observatory*—apparently shortly after the phenomenon occurred—Maunder said the object had a “remarkable dark marking down the center.”

Another astronomer, J. Rand Capron, was able to focus a spectroscope on the object. Here, however, the result must be considered incomplete or insignificant. The science of spectroscopy was not really developed to great accuracy and theory until early in the twentieth century. And in this case it is difficult to say whether or not the brightness of the object was from incident (direct) or reflected light; if reflected it could have easily have been sun or auroral light. Finally, in the magazine *Nature*, Capron admitted that he could determine little with the spectroscope because of the intense moon light.

And consequently almost all of England and portions of Holland and Belgium saw something in 1882 which, to this date, remains unidentified.

All was quiet on April 4, 1942, when a group of French soldiers led by Captain Louis Le Prieur, arrived at the Oualen Garrison in the Adrar-En-Abnet, located near the Tropic of Cancer in the Sahara Desert. The garrison was maintained by a detachment of ten camel-riders, a meteorologist named Martin, and two radio operators.

The account to follow was narrated by Aimé Michel in *The Truth About Flying Saucers*.

“We had been there a few days,” says Captain Le Prieur, “when one morning the

meteorologist N.C.O. came in and drew my attention to a kind of ‘planet’ which had appeared in the cloudless sky immediately above the fort. The object was visible to the naked eye and looked like a small aluminum speck. There were about forty of us and we saw it quite plainly, as the atmosphere was perfectly clear.

“When we examined it more closely through our field glasses and the telescope of a theodolite, the ‘planet’ looked like a small moon or a five-franc piece. It had a pale metallic glint and seemed to be suspended at an altitude of 15,000-18,000 feet.

“It appeared to be motionless, but prolonged examination with the theodolite revealed that it was slowly rotating. We counted three complete revolutions in eight hours.

“The next morning it was still there immediately overhead, and we began to take it for granted, assuming that it must be a stray star or a new satellite attracted by the gravitational pull of the earth, for at that time flying saucers had not been heard of. At dawn on the third day, there was no sign of it.”

The Captain continued:

“Algiers University was consulted for some time later [and] it informed us that the object we had seen was nothing but the star Vega.

“This explanation struck us as unexpected and improbable, as a star does not remain for two whole days in the same spot, immediately overhead and so close as to be examined at leisure with an ordinary telescope! I have often wondered what could have been the nature and origins of the *strange disc with its metallic gleam*, and what could have caused it to remain in the sky above that semi-lunar Sahara landscape where nothing of interest is to be seen apart from the small fort. Was it the proximity of its shortwave transmitter, or of the iron deposits at In Ziza, 15 miles to the south (which could well be the carrier of great magnetic activity), or was it merely due to the unaccountable workings of chance?”

Aircraft, balloon, mirage, hallucination—what could have caused the spectacle? Certainly the former three can be immediately discarded; no object or craft stays motionless for hours or days on end. The continuously varying weather conditions over a desert area constantly change, discounting the

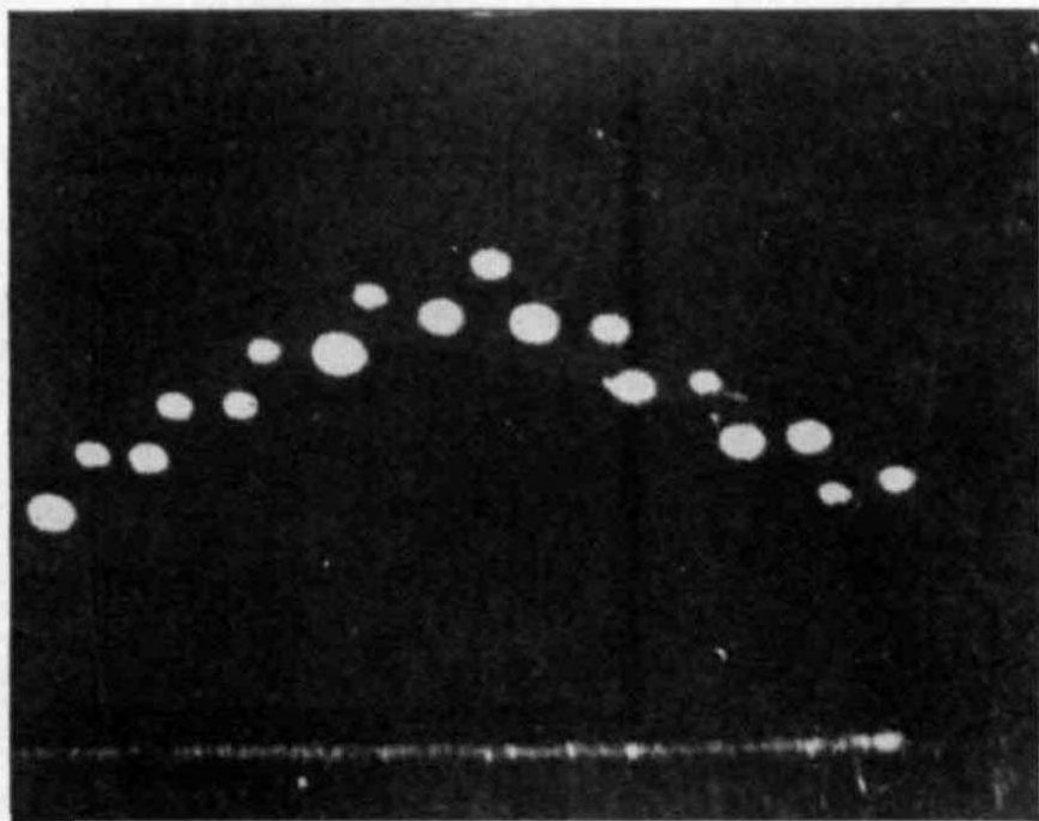

Carl Hart, Jr., said he took this picture of the famous "Lubbock (Texas) Lights" on the night of August 30, 1951. The phenomenon remains a complete mystery.

possibility of an inversion refraction. And what mirage or hallucination—simultaneously observed by forty men—exhibits "a pale metallic glint" and completed three "revolutions in eight hours"?

Perhaps it was a misidentification of a conventional object—a flying saucer, for example.

Author Michel—a former science editor of the French National Radio Network—reasoned that "there is at least one element of capital importance in the Ouallen sighting—the date." And he concludes, "If these objects were haunting the sky not only in 1942, but [earlier] . . . , it is long odds that they come—or at any rate some of them come—from elsewhere."

A series of strange phenomena plagued the greater Cincinnati area in late 1949 and early '50. And they were more than mere UFO sightings, for qualified observers and scientists repeatedly witnessed the anomalous occurrences, and these phenomena were, at times, photographed on 16mm motion picture film. But what makes it espe-

cially unusual—and somewhat intriguing—is the fact all of these observations were made of objects *caught in arc searchlight beams!* And they were viewed by thousands of local residents.

The noted UFO researcher, Leonard H. Stringfield, Director of Civilian Research, Interplanetary Flying Objects, Cincinnati, Ohio, has compiled quite a log of data of these sightings, and feels they present "more proof that 'saucers' exist" and "proof they are controlled."

Stringfield's summarization of the incidents was published in *CRIFO Newsletter*, the monthly periodical he edits. Here is one of the most conclusively dramatic and intensely correlated sequences of events to have yet occurred:

"Following is the log of Sgt. Donald R. Berger's operations with searchlight, tracking an unidentified object over Cincinnati from August 19, 1949 to March 10, 1950.

"Aug. 19, 1949. Place: St. Peter and Paul Church, Norwood, Ohio. 2015 to 2300 hours. While operating for festival, picked up ob-

ject at 1585 mils elevation. The object was stationary, appearing as a glowing disc. When I moved the searchlight away the object continued to glow. Estimated range: 4 to 5 miles. The sky was clear with thin haze at high altitude. I took no action, but the next day articles appeared in two local papers re: object.

"Sept. 11, 1949. Place: St. Gertrude Church, Madeira, Ohio. 1915 to 2315 hrs. Picked up object at 15,000 to 20,000 ft. at 1620 mils elevation. The object disappeared within few seconds, traveling straight up. I picked it up again at much greater altitude. Then, when I changed carbons I lost it again until 2115 hrs. As soon as it reappeared, I phoned Wright-Patterson Field. The sky was clear with no visible clouds or haze. Several thousand people also saw object.

"Sept. 17, 1949. Place: Milford, Ohio. 1900 to 2000 hours. Testing the searchlight about dusk, I had it set at 1600 mils. I could see an object which looked like a white glow. When I turned the light off, I could see nothing. I did this several times. As soon as it became dark I turned on the light at same elevation and caught object in the beam.

"Oct. 23, 1949. Place: St. Peter and Paul, Norwood. 1915 to 2245 hrs. I turned on the light and picked up object at 1600 mils. Also present were William Winkler, Father Gregory Miller and Robert Linn. Intelligence at Wright-Patterson was informed. About 2200 hrs., two distinct groups of triangular-shaped objects seemed to come out of the main disc. Each group had about five objects. They came down the beam then turned out of the beam. The same performance was repeated about half hour later. The disc was still visible when I turned out the light for the night.

"Oct. 24, 1949. Place: St. Peter and Paul. 1915 to 2100 hrs. Set light at 1600 mils. The object appeared immediately in the beam. A. T. I. C. agent and Lou Gerhart with me at the time. Held object in beam for about half hour until covered by clouds.

"Nov. 19, 1949. Place: Norwood, Ohio. 1830 to 2245 hrs. At 1915 hrs. the beam of the light flashed on the object. Guiding the light back on the object, it then disappeared immediately. About a minute later I picked it up again much higher. The elevation was between 1605 and 1610 mils. Many witnesses, including William Winkler.

Sky was covered with low broken clouds. At times object appeared much brighter.

"Dec. 20, 1949. Place: Norwood, Ohio. 2015 to 2200 hrs. Turned light on at 2015 and picked up object immediately. At first it was faint and small. As haze cleared, object brightened. At 2130 it got much brighter and spread out almost as large as beam, then disappeared. In a few minutes, we again picked it up in its original position. About 2200 it seemed to get faint, then disappeared. Present were Dr. D. A. Wells (U. of Cincinnati Physicist), Dr. Paul Herget (Astronomer of Cincinnati Observatory), two C. S. I. members, Father Miller, the mayor of Norwood and S. Myers.

"Jan. 11, 1950. Place: Norwood, Ohio. 1930 to 2115 hrs. Turned on light, but didn't find object until about 1945 hrs. when haze blew away. Observed it for about 15 minutes, very clearly, then it dimmed. It was called to my attention that some smaller objects were passing through the beam. I saw at least two objects several times. Also present were William Winkler, M/Sgt. R. Ekleberry, M/Sgt. John Savage and Sgt. W. Pflueger.

"March 9, 1950. Place: Norwood, Ohio. 2000 to 2200 hrs. About 2000 I picked up object with the light. About 2045 hrs. two small objects came out of the disc and it looked as if the disc was pushed out of the beam. In about ten minutes, the disc moved back into the beam. The sky was clear. Eleven people were witnesses.

"March 10, 1950. Place: Norwood, Ohio. 1900 to 2300 hrs. Caught object in beam at 1600 mils. At 1945 hrs. the object moved up and across the beam and disappeared. Half hour later, object reappeared in beam in same position. Object stayed in beam until I turned light off for the night. Present were Father Miller, Capt. Wilks, R. Myers, Wm. Winkler and others. Capt. Wilks phoned Wright-Patterson field. Capt. Wilks watched the object with glasses while I moved the light."

To this series of excellent sighting reports, researcher Len Stringfield concludes:

"The evidence is astounding! Here is proof of intelligent control; of a parent craft and its aerial brood watching greater Cincinnati. I have witnessed the 25 ft. film in the presence of Father Miller, my wife, saucer-sighter Jack C. Maish and WCPO-TV employees. I have talked with William

Winkler, now of Detroit, who viewed, thru telescope, the hovering object several times apart from Sgt. Berger. I now possess photo frames of the film, which show the searchlight beam stabbing at the disc-shaped object. These are bona fide, with negatives, and were on display at the Cincinnati Gas & Electric Company 'saucer' exhibit during August."

It is all too seldom when really well qualified observers spot UFO's; and when they do, it is rarely when the sighting is *good enough—or the right type of equipment is at hand—to be of any great objective value.* But this, fortunately, was not the case on April 24, 1949.

Qualified observers *were* present—and prepared! Accurate and the *right kind* of instrumentation were available. And the locale wasn't exactly unknown either. White Sands Proving Ground, New Mexico! The country's Number One rocket and guided missile test center. It covers an area of over 5,000 square and barren miles.

Some of the country's top flight experts-in-their-field were the "qualified" observers. These included four enlisted Naval personnel; Charles B. Moore, Jr., balloonist, graduate engineer, and aerologist; J. Gordon Vaeth, Director of New Weapons and Systems Division, U. S. Navy Special Devices Center, Office of Naval Research, and Captain (but then Commander) Robert B. McLaughlin, an Annapolis graduate, the first officer in charge of the Navy Unit at White Sands, and then working on Top Secret guided missile projects.

In his comprehensive volume, *200 Miles Up*, author and aforementioned observer J. Gordon Vaeth gave a credible account of the phenomenon. (J. Gordon Vaeth—*200 Miles Up*, Second Edition. Copyright 1955 The Ronald Press Company.)

"At 10:20 a.m. on April 24th this group . . . released a small 350-gram weather balloon for observation of upper wind velocities and directions. The balloon was followed by Moore with the theodolite until immediately after the 10:30 reading, when he relinquished the tracking instrument to look up to find the balloon with the naked eye.

"Searching the sky for the balloon, he thought he had found it when he saw a whitish spherical object right along the direction the theodolite was pointed (45° elevation and 210° azimuth). The object

was moving east at a rate of 5° of azimuth change per second.

"When the difference in angle between the theodolite and the supposed balloon became apparent, Moore took over the theodolite and found the true balloon still there, whereupon he immediately abandoned it and picked up the unidentified object as it came out of the sun. At the time, the sun was at a computed bearing of 60° elevation and 127° azimuth. The object was moving too fast to be kept in the scope through *cranking the theodolite around; one of the men, therefore, had to point the theodolite while Moore observed the object through the telescope.*

"The object was an ellipsoid about 2½ times as long as it was wide. It had a length of about .02° subtended angle and was gleaming white in color. It did not have metallic or reflected shine. Toward the underside near the tail, the gleaming white became a light yellow.

"The object, readily visible to the naked eye and seen by all the members of the group, filled the field of the theodolite's 25-power scope. Its rapid movement, unfortunately, prevented Moore from obtaining a hard or clear focus, and no good detail was observable.

"The azimuth angle decreased as the object continued on a north heading (it originally came out of the southwest). Becoming smaller in size, it moved to an azimuth reading of 20° to 25°, at which point the azimuth held constant. Coincidentally with this constant azimuth, the elevation angle suddenly increased from 25° minimum to 29°, at which point the object was lost to sight. It disappeared in a sharp climb after having been visible to Moore and his group for about 60 seconds.

"Fifteen minutes after the object had disappeared, Moore sent up another pilot weather balloon to check wind values. This balloon burst after an 88-minute flight to 93,000 feet and traveled only 13 miles in a southerly direction during that time. This was positive proof that the object could not have been a balloon moving at such angular speed below 90,000 feet.

"The object was under conditions of a cloudless sky and no haze. It left no vapor trail or exhaust. It was observed from an isolated mud flat in the New Mexico desert where there was extreme quiet; no noise of any kind was heard in connection with the

sighting, and there were no cars, airplanes, or other noises nearby which might have blotted out sound coming from the object."

J. Gordon Vaeth prefaced this sighting report by relating that many balloonists had felt the large Skyhook variety of balloons had often been mistaken for saucers and therefore indicated little interest in the reports. ". . . that is to say," wrote Vaeth, "they took little stock in them until April 24th, 1949!"

Concluding this enigmatic report, he said, "It represents one of the best substantiated and authentic unidentified object sightings on record."

But Captain R. B. McLaughlin wasn't quite so conservative. The UFO had, at one time during the observation, passed in front of a mountain range. This gave McLaughlin and some of the other observers a clew to its distance and dimensions.

The object, they estimated, was approximately 40 feet wide by 100 feet long. Its altitude was roughly 56 miles—296,000 feet! (The world's altitude record by manned rocket, held by the Bell X-1A, is about 90,000 feet—or less than one third of the UFO's altitude.)

Not only that, but McLaughlin—an expert in ballistic missiles—computed the speed of the object by comparing its altitude and apparent angular velocity.

And they found it wasn't going slow. Close to 25,000 miles per hour, they calculated. Seven miles per second.

"I am convinced," the former Commander said of the object in the March 1950 issue of *True* magazine, "that it was a flying saucer, and further, that these disks are spaceships from another planet, operated by animate, intelligent beings."

Nor was that the only UFO balloon sighting report.

A disc about one-fifth size of the full moon maneuvered violently as it traversed the sky over White Sands on April 5, 1948. On another occasion, Captain McLaughlin saw two miniature discs follow a navy rocket shortly after take-off. After a few moments, he said, they accelerated and disappeared.

And there was another incident to which skeptics were completely at a loss to explain. Some years back the crew of a C-47 spotted two UFO's come in from the horizon, circle a balloon at 90,000, then "rapidly leave." When the balloon was recovered

and examined, it was found to be *ripped*—
By a temperature inversion?

The two pilots of the C-47, according to former Air Force chief UFO investigator, Edward J. Ruppelt, "now believe in flying saucers." (*The Report on Unidentified Flying Objects* by Edward J. Ruppelt, Doubleday, 1956.)

William B. Nash is a senior pilot for one of the country's leading airlines. (They have requested that their name be withheld—apparently feeling that flying saucers and public relations do not mix.)

He and his co-pilot are two of the relatively few to have spotted UFO's below them. This phenomenon greatly—if not wholly—eliminates the possibility of the objects being "mirages" caused by a temperature inversion refraction or other meteorological phenomena.

Here is Pilot Nash's account, written expressly for the author:

"On the night of July 14, 1952, William H. Fortenberry and myself were ferrying a DC-4 from New York to Miami. Bill was in the right-hand cockpit seat, and I was in the left. The night was clear and visibility unlimited. The only clouds, practically invisible to us, were reported to be thin cirrus, three-tenths, at 20,000 feet.

"We were flying at 8000 feet over Chesapeake Bay, as we approached Norfolk, Virginia, which lay about 20 miles ahead of us on our compass course of 200 degrees magnetic. The sun had set an hour earlier. It was 8:12 p.m.

"Suddenly a red brilliance appeared ahead of us and to our right, almost on the ground it seemed, and about ten miles beyond Newport News, which lay 25 miles ahead and to the west of Norfolk. We saw it together at practically the same moment.

"What the hell is that!" one of us remarked.

"It didn't come gradually into view but rather seemed simply to have appeared on a sudden.

"Almost immediately we perceived that the brilliance consisted of six red objects streaking toward us at tremendous speed, and obviously well below us. They had the fiery aspect of hot coals, and appeared to have about twenty times the brightness of the city lights of Norfolk, over which they passed. Their shapes were clearly outlined and evidently circular. The edges were well defined, not phosphorescent or fuzzy in the

least. Their red-orange color was uniform over the upper surface of each craft. They were flying in what appeared to be a stepped-echelon formation.

"Halfway to us, across the black waters of Chesapeake Bay, the three front objects began to slide back and forth over each other, as though the leader had begun to decelerate and the second two apparently were not alerted, or—as pilots say—"loused up the formation." (This indication of "intelligence error" was one of the things which convinced us that the craft were "occupied.") They seemed to stay below 2000 feet as they shot into a position slightly forward and below us, where they appeared about equal in diameter to the wing-spread of a DC-3, or roughly 100 feet.

"Suddenly, as we thought they were going to pass beneath us, their glow diminished. Then the six coin-shaped objects performed a maneuver that has amazed us to this day: together, they flipped up on edge and reversed formation, sliding past one another to do so. When this formation was reversed, the glow increased, and they shot away from us almost in the opposite direction, heading about thirty degrees to the west of their approach track.

"Immediately two other objects shot into our view from beneath our right wing, both bigger and brighter—possibly because they appeared to be higher than the others. They dived at the rear of the others on an apparent intercept heading.

"Suddenly the original six blinked out—just as though someone had turned off an electric switch. And almost immediately, the second two blinked out. About one second passed and then they all blinked on again—all together in an in-line formation; still low, they then streaked across the western edge of Newport News, and to about ten miles beyond that.

"After a few seconds a breathtaking upward change of direction took place, and they shot away at a 45° angle into the sky. At some extreme altitude they seemed to blink out again, but separately in a mixed-up fashion. I wondered later if this might indicate that they were one-by-one disappearing into a sort of carrier ship for the small craft.

"We were stunned to say the least. We looked all around to see if there were possibly more, but there was nothing to be seen. Both of us have flown more than ten thousand hours, and this was our first experience

with anything in the sky that we could not explain. When we realized they were not coming back, we proceeded to compile some data while the weird experience was still fresh in our minds.

"We agreed that when the 'things' were on edge, their thickness appeared to be about 15 to 20 per cent of their diameters; or 15 to 20 feet thick if the craft were 100 feet in diameter. The edges seemed unlit. The bottoms must have been lighted, for when the special Air Force investigators interviewed us the next morning, they told Bill and I that seven other reports had come to them within thirty minutes after our sighting, and all from Norfolk describing six or eight red-orange objects making abrupt changes of direction in the sky.

"To compute their speed, we needed the length of time the craft were under observation and the distance they traversed. By separately punching an instrument panel stop-watch we both came up with an estimate of 12 seconds for the total time of observation. (This is quite a long period for two former Navy pilots, both of whom had been trained to identify aircraft as to nation, type and number as their likenesses were flashed on a screen for 1/100th of a second.)

"We increased the time from 12 to 15 seconds to be conservative, which would make the calculated speed of the UFO's somewhat slower. As for distance—we knew that they had traveled about ten miles toward us before passing over Newport News and an additional 20 or 30 miles after they crossed the city and had gone away from us. Still being conservative, we did not consider even that distance. We used only the distance we were certain they had transited—from Newport News to our position and back again to Newport News.

"This distance totaled 50 miles. Fifty miles in 15 seconds equals 200 miles per minute—12,000 miles per hour!

"Concluding, we are both convinced that:—

1. The objects were aircraft manufactured by intelligence.

2. Their performance demonstrated too much scientific advancement to have reached such a state without some of the intermediate stages ultimately coming within public knowledge; therefore we feel that they were not developed upon this planet.

3. They were intelligently controlled. And their performance seemed to indicate

—from their maneuvers plus the fact that they were in formation and made intelligence errors—that they were probably operated from within rather than externally via remote control.”

On September 19, 1952, the North Atlantic Treaty Organization engaged in extensive naval maneuvers in an undisclosed region of the North Sea. The maneuvers were designated “Operation Mainbrace.”

American press photographer, Wallace Litwin, was taking color photographs of carrier jet take-offs aboard the USS Franklin Roosevelt—time unrecorded—when he saw that a group deck crew and pilots were watching something. He looked, and saw—

“... a silver sphere moving across the sky just behind a fleet of ships”—wrote Edward J. Ruppelt in *The Report on Unidentified Flying Objects*.

“The object,” continued Ruppelt, “appeared to be large, plenty large enough to show up in a photo, so the reporter took several pictures. They were developed right away and turned out to be excellent. He had gotten the superstructure of the carrier in each one and, judging by the size of the object in each successive photo, one could see that it was moving rapidly.”

There was one possible explanation—a weather balloon.

But none of the ships, it was found, had dispatched a balloon.

“Naval Intelligence double-checked, triple-checked and quadruple-checked every ship near the carrier,” said Ruppelt, “but they could find no one who had launched the UFO.”

For some reason these three priceless, authenticated color photographs of an unidentified object—in action—have never been published. Why?

Nor was the USS Franklin Roosevelt incident the only sighting during “Operation Mainbrace.”

An RAF Meteor jet fighter plane was returning to England during the late morning of September 19 from the Mainbrace exercises. Three airmen and two officers of the British Coastal Command at the Dishforth Aerodrome, near the Topcliffe Naval Base, Yorkshire, were watching the plane’s approach.

As they watched, they saw something else. It was subsequently the essence of a report by the Coastal Command to the British Air Ministry. The following account, from the

official report, was published in *The Truth About Flying Saucers* by Aimé Michel.

Stated Lieutenant John W. Kilburn: “It was 10:53. The meteor was coming down from about 5,000 feet. The sky was clear, the sun shining, visibility perfect. The meteor was crossing the airfield from east to west, when suddenly I noticed a white object in the sky. It was round and silvery and circular, and seemed to be following the Meteor at about two miles distance at a speed less than that of the aircraft but on the same course, though a little above it.

“‘What on earth is that?’ I shouted. My friends looked up where I was pointing; one of them said it might be the metal cone capping of the Meteor’s engine which had come off, while another thought it was just a parachute. But while we were still watching the disc we saw it reduce speed for some seconds and then begin to come down. As it lost height, it began to flutter like a leaf or, if you prefer, oscillate like a pendulum. The Meteor swerved to circle the airfield before landing. The object began to follow it but stopped dead after a few seconds. It seemed to remain suspended in the air, revolving like a top. Suddenly it took off, accelerated and flew off westwards at a terrific speed before changing course and disappearing southeast. The whole thing lasted for about twenty seconds.

“While still in sight it seemed to change shape and become elliptical. During the short time it was revolving while stationary, we could see it shining in the sun. It then seemed to me about the same size as a pursuit plane at the same altitude.

“We are all absolutely certain that there could be no question of a balloon, or an optical illusion, or an effect produced by the Meteor’s jets. It was a solid object. I have never seen anything like that in the sky in all my life.”

On September 20, pilots of a group of six RAF jet interceptors saw a UFO coming from the direction of the Mainbrace fleet, and attempted to intercept the “shiny, spherical object,” but it soon outdistanced the jets. On returning to base, one of the pilots noticed the UFO had returned—and was following the aerial unit.

Another interception was attempted. And the object vanished into the distance.

“It was these sightings, I was told by an RAF exchange intelligence officer in the Pentagon,” declared Ruppelt in *The Report on Unidentified Flying Objects*, “that caused



Bert Bula of New York City says he saw and photographed three nebulous-like objects Feb. 16, 1956. Daylight background was dimmed deliberately. COURTESY AUGUST ROBERTS

the RAF to officially recognize the UFO."

At 12:50 p.m. on October 17, 1952, M. and Mme. Yves Prigent, with their three children, were preparing for lunch in their second story apartment at Oloron, France. M. Prigent is the general superintendent of the local high school. Jean-Yves Prigent, a son, was looking out of their panoramic window, to the north of the city.

"Oh, papa, come look, it's fantastic," he suddenly cried out.

And thus began one of the first incidents involving the so-called enigmatic "Angel's Hair." M. Prigent's verbatim account is

contained in, and reproduced from, *The Truth About Flying Saucers* by French science writer, Aimé Michel (Criterion Books, New York, 1956).

"In the north, a cottony cloud of strange shape was floating against the blue sky," described the school superintendent. "Above, it, a long narrow cylinder, apparently inclined at a 45° angle, was slowly moving in a straight line toward the southwest. I estimated its altitude as 2 or 3 kilometers (6 to 10 thousand feet). The object was whitish, non-luminous, and very distinctly defined. A sort of plume of white smoke was escaping from its upper end. At some distance in



front of the cylinder, about thirty other objects were following the same trajectory. To the naked eye, they appeared as featureless balls resembling puffs of smoke. But with the help of opera glasses it was possible to make out a central red sphere, surrounded by a sort of yellowish ring inclined at an angle. The angle was such as to conceal almost entirely the lower part of the central sphere, while revealing its upper surface. These 'saucers' moved in pairs, following a broken path characterized in general by rapid and short zigzags. When two saucers drew away from one another, a whitish streak, like an electric arc, was produced between them.

"All these strange objects left an abundant trail behind them, which slowly fell to the ground as it dispersed. For several hours, clumps of it hung in the trees, on the telephone wires, and on the roofs of the houses."

The *fil de la Vierge* trail, as the French call the "gossamer" threads, scattered across the countryside. When examined, the "Angel's Hair" resembled wool or nylon fibres. And when pressed or touched by the hands to any extent, it would become gelatinous and gradual dissipate—the same characteristics displayed by similar phenomena ever since. Because of the fibres' rapid deterioration, chemical analysis has been impossible.

M. Prigent was not the only witness to the phenomenon. Residents of the neighboring town of Geronce and travelers in the Josbaigt Valley also viewed the objects. Mayor Borbes, of Geronce, was one of those to see the strange sight.

Just ten days later—on October 27th—"the whole thing," wrote Aimé Michel, "started up all over again in the sky of Tarn, at Gaillac," France.

As the occurrence was virtually identical in all appearances to the Oloron sighting, it would be pointless to relate it here.

The following account, known as the Gulf of Mexico Incident, was cleared through the Office of Public Information, U.S. Air Force, for use by Major Donald E. Keyhoe in his volume, *Flying Saucers from Outer Space* (Henry Holt: 1953).

December 6, 1952:

A B-29 bomber was nearing the completion, in the Gulf of Mexico, of its practice run out of Florida on December 6, 1952. It was piloted by Captain John Harter on the clear, moonlit night.

At 5:24 a.m. Capt. Harter asked the radar officer, Lieutenant Sid Coleman, to turn on the radar set. The pilot said he wanted to check the Louisiana coastline on his cockpit auxiliary radar scope.

Suddenly, at 5:25, an unknown "blip" entered the edge of the scope. Coleman watched it. On the next radar sweep, the object had moved—13 miles!

The radar officer saw a second, then a third "blip" enter the scope. They were heading for the B-29!

Lieutenant Coleman and Master Sergeant

Bailey grabbed stop watches. They calculated the objects' speed.

"Captain," yelled Coleman into his intercom. "Check your scope. We just clocked an unknown at over 5,000 miles an hour."

Captain Harter ordered a recalibration. Back to the set—and to two more unknowns! This time the navigator, Lieutenant Cassidy, picked up the UFO's on another scope. The "blips" raced across the screen.

All three of the airship's radar scopes had tracked the UFO's. Their velocity: 5,240 miles per hour.

And then—"Unknown at three o'clock."

M/Sgt. Bailey sprang to the plane's back visual blister. There it was—or was it? A blue-white blur below the plane's wing. Then another group of "blips" emerged onto the scope. And nearly dead ahead. Almost as fast as they came, they were gone. The crew breathed a sigh of relief. There was a welcome lull.

But not for long.

Back they came—the third group.

Two of the UFO's shot by "at four o'clock."

Staff Sergeant Ferris was first to the blister this time. Two streaks blurred past.

Back to Captain Harter, watching five "unknowns" intersecting a course behind the bomber, forty miles distant. The blips changed direction. Now they were on a collision course with the B-29! But suddenly the UFO's cut their fantastic velocity. For the next ten seconds they followed the bomber. Rapidly accelerating, the unknowns again changed direction.

By this time, the pilot caught another object on his scope—a huge, half-inch "blip." The observers couldn't believe their eyes! The smaller "unknowns" merged with the larger craft. Then they sped off—and out of sight. It was now 5:35 a.m.

The radar men calculated. "You won't believe this," exclaimed Coleman. "It was making over 9,000 miles an hour."

The Captain concurred. "That's just what I figured." It was all over.

The crew were interrogated by Air Force Intelligence upon landing. (Captain Harter had radioed ahead.) They all signed statements.

Lt. Coleman said the phenomenon definitely "was not a set malfunction or optical illusion."

It was a night to remember.

December 29, 1952: Refer—Keyhoe: *Flying Saucers from Outer Space*.

About 7:30 p.m., an Air Base in Northern

Japan received a report from a B-26 crew of several unidentified lights. The bomber was too slow to intercept the objects.

Then the Base's radar set "blipped" an unknown.

At 7:45 an F-94 interceptor pilot reported a UFO.

Three minutes later, another pilot spotted the object. He described it as having red, white and green lights.

The pilot climbed to 35,000 feet. He noticed the lights were revolving in a counter-clockwise direction. The rotation period was between eight to twelve times per minute.

Shining outward, the pilot said, were three shafts of white light. It was as if one portion of the object was stationary while another part revolved.

As he approached the UFO, the pilot switched out his cockpit lights. This indicated that the phenomenon could not have been a canopy reflection.

The jet raced to intercept the object. The plane's speed was 500 m.p.h.

For several seconds the object kept its pace. Suddenly it sped off, and disappeared in thirty seconds.

Five minutes later, the pilot again spotted the UFO.

And again he attempted interception—this time keeping his canopy lights on.

The object accelerated. It was out of sight in five seconds.

The official Air Force conclusion: "Probably Astronomical."

August 19, 1953—like most days—began with tedious hustle and bustle to the residents of New Haven, Connecticut. By nightfall, the big city had returned to its monotony. But suddenly the complacency had been jarred. For something was seen shortly after 9 p.m.

And that *something* crashed through a signboard at the intersection of Middletown Avenue and Front Street.

Two noted UFO researchers—Joseph Barbieri, then of West Haven, Conn., and August C. Roberts, of Jersey City, New Jersey—personally investigated the intriguing occurrence on August 22.

Their on-the-spot research uncovered several disconcerting facts.

Driving along a highway a few minutes past nine on Aug. 19, an unidentified man—Barbieri later learned—saw a red ball of fire trailing sparks. As it crossed in front of him, the object grazed a tree-top, rose slightly, and disappeared in flight.

Suddenly the area surrounding Front St. and Middletown Ave., shook with a thunderous roar. A brilliant flash followed. Lights dimmed.

"Several residents of the neighborhood," said the *New Haven Journal-Courier* in a front page story the following morning, "attracted to their windows and doors, reported seeing the flash of the explosion. Others said they saw a flashing object tear through tree tops and disappear in the direction of East Rock."

The Fire Department was called. They "could find nothing suspicious" other than a signboard with a one-foot in diameter hole violently torn through it. "A check of home and other buildings in the area failed to produce any information about the source of the explosion," the newspaper continued.

And residents didn't take the occurrence lightly. Many sleepless nights followed, according to the investigators. Joe Barbieri found a witness who said the object, after hitting the sign, "continued upwards, rising 20 feet in 300 feet of flight."

Upon examination, the galvanized iron billboard was found to be "pitted profusely and in each pit there was fused another metal that resembled gold or brass."

Several pieces were carefully dislodged from the torn edges of the perforation and submitted for analysis. The author has several copies of these analyses, all from independent and highly recognized assayers. A spectrographic examination showed, in one case, the fragments to be of pure copper. Another indicated copper and copper oxide.

Copper is rarely found in such a free state. If the "ball of fire" was a missile, who—or what—launched it? And why? The impact at the signboard indicated tremendous velocity. And why did it traverse upwards after crashing through the metal sheet? Anything undirected would have been greatly slowed, if not stopped, by the collision. Meteorites of copper composition are virtually unknown, even assuming that such a body could exhibit the reported characteristics.

But there was more.

"Neighbors told us," reported Barbieri, "that a stench like that of rotten eggs pervaded the area."

And thus we have another anomalous addition to UFO history. What was it? The New Haven Police were baffled. Theories ran the gamut—but no conclusion had been attained.

A Sergeant on Duty at the nearest Aid Defense Filter Center, it was later reported, had the answer.

"Hallucinations!"

And this closes the file on New Haven, Connecticut, August 19, 1953.

The Ontario, California, International Airport was the locale of another apparently explanation-defying event in 1953. On the morning of September 22 First Lieutenant Robert Starr, a Northrup Aircraft field inspector, Richard Lierd and Houseman, both mechanics, and crew chief Muir Funk were going over an F-89 parked on the repair apron at the Ontario International Airport.

A sound unlike that of the customary Northrup jets drew their attention. Looking up, the group saw a dark, cigar-shaped object tumbling downward. Their first thought was that it was a jettisoned wing tip-tank.

"We wondered why the pilot had jettisoned the tip-tank," Starr told the *Ontario Daily Report*, "and watched as it tumbled end over end, free-falling toward the ground. We watched it for six or eight—maybe ten seconds before the object suddenly stopped its fall and seemed to change in shape."

He said the four men were in agreement as to what they saw, adding:

"It seemed to change once, halted in the air and become circular with a luminous sheen. It streaked to the north disappearing in five seconds."

Lieutenant Starr said that although he had been around aircraft for a good long while, he had never spotted anything even faintly resembling this object.

"I would be afraid to guess at the altitude of the craft or its speed," he concluded. "But it flew faster than anything I have ever seen in the way of aircraft and I've watched a good many experimental flights . . ."

British amateur astronomer F. W. Potter was observing the heavens over Norwich during the evening of October 6, 1953. At 7:15 p.m., he saw "a bright and very large object" coming from the southwest. To the naked eye, he said, it "appeared oval-shaped, like a cluster of tiny stars." The amateur astronomer then observed the object with his 3½-inch refracting telescope.

"On bringing the object into focus," Potter wrote to the *Norwich Observer*, "the apparent cluster of stars took on the appearance of a dome on a large flat disc.

The dome had apertures placed at intervals around it, four of which were in my field of view. Light from these apertures made the disc visible. The top dome did not rotate. There was no noise to be heard from where I was observing, and the object kept a constant altitude. Under the disc a cavity could be seen, and this glowed a dull red colour. I saw no traces of gas or flame.

"The object," he continued, "travelled south-west to north-east and remained in my view for three and a half minutes. The sky was perfect, with no clouds. All the constellations were visible, and this object was seen independently by at least seven other Norwich people—members (like myself) of the Norwich Astronomical Society and the British Astronomical Association.

The British Astronomical Association has expressed a favorable opinion of Mr. Potter. Apparently he is not the type to ordinarily conjure up such an ephemeral phenomenon.

November 16, 1953:

"A fluffy blanket, dead white, almost ephemeral in its delicacy and apparently electrically charged, may be the San Fernando Valley's first physical contact with visitors from outer space."

Thus began an account in the San Fernando, California, *Valley Times* on February 15, 1954.

Residents of Reseda, centering near White Oak Avenue and Haynes Street, noticed the "clinging bits of the webby stuff" still remained on trees and telephone lines many months after the incident occurred.

". . . Mr. and Mrs. Louis Dangelo, who live near the corner of White Oak and Haynes," continued the *Valley Times*, "four men who reside on White Oak, a couple of next door neighbors of the Dangelos and a bakery truck driver arriving in the area on his rounds, saw the vaporous blanket settle over the district.

"We were watching three jet planes," Mrs. Dangelo recalls. "Then, behind them, we saw a huge silvery ball. We thought maybe it was a tow-target, or something, connected to one of the jets. But then the jets peeled off and landed. The silvery ball kept flying. It moved up and down, and—even sideways. Finally, a long streamer of white stuff, almost like a vapor trail, spewed out of its back end. It detached itself from the ball and began settling earthward. It spread out, stringy, sort of, like white wool being shredded, and it drooped down all over the neighborhood like cobwebs. Wires

running to our home turned white. They still sparkle at night."

"The bakery truck driver, Bob Tilt, rolled into the neighborhood about that time.

"I began noticing white stuff, like spider webs. It was everywhere, all over my windshield," he said. "I didn't see any of it in other neighborhoods that day. I've never seen anything like it before or since."

"They called Lockheed Aircraft Corp., Burbank. In the words of one woman:

"An engineer was sent out to see us. He was young and cocky, and approached us with a very sneering attitude. When he left, with a handful of the white stuff, he was silent and bug-eyed. The next day an engineer came from North American Aviation, and on the third day one from Douglas. They've never told us what they learned, but we've heard the stuff could not be analyzed."

"The material looks like finely shredded wool or spun glass. Held between the fingers for a few minutes, it dissolves into nothing. Mrs. Dangelo, describing its static qualities, said it often seemed to 'jump' from a bush or tree and cling to one's hair.

The phenomenon closely resembled the objects and resultant "Angel's Hair" sighted over Oloron, France, on October 17, 1952, and neighboring Gaillac just 10 days later.

"Could it be nothing more than spider webs?" queried the *Valley Times*. "Observers say no. Others, familiar with plant fungi, discount the possibility the mystery substance is mealy bug fluff."

Dr. Hugh Percival Wilkins, better known as H. Percy Wilkins, is considered a reliable observer. He is a Fellow of the Royal Astronomical Society; Director of the British Astronomical Society, Lunar Section; Fellow of the British Interplanetary de la Seccion Lunar de la Sociedad Astronomique de France; Presidente Honorario de la Seccion Lunar de la Sociedad Astronomica de Espana Y America, etc. He has observed through some of the largest telescopes—at Cambridge (England), Meudon (France), Mount Wilson and Yerkes (America), and many others. He has prepared what is now acknowledged to be the standard map of the moon. He even has a lunar crater named after him. And he has seen flying saucers. (The latter, of course, being the most dubious distinction in the profession.)

Here is the astronomer's own report, taken from his volume, *Mysteries of Space and Time* (Frederich Muller, Ltd., London,

1955). In Dr. Wilkins own words:

"... I confess that I was not merely a skeptic but a firm unbeliever in any such objects until I had the pleasure of undertaking a lecture tour of the United States. On the morning of June 11, 1954, I boarded an aircraft at Charleston, West Virginia, for Atlanta, Georgia. The plane took off from Charleston at 9:45 and arrived at Atlanta at 11:46. There was a very considerable amount of cloud along the route, chiefly of the cumulus variety, extending upwards to 8,000 feet, at which altitude flight was maintained. Below were cloud masses, from the upper surfaces of which rounded heaps of cumulus towered up to a height level with and on either side of the aircraft. From one window the shadowed sides of these clouds were brilliantly illuminated by the sun. This splendid display of clouds, with occasional glimpses of the ground through gaps, continued until 10:45, when my attention was caught by two brilliant, oval, sharp-edged objects apparently suspended or hovering above the tops of two particularly lofty cumulus masses of cloud, the sides of which were shadowed and at an estimated distance of two miles. These two objects were of a yellow colour like polished brass or gold, and, quite apart from their colour, were very much brighter than the sunlit clouds on the other side of the aircraft. They looked exactly like polished metal plates reflecting the sunlight, and were in slow motion northwards, in contrast to the clouds which were drifting southwards. Suddenly a third and precisely similar oval object was seen against the shadowed side of the cloud, but this object was dull and greyish, presumably because it was not in the sunshine. While the two brilliant objects continued their slow motion, the third one began to move with accelerated velocity; it described a curve, and vanished behind another and nearer cloud mass. The whole display was visible for nearly two minutes, but the grey object completed its rapid motion in less than five seconds after it began to move.

"I was so surprised that by the time I recovered, the aircraft had travelled far ahead. These things were approximately 15 minutes of arc in length, that is to say one-half the diameter of the sun or the moon, and the distance apart of the two bright objects was five degrees. At first I naturally thought that they were merely the extreme tops of the clouds in sunshine, but soon realized that their colour and extreme bril-

liance discounted this idea. Also they were much brighter than the fully lit clouds on the other side of the aircraft."

Dr. Wilkins concludes that, "Certainly they were not caused by any optical or meteorological peculiarities . . ."

And thus the non-believers lost another member.

It is uncommon for an ordinarily staid astronomical publication to even include those two controversial words "flying saucers" between its covers. But such was not only the case in the March-April 1955 issue of *The Strolling Astronomer*, but the account of a rather remarkable phenomenon was included as well.

Relates *The Strolling Astronomer*:

"*An Unusual Sky Phenomenon.*" Under this title the leading article in Vol. 2, No. 25 of *Vega*, Mr. R. M. Baum's excellent [British] publication, describes a really amazing observation by Mr. Harold Hill, Dean Brook House, Abbeylakes, Near Wigan, Lancashire, England. Whatever one may think of flying saucers—and it is perhaps difficult at this time to say much new about them—we here have a careful observation by an outstanding lunar observer of more than twenty years' experience in astronomical work. Mr. Hill will give his own opinion as to what was seen upon request. We here summarize from *Vega* the observation itself.

"On July 8, 1954 near 20^h 30^m, U. T. (Universal or Greenwich time), at his observatory in Abbeylakes Mr. Hill suddenly noticed at an altitude of about 55° in the southern sky a bright, apparently stationary, star-like object. With 33X and 50X on a 12-inch reflector the 'star' was accompanied to the left by a loose cluster, with perhaps 15 to 20 members of what appeared to be minute stars of varying magnitudes. These were constantly moving about, a 'hive of activity.' After a short break caused by clouds, Mr. Hill saw *two* bright objects close together. The cluster had vanished, though perhaps merely outside the field of view of the telescope. 'My attention was directed to the two bright objects which showed sensible motion. They were separating as I watched and not only appeared to be gyrating and flashing but also exhibited a slow pendulum movement about each other in a manner similar to dancing partners! The increased movements of these objects made following with the 12-inch a difficult affair, and they passed out of the field as an adjustment had to be made to the

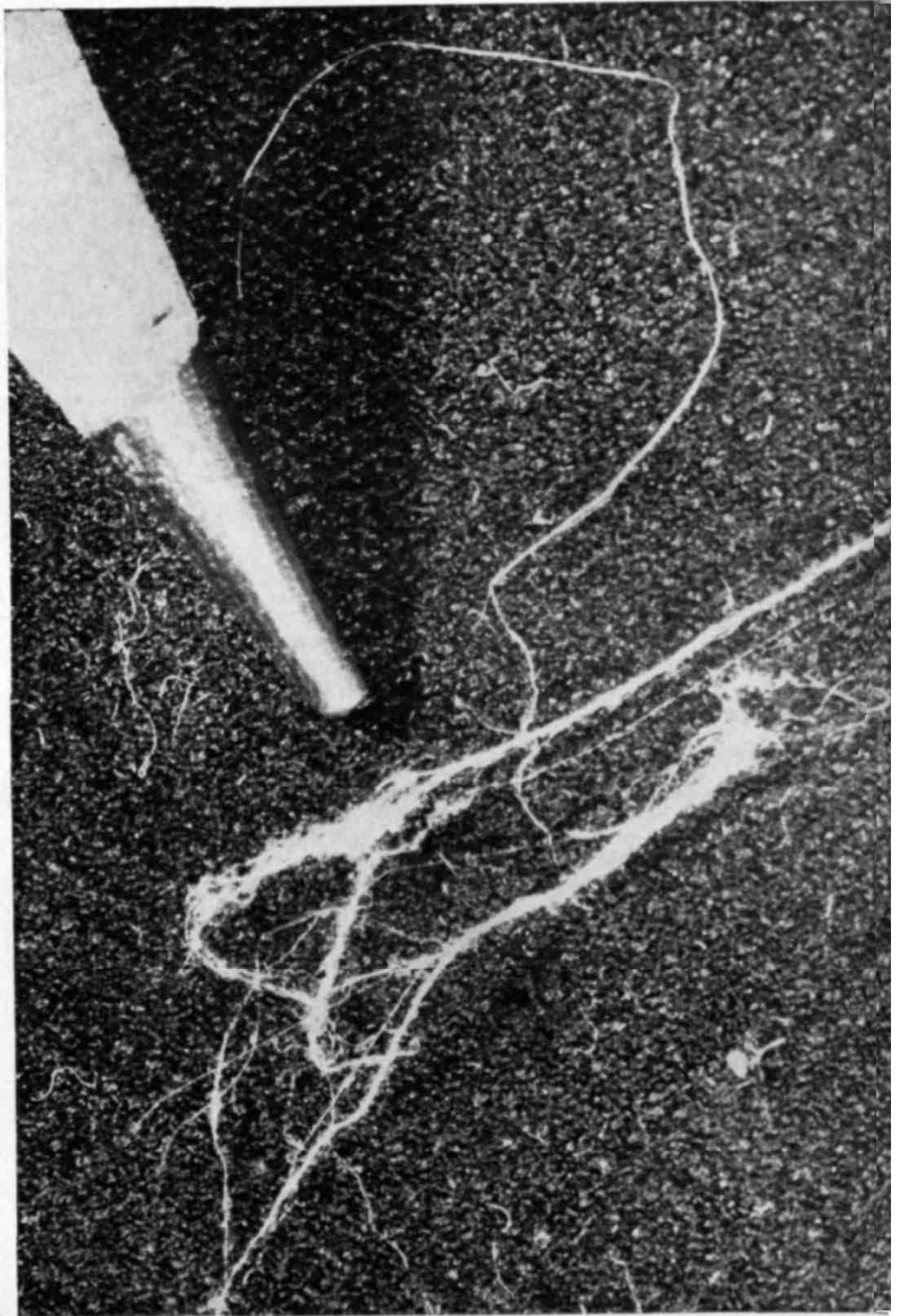

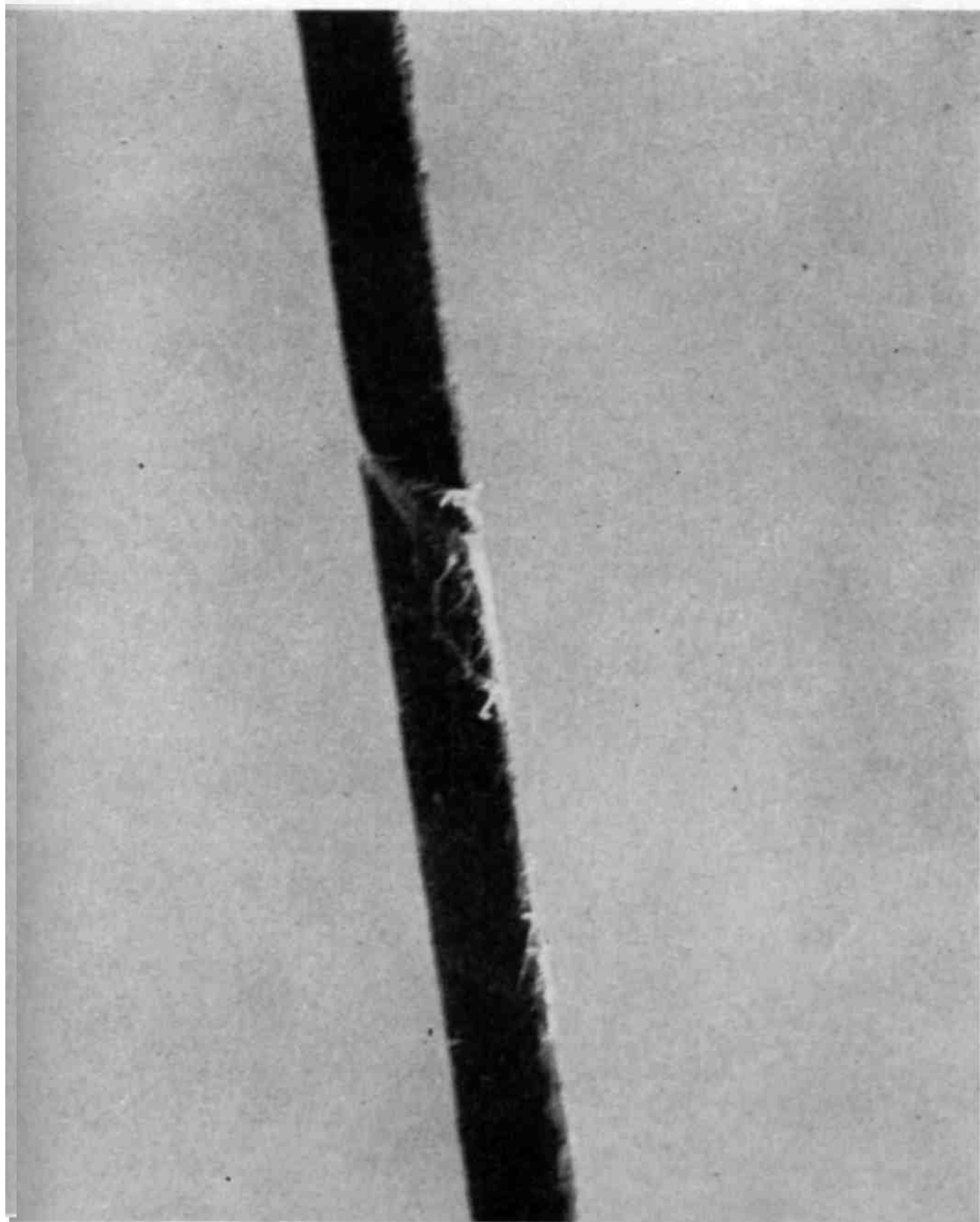

Threads of so-called "angel's hair" which spread over a several block area of the San Fernando Valley, California, in 1953. The filmy and rapidly dissipating substance was witnessed to have fallen from a large, disc-shaped craft. Similar phenomena have been reported from Central Europe, New Zealand and Australia. PHOTOGRAPHS COURTESY OF THE VALLEY TIMES

telescope.' They were also lost to Mrs. Hill who had been simultaneously watching with binoculars. Clouds ended the observation at 20^h 55^m, U. T. Mr. Hill's impression was that the objects were at a very great height. 'The two principal members defied description, they flashed as they gyrated as though metallic surfaces were reflecting the rays of the sun (now below the horizon). Probably the closest analogy to what was seen is to be found in the flashing of the facets of a diamond as it is turned in strong light.'"

One of the most interesting, and conclusive UFO sightings, in the author's opinion, took place during an eclipse on June 30, 1954, over Lifjell, Denmark. Three Scandinavian airliners, carrying a total of 50 observers, took off from Norway to witness the eclipse. The time was 2:17 p.m., altitude 15,000 feet.

One of the observers was E. Graham, the London Press Officer for the Swedish Travel Bureau. His report is reproduced from the British *Flying Saucer Review*:

"I was about to put a new film into my camera when my attention was distracted by Mr. Johansen pointing towards the Northern horizon and crying out above the engine noise 'What the hell is that?'"

"I looked out of the porthole and observed two shiny discs travelling across the horizon.

"By now the entire party were watching the objects, nobody thinking of getting a camera on to them.

"After we had studied the objects for a while Mr. Bjornulf dashed across the floor to get his camera. He searched for a while, the other cameramen urging him to hurry. It was only then that we realized that we were watching something which none of us believed in,—so-called 'Flying Saucers.'"

"We were still discussing, shouting at each other—and when the objects began to disappear pandemonium broke loose as everyone tried to get their camera ready first. By then Mr. Bjornulf trained his object finder on the discs and began filming.

"The objects were clearly revolving and showed 'stern-lines.' I am not certain whether these 'lines' may have been a kind of exhaust fumes.

"It was impossible to estimate their speed, or their size. I assume, however, that as the objects were about 15-20 miles away, the speed (and their size) must have been far beyond anything achieved by man-made aeroplanes.

"I am basing this assumption on the fact

that the objects were out in the sun, while we were still in the shadow of the eclipse. The shadow extended at least 15 miles north of our position. I cannot offer any opinion as to what these objects were, or where they might have come from."

And another anomaly is added to the UFO file.

It would be an injustice here not to include the comments to the above as expressed by the noted British publisher, Waveney Girvan. Again quoting from the *Flying Saucer Review*:

"Flying saucers would, I believe, lose much of their fascination if it were not for the skeptics, bless them, who bring an element of cosmic humour into what is essentially a most serious subject. At the private showing in London recently of the Swedish Travel Bureau film, there were a number of newspapermen present, and it was most instructive to hear their comments when the show had ended. In spite of the commentary, spoken by Mr. E. Graham, one of fifty who were present in three planes which had been sent up to record in colour the eclipse of the sun over Norway on 30th June, 1954, the skeptics devoted their whole attention to the film.

"This, after all, was only part of the evidence that had been presented. Ignoring the positive statements made by Mr. Graham, the 'will-not-to-believers' suggested that the objects might not have been flying saucers, but something else. 'Could they have been reflections in the windows of the plane?' (Mr. Graham had stated that there were no window-glasses, for they had been removed to avoid any such reflections. Also, the objects were seen from each of the three planes.)

"Momentarily baffled, the skeptics then suggested that the two objects could have been seagulls, even though Mr. Graham had clearly stated that they appeared to be perfectly circular, glowing and revolving; indeed a close inspection of the film as it was being shown proved that they pulsed in the now familiar manner—this effect could be produced by a circular object revolving slightly off its true centre. Your skeptic is a tough customer, however, and I now suggested that the eye-witnesses would all be accused of fraud or insobriety, but politeness restrained such accusations from being made in the presence of a member of the expedition.

"There were two explanations left. The true one, of course, was that here was yet another proof of the existence of flying

saucers, the film confirming the reports of fifty trustworthy witnesses. Rather than admit this, however, one of the skeptics suggested that the two aircraft—by inference he admitted that they must have been aerial machines—were Russian. He was prepared to admit to the terrifying thought that Russia was between fifty and a hundred years ahead of us in aeronautics. He preferred this gloomy speculation rather than admit that apparently harmless visitors were coming to us from outer space. His fear of the unknown must be truly great, and I think is the real explanation of the skeptics' fight against the persistent evidence that the flying saucers are real.

"In the same week as the film was being shown the new Astronomer Royal arrived in England and announced that the flying saucers were 'bilge.' As I have always held, this is the correct way to deal with the subject if you are an unbeliever. Refuse to listen to eye-witnesses and arguments and, above all, keep away from film like the one under review. If once the objective reality of the saucers is accepted, you are forced to adopt the only working hypothesis that they are aerial machines not made on this earth. Dr. Woolley is probably aware of the truth of this statement, and 'bilge' was, from his point of view, an excellent word for dismissing the whole subject."

(Britain's new Astronomer Royal, Professor Richard van der Riet Woolley, superseded Sir Harold Spencer Jones.

So as not to relate an incomplete assertion on the part of the Astronomer Royal, Dr. Woolley declared such things as space travel and flying saucers to be "utter bilge." This is an extremely more emphatic viewpoint than his predecessor, Sir Harold, who opined that these things are only "rather rot.")

"On December 16, 1954, I was dubiously fortunate to have observed a 'UFO' (Unidentified Flying Object) in the skies over Apple Valley, near Victorville, California," began, in unfortunately typical fashion, the interesting sighting report by Hart T. Goodman—one of many to witness the striking phenomenon. He continues:

"I feel that I have had enough experience with flying, radar navigation and observing to qualify for reporting the following incident with near accuracy. I am certain that the phenomena was of a tangible nature with dimensions that were real, though unbelievably so.

"The object was cigar shaped, of ex-

tremely bright silvery material. It remained stationary at an altitude of approximately 25,000 feet, almost directly above the Apple Valley Inn, from about six o'clock P.M. of the 16th until almost noon of the following day. That night the object appeared as a reddish-orange glow, but when the sun came up in the morning, the object became silvery. It was easily visible with the naked eye. I observed it in the morning with a pair of 7 x 50 binoculars and was able to make out quite a bit of the detail. This object must have been about two and a half times as long as a B-29. There were two windows or ports at one end near the bottom. It seemed separated through the length with a single row of bolts or small holes.

"There were approximately fifty people who observed the same thing that I did; among them were two deputy sheriffs from Victorville, a medical doctor, the manager of the Apple Valley Inn and most of its employees, and at least twenty guests at the Inn.

"The authorities were repeatedly called at George Airbase, which is just four miles from Victorville. The only answer that could be obtained at the time was that they had planes (jets) in the area and were investigating. They assured any callers that it was not a weather balloon or similar object but beyond that they would say nothing. The following day they denied the whole incident and denied that any inquiries had even been made by all these people.

"In the early morning there were jets all over the place. One vapor trail was visible flying directly over the object at about 35,000 feet. The jet wasn't visible with the naked eye but could be seen with binoculars. The pilot of that jet couldn't have avoided seeing the object.

"One of the guests of the Inn took some pictures of the object which, I later learned, were taken from him by the authorities.

"On Friday the 17th, I returned to Los Angeles and gave a full account of the experience to Mr. Paul Coates of the *Mirror-News*. He immediately began to check my story and verified everything that I had told him.

"The only satisfaction that he was able to get was from two non-commissioned officers who admitted knowing about the reports, but made the bad mistake of telling Mr. Coates of their knowledge. They suddenly were incommunicado at the Air Base."

Hart T. Goodman

Gene H. Miller is the manager of the Banning, California, Municipal Airport. He

is one of the many pilots to have encountered UFO's during his flying experience.

There is a doubly particular reason for including this UFO report. First of all, the UFO may have attempted to signal Pilot Miller. It may be an incentive for authorities to devise some simple means—and none could be much simpler than the method herein described, and discovered apparently quite by accident—to establish a plan of *friendly* contact if, as and when the enigmatic UFO is encountered by military and civilian pilots.

The second—and important—factor to include in this report is the competency of the observer. Gene Miller has been a commercial pilot for 15 years, has flown in every one of our 48 States, in Canada, Mexico, Europe and the Orient. He has completed numerous flights across the North Atlantic and the Pacific Oceans.

"I have done every type of flying imaginable," he relates. "Instructed for the AAF during the Second World War, was in the Air Transport Command, and after the war I operated one of the largest GI Flight Training Schools in the Pacific Northwest for veterans. From 1951 to 1954 I was with the Flying Tiger Lines. I have flown aircraft with only 27½ horsepower to aircraft with four engines totalling over 6,000 horsepower. Flying is my life and has been since 1921."

Here is his story:

"At about 1830 hours on the evening of November 14, 1955, I was returning to Banning, California, from Phoenix, Arizona, on a charter trip. I was flying a Piper Tri-Pacer and my passenger was a doctor from Redlands, California.

"The sun had been down about an hour and it was very dark outside. Flying at 5000 feet altitude and at a magnetic heading of 290 degrees, we were approaching the little town of Desert Hot Springs, when I noticed a large white light about 30 degrees to my right at our same altitude, and about seven or eight miles away. I watched it for about a minute, then called it to the attention of my passenger.

"After another minute or two had elapsed, I realized it was moving toward us, so I began to take action to avoid collision. By this time it was definitely much closer and I switched on my landing lights two times. Immediately this object's light went out, came on, went out, and came on again. When its light was off there was no shape or form or anything there. A few comments were passed between myself and the

passenger. Possibly another two minutes passed and the object was coming closer, but very slowly.

"Now it was a little over a mile away and I knew I was going to have to take evasive action. But before I did, I flashed my landing lights three more times. Again it answered in the same manner—three times.

"I was just about to reduce power and lose altitude fast when the object stopped. It stopped so abruptly that I was amazed and did not lose altitude or change course. In a few moments it started backing up. Now I knew it was no aircraft. No aircraft has a light that large. After it started backing up it seemed to move at a faster rate than it did while approaching. It moved back over a small range of mountains (the Little San Bernardinos), turned left, moved up the slope of Mt. San Gorgonio, and disappeared near the peak. At this time we were just entering the pass near White-water and encountered severe turbulence. We were forced to turn around and had decided to land at Palm Springs.

"When we were finally out of the turbulence, and headed toward Palm Springs, I looked around in the direction of San Gorgonio peak. Down the side of the mountain came the light again. It seemed to follow a ridge that connected to the Little San Bernardino Mountains. I judged that it was only about 500 feet above the terrain.

"I swung the airplane around a few degrees so that I could see it better, and we watched it follow the skyline toward the southeast, past Desert Center and on towards Blythe until it passed from view. I estimated that it covered about 70 miles in four minutes.

"We landed in Palm Springs and phoned to Banning for some transportation. Although the sighting was not discussed after we landed, my passenger said several times, 'I wonder what it was?'

"In summing up this experience I wish to say that it was the most unusual sighting that I have had to date. Through the past 15 years I have been fortunate enough to have made about 10 sightings of UFO's before my wife and I moved to Banning in June 1955. I have had four definite sightings since then. And I consider myself as quite capable of distinguishing between aircraft, weather balloons, clouds, et cetera, and unidentified flying objects."

Bud Pecaro was traveling with his parents by automobile from Los Angeles to Greenwich, Connecticut in late April 1956.

"As we were starting out in the morning on the highway to Tempe, Arizona (between Phoenix and Tucson) in April," he recounts, "my father remarked about an object in the sky to the right front of us. When I first looked I saw a long silver object with something seeming to shoot away from it and to the right of us.

"I immediately asked for the large pair of binoculars, as I knew my smaller ones would be ineffective. When I looked I didn't have them in focus right away but I could tell that the object was a long cigar shape with a dark spot, or hole, in the center. I then handed the glasses to my father. After a while he said he saw what looked like a row of windows or ports that kept flashing light or flames along the side of the thing, and that while he was watching, something like a little meteor came shooting out of the bottom. About this same time I noticed that the thing seemed to flare up, after which it appeared to be farther away.

"Finally, after we were out of the traffic, we stopped along side of the road to get a better look at the object. By this time it had moved from the right to the left of the highway, and away from the telephone poles. It was now over some mountains in the distance and seemed to have gotten there rather quickly.

"I got one last look at it through the binoculars before we and it moved away. It looked like a big ball-point pen that was glowing on top and dark underneath. The sighting, in all, lasted ten minutes." (The observer estimated the object's length as 0.75 degrees—*Author*)

M. J. Clark is a Civil Engineer in Grovetown, Blenheim, New Zealand. He is an amateur radio operator (with the call letters ZL2BU) and a member of the Institute of Engineering Technology in England.

On July 26, 1956, he saw "something" through his 20-power theodolite. He described the phenomenon by prefacing, "It appeared to be moving in three dimensions, and its greatest direction was away," in a letter to Harold H. Fulton, Director of the Civilian Saucer Investigation of New Zealand. Here is his report (in part):

"On the 26th July, 1956, I happened to glance up to the window and saw an unusual object in the sky. I set up my theodolite at 10.15 a.m. and recorded its altitude and immediately obtained a sun shot and calculated the bearing from the azimuth of the sun, and noticed that whatever it was,

was about to cross the meridian, approx. $37\frac{1}{2}$ degrees ahead of the sun. I checked with the nautical Almanac and could not find anything to correspond. The object was moving in a westerly direction, rising in altitude and moving away at great speed.

"At 11:15 a.m. another record was taken, but the object could not be seen very easily with the naked eye. At 11:30 it had dropped in altitude and became invisible. It was then I noticed Venus, a different object altogether, which was in the near vicinity all the time. The first object was similar to Venus in shape, but was flat at the bottom, where the shade ring of Venus was at right angles to the sun, making it perpendicular in the flat part.

"Venus was a distinct half sphere, but the other was not a perfect half sphere, but was more domed, with flat parts or edges and not a distinct edge of a half sphere. There may have been more edges than shown on the diagram, but the object was too distant to tell. I could not tell there was a distinct difference.

"When first observed it was much larger in the telescope than Venus, but faded smaller till right out of sight . . .

"The object appeared to have a bluish hue in front and a rusty hue behind, but that may have been atmosphere. When the clouds came between the object, there was what appeared to be a white light or glow behind the cloud, but when the clouds were not there, the white glow was not visible.

"It was not a met. balloon, as it was moving against the westerly air stream, and it would have been too far away to see a balloon. What puzzled me was the westerly movement, which was very near the sun, about 15 degrees per hour, but Venus was there as well; has been for some days and still is . . ."

M. J. Clark

Engineer Clark calculated three different positions for the UFO (from Latitude $41^{\circ} 31' 10''$ —Long. $173^{\circ} 57' 30''$), and the Civilian Saucer Investigation computed the same for Venus, as follows:

Time	UFO
10:15 a.m.	Alt. $33^{\circ} 20'$, Az. $2^{\circ} 36'$
11:15 a.m.	Alt. $34^{\circ} 20'$, Az. $347^{\circ} 25'$
11:30 a.m.	Alt. $31^{\circ} 25'$, Az. $342^{\circ} 12'$

Time	Venus
10:15 a.m.	Alt. $29^{\circ} 46'$, Az. 353°
11:15 a.m.	Alt. $26^{\circ} 57'$, Az. 338°
11:30 a.m.	Alt. $25^{\circ} 44'$, Az. 334°

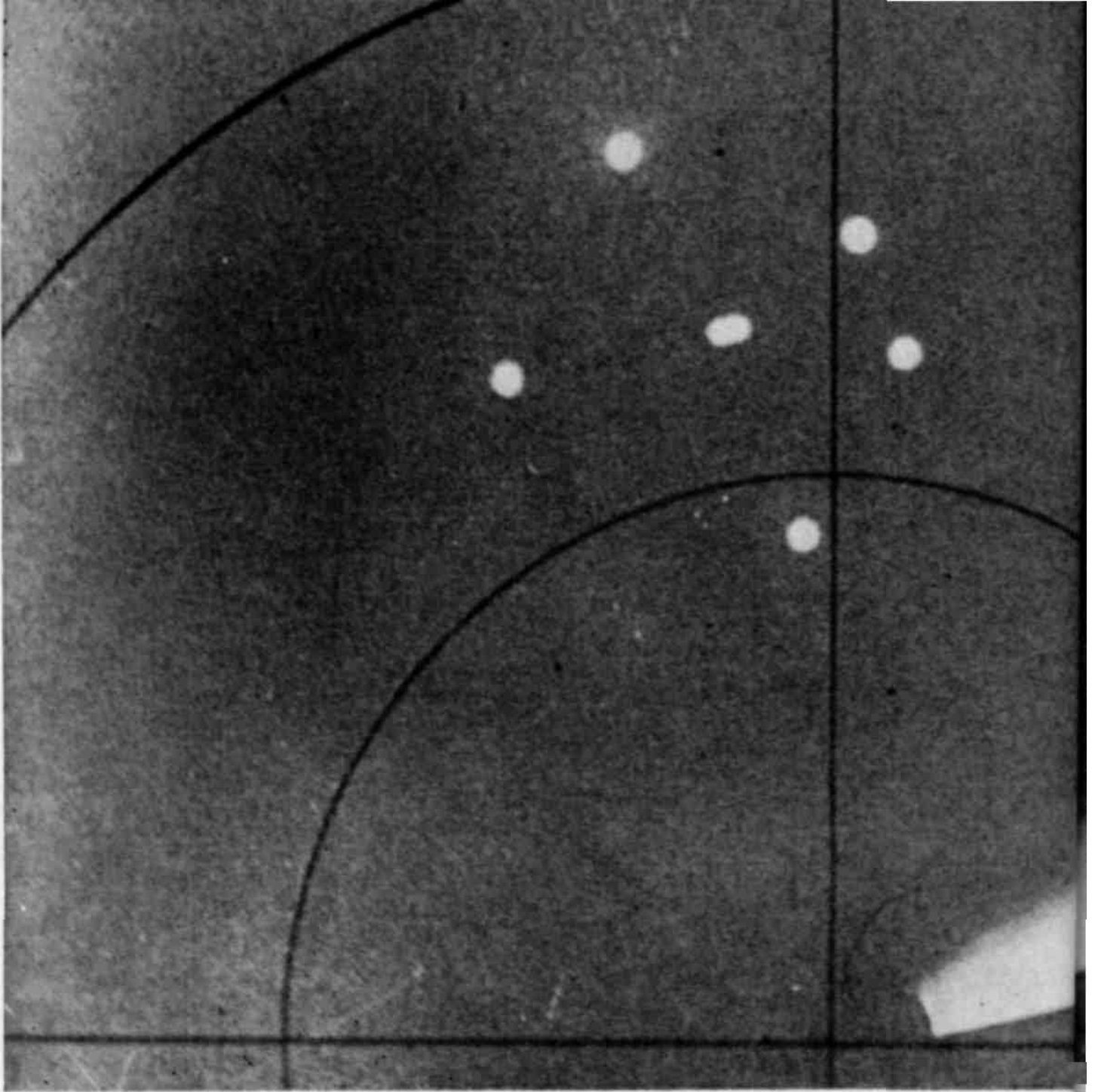

chapter 7

Contact Stories

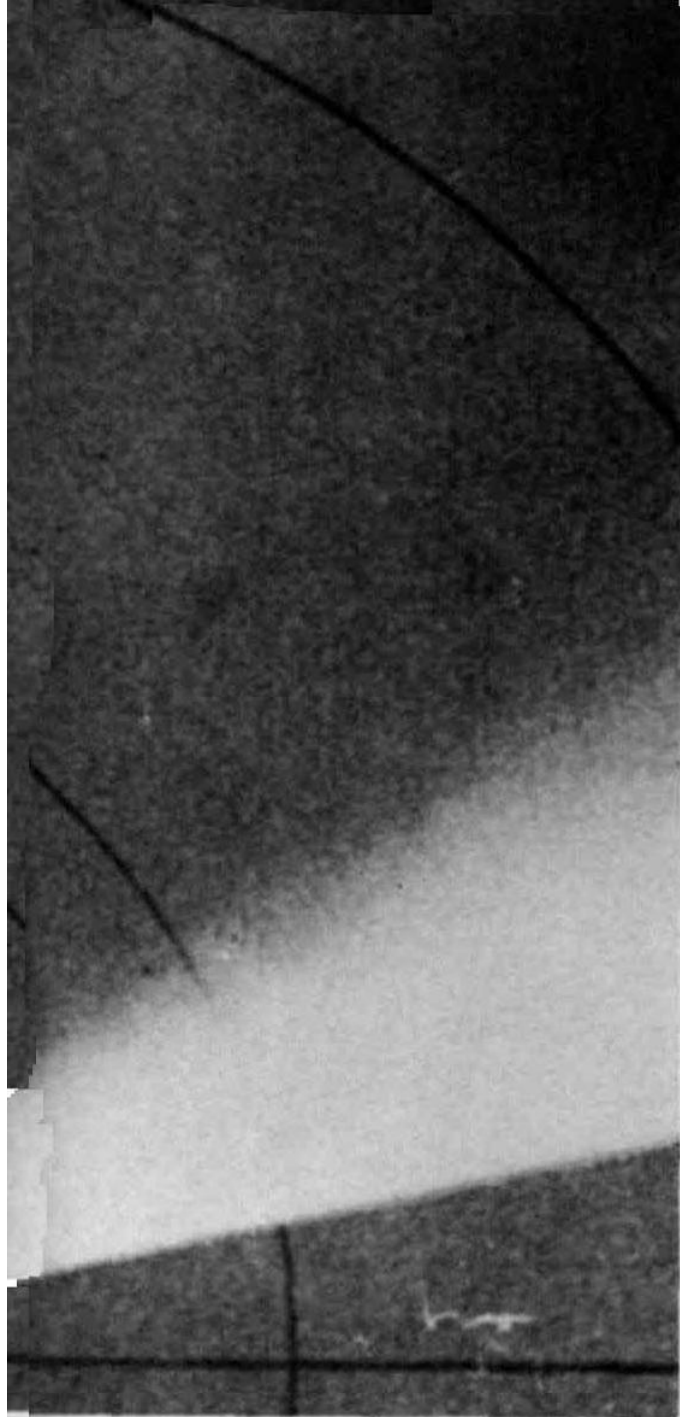

Jet interceptor is surrounded by a group of UFO's on a simulated radarscope during United Artist-released motion picture, "Unidentified Flying Objects." These sequences accurately depict events as they occurred over Washington, D.C., on July 26, 1952.

And it is next to impossible to draw the line and define as to when an unusually dramatic UFO sighting concludes and a "contact" begins.

Even the most ardent "believer" will discount some of the contact stories. Likewise, many dire "unbelievers" have been unable to completely discredit some of these so-called "experiences," several of which are accompanied by supporting affidavits.

Obvious hoaxes have been prevalent to a certain degree. Several of the "contactees"—as they have come to be known—have capitalized on the subject by selling tape recordings from "our space brothers" and "dire messages to the governments of earth."

But some are apparently not *obvious hoaxes*. Neither are they conclusive. *These accounts are seemingly independent of objective research and reports found elsewhere in this volume.*

But none can deny that these reputed "contacts with outer space intelligences" make up an intrinsic part—vital or otherwise—of the overall UFO picture. They may deserve airing.

And this is what the author is attempting. He can neither opine nor theorize relevant to these stories; he can only report. But because of the sheer bulk of such reports, the author must be a discriminating reporter.

Therefore, only several of the better or *original, "contact stories"* are presented herein. These alleged happenings, it may be interesting to note, did not begin—with one exception—in any noticeable numbers until 1952. *And those to follow are the ones which have more or less held up under extensive publicity, notoriety, discrediting and interrogation.* (The latter, largely by the thousands of private UFO investigators in this country and elsewhere.)

In prefacing these accounts the author shall briefly relate the principal objections as remonstrated by those who feel that such contact is impossible, and with the generally resultant answers following:

1. *Objection:*

Why should these "outer space beings" contact laymen—construction workers, taxi

IN RECENT years there have been increasing reports from groups or individuals who claim to have verbally communicated with humanoid beings who pilot—or at least occupy—the discoid spacecraft currently designated "flying saucers." A physical "contact" is not necessarily effected by this discourse, however.

Unquestionably these "contacts" involve the most controversial phase of UFO research. The percentages of so-called "believers" and "disbelievers" are so constantly varying that it is impossible to estimate the specific or even general interest in this group of personalities—but that they are the recipients of extreme interest cannot be denied.

Scientists and laymen alike have argued long into the night over the actuality and "import" of these purported experiences.

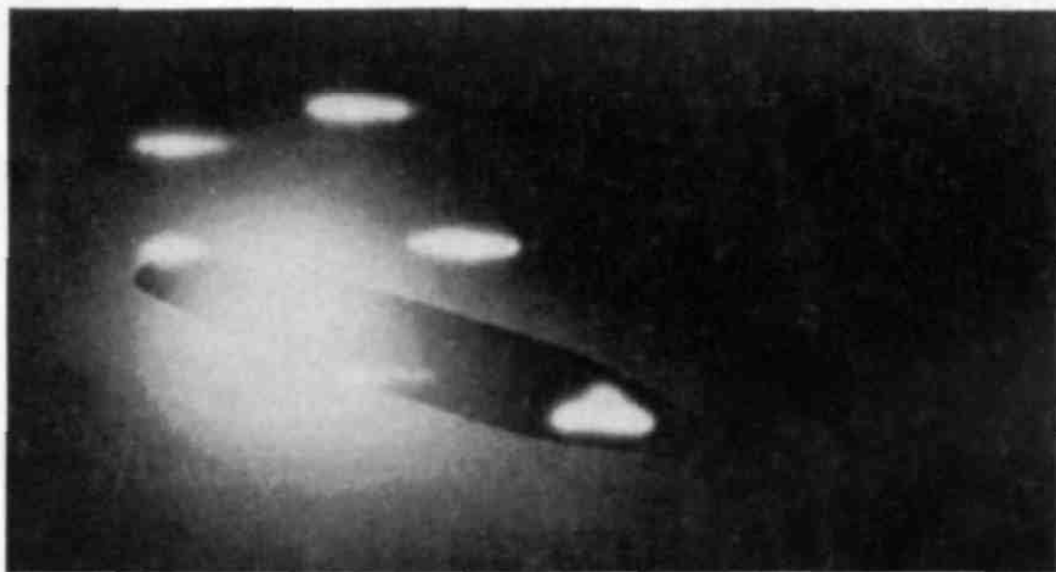
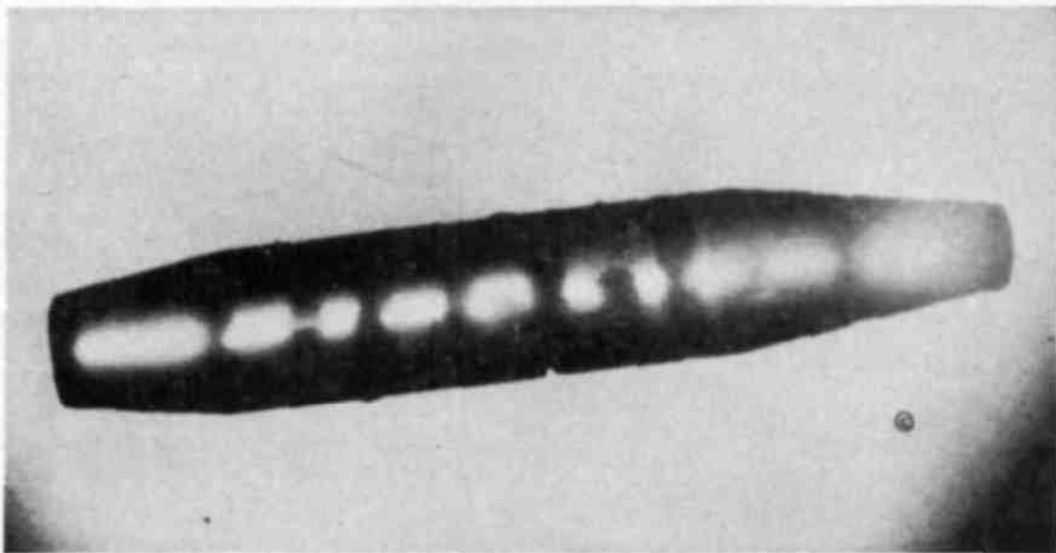

George Adamski claims he photographed space craft in our atmosphere and out in space. Pictures seen here are reproduced from "Flying Saucers Have Landed" by Desmond Leslie and George Adamski. BRITISH BOOK CENTRE

Upper photos purportedly show mother ships and "saucers" being launched, lower panel (right) shows six U.F.O.'s in space fairly close to the moon.

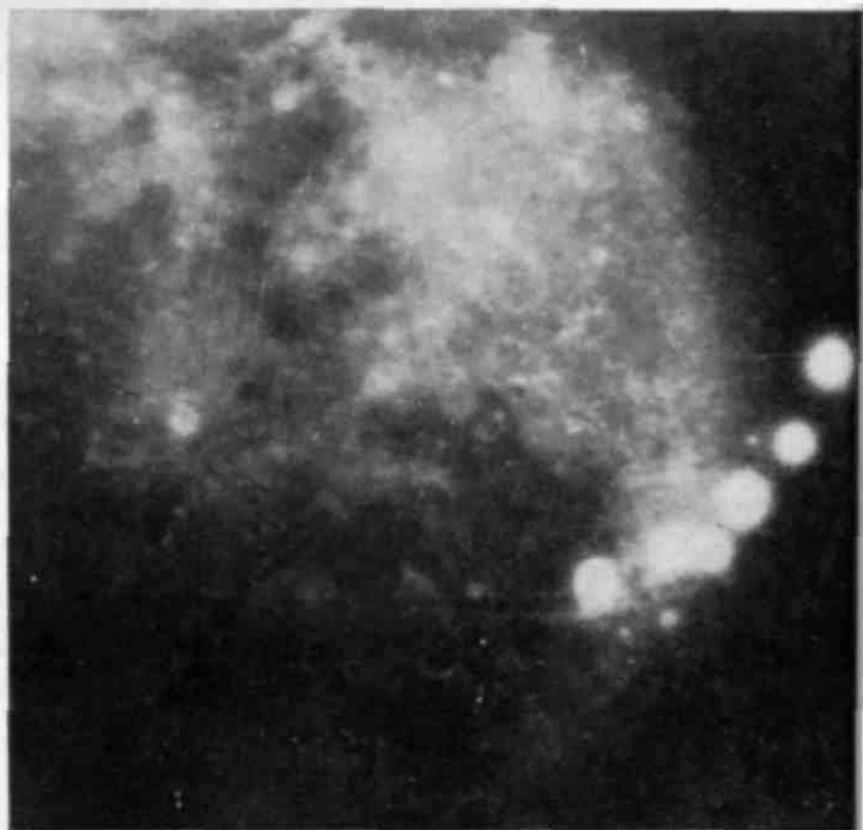

drivers, electronic specialists, and the like—rather than recognized scientists or world leaders?

Reply:

Primarily because so-called "scientists" are filled with years of indoctrinated and preconceived misconceptions. They know little about the universe without their domain, and that is dogmatically inaccurate. They are incapable of complete revision or reversal of thought, which would ultimately occur upon communing with an extra-terrestrial creature. Some laymen, on the other hand, are not so indoctrinated, and are therefore more receptive to new concepts. And, lastly, it is possible that some scientists—and world leaders—have been "contacted," but fearing ridicule and loss of eventual prestige, will not openly admit to same.

2. *Objection:*

Life on earth is an accidental "freak." Therefore, although other worldly life may exist, it would not be in the humanoid form as now claimed.

Reply:

We do not know enough about outer-space intelligence to speculate as to what type of life may be found. Also, life on our infinitesimal planet was not born by "accident," but by Divine Creation. We are here for a constructive purpose and not to haphazardly seek oblivion. Finally, the Bible tells us that God created "man in our image, after our likeness" (Genesis 1:26); therefore does this not indicate a omniversal semblance?

3. *Objection:*

Somewhere in the universe there may exist human-like creatures. But it is virtually impossible for these beings to come from even the nearest stellar solar system; and it is inconceivable to think that life as we know it may have developed on any of our planetary neighbors in this solar system. (In a survey of astronomers instigated by *Science News Letter*, Sept. 15, 1956, p. 163, it was found that 62% of the astronomers polled believe there are "creatures roughly comparable to man in the universe; 3% replied in the negative, and 35% did not opine.)

Reply:

We should be humble in our ignorance. We do not know the exact conditions prevailing on any of the other planets. Are we, then, in a position to hypothesize? Look at the material progress science made since just the turn of the century. Experimental aircraft have developed from 30 miles an hour just over 50 years ago to 2,100 m.p.h. today. Who can say what will happen with-

in the next fifty or even ten years? If a foreign stellar race were advanced several thousand years in relation to the earth, is it not just as inconceivable to speculate as to their capabilities? Perhaps they are beyond our fundamental comprehensions.

4. *Objection:*

If saucer contacts have taken place, why have they been so hit-and-miss and without apparent pattern? Why are the stories so contradictory? What positive or constructive changes have accrued to the enhancement of the world, or even our knowledge, from these "space contacts?"

Reply:

First of all, the process has not been of "hit" or "miss" variety and "without apparent pattern." Many of the "contacts" that are still recounted today are claimed to have occurred in the early or mid-year of 1952. This was before the so-called "Washington Crisis" which so embroiled the nation in bitter controversy; so if they are hoaxes, it shows remarkable foresight on the participants' part. The mid- and latter part of 1952 gave the Air Force its largest number of sightings in history. And about the only other year of note, so far as the contactees are concerned, was 1954—another year which turned out UFO reports in great flurries. Both years—1952 and 1954—occasioned (by coincidence?) close oppositions by the Planet Mars.

(Continuing:) Admittedly, the bulk of these contact stories are to some degree contradictory. But perhaps they involve communications with beings from several planets. Would not this account for the slight discrepancies? And, too, we are all human, and we are all impressed differently. What might be especially important to one person may effect an indifferent reaction in another. We all look at things varyingly; and likewise express ourselves at variance.

(Continuing:) Who defines what is constructive and what is not constructive? These men of other worlds have tried to convey fraternal friendship and understanding. What is more beneficial? They have told us to project only love and friendship—as they have done. And they have brought a certain amount of comfort and hope to thousands of people of the world. Is this not positive and constructive? Gradually—as more contacts are established and news of these discourses are disseminated—they are affecting the world. It is a slow but sure process.

The author has attempted to express an



Daniel W. Fry, who alleges he contacted a so-called "flying saucer" on July 4, 1950, at the White Sands Proving Ground, New Mexico. Fry claims he entered the craft, which whisked him by remote control to New York and back in 30 minutes. This, he adds, would indicate a speed of at least 8000 miles per hour. Fry is a part owner of an engineering plant in California.



Daniel W. Fry claims he took this photo of a mystery craft between Baldwin Park and Azusa, California, at approximately 3:30 p.m. on September 18, 1954, with Brownie Holiday camera.

objective picture of both sides of the controversy. It is only expected that the "defendants" have a right to rebut the accusations. And it is hoped that a fair-sided and intensive approach was conveyed. The object of this chapter still is to remain neutral.

And rather than to summarize or paraphrase a few of the contact stories, the author has felt it advisable to leave this up to the individuals involved. The reader will thus be enabled to perceive a greater depth of these varied personalities. And this will also permit the so-called "contactees" to more individually express themselves, conveying their reported particular reactions, impressions and highlights via their own style and phraseology.

In early 1954, Daniel W. Fry of El Monte, Calif., announced that he had established a contact with a non-terrestrial entity four years prior—in 1950—at the White Sands Proving Ground, New Mexico, during his employment with the Aerojet General Corporation, of Azusa, California. By vocation, Fry was an explosives technician and blaster. Currently, he is part owner in an electronics firm and editor of the periodical, *Under-*

standing. He has recently written and published a textbook on space travel titled *Steps to the Stars*.

Dan Fry's entire claimed experience is related in his book, *The White Sands Incident*, (New Age Publishing Co., Los Angeles, 1954) from which he summarized the following account:

THE WHITE SANDS INCIDENT

"The incident occurred at the White Sands Proving Ground, an Army and Navy missile testing area near the town of Las Cruces, New Mexico. The time was the evening of July 4, 1950. I was, at that time, temporarily employed at the base for the purpose of setting up instrumentation for the static testing of a series of very large rocket motors. The day being a holiday, I had intended to spend the evening in the nearby town of Las Cruces. Instead, I found myself stranded in the almost deserted army base by the untimely departure of the last camp bus for town.

I retired to my quarters, Room 6 in the H building directly across from the Officers Club, with the intent to do a little studying on the subject of heat transfer, a subject in which I was considerably interested at the

time. It also proved to be a timely subject, because no sooner had I commenced to study than the air conditioning system of the building apparently ceased to function, and my room became unbearably hot. Forced out of doors by the heat and the stuffiness of the building, I decided to go for a hike among the 'boondocks,' as the sandy, hummocky area surrounding the base is colloquially known.

The sun had been down for some time and the moon was not yet up, but it was far from dark. The White Sands Proving Grounds is situated upon a rather high desert plateau. The air is very clear and the stars very bright. Unless they are obscured by a heavy overcast they will always furnish ample light for comfortable hiking.

When about three quarters of a mile away from the edge of the base, I observed an object in the air coming toward me from the direction of the peaks of the Organ Mountains, which rise almost vertically above the base area. It was moving slowly, descending at an angle of about 45 degrees and constantly diminishing in speed as it approached the ground. Its operation was completely silent. There were no propeller blades, jet streams, or any other visible means of the application of the force which controlled it. Being in a position which made me, at least slightly familiar with practically all of the missiles and other aeroforms which were being developed in this country at the time, I felt certain that this was nothing which had been produced in the United States. It also seemed unlikely that the technology of any other country on earth had progressed to a point which would permit the construction of such a vehicle. With this realization, I felt a strong desire to be somewhere else, and was restrained from flight only by the knowledge that this would be the surest way to call attention to myself.

The object settled to earth some seventy feet from where I stood. It was an oblate spheroid about thirty feet in diameter at the widest part, and about sixteen feet in height, silvery in color with what appeared to be a slight violet iridescence, which might or might not have been caused by the light in which I was viewing it. After settling to earth, it remained completely silent and motionless, and eventually I managed to overcome most of the fear which its appearance had caused me.

I approached the craft cautiously and circled about it, seeing no means of entrance or signs of life. When I touched the metal

of the hull in an attempt to determine its temperature, I was warned against doing so, by a voice which I at first assumed was coming from a loudspeaker somewhere in that portion of the hull which was to my left. The voice spoke the English language, and employed the American idiom. A conversation ensued, during which I expressed skepticism concerning some of the statements made by the 'voice'. As a result, I was offered the opportunity of making a test hop in the craft for the purpose of resolving any doubts which I might have. After some hesitation, I accepted the offer and was taken for a flight which demonstrated beyond question, the remarkable abilities of the craft and the advanced nature of the intelligence which had created it.

The limited space available here does not permit the inclusion of the minute details of the trip or the craft in which it was made, but those details are available in the original book.

The flight path was from the White Sands Proving Grounds to, and over, the City of New York and return. The distance involved in the round trip was approximately 4000 miles, and the trip was completed in a little more than thirty minutes, involving a cruising velocity of about 8000 miles per hour. The flight was made at an elevation of about 35 miles except for the circular pass about the City of New York which was made at an elevation of about twenty miles. I was informed that the vehicle in which I rode was unmanned except for myself, being essentially a cargo carrier controlled from a much larger ship which was at an elevation of some 900 miles above our surface.

When the round trip had been completed, the vehicle was again brought to earth and I was requested to leave it and walk to a safe distance. When I had put a dozen paces between myself and the object, I turned just in time to see a horizontal band of orange colored light, which was apparently due to the extreme ionization of the air, appear about the central portion of the hull, and it shot upward as if released from a catapult. As it continued upward, the color of the light scanned the spectrum from orange to violet and finally passed completely from sight, ending what has come to be known as "The White Sands Incident."

TRUMAN BETHURUM

One of the first to claim contact with another planet's inhabitants was Truman Bethurum. His experiences are explored in his later published book, *Aboard a Flying*

Saucer. (DeVorss & Co., L.A., 1954).

The author first heard of Bethurum's alleged encounter in mid-1953. A letter of inquiry to this former construction mechanic and welder brought an immediate response.

He prefaced his reply, dated July 24, 1953, by relating that he had "never been interested in astrology or any kindred subjects, and up until my own personal contact with these space people, my personal belief was the stories were just that someone had seen large searchlight beams hitting an occasional cloud."

This missive by Mr. Bethurum, it should be emphasized, was written quite some time prior to his subsequent publicity—and was therefore an interesting record by a person who later attained a certain amount of fame. Apparently he had not even thought of compiling his "contacts" in book form at the time.

Nearly a month later—on August 16, 1953—"Tru," as he is known to his friends, spoke before a flying saucer convention in Los Angeles.

"This was the first intimation I had," he wrote in *Aboard a Flying Saucer*, "that there were such things as saucer clubs."

His talk at the gathering and the publication of a brief condensation of these related "contacts" evoked almost unbelievable response. This ultimately resulted in the Redondo Beach *Daily Breeze* publishing a reasonably detailed story of the account some three times. Eventually he wrote his volume, and later made a lecture circuit of the United States recounting his "experiences."

The following is Bethurum's letter to the author dated July 24, 1953—long before he was besieged by a truth-thirsty public and news-seeking media.

(The narrative to follow is reportorially accurate. It has, however, been edited to enhance its coherency. Being first in letter-form, its essence was separated by several interjections and placed varyingly throughout. This is certainly not meant as an adverse reflection upon the writer; communications are not written for publication, and several addenda were placed at the end of the missive.)

Truman Bethurum:

In July, 1952, I was employed in Nevada on Highway 91, about 70 or 80 miles out of Las Vegas toward Salt Lake City. I had been transferred from day to night shift. We worked from 4 p.m. until sometimes 8 a.m., the following morning. My job was to keep four water trucks operating, hauling

water from the Muddy river to two reservoirs out in the desert for daytime sprinkling on the highway construction.

Soon after going on the job, some fellow workers told me that the entire mesa area had been covered by the ocean at some time and there were sea shells to prove it. So one night late in July, after I was sure everything was functioning properly, I asked and received permission to visit the mesa area to get some shell souvenirs. I had a flashlight along and used it some, but didn't find what I was after. It was about 3:30 a.m. when I left my job site, driving and walking possibly an hour or so. I headed my four wheel drive Army carryall truck into the northeast and decided to take a short nap, realizing the first gleam of daylight would awake me.

I had been asleep possibly a half hour or slightly more when I was rudely awakened by what would best be described as mumbling—low talking in an unintelligible tongue. My first thought was that my boss and someone were playing a trick because of finding me asleep. But as I raised my head I quickly discovered this was not the case. About eight small sized men were in a semi-circle in front and to the right side of my truck, approximately eight to ten feet away, and apparently as curious as I was.

My thought was to get away fast, although I would have had to back around. As I raised up to see better, one of the men took a couple of steps forward toward me and said something rather low and still unintelligible to me. I shook my head to indicate that I did not understand. He came quickly back with, "You name it."

"My God," I said. "You can speak English too?"

"We have no difficulty with any language," he returned.

These fellows seemed to be of Latin extraction from their appearance. My heart was thumping—I guess from fear and excitement. At that instant I decided to get out of my truck and shake hands for a friendly gesture. As I turned to get out I saw about 75 yards away a monstrous disc shaped flying saucer. About 300 feet in diameter and roughly 18 feet "deep." Then I wondered for a split second if it could be a movie prop, but as I had been above looking down only a short time before I realized this could not be the case.

As I reached out my hand to shake hands, it seemed like a military maneuver the way they lined up as each seemed anxious to grasp my hand. Only one made any attempt



Fay M. Clark, Mayor of Hiawatha, Iowa, said two objects appeared on aerial photo of town, taken at 3 p.m., Sept. 3, 1955.

to talk to me or answer my questions. They never asked me a single question and it appeared to me to be a military type outfit they were wearing, and also the way they fell into line to shake my hand.

"Do you have a captain?" I asked.

"Sure."

"Could I speak to him please?"

"Surest thing you know," he replied. And he took hold of my right arm above the elbow with his left hand with a terribly hard squeeze. (That did not ease my mind any.)

Then I asked if they were from some European country.

"No," he said. "Our homes are in a far away land."

As I had asked about speaking to their captain, I noticed a smile on some faces that made me think, "Well, this is it. And no one will ever know what happened to me!"

He said, "You may speak to our captain in our scow."

"What a name, for a thing like that," I thought.

This man almost spun me around and started for the saucer, which seemed to be floating about four feet off the ground. As we neared it, it settled to just a few inches off the ground and tilted down on the near side at the same time. There was just one step and a single hand rail on the right side of the opening. He almost bounced me to the rim of the saucer. He had released the extreme pressure on my arm, but still had a firm grip. I was at least a foot taller than he, and I weighed approximately 180.

We went downhill inside about 50 feet and he again swung me around to the left, through a door-like opening to a room about 10 by 12 feet and fitted like a com-

bined office and lounge. I think my eyes fairly popped when I saw that their captain was a gorgeous woman, shorter than any of the men, neatly attired, and also having a Latin appearance: coal black hair and olive complexion. She appeared to be about 42 years old.

She stood up and smiled. The man released my arm immediately. I turned to say something to him, but he had disappeared instantly. As I again faced this lady, I could not for the life of me think of a single thing to say. After a couple of seconds, she again smiled and said, "Speak up, friend. You're not hexed."

After talking and asking questions for about a half hour, I realized they were definitely not Europeans. She did not tell me her name or the name of their planet at that time, just leaving me with a knowledge that they traveled interplanetary and were wise to everything going on all over our world, and other planets also. She seemed friendly, anxious to talk, etc. About the only questions asked of me was what I called the area which was Mormon Mesa, Nevada. (She later told me her name was Aura Rhanes and their home planet was Clarion. She said Clarion was definitely not a planet known by some other name, and gave me her reasons.)

I had decided not to tell anyone regarding this episode as I knew I would be called a liar. But upon returning to my job shortly after sunrise, my boss said, "Did Joe's plane come down out there where you were, out of gas?"

"No," I told him.

"Did a commercial airliner land out there near you?" he asked.

Another "no" answer.

Finally, in desperation, he said: "I could see something come down out there and there was no noise. Now if it wasn't Joe's plane, what was it?"

When I finally broke down and told him, I just got the wicked eye treatment, and as the news spread around, I was walked around, etc.

Before they left she escorted me to the outside and told me they would come again. She said you just think of the place and day. I have seen them eleven times altogether, the last on November 2, 1952. At that time she said we will see you again, possibly next month. I was in the general area until March of 1953 and have not seen anything of them or any signs that might indicate even a falling star in the skies.

Claimed flying saucer contacts are not necessarily few or far between.

Orfeo Angelucci, like Bethurum, asserts to have "contacted" outer-spatial intelligence in 1952. He compiled his experiences into *The Secret of the Saucers*. He alleges to have spoken to two saucer people one night on his way home from work at a Burbank, California aircraft plant and to have taken a trip in a saucer at a later date.

Desmond Leslie, a Londoner, co-authored *Flying Saucers Have Landed* (British Book Centre, New York, 1953). He is an intensive researcher and a capable writer.

In the fall of 1955 Leslie toured the United States and parts of Mexico. He met and interrogated Salvador Villanueva. An intriguing account by Desmond Leslie of Senor Villanueva's anomalous "contact" was recounted in the excellent British periodical, *Flying Saucer Review*.

Desmond Leslie:

"Salvador Villanueva is about forty years old. He has a wife and seven children. He neither smokes nor drinks and is well respected in his Mexico City home. By trade he is a driver; owning a car which he plies for hire, mainly to tourists.

"For some time he feared to tell of his strange experience lest people thought him deceitful or mad (how often have we heard this fear expressed!). But when the Mexican papers began a series of articles on flying saucers, he took courage and wrote to the journalist concerned asking for an interview. Since that day he has been subjected to all manner of tests for his integrity and accuracy as a reporter. He has come through them all with full marks.

"Between August 17-20, 1953, Villanueva was employed by a couple of Texan-tour-

ists to drive them from Mexico City to the Texan Border. After covering about sixty miles successfully, they had just passed Ciudad Valleys when horrible noises came from the crankshaft and the car ground to a halt. Examination showed that oil had leaked from the differential and it soon became obvious that the car would go no further, not that night at any rate. The Texans were angry. They unloaded their baggage, engaged another car and drove off without paying. Salvador tried to obtain help but without success. By then it was beginning to rain so he decided there was nothing for it but to spend the night in his car and make arrangements for repairs in the morning.

"A little later, about six p.m., he crawled under the car for another look at the damage, in the faint hope he might be able to do something to get himself away from this lonely spot. While lying on his back beneath the car he became aware that he had company. Right by his nose were two pairs of feet. The feet and the legs—what he could see of them from his prone position—were normal except that they were encased in a substance like seamless grey corduroy. Salvador scrambled up to find himself face to face with a couple of pleasant-looking men, no more than four feet six in height. Now, in Mexico, there are many short people. Many of the peasants do not exceed four and a half feet, so Villanueva was not unduly alarmed. He noticed they were both clad from neck to the tip of their toes in this one-piece grey material, broken only by a wide perforated shiny belt. Round their necks they wore metal collars and on the back of their necks small, black shiny boxes.

"Under their arms they carried helmets similar to those worn by jet-pilots or American football players, so he assumed them to be some kind of aviators who had landed nearby.

"The men smiled at him and one opened the conversation:

"'Are you having trouble?'"

"'Yes,'" answered the driver, "'my differential has broken, as far as I can see.'"

The man who addressed him smiled sympathetically and spoke of one or two casual things. He asked Villanueva a little about himself, and he seemed quite friendly. The driver, however, noticed that this man had a peculiar accent as though he seemed to be stringing words together. His companion said nothing, but occasionally smiled or made other expressions suggesting he under-



Fifteen-year-old Michael Savage reports he took this photo of a "20-foot-in-diameter" flying saucer from the back yard of his San Bernardino, California, home on the day of July 19, 1956.

stood, so Salvador asked: "Doesn't your friend speak Mexican?"

"No, but he is able to understand you."

Then it began to rain again, so he invited the two visitors to shelter with him in the car. When they were inside they continued the conversation.

"Are you aviators?"

"Yes, we are."

"Is your plane near here?"

"Not very far."

"Where have you come from, if I might ask?"

"We have come from very far." And they smiled.

Still he felt there was nothing wrong until, as the night descended, his strange new friend betrayed by his conversation that he knew far too much for an ordinary man, not only about this world but about others also. He spoke of places and cities and people that made Villanueva a little afraid.

Finally, somewhere around dawn, he asked the question that was creeping into his mind.

"No," came the answer. "We are not of this planet. We come from one far distant, but we know much about your world."

"Of course, he did not believe him right away. At first he felt they were playing some kind of practical joke on him, and the second man's silent smiles irked him. Several times during the night he accused them of "taking the mickey out of him." Poor Villanueva! By the time dawn broke he was a very confused man.

"After sunrise, his companions said they must leave. Then they asked if he would care to see their machine. Still faintly hoping to find a conventional aircraft with wings and propellers, Villanueva agreed to follow them. They led the way through the bushes across a rather swampy piece of land for about half a kilometre. Onwards

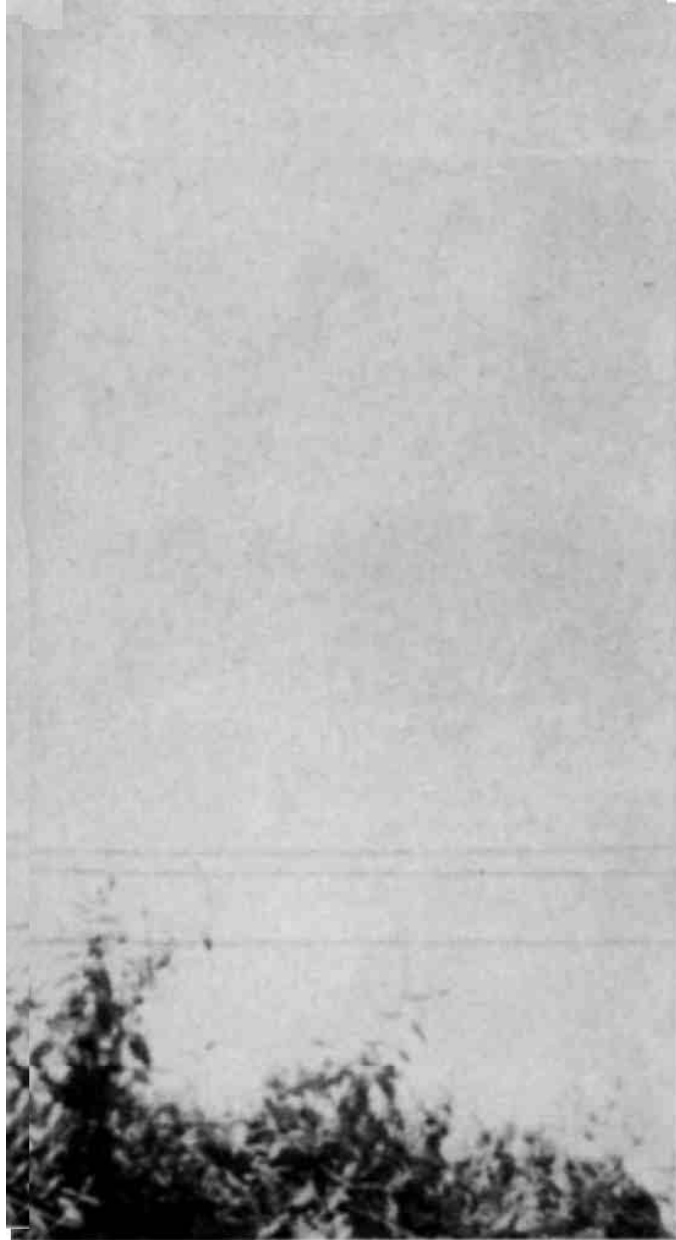

they walked, his two visitors marching ahead of him. The ground became wet and treacherous; he was sinking into muddy pools, sometimes almost to his knees. But the men in front—his eyes popped—the men in front were not sinking at all. When their grey-clad feet touched muddy pools the mud sprang away from them as if repelled by some invisible force. No dirt ever seemed to come in contact with them and they remained unspotted although his own boots were by now caked in mud.

"He hesitated. The men in front turned and smiled encouragement. So he plucked up his courage and followed through the rain-soaked scrub. Their feet fascinated him. What incredible force allowed them to walk over muddy pools uncontaminated? And what—again he felt afraid—what strange force caused their perforated belts to glow with their own light each time this happened?

"Suddenly they came out into a kind of clearing. There it stood, a great shiny craft

unlike anything the simple Mexican had ever seen. In form it had the shape of two huge soup plates joined at the rim. Above it was a shallow dome with portholes. The entire structure, about forty feet across, rested on three giant metal spheres or landing balls. Unless this was some secret invention from the United States, it was surely a ship from another world.

"As they approached, a faint humming came from within the craft and a portion of the lower hull opened outwards, much in the manner of the rear entrance to a Martin 404 air liner, so that the inner side of the panel formed a staircase to the craft and the supporting cables became handrails. The two men went up the short flight of steps, pausing on the top to turn and look at their earthly companion.

"'Would you care to come inside with us?'" came the invitation.

"Villanueva could only shake his head. His wife, his family, his job, his home and all the things he knew and loved suddenly seemed very real. No, he would be afraid to leave them for something alien and utterly beyond his understanding.

"He turned and ran.

"When he regained the road he was gasping for breath. He could hardly believe his own senses. That this should have happened to him! Impossible!

"Then he took a glance back the way he had come. Something was happening back there among the bushes; something light was appearing. Something glowing white rose slowly into view, hovering for a moment, then gaining speed it began a kind of pendulum motion, a backwards and forwards arcing movement, like a falling leaf going up instead of down. It attained an altitude of several hundred feet by this method; then, glowing brighter, shot up vertically with incredible speed. In seconds it was lost to sight. Only a faint swishing sound marked its passage.

"Villanueva told no one. He had work to do. His car needed attention and it was the next night before he got back to his home. His wife at once noticed his strained appearance and asked him what was wrong. Making quite sure none of the children were listening, he told her, faltering and hesitant, convinced she would consider him insane.

"'No,'" she replied. "'I do not think you insane. I know you. You are my husband and you would not deceive me. But others—others will not believe you. Promise me you will tell no one.'"



Truman Beburum, author of "Aboard a Flying Saucer," claims he met a crew from a flying saucer, including its lady captain, in Nevada in '52.

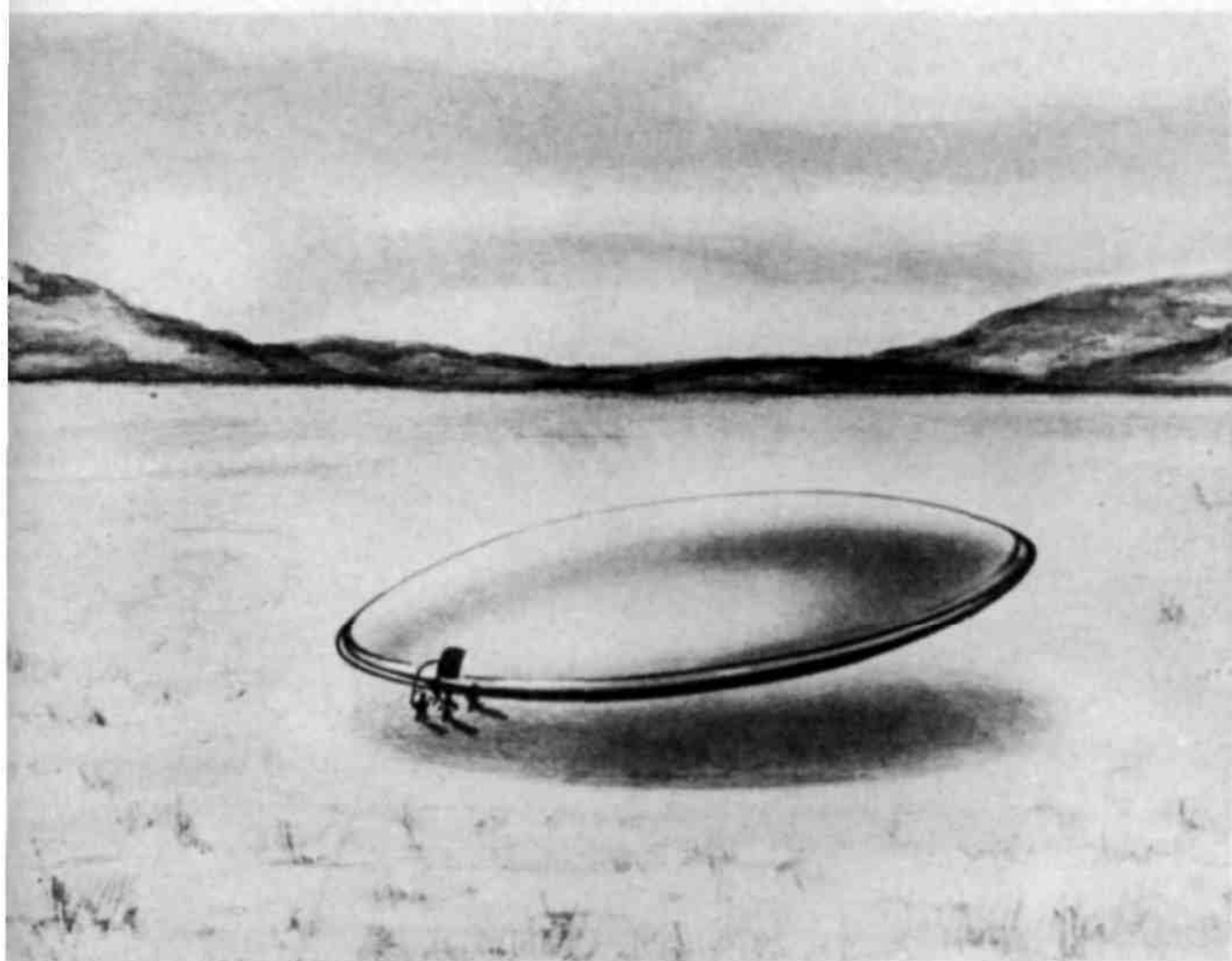

Artist's conception of the craft that Truman Bethurum said he boarded in Nevada during 1952. The drawing is reproduced from "Aboard a Flying Saucer" courtesy DeVorss & Co.

"Thus Salvador Villanueva kept the mystery to himself until a series of open-minded articles by Enrico Espinosa y Cossio prompted him to tell others of his experience. To date he has not seen his visitors again.

"Out on the road he related and reenacted the story to his examiners without change or contradiction. The whole episode was still vivid in his memory. He knew what he had seen and heard; just that and no more. A practical workingman, he had learned to use his eyes, and he was not in the habit of being deceived.

"When I showed him the photos of the Adamski saucer he said that though it was similar to his ship there were several major differences: for example, the double convex hull and the curved underside. He did not believe his visitors were Venusians. They were small and clad in this one-piece grey garment covering the feet as well as

the body. He had the impression from their talk, though they did not name any planet, that they had come from somewhere much farther than Venus, maybe from worlds beyond our vision entirely.

Notes:

"In this story," observes Desmond Leslie, "we come across the invisible repulsion field so common to 'contacts,' this time operating on the visitors' bodies to prevent muddy feet and sinking in the ooze."

"We have the 'falling leaf' or pendulum motion, described by so many close witnesses. This is now believed to be due to some kind of fluctuation on the ship as it 'falls' from one magnetic line to another while near the earth's surface.

"The costumes again," continues Leslie, "suggest a simple comfortable utility working garment. The luminous belt and the helmet carried under the arm are, however, new additions to the space-wardrobe. There



John W. Wagner of Alhambra, Calif., says this odd-shaped craft (upper right) appeared upon developing 16 mm negative of photo he snapped in 1954 at Puddingstone Dam, Pomona, Calif.

seemed to be some connection between the glowing of the belt and the power necessary to keep the wearer from sinking in the mud.

"The ship, though polished shiny metal when grounded, glowed with a bright white light on climbing, a light which increased with the speed of ascent. Another common occurrence," the writer concludes.

There is one consolation in the above "contact." At least it isn't just the poor, crazy *Americanos* who report the silly *platillo voladores*.

And in 1954 even staid Norway got into the act.

Twenty-four-year-old Edith Jacobsen and 32-year-old Asta Solvang—sisters—said they met a man from some "curious contraption . . . like two giant pot lids placed together." This description doesn't exactly fit the "official" explanation that the poor girls had met an American piloting a helicopter. It is hoped this explanation was not an "official" admission that the sisters had contacted *something*. If it was, this poor "official" is probably still wondering why he was so enigmatically transferred to Northern Iceland.

The Norwegian Magazine *NA* published Miss Jacobsen's personal story, and the translation of which was condensed in the *Flying Saucer Review*, as follows—

Edith Jacobsen:

"It was on Friday, August 20, last year, that my sister and I went berry picking with our uncle, Halvdan Jacobsen, and made the contact. We picked blueberries and cloudberries. It was a bright, sunny day, and early in the afternoon our uncle wandered off on his own. How far? It is impossible to say.

"Asta and I went out on a fen where we thought there would be some nice berries to pick, when suddenly we saw a man in the distance. At first we thought he was another berry picker, but when he came nearer we saw he was not carrying anything. We walked towards him and wondered who he was.

"As we got near him he smiled and stretched out his hand. I, too, smiled and held out my hand, but he only brushed my palm with his. Then he began to talk, but we didn't understand a word. It didn't resemble any language I had heard, and I have studied English and German, and I

am now studying Spanish. I have heard French and Russian on the radio.

"The stranger's language was very soft and melodious. It seemed to have few consonants and no gutturals at all.

"When we gathered that the man must be a foreigner from some distant country we took a closer look at him. He was of medium height, had pleasant, regular features and long hair with a natural wave. He was rather dark. We didn't notice the colour of his eyes, but I believe they were slightly oblique.

"His hands were beautiful and expressive, with fine long fingers; rather like the hands I imagined a fine pianist would have. He wore no rings.

"He was clothed in a kind of overall, but as he wore a broad belt it could have been trousers and a blouse. The blouse fitted closely at the neck, but was otherwise loose. I could not see any buttons, zippers or fastenings. We didn't notice how he was shod.

"The thing that impressed us above all was the genuine friendliness he emanated. It gave us a feeling of goodness and security so that we did not feel in the least bit alarmed at the encounter. His smile convinced us that he did not contemplate anything evil.

"When it became clear that we did not understand him, and he did not understand us, he produced something with which to write. We took it for granted that it was paper and pencil, so we took no particular notice. He drew some circles, pointed out over the moor and then at us, and then pointed at himself and another circle. I had at once the impression that he wanted to tell us something about the solar system, but perhaps I was mistaken.

"The man then made a sign for us to follow him. He turned and walked out along the fen. We followed, and not far away we saw a curious contraption. It was grey-blue and looked like two giant pot lids placed together. It was about ten feet in diameter and about four and a half feet in height.

"Because the man was still so calm and convincingly friendly we were still not afraid, even though we thought this a very curious thing to find in the wilds. We approached the thing, but he made a sign that we were not to come too close. He then opened a kind of hatch on the top of

the 'rim' which encircled the thing, crawled in and shut himself in.

"Presently, we heard a faint humming, like the droning of a large bumble bee, and the curious vessel rose slowly while rotating on its own axis.

"Then, and only then, did all I had read about flying saucers come to my mind. When the saucer reached about 100 ft. it hovered for a moment and then started rotating very fast. Finally it rose at tremendous speed and disappeared.

"Asta and I agreed not to tell anyone about the incident. The visitor had gone, and we had nothing with which to prove our story. And without proof the story would sound so fantastic that we were afraid of being ridiculed.

"It was Asta who first told the story. She couldn't hide it from her husband. That's why it spread around Mosjoen. A reporter from the local paper got hold of it and approached the police to get their confirmation. They asked us to make statements and later to take them to the locality of the landing. There were no signs to be found, but that wasn't surprising as six days had gone since our meeting.

"After that we couldn't venture out without being stopped in the street to tell the story anew.

"Many people laugh at us, and many are angry because they believe we are pulling their legs. But we have only told a story of something that definitely happened to us.

"We saw it simultaneously, and we reacted in the same way. But the questioning we went through was so intense that at times I thought I would lose my reason. The whole thing is so fantastic that I can readily understand why people who have known me all my life refuse to believe me. People have a right to their own opinions, but I earnestly wish that some responsible person like a police official or a parson had had this experience. At least they would have been believed."

Addendum by the *Flying Saucer Review*:

"Finn Norstorm, who interviewed the sisters separately, said there were no discrepancies in their accounts. He added that Edith was mischievous enough to enjoy playing a great joke on people, but that it seemed highly improbable that she should stretch the joke so far and to adhere so firmly to a fabricated story.

"Asta is a very calm and well-balanced

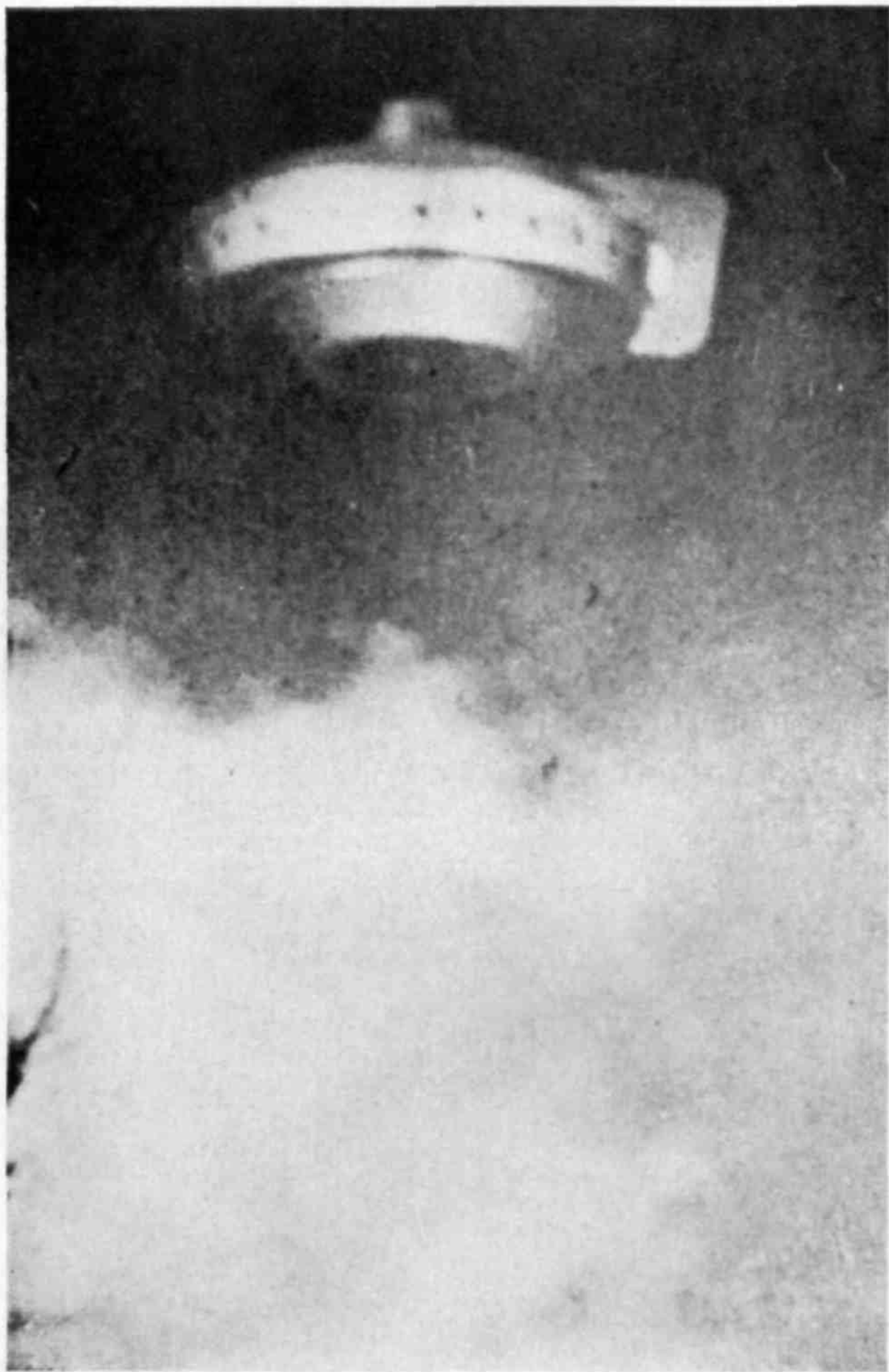

Now we have the cup to go with the saucer. No data is available on this photo, therefore its value to the UFO researcher is considered to be quite questionable. COURTESY AUGUST C. ROBERTS

person, he said, even if she feels somewhat troubled because of the uproar the affair had caused. Nobody who meets her would take her for anything else but an ordinary housewife. She is quiet, level headed and views all world problems with indifference if the porridge is in danger of burning.

"The girls' uncle, Halvdan Jacobsen, who accompanied them in their berry-picking expedition, was troubled by the situation. He said: 'I hesitate to accuse the girls of lying, but one fact is certain. No craft rose from the forest that day. I was never more than three or four minutes' walk from the girls, and I reckon I ought to have seen or heard something. No, flying saucers exist only in people's heads. We hear about them from every part of the world. They are weapons of the "cold war" causing unrest and fear of war.'

"The girls' mother believes them, however. 'That a man from another planet should land here seems incredible to me,' she said, 'but I have no knowledge of such things. I would only have pooh-poohed the whole affair if I didn't know my daughters.'

"Commented Arvid Cyen and Jan Brechan, of the local road construction service: 'We believe the story. People shouldn't be afraid to believe something unusual. We know the ladies; they are grown-up and trustworthy. We have no opinion to offer as to the place the man came from, but isn't it reasonable to suppose that inhabitants of other planets have progressed as far or farther than us?'"

Two and one-half months later, a group of American saucer enthusiasts said they had "contacted" a flying saucer. And some police officers back them up.

Young Ray Stanford, of Corpus Christi, Texas, left on the morning of November 6, 1954, with companion John McCoy. Their destination was Brownsville, Texas. They planned to join a group there to form the Texas Flying Saucer Research Group.

Ray Stanford:

"Shortly after our arrival at Charre Courts in Brownsville we met John Brand, who was in charge of the meeting, and had an interesting discussion.

"We began the meeting a little later that afternoon. During the meeting the possibilities of seeing a saucer over nearby Padre Island came into my mind. This, I

suppose, is what made me suggest that we go to the island that night and try for a saucer contact. Everyone agreed that it was a pretty good idea.

"After about two hours, the Texas Flying Saucer Research Society was organized, and the meeting was adjourned.

"We then went outside and discussed what might happen that night. I do not really know what the Brownsville fellows thought of the possibilities, as none of them had ever seen a saucer.

"At 6:30 P.M., when we—all eight—had arrived once again at the courts, we put on some long overcoats that someone had furnished and finally managed to pack ourselves into one automobile. It gets quite cool on November nights on the Padre beach when the breeze blows off the Gulf of Mexico.

"We arrived at Padre Island about 7:30 P.M. and proceeded in a northerly direction up the beach for about five miles. We were afraid to risk going any further up this beach at night for it is not very easy to get out of that kind of sand if one should get stuck.

"The island was a beautiful sight, with the light of the Moon reflecting off the miles and miles of rolling, white sand dunes.

"We decided that since eight was a rather large group, it would aid in mental concentration if we divided into two groups. One group would go about a mile north of the car and the other about the same distance south. My group of four went north.

"The group stood around for a few minutes, talking. Then acting on the theory that any race who is advanced enough to construct ships capable of interplanetary travel would also be advanced in mental powers, the two groups entered into deep concentration. This concentration would have aided in any transmission of thought that would have occurred between the two groups and the beings piloting the flying saucers.

"Suddenly a strange feeling engulfed our whole group. This feeling was unlike anything I have ever felt. The whole group had the feeling at the same time.

"A picture, as if a color movie had been turned on, passed through my mind. It was of a white globe of light moving rapidly across the sky.

"I described this to my group. They did

I, the undersigned, do solemnly swear that on the night of November 6, 1954 that I was present at Padre Island and witnessed for some period of time the "contact with a flying saucer" as told in the article, "Contact With A Flying Saucer" and that present at that event was a State Highway Patrolman, Don Hoyd, a Deputy Sheriff, Ray Hoyd, a Deputy Sheriff, Steve Woods. I observed the object which was referred to in the story; but I will not express opinions or beliefs as to the nature of the object. This affidavit is testimony that I was witness to the event, and such is the purpose of this affidavit.

THE STATE OF TEXAS,)
County of Cameron.)

Steve Woods

Before me, the undersigned authority, in and for Cameron County, Texas, on this day personally appeared Steve Woods, who being by me duly sworn, upon oath says: that stated above.

Subscribed and sworn to before me, by the said Steve Woods, this seventh day of January, 1956, to certify which witness my hand and seal of office.

My Commission expires Jan 1, 1956.



C. G. Day
C. G. Day
Notary Public Cameron
County Texas

Affidavit in support of Ray Stanford's contention that he and a group of flying saucer enthusiasts were confronted by a disc-shaped flying craft at Padre Island, Texas during year 1954.

not know what to think.

"Then it happened!

"Exactly as I had described, a white globe with great brilliance appeared parallel with the horizon. It followed a zig-zag path for quite a distance and then began to slow down and disappear.

"At last we had done it! This was the signal of a space ship from another world. We had established contact!

"Had the other group made contact? We wondered. Did they see the signal too?

"As we approached the car, we heard the group calling us. They, too, had made contact. They knew it was a signal.

"The most amazing thing, however, was that a member of the other group also had received a telepathic message that a signal would come and where it would appear.

"When both groups were together, a thought seemed to prevail unanimously—a space ship would approach at around eleven o'clock.

"Our groups went back to their places again. We waited to see if a space ship would come that night.

"The time was 10:55 P.M. Shortly a glowing object appeared out over the gulf. It came closer and performed some unique maneuvers. It had appeared at exactly the same place where the signal was last seen.

"On and on it came. We finally were able to steady our binoculars on it. It had a dome and flat bottom. We no longer felt the cold wind nor heard the roar of the gulf.

"It was a space ship from another world!"

"It was not coming toward us, however, but was approaching the car. We would have to start for the car so that we could meet the ship there.

"As we moved rapidly for the car, something happened. The space ship was now moving away! Gradually it disappeared from sight. Our hopes fell. But then we turned. Down the beach a car was approaching.

"Several times during the craft's approach, automobiles came into sight down the beach, and each time the object would mysteriously lose its luminosity.

"Then the object again came nearer—and then it hovered. This time it did not lose its luminosity. A car was coming down the beach. We couldn't understand why the object did not again disappear.

"The car drove up to us and kept its

lights on. It was the *State Highway Patrol!* Our first thought was to keep them from seeing the object, so John McCoy and David Piller walked over to the left side of the car hoping to block their view of the object. At the same time I ran over to the driver's side. A highway patrolman was driving. Inside with him were two deputy sheriffs.

"The officer asked me what we were doing. (And I shall have to admit that we were a bit suspicious looking with the long overcoats and no fishing tackle or the like.)

"'We are conducting experiments,' I replied.

"'What kind of experiments?'

"'Scientific experiments,' I told him.

"All three officers got out. They marched to the front of the car, keeping their eyes constantly upon us. I hope I will be forgiven at this point if I do not go into a description of the words and thoughts that transpired during the next few minutes. I did get one definite impression, however—and it was that it would not be very long before they had us in the car if we did not tell them what we were doing.

"So I told them: 'If you really want to know what we are doing, we came out here to contact flying saucers, and we have already made contact. In fact,' and here I pointed to the space ship, which was hovering behind and to the right of them, 'you can see it hovering there right now.'

"They did not laugh. They did not even crack a smile. They were too startled at such an amazing sight.

"One of our group handed the highway patrolman John's pair of 8x binoculars. The officer walked over to the side of the car and leaned on it. He stared at the saucer for fifteen or twenty minutes. I have never seen anyone so amazed. Then patrolman, Don Hoyd, cut off the lights of the patrol car. The window next to him was open, but he did not even move his eyes or binoculars off the craft for one second—he just reached through the window and cut the lights off.

"Several times while he was viewing it through the binoculars, some of us would go and talk to him, but he would not answer us.

"As some of us were talking to Deputy Ray Hoyd, Don his son, exclaimed that the object had a dome on top and was flat on the bottom. Hoyd assured him that he



Joseph Barbieri examines hole made by "UFO" in signboard at New Haven. A. C. ROBERTS PHOTO



ECLIPSE - PIONEER

DIVISION OF BENDIX AVIATION CORPORATION
TETERBORO, NEW JERSEY

11/10/53

Spectrographic Laboratory

Please furnish a spectrographic analysis of the following _____

Identification-----Fragment Fr. Flying Saucer

Material-----Unknown

Elements to be checked-----All

Date-----11/10/53 *J. P. [Signature]*

Plate No. 040

Remarks-----Copper---Copper---oxide

Date reported-----11/10/53 -----Signed By *[Signature]*

Spectrographic No. -----



Form No. 2077

Spectrographic analysis of metallic fragments of a UFO. Apparently these were deposited by impact of object as it tore through signboard at New Haven, Conn. COURTESY AUGUST C. ROBERTS

knew it all the time for he could see this with the unaided eye.

"One member of our group told another that he wished that the object would maneuver about so that the officers would really get excited as it would be interesting to watch their reactions. Just as he said this, as if the saucer was in definite contact, it began to maneuver.

"This, needless to say, impressed the officers.

"Then Ray Hoyd asked if we would mind if he brought a radar set into the area under G₂ Security. We told him that we believed it would be better if they did not bring one in, as Army Security would prevent us from telling our story to the public, which, we felt, was most important.

"Then he said, 'I sure would like to be around when that thing lands.' Ray Hoyd's opinion must have varied greatly, however, for he later said that he wanted to be as far away as possible should the saucer land.

"We told them that had nothing to worry about as we were sure the ship would not land with them around for two reasons: (1) The patrolman was carrying a gun—a .38 revolver. (2) The space people had come to contact us, not to land for them.

"Don Hoyd told us that he had once seen a saucer before this. He said that it traveled at a rapid rate of speed. About this time our attention was attracted by a blinking light. Steve Woods, another deputy sheriff, was trying to signal the saucer with a powerful flash light. Ray Hoyd decided to try it, too. He took a large, powerful spotlight out of the back of the car and tried to signal it but without success.

"Then Hoyd turned to us, saying, 'You know, although I told you I would like to be here when it lands, I am not so sure that you would be so anxious for it to land if you had seen some of the . . .' (Army or Air Force, he told us) 'photographs of these things that I have seen.'

"We looked at each other, then up at the ship. It made no difference to us how many pictures he had seen. We knew the people in that space ship were surely friendly. The officers had been there for about an hour.

Don Hoyd and Steve Woods had gotten into the police car. (And believe me, they were ready to get out of there fast if that thing came any closer.)

"We asked Ray Hoyd if he would be willing to sign an affidavit, if we needed one, swearing that they saw the object and that it was intelligently controlled and of extra-terrestrial origin. He answered, 'Yes, I would swear an affidavit if you ever need one.'

"Then they left. The officers had been there from about 12:35 to about 1:30 A.M. Going to our car, we discovered that we had a flat tire. When it was fixed, we found that people were watching from a distance. We knew by this that the object could not afford to land now, so we left the island between two and three A.M.

"But we left joyously, for we had now made contact with people from another world.

"The eleven witnesses to the contact were Ray Stanford (myself) and John McCoy of Corpus Christi, Texas; John Brand, David Piller, Jerry Lee Steele, Uvaldo Champion, Jr., Robert Colberge and Jimmy Rutledge of Brownsville, Texas; Deputy Sheriff Steve Woods, State Highway Patrolman Don Hoyd and his father, Deputy Sheriff Ray Hoyd, Port Isabel and Brownsville, Texas.

"Two of the officers have sworn affidavits attesting that they had witnessed the contact.

"After leaving Padre Island, we immediately returned to Brownsville. Shortly before we reached our first stop we were astonished to see directly above us and traveling in the same direction, the gigantic space ship. It was glowing brilliant green as it passed over the city at three A.M. It streaked over us and sped into the distance, as if to say—We came, are gone, but shall return again!"

This concludes the so-called "contact stories." They are admittedly fantastic. But they are also apparently an integral part of the overall picture and history of the UFO's. Either they are true or they are hoaxes. Perhaps a line can't be drawn as to where one extreme ends and the other begins. ■



chapter 8

**New Light
on the UFO**



PHOTO BY JIM NELSON

"IN THE summer of 1952 a United States Air Force F-86 jet interceptor shot at a flying saucer. This fact, like so many others that make up the full flying saucer story, has never been told."

If a book by a civilian authority on the subject commenced with the two sentences above, it would undoubtedly stir comment and controversy. But when it is written by Edward J. Ruppelt, the former captain who headed the official Air Force flying saucer investigative body—Project Blue Book—for nearly three years, a feeling of "At last—the truth!" surges within the reader. Ruppelt's book is *The Report on Unidentified Flying Objects* (Doubleday: \$4.50).

Undoubtedly one of the most objective works published to date, *The Report on Unidentified Flying Objects* is "actually more than a book," prefaces the author. "It is a report because it is the first time that anyone, either military or civilian, has brought together in one document all the facts about this fascinating subject. With the exception of the style, this report is written exactly the way I would have written it had I been officially asked to do so while I was chief of the Air Force's project for investigating UFO reports—Project Blue Book."

A myriad of hitherto unknown facts regarding the UFO enigma are made available to the public in this mass unveiling (which, incidentally, has been cleared by the U.S. Air Force). This volume relates, for the first time, that:

As early as September, 1947, the Air Technical Intelligence Center—where Project Blue Book is located—officially recognized the existence of flying saucers.

At one time during the early stage of its investigation the Air Force concluded that UFO's were space ships originating outside of this planet.

In January, 1952, the first issue of a monthly Confidential UFO Bulletin was published by ATIC. A panel of the country's foremost scientists convened in January, 1953, to analyze the UFO situation. They concluded that intelligent beings on other planets may have progressed to a highly advanced state but there was no conclusive *proof* that the UFO's were under the direction of such beings. This group urged the Air Force to keep the public up to date in developments as they occur relative to the UFO phenomena, and to withhold nothing that is not detrimental to national security.

There have been no satisfactory explanations which would solve the Tremonton, Utah, as well as the several other motion pictures of unidentified flying objects.

UFO's have been observed simultaneously both visually and via the radarscope; have maneuvered in a manner that tends to indicate intelligent control; and, if existent, far surpass any aerial device known to Earth.

After a UFO report was received at ATIC, Ruppelt reported, it was classified as "poor" or "good." The "poor" reports were immediately discarded. The remaining "good" cases—the majority of which came from qualified observers and professional men and women—were then checked to establish the objects' origin.

To help enlarge the scope of its investi-

Jim Nelson of the Wichita Eagle claims he took this photo of a UFO on the morning of July 19, 1956. On this date thousands of persons throughout central Kansas reported sighting a mysterious "ball of light," and military planes were initially reported to have sighted the object on their radarscopes. (This was denied). After sighting the UFO, Brian Coyne, city editor of Arkansas Traveler, declared: "I'm a believer now, brother. That was no reflection..."

gation, Project Blue Book engaged the services of an independent research laboratory (unofficially termed Project Ivy). In connection with this project, IBM punch cards were used to record all characteristics of the UFO: size, shape, color, velocity, physical attributes, MO (modus operandi), etc.

The data recorded on these cards were then compared with balloon charts, known astronomical bodies, meteorological phenomena, plus all other possible sources to determine a "Known," "Probable," or "Possible" conclusion. Those reports remaining unsolved were listed as "Unknowns."

By mid-January, 1953, a total of 1593 UFO reports had been analyzed. They were evaluated and sifted into these categories:

Balloons—18.51 percent.

Aircraft—11.76 percent.

Astronomical Bodies—14.20 percent.

Other—4.21 percent.

Hoaxes—1.66 percent.

Reports with insufficient data to evaluate—22.72 percent.

Nearly 27 percent of the reports defied explanation.

However, it may be significant to note that only 5.34 percent were resolved into "Known" objects; 16.74 percent were "Probables," and 22.39 percent were designated as "Possibles."

Another important but previously unknown fact brought forth by *The Report on Unidentified Flying Objects* is the Major Dewey Fournet report. Major Fournet, who was the Pentagon liaison officer to Project Blue Book, prepared for the Air Force an "analysis of the motions of the reported UFO's in an attempt to determine whether they were intelligently controlled," the author related.

"Since such critical methods of evaluation had been used, these few reports proved beyond a doubt that the UFO's were intelligently controlled by persons with brains equal to or far surpassing ours.

"The next step," Ruppelt continued, "... was to find out where they came from. 'Earthlings' were eliminated, leaving the final answer—spacemen."

(The Dept. of Defense Office of Public Information was recently asked to release the Fournet report to the press. It declined.)

The former Air Force authority on UFO's resolves the seemingly endless hassle over whether they exist into one question: "What constitutes proof?"

"Does a UFO have to land at the River Entrance to the Pentagon, near the Joint Chiefs of Staff offices?" Ruppelt asks. "Or is it proof when a ground radar station detects a UFO, sends a jet to intercept it, the pilot sees it, and looks on with his radar,

only to have the UFO streak away at a phenomenal speed? Is it proof when a jet pilot fires at a UFO and sticks to his story even under the threat of court-martial? Does this constitute proof?

"I'll give you the facts—all of the facts—you decide."

The Air Force, according to Ruppelt, has periodically blown both hot and cold on the subject.

First Project Sign—the Air Force's initial UFO investigating body—concluded, in a top secret Estimate of the Situation, that UFO's were, indeed, interplanetary vehicles. Then a complete reversal took place when the name was—significantly, according to Ruppelt—changed to Project Grudge.

"To reach their objective," he says, "Project Grudge launched into a campaign that opened a new age in the history of the UFO. If a comparative age in world history can be chosen, the Dark Ages would be most appropriate. Webster's Dictionary defines the Dark Ages as a period of 'intellectual stagnation.'"

All of which brings the rather confused history of the UFO investigation up-to-date.

What next?

"I wouldn't want to hazard a guess as to what the final outcome of the UFO investigation will be," Author Ruppelt observes,

"but I am sure that within a few years there will be a proven answer. Slowly but surely . . . they are working closer to the answer—closer to the proof."

He concludes: "Maybe the final answer will be that all of the UFO's that have been reported are merely misidentified known objects. Or maybe the many pilots, radar specialists, generals, industrialists, scientists, and the men on the street who have told me, 'I wouldn't have believed it either if I hadn't seen it myself,' knew what they were talking about. Maybe the earth is being visited by interplanetary spaceships.

"Only time will tell."

Ruppelt's book, unfortunately, was completed prior to the Air Force release of October 25, 1955, discrediting the objective existence of the flying saucer. However the author requested, and received, a statement from the former chief USAF authority on the discs (currently a research and contract engineer on guided missiles for a leading West Coast aircraft manufacturer) relevant to the derogatory Air Force news release.

As follows:

February 13, 1956

To begin with, the newspapers, or at least many of them, seemed to have badly misconstrued this release. The press bits that I saw intimated that the Air Force was saying that such things as vertical take-off fighters, the new AVRO "saucer" and several other aircraft of radical design had been sighted by people and mistaken for UFO's. I have the release and this was not the case. All that it said, possibly in an effort to throw cold water on the UFO reports, was that in the future such aircraft might be reported as UFO's. If the press, or at least those that played up these types of aircraft as "the answer," had been on the ball they would know that there are only two VTO aircraft in existence; that those two aircraft are at Edward's Air Force Base; and that they do not stray but a few miles from the instrumented test ranges at Edwards. It will be several years, probably, before this AVRO saucer-shaped aircraft ever flies. All of these data have been published in Aviation Week Magazine.

Probably the most astounding part of the press release, at least to me, was the statement that a report "based on a study by a private scientific group under the supervision of the Air Technical Intelligence Center" concluded that all but a very few UFO sightings could be explained. This was a shock to me because I was the one that had this study made, I worked with the people

Edward J. Ruppelt, former director of Project Blue Book for the Air Force.



that made it, and I know how they made it. In the first place the study wasn't made to try to solve the overall UFO problem. It was an attempt to see if a statistical study of UFO reports would give any indications that the UFO's actually were something that we knew nothing about. In other words something unknown, be the unknowns interplanetary spaceships, a new natural phenomena, some type of aircraft from some country on this earth, etc. The answer was, after spending a considerable amount of money, statistical methods were no good for a study like this. They didn't prove a thing. The results were such that by interpreting them in different ways you could prove anything that you wanted to. This is not a good study. I was out of the Air Force by the time that the report was published in its final printed form but I saw the unpublished draft and had written it off as worthless.

Another interesting point is that the report was finished in September 1953 and it wasn't released as the "latest hot dope" until October 1955.

Edward J. Ruppelt.

In early July 1956 Pat Michaels, news

chief of KWIZ, Santa Ana, California, was one of several to go on a Navy sponsored junket to Honolulu. He and the other newsmen were briefed with Naval Air Reserve Squadron VP771, at Los Alamitos Naval Air Station, California. What Michaels heard made news. His account for the Orange County News Service was dispatched upon his return in mid-July.

"The United States Navy will not publicly admit that it believes in flying saucers," he wrote, "but it has officially ordered combat-ready pilots to 'shoot-to-kill' if saucers are encountered . . ."

"The information was first learned when Navy pilots navigating trans-Pacific routes from the United States to Hawaii were ordered in a briefing session to engage and identify 'any unidentified flying objects.'

"If the UFO's (saucers) appeared hostile, the briefing officer told pilots of Los Alamitos Naval Station reserve squadron VP 771, they are to be engaged in combat.

"In Honolulu, members of the squadron talked over the unique orders. It was found that the orders are not unusual. They are a standard command issued to pilots on the trans-Pacific hop."

Michaels continued: "... although the Air Force has publicly stated it does not believe in the existence of saucers, extensive operational procedures, including forms of combat have been devised by various air defense commands . . ."

He added that "operational procedures for a UFO scramble apparently are highly classified. Most officers refused to discuss the Pentagon's plans or modes of saucer combat. However, it was learned that a concrete plan of action does exist, covering all types of saucer sightings. The plans reportedly can be swung into action within seconds."

How do Navy pilots react to the reported "orders?"

"How do we know our bullets will work on a UFO?" one pilot was quoted as asking the Orange County News Service correspondent.

"And if we do shoot," the Navy pilot continued, "that's asking them to shoot back. And we don't know what they're to shoot at us!"

The author contacted Lieutenant Commander Robert Murphey at the Los Alamitos Air Station on the following September 26 for verification or denial. Lt. Comm. Murphey said he doubted the story. But he didn't deny it.

"This is Ben Shirley at News Headquarters of the Air Force Association Convention in the Roosevelt Hotel," began the News Director of WSMB, New Orleans, at noon on August 3, 1956. "Dramatic News which could affect the lives of every man, woman and child on this earth has been given exclusively to WSMB and this reporter . . ."

"As you know, some 30 or more countries are taking part in what is technically known as PROJECT VANGUARD . . . That project is the launching of those 20-inch globes into outer space next year by this country, as a part of its participation in the International Geophysical Year.

". . . WSMB has been told by some of the highest ranking government officials in this country that the Air Force, in spite of claims to the contrary, is vitally concerned about Flying Saucers. Publicly, the Air Force *has never denied* that these flying saucers could be space ships from other planets . . ."

Shirley went on:

"Next year, when those earth satellites are shot out beyond the earth's atmosphere, at least two, and possibly more of them, will be equipped with special electronic

instruments which will be used to study Flying Saucers when they are observed.

". . . top scientists," continued the newscaster, ". . . are convinced, even though no public announcement has been made, that the earth is under constant surveillance by these vessels from outer space, and it is for this reason that at least two of those multi-million dollar earth satellites will be especially equipped to study the so-called saucers.

"Recent developments internationally," Shirley concluded, "have more than ever convinced many of the world's top scientists that the world must make every effort to contact these saucers, and their pilots and crew members."

The ambiguity of Ben Shirley's report is frustrating. Just how could these satellitic vehicles "study" and "contact" UFO's? Their internal volume is extremely limited. The data that they do accumulate will be recorded on strips of magnetic tape which will be "stored" and telemetered to *Mini-track* stations on earth for only a few seconds at a time several times per day. This will hardly grant the opportunity for any complex operations and studies. And how does a 20-inch sphere "study" a flying saucer?

The News Director of WSMB says he doesn't know.

Some of the instrumentation presently scheduled to be installed in the *Vanguard* missiles—for the detection of cosmic, solar, ultra-violets and X-radiations; geomagnetic, aurora and ionization phenomena; atmospheric density; temperature studies, and the like—conceivably may record the proximity of alien bodies without additional modification. Edward J. Ruppelt, for example, has indicated that there has been a definite relevancy between some UFO sighting reports and increases in radiation. And these increases have been recorded up to one-hundred-fold in intensity.

It is virtually impossible to conjecture as to how these miniature satellites may "contact" space ships. And why would they be needed in the first place?

Still Ben Shirley maintains his sources are good. He says that he has known one of them "as reliable and dependable" for more than 12 years, from the time he was a Washington correspondent for the United Press.

The information he was given, Shirley adds, was not "classified," although his source "emphasized that it was being kept under wraps for the time being." ■

PROJECT BLUEBOOK

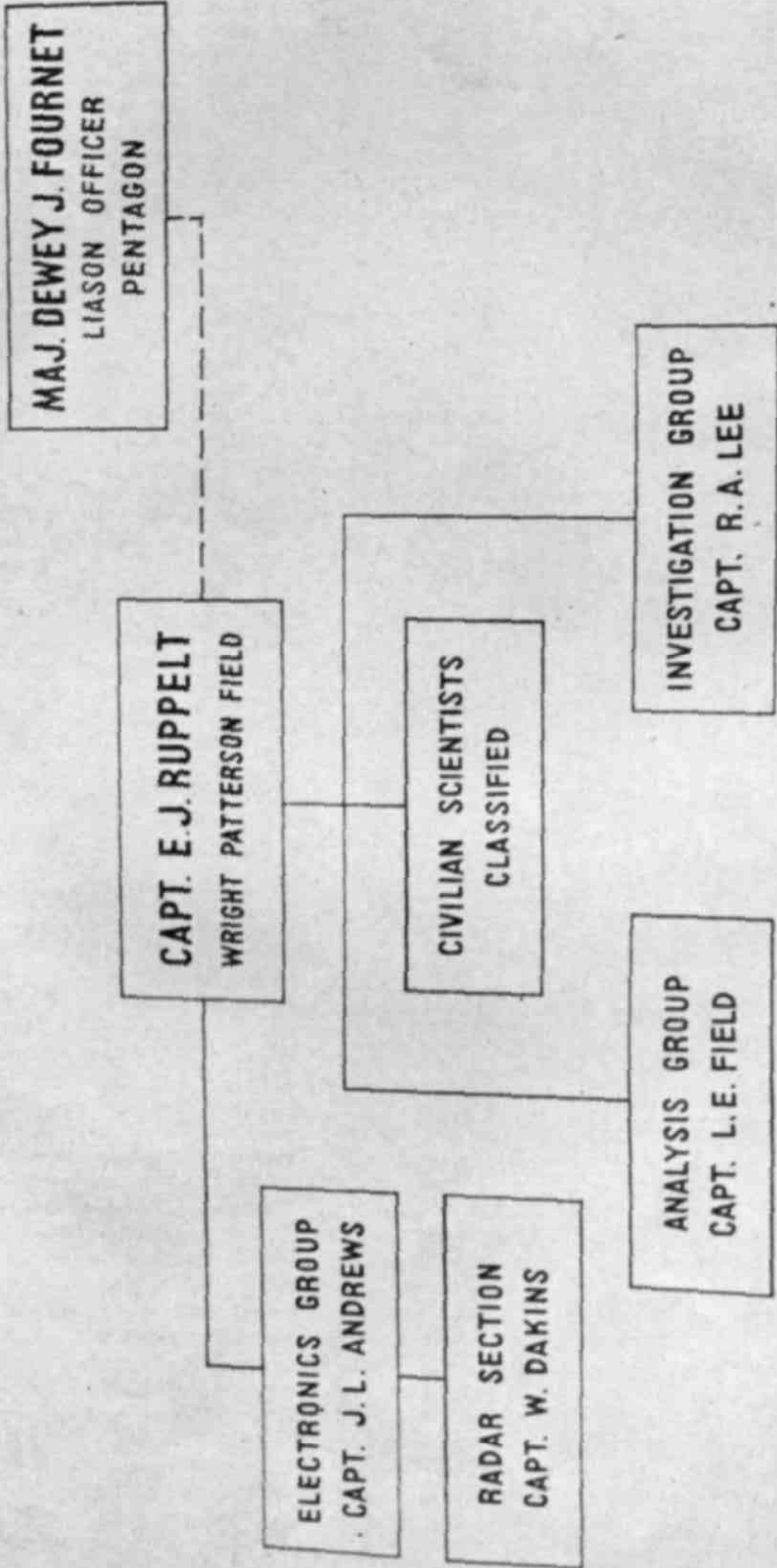

United Artists' film, "Unidentified Flying Objects," used this authentic USAF Project Blue Book format (left) in recounting accurate history of the UFO from the years 1947 through 1952.

chapter 9

The Problems Today

IF YOU shut up truth and bury it under the ground, it will but grow, and gather to itself such explosive power that the day it bursts through it will blow up everything in its way.
—Emile Zola.

The problems facing resolution of the world engrossing phenomena of the unidentified aerial objects are manifold.

The ridicule and levity laid to these disparagingly designated "flying saucers" over the years has done nothing to secure a more objective attitude from the press and public. Many who have sighted UFO's have continually refused to come forth to add some minute but possibly important data, the gradual accumulation of which will unquestionably and ultimately resolve these anomalies.

As was expressed in the preceding chapter, the Air Force has consistently—and it must not have been easy—reversed its policy relevant to the UFO enigma. Reports—reports which were obviously never released—ran the gamut from hinting to emphatically declaring the objective reality of extra-terrestrial vehicles. The author doesn't say this. But such men as Edward J. Ruppelt (for two-and-one-half years Director of Project Blue Book), Albert M. Chop (former Chief, Press Section, Air Matériel Command) and Dewey J. Fournet (former Director of Intelligence Liaison between the Pentagon and Project Blue Book) do.

Is anyone willing to call these one-time Air Force personnel liars? The Air Force hasn't—and apparently won't.

One of the country's foremost civilian authorities on UFO's and the Air Force Project Blue Book is Donald E. Keyhoe, a retired Marine Corps Major, residing near Washington, D.C. He has authored three of the fundamental books on the subject: *The Flying Saucers Are Real* (Fawcett, 1950), *Flying Saucers from Outer Space* (Henry Holt, 1953) and *The Flying Saucer Conspiracy* (Holt, 1955).

On April 3, 1956, Major Keyhoe formulated and dispatched a letter to United States Senator Harry F. Byrd (of the state of Virginia) expounding what relates—the author believes—to *The Problems Today*. The following is a verbatim reproduction of this missive, prefaced by this recent communication to the author:

Dear Mr. Miller:

You have my permission to use my letter to Senator Byrd and the related material. I believe your book summarizing the UFO situation will serve a good purpose, especially since you are not endorsing the alleged contact or communications stories.

Sincerely yours,
Donald E. Keyhoe
Major, U. S. Marine Corps, retired.
Alexandria, Virginia
April 3, 1956



Albert M. Chop, former press chief, Air Material Command, handled Blue Book press relations.

Senator Harry F. Byrd,
Senate Office Building,
Washington, D.C.

Dear Senator Byrd:

During a recent Detroit address, given before the Engineering Society of Detroit and the American Chemical Society, members of the audience asked us how to secure certain hidden facts regarding the Air Force investigation of *Unidentified Flying Objects*. I recommended that they write their elected Senators and Representatives and insist that the Air Force end its present misleading policy.

Now, as a resident, property owner and taxpayer of the State of Virginia, I am re-

questing your assistance in ending Air Force contradictions and secrecy.

First, however, I should like to identify myself. I am a U. S. Naval Academy graduate and a former Marine Corps pilot, now retired with the rank of Major, U. S. Marine Corps. After a crash at Guam, in the 20's, I became Chief of Information for civil aeronautics. In 1926, I managed the U. S. tour of the "Josephine Ford" which your brother, Admiral Richard E. Byrd, and Floyd Bennett flew over the North Pole. I believe that Admiral Byrd will vouch for my integrity. In 1927, I was assigned as aide to Col. Charles A. Lindbergh for his air tour of the 48 states. Since then, except for an

active-duty period in World War Two, I have been a writer, my articles appearing in the Reader's Digest, Saturday Evening Post, Cosmopolitan, Redbook, The American Magazine, This Week, The American Weekly and over 20 other publications.

In 1949, True Magazine asked me to investigate the "flying saucer" mystery. Since then, I have interviewed many pilots, radar-men, and other highly qualified witnesses, reporting their sightings and opinions, along with official Air Force reports, in three books. During 1952 and early '53, when high Intelligence officers were planning to tell the public the facts, I was in close cooperation with the Air Force. At this time, several official ATIC statements and 41 formerly classified UFO (Unidentified Flying Objects) reports were declassified specifically for my use. But in February of 1953 the policy again was reversed, with secrecy and an "explain away and ridicule" policy once more invoked. Because of the inherent dangers in this censorship—and the Air Force has insisted no security is involved—I urge that you forward the following questions and statements to Secretary of the Air Force Donald A. Quarles, with a request for specific answers.

1. Why has the Air Force concealed an official Intelligence report, dated Sept. 23, 1947, which stated the flying saucers were real?

For your information, this report was signed by the Chief of the Air Technical Intelligence Center, approved by all members of ATIC, and submitted via Director of Air Force Intelligence to the Commanding General, Army Air Force.

2. Why has the Air Force kept from the press the official ATIC "Estimate of the Situation," drawn up in the summer of 1948, which stated that they, the flying saucers, were interplanetary space ships?

3. With the two above-mentioned documents in its hands, why did the Air Force, in December 1949, tell the press that the flying saucers were hoaxes, mirages, hallucinations and mistakes by pilots? Why did the Air Force deliberately omit the serious reports and opinions of hundreds of veteran Service and airline pilots, airport tower controllers, radar experts and other trained observers who insisted the saucers were unknown machines under intelligent control?

4. Why has the Air Force hidden the 1952 Air Force Intelligence analysis of the flying saucers' "controlled motion" and its specific conclusion that these UFO's were interplanetary space ships?

5. Why has the Air Force kept secret the recommendations of a panel of top scientists and aviation leaders, agreed to in January 1953, that the UFO investigation be greatly enlarged and that the American people be given all information on "saucers" in Air Force possession, including the official conclusions?

6. Why has the Air Force hidden all UFO reports from the public since 1953—even those it had previously released?

7. If the flying saucers are non-existent, as Secretary Quarles has tried to convince the public, why are Service pilots, radar-men and other trained observers officially muzzled?

For your information, the official orders are JANAP 146, AFR 200-2, and official instructions to personnel of the Civil Aeronautics Administration based on JANAP 146. This latter order also applies to civilian airline pilots who report flying saucers officially, on a communication system known as CIRVIS—Communications Instructions for Reporting Vital Intelligence Sightings.

8. If the flying saucers are imaginary, why do armed Air Defense Command jets continue to chase these UFO's, by standing ADC orders? Why does the Air Force continue to spend the taxpayers' money in a global investigation of flying saucers by hundreds of Intelligence officers, the 4602d Air Intelligence Service Squadron, and by top-ranking scientists and consultants under secret Air Force contract?

9. Why did Secretary Quarles and certain Air Force officers state in Special Report 14 that no pattern had been found, no indication of intelligent maneuvers, and not enough data to build a working model—when in December 1949 the ATIC Project "Grudge" Report stated that the majority of reports described a disc-shaped object about 1/10th as thick as its diameter?

Why did this Special Report 14, dated Oct. 25, 1955, list several of its weakest sighting reports as the "cream of the crop" when actually the Intelligence files showed hundreds of baffling, unsolved reports by the most experienced pilots, guided missile trackers, and other trained observers?

10. Does the Air Force agree with General Douglas MacArthur's statement, as published by the New York Times, October 8, 1955, that the world nations will have to unite against attack by people from other planets?

11. The existence of the official documents mentioned in Para. 1, 2, 4 and 5, has been confirmed publicly by Edward J.



Secretary of the Air Force Donald A. Quarles. The Air Force has initiated a policy of "silence." Air Force regulation #200-2 prohibits the release of any data relative to the UFO, and the Office of Public Information at the Pentagon refuses all comment concerning these phenomena. U.S. AIR FORCE PHOTO

Ruppelt, formerly head of the Air Force UFO Investigative agency, Project Blue Book. Does Secretary Quarles claim that Mr. Ruppelt is lying to the public?

During the past seven years, an Air Force "silence group" has repeatedly "explained away" the most important UFO sightings; it has led millions of citizens to ignore the "saucer" reports as nonsense. To achieve this, it has ridiculed the best qualified witnesses here and abroad. To name a few:

Col. Donald J. M. Blakeslee, World War 2 ace, Commander of a fighter escort wing; Capts. Jack Adriance and W. B. Nash, Pan American Airlines; Capt. Richard Case, American Airlines; Capt. Clarence B. Chiles,

Eastern Airlines; Capt. E. J. Smith, United Airlines; Capt. Lawrence Vinther, Mid-Continent Airlines; Senior Traffic Controller (radar) Harry Barnes, Washington National Airport; Dr. Clyde Tombaugh, discoverer of the Planet Pluto, and now in charge of the official "sky search" for unknown satellites. If you wish, I can supply many other witnesses' names, of equal importance, including pilots of the Air Force, Navy, Marine Corps, guided missile trackers, CAA tower operators, and other experts, here and in a dozen other countries.

Either all the trained observers are incompetent, or liars—or the Air Force is hiding the truth from the public. Since these hun-

dreds of pilots continue to guide planes through bad weather, with many lives in their hands, I think their competency is obvious.

It has long been established that the "Saucers" could not be U. S. or Russian devices. If we had had such global machines perfected in 1947, why didn't we use them to save lives in Korea? Why have we kept on building ordinary missiles and jet planes? Why would we risk international anger by secretly operating such devices all over the world, violating other nations' boundaries and spying on their defenses? Obviously, the saucers—with their tremendous speeds and fantastic maneuvers—are not earth-made. If they were Russian, the USSR would long ago have used them to force the Free World to surrender; the Russians would not be desperately trying to beat us in the race for air and missile supremacy.

The answer, as stated by ATIC in 1948 and again in 1952, is plain; the flying saucers are interplanetary machines, observing our world for reasons unknown—or reasons hidden by the Air Force.

But the Russians, by a false claim that the "saucers" were theirs, might frighten many people in the Free World at a crucial time. For this reason alone, we should be given the truth. Secondly, if the UFO's are interplanetary, the Air Force has left us completely unprepared for any attempted communication by this unknown race.

May I respectfully request, Senator Byrd, that you examine the evidence, or have it examined by competent analysts outside the Air Force? In the best interests of the American people, and of the world, I urge that you ask for a Congressional investigation into the Air Force secrecy on this subject. Such an investigation should call for public testimony by men who have fought for the truth:

General W. N. Garland, USAF; Col. Frank Dunn, USAF; Col. W. S. Smith, Intelligence, USAF; Major Dewey Fournier, USAF; Col. D. J. Blakeslee, USAF; Edward J. Ruppelt, former head of Project Blue Book; William Lear, of Lear, Inc., electronics and aviation industrial leader, who has declared the saucers to be interplanetary; Prof. Herman Oberth, space-travel expert and rocket designer, now on secret work at Redstone Arsenal, and all the Air Force, Navy, Marine Corps and airline pilots whose reports are on record.

In such an investigation, the Air Force should be required to reveal all the now

hidden reports and analysis—the detailed sightings and ATIC explanations, all UFO motion-picture analyses, and verbatim copies of the 1947, 1948 and 1952 Intelligence documents I have mentioned.

If such a hearing is held, I shall be glad to testify, under oath, to the facts and to the censorship which I detailed in *The Flying Saucer Conspiracy*, published last December. Thus far, the Air Force has avoided answering any of the charges I made.

Undoubtedly, many, if not all, of the "silence group" believe they are acting in the best interests of the country in concealing the facts. But the 1953 recommendation to "tell the public the truth" by the top-level panel of scientists, is, I believe, the only wise course. The American people are not children; with the tremendous issues involved, they have a right to know the truth—what they may have to face, perhaps in the near future.

I am flying to Iowa tomorrow to visit my mother, but I expect to return by Sunday, the 8th. I shall telephone your office on Monday, and I am hoping that the Air Force will reply promptly when you forward my questions, or the enclosed copy of this letter.

If you desire further information, with specific names, dates, and details, I shall be glad to discuss the subject with you, or to answer your questions.

Sincerely yours,
Donald E. Keyhoe
Major, U. S. Marine Corps,
Retired

Enc. Copy of this letter.

Nearly one month later, the Air Force answered Major Keyhoe's allegations. At least they imply they did.

Here is Major General Joe W. Kelly's rebuttal, kindly submitted by Major Keyhoe:
Department of the Air Force
Washington
1 May 1956

Office of the Secretary
Dear Mr. Chairman:

I refer to your expression of interest in behalf of Major Donald E. Keyhoe concerning the Unidentified Flying Object Program.

Major Keyhoe's letter is typical of many received by the Air Force from well-meaning persons who feel that action should be taken to secure the so-called "true facts" allegedly withheld by the Air Force in its investigation and analysis of so-called "flying saucers." The Air Force strives to ana-



Wendell V. Swanson, radar specialist to Project Blue Book, Air Technical Intelligence, played himself in "Unidentified Flying Objects."

lyze and answer each letter of this type regardless of the nature, motives, or objectives of the writer.

On May 5, 1955, the Air Force declassified its special study, Project Bluebook, Report Number 14, "Analysis of Reports of Unidentified Aerial Objects." This study represents the critical analysis made of the sum total of all reports of sightings made from 1947 to May 1955. It includes the painstaking efforts of highly competent scientists, analysts, investigators and specialists. This very detailed, extensive report was prepared by a civilian scientific group.

The reports were derived from all sources, ranging from well-known scientists and experienced pilots to the average man in the street. The report is available for examination by the general public.

The Secretary of the Air Force on 25 October 1955 publicly released the summary of report Number 14 containing the results of the investigation begun by the Air Force in 1947 into this field. This summary stated that through the continued use of the services of well-trained scientists and by constantly improved analytical and investigative methods, the Air Force has reduced the

number of "unknowns" from approximately 10% in 1954 to three percent as of this date. The "unknowns" are, of course, the prime concern of the Air Force. We shall continue to investigate them regardless of how low the percentage may become. However, the following conclusions of all these studies with regard to the "unknowns" may be reiterated:

There is total lack of evidence that the phenomena observed have inimical or hostile forces behind them.

There is a total lack of evidence that they are interplanetary vehicles.

There is a total lack of evidence that they represent technological developments outside the range of present-day scientific knowledge.

There is a total lack of evidence that they constitute any threat to the security of this country.

The Air Force feels that every question or allegation posed by Major Keyhoe, as well as the many statements made by individuals in or out of the Air Force, will fall in one or more of the four major conclusions.

You may be assured that the Air Force shall continue to study, analyze, and present to the public full facts on this subject. We appreciate the opportunity of responding to your request for information in this matter.

Sincerely yours,

(Signed)

Joe W. Kelly

Major General, USAF,

Director,

Legislative Liaison

Inclosure

Honorable Harry Flood Byrd
Chairman, Committee on Finance,
United States Senate

Where are the answers?

Major Keyhoe pointedly asked 11 questions. Yet—where are the answers?

"As you will see," Keyhoe wrote to the author on May 31, 1956, "General Kelly, speaking for the Air Force, refuses to answer any of the 11 questions Senator Byrd forwarded to Secretary Quarles. Instead, he tries to divert attention by pointing to Project Bluebook Special Report 14. To my mind, Report 14 is the most flagrant of all attempts to deceive the public, in regard to flying saucers. As you were told by Capt. Ed Ruppelt, some time ago, this 'study' which the Air Force now labels the latest dope actually was thrown out in 1953 as unsound.

"It is obvious from General Kelly's letter

that not even a United States Senator can get the true facts from the Air Force, unless there is a nationwide, concerted effort by enough of the public to end this censorship . . .

"Kelly's letter," the former Marine Corps Major continues, "is full of errors in fact. Special Report 14 did not contain the results of the AF investigation since 1947. Instead, it contained a distorted picture, leaving out hundreds of the most authentic cases, covering up the fact that many top Air Force Intelligence officers believed the saucers to be interplanetary. The letter gives the impression that all but 3% of the sightings have been explained, when actually this 3% applies only to a very small number of cases in 1955. Furthermore, if you examine the amazing 'explanations' in the Project Grudge report of 1949, you will find that these were, in many cases, deliberately contrived—and that the analysts themselves admitted they were stretching the answers beyond all reason."

Concludes Major Keyhoe:

"The American people have a right to know the facts and it is high time that military censorship be put in its right place—to cover information vital to our security, and nothing else."

In a communication to the author dated October 22, 1956, Dewey J. Fournier, Jr.—the former Intelligence liaison officer in the Pentagon for Project Blue Book—indicated that he was considerably disappointed in the current Air Force policy to de-emphasize the UFO project.

He added that he felt this revised policy is not only unjustified but could eventually be detrimental to our nation's welfare.

In the *Journal of the Optical Society of America* for 1953, Professor J. Allen Hynek deplored the ridicule levied at flying saucer sightings and sighters. He said the various implications directed toward observers of these phenomena accomplishes "nothing constructive." Dr. Hynek was the chief civilian scientific consultant to Project Blue Book, and is presently Associate Director of the (Vanguard) Satellite Tracking Program for the Smithsonian Astrophysical Observatory.

Extra-terrestrial vehicles in our presence would obviously necessitate the acceptance as fact—or at least a logical assumption—that another—or other—worlds are inhabited.

Theologians have often postulated that many of these planets would not have been created for the sole purpose of remaining desolate and lifeless. There is plan and pur-

pose to the universe, they argue, so it is almost well nigh impossible for these spheres to not be habitations for some life.

Scientists generally think likewise, but base their conjectures solely upon mathematical probabilities.

"We are not alone."

These emphatic and haunting words were declared by Harlow Shapley—then the Director of a Harvard College Observatory—in the *Atlantic Monthly* for November 1954. He indicated his belief that there are at least one hundred million other inhabited planets.

Apparently not to be outdone by his predecessor, Donald H. Menzel, the present Director of the Harvard College Observatory, wrote in the December 1955 *Atlantic Monthly* that "life, even human or super-human life, may exist in millions of places in the universe."

And according to a Science Service Grand Jury survey of prominent astronomers in September 1956, only three percent indicated they did not believe in the existence of "creatures roughly comparable to man [elsewhere] in the universe." Sixty-two percent of these astronomers answered in the affirmative, while 35 percent refrained from stating an opinion.

Still many scientists and physicists—far too many, according to some of their colleagues—have never studied nor read any objective literature on the enigma or phenomena. It is interesting to note that the so-called "acceptance" as real of these objects seems to rise proportionate to their scientific examination. In other words, if an astronomer who knows nothing of these epochal occurrences were asked for an opinion, he might volunteer "utter bilge." But on the other hand—where some reflection has been initiated on these phenomena—a much more receptive, open-minded—or even positive attitude—is quite often conveyed.

On Wednesday, October 10, 1956, the author talked by telephone with a Captain Fry, Commander of the Pasadena Air Defense Filter Center. This Filter Center is the point of reception for all UFO reports via *Ground Observer Corps* members as well as from a large proportion of the populace from San Louis Obispo—in Central California—to the state's southern extremity, San Diego. The author's object was to determine the number and classification of UFO sighting reports for 1956.

Captain Fry admitted that there was a directive prohibiting Sergeants-on-Duty

from answering queries from news media and the general public, relevant to the UFO and instructing that all such inquiries be directed to the center's commanding officer or to Norton Air Force Base in San Bernardino.

The Captain confirmed a report related by the author that forms and instructions clarifying and elaborating UFO report procedure had been dispatched to GOC posts the prior August 6th.

The Commanding Officer then suggested I contact Norton AFB for additional and statistical data on the UFO investigation or recent sightings. Norton's Public Information Officer, a Major Bowers, channeled the questioner to Air Force Intelligence Lieutenant Hoskins.

Exemplifying the efficiency of military procedure, it took no less than three different telephone calls (all long distance) to Norton and most of the day to have even one question answered.

Pursuing my quarry undaunted, the answer forth came:

Air Force Regulation No. 200-2 strictly prohibits the dissemination of any and all information to civilians regarding UFOB's (Unidentified Flying Objects), except "when the object is positively identified as a familiar object . . ."

"Familiar Objects," the regulation defined, "include balloons, astronomical bodies, birds and so forth."

There I had it.

Nothing.

Lieutenant Hoskins added that no one on the base had the authority to grant me information on UFOB's "classified" or otherwise. He said he was sorry. And he wasn't the only one.

AFR 200-2 is nothing new, the author learned. But it is still forcefully in effect. It has superseded Air Force Letter 200-2 (dated 29 Apr. 1952) and was first issued in August 1953. The current AFR 200-2 (1-5) "Reg" is dated 12 AUGUST 1954: "By Order of the Secretary of the Air Force" (although signed by N. F. Twining, Chief of Staff, United States Air Force), and is distributed to ONI Naval Intelligence and G-2 Army Intelligence as well as to Air Force Intelligence agencies.

The Military restrictions under AFR 200-2 are obvious. But what about civilians? Are there other documents applying to extraneous sources?

According to Donald E. Keyhoe, in *The Flying Saucer Conspiracy*, JANAP 146(B) was issued 6 September 1951 by "The Joint

Chiefs of Staff Joint Communications-Electronics Committee."

Under "Section III—Security," it stipulates:

"209. *MILITARY AND CIVILIAN.*

"a. All persons aware of the contents or existence of a CIRVIS report are governed by the Communications Act of 1934 and amended thereto, and Espionage Laws.

"(2) CIRVIS reports contain information affecting the National Defense of the United States within the meaning of Espionage Laws, 18 U. S. Code, 793 and 794. The unauthorized transmission or revelation of the contents of CIRVIS reports in any manner is prohibited."

What are CIRVIS reports?

CIRVIS reports, according to JANAP 146(B), include "Unidentified flying objects."

As for AFR 200-2, at least as applied by Norton AFB, it appears rather illogical that the Pasadena Filter Center should instigate a policy directing inquiries referring to UFO's to Norton, only to have the enquirer confronted with a regulation prohibiting the release of any such information. It is a hopelessly blind alley.

Is it any wonder then, that the news media do not more extensively disseminate UFO sightings (and subsequently authoritative comments)?

Is it any wonder that such objective civilian research groups as Project "A" of the Ohio Northern University have prematurely terminated—for lack of cooperation and sufficient data?

Is it any wonder that the public at large is apathetic, and is likewise inhibited by fear of ridicule to report UFO's when sighted?

Is it any wonder that more intensive efforts are not being advanced by more scientists and research societies to resolve the flying saucer anomaly?

No—apparently it is not any wonder.

But UFO reports are on the increase. According to many localized press accounts, Ground Observers throughout the country are constantly being alerted. Many Air Force and Naval Air Bases are on twenty-four-hour alerts.

John Pfeiffer, a GOC skywatcher in Escondido, California, and a Lieutenant Commander (pilot) in the Naval Air Reserve, told the author on October 7, 1956, that all Navy pilots have been advised immediately to report UFO observations but were "cautioned" not to speak of these sightings in public.

As a Ground Observer Corps member, he added that forms issued of recent by the Air Filter Center have de-emphasized reporting instructions for some types of aircraft, but at the same time emphasized reporting procedure for UFO observations.

Summarizing "The Problems Today," the future does not look dismal. Truth has and shall continue to ultimately prevail. Modern technology will add a few problems (such as creating aircraft that are gradually approaching the reported characteristics of the UFO's) but conversely will also create new and improved methods of detection: longer range radar, faster interceptors, superior optical tracking and photographic devices, and a myriad of other innovations too numerous and complex to conceive at our relatively early stage of advancement.

But will this really solve anything? Aren't our problems primarily a matter of objectively examining the data accumulated to date? Are not people inherently apprehensive of the new and the unknown?

Perhaps a psychological self-analysis is in order.

In restricting UFO data from the public and various civilian investigative bodies, the Air Force has become a prime concern to the UFO researcher. Obviously—and admittedly by the Air Force itself—there is nothing essential to national defense in the bulk of these reports, and anything that was (such as intercept and radar tracking procedure) could easily be withheld.

But we may be our own inhibiting agent. How many of us objectively tread the path of ultimate truth and are not continually swayed into one extreme or another? We may have our heads in the clouds but it is inversely imperative that we should always keep our feet on the ground. But neither must we suppress new thought and concepts. A common constriction is our tendency to habitually apply an earthly solution to a relatively unearthly phenomenon.

Few can deny that the fantastic of today is the common place of tomorrow.

With diligent research, patient analyses, constructive investigation, and the ultimate cooperation of official investigative bodies, the UFO picture will slowly but surely resolve into something of which we may now perceive only turbidly.

And that day will come. Until then, we must continually evaluate and discriminate. Keep an alert eye and ear. And wait.

For as Albert Einstein said:

"Those people saw something." ■

Glossary of UFO Terminology

ADC—Air Defense Command.

AFR 200-2—Air Force Regulation No. 200-2. The current regulation prohibiting the release of UFO data to news media and the public by Air Force bases and USAF Intelligence groups.

AFSB—Australian Flying Saucer Bureau. Now believed defunct, this group was headquartered at Fairfield, New South Wales.

AFSRS—Australian Flying Saucer Research Society, located at Kilburn, South Australia.

AP—Associated Press.

APRO—Aerial Phenomena Research Organization. A private UFO research group with headquarters at Alamogordo, New Mexico.

ATIC, A. T. I. C.—Air Technical Intelligence Center. Located at Wright-Patterson Air Force Base, Dayton, Ohio. ATIC coordinates the USAF study of unidentified aerial phenomena.

CAA—Civil Aeronautics Administration.

CFSI—Civilian Flying Saucer Intelligence. A group in Seattle disseminating UFO sighting reports.

CIA—Central Intelligence Agency.

CIRVIS—Communication Instruction for Reporting Vital Intelligence Sightings (from Aircraft).

CSI (NY)—Civilian Saucer Intelligence of New York.

CSI (NZ)—Civilian Saucer Investigation (New Zealand), at Auckland.

C. R. I. F. O.—Civilian Research, Interplanetary Flying Objects. A UFO news disseminating group at Cincinnati, Ohio.

Flap—Applied to the UFO, a flap designates anything from a "flurry" to a "panic" of sighting reports and the resultant effects.

Flying Disc (or Disk)—A term often used in reference to UFO's from 1947 up to and including the early '50's.

Flying Saucer—Generally, any aerial phenomena remaining for at least a brief time unidentified. Specifically, an aerial object which exhibits a circular or oval shape.

Fortean—Pertaining to, or the work of, or the type of anomalous phenomena catalogued by, Charles Hoy Fort (1874-1932). Fort's principal works—*The Book of the Damned*, *New Lands*, *Lo!*, and *Wild Talents*—comprise *The Books of Charles Fort* (published 1941 by Henry Holt for the Fortean Society).

GOC, G. O. C.—Ground Observer Corps.

Gravitic—pertaining to gravity, the principles of, and applications thereto.

INS—International News Service.

JANAP—Joint-Army-Navy-Air-Publication.

LB, L-B—Light-Beam. A communications method primarily developed for the restricted interchange of intelligence data during the Second World War. More recently, it has been adapted for attempting extra-terrestrial contact (communication).

MO—*Modus Operandi* (Method of Operation).

NTO—Non-Terrestrial Object.

OPI—Office of Public Information. Sometimes known as **OPI/DD**, the latter abbreviating Department of Defense.

PIO—Public Information Officer.

Project Blue Book—The current Air Force investigative body for the acquisition and analyses of UFO data. It is located at Air Technical Intelligence Center, Ohio.

Project Grudge—The USAF center for UFO research which preceded Project Blue Book and succeeded Project Sign.

Project Magnet—A program initially established by the Canadian Government for the ultimate development of a discoid airfoil motivated by electro-magnetic energy. Recently, **Project Magnet** has been more extensively noted for its attempt to electronically detect the proximity of UFO's to its sighting station at Shirley's Bay (near Ottawa), Ontario.

Project Sign—The code name assigned to the first group within the Air Force to investigate "flying saucer" reports.

Project Twinkle—A U. S. Air Force project to resolve what has become known as the "Green Fireball" phenomenon, plaguing the Southwestern United States since 1948.

UAO—This designation for Unidentified Aerial Object has been replaced in recent years by UFO (or UFOB).

UFO, U. F. O., u.f.o.—(Pronounced Yoo-foe.) Unidentified Flying Object. The current, semi-official designation for the phenomena oftentimes termed "flying saucers." Plural is initiated by adding apostrophe and a non-capitalized s, i.e. UFO's. (See UFOB.)

UFOB—(Pronounced Yoo-fob.) Official U. S. Government designation for Unidentified Flying Objects.

UP—United Press.

Vailx—Purported Atlantean term for a cigar-shaped aircraft, or space ship.

Vimana (Sanskrit), **Vimanam** (Pail) — Archaic designation for a self-propelled "air boat." ■

BOOKS

FOR "ACTIVE" MEN

Books by experts—with facts and practical information, all profusely illustrated!



ARCHERY ADVENTURES

First popular priced book on this fascinating hobby that is attracting new enthusiasts by leaps and bounds. Howard Hill, acknowledged master archer, gives you the real facts about hunting predators and big and small game with bow and arrow, for meat as well as for sport. Share his adventures in this fascinating book; learn the art of stalking game—"hunting the hard way." Read his thrilling stories on successful hunts for buffalo, bobcats, mule deer, mountain sheep, alligators and even hunting game fish underwater. Chapters describe how to make your own bows, strings and arrows; fine points of using archery equipment.

tures in this fascinating book; learn the art of stalking game—"hunting the hard way." Read his thrilling stories on successful hunts for buffalo, bobcats, mule deer, mountain sheep, alligators and even hunting game fish underwater. Chapters describe how to make your own bows, strings and arrows; fine points of using archery equipment.



MODEL RAILROADING

How to get more pleasure from this fascinating hobby. This complete book will show you how to plan your pike; how to select the right gauge for you; tables and bench work, track layout, building shops, towns, manufacturing plants along the right of way, scenery, wiring, bridges and other structures. Then into the mechanical divisions, here are all types of locos and cars illustrated and described for you. How to paint rolling stock for greatest realism and for easy servicing and maintenance; tips on how to "keep 'em rolling." Profusely illustrated.



SPIN FISHING

Here are the secrets of catching more fish with light tackle in the exciting sport of spin casting that has revolutionized sport fishing in a few years time. Get the facts on how to select the right rod, reel, line and lures for your greatest enjoyment. In practical, step-by-step fashion you see basic techniques of spin casting, with modifications for lake, stream and river fishing for gamesters and panfish, plus special suggestions on salt water spinning from shore, pier, boat and in the surf. Many illustrations make this an easy-to-understand book for every avid sportsman.



JAZZ AMERICANA

The story of jazz and the fabulous bands and musicians who made this strictly American form of modern music. From the opening pages giving the first good definition of jazz, you'll find dozens of pictures of jazz greats of all time, pictures unobtainable elsewhere. Read the growing pains era, in poverty, through the roaring twenties, then swing and the big band era, and contemporary evolution. Most important is the discography—a guide to more than 10,000 most enduring jazz recordings, grouped by Traditional, Big Bands, Small Bands and Combes, Piano Jazz and Anthology sections.



CUSTOM CARS ANNUAL

Topping anything ever done before, this collection of fabulous custom creations and photo-stories on how they are built make this '57 edition the greatest you've ever seen. Here are the newest slants of the customizers art; how to make your own shaded headlights, hood scoops, bumper exhausts and many other popular custom features. You'll find hundreds of pictures of beautiful custom creations, beginning with the top ten prize winners of the year, followed by the greatest array of the bizarre, spectacular and the smoothies that help create Detroit styling trends.



HAND GUNS OF THE WORLD

The fascinating saga of the hand gun is told for the first time in this new book at popular prices. If you shoot, collect or have any special interest in pistols and revolvers, this is for you. From the initial pages on the history of hand guns to the chapters on their care and repair, you'll find it packed with practical information you can use. Inside facts on how to buy handguns whether as collector pieces or for shooting tell you the market prices as well as data on manufacturers and specifications. Read the secrets of accurate shooting, the quick draw; the Colt; handgun ammunition.



HOT ROD ANNUAL

The outstanding hot rod handbook of the year; this 1957 edition brings you new photos, new facts; new practical and down-to-earth construction details written by the experts and compiled by Jim Potter and George Harris. Here you'll find dragsters and laksters—a pictorial section with full photo-details; a full section on roadsters and competition coupes; 13 specific frame and body modifications for rods; complete construction details and photos, step-by-step in building a competition coupe; flame painting and striping; and a full chapter on rodding the new engines.



DRAW & PAINT

Open the door to this old but ever new fascinating hobby of creating your own drawings and paintings. This book, written by expert Arthur Zaidenberg, well-known art instructor, is designed to help the beginner get started, and to help the expert review basic techniques. Beginning with the basic use of stick figures to delineate action, the book continues with detailed chapters on rendering components, figure sketching, animation, composition. Then you find descriptions of the various techniques—pen and ink, pencil sketching, wash drawings; oil and water colors.



PHOTOGRAPHY FOR PROFIT

It's easy to turn your photography hobby into cash; marketing good photos is made easy with this guide book and directory of photo buyers, what they want, what they need in the way of prints or negatives, and approximate rate of pay. Increasing needs of newspaper, magazine, and other buyers make photography a profitable hobby. This book also offers suggestions on how to take marketable photos; hints on composition, pro-traits, posing of models, special techniques for special effects. This is a complete guide on how to shoot and sell your photos.

ONLY **75¢** EACH AT YOUR NEWSSTAND NOW!

Or if your dealer cannot supply you, send 85c per book (to cover postage, etc) to:
TREND BOOKS
5959 Hollywood Blvd., Los Angeles 28, Calif.

Although a comparatively young man, author Max B. Miller has put in a world of objective Flying Saucer research since he first became interested in the phenomena in 1947. He founded Flying Saucers International in 1952 and still operates it as a non-profit investigation unit, delving into all facets of Unidentified Flying Objects. Exhaustive research findings are dispensed to the public through the quarterly publication "Saucers" which is believed to have one of the largest circulations of its kind in the world. Currently Miller holds memberships in many local and overseas UFO and space groups including: The British Interplanetary Society, Association of Lunar and Planetary Observers, The Meteoritical Society, Civilian Saucer Intelligence of New Zealand and associate member of the American Rocket Society.

