

HOLOCAUST HANDBOOKS · VOLUME 24

CARLO MATTOGNO & FRANCO DEANA

**The
CREMATION
FURNACES
of
AUSCHWITZ**

A TECHNICAL AND HISTORICAL STUDY

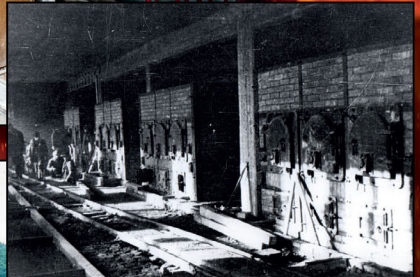

PART 1: HISTORY AND TECHNOLOGY

PUBLISHED BY CASTLE HILL PUBLISHERS

THE CREMATION FURNACES OF AUSCHWITZ, PART 1

The Cremation Furnaces of Auschwitz

A Technical and Historical Study

Part 1: History and Technology

By Carlo Mattogno

With Contributions by Dr.-Ing. Franco Deana



Castle Hill Publishers
P.O. Box 243, Uckfield, TN22 9AW, UK
October 2021

HOLOCAUST HANDBOOKS, Volume 24:

Carlo Mattogno:

The Cremation Furnaces of Auschwitz: A Technical and Historical Study.

Part 1: History and Technology

With Contributions by Dr.-Ing. Franco Deana

Uckfield, East Sussex: CASTLE HILL PUBLISHERS

PO Box 243, Uckfield, TN22 9AW, UK

2nd, revised edition, October 2021

Originally published in Italian in 2011 as *I forni crematori di Auschwitz: Studio storico-tecnico*, by Effepi, Genoa. Translated from the Italian by Henry Gardner and Germar Rudolf

ISSN: 1529-7748

Part 1: History and Technology

ISBN: 978-1-59148-936-8 (hardcover)

ISBN: 978-1-59148-275-8 (paperback)

Part 2: Documents

ISBN: 978-1-59148-935-1 (hardcover)

ISBN: 978-1-59148-276-5 (paperback)

Part 3: Photographs

ISBN: 978-1-59148-934-4 (hardcover)

ISBN: 978-1-59148-277-2 (paperback)

Published by CASTLE HILL PUBLISHERS

Manufactured worldwide

© by Carlo Mattogno 2011, 2015, 2021

Distribution worldwide by:

Castle Hill Publishers, PO Box 243

Uckfield, TN22 9AW, UK

<https://shop.codoh.com>

Set in Times New Roman

www.HolocaustHandbooks.com

Cover illustrations: top: reconstructed cremation furnaces at the Auschwitz Main Camp (Photo 87); right: furnace hall of Crematorium II at Birkenau in 1943 (Photo 111); bottom: ruins of Crematorium V at Birkenau in 1991 (Photo 228); left: ruins of the Crematorium II furnace hall in 1991 (Photo 220).

Contents

Part 1: History and Technology

	Page
Preface to the First Edition	11
Preface to the Second Edition	19
Unit I: Modern Cremation.....	21
1. The Cremation	23
1.1. General Principles of Combustion Technology.....	23
1.2. The Chemical Processes during Cremations	28
1.3. The Cremation Process.....	32
2. Cremation Technology of Coke-Fired Furnaces.....	35
2.1. Structure and Operation.....	35
2.2. General Theoretical and Structural Principles.....	36
2.2.1. The Gasifier.....	36
2.2.2. The Cremation Chamber or Muffle	38
2.2.3. The Recuperator	39
2.2.4. The Chimney	41
2.2.5. Drying Out a New Furnace.....	43
2.2.6. Test Cremations.....	44
3. Origin and Development of Modern Cremation Furnaces.....	46
4. Cremation Experiments in Germany in the 1920s	62
5. Technical Developments of Cremation Furnaces in Germany in the 1930s77	
5.1. Furnaces with Coke-Fed Gasifiers	77
5.2. Furnaces Heated with City Gas	81
5.3. Electrically Heated Furnaces.....	94
6. The Duration of the Cremation Process	98
6.1. Cremation Furnace with a Coke-Fed Gasifier.....	103
6.2. Cremation Furnace with Briquette-Fed Gasifier	103
6.3. Cremation Furnace Heated with Gas.....	104
6.4. Cremation Furnace Fired Electrically	105
7. Heat Balance of a Coke-Fed Cremation Furnace.....	109
8. Legal, Ethical and Professional Standards for Cremations in Germany	127
9. Cremation Statistics	136
9.1. Statistics for Germany (1878-1939)	136
9.2. Statistics of Other Countries.....	140
10. Mass Cremation for Hygienic and Sanitary Purposes.....	143
11. Notes on Present-Day Cremation Furnaces	156
Unit II: J.A. Topf & Söhne.....	161
1. Historical Notes on the Topf & Söhne Company	163

2.	The Topf Cremation Furnaces for Civilian Use.....	169
2.1.	The Cremation Furnace with a Coke-Fed Gasifier	169
2.2.	The Gas-Fired Cremation Furnace	174
2.3.	The Cremation Furnace with Electrical Heating.....	178
3.	The Topf Patents of the 1920s and 1930s	183
4.	Topf Waste Incinerators	196
5.	Topf Cremation Furnaces for Concentration Camps	198
5.1.	The Coke-Fired Cremation Furnace with One Muffle.....	198
5.2.	The Oil-Fired Mobile Cremation Furnace with Two Muffles	203
5.3.	The Coke- or Oil-Fired Cremation Furnace with Two Muffles.....	208
5.4.	The Coke-Fired Cremation Furnace with Two Muffles Placed Opposite Each Other.....	212
6.	The Topf Co. and the Construction of the Cremation Furnaces at Auschwitz-Birkenau.....	212
6.1.	The Furnaces of Crematorium I at Auschwitz	212
6.2.	The Furnaces of Crematoria II and III at Birkenau.....	228
6.3.	The Furnaces of Crematoria IV and V at Birkenau	247
7.	Structure and Operation of the Topf Cremation Furnaces at Auschwitz-Birkenau.....	251
7.1.	The Coke-Fired Double-Muffle Furnace Auschwitz Type	251
7.2.	The Coke-Fired Triple-Muffle Furnace	266
7.3.	The Coke-Fired 8-Muffle Furnace.....	280
7.4.	The Plans for Mass Cremations at Auschwitz-Birkenau	288
7.4.1.	The Furnace Designed by Fritz Sander	288
7.4.2.	Crematorium VI.....	291
7.4.3.	The Annular Incineration Furnace	292
7.4.4.	The Furnace of the Quotation Dated 1st April 1943	292
8.	The Duration of the Cremation Process in the Topf Furnaces at Auschwitz-Birkenau.....	294
8.1.	The Documents.....	294
8.2.	Richard Kessler's Cremation Experiments	298
8.3.	The List of Cremations in the Gusen Crematorium.....	301
8.4.	The List of Cremations at the Westerbork Crematorium.....	306
8.4.1.	Adults Cremated Individually	308
8.4.2.	Infants Cremated Individually	308
8.4.3.	Infant Double Cremations	308
8.4.4.	Mixed Double Cremations	309
8.4.5.	Staggered Cremations	310
8.5.	Conclusions	311
9.	The Cremation Capacity of the Cremation Furnaces at Auschwitz- Birkenau	314
9.1.	Continuous Operation of the Furnaces	315
9.1.1.	The Formation of Slag	315
9.1.2.	Slag Removal.....	316
9.2.	Concurrent Cremation of Several Corpses	317
9.2.1.	Experiments with Animal-Carcass-Incineration Furnaces	317
9.2.2.	Experiences with the Westerbork and Gusen Crematoria.....	319

9.2.3.	Documents on Multiple Cremations.....	320
9.2.4.	Thermal Inadequacy during Water Evaporation.....	323
9.2.5.	Thermal Overload during Main Combustion	326
9.3.	Soviet and Polish Technical Investigations	327
9.3.1.	The Soviet Report on the Kori Cremation Furnaces at KL Lublin-Majdanek.....	327
9.3.2.	The Soviet Report on the Kori Cremation Furnaces at KL Sachsenhausen.....	330
9.3.3.	The Soviet Report on the Kori Cremation Furnaces at KL Stutthof.....	333
9.3.4.	Discussion of the Soviet Reports on the Kori Furnaces	333
9.3.5.	The Soviet and Polish Reports on the Topf Cremation Furnaces at Auschwitz-Birkenau.....	337
9.3.6.	The Presence of Child Corpses.....	339
9.4.	Maximum Theoretical Cremation Capacity	340
9.5.	Normal Cremation Capacity.....	341
9.6.	Discussion of the <i>Zentralbauleitung</i> Letter of 28 June 1943.....	344
9.7.	The Durability of Refractory Lining	348
9.8.	The Effective Equivalent Operating Time of the Birkenau Cremation Furnaces.....	350
9.9.	The Auschwitz-Birkenau Crematoria in the General Operation of the Camp.....	351
10.	Heat Balance of the Topf Furnaces at Auschwitz-Birkenau	353
10.1.	Remarks on the Method Used	353
10.2.	Technical Data.....	354
10.2.1.	Basic Data on Coke	355
10.2.2.	Basic Furnace Data.....	355
10.2.3.	Basic Data on Corpses.....	360
10.3.	Heat Balance of the Double-Muffle Furnace at Gusen	362
10.4.	Heat Balance of the Double-Muffle Furnace at Auschwitz.....	365
10.4.1.	Heat Losses for the Corpses	365
10.4.2.	Heat Losses from the Furnace	365
10.5.	Remarks on the Heat Balance	369
10.6.	Heat Balance of the Topf Triple-Muffle Furnace.....	372
10.7.	Heat Balance of the Topf 8-Muffle Furnace	375
10.8.	Observations on the Coke Consumption of the Triple- and 8- Muffle Furnaces	375
10.9.	A Comparison with the Kori Furnace at the Westerbork Camp and the Kori Slaughterhouse Furnaces.....	378
10.10.	Some Thermal Aspects of the Triple-Muffle Furnace.....	379
10.11.	On Claims of Flaming Chimneys.....	382
11.	The Cremation Furnaces Built by Other German Companies: Kori, Ignis-Hüttenbau and Didier.....	387
11.1.	Historical Remarks Concerning the H. Kori Co. of Berlin.....	387
11.2.	The Coke-Fired Kori Cremation Furnaces for the Concentration Camps.....	388
11.2.1.	The Furnace at the Mauthausen Crematorium.....	388
11.2.2.	The “ <i>Reform-Einäscherungsöfen</i> ”.....	389
11.2.3.	The Furnaces in the Crematorium at the Dachau Camp.....	391

11.2.4. The Furnaces at the Stutthof Crematorium	393
11.2.5. The Furnaces of the Crematorium at Sachsenhausen.....	394
11.2.6. The Furnaces of the New Crematorium at Lublin-Majdanek... 394	
11.3. The Oil-Fired Kori Cremation Furnaces for the Concentration Camps	398
11.4. The Oil-Fired Cremation Furnaces Built by Ignis-Hüttenbau A.G. at the Terezín Crematorium	400
11.5. The Didier Cremation Furnaces for Concentration Camps.....	405
11.6. Comparison of the Designs by Kori, Ignis-Hüttenbau, Didier and Topf.....	407
12. The Topf Furnaces and Regulations on Cremations in Greater Germany at the Outset of World War II.....	409

Appendices.....419

1. Tables	419
1.1. List of Cremations at the Westerbork Crematorium	419
1.2. List of Cremations at the Terezín Crematorium	425
1.3. Summary of the Topf Company's Activities at Auschwitz- Birkenau	433
1.4. Patents (and Patent Applications) by J.A. Topf & Söhne	434
1.5. Patent Applications by Department "DE" of J.A. Topf & Söhne ...	435
2. Glossary	437
3. Symbols.....	444
4. Abbreviations of Archive Names	445
5. Bibliography.....	447
5.1. Alphabetical Listing.....	447
5.2. Subject Listing	461
5.2.1. Modern Cremation	461
5.2.2. Topf & Söhne, Erfurt	473
5.2.3. Holocaust History	474
6. Indices	477
6.1. Names	477
6.2. Concentration Camps.....	480
6.3. Crematorium Locations (Civilian).....	481

Part 2: Documents (separate book)

List of Documents

- I. Civilian Cremation Furnaces
- II. TOPF, Civilian Activities
- III. TOPF, Correspondence with the SS

Part 3: Photographs (separate book)

List of Photographs

- I. Photographs 1-35: Gusen
- II. Photographs 36-50: Dachau
- III. Photographs 51-85: Mauthausen
- IV. Photographs 86-110: Auschwitz Main Camp
- V. Photographs 111-215: Buchenwald
- VI. Photographs 216-235: Auschwitz-Birkenau
- VII. Photographs 236-332: Kori Cremation Furnaces
- VIII. Photographs 335-344: Kori Furnaces in Other Camps
- IX. Photographs 345-362: Terezín
- X. Photographs 363-365: Urns
- XI. Photographs 366-367: Stoking Tools
- XII. Photographs 368-370: Cremation Experiments
- XIII. Color Documents from Part 2

Preface to the First Edition

The problem of the cremations at Auschwitz – one of the most-important and still-unresolved questions in the orthodox historiography of that camp – started to come out of the general hysteria to which it had been relegated for decades and to take on some scientific qualities only in 1989, thanks to Jean-Claude Pressac (Pressac 1989). The merits of this French researcher, however, stopped there: while he did indeed try to approach the problem from a scientific standpoint, his analytic procedure and his conclusions only made a sound scientific treatment of the matter the more pressing (cf. Mattogno 2019, esp. Chapter 9); his severe lack of technical training is also demonstrated by his second work on Auschwitz (Pressac 1993; cf. Mattogno 2016a).

This deficiency has become even more serious, because now that Pressac is no longer with us, the problem of the Auschwitz cremations has relapsed into the propagandistic hysteria of the immediate post-war years, as is highlighted by a number of more-recent pseudo-scientific works on the issue:

- The first case in point is Robert Jan van Pelt’s study on *Auschwitz* (van Pelt 2002), which I have dealt with thoroughly in a dedicated volume (Mattogno 2019, esp. Chapter 12).
- The collective work by Assmann *et al.* of the same year about the Topf Company, which had supplied the cremation furnaces for Auschwitz, is absolutely devoid of any technical and scientific character and supplies no new information on the Topf furnaces at Auschwitz (Assmann/Hiddemann/Schwarzenberger 2002).
- The recent *Encyclopedia of Cremation* (Davies/Mates 2005), though claiming to be scientific, devotes to “Auschwitz” one purely propagandistic page (p. 66) which is based on the works of Danuta Czech, Franciszek Piper and Jean-Claude Pressac!
- Just as inconsistent are the pages which Norbert Fischer devoted to Auschwitz and the other German concentration camps in a text on cremations in Germany (Fischer 1996, ch. 5.3b, pp. 260-265).

The only really substantial source is the website on Topf, which provides various significant documents (www.TopfundSoehne.de).

Personally, I started to become generally involved in the study of cremations in the summer of 1987. The following year brought the onset of the valuable collaboration with Franco Deana, doctor of engineering, which was essential for the technical foundation of this study. In the intensive correspondence that ensued, he has always been a rich source of explanations and of technical analyses for the many points of discussion. His name must therefore stand on the front page of this work, together with that of the author. Sadly, Dr. Deana passed away in 2005. Just as precious has been the support of the German engineer H.N. who unfortunately passed away already in 1991. Thanks to him, as well as

others, I was able to visit, for the first time, the camps of Buchenwald, Dachau, Mauthausen and Gusen.

Initially my studies centered upon such technical problems as the duration of the cremation process and the corresponding requirements for fuel. The publication of Pressac's first book in 1989 prompted me to widen the perspective of my approach and to include the historical context as well.

When the work had been completed in 1993, Pressac, in his second book, brought to light the enormous amount of documentary evidence concerning the Auschwitz crematoria that had been preserved in the Moscow archives of Vi-borgskaya. An update of my study on the basis of the new documents that Pressac had identified (some of which I had already seen as copies in the Auschwitz Museum's archive) appeared a year later (Gauss 1994, pp. 281-320).

In 1995, together with Jürgen Graf and the late Russell Granata, I was able to view, in the Moscow archives, the collection of some 88,200 pages of documents stemming from the Auschwitz Central Construction Office (*Zentralbau-leitung*). The collection contains a massive correspondence between that office and the Topf & Söhne Company of Erfurt, which had built the Auschwitz cremation furnaces. In 1997 and 1998 I found further important documents in Poland and Holland. In the spring of 1999 I visited, among many other sites, the museum and the crematorium at Terezín (Theresienstadt), which both turned out to be of considerable importance for the purposes of the problem dealt with here. During the summer of that year, I examined the files kept in the municipal archives of the city of Erfurt which, since 5 August 1996, has been preserving a highly informative documentation on all the activities of the Topf Co., not limited to the mere question of crematoria. An overview of this documentation was published as an article in 2000 (Gauss 2000, pp. 373-412; Rudolf 2003, ditto) and a more extensive summary followed in 2009 (Mattogno 2009, pp. 210-294; English 2010a, Chapter 8, 229-320; 2019, pp. 207-289).

With the passage of time, the initial scope of the study broadened considerably, both into the historical domain and into the field of technology, and a publication in separate volumes thus became necessary: one for the text as such (the present Part 1) and the two others for the corresponding voluminous documents (Part 2, in black & white) and the photographs (Part 3, in color).

Various difficulties and obstacles have delayed the publication of this study until today. In the meantime, though, I have continued to search for and collect more sources and documents.

The cremation furnaces of Auschwitz, fired by means of coke-fed gasifiers, constituted a development – or rather a simplification – of the civilian types; however (as I found out in the early stages of my work) it is difficult to locate detailed information on these furnaces even in the specialized literature. I therefore decided to place, at the head of the specific topic of the present study, a rigorous introductory treatment of those furnaces as Unit I of Part 1 of this study.

Furthermore, in view of the fact that cremation furnaces are, fundamentally speaking, nothing but combustion devices, I felt that it would be helpful for the reader to become, on the one hand, acquainted with the general principles of

combustion technology and the chemical processes which come into play during a cremation, and on the other hand with the theoretical and design principles of a cremation furnace with a coke-fed gasifier, supplemented by a detailed description of its structure and its operation. In this way the reader will come to a better understanding of cremation technology, and a better ability to evaluate the Holocaust accounts of cremations at Auschwitz.

Finally, as the Auschwitz cremation furnaces were products of the technology of their era, I felt that it would be useful to present an overview of the history of cremation in modern times with a particular emphasis on furnaces with coke-fed gasifiers such as those at Auschwitz, but without leaving aside systems based on other energy sources – gas, naphtha (oil) or electricity. In this way the reader can appreciate the technological development of these combustion devices from the latter decades of the 19th Century through the Second World War, with all the technical problems which had to be solved. This historical presentation of cremation furnaces is complemented by a parallel study of devices for mass cremations for sanitary and hygienic reasons (in connection with wars or epidemics) and concludes with a brief analysis of the cremation furnaces of today.

The scientific cremation experiments carried out in Germany (and in Switzerland) at the end of the 1920s provide us with a solid experimental basis for tackling and resolving the essential questions of the duration and the corresponding fuel consumption for a cremation in a cremation furnace with a coke-fed gasifier; these aspects will be analyzed in detail in two specific chapters.

Aiming for a comprehensive presentation of the subject of this book, I have not neglected the legal and statistical aspects of cremation, especially for the case of Germany. The above topics are presented in Unit I of the present volume; by their very nature, these topics apply to the present, therefore the treatment of the problems will often refer to our day and age, especially when it comes to the descriptions of the various devices.

In Unit II, I have primarily outlined the activities of the Topf Company in the field of the design and construction of civilian cremation furnaces and other combustion devices, describing in detail the structure and the operation of the various types of Topf cremation furnaces, heated by means of coke, gas or electricity. I have also presented the numerous patents (and patent applications) granted, acquired or filed between the 1920s and the 1950s.

After this general introduction concerning the Topf line of cremation furnaces for civilian use, I have taken up the cremation devices which the company supplied or designed for the concentration camps, starting with those for Dachau and Gusen (furnaces with two muffles, *i.e.* cremation chambers, heated with oil (naphtha) and later converted to coke).

At this point we enter the core topic of the present work, which begins with a documented history of the construction of cremation furnaces at Auschwitz-Birkenau. It is followed by a detailed technical description of the structure and the operation of these devices – the furnaces with two, three and eight muffles – and a survey of the Topf projects for mass cremations in that camp.

The three fundamental questions – the duration of the cremation process, the capacity of the furnaces and the fuel consumption – will then be treated for the Topf cremation furnaces at Auschwitz-Birkenau in a scientifically rigorous fashion on the basis of a wide variety of documents.

For the determination of the duration of the cremation process, I have based myself primarily on experimental data, in particular those resulting from the cremation experiments with a coke-fired furnace undertaken by the engineer R. Kessler in Germany at the end of the 1920s and those stemming from the experiments with a gas-fired furnace done by Dr. E. Jones in England in the 1970s, as well as on the detailed description of 15 cremations carried out in a modern gas-fired furnace as part of a study in forensic medicine.

I have also taken into account a large portion of a list of cremations at Gusen and the nearly complete list of cremations at the Westerbork Crematorium. The name lists of cremations in the Terezín (Theresienstadt) Crematorium (a vast sampling of 717 cremations carried out between 3 October and 15 November 1943 over 41 days of operation) furnish us, moreover, with a very-useful account inasmuch as the average duration resulting for these cases constitutes the lower documented limit that could be achieved in the cremation devices of that period.

The result of the study – that the average duration of the cremation process was one hour – is confirmed also by the statements given by the Topf engineer Kurt Prüfer, the designer of the furnaces with three and with eight muffles, and by Karl Schultze, who designed and built the blower for the former.

The section dealing with the capacity of the crematoria at Auschwitz-Birkenau contains a preliminary evaluation of the limits of the continuous operation of the devices (imposed by the unavoidable formation and the necessary removal of slag from the hearth) and of the loading of the muffles, *i.e.* an evaluation of the possibility of burning simultaneously, in a useful manner, more than one corpse in one muffle. This possibility is ruled out on the basis of experimental data (tests run in the crematoria at Westerbork and Gusen, as well as in slaughterhouses).

The Topf furnaces at Auschwitz-Birkenau were designed for individual cremations, and alleged attempts at extending their technical limits would have provided no advantage with respect to the economy of the cremation. The Polish and Soviet expert reports on the coke-fired cremation furnaces of the Lublin-Majdanek, Sachsenhausen and Stutthof Concentration Camps, which are presented here for the first time in English translation and with their propagandistic digressions removed, supply us with an indirect confirmation of this view.

In the present treatise I have not limited myself to the mere verification of numerical data, but I have also examined the historical question of the purpose of the design and the construction of the crematoria furnaces at Auschwitz-Birkenau.

The heat balance – *i.e.* the calculation of the coke consumption of the furnaces – is based on a sound experimental footing: the consumption of the Topf double-muffle furnace in the crematorium at Gusen with its average consumption of 30.6 kg of coke for 677 individual cremations. Compared to my sum-

mary of 1994 (Gauss 1994 pp. 281-320), the heat balance presented today has a foundation which is methodically superior: whereas the former was based on a theoretical calculation corrected for the experimental data of the Gusen Furnace, the balance offered here analyzes and explains those very data which constitute the departure point of the calculation; this has led to results diverging from those previously published, but to an almost-insignificant degree (the standard deviation is less than 8%).

The calculation takes into account the technical data concerning coke, the furnaces (with a detailed computation of the hourly heat loss by radiation and conduction of the Gusen Furnace and of the double- and triple-muffle furnaces at Auschwitz-Birkenau) and the corpses, which are divided into three types: normal, average and lean. The fuel consumption (including total combustion air, theoretical air consumption and excess air) is derived for each type of furnace and for each type of corpse.

The analysis of the thermal balance of the Auschwitz-Birkenau furnaces, moreover, evidences a design error for the triple-muffle furnace, on account of which the combustion gases fed to or forming in the center muffle did not have enough dwell time to burn completely but were sucked up by the chimney draft and finished burning in the flue ducts. This phenomenon caused serious damage to the refractory lining of the flue ducts and of the chimney of Crematorium II at Birkenau in March 1943.

But could this surge of flames also show on the outside and produce the phenomenon of flaming chimneys attested to by many witnesses? On the basis of calculations, these flames should have exhausted themselves within the smoke ducts of the crematoria. However, in order to verify this experimentally, I have conducted two experiments with animal grease in a simple furnace I built for the purpose. The experimental results fully bore out the implications of the theoretical data.

For a better judgment regarding the Topf cremation furnaces at Auschwitz-Birkenau, I have also made an extensive analysis of the oil- and coke-fired furnaces supplied to the concentration camps by Topf's major competitor, the Hans Kori Co. of Berlin, as well as those installed at the Terezín Camp by Ignis-Hüttenbau Co., undoubtedly the most-efficient devices built anywhere in Europe in the 1940s.

The final problem dealt with in Unit II concerns the legal requirements regarding the cremations in the concentration camps and the compatibility of the furnaces in use there with those requirements. In that context, I have quoted *in extenso* the important "Decree concerning the conduct of cremations in the crematorium of the Sachsenhausen Concentration Camp" issued by Himmler on 28 February 1940, showing that – initially at least – the customary use of coffins and urns for the ashes was the rule.

To make the text more-easily readable, I have added an Appendix which contains the extensive details of cremation statistics for Westerbork and Terezín (altogether 41 tables), a synopsis of the activities of the Topf Co. at Auschwitz-Birkenau, and a list of the patents as well as patent applications and patent descriptions of the Topf Co.

As the translation of German technical terms in the field of furnace technology sometimes presents difficulties even for persons fluent in the language, I have added a glossary, which also contains the essential explanations. As far as the administrative terms which appear in this work are concerned, I refer the reader to the glossary of my study on the Central Construction Office at Auschwitz (Mattogno 2015, pp. 164-174).

The present work is strictly based on unimpeachable primary sources. Published sources are listed in the bibliography, whereas the documental references are given in the footnotes.

I have, above all, brought together the German historical and technical literature which exists on this subject, supplementing it with the patents concerning civilian/commercial systems to the extent that such documents still exist (many have been lost on account of Allied air raids). At the same time I have been in touch with various manufacturers of cremation equipment and have personally visited several crematoria in Italy and France.

For a better understanding of the functioning of the Topf and the Kori systems, I have studied the available German documents, especially those of the Central Construction Office at Auschwitz as well as other documents preserved in various European archives. As a result, Part 2 of this study contains 300 documents, many of which are heretofore-unpublished or -unknown even to specialists. The first 109 documents concern civilian cremation systems, Nos. 110 through 162 refer to the civilian/commercial activities of the Topf Co., and under Nos. 163 through 300, finally, we have a selection of the most-important documents regarding the Topf cremation systems at Mauthausen, Gusen, Buchenwald and Auschwitz-Birkenau (plans, drawings, proposals, cost estimates, shipping documents, invoices, operating instructions, charts etc.), regarding the Kori systems in the camps mentioned (especially original drawings and very-detailed drawings prepared by the Soviet experts), regarding technical and administrative questions, and on the bureaucratic formalities for cremations in the concentration camps.

In addition to my archival studies, I have also inspected and taken photos of devices still remaining in German concentration camps at:

- Auschwitz: 2 double-muffle Topf furnaces poorly rebuilt by the Poles; the mobile oil-fired Kori furnace;
- Buchenwald: 2 coke-fired triple-muffle Topf furnaces (one adapted for optional use with oil) identical to those installed in Crematoria II and III at Birkenau;
- Dachau: 1 double-muffle coke-fired Topf furnace, originally a mobile furnace fired with oil; 4 coke-fired Kori furnaces;
- Gusen: 1 double-muffle coke-fired Topf furnace, originally a mobile furnace fired with oil;
- Mauthausen: 1 double-muffle coke-fired furnace identical to the 3 double-muffle furnaces installed at Crematorium 1 of the Auschwitz Main Camp: 1 coke-fired Kori furnace;
- Gross-Rosen: 1 mobile oil-fired Kori furnace:

- Lublin: 5 coke-fired Kori furnaces; 1 mobile naphtha-fired Kori furnace;
- Stutthof: 2 coke-fired Kori furnaces; 1 mobile oil-fired Kori furnace;
- Terezín: 4 stationary oil-fired Ignis-Hüttenbau furnaces.

In Part 3 of this work, I have extensively illustrated the descriptions of these devices with 370 photos – most in color – divided into twelve sections, each one corresponding to a specific device. This collection contains illustrations of devices heretofore unknown (the furnaces of the Terezín Crematorium Photos 345-362) or unfamiliar even to specialists, such as the photos of the furnaces at Gusen (Photos 1-35), Gross-Rosen (Photos 332-334), Stutthof (Photos 270-284 and 328f.), as well as Lublin-Majdanek (Photos 285-327). However, even the photos of the well-known devices constitute a relevant contribution inasmuch as they depict, for the first time, the essential components of these units, which is indispensable for an understanding of their structure and their way of operation.

Although composed mainly for the specialist, this three-volume study will also allow the interested layman to become acquainted with the problems treated here; even though he may not have the specific prerequisites in this field, he will thus command all the tools needed for a verification of the soundness of the conclusions drawn.

Carlo Mattogno

Preface to the Second Edition

The original text of this work – *I forni crematori di Auschwitz. Studio storico-tecnico con la collaborazione del dott. Ing. Franco Deana* (Effepi, Genoa) – appeared in 2012, and in 2015, the English translation was published under the title *The Cremation Furnaces of Auschwitz. A Technical and Historical Study*.

In the meantime, I had been made aware of the second edition of Annegret Schüle’s volume *Industrie und Holocaust: Topf & Söhne – Die Ofenbauer von Auschwitz* (*Industry and Holocaust: Topf & Söhne – The Furnace Makers of Auschwitz*), which is important only for the documents presented in it. Regarding the book’s technical claims – especially in its Chapter 3 – it is in fact worthless, being a mere regurgitation of the most-trite Holocaustic myths, as I have shown in a detailed analysis (Mattogno 2014, pp. 73-90).

Due to a mishap, the update that I had prepared for the English edition was not published, so that Schüle’s work is not mentioned in it. This omission is rectified in this edition.

In the subsequent mental vacuity of the orthodox Holocaust literature, only Robert Jan van Pelt’s rather-pretentious attempt at a scientific treatment of the subject of cremation at Auschwitz stands out, meaning his article “*Sinnreich erdacht: Machines of Mass Incineration in Fact, Fiction, and Forensics*” (Anstett/Dreyfus, pp. 117-145), which I have refuted in a systematic and detailed manner in a separate study (Mattogno 2020). Justyna Majewska’s Polish article, whose title translates to “The Technicians of the ‘Final Solution’. Topf & Söhne – the Furnaces Builders of Auschwitz,” is even-more-unfounded, while the article “The Oven Builders of the Holocaust” by Annika Van Baar and Wim Huisman is completely devoid of historical relevance due to its “criminality” slant.

Otherwise, the 2012 text does not require major changes and is presented here in a revised and corrected edition.

Carlo Mattogno, July 2021

Unit I: Modern Cremation

**with Particular Emphasis
on Furnaces Using a Coke-Fed Gasifier**

1. The Cremation

1.1. General Principles of Combustion Technology¹

From the physico-chemical point of view, the cremation of a corpse is a normal combustion process. In fact, the combustible substances of the human body are much the same as those of wood, coal or any other type of combustible: carbon and hydrogen (and, to a very small extent, sulfur). The difference resides only in their respective ratios and in their ratios with respect to the other components making up a human body (oxygen, nitrogen, ash), as well as in the fact that all these substances are, as it were, suffused in water, which accounts for some 60-65 % of the total mass of the human body.² Thus, the same physico-chemical laws that govern a normal combustion also apply essentially to a cremation.

By combustion we understand the combination of a substance (the fuel or combustible) with the oxygen of the air (the combustion agent)³ under conditions of ignition (ignition temperature) with the generation of heat, normally accompanied by the visible phenomenon of a flame, which is characteristic of any live combustion.

The combustible is any substance rich in hydrogen or carbon, or both, which, in the presence of oxygen and a suitable igniter (such as an existing flame), burns with the generation of heat. For this to occur, it is also necessary that the combustion agent (oxygen) be present in an amount adequate for the amount of combustible and to sustain the process. In practice, the combustion oxygen is furnished by air, which has the following composition:

Component	Volume %	Mass %
Oxygen	21	23
Nitrogen	79 ⁴	77
<i>Air</i>	<i>100</i>	<i>100</i>

Assuming as units of ratio the volume and the mass of oxygen, we have

Component	rel. Volume	rel. Mass
Oxygen	1.00	1.00
Nitrogen	3.78	3.34

¹ This subchapter is based on, *i.a.*, Pierini 1977, pp. 209-214; Salvi 1972, pp. 72f., 76; *Enciclopedia Curcio...* 1973, Vol. 3, entry "Combustione," pp. 1165f.; Giua/Giua-Lollini 1948, entry "Combustibili e combustione," Vol. I, pp. 991ff. *Hütte* 1931, vol. I, pp. 561ff.

² Although green wood can contain between 30 and 200% of water as well; see Forest Products Laboratory 2010.

³ In certain installations, for example in steel works or in waste incinerators etc. operating at high temperatures, the combustion agent is pure oxygen, which allows the necessary temperatures to be reached.

⁴ Correctly speaking there is only 78.1% of nitrogen in the air plus 0.9% of argon, but the difference is marginal and negligible within the error margins of the subsequent calculations.

The volume is expressed in Normal cubic meters (Nm³), the mass in kilograms (kg). One Nm³ is equal to 1 m³ of a gaseous substance at the temperature of 0°C and a pressure of 760 mm Hg (mercury) (Torr), which is 1 atmosphere or 1013.25 mbar (10 m water column); one Nm³ of air has a mass of about 1.293 kg.⁵ Throughout this study, when I speak of m³, one should always read Normal cubic meters, unless indicated otherwise.

The reaction of the complete combustion of carbon is:

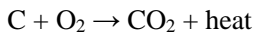

i.e. one atom of carbon, of a molar mass of 12 g/mol, combines with one molecule (two atoms) of oxygen, of a molar mass of 32 g/mol, to form one molecule of carbon dioxide as well as heat.

The reaction of the combustion of hydrogen is:

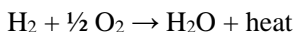

i.e. one molecule of hydrogen, of molar mass 2 g/mol, combines with half a molecule (one atom) of oxygen, of molar mass 16 g/mol, to form water, of molar mass 18 g/mol, as well as heat.

In practical terms, taking kg as the unit of mass, we have:⁶

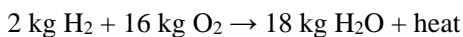
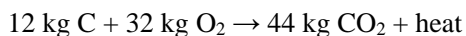

It follows that for the combustion of 1 kg of carbon or hydrogen, the following amounts of oxygen are needed, with the amount of energy in the form of heat released as given with the unit kcal (thousands of calories):⁷

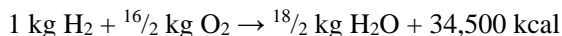
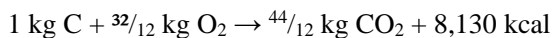

Hence, for the complete combustion of 1 kg of carbon $\frac{32}{12} = 2.667$ kg of oxygen is required, *i.e.* $2.667 \cdot 4.34 = 11.57$ kg of air, whereas for 1 kg of hydrogen we need 8 kg of oxygen, *i.e.* $8 \cdot 4.34 = 34.72$ kg of air.

The combustion reaction of hydrogen set out above, in which the water produced is assumed to be in the liquid state, yields its so-called Upper Heating Value (u.h.v.). If the combustion produces water vapor, the evaporation of this water absorbs a certain amount of heat. As the combustion of 1 kg of hydrogen produces 9 kg of water, and considering that the evaporation of 1 kg of water at atmospheric pressure and 100°C requires 639.4 kcal, one kilogram of hydrogen produces $34,500 - (639.4 \cdot 9) = 28,745.4$ or about 28,700 kcal. This amount of heat represents the Lower Heating Value (l.h.v.) of the fuel, which can be calculated by using the following equation (all rounded factors in kcal/kg):

$$\text{l.h.v.} = 8,100 \cdot \text{C} + 28,700 \cdot (\text{H} - \frac{\text{O}}{8}) + 2,210 \cdot \text{S} - 600 \cdot \text{M}, \quad [1]$$

⁵ With 22.4 liters per mol of ideal gas (at 0°C and 1,013.25 mbar), dry air with 28.956 g/mol results in 1,293 g/m³.

⁶ The respective equation for sulfur is: $32.1 \text{ kg S} + 32 \text{ kg O}_2 \rightarrow 64.1 \text{ kg SO}_2 + \text{heat}$

⁷ For sulfur: $1 \text{ kg S} + 1 \text{ kg O}_2 \rightarrow 2 \text{ kg SO}_2 + 2,210 \text{ kcal}$; see Salvi 1972, pp. 72f.

where C and S represent the masses of the respective elements, $H^{-O/8}$ is the mass of hydrogen to be burned reduced by an eighth of the mass of the oxygen already contained in the combustible,⁸ and M is the liquid water (Moisture) content of the fuel, all in kg.

The theoretical quantity of air (A_t) needed for the complete combustion of 1 kg of fuel is arrived at by means of the following equations:

$$A_t = 11.57 C + 34.72 (H^{-O/8}) + 4.33 S \quad \text{in kg} \quad [2]$$

$$A_t = 8.95 C + 26.85 (H^{-O/8}) + 3.35 S \quad \text{in Nm}^3 \quad [3]$$

In practice, however, if a complete combustion is to be attained, it is necessary to use an amount of air larger than the theoretical value: this extra air, which depends on the type of fuel and the type of hearth or burner used, is called "Excess Air" (m) and is quantified with a coefficient or an index. The Excess-Air ratio is given by the ratio of the effective, actual amount of air (A_e) and the theoretical amount of air required for complete combustion (A_t), as:

$$m = \frac{A_e}{A_t} \quad [4]$$

or by the ratio of the theoretical amount of CO_2 that would be produced, (CO_{2t}) and the effective amount of CO_2 (CO_{2e}) actually produced, *i.e.*:

$$m = \frac{CO_{2e}}{CO_{2t}} \quad [5]$$

If the quantity of combustion air is insufficient for the amount of fuel, we will have incomplete combustion. The reaction of the carbon would then be:

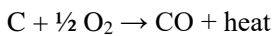

If we use masses for this case, we have:

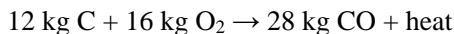

and, for 1 kg C:

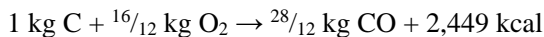

Thus, from the combustion of 1 kg of carbon with 1.333 kg of oxygen we obtain 2.333 kg of carbon monoxide and only 2,449 kcal of heat, instead of the 8,130 kcal that would be yielded by the complete combustion.

The theoretical amount of dry exhaust gases (F_{ts}) produced by the combustion of 1 kg of fuel can be calculated in the following way:⁹

$$F_{ts} = 12.49 C + 26.46 (H^{-O/8}) + 3.51 S + N \quad \text{in kg} \quad [6]$$

$$F_{ts} = 8.95 C + 21.17 (H^{-O/8}) + 3.35 S + 0.796 N \quad \text{in Nm}^3 \quad [7]$$

⁸ A correction necessary to take into account that some of the matter in the combustible is already oxygenated to some degree.

⁹ Since the oxidation products of organic nitrogen compounds (N) are very diverse, this is not treated in detail here. These and the previous equations are taken again from Salvi 1972, pp. 72f.

The quantity of water vapor (W) in the exhaust gases can be arrived at by using the equations:

$$W = 9 H + M \quad \text{in kg} \quad [8]$$

$$W = 11.19 H + 1.243 M \quad \text{in Nm}^3 \quad [9]$$

Combining the two equations, the total amount of theoretical exhaust gases (F_t) becomes:

$$F_t = 12.49 C + 35.46 H - 26.46 \text{ O}_8 + 3.51 S + N + M \quad \text{in kg} \quad [10]$$

$$F_t = 8.95 C + 32.36 H - 21.17 \text{ O}_8 + 3.35 S + 0.796 N + 1.243 M \quad \text{in Nm}^3 [11]$$

The efficiency (η) of a combustion device – and this applies obviously to a cremation furnace as well – is the ratio of the heat supplied to the heat generated. If there were no heat losses, the efficiency would be equal to 1, or 100%; yet since heat losses will inevitably occur, the efficiency is necessarily less than 1, or below 100%.

The heat losses, which influence the efficiency of the device in a major way, can be identified as four factors:

1. the excess air;
2. the temperature of the exhaust gases;
3. the unburned components in the exhaust gases and in the slag from the hearth;
4. the heat losses of the device by radiation and conduction.

The heat loss due to Excess Air arises from the fact that, if the amount of combustion air is increased, the quantity of exhaust gases increases proportionally, but since the heat generated by the fuel remains unchanged, the temperature of the exhaust gases will drop; furthermore, as the amount of discharged gas increases, the heat lost through the chimney rises as well because of the sensible heat of the discharged gases.

For example, a fossil coal with an l.h.v. of 7,500 kcal/kg would have a theoretical combustion temperature of 2,280°C; if the gases leave the system at 500°C, there is a heat loss of 19.2% of the l.h.v. of the fuel, and we would thus have an efficiency of the fuel of $7,500 \cdot (1 - 0.192) = 6,060$ kcal/kg. If, instead, we assume an Excess-Air ratio of $m = 3$, the theoretical combustion temperature drops to 915°C and the heat losses due to the exhaust gases rises to 52.8% (*Hütte* 1931, vol. I, p. 578). In this case, the efficiency of the fuel would amount to $7,500 \cdot (1 - 0.528) = 3,540$ kcal/kg.

The gases leaving the chimney contain heat, called their sensible-heat content, which is determined by their specific heat capacity¹⁰ and their temperature: the higher their temperature, the higher the sensible heat of the gases and the higher the heat loss. For example, the heat lost by 100 Nm³ of air at 500°C, with an average specific heat capacity (c_{pm}) of 0.312 kcal Nm⁻³ °C⁻¹ (Recknagel-Sprenger, p. 47), amounts to $100 \text{ Nm}^3 \cdot (0.312 \text{ kcal Nm}^{-3} \text{ °C}^{-1} \cdot 500\text{°C}) = 15,600$ kcal; at 800°C, instead, it amounts to $100 \cdot (0.331 \cdot 800) = 26,480$ kcal.

¹⁰ The number of kcal needed to raise the temperature of 1 kg (or here 1 Nm³) of a substance by 1°C.

For the computation of the heat loss due to the sensible heat of the exhaust gases through a chimney, a specific equation exists, which we will consider in Chapter 7. The one given below (cf. Document 91) takes into account the CO₂ and the water vapor (which stems from the combustion of hydrogen and from the water content of the fuel) in the exhaust gases:

$$\left[0.32 \cdot \frac{C}{0.536 \cdot \text{CO}_2} + 0.0048 (9H + W) \right] (T_F - t_0) \cdot \frac{100}{H_u} \quad [12]$$

where W = water vapor
 T_F = temperature of exhaust gas
 t_0 = temperature of outside air
 H_u = l.h.v. of fuel

The equation allows us to determine the percentage of heat loss for 1 kg of fuel. Assuming the values of C , CO_2 , H , W and H_u presented in Chapter 7, the heat loss for $T_F = 500^\circ\text{C}$ amounts to 27.87% of the l.h.v. of the fuel, whereas for $T_F = 800^\circ\text{C}$ it is 44.93%.

The effective l.h.v. of a solid fuel is always less than the theoretical value arrived at by means of the above equation, because a small portion of the fuel (unburnt solids on the hearth) and of the gases which form during the gasification of the coke (unburnt gases) escapes from the combustion process. For the determination of the heat lost, a chemical analysis is needed. Experience tells us that the unburnt fuel on the hearth contributes some 4-5%. The heat loss due to unburnt gases is given by

$$\frac{F_s (3,050 \text{ CO} + 2,580 \text{ H}_2)}{\text{l.h.v.}} \quad [13]$$

Where F_s corresponds to the dry exhaust gases in one Nm³.

If we assume an l.h.v. of 6,470 kcal/kg, $A_t = 7.17 \text{ Nm}^3/\text{kg}$, $\text{CO}_2 = 13\%$, hence $m = 1.57$, with a mere 1% of unburnt CO and H, this would bring about a heat loss of

$$\frac{1.57 \cdot 7.17 (3,050 \cdot 1 + 2,580 \cdot 1)}{6,470} = 9.78\%. \quad [14]$$

The heat loss by conduction and radiation is determined by the temperature difference between the inner wall of the furnace and the outside. If the mass of the refractory brickwork of the furnace is, for example, 6,000 kg, the heat required (*i.e.* lost) to bring this mass up to an average operating temperature of 800°C can be evaluated according to the equation $c_p \cdot P \cdot (T_m - t_0)$, where c_p = specific heat capacity of the brickwork = $0.21 \text{ kcal/kg}^\circ\text{C}$, P = mass of the brickwork, T_m = mean temperature of the brickwork = 800°C , t_0 = ambient temperature = 20°C , which turns out to be $0.21 \cdot 6,000 \cdot (800 - 20) = 982,800 \text{ kcal}$.

A certain amount of heat escapes by conduction through the wall of the furnace from the inside to the outside and is then lost by radiation and convection. This heat loss depends therefore on the mean temperature in the refractory wall of the furnace, on its thermal insulation and, of course, on the time considered. The heat lost in this way is given by the following equation:

$$C = \alpha \cdot S \cdot (T_m - t_0) \cdot Z \quad [15]$$

where C = heat loss (in kcal)
 α = heat transfer coefficient (in kcal m² °C⁻¹ hr⁻¹)
 S = surface area of the furnace (in m²)
 T_m = mean temperature of the refractory brickwork (°C)
 t₀ = ambient temperature in the room (°C)
 Z = time considered in hours

If we assume, as an example, a uniform $\alpha = 0.7 \text{ kcal m}^{-2} \text{ °C}^{-1} \text{ hr}^{-1}$, $S = 50 \text{ m}^2$, $T_m = 800^\circ\text{C}$, $t_0 = 20^\circ\text{C}$, $Z = 1 \text{ hour}$, the heat loss would be:

$$0.7 \text{ kcal m}^{-2} \text{ °C}^{-1} \text{ hr}^{-1} \cdot 50 \text{ m}^2 \cdot (800^\circ\text{C} - 20^\circ\text{C}) \cdot 1 \text{ hr} = 27,300 \text{ kcal.}$$

Before electric pyrometers came into use, the temperature of a furnace was determined by Seger cones, made of mixtures of silicates and fluxes in the form of pyramids with a triangular base; there were 59 types, each with a different melting temperature. They were used mainly in the ceramics industry to determine the temperature within a furnace on the basis of the melting point of a particular cone.

Sometimes, when Seger cones were unavailable, the temperature would be estimated on the basis of the color of the refractory material according to the following table (Bordoni 1918, p. 13):

Color	Temperature	Color	Temperature
Incipient red	525°C	Dark orange	1,100°C
Bright red	700°C	Bright orange	1,200°C
Incipient cherry red	800°C	White	1,300°C
Bright cherry red	1,000°C	Gleaming white	1,500°C

In German usage, incipient cherry red (800°C) was simply referred to as red.

1.2. The Chemical Processes during Cremations

Opinions diverge considerably with respect to the chemical composition of the human body. Some cremation specialists (cf. Chapter 7) assert that a human body of mass 70 kg is made up of

10.92 kg of carbon	3.57 kg of nitrogen
1.47 kg of hydrogen	45.50 kg of water
4.83 kg of oxygen	3.50 kg of ash
0.21 kg of sulfur	<u>Total: 70.00 kg</u>

Engineer Wilhelm Heepke assumed that the human body is made up of 65% water, 30% combustible substances (mainly fat and protein) and 5% incombustibles (ash; see Chapter 7). For the combustible substances he gave the following chemical composition:

Carbon:	52%	Sulfur:	1%
Hydrogen:	7%	Nitrogen:	17%
Oxygen:	23%	<u>Total:</u>	<u>100%</u>

On the basis of these data, a body of 70 kg contains

$$\begin{array}{r}
 70 \cdot 0.65 = 45.5 \text{ kg of water} \\
 70 \cdot 0.30 = 21.0 \text{ kg of combustible substances} \\
 70 \cdot 0.05 = 3.5 \text{ kg of ash} \\
 \hline
 \text{Total:} \quad 70.0 \text{ kg}
 \end{array}$$

The combustible substances are made up of

$$\begin{array}{r}
 21 \cdot 0.52 = 10.92 \text{ kg of carbon} \\
 21 \cdot 0.07 = 1.47 \text{ kg of hydrogen} \\
 21 \cdot 0.23 = 4.83 \text{ kg of oxygen} \\
 21 \cdot 0.01 = 0.21 \text{ kg of sulfur} \\
 21 \cdot 0.17 = 3.57 \text{ kg of nitrogen} \\
 \hline
 \text{Total:} \quad 21.00 \text{ kg}
 \end{array}$$

The percentage composition of the human body therefore results as:

$$\begin{array}{r}
 10.92 \div 70 \cdot 100 = 15.6\% \text{ of carbon} \\
 1.47 \div 70 \cdot 100 = 2.1\% \text{ of hydrogen} \\
 4.83 \div 70 \cdot 100 = 6.9\% \text{ of oxygen} \\
 0.21 \div 70 \cdot 100 = 0.3\% \text{ of sulfur} \\
 3.57 \div 70 \cdot 100 = 5.1\% \text{ of nitrogen} \\
 \quad \quad \quad 65.0\% \text{ of water} \\
 \quad \quad \quad 5.0\% \text{ of ash} \\
 \hline
 \text{Total:} \quad 100.0\%
 \end{array}$$

Heepke further indicated the composition of the combustible substances: 15% of proteins, 12% of fat and 3% of other substances (primarily sugars). The fat has an average chemical composition of:

$$\begin{array}{r}
 79.10\% \text{ of carbon} \\
 11.15\% \text{ of hydrogen} \\
 9.75\% \text{ of oxygen} \\
 \hline
 \text{Total: } 100.00\%
 \end{array}$$

The average composition of the proteins (on the basis of fibrin¹¹ which does not differ materially from that of the other proteins) is the following:

$$\begin{array}{r}
 52.70\% \text{ of carbon} \\
 6.90\% \text{ of hydrogen} \\
 15.40\% \text{ of nitrogen} \\
 23.80\% \text{ of oxygen} \\
 1.20\% \text{ of sulfur} \\
 \hline
 \text{Total: } 100.00\%
 \end{array}$$

The l.h.v. of 1 kg of fat thus results as:

$$8,100 \cdot 0.791 + 28,700 (0.1115 - 0.0975 \div 8) = 9,257 \text{ kcal.}^{12} \quad [16]$$

¹¹ Fleck 1874, pp. 163f.; for fibrin, Giua/Giua Lollini (1948, Vol. II, p. 295) give a practically identical composition: C = 53%; H = 7%; O = 23%; N = 17%; S = 1%. Fibrin (also called Factor Ia) is a fibrous, non-globular protein involved in the clotting of blood.

The l.h.v. of 1 kg of proteins, on the other hand, is:

$$8,100 \cdot 0.527 + 28,700 (0.069 - 0.238 \div 8) + 2,210 \cdot 0.012 = 5,422 \text{ kcal. [17]}$$

Now, if a body of mass 70 kg is made up of 12% fat and 15% protein, the l.h.v. of its solid matter amounts to

$$70 (0.12 \cdot 9,257 + 0.15 \cdot 5,422) = 134,690 \text{ kcal, [18]}$$

while not taking into account the remaining 3% of sugars and other combustible substances. However, the chemical composition mentioned initially would result in an l.h.v. of:

$$8,100 \cdot 10.92 + 28,700 (1.47 - 4.83 \div 8) + 2,210 \cdot 0.21 = 113,777 \text{ kcal. [19]}$$

In view of the fact that these two values differ considerably, it is clear that the chemical composition mentioned initially is low in combustible matter. Actually, these percentages depend essentially on the fat and the proteins present in the human body, but even in this respect, the data differ: Schläpfer, for example, speaks of 10% fat and 20% proteins (as well as 1% of sugars; Schläpfer 1937, p. 10), whereas Fleck has 20% fat and 10% proteins (Fleck 1874, p. 163). In this study we shall henceforth assume values of 12% fat and 18% proteins for our calculations. On the basis of these assumptions, a human body of 70 kg would be made up of

$$70 \cdot 0.18 = 12.6 \text{ kg of protein}$$

$$70 \cdot 0.12 = 8.4 \text{ kg of fat}$$

The 12.6 kg of protein therefore contain:

$$12.6 \cdot 0.527 = 6.6402 \text{ kg of carbon}$$

$$12.6 \cdot 0.069 = 0.8694 \text{ kg of hydrogen}$$

$$12.6 \cdot 0.154 = 1.9404 \text{ kg of nitrogen}$$

$$12.6 \cdot 0.238 = 2.9988 \text{ kg of oxygen}$$

$$12.6 \cdot 0.012 = 0.1512 \text{ kg of sulfur}$$

$$\text{Total:} \quad 12.6000 \text{ kg}$$

And the 8.4 kg of fat contain:

$$8.4 \cdot 0.7910 = 6.6444 \text{ kg of carbon}$$

$$8.4 \cdot 0.1115 = 0.9366 \text{ kg of hydrogen}$$

$$8.4 \cdot 0.0975 = 0.8190 \text{ kg of oxygen}$$

$$\text{Total:} \quad 8.4000 \text{ kg}$$

A body having a mass of 70 kg thus contains (as kg and %):

¹² According to another source, the value for animal fat is ≈ 9.500 kcal/kg (DeHaan 1999, p. 28).

C = 6.6402 + 6.6444 =	13.2846 kg =	$13.2846 \div 70 \cdot 100 =$	18.978%
H = 0.8694 + 0.9366 =	1.8060 kg =	$1.8060 \div 70 \cdot 100 =$	2.580%
O = 2.9988 + 0.8190 =	3.8178 kg =	$3.8178 \div 70 \cdot 100 =$	5.454%
N =	1.9404 kg =	$1.9404 \div 70 \cdot 100 =$	2.772%
S =	0.1512 kg =	$0.1512 \div 70 \cdot 100 =$	0.216%
<hr/>			
Total:	21.0000 kg =		30.000%

The l.h.v. of the dry solids thus results as:

$$12.6 \cdot 5,422 + 8.4 \cdot 9,257 = 146,076 \text{ kcal.} \quad [20]$$

However, the body also contains 45.5 kg of water, which has to be evaporated, subtracting ($45.5 \cdot 600 =$) 27,300 kcal, and the l.h.v. of the entire body hence becomes $146,076 - 27,300 = 118,776$ kcal, or $118,776 \div 70 = 1,697$ kcal/kg, which is an intermediate value between the values arrived at by Schläpfer (1937, p. 10: 1,600 kcal/kg) and those by Kraupner (1970: 1,800 kcal/kg).

According to most recent evaluations, human corpses typically consist of 15.3% proteins, 14% fat and 64% water (Davies/Mates 2005, p. 134); from this results a l.h.v. of 1,741 kcal/kg, which confirms my assumed value.

This having been established, let us now move on to the chemical processes which occur during a cremation (cf. Kraupner/Puls 1970; Löffler 1926, pp. 3f.):

1 kg of C burns to CO ₂ with	2.667 kg or 1.867 Nm ³ of O
1 kg of C burns to CO with	1.333 kg or 0.933 Nm ³ of O
1 kg of S burns to SO ₂ with	1.000 kg or 0.700 Nm ³ of O
1 kg of H burns to H ₂ O with	8.000 kg or 5.600 Nm ³ of O

We therefore have as products from

1 kg of C:	1.867 Nm ³ of CO ₂	[21]
1 kg of C:	1.867 Nm ³ of CO	
1 kg of S:	0.700 Nm ³ of SO ₂	
1 kg of H:	11.200 Nm ³ of H ₂ O	

The specific volumes, i.e. the volumes of one kg of each substance, are as follows:

CO ₂	0.509 Nm ³ /kg	O	0.700 Nm ³ /kg
CO	0.800 Nm ³ /kg	N	0.800 Nm ³ /kg
SO ₂	0.350 Nm ³ /kg	H ₂ O	1.244 Nm ³ /kg
H	11.200 Nm ³ /kg		

One Nm³ of air contains 0.209 Nm³ of O and 0.791 Nm³ of N. With the above values, the theoretical oxygen requirements are as follows:

for C to CO ₂ :	$13.2846 \cdot 1.867 =$	24.8023 Nm ³
for H to H ₂ O:	$1.8060 \cdot 5.600 =$	10.1136 Nm ³
for S to SO ₂ :	$0.1512 \cdot 0.700 =$	0.1058 Nm ³
<hr/>		
Total =		35.0217 Nm ³

of which $(3.8178 \cdot 0.7 =) 2.6724$ are supplied by the corpse itself, so that the effective theoretical oxygen requirement is $35.0217 - 2.6724 = 32.3493 \text{ Nm}^3$ of O, corresponding to

$$32.3493 \cdot 100 \div 20.9 = 154.78 \text{ Nm}^3 \text{ of air} \quad [22]$$

containing

$$79.1 \cdot 154.78 \div 100 = 122.43 \text{ Nm}^3 \text{ of nitrogen.} \quad [23]$$

Therefore, the following quantities of moist combustion gases are generated during the cremation of a 70 kg corpse:

– from 13.2846 of kg C:	$13.2846 \cdot 1.867 =$	24.80 Nm^3 of CO ₂
– from 1.8060 of kg H:	$1.8060 \cdot 11.200 =$	20.23 Nm^3 of H ₂ O*
– from 1.9404 of kg N:	$1.9404 \cdot 0.800 =$	1.55 Nm^3 of N
– from 0.1512 of kg S:	$0.1512 \cdot 0.700 =$	0.10 Nm^3 of SO ₂
– from 45.5000 of kg H ₂ O:	$45.5000 \cdot 1.244 =$	56.60 Nm^3 of H ₂ O*
<i>Subtotal:</i>		103.28 Nm^3 * as vapor
Plus N from the air:		122.43 Nm^3
<i>Total:</i>		225.71 Nm^3

Applying the equations arrived at in Subchapter 1.1., we have:

1. Theoretical volume of necessary air:

$$\begin{aligned} A_t &= 8.95 \cdot 13.2846 + 26.85 \cdot (1.806 - 3.8178 \div 8) + 3.35 \cdot 0.1512 \\ &= 155.08 \text{ Nm}^3 \end{aligned} \quad [24]$$

Theoretical volume of moist exhaust gases:

$$\begin{aligned} F_t &= 8.95 \cdot 13.2846 + 32.36 \cdot 1.806 - 21.17 \cdot 3.8178 \div 8 + 3.35 \cdot 0.1512 \\ &+ 0.796 \cdot 1.9404 + 1.244 \cdot 45.5 = 225.89 \text{ Nm}^3 \end{aligned} \quad [25]$$

The normalized volume of dry exhaust gases then is:

$$225.89 - (20.23 + 56.60) = 149.06 \text{ Nm}^3 \quad [26]$$

The maximum percentage of CO₂ becomes:

$$24.80 \cdot 100 \div 149.06 = 16.64\% \quad [27]$$

1.3. The Cremation Process

The cremation of a corpse proceeds in four functionally distinct, yet not temporally separated phases in the following sequence:

1. desiccation (evaporation of water)
2. the gasification (evaporation of combustible gases)
3. the combustion
4. the incineration

A human body contains a large amount of water and cannot burn spontaneously, no matter what temperature it is exposed to. Before the corpse reaches the tem-

perature at which the gases formed during the gasification phase will ignite, the water it contains must first be evaporated, a process which takes place at a noticeable pace from about 100°C. Once the water has evaporated, the temperature will increase to around 400 to 500°C, at which point combustible constituents of the corpse, *i.e.* fat and protein, begin to decompose. During this process gases like carbon monoxide and hydrocarbons are released which burn in the presence of sufficient oxygen. However, before this combustion can occur, these gases must be brought to their ignition temperatures. The less-flammable gases, *i.e.* the heavier hydrocarbons, have ignition temperatures of around 650 to 700°C. The proteins, on the other hand, as has been pointed out by Klettner (Bundesrepublik Deutschland 1953, see Document 160), have a relatively high nitrogen content and tend to resist combustion; their ignition temperature – or rather the temperature at which the nitrogen splits off from the hydrocarbon portion – is on the order of 800°C (cf. Chapter 6).

After the combustion of the volatile, flammable substances of the corpse, there is a post-combustion and incineration phase of the non-volatile remnants, during which these glowing, mainly carbonaceous particles are transformed into CO₂ and ash (Maccone 1932, p. 104).

As established by de Pietra Santa already at the end of the 19th Century (1889, pp. 18f.), the whole process extends over something like one hour, with the individual phases lasting approximately:

- 30 minutes for the desiccation
- 15 minutes for the gasification and combustion
- 15 minutes for the post-combustion (incineration proper)

The cremation of a corpse in a cremation furnace with a gasifier proceeds in the following steps:

The skin and the long muscles burn first, followed by the heart and the lungs, with the spleen and the liver being consumed last. The parts of the face that are exposed to the high temperature gases from the gasifier carbonize quickly, the hairy scalp detaches from the skull and burns rapidly. The cranial bones separate, the seams between them split, and the brain, appearing as a carbonized black mass, burns slowly. The lower jaw falls off and even the teeth, somewhat protected in their cavities, are reduced to ash. The long bones are disarticulated. The articulations of the hand and of the fingers come apart and are consumed. The body parts resting on the grate burn less rapidly. The combustion of the skeleton proceeds from the head to the feet in keeping with the direction of the flow of the gases from the gasifier (normally corpses are loaded into the furnace head-first). The bones are calcined by the high temperature of the furnace, the organic matter is destroyed. Only ash remains, which is primarily composed of calcium carbonate and calcium phosphate as well as magnesium, iron, sodium and potassium salts which resist the obtained high temperatures (Maccone 1932, pp. 104f.; Küchenmeister 1875, pp. 74f.).

The mass of the ash is about 5% of the corpse's original mass, its density approximately 0.5 g/cm³ (Davies/Mates 2005, p. 134; *Enciclopedia Italiana* 1949, vol. XI, p. 825; Huber 1903, p. 17).

The furnace will generally be operated in the following way:

Before the coffin is introduced into the cremation chamber or muffle, the pilot hearth is lit and the air vents, the damper and the hearth door are opened. At the normal operating temperature of 800 to 900°C the coffin ignites as soon as it is introduced into the muffle. After the muffle door is closed, the furnace generally needs only little air and not much draft, because initially the coffin burns only on its relatively small surface. After a short time, the hull of the coffin will break apart in a number of places and the burning surface increases considerably. At this point it is therefore necessary to provide for maximum draft and maximum air, which is achieved by opening up the air vents and the damper. At this phase of the process of cremation, so much gas is generated within the muffle that the air feed becomes insufficient for complete combustion: Hence the muffle is filled with glowing fumes, and black smoke develops. More air must now be fed in. If this is done in an adequate way, the smoke will clear almost instantly.

For this reason, it is important that the furnace be equipped with measuring instruments to alert the operator as soon as smoke begins to form. If smoke develops, the combustion will be incomplete, heat generation and CO₂ content will decrease and the temperature will fall. Additional air has to be fed at a sufficient rate if an excessive cooling of the furnace is to be avoided.

As a next stage the evaporation of the corpse's water will start soon. As a consequence, the muffle tends to cool, combustion slows and smoke reappears. Therefore the air vents must now be throttled. Simultaneously there is incipient gasification, which follows closely the desiccation process of the tissues layer by layer, from the outside to the inside as the evaporation proceeds. At this point, relatively little air is required, and the vents have to be almost totally closed, as otherwise smoke will develop because of excessive cooling due to cold air (relative to the muffle temperature) entering the muffle through the vents. In this case, the smoke is caused by the fact that the muffle cools to a temperature below the ignition point of the heavier hydrocarbons that form during the gasification. Another contribution to the cooling tendency comes from gasification itself, an endothermic process, which means that it absorbs heat.

Normally the combustion of the corpse will then, for a while, become somewhat more pronounced, as desiccation and gasification proceed, resulting in a demand for more air and hence a stronger draft. Slowly, though, as the cremation advances, combustion will gradually die down. When combustion has come to a stop, the glowing ash is to be removed from the inclined plane of the muffle into the ash chamber for the final burnout, and another coffin can be introduced into the combustion chamber.

Cremation must be carried out between well-defined thermal limits: at temperatures above 1,100 to 1,200°C, sintering will occur, *i.e.* the bones of the corpse and the refractory material will soften and fuse; at temperatures below 700 to 600°C there is only carbonization of the corpse. The optimum temperature for the introduction of the coffin has been found by experiments to lie between 850 and 900°C (Kessler 1930, pp. 136f.). The maximum temperature that

may be registered in a muffle, but only for a few moments, was on the order of 1,100°C (see Chapter 4).

2. Cremation Technology of Coke-Fired Furnaces

2.1. Structure and Operation

Documents 1 and 2 (Figures 1-4) show the typical structure of a cremation furnace with a coke-fired gasifier. The drawings are those of the Wilhelm Ruppmann Company of Stuttgart (Germany) for the furnace installed at Biel¹³ (Switzerland) in 1911.¹⁴

The furnace consisted of gasifier A (*Generator*), a cremation chamber L (*Verbrennungsraum*, also called *muffle*) with its post-combustion chamber below (*Nachglühraum*) and the heat recuperator (*Rekuperator*). In front of the chimney there is also a pilot hearth (*Lockfeuer*), also called chimney hearth (*Kaminfeuer*) – not shown in the drawings – which served mainly to activate and reinforce the draft and for the post-combustion of the flue gases.

The operation of the device under normal conditions was as follows: Before the gasifier was lit, the damper S of the flue duct was opened and the pilot hearth was lit. Next some wood and a little coke were lit on the grate N of the gasifier. Once the coke had started to glow, more fuel was added through the loading chute B. Heating of the initially cold furnace up to the temperature at which the corpse would be loaded (800°C) took about three hours and required some 260 kg of coke.

During the preheating phase the air vents stayed closed, and only Vent T of the hearth was open. The gases from the gasifier entered the muffle through the outlet of the gasifier, flowed into the post-combustion chamber and Duct Z and then onward into the heat recuperator and from there via the flue into the chimney. The heat recuperator consisted of a number of channels made of refractory brick, some of which were traversed by the exhaust gases in a downward direction while the others were traversed by the incoming combustion air in an upward direction.

When the furnace had reached its operating temperature, Door K was opened and the coffin introduced into the muffle. The coffin was placed onto the muffle grate, which consisted of 9 transversal and 2 longitudinal bars of refractory clay. Because of the high temperature of the muffle, the coffin caught fire as soon as it was introduced into the chamber and burned rapidly, leaving the corpse on the grate exposed to the flow of the combustion gases from the gasifier, which traveled through the muffle with a high temperature.

At that time the evaporation of the corpse's body water and the gasification of its combustible components began, followed by the combustion as such. The combustion residues fell through the grate into the post-combustion chamber,

¹³ The French name of the town is Bienne, as it appears in Documents 54 and 56.

¹⁴ Cf. the account of the test cremation for this furnace in Section 2.2.6.

where they continued to burn. When the flames had died down, the glowing cinders, by means of a rake introduced through the upper opening of the ash chamber, were raked forward from the inclined plane into the Receptacle H, where they burned out little by little.

The operation of the furnace was controlled by means of a number of devices (air vents, fire doors, dampers of the flue ducts, and the pilot fire). During their passage through the heat recuperator, the hot combustion gases transmitted some of their heat to the brickwork, heating it up. The combustion air entering the recuperator through the air vents at D was warmed up in the upper part of the furnace, traveled through duct E, and then a part of it entered the muffle through Openings F, whereas the remainder entered the top of the gasifier through the Openings G. Here the air mixed with the hot combustible gases produced during the coke gasification in the generator, and the mixture of burning gases and flames then flowed into the muffle striking the coffin and the corpse.

In order to reduce the formation of slag, Vessel P, located beneath the hearth grate, is filled with water. This water evaporates and rises as vapor through the hearth grate and the glowing coke; the heat breaks up the water vapor, and subsequently both the grate and the ash cool down,¹⁵ thus reducing the formation of slag. In this way, "water gas" is also generated in the gasifier (see next subchapter):

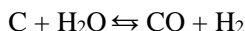

2.2. General Theoretical and Structural Principles

2.2.1. The Gasifier¹⁶

The gasifier is a vertical chamber lined with refractory material on the inside. The hearth is in its lower part and consists of the grate and the door for the primary air and the removal of ashes and slag. In its upper part the chamber tapers off on one side into a duct (the neck of the gasifier) through which the products of the coke gasification enter the muffle and, on the other side into a vertical or slanted chute connected to the outside through which the coke is fed into the gasifier.

The function of the gasifier is the gasification of coke, *i.e.* its transformation into combustible gases, in this case into generator gas or water gas.

The generator gas is formed during the incomplete combustion of the coke, according to the following reaction:



This is brought about by having air pass through a layer of glowing coke. Initially, in the lower layers of the coke, carbon dioxide forms in the presence of sufficient oxygen according to the following reactions:

¹⁵ The evaporation of 1 kg of water absorbs about 3,800 kcal.

¹⁶ The following description is based on *Enciclopedia Curcio*..., vol. 5, p. 1842; Giua 1948, vol. II, p. 382; Bordoni 1918, pp. 51-54; Heepke 1905b, pp. 31ff.

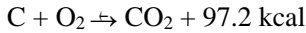

In the upper layers, on the other hand, carbon monoxide is formed due to the deficiency of oxygen according to the following reaction:



Thus CO is produced by the direct reaction of C and O and by the reduction of CO₂. The CO of the generator gas formed in this way leaves through the neck of the gasifier and – just before it enters the muffle – reacts with the preheated outside air (secondary combustion air) to form CO₂ once again, giving up part of its heat to the muffle. Then the combusted gases pass through the post-combustion chamber, enter the recuperator, then the flue and finally the chimney.

The composition of the coke depends, of course, upon the type of coal from which it was made and upon the type of coking.

Leaving aside the minute quantities of hydrogen, oxygen, nitrogen and sulfur which the coke still contains and considering only the carbon, 1 kg of C requires 2.667 kg of O and hence:

$$2.667 \cdot \frac{100}{23} = 11.59 \text{ kg of air,} \quad [28]$$

assuming a composition of air as being 23 kg of O₂ and 77 kg of N₂ for 100 kg of air. Thus, the 11.59 kg of air contain

$$11.59 - 2.667 = 8.923 \text{ kg of N}_2. \quad [29]$$

In the lower layers of the glowing coke in the gasifier, the gas is therefore generated according to the reaction

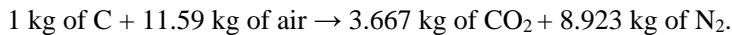

In successive layers we have accordingly the transformation of CO₂ to CO:

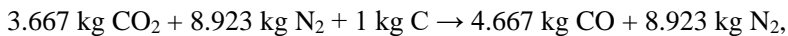

and the pure generator gas therefore contains, in theory,

$$4.667 \cdot \frac{100}{(4.667 + 8.923)} = 34.34\% \text{ of CO} \quad [30]$$

and

$$100 - 34.34 = 65.66 \% \text{ of N}_2. \quad [31]$$

Normally, though, one obtains from the coke a generator gas having the following average composition: CO = 26%, N₂ = 65%, CO₂ = 2.8%, SO₂ = 0.2%, CH₄ = 1.5%, H₂ = 0.5%.¹⁷ The l.h.v. of this gas is about 1,000 kcal/Nm³, the density is about 0.97 relative to air.

¹⁷ The sum of these percentages yields 96%. The rest consists of other gases, among them oxygen and water.

Thus, 2 kg of C will produce 4.667 kg of CO, but if we assume an effective yield of 26%, we obtain only

$$\frac{4.667 \cdot 26}{34.34} = 3.53 \text{ kg of CO.} \quad [32]$$

Exactly 0.5714 kg of O are needed for the complete combustion of 1 kg of CO into CO₂, *i.e.*

$$\frac{0.5714 \cdot 100}{23} = 2.484 \text{ kg of air.} \quad [33]$$

The products from this combustion are:

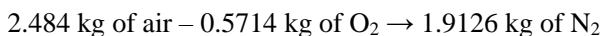
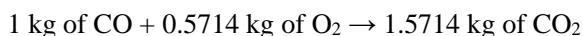

With preheated air and perfect mixing, the theoretical Excess Air for the combustion of CO into CO₂ is at most 10%, but in practice the Excess Air is over 50%.

If 1 kg of CO is completely converted into CO₂ by combustion, 2,449 kcal are generated. If a reservoir of water is placed under the grate of the hearth, the gasifier will produce water gas.

Water gas is a mixture of carbon monoxide and hydrogen and results from steam being passed through a coal or coke bed heated to around 1,000°C. The corresponding reaction is as follows:

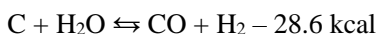

Below 600°C, the reaction produces a mixture of CO₂ and H₂:

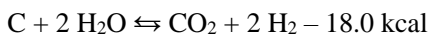

In order to keep the latter from happening, it is necessary to maintain the bed of coke at a sufficiently high temperature. The water gas which is generated according to the first of the above two equations would theoretically be a mixture of equal volumes of carbon monoxide and hydrogen with a calorific value of 2,810 kcal/Nm³. Under actual conditions, however, it has the following composition (by volume): CO = 38.5%; H₂ = 52%; CH₄ = 1%; CO₂ = 4.5%; H₂S = 0.2%; N₂ = 3.8% and a calorific value of 2,650 kcal/Nm³. Its density is 0.5330 relative to air; one Nm³ has a mass of 0.689 kg.

In a device like the Schneider Furnace (cf. Chapter 3) with a water container of some 0.2 to 0.4 m³ placed beneath the hearth grate, an increase of 5 to 15% in the calorific value of the gasifier gas was obtained.

2.2.2. The Cremation Chamber or Muffle

The muffle is a horizontal combustion chamber, the upper part and ceiling of which are made of refractory bricks. In the earliest models its dimensions were as follows (cf. Document 3):

Width: 850 – 1,000 mm
 Height: 800 – 900 mm
 Length: 2,200 – 2,500 mm

The “Norms for the construction and operation of furnaces for the cremation of human corpses” of 1937 specified the following minimum dimensions (cf. Chapter 8):

Width: 900 mm
 Height: 900 mm
 Length: 2,500 mm

The muffle is closed at its front end by a door made of refractory clay which slides sideways along a special track. An outer door is located in front of that sliding door.

Because the front end of the coffin caught fire as soon as it entered the muffle and because smoke formed on account of the varnish, later models were equipped with a hood above the door which collected this smoke while the coffin was introduced, and discharged it to the exterior.

In its rear portion the muffle is linked to the gasifier by means of the gasifier neck. Its bottom consists of a grate of refractory clay, usually with longitudinal and transversal bars on which the coffin rests.

Beneath this grate is located the inclined plane on which the residues of the corpse burn out completely after having fallen through the openings of the grate. This inclined plane for the ash has at its front end a space for the ash container. The ash is moved into this container by means of a suitable rake.

In the 1930s a post-combustion grate for the ash was placed at the front end of the inclined plane.

The walls of the muffle underneath the grate of refractory clay are inclined towards the center, thus forming a small chamber (post-combustion chamber) which receives the remains of the corpse. The walls of this chamber have perforations for the discharge channels through which exhaust gases flow into the recuperator.

Some systems with an indirect heating system had furnaces with a shutter made of refractory material which closed the opening leading from the gasifier to the muffle. The gasifier gas could thus be diverted through appropriate channels around the muffle in order to heat the latter merely indirectly from the outside. This device served to keep the combustion gases from coming into direct contact with the corpse in accordance with Prussian legislation in force until 24 October 1924 (cf. Chapter 4).

2.2.3. The Recuperator

The recuperator (cf. Documents 1 and 2, Figures 1 and 3) is a heat exchanger made of refractory material with a mass of 7,000 to 8,000 kg, placed in the lower part of the furnace, with usually two levels. It consisted of two counterflow systems of intertwined channels with an appropriate upper opening in the muffle and the lower opening at the furnace’s bottom. The exhaust gases from the muffle flow in a downward direction while the combustion air from the outside

flow in an upward direction. In that process the combustion gases transfer some of their heat to the channel walls. As a result of this, the heat disperses throughout the entire recuperator by way of conduction, with its temperature varying between 400 and 600°C or higher.

In older furnaces equipped with an entirely indirect heating system, the recuperator was preheated, just like the muffle, to a temperature of 1,000°C, after which the arrival of the combustion products of the gasifier into the muffle was stopped. The combustion air moved upwards through the recuperator while getting heated and entered the muffle at basically the same temperature.

In the furnaces of the 1920s and 1930s, which usually worked with semi-direct or direct processes,¹⁸ the recuperator was heated to a considerably lower temperature, and the heat needed to bring the cremation to an end was provided by the radiation from the muffle walls and by the gas coming from the gasifier.

In the Klingenstierna Furnace (cf. Chapter 3) the recuperator consisted of a bank of metal tubes directly exposed to the flames and the exhaust gases from the muffle, thereby becoming red-hot, with the combustion air flowing through the tubes; in the modified type produced by Gebrüder Beck of Offenbach, the tubes were replaced by a recuperator of refractory clay.

The Siemens furnace of the Gotha Crematorium (cf. Chapter 3) did not have a recuperator, but a regenerator. A regenerator is a heat exchanger working intermittently and consisting of a structure of refractory bricks with a system of channels linking the muffle and the flue duct as in the case of a recuperator, but – as opposed to the latter – *all* channels are alternately traversed by *either* the exhaust gases from the gasifier in a downward direction *or* by the combustion air in an upward direction. Not having separate channels for the exhaust gases and the combustion air, the regenerator is operated discontinuously, with alternating heating and cooling phases. The exhaust gases from the gasifier flow through it only while the furnace is being heated up. When the latter has reached its operating temperature and the coffin is introduced into the muffle, the combustion gases are shunted directly to the chimney through appropriate channels. Combustion air is then heated by being made to flow upwards through the regenerator. It strikes the coffin and the corpse at a temperature of 900 to 1,000°C. During this process the regenerator cools down and has to be heated up again before the next cremation (Schläpfer 1937, p. 8; Kaiserliches Patentamt, 1913b).

In order to allow such a system to operate continuously, two regenerators working in tandem are necessary, as in F. Siemens's patent referred to above (cf. Chapter 3). Here, the exhaust gases from the muffle and from the gasifier are discharged through a second regenerator that heats up while the combustion air flows into the muffle through the first regenerator, cooling it down. In this way one of the regenerators is always hot in each phase of the cremation.

Because of the impracticality of such a system, nearly all cremation furnaces operate using a recuperator.

¹⁸ For the definitions of these terms see Chapter 4.

During the cremation experiments run in the Biel Crematorium by the engineer Richard Kessler at the end of the 1920s, it was established that the recuperator had another important function: the post-combustion of gases leaving the muffle not completely burned (cf. Chapter 4).

2.2.4. The Chimney¹⁹

The discharge of the exhaust gases from the furnace is assured by a system consisting of a flue (*Fuchs*) and the chimney (*Schornstein*), sometimes supplemented by a pilot flame (*Lockfeuer*) or a forced-draft device (*Saugzuganlage*).

In accordance with the findings of the furnace specialist Beutinger, the flue duct, *i.e.* the link between the furnace itself and the chimney, must be lined internally with refractory material. It must also have a sufficient number of openings for cleaning; wherever possible, these apertures must be equipped with a double lid to avoid leakage of ambient air into the duct.

At the point where the flue duct enters the chimney or possibly even upstream of this point, Beutinger recommends the installation of a throttle, moving vertically, which allows control of the draft by increasing or decreasing the cross-section of the duct in keeping with the operating conditions.

The pilot flame must be placed at the bottom of the chimney; its function is to heat the layers of cold air above it and to force up the cold air which is in the duct and the furnace itself. Besides activating the draft when the furnace is cold or has difficulties on account of adverse atmospheric conditions, this flame also serves for the post-combustion of the smoke.

In the furnaces built in the 1920s and 1930s, the pilot flame was usually replaced by a forced-draft device, a blower placed at the base of the chimney in such a way that it created a lower pressure in the flue compared to the furnace. Such an effect could be achieved in one of two ways (*Enciclopedia Curcio...* 1973, vol. 8, p. 3247):

“One can either have all the combustion products pass through the blower, or one can place the blower in a shunt. It would then draw in only a portion of the flue gases, ejecting them at high velocity into the base of the chimney, which has to have a converging/diverging shape, like a venturi. The jet produced by the blower drags the flue gases along at a high speed; in the diverging part of the duct the air velocity drops, and the kinetic energy is transformed into pressure energy. The output pressure of the blower has to be such that it overcomes the resistance in the duct caused by friction, by elbows etc.”

If several furnaces operating simultaneously are to be installed, it is necessary to build separate chimneys; a common chimney is not advisable because in the case of partial operation its cross-section and hence the cooling effect would be too large, especially if one furnace is taken out of service.

In some cases, a damper can be installed in the upper part of the chimney to prevent cold air and humidity from entering. Large obstructions at the head of

¹⁹ This subchapter is based on: Beutinger 1911, pp. 143-146; Heepke 1905b, pp. 67-75; Bordoni 1918, pp. 43, 56-62, 224-225, 230-234; Lebrasseur 1922, pp. 56f.; Salvi 1972, pp. 617-622; *Enciclopedia Curcio...* 1973, vol. 8, p. 3247.

the chimney should be avoided because they can lead to a reduction in the draft, mainly through the formation of air eddies and downdrafts beneath any such large protuberances. If the chimney does not have an outside brick covering, it must have a layer of insulation on the inside, possibly made of refractory material. If the temperature of the gases at the bottom of the chimney is expected to reach 500°C, the chimney has to be clad internally, over the lower third of its height, by a layer of refractory bricks set with refractory mortar.

In the case of a cremation furnace with a coke-fired generator the main function of the chimney is not the discharge of the exhaust gases but the creation of sufficient draft to provide enough combustion air at the grate of the hearth. In fact, the highest resistance that the combustion air encounters resides in the grate and the layer of coke. The resistance of the grate depends on the air flow-rate and on the open cross-sectional area of the grate. A theoretical equation has been proposed by M. Lebrasseur:

$$H = \gamma \cdot V^2 (N^2 - 1) \quad [34]$$

where H = resistance
 γ = specific density of the air
 V = air velocity
 N = open cross-sectional area of the grate

The resistance of the layer of coke on the grate depends on the mass of the coke and the thickness of the layer. According to M. Lebrasseur, this resistance, H, can be expressed as

$$H = \frac{c \cdot l \cdot P^2}{100} \quad [35]$$

where c is a factor taking into account the size of the pieces of coke, l is the thickness of the layer and P the mass of coke per 1 m² of grate surface (Lebrasseur 1922, pp. 56f.).

The draft of the chimney can be natural or artificial. Natural draft is caused by the density difference – and hence by the temperature difference – of the fumes entering the chimney at its base and the ambient air at the top of the chimney. The hot gases, having a lower specific density than the surrounding air, cause an updraft, which in turn creates a reduced pressure at the base of the chimney.

The draft is measured in mm of water column, 1 mm of water column being equivalent to a pressure of 1 kg per square meter (10 m of water column roughly equals atmospheric pressure near sealevel). The measuring instrument is called a vacuum indicator. In its simplest form, it is a glass U-tube filled to half its height with colored water. One end of the tube is connected to the inside of the chimney while the other is open to ambient air. The level difference between the two parts of the glass tube represents the draft of the chimney and is given in mm of water column (mm *Wassersäule*, mmWs, in the German literature). The draft can also be measured electrically by means of an instrument with a scale in the form of the arc of a circle (Cantagalli 1940, p. 86).

According to Heepke, for cremation furnaces with coke-fed gasifiers the minimum allowable draft is 10 mm of water column, the maximum 30 mm. The draft is a function of the height of the chimney according to Salvi's equation:

$$E = 1.29 \cdot \left(\frac{1}{1 + 0.00367 \cdot t_a} - \frac{1}{1 + 0.00367 \cdot t_f} \right) \cdot h_c \quad [36]$$

where E = draft
 h_c = height of chimney
 t_a = temperature of ambient air
 t_f = temperature of fumes

This equation also allows calculating the height of a chimney as a function of its draft:

$$h_c = \frac{E}{1.29 \cdot \left(\frac{1}{1 + 0.00367 \cdot t_a} - \frac{1}{1 + 0.00367 \cdot t_f} \right)} \quad [37]$$

For example, assuming h_c = 20 m, t_a = 10°C, t_f = 300°C, the draft would be equal to 12.6 mm of water column. With such temperatures, the height of the chimney should be at least 16 m for a draft of 10 mm of water column to be attained. In practice, however, the height should be greater in order to overcome pressure losses in the flue and the chimney due to friction.

The cross-sectional area of the chimney is also very important, because it determines the velocity of the gases passing through the chimney. This velocity varies with the square root of the draft, and normally has an order of magnitude of 3 to 5 meters per second, depending on the size of the plant.

The recommended cross-sectional area of the chimney can be derived from Colombo's equation:

$$q = \frac{F \cdot V \cdot (1 + \alpha \cdot t)}{3,600 \text{ sec/hr} \cdot v} \quad [38]$$

where q = cross-sectional area of the chimney, in m²
 F = fuel consumption in kg/hr
 α = 1/273 °C⁻¹
 t = fume temperature at the chimney base in °C
 V = volume of the fumes in Nm³/kg fuel
 v = exit speed of the fumes at the chimney top, m/sec

Heepke proposes the following equation for the calculation of the exit velocity of the gases discharged:

$$v = \frac{G \cdot B \cdot (1 + \alpha \cdot t)}{1.293 \cdot 3,600 \text{ sec/hr} \cdot q \cdot \gamma} \quad [39]$$

where G = mass of gas generated by combusting
 1 kg of coke (with Excess Air ratio m = 2)
 B = mass of the coke in kg
 q = cross-sectional area of chimney
 γ = density of the gas

2.2.5. Drying Out a New Furnace

The drying out of a newly built cremation furnace is a rather delicate operation. If it is done poorly, it can lead to damage in the wall structure of the plant. In his classic work on cremation, Beutinger describes it as follows (1911, p. 127):

“Since a large quantity of water is introduced into the body of the furnace during the construction of the furnaces, a thorough drying out is therefore necessary after its completion, including the flue duct and the chimney. The drying operation is to be done slowly, because an intensive and rapid heating would lead to the generation of large quantities of water vapor, the pressure of which, under some circumstances, would lead to individual parts of the furnace being torn apart, or to the formation of cracks, which could potentially lead to the discharge of gas or smoke from the furnace. Even the most-solid structure and the best anchorings themselves could be damaged. Therefore, it is expedient to leave the drying of the furnace to the builder of the furnace, which takes several weeks, after all; the slower it occurs, the better the probable future longevity of the furnace. In the beginning, only a small fire with wood shavings may be used, to which thin pieces of wood are added a little later, from the third day onward. After the first week, a stronger wood fire can be maintained, with all flue ducts wide open in order to allow the hot air to remove the water vapor forming. After a steady increase of the heat, the furnace is dried out completely by adding step by step small quantities of coke to the wood, in order to achieve a complete drying out of the furnace.”

2.2.6. Test Cremations

The test cremation is a means for testing the proper functioning of the furnace. In this respect, architect Beutinger writes (*ibid.*, pp. 127f.):

“Before the test cremation, it is necessary to check the furnace thoroughly, including the control devices, the closures, the introduction trolley, etc. If the furnace has been idle for some time, the chimney has to be prewarmed by means of the pilot fire to ensure a good draft. The test run must be made by the builder of the furnace who also trains the operating personnel at the same time. Minutes of the test cremation and its results are kept, recording the various phases of the combustion and their progression. The generation of smoke and the composition of the ash must be recorded.

With respect to the development of smoke from the chimney, it must be kept in mind that, for all such systems, smoke is favored both by a lack of air and by an excess of air, because the latter state leads to a lowering of the furnace temperature and hence to a decrease in the ability of the gases to ignite.

For the heating and the cremation test, the furnace is warmed up in accordance with its operating instructions and brought to its necessary temperature. The weight and the quality of the fuel used for heating up and for the cremation as such must be checked and recorded in a similar way as shown on pages 116 and 117.

For the cremation any kind of animal carcass can be used, for example a horse, whose overall size and whose weight percentage of flesh, bones and also of the parts which burn rather poorly, such as the heart, the lungs, the liver, correspond roughly to the proportions in the corpse of a human adult.

The carcass is placed in a coffin-shaped box made of dry wooden unplanned boards, 15-18 mm thick, like those used for coffins, 1.90 m in length, 0.60 m wide and 0.50 m high. It is best to use a coffin made according to the general practice. The weight of the carcass, its type and the various portions of its indi-

vidual parts such as bones, flesh, heart, lungs, fat etc., as well as the weight of the coffin must be recorded, and the various phases of the combustion verified during the entire process of the cremation. Seger cones for temperatures between 900 and 1100°C must be placed at appropriate locations in the cremation chamber to establish the temperatures reached on the basis of their melting.

When the inside of the furnace has reached the temperature necessary during preheating, the carcass is introduced and must be observed constantly through the inspection opening. The ash is collected in the space provided, and its composition is examined. The test cremation must be carried out in the actual presence of the supervising authority. Depending on the outcome of the cremation, for which minutes are drawn up and signed by the public authorities present, the use of the furnace for the cremation of human corpses is authorized.”

As an example I reproduce the minutes of the test cremation of the Ruppmann-type cremation furnace with a coke-fed gasifier at the Biel Crematorium (Nagel 1922, p. 40):

“Protocol

of the test cremation carried out in the crematorium at Biel at 2 p.m. on Friday, 25 August 1911.

The president of the cremation association of [the city of] Biel reads to those present the text of the supply contract. Then, around 2:25 p.m., a coffin filled with animal remains is introduced into the furnace. The furnace had been lit at 10 a.m. and had been ready for use for two hours. The experts ascertained a temperature of around 1000°C on the basis of the Seger cones placed inside it. The coffin contained some 80 kg of meat supplied by the administration of the Biel Slaughterhouse, consisting of 85% of soft tissue and 15% of bones.

***The introduction of the coffin by means of the Ruppmann trolley was very easy. The closure plate works well and shuts immediately upon introduction of the coffin into the cremation chamber.** The doors of the furnace were closed. Through the inspection ports in the front of the furnace one can see that the coffin catches fire immediately, and intense flames develop. At that moment, a little smoke can be observed above the chimney. Later, too, there is at times a little smoke, but it is barely visible.*

At 5:25 p.m. it can be seen that the contents of the coffin, except for a few small pieces, have been completely reduced to ash. In the post-combustion chamber the bones can be seen, i.e. the incinerated remains of the bones, in an incandescent state.

Due to the advanced time of day, Mr. Lanz, as a member of the commission for sanitation, is asked to examine the ashes the next day.

The management [of the crematorium] finds that the furnace is working well, and that the large masses and the well-compacted pieces of flesh have been consumed by the flames in a relatively swift fashion.

Biel, 25 August 1911.

The Biel Association for Cremation:

The President: (signed) Albrecht

The Secretary: (signed) Fehlmann.”

3. Origin and Development of Modern Cremation Furnaces

Corpse cremation was practiced in Europe as early as a thousand years before Homer (Schuchhardt 1920, p. 502) and continued to be practiced up to the year 785 AD, when it was prohibited, under pain of death, by the Paderborn Decree (*Capitulare Paderbrunnense*) of Charlemagne (Pauly 1904, p. 8). Over the following centuries the cremation of corpses fell completely into disuse as a funerary habit throughout Christian Europe.

The idea of cremation of corpses arose again during the French Revolution, but did not take hold before the second half of the 19th Century. In its session of the 14th Floréal of Year VII (3 May 1799), the central administration of the Seine Department promulgated a decree giving complete freedom to the citizens to have their own corpses buried or cremated, and even proposed to have a “resting field” arranged on Montmartre where solemn incinerations of corpses could be practiced without the use of wood, but using “furnaces ingeniously prepared by modern chemistry.”²⁰ Two drawings of this monumental crematorium (before the word came into use) have survived (Documents 4 and 5; Reber 1908).

The birth of the movement for the cremation of corpses can be traced back to 1849, when the philologist Jakob Grimm gave a memorable speech on this subject at the Berlin Academy of Sciences. The speech was a long and learned treatment on the funerary customs (cremation) of ancient peoples, full of quotations in Greek, Latin and Old Saxon.²¹ The idea was picked up by Prof. Jakob Moleschott in 1852 and by Dr. Francesco Coletti in 1857 (cf. his *Memoria*) and enthusiastically spread by untiring pioneers such as Army Surgeon J.P. Trusen, Prof. Richter, Prof. Reclam and Prof. Küchenmeister, and in Italy by Du Jardin, Bertani, Castiglioni and by the selfsame Coletti during various conventions which took place between 1858 and 1869.

In this chapter I will not describe the history of modern cremation – a great many books have already been published on this topic as listed in the present book’s bibliography – but rather a specific history of cremation *installations*. I shall therefore limit myself to the essential historical points.

In Europe, the first cremation in a cremation furnace took place at Dresden on 9 October 1874 in an experimental furnace built by Siemens. At that time the corpse was that of an Englishwoman, Lady Dilke, the wife of the Secretary of State Dilke. It was followed on 6 November by the cremation of the wife of the Medical Councillor D. Thilenius of Wiesbaden as well as several other cremations before such experimental incinerations were stopped by the government of Saxony (Pauly 1904 p. 18).

²⁰ On the Seine Department’s decree see in detail Lacassagne/Dubuisson 1874, pp. 32-35. “Floréal” was the name of a month in the revamped calendar of revolutionary France.

²¹ The speech, entitled “*Über das verbrennen der Leichen*” (“On the cremation of corpses”) was published the year after (Grimm 1850).

Italy soon placed herself in the vanguard of the modern cremation movement, both from the legal and the technical points of view. The principle of corpse cremation was recognized in that country by the sanitary regulations of 6 September 1874 (Pini 1885, p. 16).

Cremations spread rapidly in the United States. The first crematory was erected in Washington, D.C. in 1876. In 1895 already 19 crematories existed there (Probst 1895; Guilbert 1895).

In France cremations were once more legalized on 15 November 1887, but effectively only on 27 April 1889 with the promulgation of governing regulations.²²

Since 1874, the proponents of cremation in England highlighted its advantages compared to burial from the point of view of health and hygiene (Eassie 1874), but in 1881, changing the law that prohibited the construction of crematoria was still being discussed.²³

The 1870s saw a massive amount of work being done in this field, theoretical as well as experimental, and various types of furnaces were built. Modern cremation had to fulfill numerous ethical, esthetic and economic requirements. The general congress on cremations held at Dresden on 7 June 1876 specified the following principles (Pauly 1904, pp. 14f.):

1. *Cremation must be complete and must not leave any charcoaled remains.*
2. *Cremation of corpses must be carried out only in installations expressly built for this purpose.*
3. *No malodorous gases must be generated; cremation must hence be odorless.*
4. *The ashes must be white, clean and easy to collect.*
5. *The cost of the equipment and of the cremation must be as low as possible.*
6. *The equipment must be able to allow several cremations in succession.*"

The first European crematorium was built in Milan in 1875. It was equipped with a Polli-Clericetti Furnace and inaugurated on 22 January 1876 with the cremation of the corpse of Alberto Keller.²⁴ The first crematorium in Germany went into service at Gotha on 10 December 1878.

The pioneers of cremation were confronted with a serious problem. The hopes and the disappointments that accompanied the first experiments using animal carcasses are vividly described by the words of Dr. Gaetano Pini (Pini 1885, p. 128):

"We, who were present at the first experiments of Polli (12 June and 12 December 1872) and of Gorini (1 September 1872), have not forgotten the illusions and the discouragements we experienced, shut in for hours as we were in that small space as we anxiously and restlessly awaited the results of the trials with animals. How long it took to burn that beast! What a foul smell there was! How much smoke! And yet, each new experience seemed like a victory to us, and

²² "La crémation à Paris" 1891. About the early history of cremations in France see "La crémation des morts..." 1888 (twice); "Crémation" 1889; Salomon 1893; "La crémation" 1890; Rochard 1890; "Crémation" 1892.

²³ "A Discussion..." 1891; the origins of cremation in England are well outlined in Thompson 1884.

²⁴ Pini 1885, p. 30; Paolo Gorini (1876, pp. 79-107) dedicated many pages to the narration of the antecedents and the description of the event.

without doubting the difficulties which we still had to overcome, we thought we had reached our goal."

Soon, the first experimenters realized that the cremation of a human corpse was an even-more-difficult problem. Dr. Pini wrote in this regard (*ibid.*, p. 129):

"The disappointments began with the first tentative incinerations of human corpses. Experience then taught us that there was still a long road ahead of us before we would be able to burn a human body completely within a short time and at little cost."

One of the most-diligent and -tenacious pioneers was Paolo Gorini, who since 1872 had experimented with the complete combustion of body parts in a crucible with "incandescent volcanic liquid" or "volcanic matter in a state of fusion", a procedure that he had to give up because it was impossible to obtain a crucible large enough to contain a whole corpse (Gorini 1876, pp. 70-75). From June 12 to July 1, 1875, he performed 17 cremations of entire corpses in an apparatus of his invention that he gradually improved, until it became the "Lodigiano Crematory" (see below); ten of these cremations he described with great care (*ibid.*, pp. 130-197).

The first types of cremation equipment used in Italy employed muffles. The corpse had to be placed into a metal cylinder heated on the outside by coke (Du Jardin, 1867) or city gas (Polli-Clericetti).²⁵

Brunetti's device (1873) consisted of four little walls of ordinary brick, making up the hearth, upon which was placed a thin sheet of steel which covered only a small part of the hearth. Above it was a large hood linked to the chimney. The corpse was tied to the steel plate with wire to keep it from falling off on account of sudden muscular contractions during the burning. On the hearth, below the steel sheet, a fire of wooden logs was lit. The flames caused the steel sheet to glow and surrounded the corpse from both sides. Cremation took about six hours.²⁶

The Polli-Clericetti Furnace, enclosed in an "urn" in the form of an antique sarcophagus (Document 7), consisted of a cremation chamber with a horizontal grate on which the corpse was placed. It had 217 nozzles of air and gas, the jet-like flames of which impinged directly on the corpse and heated the chamber to a temperature of 1,100°C. This furnace was set up in the Milan Crematorium and used for the cremation of Alberto Keller²⁷ and for another two cremations.²⁸

²⁵ Pini 1885, pp. 130f. A detailed description is given by Wegmann-Ercolani 1874, pp. 30-33. In this work one can also find the drawing which I have reproduced as Document 6.

²⁶ Pini 1885, p. 132. The first experiments by Lodovico Brunetti are described in detail in Pini 1973; the following has been taken from Pini 1885, pp. 128-171, unless otherwise stated. Cf. also de Cristoforis 1890, pp. 56-135; de Pietra Santa/de Nansouty 1881; Vallin 1880, pp. 854f.; Maccone 1932, pp. 102-124; Eassie 1875 presented an accurate description of the early years of cremations in Italy, Switzerland, France, Belgium, Austria, Germany, the U.S. and England (pp. 68-88) and of the first cremation devices with special reference to the Siemens Furnace (pp. 89-126). See also Rolants 1910; du Mesnil 1877; de Pietra Santa 1888a-c.

²⁷ Polli 1876a; "La prima cremazione..." 1876. The cremation lasted one hour and 30 min.; the corpse weighed 60 kg and resulted in 3 kg of ashes.

²⁸ The second cremation was that of the corpse of Anna Pozzi Locatelli, who weighed 50 kg and produced 3.6 kg of ashes. The cremation took one hour and 45 min. Polli 1876b; "La seconda cremazione..." 1876. The third cremation was that of the corpse of a man of 71 years of age from a hospital; the cremation took two hours and 30 min.; the corpse weighed 43 kg and left 2.3 kg of ashes. G.

On account of its excessively high costs, it was dismantled afterwards and replaced by a Betti-Terruzzi Furnace in 1877. This device was a muffle furnace consisting of a cast-iron cylinder located in the center of a large coke-fired furnace. When the cylinder started to glow, the corpse was introduced through a kind of steel guide rail. Cremation was fairly complete, but the process took at least five hours and the costs were high. After nine cremations, this type, too, was demolished.

The Cadet Furnace (Document 8), another muffle device, was used only for experiments with animal carcasses.

The Muller-Fichet Furnace (Document 9), shown at the Paris Universal Exhibition of 1878, consisted of a muffle made of refractory brick (*f*) into which the coffin (*g*) was placed. It was lined below and on the sides with refractory bricks (*e*) which acted as heat accumulators. The muffle was made white-hot by means of the combustion products coming from a large gasifier (*a*) with a stepped grate, and then the coffin was introduced.

The Lagénardière Furnace (Document 10) with its center muffle and two lateral coal-fed hearths and a recovery system for the hot gases was never used for cremation experiments.

The Kopp Furnace was based on the same principle as the Betti-Terruzzi type, but had a muffle made of refractory brick. It was set up in the Washington, D.C., crematorium. Six hours were needed for a complete cremation.

The Gorini Furnace (Document 11), called “Lodi furnace,” was based on the principle of direct combustion with live flames. It worked in the following way: after placing the corpse in the cremation chamber (*C*) through the door (*E*), a small auxiliary fire was lit on the auxiliary hearth (*G*) which burned throughout the duration of the cremation, first as a pilot flame, later as a post-combustion fire for the exhaust gases. After three or four minutes, furnace (*A*) with its grate and ash receptacle (*B*) was lit. The flames from the fuel, normally consisting of bundles of wood, struck the corpse lengthwise. The combustion products flowed down into the discharge duct (*F*) through the auxiliary hearth (*G*) where any unburnt gases were consumed and then left through the chimney (*H*). The cremation chamber had lateral ports (*L*) for the direct induction of combustion air. The draft of the furnace was controlled by a damper located in the chimney. The prototype of this furnace was inaugurated in the Riolo crematorium on 6 September 1877. The duration of one cremation was generally between one and a half and two hours, with a wood consumption of 100 to 150 kg. The Gorini furnace inaugurated on 15 December 1887 at the cemetery of Père-la-Chaise²⁹ in Paris (Document 12), used 300 to 450 kg of wood for one cremation, which lasted on average one hour and 45 min.³⁰

The Venini Furnace was the first Italian device using a coke-gas generator (gasifier). As can be seen from the drawings (Document 13), it was a rather complex piece of equipment. The cremation was brought about by the flames

Polli 1877.

²⁹ Today it is spelled Père-Lachaise.

³⁰ “La crémation à Paris” 1890. The device and the first three experimental cremations, including an analysis of the fumes, were accurately described by du Mesnil 1888.

coming from a mobile gasifier and reaching the cremation chamber after having passed through a connecting duct; they struck the corpse directly. The introduction temperature was 800°C, and the duration of a cremation was normally one hour and a quarter.

The mobile Rey Furnace (Document 14) was practically a Gorini Furnace mounted on a sheet-metal cart, lined internally with refractory brick and having a hearth at its far end. The corpse was fed into the front end by means of a suitable metal trolley.

Another mobile cremation furnace, although never used, was presented during the Brussels Hygiene Exposition in 1876 by Kuborn & Jacques (Documents 15, 15a). It consisted of a sort of locomotive that could also move on roads. It was internally lined with refractory material, which contained two inclined ledges. Below them were two adjacent hearths, and the smoke conduit connected to a vertical chimney stuck out of the car's roof. The plant could cremate a dozen corpses at a time. The first hearth heated the ledges with the corpses, and the combustion products passed on to the second hearth, which burned them completely; then they went out the chimney (du Mesnil 1877).

The Guzzi Furnace (Document 16) brought together the principles of direct cremation by means of live flames and of indirect cremation by means of clean hot air, of which I shall speak later. In this device, the cremation chamber (A) was heated either by the combustion products coming from the hearth (D) or by hot air heated in the regenerator (B). The primary combustion air entered the furnace at the front, ahead of the introduction damper (V), through an opening (K) linked to a channel running above the cremation chamber (L), and fed, pre-heated, into the ash-box (N) beneath the grate (E) of the hearth. The grate was in a slanted position and rested on a water-filled vessel (H) that cooled it. A secondary combustion chamber (C) ensured the post-combustion of any unspent gases coming from the cremation chamber.

The Spasciani-Messmer Furnace (Documents 17, 17a and 17b) installed at Leghorn and Venice was a device with a gasifier (G) having a horizontal grate and a feeding chute (T) for the fuel. The combustion gases produced there fed into a channel (D) placed above the cremation chamber (C), which had four openings (b) with control vanes allowing the body to be struck by four jets of flame at the head, on the chest, on the abdomen and on the legs. The control vanes allowed the fire to be aimed and concentrated on those parts of the body that offered the greatest resistance to cremation. The corpse was introduced into the chamber on a trolley, the upper surface of which was made of refractory brick and closed off the lower portion of the cremation chamber in such a way that the metal parts of the trolley were protected from the high temperature of the cremation chamber. It took 8 to 10 hours to warm up the furnace and some 2,000 kg of coke were needed for this phase; one cremation then consumed a further 200 to 300 kg of coke.

The Toisoul-Fradet Furnace (Document 18) was a device using a gasifier and having three levels: the gasifier (A) was in the basement, the recuperator (E) at ground level and the cremation chamber (G) on the floor above. Cremation took about one hour and coke consumption was 100 kg. This plant was inaugu-

rated in Paris on 5 August 1889. Its schema (Document 19) shows a large gasifier (A) with the loading funnel (C) and the opening for the stoker (D), the sloping hearth grille and an ash-extraction door (B). A long vertical shaft leads the fuel gas produced in the gasifier to the back of the cremation chamber (G), called the “laboratory,” but before entering it is ignited by two burners (F). The cremation chamber is closed at the front with Door (H). The coffin (M) was introduced by the Load Cart (K). Inside the cremation chamber the Coffin (M) is engulfed by the flames, and the combustion products descend through the Recuperator (E) into the Flue (I), while the outside air flows countercurrently, gets heated to a high temperature and exits into the Burner (F).

The furnaces considered so far operated on the basis of the principle of total direct combustion, *i.e.* the corpse was struck directly by the flames generated on a hearth (as in the Gorini Furnace) or by the burning products of a gasifier (as in the Venini Furnace). The system invented by Friedrich Siemens introduced the process of totally indirect combustion by means of clean hot air, which dominated in Germany unchallenged until 1924. This new process, as we have seen, rested on the principle that the cremation was effected by clean air heated to 1000°C in a regenerator or recuperator.

The prototype of the Siemens Furnace (Document 20) was used for the first time with animal carrion on 2 June 1874 in the presence of the Professors Fleck, Küchenmeister, Roth and other celebrities of the medical field. The inventor described it as follows (Küchenmeister 1875, pp. 69-71):

“The entire device consists of three separate parts:

- 1) a gasifier outside the building,*
- 2) the furnace proper with the regenerator and the cremation chamber inside the building,*
- 3) the chimney for the discharge of the combustion products. [...]*

The cremation process runs as follows:

The gasifier is operated in such a way that new fuel – hard coal, lignite, peat or wood – replacing the fuel consumed, is added through the filling device every few hours.

The gases formed are led through a channel (a) equipped with a control shutter into the regenerator where they meet with a controllable air stream (b) and turn into flames. The flames formed in this way traverse the regenerator chamber (R) and heat to white heat the bricks stacked up in it.

The residual heat contained in the flames still serves to preheat to red heat the furnace or the Chamber (K) destined to receive the corpse; the flames then disappear through channel (c) into the flue. As soon as the furnace has reached this state, the process of cremation can begin.

The Shutter (D) of the furnace is raised or pushed aside by the person assigned, and the body to be burned is introduced into the cremation chamber.

*After the furnace has been closed, the body is exposed to the effect of the red heat, losing its water content, *i.e.* drying out, over a certain period of time which depends upon its physical particulars.*

Once this part of the cremation is over – which usually takes about a quarter of an hour – the gas shutter is closed. As a result, now only air enters the cremation chamber through the regenerator. This air heats up in the regenerator to

almost white heat, and in this state strikes the preheated and largely desiccated body, provoking a rapid decomposition of all its combustible parts. The incombustible parts decompose under the effect of heat as in a chemical process: CO₂ escapes, and lime remains in the form of powder, falling through the grate (e) into the ash chamber (A), where it can be easily collected by means of a special device placed there, and then extracted through the port mounted at it. In this way, as has been explained above, the remaining ash can be handed to the family in an urn or other container for burial or other type of conservation.

The entire process lasts approximately one hour, with a consumption of 100 kg of lignite or 50 kg of hard coal, not counting the initial heating phase; this would also be the total fuel consumption, if the various cremation operations can be carried out in succession.

If that is not possible, a proportionately larger amount of fuel is consumed during the idle periods for warming up the furnace. [...]

Furthermore, there is also a gas conduit (f) through which the gas can enter the upper part (h) of the regenerator. The gas entering here serves to protect the Cremation Chamber (K) from excessive cooling in the case of a cremation taking longer, e.g. the cremation of an entire animal.”

With some modifications, this Siemens Furnace was installed in 1878 only at the Gotha Crematorium (Documents 21-23), but its performance did not come up to the expectations of its inventor. Actually, according to Heepke, a cremation in that furnace generally took two hours and a quarter; 1,500 kg of lignite were needed for a first cremation and 250 to 300 kg for each subsequent one.³¹

The Klingenstierna Furnace (Document 24) was a major improvement of the Siemens model. It had a Main Hearth (A) and a Secondary Hearth (H) which served mainly as an afterburner for the fumes; the combustion air was heated in a recuperator made of metal tubes (J). The corpse was introduced into the Cremation Chamber (F) by means of a Cart (O) which stayed in the chamber through the duration of the process.

In Germany this Swedish design was perfected by E. Dorovius and built by the Gebrüder Beck Co. of Offenbach. The first models, installed at Heidelberg in 1891 and at Jena in 1898, still had the trolley for the introduction of the coffin, but for the furnace set up at Offenbach in 1899 this detail was eliminated. The cremation chamber was given a grate made of refractory clay, below which two funnel-shaped inclined planes conducted the ashes into the ash receptacle.

The Mainz version of 1903 had a single inclined plane beneath the grate, as did all the later furnaces, but was still equipped with a recuperator having metal tubes (Heepke 1905b, pp. 45f.). This type of recuperator was subsequently replaced by one of refractory brickwork, and the furnace took on the typical shape of German cremation furnaces with coke-fed gasifiers (Document 25).

The furnace was arranged on two levels: The hearth and the recuperator were in the basement, the cremation chamber on the ground floor. The device operated in the following way: The hearth (*Feuerung*) had two doors, one for

³¹ Heepke 1905b, p. 20. This work contains a very detailed description of the Siemens, Klingenstierna and Schneider Furnaces with very-accurate technical drawings, pp. 41-58. For these furnaces, beyond Beutinger's study mentioned above, cf. also von Engerth 1892 & 1897; as an appendix in Ortloff 1907: "Das Verbrennungssystem Rich. Schneider, vorm. Dresden, jetzt Berlin," pp. 60-73.

loading the fuel, the other for removing the slag. The water container for cooling the slanting grate was at the bottom. The combustion gases, which formed in the gasifier, left through a vertical duct (*Feuerhals*) and mixed with the combustion air on entering the cremation chamber (*Verbrennungsraum*). The combustion air came from two lateral openings connected to a network of channels into which the air entered through a control device located in the upper part of the furnace, above the peephole (*Schau-Öffnung*). The gases produced by the cremation of the corpse passed through the ash chamber (*Aschenraum*), entered the lateral channels of the recuperator flowing downwards into the flue duct (*Fuchs*) and then left through the chimney (*Schornstein*).

The recuperator consisted of a refractory body with three channels (Document 26): the discharge gases traveled downwards through the two lateral ducts transferring part of their heat content to the brickwork, whereas the combustion air for the corpse traveled upwards through the central channel while heating up along the way. The combustion air entered the recuperator through an opening at the base of the furnace.

The remains of the corpse fell through the bars of the grate onto the inclined plane of the ash chamber (*Aschenraum*), from which it was removed by means of a rake into the collection bin (*Pfanne*), which was then taken out through the door of the ash chamber.

The first cremation required some 300 kg of coke including the preheating of the furnace, the subsequent ones 50 to 100 kg each. The duration of a cremation generally took one hour to one hour and a half.³²

This type, together with the Schneider Furnace that we shall look at presently, had all the essential features of the coke-fired cremation furnace with a gasifier from which all furnaces of this type built in Germany through the 1930s were derived.

The prototype of the Schneider Furnace (Document 27) was built for the Hamburg Crematorium in 1892. Its structure was very similar to that of the Klingenstierna-Beck Model. The most-significant innovations concerned the hearth, which had a horizontal grate and a primary combustion-air vent below it; the gasifier was placed vertically above the grate and had a coke-feeding chute in the upper part of the furnace. The combustion air for the gasifier entered through two controllable openings located on either side of the hearth door, flowed through appropriate channels in the gasifier wall, getting heated there and emerging from both sides into the neck of the gasifier. The combustion air for the corpse entered the channels of the recuperator through two controllable openings located in the base of the recuperator at the front of the furnace, passed through the recuperator, where it warmed up to 1,000°C and emerged from two lateral openings near the top of the gasifier neck into the cremation chamber, striking the corpse. The combustion products were led through the ash chamber, entered the channels of the recuperator through suita-

³² Beutinger 1911, pp. 107-110. This work devotes a chapter of considerable interest to the cremation furnaces, with detailed technical drawings (pp. 94-127). The information which follows has been taken from that source.

ble openings, flowed downwards through them while losing some of their heat and reached the chimney through the flue duct.

Preheating the furnace took about three and a half hours. Some 45 to 90 minutes were needed for one cremation, with a coke consumption of 250 to 300 kg for a single cremation and 50 to 100 kg for any succeeding ones.

The Ruppmann Furnace (Document 28) was described in detail in Chapter 2. Although this device, like all other German furnaces so far examined, had been conceived as an indirect hot-air furnace, it could also be operated for direct cremation. Actually, the cremation process depended not so much upon the structure of the furnace as upon its operation, which had to satisfy the local legal requirements. For a direct cremation, all that was needed was to have the combustion products from the gasifier arrive directly in the cremation chamber, as during the preheating phase. In that case, heating the recuperator to 1,000°C became superfluous, because the heat necessary for the cremation and for maintaining the thermal equilibrium of the furnace came from the gasifier; the heat consumption thus decreased correspondingly. The description of the Ruppmann Furnace given in Chapter 2 is based specifically on the direct cremation process.

The Swedish Knös Furnace (Documents 29 & 29a) brought along more improvements on the Klingenstierna-Beck Furnace. The passage of the gas from the gasifier was controlled by two valves (*a* and *b*). During the preheating phase, Valve *b* was closed, and Valve *a* was open. The gases entered into two channels which ended in the side walls of the inclined ash plane. The hot air channels for the air coming from the recuperator also opened into those channels, causing the combustion of the gases from the gasifier. The ensuing flames and combusted gases entered the ash chamber with its inclined plane, passed through the grate into the cremation chamber, flowed out into two ducts having their openings in the side walls at the far end of the chamber, traveled downwards through two vertical channels and then entered the recuperator; after having passed through it, they arrived in the flue duct and left through the chimney.

During the cremation, however, Valve *b* was open and Valve *a* closed. The gases from the gasifier flowed directly into the recuperator, mixing with the exhaust gases from the combustion of the corpse and burning up any uncombusted gases. The combustion air for the corpse entered the recuperator through two lateral openings at the base of the furnace, passed through it in an upward direction, entered the two channels mentioned previously and flowed out into the ash chamber with its inclined plane, striking the corpse from below. The products of the combustion of the corpse followed the path already described.

Coke consumption was about 300 kg for the preheating phase and the first cremation, and 50 to 90 kg for any subsequent ones. The rights to this furnace for Germany belonged to the Gebrüder Beck Co. of Offenbach.

The Fichet Furnace was inaugurated at the crematorium of Paris on 19 January 1891 (Document 30). The combustion gases of the large gas generator located in the basement (with its feed chute at ground level) flowed up a vertical shaft and entered from a lateral opening into the cremation chamber located on the first upper floor, then through two openings in the ceiling of the cremation chamber, next to the corpse-introduction door, into two channels, which ran first

above and then behind the cremation chamber and entered the long recuperator, heating up its channels, and flowed from there into the flue and the chimney. Through a channel that ran beneath the gasifier, the combustion air entering the regenerator was warmed up along the channels and entered the cremation chamber at high temperature from an opening on its left side. The combustion products left through another opening on the right side and followed the path of the gasifier's combustion gasses.

The Swiss Bourry Furnace was equipped with a lateral gasifier and with a recuperator beneath the cremation chamber sporting a closed floor to accommodate the corpse. It took 8 to 9 hours to heat the furnace, and a cremation lasted two hours and a half to three hours, with a consumption of 1,250 kg of coke.

The furnace by Simon & Bourry installed in the crematorium at Manchester was characterized by the fact that the combustion gases of the gasifier with a stepped hearth entered the cremation chamber from the bottom. By getting mixed with the combustion air preheated in the recuperator, it produced a flame that enveloped both sides of the chamber floor and the coffin on it. The exhaust gases left through two openings in the ceiling of the cremation chamber. Introducing preheated combustion air beneath the chamber's ceiling guaranteed the complete combustion of the fumes. The exhaust fumes then left through two vertical channels located on both sides of the furnace, flowed through the recuperator and from there into the chimney. The chamber floor had slits through which the corpse remnants fell into a post-combustion chamber below, from which their ashes were extracted. The duration of the cremation ranged from one hour to one hour and twenty minutes, and the coke consumption was 1,000 kg for the first cremation and 100 to 150 kg for subsequent cremations.

The American cremation furnaces had several heating systems. The furnace in Boston was equipped with oil burners of the Ames Oil Burner Company, North Easton, Massachusetts. Three burners were located in the cremation chamber and a fourth at the base of the chimney to initiate a draft and for post-combusting the flue gasses. A 6-hp steam engine drove a blower and an oil pump. The cremation lasted on average an hour to an hour and a half.

The furnace by Engle Sanitary & Cremation Co., Ltd. of Des Moines, Iowa, also worked with oil and consumed 1.5 to 2 barrels of fuel for one cremation. The crematorium in Pittsburgh used natural gas, which burned in separate special combustion chambers placed beneath and behind the cremation chamber. The combustion products entered the cremation chamber through a grille-like wall and left through openings in its side walls. The cremation lasted an hour and a quarter, with a consumption of 300 to 425 cubic meters of gas.

In the Davies Furnace installed in crematories at Lancaster, Philadelphia, Baltimore and Davenport, an anthracite hearth heated the cremation chamber directly, and the combustion products went through the hearth before leaving through the chimney.³³

³³ Freygang 1908. Hugo Erichsen (1887) reproduced the drawings of several American crematoria. The most-important ones are those relating to the facilities in Washington, D.C. (p. 41: crematorium exterior; p. 48: furnace), Lancaster (p. 109: furnace layout; p. 239: frontal view with introduction carriage), Buffalo (p. 116: furnace with Venini System) and Cincinnati (p. 123: furnace similar to the

Toisoul and Fradet improved the process employing city gas already put to use in the Polli-Clericetti Furnace in 1876. Their furnace (Document 31) had gas burners instead of the gasifier, but also operated according to the clean-hot-air principle. The air was provided by a recuperator made of metal tubes instead of refractory brick. A furnace of this type was set up at the Dessau Crematorium in 1910. The operating temperature of 1,000°C was reached after two and a half to three hours of preheating. Consumption was 215 m³ of gas for each cremation.

The first European experiments with naphtha-fired furnaces were run at the Jena Crematorium in 1913 (Phoenix 1913), but such a heating system was not really introduced until the 1920s.

Document 32 shows the vertical, longitudinal and transverse sections of the naphtha-fired cremation furnace conceived by Rothenbach & Co. of Bern (Swiss Patent 86533). The later naphtha-fired furnaces were derived from this very-modern design. The description of the device is as follows (Georgius 1923, p. 56):

“The upper part of the furnace consists of a cremation chamber 1 separated by a grate of refractory clay 2 from the ash space 3. The latter has an inclined plane and an opening 4 for the removal of the ash. Two burners 5 emerge from the side walls of the cremation chamber. The cremation chamber has a double vault whose hollow space acts as preheater for the compressed air fed to the burners. In the lower part of the furnace is the recuperator 10 in which the air is heated along a serpentine line. Above the air preheater is a hot-air-collection space 11 to which suitably controllable air channels 12 are connected at the top, which emerge laterally into the cremation chamber 1. The air is controlled and fed to the recuperator via shaft 13. A second set of burners, consisting of at least one burner 15, is connected to the air preheater.

When the furnace is used, initially the two upper burners 5 are used. The naphtha fed to the burners is injected at a pressure of 300 mm [of water column]. After having been vaporized, the mist mixes with the preheated air coming from the two air channels 12. The burning gases then enter the cremation chamber 1, where complete combustion takes place on account of the mixing with the combustion air coming from the channels 12. Through channels 20, the combusted gases from the burners 5 reach the ducts 10 of the air preheater and preheat the air.

In this way, the walls of the cremation chamber 1 heat up to a high temperature, whereas the very hot combusted gases are used to heat the space of the air preheater. When the furnace reaches the required temperature and the air coming from the preheater has a temperature of 800°C, the cremation of the corpse can begin. The upper burners 5 are shut off, and the lower burner 15 is started up in this phase of the activity of the furnace to prevent as much as possible any cooling of the furnace during the cremation. The cold air entering shaft 13 through the now open disc valve spreads into the air channels 10' and, rising counter-currently in natural convection because of its increasing temperature, reaches

the hot-air-collection space 11 from where it flows through the channels 12 into the cremation chamber.”

Electricity as a heat source was introduced only in the 1930s. The experimental furnace shown in Document 33 was realized at the beginning of the 20th century as a small-scale model by the Frankfurt Prometheus Co. and was used merely for experimental incinerations involving a few kilograms of animal flesh.

Document 34 shows vertical, longitudinal and transversal sections of the electrically heated Conley experimental cremation furnace (U.S. Patent 988862 of 4 April 1911). The very-elaborate device was characterized by three fundamental elements: a muffle enclosed by a triple wall with insulating air spaces. This triple wall was penetrated by eight sets of three carbon electrodes each, converging towards the center of the muffle. They could be retracted and controlled individually by means of cams and cogwheels. Discharge of the combustion gas took place at the top, directly into the chimney (*ibid.*, p. 57).

The early 20th Century was a period of intense activity in the development of new cremation furnaces, as witnessed by a series of patents I have been able to identify.

Figures 1, 2 and 3 of Document 35 illustrate a patent dated 19 December 1912 concerning a “Cremation furnace with gasifier connected to the combustion chamber at the front and a regenerator” This patent, granted to Wilhelm Sauerland of Dresden, is interesting in particular because it clearly shows the functioning of a regenerator. The description of the furnace and of the cremation process is as follows (Kaiserliches... 1915):

“The gasifier (a) is directly linked, in the upper part of its front side, with the cremation chamber (e) by means of the burner (d) which becomes smaller in its front section and is fed with heated secondary air at (b) and (c) in the cladding of the gasifier. The combustion chamber (e) has a perforated floor, below which is the ash chamber (f) with its opening (t), whereas the regenerator (g), built in the usual way, is located beneath the ash chamber. Some slits or apertures (h) in both sidewalls of the combustion chamber are linked with the channels (i) arranged vertically in the lateral brickwork and with the regenerator (g). The ash chamber (f) is also linked with the latter through slits or openings (j). From the ash chamber (f) several discharge channels (k) lead to the discharge channels (l) located under the floor; these open into the chimney duct (m) and can be closed by means of valves (n). Underneath the regenerator (g) is the discharge channel (o) which, when valve (p) is opened, can be connected to the chimney duct, and, when aperture (q) is opened, can be connected to the atmosphere. To start up the furnace, valve (p) is opened and valves (n) are closed. Then gas is produced in the gasifier in the usual way and is burned with the warm air entering at (b) and (c). The flame thus produced thins down in burner (d) and darts as a clean bright flame into the combustion chamber (e). From here the combusted gases pass partly through the slits (h) and partly through the perforated floor into ash chamber (f) and along its slits (j) into the channels (i) of the regenerator (g), flowing from top to bottom through its content, and then travel through the discharge duct (o) into the chimney duct (m). When the combusted gases have given up a sufficient portion of their heat content to the walls they strike and to the packing of the regenerator causing them to glow, valve (p) is

closed. By closing the door of the ash chamber of the gasifier, gas production is stopped. Any gas still present continues to burn in burner (d). By slightly opening valves (n), these combusted gases are channeled through the draft channels (k) of the ash chamber into the draft channels (l) under the floor and into the chimney duct (m). Now the corpse to be cremated is introduced into the combustion chamber (e), valves (n) are closed almost completely and the inlet air vent (q) is opened. The air entering here rises towards the channel (o) through regenerator (g) filled with the glowing bricks, enters the channels (i) and leaves at high temperature into the ash chamber (f) through the slits (j). The combustion of the corpse or rather of the coffin begins immediately, because from both sides several jets of heated air strike it over its total length, and from above, from burner (d), air heated to a high temperature is ejected. The combusted gases flow down into the ash chamber (f) where they are burned to the greatest extent possible by the high-temperature air entering through slits (j); they travel through the discharge channels (k) into the discharge channels (l) of the ash chamber and into the chimney duct (m).

After the complete combustion of the corpse, the inlet air vent (q) is closed and the ash is taken out through damper (t). Then the door of the ash chamber of the gasifier and valve (p) are opened, whereas valves (n) are closed, and the furnace is ready for the subsequent cremation."

As I have already explained, the regenerator cools down during the cremation, transferring to the combustion air the heat stored during the heating phase. It must thus be heated again before a subsequent cremation. Hence it was not possible to carry out continual cremations. To remove this inconvenience, Friedrich Siemens patented a furnace on 18 August 1911 with two regenerators (Figures 1, 2 and 3 of Document 36; Kaiserliches... 1913b), whose operation can be summarized in the following way:

During the warm-up phase of the cremation chamber *a* and the regenerator *b*, the air enters through inlet *c*, travels through channel *d* and through another channel – not shown – behind channel *d* and behind the lower part of regenerator *b* into regenerator *e* from bottom to top. It leaves in the upper part through the two channels *f*. There it meets the gas coming through the openings *g* from the gasifier *h* via channels *i* and valve *k*, which is open in this phase, and flows through channels *l*. The flame which forms travels through the cremation chamber *a*, leaves through aperture *m* and arrives in channel *n*. Because the valve *o* of the gasifier is closed in this phase, the combusted gases enter regenerator *b* through channel *n* heating it up to a high temperature and leave through channel *d* into the discharge duct *p*.

When vent *c* is opened, the air enters channel *d*, heats up in the regenerator *b*, leaves through channel *n* and reaches channel *m* together with the combustion gases arriving in channel *m* through channel *q*, because valve *k* is now closed and valve *o* is open. The developing flame travels through the cremation chamber *a* and flows via the two channels *f* into the regenerator *e* and the chimney duct *p*.

When the cremation chamber and the two regenerators, having gone through this cycle several times, have become sufficiently hot, the cremation can begin.

The air entering through inlet *c* heats up in regenerator *e*, rises and arrives in the cremation chamber *a* via channels *f*. In this phase, valve *k* is closed to prevent the gas from entering through opening *g*. Leaving the cremation chamber *a*, the hot air takes along the gases which form during the cremation of the corpse. These gases mix in channel *m*, and a flame develops, heating regenerator *b*. The combusted gases leave from the lower part of the regenerator and travel along channel *d* into the discharge channel *p*.

When the heat of the regenerator *e* has been used in this way, the air flow is inverted; it now travels through opening *c* into channel *d*, passes through the regenerator *b* and enters the cremation chamber through channels *n* and *m*. On leaving it through openings *f* it mixes with the gas arriving at opening *f* from the gasifier through valve *k* and channels *l* and *g*. The flame which forms heats up regenerator *e*. From there the exhaust gases flow to the chimney through the chimney duct *p*. In this way, one of the regenerators is always hot and the furnace can handle one cremation after another without interruption.

The patent of Max J. Kergel of Beuthen (Upper Silesia) presents a more-modern furnace concept (Figures 1-3 of Documents 37, 37a), although it is a few years older (4 October 1908). His furnace, in fact, has a recuperator instead of the one or two regenerators and an ingenious heating system from the outside for the muffle. These ideas will be picked up and improved on in later years. This is the description of the device (Kaiserliches... 1910):

“The invention consists in the fact that around the cremation chamber (a) there are heating chambers (b) and, above them, channels or air chambers (c). The latter are directly linked to the cremation chamber such that the air that has been heated to a high temperature in chambers (c) on account of a combustion of gas in the heating chambers (b) flows continuously through the cremation chamber (a).

Under the cremation chamber is the recuperator consisting of heating channels (e) and air channels (f). The air channels (f) are linked to the air channels (c) which surround the cremation chamber. The combustion gas is fed through channel (g) whence the gas reaches the channels (h) and (h¹).

The operation of the furnace is as follows:

First of all, gas is fed to the cremation chamber (a) through the central channel (h) and at the same time air from channels (c) is brought in as well. The combusted gases of this mixture arrive through the grate on the inclined plane (d) for the ashes and leave via channel (i) for the heating channels (e). When the cremation chamber is sufficiently hot, the central channel (h) is closed and the two side channels (h¹) are opened. Now the combustion of the gases takes place in the heating chambers (b), because they ignite on the hot walls. In this way, there is simultaneous heating of the outside wall of the cremation chamber (a) and of the air flowing through channels (c). The combusted gases from the heating chamber (b) reach the air-feed channels (f) in such a way that the air which is to be fed to channels (c) is preheated.”

The patent of “Bunzlauer Werke Lengensdorff & Comp.” of Bunzlau (Silesia) dated 6 July 1911 (Documents 38, 38a-c) concerned a new distribution system for both the discharge gas and the combustion air for the gases of the gasifier

and the corpse. This air was fed through the gaps of the refractory grate. The claims of the patent are the following (Kaiserliches... 1913c):

“1. A process for the cremation of corpses with combustible gases and air pre-heated by a heat source characterized by the fact that the heated air is partitioned and the amount of air needed for the combustion of the carbon monoxide is brought to the combustion chamber of the gasifier, and the air which mainly serves for the cremation is brought directly to the cremation chamber.

2. A system for the realization of the process characterized by the fact that the discharge gases are partitioned and taken, for the recovery of their heat content, to separate recuperators that can be connected one to the other by means of a control device.

3. A furnace for the process according to Claims 1 and 2 characterized by the fact that for the combusted gases discharge channels are provided, one feeding into the cremation chamber and another into the ash chamber.

4. A device for the realization of the process according to Claims 1 and 2 characterized by the fact that the hot air is fed into the cremation chamber through the refractory grate toward the coffin.”

The system of feeding the combustion air through the bars of the grate was further developed in a subsequent patent (9 September 1933) taken over by the J.A. Topf & Söhne Company of Erfurt on 27 November 1937 (see Unit II, Chapter 3).

The patent of a “cremation furnace for corpses with naphtha combustion” of the Körting brothers at Linden (30 June 1911; Kaiserliches... 1913a) does not concern the substitution of a naphtha burner for the gasifier – obviously already protected – but a post-combustion system for the fumes based on the suction produced by the flame of the burner. Figure 1 (Document 39) shows a typical realization of the system, which resembles a pilot hearth for the chimney. The gases burned in Burner *h* diffuse into the post-combustion Chamber *b* and enter via Apertures *c* into the Cremation Chamber *a*. The gases resulting from the combustion of the corpse are drawn up by the draft due to the Auxiliary Burner *i* through Channel *d* and enter into the Combustion Chamber *e* where they mix with the gases from the burner and burn to completion; they then leave through the Discharge Channels *f*, *g*.

In Figure 2 the gases stemming from the combustion of the corpse are drawn in directly by the main burner, enter into the Combustion Chamber *b* and pass into the cremation chamber, where they burn completely due to the combustion air for the corpse.

The “Cremation furnace for corpses using naphtha or gas heating with a collection vessel for the ashes beneath the cremation chamber having slanted walls” was patented by Wilhelm Buess on 22 August 1913 (Kaiserliches... 1914). The furnace (Documents 40 and 40a) consists of a cremation chamber closed by Valve *a* and having as a floor Grate *b* below which there are two inclined Planes *c* which end in Funnel *d*. Beneath Funnel *d* is a cylindrical Shaft *e* with a Bottom *f* which can be moved up and down, in which there is the Crucible *g* which is directly connected to the funnel. Between the crucible and the bottom there is the Support *h* which acts as a distributor for the flame coming

out of Nozzle *i*. The bottom of the crucible is perforated; above the hole there is a Lid *k* with a channeled rim. Beneath the hole of the crucible, within the Support *h*, there is a vertical Duct *h'* with a Run-off Channel *f'*.

The operation of the device is as follows:

The flame projected from Nozzle *i* is distributed by Support *h*; the combustion gases leave along Channel *l* and enter the cremation chamber through the Openings *m*, striking the coffin and the corpse from behind. The combustion products pass through the grate downwards and enter Slits *n* located in the walls opposite the two inclined planes. These slits are connected to two Channels *o* which envelop the cremation chamber completely from both sides and lead into the Chimney *p*. The ash of the corpse falls through the Grate *b* onto the two inclined Planes *c* below, from which they slide via the Funnel *d* into the Crucible *g*. If a zinc coffin is used, the molten metal flows into the crucible and enters the vertical Duct *h'* via the channels on Lid *k*; it can be retrieved at the outlet of the Run-off Channel *f'*.

The ashes of the corpse float on the molten metal and settle on the bottom of the crucible when the metal has flowed out completely. Any uncombusted parts will burn completely in the crucible which is heated directly by the flame coming out of the Nozzle *i*.

At the end of the cremation, Bottom *f* of the cylindrical Shaft *e* is lowered; the Crucible *g* with the ashes of the corpse can be removed and another crucible put in its place. The bottom is then raised, and the furnace is ready for another cremation.

According to the inventor, this furnace could be used as a mobile device in times of war or epidemics.

The electric furnace for the cremation of corpses invented by the American Lawson Henry Giddings (Document 41) was patented in Germany on 11 April 1911 (Kaiserliches... 1912). It was a device in which the electrical heating elements, besides heating the walls of the furnace, heated also the combustion air for the corpse. The cremation process was completely indirect.

In the upper part of the furnace, combustion air enters via the Aperture 3, which could be regulated by means of Valve 7. This opening is connected to the Air Channels 4, which cover the Cremation Chamber 2 above, on the sides and in the rear. The floor and the side walls of the cremation chamber are provided with longitudinal Air Channels 11 and 16 – connected to a transverse Channel 10, which in turn is connected to the Air Channels 4 – in which the electrical heating elements are located. The Air Channels 10 and 11 are closed above by means of a cover 8 made of refractory material, which extends almost to the Door 6 of the cremation chamber. The lateral Ribs 13 and the curled-up Edges 14 retain the ashes and the molten metal parts of the coffin. The Cremation Chamber 2 is connected to the Chimney 15 via Opening 17.

To carry out a cremation, the coffin is moved into the cremation chamber through the chamber door. Then Valve 7 is opened and Switch 18 is thrown, allowing current to flow to the electrical heating elements. The combustion air enters the Air Channels 4 through Opening 3, moves on to Channel 10 and then into the Channels 11, where the glowing electrical elements are located. The air

then enters the cremation chamber at a high temperature through the slit located in front of the chamber door and strikes the coffin with the corpse. The combustion products enter into Opening 17 situated in the rear portion of the cremation chamber and from there into the chimney. This process was never used in Germany.

In the United States, cremation technology developed independently of European technology, at least in the beginning. In 1887 Hugo Erichsen reproduced some drawings of this technology (Erichsen 1887, S. 41).

The Washington Crematorium was a very austere building, almost stark, and inside there was a cremation furnace that resembled the future H. Kori furnace, but of much cruder workmanship (*ibid.*, p. 48).

The Lancaster Crematorium operated on the basis of the completely indirect system, that is, the corpse was placed in a muffle (retort) around which, through two special ducts, flowed the products of combustion of a hearth that was located below the muffle (*ibid.*, p. 109).

4. Cremation Experiments in Germany in the 1920s

After the end of the First World War, the shortages of coal due to Germany's loss of major coal-producing territories and the forced exportation of coal to the victorious powers imposed by the Treaty of Versailles made it imperative for Germany to use its remaining coal resources with great economy. For that reason, in the years following the war, German industry strove to optimize all of its installations consuming coal or coal derivatives in an effort to obtain the greatest possible efficiency.

This need for scrupulous heat management affected also the cremation furnaces. This had become inevitable, because the Prussian Law of 14 September 1911 permitted only cremation systems using clean air (completely indirect processes), such as those invented by Friedrich Siemens, in which the corpse was consumed by air heated to 1,000°C in a recuperator without having contact with the gases produced in the gasifier. The "Directive for the application of the law concerning cremation of 14 September 1911" issued by the Prussian Ministry of the Interior on 29 September 1911, in fact, stated in this respect (Lohmann 1912, pp. 54f.):

"Cremation must not take place by direct contact with the fuel, but only in special cremation chambers separated from the hearth. The combustion products of the hearth must not enter into the cremation chamber directly during the cremation and must not heat it indirectly. The cremation must instead be executed in the cremation chamber heated to the proper temperature by sufficient combustion air preheated to high temperature."

This system of cremation was not only enormously expensive, it did not even guarantee a thorough result. Its justification was an "esthetic" one, *i.e.* the association of the Prussian societies for cremation considered it to be improper that

the corpse be touched by the flames and by the spent gases coming from the gasifier – that was barbaric, a return to the pyres of old.

At a time when the cremation movement was still contending with opposition, these considerations also contained a certain element of public relations which aimed for a description of the process of cremation as being the most-agreeable – or the least disagreeable – possible and which went as far as giving a false description of what was really happening: it was asserted, in fact, that in the case of a completely indirect process the corpse in the muffle did not actually burn, but was gradually consumed by the hot air which struck it.

By 1924 German engineer Hans Kori had three decades of experience in the design and construction of incinerators for slaughterhouses which used a totally direct process, *i.e.* the combustion products from the hearth struck directly the animal carcasses to be incinerated. This afforded a significant reduction in fuel requirements compared to the indirect process.

In February of that year Kori approached the police authorities of Berlin-Schöneberg with a proposal for the revision of the law of 14 September 1911. Hans Kori stressed the inconsistency in the claim of a flameless consumption of the corpse by pointing out that the body was normally introduced into the furnace enclosed by a coffin which obviously burned and thus generated flames, and by stating that the corpse itself, after desiccation, burned generating its own flames. Finally, in the case of a completely indirect process, a strong temperature drop occurred during the evaporation of the water contained in the corpse which could only be counteracted by feeding into the muffle the combustion products from the gasifier. Hence, Kori proposed acceptance of the direct cremation process as legal.

The Berlin police authorities turned to the Ministry of the Interior, which was so interested in the matter that on 19 July 1924 Kori submitted to it a detailed presentation of his proposal (Kori 1924).

The question was examined by the Berlin study group for energy conservation (*Arbeitsgemeinschaft für Brennstoffersparnis*), which drew up an opinion accepting Kori's proposal and ending with the following recommendation (*Arbeitsgemeinschaft...* 1924):

“For reasons of heat technology and in the interest of fuel savings it is recommended to modify the legal requirements of 14 September 1911 for the construction and operation of crematoria in the sense that, as a rule, the addition to the hot air of combusted gases without fly ash is accepted.”

This recommendation was taken up by the Prussian Ministry of the Interior which issued the following decree on 24 October 1924 (“Amtliches...” 1925):

*“In the directive of 29 September 1911 concerning the application of the Prussian Law on cremations dated 14 September 1911, (Statutes p. 193) in Section II, Number 3, Paragraph 7b etc. it is stated that cremation must not occur under the direct effect of fuel, but only in special cremation chambers separated from the hearth. By a regional state legal authority we have been made aware of the fact that it is often insufficient to conduct a cremation under total exclusion of combusted gases, *i.e.* when several corpses must be incinerated in the same device in succession. The reports that, in consequence, have been requested by the*

regional state police have been submitted to the Berlin study group for energy conservation for an opinion. I have the honor to attach a copy of this opinion for kind consideration. We have therefore no objection to rule against a temporary influx of gasifier gases into the corpse chamber. For the moment we desist from a modification of the application dispositions."

On 9 October 1925 the Association of Prussian Societies for Cremation objected to this decree which accepted a mixed or semi-direct cremation process. The objection was examined by the Berlin Study Group for Fuel Economy, which rejected it in another opinion (22 December 1925) restating the reasoning already laid out in the previous opinion and arguing that such a cremation process had been used in Prussia, in practice, for quite some time, and it was now only a matter of legalizing the state of things (Arbeitsgemeinschaft... 1926a).

But previously, on 29 December 1924, an objection against the decree of the Prussian Ministry of the Interior had already been filed by the firm J.A. Topf & Söhne of Erfurt. I shall address this matter in more detail in Unit II of this study. Here I will say only that the Berlin Study Group for Fuel Economy rejected also this objection, but with one concession: it proposed to substitute the term "*Generatorgase*" (gasifier gases) in the Decree of 24 October 1924 by the expression "*flugaschefreie Verbrennungsgase*" (combustion gases free of fly ash). In the eyes of the proponents of a completely indirect combustion, this concession was not acceptable in a compromise formula inasmuch as it specified that the combustible gases produced in the gasifier should burn completely in the gasifier itself in such a way that the corpse would not be struck by the flames but by spent high-temperature gases free of fly ash in order to prevent an esthetically objectionable contact of these ashes with the corpse (Arbeitsgemeinschaft... 1926c).

The proposal was accepted by the Prussian Ministry of the Interior, which, with its Decree of 4 December 1926, modified the Decree of 24 October 1924 in the sense that the word "*Generatorgase*" was substituted by the expression "*flugaschefreie Verbrennungsgase*" ("*Amtliches...*" 1927).

However, Dr. Mühling, president of the Association of German-Speaking Societies for Cremation, was dissatisfied with the modification and asked for a meeting to be convened with the representatives of the Berlin Study Group for Fuel Economy, which took place on 5 March 1927 and which confirmed the validity of the cremation process accepted by the Decree of 24 October 1924 and its subsequent modification, all the more so as it was valid only in Prussia and did not rule out the completely indirect process, but simply accepted also the semi-direct process (Arbeitsgemeinschaft... 1927).

The controversy did not stop, being fed also by the builders of cremation furnaces, who felt that their completely indirect furnace models were threatened by the new cremation system, which would inevitably lead – as in fact it did – to major technological changes. Thus, while one of the more prominent members of the Berlin Study Group for Fuel Economy, Chief Engineer Tilly, dedicated himself to the demonstration that the direct cremation system was economically more advantageous, Chief Engineer A. Peters, general agent of the Gebrüder Beck Co. of Offenbach and of Schamottefabrik of Stettin, formerly Didier, attempted to refute the calculations of the other side, going so far as to

assert that the Beck Furnaces in the crematorium at Berlin-Treptow had required approximately the same quantity of fuel for the cremation of 20 corpses in succession as the amount used by Tilly for the cremation of an equal number of corpses with the direct process (Peters/Tilly 1926; cf. Chapter 7).

The general question of the economy of cremation furnaces could only be resolved by scientific cremation experiments.

The most-important experiments of that period were run in the Dessau Crematorium in 1926 and 1927 by German engineer Richard Kessler who wrote a long scientific paper about them (Kessler 1927).

At that time this crematorium was equipped with two cremation furnaces, one based on the Toisul-Fradet System using city gas, built in 1910, and another, more-modern one built in 1923 and based on the Gebrüder Beck System using either gas or coke. Kessler was given the task of executing scientific cremation experiments in this furnace to determine the most-economical heating system. The fuels used for the experiments were city gas, coke and briquettes.

During the preliminary tests, Kessler noted the various factors having a negative effect on the heat economy of the furnace. He determined experimentally that an excess of air – signifying heat loss and hence fuel consumption – was partly due to leakage air entering the furnace through cracks and openings that did not shut properly. Concerning the first point, Kessler wrote (*ibid.*, No. 8, p. 136):

“We have ascertained experimentally that the cracks in the brickwork which form to a greater or lesser extent in the cremation furnaces themselves because of the continuous stress to which they are exposed, allow a certain quantity of air, more precisely of cold air, to enter the cremation chamber during the final phase of the cremation; this amount of air is far greater than what is needed at this stage for the combustion of the remnants of the corpse. The consequence of this is, of course, a deleterious cooling of the furnace (heat loss).”

At that time this impairment was almost unavoidable. Kessler himself states that “it is technically impossible to execute the brickwork of a combustion device in a way such as to prevent leakage of air entirely” (*ibid.*). To limit the leakage of air through the openings of the furnace (muffle door, air vents, smoke vane etc.), he designed a special hermetic closure shown in Documents 42 and 43 (Figures 1-6).

Kessler held the following instruments to be absolutely necessary:

1. An electric pyrometer to measure and record the temperature of the muffle.
2. One or more pressure gauges to measure the draft in the chimney from time to time.
3. Measuring devices for CO and CO₂ to maintain proper combustion and to check the development of smoke.
4. Several thermometers to determine the temperature in the lower part of the furnace and in the flue duct, and in particular the temperature of the combustion air.
5. A manometer in case of operation with gas.

It turned out that the possibility to monitor the temperature profile of the muffle over time by means of an electric pyrometer was of great importance. In that way the attendant could, at any moment, take the measures necessary for an optimum control of the cremation process. The experiments showed that the optimum temperature for the introduction of the corpse was 850 to 900°C.

Another major factor adversely affecting heat economy was improper operation of the furnace due to insufficient training of the operator(s). After having eliminated the problems that had been identified in the initial tests, Kessler was able to carry out the fundamental cremation experiments as such.

These experiments entailed the cremation of eight corpses in succession, the furnace being heated by three different types of fuel – coke, briquettes and city gas. Kessler published the technical charts for the three crucial experiments as well as other data concerning the furnace, as they are reproduced below.

In the following paragraphs I have summarized Kessler's long account as briefly as possible, directing attention in particular to the experiments with coke and briquettes. For a detailed description of the furnace's structure and arrangement of measuring points see Document 46.

Cremation Experiment with Coke (5 January 1927)

Operation of the Furnace

Document 47 shows a detailed chart with various parameters measured during the operation of the furnace. For details see there.

Preheating (7:18 – 9:30 a.m.)

The coke loaded into the gasifier prior to the start of the preheating was about 5.2 *Zentner* (A) or 260 kg. The door of the Ash Chamber (M) stayed open for about 90 minutes with a section of 190 mm. The air vents to the Hearth (F) and to the Gasifier (G) were closed. The main damper of the Flue Duct (H/K) was open with a vertical section of about 380 mm. The draft of the Hearth (D) rose to 5 mm water column once the combustion was well under way, and stayed constant with slight variations at around 5-7 mm water column; that of the flue duct rose to 10 mm water column, and then fluctuated between 10 and 12 mm water column. Then, a little before 9 a.m., the door of the Ash Chamber (M) was closed completely, and the air vent to the Hearth (F) was opened (200 mm), as was, somewhat less, that of the Gasifier (G). Now the gasifier produced CO, which burned to CO₂ before entering the muffle. The main damper of the flue duct was lowered to 150 to 180 mm. The draft of the hearth held at 5 to 7 mm water column; that of the flue duct at 10 mm water column.

Cremations (9:30 a.m. to 9 p.m.)

The first cremation began at 9:30 a.m. As soon as the coffin was introduced, there was formation of dark smoke for about 4 minutes, then of light smoke for about 2 minutes (E). The furnace was switched to smoke combustion and stayed that way until 9:44 when the threat of smoke was over.

The air vent of the Gasifier (G) was opened for about 4 minutes to a vertical section of over 200 mm – because when the furnace was switched to smoke combustion, this air carried the smoke back to the gasifier where it burned completely – and was then closed once again. During smoke combustion, the air Vent for the Primary Air (L) was held open for the same time and with the same open cross-section, but its cross-section was then reduced again to 20 to 25 mm; the air vent of the air to the Hearth (F) was reduced to about 140 mm.

At the beginning of the cremation, the main damper of the Flue Duct for normal combustion (H; No. 16 in Doc. 46) was closed completely and the main Damper for Smoke Combustion (K; No. 15 in Doc. 46) was opened, staying in that position for the whole duration of the smoke combustion, *i.e.* until 9:44 a.m. Then this damper was closed completely and the other reopened, staying open with decreasing cross-section until the end of the cremation.

The remaining seven cremations were handled in the same way. The main aspects are the following:

In the course of the second cremation, another 2.9 *Zentner* of coke (145 kg) were fed to the gasifier, and a further 1.04 *Zentner* (52 kg) during the sixth, for a total of 9.14 *Zentner* (457 kg) of which, as we have seen, 0.42 *Zentner* remained unconsumed, so that the total effective consumption amounts to 436 kg. During the loading, the door of the ash chamber normally stayed open to allow the coke to become incandescent. At the start of each cremation, there was a more-or-less-pronounced development of smoke stemming from the burning of the coffin. It lasted between 4 and 18 minutes. During the seventh cremation, the furnace smoked also in a more-advanced phase of the combustion. The air vent of the Hearth (F) was kept open only intermittently, with a larger section during the coke-feeding operation. The vent of the Gasifier (G) was opened wide only when there was generation of smoke, for the reason explained above.

The main damper of the Flue Duct (H) was kept open with a small section (100 to 120 mm) during normal combustion, while during smoke combustion it was closed, and the Damper for smoke combustion (K) was opened wide (400 mm). The air Vent of primary air for smoke combustion (L; No. 21 in Doc. 46) was opened wide to 300 mm during the smoke-combustion phase, while the Vent for primary air for normal combustion (I; No. 20 in Doc. 46) stayed closed during this phase, or was opened only exceptionally and to a very small degree.

The main Dampers (H, K) which controlled the velocity of the discharge gases acted directly on the Draft of the hearth (D) which went up in proportion to the increase in the open cross-sectional area of these dampers. The rise in the draft on the hearth was even higher during smoke combustion, because then the corresponding Damper (K) was opened wide. An increase in the cross-section of the two dampers – which operate in tandem – caused in fact an increase in the speed of the discharge gases in the flue duct and, therefore, a lower pressure in the furnace and in the hearth with a greater suction of air through the door of the ash chamber and the air vent of the hearth, even if closed, such as was the case during the sixth cremation. Hence, a more-active combustion ensued. This suction was due to the fact that the doors and vents in question did not seal hermetically.

The Temperature Curves

Document 48 shows detailed charts of the temperature curves as measured throughout the cremation by various detectors throughout the furnace. For details see there.

Preheating

At the beginning of the preheating operation, the muffle had a temperature of about 100°C. It then rose steadily up to about 785°C (9:30 a.m.), when the first corpse was introduced. The temperature of the discharge gas in the lateral upper right-hand channel rose to 600°C, then dropped to 460°C and at 9:30 rose again to 500°C due to the positions of the ash chamber door, the hearth's air vent, the gasifier's air vent and the main damper (cf. preceding chart). The combustion air in the upper left-hand Channel (D) hardly exceeded 50°C. The air entering the Gasifier (F) remained at around 100°C. The temperature of the discharge gas in the Flue Duct (G) rose to 250°C and then varied between 230 and 240°C. In the basement where the lower part of the furnace was located, the temperature hardly exceeded 20°C, while the temperature was a little higher on the ground floor with the upper part of the furnace (muffle). The outside temperature was around 1°C.

During the preheating phase the CO₂ content was about 11% (Excess-Air ratio: $20.5 \div 11 = 1.86$).

Cremations

The temperature curve of the Muffle (A) allows the cremation of the corpse to be followed through all its phases. Although no two cremations were identical, the cremation process ran in the same way and may be summarized essentially as follows:

The coffin caught fire even as it was loaded into the muffle; it burned completely, or nearly so, within 15 to 20 minutes. The heat generated by its combustion led to a rapid rise in the temperature by about 200 to 300°C, and the highest temperature (up to 1,100°C) was reached in this phase. Because initially the combustion air was insufficient, smoke formed to a greater or lesser degree, which stopped when the furnace was switched into the smoke-combustion mode: the Main Damper (H) was closed and the smoke-combustion damper was opened, the gases forming in the muffle flowed back to the gasifier and mixed with the air coming from the air vent of the gasifier which, as we have seen, was open wide (300 mm) at this stage. At the same time the discharge gases were diverted and entered the lateral upper left-hand Channel (E) – in which the primary combustion air (D) flowed during normal mode – and then entered the flue gas duct controlled by the smoke-combustion damper (Document 46, No. 15). Conversely, the primary combustion air now flowed into the lateral upper right-hand Channel (C) through which the discharge gases passed during normal mode. This mode of operation caused the smoke to be burned and to disappear within a few minutes.

This explains why the temperature Curve of the primary air in the lateral upper right-hand channel during the smoke-combustion phase (C) is the continuation of the temperature Curve of the discharge gases in this channel during normal combustion (B), and also why the Curve for the discharge gases in the lateral upper left-hand channel during smoke combustion should be the continuation of that of the primary air at this point in normal operation (D).

During the smoke-combustion phase, the temperature of the combusted gases (E) reached 450°C during the first cremation, then rose even higher, settling at around 600°C for the last three, with a peak of 800°C for the second cremation. The primary combustion air (C) is represented by the downward branch of the Curve for the discharge gases during normal combustion (B), because in the lateral upper right-hand channel, previously traversed by the discharge gases at high temperature, we now have preheated air flowing to the recuperator, but at a much lower temperature. This led to a steady cooling of the channel, and the temperature dropped abruptly. The greatest difference occurs during the seventh cremation, during which the temperature of this channel dropped from 1,150 to about 670°C.

During the smoke-combustion phase, the discharge gases flowed through the channel traversed by the primary combustion air in normal operation, therefore their temperature went down noticeably, and the corresponding Curve (E) is usually below that of the temperature of the discharge gases during normal combustion. Moreover, the duration of the smoke-combustion mode was far shorter than that of the normal mode, thus the discharge gases traversed the respective channel only for a brief span of time. It follows that the lateral upper right-hand channel stored much more heat than the left-hand one, which, being cooler, was more strongly cooled by the normal primary combustion air (D), and that is the reason why the Curve D shows maximum and minimum peaks that are lower than those for Curve C.

During the second cremation, Curve D dropped to a point as low as 100°C. The temperature of the exhaust gases in the Flue Duct (G) stayed between 250 and 350°C during normal combustion, but went up by 50 to 150°C during smoke combustion. The reason is that at this stage the highest temperature of the muffle was reached. The temperature Curve for the gasifier air (F) follows that of the combusted gases, rising and falling with the variations of the latter. While the coffin burned, the evaporation of water from the corpse already began. It intensified with the progressing combustion of the coffin, and at the same time the gasification of the corpse set in. Both processes absorb heat and led to a sudden drop in the muffle's temperature by 200 to 250°C.

In the main phase of the cremation process, when the corpse began to burn with live flames, the temperature rose strongly, depending on the type of corpse, such as in the third and the seventh cremations, or oscillated weakly, as during the sixth and the eighth cremations.

In the final stage of the cremation process, the remains of the corpse, which still burned on the grate and burned out in the post-combustion chamber, had such a small mass that the excess of air in the furnace was very high, even with all apertures closed, and the temperature of the muffle dropped accordingly.

During the second cremation it fell to 575°C. Professor Schläpfer explains (Schläpfer 1938, p. 152):

“Only in the early stages of the cremation, as long as the body is still lying intact on the grate and the incoming air finds combustible material everywhere, is it possible to work with small amounts of excess air. Towards the end of the cremation, on the other hand, when combustible material can be found only here and there, a large part of the air passes through the muffle without coming into contact with any combustible material.”

Kessler has not indicated the average CO₂ content and the Excess Air for the eight cremations with coke. He has noted only that during the preheating phase, with an average CO₂ content of 11% corresponding to an Excess Air ratio of 1.86, the combustion can be considered economical, and merely adds (Kessler 1927, No. 9, p. 152):

“During the cremation of the corpse it is more difficult to maintain an economically good combustion, because in the initial phase of the cremation one must feed the greatest possible amount of air in order to suppress smoke formation, while in the second phase, even with the air vents completely closed, the quantity of air flowing into the muffle through the invisible cracks in the furnace is rather higher than what is needed for the remains of the corpse burning on the grate. The attendant has the task of maintaining combustion as economical as possible in both cases (high CO₂ content with minimum excess air). The control equipment mentioned initially gives the necessary indications in this respect.”

The chart for CO₂ + O₂, which is shown above the temperature curves (document 48), is insufficient to judge the economics of the combustion: there are only few data points, and they are moreover limited mainly to the initial stage of the cremation. Here we have an average CO₂ content around 10 to 11% with a few peaks at 17%. In the second phase the average CO₂ content dropped noticeably down to 3 to 4%.

The experiments of cremation with briquettes (Documents 49 & 50) and with city gas (Documents 51 & 52) can be retraced in the same way on the respective charts.

The cremation experiments with briquettes were similar to those with coke. Of course, briquettes having a lower l.h.v. than coke, the fuel consumption increases, as shown in the chart of the furnace operation (Document 47). The Total Consumption (A) was, in fact, 10.66 *Zentner* or 533 kg. The more-frequent loading with smaller amounts of briquettes was required by the nature of the fuel. The control of the vents and of the doors followed essentially the same pattern as with coke, but the Curve for the draft of the hearth (D) shows stronger fluctuations (between 1 and 8 mm water column). The formation of smoke, too, was almost equivalent.

The temperature curve for the muffle (Document 50) rises in a very irregular way in the preheating stage. The first corpse was introduced at about 960°C. The shape of this curve clearly reflects the various phases of the cremation: strong initial temperature rise (up to 1,080°C) when the coffin burns, strong drop (down to 670°C) during the evaporation phase, renewed increase during

the combustion of the corpse and a decrease towards the end because of the excess air.

In the cremations with gas (Document 51), the Consumption (A) was 202 m³. Smoke formation seems to have been higher. Of particular interest are the Curves E and F for the draft at the two dampers of the flue duct. Kessler writes in this respect (*ibid.*):

“When one damper is open, the other must be closed. The chart shows that the draft at the damper closed from time to time does not go down to zero; this is due to the fact that the dampers do not close hermetically against their frames. Here the chimney draft absorbs a portion of the combustion air (primary air) brought to the muffle of the furnace.”

The temperature chart (Document 52) shows for all cremations – except the fourth – a drop in the muffle temperature immediately upon the introduction of the coffin varying between 40°C (first and eighth cremations) and 100 to 110°C (third and seventh cremations) with a peak at 190°C for the sixth cremation. A similar effect, although on a smaller scale, was noticed also for cremations with briquettes (drops between 20 and 75°C) and, to an even lesser degree, for coke operations (drops between 10 and 30°C in the second, fourth, fifth and eighth cremations). Kessler links this effect to four causes (*ibid.*, No. 10, p. 166):

- “1. Cooling of the muffle caused by an influx of colder ambient air when the coffin is loaded.*
- 2. Heat loss from the wall of refractory clay due to the necessity of bringing the coffin, its fixtures and the corpse up to the ignition temperature.*
- 3. Thermal balancing between the colder combustion air – fed to the muffle in large amounts during the early stages to prevent smoke formation – and the muffle temperature.*
- 4. Leakage of air into the muffle through the cracks of the furnace; this air, depending on the chimney draft, has a temperature to a greater or lesser degree lower than that of the air entering along the intended path.”*

The initial temperature drop for cremations with coke and briquettes is smaller than in the case of gas because in this latter case the burners are shut before the coffin is introduced, whereas with coke and briquette-fired furnaces there is still enough heat flowing into the muffle from the gasifier to limit this temperature decrease. As Kessler explains (*ibid.*, p. 168):

“A reduction of the muffle temperature to a certain degree during and after the introduction of the corpse is an unavoidable and inescapable necessity of the cremation process, even in well-run furnaces. The extent to which this temperature decrease can be opposed without additional heat brought in from the heat generator depends on the following factors:

- a) whether and to what degree the corpse produces heat during the cremation and transmits it to the muffle of the furnace;*
- b) the possibility of supervising the cremation process in the furnace from the heat-technological point of view by means of appropriate instruments and of controlling the combustion air by means of closures which seal properly and hermetically;*
- c) the mass of refractory clay which acts as a thermal accumulator.”*

The primary objective of Kessler's experiments was to determine the kind of fuel which would provide the most-economical cremations. The results are shown in the following table:

Table 1: Fuel Consumption during Kessler's Experimental Cremations

Fuel	Consumption				
	preheat	8 cremations	Total	per cremation (+ preheating)	per cremation (- preheating)
Coke	200 kg	236 kg	436 kg	54.500 kg	29.500 kg
Briquettes	276 kg	257 kg	533 kg	66.625 kg	32.125 kg
Gas	108 m ³	94 m ³	202 m ³	25.250 m ³	11.750 m ³

The l.h.v. of the three types of fuel as given by Kessler was 7,000 kcal/kg for coke, 5,000 kcal/kg for briquettes and 4,500 kcal/m³ for city gas. This results in the following table for the heat consumption in 1,000 kcal (Mcal):

Table 2: Energy Needs during Kessler's Experimental Cremations

Fuel	Energy consumed (Mcal)				
	preheat	8 cremations	Total	per cremation (+ preheating)	per cremation (- preheating)
Coke	1,400	1,652	3,052	381.500	206.500
Briquettes	1,380	1,285	2,665	333.125	160.625
Gas	486	423	909	113.625	52.875

Kessler's comment on the consumptions for the preheating stage is as follows (*ibid.*, No. 9, p. 159):

"The muffle is taken from the same initial temperature to the same introduction temperature in all three cases. If we assume that the amount of heat developed during the preheating stage with gas is transferred completely to the muffle, we may say that, for coke and briquette operation, some 900,000 kcal are lost mainly for heating the walls of the gasifier and those parts of the refractory material in the furnace which are not touched by the gas, as well as through radiation from these parts to the surroundings. These losses should be avoided if at all possible."

The ratio of heat consumption for gas to that for coke is $486 \div 1,400 = 0.35$ for the preheating phase and even less for the 8 subsequent cremations: $423 \div 1,652 = 0.25$, *i.e.*, for the cremations the energy consumption in the case of gas is one quarter that for the case of coke. This depends on yet another important factor, as explained by Kessler (*ibid.*):

"Whereas for gas heating the heat required can be precisely controlled, in the case of coke or briquettes heat is produced even at times when it is not needed, because even though it is possible to reduce the combustion in the generator, it cannot be stopped altogether; otherwise the fire would go out."

From these considerations we can see clearly that the heat consumptions of a coke-fired furnace and a gas-fired one are not directly comparable, and this is all-the-more-true for a furnace designed to run exclusively on gas, such as the Volckmann-Ludwig Furnace (cf. next chapter).

The experiments described in this chapter were carried out under optimum conditions using proper instrumentation and under the supervision of a specialized engineer. This had a marked influence on the fuel consumption. Kessler himself notes with respect to the use of gas as a heat source (*ibid.*, p. 153):

"I wish to point out that previously, because of insufficient supervision of the furnace and excess of air, consumption was roughly twice the above figures or more."

The question of the durations of cremations will be dealt with in Chapter 6.

In 1927 scientific cremation experiments in a coke-fired furnace were also run at the Biel Crematorium (Wilhelm Ruppmann System; Document 53) under the guidance of the engineer Hans Keller, who wrote two extensive reports about the work done (H. Keller 1928 & 1929). We will summarize the essential results of the experiments for this case as well.

Concerning the temperature evolution, H. Keller noted (1929, p. 2):

"After the introduction of the corpse, the coffin catches fire immediately and the temperature goes up by 100-150°C. Five minutes later, it again goes down by 100-200°C, even though the lid of the coffin has not yet burned and the temperature of the combusted gases [coming from the gasifier] is 1,000°C and higher. The heat provided by the combustion of the coffin and the heat supplied by the combusted gases therefore do not suffice to maintain the temperature at a high level. From this we can see how intense the evaporation [of the corpse water] is. The temperature then fluctuates continuously over a half hour. This underlines the irregularity of the cremation. If, on account of the generation of water vapor and a subsequent increase in internal pressure, an organ bursts in such a way that its liquid diffuses into the cremation chamber, the temperature drops immediately because the liquid evaporates.

These fluctuations of the temperature also affect the formation of smoke. At this stage, with the instruments at his disposal and depending upon the size of the corpse, the operator can sometimes just barely avoid the formation of smoke and sometimes not at all. After half an hour the temperature becomes more stable, the combustion steadies, evaporation dies down, possibly because the major part has already taken place, and the temperature in the cremation chamber now begins to drop steadily, down to about 800°C at the end of the cremation."

In the other report H. Keller explains the matter in greater detail (H. Keller 1928, pp. 24f.):

"After the introduction of the corpse, first of all the coffin burns partially. The temperature of the cremation chamber therefore rises by about 100°C. At the same time, however, we have an intense vaporization of the volatile parts of the body, which account for 70% of the body weight. This phase change requires a great deal of heat, and the temperature drops rapidly. The instruments record [a temperature decrease of] 100-200°C. During the evaporation, the solid substances, too, begin to decompose, and the products begin to burn, if they are at the necessary ignition temperature and if there is enough air. This decomposition, likewise, absorbs much heat and thus causes a temperature drop in its turn. If the ignition temperature is not reached, the gases will leave the cremation chamber and possibly even the chimney uncombusted, forming visible smoke.

Heat must therefore be supplied. While there is substantial heat available in the walls [of the cremation chamber], it cannot be supplied to the individual parts [of the corpse] in sufficient amounts nor quickly enough. This means that after the gases have formed, they are immediately drawn into the chimney by the draft and cannot combine well with the required oxygen; an indispensable element for the combustion is therefore missing. Hot air improves conditions considerably. It is present during the formation of the gases, promotes them and combines with them quickly and easily. If, because of the draft of the furnace, the combustion no longer takes place in the cremation chamber, the mixture is still present and combustion can occur in the post-combustion chamber or in the recuperator. One therefore has to make sure that the air is sufficiently hot and does not cool down excessively on account of the evaporation and the decomposition, because it has only a low heat content, and the temperature drops significantly with even minor heat losses. The accumulation of heat is necessary precisely in order to avoid excessive cooling."

These considerations take us to an important observation by H. Keller with respect to the function of the recuperator (*ibid.*, pp. 27f.):

"Like everything else in the world, cremation, too, takes time. In the course of the cremation, the chemical and thermal processes are so difficult and complex that they cannot occur suddenly, as for example in the case of gasoline; evaporation, dissociation, decomposition, gas formation etc. of the parts to be burned proceed rather slowly. When combustible gases – light and heavy hydrocarbons as they are called in chemical and technical terms – are formed in this way, they are immediately drawn along by the chimney and, for the greater part, can no longer burn in the cremation chamber or the post-combustion chamber but move into the recuperator. If [this device] is sufficiently hot, they will ignite, because there is sufficient air, even hot air, and the technical process of combustion will take place here. The lighter hydrocarbons will probably undergo combustion already in the post-combustion chamber, but for the heavier ones – the majority – sometimes even the recuperator is insufficient, and they will leave the chimney in the form of smoke and enter the atmosphere. From this explanation it can be seen that the main function of the recuperator is the realization and more particularly the completion of the combustion and not [just] the preheating of the air."

The cremation experiment H. Keller described in his two accounts concerns a corpse of 100 kg. Cremation took three hours, coke consumption was 79 kg. Hence, we have here a cremation decidedly different from those considered previously: H. Keller tried to maintain Excess Air at a level as low as possible – operating for the better part of the cremation with a coefficient of hardly 1.55 (H. Keller 1929, p. 2) – but in so doing he slowed down the combustion process considerably, and hence the cremation lasted three hours, more than twice the average time for Kessler's cremations with coke (86 minutes).

The experiments run by Hans Keller at Biel in the 1940s, in his effort to determine the causes for the creation of smoke during cremation, are particularly interesting and merit our attention, although they concerned an electric furnace (Brown Boveri & Co. System; see the next chapter). Actually, these experi-

ments yielded data which complement those gathered in the late 1920s by Kessler and H. Keller himself.

H. Keller's account (1945b) includes various charts, which I have reproduced in the documents volume, and on which I will make comments.

Charts of Figures 1a, 1b, and 2 (Documents 54-56)

In these charts the vertical axis shows the volume of the discharge gas in m³/hr, drawn in by the furnace fan (a forced-draft device), the horizontal axis shows the cremation time in minutes. The curves thus show the rate of discharge gas at any stage of the cremation and hence also the combustion speed of the coffin and of the corpse.

For example, in the first chart (Document 54),³⁴ at the beginning of the cremation of a 110 kg corpse, the volumetric gas rate (at 380°C) is 1,750 m³/hr. It goes up to 2,975 m³/hr after 10 minutes because of the combustion of the coffin and then drops to 2,730 m³/hr, as evaporation sets in, slowing the combustion. Then, with increasing gasification activity, combustion becomes more pronounced and the curve starts to rise again. After one hour it reaches a peak at 3,570 m³/hr and then gradually drops to 1,200 m³/hr at the end of the cremation after 90 minutes. This body has therefore been readily combustible.

In the chart of Figure 1b (Document 55), the corpse of 110 kg is likewise easily combustible. Here the apex of the curve is at 2,980 m³/hr and occurs 50 minutes after the introduction of the coffin. In the other cremations the maximum is reached after 10 minutes, *i.e.* during the combustion of the coffin.

The chart in Figure 2 (Document 56) shows the curves for a 110-kg and an 80-kg corpse. H. Keller comments (*ibid.*, pp. 18f.):

"As shown by Figure 2, the recorded points are so numerous that we may say with assurance that 2,740 m³/hr was the maximum gas-flow rate. It is surprising that this point was reached after 15 minutes. This is the result of the combustion of the coffin. When it has mostly taken place and has been replaced by evaporation, combustion is slower, the gas-flow rate lower and the curve drops. After 30 minutes there was a sudden decrease in the flow rate that was probably caused by the bursting of an organ. This increased the formation of water vapor. The heat thus consumed slows down the combustion, and the curve drops because the gas rate goes down. This repeats itself several times up to Point 7, one hour and 16 minutes after introduction. From that point on the curve drops rapidly and cremation is essentially finished. The other curves show similar features; they are lower, simply because the corpses were not as heavy and developed less gas.

The cremation of the 110-kg corpse was finished earlier than that of the 80-kg body. The flame progresses more quickly, therefore the curve rises higher. In other words, the corpse of 110 kg burns better than the one weighing 80 kg. Actually, in the case of the 110-kg corpse, one could see only flames. When they died down, the cremation was done."

³⁴ In this document the two cremations of 21 August 1940 are represented by a single curve.

In the charts mentioned, the flow rate of the fumes is not given in Nm³ but in physical cubic meters at the respective temperatures indicated. The flow rate of the fumes (V_f) is directly proportional to the absolute temperature and follows the temperature according to the equation:

$$V_f = V_0(1 + \alpha t) \quad [40]$$

Where $\alpha = 1/273^\circ\text{C}^{-1}$ and V_0 is the flow rate at 0°C. To obtain the flow rate in Nm³ it is thus necessary to apply to the values indicated in the charts the equation:

$$V_0 = V_f / (1 + \alpha t) \quad [41]$$

The values obtained with Charts 1a and 1b (Chart 2 does not show the temperature of the discharge gases) 50 minutes after the introduction of the coffin with the body are as follows:

– Figure 1a (Document 54)

1,492 m³/hr for the corpse of 110 kg

710 m³/hr for the corpse of 70 kg

627 m³/hr for the corpse of 55 kg

– Figure 1 b (Document 55)

921 m³/hr for the corpse of 110 kg

541 m³/hr for the corpse of 70 kg

340 m³/hr for the corpse of 50 kg.

The three cremations of the corpses weighing 110 kg had the same duration, 90 minutes, and also a fairly similar pattern: in the first 10 minutes the gas-flow rate went up because of the combustion of the coffin, then it dropped noticeably for another 10 minutes, after which it picked up again reaching a peak around 50 to 55 minutes after the start of the cremation. It then dropped suddenly toward the end of the cremation (Figures 1a and 1b) or after having fluctuated around the maximum values for about 20 minutes (Figure 2).

It is obvious that, everything else being equal, the gas-flow rates for a coke gasifier would have been even greater, because we would not only be dealing with the gases from the corpse but also with those of the gasifier.

Figure 3 (Document 57) refers to the content analysis of the discharge gases of three cremations. In the corresponding charts, the lower curve gives the CO content, the middle one the CO₂ + O₂ content, and CO₂ represents an excess of oxygen, which is proportional to the excess of air.

In the upper and middle chart, Excess Air, at 10 to 15 minutes after the introduction of the coffin, is very slight; hence, there was smoke generation. The amount of air is very close to the theoretical value. When this is reached, the two curves coincide. In the upper chart, their distance apart indicates an excess of air of 5% (Excess-Air ratio of 1.05). When the Excess Air increases, the smoke disappears. In the first half hour, CO also forms, which reaches 3% at its maximum. At the end of the cremation, the Excess-Air ratio rose to 4.25, and in the middle chart even to 9.50; in the lower one it reached 6.00.

The average amount of CO₂ is 7.8% for the upper chart, 9.8% for the middle one, and 8% for the lower one.

Figure 4 (Document 58) shows the temperature curves for two cremations. Curves I and II refer to the temperatures in the cremation chamber and at the inlet to the recuperator, Curve III shows the temperature of the air beyond the recuperator, and Curve IV the temperature of the gases just upstream of the ventilator. As H. Keller notes (*ibid.*, pp. 24f.):

“If the second curve crosses over the first, we have in the [discharge] gas channels a temperature which is higher than in the muffle, hence there is combustion. This means that combustion in the muffle is not yet complete but continues in the recuperator.”

This happened precisely in the second cremation and confirms H. Keller’s observation of 1927 regarding the function of the recuperator.

For this case, too, we must stress that the efficiency of an electric furnace, because of its different system of operation, cannot be directly compared with that of a coke-fired furnace.

5. Technical Developments of Cremation Furnaces in Germany in the 1930s

The experience and knowledge acquired in the 1920s were put to use in the new installations built at the end of that decade and in the following one: the furnaces with coke-fed gasifiers were perfected, but at the same time other heating systems were developed using gas and electricity, which were soon to supplant coke furnaces because of their greater practicality and better economy.

5.1. Furnaces with Coke-Fed Gasifiers

The structure of the new models took into account the decisive factors for an improved heat management brought to light by Kessler’s experiments; they showed a marked improvement in efficiency. The Dessau engineer Peters reported that the old Beck Furnace, after being rebuilt on the basis of the new principles of heat technology, saw its coke consumption halved, going from 300 to 150 kg of coke for the preheating and the first cremation. The new gasifier furnaces required 150 to 175 kg of coke for the preheating and the first cremation and some 50 kg for each subsequent 6 to 8 cremations in succession (Peters 1930, pp. 56f.).

Among the most-important technical innovations of that period one may cite the reduction of the horizontal cross-sectional area of the gasifier, which went from 70 cm by 90 cm to 40 cm by 50 cm, the installation of a post-combustion grate, an improved air feed and, finally, more-efficient recuperators.

At that time, the most-significant German companies for the design and construction of cremation furnaces – aside from J.A. Topf & Söhne of Erfurt, which led the field in sales – were Gebrüder Beck of Offenbach, Didier (later Stettiner

Schamottefabrik A.G.) of Stettin, Ruppmann of Stuttgart, and Kori of Berlin. In the early 1930s, H.R. Heinicke of Chemnitz made its entry into the market with the Volckmann-Ludwig Furnace, which we will discuss in Section 2 of this present chapter.

The new Beck Furnace (Document 59) contained major technical innovations which Wilhelm Heepke describes as follows (1933, pp. 123f.):

“In the most-recent Beck design, Fig. 3, the change from rectangular recuperator channels to patented triangular sections c_1 and c_2 is of interest, as is the increase of the cross-sectional areas of the discharge-gas channels c_1 at the expense of those of the air channels c_2 in the Didier furnace, fig. 4 [Document 60]. These measures aim at a better adaptation of the channel sections to the flow rates and, in particular, to the large amounts of discharge gases generated here for the purpose of the elimination of smoke.

The triangular recuperator of the Beck design permits the air to be heated to 600°C and higher. The incorporation of several openings for the corpse-combustion air into the vault of the coffin muffle can be considered a further innovation.

The Beck furnace has the advantage that the combustion gases are drawn from the front to the rear. Thus, no gases can escape into the furnace hall when the main gate is opened for the introduction of the coffin. Once the ash has fallen onto the inclined plane below the coffin grate, possibly still containing some combustible portions, it is moved to the post-combustion grate e, where it burns out completely. Then this grate is turned over, causing the ash to fall into the ash-container d below.”

Didier’s new furnace, too, was much improved (Document 60). In this respect, Heepke notes (*ibid.*, p. 124; cf. Chapter 7):

“The Didier furnace is a rather heavy structure for large crematoria and continuous operation. For installations with relatively few cremations, the furnace is held in stand-by at a lower temperature in its bottom by closing one or two channels of the recuperator so that reheating can be done more quickly. Finally, with the Didier furnace, there is the possibility of feeding back into the muffles, by way of the flue duct, the combusted gases coming from the muffle a before they enter the recuperator c, which leads to energy savings when heating the muffle a for the cremation of a subsequent corpse. On account of the separation of the gasifier b from the muffle a, fire management for heating the muffle can be run in such a way that the combusted gases from the hearth cannot enter the cremation chamber during the cremation itself.”

Noteworthy also is the cremation furnace built by a relatively unknown firm, W. Müller of Allach. This furnace is described in great detail in an offer from the owner of the company to the Dachau Concentration Camp. It refers to the following items:³⁵

“1. Supply of the bricks needed for the erection of the furnace, including sand, lime and cement for about 10 m³ of brickwork in red brick.

³⁵ W. Müller, Ingenieurbüro/Industriefenbau. Allach bei München. *Angebot auf einen Feuerbestattungsofen mit Koksbeheizung nach beiliegender Zeichnung*. An die Reichsführung SS der NSDAP, München, Karlstrasse. 2 June 1937. AKfSD, 361/2111.

2. Supply of all refractory material including mortar all in best quality suitable for the purpose. Total weight about 15,500 kg.
3. Supply of insulating material needed, in a weight of about 1,200 kg.
4. Supply of the following equipment: one coke hearth complete with front plate [of grate], doors for slag and ash, door for hearth, the complete grate with supports and bars, air-feeding equipment with controls, air vents for secondary air, discharge-gas damper with steel ribs, a complete closure for the cremation chamber with lifting device, a door for closing the furnace in wrought iron with frame, a wrought-iron hood for the closure of the cremation chamber, a reversible grate for the post-combustion chamber, various small parts, a wrought-iron box for the ash, maintenance tools. Total weight about 2,300 kg.
5. Supply of a complete facing of wrought iron, including bolts, with silver-grey refractory aluminum paint. Total weight about 2,800 kg.
6. Erection of the furnace from the foundation to the smoke damper by my specialists, except for the supply of assistants and helpers.
7. Travel costs for my specialists and their tools.
8. Expenses for the rail shipment of my goods to Dachau Station including transport to site as well as unloading and storage at site (on basis of a maximum distance from crematorium to unloading site of 2 km).
9. Drying and start-up of furnace by my operators or engineers as well as a test cremation during which your personnel will be instructed in the proper control of the furnace. It is assumed that the start-up will take place as soon as the furnace has been completed.” (Emphasis in original)

The offered price of this furnace amounted to 9,250 RM (Reichsmark). Excluded from the offer were all building works not concerning the furnace directly and also “the supply of an animal carcass and of a coffin for the test cremation, as well as the supply of fuel for the drying-in of the furnace and the test cremation.”

The accessories for the furnace consisted of an introduction cart for the coffin (380 RM), a special blower for the hearth (420 RM), a coke-fired pilot hearth for the chimney (400 RM), a device for measuring the temperature of the cremation chamber (195 RM) a manometer for measuring the draft in the discharge channel (3.5 RM). The Müller Company offered furthermore the materials for and the erection of an 18-m-high chimney (except foundations) with a cross-sectional area of 50 cm · 50 cm and an internal lining of refractory material up to 1/3 of the height (6 m) for a price of 2,100 RM.

The furnace was designed on the basis of a new, patented process of heating and cremation, which the owner of the firm describes in the following terms (*ibid.*):

“The furnace is furthermore equipped with a grate made of refractory clay of a special type which allows the retention and the accumulation of heat during heating-up.

In contrast to the furnaces built in the past, the combustion of the coffin and of the corpse is carried out in an upward direction, the combusted gases being blown against the vault and the sidewalls, which store the heat given up by them [i.e. the gases]. After the exothermic phase of the combustion, the accumulated heat is returned for the remainder of the combustion period.

In the spaces between the individual refractory bars of the grate, along the centerline of the furnace, special radiating and deflecting roof-like devices have been placed in such a way that the air blown in from both sides via tubes on the inclined planes flows upwards through the open spaces, and when this happens, the air strikes the bottom of the coffin or the back of the corpse strongly and, moreover, necessarily envelops the corpse from below over its entire surface in a thin layer [of air].

With this operating system, the amount of air can be controlled so as to conform to the real or theoretical requirements.

With my cremation process, the cremation of the corpse takes place within a shorter period of time than before; the ashes, as with a normal grate of refractory clay, drop down into the post-combustion chamber.

Thanks to the special system of controlled air flow and to the upward combustion, subsequent cremations – in the case of several cremations in one day – can be executed without further additions of fuel, or nearly so.

The coke-gas needed for the burners is produced in a gasifier located directly below the floor of the post-combustion chamber. In this way, the radiation from the glowing coke and the heat of the gas are used to heat the bottom plate of the post-combustion chamber.

The coke gas forming in the gasifier leaves from both sides in a lengthwise direction through a series of openings slanting upwards and burns there together with the air coming from the side vents.

The operation of the coke gasifier, as well as the cremation itself, takes place by means of air coming from a blower, because only with pressurization can an efficient production and combustion of the coke gas be obtained, yielding high flame temperatures.

The total mass of the furnace in my cremation process is reduced; the furnace itself has been given a smaller and very precise shape. The operation can be adapted very precisely to the various phases of the combustion.” (Emphases in original)

The supplier then lists the following technical data (*ibid.*):

“Fuel: good coke, in pieces, of about 6,500 kcal/kg

Weight of the corpse: about 75 kg.

Weight of the coffin: about 35 kg

Average duration of the cremation: about 1 ½ hours

To heat the furnace:

1. From a cold furnace to the introduction temperature: about 2 hours.

2. If in operation the previous day: 1 – 1 ½ hours.

3. If furnace is in operation every day: ½ to ¾ hours.

Fuel consumption:

1. For heating the cold furnace and for the first cremation: about 175 kg.

2. For the second and third cremations following immediately: no consumption of fuel [in addition to the coffin’s wood].

3. If a cremation takes place every day, the coke consumption is about 100 kg for the first cremation; no consumption for the second and third.

Consumption of wood: For each heating, about 3-5 kg of wood are consumed.” (Emphases in original)

5.2. Furnaces Heated with City Gas

The 1930s saw the development and perfection of heating systems based on city gas, primarily due to the promotion by the building councilor Volckmann and the engineer Ludwig who designed a revolutionary furnace at the end of the 1920s. Their patent, granted on October 30th, 1928, reads as follows (Deutsches Reich 1930c.):

“The invention concerns a cremation process and a device for its realization. Compared to the devices known (cremation furnaces) the furnace of this invention has a much-simplified and less-expensive structure and works with considerable fuel savings which can even be total in case of continuous operation.

The processes and devices known, besides a hearth having to be in continual operation, have regenerators or recuperators of large dimensions. The process and the device of this invention, on the other hand, function without auxiliary plants of this type and therefore require only about one third of the space needed heretofore.

The operating costs of the device covered by this invention are extremely low because in continuous operation no heat source is used [except for the coffin’s wood] and the expenses for the initial heating of the small device are minimal.

The process covered by the invention consists of a cremation muffle which is maintained at a temperature higher than the ignition temperature of the object to be burned, by means of the heat developed during the cremation process. This is achieved by blowing small jets of air directly onto the object to be burned in such a way that they direct the oxygen needed for the cremation only towards the object to be cremated; here the diffusion of air throughout the whole space of the furnace – as is the case in the furnaces known – is prevented or limited considerably. The jets of air covered by this invention are directed so as not to strike and cool the walls of the furnace. In this way, these walls come into contact only with the gases produced during the cremation. They absorb the heat [of the combusting gases], accumulate it and radiate it back to the object being cremated. In this way, the cremation process is maintained and the furnace can carry out as many cremations as desired without additional fuel, only air being needed. This air can even be cold, even if there are longer operating pauses.

A device for the implementation of the process covered by the invention consists of a cremation muffle with controllable air vents and tubing for compressed air connected to them. The air vents are placed in such a way that the air jets coming from them do not strike the walls of the muffle but only the object to be cremated. In addition to the muffle there is a post-combustion chamber [Nachbrennraum] of the usual type which serves for the combustion of the smoke and of the solid residues; in this invention it is heated only with the glowing combusted gases drawn into the chimney.

The drawing shows a schematic representation of an example of the realization of the cremation device, in Figure 1 as a vertical section, in Figure 2 as a respective horizontal section [cf. Document 61].

A muffle b formed by a brick lining a serves to receive the object c to be cremated. Connected to the muffle is a post-combustion chamber d in which the ashes are freed from the charcoal stemming from the combustion of the coffin with which they are mixed and burned by the fumes on a grate e. Below the chamber

d there is a collection chamber *f*. The chambers *d* and *f* are accessible through service openings *r* and *s*, which can be closed. The combusted gases flow to the chimney (not shown) via a flue duct *g*.

The vault of the muffle has a directing surface *h* protruding from a table *i*. This table is low and rounded so that the remains of the cremation can be moved easily through the door *l* into the post-combustion chamber *d* by means of a rake. A closable channel *k* supplies the air for the smoke combustion behind table *i*.

Muffle *b* is equipped with a certain number of vents for air and gas which can all be controlled and directed from the outside, e.g. by means of the closing devices *v* in the pipes *u* or by means of valves, dampers or similar, not shown. For the initial heating of the muffle, there are vents for combustible gas and closable outlets from channels through which outside air can flow in the direction of the arrow *t*. These gas vents *m* and the air channels *n* are closed as soon as the muffle is hot enough for the cremation process in order to maintain itself without any further addition of combustible gas. Instead of this type of additional heating with gas, any other kind of fuel may be substituted.

When the ignition temperature of the object to be cremated is reached, the compressed-air vents *o* and *p* must be controlled. They can be operated either individually or in groups. They are placed on both sides of the muffle in such a way that the jets of compressed air emitted by them strike only the surface of the object to be cremated and not the walls of the muffle.

The floor of the muffle may consist of an inclined plane, at the bottom of which there is a closable opening *q* for the removal of any metal residue (zinc).

Claims:

1. A cremation process characterized by the fact that in the muffle of a cremation furnace, once the operating temperature has been reached by means of a heat source of known type and after the extinction of the heat source, the air needed for the cremation is directed solely towards the object to be cremated in the form of thin controllable jets from nozzles or similar devices.
2. A device for the implementation of the process according to Claim 1 characterized by the fact that a cremation muffle is equipped with nozzles for the introduction of controllable air jets which, on being ejected, do not touch the walls of the muffle but strike only the object to be cremated.
3. A device in accordance with Claim 2 characterized by the fact that the post-combustion chamber of a known type which is equipped with the means already described for the combustion of the smoke and of the solid residues is installed immediately below the outlet for the discharge gases from the cremation muffle and below a baffle wall which creates a turbulence in the combusted gases and pushes them downwards into the post-combustion chamber."

The inventors of the new process granted an exclusive license of the patent for Germany to the H.R. Heinicke Company, then of Chemnitz, which still holds it (cf. Chapter 11).

The first experimental furnace built on the basis of the new system was set up in the crematorium of Hamburg-Ohlsdorf in 1929; a year later, another and also-experimental furnace was built there. In 1930 Volckmann himself drew up a lengthy report on the results of the operation of the first furnace (2,500³⁶ cre-

³⁶ Volckmann 1930; the text states "3,500," but this is a mistake later corrected by Volckmann (1931, p.

mations had been carried out in seven months with a total consumption of 103 m³ of gas!), a report that was bitterly criticized by the engineer Kurt Prüfer of the J.A. Topf & Söhne Co. of Erfurt. A feud ensued, into which Richard Kessler was also drawn. We will come back to this question in Chapter 1 of Unit II of this study.

The Hamburg experimental furnaces were extensively described in various technical articles. Here we present what the engineer Friedrich Hellwig had to say in this respect. For greater clarity, we also publish Kessler's drawings which provide us with schematic representations of the two furnaces in question (Document 62):³⁷

"The furnace differs from those built in the past in that it has neither recuperator nor grate. It consists essentially of a muffle of refractory brick 90 cm wide on the inside, 90 cm high below the apex and some 3.20 m long, of an outer wall of brick and a layer of insulation in between. The floor of the muffle consists of tiles of refractory material, which begin only 30 cm beyond the introduction door. The combusted gases escape through the resulting gap and along the same route; the residues of the cremation are withdrawn from the muffle to the post-combustion grate located below. The latter consists of grate bars narrowly spaced, with the smaller parts of the ashes dropping through the gaps while the large portions remain on the grate until they eventually disappear or until they have finished their combustion. While the remains of one corpse thus burn out on the grate, another coffin is introduced into the muffle above, the flames of which slip through the post-combustion grate into the smoke channel below the muffle and on through the flue duct into the chimney.

For heating the muffle, a number of gas burners have been placed into the rear wall and the two sidewalls some 20 cm above the muffle floor. Their number and their locations have so far been varied in the experimental furnaces. On the rear wall, there have been 4 or 5 burners acting as baffle burners perpendicularly to the flames of the other burners; they cause a certain heat concentration within the muffle.

The combustion-air feed takes place via two openings in the rear wall, which can be closed by means of a vertical-gate valve, and via 20 diffusers spread out over both sidewalls and the rear wall. Moreover, on the rear wall at the level of the floor there is a sleeve through which a steel tube can be moved towards the object to be cremated, the tube being connected to the compressed-air supply by means of a flexible hose. The diffusers are connected, by means of steel tubes, to a manifold with valves visible from the outside of the furnace, and ultimately to the main tube of the air supply which is fed cold air from a motor-driven bellows pump. The various diffusers and their control valves allow the air feed to be directed to individual parts of the furnace. [...]

The furnace is characterized by the fact that

80).

³⁷ Hellwig 1931a, pp. 396f. A few months later this journal published a reply by Volckmann and Ludwig on the question of the acceptability of their furnace in Prussia (Volckmann/Ludwig 1931) and Hellwig's reply (1931b, pp. 616f.).

- 1) the muffle is simple, very small, has no regenerator, no recuperator and, in some cases, no grate, and is equipped with a single floor and with distribution devices which take the necessary air to the surface of the object to be cremated;
- 2) the muffle has a diagonally cut flat table;
- 3) on both sidewalls of the muffle are located groups of exchangeable, controllable injection devices whose direction can be controlled [Document 63];
- 4) there is a further hearth with a nozzle for a gas burner and an air channel opening up below, both controllable and closable;
- 5) the floor of the muffle is slightly slanted diagonally.

In Issue No. 5 of the second year of *Zentralblatt für Feuerbestattung*, the civil engineer Volckmann has written at length about the results of the operation of the experimental furnace in Hamburg-Ohlsdorf, which conforms to the above specifications. Unfortunately, the furnace on which the report was based was dismantled after 14 months of operation, and the presently available furnaces built in accordance with the same principle do not work quite as well. During our observations, the combustion of the smoke was incomplete. The average consumption of city gas as a fuel is not 0.03 m³^[38] either, but about 1.0-1.1 m³ for each corpse, as opposed to 11-15 m³ in crematoria having the same frequency [of cremations]. The savings are therefore quite considerable and the operating cost for each cremation are at present 1 m³ of gas at 0.13 marks and 3.5 kWh of electricity for the blower at 0.16 marks [per kWh], for a total of 0.69 marks. We know, on the other hand, that the operational expenses at Dessau are 3.10 marks and at Treptow 4.50 marks. However, here it is possible to go down to 2.00 marks if, as in Hamburg, 16 corpses per day are cremated, because there is less preheating. This energy saving is due to the heat being contained in the small muffle and to an operation at minimum draft and rather low temperatures (between 500 and 650°C).^[39] here the calorific value of the coffin and of the combustible parts of the corpse take effect.”

Hellwig then notes that under favorable conditions it was possible to perform the cremation on the basis of the heat furnished by the coffin and the corpse alone, without additional fuel, and adds (*ibid.*):

“These conditions exist in a Volckmann-Ludwig furnace when it is heated to a temperature of about 600°C. If one normal corpse follows another, the process goes on without additional fuel, and even the next day, if the insulation is good, a minute supply of gas of a few cubic meters is enough to keep the furnace ready to be used the whole day. The corpses of persons who died of cancer, of lung diseases and those of the elderly require additional fuel; with these, the calories of the fatty tissue of the body have been consumed by the disease or by old age. For all corpses, the cremation of the solar plexus (a complex of nerves at the pit of the stomach) takes longer because it contains much humidity. There are also a few special cases, for example the lungs of a stonemason, which contain sandstone dust. At the present time, the Hamburg furnace does not burn the solar plexus completely within the muffle; this takes place only on the post-combustion grate, and from that point of view there is still progress to be made. According

³⁸ The reference is to Volckmann’s assertion in the journal mentioned above to the effect that the experimental furnace at Hamburg had carried out 3,500 (actually 2,500) cremations with 100 m³ of gas, i.e. an average of 0.03 m³ per cremation.

³⁹ Coffin-introduction temperatures.

to legislation now in force, this furnace is not acceptable in Prussia because it houses – albeit in two separate locations – two corpses at the same time.”

In 1932, after the demolition of the two experimental furnaces, four new Volckmann-Ludwig Furnaces were installed in the Hamburg Crematorium (Documents 64f.). Volckmann describes them in the following way (Schumacher 1939, pp. 24f.; cf. Manskopf 1933, pp. 772-775):

“Each of the four furnaces installed for Hamburg has three powerful gas burners, one with an hourly throughput of 30 m³, the other two set up for an output of 5 m³ per hour each. The gas arrives at the burners under the pressure of the gas line; the combustion air is fed by means of a blower, so that disruptions in the gas combustion – for example on account of an excessive closure of the smoke damper – are eliminated. A single lever, acting simultaneously on the gas and on the air feed, controls the flames. By turning the lever in the opposite direction, it is moreover possible to close only the gas supply and to feed a larger or smaller amount of air to the furnace through the burners. The air-supply system continuously returns to the cremation process a large part of the heat generated during the cremation without the need for recuperators, and thus allows – once the furnace has reached its operating temperature – to carry out a cremation without additional gas. An essential feature of the new furnaces is that, in contrast to older types, the cremation air is brought only to those points where it is needed at that moment. Only in this way is it possible to carry out the cremation with clean air only. The cremation proceeds practically without smoke and requires so little time that a single furnace, in an uninterrupted 24-hour operation, can handle 20-22 cremations per day. However, generally this capacity is not exploited. Rather, so many furnaces should be operating simultaneously that a coffin can be introduced right after the end of the funeral ceremony, so that the bereaved can be present during the introduction. The gas consumption, which depends upon the reheating after interruptions in the operation, is generally about 1.5 m³ per cremation for intensive use of the furnaces. Thanks to the elimination of the recuperators, it has been possible to place the furnaces on one floor and to provide, in this way, a large and well-lit workspace.

All the devices needed for the operation have been brought together on the front panel and are well arranged so that their use is extremely simple. The whole operation can be done without effort and with the most meticulous cleanliness. The introduction chamber is separated from the service room of the furnaces. On the outside, the furnaces are covered with a cladding of aluminum and are thus not only protected from air leakage but also fit visually into their environment in a dignified way.”

A Volckmann-Ludwig Furnace was installed by the H.R. Heinicke Company at the Stuttgart crematorium as early as 1931. In the following year, the municipal building superintendent R. Wolfer wrote a detailed description of the results achieved with this furnace (Document 66) from which I quote foremost the precise technical description of the device (Wolfer 1932a, pp. 151-154):

“The Volckmann-Ludwig furnace, designed by the Hamburg civil engineer Volckmann together with the engineer Ludwig and tested in the Ohlsdorf crematorium over the past few years, differs considerably from the furnaces used so far, especially because instead of the usual grate it has a particularly shaped

and completely closed muffle which encloses the coffin in the tightest way possible. A recuperator has been entirely left out, except for a small preheating device for the combustion air. The design, with its compact structure and a considerable reduction in the heat accumulation, aims for a minimal preheating time and minimal heat consumption. Furthermore, this design is especially noteworthy for the layout of its combustion-air supply to the muffle, well-planned and patented, which uses so-called diffusers of hot and cold air.

The furnace erected at Stuttgart has maintained essentially the basic structure of the Hamburg experimental furnaces and of the normal furnaces built by the Heinicke Co., but it does present a number of differences, partly on account of local conditions, partly for reasons of more-recent developments.

The cremation facilities already existing at Stuttgart caused the furnace to be adapted accordingly. Normally, it needs only a large space in the back, but no basement specially built for the purpose; here, it was integrated into two floors.

The control of the furnace takes place only on the upper floor. There have been structural reasons for the combustion gases to be channeled down into the basement and to be fed into the existing flue-gas duct running below its floor. Any doubts that were raised earlier with respect to this downward channel of some 3.5 m in length in a gas-fired furnace turned out to have been entirely unfounded. The draft of the existing chimney, rising some 20 m above the flue duct and having an internal diameter of 650 mm, is impeccable. Moreover, the floor of the muffle, which in the normal type [of furnace] is a little below the floor of the hall, has been raised some 400 mm above it to bring the introduction opening into line with the furnace next to it, for esthetic reasons and also in order to be able to make use of the existing trolley for the introduction of the coffin.

Aside from these changes in the fundamental structure [of the furnace], which were due to local conditions and partly to our initiative, the Stuttgart furnace has for the first time incorporated a number of innovations which can, without doubt, be called improvements on the original design. The spent gases, which in the Hamburg furnaces leave near the introduction door, are now discharged along the two sidewalls of the furnace into three channels on either side at a certain distance from one another. Before entering the vertical flue duct, they cover the entire floor of the muffle and heat it from below in the most satisfactory way. This arrangement also prevents any excessive heating of the closure of refractory clay, which shuts the muffle. Furthermore, the spent gases are no longer directed into the post-combustion chamber as in the Ohlsdorf experimental furnaces. Instead, this [chamber] is completely separated from the muffle by means of a lid made of refractory clay which stays closed throughout the cremation and is opened only when the cremation has reached a point at which the residues may be moved to the post-combustion; the residues are then raked down and the lid is closed immediately.

Now the furnace is ready for a further cremation, even as the ashes from the preceding corpse and the wood of the coffin, which has still not burned completely, can burn out on the post-combustion grate, which, if needed, can be heated further by means of a special burner. Therefore, any risk of mixing the residues of the corpses simultaneously present in the same furnace is completely eliminated.

The number of cremations is always rather large (some 1,200 per year, up to 10 per day) and thus, for reasons of economy and to avoid any congestion, one must try to introduce a corpse into the muffle as soon as the previous one has been moved to the post-combustion grate.

The complete isolation of the post-combustion chamber and its separate heating system obviously entails a slight increase in gas consumption. The unloading of the furnace after each cremation is not done, as in Hamburg, by opening the introduction door at the front – an operation by which much heat is lost – but via an opening in the rear, using special rakes. That is the only manual operation still needed.

Recent efforts by some companies in the field aim at eliminating even this manipulation and at devising a totally automatic cremation process, for example by placing the coffin on a mobile support or similar. It remains to be seen, however, whether such new designs turn out to be efficient in actual operation and, first and foremost, whether such further mechanizations and refinements of the cremation will demonstrate that they fulfill sufficiently the requirements of esthetics and reverence, which are always stressed, with good reason, by the proponents of cremation.

The section of the muffle is more-or-less parabolic and thus ensures not only a solid brick structure but also favorable radiation conditions.

The post-combustion grate consists of cast-iron bars with narrow slits (only about 4 mm wide) between the bars, and therefore only very fine and well-burnt particles can fall through into the ash receptacle. The latter is 420 mm wide and 600 mm long. The post-combustion chamber as such is 550 mm high. Thus, it offers sufficient space for the combustion of the residue and of remnants of the coffin dragged along from the muffle.

The necessary combustion air enters through a grate in the rear part of the furnace. It is well heated by passing through a system of channels in the furnace outlet. The discharge gases from the post-combustion are led to the main discharge line through a short collection channel. When the residue on the grate of the post-combustion chamber is completely consumed, the post-combustion grate, set in a wrought-iron frame and easily moved, is extracted with a pair of tongs. At this point the ashes are removed, falling automatically onto an inclined plane and into the ash collector placed at a convenient level in the basement.

The outward shape of the furnace differs very favorably and markedly from the traditional shape of a cremation furnace. Its dimensions are smaller than those used in the past (width 2.20 m, length 3.10 m, height 1.70 m). The front surface is not truly rectangular; rather, the upper angles are bevelled to be more in keeping with the shape of the muffle. The sidewalls and the roof of the furnace, as is the introduction door, are clad in a most-agreeable and at the same time most-appropriate way by aluminum plates. Thus, the furnace is well-protected against any air leakage.

The weight of the refractory material of the furnace has intentionally been kept low to make preheating easy. On the other hand, this makes a good insulation of the furnace mandatory. Therefore, the muffle is insulated along its entire length as well as at the top with a layer of pumice sand some 200-300 mm thick. Furthermore, the aluminum sheets of the furnace cladding are internally lined with Heraklit boards [fiber boards].

To enable the draft channels to be properly cleaned, especially the flue duct below the muffle, a sufficient number of cleaning apertures have been provided.

All the equipment for the operation of the furnace is arranged on the back of the furnace, the real workplace of the attendant. Here we have the two main burners and their controls with a [maximum] throughput of 25 m³ per hour each, which cover the upper part of the muffle and are mainly used for preheating and for intermediate heating between two cremations, normally needed only on occasion. There are also the two so-called hot-air diffusers, patented, which cover the floor of the muffle and have an hourly throughput of 5-6 m³; if necessary – for example in case of corpses burning particularly poorly – they can be operated even throughout the whole duration of the cremation without violating the general principles of cremation by generating a live flame. Finally, there is another burner with an hourly throughput of 5-6 m³ for the post-combustion.

In practice, the hot-air diffusers are used occasionally in the morning to preheat the rear portion of the muffle and also quite often during the day to feed non-preheated air. The compressed air needed for the various burners – which were furnished by the Hamburg company Pharos – is produced by means of a blower with an hourly capacity of 360 m³ situated in an adjacent room and supplying air at a pressure of about 400 mm of water column.

This blower feeds also the so-called cold-air diffusers, 20 in all, which supply combustion air to the muffle in an optimum manner via aluminum tubes, 8 for each sidewall and 4 in the upper portion. It has turned out that the two cold-air diffusers in the upper part of the furnace near the back are not indispensable for the practical operation of the furnace. Throughout the whole duration of the cremation, the air fed to the cold-air diffusers can be controlled as needed. After the combustion of the parts of the corpse which are consumed quickly, the valves of the air nozzles aimed at those parts are closed. These opening and closing devices are, again, located behind the furnace at the workplace of the attendant.

The vents for the direct feed of secondary air to the two groups of 3 lateral draft channels are also manipulated from behind the furnace. Two peepholes located at different levels allow the attendant to observe the cremation process in the muffle clearly and comfortably; there is another such hole for viewing the post-combustion grate. The manipulation of the refractory lid of the post-combustion chamber already mentioned, as well as that of the post-combustion grate, is done here.

To let the attendant know of any smoke emission and to give him the possibility of intervening immediately by adding air, the top of the chimney can be seen from the position of the operator by means of a pair of mirrors. The control of the smoke damper is likewise done from this position. The control and the observation of the furnace are thus concentrated in a single location, which is of prime importance for the proper running of the installation.

Among the other devices for the operation of the furnace, there is a ventilation system which not only serves the hall but also takes care – via a hood above the furnace door – of the elimination of any combusted gases which emerge occasionally when the coffin is introduced.

Among the instruments for the control of the combustion, we have two electric pyrometers (Siemens & Halske system) – one in the front section of the furnace vault, the other in the vertical smoke duct – which record the respective temper-

atures automatically on a recorder likewise furnished by Siemens & Halske. The temperature of the muffle, moreover, can be followed by means of a normal indicator. If need be, the draft can also be measured by means of a manometer. Gas consumption is given by a gas counter. There is, furthermore, a recorder for the gas flow (system Hartmann & Braun). For control of the gas pressure, normally 60 mm [of water column], there is a gas-pressure gauge."

Wolfer then goes on to describe the operation of the furnace (1932b, pp. 162f.):

"Once built, the furnace is heated with wood for drying out. As the construction work had not yet been terminated [on the remainder of the building] and as the furnace was to go into operation only after that, this was done without any haste over a period of 14 days. Towards the end of the drying-out, the burners were approved and adjusted; for those operations on the furnace, up to the first utilization of the furnace on Monday, October 19th, 1931, at 3 p.m., some 84 m³ of gas were consumed. At that moment, the pyrometer gave a reading for the temperature of the muffle of 780°C. This temperature was strongly affected by the main burners then being used. The actual temperature of the furnace was certainly lower, because the furnace was of course far from having reached a steady state.

The first cremation required 25 m³ of gas. It was seen that the furnace was still quite humid; water leaked from all cracks in the form of steam or in drops. This state persisted throughout the first week, from October 19th through 24th, and even during the week following, October 26th through 31st, there were small signs of humidity."

The consumptions recorded during the first four weeks of operation were the following (average consumption per cremation):

- first week (October 19-24), 15 cremations: 19.73 m³ per corpse
- second week (October 26-31), 26 cremations: 7.27 m³ per corpse
- third week (November 2-7), 26 cremations: 6.08 m³ per corpse
- fourth week (November 9-14), 25 cremations: 7.04 m³ per corpse

Wolfer furthermore published two charts for the cremations carried out on October 23rd and 30th (Documents 81 and 82). The five cremations of October 23rd were done at a time when the furnace had not yet reached a thermal steady state: no cremation had taken place the day before and the furnace temperature had dropped to 60°C; the gas consumption was therefore very high – 84 m³ – the average being 16.80 m³ per cremation. The five cremations on October 30th were, on the other hand, carried out after the furnace had reached its thermal equilibrium: three cremations had been done the day before and the furnace temperature was still 350°C the following morning: gas consumption was therefore very low: 19 m³, or 3.80 m³ per cremation.

In February of 1932, with a greater load on the furnace (28 cremations per week) the average consumption dropped to 1.8 m³ per corpse, the equivalent of 6,000 to 7,000 kcal. The old coke furnace had required 92 kg of fuel per corpse.

The average duration of one cremation was about one hour. Smoke formation was minimal and could easily be contained via the furnace controls.

With respect to the furnace structure, seen from an ethical point of view, the closure which separated the muffle from the post-combustion chamber was par-

ticularly important, precluding, as it must, the risk of mixing of ashes from different corpses. From the thermal and economical point of view the essential innovation was the combustion air feed to the muffle, which was designed in such a way that even after the disappearance of the coffin the air jets are still directed onto the remains of the corpse without impinging on the walls of the muffle.

The insulation of the furnace can be considered generally good, even though on some parts of the aluminum cladding temperatures of 50 to 60°C were noted.

The most-favorable introduction temperatures lay between 700 and 750°C, guaranteeing the immediate self-ignition of the coffin. During the cremations, the muffle temperatures fluctuated between 700 and 950°C. After a day of activity, the muffle still had a temperature of 300 to 350°C the following morning; after a day without activity it went down as far as 260 to 320°C. The ashes were in no way different from ashes obtained with other furnace systems, neither qualitatively nor quantitatively.

Wolfer concludes his report by stating that the polemic against the Volckmann-Ludwig Furnace was unfounded because the furnace represented “a well-devised new design that had proven itself in practical operation and was quite usable” and that it was “aesthetically as flawless as that of older designs” (*ibid.*, p. 165).

Obviously, other companies, too, designed gas-fired cremation furnaces:

In 1931, Didier installed a gas-fired cremation furnace of a new design at the Berlin-Wilmersdorf Crematorium, which went into operation in July. Thanks mainly to a new combustion-air-feed system, along the lines of the Volckmann-Ludwig Furnace, the new furnace functioned practically without smoke and with a very low fuel consumption: Between August 1st, 1932 and March 4th, 1933, 2,466 corpses were cremated with a total gas consumption of 3,098 m³ of gas, an average of 1.25 m³ per corpse. This was partly due to the very-large number of cremations in that crematorium – 2,500 to 3,500 per year – and an operation of the furnace of 16 hours per day (Kessler 1932, pp. 10-14).

A few years later, in a response to ethical requirements for a non-manual removal of the ashes from the furnace, Didier designed and patented a tiltable cylindrical furnace, gas-fired, which allowed the ashes to drop directly into the urn under the force of gravity when the furnace was raised to an upright position (Storl 1934, pp. 72-74).

The Ruppmann Co. developed a furnace of a very-sophisticated design patented on June 23rd, 1936 (Document 67). The claims of the patent cover (Deutsches Reich 1938b):

“1. Cremation furnace for corpses, with grate, characterized by the fact that the grate is made up of alternating bars of varying height (b, c) and by the fact that at the same time the empty space of the furnace at the level of the bars has walls (d) strongly inclined towards the inside in such a way that at the level of the lower edge of the bars there is only a narrow gap (e) for the passage of the ashes.

2. Cremation furnace for corpses according to Claim 1 characterized by the fact that under the bars of the grate (b) are installed rotating valves (k) made of steel resistive to the high temperatures, or closures that can be extracted sideways

which split the grate and the post-combustion chamber (f) below into chambers (9, 10, 11, 12) which enable the combustion gases to be made to flow in a controlled way upward through one part of the grate and downward through the other.

3. Cremation furnace for corpses according to Claims 1 and 2 characterized by the fact that for the combustion-air feed three groups of air vents at three different levels are provided, the first group (g) being situated at the level of the upper edge of the high bars of the grate (b), the second group (h) at the level of the upper edge of the low bars of the grate (c), and the third group (i) at the lower edge of the bars of the grate and by the fact that each individual opening can be controlled separately.

4. Cremation furnace for corpses according to Claims 1-3 characterized by the fact that, in order to bring about the well-known circulation of the combustion gases and the combusted gases, there is a blower (s) which takes in the combustible gases or the combusted gases via discharge vents (r) located in the vault of the cremation chamber and pushes them through diversion channels (v, w) as well as distribution channels (6, 7 and 8) into the post-combustion chamber (f) from where the combustion gases or the combusted gases return cyclically into the cremation chamber passing in front of the bars of the grate with its burners or heating bars."

Noteworthy also is the design of the Swiss Company E. Emch & Co. of Winterthur, which installed two gas-fired furnaces in the Zürich Crematorium in the fall of 1932, replacing older coke-fired furnaces. They are described as follows by H. Henzi (Henzi 1934, pp. 63-65; Document 68):

"The Emch furnace consists of a muffle, an ash channel, an ash chamber and a recuperator for the preheating of the combustion air by means of the hot discharge gases. The discharge gases flow into the furnace from the top down, countercurrently to the combustion air. The removal of the glowing ashes from the ash channel into the ash chamber is done in the Zürich Furnace by means of a brush running on a rail.

In two neighboring rooms, one of which was formerly used for coke storage, an almost-silent blower (Sulzer) is set up in suction for each furnace providing the draft needed for the cremation; the draft is adjusted to the variations of the demand by means of the chimney damper. The air vents and the chimney damper can be operated from a central location, i.e. from the first floor, where the gas burners and the instruments for the control of the furnace temperatures and of the draft are located. The small dimensions of the existing chimneys and the height of the furnace (4.5 m between the grate of the muffle and the smoke trap) have made necessary the blowers in suction, especially for the first phase of the cremation. Moreover, the chimneys have been shortened by 80 cm during the reconstruction of the furnaces to hide them from view from the front part of the crematorium. For the heating and the possible reheating during the final phase of the cremation, two GAKO turbulence burners have been installed (Gesellschaft für Gas- und Kohlenstaubfeuerungen, Essen). They allow both the primary and the secondary air to be controlled.

The secondary air, moreover, on entering the furnace, passes through a tube in which there is a 'distributor'; in this way it receives a high kinetic energy and

produces a long and wide flame. In order to obtain a good radiation, the temperature of the flame is taken only up to bright yellow. The two gas burners are located some 30 cm above the grate of the muffle in the front part of the furnace. To be on the safe side, in the first furnace, in the first discharge channels under the ash channel, two more burners had been installed simply to facilitate heating. But it soon turned out that the two upper burners were sufficient for the task, and those burners were therefore dropped for the second furnace. In an adjoining room is a pressure-control device for the gas, a safety valve which is closed when the flow of gas is interrupted, as well as two gas meters. The room is well ventilated to the outside and can be entered only through a door located on the ground floor of the furnace hall. The furnace hall itself can be ventilated easily and the service staff of the crematorium can enter and leave at any time."

Henzi then goes on to discuss the performance and the results of the operation of the new furnaces (*ibid.*, p. 65):

"After some minor difficulties earlier on, which were due to the training of the personnel with respect to the new fuel, the unit satisfied all interested parties and fulfilled expectations. In the Zürich Furnaces a cremation takes one hour to one hour and a half on average. Hence, during the normal working shifts [of the operators] 6-7 cremations per day can be carried out without any difficulty. During the construction period, with only one furnace being available, it was at times necessary to perform up to 9 cremations per day by having the personnel work overtime. The burners make only a very low noise, which cannot be heard in the hall where the funeral services take place. As the two blowers are located in separate rooms, the furnaces can function freely even during the funeral service.

The gas consumption depends primarily on an experienced and attentive operator, especially with respect to proper control of the chimney draft and of the air vents which must be constantly adjusted to the cremation process and therefore requires continual attention. It is also affected to a great extent by the particulars of the corpse, by the uniformity of the heating, and by the throughput load on the furnace. When the load is high, the amount of gas needed for heating averages out over several cremations and the average gas consumption, i.e. the consumption per cremation calculated over the span of one day, becomes small. The days from Tuesday through Friday show the most favorable consumption, with the furnace already having been in operation on Monday and therefore being well warmed up. On Saturday cremations usually take place only in the morning; therefore, the specific consumption is a little higher on that day.

By means of two temperature charts from the temperature recorder [Documents 79 and 80], it is possible to verify the course of the cremation and the operation of the furnaces. The initial phase of a cremation requires a particularly high air feed and a strong draft of the chimney; on the temperature charts this shows up in a strong increase in the temperature of the discharge gases in the lower channels."

The two charts published by Henzi in the article cited cover 5 and 7 cremations, respectively, carried out on October 26th and 27th, 1933, with average consumptions of 28 and 26.9 m³ of gas for each cremation respectively. The temperature of the preheated air (lower curve) stayed around 200°C, that of the

combusted gases in the lower channels of the recuperator (middle curve) fluctuated between 350 and 500°C, whereas the muffle temperature (upper curve) held between 700 and 800°C (Documents 79 & 80).

In the six months between July 1st and December 31st, 1933, 510 cremations took place in Furnace I on 112 operating days with an average consumption of 34 m³ of gas per cremation (about 136,000 kcal); Furnace II saw 288 cremations on 92 days with an average consumption of 59 m³ of gas (about 236,000 kcal) per cremation. In comparison, the coke-fired furnaces, which had been in service previously, had cremated 1,834 corpses with an average consumption of 112 kg of coke (about 784,000 kcal) for each cremation between January and November 1932.

A third gas-fired furnace was installed at the Zürich Crematorium in 1935 (Document 69). It exploited the operational experience gathered in the meantime with Furnaces I and II.

The experiments done by Professor Schlöpfer with those furnaces at that time show that the average CO₂ content of the combusted gases was 4.5% in these furnaces, while that of Furnace III was 7% (Schlöpfer 1937, p. 159). As the maximum CO₂ content was 17.9% (*ibid.*, p. 151), the respective Excess Air ratios were 3.97 and 2.55 on average.

Professor Schlöpfer published various technical charts which are of particular interest. Here we will examine those which give the CO₂ content in the combusted gases during the cremation.

Figure 9 (Document 70) shows the recordings made on November 30th, 1932 for the muffle temperature, for the temperature of the discharge gases in the flue duct and for the CO₂ content over five consecutive cremations done in Furnace II with air feed from above. Initially the CO₂ content rose to 10% but later settled rapidly around 3 to 4%.

Figure 10 (Document 71) shows measurements taken on February 27th, 1936, on Furnace III with lateral air feed. Nine corpses were cremated on that day. The CO₂ content initially rose up to 16% but went down to 1% towards the end.

Figure 11 (Document 72) represents the heat loss of the combusted gases in kcal/min and in % of the heat input from the combustion of the corpse over the same span of time in relation to the CO₂ content of the combusted gases. We see that for a CO₂ content of 4% the heat loss via the combusted gases is as high as the heat generated during the cremation (100%).

Figure 13 (Document 73), on the other hand, illustrates the variations in the heat requirements per cremation as a function of the number of daily cremations for Furnaces II and III.

The heat balance of Furnace II for the tenth cremation is the following:

– heat lost with the discharge gases:	–177,000 kcal
– heat loss due to radiation and conduction:	–72,000 kcal
– heat contribution from the corpse and the coffin:	150,000 kcal

On balance, we have $150,000 - (177,000 + 72,000) = -99,000$ kcal, or $99,000 \div 4,500 = 22$ m³ of city gas (heat consumption for the tenth cremation). Here the

losses have been arrived at experimentally. The daily heat loss due to conduction and radiation is 720,000 kcal. On Schläpfer's chart, this heat is distributed over the number of cremations (actually, over the hours of operation of the furnace), and in this particular case, it amounts to $720,000 \div 10 = 72,000$ kcal per cremation.

5.3. Electrically Heated Furnaces

As we have seen in Chapter III, the use of electricity was considered as early as the beginning of the last century and was then perfected and used for the first time in an actual cremation furnace in the 1930s.

In April of 1930, the Swiss Confederation granted a patent for an electrically heated cremation furnace to Emch & Co. of Winterthur; the rights for Germany were ceded to J.A. Topf & Söhne of Erfurt.

Friedrich Hellwig published a vertical cross-sectional view of this furnace (Document 74) and commented on it as follows (1931a, pp. 397f.):

“On the side walls of the cremation muffle V there are heating elements H. Other elements are located on the sides of the inclined planes and below the floor O. The combusted gases leave the muffle through the grate Ro downwards, then enter the lateral channels A, arriving in the post-combustion chamber N, and leave via the chimney K which is above the furnace. Between the smoke channels A and the muffle are the recuperators Re, into which the fresh air flows from below, and arrives, after having been heated, in the cremation chamber via the slits B in the upper part of the muffle.

The idea is that the furnace is heated during the night with cheaper electricity and thus needs only little additional current for the actual cremation.

During heating, the chimney damper Kl and the fresh-air inlets of the recuperators must be closed, but in this phase the upper closure S of the muffle must be open. In this way, a continuous circulation of the air within the furnace is generated, leading to the walls of the muffle starting to glow and the other parts heating up well.

Before the first corpse is introduced, the chimney damper Kl and the fresh-air inlets to the recuperator are opened.

The total power of the heating elements, some 100 kW, is distributed over three groups:

a) The vertical walls of the cremation chamber above the level of the coffin with a total height of 800 mm and a total radiating surface of 3.6 m² and an output of 57 kW.

b) The inclined sidewalls below the coffin with a height of 300 mm and a total radiating surface of 1.4 m² and an output of 21 kW.

c) The floor of the muffle with a total surface area of 1.4 m² and an output of 21 kW.

This output allows the complete heating of the furnace in two and a half hours with an energy consumption of 200-250 kWh. For the subsequent cremations, which require 43 m³ of gas on average, the consumption would be some 156 kWh per cremation.

Group a) on the one hand and groups b) and c) on the other are separately connected to three lines, which allows them to be fed 42, 57 or 99 kW. Only parts b) and c) should be needed for the cremation and the reduction of the ash.

As far as the structure is concerned, heating elements a) and b) are constituted by bricks with two longitudinal openings forming a unit which can be inserted at the points provided for it. The bricks mentioned have further openings towards the furnace chambers; the elements can therefore radiate directly. They are made of a special nickel-chromium alloy and are said to have a section of 80 mm², which would correspond to a diameter of 10 mm. They have a large thermal inertia to avoid any overheating that would be caused primarily by the flames. For using elements of this diameter they must be connected to a supply of about 100 volts.

The layout of this furnace appears to be very sound, and the fact that during the preheating neither gases nor smoke is generated allows the furnace to be closed; the heat is thus accumulated totally, aside from radiation losses from the outside of the furnace."

In Europe the first electrically fired furnace was started up in the Biel Crematorium on August 31, 1933. Other furnaces of this kind were installed at Erfurt (December 1933), at Essen (October 1935) at Harrogate, England (October 1936), at Croydon, England (May 1937) and at Semil, Czechoslovakia (July 1937) (in that order; *Phoenix* 1938, p. 18).

The electric furnace at Biel was built by Brown, Boveri & Co. of Baden, a company still active in this field today,⁴⁰ under the supervision of Hans Keller, who had called for electrical firing already while doing his experiments with the coke-fired furnace. H. Keller has written two accounts on the performance of the experimental furnace at Biel (H. Keller 1934, abridged in H. Keller 1935a, pp. 65-70; H. Keller 1935c). I present a summary of the essential parts.

As results from Documents 75 and 76 showing the vertical and horizontal sections of the old coke furnace (A) and the new electric furnace (B), the latter had a considerably lower volume, 11 m³ as against 80 m³ for the coke furnace. With respect to the duration of a cremation, H. Keller wrote (1935c, p. 3):

"The duration of the cremation for an initial temperature of 700°C is 2 hours. It is thus a little shorter than for a coke furnace.^[41] This is due to the fact that the cremation takes place in pure hot air; hence, there are no gases acting against the combustion, except for nitrogen. The size of the corpse has little effect on the time, more on the speed at which the flame spreads and on the combustibility of the corpse. The great majority burns within two hours with an initial temperature of 700°C. Cases in which the cremation is over in one and a half hours are very rare. Somewhat more frequent are cases in which the corpse does not burn easily and the cremation may take up to five hours."

On this point, he has some further remarks (1934, pp. 12f.):

"There are corpses which burn easily and thus require a short time for the cremation. But there are other corpses that do not want to burn, requiring three

⁴⁰ The present name is BBC Brown Boveri AG (cf. Chapter 11).

⁴¹ As reference point for the end of the cremation, Keller obviously assumes the moment at which the ashes are removed from the furnace.

hours and even longer. This variability shows up also in the composition of the gas and in the temperature. Corpses burning easily will initially produce up to 16%, even 17% of CO₂; with corpses that are difficult to burn, this value goes down to 4%. The cause of this interesting phenomenon is still unknown and requires further scientific research.

In the case of a normal body, the duration for the electric furnace at Biel is around two hours. The CO₂ content is 14-16% initially, stays at that level for about one-half hour, and then decreases continuously until the end of the cremation has been reached. Something similar can be said about the temperature. If the corpse burns well, the temperature rises from 700 to 1000°C and higher without additional heating of the cremation muffle. If the corpse belongs to the type that does not burn well, it is difficult to hold the temperature at 700°C. The same thing can be said about the formation of smoke. If smoke develops, the combustion is incomplete, heat generation and CO₂ content are minimal, and the combustion temperature is low.”

H. Keller had 23 temperature probes installed in the furnace; thanks to them, it was possible to observe the cremation process through all of its phases from the point of view of heat technology. He produced two charts covering three cremations (Documents 83 and 84). The six curves of these charts refer to the following temperature values:

Curve 1: cremation chamber

Curve 2: post-combustion channel

Curve 3: combusted gases behind the furnace and in front of recuperator

Curve 4: combusted gases behind recuperator

Curve 5: combustion air behind recuperator

Curve 6: combustion air behind the electric heating coils and in front of entry into the cremation chamber

The charts show that the combustion air entered the muffle at a temperature of 600 to 700°C, and that was one of the reasons for the better combustion on the electric furnace. As Kessler noted, combustion in the electric furnace no longer took place only in the cremation chamber, but occurred essentially in the post-combustion channels. This resulted in a better heat distribution in the furnace, which contributed to an increase in its life (H. Keller 1935c, pp. 3f.). According to H. Keller's results, energy consumption for the electric furnace was only 13 to 14% of that of a coke-fired furnace (1934, p. 6).

In the succeeding years, Brown Boveri & Co. designed a standard furnace (Document 77), from which the more-recent model of BBC Brown Boveri is derived. The structure of the new device is described by G. Keller (not to be confused with Hans Keller). It showed a performance positively superior to that of the first experimental furnace at Biel (G. Keller 1942, p. 4):

“The cremation chamber, one meter wide, one meter high and two meters forty long, is divided by the grate placed on its longitudinal axis into the main cremation chamber and the ash-collection chamber. Alongside and below the ash-collection chamber are located the post-combustion channels in which the smoke combustion takes place.

This ash-collection chamber, surrounded on three sides by the well-heated post-combustion channels, holds the ashes until they are moved to the post-combustion grate in a glowing state; they thus burn out completely to the point of turning white. The narrow gaps of the main grate prevent larger uncombusted parts from falling through. The smaller particles, mainly charcoal, which do not burn to completion in the ash-collection chamber, can be placed onto a shell-shaped post-combustion grate where they turn to ash. This post-combustion grate can be separated from the ash-collection chamber by means of a refractory plate, therefore a further cremation can be carried out in the main cremation chamber while the ash of the previous corpse burns out, and there is no mixing of ashes from the two corpses.

The cremation air enters sideways above the grate and the combusted gases flow downwards through the grate into the ash-collection chamber; from there, through side channels below it, they flow into the recuperator and to the chimney. Jets of hot air directed at certain points in the post-combustion channels by means of nozzles reduce the formation of smoke. The great variation of bodies to be cremated with respect to the amount of combustible parts (which produce heat) requires appropriate measures for the control of primary air, fed to the main cremation muffle, and of secondary air, fed to the post-combustion channels.

Good preheating of the combustion air is, moreover, useful for the prevention of smoke and, at the same time, for a recovery of the cremation heat. This preheating takes place in a metallic recuperator with spiral channels [Document 77, No. 3]. The combusted gases, which go to the chimney, flow through the inner channel of the coil from the center to the outside whereas the fresh air flows through the outer channel from the outside towards the center. The cooling of the combusted gases and the heating of the combustion air are shown on the temperature trace of a cremation, as well as on the complete temperature chart of a cremation. The good heat exchange of 40,000 kcal/hr in a piece of equipment only 0.25 m³ in size results from the opted-for high velocity of the gases and of the air. In order to reduce the pressure loss which occurs in the recuperator, the static pressure of the fresh-air blower and that of the combusted gases was set sufficiently high."

G. Keller also published a temperature chart for four cremations in the crematorium at St. Gallen (Document 85), which shows a considerably shorter cremation time than was obtained with the Biel furnace: about one hour and twenty minutes.

The consumption of electrical energy in this unit was extremely low, even in cases of isolated cremations: for example, data published by G. Keller for the Bern furnace show that in January and February of 1942, with 67 and 60 cremations respectively, the average consumption for one cremation was 12.47 kWh (*ibid.*, p. 5).

The electric furnace rapidly became the most potent competitor for the gas-fired furnace, and thus we also encounter polemics concerning the economies of the two heating systems, which involved Hans Keller directly as one of the major proponents of electric heating at that time (H. Keller 1935b, p. 176; Jordan/Deringer 1936, p. 16).

By the beginning of the 1930s, coke-fired cremation furnaces with a gasifier had reached the pinnacle of their technical perfection but also began their inexorable decline: their destiny now was demolition⁴² or the retrofitting to gas firing (Repky 1932).

6. The Duration of the Cremation Process

Cremation is a physico-chemical process which for its completion requires a duration that may be called natural, in the sense that it is not possible to shorten it at will, whatever the furnace system used.

This duration depends essentially upon the chemical composition of the human body, whose protein structure strongly resists combustion, as has already been noted by the engineer Martin Klettner (see Unit II, Chapter 3) and has been confirmed by the specific scientific experiments run in England in the 1970s, which we will discuss later. This is due to the body's relatively high nitrogen content, to its high ignition temperature, and to the chemical changes which the proteins undergo at higher temperatures, all being aggravated further by the fact that these substances are, as it were, immersed in the water of the human body to the effect that nothing will burn until this water has evaporated.

In other words, a cremation which takes place under optimum conditions cannot proceed more quickly than the "natural" time needed for the progression of the combustion. In the same way, a cremation takes longer the more it is performed under non-optimal conditions, be that because of incompetent or negligent operation of the furnace, and/or because of inadequacies in the design or condition of the unit. In present-day gas-fired furnaces, this lower limit is about one hour (see Chapter 11).

Before we look at the data found in the specialized literature, we must define what we mean by the duration of a cremation. Although it may be said that a cremation is over only when the ashes of the corpse are removed from the furnace, normally the duration of a cremation in a furnace not equipped with a post-combustion grate is the time elapsed between the introduction of the coffin into the cremation chamber and the transfer of the ashes from the inclined plane of the post-combustion chamber into the ash chamber where they will eventually burn out. In a furnace with a post-combustion grate, such as the gasifier furnaces built by Beck and Topf in the 1930s or the Volckmann-Ludwig gas-fired furnace, the reference time is given by the moment at which the glowing ashes are moved from the inclined plane of the post-combustion chamber or from the floor of the muffle to the post-combustion grate.

However, even though this was contrary to Kessler's ethical and professional norms drawn up in 1932 (see Chapter 8), some crematoria would introduce a

⁴² For example, the old coke-fired furnaces at the Hamburg Crematorium were replaced by the experimental gas-fired Volckmann-Ludwig Furnace as early as 1928 (Manskopf 1933); in the years 1937-1938, the old coke-fired furnace at the Dortmund Crematorium was torn down and replaced by two gas-fired Volckmann-Ludwig Furnaces (Kämper 1941).

subsequent corpse into the cremation chamber even as the residues from the previous body were still burning out on the inclined plane of the post-combustion chamber. Thus, two corpses were in the same furnace simultaneously, albeit in separate chambers and in different phases of the cremation. As we have seen in the preceding chapter, such a procedure was standard practice in furnaces like the Volckmann-Ludwig unit at Stuttgart, which had a lid for the isolation of the post-combustion chamber.

The difference in the durations of cremations carried out in accordance with these two different criteria is not irrelevant, as is shown for example by Kessler's observations with the experimental Volckmann-Ludwig Furnace at Hamburg in 1931: on average, a cremation up to the transfer of the residues of the corpse from the plate at the floor of the cremation chamber (which, in this type of furnace, played the part of a grate) to the post-combustion grate for the final burn-out took about one hour in case of continuous operation of the furnace, but for the overall cremation (up to the final withdrawal of the ashes) Kessler recorded durations varying between 1 hour and 43 minutes and 2 hours and 45 minutes (Kessler 1931a, p. 37).

In the experimental Volckmann-Ludwig Furnace, the solar plexus of the corpse did not burn completely in the cremation chamber but only on the post-combustion grate, therefore, when the next corpse was introduced into the cremation chamber, the cremation of the previous one wasn't over yet. Heated by means of city gas as it was, this furnace could be run uninterruptedly and could carry out 20 to 22 cremations per day in 24 hours of continuous operation according to its designers (see Chapter 5).

In furnaces not having a post-combustion grate it was no doubt possible to introduce the next corpse into the cremation chamber as soon as the residues of the previous one had dropped through the bars of the grate onto the inclined plane without waiting for them to burn out completely, even though this was not allowed for ethical and esthetic reasons. Still, if we are to believe the minimum times reported for the Schneider and Topf gasifier furnaces (45 minutes) in some crematoria, one has to assume that this rule apparently was not always followed.

Not fulfilling this requirement – which specified that the residues of a corpse could only be moved when they were no longer aflame – was of course possible also in furnaces with a post-combustion grate, and so R. Kessler explains precisely along those lines the stupendous results of the experimental furnace at Hamburg (2,500 corpses cremated in 7 months with a total consumption of 100 m³ of gas; Kessler 1931a, pp. 37f.):

“The administration of the Hamburg-Ohlsdorf C emetery generally assumes an average consumption of 7 m³ for a cremation. The operators receive a bonus amounting to half the cost of the gas in case of a lower consumption. Here we have, no doubt, a great risk for cremations to be run not in accordance with the rules. The operator is obviously interested in not letting the temperature of the furnace drop too far. This possibility exists mainly in the final phase of the cremation. If he feeds little air so as not to let the furnace cool and thus arrive at a savings, the end of the cremation is drawn out. If he speeds the cremation with

sufficient air feed, following his instructions to the letter, the furnace will cool and he has to supply more gas to heat it up again. That reduces his bonus. Therefore, there is the risk that, because of a disregard for the operating instructions, the remains [of the corpse] are moved to the post-combustion grate already before all the combustible matter of the corpse has been consumed."

In the table below I have summarized the data for the average duration of a cremation in furnaces with a gasifier:⁴³

FURNACE SYSTEM	AVERAGE DURATION OF A CREMATION [hr]
Siemens	1½
Klingenstierna	1 – 1½
Schneider	¾ – 1½
Ruppmann	1¼ – 1¾
Topf	¾ – 1½

In a publication concerning the Paris Crematorium of Père-la-Chaise the following operating result of the years 1889-1893 are given (Préfecture... 1893, p. 14.):

1889 – FURNACE TOISUL & FRADET							
AGE [yrs]	SEX		TOTAL	DURATION OF CREMATION [hrs]			Average
	M	F		< 1	1 – 1½	> 1½	
0-9	3	2	5	5	/	/	40 min.
10-29	3	2	5	2	2	1	60 min.
30-50	8	5	13	3	9	1	70 min.
≥60	9	4	13	/	11	2	75 min.
Totals	23	13	36	10	22	4	

1890 – FURNACE TOISUL & FRADET							
AGE [y]	SEX		TOTAL	DURATION OF CREMATION [h]			Average
	M	F		< 1	1 – 1½	> 1½	
0-9	12	6	18	17	1	/	40 min.
10-29	5	2	7	3	4	/	60 min.
30-50	28	14	42	12	30	/	62 min.
≥60	34	20	54	10	41	3	65 min.
Totals	79	42	121	42	76	3	

1891 – FURNACE FICHET							
AGE [yrs]	SEX		TOTAL	DURATION OF CREMATION [hrs]			Average
	M	F		< 1	1 – 1½	> 1½	
0-9	8	5	13	12	1	/	38 min.
10-29	2	6	8	5	3	/	58 min.
30-50	49	15	64	38	25	1	59 min.
≥60	36	13	49	21	27	1	59 min.
Totals	95	39	134	76	56	2	

⁴³ Beutinger 1911, pp. 106, 110, 113, 115; Topf 1926 (see Unit II, Chapter 2). In the Schneider Furnace at the Gotha Crematorium a cremation generally took 1 hr 15 min (Stadtvorstand Gotha 1928, p. 25).

1892 – FURNACE FICHET and subsequently TOISUL & FRADET							
AGE [yrs]	SEX		TOTAL	DURATION OF CREMATION [hrs]			
	M	F		< 1	1 – 1½	> 1½	Average
0-9	9	4	13	12	1	/	38 min.
10-29	6	6	12	6	4	2	63 min.
30-50	55	23	78	27	45	6	66 min.
≥60	35	21	56	26	27	3	64 min.
Totals	105	54	159	71	77	11	

1893 – FURNACE FICHET and subsequently TOISUL & FRADET							
AGE [yrs]	SEX		TOTAL	DURATION OF CREMATION [hrs]			
	M	F		< 1	1 – 1½	> 1½	Average
0-9	6	7	13	13	/	/	37 min.
10-29	11	1	12	9	3	/	51 min.
30-50	38	21	59	41	18	/	55 min.
≥60	48	18	66	41	24	1	54 min.
Totals	103	47	150	104	45	1	

The data for the years 1891 and 1893 are at or even below the limit of the later operations and, if they are accurate,⁴⁴ can only refer to the main combustion, not including the time needed for the post-combustion. This is evident already from a simple comparison with an extract of the report of the Municipal Construction Office of Stuttgart as authored by Prof. Robert Nagel concerning 48 cremations carried out between July 20th and September 15th, 1909, in the local Ruppmann furnace. The average duration of a cremation was 1 hour and 33 minutes, the minimum was 1 hour and 10 minutes and the maximum was 2 hours and 30 minutes (Nagel 1922, p. 36).

Paul Freygang adds more important technical data: Average consumption of coke for each cremation: 207 kg; chimney draft: 11.3 mm water column shortly before the introduction of the corpse and 10.8 mm after the cremation. The average temperatures of the cremation chamber, exhaust and combustion air exiting the recuperator, as measured by thermocouples, are summarized in the following table (Freygang 1914, p. 476):

⁴⁴ The data do not match charts drawn from data recorded by the furnaces' instruments.

Measuring time	Temperatures [°C]			
	muffle	exhaust gases	air ducts	
			left	right
Right before introduction	1002	547	442	421
Right after introduction	997	612	416.5	389.5
After 10 min.	975	656	401.5	372.5
After 20 min.	968.5	872	391.5	369.5
After 30 min.	972	671.5	393.5	373.5
After 45 min.	979.5	658	398	376
After 60 min.	986.5	639	410	389
After 75 min.	989	620	417.5	397.5
After 90 min.	982	608.75	421	402
Shortly after end	973	596	409	402

The furnace offered by the W. Müller Co. to the Dachau Concentration Camp specified an average of 1 hour and 30 minutes for one cremation, according to the supplier.

A survey carried out by Prof. Paul Schläpfer on the Swiss crematoria in the 1930s yielded the following data for coke-fired furnaces (Schläpfer 1937, table outside of text):

LOCATION	YEAR BUILT	AVERAGE DURATION (hrs)
Davos	1913	2
Rüti	1929	3 ⁴⁵
Solothurn	1924/25	2 – 3
Olten	1918	1 – 2
Neuchâtel	1923	2
Lugano	1916	1
Schaffhausen	1914	1½ – 2
Lucerne	1924	2½ – 3
Biel	1911	1 – 2
Aarau	1912	2½ – 3
St. Gallen	1902	2¾
St. Gallen	1926	1½ – 1¾

The figures quoted have only an indicative value, as they may have been affected by motives of propaganda or competition. Hence, as an objective and unassailable reference point, I shall instead use the figures presented in a series of charts concerning cremations produced by technical measuring devices installed in the furnaces. The charts concerning the experiments performed by Richard Kessler, which we examined in Chapter 4, are particularly important in this respect. For these, we may rightly assume that the cremations took place under optimum conditions, not only because of the advanced design of the furnace (Gebrüder Beck, Offenbach), but also because of the care exercised by Kessler in preventing leakage of air, because of the use of proper instruments to observe the cremation process throughout all of its stages, and because of the particular-

⁴⁵ Up to the removal of the ashes.

ly careful operation of the furnace under the supervision of a specialized engineer.

The average duration of a cremation was 1 hour and 26 minutes in the case of coke, and 1 hour and 22 minutes in the case of briquettes.

Let us now look at the individual charts.

6.1. Cremation Furnace with a Coke-Fed Gasifier

Chart No. 1 (Documents 47f.)

Furnace design:	Gebrüder Beck, Offenbach
Location:	Dessau
Number of consecutive cremations:	8
Start of first cremation:	9:30 AM
End of last cremation:	9:00 PM
Total duration of cremations:	11 hr 30 min
Average duration of one cremation:	1 hr 26 min
Duration of the individual cremations:	
1) from 9:30 to 11:13 =	1 hr 43 min
2) from 11:14 to 12:55 =	1 hr 41 min
3) from 12:58 to 14:10 =	1 hr 12 min
4) from 14:15 to 15:31 =	1 hr 16 min
5) from 15:34 to 16:39 =	1 hr 05 min
6) from 16:40 to 18:38 =	1 hr 58 min
7) from 18:38 to 19:56 =	1 hr 18 min
8) from 20:00 to 21:00 =	1 hr
Duration of shortest cremation:	1 hr

Chart No. 2 (Document 78)

Furnace design:	not indicated
Location:	not indicated
Number of consecutive cremations:	3
Start of first cremation:	10:30 AM
End of last cremation:	3:45 PM
Total duration of cremations:	5 hrs 15 min
Average duration of one cremation:	1 hr 45 min
Duration of shortest cremation:	1 hr 15 min (child)

6.2. Cremation Furnace with Briquette-Fed Gasifier

Chart No. 3 (Documents 49f.)

Furnace design:	Gebrüder Beck, Offenbach
Location:	Dessau
Number of consecutive cremations:	8
Start of first cremation:	9:00 AM
End of last cremation:	8:00 PM

Total duration of cremations:	11 hrs
Average duration of one cremation:	1 hr 22 min
Duration of individual cremations:	
1) from 9:00 to 10:44 =	1 hr 44 min
2) from 10:45 to 12:00 =	1 hr 15 min
3) from 12:00 to 13:30 =	1 hr 30 min
4) from 13:34 to 14:45 =	1 hr 11 min
5) from 14:45 to 16:02 =	1 hr 17 min
6) from 16:02 to 17:15 =	1 hr 13 min
7) from 17:18 to 18:20 =	1 hr 02 min
8) from 18:20 to 20:00 =	1 hr 40 min
Duration of shortest cremation:	1 hr 02 min

6.3. Cremation Furnace Heated with Gas

Chart No. 4 (Documents 51f.)

Furnace design:	Gebrüder Beck, Offenbach
Location:	Dessau
Number of consecutive cremations:	8
Start of first cremation:	8:22 AM
End of last cremation:	6:00 PM
Total duration of cremations:	9 hrs 38 min
Average duration of one cremation:	1 hr 12 min
Duration of individual cremations	
1) from 8:22 to 9:30 =	1 hr 8 min
2) from 9:31 to 10:30 =	59 min
3) from 10:32 to 11:39 =	1 hr 7 min
4) from 11:40 to 12:32 =	52 min
5) from 12:35 to 13:55 =	1 hr 20 min
6) from 13:56 to 15:12 =	1 hr 16 min
7) from 15:14 to 16:39 =	1 hr 25 min
8) from 16:41 to 18:00 =	1 hr 19 min
Duration of shortest cremation:	52 min.

Chart No. 5 (Document 79)

Furnace design:	E. Emch & Co., Winterthur.
Location:	Zürich
Number of consecutive cremations:	5 ⁴⁶
Beginning of first cremation:	8:00 AM
End of fourth cremation:	around 3:45 PM
Total duration of cremations:	7 hrs 45 min
Average duration of one cremation:	1 hr 56 min

⁴⁶ As the end of the last cremation is not clearly indicated, we shall ignore it here.

Chart No. 6 (Document 80)

Furnace design:	E. Emch & Co., Winterthur (modified design)
Location:	Zürich
Number of consecutive cremations:	7 ⁴⁶
Start of first cremation:	around 8:50 AM
End of last cremation:	5:00 PM
Total duration of cremations:	8 hrs 10 min
Average duration of one cremation:	1 hr 21 min.

Chart No. 7 (Document 81)

Furnace design:	Volckmann-Ludwig
Location:	Stuttgart
Year:	1931
Number of consecutive cremations:	5
Start of first cremation:	around 9:50 AM
End of last cremation:	around 5:20 PM
Total duration of cremations:	about 7 hrs 30 min
Average duration of one cremation:	about 1 hr 30 min

Chart No. 8 (Document 82)

Furnace design, location, year:	as above
Number of consecutive cremations:	5
Start of first cremation:	around 10:45 AM
End of last cremation:	around 5:35 PM
Total duration of cremations:	about 6 hrs 50 min
Average duration of one cremation:	about 1 hr 22 min.

6.4. Cremation Furnace Fired Electrically

Chart No. 9 (Document 83)

Furnace design:	Brown, Boveri & Co., Baden (prototype)
Location:	Biel
Year:	1934
Number of consecutive cremations:	1
Duration of the cremation:	around 2 hrs 38 min.

Chart No. 10 (Document 84)

Furnace design, location, year:	as above
Number of consecutive cremations:	2
Total duration of cremations:	about 4 hrs 8 min
Average duration of one cremation:	about 2 hrs 4 min.

Chart No. 11 (Document 85)

Furnace design:	as above
Location:	St. Gallen
Year:	1942
Number of consecutive cremations:	4
Total duration of cremations:	5 hrs 20 min (effective)
Average duration of one cremation:	about 1 hr 20 min.

Chart No. 12 (Document 54)

Furnace design:	Brown, Boveri & Co., Baden
Location:	Biel
Year:	1940
Duration of shortest cremation:	about 1 hr 10 min.

Chart No. 13 (Document 55)

Furnace design:	as above
Location:	Biel
Duration of shortest cremation:	about 1 hr 10 min.

Chart No. 14 (Document 56)

Furnace design, location:	as above
Year:	1943
Durations of the individual cremations:	
1) from 10:03 to 11:30 =	1 hr 27 min
2) from 14:18 to 15:50 =	1 hr 32 min
3) from 8:28 to 10:15 =	1 hr 47 min

Chart No. 15 (Document 57, upper chart)

Furnace design, location:	as above
Year:	as above
Start of cremation:	11:03 AM
End of cremation:	12:05 PM
Duration of cremation:	1 hr 2 min.

Chart No. 16 (Document 57, middle chart)

Furnace design, location:	as above
Year:	as above
Start of cremation:	1:33 PM
End of cremation:	2:50 PM
Duration of cremation:	1 hr 17 min.

Chart No. 17 (Document 57, lower chart)

Furnace design, location, year:	as above
Start of cremation:	11:00 AM

End of cremation:	12:05 PM
Duration of cremation:	1 hr 5 min.

Incineration lists of crematoria are no doubt reliable documents as well. Here I present an extract from a list of the Bielefeld Crematorium covering 26 cremations that took place between 5 and 23 December 1941 (Document 86). The majority of those cremated were detainees from the Wewelsburg Concentration Camp. The list is in conformity with the decree of the Reich Ministry of the Interior of August 10th, 1938 (see Chapter 8). The Bielefeld Crematorium was started up in 1938 and was coke-fired. The duration of the consecutive cremations is shown in the table below (the letter “W” indicates that it concerned the cremation of a Wewelsburg inmate).

December 5, 1941

No. 1289 from 9:30 AM to 10:30 AM =	1 hr W
No. 1290 from 10:30 AM to 1:00 PM =	1 hr 30 min W
No. 1291 from 1:00 PM to 3:00 PM =	2 hrs
No. 1292 from 3:00 PM to 5:00 PM =	2 hrs

December 10, 1941

No. 1294 from 8:30 AM to 10:00 AM =	1 hr 30 min W
No. 1295 from 10:00 AM to 11:30 AM =	1 hr 30 min W
No. 1296 from 11:30 AM to 2:00 PM =	2 hrs 30 min
No. 1297 from 2:00 PM to 4:45 PM =	2 hrs 45 min

December 15, 1941

No. 1299 from 9:00 to 10:30 AM =	1 hr 30 min W
No. 1300 from 10:30 AM to 12:00 PM =	1 hr 30 min W
No. 1301 from 12:00 PM to 2:00 PM =	2 hrs W
No. 1302 from 2:00 PM to 3:30 PM =	1 hr 30 min W
No. 1303 from 3:30 PM to 4:30 PM =	1 hr W

December 18, 1941

No. 1305 from 8:00 AM to 9:30 AM =	1 hr 30 min
No. 1306 from 9:30 AM to 11:00 AM =	1 hr 30 min W
No. 1307 from 11:00 AM to 12:00 PM =	1 hr W
No. 1308 from 12:00 PM to 1:30 PM =	1 hr 30 min W
No. 1309 from 1:30 PM to 3:15 PM =	1 hr 45 min W
No. 1310 from 3:15 PM to 4:15 PM =	1 hr W
No. 1311 from 4:15 PM to 5:15 PM =	1 hr W
Average duration of one cremation:	1 hr 30 min
Duration of shortest cremation:	1 hr.

In the 1970s, scientific experiments were done in England with the aim of identifying the most-important factors having an influence on the cremation process.

The results were read at the annual convention of the Cremation Society of Great Britain in July of 1975.

The experiments were done along two lines: a preliminary investigation in the Breakspear Crematorium at Ruislip, and a full investigation in the Chanderrlands Crematorium at Hull. The researchers conducting the experiments initially selected the following factors to be considered: the fuel, the type of furnace, the dimensions of the coffin (and of the corpse), the hygienic treatment (embalming) of the corpse, the cause of death, the furnace operator, and the use of different furnaces. The effects of varying technical factors were reduced by adopting the same gas-fired furnace (Dowson & Mason Twin Reflux Cremator) and the same furnace operator at both locations (Jones 1975, p. 81).

Taking into account these factors, 200 to 300 cremations were observed, and the data gathered were handed to the statistician of the group for a preliminary report. This analysis showed that, out of the factors considered initially, only four were significant: the age and the gender of the deceased, the cause of death and the temperature of the furnace. On the basis of these findings, the research was continued at the Hull Crematorium. Here it was found that the really decisive factors were the maximum temperature of the furnace and the gender of the deceased. The results obtained were incorporated into a chart by the statistician (Document 87), which one of the researchers, Dr. E. W. Jones, comments upon as follows:

“From his graph he [the statistician] was able to tell us (we felt this to be rather interesting) that there is a maximum point, or rather a minimum point, of incineration time below which it is impossible to go, and our statistician defined this as a thermal barrier that, because of the make, the nature of human tissues, you cannot incinerate them at a rate which is below round about 63 minutes.”

Some corpses may burn even within 60, 59 or 58 minutes: this is the lower limit of the thermal barrier (*ibid.*, p. 88).

The chart shows that the duration which comes closest to the thermal barrier, set at 60 minutes, corresponds to a temperature of 800°C. When the temperature is raised to 1,000°C, the duration of the cremation rises to 67 minutes, and then drops again to 65 minutes at 1,100°C. At higher temperatures, which were not investigated, the duration should eventually fall and should drop below the thermal barrier at super-high temperatures. If one wanted to reduce the cremation time to 20 or 15 minutes – says Dr. Jones – it would be necessary to devise a furnace capable of running at 2000°C.

Then Dr. Jones adds (*ibid.*):

“Our statistician colleague did some work, he looked into the records of crematoria in Germany during the last war, and it would appear that the authorities there were presented with a similar problem – that they came up against a thermal barrier. They could not design a furnace that reduced the mean incineration time to a very practical effective level. So we started to look at why there is this thermal barrier with human tissues.”

The conclusion of the researchers is that the proteins of the human body undergo a chemical change when heated to 800 to 900°C, dissociating and recombining

ing to form “that can only be described as a hard crust” which resists the process of cremation (*ibid.*).

I wish to add that the first part of the chart which covers the temperature of 400 to 600°C cannot correspond to actual experiments – because the ignition temperature of the heavy hydrocarbons which form during the gasification of the corpse is about 650°C – unless these temperatures are not the maximum temperatures but the temperatures at the moment of the introduction of the coffin.

While we are able to say, in a nutshell, that the cremation time has a lower limit of about 60 minutes and that this is an undeniable fact, we must stress, though, that this is not an absolute but a general limit: it refers to the average duration of several cremations, rather than to any single one. This appears clearly in Chart No. 4 where the shortest time (52 min) is below the limit, but the average duration of the cremations (1 hr 12 min) is well above it.

In any case, as the cremation time depends also on the mass of the corpse, it is obvious that, for any given combustion rate, the cremation of a normal corpse of lower mass takes less time. Here, of course, we are not speaking of a lean corpse as opposed to a fat one, but of a small body having, in proportion, the same fat and protein content of a normal body.

In the furnaces with a gasifier, as Kessler has shown in his experiments, the lower limit is about 80 to 85 minutes.

7. Heat Balance of a Coke-Fed Cremation Furnace

The consumption of fuel of a cremation furnace depends essentially on the design of the furnace, the cremation process, the frequency of cremations, the composition of the corpses, and the management of the furnace.

The design of the furnace is important because a more-massive structure absorbs a greater amount of heat before the thermal steady state is reached. For example, the Siemens Furnace at the Gotha Crematorium required 1,500 kg of lignite for the first cremation, the Schneider Furnace needed 400 to 500 kg of coke, and the Klingenstierna Furnace consumed 280 to 400 kg of coke (Heepke 1905b, p. 20).

Furthermore, as results from Schläpfer’s charts for the temperature profile in the walls of a muffle at various stages of the preheating process (Documents 88f.), a well-insulated furnace loses less heat through convection and radiation than a poorly protected one. From the studies run on the furnaces of the Zürich Crematorium in the 1930s one can see for example that the first two furnaces, poorly insulated, lost 720,000 kcal over 24 hours, whereas the third one, better-insulated, lost only 480,000 (Schläpfer 1938, p. 154).

The feed system and the temperature of the secondary combustion air are also of great importance. The design of the furnace being dependent on the type of cremation process, the process type affects indirectly also the consumption of fuel. As I have mentioned, by cremation process type I mean the way in which

the combustion products of the gasifiers are put to use. There are three different cremation process types:

- *indirect*: the combustion products of the gasifier do not have direct contact with the corpse;
- *semi-direct*: the combustion products of the gasifier are in contact with the corpse only in the final stage of the cremation;
- *direct*: the combustion products of the gasifier are in contact with the corpse throughout the cremation.

The indirect process is based on the cremation system using purely hot air, as invented by F. Siemens, which we have discussed in Chapter 3 and which is obviously the most-expensive one.

The experiments carried out by R. Kessler in the gas-heated furnace showed for two consecutive cremations a consumption of 398 m³ of gas for the indirect cremation, of 156 m³ of gas for the semi-direct method, and of 137 m³ of gas for the direct cremation (Kessler 1927, No. 11, p. 177).

The number of consecutive cremations has an overriding effect on the fuel consumption. If, in fact, only one cremation takes place in a given furnace in the span of one day, the consumption of fuel for the purpose of bringing the furnace up to the operating temperature is totally assigned to that cremation. If, instead, several consecutive cremations are carried out, the initial consumption is evenly allocated to all cremations, and the apparent average consumption for any one cremation drops considerably. This may be seen clearly from Schläpfer's chart for the coke consumption per cremation for several consecutive cremations (Documents 90, 90a). It shows that some 415 kg of coke were needed for the first cremation starting with a cold furnace, but for 20 cremations in succession on average only 37.5 kg of coke were need for each cremation. This means that 20 discontinuous cremations run at intervals of several days would consume a total of 8,300 kg of coke as compared to a consumption of only 750 kg if run in succession.

The compositions of the corpses also affect the cremation process and hence the fuel consumption, because corpses contribute more or less heat to the muffle on account of their varying amounts of fat and proteins. According to Hellwig, out of 100 corpses, 65 will burn normally, 25 burn with difficulty, and 10 with great difficulty (Hellwig 1931a, p. 373). As we have seen in Chapter 5, corpses that burn well generate up to 16 or 17% of CO₂ in the early phases of the cremation, while for difficult corpses the CO₂ content drops to 4%, which corresponds to a much-higher Excess-Air ratio.

Finally, the way a furnace is operated has a major effect on heat economy as well: erratic or inattentive operation can lead to a doubling of the fuel consumption, as happened in the Dessau Crematorium according Kessler's account, prior to his scientific cremation experiments.

Calculating the theoretical heat balance of a cremation furnace with a coke-fed gasifier is a very difficult problem, because in practice many variables arise which cannot be predetermined theoretically, but the way the furnace is operat-

ed has to be adjusted to them from time to time. H. Keller observed quite correctly (H. Keller 1928, p. 30):

“There is no technical combustion device for which the difference between the amount of heat theoretically needed and the amount used is as large as in a cremation furnace.”

Various ways of calculating the heat balance have been proposed in the expert literature. Let us look at the most interesting ones:

The engineer Fichtl argues as follows (Fichtl 1924, p. 395):

“In the furnaces for cremating animal carcasses, such as those being used in stockyards or similar, the fuel consumption is based more-correctly on the weight (in kg) of the material cremated, and here, in fact, a fuel consumption corresponding to 15-20% of the weight of the material to be cremated (offal) is considered adequate. This latter principle has also been demonstrated in unsailable acceptance tests concerning such furnaces for animal carcasses. If this is applied to cremation furnaces, a coke consumption of 12-16 kg results for a human body weighing 80 kg on average and assuming a continuous operation. On the basis of certain hypotheses whose validity, however, cannot be irrefutably verified, one can also calculate the fuel consumption needed theoretically for the thermal destruction of a human body. The flesh, the main constituent of our body, consists of 70-80% of water, as is well known; the remainder is made up of 17-21% of protein substances (nitrogenous substances), of 1-3% of fat and of 1% of salts (mineral elements); its specific heat is about 0.8 WE/kg/°C [sic; WE = Wärme-Einheit= heat unit = kcal]. As the destruction of the body takes place at a fairly constant temperature of 1000°C, the heat needed in this case amounts to $80 \cdot 0.8 \cdot 1000 = 64,000$ kcal, the equivalent of $64,000 \div 3,000 = 21$ kg of coke; here, however, it is assumed that the specific heat stays constant over the temperature range between 0 and 1000°C, which has not yet been demonstrated experimentally, and also that the decomposition of the body sets in only at a temperature of more than 1000°C. Another approach, by way of the heat needed for vaporization and superheating of the body water, arrives at a similar result in the following manner:

$$\frac{75}{100} \cdot 80 \cdot (600 + 0.5 \cdot 900) = [63,000;] \frac{63,000}{3,000} = 21 \text{ kg of coke.} \quad [42]$$

In these attempts to arrive at the minimum fuel consumption via computations, one has not considered the heat contribution of those materials which burn together with the body, such as the wood of the coffin, the mattress of wood shavings, the garments etc., nor that of the inner substances, such as the fat or similar tissue, which produce further heat during the combustion. This heat supply to the furnace – which translates into an increase in the temperature of the discharge gases by 50-100°C – should be approximately 15,000-20,000 kcal for each corpse and should be deducted from the 60,000-65,000 kcal calculated above, if it were not for an amount of air, difficult to define but needed for an odorless and smokeless cremation, which must also be heated up from ambient temperature to that of the furnace. This happens primarily in the channels of the recuperator and therefore, for our purposes, we do not have to compute it. All told, the amount of coke theoretically needed for the cremation of a human body can be considered to be

$$\frac{64,000 - 15,000}{3,000} \approx \frac{50,000}{3,000} \approx 16-17 \text{ kg} \quad [43]$$

The heat content of the coke (metallurgical or from coke furnaces) burning in the gasifier is assumed here to be 6,000 kcal/[kg] and its efficiency in the cremation furnace to be 50%. This latter value, however, would be too high for the furnace systems built so far. The temperature of the combusted gases has been shown to be 500-700°C in repeated investigations, hence extremely high, while the CO₂ content proved to be very low, around 3-4%. The high temperatures of the discharge gases in cremation furnaces are in a way an inconvenient yet inevitable characteristic that cannot easily be avoided because of the high temperature – 1000°C – which must be maintained in the cremation muffle with its considerable mass of refractory materials storing heat, and because of the relatively short path between the muffle and the smoke trap. From the point of view of combustion technology, it would be easy to reduce the temperature of the discharge gases to 200-300°C with larger heated surfaces in the recuperators and with preheaters using the discharge gases. But in the first case, instead of losing the heat through the chimney, the result would only be a heating up of the refractory material or of the baffles in the recuperator. As the recuperator has an insulating effect downwards on the muffle during operation, this would yield only a slight economic gain, while during the warm-up phase and the inactive periods it would lead to an undesirable heating of the ambient air in the furnace hall.

The use of the discharge gases in preheaters for central heating or other such applications would face insurmountable difficulties of the type already mentioned [i.e. against the requirements of respect], and considering that the cremation process from this point of view has so far been flawless, it is best not to explore such venues. Hence, the heat losses via the discharge gases amount to 50-60% from the start. Furthermore, the furnaces now in operation transmit an excessively high and very-much-noticeable amount of heat to their surroundings by conduction and radiation of the furnaces' surfaces. With a space heater, for example, this would be an advantage, but here it must be considered a loss. This is due to the relatively weak insulation between the large mass of refractory material inside the furnace, at red heat, and the rather-thin outside walls. Therefore, temperatures of 60-80°C are not uncommon, and even-higher values may occur on the vault of the furnace and on the rear wall of the recuperator with its many steel-faced access ports. The heat losses by radiation and conduction from the surfaces of the furnace can therefore be calculated to be around 25-30%. Practically then, leaving aside the inevitable losses through incombustibles and furnace residues, we have at best an efficiency of 10-20%, so that the effective consumption of fuel for one corpse, as calculated, can be taken to be

$$\frac{50,000}{600 \text{ to } 1,200} \approx 85 \text{ to } 42 \text{ kg.}'' \quad [44]$$

This result, when compared to the average values for the fuel consumption actually recorded in practice, appears however somewhat high, even for an indirect-cremation process.

Tilly has used a different and more-precise method to arrive at a heat balance (Tilly 1926a, pp. 134ff.):

"In what follows, the basis of the calculation is a human body of 70 kg. If we assume an average water content of 65%, we must evaporate a total amount of $0.65 \cdot 70 = 45.5$ kg of water at atmospheric pressure, which requires a heat supply of $45.5 \cdot 600 = 27,300$ kcal. As the body contains 35 % of solids and only 30% of combustible substances, $0.3 \cdot 70 = 21$ kg of matter is available for the cremation process. According to Professor Zuntz, this matter consists of 52% carbon, 7% hydrogen, 23% oxygen, 1% sulfur and 17% nitrogen, which yields the following composition:

$$\begin{aligned} 0.52 \cdot 21 &= 10.92 \text{ kg carbon} \\ 0.07 \cdot 21 &= 1.47 \text{ " hydrogen} \\ 0.23 \cdot 21 &= 4.83 \text{ " oxygen} \\ 0.01 \cdot 21 &= 0.21 \text{ " sulfur} \\ 0.17 \cdot 21 &= 3.57 \text{ " nitrogen} \\ \text{Total} &= 21.00 \text{ kg substance} \end{aligned}$$

The air needed for the combustion of those elements can be calculated with the known equation^[47]

$$\frac{(2.667 \cdot 10.92) + (8 \cdot 1.47) + 0.21 - 4.83}{1.43 \cdot 0.21} = 123 \text{ m}^3 \text{ of air [recte } 121 \text{ m}^3] \text{ [45]}$$

at 0°C and 760 mm Hg, hence, for an excess of air of 50% we have about 185 m³ of air at 0°C and 760 mm Hg. In direct cremation, this volume of air is heated by the combustion products to about 950°C, requiring $(185 \cdot 1.293 \cdot 0.237 \cdot 950) = 54,000$ kcal. The water vapor generated by the corpse is likewise superheated to 950°C, the corresponding consumption of heat is $(45.5 \cdot 0.47) \cdot (950 - 100) = 18,000$ kcal. The heat generated by the oxidation of the elements mentioned above can be arrived at by means of the well-known equation:

$$\begin{aligned} (8,100 \cdot 10.92) + 29,000 \cdot \left(1.47 - \frac{4.83}{8}\right) + (2,500 \cdot 0.21) - (600 \cdot 45.5) \\ = 86,907 \text{ kcal [actually } 86,798 \text{ kcal]} \end{aligned} \quad [46]$$

Here, 27,300 kcal have been deducted for the evaporation of the water.

Let us now look at the two ways in which, by choice, the cremation of a human body proceeds.

First case: The corpse is brought directly into contact with the products of the combustion [of the gasifier] together with the excess air. The temperature of the hearth of a cremation furnace is about 1,300°C, with the temperature of the refractory material of the hearth, of the collecting channels, of the grate, of the ash chamber, and of the cremation chamber being taken to be 1,100°C. The temperature of the air must not drop below 800°C, therefore one may assume an average temperature of

$$(1,100 + 800) \div 2 = 950^\circ\text{C}.$$

The mass of the brickwork of refractory material may be taken to be 6,500 kg for one of the usual furnace designs. A heat amount of

⁴⁷ The equation $(2.67 \text{ C} + 8 \text{ H} + \text{S} - \text{O})/1.43 \cdot 0.21$, which has in the numerator the weight (in kg) of oxygen needed for the combustion, in the denominator the transformation index for changing from weight (kg) to volume (Nm³) and the vol.% of oxygen in air (approx. 21%), to compute the amount of air needed.

$$6,500 \cdot 0.21 \cdot 1,100 = 1,500,000 \text{ kcal}$$

is needed to bring it to $1,100^{\circ}\text{C}$.

Now, for the fuel consumption the following computation applies, depending upon whether one, five, twelve or twenty corpses are cremated in succession:

a) heating of refractory wall:	1,500,000 Cal.
b) heating of combustion air:	54,000 Cal.
c) superheating of steam:	<u>18,000 Cal.</u>
	1,572,000 Cal.
subtracting the heat generated by the corpse:	<u>86,907 Cal.</u>
Hence to be provided for the cremation of one corpse:	1,485,093 Cal.

which is the heat to be supplied for one cremation; assuming 3,500 kg for each kg of coke (taking into account the large heat losses via the discharge gases) this corresponds to an amount of coke of $1,485,093 \div 3,500 = 420$ kg.

As the heat generated by the body covers the heat required for the cremation, we can assume that, after the cremation of the first corpse, no heat is removed for this from the refractory wall, and only the heat needed to get the refractory brickwork to the operating temperature is considered in proportion, plus the additional heat needed to compensate for the natural losses due to cooling. On the basis of the operational results at Berlin and Dortmund, these [losses] can be taken to be 100% if more than five corpses are cremated in succession.

Hence, for the cremation of five corpses we have a fuel consumption of 85 kg each, for 12 corpses a consumption of 71 kg (with an additional requirement of 100% for the heat losses due to cooling)^[48] and for 20 corpses, including a corresponding increase, a consumption of 43 kg each. These figures are in good agreement with practical results, as shown by a comparison between the results obtained at the Berlin and Dortmund Crematoria and the above computations:

For one cremation:	420 kg per computation 480 kg per Dortmund data
For five corpses:	85 kg per computation 80 kg per Dortmund data
For twelve corpses:	71 kg per computation 75 kg per Berlin-Wilmersdorf data
For twenty corpses:	43 kg per computation 38 kg per Berlin-Wilmersdorf data

Second case: The corpse is in contact with hot air only, all of the refractory brickwork is brought to $1,100^{\circ}\text{C}$ by the combustion products of the hearth. A recuperator of 8,200 kg has been provided for heating the air. Considering the preheating of this device by means of discharge gases, the [heat] requirements to reach the operating temperature are:

⁴⁸ i.e. $(420 \div 12) = 35$ kg, plus 100% for the heat losses = 70 kg.

a) $8,200 \cdot 0.21 \cdot (1,100 - 500)$	1,000,000 Cal.
b) plus the heat necessary for the remainder of the refractory brickwork as in the first case	1,500,000 Cal.
c) same for heating of air	54,000 Cal.
d) same for superheating the steam	18,000 Cal.
	<hr/>
	2,572,000 Cal.
Less the heat produced by the corpse	-86,907 Cal.
	<hr/>
	2,485,093 Cal.

Therefore, the fuel consumption for the

– cremation of one corpse	= 710 kg
– cremation of five corpses	= 142 kg
– cremation of twelve corpses (+ 100%)	= 120 kg
– cremation of twenty corpses (+ 100%)	= 70 kg ^[49]

The case where the whole of the refractory brickwork is heated by means of hot air may be ignored, because the quantities of 4,600 kg, 875 kg, 440 kg of coke per corpse are never used in practice.”

In a later article Tilly arrives at a total consumption of 2,694,343 kcal via a different computation and concludes that “with the indirect cremation one consumes about 80% more coke than with the direct cremation” (Tilly 1927, p. 22).

The most-rigorous computation of the heat balance for a cremation furnace with a coke-fed gasifier was no doubt produced by Engineer Wilhelm Heepke in 1931. Even if his approach contains some erroneous attributions of factors – which confirms the great difficulty of the whole matter – it is of fundamental importance for the solution of the problem and merits quotation as a whole, together with the original text (Document 91). To avoid useless repetition, I have omitted the passages already quoted in Subchapter 5.1. (Heepke 1933, No. 9; see Document 91):

“The heat-flow chart in Fig.2 gives an overview of the interplay between the various combustion processes; the numerical values will be derived later on. The various amounts of heat resulting from the incineration process have been entered into Fig. 2 as percentages of the fuel efficiency and are shown as dot-dash lines. For the first process of coke combustion, the heat losses are shown as solid lines.

If we disregard the Gotha Furnace – which was initially heated with Bohemian lignite anyway – the only types of modern design are coke furnaces with a recuperator. The latter is made up of firebricks. The first Beck-type furnaces of the [18]90s were equipped with cast-iron air recuperators in line with the Klingensstierna System. It should be noted that there is at present a tendency in the steel industry to return to recuperators using metal tubes.”

At this point I have left out the paragraphs already quoted in Subchapter 5.1.

“If a computation is to be arrived at, only certain normal, maximum, or minimum values – as the case may be – must be defined, aside from variations in the amounts of heat and of temperature.

⁴⁹ These data refer to the average consumption for the cremation of one corpse as a function of the consecutive cremations shown.

The weight of the corpse of an adult person will run between 70 and 100 kg. Of this, 65% represent is water content, thus 35% are dry substances, of which 5% are incombustibles (ash). The $35 - 5 = 30\%$ of combustibles are composed of 12% fat, 15% proteins and 3% other substances, i.e. of 52% C, 7% H, 23% O, 1% S and 17% N. Thus, for an average corpse weighing $0.5 \cdot (100 + 70) = 85$ kg, one obtains a total of $0.3 \cdot 85 = 25.5$ kg of combustibles consisting of:

$$\begin{array}{r} 0.12 \cdot 85 = 10.20 \text{ kg of fat} \\ 0.15 \cdot 85 = 12.75 \text{ kg of protein} \\ 0.03 \cdot 85 = 2.55 \text{ kg of other substances} \\ \hline 25.50 \text{ kg} \end{array}$$

or of:

$$\begin{array}{r} c = 0.52 \cdot 25.5 = 13.260 \text{ kg of C} \\ h = 0.07 \cdot 25.5 = 1.785 \text{ kg of H} \\ o = 0.23 \cdot 25.5 = 5.865 \text{ kg of O} \\ s = 0.01 \cdot 25.5 = 0.255 \text{ kg of S} \\ n = 0.17 \cdot 25.5 = 4.335 \text{ kg of N} \\ \hline 25.500 \text{ kg} \end{array}$$

For a combustible substance of this kind, which is similar to a solid fuel, we have an Excess-Air ratio $m = 20.5 \div \text{CO}_2$. Experience tells us that $\text{CO}_2 \approx 13\%$, hence $m = 20.5 \div 13 = 1.5$. For the complete combustion of the parts mentioned, the effective amount $L^{[50]}$ of combustion air needed is:

$$\begin{aligned} L &= m \cdot \frac{2.67C + 8H + S - O}{0.3} = 1.5 \cdot \frac{2.67 \cdot 13.260 + 8 \cdot 1.785 + 0.255 - 5.865}{0.3} \\ &= 220.365 \approx 220 \text{ m}^3 \text{ at } 0^\circ\text{C and } 760 \text{ mm.} \end{aligned} \quad [47]$$

Experience as well as precise tests have shown that the temperature t in the coffin muffle must not be less than $\approx 800^\circ\text{C}$ nor more than 1000°C , if a combustion as complete as possible is to be achieved, yielding totally burned-out white ash. At $t > 1000^\circ\text{C}$, combustion would proceed more rapidly, but the bones would become black and hard. We will therefore assume $t = 900^\circ\text{C}$.

In the recuperator, the air is heated from the initial or room temperature $t_0 = 10^\circ\text{C}$ to $t_1 = 350^\circ\text{C}$. We have selected $t = 350^\circ\text{C}$, because the ignition temperature of the coffin's wood is around $325\text{-}350^\circ\text{C}$. Thus, an additional amount of heat has to be provided for the air amounting to:

$$\begin{aligned} W_1 &= 0.31 \cdot L \cdot (t - t_1) = 0.31 \cdot 220 \cdot (900 - 350) \\ &= 37,510 \approx 38,000 \text{ kcal.} \end{aligned} \quad [48]$$

The 65% of water (Q) present in the corpse, or $Q = 0.65 \cdot 85 = 55.25$ kg, must also be heated to $t = 900^\circ\text{C}$, which means that it has to be converted to saturated steam at 100°C and then superheated to 900°C . With a heat $i = 640$ kcal/kg needed to bring this about at 1 atm (abs.) and a specific heat for superheating $c_p = 0.48$, we arrive at a heat requirement for this evaporation of:

$$\begin{aligned} W_2 &= q \cdot [i + c_p \cdot (t - t_0)] = 55.25 \cdot [640 + 0.48 \cdot (900 - 10)] \\ &= 58,963 \approx 60,000 \text{ kcal.} \end{aligned} \quad [49]$$

⁵⁰ $L = \text{Luft}$, air.

During the incineration process, the incombustibles, i.e. the 5% of bones weighing $0.05 \cdot 85 = 4.25$ kg and having a specific heat of 0.2, will tie up an amount of heat of:

$$\begin{aligned} W_3 &= 0.2 \cdot 4.25 \cdot (900 - 10) \\ &= 740.5 \text{ [recte: 756.5]} \approx 800 \text{ kcal,} \end{aligned} \quad [50]$$

which must be considered lost once the ash has been removed from the ash collector.

The fire-brick lining of the upper part of the furnace with the muffle, grate, channels, and ash-collection space can be assumed to be $\approx 3 \text{ m}^3$; thus, for a density of $1,800 \text{ kg/m}^3$ we have a total weight of $G_1 = 3 \cdot 1,800 = 5,400$ kg. The temperature of this fire-brick portion has been measured as being approximately $\vartheta = 800^\circ\text{C}$. Hence, to heat this upper portion of the furnace from 10°C to 800°C , given a specific heat of 0.21, we have to supply:

$$\begin{aligned} W_4 &= c_p \cdot G_1 \cdot (\vartheta - t_0) = 0.21 \cdot 5,400 \cdot (800 - 10) \\ &= 895,600 \approx 900,000 \text{ kcal.} \end{aligned} \quad [51]$$

The lower part of the furnace contains $\approx 4 \text{ m}^3$ of firebrick and thus has a weight $G_2 = 4 \cdot 1,800 = 7,200$ kg. Assuming unfavorably low [=cold] conditions, the hot gases enter the recuperator at $T_1 = 600^\circ\text{C}$ and leave it through the flue duct at $T_F = 200^\circ\text{C}$. Thus we have:

An average temperature of the discharge gases:

$$T_m = \frac{T_1 + T_F}{2} = \frac{600 + 200}{2} = 400^\circ\text{C,} \quad [52]$$

and an average air temperature:

$$t_m = \frac{t_0 + t_1}{2} = \frac{10 + 350}{2} = 180^\circ\text{C.} \quad [53]$$

With $s = \frac{1}{2}$ of fire-brick of recuperator walls, thus a thickness of 0.065 m ;
 $\lambda =$ thermal conductivity of firebrick = 0.60 at 400 to 500°C ;
 $\alpha =$ heat-transfer coefficient for rough surfaces = 9.0 for $v \leq 5 \text{ m/sec}$
 (acc. to Jürges),

we get for the thermal transmittance K through the recuperator walls:

$$K = \frac{1}{\frac{1}{\alpha} + \frac{s}{\lambda} + \frac{1}{\alpha}} = \frac{1}{\frac{1}{9} + \frac{0.065}{0.6} + \frac{1}{9}} = \frac{1}{0.33} = 3.33 \text{ kcal/m}^2 \text{ }^\circ\text{C hr.} \quad [54]$$

This provides us with the two surface temperatures of the recuperator bricks:

$$\vartheta' = T_m - (T_m - t_m) \cdot \frac{k}{\alpha} = 400 - (400 - 180) \cdot \frac{3.33}{9} = 318^\circ\text{C,} \quad [55]$$

$$\vartheta'' = t_m + (T_m - t_m) \cdot \frac{k}{\alpha} = 180 + (400 - 180) \cdot \frac{3.33}{9} = 262^\circ\text{C,} \quad [56]$$

and the average brick temperature:

$$\vartheta_m = \frac{\vartheta' + \vartheta''}{2} = \frac{318 + 262}{2} = 290^\circ\text{C.} \quad [57]$$

As by definition $\alpha = \alpha' = \alpha'' = 9.0$, we also must have:

$$\vartheta_m = \frac{T_m + t_m}{2} = \frac{400 + 180}{2} = 290^\circ\text{C}. \quad [58]$$

If $\vartheta_m \approx 300^\circ\text{C}$, then the heat required for heating the recuperator becomes:

$$W_5 = c_p \cdot G_2 \cdot \vartheta_m = 0.21 \cdot 7,200 \cdot 300 = 453,600 \approx 454,000 \text{ kcal} \quad [59]$$

which serves to heat the air from 10 to 350°C .

As the furnace temperature thus exceeds the ignition temperature of the coffin material, the latter, as well as the corpse in due course, will ignite soon after the introduction of the coffin under the effect of the hot air, i.e. the oxygen it contains.

The cremation coffin has a weight $G_3 = 40$ kg and could supply an amount of heat equal to $H_u \cdot G_3 = 3,000 \cdot 40 = 120,000$ kcal with H_u [l.h.v.] = 3,000 kcal/kg for wood. However, the whole amount does not become effective, because the effect is reduced by 33% under the action of the varnish, the filling material of the coffin, and the clothes of the corpse, hence the gain as heat from the combustion of the coffin, will be only:

$$W_6 = 120,000 - 0.33 \cdot 120,000 = 80,400 \approx 80,000 \text{ kcal}. \quad [60]$$

As the combustible portions of the corpse are made up of the same organic components as a solid fuel, the heat generated by the combustion of the corpse can be arrived at by means of the usual compound equation:

$$\begin{aligned} W_7 &= 8,100 \cdot C + 29,000 \cdot \left(H - \frac{O}{8}\right) + 2,500 \cdot S - 600 \cdot Q \\ &= 8,100 \cdot 13.26 + 29,000 \cdot \left(1.785 - \frac{5.865}{8}\right) \\ &\quad + 2,500 \cdot 0.255 - 600 \cdot 55.25 = 105,402 \text{ kcal}. \end{aligned} \quad [61]$$

Including the fatty tissue of the corpse and assuming the heating value of the fat to be 8,000 kcal/kg and that of the proteins and other substances to be 1,500 kcal/kg, we obtain:

$$W_7 = 8,000 \cdot 10.2 + 1,500 (12.75 + 2.55) = 104,550 \text{ kcal}. \quad [62]$$

However, one can also use proven empirical values from animal-carcass incinerators for the computation of W_7 . With good furnaces of this type, one uses a coke consumption of 0.350 to 0.375 kg for the incineration of 1 kg of flesh in 1 minute. For $\eta = 0.5$ and $H_u = 7,000$ kcal/kg we get:

$$W_7 = 0.5 \cdot 7,000 \cdot 0.350 \cdot 85 = 104,125 \text{ kcal}. \quad [63]$$

Hence, as a definitive value, we can state:

$$W_7 = 105,000 \text{ kcal}.$$

For the cremation of an 85-kg corpse we thus get, on the basis of the empirical data, a combustion time of 85 minutes = 1 hour and 25 minutes. This is a duration which must also be applied to modern cremation furnaces.

For a first cremation, including the preheating of the furnace, we now have the following heat balance:

Heat to be supplied:

for heating of cremation air	$W_1 =$	38,000 kcal
for water evaporation	$W_2 =$	60,000 kcal
for heating the ash	$W_3 =$	800 kcal
for heating upper part of the furnace	$W_4 =$	900,000 kcal
for heating lower part of the furnace	$W_5 =$	454,000 kcal
	$\Sigma(W_{1\text{ to }5}) =$	1,452,800 kcal

Heat generated:

by combustion of the coffin	$W_6 =$	-80,000 kcal
by combustion of the corpse	$W_7 =$	-105,000 kcal
	$\Sigma(W_{6+7}) =$	-185,000 kcal

Hence, we have for a first incineration a net heat requirement of

$$W_{\text{net}} = 1,267,800 \text{ kcal}$$

As a fuel we consider coke in the form of gas coke or metallurgical coke. For our purposes we will use a metallurgical coke having the following composition: $C = 78.84$; $H = 0.51$; $O = 1.0$; $S = 0.91$; $W[\text{ater}] = 8.21$; $A[\text{sh}] = 10.53$ %. This gives us a theoretical l.h.v.:

$$\begin{aligned} H_u &= 81C + 290 \cdot \left(H - \frac{O}{8}\right) + 25S - 6W \\ &= 81 \cdot 78.84 + 290 \cdot \left(0.51 - \frac{1.00}{8}\right) + 25 \cdot 0.91 - 6 \cdot 8.21 \\ &= 6,471.18 \approx 6,470 \text{ kcal/kg.} \end{aligned} \quad [64]$$

To determine the effective heat requirements, i.e. the efficiency η ,^[51] we must consider the heat losses of the furnace, which are composed of loss through the chimney, conduction and radiation losses, incomplete combustion, and hearth residue (ash). For this purpose we will use empirical values having been ascertained through tests or by experience for the fuel used. Partly, of course, we must use average values for this computation. We have thus found: flue duct temperature $T_F = 200^\circ\text{C}$, room temperature at start of heating $t_0 = 10^\circ\text{C}$ and at start of operation $t'_0 = 20^\circ\text{C}$, analysis of the discharge gas (flue gases) $\text{CO}_2 = 13$; $\text{O}_2 = 7.3$; $\text{CO} = 0.5$; $\text{H}_2 = 0.4$; $\text{CH}_4 = 0.3$, and $\text{N} = 70.5$ % by volume, ash content of the coke for a first heating $A' = 12$ kg with an analysis of $C_a = 47.8$; $H_a = 0.1$; $S_a = 1.6$; incombustibles 50.5%, hence uncombusted and incombustible materials in the ash $U_a = (C_a + H_a + S_a) = 47.8 + 0.1 + 1.6 = 49.5\%$.^[52]

By means of the combustion test in the Berthelot-Mahlert vessel, the heating value of U_a was found to be H_{ua} ^[53] = 3,650 kcal/kg.

This yields a chimney loss of:

$$\begin{aligned} V_{\text{sch}}^{[54]} &= 0.32 \cdot \left(\frac{C}{0.536 \cdot \text{CO}_2} + 0.0048 \cdot (9H + W) \right) \cdot (T_F - t_0) \cdot \frac{100}{H_u} \\ &= 0.32 \cdot \left(\frac{78.84}{0.536 \cdot 13} + 0.0048 \cdot (9 \cdot 0.51 + 8.21) \right) \cdot (200 - 10) \cdot \frac{100}{6,470} \end{aligned}$$

⁵¹ The original erroneously has "G," which would normally stand for the weight.

⁵² $U = \text{Unverbranntes}$ (uncombusted); $U_a =$ uncombusted in the ash (subscript "a" = *Asche*, ash). The capital letters signify the chemical elements. Hence, C_a means that the 12 kg of ash contained 47.8% (= 5.736 kg) of carbon, and so on.

⁵³ $H_{ua} =$ unterer Heizwert *Asche*, lower heating value of ash.

⁵⁴ $V_{\text{sch}} =$ Verlust *Schornstein*, loss through chimney.

$$= 10.80\%. \quad [65]$$

Or with the volume of the dry combustion gases:

$$R_v^{[55]} = \frac{0.01 \cdot C}{0.536 \cdot \frac{CO_2 + CO + CH_4}{100}} = \frac{0.01 \cdot 78.84}{0.536 \cdot \frac{13 + 0.5 + 0.3}{100}} = 10.7 \text{ m}^3/\text{kg}. \quad [66]$$

Using the average specific heat of the discharge gases:

$$c_{pm} = 0.318 + 4.6 \cdot 10^{-5} \cdot (T_f - t_0) = 0.318 + 4.6 \cdot 10^{-5} \cdot (200 - 10) = 0.32 \quad [67]$$

we get:

$$V_{sch} = \frac{R_v \cdot c_{pm} (T_f - t_0) \cdot 100}{H_u} = \frac{10.7 \cdot 0.327 \cdot (200 - 10) \cdot 100}{6,470} = 10.30\%. \quad [68]$$

Or, using the Excess-Air $m_1 = 1.5$ in the generator, the weight of the discharge gases is:

$$R_g^{[56]} = 1.4 \cdot \frac{m_1 \cdot H_u}{1,000} = 1.4 \cdot \frac{1.5 \cdot 6,470}{1,000} = 13.57 \text{ kg}. \quad [69]$$

With the radiation ratio $\sigma = 0.15$, the specific heat of the gases $c \approx 0.24$, and the efficiency of the generator $\eta \approx 0.90$, the hearth temperature is:

$$T = t_0 + \eta_1 \cdot \frac{H_u \cdot (1 - \sigma)}{R_g \cdot c} = 10 + 0.90 \cdot \frac{6,470 \cdot (1 - 0.15)}{13.57 \cdot 0.24} \\ = 1,516^\circ\text{C} \approx 1,500^\circ\text{C}, \quad [70]$$

and thus with more-precise specific heats of $c = 0.282$ at $T = 1,500^\circ\text{C}$ and $c_F = 0.235$ at $T_F = 200^\circ\text{C}$ (from Fig. 5) we obtain:

$$V_{sch} = \frac{T_f \cdot c_F}{T \cdot c} \cdot 100 = \frac{200 \cdot 0.235}{1,500 \cdot 0.282} \cdot 100 = 11.14\%. \quad [71]$$

And finally, according to Sie g e r t :

$$V_{sch} \approx 0.70 \cdot \frac{T_f - t_0}{CO_2} = 0.70 \cdot \frac{200 - 10}{13} = 10.50\%. \quad [72]$$

The loss through uncombusted gases (incomplete combustion) corresponds to the presence of uncombusted substances such as CO and CH₄ and can be given as:

$$V_{un}^{[57]} = \frac{R_v \cdot (3,050 \cdot CO + 2,580 \cdot H_2)}{H_u} \\ = \frac{10.7 \cdot (3,050 \cdot 0.5 + 2,580 \cdot 0.4)}{6,470} = 4.25\%, \quad [73]$$

or, roughly, following B r a u s s , as:

$$V_{un} \approx \frac{70 \cdot (CO + H_2)}{CO_2 + CO + H_2} = \frac{70 \cdot (0.5 + 0.4)}{13 + 0.5 + 0.4} = 4.53\%. \quad [74]$$

⁵⁵ R_v = Rauchgase Verlust, loss due to discharge gases.

⁵⁶ R_g = Rauchgase Gewicht, weight of discharge gases.

⁵⁷ V_{un} = Verlust Unverbranntes, loss due to uncombusted matter.

The loss through hearth residues (ash, slag) can be arrived at by the assumptions made above and with a provisional estimated fuel consumption (empirically) $B^{[58]} \approx 300$ kg, as:

$$V_a^{[59]} = U_a \cdot \frac{A' \cdot 8,100}{B \cdot H_u} = 49.5 \cdot \frac{12}{300} \cdot \frac{8,100}{6,470} = 2.48\%. \quad [75]$$

Or:

$$V_a = \frac{A' \cdot H_{ua} \cdot 100}{B \cdot H_u} = \frac{12 \cdot 3,650 \cdot 100}{300 \cdot 6,470} = 2.26\%. \quad [76]$$

Loss by heat conduction and radiation must often be estimated by difference in the final amounts. Here, however, we can define it on the basis of the heat transmission by conduction.

The free-standing furnace block has an outside surface $F^{[60]} = 90$ m². The average temperature of the inside walls can be taken to be:

$$g'_m = \frac{g + g_m}{2} = \frac{800 + 300}{2} = 550^\circ\text{C}. \quad [77]$$

For the thermal transmittance K we have, with $\alpha_1 = \alpha_2 = 7$ (inside wall), on the basis of fig. 6:

$$K = \frac{1}{\frac{1}{\alpha_1} + \frac{s_1}{\lambda_1} + \frac{s_2}{\lambda_2} + \frac{s_3}{\lambda_3} + \frac{1}{\alpha_2}} = \frac{1}{\frac{1}{7} + \frac{0.12}{0.7} + \frac{0.01}{0.6} + \frac{0.38}{0.45} + \frac{1}{7}}$$

$$\approx \frac{1}{1.317} = 0.76 \text{ kcal/m}^2 \text{ }^\circ\text{C hr}. \quad [78]$$

Over $Z^{[61]} = 3$ hours of heating the incineration furnace, after reaching a steady state in the generator, the heat loss through the brickwork of the furnace is:

$$V_{ls}^{[62]} = k \cdot F \cdot (g'_m - t'_0) \cdot Z = 0.76 \cdot 90 \cdot (550 - 20) \cdot 3$$

$$= 108,756 \text{ kcal}; \quad [79]$$

or:

$$\frac{V_{ls} \cdot 100}{B \cdot H_u} = \frac{108,756 \cdot 100}{300 \cdot 6,470} = 5.60\%. \quad [80]$$

If we add another 30% for the considerable, but not easily measurable losses through leakage of air and open areas in the brickwork or around traps and gates, we get:

$$V_{ls} = 1.3 \cdot 5.60 = 7.28\%. \quad [81]$$

All of the above percentages of the heat losses refer to the percentage ratios in H_u . Taking the maximum of the percentages thus arrived at, we get, for the total effective heat (cf. also fig. 2):

⁵⁸ B = Brennstoff, fuel.

⁵⁹ V_a = Verlust Asche, loss through ash.

⁶⁰ F = Fläche, surface area.

⁶¹ Z = Zeit, time.

⁶² V_{ls} = Verlust Leitung Strahlung, loss due to conduction and radiation. In the text, the letter "W" appears erroneously.

$$100 - (V_{sch} + V_{um} + V_a + V_{ls}) = 100 - (11.4 + 4.25 + 2.48 + 7.28) = 100 - 25.15 \\ = 74.85 \approx 75\% \quad [82]$$

or an efficiency of:

$$\eta = 0.75,$$

which means that the effective heating value of the coke is:

$$\eta \cdot H_u = 0.75 \cdot 6,470 = 4,850 \text{ kcal/kg.} \quad [83]$$

Thus, for a first cremation, the fuel requirement is:

$$B_I = \frac{W_I}{\eta \cdot H_u} = \frac{1,267,800}{4,850} = 262 \text{ kg.} \quad [84]$$

For heavy-duty furnaces, G and G_2 and hence W_4 and W_5 are higher to such a degree that B_I goes up to 300 to 400 kg and higher.

For a second cremation in succession, we must supply, on the one hand, the amounts of heat needed for the preheating of the combustion air, for the evaporation of the water and for the heat absorbed in the ash, i.e.:

$$W_1 + W_2 + W_3 = 38,000 + 60,000 + 800 = 98,800 \text{ kcal,} \quad [85]$$

plus $\approx 30\%$ for the heat losses from the furnace due to absorption, conduction, radiation, air leakage, introduction of the coffin, dampers and gates etc., thus:

$$0.30 \cdot (W_4 + W_5) = 0.30 \cdot (900,000 + 454,000) = 406,200 \text{ kcal.} \quad [86]$$

Combustion of the coffin and the corpse yield:

$$W_6 + W_7 = 80,000 + 105,000 = 185,000 \text{ kcal,} \quad [87]$$

but $\approx 15\%$ of this amount is lost through the chimney, hence we have:

$$0.85 \cdot (W_6 + W_7) = 0.85 \cdot 185,000 = 157,250 \text{ kcal.} \quad [88]$$

Thus, for the second cremation, we must supply:

$$W_{II} = (98,800 + 406,200) - 157,250 = 347,750 \text{ kcal,} \quad [89]$$

and:

$$B_{II} = \frac{W_{II}}{\eta \cdot H_u} = \frac{347,750}{4,850} = 72 \text{ kg [of coke].} \quad [90]$$

Given that each further operating hour leads to a decrease of the heat loss by absorption in the brickwork, up to the point where a certain steady state is reached, for any further operating hour we may reduce this heat loss linearly, on the basis of experience and through measurements, down to a limiting steady state at $\approx 15\%$.^[63]

For the third through the fifth cremations, we may assume an average between 30 and 15%, hence $\approx 22\%$, which yields:

$$W_{III} = 0.22 \cdot (W_4 + W_5) + (W_1 + W_2 + W_3) - 0.85 (W_6 + W_7) \\ = 0.22 \cdot 1,354,000 + 98,800 - 157,250 = 239,430 \text{ kcal} \quad [91]$$

⁶³ See the table of coke consumption of certain German crematories in the original text, Document 91, table on page 127 of Heepke's paper.

and:

$$B_{III} = \frac{W_{III}}{\eta \cdot H_u} = \frac{239,430}{4,850} = 49.4 \approx 50 \text{ kg [of coke].} \quad [92]$$

By the fifth or the sixth cremation the steady state of the furnace will have been more-or-less attained, and one may now use the lower limiting value of 15% with reasonable confidence. Then, for the n th cremation, we obtain:

$$W_n = 0.15 \cdot 1,354,000 + 98,800 - 157,250 = 144,650 \text{ kcal} \quad [93]$$

and:

$$B_n = \frac{W_n}{\eta \cdot H_u} = \frac{144,650}{4,850} = 30 \text{ kg.} \quad [94]$$

All these theoretical values are in good agreement with practical experience. Many crematoria use a daily or yearly average, depending on the demands of the installation. One thus finds for a first cremation including preheating:

- $B = 175$ to 275 kg for a normal medium-size furnace
- $= 300$ to 450 kg for a heavy-duty furnace in continuous use
- $= 75$ to 50 kg a further cremation in succession.

Because the administrations of the crematoria are evening out their fuel consumption over longer periods of time, one can find only very few concrete indications for the consumption of coke for individual cremations in succession. Basically, such data can only be gathered by heating tests. A limited survey of the situation is given in table 1. The preheating time has been taken as some 2 to 3 hours, the cremation time as $\frac{3}{4}$ to $1\frac{1}{2}$ hours throughout. We have intentionally refrained from indicating the furnace systems.

The greatest number of cremations were carried out in 1930 at the Berlin-Wilmersdorf crematorium, 3,784 altogether; for 52 weeks per year and six operating days per week, this corresponds to an average daily load of $3,784 \div (52 \cdot 6) \approx 12$. The average consumption was 35 kg of coke for one cremation."

As I have already mentioned, this heat balance contains some mistakes in the attribution of factors as well as a few computational errors.

In the equation for W_2 regarding the heat of vaporization and of superheating (Eq. 49: $W_2 = Q \cdot [i + c_p \cdot (t - t_0)]$), the heat needed for superheating water vapor starts at 100°C , so t_0 is actually 100°C . In addition, the energy needed to heat liquid water from 10°C to 100°C and then evaporate it (i) is actually 633 kcal/kg.⁶⁴

Furthermore, the heat actually lost due to superheating the vapor generated by the corpse water should not be based on the temperature of the muffle, but on that of the flue gases at the exit of the recuperator (at least 200°C),⁶⁵ because the difference has been recovered in the recuperator and has already been taken into account in Eq. 59 for W_5 (p. 118).

⁶⁴ Vaporization heat of water: 2.27 MJ/kg, or 543 kcal/kg; add to this 90 kcal/kg to heat the water from 10°C to 100°C ; cf. www.engineeringtoolbox.com/water-thermal-properties-d_162.html and other sources (e.g. Wikipedia).

⁶⁵ Note: This is *not* applicable to the Auschwitz furnaces, which did not have recuperators.

With an average heat capacity of steam in the temperature range of interest (0.46 kcal/kg/°C⁶⁶) the correct equation becomes:

$$\begin{aligned} W_2 &= 55.25 \cdot [633 + 0.46 \cdot (200 - 100)] \\ &= 37,514.75 \approx 37,500 \text{ kcal (instead of Heepke's 60,000 kcal).} \end{aligned} \quad [95]$$

In Eq. 61 (W_7 , p. 118) used by Heepke to calculate the l.h.v. of the corpse:

$$W_7 = 8,100 \cdot C + 29,000 \cdot (H - O/8) + 2,500 \cdot S - 600 \cdot Q$$

the heat removed by the vaporization of the water contained in the corpse (with reference value at 0°C = 595 kcal/kg \approx 600 kcal/kg and 55.25 kg water, hence 33,150 kcal) is already included, and Heepke thus counts this heat of vaporization of the corpse water twice.

Heepke, moreover, calculates the efficiency of the hearth as a function of the heating process, *i.e.* for an empty muffle, and consequently uses a CO₂ content of 13%, which he also applies to the corpse. However, in the chart he published in the same article (Document 78) the CO₂ content is very low, with a maximum of 7% and a minimum of 1%. The average does not even come up to 4%. This means that the Excess-Air ratio, if it is also applied to the corpse, is considerably higher than that of the hearth by itself.

When subtracting the heat loss due to the sensible heat of the fumes (0.85 · W_7 in Eq. W_{III} [91]) from the l.h.v. of the corpse, Heepke counts this loss twice: once when it enters the muffle (W_1 [48]) and again when it leaves the chimney (W_{III}).

Because heating the theoretical combustion air of the coffin ($\approx 140 \text{ m}^3$) requires $\approx 8,200$ kcal of heat, the sensible heat of the fumes of the coffin is already contained in the heat loss of 33% of the l.h.v. assumed by Heepke in W_6 , with an Excess Air ratio of 2 or 3, hence it is not necessary to account for this loss in W_{III} (0.85 · W_6); in that case, the heat loss would be (0.33 + 0.15) · 100 = 48%, certainly an excessive value. The same heat loss of some 33% appears moreover dubious, because the cushioning material in the coffin by law had to be combustible and the clothes are combustible as well.⁶⁷

Bringing the heat content of the walls into play (W_4 and W_5) makes sense only if one intends to calculate the average consumption for each cremation *including* the preheating. Heepke instead wants to calculate the consumption for each individual cremation *independently* of the preheating, as we can see from the fact that for him the first cremation would require ≈ 262 kg of coke, but the second one only 72 kg; this value cannot also include the consumption for the first cremation, because in that case the second cremation would have had to bear (262 ÷ 2 =) 131 kg. However, Heepke considers the heat content of the refractory brickwork even in his computation for the *n*th cremation (W_n and B_n), after the latter has already reached a thermal steady state.

This discrepancy can be explained: Heepke did a theoretical calculation which he then wanted to confirm with experimental data from the crematoria.

⁶⁶ http://www.engineeringtoolbox.com/water-vapor-d_979.html

⁶⁷ Leather shoes contribute 4,020 kcal/kg, wool 4,600 kcal/kg, cotton 3,600 kcal/kg (Salvi 1972, p. 786).

These data represent, for the second cremation, an approximate consumption of 30% of the heat accumulated in the refractory brickwork of the furnace, of 22% for the third through the fifth cremation, and of 15% each from the sixth cremation onwards, because the furnace has now reached its thermal equilibrium. But as the refractory brickwork of the furnace in this phase no longer absorbs any heat, hence $(W_4 + W_5) = 0$, the consumption of 15% refers necessarily to the heat losses, which Heepke calculated only partly or not at all, as well as to those which cannot be calculated exactly. Of all these losses, the greatest by far is the one concerning the heating of the combustion air for the corpse, which has a volume much larger than that calculated by Heepke.

This having been said, the heat consumption for the n th cremation can be approximately corrected in the following manner:

As far as the efficiency of the gasifier is concerned, we will assume Heepke's data (Eq. 82) for losses due to the heat of the exhaust gases (11.14%), due to uncombusted portions of the discharge gases (4.25%), and due to hearth residues (2.48%).

Then the efficiency of the hearth becomes:

$$100 - (11.14 + 4.25 + 2.48) = 82.13 \approx 82\%. \quad [96]$$

The heat value of the coke thus becomes:

$$0.82 \cdot 6,470 \approx 5,300 \text{ kcal/kg.} \quad [97]$$

The heat losses due to radiation and conduction are not included in the efficiency, because they tend to stabilize as the furnace reaches a thermal steady state, and their values are a function of time; therefore, we prefer to calculate them directly. For the cremation process one may assume an average duration of one and a half hours (cf. Chapter 6), hence the heat loss by radiation and conduction from the brickwork of the furnace is:

$$V_{1s} = 0.76 \cdot 90 \cdot (550 - 10) \cdot 1.3 \cdot 1.5 \approx 72,000 \text{ kcal.} \quad [98]$$

The theoretical volume of combustion air for a body of 85 kg on the basis of the composition assumed by Heepke is $\approx 147 \text{ m}^3$, hence the heat required for heating the combustion air of the corpse is:

$$W_1 = 1.5 \cdot 147 \cdot 0.31 \cdot (200 - 10) \approx 13,000 \text{ kcal.} \quad [99]$$

For the evaporation and superheating of the body water we have:

$$W_2 \approx 37,500 \text{ kcal.} \quad [100]$$

The heat lost with the removal of the ashes is:

$$W_3 \approx 800 \text{ kcal.} \quad [101]$$

The heat accumulated in the refractory brickwork of the furnace is:

$$W_4 = 900,000 \text{ kcal;} \quad [102]$$

$$W_5 = 454,000 \text{ kcal.} \quad [103]$$

The effective heat value of the coffin is:

$$W_6 \approx 80,000 \text{ kcal.} \quad [104]$$

The upper heating value of the corpse is:

$$\begin{aligned} W_7 &= 8,100 \cdot 13.26 + 28,700^{[68]} \cdot 1.785(5.865/8) + 2,210 \cdot 0.255 \\ &\approx 138,200 \text{ kcal,} \end{aligned} \quad [105]$$

without subtracting the evaporation heat of the water already contained in W_2 .

On this basis, one may write the following heat balance for the n th cremation as:

$$\begin{aligned} &\frac{0.15 \cdot (900,000 + 454,000) + (13,000 + 37,500 + 800 + 72,000) - (138,200 + 80,000)}{5,300} \\ &= \frac{108,200}{5,300} = 20.4 \text{ kg of coke.} \end{aligned} \quad [106]$$

This result is in good agreement with the experimental results. The following consumption data for coke were found in R. Kessler's experiments described in Chapter 4:

- a. total consumption: 436 kg
- b. consumption for preheating of furnace: 200 kg
- c. consumption for 8 consecutive cremations: 236 kg
- d. average consumption for one cremation incl. preheating of furnace:
 $436 \div 8 = 54.5 \text{ kg}$
- e. average consumption for one cremation without preheating of furnace:
 $236 \div 8 = 29.5 \text{ kg}$

Consumption (c) for the eight cremations (excluding consumption for preheating the furnace) includes the heat which is absorbed by the refractory brickwork until at some point thermal equilibrium is reached. Since the average consumption of fuel, including preheating (d), is 54.5 kg per cremation, preheating therefore consumes $(54.5 - 29.5 =)$ 25 kg of coke, or $25 \div 54.5 \cdot 100 = 45.87\%$ of the fuel of the average cremation. Furthermore, since the muffle has reached a temperature of 800°C at the end of the preheating phase but is not yet in thermal equilibrium, it is clear that the proportion of fuel consumed to reach equilibrium during the cremations is necessarily lower than that for the preheating phase, and it continues to decrease with each cremation. If the proportion were the same as for the preheating phase, it would be $(236 \cdot 0.4587 \approx)$ 108 kg of coke. The theoretical minimum coke consumption for a small incineration series (e.g., 8) would then be $(236 - 108) \div 8 \approx 16 \text{ kg}$. The actual consumption must therefore lie between this purely hypothetical lower limit and the average consumption (e) of this small series, i.e. 29.5 kg. We take this here as the upper limit of the range of values to be assumed.

If we assume that furnace's fuel absorption does not remain constant, but decreases linearly (from 108 kg to 0 kg) in order to reach the equilibrium

⁶⁸ We use the value indicated in Subchapter 1.1.

weight, its average value is $(108 \div 2 =) 54$ kg. Then the average consumption for one cremation would be:

$$(236 - 54) \div 8 \approx 23 \text{ kg of coke.} \quad [107]$$

The experimental data for the crematorium at Berlin-Wilmersdorf, too, confirm an average consumption for the n th cremation well below Heepke's result. In fact, the actual average consumption of some 35 kg per cremation contains both the coke consumption for 52 preheating operations on Mondays after the weekend, and the 208 preheating operations after the twelve hours of cooling on each operating day during the week, from Tuesday through Friday (hence 52×4).

8. Legal, Ethical and Professional Standards for Cremations in Germany

Although the first German crematorium was built as early as 1878, cremation in Germany was not legally recognized for quite some time; in Prussia it became a legal option only with the law on cremation of September 14th, 1911 (see Lohmann 1912). In the other parts of the Reich, it was accepted between 1899 and 1925, albeit with rather divergent regulations (Marcuse 1930, pp. 121-133). Legislation was unified only in the 1930s: the first "Law on Cremation" as such was promulgated on May 15th, 1934. It contained 11 articles that concerned in particular the medical and legal aspects of cremation as well as the oversight authority of the police in the matter. Shortly thereafter specific ordinances concerning the cremation furnaces and the cremation process were issued: "Service regulation for cremation devices" on November 5th, 1935, and "Decree concerning the application of the law on cremation" on August 10th, 1938. Below follows a translation of those two decrees.

"Service regulation for cremation devices of November 5th, 1935

§ 1

The person in charge of the cremation installation is responsible for its operation.

§ 2

(1) The corpses may only be accepted if the consignor can prove without doubt his own identity as well as that of the corpse. The corpses must be presented in coffins made of wood or of zinc. The coffins must be free from incombustible metallic decorations (fittings, handles) to the greatest extent possible and must be of a size and quality such as not to cause any difficulty during introduction into the cremation chamber and to guarantee a subsequent combustion without smoke or odor.

(2) The coffins must not exceed the following measurements:

Length: 2100 mm

Width: 750 mm (in exceptional cases 800 mm)

Height: 720 mm (excluding feet)

(3) *On the front part of each coffin must be affixed a label of the consignor clearly showing last name and first name of the deceased as well as the date and hour of the funeral ceremony.*

(4) *If there are any objects of value on the corpse, the consignor must indicate this and the recipient must verify their presence.*

(5) *The consignment of a corpse must be recorded in a book (book of consignments) with the following details:*

a) Last name and first name of the corpse consigned

b) Name (firm) of consignor

c) Date of consignment

d) Presence of any valuables on corpse

The recipient and the consignor must certify the accuracy of the above by their signatures in the book.

§ 3

(1) *The person in charge declares the time of incineration.*

(2) *Cremation must not take place prior to the expiry of a period of 24 hours counted from the moment of the presentation of the request to the police authorities at the place of cremation. It may take place only if the written permission of the police authority at the place of cremation is presented (§3 of the Law). It must, however, be carried out within 72 hours starting with the issuance of the permission by the police. If this period cannot be observed, the person in charge must request from the police authority an extension of the period, specifying the reasons for the delay.*

§ 4

The funeral hall of the cremation installation – of the cemetery – is available for funeral ceremonies. The corpses are preserved in the mortuary. Corpses with valuables must be placed under special custody. On reception, any fittings attached by screws must be removed. The coffins will be closed not later than half an hour before the funeral ceremony. If the operation allows, the bereaved may view the corpse up to the beginning of the funeral ceremony. Public exposure of the corpse and opening of the coffin during the funeral ceremony are prohibited unless the police authority has granted an exception.

(2) *For corpses of persons having died from a contagious disease, the dispositions of the Reich and of the regional states in force for such cases will be applicable. The opening of the coffin in such cases will not be permitted.*

§ 5

(1) *The corpses may be cremated in the coffins or coffin inserts in which they have been received. Only one corpse at a time may be cremated in one cremation chamber.*

(2) *The body of a stillborn child or of a child having died during birth may be cremated together with the body of the mother.*

(3) *Care has to be taken for the cremations to take place in a dignified manner.*

(4) *Prior to the introduction of the corpse, the cremation furnace must be heated until the walls of the [cremation] chamber have started to glow in order for the cremation process to proceed without further or supplementary supply of heat. In exceptional cases, supplementary heating may be added during the cremation.*

(5) Prior to the introduction of the coffin, an indestructible plate must be placed on the coffin, clearly embossed with the entry number in the cremation registry and the name of the cremations installation.

(6) During the cremation process, care has to be taken to prevent to the greatest possible extent that smoke becomes visible above the chimney. Any kinds of measures aimed at an acceleration of the process are strictly prohibited.

(7) When the coffin is introduced into the furnace, the presence of two relatives of the deceased or two persons designated by them is permitted. The observation of the cremation itself is not permitted to the relatives nor to third parties, but only to the attendants of the installations. The municipal director or the office authorized by him may allow the observation to certain individuals, provided they demonstrate a scientific objective.

§ 6

Treatment of the ashes

(1) After the end of the cremation, the cremation chamber must be carefully cleaned. The ashes remaining must be removed from the furnace, cooled, freed from any metal parts by means of magnets and then transferred, together with an identification plate, into a metal container, air and watertight over a long period, which must be officially sealed. The lid of the container must be of a resistant metal (e.g. steel plate). The lid or a metal plate attached to it must be clearly embossed in relief as high as possible with the following data:

1. The cremation number corresponding to the cremation number and to the number plate of the ashes,
2. last name, first name and state of the deceased,
3. place, date and year of his birth,
4. place, date and year of his death,
5. place and date of the cremation.

(2) The containers must correspond to the norm set up by the German Institute for Standardization of Berlin, DIN standard 3198 "Ash lids for urns."

§ 7

Register of cremations

A register for cremations carried out must be kept in accordance with Attachment 2 of Section 11 of the Decree of June 20th, 1934, concerning application of the Law on Cremations (Reich official gazette, I, 519). At the end of the calendar year it must be closed and verified against the one kept by the police authority.

§ 8

Burial of the ashes

(1) The ashes of each corpse must be interred in a hall, in a wood, or in a place of burial for urns, unless an exception has been granted by the police authority on the basis of §9, section 3, of the Reich Law on cremations.

(2) The ashes must not remain in the possession of the relatives, not even temporarily. Therefore, the container of the ashes may not be handed to them or to their trustees, not even for the burial elsewhere." (Schumacher 1939, pp. 118f.)

The "Decree Concerning Application of the Law on Cremation" of August 10th, 1938 (Document 92) specified the following:⁶⁹

⁶⁹ Reichsgesetzblatt 1938, Teil I, pp. 1000f.; also in Schumacher 1939, pp. 119f.

“By authority of §10 of the Law on Cremation dated May 15th, 1934 (Reichsgesetzblatt I, p. 380) it is decreed:

§1. An expression certifying the wish directed towards cremation, laid down on the form of an association for cremation and personally signed, will stay valid even if it not written personally.

§2 (1) The police authority for the place of cremation must maintain a register for all cremations authorized by it, separately for each independent installation if applicable, specifying by consecutive numbers:

1. last name and first name of the deceased

2. date and place of birth

3. date and place of death

4. last residence

5. rank or profession

6. religious affiliation

7. cause of death

8. date and hour of cremation

9. date and number of authorization certificate

10. place of disposal of ash remains

11. change of place of disposal of ash remains (§ 10, par. 2).

(2) The register is to be preserved, together with the certificates and proof documents pertaining to the authorization, for 30 years following the last entry in the register.

§3 (1) The official medical certificate prescribed in accordance with §3, par. 2, No. 2, of the Law must be prepared by the official or medical examiner licensed in the place of death or the place of cremation in conformity with the form attached.

(2) The supreme regional authorities may, if necessary, authorize other physicians for the inquest and the preparation of the certificate, provided these persons have passed the official medical examination for local or regional medical examiners, or have successfully attended a special course imparting the knowledge necessary for forensic inquests, or had been entrusted with these activities before promulgation of the Law.

§4. In the case of corpses being transferred for cremation from a foreign country, the police authorities of the place of cremation will decide whether the corpse passport established in accordance with the international agreement concerning the transportation of corpses is sufficient for proof of the cause of death. Any doubts must be resolved by an official inquest as specified in §3, par.2, No. 2 of the Law.

§5. The expression of the wish towards cremation may be revoked. The revocation must be proven in an irrefutable manner; irrefutable proof is considered as having been furnished in particular if the revocation takes one of the forms laid down in §4, Nos. 1 to 3, of the Law.

§6. The cremation installation must have available a corpse repository, in which the corpses can be kept prior to cremation. Furthermore, a room for autopsies must be provided, containing the equipment needed for such purpose.

§7. The cremation installation and its operation are subject to the oversight of the police authorities at the place where the installation is located. The opera-

tion will follow the operational procedures, must be approved by the supreme state authorities, and will specify the fees applicable.

§8. The person in charge of the operation of the cremation installation must be expressly authorized by the supervising police authority.

§9. Cremation may only be undertaken after the written authorization of the police authority of the place of cremation (§3 of the Law) has been provided to the person in charge of the operation of the cremation installation. The cremation must be undertaken within three times 24 hours after issuance of the police authorization. If this period cannot be respected, the person in charge of the operation of the cremation installation must submit an application for an extension of the period to the police authorities specifying the reasons for the delay.

§ 10 (1). The person in charge of the operation of the cremation installation must immediately notify the cognizant police authority of the cremation and of the disposal or shipment of the ash remains. In this connection, the following must be specified: Last name and first name of the person cremated, number and date of the authorization document of the police, time of cremation, time and place of disposal of ash remains, address to which the ash remains have been transferred in case of transfer. Transfer of ash remains may only be undertaken when the person in charge has received a certificate of the cemetery administration concerning the approval of burial.

(2) If the ash remains have been transferred for burial to a different location, the cemetery administration or the police authority of this location must notify the police authority of the place of cremation of the execution of the burial. Any shipment of ash remains previously buried must be reported to the police authority of the place of cremation.

(3) Ash remains must not be handed over to the family or their agents, be it for burial at a different location, subject to the exception in §9, par. 3 of the Law.

(4) The resting period for ash remains is twenty years, if a resting period of 20 years or more is applicable for interments at the same location; in all other cases the resting period for ash remains must be at least equal to the resting period specified for interments at the same location. After the end of the resting period, the ash remains and their containers still present and recognizable as such are to be incorporated into the ground in a collective burial site.

§ 11 (1). A register in accordance with the sample attached (cremation register) must be kept for the cremations carried out in the cremation installation. At the end of each calendar year, this register must be closed and must be compared with the register kept by the police authority (§2).

(2) The register of cremations, together with the corresponding authorization documents, is to be preserved for thirty years following the last entry made in the register.

§12 (1) The corpses must be cremated in the coffins or coffin inserts in which they arrive at the cremation installation. The coffins must be made of thin wood or zinc plate and be free from metal fixtures. Pitch must not be used for filling of cracks. As a mattress for the corpse as well as for the filling of any cushions, sawdust or plane shavings, excelsior or peat mull are to be used. The lining of the coffin and the garments of the corpse may be prepared in the usual way, however, metal nails for the lining and needles, hooks and eyes for closing the garments are not authorized, simple cloth-covered buttons being permitted.

(2) *The Reich Minister of the Interior may allow other substances than those mentioned in Par. 1, to be used for the mattress of the corpse and as filling material for the cushions.*

§13. *Only one corpse may be cremated in the cremation chamber at any one time. Before their introduction into the cremation furnace, the coffins must be equipped with a plate which cannot be destroyed by the heat of the furnace and which displays in a clearly visible manner the entry number in the cremation register concerning the cremation as well as the name of the cremation installation. The ash remains of each corpse must be collected, together with the number plate, in a solid, permanent and air- and watertight vessel, which must be closed by an officially recognized person. The lid of the vessel is to be provided with a well-attached plate showing the following indications in a clear embossed lettering:*

1. *the cremation number, identical to the cremation register and the ash number plate*
2. *last name and first name of the deceased person*
3. *place, date and year of birth*
4. *place, date and year of death*
5. *place and date of cremation.*

§14 (1) *The expenses for the official inquest are to be computed on the basis of the minimum rates of the rate-table for official or forensic medical procedures. The costs thus generated will be borne by the person responsible for the interment.*

(2) *To the extent that any fees are charged for the police authorizations, they should not exceed three Reichsmarks.*

§ 15 (1) *This decree will come into force the day following its publication.*

(2) *At the same time, the following will be rescinded:*

- *the Decree for the execution of the law on cremation dated June 26th, 1934 (Reichsgesetzblatt I, p. 519),*
- *the Decree concerning the alteration of the decree concerning the execution of the law on cremation dated October 16th, 1936 (Reichsgesetzblatt I, p. 884) and*
- *the Second Decree concerning the alteration of the Decree concerning the execution of the law on cremation dated October 13th, 1937 (Reichsgesetzblatt I, p. 1132).*

Berlin, August 10th, 1938.

Reich Minister of the Interior

By procuration, Dr. Stuckart”

The way toward these legislative provisions had been prepared and paved in Germany by ethical and professional norms which were suggested by the cremation associations and the administrations of the German crematoria. In 1932, the Union of Cremation Societies for Greater Germany requested the engineer Richard Kessler to draw up ethical and professional guidelines for cremation, which were published the same year under the title “Norms for the construction of furnaces for the cremation of human corpses” (Kessler 1932, 1933b).

These norms considered cremation from four points of view: ethical, esthetic, hygienic and economic. In 1937 the Union of Cremation Societies for Greater Germany decided to review the norms defined by Kessler – who, incidental-

ly, had died on June 24th, 1933 – in view of the laws on cremation promulgated in 1934 and 1935. This re-elaboration was published under the title “Norms for the construction and operation of furnaces for the cremation of human corpses”; it was divided into four sections, the last of which consisted of the law of November 5th, 1935. The norms laid down in the first three sections were the following (Großdeutscher... 1937):

“The cremation furnace, in the same way as the various central, operational and ancillary buildings necessary for a crematorium, must be conceived in conformity with the solemn purpose in such a way as to guarantee the general principles of ethics, esthetics and economy. In the construction and operation, the following demands must be satisfied:

A Layout of the Rooms

- 1. The operating hall must be divided, by means of a partition, into an ante-chamber (introduction room) and the furnace hall as such.*
- 2. The introduction room must be realized in a particularly dignified manner in view of the purpose which it serves.*
- 3. The introduction device for the coffin must operate without noise and must moreover be built in such a way as not to clash with the architecture of the introduction room.*
- 4. The introduction opening of the furnace must be provided not only with the usual closure of refractory clay but also with a closure adapted to the style of the introduction room.*
- 5. The introduction and operating rooms must be equipped with good means of ventilation.*

B Cremation Furnace

- 1. The cremation furnace must be built in such a way that*
 - a) only one body at a time can be cremated in the cremation chamber,*
 - b) the cremation process can be observed through viewing ports,*
 - c) the internal devices can be cleaned easily and comfortably without any sanitary risk for the personnel,*
 - d) during the heating operations to achieve the operating temperature the solid, liquid or gaseous fuel used will burn without smoke or odor,*
 - e) the cremation of the corpse takes place without smoke or odor,*
 - f) at the entry to the chimney a draft of at most a quarter of that of the flue may be perceived,*
 - g) no combusted gases escape into the room during or after the introduction of the corpse,*
 - h) any and all liquid substances forming during the cremation are retained and completely dissolved within the furnace.*
- 2) The introduction of the coffin into the cremation chamber may take place only after the latter has been preheated to 500°C. In furnaces with internal firing, the heat supply must, in principle, be cut before the corpse is introduced. If, in special cases, it should be necessary to supply additional heat during the cremation, this must take place **only** during the second phase of the cremation and by means of clean combusted gases; the use of jet flames is not allowed. If the cremation chamber is heated by means of electricity or from outside the chamber, additional heat supply is **always** permitted.*

3. In furnaces having mixed heating, the switchover from one to the other heating system must be possible during the cremation without an interruption of the cremation process.

4. The outside surfaces must have a dignified appearance and must be easy to clean. The cladding must be easy to disassemble and to re-use. If there are technical parts directly on the furnace (pipes, anchor bolts, etc.), they must be hidden to the greatest possible extent.

5. All external surfaces of the furnace must be sufficiently well insulated against heat radiation. For the insulation, only insulating materials that can be easily removed and re-employed in case of repair work are to be used. Insulation simply by means of simple air chambers is not acceptable.

6. Taking into account the economics of the process, the cremation chamber must be laid out in such a way that a normal coffin can be placed into it.

For this purpose, the following **minimum internal dimensions** are specified:

Width: 900 mm, surface of the floor at least 800 mm, diameter of semi-circular vault 800 mm; this reduction starts at a level of 250 mm

Height: 900 mm

Length: 2,250 mm

From these furnace dimensions, taking into account the demands of heat technology, the following **maximum** dimensions for the usable coffins are derived:

Height: 720 mm, not counting the feet

Width: 750 mm, exceptionally 800 mm maximum

Length: 2,100 mm

Coffins exceeding the above dimensions must be refused.

7. The inside of the cremation chamber must be as smooth as possible; open joints in which ash particles could settle are to be avoided.

8. With respect to the design of the cremation chamber, both a grate and a plate are acceptable for the floor.

In furnaces with grates, the open width of the grate bars must not exceed 210 mm for transverse grates or 100 mm for longitudinal grates.

In furnaces with movable or invertable floor plates for the removal of the ashes, these plates must not be moved before the end of the cremation. Safety measures must be taken to avoid any premature movement of the plates.

9. The refractory material used must be absolutely insensitive to the high temperatures and the temperature fluctuations that the furnace undergoes.

10. From the structural point of view, the refractory mass of the cremation furnace must be such that the heat accumulated during the preheating phase up to the operating temperature is sufficient for the cremation to be carried out by means of cold or preheated combustion air.

11. The cremation chamber and the post-combustion chamber must be separated by a separating wall. It may be invertable but must close sufficiently tight to prevent ash particles from falling through.

12. With cremation furnaces for normal and continuous usage, a recovery system should be considered for the greatest possible exploitation of the discharge gases, to the extent that the design of the furnace allows it.

13. To enhance the draft of the chimney, forced-draft devices are acceptable in cases where chimneys cannot be built sufficiently high for architectural reasons.

However, the discharge gases must be discharged in a way such that the environment is not affected.

14. The utilization of the discharge gases for purposes other than the mere execution of the cremation must be prohibited for reasons of reverence.

15. All closures and other control devices on the furnace, in the flue duct, and in the chimney must be made tight in a way such that extraneous air currents are excluded.

16. In order to follow the course of the preheating to the operating temperature and of the subsequent cremations, it is absolutely necessary to equip [the furnace] with at least the following control instruments:

- a) temperature measuring device in the cremating chamber,*
- b) temperature measuring device in the flue duct,*
- c) temperature recorder,*
- d) manometer.*

*17. For the cremation the furnace must be designed moreover in such a way that during the period between the introduction of the coffin and the end of the cremation process **no direct manipulations** are necessary. After the cremation has taken place, [such manipulations] must be limited **exclusively** to:*

- a) the cleaning of the cremation chamber,*
- b) to the transfer of the ashes from the upper ash collection point into the post-combustion chamber,*
- c) to the transfer of the ashes from the post-combustion chamber to the ash-removal vessel.*

18. In the case of zinc coffins, the liquid zinc must be withdrawn into a special container.

C. Ashes

1. The ashes must be completely burnt out and free from charcoal residue and other combustibles.

2. The removal of the ashes from the post-combustion chamber must be done in a dignified manner.

Before being placed into the urn, the ashes must be freed from charcoal particles and metal parts of the coffin, outside the furnace.

3. The handling of the ashes after their removal from the furnace up to the closing of the urn must absolutely be done without [creating] any dust.

D. General Remarks

1. All devices necessary for the operation of the installation must work silently. It is imperative to prevent the transmission of any unavoidable sounds into the other rooms.

2. For the operation of the installation, other than the norms set out above, the following 'Service regulations for cremation plants dated November 5th, 1935' are binding." (Followed by the text of the law.)

The resurgence, in these norms, of the ideal of a completely indirect cremation process – which had given rise to many vigorous attacks against the Decree of October 24th, 1924, with its acceptance of the semi-direct process – shows how strongly the German cremation societies clung to the primacy of the ethical and esthetic aspects of cremation. In practice, however, the crematoria were more-inclined to follow a course favored by considerations of economy, a develop-

ment which had already started prior to the above decree. Hence what these norms regarded as the exception, at least for furnaces with a gasifier, tended to become the rule.

9. Cremation Statistics

9.1. Statistics for Germany (1878-1939)

The first German crematorium went into operation at Gotha on December 10th, 1878; for the ensuing twelve years, it was also the only one. Over the last decade of the 19th Century, the number of crematoria rose very slowly: in 1900, there were hardly five. A notable increase occurred only in the years preceding the First World War: by 1913 there were 40 crematoria, and by the end of the war, 52 had been built. In the period between the two world wars the movement for cremation grew at a rapid pace, and the number of crematoria increased accordingly. There were 54 in 1920, 68 in 1925, 104 in 1930, and 114 in 1935. With the inauguration of the Lahr Crematorium (July 16th, 1939) – the last crematorium built before the outbreak of the Second World War – the number of crematoria in the Old Reich reached 122, but on the territory of Greater Germany, a total of 131 existed, five of which were in Austria and four in the Sude-ten Territory.

The following table covering the period between December 10th, 1878, and April 10th, 1928, presents data concerning the first 83 German crematoria (Verband... 1928, pp. 82-87; see Document 112).

Table 3: Chronological List of German Crematoria between 1878 and 1928

#	Location	Start-up Date (dd/mm/yyyy)	# of Furnaces	Furnace System and Manufacturer
1	Gotha	10/12/1878	2	1. Friedrich Siemens, Dresden 2. Richard Schneider, Dresden
2	Heidelberg	22/12/1891	1	Klingenzierna (Gebr. Beck), Offenbach
3	Hamburg	19/11/1892	2	Richard Schneider, Dresden
4	Jena	14/02/1898	2	Klingenzierna (Gebr. Beck), Offenbach
5	Offenbach a.M.	07/12/1899	1	Klingenzierna (Gebr. Beck), Offenbach
6	Mannheim	20/02/1901	1	Richard Schneider, Dresden
7	Eisenach	20/01/1902	1	Richard Schneider, Dresden
8	Mainz	03/05/1903	2	Klingenzierna (Gebr. Beck), Offenbach
9	Karlsruhe	25/04/1904	1	Richard Schneider, Dresden
10	Heilbronn	26/06/1905	1	Klingenzierna (Gebr. Beck), Offenbach
11	Ulm	01/01/1906	2	1. Klingenzierna-Beck, Offenbach 2. Gebrüder Beck, Offenbach
12	Chemnitz	15/12/1906	2	1. Richard Schneider, Dresden 2. Gebrüder Beck, Offenbach
13	Bremen	24/02/1907	2	1. Klingenzierna-Beck, Offenbach 2. Alfred Schmidt, Bremen
14	Stuttgart	06/04/1907	2	1. Klingenzierna-Beck, Offenbach 2. Wilhelm Ruppmann, Stuttgart
15	Coburg	12/11/1907	2	Gebrüder Beck, Offenbach

#	Location	Start-up Date (dd/mm/yyyy)	# of Furnaces	Furnace System and Manufacturer
16	Pössneck	16/10/1908	1	Gebrüder Beck, Offenbach
17	Zittau	01/04/1909	1	R. Schneider, Techn. Ofenbaubüro, Berlin
18	Baden-Baden	25/10/1909	1	Gebrüder Beck, Offenbach
19	Zwickau	01/11/1909	2	Gebrüder Beck, Offenbach
20	Leipzig	01/01/1910	3	R. Schneider, Stettiner Schamottefabrik
21	Lübeck	15/05/1910	2	Gebrüder Beck, Offenbach
22	Dessau	18/05/1910	2	1. Toisul & Fradet, Paris 2. Gebrüder Beck, Offenbach
23	Gera	12/06/1910	2	Gebrüder Beck, Offenbach
24	Reutlingen	01/01/1911	1	Wilhelm Ruppmann, Stuttgart
25	Dresden	22/05/1911	3	2 × R. Schneider, Stettiner Schamottefabrik; 1 × J.A. Topf & Söhne, Erfurt
26	Göppingen	08/10/1911	1	Wilhelm Ruppmann, Stuttgart
27	Meiningen	08/10/1911	1	Gebrüder Beck, Offenbach
28	Weimar	14/12/1911	2	1. R. Schneider, Stettiner Schamottefabrik; 2. J.A. Topf & Söhne, Erfurt
29	Sonneberg i.Th.	20/12/1911	1	Gebrüder Beck, Offenbach
30	Hagen i.W.	16/09/1912	2	1. Custodis, Düsseldorf 2. Kori, Berlin
31	Frankfurt a.M.	12/10/1912	2	R. Schneider, Stettiner Schamottefabrik
32	Berlin, Gerichtsstr.	28/11/1912	3	R. Schneider, Stettiner Schamottefabrik
33	Munich	28/11/1912	2	R. Schneider, Techn. Ofenbaubüro, Berlin
34	Wiesbaden	19/12/1912	2	R. Schneider, Stettiner Schamottefabrik
35	Nuremberg	15/05/1913	2	Wilhelm Ruppmann, Stuttgart
36	Berlin-Treptow	23/06/1913	2	Gebrüder Beck, Offenbach
37	Tilsit	09/09/1913	1	R. Schneider, Stettiner Schamottefabrik
38	Esslingen	01/10/1913	1	Wilhelm Ruppmann, Stuttgart
39	Greifswald	26/10/1913	1	Gebrüder Beck, Offenbach
40	Görlitz	28/11/1913	1	R. Schneider, Stettiner Schamottefabrik
41	Freiburg i. Br.	15/04/1914	1	J.A. Topf & Söhne, Erfurt
42	Darmstadt	10/10/1914	1	Gebrüder Beck, Offenbach
43	Danzig	15/10/1914	2	R. Schneider, Stettiner Schamottefabrik
44	Augsburg	25/05/1915	1	Gebrüder Beck, Offenbach
45	Braunschweig	01/07/1915	2	R. Schneider, Stettiner Schamottefabrik
46	Hirschberg i.Schl.	22/08/1915	1	J.A. Topf & Söhne, Erfurt
47	Krefeld	04/10/1915	1	R. Schneider, Stettiner Schamottefabrik
48	Halle a.d.S.	23/12/1915	2	J.A. Topf & Söhne, Erfurt
49	Kiel	14/02/1916	1	Gebrüder Beck, Offenbach
50	Friedberg/Hess.	15/03/1917	1	Gebrüder Beck, Offenbach
51	Pforzheim	02/08/1917	1	Wilhelm Ruppmann, Stuttgart
52	Plauen i.V.	01/02/1918	1	R. Schneider, Stettiner Schamottefabrik
53	Königsberg/Pr.	05/12/1918	2	Wilhelm Ruppmann, Stuttgart
54	Konstanz	15/05/1920	1	Gebrüder Beck, Offenbach
55	Rudolstadt/Th.	15/06/1921	1	R. Schneider, Stettiner Schamottefabrik
56	Berlin-Wilmersd.	11/05/1922	2	R. Schneider, Stettiner Schamottefabrik
57	Ilmenau	22/10/1922	1	J.A. Topf & Söhne, Erfurt
58	Hanover	24/02/1923	2	J.A. Topf & Söhne, Erfurt
59	Erfurt	04/04/1923	2	J.A. Topf & Söhne, Erfurt
60	Suhl	11/08/1923	1	J.A. Topf & Söhne, Erfurt
61	Magdeburg	22/11/1923	2	J.A. Topf & Söhne, Erfurt
62	Grünberg/Schl.	05/01/1924	1	J.A. Topf & Söhne, Erfurt
63	Dortmund	24/05/1924	2	J.A. Topf & Söhne, Erfurt

#	Location	Start-up Date (dd/mm/yyyy)	# of Furnaces	Furnace System and Manufacturer
64	Arnstadt i.Th.	1/10/1924	1	J.A. Topf & Söhne, Erfurt
65	Guben	19/11/1924	1	J.A. Topf & Söhne, Erfurt
66	Selb i.B.	7/02/1925	1	J.A. Topf & Söhne, Erfurt
67	Bernburg	17/02/1925	1	J.A. Topf & Söhne, Erfurt
68	Stettin	17/02/1925	2	1. R. Schneider, Stettiner Schamottefabrik; 2. idem (improved device)
69	Apolda	16/04/1925	1	J.A. Topf & Söhne, Erfurt
70	Wilhelmshaven	11/02/1926	1	J.A. Topf & Söhne, Erfurt
71	Breslau	12/04/1926	1	Gebrüder Beck, Offenbach
72	Kassel	21/05/1926	1	J.A. Topf & Söhne, Erfurt
73	Höchst a.M.	01/06/1926	1	J.A. Topf & Söhne, Erfurt
74	Liegnitz	08/07/1926	1	J.A. Topf & Söhne, Erfurt
75	Gießen	07/08/1926	1	J.A. Topf & Söhne, Erfurt
76	Brandenburg (II.)	17/10/1926	1	J.A. Topf & Söhne, Erfurt
77	Weissenfels a.S.	07/02/1927	1	Kori, Berlin
78	Tuttlingen	14/08/1927	1	Wilhelm Ruppmann, Stuttgart
79	Eisfeld	29/09/1927	1	J.A. Topf & Söhne, Erfurt
80	Ludwigsburg	22/10/1927	1	Wilhelm Ruppmann, Stuttgart
81	Hildburghausen	27/10/1927	1	Gebrüder Beck, Offenbach
82	Freiberg i.S.	02/03/1928	1	Gebrüder Beck, Offenbach
83	Quedlinburg	10/03/1928	1	J.A. Topf & Söhne, Erfurt

The number of furnaces indicated corresponds to those actually existing in 1928. In certain crematoria, the old furnaces had been demolished and replaced with new devices. The last column of the list quoted contains furnaces which were subsequently demolished.

By the end of 1928, the number of German crematoria had risen to 88, because between March 10th and December 31st five more crematoria were built: at Rostock, Schwenningen, Langensalza, Nordhausen and Saalfeld. Another 34 crematoria were set up between 1929 and 1939. The following table lists them by number, by location and by year of construction:

#	Location	Year	#	Location	Year
89	Bielefeld	1929	106	Lindau	1931
90	Wetzlar	1929	107	Cuxhaven	1931
91	Hof	1929	108	Duisburg-H.	1932
92	Mühlhausen	1929	109	Landau	1932
93	Altenburg	1929	110	Fürstenberg	1934
94	Forst	1930	111	Naumburg	1934
95	Reichenbach	1930	112	Lauscha	1934
96	Hanau	1930	113	Celle	1935
97	Potsdam	1930	114	Essen	1935
98	Bremerhaven	1930	115	Düsseldorf	1936
99	Saarbrücken	1930	116	Cologne	1937
100	Sondershausen	1930	117	Osnabrück	1937
101	Eisleben	1930	118	Schneidemühl	1937
102	Kolberg	1930	119	Döbeln	1938
103	Frankfurt a.O.	1930	120	Flensburg	1938
104	Schwerin	1930	121	Gleiwitz	1938
105	Meissen	1931	122	Lahr	1939

Sources: "Die Feuerhallen..." 1939, p. 7; "Einäscherungen..." 1940, pp. 20, 29

In the Sudeten Territory there were four crematoria: at Reichenberg (1918), Brüx (1924), Aussig (1932), and Karlsbad (1933); Austria had five crematoria: in Vienna (1923), at Steyr (1927), at Linz (1929), at Salzburg (1931), and at Graz (1932). Thus there were altogether 131 crematoria in *Grossdeutschland* in 1939.

Because initially the practice of cremation was a novelty, often repressed by the dominant cultural factors and because consequently there existed only few crematoria, the annual number of cremations remained very low for a long time, beginning to grow consistently only after the end of the First World War: It stayed below 100 until 1886, below 1,000 until 1902, and below 10,000 until 1912. In 1918 there were 15,878 cremations, and in the years thereafter the figure grew rapidly, exceeding 100,000 in 1939. The following table shows the number of cremations in Germany year by year:

Year	Cremas	Cremations	Year	Cremas	Cremations
1878	1	1	1893	3	256
1879	1	17	1894	3	267
1880	1	16	1895	3	263
1881	1	33	1896	3	312
1882	1	33	1897	3	374
1883	1	46	1898	4	423
1884	1	69	1899	5	511
1885	1	76	1900	5	639
1886	1	95	1901	6	692
1887	1	110	1902	7	861
1888	1	95	1903	8	1.075
1889	1	128	1904	9	1.381
1890	1	111	1905	10	1.769
1891	2	165	1906	12	2.052
1892	3	221	1907	15	2.980
1908	16	4,049	1924	63	33,477
1909	19	4,773	1925	68	36,110
1910	23	6,094	1926	75	40,040
1911	29	7,551	1927	81	45,758
1912	34	8,858	1928	88	47,783
1913	40	10,215	1929	93	56,060
1914	43	11,140	1930	104	53,203
1915	48	10,640	1931	107	58,259
1916	49	11,448	1932	109	60,266
1917	51	13,952	1933	109	63,674
1918	52	15,878	1934	112	62,262
1919	53	15,895	1935	114	70,062
1920	54	16,855	1936	115	76,624
1921	54	19,350	1937	118	80,407
1922	56	26,928	1938	130	84,634
1923	60	33,475	1939	131	102,022

Sources: Weinisch 1929, p. 33; "Die deutschen Krematorien..." 1940, p. 13; "Tabelle..." 1944, p. 17.

The list contains the data for Austria and for the Sudeten Territory from the time they became part of Greater Germany.

Between 1878 and 1939 altogether 1,201,823 corpses were cremated in Germany.

In 1939 the number of deaths in Germany was 1,007,122, that of corpses incinerated was 102,022, hence some 10 percent.⁷⁰ This percentage of bodies cremated grew steadily from the beginning of the century, in line with the increasing presence of crematoria and their increasing acceptance: in 1900 it was 0,5%, in 1910, 0.6%, in 1920, 1.8%, in 1930, 7.4%, in 1935, 9%, in 1936, 9.5%, in 1937, 9.9% and in 1938, 10.5% (Helbig 1940, p. 29).

In 1940, there were 108,630 cremations (=10.3%), in 1941, 107,103 (=10.75%), and in 1942, 114,184 (=11.5%).⁷⁰

9.2. Statistics of Other Countries

As already mentioned in Chapter 3, 19 crematories were constructed in the United States between 1876 and 1895, but the number of cremations remained rather low, as may be seen from the following table (Probst 1895, p. 181):

City	Inauguration Year	Total Cremations	Gender	
			Male	Female
Washington, D.C.	1876	38	29	9
Lancaster, Pa.	1884	89	67	22
Fresh Pond, New York	1885	1,554	1,084	470
Buffalo, N.Y.	1885	250	166	84
Pittsburgh, Pa.	1886	100	63	37
Cincinnati, Ohio	1887	314	214	100
Detroit, Mich.	1887	183	111	72
Los Angeles, Cal.	1887	182	119	63
St. Louis, Mo.	1888	437	300	137
Philadelphia, Pa.	1888	399	264	135
Baltimore, Md.	1889	84	57	27
Swinburne Is., N.Y.	1889	109	?	?
Troy, N.Y.	1890	56	37	19
Waterville, N.Y.	1891	5	1	4
Davenport, Iowa	1891	36	27	9
San Francisco, Cal.	1893	200	112	88
Chicago, Ill.	1893	87	54	33
Boston, Mass.	1893	118	59	59
San Francisco, Cal.	1895	28	18	10
Total		4,269		

8,594 cremations were performed in the U.S. during the five years spanning from 1896 to 1900.⁷¹ The Fresh Pond Crematory on Long Island began its oper-

⁷⁰ *Die Feuerbestattung*, Vol. 16, 1944, p. 17.

⁷¹ Cobb 1901, pp. 117f. The author presents detailed statistical tables on cremations in the U.S. and UK, in Italy, Denmark, France, Germany, Sweden and Switzerland sorted by the crematory location and year (pp. 117-121).

ation on December 4, 1885; up to March 1892, 745 cremations were carried out there, of which 373 were of people born in Germany and 240 were born in the United States; the remainder were mostly born in European countries (England, Austria, Switzerland, France, Ireland, Italy, Hungary, Denmark, Scotland, Belgium, Holland; A. Cobb 1892, pp. 146f.). In 1928, 109 crematories existed in the U.S., and the number of cremations exceeded 300,000 (Ichok 1931, p. 683):

Period	Creemas	Cremations	Period	Creemas	Cremations
1876-1884	2	28	1904-1908	37	24,356
1885-1888	9	395	1909-1913	51	38,963
1889-1893	15	2,257	1914-1918	77	65,571
1894-1898	22	5,937	1919-1923	87	72,647
1899-1903	28	13,784	1924-1928	109	101,467
Total					325,405

The first British crematory was built in 1885. By the end of 1909 some 8,000 cremations had been performed as follows:⁷²

City	first cremation	Cremations Until 1909
Woking	1885	3,220
Manchester	1892	1,348
Glasgow	1895	323
Liverpool	1896	464
Hull	1901	181
Darlington	1901	51
London-Golders Green	1902	2,808
Leicester	1902	87
Birmingham	1903	148
Leeds	1905	90
Ilford	1905	93
Bradford	1905	47
Sheffield	1905	61
Total		8,121

The following table shows the record of British crematories and cremations up to 1930 (Ichok 1931, p. 678):

Year	Crematories	Cremations	Year	Crematories	Cremations
1885	1	3	1910	13	840
1890	1	54	1915	14	1,410
1895	3	209	1920	14	1,796
1900	4	444	1925	16	2,701
1905	13	604	1930	21	4,533
Total					12,594

⁷² Rolants 1910, p. 1123; accurate statistics can be found in: Thompson 1889a, pp. 713-715; "Cremation..." 1909, pp. 349-351; "Progress..." 1910, pp. 579-581; "The progress..." 1914, pp. 926-928; The 1905 article "Cremation in Great Britain" gives the number of cremations performed in the first nine crematoria listed here for 1903 and 1904, as well as the total (4,407).

In France the crematory of Père-Lachaise performed a little less than 5,500 cremations during the first 21 years of its operation, omitting hospital remains and embryos (Rolants 1910, p. 1121):

Year	Cremations	Year	Cremations	Year	Cremations
1889	49	1896	200	1903	307
1890	121	1897	210	1904	354
1891	134	1898	231	1905	341
1892	159	1899	243	1906	362
1893	189	1900	297	1907	451
1894	216	1901	306	1908	403
1895	187	1902	299	1909	394
Total					5,453

In 1930 Denmark had five crematories, in which 15,005 cremations were performed between 1893 and 1930 (Ichok 1931, p. 682). In the Netherlands 3,852 cremations were performed between 1914 and 1930 (*ibid.*, p. 684); in Italy 17,503 between 1876 and 1930 (*ibid.*, p. 685); in Norway 9,424 between 1920 and 1930 (*ibid.*, p. 686). In Russia the first crematory was inaugurated in Moscow on 7 October 1927; it cremated 225 corpses until the end of that year, 4,025 in 1928, and 5,208 in 1929 (*ibid.*, p. 688).

In Switzerland 20 crematories existed in 1930; the total number of cremations exceeded 34,000 (*ibid.*):

Year	Crematory Furnaces	Cremations	Year	Crematory Furnaces	Cremations
1889	1	21	1924	17	3,297
1894	1	40	1925	18	3,549
1899	2	95	1926	19	3,670
1904	3	376	1927	19	4,228
1909	7	914	1928	19	4,528
1914	12	1,960	1929	20	5,029
1919	14	2,050	1930	20	4,885
Total					34,642

In 1930 Czechoslovakia had nine crematories with 32,311 total cremations since 1918 (*ibid.*, p. 689).

At the end of 1938, Germany counted 130 crematoria, England 47, Italy 37 (with 8 out of service), in Sweden and Switzerland there were 22 each, in Denmark 16, in Norway 10, in Czechoslovakia 9, in France 6, in Russia 2 and in Belgium, Finland, Holland, Portugal and Rumania 1 each. Behind Germany, the countries with the greatest numbers of cremations were England (16,312 cremations = 3.01% of all deaths), Switzerland (7,071 cremations or 14.55%), the Protectorate of Bohemia and Moravia (5,535 cremations or 6.04%), Sweden (4,434 cremations or 6.10%), Norway (2,262 cremations or 7.79%) and France (1,340 cremations or 0.20%; "Statistisches" 1939, p. 41).

Both for the number of crematoria and the number of cremations, the list was topped by Japan. Cremation furnaces were introduced in 1871. One decade

later some 9,000 corpses were cremated in Tokyo annually. The installations were very rudimentary and permitted even collective cremations. The fuel was largely kindling wood, and a cremation lasted from eight in the evening until six in the morning (“*La crémation au Japon*” 1883, p. 94). In 1897 some 15,000 cremations were performed in Tokyo, which amounted to 40% of the deceased. This percentage remained almost constant until the end of 1899. In 1900 the city had seven crematories (“*La crémation au Japon*” 1900, pp. 380f.). By 1912 the entire country had 36,723 cremation installations (Pallester 1912, p. 28). In subsequent years this number remained almost unchanged, while the number of cremations exceeded 600,000 corpses (Ichok 1931, p. 685):

Year	Cremation Furnaces	Cremations	Year	Cremation Furnaces	Cremations
1918	35,522	572,159	1924	36,422	559,635
1919	36,495	527,273	1925	36,652	551,838
1920	36,803	605,206	1926	35,866	538,017
1921	36,782	553,852	1927	35,800	580,000
1922	36,285	546,069	1928	35,745	606,531
1923	36,697	587,143	1929	35,385	622,492
				Total	6,850,215

10. Mass Cremation for Hygienic and Sanitary Purposes

In the following I use the term “mass cremation” in a broad sense, because a proper cremation in the narrow sense of the word can only be carried out in a cremation furnace.

In his 1932 book, Prof. Luigi Maccone devoted a very interesting and amply documented chapter to this topic titled “Cremation in Times of Epidemics, of Wars and Earthly Disasters (*“La Cremazione in tempo di epidemie, di guerre e di disastri tellurici”*)”, which I can recommend to the italophone reader (Maccone 1932, pp. 161-166).

Mass cremation on pyres for hygienic and sanitary reasons has been practiced frequently in historic times, mainly in Italy, for example after the Battle of Formovo in 1495, and in Venice in 1509 and 1576 in connection with an epidemic of the Bubonic Plague, in 1627 in Apulia after an earthquake, in 1630 at Mantua, in 1656 at Naples, in 1743 at Reggio Calabria in connection with epidemics, and in 1764 in Dalmatia (Huber 1903, p. 4). Numerous other such examples were set forth by Hugo Erichsen in a specific chapter of one of his documented works on cremation (1887, Chapter III, “Cremation in Times of War”, pp. 129-139).

In the 19th Century, after the Battle of Paris on March 30th, 1814, 4,000 corpses that had been exhumed and taken to Montfaucon were burned on 10 large grates made of steel bars placed on rocks (Fröhlich 1872, p. 44). In all of these cases, what was aimed for and what actually occurred was not a true and

proper cremation, *i.e.* a reduction to ashes, but merely a carbonization of the soft tissue of the corpses in order to remove them from a process of decomposition that would have been dangerous for public hygiene because of the large number of corpses involved.

On September 1st, 1870, 390,000 men clashed at Sedan. The tens of thousands of men killed were hastily buried in mass graves. This aroused the legitimate fear of neighboring Belgium so much that in the following year, in order to cope with a situation that worsened with the approaching spring warmth, a “Committee for the Disinfection of the Battle Fields” was constituted in Brussels under the presidency of Prince Orloff, the Russian Ambassador to Belgium. Two members of this committee, the Military Surgeon Lante and the Chemist Créteur, both Belgian, traveled to Sedan in early March. Having visited the battlefield, Créteur proposed to burn the bodies with tar and crude oil (petroleum) in the graves in which they were lying. The proposal was accepted by the committee and implemented. The operations were started in the second half of March of 1871; Créteur himself described them in the following way (Créteur 1915, p. 562; cf. Fröhlich 1872, p. 101; Marmier 1876, pp. 33f.; Duroux 1878, pp. 13f.):

“I had the earth removed from the burial mounds up to the first layer of corpses; then I had them covered with a layer of chloride of lime in order to neutralize the bad smell. [...]

On top of my layer of chloride of lime, I had tar poured; I then lit the whole thing with petroleum oil. The ignited petroleum spread over the whole layer of tar, which immediately ignited, attacking the flesh and melting the fat. The fatty substances, by mixing with the tar, raised the temperature so as to reduce a hundred corpses in less than an hour.”

After the combustion, the contents of the grave had shrunk to three quarters of the original volume and there were only bones left, covered with a resinous layer that isolated them from atmospheric agents. The amount of tar used depended on the number of corpses to be burned. For a grave of some 250 to 300 corpses, Créteur used 5 to 6 tons, for 30 to 40 corpses, 2 tons (Fröhlich 1872, p. 102). Créteur stated to have treated, between the 10th and the 20th of March 1871, and with the aid of 27 men, 3,213 mass graves of soldiers and animal carcasses, with at least three fourths having been dealt with in the manner described above. The total consumption of tar amounted to 384 tons.

Other members of the committee, however, Dr. Lante in particular, raised doubts concerning Créteur’s account, with respect to both the amount of tar used for each grave and the number of graves treated, even going so far as to question the results obtained.

In his account, Dr. Lante argued that a grave with 10 corpses required 2 tons of tar and that, with the 384 tons of tar consumed, Créteur – in the face of his own figures, some 2 to 5-6 tons per grave – could not, in any case, have treated 3,213 graves (*ibid.*, p. 103). Even with respect to the actual results achieved, Créteur’s claims turned out to be rather untenable. The contemporary author Fröhlich of the [German] Imperial General Staff noted (*ibid.*, pp. 109f.):

“One cannot claim, as the Chemist Créteur asserts to have demonstrated, that the so-called combustion process has been satisfactory. The result of the procedure was not, in fact, a combustion in the chemical sense, but only a carbonization; however, even this result – which in itself would have been sufficient from hygienic a point of view – would not at all have been achieved to a degree necessary to render the corpses innocuous. Actually, in the first place, the tar hydrocarbons certainly burned, before the soft parts of the corpses would have caught fire.

Consequently, the oxygen in the air would have been spent to a point where, for the carbonization, only a small quantity would have remained available; this, moreover, would have produced a direct effect of carbonization only if the fleshy parts of the corpses had already lost a large part of their water content. Thus, only the more-superficial parts of the corpses would have been carbonized, but the contents at the bottom [of the graves], to which the oxygen would not have penetrated (and that should apply to the mass graves in particular), were not involved in the process, or were involved only in part, and the flesh of the lower layers would, in the best of cases, have [merely] been roasted.”

Another authoritative source, Dr. Wilhelm Roth, the author of a major treatise on issues of military hygiene, also raised serious doubts as to the claimed results of these mass incinerations, all the more so as they were done within graves, basing himself upon the completely different findings of the Metz Commission.

In the Metz Area, between August 14th and October 27th, 1870, two armies of some 500,000 men fought a number of battles. In the Gozze Sector alone, 14,000 men died as a result of the battle of August 16th, and there were some 30,000 fatalities in the whole campaign. The decomposing bodies poisoned the air and polluted the groundwater. On February 16th, 1871, a commission was set up to carry out disinfection work. It was headed by the Army Surgeon D’Arrest, M.D., from the Supreme Command, and by Major Bode, M.D., the state physician (*ibid.*, pp. 46f.; Roth 1872, p. 549).

This commission undertook cremation experiments that were later described in detail in a report by the two physicians mentioned. The experiments were done only in rather small graves and, for reasons of piety, only on the carcasses of horses. For that purpose, the commission chose those carcasses that could no longer stay in the places where they had been found but whose transportation to a more suitable site would have been especially difficult. The actual procedure was as follows (Roth 1872, pp. 556f.):

“We thus unearthed the carcasses, which had only been interred in a cursory way, using the measures mentioned in the description of the exhumations, but with the difference that instead of chloride of lime we used the tar itself, which was poured in the most copious manner possible on the exposed fleshy parts. Then the tar-covered carcasses were removed from their original sites, generally somewhat humid, and were placed on a kind of hearth made up of large and thick stones. Here, they were covered from all sides with dry branches and straw, abundantly doused with tar, then soaked with petroleum and finally set alight. High flames rose immediately, generating thick columns of pitch-black smoke all around, as well as a heat so intense that one would have thought that the carcasses, surrounded as they were by fire on all sides, would very quickly

have been carbonized. However, within a mere half hour the flames died down to a level such that, in order to keep the fire from going out altogether, it had to be continually revived by pouring on more tar and petroleum.

After about two hours, the heads, the necks and the legs of the animals were strongly burned, but the large masses of flesh of the body were only roasted and covered by a layer of pitch which no doubt prevented the heat from penetrating further. For that reason we made a large number of deep cuts into the flesh, i.e. into the muscles of the rear parts, the abdominal cavities were opened, the guts which had become hardly warm taken out and replaced by dry branches and straw; then the carcasses were again covered with tar and petroleum in the most abundant and appropriate way possible, and ignited.

Again, there were enormous sooty flames and a tremendous heat, but again, after two hours, very little progress with the destruction. After five hours of work, done on several carcasses simultaneously and repeated elsewhere, it was still not possible to achieve a satisfactory result, i.e. the carbonization of the organic masses; the only thing left to do was to place the fleshy parts still visible on a kind of sled and bring them up onto the hill in order to bury them there well."

It was therefore decided to abandon these attempts at disposing of the carcasses. Summing up his experiments, Dr. Roth concluded (*ibid.*, p. 557):

"Hence one may conclude that Créteur's way of operation most probably results only in a carbonization of the top layer of corpses, whereas inside there was only very little change, and whole corpses may even have remained intact inside the graves."

Still, Créteur had brought up the idea in a general way, and the problem of mass burnings of corpses resulting from wars (in spite of the opposition of some military physicians)⁷³ and epidemics would henceforth be studied by specialists in the field of combustion.

In 1875 Friedrich Küchenmeister published the design of a mass cremation device for the corpses of soldiers who had died on the battlefield, which he had specifically ordered from Friedrich Siemens, the inventor of the first hot-air cremation furnace.

We set forth below the text of the description of the project as well as the accompanying drawing (Document 93; Küchenmeister 1875, pp. 82f.):

"Mr. Siemens says:

'As shown in the drawing, the shaded portions A of the furnace are best realized in brickwork of solid construction, if such material is available, especially in the lower portion, because they contain the hearths and the whole structure rests upon them. The excavated earth can be used for the packing B of the surrounding walls.

Above the hearths, inside the four surrounding walls, normal stones D are placed up to the first shaded line, and the corpses, covered with more stones, are placed upon them.

The space in front of the hearths must be filled with loose stones; by removing one or more of them, the flow of air can be regulated quite well.

⁷³ Schultz-Schultzenstein 1870, pp. 364-367; other military surgeons were enthusiastic supporters of burning; cf. Lanyi April 1874, pp. 91-95; Dechambre July 1870, p. 465; September 1870, pp. 545f.

The grates needed for the hearths have to be carried along; this can be done easily, as they consist simply of ordinary iron bars of a certain length and represent only a rather small portion of the total weight for one furnace.

The whole structure can be built well within two days by a few qualified bricklayers so that the furnace can go into operation on the third day.

The cremation process should be run in the following way: When the corpses have been placed on the loose stones, which have been arranged in such a manner as to leave much space between them, and have been covered with a layer of such stones, the fire under the grate is lit. The combustion products, which escape through the cracks, give up their heat to the stones D above the grate and heat them gradually, over something like an hour, until they have become bright red. The fire is reduced, and great amounts of atmospheric air are allowed to enter through the hearths. This air, on contact with the [glowing] stones, heats up to a high temperature and strikes the corpses which, by then, are somewhat desiccated on the surface; this leads to a rather rapid combustion of all portions which are subject to rotting.

It is obvious that the cremation in this furnace is not complete, as is the case in the furnace described above,⁷⁴ but because the starting conditions are very different (the furnace must destroy in the simplest and quickest way all the fleshy and muscular parts of the corpses which might rot and must eliminate any source of harmful vapors etc.), the furnace corresponds perfectly well to the task and will produce much better results than those obtained so far with cremations on the battlefield. R.S.⁷⁵

Even in its rudimentary simplicity, this device is in agreement with the principles of combustion technology. Although it is partly buried, it has true and proper hearths with grates placed at a height such that air can enter and flow through them without hindrance and the ashes can fall down without piling up on the grate. By means of the rocks, the openings of the hearths can be gradually blocked and the combustion air controlled, albeit in an approximate manner. The outside brick walls and the rocks on the hearths constitute a good reservoir for storing the heat produced initially by the hearths and for releasing it later by radiation and conduction. Temporary or mobile cremation devices were also planned and built with a view to possible epidemics. The crematorium was in fact considered “the only infallible germicide” (Beugless 1884, p. 143).

In November of 1901, during a meeting of the Chamber of Physicians of Brandenburg Province, Dr. Weyl proposed to cremate the victims of a typhus epidemic then raging in that area. He turned to Engineer Hans Kori who replied with the following proposal (“Eingabe...” 1902):

⁷⁴ The hot-air Siemens furnace described in Chapter 3.

⁷⁵ The initials “R.S.” are probably those of Richard Schneider, the Siemens engineer who designed the furnace.

“Berlin W., February 10th, 1902.

*To Th. Weyl, M.D.
Charlottenburg-Berlin W.
Carmerstr. 5.*

Dear Sir,

I have the honor to reply as follows to your esteemed query of the 8th of the current month:

The construction of temporary or mobile furnaces in which corpses of persons having died from the plague can be cremated safely and in a short time does not present particular technical difficulties.

The cremation furnace having a retort [muffle] with a separate front firing [Vorfeuerung], which I have built on the basis of several years' experience in the construction of cremation furnaces for slaughterhouses, hospitals etc., ensures a rapid cremation of the corpses and has the advantage of being easy to use. If all the parts of a furnace are available, it can be set up within 36 hours and then go into operation immediately. For the discharge of the combusted gases etc. one can use any appropriate tall chimney; the best solution would, of course, be a boiler plant.

The price of the completely erected furnace, without the connection to the chimney, would be about 2,750 marks.

*Remaining at your disposal for any more detailed information, I am yours
sincerely*

H. Kori.”

The technological progress achieved in the last two decades of the 19th Century had more and more inventors turn to the design of special furnaces to solve the problems of mass cremations, and much space was devoted to these questions in the specialized literature of that era. Let us look at the most-interesting projects which were proposed. The first I want to quote at length stems from the Italian engineer Pini (1885, pp. 155f.):

“MASS CREMATION FURNACE IN TIMES OF WAR.

Regarding a crematory destined to purify within a very short period of time the multitude of casualties left on a battlefield, one can no longer maintain the usual distinction between bed [muffle] and hearth; the two parts, instead, form a single large entity that has been named a receptacle. This crematorium is made of refractory brick and consists of only two parts, the receptacle and the chimney, both square, which rise up vertically one next to the other with a connection between them. We will describe a crematorium that can handle a thousand corpses in three days.

Both the receptacle and the chimney have a grate in their lower part. The receptacle should be 1.5 m wide and 2 m high. The cross-section of the chimney is 75 cm, its height is 10 m above the juncture with the receptacle.

The vault covering the receptacle and reaching as far as the chimney links the two parts and enters the chimney below the grate, on top of which there must always be a considerable amount of coke in combustion. The vault must extend over the whole receptacle without, however, covering it completely; rather, on both sides of it, there must be two large openings for the introduction of the fuel and of the corpses.

The hearth in the chimney must have three doors: one, at the level of the grate, for the removal of the coke residue when the cremation is over, another, above it, for feeding the fuel into the hearth, and a third, below the grate, to allow air to enter the hearth and the ashes of the coke to be removed.

The chimney must be built directly on the ground, but the receptacle must have its base more than two meters further down, in such a way that the two openings through which it is loaded are level with or slightly higher than the ground. This facilitates greatly the introduction of whatever has to be loaded, the fuel and the corpses. For that reason, if the land offers a favorable location, such as a slope, one should make use of it; otherwise one has to make a sizable excavation for the bottom at least two meters below ground.

We have said that the receptacle must have a grate in the lower part. The front portion, i.e. the side away from the chimney, must be left free up to the level of the grate such that the mouth of the receptacle is always open. The sidewalls, over a certain height above and below the grate, have as many vertical slots as there are horizontal slots in the grate; they are, so to speak, their continuations. In this manner, by using suitable tools, it is possible at any time to free the grate of any ash piling up and threatening to block it. At various levels the walls must have vertical slots to allow an abundant supply of air to be fed.

To use the furnace, the fire is first lit in the chimney and then the fuel that has been stacked on the grate of the receptacle is set on fire. A number of corpses are loaded on the fire, mixed with broken coal and coke in such a way that they form a layer on which more corpses are placed until some thirty corpses have been introduced. The whole mass will catch fire. The first corpses to burn will be those on the bottom. As they are being consumed, one uses the tools mentioned above to move the ashes down through the slots in the grate; they can then be removed with an appropriate rake. The mass of corpses will thus sag, leaving an empty space in the upper portion that must be continuously filled with fresh corpses and more fuel. One can compute that thirty corpses will burn within two hours and that more than a thousand can be cremated in three days.

The combustion products, after having been completely cleaned by passing through the glowing hearth in the chimney, will mix in with the surrounding air in a perfectly odorless and inoffensive way.

About 4,000 bricks are needed for the construction of such a furnace; together with the necessary lime, they can be transported on a dozen carts.

If one wants to build a crematorium to incinerate 10,000 corpses in three days without raising the height of the receptacle, the latter must be widened considerably, to some 4 m, and the chimney to 2 meters."

What we have here in practice is a large hearth on which alternating layers of corpses and fuel are placed; the efficiency of the hearth must be assured by a tall chimney with an after-burner for the combustion of the fumes. However, the indicated throughput rate appears somewhat dubious.

As opposed to the above, which never went beyond the planning stage, the device described below was actually built and operated, but only for the incineration of animal carcasses (see Document 94; de Cristoforis 1890, pp. 125-128):

“FEIST APPARATUS.

Initially, this device was invented by Dr. Feist only for the purpose of a hygienic destruction of carcasses of animals having died of contagious diseases, but one can easily see that with proper modifications it can also be used to incinerate human remains in case of a sudden high mortality, such as in wartime or during an epidemic, when the number of victims or the lack of time or money do not allow a special crematorium to be built, and finally in all the cases which Captain Rey had in mind when he invented his mobile crematorium.

We owe to the veterinarian Georg Feist the idea of rendering inoffensive the remains of animals having died of contagious diseases; he was convinced of the idea that any burial would only create a new source from which the disease would spread into the zone where it was raging, thus ruining the economy of the region at the same time. Feist's ideas were soon picked up by his colleague, the veterinarian Zündel, and by the local authorities. The Strasburg authorities approved the construction of a special furnace in each of the larger regions struck by the disease, i.e. at Johannes-Rohrbach and in the County of Saarlben.

The first Feist Furnace was set up on a hill only some 20 km south of the Village of Rohrbach; it was fashioned after the principle used in limekilns. The prevailing wind in the area is east-southeast; the mouth of the furnace faced in that direction.

The vertical space for the carcasses is perfectly round at either end: it is 1.75 m high and has a diameter of 1.60 m at the top and of 0.90 m at the bottom, at the level of the second grate. At first, a little straw is introduced into this space, together with dry branches or wood shavings, then hard coal, up to a layer some 40-50 cm high. Then the carcass is loaded, and the gaps between it and the walls as well as the space above are filled with more hard coal, and additional straw and bundles of wood. Finally, all this is doused with 5-10 liters of petroleum. Then a funnel-shaped lid of sheet metal, 2 mm thick, is placed on top, and the fire is lit in a suitable way at the level of the first grate, located some 65 cm above the ground. Underneath the furnace, there is a sheet-metal box in which the fluids flowing out because of the heat are absorbed by the ashes. The complete combustion takes about 5 to 6 hours for small animals and 8 to 9 hours for the larger ones, weighing 250 to 500 kg, i.e. as much as 4 to 8 corpses weighing 60 kg each. Over this period of time, by the way, the load is totally destroyed, leaving only an ash residue of 1 to 2.5 kg.⁷⁶

The attendant in charge of the cremation receives 20 francs per carcass, but he has to provide all the fuel and thus retains about half of that sum. The consumption is about 500 to 600 kg of coal, 5 to 10 liters of petroleum, and some 75 centimes' worth of straw and wood bundles.”

In 1908 the Mexican Government ordered a Richard Schneider mass-cremation device from Germany. The unit was laid out for the concurrent cremation of five corpses for a total throughput of 50 corpses daily (“Einführung...” 1908, column 10).

The bloody encounters of the First World War presented the problem of the disinfection of battlefields in all its urgency. Articles dealing with this question

⁷⁶ The actual amount should rather be 10-15 kg. This is probably a typographical error.

appeared in the German-language press as early as the end of 1914⁷⁷ and in the French press a year later (Barrier/Salomon 1915, pp. 545-563). In October of that year, the Berlin Cremation Society forwarded to the Ministry of War a letter from the Topf Company concerning the cremation of soldiers who had died in battle, but the request was turned down (“Feuerbestattung im...” 1914).

In an article published in March 1917, Adolf Marsch proposed a plan for a collective cremation furnace for the mass cremation of the corpses of soldiers killed on the battlefield. I quote the essential points of this article and show the two drawings that illustrated the project (Documents 95 and 95a). Having stated that it is considered a mass operation only if a unit is able to cremate at least 100 corpses or their remnants in 24 hours of continuous operation, the article continues (Marsch 1917, cols. 45-48):

“So far neither a practical proposal nor any sketch showing a usable cremation furnace for the mass cremation of the corpses of soldiers killed – be they fresh or previously buried – has been published. The author has set himself the task of resolving this question in an absolutely feasible manner.

Cremation furnaces used until now in civilized countries consist mainly of a horizontal retort [muffle] into which the corpse is introduced and then consumed. The time needed for this operation has been given as at least one hour, plus a further half hour for the preparation of the subsequent load, so that in order to achieve a minimum throughput of 100 corpses in 24 hours, it would be necessary to set up a large number of furnaces one next to the other. One must also consider the fact that, for a horizontal retort, the void space inside will fill up with a large amount of gas, thus making it difficult to maintain the mixture of primary and secondary combustion air at the proper ratio. Furthermore, the carbon-monoxide gases are not completely converted to carbon dioxide, which presents the inconvenience that part of the discharge gases leaving the chimney consists of carbon monoxide, which is dangerous [even] at a great distance and harmful to the environment from the point of view of hygiene.

If the layout is adequate, these drawbacks will not occur in a vertical retort of cylindrical shape, sufficiently large to accept a great number of corpses.

For this purpose, a cylinder of 3 m internal diameter has been chosen, the height of which enables it to be loaded with a pile of corpses in three layers of 3 corpses each, for a total of 9 corpses; they can thus be burned in a hygienically satisfactory manner in a matter of an hour or an hour and a half. Automatic measuring devices for the temperature and the gas composition placed in the body of the furnace or in the flue duct allow the operation to be controlled at any moment.

Such a furnace can be built from the foundations on up in a rather brief span of time and will be long-lasting; in any case, if it is operated continuously day and night, it will allow 3,000 corpses or their remnants to be burnt in one month without fear of incidents. Experience has shown that the operation need be interrupted only if and when certain parts highly exposed to the fire must be replaced. If several such furnaces are built together under one roof in a suitable pattern, such interruptions become irrelevant. Abandoned factory sites, after

⁷⁷ “Feuerbestattung auf...” 1914; “Aus der... Pardubitz,” 1915; “Aus der... Zsolna,” 1915.

proper reconstruction, can be used to advantage as a building site for the furnaces, provided that the chimney is intact and that there is a railway siding.

If this is not the case, it is advisable to build a new building, quite simple in view of its temporary use, which does away with all the defects and disadvantages one faces inevitably when rebuilding an existing one.

In principle, the operation is carried out in such a way that the corpses to be burned, after having been released by the military authorities, are transferred to the site wrapped in sailcloth with an addition of disinfectant – e.g., lime – and placed in containers of certain maximum dimensions (190 · 60 · 45 cm). After having been accepted by the personnel in charge, the introduction into the furnace is carried out by the site management. The ashes of the corpses, which are settling separately at the end of each cremation – without mixing them with the ash stemming from the hearth – are properly collected and preserved in individual containers with exact indications as to their origin, to be disposed of later by the military authorities. In this manner, it is possible to wait for the proper moment for them to be buried, either in their home country or on the battlefield, in a common grave or simply spread directly on the ground.

There is no doubt that, if set up at the proper locations and in sufficient numbers, the equipment just described will constitute a solid barrier to the threat of epidemics and will remove a fundamental obstacle to subsequent peaceful use of the theater of the war.”

This project was based on a patent granted the same Adolf Marsch on September 30th, 1915, for a “Shaft furnace for the concurrent cremation of a larger number of human corpses or animal carcasses.” The patent is accompanied by 5 figures (see Documents 96 and 96a).

The structure of the furnace is rather complicated. I will summarize only the essential elements. The cremation chamber *b*, of cylindrical shape, is closed at the top by two movable lids *d* attached to chains which allow them to be raised until they are flush with the sidewalls of the desiccation antechamber *g* which, in turn, can be closed by a closure-plate *h*; in its lower part, the cremation chamber assumes a square cross-section and is terminated by the steel grate *c*, to which it is connected by the inclined planes *t*.

Underneath the grate, there is an ash container *n*, below which is chamber *k* with the protrusions *l* and *m* for better heat recovery. Via channel *s*, which can be shut by means of a valve, this chamber is connected to the mouth of the gasifier, which has at its base the hearth grate *a*; loading takes place through opening *c*. The cremation chamber has four openings for the discharge channels of the fumes *i*, which run down in the walls of the furnace into chamber *k*, which is linked to the chimney via the flue-gas channel *u*. The desiccation antechamber *g* also has four openings for the discharge-gas channels *o* that run below the brickwork of the furnace and open into the channels *i*.

The furnace is laid out for a load *f* of 700 to 750 kg consisting of nine corpses arranged as shown in Figure 4 on a wooden grate.

It works in the following manner: after opening the closure plates, the load, which is hanging from a chain running over a system of pulleys, is lowered into the desiccation antechamber. The plates are then closed and the dampers *d* are opened. The gases generated at low temperature which form at this time are

sucked up by the draft of the chimney through the openings *o*. The load is then lowered onto grate *c*, and the chain is disengaged and removed, and the openings are closed. The combustion products of the hearth *a* strike the load from below through the openings of the grate and the lateral slots *r*. A portion of the combustion products enters the cremation chamber directly through channel *p* and burns the gases generated at low temperature. Through the openings *i* the fumes enter the vertical channels, which open into chamber *k* and leave it through the flue duct *u* towards the chimney (Deutsches Reich 1921).

In the 1920s and 1930s, mass-cremation furnaces were improved further. Professor Luigi Maccone describes a unit for the concurrent cremation of several corpses (1932, pp. 115f):

“The furnace is composed of several cremation beds [muffles] arranged side-by-side in such a way that two adjacent beds are separated only by a joint partition. Each [muffle] is built exactly in the same way as ordinary furnaces; the first bed including the furnace [hearth], which is attached to it, constitutes a normal crematorium in every respect. The others, however, have only a much-smaller furnace at their extremity, called an activating or ‘auxiliary’ furnace because of the end it serves. The chimney rises next to the last of these activating furnaces; internally it contains a cleaning and draft furnace [hearth for the post-combustion of the fumes and for promotion of the draft] and is otherwise built like one for ordinary furnaces.

A duct opening into the chimney runs below the crematorium and along the side where the furnaces are located, a further, similar duct runs along the same side above the crematorium and also opens into the chimney. The cleaning and draft furnace is located between these two ducts. The connections between the latter and the chimney are equipped with closures. The flue duct of the crematorium bed will normally open into the lower channel, but the smoke of the first furnace does not have to enter it right away: it can be made to take a longer way by having it pass through the 2nd furnace and through the whole length of the 2nd cremation chamber. It can be allowed to go out into the channel after having followed this path, but it can also be diverted and made to flow through the 3rd furnace and the 3rd cremation bed and so on until, in the end, it has passed through all the incinerating chambers. One can see that this is possible because the flue duct from the bed is split into two sections, the outlets of which are equipped with valves, and, depending upon which of these is open, the smoke will flow into the channel which leads directly to the chimney, or, moved along by the auxiliary furnace, will enter a further chamber.

This having been said, 4 corpses in a mass furnace with 6 beds will burn as follows. At first the coke on the hearth of the chimney is lit, with the lower tube closed and the upper open: the connections between the furnaces and the beds are held shut, and those between the furnaces and the upper duct are opened. The first 4 furnaces are lit, the smoke will flow to the chimney through the upper duct, and the flames will not strike the beds and will not heat them. The outlets from the first 3 furnaces into the lower duct are held closed, and the ones between the first 4 beds are held open. The connection between the 4th bed and the lower duct is held open and, instead, the connection between the 4th and the 5th bed is closed. When this is done, the corpses are introduced into the 4 beds: the

connections between the first 4 furnaces and the respective beds are then opened, as is the outlet of the lower duct; the connections between the furnaces and the upper duct are cut [closed]. After that, cremation of the four corpses takes place concurrently. The first corpse is in a position as if it were in a normal furnace, and its incineration does not take longer and is not more costly.

The smoke leaving the 1st chamber, which is full of heat and easily combustible substances from the decomposition of the first corpse, does not become simply lost by escaping through the chimney but goes into the 2nd furnace (or rather the 1st auxiliary furnace), in which the combustibles catch fire, and then enters the 2nd chamber to consume the corpse which is in it, by means of the heat of said furnace. Flowing from there into the 2nd auxiliary furnace and enriched by the products of the combustion which occurs there, the smoke then enters the 3rd chamber, strikes the 3rd corpse and consumes it. After that, it flows through the 3rd auxiliary furnace, the smoke enters the 4th compartment and consumes the 4th corpse. On leaving it, the smoke does not enter the 5th [muffle], which does not contain a corpse, but is led via the lower channel to the chimney, from which it leaves, clean, transparent, and odorless into the atmosphere, having lost any combustibles by passing through the furnace [of the chimney].

It should be stated here that, if the 4 corpses had been incinerated in 4 ordinary crematoria, there would have been a loss of heat and fuel via the chimney 4 times as high as in the mass crematorium. The latter thus presents a sizeable economy in terms of fuel and service cost, and an even higher saving in construction costs inasmuch as we have less material to be handled, fewer working days and a single chimney. The cremation of the corpses must take place and end simultaneously. If the incineration of one corpse proceeds more slowly than that of the others – which can be observed through the peephole in the center of the front door of the incinerating chamber – its fire is increased correspondingly by the addition of fuel to the auxiliary furnace and by feeding in the air needed for a good combustion.

Once all corpses have been cremated, the dampers are set so that the combustion products can no longer enter the chambers but flow directly to the chimney via the upper channel. Then the doors are opened, the ash containers removed and the ashes transferred to the urns that have been held in readiness.”

This furnace realizes Gorini’s idea of using the heat produced by one corpse to burn another; as we shall see in Unit II, this idea was taken up by the engineers of Topf & Söhne of Erfurt when they conceived their cremation furnaces with three and eight muffles.

Adolf Marsch had instead gone back to an improved version of the Feist Furnace, the original layout of which we have already explained. The new model (Document 97) has a funnel-shaped combustion chamber *a* ending in a double grate *G* and *H* at the bottom. The upper part of the cylinder, through which loading takes place, has a conical steel cover *B* with an inspection and loading opening *b* and with rollers. The positioning of the cover is achieved by means of a worm gear with crank *W*. During combustion, the cover is placed over the cylinder. The forming gases rise upwards through channel *K* into the auxiliary hearth *D* with its stepped grate and enter the chimney *E* in a completely burnt-out state. The combustion air arrives at the double grate *G* and *H* through the air

duct *I* with its opening *M*, which is placed in the direction of the wind prevailing in the area.

The operation of the furnace is as follows: The auxiliary hearth *D* is lit first, then the main hearth *G* is loaded with wood and rags soaked in petroleum, and a layer of coal about half a meter high. Then on grate *H* a small fire of straw and rags is lit, which in turn lights the fire on the grate above. The incineration of a large animal takes about 5 to 6 hours (Heepke 1905a, pp. 45-48).

Although the furnaces produced by the Hans Kori Co. were conceived specifically for the disposition of animal carcasses and slaughterhouse refuse, in case of need they could have likewise been used for the mass cremation of corpses. Document 98 shows the Kori standard furnace for the combustion of animal carcasses and slaughterhouse refuse. The furnace consists of a combustion chamber *VR* (*Verbrennungsraum*) with an inclined grate *G1* and *G2* and a flat extension *G3*. The inclined portion *G2* has eight pairs of parallel slots that link the combustion chamber with the channel *K* below. At the end of the grate *G3* is the mouth of the hearth with the inclined grate *F* of the main hearth below. The furnace is also equipped with a secondary hearth *St* and the respective flue ducts.

The furnace operates in the following way: The carcass is loaded into the combustion chamber through the loading shaft *E* and placed on the grate *G* where it is struck by the flames from the hearth *F*; a portion of the combustion products enters channel *K* and strikes the carcass from below through the slots of grate *G2*. The combustion products enter into the vertical ducts *Z1* and *Z2* through two openings located under the vault of the combustion chamber on either side of the loading shaft, leave from the outlet of channel *K* under the grate of the combustion chamber and enter the smoke duct *O*; they pass over the secondary hearth *St* and reach the chimney in a completely burnt-out state (*ibid.*, p. 40).

Among others, the furnace for the municipal slaughterhouse at Nijmegen was erected along this principle. In 1902, a total of some 50,000 kg of offal were burnt there with an average consumption of 0.375 kg of coal for 1 kg of flesh and an average duration of 1 minute for 1 kg of flesh (*ibid.*, pp. 40f.).

The furnace for the Liegnitz Slaughterhouse (Document 99) had a structure similar to the one described above, except that below the final section *f* the grate of the combustion chamber, it had an ash container *a* (*ibid.*, p. 42).

The furnace for the Nuremberg Slaughterhouse – the first one of this type built by Kori (1892) – had the feed opening in the vault of the combustion chamber to allow the offal to be loaded directly from the operation room (*ibid.*).

Document 100 shows a furnace for combined operation, *i.e.* a furnace connected to the flue duct of a boiler plant. The smoke from the latter enters the furnace through channels *K1* and *Z*, strikes the material which is on grate *G3*, enters opening *K3* and flows down into flue duct *a*, which is connected to the chimney. The combustion as such is accomplished by the combustion products coming from the hearth *F*, which strike the material on grate *G2* either from below through the slots in the grate or from above through the wide opening located below the grate. The discharge gases enter opening *K4* and flow down, likewise, into the flue duct *a* (*ibid.*).

11. Notes on Present-Day Cremation Furnaces

Although Part One of this study is devoted to furnaces built before the Second World War, our treatment of the subject would be incomplete without at least a few remarks on today's cremation furnaces, if only to show the enormous progress made by cremation technology since the end of the war. The furnaces of the latest generation have, in fact, electronic controls, and although they are in no way comparable with the old gasifier furnaces, this very fact shows the limits that nature has placed on the process of cremation. Actually, even with these highly advanced furnaces, the average duration of a cremation still stands at around 60 minutes.

In this chapter, we will examine briefly five types of furnaces, two of which represent improvements on models already in use in the 1930s and 1940s. Let us start with these.

Document 101 shows the gas-fired furnace of the H.R. Heinicke Co. of Stadthagen, which evolved from the Volckmann-Ludwig Furnace of the 1930s. For a description of the elements making up the furnace see the document.

Heinicke built, among others, four furnaces of this type for the crematorium at Hamburg-Öjendorf in 1964 and another four for the Hamburg-Ohlsdorf crematorium in 1968.

Answering a specific request from the author on the operation of those furnaces, the cognizant authorities supplied the following information:

The duration of a cremation is between 50 and 70 minutes. The average gas consumption for one cremation varies between 8 and 20 m³, depending on whether the cremation takes place individually or as one of several cremations; it is possible to use the furnace continuously, 24 hours a day, in three shifts of eight hours. The coffin is introduced at a temperature of 700 to 750°C; the combustion of the coffin causes the temperature in the muffle to rise by 100 to 150°C, the cremation temperature therefore is 800 to 900°C.⁷⁸ According to the supplier, heating the furnace from 20 to 800°C requires 500,000 kcal; one cremation in a series requires 160,000 kcal⁷⁹ supplied mainly by the combustion of the coffin.

The company's technical brochure describes the furnace as follows (see also the illustration in Document 101):

"The Heinicke Cremation Furnace is equipped with high-resistance refractory brickwork and a particularly good insulation. Experience has shown that, after the initial warming-up of the muffle, one can carry out one cremation after another without additional supply of heat. Thanks to a forced supply of the combustion air through coiled tubing and air nozzles with control valves, the air can be fed to the muffle in keeping with the requirements of the course of the cremation; this guarantees a cremation without smoke. On account of the particular layout and shape of the channels for the combusted gases, the floor of the muffle is heated also from below, as the combusted gases reach the smoke discharge

⁷⁸ Freie und Hansestadt Hamburg. Umweltbehörde – Amt für Naturschutz und Landschaftspflege – Garten- und Friedhofsamt, letter to the author of May 5th, 1987.

⁷⁹ H.R. Heinicke Feuerungs- und Schornsteinbau, letter to the author of June 21st, 1988.

axially. The muffle is separated from the post-combustion chamber by a closure, and the efficiency can thus be increased: the final combustion takes place in the post-combustion chamber; the muffle, once it has been emptied out, is ready for the subsequent cremation. By briefly operating the post-combustion burner, the scant remains of the cremation that may still be present on the grate and which are difficult to burn, can be heated so intensively that they decompose rapidly.”

Starting from the 1930s model described in Chapter 5, Asea Brown Boveri Co. has developed a number of electrically fired furnaces presently in operation, i.a., at the crematoria of St. Gallen (1982), Albstadt-Ebingen (1979), Tuttlingen (1982f.) and Zürich, Nordheim Cemetery (1967).⁸⁰ The operating principle of the furnace is illustrated by Document 102. The structure of the furnace is shown in Documents 103, 103a&b, whereas Documents 104a&b show a cremation hall with two such Model RK1-S Furnaces.

The manufacturer describes the furnace in the following manner:⁸¹

“In the BBC Electric Cremation Furnace, cremation takes place exclusively in hot air, i.e. the cremation process occurs in a closed chamber by means of the heat stored in the brickwork, and takes 50-80 minutes, depending on the quality of the coffin. Thanks to a well-designed and remotely controlled system of air supply, the cremation can be guaranteed to be smokeless and odorless.

Before loading, the muffle of the furnace is heated to 600-700°C. The cremation process as such is exothermic, i.e. the temperature of the muffle rises during the first half to about 1,000°C due to the energy thus supplied, without any [other] energy being added during the cremation. The amount of heat generated in this phase covers not only the heat requirements of the process, but is also partly stored in the brickwork of the vault as residual heat. This heat sustains the final phase of the combustion and at the same time creates the operational conditions for the subsequent cremation. Thus, in case of a series of cremations, further heat supply is not needed. Only the ancillary equipment requires some 4-6 kWh during the cremation. If 5-6 cremations take place during the day, heating during the night is generally not necessary. If the intervals between operations are rather long, heating should be carried out during the night (lower electricity rates), and their duration can be controlled by means of a timer.

In the electric furnace, the coffin is introduced by means of the feeding device and placed on the eight bars (grate), which support the coffin. The parts which fall through these bars during the cremation drop onto the ash floor below. Here, these parts are maintained in an incandescent state and burn completely in the fresh air supplied along the ash floor (BBC patent).

Once the bars (grate) supporting the coffin are clear, the ashes that have dropped down onto the ash floor are moved to the ash openings by means of a tool; they burn out completely in a further stream of fresh air. The ash stays in this covered area without mixing with the ashes of subsequent cremations.

The ash that is in front of the ash openings is then transferred to the flanged ash container below, where it is rapidly cooled by a fresh-air draft. Operating the

⁸⁰ On this subject exists an interesting album edited by Asea Brown Boveri with 29 photos.

⁸¹ BBC Brown Boveri, *BBC-Elektro-Kremationsöfen im Dienste der Feuerbestattung*; company brochure.

invertable grate allows the ashes to fall into the ash receptacle placed underneath; they can then be moved to the ash preparation [area].

The post-combustion of the discharge gases takes place in the discharge-gas-combustion section connected to the cremation chamber. For that purpose, the discharge-gas channels can be heated (BBC patent) to ensure that the discharge gases catch fire from the very start of the cremations. This post-combustion section also conforms to the requirements of environmental-protection regulations. Initially, the discharge-gas channels are heated to 800°C (legal requirement). The combustion of the discharge gases is an exothermic process, as is the cremation itself. During the cremation, the temperature at that point rises to 1,200°C without any supply of outside energy. The long dwell time (1.3 – 2.3 seconds) of the combusted gases in the hot zones, as well as the turbulence caused by their repeated changes of direction over 360 degrees, establish the prerequisites for an optimum burn-out of the discharge gases, as has been ascertained by analyses of these gases.”

The Ferbeck & Vincent Type C411 Furnace (Document 105) comes as a single unit that can be placed directly on the floor of the furnace hall.

The duration of the cremation is 60 to 75 minutes. The main burner has an output of 300,000 kcal/hr, the secondary one 5,000 kcal/hr. The consumption for the first cremation, including preheating, is 40 to 80 m³ of natural gas, or 320,000 to 640,000 kcal, 70 to 80% of which are needed for the preheating.

The structure of the Tabo Furnace is shown in Document 106. The duration of a cremation is about 60 minutes; the average consumption is about 25 m³ of natural gas.⁸²

Documents 107 and 107a show the Ener-Tek II Furnace. According to the manufacturer, the Industrial Equipment & Engineering Co., the heat requirements for a cremation within a series of 6-8 cremations per day are 400,000 to 500,000 BTU⁸³ (*i.e.* about 101,000 to 126,000 kcal) plus another 450,000 to 550,000 BTU (*i.e.* about 113,000 to 137,000 kcal) for the post-combustion. The duration of the cremation is not indicated. The technical characteristics are similar to those set out above. The company guarantees moreover a particularly long life for the refractories:⁸⁴

“The refractory and insulating materials used in the construction of Ener-Tek II are of the highest quality and will ensure many thousands of cremations before any repair work on the bricks becomes necessary.”

The most-common furnace systems in Germany are of two types: the *Etagen-ofen* (multi-story furnace, Document 108, drawing on the left, and 109) and the *Flachbett-ofen* (flatbed furnace; Document 108, drawing on the right). Both have a main combustion chamber, a chamber to complete the combustion (*Ausbrennraum*), and a post-combustion chamber.

These devices are described as follows (Sircar 2002, pp. 14f.):

⁸² Letter from the Tabo Co. to the author of November 22nd, 1990.

⁸³ BTU = British Thermal Unit = 0.252 kcal.

⁸⁴ Industrial Equipment & Engineering Co., Features of the Ener-Tek II. The documentation regarding this furnace is published in Leuchter 1988.

“Each cremation chamber is equipped with a burner that is at times turned on or off at adjustable, predefined temperatures. The loading and actual cremation process takes place in the main combustion chamber (muffle). The combustion chamber is used to completely mineralize the ashes. In order that the combustion is as complete as possible, the combusted gases are passed at temperatures above 850 °C through a post-combustion chamber. The shape of the main combustion chamber exhibits some differences. Bridge-shaped coffin support stones are the main feature of the multi-story furnaces. Beneath them are two or more heat-resistant turntables. The space between the turntables is the area for completing the combustion. During the cremation the developing ashes fall onto the upper turntable. After the end of the process, this turntable is turned so that the ashes fall onto the lower turntable. The operation of the turntables and possibly other ash grates occurs at certain intervals. In this way, the ashes are brought gradually to the ash-extraction area. The dwell time of the ashes in the area of complete combustion and the cooling process depend on the number of turntables of the respective system and on the time schedule of the technical operation. With an appropriate choice of these parameters, one gets both a good combustion and a uniform cooling of the ashes.

This is especially important in relation to the quality of ash (clumping consistency of the ashes in case of sudden cooling, elimination of odors). Due to the zone design of the multi-story furnaces, a new charge can be loaded into the main combustion chamber, after the upper turntable has been turned. The manual and/or automatic operation of the turntables ensures that the ash remains do not mix.

Flatbed furnaces are characterized by a single area as a supporting surface for the coffin. The ash residues in the muffle are brought into the area for completing the combustion by means of vanes. Similar to the multi-story furnace, the chamber to complete the combustion is delimited by two turntables enclosing the areas. One advantage of the flatbed furnaces is probably that they need relatively little space.”

The Ruppmann Furnace (Document 109) is a typical *Etagenofen*. The furnace damper (*Ofenschieber*; 1) is topped by a fume hood (*Schwadenabsaugung*, 8) coming out of the opening of the damper. The muffle (*Hauptbrennraum*, 2) is equipped with a gas burner (B1) and at the bottom delimited by three coffin support stones (*Sargbrückensteine*, S) and is closed by the first turntable (*Drehplatte*, D1). Below it is located the second turntable (D2) and further below the third (D3). The three turntables delimit two chambers, of which the upper is the chamber to complete the combustion of the ashes (*Ascheausbrennkammer*, 3), which is equipped with an auxiliary burner (B2), and the lower is the ash-cooling chamber (*Ascheabkühlkammer*, 4). At the bottom the ashes are extracted (*Ascheentnahme*, 5). The gases developing in the muffle and in the complete combustion chamber are led into a post-combustion chamber for the fumes (*Rauchgasnachbrennkammer*, 6) equipped with an afterburner (B3). The combustion air is channeled into the muffle at various spots by means of a blower (G).

Here is the operation description of a Ruppmann Furnace at the Dresden Crematorium (Schetter/Burk 2006, p. 5):

“The coffin is placed in the main combustion chamber on a specially designed support grate by means of an automatic introduction machine. After closing the furnace door, the cremation as such takes place in the main combustion chamber. There the combustion process occurs by means of heat transfer between the combustion chamber walls and the coffin, and by a defined supply of primary combustion air. If necessary, the cremation process is supported by the main gas burner. The design of the furnace chamber in connection with the coffin’s grate support produces an intense mixture of the combustible gases with the combustion air due to the formation of vortices. The unprocessed gases coming out of the main combustion chamber pass into a post-combustion chamber where they are burned completely by means of additional, secondary air. The required afterburner temperature is maintained by another gas burner. After about an hour, the remaining ashes are moved to the lower ash-combustion chamber where they are heat-treated. After another hour, the heat-treated ashes are brought to a cooling grate and then to the ash container.”

At the end of 1998 there were 113 crematoria in Germany with altogether 211 furnaces, 90% of which were heated with gas, 8% with electricity, and 2% with naphtha. The average duration of a cremation was 60-70 minutes (Sircar 2002, pp. 10, 15, 24).

Unit II: J.A. Topf & Söhne

and the Cremation Furnaces of Auschwitz and Birkenau

1. Historical Notes on the Topf & Söhne Company

The most-detailed account of the origins and development of the Topf Company can be found in the already-mentioned book *Industrie und Holocaust* by Anne-gret Schüle, especially in its Chapter I, which covers the period from 1878 to 1930.

The Topf Company was founded in 1878 by Johann Andreas Topf (1816-1891), a master brewer who also worked on improving industrial incinerators. In 1884, his son Max Julius Ernst (1859-1914) joined the company, and the following year also his other son Wilhelm Louis, called Ludwig (1863-1914), so that on April 1, 1885 the company was renamed J.A. Topf & Sons. In the following years, the other two brothers joined the company: Albert (1857-1893) in 1886 and Gustav (1853-1896) in 1888. Ludwig remained the sole owner until his death by suicide on February 15, 1914. By a tragic irony of fate, his son, who bore the same name, also took his own life on May 31, 1945. Ludwig, the father, was a proponent of cremation, which was still in its infancy in Germany at the time. Consequently, he had himself cremated after his death. The ceremony took place on February 18, 1914, at the Gotha Crematorium. His two sons, Viktor Karl Ludwig (1903-1945) and Ernst Wolfgang (1904-1979), were still children at this time and did not take over the business until the 1930s: Ernst Wolfgang in 1929, followed by Ludwig in 1931. On December 30, 1935, the two brothers reorganized the company into a limited partnership.

At the beginning of the 1920s, Topf was known not only in Germany but also abroad. At that time, the company consisted of two main departments, one responsible for the design and construction of steam-boiler plants and the other for complete malting plants. The company's activities also extended to various firing equipment, such as mechanical firing apparatus (grate feeders), preheaters for the utilization of exhaust-gas heat, forced-draft devices, chimney constructions, industrial furnaces of all kinds, and cremation furnaces. Topf was very successful with its high-performance furnace with pre-gasification shaft for the economical combustion of lignite.

In the two decades that followed, Topf developed enormously and exported its products all over the world until the eve of the Second World War.

From 1878 to 1934, the Furnace Construction Department built about 30,000 furnaces, including about 25,000 of its own designs, for which it manufactured various types of grate bars, grates and spare parts.⁸⁵

Between 1924 and September 1937, Topf had delivered or had been contracted in 3,710 cases to deliver items relating to 22 different types of malting equipment and storage facilities to Germany and abroad, including 39 silo gas-sing systems, about 700 barley, green-malt and malt worm conveyors and 375 barley, green-malt and malt elevators.⁸⁶

⁸⁵ Company flyer of March 1934 with the headline "*Topf-Roststäbe*". SE, 5/411 A 195.

⁸⁶ Company flyer of 1937 with the headline "*Zahlen sprechen...*". SE, 5/411 A 191.

In the field of cremation, the Topf Company began its activities on the eve of the First World War. In 1914, it built two furnaces with coke-fired gas generators at the Halle (Saale) Crematorium; another furnace of the same type was inaugurated at the Freiburg Municipal Crematorium on April 15, 1914; and another was installed at the Hirschberg Municipal Crematorium, which opened on August 22, 1915. From the early 1920s, the company began its slow but inexorable rise to become the market leader among German companies in this industry over the next two decades. By 1934, 74 cremation furnaces had been built, including three abroad (two in Moscow and one in Brussels). 29 coke-fired furnaces, 44 gas-fired furnaces and one electric furnace; four of the gas furnaces had been converted from former coke-fired furnaces. Contributing to this success was the fact that Topf soon achieved a very-advanced technological standard and manufactured high-quality equipment; it is credited with building Germany's first gas-fired cremation furnace in Dresden in 1927, as well as Germany's first electric cremation furnace, which went into operation in Erfurt in 1933. In 1934, Topf patented a new type of gas-fired furnace, the "High-performance furnace with tiltable grates D.R.P."⁸⁷ or "Topf Cremation Furnace 1934," which was also capable of using electric heating.

Topf's research activity is also evidenced by the numerous patents granted to it, especially in the 1930s, some of which – such as the post-combustion grate and tiltable grate – introduced important innovations in cremation technology.

At the beginning of the 1940s, the Topf Company had a very-complex structure. The twelve technical departments were divided into 99 sections, but these twelve departments occupied only numbers 74-85 of the company's total of 89 departments.⁸⁸

The Topf engineers of interest in the context of the present study were:

- Kurt Prüfer, born in 1891, with the Topf Company from 1920, chief engineer since December 2, 1935,⁸⁹ director of Subdepartment DIV, furnace construction, crematoria, waste-incineration furnaces and recovery furnaces for the recovery of metals.
- Karl Schultze, born in 1900 in Berlin, with the Topf Company from 1928, chief engineer, director of Department B, which dealt with heating, ventilation and fan construction.
- Fritz Sander, born in 1876 in Leipzig, with the Topf Company from 1910, chief engineer, proxy of Department D, which in its four sub-departments was engaged in boiler and furnace construction.

During the investigation of the criminal case brought against Prüfer by the Soviets, which will be discussed below, he personally drew a chart of the Topf Company's organizational structure, which he explained in a brief explanatory

⁸⁷ *Deutsches Reichspatentamt Patentschrift*, Patent description filed with the German Imperial Patent Office.

⁸⁸ SE, 5/411 A 163, J.A. Topf & Söhne, *Organisation der Unternehmung. Katalog der Sonderakten*. See Documents 131f.

⁸⁹ Prüfer was informed of the appointment in a letter dated December 2, 1935, marked "ET" (Ernst Topf). APMO, BW 30/46, p. 2.

note (see Illustration 1). According to this chart, the company was hierarchically structured as follows:⁹⁰

- Ernst Wolfgang and Ludwig Topf, proprietors of the company
- administration office
- general planning, under the direction of Heinrich Mersch, and operations management, with Gustav Braun as head
- project preparation and standards office
- accounting, preliminary and final cost calculation, purchases and assembly office
- Department D – proxies: Fritz Sander and Paul Erdmann, with Subdepartments B (headed by Karl Schultz[e]), DI, DII, DIII, DIV (headed by Kurt Prüfer)
- Department E – proxies: Hermann and Kurt Schmidt, with Subdepartments A, C, EI, EII, EIII, EIV
 - locksmith shop, lathe shop, furnace shop, welding shop, carpentry shop
 - materials warehouse, motor pool and garage, shipping

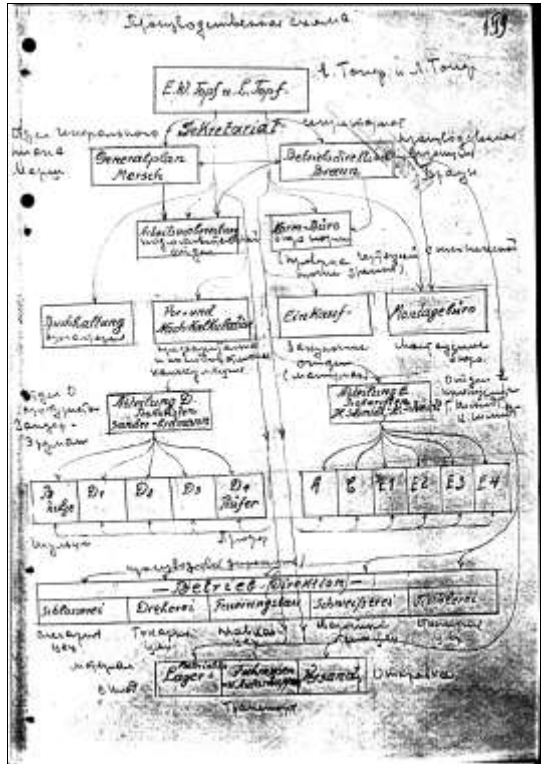

Illustration 1: Organizational chart of the Topf Company drawn by Kurt Prüfer while in Soviet captivity

Prüfer's explanations of the company structure, which he set down during his Soviet imprisonment, are to be found in Prüfer's criminal file compiled by the Soviets as a typewritten transcript peppered with errors and lacking umlauts, probably prepared by the Soviets on the basis of a handwritten text by Prüfer. It reads as follows:⁹¹

“Mr. TOPF, Ludwig and Ernst-Wolfgang were the owners and bosses of the company and managed it directly.

Both gentlemen were in charge of selecting the orders to be produced by the company in the factory.

From here it was decided which orders should be accepted and which should be rejected.

The directly subordinate secretariat, staffed by two ladies, passed on the instructions of Mr. TOPF to the individual departments, and it was here that the incom-

⁹⁰ FSBRF, N-19262, Criminal Case 1719, p. 159.

⁹¹ *Ibid.*, pp. 160-162.

ing and outgoing mail was handled and the personnel matters of the employees were processed.

The General Plan Office examined the orders received, together with TOPF, on acceptance or rejection and, if accepted, assigned a level of priority. It was also here that the control tokens or bills were received and forwarded. This office was the most important in the company and was headed by Mr. MERSCH.

The plant director, as head of the entire plant (with the exception of the technical offices), had to supervise the handling of orders within the factory, and help determine which orders were urgent and which were unsuitable for the plant and had to be rejected. In addition, it was from here that the work was distributed to the individual operating units, and the method of production was discussed and determined. Workers were also accepted [hired] and dismissed here. In the project preparation office, the machine parts to be manufactured were broken down into the individual operations, the costs for machining the parts were determined, i.e. the piecework wages were set, the parts lists and the shop drawings were checked and errors corrected, and it was checked which machine parts in stock were to be used.

This office reported directly to the plant director (BRAUN).

The standards office checked all drawings and parts lists prepared for the workshop for 'standard' and correctness, and especially for the correctness of the dimensions. This office was also under the direction of the plant director.

In the accounting department, all incoming and outgoing orders were entered into the books, and invoices were prepared.

The pre- and post-calculation checked the cost estimates and, after processing the individual machine parts, calculated the expenses and also the costs of manufacturing the machines, in order to finally determine the total costs and consequently the profit or loss.

This office was under the direction of Mr. TOPF.

In the assembly office, the assemblers for [the] individual construction sites were dispatched, and the assembly wages were determined and settled, the travel prices were prepared and the assembly duration was determined. In addition, the hand tools for the construction sites were assembled and sent off. This office was under the command of Director BRAUN.

The department head management (D) – headed by the directors and senior engineers SANDER and ERDMANN – supervised the individual Departments B-D₁-D₂-D₃-D₄, distributed the incoming mail handed over by Mr. TOPF, and consequently assigned the technical office work, checked the drawings and factory parts lists for correctness, and supervised the outgoing mail.

Department (D) handled steam-boiler hearths, bricking-in of boilers, boilers, aeration and deaeration systems, and furnaces of all designs, garbage and waste-incineration furnaces, industrial furnaces, cable incinerators and cremation furnaces, and factory chimneys

Department Management E, – management by authorized signatories Hermann SCHMIDT and Kurt SCHMIDT, supervised the individual Departments A-C-E₁-E₂-E₃-E₄. This department processed brewery machinery and all machines necessary for malt production. Steel silos for grains of all kinds, whole malting plants and grain-drying plants. Both Departments (D and E) were under Mr. TOPF.

The plant, which consisted of a locksmith's shop, a lathe shop, a furnace shop, a welding shop, and a carpentry, employed about 650 workers, and here, by means of the existing machines, all the parts for the complete devices manufactured by the company and described above were made.

The raw iron and non-fabricated iron parts were stored in the materials warehouse and distributed according to need.

The sub-departments of transportation and shipping handled the machines finished for shipment in the factory.

The plant was under the direct supervision of Mr. TOPF and Director BRAUN."

The organizational chart of the Topf Company dated February 22, 1943, however, shows a much-more-complex structure. The main departments, which were subdivided into numerous subdepartments, were thus as follows (reproduced in Schüle 2011, p. 167):

- Operations management with the two Topf brothers as bosses, including management and general administration
- commercial departments
- technical administration
- technical departments
- the operating department, including the plant production schedule, headed by Gustav Braun, the project-preparation department, and the plant floor;
- the assembly department

In 1940, the Topf Company reached its highest number of employees: 1,064 persons, of whom 766 were blue-collar workers and 298 white-collar employees (*ibid.*, p. 78). After the beginning of the Second World War, foreign workers, prisoners of war and civilians were conscripted to the Topf Company. At the end of 1942, 270 of these conscripted workers worked for Topf, and in 1943 there were already 341 (*ibid.*, p. 76). On December 31, 1943, the company had 840 employees.⁹² From an "employee report" of January 31, 1944, it appears that the Topf Company had 830 employees at that time, of whom 726 were men and 104 women, including 157 salaried employees and 198 skilled workers.

After the war, the Topf Company started its activities for the Soviet Office for War Reparations and Supplies of the Soviet Administration in Germany. In October 1945, it erected a waste-incineration furnace in Arnstadt.⁹³ An order dated February 19, 1946 for a "Cartox"⁹⁴ fumigation device for 5,000-ton storage" was completed on May 30, 1948 with the site-acceptance test of the plant.⁹⁵

In April 1948, the company was still called J.A. Topf & Sons, but was now a nationalized company with the "State Owner" Max Machemehl, the plant manager Herbert Bartels and Friedrich Schiller as head of the employee organiza-

⁹² *Beschäftigtenmeldung*, 31 January 1944. BAK, R 13III/321 H 4.

⁹³ File memo of *Betriebsdirektor* Braun added to Kurt Prüfer's personnel file. APMO, BW 30/46, p. 21.

⁹⁴ Cartox was a disinfection agent for grain in silos, consisting of nine parts liquid ethylene oxide and one part carbon dioxide. Topf also manufactured Areginal fumigation systems, for which it distributed the corresponding "Operating Instructions for Areginal Fumigation Systems." SE, 5/411 A 182. Areginal was a disinfection agent based on ethyl formate.

⁹⁵ Test Report No. 103/24 of 30 May 1948. SE 5/411 A 138.

tion. Günter Mann was entrusted with the construction of cremation furnaces under the direction of engineer Hans Streichardt.⁹⁶

During the same year, the company was renamed Nagema Topfwerke Erfurt VEB, and the construction of cremation furnaces was relocated to Zwickau. In 1957, the company changed its name to “VEB Erfurter Mälzerei- und Speicherbau” (EMS) and was privatized in 1993 as “Erfurter Mälzerei- und Speicherbau GmbH” (EMS).

In 1951, Ernst Wolfgang Topf moved to Wiesbaden, where he reestablished the company J.A. Topf und Söhne, but it was dissolved in 1963.

Kurt Prüfer was arrested by U.S. intelligence agents on May 30, 1945, but was released on June 13. Ludwig Topf committed suicide on May 31. On July 3, U.S. occupation forces withdrew from Erfurt and were replaced by Soviet troops.

In early March 1946, Prüfer, Schultze, Sander and Braun were arrested by the Soviets. The arrest warrant was issued on March 6 by the head of the Smersh counterintelligence service,⁹⁷ Colonel Zagorul'onii, and by the military prosecutor, Colonel Žmirov of the VIII^a Guard Army. The four engineers were suspected of crimes as stipulated in the first part of the Decree of the Supreme Soviet of the USSR of April 19, 1943 concerning “punitive measures for German-fascist criminals guilty of murder and torture of Soviet civilians and prisoners of war, for spies, traitors to the fatherland among Soviet citizens and their accomplices.”

The accused were subjected to a total of 36 interrogations, 20 of which took place in Berlin between March 4 and 28, 1946, and 16 in Moscow between February 11 and March 11, 1948.

On March 28, 1946, Smersh Captain Kazantsev signed for Sander, by then deceased, an “order to cease prosecution due to the death of the accused.”

On March 15, 1948, Criminal Case No. 1719 against the remaining three engineers of the Topf Company was closed with a motion for conviction signed by three senior officers of the State Security Service. On April 3, an “Order to send them to a special camp of the Ministry of the Interior” was issued against the three engineers, sentencing them to 25 years in prison.⁹⁸

Prüfer died in Soviet captivity on October 24, 1952. Schultze and Braun were released on the basis of a decree issued by the Presidium of the Supreme Soviet on September 28, 1955 as part of an amnesty.

On June 30, 1992, the Prosecutor’s Office of the Russian Federation decided not to rehabilitate the three convicted engineers. (For details see Mattogno 2014).

⁹⁶ Letter “To the city commandant’s office, Col. Proskurin” of 6 April 1948. SE, 5/411 A 100.

⁹⁷ Abbreviation for “smert špionam” – Death to the Spies.

⁹⁸ FSBRF, N-19262, Criminal Case 1719, pp. 451f. (Penalty order for Prüfer), p. 453-456 (Penalty order for Schultze).

2. The Topf Cremation Furnaces for Civilian Use

2.1. The Cremation Furnace with a Coke-Fed Gasifier

The first cremation furnace with a coke-fed gasifier built by the Topf Co., while retaining the essential features of existing furnaces, introduced a number of innovations based on prior ideas, but in a novel configuration. In particular, the Topf furnace had an external heat source for the muffle (per Max Kergel's patent of 4 October 1908) controlled by a damper made of refractory material and located in front of the gasifier outlet (following an idea incorporated into the Knös Furnace). This damper, by keeping the combustion gases from entering the muffle, ensured a completely indirect cremation. With this furnace, Topf aimed for a front-rank position in the field of totally indirect cremation, which explains its objection to the decree issued by the Prussian ministry of the interior on 24 October 1924.

The structure and operation of this type of furnace were described at the time in the expert literature as follows (Reichenwallner 1926, pp. 28f.; cf. Document 133):

“The cremation furnace consists of a coke-fed gasifier, a cremation chamber (muffle), closed onto itself, of the system of channels (recuperator) located below which serves to preheat the combustion air, and of the duct taking the gases around the muffle.

When a cold furnace is to be heated up, a small fire of wood is lit in the gasifier and is switched over to coke step by step. The gases produced by the coke or the wood move upwards and into the muffle, passing through the gasifier outlet. They then flow through the recuperator and into the flue duct of the chimney, transferring the heat they contain to the walls of the recuperator along the way; the latter are made of refractory material. In this manner, the furnace is heated to incandescence (1,000°C). The necessary gas mixture is produced with a supply of air.

At this point (1,000°C) the furnace is ready for the cremation. The damper at the outlet of the gasifier is closed in such a way that the gases flow through the channel surrounding the muffle, maintaining the latter at incandescence from the outside. Thus the gases can no longer enter the muffle. The front introduction door of the muffle is opened and the coffin is introduced by means of the introduction cart; in this way the coffin is deposited on the cremation grate and the cart is immediately withdrawn from the muffle. The front opening as well as its outside cover are closed immediately. The necessary combustion air – which flows into the cremation chamber at a high temperature and incinerates the corpse – enters the series of channels below through the open dampers, rises through the channels in a direction opposite to that of the discharge gases up to the highest point of the vault above the muffle and there enters the muffle at a high temperature.

Just before it leaves the muffle, the saturated combustion air is diluted with preheated air; an operation without smoke or odor is obtained in this manner. The duration of a cremation is 60-75 minutes, depending on the size of the corpse.

The entire cremation process can be observed by the operator through viewing glasses in front and rear. The furnace combines the two corpse-cremation systems, i.e. direct and indirect cremation. Furthermore, the most-modern conceptual and technical elements have been incorporated. The advantages of the furnace are ease of use and control, minimal fuel requirements, very-rapid cremation, odorless and smokeless operation.

The design of the furnace is very solid. Between the inner wall of refractory material and the outer brick wall, there is a thick layer of rock wool which brings loss by radiation down to a minimum. The furnace consists of massive, top-quality refractory clay which not only makes for a stable structure but also serves to accumulate heat. This system design aims for a long life of the furnace. The outer brickwork is built in an arch-like way, as a vault, and held together by steel bars, angled or in T-shapes; the latter are linked by solid bolts.

The ashes are cooled near the front of the lower section of the furnace in an ash container with a smoke-extraction fan, and is then transferred to the urn.

The cremation process as such takes place out of sight of the bereaved. The coffin, set up in a dignified manner in the chapel, is lowered slowly and silently to the sound of a solemn piece of music and is then introduced into the cremation chamber by means of a cart of appropriate design. The remains of the ash, purely white, are collected in the ash container and can then be buried or placed in a columbarium."

Topf had become a major competitor also in the fields of design and construction of cremation furnaces by the early 1920s. At that time, its most-resounding success was undoubtedly the erection of two cremation furnaces in Moscow in 1926. A publicity leaflet of the same year, entitled "Furnaces for crematoria, Topf system" informs us about the activities and developments of the company (Topf 1926; cf. Document 134):

"The 'Topf' Furnace for crematoria is the result of nearly fifty years of experience in the field of technical combustion equipment and is suitable for both direct and indirect cremation.

The furnace consists of the coke gasifier with its routing of the carbon-monoxide gases, the independent cremation chamber (muffle) and the channel system beneath (recuperator) which is used for preheating the air needed for the cremation. The preheated air thusly produced does not enter into contact with the spent gases, because the air channels are totally isolated from the flue-gas channels, so that, in the case of indirect cremation, the cremation takes place with pure atmospheric air which is heated up to the required temperature only on its way to the muffle.

Between the internal and the external brickwork, over the whole length and height of the furnace, is laid a thick layer of insulation made of bricks of diatomaceous earth; in this way the thermal radiation is reduced to a minimum. In the design of our most-recent model we have made use of our extensive knowledge in the domain of heat economy applicable in this field with this particular idea in mind. The ensuing advantages show up most clearly when the furnace is not in daily use. The insulating layer of diatomaceous earth retains the heat over a long period, and the amount of heat required for a new incinera-

tion series is correspondingly less. Moreover, the time needed for preheating is considerably shortened.

The external brickwork is designed in accordance with the Topf Arch System of proven effectiveness; it ensures that the brickwork in the shape of an upright vault is wedged between robust steel beams, both angular and I-shaped. This system of construction guarantees a long service life and prevents the formation of cracks, which would otherwise develop quite easily because of the high temperatures. The fittings are made from refractory castings.

In recent years, we have erected a series of cremation installations attached to existing benediction chapels or similar halls. In most cases, such an arrangement obviates the need for a lowering device and now enables all those municipalities that had to reject the idea of building their own crematorium again and again for financial reasons, to acquire a cremation installation at a rather moderate cost. Along these lines, the crematoria at Erfurt, Grünberg, Guben, Höchst a.M., Ilmenau, Magdeburg, and Suhl came into being.

Lately we have added air heaters which make use of the spent gases; these devices are incorporated into the flue duct just upstream of the chimney. They consist of a heat exchanger with a large number of so-called bags in which the spent gases and the air circulate separately: a blower mounted in front draws in fresh air and pushes it through the air bags. The spent gases are led through adjacent bags; in this manner the air warms up and can be taken through ducts into the chapel to heat the latter. Such an arrangement makes the installation of a central heating system superfluous. Leaving aside the fact that the capital outlay is far-lower than for a separate boiler for central heating, the small blower has such low operating costs that heating is essentially free of cost.

Crematoria with furnaces and Topf mechanical systems under construction in 1926 are located at

Wilhelmshaven	1 furnace
Giessen	1 furnace
Moscow	2 furnaces

Since 1922 we have thus built or received orders for 28 furnaces, an achievement so-far-unsurpassed.

Figures 8 and 9 show the church of the Donskoye Cemetery in Moscow where 2 furnaces are presently being built by us.

The City Director
 Arnstadt in Thuringia
 Dept. IV

Arnstadt, 10 February 1925

[To:] J.A. Topf & Söhne Co., Erfurt

The cremation furnace installed by Topf & Söhne Co., Erfurt, was handed over and started up on 1 October 1924. Up to now, 57 cremations have been carried out. Cremations take place irregularly, which leads to uneven periods of preheating and coke consumption for the individual cremations. Gas coke is being used as fuel. Preheating the furnace requires 2-2 ½ hours.

From the beginning of preheating up to incandescence and complete combustion, coke consumption has been as follows:

<i>for the cremation of one corpse</i>	169-260 kg	} incl. } preheating
<i>" " " of two corpses on one day</i>	234-314 kg	

The cremations take place without generation of smoke or odor over a period of ¾ to 1 ¼ hours for each corpse. The chimney, 18.0 m high and erected by J.A. Topf & Söhne Co., functions satisfactorily. The same applies to the [coffin-] lowering mechanism, likewise supplied by the company.

In connection with the channel for the gas flow from the cremation furnace to the chimney, J.A. Topf & Söhne Co. have installed an air-heating device for heating the cemetery chapel. The air temperature at the exit points in the chapel is 50°C on average. In the case of cremations, the chapel can thus be heated quickly and without any additional fuel.

The cemetery department.

Signed: signature

* * *

City of Erfurt

Erfurt, 25 June 1925

Department of Gardens and Cemeteries

[To:] J.A. Topf & Söhne Co., Erfurt

The cremation installation with two furnaces erected by J.A. Topf & Söhne Co. went into operation on 11 April 1923. Up to date, 700 cremations have been carried out.

Over the two years of operation of the furnaces, no failures have occurred up to now.

The special design of the furnaces and the good insulation have led to very low temperature variations, which is also very beneficial for the durability of the brickwork. We must underline the exceptionally simple control of the furnaces.

Unfortunately the cremation furnaces are not yet in daily operation. Therefore, the determination of the fuel requirements per corpse cannot yet be fully assured.

Using gas coke as fuel, for the period starting with preheating up to incandescence, complete incineration, and removal of ash remains, our records permit us to report the consumption as follows:

<i>1. for the incineration of 1 corpse in one day</i>	<i>3¼ hwt. of gas coke</i>
<i>2. " 2 corpses in succession</i>	<i>5 "</i>
<i>3. " 3 "</i>	<i>7¼ "</i>
<i>4. " 4 "</i>	<i>9 "</i>
<i>5. " 5 "</i>	<i>10¼ "</i>
<i>6. " 6 "</i>	<i>10½ "</i>
<i>7. " 7 "</i>	<i>10½ "</i>

The design of the Topf System allows the cremations to be executed completely without any smoke and odor.

The maximum duration of a cremation amounts to 1¼ hours.

The Municipal Department of gardens and cemeteries

Signed: signature

* * *

*The Director of the
Land Capital (Buildings Department)*

Weimar, 30 May 1925

[To:] *J.A. Topf & Söhne Co., Erfurt*

In reply to your request of the 22nd of this month we inform you that the cremation furnace installed by you in this crematorium has operated successfully up to now. In order to bring about a more economical operation, cremations are carried out only on Tuesdays and Fridays. Preheating requires 2-3 hours, a cremation lasts 1-1½ hours. Each of the latest 24 cremations required on average 2.7 hl [hektoliters] of gas coke (incl. preheating).

The Deputy Mayor

Signed: signature

* * *

*Administration of
Gertrauden Cemetery*

Halle upon Saale, 7 October 1924

[To:] *J.A. Topf & Söhne Co., Erfurt*

In reply to your letter of 3 inst. we are pleased to inform you that the cremation furnaces erected by you in 1915 have been operating so far to our complete satisfaction. The installation was started up on 15.12.1915, and altogether 2,670 corpses have so far been cremated in the two furnaces. In order to reach a temperature of 1,000-1,100°C with a cold furnace, we require some 3½ to 4 hwt. of metallurgical coke, whereas only 1 hwt. of this fuel is needed with a furnace already in operation. The duration of a cremation depends upon the size and nature of the deceased and amounts to ¾-1¼ hours at this plant.

Signed: signature

* * *

*Municipal Operations Dept.
Heating and Machinery Section*

Hanover, 10 October 1924

[To:] *J.A. Topf & Söhne Co., Erfurt*

In reply to your letter of 3 inst. we can inform you that the operation of our crematorium has not yet reached a level allowing us to establish a certificate concerning the furnaces. For the time being, we can only confirm that we are satisfied with the furnaces supplied and have not yet noticed any substantial wear after the 300 cremations carried out so far. As a consequence of low and infrequent usage, at the present time, we require some 100 kg of metallurgical coke for each cremation. We hope that, with the completion of the whole plant, usage of the furnaces will intensify leading to a lower fuel requirement.

In any case, we are satisfied with the furnaces to such a degree that we have always replied in a positive way to the various inquiries addressed to us.

Signed: signature

* * *

*The Municipal Directorate
Municipal Building Department*

Ilmenau in Thuringia, 2 August 1924

[To:] *J.A. Topf & Söhne Co., Erfurt*

As requested, we are pleased to confirm that we are satisfied with the furnace plant erected by you in our crematorium. The installation has functioned very well with respect to the directions concerning the cremation of corpses and from

the point of view of fuel economy. When properly operated, the furnace has so far not led to any odor nuisance in the vicinity. In spite of the sometimes intensive use of the furnace, no wear or tear has been noticed so far.

Signed: signature

* * *

*Association for Cremation (reg. ass.)
Suhl*

Suhl, 20 October 1923

[To:] *J.A. Topf & Söhne Co., Erfurt*

We are happy to inform you that, technically speaking, we are satisfied with the installation erected by you in our crematorium. The furnace works well and has relatively low coke requirements. The operation of the draft enhancer is excellent and the chimney, as linked to it, works particularly well. Overall, the execution of the work involved has been most-exact.

Signed: signature

* * *

*The City Council at
Hirschberg in Silesia*

Hirschberg, 26 May 1923

[To:] *J.A. Topf & Söhne Co., Erfurt*

In reply to your letter of 19 inst. we confirm that the cremation furnace supplied by you in 1914 works satisfactorily.

Operation is easy and simple. The design has turned out well. As far as the installation is concerned, no deficiencies have been noticed so far.

The following amounts of coke are needed:

<i>for the first incineration</i>	<i>5 hwt.</i>
<i>" " second "</i>	<i>3 "</i>
<i>" " third "</i>	<i>1 "</i>
<i>" " fourth "</i>	<i>- "</i>

The duration of a cremation is about 1½ hours. Preheating takes 2-3 hours. For a single preheating operation, the generator damper is closed. However, as additional feeds are required for each succeeding cremation, the generator damper must be opened [again].

Signed: signature"

2.2. The Gas-Fired Cremation Furnace

The gas-fired furnace mentioned by Sander in his letter of 14 April 1936 is the "High-performance furnace with rotatable ash-grate, D.R.P. (Deutsches Reichspatent)" model 1934. The operation is still an indirect one, using hot air from metal tubes located above the muffle. The post-combustion chamber is equipped with a rotatable grate in accordance with the patent granted to Viktor Quehl on 17 October 1932 and taken over by Topf on 17 May 1934 (cf. following chapter). The furnace appears more-elaborate and considerably more-voluminous than the Volckmann-Ludwig Furnace: it still has the two-level design of the coke-fired furnace, with a total height of some 5 meters; the controls for rotating the grate and the ash-removal device are located on the lower level. Even

the section located in the furnace hall, measuring 3.70 by 2.60 m, is far-more-voluminous than the Volckmann-Ludwig Furnace (3.10 by 1.70 m).

Two furnaces of this type were set up in the Cologne Crematorium. A contemporary article describes the design and operation in the following words (Etzbach 1935, pp. 3-5):

“As the furnace is heated each day in the early morning by means of a gas burner and is at incandescence (around 1000°C) after one hour of preheating, the coffin is set alight right after its introduction into the furnace, because wood immediately catches fire at that temperature. Of course, the gas burners are closed first, so that the corpse is now being cremated by means of air at a high temperature, and after approximately one hour only pure ash from the bones remains (about 2 liters).

The generation of the high-temperature air is effected by a metallic air heater, which is located within the furnace and is fed by a blower located outside. On their way to the chimney, the discharge gases from the furnace must pass through this heater and heat it to the point where its tubes begin to glow. In this way, a noticeably shorter cremation time is achieved. Moreover, with high-temperature air, smoke can be prevented, which would otherwise not be the case, if heavily varnished coffins or similar are used.

The cremation furnace [Document 135] consists of the cremation chamber (a) with the tiltable plates of the grate (b) below and with the ash chamber and its ash grate (c) located underneath it. The movable burner for low-pressure gas (d) is situated in the front part of the furnace on the inside. The cremation itself may be viewed through an observation device (e). The tubes of the air heater are located above the cremation chamber.

Once the corpse has decomposed under the effect of atmospheric air at high temperature, the ash (bone residue consisting of calcium phosphate and iron oxide) falls through the refractory blocks of the grate onto plates of cast-iron Pyrodur (b) under the effect of gravity. These rotatable plates are turned from the outside of the furnace and remain in a vertical position. In that way, the ash falls onto the ash grate (c). This grate, too, can be tilted and is controlled from outside the furnace. Below this grate is the ash receptacle. If the grate is tilted 90°, the ash falls into the receptacle beneath. After a suitable cooling period, the ash is transferred into a (metallic) urn of some 15 cm in diameter and a height of 20 cm; here, for reasons of reverence, suitable tools are used in order to avoid any contact between the ash and [human] hands. The urn is then closed and marked with the name and the necessary data to be held in the chapel hall or taken to another location which possesses the required characteristics of reverence.

We must also stress in particular that, before a coffin is introduced into the furnace, a control token made of refractory material (Schamotteemarke) is attached to it, showing the serial number under which the coffin has been registered in the list of the crematorium administration. This refractory token, which is fire-proof, accompanies the entire process and ends up with the ash; it is removed and attached to the lid of the urn.”

The next type of furnace (Document 136) shows technical improvements in the tube system of the air heater and in the ash-extraction system, aside from the incorporation of a second, smaller burner into the post-combustion chamber. The

engineer Fritz Schumacher describes it as follows (Schumacher 1939, pp. 25-27):

“The Topf Furnace has an outer brick casing with clinker or brick facing. A strong reinforcing framework of T, U, or angle bars made of wrought iron holds the enclosure together. The visible outside surfaces of the furnace possess an arch-like brickwork in order to prevent the formation of cracks.

The inside of the furnace is made of highly suitable fireclay material, and between it and the enclosure is located a continuous layer of insulation made from bricks of diatomaceous earth and rock wool.

Within the furnace we have the cremation chamber with lateral discharge of the gases and the gas-discharge channels situated on the right and on the left side, the cremation grate, the tiltable ash grate below, and the post-combustion chamber with the ash-extraction grate.

To the right and left of the cremation chamber there are the tubes of the air heater providing high-temperature air. Whereas the upper four heating coils are made from Sikromal Steel, which withstands temperatures up to 1200°C, wrought-iron tubes with especially thick walls are used for the lower portion. A blower located outside and guaranteed to run silently feeds air to the two tube systems. In order to ensure that the tube systems on both sides are fed equal amounts of discharge gas, there are refractory baffles which direct the discharge. These refractory baffles, arranged horizontally, also serve to store heat. On the inside of the front is a low-pressure gas burner rated at 30 m³ per hour. This burner is movable.

As the Reich legislation on crematoria allows the use of fuel during the cremation only in particularly difficult cases, the Topf Furnace, in order to respond to the wishes of the legislature, is provided from the outset with a burner in such a way that, once the furnace has reached its operating temperature, it can be retracted, and a cast-iron flap next to the burner seals its opening. Above the post-combustion grate is another small burner, rated at about 5 m³ per hour, which is used only in special cases.

For closing the cremation chamber a muffle-closing device is used consisting of two parts and made of cast iron, lined with fireclay, which rests on the framework of the furnace. Immediately in front of this closure is an insulating plate consisting of two sections made of a double layer of asbestos held by a frame of wrought iron to prevent heat losses to the outside.

Both above the tiltable ash grate and within the cremation grate there are outlets for the hot air needed for the combustion. A further hot-air outlet is provided over the ash-extraction grate.

The tiltable ash grate is designed to be operated from the outside. This grate has a highly refractory Pyrodur frame, and the interstices are filled with monolite clay. Another closure in the flue channel completely closes the furnace against the chimney.

The ash box has two pairs of wheels for easy moving. The hot-air-closing devices are located in the front portion of the furnace above the main burner. They are labeled: muffle – post-combustion – tiltable ash grate – ash extraction.

The controls of the flue-duct damper are also located next to those of the hot air. The discharge gases pass through the furnace along the following route:

From the gas burner they move to the underside of the refractory grate where they heat up the tiltable ash grate, and from there they flow on into the cremation chamber through the blocks of the grate. After having passed through the chamber, they pass into the openings in the vault of the muffle, strike the muffle laterally and drop down through the lateral discharge channels. They leave the channels here on both sides, cover the post-combustion grate, come together behind it, only to split up again when entering two side channels running along the cremation grate, from where they move into the flue duct.

Thanks to this gas routing, the mass of refractory brick heats up uniformly inside and out; in this way a longer service life of the refractories is guaranteed. The heat content of the gases is, moreover, made good use of, and the gases leave the chimney with little smoke and odor.

Thanks to the tiltable grate, no stoking tools are needed in the Topf Furnace in order to remove the ashes of the corpse."

On 24 June 1950 Martin Klettner, an engineer working for the Topf Co. which had moved to Wiesbaden after the war,⁹⁹ patented a new type of cremation furnace which will be described in Chapter 3. The furnace had already been built at Wiesbaden prior to the issuance of the patent, as we can see from the following letter written by the Wiesbaden city authorities on 19 December 1949 (see Document 137):

"We confirm herewith that Senior Engineer Martin Klettner has executed the intended reconstruction of the cremation furnace over a period of 2½ weeks and has incorporated improvements based on your experience.

Mr. Klettner has demonstrated the operation of the furnace and has handed it over after a test run extending over three days and involving a total of 16 cremations to our complete satisfaction.

The performance of the furnace surpassed all expectations, especially with respect to the fuel consumption. As early as the third day, cremation times of 40 minutes were attained without any fuel consumption except for preheating.

You are at liberty to show the furnace to interested parties after giving us sufficient notice.

A ny publication of this letter without our prior approval is not permitted."

Klettner had probably only revised a plan and a "provisional construction drawing" of the furnace that the Topf Company of Erfurt, which had been nationalized by communist East Germany in the meantime, claimed for itself in a letter dated April 6, 1948.¹⁰⁰

In 1989 two gas-fired Topf furnaces were still in operation at the crematorium of the Dortmund Central Cemetery. They had obviously been modernized with respect to automation and had been equipped with technical control devices.

We will now describe the operation of these installations: Cremation takes place at two levels: the main cremation takes place on the upper floor. After the introduction of the coffin into the muffle, the cremation residues drop into the

⁹⁹ Ernst Wolfgang Topf, one of the two brothers who owned the company of the same name (the other, Ludwig, had committed suicide on May 30, 1945), moved to Wiesbaden in 1951, where he re-established the J.A. Topf und Söhne Company, which was dissolved in 1963, however. M. Klettner's patent bears the heading "J.A. Topf & Söhne, Wiesbaden" because it was issued on January 5, 1953.

¹⁰⁰ "An die Stadtkommandantur, Oberlft. Proskurin, 6.4.48." SE, 5/411 A 100. See Document 138.

post-combustion chamber beneath when the grate is tipped, where they burn out completely. In the meantime, another coffin is introduced into the muffle above. The ash is removed when the post-combustion is complete.

Before introducing coffins successively into the muffle, they are given an identification token made of refractory clay, bearing a serial number, which remains with the corpse and the ash over the whole duration of the cremation and allows identifying the decedant when the ash is extracted.

The time required for the cremation varies between one-and-a-quarter and one-and-three-quarters hours, depending on the nature of the corpse. In a normal shift of eight hours, five corpses per furnace are usually cremated. In early 1989, because of the great number of corpses awaiting cremation, double shifts were arranged, with 10 corpses, sometimes up to 12, being cremated within a day, with a consumption of some 21 m³ of gas per cremation. Later on, after air- and gas-flow controls were added, consumption went down to less than 17 cubic meters.¹⁰¹

2.3. The Cremation Furnace with Electrical Heating

Topf built the first electrically fired German cremation furnace; it was set up at the Erfurt Crematorium in 1933. Like the gas-fired furnace, this device, too, had two levels. The 1934 model mentioned in the preceding subchapter had a basic design which was suitable for both gas firing and electrical firing (Documents 140f.).

The new design is explained in an article which summarizes the patent application filed by Topf (“Elektrisch...” 1935, pp. 89f.; cf. Document 139):

“The electrically heated Topf Furnace installed at the Erfurt Crematorium consists of a cremation chamber which is heated on both sides by 6 heating coils made of nickel-chromium alloy, through which passes an electric current and which are placed in the recesses of specially shaped bricks. The heating coils are protected from the direct effect of the flames which develop during the combustion of the coffin by stainless-steel plates placed in front of them.

These 12 coils have an output of 40 kW. The muffle is closed by a door and by a panel made of fireclay.

The grate is cross-shaped and has also two heating coils with an output of 12 kW.

Underneath the grate is the inclined plane for the ash made of specially shaped refractory bricks which, again, contain 4 heating coils having a total output of 18 kW.

The inclined plane ends at a closure plate below which the post-combustion chamber is located with its 7-kW heating coil. The floor of the post-combustion chamber consists of a perforated plate. Beneath it is the ash receptacle. The heating coils of the Topf Furnace at Erfurt have a total power output of 95 kW.

In the flue-gas channels of the cremation chamber, Aeroterm^[102] tubes arranged along a slope are installed. They are fed by means of a blower located on the

¹⁰¹ Letters of *Grünflächenamt* (public parks department) of the City of Dortmund to the author dated 18 January and 24 February 1989.

¹⁰² Aeroterm tubes “consist essentially of a battery of finned tubes and a helical blower inside a metal

outside of the furnace. The air which is heated in these tubes to a high temperature enters the cremation chamber below the refractory grate through two channels, each of which has four openings. Before striking the corpse, the air flows past the glowing mass of refractory clay. These air outlets are not mere nozzles; their dimensions are 70 by 100 mm.

Above the cremation chamber is the discharge outlet for the gases, which can be closed. The spent gases leave the cremation chamber at the top, strike its upper portion, and are then led downwards by means of two channels on the sides of the cremation chamber, passing through the lower portion of the inclined plane towards the flue-gas channels and from there into the chimney.

The operation of the furnace is very simple. The heating coils are switched on and off by means of a remote-control switch. All the controls are grouped in a box which can be placed next to the introduction door. In order to benefit from cheaper night-rate electricity, the furnace is switched on automatically by a timer; thus, attendance is required only, and in a limited way, when the coffin is introduced. Heating is controlled by a device which shuts off the furnace when the temperature has reached any desired level, so as to avoid any wastage of electrical power."

Quite soon, however, this furnace would exhibit serious operational problems, especially the generation of smoke during cremations. Exacting investigations by the administration of the Erfurt Crematorium showed that, with a draft of 12 to 24 mm of water, the velocity of the spent gases was so high that they did not have sufficient time to burn out within the muffle and cooled down to a level below their ignition temperature as soon as they entered the flue duct. The administration of the crematorium was therefore obliged to carry out technical modifications of the plant: a combustion chamber (*Brennkammer*) was installed above the muffle in an effort to bring down the gas velocity, and the damper at that point was removed; the cross-section of the channels for the combustion air were enlarged, and two new channels were added which brought air into the muffle through two openings in its upper part. The flat supporting beam for the coffin was replaced by a corrugated beam.

In 1934 Topf designed, moreover, a cremation furnace which could operate with either gas or electricity. Document 140, consequently entitled "Topf Cremation Furnace 1934 (For gas and electrical heating)," shows the installation from the outside. Document 141, "Topf Cremation Furnace 1934," illustrates its design. Following the example provided by the Volckmann-Ludwig Furnace, it had an outer metal facing (*Blechummantelung*), which provided it with a very-modern appearance. The incineration chamber (*Einäscherungsraum*) was closed by means of a sliding door, mounted obliquely; a decorative door (*Prunktür*) was mounted in front of it. The opposing part sported a viewing port (*Schau Luke*). Each of the side walls had three openings for the spent gases. The coffin rested on three corrugated refractory beams. Below it was located the tiltable

container with baffles which allow steering the flow of hot air. The heat exchange takes place in forced convection with a high thermal efficiency (1,500 – 3,000 kcal/m² hr), and is highly adaptable depending upon the design. The air velocity is higher than what would normally be agreeable (0.20 – 0.40 m/sec) and the noise level is high (50-60 dbA); hence, in view of the high output, their usage is primarily in industrial and large-scale installations." *Manuale...* 1990, p. E 589.

grate for the collection of the ash (*drehbare Asche-Sammelplatte*) with the ash post-combustion chamber (*Nachverbrennungskammer*) below; its tiltable grate permitted the transfer of the ash to the receptacle underneath and its removal through a suitable opening (*Ascheentnahme*).

In the front part of the furnace, but on the lower level, there was a blower (*Druckluftgebläse*) feeding air through a double coil of tubes acting as an air heater (*Röhren-Luft-Erhitzer*); the air from these tubes passed through the six vertical flue-gas ducts, located on both sides of the cremation chamber, where the flue gases transferred their heat content. The combustion air heated in this way flowed through eight openings below the coffin, passed between the refractory beams, continued through another eight openings above and below the tiltable plate, and then entered the post-combustion chamber. A chamber with dampers was placed above the cremation chamber in order to reduce the velocity of the fuel gases.

When these changes had been carried out, test cremations were undertaken at the Erfurt Crematorium. The chart published by engineer Konrad Weiss (Document 142) refers to five cremations which took place on 17 and 18 April 1934. The duration of the individual cremations was as follows:

First cremation about	1 hr 45 min.
Second "	2 hr
Third "	1 hr 40 min.
Fourth "	1 hr 50 min.
Fifth "	1 hr 30 min.

The temperature recorded at the center of the muffle was higher than that in the rear portion and varied between 850 and 950°C. The temperature of the inclined plane was always below 600°C (Weiss 1934, pp. 453-457).

A total of 1,622 cremations were carried out in this furnace before it was dismantled and replaced by a more-modern model set up in the Erfurt Crematorium in 1936. Compared to the former, this model (Documents 143-145) presented numerous technical improvements. The vault of the muffle is closed, and both the additional combustion chamber and the channel for the spent gases are absent. The lateral walls of the muffle, below the onset of the semicircular vault, are strongly inclined and extend below the grate as inclined planes for the ash; they reach down to a previously non-existent tiltable grate. Below the latter is an electrically heated and retractable post-combustion grate. The supporting grate for the coffin consists of three corrugated beams.

The spent gases leave the muffle through four square openings in each of the side walls and enter two channels which go down vertically and open up above the post-combustion grate, which they traverse downwards and then enter the flue duct. On the inside of these two vertical channels there are four horizontal metal heat-recovery tubes, 120 mm in diameter, into which a blower, located outside the furnace, feeds the combustion air which in turn enters the muffle through two openings set into each of the side walls, above the tiltable grate and below the muffle grate. Through other channels, combustion air also enters the muffle from an opening behind the last supporting beam of the grate. From there it flows also into the space below the post-combustion grate. The heating

coils are no longer contained in recesses protected by metal plates but in appropriate channels made of shaped refractory bricks.

This furnace is described by the Topf Co. in the following manner (Schumacher 1939, pp. 28, 30; cf. Weiss 1937, pp. 159-162):

“The furnace consists of an outer cladding of sheet metal which is held in place by robust T, U, and angle-shaped bars. The entire furnace is built from the most-appropriate refractory material, and between it and the outer shell there is a thick layer of diatomaceous earth bricks as well as glass-fiber and rock-wool panels.

The furnace itself consists of the cremation chamber with its flue-gas channels to the right and left, of the cremation grate with the tiltable ash grate below, of the post-combustion chamber and a grate for ash extraction. On either side of the cremation chamber, preheating tubes for the combustion air are set into the flue-gas channels, heating the air to a high temperature. Whereas the coils of the two top sections are made of Sikromal Steel, we use cast-iron tubes with particularly thick walls for the lower sections. A low-noise blower located outside the furnace feeds both sets of tubes.

For the closure of the cremation chamber there is a muffle closure which can be suspended either from the furnace framework or from the ceiling of the furnace hall. In front of this closure, there is an insulating plate made from double asbestos panels held by a wrought-iron frame.

Above the tiltable ash grate, as well as within the cremation grate, feed openings for the hot air required for the combustion have been placed. A further opening for the hot air is located above the ash-extraction grate. This grate has a rim of Pyrodur wrought iron, and the interstices are filled with compressed Monolite.

The furnace is well separated from the chimney by a draft damper. The ash receptacle has two sets of wheels for easy movement. The discharge gases take the following route:

The discharge gases leave the cremation chamber through two openings set into the right and left sides of the cremation chamber, pass through the upper channel around the horizontally arranged plate of refractory clay into the second and third channels and leave to the right and left of the combustion grate, enveloping it, then flow behind and below it through a common channel and are then led to the chimney via the flue duct.

The refractory material is heated uniformly, inside and out, by the discharge gases, guaranteeing in this fashion a longer service life of the refractory material. Furthermore, the spent gases are used up completely and leave the chimney with minimal smoke and odor. No devices are needed for the extraction of the corpse ash.

Location of the electrical equipment for cremation:

The maximum total power output is 85 kW, of which 48 kW are installed in the two side walls of the main cremation chamber (muffle), 15 kW in the chamber below the grate, 10 kW in the post-combustion and 12 kW in the air channels located on either side of the grate.

In the main cremation chamber there are 6 openings on either side, for a total of 12, which contain two electrical circuits. In this way it is possible to switch the two sides on or off separately.

The coils that are located in the rear portion of the furnace are linked by cables to the control panel, which is located on the wall of the building behind the furnace. This panel is equipped with the timers, the ignition device, the timer clock, and the pushbuttons for ignition with their control lights.

All electrical circuits have push-button controls with control lights in such a way that one can see at any time which circuit is powered.

The ignition device prevents excessive temperatures in the furnace. For this, the furnace starts and stops automatically at 700 and 900°C, respectively, as a function of the desired temperature. The furnace can moreover be switched on or off at any moment by means of the ignition control, even at times when no attendant is present.

This means that the furnace can switch on and preheat to the operating temperature automatically, even during the night, at any desired moment without manual action.”

The chart for this furnace published by the engineer Konrad Weiss (Document 146) covers two consecutive cremations. The durations of the cremations turn out to be considerably shorter than in the previous furnace, between 55 and 70 minutes. This is due to the thermotechnical improvements of the second furnace, above all by the incorporation of a tiltable grate which – allowing as it did the separation of individual corpses – permitted the introduction of another corpse while the residues of the former burned out in the post-combustion chamber.

After some 3,000 cremations carried out over a period of three and a half years of operation, this furnace was worn out to the point that it had to be dismantled and rebuilt.

The new furnace (Document 147) brought along further technical improvements: the combustion air flowed from a single hole in the rear portion of the muffle, striking the coffin from below; another conduit moved air below the post-combustion grate. Furthermore, the spent gases no longer flowed through the post-combustion grate, leaving instead through two holes in the rear part of the post-combustion chamber and from there into the flue-gas channel.

Construction work on the new furnace ended on 1 December 1939, and the furnace was slowly dried until 31 January 1940 by means of 750 kg of wood. Its performance was much improved. The performance of this furnace was documented by the engineer Rudolf Jakobskötter (Document 148) on the basis of three cremations in succession. Cremation times were very short: some 65, 50 and 40 minutes respectively.

In the light of what we have stated in Chapter 4 of Unit I, it is obvious that for the cremations shown in the chart – which had the purpose of highlighting the efficiency of this furnace – combustion did not come to completion on the tiltable grate, but continued and ended in the post-combustion chamber, as it had done in the Volckmann-Ludwig Furnace at Hamburg, in which the solar plexus was burned in the post-combustion chamber.

Document 149 shows an electrically heated Topf furnace with further technical modifications, the most-important of which were the double door for the closure of the muffle, the tiltable post-combustion grate and the heat-recovery

system with its metal tubes set into a separate chamber upstream of the flue duct (Jakobskötter 1941, pp. 579-587).

3. The Topf Patents of the 1920s and 1930s

In the preceding chapters we have seen that Topf introduced a series of truly novel ideas into the technology of cremation, which made it the most-important company in Germany in that sector within a single decade. Its untiring research and development activity is also reflected in the patents directly issued to it or which it acquired over the years of its most intensive activity. All this time, however, construction of furnaces for crematoria remained a marginal activity in the plants and on the financial statements of the company, and the patents which the firm obtained clearly reflect this fact.¹⁰³

In this chapter we will publish the text of all Topf patents relating to cremation furnaces and other combustion devices, but will translate only the most-important ones, leaving aside the two patents referring to the coffin-introduction device (24 August 1920 and 4 May 1938; Documents 150 and 154) and the patent application of 16 November 1942 concerning “Air-cooled grate plate for mechanical push grate” (Document 159), which does not concern cremation furnaces but industrial gasifiers.¹⁰⁴

* * *

1) *Deutsches Reich. Published on 24 August 1920. Reich Patent Office.*

Description of Patent No. 324252. Class 24 d. Group I

J.A. Topf & Söhne in Erfurt.

Device for the introduction of the coffin for cremation furnaces with support cart that can be raised and lowered.

Patented in the German Reich from 24 April 1915. [Not translated, Document 150]

* * *

2) *Deutsches Reich. Published on 5 March 1930. Reich Patent Office.*

Description of Patent No. 493042. Class 24 d. Group I. T 36626

V/24d

Day of publication of issuance of patent: 13 February 1930.

J.A. Topf & Söhne in Erfurt.

Device for post-combustion of residues in corpse-cremation furnaces

Patented in the German Reich from 29 March 1929.

¹⁰³ Cf. the corresponding list shown in Appendix 1.4.

¹⁰⁴ The patents mentioned in this chapter derive from the *Deutsches Patentamt* in Berlin. Documents 155 & 159 are merely patent applications not indicating whether any patent was eventually granted.

The invention relates to a device for the post-combustion of residues in corpse-cremation furnaces, primarily for the purpose of burning the wood ash which is mixed with the corpse ash.^[105] The object of the invention differs from known post-combustion devices in that the removable receptacle for the combustion residues, placed at the end of the inclined floor of the ash-dropping area, has a perforated bottom and is placed over the outlet of a controllable feed of combustion air. This arrangement has the advantage of being very simple. Furthermore, above the residue receptacle and below the lateral gas exhausts there is a gas-permeable slide, blocking ash from dropping into the receptacle, which enables the ash, still undergoing post-combustion in the receptacle, to be kept separate from a further cremation in the case of cremations in succession.

Fig. 1 shows the longitudinal section of the furnace in the schematic chart of an example of the realization. Fig. 2 is the front view of the post-combustion device.

At the front end of the furnace, below the ash-dropping area, there is a receptacle *a*, equipped with a perforated bottom *b* and a combustion-air supply *c* located beneath the latter. The supply can be controlled by dampers *d* or similar.

The combustion residues are moved into receptacle *a* shortly before the end of the incineration process and subjected there to a post-combustion process with the spent gases escaping through the lateral exhausts *g* of the furnace.

In order to prevent the residues of two successive cremations from reaching receptacle *a* concurrently, a retractable plate *e* is mounted above receptacle *a* which isolates the receptacle from the ash-dropping area *f*. This plate is permeable for the gases, *e.g.* by possessing small holes, in such a way that the post-combustion gases can leave, but no ash residues from ash dropping area *f* can reach receptacle *a*. Consequently, a fresh cremation may be started before the post-combustion of the residues of a previous cremation has come to an end in receptacle *a*.

Patent claims:

1. A device for the post-combustion of residues in corpse-cremation furnaces, characterized by the fact that the removable receptacle (*a*) placed at the end of the inclined floor of the ash-dropping area (*f*) has a perforated bottom (*b*) and is located above the outlet of a controllable combustion-air supply (*c*, *d*).

A device in accordance with Claim 1, characterized by the placement of a gas-permeable retractable plate (*e*) above the receptacle, below the lateral gas exhausts (*g*), to shield the receptacle against any ash dropping from the furnace. [Document 151]

* * *

¹⁰⁵ This refers to the complete combustion of the combustible substances.

3) *Deutsches Reich*. Published on 17 October 1930. Reich Patent Office.

Description of Patent No. 561643. Class 24 d. Group I. Q 1735 V/24d

Day of publication of issuance of patent: 29 September 1932.

Viktor Quehl of Gera. Transferred to: J.A. Topf & Söhne, Erfurt, 17.5.1934.

Cremation furnace with tiltable grates

Patented in the German Reich from 15 April 1931.

Existing cremation furnaces possess stationary furnace sections – the muffle grate and the ash grate – to support the coffin and the corpse parts to be incinerated.

These have the disadvantage that after their incineration the corpse parts have to be scraped from these surfaces by means of a scraping device. Such an intervention into the incineration process does not constitute a dignified form of cremation. Furthermore, the introduction of the scraping device into the furnace provokes a considerable loss of heat by allowing cold air to enter the furnace through the doors while they are open. The iron scrapers may also easily damage the glowing brickwork.

This invention obviates the use of scraping and stoking devices in such a way that the muffle grate which supports the coffin and the corresponding ash grate can be pivoted from the outside around one or several axes, with the grates being optionally split into several pivotable sections with an arbitrary orientation of the axes.

This makes it possible to remove totally or in part, from the outside without opening the furnace, any remaining incineration residues from the muffle grate and the ash grate without the use of scraping or stoking devices, in line with the progress of the incineration, by simply pivoting the surfaces.

The drawing shows an example for the realization of the invention. We designate by *m* the muffle grate pivotable around an axis *a*, by *b* the ash grate, subdivided into separate surfaces *f* which can be pivoted individually around their individual axes *e*.

The object of this invention may, in certain respects, be executed differently, as long as the essence of the invention, namely the pivotable character of the muffle grate and the ash grate, is maintained.

Patent claims:

1. Cremation furnace with pivotable grates characterized by the fact that the muffle grate which supports the coffin and the ash grate are arranged in such a way that they can be pivoted from the outside.

2. Cremation furnace according to Claim 1, characterized by the fact that the muffle grate and the ash grate are divided into several surfaces which can be pivoted individually.

Attachments: 1 sheet of drawings. [Document 152]

4) *Deutsches Reich*. Published on 19 November 1936. Reich Patent Office.
 Description of Patent No. 638582. Class 24 d. Group I. B 162300
 V/24d

Day of publication of issuance of patent: 29 October 1936.

Wilhelm Basse of Hamburg. Transferred to: *J.A. Topf & Söhne, Erfurt*,
 27.11.1937.

Incineration furnace

Patented in the German Reich from 9 September 1933.

The object of the present innovation is a device for incineration furnaces, and it aims *i.a.* at an improvement of the combustion by a special way of feeding the combustion air.

It is known that the air feed of incineration furnaces equipped with a grate or a solid floor plate has deficiencies, and, in particular, these deficiencies are caused by the fire path in the cremation chamber, resulting from the design of the plate or the grate. Due to its massive construction, the floor plate has the advantage of storing heat. On the other hand, it has the great disadvantage that the combustion air cannot reach the central parts of the matter to be combusted, because the disintegration [of the latter] can only take place on its periphery where it is exposed to the oxygen. As the coffin with its central portions rests directly on the floor plate, combustion in that area is incomplete or retarded. This disadvantage is eliminated by the grate. It enables the air to be moved to the center of the burning coffin and thus to accelerate the incineration. In this case however, there are problems as well:

1. As the grate is open, the gas distribution of the fuel gases within the muffle can no longer be controlled.
2. During the incineration of the inner, combustion-resistant parts of the matter to be incinerated, excess air enters the furnace through the openings on the sides of the grate, cooling down the furnace.
3. The grate has a low heat-holding capacity.

Still, furnaces with solid floor plates have been built with the combustion air being blown from the side and from above by means of nozzles onto the object to be combusted.

This kind of air feed is considerably more-effective, but we still have the disadvantage that the object to be combusted is exposed initially to the combustion air only at its top and sides; air supply to the bottom part of the combustion object is, however, absent. It is at this point, though, that the air feed is highly effective, because the flames generated there will envelop the combustion object from all sides and thus enshroud it completely.

Hence, this invention plans to feed combustion air through nozzles mounted in the floor plate. For that reason, the floor plate is equipped with valley-like depressions which give it a grate-like appearance. The air nozzles are located between the grate ridges.

It is expedient to build the floor plate from individual bricks that by their shape and their arrangement confer a grate-like design to the plate. The bricks are hollow to contain the compressed-air tubes. Air feed to the nozzles is de-

signed in such a way that the nozzles can be controlled individually. For this function, the nozzles can be arranged in groups.

If arranged in accordance with this invention, the compressed air coming from the nozzles will create strong flames beneath the coffin, leading to a strong heating of the grate plate and to a good storage of the heat on account of the closed design of the floor plate. The latter effect is important because it contributes to a considerable reduction in the duration of any succeeding incinerations.

The drawing shows an example of the implementation. Fig. 1 is a vertical section of the furnace and Fig. 2 is a top view of the floor plate.

Here, we designate as *a* the bricks making up the grate plate, *b* the support of the furnace itself, *c* the muffle walls, *d*, *d*₁ the compressed-air tubes, *e* the corresponding conical gaskets, *f* the air channels in the bricks, *g* the air-discharge holes in the nozzles.

In Fig. 2, the bricks are numbered 1 to 20.

The shaped bricks shown in the form illustrated here have slanted roof-like surfaces on both sides which create the grate-like shape of the floor plate. The nozzles set into these bricks open up into the depressions between the individual bricks in such a way that the air jet strikes the combustion object directly. This brings about the most-effective and most-economical use of the combustion air. Moreover, the nozzles are staggered with respect to one another producing a complete and uniform air feed about the matter to be combusted.

This arrangement has the additional advantage that, on account of the nozzles being set into the slanted surfaces of the grate plate, they are protected against being accidentally covered by the combustion matter above. The nozzle orientation, moreover, makes it possible, when the ash is recovered, to blow away the fine fly ash, which is then sucked up by the draft of the chimney.

The channel-like depression *f* of the bricks (Fig. 2) can be limited to the length of one brick, such as Bricks 6 and 10, or extended over several bricks, such as Bricks 1 and 5 or Bricks 13 and 17.

In each of these cases, only one tube *d*₁ can serve for the adduction of compressed air, whereas each separated brick must obviously have its own connection to the air feed.

The easily manufactured bricks can be replaced conveniently in the case of any repair made necessary by heat wear or mechanical damage (emplacement of the coffin), without loosening the constitution of the grate plate.

Patent claims:

1. Incineration furnace with a floor plate closing the lower part of the incineration space and with air nozzles directed towards the incineration object, characterized by the fact the floor plate consisting of shaped bricks (*a*) presents a grate-like surface and by having nozzles (*g*) discharging into the depressions between the grate ridges.

2. Incineration furnace in accordance with Claim 1 characterized by the fact that the shaped bricks (*a*) are hollow for the insertion of the compressed-air tubes.

3. Incineration furnace in accordance with Claims 1 and 2 characterized by the fact that the air nozzles (g) are arranged so as to be controllable individually or in groups. [Document 153]

* * *

5) *Deutsches Reich. Published on 4 May 1938. Reich Patent Office. Description of Patent No. 659405. Class 24 d. Group I. T 47769 V/24d*

Day of publication of issuance of patent: 7 April 1938.

Hans Geerhardt of Erfurt has been named as the inventor.

J.A. Topf & Söhne in Erfurt.

Loading device for incineration furnaces

[Not translated, Document 154]

* * *

6) *Duplicate. Patent application 760198. 5. Nov. 1942*

J.A. TOPF & SÖHNE ERFURT

4. Nov. 1942

To: Reich Patent Office, Berlin SW 61

Description

(Attachment 2 to today's application)

Continually operating corpse-combustion furnace for large-scale operation

The collection camps in the occupied eastern territories set up on account of the war and its consequences with their inevitably high mortality do not permit the interment of the large number of deceased camp occupants. There is, on the one hand, a shortage of space and labor, and, on the other, the risk of exposing the vicinity, near or far, to the dangers presented directly or indirectly caused by any burial of the deceased, many of whom have succumbed to infectious diseases.

The need thus exists to eliminate safely, quickly, and hygienically the corpses occurring frequently in large numbers. In that case it is obvious that one cannot proceed in accordance with the legal requirements in force in the Reich territory. Hence, it is not conducive to incinerate only one corpse at a time, and such a process cannot be carried out without post-heating or additional heating. Rather, several corpses must be cremated together on a continual basis, and over the total duration of the incineration process the flames must act directly on the corpses to be cremated. A separation of the ashes of the corpses cremated concurrently cannot be undertaken; the corpse ash can only be recovered en masse. Hence, in the case of installations which serve as a means for the elimination of corpses as described above, one cannot speak of a cremation (*Einäscherung*); in fact, we are dealing with corpse combustion (*Leichenverbrennung*).

To carry out this combustion – in line with the viewpoints exposed above – in some of these camps multiple-muffle furnaces were erected which still had to be loaded and operated sequentially. For this reason, these furnaces are not en-

tirely satisfactory, as the combustion in them does not proceed quickly enough to permit the elimination of the large numbers of corpses generated continually within a short period of time.

Such an objective can only be achieved by means of furnaces which can be loaded continuously and operate in the same way. One might think for example of tunnel furnaces. In such an installation, the corpses to be burned would be loaded at the front of a long and internally heated furnace onto a moving device which moves lengthwise through the furnace, with the corpses being conveyed from a preheating zone into the combustion zone, and yielding the corpse ash at the other end of the furnace. Such a construction, however, is rendered difficult by the problem encountered on other occasions of keeping the moving metal parts – exposed to the effect of fire or flue gases – continually in motion, even if – as in the present case – these moving parts are covered to the extent possible with fireclay or other refractory substance. A further difficulty – in the case of combustion equipment operating, as in this case, with a draft, *i.e.* with different air or gas pressures in the various sections – is the task of securing the moving parts to the stationary ones to the greatest extent possible. Moreover, such units would require a permanent supply of power to actuate the moving device. Finally, the arrangement of the flue-gas ducts etc. would be complicated, which means that, for all these reasons, tunnel furnaces are not recommended for the combustion of corpses.

In an effort to avoid the disadvantages of muffle or tunnel furnaces while conserving all the advantages of continuous loading and operation even in the case of corpse-combustion furnaces, together with a most-efficient use of the required fuel, this invention proposes a furnace operating continuously in which, by avoiding structural elements which would have to move through flames, the movement of the corpses introduced at the top end of the furnace would take place automatically within the furnace. The corpses slide by gravity into the heated furnace onto chutes shaped and inclined in a suitable manner and then further down, catching fire in the process and finally burning out and turning into ash at an appropriate point within the furnace.

Fig. 1 shows the vertical section of an example of implementation.

Fig. 2 is Section A-B shown in Fig. 1.

The invention concerns, for example, a furnace with several internal chutes inclined with respect to the horizontal – the drawing shows three such possible chutes, labeled *a*, *a1*, *a2* – in a zig-zag-like arrangement. Each chute consists of several longitudinal beams *b* made of fireclay, which are supported by arched ribs *c* mounted beneath for better service life. Between the longitudinal beams *b* are located transverse bricks *d* in such a way that each chute surface is in the form of a grate. The longitudinal fireclay beams rest with their upper end in the external brickwork *e* of the furnace; the lower end is held by suitable refractory brickwork arches *f* placed transversely. The upper chutes are individually surmounted by a vault *g*, inclined from the horizontal as well, which possesses openings. The covering of the front part of the uppermost chute does not contain such openings.

At the top, where a suitable platform h or similar has been arranged, the uppermost chute has, at its top end, a sufficiently wide feed opening i which is normally closed by a self-sealing trap k extending into the antechamber. The corpses to be burned are loaded transversely through this trap onto the uppermost chute a . In order to enable such a transverse loading to be effectuated, the furnace is built to a corresponding width. The loading pace of the individual corpses to be burned in the furnace is determined by the progress of the overall combustion which is, as we have already stated, to be accelerated in the best possible way by the configuration of the furnace.

At the lower end of the first chute a , the reversal point, a further chute $a1$ is arranged followed by the succeeding one, $a2$, and at the lower end of the last chute there is the horizontal fireclay grate l for the burn-out, with its ash-collection chamber below. In front of this burn-out grate there is the flame-generation section n which can be designed at will as a flat grate, a stepped grate, a generator, a gas or oil heater or in some other way, depending on the fuel which has to be used. The path of the flame and/or the combustion gas is arranged in such a way that, aside from the burn-out grate l , the grate-like chutes and all perforated vaults enable the flames and the combustion gases to move upwards. At the upper end of the furnace, opposite the loading opening i , we have the exit o of the spent gases which are to be removed and taken to chimney p in a suitable manner. Obviously, the flue gases can be led through an appropriate flue-gas preheater (not shown) before entering the chimney in order to make use of the heat they contain for preheating the combustion air.

On their way through the furnace, the corpses to be burned are exposed to the flames and/or combustion gases moving in the opposite direction. Multi-part fireclay slides q , set into the reversal points at the lower ends of the upper chutes a , $a1$, $a2$, and operable from the outside, allow the retardation or the interruption of the passage of the corpses through the furnace. Moreover, suitably arranged stoking openings r allow intervention from the outside in case of caking or adhesion of the objects to be combusted. To the greatest extent possible, ash generated inside the furnace during combustion is to fall into the ash-collection chamber through the openings in the chutes a , $a1$, $a2$ and in the ceiling vaults. Any ash that might collect along the way on brickwork sections can be removed from the outside through suitable ash-cleaning openings s . The major portion of the ash will collect below burn-out grate l in the ash-collection chamber mentioned where its surface is permanently exposed to the heating gases in such a way that any uncombusted remains of the objects to be burned can keep on burning and burn out in this ash space. Through appropriately arranged air channels t opening to the inside of the furnace sufficient air supply along the whole way of the combustion objects through the furnace is assured for the promotion of the combustion process of the corpses. This air may also be preheated in a flue-gas/air preheater (not shown in the drawing). The supply of cold or preheated air may be performed under pressure in order to obtain at all times good turbulence of the flue gases.

It is also possible to equip the furnace, at the locations where stoking openings r , as shown in fig. 1, are provided, with additional loading openings i with

self-sealing traps *k*, if the furnace is to be operated at a reduced capacity from platforms located there. In that case, depending upon the desired degree of capacity reduction, one or both of the multi-part fireclay slides *q* can be closed.

Patent claims:

- 1.) A continually operating corpse-combustion furnace for large-scale use, characterized by the fact that within it are arranged several grate-like chutes (*a*, *a1*, *a2*), inclined longitudinally against the horizontal, following one another in a zig-zag-like manner; upon them, the corpses to be burned, fed through the upper loading gate (*i*) and entering the furnace and descending under their own weight, are ignited by the combustion gases which move in the opposite direction, [with the corpses] burning out and turning into ash upon the ash grate (*l*) placed at the lower end of the lowermost chute (*a2*).
- 2.) A furnace in accordance with Claim 1.) characterized by the fact that the chutes each consist of several fireclay beams (*b*) with transverse supporting bricks (*d*) between them, the beams being supported by arched ribs (*c*) located below them.
- 3.) A furnace in accordance with Claims 1.) and 2.) characterized by the fact that the upper chutes (*a*, *a1*) are surmounted by perforated vaults (*g*).
- 4.) A furnace in accordance with claims 1.) to 3.) characterized by the fact that ash-removal openings (*s*) are installed above each of the vaults (*g*).
- 5.) A furnace in accordance with Claims 1.) and 2.) characterized by the fact that at the reversal points at the lower ends of the upper chutes (*a*, *a1*) fireclay slides (*q*) moving and operated sideways have been arranged to slow down or interrupt the passage of the corpses.
- 6.) A furnace in accordance with Claims 1.) to 4.) characterized by the fact that, within the chutes, channels (*t*) have been arranged for additional air supply.
- 7.) A furnace in accordance with Claims 1.) to 6.) characterized by the fact that instead of stoking openings (*r*) introduction gates (*i*) with self-sealing dampers (*k*) have been arranged in order to be able to feed and operate the furnace at reduced rates from platforms located there. [Document 155]

* * *

This patent application is the revised and corrected version of an application dated 26 October which mentions Fritz Sander, chief engineer of Topf, as being the inventor. I refrain from publishing this latter document, because the copy in my possession is of very poor quality.¹⁰⁶ I shall return to Sander's project later (cf. Section 7.4.1.).

* * *

¹⁰⁶ APMO, BW 30/46, pp. 7-14.

7) *Deutsches Reich*. Published on 19 March 1930. Reich Patent Office.
Description of Patent No. 494136. Class 24 f. Group 10. T 35607
V/24f

Day of publication of issuance of patent: 6 March 1930.
J.A. Topf & Söhne in Erfurt.

Retractable slag-grate for hearths with air-feed from below.

Patented in the German Reich from 22 August 1928.

[Not translated, Document 156]

* * *

8) *Deutsches Reich*. Published on 24 May 1933. Reich Patent Office.
Description of Patent No. 576135. Class 24 f. Group 1202. T 39364
V/24f

Day of publication of issuance of patent: 20 April 1933.
J.A. Topf & Söhne in Erfurt.

Plate-grate with nozzles

Patented in the German Reich from 27 August 1931.

[Not translated, Document 157]

* * *

9) *Deutsches Reich*. Published on 31 October 1933. Reich Patent Office.
Description of Patent No. 587149. Class 24 f. Group 10. T 35607
V/24f

Day of publication of issuance of patent: 12 October 1933.
J.A. Topf & Söhne in Erfurt.

Process and furnace for the recovery of lead and pieces of wires from cables

Patented in the German Reich from 29 September 1932.

[Not translated, Document 158]

* * *

10) *Duplicate. Patent application 789491, 17.11.1942*

J.A. Topf & Söhne Erfurt

16.11.42

To: Reich Patent Office, Berlin SW 61

Description:

Air-cooled grate plate for mechanical push grate.

[Not translated, Document 159]

* * *

The last known patent of the Topf Company dates from the early 1950s after the company had moved to Wiesbaden.

* * *

11) *Bundesrepublik Deutschland. Issued on the basis of the First Transfer Law of 8 July 1949. (WIGBL [Gazette for Economic Laws] p. 175). German Patent Office. Description of Patent No. 861731, Class 24d, Group 1, T 1562 V/24d*

*Martin Klettner of Recklinghausen has been named as inventor.
J.A. Topf & Söhne, Wiesbaden.*

Process and device for the combustion of corpses, carrion, or parts thereof

Patented in the territory of the Federal Republic of Germany from 24 June 1950.

Patent application published on 31 October 1950.

Patent issuance published on 13 November 1952.

The invention concerns a process for the burning of corpses, carrion, and parts thereof by combustion air heated in a recuperator as well as a device for the implementation of the process.

Nearly all incineration processes known today employ combustion air heated in a recuperator for the burning of corpses. In line with all combustion processes of heat technology, the combustion process has to be facilitated by preheating the air to very high heat levels, thus increasing the combustion temperature.

The heating value of a corpse, or its combustion value, has in the past been judged basically on the fat content of the corpse. Some of the CH (hydrocarbon) compounds (fats) exhibit very low ignition temperatures and burn at very high temperatures. As opposed to this, in the absence of pure fats, *i.e.* of pure CH compounds, it has so far been impossible to burn exothermally the CH compounds containing N (nitrogen) present in the proteins. The proteins with their rather high N content (some 25%) resist combustion most-strongly. Their ignition temperature is around 800°C.

At the air temperatures of 400 to 500°C used so far, the nitrogen component of the proteins thus could not be made to lose its resistance to combustion.

It is known that only under the influence of air at 800 to 900°C can the separation of N from the CH compounds be achieved, even though the proteins are not constituted by a chemical compound of N + CH but only by one of the loose combinations of N, in line with the way this somewhat inert gas has been known to behave. One may assume that a certain amount of heat is consumed for the removal of N. However, we will never be required to produce the large amount of heat required to remove N from a true chemical compound. Moreover, the combustion of the CH compounds contained in the proteins releases nearly the same amount of heat as would be released by the combustion of equivalent amounts of pure CH compounds.

For a human corpse of about 70 kg, containing some 12 kg of C, some 2 kg of H₂, and about 0.5 kg of P, as well as some 55.5 kg of H₂O and N, we can calculate a minimum heating value of about 160,000 caloric units [kcal], to which the fuel value of the coffin must be added.

The ultimate objective of the cremation thus had to consist in taking the required amount of combustion air to a temperature of 800 to 900°C without any

additional fuel consumption, solely by using the flue gases, in order to completely burn the considerable amounts of CH contained in the proteins yet linked to N, and so to allow the combustion of any human corpse without any additional supply of heat merely by the conversion of the amounts of energy contained therein.

This objective has been reached by means of the incineration process outlined for this invention. Not only has it been possible to generate the heat required for the evaporation and removal of the water contained in the corpse, but also the heat needed for the combustion and the incineration of the corpse itself. Even if the heat lost in the waste gases is considered, significant amounts of heat still remain available to heat the furnace and/or maintain its state.

A process as discussed earlier on and as part of the invention is implemented in such a way that the corpse with its coffin is located on a grate in the muffle and exposed to an air current heated in a recuperator by a supply of heat generated by means of fuel and/or exposed to the radiant heat of the hot muffle walls for a sufficiently long time to ignite the coffin and the corpse, made combustible by the evaporation of its water content, decomposes, with the remnants burning out exothermally on a rather-small ash grate located below under the influence of the necessary combustion air which is heated by recuperation to 800 to 900°C mainly by making use of the heat value of the corpse parts. The combustion gases thus generated flow out, downwards through the burn-out grate, and mix with hot combustion air fed below the burn-out grate in order to burn the volatile components completely. The combusted gases then move directly into a recuperator, where they transfer their heat content to the combustion air such that the combustion can be maintained without any further supply of fuel.

The illustration shows a furnace for the implementation of the process.

Muffle *A*, of a size suitable for the coffin sizes involved and built in the standard dimensions, is effective as a combustion chamber, in terms of fuel economy, only provided the muffle volume is completely filled by the combusting gases. The early phase of the combustion process, which takes place exclusively in the muffle, must be terminated as such and become a drying process when the grate, consisting of only two stones, allows the remaining body parts to drop under their own weight into the actual small combustion chamber *B* located above the pivotable grate. This [terminal] point is reached when the coffin has been consumed and the head and limbs fall off. This process in the muffle requires about 20 to 30 minutes.

In the small combustion chamber, the air heated to 800 to 900°C mixes intimately with the as-yet-uncombusted proteins, removes the N from the CH compounds, and burns the CH completely at temperatures of up to more than 1,200°C. This true combustion process takes between 10 and 15 minutes. The pivotable plate can be turned, and the remaining ash falls into the third combustion space above ash grate *C*.

The necessary combustion air is heated in an air heater *D* made of fireclay or of metal to 800 to 900°C. On start-up, a hot-air gas burner *E* generates combustion gases at 1,200 to 1,300°C to preheat the air heater. Controlled amounts of

air are fed into the muffle above the pivotable plate and below the ash grate. The hot-air gas burner, too, is supplied with combustion air at 600°C max.

As soon as the furnace has reached a steady state, the gas burner is switched off, and heating of the air heater takes place only by the waste gases which can be very hot during the actual combustion on the pivotable grate where the proteins burn actively.

The new process allows reducing the overall duration of the incineration by up to 45 minutes, with 30 minutes being often observed.

The ash quality can be called entirely combusted, free of germs; it has such a low volume that the normal urn will rarely be filled completely.

Patent claims:

1. A process for the combustion of corpses, carrion, and parts thereof by means of combustion air heated in a recuperative manner, characterized by the fact that the corpse with the coffin, in a muffle and resting on a grate of beams, is exposed to an air current heated in a recuperative way by making use of a fuel and/or exposed to the radiant heat of the hot muffle walls until the burning coffin and the corpse, made combustible by the evaporation of its water content, fall apart. The parts burn out exothermally on the small burn-out grate located below, with the necessary combustion air being heated to 800 – 900°C in a recuperative manner primarily by the combustion heat of the body parts. The combustion gases being formed flow out downwards through the burn-out grate, mixing with hot combustion air added below the burn-out grate to achieve complete burn-out of the volatile components. The spent gases are taken directly into the recuperator, giving up their sensible heat to the combustion air, thus allowing the combustion to be sustained without any further fuel supply.

2. A furnace for the combustion of corpses, carrion, and parts thereof, in a manner described in Claim 1, by means of combustion air heated in a recuperative way, and consisting of a burn-out grate which can be folded out of the way or retracted and which is located below the grate-like beams of a muffle, characterized by the fact that the grate consists of only two beams and is located above a funnel-shaped floor, the inclined walls of which serve to move the coffin and body parts onto the burn-out grate, which can be folded out of the way or retracted, [further characterized] by the presence of air outlets for the primary air feed above the burn-out grate and by the presence, in the space below the burn-out grate, of spent-air-evacuation outlets towards the recuperator, of a hot-air gas burner for temporary heating of the recuperator, and of feed outlets for secondary air. This space is also equipped with a foldable and, in view of the progression of the combustion, correspondingly smaller grate for the final burn-out.

3. A furnace in accordance with Claim 2, characterized by the fact that the combustion chamber is furnished with a relatively thin cladding of low heat capacity and is surrounded by a thick layer of insulation.

Printed matter consulted: German Patent No. 669 645.

Attached: 1 sheet of drawings. [Document 160]

4. Topf Waste Incinerators

Topf's activity in this sector of public health where combustion devices of various types were employed can be judged from a 1940 publicity brochure, of which I translate the essential part.¹⁰⁷

*“PUBLIC HEALTH AND HYGIENE constitute the starting point for the very-careful treatment of special questions which our **furnace-construction department** has been dealing with for decades. Our special furnaces hence aim for the effective fight against the spread of disease.*

Prevention is better

Our technical and scientific knowledge together with our considerable practical experience have enabled us to accomplish a complete destruction of the germs present in hospital refuse, garbage, or similar substances, by the purifying power of flame.

Topf furnace construction

In this field, we have been able to profit from experience gathered over sixty years in the area of combustion technology and heat economy. The quality of our special designs shows up in an odorless and nearly smokeless combustion and in the most-efficient use of the fuel, i.e. in the flawless operation which these furnaces exhibit in terms of heat economy.

TOPF waste incinerators – for gas, coal, oil or electrical firing – thus operate not only technically without reproach but also in the most-economical manner.

Refuse destruction for hospitals

*Hospitals, clinics and private sanitariums increasingly tend to use **special furnaces for the destruction of patients' refuse**, bandage remnants, or amputated parts. (Boilers for a central heating system are not suitable for these applications.) The furnaces require only little space and low attention; hence they are suitable for smaller as well as larger establishments.*

Management of industrial refuse

The use of special furnaces for refuse elimination in large industrial sites has been progressing actively over the last decade, in view of the fact that storage of refuse, for example, requires much space and has unhygienic consequences. Moving such substances requires much labor, time and money. Combustion of such refuse thus leads to savings and also allows the heat released to be used for the production of hot water or space heating.

Value conservation

The Four-Year Plan has taught us to pursue the recovery even of small amounts of valuable raw materials. Hence, we are dealing here not only with refuse destruction but also with the preservation of the materials contained, which represent valuable contributions to our economy.

Beyond the significance of this destruction of refuse for industrial locations, it has assumed a steadily growing significance at state enterprises, utility services and municipalities. Our specialized products have evolved in line with these requirements and are being used in a great variety of applications:

1. Furnaces for the combustion of cables

¹⁰⁷ RGVA, 502-1-327, pp. 161-165; cf. Document 161.

Such a device allows the complete recovery of the valuable metals. The furnace has been conceived in such a way as to allow the concurrent separation of copper and lead.

2. Waste incinerators

These furnaces find their application in municipalities. (The ash constitutes a promising fertilizer.)

3. Wreath incinerators

These devices constitute a valuable tool for cemetery management. The great number of wreaths, accumulating every day of the year and difficult to store, can be eliminated quickly. The metal of the wires is reclaimed.

4. Mattress incinerators

Such furnaces allow an efficient and hygienic destruction as well as the recovery of the metals contained in the mattresses.

FOUR TYPES OF TOPF FURNACES

The refuse-destruction furnace AV1

(Fig. 1)^[108] is easy to install. It is therefore suitable for scientific institutions, smaller hospitals, sanitariums and birthing clinics. It destroys amputated parts, test animals and patients' refuse with extremely low generation of smoke and odor. This furnace is similar to the type for the destruction of phlegm. It is clad on the outside with wrought iron, lined with fireclay bricks, and insulated with diatomaceous earth. The loading box A has an insulated door opening sideways. Below this box are located the hearth C and the ash box D. The rear wall of the combustion chamber is equipped with a grate of fireclay, behind which the flue-gas channel E is located. Flue-gas damper F, placed on the outside of the furnace cladding, isolates it from the chimney and allows control of the draft.

Refuse-destruction furnace type AV2

(Fig. 2).^[109] Ease of operation, rapid elimination of refuse with low fuel consumption and low generation of smoke and odor. Very well suited for medium-size hospitals, clinics, hotels etc. This type consists of a brick housing, which solidly protects the fireclay lining and the insulation. Loading box A can be mounted either on top of the furnace, or it can replace the closure V (type AV3). Below the combustion chamber B there is the refractory grate B1 heated by the hearth C. This grate will accept wet refuse and other poorly combustible materials. By means of the pivotable grate D any remaining ash can be transferred easily to the ash chamber E. The flue-gas channel F is placed behind a fireclay grate. Damper H closes this channel. Tubes for air heating or coils for warm-water production may be installed in this duct.

The furnace for the destruction of medical waste SV

(Fig. 3) has a wrought-iron facing. This facing protects the inside of the furnace from damage. [The furnace] contains the gas burner A and the loading box B. The fireclay plate P isolates the combustion chamber C from the post-combustion chamber D and the flue-gas channel E, which leads to the chimney. The cardboard containers of the phlegm to be destroyed are fed through the loading box onto the fireclay plate, on which they burn. The post-combustion chamber

¹⁰⁸ Page 1 of Document 161 contains a photo of the device, p. 4 the vertical and horizontal sections.

¹⁰⁹ *Ibid.*, p. 4, and Document 162.

ensures a good combustion of the waste gases and thus an odorless and smokeless operation. Flue-gas channel damper F is located outside the furnace facing and is used to regulate the draft. Between the metal facing and the fireclay brickwork there is an insulating layer of diatomaceous earth to reduce heat loss.

The furnace for the combustion of refuse MV

(Fig. 4) destroys rapidly and safely without smoke or odor and with a minimum amount of fuel the refuse which is generated daily in such locations as warehouses, industrial establishments, hotels, market halls etc. The furnace has a brick lining with a solid wrought-iron facing. Before use, the furnace is preheated to operating temperature by means of a small auxiliary burner F. Moist refuse is fed through door B onto the fireclay grate C and dry refuse is loaded through box A onto grate D. After combustion, the pivotable grate E easily allows transferring the ash to the ash box G.

The quality and productivity of Topf furnaces have been confirmed by the following report:

‘Over the past four weeks, the municipal refuse-elimination service has delivered enormous mountains of old sofas and mattresses which had to be destroyed as quickly as possible within 24 hours. On that occasion, our furnace has operated continuously, burning 120-130 mattresses in 24 hours and producing enormous quantities of wire springs.’

5. Topf Cremation Furnaces for Concentration Camps

Towards the end of the 1930s, Topf as well as other German companies – in particular Hans Kori of Berlin (see Chapter 11) and Didier-Werke, likewise of Berlin – began to work on cremation furnaces for concentration camps using a simpler design than the one used for civilian settings.

Topf Co. designed seven furnace models for this application and erected some of them:

1. coke-fired cremation furnace with one muffle
2. oil-fired mobile cremation furnace with two muffles
3. coke- or oil-fired cremation furnace with two muffles
4. coke-fired cremation furnace with two muffles placed opposite each other
5. coke-fired cremation furnace with two muffles, Auschwitz Type
6. coke-fired cremation furnace with three muffles
7. coke-fired cremation furnace with eight muffles

In this chapter I will discuss the first four types; the Auschwitz-Birkenau Furnaces will be addressed in Chapters 6 & 7.

5.1. The Coke-Fired Cremation Furnace with One Muffle

On this type of Topf Furnace, two documents have come down to us which enable us to describe its design and operation:

1. The drawing “Incineration furnace with one muffle” produced by Topf on 8 January 1941 for the SS New Construction Office (*SS Neubauleitung*) of the

Mauthausen Concentration Camp labeled with the Number D58173 (Documents 163-163c).

2. The cost estimate for “1 coke-fired Topf incineration furnace with one incineration chamber” prepared by Topf on 6 January 1941 for the Mauthausen Camp mentioned above (Document 164). The second part of this document concerns the proposal for “a Topf cremation furnace with one cremation chamber” which I will examine in Subchapter 6.1. Here I provide the translation of the first part:¹¹⁰

“Cost estimate of 6.1.1941

Titl.

Reichsführer SS,

Main Office Budget a. Construction,

SS New Construction Office Concentration Camp

Mauthausen.

Subject: 1 coke-fired Topf incineration furnace with one incineration chamber optional:

1 Topf cremation furnace with a double cremation chamber heated by coke

1 Topf draft enhancer in suction

<i>Qty.</i>	<i>Items covered by this estimate:</i>
	<p><i>Supply of a coke-fired Topf incineration furnace with one incineration chamber, with blower, comprising the following jobs and supplies:</i></p> <p><i>The foundations of the furnace and of the smoke conduits must be provided by the customer in accordance with our instructions, free of charges to us.</i></p> <p><i>For the outer brickwork, bricks, sand, lime and cement. The best bricks will be selected for the furnace lining.</i></p> <p><i>The necessary fireclay, in the form of normal bricks, specially shaped bricks and wedge-bricks, Monolite piling mass, as well as the necessary mortar.</i></p> <p><i>For the insulation of the furnace, the required bricks of diatomaceous earth, the rock wool and the mortar of diatomaceous earth.</i></p> <p><i>The wrought-iron anchor bars in T, U and angled shapes, drawing rods, bolts, and nuts.</i></p> <p><i>cast-iron and wrought-iron fittings, such as:</i></p>
<i>1</i>	<i>the closure block of the muffle in wrought iron with a Monolite lining, including the required cast-iron pulley, cable, and hand-operated crank</i>
<i>6</i>	<i>closure devices, cast-iron, for the air ducts</i>
<i>1</i>	<i>cast-iron door for ash removal</i>
<i>1</i>	<i>cast-iron closure for the gasifier feed</i>
<i>2</i>	<i>wrought-iron containers for the ash</i>
<i>1</i>	<i>cast-iron door for the hearth</i>
<i>1</i>	<i>wrought-iron grate, horizontal, consisting of square bars</i>

¹¹⁰ *Kosten-Anschlag, BAK, NS 4/Ma 54.*

<i>Qty.</i>	<i>Items covered by this estimate:</i>	
1	<i>with supports of the grate and the required tools</i>	
1	<i>blowing device consisting of a blower with a 1.5-hp three-phase motor mounted directly and the required ducting</i>	
1	<i>wrought-iron corpse-introduction device consisting of the coffin-introduction cart and the required guide rails</i>	
	<u><i>Furnace installation</i></u>	
	<i>Presence of a specialist for the installation of the furnace, including travelling expenses, daily allowances and social-security contributions</i>	
	<i>Price for item 1)</i>	RM 5,996
	<i>Kennziffer weight:^[111] 1,750 kg''</i>	

As far as I know, this furnace never moved beyond the design stage. The description which follows is based on the above two documents and on the examination of the Topf cremation furnaces with two and three muffles which still exist at Mauthausen and Buchenwald.

The furnace (Documents 163b and 163c) is enclosed in a solid frame consisting of an assembly of T-, U-shaped and angled wrought irons (*T- U- und Winkeleisen*), anchor bars (*Verankerungseisen*), drawing rods (*Anker*), bolts and nuts. The dimensions of the furnace are as follows:

Height (front side):	2,450 mm
Height (furnace body):	1,900 mm
Width (front side):	2,000 mm
Width (furnace body):	1,550 mm
Depth (w/o gasifier):	2,950 mm
Depth (with gasifier):	3,650 mm

The furnace consists of a vaulted incineration chamber (*Einäscherungskammer* or *Einäscherungsraum*), also called muffle (*Muffel*; No. 1^[112]) which has the following dimensions:

Height:	700 mm
Width:	700 mm
Depth:	2,100 mm

By keeping in mind the furnaces with two or three muffles to be discussed later, and on the basis of the number of closures for the air channels (*Luftkanalverschlüsse*) – six – one may conclude that the lateral walls contained two air channels (*Luftkanäle*) running horizontally within the brickwork of the furnace, parallel to the muffle, to which they were connected by means of transverse quadrangular openings – presumably four, as in the furnaces with two or three muffles. These two channels formed right angles in front of the vertical channels of the discharge gases and opened up in the lateral walls of the furnace, forming two air-feed holes (*Lufteintritte*) closable at the front by two raisable cast-iron doors, like the two air-feeding channels of the post-combustion cham-

¹¹¹ *Kennziffergewicht*. The *Kennziffer* (identification number) concerned the allotment of metal by the *SS-Rohstoffamt* (raw materials office) at Berlin-Halensee.

¹¹² The subsequent numbers refer to Documents 163a through 163c.

bers (ash containers) of the Auschwitz double-muffle furnace. These channels served to bring air into the muffle for the combustion of the corpse.

At the top of the muffle vault, in line with its longitudinal axis, were located the openings (No. 2) of four conduits connected to the compressed-air conduit (*Druckluftleitung*; No. 3), which was in turn connected to the blower (*Druckluftgebläse*; No. 4) situated next to the furnace.

The muffle was closed at its front end by a closure (*Absperrschieber* or *Muffelabsperrschieber*; No. 5) sliding along a suitable and slightly inclined frame (No. 6). The upper part of the frame was housed in a brick structure (No. 7) some 600 mm thick, which rose 550 mm above the level of the top part of the furnace. Raising and lowering of the closure was accomplished by a manual crank (*Handwinde*) with its pulley (*Rolle*) and cable (*Drahtseil*). The closure was lined on the inside with refractory.

At the rear, the muffle was closed in its upper portion by refractory brickwork, its lower portion opened up to the generator neck (*Generatorhals*; No. 8).

Into the side walls of the muffle are set two rectangular openings (about 500 mm by 250 mm; No. 9) for the discharge gases leading into an equal number of vertical conduits, also having a rectangular section (No. 10), set into the furnace walls. These conduits passed vertically through the whole furnace and opened up into the horizontal smoke channel (*Rauchkanal*; No. 11) located underneath the furnace and connected to the chimney.

The smoke channel could be closed by means of a suitable closure (*Rauchkanalschieber*; No. 12) made of fireclay running vertically in a frame (*Rauchkanalschieberrahmen*; No. 12a) equipped with its pulley (*Rolle*) and a cable (*Drahtseil*; No. 12b).

The lower part of the muffle consisted of a horizontal fireclay grate (*Schamotterost*; No. 13) consisting of five transverse beams of refractory material (*Schamotteroststeine*; No. 14) on which the corpse rested.

Underneath the muffle was an inclined and funnel-shaped plane for the ash (*Aschenschräge*; No. 15) ending up in a narrower chamber – the ash chamber (*Aschenraum*) – where the post-combustion (*Nachverbrennung*) of the corpse parts having fallen through between the grate beams took place and which functioned in this sense as a post-combustion chamber for the solid residues (No. 16).

The glowing ash was removed by means of the appropriate scraper (*Kratze*) through the ash-removal opening (*Ascheentnahmetür*; No. 17) – located at the front part of the furnace, below the muffle closure – and was transferred into the ash receptacle (*Aschebehälter*) for cooling.

In the sidewalls of the ash chamber, there were two horizontal air channels which ran parallel to it over its whole length and were connected to it by means of transverse openings.

These two channels, which went through the brickwork between the ash chamber and the two vertical conduits for the exhaust gases, opened up at the front of the furnace. These openings could be closed by means of separate covers located on the two sides of the ash-removal door, as in the eight-muffle

furnace (cf. Chapter 7). They had the purpose of supplying air to the post-combustion chamber (ash chamber).

In front of the rear part of the furnace there was a maintenance access (*Schacht*; No. 18), which had a horizontal section of 1,000 mm (width) by 1,200 mm (length) and a depth of 850 mm, through which one could reach the gasifier, housed in a brick structure measuring 1,550 mm (width) by 700 mm (length) by 1,550 mm (height).

On the upper inclined surface of this brickwork (some 800 mm in length) there was the cast-iron door for the gasifier fuel (*Generatorfüllschachtverschluss*; No. 19). The feeding chute of the gasifier (*Generatorfüllschacht*; No. 20) opened up into the gasifier.

The gasifier (*Generator*; No. 21) was a pit-like chamber closed at the bottom by means of by the horizontal grate (*Planrost*; No. 22) of the hearth, which was constituted by square steel bars (*Vierkantstäbe*) and the supports of the grate (*Rost-Auflager*). The grate measured about 500 mm by 500 mm = 0.250 square meters.

The upper part of the gasifier narrowed into a neck (gasifier neck; No. 8), which opened up behind the refractory bars of the grate (No. 14) between the muffle (No. 1) and the ash chamber (No. 16.). The gasifier, up to the fire bridge in the neck (No. 23), had a volume of about 0.250 cubic meters.

In addition to the horizontal grate (No. 22), the hearth (*Feuerung*) consisted of the cast-iron furnace door (*Feuertür*; No. 24), which was used to remove the ash and to clean out the coke slag from the grate, as well as two air openings, closed by means of raisable cast-iron gates in a manner similar to the other four described earlier, and located on either side of the furnace door, as in the case of the Auschwitz double-muffle furnace, or one above the other as in the case of the mobile double-muffle furnace (cf. Subchapter 5.2.). In this case, the lower opening fed combustion air below the hearth grate; the upper one carried air into the gasifier.

The refractory brickwork of the furnace (No. 27) had a thickness of 250 mm and consisted of normal firebricks as well as of bricks having special or wedge-like shapes (*Normal-, Form- und Keilsteine*), of Monolite mass and of refractory mortar (*Schamottemörtel*).

The insulation (*Isolierung*; No. 26) of the furnace was obtained by means of bricks of diatomaceous earth (*Kieselgursteine*), slag wool (*Schlackenwolle*) and diatomaceous-earth mortar (*Kieselgurmörtel*).

The outer brickwork (*Mauerwerksmantel*; No. 25) consisted of ordinary bricks.

The blower device (*Druckluft-Anlage*) was constituted by a blower (*Druckluftgebläse*) with its 1.5-hp three-phase motor and the necessary conduits (*Rohrleitung*). The corpse was introduced into the furnace by means of a corpse-introduction device (*Leicheneinführungs-Vorrichtung*) consisting of the cart for the introduction of the coffin (*Sargeinführungswagen*) and the corresponding rails (*Laufschienen*). This device is described in detail in Chapter 7.

The system of vertical gas-discharge channels for the flue gases of this furnace corresponds to the one used by Topf for the second and third electrical fur-

naces (cf. Documents 145 and 147), but, as opposed to these models, the discharge gases did not pass through the post-combustion chamber, and there was no preheating system for the combustion air.

5.2. The Oil-Fired Mobile Cremation Furnace with Two Muffles

This type of cremation furnace was installed at the Gusen Camp (sub-camp of the Mauthausen Concentration Camp) and at Dachau Concentration Camp. It was the improved version of a *Fahrbarer Verbrennungsofen System "Topf"* (Topf Mobile Combustion Furnace) going back to the beginning of the last century. It was, however, originally conceived as a combustion furnace for animal carcasses. A Topf brochure of the time describes it in the following words (see Document 165):

"The furnace described below is mobile and therefore has the advantage of being able to be taken to the object of the cremation. The furnace is indispensable in particular for major land-owners with large tracts of rangeland, because it can destroy immediately any dead animals near watering places without first transporting them over a great distance. The advantages of this furnace are ease and convenience of transport, long service life and a sturdy frame. The boiler is lined with refractory, hence radiation is minimal. This furnace can also be built with oil or gas heating."

The furnace was completely redesigned at the end of the 1930s. Topf Drawing D55719 shows a single-muffle *Fahrbarer, ölbeheizter Topf-Einäscherungsofen* (mobile oil-fired Topf incineration furnace) with the oil reservoir mounted above the furnace structure, a blower and two burners mounted laterally (cf. Document 166). There exists also a frontal photo of a furnace with two muffles clearly showing the two burners, mounted next to the ash opening below the muffle doors. The larger conduit running below the floor comes from the blower and feeds combustion air to the burners; the two smaller tubes coming down along the edges of the furnace are connected to the oil reservoir (Document 167).

This is the basic model of the cremation furnaces which were set up at Gusen and Dachau with the modifications to be explained later.

The first one was ordered from Topf by the New Construction Office of KL Mauthausen on 21 March 1940 as a mobile, oil-heated furnace (*fahrbarer Ofen mit Ölbeheizung*), but on 9 October 1940 it was decided to convert the heating system from oil to coke.¹¹³ Topf shipped the furnace by rail on 12 December 1940, and it arrived at the site on 19 December. On the same day, the New Construction Office sent Topf a cable requesting the urgent dispatch of a technician.¹¹⁴ Topf decided to send technician August Willing for 27 December.¹¹⁵ Work started the same day and was finished on 22 January 1941. The two coke gasifiers were built during the erection of the furnace¹¹⁶ which went into opera-

¹¹³ Topf letter to *SS-Neubauleitung* at KL Mauthausen dated 26 February 1941. BAK, NS 4 Ma/54.

¹¹⁴ Telegram from *SS-Neubauleitung* at KL Mauthausen to Topf dated 19 December 1940. BAK, NS 4 Ma/54.

¹¹⁵ Topf letter to *SS-Neubauleitung* at KL Mauthausen dated 23 December 1940. BAK, NS 4 Ma/54.

¹¹⁶ Topf, "*Bescheinigung über gegen besondere Berechnung geleistete Tagelohn-Arbeiten für Firma: SS-*

tion at the end of the month.¹¹⁷ The first load of coke was fed on 29 January.¹¹⁸ The furnace parts are listed in the bill of lading of 12 December 1940 (Document 168). Concerning the conversion there is a Topf invoice dated 5 February 1941 (Document 169).

The furnace at KL Dachau was handed over even earlier, as we can see from a letter written by Topf to the New Construction Office at that camp, dated 25 July 1940, which states, *i.a.*:¹¹⁹

“We wish to mention that KL Dachau received the same furnace from us some time ago. Said camp can, however, not operate the furnace, because the necessary oil is not available. If such a furnace is urgently needed on your part, then perhaps you could take over this furnace from KL Dachau, and we would then build a stationary, coke-fired furnace for the latter camp.”

But the camp authorities at KL Dachau also decided to convert the heating section of the furnace by installing two coke gasifiers in place of the oil burners. Both furnaces, in their converted form, still exist at the sites of the former concentration camps mentioned. Initially, the conversion of the heating system of the cremation furnaces for lack of oil was decided locally, but on 17 December 1943 the head of Office CIII (*Technische Fachgebiete*; technical services) of SS Economic Administrative Main Office (*SS Wirtschafts-Verwaltungshauptamt*; WVHA) issued a memorandum stating:¹²⁰

“In the crematoria, the consumption of liquid fuels can no longer be permitted. A conversion to solid fuel has been carried out everywhere.”

The Gusen Furnace consisted of the following parts (Document 168):¹²¹

<i>Bill of lading of 12.12.1940</i>	
<i>Parts of cremation furnace</i>	
<i>1</i>	<i>Mobile incineration furnace with two muffles</i>
<i>2</i>	<i>Tubes</i>
<i>1</i>	<i>Metal tube ø 120 with two elbows</i>
<i>1</i>	<i>Dto.</i>
<i>1</i>	<i>Cart for the blower unit with 3 blowers 120/520, 120/300 and 400 plus 3 electric motors 5.5, 1.5 hp 380 V, 3 hp 380 V</i>
<i>2</i>	<i>Metal tubes ø 120</i>
<i>1</i>	<i>Metal sleeve 280/430</i>
<i>4</i>	<i>Stoking tools</i>
<i>1</i>	<i>Ash box</i>
<i>1</i>	<i>Frame with rollers for introduction device</i>
<i>1</i>	<i>Introduction trough</i>
<i>4</i>	<i>[Cast-iron] fire doors 350/280</i>
<i>4</i>	<i>[Cast-iron] air-channel closures 108/128</i>

Neubauleitung d. Kz.L. Mauthausen.” WVHA BAK, NS 4 Ma/54.

¹¹⁷ Letter from *SS-Neubauleitung* at KL Mauthausen to Topf dated 14 February 1941. BAK, NS 4 Ma/54.

¹¹⁸ ÖDMM, Archiv, Sign. B 12/31, pp. 352f.

¹¹⁹ Topf letter to *SS-Neubauleitung* at KL Mauthausen dated 25 July 1940. BAK, NS 4 Ma/54.

¹²⁰ AGK, NTN, 94, p. 177.

¹²¹ Topf shipping advice to *SS-Neubauleitung* at KL Mauthausen dated 12 December 1940 concerning parts for a Topf mobile cremation furnace with two muffles and heated by oil. BAK, NS 4/Ma 54.

20	Square bars 30/30, length 600
4	Shaped bricks
1	Metal sleeve
1	Con[ical] metal tube
	6 m ² asbestos sheets
6	Monolite grate bricks length 750
8	Monolite slabs 500/600/100
	250 kg rock wool
1	Oil-level [indicator]
	Various bolts
	Various gaskets

Topf Invoice No. D 41/107 of 5 February 1941 lists in particular the work done in connection with the conversion of the furnace (Document 169):¹²²

<i>Re: KL Mauthausen</i>	<i>RM</i>
<i>Supply of a mobile incineration furnace with 2 muffles, consisting of:</i>	
<i>Wrought-iron furnace cladding with supporting frame and roller frame, wrought-iron foldable chimney, 4 m in height, draft enhancer, fireclay lining and insulation, furnace fittings of wrought and cast iron, and oil-burner device, otherwise as per description in our estimate of 29.2.1940</i>	8,950.--
<i>Addition of two coke generators to the mobile incineration furnace with two muffles, viz.</i>	
<i>Supply of 1,000 fireclay bricks, normal and conical, S.K. 34</i>	380.--
<i>500 kg of fireclay mortar</i>	
<i>Carried forward</i>	9,330.--
<i>Brought forward</i>	9,330.--
<i>460 insulating bricks</i>	163.--
<i>200 kg insulating mortar</i>	
<i>4 cast-iron furnace and ash doors, fireclay-lined</i>	180.--
<i>20 wrought-iron square bars for gasifier grates</i>	51.--
<i>4 cast-iron air-duct closures</i>	28.--
<i>Manual adaptation of wrought-iron cladding and anchoring bars</i>	100.--
<i>Packaging and freight to Mauthausen according to our cost estimate of 1.10.1940</i>	262.--
<i>Delegation of our supervisor Schilling for the period of 26.12.40 through 4.2.41 for mounting of the generators acc. to daily work sheets attached:</i>	
<i>31 hours travelling time @ 2.--</i>	62.--
<i>267 hours working time @ 2.--</i>	134.--[sic]
<i>48 hours overtime supplement @ 0.50</i>	24.--
<i>38 hours Sunday supplement @ 1.--</i>	38.--

¹²² Topf invoice (*Rechnung*) No. D 41/107, dated 5 February 1941, for the supply of a mobile oil-fired Topf incineration furnace with two muffles, to SS-*Neubauleitung* at KL Mauthausen. BAK, NS 4/Ma 54.

29 daily allowances @ 7.--	203.--
Traveling costs Erfurt-Mauthausen-Dachau	46.80
Expenses, transport of tools etc.	13.60
<i>Total RM</i>	<i>10,635.40</i>

The description which follows refers to the furnaces of the former concentration camps at Gusen and Dachau, which had been converted to furnaces with coke-fired gasifiers. It is complemented by photos illustrating the various elements making up the furnaces, taken personally on site by the author.

The furnace consists of a basic structure taken over from the oil-fired furnace, with a facing of wrought iron – consisting, in its front part, of the block containing the muffle and ash chamber (post-combustion chamber), at the rear of the gas-discharge unit (flue-gas ducts and chimney) – and two gasifiers mounted successively next to each muffle (Photos 1-3, 32f., 35-38, 45f.). Initially, the furnace was placed on metal rollers which have survived only in the rear part of the Dachau Furnace (Photos 45f.).

The gasifiers (Photos 4, 8f., 29f., 37f.) are made of bricks and measure 1,440 mm (height) × 1,130 mm (width) × 1,640 mm (length; furnace at Dachau). The brickwork is strengthened by anchor bars. In their front parts, they each have a gasifier-loading shaft made of cast iron, standard type, (270 × 340 mm; Photos 4, 8f.). On the Gusen Furnace, at the base of each gasifier at floor level, there is an air duct for the combustion air feed to the hearth grate, closed by a cast-iron door of standard type (108 × 126 mm; Photos 4, 6-8); the Dachau Furnace has two air ducts for each gasifier, one located next to the loading door of the gasifier to feed combustion air to the gasifier, the other, right beneath it, to feed combustion air to the hearth (Photo 39). The hearths are located below floor level. Access was possible through two small service pits set into the floor at the feet of the two gasifiers (at the Dachau Furnace these shafts are now protected by grates). The hearths are closed by a door of standard type (280 × 350 mm).

The refractory structure of the gasifiers is made up of 1,000 fireclay bricks and 500 kg of refractory mortar; it has a total mass of some 4,000 kilograms.

The furnace has two vaulted muffles (Photos 1, 2, 36-38) which have the following dimensions (for the Dachau Furnace):

height: 600 mm
width: 600 mm
length: 2,000 mm

The muffles are directly linked to each other by means of three rectangular openings set into the central wall (Photos 20, 22f.), and are closed at the rear by the refractory brickwork.

The Dachau Furnace has, on its muffles' vaulted roofs, outlets arranged obliquely and connected to the blower tubing (Photos 41f.); they are located on the right side for the left-hand muffle and on the left side for the right-hand one. The internal tubes are bricked into the furnace above the center wall of the muffles. In the case of the Gusen Furnace, these outlets are placed at the apex of the muffles' vaults (Photos 19, 26) as in the Auschwitz double-muffle furnace,

where two ducts are incorporated in the brickwork (*i.e.* one in each muffle). No trace of any outer tubing remains, neither at Dachau nor at Gusen.

In their lower portions, each of the muffles is limited by a grate consisting of three transverse and one longitudinal beam of fireclay (Photo 40), set at an appreciable distance from one another (some 300 mm). Below these grates are the ash chambers having in their sidewalls the openings toward the gasifiers (Photos 16, 18, 27f.).

At the front, the muffles are closed by two cast-iron doors having on the outside a little rectangular closure of an air feed, with two round inspection holes (Photos 11, 13, 43f.), and lined with fireclay on the inside (Photos 12, 14, 43). These doors are of the same type as those on the Auschwitz double-muffle furnace (600 mm × 600 mm). Below the muffle doors there are two round metal covers, welded shut, closing the openings which, earlier, had housed the oil burners (*cf.* Document 167).

Because the furnace was designed originally as a mobile furnace, there is no flue-gas channel underneath the floor below the furnace, as in stationary furnaces; the exhaust gas evacuation took place instead via a rectangular opening set into the rear wall of the muffle on the right, below the level of the grate (Photo 25) from where the gases flowed into a box lined with sheets of wrought iron, located behind the furnace in line with the muffle on the right side and linked directly with the chimney (Photos 31f., 45-47), and probably containing a short flue duct through which the gases reached the chimney.

The chimney consists of a square metal duct, crowned by a truncated conical socket, onto which a cylindrical sheet-metal tube is welded (*see* Photos 32, 47-49). This has been preserved in case of the Dachau furnaces. At the base of the chimney there is a small hearth for preheating (pilot flame), which can be closed by a suitable door (Photos 33f., 50).

Initially, the furnace possessed three blowers, located on a cart-like support, two of which fed combustion air to the muffles and the burners, respectively, whereas the third was part of the forced-draft device. The blower for this device was located at the base of the chimney and was linked to it as shown in the figure of Document 170.¹²³ When the blowers were removed after the furnace activity had come to an end, the corresponding connection openings were closed by welding them shut with a metal plate (Photos 34 and 47).

As the chimney at present takes up the whole space behind the rear part of the furnace, corresponding to the muffle on the left, we may assume that it was initially in a different position, as is also suggested by Document 169, which mentions a mobile chimney (*umlegbaren Schornstein von 4 m Höhe*).

The oil tank was no doubt mounted above the furnace, as shown by Drawing D55719 and as was the case for the Buchenwald triple-muffle furnace mentioned above (Photo 201). At Dachau, this tank is presently situated in a brick

¹²³ As stated in an undated Topf letter to *SS-Neubauleitung* at KL Mauthausen in reply to a text dated 11 November 1940 on the subject of the Gusen Crematorium, the draft enhancer (*Zugverstärkungs-Anlage*) – consisting of a draft suction device – was necessary because of the insufficient height of the chimney (BAK, NS 4 Ma/54). This was also true for the Dachau Furnace, likewise equipped with a rather short metal chimney.

structure above the gasifier on the right where it serves no useful purpose for the furnace; we may, therefore, assume that it was placed there after the liberation of the camp by persons unfamiliar with the operation of the furnace.

5.3. The Coke- or Oil-Fired Cremation Furnace with Two Muffles

On 18 June 1938, the Construction Office of the SS administration for the camps of Buchenwald and Sachsenhausen sent a request to *Gruppenführer* Eicke, head of *Totenkopfverbände* and concentration camps, asking for authorization to build a crematorium at the Buchenwald Camp. Eicke passed it on to the Head of the SS administration in Munich with a note in which he supported the request, because the increase in the Buchenwald Camp census had led to a corresponding increase in the number of deaths among the inmates, whose corpses had to be taken to the municipal crematorium at Weimar for cremation (NO-4353). The request was accepted, and authorization was granted by *Hauptamt Haushalt und Bauten* (HBB) in early December of 1939.

For the erection of this “emergency crematorium” (*Notkrematorium*) as it was called in the German administrative documents, the Topf Co. at Erfurt was contacted, and on 21 December 1939 Topf submitted to the cognizant authorities a cost estimate for “1 Topf incineration furnace, oil- or coke-fired, with double muffle and compressed-air unit, as well as a draft-enhancing unit” (“1 öl- oder koksbeheizter Topf-Einäscherungs-Ofen mit Doppelmuffel und Druckluft-Anlage, sowie Zugverstärkungs-Anlage”) for the price of 7,753 RM plus 1,250 RM for the draft enhancer (Document 171). Attached to this was the Drawing D56570 “double-muffle cremation furnace with oil burner” (“*Doppelmuffel-Einäscherungs-Ofen mit Ölbrenner*”) drawn on the same day (Document 172).

The “Description of the structure of the new emergency crematorium building in the camp for detainees of Buchenwald Concentration Camp,” written on 10 January 1940 by the New Construction Office at Buchenwald, states in this respect (NO-4401):

“On account of the high mortality at the Buchenwald Concentration Camp, the need has arisen for the construction of an emergency crematorium with a furnace (double-muffle furnace) heated by oil. For this, a building [with a floor space] of 6 by 9 m, 4 m high, is required. The furnace will be supplied and erected by J.A. Topf & Söhne Co. of Erfurt, Dreysestraße 7-9. A description of the furnace is provided by the cost estimate of Topf & Söhne Co. dated 21.12.39, as attached. The erection is pursuant to the orders given by the head of Hauptamt Haushalt und Bauten of 9 and 11.12.39 resp., Amt II/b 265 Ri/Sa.”

The document just quoted refers to this emergency crematorium and contains a “cost estimate,” a “cost summary” and finally a “weight computation” of the emergency crematorium for Buchenwald, for which a price of 14,200 RM was estimated. An undated drawing (probably of December 1939) bearing the heading “Krematorium des K.L. Bu.” (crematorium of Buchenwald Camp) shows

the crematorium building measuring precisely 6 m × 9 m × 4 m (Document 173).

I have found no documents concerning the realization of this project. A later project by the “Administration – Construction Office Buchenwald-Sachsenhausen” (“*Verwaltungsamt – SS Bauleitung Buchenwald-Sachsenhausen*”), undated but probably from early 1940, shows a more elaborate crematorium labeled “K.L. Buchenwald Krematorium”, with outside walls measuring 14 by 12 m, consisting of five rooms. The furnace hall, however, measuring 6.50 by 4.99 m, contains a single furnace with only one muffle (Document 174). No documents are known about the realization of this project either, and witness statements are contradictory in this respect.¹²⁴ The crematorium which was eventually built at Buchenwald had a totally different layout with a half-basement and two furnaces of three muffles each (cf. Chapter 7).

Before going into the description of the oil- or coke-fired double-muffle cremation furnace, I will present the translation of the Topf cost estimate of 21 December 1939 (Document 171; NO-4448):

	<i>Object of cost estimate</i>	
1.	<i>Oil- or coke-heated Topf incineration furnace with double-muffle and compressed air unit, as well as draft enhancer including</i> <i>The brickwork housing consisting of ordinary bricks the best of which will be selected for the outer facing of the furnace, including the necessary sand and cement-lime, the fireclay material consisting of normal, shaped, and conical bricks, Monolite packing material and fireclay mortar</i> <i>For a total weight of about 10,200 kg of fireclay material</i> <i>The wrought-iron anchoring bars consisting of T, U and angle-shaped bars, anchors, bolts and nuts</i> <i>For a total weight of about 800 kg</i> <i>The fittings made of cast and wrought iron consisting of</i>	
2	<i>Pcs. cast-iron introduction doors with their cast-iron frames, the insides of the doors will be lined with tamped Monolite mass</i>	
2	<i>Cast-iron ash-chamber doors</i>	
3	<i>Cast-iron air-channel closures</i>	
1	<i>Cast-iron flue-gas damper in its air-tight guide casing, including rollers, cable and counterweight</i>	
2	<i>Pcs. wrought-iron ash containers</i> <i>The necessary stokers</i>	
1	<i>Compressed-air unit, coupled directly to a 1.5-hp three-phase motor, and the necessary ducting</i>	
1	<i>Oil-burner unit consisting of:</i>	
2	<i>Pcs. oil burners for 6 to 25 kg/hr</i>	

¹²⁴ Eugen Kogon affirms that “in the winter of 1940/41 a mobile crematorium was supplied to the camp, lent from elsewhere” (Kogon 1946, p. 125). According to the Buchenwald ex-detainee Erich Haase, the first furnace (with two muffles, coke-heated) was set up in the spring of 1940 (Kommunistischen Partei..., p. 80).

2	<i>Pcs. cut-off valves</i>	
2	<i>Pcs. manual vane pumps</i>	
2	<i>Pcs. air-pressure meters</i>	
1	<i>Compressed-air unit with a 2 ½-hp motor, coupled directly, with the necessary tubing for oil feed and return</i>	
1	<i>Oil tank for 250 liters of oil</i>	
1	<i>Wrought-iron corpse-introduction device</i>	
	<i>Total weight about 1,325 kg</i>	
	<u><i>Installation of furnace</i></u>	
	<i>Delegation of technicians (3 persons) for the erection of the furnace, including daily allowances, social security contributions and travelling expenses.</i>	
	<i>Delegation of one supervisory engineer for erection control and start-up of the furnace</i>	
	<i>Freight and carriage to Site Buchenwald</i>	
	<i>Price of Item I RM</i>	7,735.-
II.	<u><i>One Topf draft enhancer</i></u>	
	<i>For about 4,000 m³ of discharge gas, with 3 hp three-phase motor and starter, with suction and pressure connectors and an air flap separating suction chamber from pressure chamber</i>	
	<i>Total weight about 260 kg</i>	
	<i>Price for Item II RM</i>	1,250.-
	<i>During erection, our technicians must be provided with three helpers, at no charge to us. For the listed items made of cast or wrought iron we need an authorization code with Indicator Z which must be made known to us immediately upon placement of order.</i>	

The description which follows refers to a coke-fired furnace. The numbers in parentheses with prefix “No.” refer to Documents 172 a through c.

The furnace was held together by a solid brick structure consisting of wrought-iron anchor bars (*Verankerungseisen*) having T, U or angled sections (*T-, U- und Winkeleisen*), anchoring rods (*Anker*), bolts and nuts, for a total weight of about 800 kilograms.

The furnace dimensions are as follows:

Height: 2,100 mm

Width: 2,450 mm

Length: 2,700 mm (w/o gasifier)

3,850 mm (with gasifier)

It was equipped with two muffles (*Muffel*) having the same dimensions as those of the Auschwitz double-muffle furnace:

Height: 700 mm

Width: 700 mm

Length: 2,000 mm

On the outside halves of both muffle vaults there were the nozzles (No. 2) for the air ducts coming from the blower unit. These ducts, set diagonally, were connected to the blower ducts (*Rohrleitung*) the inner part of which (No. 4) ran horizontally in the two upper edges of the furnace.

The position of the blower (*Druckluftgebläse*) is not shown on the Topf drawing but was no doubt on the side, as in the Auschwitz double-muffle furnace and the triple-muffle furnace.

Two rectangular holes (No. 5) were set into the inside wall of the two muffles for heat exchange.

The muffles were closed in front by two cast-iron introduction doors (*Einführungstüren*; No. 6) lined with fireclay.

The lower part of the muffle was made up by a horizontal grate of fireclay (*Schamotterost*; No. 7) which was constituted by five transversal bars (No. 8) of refractory material.

Below each grate we have the funnel-shaped and inclined ash plane (*Aschenschräge*; No. 9) which ended at the post-combustion chamber (No. 10) underneath; the front part of the post-combustion chamber served as an ash container (No. 11). The embers were removed by means of suitable scrapers (*Kratzer*) through two cast-iron openings for ash removal (*Ascheentnahmetüren*; No. 12) at the front of the furnace, below the introduction door of the muffle, and was transferred to the appropriate receptacles (*Aschebehälter*) for cooling.

On the inside walls of the two post-combustion chambers were two openings (No. 13) for the discharge of the spent gases, which went to a smoke channel (*Rauchkanal*; No. 14) having a section of 300 mm by 650 mm which ran horizontally in the lower part of the furnace between the two post-combustion chambers and which could be closed by means of a hermetic cast-iron damper in the smoke conduit (*Rauchkanalschieber*; No. 15) which moved in a suitable track and could be operated by means of rollers, cable and counterweight.

The smoke conduit went into the chimney (*Schornstein*; No. 16) the inner section of which measured 500 by 500 millimeters. The furnace was equipped with a draft enhancer (*Saugzug-Anlage*) for about 4,000 m³/h of gas driven by an electric three-phase 3-hp motor.

In the rear, the muffles were closed by refractory brickwork in which there was the opening (No. 17) for the gasifier neck (No. 18).

The drawing does not show whether the gas feed came from one or two coke gasifiers. The enormous grate of the hearth, however, suggests a single gasifier centrally located in the rear part of the furnace with its neck bifurcated to feed two muffles simultaneously.

The gasifier (No. 19), placed into a brick housing (No. 25) of 1.15 by 1.15 m, was a rather spacious pit-like chamber (0.80 by 0.80 m), bounded at its bottom by the horizontal grate of the hearth (*Planrost*; No. 20) with a usable surface of 0.80 m by 0.80 m = 0.64 m² (more than twice that of the triple-muffle furnace). The hourly load of the gasifier was thus about 75 kg of coke.

Below the grate we have the ash chamber (No. 21) closed by the hearth door (*Feuertür*; No. 22). The ash chamber was concave, as in the furnaces for civilian use, which suggests that it was laid out to contain water to cool the grate and to produce water gas at the same time.

At the top, towards the inside of the furnace, the gasifier became smaller up to the fire bridge (No. 18) in the gasifier neck (*Generatorhals*; No. 17) which led into the two muffles; on the outside, there was the gasifier-loading chute

(*Generatorfüllschacht*; No. 23) closed at the top by a lid (*Generatorfüllschachtverschluss*; No. 24).

The oil-fired furnace, obviously, had no gasifier; in the rear portion, in line with the muffles, we have instead two burners (No. 26) fed via a suitable tube from a tank (No. 27) located above the furnace (No. 28). Combustion air was brought to the burner by a further tube, connected to a suitable blower.

The furnace was made of some 10,200 kg of refractory bricks (No. 30), covered by a thick layer of thermal insulation (No. 31) and the outer brick housing.

5.4. The Coke-Fired Cremation Furnace with Two Muffles Placed Opposite Each Other

This type of furnace appears solely on a drawing for a crematorium at the Plaszów Camp near Krakow (cf. Document 175). Whether it was ever built is unknown. The date on the drawing is illegible. The crematorium had two furnaces with two muffles each, the first furnace being set parallel to the crematorium's longest wall, the second one perpendicular to it. The design of the furnaces is the same as for the eight-muffle furnace, with two opposing muffles the doors of which were located at the two extremities of the furnace itself, whereas on the sides we have two gasifiers with their access pits.

For the first furnace, the gasifiers were placed on either side of the furnace; for the second, they were in a central position as well, but on the outside wall, because the inside wall was built against the wall of the crematorium, on the other side of which there was the chimney. Each furnace had its own chimney to which it was connected by two smoke ducts. These ducts, however, differ from the layout of the eight-muffle furnace in that they came out at the front of the muffles and not on their sides which means that the discharge of the gases was located at the front part of the device, as in the single-muffle furnace.

6. The Topf Co. and the Construction of the Cremation Furnaces at Auschwitz-Birkenau

6.1. The Furnaces of Crematorium I at Auschwitz

The budget for the Auschwitz Camp, drawn up by *SS Obersturmführer* Fritz August Seidler on 30 April 1940, included an item for the construction of a new crematorium (*Neubau Krematorium*) at a cost of 15,000 Reichsmarks (RM).¹²⁵ Instead of erecting a new building, however, the equipment was eventually installed in a bunker of the former Polish artillery barracks which constituted the nucleus of the new concentration camp. The plans for the crematorium were drawn up in the week of 14 to 20 June.¹²⁶ The firm J.A. Topf & Söhne of Erfurt which the Main Office Budget and Construction (*Hauptamt Haushalt und Baut-*

¹²⁵ Kostenaufstellung für das Lager Auschwitz bei Kattowitz. RGVA, 502-1-176, p. 37.

¹²⁶ *Tätigkeitsbericht* dated 20 June 1940, for the period of 14-20 June. RGVA, 502-1-214, p. 102.

en, HHB) had contacted for the supply of the equipment, had already informed the New Construction Office at Auschwitz on 25 May that the drawings of the foundations of the cremation furnace would be sent within a few days, and that their erection supervisors would arrive at the camp within two weeks for the installation.¹²⁷ The furnace ordered by HHB was an oil-fired double-muffle furnace (*ölbeheizter Doppelmuffel-Ofen*).¹²⁷ On 10 June 1940 Topf sent to the New Construction Office Drawing D57253, executed the previous day, concerning a “Cremation furnace heated by coke and plan of the foundations” (cf. Document 202). Topf advised, moreover, that “instead of the oil firing originally planned, 2 coke generators will be mounted in accordance with the advice from your superior authority.”

Topf added that this would result in a delay of the shipment and announced that the materials for the furnace would probably be shipped on 15 July.¹²⁸ Actually, Topf did not modify anything, because HHB decided to install at Auschwitz a furnace of a different type, patented on 6 December 1939 as an “*Einäscherungs-Ofen mit Doppelmuffel*” (cremation furnace with double muffle)¹²⁹ which had already been proposed to the New Construction Office at Auschwitz in April. The pertinent cost estimate (*Kostenanschlag*) of 17 April 1940 in fact referred to the “supply of a coke-fired Topf cremation furnace with two muffles and compressed-air unit, plus 1 Topf draft-enhancing unit.”¹³⁰

The New Construction Office replied on 15 June by cable, stating that supply was “extremely urgent” (*äußerst dringend*).¹³¹ On 20 June, Topf confirmed receipt of the cable and stated that the firm had shipped the furnace materials in the fastest way available and that the technicians would arrive at Auschwitz towards the middle of the following week. Erection time of the furnace was 16 days.¹³² The refractory materials were shipped on 22 June by the firm Collmener Schamottewerke G.m.b.H. of Colditz on Topf’s account.¹³³

In the week of 21 to 27 June, the New Construction Office continued work on the design of the crematorium (*Bauabschnitt IV*) which constituted the last of the four construction sectors under the responsibility of this office.¹³⁴ Revamping of the former bunker began the following week (opening of windows, erection of partitions) and the materials¹³⁵ shipped by Topf on 1 July arrived as well.¹³⁶ Between 5 and 11 July, brick-laying and concrete work continued, and the furnace foundations were poured. The Topf technicians arrived at Auschwitz and began work immediately.¹³⁷

¹²⁷ Letter from Topf to *SS-Neubauleitung* of Auschwitz dated 25 May 1940. RGVA, 502-1-327, p. 231.

¹²⁸ Letter from Topf to *SS-Neubauleitung* dated 11 June 1940. RGVA, 502-1-327, p. 224.

¹²⁹ List of patents of department “D” of Topf dated 20 November 1945. From website www.TopfundSoehne.de/media_de/. Cf. Appendix 1.4f: Patents by J.A. Topf & Söhne.

¹³⁰ Letter from Topf to *SS-Neubauleitung* dated 9 October 1940. RGVA, 502-1-327, pp. 209f.

¹³¹ Telegram, undated, from *SS-Neubauleitung* to Topf. RGVA, 502-1-327, p. 228. The date of 15 June 1940 is mentioned in Topf’s letter dated 20 June.

¹³² RGVA, 502-1-327, p. 221.

¹³³ Topf *Information-Instruktion* dated 27 July 1940. RGVA, 502-1-327, p. 219.

¹³⁴ *Tätigkeitsbericht* dated 27 June 1940, for the period of 21-27 June. RGVA, 502-1-214, p. 100.

¹³⁵ *Tätigkeitsbericht* dated 5 July 1940, for the period of 28 June – 4 July. RGVA, 502-1-214, p. 98.

¹³⁶ RGVA, 502-1-327, p. 200.

¹³⁷ *Tätigkeitsbericht* dated 12 July 1940, for the period of 5-11 July. RGVA, 502-1-214, p. 97.

Work on the rebuilding of the crematorium and on the brickwork of the furnace ended in the week of 19 to 25 July;¹³⁸ a few days later, the *Bauleiter*, SS *Untersturmführer* August Schlachter sent Topf a cable requesting the shipment of the items still missing: blower, draft enhancer, gasifier doors, corpse-introduction cart, rails and pulleys for the closure of the smoke conduit.¹³⁹ On 29 July, Topf confirmed receipt of the telegram and informed the New Construction Office of the imminent arrival of the requested parts.¹⁴⁰

In all probability, drying-in of the furnace began as soon as the brickwork was in place. The test cremation was, in fact, carried out on 15 August. The activity report (*Tätigkeitsbericht*) for the period of 9-15 August states:¹⁴¹

“The entire erection of the crematorium, including the cremation unit as such, was completed so that at the end of the week of this report the first cremation could be realized.”

A further, undated, document mentions the exact date of 15 August:¹⁴²

“This construction office certifies that the erection work for the cremation furnace was completed on 15 August 1940. The test cremation of the first corpse took place the same day.”

On 27 August, Topf asked the New Construction Office for payment of the invoice covering the cremation furnace, in an amount of 10,679 RM, or at least a down payment of 9,000 Reichsmarks.¹⁴³

On 16 September, the New Construction Office forwarded to Office II of *HHB* Topf's invoice with the following comment:¹⁴⁴

“The cremation installation is completely finished and has been in operation for weeks. As no malfunction at all has been noted, complete payment for the unit should not encounter any problems.”

Two days later, Topf sent out a demand for the payment of the total amount or of the down payment,¹⁴⁵ followed by another, merely for the down payment¹⁴⁶ on 23 September and a further demand on 30 September.¹⁴⁶ On 2 October, *Bauleiter* Schacht informed Topf that he had forwarded to *HHB* Topf's request for the down payment of 9,000 RM, asking the Erfurt company to get in touch with that office directly.¹⁴⁷ When Topf followed the advice and contacted *HHB*, there was an unpleasant surprise: The invoice of 27 August 1940, in an amount of 10,283 RM¹⁴⁸ had not reached this office yet.¹⁴⁹

At the end of September, the crematorium still did not possess a room for autopsies. On 28 September, the *SS Standortarzt* (camp physician) sent camp

¹³⁸ *Tätigkeitsbericht* dated 26 July 1940, for the period of 19-25 July. RGVA, 502-1-214, p. 95.

¹³⁹ RGVA, 502-1-327, p. 223. The telegram bears no date but undoubtedly stems from the end of July because Topf confirmed receipt on 29 July.

¹⁴⁰ RGVA, 502-1-327, p. 218.

¹⁴¹ *Tätigkeitsbericht* dated 17 August 1940, for the period of 9-15 August. RGVA, 502-1-214, p. 92.

¹⁴² *Kontrollzettel für die Firma J.A. Topf & Söhne*, Erfurt. RGVA, 502-1-327, p. 215.

¹⁴³ Letter from Topf to *SS-Neubauleitung* dated 18 September 1940. RGVA, 502-1-327, p. 214.

¹⁴⁴ Letter from *SS-Neubauleitung* to *HHB, Amt II*, dated 16 September 1940. RGVA, 502-1-327, p. 216.

¹⁴⁵ RGVA, 502-1-327, p. 213.

¹⁴⁶ *Ibid.*, p. 212.

¹⁴⁷ *Ibid.*, p. 211.

¹⁴⁸ It is not known why an amount of 10,283 RM is mentioned here instead of 10,679 RM.

¹⁴⁹ Letter from *HHB* to *SS-Neubauleitung* dated 4 November 1940. RGVA, 502-1-327, p. 207.

command a detailed request for the installation of such a facility, explaining that “in the case of deaths the causes of which are not clear, autopsies are to be carried out, in particular for executions by shooting or in the case of fatalities caused by external force.”¹⁵⁰

The camp command turned to the New Construction Office, which replied directly to the *SS Standortarzt*, explaining that an autopsy facility could not be installed immediately because certain essential pieces of equipment – such as the dissecting table – were not yet available.¹⁵¹ On 7 November 1940, Schlachter informed Topf as follows:

“The present level of usage of the combustion unit installed here by your company has shown that the unit is in fact too small.”

The New Construction Office intended to double the cremation facility and asked Topf to send a representative to Auschwitz to discuss the matter on site.¹⁵² On 13 November, Topf replied that engineer Prüfer would be at Auschwitz on the 16th with a cost estimate and the drawings of the second furnace. On the same day, Topf drew up two quotations concerning the second furnace (cf. Document 193), which was proposed for a price of 7,753 Reichsmarks. In the letter of transmittal, likewise dated 13 November, Topf – assuming that the second furnace would be connected to the same chimney – judged another draft enhancer (*Zugverstärkungs-Anlage*) to be superfluous because the existing one was sufficient for an alternating operation of both furnaces, which could, however, be in operation at the same time as well.¹⁵³ On 22 November, the New Construction Office sent a request to Office II C2 of *HHB* asking for the authorization to install the second furnace, giving the following justification:¹⁵⁴

“The operation of the crematorium in the past has shown that, even in the relatively favorable season, the furnace with its 2 [cremation] chambers is too small. The camp command and Political Department have therefore approached the New Construction Office with the urgent request to enlarge the unit by 2 chambers.”

The request was granted, and Topf went to work: on 30 November, Drawing D57999 showing the positioning of the second furnace in the crematorium was prepared (cf. Document 204). On 5 December, this drawing was sent to the New Construction Office, and Topf informed them that the refractory and insulating materials for the second furnace had already been shipped;¹⁵⁵ some of these materials, however, were shipped later: 2 refractory plates left on 20 December¹⁵⁶ and 50 bags of mortar mix the following day.¹⁵⁷

In early January of 1941, the situation in the crematorium became critical. On 8 January, Schlachter sent Topf an alarming letter in which he declared:¹⁵⁸

¹⁵⁰ Letter from *SS-Standortarzt* to *Kommandantur* dated 28 September 1940. RGVA, 502-1-52, p. 3.

¹⁵¹ Letter from *SS-Neubauleitung* to *SS-Standortarzt* dated 3 October 1940. RGVA, 502-1-342, pp. 3-3a.

¹⁵² RGVA, 502-1-312, p. 146.

¹⁵³ RGVA, 502-1-327, pp. 166, 175.

¹⁵⁴ *Ibid.*, p. 173.

¹⁵⁵ RGVA, 502-1-312, pp. 143f.

¹⁵⁶ RGVA, 502-1-327, p. 205.

¹⁵⁷ *Ibid.*, p. 204.

¹⁵⁸ *Ibid.*, p. 180.

“New Construction Office has already informed you by telegram that the first furnace unit shows damage due to intensive usage and hence can no longer be operated to capacity. The enlargement of the unit is therefore imperative. You are requested to inform us by telegram as to when you will begin to take the preliminary steps for an enlargement.”

The installation of the new cremation furnace, constituting as it did an enlargement of the crematorium, was therefore rightly designated by the New Construction Office as *Erweiterung des Krematoriums* or *Krematoriumserweiterung*.

On 10 January 1941, Topf confirmed receipt of Schlachter’s cable concerning the damages to the first furnace and the urgency of the installation of a second one and reported that all the necessary materials for the construction of the furnace had already been shipped, whereas shipment of the metal parts could take place only after the end of the goods embargo (*Gütersperre*). On the subject of the furnace damage, Topf stood ready to dispatch its technician Wilhelm Koch for repair work.¹⁵⁹

In the meantime, the situation worsened. On 13 January, Schlachter informed Topf that the Monolite grates (*Monolitroste*) of the muffle and the internal walls (*Innenwände*) of the gasifiers had burned through (*durchgebrannt*) and demanded the immediate dispatch of a technician.¹⁶⁰ In line with bureaucratic practice, Topf replied two days later by sending a cost estimate (*Kostenanschlag*) for providing a technician (*Monteurgestellung*).¹⁶¹ On 21 January, Schlachter informed Topf that the order for the repair work (*Reparaturarbeiten*) would be issued by the camp administration (*Verwaltung*) within the next few days and added the following order:¹⁶²

“Furthermore, 2 generator closures must be supplied a.s.a.p. for the repair work, as the old ones are completely burned through.”

The camp administration returned the Topf cost estimate of 15 January to the New Construction Office, explaining that the transfer certificate (*Übergabe-Verhandlung*) for the crematorium was still missing, without which it was impossible, for reasons of authorization, to pay for the repair work.¹⁶³ On 29 January, Topf confirmed receipt of the order from the New Construction Office for “2 two cast-iron closure doors for the generators” for the price of 180 RM and stated that shipment would take place eight weeks later.¹⁶⁴ Repair work was carried out much sooner, though, while the second furnace was being erected. In his report of 1st March, Schlachter, in fact, wrote that everything had been repaired.¹⁶⁵

¹⁵⁹ RGVA, 502-1-312, pp. 131f.

¹⁶⁰ Telegram from *SS-Neubauleitung* to Topf dated 13 January 1941. RGVA, 502-1-312, p. 130.

¹⁶¹ RGVA, 502-1-327, pp. 167-167a.

¹⁶² *Ibid.*, pp. 185-185a.

¹⁶³ Letter from the head of KL Auschwitz administration to *SS-Neubauleitung* dated 22 January 1941. RGVA, 502-1-312, p. 80.

¹⁶⁴ RGVA, 502-1-327, pp. 183f.

¹⁶⁵ *Tätigkeitsbericht* dated 1st March 1941, for the period of 23 February - 1st March. RGVA, 502-1-214, p. 67.

The parts for the second furnace were shipped by Topf on 17 January 1941; the total weight came to 3,193 kilograms (cf. Document 197), and two days later the two cement counter-weights (*Zement-Gegengewichte*) for the two flue-gas dampers¹⁶⁶ followed. The weekly activity reports (*Tätigkeitsberichte*) for this period allow us to follow in detail the work involved in the installation of the new unit:

- Week of 26 January – 1st February: “In the crematorium, the foundations of the new furnace were poured and the partition¹⁶⁷ was erected using insulating bricks. Installation of the new combustion furnace was begun.”¹⁶⁸
- 2-8 February: “In the crematorium, work continued on the completion of the new combustion unit.”¹⁶⁹
- 9-15 February: “In the crematorium, the new combustion unit has been completed, except for a few minor details.”¹⁷⁰
- 16-22 February: “The new combustion unit in the crematorium has been completed.”¹⁷¹

The next report stated again that “in the crematorium, work on the new combustion unit was completed,”¹⁷² which probably means that the furnace was finally able to function; it is likely that the drying-in process extended over several weeks.

The new furnace had not been in operation for more than two weeks when the first technical problems arose. On 2 April, the New Construction Office sent Topf a telegram stating: “Second furnace has no draft, send technician here immediately.”¹⁷³ In a letter to Topf of the same day, Schlachter explained that “the second furnace unit does not have sufficient draft which means that the combustion cannot be carried out completely.”¹⁷⁴

Topf replied that no technicians were available, but that the problems could be solved by the crematorium attendants: The two units were connected to the same suction device (*Saugzug-Anlage*) and that, when both were in operation simultaneously, the second one, being farther away from this unit, would have a lower draft. It was necessary, first of all, to close the two flue dampers of the first furnace and to set those of the second one, then to open those of the first one again and to balance the two.¹⁷⁵

In early June, the second furnace was in operation “nearly every day” (*fast täglich*);¹⁷⁵ this probably led to a deterioration of the chimney, which was re-

¹⁶⁶ RGVA, 502-1-327, p. 200.

¹⁶⁷ This partition, set up in the morgue, was to create a space for urns (*Urnenraum*) in accordance with advice from *SS-Neubauleitung* to Topf dated 21 January 1941. RGVA, 502-1-327, p. 185.

¹⁶⁸ *Tätigkeitsbericht* dated 1st February 1941, for the period of 26 January – 1st February. RGVA, 502-1-214, p. 72.

¹⁶⁹ *Tätigkeitsbericht* dated 10 February 1941, for the period of 2-8 February. RGVA, 502-1-214, p. 71.

¹⁷⁰ *Tätigkeitsbericht* dated 17 February 1941, for the period of 9-15 February. RGVA, 502-1-214, p. 70.

¹⁷¹ *Tätigkeitsbericht* dated 22 February 1941, for the period of 16-22 February. RGVA, 502-1-214, p. 68.

¹⁷² *Tätigkeitsbericht* dated 1st March 1941, for the period of 23 February – 1st March. RGVA, 502-1-214, p. 67.

¹⁷³ Letter from Topf to *SS-Neubauleitung* dated 2 April 1941, repeating the text of the telegram: “Zweite Ofenanlage hat keinen Zug sofort Monteur nach hier beordern.” RGVA, 502-1-312, pp. 115f.

¹⁷⁴ RGVA, 502-1-312, p. 113.

¹⁷⁵ Letter from head of Political Section to *SS-Neubauleitung* dated 7 June 1941. RGVA, 502-1-312, p.

paired, in the week of 23-28 June, by strengthening it with angle irons (*Winkelisen*) and tension bolts (*Spannschrauben*).¹⁷⁶ It appears that over the following months, the two furnaces were not able to cope with the number of deaths among the detainees in the camp, even though the Auschwitz Camp was still rather small.¹⁷⁷ Towards the end of September, Topf received a verbal order for “a double-muffle Topf cremation furnace with blower, introduction cart and rotatable platform.”¹⁷⁸

The Topf cost estimate, dated 25 September, showed a price of 7,332 RM, solely for the furnace with the blower.¹⁷⁹ The previous day, Topf had sent the New Construction Office three copies of the operating instructions (*Betriebsvorschrift*) of the double-muffle furnace¹⁸⁰ and of the draft-enhancement device.¹⁸¹ The two documents reached Auschwitz on 26 September as shown by the registration stamp of the New Construction Office. In keeping with bureaucratic regulations, the New Construction Office then confirmed the order by registered mail,¹⁸² and Topf in turn confirmed this confirmation.¹⁸³ The furnace parts, having a total weight of 3,548.5 kg, were shipped by Topf on 21 October.¹⁸⁴

During the month of October, mortality among the detainees rose to 85 deaths per day, and would hit 169¹⁸⁵ the following month. The situation was disastrous. On 11 November, *SS Hauptsturmführer* Karl Bischoff, who had taken over Schlachter’s place as head of the Construction Office¹⁸⁶ on 1st October, sent Topf a telegram in which he informed the company that setting up the third furnace was “extremely urgent” (*äußerst dringend*), and asked when it would be installed.¹⁸⁷ Two days later, Topf confirmed receipt of the cable and announced the arrival of their technician for the 19th.¹⁸⁸ On 17 November, Topf cabled Auschwitz about the date of arrival of the technician Albert Mehr,¹⁸⁹ who, however, did not reach Auschwitz until 29 November because a number of difficulties had been encountered: Topf’s supplier, the firm Collmener Schamottewerke, had not been able to ship the refractory for the new furnace on account of

111.

¹⁷⁶ *Tätigkeitsbericht* dated 28 June 1941, for the period of 23-28 June. RGVA, 502-1-214, p. 31.

¹⁷⁷ The average mortality in the months of August and September was around 36 deaths per day; see Mattogno 2019a, p. 248.

¹⁷⁸ Letter from Topf to *SS-Neubauleitung* dated 25 September 1941. RGVA, 502-2-23, pp. 270f.

¹⁷⁹ *Kostenanschlag* dated 25 September 1941. 502-2-23, pp. 264-268. Cf. Document 198.

¹⁸⁰ APMO, BW 11/1/3, p. 2f. Cf. Document 210.

¹⁸¹ APMO, BW 11/1/3, p. 1. Cf. Document 209.

¹⁸² Letter from *SS-Neubauleitung* to Topf dated 3 October 1941. RGVA, 502-2-23, p. 269.

¹⁸³ Letter from Topf to *SS-Neubauleitung* dated 9 October 1941. RGVA, 502-2-23, p. 272.

¹⁸⁴ *Versandanzeige* dated 21 October 1941. 502-1-312, pp. 104f. Cf. Document 199.

¹⁸⁵ APMO, *Leichenhallenbuch*, D-AuI-5/3; *Totenbuch*, D-AuI-5/1; NO-5850; AGK, NTN, 92, pp. 135f. and 140f.

¹⁸⁶ On 1st July 1941, *SS Neubauleitung* was promoted to *Bauleitung der Waffen-SS und Polizei Auschwitz*, but the correspondence, for some time to come, would bear the former designation. On 14 November 1941 *Bauleitung* promoted to *Zentralbauleitung der Waffen-SS und Polizei Auschwitz*. In the following references, we will quote the designations actually appearing in the respective documents.

¹⁸⁷ RGVA, 502-1-312, p. 102.

¹⁸⁸ RGVA, 502-1-312, pp. 100f.

¹⁸⁹ RGVA, 502-1-312, p. 99.

an embargo of freight cars (*Waggonsperre*).¹⁹⁰ Bischoff sent this company a copy of the permit issued by *Transportkommandantur Oppeln* for the shipment of the refractory materials,¹⁹¹ but the company still was not allotted a freight car.¹⁹² Technician Mehr stayed at Auschwitz from 27 November through 4 December, for a total of 56 working hours and 14 hours of overtime.¹⁹³ As we know from a Topf letter dated 9 December, he “had finished the foundations of the new cremation furnace, as well as repair work on the two coke-fired double-muffle cremation furnaces.”

In this letter, Topf confirmed the order for “providing a technician” it had received from *Bauleiter Schlachter*, announced that the Plützsch Company of Fichtenhainiken/Rositz had loaded a freight car of refractory, and stated:¹⁹⁴

“These materials were ordered by your local KL administration as spares for repair work. We can, however, temporarily make use of these materials – which suffice for the construction of a furnace – for the new furnace and kindly ask you to inform us in time to allow us to dispatch a technician to the site for the erection of the furnace.”

The freight car with the refractories of the Plützsch Company left on 12 December,¹⁹⁵ but arrived at Auschwitz only on 2 January 1942.¹⁹⁶ Topf declared themselves to be ready to dispatch technician Koch to Auschwitz on 5 January 1942.¹⁹⁵ The Central Construction Office changed the date to 5 February, but on 1st February Koch’s departure was postponed to a date yet to be determined.¹⁹⁷ On the other hand, a Topf technician charged the Central Construction Office for 86 hours of work done at the crematorium between 18 and 26 December 1941, including travel and 12 hours of overtime: Who was this technician and what kind of work did he do?

The existing documents, being incomplete, do not allow us to answer that question with certainty. Probably, Topf, pursuant to the Central Construction Office request for “providing a technician” mentioned in the letter of 9 December 1941, had once again sent their technician Mehr to Auschwitz for more repair work on the two furnaces of the crematorium, possibly making use of part of the two tons of insulating material which had arrived at Auschwitz on 15 December 1941 on Topf’s account.¹⁹⁸ It is also certain that a Topf technician worked in the crematorium in the latter half of January 1942, which makes an understanding of the events during that period even more difficult.

¹⁹⁰ Letter from Topf to *Zentralbauleitung* dated 24 November 1941. RGVA, 502-1-312, p. 98.

¹⁹¹ Letter from *Zentralbauleitung* to Collmener Schamottewerke dated 27 November 1941. RGVA, 502-1-312, p. 94.

¹⁹² Letter from Topf to *Zentralbauleitung* dated 5 December 1941. RGVA, 502-1-312, pp. 89f.

¹⁹³ Letter from *Zentralbauleitung* to Topf dated 5 January 1942. RGVA, 502-1-312, p. 82.

¹⁹⁴ APMO, BW 11/1, pp. 4f.

¹⁹⁵ Letter from Topf to *Zentralbauleitung* dated 22 December 1941. RGVA, 502-1-312, p. 81.

¹⁹⁶ Letter from *Zentralbauleitung* to Topf dated 3 January 1942. RGVA, 502-1-312, p. 83.

¹⁹⁷ Telegram from *SS-Hauptsturmführer* Norbert Grosch to *Zentralbauleitung* dated 1st February 1942. RGVA, 502-1-313, p. 176.

¹⁹⁸ RGVA, 502-1-175, p. 339.

On 9 January 1942, the head of the camp administration, ordered to do so by the camp commandant, requested the following jobs for the crematorium to be carried out by the detainee workshop of the Central Construction Office:¹⁹⁹

“Make 2 flat bars 700 × 80 × 8 mm

Repair 3 furnace doors

Repair 2 grates 700 × 30 × 30”

The flat bars (*Flacheisen*) were part of the anchoring system of the third furnace, which was under construction at that time. The *Ofentüren* to be repaired could have been either the doors of the muffles through which the corpses were introduced (*Einführungstüren*) or the hearth gates (*Feuerungstüren*); the latter are more probable because two hearth grates also needed to be fixed. The work was done during the week of 14 through 21 January.²⁰⁰ On 16 January the detainee workshop received the order to “cut threads on the furnace anchoring bolts” (*für die Ofenverankerung*)” and to “make a frame 50 by 50 according to instructions by technician (*n. Angabe des Monteurs*).” The job was executed between 22 and 24 January.²⁰¹ On 31 January, Maximilian Grabner, head of the Political Section, sent to the camp command the following request:²⁰²

“As an engineer of Topf and Sons is presently on the site for the construction of a furnace in this camp, it is requested to repair, on this occasion, Furnace No. 2 of the crematorium, which is in need of repair work.”

The Topf engineer in question was undoubtedly the technician mentioned in the 16 January order to the detainee workshop, and his presence may have rendered the arrival of Technician Koch superfluous.

The repair work on the second furnace, requested by Grabner, was carried out on 4 February, as we can see from a handwritten note on his above-mentioned letter.²⁰² On 10 February, the detainee workshop did further repair work on two hearth gates (“*2 Türen für die Feuerung gangbar machen*”), and fabricated 4 angle irons (*Winkelleisen*)²⁰³ which were part of the anchoring system of the third furnace. On 20 February, another freight car with refractory bricks and mortar shipped by Plützsch Co. on Topf’s account arrived at Auschwitz,²⁰⁴ which means that the shipment from that company which had arrived on 3 January was probably used for the repair work it was intended for.

Construction work on the third furnace ended in late March. The work-in-progress report (*Baufristenplan*) for the month of February indicates the degree of completion for the enlargement (*Erweiterung*) of the crematorium to be 90%²⁰⁵ and the March report states that work had been completed 100% by 31 March.²⁰⁶ This date is confirmed as well by the report on construction of buildings dated 1st April 1942.²⁰⁷

¹⁹⁹ *Werkstättenauftrag Nr. 330* dated 9 January 1942. RGVA, 502-2-1, p. 70.

²⁰⁰ *Häftlingsschlosserei, Arbeitskarte* dated 13 January 1942, *Auftrag Nr. 630*. RGVA, 502-2-1, p. 71.

²⁰¹ *Häftlingsschlosserei, Arbeitskarte* dated 16 January 1942, *Auftrag Nr. 651*. RGVA, 502-2-1, p. 60.

²⁰² RGVA, 502-1-312, p. 77.

²⁰³ *Häftlingsschlosserei, Arbeitskarte* dated 3 February 1942, *Auftrag Nr. 747*. RGVA, 502-2-1, p. 61.

²⁰⁴ RGVA, 502-1-175, p. 108.

²⁰⁵ *Baufristenplan* dated 9 March 1942. RGVA, 502-1-22, p. 12.

²⁰⁶ *Baufristenplan* dated 15 April 1942. RGVA, 502-1-22, p. 11.

²⁰⁷ *Baubericht über den Stand der Bauarbeiten* dated 15 April 1942. RGVA, 502-1-24, p. 320.

“Crematorium: degree of completion in %: 100%. Installed in existing bunker: Cost of construction according to cost estimate I of 31 October 1941: RM 52,000, cost estimate II of 31 October 1941: RM 30,000, so far approved by decree of 25 May 1940: RM 52,000. Ref.: II/E-901/Schr.Sa. Expenses up to 28 February 1942: RM 44,210.18.”

Finally, the third furnace appears in the “Inventory plan of Building No. 47a, BW 11. Crematorium” drawn on 10 April 1942 by Detainee No. 20033,²⁰⁸ the Polish engineer Stefan Swiszcowski who worked as a draftsman at the Central Construction Office.²⁰⁹

Topf’s partial invoice (*Teil-Rechnung*) for the third furnace, made out on 16 December and stamped by Bischoff on 22 December, amounted to 7,518.10 Reichsmarks.²¹⁰ On the basis of this invoice, the Central Construction Office, on 7 January 1942 issued a payment voucher for a progress payment of 3,650 RM, which was paid out on 27 January.²¹¹ Topf sent out a second partial invoice, likewise back-dated to 16 December 1941, which reached Auschwitz only on 22 May 1942,²¹² however, showing a balance of 3,868.10 RM, the result of subtracting from the original cost estimate the 3,650 RM already paid as a progress payment by the SS administration. The final invoice (*Schlussrechnung*), again back-dated to 16 December 1941, which reached Auschwitz on 10 July 1942, shows a balance of 3,768.10 RM including a deduction of 82 RM concerning a rotatable platform (*Drehscheibe*) which had not been supplied.²¹³ The payment voucher for the final payment (*Schlussabrechnung*), in this amount, was issued by the Central Construction Office on 17 July 1942 and payment was effected on 29 July.²¹⁴

During the latter half of May, work on the exterior was carried out: the yard in front of the crematorium was fenced in and provided with two wooden gates, the old pavement was replaced.²¹⁵

After the installation of the third furnace, even-more-serious problems than before arose in the crematorium. On 13 May, the head of the camp administration requested the Central Construction Office to “repair the chimney and the

²⁰⁸ *Bestandplan des Gebäude Nr. 47a B.W.11. Krematorium*. Drawing no. 1241 dated 10 April 1942. RGVA, 502-2-146, p. 21. Cf. Document 206.

²⁰⁹ RGVA, 502-1-256, p. 171.

²¹⁰ Topf, *Teil-Rechnung Nr. 2363* dated 16 December 1941. RGVA, 502-2-23, pp. 263-262a. Cf. Mattogno 2015, Document 25, pp. 98f.

²¹¹ *Abschlagszahlung Nr. 1 für J.A Topf & Söhne in Erfurt* dated 7 January 1942. RGVA, 502-2-23, pp. 262-262a. Cf. Mattogno 2015, Document 26, pp. 100-102.

²¹² Topf, *Teil-Rechnung* dated 16 December 1941. RGVA, 502-1-327, pp. 114-114a.

²¹³ Topf, *Schlussrechnung* dated 16 December 1941. RGVA, 502-1-23, pp. 261-261a (cf. Mattogno 2015, Document 27, pp. 103f.); letter from Topf to *Zentralbauleitung* dated 7 July 1942. RGVA, 502-1-327, p. 104. The rotatable platform was later installed in the furnace hall of the crematorium, where it still exists.

²¹⁴ *Zentralbauleitung, Schlussabrechnung über Lieferung und Errichtung eines Einäscherungssofen der Firma J.A. Topf & Söhne, Erfurt*, dated 17 July 1942. RGVA, 502-2-23, pp. 258-259a; cf.: Mattogno 2015, Document 28, pp. 105-107.

²¹⁵ *Zentralbauleitung, Auftrag Nr. 436, Arbeitskarte Nr. 20 for Tischlerei* dated 13 May 1942: manufacture of two entrance gates (*Einfahrtstoren*) 4 × 3.20 m, work done between 21 and 25 May. RGVA, 502-2-1, p. 24. Description of the job: *Tätigkeitsbericht für den Monat Mai 1942*, RGVA, 502-1-24, p. 299, and *Baubericht für Monat Mai 1942*, RGVA, 502-1-24, p. 261.

motor shed (*Motorenhaus*)^[216] of the crematorium.”²¹⁷ The work was carried out on 14 and 15 May; the first item did not concern the chimney as such but the “*Kaminunterkanal*” *i.e.* the flue-gas channel which linked the three furnaces to the chimney: 50 refractory bricks were replaced, using 50 kg of refractory mortar.²¹⁸ But this was only a skirmish. On 30 May, *SS Oberscharführer* Josef Pollok, acting as the local building inspector, addressed to Bischoff the following report:²¹⁹

“On the chimney of the crematorium at KL Auschwitz, the chimney bracing^[220] has loosened. This was caused by improper execution, as well as, partly, an overheating of the chimney. The braces have not been made as a framework in accordance with their purpose and are therefore useless. As the chimney already shows wide cracks which, though refilled on the outside, also extend into the brickwork in my opinion, there is the danger that the chimney may collapse under a strong wind. To avoid unforeseeable consequences, I ask the head of Central Construction Office to take immediate measures to eliminate this defect. For this purpose, it would be necessary to make sure that all braces are removed and replaced by an appropriate framework in line with good trade practice.”

On 1st June, Bischoff, in a letter to the camp command, endorsed Pollok’s report and, as head of the Central Construction Office and in his capacity as local representative of the building inspectorate (*Baupolizei*), prohibited the use of the chimney on the basis of Article 365 of the civil code, as long as repair work was not carried out completely. Bischoff also asked to forward a request for repair of the chimney to the *WVHA*.²²¹ Sending a copy of his letter to the *WVHA*, Bischoff added:²²²

“The chimney has suffered from overheating on account of its continuous use (operation day and night).”

The camp command no doubt informed the *WVHA* by cable, because on the following day, *SS Brigadeführer* Hans Kammler, head of Office Group C at *WVHA* gave the order for the reconstruction of the crematorium chimney.²²³ On 4 June, Kammler confirmed the order for the immediate reconstruction of the chimney, and asked why he had not been informed in time.²²⁴ Bischoff replied that he had already sent the respective information to the *WVHA* and that he had

²¹⁶ The small building next to the crematorium and the chimney which housed the motor of the draft enhancer.

²¹⁷ *Verwaltung KL Auschwitz. Bestellschein Nr. 451* dated 13 May 1942. APMO, BW11/5, p. 3: “*Den Kamin und das Motorenhaus des Krematoriums instanzzusetzen.*”

²¹⁸ *Aufstellung der ausgeführten Bauarbeiten.* 20 May 1942. APMO, BW 11/5, pp. 5f., and *Bericht über ausgeführte Arbeiten im Krematorium* dated 1st June 1942. APMO, BW11/5, p. 1f.

²¹⁹ RGVA, 502-1-314, p. 12, and 502-1-312, p. 64. Cf. Document 176.

²²⁰ The flat metal braces which enclosed the brickwork of the chimney.

²²¹ RGVA, 502-1-132, p. 62.

²²² RGVA, 502-1-272, p. 256.

²²³ Telegram from *WVHA* dated 2 June 1942 signed by *SS-Obersturmbannführer* Arthur Liebehenschel. RGVA, 502-1-312, p. 61.

²²⁴ Radio message from Kammler received on 4 June 1942 by *Standort-Funkstelle* of Auschwitz. RGVA, 502-1-312, p. 33 and 55.

started to undertake the rebuilding of the chimney as soon as he had received Kammler's radio message.²²⁵

In fact, the very next day, the Central Construction Office got in touch with the firm Robert Koehler at Myslowitz for the reconstruction of the chimney. Koehler explained that the new chimney should measure 25 to 30 m in height, for an internal diameter of 65 to 70 cm, but that a precise design required technical details from Topf. The Political Section, however, wished that the new chimney not be higher than 8 to 10 m and that it should be placed on the same spot as the existing one.²²⁶

The following day, Bischoff informed Topf that the chimney had to be rebuilt at a distance of 7 m from the old one and asked Topf to indicate height and cross-section.²²⁷ On 6 June, Topf replied by telegram, indicating the dimensions in question – a height of 15 m and a cross-section of 0.8 to 1.0 m² – and announced the mailing of a drawing.²²⁸ This drawing – No. D59463 – was delivered at Auschwitz on 12 June. Meanwhile, the Central Construction Office had decided to move the new chimney by 10 m and asked Topf for the dimensions of the corresponding flue-gas channel (*Rauchkanal*).²²⁹ A list dated 13 June shows that the materials required for the rebuilding of the chimney and the flue-gas channel came to 27 tons of refractory bricks of normal size and a Seger-cone index of 26 to 28, for temperatures up to 1,200 to 1,300°C, as well as 2.7 tons of refractory mortar, 25 tons of facing bricks and 100 bags of cement.²³⁰

On 16 June, the Koehler Company presented their proposal to the Central Construction Office: for the construction of a chimney measuring 15 by 0.8 by 1.0 m they demanded 3,650 RM, for the installation of the 12 m flue-gas duct, 1,050 RM, and for the demolition of the old chimney and removal of the rubble 860 Reichsmarks. The work required 24,210 bricks, 6 m³ of slaked lime, 4,400 kg of cement, 20 m³ of sand, 16 m³ of gravel, 27 tons of normal refractory bricks 25 by 12 by 6.5 cm with a Seger-cone index of 28 to 29, 2,700 kg of refractory mortar, 70 iron steps, 6 hand rails, one lightning rod, one access door for cleaning.²³¹ On 20 June, Robert Koehler elaborated the structural design of the chimney²³² and the corresponding drawing.²³³

Two days later, the Central Construction Office gave Robert Koehler the official order (*Auftragserteilung*) for the rebuilding of the chimney on the basis of his offer of 16 June for a total amount of 5,560 RM,²³⁴ but Koehler confirmed receipt only on 14 July.²³⁵ The contract, dated 7 July (Bischoff signed it the fol-

²²⁵ RGVA, 502-1-272, p. 246.

²²⁶ Letter from Robert Koehler to *Zentralbauleitung* dated 5 June 1942. RGVA, 502-1-312, p. 48.

²²⁷ Handwritten telegram from *Zentralbauleitung* to Topf dated 5 June 1942. RGVA, 502-1-312, p. 53. The typed text is contained in Topf's letter dated 6 June. RGVA, 502-1-312, p. 52.

²²⁸ RGVA, 502-1-312, p. 51.

²²⁹ Registered letter from *Zentralbauleitung* to Topf dated 12 June 1942. RGVA, 502-1-312, p. 50.

²³⁰ *Materialbedarf Schornstein (Krematorium Altbestand)*. RGVA, 502-1-318, pp. 3 and 5.

²³¹ RGVA, 502-2-23, pp. 15-15a.

²³² RGVA, 502-1-316, pp. 44-46a. Cf. Document 177.

²³³ "*Schornstein von 15 m. Höhe für die Zentral-Bauleitung der Waffen-SS und Polizei Auschwitz O/S.*" RGVA, 502-2-23, p. 17. Cf. Document 178.

²³⁴ RGVA, 502-1-312, p. 49.

²³⁵ Letter from the Robert Koehler Company to *Zentralbauleitung* dated 14 July. RGVA, 502-2-23, p.

lowing day), was divided into four sections: the contract as such which mentioned the total cost of 5,560 RM, the “Special contractual conditions” which specified the immediate start of the work and its completion within four weeks, as well as a two-year warranty, the “Supplementary contractual obligations” drawn up by the Central Construction Office on 22 June and signed by Koehler on 14 July, and finally the “Assurances by the contractor concerning special obligations” signed by Koehler on 14 July.²³⁶

The budget for the new chimney established by the Central Construction Office on 3 July specified a cost item of 11,500 RM including the materials and work not furnished by Koehler.²³⁷

Various documents mention the work being carried out during the month of June. The *Baufristenplan* for this month states that the work on the chimney began on 12 June on the basis of the order placed on 4 June, degree of progress was 10% with completion scheduled for 10 August.²³⁸ The *Baubericht* informs us that the foundations of the new chimney had been cast and brickwork had started.²³⁹ The *Tätigkeitsbericht der Fahrbereitschaft* (motor-pool log) shows 17 trips to the crematorium by truck for the transportation of the building material and wood.²⁴⁰

On 1st July, the Central Construction Office asked the detainee workshop to fabricate 37 step irons (*Steigeisen*) measuring 25 by 25 cm – to be set into the wall of the chimney to allow access to the top – as well as 6 guard rails and a double door for the soot pit.²⁴¹ The work-sheet was passed on to the detainee workshop the following day, and the job was carried out between 2 and 6 July.²⁴² On 3 July, the Polish engineer Stefan Swiszcowski, Detainee No. D20033, made a new drawing of the crematorium – on the basis of his Drawing No. 1241 of 4 April – showing the positioning of the new chimney and the corresponding flue duct (Pressac 1993, Document 8 (outside of text); cf. my Document 207).

This job was realized only in part, because the flue-gas duct, having a length of 12.20 m, shown on this drawing, was connected only to Furnaces 1 and 2, whereas for Furnace 3, a further, transverse, flue-gas duct was built, 7.375 m long, bringing the total length of the ducts to 19.575 m as shown on the Koehler Drawing of 11 August 1942.²⁴³ On the same day, the Central Construction Office prepared an explanatory report (*Erläuterungsbericht*) for the construction of the chimney, in which we can read:

14.

²³⁶ RGVA, 502-2-23, pp. 5-9.

²³⁷ *Kostenvoranschlag für die Errichtung eines neuen Schornsteines im Krematorium des Konzentrationslager Auschwitz O.S.*, RGVA, 502-1-312, pp. 35f.

²³⁸ *Baufristenplan 1942. Berichtsmonat Juni*. RGVA, 502-1-22, p. 27.

²³⁹ *Baubericht für den Monat Juni 1942*. 502-1-24, p. 221.

²⁴⁰ *Tätigkeitsbericht der Fahrbereitschaft der Zentralbauleitung der Waffen-SS und Polizei Auschwitz für den Monat Juni 1942*. RGVA, 502-1-181, p. 283.

²⁴¹ *Anforderung Nr. 6805* dated 1st July 1942. RGVA, 502-2-1, p. 65.

²⁴² *Auftrag Nr. 1702* dated 2 July 1942. RGVA, 502-2-1, p. 63, and *Arbeitskarte* dated 3 July 1942, *Auftrag Nr. 1702*, *ibidem*, p. 67.

²⁴³ Robert Koehler, *Rauchkanal für die Zentral-Bauleitung der Waffen-SS und Polizei Auschwitz O.S.* dated 11 August 1942. RGVA, 502-2-23, p. 18. Cf. Document 179.

“On account of continual and excessive operation of the crematorium and the ensuing overheating of the chimney, the latter shows major cracks presenting the danger that the chimney might collapse. Repairing the old chimney is not possible. Therefore, by telex dated 2 June 1942, head of Office Group C, SS Brigadeführer and Major-General of Waffen-SS Dr.-Ing. Kammler gave the order for the replacement of the chimney.”

The report goes on to explain that the new chimney had a square cross-section of 90 by 90 cm, and a flue-gas duct 12 m in length with a square cross-section of 70 by 70 cm and a refractory lining of 12 cm in thickness.²⁴⁴ A list of materials compiled by the Central Construction Office on 4 July shows the same items as those mentioned by the Koehler Company in their letter of 16 June.²⁴⁵

In the meantime, the old chimney had not only not been dismantled but was being used intensively. In this matter, SS *Oberscharführer* Pollok sent Bischoff another report on 6 July:²⁴⁶

“During the building safety inspection of the work on the crematorium it was found that the old chimney has developed more cracks, both horizontal and vertical, which must result in a collapse of the chimney. This is due to the fact that the chimney has continued to be used to excess, although Central Construction Office der Waffen-SS und Polizei had prohibited its use by letter of 4 June, Bftgb. 8195/42/Po/Qu., addressed to the camp command.

I ask the Head of Central Construction Office to prohibit once again continued use of the chimney and to ensure that it is demolished immediately, because otherwise the consequences would be incalculable.”

This time, Bischoff’s order was obeyed: during the course of the month, the old chimney was demolished. The *Baubericht* for that month states:²⁴⁷

“BW 11 crematorium. Completion of the new chimney and dismantling of the damaged one including removal of the rubble. At present, laying of the new connecting channel.”

The activity report of SS *Unterscharführer* Heinz Lubitz for July 1942 confirms that the brickwork of the chimney had been completed (*Schornsteinmauern fertiggestellt*) and that the flue-gas channel had been dug and built (*Kanal ausgeschachtet und gemauert*).²⁴⁸

For the very reason that the flue channel was still being worked on, the *Baufristenplan* for that month shows a work progress of 80%.²⁴⁹ During July, the trucks of the Central Construction Office made 15 trips to the crematorium for the transportation of building materials.²⁵⁰

On 24 July, the Koehler Company advised the Central Construction Office that there had been an error in their cost estimate for the demolition of the old

²⁴⁴ *Erläuterungsbericht für die Errichtung eines neuen Schornsteines am Krematorium des Konzentrationslager Auschwitz O/S.* RGVA, 502-1-312, p. 34.

²⁴⁵ *Materialbedarf für Schornsteinbau (Altbestand Krematorium).* 7 Dec. 1942; RGVA, 502-1-318, p. 5. Cf. Document 180.

²⁴⁶ RGVA, 502-1-312, pp. 29 & 31. Cf. Document 181.

²⁴⁷ *Baubericht für Monat Juli 1942.* RGVA, 502-1-24, p. 181.

²⁴⁸ RGVA, 502-1-24, p. 16.

²⁴⁹ *Baufristenplan 1942. Berichtsmonat Juli.* RGVA, 502-1-22, p. 35.

²⁵⁰ *Tätigkeitsbericht der Fahrbereitschaft der Zentral-Bauleitung der Waffen-SS und Polizei Auschwitz für den Monat Juli 1942.* RGVA, 502-1-181, p. 272.

chimney: construction of the new chimney would cost 2,790 rather than 3,650 Reichsmarks.²⁵¹ The new and corrected offer was sent by Koehler to the Central Construction Office on 14 August.²⁵² Work ended in the first ten days of August, and over the whole month there were only five trips to the crematorium by the trucks of the Central Construction Office.²⁵³ The *Tätigkeitsbericht* for the month of August states:²⁵⁴

“New smoke channels linked to the 3 pcs. double-muffle furnaces, covered by slab of reinforced concrete, lightning rod connected and handed over to political administration for operation. Work terminated except for finishing touches.”

The *Baufristenplan* speaks of a degree of completion of 100% as of 10 August,²⁵⁵ but a memo of 7 December gives 8 August as the date of completion: between 12 June and 8 August, 688 detainees had worked on the new chimney – for a total of 7,568 working hours – plus 123 civilian workers – for a total of 1,353 working hours (both groups worked 11 hours per day). The materials used had exceeded the estimates by very little: 25,000 bricks, 6 m³ of white lime, 200 bags of cement, 31 tons of refractory bricks, 3.7 tons of refractory mortar, 66 iron steps, six hand rails, plus three liters of oil, ten liters of gasoline, 17 rolls of roofing felt and 50 liters of inert oil.²⁵⁶

Four days after the work had come to an end, the new chimney was already damaged, because the three furnaces had been operated at full load without waiting for the brickwork to dry out. On 13 August, Bischoff, referring to his telephone conversation with *SS Hauptsturmführer* Robert Mulka the day before, sent the following message to the camp command.²⁵⁷

“On the basis of the telephone conversation mentioned above, camp command was informed that due to a too-rapid heating of the new chimney installation of the crematorium (all 3 furnaces are in operation) damage to the brickwork has already been observed.

As the start-up of the 3 combustion furnaces took place at full load before the mortar of the chimney brickwork had dried out completely, any further responsibility [of this office] for the building must be rejected.”

After all the exertion, the same situation as in June had come about. On 14 August, after a telephone conversation of *SS Unterscharführer* Kirschnek and Robert Koehler, the latter was called to Auschwitz by Bischoff.²⁵⁸ On 19 August, Kirschnek and Koehler inspected the damage to the new chimney.²⁵⁹ Three days later, Koehler, having been asked to do so (*wunschgemäß*), sent to

²⁵¹ RGVA, 502-2-23, p. 13.

²⁵² RGVA, 502-2-23, pp. 11f.

²⁵³ *Tätigkeitsbericht der Zentral-Bauleitung der Waffen-SS und Polizei Auschwitz für den Monat August 1942*. RGVA, 502-1-181, p. 264.

²⁵⁴ *Tätigkeitsbericht des SS-Uscha. Kirschnek Bauführer Abt. Hochbau für Monat August 1942*. RGVA, 502-1-24, p. 197.

²⁵⁵ *Baufristenplan 1942. Berichtsmont August*. RGVA, 502-1-22, p. 38.

²⁵⁶ Handwritten note “*Schornstein-Krematorium. BW 11*” dated 7 December 1942. RGVA, 502-1-318, pp. 4f.

²⁵⁷ RGVA, 502-1-312, p. 27. Cf. Document 182.

²⁵⁸ Letter from *Zentralbauleitung* to Robert Koehler dated 14 August 1942 (erroneously dated 13). RGVA, 502-1-312, p. 26.

²⁵⁹ *Aktenvermerk* dated 21 August 1942. RGVA, 502-1-313, pp. 159f., and APMO, BW 30/27, pp. 13f.

the Central Construction Office a new offer for the erection of another chimney, 15 m high, amounting to 3,100 RM, with an increase of 2,690 RM in case of employment of detainees at company expense; the building materials were offered at 4,195 Reichsmarks. The offer also mentioned the erection of another cremation furnace, as per Drawing 914 of the Central Construction Office, for the price of 12,690 Reichsmarks. But a handwritten note on this letter, dated 26 August and referring to the furnace, states: “*Kommt nicht zur Ausführung,*” i.e. “will not be realized.”²⁶⁰

The camp administration had submitted to *WVHA* the construction request for the chimney as early as 18 August, but the head of Office C VI of that office, *SS Standartenführer* Franz Eirenschmalz, made a mistake when he approved the amount of 11,500 RM, thinking that the approval referred to the chimney that had already been built, as one can see from special observations in his letter, which refer to a reconstruction order by Kammler of 2 July 1942,²⁶¹ while this order was really dated 2 June. Actually, the 11,500 RM so approved concerned the cost estimate for the reconstruction of the chimney dated 3 July.

I have been unable to ascertain with certainty whether the chimney was rebuilt, even though on 29 April 1943 Bischoff informed *WVHA* about the completion (*Fertigstellung*) of the crematorium chimney (and of the shed housing the pumps for the water supply to this plant).²⁶² For reasons of chronology, this report could not easily have referred to a chimney that would have been built by Koehler nearly nine months earlier. Besides, there is no trace in any document for work done on such a project, and moreover, the *Bauausgabebuch* (log of building expenses) for the crematorium, which covers the period of 1st April 1942 through 31 July 1943, has entries only for payments to Koehler in connection with the chimney built in July and August of 1942, viz. 4,659.94 RM,²⁶³ the figure which appears also in Koehler’s invoice of 26 August 1942²⁶⁴ as well as in their final invoice²⁶⁵ and in the final settlement by the Central Construction Office dated 10 February 1943.²⁶⁶

This figure stems from Koehler’s second offer of 14 July 1942, but shows a price increase, because, as we have already stated, in addition to the flue-gas channel covered by the first offer, Koehler had built a further channel, changing the total channel length from 12 to 19.5²⁶⁷ meters. The pertinent addendum to the contract between the Central Construction Office and Koehler explains the details.²⁶⁸

²⁶⁰ RGVA, 502-1-313, p. 157.

²⁶¹ Letter from *WVHA* to *Verwaltung des Konzentrationslager Auschwitz /O.S* dated 31 August 1942. RGVA, 502-1-312, p. 23.

²⁶² RGVA, 502-1-312, p. 9, and 502-1-149, p. 336.

²⁶³ *Bauausgabebuch 11. Bauwerk 11 – Krematorium*. RGVA, 502-2-37, pp. 26-32.

²⁶⁴ Robert Koehler, *Rechnung* dated 26 August 1942. RGVA, 502-1-312, p. 23.

²⁶⁵ Robert Koehler, *Schlussrechnung* dated 22 December 1942. RGVA, 502-2-23, p. 4

²⁶⁶ *Zentralbauleitung, Schlussabrechnung* dated 10 February 1943. RGVA, 502-2-23, p. 1-1a.

²⁶⁷ More precisely 19.575 m as we can see from the two invoices from Koehler mentioned above.

²⁶⁸ *Nachtrag zur Vertragsurkunde* dated 23 November 1942. RGVA, 502-2-23, p. 16.

After August 1942, the only reliable information I have found concerns the repair of an electric blower (*Gebläse*) on Furnace 2 on 1st September 1942 (for the blower (*Druckluftanlage*) of this furnace).²⁶⁹

In January of 1943, a *Schweizer Baracke*²⁷⁰ for the Political Department²⁷¹ was erected next to the crematorium, which suggests that the chimney had at last been repaired.

It is nearly certain that the crematorium ceased its operation on 17 July 1943, in accordance with the following letter written by Bischoff the previous day and addressed to the head of SS garrison administration (*SS Standortverwaltung*), *SS Obersturmbannführer Möckel*:²⁷²

“This office informs you that the placement of the two barracks for the Political Department, the Schweizer Baracke in particular, was based on the condition that Crematorium I would cease its operation completely, as we were assured in the a.m. discussion with SS Ustuf. Grabner.

Now that work on the two barracks has almost been completed, we have found that the crematorium went into operation once again.

The high flammability of these structures requires that the crematorium be taken out of service; any responsibility for ensuing damage by fire must be rejected [by this office].”

6.2. The Furnaces of Crematoria II and III at Birkenau

The problems concerning cremations became even more serious when construction of the Birkenau Camp was launched on 15 October 1941. For the new camp, which was originally projected to take in 125,000 Soviet PoWs – its official designation *Kriegsgefangenenlager (KGL or K.G.L.)*²⁷³ reflects this – the Construction Office had planned for a crematorium with five furnaces of three muffles each, plus an underground morgue (*Leichenkeller*) and waste incinerator (*Müllverbrennungsofen*); but the installation was to be set up within *KL Auschwitz (Main Camp)* rather than in Birkenau;²⁷⁴ for the Birkenau *KGL* only a mortuary hall (*Leichenhalle*) was planned, as we can gather from the earliest known document (7 October 1941).²⁷⁵ As opposed to this, the plan for the *KGL* dated 5 January 1942 shows ten morgues and two cremation halls (*Verbrennungshallen*),²⁷⁶ each of which was to be provided with one triple-muffle furnace of a simplified design.

²⁶⁹ RGVA, 502-1-153, p. 5.

²⁷⁰ Wooden barracks measuring 28.20 by 6.20 meters.

²⁷¹ The respective *Übergabeverhandlung* is dated 8 February 1943. RGVA, 502-2-150, pp. 7-9; cf. Mattoigno 2015, Documents 13-15, pp. 78-80.

²⁷² RGVA, 502-1-324, p. 1; cf. Document 183.

²⁷³ As opposed to this, the official designation for the Auschwitz Camp was *Konzentrationslager (K.L.)*.

²⁷⁴ *Erläuterungsbericht zum Vorentwurf für den Neubau des Kriegsgefangenenlagers der Waffen-SS, Auschwitz O/S*. RGVA, 502-1-233, p. 20.

²⁷⁵ *Lageplan des Kriegsgefangenenlagers-Auschwitz O.S.* dated 7 October 1941, in: Pressac 1989, p. 185.

²⁷⁶ *Lageplan des Kriegsgefangenenlagers Auschwitz Ober-Schlesien* dated 6 January 1942, in: *ibid.*, p. 189; *Lagerskizze des Vorhabens Kriegsgefangenenlager der Waffen-SS in Auschwitz. Einfriedigung (fence)*. RGVA, 502-1-235, p. 13; cf. Document 184.

A “Lay-out plan of the PoW camp at Auschwitz, Upper Silesia, Plan No. 885,” drawn by *SS WVHA* on 5 January 1942,²⁷⁷ checked (“*geprüft*”) by *SS Untersturmführer* Dejaco on 5 January and approved (“*genehmigt*”) by Bischoff the following day, 6 January, does maintain in its legend the indication “*V...Verbrennungshalle*,” but no longer shows the symbols representing these two installations; instead, we have a “*Krematorium*” measuring 55.50 m by 12.0 m with a chimney wing of 12 by 10 meters – the future Crematorium II (cf. Document 185). This means that the decision to move the new crematorium with its five triple-muffle furnaces from the Main Camp to the Birkenau *KGL* had already been taken in Berlin.

According to the Topf estimate of 12 February, the two furnaces initially planned for the cremation halls were priced at 14,212 RM, plus 440 RM for the chimney lining (cf. Document 228). On 27 February, when *SS Oberführer* Kammler came to Auschwitz on an inspection tour, the decision to move the new crematorium to Birkenau was confirmed, and the order for the two triple-muffle furnaces originally to be installed there was cancelled. Topf, though, requested 1,769.36 RM as payment for the design work.²⁷⁸ In order to avoid paying out this sum for no useful purpose, the Central Construction Office, with the approval of the head of Office C/III of *WVHA*, *SS Sturmbannführer* Wirtz, decided to maintain the project and to use the furnaces in a different building.²⁷⁹ Topf was informed of this decision on 8 April,²⁸⁰ but the company had already mailed the corresponding invoice to the Central Construction Office on 17 March.²⁸¹ As we will see, the two furnaces are mentioned for the last time in a file memo of the Central Construction Office dated 21 August 1942 (cf. Document 187), but it is not known whether they were ever set up.

The KL Auschwitz construction program for the third year of the war, drawn up after Kammler’s visit on 27 February, included the installation of a “crematorium in the PoW camp” (*Krematorium im Kriegsgefangenenlager*)²⁸² budgeted at 403,000 RM, less than 2% of the total budget (24,254,300 RM).²⁸³ This crematorium was the one originally planned for the *Stammlager*.

Work was assigned to the Topf Company. On 11 October 1941 the Construction Office cabled the Erfurt firm asking for Prüfer to be sent to the camp “for the new construction of a crematorium.”²⁸⁴ On the 14th Topf confirmed receipt of the telegram, saying that Prüfer would arrive on the 21st at 9 o’clock,

²⁷⁷ *Lageplan des Kriegsgefangenenlagers Auschwitz – Ober-Schlesien*, Plan Nr. 885, RGVA, 502-2-95, p. 7.

²⁷⁸ According to Bischoff’s letter dated June 1943, the project referred to the construction of the chimney, cf. Subchapter 6.2.

²⁷⁹ Letter from *Zentralbauleitung* to head of *Amt C/III* at *WVHA* dated 30 March 1942. RGVA, 502-1-313, p. 174.

²⁸⁰ Letter from *SS-Sturmbannführer* Wirtz to Topf dated 8 April 1942. RGVA, 502-1-313, p. 173.

²⁸¹ Letter from *Zentralbauleitung* to *Amtsgruppe C III/I* at *WVHA* dated 15 April 1942. RGVA, 502-1-313, p. 171.

²⁸² Letter from *WVHA* to *Zentralbauleitung* dated 2 March 1942. RGVA, 502-1-319, p. 211, and NO-4464.

²⁸³ Letter from *Zentralbauleitung* to *WVHA* dated 17 March 1942. RGVA, 502-1-319, pp. 202-206.

²⁸⁴ RGVA, 502-1-313, p. 179.

which was what happened.²⁸⁵ On 21 and 22 October, Prüfer, in fact, had meetings with *Bauleiter* Bischoff during which the latter gave a verbal order to Topf for: five triple-muffle furnaces with blower, two Topf draft-enhancing devices in suction for about 10,000 m³ per hour, and a waste incinerator. Delivery was to be three months and the foundations were to be poured within eight weeks. On the basis of the plans handed to Prüfer, Topf was furthermore to calculate the required height and cross-section of the chimney.²⁸⁶ Referring to these meetings, Topf asked the Construction Office on 31 October for a written confirmation (*Bestätigungsschreiben*) of Bischoff's verbal order²⁸⁷ and announced the forthcoming dispatch of various documents concerning the crematorium (cost estimates, drawings for the triple-muffle furnace, for the foundations, for the chimney etc.).

The first detailed description of the new crematorium is contained in a letter written by Topf on 4 November which is important enough to be quoted in its entirety:²⁸⁸

"We thank you for the order concerning
5 Topf triple-muffle incineration furnaces with blower
2 coffin-introduction devices with rail system for 5 furnaces
3 Topf draft enhancers in suction
1 Topf waste incinerator.

Flue-gas section

We accept this order on the basis of the cost estimate attached^[289] and its conditions, for a total price of 51,237 RM.

We supply:

- a) For the 5 Topf triple-muffle cremation furnaces all refractories and insulating materials, fittings of cast and wrought iron, the blowers with drives and the cost of two builders for the supervision of the work.*
- b) The 2 coffin-introduction devices with their mobile carts, including distribution rails for the 5 cremation furnaces.*
- c) The 3 Topf draft enhancers in suction including drives, and supply of a builder for installation of the devices*
- d) For the waste incinerator, all refractories and insulating materials, including the fittings of cast and wrought iron, and the cost of a builder for the supervision of the work.*
- e) For the flue-gas ducts, all refractories and insulating materials, and the supply of a builder.*

To be supplied by the customer:

For the furnaces and the flue ducts, all construction materials such as bricks, sand, lime and cement in the quantities to be derived from the cost estimate as well as all wrought-iron anchor bars at no cost to us.

You will, moreover, supply our builders with a sufficient number of assistants at no cost to us.

²⁸⁵ Letter from Topf to *SS-Neubauleitung* dated 14 October 1941. RGVA, 502-1-313, p. 178.

²⁸⁶ Letter from *SS-Neubauleitung* to Topf dated 22 October 1941. RGVA, 502-1-313, pp. 36f., and AP-MO, BW 30/34, p. 116; BW 30/27, p. 27.

²⁸⁷ Letter from Topf to *SS-Neubauleitung* dated 31 October 1941. RGVA, 502-1-312, p. 103.

²⁸⁸ Letter from Topf to *SS-Neubauleitung* dated 4 November 1941. RGVA, 502-1-313, pp. 81-83. Cf. Document 186.

²⁸⁹ I have not found this document.

Construction time of the plant as estimated by us must not exceed 8 weeks, because we have based the dispatch of our personnel on this period. If construction time were to be extended, working hours furnished must be reimbursed at daily rates.

In view of the fact that the cold season will not allow work on the furnaces to be carried on in unheated surroundings, you will ensure the rapid construction of the furnace hall and its heating.

Delivery:

We shall do our best to ensure delivery of the furnaces within the 3 months requested by you. This assumes that no delay is encountered in the supply of the materials and that no further manpower is removed [for military or other duties].

We shall require from you 6 freight bills with the necessary priorities and we ask you to let us have them as soon as possible.

Kennziffer:

We ask you to ensure that an authorization code for 17,600 kg be assigned to us as soon as possible.

Drawings:

You will receive shortly the drawings for the preparation of the foundations of the furnaces and for the manufacture of the anchor bars.

We attach the drawing for the overall lay-out with the positioning of the furnaces, the flue-gas channels and the de-aeration section, as well as a drawing of the triple-muffle furnace.

Design:

We wish to underline that the furnace muffles are now larger than in the previous furnaces. By this, we intend to achieve a higher efficiency.^[290] For the same reason, we have included 3 draft enhancers in suction instead of 2, also taking into account that frozen corpses will have to be incinerated as well, requiring more fuel and thus increasing the spent-gas volume.

We assure you of the supply of an installation in keeping with the state of the art, and of proper workmanship, and salute you, Heil Hitler."

Prüfer tried furthermore to make use of his increasingly influential situation at Auschwitz in order to obtain a special treatment for Ludwig Topf, one of the two co-directors of the firm, who was doing military service at the time as a *Bausoldat* in the 3rd Construction Reserve Battalion (*Bau-Ersatz-Bataillon*) stationed in Thuringia – very-probably in keeping with a request of the other co-director of the firm, Ernst Wolfgang Topf. On 12 November 1941, after a telephone conversation with a Topf employee – Prüfer, most-likely – Bauleiter Bischoff sent a letter to the Weimar *Rüstungskommando* requesting a temporary-duty assignment of three weeks for Ludwig Topf, wrongly described as a Topf project engineer (*Sachbearbeiter*), for the new crematorium-construction work which was to begin on 18 November. In this letter, Bischoff gives some interesting explanations concerning the purpose of the new crematorium.²⁹¹

"The Topf & Söhne Co. combustion plants, of Erfurt has been ordered by this authority to build a cremation plant as quickly as possible, in view of the fact

²⁹⁰ The term *Leistung* also indicates the performance.

²⁹¹ RGVA, 502-1-314, pp. 8-8a.

that Concentration Camp Auschwitz has been augmented by a PoW camp which is to take in some 120,000 Russians shortly. The construction of the incineration unit is most urgent, if epidemics and other risks are to be avoided."

It appears that the leave was not granted, because on 21 November, Prüfer launched another effort by means of a letter to Bischoff, marked "strictly personal." Prüfer, who was about to go to Auschwitz, wanted to take Ludwig Topf along and have him participate in the discussions in the alleged role of a project engineer for the triple-muffle furnace.²⁹² For this reason, he asked Bischoff to send Topf a cable as follows:²⁹³

"Urgently requesting visit by Ludwig Topf 2-5 December for discussion new furnace construction."

Bischoff accepted and sent Topf a telegram with this text, undated,²⁹⁴ but surely transmitted on 25 November, the day on which Prüfer's letter was registered at Auschwitz. What happened after that is not known, as Ludwig Topf's name no longer appears in the correspondence between the company and the Central Construction Office.

The first drawing of the new crematorium was prepared by *SS Untersturmführer* Walter Dejaco on 24 October 1941.²⁹⁵ On 20 November 1941, *HHB* sent the Central Construction Office two sketches approved by the head of Office II B,²⁹⁶ in which, however, the chimney with its two smoke ducts was located in an unsuitable position. On 3 December, the Central Construction Office forwarded to the head of Office II B a drawing showing the positioning of the crematorium, the chimney, the flue ducts and the draft enhancers, pursuant to Topf's layout. In particular, it was requested to approve the central location of the chimney as a means of avoiding overly long ducts.²⁹⁷

The parts of the five triple-muffle furnaces were sent by Topf in two separate shipments: the first freight car (No. 4.62703 B.M.B.) left on 16 April 1942 with a load of 11,149 kg and arrived at Auschwitz on the 18th (cf. Document 213); the second one (No. 93413 Erfurt X) with a load of 4,948 kg followed on 18 June and arrived on the 20th (cf. Document 214). On 8 May, Topf sent the Central Construction Office the drawing for the installation of the three draft enhancers (D59389) and the drawing for the waste incinerator (D59434), which could be fed from either side.²⁹⁸ During May, Topf installed at Buchenwald the first of the two triple-muffle furnaces for the local crematorium; this furnace, which was of the same type as the five triple-muffle furnaces planned for Auschwitz, could however not be started up for lack of the blower (*Gebläse*) and its motor.

²⁹² Actually, the furnace with three muffles, just like the 8-muffle furnace, was designed by Prüfer. Letter from Kurt Prüfer to Ludwig and Ernst Wolfgang Topf dated 6 December 1941. APMO, BW 30/46, p. 6.

²⁹³ RGVA, 502-1-314, pp. 2f.

²⁹⁴ RGVA, 502-1-314, p. 5.

²⁹⁵ The drawing includes the façade and the elevation of the crematorium. The two drawings have been published by Pressac 1993, his Document 9.

²⁹⁶ RGVA, 502-1-313, p. 68. The two sketches have been published by Pressac (1993, Documents 10f.).

²⁹⁷ RGVA, 502-1-312, p. 93.

²⁹⁸ Letter from Topf to *Zentralbauleitung* dated 8 May 1942. RGVA, 502-1-312, pp. 65-68.

Therefore, on 29 May, Topf asked the Auschwitz Central Construction Office to send this device to the Weimar-Buchenwald Central Construction Office by taking it from the Auschwitz parts, but Auschwitz refused: the blower was intended for the Auschwitz furnaces and would be required shortly. Topf was also told by Auschwitz that the construction of the crematorium was proceeding at “full throttle.”²⁹⁹ Work, in fact, had begun on 2 June³⁰⁰ with the digging of the pit (*Baugrube*) for the foundations,³⁰¹ which concluded in July.³⁰² On 2 August, the Central Construction Office sent to the Huta Company the crematorium Drawings Nos. 936, 1173, 1174, 934, 980, 933, 1311, 932, 1301 and 1341 for the structural design of the building.³⁰³

By 14 August, the *Kommando Krematorium* was already 80-inmates strong.³⁰⁴ On Monday, 17 August, Topf cabled the Central Construction Office that Engineer Prüfer would arrive on Wednesday, 19, at 8 o'clock.³⁰⁵ In fact, at 2 PM on 19 August, Prüfer had a long meeting with SS *Untersturmführer* Fritz Ertl in the offices of the Central Construction Office, possibly in the presence of Robert Koehler, which Ertl recorded in a detailed memo (*Aktenvermerk*) on 21 August. The decisions taken at the meeting were as follows:³⁰⁶

“1) *Mechanic Holik will arrive here from Buchenwald on 26/27 August at the latest, Builder Koch in two weeks. Erection of the 5 pcs. triple-muffle furnaces at KGL will start immediately. The Koehler Co. of Myslowitz will undertake the lining of the furnaces and the ducts as well as the erection of the chimney in accordance with the drawings and specifications of Topf & Söhne Co.*

2) *Concerning the placement of 2 triple-muffle furnaces near the ‘bathing facilities for special actions’³⁰⁷ Eng. Prüfer suggested to take these furnaces from a consignment to Mogilev ready to be shipped; the [Auschwitz] section chief presently at SS Wirtschafts- und Verwaltungshauptamt in Berlin was notified of this immediately by telephone and was requested to take the necessary steps.*

3) *Concerning the erection of a 2nd crematorium with 5 triple-muffle furnaces as well as aeration and de-aeration installations, results of the negotiations on assignment of materials, already under way with Reichssicherheitshauptamt (RSHA), must first be waited for.*

4) *Topf & Söhne Co. has by mistake sent to Auschwitz the parts of a double-muffle incineration furnace actually destined for Mauthausen. Eng. Prüfer suggests erecting this furnace here. The 2 introduction doors and the 2 ash-removal doors still missing can in the meantime be taken from the shipment of the 5 triple-muffle furnaces.*

5) *The damages to the newly erected chimney for the existing crematorium [at the Main Camp] were inspected in the company of Herr Koehler and SS Unter-*

²⁹⁹ Letter from *Zentralbauleitung* to Topf dated 5 June 1942, RGVA, 502-1-272, p. 499, and letter from Topf to *Zentralbauleitung* dated 6 June 1942, RGVA, 502-1-312, p. 52.

³⁰⁰ The *Baufristenplan* dated 2 October 1943 erroneously speaks of 2 July 1942. RGVA, 502-1-320, p. 7.

³⁰¹ *Zentralbauleitung, Baubericht für Monat Juni 1942*. RGVA, 502-1-24, p. 224.

³⁰² *Zentralbauleitung, Baubericht für Monat Juli 1942*. RGVA, 502-1-24, p. 184.

³⁰³ RGVA, 502-1-313, p. 164.

³⁰⁴ Letter from *Zentralbauleitung* to *Kommandantur* dated 14 August 1942. RGVA, 502-1-313, p. 162.

³⁰⁵ RGVA, 502-1-272, p. 507.

³⁰⁶ RGVA, 502-1-313, pp. 159f. Cf. Document 187.

³⁰⁷ *Badeanstalten für Sonderaktionen*. Concerning these installations, cf. Mattogno 2016, pp. 70-76.

scharführer Kirschnek and measures to be taken were discussed. – As the chimney lining expands under the great heat, it must be enabled to move freely at the top and must not be attached to the outer mantle.

6) On Thursday, 20 August 1942, the building site of the 5 triple-muffle furnace [sic] at KGL was inspected in the presence of SS Strm. [Sturmmann] Janisch and Herr Koehler, and the necessary measures were discussed.

7) Eng. Prüfer requested a written order for the supply of the 2 pcs. triple-muffle furnace and the double-muffle incineration furnace, as well as to be informed soonest as to whether the furnaces of the Mogilev consignment can be diverted.

8) For the supply of the fireclay and other materials still missing, Topf & Söhne Co. must immediately be supplied with 10 freight bills.”

In an effort to support his suggestions, Prüfer asked Topf to send four copies of Drawing D59599 of the triple-muffle furnace, which went out on 20 August;³⁰⁸ however, as we shall see in the following section, the only suggestion accepted was the diversion to Auschwitz of two furnaces from the Mogilev consignment.

On 24 August, Robert Koehler proposed to the Central Construction Office the construction of the flue ducts, having sections of 1.20 m × 0.80 m and 0.70 m × 0.60 m respectively, on the basis of Drawing No. 932 for the sum of 3,950 RM, as well as the installation of the triple-muffle furnaces (lining and flue duct) on the basis of Drawing No. D59090, for a price of 2,100 RM per furnace.³⁰⁹

On 11 September, the Central Construction Office asked the firm Huta Hoch- und Tiefbau A.G. urgently to provide to Topf five bricklayers “for the erection of the combustion furnaces in the KGL crematorium.”³¹⁰ Work on the furnaces began during that month;³¹¹ by October, one furnace had been finished with another under way,³¹² in November, two furnaces had been completed with another two under construction.³¹³ Work, including the flue ducts and the chimney, was finished in January of 1943.³¹⁴

Work on the chimney ended in October of 1942 with the installation of the lightning rods, as shown by an order given by the Central Construction Office to the electricians’ section on 17 October for the following job on the [future] Crematorium II: “Fabricate and install a four-part lightning rod on the chimney of Crematorium I of KGL”; the work was done between 23 and 27 October.³¹⁵

Construction of Crematorium III began on 14 September 1942³¹⁶ with the necessary excavations (*Schachtarbeiten*);³¹⁷ initially, on 23 September, 60 detainees were assigned to this job.³¹⁸ Two days later, the Central Construction

³⁰⁸ Letter from Topf to *Zentralbauleitung* dated 20 August 1942. RGVA, 502-1-313, p. 161.

³⁰⁹ Letter from Robert Koehler to *Zentralbauleitung* dated 24 August 1942. RGVA, 502-1-313, p. 157.

³¹⁰ RGVA, 502-1-313, p. 133.

³¹¹ *Zentralbauleitung, Baubericht für Monat September 1942*. RGVA, 502-1-24, p. 138.

³¹² *Zentralbauleitung, Baubericht für Monat Oktober 1942*. RGVA, 502-1-24, p. 86.

³¹³ *Zentralbauleitung, Baubericht für Monat November 1942*. RGVA, 502-1-24, p. 53.

³¹⁴ Bericht Nr. 1 of *Zentralbauleitung* concerning Krematorien Kriegsgefangenenlager. Bauzustand sent to WVHA on 23 January 1943. RGVA, 502-1-31, p. 54.

³¹⁵ *Zentralbauleitung, Arbeitskarte, Auftrag Nr. 2250/250* dated 17 October 1942. RGVA, 502-2-8, p. 8-8a.

³¹⁶ *Zentralbauleitung, Baufristenplan* dated 2 October 1943. RGVA, 502-1-320, p. 7.

³¹⁷ *Zentralbauleitung, Baubericht für Monat September 1942*. RGVA, 502-1-24, p. 138.

³¹⁸ Phone call by SS *Obersturmführer* Schwarz of 22 September 1942. RGVA, 502-1-19, p. 271.

Office placed an order with Topf by telephone for five triple-muffle furnaces, three draft enhancers in suction and the necessary refractories for the flue ducts of Crematorium III. As we can see from Topf's letter of confirmation, the corpse-introduction system for these furnaces had been simplified:³¹⁹

"Furthermore, for the new order, we have altered the coffin-introduction device by providing each furnace with a wrought-iron stretcher for the placement of the corpses, and with the necessary rollers on the furnace."

This system obviously rendered the rail device superfluous. On 5 October, Topf sent the Central Construction Office Drawing No. D59389 concerning the draft enhancers for Crematoria II and III.³²⁰ On 6 October, Topf's master bricklayer (*Polier*), Wilhelm Koch, who was working on the furnaces for Crematorium II, received permission from Bischoff to enter the Central Construction Office workshops "to check on the fabrication of anchoring parts for the KGL crematorium."³²¹

The detainee workshop (*Häftlings-Schlosserei*) had been assigned this job on 8 September, and worked on it with 22 detainees between 9 September and 11 December 1942 for a total of 2,389 working hours, 24 of which were devoted to welding.³²²

On 26 October, the Central Construction Office informed Topf that Crematorium III would be built facing Crematorium II and would be its mirror image.³²³ On the same day, the Central Construction Office confirmed to Topf in writing its verbal order of 25 September on the basis of Topf's estimate of 30 September, viz.: five furnaces of three muffles with five coffin-introduction stretchers (*Sarg-einführtragen*) for 39,150 RM, three draft enhancers in suction for 9,048 RM; the refractory materials for the flue ducts for 5,504 RM; for a total of: 53,702 Reichsmarks.³²⁴

On 31 October, Topf gave written confirmation of the order at the prices indicated.³²⁵ On 28 October and at the request of the Central Construction Office dated 22 October, Topf sent to Auschwitz Drawing No. D59394 "for furnace II and III of KGL."³²⁶ During October, the foundations of the chimney were poured, and chimney construction was begun for Crematorium III,³²⁷ by the end of November, the chimney had reached a height of 9 meters.³²⁸

On 27 November, Prüfer inquired by telephone as to the priorities of the three items of the order dated 26 October and the corresponding erection work; the inquiry was repeated in writing on 30 November. The Central Construction

³¹⁹ Letter from Topf to *Zentralbauleitung* dated 30 September 1942. APMO, BW 30/34, p. 114, and BW 30/27, p. 30.

³²⁰ Letter from Topf to *Zentralbauleitung* dated 5 October 1942. RGVA, 502-1-313, p. 115.

³²¹ *Zentralbauleitung, Bescheinigung* dated 6 October 1942. RGVA, 502-1-41, p. 159.

³²² *Zentralbauleitung, Häftlings-Schlosserei. Arbeitskarte. Auftrag Nr. 1962, "Verankerungen für 5 Stück Muffelöfen lt. beiliegender Zeichnung"* dated 8 September 1942. RGVA, 502-2-8, pp. 37-37a.

³²³ RGVA, 502-1-313, p. 95.

³²⁴ Letter from Topf to *Zentralbauleitung* dated 26 October 1942. RGVA, 502-1-313, p. 93 and 502-2-26, p. 216.

³²⁵ Letter from Topf to *Zentralbauleitung* dated 31 October 1942. RGVA, 502-1-313, p. 87.

³²⁶ APMO, BW 30/34, p. 95.

³²⁷ *Zentralbauleitung, Baubericht für Monat Oktober 1942*. RGVA, 502-1-24, p. 86.

³²⁸ *Zentralbauleitung, Baubericht für Monat November 1942*. RGVA, 502-1-24, p. 53.

Office replied that it intended to give priority to the de-aeration of the old crematorium at KL, and then to the installation of the draft enhancers of Crematorium II.³²⁹ In December of 1942, work was stopped for several days – a disinfection and disinfection campaign had become imperative because the typhus epidemic which had broken out in early July was still ravaging the camp. As hand-over dates, under conditions of favorable weather, for the three most-advanced crematoria were projected:³³⁰

- Crematorium II: 31 January 1942
- Crematorium III: 31 March 1943
- Crematorium IV: 28 February 1943.

On 22 December 1942, the Central Construction Office informed Topf that Himmler had declared the above dates to be inextensible for Crematoria II and III: the Erfurt company was asked to make the necessary efforts with respect to the deliveries and the erection work. A visit by Prüfer was suggested in order to check on the progress of the project.³³¹ The deadlines set by Himmler were illusory, as the degree of completion of the crematoria was still low at the end of December: Crematorium II: 60%; Crematorium III: 20%; Crematorium IV: 15%; Crematorium V: 5%.³³²

Realizing this, the Central Construction Office asked WVHA for an extension, which Kammler granted on the condition that the work be accelerated in spite of the difficulties encountered. He also requested to be informed weekly by telegram of the degree of progress.³³³ Bischoff applied Kammler's conditions to the letter and, as early as 20 November, gave a job order to the electricians' section for "Construction lighting in Crematorium II, as well as aiming of searchlights for night work / sentry chain."³³⁴

On 23 January the Central Construction Office placed an order with the Otto Schuler Co. of Beuel for 10 coal-hauling carts (*10 Stück Kohletransportwagen*) for Crematorium II, but the company was not in a position to supply them.³³⁵ On 6 and 31 January 1943, Central Construction Office trucks performed four trips transporting refractories and mortar to Birkenau for the Topf project.³³⁶ On 29 January, Prüfer inspected the worksites and wrote a report on the state of progress. The five triple-muffle furnaces of Crematorium II were being dried in ("werden z. Zt. trockengeheizt"), and start-up was scheduled for 15 February.

On the subject of Crematorium III, Prüfer wrote:³³⁷

³²⁹ Letter from Topf to *Zentralbauleitung* dated 30 November 1942. RGVA, 502-1-313, p. 61; letter from *Zentralbauleitung* to Topf dated 30 November 1942. RGVA, 502-1-314, p. 17.

³³⁰ *Fernschreiben* (telex) from *Zentralbauleitung* to the WVHA dated 18 December 1942. APMO, BW 30/27, p. 17.

³³¹ Letter from *Zentralbauleitung* to Topf dated 22 December 1942. APMO, BW 30/27, p. 19.

³³² *Zentralbauleitung, Baubericht für Monat Dezember 1942*. RGVA, 502-1-24, p. 7.

³³³ Letter from WVHA to *Zentralbauleitung* dated 11 January 1943. RGVA, 502-1-313, p. 59.

³³⁴ *Zentralbauleitung, Arbeitskarte, Auftrag Nr. 98/291* dated 20 December 1942. RGVA, 502-2-8, pp. 1-1a.

³³⁵ Letter from Otto Schuler Co. to *Zentralbauleitung* dated 28 January 1943. RGVA, 502-1-313, pp. 51-51a.

³³⁶ *Tätigkeitsbericht der Fahrbereitschaft der Zentral-Bauleitung der Waffen-SS und Polizei Auschwitz O/S für den Monat Januar 1943*. RGVA, 502-1-181, p. 221.

³³⁷ *Prüfbericht des Ing. Prüfer* to *Zentralbauleitung* dated 29 January 1943. APMO, BW 30/34, p. 101.

“The outer walls of the furnace building as well as the chimney have been completed. Work on the smoke ducts for the incineration furnaces will begin in 8 days. Installation of the 5 pcs. triple-muffle incineration furnaces could begin in about 5 weeks’ time. Start-up for these incineration furnaces is possible on 17 April 1943 at the earliest.”

In his file memo (*Aktenvermerk*) of the same day, *SS Untersturmführer* Kirschnek, who had accompanied Prüfer during the inspection tour, added that the ceiling of the furnace hall at Crematorium III was under construction, and that the respective chimney would be ready in three days’ time.³³⁸ To make sure that everything would run on schedule, the Central Construction Office asked Topf on 2 February that Prüfer be delegated to Auschwitz for three days of each week. The Erfurt company gave its approval,³³⁹ but it is not certain that Prüfer returned before 15 February. However, on account of various obstacles, partly caused by failures on Topf’s part, work proceeded slowly, and start-up of Crematorium III was moved back to 10 April 1943.³⁴⁰

For Crematorium II, the Central Construction Office placed an order with Topf on 10 February for a coal-loading device and an ash-removal device (*Kohlenbeschickungs- und Aschentransportvorrichtung*)³⁴¹ as well as, the following day, for a waste incinerator (*Müll-Verbrennungsofen*) for Crematorium III for a total of 5,791 Reichsmarks.³⁴² In an effort to render Topf more responsive, the Central Construction Office meanwhile turned to Kammler, explaining the problems encountered with this company.³⁴³ On 12 February, Topf confirmed receipt of the cable from the Central Construction Office two days earlier, and announced Prüfer’s arrival at Auschwitz on the 15th, for transmittal of the proposals concerning the coal-loading and the ash-removal devices.³⁴⁴ The visit probably did take place, because a Topf letter dated 26 February mentions a meeting (*Unterredung*) of Prüfer and the civilian employee Jährling on the subject of the disinfection furnaces (*Entwesungs-Öfen*) for *BW 32 (Zentralsauna)*. As an attachment to this letter, Topf sent to the Central Construction Office, for filing, Drawing No. D59090 of the triple-muffle furnace.³⁴⁵

According to a report by Kirschnek dated 20 February 1943, Crematorium II went into operation on 20 February 1943,³⁴⁶ but it is likely that no cremations

³³⁸ *Aktenvermerk* dated 29 January 1943. APMO, BW 30/34, p.105. The document bears no signature, but the registration number (*Bftgb.-Nr. 43/Ki/Lp*) shows Kirschnek’s abbreviation, “Lp” is the abbreviation for the name of civilian employee Lippert, who worked at *Bauleitung* of K.G.L. “Bftgb.” signifies “*Briefstagebuch*” = daily journal of correspondence.

³³⁹ Letter from Topf to *Zentralbauleitung* dated 2 February 1943. RGVA, 502-1-313, p. 46.

³⁴⁰ Letter from *Zentralbauleitung* to Topf dated 11 February 1943. APMO, BW 30/34, p. 88.

³⁴¹ Letter from *Zentralbauleitung* to Topf dated 11 February 1943. APMO, BW 30/34, p. 87.

³⁴² *Zentralbauleitung*, letter to Topf dated 11 January 1943, *Auftrag Nr. 149*. APMO, BW 30/34, pp. 88f.

³⁴³ Letter from *Zentralbauleitung* to Kammler dated 12 February 1943 concerning: “*Auftretende Schwierigkeiten mit der Fa. Topf u. Söhne*” (difficulties arising with Topf & Söhne). APMO, BW 30/27, pp. 60f.

³⁴⁴ Letter from Topf to *Zentralbauleitung* dated 12 February 1943. APMO, BW 30/27, p. 61, and BW 30/34, p. 84.

³⁴⁵ RGVA, 502-1-336, p. 67.

³⁴⁶ *Tätigkeitsbericht des SS-Ustuf. (F) Kirschnek, – Bauleiter für das Schutzhaftlager und für landwirtschaftliche Bauvorhaben. Zeit 1. Januar 1943 bis 31. März 1943* drawn up on 29 March 1943. RGVA, 502-1-26, p. 61.

were carried out there before the beginning of March. At that time, in fact, the painters' section of the Central Construction Office, which was covering Crematorium II with whitewash,³⁴⁷ was given the job of painting black all metal parts of the cremation furnaces and of applying a coat of rust-proofing lacquer to all piping, *i.e.* very probably the compressed-air ducts leading into the furnaces. The job was completed on 27 February.³⁴⁸

Operation of the crematorium began in earnest in early March of 1943. On 2 March and on the request of the Auschwitz camp administration, *SS Obersturmbannführer* Arthur Liebehenschel, assistant head of Office Group D of *WVHA*, ordered *KL* Buchenwald to transfer immediately to Auschwitz *Kapo* August Brück³⁴⁹ for work at the crematorium. (At that time August Brück was *Kapo* of the crematorium at the Buchenwald Camp.) Brück arrived at Auschwitz on 5 March.³⁵⁰ The day before, *Kapo* Mieczysław Morawa, *Kapo* of Crematorium I at Auschwitz, had been transferred to Crematorium II to take on the function of *Kapo* in that facility.³⁵¹

On 11 March, the Central Construction Office sent to the camp administration in triplicate the operating instructions for the triple-muffle furnace: two copies were to be posted in Crematorium II, a third one was filed.³⁵² On 17 March, Jährling wrote a memo for the file on the subject "Estimation of coke consumption at Crematorium II, *KGL*, based on data received from the Topf & Söhne Co. (builders of the furnaces) on 11 March 1943."³⁵³ The estimate of the consumption of coke, however, refers to all four crematoria at Birkenau (see Chapter 10).

This file memo was the corrected version of a note penned by Jährling on 12 March – transmitted the same day to Bischoff and to the camp's commandant, *SS Obersturmbannführer* Höss – which, however, had contained two mistakes, one in the calculation of the consumption of Crematoria IV and V, the other in the sum total.³⁵⁴ On 20 March, *SS Standortarzt* at Auschwitz, *SS Hauptsturmführer* Eduard Wirths, addressed a letter to the camp commandant on the subject of the detainee infirmary (*Häftlings-Krankenbau, HKB*) at *KGL* in which he requested *i.a.*³⁵⁵

"For the removal of the corpses from the HKB to the crematorium, 2 covered hand-carts must be provided, allowing the transportation of 50 corpses each."

³⁴⁷ "Whitewash all rooms of Crematorium II" (*Weissigen* [sic] *sämtliche Räume des Krematoriums II*): work done between 18 and 23 February 1943 for 406 hours of work. *Zentralbauleitung, Arbeitskarte, Auftrag Nr. 200/4* dated 18 February 1943. RGVA, 502-1-314, pp. 26-26a.

³⁴⁸ *Zentralbauleitung, Malerei, Arbeitskarte, Auftrag Nr. 210/7* dated 24 February 1943. RGVA, 502-1-314, pp. 27-27a.

³⁴⁹ APMO, D-AuI-3a, p. 72.

³⁵⁰ APMO, D-AuI-3a, p. 101. Czech 1989, p. 431.

³⁵¹ APMO, D-Mau-3a/16408.

³⁵² Letter from *Zentralbauleitung* to *Verwaltung der Kommandantur K.L. Auschwitz* dated 11 March 1943. APMO, BW 30/34, p. 56.

³⁵³ I have not found this letter.

³⁵⁴ *Aktenvermerk* by Jährling dated 12 March 1943. APMO, 30/7/34, p. 68.

³⁵⁵ RGVA, 502-1-261, p. 112.

At that time, on account of the enormous mortality among the detainees – more than 200 deaths per day³⁵⁶ – the two crematoria already in operation (II and IV) were being used at full capacity, which immediately caused damage to them. The first problems at Crematorium II were encountered even before the official hand-over transaction of the building was concluded with the camp command (*Übergabeverhandlung*), which took place on 31 March.³⁵⁷ On 25 March, Kirschnek had written a file memo on the subject of a meeting that had taken place at Auschwitz on 24 and 25 March between the Topf representatives Prüfer and Schultze and the Central Construction Office representatives, *SS Untersturmführer* Kirschnek and, most probably, the civilian employee Lehmann.³⁵⁸ In this memo, Kirschnek noted with respect to Crematorium II *i.a.*:³⁵⁹

“As the three draft enhancers in suction have not proved to be useful in any way and have even suffered damage after the first usage at full load because of high temperatures, they will be dismantled at the expense of Topf & Söhne Co. and removed by this company.”

Central Construction Office intended to keep the three electrical motors of 15 hp each in case they were not damaged by the high temperatures and to replace the coffin-introduction carts (*Sargeinführungswagen*) by the more-practical stretchers (*Leichentragen*). On the subject of Crematorium III, Kirschnek wrote:

“On account of the experience at Crematorium II, the draft enhancers projected and supplied will not be mounted, but will be taken over and stored by the Central Construction Office.”

It is clear that the problems arose a few days earlier, because Schultze and Prüfer would have had to be notified first and then travel from Erfurt to Auschwitz. The damage was due to the combined effect of two causes: in order to raise the capacity of the furnaces, the draft enhancers were run at full speed, and this, together with a mistake in the design of the triple-muffle furnace,³⁶⁰ led to a rise in the flue-gas velocity such that the combustion gases generated by the corpses in the center muffles left the furnaces in an uncombusted state, with combustion taking place essentially in the flue ducts, where it caused overheating. In this manner, the three draft enhancers, placed upstream of the chimney, suffered irreparable damage. Topf could not but assume responsibility. On 16 April, they declared themselves ready to take back the three faulty draft enhancers, crediting the Central Construction Office with the sum of 3,705 RM;³⁶¹ the devices were dismantled by the Topf technician Messing between 17 and 19 May.³⁶²

³⁵⁶ Staatliches Museum..., Vol. 1, p. 237. *Sterbebuch* 10 for 1943, has 1,452 death certificates between 18 and 24 March.

³⁵⁷ *Zentralbauleitung*, *Übergabeverhandlung* for Bauwerk Nr. 30 K.G.L. Krematorium II to Kommandantur (Unterkunftsverwaltung) des K.L. Auschwitz dated 31 March 1943. RGVA, 502-2-54, p. 77.

³⁵⁸ The document was registered as “45629/43/Kir/Lm”: “Lm” was the abbreviation of the name of civilian employee Lehmann.

³⁵⁹ APMO, BW 30/25, p. 8.

³⁶⁰ Cf. in this connection Subchapter 10.10.

³⁶¹ Letter from Topf to *Zentralbauleitung* dated 16 April 1943. APMO, BW 30/34, p. 36; *Postkarte* from Topf to *Zentralbauleitung* dated 16 April 1943. RGVA, 502-2-26, pp. 231-231a.

³⁶² Topf, *Arbeitszeit-Bescheinigung* for Messing, 17-19 May 1943: “Im Krematorium II (Bauwerk 30) die 3 Stück Saugzulanlagen abmontiert.” RGVA, 502-1-306, pp. 91-91a.

Thus, the Birkenau crematoria operated without forced-draft devices, just like the old crematorium at the Auschwitz Main Camp after the replacement of the chimney.³⁶³ Quite soon, however, the Central Construction Office would discover that the damage caused by the March incidents was not limited to the draft enhancers: the refractory lining of the chimney was damaged and had partly collapsed, as had parts of the vaults (*ganze Gewölbeteile*) of the flue ducts.³⁶⁴ Repair work was assigned to the Koehler Co., which had built both the chimney and the ducts, whereas Topf had to redesign the damaged sections. The Erfurt company, though, possibly in an effort to avoid being once again blamed for the incidents, attempted from the beginning to stall matters.

As early as April, when Prüfer visited Auschwitz, the Central Construction Office asked Topf for a new design of the refractory lining of the chimney.³⁶⁵ As Topf was dragging its feet, the Central Construction Office began to bombard the company with urgent cables; the first one, sent by SS *Untersturmführer* Kirschnek on 11 May, requested the immediate arrival of Prüfer “with all drawings and calculations of the chimneys.”³⁶⁶ Kirschnek used the plural “chimneys,” because meanwhile the two chimneys of Crematorium IV had run into the same problems, as we can see from the urgent telegram sent by Bischoff on 14 May:³⁶⁷

“Bring thermotechnical and structural calculations for chimneys of Crematoria II and IV. Presence of Chief Engineer Prüfer imperative immediately.”

On the same day, civilian employee Rudolf Jährling called Topf on the telephone only to learn that Prüfer was away on a business trip to the Rhineland; he was assured that Prüfer would come to Auschwitz on 17 May,³⁶⁸ but that did not happen. On 21 May, Koehler sent the Central Construction Office a letter concerning repair work on the lining of the chimney at Crematorium II. Koehler had learned from Kirschnek that Prüfer would not bring the design plans for the new project before the middle of the following week. To gain time, he proposed to dismantle the remaining parts of the chimney lining so that two of his specialists could begin with the repair work as soon as the design plans for the new project arrived. Before sending his men, he wanted to receive the order from the Central Construction Office,³⁶⁹ which was issued on 29 May.

Prüfer actually did go to Auschwitz very briefly on 24 May, although not in order to bring the new drawings for the chimney lining, but to request payment of some outstanding invoices.³⁷⁰ In the meantime, Topf sought to evade their responsibilities by claiming that they had not been given the order for the construction of the chimney, which had instead been placed with the Koehler Co.,

³⁶³ *Fragebogen*, undated, but probably dating from June 1943: RGVA, 502-1-312, p. 7 (for Auschwitz), p. 8 (for Birkenau).

³⁶⁴ Letter from *Zentralbauleitung* to Topf dated 17 July 1943. APMO, BW 30/34, p. 17.

³⁶⁵ Letter from *Zentralbauleitung* to Topf dated 19 June 1943. APMO, BW 30/34, pp. 22f.

³⁶⁶ *Dringendes Telegramm* from Kirschnek dated 11 May 1943. APMO, BW 30/34, p. 44.

³⁶⁷ *Dringendes Telegramm* from Bischoff dated 14 May 1943. APMO, BW 30/34, p. 41.

³⁶⁸ Note by Jährling on the above *Telegramm*, *ibid.*

³⁶⁹ Letter from Robert Koehler to *Zentralbauleitung* dated 21 May 1943. RGVA, 502-1-313, p. 37.

³⁷⁰ Letter from Topf to *Zentralbauleitung* dated 25 May 1943. RGVA, 502-1-327, p. 83.

making Koehler the only party responsible.³⁷¹ This was only partly true, however, because Koehler had built the chimney on the basis of Topf's specifications, and Topf had also carried out the necessary thermo-technical calculations. Following Koehler's advice, the Central Construction Office embarked on the preliminary repair work. An undated sketch, certainly dating from that period, shows the damaged parts of the chimney.³⁷²

On 29 May, Bischoff cabled Topf that the drawings promised by Prüfer had not yet been received, and requested their immediate dispatch, otherwise the work would have to be interrupted. The next day Bischoff reiterated his request in another urgent telegram, and stated that the work would be interrupted that day "wegen Fehlen der Zeichnung". Topf explained that Koehler had mailed to them the original drawing and the structural calculations ten days earlier but had recalled them immediately; Topf thus had sent them back. On 29 May, Koehler had asked Topf for the preparation of a new drawing and new structural calculations, but in order to do this, Topf required the old drawing and calculations, which meant that the new drawing could only be prepared once those documents were received.³⁷³

On 19 June, Bischoff decided to clarify once and for all the responsibility for the chimney damage at Crematorium II. He sent Topf a letter in which he expressed his point of view quite explicitly: the previous exchange of letters and telegrams had raised the suspicion that Topf wanted to bury the whole matter. Already on the occasion of Prüfer's previous visit to Auschwitz in April, the Central Construction Office had asked him for a new design of the chimney lining, because the former one had turned out to be faulty under practical conditions. The negotiations between Robert Koehler and Prüfer had ended with the latter's promise that he would send the new design as soon as possible.

"Herr Prüfer knew that the former chimney installation was executed by the Koehler Company exactly in accordance with the drawing provided by you (for the development of the project, your company at the time charged 1,769.36 RM) and with the fireclay lining specified by you in your cost estimate dated 12.2.42, Item II. In spite of this, your company asked Herr Koehler in Myslowitz for a drawing and the structural calculations of the chimney, which you did receive in the end."

Instead of coming up with a new design, Topf continued to stall for unknown reasons. "Since the facility, which was still being needed most-urgently, could not be used without the completion of the new chimney lining," Bischoff asked Topf to keep its word and to send the new design to the Koehler Co. immediately.³⁷⁴

Finally, Topf sent the requested documents. On 19 July, the Central Construction Office informed Topf that "the subject work was nearly finished" and placed the responsibility squarely on the Erfurt company.³⁷⁵

³⁷¹ Letter from Topf to *Zentralbauleitung* dated 25 May 1943. RGVA, 502-1-313, pp. 36-36a.

³⁷² APMO, BW 30/34, p. 24.

³⁷³ Letter from Topf to *Zentralbauleitung* dated 2 June 1943. RGVA, 502-2-54, pp. 87-87a.

³⁷⁴ Letter from *Zentralbauleitung* to Topf dated 19 June 1943. APMO, BW30/34, pp. 22f.

³⁷⁵ Letter from *Zentralbauleitung* to Topf dated 17 July 1943. APMO, BW 30/34, p. 17.

“On the basis of the new drawings supplied by you one can see that your initial design of the chimney did not take into account the differences in the thermal expansions and the high temperatures to be expected and that this was taken into consideration only in your second design. The question of responsibility is thus unresolved until we receive respective instructions from our superiors in Berlin. We advise you furthermore that the very-seriously affected heating channels (on various occasions complete sections of the vaults collapsed) will have to be repaired and/or rebuilt shortly.”

In their long reply to this letter, Topf reiterated that they had nothing to do with the construction of the chimney, for which they had specified merely the height and the cross-sectional area, and insinuated that Koehler Co. might have used bricks of poor quality and ordinary mortar instead of clinkers and refractory mortar. Moreover, Topf knew nothing of the damage to the flue ducts:³⁷⁶

“Our supervisor Koch who returned from your site 3 weeks ago did not report any such damage, although he had once again checked everything before leaving. As the crematorium has been out of service for 6 weeks, we cannot explain who has caused the alleged collapse of the ducts.”

On 10 September 1943, Prüfer visited the Central Construction Office to discuss with Bischoff and Kirschnek the liability for the chimney damage and the expenses involved. The following day, Robert Koehler was summoned as well. SS *Untersturmführer* Kirschnek wrote a long account of the discussions on 13 September,³⁷⁷ which, however, was full of mistakes and was not approved by Bischoff and had to be redrafted the day after.³⁷⁸ This document, which we summarize here, sets out the positions of the three parties involved. The Central Construction Office asserted that the damage to the chimney was primarily due to mistakes in the design and to poor advice from Topf on the subject of the construction.

In 1942, Prüfer had been the consultant for the entire installation, and had declared to members of the Central Construction Office that the crematoria had to be built in accordance with the drawings provided by Topf. As far as the chimneys (of Crematoria II and III) were concerned, they had, on the one hand, been erected in accordance with the specifications of the chimney originally to be built at the *Stammlager* and, on the other hand, the dimensions and structural details had been taken from Topf drawings. The original drawings showed a refractory lining 12 cm in thickness up to a height of 6 meters; above this level, there were ordinary bricks. The Central Construction Office insisted, moreover, on the correctness of the information concerning the partial breakdown of the flue ducts which Topf had put in doubt: these facts had been ascertained by the *Ober-Kapo* of the crematoria.

“On this occasion – Kirschnek goes on to say – it was also observed that all [flue-duct] dampers controlling the draft had melted on account of their wrong

³⁷⁶ Letter from Topf to *Zentralbauleitung* dated 23 July 1943. RGVA, 502-1-313, pp. 28f.

³⁷⁷ *Zentralbauleitung, Aktenvermerk* by Jährling dated 13 September 1943. APMO, BW 30/25, pp. 11f.

³⁷⁸ *Zentralbauleitung, Aktenvermerk* by Jährling dated 14 September 1943. RGVA, 502-1-26, pp. 144-146.

installation; the problems were resolved on the basis of [our] own experience and currently permit flawless operation.”

Prüfer, for his part, brought in a new explanation which again blamed the Koehler Co.: the damage was due to the fact that, above 6 m, ordinary mortar instead of refractory mortar had been used, and also because of mistakes in the structural calculations of the chimney, but this was denied by Robert Koehler, who was questioned on this point the following day. The Central Construction Office could not but reproach Prüfer for giving a different reason on each of his visits to Auschwitz.

“On his last visit but one he named, in the presence of the commandant, the great stresses due to the firing of single furnaces – something not considered in the design – to have been the cause.”

The Central Construction Office agreed with this explanation, all the more-so as Topf’s new design for the chimney lining contained a number of open gaps, “so that the expansion of the brickwork relative to that of the lining can absorb possible stresses caused by the firing of single furnaces.”

Robert Koehler’s case rested on the overloading of the chimney. In the end, a compromise was reached which terminated the controversy for good: each of the parties involved – Topf, Robert Koehler, the Central Construction Office – would pay one third of the cost of the repair work, estimated to be 5,000 RM,³⁷⁸ but actually only amounting to 4,500 RM when the job was finished. Topf confirmed Prüfer’s decision on 16 September, reluctantly accepting to pay its share.³⁷⁹ On 28 September the Central Construction Office reminded Robert Koehler of his obligation, and informed him that he would receive the corresponding invoice in a few days.³⁸⁰ Topf was sent their own invoice – in the amount of 1,621.30 RM – a day later.³⁸¹

Summarizing matters, the damage to the chimney and the flue ducts occurred in the latter half of March but was discovered only in the following month,³⁸² as the Central Construction Office requested Prüfer to send a new design for the chimney lining at that time. Work on the dismantling of the damaged refractory lining began a few days after the arrival of Robert Koehler’s letter of 21 May, probably on 24 May, after Bischoff’s telephone conversation with Prüfer; it stopped on 1st June, but it was not possible to carry out further repairs, because the new design of the chimney lining had not yet been received. This repair project was assigned to the Koehler Co., whose personnel were surely present at Auschwitz on 29 May, and it is probable that Koehler took part in the dismantling job.

In the Topf letter of 23 July, it is said that Crematorium II had been out of service for six weeks, *i.e.* since 11 June, but any cremation activity surely ended

³⁷⁹ Letter from Topf to *Zentralbauleitung* dated 19 September 1943. RGVA, 502-1-313, p. 16.

³⁸⁰ Letter from *Zentralbauleitung* to Koehler Co. dated 28 September 1943. APMO, BW 30/34, p. 16.

³⁸¹ Letter from *Zentralbauleitung* to Topf dated 29 September 1943. APMO, DZ-Bau, nr. inw. 1967, p. 183.

³⁸² Inspection of the flue-gas ducts and of the base of the chimney was possible earlier, because each of the five ducts was equipped with an inspection hole 45 cm × 51 cm closed by a double lid (*Fuchseinsteigeschachtverschluss. Rahmen [frame] mit Doppeldeckel*), while the chimney possessed a cleaning port 39 cm × 51 cm with closure (*Reinigungstür*).

earlier than that, because one cannot imagine any cremations being carried out with workers present inside the chimney; hence, cremations must have stopped around 24 May.

The crematorium was possibly used normally until the damage was discovered, but, keeping in mind the Central Construction Office's experience with the Main Camp Crematorium, it is difficult to believe that operation would have been at full load later on; in fact, between 24 and 30 April 1943 all windows of the furnace hall of Crematorium II as well as those of the adjoining rooms were being blackened³⁸³ (a countermeasure against air raids). Repair work on the chimney lining began after 19 June – when Koehler had not yet received Prüfer's new design – and was essentially concluded on 17 July 1943, but it was still necessary to repair the flue ducts. The repair work on the flue ducts probably ended only in late August, because on 30 August the Central Construction Office asked the materials store (*Materialverwaltung*) for the supply to Crematorium II of various lacquer products for use by the inmate paint shop (*Häftlings-Malerei*).³⁸⁴

At the end of March 1943, the construction of the cremation furnaces had hardly begun on Crematorium III.³⁸⁵ Even though the Central Construction Office attempted to speed matters up – for the first two days of May it asked the camp command that the *Kommando Krematorium* be increased to 250 detainees for urgent tasks³⁸⁶ – work dragged on well beyond the target date of 10 April 1943. The hand-over transaction, in fact, bears the date of 24 June 1943,³⁸⁷ and that is probably also the start-up date, because the lightning rods of the chimney were installed on 21 and 22 June.³⁸⁸ On 28 June, the Central Construction Office reported to *WVHA* the completion of Crematorium III. This letter begins with the following words (cf. Documents 248, 248a):

“I announce completion of Crematorium III as of 26 June 1943.”

This is followed by the report of the “throughput” (*Leistung*) of the four existing crematoria “for an operating time of 24 hours”: 340 “persons” (*Personen*) for Crematorium I (six muffles), 1,440 “persons” for each of Crematoria II and III (fifteen muffles each), 768 “persons” for each of Crematoria IV and V (eight muffles each); for a total of 4,756 “persons.” Concerning the data given in this letter – absolutely incredible from a technical point of view (coke consumption

³⁸³ *Zentralbauleitung, Arbeitskarte für Malerei*, Auftrag Nr. 271/15 dated 17 March 1943: “*Streichen sämtlicher Fenster des Verbrennungsraumes u. Nebenräume mit blauer bzw. schwarzer Verdunkelungsfarbe.*” RGVA, 502-1-314, pp. 25-25a.

³⁸⁴ *Zentralbauleitung, Anforderung* no. 27 dated 30 August 1943. *An die Materialverwaltung*. RGVA, 502-1-314, p. 23.

³⁸⁵ *Tätigkeitsbericht des SS-Ustuf. (F) Kirschnek, – Bauleiter für das Schutzhaftlager und für landwirtschaftliche Bauvorhaben. Zeit 1. Januar 1943 bis 31. März 1943* dated 29 March 1943. RGVA, 502-1-26, p. 61.

³⁸⁶ Letter from *Zentralbauleitung* to *Kommandantur des K.L. Auschwitz* dated 30 April 1943. RGVA, 502-1-256, p. 154.

³⁸⁷ *Zentralbauleitung, Übergabeverhandlung* for *Bauwerk Nr. 30a KGL. Krematorium II* dated 24 June 1943. RGVA, 502-2-54, p. 84.

³⁸⁸ *Zentralbauleitung, Arbeitskarte, Auftrag Nr. 183/301* dated 9 February 1943. RGVA, 502-1-315, pp. 22-22a.

and duration of the cremation) – we refer the reader to Chapters 8-10, in particular to Subchapter 9.6.

On 20 August 1943 the Plützsch Co. sent to Auschwitz on Topf's orders a freight car with 3,750 normal refractory bricks, 400 conical refractory bricks and 1,500 kg of refractory mortar, but the *Materialverwaltung* (materials administration) did not credit the shipment to Topf "because the work had not yet been finished." Consequently, the Central Construction Office, believing that they had paid for the materials out of their own pocket, sent Topf the corresponding invoice in an amount of 887.95 Reichsmarks. Topf, on 7 December, suspecting a mistake, asked the Central Construction Office to check into the matter; on 16 December the mistake was rectified.³⁸⁹

The work referred to by the *Materialverwaltung* did not, however, concern the crematoria, but the two hot-air-disinfestation chambers to be installed in the *Zentralsauna*.

The first damage to the cremation furnaces themselves arose at the end of October of 1943. On 27 October, the Central Construction Office ordered the metal-working shop at *DAW*³⁹⁰ to repair 20 ash-removal doors. Work was finished on 27 January 1944.³⁹¹

On 22 November, the garrison administration asked the Central Construction Office for the "installation of heating stoves in the crematoria constructed, as well as erection of a roof over the refuse pit near Crematorium II."³⁹² A month later, *SS Untersturmführer* Josef Janisch, *Bauleiter* at *KGL*, replied that "the stoves needed in the detainee housing area of Crematorium II have been installed,"³⁹³ which suggests at least the imminent transfer of the detainees working at Crematorium II into the lodgings arranged for them in the attic of the building.

On 30 January 1944, the Central Construction Office sent Topf a telegram asking Prüfer and the mechanic Koch to come to Auschwitz immediately to repair the walls of the hot-air chambers of the disinfestation facility set up at the *Zentralsauna*. Topf accepted (albeit sending foreman Holick rather than Koch),³⁹⁴ and on 2 February 1944, the Central Construction Office requested the camp commandant *SS Obersturmbannführer* Liebehenschel, to issue a camp-access permit for the two men, giving the following reason:³⁹⁵

"Senior Engineer Prüfer and Herr Holick have been called here by this authority to inspect and/or repair the damage detected at the large disinfestation unit of KGL and at the crematoria."

³⁸⁹ Letter from Topf to *Zentralbauleitung* dated 7 December 1943. RGVA, 502-1-327, pp. 38-38a, and letter from *Materialverwaltung* to *Abteilung Rechnungslegung* dated 16 December 1943. RGVA, 502-1-327, p. 40.

³⁹⁰ *Deutsche Ausrüstungswerke*, German Equipment Works, an SS enterprise producing and repairing construction accessories.

³⁹¹ APMO, Höss Trial, Dpr.-Hd/11a, p. 95.

³⁹² Letter from *Bauleiter* Jothann to *Bauleitung KGL* dated 22 November 1943. RGVA 502-1-313, p. 17.

³⁹³ Letter from *Bauleiter* Janisch to *Zentralbauleitung* dated 21 January 1944. RGVA, 502-1-313, p. 15.

³⁹⁴ Letter from Topf to *Zentralbauleitung* dated 9 February 1944. RGVA, 502-1-336, pp. 88-88a.

³⁹⁵ Letter from *Zentralbauleitung* to *SS-Obersturmbannführer* Liebehenschel dated 2 February 1944. RGVA 502-1-345, p. 50.

Damage to the disinfestation furnaces was less-serious than had been feared: only the joints between the heating channels and the brickwork had opened up, and Holick would close them up with Monolite mortar,³⁹⁶ a refractory material. Damage to the crematoria furnaces, however, was more-serious. On 22 February, the garrison administration ordered the Central Construction Office to supply 20 sacks of Monolite, 200 refractory bricks and 200 refractory wedge bricks for “imminent repairs on the crematoria.”³⁹⁷

On 13 April 1944, the Central Construction Office ordered *Schlosserei* of DAW to repair 20 furnace doors and 10 scrapers at Crematoria II and III. The job was completed on 17 October 1944.³⁹⁸ In early May, damage to the brickwork was reported, certainly in the flue ducts or the chimneys, because on 9 May the *Bauleiter* of KL II (Birkenau) asked the camp command for a “permit for entry to Crematoria I-IV” to be issued for Koehler Co., because the firm had been contracted to execute “urgent repairs on [the] crematoria.”³⁹⁹

At the end of the month, more damage struck the furnaces. On 31 May, the Crematoria Administration at Birkenau ordered DAW to repair two muffle doors and five closures,⁴⁰⁰ plus other minor jobs. The repair work was done between 20 June and 20 July and cost 46.90 RM (Czech 1989, p. 789). A later order, dated 7 June 1944, concerned “required repairs on Crematoria 1-4 between 8 June and 20 July 1944.” Work was reported completed on 6 September 1944.³⁹⁸

Operation of Crematoria II and III ceased in early December of 1944: On 1st December, a women’s detail was set up for the demolition of Crematorium III (Czech 1989, p. 939); on the 8th, the head of the Central Construction Office, *SS Obersturmführer* Jothann, asked *Abteilung IIIa* (assignment of detainees) to assign immediately 100 detainees for demolition work “near crematorium camp II),⁴⁰¹ undoubtedly meaning Crematorium II.

On 20 December 1941, Topf sent to Auschwitz a preliminary invoice, dated 18 December, in accordance with its cost estimate of 4 November, of which only the first page has been preserved: the five triple-muffle furnaces cost 6,378 RM each, the coffin-introduction devices 1,780 RM, the complete flue ducts 4,045 RM, and the three draft enhancers 3,016 RM each.⁴⁰² These amounts are in agreement with those appearing in Topf’s Invoice No. 69 of 27 January 1943⁴⁰³ and in the final invoice bearing the same date.⁴⁰⁴ Besides the items mentioned above, these invoices also comprise a waste incinerator at an amount of 4,474 Reichsmarks.

³⁹⁶ Letter from Topf to *Zentralbauleitung* dated 9 February 1944. RGVA, 502-1-336, p. 88a.

³⁹⁷ Letter from *SS-Standortverwaltung* to *Zentralbauleitung* dated 24 February 1944. RGVA, 502-1-313, p. 13.

³⁹⁸ APMO, Höss Trial, Dpr.-Hd/11a, p. 96.

³⁹⁹ Letter from *Bauleiter des Lagers II* to *Kommandantur des K.L.II Birkenau* dated 9 May 1944. RGVA, 502-1-83, p. 377.

⁴⁰⁰ The closures of the ash chambers or of the hearths or of the loading ports of the gasifiers.

⁴⁰¹ RGVA, 502-1-67, p. 227.

⁴⁰² RGVA, 502-1-327, p. 46.

⁴⁰³ Topf, *Rechnung Nr. 69* dated 21 January 1943 concerning the construction of 5 triple-muffle furnaces at Crematorium II. RGVA, 502-1-327, pp. 100-100a.

⁴⁰⁴ Topf, *Schluss-Rechnung* dated 27 January 1943 concerning the construction of 5 triple-muffle furnaces at Crematorium II. RGVA, 502-2-26, pp. 230-230a. Cf. Document 215.

The total cost of the devices supplied and installed by the Topf Company thus came to 51,237 Reichsmarks. From this figure, 3,705 RM were deducted as reimbursement of the three draft enhancers taken back by Topf after they had been damaged. The remaining 47,532 RM were paid by *Kasse der Bauinspektion der Waffen-SS und Polizei Reich-“Ost”* in two advance installments of 25,000 RM on 13 February 1942 and of 15,000 RM on 17 September, and a final amount of 7,532 RM on 22 November 1943.⁴⁰⁵

The total cost of the devices supplied by the Topf Company and installed in Crematorium III was 53,702 RM: 39,150 for the five triple-muffle furnaces (costing 7,830 RM each), 9,048 RM for the three draft enhancers mentioned in the invoice in accordance with the cost estimate of 30 September 1942, actually supplied by Topf but never installed by the Central Construction Office, 5,504 RM for the supervision of the construction work of the flue ducts.⁴⁰⁶ Payment was effected by an installment of 27,000 RM on 4 December 1942, a second payment of 5,500 RM on 8 December 1942, and a final payment of 21,202 RM on 22 November 1943.⁴⁰⁷

6.3. The Furnaces of Crematoria IV and V at Birkenau

On 4 December 1941, *HHB* in Berlin ordered from Topf “4 pcs. Topf double-4-muffle incineration furnaces,” *i.e.* four furnaces with eight muffles for Mogilev in Russia,⁴⁰⁸ where PoW Transit Camp No. 185 was located. Topf confirmed receipt of the order on 9 December, but on 30 December only one half of a furnace was sent to Mogilev, *i.e.* four muffles; as we will see, two furnaces would be set up at Auschwitz while one and a half furnaces were temporarily held in Topf’s warehouse.⁴⁰⁹

Accepting the suggestion made by Prüfer when he visited Auschwitz on 19 August 1942, *WVHA* decided on 26 August to send to Auschwitz two of the furnaces on order for Mogilev. The Central Construction Office went to work immediately. A telegram went out to Topf the same day requesting the drawing of the building meant to house for the 8-muffle furnace (the future Crematorium IV), because construction work was to begin immediately.⁴¹⁰ For 31 August, Topf provided the *Monteur* Martin Holick,⁴¹¹ who also brought with him the necessary plans (D60125).⁴¹²

For the 8-muffle furnace, Topf had designed two chimneys, each 16 m high with internal cross-sectional dimensions of 0.80 m × 0.80 m, and refractory lin-

⁴⁰⁵ *Zentralbauleitung, Schlussabrechnung über Errichtung von 5 Stück Dreimuffel-Einäscherungsöfen*, BW 30, 11 November 1943. RGVA, 502-2-26, pp. 226-228. Cf. Document 188.

⁴⁰⁶ Topf, *Rechnung Nr. 728* dated 27 May 1943 concerning the construction of five triple-muffle furnaces at Crematorium III. RGVA, 502-1-327, pp. 190-190a. Topf, *Schluss-Rechnung Nr. 728* dated 27 May 1943 concerning the construction of five triple-muffle furnaces at Crematorium III. RGVA, 502-2-26, pp. 215-215a. Cf. Document 216.

⁴⁰⁷ *Zentralbauleitung, Schlussabrechnung über Errichtung von 5 Stück Dreimuffel-Einäscherungsöfen*, BW 30a, 11 November 1943. RGVA, 502-2-26, pp. 211-213. Cf. Document 189.

⁴⁰⁸ Letter from *HHB* to Topf dated 4 December 1941. RGVA, 502-1-327, pp. 47f.

⁴⁰⁹ Letter from Topf to *Zentralbauleitung* of 9 December 1941. APMO, BW 11/1, pp. 4f.

⁴¹⁰ Telegram from *Zentralbauleitung* to Topf dated 26 August 1942. RGVA, 502-1-313, p. 155.

⁴¹¹ Letter from Topf to *Zentralbauleitung* dated 27 August 1942. RGVA, 502-1-313, p. 152.

⁴¹² Letter from Topf to *Zentralbauleitung* dated 31 August 1942. RGVA, 502-1-313, p. 150.

ing up to a height of six meters. As these furnaces had originally been destined for Mogilev, where coke supply was difficult, they were equipped with hearths for wood, which Topf, for the furnaces going to Auschwitz, adapted for use with coke by means of inclined and horizontal grates: two gasifiers were equipped with horizontal grates only; the other two had inclined hearth bars changed to horizontal grates. In view of the extremely short service life expected for the inclined hearth bars, Topf recommended to the Central Construction Office to order spare coke-hearth bars. Furthermore, because of transportation problems, the Mogilev Furnaces had been designed without insulation, but Topf was ready to furnish insulating material to the Central Construction Office on request.⁴¹² On 1st September, the Central Construction Office sent Topf 20 freight bills for the shipment of the furnaces and the refractory material.⁴¹³

On 4 September, Topf sent the Central Construction Office the drawing of the furnace foundations (D59555) and the drawing of the anchoring system (D60129),⁴¹⁴ plus a list of the individual anchor bars,⁴¹⁵ which would be fabricated locally by the detainee workshop for the Central Construction Office.⁴¹⁶ On 7 September, the furnace drawing itself (D60132) was ready. In the letter of transmittal, Topf explained to the Central Construction Office that one gasifier had been allocated to each pair of muffles; the furnace thus had eight muffles and four gasifiers, which were positioned in the central part of the furnace; two pairs of muffles would be given a common chimney having the dimensions previously indicated in Topf's letter dated 31 August 1942. Topf also announced the arrival of Builder Wilhelm Koch within a week.⁴¹⁷

The following day, Topf dispatched a freight car containing the metal parts of the two furnaces with a total weight of 12,186 kg, which arrived at Auschwitz on the 11th.⁴¹⁸ In accordance with Topf's offer of 2 September concerning the changes in the type of fuel and the corresponding modifications, the Central Construction Office ordered on 15 September four wrought-iron covers for the hearths with frames, jackscrews and refractory lining, as well as 2,500 insulating bricks and 600 kg of rock wool for each of the furnace's insulation, plus the replacement bars for the hearths of the gasifiers, at a total price of 3,258 Reichsmarks.⁴¹⁹ As the two furnaces had altogether eight gasifiers, there were eight covers and not four, as Topf was quick to rectify.⁴²⁰ However, the respective invoice paid on 2 February 1944 still spoke of four covers – probably for reasons of accounting.⁴²¹ On 26 October, referring to the *WVHA* letter addressed to Topf on 26 August, the Central Construction Office transmitted to the Erfurt company the post-dated confirmation of the order for two furnaces with eight

⁴¹³ Letter from *Zentralbauleitung* to Topf dated 1st September 1942. RGVA, 502-1-313, p. 148.

⁴¹⁴ Letter from Topf to *Zentralbauleitung* dated 4 September 1942. RGVA, 502-1-313, p. 140.

⁴¹⁵ Topf, *Verankerung zu einem 8-Muffel-Ofen*. RGVA, 502-1-313, p. 141. Cf. Document 237.

⁴¹⁶ Note from *Schlosserei* to *Zentralbauleitung* dated 15 September 1942. RGVA, 502-1-313, p. 132.

⁴¹⁷ Letter from Topf to *Zentralbauleitung* dated 7 September 1942. RGVA, 502-1-313, pp. 139-139a.

⁴¹⁸ Topf, *Versandanzeige* dated 8 September 1942 concerning "2 kompl. Achtmuffel-Einäscherungsöfen." RGVA, 502-1-313, pp. 143-143a. Cf. Document 231.

⁴¹⁹ Letter from *Zentralbauleitung* to Topf dated 15 September 1942. RGVA, 502-1-312, p. 22; letter from Topf to *Zentralbauleitung* dated 22 September 1942. RGVA, 502-1-313, pp. 127-127a.

⁴²⁰ Letter from Topf to *Zentralbauleitung* dated 30 September 1942. RGVA, 502-1-313, p. 118.

⁴²¹ Topf, *Rechnung Nr. 322* dated 23 March 1943. RGVA, 502-1-327, p. 22.

muffles as per Drawing D60125, and for the technical modifications resulting from the change of the fuel type.⁴²² The next day, the Central Construction Office sent Topf a telegram inquiring as to the cost of an 8-muffle furnace designed for Mogilev, with anchoring and hearths for wood firing. Topf replied the same day by telegram quoting a price of 13,800 RM for the furnace.⁴²³ Believing that the Central Construction Office wanted to order another wood-fired 8-muffle furnace, Topf tendered a quotation for such a device on 29 October. The error was soon corrected, though: the Central Construction Office only wanted a cost estimate for a furnace of the Mogilev Type for purely administrative reasons. Topf took this into account, and attached to their explanatory letter⁴²⁴ a quotation for an 8-muffle furnace without anchoring (because the anchoring parts would come from the detainee workshop at Auschwitz) and with wood-fired gasifiers (because the modification of the fuel system was covered by a different contract).⁴²⁵ The Central Construction Office transmitted the quotation to the WVHA for approval of the order.⁴²⁶

Other misunderstandings arose later with respect to payment for the two 8-muffle furnaces. On 5 April 1943, Topf drew up the respective invoice for a total of 27,632.30 RM (27,600 RM for the furnaces plus 32.30 RM for transportation).⁴²⁷ On 2 June, the head of *Gruppe C/Bauwesen* of Higher SS and Police Leader Central Russia notified the Construction Inspectorate of the Waffen SS and Police East Germany (*Bauinspektion der Waffen-SS und Polizei Reich-Ost*), to which the Central Construction Office was attached, that the Construction Inspectorate Central Russia had already paid 42,600 RM for the four furnaces originally ordered for Mogilev.⁴²⁸ When the Central Construction Office learned about this, it not only felt that Topf's invoice of 5 April 1943 was unfounded, but also that the Erfurt company had received (42,600 – 27,632.30 =) 14,967.70 RM more than it should have. Furthermore, the SS did not see why the invoice of 5 April 1943 amounted to 27,600 RM (plus 32.30 RM for shipment) or 13,800 RM per furnace, whereas the cost estimate of 16 November 1942 spoke only of 12,972 RM for one furnace.⁴²⁹

Topf replied that *Reichsführer-SS* had ordered four 8-muffle furnaces for a total price of 55,200 RM on 4 December 1941; moreover, as the SS had requested various modifications in the design of the 8-muffle furnace, Topf had applied a price increase of 6% or 828 RM, thus yielding a final cost of 13,800 Reichsmarks.⁴³⁰ Of the four furnaces ordered, one half of one furnace (four

⁴²² Letter from *Zentralbauleitung* to Topf dated 26 October 1942. RGVA, 502-1-313, p. 94.

⁴²³ Letter from Topf to *Zentralbauleitung* dated 27 October containing the text of both telegrams (RGVA, 502-1-313, p. 88), and telegram from Topf to *Zentralbauleitung* dated 27 October 1942 (RGVA, 502-1-313, p. 89).

⁴²⁴ Letter from Topf to *Zentralbauleitung* dated 16 November 1942. RGVA, 502-1-313, p. 71.

⁴²⁵ Topf, *Kostenanschlag über einen Topf-Achtmuffel-Einäscherungssofen* dated 16 November 1942. RGVA, 502-1-313, pp. 72-76. Cf. Document 230.

⁴²⁶ Letter from Topf to the WVHA dated 24 November 1942. RGVA, 502-1-313, p. 77.

⁴²⁷ Topf, *Rechnung Nr. 380 dated 5 April 1943*. RGVA, 502-1-314, pp. 29-29a.

⁴²⁸ RGVA, 502-1-314, pp. 35-36a.

⁴²⁹ Letter from *Zentralbauleitung* to Topf dated 2 July 1943. APMO, D-Z/Bau, nr. inw. 1967, p. 170.

⁴³⁰ Actually, 828 RM represents 6% of 13,800 RM and not of 12,792; 6% of this latter figure would be 778.32 RM, and a furnace should have cost 13,750.32 Reichsmarks.

muffles) had gone to Mogilev, two were at Auschwitz, and the remaining furnace-and-a-half was still being held in the Topf warehouse at the disposition of *Reichsführer-SS*.⁴³¹

At Auschwitz the matter was definitely clarified by civilian Employee Jährling, who made two hand-written entries on a copy of the letter from the Construction Inspectorate Central Russia, dated 2 June 1943, which the Central Construction Office had received. The first entry dates from 31 January, the second from 21 February 1944; Jährling summarizes the questions of payment from the administrative point of view: the SS had ordered four 8-muffle furnaces for a total price of 55,200 RM; the Construction Inspectorate Central Russia had already paid Topf on account 42,600 RM, to which the SS garrison administration Auschwitz had added another 10,000 RM on account,⁴³² which meant that Topf was still entitled to 2,600 RM.⁴³³

For all intents and purposes, the remaining furnace-and-a-half, still held by Topf, was the property of *Reichsführer-SS*; Jährling's computation was therefore correct, and Topf received only what it was still owed. The Construction Inspectorate Central Russia was late to be informed, because on 11 August 1944 this office once again asked the Central Construction Office whether the 42,600 RM already paid to Topf would be deducted from the final payment.⁴³⁴

In line with Topf's letter of 7 July 1943, the remaining furnace-and-a-half were taken over by *WVHA*. On 16 August, the *SS-Wirtschafter* (business manager) at Higher SS and Police Leader (*Höherer SS- und Polizeiführer*) of the Government General sent a note to the Central Construction Offices at Heidelager, Krakow, Lemberg, Lublin and Warsaw, as well as to the New Construction Office at Radom, explaining that Office CIII held "a cremation furnace and a half = 12 muffles" and asked to be informed by 1st September whether the above offices had any use for it.⁴³⁵

We know of a reply by the *Bauleiter* of Trawniki, a subcamp of Lublin (Majdanek) who, on 2 September, wrote to the Central Construction Office of the Main Camp – which had sent him a copy of the note of the SS business manager – the following letter:⁴³⁶

"No crematorium exists at this camp. Many protests have been raised against this situation. Construction of a crematorium would, however, be an urgent necessity. Of course, should the furnace and half available at Office C III be taken into consideration for Trawniki, this would have to be decided there [by the Lublin Central Construction Office]."

I found no evidence that this request was responded to.

⁴³¹ Letter from Topf to *Zentralbauleitung* dated 7 July 1943. RGVA, 502-1-327, pp. 43-45.

⁴³² *Zentralbauleitung, Abschlagszahlung Nr. 1* dated 1st February 1944. RGVA, 502-1-310, pp. 16-16a.

⁴³³ Letter from *Leiter der Gruppe C Baugruppe of Höherer SS- und Polizeiführer Russland-Mitte to Bauinspektion der Waffen-SS und Polizei Reich-Ost* dated 2 June 1943 and handwritten notes by civilian employee Jährling dated 31 January and 21 February 1944. RGVA, 502-1-314, pp. 36-36a.

⁴³⁴ Letter from *Abwicklungsstelle der Baugruppe der Waffen-SS und Polizei Russland-Mitte to Zentralbauleitung* dated 11 August 1944. RGVA, 502-1-314, p. 28.

⁴³⁵ WAPL, *Zentralbauleitung*, 268, p. 132. Cf. Document 190.

⁴³⁶ WAPL, *Zentralbauleitung*, 268, p. 147. Cf. Document 191.

Little is known about the construction and the operation of the two 8-muffle furnaces of Crematoria IV and V. Construction of Crematorium IV began officially on 9 October 1942,⁴³⁷ but Huta Co. had already embarked on preparatory work on 23 September.⁴³⁸ The facility was handed over to the camp administration on 19 March 1943.⁴³⁹ Construction of Crematorium V began on 20 November 1942,⁴⁴⁰ hand-over to the camp administration occurred on 4 April 1943.⁴⁴¹

After a few weeks of operation, the furnace at Crematorium IV began to show cracks, as the Central Construction Office informed Topf on 3 April; Topf agreed to carry out the repairs free of charge, as the warranty of two months had not yet expired.⁴⁴² Damage was undoubtedly more serious, however, because in the telegram of 14 May 1943 mentioned above, the Central Construction Office urgently requested Topf to make thermal and structural calculations for the chimneys at Crematorium IV as well.

More repair work on Crematorium IV was carried out between 1 and 7 June 1944 (30 doors and/or closures of the furnaces),⁴⁴³ and between 7 June and 4 July 1944, repair work was carried out on all four crematoria.⁴⁴³ Crematorium IV was rendered unserviceable in the so-called revolt of *Sonderkommando* on 7 October 1944; the service personnel (down to 53 men from 169) were only withdrawn on the 10th,⁴⁴⁴ however. On that date, the manpower at Crematorium V was also brought down, from 156 to 66 detainees.⁴⁴⁴ On 16 January 1945, Crematorium V was still in service with a workforce of 30 detainees.⁴⁴⁵ It was blown up by the camp SS guards just before the arrival of the Soviets.⁴⁴⁶

7. Structure and Operation of the Topf Cremation Furnaces at Auschwitz-Birkenau

7.1. The Coke-Fired Double-Muffle Furnace Auschwitz Type

Topf Co. built four furnaces of this type, three of which were set up in Crematorium I or the old crematorium at Auschwitz, with a fourth one built in the Mau-thausen Crematorium.

⁴³⁷ *Baufristenplan* dated 2 October 1943. RGVA, 502-1-320, p. 7.

⁴³⁸ Huta, *Rechnung* dated 31 December 1942 concerning work done between 23 September and 23 December 1942. RGVA, 502-2-54, pp. 43-44b, and *Tagelohnliste Nr. 1* of Huta Co. concerning work done between 23 September and 2 October 1943. 502-2-54, p. 45. Cf. Document 192.

⁴³⁹ *Übergabeverhandlung* for Crematorium IV. 19 March 1943. RGVA, 502-2-54, p. 25.

⁴⁴⁰ *Baufristenplan* dated 2 October 1943. RGVA, 502-1-320, p. 7.

⁴⁴¹ APMO, BW 30/25, p. 14.

⁴⁴² Letter from Topf to *Zentralbauleitung* dated 10 April 1943. BW 30/34, p. 42.

⁴⁴³ APMO, Höss Trial, Dpr.-Hd/11a, p. 96.

⁴⁴⁴ Daily list of detainees employed at the crematoria drawn up by the Soviets on the basis of the “*Arbeitseinsatz*” lists for the men’s camp at Birkenau compiled by *Abteilung IIIa*. GARF, 7021-108-20, p. 142.

⁴⁴⁵ *KL Birkenau, Arbeitseinsatz für den 16. Januar 1945*. RGVA, 502-1-67, p. 17a.

⁴⁴⁶ In the aerial photo of 19 February 1945, Crematorium V appears to have been entirely destroyed. National Archives, Washington, GX 12337, exp. 145.

The Mauthausen Furnace was ordered from Topf on 16 October 1941, but the New Construction Office of *KL* Mauthausen hesitated for a long time before installing it. The parts of the furnace were shipped to Mauthausen between 6 February 1942 and 12 January 1943,⁴⁴⁷ but only at the end of 1944 was it decided to erect it. A letter from Topf dated 20 December 1944 tells us that preparations were going on in the crematorium concerning the foundations of the furnace and the flue duct; Topf was waiting for this work to be finished before sending one of its builders.⁴⁴⁸ On 3 January 1945, Topf announced the arrival of the technician, Chief Engineer Schulze, scheduled for 9 January.⁴⁴⁹ The furnace was therefore built in January/February of 1945, which explains the fact that it has been preserved rather well. This furnace has remained practically intact and can be examined *in situ*.

As opposed to this, the two coke-fired Topf double-muffle cremation furnaces which are presently shown in Crematorium I at Auschwitz were refabricate by the Poles after the war in a haphazard way, with original parts taken from the furnaces dismantled by the SS in 1944. It is therefore useless to examine these refabrications in an effort to understand the structure or the operation of this type of furnace. Our technical description will hence be based on the Mauthausen Furnace. It will be illustrated by 35 photos of our own and will take into account the available documents concerning the furnaces at Auschwitz and Mauthausen which were of the same type. In fact, a letter from Topf to the Mauthausen Camp says in this respect:⁴⁵⁰

“We wish to underline that KL Auschwitz in Upper Silesia has just ordered from us a second coke-fired double-muffle furnace of the same design as intended for you.”

Furthermore, the “order slip” sent by the Mauthausen New Construction Office to Topf on 16 October 1941 refers explicitly to a “double-muffle furnace, Auschwitz type.”⁴⁵¹ Furthermore, the Topf letter dated 1st November 1940 had as an attachment the Topf Drawing No. D57253 (Document 202), which is exactly the design used for the first double-muffle furnace set up at the Auschwitz Crematorium. Another attachment to the letter was Drawing No. D58173, which we have studied in the preceding chapter (Document 163).⁴⁵² We will show, first of all, the Topf cost estimate for *KL* Auschwitz dated 13 November 1940 (Document 193), which is practically identical with the one for Mauthausen dated 6 January 1941 (Document 164):⁴⁵³

⁴⁴⁷ Letter from *SS-Bauleitung* of *KL* Gusen to Topf dated 24 October 1942; letter from Topf to *SS-Bauleitung* of *KL* Gusen dated 16 January 1943. BAK, NS4 Ma/54.

⁴⁴⁸ Letter from Topf to *SS-Bauleitung* of *KL* Mauthausen dated 20 December 1944, *ibid*.

⁴⁴⁹ Letter from Topf to *SS-Bauleitung* of *KL* Mauthausen dated 3 January 1945, *ibid*.

⁴⁵⁰ Letter from Topf to *SS-Neubauleitung* of *KL* Mauthausen dated 23 November 1940, *ibid*.

⁴⁵¹ Letter from *SS-Neubauleitung* of *KL* Mauthausen to Topf dated 16 October 1941, *ibid*.

⁴⁵² Letter from Topf to *SS-Neubauleitung* of *KL* Mauthausen dated 1 November 1940. *ibid*.

⁴⁵³ Topf *Kosten-Anschlag* dated 13 November 1940 for *SS-Neubauleitung* at Auschwitz concerning the second Topf coke-fired double-muffle furnace of Crematorium I. RGVA, 502-1-327, pp. 168-172.

“Quotation

Our Department: D/Prf.
 Offer No. 40/999
 House Phone No. 123
 Date: 13 Nov. 40

*Reichsführer SS,
 Head of German Police,
 Main Office Budget and Construction,
 New Construction Office KL Auschwitz,
 Auschwitz /Upper Silesia*

*Subject: 1 coke-fired Topf double-muffle cremation furnace with blower
Prepared by head engineer Prüfer!
 Prep.: Prf/Hes.*

#	Description	
1	<p><i>coke-fired Topf double-muffle furnace with blower including the following services and parts The foundations of the furnace and of the flue duct must be provided by the customer in accordance with our specifications, at no cost to us. Bricks, sand, lime and cement of the outer brickwork. The best bricks will be selected for the facing of the furnace. The necessary refractory materials consisting of normal and wedge-shaped bricks, Monolite packing and the corresponding mortar. For the insulation of the furnace, bricks of diatomaceous earth, rock wool and the necessary diatomaceous-earth mortar. Wrought-iron anchoring bars, with T, U and angled sections, tightening rods, bolts and nuts. Coke-fired Topf double-muffle furnace with blower including the following services and parts The foundations of the furnace and of the flue duct must be provided by the customer in accordance with our specifications, at no cost to us. Bricks, sand, lime and cement of the outer brickwork. The best bricks will be selected for the facing of the furnace. The necessary refractory materials consisting of normal and wedge-shaped bricks, monolite tamping mass and the corresponding mortar. For the insulation of the furnace, bricks of diatomaceous earth, rock wool and the necessary diatomaceous-earth mortar. Wrought-iron anchoring bars, with T, U and angled sections, tightening rods, bolts and nuts. Cast- and wrought-iron fittings such as:</i></p>	
2	<p><i>Cast-iron introduction doors with cast-iron frames. The doors will have Monolite cladding on the inside.</i></p>	

<p>6 Cast-iron closures for the air channels. 4 Cast-iron ash-extraction doors. 2 Cast iron loading doors for the gasifiers. 2 Wrought-iron ash receptacles. 2 Wrought-iron frames for the flue-duct dampers, lined with Monolite, including pulleys, cables and counterweights, the necessary stokers. 2 Cast-iron hearth covers. 2 Horizontal grates. 1 Blower device consisting of a blower with its 3-phase directly coupled 1.5-hp motor and the necessary conduits.</p> <p><u>Installation of the furnace</u> Presence of a builder for the construction of the furnace, including travel expenses, daily rates as well as social-security contributions.</p> <p>1 Corpse-introduction system, wrought iron, consisting of a mobile wrought-iron cart with the necessary rails. Free delivery to Auschwitz/Upper Silesia Price of the furnace:</p> <p>Weight for authorization code: 2,600 kg of iron.</p> <p>During construction, our builder must be supplied with two assistants at no cost to us.”</p>	<p>RM 7,753</p>
--	-----------------

Beside the offer dated 6 January 1941, we have three more estimates for the coke-fired double-muffle furnace sent by Topf to Mauthausen, dated 1st November 1940, 30 April and 31st October 1941 (Documents 194-196) which differ only in the prices and the weights of the metal parts.

Document 197, translated here, lists the elements of the second cremation furnace for KL Auschwitz, shipped by Topf on 17 January 1941.⁴⁵⁴

ID	#	Packing Type	No. of Pieces	Description	Weight in kg	
					net	gross
22293	6	loose	6	<u>Parts for double-muffle furnace</u> U-bars NP 12, each 1,950 mm long		
	4	“	4	I-bars NP 12, each 1,950 mm long		
	2	“	2	Angle bars 50/5, each 2,780 mm long		
	2	“	2	Dto. each 2,400 mm long		
	4	“	4	Dto. each 1,070 mm long		
	4	“	4	Dto. 80/8, each 1,070 mm long		
	4	“	4	Dto., 40/4, each 1,232 mm long		
	4	“	4	Dto., 60/6, each 800 mm long		
	2	“	2	Flat bars 100/10 mm with 4 rollers		
	2	“	2	Introduction doors 600/600 mm clearance		
	2	“	2	Hearth doors 280/350 mm		
	14	“	14	Anchoring bolts Ø 19 mm		

⁴⁵⁴ Bill of lading from Topf to the SS-Neubauleitung at Auschwitz dated 17 January 1941 concerning parts for the second coke-fired Topf double-muffle furnace for Crematorium I. RGVA, 502-1-327, pp. 201-203.

ID	#	Packing Type	No. of Pieces	Description	Weight in kg			
					net	gross		
	2	"	2	Hearth doors 280/350 mm	} 2,036	} 2,036		
	2	"	2	Angle bars 80/8, length each 1,650 mm				
	1	"	1	T-bars, 80/80, length 1,650 mm				
	1	"	1	Flat bar 50/8, length 2,500 mm				
	2	"	2	[p. 2, cont'd.] also				
	2	"	2	Flue-gas dampers 350/600 mm				
	2	"	2	Housing for latter				
	6	"	6	Air-channel closures 108/128 mm				
	2	"	2	Ash receptacles 350/320 mm				
	2	"	2	Stokers, length circa 3,000 mm				
	30	"	30	Square bars 40/40 each 630 mm long				
	34	"	34	Dto., each 740 mm long				
	1	"	1	Tubing 120/124 mm				
	1	"	1	Boiling tube 82/89 Ø, length 1,560 mm				
	1	"	1	Dto. length 1,660 mm				
	2	"	2	Loading-shaft closures				
	10	"	10	Rails 50/50/5 with anchors				
	1	box (?)	2	Asbestos panels 5 mm thick			10.5	14
	13	paper bags	rock wool				500	
	2	"	Monolite					
	1	cloth bag	Monolite	117	117			
22515	10	loose	10	Fireclay bricks, 560 mm long	460	460		
22469	1	"	1	Blower 120/300 with electric motor SO 37/2, 5,5 hp	90	90		
	1	box	4	Lag bolts 3/8 × 150 mm	0.5	81		
			1	3-way switch, star type	4			
22293			4	Fireclay bricks for fire door	48			
			1	Metal cable Ø 10 mm, length 10 m	3.5			
			4	Grommet thimbles, 8 blocking devices	1.5			
				Various bolts and spacers	8			
				Subtotal		3,181		
		box	8	Lag bolts 3/4" length 250 mm	5			
			4	Lag bolts 3/8" length 100 mm	0.5			
98265			4	Cable rollers 150/125 Ø	6.5			
20809	1	box	1	Complete engraving device		12		
				Total weight		3,193		

The second furnace included, moreover, a case of custom-shaped refractory bricks (305 by 250 by 60 mm, net weight 16.5 kg) which Topf shipped on 20 December 1940,⁴⁵⁵ 50 bags of mortar mixture shipped a day later⁴⁵⁶ as well as two cement counter-weights with eyelet holes which went out on 21 January 1942,⁴⁵⁷ similar to those shown in Photo 172 which were used to move the dampers of the flue duct.

The cost estimate of the third furnace, dated 25 September 1941 (Document 198) is practically the same as the one dated 13 November 1940 concerning the

⁴⁵⁵ RGVA, 502-1-327, p. 205.

⁴⁵⁶ RGVA, 502-1-327, p. 204.

⁴⁵⁷ RGVA, 502-1-327, p. 200.

second furnace; the only differences are the price (7,332 instead of 7,753 RM), the weight of the metal parts (2,870 instead of 2,100 kg) and the mention of a rotatable platform (*Drehscheibe*).

The bill of lading of 21 October 1941 (Document 199), translated here, refers also to the third furnace:⁴⁵⁸

ID	#	Packing Type	No. of Pieces	Description	[Weight]	
41/1980/1				<i>Parts for TOPF coke-fired double-muffle incineration furnace</i>		
23131	2	loose	2	Angle bars 90/9, length 2,000 mm	62	62
	4	"	4	" 80/8, length 1,235 mm	47	47
	2	"	2	Introduction doors 600/600 mm	425	425
	4	"	4	Angle bars 50/5, length 1,235 mm	19	19
	2	"	2	Hearth doors 280/350 mm	90	90
	1	"	1	Angle bar 50/5, length 2,330 mm	8.5	8.5
	6	"	6	Air-channel closures 108/126 mm	50	50
	1	"	2	Angle bars 60/6, length 1,945 mm riveted	24.5	24.5
	13	"	13	Anchoring rods \varnothing 16 mm	55	55
	4	"	4	I-bars NP 12, length 2,000 mm	90	90
	6	"	6	Angle bars 50/5, length 824 mm	18	18
	2	"	2	Angle bars 90/9, length 2,000 mm	56	56
	2	"	2	Angle bars 50/5, length 1,130 mm	8	8
	1	"	1	Flat bars 70/10, length 2,520 mm	13	13
	2	"	2	Angle bars 80/8, length 1,600 mm	30	30
	2	"	2	Dto.	30.5	30.5
	4	"	4	Dto. 50/5, length 1,235 mm	19.5	19.5
	2	"	2	Hearth doors 280/350 mm	90	90
	1	"	1	Flat bars 70/10, length 2,520 mm	13	13
	4	"	4	Flat bars 80/8, actual length 790 mm	19	19
	2	"	2	Loading-shaft closures 270/340 mm clear space	126	126
				<i>Subtotal</i>		1,294
	2	"	2	Flat bars 70/10, length 770 mm	8	8
	2	"	2	Flat bar holders with 2 cable rollers	27	27
	2	"	2	Frame for flue-channel dampers	19	19
	2	"	2	Housings for flue-channel dampers	34	34
	2	"	2	counterweights \varnothing 240 mm	72	72
	2	"	2	Ash receptacles	12	12
	2	"	2	Stokers	12	12
	30	"	30	Square bars 40/40, length 630 mm	255	255
	4	"	4	Square bars 40/40, length 740 mm	37	37
	3	"	3	Sheet-metal tubing \varnothing 120 mm	46	46
	10	"	10	Fireclay grate blocks K 6 length 650 mm	440	440
23133	10	"	10	Rails for introduction cart	83	83
	1	"	1	Mobile cart	100	100
	1	"	1	Introduction cart with discharge device	303	303
	6	"	6	counterweights 300/190/210 mm	264	264

⁴⁵⁸ Topf *Versandanzeige* dated 21 October 1941 to SS-Neubauleitung at Auschwitz. RGVA, 502-1-312, pp. 104f.

ID	#	Packing Type	No. of Pieces	Description	[Weight]	
23238	1	“	1	Blower 120/300 with 3-phase 1.5 hp motor	50	50
27410	10	“	10	Fireclay grate blocks K 6a, length 650 mm	440	440
23131	1	“	1	I-bar NP 12, length 2,000 mm	22.5	22.5
23131	1	case	2	Company name plates	0.1	0.1
			10	Lin. meters of cable Ø 10 mm with grommet thimbles and blocking device	5	
				Various bolts	16	
					3,548.5	

The final invoice (*Schluss-Rechnung*) for the third furnace (Document 200) not only lists the parts supplied by Topf to the Central Construction Office, but also shows the on-account made by the cashier of *Bauinspektion der Waffen-SS und Polizei Reich “Ost”* and the credit granted by the company on 13 July 1942. In accordance with normal practice, the invoice has the date of the preceding partial invoice (*Teil-Rechnung*), dated 16 December 1941, but was itself established in early June of 1942.⁴⁵⁹

#	Object	
	<p>concerning: Supply and erection of a Topf coke-fired double-muffle incineration furnace without foundations or smoke channel, viz: Supply of bricks and mortar materials for the brick mantle, the necessary fireclay materials, Monolite tamping mass, bricks of diatomaceous earth, diatomaceous mortar and slag wool for the insulation of the furnace, wrought-iron anchoring, cast- and wrought-iron doors, as well as compressed-air unit consisting of compressed-air blower with 3-phase motor and the necessary conduits. Dispatch of a builder including his travel expenses, daily rates and social-security contributions for the construction of the furnace. Supply of wrought-iron corpse-introduction device consisting of coffin-introduction cart, shoving cart, rails and rotary plate. In other respects in accordance with our cost estimate of 25 September 1941 and our order confirmation of 25 September 1941. Cost of transportation for the steel parts loaded at Erfurt as per freight bill of 21 October 1941</p>	
		7,332
		186.10
		7,518.10
	– payment on account of 31 January 1942	3,650.--
		3,868.10

⁴⁵⁹ Topf *Schluss-Rechnung* of July 1942 backdated to 16 December 1941 concerning the third Topf coke-fired double-muffle furnace for Crematorium I at Auschwitz. RGVA, 502-2-23, pp. 261-261a.

<p>– credit for rotatable platform not supplied</p> <p>Our order no. 41 DI980 Our invoice no. 2363</p> <p>To: Reichsführer-SS and head of German police Hauptamt Haushalt und Bauten KL Auschwitz, Upper Silesia.</p>	<p>82.--</p> <p>3,786.10</p>
---	------------------------------

The elements of the Mauthausen Furnace are likewise listed in the Topf Bill of Lading of 12 January 1943 (Document 201, not translated) which we shall discuss later.

The design of the coke-fired double-muffle furnace is shown in Topf Drawing D57253, dated 10 June 1940, which refers to the first furnace set up in the Auschwitz Crematorium (Document 202). The description which follows is based on this drawing and on the examination of the Mauthausen Furnace, as well as on the documents concerning the double-muffle cremation furnace, Auschwitz Type, presented in this chapter. The numbers in parentheses refer to Documents 202a through e.

The furnace (photo 51) is enclosed in a solid outer brick structure by means of a number of anchoring bars (*Verankerungs-Eisen*) consisting of bars having a T-section (No. 1) a U-section (No. 1a) and an angled section (No. 1b; *T-, U- und Winkelleisen*), anchoring rods (*Anker*), bolts and nuts.

The dimensions of the Mauthausen Furnace are practically identical to those shown in Drawing D57253, which correspond to the dimensions of the anchor bars, as shown in the following table:

	Mauthausen Furnace	Drawing D57253	Anchor bars
Height	1,860 mm	1,850 mm	1,950 mm
Width	2,520 mm	2,500 mm	2,500 mm
Length (w/o gasifiers)	2,800 mm	2,780 mm	2,780 mm
Length (with gasifiers)	3,430 mm	3,380 mm	
Surface area (w/o gasifiers)	25 m ²		
Surface area of gasifiers	7 m ²		
Surface area, total	32 m ²		

The furnace is equipped with two incineration chambers (*Einäscherungskammer*) or muffles (No. 2; Photos 52-56), each of which has the following dimensions:

Height:	700 mm
Width:	700 mm
Length:	2,000 mm
Surface area (w/o grate):	4.5 m ²
Volume (including ash chamber):	1.4 m ³

The lateral walls of the muffles possess four rectangular openings (Photos 52-54) linked to two air-supply channels (*Luftkanäle*; Photo 57) which run through

the sidewalls of the furnace parallel to the muffles and open up to the outside as two air-intake vents (*Lufteintritte*) closed by two raisable cast-iron doors (*Luftkanalverschlüsse*), 108 by 128 mm in size, at the front next to the corpse-introduction doors of the muffles (Photos 58f.). These channels allow feeding secondary combustion air to the muffles.

At the apex of the vaults of both muffles, in line with the longitudinal axis, we have the openings of four tubes (Photos 60f.) connected to the blower ducts (*Druckluftleitung*) coming from the blower itself (*Druckluftgebläse*). The function of this device is to feed combustion air to the muffle, especially if a coffin is used.

The central wall separating the two muffles has three rectangular openings (No. 3; Photos 62-65) some 210 mm × 270 mm in size. The thickness of the refractory brickwork is 260 mm. These openings are to ensure the heat exchange between the two muffles.

At the front (Photos 66), the muffles are closed by two cast-iron corpse-introduction doors (*Einführtüren* or *Einführungstüren*) 600 mm × 600 mm, opening to the outside. These doors are lined on the inside with refractory (Photo 67). In the center of the lower portion of the doors there is an air-feed hole closed on the outside of the door by means of a raisable cast-iron lid of standard type, which, however, has in its center a round inspection hatch (*Schauluke*), 45 mm in diameter (Photos 67f.). At the rear the muffles are closed by the refractory brickwork (Photo 65).

The floor of the muffle is constituted by a horizontal grate made of fireclay (*Schamotterost*; No. 5) consisting of five transverse fireclay bars (*Schamotteroststeine*; No. 6; Photos 52-54) on which the corpse was placed.

Underneath each grate, there is an inclined and V-shaped ash floor (*Aschenschräge*; No. 7) which ends in a narrower (340 mm) combustion chamber (No. 8; Photo 72) where the post-combustion (*Nachverbrennung*) of the corpse parts took place which had dropped through the grate. The front portion of the post-combustion chamber acted as an ash receptacle (*Aschenraum*; Photos 69-71). The ashes were extracted by means of dedicated scrapers (*Kratzer*) through the cast-iron ash-removal ports (*Ascheentnahmetüren*; No. 9), 280 mm × 350 mm in size, positioned at the front of the furnace below the muffle doors (Photos 69-71). On the side walls of the two post-combustion chambers, towards the front of the furnace, are two rectangular outlets (No. 10) through which the discharge gases passed on into the two lateral flue-gas ducts (*Rauchkanäle*; No. 11) below ground. In the Mauthausen Furnace, the ash chambers of the two muffles are linked by a large opening in the central wall (Photo 72), whereas at Auschwitz the combustion chambers were separate.

The flue-gas ducts have a cross-section of 350 mm × 600 mm, and each one could be closed by a damper set into the duct (*Rauchkanalschieber*; No. 12), made of refractory material and measuring 350 mm × 600 mm as well, running vertically in a wrought-iron frame (*Rauchkanalschieberrahmen*) and operated by means of a cable (*Drahtseil*) and two rollers (*Seilrollen*). The rollers were welded to an anchoring bar which appears in Photos 100f.

Before reaching the chimney (*Schornstein*; No. 13a), the two flue ducts come together in a single duct which could be closed by means of the main damper of the flue duct (*Hauptkanalschieber*; No. 13) which operates like the secondary dampers.

On each of the side walls of the furnace we have an air-entry port (*Lufttritt*) closed by means of a cast-iron cover of standard type, which can be raised (Photos 73f.); these openings are linked to two air channels each which open up inside the post-combustion chambers as two small rectangular openings on their external side walls (Photo 72) and were used to feed combustion air into these chambers. On the left side of the furnace one can see a portion of the compressed-air duct (*Druckluftleitung*; No. 14; Photos 75f.) which was originally connected to the blower (*Druckluftanlage*; No. 15) located below, at the point where the floor has no tiles.

The rear wall of the furnace sports a service pit (*Schacht*; No. 16; Photo 77) whose dimensions are 2,610 mm (width) × 1,540 mm (length) × 950 mm (height). It has four steps (No. 16a) and provides access to the two gasifiers, housed in a brick structure (No. 17; Photos 75, 77f.), measuring 2,520 mm (width) × 630 mm (length) × 1,430 mm (height). The corresponding dimensions of Drawing D57253 are 2,500 mm × 600 mm × 1,400 mm, respectively.

On the inclined top surface of this brick structure there are the two closures (*Generatorfülltüren*; No. 18; Photos 77f.) of the gasifiers' loading shafts (*Generatorschächte*; No. 18a; Photo 79) which open into the generators themselves.

The generators (*Generatoren*) are shaft-like chambers, closed below by the horizontal grates (*Planroste*; No. 20) of the hearths. The grates are constituted by eight square bars (*Vierkanteisen*) measuring 40 mm × 40 mm × 630 mm and four support bars (*Auflager-Eisen*) having the same section but a length of 740 mm (Photos 99-101). The grate itself measures 500 mm × 500 mm, or 0.250 square meters. The throughput capacity of the grate is about 30 kg/hr of coke.⁴⁶⁰ In their upper portions, towards the muffle interior, the gasifiers narrow into the gasifier neck (*Generatorhals*; No. 21), which opens up into the muffle below the bars of the grate.

Up to the level of the fire bridge (*Feuerbrücke*; No. 22) in the neck, the gasifier has a volume of about 0.175 cubic meters.

Aside from the horizontal grate (*Planrost*; No. 20), the hearth (*Feuerung*) consists of the hearth door (*Feuertür*; No. 23; Photo 80) used for removing of coke slag and ash (hence it is also called ash-removal door – *Ascheentnahmetür*), and an air-feed opening (*Lufttritt*) for the primary combustion air to the gasifier, equipped with a raisable standard cast-iron closure (Photo 81).

According to the “List of materials for a Topf double-muffle incineration furnace” dated 23 January 1943 (Document 203) the refractory mass of the furnace consisted of:

- 800 standard fireclay bricks, Type SS
- 800 standard fireclay bricks, Type A

⁴⁶⁰ Quantity of coke burned on the grate in one hour. For the calculation of the throughput cf. Subchapter 8.3.

- 500 standard fireclay wedges, Type SS
- 400 standard fireclay wedges, Type A
- 1,400 kg of fireclay mortar
- 2,500 kg Monolite packing mass

The insulation of the furnace was assured by 1,300 white bricks of diatomaceous earth (insulating bricks) and 400 kg of insulating mortar. The standard bricks (*Normalstein*) measured 65 mm × 120 mm × 250 mm,⁴⁶¹ giving a volume of 1,950 cubic millimeters. The wedge or semi-wedge bricks (*Halbwölber*) measured 66/58 mm × 120 mm × 250 mm for a volume of 1,845 cubic centimeters.⁴⁶²

As the density of the fireclay bricks is about 1,800 kg/m³, the mass of the two types of bricks was:

$$\frac{1950 \text{ cm}^3 \times 1800 \text{ kg/m}^3}{10^6 \text{ cm}^3/\text{m}^3} = 3.51 \text{ kg and } \frac{1845 \text{ cm}^3 \times 1800 \text{ kg/m}^3}{10^6 \text{ cm}^3/\text{m}^3} = 3.32 \text{ kg, respectively.} \quad [108]$$

Hence, the mass of the furnace refractory brickwork was:

$$\begin{array}{r} 800 \times 3.51 \text{ kg} = 2,808 \text{ kg} \\ 800 \times 3.51 \text{ kg} = 2,808 \text{ kg} \\ 500 \times 3.32 \text{ kg} = 1,660 \text{ kg} \\ \underline{400 \times 3.32 \text{ kg} = 1,328 \text{ kg}} \\ 8,604 \text{ kg} \end{array}$$

To this the mass of the fireclay mortar (1,400 kg) must be added, resulting in a total mass of about 10,000 kilograms. The Monolite caulking mass, being located in the space behind the insulation, is not counted as part of the refractory brickwork.

For the two gasifiers feeding the mobile oil-fired double-muffle furnace for the Gusen Crematorium, 1,000 normal and wedge-type bricks were used as well as 500 kg of fireclay mortar (Document 169), resulting in a total weight of roughly 4,000 kilograms.

Hence, the weight of the refractory brickwork of the double-muffle furnace can be split up in the following manner:

$$\begin{array}{r} 2 \text{ muffles of } 3,000 \text{ kg each} = 6,000 \text{ kg} \\ \underline{2 \text{ gasifiers of } 2,000 \text{ kg each} = 4,000 \text{ kg}} \\ 10,000 \text{ kg} \end{array}$$

The post-combustion chamber is included in the weight of the muffle.

⁴⁶¹ *Brockhaus*... 1958, p. 632. These dimensions also appear in the letter from R. Koehler to *Zentralbauleitung* at Auschwitz dated 16 June 1942. RGVA, 502-2-23, p. 15.

⁴⁶² Letter from Topf to *SS-Bauleitung* of KL Gusen dated 24 February 1943. BA, NS4 Ma/54. In February of 1944 the sizes of the various types of refractory bricks were standardized and somewhat modified: the *Normalstein* measured 250 mm × 123 mm × 65 mm; for the *Halbwölber*, there were five types (2 H 6, -10, -16, -26, -38) with two fixed dimensions (height = 123 mm and longer side of base = 250 mm) and two variable ones (shorter sides of 68, 70, 73, 78, 84 and 62, 60, 57, 52 and 46 mm respectively). "Erläuterungen zur Vereinheitlichung der Schamottesteinformate für den Feuerungs-bau," received by *Zentralbauleitung* on 17 February 1944. RGVA, 502-1-166, unpaginated flyer.

The Auschwitz Crematorium (Photo 86) was originally designed as shown on the Topf Drawing D57999 dated 30 November 1940 (Document 204). The second furnace had not yet been erected. The morgue (*Leichenhalle*) still had an L-shaped extension on the right-hand side.

Topf Drawing D59042 (25 September 1941) shows the positioning of the third furnace in the crematorium (Document 205). On this drawing, the extension of the morgue has been separated by a wall and has become a storage space for urns. The Central Construction Office Drawing 1241 of 10 April 1942 shows the definitive layout of the crematorium as of that date (Document 206). On 3 July 1942, this drawing was revised to show the location and structure of the new chimney (Document 207).

It is highly likely that the crematorium ceased its operation on 19 July 1943; the furnaces were torn down later. After the end of World War II, the Poles fabricated Furnaces 1 and 2, using the original parts which the SS had dismantled; many of these parts are still held in the former coal store of the crematorium (Photos 107-109), but some elements from the 8-muffle furnace were used as well.

In spite of the existence of the above drawing and probable advice from former detainees who had worked in the crematorium, the refabrication was carried out in a manner heedless of technical or historical accuracy. In the front portion, both the transverse anchor bars and the air channels next to the muffle doors are missing; moreover, the introduction doors of the two furnaces have been switched from one side to the other: the left-hand door to the right and vice-versa (Photos 87-91; cf. Photo 51).

In the rear portion, the brickwork of the gasifier is missing (Photos 97f.; cf. Photos 75, 77 and 78); the lids of the gasifier-loading shafts are set into a smooth vertical wall above the grates, as in an ordinary stove, and the hearth doors were placed underneath the former, like ash removal doors, again as in a normal stove. The furnaces could not have operated in this manner.

Due to this faulty refabrication, the two furnaces have been lengthened from about 2.80 to 3.40 meters. On the sides two closure devices for the air feed were mounted (Photo 96), the smaller one of which is original but in the wrong place (cf. Photos 73 and 74) whereas the larger one belonged to the 8-muffle furnace.

The rear part of the muffles was aged artificially, presumably by burning wood in the muffles (Photos 92-95).

The muffle grates consist of six shaped fireclay blocks (Photos 93-95) with slits of some 50 mm, which are neither in agreement with Topf Drawing D57253 nor with the grate bars of the Mauthausen furnace. The Topf bill of lading of 17 January 1941 (Document 197) mentions ten fireclay blocks for the grate (*Schamotte-Roststeine*) – five for each muffle – having a length of 56 mm and a total weight of 460 kg, thus 46 kg for each block. The digits indicating the length have been swapped by mistake, as can be seen from the Topf bill of lading dated 21 October 1941, which speaks of ten fireclay blocks for the grate, Type K6, having a length of 65 cm (total weight 440 kg) and ten more, Type K6a, having the same length (and weight). Each muffle, though, required only five such blocks, which would indicate that the other ten were surely spares.

In the furnaces of Crematorium I at Auschwitz there are currently six such blocks, which means that during the refabrication the furnace was made longer than it originally was. The blocks rested on the brickwork of the post-combustion chamber, about 25 mm from the muffle walls, which means that the muffles were 700 mm wide; the joints were filled with refractory mortar. This type of grate was not intended for a rapid cremation, because with slits of hardly 50 mm, combustion takes place entirely in the muffle, with only the ash itself dropping down into the post-combustion chamber; the initial part of a cremation taking place in the main combustion chamber is thereby prolonged considerably as compared to the time required with grates with wider openings.

In the foundations of the third furnace, which was not rebuilt, the remains of the hearth grates can still be seen (Photos 100f.). The grates consist of seven longitudinal square bars (Photo 99) supported by two square bars placed transversely (Photo 101); the cross-section (40 mm × 40 mm) and the length of the longitudinal bars (630 mm), as well as that of the supporting bars (740 mm) are the same as indicated in Topf's bills of lading of 17 January and 21 October 1941. The first document mentions 34 supporting bars, but this is a mistake, as we can see from the second document as well as from the bill of lading dated 12 January 1943 and the one dated 24 February 1943 (Document 208, not translated) which have 30 square bars 40 mm/40 mm × 630 mm and four bars 40 mm/40 mm by 740 mm for the gasifier grates. Fifteen grate bars and two supporting bars were thus shipped for each gasifier.

The original grates that are still visible and the respective width of the gasifier necks (some 50 cm) exclude the possibility that the fifteen bars for each one of the hearths were mounted all at the same time. The left-hand grate of the third furnace has seven bars, but one has been removed; we may hence rightly assume that the grates initially consisted of 8 bars.

The discharge-gas system is shown in Topf Drawing D57253 for the first furnace (Document 202; in particular Documents 202a, 202b, and 202d), and D59042 for the third (Document 205). At the Auschwitz Crematorium, the outlets of two smoke ducts are still visible in the foundations of the third furnace (Photo 102).

Each furnace had its dedicated blower device (*Druckluftanlage*; for the first furnace cf. Document 202b, No. 15) consisting of the blower itself (*Druckluftgebläse*; No. 15a), driven by a directly mounted 3-phase electric motor of 1.5 hp (No. 15b), and the air conduits (*Druckluftleitung* or *Rohrleitung*; No. 14). Structure and operation of the blowers will be discussed in the next chapter.

For the first and the third furnace, the blower is shown in Drawings D57253 and D59042, respectively, and for the second furnace it is mentioned in the quotation of 13 November 1940 (Document 193).

Originally, the chimney (*Schornstein*; Document 202e, No. 13a) had a square cross-section, 500 mm × 500 mm. The draft enhancer (*Saugzug-Anlage*; Document 202e, No. 13b), which had a capacity of about 4,000 m³/hr of spent gas, consisted of a blower (*Saugzug-Gebläse*; No. 13d) driven by a directly mounted 3-phase 3-hp electric motor (No. 13c) and a rotary vane (*Drehklappe*)

separating the intake chamber from the compression chamber. The operation of this device is explained in Topf's service instructions (Document 209):⁴⁶³

"Operating instructions for the Topf draft enhancer.

If the draft of the furnace is insufficient, the draft enhancer mounted on the chimney must be started up.

Care must be taken to start the motor first, and only then the damper in the chimney may be closed. The water supply for the water-cooled bearing must run at all times.

After the end of the incineration, the rotary vane in the chimney must be opened first, before the motor and the cooling water are stopped.

Furthermore, it is necessary to make sure that there is always enough water in the tank."

Topf's cost estimate of 13 November 1940 does not speak of a draft enhancer. The explanation is provided by Topf's letter of transmittal in which we can read:⁴⁶⁴

"As we assume that this furnace will be connected to the same chimney of the present crematorium, the purchase of a further draft enhancer is not necessary as [the existing one] can be used in alternation for both furnaces. It is also possible to operate both furnaces [simultaneously] with this device."

The draft enhancer is not mentioned either in Topf's bill of lading of 21 October 1941, nor in the final invoice for the third furnace because this furnace was connected to the existing device as well; this is confirmed by Drawing D59042 showing only one draft enhancer in the space between the building and the chimney.

As we have seen in Chapter 6, the chimney of the crematorium was taken down and replaced by another between June and August of 1942. The new chimney, displaced some 10 meters along the axis of the old one, had a square cross-section 0.90 m × 0.90 m and was 15 m high (Document 178). The three double-muffle furnaces of the crematorium were linked to it by means of two flue ducts, 0.70 m × 0.80 m, which had a refractory lining 12 cm thick. The duct in line with the old chimney, having a length of 12.20 m, was used for Furnaces 1 and 2, the transverse one, 7.375 m long, for the third furnace (Document 179).

The loading system of the muffles themselves consisted of a corpse-introduction device (*Leicheneinführungs-Vorrichtung*) having a coffin-loading cart (*Sargeinführungswagen*) moving on rails (*Laufschienen*; Document 202b, No. 24) and a semi-cylindrical cart (*Verschiebewagen*) running above it. These devices are still visible today in the Auschwitz Crematorium (Photo 87). Their operation can be described in the following manner:

In front of each one of the three furnaces are two rails set into the floor for moving the cart; perpendicular to these rails are connected two wider rails which carry a rotatable platform (*Drehscheibe*) mounted on a flat cart (Document 205a, No. 25 and 26, and Photos 105f.). This platform enabled the carts to be moved from one set of rails to the other.

⁴⁶³ Topf, *Betriebsvorschrift über die "Topf"-Saugzuganlage*. 26 September 1941. APMO, BW 11/1, p. 2.

⁴⁶⁴ RGVA, 502-1-327, p. 166.

In the ceiling of the furnace hall of the Auschwitz Crematorium, above the first and the second furnaces, we have two ventilation shafts (Photo 103) opening up into two small shafts (Photo 104) on the flat roof of the crematorium.

The crematorium chimney shown in Photo 86 was rebuilt by the Poles after the war. The administration of the Auschwitz Museum has attached a commemorative plaque to the wall next to the second furnace, bearing an inscription in four languages (Polish, English, French and Russian), stating (see Photo 110):⁴⁶⁵

“Crematorium I was working in the period from 1940 to July 1943. About 70000 corpses prisoners, gased, shot, killed at work or deceased in camp, were cremated here.” (Bad English in the original)

The operation of the double-muffle furnace is explained in Topf’s operating instructions (Document 210). For the sake of clarity, I have added comments and references to the photos and other documents concerning the furnace in brackets [...]. Text in normal parentheses (...) appear in the original text.⁴⁶⁶

“Operating instructions for the coke-fired Topf double-muffle incineration furnace.”

Before any coke is fed to the two coke generators [Photo 78, through the two loading shafts, Photo 79], both flue-duct dampers [Documents 202b & 202d] on the furnace must be opened, as well as the main flue-duct damper [Document 202e, No. 13] and/or the rotating vane [of the Saugzuganlage] on the chimney.

Now fire can be lit and maintained in the two generators; care must be taken to make sure that the secondary covers to the right and left of the ash-removal doors [Photos 78 and 81] (coke generator) are open.

Once the incineration chamber shows a satisfactory red glow (about 800°C), the corpses can be introduced successively into the two chambers.

At this point, it is advisable to switch on the air compressor located at the side of the furnace [Document 202b, No. 15] and to let it run for about 20 minutes. By observation, it must be decided whether too much or too little fresh air enters the two chambers.

Control of the air flow is effected by means of the rotary vane located in the air duct. Furthermore, the air-entry ports to the right and left of the introduction doors [Photos 58 and 59] must be half-open.

As soon as the corpse parts have dropped from the fireclay grate [Photo 52] onto the inclined ash-plate below [into the post-combustion chamber, Photo 72], they must be moved forward towards the ash-removal door [Photo 71] by means of the scraper. These parts may remain here for another 20 minutes for post-combustion. Then the ash is transferred into the ash container and set aside for cooling.

In the meantime, new corpses will be introduced successively in the chambers.

The two generators must be loaded with fuel from time to time. Each night the generator grate must be freed of coke slag and the ash must be removed.

It is important, furthermore, that after the end of the operation as soon as the generator has burned itself out and embers are no longer present, all air damp-

⁴⁶⁵ The brickwork of the furnaces could last for some 16,000 cremations. See Subchapter 9.7. in this Unit.

⁴⁶⁶ APMO, BW 11/1, p. 3.

ers and doors [of the ash chambers, the gasifiers' loading shafts, of the muffles' ash chambers, and of the introduction doors], as well as the flue-duct dampers, must be closed in order to avoid cooling of the furnace.

After each incineration, the furnace temperature will increase. Therefore, care must be taken not to let the internal temperature exceed 1100°C (white hot).

This temperature increase can be avoided by feeding air.

26 September 1941" (Emphasis in original)

7.2. The Coke-Fired Triple-Muffle Furnace

The Topf Co. built a total of 14 triple-muffle furnaces: ten for the Birkenau Crematoria II and III, two for the Buchenwald Crematorium and two for the crematorium at the Gross-Rosen Camp. Practically nothing is known about the furnaces for the last camp. In 1948, the Soviet counter-espionage service (SMERSH) was in possession of the documentation of a project, elaborated by Topf in 1941, for the crematorium of Gross-Rosen, which did, in fact, concern two triple-muffle furnaces. Their installation was confirmed by engineer Prüfer.⁴⁶⁷ In his interrogation of 21 March 1946, he declared to have designed the triple-muffle furnace himself, together with Ludwig Topf, as early as 1939. The respective projects had then been submitted to the War Ministry and were accepted by the SS in 1940.⁴⁶⁸

This statement is, however, in disagreement with a letter dated 6 December 1941, addressed by Prüfer to the two co-directors of the firm, Ludwig and Ernst Wolfgang Topf, in which he stated that he had designed the triple- and eight-muffle furnaces by himself, essentially in his spare time.⁴⁶⁹ However, no documentary trace dated earlier than the end of 1941 exists for these two furnace types; hence, they were most-likely designed at that time (1941).

On 22 October 1941, the New Construction Office at Auschwitz ordered from Topf "5 Topf triple-muffle furnaces with blower," as well as "2 Topf draft enhancers for about 10,000 m³ of exhaust gas each" and "1 waste incinerator"⁴⁷⁰ for the new crematorium which at that time the Auschwitz camp authorities were still planning for the Auschwitz Main Camp.

In the "Explanatory report for the preliminary project for the new construction of the *Waffen-SS* PoW camp at Auschwitz, Upper Silesia," dated 30 October 1941, one reads:⁴⁷¹

"On account of the considerable quartering (125,000 prisoners) a crematorium will be built. It contains 5 furnaces with 3 muffles each for two men, and will thus allow incinerating 60 men in one hour. Furthermore, a corpse cellar as

⁴⁶⁷ Interrogation of engineer Kurt Prüfer by Soviet SMERSH interrogators on 9 March 1948. FSBRF, N-19262, p. 183.

⁴⁶⁸ Interrogation of Kurt Prüfer by Soviet SMERSH interrogators on 15 March 1946. FSBRF, N-19262, pp. 41f.

⁴⁶⁹ Letter from Kurt Prüfer to Ludwig and Ernst Wolfgang Topf dated 6 December 1941. APMO, BW 30/46, p. 6.

⁴⁷⁰ RGVA, 502-1-313, pp. 36f. and APMO, BW 30/27, p. 27 and BW 30/34, p. 116.

⁴⁷¹ *Erläuterungsbericht zum Vorentwurf für den Neubau des Konzentrationslagers der Waffen-SS, Auschwitz O/S.* RGVA, 502-1-233, p. 20; cf. Document 211.

well as a waste incinerator will be installed. The crematorium will be erected within the area of the K.L.”

The furnaces mentioned in this report were of a design different from the ones which were later built. They were, in fact, conceived to accommodate two corpses in each muffle and would thus have required larger muffles and generators. We can gather this also from page 6 of the explanatory report where the estimated cost for the five triple-muffle furnaces is listed as being 60,000 RM (Document 212), whereas the Topf estimate for the five triple-muffle furnaces actually built in Crematorium II at Birkenau not only has a much-lower price (51,237 RM, including the two coffin-loading devices and the three draft enhancers), but also shows a later date (4 November 1941). In addition, the operating instructions supplied by Topf to the Auschwitz Central Construction Office specify that the corpses be loaded “*hintereinander*” (Document 227), *i.e.* successively. This means that the furnace was not designed for the simultaneous incineration of two corpses in one muffle.

According to Pressac, the first two triple-muffle furnaces built by Topf were started up in the crematorium at the Buchenwald Camp on 23 August and 3 October 1942, respectively (Pressac 1993, pp. 116f.; 1994, pp. 130f.).

The parts for the five triple-muffle furnaces at Crematorium II are listed in the Topf bills of lading of 16 April⁴⁷² and 18 June 1942.⁴⁷³ The shipment of 16 April included also several parts of the double-muffle furnace at Mauthausen – shipped to Auschwitz by mistake and with an erroneous reference to the order for the third furnace at the crematorium of the Main Camp (*Auftrag 41/1980/1*) – and with the blower for this crematorium (*Auftrag 41 D 314*). The shipment of 18 June included some parts for the waste incinerator (*Müllverbrennungsofen*) of Crematorium II.

The main elements of the five triple-muffle furnaces listed in the two above documents are the following:

Parts for the Topf triple-muffle furnace

- 15 *Einführungstüren* (introduction doors) 600 × 600 mm, 10 right-handed and 5 left-handed
- 30 *Feuertüren* (closures for the hearths and the ash chambers) 280 × 350 mm and 2 of 250 × 250 mm
- 56 *Luftkanalverschlüsse* (closures for air channels) 108 × 128 mm
- 10 *Füllschachtverschlüsse* (closures for loading shafts for the gasifiers) 270 × 340 mm
- 6 *Rauchkanalschieber* (flue-duct dampers) 600 × 700 mm
- 5 *Gebälse* (blowers) No. 275,⁴⁷⁴ 2 clockwise and 3 counter-clockwise

⁴⁷² RGVA, 502-1-313, pp. 167-170. Topf, *Versandanzeige*, 16 April 1942; Document 213.

⁴⁷³ RGVA, 502-1-313, pp. 165f. Topf, *Versandanzeige*, 18 June 1942; Document 214.

⁴⁷⁴ The number of the blower corresponded to the diameter (in mm) of the tube on the pressure side.

Parts for the flue ducts and the chimney

- 5 *Fuchseinsteigeschachtverschlüsse* (access ports for the flue ducts) 450 × 510 mm
- 1 *Reinigungstür* (cleaning door for chimney) 390 × 510 mm
- 3 *Rauchkanalschieber* (flue-duct dampers) 1200 × 800 mm
- 3 *Schieberplatten* (damper plates) 1250 × 840 mm
- 3 *Gebläse* (blowers) No. 625.

The bill of lading of 16 April 1942 mentions, moreover, a “*zweiflügelige Feuer-tür*” (double door for hearth) 600 mm × 600 mm which surely belonged to the waste incinerator.

The two above lists contain more shipment errors: the air-channel closures for the five furnaces numbered not 56 but 55, or eleven for each furnace, placed at the following points: one placed on each introduction door of the muffles (*i.e.* 3 per furnace), two placed next to the introduction door of the right-hand muffles and two for the left-hand muffles, as well as two behind the center muffles (*i.e.* six per furnace), and one on the closure of each gasifier hearth (*i.e.* two in total). Furthermore, the two *Feuertüren* 250 mm × 250 mm did not belong to the triple-muffle furnaces and, finally, neither one of the advices has the grate bars for the hearths or the grate bars for the muffles.

Topf's overall supply for the five triple-muffle furnaces at Crematorium II is detailed on the final invoice dated 27 January 1943 (Document 215) translated below:⁴⁷⁵

<i>Object</i> <i>BW 30 = Crematorium II</i>	<i>Amount</i> <i>RM</i>
<i>41 D 2249</i>	
<i>Construction of 5 pcs. triple-muffle incineration furnaces, viz.: Supply of normal, wedge-type, and special fireclay bricks, fireclay mortar and Monolite packing mass for the construction of the fire-resistant brick structure of the furnace, of cast- and wrought-iron fittings for furnace and compressed-air units as per description in our cost estimate of 4 November 1941, item I. Supply of an erection supervisor for furnace construction, including daily rates, travelling expenses and social-security contributions. Transportation of building materials to Erfurt Station @ 6,378.-- Supply of 2 coffin-introduction devices each consisting of a coffin-introduction cart, shoving cart, and rail system for 5 incineration furnaces</i>	<i>31,890.--</i>
<i>Subtotal</i>	<i>1,780.--</i>
<i>Supply of: 10,000 normal refractory bricks, Seger Cone 30 3,000 wedge-type refractory bricks, Seger Cone 30 7,000 kg of mortar M 2 and</i>	<i>33,670.--</i>

⁴⁷⁵ Topf, *Schluss-Rechnung Nr. 69* dated 27 January 1943. RGVA, 502-2-26, pp. 230-230a.

Supply of our technician for construction of smoke installation	4,045.--
Supply of 3 Topf draft enhancers in suction, each consisting of 1 blower in suction for an output of 40,000 m ³ of smoke gases against a total pressure of 30 mm water column with 2 suction fittings, mounted, and 1 pressure fitting, 1 smoke-channel-blocking damper 0.9 by 1.2 m, with air-tight guide, rollers cable and hand crank, 1 380-Volt 50 c/s 3-phase motor, spray protected, nominal output 15 hp with slip-ring rotor, full-load starter and buffered-bolt clutch,	9,048.--
Supply of our technician for installation @ 3,016.-- each	
Construction of a waste incinerator, viz: Supply of normal, wedge-type, and shaped fireclay bricks, fireclay mortar, Monolite packing mass, bricks of diatomaceous earth, insulating mortar and rock wool for erection and insulation of fire-resistant furnace brickwork, cast- and wrought-iron fittings, wrought-iron loading box, and smoke-channel damper, Supply of our erection supervisor for construction work. Delegation of an engineer for start-up, as per our cost estimate of 4 November 1941 and our letter of 4 November 1941.	4,474.--
	51,237.--
Reference: order of 22 November 1941 of Reichsführer-SS, Hauptamt Haushalt und Bauten – New Construction Office KL Auschwitz, order number 215/41 Ho.	
Credit for 3 draft enhancers in suction of 16 April 1943	3,705.--
	47,532.--

The final invoice for the five triple-muffle furnaces at Crematorium III (Document 216) is dated 27 May 1943 and is translated below:⁴⁷⁶

Object		
<i>BW 30a = Crematorium III</i>		
42 D 1454 Construction of 5 pcs. triple-muffle furnaces, viz.: Supply of normal, wedge-type, and shaped fireclay bricks and fire-resistant tamping mass for construction of fire-resistant furnace brickwork, supply of insulating materials for furnace insulation. Supply of cast- and wrought-iron fittings for furnace and compressed-air unit, anchoring parts for furnace brickwork and one corpse-introduction device each, stretcher type, with their guide rollers and fixation bars, FOB Erfurt Station. Supply of our builder for supervision of construction, as per our offer of 30 September and letter of 30 September 1942. Supply and installation of 3 Topf draft enhancers each with their	7,830.--	39,150.--
Subtotal		39,150.--

⁴⁷⁶ Topf, *Schluss-Rechnung Nr. 728* dated 27 May 1943. RGVA, 502-2-26, pp. 215-215a.

<i>suction fittings, 1 pressure fitting, 1 smoke channel blocking damper with rollers, cable and hand-crank, 1 380-Volt 50 c/s 3-phase ca. 15 hp nominal, with slip-ring rotor and full-load starter, 1 elastic-insulated buffered-bolt clutch. Construction of a smoke-channel system for the 5 incineration furnaces, i.e. supply of necessary normal and wedge-type fireclay bricks and the necessary fireclay mortar Supply of our builder for supervision of construction work on smoke channels, as per our offer of 30 September and our letter of 30 September 1942.</i>	5,504.--
<i>Ref. your order of 26 October 1942, journal number 16496/42/Jäh/Lp. KL Auschwitz KGL – second crematorium.</i>	53,702.--

The description of the Topf triple-muffle furnace which follows is based on the documents presented in this subchapter, and on a direct investigation of the two Buchenwald Furnaces; it is supported by four drawings (Documents 217-220) and by the photos in Section V of the collection of photos. The numbers in parentheses refer to the above drawings.

Three photos taken by the SS confirm that the triple-muffle furnaces set up in Crematoria II and III at Birkenau were of the same type as those in the crematorium of the Buchenwald Camp, though one of the latter was designed to also use oil as fuel (Photos 111-116).

As far as its layout is concerned, the triple-muffle furnace consisted basically of a double-muffle furnace with a third muffle inserted in the middle, as well as some other technical modifications to be described below.

The furnace itself is held in a solid brick structure by wrought-iron T, U, and angular anchor bars, tightening rods, bolts and nuts. Its dimensions are as follows:

Height	2,000 mm
Width	3,460 mm
Length (w/o gasifiers)	2,780 mm
Length (with gasifiers)	3,400 mm
Surface area of the furnace without gasifiers	33 m ²
Surface area of the gasifiers	10 m ²
Overall surface area	43 m ²

The furnace is equipped with three cremation chambers or muffles (No. 1) each of which has the following dimensions:

Height	800 mm
Width	700 mm
Length	2,000 mm
Surface area (w/o grate)	5 m ²
Volume (including ash chamber)	1.5 m ³

At the apex of the vault, arranged along the longitudinal axis, each muffle has four rectangular openings 100 mm × 80 mm in size (No. 2; Photos 132f., 137, 139, 143, 146), which lead into a horizontal duct running lengthwise inside the muffle ceiling (No. 3). These three ducts merge into a transverse and common duct located behind the furnace, which exhausts to the outside and is connected with a pipe (No. 25) to the blower (No. 23f.), which feeds combustion air into all three muffles jointly, especially in cases of incineration with a coffin.

The side walls of the outer muffles had four rectangular openings (Photos 131, 140f., 147), 110 mm × 130 mm, linked to the two air channels which ran lengthwise through the two outer walls and ended in two air inlets at the front (Photos 149, 151) closed by two raisable cast-iron covers (Photos 148, 150, 153) of standard size (108 mm × 128 mm) and shape. The two air channels at the rear of the furnace turned downwards 180° and ran back; the four inlets mentioned were arranged in this section of the channel as we may deduce from the fact that the respective covers are located higher than the openings set into the muffle. These channels served to bring combustion air to the outer muffles.

The center muffle was connected to the outer ones by three large openings of some 200 mm × 300 mm set into each of its side walls (No. 4; Photos 135-138). These outlets passed through the refractory brickwork (about 250 mm thick) on both sides and discharged through the inner walls of the outer muffles (Photos 134, 140, 142, 144f.). These openings are part of the discharge system of the combusted gases; for that reason, as opposed to the design of the double-muffle furnace, they are essential for the operation of the furnace.

The two walls separating the inner muffle from the outer ones had a thickness which was too thin to place any combustion-air channel in them similar to the design of the outer muffles; instead, the air channel to the center muffle was set into the brickwork of the rear portion of the furnace, opening on the inside into the muffle through a rectangular opening located near the top in the center of the muffle's rear brick wall (Photos 135-137), and at the outside into an opening (Photo 170) located in the rear wall of the furnace between the two gasifiers; it could be closed by means of a standard-sized raisable cast-iron cover (Photo 168). This exterior opening is located lower than the opening inside the muffle itself. The channel therefore is not a straight horizontal duct; coming from the inside, it angles down 90°, then angles 90° back to exit as a horizontal duct.

The muffles are closed at the front by three cast-iron corpse-loading doors, 600 mm × 600 mm (No. 5; Photo 127) clad with refractory on the inside (Photo 129). In the lower central part of the doors is an air inlet, closed on the outside by means of a standard-sized raisable cast-iron cover, which has at its center an inspection hole 45 mm in diameter covered by a round cast-iron plate held by a hinge. The upper part of the door sports another inspection hole, also closed by a thin metal plate rotating around a pin (Photos 127, 129).

At the rear, the muffles are closed by refractory brickwork. Their lower part consists of a horizontal grate (No. 6) composed of five refractory bars (No. 7; Photos 122, 136, 145, 147) some 90 mm thick in their upper part, spaced some 210 mm apart, on which the corpse would be placed.

Below each grate was located the inclined V-shaped ash plate (No. 8; Photos 131, 140f.), which ended in a narrower post-combustion chamber (No. 9; Photos 156f.), in which the corpse parts that had dropped down between the bars burned out completely, hence the name post-combustion chamber. The front part of this chamber constituted the ash chamber as such. The glowing ash was extracted by means of dedicated scrapers through the ash-removal openings (No. 10) located at the front of the furnace below the loading doors of the muffles. They then fell into the ash receptacles placed in front of the furnace on the floor of the furnace hall (Photo 155).

On the sidewalls of the post-combustion chamber of the center muffle, in its front portion, were two large rectangular discharge openings (No. 11; Photo 156) through which the combusted gases flowed into two short vertical channels (No. 12) which, in turn, led to the flue duct (No. 13) located beneath the furnace, as shown in Documents 219f. The flue duct connecting the furnace to the chimney could be closed by an appropriate fireclay vane running vertically in a frame. It was operated by means of a metal cable, a pulley, a manual crank, and a counterweight. A cement counterweight with a hole can be seen in Photo 172; Photo 168 shows the manual crank.

At the center of the rear wall of the post-combustion chamber, below the air-channel opening feeding air into the upper part of the muffle, is the opening of the straight secondary air channel into the center muffle's post-combustion chamber (Photo 171), which can be closed by a raisable standard-type cast-iron cover (see Photo 169).

The post-combustion chambers of the outer muffles have solid side walls (Photo 157). Combustion air was fed into them through a channel ending on the outside at the front of the furnace located below the air-channel opening feeding air into the muffle itself (Photos 148, 150, 152f.). It, too, had the usual raisable standard cast-iron cover. This channel makes a 90° downward turn and then bends once again into the horizontal, running parallel to the post-combustion chamber to which it is connected by appropriate openings (in Photo 157, these openings are covered by trash which has fallen into the post-combustion chamber).

Behind the rear part of the furnace, there is a service pit with four steps (No. 14), some 880 mm deep (Photo 158). It allows access to the two gasifiers, each with its own brick housing, set behind the outer muffles (No. 15; Photos 158f., 205); the housing is some 1,380 mm wide and 1,280 mm high up to the upper edge of the inclined plate.

On the inclined plate, some 900 mm long, there is the cover of the gasifier's loading shaft measuring 270 mm × 340 mm (No. 16; Photos 160-162). This shaft opens into the upper part of the gasifier (No. 17; Photos 163f.).

As the loading ports of the gasifiers are relatively high above the floor of the service pit, a metal step has been placed in front of the gasifiers at the floor level of the furnace hall (Photos 199f.).

The gasifier (No. 18) is a shaft-like chamber, closed below by the horizontal grate of the hearth (Photos 167, 174, 177) consisting of twelve square bars 40 mm × 40 mm × 630 mm, held by two standard bars of the same cross-section

but having a length of 740 mm. The grate measures about 600 mm × 500 mm, or 0.3 square meters. The throughput capacity of the grate is about 35 kg of coke per hour.

At the top, towards the inside of the furnace, the gasifier narrows into a neck which opens up in the rear part of the post-combustion chamber (No. 19; Photos 140-142).

The generator consists of the hearth which includes, besides the horizontal grate, the hearth's ash-chamber door (No. 20; Photos 165, 173, 175f.), which is used for the removal of the ash from the ash compartment and for cleaning the grate, *i.e.* for the removal of the coke slag, as well as the channel for the combustion air to the gasifier, which has its inlet (Photo 166) on the outside next to the hearth door, but somewhat higher up; it can be closed by means of the usual standard cover (Photos 165, 173, 175f.).

The Buchenwald Furnace, designed for use with oil, has two burners set into the rear part of the brickwork, above the gasifiers and behind the outer muffles (Photos 200f.) entering inside by means of a round opening in the muffles' rear wall (Photos 130, 139). Above the furnace we have the cylindrical oil tank (Photos 114-121, 200-203) with a diameter of about 400 mm and a length of about 2.5 m. It is accessible by means of an iron ladder welded onto the lateral anchoring bars of the furnace (Photo 203). The tank fed each burner through a flexible tube connected to a metal pipe, which itself was connected to the upper part of the burner (Photos 201f., 204); its lower part was connected to the compressed-air tube having a larger cross-section (Photo 204).

Two blowers are located between the two furnaces (Photo 188). The front blower (Photos 189-191) fed air into two large pipes, each of which was connected to the air-feed channels set into both furnaces' walls (Photos 188, 192f.). Each pipe was equipped with a butterfly valve for the control of the air-flow rate (Photos 192, 194).

The rear blower (Photos 195-197) was connected to a pipe located above the gasifiers, which fed air into the burners of the furnace that could also be fueled with oil (Photos 197-201).

The corpse-introduction device (*Leicheneinführungs-Vorrichtung*) consisted of a cart for the introduction of the coffin (Photos 181-183), running on rails (*Laufschienen*; Photo 184), and of a semi-cylindrical cart running above it (*Verschlebewagen*; Photos 182f.). At its front end, the coffin-introduction cart was equipped with a metal stretcher some 2,700 mm long, on which the corpse was placed and which was introduced into the muffle (Photo 185).

The stretcher consisted of a wrought-iron plate with two side plates welded to it, forming a ┌─┐ shape. The top parts of that plate (Photo 185) kept the corpse from falling off during the positioning of the cart, while the lower ones ran on a pair of wheels (*Laufrollen* or *Einführrollen*; Photos 186f.) attached to a movable frame (Photos 178f.) which was itself threaded through a mounting bar (*Befestigungs-Eisen*) welded to the anchoring bars of the furnace below the muffle doors (Photos 117, 122). Pushing the introduction cart towards the open muffle, the two lower side plates inserted themselves into the concave rims of the wheels (Photos 186f.), and ran along them, thus allowing the corpse to be

moved easily into the muffle (Photo 185). Next, the semi-cylindrical cart was pushed forward over the stretcher (Photos 87, 89) into the muffle, until its front part touched the corpse; finally, the introduction cart was withdrawn, whereas the semi-cylindrical cart was held firmly in place within the muffle, pressing downward with the stoker attached to its rear part in such a way that the introduction cart below could move out of the muffle while the corpse slipped onto the grate. The movable frame with the wheels could slide laterally on the mounting bar and was thus used for all three muffles of one furnace.

In front of each muffle, on the floor of the furnace hall, there is a pair of rails for the corpse-introduction carts. These rails are connected to another pair of rails running the whole length of the furnace room (Photos 181, 184), up to the corpse elevator. The layout of the rails is similar to the arrangement used in the old Auschwitz Crematorium (Photo 105).

The style of the Buchenwald crematorium (Photos 207f.) is very similar to that of Crematoria II and III at Auschwitz. The crematorium has an underground morgue, accessible via a stairwell to the left of the chimney (Photo 208). The corpses were taken there by way of a slide (Photo 210), the upper end of which was closed by means of a trap-door (Photo 209). Opposite its lower end was a steel elevator (Photos 212-215), which went up to the furnace hall above (Photos 214f.). Photo 206, taken after the capture of Buchenwald in April 1945, shows a U.S. soldier standing in front of the furnace equipped for oil firing.

The design of the triple-muffle furnaces at Birkenau was essentially the same as that of the Buchenwald furnaces described above, with only very slight differences (Photos 111, 113, 115):

- The muffle doors did not have the upper inspection port (Photos 115 and 128).
- The closures of the air channels for the combustion air to the muffle and to the outer post-combustion chambers were placed lower; from their position (Photo 115) one may deduce that the combustion-air channels were straight, *i.e.* they ran in the furnace wall parallel to the muffles and to the ash chambers without any bends.
- Each furnace had its own blower, No. 275. These blowers, two counter-clockwise blowers and three clockwise blowers, were positioned as shown in Document 222a.

The way the doors opened was the same as for the Buchenwald furnaces: the door of the left-most muffle opened to the left, the other two to the right.

No document I know precisely indicates the mass of the refractory masonry of the triple-muffle furnace. The figure I had assumed hypothetically in the first Italian and English editions of the present work (2012/2015, Vol. I, pp. 323/273f.), as listed in the invoice of January 27, 1943 (DOCUMENT 215), seems to refer to the smoke ducts rather than the furnaces. It is known, however, that the triple-muffle furnace was practically nothing other than a double-muffle furnace with a third muffle inserted in the middle (without its gasifier); since the refractory masonry of half the furnace weighed 5,000 kg (3,000 kg for the muffle including the ash chamber and 2,000 kg for the gasifier), the maximum mass of

the triple-muffle furnace was 5,000 (lateral muffle + gasifier) + 3,000 (center muffle) + 5,000 (lateral muffle + gasifier) = 13,000 kg. The actual mass was undoubtedly lower, because Topf's policy was to save as much material as possible, as shown by the eight-muffle furnace, whose refractory masonry weighed 24,100 kg (see further below). Assuming a standard mass for the four gasifiers of 2,000 kg each, hence a total of 8,000 kg, for the eight muffles there would remain $([24,100 - 8,000] \div 8 =)$ about 2,000 kg per muffle. It is therefore probable that for each muffle of the triple-muffle furnace, the Topf Company had foreseen a more-or-less-intermediate mass, around 2,500 kg, and that the total mass was around 11,500 kg.

In comparison with other furnace types, the triple-muffle furnace was a simplified device, as one can also see from its low price. The third double-muffle furnace for the old Auschwitz Crematorium cost 7,332 RM, including the blower and a corpse-introduction system with the necessary rails, whereas the furnaces for Crematorium II ran to 6,378 RM each, including the blower. As the two introduction carts and the rails for five furnaces were billed at 1,780 RM, the triple-muffle furnace was actually cheaper than the double-muffle type, including the same accessories for both. The unit price of the furnaces at Crematorium III, however, was slightly higher at 7,830 RM (without the corpse-introduction cart), but it was still very economical.

The drawings shown in Documents 221 and 222 refer to Crematorium II, but apply also to Crematorium III, the mirror image of Crematorium II. The Birkenau Crematoria II and III each had a capacious furnace hall (Document 222a, No. 1) measuring 30 m \times 11.24 m. The five triple-muffle furnaces were arranged lengthwise, as shown in Photos 111, 113 & 115. In front of each muffle there were three pairs of rails (No. 2) connected to two rails for loading the furnaces (No. 3) running perpendicularly to the former towards the elevator (No. 4). These rails supported a rotatable disk, mounted on metal rollers, which one can just about make out in Photo 115; the set-up in the old crematorium at the Auschwitz Main Camp had been similar (Photo 106).

The ruins of the furnace hall at Crematorium II (Photo 216) still show the rails located in front of the muffles (Photos 217f.); the traverse rails connecting them, on the other hand, have been removed, but the grooves into which they were set were not filled with cement (Photos 219f.), which means that the rails were probably taken out some time after the crematorium had ceased operating but before it was blown up.

Behind the furnaces was another pair of rails for the coke supply of the gasifiers (No. 5); they ran parallel to the side walls of the furnace hall and right in front of the five gasifiers' service pits, and went as far as the coke-storage area (No. 6).

A side wing of the crematorium, some 10 m \times 12 m, was located next to the furnace hall. It was divided into two rooms by a partition. The smaller room, which could be reached from the furnace hall, was itself split into three rooms: two for the motors (Nos. 7, 9) and one room for one of the three draft enhancers (No. 9) which were originally built for this crematorium. The other room contained the chimney (No. 10) as well as the other two draft enhancers (Nos. 11f.)

and the waste incinerator (No. 13), from which this room took its name (*Müll-verbrennungsraum*; No. 14).

The waste-gas-discharge system was designed as follows: The gas produced in the gasifiers entered the outer muffles through the gasifier neck, passed on into the center muffle through the six holes between the muffles, flowed into that muffle's post-combustion chamber, left through the two openings in the side walls and then flowed on into a flue duct, which had a cross-section of 60 cm × 70 cm and was located beneath the furnace (Documents 219f.; No. 13). Each flue duct had its own damper (*Rauchkanalschieber*), 60 cm × 70 cm, located at the furnace's rear end, as on the H. Kori furnaces at Dachau (Photos 258f.), and running vertically along the rear wall of the center muffle (Document 220; No. 14).

The crematorium had a total of six flue ducts (Documents 223, 223a), one for each of the five furnaces and one for the waste incinerator. Each pair of ducts merged into a single duct, which led to one of the three smoke ducts into which the chimney was divided. The ducts of Furnaces 1 and 2 went into the smoke duct on the left, those of Furnaces 3 and 4 into the central smoke duct, and those of Furnace 5 and the waste incinerator into the smoke duct on the right. At the flue ducts' merging point, their cross-sectional dimensions increased from 60 cm × 70 cm to 80 cm × 120 cm (the cross-section of each of the chimney's smoke ducts) in order to compensate for the potentially doubled volumetric flow.

Each of these three smoke ducts was connected to a draft enhancer through a short vertical shunt as shown in Document 224a (No. 26 & 28); at the end of the three vertical shunts, below the corresponding blower, was a moveable damper plate (*Schieberplatte*; No. 27), 125 cm × 84 cm in size, which, by closing of the vertical duct, allowed the chimney to function under natural draft.

The draft enhancer's blower was of a type as shown in Photo 195, but much larger. It sucked in a part of the combustion gases through an appropriate opening (No. 29) and released them at a high flow rate into one of the chimney's smoke ducts (No. 31), thus creating a strong drop in the gas pressure, which then caused more gas to flow from the flue ducts into the smoke duct. The three blowers each had a capacity of 40,000 m³ of combustion gas at a pressure of 30 mm of water column. Just before the chimney were located three dampers (*Rauchkanalschieber*), 80 × 120 cm in size, running vertically and allowing the chimney's smoke ducts to be closed against the flue ducts feeding into them (No. 30).

The chimney, which had a height of 15.46 m, was divided into three smoke ducts with a cross-section of 80 cm × 120 cm (Nos. 31f.) each. Its foundations are still visible in the rubble of Crematorium II (Photo 221).

The waste incinerator, in all likelihood, was the *Müll-Verbrennungsofen MV* (Document 225, 225a) described in Topf's leaflet quoted in Chapter 3 (Document 161). The waste incinerator for Crematorium III was ordered by telephone on 5 February 1943, and confirmed in writing on 11 February. It cost 5,791 RM all-inclusive (Document 226).

As we have already mentioned, the draft enhancers of Crematorium II were seriously damaged in March of 1943 and had to be dismantled. In view of this, the respective devices for Crematorium III were never installed. Nor was Crematorium III equipped with loading rails for the introduction of corpses as discussed above; the introduction carts were replaced by standard stretchers (Document 216). These stretchers, also used for the Topf Furnaces at Mauthausen, consisted of two parallel metal tubes, 3 cm in diameter (Photos 83-85) and 350 cm long. A slightly concave metal plate, 190 cm long and 38 cm wide (Photos 52f.), was welded to the front part of these tubes, *i.e.* to the portion which was inserted into the furnace. To ensure a better way of handling them, these tubes, over the rest of their length were set further apart (49 cm) by means of two elbow bends (Photos 67 and 84). The distance between the tubes at the leading end corresponded to the spacing of the guide rollers (*Führungsrollen*) at the lower end of the furnace doors; they could thus be placed on them with ease (Photos 84f.).

Towards the outside, the two tubes which supported the metal plate had two stops consisting of two steel bars which were welded to the underside of each tube in the shape of a V. They stopped the stretcher at the rollers (Photo 67), thus keeping the stretcher from being pushed too far into the muffle, which would have damaged the muffle's rear wall. One stretcher weighed about 51 kilograms. In March of 1943, this system was introduced in Crematorium II as well.

The operation of the coke-fired triple-muffle furnace is detailed in Topf's instruction sheet (Document 227). It is similar to that for the double-muffle furnace. For greater clarity, I have again added – to the translated text and in square brackets – my explanations and/or references concerning relevant photos and documents. Text in rounded parentheses appears in the original text:⁴⁷⁷

“Operating instructions for the coke-fired Topf triple-muffle incineration furnace.”

Before any coke is fed to the two coke generators [Photo 158; through the two loading shafts, Photos 160-164], the flue-duct damper [Documents 202b&c] on the furnace must be opened.

Now fire can be lit and maintained in the two generators; care must be taken to make sure that the secondary covers to the right [Photo 165] and left [Photo 173] of the ash-removal doors (coke generators) are open.

Once the incineration chamber shows a satisfactory red glow (about 800°C), the corpses can be introduced successively into the three chambers.

At this point, it is advisable to switch on the air compressor located at the side of the furnace [Photos 188-191] and to let it run for about 20 minutes. By observation, it must be decided whether too much or too little fresh air enters into the three chambers.

Control of the fresh-air flow is effected by means of the rotary vane [Photos 192 & 194] located in the air duct. Furthermore, the air-entry ports to the right [Photo 148] and left [Photo 150] of the introduction doors must be half-open.

⁴⁷⁷ Topf, *Betriebsvorschrift des koksbeheizten Topf-Dreimuffel-Einäscherungssofen*. March 1943. From: Pressac 1989, p. 222.

As soon as the corpse parts have dropped from the fireclay grate [Photos 145 & 147] onto the inclined ash plate below [Photos 131, 134, 140f., 156f.], they must be moved forward towards the ash-removal door [Photo 71] by means of the scraper. These parts may remain here for another 20 minutes for post-combustion. Then the ash is transferred into the ash container [Photo 155] and set aside for cooling.

In the meantime, new corpses will be introduced successively into the chambers. The two generators must be refueled from time to time.

Each night the generator grate [Photos 167, 174] must be freed of coke slag and the ash must be removed.

It is important, furthermore, that after the end of the operation as soon as the generator has burned itself out and [coke] embers are no longer present, all air dampers and doors [of the ash chambers, the gasifiers' loading shafts, the muffles' ash chambers, and the introduction doors], as well as the flue-duct dampers, must be closed in order not to cool down the furnace.

After each incineration, the furnace temperature will increase. Therefore, care must be taken not to let the internal temperature exceed 1100°C (white heat).

This temperature increase can be avoided by feeding air."

The two large-size triple-muffle furnaces (*Groß-Einäscherungsöfen*) originally ordered by the Auschwitz Central Construction Office for the PoW camp at Birkenau, but never built, were structurally different from those set up in Crematoria II and III at Birkenau, as shown by the Topf quotation for these two furnaces dated 12 February 1942 (Document 228).⁴⁷⁸

<i>Copy/Go</i>		<i>J. A. Topf und Söhne</i>		
<i>To</i>				
<i>Central Construction Office</i>				
<i>of the Waffen-SS and Police</i>				
<i>Auschwitz/Upper Silesia.</i>		<i>Erfurt, Feb. 12, 1942</i>		
<i>Subject:</i>	<i>Your ref.:</i>	<i>Our department: D IV</i>		
<i>Crematorium,</i>	_____	<i>Prf.</i>		
<i>Cremation furnaces</i>				
<i>Quotation for the supply of 2 triple-muffle cremation furnaces and construction of chimney lining with cleaning port.</i>				
<i>Item</i>	<i>Qty</i>	<i>Description</i>	<i>Unit pr.</i>	<i>Total</i>
<i>1)</i>	<i>1</i>	<i>Coke-fired triple-muffle incineration furnace</i> <i>With the following services and supply:</i> <i>The necessary fireclay materials consisting of normal, wedge-type and shaped bricks and mono-lite tamping material with the corresponding mortar. For the insulation of the furnaces the necessary bricks of diatomaceous earth, rock wool and</i>		

⁴⁷⁸ Topf, *Kostenanschlag für Zentralbauleitung* dated 12 February 1942 concerning two triple-muffle cremation furnaces of simplified type. APMO, BW30/34, pp. 27, 32, 29 (sic).

<i>Item</i>	<i>Qty</i>	<i>Description</i>	<i>Unit pr.</i>	<i>Total</i>
		<i>diatomaceous-earth mortar.</i>		
	3	<i>Cast- and wrought-iron fittings such as: Wrought-iron blocking dampers lined with Mono- lite, including one corrugated-metal plate covering on front side of damper and installation of an ob- servation port,</i>		
	6	<i>Cast-iron chain rollers,</i>		
	6	<i>Cast-iron bearings</i>		
	3	<i>Cast-iron wall cranks for loads of 500 kg each, The necessary cables and 4 chains for the dampers,</i>		
	10	<i>Cast-iron air-channel closures,</i>		
	5	<i>Cast-iron ash-removal doors, lined with fireclay,</i>		
	1	<i>Cast-iron gasifier-loading-shaft closure, with insu- lating cover,</i>		
	2	<i>Cast-iron ash container,</i>		
	1	<i>Cast-iron smoke-channel damper sliding in air- tight guide, including rollers, cable and counter- weight, The necessary stokers for the gasifier, The horizontal grate made of wrought-iron square bars including supporting bars,</i>		
	1	<i>Wrought-iron coffin-introduction device consisting of a stretcher and 6 pcs. rollers with fixation bar, Delegation of builder for construction of furnace and of one engineer for hand-over of furnace. Price of Item I) for 1 furnace RM</i>	7,106.-	
		<i>Price of Item I) for 2 furnaces RM</i>		14,212.-
II)		<i>The fireclay lining for the chimney up to a height of 6 m, thickness 12 cm: 1,400 normal refractory bricks, Seger Cone 30, 700 kg of refractory mortar M 2 1 cast-iron manhole for cleaning. Price of Item II) RM</i>		440.-
		<i>The anchor bars necessary for the furnace must be manufactured by the client, at no cost to us, as per our drawing. Furthermore, for each furnace, the client will supply, at no cost to us: about 4,000 pcs. bricks 6 m³ of construction-type sand 1,200 kg of lime 500 kg of cement These materials belong to the outer brick casing. For the duration of the job our builder must be</i>		

<i>Item</i>	<i>Qty</i>	<i>Description</i>	<i>Unit pr.</i>	<i>Total</i>
		<i>supplied by the client with 3-4 helpers, at no cost to us. Total authorization-code weight 3,450 kg Our prices are ex works, without packing</i>		

This furnace is characterized by the presence of only one gasifier – the cost estimate, in fact, speaks of only one grate (*Planrost*) and one closure for the loading shaft of the gasifier – and mentions only a single flue duct – there is only one flue-gas damper – and muffle doors running vertically like those in a single-muffle furnace (Document 163).

The parts, as listed in the cost estimate, seem to be those of a furnace with the gasifier located behind the center muffle, as shown by the respective drawing (Document 229): the gases from the generator first flow into the center muffle, then through the openings between the muffles, on into the outer muffles; the spent-gas system could be similar to the one of a single-muffle furnace (Document 229a) or to the system of the Auschwitz-type double-muffle furnace (Documents 229b & 229c). The air-feed system for the combustion air was similar to that of the triple-muffle furnaces at Buchenwald and Birkenau, with their ten closures for the air channels instead of eleven, because the furnace had only a single gasifier.

The fact that five ash-removal doors are listed (instead of four – three for the muffles and one for the gasifier) is explained by the fact that this figure includes the closure for the loading shaft of the gasifier as well, it being identical to the ash-removal doors in this case. This type of furnace had neither a blower nor a draft enhancer. The coffin-introduction device consisted of three pairs of rollers mounted on a bar like the rollers of the Topf 8-muffle furnace (see the next subchapter) and a stretcher as described above.

7.3. The Coke-Fired 8-Muffle Furnace

This furnace was designed by Engineer Prüfer probably towards the end of 1941. Its original concept is described in a Topf cost estimate dated 16 November 1942 (Document 230):⁴⁷⁹

<i>Quotation for one Topf 8-muffle cremation furnace</i>	
<i>#</i>	<i>Description</i>
	<u><i>Supply and construction of a Topf 8-muffle incineration furnace</i></u> <i>including:</i> <i>For the outer brick coat</i> <i>approx.. 9,000 bricks (normal size)</i> <i>approx.. 14 m³ sand, construction type</i> <i>approx.. 3,000 kg of building lime</i> <i>approx.. 500 kg of cement</i> <i>(These materials must be made available to our builders free</i>

⁴⁷⁹ Topf, *Kostenanschlag über einen Topf-Achtmuffel-Einäscherungs-Ofen* dated 16 November 1942. RGVA, 502-1-313, pp. 72-74.

	of charge).	
	<i>The fireclay materials, viz.:</i>	
	<i>1,600 wedge-type fireclay bricks, Seger Cone 33/34</i>	
	<i>3,000 normal fireclay bricks, Seger Cone 33/34</i>	
	<i>1,500 normal fireclay bricks, Seger Cone 32</i>	
	<i>3,000 kg refractory mortar M I</i>	
	<i>35 fireclay grate bricks, special shape</i>	
	<i>35 fireclay plates, special shape</i>	
	<i>2,000 kg Monolite caulking mass.</i>	
	<i>The cast- and wrought-iron fittings, such as:</i>	
4	<i>Hearths for wood firing consisting of their cast-iron inclined grate, cast-iron flat grates, loading-shaft covers of corrugated metal with reinforcing bars, and the wrought-iron supporting bars for the grates,</i>	
2	<i>Cast-iron flue-gas-channel damper running in its air-tight guide, including rollers, cables and counterweights</i>	
8	<i>Wrought-iron muffle-blocking dampers with chains and suspension bars (these dampers will be lined with Monolite),</i>	
10,000	<i>kg of diatomaceous-earth insulating mass,</i>	
16	<i>Cast-iron chain rollers and the necessary cast-iron bearings with wrought-iron shafts,</i>	
2	<i>Wrought-iron stokers, consisting of scraper and stoking rods, The necessary cables, chain and cable rollers as well as counterweights,</i>	
1	<i>Supporting bars for fixation of cable and chain rollers,</i>	
4	<i>Wrought-iron ash boxes with reinforcing bars and 2 handles each,</i>	
20	<i>Cast-iron closures for the air channels,</i>	
8	<i>Cast-iron ash-removal doors, fireclay lined, with frame and coil handles,</i>	
2	<i>Coffin-introduction devices, each consisting of a wrought-iron stretcher, and rollers with their fixation bars for each muffle.</i>	
	<i><u>Supply of builder(s)</u> for construction of the furnace, including daily rates, social security contributions and travel expenses.</i>	
	<i>Price of the furnace RM</i>	12,972.--
	<i>Authorization-code weight 3,600 kg.</i>	
	<i>The price is quoted f.o.b. Erfurt Station.</i>	
	<i>For the duration of the construction, our builder must be supplied with a sufficient number of helpers at no cost to us. On arrival [of the parts] on site, the foundations must have been made ready by the client. If supervision of the furnace foundation by our builders is desired, we would provide the latter at daily rates at your expense.</i>	

In the Topf bill of lading (*Versandanzeige*) of 8 September 1942, there is a list of parts for two 8-muffle furnaces (Document 231). The document is translated

below, with the exception of the first two columns, which contain the name of the company and the order number:⁴⁸⁰

Number of cases	Packing Type	#	Object	weight in kg	
				net	gross
		2	Complete 8-muffle incineration furnaces consisting of:		
16	loose	16	Cast-iron fire doors 280/350 mm	736	736
24	"	24	Cast-iron air-channel closures 108/126 mm, Model 311a	180	180
16	"	16	Cast-iron air-channel closures	232	232
4	"	4	Cast-iron smoke-channel dampers (800 mm high, 700 mm wide) consisting of:		
4	"	4	guides	280	280
4	"	4	Cast-iron dampers	342	342
4	"	4	Damper rods	8	8
1	pack	8	Cable rollers, fig.2	13	13
17	loose	17	Cast-iron chain rollers, 210 mm segment diameter, bore Ø 35 mm	90	90
16	"	16	Muffle-blocking dampers	736	736
4	"	4	Introduction stretchers	204	204
15	"	15	Cable roller with support	60	60
2	"	2	Cast-iron covers, Model 8973 for closing of gasifier-loading shaft	23	23
8	"	8	Closures for gasifiers	252	252
4	"	4	Angle bars 60/60/6, each 2,300 mm long	44	44
4	"	4	Ash receptacle, metal plate	24	24
4	"	4	Stokers	22	22
4	"		Subtotal		3,246
4	"	4	Stoking rods	13	13
8	"	8	Gas piping 2," each 1,250 mm long	44	44
8	"	8	Angle irons 80/80/10, each 1,250 mm long	100	100
105	"	105	Cast-iron bars for horizontal grate, each 600 mm long, Model 15377	525	525
235	"	235	Cast-iron bars for inclined grate, each 940 mm long, Model 8735	1,504	1,504
16	"	16	Cable rollers diam. 152/190 mm Figure 6	114	114
16	"	16	Angle bars 70/25 mm, each 1,200 mm long	272	272
1 metal drum		260	Angle supports 20/20 each 150 mm extended length	131	133
8	loose	8	Angle bars 60/60 mm, each 1,200 mm long	256	256
8	"	8	U-bars NP 10, each 2,600 mm long	636	636
1	box	16	Angle bars 60/60/8, each 150 mm long	16	343
		265	Square holders 10/10 mm, each 260 mm extended length	47	

⁴⁸⁰ Topf, *Versandanzeige* for Zentralbauleitung dated 8 September 1942. RGVA, 502-1-313, pp. 143f.

Number of cases	Packing Type	#	Object	weight in kg		
				net	gross	
64		64	Lag bolts 3/4" × 250 mm with nuts	39		
		16	Grommet thimbles, for cable 8 mm	0.5		
		16	Dto., clamps	2		
		65	Grommet thimbles, for cable 10 mm	3		
		65	Dto., clamps	10		
		32	Angle bars 100/50/8 mm, each 180 mm long	35		
		16	Shafts, 40 mm Ø, each 510 mm long	80		
		32	Rollers 60 mm Ø, each 50 mm long	34		
		32	Blank spacers 43	2		
		32	collars 42 with screws	7.5		
		64	Lag bolts 16 mm Ø, each 170 mm with nuts	22		
		5	Star-type 3-way switches for 3-hp motor	20		
		20	bags	Monolite	1,000	1,000
		60	loose	60	4,000	4,000
40	"	40				
30	"	30				
				12,186		

The final invoice, drawn up by Topf on 5 April 1943 (Document 232) lists the parts actually supplied to the Central Construction Office:⁴⁸¹

Item	Number	Amount
[Invoice] concerning supply and services for erection of 2 Topf large-size incineration furnaces having 8 muffles each, viz.:		
a. <u>Supply</u>		
of normal, shaped and wedge-type fireclay bricks, fire-resistant mortar and fire-resistant Monolite packing mass, additional anchoring bars for damper-suspension and gasifier-loading shafts, of cast- and wrought-iron fittings for wood-fired hearths, muffle- blocking dampers with rollers, cables and hand cranks, stokers, ash boxes, ash-removal doors, air channel-closures with their frames, introduction device,		
b. <u>Provision</u> of our builder for construction of furnace		
As per our letter of 8 December 1941 and our letter of 9 December 1941 for 1 furnace	13,800.--	
for 2 furnaces		27,600.--
Expenses for freight for our shipment of 29 March 1943		32.30
Reference: letter with order from Reichsführer SS dated 4 December 1941 II/7/3 Wi/FI.		27,632.30
Payment from Amtskasse Waffen-SS Posen on 5 May 1942 RM 27,600.--.		

⁴⁸¹ Topf, *Schlussrechnung* Nr. 380 for Zentralbauleitung dated 5 April 1943. RGVA, 502-1-314, pp. 29-29a.

This list is completed by Topf's Final Invoice No. 322, of 12 July 1944, but back-dated to 23 March 1943 (Document 233) as far as the additional equipment ordered by the Central Construction Office goes:⁴⁸²

<i>Item</i>	<i>Amount</i>
<i>We supplied on 25 January and on 19 March 1943</i>	
<i>4 cast-iron doors with cast-iron frame, coil handles for fireclay lining</i>	360
<i>7,500 kg of rock wool instead of 5,000 insulating bricks and 1,200 kg of rock wool</i>	1,218
<i>4 gasifier grates made of square bars 40/40 each 1,200 mm long</i>	1,680
	3,258
<i>As per our cost estimate of 2 September and letter of 22 September 1942 concerning your order of 15 September 1942</i>	
<i>Your payment of 2 February 1944</i>	
<i>RM 3,258.--.</i>	

As mentioned in Chapter 6, there were actually eight cast-iron closures.

The above documents, the Drawings of the Birkenau Crematorium IV (and hence, of Crematorium V, its mirror image) 1678, 2036 and 2036(p) (Documents 234-236) – which show the foundations and the vertical section of the 8-muffle furnace – the photos of the crematorium ruins taken by the Poles in 1945, as well as an inspection on-site allow us to re-establish the design of this furnace with satisfactory precision. Its overall dimensions can be deduced from the list of anchoring bars etc. drawn up by Topf on 4 September 1942 (Document 237) for the 8-muffle furnace:

Dimensions of the Auschwitz 8-muffle furnace (see Illustrations 3f.):

Muffle block (each with 2 × 2 muffles; two of them):

height	2,450 mm
length	4,430 mm
width	2,545 mm

Length of parapet housing the muffle damper 720 mm

Distance between two opposing muffle-damper parapets 2,990 mm

Gasifier block (2 × 2 generators):

height	2,060 mm
length	3,225 mm
width	2,290 mm

The furnace, including the gasifier, thus measured 4.43 m × [(2.545 × 2) + 2.290 =] 7.38 m.

Judging from the dimensions of the steel bars still apparent at Crematorium V, these overall dimensions of this furnace complex were followed during construction.

⁴⁸² Topf, *Schluss-Rechnung Nr. 322 for Zentralbauleitung* dated 23 March 1943. RGVA, 502-1-327, p. 22.

The description which follows is based on the documents mentioned in this section, on the Polish photos of 1945, and on our visual observation of the ruins of Crematorium V. For greater clarity, the description is illustrated by three drawings prepared by ourselves (Documents 238-240). The numbers in parentheses which appear in the description refer to these documents.

The Topf coke-fired 8-muffle furnace was made up of eight single-muffle furnaces as per Topf Drawing D58173 (Document 163) arranged in two groups of four furnaces; each group consisted of two pairs of furnaces opposing each other in such a way that they shared their rear walls and the central walls of the muffles (Document 238) in a manner already used in the

Plaszów Crematorium (cf. Document 175). The two furnace groups were connected to four gasifiers coupled in the same way (Document 238, *Generator 1-4*) and thus formed a single 8-muffle furnace, also called “*Großraum-Einäscherungs-ofen*,” literally “large-scale incineration furnace.”

The furnace was contained in a solid brick structure by means of anchor and retaining bars still clearly visible on the Polish photos of 1945 depicting the ruins of Crematorium V (Photos 222-225) and still visible half a century later (Photos 228-230).

The muffles (No. 1) had doors (No. 2) weighing 46 kg and running vertically in a frame set into the frontal brickwork (No. 3) above each pair of muffles. The doors were operated by means of pulleys attached to the roof beams, cables and counterweights.

In the outside wall of each of the four outer muffles, in their rear portion, was an outlet for the spent gases (No. 4) leading into a vertical duct (No. 5) in

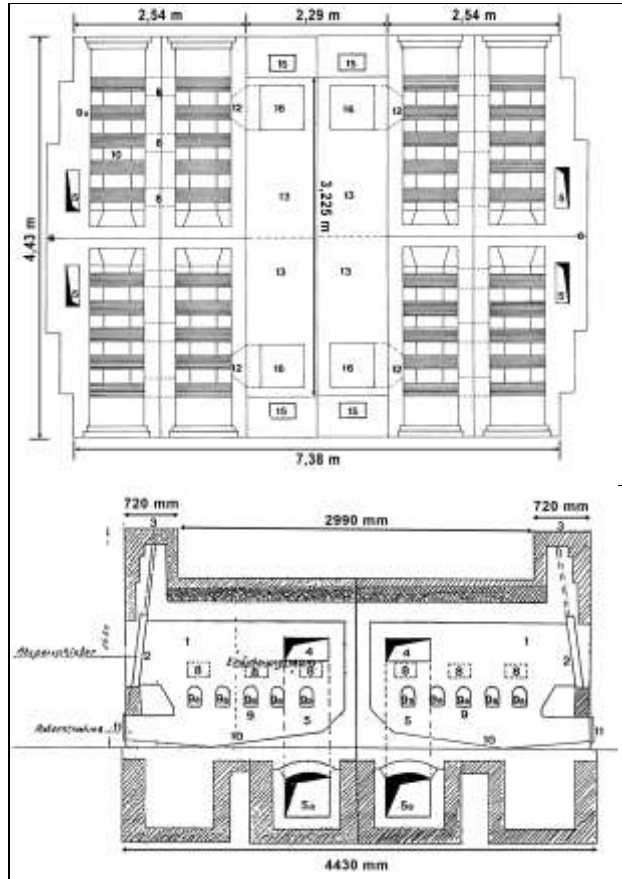

Illustrations 2+3: Schematic drawings of the Topf eight-muffle furnace; top: cross-section at the level of the muffle grate; bottom: longitudinal section through a lateral muffle (Documents 239 and 240) with dimensions added.

such a way as to form two parallel pairs of ducts – one for each group of two muffles. Each was housed in a brickwork structure (No. 6) located on either side of the furnace. The two pairs of ducts fed each separately into two horizontal ducts (No. 5a) which merged into a single one (No. 7) with its damper operated by means of a pulley with its cable and counterweight. Each damper measured 0.8 m × 0.7 m and weighed 85.5 kilograms.

The two ducts ran horizontally in opposite directions below the floor of the furnace hall and ended in a chimney, having a square cross-section of 0.8 m × 0.8 m and a height of 16.87 m (photo 233). The flue ducts did not have inspection manholes. The chimneys had no draft enhancers.

The interior wall of each pair of muffles had connecting openings (No. 8), probably three in number as in the double- and triple-muffle furnaces. The rear walls of the muffles were totally closed by refractory brickwork. The floors of the muffles consisted of a fireclay grate (No. 9), probably made up of five fireclay bars as in the single-muffle furnace. In this respect, the information supplied by the bill of lading of 8 September 1942 is unclear, because this document speaks of 60 bars 140 mm × 250 mm × 650 mm and 40 bars 120 mm × 250 mm × 850 mm for a total of 16 muffles, but dividing the total number of bars by the total number of muffles does not result in an integer ($100 \div 16 = 6.25$). It is thus likely that this supply item included spare bars. The width of the grate, and hence that of the muffle, must have been 700 mm as in the double-muffle furnace, which had bars of the same length. If the width had been 850 mm, then the 650-mm bars would have been too short. The difference in length between the two different types of bars can perhaps be explained by assuming that the 650-mm bars may have rested on protruding specially shaped bricks at the edge of the ash chamber, whereas the 850-mm bars extended into the muffle wall by 75 mm on either side.

Below the muffle grate was the post-combustion chamber (ash chamber; No. 10) closed at the front end by the ash-removal door (No. 11). This type of door, 280 mm × 350 mm, was the same as used for the gasifier hearths, therefore, in the bill of lading of 8 September 1942, these ash-chamber doors are labeled “*Feuertüren*.”

Combustion air was fed to the individual furnaces and to the gasifiers through 20 air channels having an equal number of raisable closures, twelve standard closures (108 mm × 126 mm, weight 7.5 kg) and eight larger ones (14.5 kg) like those mistakenly installed in the side walls of the poorly reconstructed double-muffle furnaces of today’s Crematorium I (cf. Photos 87 and 96). These closures were arranged as follows:

- one, standard type, next to the ash-chamber door as shown on Photos 226f. (= 8 closures);
- one, large type, next to the muffle door as on the Topf Mauthausen furnace (= 8 closures);
- four, standard type, next to the gasifier-hearth grate (= 4 closures).

The use of air channels to the muffles larger than those on the two- and triple-muffle furnaces was probably meant to at least partly compensate for the absence of blowers.

On the outer part of the post-combustion chamber was a horizontal air channel running parallel to it and linked to it by means of transverse openings. This channel let out at the front of the furnace, next to the ash-removal door, and was closed by a standard-type raisable cast-iron closure already mentioned. The channel constituted the air feed for the post-combustion chamber.

On the inner sidewall of the post-combustion chamber of the four inner muffles one or two openings were located (No. 12) which were connected to the gasifiers, as in the Gusen Furnace (Photos 16, 27).

The furnace was equipped with two pairs of gasifiers (No. 13) located on opposite sides between the two groups of four muffles. Each pair fed the two muffles next to it.

As far as their lateral position and their connections to the muffles are concerned, the gasifiers were structurally similar to those of the Gusen Furnace (Photo 1): the Auschwitz pair of furnaces plus gasifier on the left compares to the two furnaces plus only the right-hand gasifier of the Gusen Furnace, while the Auschwitz pair of muffles plus gasifier on the right compares to the two muffles and only the left-hand gasifier of the same Gusen Furnace, meaning that at Auschwitz the gasifiers were housed one beside the other in a single brick structure. To visualize it, I have prepared a Foto composition (Document 241), realized on the basis of the Gusen Furnace, which reflects rather well the concept of the eight-muffle furnace and shows clearly to what extent this furnace was inspired by the furnace at Gusen.

As opposed to this, the gasifiers were probably similar to those of the Topf Furnace at Mauthausen (Photos 75, 77f.) with a sloping plate, on which was placed the gasifier-loading-shaft door. Furthermore, the four gasifiers of an 8-muffle furnace possessed a rather light-weight (11.5 kg) “cast-iron lid Model 8973 for closing the loading shaft of the gasifier,” whose mechanics are unclear. The service pits (No. 14; Photos 222, 224, 232) – which allowed access to the gasifiers with their loading doors (No. 15) the hearth doors – were located in front of the gasifiers.

The hearth frames were attached to the anchoring bars of the gasifiers by means of two rods still visible in the rubble of the furnace (Photo 230f.). The steps shown on drawings 1678 and 2036 were replaced by a ladder with wrought-iron rungs, visible on Photos 230 and 232.

As I have explained in Chapter 6, the 8-muffle furnace for Mogilev, which were taken over later by the Central Construction Office at Auschwitz had hearths with inclined grates for wood firing (without lids). For the grates of the furnaces shipped to Auschwitz, both inclined and level bars for coke firing were used. The available documents diverge as to the number and the lengths of these bars; it is certain, however, that the throughput capacity of the grates was 35 kg of coke per hour (see Document 264).

The corpse-introduction system consisted of a stretcher for the corpses as described in the preceding section, clearly shown on Photo 222, and by two

rollers of simplified design. These rollers consisted of a metal cylinder rotating around an inside axle which was attached to two vertical bars bolted onto an angled anchoring bar at the level of the fireclay grate of the muffle as shown in Photo 226.

At the two extremities of the cylinder, guide disks were welded, 6 cm wide and 10 cm in diameter, supporting the lateral tubes of the corpse stretcher, and with the entire cylinder rotating around its own axle. Photo 226 shows furthermore four steel servicing tools resting on the anchoring bar of the furnace, and on the ground, below them, several square bars that were part of the gasifier grates.

Originally, 2,500 insulating bricks and 600 kg of rock wool had been foreseen for the insulation of one 8-muffle furnace,⁴⁸³ but later, as can be seen on the final invoice No. 322 backdated to 23 April 1943 (Document 233), the 2,500 insulating bricks were substituted for by 3,750 kg of rock wool; hence each one of the two 8-muffle furnaces was insulated by 4,350 kg of rock wool.

The brickwork of one 8-muffle furnace was composed of:

- 1,600 wedge-shaped refractory bricks \approx 5,300 kg
- 4,500 normal refractory bricks \approx 15,800 kg
- 3,000 kg of refractory mortar,

for a total weight of about 24,100 kg.

Assuming for the four gasifiers a total weight of the brickwork of 8,000 kg, the refractory brickwork of each muffle weighed some 2,000 kilograms. Judging by its flimsy structure, the 8-muffle furnace was the least-reliable of the furnaces built by the Topf Co.

7.4. The Plans for Mass Cremations at Auschwitz-Birkenau

7.4.1. The Furnace Designed by Fritz Sander

In Chapter 3 of this unit, I presented the uncommented translation of a patent application by Fritz Sander dated 4 November 1942 concerning a “Continually operating corpse-combustion furnace for large-scale operation.” I will now discuss the significance and the scope of such a device in the light of another document.

On 14 September 1942, the Topf engineer Fritz Sander wrote a letter to the brothers Topf, owners of the firm in which he worked, explaining to them the “new design” of a furnace he had invented. Of this letter, only the first page and some excerpts of other pages have been published (Schüle 2011, pp. 443-447):

“The great demand for cremation furnaces for concentration camps which has lately manifested itself especially in the case of Auschwitz and which has, according to the report by Herr Prüfer, led to a further order for 7 triple-muffle furnaces,^[484] has prompted me to look into the question of whether the concept

⁴⁸³ Letter from *Zentralbauleitung* to Topf dated 15 September 1942. RGVA, 502-1-312, p. 22.

⁴⁸⁴ We can see from K. Prüfer’s note of 8 September 1942 (cf. Subchapter 8.2) that besides the five triple-muffle furnaces of Birkenau Crematorium II, the *SS-WVHA* had ordered another three 8-muffle furnaces, but still, the number of muffles was insufficient. Actually, for Crematorium III, another five triple-muffle furnaces were ordered, and another two for the crematorium at Gross-Rosen, so twelve

of muffle furnaces used so far at the places mentioned is indeed the most-suitable one.

In my opinion, in a muffle, the cremation does not proceed quickly enough to ensure the elimination of a great number of corpses at a desirably high rate. As a makeshift solution, one has tried to use a series of furnaces or muffles and by loading them with more corpses, but this does not solve the basic problem, i.e. the drawbacks of the muffle system. These drawbacks of the muffle furnace, which cannot be solved even by assembling more muffle furnaces (triple- or 8-muffle furnaces) and loading more corpses into an individual muffle, are in my judgment the following:

1) Discontinuous operation.

Each muffle, at regular intervals, must be loaded, cleaned, then loaded again and cleaned again, and this goes on for the [whole] duration of the operation of the furnace. Each time [a cremation is undertaken] it is necessary to open the introduction door at the front, and the corpses must be loaded into the muffle through this front door. While this goes on, cold air flows into the furnaces, cooling the muffle, which not only reduces its service life, but also causes heat losses which have to be made up by additional fuel.

2) Problems of introduction.

In any case, it is difficult and unpleasant work to insert the corpses into the muffle in the longitudinal direction, especially if several corpses have to be packed into the muffle at the same time. In the long run, it will also be impossible to avoid damaging the delicate muffle masonry.

3) Large space requirement of the multi-muffle furnaces.

In terms of floor space, the multiple-muffle furnaces take up quite a bit of room and require a considerable amount of material for their construction. Moreover, the corpses to be cremated have to be transported each time in front of the opening of the respective muffle, i.e. they have to be distributed over a number of such places. They are thus scattered over the entire floor space of the cremation room. The same applies to a certain extent to the fuel.

To overcome the above disadvantages, and in my opinion as the ideal solution with regard to the design of a cremation furnace for the purpose of a concentration camp, I consider a furnace with continuous loading and also continuous operation.”

This is followed by a discussion of the options for such a continuously operating furnace and a detailed description of a furnace which over wide areas reads like an anticipation of the later patent application (see Document 242). After describing the furnace he had invented, Sander continued:

“I realize very well that this kind of furnace must be considered a mere device of destruction and that one has to cast aside all considerations of piety, separation of the ashes, or any sentimental factor. But all this is already with us in the case of multi-muffle furnaces. After all, we have special conditions in the concentration camps due to the war which force [us] to adopt such a procedure. [...]

In view of the considerations set out above, it is to be assumed that the authorities in charge will also approach other furnace manufacturers for the supply of

cremation furnaces functioning quickly and well. These [firms], too, will look for the best design of furnaces for the applications mentioned. I must therefore assume that this question is now being addressed by all sides, and that ideas for new types of such furnaces are thus emerging in other furnace-construction companies as well. For this reason, I believe it to be urgent to apply for a patent for my proposal in order to protect our priority."

This patent application concerning a "cremation furnace for corpses in continuous operation for mass application" was drawn up by Sander on 26 October 1942, and then revised by him on 4 November 1942. The patent application of 4 November 1942 confirms Sander's ideas as described in the letter of 14 September 1942:

"The collection camps in the occupied eastern territories set up on account of the war and its consequences with their inevitably high mortality do not permit the interment of the large number of deceased camp inmates. There is, on the one hand, a shortage of space and labor, and, on the other, the risk of exposing the vicinity, near or far, to the dangers presented directly or indirectly by any burial of the deceased, many of whom have succumbed to infectious diseases. The need thus exists to eliminate safely, quickly, and hygienically the corpses generated continuously in large numbers."

Sander explained that this task could not be accomplished in accordance with the legal requirements applicable within the Reich territory, for it imposed the need to burn such corpses jointly and concurrently, with the flames and combustion products striking the corpses directly throughout the entire process; thus, one could not speak of a proper *cremation* but rather only of a *combustion* of the corpses. He continued:

"For the execution of this combustion – in line with the viewpoints exposed above – in some of these camps multiple-muffle furnaces were erected which obviously had to be loaded and operated serially. For this reason, these furnaces are not entirely satisfactory, as the combustion in them does not proceed quickly enough to permit the elimination of the large number of corpses generated continually within a short period of time."

Sander's design was nothing but an adaptation of Topf's waste incinerator "Müll-Verbrennungsofen MV," which was practically copied from Kori's "Ofen mit doppelten Verbrennungskammern" (Furnace with two combustion chambers).⁴⁸⁵ The idea of a vertical cylindrical combustion chamber, on the other hand, was taken from the patent of Adolf Marsch, which I discussed in Chapter 10 of Unit I (Documents 96 & 96a).

The reference to the "multi-muffle furnaces" is clearly to Topf's own double-, triple- and eight-muffle furnaces already built at Auschwitz, Buchenwald and Mogilev. The reference to high mortality in the "collection camps in the occupied eastern territories" and of the corpses who "have succumbed to infectious diseases" concerns the concentration camps, Auschwitz in particular, where mortality was extremely high because of the typhus epidemic ravaging the camp at that time.

⁴⁸⁵ Cf. Chapter 11 and Document 225a&b.

What is most-significant in the patent application and the letter mentioned above is that the very inspiration for the new design was the fact that Topf's chief engineer rated the mass cremation in multi-muffle furnaces – of which Topf was the only manufacturer – to be rather unsatisfactory.

7.4.2. Crematorium VI

In early 1943, Topf elaborated two mass-cremation devices for Auschwitz-Birkenau. A letter written by the head of the Auschwitz Central Construction Office, *SS Sturmbannführer* Bischoff, to the camp commandant, *SS Obersturmbannführer* Höss, dated 12 February 1943, explains the idea of “Crematorium VI” in the following way (Document 243):⁴⁸⁶

“With reference to the discussion of the undersigned with engineer Prüfer of Topf & Söhne Co. on 29 January 1943, the project of a sixth crematorium (an open combustion chamber 48.75 by 3.76 m) was considered. The Central Construction Office had therefore requested Topf & Söhne Co. to prepare a sketch of this open combustion chamber, which is attached.

If the construction of this sixth crematorium were to be undertaken, it is requested to forward the respective application to Office Group C via Office Group D.

In case of a possible realization of this installation, more manpower than presently employed must be provided by the command. For this, one would require:

150 detainee bricklayers

200 detainee helpers

The realization of the building project depends on the availability of the manpower mentioned above.”

The sketch of the device has not been preserved. In my opinion, the design of Crematorium VI was based on F. Siemens's field furnace described in Chapter 10 of Unit I. In the Siemens drawing (Document 93) the width of the installation (Section C-D) was about 3.90 m, the length about 5.50 m; the thickness of the walls, Section a-b, was about 35 to 40 cm, the internal dimensions about 3 m × 4.80 m. The “open combustion chamber” of the Crematorium VI Project measured 48.75 m × 3.76 m, which corresponds to a Siemens field furnace of the same width but 10 times longer, *i.e.* of the following dimensions:

– width: 3 m (clear width) + 2 × 0.38 m (outside walls) = 3.76 m.

– length: 10 m × 4.80 m (clear space) + 2 × 0.375 m (outside walls) = 48.75 meters.

The use of bricks for this furnace was an option, but engineer Prüfer could have simplified matters by placing the corpses directly on the grates constituting the top part of the hearth. Separating the individual hearths as in the Siemens furnace, Crematorium VI would have had 60 hearths with a usable surface of 144 square meters, sufficient for the concurrent cremation of some 150 corpses.

⁴⁸⁶ Letter from *Zentralbauleitung* to the camp commandant dated 12 February 1943. APMO, BW 30/34, p. 80.

7.4.3. The Annular Incineration Furnace

Topf's letter to the Central Construction Office of 5 February 1943 ends as follows:⁴⁸⁷

"You will receive the cost estimate for the large ring incineration furnace on Tuesday of next week at the latest. In case a purchase is planned, we kindly ask for an order to be placed soonest to enable us to order the cast-iron and wrought-iron parts right away or start with their fabrication [ourselves]."

A ring furnace (*Ringofen*) is usually used for the sintering of bricks, laid out as shown in Document 244. It consists of a ring-shaped sintering channel (*Brennkanal*), some 2 to 4.5 m wide, 2.5 m high and 60 to 120 m long, into which the material to be sintered is placed. Heating is effected by means of hearths with grates, until the material becomes incandescent. The spent gases leave the sintering channel through flue ducts below, flow into a collection channel and then on into a smoke duct, which takes them into the chimney.

Some 12 to 20 openings are arranged in the side walls of the furnace for the loading and removal of the material to be sintered. The sintering channel is divided into an equal number of chambers linked to one another. The actual sintering takes place in two or three chambers, whereas in the others there is a progressive preheating in one direction and a gradual cooling in the other.⁴⁸⁸

Because of the structure and the technical characteristics of such a device which, among other things, operated intermittently, and also because such a device had never been manufactured by Topf, we may exclude that the "ring incineration furnace" suggested by Topf was of this type. The designation would rather refer to the "cremation furnace for corpses in continuous operation for mass application" devised by Fritz Sander with its cylindrical combustion chamber.

7.4.4. The Furnace of the Quotation Dated 1st April 1943

Another project for a mass cremation device appears in a Topf cost estimate, of which R. Schnabel presents only the last page (Document 245; Schnabel 1957, p. 351):

<i>J.A. Topf & Söhne</i>	
<i>Quotation of 1 April 1943 for Auschwitz</i>	
<i>reg. no.</i>	<i># Object</i>
	<i>1 Cast-iron damper for smoke channel with rollers, metal cable and hand crank, The necessary stokers. Provision of builders for construction of the furnace including travelling expenses, daily rates, and social security contributions. Price of furnace: RM 25,148.-- Weight for authorization code: 4,037 kg</i>

⁴⁸⁷ Letter from Topf to *Zentralbauleitung* at Auschwitz dated 5 February 1943. APMO, BW AuII 30/4/34, D-Z-Bau/2544/2 (illegible page number).

⁴⁸⁸ *Hütte* 1938, vol. IV, pp. 739f.

*For the duration of the construction our builders must be supplied with a sufficient number of helpers at no cost to us.
All construction materials such as bricks, sand, lime and cement must be provided at the site in time; these materials must likewise be supplied at no cost to us.
They concern:
about 19,000 bricks
about 20 m³ of sand
about 800 kg of cement
about 6,000 kg of lime.
Our price is given FOB railway freight car at station
By order. J.A. Topf & Söhne
signed: Sander, Erdmann.*

We do not know where the original of this document might be. When comparing it to the known Topf estimates, we see that it is the last page of an estimate: there is no letterhead of the firm, no addressee, no description of the device, and the data which do appear are those normally shown at the end of estimates. It is certain, in any case, that the furnace described in this estimate was a real cremation furnace, even if of a special type. The presence of a flue-duct damper (*Rauchkanalschieber*) leaves no room for doubt in this respect.

A comparison of this device with the constituents of the 8-muffle Mogilev Furnace shows that it was an even-bigger furnace:

	8-muffle furnace	Furnace of estimate of 1st April 1943
Bricks	9,000	19,000
Sand	14 m ³	20 m ³
Lime	3,000 kg	6,000 kg
Cement	500 kg	800 kg
Metal	3,600 kg	4,037 kg
Price	12,972 RM	25,148 RM

The comparison shows that the number of bricks for the outer facing of the furnace in question was twice as large as that of the 8-muffle furnace, and one may thus suppose that the outer surface also was roughly twice the size.

The enormous price difference between the two devices, even if the weight of the metal is not very different, can probably be explained by a most-relevant difference in weight for the refractory and the insulating material and would hence confirm the gigantic dimensions of this furnace. These dimensions agree much better with a special furnace such as the one invented by Fritz Sander which, incidentally, also had only one smoke duct.

The devices described in this section were never built, probably because conditions had changed. In January of 1943, the Birkenau crematoria were still being erected; by the end of March, Crematoria II and IV were in operation, with Crematorium V joining them in early April.

The cost estimate of 1st April 1943 certainly responded to a request by the Central Construction Office made a few weeks earlier when the sanitary situa-

tion in the camp was disastrous because of a resurgence of the typhus epidemic which had struck the previous year. Between 2 March and 1st April of 1943, a total of 7,300 detainee deaths were recorded in the *Sterbebücher*.⁴⁸⁹ From April onwards, mortality went down considerably, and that is probably the reason why the Central Construction Office abandoned these projects.

8. The Duration of the Cremation Process in the Topf Furnaces at Auschwitz-Birkenau

8.1. The Documents

In this chapter, we will consider the controversial question of the cremation capacity of the Topf furnaces from the point of view of the duration of the process. There are four documents on this topic, which, however, yield rather diverging data.

In the Topf letter sent to the New Construction Office of *KL* Mauthausen on 1 November 1940, with an attachment of a cost estimate concerning “one coke-fired Topf double-muffle cremation furnace, with compressed-air system” as well as one concerning a “Topf draft-enhancing device” (Document 194), we read:⁴⁹⁰

“Our Herr Prüfer had already informed you that in the furnace previously proposed [on 31 October 1941] two corpses per hour can be incinerated.”

As we are dealing here with the Auschwitz-type double-muffle furnace, Prüfer’s statement refers to the cremation of one corpse in one muffle in one hour. This corresponds to a theoretical cremation capacity of 48 corpses in 24 hours.

A few months later, on 9 July 1941, the SS New Construction Office at *KL* Mauthausen sent Topf the following request:⁴⁹¹

“This office asks to be informed about the number of cremations which may be carried out in one furnace per day without danger to the equipment (coke-firing). Furthermore, we ask you for the supply of 2 service instructions for the furnaces.”

Topf replied on 14 July by the following letter (Document 247):⁴⁹²

“Re: Your letter of 9 July 1941. Cremation furnace.

In pursuance of our [sic] letter mentioned above we are sending you the requested instructions in triplicate and ask you to exhibit one at a visible spot close to the furnace hall. The other two may be placed in your files.

In the Topf coke-fired double-muffle cremation furnace, 30-36 corpses can be cremated in about 10 hours. This number may be cremated daily without undue strain on the furnace. It is not harmful either to carry out cremations day and

⁴⁸⁹ Staatliches Museum... 1995, Vol. I, p. 236.

⁴⁹⁰ Letter from Topf to *SS-Neubauleitung* at Mauthausen dated 1st November 1941. BAK, NS 4/Ma 54. Cf. Document 246.

⁴⁹¹ Letter from Topf to *SS-Neubauleitung* at Mauthausen dated 9 July 1941. BAK, NS4/Ma 54.

⁴⁹² Letter from Topf to *SS-Neubauleitung* at Mauthausen dated 14 July 1941. SW, LK 4651.

night, one after the other, if operations require this. It is a fact that the refractory lasts longer if a uniform temperature is constantly maintained in the furnace. We hope to have been useful to you in the best way in this matter and salute you Heil Hitler
By proc. J.A. Topf & Söhne
Sander, Erdmann.”

On the basis of what is said in this letter, the duration of one cremation in one muffle would have been some 33 to 40 minutes, and the theoretical capacity of the furnace would therefore have been 72 to 86 corpses per 24 hours.

The third document is the following letter, dated 28 June 1943 and sent by the head of the Auschwitz Central Construction Office (*SS Sturmbannführer Bischoff*) to the head of Office Group C of WVHA (*SS Brigadeführer Kammler*; Documents 248, 248a):⁴⁹³

“28 June 1943.

31550/Ja./Ne.–

Re: Completion of Crematorium III

Reference: none

Attachments: -/-

To the

SS Economic-Administrative Main Office, Head of Office Group C

SS Brigadeführer and Major General

Dr.-Ing. K a m m l e r

Berlin – Lichterfelde – West

Unter den Eichen 126 – 135

I [hereby] inform you of the completion of Crematorium III on 26 June 1943. Therefore all crematoria ordered have now been completed.

Performance of the crematoria presently existing
over an operating period of 24 hours:

1.) old Crematorium I

3 x 2-muffle furnaces 340 persons

2.) new Crematorium at PoW Camp II

5 x 3-muffle furnaces 1440 persons

3.) new Crematorium III

5 x 3-muffle furnaces 1440 persons

4.) new Crematorium IV.

8-muffle furnace 768 persons

5.) new Crematorium V.

8-muffle furnace 768 persons

at 24-hour operation a total of 4756 persons

*The Head of Central Construction Office
of the Waffen-SS and Police Auschwitz.
SS Sturmbannführer.”*

⁴⁹³ RGVA, 502-1-314, p. 14a.

Thus, on the basis of this document, the average duration of one cremation was 25 minutes in the double-muffle furnace, and 15 minutes in the furnaces with three or eight muffles.

The fourth document is an internal memo (translated below) written by Engineer Prüfer, dated 8 September 1942.⁴⁹⁴

“TOPF

To: J. A. TOPF UND SÖHNE

Erfurt, 8 September 1942

Department D IV

Our reference: D IV/Prf./hes

Concerning: Reichsführer SS, Berlin-Lichterfelde-West.

Subject: Crematorium-Auschwitz.

Confidential! Secret!

8 September 1942: Obersturmführer Krone called and informed us that he has to report to Brigadeführer Kämmer [Kammler] and that he has to give an account of his visit to the Auschwitz Crematorium, from which he came back yesterday. He has not been told anything about the Auschwitz installation and would therefore like to know exactly how many muffles are presently in operation and how many muffle furnaces we are presently building for forthcoming delivery.

I explained to him that 3 furnaces with 2 muffles are now in operation with a [cremation] capacity of 250 [corpses] per day. Furthermore, 5 furnaces with 3 muffles are now under construction for a [cremation] capacity of 800 [corpses].

Today and over the next few days the 2 furnaces with 8 muffles will be shipped, taken from the Mogilev [job], with a [cremation] capacity of 800 [corpses] each. Herr K. declared that this number of muffles was still insufficient; we are to supply yet more furnaces as soon as possible. It is therefore advisable for me to go to Berlin on Thursday morning to discuss with Herr Krone any further orders. I am to bring with me documents concerning Auschwitz so that these urgent calls would stop once and for all.

I have announced [my] visit for Thursday.”

If we follow this document, the average duration of a cremation in the double-muffle furnace was 34 to 35 minutes, in the triple-muffle furnace 27 minutes and in the 8-muffle furnace 14 to 15 minutes. The corresponding cremation capacities of each type of furnace were about 83, 160, and 800 corpses per 24 hours, respectively.

Summarizing, the capacities claimed in these four documents are as listed in the following table, with the time given in minutes and the capacity in corpses per muffle and per 24 hours of operation per day:

Furnace	Document 1		Document 2		Document 3		Document 4	
	time	capacity	time	capacity	time	capacity	time	capacity
two muffles	60'	24	33-40'	36-44	25'	57	34-35'	42
three muffles					15'	96	27'	53
eight muffles					15'	96	14-15'	100

⁴⁹⁴ K. Prüfer's memo of 8 September 1942. *EMS/Erfurter Mälzerei- und Speicherbau*, 241, II 80 Tech. Abteilung D IV. Published online at: <http://veritas3.holocaust-history.org/auschwitz/topf/>. Cf. Document 249.

It is obvious that at best only one of these numbers can be correct.

The first document stems from the copious correspondence between Topf and KL Mauthausen, held at the *Bundesarchiv* at Koblenz; the second one was originally part of this correspondence, but it is no longer there, having been transferred to the Weimar *Staatsarchiv*. It is unclear how the document arrived at the Weimar *Staatsarchiv*, which is all the more strange, as it is not Topf's own filed copy but the original of the letter directed to Mauthausen, as we can see from the *in* stamp it bears.

The photocopy sent to this author (Document 247) shows, on the left, several vertical lines whose ink has faded; on the lower-left-hand corner we have, attached to the sheet, a slip of paper with the hand-written entry "in 1943, up to 300 corpses were burned in such a [*im gleichen*] furnace in 10 hours." The author of this hand-written remark is unknown; the remark must, in any case, be considered worthless from a technical point of view and false from a historical point of view. Actually, the incineration of 300 corpses in 10 hours in a double-muffle furnace is equivalent to a time of 4 (four) minutes for each cremation, which is technically impossible. On the other hand, the "such a furnace," *i.e.* the double-muffle furnace, Auschwitz Type, had not yet been installed at Mauthausen in 1943. The authenticity of the typed letter is not in doubt, but the hand-written note was certainly added to it after the war.

The third document, which comes from the Moscow Archives, presents serious problems of form and content which will be treated in Subchapter 9.6.

The fourth document was discovered by Jean-Claude Pressac in 1995 during a search of the archives of the firm *EMS / Erfurter Mälzerei- und Speicherbau*, successor to *Topf & Söhne* at Erfurt. After Pressac's death, part of the documentation on this company which he had collected, including the documents from the above archives, were donated, as he had wished, to the *Thüringisches Hauptarchiv* at Weimar, where it is now held.

In our effort to judge the factuality of the data given in these four documents, and to ascertain the average duration of a cremation in the Topf furnaces at Auschwitz-Birkenau, we shall use three objective criteria, all based on practical conditions: the results of the experimental cremations with coke carried out by R. Kessler on 5 January 1927, a fragment of the list of cremations in the crematorium of the Gusen Camp, and the numerous fragments of such lists concerning the crematorium at the Westerbork Camp (Netherlands).

A further important experimental criterion is provided by the experiments with the incineration of animal carcasses and offal from slaughterhouses run on Kori furnaces. The technical assessments carried out by the Soviets and the Poles on the Majdanek (August 1944), Sachsenhausen (June 1945) and Stutthof Furnaces (May 1945) have yielded still more useful indications.

The lists of cremations in the crematorium of the Terezín Ghetto – which was equipped with four oil-heated *Ignis-Hüttenbau* furnaces, undoubtedly the most-productive of all the furnaces built during the Second World War – provide us, finally, with an essential benchmark allowing us to set the lower limit of the cremation time achievable in plants operated in German concentration camps and ghettos in the 1940s (see Subchapter 11.4.).

8.2. Richard Kessler's Cremation Experiments

As we have explained in Chapter 6 of Unit I, the duration of the cremation process involving one corpse depends essentially on the constitution and the chemical composition of the body, but – to a not-irrelevant extent – also on the furnace system and the operational procedure of the cremation.

Since the Auschwitz-Birkenau furnaces had a coke-fired gasifier, the experiments carried out by the engineer Richard Kessler in the Dessau Crematorium on 5 January 1927 can be used as a yardstick, if we want to understand how the cremation process unfolded in the furnaces of Auschwitz-Birkenau (cf. Chapter 4 of Unit I). However, if we want to stay in line with actual conditions, we must look at the design differences between the Gebrüder Beck Furnace used by R. Kessler and the Topf double-muffle furnace, Auschwitz Type, the furnace which resembled most-closely the furnaces for civilian use.

The Beck Furnace had a refractory mass of at least 12,000 to 13,000 kg, which allowed for a considerable amount of heat to be stored in the walls, and which reduced the temperature fluctuations during the cremation. The Topf Furnace had a refractory mass of some 10,000 kg, *i.e.* 5,000 kg per muffle and gasifier, hence they stored less heat, which in turn led to more-pronounced temperature fluctuations.

On account of its recuperator, the Beck Furnace possessed an efficient system of preheating the incoming combustion air to high temperatures, which supported supported the mixing process of the combustion air with the combustible gases coming from the gasifier and from the decomposing corpses, thus reducing the amount of Excess Air and increasing the combustion temperature. Furthermore, the recuperator supported the post-combustion of the heavier hydrocarbons leaving the cremation chamber uncombusted, thus returning part of their heat to the furnace.

The Topf Furnace had no recuperator and no preheating system and thus worked with an air-feed system which had already been tried out in the 1930s and had been found unsatisfactory from the point of view of heat economy. Here, the cold air entered the muffle through four openings set into its vault and was fed into both muffles by means of a single blower, which did *not* allow controlling the air-feed to individual muffles (cf. Schläpfer 1938, p. 155).

The Beck Furnace, moreover, could be switched over to a smoke-combustion mode which reduced the heat loss through otherwise-uncombusted gases and thus attenuating a corresponding reduction of the muffle temperature at a point in the process at which the Topf Furnace (having no smoke-combustion mode) experienced a more-pronounced temperature drop in the muffle (and concomitant greater formation of smoke).

Both furnaces worked with direct combustion, allowing the combustion products of the gasifier to enter the muffle.

We will now consider the results of Kessler's cremation experiments, which I have summarized in Documents 250f. On average, the initial temperature of the cremations was around 800°C (Column 2); the maximum temperature during the combustion of the coffin was around 1,000°C (Column 3), the tempera-

ture at the start of the combustion of the corpses was around 780°C (Column 5), and the maximum temperature during the combustion of the corpses was around 900°C (Column 7). As far as the durations are concerned, the average time taken for the temperature to reach its maximum after the coffin had been introduced was 12 minutes, the average time for the evaporation of the corpse water was 27 minutes, and, finally, the average time taken for the combustion of the corpses to reach the highest temperature was 28 minutes, whereas the average duration of the entire process up to the second peak temperature was 55 minutes.

Here we must underline the fact that the above times taken for the coffin and for the corpse to be consumed, respectively, are merely measured up to the point where the highest temperature is reached. In both cases, the combustion obviously continues even after the peak temperature has been reached, albeit at a lower rate (Document 251). This is why we have taken 55 minutes to be the average duration of the entire combustion process in Documents 250f., whereas in Kessler's experiments it was taken to be 86 minutes. Hence, even after the most-active combustion phase of the corpses, the combustion process continues for another 31 minutes.

These considerations are important because the Topf cremation furnaces at Auschwitz-Birkenau, or more-precisely their method of operation, was different from Kessler's: on account of both professional ethics and legal requirements as discussed in Chapter 8 of Unit I, Kessler no doubt waited for the ashes to stop burning before moving them into the ash chamber; as opposed to this, the operating guidelines for Topf's furnaces at Auschwitz-Birkenau allowed for the introduction of the next corpse as soon as the remains of the former corpse had fallen through the muffle grate. Thus, the duration of a cremation in the Topf furnaces ended once the remains of the corpse had fallen through the muffle grate bars into the post-combustion (or ash) chamber, where they would go on burning for another 20 minutes, as indicated by the operating instructions.

In both furnaces, however, combustion of the corpses took place primarily within the muffles.

When we look at the chart summarizing Kessler's experiments (Document 251), we see that at the very moment when the combustion temperature of the corpses reached its maximum, *i.e.* after 55 minutes, the corpses themselves were still in the muffle, as is borne out by the fact that the muffle temperature continued to rise as high as 900°C. Therefore, the duration of the combustion process in the muffle up to the point where the remains of the corpse fall through the grate bars into the ash chamber was necessarily longer than the 55 minutes.

When comparing Kessler's cremations and those carried out in the Topf double-muffle furnace at Auschwitz, we must take two more relevant points into consideration:

First of all, cremations in the Beck Furnace were done with coffins, whereas at Auschwitz the corpses entered the muffle unboxed.⁴⁹⁵ The coffin has a negative (*i.e.* lengthening) effect on the duration of the cremation, because, for sev-

⁴⁹⁵ At the beginning of WWII, the use of coffins was provided for. Cf. Chapter 12.

eral minutes until it breaks down under the heat, it acts as a heat shield for the corpse, thus delaying the evaporation of the corpse water. But after the coffin has broken down, it has a positive effect and speeds up the evaporation process of the corpse water, because the burning wood increases the muffle temperature. Finally, part of the heat contributed by the combustion of the coffin accumulates in the muffle walls and is released again when the thermal conditions in the muffle allow this. This contribution, though, becomes ever-less-significant as the refractory mass of the muffle increases.

Second, the Beck Furnace possessed all measurement devices needed for a continuous observation of the cremation process at any moment of the cremation, and the cremations were carried out under the eye of an expert engineer, and were thus performed in the best possible manner.

From the first, negative, effect we may draw the following conclusion: since the maximum temperature of the coffin's combustion was reached after 12 minutes, we may assume that the evaporation of the corpse water began after some 5 to 6 minutes, which means that the cremation of a corpse without a coffin would take about 50 minutes up to the maximum of the main combustion phase.

In Kessler's cremation experiments, the minimum duration of the cremation process up to the high point of the main combustion phase – 40 minutes – was registered for the last two cremations; the average duration and the temperatures reached in the individual phases were as follows:

- from the moment of introduction (at 805°C) up to the highest temperature (1015°C) reached during the combustion of the coffin: about 14 minutes;
- from the introduction until the end of the desiccation of the corpse (810°C): 30 minutes;
- from the end of the desiccation up to the highest temperature reached during the combustion of the corpse (955°C): 40 minutes.

As the combustion of the coffin reached its highest point after 14 minutes, we may assume that vaporization of the corpse water begins after six to seven minutes, which brings us to a minimum duration of the main combustion phase under optimum conditions of 32 to 33 minutes.

In modern furnaces, the main combustion phase lasts about 30 to 40 minutes.⁴⁹⁶ On this point, the engineer L.G.A. Leonard of the French company Tabo, manufacturer of cremation furnaces, gave an account of his experiments at the meeting of the Cremation Society of Great Britain in 1975, saying (Jones 1975, p. 83):

“After about half an hour, whether the furnace has got up to a temperature of 1,100° C or whether it is 900° C, there is a rapid fall away, and I think the investigations should be concerned with the last twenty minutes or so of the cremation cycle. At that time you have in the cremator a very very small quantity of body material in the shape of chest and lung material, roughly the size of a rug-

⁴⁹⁶ *I.e.* the time from the introduction of the corpse into the muffle up to the end of the main combustion phase.

by football, about twenty minutes from the end of the cremation, and this is the thing which is most-difficult to remove.”

A chart summarizing the phases of the cremation process in a modern crematorium attributes 34 to 38 minutes to the duration of the main combustion (cf. Document 252).

However, actual experiments show longer durations. In the 1990s, Michael Bohnert *et al.* observed fifteen cremations carried out in a modern *Etagenofen* (multiple-hearth incinerator) as part of a study in forensic medicine (Bohnert *et al.* 1998). The gas-fired furnace had a cremation chamber with a post-combustion chamber underneath. The latter had a rotatable grate. The ash chamber was located further below.

The corpses concerned were those of seven men and eight women, between 68 and 100 years of age. The cremation process was observed through a viewing port 13 cm × 11 cm set into the muffle. The phenomena occurring during combustion were recorded at intervals of 10 minutes. The average duration of a cremation in the muffle (main combustion) was about one hour,⁴⁹⁷ after which the remains were moved into the post-combustion chamber, where they burned out over another hour.

After 30 minutes, the skull and the trunk were still recognizable: the thorax was open, and the internal organs could be seen (cf. Document 253). After 40 minutes, the ribs had lost their soft tissue, and the base of the skull was visible (cf. Document 254). After 50 minutes, combustion was still intense, and the appearance of the corpse was as follows (*ibid.*, p. 16):

“The facial bones had mostly disintegrated. The base of the skull was visible. The upper parts of the spinal column tended to extend. The vertebrae were calcined and the disks between the vertebrae were missing. The shape was maintained primarily by the remains of the strongly deformed neck muscles. The internal organs, meanwhile, showed a considerable shrinkage. In most cases, only the liver was still recognizable, even though it had been reduced to a sponge-like structure. The soft tissue of the basin which had been protected for a long time had now been consumed by the fire, and the iliacus presented only sparse remains of carbonized soft tissue adhering to the bone. The arms had been completely destroyed. The upper thighs had been reduced to calcined bone stumps.”

The cremation in the muffle went on for another 15 minutes on average.

In conclusion it may be said that, as a reference point, the duration of the main combustion phase is about 50 minutes.

8.3. The List of Cremations in the Gusen Crematorium

Among the few documents concerning the crematorium at the Gusen Camp to have been preserved, there is a record drawn up by *SS Unterscharführer* Wassner, head of the crematorium, which lists the number of detainees cremated, and the corresponding consumption of coke, for the period of 26 September

⁴⁹⁷ Bohnert *et al.* 1998, p. 12. From Table 1 shown on this page we obtain an average duration of 66 minutes. The average temperature in the muffle was about 750°C.

through 12 November 1941.⁴⁹⁸ The list contains four columns. The first column shows the time; next to it we have the number of cartloads of coke supplied. The second column gives the date of the cremation, the third the number of corpses cremated, and the fourth the total number of cartloads of coke (1 cartload = 60 kg). The coke figures in the first column are listed cumulatively, so that the last figure in the first column is the same as the figure in the fourth column.

The document poses some problems, though:

1. Does the date column really indicate the days on which the cremations were carried out? At three points (entries for 31 October, 7 November, and 8 November) the cremations cycle into the early hours of the following day, hence rather than speaking of cremation *days*, we should rather speak of cremation *cycles* or *series*. Each cycle comprises the number of corpses shown in the record and may extend into the following calendar day.
2. Does the number of coke cartloads registered in the first column correspond to the coke *loaded* into the generators at the hour indicated? This possibility must be discounted for the following reason: 1 m³ of loose coke has a weight of 380 to 530 kilograms (*Hütte* 1931, vol. I, p. 718). Let us assume the maximum value of 530 kilograms.

The two gasifiers at Gusen had a flat grate of 50 cm × 50 cm, like the Auschwitz double-muffle furnace. The loading port of the gasifier stood at a level of 80 cm above the grate. The effective volume of one gasifier was thus 0.5 m × 0.5 m × 0.8 m = about 0.2 m³, which means that each gasifier could load (530×0.2=) 106 kg of coke, *i.e.* 212 kg for both gasifiers. Now, in the above record, the first figure in the first column is, in several cases, between 11 and 16, or between 660 to 960 kg of coke, but in order to take in (960÷2=) 480 kg of coke, each gasifier would have had to have an effective volume of about 1 m³; hence the number of cartloads of coke does not refer to the coke loaded into the gasifiers for the hour indicated.

3. Does the number of coke cartloads shown in the first column refer to the coke *consumed* up to the hour indicated? This hypothesis must be excluded as well, because, for 11 November, at 8:00 PM, 23 cartloads of coke are mentioned (=1,380 kg). The following entry, at 9:20 PM, speaks of 32 cartloads (=1,920 kg). Hence within the 80 minutes between the two entries (1,920 – 1,380=) 540 kg (or 405 kg per hour) would have been consumed, a technically impossible amount. The same reasoning also applies to other cycles, *e.g.* for 6 November we have 600 kg of coke between 10:25 and 14:45 hours, *i.e.* over 4 hours and 20 minutes, or 138 kg/hr, for 7 November: 420 kg of coke between 3:30 and 5:00 AM, *i.e.* over 90 minutes = 280 kg/hr; for 12 November: 420 kg of coke between 15:20 and 18:15 hours, *i.e.* over 175 minutes = 144 kg/hr; etc.
4. Do the times shown in the first column refer to the *beginning* (first figure) and to the *end* (last figure) of the cremations carried out on that day? This question is closely related to the preceding one. If the first figure really re-

⁴⁹⁸ Cf. Document 255; ÖDMM, Archiv, B 12/31.

ferred to the beginning of the cremations, the figure for the number of cart-loads shown next to it would concern the amount loaded into the gasifiers, which cannot be the case.

Moreover, this hypothesis would lead to technical impossibilities, as we can gather from the explanatory table (Document 256). In this table, Column 1 indicates the date of the various cremation cycles, Column 2 the total consumption of coke, Column 3 the total number of cremations, Column 4 the average coke consumption for each cremation, Column 5 the total time for each cycle (based on the first column of the list of cremations), Column 6 the average duration of each cremation (provided the first and last figures of the list refer to the beginning and the end of the cremations), and Column 7 gives the hearth grate's throughput rate under the same conditions.

We see immediately that the duration of the cremations (Column 6) in certain cases would be only 13, 12 or even 8 minutes, but if we follow Kessler's experiments, these times would not even be sufficient for the complete evaporation of the corpse water.

Next, the average duration of discontinuous cremations (26 September – 15 December) – 17 minutes – would be less than the duration of cremations run continuously (31 October – 12 November) – 23 minutes – whereas the contrary should be the case.

Finally, for this hypothesis the coke consumption for each hearth would be 163 kg/hr for the cremations between 26 September and 15 October (Column 7) and 80 kg/hr for those between 31 October and 12 November.

According to the Colombo Engineering Handbook, the throughput of a hearth grate under natural draft is about 90 to 120 kg of coal per hour per square meter (Colombo 1926, p. 398). For the Topf Furnaces, the maximum figure applies, as we can gather from the file memo (*Aktenvermerk*) of 17 March 1943,⁴⁹⁹ which gives the grate throughput for the triple- and 8-muffle furnaces: 35 kg of coke per hour.

As the surface area of the hearth grates for the triple-muffle furnaces was 0.3 m² (cf. Subchapter 7.2.), the unit throughput on 1 m² was (35÷0.3=) 116.7 kg or about 120 kg per hour.

As far as forced draft is concerned, the following data are found in Colombo's engineering handbook (Colombo, p. 366; in the third column the data for the furnace of the Gusen Camp is shown):

Draft [mm water column]	Throughput [kg/(hr×m ²)]	Gusen Furnace (one hearth) Throughput [kg/hr]
10 – 20	120 – 150	30.0 – 37.5
20 – 30	150 – 180	37.5 – 45.0
That is to say:		
10	120	30.0
20	150	37.5
30	180	45.0

⁴⁹⁹ APMO, BW 30/7/34, p. 54; cf. Subchapter 10.8. and Document 264.

According to Heepke, chimneys of the cremation furnaces operated with a maximum draft of 30 mm of water column (Heepke 1905b, p. 71). Even the three draft enhancers initially installed at Crematorium II of Birkenau operated with a draft of 30 mm of water column for a flow rate of 40,000 m³/hr of flue gas and a 380-V motor of 15 hp each (see invoice quoted on p. 269).

The forced-draft device for the Gusen Furnace was a standard device, also installed at the Auschwitz Crematorium, with a throughput of 4,000 m³/hr and a 3-hp engine. The working pressure is not known, but could not have been more than 30 mm of water column in any case.

Looking at the summary (Document 256), it is obvious that a daily average throughput of 163 kg/hr of coke on each grate – even a lower one of 78 kg/hr for November 1941 – would have been technically impossible, because even at maximum draft of 30 mm water column, the Gusen Furnace could only have handled 45 kg/hr of coke each.

The only conclusion we can draw from the above considerations is that the individual entries for the coke supply refer *neither* to the coke loaded into the gasifiers *nor* to the amount consumed up to the time mentioned in the lists, but to the coke brought from time to time to the gasifiers from the coke storage area of the crematorium so that the attendants would always have a sufficient amount of coke available.

As in any change of shifts, the attendant took over the unloaded coke and was responsible for its use, indicating the time and the number of cartloads when the unloading ended, not when it began. The furnace, though, would be operated as soon as the first load had arrived. Hence the indication “time” on the document in question does not by itself refer to the beginning of the cremation but to the end of the delivery of the first batch of cartloads.

This, again, means that the times recorded in the first column of the list correspond neither to the beginnings nor to the ends of the cremations, which therefore began before the first hour entered and ended later than the last.

As far as the average coke consumption is concerned, it is likely that a certain amount of coke was left over after the end of a cremation cycle and was used for the beginning of the following series of cremations, but it is just as likely that this amount was always more or less the same (an amount necessary for restarting the furnace) in such a way that, overall, what remained at the end of the day was used for the start-up of the furnace for a new cycle of cremations.

Here, however, we run into the fundamental problem: how can we determine the times of the beginnings and the ends of the cremations?

To solve this problem, one can use the duration of the combustion of coke in the gasifier hearths. First, though, we must determine the total time over which the 677 cremations were carried out. If we assume that they began at 7:00 AM on 31 October and ended at 11:00 PM on 12 November (i.e. 12 $\frac{2}{3}$ days), we have a total time of 304 hours or 18,240 minutes. The time needed for the combustion of 20,700 kg of coke actually consumed obviously depends on the throughput rate of the gasifier grates; as the time taken for the consumption of

the coke is inversely proportional to the throughput rate of the grate, with the shortest time corresponding to the highest throughput rate.

We have seen that the highest throughput rate for the two hearths obtainable with a forced draft of 30 mm of water column was about ($2 \times 45 =$) 90 kg/hr of coke overall and we thus find:

- total combustion time of the coke: $20,700 \text{ kg} \div 90 \text{ kg/hr} = 230 \text{ hours}$ or 13,800 minutes
- average daily activity of the furnace: $230 \text{ hrs} \div 12.67 \text{ days} \approx 18 \text{ hr/day}$
- average time of coke combustion for each corpse ($30.6 \text{ kg/corpse} \div 45 \text{ kg/hr}$) $\times 60 \text{ min/hr} \approx 41 \text{ minutes}$
- average daily shut-down time of the furnace: $\approx 6 \text{ hours}$
- heat loss from the furnace during shut-down: $\approx 200,000 \text{ kcal}^{500}$
- time spent daily on reheating the furnace to operating temperature (with an efficiency of $\eta \approx 0.54$):⁵⁰¹

$$\frac{200,000 \text{ kcal} \cdot 60 \text{ min/hr}}{90 \text{ kg/hr} \cdot 6,470 \text{ kcal/kg} \cdot 0.54} \approx 40 \text{ minutes}; \quad [109]$$

- daily coke consumption for preheating the furnace to operating temperature: $90 \text{ kg/hr} \times (40 \text{ min} \div 60 \text{ min/hr}) = 60 \text{ kg of coke}$;
- total preheating time of the furnace: $40 \text{ min/day} \times 12.67 \text{ days} \approx 510 \text{ minutes}$;
- total amount of coke used for reheating the furnace: $60 \text{ kg/day} \times 12.67 \text{ days} \approx 760 \text{ kg}$;
- average duration of the cremation of a corpse: $(13,800 \text{ min} - 510 \text{ min}) \div 677 \text{ corpses} \times 2 \text{ muffles} \approx 40 \text{ minutes/corpse}$
- daily operating time of the furnace: about 18 hours, of which about 17 hr 20 min for cremations and about 40 min for preheating
- average coke consumption for each cremation: $\approx 30.6 \text{ kg}$, of which $(20,700 \text{ kg} - 760 \text{ kg}) \div 677 \approx 29.5 \text{ kg}$ for the corpse and 1.1 kg for preheating the furnace.

These data represent *minimum theoretical* values; if, in fact, a grate throughput rate halfway between the maximum (90 kg/hr) and the minimum (20,700 kg \div 304 hrs = 68 kg/hr) is assumed, *i.e.* ca. 80 kg/hr, we obtain the equivalent of an average daily operating time of the furnace of about 20 hours, and the average duration of a cremation would be 45 minutes, while the average amount of coke for preheating the furnace would drop to 0.8 kg for each cremation.

As the heat balance as calculated in Chapter 10 will be based on minimum theoretical values corresponding to an average daily operating time of 18 hours, the amount of coke would go down negligibly for an operating time of 20 hours per day: $(1.1 - 0.8 =) 0.3 \text{ kg per cremation}$, *i.e.* by about $(0.3 \div 30.6 =)$ about 1 percent.

According to the Topf operating instructions for the double- and triple-muffle furnaces, the post-combustion of the corpse residues took about 20 minutes; adding to this the time needed for the main combustion – 40 minutes – one ob-

⁵⁰⁰ Calculated on the basis of a heat loss of 41,709 kcal during the operation; cf. Subchapter 10.2.

⁵⁰¹ The calculation is explained in Subchapter 10.3.

tains for the total duration of the cremation process a time of 60 minutes, which represents the limit called “thermal barrier” by Dr. Jones, *i.e.* the minimum duration which cannot be pushed any lower (cf. Unit I, Chapter 6) by any practical means.

This duration is valid for the furnace of the Gusen Camp and, as I shall explain in Subchapter 8.5., cannot be applied directly to the inferior Auschwitz double-muffle furnace, to which the Topf letter of 14 July 1941 refers explicitly.

8.4. The List of Cremations at the Westerbork Crematorium

The crematorium of the Westerbork Camp in the Netherlands was equipped with a coke-fired Kori Furnace. The “operating instructions for cremations” which exist in the camp documentation refer to the oil-fired Kori Furnace (cf. Document 286) and make sense only if the furnace worked initially with this fuel.

The furnace was, without doubt, a mobile oil-fired furnace that was later converted into a coke-fired furnace by the addition of a gasifier, probably as shown on the Kori Drawing J. Nr. 9239 of 15 February 1944.⁵⁰² The crematorium went into operation on 15 March 1943 at a time when the mortality was still very low but rising sharply. In 1943, the number of deaths rose to 593 from 108 in the second half of 1942 and then went down drastically: to 50 in 1944 and 4 in 1945.⁵⁰³ A number of documents concerning this crematorium have survived. The most-important ones are:

- a large fragment of the “*Krematorium Betriebsbuch*” indicating the names of the persons deceased between 23 June 1943 and 31 March 1944, with dates of birth and death and consecutive registration numbers (277 to 510) corresponding to the number on the urn used;⁵⁰⁴
- numerous cremation lists giving the number of corpses cremated, the duration of each cremation, and the total coke consumption (cf. Documents 257f.).

There is also a “name list of Jewish persons who died in the concentration camps of Westerbork and Buchenwald and were buried in Dutch cemeteries,” drawn up by the Dutch Red Cross, giving an alphabetical list of the Jews who died at Westerbork, complete with their dates of birth, of death and of cremation, as well as the urn number.⁵⁰⁵

As the cremations were carried out in the order of the entries, these documents allow us to personalize the cremation lists by linking each number with the corresponding name list. For the first three months, the lists have many gaps. Hence we can only identify the day of a cremation and the number of cremations carried out. The day with the highest activity, of 17 cremations, was

⁵⁰² H. Kori, drawing J.Nr. 9239 “*Anbau einer Kohlenfeuerung am ölbeheizten Krematoriumssofen*” dated 15 February 1944. ÖDMM, Archiv, N 17, Nr. 6.

⁵⁰³ *Rapport over de sterfte in het Kamp Westerbork in het tijdvak van 15 Juli 1942 tot 12 April 1945* (Report on the mortality at camp Westerbork over the period from 15 July 1942 through 12 April 1945). ROD, C[64] 514, p. 1

⁵⁰⁴ ROD, C[64] 292.

⁵⁰⁵ ROD, C[64] 314.

14 May 1943. The first list we have covers 27 April 1943, followed by the list for 10 May after a gap of four operating days.⁵⁰⁶

The lists of individual cremations are listed in the Appendix, although without the names. I have omitted the small number of lists for 1943 in which there are only five cremations or fewer (with one exception to be explained later) and those for 1944, a year with very few cremations. The list shows:

- the number of cremations
- the consecutive registration numbers
- the sex of the deceased
- the age of the deceased
- the date of birth of the deceased
- the date of death of the deceased
- the beginning and the end times of the cremation
- the duration of the cremation.

In order to allow the proper interpretation of the data presented, we must give some further explanations.

Cremations were not carried out every day, but only when a sufficient number of corpses had been collected in the morgue. This was done to save fuel.

In the Westerbork Camp, there was a very high infant mortality, with peaks of 25% in May and June of 1943, and even 40% in August.⁵⁰⁷ It concerned for the most part babies who were a few months and at times only a few days old, and who were normally cremated by placing two small corpses into the muffle, or at times one infant and an adult corpse.

A few small corpses were introduced between two consecutive cremations of adults in such a way that their cremation overlapped the final phase of the preceding corpse and the initial phase of the following corpse.

In the cases of double cremations, entries concerning the corpse of the infant are marked with an ×. In Document 258, this is the case for the seventh and the eighth cremations (a 90-year-old woman and a baby girl two months of age) and for the eleventh and twelfth cremations (a 46-year-old man cremated together with a child of ten months).

Even though the cremations generally followed strictly the consecutive order of the morgue entries, there are some gross anomalies which lead us to believe that the order was mixed up in these cases. For example, the seventh cremation on 26 May 1943 lasting 25 minutes cannot possibly have referred to a man of 72, but obviously concerned a child of two months listed as No. 9. Similarly, the third and the fifth cremations on 4 June must have been swapped, as it is difficult to see how the cremation of a 78-year-old woman should have taken 35 minutes, whereas that of an 18-month-old child extended over one whole hour. A similar switch must also be assumed for the fourth and fifth cremations on 11 June where the cremation of the corpse of a one-year-old child is said to have taken an unlikely 55 minutes, and that of an 81-year-old man only 35 minutes.

⁵⁰⁶ Although there are 13 days between 27 Apr. & 10 May, the crematory operated only on four of these days.

⁵⁰⁷ Rapport... *op. cit.* (note 503), p. 2.

Also, the first and third cremations on 18 October 1943 (lasting 20 minutes), referring respectively to a man of 45 and a woman of 59, must obviously take the place of the second and fourth cremations attributed to a child aged one month and another child aged two months.

After these cases have been corrected accordingly, we can interpret the tables in the Appendix in a valid manner.

8.4.1. Adults Cremated Individually

There are altogether 128 individually cremated adults. In the table below I have listed the number of corpses cremated in the order of the duration of the cremations. The average duration of one of these 128 cremations was 50 minutes:

Duration [min]	# of corpses	Duration [min]	# of corpses
30	6	65	3
35	5	70	2
40	19	75	2
45	24	80	3
50	21	90	2
55	15	95	1
60	25	<i>Total:</i> 128	

8.4.2. Infants Cremated Individually

As explained above, children’s corpses were, as a rule, cremated together with another child or an adult. There are only seven individual cremations of children, as listed in the table below, together with the respective ages of the infants:

Duration [min]	# of corpses	Ages
20	2	2 months 1 day
30	1	5 months
35	2	18 months 12 months
40	2	1 month 2 months
<i>Total:</i>		7

8.4.3. Infant Double Cremations

The lists mention seven cremations of this type, four of which, however, are obviously abnormal. Let us first consider the regular cases:

Duration [min]	# of corpses	Ages
20	2	2 months 1 day
30	3	1 month 5 months 3 months
40	2	3 years 2 years

The other four cases show obviously abnormal data:

Duration [min]	# of corpses	Ages
45	2	8 months 10 months
50	2	2 months 1 day
70	2	17 months 4 years
75	2	8 months 14 months

When comparing these entries with those in the table above, one can see that these cremations should have taken 20 or 30 minutes. Nothing justifies such long durations, unless we assume errors in the entries of the dates of birth or that each pair of corpses consisted of one adult and one child. The latter hypothesis seems to be the most-reasonable explanation, which we will therefore adopt in this case.

8.4.4. Mixed Double Cremations

There are 56 corpses to be considered here, or 28 pairs. The average age of the adults was 70 years, that of the children about 1 year:

Duration [min]	# of corpses	# of cremations	Total min
40	2	1	40
45	16	8	360
50	8	4	200
55	4	2	110
60	14	7	420
70	4	2	140
75	4	2	150
80	2	1	80
105	2	1	105
<i>Totals:</i>	56	28	1605
<i>Average:</i>	$1605 \text{ min} \div 28 = 57.32 \text{ min}$		

8.4.5. Staggered Cremations

There are four instances of cremations in the course of which an additional corpse was introduced before the cremation of the preceding one had ended. We shall consider the cases one-by-one.

a) 10 May 1943

Cremation order	Time	# of corpses	Age
Second	09:15 – 10:10	1	65 years
Third	09:50 – 10:30	1	27 months
Fourth	10:10 – 11:00	1	69 years

The corpse of a child 27 months old was introduced into the furnace 35 minutes after the introduction of the corpse of a 65-year-old man; the child's cremation lasted 40 minutes and overlapped the cremation of the latter corpse for the first 20 minutes; for the remaining 20 minutes, it overlapped the cremation of the corpse of a 69-year-old woman, introduced at 10:10 AM.

b) 26 May 1943

Cremation order	Time	# of corpses	Age
Seventh	13:15 – 13:40	1	2 months
Eighth	13:30 – 15:30	1	4 years
Ninth	13:30 – 15:30	1	72 years

The cremation of the corpse of a child of two months took 25 minutes; ten minutes before it ended, two corpses were introduced simultaneously into the furnace, the corpse of a woman aged 72 and that of a child of four years of age. The cremations took two hours altogether.

c) 1st September 1943

Cremation order	Time	# of corpses	Age
Fourth	10:40 – 11:35	1	50 years
Fifth	11:00 – 11:35	1	1 day

At 10:40 AM, the body of a 50-year-old woman was introduced into the furnace; 20 minutes later, the corpse of a baby who had died at birth was added. Both cremations were over by 11:35, the cremation of the woman lasted 55 minutes, that of the baby 35 minutes.

d) 22 June 1943

Cremation order	Time	# of corpses	Age
Third	10:20 – 11:20	1	81 years
Fourth	10:20 – 10:50	1	14 months
Fifth	10:55 – 11:35	1	84 years

At 10:20 AM, the corpse of an 81-year-old woman was introduced into the furnace, together with the body of a girl aged 14 months; 35 minutes later, another corpse was added, the cremation of which ended at 11:35 AM. Hence the bodies of two adults and one infant were cremated within 75 minutes. This would be an exceptional case for two reasons, both on account of the short overall duration of the cremation, and because in the available documents no other case involving the concurrent or staggered cremation of two adults can be found.

If we are not dealing with a mistake in the log entries, this would be a most-unusual event; on both accounts, we may discard this case.

The *only* case of a concurrent cremation of two adult corpses *apparently* took place on 1st July 1943, the day on which the eighth and ninth corpses were introduced into the furnace at the same time, *i.e.* 1:30 PM; according to the *Betriebsbuch* of the crematorium, the cremation concerned a man of 73 and a young man of 20. However, in the cremation list for that day, the ninth corpse is marked with an \times and was therefore the corpse of a child. This is borne out by the fact that the other two corpses marked in the same manner – the fifth and the eleventh – do concern the corpses of a one-year-old child and that of a child 20 months old. This suggests that the second body was not a 20-year-old male, but a 20-month-old boy.

In the Westerbork Crematorium, the end of the cremation corresponded to the moment when the corpse residues went into the ash compartment, and the muffle was thus ready for a fresh corpse. As we have seen, the average duration of cremations involving individual adults was 50 minutes. This confirms basically the value derived from Kessler's experiments, except for the fact that Kessler's value referred to the average duration of the cremation process up to the maximum point of the main cremation; hence, the average value for the Westerbork cremations is a little lower. This difference may have been caused by various factors, such as the modal type of corpse or the structure of the muffle grate.

The 600 cremations carried out in the crematorium of the Père-Lachaise Cemetery in Paris between 1889 and 1893 (cf. tables pp. 100f.) provide us with the following data: The cremation of a child nine years old or less took some 39 minutes on average, cremations of children ten and over and of adults took some 61 minutes.

8.5. Conclusions

From an analysis of the data given above, we may draw the following conclusions:

1. The *minimum* duration of the main combustion of a corpse introduced without coffin into the muffle is approximately half an hour under optimum conditions, *i.e.* when the cremation chamber is constantly maintained at a temperature of at least 850°C; at lower temperatures, the process takes longer.
2. The *minimum* duration of the cremations carried out in the Gusen Furnace over the period mentioned was 40 minutes on average with the furnace in

thermal balance⁵⁰⁸ and in continuous operation. This duration is valid for the Gusen Furnace. It cannot be applied directly to the Auschwitz double-muffle furnace, to which the Topf letter of 14 July 1941 refers explicitly. In support of this, we may cite the following facts:

- The Gusen Furnace had a refractory grate of three transverse bars, placed about 30 cm from each other, as well as a longitudinal bar in the center; thus, the plane of the grate had eight openings some 30 cm × 25 cm in size, whereas the grate of the Auschwitz furnaces consisted of five transverse bars (*Schamotte-Roststeine*) placed 20 cm from each other (or even of bars with an opening of hardly 5 cm). This means that the grate of the Gusen Furnace allowed larger corpse remnants to drop into the ash chamber. Hence the muffle emptied itself more rapidly, with the main combustion finishing not in the muffle but in the ash chamber below.
 - Although the Auschwitz crematorium possessed a forced-draft system of the same type as the Gusen Furnace, the latter served only two muffles, whereas the Auschwitz device served six. Hence, when all the three furnaces were in operation, each one was allotted only a third of the draft available for a single furnace. Therefore, under forced-draft conditions, the Auschwitz Furnaces could not attain the performance of the Gusen Furnace. In the summer of 1942, this draft enhancer was even completely removed at Auschwitz when the chimney of the crematorium was rebuilt (cf. Subchapter 6.1.).
3. The duration of the cremations at Westerbork was 50 minutes, which is in rough agreement with Kessler's experiments.
 4. On account of the greater amount of heat available in the Kori Furnace at Westerbork with its hearth grate of 0.8 m × 0.6 m and a coke throughput rate of some 58 kg/hr⁵⁰⁹ – as compared to the hearth grate of 0.5 m × 0.5 m and a coke throughput of some 30 kg/hr for the Auschwitz double-muffle furnaces – and also taking into consideration the Topf letter of 1st November 1940 mentioned above, one may assume an average duration of one hour for cremations of normal corpses in the Topf Furnaces at Auschwitz-Birkenau.

This duration – which includes the time needed for the introduction of a corpse into the muffle, some three minutes (cf. Subchapter 9.3. below), and the time for cleaning the muffle after the cremation⁵¹⁰ – was confirmed by two Topf engineers during their interrogation by the Soviet counter-espionage service (SMERSH). On 5 March 1946, the Soviet interrogator Shatanovski asked Prüfer:⁵¹¹

“How many corpses could be cremated at Auschwitz in one crematorium in one hour?”

The Topf engineer replied:

⁵⁰⁸ Thermal balance is the state of the furnace where the furnace brickwork no longer absorbs any additional heat to reach the operating temperature.

⁵⁰⁹ H. Kori Drawing J.Nr. 9239.

⁵¹⁰ This procedure is mentioned by Fritz Sander in his letter of 14 September 1942; cf. Section 7.4.1.

⁵¹¹ Interrogation of K. Prüfer on 5 March 1946. FSBRF, N-19262, pp. 33f.

"In a crematorium of five furnaces or fifteen openings [muffles] fifteen corpses were cremated in one hour."

This amounts to the cremation of one corpse in one muffle in one hour. The previous day, the Topf engineer Karl Schultze, who was thoroughly familiar with the triple-muffle furnaces because he had designed their blowers, had stated:⁵¹²

"In each of two crematoria there were five furnaces and three corpses were introduced from time to time into each furnace, i.e. there were three openings [muffles] in one furnace. In one hour, fifteen corpses could be burned in a crematorium with five furnaces."

Hence, Schultze as well confirmed a cremation throughput rate of one corpse per muffle in one hour.

We still have to explain why the Topf letter of 14 July 1941 speaks of a duration of 33 to 40 minutes per cremation. The answer lies in the forced draft for the furnace obtained by means of the forced-draft device (*Saugzuganlage*). That the duration of a cremation can actually be reduced in this manner is supported by experiments carried out in 1939 with a Topf Furnace, albeit a gas-heated model, in the Gera Crematorium. The engineer Heinrich Stenger says in this respect (Stenger 1939, pp. 17f.):

"In the course of one shift, up to 8 incinerations are carried out. If needed, the incineration times may be shortened by switching on a suction device, thus allowing more than 8 incinerations. It has yet to be ascertained, however, whether it is more-advantageous to accept longer incineration times in order to maintain the service life of the furnace rather than reduce the service life by raising its throughput by means a suction device."

In coke-fired furnaces the effect of a forced draft was even greater.⁵¹³

The data given in the Topf letter of 14 July 1941 were probably based on the practical experiences with the Gusen Furnace, rather than the furnaces at Auschwitz, and the maximum capacity of 30 corpses in 10 hours (or 40 minutes per cremation) can be considered to be the maximum capacity obtainable under forced-draft operation; the capacity of 36 corpses in 10 hours (or 33 minutes per cremation) may represent the theoretical limit of the installation, attainable only for a short period of time and under optimum conditions.

Taking into account that the cremations of children under 9 in the Père-Lachaise Crematorium took 39 minutes on average, we may also be dealing with somewhat-inflated figures as a sales pitch.

As far as the Central Construction Office letter of 28 June 1943 is concerned (Document 248) and Prüfer's memo of 8 September 1942 (Document 249), we see right away that the cremation capacity mentioned for individual cremations is technically impossible. When we look at Prüfer's memo of 8 September 1942, we must remember that at that time the furnaces with three and eight muffles had not yet been built at Auschwitz, and that the figures stated for the cremation capacities were not based on experience but rather on mere expectations.

⁵¹² Interrogation of K. Schultze on 4 March 1946. FSBRF, N-19262, p. 52.

⁵¹³ Cf. Unit I, Section 2.2.4.

It is true that the first triple-muffle furnace had already been completed at KL Buchenwald on 23 August 1942, but between 23 August and 8 September the average mortality there amounted only to some 10 deaths per day.⁵¹⁴ Therefore the cremation capacity of (800÷5 furnaces=) 160 corpses per day in a triple-muffle furnace could in any case not be based on operational results achieved with the furnace but was simply an extrapolation. Furthermore, the memo in question presents inexplicable contradictions with other documents as well as with the facts.

One such contradiction is the fact that the cremation capacities of the individual plants listed in the memo are in extreme and random disagreement with those given in the third document mentioned above, *i.e.* the Central Construction Office letter of 28 June 1943. In the last document, as we have seen, the six muffles of Crematorium I are listed with a daily capacity of 340 corpses, the five triple-muffle furnaces at Crematoria II and III with 1,440 corpses, and the 8-muffle furnaces at Crematoria IV and V with 768 corpses per day.

Prüfer's memo instead gives the six muffles of Crematorium I a daily capacity of 250 corpses (73.5% of the above figure), the five triple-muffle furnaces at Crematoria II and III one of 800 corpses (55.5%) and the eight muffles of Crematoria IV and V a capacity of likewise 800 corpses (104.1%).

Prüfer's memo contains yet another, even more-mysterious contradiction: it attributes to the eight muffles of the future Crematoria IV and V the same capacity of 800 corpses per day as to the 15 muffles of the future Crematorium II. It follows that the 8-muffle furnace would have had a cremation capacity per muffle almost twice that of the five triple-muffle furnaces: (800÷8=) 100 corpses per muffle and day against (800÷15=) 53. This is completely out of line with reality, because by its very design the 8-muffle furnace had an even lower efficiency than the triple-muffle furnace (cf. Mattogno 2019, Subchapter 12.3., pp. 398-402, for a more details).

We have yet to deal with the question whether and within what limits the Topf Furnaces at Auschwitz-Birkenau allowed multiple cremations (for example, of four corpses in one muffle within 60 minutes), in which case the capacities given in the letter would have a foundation in reality. This problem will be analyzed in the next chapter.

9. The Cremation Capacity of the Cremation Furnaces at Auschwitz-Birkenau

The duration of the cremation process is an important factor for judging the capacity of such installations, but it is not the only one. There are two more factors which matter in this case: the duration of the "duty cycle" of the furnace as well as its load. It is easy to see that the overall cremation capacity rises with

⁵¹⁴ At Buchenwald, 335 detainees died between 3 and 30 August, and 203 detainees between 31 August and 27 September; Internationales Lagerkomitee Buchenwald 1949, p. 85.

the length of time the furnace operates over the span of a day and with the number of corpses loaded into each muffle.

In this chapter we will deal primarily with these technical problems and determine the maximum theoretical capacity of the furnaces at Auschwitz-Birkenau. Such an analysis would, however, be incomplete without a simultaneous treatment of the question regarding the normal cremation capacity of these furnaces, which may be summarized by the following question: What was the capacity for which the Birkenau Furnaces were *designed*?⁵¹⁵ This is a historical question which concerns the genesis, the function, and the purpose of the crematoria at Birkenau.

9.1. Continuous Operation of the Furnaces

In line with all solid-fuel (and fixed-grate) combustion plants, the operation of coke-fired cremation furnaces depended on the capacity of the hearth grate which inevitably decreases with time (since last cleaning) because of the formation of slag. For this reason, the Topf instructions for the operation of double- and triple-muffle furnaces specify (cf. Documents 210 & 227):

“Each night, the gasifier grate must be freed from the coke slag and the ash must be removed.”

Let us take a closer look at the problem.

9.1.1. The Formation of Slag

In a contemporary technical article on the subject of (boiler) grates, it is stated (Schulze-Manitius 1935, p. 89):

“Any fuel, even washed coal, carries incombustible substances along into the hearth, which will liquefy if the temperature is high enough, flow through the fuel layers and solidify again underneath the grate under the effect of the cooling provoked by the combustion air. This slag must be removed because it obstructs the feed of combustion air.”

The formation of slag in gasifier hearths was an inevitable phenomenon, because the melting temperature of the slag, while varying between 1000 and 1500°C depending on the type of coal, is usually 1,100 to 1,200°C (ter Linden 1935, p. 14), whereas the hearth temperature is around 1,500°C (H. Keller 1928, p. 3). The slag from the fossil coal of Upper Silesia used at Auschwitz had a melting temperature of 1,200 to 1,300°C (see Subchapter 9.7.).

In order to gain an appreciation of the amount of slag forming on the grates, one may refer to Kessler’s experiments of 5 January 1927 which, for a load of 436 kg of coke, yielded some 21 kg of (4.8 %) of “incombustible” material in the form of slag. If we apply this percentage to the Topf triple-muffle furnace, the same amount of slag would have been produced in each of the two gasifiers over an operation of 18 hours with normal corpses.

⁵¹⁵ This question does not arise for the history of Crematorium I at Auschwitz.

9.1.2. Slag Removal

The slag was removed from the grate's surface by means of two tools: a poker, or straight rod, for breaking off the slag, and a scraper for pulling out the slag fragments (cf. Document 259 and Photos 366f.). This method of cleaning obviously required that the grate was clear (and the gasifier hence not in operation), because the work was carried out from both above and below.

The grates of the triple-muffle furnaces consisted of twelve square steel bars (*Vierkanteseisen*) measuring 40 mm × 40 mm × 630 mm, and of two transverse supporting bars (*Auflager-Eisen*) 40 mm × 40 mm × 740 mm. As the bars were imbedded in the brick walls of the gasifiers, the grate dimensions were 600 mm × 500 mm. The steel bars were arranged in such a way as to form a central slot some 20 mm wide and ten lateral slots some 10 mm wide each. In front of the the grate, in the upper part of the hearth door, the brickwork had an arched shape, the center of which was about 10 cm above the grate (cf. Photos 167, 174 and 177).

The hearth doors (*Feuertüren*) were set at floor level; the grate was some 20 cm above floor level. Once the fire on the hearth had gone out, the attendant opened the ash-chamber door, removed any embers with the scraper, broke off the layer of slag with the poker, possibly using a curved rod to free the slots from beneath, and scraped out the residues with the scraper.

The down-time depended not only on the duration of the cleaning operation as such, but also on the time needed for cooling the furnace down and restarting it later.

According to the letter of 23 October 1941 written by Hans Kori to SS *Sturmbannführer* Lenzer at KGL Lublin, the production of hot water – heated by means of the exhaust gas from the five-muffle furnace Kori had built for the crematorium – for 50 showers in continuous operation was based on a daily operating time of 20 hours.⁵¹⁶ As Kori in this case was aiming for maximum production, it is clear that he was taking a daily down-time of four hours for the furnaces into consideration, and this down-time could have no reason other than for cleaning the grates. We may thus assume that the continuous operating period of the furnaces was 20 hours per day under normal conditions.

This obviously does not mean that the furnaces could not operate continuously for a longer span of time than 20 hours, but that 20 hours was a duration which ensured their optimum performance; beyond this value, the efficiency of the grates gradually diminished, and eventually operation would cease altogether. Greater amounts of slag would have caused considerable difficulties and longer down-times for their removal. The best way of running the furnaces was therefore to operate them continuously but with a daily interval for cleaning the grates.

⁵¹⁶ APMM, sygn. VI-9a, Vol. 1.

9.2. Concurrent Cremation of Several Corpses

For an assessment of the performance of the Topf Furnaces, we must examine whether, and if so to what extent, it would have been possible to raise the cremation capacity by increasing the load by introducing two or more corpses at once into one muffle.

In crematoria for civilian use this was prohibited by law; at the crematorium of the Westerbork Camp, it was done only in a limited number of cases by placing the corpse of a small child next to an adult corpse. At the crematorium of the Terezín Ghetto with its four oil-fired furnaces (see Subchapter 11.4.), the simultaneous presence of two corpses in one muffle was normal, but they were and processed in a staggered manner. Such a procedure required a furnace design totally different from that of the Topf Furnaces installed in concentration camps. The performance of the Terezín Crematorium therefore cannot be used as a reference point for the problem we are considering here. This question will be discussed at greater length in Chapters 11.5f.

9.2.1. Experiments with Animal-Carcass-Incineration Furnaces

From a merely technical point of view, what comes closest to the concurrent combustion of several corpses in one muffle is the operation of furnaces for the destruction of animal carcasses. Although such a comparison might appear disrespectful,⁵¹⁷ data collected with such furnaces provide reliable reference points for the cremation of corpses as well – from a purely technical point of view.

Document 260 provides us with the operational results for eight carcass-destruction furnaces built by the Kori Co. as already described in Chapter 10 of Unit I. On the basis of this document, I have established the data given in Table 4 below.

Table 4: Features of Animal-Carcass-Incineration Furnaces

Type	Load	Coal used	Cremation Time	$\frac{\text{kg Coal}}{\text{kg Load}}$	$\frac{\text{Time}}{\text{kg Load}}$	$\frac{\text{kg Load}}{\text{min}}$
1a	250 kg	110 kg	5 hr	0.440	72 sec	0.83
1b	310 kg	130 kg	6 hr	0.419	70 sec	0.86
2a	370 kg	150 kg	7 hr	0.405	68 sec	0.88
2b	450 kg	170 kg	8 hr	0.377	64 sec	0.94
3a	540 kg	200 kg	9.5 hr	0.370	63 sec	0.95
3b	650 kg	225 kg	10.5 hr	0.346	58 sec	1.03
4a	750 kg	265 kg	12 hr	0.353	58 sec	1.04
4b	900 kg	300 kg	13.5 hr	0.333	54 sec	1.11

⁵¹⁷ Although what happens in real life is at times even more-disrespectful. For example, the city of Genoa has been authorized to send to the municipal refuse incineration station the residues of exhumations and of remains from mausolea at the Staglione Cemetery with the instruction that the “operation of the plant must be carried out in keeping with the legal norms for the elimination of refuse.” *Bollettino...* 1992. Regulation No. 22, Item f, of the Italian Region of Liguria, decreed on 22 February 1997, defines as solid urban refuse “refuse stemming from exhumations and remains from mausolea, as well as other refuse stemming from cemetery activity [...]” Regione Liguria 1998.

The preheating of the furnace up to thermal balance (steady state) requires both time and fuel, and may be calculated in the following way (for Furnace Type 1a):

- Mass of the brickwork: 950 kg
- Hourly coke feed: $110 \div 5 = 22$ kg
- Hearth efficiency (acc. to Heepke): 0.75
- Lower heating value of hard coal: 7,500 kcal/kg
- Coal required for heating the brickwork from 20°C to 800°C:

$$\frac{950 \text{ kg} \cdot 0.21 \text{ kcal kg}^{-1} \text{ }^{\circ}\text{C}^{-1} \cdot (800^{\circ}\text{C} - 20^{\circ}\text{C})}{7,500 \text{ kcal kg}^{-1} \cdot 0.75} \approx 28 \text{ kg} \quad [110]$$

- Hard-coal consumption other than for preheating of furnace: $(110 - 28) = 82$, or $(82 \div 250 =) 0.328$ kg for 1 kg of organic substance.
- Assuming that the first 28 kg of coal were used to preheat the furnace without any cremations taking place, this results in a maximum preheating time of $(28 \text{ kg} \div 22 \text{ kg/hr}) \approx 1.27$ hr, yielding a minimum net cremation time of $(5 - 1.27)$ some 3.73 hours, which in turn yields a maximum cremation rate of $(250 \text{ kg} \div 3.73 \text{ hr} \div 60 \text{ min/hr}) \approx 1.12$ kg/min.

Applying this method to the other furnace models as well, we obtain the following data, where the last column gives the surface area of the combustion chamber:

Table 5: Corrected Features of Animal-Carcass-Incineration Furnaces

Type	Load	Coal used	Cremation time	$\frac{\text{kg Coal}}{\text{kg Load}}$	$\frac{\text{kg Load}}{\text{min}}$	Chamber Size
1a	250 kg	110 kg	5 hr	0.328	1.12	0.68 m ²
1b	310 kg	130 kg	6 hr	0.325	1.12	0.90 m ²
2a	370 kg	150 kg	7 hr	0.310	1.15	1.11 m ²
2b	450 kg	170 kg	8 hr	0.295	1.20	1.38 m ²
3a	540 kg	200 kg	9.5 hr	0.290	1.22	1.65 m ²
3b	650 kg	225 kg	10.5 hr	0.275	1.30	1.97 m ²
4a	750 kg	265 kg	12 hr	0.280	1.31	2.29 m ²
4b	900 kg	300 kg	13.5 hr	0.268	1.39	2.67 m ²

These data are useful as reference points for the subject of this section as well, because they deal with practical cases where several carcasses or parts thereof were incinerated in the same combustion chamber.

Furnace Model 2b had a combustion chamber with a floor area of 1.38 m², practically equal to that of a muffle of Topf's triple-muffle furnace (1.4 m²); in this device, the cremation of several corpses of a total weight equal to the maximum load (450 kg or 326 kg/m²) proceeded at a rate of 1 kg in 50 sec. If we apply this rate to a corpse of 70 kg, we obtain $(70 \text{ kg} \times 50 \text{ sec/kg} \div 60 \text{ sec/min}) \approx 58$ minutes, which is more-or-less the same time as for an individual cremation in the Topf Furnace (60 minutes).

In the furnace with the highest throughput, Model 4b, the cremation of a corpse of 70 kg would have required $(70 \text{ kg} \times 43 \text{ sec/kg} \div 60 \text{ sec/min} =) 50$ minutes.

We may thus conclude that exceeding the thermal design limits of the Topf furnaces by overloading the muffles would not have led to any gain in productivity. Quite to the contrary: the maximum cremation capacity of the Topf Furnaces are based on the introduction of a *single* normal corpse into the muffle, in line with the design parameters.

9.2.2. Experiences with the Westerbork and Gusen Crematoria

The practical experience gathered for cremations carried out at Westerbork and Gusen fully bears out the above conclusion.

As we have seen, cremations of two adult corpses together were never undertaken at the Westerbork Crematorium, except in one rather-dubious case, which carries no weight on account of its conditions. The only kind of double cremations at that location involved the concurrent incineration of one adult corpse grouped with the corpse of a small child, and it is clear that these cremations which go against of the ethics and esthetics of civilian crematoria were motivated only by reasons of thermo-technical economy.

But then, if it had been thermo-technically economical to cremate two or more adult corpses simultaneously, why did the attendants of the crematorium never proceed that way? The answer is contained in the fact that during occasional cremations of one small child together with one adult corpse it had been observed that the small corpses had a significant effect on the cremation process, extending its average duration by 14% (from 50 to 57 minutes) beyond the average cremation time of single adult corpses. This effect shows in its tendency that two normal adult corpses loaded concurrently would basically have doubled the duration of the cremation.

This is in agreement with the cremations carried out in the crematorium of the Père-Lachaise Cemetery mentioned earlier. In fact, the time needed for the cremation of children under nine years of age was around 39 minutes, whereas it took some 61 minutes to cremate children or adolescents aged ten or over – a rise of 56%. Thus, the concurrent cremation of several corpses in one muffle would have tended to lengthen the time needed in proportion to their weight.

As far as the Gusen Furnace is concerned, we possess, for the period of its continuous operation (30 October through 12 November 1941), the actual number of corpses cremated (677), the actual consumption of coal (20,700 kg) for these cremations, and the minimum duration of the cremations (221 hours and 30 minutes, or 13,290 minutes). At that time, all the conditions favoring multiple cremations in one muffle existed at Gusen, viz.:

- The furnace had been inactive between 16 and 25 October because of repair work, which meant that the corpses of detainees who had died in the meantime were piling up in the morgue and it was most urgent to dispose of them.
- The furnace was restarted under the supervision of a specialist, the Topf technician August Willing, who stayed at the crematorium until 9 November.⁵¹⁸

⁵¹⁸ Topf, *Bescheinigung über besondere Berechnung geleisteter Tagelohn-Arbeiten für Bauleitung der Waffen-SS und Polizei Gusen*, 12 October – 9 November 1941. BAK, NS 4/Ma 54.

The basic data set out above can refer only to two possible scenarios: Either only single cremations were carried out or multiple cremations.

1. In the first case, we would have 677 cremations in 13,290 minutes in two muffles, *i.e.*, in rounded figures, 338 cremations in 13,290 minutes in one muffle, hence some 40 minutes for one cremation in one muffle.
2. In the second case, assuming that two corpses were loaded jointly into each muffle in each case, 338 such double cremations would have taken place in the two muffles and lasted 13,290 minutes altogether, *i.e.* 169 double cremations in a single muffle over 13,290 minutes, the equivalent of a double cremation lasting 80 minutes in a single muffle. The same reasoning is valid for the coke consumption.

Thus, if the above data refer to double cremations, the duration of the cremation of each such load would have required 80 minutes and the capacity of the furnace would not have been affected.

9.2.3. Documents on Multiple Cremations

On 4 February 1944, Hans Kori sent the following letter to the Waffen SS and Police PoW camp at Lublin Majdanek:⁵¹⁹

“Re: Crematorium

In addition to our report of today’s date concerning the operation of the incineration furnaces at Konz.-Lager Lublin, we wish to inform you that, in the case of the operation of stationary crematoria, the fuel requirements can be reduced to a very low consumption if observation of the operation is carried out properly, because the load to be incinerated contributes to fuel savings on account of its good combustibility, if the temperature of the crematorium is around 700°C.

For the fuel supply for a given heating period one may assume that for preheating the furnace 50 kg of coke are required, in addition to 25 kg of coke for each incineration. For 10 incinerations in one day, this leads to a total consumption of some 300 kg. It is of no importance whether coke is used exclusively or a mixture of coke and hard coal is used. In the latter case, one would operate with a mixture of 150 kg [of coal] and 150 kg [of coke]. An equal amount of 300 kg for one day would also allow 20 incinerations to be handled easily, if one abandons individual introductions.”

The coke consumption stated for one cremation – 25 kg – confirms with satisfactory accuracy the consumption at Gusen. The fact that the fuel requirements were calculated for ten cremations in each muffle (or a total of 50 cremations per day) means that the duration of one cremation was at least one hour (two hours of preheating plus the hours of cremation = one operating day of 12 hours).

The reference to abandoning “individual introductions” (*Einzeleinführungen*) alludes to the simultaneous introduction of two corpses into one muffle, which would bring about fuel savings of 50%, *i.e.* $([300-50] \div 20 =)$ 12.5 kg of coke for each corpse. Yet the man responsible for this crematorium, *SS Haupt-*

⁵¹⁹ APMM, sygn. VI-9a, Vol. 1, p. 27; cf. Document 261.

scharführer Erich Mussfeldt, declared with respect to the new crematorium at Majdanek during the Krakow Trial of the Auschwitz camp garrison:⁵²⁰

“Only one corpse was introduced into each muffle, its cremation lasted one hour.”

This duration, as we have seen, is confirmed by numerous sources and documents and is therefore reliable.

Also, one cannot imagine that Hans Kori would have made a statement which was in direct disagreement with the performance of his own furnaces for the cremation of animal carcasses.

To the above letter, a report of the same date was attached on the subject of the crematoria. In it, Kori explained the reasons for some problems encountered in the operation of the furnaces:⁵²¹

“But if, on opening the hearth doors, a bright flame juts forth from the slots of the smoke dampers, this is caused by the pressure of ‘false air.’ It is merely necessary to fill the unnecessarily wide air gaps around the damper plates in order to prevent both cold air from entering the furnace and the appearance of such flames.”

This inconvenience was due to the fact that it had not been technically possible to manufacture refractory dampers which could be hermetically closed – a gap of 4.5 mm⁵²² remained through which cold air entered into the smoke duct. Another problem concerned the temperature of the muffle:

“If, as was noted during the trial runs, the temperature in the forward portion of the incineration chamber, i.e. directly behind the introduction door, is not high enough for a rapid incineration of the material placed at this point, this, too, is caused primarily to the leakage of ‘false air’ [into the muffle].”

According to Kori, this inconvenience would also disappear with the elimination of the gaps mentioned above.

We should underline the fact that, if a temperature of 700°C in the front part of the muffle could not be maintained simply because “false air” entered the smoke duct, the introduction of two normal corpses into the muffle would have brought about an even-greater temperature drop during the evaporation phase, with a significant degradation of the performance of the cremations.

If it took one hour and 25 kg of coke to cremate a single corpse, an unchanged coke consumption in the case of two corpses would indicate that such a double-cremation would also have lasted only one hour, but this is in disagreement with the practical results discussed above.

The hypothetical statement contained in the above letter is thus completely discredited by the facts.

The document in question is the typewritten copy (“*odpis*”) of a (probably likewise) typewritten German copy (“*Abschrift*”) prepared at the request of the Polish-communist prosecutor Jan Grzybowski at an unknown point in time.

⁵²⁰ APMO, ZO, sygn. D-pr-20/61a, p. 76: “*Do jednej retorty wkładano tylko jedne zwłoki, spalenie ich trwało około 1 godziny.*”

⁵²¹ Attachment to the letter from Hans Kori to *Kommandantur* of KL Lublin dated 4 February 1944. APMM, VI-9a, Vol. 1, pp. 25f.

⁵²² The text actually states 45 mm, but that is probably an error.

Neither the original nor even the German-language copy has been published, and one must therefore regard the Polish-language version with great suspicion.

There is also a Topf document on the subject of the concurrent introduction of several corpses into a muffle, the letter of Fritz Sander of 14 September 1942 already mentioned (Section 7.4.1.):

“As a makeshift solution, one has tried to use a series of furnaces or muffles and by loading them with more corpses, but this does not solve the basic problem, i.e. the drawbacks of the muffle system. These drawbacks of the muffle furnace, which cannot be solved even by assembling multiple-muffle furnaces (triple- or 8-muffle furnaces) and loading more corpses into the individual muffles, are in my judgment the following:”

Sander greatly underestimated the problem of introducing multiple adult male corpses⁵²³ into a muffle. The loading system of the double- and triple-muffle furnaces was in fact constrained by the dimensions of the muffles’ introduction openings, which measured 60 cm × 60 cm, with the lower half having the shape of a 30 cm × 60 cm rectangle, while the upper half was a semicircle with a radius of 30 cm.

Illustration 4 gives all the relevant measurements. The top part of the introduction stretcher, whose side tubes ran over the guide rollers, was 12 cm above the bottom of the muffle door and the refractory grate; the two horizontal lines show the height of a first (18 cm) and a second emaciated corpse (18 cm) introduced one on top of the other into the muffle; the remaining space clearly would have been insufficient for a third emaciated corpse. Loading the second corpse sideways (with the shoulder line vertical instead of horizontal), and then a third one horizontally, would have required the tilting of the stretcher by at least 45°, an extremely complicated operation, not to say impossible. It is clear that the simultaneous loading of two normal corpses would have at least presented great difficulties; introducing three or four corpses at once would have been absolutely impossible.



Illustration 4: Muffle door of the Topf double-muffle furnace at the Mauthausen Camp, identical to those of the double-, triple- and 8-muffle furnaces at Auschwitz.
© C. Mattogno

⁵²³ It should be kept in mind that back then, the future Crematorium II was still planned for a PoW camp for 125,000 Soviet PoWs, which would have included no women or children. The capacity indicated in the “Explanatory report for the preliminary project for the new construction of the *Waffen-SS* PoW camp at Auschwitz, Upper Silesia,” of 30 October 1941 (60 corpses in one hour, hence four corpses per muffle in one hour; cf. Document 211) is impossible already because of the insurmountable problems of loading the muffles as shown here.

From Sander's letter we can glean that "the cremation did not proceed quickly enough to ensure the elimination of a great number of corpses at a desirably high rate" even when "loading more corpses into the individual muffles," clearly meaning such multiple cremations evidently did not produce appreciable improvements with respect to productivity of cremations.

9.2.4. Thermal Inadequacy during Water Evaporation

The essential condition for good cremation performance is that the muffle temperature never drops below 600°C, because below that temperature the corpses merely carbonize, but are no longer cremated.

Let us look at the heat phenomena associated with a triple-muffle furnace in the normal case of the cremation of a single adult corpse in each muffle, and in the hypothetical case of two corpses per muffle.

Single Adult Corpse

A body of 70 kg contains, on average, some 45.5 kg of water. Hence the energy needed to heat, vaporize and superheat this water from 10°C to 600°C for three corpses is (cf. p. 124):⁵²⁴

$$3 \cdot 45.5 \text{ kg} \cdot [633 \text{ kcal kg}^{-1} + 0.487 \text{ kcal kg}^{-1}\text{C}^{-1}(600^\circ\text{C} - 100^\circ\text{C})] \approx 119,600 \text{ kcal} \quad [111]$$

The evaporation process, as determined experimentally, required about one-half hour. The coke throughput rate for the triple-muffle furnace was 70 kg/hr (two hearths with a throughput rate of 35 kg/hr each), hence the theoretical heat available in half an hour was 6,470 kcal/kg \times 35 kg = 226,450 kcal.

The heat actually available was much less, because much of the heat produced in the gasifiers was lost. In the evaporation phase, the most-important heat losses were those by radiation and by conduction, which amounted to about 62,500 kcal/hr at 800°C, and which we may assume to be around 46,900 kcal/hr at 600°C, or 23,450 kcal in half an hour. This corresponds to $(23,450/226,450 \times 100 =) 10.3\%$. The sensible heat of the exhaust gases at 600°C can be calculated to be 31.3%. The unburnt gases contributed 4%, and the incombustibles on the hearth about 3.1% to the total loss.

The efficiency of the furnace was therefore $(100 - [10.3 + 31.3 + 4 + 3.1] =) 51.3\%$. Hence the effective yield of the coke was $(6,470 \times 0.513) \approx 3,320$ kcal, and the available heat was $(35 \text{ kg} \times 3,320 \text{ kcal/kg} =) 116,200$ kcal. To maintain the furnace at 600°C, a heat supply of $(116,200 - 119,600 =) 3,400$ kcal would therefore have had to be provided by the radiation from the muffle walls, where it was readily available in this phase of the process.

Two Adult Corpses

Let us now examine the second case. All values go up by a factor of two with respect to the previous case. The water content of the corpses would be 273 kg, and the heat of vaporization at 600°C about 239,200 kilocalories.

⁵²⁴ On average 0.487 kcal kg⁻¹C⁻¹ between 100°C and 600°C; see www.engineeringtoolbox.com/water-vapor-d_979.html.

Available heat remained constant at 116,200 kcal in 30 minutes, hence the heat deficit is (116,200 – 239,200=) 123,000 kcal or 41,000 kcal per muffle. Would the radiation from the muffle walls have been enough to make up for this deficit? It is difficult to establish precisely the heat supply to the corpse from the radiating muffle, both for reasons of geometry and because of the progressive cooling of the muffle wall.

The problem was treated in the 1930s in a specific article by Professor Schläpfer, one of the most-eminent specialists in the field of cremation at the time, and the article provides us with a credible estimate of the heat radiated from the muffle walls onto a corpse at various wall temperatures. Schläpfer gives a chart, from which we can draw the data given in the following table (Schläpfer 1938, p. 153; cf. Mattogno 2019, Document 47, p. 651):⁵²⁵

Temperature of muffle walls	Heat radiated onto the corpse (per Schläpfer)
800 °C	1,400 kcal/min
700 °C	930 kcal/min
600 °C	600 kcal/min
500 °C	360 kcal/min

In the case of radiation towards a hypothetical load of two corpses in one muffle, the geometry obviously changes. Most importantly, the surface/volume ratio of such a load would be less favorable than for a single corpse, because the two corpses would cover each other partly. But even aside from this consideration, the heat required to evaporate and superheat the water contained in two corpses, ca. 79,700 kcal, would become available only over a period of (79,700 kcal ÷ 600 kcal/min =) some 130 minutes at a constant temperature of 600°C. However, the wall temperature of the muffle would not stay constant for such a long time but would drop rather significantly. Hence the thermal conditions would soon become very unfavorable, because, as we can see from Schläpfer's chart, the radiation heat flow drops rapidly with decreasing surface temperatures. At 500°C, the heat transfer would be cut to a mere 60% of the value at 600°C.

The engineer Hans Kori, speaking about a similar problem, noted (Kori 1924, p. 117):

“If the internal wall of the cremation chamber has a surface area of about 4 m² with a specific gravity of 2.1, a layer 5 cm in thickness weighs about 420 kg. Specific heat of refractory is about 0.2 [kcal kg⁻¹ °C⁻¹]; if a layer of 5 cm were to give up its heat in a sufficiently rapid and complete manner, with a temperature drop from 1000° to 800°C, its heat contribution would be only 200 × 0.2 × 420 = 16,800 [kilo]calories. Actually, not even this is possible, because the wall does not release the stored heat as fast as the temperature drops.”

In the triple-muffle Topf Furnace, the weight of the radiating brickwork of one muffle was about (0.15 m thick × 5 m² surface × 2,000 kg/m³ density =) 1,500 kg. In order to supply the heat lost by the evaporation of the water from two

⁵²⁵ Radiation heat transfer is proportional to the fourth power of the temperature difference, cf. http://www.engineeringtoolbox.com/radiation-heat-transfer-d_431.html.

corpses, each muffle would have had to contribute 79,700 kcal, which would mean that the average wall temperature of the muffles would have had to drop by $(79,700 \text{ kcal} \div 0.2 \text{ kcal kg}^{-1} \text{ }^\circ\text{C}^{-1} \div 1,500 \text{ kg} =)$ about 265°C . Hence, if the muffle temperature had been at the required 800°C during the introduction of the corpses, it would have dropped down to some 535°C during the evaporation phase, slowing the evaporation process drastically.

Of course, the massive heat loss of the muffle walls during the evaporation of the corpse water would have had to be compensated for later on. In order to re-establish the thermal conditions for subsequent cremations, a period of re-heating would therefore have been required. The heat supplied to each muffle in one minute was:⁵²⁶

$$\frac{3,320 \text{ kcal/kg} \cdot 70 \text{ kg/hr}}{3 \cdot 60 \text{ min/hr}} = 1,291 \text{ kcal/min} \quad [112]$$

Hence $79,700 \text{ kcal} \div 1,291 \text{ kcal/min} \approx 62$ minutes or one hour would have been needed to get the muffles back into thermal shape for the next load.

I have simplified here the evaporation process, which is more-complex in reality, because other factors come into play, but these factors apply in the same way both to individual and to multiple cremations; therefore, the enormous difference of the order of magnitude of the heat involved in each case remains valid as calculated and demonstrated.

The Topf design of the triple- and 8-muffle furnaces was also inadequate for simultaneous multiple cremations not only for the reasons of thermodynamics set out above. In addition, the introduction of two or three corpses into a muffle would have caused an obstruction of the combustion-gas flow through the three openings which connected the lateral muffles to the center muffle in the triple-muffle furnace or those linking the inner to the outer muffles in the 8-muffle furnace. Several corpses placed on the refractory grate of the center muffle in the triple-muffle furnace or on that of the lateral muffles of the 8-muffle furnace would have, moreover, partially blocked the slots between the grate bars, impeding the flow of the combustion gases toward the flue ducts. This would have led to a decrease in the draft of the chimney and that of the gasifier with a corresponding decrease in the heat supply to the muffle.

Furthermore, the introduction of several corpses into a single muffle would have reduced the free muffle volume. As a result, the dwell time of the combustion gas flowing through the muffle would have been reduced to the point where it would have partially burned in the smoke duct rather than in the muffle, resulting in a lower heat transfer to the corpse and the muffle walls, resulting in even-lower temperatures during the evaporation phase, and potentially causing heat damage to the flue ducts.

All this proves that the triple- and 8-muffle furnace were conceived for the cremation of one corpse at a time in each muffle and that the introduction of two or more corpses into a muffle would inevitably have extended the duration

⁵²⁶ 3,320 kcal/kg: effective heating value of coke; 70 kg/hr: coke consumption of the two gasifiers; 3: number of muffles.

of the cremation considerably more than by the simple factor contributed by the number of corpses introduced, *i.e.* considerably more than twice as long for two corpses.

9.2.5. Thermal Overload during Main Combustion

The concurrent cremation of several normal corpses in one muffle brings into focus another insurmountable thermal problem: the increased thermal load on the combustion chambers (muffle and ash chamber) during the main combustion phase of the corpses after their water has evaporated.

The refractory walls of a combustion chamber can be damaged by slag and molten ash, and their temperature must therefore be kept below the melting point of slag and ash, which, as we have seen, normally lies between 1100 and 1200°C. If such a temperature is reached, encrustations and adhering particles will form on the grates and the walls as well as along the flue ducts. Such fouling will affect the geometry of the furnace and result in a lowered performance.

The problem is of particular importance in the design of solid-fuel hearths for boilers.⁵²⁷ The specific thermal loads used for the design of coal-fired combustion plants vary greatly, depending on the combustion system used, the type of fuel, and the type of combustion chamber. In practical design work, the thermal loads permitted for powdered-coal firing, over a very wide range of sizes, is between 100,000 and 200,000 kcal m⁻³ hr⁻¹. Thermal loads of gas-fired installations are normally the following:

For lean gases	150,000 kcal m ⁻³ hr ⁻¹
For methane	140,000 kcal m ⁻³ hr ⁻¹
	170,000 kcal m ⁻³ hr ⁻¹
For rich gases	220,000 kcal m ⁻³ hr ⁻¹
	300,000 kcal m ⁻³ hr ⁻¹

For steam generators with an average output of 2,500 kg hr⁻¹, one may use specific thermal loads of 150,000 kcal m⁻³ hr⁻¹ for the combustion chambers (all data from Fornasini 1960, pp. 225, 232f.).

For urban-waste incinerators “the volume of the combustion chamber, including the volume of a possible post-combustion chamber, must be such that the specific thermal load does not exceed a value of 630,000 kJ m⁻³ hr⁻¹ (150,000 kcal m⁻³ hr⁻¹) in normal continuous operation” (*Manuale...* 1990, p. E740). We may hence base ourselves, for the triple-muffle furnace, on a maximum thermal load of 150,000 kcal m⁻³ hr⁻¹ or 225,000 kcal hr⁻¹ for the combustion chamber (muffle and ash chamber).⁵²⁸

Theoretically, for each one of the outer muffles, we have a heat supply of (23.5 kg/hr × 6,470 kcal/kg) ≈ 152,050 kcal/hr from the coke combustion plus 146,100 kcal/hr from the combustion of the corpse, for a total of 298,150 kcal/hr. Actually, however, part of the heat of the coke is lost with the unburnt

⁵²⁷ Cf. in this respect ter Linden 1935, who gives a detailed calculation of the hearth walls and discusses various systems for cooling them.

⁵²⁸ The volume of the combustion chamber was ≈ 1.5 m³.

materials ($6.8\% \approx 9,900$ kcal/hr), another loss is brought about by the heat lost through radiation and conduction (calculated to be $\approx 22,500$ kcal/hr for each of the two outer muffles), and finally part of the available heat is taken up by the evaporation of the corpse water ($\approx 46,300$ kcal/hr). Adding the various other losses entering into the heat balance – some $28,000$ kcal/hr – we see that the actual heat supplied does not exceed ($298,150 - 9,900 - 22,500 - 46,300 - 28,000 =$) $191,450$ kcal/hr, or $\approx 127,600$ kcal m^{-3} hr^{-1} .

The effective heat produced by the corpse is ($146,100 - 46,300 - 11,400 - 9,900 =$) $78,500$ kcal, that produced by the coke is ($191,450 - 78,500 =$) $112,950$ kcal.

Even if we assume that the heat from the corpse is produced entirely during the last half-hour, the maximum heat generation would be ($[78,500 \times 2] + [112,950 \div 2]$) $\approx 213,500$ kcal per hour and per combustion chamber, or ($211,850 \div 1.5$) $\approx 142,300$ kcal m^{-3} hr^{-1} , which confirms that the maximum heat load was around $150,000$ kcal m^{-3} hr^{-1} .

On the basis of what has been stated above, we can see that the simultaneous cremation of two normal corpses in each one of the two lateral muffles would, in any case, have required twice as much fuel and considerably more than twice the time. *If*, hypothetically speaking, the cremation of two corpses had taken place within only one hour, with a main combustion phase of one half-hour, then the maximum amount of heat so generated during the main combustion phase would have been ($141,200 \times 2 =$) $282,400$ kcal m^{-3} hr^{-1} , or nearly twice the permissible thermal load. This would have inevitably damaged the furnaces in the long run.

9.3. Soviet and Polish Technical Investigations

After the occupation of the concentration camps in Eastern Europe, the Soviets set up a number of “Commissions of Inquiry,” which produced, *i.a.*, technical reports on the cremation furnaces at such locations. I will present the full translation of the investigations concerning the furnaces at Majdanek and Sachsenhausen, and brief excerpts from the report on the furnace at the Stutthof Camp. A detailed description of the furnaces will follow in Sections 11.2.5/6. The report on Majdanek was written in August of 1944, the one on Sachsenhausen in June of 1945, and the one on Stutthof in May of 1945.

9.3.1. The Soviet Report on the Kori Cremation Furnaces at *KL* Lublin-Majdanek

“Productivity of the cremation furnaces.

The cremation capacity of the cremation furnaces depends on:

- 1) the temperature of the cremation chamber*
- 2) the time needed for loading*
- 3) the amount of corpses loaded*
- 4) the cremation time of a single load*

1. The temperature in the cremation chamber

The cremation chamber, lined with standard refractory,^[529] was designed for a temperature of 1300-1400°C. On inspection, the blocks of the cremation furnaces showed: in all cremation chambers, the standard brickwork presented noticeable fusion, and the standard [refractory] bricks of the grate bars [of the hearth] showed intensive fusion of the ash and a change^[530] of the silica. The cast-iron dampers of the horizontal [smoke] collection duct are deformed in their lower part on account of fusion.

The fusion of the standard refractory of the cremation chambers and the changes in the silica demonstrate that the temperature of the cremation chamber was higher than 1500°C. The deformation and fusion of the cast-iron dampers demonstrate that the temperature of the off-gases was around 1200°C.

2. The time needed to load the corpses into a chamber.

Loading of corpses into the cremation chamber could be carried out from only one side of the block of cremation furnaces. At the time of inspection of the block of cremation furnaces, some corpses with their limbs cut off and heavily damaged by fire were encountered on the loading side of the cremation chambers, which indicates a preliminary piling up of corpses in the space in front of the furnaces to speed up the loading [operation].

The iron stretchers in front of the furnaces were used only to load the corpses into the cremation chambers, which is confirmed by the presence of rails and rollers in front of each furnace.

On account of the high temperature of the furnaces, loading of the corpses may have been carried out in the following manner:

- a) the corpses were laid out on the iron stretcher placed on the rails and the rollers;
- b) the doors of the cremation chamber were opened;
- c) the corpses on the stretcher were pushed via the rollers toward the [grate] bars and then placed on the [grate] bars of the cremation chamber by means of a rod.

All the operations for loading the furnaces outlined above, with a pile of 'treated'^[531] corpses in front of each cremation chamber, could be executed within 2 to 3 minutes.

3. The quantity of corpses loaded into one cremation furnace.

The presence, at the time of the inspection, of a large amount of bone ash in the cremation chamber, in the space below the bars of the hearth and on the bars of the hearth [used] for heating the furnaces, as well as that of a pile of corpses with their limbs cut off and in front of the line of furnaces, demonstrates the simultaneous combustion of several corpses in each furnace. In practice, two complete corpses or four corpses with their limbs cut off could be loaded into each furnace.

⁵²⁹ *Dinasovo*, literally: in accordance with DIN norms (DIN = *Deutsches Institut für Normung*, German Institute for Standardization). It is a word coined by the Soviet experts on the basis of the abbreviation DIN.

⁵³⁰ *Pererogdenie modifikatsii*, literally "denaturation of the [silica] modification."

⁵³¹ *I.e.* with their limbs cut off.

4. The time needed for the cremation of a single load of corpses.

In order to establish the time needed for the complete cremation of the corpses, we will take as a base for calculation the cremation of one corpse in one furnace. We will assume:

a) a human body contains 66% of water, 1.1% of carbohydrates, 27.3% of fat and protein, and 5.6% of ash;

b) on a weight basis, assuming the weight of an emaciated corpse to be 50 kg [we have] 33 kg of water, 0.6 kg of carbohydrates, 13.65 kg of fat and protein and 2.8 kg of ash;

c) the organic part, essentially fat and protein, is made up roughly by carbon and hydrogen in a ratio of 4:1, i.e. 80% carbon and 20% hydrogen, leaving aside the oxygen content of the carbohydrates as well as the sulfur and nitrogen in the organic portions because of their insignificant weight.

Therefore, a body contains 11.2 kg of carbon and 2.8 kg of hydrogen.

In the course of the combustion of the corpse, 11.2 kg of carbon will produce 41 kg of carbonic [acid] anhydride, 2.8 kg of hydrogen and 25 kg of water (vapor).

For the combustion of 11.2 kg of carbon, a theoretical amount of 29.5 kg of oxygen is required, and for 2.8 kg of hydrogen, 22.3 kg of oxygen. Hence, a total amount of 51.8 kg of oxygen is required.

Assuming the combustion of the corpse to be carried out with an excess air [ratio] = 1.3, a total of 67.4 kg of oxygen would be needed.

Such an amount is associated with 225.9 kg of nitrogen in air.

The composition by weight of the combustion products generated during the cremation is as follows:

<i>water vapor</i>	<i>58.2 kg</i>
<i>carbonic anhydride</i>	<i>41.6 kg</i>
<i>oxygen</i>	<i>15.6 kg</i>
<i>nitrogen</i>	<i>225.9 kg</i>

or, in volumetric terms:

<i>water vapor</i>	<i>72.4 m³</i>
<i>carbonic anhydride</i>	<i>21.2 m³</i>
<i>oxygen</i>	<i>10.9 m³</i>
<i>nitrogen</i>	<i>180.9 m³</i>

In total, the cremation of one corpse produces 285 m³ of combustion products.

Under normal conditions, we assume an exit temperature for the cremation products leaving the chimney of 400°C. At that temperature, the volume of smoke from one corpse is about 685 m³.

On the basis of the attached chart, which shows the cremation time required in various cremation furnaces as a function of temperature, [we have] a cremation time for one corpse in a furnace with standard lining, with a temperature of the cremation chamber of 1400°C, of not more than 20 minutes.

Assuming, for the smoke in the smoke channel – without a forced draft – a velocity of 3 m/sec and an operation of both furnaces at the same time, the cross-sectional area of the lower part of the smoke duct is 0.36 m², which is in agreement with the cross-sectional area of the smoke duct of the cremation furnaces inspected in the concentration camp of the City of Lublin, without taking into account the two powerful ventilators present with a capacity of 168 m³ per minute.

The simultaneous operation of the two ventilators induced a considerably more-rapid progress of the cremation and allowed to maintain a temperature in the cremation chamber [not] lower than 1500°C at full load.

Therefore, taking into account the attached chart for the determination of the cremation time, we conclude that the cremation of the corpses did not take longer than 10-12 minutes.

Our calculation is also confirmed by the fact that with a [forced] suction of the fumes the furnace operated in an abnormal manner because of the absence of temperature differences, as we can see from a letter dated 8 January 1943 by the H. Kori Co. and addressed to Hauptamt CIII of the Reichsführer SS and Chief of the German Police in connection with the crematorium of the concentration camp at the City of Lublin. In this letter, it is recommended to install large devices for the production of hot water in order to ensure proper control of the smoke temperature.

On the basis of the above calculations, we see that:

- a) the temperature of the cremation chambers was maintained at 1500°C;*
- b) cleaning of the lower container and loading the furnace with corpses did not take more than 3 minutes;*
- c) four 'treated' corpses including their cut off limbs could be loaded simultaneously into one furnace;*
- d) the time needed to cremate one load was less than 12 minutes.*

Hence, for an operation of the cremation furnaces over 24 hours, their cremation capacity in 24 hours was

$$\frac{24 \times 60 \times 4 \times 5}{15} = 1,920 \text{ corpses.} \quad [113]$$

*The president of the commission of experts
Architectural Engineer Krauze*

Members:

Engineer, Major, Instructor Telyaner,

Engineer, Major, Instructor, Candidate in Technical Science Grigor'ev."⁵³²

9.3.2. The Soviet Report on the Kori Cremation Furnaces at *KL Sachsenhausen*

"Capacity of the cremation furnaces.

The cremation capacity of cremation furnaces depends:

- 1. on the temperature of the cremation chamber,*
- 2. on the time needed for loading the furnace,*
- 3. on the number of corpses loaded into the furnace*
- 4. on the duration of the cremation of a single load.*

1. The temperature of the cremation chamber.

The cremation chambers were lined with standard refractory bricks and were designed for a temperature of 1400-1450°C. Inspection of the block of the cremation furnaces in the crematorium showed that in all cremation chambers the standard [refractory] brickwork did not show considerable fusion and that the

⁵³² GARF, 7021-107-9, pp. 245-249. The original text of the report is published in Graf/Mattogno, p. 318.

standard [refractory] bricks of the bar grate [of the hearth] showed minor fusion of the ash and a very small alteration of the silica. All this goes to show that the temperature in the furnaces of the stationary crematorium did not exceed 1200-1300°C.

The furnaces of the mobile crematoria worked with forced draft. Inspection of these furnaces revealed that in all cremation chambers the standard [refractory] brickwork showed minor fusion and slag with a surface covering of inorganic salts, and that the standard [refractory] bricks of the [hearth] grate showed profound fusion of the ash and an alteration of the silica.

All of this demonstrates that the temperature of the cremation chamber was not maintained below 1400°C.

2. The time needed for loading one [cremation] chamber with the corpses.

Loading of the corpses into the cremation chamber could be effected only from one side of the aligned row of furnaces, in the following sequence:

- a) the corpses were placed on an iron stretcher;
- b) the doors of the cremation chamber were opened and the gate was raised;^[533]
- c) the corpses on the stretchers were pushed via a series of rollers into the cremation chamber and were arranged on the standard bars by means of an iron rod;
- d) the gate was lowered and the doors were closed.

The execution of all loading operations of the furnaces as described above did not require more than 5 minutes.

3. The number of corpses loaded.

Within 5 minutes it was possible to load 4-6 corpses into the cremation chamber of the furnace, depending on their sizes, according to the sketch attached:

- (6) Sketch showing the maximum
- (5) (4) manner of loading of a cremation
- (3) (2) (1) chamber

4. The time needed for the cremation of a single furnace load.

In order to determine the time needed for the complete cremation of the corpses, we will base ourselves on the indicative chart for the determination of the cremation times in various cremation furnaces as a function of temperature, on file. From the chart, we can see that the cremation of a single load of corpses in the furnaces lined with standard [refractory] bricks, for a temperature of 1200°C in the cremation chamber, was about one hour. At a temperature of 1400°C it was half of that, i.e. about 30 minutes.

C. Calculation of the cross-sectional area of the chimney ducts for the purpose of control.

For the verification of the [cross-sectional area] of the smoke ducts for the off-gases of the combustion products we will assume:

- a) a human body contains 66% of water, 1.1% of carbohydrates, 27.3% of fat and protein and 5.6% of ash;
- b) on a weight basis, assuming the weight of an emaciated corpse to be 50 kg [we have] 33 kg of water, 0.6 kg of carbohydrates, 13.65 kg of fat and protein and 2.8 kg of ash;

⁵³³ The refractory closure of the muffle (*Schamotteabsperrplatte*); cf. Chapter 11.

c) assuming that the organic part, essentially fat and protein, is made up roughly by carbon and hydrogen at a ratio of 4:1, i.e. 80% carbon and 20% hydrogen, leaving aside the oxygen content of the carbohydrates, as well as the sulfur and nitrogen in the organic portions because of their insignificant weight.

Therefore, a body contains 11.2 kg of carbon and 2.8 kg of hydrogen.

In the course of the combustion of the corpse, 11.2 kg of carbon will produce 41 kg of carbonic [acid] anhydride, 2.8 kg of hydrogen and 25 kg of water (vapor).

For the combustion of 11.2 kg of carbon a theoretical amount of 29.5 kg of oxygen is required, and for 2.8 kg of hydrogen 22.3 kg of oxygen. Hence, a total amount of 51.8 kg of oxygen is required.

Assuming the combustion of the corpse to be carried out with an excess air [ratio] = 1.3, a total of 67.4 kg of oxygen would be needed.

Such an amount is associated with 225.9 kg of nitrogen in air.

The composition by weight of the combustion products generated during the cremation is as follows:

water vapor	58.2 kg
carbonic anhydride	41.6 kg
oxygen	16.6 kg
nitrogen	225.9 kg

or, in volumetric terms:

water vapor	72.4 m ³
carbonic anhydride	21.2 m ³
oxygen	10.9 m ³
nitrogen	180.8 m ³

In total, the cremation of one corpse produces 285 m³ of combustion products.

For one furnace, assuming a single load of 6 corpses, we have 285 × 6 = 1,710 m³ of combustion products.

Furthermore, the cremation of 6 corpses requires 60 kg of coke – or, in the mobile furnaces, 42 kg of oil.

During the combustion of coke, 790 m³ of combustion products are formed, if we assume an excess air [ratio] = 1.3.

Thus, for one furnace:

$$1,710 + 790 = 2,500 \text{ m}^3 \text{ of combustion products,}$$

for two furnaces: 2,500 × 2 = 5,000 m³/hr.

If we assume a combustion temperature at the entrance of the chimney ducts of 1000°C and a smoke-flow rate of 3 m/sec, the lower cross-section of the chimney duct is

$$\frac{5,000/273 + 1/273 \times 1,000}{3,600 \times 3} = \frac{23,000}{3,600 \times 3} = 2.1 \text{ m}^2. \quad [114]$$

This corresponds to an effective cross-sectional area of half of a chimney duct – 2.0 m² – and enables the simultaneous cremation of 12 corpses in one hour or 24-25 corpses in 4 furnaces.

⁵³⁴ The equation used here is wrong, and it does not result in 2.1 m² either. The proper equation would be $\frac{5,000 \text{ m}^3/\text{hr} \cdot (1 + 1,000^\circ\text{C}/273^\circ\text{C})}{3,600 \text{ sec}/\text{hr} \times 3 \text{ m}/\text{sec}} = 2.16 \text{ m}^2$.

If the stationary furnaces were in continuous operation, the crematorium could cremate $4 \times 6 \times 24 = 576$ corpses per day.

In continuous operation of the mobile furnaces [as well], one could thus cremate

$$\frac{3 \times 6 \times 60 \times 24}{30} = 864 \text{ corpses per day.} \quad [115]$$

The experts: Engineer, Major Telyaner
 Engineer, Major Grigor'ev.⁵³⁵

9.3.3. The Soviet Report on the Kori Cremation Furnaces at *KL* Stutthof

The Soviet report on the Kori Furnaces at *KL* Stutthof is part of a more-extensive report on the general situation in this camp, dated 14 May 1945, from which we have selected the following pertinent passages:⁵³⁶

"The internal volume of a cremation furnace is $0.5 \times 0.5 \times 3.2 = 0.96 \text{ m}^3$. Considering the extreme state of meagerness of the corpses which caused one corpse to occupy, on average, a space of $0.25 \times 0.2 \times 1.56 = 0.8 \text{ m}^3$, the furnace could contain $0.96 \div 0.8 = 12$ corpses. Running it at full capacity, one could therefore lodge 12 corpses in the furnace, introduced lengthwise in two layers. The design of the furnace allowed it to reach $900 - 1,000^\circ\text{C}$ with coke firing, and at those temperatures the cremation process took 56-60 minutes. [...]

In the concentration camp, there were three cremation furnaces. Starting from the assumption that, as stated, 12 corpses could be introduced at one time, that the cremation process lasted 50 minutes and that 10 minutes were needed to load the furnace, we find a total cremation capacity of

$$\frac{24}{1} \times 12 \times 3 = 864 \text{ corpses in 24 hours.} \quad [116]$$

If the temperature is lower, i.e. $450-500^\circ\text{C}$, the cremation process naturally takes twice as long, or one hour and forty minutes, and we would thus have a capacity of

$$\frac{24}{2} \times 12 \times 3 = 432 \text{ corpses.} \quad [117]$$

9.3.4. Discussion of the Soviet Reports on the Kori Furnaces

The reports assume that the cremation capacity depended on four factors:

1. the temperature of the cremation chamber;
2. the time needed for loading the furnace;
3. the number of corpses loaded into one cremation chamber;
4. the duration of the cremation of one load of corpses.

As these factors are interdependent, we must examine them together.

The Soviet experts claim that the coke-fired furnaces at Majdanek normally operated at a temperature of $1,500^\circ\text{C}$; those at the Sachsenhausen crematorium

⁵³⁵ GARF, 7021-104-3, pp. 26-31.

⁵³⁶ "Minutes of the technical report on the SS concentration camp at Stutthof," 14 May 1945. GARF, 7021-106-216, pp. 5f.

at 1,200 to 1,300°C (for the 4 coke-fired furnaces) or at 1,400°C (for the 2 oil-fired furnaces). These statements are technically unsound. On this subject, the engineer Richard Kessler noted (Kessler 1930, p. 136):

“Introduction temperatures of 1,200-1,500°C, as they often appear in reports on the operation of crematoria (in the journal ‘Die Flamme’, a temperature as high as 2,000°C was reported) are probably estimated values which, however, were never measured. At such temperatures, both the refractory and the bones would melt and adhere to each other. At the Dessau Trials, the most-suitable temperatures were found to be between 850 and 900°C.”

As far as the Majdanek Furnaces are concerned, I have already noted that initially, in the front portion of the cremation chamber, it was not possible to maintain a temperature even as low as 700°C because of the entry of false air into the flue duct through a gap of 4.5 mm. A “normal” operation at a temperature of 1,500°C can have no factual basis, nor technical possibility. Furthermore, the refractory wall of these furnaces showed completely negligible traces of melting (cf. Section 11.2.6.). Hence the statements of the Soviet experts have no foundation in reality.

The Soviet experts derived the duration of cremations from a self-concocted “indicative chart for the determination of the combustion time of corpses in various cremation furnaces as a function of temperature” (Document 262), which has the “time in minutes” as its ordinate and as its abscissa the “temperature in °C.” This chart starts at a muffle temperature of 800°C and goes up to a temperature of 1,500°C. The relationship between temperature and duration of cremations is shown as follows:

800°C:	120 min.	1. (Klingenstierna Furnace)
900°C:	105 min.	
1,000°C:	90 min.	2. (Siemens Furnace)
1,100°C:	75 min.	
1,200°C:	60 min.	3. (Schneider Furnace)
1,300°C:	45 min.	
1,400°C:	30 min.	
1,500°C:	15 min.	

We do not know the sources from which these specifications were drawn, but it is certain that, for temperatures in excess of 1,000°C, these data are completely untrustworthy.

The chart in question assigns to the Klingenstierna Furnace a duration of 120 minutes for a temperature of 800°C, as against 90 minutes at 1,000°C for the Siemens Model and finally 50 minutes at 1,200°C for the Schneider Furnace. As I have explained in Chapter 3 of Unit I of this study, the three above devices all operated on the principle of indirect cremation employing hot air: the regenerators or recuperators, after having been heated to 1,000°C, were fed atmospheric air that entered the muffle at the listed temperature and then caused the combustion of the corpse. According to Architect Beutinger, the duration of a cremation was 90 minutes for the Siemens Furnace at Gotha operating at 900°C, 60 to 90 minutes for the Klingenstierna Furnaces operating at 1,000°C, and 45 to 90

minutes for the Schneider Furnaces, which reached 1,000°C as well (see table p. 100).

According to a report of the Stuttgart City Building Administration, covering 48 cremations carried out between 20 July and 15 September 1909 in a Wilhelm Ruppmann Furnace, the briefly attained maximum temperature in the cremation chamber was 1,120°C (Nagel 1922, p. 37).

In the cremation experiments carried out by the engineer Richard Kessler at the Dessau Crematorium between 1 November 1926 and 12 January 1927 using a Beck Furnace (an improved version of the Klingenstierna Model), the highest temperature reached in the cremation chamber was 1,100°C, but this maximum was attained only for a few moments during the combustion of the coffin (cf. Document 48).

In the analysis proffered in Chapters 5f. of Unit I, I referred to various cremation charts for operation with coke, gas, and electricity which all show that the temperature of the muffle never reached a point above 1,100°C.

In the three charts known to me describing the operation of the electrical Topf Furnaces at Erfurt (Documents 142, 146 & 148) the highest temperature reached momentarily was around 1,120°C.

It is thus a fact that, in the furnaces for civilian use referred to by the Soviet experts, cremation-chamber temperatures higher than 1,100°C had not been established; effective temperatures of 1,500°C occurred only on the hearth grates (H. Keller 1929, p. 3).

It follows that the Soviet chart, to the extent that it covers temperatures higher than 1,000°C, is based on an inadmissible extrapolation. This is confirmed by the experiments carried out in England in the 1970s which I discussed in Chapter 6 of Unit I: in the chart illustrating the time-temperature relationship (Document 87), the temperature describes a wave-like curve: the minimum cremation time – 61 minutes – occurred at a temperature of 800°C; as the temperature rose up to 1,000°C, the time increased as well: 65 minutes at 900°C, and 67 minutes at 1,000°C. Then it started decreasing again, reaching 65.5 minutes at 1,100°C. At higher temperatures, unreached by experiments, Dr. Jones surmised that the duration should diminish further and should go below the thermal barrier at some threshold temperature. If one wanted to reduce the cremation time in this manner for example to 20 or 15 minutes, it would be necessary to design a furnace operating at around 2,000°C (see pp. 108f.).

The Soviet experts made another inadmissible extrapolation with respect to the furnace load. As the cremation of several corpses simultaneously in the same cremation chamber was prohibited for civilian cremations, no experimental data exist in this regard. Hence the Soviet chart necessarily rests on data for individual cremations. The Soviet experts therefore illicitly assign data valid for individual cremations to loads of two to twelve corpses in one muffle. Loading twelve corpses into one muffle is merely an arithmetical maneuver in order to artificially raise the furnaces' capacity. In this way, the three Stutthof Furnaces were attributed a capacity identical to the six furnaces at Sachsenhausen!

However, in the preceding section we have seen that increasing the load in a cremation chamber inevitably leads to a longer duration of the incineration and

that, for a furnace designed for individual cremations, this increase in time is such that no practical advantage can be gained from such a procedure.

The coke consumption purported by the Soviet experts – 60 kg for six emaciated corpses of 50 kg each – is mere conjecture without any technical basis. Let us recall the fact that in the Model 1b Kori Furnace, the incineration of 310 kg of organic substance – the equivalent of six corpses of some 51 kg each – necessitated, at steady-state conditions, a supply of some 130 kg of solid fuel, the equivalent of 140 kg of coke altogether, or 23 kg per corpse.

On the subject of the loading of corpses at the Lublin Crematorium, the Soviet experts really allow their imagination to run wild: the claim that, in front of the furnaces, they had found corpses without legs and without arms, “heavily damaged by fire” (*mnogo obgorebshich*), does not prove that the limbs of these corpses were cut off before being loaded into the furnace, it rather demonstrates that the last cremations were not carried out to the end, and when the carbonized corpses were later pulled out, they no longer had any arms or legs simply because the limbs burned faster than the trunks (as indeed they do).

The Soviet experts’ assertions are technically untenable also with respect to the discharge gases and the cross-sectional area of the chimney at the Lublin crematorium.

First of all the experts misread Kori’s letter of 8 January 1943.⁵³⁷ The document merely states that the two forced-draft devices were necessary in order to be independent of weather conditions. The chimney draft was in fact affected by the fact that the exhaust gases cooled noticeably when they lost some of their heat in the two recuperator chambers for the purpose of preparing hot water for inmate showers. As a result of high outside temperatures during the summer months (the document says “especially on hot summer days”), the natural chimney draft could be reduced too much, which should be quite obvious.

The calculation of the cross-section of the two smoke ducts – the experts give only the result – is wrong, first of all because of the erroneous assumption that cremation proceeded with an excess-air ratio of 1.3. This is only half of what is actually needed. Furthermore, the result of the computation itself is wrong. As we can see from the Soviet experts’ report on the furnaces at the Sachsenhausen Camp, the calculation of the chimney section carried out by the experts was based on the following formula (cf. page 43):

$$q = \frac{V(1 + \alpha t)}{3,600 \text{ sec/hr} \cdot v} \quad [118]$$

where q = cross-sectional area of chimney

V = volume of off-gas in Nm^3 per hr

α = $1/273 \text{ } ^\circ\text{C}^{-1}$

t = temperature of the off-gas in the chimney, $^\circ\text{C}$

v = velocity of the off-gas in the chimney in m/sec.

Assuming a load of four corpses in each muffle, a duration of the cremation of 12 minutes, a generation of 285 m^3 off-gas per corpse, an off-gas temperature in the chimney of 400°C , and a gas velocity of 3 m/sec as assumed by the Soviets

⁵³⁷ GARF, 7021-107-9, p. 250; Dokument published in Graf/Mattogno, p. 313.

(see p. 329), we obtain for the required cross-section of one chimney duct collecting the gases of 2.5 muffles (there were two ducts for five muffles):

$$S = \frac{285 \text{ Nm}^3/\text{hr} \cdot 4 \text{ corpses/muffle} \cdot 2.5 \text{ muffles/duct} (1 + \alpha \cdot 400^\circ\text{C})}{3,600 \text{ sec/hr} \cdot 3 \text{ m/sec}} \cdot \frac{60 \text{ min/hr}}{12 \text{ min/corps}} \\ = 3.25 \text{ m}^2. \quad [119]$$

In other words, the calculated hourly generation of 35,100 m³ of off-gas would have required a cross-sectional area of 3.25 m² for each of the two chimney ducts, or nine times the actual dimension (with the actual cross-section, the gas velocity would have had to amount to 27 m/sec, or 60 mph – a true storm!). But in their computation the Soviet experts did not even consider the gas stemming from the combustion of the coke – as if the corpses underwent a process of auto-combustion!

In conclusion we may say that, as no cremation furnace actually operated at average temperatures higher than 1,000°C, and as any loading of several corpses into one muffle would at least have multiplied the time taken in proportion to the number of corpses loaded, the chart produced by the Soviet experts is counterfactual or totally afactual.

In fact, the Kori furnaces at Sachsenhausen, Majdanek and Stutthof, if we assume an average operating temperature of 800°C and a duration of 50 minutes for a single cremation (as in the Kori Furnaces at Westerbork), had cremation capacities of 144, 115, and 58 corpses in 24 hours, respectively.

This means that the Soviet experts, by using a technical sleight of hand, multiplied the actual cremation capacities by a factor of five for Sachsenhausen, a factor of thirteen for Majdanek, and a factor of ten for Stutthof! What should be stressed here, though, is that not even the Soviet experts ventured so far as to attribute to any actual cremation temperature a duration of less than 60 minutes for the cremation process: even to the highest temperature, 1100°C, occurring only for a few moments, they assigned a substantial duration of 75 minutes.

9.3.5. The Soviet and Polish Reports on the Topf Cremation Furnaces at Auschwitz-Birkenau

In February of 1945, the Soviet commission of inquiry investigating Auschwitz assigned the task of giving an expert opinion on the subject of the cremation furnaces at that camp to the engineers Dawidowski, Dolinskii, Lavrushin and Shuer. The experts, however, limited themselves to furnishing the following very-sparse data without any technical explanation:⁵³⁸

Crematorium I

- 3 to 5 corpses were loaded simultaneously into each muffle;
- cremation took 90 minutes;
- the number of corpses cremated amounted to 300 to 350 per day.

⁵³⁸ “Akt 14 February – 8 March 1945. City of Oswiecim.” GARF,7021-108-14, pp. 2-7.

Crematoria II/III

- 3 to 5 corpses were loaded together into each muffle;
- the cremation of which took 20 to 30 minutes;
- at full capacity, 6,000 corpses per day could be cremated in the 30 muffles of the two crematoria.

Crematoria IV/V

- 3 to 5 corpses were loaded into each muffle;
- the cremation took 30 to 40 minutes;
- at full capacity, 3,000 corpses per day could be cremated in the 16 furnaces of these crematoria.

On 26 September 1946, the engineer Roman Dawidowski, an expert witness with the court conducting the Rudolf Höss Trial, drew up a long opinion on the crematoria at Auschwitz-Birkenau.⁵³⁹ Dawidowski was a mechanical engineer in the field of heat and combustion technology, but his opinion shows only a very rudimentary knowledge with respect to cremation furnaces. His documentation on the civilian crematoria in Germany consists of an excerpt of the “Law on Cremation” of 15 May 1934 (pp. 13-16) and of three drawings of cremation furnaces of the Siemens type (p. 16) – similar to those published here (Document 21) – as well as of the Didier (p. 17) and Gebrüder Beck Furnaces (p. 18), identical to those published here (Documents 59f.) and stemming from the same source.

On the subject of the Auschwitz-Birkenau Furnaces, Dawidowski merely reiterated the statements made in the report of the Soviet experts mentioned above without any further explanation:

Crematorium I

“The cremation of a load in 4 muffles took about one half-hour, therefore, in continuous operation over 14 hours per day, the cremation capacity of Crematorium I in its original state [with two furnaces] was more than 200 corpses per day. [...] After this enlargement [i.e., after adding the third furnace], the cremation capacity of Crematorium I rose to some 350 corpses per day.” (pp. 24f.)

Crematoria II/III

“On average, five corpses were loaded into each muffle at one time. Cremation of such a load took 25-30 minutes. The 30 muffles of the two Crematoria II and III could cremate 350 corpses per hour. In the expert’s opinion, for a continuous operation in two shifts of 12 hours per day and setting aside 3 hours of inactivity per day for the extraction of the slag from the gasifiers and for other minor work, with the unavoidable interruptions of continuous operation, the average number of corpses actually cremated in the two crematoria in 24 hours was 5,000 corpses. This figure agrees with the testimonies of the eye-witnesses Tauber and Jankowski.” (p. 47)

⁵³⁹ AGK, NTN, 93, pp. 1-57; subsequent page numbers from there unless stated otherwise.

Crematoria IV/V

“In these crematoria, too, 3-5 corpses were loaded into each muffle. Cremation of such a load took about 30 minutes. In the expert’s opinion, the two Crematoria IV and V, at full capacity with 2 shifts of 12 hours, considering stoppages for the removal of slag from the gasifiers, unforeseen incidents, bottle-necks etc., could cremate 3,000 corpses per day on average. This figure is in agreement with the depositions of eye-witnesses.” (p. 48)

In order to attain such performances – if we follow the Soviet chart discussed above – the furnaces at Crematorium I would have had to be operated at 1,000°C, those at Crematoria III and IV at more than 1,400°C, and those at Crematoria IV and V at more than 1,300°C. Yet only the first temperature mentioned is in any way feasible. As I have already stated, Topf’s operating instructions for the triple-muffle furnaces recommended not to exceed a temperature of 1,000°C in the muffles. Even Dawidowski himself, during the fourteenth session of the Höss Trial, declared explicitly that⁵⁴⁰

“the cremation process for corpses is very difficult, requiring a precise temperature of 1,000°C; if the temperature is higher, the ash does not remain loose but attaches itself to the slag [forming] a compact mass. If the temperature is less than 1,000°C, the muscles will not burn....”

A duration of the cremation process of 25 to 30 minutes is without any technical foundation as well, while the simultaneous cremation of three to five corpses in each muffle would at least have multiplied the duration of the process by a factor of 3 to 5.

Just like the Soviet expert opinions, Dawidowski’s did not have a scientific character, but a political one, as it was to back up the wild exaggerations of the witnesses regarding the claimed aggregate number of cremations. The cremation capacities averred by the experts were not the result of an investigation, but of its afactual premises.

Summarizing our findings, we see that the practical performance of the double-muffle Topf Furnace at Gusen and of the Kori Furnace at Westerbork, the practical experience with the Kori Furnaces for the destruction of animal remains, the thermal load on the muffles, the calculation of the chimney cross section, as well as, indirectly, the findings of the Soviet and Polish experts concur to demonstrate that in the Topf Furnaces at Auschwitz-Birkenau a good and efficient cremation (with respect to time and fuel consumption) of several corpses in one muffle was technically impossible and any cremation of several corpses in one muffle would not have boosted the cremation performance of the furnaces in any way. As a matter of fact, it most-likely would have reduced the performance, in particular for more than two corpses per muffle.

9.3.6. The Presence of Child Corpses

For completeness’s sake we must also consider the possibility that there were children and undersize adults among the corpses. The number of Jewish children and adolescents deported to Auschwitz has been estimated at about

⁵⁴⁰ AGK, NTN, 111, p. 1572.

216,300 (Kubica 1999, p. 349) out of 1,095,000 deported (Piper 1993, p. 200), which amounts to 19.75%, or about one child among five deportees. The percentage, however, is calculated in relation to those presumed murdered – about 607,800 (Mattogno 2019, pp. 471f.) – and corresponds to about every third such deportee. The average weight of children up to the age of 16 is about 35 kg (Graf/Kues/Mattogno, pp. 138-141), so the average weight of two adults and one child is $[(70+70+35)\div 3=]$ 58 kg. In the Westerbork Crematorium the cremation of an adult corpse alone and that of an adult and a child corpse together lasted on average $[(50+57)\div 3=]$ 35 minutes per corpse. Considering, however, that an average cremation of an adult corpse lasted 60 minutes in the Topf Furnaces (not 50) and that the ages of the children ranged from one day to 16 years (and not merely from one day to one year), it is evident that the average cremation at Auschwitz lasted well over 35 minutes. Reasoning by analogy with the furnaces for the destruction of animal carcasses, we can assume that the simultaneous cremation of an average adult of 70 kg and an average child of 35 kg in one muffle lasted $[(70+35) \text{ kg} \times (50 \text{ sec/kg} \div 60 \text{ sec/min}) =]$ 87.5 minutes, and that the average duration of the cremation of the bodies of two adults and one child lasted $(175 \text{ kg} \times \frac{5}{6} \text{ min/kg} \approx)$ 146 minutes, or on average 48.6 minutes per corpse. This duration appears credible given the fact that, as mentioned earlier, in the Paris crematorium of Père-Lachaise the average duration of the cremation of the bodies of children up to 9 years was about 39 minutes. Therefore, the presence of children among the cremated corpses would have enhanced the capacity of the cremation furnaces only marginally by some 20%, yet even that would not even get close to the capacities claimed in the letter by the Central Construction Office of 28 June 1943 and in Prüfer's memo of 8 September 1942.

9.4. Maximum Theoretical Cremation Capacity

Our final task is to present the general conclusions concerning the performance of the Topf Furnaces at Auschwitz-Birkenau.

Assuming an average operating time of the furnaces of 20 hours per day and an average cremation time of 60 min per normal corpse, resulting in 20 cremations per day and muffle, the maximum cremation capacities of these devices were as follows:

Table 6: Maximum Daily Cremation Capacity*

Crematorium	# of muffles	# of cremations
I	6	120
II	15	300
III	15	300
IV	8	160
V	8	160
<i>Total</i>		<i>1,040</i>

* assuming 1hr cremation time per corpse and 20hr/day operation

9.5. Normal Cremation Capacity

The cremation capacities as given in the preceding subchapter are purely theoretical, as they do not take into account one crucial element: according to the *Aktenvermerk* of 17 March 1943 (cf. Document 264), which will be analyzed in Chapter 10, the normal activity of the crematoria was set at 12 hours per day, which took into account the inevitable wear and tear of the equipment. The normal cremation capacities thus correspond to 60% of the above values, or:

Table 7: Normal Daily Cremation Capacity*

Crematorium	# of muffles	# of cremations
I	6	72
II	15	180
III	15	180
IV	8	96
V	8	96
<i>I to V</i>	52	624
<i>II to V</i>	46	552

* assuming 1hr cremation time per corpse and 12hr/day operation

The last row shows the total after deducting Crematorium I, which was replaced by the new Crematoria II to V.⁵⁴¹

Was this an excessive capacity? To answer this question, we must go more deeply into the history and the function of the Birkenau Crematoria. The “new crematorium” with its five triple-muffle furnaces (the future Crematorium II) was designed for a camp with 125,000 Soviet prisoners of war. Thus, a detainee-to-muffle ratio of $(125,000 \div 15 =) 8,333$ was assumed. The explanatory report (*Erläuterungsbericht*) of 30 October 1941 set forth that each muffle was to cremate two corpses concurrently, thus enabling the cremation of 60 corpses in one hour or two corpses in one muffle every 30 minutes (see p. 266).

For a daily operating period of 12 hours, the daily cremation capacity would thus have been $(60 \times 12 =) 720$ corpses. Actually, though, as we have noted in Chapter 7, the type of triple-muffle furnace that was eventually built did not correspond to the technical characteristics of the devices considered in the file memo. Hence the capacity mentioned in the file memo did not correspond to the later reality, all the more so as even the cremation of a single corpse in one muffle within 30 minutes (on average) would have been technically impossible.

This observation, however, does not touch in any way on the intentions of the Auschwitz SS who, for a crematorium built without any criminal aim, counted on a normal cremation capacity of $(720 \times 30 =) 21,600$ deaths per month, or a mortality of $(21,600 \div 125,000 \times 100 \approx) 17.3\%$ of the total camp strength per month. This high level of mortality had occurred in October of 1941.⁵⁴² The above computation is presented only as a concrete point of reference.

⁵⁴¹ In this context we also ought to consider the concept of reserve furnaces; for example, at the new Lublin Crematorium, the central furnace (one out of five) was specifically labelled “*Reserveofen*.” Cf. Section 11.2.6. Assuming that every fifth furnace served as a reserve, this would further reduce the contemplated capacity to $552 \times 0.8 = 442$ corpses in 12 hours.

⁵⁴² Between 7 and 31 October 1941, 2,128 detainees died; the average strength for that month was

Obviously, as we shall see presently, the camp administration did not expect to see a loss as high as 21,600 detainees per month throughout the entire year; the camp headquarters – in line with the initial estimates – merely wanted to be able to cope with emergency situations of a daily mortality of up to 720 detainees for short periods of time.

The origins of the other three crematoria at Birkenau had two causes: the outbreak of a disastrous typhus epidemic, and the plans for the enlargement of the camp (see Mattogno 2010). The August of 1942 was the month during which the typhus epidemic took on horrifying proportions. This was also the month during which the decision was taken to build the other three crematoria.

In the course of the month, a total of 8,354 detainees (6,829 men and 1,525 women) died, 269 per day on average.⁵⁴³ Over the first 19 days of the month of August, 4,113 deaths were registered in the men's camp alone. Between 10 and 19 August, 2,824 detainees would die, 282 per day on average, with daily maxima of 390 deaths on the 18th, 324 on the 13th, and 301 on the 11th.⁵⁴⁴ Considering the fact that mortality was 49 per day in the women's camp, it is not overly adventurous to say that in August of 1942 the daily death rate exceeded 300 per day, with high points above 400 cases.

This catastrophic scenario unfolded at a time when high-flying plans for the Birkenau Camp were being mulled over. As early as June of 1942, the *WVHA* planned to raise the PoW camp strength to 150,000 detainees,⁵⁴⁵ and in August this planning figure had reached 200,000 detainees.⁵⁴⁶ Of course, the planned installation of appropriate hygienic and sanitary facilities as well as disinfection plants would help to suppress another virulent outbreak of such an epidemic, but how could one be sure?

The decision to build more crematoria practically imposed itself, along with the choice of a sufficient number of muffles for the new installations, or in practical terms their cremation capacity. It was influenced by the two facts mentioned above: the excessive mortality among the detainees, and the plans for enlargement of the Birkenau Camp, which would have brought about an enormous increase in the number of inmates.

Available statistics allow us to say that in August 1942 the detainee mortality reached a level of 29.8% of the average camp strength in the men's camp (some 22,925 detainees), hitting highs of 37.9% of the average strength of 23,142 detainees between the 10th and the 19th of that month.⁵⁴⁷

If then – for the men's camp alone with an average strength of 23,000 inmates – there were 6,829 deaths equivalent to a momentary rate of 37.9% of the camp strength, what would or could happen with a camp strength of 150,000 or 200,000 detainees?

12,500 detainees, which yields a mortality rate of about 17%.

⁵⁴³ PRO, HW 1/929 xc 11768.

⁵⁴⁴ *Stärkebuch*, analysis by Jan Sehn. AGK, NTN 92, pp. 82f.

⁵⁴⁵ Radiomessage from Kammler to Bischoff dated 22 June 1942. GARF, 7021-108-32, p. 32.

⁵⁴⁶ Letter by Bischoff to Kammler dated 27 August 1942. GARF, 7021-108-32, p. 41.

⁵⁴⁷ *Stärkebuch*, analysis by Jan Sehn. AGK, NTN 92, pp. 82f.

At that level, the effective cremation capacity of 624 corpses per day (of 12 operating hours) or some 19,000 in one month would have corresponded to a mortality of 12.5% for a camp strength of 150,000 and no more than 9.4% for a strength of 200,000 detainees; in other words, only one third or one quarter, respectively, of the levels reached in August of 1942.

These considerations help us in understanding the problems which affected the SS's choice for a suitable capacity for the new crematoria. Fortunately, a Central Construction Office document of 10 July 1942 furnishes us with the criteria of that decision: On 15 June 1942, the Construction Office of the Stutthof Camp sent a request to the Central Construction Office at Auschwitz regarding information concerning the installation of a crematorium. On 10 July, Bischoff answered with the following letter (Document 263):⁵⁴⁸

"In the attachment, we are sending you the plans for a crematorium for 30,000 detainees. The plant consists of 5 triple-muffle cremation furnaces. According to information supplied by Topf & Söhne Co. of Erfurt, a cremation takes about one half-hour.

The basement has been raised because the ground-water level at the construction site is high. Concerning technical installation, we refer you to Topf & Söhne Co. of Erfurt."

The duration of half an hour for one cremation was nothing but an extrapolation on Topf's part, because at that moment no triple-muffle furnace had yet been built. What is important in this letter, however, is the ratio of muffles to detainees established by the Central Construction Office, viz. $(30,000 \div 15 =)$ one muffle for 2,000 detainees.

This clearly shows that the Central Construction Office did, in fact, not trust the data of the explanatory note of 30 October 1941 (which Topf had provided), because on the basis of such data, and assuming an operation of 12 hours per day, the crematorium would have been able to handle $(720 \times 30 =)$ 21,600 corpses per month or $[(21,600 \div 30,000) \times 100] = 72\%$ of the camp strength for which it was designed.

In practical terms, the Central Construction Office approved an enormous reduction of the new crematorium's capacity when it set the effective cremation capacity to be sufficient no longer for 125,000 inmates, as stated in the explanatory report, but rather for 30,000 inmates, or at $(30,000 \div 125,000 \times 100 =)$ 24%; i.e. in numerical terms, at $(720 \times 0.24 \approx)$ 173 cremations per day.

On the basis of the ratio of muffles to detainees set by the Central Construction Office, the 46 muffles of the four crematoria at Birkenau were sufficient for $(46 \times 2,000 =)$ 92,000 detainees. This computation by the Central Construction Office formed the basis for the later decision to build the other three crematoria and constituted the criterion for the choice of the number of muffles.

The increase of the camp strength to a level of 200,000 detainees was mere conjecture and turned out to be increasingly illusory over the following months. The layout of the PoW camp of 15 August 1942 (Pressac 1989, p. 203), though based on a population of 200,000 detainees, showed only two crematoria (the

⁵⁴⁸ Letter from Bischoff to *Bauleitung* of Stutthof dated 10 July 1942. RGVA, 502-1-272, p. 168.

future Crematoria II and III), or a ratio of muffles to detainees of $(30 \div 200,000 =) 1:6,666$. The drawing of 22 September 1942 (*ibid.*, p. 209), still showing merely the two crematoria just mentioned, was elaborated for a strength of only 140,000 detainees or a ratio of $(140,000 \div 30 =)$ one muffle for 4,667 detainees.

The final drawing of 6 October 1942,⁵⁴⁹ including all four crematoria for an unchanged camp strength of 140,000 detainees, yielded a new ratio of $(140,000 \div 46 =)$ 1 muffle for 3,043 detainees. Taking into account the slow progress of the construction of the camp, the strength of 140,000 remained purely theoretical;⁵⁵⁰ it was reached only as late as August 1944 under the enormous overload caused by the deported Hungarian Jews.⁵⁵¹

Considering the fact that the projected strength for the Birkenau Camp stood at 140,000 detainees and the normal strength of the Auschwitz Camp amounted to 10,010 in November of 1942,⁵⁵² *i.e.* a total of 150,000 detainees, we may say, based on the Central Construction Office calculations, that the crematoria eventually installed were most inadequate for the aimed-at increase of the camp strength, which would indeed have necessitated $(150,000 \div 2,000 =)$ 75 muffles as compared to the 46 eventually built.

The conclusion of the matters discussed above is that the Birkenau Crematoria were conceived only on the basis of registered detainees, without any criminal intentions, and were to allow for possible future emergency situations with considerable peaks in mortality, in line with the experience gathered in August of 1942. They reflected an effective cremation capacity of only 50% of the theoretical, and thus an effective average operating time of 12 hours per day.

Although the projected strength of the Birkenau Camp was 140,000, the four crematoria – which were really designed for a strength of only 92,000 – were not used to full capacity for two reasons: first of all, the actual strength stood nearly always below this limit.⁵⁵³ Secondly, the actual construction of the camp with all the projected sanitary, hygienic, and medical installations, led to a considerable drop in mortality. After the 1942 typhus epidemic, such a drop occurred as early as April of 1943, and over that year the mortality dropped steadily, reaching a low of 2.3% in October 1942 (Langbein 1965, vol. 1, pp. 100f.).

9.6. Discussion of the *Zentralbauleitung* Letter of 28 June 1943

At the end of the preceding subchapter, we left in suspension the technical examination of the cremation capacity as indicated in the Central Construction Office letter of 28 June 1943. Now, having ruled out – in terms of economy and duration – the efficient simultaneous cremation of multiple corpses in one muffle in the Auschwitz-Birkenau Furnaces, we can state with certainty that such a capacity is technically impossible.

⁵⁴⁹ VHA, OT 31(2)/8.

⁵⁵⁰ It is known that *Bauabschnitt III* was never finished.

⁵⁵¹ According to information gathered by the Polish resistance movement, the camp strength of the Auschwitz-Birkenau Camp was 135,168 detainees in August of 1944 (Czech 1989, p. 860).

⁵⁵² “*Normale Block-Belegstärke im K.L. Auschwitz.*” 3 November 1942. RGVA, 502-1-272, p.56.

⁵⁵³ In 1943, the maximum camp strength was 88,251 detainees (1st December). *Übersicht über den Häftlingseinsatz im K.L. Auschwitz. Dezember 1943.* APMO, D-AuI-3a/370, pp. 438, 448.

This judgment is strengthened further by the fact that, as we shall see in Chapter 10, the minimum theoretical fuel requirement of a Topf triple-muffle or 8-muffle furnace for the type of corpse which demanded the lowest amount of fuel was 16 and 12 kg of coke per corpse, respectively. In view of the fact that the furnaces of Crematoria II and III of Birkenau could burn (35 kg/hr/hearth · 2 hearths/furnace · 5 furnaces · 24 hr =) 8,400 kg of coke in 24 hours and those of Crematoria IV and V (35 kg/hr/hearth · 4 hearths/furnace · 24 hr =) 3,360 kg, if the Crematoria II and III did in fact have a capacity of 1,440 corpses in 24 hours, the average coke consumption per corpse would have been a mere (8,400÷1,440=) 5.83 kg; for Crematoria IV and V, a capacity of 768 corpses in 24 hours would have meant an average consumption of only (3,360÷768=) 4.37 kg of coke, but such figures would be only about one third of the minimum theoretical requirements.

The capacity indicated in the letter of 28 June 1943 is, therefore, technically impossible to attain. How can we explain this dilemma?

Jean-Claude Pressac has shown correctly (1989, p. 244) that the cremation capacity given in the document, as far as Crematoria II-V are concerned, is closely linked arithmetically to the capacity mentioned in the previously mentioned explanatory report of 30 October 1941 (Document 211), *i.e.* two corpses in one half-hour in one muffle or four corpses per hour per muffle, which match precisely the numbers in the letter:

$$4 \times 15 \times 24 = 1,440 \text{ corpses in 24 hours in Crematoria II-III}$$

$$4 \times 8 \times 24 = 768 \text{ corpses in 24 hours in Crematoria IV-V}$$

However, there is no direct relationship between the five triple-muffle furnaces mentioned in that report and the furnaces that would eventually be installed in Crematoria II and III at Birkenau. In October of 1941, the triple-muffle Topf Furnace was still on the drawing boards, and the only determined basic design fact was that it would consist of three muffles which were linked in one way or another. The reference which appears in the explanatory report of 30 October 1941 therefore concerned an elusive project in Kurt Prüfer's mind, different from what was later realized, in the same way as the project described in the "quotation for the delivery of two triple-muffle cremation furnaces" of 12 February 1942 (Document 228), in which the triple-muffle furnace still had a single gasifier situated behind the center muffle.

The link between the projected cremation capacity of the triple-muffle furnaces in the explanatory report of 30 October 1941 and the letter of 28 June 1943 was thus purely formal. But what was the basis for such a link? The document in question allows us to formulate a plausible answer. The document, in fact, betrays certain anomalies, the most-important of which are the presence of a bureaucratic element which should not be there and the absence of one which should be there.

The letter of 28 June 1943 refers to the "completion of Crematorium III." A report about the completion of a construction site (or building) was an official document sent to the *WVHA* in compliance with a specific order by Kammler of

6 April 1943.⁵⁵⁴ What was required in this case was the notification of the completion of a construction project and a report about the respective hand-over negotiation (*Übergabeverhandlung*).

For this reason, the “list of construction projects already handed over to the camp administration,”⁵⁵⁵ drawn up by Bischoff in accordance with Kammler’s directives, contains, *i.a.*, the registration number of the letter by which the hand-over negotiation for the four Birkenau Crematoria had been reported to the camp commandant of the Auschwitz Camp, and the handover date and registration number of the letter of notification to the head of Office Group C at the *WVHA*.

Now, even though the report about the hand-over negotiation of Crematorium III was drawn up on 24 June 1943⁵⁵⁶ and passed on to the *Kommandantur* probably on the same day⁵⁵⁷ and even though the garrison administration had taken over Crematorium III officially on 25 June,⁵⁵⁸ the letter of 28 June does not address this state of the matter at all, and that is what should be there but is not.

The notification of completion was a purely formal act simply conveying the fact that a construction project had been finished, but it never gave any technical details of the project, which means that the listing of cremation capacities in the letter of 28 June 1943 makes no sense, bureaucratically speaking, and this is the element which should not be there.

What is even odder is the fact that this notification of completion is only about Crematorium III, but the letter mentions the cremation capacity of *all* crematoria. One would have to surmise that Bischoff must have been requested explicitly the supply of such information to Kammler. But in that case, bureaucratic practice would have required that he reply by a specific letter mentioning, in the line *Bezug* (reference) the registration number and the date of Kammler’s letter. Instead, the letter of 28 June 1943 merely states *Bezug: ohne* (reference: none).

The letter shows two more anomalies. First of all, the use of the word *Personen* (persons) as the cremation units. This term is somewhat odd, as one would rather expect the term “corpses” (*Leichen*) or at least “detainees” (*Häftlinge*). Furthermore, in the letter in question, the cremation capacity is given for a continuous operation of 24 hours per day, but – as we have explained in Subchapter 9.1. – this was not feasible with coke-fired furnaces. It is not by accident that the file memo of 17 March 1943 has a “daily operation” of 12 hours.

It is highly unlikely that Bischoff, in a formal official document, would have made so many gross mistakes.

Another strange thing worth noting is that the letter in question is a unique document, unrelated to others: no other document exists which mentions or in

⁵⁵⁴ Letter from Kammler “to all building inspectorates and building sections” (*an sämtliche Bauinspektoren und Baugruppen*) dated 6 April 1943. WAPL, *Zentralbauleitung*, 54, p. 68.

⁵⁵⁵ APMO, 30/25, p. 14.

⁵⁵⁶ RGVA, 502-2-54, p. 84.

⁵⁵⁷ Bischoff’s letter of transmittal erroneously has the date of 23 June 1943. RGVA, 502-2-54, p. 21.

⁵⁵⁸ APMO, 30/25, p. 14.

any way refers to the cremation capacities claimed in it. The matter is even more mysterious, as it is an official document addressed to the Head of Office Group C of the *WVHA*, *SS Brigadeführer und Generalmajor der Waffen-SS* Kammler. Office C/III handled technical matters and encompassed four main departments, among which we have one for civil engineering (C/III/1) and one for mechanical and electrical engineering (C/III/3) which also included a subsection for heating and ventilation (C/III/3a).⁵⁵⁹

Since the cremation capacities mentioned in this letter were technically impossible, how can we believe that the engineers of Office C/III, in the face of such obviously erroneous statements, would not have asked Bischoff for more information? Bischoff would have had to answer, and a correspondence would have ensued of which there is, however, not the slightest trace.

The most-obvious conclusion we may draw from the remarks made above is that the author of this letter was completely unfamiliar with the technical question of the capacity of the cremation furnaces, and not very familiar with the bureaucratic practices in place here either, something which certainly does not apply to Bischoff and makes us rather think of someone from another branch of the Central Construction Office⁵⁶⁰ and with a still-limited knowledge of the procedures followed in this office, possibly *SS Sturmmann* Nestripke, whose initials appear in the registration number of the document.

The author of the letter, being inexperienced, left out the data required for a report about the hand-over transaction, and added to the notification of completion, on his own initiative, the unrequired data about the crematoria's capacity, based on the explanatory report of 30 October 1941, because he might have thought that for bureaucratic reasons – as Pressac has pointed out – the furnace capacities had to correspond to the 1941 explanatory report.⁵⁶¹ In that case, we would not be dealing with an intentional “exaggeration”, a bragging about unattainable performances (as Pressac believed), but with a simple case of incompetence within bureaucratic procedures.

That this might be true is demonstrated by Bischoff's letter to the Construction Office of the Stutthof Camp of 10 July 1942, which we have discussed earlier. It is obvious that Bischoff could not reasonably have recommended an installation with an actual capacity of 1,440 corpses in 24 hours for a camp with a mere 30,000 detainees, because this would have corresponded to a capacity of (1,440×30=) 43,200 corpses per month, *i.e.* 13,200 more than the number of detainees concerned.

Hence, Bischoff would have been fully aware of the erroneous character of the cremation capacity given in the letter of 28 June 1943, which is yet another confirmation of the utter strangeness of this document.

We have yet to look at one more point: was the letter of 28 June 1943 ever sent to the *WVHA*? As we have already pointed out, this would have undoubtedly-

⁵⁵⁹ RGVA, 502-1-4, p. 28.

⁵⁶⁰ In January of 1943, the *Zentralbauleitung* at Auschwitz comprised 14 departments (*Sachgebiete*) and was divided into 5 *Bauleitungen*. Cf. C. Matogno 2015.

⁵⁶¹ However, the cremation capacity attributed to Crematorium I had no relationship either with the above document or with reality and it is very difficult to say where the figure came from.

ly led to an exchange of letters, of which there is neither a trace in the Central Construction Office archives nor in the records of the Pohl Trial (Pohl was the head of the *WVHA*).

The fact that the letter bears no signature could mean that Bischoff, noticing the double error it contained, refused to sign it and had it retyped in a corrected version mentioning the hand-over transaction and omitting the capacity of the furnaces. There are instances of documents thrown out and retyped correctly with the registration number unchanged, for example the file memo of 13 September 1943, of which we have one version full of mistakes corrected by hand⁵⁶² and a retyped and corrected version signed by Kirschnek and Bischoff.⁵⁶³ The fact that no copy of the corrected version of the document discussed here exists in the Moscow Central Construction Office archives may of course have been caused by the selection of the documents as practiced by the Soviets. The fact that the archives of the Central Construction Office, kept partly in Moscow and partly in Auschwitz, do not contain any drawings of the Topf Crematoria is undoubtedly due to this selection process.

9.7. The Durability of Refractory Lining

Due to the thermal stresses to which it is subjected, the refractory lining of a cremation furnace undergoes inevitable wear and tear that seriously compromises the efficiency of the plant eventually.

In an article published on 25 October 1941, engineer Rudolf Jakobskötter described the third electric furnace at the Erfurt Crematorium and noted in this context (1941, p. 583):

“Since over 3000 cremations have been performed in the second electric furnace in Erfurt, while the muffles had previously only withstood about 2000 cremations, depending on their design, it can be claimed that the design has fully proven itself in terms of durability. The manufacturing company expects a service life of 4000 cremations per muffle in the future.”

In the municipal crematorium of Erfurt, three electric furnaces had been built in succession. The first (1934-1935) had performed 1,294 cremations, after which it was dismantled; after 2,910 cremations conducted between 1936 and 1939, this second furnace was replaced by the third furnace, which performed 1,417 cremations in the period from 1940 to April 1941 (*ibid.*, p. 586). The 3,000 cremations mentioned above referred (with some exaggeration) to the second furnace, the 4,000 cremations were an expectation relegated to the future, perhaps connected to the third furnace, while the 2,000 cremations concerned the coke and gas furnaces.

For the furnaces at the concentration camps, the problem of wear and tear on the refractory lining was more serious, both because of the lower mass and the low quality of the refractory lining, and because of the greater stress on the equipment – both due to mechanical stress and also because the inmate staff was certainly not motivated to run the furnaces with great care.

⁵⁶² APMO, BW 30/25, pp. 11f.

⁵⁶³ RGVA, 502-1-26, pp. 144-146.

How real the effect of these factors was is demonstrated by the case of the Topf double-muffle furnace at the Gusen Camp. This furnace was commissioned on 29 January 1941,⁵⁶⁴ but after only eight months, it was already seriously damaged. On 24 September of 1941, the Mauthausen Construction Office asked Topf to send a technician to repair the furnace immediately.⁵⁶⁵ Topf sent the technician August Willing, the same man who had built the device. Willing arrived at Gusen on 11 October 1941 and started work the next day. The receipts for the work show that the work was carried out from 12 October to 9 November 1941. In the week of 16 to 22 October, he replaced the refractory lining of the furnace in 68 hours of work. The following week, during 68 hours of work, he completed the reconstruction of the outer brick sheathing of the furnace and performed a test cremation. Willing remained in Gusen until 9 November to fine-tune the furnace and supervise its operation.⁵⁶⁶

From 1 February to 15 October 1941, the day on which the last cremations were carried out before the furnace was shut down for repairs, hence within 260 days, 2,876 inmates had died and had been cremated at the Gusen Camp, in addition to about 14 more inmates between 29 and 31 January, hence a total of 2,890 inmates. Therefore, 1,445 cremations had been carried out in each muffle (Marsalek 1980, p. 156).

This confirms that the average duration of the refractory lining of a muffle was of the order of magnitude of 2,000 cremations. The attainment of 3,000 cremations mentioned above referred to the second electric furnace in Erfurt. However, an electric furnace, because of the uniform distribution of the heat it provided, had a longer life span than coke-fired furnaces, because its refractory lining was subjected to less thermal stress. Therefore, this figure is not applicable to coke-fired furnaces.

Replacing the entire refractory linings of the cremation muffles at the Auschwitz crematoria would have required an enormous amount of material and labor, inevitably producing a large number of documents, but there is no trace of any such documents in the voluminous correspondence between the Topf Company and the Central Construction Office of the Auschwitz Camp. The extant documents do not even contain passing hints or references to them. More crucially, such a massive replacement project is not part of the activities carried out by the Topf Company at Auschwitz-Birkenau, which we were able to reconstruct completely thanks to the complete set of invoices.

From these documents, as I mentioned earlier, it appears that only one railway car of refractory material was sent to Auschwitz as replacement material: on 9 December 1941, the Central Construction Office had ordered a rail-car load of refractory material “as spare materials for repair work.” They were used for the repair of the second furnace at the crematorium in the Auschwitz Main Camp. Taking into consideration this single replacement of the refractory ma-

⁵⁶⁴ Data taken from the list of coke deliveries to the Gusen Crematorium. ÖDMM. B 12/31, p. 352.

⁵⁶⁵ Letter of the SS *Bauleitung* of the Mauthausen Camp to Topf of 24 September 1941. BAK, NS 4 Ma/54.

⁵⁶⁶ J.A. Topf & Söhne, “*Bescheinigung über besondere Berechnung geleistete Tagelohn-Arbeiten*” by the SS *Bauleitung* of the Gusen Camp, 12 October to 9 November 1941. BAK, NS 4/Ma 54.

sonry of two muffles, the furnaces of this crematorium could have cremated a maximum of $(2,000 \times 6 + 2 \times 2,000 =)$ 16,000 corpses. Therefore, the total number of corpses that could have been cremated in the furnaces at Auschwitz and Birkenau together was approximately $(46 \times 2,000 + 16,000 =)$ 108,000 corpses.

For a more-detailed discussion of this topic, I refer the reader to a separate study (Rudolf/Mattogno 2017, pp. 144-150).

9.8. The Effective Equivalent Operating Time of the Birkenau Cremation Furnaces

Due to the Topf Furnaces' oversimplified and in-part-flawed design – with their refractory masonry being too light and their lack of regulating devices for the individual muffles – they constantly experienced breakdowns and had damaged components in need of repair, which frequently interrupted their activity, sometimes even for long periods, as we have documented in Chapter 6 of Unit II. We summarize here the relevant data with the necessary explanations.

In 1943, Crematorium II operated at reduced capacity at least from 9 April to 16 May, hence for at least 38 days. In view of the caution that the damage to the old chimney of Crematorium I (which had to be demolished and rebuilt) must have inspired in the Central Construction Office, for this period we can assume a 50% operation time (= 10 hours per day), which is equivalent to a shut-down time of 19 days. From 17 May to 31 August, hence for 107 days, this crematorium was completely closed for major repairs.

The inactivity of individual furnaces of Crematoria II and III in connection with the repair of the furnace doors or closures, considering that a triple-muffle furnace had ten doors and/or closures and that twenty were being repaired for 294 days and seven of them for 30 days, which is equivalent to ten doors and/or closures for about 600 days, and considering that there were ten furnaces in these crematoria, this all corresponds to about 60 more days of inactivity for these two crematoria.

On 2 February 1944, damage to the refractory masonry of “furnaces” (plural) of Crematoria II and III was discovered, which was repaired after 22 February. Therefore, the damage concerned at least two furnaces (in each of the two crematoria), which remained idle for at least 25 days, which is equivalent to a shut-down time of $(1 \times 25/5 =)$ five days of activity for each crematorium.

Rudolf Höss stated after the war that Crematorium IV “failed completely after a short time and later ceased to be used altogether” (Höss 1959, p. 143). Although various documents mention repairs made to this crematorium, there is in fact no documentary evidence that it was in operation in the second half of 1943 and in 1944.

At the beginning of May of 1944, damage to the refractory masonry of the smoke ducts or chimneys of Crematoria II, III and IV was discovered. In the absence of reference points, we can assign a minimum time of three days for the repair work for each crematorium.

Altogether, therefore, Crematoria II and III were idle for at least (60 + 5 + 5 + 3 + 3 =) 76 days in 1944, an average of 38 days per crematorium; Crematorium IV for at least 3 days.

From the available documents, the following picture of the activity and inactivity of the crematoria at Birkenau emerges:

1943	TIME PERIOD	EXISTENCE	ACTIVE	INACTIVE
Crematorium II	14 March – 31 December	293 days	167 days	126 days
Crematorium III	25 June – 31 December	190 days	190 days	/
Crematorium IV	22 March – 31 December	285 days	50 days	235 days
Crematorium V	4 April – 24 June	272 days	82 days	190 days
TOTAL:		1,040 days	489 days	551 days

1944	TIME PERIOD	EXISTENCE	ACTIVE	INACTIVE
Crematorium II	1 January – 30 October	304 days	266 days	38 days
Crematorium III	1 January – 30 October	304 days	266 days	38 days
Crematorium IV	–	–	–	–
Crematorium V	1 January - 30 October	304 days	144 days	160 days
TOTAL:		912 days	676 days	236 days

These two tables do not take into account the days of inactivity caused by the failures of individual furnaces as mentioned in Chapter 6. The duration of activity considered here stops in 1944 on 30 October because at that time the alleged murderous function of the crematoria is said to have ceased.

The total number of days the crematoria at Birkenau were in operation can now be calculated:

Crematorium	Total Days in Service
Crematorium II	889
Crematorium III	
Crematorium IV	276
Crematorium V	

However, these figures are a purely theoretical maximum, because it is not known for how many days which and how many furnaces were actually in operation. It should also be mentioned that, according to a note by civilian employee Jährling dated 17 March 1943 on the “Estimation of coke consumption at Crematorium II, *KGL*, based on data received from the Topf & Söhne Co. (builders of the furnaces) on 11 March 1943,” the daily service time of the crematoria was calculated only for 12 hours.

9.9. The Auschwitz-Birkenau Crematoria in the General Operation of the Camp

In the preceding section we investigated the question of the design and construction of the Birkenau crematoria. To round out our treatment, we have yet to look into the importance which the camp administration attributed to them.

The documents tell us not only that the Auschwitz-Birkenau Crematoria never played a major role in the history of the camp, but that they did not even

enjoy the same degree of attention which the Central Construction Office devoted to a much more prosaic combustion plant: the local heating plant (*Fernheizwerk*), BW 161. We will limit ourselves to a few significant aspects.

On 27 June 1942, Friedrich Boos, the contractor for this installation, informed the Central Construction Office that the firm Walther & Co. Dampfkesselwerk at Cologne, which he had contacted, required the following data for an offer concerning the steam boilers it manufactured:⁵⁶⁷

1. type of fuel
2. moisture content of the fuel
3. ash content of the fuel
4. volatiles in the fuel
5. granularity of the fuel
6. melting point of the slag from the fuel
7. softening point of the slag
8. analysis of the feed water.

The installation required 45 to 50 tons of coal daily!

As the district heating plant was to use hard coal from Upper Silesia, the Central Construction Office forwarded the questions to the Mining and Metallurgical Association of Upper Silesia,⁵⁶⁸ and received the following information.⁵⁶⁹

	Lump coal, Types III/IV	Ground coal
Size	10/20 mm, 20/30 mm	0 – 10 mm
Humidity	8 – 12%	10 – 14%
ash	7 – 10%	10 – 15%
volatiles	35 – 40%	33 – 38%
Ash melting point: in general 1,200 to 1,300°C.		

To assess the suitability of various types of coal, specific combustion experiments were carried out.⁵⁷⁰ For the district heating plant, four “Holland” type boilers were to be installed with a heating-surface area of 150 m² and a total consumption of hard coal of about 400 to 500 kg/hr, depending on size,⁵⁷¹ but probably only three boilers were eventually installed, because on 13 October 1944 the Central Construction Office ordered from Friedrich Boos “3 pcs. suction and fly-ash-removal devices” for three “Holland boilers” with a heating surface of 150 m² at a price of 21,909.50 RM each.⁵⁷² The chimney to which

⁵⁶⁷ Letter from F. Boos to *Zentralbauleitung* dated 27 June 1942. RGVA, 502-1-138, pp. 513-513a.

⁵⁶⁸ Letter from *Zentralbauleitung* “an den Oberschlesischen Berg- und Hüttenmännischen Verein” with its seat at Kattowitz, dated 14 July 1942. RGVA, 502-1-138, p. 508.

⁵⁶⁹ Letter from Oberschlesisches Steinkohlen-Syndikat G.m.b.H. to *Zentralbauleitung* dated 20 July 1942.

⁵⁷⁰ Letter from F. Boos “an die Vereinigten Kesselwerke Aktiengesellschaft Düsseldorf” dated 24 May 1943 on the subject of “fuel trial at the home for the handicapped at Beuthen on 5 and 6 May 1943” “*Brennstoffversuch im Krüppelheim in Beuthen am 5. und 6.5.43.*” RGVA, 502-1-138, pp. 126-126a.

⁵⁷¹ *Lieferungsumfang* without a date but originating from the first half of 1943. RGVA, 502-1-138, pp. 119-121.

⁵⁷² Letter from F. Boos to *Zentralbauleitung* dated 27 October 1944. RGVA, 502-1-138, p. 5.

these devices were to be connected had a height of 22.2 m and three ducts 0.70 by 0.70 m each.⁵⁷³

Boos's proposal for the forced-draft devices took into account all pertinent physical data. For the *Saugzuganlage Type H 13* serving a boiler of 150m² heating surface, the proposal specified:⁵⁷⁴

– volumetric flow rate of the gases:	13,000 m ³ /hr or 3.75 m ³ /sec
– gas temperature:	310°C
– density of the gas:	0.62 kg/m ³
– static pressure at blower exit:	40 mm water column
– margin of 10% as requested:	4 mm water column
– margin for flow resistance:	55 mm water column
– difference in static pressure:	99 mm water column
– power requirement for blower:	10 hp
– speed of blower:	1,435 rpm

In the documentation concerning the Birkenau Crematoria there is no instance of comparable diligence.

10. Heat Balance of the Topf Furnaces at Auschwitz-Birkenau

10.1. Remarks on the Method Used

In Subchapter 8.3 we analyzed the list of cremations carried out in the crematorium at the Gusen Concentration Camp, which possessed a coal-fired Topf double-muffle furnace. Among other things, this list contains the consumption of coke for each cycle of cremations. This allows us to calculate the average coke consumption for each corpse. As these consumptions represent data obtained under actual conditions of operation, they constitute a valuable point of departure for the calculation of the overall heat balance of the Topf Furnaces at Auschwitz-Birkenau.

These data will be used to arrive at reliable results, to the greatest extent possible, by means of the method employed by engineer Heepke as described in Chapter 7 of Unit I, but with the considerable advantage – in the case of the Gusen Furnaces – that we know in advance what the actual result of the heat balance should be. Without this knowledge, such a heat balance might be in agreement with furnaces for civilian use, but not for those erected in the concentration camps, whose main feature was their greater economy as compared to the civilian furnaces, both in terms of price and fuel economy.

The Topf Furnace at Gusen was similar in design to the Topf double-muffle furnace at Auschwitz, although it had structural differences which had a certain

⁵⁷³ *Zentralbauleitung, Kosten-Berechnung über den Neubau eines Schornsteines* (cost estimate for the new construction of a chimney) for BW 161. 1943. RGVA, 502-1-139, p. 7.

⁵⁷⁴ Letter from F. Boos to *Zentralbauleitung* dated 24 May 1943. RGVA, 502-1-138, pp. 218-218a.

bearing on the heat balance: due to a different structure of the muffle grate and the availability of a draft enhancer which brought about a higher heat availability, the Gusen Furnace's average duration of a cremation was around 40 minutes; thus, the average temperature of this furnace was higher than that of the Auschwitz-Birkenau Furnaces, for which we have calculated an average duration of 60 minutes for the cremation of one normal corpse.

The operating temperature of the Auschwitz furnaces being 800°C, as imposed by the applicable operating instructions and in line with civilian furnaces, we may assume an average temperature of 850°C for the Gusen Furnace. Since we have no operational data about the off-gas temperature of the Auschwitz-Birkenau Furnaces, we must use the highest values encountered in civilian furnaces, because the furnaces in the concentration camps had no recuperators and would thus necessarily have had a higher off-gas temperature than civilian furnaces.

Operational data for the Berlin Gerichtsstraße Crematorium tell us that it operated with an off-gas temperature of 700°C at the flue-gas damper, with an excess-air ratio three times the volume of the theoretical combustion air (Tilly 1926b, p. 190). The four gas-fired Volckmann-Ludwig Furnaces, built in 1932 by the H.R. Heinicke Co. at the Hamburg-Ohlsdorf Crematorium, functioned with an average temperature of 800 to 900°C; the flue-gas temperature, measured directly behind the damper, was normally 100°C lower (Manskopf 1933, p. 775). These furnaces did not have a recuperator, which means that the flue-gas discharge was comparable to the Topf Furnaces at Auschwitz-Birkenau.

Consistent with these documents, one may also assign to the Topf Furnaces an off-gas temperature some 100°C lower than that of the furnace itself, hence 750°C for the Gusen Furnace and 700°C for the furnaces at Auschwitz-Birkenau.⁵⁷⁵

For comparison, we also present two other series of coke-consumption figures obtained during actual operation, meaning those for the Kori Furnace at Westerbork (Subchapter 8.4) and the Kori Furnaces for slaughterhouses already analyzed in Section 9.2.1.

10.2. Technical Data

Following German contemporary literature, we will subsequently use the abbreviations used in the pertinent literature for the following physical properties:

V_{sch} = *Verlust durch Schornstein*, chimney losses (sensible heat of the flue gases; see Eq. 65, p. 120)

V_a = *Verlust durch Asche*, ash losses (incombustibles of the hearth; see Eq. 75, p. 121)

V_{un} = *Verlust Unverbranntes*, losses due to unburnt gases (see Eq. 74, p. 120)

R_g = *Rauchgasgewicht*, weight of discharge gases (see Eq. 69, p. 120)

⁵⁷⁵ The irreparable damage to the chimney of Crematorium I and to the flue ducts of Crematorium II (cf. Chapter 6) confirm the high flue-gas temperatures. The replacement of the refractory lining of the chimney's inner walls was carried out when the temperature of the smoke exceeded 500°C (Colombo 1926, p. 400). The new chimney for Crematorium I was lined with bricks having a Seger value of 26/28, which withstood temperatures up to 1,200-1,300°C (RGVA, 502-1-318, p. 1).

η = Wirkungsgrad, efficiency

η_{H_u} = Wirkungsgrad, unterer Heizwert, lower heating value as a function of efficiency (see Eq. 83, p. 122)

V_{ls} = Verlust durch Leitung/Strahlung, loss through conduction and radiation (see Eq. 81, p. 121)

10.2.1. Basic Data on Coke

a. The chemical composition of the coke most-likely used was:⁵⁷⁶

C	78.84%
H	0.51%
O	1.00%
S	0.91%
water	8.21%
ash	10.53%
	100.00%

b. Theoretical combustion air (see Eq. 3, p. 25):

$$8.93 \times 0.7884 + 26.79 \times (0.0051 - 0.01/8) + 3.35 \times 0.0091 = 7.17 \text{ m}^3/\text{kg} \quad [120]$$

c. Theoretical smoke volume (dry, see Eq. 7, p. 25):

$$8.93 \times 0.7884 + 21.17 \times (0.0051 - 0.01/8) + 3.35 \times 0.0091 = 7.15 \text{ m}^3/\text{kg} \quad [121]$$

d. CO₂ content (see Eq. 21, p. 31):

$$0.7884 \times 1.867 = 1.472 \text{ m}^3/\text{kg}; 1.472 \times 100 \div 7.17 = 20.50\% \quad [122]$$

e. Lower heating value (see Eq. 1, p. 24):

$$8,100 \times 0.7884 + 28,700 \times (0.0051 - 0.01/8) + 2,210 \times 0.0091 - 600 \times 0.0821 \approx 6,470 \text{ kcal/kg.} \quad [123]$$

10.2.2. Basic Furnace Data

1. Auschwitz Double-Muffle Furnace

Dimensions

- surface area: 32 m²
- surface area of gasifiers: 7 m²
- surface area of furnace body: 25 m²
- weight of refractory brickwork: 10,000 kg
- average brickwork composition:

	thickness [cm]	λ (800°)
refractory bricks:	15	0.73
thermal insulation:	7	0.13
ordinary bricks:	20	0.45
total:	42	–

with λ = thermal conductivity [kcal m⁻¹ °C⁻¹ hr⁻¹]

⁵⁷⁶ According to the chemical analysis given by Heepke; cf. Unit I, Chapter 7.

- average smoke temperature: 700°C
- load: 2 corpses
- average duration of a cremation: 60 min
- heat loss by radiation and conduction:

Doors	Dimensions [m]	Surface area [m ²]
2 vaulted muffle doors (<i>Einführungstüren</i>)	0.60 × 0.60	0.64 ⁵⁷⁷
2 hearth doors (<i>Feuertüren</i>)	0.28 × 0.35	0.20
2 ash-chamber doors (<i>Ascheentnahmetüren</i>)	0.28 × 0.35	0.20
2 gasifier closures (<i>Generatorfüllschachtverschlüsse</i>)	0.27 × 0.34	0.18
6 combustion-air-channel closures (<i>Luftkanalverschlüsse</i>), four in furnace body, two in gasifier	0.108 × 0.126	0.08
total surface area		1.30
Muffle doors		
thickness	0.10	
packing mass thickness (<i>Stampfmasse</i>)	0.08	
packing mass surface area		~ 0.32 m ²
surface area of solid metal		~ 0.32 m ²
surface area of frames (solid metal)		~ 0.23 m ²
total surface area of solid metal		~ 0.55 m ²

Muffle-Door Losses

Following Eq. 54 (p. 117) and using a thermal conductivity of 40 kcal m⁻¹ °C⁻¹ hr⁻¹ for the 0.02 m of cast iron, we calculate the thermal transmittance K for the muffle doors:

$$K = \frac{1}{\frac{1}{7} + \frac{0.08}{0.73} + \frac{0.02}{40} + \frac{1}{7}} \approx 2.6 \text{ kcal m}^{-2} \text{ °C}^{-1} \text{ hr}^{-1} \quad [124]$$

Other-Door Losses (hearths, ash chambers and gasifiers)

- total thickness: 0.080 m
- thickness of packing mass: 0.065 m
- thickness of cast iron: 0.150 m
- total surface area: 0.580 m²

$$K = \frac{1}{\frac{1}{7} + \frac{0.065}{0.73} + \frac{0.015}{40} + \frac{1}{7}} \approx 2.7 \text{ kcal m}^{-2} \text{ °C}^{-1} \text{ hr}^{-1} \quad [125]$$

Brickwork Losses

$$K = \frac{1}{\frac{1}{7} + \frac{0.15}{0.73} + \frac{0.07}{0.13} + \frac{0.20}{0.45} + \frac{1}{7}} \approx 0.68 \text{ kcal m}^{-2} \text{ °C}^{-1} \text{ hr}^{-1} \quad [126]$$

⁵⁷⁷ The upper half of the doors was a semi-circle, hence: 0.6 m × 0.3 m + π × 0.3² m²/2 = 0.321 m² each.

Losses by Conduction and Radiation (V_{ls})

i) Furnace body:

a) Muffle doors:

$$V_{ls} \text{ (tamping mass)} = 0.32 \text{ m}^2 \cdot 2.6 \text{ kcal m}^{-2} \text{ }^\circ\text{C}^{-1} \text{ hr}^{-1} \cdot (800^\circ\text{C} - 20^\circ\text{C}) \\ = 649 \text{ kcal/hr}$$

$$V_{ls} \text{ (solid metal)} = 0.55 \text{ m}^2 \cdot 40 \text{ kcal m}^{-2} \text{ }^\circ\text{C}^{-1} \text{ hr}^{-1} \cdot (800^\circ\text{C} - 20^\circ\text{C}) \\ = 17,160 \text{ kcal/hr}$$

b) Ash-chamber doors:

$$V_{ls} = 0.20 \text{ m}^2 \cdot 2.7 \text{ kcal m}^{-2} \text{ }^\circ\text{C}^{-1} \text{ hr}^{-1} \cdot (800^\circ\text{C} - 20^\circ\text{C}) = 421 \text{ kcal/hr}$$

c) Combustion-air-channel closures:

$$V_{ls} = 4 \cdot (0.108 \text{ m} \cdot 0.126 \text{ m}) \cdot 40 \text{ kcal m}^{-2} \text{ }^\circ\text{C}^{-1} \text{ hr}^{-1} \cdot (800^\circ\text{C} - 20^\circ\text{C}) \\ = 1,698 \text{ kcal/hr}$$

d) Brickwork (surface area of furnace body minus aggregate door surface a) to c):

$$V_{ls} = (25 - 1.1) \text{ m}^2 \cdot 0.68 \text{ kcal m}^{-2} \text{ }^\circ\text{C}^{-1} \text{ hr}^{-1} \cdot (800^\circ\text{C} - 20^\circ\text{C}) \\ = 12,677 \text{ kcal/hr}$$

ii) Gasifiers:

a) Doors (hearths and gasifiers):

$$V_{ls} = 0.38 \text{ m}^2 \cdot 2.7 \text{ kcal m}^{-2} \text{ }^\circ\text{C}^{-1} \text{ hr}^{-1} \cdot (1000^\circ\text{C} - 20^\circ\text{C}) = 1,005 \text{ kcal/hr}$$

b) Combustion-air-channel closures:

$$V_{ls} = 2 \cdot (0.108 \text{ m} \cdot 0.126 \text{ m}) \cdot 40 \text{ kcal m}^{-2} \text{ }^\circ\text{C}^{-1} \text{ hr}^{-1} \cdot (1000^\circ\text{C} - 20^\circ\text{C}) \\ = 1,066 \text{ kcal/hr}$$

c) Brickwork (surface area of gasifiers minus doors a) & b):

$$V_{ls} = (7 - 0.39) \text{ m}^2 \cdot 0.68 \text{ kcal m}^{-2} \text{ }^\circ\text{C}^{-1} \text{ hr}^{-1} \cdot (1000^\circ\text{C} - 20^\circ\text{C}) \\ = 4,405 \text{ kcal/hr}$$

iii) Total losses:

$$649 + 17,160 + 421 + 1,698 + 12,677 + 1,005 + 1,066 + 4,405 \approx 39,000 \text{ kcal/hr [127]}$$

2. Gusen Double-Muffle Furnace

- surface area: 28 m²
- surface area of gasifiers: 16 m²
- surface area of furnace body: 12 m²

Losses by Conduction and Radiation (V_{ls})

i) Furnace body:

a) Muffle doors:

$$V_{ls} \text{ (caulking mass)} = 0.32 \text{ m}^2 \cdot 2.6 \text{ kcal m}^{-2} \text{ }^\circ\text{C}^{-1} \text{ hr}^{-1} \cdot (850^\circ\text{C} - 20^\circ\text{C}) \\ = 690 \text{ kcal/hr}$$

$$V_{ls} \text{ (solid metal)} = 0.55 \text{ m}^2 \cdot 40 \text{ kcal m}^{-2} \text{ }^\circ\text{C}^{-1} \text{ hr}^{-1} \cdot (850^\circ\text{C} - 20^\circ\text{C}) \\ = 18,260 \text{ kcal/hr}$$

b) Ash-chamber doors:

$$V_{ls} = 0.20 \text{ m}^2 \cdot 2.7 \text{ kcal m}^{-2} \text{ }^\circ\text{C}^{-1} \text{ hr}^{-1} \cdot (850^\circ\text{C} - 20^\circ\text{C}) = 448 \text{ kcal/hr}$$

c) Combustion-air-channel closures:

$$V_{ls} = 0.054 \text{ m}^2 \cdot 40 \text{ kcal m}^{-2} \text{ }^\circ\text{C}^{-1} \text{ hr}^{-1} \cdot (850^\circ\text{C} - 20^\circ\text{C}) = 1,793 \text{ kcal/hr}$$

d) Brickwork:

$$V_{ls} = (12-1.1) \text{ m}^2 \cdot 0.68 \text{ kcal m}^{-2} \text{ }^\circ\text{C}^{-1} \text{ hr}^{-1} \cdot (850^\circ\text{C}-20^\circ\text{C}) = 6,152 \text{ kcal/hr}$$

ii) Gasifiers:

a) Doors (of hearths and gasifiers):

$$V_{ls} = 0.38 \text{ m}^2 \cdot 2.7 \text{ kcal m}^{-2} \text{ }^\circ\text{C}^{-1} \text{ hr}^{-1} \cdot (1,150^\circ\text{C} - 20^\circ\text{C}) = 1,159 \text{ kcal/hr}$$

b) Combustion-air-channel closures:

$$V_{ls} = 0.027 \text{ m}^2 \cdot 40 \text{ kcal m}^{-2} \text{ }^\circ\text{C}^{-1} \text{ hr}^{-1} \cdot (1,150^\circ\text{C} - 20^\circ\text{C}) = 1,220 \text{ kcal/hr}$$

c) Brickwork:

$$V_{ls} = (16-0.4) \text{ m}^2 \cdot 0.68 \text{ kcal m}^{-2} \text{ }^\circ\text{C}^{-1} \text{ hr}^{-1} \cdot (1,150^\circ\text{C}-20^\circ\text{C}) = 11,987 \text{ kcal/hr}$$

iii) Total losses:

$$690+18,260+448+1,793+6,152+1,159+1,220+11,987 \approx 41,709 \text{ kcal/hr [128]}$$

3. Auschwitz Triple-Muffle Furnace

Dimensions

- surface area: 43 m²
- surface area of gasifiers: 10 m²
- surface area of furnace body: 33 m²
- weight of refractory brickwork: 11,500 kg
- average brickwork composition:

	thickness [cm]	λ (800°)
refractory bricks:	15	0.73
thermal insulation:	7	0.13
ordinary bricks:	20	0.45
total:	42	
with λ = thermal conductivity [kcal m ⁻¹ °C ⁻¹ hr ⁻¹]		

- average off-gas temperature: 700°C
- load: 3 corpses
- average duration of cremation: 60 min
- heat loss by radiation and conduction:

Doors	Dimensions [m]	Surface area [m ²]
3 muffle doors (<i>Einführungstüren</i>)	0.65 × 0.65	1.13 ⁵⁷⁸
2 hearth doors (<i>Feuertüren</i>)	0.28 × 0.35	0.20
3 ash-chamber doors (<i>Ascheentnahmetüren</i>)	0.28 × 0.35	0.30
2 gasifier-feed-shaft closures (<i>Generatorfüllschachtverschlüsse</i>)	0.27 × 0.34	0.18
8 combustion-air-channel closures (<i>Luftkanalverschlüsse</i>)	0.108 × 0.126	0.11
total surface area		1.92

⁵⁷⁸ The upper half of the doors was a semi-circle: $0.65 \text{ m} \times 0.325 \text{ m} + \pi \times 0.325^2 \text{ m}^2/2 = 0.377 \text{ m}^2$ each.

Muffle Doors		
thickness	0.10	
packing mass thickness (<i>Stampfmasse</i>)	0.08	
caulking mass surface area		≈ 0.565
surface area of solid metal		≈ 0.565
surface area of frames		≈ 0.460
total surface area of solid metal		≈ 1.025

Door and Brickwork Losses

Due to identity in their features, these coefficients are the same as for the Auschwitz Topf double-muffle furnaces (see there).

Losses by Conduction and Radiation (V_{ls})

i) Furnace body:

a) Muffle doors:

$$V_{ls} \text{ (packing mass)} = 0.565 \text{ m}^2 \cdot 2.6 \text{ kcal m}^{-2} \text{ }^\circ\text{C}^{-1} \text{ hr}^{-1} \cdot (800^\circ\text{C} - 20^\circ\text{C}) = 1,146 \text{ kcal/hr}$$

$$V_{ls} \text{ (solid metal)} = 1.025 \text{ m}^2 \cdot 40 \text{ kcal m}^{-2} \text{ }^\circ\text{C}^{-1} \text{ hr}^{-1} \cdot (800^\circ\text{C} - 20^\circ\text{C}) = 31,980 \text{ kcal/hr}$$

b) Ash-chamber doors:

$$V_{ls} = 0.30 \text{ m}^2 \cdot 2.7 \text{ kcal m}^{-2} \text{ }^\circ\text{C}^{-1} \text{ hr}^{-1} \cdot (800^\circ\text{C} - 20^\circ\text{C}) = 631 \text{ kcal/hr}$$

c) Combustion-air-channel closures:

$$V_{ls} = 0.08 \cdot 40 \text{ kcal m}^{-2} \text{ }^\circ\text{C}^{-1} \text{ hr}^{-1} \cdot (800^\circ\text{C} - 20^\circ\text{C}) = 2,496 \text{ kcal/hr}$$

d) Brickwork:

$$V_{ls} = (33 - 2.1) \text{ m}^2 \cdot 0.68 \text{ kcal m}^{-2} \text{ }^\circ\text{C}^{-1} \text{ hr}^{-1} \cdot (800^\circ\text{C} - 20^\circ\text{C}) = 16,389 \text{ kcal/hr}$$

ii) Gasifiers:

a) Doors (hearths and gasifiers):

$$V_{ls} = 0.38 \text{ m}^2 \cdot 2.7 \text{ kcal m}^{-2} \text{ }^\circ\text{C}^{-1} \text{ hr}^{-1} \cdot (1000^\circ\text{C} - 20^\circ\text{C}) = 1,005 \text{ kcal/hr}$$

b) Combustion-air-channel closures:

$$V_{ls} = 0.03 \cdot 40 \text{ kcal m}^{-2} \text{ }^\circ\text{C}^{-1} \text{ hr}^{-1} \cdot (1000^\circ\text{C} - 20^\circ\text{C}) = 1,176 \text{ kcal/hr}$$

c) Brickwork, identical with double-muffle furnace:

$$V_{ls} = (10 - 0.4) \text{ m}^2 \cdot 0.68 \text{ kcal m}^{-2} \text{ }^\circ\text{C}^{-1} \text{ hr}^{-1} \cdot (1000^\circ\text{C} - 20^\circ\text{C}) = 6,397 \text{ kcal/hr}$$

iii) Total losses:

$$1,146 + 31,980 + 631 + 2,496 + 16,389 + 1,005 + 1,176 + 6,397$$

$$\approx 61,220 \text{ kcal/hr} \quad [129]$$

Heat loss from the center muffle:

i) Furnace body:

a) Muffle door: one door, of three total, hence a third of the total value:

$$V_{ls} \text{ (muffle door)} = \frac{1,146 \text{ kcal/hr} + 31,980 \text{ kcal/hr}}{3} = 11,042 \text{ kcal/hr}$$

b) Ash-chamber doors: one of three total, hence a third as well:

$$V_{ls} \text{ (ash door)} = \frac{631 \text{ kcal/hr}}{3} \approx 210 \text{ kcal/hr}$$

c) Combustion-air-channel closures: two out of a total of eight:

$$V_{ls} \text{ (air channel lids)} = \frac{2,496 \text{ kcal/hr} \cdot 2}{8} \approx 624 \text{ kcal/hr}$$

d) Brickwork: roughly 8 m² out of a total of 30.9 m²:

$$V_{ls} \text{ (brickwork)} = \frac{16,389 \text{ kcal/hr} \cdot 8}{30.9} \approx 4,243 \text{ kcal/hr}$$

iii) Total losses:

$$(11,042 + 210 + 624 + 4,243) \text{ kcal/hr} \approx 16,120 \text{ kcal/hr} \quad [130]$$

Heat loss from both lateral muffles:

$$61,220 \text{ kcal/hr} - 16,120 \text{ kcal/hr} \approx 45,100 \text{ kcal/hr} \quad [131]$$

10.2.3. Basic Data on Corpses

1. Normal Corpse

Weight: 70 kg; chemical composition (cf. Unit I, Subchapter 1.2.):

Compound	Weight	Proteins	Fats
C	13.2846 kg	6.6402 kg	6.6444 kg
H	1.8060 kg	0.8694 kg	0.9366 kg
O	3.8178 kg	2.9988 kg	0.8190 kg
S	0.1512 kg	0.1512 kg	0.0000 kg
N	1.9404 kg	1.9404 kg	0.0000 kg
water	45.5000 kg		
ash	3.5000 kg		
<i>Total:</i>	<i>70.0000 kg</i>	<i>12.6000 kg</i>	<i>8.4000 kg</i>

Using the pertinent equation as indicated, we obtain the following values:

QUANTITY	VALUE	EQUATION
theoretical combustion air:	155 m ³	3, p. 25
theoretical dry-smoke volume:	149 m ³	7, p. 25
theoretical moist-smoke volume:	226 m ³	11, p. 26
water vapor:	77 m ³	9, p. 26
upper heating value:	146,100 kcal	105, p. 126

2. Lean Corpse

The influence of the combustibility of a corpse on the amount of fuel required for a cremation (as well as on its duration) has been demonstrated repeatedly. An important observation was made by the engineer Hans Keller, who said (cf. Unit I, Subchapter 5.3.):

“Corpses burning easily will initially produce up to 16%, even 17% of CO₂; with corpses that are difficult to burn, this value goes down to 4%.”

Experimental data collected in Germany in the 1930s show that 65% of all corpses burned normally, 25% poorly and 10% burned with difficulty (Jakobs-kötter 1941, p. 587). Speaking of the electric furnace at Biel in Switzerland, H. Keller says in this connection (H. Keller 1935c, p. 3):

“The great majority by far [of the corpses] will burn within two hours for an initial temperature of 700°C. Cases for which the cremation is complete within an hour and a half are very rare. A little more common are cases in which the corpse does not burn easily and cremation requires up to five hours.”

The bodies of registered detainees who died in the concentration camps, in Auschwitz-Birkenau in particular, belonged to the category of corpses which burned poorly or with difficulty, because the highest mortality struck detainees whose bodies had been diminished by epidemics, hunger or deprivation. Extreme cases of this nature were described as “*Muselmänner*” [Moslems] in the camp jargon. For our purposes, we will assume a corpse of this type, with a weight loss of 30 kg – from 70 kg down to 40 kg⁵⁷⁹ – and a proportional loss of its proteins of 50% (3.5 kg) and 60% of its body fat (1.8 kg), as compared to a normal corpse, which means that it would have had the following composition:

Chemical composition:

Water:	31.2 kg
Proteins:	3.5 kg
Fat:	1.8 kg
Incombustibles (Ash):	3.5 kg
<u>Total:</u>	<u>40.0 kg</u>

The combustible portions of the corpse are (3.5 + 1.8 =) 5.3 kg and have the following chemical composition:

C = 3.5 · 0.527 + 1.8 · 0.7910 =	3.27 kg
H = 3.5 · 0.069 + 1.8 · 0.1115 =	0.44 kg
O = 3.5 · 0.238 + 1.8 · 0.0975 =	1.01 kg
N = 3.5 · 0.154 =	0.54 kg
S = 3.5 · 0.012 =	0.04 kg
<u>Total</u>	<u>5.30 kg</u>

The upper heating value of the combustible substances amounts to (see the caloric values for fat and protein in Eq. 16, p. 29):

$$\text{u.h.v.} = 3.5 \text{ kg} \cdot 5,422 \text{ kcal/kg} + 1.8 \text{ kg} \cdot 9,257 \text{ kcal/kg} \approx 35,600 \text{ kcal} \quad [132]$$

The theoretical volume of combustion air is (see Eq. 3, p. 25):

$$8.93 \cdot 3.27 + 26.77 \cdot (0.44 - 1.01/8) + 3.35 \cdot 0.04 = 38 \text{ m}^3 \quad [133]$$

⁵⁷⁹ A weight loss of 35-40% is normally fatal (McPhee/Papadakis/Tierney 2008, p. 1085). Here, we are looking at a lethal weight-loss as high as 42.8%.

3. Average Corpse

For the sake of completeness, we will also consider an intermediate case between the two extremes of a normal and an emaciated corpse, *i.e.* a corpse with a loss of 25% of its proteins and 30% of its fats as compared to a normal corpse. This would thus have the following composition:

Water:	39.6 kg
Proteins:	7.3 kg
Fat:	4.6 kg
Incombustibles (Ash):	3.5 kg
<hr/> Total:	<hr/> 55.0 kg

This amounts to a loss of 15 kg or half the weight loss assigned to an emaciated body.

The combustible substances of such a body amount to 11.9 kg, with the following chemical composition:

C = $7.3 \cdot 0.527 + 4.6 \cdot 0.7910 =$	7.49 kg
H = $7.3 \cdot 0.069 + 4.6 \cdot 0.1115 =$	1.01 kg
O = $7.3 \cdot 0.238 + 4.6 \cdot 0.0975 =$	2.19 kg
N = $7.3 \cdot 0.154 =$	1.12 kg
S = $7.3 \cdot 0.012 =$	0.09 kg
<hr/> Total	<hr/> 11.90 kg

The upper heating value is:

$$\text{u.h.v.} = 7.3 \cdot 5,422 + 4.6 \cdot 9,257 \approx 82,200 \text{ kcal} \quad [134]$$

The theoretical amount of combustion air is (Eq. 3, p. 25):

$$8.93 \cdot 7.49 + 26.77 (1.01 - 2.19/8) + 3.35 \cdot 0.09 \approx 87 \text{ m}^3 \quad [135]$$

10.3. Heat Balance of the Double-Muffle Furnace at Gusen

A total of 677 corpses were burned at the Gusen Crematorium with an average specific consumption of 30.6 kg of coke per corpse. I summarize the results of these operations in the following table for the 13 pertinent cremation series:

Table 8: Coke Consumption of the Gusen Crematory

CREMATION SERIES	START OF SERIES	TOTAL COKE CONSUMPTION	CORPSES	KG COKE PER CORPSE
1	31/10/1941	2,100 kg	63	33.3 kg
2	01/11/1941	1,260 kg	38	33.1 kg
3	02/11/1941	1,260 kg	42	30.0 kg
4	03/11/1941	1,140 kg	42	27.1 kg
5	04/11/1941	1,380 kg	49	28.1 kg
6	05/11/1941	1,320 kg	45	29.3 kg
7	06/11/1941	2,040 kg	57	35.7 kg
8	07/11/1941	2,700 kg	94	28.7 kg
9	08/11/1941	2,100 kg	72	29.1 kg
10	09/11/1941	1,140 kg	34	33.5 kg
11	10/11/1941	840 kg	30	28.0 kg
12	11/11/1941	1,920 kg	58	33.1 kg
13	12/11/1941	1,500 kg	53	28.3 kg
<i>Total</i>	–	<i>20,700 kg</i>	<i>677</i>	<i>30.6 kg</i>

Subsequently the heat balance is calculated for the three types of corpses mentioned before. I use the following abbreviation for the respective quantities:

- W = *Wärme*, heat.
- W_2 = heat of vaporization of the corpse water and its heating up to flue gas temperature (750°C; see Eq. 95, p. 124⁵⁸⁰).
- W_{2a} = heat required for heating up to flue-gas temperature the water vapor formed by combustion of the hydrogen contained in the dry substance of the body. Equation as before, but here a factor of 9 is applied because water (18 g/mol) has nine times the mass of the hydrogen contained in it (2 g/mol).
- W_3 = heat used for heating of ash to operating temperature (850°C; see Eq. 50, p. 117).
- W_7 = upper heating value of the corpse, explained in each instance below.

Physical units are given only for the first case, thereafter omitted for brevity's sake.

Two Lean Corpses:

$$\begin{aligned}
 W_2: 2 \cdot 31.2 \text{ kg} \cdot [633 \text{ kcal kg}^{-1} + 0.50 \text{ kcal kg}^{-1} \text{ }^\circ\text{C}^{-1} \cdot (750^\circ\text{C} - 100^\circ\text{C})] &= 59,779 \text{ kcal} \\
 W_{2a}: 2 \cdot 0.44 \text{ kg} \cdot 9 \cdot 0.50 \text{ kcal kg}^{-1} \text{ }^\circ\text{C}^{-1} \cdot (750^\circ\text{C} - 100^\circ\text{C}) &= 2,574 \text{ kcal} \\
 W_3: 2 \cdot 0.2 \text{ kcal kg}^{-1} \text{ }^\circ\text{C}^{-1} \cdot 3.5 \text{ kg} \cdot (850^\circ\text{C} - 20^\circ\text{C}) &= 1,162 \text{ kcal} \\
 W_7 \text{ (see Eq. 132, p. 361):} &= 71,200 \text{ kcal}
 \end{aligned}$$

⁵⁸⁰ The average heat capacity of steam between 100°C and 750°C is roughly 0.50 kcal kg⁻¹ °C⁻¹, see www.engineeringtoolbox.com/water-vapor-d_979.html.

Two Average Corpses:

$$\begin{aligned} W_2: 2 \cdot 39.6 \cdot [633 + 0.5 \cdot (750 - 100)] &= 75,874 \text{ kcal} \\ W_{2a}: 2 \cdot 1.01 \cdot 9 \cdot 0.5 \cdot (750 - 100) &= 5,909 \text{ kcal} \\ W_3: 2 \cdot 0.2 \cdot 3.5 \cdot (850 - 20) &= 1,162 \text{ kcal} \\ W_7 \text{ (see Eq. 134, p. 362):} &= 164,400 \text{ kcal} \end{aligned}$$

Two Normal Corpses:

$$\begin{aligned} W_2: 2 \cdot 45.5 \cdot [633 + 0.5 \cdot (750 - 100)] &= 87,178 \text{ kcal} \\ W_{2a}: 2 \cdot 1.806 \cdot 9 \cdot 0.5 \cdot (750 - 100) &= 10,565 \text{ kcal} \\ W_3: 2 \cdot 0.2 \cdot 3.5 \cdot (850 - 20) &= 1,162 \text{ kcal} \\ W_7 \text{ (see Eq. 105, p. 126):} &= 292,200 \text{ kcal} \end{aligned}$$

Heat Losses from the Furnace:

I have here used the abbreviations and equations as indicated at the beginning of Subchapter 10.2.

$$\begin{aligned} V_{\text{sch}} &= \left(0.32 \cdot \frac{78.84}{0.536 \cdot 13.7} + 0.0048 \cdot (9 \cdot 0.51 + 8.21) \right) \cdot (750 - 20) \cdot \frac{100}{6,470} \\ &\approx 39.4\% \end{aligned}$$

$$V_a = 49.5 \cdot \frac{2.8 \cdot 8,100}{61 \cdot 6,470} \approx 2.8\%$$

$$R_g = \frac{0.01 \cdot 78.84}{0.536 \cdot \frac{13.7 + 0.5 + 0.3}{100}} \approx 10.1 \text{ kg}$$

$$V_{\text{un}} = \frac{10.1 (3,050 \cdot 0.5 + 2,580 \cdot 0.4)}{6,470} \approx 4\%$$

This results in an efficiency of:

$$\eta = 100 - (39.4 + 2.8 + 4) = 53.8\%$$

and thus an effective lower heating value of coke of:

$$\eta H_u = 6,470 \cdot 0.538 \approx 3,480 \text{ kcal/kg}$$

Heat Balance for an Average Corpse

As the average consumption of the furnace is known (30.6 kg per corpse, or 61.2 kg for two of them), we will develop the heat balance as an equation in which the unknown stands for the heat needed to heat the combustion air for the corpse and to compensate for the other heat losses not treated by Heepke which, so far, we had not taken into account because they have no effect on the heat balance as such, but only on the volume of the combustion air and hence on that of the off-gas:

$$30.6 \text{ kg} \cdot 2 \cdot 3,480 \text{ kcal/kg} \approx 213,000 \text{ kcal} \quad [136]$$

$$x + W_2 + W_{2a} + W_3 + V_{ls} - W_7 = 213,000 \text{ kcal} \quad [137]$$

$$x + 75,874 + 5,909 + 1,162 + 27,806^{581} - 164,400 = 213,000 \text{ kcal}$$

$$x = 266,649 \text{ kcal}$$

And hence, vice-versa, the heat balance for one average corpse is as follows:

$$\frac{x + W_2 + W_{2a} + W_3 + V_{ls} - W_7}{2 \cdot \eta H_u} = \frac{266,649 + 75,874 + 5,909 + 1,162 + 27,806 - 164,400}{2 \cdot 3,480} = 30.6 \text{ kg of coke} \quad [138]$$

10.4. Heat Balance of the Double-Muffle Furnace at Auschwitz

10.4.1. Heat Losses for the Corpses

Two Lean Corpses

$$\begin{aligned} W_2: 2 \cdot 31.2 \cdot [633 + 0.49 \cdot (700 - 100)] &= 57,845 \text{ kcal} \\ W_{2a}: 2 \cdot 0.44 \cdot 9 \cdot 0.49 \cdot (700 - 100) &= 2,328 \text{ kcal} \\ W_3: 2 \cdot 0.2 \cdot 3.5 \cdot (800 - 20) &= 1,092 \text{ kcal} \\ W_7: &= 71,200 \text{ kcal} \end{aligned}$$

Two Average Corpses

$$\begin{aligned} W_2: 2 \cdot 39.6 \cdot [633 + 0.49 \cdot (700 - 100)] &= 73,418 \text{ kcal} \\ W_{2a}: 2 \cdot 1.01 \cdot 9 \cdot 0.49 \cdot (700 - 100) &= 5,345 \text{ kcal} \\ W_3: 2 \cdot 0.2 \cdot 3.5 \cdot (800 - 20) &= 1,092 \text{ kcal} \\ W_7: &= 164,400 \text{ kcal} \end{aligned}$$

Two Normal Corpses

$$\begin{aligned} W_2: 2 \cdot 45.5 \cdot [633 + 0.49 \cdot (700 - 100)] &= 84,357 \text{ kcal} \\ W_{2a}: 2 \cdot 1.806 \cdot 9 \cdot 0.49 \cdot (700 - 100) &= 9,557 \text{ kcal} \\ W_3: 2 \cdot 0.2 \cdot 3.5 \cdot (800 - 20) &= 1,092 \text{ kcal} \\ W_7: &= 292,200 \text{ kcal} \end{aligned}$$

10.4.2. Heat Losses from the Furnace

$$V_{sch} = \left(0.32 \cdot \frac{78.84}{0.536 \cdot 13.7} + 0.0048 \cdot (9 \cdot 0.51 + 8.21) \right) \cdot (700 - 20) \cdot \frac{100}{6,470}$$

$$\approx 36.7\%$$

$$V_a = 49.5 \cdot \frac{2.8 \cdot 8,100}{56 \cdot 6,470} \approx 3.1\%$$

$$V_{un} = 4\%$$

⁵⁸¹ The total heat loss by radiation and conduction over 40 minutes is: 41,709 kcal/hr \times (40min \div 60min/hr) = 27,806 kcal; see Eq. 128. p. 358.

$$\eta = 100 - (36.7 + 3.1 + 4) = 56.2\%$$

$$\eta H_u = 0.562 \cdot 6,470 \approx 3,640 \text{ kcal/kg}$$

Heat Balance for an Average Corpse

For the double-muffle furnace at Auschwitz, the heat loss associated with the combustion air of the corpses is lower than that for the Gusen Furnace, because for Auschwitz we have assumed a somewhat lower exhaust-gas temperature of 700°C, thus resulting in an energy requirement of:⁵⁸²

$$\frac{266,649 \cdot 0.328 \cdot (700 - 20)}{0.329 \cdot (750 - 20)} \approx 247,630 \text{ kcal} \tag{139}$$

This corresponds to the heat needed for some 1,123 m³ of air to be brought to a temperature of 700°C. The coke required for the cremation of an average corpse is therefore:

$$\frac{x + W_2 + W_{2a} + W_3 + V_{ls} - W_7}{2 \cdot \eta H_u} = \frac{247,630 + 73,418 + 5,345 + 1,092 + 39,000^{583} - 164,400}{2 \cdot 3,640} \approx 27.8 \text{ kg} \tag{140}$$

Heat Balance for Lean and Normal Corpses

Before we proceed to lean and normal corpses, some further remarks on the Gusen cremation statistics are due.

In Table 8, I have list the cremations in the Gusen crematory with their respective coke consumption. Listing the same data sorted by increasing average coke consumption per corpses yields the following table:

Table 9: Ranked Gusen Coke Consumption for Cremations

coke/corpse [kg]	no. of corpses	coke/corpse [kg]	no. of corpses
27.1	42	30.0	42
28.0	30	33.1	38
28.1	49	33.1	58
28.3	53	33.3	63
28.7	94	33.5	34
29.1	72	35.7	57
29.3	45		

The differences in consumption are too large to be attributable simply to the furnace itself. They are no doubt due to differences in the types of corpses cremated. This is confirmed by the observation that the amount of coke used per corpse is not inversely correlated to the number of cremations, as one would expect. For example, on 3 Nov.⁵⁸⁴ we have 42 cremations with an average consumption of 27.1 kg of coke per corpse, yet on the next day we have, for a total

⁵⁸² The factors 0.328/0.329 are a minute correction for the changed heat capacity of the exhaust gases at the lower temperature per Recknagel-Spreng, p. 47.

⁵⁸³ See Eq. 127, p. 357, assuming a cremation took an hour, see Subchapter 8.5.

⁵⁸⁴ For reasons of convenience, I use the date corresponding to the beginning of the series.

of 49 cremations (seven more than the day before), an *increase* to 28.1 kilograms. The following day, the average consumption for 45 cremations rose still further to 29.3 kg, and hit a maximum value of 35.7 kg on 6 Nov. for 57 corpses. On 8 Nov., after 94 cremations, consumption rose from 28.7 to 29.1 kg, and on 9 Nov., after 72 cremations, it rose again from 29.1 to 33.5 kg; the minimum consumption of 27.1 kg was obtained on 3 Nov., with 42 cremations performed after the equally 42 cremations of the previous day, and the maximum value of 35.7 kg occurred on 6 Nov., with 57 cremations performed after the 45 cremations of the previous day. On 10 Nov., we have 33.5 kg/corpses for 34 corpses, yet the following day (11 Nov.), the average coke consumption *sank* to 28 kg, although the number of cremations also went down to 30. The next day (12 Nov.) saw a drastic increase in coke consumption per corpse to 33.1 kg in spite of an almost doubling of the number of cremations from 30 to 58.

If the higher consumption, compared to the general average, depended essentially on the furnace (accumulation of heat in the refractory masonry), more cremations would correspond to lower consumption, but the opposite happens at times in the cases mentioned above.

These differences in the specific consumption cannot be attributed to the handling of the furnace either, because up to 9 November the cremations were carried out under the supervision of Topf Technician August Willing.⁵⁸⁵ Thus, a higher or lower consumption depends essentially on the type of corpse predominantly cremated.

The average coke consumption as a function of the type of corpse cremated can be split into two main groups:

- Between 27.1 and 30.0 kg: 427 corpses, or 63%
- Between 33.1 and 35.7 kg: 250 corpses, or 37%

It is easy to see that one may attribute to the first group primarily the corpses of an average to normal type, while those of an average to lean type would fall into the second category.

On a weighted-average basis, the former group has an average consumption of 28.6 kg of coke per corpse, the latter of 33.8 kg. The consumption of coke for the average corpse thus becomes $[(33.8 + 28.6) : 2 =]$ 31.2 kg, essentially the same figure as the average specific consumption of 30.6 kilograms.

On the basis of these data, one can calculate the heat balance for each one of these groups to a fair degree of accuracy:

Heat Balance of the First Group (Normal to Average Corpses)

$$28.6 \text{ kg} \cdot 2 \cdot 3,480 \text{ kcal/kg} \approx 199,100 \text{ kcal} \quad [141]$$

$$x + W_2 + W_{2a} + W_3 + V_{1s} - W_7 = 199,100 \text{ kcal}$$

Using the data as listed on p. 364 we obtain:

$$x + 87,178 + 10,565 + 1,162 + 27,806 - 292,200 = 199,100 \text{ kcal} \quad [142]$$

⁵⁸⁵ Topf, "Bescheinigung über besondere Berechnung geleisteter Tagelohn-Arbeiten für Bauleitung der Waffen-SS und Polizei Gusen," 12 October – 9 November 1941. BAK, NS 4/Ma 54.

$$x = 364,589 \text{ kcal}$$

This results in an energy requirement of:

$$\frac{364,589 \cdot 0.328 \cdot (700 - 20)}{0.329 \cdot (750 - 20)} \approx 338,600 \text{ kcal} \quad [143]$$

and by using the values for the Auschwitz furnace (p. 365) thus a coke requirement of:

$$\frac{338,600 + 84,357 + 9,557 + 1,092 + 39,000 - 292,200}{2 \cdot 3,640} \approx 24.8 \text{ kg} \quad [144]$$

Heat Balance of the Second Group (Average-to-Lean Corpses)

$$33.8 \text{ kg} \cdot 2 \cdot 3,480 \text{ kcal/kg} \approx 235,200 \text{ kcal} \quad [145]$$

$$x + 59,779 + 2,574 + 1,162 + 27,806 - 71,200 = 235,200 \quad [146]$$

$$x = 215,079$$

$$\frac{215,079 \cdot 0.328 \cdot (700 - 20)}{0.329 \cdot (750 - 20)} \approx 199,740 \text{ kcal} \quad [147]$$

and thus a coke requirement of:

$$\frac{199,740 + 57,845 + 2,328 + 1,092 + 39,000 - 71,200}{2 \cdot 3,640} \approx 31.4 \text{ kg} \quad [148]$$

As the two groups comprise average-to-normal and lean-to-average corpses respectively, coke consumption for one normal corpse is somewhat less than 24.8 kg, and that of a lean corpse somewhat higher than 31.4 kilograms.

In the Kori Furnaces for the destruction of animal remains, lowest consumption was 0.268 kg of *hard coal* for 1 kg of organic substance, thus the minimum *coke* consumption for a normal corpse should be:

$$\frac{70 \text{ kg} \cdot 0.268 \text{ kg coal/kg} \cdot 7,500 \text{ kcal/kg hard coal}}{6,470 \text{ kcal/kg coke}} = 21.7 \text{ kg} \quad [149]$$

We may therefore assume the average value of about $[(24.8 + 21.7) \div 2 =] 23.3$ kg of coke for one normal corpse. Consumption of coke for the cremation of one lean corpse is thus $[27.8 + (27.8 - 23.3) =] 32.3$ kg, because the value for an average corpse is 27.8 kg and that of a normal corpse is 23.3 kilograms per corpse.

Based on these values, the heat balance is as follows:

Heat Balance for a Normal Corpse:

The energy stemming from the fuel is:

$$23.3 \text{ kg} \cdot 2 \cdot 3,640 \text{ kcal/kg} \approx 169,600 \text{ kcal} \quad [150]$$

The total energy requirement x is hence:

$$x + 84,357 + 9,557 + 1,092 + 39,000 - 292,200 = 169,600 \text{ kcal} \quad [151]$$

$$x \approx 327,800 \text{ kcal}$$

Heat Balance for a Lean Corpse:

Again, the energy stemming from the fuel is:

$$32.3 \text{ kg} \cdot 2 \cdot 3,640 \text{ kcal/kg} \approx 235,150 \text{ kcal} \quad [152]$$

and hence the total energy requirement x:

$$x + 57,845 + 2,328 + 1,092 + 39,000 - 71,200 = 235,150 \text{ kcal} \quad [153]$$

$$x \approx 206,100 \text{ kcal}$$

Summarizing, then, we have the following coke consumptions for the Auschwitz type Topf double-muffle furnace:

Table 10: Coke Consumption of the Auschwitz Double-Muffle Furnaces

TYPE OF CORPSE	COKE/CORPSE
Normal	23.3 kg
Average	27.8 kg
Lean	32.3 kg

10.5. Remarks on the Heat Balance

If the heat loss covered by the unknown “x” were entirely assignable to the combustion air, the following values would be valid for the three cases under consideration:

Table 11: Combustion-Air Requirement for the Cremation of Various Types of Corpses

CORPSE	x [kcal]	TOTAL AIR ⁵⁸⁶	THEORETICAL AIR VOLUME ⁵⁸⁷	EXCESS-AIR FACTOR
Normal	327,800	1,970 Nm ³	644 Nm ³	3.06
Average	247,630	1,708 Nm ³	572 Nm ³	2.99
Lean	206,100	1,627 Nm ³	540 Nm ³	3.01

As we can see, the excess-air ratio would be the same as for civilian crematoria, which appears too high; actually, there are heat losses not taken into account by Heepke in his calculation but which are here included together with the combustion-air losses:

1. heat loss due to incombustibles of the corpse;

⁵⁸⁶ Equation used for normal corpses, e.g.: $[327,800 \text{ kcal}/0.328 \text{ kcal}^\circ\text{C}^{-1} \text{ m}^3 (700^\circ\text{C} - 20^\circ\text{C})] + 23.3 \text{ kg} \cdot 2[\text{corpses}] \cdot 1.5[\text{Excess-Air Coefficient, see p. 116}] \cdot 7.17 \text{ Nm}^3/\text{kg} \approx 1,970 \text{ m}^3$.

⁵⁸⁷ Total theoretical air volume = volume needed for the corpse + volume needed for the fuel (coke); for corpse: Eq. 3, p. 25, with corpse data from Section 10.2.3, resulting in: 155 Nm³ (normal), 87 Nm³ (average) and 38 Nm³ (lean) (see Section 10.2.3).
 For coke: Eq. 120, p. 355 ($A_v = 7.17 \text{ Nm}^3/\text{kg}$), with coke consumption following Table 10, resulting in: 167 Nm³ (normal), 199 Nm³ (average) and 232 Nm³ (lean).
 Hence for two muffles/corpses in the double-muffle furnace: normal: $2 (155+167) \text{ Nm}^3 = 644 \text{ Nm}^3$; average: $2 (87+199) \text{ Nm}^3 = 572 \text{ Nm}^3$; lean: $2 (38+232) = 540 \text{ Nm}^3$

2. heat loss due to heating of the dry matter of the corpse up to muffle temperature;
3. heat loss due to heating of coke up to its ignition temperature;
4. heat loss due to the muffle heat absorbed by the corpse introduction device.

These heat losses may be calculated with sufficient accuracy in the following manner:

1. The heat loss through incombustibles of the corpse may be taken to be of the same order of magnitude as those of the coke (7% of the upper heating value of the corpse),⁵⁸⁸ which gives us (Gusen Furnace; see Subchapter 10.3):

$$\text{normal: } 292,200 \text{ kcal} \cdot 0.07 \approx 20,450 \text{ kcal} \quad [154]$$

$$\text{average: } 164,400 \text{ kcal} \cdot 0.07 \approx 11,500 \text{ kcal}$$

$$\text{lean: } 71,200 \text{ kcal} \cdot 0.07 \approx 5,000 \text{ kcal}$$

2. H. Keller based his calculations on a value of the specific heat of $1 \text{ kcal kg}^{-1} \text{ }^\circ\text{C}^{-1}$, as applies to water (H. Keller 1929, p. 3), which appears to be too high, however (see H. Keller's own remark to that effect quoted on p. 111 and marked with "[sic]"). Assuming a specific heat of 0.8, we get for the various types of corpse's combustible dry matter (see Subsection 10.2.3.3):

$$\text{normal: } 2 \cdot 21.0 \text{ kg} \cdot 0.8 \text{ kcal kg}^{-1} \text{ }^\circ\text{C}^{-1} \cdot (850^\circ\text{C} - 20^\circ\text{C}) \approx 27,900 \text{ kcal} [155]$$

$$\text{average: } 2 \cdot 11.9 \text{ kg} \cdot 0.8 \text{ kcal kg}^{-1} \text{ }^\circ\text{C}^{-1} \cdot (850^\circ\text{C} - 20^\circ\text{C}) \approx 15,800 \text{ kcal}$$

$$\text{lean: } 2 \cdot 5.3 \text{ kg} \cdot 0.8 \text{ kcal kg}^{-1} \text{ }^\circ\text{C}^{-1} \cdot (850^\circ\text{C} - 20^\circ\text{C}) \approx 7,000 \text{ kcal}$$

3. As the heating value of coke is not something obtained by precise calorimetric measurements, but the result of a theoretical calculation, the coke will absorb, up to the ignition temperature,⁵⁸⁹ a certain amount of heat⁵⁹⁰ which, in our case, is:

$$\text{normal: } 2 \cdot 25.6 \text{ kg} \cdot 0.24 \text{ kcal kg}^{-1} \text{ }^\circ\text{C}^{-1} \cdot (700-20)^\circ\text{C} \approx 8,400 \text{ kcal} [156]$$

$$\text{average: } 2 \cdot 30.6 \text{ kg} \cdot 0.24 \text{ kcal kg}^{-1} \text{ }^\circ\text{C}^{-1} \cdot (700-20)^\circ\text{C} \approx 10,000 \text{ kcal}$$

$$\text{lean: } 2 \cdot 35.5 \text{ kg} \cdot 0.24 \text{ kcal kg}^{-1} \text{ }^\circ\text{C}^{-1} \cdot (700-20)^\circ\text{C} \approx 11,600 \text{ kcal}$$

4. In the Gusen Furnace, as in those at Birkenau, the corpse was introduced by means of a metal stretcher as described in Chapter 7, which weighed about 50 kilograms. As the device went into the muffle for the equivalent of 75% of its mass and stayed there for several minutes, we may assume, taking into account the low thickness of the metal parts, that this portion heated up to about 300°C ,⁵⁹¹ hence this heat loss, independent of the kind of corpse, is:

⁵⁸⁸ "The experiments done by Debette show that the heat loss due to incomplete combustion is around 2% when the smoke is perfectly clear, but may reach 10% when the smoke is black and dense." Bordoni 1918, p.39.

⁵⁸⁹ The ignition temperature of coal is around 700°C .

⁵⁹⁰ "We must remember that on introduction the coal is cold and must be heated to ignition temperature by draining heat from the hearth; if all of the coal is added at once, the heat so drained may even perturb the combustion of the coal already burning." Cantagalli 1940, p. 111. As an internet search reveals, the heat capacity of coke varies with the type of coal, the degree of coking, and significantly with the temperature. The value used here ($0.24 \text{ kcal kg}^{-1} \text{ }^\circ\text{C}^{-1}$) is an average. The Gusen coke consumption for normal and lean corpses was taken from Table 10 multiplied by a factor 1.1 resulting from the average coke consumption in the Gusen Furnaces (30.6 kg/corpse) being 10% higher than that calculated for the Auschwitz Furnaces (27.8 kg).

⁵⁹¹ Heat radiation to the underside of the stretcher, a surface area of some 0.5 m^2 resting on the grate bars of the muffle, was the equivalent of about 650 kcal/min or $1,300 \text{ kcal}$ within 2 minutes, which would have resulted in heating the stretcher to about 300°C . For the heat capacity of iron see

$$2 \cdot 0.75 \cdot (50 \text{ kg}) \cdot 0.11 \text{ kcal kg}^{-1} \text{ }^{\circ}\text{C}^{-1} \cdot (300^{\circ}\text{C} - 20^{\circ}\text{C}) \approx 2,300 \text{ kcal} \quad [157]$$

Assuming a duration of an hour for the cremation, the total value of these heat losses is therefore roughly:

$$\text{normal: } 20,450 + 27,900 + 8,400 + 2,300 \approx 59,000 \text{ kcal/hr} \quad [158]$$

$$\text{average: } 11,500 + 15,800 + 10,000 + 2,300 \approx 39,600 \text{ kcal/hr}$$

$$\text{lean: } 5,000 + 7,000 + 11,600 + 2,300 \approx 25,900 \text{ kcal/hr}$$

In percent of the unknown value x in the heat balance of the Gusen Furnace (Eqs. 142, 137, 146) this is:

$$\text{normal: } 59,000 \div 364,589 = 16.18\% \quad [159]$$

$$\text{average: } 39,600 \div 266,649 = 14.85\%$$

$$\text{lean: } 25,900 \div 215,079 = 12.04\%$$

As the above figures are approximations, we assume rounded figures when calculating the heat loss due to the combustion air:

$$\text{normal: } 364,600 - 59,000 = 305,600 \text{ kcal/hr} \quad [160]$$

$$\text{average: } 266,600 - 40,000 = 226,600 \text{ kcal/hr}$$

$$\text{lean: } 215,100 - 26,000 = 189,100 \text{ kcal/hr}$$

This amount of heat is needed to heat the following amount of air from 20°C to 750°C :

$$\text{normal: } 305,600 \text{ kcal} \div 0.329 \text{ kcal}^{\circ}\text{C}^{-1}\text{m}^{-3} \cdot 730^{\circ}\text{C} = 1,272.4 \text{ Nm}^3 \quad [161]$$

$$\text{average: } 226,600 \text{ kcal} \div 0.329 \text{ kcal}^{\circ}\text{C}^{-1}\text{m}^{-3} \cdot 730^{\circ}\text{C} = 943.5 \text{ Nm}^3$$

$$\text{lean: } 189,100 \text{ kcal} \div 0.329 \text{ kcal}^{\circ}\text{C}^{-1}\text{m}^{-3} \cdot 730^{\circ}\text{C} = 787.4 \text{ Nm}^3$$

In the Topf double-muffle furnace at Auschwitz the heat needed to raise this volume of air to 700°C amounts to:

$$\text{normal: } 1272.4 \text{ Nm}^3 \cdot 0.328 \text{ kcal}^{\circ}\text{C}^{-1}\text{Nm}^{-3} \cdot 680^{\circ}\text{C} \approx 283,800 \text{ kcal} \quad [162]$$

$$\text{average: } 943.5 \text{ Nm}^3 \cdot 0.328 \text{ kcal}^{\circ}\text{C}^{-1}\text{Nm}^{-3} \cdot 680^{\circ}\text{C} \approx 210,400 \text{ kcal}$$

$$\text{lean: } 787.4 \text{ Nm}^3 \cdot 0.328 \text{ kcal}^{\circ}\text{C}^{-1}\text{Nm}^{-3} \cdot 680^{\circ}\text{C} \approx 175,600 \text{ kcal}$$

Expressed in percent of the x values listed in Table 11:

$$\text{normal: } 283,800/327,800 \approx 86.6\% \quad [163]$$

$$\text{average: } 210,400/247,630 \approx 85.0\%$$

$$\text{lean: } 175,600/206,100 \approx 85.2\%$$

We may therefore conclude that the total volume of combustion air for the Topf double-muffle furnace at Auschwitz was:

$$\text{normal: } 1272.4 \text{ Nm}^3 + 2 \cdot 23.3 \text{ kg} \cdot 7.17 \text{ Nm}^3/\text{kg} \cdot 1.5^{[592]} = 1,774 \text{ Nm}^3 \quad [164]$$

$$\text{average: } 943.5 \text{ Nm}^3 + 2 \cdot 27.8 \text{ kg} \cdot 7.17 \text{ Nm}^3/\text{kg} \cdot 1.5 = 1,541 \text{ Nm}^3$$

$$\text{lean: } 787.4 \text{ Nm}^3 + 2 \cdot 32.3 \text{ kg} \cdot 7.17 \text{ Nm}^3/\text{kg} \cdot 1.5 = 1,482 \text{ Nm}^3$$

The excess-air ratio was therefore:⁵⁹³

$$\frac{1,542 \text{ m}^3}{2[\text{corpses}] \cdot 87 \text{ m}^3/\text{corpse} + 2[\text{corpses}] \cdot 27.8 \text{ kg} \cdot 7.17 \text{ Nm}^3/\text{kg}} \approx 2.7 \quad [165]$$

The initial table must therefore be corrected as follows:

www.engineeringtoolbox.com/specific-heat-metals-d_152.html.

⁵⁹² Excess-Air Coefficient, see p. 116.

⁵⁹³ For the theoretical combustion volume per average corpse of 87 m^3 see p. 362.

Table 12: Corrected Total Combustion Air Need for Various Corpses

TYPE OF CORPSE	TOTAL AIR	THEORETICAL AIR VOLUME	EXCESS-AIR FACTOR
Normal	1,774 m ³	644 m ³	2.75
Average	1,541 m ³	572 m ³	2.69
Lean	1,482 m ³	540 m ³	2.74

10.6. Heat Balance of the Topf Triple-Muffle Furnace

The triple-muffle furnace consists of a furnace with two muffles to which a center muffle has been added. The two outer muffles operated as in a double-muffle furnace but discharged their off-gases into the center muffle. As the furnace operated with a rather high excess-air ratio, the off-gas contains a certain amount of oxygen which could be used for the combustion of the corpse in the center muffle, thus bringing about a certain saving in coke consumption. The following table gives the volume of air which passed on into the center muffle from the outer ones (available air):

Table 13: as Table 12, plus Available Uncombusted Air for Center Muffle

TYPE OF CORPSE	TOTAL AIR	THEORETICAL AIR VOLUME	EXCESS-AIR RATIO	AVAILABLE AIR
Normal	1,774 m ³	644 m ³	2.75	1,130 m ³
Average	1,541 m ³	572 m ³	2.69	969 m ³
Lean	1,482 m ³	540 m ³	2.74	942 m ³

In the case of a normal corpse, for example, 1,130 Nm³ of uncombusted air entered the center muffle, whereas the combustion air of the corpse and the coke for each of the outer muffles amounted to only $(1,774 \div 2 =) 887$ Nm³ of air.

However, the amount of coke consumed by the two outer muffles could not be less than in the double-muffle furnace; rather, it had to be slightly more, as they had greater heat losses by radiation and conduction (see Eq. 127, p. 357, compared to Eq. 131, p. 360). For example, the cremation of a normal corpse in the outer muffles required this much coke:

$$23.3 \text{ kg} + \frac{45,100 \text{ kcal/hr} - 39,000 \text{ kcal/hr}}{2 \cdot 3,640 \text{ kcal/kg}} \approx 24.1 \text{ kg} \quad [166]$$

Furthermore, in the center muffle, there are various other sources of air:

- Air entering the muffle during the introduction of the corpse.
- False air entering through the cracks around the doors and closures.
- Air coming from the blower (*Druckluftgebläse*) which could not be individually controlled and thus fed air simultaneously into all three muffles.

On the other hand, a possible overheating of the center muffle does not affect the overall heat balance in a significant manner, because, while the center muffle heats up essentially by radiation, the two outer muffles heat up mainly by conduction. Thus, even if the center muffle had been 200°C hotter than the outer muffles (1000°C instead of 800°C), the heat loss through conduction (V_i) would be minor:

$$V_1 = \frac{\lambda \cdot F \cdot \Delta T}{d} \quad [167]$$

With the heat conductivity of refractory brick $\lambda = 0.73$ (see Subsection 10.2.2.1), the internal contact surface $F = (2 \cdot 2 \text{ m} \cdot 0.3 \text{ m})^{594} 1.2 \text{ m}^2$, the thickness of that material $d = 0.25 \text{ m}$, and the assumed temperature difference ΔT of 200°C , we obtain:

$$\frac{0.73 \text{ kcal m}^{-1} \text{ }^\circ\text{C}^{-1} \text{ hr}^{-1} \cdot 1.2 \text{ m}^2 \cdot 200^\circ\text{C}}{0.25 \text{ m}} \approx 700 \text{ kcal/hr}$$

to the outer muffles while, at the same time, leading to a drastic drop in furnace efficiency due to the high temperature of the exhaust gases⁵⁹⁵ and a correspondingly drastic increase in coke consumption.

Other factors also have a negative effect on the heat balance:

- As will be explained in Subchapter 10.10., the dwell time of the off-gases in the muffle is insufficient for a complete combustion of the unburnt gases, which means that the gases generated by the gasification of the corpse either burn in the flue ducts or leave the chimney unburnt in the form of smoke.
- Furnace management was effected by means of a single flue-gas damper for all three muffles. The combustion of the corpses thus cannot be controlled individually for each muffle, and thus leads to an increase in the portion of unburnt gases.

From the above it can clearly be seen that the combustion air was not proportional to what was available in the double-muffle furnace. Hence one cannot calculate a heat balance along the same lines. However, knowing, as we do, that consumption of coke for three corpses could not have been less than what can be observed for the two outer muffles, we are able to calculate a minimum theoretical limit for the consumption.

We know that the triple-muffle furnace's heat loss by radiation and conduction was 61,220 kcal/hr, and that of the center muffle was 16,120 kcal/hr [Eqs. 129 & 130, p. 359]. Theoretically, the triple-muffle furnace behaved like a double-muffle furnace with the center muffle inserted, hence resulting in an additional heat loss of 16,120 kcal/hr. The triple-muffle furnace's theoretical minimum consumption of coke was therefore equal to that of the double-muffle furnace plus that of the center muffle. We therefore add to the double-muffle furnace's coke consumption that caused by the additional heat loss of the triple-muffle furnace due to its center muffle, and apply this to three instead of just two corpses:

Normal Corpse

$$\left(23.3 + \frac{16,120 \text{ kcal/hr}}{2 \cdot 3,640 \text{ kcal/kg}} \right) \cdot \frac{2}{3} \approx 17 \text{ kg per corpse.} \quad [168]$$

⁵⁹⁴ 2 muffle walls, 2 m long, 0.3 m high from the muffle grate to the beginning of the vaulted muffle ceiling.

⁵⁹⁵ For a smoke temperature of 900°C , the efficiency would be around 45%.

Average Corpse

$$\left(27.8 + \frac{16,120 \text{ kcal/hr}}{2 \cdot 3,640 \text{ kcal/kg}}\right) \cdot \frac{1}{3} \approx 20 \text{ kg per corpse.} \quad [169]$$

Lean Corpse

$$\left(32.3 + \frac{16,120 \text{ kcal/hr}}{2 \cdot 3,640 \text{ kcal/kg}}\right) \cdot \frac{1}{3} \approx 23 \text{ kg per corpse.} \quad [170]$$

The amount of coke for lean corpses corresponds well to the maximum hourly coke throughput rate of the two gasifiers, split up for the three muffles:

$$\frac{2 \cdot 35 \text{ kg/hr}}{3 \text{ lean corpses}} = 23.3 \text{ kg per hour and corpse} \quad [171]$$

As previously explained, the above calculation of the coke consumption is the theoretical *minimum*. In practice, if the hourly coke consumption was 70 kg, and if the cremation lasted one hour on average, 23.3 kg of coke was also the real consumption for the cremation of a normal corpse. In this case the excess heat (since by hypothesis the furnace was in thermal equilibrium and did not absorb additional heat) was lost in the fireplace and through the chimney.

In practice only the cremation of a normal corpse lasted one hour, though. We know from experience that the cremation of lean corpses lasted longer, as much as 1.5 hours or more. As a result, the *actual* coke consumption during the cremation of lean corpses was closer to $(1.5 \text{ hr} \cdot 23.3 \text{ kg}) \approx 35 \text{ kg}$ or even higher in the triple-muffle furnaces.

We clearly have reached here the limits of our extrapolations, but we may assume that additional heat losses due to excess air in the center muffle are minor compared to the contribution of the two lateral muffles.

Hence, for simplicity's sake I abstain from listing any concrete contribution to the excess air by the center muffle in the following table, and indicate only that it would be greater than zero. We thus obtain for the triple-muffle furnace the following *minimum* excess-air ratios:

Table 14: Combustion-Air Availability in Auschwitz Triple-Muffle Furnace

TYPE OF CORPSE	AIR OUTSIDE MUFFLE	THEORETICAL AIR	CENTER MUFFLE AIR	EXCESS-AIR RATIO
Normal	1,774 m ³	810 m ³	> 0 m ³	> 2.19
Average	1,541 m ³	671 m ³	> 0 m ³	> 2.30
Lean	1,482 m ³	588 m ³	> 0 m ³	> 2.52

In the letter Kurt Prüfer wrote on 15 November 1942 to the owners of the Topf Firm, Ludwig and Ernst-Wolfgang Topf, he stated that the triple-muffle furnaces designed by him, which had been set up in the Buchenwald Crematorium, had shown a performance one third higher than what he had expected.⁵⁹⁶ The cause of this decrease in coke consumption can only be what we have set out

⁵⁹⁶ APMO, BW 30/46, p. 18.

above. As Prüfer had based himself on a grate-throughput rate of 70 kg of coke per hour for the two gasifiers under natural draft, a reduction of one third corresponds to 46.67 kg of coke per hour, or 15.5 kg of coke for each muffle. In view of the fact that a cremation lasted one hour as well, this consumption also refers to one cremation in one muffle and is thus close to what we have calculated for a normal corpse.

10.7. Heat Balance of the Topf 8-Muffle Furnace

The 8-muffle furnace consisted of four pairs of independent muffles, but the two muffles of each pair were connected. Because in this case, too, the combustion products of the first muffle passed on through the second, what I said earlier for the triple-muffle furnace applies here as well: the off-gas from the first muffle contained an amount of oxygen theoretically high enough for the combustion of the corpse in the second muffle, as shown in the table below:

Table 15: Combustion-Air Data for Auschwitz 8-Muffle Furnace

TYPE OF CORPSE	TOTAL AIR*	THEORETICAL AIR*	AVAILABLE AIR
normal	887 m ³	– 322 m ³ =	565 m ³
average	771 m ³	– 286 m ³ =	485 m ³
lean	741 m ³	– 270 m ³ =	471 m ³

* Half of values of Table 12, p. 372

In this case as well, a possible overheating of the second muffle could not affect, in a relevant manner, the overall heat balance, because the coke consumption could not be less than for the first muffle. We will therefore assume also for this furnace a *minimum theoretical consumption* corresponding to half of that for the double-muffle furnace:

- Normal corpse: $23.5/2 = 11.75$ kg, rounded to 12 kg
- Average corpse: $28.0/2 = 14.00$ kg
- Lean corpse: $32.5/2 = 16.25$ kg, rounded to 16 kg

Table 16: General summary of the coke consumption

TYPE OF CORPSE	DOUBLE-MUFFLE	TRIPLE-MUFFLE	8-MUFFLE
normal	23.3 kg	≥17 kg	≥12 kg
average	27.8 kg	≥20 kg	≥14 kg
lean	32.3 kg	≥23 kg	≥16 kg

10.8. Observations on the Coke Consumption of the Triple- and 8-Muffle Furnaces

The *Aktenvermerk* (file memo) of 17 March 1943, written by the civilian employee Jährling and established “according to data supplied by Topf & Söhne”⁵⁹⁷ contains an estimate of the coke consumption of the four Birkenau Crematoria. This document requires some explanations.

⁵⁹⁷ APMO, BW 30/7/34, p. 54. Cf. Document 264.

The heading “10 Feuerungen = 350 kg/stdl.” (10 hearths = 350 kg/hr) means that the five triple-muffle furnaces located in each of the Crematoria II and III had a total of 10 gasifier hearths, two per furnace, each with a grate throughput rate of 35 kg/hr of coke, just as the 8-muffle furnaces of Crematoria IV and V had four hearths each, each one with a throughput of 35 kg of coke per hour.

The reduction of coke consumption by 1/3 “*bei Dauerbetrieb*” (in continuous operation) is based on the fact that, in this case, consumption was considerably lower than what was needed in discontinuous use.

The letter by Topf giving the data mentioned by Jährling has not been found, but it is improbable that it contained a calculation similar to the one presented by the Central Construction Office employee. The computation, although basically correct, is, in fact, somewhat misleading, as it refers to the grate throughput rather than to the number of corpses cremated, which would have been more-pertinent and more-useful in practice, as was the case in the chart giving coke consumptions as a function of the number of cremations in civilian crematoria which was presented in Unit I (cf. Document 90).

In line with such a chart, applicable only to a few civilian furnaces, Topf would surely have referred to a reduction of coke consumption with an increasing number of corpses cremated and an increasing frequency of cremations, as was shown in actual operation for the Gusen Furnace.

Between 26 September and 15 October 1941, over a total span of 20 days, 193 corpses were cremated in the Gusen Furnace on ten days of operation. On average, cremations took place every other day, with 19 corpses cremated during each cycle and a consumption of 47.5 kg of coke per corpse.

Between 26 and 30 October, over a span of five days, 129 corpses were cremated in the Gusen Furnace. Cremations took place each day, with 26 corpses being cremated daily on average, leading to a coke consumption of 37.2 kg per corpse.

Between 31 October and 12 November, a span of 13 days, 677 corpses were cremated in the Gusen Furnace. Cremations took place each day, for an average number of 52 corpses cremated daily and a consumption of 30.6 kg of coke per corpse.

Thus, moving from a discontinuous operation (cremations every other day) and relatively few cremations (19 per day)⁵⁹⁸ to a continuous operation (daily cremations) with many cremations (52 per day), specific coke consumption dropped from 47.5 to 30.6 kg, *i.e.* to $[(30.6 \div 47.5) \cdot 100 =]$ 64.42%, for a saving in coke of a little more than one third.⁵⁹⁹ In practice, if the cremation of 20 corpses required $(20 \cdot 47.5 =)$ 950 kg of coke in the first case, only $(950 \cdot 0.6442 =)$ 612 kg – or $(30.6 \cdot 20 =)$ 612 kg – were needed in the third case. The difference of $950 - 612 = 338$ kg was consumed in heating up the furnace after it had cooled for more than 24 hours.

⁵⁹⁸ The reader should remember that the furnace had two muffles and 19 cremations per day, thus corresponded to about 10 loadings per muffle.

⁵⁹⁹ For an intermediate case of daily, but not-very-numerous cremations, coke saving would have been about 1/6.

In the same way, in the file memo of 17 March 1943, the reduction in coke consumption of one third in 12 hours of operation – from 4,200 to 2,800 kg – can only mean that the difference of 1,400 kg was used for heating the five furnaces,⁶⁰⁰ and the remainder of 2,800 kg concerned the cremations themselves. This does not mean, however, that the normal grate-throughput rate would drop by one third in continuous operation.

We must remember that the gasifiers could not be controlled like a gas burner, which can easily be turned on and off in line with the cremation demand at hand. The coke on the grates burned continuously for the whole duration of the cremations. This can be seen very clearly in Document 47, in which the line “D” shows the hearth draft, curve “C” the chimney draft and the figures for “G” indicate the degree and duration of the opening of the combustion-air inlets of the gasifier.

After the preheating phase, when the furnace had reached its operating temperature, the curve of the hearth draft, logically, follows the curve of the chimney draft; the one maintaining itself, with minor fluctuations, around 10 mm of water column, the other, in a similar manner, around 5 mm. In line with the brief periods during which the gasifier door was open, the chimney draft then touched a level of 15 mm; that of the hearth, 10 mm of water column. In the long intervals in between, when this door stayed shut, the chimney normally had a draft of 10 and the hearth of 5 mm water column. This demonstrates that the normal combustion rate of the hearth was about 33.3 kg of coke⁶⁰¹ per hour all through the cremation, without major differences between preheating and cremating periods.

As I explained in Subchapter 8.3, the normal grate-throughput rate of 120 kg h⁻¹ m⁻² could be increased by increasing the draft by means of a draft enhancer, but it could not be reduced to any significant degree. It follows that, although the triple-muffle and the 8-muffle furnaces theoretically had an average coke requirement of [(17+20+23)÷3 =] 20 and [(12+14+16)÷3 =] 14 kg of coke per hour respectively, actual consumption in continuous operation was as follows:

Table 17: Actual Coke Consumption of Triple- and 8-Muffle Furnaces

	GRATE-THROUGHPUT RATE OF HEARTHS	COKE PER HOUR, MUFFLE & CORPSE
Triple-muffle furnace	70 kg/hr	23.3 kg
8-muffle furnace	140 kg/hr	17.5 kg

If, for greater coke economy, one had wanted to slow down the combustion on the hearths, it would have been necessary to reduce the chimney draft, but that would have affected the cremation as well and lengthened it, which would, in turn, have led to an increase in the consumption of coke per cremation in proportion to the increasing duration of the cremation.

⁶⁰⁰ By this, we mean preheating all of the furnace brickwork to a steady state.

⁶⁰¹ This is obtained by dividing the coke consumption (457 kg) by the total operating time of the furnace (13 hours and 42 minutes).

10.9. A Comparison with the Kori Furnace at the Westerbork Camp and the Kori Slaughterhouse Furnaces

Thanks to its design, the Kori Furnace at the Westerbork Camp showed a better performance than the Topf Furnaces. As there were many corpses of children among the corpses cremated, it is not possible to deduce with certainty the amount of coke needed for an average adult corpse. If we base ourselves on the cremations listed in Subchapter 8.4. for which the coke consumption is documented, we find a total weight of 3,170 kg of coke for 163 cremated corpses, 43 of them children who together could be considered the equivalent in weight of six adult corpses. This yields an average coke consumption of about $(3,170 \div (163 - 43 + 6) =)$ 25.2 kg per adult-corpse equivalent.

The minimum consumption is shown for 7 June 1943, 150 kg of coke for 13 corpses, among them two babies of 2 and 10 months, respectively. Such a low value can only be explained by assuming the use of a light-weight coffin of raw boards, such as the one shown in Photo 362.

This does not affect the heat balance of the Topf Furnaces, however, as the latter is based on the effective consumptions of the Topf Furnace at Gusen.

On the other hand, the data from the Kori Furnaces for slaughterhouses agree rather well with the data from the Topf Furnace at the Gusen Camp and with those for the double-muffle furnace at Auschwitz, not only as far as consumption is concerned, but also with respect to duration of the cremations, as we can gather from the table below in which the results for different models of Kori Furnaces refer to an equivalent corpse of about 70 kilograms (see Section 9.2.1.):

Table 18: Kori slaughterhouse-furnace performance data for an average 70 kg corpse

FURNACE TYPE	COAL CONSUMPTION	DURATION OF CREMATION
1a	≈ 23.0 kg	≈ 63 min
1b	≈ 22.7 kg	≈ 62 min
2a	≈ 21.7 kg	≈ 60 min
2b	≈ 20.6 kg	≈ 58 min
3a	≈ 20.3 kg	≈ 57 min
3b	≈ 19.2 kg	≈ 54 min
4a	≈ 19.6 kg	≈ 52 min
4b	≈ 18.8 kg	≈ 50 min

The consumption figures refer to fueling with hard coal, which has a higher heating value than coke (7,500 kcal/kg on average). For coke, they would have to be increased by 3 to 3.7 kg in each case. Thus, the equivalent consumption of coke would become about 26.7 kg for a Type 1a Furnace, or 21.8 kg for a Type 4b Furnace.

10.10. Some Thermal Aspects of the Triple-Muffle Furnace

In Chapter 2, the fact was mentioned that the first electrically fired Topf Furnace set up in the Erfurt crematorium immediately presented a problem in that smoke formed during the cremations. An investigation of this phenomenon resulted in the following assessment (Weiss 1934, pp. 454f.):

“The smoke was not due to the fact that the carbon particles could not burn completely because of a lack of oxygen. The muffle had been designed to the lowest possible dimensions for avoiding waste of heat during preheating, and the carbon particles therefore had to burn in the flue ducts. On account of the very-strong enhanced draft of 12-24 mm of water column, the flue-gas velocity was high, and the dwell time of the particles in the flue ducts was thus too short. This residence time was insufficient to allow the particles to burn out completely; instead, immediately on entering the flue ducts they cooled down far enough to stop burning. This strong cooling of the fumes was aggravated by other factors. First of all, because of the high velocity in the narrow tubes of the preheater, the combustion air was insufficiently preheated, which meant that, from the very beginning, high flame temperatures could not be maintained at such a high excess air ratio.

Secondly, because of the strong draft, the furnace drew in large amounts of false air through the cracks around the closures and on account of other defects of caulking which caused further cooling of the fumes. Thirdly, during the decomposition of the corpse, large amounts of water vapor were generated, which absorbed from the fumes the heat necessary for vaporization and cooled them still more. Thus, the oil vapors generated at the same time could no longer burn. Measurement of the discharge-gas temperatures proved conclusively that the flames, at best, were extinguished even before entering the flue duct.”

This phenomenon had already been observed by the engineer H. Keller who had noted, in connection with the Ruppmann Gasifier at the Biel Crematorium (H. Keller 1928, pp. 27f.):

“When combustible gases are generated by these processes, such as light or heavy hydrocarbons as they are called in the language of chemical engineering, they are immediately sucked up by the chimney and, for the most part, can no longer burn in the cremation chamber or the post-combustion chamber, but instead move on into the recuperator. If this part is hot enough, [the hydrocarbons] will ignite, and combustion will take place there.

The lighter hydrocarbons will certainly finish their combustion in the post-combustion chamber, but for the heavier ones, present in larger quantities, at times even the recuperator is insufficient, and they will exit the chimney into the atmosphere in the form of smoke.”

To make matters clearer, we have to take a closer look at the thermal phenomena encountered here.

The intensity in space of a combustion, expressed as kcal per m³ and h, is essentially a function of the amount of fuel burnt per hour, and the maximum intensity is controlled by the rate of combustion, which can be defined as the volumetric velocity of the spread of the flame per unit area; therefore, the combustion time must always be equal to or less than the residence time of the fuel in

the cremation chamber. If this condition is not fulfilled, the flame will extend beyond the cremation chamber, provided, of course, that conditions for combustion can be found there (Salvi, p. 217).

Thus, if the flow rate of a combustible-gas mixture in a combustion chamber is higher than its rate of combustion, the mixture will not completely burn in the cremation chamber but will continue to burn downstream of it if conditions there are favorable, or it will leave the installation unburnt if conditions are unfavorable.

In order to prevent any such emission into the atmosphere, modern cremation equipment has a post-combustion chamber for any such fumes.⁶⁰²

As an example, we may look at incinerators for urban waste. The operating temperature for such furnaces must be between 900 and 1000°C, with an optimum value around 950°C. The slag and the ash have softening points between 1050 and 1150°C;⁶⁰³ if such a temperature is reached and maintained for a sufficiently long time, deposits and incrustations will form on the grates, on the walls of the incineration chamber and along the flue ducts, affecting the geometry of the installation and lowering its combustion performance.

The combustion products must remain in the post-combustion chamber for at least two seconds; the latter must be equipped with an auxiliary combustion device with automatic control in order to ensure that a minimum temperature of 950°C is maintained (Colombo, p. E740f.).

During the decomposition of a corpse in a cremation chamber, combustible gases such as carbon monoxide or light and heavy hydrocarbons will form, in addition to volatile carbon particles. The maximum ignition rate of most hydrocarbons in air under atmospheric conditions varies between 25 and 100 cm/sec, or, volumetrically, between 0.25 and 1 m³/sec (*Enciclopedia della Scienza...* 1963, vol. III. pp. 365f.). In normal practice, however, higher values will be used. This is true not only for incinerators, but also for crematoria. For the most-recent electrically heated cremation furnaces built by the Brown Boveri AG Co., a dwell time of 1.3 to 2.3 seconds in the post-combustion channels is maintained, with preheating to 800°C (see Unit I, Chapter 11). For the Therm-Tec Models SQC 300 and 400 Furnaces (Sherwood, Oregon, USA), this dwell time is 1.5 seconds (see Document 109a).⁶⁰⁴

Hence, for the necessary minimum dwell time of the gases generated during the decomposition of a body, we may assume 1.3 seconds.

The experiments carried out by the engineer H. Keller on the electrically heated furnace at Biel are an excellent example to illustrate this problem of heat engineering. During the cremation of a corpse weighing 110 kg on 26 September 1940, a maximum generation rate of 3,570 m³ of exhaust gas per hour at an

⁶⁰² Even the refuse-incineration furnace installed at the cemetery of Frankfurt/Main in Germany at the end of the 1930s had a post-combustion chamber for the fumes, located above the combustion chamber. Heinemann 1940, pp. 189f.

⁶⁰³ Since ash is an amorphous mixture of various compounds, it does not have a sharply defined melting point, but softening occurs continuously over a wide temperature range.

⁶⁰⁴ <https://web.archive.org/web/20190218153821/http://thermtec.com/sites/default/files/pdf-library/SQC-400%20SPECS.pdf>; .../SQC-300 SPECS_0.pdf

exhaust temperature of 380°C was observed 50 minutes after introduction of the corpse into the furnace (cf. Document 54). This rate corresponds to:

$$3,570 \text{ m}^3/\text{hr} \cdot \frac{273^\circ\text{C}}{380^\circ\text{C} + 273^\circ\text{C}} = 1,492 \text{ Nm}^3/\text{hr} \quad [172]$$

At 800°C inside the muffle, this corresponds to a volumetric rate in the muffle of:

$$1,492 \text{ Nm}^3/\text{hr} \cdot \frac{800^\circ\text{C} + 273^\circ\text{C}}{273^\circ\text{C}} = 5,864 \text{ m}^3/\text{hr} \quad [173]$$

or

$$\frac{5,864 \text{ m}^3/\text{hr}}{3,600 \text{ sec/hr}} = 1.63 \text{ m}^3/\text{sec}. \quad [174]$$

The cremation chamber of the furnace in question, including the space below the grate, had a volume of some 2.5 m³, hence the average residence time of the fumes in the cremation chamber was 2.5 ÷ 1.63 = 1.53 seconds.

If we apply the same reasoning to the Topf double-muffle furnace, we obtain, for one muffle with one normal corpse and a cremation time of 60 minutes (see Table 12, p. 372), 1,774 Nm³ ÷ 2 = 887 Nm³ of dry fumes, which at 800°C becomes:

$$887 \text{ Nm}^3/\text{hr} \cdot \frac{800^\circ\text{C} + 273^\circ\text{C}}{273^\circ\text{C}} = 3,486 \text{ m}^3/\text{hr} \quad [175]$$

or on average:

$$\frac{3,486 \text{ m}^3/\text{hr}}{3,600 \text{ sec/hr}} = 0.97 \text{ m}^3/\text{sec}. \quad [176]$$

This yields an average dwell time of:

$$\frac{1.4 \text{ m}^3}{0.97 \text{ m}^3/\text{sec}} = 1.44 \text{ seconds} \quad [177]$$

This is the average time for the passage of the combustible gases through the cremation chamber.⁶⁰⁵ This issue points out a serious flaw in the design of the Topf triple-muffle furnace.

We have seen in the preceding section that Engineer Prüfer, when designing the triple-muffle furnace, did not realize initially the advantage in heat consumption brought about by the passage of the fumes from the two outer muffles into the center one; but the fact that he gave to this muffle exactly the same dimensions as he had used for the outer muffles shows, moreover, that he had also not noticed a serious drawback of his design, directly related to the advantage it had: The gas volume which passed through the center muffle was more than twice that going through one muffle of the double-muffle furnace. As we have seen, the dwell time for such a muffle already touched the minimum of the combustion time of these gases; therefore, if one wanted to maintain in the cen-

⁶⁰⁵ The varying intensity of smoke generation during a cremation could be compensated by a possible staggering of cremations.

ter muffle a dwell time equal to that applying to the double-muffle furnace, it would have been necessary to at least double the volume of the center muffle, in a similar fashion as, during the design of the smoke ducts of Crematoria II/III, it was provided that the cross-section of the smoke ducts was increased from 60 cm × 70 cm to 80 cm × 120 cm when two individual furnace flues merged into one chimney duct, as mentioned before, precisely because the exhaust gases from two furnace flues merged in each duct.

Prüfer, however, had not recognized this bottleneck. If he had wanted to obtain a complete combustion of all the gases in the center muffle of the designed size, he would have had to reduce the combustion rate of the corpse in that muffle by half. Taking the calculated *minimum* total gases flowing through the center muffle during the cremation of a lean and a normal corpses (see Table 14, p. 374), these 1,482 m³ and 1,774 m³ Nm³/hr speeds of dry fumes, respectively, became at 800°C:

$$\text{Normal: } 1,744 \text{ Nm}^3/\text{hr} \cdot \frac{800^\circ\text{C} + 273^\circ\text{C}}{273^\circ\text{C}} = 6,855 \text{ m}^3/\text{hr} \quad [178]$$

$$\text{Lean: } 1,482 \text{ Nm}^3/\text{hr} \cdot \frac{800^\circ\text{C} + 273^\circ\text{C}}{273^\circ\text{C}} = 5,825 \text{ m}^3/\text{hr}$$

This is equivalent to:

$$\text{Normal: } \frac{6,855 \text{ m}^3/\text{hr}}{3,600 \text{ sec/hr}} = 1.90 \text{ m}^3/\text{sec} \quad [179]$$

$$\text{Lean: } \frac{5,825 \text{ m}^3/\text{hr}}{3,600 \text{ sec/hr}} = 1.62 \text{ m}^3/\text{sec}$$

This led to an average residence time in the center muffle of:

$$\text{Normal: } \frac{1.5 \text{ m}^3}{1.9 \text{ m}^3/\text{sec}} = 0.79 \text{ sec} \quad [180]$$

$$\text{Lean: } \frac{1.5 \text{ m}^3}{1.62 \text{ m}^3/\text{sec}} = 0.93 \text{ sec}$$

This means that the heavier hydrocarbons which formed during the decomposition of the corpse located in the center muffle did not have enough time to burn out completely and left the muffle unburnt. If the temperature in the flue duct was lower than the ignition temperature of these gases, smoke would have been generated. But if the temperature was high enough, the off-gas could burn out in the duct, potentially damaging it, as in fact happened at the end of March 1943.

10.11. On Claims of Flaming Chimneys

The question of flaming chimneys, which some witnesses claim to have observed, is directly linked to the matters dealt with in the preceding subchapter: could the combustion of unburnt gases have moved through the flue ducts to the atmosphere and thus given rise to the appearance of flaming chimneys? Let us first look at this question in connection with Crematoria II and III.

A calculation based on the actual conditions in these crematoria shows that the phenomenon could not occur, even under the most favorable conditions, *i.e.* in the case of three normal corpses in the pair of furnaces having the shortest flue duct, without taking the volume of the cremation chamber into account. The third and fourth furnaces of these crematoria had flue ducts of a cross-sectional area of 0.42 m² (0.6 m × 0.7 m) and respective lengths of some 6.5 and 10.5 m. Both opened into the duct of the central forced-draft device, which had a length of 2 m and a cross-section of 0.8 m × 1.2 m, which itself opened into the central duct of the chimney. The latter was 15.46 m high and had a cross section of 0.8 m × 1.2 meters.

Hence, the average section of the shortest duct was:

$$\frac{6.5 \text{ m} \cdot 0.42 \text{ m}^2 + \frac{17.5 \text{ m} \cdot 0.96 \text{ m}^2}{2}}{24 \text{ m}} = 0.46 \text{ m}^2. \quad [181]$$

In this calculation, we have divided by two the cross-sectional area of the duct common to the forced-draft device and the chimney duct, because the gas volume doubled on account of the gas coming from the fourth furnace; we have also given the chimney an approximate height of 15.5 meters, so that the overall length of the flue duct plus the chimney duct is 24 meters.

Three normal corpses and the necessary amount of coke will generate 1,774 Nm³ of dry fumes and 230.5 Nm³ of water vapor,⁶⁰⁶ for a total of almost 2,005 Nm³ of moist gas, which, at 700°C, had a volume of about:

$$2,005 \text{ Nm}^3 \cdot \frac{700^\circ\text{C} + 273^\circ\text{C}}{273^\circ\text{C}} = 7,146 \text{ m}^3. \quad [182]$$

If that gas is discharged over a time span of one hour, the average gas velocity thus becomes:

$$\frac{7,146 \text{ m}^3/\text{hr}}{0.46 \text{ m}^2 \cdot 3,600 \text{ sec}/\text{hr}} \approx 4.3 \text{ m}/\text{sec}. \quad [183]$$

Hence the dwell time of the gas within the discharge ducts is:

$$\frac{24 \text{ m}}{4.3 \text{ m}/\text{sec}} = 5.5 \text{ sec}. \quad [184]$$

This time is more than sufficient for the combustion of any unburnt gases, all-the-more-so as we have not even included the volume of the three cremation chambers themselves.

In order to verify experimentally the validity of this calculation, I have carried out a number of experiments involving the incineration of animal fats in a field furnace which gave rise to the phenomenon of a flaming chimney. The field furnace had two grates, the lower one for wood (the hearth), and the upper one for the fat. Photo 368 shows the result of an experiment carried out on 21 October 1994.

⁶⁰⁶ See list on page **Error! Bookmark not defined.**: 3 corpses · (20.23 Nm³ + 56.60 Nm³) = 230.5 Nm³.. For a simplification of the calculations, we assume the dry fumes to be the equivalent of the combustion air.

On the upper grate of the field furnace, the author placed an aluminum tray (33 cm × 25 cm × 5 cm) containing 400 grams of lard (pork fat). Then he lit the wood piled up on the lower grate, partly blocking the opening of the combustion chamber with a block of tuff.

After melting, the lard started to boil, and the vapors caught fire immediately. The flames were visible a few centimeters above the surface of the boiling fat, with the latter remaining clearly visible. In the most-intense phase of combustion, the flames shot out of the chimney to a height of one and a half meters above its mouth and more than two meters above the tray with the boiling fat. Combustion took about five minutes.

The explanation of the phenomenon is as follows: the volumetric velocity of the gases which developed from the decomposition of the fat was higher than their combustion velocity, *i.e.* their residence time in the combustion chamber was lower than the time needed for their complete combustion, which then took place outside the combustion chamber and even above the chimney.

In order to verify this explanation, the author then carried out two more combustion experiment with animal fat:

1. Combustion Chamber with a Short Chimney (10 January 1995)

The experiment was carried out in a field furnace of tuff blocks with two grates, the lower one for wood as fuel, the upper one for the fat. The combustion chamber measured about 0.05 m³, and possessed a chimney 0.54 m high with a cross-sectional area of 0.27 m × 0.27 m, set at a level of 10 cm above the upper grate. The author placed an aluminum tray (17 cm × 22 cm) containing 200 grams of lard on this grate. He then loaded the lower grate with wood and lit it. After a few minutes, the boiling fat caught fire, and tall flames shot out of the chimney up to a level of 70 cm above its mouth (Photo 369). Combustion of the fat took three minutes, and was most-intense for about two minutes and 45 seconds.

2. Combustion Chamber with a Long Chimney (10 January 1995)

The author then removed one layer of tuff blocks from the chimney and placed there an ordinary stove pipe of a length of 2.10 m and a cross-section of 40 cm × 20 cm, thus obtaining a total volume of some 0.2 m³ for the combustion chamber. He then placed on the upper grate an aluminum tray identical to the one used in the preceding experiment, but containing 300 grams of lard. He then loaded the hearth grate with wood and lit it, whereupon the fat again caught fire rapidly, but this time without any flames or isolated flame jets above the chimney (Photo 370). Combustion of the fat took three minutes and 45 seconds, including three minutes and 30 seconds of intense combustion.

3. Conclusions

The two experiments were carried out under similar conditions, except, of course, for the presence of the stovepipe in the second case. In spite of the fact that in the latter experiment more fat was used, no flames appeared above the

chimney, because the gases which developed during the decomposition of the fat had at their disposal a combustion chamber four times as large and were thus able to burn out completely within the chimney.

As we are dealing here with physico-chemical phenomena, the results are applicable *mutatis mutandis* to the Birkenau Crematoria.

4. Crematoria II and III

Volume of shortest flue duct (including chimney duct):

$$0.46 \text{ m}^2 \cdot 24 \text{ m} = 11.04 \text{ m}^3 \approx 11 \text{ m}^3 \quad [185]$$

Combustion chamber:

$$1.5 \text{ m}^3 \cdot 3 = 4.5 \text{ m}^3 \quad [186]$$

Total volume:

$$(11 \text{ m}^3 + 4.5 \text{ m}^3) = 15.5 \text{ m}^3 \quad [187]$$

a) For the First Experiment:

During the first experiment we had 0.2 kg of fat in a total combustion volume of 0.05 m³ burning within three minutes, which amounts to 4 kg of fat burning within an hour in this volume, and to 80 kg of fat per hour and m³.

Hence, the appearance of flames out of the chimneys of Crematoria II & III would have required at least the combustion in the triple-muffle furnace closest to the chimney of

$$80 \text{ kg/hr/m}^3 \cdot 15.5 \text{ m}^3 = \text{some } 1,240 \text{ kg of fat per hour} \quad [188]$$

b) For the Second Experiment:

During the second experiment we had 0.3 kg of fat in a total combustion volume of 0.2 m³ burning within four minutes, which amounts to 4.5 kg of fat burning within an hour in this volume, and to 22.5 kg of fat per hour and m³.

In this case, no appearance of any flames out of the chimneys of Crematoria II & III would have occurred in case of the combustion in the triple-muffle furnace closest to the chimney of

$$22.5 \text{ kg/hr/m}^3 \cdot 15.5 \approx 350 \text{ kg of fat per hour.} \quad [189]$$

Hence, when burning some 350 kg of fat per hour in the three muffles of the furnace mentioned, no flames would have formed above the chimney.

We are speaking here of *pure fat*, which means that from the cremation of three corpses in one hour in the three muffles of the furnace mentioned, it would not have been possible to cause the appearance of flames above the chimney. Actually, the fat content of a body of 70 kg is about 25 kg, and 350 kg would thus have corresponded to the fat content of 42 corpses, or 14 per muffle and hour.

We are not taking into account here the protein content of the corpses, because proteins have a considerably lower combustion rate than fats.

5. Crematoria IV and V

Crematoria IV and V had two chimneys each. Each chimney was linked to a group of four muffles. The total volume available to the combustion gases (combustion chamber, flue duct, chimney duct) was about 18 m³. In line with the preceding calculation, we would have:

a) For the First Experiment:

80 kg of fat per 1 m³ of the combustion chamber in one hour means for Crematoria IV & V:

$$80 \text{ kg/hr/m}^3 \cdot 18 \text{ m}^3 = 1,440 \text{ kg of fat per hour for four muffles} \quad [190]$$

Appearance of flames would have been possible, if some 1,440 kg of fat or more had been burned in one hour.

b) For the Second Experiment:

22.5 kg of fat per 1 m³ of the combustion chamber in one hour means for Crematoria IV & V:

$$22.5 \text{ kg/hr/m}^3 \cdot 18 = 405 \text{ kg of fat per hour for four muffles} \quad [191]$$

Flames would therefore not even have appeared above the chimney if over 100 kg of pure fat had been burned in *each* of the four muffles in one hour, corresponding to the fat content of 12 corpses per muffle and hour.

6. Final Remarks

The above calculations are based on a time of one hour, but it is obvious that the combustion of *all* of the fat contained in the corpses would have taken much less time than one hour. We must however take into account that the combustion of the corpse fat did not take place continuously, unlike the combustion in the above experiments; outer and inner fat would liquefy, gasify and burn in line with the processes of vaporization and combustion, therefore the combustion of *all* of the fat contained in a corpse required less than 1 hour, but at least 30 minutes.

This does not affect the results, however, as for Crematoria II and III the upper limit for visible flames above the chimney would still be 175 kg of fat in 30 minutes, as opposed to 25 kg actually burned; for Crematoria IV and V, the figures would be 202.5 kg of fat in 30 minutes against some 34 kg actually available.

What we have tried to show here does not mean that flames visible above the chimneys were altogether impossible, but that this was impossible in *direct* relation to a cremation, *i.e.* as a function of corpses being cremated. It was, on the other hand, possible in an *indirect* relation with the cremation, namely in connection with the coke on the furnace grates.

It is known that the incomplete combustion of carbonaceous fuel will generate carbon particles which will adhere to the walls of the chimney ducts in the form of soot. Under favorable conditions (a sufficiently thick layer of soot and a

temperature high enough), the soot will ignite and lead to the phenomenon of a flaming chimney.

Before World War Two, when domestic heating was done almost exclusively with wood and coal, this phenomenon was so widespread that on occasion it was caused intentionally to be studied from a scientific point of view. Experiments of this kind were, for example, carried out in a chimney duct of a nearly abandoned four-story building in Berlin in early 1933 (Kristen 1933, pp. 83-85). The temperature chart for this experiment (Document 265) shows that 95 minutes after the ignition of the soot on the ground floor, at a level of 1 m above the chimney base, the temperature in the chimney duct reached 1060°C.

This is not really surprising, because soot is essentially carbon, which has an ignition temperature of 700°C.

Obviously, the phenomenon would not be continuous, but occur only on occasion when, after a certain time, the soot layer had once again become thick enough.

11. The Cremation Furnaces Built by Other German Companies: Kori, Ignis-Hüttenbau and Didier

11.1. Historical Remarks Concerning the H. Kori Co. of Berlin

Topf's most active competitor in the field of cremation furnaces for the German concentration camps was the Hans Kori Co. located in Berlin. The historical review of Kori's cremation furnaces presented below, besides being of a certain value as far as the history of this technology is concerned, is also a useful means for assessing the technical status of the Topf furnaces.

Founded in 1887, the Kori Co. specialized in the design and construction of furnaces for the disposal of animal residue (*Tierleichen-Verbrennungsöfen*). The first such device was built in 1892 at the Nuremberg municipal slaughterhouse. By 1901, the company had become so well-known that Dr. Weyl from the medical association of the Prussian province of Brandenburg turned to Kori for solving the sanitary problems which had arisen in connection with a typhus outbreak in that province (cf. p. 148). In 1905, Kori could already boast of having built 55 furnaces for the disposal of animal carcasses, a figure which would rise to 160 over the nine years to come (Kori 1924, p. 115).

I have described the main models of this type of equipment manufactured by Kori at that time in Chapter 10 of Unit I (cf. Documents 98-100). Later on, the firm branched out into the field of incineration plants for all types of refuse. In 1927, Kori sold some 3,500 such units (Documents 266-268).

Although Hans Kori had made an important contribution to the cremation of human corpses in Germany when he managed to get the Prussian Ministry of the Interior to change the law on cremations of 14 September 1911 by the Decree of 24 October 1924 (cf. pp. 63f.), his own company went into the market segment of cremation furnaces rather late, at a time when the German market

was solidly dominated by four companies: Richard Schneider/Didier of Stettin, Gebrüder Beck of Offenbach, J.A. Topf & Söhne of Erfurt, and the Wilhelm Ruppmann Company of Stuttgart. While the first two were in clear decline, Topf experienced a steep rise in sales.

Kori managed to break into the market, albeit with some difficulty, and installed five furnaces during its first five years of activity: two furnaces at the crematorium of Hagen in Westphalia in 1926, one at the Weissenfels Crematorium in 1927 and two furnaces at the crematorium of Schwerin in 1930.⁶⁰⁷ In the early 1930s, Topf was the leader in the field, while Kori came in last, after Gebrüder Beck, Schneider-Didier and Ruppmann (Hellwig 1931a, p. 370).

11.2. The Coke-Fired Kori Cremation Furnaces for the Concentration Camps

The H. Kori Co. came into its own after the outbreak of the Second World War when the SS decided to set up crematoria in the concentration camps. The firm succeeded in placing its products at many locations, such as Bergen-Belsen, Blechhammer, Dachau, Dora-Mittelbau, Ebensee, Flossenbürg, Gross-Rosen, Lublin-Majdanek, Mauthausen, Natzweiler-Struthof, Neuengamme, Ravensbrück, Sachsenhausen, Stutthof, Trzebinia, Vught, and Westerbork.

11.2.1. The Furnace at the Mauthausen Crematorium

The coke-fired Kori Furnace at KL Mauthausen, which went into operation on 4 May 1940 (Photo 247), is probably the first furnace designed by Kori for concentration camps. This furnace is set on a brick platform with its right side placed against the wall of the furnace hall (Photo 236). The front part has the typical double-leaf muffle closure.

The muffle had a grate consisting of three transverse bars and one longitudinal bar in the center, like the grate of the Topf Furnace at Dachau (Photo 239); on the inner left sidewall are three rectangular apertures connected to a channel for the combustion-air feed. In the front part of the furnace, this channel bent downward by 90°, then again by 90° to the horizontal, and let out below the left edge of the muffle door, where it had a butterfly valve (Photos 236f.). A similar valve was also located below the right edge of the muffle door (Photo 236), but the muffle wall on the right had no openings (Photo 242). This air inlet was probably used to supply combustion air to the flue duct for the post-combustion of the unburnt gases.

The ash chamber (Photo 243) was located below the grate and had its door in the front part of the furnace (Photo 236). The gasifier was located in the rear portion of the furnace. The door of the gasifier's loading shaft and the hearth door below it were on the left side of the furnace (Photo 245).

The hearth grate consisted of 14 bars and 2 transverse supporting bars. The loading shaft of the gasifier had an oblique grate of bars at its end, suitable for

⁶⁰⁷ Verband... 1928, p. 82; *Einäscherungssofen System "Kori" im Krematorium der Stadt Hagen/Westf.* (Document 269); *Einäscherungssofen System "Kori" im Krematorium der Hauptstadt Schwerin* (Document 270), company brochures from the 1930s, APMM, sygn. VI-9a, Vol. 1.

wood use (Photo 246). No service provisions were located in the rear wall of the furnace.

The gas-discharge system consisted of an opening in the vault of the muffle, toward the front, and of a horizontal flue duct, which could be closed by a metal damper (Photo 238).

The corpse-introduction device consisted of a stretcher, guide rollers and the necessary support and blocking frame. We shall come back to this point when we describe the cremation furnaces at the Dachau Camp.

Similar furnaces were set up in the crematoria at *KL Flossenbürg* (Photo 335) and *KL Ebensee* (Photo 336).

11.2.2. The “*Reform-Einäscherungsofen*”

The next model of the Kori Furnaces was an improved version, as it is also expressed in its designation (*Reform-Einäscherungsofen*).

A Kori letter of 18 May 1943, addressed to Office CIII of the *WVHA* contains the following description as part of an offer for this type of furnace (Document 271):⁶⁰⁸

“Re: Cremation furnaces

In pursuance of the conversation we had with you concerning the supply of a cremation device of a simplified nature, we propose our coal-fired ‘Reform’ cremation furnaces, which so far have shown very good results in actual operation. For the project in question, we propose two cremation furnaces, but we suggest ascertaining, in a further discussion, whether these two furnaces will be sufficient for the task. It is also necessary to clarify the positioning of these furnaces, because the fabrication of the fittings and of the anchoring structure depends on this question.– If at all possible, these furnaces must be placed into a closed building and connected to a chimney which may exist at the site. If such a building has already been identified, we beg you to send us a drawing to allow us to propose to you a suitable positioning. From the enclosed drawing, you can gather the space needed for the furnaces with their control station and stoking station. Drawing J.Nr.8998 shows the placement of two furnaces, whereas four furnaces were built for the construction project Dachau shown in Drawing J.Nr.9112. Another drawing with J.Nr.9080 shows the Lublin device with five cremation furnaces and two built-in recuperators.

Concerning the purchase prices for two crematoria [furnaces], we offer the following:

1) 2 ‘Reform’ cremation furnaces of latest design with vaulted coffin chamber and horizontal floor of the ash chamber, including all fittings, doors for introduction, operation and cleaning, air valves, accessories for the main hearth and the post-combustion grate, complete anchoring structure consisting of strong, angled and U-shaped iron bars connected to by anchoring rods, all building materials a first-class standard and specially shaped refractory bricks, refractory mortar, bricks for the front and rear walls, mortar and cement for brickwork as well as complete installation by one of our technicians for combustion devices, while supplying all necessary helpers, each for 4,500 Reichsmarks.

⁶⁰⁸ Letter from H. Kori dated 18 May 1943 to Engineer Waller, at *Amt C III of SS-WVHA*. KfSD, 660/41.

If the second furnace is installed together with the first, the price of the second furnace would be reduced to 4,050 Reichsmarks.

This amount, however, does not include loading and shipment costs free on site, nor the traveling cost and expenses for our technician and the daily allowance. We will invoice these expenses separately in a specific list.

Our offer likewise excludes secondary construction work on site, such as earth-work, furnace foundation, construction of the furnaces room as well as the flue ducts to the chimney and the chimney itself.

However, as soon as the arrangement question for the furnace system has been clarified, we will be happy to provide you with a specific offer for building the smoke ducts.

For the introduction of the corpses into the combustion chamber we offer furthermore:

<i>1) 2 cremation carts, concave, with rollers and handles, each at RM 160.-</i>	<i>RM 320.-</i>
<i>2) stands with rollers for placement of the introduction cart, each at RM 75.-</i>	<i>RM 150.-</i>
	<u><i>RM 470.-</i></u>

We guarantee the efficiency of the cremation furnaces supplied, as well as their durability and the supply of the best materials and first-rate labor.

The shipment of the cast-iron fitting and anchoring parts, as well as the specially shaped refractory bricks, can take place at short notice, provided Wehrmacht freight papers are placed at our disposal.

For the shipment of the metal parts of the furnaces we need 1,460 kg per furnace, i.e. 2,920 kg for two furnaces. We enclose the forms for the iron requirements for these parts.

Awaiting your further decisions we salute you

Heil Hitler!

H. Kori Ltd.

Enclosures: *3 drawings – J.Nr.8998, J.Nr.9122, J.Nr.9080 – Forms for iron requirements.”*

The *Reform-Einäscherungs-ofen* was essentially characterized by a positioning of the gasifier on the side of the furnace, a secondary hearth next to it, and an upward flue-gas discharge through the muffle vault. Kori adapted this type to the requirements at the various crematoria, and supplied single furnaces or assembled two, four, or five furnaces in a single brick structure.

The three drawings attached to the above letter are preserved in the Belgrade Archives of the State Commission for Crimes of the Occupiers and Their Collaborators. Our request for the supply of photocopies received no reply. The drawings which we show here (Documents 272f. & 277) are photocopies supplied by the above commission to the Soviets for use at the Nuremberg Trial.⁶⁰⁹

Drawing J.Nr. 8988 (Document 272) is a layout for the crematorium of the New Construction Office at KL Neuengamme, with two furnaces connected to the chimney via a common flue.

⁶⁰⁹ GARF, 7445-2-125, pp. 89-91.

Drawing J.Nr. 9122 is the design on the basis of which the furnaces in the new crematorium at Dachau were built (“*Baracke X*”, Photo 248). These furnaces were structurally the same as those in the Sachsenhausen Crematorium – of which there exist some post-war drawings prepared by the Soviets – but differed from the latter in the design of the flue-gas discharge system. The Soviet drawings and a visit to the site allow us to describe with sufficient accuracy the structure and operation of the *Reform-Einäscherungsöfen* in the various crematoria. The numbers given subsequently in parentheses preceded by the letters “No.” refer to the numbers contained in Documents 274-276.

11.2.3. The Furnaces in the Crematorium at the Dachau Camp

The four furnaces are arranged as shown on drawing J.Nr. 9122 (Document 273 and Photo 249). The two central furnaces have a common wall, but their muffles are not directly interconnected. This pair of furnaces is almost identical to the one installed at the Stutthof Crematorium, from which it differs in secondary aspects which we will discuss later. In its front portion, the furnace is designed like the Mauthausen Furnace and similar to the one installed at the Sachsenhausen Camp.

It presents the typical double-leaf introduction door (*Einführungstür*) with the characteristic round openings for viewing and combustion-air feed (65 mm in diameter; Photos 250f.; see *No. 1* in the drawing of the Sachsenhausen Furnace. Documents 274f.; all subsequent numbers refer to these documents). Below it is the ash-chamber door (*Ascheentnahmetür*; *No. 4*) with the rosette-shaped combustion-air inlets (*Luftrosetten*; *No. 5*; Photo 251). These rosettes close the two combustion-air channels (*Luftkanäle*; *No. 6*) set into both side walls of the muffle, leading to the three rectangular apertures in the muffle walls (Photos 253f.; *No. 7*).

The muffle itself (*Einäscherungskammer*; *No. 8*) is 2.20 m long, 0.65 m high and 0.80 m wide. The muffle grate (*Schamotterost*; Photo 268; *No. 9*) consists of 24 transverse refractory T-bars which are flat at the top but arched on the underside, thus forming a flat grate on top and the vault of the ash chamber below, as we can see in Photos 313f.

The gasifier (*Generator*; *No. 11*) is located in the rear portion of the furnace. The gasifier loading door with its two leaves (*Generatorfüllschachtverschluss*; Photo 261; *No. 13*) and the ash-chamber door below (*Feuertür*; *No. 14*; Photo 262) with its air-inlet rosette are positioned on one side wall of the furnace (Photo 257). This rosette (*Luftrosette*; *No. 15*) closes the combustion-air-feed channel (*Luftkanal*; *No. 16*) which enters into the hearth above the hearth grate (*Luftöffnung*; *No. 17*).

The grate of the main hearth (*Hauptfeuerung*) consists of eleven double bars (Photos 263f.) and measures some 80 by 40 cm (*Planrost*; *No. 12*). The grate throughput rate is around 38 kg of coke per hour.

Next to the gasifier is an auxiliary hearth equipped with the ash-chamber door with an air-inlet rosette at the bottom and a single-leaf loading door on top (Photo 260; *Nos. 18f.*) connected to the post-combustion chamber (ash chamber)

via a suitable opening (*No. 20*). We will discuss the connection system of the gasifier and auxiliary hearth to the muffle and post-combustion chamber in the section devoted to the furnaces at Stutthof.

The gases coming from the gasifier enter the muffle and the ash chamber from the rear portion of the furnace (Photo 268), strike the corpse from above and below, and enter the vertical smoke duct, which is located above the forward portion of the muffle (*Rauchkanal; No. 21*). The gas-discharge system is shown very clearly in the vertical section of the furnace in Drawing J.Nr. 9122 (Document 273, “*Schnitt c-d*”, upper right): the muffle vault, in its front part, has an opening for the gas discharge leading into a smoke duct, which runs above the muffle within the brickwork of that part of the furnace (Photo 257) and then drops down, first vertically then at an angle, past the gasifier within the rear brickwork of the furnace. It finally runs below the floor of the furnace hall and continues horizontally toward the chimney. At the rear of the furnace is a door for cleaning the smoke conduit (Photo 259). Beneath this door, in the floor, is the flue-gas damper (*Rauchkanalschieber*) which moves vertically by means of a metal cable (*Drahtseil*) and rollers (*Rollen*) mounted on the upper portion of the brickwork (Photo 259). The flue-gas channels (*Rauchkanal*) set below the floors of Furnaces 1-2 and 3-4 converge as two conduits which lead, respectively, to the right and left chimney channels, each one of the latter having an internal cross-section of 0.60 m × 0.60 m.

The corpse-introduction system consists of introduction stretchers (*Tragbahren*; Photos 249 & 253f.; *No. 28*) like those used for the Topf and Kori furnaces at Mauthausen, which moves on two rollers (*Rollen*; Photos 252 & 267; *No. 30*) set on a metal stand (*Rollenbock*, *No. 31*) whose horizontal elements are welded to the frame of the muffle door (Photo 250) with the vertical ones set into the floor (Photo 251). The corpse was placed on the stretcher, the side bars of which moved on the rollers, thus allowing it to be easily introduced into the muffle.

The distinguishing feature of the Kori System was an ingenious system for blocking the corpse in the muffle. This device consisted of a refractory blocking plate (*Schamotteabsperplatte*) running vertically, like a guillotine, along two guide rails set into the furnace brickwork behind the muffle door (*No. 3*). In the lower part, this plate had a metal frame in the shape which matched the vertical section of the stretcher with its convex upper edge (Photo 266). The plate normally sat in a wrought-iron housing located above the front part of the muffle; it was moved by a metal cable and two pulleys with counterweights (*Gegengewicht*; Photos 255f.). The metal cable ended in a crank. When the plate was not utilized, the crank was held back by means of a hook set into the wall near the muffle door (Photo 265); when it was to be used, after the corpse had been introduced into the muffle, the cable was unhooked, and the plate (in the upper position in Photos 253 and 267) was lowered down to the muffle floor (Photos 265f.). The function of this plate was to retain the corpse in the muffle when the stretcher was withdrawn.

11.2.4. The Furnaces at the Stutthof Crematorium

The Stutthof Crematorium was destroyed, probably by the SS prior to the arrival of the Soviets. The chimney collapsed completely, but the cremation furnaces remained almost unscathed. Photo 270 shows the two coke-fired furnaces as found by the Soviets on their occupation of the camp. At present, the furnaces are located in a building set up after the war (Photo 271). The furnaces are structurally identical to the middle pair of furnaces at the Dachau Crematorium, differing from the latter merely by the absence of blocking plates for retaining the corpse and by a different arrangement of the two rosette valves of the air inlet (next to the muffle doors, instead of being located next to the ash-chamber doors). The refractory brickwork of the muffle shows serious signs of wear (Photos 272 and 274).

For these furnaces we were able to take photos of the way the two hearths are connected to the muffles and ash chambers. Photo 276 shows the two hearths of the right-hand furnace, with the main hearth to the right with the single-leaf door of the ash chamber below, and the double-leaf gasifier loading door above. The secondary hearth is on the left, with its ash-chamber door below and the hearth door above. Photo 277 shows the remains of the hearth grate.

Photo 278 shows the upper portion of the gasifier chamber, which is connected to the ash chamber (lower chamber) and to the muffle (upper chamber). The two chambers are set apart from the refractory grate of the muffle, which appears near the center of the photo, to the left. The upper part of the gasifier chamber ends at the level of the refractory grate of the muffle. Photo 279 shows the muffle as seen from the gasifier outlet. In the upper background, in front of the introduction door, one can see the opening of the vertical conduit for the discharge gases. On the wall to the right, two of the rectangular inlets of the combustion-air feed are visible.

The two auxiliary hearths, one for each furnace, are connected to the respective ash chambers. Photo 280 shows the hearth of the furnace on the left; the upper door is missing. On the inside one can see a broken grate bar, held by a supporting bar. In Photo 281, showing the end of the grate bar in the foreground, one can see the opposite wall of the post-combustion chamber (ash chamber), where we can just perceive, in the lower portion on the right, a part of the ash-chamber floor. Photo 282 shows the post-combustion chamber seen from inside the left-hand auxiliary hearth. The white section appearing in the left-hand corner of the photo is the dislodged end of the grate bar.

The grate of the auxiliary hearth is positioned at the floor level of the post-combustion chamber. It supplied extra heat to the muffle from below through the refractory bars of the muffle grate and also served as a post-combustion grate for those parts of the corpse which had dropped down from the muffle through the bars mentioned. Photo 283 shows the inside of the (destroyed) auxiliary hearth of the furnace on the right. In the background, one can see the opposite wall of the post-combustion chamber with a section of the vault formed by the refractory grate bars. The post-combustion chamber stretches to the right

and left of the auxiliary hearth. Its right-hand portion, seen in Photo 284, is the final portion and is connected to the gasifier chamber.

The outlet of the auxiliary hearth appears on the lower left in Photo 273, which shows the ash/post-combustion chamber of the left-hand furnace. The opening is located at the far end of the floor of the chamber, with the end of the hearth grate bar sticking out at an angle (Photos 280-282). On the left, in the background, one notices the gasifier chamber with the vault formed above by the refractory-grate bars of the muffle grate. Photo 275 shows the ash/post-combustion chamber of the right-hand furnace.

11.2.5. The Furnaces of the Crematorium at Sachsenhausen

The four furnaces of the Sachsenhausen Crematorium (Document 274) were built along the same lines as the Dachau Furnaces, but – as we have mentioned earlier – were equipped with a different layout for the discharge gas. They were grouped together as a single unit 12.46 m long and 2.66 m high (Document 274, A & B). Document 275 shows the horizontal and vertical sections of Furnaces 1 to 3. The gas-discharge system, schematically illustrated in Document 275 (top) and 275a, consisted of a vertical flue channel (*No. 21*) with a right-angle bend above the muffle (*No. 22*) which connected it to another horizontal channel perpendicular to it (*No. 24*) and running within the brickwork above the unit (*No. 25*).

Furnaces 1 through 3 were equipped with a refractory damper set just ahead of the outlet of this channel (Document 274, *Nos. 20a, b, c*); the damper of Furnace 4 was instead placed in the transverse channel, ahead of Furnace 3 (*No. 20d*). This channel was split in two by a central wall (*Nos. 24a & b*): the conduit on the left discharged the fumes coming from Furnaces 1 and 2, the conduit on the right, those of Furnaces 3 and 4. Both channels, via a right-angle bend, fed into two ducts (*Nos. 26a & b*), which each ended up in one of the two ducts (*Nos. 28a & b*) of the chimney (*No. 29*). Only the foundations of these furnaces are left (Photo 337).

11.2.6. The Furnaces of the New Crematorium at Lublin-Majdanek

The crematorium at *KL* Lublin-Majdanek were set on fire by the SS before they left the camp, but the furnaces and the chimney remained intact. The present crematorium building (Photo 285) is a post-war refabrication.⁶¹⁰ Photo 286 shows the furnaces, open to the sky, as they stood at the time of the camp's occupation by the Red Army.

The five furnaces of the Lublin-Majdanek Crematorium (Photo 287) were assembled into a single brick structure, in conformity with the original Drawing J.Nr. 9080 (Document 277), so as to constitute a single cremation plant with five furnaces. A Kori letter of 23 October 1941, addressed to *SS Sturmbannführer* Lenzer, describes the unit as follows:⁶¹¹

⁶¹⁰ On the crematoria at *KL* Lublin-Majdanek cf.: Graf/Mattogno 2012, pp. 95-116.

⁶¹¹ Letter from Kori Co. to *SS-Sturmbannführer* Lenzer dated 23 October 1941. APMM, sygn. VI-9a, Vol. 1.

“Our drawing, Sheet 2 (J.Nr. 9079), shows the solution of the space issue for a total of 5 cremation furnaces, with Furnace Number 5, in the center, having been conceived as a reserve furnace. Thus, for normal operation, only Furnaces 1-4 have been conceived, and these [furnaces] have a common recuperator placed between the two furnaces for utilizing the combustion gases. Each group, constituted by two furnaces with a recuperator, therefore occupies a floor space of 4.80 by 3.00 meters. The introduction doors are in the front portion and below [them] there is the access door for the removal of the ashes. At the other side, i.e. in the rear portion of the furnace, we have the hearths, operation of which is effected together from the service or stoking post.

At this point, the floor is 0.40 m lower than the floor of the hall, with stone steps placed on the right and left sides of the furnaces. These steps at once also compensate for the difference in height. Above the furnaces is the common flue duct, provided with a by-pass for each one of the 2 [lateral] cremation furnaces, allowing the feeding of the gases either directly into the chimney or through the recuperator in order to make use of the [heat in the] discharge gases. The chimney for one group of furnaces will be built with an open passage 60 by 60 cm and a height of 8-10 meters.

In order to be independent of atmospheric conditions which affect the draft of the chimney, a forced-draft device in suction will be installed ahead of the chimney. It will likewise have a by-pass for the off-gas to enable an operation with natural draft as well, if conditions are normal. The flue-gas duct itself which connects the furnaces to the chimney is located below the floor of the hall, as shown by the dotted lines, and can be controlled by means of a flue-gas damper.”

The structure of the plant is illustrated by several technical drawings prepared in August of 1944 by the Polish-Soviet expert commission which investigated it after the occupation of the camp (Documents 278-283, individual portions being indicated, as before, by “no...”).

The five-muffle cremation plant of *KL* Lublin-Majdanek consisted of two pairs of muffles, one pair on each side, (Document 279, *B*, *Ofen 1-2 and 3-4*) plus one central furnace (*Ofen 5*). Between the two pairs of the lateral furnaces were two recuperators (*Heizkammer*). Photos 288-294 show, successively, the front of the furnaces and the recuperators, starting from the left-most furnace (No. 1).

The design of the individual furnaces shows some modifications with respect to those at Dachau and Sachsenhausen. In the front part, we have the typical double-leaf introduction door (*Einführungstür*), 0.55 m × 0.65 m in size, with the usual round openings for inspection and air feed (Photo 290; *No. 1*). This muffle door leads into a cremation chamber 0.77 m wide and 0.67 m high (Photos 295-301; *No. 2*), whose floor is made up by a refractory grate (*Schamotterost*) consisting of nine pairs of standard transverse bars (Photo 296; *No. 3*). The effective volume of the muffle is 2.17 cubic meters. The ash chamber (*Aschenraum*) is located below the refractory grate (Photos 313f.; *No. 4*) with a post-combustion grate (*Ausglührost*) in its front part (photos 303f.; *No. 5*). At the front, the ash chamber is closed by two doors (Photo 288): the upper (*Ascheentnahmetür 1*), located immediately below the muffle door (Photo 303;

No. 6), permitted raking, by means of a special tool, the corpse residues which had fallen through the interstices of the refractory grate onto the post-combustion grate, where they would burn out completely; the lower one (*Ascheentnahmetür* 2), located below the former (Photo 304; No. 7), was used to remove the ashes of the corpse itself. This door had a rosette vane for feeding air to the post-combustion grate. On the sides of the upper door were two rosette vanes (*Luftrosetten*; Photo 294; No. 8) which closed off the two channels feeding combustion air to the muffle (*Lufteintritt*; No. 9). These channels (*Luftkanäle*) ran horizontally through the furnace brickwork, then turned upward at a right angle (No. 10), bending once again into the horizontal at the level of the muffle, and now ran parallel to it (No. 11), feeding air to the muffle through four openings, 8 cm × 8 cm, two on each side (Photos 297-301; No. 12).

The gasifier (*Generator*; No. 13) was located in the rear portion of the furnace; the hearth (*Feuerung*) consisted of a flat grate (*Planrost*; No. 14) 0.68 m × 0.63 m or 0.43 m². The coke throughput rate under natural draft was around 50 kg/hr of coke. The double-leaf loading door of the gasifier (*Generatorfüllschachtverschluss*; Photo 305; No. 15) was located in the rear part of the furnace, as was the single-leaf door of the hearth (*Feuertür*; Photo 305; No. 16). The gasifier-loading door closed a vaulted opening located in the rear part of the furnace ahead of the refractory grate, as can be seen from Photos 313f. The vaulted top of this opening is also visible from the side of the muffle door (Photos 295 and 301).

The loading shaft of the gasifier had a fire bridge at its upper end, located just below the start of the refractory grate (clearly visible on Photo 313). Beyond the fire bridge the shaft opened up to the vaulted plane of the gasifier neck linking the gasifier to the muffle in such a way that the combustion products leaving the neck struck the refractory grate – and the corpse resting upon it – both from above and below.

The refractory lining of the furnace had a thickness of 12 cm (*Schamotte-mauerwerk*; No. 17). The gas-discharge system was similar to that of the furnaces at *KL Sachsenhausen* except that the muffle, via a vertical conduit (Photo 302; No. 18), was linked directly to the horizontal flue duct (*Rauchkanal*; No. 19) in the brickwork of the unit (No. 20). The latter duct had two cleaning doors at either end (*Reinigungstüren*; Photos 309f.; No. 21). This duct contained six refractory dampers (*Rauchkanalschieber*; Nos. 22a-f), 0.60 m × 0.45 m in size.

Dampers *a* and *b* controlled the flue-gas flow from Furnaces 1 and 2, respectively. Dampers *c* and *d* belonged to Furnace 5, the center furnace, and allowed the discharge of the flue gas to the right or to the left of both sections. Dampers *e* and *f* controlled the flow from Furnaces 3 and 4. The dampers were balanced by counterweights and moved by metal cables via pulleys suspended from the ceiling beams. The counterweights ran inside two metal rings mounted on the furnace's brickwork next to the rosette vanes for the air, as shown in Photo 289.

Between Furnaces 1-2 and 3-4 two recuperators were located (*Heizkammer*; No. 23) consisting of two chambers. Each of the chambers contained a heating coil for the production of hot water (*Heizschlange*; No. 24). The coils had an outside area of 15 m² and were linked to two horizontal tubes installed outside

of the chambers, in the rear part of the furnace, through eight vertical tubes of a smaller diameter (Photos 305-308; *No. 25*). Below the second tube was an inspection door (*No. 26*). The two tubes were connected to two boilers located above the recuperator chambers in the manner shown in Drawing J.Nr. 9080 (*Schnitt c-f*, upper right). Such a heat-recovery system for producing hot water had been used by Kori for several decades.⁶¹²

Document 284 shows the design of such a unit for a single recuperator chamber. When all four furnaces were in operation, they could make use of a heating surface of 30 m², with an hourly capacity of 300,000 kilocalories. This was sufficient for 50 shower heads and could accommodate, over an operating period of 20 hours per day, some 5,000 to 6,000 persons in six shifts per hour for an effective showering time of five minutes each.⁶¹¹

The discharge gases from Furnaces 1 & 2 (or 5) and 3 & 4 (or 5) passed through the recuperator downward (Document 284, 284a), heating the coil and thus heating water, and then flowed into two underground flue ducts (*Rauchkanäle*; *No. 27*) with a cross-section of 0.70 m × 0.75 m, which led to two draft enhancers in suction (*Saugzuganlagen*; *No. 28*). These devices consisted of a vertical branch (*No. 29*) and an angled branch (*No. 29a*) with a horizontal damper permitting the shutting off of the device; they had a blower (*Gebläse*; *No. 30*) with its electric motor (*No. 31*). The two blowers were each linked to one of the two chimney ducts (*Züge*; *No. 32*) into which the chimney was split (*Schornstein*; *No. 33*). Document 283 shows the flue-gas course for the gases from Furnaces 3 & 4.

The corpse-introduction system consisted of the introduction stretcher with rollers and their stand (Photo 288), but had no corpse blocking plate.

An explanatory sign in five languages, now shown in the reconstructed furnace hall of the crematorium (Photo 317), states:

"The crematorium was built in the autumn of 1943. It was heated by coke. The bodies were cremated at a temperature of 700°C. The daily yield was about 1000 bodies."

This alleged capacity exceeds the actual capacity by a factor of seven.

Contrary to what was asserted by the experts of the Soviet investigative commission, the brickwork of the muffles shows only minor traces of melting of the refractory parts (Photos 297-301); they appear, moreover, only in the vault of the gasifiers. The negligible character of these traces becomes obvious when compared with the obvious appearance of fusion in the gasifier walls of the double-muffle furnace at Gusen (cf. Photo 5), which had been exposed to temperatures of 1,200 to 1,300°C.

Another two *Reform-Einäscherungsöfen* were set up in the crematorium of KL Ravensbrück (Photo 338).

⁶¹² Cf. Document 266, illustration at the bottom left, which is a "*Verbrennungsanlage mit angeschlossener Warmwasserbereitung*" – incineration device with connected warm-water generation. Cf. also Kori Drawing J.Nr. 7181 "*Warmwasserbereitung zum Verbrennungs-Ofen für die Charité Berlin*" of April 1932. APMM, sygn. VI-9a, vol. 1.

11.3. The Oil-Fired Kori Cremation Furnaces for the Concentration Camps

The structure and the operation of the mobile oil-fired Kori cremation furnaces are well described in a drawing by the Krakow “Technical Institute for Heat and Fuel” of the Krakow Mining Academy concerning the furnace at Trzebinia⁶¹³ (Photos 330f.), an Auschwitz subcamp. In all probability, the original Kori documents (Document 285)⁶¹⁴ were used for this purpose.

Furnaces of this type were set up at Stutthof (Photos 328f.), Lublin-Majdanek (Photos 318-327), Gross-Rosen (Photos 332-334), Blechhammer (another Auschwitz subcamp; Photo 331a), Bergen-Belsen (Photo 339), Dora-Mittelbau (Photo 340), Natzweiler-Struthof (Photo 341), Neuengamme (two furnaces; Photo 342), Sachsenhausen (two furnaces; Photo 343) and at Vught in Holland (Photo 344).

The subsequently given numbers in parentheses preceded by “No.” refer to Document 285a.

The furnace was shaped like a muffle, and on its sides, lined with sheet metal (Photo 318; *No. 10*). At the front, we have the typical double-leaf door (*No. 5*) with the ash-chamber door below (*No. 6*) and the two rosette-type air vanes (*No. 7*) next to it for the air feed to the muffle as in the coke-fired models (Photo 319). The two air channels set inside in the side walls of the muffle were connected to the muffle by three square openings (Photo 320; *No. 2*⁶¹⁵). The muffle (Photo 320; *No. 1*) was 1.95 m long, 0.60 m high, and 0.70 m wide.

In the rear portion of the muffle was the jet of the main burner (Photo 320; *No. 21*). The muffle grate consisted of twenty refractory bars arranged in two rows and connected in the center (Photo 322; *No. 3*). Below the grate was the post-combustion chamber (ash chamber; *No. 4*) which had the jet of the secondary burner at its far end (Photo 323; *No. 22*). Above the furnace, on the left side, we have the blower (*No. 14*; only the support rack left in Photos 325, 327) with its electric motor (*No. 15*), which fed combustion air to the two burners located at the far end of the furnace (Photo 327; *No. 19*: main burner; *No. 20*: secondary burner) via a system of pipes (*No. 17*).

On the right side of the furnace was the oil tank (*No. 16*), clearly visible on the Stutthof Furnace (Photo 329), from which the fuel was fed to the burners through smaller pipes (*No. 18*). On the lower right-hand side of the furnace was an inspection port for the secondary burner (*n. 8*) and above it, a rosette vane for combustion-air feed to the post-combustion chamber (Photo 326; *No. 7*). The off-gases left the muffle through an opening located in its vault (*No. 11*), in the forward portion of the furnace (Photo 321), and through a short flue duct of wrought iron which rose above the furnace as a small square wrought-iron chimney duct (Photos 324-326) which in turn had a conical wrought-iron shroud bolted onto it (Photos 330f.; *No. 12*; no longer present on the other fur-

⁶¹³ “Aussenlager Trzebinia” was located near the Trzebionka Hamlet, and therefore it is at times referred to by that name.

⁶¹⁴ *Obozowe krematorium w Trzebionce* (crematorium of the Trzebionka Camp). APMO, no. Neg. 6671.

⁶¹⁵ Only two openings are shown in the Polish drawing.

naces). The shroud was surmounted by the chimney proper, a wrought-iron tube (No. 13) as on the Gross-Rosen Furnace (Photo 332). The introduction system consisted of a stand (No. 24) with rollers (No. 25), as for the coke-fired furnaces.

The cremation furnace installed at *KL* Gross-Rosen (Photo 332), which started operating as early as June of 1941,⁶¹⁶ differed from the other types by the absence of a refractory grate of the muffle, instead of which it had a stretcher in the form of a concave iron grate. The stretcher moved along an iron guide on either side by means of four rollers, likewise made of iron (Photos 333f.), in such a way as to be able to move up to the door of the muffle where the corpse would be introduced.

During the cremation process, the stretcher remained inside the muffle. At present, the furnace is shown without its refractory lining, which was removed at an unknown time (Photo 334).

Document 285 (numbered by me in Document 285a) also shows a schematic drawing of a burner (No. 25), manufactured by the Kubitz Co. in Berlin. It consisted of: a jet injecting the combustible mixture (oil sprayed by compressed air; No. 26), the combustion-air ducting with its damper (*Luftklappe*; No. 27), a control lever (*Regulierhebel*; No. 28), the oil-feed tubing (No. 29) and its control valve (*Reguliertventil*; No. 30).

According to professor Dawidowski, the main burner had a feed rate – depending on the control setting – of 4, 6, 9.5, and 13 kg of oil per hour. The secondary burner operated at 1.5, 2.5, and 3.8 kg/hr of oil. Dawidowski's statement, however, that the furnace operated at a temperature of 1,500 to 1,800°C is absolutely unfounded.⁶¹⁷

Document 286 contains the operating instructions for this type of furnace:⁶¹⁸
“Operating instructions for the incineration.

Lighting the burners:

A. If the furnace is still warm and the control setting of the burners has not been changed from the previous utilization, no change is necessary, if the fuel is similar.

Lighting is carried out in the following order:

- 1.) Turn on ventilator*
- 2.) Close damper for burner air*
- 3.) Open on-off valve for oil*
- 4.) Introduce burning wick*
- 5.) Open air damper*

As soon as lighting has taken place, close air damper slowly until flame no longer spurts but burns in a stable manner without generation of smoke. If lighting does not take place right away, turn control valve to the left about one quar-

⁶¹⁶ Letter from the head of administration of the Gross-Rosen Camp to *Reichsführer-SS – Inspekteur der Konz.-Lager-Verwaltung-Oranienburg*, dated 24 June 1941 on: “ash urns.” APMGS, sygn. 2593/DP. Cf. Chapter 12.

⁶¹⁷ AGK, NTN, 145, p. 8, report by Jan Sehn about the Trzebieńka camp dated 8 August 1945. This report contains the drawing *Obozowe krematorium w Trzebieńce* and various photographs of the ruins of the cremation furnace.

⁶¹⁸ “Betriebsvorschrift für die Einäscherung.” ROD, C[64]392.

ter turn with the vertical control lever, then, when burner lights up, turn it slowly to the right again. When the furnace has warmed, try feeding more air by opening the air damper. After 5 minutes, open the air rosette on the furnace by about 3 centimeters.

B. If the furnace is cold, or if the control setting of the burners has been changed, control of the burners must be done as follows:

- 1.) Raise cross stroke by about one half
- 2.) Turn on blower
- 3.) Close air feed to burner
- 4.) Set control lever to an upright position
- 5.) Open upper control valve by about 2 turns, lower control valve by about one and one-half turns
- 6.) Introduce burning wick
- 7.) Open oil on-off valve
- 8.) Close air damper completely.

If lighting does not take place immediately, open control valve a little more. A few minutes after lighting, close it until flame burns well. If flame smokes, raise cross stroke a little toward 'closed' position. Once the burner has been in operation for a few minutes, the control lever must be turned all the way to the right. If the flame burns well, link control lever to control valve.

If needed, control once more by raising if smoke forms in case of large-scale production [cremation]. If flame goes off and on again intermittently (sputtering), there is too much air. In that case, close air damper until flame burns steadily. When the furnace has warmed up, the air vane may be opened. After 5 minutes, open air rosette vane of furnace air by about 3 centimeters."

11.4. The Oil-Fired Cremation Furnaces Built by Ignis-Hüttenbau A.G. at the Terezín Crematorium

In the course of 1942, at Terezín, then called Theresienstadt, a crematorium was built for the ghetto's populace. On 10 October 1941, during a meeting on the subject of establishing the ghetto, the governing proposal had already been defined in the following terms:⁶¹⁹

"The Jews must not, in any case, be buried, but it is instead necessary to carry out a local cremation within the ghetto on the smallest scale possible, not accessible to the public."

On the construction of the crematorium, a detailed cost estimate exists which was made on 2 April 1942 by the firm Ignis-Hüttenbau A.G. of Teplitz-Schönau, now Teplice in the Czech Republic, most parts of which at the time belonged to the German Protectorate of Bohemia and Moravia.

I will translate here merely the part which concerns the cremation devices:⁶²⁰

⁶¹⁹ "Notizen aus der Besprechung am 10.10.41 über die Lösung der Judenfrage," German text in Kryl 1983, p. 41.

⁶²⁰ Letter and cost estimate from Ignis-Hüttenbau A.G. of Teplitz-Schönau dated 2 April 1942 "An die Zentralstelle für jüdische Auswanderer, z.Hd. des Kommandos der Waffen-SS in Theresienstadt" concerning "Errichtung eines Krematoriums in Theresienstadt." PT, A 7-856.

“Based on the delivery conditions as set out below, as well as on Drawing No. 10986, we offer you a gas- or oil-fired cremation furnace as follows:

Our supply includes:

- a) the supply of all refractory bricks and insulating materials for a weight of 18,000 kilograms;*
- b) the supply of the complete anchoring system of the furnace made of steel, as well as the cast-iron doors, the door panels^[621] and various parts of the furnace, with the iron damper and its handling device, as well as the supply of an introduction cart, with its rail, a hand-winch including the cable for the handling of the furnace door, for a weight of about 3,000 kilograms;*
- c) the supply of a blower for the combustion air with an output of about 8 m³ per minute, 400 mm water column, including a motor of about 2 hp, as well as the supply of an exhaust device for removing the flue gases with an output of 60 m³ per minute and a motor 3 hp, including the supply of the ducting and smaller tubing^[622] for the furnace, as well as the fittings for the air-control valves for a weight of about 950 kilograms;*
- d) the oil or gas burners with their controls, for a weight of about 50 kilograms;*
- e) the instrument panel about 800 by 800 mm in size, including temperature indicator, switch, and two thermocouples, as well as dynamometer, for a weight of about 60 kilograms;*
- f) the complete construction of the furnace as well as the mounting of the metal parts by our technicians.*

On the basis of the above conditions, the price of a complete oil-fired furnace, complete with oil tank 600 mm in diameter and 900 mm high and its preheater, electrical heating cartridge and fittings, excluding shipment, excluding loading, with assistants supplied, without wood supply for drying in the furnace, with start-up and training of operators, amounts to 15,200 Reichsmarks.

The price of the furnace does not include the flue-gas conduit up to the chimney, nor lighting and water for the construction, but includes the supply of all scaffolding.

The weight needed for the supply [of metal] for the gas-fired furnace is 4,600 kg of iron materials.

For the consumption of gas, we attach Sheet 1741.

The consumption of gas thus depends essentially on the number of cremations.

Delivery time.

Delivery time for the oil-fired furnace is presently – for a case of maximum urgency – about 8-10 weeks after receipt of the iron.

Warranty.

As shown on Sheet 1741, consumption of oil or gas depends on the number of cremations. In the case of continuous operation, day and night, the furnace can carry out 15-20 cremations in 24 hours, and for the number of cremations mentioned, oil or gas consumption is minimal and thus insignificant.

In the case of an uninterrupted operation and with 250 cremations per year, oil consumption is about 5 kg per cremation, if cremations are carried out every 10 days.

⁶²¹ *I.e. the doors of the muffle itself.*

⁶²² *Read “Leitungen” instead of a meaningless “Leistungen” in the German original.*

Normal duration of a cremation is 1-1.5 hours, preheating time of the furnace from a cold state is around 3 hours, from a warm state around 1 hour.

The furnace in this specific case has been chosen to have the simplest possible structure, and no effort has been made to present a particularly attractive construction or cladding. It does, however, fulfill completely all conditions regarding its construction or its appearance."

On account of a rapid increase in mortality registered at the Theresienstadt Ghetto – from 256 deaths in April of 1942 to 2,327 in May and 3,941 in June (Terežinská Iniziativa 1995, vol. I, p. 33) – the crematorium was eventually equipped with four furnaces of the type described in the cost estimate.

The furnaces, each one 1.60 m high (front), 1.90 m wide and 3.40 m long, were set up in the four corners of the furnace hall and formed two pairs of mirror images as shown in Photos 345, 345a.

In the front portion of the furnaces was the muffle door with its two leaves (100 cm × 90 cm) which was at the level of the pavement to allow manipulation of the low cart for the introduction of the coffin (Photo 346). Behind this door was a refractory closure (*Türplatte*) which ran vertically along two guide bars set into the furnace brickwork and which allowed closing the mouth of the muffle completely (Photos 346 and 359). The muffle was 100 cm high, 90 cm wide and 2.60 m long.

At the rear portion of the furnaces (Photo 348) was the service area on a lower level that could be accessed via five steps. At that part of the furnace were installed, from top to bottom, the oil burner, the inlet for the removal of the cremation residues, the door of the post-combustion chamber, and the door of the ash compartment.

Two metal tubes fed into the burner, one for the fuel (smaller section), and the other for the combustion air (larger section). Each pair of furnaces had an oil tank set on a metal stand attached to the upper portion of the right-hand wall of the cremation hall, as shown in Photo 345. From each tank, a tube went down along the wall and then branched out into two tubes: one continued along the wall and went to the furnace nearest the wall, the other ran horizontally through the furnace hall up to the opposite wall and fed the furnace located there. Both tubes, before reaching their respective burner, passed through an oil preheater located on a stand between the furnace and the wall (Photo 349).

The combustion-air tube passed beneath the floor and went to a blower set into the service pit along the wall flanking the furnace (cf. Photos 356 and 358). Re-emerging from the floor near the furnace, this tube ran vertically along the rear wall of the furnace, then turned at a right angle and ran horizontally along the upper part of the furnace, made another right-angle turn and ran down vertically. From both vertical portions which ran along the two edges of the furnace, eight parallel pipes of smaller diameter left towards the outside and one towards the inside (cf. Photo 348).

The sixteen outer tubes, each with a valve for control of the air flow, bent at a right angle and ran along the sidewall of the furnace (Photo 347). Each tube went through the brickwork of the furnace at a certain interval from the others, and was connected to a jet inside the muffle. The two inner tubes went through

the brickwork at the rear of the furnace and emerged from the rear wall of the furnace as two lateral jets located between the burner and the door for the removal of the cremation residues. This air-feed system was copied from the Volckmann-Ludwig Furnace, as was the elliptical vault of the muffle (cf. Photo 352) and the muffle floor, which was not a grate but a solid refractory plate (Photo 353).

In the front part of the furnace, the floor was level with the introduction door; at the rear, on the other hand, it ended in front of the door for the removal of the combustion ash in a kind of deep step, and the resulting space constituted the post-combustion chamber. The floor of this chamber, in turn, ended in something like a step, ahead of the rear wall of the furnace, thus creating the space of the ash chamber itself. The ash chamber held a movable sheet-metal box (Photos 351 and 355).

The corpse-introduction device consisted of a metal cart running on rails (Photo 361). The muffle door was moved by a hand winch with metal cable, counterweight and pulley (Photo 360). The corpses were burned in lightweight coffins of rough wooden boards (Photos 361a, 362).

The crematorium had two chimneys running along the side walls of the furnace hall as shown in Photo 345a. Each chimney had its forced-draft device with a blower with an output of 60 m³ of smoke per minute set up at its base. The device positioned at the base of the chimney on the left (adjacent to the main door of the crematorium) served the first pair of furnaces (the pair situated near the main entrance), while the device at the base of the chimney on the right was connected to the second pair (the one near the rear door of the crematorium).

According to the supplier, if the furnace was operated properly, each furnace would have permitted 15 to 20 cremations in 24 hours. However, the crematorium personnel had devised an operating procedure which, while being illegal, allowed reaching a maximum capacity with a minimum of fuel consumption. This practice was made possible by the unusual length of the muffle and ran as follows:

After preheating, the first corpse was introduced into the furnace. The coffin was placed in the front part of the muffle, where it was struck by the combustion air coming from the eight air jets located there, and it burned rapidly. At that time, drying of the corpse began. When, after something like 30 to 35 minutes, the desiccation process had reached an advanced stage or had come to an end, the desiccated and dismembered corpse would be pulled into the rear portion of the furnace close to the burner by means of a 4-m-long rake (clearly showing in Photo 349) introduced from the opening at the far end of the furnace, and the main combustion phase took place in that area of the furnace. Here, the corpse was directly exposed to the adjustable flame of the burner and to the combustion air coming from the ten air jets located there. When the main combustion was complete, the corpse residues were raked down into the post-combustion chamber, where they burned out, and then, reaching through the door of the post-combustion chamber, the operator raked the ashes into the ash chamber, where they cooled down.

Operating in this manner continuously, there were two corpses in the furnace at any given time, one in the drying phase, and the other in the combustion phase. Hence the duration of the cremation generally coincided with the time taken by the desiccation of a corpse.

From the point of view of heat management, the heat generated by the combustion of the corpse in the rear part of the muffle was partly used for the desiccation of the corpse in the forward section, with a considerable portion of the heat needed for this being contributed by the coffin's combustion. This reduced fuel consumption even further.

The operating results of the Terezín Furnace demonstrate the great efficiency of such a procedure. In Appendix 1.2., I present a statistical analysis of a part of the cremation lists recorded for this crematorium. This analysis is based on a sample of 717 cremations carried out between 3 October and 15 November 1943 on 41 operating days. In addition to the table showing the summary of my results (Table 1, App. 1.2.), I also present 11 tables with all original documents (cf. Documents 289f.), except for the names of the persons cremated, for whom I only mention the gender. For reasons of space, the tables refer only to days on which at least 24 cremations were carried out. Document 289 shows the manner in which the lists of cremations in the Terezín Crematorium were kept.

The minimum average duration of cremations on any single day was about 32 minutes in Furnace No. III (9 November 1943, with 23 cremations) and 31 minutes in Furnace No. IV (on 10 October 1943, with 17 cremations). The average duration of a cremation was about 36 minutes for both furnaces.⁶²³

For the 682 cremations where the duration is indicated,⁶²⁴ a total of 491, or some 72%, took 35 minutes or less, 148 cases, or about 22%, took between 35 and 45 minutes, 42 lasted between 45+ and 60 minutes, and one cremation took longer than 60 minutes, as shown in the following table:⁶²⁵

Table 19: Duration of Cremations at the Terezín Crematorium

DURATION [MIN]	MALES	FEMALES	DURATION [MIN]	MALES	FEMALES
15	1	0	45	26	16
25	3	5	50	12	26
30	59	114	55	1	0
35	146	163	60	2	1
40	57	49	70	1	0
			Total	308	374

The average duration of a cremation of a female corpse was around 35 minutes, that of a male corpse 36½ minutes. Each furnace, hence, was usually able to cremate 40 corpses in 24 hours, with highs of around 45 to 46 corpses.

⁶²³ I have left out the data concerning Furnace II because only 22 cremations took place there.

⁶²⁴ At times, the documents give only the time of the beginning of the last cremation but not that of its completion.

⁶²⁵ Two cremations, on 7 October 1943, had an exceptionally long duration (one and a quarter hours and three and a quarter hours) because of a failure of the electric power supply.

In order to save fuel, cremations were carried out in a single furnace which, in this manner, would always stay warm. After a certain number of cremations, another furnace would be used, and so on, in a rotating cycle of operations.

The crematorium staff normally worked two shifts, one from 6 AM to 1 PM, the other from 1 PM to 8 PM (cf. Document 290).

Over the 41 days of activity analyzed here, Furnace No. II was used twice (22 cremations), Furnace No. III 17 times (298 cremations), Furnace No. IV 22 times (397 cremations). Overall, there were nine cycles with up to ten cremations, 16 cycles involving between 11 and 20 cremations, 16 cycles of more than 20 cremations, up to a maximum of 27.

11.5. The Didier Cremation Furnaces for Concentration Camps

The Berlin company Didier-Werke AG likewise built cremation furnaces for the concentration camps. A letter from this company addressed to a certain Boriwoje Palitsch in Belgrade on 25 August 1943 contains the following offer (Document 287):⁶²⁶

“Cremation unit for SS at Belgrade

With reference to the visit of your esteemed son and to the meeting our section manager Storl had with him, we take note of the fact that the SS unit at Belgrade intends to build a cremation plant for a rather-large concentration camp and that you have been requested to design and build the plant, together with an architect stationed there.

As you have no experience with furnace construction, you would like to obtain the necessary drawings.

We declare to be ready to execute the drawing of the furnace with its anchoring system and the drawings of the fittings limited to this particular case exclusively. The corresponding costs would be 600 RM, payable one half with the confirmation of the order and one half on notification that the drawings have been completed.

In the design of the furnace, we have paid particular attention to the fact that the inner structure can be built with normal refractory bricks, avoiding the use of bricks of special shape, in order to enable a rapid erection of the unit. The metal parts will be designed with this point in mind as well.

For the introduction of the corpses into the furnace, we propose a simple fork made of tubing, running on two rollers.

The furnaces will each have a cremation chamber only 600 mm wide and 450 mm high, because coffins are not intended to be used.

For the transportation of the corpses from the holding location to the furnaces we recommend using a transfer cart and will provide you with a sketch also giving the dimensions for this device.

The chimney necessary for the operation of the furnaces must have an open cross-sectional area 500 by 500 mm and must be built to a height of 14-16 meters. If, for special reasons, such a chimney cannot be built, it will be necessary to install a draft enhancer in suction between the furnace and the chimney.

⁶²⁶ Letter from Didier-Werke AG to Boriwoje Palitsch dated 25 August 1943. Document USSR-64.

As the furnaces operate at elevated temperatures, the wall of the combustion chamber must not be too thin in order to avoid excessive heat loss by radiation. For this reason, the furnaces must have an outside width of about 2,000 millimeters. For the same reason, we have suitably altered the building project which has been supplied to us and send you a sketch No. 0913, on which we have indicated the minimum dimensions needed.

In order to enable you to draw up a preliminary estimate as soon as possible, please note that the requirements for one furnace are:

- 1,100 kg vault bricks, Seger Cone No. 33*
- 5,500 kg normal bricks, Seger Cone No. 33*
- 1,000 kg fireclay mortar*
- 5,000 pieces ordinary bricks for the outer brickwork of the furnace*
- 100 kg lime*
- 3.6 m³ sand*
- 2 m³ argillaceous earth*

For the steel parts:

- 500 kg iron for anchoring*
- 60 kg round anchor bars*
- 85 kg muffle-door frame with counterweights and cable pulley*
- 40 kg smoke-duct damper frame with counterweights and cable pulley*
- 25 kg 2 air inlets*
- 200 kg one hearth, slag-removal and ash-removal door each^[627]*
- 25 kg poker*
- 10 kg 2 ash boxes*
- 160 kg cast-iron bars of the grate*
- 60 kg supporting bars of the grate.*

One must add the same quantities for the second furnace and the building material for the flue duct and the chimney. The flue duct as well as the lower part of the chimney up to a height of 3-4 m must be lined with refractory bricks. For this purpose, however, a lower grade may be used.

The hearth of the furnaces will be designed in such a way that besides coke, coal or wood may be used as well.

Respectfully yours

Didier-Werke A.G."

Drawing No. 0913 (Document 288),⁶²⁸ prepared by Didier-Werke on 23 August 1943, shows two cremation furnaces 2,000 mm × 2,000 mm × 2,800 mm (length) with introduction doors running vertically and manipulated by means of a metal cable and two pulleys, suspended from the ceiling, and balanced by a counterweight next to the furnace. The furnaces are connected to a chimney with an internal open cross-sectional area of 500 mm × 500 mm and a height of 16 meters.

⁶²⁷ This weight is too high by comparison and obviously in error.

⁶²⁸ GARF, 7445-2-125, p. 92.

11.6. Comparison of the Designs by Kori, Ignis-Hüttenbau, Didier and Topf

The coke-fired Kori Furnaces are more massive than the multi-muffle Topf furnaces. A single-muffle Kori Furnace has, in fact, a volume more or less the same as a double-muffle Topf Furnace. One must assume that the refractory brickwork of the furnace was heavier as well. A comparison with the Didier single-muffle furnace – with its refractory brickwork of 7,600 kg – shows in any case that the Topf Furnaces with two, three and four muffles had a very light-weight brickwork: some 10,000 kg for the double-muffle furnace, 10,500 kg for the triple-muffle furnace, and some 12,000 kg for the four-muffle furnace; or per muffle: 5,000 kg for the double-, 3,500 kg for the triple-, and 3,000 kg for the four-muffle furnace (including their share of the generators). This led to a greater heat loss by radiation and a shorter service life of these Topf Furnaces.

The Kori Furnaces, furthermore, had a much more-advantageous arrangement of the gasifier and the flue duct as far as heat economy is concerned, but the Topf triple- and eight-muffle furnaces had a lower fuel consumption.

Another very positive feature of the multi-muffle Topf Furnaces was their decidedly more-competitive price: While a single Kori Furnace, without extras, would cost 4,500 RM in 1943, a triple-muffle Topf Furnace, without extras, sold for 6,378 RM in 1941, or 2,126 RM per muffle; an eight-muffle furnace, in 1941, was priced at only 13,800 RM, including the introduction device, or barely 1,725 RM for one muffle.

Kori had offered to reduce the price from 4,500 to 4,050 RM for the second furnace if two furnaces were built side-by-side, thus having a common central wall, like the two central furnaces at the Dachau Crematorium or the two furnaces at Stutthof. An even larger price reduction was offered if several furnaces were grouped in a single brick structure, like the furnace with four muffles at *KL Sachsenhausen* or the five-muffle furnace at Lublin-Majdanek. But it seems that they never went so far as to design a furnace with several interlinked muffles such as the Topf Furnaces with two, three or eight muffles.

In my opinion, Kori felt that their design was more profitable, even though the Topf multi-muffle furnaces were not protected by any patents. Actually, their designer, Engineer Kurt Prüfer, had simply taken over and adapted an idea which had been around since the end of the preceding century with respect to collective crematoria (cf. Unit I, Chapter 10).

The Ignis-Hüttenbau Furnaces set up at the Terezín Crematorium cannot be compared directly to the Topf Furnaces, because of their different design and on account of the fuel used. As explained earlier, these furnaces were much more like civilian furnaces, especially in the case of the Volckmann-Ludwig types, than like furnaces designed for concentration camps. For that reason, the operating performances of these furnaces are unique. Cremation procedures such as those performed normally at the Terezín Crematorium could not have been replicated in any of the coke-fired furnaces built by Topf, Kori or Didier.

Even though the operating instructions for the double- and triple-muffle Topf Furnaces allowed for the simultaneous presence of two corpses in one fur-

nace, they were in separate chambers and in different stages of cremation: One corpse was in the final phase of post-combustion in the ash chamber, while the other, located in the muffle, was in the early stages of the drying phase. For that reason, the time for which the two cremations overlapped was actually the period of post-combustion (some 20 minutes), and the average duration of the cremation process was therefore the time needed to reach the high point of the main combustion in the muffle (about one hour).

As against this, the management of the Ignis-Hüttenbau Furnaces allowed the simultaneous presence of two corpses in the same chamber (muffle), the first one in the combustion phase and the second one in the desiccation phase. Hence the time for which the two overlapped was the total time needed for the combustion and the post-combustion, and the actual cremation time thus corresponded to the duration of the desiccation.

It is obvious that such a mode of operation was impossible in Topf Furnaces, because the muffle was too short to allow placing two corpses, one behind the other, and because the grate operated vertically: the muffle was free for the introduction of a fresh corpse only when the remains of the previous corpse had dropped into the ash chamber through the openings in the grate, which occurred only after the high point of the main combustion. The floor of the Ignis-Hüttenbau Furnaces, because of its unusual length, operated in a horizontal fashion instead.

To carry out such a procedure in a furnace with a grate operating vertically it would have been necessary to use a device such as the one designed by Martin Klettner. Here, the muffle no longer is a cremation chamber, but a drying chamber, whereas the post-combustion chamber becomes the combustion chamber as such. The muffle grate consists of only two supporting bars for the coffin, set apart widely at some 40 cm, and 65 and 50 cm from the start of the inclined plane on either side.

The inventor proposed that the corpse, once the coffin has burned, will first of all dry out and fall apart in the muffle in such a manner that its combustible parts, still having an appreciable mass, fall into the combustion chamber where they will then burn actively. If, at that point, another corpse is introduced into the muffle, the furnace will contain two corpses concurrently, one in the drying phase and one in the combustion phase, exactly as in the crematorium at Terezín, and that explains the extremely short duration of cremations undertaken in the Martin Klettner Furnace (cf. Document 137).

The results of the operation of the Terezín Crematorium indirectly confirm our conclusions concerning the cremation of several corpses in one muffle (cf. Subchapter 9.2.), because they demonstrate that the simultaneous cremation of two corpses in one furnace (with a staggered way of introduction), while being possible, required a design and a heating system different from what was used for the Topf Furnaces, in which such an operation would not have been technically feasible.

12. The Topf Furnaces and Regulations on Cremations in Greater Germany at the Outset of World War II

When the first concentration camps were set up in Germany, the SS did not even have the slightest notion of the high level of mortality which would strike these camps in later years and, for that reason, they never worried about cremating, within the camps, the corpses of any detainees who died there. Initially they simply let nearby civilian crematoria take care of these matters, and only when, against all expectations, mortality began to get out of hand, they decided to build crematoria within the camps themselves.

Originally, the Buchenwald Camp used the State Crematorium at Weimar for this purpose.⁶²⁹ Between 5 September 1938 and 3 May 1940, the corpses of detainees who had died at the Mauthausen Camp were sent to the Municipal Crematorium at Steyr.⁶³⁰ At least until December of 1941, the Wewelsburg Camp relied on the Bielefeld Crematorium (cf. Document 86), while the PoW/labor camp at Gross-Rosen used the Liegnitz Municipal Crematorium.⁶³¹ Even the Auschwitz Camp, in its early days, sent its deceased to the civilian crematorium of Gleiwitz (today Gliwice; Piper 1994, p. 158).

When the first crematoria began to be set up in concentration camps later on, they were subject to strict regulations, perfectly complying with current legislation applying to civilian crematoria. In this respect, Himmler's "Decree concerning the execution of cremations in the Sachsenhausen Concentration Camp," promulgated on 28 February 1940, is of particular importance, hence I present the translation of the entire text:⁶³²

"C o p y

*The Reichsführer SS
and Head of the German police
IV – 509/40g*

Berlin, 28 February 1940

Decree concerning the execution of cremations in the Sachsenhausen Concentration Camp.

I. General principles

(1) The detainees deceased in the camp will, in principle, be cremated in the local [i.e. in the camp] crematorium.

Only in exceptional cases and with the approval of the Head of the Security Police and the Security Service may the corpse be handed over to relatives for burial.

At times (e.g. in times of war) when the handing over of corpses to relatives for the purpose of transfer to the country of origin is prohibited, all deceased detainees will be cremated in the camp crematorium.

⁶²⁹ NO-4353. Letter from *Bauleitung* of KL Buchenwald to *SS-Gruppenführer* Eicke dated 18 June 1938.

⁶³⁰ ÖDMM, Archiv, 7, 4.

⁶³¹ Czuj/Kempisty 1977. During that time, the corpses of 3,591 detainees from that camp were incinerated at the crematorium at Liegnitz (p. 113). The article is based on the *Einäscherungslisten* (incineration lists) of this crematorium.

⁶³² "Erlass über die Durchführung von Einäscherungen im Krematorium des Konzentrationslagers Sachsenhausen." BAK, NS 3/425.

II. Official certificate by the camp physician, autopsy, release by public prosecutor.

(1) After each case of death, the camp physician must establish an official certificate on the cause of death.

(2) In cases of violent death (e.g. an accident causing immediate death or death after a longer period of illness, suicide, death by shooting during an escape) the camp physician, together with another SS physician, must carry out an autopsy of the corpse and establish, in the usual manner, a detailed report on the results of the autopsy.

(3) An SS Führer, appointed by the camp commandant, must be present at the autopsy and countersign the report. The SS Führer appointed to participate in the autopsy must be appointed in advance, for a considerable period and for all cases which may occur.

(4) Furthermore, in cases of violent death, the competent public prosecutor must be informed immediately. The camp commandant may issue the incineration order (IV,4) only after the receipt of the release notice from the public prosecutor.

III. Notification of relatives.

(1) In all cases of death, the camp commandant must immediately notify the relatives of the deceased detainee by telegraph, if the address of the relatives is known at the camp.

(2) If the address is not known, the camp will get in touch as quickly as possible with the (directing) office of the State Police which ordered the internment of the deceased. The (directing) offices of the State Police are charged to forward the notification without delay.

(3) If (e.g. during war) it is not possible to hand the corpse as such over to the relatives, they must be informed in the notification that the deceased will be cremated. At the same time, they must be informed – unless particular reasons forbid this – that, at their request – to be expressed telegraphically within 24 hours – they will be given the possibility, up to a certain point in time, to view the detainee in the camp one last time.

(4) The permissible time span given to the relatives for a possible last visit of the deceased must be set in such a way that the relatives have enough time to travel to the camp. As a rule, the time span must not exceed 3 days.

IV. Operating rules for the crematorium at the Sachsenhausen Camp.

1.

Responsible head.

(1) The camp commandant is responsible for the management of the crematorium and for the execution of the cremation in accordance with the rules.

(2) He must designate a crematorium head immediately responsible and subordinated to him. The latter may receive orders only from the camp commandant. If the orders of the camp commandant violate the provisions of this decree, he must so inform the camp commandant.

If necessary, a decision from the Inspector of the Concentration Camps must be requested.

For fundamental questions, the decision of the Head of the Security Police and the Security Service must be requested.

2.

Keeping of the list

(1) *The camp commandant must maintain a special death register of the deceased detainees to be cremated. In this list, each deceased detainee must be assigned a consecutive registration number. Furthermore, the list must mention his [family] name and first name, ID number, place and date of birth, last residence, profession, brief mention of reasons of internment, date and cause of death.*

(2) *This registration number must appear on the other documents (official medical certificate, autopsy report, cremation order of camp commandant).*

3.

Corpse handling

(1) *The corpses must be taken to the morgue of the crematorium and be arranged there in such a way as to be able to be possibly viewed there by the relatives.*

(2) *The corpses must be lodged in wooden coffins. The coffins must not have any incombustible metallic decorations, handles etc., and must be of a size and a kind so as not to impose difficulties for the subsequent cremation. No pitch may be used for filling out any joints.*

(3) *At the head of the coffin must be attached a metal tag with the embossed or imprinted number of the death register (cf. 2).*

(4) *Any objects of value still present (e.g. rings) must be removed from the corpse and handed over to the relatives together with other things left [by the dead person], against receipt.*

(5) *Special legal dispositions apply for the treatment of detainees who may have died of an infectious disease. Any measures necessary in such cases (e.g. prohibition of opening the coffin and possibly prohibition of visits by relatives) must be decided by the camp physician.*

4.

Cremation

(1) *The cremation may take place only after [issuance of] the order of the camp commandant. The camp commandant may give this order only after an official medical death certificate and/or possibly an autopsy report have been issued and after the relatives have viewed the deceased or after the permissible time span for such a visit has elapsed, as the case may be.*

(2) *The camp commandant must give the cremation order in writing, and this order, together with the official medical death certificate or autopsy report, and with the release notice by the public prosecutor in the case of violent death, and possibly with the police dispositions on the part of the camp physician (which may exclude visitation by the relatives) must be transmitted to the head of the crematorium.*

(3) *The head of the crematorium may undertake the incineration only after these documents have been received.*

(4) *The cremation must take place not later than 24 hours after the cremation order has been issued. If this time limit cannot be maintained, the head of the crematorium must request an extension and give the reason for the delay.*

(5) *In one incineration chamber only one corpse may be incinerated at one time.*

(6) *Before the introduction of the corpse, the cremation furnace must be heated until the walls of the [cremation] chamber are glowing, so that the incineration*

process may take place without further or supplemental heating. Only in exceptional cases may additional heat be provided during the incineration process.

(7) During the incineration process, care must be taken so that, if at all possible, no smoke escapes from the chimney.

(8) The observation of the incineration itself is not permitted either to the relatives or to any third persons, but only to the employees of the crematorium. In special cases, the camp commandant may personally issue permission to individual persons to view the process, if such permission is required for special reasons.

(9) After the end of a cremation, the incineration chamber must be thoroughly cleaned.

5.

Treatment of the ashes

(1) After the cremation, the ashes must be removed from the furnace, cooled, freed by means of magnets of any metallic parts and then collected together with the identification tag in a strong and durable container, air- and water-tight, and then closed. The ashes of each corpse must be collected in a separate ash container. The lid of the container must be made of durable material as well. A durable metal tag attached to the container must contain the following data:

1) Cremation sequence number agreeing with the cremation register (cf. No. 6) and with the numerical tag [placed at the head of the coffin],

2) Last name and first name

3) Date and place of birth

4) Date of death

5) Day of cremation.

(2) The containers are to be in conformity with DIN Standard 3198 'Ash Capsules for Urns' set by the German Standards Institute in Berlin.

6.

Register of cremations

(1) For the cremations performed, a register must be kept by the personnel containing the same data as the corresponding list of deaths concerning the corpses taken to the crematorium kept by the command in accordance with Item 2.). Here, however, mention must also be made of the day of the cremation and of the administration of the cemetery to which the ashes have been sent. The register must be closed at the end of each calendar year and must be checked against the book kept by the administration.^[633] This counter-check and the agreement must be certified in the closing note.

7.

Interment of the ashes.

(1) The ashes, if at all possible, must not be interred in the camp cemetery or in the Municipal Cemetery of Sachsenhausen, but shall – if no particular reasons speak against it in the case in question – in principle be sent to the place of residence of the relatives to allow them [i.e. the ashes] to be interred in the local cemetery.

(2) Before shipping the ashes of a prominent detainee, the decision of the Head of the Security Police and the Security Service must be awaited.

⁶³³ The word *Verwaltung* (administration) is struck out and replaced by the handwritten entry *Polit. Abteilung* (Political Department).

(3) *In case the interment of the urns in the local cemetery of the relatives presents any difficulties, the relatives must be requested to indicate the cemetery to which the ash container is to be sent.*

(4) *The ashes must not remain in the possession of the relatives, even temporarily. Therefore, they or their appointees must not be given custody of the container, not even for interment at some other location. The ashes must rather be sent to the administration of the cemetery where interment is to take place.*

(5) *If no relatives of the deceased exist, it should be verified whether the interment of the ashes in the cemetery of the last place of residence does not present any difficulty. If interment is possible there, the ashes are to be sent to the administration of that cemetery.*

In all cases where the shipment to the administration of the cemetery at the last place of residence is not advisable, the ashes must be transferred to one of the cemeteries of Greater Berlin after notification to the municipal administration of the Reich capital Berlin. In doing so, care must be taken to the effect that the urns are distributed evenly throughout all cemeteries concerned in the Greater Berlin area.

(6) *Shipment of the ashes is to be made, in principle, at the expenses of the relatives.*

(7) *If the relatives are not in a position to bear such expenses, it is necessary to request reimbursement of the costs by the competent local aid association. Cremation fees must not be charged to the relatives.*

8.

Final report.

(1) *After the execution of the cremation and shipment of the ashes, the head of the crematorium must transmit to the camp commandant a final report.*

(2) *The official medical certificates, the reports on the autopsy, the release notice from the public prosecutor and similar documents sent together with the cremation order must remain in the crematorium office.*

V. Exceptions

(1) *In individual cases, the Reichsführer-SS and Head of the German Police may order deviations from the above provisions.*

VI. Supervision.

(1) *Once a year routine scheduled inspection and once a year an unannounced inspection of the crematorium service must take place. The performance of these inspections is under the authority of the Inspector of Concentration Camps then in charge. A report on the individual inspections and their results must be presented to the Reichsführer-SS. A copy of this report must be sent to the Head of the Security Police and the Security Service.*

Sgd. H. H i m m l e r

(Office stamp)

Authenticated:
sgd. S c h m i d t
chancery employee

Certified copy:
[illegible signature]
SS Untersturmführer.”

The close similarity of this text to the “Operating regulations for cremation equipment” of 5 November 1935 is obvious (see p. 127). There is reason to believe that, at least within Greater Germany, such regulations remained in force up to the end of the war.

On 17 October 1942, *SS Obersturmbannführer* Liebehenschel, head of Office Group D at the *WVHA*, sent to all commandants of concentration camps a circular entitled “Advice to relatives of detainees deceased in concentration camps” in which he stated with reference to Himmler’s above-mentioned decree.⁶³⁴

“Several camp commandants have requested to prohibit viewing of the corpses by relatives during the summer months for hygienic reasons. After consultations with the RSHA, you are informed that a change in the RFSS decree is not possible at the moment.”

Fritz Sander’s patent application of 26 October 1942 tells us that the “Law on cremations” of 15 May 1934 and the “Operating regulations for cremation equipment” of 5 November 1935 as well as the “Decree concerning the application of the law on cremations” of 10 August 1938 were still in force in the Reich at that moment. On 13 March 1942, these laws were extended to the *Reichsgau Sudetenland* (Roland 1942, p. 62).

The official form concerning the transfer of the body to the head of the crematorium of a concentration camp also refers to the “Law on cremations” of 15 May 1934. In line with the rules regarding civilian cremations, the regulations concerning the transfer stipulate that “the cremation of the corpse must be carried out within 24 hours.” At Stutthof Camp, this practice has been confirmed up to December of 1944 (cf. Document 292). This type of form was also in use at Auschwitz.⁶³⁵

The head of the crematorium had to keep a register in which were recorded the number of the funeral service, the last and first name of the deceased, the file number, the type of the detainee, his date of birth, his origin (town and county), the date of death, the number of the death certificate of the public registrar’s office in charge of the place where the death had occurred – at the detainee hospital or elsewhere – the cause of death, the cremation date, the cemetery to which the urn was sent for burial, and any possible criminal record of the deceased.⁶³⁶

*“The corpse will be cremated in the state crematorium. There are no objections to a shipment of the urn provided that a certificate of the administration of the local cemetery is issued to the effect that a regular interment will be carried out. Such a certificate is to be sent as soon as possible to the crematorium of Stutthof Concentration Camp near Danzig. The urn will be shipped free of charge. The death certificate is attached. You may request an official death certificate from the registrar’s office of Stutthof Concentration Camp near Danzig. The personal belongings will be shipped presently.
The camp commandant”*

⁶³⁴ NO-1510.

⁶³⁵ Reproduced in Blumental 1946, Vol. I, pp. 106f.; cf. Document 293.

⁶³⁶ AMS, I-VD-1; cf. Document 295.

Shipment of urns is also documented for the Mauthausen Camp, at least until March of 1942 (Document 296). At the Buchenwald Museum, a number of urns of various shapes are still preserved in a display case (Photos 364f.). Urns of a simpler type are also kept in a pavilion of the Mauthausen Museum (Photo 363).

The use of urns for the ashes of incinerated detainees was still mandatory in 1941. On 24 June, the head of the administration of the Gross-Rosen Camp sent to the Inspectorate of the Concentration Camps, which had its seat at Oranienburg north of Berlin, a request for “1,000 pcs. ash urns” to “preserve in an orderly fashion the corpse ash resulting” from the cremations.⁶³⁷

In the reply, dated 27 June, the Inspectorate of Concentration Camps advised that the purchase of ash urns was centralized with the company “Grosskopf, Ludwig & Co. of Ilmenau in Thuringia,” to which the Gross-Rosen administration was to address their request for urns (as per DIN Standard 3198).⁶³⁸ The letter asking for shipment of “1000 pcs. ash urns” was sent by this office on 11 July 1941.⁶³⁹

Initially, the Sachsenhausen legal requirements were applied also at Auschwitz. One of the first letters Topf sent to the New Construction Office opened with the following words (Document 297):

“For the start-up of the crematorium, you furthermore require ash urns, an imprinting device for the urn lids, and fireclay markers.”

For the immediate needs of the crematorium, Topf offered the supply of 500 ash urns DIN standard, of black sheet metal with a sheet-metal lid of the same color for the price of RM 675; 500 fireclay markers numbered 1 to 500, priced RM 65, and an imprinting device at 150 Reichsmarks.⁶⁴⁰

The numbered fireclay markers identified the ashes of the incinerated corpse. This manner of operation indicates a procedure in accordance with the applicable legal norms. The creation of a room for the urns (*Urnenraum*) within Crematorium I is already mentioned in the New Construction Office letter of 21 January 1941;⁶⁴¹ it was implemented by partitioning off a section of the morgue.⁶⁴²

On 29 April, the Political Department of the camp, which had authority over the crematorium, sent the following request to the New Construction Office (Document 298):⁶⁴³

“In line with the requirements of the Inspector of Concentration Camps, approved by RSHA, the ashes of the deceased detainees must be held in one of the

⁶³⁷ Letter from head of administration of the Gross-Rosen Camp to *Reichsführer-SS – Inspekteur der Konz.-Lager-Oranienburg* dated 24 June 1941. APMGR, sygn. 2593/DP.

⁶³⁸ Letter from *Leiter der Verwaltung der Inspektion K.L. at Verwaltung des Konz.-Lagers Gross-Rosen* dated 27 June 1941. APMGR, sygn. 2594/DP. The price was RM 95 for 100 pieces, with a 2% discount for payment within 30 days.

⁶³⁹ Letter from *Leiter der Verwaltung des Konz.-Lagers Gross-Rosen* to Grosskopf, Ludwig u. Co. Ilmenau/Th. dated 11 July 1941. APMGR, sygn. 2595/DP.

⁶⁴⁰ RGVA, 502-1-327, pp. 226f.

⁶⁴¹ RGVA, 502-1-327, pp. 185-185a.

⁶⁴² Topf Drawing D 57999 of 30.11.1940 (RGVA, 502-1-312, p. 134) and *Zentralbauleitung* Drawing No. 1241 of 10 April 1942 (RGVA, 502-1-146, p. 21). The room for the urns (*Urnen*) appears on this drawing for the first time. Cf. Documents 204 and 206.

⁶⁴³ RGVA, 502-1-314, p. 1.

buildings [of the camp]. For that reason, the camp commandant has ordered that a room in the attic of the infirmary building be used for that purpose. In order for the urns to be collected in that room in an orderly fashion, appropriate shelves must be provided together with some other minor modifications. A specialist is requested for the inspection of the room and for the necessary preparations.”

Jean-Claude Pressac shows the photo of an urn from the Auschwitz Crematorium which contains the ashes of Karl Witalski, who died on 28 March 1941 and was cremated on 2 April (Pressac 1989, p. 133). These data are imprinted on the lid of the urn, which is of the same type as those shown in Photo 7 of Document PS 2430, which depicts an urn repository at the crematorium at Natzweiler Camp (*IMT*, Vol. 30, p. 429; see Photo 365). For Auschwitz, the use of urns is documented until November of 1941. From the few documents to have survived, we can gather that, since 6 January 1941, the Political Department of the camp requested from the carpentry workshop of the New Construction Office the fabrication of hundreds of “cases” and “boxes” for urns.⁶⁴⁴ The latest known request, dated 27 November 1941, refers to 50 “urn-shipment boxes”⁶⁴⁵ (Documents 299f.).

The cases or boxes for the urns were used as packing cases for the shipment of urns to the cemetery of the place of residence of the relatives or to some other cemetery, in keeping with Section 4, Paragraph 7 of Himmler’s decree of 28 February 1940, after telegraphic notification by the camp commandant of the death of the detainees, as per Section 3, Sub-Section 1 of this decree.⁶⁴⁶

In some cases, shipment of urns was prohibited by the SS authorities for reasons of public order.

On 28 May 1941, the *Befehlshaber der Sicherheitspolizei und des SD* in the Government General informed the camp commandant at Auschwitz that he had submitted to the *RSHA*, on 21 April, a proposal concerning the “shipment of ash urns of deceased persons.” The proposal contained, *i.a.*, the following procedure:⁶⁴⁷

“Shipment of urns to the Government General will no longer be effected; instead, the relatives will be informed immediately that an interment of the urns has taken place at the urn cemetery.”

This measure was intended to prevent the urns from being turned into objects of anti-German propaganda, as the head of Office Group D of the *WVHA* makes clear in a circular to the commandants of all concentration camps dated 12 September 1942. In this letter, which concerns the “Shipment of urns of detainees who died in the concentration camps,” *SS Obersturmbannführer* Liebehenschel noted that urns with the ashes of Czechs or Jews sent back to the Protectorate of

⁶⁴⁴ Up to 27 November 1941: 575.

⁶⁴⁵ *SS-Neubauleitung, Arbeitskarte. Auftrag Nr. 1009* of 27.11.1941 and *Werkstättenauftrag Nr. 212. Beleg-Nr. 1009* of 27.11.1941. RGVA, 502-2-1, pp. 34-34a & 31-31a. The work was carried out between 28 November and 13 December. For the other orders, cf.: RGVA, 502-2-1, pp. 28, 29, 41, 45-48.

⁶⁴⁶ Cf. telegram of 19 January 1942 announcing the death of detainee Aleksander Glodek, deceased two days earlier, in: Staatliches Museum Auschwitz 1995, Vol. 1, p. 132 of Appendix of documents.

⁶⁴⁷ AGK, NTN, 94, p. 166.

Bohemia and Moravia had provoked demonstrations, processions, etc. For that reason, he prohibited, with immediate effect, the shipment of such urns to the Protectorate, adding:⁶⁴⁸

“The urns will be preserved in the concentration camps. In case of doubt concerning the preservation of the urns, oral instructions are to be requested from this office.”

Aside from the system of completely direct incineration which, in actual operation, was also frequently practiced in civilian crematoria, we can say that the Topf Furnaces for concentration camps were designed and built in accordance with the ethical and legal norms applicable at the time. In fact, in the cost estimates for the double- and triple-muffle furnaces, carts or devices for the introduction of coffins into the muffle were specifically mentioned, which means that cremation with a coffin was provided for.⁶⁴⁹

This is confirmed by the operating instructions of these furnaces (Documents 210 and 227), which specified the start-up of the blower immediately after the introduction of the corpse into the muffle and maintaining it for some 20 minutes. This practice is completely consistent with corpses introduced into the muffle in coffins, because the rapid and intensive combustion of the coffin required large amounts of air,⁶⁵⁰ whereas it is wasteful for a cremation without a coffin, because feeding large amounts of cold air into the muffle during the vaporization phase of the corpse water – a period during which a considerable amount of heat was drained from the furnace – would only have impeded the cremation process.

The coffins used were probably similar to those used in the Terezín Crematorium (cf. Photo 362).

We may also deduce from Topf’s operating instructions that the double- and triple-muffle furnaces were designed to cremate a single corpse at a time and to ensure, if the instructions were correctly applied, segregation of the ashes of the corpses cremated.

We must, therefore, accept as a fact that, with regard to the design of their furnaces, the Topf Company and Engineer Prüfer in particular took into account the usual requirements of decorum and respect.

⁶⁴⁸ NO-1510.

⁶⁴⁹ Even the metal stretcher of simplified design which succeeded these devices was called *Sargeinführtrage*, stretcher for coffin introduction.

⁶⁵⁰ For this reason, the first electric furnace built by Topf at Erfurt was equipped with a blower having a capacity of 1,000 m³/hr for a pressure of 200 mm of water column; Jakobskötter 1941, p. 580.

Appendices

1. Tables

1.1. List of Cremations at the Westerbork Crematorium

Date format: dd/mm/yyyy

Table I: 27 April 1943

#	No.	Sex	Age	Date of Birth	Date of Death	Start	End	Duration
1	119	F	60	16/05/1883	23/04/1943	09:30	10:10	40 min
2	120	F	87	14/03/1856	23/04/1943	10:10	10:50	40 min
3	121	M	65	22/05/1878	23/04/1943	10:50	11:50	60 min
4	122	M	59	24/07/1884	23/04/1943	11:50	12:50	60 min
5	123	M	56	27/03/1887	24/04/1943	12:50	14:10	80 min
6	124	M	9	17/04/1934	26/04/1943	14:10	15:00	50 min
7	125	F	93	02/10/1850	24/04/1943	15:00	15:40	40 min
8	126	F	65	22/01/1878	24/04/1943	15:40	16:20	40 min
9	127	F	70	03/04/1873	25/04/1943	16:20	17:00	40 min
10	128	F	80	26/06/1863	25/04/1943	17:00	17:50	50 min
11	129	F	5 m	14/11/1942	22/04/1943	17:50	18:20	30 min

Table II: 10 May 1943

#	No.	Sex	Age	Date of Birth	Date of Death	Start	End	Duration
1	162	F	92	17/08/1851	07/05/1943	08:30	09:15	45 min
2	163	M	65	22/02/1878	07/05/1943	09:15	10:10	55 min
3	164	M	3	21/10/1940	08/05/1943	09:50	10:30	40 min
4	165	F	69	02/11/1874	08/05/1943	10:10	11:00	50 min
5	166	M	86	18/02/1857	09/05/1943	11:00	12:15	75 min
6	167	M	8 m	11/09/1942	08/05/1943	12:15	13:00	45 min
7	168	M	10 m	26/07/1942	08/05/1943	12:15	13:00	45 min
8	169	M	80	16/10/1863	09/05/1943	13:15	14:15	60 min

Table III: 26 May 1943

#	No.	Sex	Age	Date of Birth	Date of Death	Start	End	Duration
1	211	F	78	17/11/1865	21/05/1943	08:20	09:00	40 min
2	212	M	62	13/09/1881	21/05/1943	09:00	09:50	50 min
3	213	F	72	10/09/1871	24/05/1943	09:50	10:35	45 min
4	214	F	89	26/03/1854	24/05/1943	10:35	11:30	55 min
5	215	M	73	07/06/1870	24/05/1943	11:30	12:20	50 min
6	216	F	74	12/04/1869	24/05/1943	12:20	13:10	50 min
7	217	F	72	02/02/1871	24/05/1943	13:15	13:40	25 min
8	218	F	4	26/01/1939	26/05/1943	13:30	15:30	120 min
9	219	M	2 m	19/03/1943	26/05/1943	13:30	15:30	120 min

Table IV: 4 June 1943

#	No.	Sex	Age	Date of Birth	Date of Death	Start	End	Duration
1	230	M	58	19/02/1885	31/05/1943	08:30	09:15	45 min
2	231	M	80	23/09/1863	31/05/1943	09:15	10:10	55 min
3	232	F	78	15/06/1865	01/06/1943	10:10	10:45	35 min
4	233	F	54	30/03/1889	01/06/1943	10:45	11:30	45 min
5	234	F	18 m	02/12/1941	01/06/1943	11:30	12:30	60 min
6	235	F	60	16/05/1883	02/06/1943	12:30	13:30	60 min

Table V: 7 June 1943

#	No.	Sex	Age	Date of Birth	Date of Death	Start	End	Duration
1	236	F	55	25/07/1888	01/06/1943	08:20	09:10	50 min
2	237	F	59	05/06/1884	01/06/1943	09:10	10:00	50 min
3	238	M	62	29/03/1881	02/06/1943	10:00	10:45	45 min
4	239	F	83	30/05/1860	03/06/1943	10:45	11:30	45 min
5	240	M	75	01/04/1868	04/06/1943	11:30	12:10	40 min
6	241	F	49	06/09/1894	06/06/1943	12:10	12:50	40 min
7	242	F	90	08/01/1853	06/06/1943	12:50	13:35	45 min
8	243	F	2 m	30/04/1943	05/06/1943	12:50	13:35	45 min
9	244	M	63	01/05/1880	06/06/1943	13:35	14:35	60 min
10	245	F	77	29/12/1866	06/06/1943	14:35	15:25	50 min
11	246	M	46	12/09/1897	06/06/1943	15:25	16:25	60 min
12	247	M	10 m	29/08/1942	07/06/1943	15:25	16:25	60 min
13	248	F	89	10/12/1854	06/06/1943	16:25	17:00	35 min

Table VI: 11 June 1943

#	No.	Sex	Age	Date of Birth	Date of Death	Start	End	Duration
1	249	F	66	20/01/1877	07/06/1943	08:30	09:20	50 min
2	250	F	50	16/03/1893	09/06/1943	09:20	10:15	55 min
3	251	F	32 m	08/10/1940	08/06/1943	09:20	10:15	55 min
4	252	F	1	19/06/1942	09/06/1943	10:15	11:10	55 min
5	253	M	81	17/09/1862	11/06/1943	11:10	11:45	35 min
6	254	F	86	31/08/1857	11/06/1943	11:45	13:00	75 min

Table VII: 15 June 1943

#	No.	Sex	Age	Date of Birth	Date of Death	Start	End	Duration
1	255	F	76	07/07/1867	12/06/1943	8:20	8:55	35 min
2	256	F	67	30/11/1876	11/06/1943	8:55	9:40	45 min
3	257	F	15 m	30/03/1942	12/06/1943	8:55	9:40	45 min
4	258	F	77	18/02/1866	12/06/1943	9:40	10:40	60 min
5	259	F	76	11/07/1867	13/06/1943	10:40	11:25	45 min
6	260	F	19 m	12/11/1941	12/06/1943	10:40	11:25	45 min
7	261	M	75	27/09/1868	14/06/1943	11:25	13:10	105 min
8	262	M	11 m	24/07/1942	14/06/1943	11:30	13:10	100 min

Table VIII: 18 June 1943

#	No.	Sex	Age	Date of Birth	Date of Death	Start	End	Duration
1	268	F	75	23/12/1868	17/06/1943	08:30	09:20	50 min
2	264	F	72	25/03/1871	16/06/1943	09:20	10:05	45 min
3	265	M	58	24/03/1885	17/06/1943	10:05	10:55	50 min
4	266	F	64	24/04/1879	17/06/1943	10:55	12:00	65 min
5	267	M	84	27/06/1859	18/06/1943	12:00	12:50	50 min
6	269	M	17 m	11/01/1942	17/06/1943	12:50	14:00	70 min
7	270	M	4	09/07/1939	16/06/1943	12:50	14:00	70 min

Table IX: 22 June 1943

#	No.	Sex	Age	Date of Birth	Date of Death	Start	End	Duration
1	271	M	60	19/10/1883	21/06/1943	08:30	09:20	50 min
2	272	M	71	24/12/1872	20/06/1943	09:20	10:20	60 min
3	273	F	81	18/03/1862	18/06/1943	10:20	11:20	60 min
4	274	F	14 m	01/04/1942	19/06/1943	10:20	10:50	30 min
5	275	M	84	28/06/1859	21/06/1943	10:55	11:35	40 min
6	276	M	83	13/11/1860	20/06/1943	11:35	13:10	95 min

Table X: 25 June 1943

#	No.	Sex	Age	Date of Birth	Date of Death	Start	End	Duration
1	277	M	88	10/02/1855	23/06/1943	08:30	09:25	55 min
2	278	F	80	14/03/1863	23/06/1943	09:25	10:30	65 min
3	279	F	82	05/04/1861	23/06/1843	10:30	11:30	60 min
4	280	F	4 d	19/06/1943	23/06/1943	10:30	11:30	60 min
5	281	M	70	27/01/1873	23/06/1943	11:30	12:45	75 min
6	282	M	4 m	20/02/1943	25/06/1943	11:30	12:45	75 min
7	283	F	8 m	25/10/1942	24/06/1943	12:45	14:00	75 min
8	284	M	14 m	21/04/1942	25/06/1943	12:45	14:00	75 min

Table XI: 28 June 1943

#	No.	Sex	Age	Date of Birth	Date of Death	Start	End	Duration
1	285	M	63	07/01/1880	25/06/1943	08:30	09:15	45 min
2	286	M	62	23/05/1881	26/06/1943	09:15	10:15	60 min
3	287	F	80	28/01/1863	26/06/1943	10:15	11:10	55 min
4	288	F	74	18/05/1869	26/06/1943	11:10	12:10	60 min
5	289	M	1 m	06/05/1943	26/06/1943	11:10	12:10	60 min
6	290	M	67	21/05/1876	27/06/1943	12:10	13:10	60 min
7	291	F	19 m	24/11/1941	27/06/1943	12:10	13:10	60 min
8	292	F	72	10/07/1871	26/06/1943	13:10	14:00	50 min
9	293	F	15 m	07/03/1942	28/06/1943	13:10	14:00	50 min
10	294	F	85	28/04/1858	27/06/1943	14:00	15:00	60 min
11	295	F	18 m	21/12/1941	27/06/1943	14:00	15:00	60 min

Table XII: 1 July 1943

#	No.	Sex	Age	Date of Birth	Date of Death	Start	End	Duration
1	296	F	84	19/01/1859	28/06/1943	08:30	09:05	35 min
2	297	M	70	20/12/1873	29/06/1943	09:05	10:00	55 min
3	298	F	53	12/03/1890	28/06/1943	10:00	10:55	55 min
4	299	M	57	30/11/1886	29/06/1943	10:55	11:45	50 min
5	300	M	1	02/06/1942	30/06/1943	10:55	11:45	50 min
6	301	F	65	04/12/1878	29/06/1943	11:45	12:45	60 min
7	302	F	52	15/08/1891	30/06/1943	12:45	13:30	45 min
8	303	M	73	23/03/1870	30/06/1943	13:30	14:25	55 min
9	304	M	20	09/02/1923	30/06/1943	13:30	14:25	55 min
10	305	M	89	24/09/1854	30/06/1943	14:25	15:10	45 min
11	306	F	20 m	04/10/1940	30/06/1943	14:25	15:10	45 min
12	307	F	61	25/09/1882	01/07/1943	15:10	16:00	50 min

Table XIII: 7 July 1943

#	No.	Sex	Age	Date of Birth	Date of Death	Start	End	Duration
1	308	M	43	09/07/1900	05/07/1943	08:15	09:15	60 min
2	309	M	46	24/03/1897	05/07/1943	09:15	10:15	60 min
3	310	M	82	26/09/1861	02/07/1943	10:15	11:10	55 min
4	311	F	79	26/01/1864	01/07/1943	11:10	12:00	50 min
5	312	M	37	28/11/1906	01/07/1943	12:00	12:45	45 min
6	313	F	10 m	17/09/1942	01/07/1943	12:00	12:45	45 min
7	314	M	75	23/01/1868	06/07/1943	12:45	13:30	45 min
8	315	F	45	01/10/1898	06/07/1943	13:30	14:15	45 min
9	316	F	1 d	06/07/1943	06/07/1943	13:30	14:15	45 min
10	317	M	56	03/12/1887	06/07/1943	14:15	16:45	150 min
11	318	M	2 m	12/05/1943	06/07/1943	15:10	16:45	95 min

Table XIV: 12 July 1943

#	No.	Sex	Age	Date of Birth	Date of Death	Start	End	Duration
1	319	F	66	12/10/1877	07/07/1943	08:15	09:00	45 min
2	320	F	82	06/12/1861	07/07/1943	09:00	09:40	40 min
3	321	F	80	17/01/1863	08/07/1943	09:40	10:30	50 min
4	322	M	53	05/06/1890	07/07/1943	10:30	11:15	45 min
5	323	F	65	05/07/1878	08/07/1943	11:15	11:55	40 min
6	324	M	61	26/07/1882	10/07/1943	11:55	12:50	55 min
7	325	F	8 m	15/11/1942	11/07/1943	11:55	12:50	55 min
8	326	M	82	31/03/1861	09/07/1943	12:50	13:35	45 min
9	327	F	80	28/10/1863	09/07/1943	13:35	14:30	55 min

Table XV: 16 July 1943

#	No.	Sex	Age	Date of Birth	Date of Death	Start	End	Duration
1	328	M	69	29/06/1874	12/07/1943	10:30	11:30	60 min
2	329	M	91	29/10/1852	13/07/1943	11:30	12:30	60 min
3	330	M	10 d	05/07/1943	15/07/1943	11:30	12:30	60 min
4	331	M	80	10/05/1863	16/07/1943	12:30	13:30	60 min
5	332	M	15 m	24/04/1942	14/07/1943	12:30	13:30	60 min
6	333	F	61	14/05/1882	16/07/1943	13:30	14:50	80 min
7	334	M	18 m	30/01/1942	16/07/1943	13:30	14:50	80 min
8	335	M	90	03/11/1853	16/07/1943	15:00	16:20	80 min

Table XVI: 22 July 1943

#	No.	Sex	Age	Date of Birth	Date of Death	Start	End	Duration
1	336	F	27	07/07/1916	21/07/1943	08:15	09:15	60 min
2	337	M	78	05/05/1865	21/07/1943	09:15	10:00	45 min
3	338	M	63	17/04/1880	18/07/1943	10:00	10:45	45 min
4	339	M	14 m	27/05/1942	21/07/1943	10:00	10:45	45 min
5	340	M	83	17/11/1860	19/07/1943	10:45	11:25	40 min
6	341	F	3 m	21/04/1943	18/07/1943	10:45	11:25	40 min
7	342	M	44	01/08/1899	20/07/1943	11:25	12:20	55 min
8	343	F	70	13/10/1873	19/07/1943	12:20	13:00	40 min
9	344	F	87	07/11/1856	19/07/1943	13:00	14:00	60 min
10	345	M	70	06/08/1873	22/07/1943	14:30	16:00	90 min

Table XVII: 28 July 1943

#	No.	Sex	Age	Date of Birth	Date of Death	Start	End	Duration
1	346	F	81	12/08/1862	23/07/1943	08:30	09:05	35 min
2	347	M	78	10/03/1865	25/07/1943	09:05	10:05	60 min
3	348	M	67	05/08/1876	25/07/1943	10:05	11:10	65 min
4	349	M	46	12/06/1897	25/07/1943	11:10	12:30	80 min
5	350	F	74	25/03/1869	25/07/1943	12:30	13:15	45 min
6	351	M	66	26/02/1877	28/07/1943	13:15	14:45	90 min

Table XVIII: 2 August 1943

#	No.	Sex	Age	Date of Birth	Date of Death	Start	End	Duration
1	352	M	70	29/01/1873	29/07/1943	09:30	10:30	60 min
2	353	F	67	13/12/1876	30/07/1943	10:30	11:15	45 min
3	354	F	86	11/04/1857	01/08/1943	11:15	12:00	45 min
4	355	F	81	27/08/1862	01/08/1943	12:00	12:45	45 min
5	356	F	71	20/07/1872	02/08/1943	12:45	13:55	70 min

Table XIX: 9 August 1943

#	No.	Sex	Age	Date of Birth	Date of Death	Start	End	Duration
1	358	M	22	26/05/1921	07/08/1943	03:05	04:00	55 min
2	359	M	5 m	05/03/1943	06/08/1943	04:00	04:30	30 min
3	360	M	3 m	21/05/1943	07/08/1943	04:00	04:30	30 min
4	361	M	1 m	16/07/1943	06/08/1943	04:00	04:30	30 min
5	362	F	1 m	11/07/1943	06/08/1943	04:50	/	/

Table XX: 16 August 1943

#	No.	Sex	Age	Date of Birth	Date of Death	Start	End	Duration
1	363	F	78	15/01/1865	13/08/1943	09:00	09:55	55 min
2	364	M	75	03/10/1868	14/08/1943	09:55	10:45	50 min
3	365	F	34 m	30/10/1940	12/08/1943	09:55	10:45	50 min
4	366	M	26	11/03/1917	15/08/1943	10:45	11:35	50 min
5	367	M	61	15/05/1882	15/08/1943	11:35	12:15	40 min
6	368	M	84	16/05/1859	14/08/1943	12:20	13:30	70 min
7	369	M	2	23/08/1941	16/08/1943	12:20	13:30	70 min

Table XXI: 20 August 1943

#	No.	Sex	Age	Date of Birth	Date of Death	Start	End	Duration
1	370	F	59	24/09/1884	19/08/1943	10:00	11:00	60 min
2	371	M	53	31/12/1890	18/08/1943	11:00	11:40	40 min
3	372	M	3	19/08/1940	17/08/1943	11:40	12:20	40 min
4	373	M	2	31/08/1941	18/08/1943	11:40	12:20	40 min

Table XXII: 23 August 1943

#	No.	Sex	Age	Date of Birth	Date of Death	Start	End	Duration
1	374	M	71	14/02/1872	21/08/1943	14:15	15:05	50 min
2	375	M	68	07/07/1875	22/08/1943	15:05	16:00	55 min
3	376	M	2 m	26/06/1943	21/08/1943	16:00	16:20	20 min
4	377	?	1 d	21/08/1943	21/08/1943	16:00	16:20	20 min
5	378	F	66	07/02/1877	23/08/1943	16:20	16:55	35 min

Table XXIII: 1 September 1943

#	No.	Sex	Age	Date of Birth	Date of Death	Start	End	Duration
1	382	F	78	03/04/1865	30/08/1943	08:30	09:10	40 min
2	383	M	16	02/08/1927	31/08/1943	09:10	09:50	40 min
3	384	M	16	14/06/1927	31/08/1943	09:50	10:35	45 min
4	385	F	50	22/06/1893	28/08/1943	10:40	11:35	55 min
5	386	F	1 d	31/08/1943	31/08/1943	11:00	11:35	35 min
6	387	F	42	20/07/1901	30/08/1943	11:35	12:15	40 min
7	388	M	82	27/11/1861	31/08/1943	12:20	13:20	60 min
8	389	F	71	25/06/1872	31/08/1943	13:20	14:00	40 min
9	390	M	79	25/12/1864	31/08/1943	14:05	15:05	60 min

Table XXIV: 13 September 1943

#	No.	Sex	Age	Date of Birth	Date of Death	Start	End	Duration
1	394	F	54	30/06/1889	09/09/1943	08:30	09:20	50 min
2	395	M	58	06/11/1885	08/09/1943	09:20	10:05	45 min
3	396	M	54	01/07/1889	10/09/1943	10:10	11:00	50 min
4	397	F	63	29/07/1880	13/09/1943	11:00	11:40	40 min
5	398	M	2 m	06/07/1943	12/09/1943	11:40	12:30	50 min
6	399	?	1 d	10/09/1943	10/09/1943	11:40	12:30	50 min

Table XXV: 4 October 1943

#	No.	Sex	Age	Date of Birth	Date of Death	Start	End	Duration
1	409	M	86	21/06/1857	29/09/1943	09:00	09:30	30 min
2	410	M	31	19/02/1912	01/10/1943	09:30	10:30	60 min
3	411	M	70	20/01/1873	02/10/1943	10:30	11:20	50 min
4	412	M	77	06/12/1866	04/10/1943	11:20	12:20	60 min

Table XXVI: 13 October 1943

#	No.	Sex	Age	Date of Birth	Date of Death	Start	End	Duration
1	416	F	35	23/12/1908	09/10/1943	08:30	09:00	30 min
2	417	M	58	10/04/1885	10/10/1943	09:00	10:10	70 min
3	418	F	66	07/03/1877	09/10/1943	10:10	10:40	30 min
4	419	M	65	12/09/1878	13/10/1943	10:40	11:50	70 min
5	420	M	2 m	26/08/1943	13/10/1943	10:45	11:50	65 min

Table XXVII: 18 October 1943

#	No.	Sex	Age	Date of Birth	Date of Death	Start	End	Duration
1	421	M	45	26/02/1898	17/10/1943	03:00	03:20	20 min
2	422	F	13 m	07/09/1942	17/10/1943	03:20	04:00	40 min
3	423	F	59	10/10/1884	18/10/1943	04:00	04:20	20 min
4	424	F	2 m	26/08/1943	14/10/1943	04:20	05:00	40 min

Table XXVIII: 22 October 1943

#	No.	Sex	Age	Date of Birth	Date of Death	Start	End	Duration
1	425	F	88	27/4/1855	19/10/1943	08:30	09:00	30 min
2	426	M	69	22/1/1874	19/10/1943	09:00	10:00	60 min
3	427	M	43	23/2/1900	19/10/1943	10:00	11:00	60 min
4	428	F	73	06/6/1870	20/10/1943	11:00	11:45	45 min
5	429	M	62	28/2/1881	20/10/1943	11:45	12:30	45 min
6	430	M	72	09/4/1871	21/10/1943	12:30	13:00	30 min
7	431	M	84	02/5/1859	22/10/1943	13:00	/	/

Table XXIX: 3 November 1943

#	No.	Sex	Age	Date of Birth	Date of Death	Start	End	Duration
1	437	M	58	18/02/1885	31/10/1943	08:35	09:15	40 min
2	438	M	77	20/05/1866	29/10/1943	09:15	10:15	60 min
3	439	M	62	10/07/1881	02/11/1943	10:15	10:50	45 min
4	440	F	79	27/12/1864	31/10/1943	10:50	11:35	45 min
5	441	F	78	27/07/1865	01/11/1943	11:35	12:05	30 min
6	442	F	76	01/06/1867	02/11/1943	12:05	13:00	55 min
7	443	F	25	24/04/1918	01/11/1943	13:00	14:00	60 min

1.2. List of Cremations at the Terezín Crematorium

A) Summary Data

Table I: Summary of Daily Cremations

Date dd/mm/yyyy	Furnace No.	#	Sex		Average Duration [min]	Coffin numbers
			M	F		
03/10/1943	IV	22	10	12	34	19527-19548
04/10/1943	IV	24	12	12	35	19549-19572
05/10/1943	IV	24	12	12	35	19573-19596
06/10/1943	IV	24	12	12	35	19597-19620
07/10/1943	IV	10	5	5	61	19621-19630
08/10/1943	IV	20	10	10	35	19631-19650
10/10/1943	IV	17	6	11	31	19651-19667
11/10/1943	IV	25	9	16	32	19668-19692
12/10/1943	IV	25	11	14	32	19693-19717
13/10/1943	IV	24	15	9	33	19718-19741
14/10/1943	IV	7	4	3	50	19742-19748
15/10/1943	IV	6	3	3	38	19749-19754
16/10/1943	IV	14	6	8	36	19755-19768
17/10/1943	IV	24	12	12	34	19769-19792
18/10/1943	IV	24	10	14	35	19793-19816
19/10/1943	IV	24	10	14	35	19817-19840
20/10/1943	IV	24	10	14	34	19841-19864

Date dd/mm/yyyy	Furnace No.	#	Sex		Average Duration [min]	Coffin numbers
			M	F		
21/10/1943	IV	10	6	4	37	19865-19874
22/10/1943	IV	16	8	8	40	19875-19890
23/10/1943	IV	10	4	6	36	19891-19900
24/10/1943	IV	17	7	10	42	19901-19929
24/10/1943	II	14	6	8	42	19907-19931
25/10/1943	II	8	6	2	45	19932-19939
25/10/1943	III	11	3	8	37	19940-19950
26/10/1943	III	18	6	12	43	19951-19968
27/10/1943	III	20	6	14	39	19969-19988
28/10/1943	III	12	6	6	35	19989-20000
29/10/1943	III	18	9	9	39	20001-20018
31/10/1943	III	6	3	3	42	20019-20023
01/11/1943	III	16	6	10	37	20024-20039
02/11/1943	III	17	4	13	37	20040-20056
03/11/1943	III	7	1	6	35	20057-20063
04/11/1943	III	17	9	8	36	20064-20080
05/11/1943	III	17	12	5	38	20081-20097
06/11/1943	III	23	14	9	34	20098-20120
08/11/1943	III	22	11	11	33	20121-20142
09/11/1943	III	23	10	13	32	20143-20165
10/11/1943	III	22	11	11	33	20166-20187
12/11/1943	III	10	3	7	41	20188-20197
13/11/1943	III	18	12	6	39	20198-20215
15/11/1943	III	27	12	15	35	20216-20242
Total		717	332	385		

B) List of Cremations at the Crematorium at Terezín

Containing at least 24 consecutive cremations.

Table II: 4 October 1943 – Furnace No. IV

#	Start (time)	End (time)	Duration [min]	Sex	Coffin number
1	06:00	06:50	50	F	19549
2	06:50	07:30	40	M	19550
3	07:30	08:05	35	M	19551
4	08:05	08:40	35	F	19552
5	08:40	09:15	35	M	19553
6	09:15	09:50	35	F	19554
7	09:50	10:25	35	F	19555
8	10:25	11:00	35	F	19556
9	11:00	11:35	35	M	19557
10	11:35	12:05	30	F	19558
11	12:05	12:35	30	M	19559
12	12:35	13:00	25	F	19560
13	13:00	13:35	35	F	19561
14	13:35	14:10	35	M	19562
15	14:10	14:45	35	F	19563
16	14:45	15:20	35	M	19564
17	15:20	15:55	35	M	19565

#	Start (time)	End (time)	Duration [min]	Sex	Coffin number
18	15:55	16:30	35	M	19566
19	16:30	17:05	35	F	19567
20	17:05	17:40	35	M	19568
21	17:40	18:15	35	M	19569
22	18:15	18:50	35	F	19570
23	18:50	19:25	35	M	19571
24	19:25	/	/	F	19572
Average Duration \approx 35 min					

Table III: 5 October 1943 – Furnace No. IV

#	Start (time)	End (time)	Duration [min]	Sex	Coffin number
1	06:00	06:50	50	F	19573
2	06:50	07:30	40	F	19574
3	07:30	08:05	35	M	19575
4	08:05	08:35	30	F	19576
5	08:35	09:10	35	M	19577
6	09:10	09:40	30	F	19578
7	09:40	10:15	35	M	19579
8	10:15	10:45	30	F	19580
9	10:45	11:15	30	M	19581
10	11:15	11:45	30	F	19582
11	11:45	12:15	30	M	19583
12	12:15	13:00	45	F	19584
13	13:00	13:35	35	F	19585
14	13:35	14:10	35	M	19586
15	14:10	14:45	35	F	19587
16	14:45	15:20	35	M	19588
17	15:20	15:55	35	M	19589
18	15:55	16:30	35	M	19590
19	16:30	17:05	35	F	19591
20	17:05	17:40	35	M	19592
21	17:40	18:15	35	F	19593
22	18:15	18:50	35	M	19594
23	18:50	19:25	35	M	19595
24	19:25	/	/	F	19596
Average Duration \approx 35 min					

Table IV: 6 October 1943 – Furnace No. IV

#	Start (time)	End (time)	Duration [min]	Sex	Coffin number
1	06:30	07:05	35	F	19597
2	07:05	07:45	40	M	19598
3	07:45	08:15	30	F	19599
4	08:15	08:45	30	F	19600
5	08:45	09:15	30	F	10601
6	09:15	09:40	25	F	19602
7	09:40	10:10	30	F	19603
8	10:10	10:35	25	F	19604
9	10:35	11:20	45	M	19605
10	11:20	11:45	25	F	19606
11	11:45	12:15	30	F	19607

#	Start (time)	End (time)	Duration [min]	Sex	Coffin number
12	12:15	12:50	35	M	19608
13	12:50	13:30	40	F	19609
14	13:30	14:10	40	M	19610
15	14:10	14:45	35	F	19611
16	14:45	15:20	35	F	19612
17	15:20	15:55	35	M	19613
18	15:55	16:30	35	F	19614
19	16:30	17:05	35	M	19615
20	17:05	17:40	35	F	19616
21	17:40	18:15	35	M	19617
22	18:15	18:50	35	M	19618
23	18:50	19:25	35	M	19619
24	19:25	/	/	M	19620
Average Duration \approx 34 min					

Table V: 11 October 1943 – Furnace No. IV

#	Start (time)	End (time)	Duration [min]	Sex	Coffin number
1	06:00	06:30	30	F	19668
2	06:30	07:00	30	F	19669
3	07:00	07:30	30	F	19670
4	07:30	08:05	35	M	19671
5	08:05	08:40	35	F	19672
6	08:40	09:15	35	M	19674
7	09:15	09:50	35	F	19675
8	09:50	10:25	35	M	19675
9	10:25	11:00	35	F	19676
10	11:00	11:35	35	M	19677
11	11:35	12:10	35	F	19678
12	12:10	12:45	35	F	19679
13	12:45	13:00	15	M	19680
14	13:00	13:35	35	F	19681
15	13:35	14:10	35	F	19682
16	14:10	14:45	35	F	19683
17	14:45	15:20	35	M	19684
18	15:20	15:55	35	F	19685
19	15:55	16:30	35	M	19686
20	16:30	17:00	30	F	19687
21	17:00	17:30	30	M	19688
22	17:30	18:00	30	F	19689
23	18:00	18:30	30	F	19690
24	18:30	19:00	30	F	19691
25	19:00	19:30	30	M	19692
Average Duration \approx 32 min					

Table VI: 12 October 1943 – Furnace No. IV

#	Start (time)	End (time)	Duration [min]	Sex	Coffin number
1	06:00	06:30	30	F	19693
2	06:30	07:00	30	F	19694
3	07:00	07:30	30	F	19695
4	07:30	08:00	30	M	19696

#	Start (time)	End (time)	Duration [min]	Sex	Coffin number
5	08:00	08:30	30	M	19697
6	08:30	09:00	30	F	19698
7	09:00	09:30	30	F	19699
8	09:30	10:00	30	M	19700
9	10:00	10:30	30	F	19701
10	10:30	11:00	30	M	19702
11	11:00	11:55	55	M	19703
12	11:55	12:30	35	F	19704
13	12:30	13:00	30	M	19705
14	13:00	13:35	35	F	19706
15	13:35	14:10	35	F	19707
16	14:10	14:40	30	F	19708
17	14:40	15:15	35	M	19709
18	15:15	15:45	30	F	19710
19	15:45	16:20	35	M	19711
20	16:20	16:50	30	F	19712
21	16:50	17:25	35	M	19713
22	17:25	17:55	30	F	19714
23	17:55	18:30	35	M	19715
24	18:30	19:00	30	F	19716
25	19:00	/	/	M	19717
Average Duration \approx 32 min					

Table VII: 13 October 1943 – Furnace No. IV

#	Start (time)	End (time)	Duration [min]	Sex	Coffin number
1	06:00	06:30	30	F	19718
2	06:30	07:05	35	M	19719
3	07:05	07:35	30	F	19720
4	07:35	08:10	35	M	19721
5	08:10	08:40	30	F	19722
6	08:40	09:15	35	M	19723
7	09:15	09:45	30	F	19724
8	09:45	10:20	35	M	19725
9	10:20	10:50	30	F	19726
10	10:50	11:25	35	M	19727
11	11:25	12:00	35	M	19728
12	12:00	12:40	40	M	19729
13	13:00	13:35	35	M	19730
14	13:35	14:10	35	F	19731
15	14:10	14:40	30	M	19732
16	14:40	15:10	30	M	19733
17	15:10	15:40	30	M	19734
18	15:40	16:15	35	F	19735
19	16:15	16:50	35	M	19736
20	16:50	17:20	30	M	19737
21	17:20	17:50	30	M	19738
22	17:50	18:25	35	M	19739
23	18:25	19:00	35	F	19740
24	19:00	/	/	F	19741
Average Duration \approx 33 min					

Table VIII: 17 October 1943 – Furnace No. IV

#	Start (time)	End (time)	Duration [min]	Sex	Coffin number
1	06:15	06:45	30	F	19769
2	06:45	07:20	35	M	19770
3	07:20	08:00	40	M	19771
4	08:00	08:30	30	F	19772
5	08:30	09:00	30	M	19773
6	09:00	09:30	30	F	19774
7	09:30	10:00	30	F	19775
8	10:00	10:40	40	M	19776
9	10:40	11:10	30	F	19777
10	11:10	11:40	30	M	19778
11	11:40	12:10	30	F	19779
12	12:10	12:45	35	M	19780
13	12:45	13:20	35	F	19781
14	13:20	13:55	35	F	19782
15	13:55	14:30	35	F	19783
16	14:30	15:05	35	M	19784
17	15:05	15:40	35	F	19785
18	15:40	16:15	35	M	19786
19	16:15	16:50	35	F	19787
20	16:50	17:25	35	M	19788
21	17:25	18:00	35	M	19789
22	18:00	18:35	35	F	19790
23	18:35	19:10	35	M	19791
24	19:10	/	/	M	19792
Average Duration \approx 34 min					

Table IX: 18 October 1943 – Furnace No. IV

#	Start (time)	End (time)	Duration [min]	Sex	Coffin number
1	06:00	06:50	50	F	19793
2	06:50	07:30	40	F	19794
3	07:30	08:05	35	M	19795
4	08:05	08:40	35	F	19796
5	08:40	09:15	35	M	19797
6	09:15	09:50	35	F	19798
7	09:50	10:25	35	F	19799
8	10:25	11:00	35	F	19800
9	11:00	11:30	30	F	19801
10	11:30	12:00	30	M	19802
11	12:00	12:30	30	F	19803
12	12:30	13:00	30	M	19804
13	13:00	13:35	35	F	19805
14	13:35	14:10	35	M	19806
15	14:10	14:45	35	F	19807
16	14:45	15:20	35	M	19808
17	15:20	15:55	35	F	19809
18	15:55	16:30	35	M	19810
19	16:30	17:05	35	F	19811
20	17:05	17:40	35	M	19812
21	17:40	18:15	35	F	19813

#	Start (time)	End (time)	Duration [min]	Sex	Coffin number
22	18:15	18:50	35	M	19814
23	18:50	19:25	35	F	19815
24	19:25	/	/	M	19816
Average Duration \approx 35 min					

Table X: 19 October 1943 – Furnace No. IV

#	Start (time)	End (time)	Duration [min]	Sex	Coffin number
1	06:00	06:45	45	M	19817
2	06:45	07:20	35	M	19818
3	07:20	07:50	30	M	19819
4	07:50	08:25	35	F	19820
5	08:25	09:00	35	M	19821
6	09:00	09:30	30	F	19822
7	09:30	10:05	35	M	19823
8	10:05	10:35	30	F	19824
9	10:35	11:10	35	M	19825
10	11:10	11:45	35	F	19826
11	11:45	12:20	35	F	19827
12	12:20	13:00	40	M	19828
13	13:00	13:25	35	M	19829
14	13:35	14:10	35	F	19830
15	14:10	14:45	35	F	19831
16	14:45	15:20	35	F	19832
17	15:20	15:55	35	M	19833
18	15:55	16:30	35	F	19834
19	16:30	17:05	35	F	19835
20	17:05	17:40	35	F	19836
21	17:40	18:15	35	M	19837
22	18:15	18:50	35	F	19838
23	18:50	19:25	35	F	19839
24	19:25	/	/	F	19840
Average Duration \approx 35 min					

Table XI: 20 October 1943 – Furnace No. IV

#	Start (time)	End (time)	Duration [min]	Sex	Coffin number
1	06:00	06:35	35	F	19841
2	06:35	07:10	35	F	19842
3	07:10	07:45	35	F	19843
4	07:45	08:20	35	M	19844
5	08:20	08:55	35	F	19845
6	08:55	09:30	35	M	19846
7	09:30	10:00	30	F	19847
8	10:00	10:35	35	F	19848
9	10:35	11:20	35	M	19849
10	11:20	12:00	40	M	19850
11	12:00	12:35	35	M	19851
12	12:35	13:00	25	F	19852
13	13:00	13:35	35	F	19853
14	13:35	14:10	35	F	19854
15	14:10	14:45	35	M	19855

#	Start (time)	End (time)	Duration [min]	Sex	Coffin number
16	14:45	15:20	35	F	19856
17	15:20	15:55	35	F	19857
18	15:55	16:30	35	M	19858
19	16:30	17:05	35	F	19859
20	17:05	17:40	35	F	19860
21	17:40	18:15	35	M	19861
22	18:15	18:50	35	F	19862
23	18:50	19:25	35	M	19863
24	19:25	/	/	M	19864
Average Duration \approx 34 min					

Table XII: 15 November 1943 – Furnace No. III

#	Start (time)	End (time)	Duration [min]	Sex	Coffin number
1	04:30	05:10	40	F	20216
2	05:10	05:40	30	F	20217
3	05:40	06:15	35	F	20218
4	06:15	06:45	30	M	20219
5	06:45	07:15	30	F	20220
6	07:15	07:45	30	F	20221
7	07:45	08:15	30	F	20222
8	08:15	08:45	30	M	20223
9	08:45	09:15	30	M	20224
10	09:15	09:45	30	F	20225
11	09:45	10:15	30	M	20226
12	10:15	10:45	30	F	20227
13	10:45	11:15	30	M	20228
14	11:15	11:40	25	M	20229
15	11:40	12:10	30	F	20230
16	12:10	12:35	25	M	20231
17	12:35	(13:10)	35	F	20232
18	12:30	13:10	40	M	20233
19	13:10	13:50	40	F	20234
20	13:50	14:30	40	M	20235
21	14:30	15:10	40	F	20236
22	15:10	15:50	40	M	20237
23	15:50	16:30	40	F	20238
24	16:30	17:10	40	M	20239
25	17:10	17:50	40	F	20240
26	17:50	18:30	40	M	20241
27	18:30	/	/	F	20242
Average Duration \approx 35 min					

1.3. Summary of the Topf Company's Activities at Auschwitz-Birkenau

The Topf Company's area of activities was not strictly limited to cremation furnaces, as outlined in Unit II of this study. It extended into two other important areas: ventilation systems and disinfestations with hot air. The table below lists almost all deliveries ever made, and projects carried out, by Topf at the Auschwitz-Birkenau Camp. These activities yielded a turnover of more than 240,000 Reichsmarks to this Erfurt firm. Where data are unknown, the respective cell is left blank. Date format is dd/mm/yyyy.

Invoice Date	Order No.	Amount RM	Date of Cost Estimate	Object	Building*
27/08/1940		10,679	17/4/1940	Furnace No. 1	K I
	40 D 945	146	9/10/1940 (A)	11 muffle-grate bars, 200 kg of compressed Monolite	K I
	40 D 1090	7,753	13/11/1940	Furnace No. 2	K I
?/01/1941	41 D 38	300			K I
15/01/1941	41 D 73	444		sending a technician	K I
	41 D 112	180		2 gasifier doors	K I
	41 D 291	300			K I
05/08/1941	41 D 719				K I
16/12/1941	41 D 1980	7,518.10	25/9/1941	Furnace No. 3	K I
	41 D 2434/2	71		repair work – 27/11 to 4/12/1941; 18 to 26/12/1941	K I
06/06/1942		251.50		installation work	K I
12/11/1942	42 D 1447	355.62		sending a technician	K II
20/11/1942	41 D 2435	1045.50		sending a technician for the foundation of K IV	K IV
27/01/1943	41 D 2249	51,237	4/11/1941	5 triple-muffle furnaces	K II
22/02/1943	42 D 243	7,820		ventilation system	K II
22/02/1943	42 D 243/1	921.60		Messing – installation of forced-draft blowers	K II
22/02/1943	42 D 1454	112		Koch – installation work from 18 to 21/1/1943	
23/03/1943	42 D 1422/3	3,258		– 4 ash chamber doors – 8,700 kg of rock wool – 4 gasifier grates	K IV & V
23/03/1943	43 D 145/1	908		<i>Demag-Elektrozug</i> (provisional freight elevator)	K II
28/04/1943	42 D 1454	1,128		installation work 1-28/4/1943	
05/04/1943	41 D 2435	27,632.30		2 eight-muffle furnaces	K IV & V
24/05/1943		522		three-phase engine	
27/05/1943	42 D 1454/1	53,702	30/9/1942	5 triple-muffle furnaces	K III
27/05/1943	42 D 1520	7,820		ventilation system	K III
27/05/1943	41 D 2249 & 42 D 243	916		Messing	
27/05/1943		40.60		steel types (<i>Stahltypen</i>)	
27/05/1943	41 D 314/15	1,884		ventilation system	K I

Invoice Date	Order No.	Amount RM	Date of Cost Estimate	Object	Building*
11/06/1943	43 D 219	1,070		Warm-air-supply duct (<i>Warmluftzuführung</i>)	K II
16/06/1943		1,348		extension (<i>Erweiterung</i>)	K II & III
16/06/1943		842		work in the crematorium	
30/06/1943	42 D 243/1	1,583		Messing – installation work 1 through 30/4/1943	
30/06/1943		1,255		sending a technician	
15/07/1943		968		housing for blowers	K II & III
23/08/1943	43 D 150	5,791	5/2/1943	waste incinerator (<i>Müll-Verbrennungsofen</i>)	K III
23/08/1943		365		installation & travel expenses	K III
19/10/1943	43 D 204/1	39,192	5/2/1943	disinfestation facility (<i>Entwesungsanlage</i>)	Z**
23/10/1943		1,503.50		installation work	
28/10/1943		365		installation work	
23/12/1943	43 D 775	2,524		ventilation system	K IV & V
16/03/1944		46		6 rod thermometers	Z**
25/03/1944	43 D 145/3	18,760		2 electric freight elevators	BW 14
		242,755.72			

* K = crematorium. ** Z = *Zentralsauna*

1.4. Patents (and Patent Applications) by J.A. Topf & Söhne

Patents on cremation furnaces are in italics.⁶⁵¹

Ref. No.	Country	Pat. No.	Object
/	Germany	324252	<i>Sargeeinführvorrichtung für Verbrennungsofen mit heb- und senkbarem Fahrgestell für den Sargträger</i>
/	Germany	493042	<i>Vorrichtung zum Nachverbrennen der Rückstände in Leichenverbrennungsofen</i>
28/2	Germany	494136	Ausfahrbarer Schlackenrost für mit Unterwind betriebene Feuerungen
34/2	Germany	561643	<i>Feuerbestattungsofen mit drehbaren Rosten</i>
31/12	Germany	576135	Düsenplattenrost
32/9	Germany	587149	Verfahren u. Ofen zur Zurückgewinnung von Blei und Kupferdraht aus Kabeln
37/2	Germany	592658	Saugdüse
35/1	Germany	608462	Wendeschraube f. mech. Wendeapparate
29/5	Germany	612193	Verfahren z. gleichzeitigen Weichen und Ankeimen von Malz
32/3	Germany	621449	Luft- Zu- u. -Abführungs-Vorrichtung an drehbaren Trockentrommel m. Geschlossenem Aussenmantel
34/1	Germany	633197	Kegelförmige Absperrvorrichtung
38/1	Germany	638582	<i>Einäscherungsofen</i>
35/2	Germany	651506	Belüftungs-Einrichtung für staubförmige oder staubhaltige Massengüter

⁶⁵¹ Thüringische Verwaltungsstelle – Kreisstelle Erfurt, Erfurt, Hindenburgstrasse. Patente der Firma J.A. Topf & Söhne, Erfurt, 20 November 1945. SE, 5/411 A 172. The list was completed with the results of our research.

Ref. No.	Country	Pat. No.	Object
36/2	Germany	659405	<i>Beschickungseinrichtung für Einäscherungsöfen</i>
38/4	Germany	695325	Mehrorden-Malzdarre
38/4	Germany	718946	Mehrorden-Malzdarre
41/11	Germany	721513	Gutbehälterauslauf für Saugförderanlagen in Speichern mit Mehreren Gutbehältern
41/7	Germany	724940	Verfahren und Vorrichtung zur selbsttätigen Belüftung von Getreideweichen mit mehreren Weichgefässen
41/4	Germany	724941	Vorrichtung zur selbsttätigen Regelung der Arbeitsvorgänge von Kasten-Keimtrommeln
41/8	Germany	728405	Kuppelvorrichtung für Kasten-Keimtrommeln
41/6	Germany	728529	Vorrichtung zum selbständigen Regeln des Bewegungsvorganges von Malzwendern, insbesondere von Keimkästen
41/12	Germany	733328	Vorrichtung zum Pressen und Imprägnieren von Malzkeimen oder anderen landwirtschaftlichen Abfallstoffen
/	Germany	patent appl.	<i>Kontinuierlich arbeitender Leichen-Verbrennungsöfen für Massenbetrieb</i>
/	Germany	patent appl.	Luftgekühlte Rostplatten für Vorschubroste
42/5	Germany	756205	Rückmelde- oder Sicherheitsschalter
/	Germany	861731	<i>Verfahren und Vorrichtung zur Verbrennung von Leichen, Kadavern und Teilen davon</i>
25/6	USA	1596977	Kastentrommel
30/17	France	710023	Keimkasten mit fahrbarem Wender
25/8	Switzerland	65465	Kastentrommel
41/18	Switzerland	216678	Mehrorden-Malzdarre

1.5. Patent Applications by Department “DE” of J.A. Topf & Söhne

Date format: dd/mm/yyyy.⁶⁵²

Ref. No.	Protocol No.	Object	Request Date
D 39/1	T 52 739 V/24 f	Mechanischer Stufenrost m. Wasserlaufkühlung	25/08/1939
D 39/2	T 52 961 V/24 f	Rostbelag zu mechanischen Stufenrosten	21/10/1939
D 39/3	T 53 166 V/24 d	<i>Einäscherungsöfen mit Doppelmuffel</i>	06/12/1939
D 41/4	T 56 022 V/24 f	Mechanischer Vorschubrost mit gekrümmten Rostplattenträgern	05/08/1941
D 41/5	T 56 340/V 24 f	Mechanischer Zonen-Vorschub-Rost	15/10/1941
D 42/3	T 58 240/V 24 d	<i>Kontinuierlich arbeitender Leichen-Verbrennungsöfen für Massenbetrieb</i>	05/11/1942
D 42/4	T 58 282/V24 f	Luftgekühlte Rostplatten für mechanische Vorschubroste	16/11/1942
D 42/6	T 58 411 /V82 a	Querstromtrockner für körnige Brennstoffe u. andere Schüttgüter mit vor- u. nachgeschalteten-Mahlgang	17/12/1942
D 42/7	T 58 449 III/30 c	Mühle für Brennstoffe u. andere Schüttgüter	17/12/1942
D 43/1	T 58 825 V/24 i	Schornstein und Entlüftungsaufsatz	10/03/1943

⁶⁵² J.A. Topf & Söhne, Erfurt, *Z. Zeit laufende Patentanmeldungen “D”*, 20 November 1945. Source: www.topfundsoehne.de/media_de/

D 44/1	/	Verfahren zur mechanischen Längs- und Querschürung des Brennstoffbettes bei mechanischen Schürrosten	10/03/1944
--------	---	--	------------

- Description of patents sent to the patent office of the German Reich:
 - *Hochleistungsöfen mit Aschendreurost D.R.P. angem.*, 1934.
 - *Elektrisch betriebener Topf-Einäscherungsöfen D.R.P. angem.*, 1935.

2. Glossary

<i>Abfall-Vernichtungs-Ofen</i>	Waste-disposal incinerator
<i>Abgase</i>	exhaust/smoke/flue gas
<i>Abgaskanäle</i>	exhaust/flue-gas channels
<i>Abgasventilator</i>	exhaust fan
<i>Absperrschieber</i>	closing slide/damper
<i>Absperrventil</i>	closing valve
<i>Achtmuffel-Einäscherungsofen</i>	eight-muffle cremation furnace
<i>Anker</i>	anchor irons/rods, drawing rods
<i>Armaturen</i>	fittings, displays
<i>Asche-Urne, Ascheurne</i>	ash urn
<i>Ascheabkühlkammer</i>	ash-cooling chamber
<i>Ascheausbrennkammer</i>	ash post-combustion chamber
<i>Aschebehälter</i>	ash container
<i>Aschedrehrost</i>	tiltable ash grate
<i>Ascheentnahmerost</i>	ash-removal grate
<i>Ascheentnahmetür</i>	ash-removal door
<i>Aschekapsel</i>	ash capsule, urn
<i>Aschekasten</i>	ash container
<i>Aschenaufnahmebehälter</i>	ash container
<i>Aschenraum</i>	ash chamber
<i>Aschenschräge</i>	ash slope
<i>Aschentransportvorrichtung</i>	ash-transport device
<i>Auflager-Eisen</i>	supporting iron bars (transverse)
<i>Ausbrennraum</i>	chamber to complete combustion
<i>Ausglührost</i>	post-combustion grate
<i>äusseres Ziegelmauerwerk</i>	external brick masonry
<i>Befestigungs-Eisen</i>	holding iron bar
<i>Beharrungszustand</i>	steady state
<i>Beheizung</i>	heating
<i>Beladung</i>	loading
<i>Belastung</i>	load, strain
<i>Beschickungseinrichtung</i>	loading device
<i>Beschriftungs-Apparat</i>	labeling device
<i>Betriebsvorschrift</i>	operating instruction
<i>Brenner</i>	burner
<i>Brennereinstellung</i>	burner adjustment
<i>Brennkammer</i>	cremation chamber
<i>Brennstoff</i>	fuel
<i>Brennstofflager</i>	fuel storage
<i>Brennstoffverbrauch</i>	fuel consumption
<i>Brikett</i>	briquette
<i>D.R.P. (Deutsches Reichspatentamt)</i>	patent office of the German Reich
<i>Dauerbetrieb</i>	continuous operation
<i>DIN (Deutsche Industrie-Norm; Deutsches Institut für Normung)</i>	German industrial standard; since 1975: German Institute for Standardization
<i>direkte Einäscherung</i>	direct cremation
<i>Doppelmuffel Einäscherungsofen</i>	double-muffle cremation furnace
<i>Drahtseil</i>	wire cable

<i>drehbare Asche-Sammelplatte</i>	tiltable ash-collection grate
<i>Drehklappe</i>	rotary vane
<i>Drehrost</i>	tiltable grate
<i>Drehrostplatte</i>	tiltable grate panel
<i>Drehscheibe</i>	rotatable platform
<i>Dreimuffel-Einäscherungssofen</i>	triple-muffle cremation furnace
<i>Druckluftleitung</i>	compressed-air conduits
<i>Dunstaube</i>	fume (extractor) hood
<i>Einäscherung</i>	cremation
<i>Einäscherungsanlage</i>	cremation facility
<i>Einäscherungskammer</i>	cremation chamber
<i>Einäscherungssofen</i>	cremation furnace
<i>Einäscherungsraum</i>	cremation room/hall
<i>Einäscherungsverfahren</i>	cremation method
<i>Einführrollen</i>	introduction rollers
<i>Einführtrage</i>	introduction stretcher
<i>Einführtür</i>	introduction door
<i>Einführungsschieber</i>	introduction
<i>Einführungstür</i>	introduction door
<i>Einführungswanne</i>	introduction tub
<i>Einmuffel-Einäscherungssofen</i>	single-muffle cremation furnace
<i>Entaschung</i>	ash removal
<i>Entwesungssofen</i>	disinfestation furnace
<i>Essengas</i>	flue gas
<i>Essenkanal</i>	flue channel
<i>Etageofen</i>	multi-story furnace
<i>Exhaustor</i>	exhauster, extraction fan
<i>fahrbarer Ofen</i>	mobile furnace
<i>Fahrgestell</i>	chassis
<i>Falschlufft</i>	unwanted air
<i>Feldofen</i>	field furnace
<i>feuerbeständig</i>	fire-resistant
<i>Feuerbestattung</i>	cremation
<i>Feuerbestattungssofen</i>	cremation furnace
<i>Feuerbestattungsanlage</i>	cremation facility
<i>Feuerbrücke</i>	fire bridge
<i>feuerfest</i>	fire-proof
<i>Feuertür</i>	fire door/hearth door
<i>Feuerung</i>	firing/firebox
<i>Flachbettofen</i>	flatbed furnace
<i>Flugaschefreie-Verbrennungsgase</i>	combustion gases free of fly ash
<i>Flugasche</i>	fly ash
<i>Flugaschen-Entstaubungsanlage</i>	fly-ash-removal device
<i>Formstein</i>	cinder block
<i>Frischluffventilator</i>	fresh-air fan
<i>Fuchs</i>	flue
<i>Fuchseinsteigeschachtverschluss</i>	lid of flue access shaft
<i>Führungsrollen</i>	guide rollers
<i>Füllschachtverschluss</i>	closure of loading shaft
<i>Gasabzug</i>	gas/smoke/exhaust duct
<i>gasbeheizt</i>	gas-fired
<i>Gaserzeuger</i>	gas generator/gasifier
<i>Gasfeuerung</i>	gas-fired system
<i>Gaskanal</i>	gas channel

<i>Gaskoks</i>	gas coke
<i>Gebläse</i>	fan, blower
<i>Gegengewicht</i>	counter weight
<i>Generator</i>	generator/gasifier
<i>Generatorfüllschacht</i>	generator-/gasifier-loading shaft
<i>Generatorfüllschachtverschluss</i>	closure of generator-/gasifier-loading shaft
<i>Generatorfülltür</i>	door of generator-/gasifier-loading shaft
<i>Generatorgase</i>	generator gas, producer gas
<i>Generatorhals</i>	generator/gasifier neck
<i>Generatorschacht</i>	generator/gasifier shaft
<i>geruchlos</i>	odorless
<i>Gewölbe</i>	vault
<i>Gleis zur Beschickung der Öfen</i>	rails for loading the furnaces
<i>Gleis zur Kokszufuhr</i>	rails for coke delivery
<i>Gleittür</i>	sliding door
<i>halbindirekte Einäscherung</i>	semi-indirect cremation
<i>Halbwölber</i>	semi-wedge bricks
<i>Handwinde</i>	hand crank
<i>Hauptbrenner</i>	main burner
<i>Hauptbrennraum</i>	main combustion chamber
<i>Hauptfeuerung</i>	main hearth
<i>Hauptkanalschieber</i>	main-channel/duct/flue damper
<i>Hauptverbrennung</i>	main combustion
<i>Heisslufteinäscherungsöfen</i>	hot air cremation furnace
<i>Heizfläche</i>	heating surface
<i>Heizgase</i>	heating gases
<i>Heizkammer</i>	heating chamber, of recuperator
<i>Heizschlange</i>	heating coil
<i>Heizspirale</i>	heating coil, heating element
<i>Heizspule</i>	heating coil
<i>Heizung</i>	heating
<i>Heizversuch</i>	heating experiment
<i>Hochheizung</i>	heating/firing up
<i>Holzfeuerung</i>	wood-fired system
<i>Hüttenkoks</i>	foundry coke
<i>indirekte Einäscherung</i>	indirect cremation
<i>Isolierabsperrschieber</i>	insulating damper
<i>Isoliermörtel</i>	insulation mortar
<i>Isolierstein</i>	insulation brick
<i>Isolierung</i>	insulation
<i>Kamineinband</i>	chimney framing
<i>Kaminfeuer</i>	chimney fire
<i>Keilstein</i>	wedge brick
<i>Kieselgurmörtel</i>	diatomaceous-earth mortar
<i>Kieselgurstein</i>	diatomaceous-earth stone
<i>Klemme</i>	clamp
<i>Kohlenbeschickungsvorrichtung</i>	coal-loading device
<i>Kohlensäuregehalt</i>	CO ₂ content
<i>Kohlentransportwagen</i>	coal transportation cart
<i>Koks</i>	coke
<i>koksbeheizt</i>	coke-fired
<i>Koksfeuerung</i>	coke-fired system
<i>Koksofen</i>	coke furnace
<i>Kratze</i>	scraper

<i>Kremation</i>	cremation
<i>Kremationsofen</i>	cremation furnace
<i>Krematorium</i>	crematorium
<i>Laufrolle</i>	guide roller/wheel
<i>Laufschiene</i>	guide rail
<i>Leicheneinäscherungssofen</i>	corpse-cremation furnace
<i>Leicheneinführungs-Vorrichtung</i>	corpse-introduction device
<i>Leichenhalle</i>	corpse hall, morgue, mortuary
<i>Leichenkeller</i>	corpse basement, underground morgue
<i>Leichenraum</i>	corpse room, morgue
<i>Leichentrage</i>	corpse stretcher
<i>Leichenverbrennung</i>	corpse cremation
<i>Leichenverbrennungssofen</i>	corpse-cremation furnace
<i>Leistung</i>	power, performance
<i>Lockfeuer</i>	pilot flame
<i>Luftabschlussklappe</i>	air shutter
<i>Luftabschlusschieber</i>	airclosing slider/damper
<i>Luftaustrittsdüsen</i>	air-exhaust nozzle
<i>Luftdüsen</i>	air nozzle
<i>Lufteintritt</i>	air-feed opening
<i>Lufterhitzer</i>	air heater
<i>Lufterhitzrohr</i>	air-heating pipe
<i>Luftgas</i>	air gas
<i>Luftkammer</i>	air chamber
<i>Luftkanal</i>	air channel
<i>Luftkanalverschluss</i>	closure for air channel
<i>Luftklappe</i>	air shutter
<i>Luftrosette</i>	air rosette
<i>Luftschieber</i>	air damper
<i>Luftüberschuss</i>	air excess
<i>Luftverteiler</i>	air manifold
<i>Luftzuführung</i>	air supply
<i>Luftzutritt</i>	air intake
<i>Mauerwerksmantel</i>	outer brickwork
<i>mm WS (Wassersäule)</i>	mm water column (pressure)
<i>Monolit</i>	Monolite
<i>Motor-Raum</i>	engine room
<i>Muffel</i>	muffle
<i>Muffelabsperrschieber</i>	sliding muffle closure
<i>Muffelgewölbe</i>	muffle vault
<i>Müllverbrennungssofen</i>	waste incinerator
<i>Müllverbrennungsraum</i>	waste incinerator room
<i>Nachbrennkammer</i>	post-combustion chamber
<i>Nachbrennraum</i>	post-combustion chamber
<i>Nachglühraum</i>	post-combustion chamber
<i>Nachverbrennungskanäle</i>	post-combustion channels
<i>Nachverbrennung</i>	post-combustion
<i>Nachverbrennungsrost</i>	post-combustion grate
<i>Nebenbrenner</i>	auxiliary burner
<i>Normalstein</i>	standard brick
<i>Normalverbrennung</i>	standard combustion
<i>Notkrematorium</i>	makeshift crematorium
<i>Oberluft</i>	upper air supply
<i>Ofenanlage</i>	furnace facility

<i>Ofengruppe</i>	furnace group
<i>Ofenmantel</i>	furnace
<i>Ofenschieber</i>	furnace damper
<i>offene Verbrennungskammer</i>	open combustion chamber
<i>offene Verbrennungsstätte</i>	open cremation site
<i>ölbeheizt</i>	oil-/naphtha-fired
<i>Ölbrenner</i>	oil/naphtha burner
<i>Ölfeuerung</i>	oil/naphtha firing
<i>Ölvorwärmer</i>	oil/naphtha pre-heating
<i>Patentanmeldung</i>	patent application
<i>Patentanspruch</i>	patent claim
<i>Patenterteilung</i>	patent issuance
<i>Patentschrift</i>	patent specification
<i>Pfanne</i>	pan
<i>Planrost</i>	flat grate
<i>Planroststäbe</i>	flat-grate bars
<i>primäre Luft</i>	primary air supply
<i>Probeeinäscherung</i>	cremation experiment
<i>Prunktür</i>	decorative door
<i>Rauchabzug</i>	smoke duct
<i>Rauchgasabzug</i>	smoke-gas duct
<i>Rauchgasausnutzung</i>	exploitation of smoke gas (heat)
<i>Rauchgase</i>	smoke/exhaust/discharge gases
<i>Rauchgasnachbrennkammer</i>	smoke-gas post-combustion chamber
<i>Rauchgasventilator</i>	smoke-gas fan
<i>Rauchkanal</i>	smoke duct/flue
<i>Rauchkanalschieber</i>	smoke-duct damper
<i>Rauchkanalschieberrahmen</i>	frame of flue damper
<i>rauchlos</i>	smokeless
<i>Rauchverbrennung</i>	smoke combustion
<i>Reform-Einäscherungsöfen</i>	improved cremation furnace
<i>Regenerator</i>	regenerator
<i>Regulierhebel</i>	control lever
<i>Reguliertventil</i>	control valve
<i>Reichspatentamt</i>	Reich Patent Office
<i>Reinigungstür</i>	cleaning door
<i>Rekuperation</i>	recuperation
<i>Rekuperator</i>	recuperator
<i>Reserveofen</i>	back-up furnace
<i>Ring-Einäscherungsöfen</i>	ring cremation furnace
<i>Ring-Ofen</i>	ring furnace
<i>Rohrgabel</i>	tube yoke
<i>Rohrleitung</i>	pipng
<i>Rollenbock</i>	roller stand/stretcher support
<i>Rost-Auflager</i>	grate support
<i>Rostauflegerbalken</i>	beam for grate support
<i>Rückstände</i>	remnants, remains
<i>Rundeisenanker</i>	round iron anchors
<i>Sarg</i>	coffin
<i>Sargbrückenstein</i>	coffin-support stone
<i>Sargeinführtrage</i>	coffin-introduction stretcher
<i>Sargeinführungsvorrichtung</i>	coffin-introduction device
<i>Sargeinführungswagen</i>	coffin-introduction cart
<i>Saugzug-Anlage</i>	forced-draft device

<i>Saugzug-Gebläse</i>	forced-draft blower
<i>Schacht</i>	shaft
<i>Schamotte</i>	refractory clay, fireclay
<i>Schamotteabsperplatte</i>	refractory damper
<i>Schamotteausmauerung</i>	refractory lining
<i>Schamottefutter</i>	refractory lining
<i>schamottegefütert</i>	lined with refractory clay
<i>Schamottemarken</i>	refractory tags
<i>Schamottemauerwerk</i>	refractory masonry
<i>Schamottemörtel</i>	refractory mortar
<i>Schamotterost</i>	refractory grate
<i>Schamotteroststeine</i>	refractory grate bars
<i>Schau-Öffnung</i>	inspection opening
<i>Schauloch</i>	inspection hole
<i>Schauluke</i>	inspection port
<i>Schieberplatte</i>	damper plate
<i>Schlacke</i>	slag, cinder
<i>Schlackenwolle</i>	slag wool
<i>Schlangensystem</i>	coil system
<i>Schornstein</i>	chimney, smokestack
<i>Schornsteinmantel</i>	outer chimney masonry
<i>Schornsteinrohr</i>	chimney pipe
<i>Schrägrost</i>	slanted/sloping grate
<i>Schrägroststübe</i>	slanted/sloping grate bars
<i>Schürgeräte</i>	poker
<i>Schürstange</i>	poking bar
<i>Schwadenabsaugung</i>	fume extraction
<i>Seilkausche</i>	rope thimble
<i>Seilrolle</i>	cable pulley
<i>Seitenluft</i>	lateral air (supply)
<i>sekundäre Luft</i>	secondary air
<i>SK (Segerkegel)</i>	Seeger cone
<i>Sohle</i>	bottom, floor
<i>Spannschraube</i>	clamping/tension screw
<i>Spiralenrekuperator</i>	coil recuperator
<i>Stampfmasse</i>	caulking/packing mass/mix
<i>Steigeisen</i>	climbing/step iron
<i>Stundenleistung</i>	hourly performance
<i>T-Eisen</i>	T-iron
<i>thermisches Gleichgewicht</i>	thermal equilibrium
<i>Tierleichen-Verbrennungsöfen</i>	animal-carcass-incineration furnace
<i>Trage</i>	stretcher
<i>Trockenheizung</i>	heat drying
<i>Trocknung</i>	drying out, desiccation
<i>Türplatte</i>	(refractory) door plate
<i>U-Eisen</i>	U-iron
<i>Umführungsrauchkanal</i>	flue/smoke duct
<i>Umleitung der Kohlenoxydgase</i>	diversion of CO gases
<i>Urne</i>	urn
<i>Urnenkasten</i>	urn case
<i>Urnenkisten</i>	urn box
<i>Urnenraum</i>	urn room
<i>Ventilator</i>	ventilator, fan
<i>Verankerung</i>	anchoring, bracing

<i>Verankerungs-Eisen</i>	anchoring/bracing (iron) bar
<i>Verbrennung</i>	combustion
<i>Verbrennungsgase</i>	combustion gases
<i>Verbrennungsgegenstand</i>	combustion object
<i>Verbrennungsraum</i>	combustion chamber
<i>Versandkasten</i>	shipping box
<i>Verschiebwagen</i>	relocation cart
<i>Vierkanteisen</i>	square iron
<i>Vierkantstäbe</i>	rectangular bars
<i>Vorheizung</i>	preheating
<i>Vorwärmer</i>	preheater
<i>Wärmebelastung</i>	thermal load/stress
<i>Wärmebilanz</i>	heat/thermal balance
<i>Wärmespeicher</i>	heat accumulator/reservoir
<i>Wasserbehälter</i>	water container
<i>Wassergas</i>	water gas
<i>Windleitung</i>	blast pipe
<i>Winkeleisen</i>	angle iron
<i>Wirkungsgrad</i>	efficiency (rate/factor)
<i>Wölbstein</i>	arch brick
<i>Zentner</i>	50 kg
<i>Zug</i>	chimney duct or draft
<i>Zugmesser</i>	draft gauge
<i>Zugstärke</i>	draft strength/intensity
<i>Zugverstärkungs-Anlage</i>	Draft-improvement device

3. Symbols

Not included are chemical (element) symbols.

- α = Heat-transfer coefficient (*Wärmeübergangszahl*) = $1/273 \text{ }^\circ\text{C}^{-1}$
- γ = specific density
- η = efficiency factor (*Wirkungsgrad*)
- λ = thermal conductivity (*Wärmeleitzahl*; in $\text{kcal m}^{-1} \text{ }^\circ\text{C}^{-1} \text{ h}^{-1}$)
- σ = radiation ratio (*Ausstrahlungsverhältnis*)
- A = ashes (*Aschen*)
- B = fuel (*Brennstoff*)
- BTU = British Thermal Unit (1 BTU = 0.252 Kcal)
- c_p = specific heat (*spezifische Wärme*)
- c_{pm} = average specific heat (*mittlere spezifische Wärme*)
- F = surface, area (*Fläche*)
- G = weight (*Gewicht*)
- H_o = u.h.v., upper heating value (*oberer Heizwert*)
- hp = horsepower
- H_u = l.h.v., lower heating value (*unterer Heizwert*)
- H_{ua} = lower heating value of ashes (*Unterer Heizwert Asche*)
- i = heat, enthalpy (thermal contents)
- K = thermal transmittance (*Wärmedurchgangszahl*)
- L = air (*Luft*)
- m = Excess-air ratio (*Luftverhältnis*)
- q = cross-sectional area of chimney (*Querschnitt*)
- PS = horsepower (*Pferdestärke*)
- R = smoke gas (*Rauchgase*)
- R_g = weight of smoke gas (*Rauchgase Gewicht*)
- R_v = heat loss via smoke gas (*Rauchgase Verlust*)
- U = uncombusted (*Unverbranntes*)
- V = heat loss (*Verlust*)
- V_a = heat loss via ashes and slag (*Verlust Asche*)
- V_{ls} = heat loss via masonry by conduction and radiation (*Verlust Leitung-Strahlung*)
- V_{sch} = heat loss via chimney (*Verlust Schornstein*)
- V_{un} = heat loss via uncombusted gas (*Verlust unverbrannt*)
- W = heat (*Wärme*) / water (*Wasser*)
- WS = water column (*Wassersäule*): 1 mm WS = 1 kg/m^2
- Z = time (*Zeit*)

4. Abbreviations of Archive Names

AGK	Archiwum Głównej Komisji Badania Zbrodni Przeciwko Narodowi Polskiemu Instytutu Pamięci Narodowej (Archive of the Central Commission for the Investigation of Crimes against the Polish People, National Memorial) now <i>Instytut Pamięci Narodowej</i> (Institute for national Commemoration), Warsaw
AKfSD	Archiv des Kuratoriums für Sühnemal KZ Dachau (Archive of the Foundation for Atonement at KZ Dachau)
AMS	Archiwum Muzeum Stutthof (Archive of the Museum at Stutthof)
APMGR	Archiwum Państwowego Muzeum Gross-Rosen (Archive of National Museum of Gross-Rosen), Wałbrzych
APMM	Archiwum Państwowego Muzeum na Majdanku (Archive of National Museum at Majdanek)
APMO	Archiwum Państwowego Muzeum w Oswiecimiu (Archive of National Museum at Auschwitz)
BAK	Bundesarchiv Koblenz
DPA	Deutsches Patentamt, Berlin
FSBRF	Federal'naja Služba Bezopasnosti Rossiskoi Federatsii, (Federal Security Office of the Russian Federation), Moscow
GARF	Gosudarstvenni Archiv Rossiskoi Federatsii (National Archive of the Russian Federation), Moscow
IMT	Trial of the Major War Criminals before the International Military Tribunal, published in Nuremberg 1947
KfSD	Kuratorium für Sühnemal KZ Dachau
ÖDMM	Öffentliches Denkmal und Museum Mauthausen
PRO	Public Record Office, London
PT	Památník Terezín (Terezín/Theresienstadt Monument)
ROD	Rijksinstituut voor Oorlogsdocumentatie (National Institute for War Documentation), Amsterdam
SB	Sennefriedhof Bielefeld
SE	Stadtarchiv Erfurt
SW	Staatsarchiv Weimar
RGVA	Rossiysky gosudarstvenny voyenny arkhiv (Russian State War Archive), Moscow
VHA	Vojensky Historicky Archiv (Archive of Military History), Prague
WAPL	Wojewódzkie Archiwum Państwowe w Lublinie (National Provincial Archive, Lublin)

5. Bibliography

5.1. Alphabetical Listing

- “60 Jahre Feuerbestattung in Deutschland (Eine statistische Skizze),” in: *Die Feuerbestattung*, Vol. 12, 1940, No. 1, pp. 8f.
- “60 Jahre Feuerbestattung in Europa,” in: *Phoenix. Zeitschrift des Vereines der Freunde der Feuerbestattung Die Flamme in Wien*, 50. Vol., No. 1, 1937, pp. 6-9.
- “A Discussion on the Disposal of the Dead. In the Section of Public Medicine at the Annual Meeting of the British Medical Association held in Bournemouth, July, 1891,” in: *The British Medical Journal*, 19. September 1891, pp. 627-631.
- “Amtliches. Bau und Betrieb von Krematorien,” in: *Die Wärmewirtschaft*, Vol. 2, No. 7, 1925, pp. 107f.
- “Amtliches. Betr. Ofenanlage in Krematorien,” in: *Die Wärmewirtschaft*, Vol. 4 No. 3, 1927, p. 51.
- Anstett, Elisabeth, Jean-Marc Dreyfus (eds.), *Destruction and Human Remains: Disposal and Concealment in Genocide and Mass Violence*. Manchester University Press, Manchester/New York, 2014.
- Arbeitsgemeinschaft für Brennstoffersparnis, e.V., Berlin, “Bau und Betrieb von Krematorien. Gutachten,” in: *Die Wärmewirtschaft*, Vol. 1, No. 8, 1924, pp. 119f.
- Arbeitsgemeinschaft für Brennstoffersparnis, e.V., Berlin, “Bau und Betrieb von Krematorien,” *Die Wärmewirtschaft*, Vol. 2, No. 6, 1925, pp. 89-91.
- Arbeitsgemeinschaft für Brennstoffersparnis, e.V., Berlin, “Bau und Betrieb von Krematorien. Erwidern auf den Einspruch des Verbandes der Preussischen Feuerbestattungsvereine vom 9. Oktober 1925 gegen den Erlass des Herrn Ministers des Innern II T 2015 – vom 24. Oktober 1924,” in: *Die Wärmewirtschaft*, Vol. 3, No. 1, 1926a, pp. 9-12.
- Arbeitsgemeinschaft für Brennstoffersparnis, e.V., Berlin, “Zur Frage der Krematorienbeheizung in Preussen,” in: *Die Wärmewirtschaft*, Vol. 3, No. 6, 1926b, pp. 95f.
- Arbeitsgemeinschaft für Brennstoffersparnis, e.V., Berlin, “Zur Frage der Krematorienbeheizung in Preussen,” in: *Die Wärmewirtschaft*, Vol. 3, No. 7, 1926c, pp. 105f.
- Arbeitsgemeinschaft für Brennstoffersparnis e.V., Berlin, “Mitteilungen,” in: *Die Wärmewirtschaft*, Vol. 4, No. 3, 1927, pp. 47f.
- Assmann, Aleida, Frank Hiddemann, Eckhard Schwarzenberger (eds.), *Firma Topf & Söhne – Hersteller der Öfen für Auschwitz. Ein Fabrikgelände als Erinnerungsort?*, Campus Verlag, Frankfurt/New York, 2002.
- “Aus der nichtdeutschen Bewegung. Pardubitz,” in: *Blätter für wahlfreie Feuerbestattung und verwandte Gebiete*, Vienna, Vol. XXVIII, No. 4, 1915, Column 126.
- “Aus der nichtdeutschen Bewegung. Zsolna,” in: *Blätter für wahlfreie Feuerbestattung und verwandte Gebiete*, Vienna, Vol. XXVIII, No. 2, Column 40.
- Barrier, M., Georges Salomon, “La crémation des cadavres sur les champs de bataille,” in: *Revue d'hygiène et de police sanitaire*, No. 37, 1915, pp. 545-588.
- BBC Brown Boveri Elektro-Kremationsöfen*, company brochure.
- Beugless, John D., “Cremation as a Safeguard against Epidemics,” in: *Public Health Papers and Reports*, Vol. 10, 1884, pp. 140-144.
- Beutinger, E., *Handbuch der Feuerbestattung*. Carl Scholze Verlag, Leipzig 1911.
- Blumental, Nachman, *Dokumenty i materiały*. Wydawnictwa Centralnej Żydowskiej Komisji Historycznej w Polsce, Łódź 1946, 2 volumes.
- Boegl, Ludwig, *Deutschland Städtebau. Erfurt*. Bearbeitet im Auftrage des Magistrats Erfurt. “Dari” Deutscher Architektur- und Industrie-Verlag, Berlin-Halensee 1922.

- Bohnert, Michael, Thomas Rost, Stefan Pollak, "The Degree of Destruction of Human Bodies in Relation to the Duration of the Fire," in: *Forensic Science International*, Vol. 95, 1998, pp. 11-21.
- Bollettino Ufficiale della Regione Liguria*, Part II, No. 15 of 8 April 1992.
- Bordoni, Ugo, *Tecnologia del calore. Collana Trattato generale teorico pratico dell'arte dell'ingegnere civile, industriale ed architetto*. Casa Editrice dottor Francesco Vallardi, Milan 1918.
- Brockhaus der Naturwissenschaften und der Technik*. F.A. Brockhaus, Wiesbaden 1958.
- Bundesrepublik Deutschland. Deutsches Patentamt. Patentschrift No. 861731. Klasse 24d. Gruppe 1. Ausgegeben am 5. Januar 1953. Martin Klettner, Recklinghausen, ist als Erfinder genannt worden. J.A. Topf & Söhne, Wiesbaden. *Verfahren und Vorrichtung zur Verbrennung von Leichen, Kadavern und Teilen davon*. Patentiert im Gebiet der Bundesrepublik Deutschland vom 24. Juni 1950 ab.
- Cantagalli, Alberto, *Nozioni teorico-pratiche per i conduttori di caldaie e generatori di vapore*. G. Lavagnolo Editore, Turin 1940.
- Cobb, Augustus G., *Earth-Burial and Cremation: The History of Earth-Burial with its Attendant Evils, and the Advantages Offered by Cremation*. G.P. Putnam's Sons, New York/London, 1892.
- Cobb, John Storer, *A Quarter Century of Cremation in North America*. Knight and Millet, Boston, 1901.
- Coletti, Francesco, *Memoria sulla incinerazione dei cadaveri*, Padova, 1857.
- Coletti, Francesco, "L'incenerimento dei cadaveri sul campo di battaglia," con una "Nota di G. Polli," in: *Annali di chimica applicata alla medicina cioè alla farmacia, alla tossicologia, all'igiene, alla fisiologia, alla patologia e alla terapeutica*. Serie 3, vol. 51, fascicolo 3, settembre 1870, pp. 160-167.
- Colombo, Gusieppe, *Manuale dell'ingegnere civile e industriale*, Hoepli, Milan 1916 and 1926.
- "Crémation," in: *Revue d'hygiène et de police sanitaire*, No. 11, 1889, pp. 788-792.
- "Crémation," in: *Revue générale d'administration*, vol. I, January-April 1892, pp. 395-400.
- "Cremation in Great Britain," *The British Medical Journal*, 14. January 1905, p. 99.
- "Cremation. Progress of Cremation," *The British Medical Journal*, 6 February 1909, pp. 349ff.
- Créteur, M., "La pratique de la crémation des cadavres sur les champs de bataille de Sedan en 1871," in: *Revue d'hygiène et de police sanitaire*, No. 37, 1915, pp. 558-563.
- Czech, Danuta, *Kalendarium der Ereignisse im Konzentrationslager Auschwitz-Birkenau 1939-1945*. Rowohlt Verlag, Reinbek bei Hamburg 1989.
- Czuj, Tadeusz, Czesław Kempisty, "Spopielanie zwłok więźniów obozu Gross-Rosen w komunalnym krematorium Legnicy w latach 1940-1943," in: *Biuletyn Głównej Komisji Badania Zbrodni Hitlerowskich w Polsce*, Vol. XXVII, 1977, pp. 106-119.
- "Das Hanauer Krematorium," in: *Zentralblatt für Feuerbestattung*, Vol. 2, No. 4, 1930, p. 62.
- "Das Krematorium zu Hirschberg in Preussisch-Schlesien," in: *Phoenix. Blätter für wahlfreie Feuerbestattung und verwandte Gebiete*, Vienna, Vol. XXVIII, No. 10, 1915, pp. 296-298.
- Davies, Douglas J., Lewis H. Mates (eds.), *Encyclopedia of Cremation*, Ashgate, London 2005.
- de Cristoforis, Malachia, *Etude pratique sur la crémation moderne*. Imprimerie Treves Frères, Milan 1890.
- DeHaan, J.D., S.J. Campbell, S. Nurbakhsh, "Combustion of animal fat and its implications for the consumption of human bodies in fires," in: *Science & Justice*, Vol. 39, No. 1, 1999, pp. 27-38.
- de Pietra Santa, Prosper, *La crémation des morts en France et à l'étranger*. Librairie J.-B. Baillière et fils, Paris 1874.

- de Pietra Santa, Prosper, "Chronique de la crémation," in: *Journal d'hygiène*, No. 590, 12 janvier 1888a, pp. 13-16 ; No. 592, 26 janvier 1888b, pp. 37-39 ; No. 593, 2 février 1888c, pp. 49-51.
- de Pietra Santa, Prosper, *Modern Cremation*. Publication de la Société Française d'Hygiène. Au bureau de la Société. Paris 1889.
- de Pietra Santa, Prosper, de Nansouty, "La crémation," in: *Le génie civil*, 1881, No. 8, pp. 169-172; No. 9, pp. 193-195; No. 10, pp. 229-231; No. 11, pp. 256-258; No. 12, pp. 281-283, 15 February-15 April 1881.
- Dechambre, A., "La crémation des morts sur les champs de bataille," in: *Gazette hebdomadaire de médecine et de chirurgie*, série 2, vol. 7, 29 juillet 1870a, pp. 465f.
- Dechambre, A., "Encore la crémation des morts," in: *Gazette hebdomadaire de médecine et de chirurgie*, série 2, vol. 7, 1er septembre 1870b, pp. 545f.
- Deutsches Reich. Reichspatentamt. Patentschrift No. 324252. Klasse 24d. Gruppe 1. Ausgegeben am 24. August 1920. J.A. Topf & Söhne in Erfurt. *Sargeinführvorrichtung für Verbrennungsöfen mit heb- und senkbarem Fahrgestell für Sargträger*. Patentierte im Deutschen Reiche vom 24. April 1915 ab.
- Deutsches Reich. Reichspatentamt. Patentschrift No. 331628. Klasse 24d. Gruppe 1. Ausgegeben am 11. Januar 1921. Adolf Marsch in Gera, Reuss. *Schachtofen zur gleichzeitigen Einäscherung einer grösser Anzahl von Menschenleichen oder Tierkadavern*. Patentierte im Deutschen Reiche vom 30. September 1915 ab.
- Deutsches Reich. Reichspatentamt. Patentschrift No. 493042. Klasse 24d. Gruppe 1. Ausgegeben am 5. März 1930a. J.A. Topf & Söhne in Erfurt. *Vorrichtung zum Nachverbrennen der Rückstände in Leichenverbrennungsöfen*. Patentierte im Deutschen Reiche vom 24. März 1929 ab.
- Deutsches Reich. Reichspatentamt. Patentschrift No. 494136. Klasse 24f. Gruppe 10. Ausgegeben am 19. März 1930b. J.A. Topf & Söhne in Erfurt. *Ausfahrbarer Schlackenrost für mit Unterwind betriebene Feuerungen*. Patentierte im Deutschen Reiche vom 22. August 1928 ab.
- Deutsches Reich. Reichspatentamt. Patentschrift No. 506627. Klasse 24d. Gruppe 1. Ausgegeben am 6. September 1930c. Tag der Bekanntmachung über Erteilung des Patents: 28. August 1930. Dipl.-Ing. Hans Volckmann und Dipl.-Ing. Karl Ludwig in Hamburg. *Verfahren und Vorrichtung zur Einäscherung*.
- Deutsches Reich. Reichspatentamt. Patentschrift No. 561643. Klasse 24d. Gruppe 1. Ausgegeben am 17. Oktober 1932 (Viktor Quehl in Gera). Umgeschrieben auf: J.A. Topf & Söhne, Erfurt. 17.5.1934. *Feuerbestattungsöfen mit drehbaren Rosten*. Patentierte im Deutschen Reiche vom 15. April 1931 ab.
- Deutsches Reich. Reichspatentamt. Patentschrift No. 576135. Klasse 24f. Gruppe 12 02 1560. Ausgegeben am 20. Mai 1933a. J.A. Topf & Söhne in Erfurt. *Düsenplattenrost*. Patentierte im Deutschen Reiche vom 27. August 1931 ab.
- Deutsches Reich. Reichspatentamt. Patentschrift No. 587149. Klasse 24f. Gruppe 1202. Ausgegeben am 31. Oktober 1933b. J.A. Topf & Söhne in Erfurt. *Verfahren und Ofen zur Zurückgewinnung von Blei und Kupferdraht aus Kabeln*. Patentierte im Deutschen Reiche vom 29. September 1932 ab.
- Deutsches Reich. Reichspatentamt. Patentschrift No. 638582. Klasse 24d. Gruppe 1. Ausgegeben am 19. November 1936. (Wilhelm Basse in Hamburg). Umgeschrieben auf: J.A. Topf & Söhne, Erfurt. 27.11.1937. *Einäscherungsöfen*. Patentierte im Deutschen Reiche vom 20. November 1936 ab.
- Deutsches Reich. Reichspatentamt. Patentschrift No. 659405. Klasse 24d. Gruppe 1. Ausgegeben am 4. Mai 1938a. Hans Geerhardt in Erfurt ist als Erfinder benannt worden. J.A. Topf & Söhne in Erfurt. *Beschickungseinrichtung für Einäscherungsöfen*. Patentierte im Deutschen Reiche vom 20. November 1936 ab.
- Deutsches Reich. Reichspatentamt. Patentschrift No. 669645. Klasse 24d. Gruppe 1. Ausgegeben am 31. Dezember 1938b. Firma Wilhelm Ruppmann in Stuttgart. Tag der Be-

- kanntmachung über die Erteilung des Patents: 8. Dezember 1938. *Leichenverbrennungs-ofen*. Patentiert im Deutschen Reiche vom 23. Juni 1936 ab.
- Deutsches Reichs-Adressbuch für Industrie, Gewerbe Handel*. Buch II: Adressen-Verzeichnis. Ausgabe 1940. Druck: Buch- und Tiefdruck Gesellschaft m.b.h., Berlin.
- “Deutschlands neueste Feuerehrungshalle in Lauscha,” in: *Zentralblatt für Feuerbestattung*, Vol. 7, No. 1, 1935, p. 10.
- “Die deutschen Krematorien im Jahre 1938,” in: *Die Feuerbestattung*, Vol. 12, 1940, p. 13.
- Die Feuerbestattung*, Vol. 16, 1944, p. 17.
- “Die Feuerhallen der Ostmark,” in: *Phoenix. Blätter für wahlfreie Feuerbestattung und verwandte Gebiete*, Vienna, 50. Vol., 1939, p. 7.
- Die Grossunternehmen im Deutschen Reich*. Band 7: Handbuch der Ges. m.b.H. mit einem Kapital ab RM 500 000 einschl. der Kom.-Ges., Off. Handels-Ges. und Einzelfirmen der gleichen Grössenordnung. 1941. Verlag Hoppenstedt & Co., Berlin C 2.
- “Die Hirschberger Feuerhalle,” in: *Phoenix. Blätter für wahlfreie Feuerbestattung und verwandte Gebiete*, Vienna, XXIX. Vol., No. 4, 1916, pp. 97-104.
- Długoborski, Waclaw, Franciszek Piper (eds.), *Auschwitz 1940-1945. Studien zur Geschichte des Konzentrations- und Vernichtungslagers Auschwitz*, Verlag des Staatlichen Museums Auschwitz-Birkenau. Oświęcim, 1999.
- Dönitz, W., “Technik der Leichenverbrennung in Japan,” in: *Deutsche Medicinische Wochenschrift*, Vol. II, No., 1876, pp. 377-379.
- du Mesnil, O., “L'exposition et le congrès d'hygiène et de sauvetage de Bruxelles en 1876,” in: *Annales d'hygiène publique et de médecine légale*, 1877, série 2, No. 47, pp. 42-58.
- du Mesnil, O., “Le monument crématoire du cimetière de l'est. La crémation à Paris,” in: *Annales d'hygiène publique et de médecine légale*, 1888, série 3, No. 19, pp. 77-81.
- Duroux, Charles, *Essai sur l'assainissement des champs de bataille*. Thèse pour le doctorat en médecine. Typographie A. Viollet, Paris 1878.
- Eassie, William, “Cremation in its Bearing upon Public Health,” in: *The British Medical Journal*, 1 August 1874, pp. 134-138.
- Eassie, William, *Cremation of the Dead*. London, 1875.
- “Einäscherungen im Grossdeutschland,” in: *Phoenix. Blätter für wahlfreie Feuerbestattung und verwandte Gebiete*, Vienna, Vol. 12, 1940, pp. 20 & 29.
- “Einführung der Feuerbestattung in Mexico,” in: *Blätter für wahlfreie Feuerbestattung und verwandte Gebiete*, Vienna, XXI. Vol., No. 1, 1908, p. 10.
- “Eingabe vom 20. Februar 1902 wegen Verbrennung von Pestleichen.” An den Deutschen Reichstag, Addendum II.
- Einwohnerbuch der Stadt Erfurt 1931/32*. Bearbeitet und herausgegeben von Gebr. Richters Verlagsanstalt, Erfurt, unter Mitarbeit der Behörde und Gemeinden.
- “Elektrisch betriebener Topf-Einäscherungsöfen. D.R.P. angem.,” in: *Zentralblatt für Feuerbestattung*, Vol. 7, No. 6, 1935, pp. 88-90.
- Enciclopedia Curcio di Scienza e Tecnica*. Armando Curcio Editore, Rome 1973.
- Enciclopedia della Scienza e della Tecnica*. Mondadori, Milan 1963.
- Enciclopedia Italiana*, entry “cremazione,” vol. XI, Rome 1949, p. 825.
- Equipements de crémation Tabo*, company brochure.
- Erichsen, Hugo, *The Cremation of the Dead Considered from an Aesthetic, Sanitary, Religious, Historical, Medico-Legal, and Economical Standpoint*. D.O. Haynes & Company, Detroit, 1887.
- Etzbach, Hugo, *Der technische Vorgang bei einer Feuerbestattung*. Druck Johannes Friese, Cologne 1935.
- Faber, Heinrich, *Ein neues Krematorium für Wien/Die letzte Wohnung*. Diplomarbeit, Technische Universität Wien, 1981.
- Feischner, “Die Einäscherungsöfen mit Gasfeuerung im Krematorium Berlin-Treptow,” in: *Technische Monatsblätter für Gasverwendung*, Vol. 6, No. 2, 1930/31, p. 22.
- Ferbeck & Vincent, *Fours de crémation Modulaires, type C 411*.

- “Feuerbestattung auf dem Schlachtfelde,” in: *Blätter für wahlfreie Feuerbestattung und verwandte Gebiete*, Vienna, XXVII. Vol., No. 12, 1914, Column 402.
- “Feuerbestattung im Kriege,” in: *Blätter für wahlfreie Feuerbestattung und verwandte Gebiete*, Vienna, XXVII. Vol., No. 12, 1914, Columns 386f.
- Fichtl, “Wärmewirtschaft in Krematorien,” in: *Die Wärme – Zeitschrift für Dampfkessel und Maschinenbetrieb*, Vol. 17, No. 34, 1924, pp. 394-397.
- Fischer, Norbert, *Vom Gottesacker zum Krematorium – Eine Sozialgeschichte der Friedhöfe in Deutschland seit dem 18. Jahrhundert*. Cologne/Weimar/Vienna, 1996.
- Fleck, H., “Beitrag zur Beantwortung der Frage von Leichenverbrennung,” in: *Zeitschrift für Epidemiologie*, Vol. I, 1874, pp. 161-169.
- Forest Products Laboratory (ed.), *Wood Handbook: Wood as an Engineering Material*, U.S. Department of Agriculture, Madison, WI, 2010; www.fpl.fs.fed.us/documnts/fplgtr/fplgtr190/chapter_04.pdf.
- Fornasini, Giulio, *Generatori di vapore*. Briano Editore, Genoa 1960.
- Freygang, Paul, “Leichenverbrennung,” in: Otto Lueger, *Lexikon der gesamten Technik und ihrer Hilfswissenschaften*. Deutsche Verlags-Anstalt, Stuttgart and Leipzig, vol. 6, 1908, pp. 120-127.
- Freygang, Paul, “Leichenverbrennung,” in: Otto Lueger, *Lexikon der gesamten Technik und ihrer Hilfswissenschaften*. Ergänzungsband zur zweiten Auflage. Deutsche Verlags-Anstalt, Stuttgart and Leipzig, vol. 9, 1914, pp. 475-480.
- Fröhlich, H., “Zur Gesundheitspflege auf den Schlachtfeldern,” in: *Deutsche Militärärztliche Zeitschrift*, No. 1-4, Januar-April 1872, pp. 39-116.
- Gauss, Ernst (ed.), *Grundlagen zur Zeitgeschichte. Ein Handbuch über strittige Fragen des 20. Jahrhunderts*. Grabert-Verlag, Tübingen 1994.
- Gauss, Ernst (ed.), *Dissecting the Holocaust. The Growing Critique of “Truth” and “Memory.”* Theses & Dissertations Press, Capshaw, AL, 2000.
- Georgius, “Neuere Leichenverbrennungstechnik,” in: *Gesundheits-Ingenieur*, Vol. 46, No. 5, 1923, pp. 555-559.
- Gesetz über die Feuerbestattung. Vom 15. Mai 1934*. Reichsgesetzblatt, Vol. 1934, Teil I, pp. 380-381.
- Giua, Michele, Clara Giua-Lollini, *Dizionario di chimica generale e industriale*. Unione Tipografico-Editrice Torinese, Turin 1948.
- Goppelsroeder, Friedrich, *Ueber Feuerbestattung*. Druck und Verlag von Wenz u. Peters, Mühlhausen i. Els. 1890.
- Gorini, Paolo, *Sulla purificazione dei morti per mezzo del fuoco. Considerazioni, sperimenti e proposte*. Presso Natale Battezzati Editore, Milan, 1876.
- Graf, Jürgen, Thomas Kues, Carlo Mattogno, *Sobibór. Holocaust Propaganda and Reality*. 2nd ed., Castle Hill Publishers, Uckfield 2020.
- Graf, Jürgen, Carlo Mattogno, *Concentration Camp Majdanek: A Historical and Technical Study*. 3rd edition, The Barnes Review, Washington, DC, 2012/Castle Hill Publishers, Uckfield, 2016.
- Grimm, Jacob, *Über das verbrennen der leichen. Eine in der academie der wissenschaften am 29. november 1849 von Jacob Grimm gehalten [sic] vorlesung*. Berlin. Gedruckt in der druckerei der akademie der wissenschaften 1850. Ferd. Dümmler’s buchhandlung.
- Grober, “Zur Feuerbestattung im Kriege,” in: *Deutsche medizinische Wochenschrift*, 24 September 1914, p. 1781.
- Großdeutscher Verband der Feuerbestattungsvereine e.V., *Richtlinien für den Bau und Betrieb von Öfen zur Einäscherung menschlicher Leichen*, Verlag des Grossdeutschen Verbandes der Feuerbestattungsvereine e.V, Berlin 1937.
- Große Brockhaus, Der*, 1930, entries “Krematorium” (pp. 581f.) & “Feuerbestattung” (pp. 187f.).
- Grüder, Fritz, “Die neue Flammbestattung auf dem Friedhof in Berlin-Wilmersdorf,” in: *Zentralblatt der Bauverwaltung*, Vol. 42, No. 75, 16 September 1922, pp. 449-451.

- Guilbert, Edward A., "Cremation or earth burial, which?" in: *Public Health Papers and Reports*, Vol. 21, 1895, pp. 201-216.
- Gutman, Yisrael, Michael Berenbaum (eds.), *Anatomy of the Auschwitz Death Camp*. Indiana University Press, Bloomington and Indianapolis 1994.
- Gutsche, Willibald (ed.), *Geschichte der Stadt Erfurt*. Hermann Böhlaus Nachfolger, Weimar 1986.
- Heinicke Feuerungs- und Schornsteinbau, *H.R. Heinicke Einäscherungsöfen*, undated commercial brochure.
- Heepke, Wilhelm, *Die Kadaververnichtungsanlagen*. Verlag von Carl Marhold, Halle a. S. 1905a.
- Heepke, Wilhelm, *Die Leichenverbrennungs-Anstalten (die Krematorien)*. Verlag von Carl Marhold. Halle a. S. 1905b.
- Heepke, Wilhelm, "Die neuzeitlichen Leicheneinäscherungsöfen mit Koksfeuerung, deren Wärmebilanz und Brennstoffverbrauch," in: *Feuerungstechnik*, XXI. Vol., No. 8. pp. 109-111; No. 9, pp. 123-128, 1933.
- Heil, Karl, *Die Feuerbestattungs-Literatur*. Selbstverlag der Feuerbestattungsvereine Deutscher Sprache. Königsberg Pr. 1930.
- Heinemann, Ferdinand, "Ein neuer Verbrennungsöfen für Friedhofsabraum," in: *Gesundheits-Ingenieur*, Vol. 63, No. 16, 1940, pp. 189f.
- Helbig, Erwin, "Die deutschen Krematorien im Jahre 1939," in: *Die Feuerbestattung*, Vol. 12, 1940, No. 3, pp. 28-31.
- Heldwein, Johannes, *Die Geschichte der Feuerbestattung und deutsche Krematorien*. Franzmathes Verlag, Frankfurt am Main 1931.
- Hellwig, Friedrich, "Vom Bau und Betrieb der Krematorien," in: *Gesundheits-Ingenieur*, Vol. 54, 1931a, No. 24, pp. 369-374; No. 25, pp. 395-399.
- Hellwig, Friedrich, "Entgegnung zu vorstehenden Ausführungen," in: *Gesundheits-Ingenieur*, Vol. 54, No. 41, 1931b.
- Hellwig, Friedrich, "Vom Bau und Betrieb der Krematorien," in: *Zentralblatt für Feuerbestattung*, Vol. 4, No. 1, 1932a, pp. 8-14.
- Hellwig, Friedrich, "Vom Sarg zur Urne," in: *Zentralblatt für Feuerbestattung*, Vol. 4, 1932b, pp. 37-43.
- Henzi, R., "Die Zürcher Einäscherungsöfen mit Gasfeuerung," in: *Schweiz. Verein von Gas- und Wasserfachmännern*, XIV. Vol., No. 3, 1934, pp. 63-66.
- Höss, Rudolf, *Commandant of Auschwitz: The Autobiography of Rudolf Hoess*, The World Publishing Company, Cleveland/New York, 1959.
- Houzeau, M., "Note sur la crémation des corps," in: *Précis analytique des travaux de l'Académie des Sciences, Belles-Lettres et Arts de Rouen pendant l'année 1880-1881*. Rouen, Imprimerie d'Espérance Cagniard, 1882, pp. 135-141.
- Huber, Walter, *Die Feuerbestattung ein Postulat kultureller Entwicklung und das St. Galler Krematorium*. Selbstverlag des Verfassers, St. Gallen 1903.
- "Hütte" des Ingenieurs Taschenbuch. Verlag von Wilhelm Ernst und Sohn, Berlin, Vol. I: 1931; Vol. IV: 1938.
- Ichok, G., "La crémation," in: *Revue d'hygiène et de médecine préventive*, No. 52, 1930, pp. 41-53.
- Ichok, G., "L'action sanitaire à l'étranger. La crémation à l'étranger," in: *Revue d'hygiène et de médecine préventive*, No. 53, 1931, pp. 677-691.
- Industrial Equipment & Engineering Co. Ener-Tek II Cremator*, company brochure.
- Internationales Lagerkomitee Buchenwald (ed.), *Konzentrationslager Buchenwald. Bericht des internationalen Lagerkomitees Buchenwald*. Thüringer Volksverlag, Weimar, undated (but 1949).
- Jakobsköter, Rudolf, "Die Entwicklung der elektrischen Einäscherung bis zu dem neuen elektrisch beheizten Heisslufteinäscherungsöfen in Erfurt," in: *Gesundheits-Ingenieur*, Vol. 64, No. 43, 1941, 579-587.

- Jeanson, "Die elektrische Einäscherung in Theorie und Praxis," in: *Zentralblatt für Feuerbestattung*, Vol. 7, No. 8, 1935, pp. 118-122.
- Jones, E.W., "Factors Which Affect the Process of Cremation. Third Session." Extract from the Cremation Society of Great Britain's *Annual Cremation Conference Report*, 1975, pp. 77-87.
- Jordan, H., H. Deringer, "Wärmeverbrauch des mit Gas und mit Elektrizität geheizten Krematoriumsofens," in: *Die Feuerbestattung*, VII. Vol., No. 1, 1936, p. 16.
- Kaiserliches Patentamt. Patentschrift No. 218581. Klasse 24d. Ausgegeben den 8. Februar 1910. Max J. Kergel in Beuthen, O.-S. *Leichenverbrennungsofen mit Rekuperator*. Patentiert im Deutschen Reiche vom 4. Oktober 1908 ab.
- Kaiserliches Patentamt. Patentschrift No. 244887. Klasse 24d. Ausgegeben den 20. März 1912. Lawson Henry Giddings in Pasadena, Calif. *Elektrischer Leichenverbrennungsofen*. Patentiert im Deutschen Reiche vom 11. April 1911 ab.
- Kaiserliches Patentamt. Patentschrift No. 257576. Klasse 24d. Ausgegeben den 13. März 1913a. Gebr. Körting Aktiengesellschaft in Linden b. Hannover. *Leichenverbrennungsofen mit Ölfueuerung*. Patentiert im Deutschen Reiche vom 30. Juni 1911 ab.
- Kaiserliches Patentamt. Patentschrift No. 258066. Klasse 24d. Ausgegeben den 28. März 1913b. Friedrich Siemens in Berlin. *Leicheneinäscherungsofen mit Regeneratoren und einem Gaserzeuger*. Patentiert im Deutschen Reiche vom 18. August 1911 ab.
- Kaiserliches Patentamt. Patentschrift No. 263725. Klasse 24d. Ausgegeben den 6. September 1913c. Bunzlauer Werke Lengerdorff & Comp. in Bunzlau i. Schles. *Verfahren und Vorrichtung zur Einäscherung von Leichen mit Verbrennungsgasen und Luftherhitzer mit einer Wärmequelle*. Patentiert im Deutschen Reiche vom 6. Juli 1911 ab.
- Kaiserliches Patentamt. Patentschrift No. 279830. Klasse 24d. Ausgegeben den 29. Oktober 1914. Wilhelm Buess in Hannover. *Leichenverbrennungsofen mit Öl- oder Gasfueuerung mit einem unter dem schräg abfallenden Verbrennungsraum liegenden Aschenaufnahmebehälter*. Patentiert im Deutschen Reiche vom 22. August 1913 ab.
- Kaiserliches Patentamt. Patentschrift No. 284163. Klasse 24d. Ausgegeben den 12. März 1915. Wilhelm Sauerland in Dresden. *Einäscherungsofen mit an der einen Stirnseite mit dem Verbrennungsraum verbundenem Gaserzeuger und einem Regenerator*. Patentiert im Deutschen Reiche vom 19. Dezember 1912 ab.
- Kämper, Hermann, "Der Umbau der Leichenverbrennungsofen und die Einrichtung von Leichenkühlräumen auf dem Hauptfriedhof der Stadt Dortmund," in: *Gesundheits-Ingenieur*, Vol. 64, No. 12, 1941, pp. 171-176.
- Keller, G., *Die Elektrizität im Dienste der Feuerbestattung*. Aktiengesellschaft Brown, Boveri & Cie, Baden (Schweiz). Sonderabdruck aus den Brown Boveri Mitteilungen A.G., No. 6/7 1942.
- Keller, Hans, *Mitteilungen über Versuche am Ofen des Krematoriums in Biel*. Bieler Feuerbestattungs-Genossenschaft in Biel. Jahresbericht pro 1927/28, Biel 1928.
- Keller, Hans, "Versuche an einem Feuerbestattungsofen." Sonderabdruck aus der Zeitschrift *Archiv für Wärmewirtschaft und Dampfkesselwesen*, Vol. 10, 1929, No. 6, pp. 1-3.
- Keller, Hans, *Der elektrische Einäscherungsofen im Krematorium Biel*. Bieler Feuerbestattungs-Genossenschaft in Biel. Jahresbericht pro 1933. Biel 1934.
- Keller, Hans, "Die Einäscherungsofen mit elektrischer Aufheizung im Krematorium in Biel," in: *Zentralblatt für Feuerbestattung*, Vol. 7, No. 5, 1935a, pp. 65-70.
- Keller, Hans, "Wärmeverbrauch des mit Gas und mit Elektrizität geheizten Krematoriumsofens," in: *Zentralblatt für Feuerbestattung*, Vol. 7, No. 12, 1935b, p. 176.
- Keller, Hans, *Der elektrifizierte Ofen im Krematorium Biel*. Graphische Anstalt Schühler A.G., Biel 1935c.
- Keller, Hans, *Mitteilungen über den Betrieb des Krematoriums Biel von 1927 bis 1945*. BFG Bieler Feuerbestattungs-Genossenschaft in Biel, Jahresbericht pro 1945a.
- Keller, Hans, *Ursache der Rauchbildung bei der Kremation*. Bieler Feuerbestattungs-Genossenschaft in Biel. Jahresbericht pro 1944. Biel 1945b.

- Kessler, Richard, "Rationelle Wärmewirtschaft in den Krematorien nach Massgabe der Versuche im Dessauer Krematorium," in: *Die Wärmewirtschaft*, Vol. 4, 1927, No. 8, pp. 134-140; No. 9, pp. 148-159; No. 10, pp. 165-169; No. 11, pp. 177-181.
- Kessler, Richard, "Rationelle Wärme-Wirtschaft in Krematorien unter besonderer Berücksichtigung der Leuchtgasfeuerung," in: *Verband...* 1930, pp. 133-143.
- Kessler, Richard, "Der neue Einäscherungs-Ofen System Volckmann-Ludwig," in: *Zentralblatt für Feuerbestattung*, Vol. 3, No. 3, 1931a, pp. 34-40.
- Kessler, Richard, "Entwicklung und Zukunftswege der Einäscherungstechnik," in: *Zentralblatt für Feuerbestattung*, Vol. 3, No. 6, 1931b, pp. 83-89.
- Kessler, Richard, *Richtlinien für den Bau von Öfen zur Einäscherung menschlicher Leichen. Neue Fortschritte im Einäscherungs-Ofenbau*. Veröffentlichungen des Grossdeutschen Verbandes der Feuerbestattungsvereine No. 5, Königsberg 1932.
- Kessler, Richard, "Die wärmewirtschaftliche Ausnutzung der Abgase bei Einäscherungs-öfen," in: *Zentralblatt für Feuerbestattung*, Vol. 5, No. 2, 1933a, pp. 21-26.
- Kessler, Richard, "Richtlinien für den Bau von Öfen zur Einäscherung menschlicher Leichen aufgestellt vom Grossdeutschen Verbande der Feuerbestattungsvereine," in: *Zentralblatt für Feuerbestattung*, Vol. 5, No. 6, 1933b, pp. 87-93.
- Klatte, Günther, "Krematoriumsöfen mit Gasfeuerung," in: *Industriegas*, No. 3, 1931, pp. 63-66.
- Kogon, Eugen, *Der SS-Staat. Das System der deutschen Konzentrationslager*. Verlag Karl Alber, Munich 1946.
- "Köln erhält ein Krematorium," in: *Zentralblatt für Feuerbestattung*, Vol. 7, No. 2, 1935, p. 27.
- Kommunistischen Partei Deutschlands (ed.), *Das war Buchenwald! Ein Tatsachenbericht*. Verlag für Wissenschaft und Literatur, Leipzig, undated.
- Kori, Hans, "Bau und Betrieb von Krematorien. Neue Wege und Ziele," in: *Die Wärmewirtschaft*, Vol. 1, No. 8, 1924, pp. 115-119.
- Kori, Hans, GmbH. Berlin, *Einäscherungs-Ofen System "Kori"* (Publicity leaflet from the late 1920s).
- Kori, Hans, GmbH., Berlin, *Verbrennungsöfen für Abfälle aller Art* (leaflet from the 1930s).
- Krapner, Hans, "Neuere Erkenntnisse und Erfahrungen beim Betrieb von Einäscherungs-öfen." reprint from: *Städtehygiene* 8/1970, Uelzen.
- Krapner, Hans, Franz Puls, "Die chemische Vorgänge bei einer Einäscherung," reprint from: *Städtehygiene* 8/1970, Uelzen.
- Kremationsöfen, System Ruppmann Typ 070/3*.
- "Krematorium Forst (Lausitz)," in: *Zentralblatt für Feuerbestattung*, Vol. 2, No. 4, 1930, p. 60.
- Kristen, "Ausbrennversuche an Schornsteinen," in: *Wärmewirtschaftliche Nachrichten für Hausbau, Haushalt und Kleingewerbe*, Vol. 6, 7 No., 1933, pp. 83-85.
- Kryl, Mirosław, "Deportacja więźniów terezynskiego getta do obozu koncentracyjnego na Majdanku w 1942 roku," in: *Zeszyty Majdanka*, vol. XI, 1983.
- Kubica, Helena, "Kinder und Jugendliche im KL Auschwitz," in: *Długoborski/Piper* 1999, Vol. II, pp. 251-351.
- Küchenmeister, Friedrich, *Ueber Leichenverbrennung*. Vortrag gehalten am 8. April 1874 zum Besten des Neustädter Gymnasial-Stipendienfonds. Verlag von Ferdinand Enke, Erlangen 1874.
- Küchenmeister, Friedrich, *Die Feuerbestattung. Unter allen zur Zeit ausführbaren Bestattungsarten die beste Sanitätspolizei des Bodens und der sicherste Cordon gegen Epidemien*. Verlag von Ferdinand Enke, Stuttgart 1875.
- "La crémation," in: *La Science Illustrée*, vol. V, 1890, premier semestre, No. 118, pp. 209f.
- "La crémation à Paris. Son état actuel," in: *L'année scientifique et industrielle*, Vol. 34 (1890), Paris, 1891, pp. 419-422.
- "La crémation au Japon," in: *Nice-médical*, Vol. 7, No. 6, March 1883, p. 94.

- “La crémation au Japon,” in: *Annales d'hygiène publique et de médecine légale*, 1900, série 3, No. 43, pp. 380f.
- “La crémation des morts à Paris,” in: *La Science Illustrée*, vol. I, 1888, premier semestre, p. 111.
- “La crémation des morts et l'édifice crématoire du Père-Lachaise,” in: *La Science Illustrée*, vol. I, 1888, premier semestre, pp. 12-14.
- “La prima cremazione in Milano,” in: *Annali universali di medicina e chirurgia*. Series 1, vol. 235, fascicolo 703, January 1876, pp. 90-93.
- “La seconda cremazione a Milano,” in: *Annali universali di medicina e chirurgia*. Series 1, vol. 235, fascicolo 706, April 1876, pp. 290-292.
- Lacassagne, A., P. Dubuisson, “Crémation,” in: *Dictionnaire encyclopédique des sciences médicales*, vol. 23, CRE-CRU, Paris, 1874, pp. 5-91.
- Langbein, Hermann, *Der Auschwitz-Prozess. Eine Dokumentation*. Europa Verlag, Vienna, Frankfurt, Zürich 1965, 2 volumes.
- Lange, Martina, Holger Schutkowski, Susanne Hummel, Bernd Herrmann, *A Bibliography on Cremation / Leichenbrand – Bibliographie, Pact*, Vol. 19, Conseil d'Europe, Strasbourg 1987.
- Lanyi, “Ueber die Verbrennung der Leichen am Schlachtfelde,” in: *Allgemeine Militärärztliche Zeitung*, 12 April 1874, pp. 91-95.
- Lebrasseur, M., “Tirage naturel et tirage mécanique des appareils thermiques,” in: *Ge-sundheits-Ingenieur*, Vol. 45, No. 5, 1922 (review), pp. 56f.
- Leuchter, Fred A., *An Engineering Report on the Alleged Execution Gas Chambers at Auschwitz, Birkenau and Majdanek, Poland*, Fred A. Leuchter, Associates, Boston, Mass., April 1988.
- Leuchter, Fred A., Robert Faurisson, Germar Rudolf, *The Leuchter Reports: Critical Edition*, 5th ed., Castle Hill Publishers, Uckfield 2017.
- Löffler, Rudolf, “Die wichtigen Verbrennungs-Oxydationsvorgänge,” in: *Die Volks-Feuerbestattung*, Vol. 1, No. 7/8, 1926, pp. 3f.
- Lohmann, W., *Gesetz, betreffend die Feuerbestattung, vom 14. September 1911 nebst Ausführungsanweisung vom 29. September 1911*. J. Guttentag Verlagsbuchhaltung, Berlin 1912.
- Łukaszkiwicz, Zdzisław, “Obóz koncentracyjny i zagłady Majdanek,” in: *Biuletyn Głównej Komisji Badania Zbrodni Niemieckich w Polsce*, Vol. 4, 1948, pp. 63-105.
- Maccone, Luigi, *Storia documentata della cremazione presso i popoli antichi ed i moderni con speciale riferimento alla igiene*. Istituto Italiano d'Arti Grafiche, Bergamo 1932.
- Majewska, Justyna, “Technicy “ostatecznego rowiązania”. Topf & Söhne – konstruktorzy pieców dla Auschwitz”, *Zagłada Żydów: studia i materiały*, No. 13 (2017), pp. 854-859.
- Manskopf, H., “Gas als Brennstoff für Einäscherungsöfen,” in: *Das Gas- und Wasserfach*, Vol. 76, No. 42, 1933, pp. 772-775.
- Manuale dell'ingegnere Nuovo Colombo*. Hoepli, Milan 1990.
- Marcuse, O., *Die wichtigsten Bestimmungen der deutschen Landesgesetze über Feuerbestattung nebst dem Entwurf eines Reichsgesetzes*, in: *V. Jahrbuch des Verbandes der Feuerbestattungs-Vereine Deutscher Sprache*. Königsberg i. Pr. 1930.
- Marmier, Fernand, *Utilité de la crémation des cadavres à la suite des grandes batailles et épidémies*. Thèse pour le doctorat en médecine. A. Parent, Imprimeur de la Faculté de médecine, Paris 1876.
- Marsalek, Hans, *Die Geschichte des Konzentrationslagers Mauthausen. Dokumentation*, Österreichische Lagergemeinschaft Mauthausen, Vienna, 1980.
- Marsch, Adolf, “Masseneinäscherung von Kriegerleichen im Felde als Schutz gegen Seuchengefahr und später fühlbar werdende Verkehrshindernisse,” in: *Phoenix. Blätter für wahlfreie Feuerbestattung und verwandte Gebiete*, Vienna, XXX. Vol., No. 2, 1917, pp. 35ff.

- Mattogno, Carlo, *Le camere a gas di Auschwitz. Studio storico-tecnico sugli "indizi criminali" di Jean-Claude Pressac e sulla "convergenza di prove" di Robert Jan van Pelt*. Effepi, Genoa 2009.
- Mattogno, Carlo, "Origins and Functions of the Birkenau Camp", *Inconvenient History*, Vol. 2, No. 2, 2010, <http://www.inconvenienthistory.com/2/2/3113>.
- Mattogno, Carlo, *Auschwitz: The Case for Sanity*, The Barnes Review, Washington, D.C., 2010a.
- Mattogno, Carlo, *I verbali degli interrogatori sovietici degli ingegneri della Topf. Le dichiarazioni di Kurt Prüfer, Karl Schultze, Fritz Sander e Gustav Braun su "camere a gas" e forni crematori di Auschwitz: analisi storico-tecnica*. Effepi, Genoa, 2014.
- Mattogno, Carlo, *The Central Construction Office of the Waffen-SS and Police Auschwitz*. 2nd ed., Castle Hill Publishers, Uckfield, 2015.
- Mattogno, Carlo, *Special Treatment at Auschwitz. Origin and Meaning of a Term*, 2nd ed., Castle Hill Publishers, Uckfield, 2016.
- Mattogno, Carlo, "Auschwitz: The End of a Legend," in: G. Rudolf (ed.), *Auschwitz: Plain Facts—A Response to Jean-Claude Pressac*, 2nd ed., Castle Hill Publishers, Uckfield, 2016a, pp. 131-212.
- Mattogno, Carlo, *The Real Case for Auschwitz*, 3rd ed., Castle Hill Publishers, Uckfield 2019.
- Mattogno, Carlo, *Auschwitz: Trasporti, Forza, Mortalità*. Effepi, Genoa, 2019a.
- Mattogno, Carlo, *Le farneticazioni di Robert Jan van Pelt sui forni crematori di Auschwitz-Birkenau*, Effepi, Genoa, 2020.
- McPhee, S., M. Papadakis, L. Tierney, *Current Medical Diagnosis and Treatment*, vol. 47, McGraw-Hill Professional, New York 2008
- Meyers *Grosses Konversations-Lexicon*, 6th ed., 1905, entry "Leichenverbrennung," pp. 362-364.
- Meyers Handbuch über die Technik*. Bibliographisches Institut, Mannheim 1964.
- Meyers Lexikon*, 7th ed., 1926, entry "Feuerbestattung," pp. 644-646.
- Müller, Rudolph, "Ueber Leichenverbrennung." Reprint from: *Medizinische Jahrbücher*, Vienna, Vol. 199, No. 1, 1883, pp. 73-82; Italian translation: "Sulla cremazione die cadaveri," in: *Annali universali di medicina e chirurgia*, Vol. 268, 1st Semester 1884, Milan, Fratelli Rechiedei Editori, 1884, pp. 177-228.
- Nagel, Robert, *Wege und Ziele der modernen Feuerbestattung*. Verlag Wilhelm Ruppmann, Stuttgart 1922.
- Nagel, Robert, *Die Vorzüge der Feuerbestattung*. Selbstverlag des Verfassers, Vienna 1931.
- Nyiszli, Miklos, *Im Jenseits der Menschlichkeit. Ein Gerichtsmediziner in Auschwitz*. Dietz Verlag, Berlin 1992.
- Olshausen, O., "Die Leichenverbrennung in Japan," in: *Zeitschrift für Ethnologie*, 40. Vol., 1908, pp. 100-106.
- Ortloff, Hermann, *Gleichberechtigung der Feuer- und Erdbestattung. Anhang: Das Verbrennungssystem Rich. Schneider, vorm. Dresden, jetzt Berlin*. Felix Dietrich, Leipzig 1907.
- Pallester, Paul, *Mitteilungen über die Feuerbestattung in Japan*. Verlag des Vereines der Freunde der Feuerbestattung "Die Flamme" in Wien. Vienna 1912.
- Pauly, Max, *Die Feuerbestattung*. Verlagsbuchhandlung von J.J. Weber, Leipzig 1904.
- Pein, Théodore, *Essai sur l'hygiène des camps de bataille*. Paris, Librairie JB. Baillière et Fils, 1873.
- Peters, A., "Winke für den Betrieb von Einäscherungsanlagen," in: *Zentralblatt für Feuerbestattung*, Vol. 2, No. 4, 1930, pp. 56-58.
- Peters, A., H. Tilly, "Die Wirtschaftlichkeit von Anlagen zur Einäscherung menschlicher Leichen," in: *Die Wärmewirtschaft*, Vol. 3, No. 11, 1926, pp. 176-178.
- Phoenix. Blätter für wahlfreie Feuerbestattung und verwandte Gebiete*, Vienna 1913, No. 1, p. 32.
- Phoenix. Blätter für wahlfreie Feuerbestattung und verwandte Gebiete*, Vienna 1938, No. 2, p. 18.

- Pierini, Ferdinando, *La conduzione dei generatori di vapore*. A.N.C.C., Rome 1977.
- Pini, Gaetano, "Sulla cremazione dei cadaveri," in: *Annali di chimica applicata alla medicina cioè alla farmacia, alla tossicologia, all'igiene, alla fisiologia, alla patologia e alla terapeutica*. Serie 1, vol. 226, No. 678, December 1873, pp. 529-550.
- Pini, Gaetano, *La crémation en Italie et à l'étranger de 1774 jusque'à nos jours*. Ulrich Hoepli Editeur Libraire, Milan 1885.
- Piper, Franciszek, "Das Nebenlager Blechhammer," in: *Hefte von Auschwitz*, Wydawnictwo Panstwowego Muzeum w Oswiecimiu, Vol. 10, 1967, pp. 19-39.
- Piper, Franciszek, *Die Zahl der Opfer von Auschwitz*. Verlag des Staatlichen Museums in Oświęcim, 1993.
- Piper, Franciszek, "Gas Chambers and Crematoria," in: Gutman/Berenbaum 1994, pp. 157-182.
- Polli, Giovanni, "La cremazione del cadavere del cav. Alberto Keller," in: *Annali di chimica applicata alla medicina cioè alla farmacia, alla tossicologia, all'igiene, alla fisiologia, alla patologia e alla terapeutica*. Serie 3, vol. 62, January 1876a, pp. 5-14.
- Polli, Giovanni, "Cremazione Pozzi," in: *Annali di chimica applicata alla medicina cioè alla farmacia, alla tossicologia, all'igiene, alla fisiologia, alla patologia e alla terapeutica*. Serie 3, vol. 62, No. 4, April 1876b, pp. 248-250.
- Polli, Giovanni, "Terza cremazione di un cadavere umano in Milano," in: *Annali di chimica applicata alla medicina cioè alla farmacia, alla tossicologia, all'igiene, alla fisiologia, alla patologia e alla terapeutica*. Serie 3, vol. 64, No. 3, March 1877, pp. 191f.
- Préfecture du Département de la Seine. Direction des Affaires Municipales. *Note sur la crémation à Paris au 1^{er} novembre 1893*.
- Pressac, Jean-Claude, *The Struthof Album: Study of the Gassing at Natzweiler-Struthof of 86 Jews Whose Bodies Were to Constitute a Collection of Skeletons*. The Beate Klarsfeld Foundation. New York 1985.
- Pressac, Jean-Claude, *Auschwitz: Technique and Operation of the Gas Chambers*. The Beate Klarsfeld Foundation. New York 1989.
- Pressac, Jean-Claude, *Les crématoires d'Auschwitz. La machinerie du meurtre de masse*. CNRS Editions, Paris 1993.
- Pressac, Jean-Claude, *Le macchine dello sterminio. Auschwitz 1941-1945*. Feltrinelli, Milan 1994.
- Probst, C.O., "Report of the Committee on the Disposal of the Dead," in: *Public Health Papers and Reports*, Vol. 21, 1895, pp. 177-191.
- "Progress of the Cremation," *The British Medical Journal*, 5 March 1910, pp. 579ff.
- Prüfer, Kurt, "Ein neues Einäscherungsverfahren.' Eine Entgegnung," in: *Die Flamme*, Berlin, Vol. 48, 1931a, pp. 5f.
- Prüfer, Kurt, "Ein neues Einäscherungsverfahren," in: *Die Urne*, Vol. 4, No. 3, March 1931b, pp. 27-29.
- Quehl, Viktor, "Feuerbestattung und Einäscherungsöfen," in: *Gesundheits-Ingenieur*, Vol. 59, No. 38, 1936, pp. 559-561.
- Reber, B., "Un crématoire du temps de la révolution française," in: *Société de crémation de Genève*, Bulletin VIII, Geneva, Imprimerie Centrale, 1908, pp. 26-29.
- Recknagel-Sprenger, *Taschenbuch für Heizung, Lüftung und Klimatechnik*. R. Oldenbourg, Munich 1959.
- Regione Liguria, Dipartimento ambiente e territorio, *Servizio Gestione ciclorifiuti*. Genoa, 29 December 1998.
- Reichenwallner, Balduin, *Tod und Bestattung*. Katakomben-Verlag/Balduin Reichenwallner, Munich 1926.
- Reimann, W., *Aufklärungen über die Feuerbestattung*. Selbstverlag des Herausgebers, Berlin 1925.
- Repyk, "Der Umbau koksgefeuerter Kremationsöfen auf Leuchtgasbeheizung," in: *Gesundheits-Ingenieur*, Vol. 55, No. 42, 1932, pp. 506-509.
- Richardson, Aubrey, *The Law of Cremation*. Reeves & Turner, London, 1893.

- Rochard, Jules, "La crémation," in: *Revue des Deux Mondes*, Year LX, vol. XCVIII, 1890, pp. 916-944
- Roland, Hans, "Zur Einführung des Reichsgesetzes über die Feuerbestattung," in: *Die Feuerbestattung*, Vol. 12, No. 3, 1942, p. 62.
- Rolants, M.E., "État actuel de la crémation des cadavres," in: *Revue d'hygiène et de police sanitaire*, No. 32, 1910, pp. 1109-1126.
- Roth, Wilhelm, "Desinfektionsarbeiten auf Schlachtfeldern," in: Lex Roth, *Handbuch der Militärgesundheitspflege*, 1872, pp. 548-558.
- Rudolf, Germar (ed.), *Dissecting the Holocaust. The Growing Critique of "Truth" and "Memory,"* 2nd ed., Theses & Dissertations Press, Chicago 2003; 3rd ed., Castle Hill Publishers, Uckfield, 2019.
- Rudolf, Germar, Carlo Mattogno, *Auschwitz Lies: Legends, Lies, and Prejudices on the Holocaust*, 4th ed., Castle Hill Publishers, Uckfield, 2017.
- Ruppmann, Wilhelm, *Der Feuerbestattungssofen System Ruppmann*, company brochure, 1910.
- Salomon, Georges, "État actuel de la crémation en France," in: *Revue d'hygiène et de police sanitaire*, No. 15, 1893, pp. 520-535.
- Salvi, Giuliano, *La combustione. Teoria e applicazioni*. Tamburini Editore, Milan 1972.
- Sausse, "Gasgefeuerte Einäscherungsöfen," in: *Technische Monatsblätter für Gasverwendung*, Vol. 6, No. 2, 1930/31, pp. 21-23.
- Schetter, Gebhard, Henning Burk, *Das Krematorium Dresden. Ein Beispiel für umweltgerechte Einäscherung unter betriebswirtschaftlichen Gesichtspunkten*. Friedhofskultur, year 96, October 2006 (PDF).
- Schirm, E., "Feuerbestattungsöfen ohne Zusatzfeuerung," in: *V.D.I. Zeitschrift*, Vol. 76, No. 4, 1932.
- Schläpfer, Paul, *Über den Bau und Betrieb von Kremationsöfen*. Separatabdruck aus dem Jahresbericht des Verbandes Schweizer Feuerbestattungsvereine, Zürich 1937.
- Schläpfer, Paul, "Betrachtungen über den Betrieb von Einäscherungsöfen," in: *Schweiz. Verein von Gas- und Wasserfachmännern Monatsbulletin*, XVIII. Vol., No. 7, 1938, pp. 147-160.
- Schnabel, Raimund, *Macht ohne Moral. Eine Dokumentation über die SS*. Röderberg-Verlag, Frankfurt/Main 1957.
- Schnitzer, Joseph, *Die Religions-psychologische Grundlage der Feuerbestattung*. Selbstverlag der Genossenschaft Luzerner Feuerbestattung, Munich 1933.
- Schuchhardt, Carl, "Die Anfänge der Leichenverbrennung," in: *Sitzungsberichte der Preussischen Akademie der Wissenschaften*. Philosophisch-Historische Klasse, 1920, pp. 499-521.
- Schüle, Annegret, *Industrie und Holocaust: Topf & Söhne – Die Ofenbauer von Auschwitz*, 2n ed., Wallstein Verlag, Göttingen, 2011.
- Schultz-Schultzenstein, "Luftverpestung im Felde und deren Verhütung," in: *Allgemeine Militärärztliche Zeitung*, No. 46, 1870, pp. 364-367.
- Schulze-Manitius, Hans, "Moderne Feuerungsroste," in: *Feuerungstechnik*, Vol. XXIII, No. 8, 1935, pp. 86-90.
- Schumacher, Fritz, *Die Feuerbestattung*. J.M. Gebhardt's Verlag, Leipzig 1939.
- Siedek, Egon, "Die Einäscherung von Leichen auf elektrischem Wege," in: *Phoenix. Blätter für fakultative Feuerbestattung und verwandte Gebiete*, Vienna, XXII. Vol., No. 10, 1909, p. 429.
- Sircar, Robin, *Untersuchung der Emissionen aus Einäscherungsanlagen und der Einsatzmöglichkeiten von Barrierenentladungen*. Doctoral thesis presented at Martin-Luther Universität Halle-Wittenberg on 28 June 2002.
- Staatliches Museum Auschwitz (ed.), *Sterbebücher von Auschwitz*. K.G. Saur. Munich 1995, 3 volumes.
- Stadtvorstand Gotha (ed.), *Gedenkschrift zum 50-jähr. Bestehen des Krematoriums in Gotha*, Gotha 1928.

- “Statistisches. Europäische Länder mit den Verhältniszahlen der Einäscherungen zu den Gestorbenen im Jahre 1938,” in: *Die Feuerbestattung*, Vol. 11, 1939.
- Stenger, Heinrich, “Ergebnisse mit einem gasbeheizten Einäscherungssofen neuer Bauart,” in: *Gesundheits-Ingenieur*, Vol. 62, No. 2, 1939, pp. 17f.
- Storl, Richard, “Ein neuer, den Richtlinien Kesslers entsprechender Einäscherungssofen,” in: *Zentralblatt für Feuerbestattung*, Vol. 6, No. 5, 1934, pp. 72-75.
- Storl, Richard, “Die technische Einrichtungen neuzeitlicher Krematorien,” in: *Die Feuerbestattung*, Vol. 11, No. 1, 1939.
- Stort, “Der menschliche Körper als Heizstoff,” in: *Die Umschau in Wissenschaft und Technik*, No. 26, 1931, pp. 513f.
- “Tabelle der europäischen Länder mit den Verhältniszahlen der Einäscherungen zu den Gestorbenen in den Jahren 1939 bis 1942,” in: *Die Feuerbestattung*, Vol. 16, No. 2, 1944, p. 17.
- Tatzl, Johann, *Krematorium und Friedhofsgestaltung für den Stadtfriedhof Bruck an der Mur*. Diplomarbeit WS 1984-85. Technische Universität Graz.
- “Technical aspects of cremation,” *The British Medical Journal*, 23 February 1946, p. 286.
- ter Linden, A.J., “Feuerräume und Feuerraumwände,” in: *Feuerungstechnik*, XXIII, Vol., No. 2, 1935, pp. 14-20.
- Terezínská Iniziativa (ed.), *Terezínská Pamětní Kniha*, Terezínská Iniziativa Melantrich, 1995.
- The John Crerar Library, *A List of Books, Pamphlets and Articles on Cremation*. Including the Cremation Association of America Collection. Printed by order of the Board of Directors, Chicago 1918.
- “The progress of the cremation,” *The British Medical Journal*, 25 April 1914, pp. 926ff.
- Thompson, Henry, *Cremation. The Treatment of the Body after Death*. Smith, Elder, & Co., London, 1884. This book includes a contribution by Sir. T. Spencer Wells titled “Cremation or Burial? (A Paper read at the Meeting of the British Medical Association in Cambridge, August 1880)” and one by Mr. Justice Stephen on the “Law of Cremation. Charge to the Grand Jury, at the Crown Court, Cardiff, in February 1884.”
- Thompson, Henry, “Observations on cremation and death registration,” in: *The British Medical Journal*, 25 March 1889a.
- Thompson, Henry, *Die moderne Leichenverbrennung*. Fischer’s Medicinische Buchhandlung H. Kornfelds, Berlin 1889b.
- Tilly, H., “Versuch einer rechnermässigen Erfassung der Vorgänge bei der Einäscherung menschlicher Leichen,” in: *Die Wärmewirtschaft*, Vol. 3, No. 8, 1926a, pp. 134-136.
- Tilly, H., “Luftüberschuss und Brennstoffverbrauch bei der Einäscherung menschlicher Leichen,” in: *Die Wärmewirtschaft*, Vol. 3, No. 12, 1926b, pp. 190f.
- Tilly, H., “Ueber die Wirtschaftlichkeit von Anlagen zur Einäscherung menschlicher Leichen,” in: *Die Wärmewirtschaft*, Vol. 3, No. 9, 1926c, pp. 143-145.
- Tilly, H., “Über die Einäscherung menschlicher Leichen,” in: *Die Wärmewirtschaft*, Vol. 4, No. 2, 1927, pp. 19-25.
- Topf, J.A., & Söhne, Erfurt, *Öfen für Krematorien System Topf* (brochure of 1926).
- Topf, J.A., & Söhne, Erfurt, *Topf Abfall-Vernichtungs-Ofen* (brochure of 1940).
- Topf, J.A., & Söhne, Erfurt. Patentanmeldung. 26.10.1942a. “Kontinuierlich arbeitender Leichen-Verbrennungssofen für Massenbetrieb.”
- Topf, J.A., & Söhne, Erfurt. Patentanmeldung. 16.11.1942b. “Luftgekühlte Rostplatten für mechanische Vorschubroste.”
- Trusen, J.P., *Die Leichenverbrennung als die geeignetste Art der Todtenbestattung oder Darstellung der verschiedenen Arten und Gebräuche der Todtenbestattung*. Verlag von Wilhelm Gotti, Korn, Breslau 1855.
- Vallin, E., “Une séance de crémation à Milan,” in: *Revue d’hygiène et de police sanitaire*, No. 2, 1880, pp. 854-865.
- van Baar, Annika, Wim Huisman, “The Oven Builders of the Holocaust,” *British Journal of Criminology*, Vol. 52, No. 6 (2012), pp. 1033-1050.

- van Pelt, Robert Jan, *The Case for Auschwitz. Evidence from the Irving Trial*, Indiana University Press. Bloomington and Indianapolis, 2002.
- Verband der Feuerbestattungs-Vereine Deutscher Sprache, *II. Jahrbuch*, Vereinsbuchdruckerei, Pymont 1912.
- Verband der Feuerbestattungs-Vereine Deutscher Sprache, *III. Jahrbuch*, Druck von Carl Wull, Heilbronn a. N. 1913.
- Verband der Feuerbestattungs-Vereine Deutscher Sprache, *IV. Jahrbuch*, Königsberg i. Pr. 1928a.
- Verband der Feuerbestattungs-Vereine Deutscher Sprache (ed.), *Verfahren und Vorrichtung zur Einäscherung*. Patentiert im Deutschen Reiche vom 30. Oktober 1928b ab.
- Verband der Feuerbestattungs-Vereine Deutscher Sprache, *V. Jahrbuch*, Königsberg i. Pr. 1930.
- Verein für Feuerbestattung Berlin (ed.), *Eine moderne Feuerbestattung erläutert an einem dem Verein für Feuerbestattung in Berlin gehörigen Modell eines Krematoriums*. Berlin 1897.
- “Verordnung zur Durchführung des Feuerbestattungsgesetzes vom 10. August 1938.” *Reichsgesetzblatt*, Vol. 1938, Teil I, pp. 1000f.
- Volckmann, Hans, “Ein neues Einäscherungsverfahren,” in: *Zentralblatt für Feuerbestattung*, Vol. 2, No. 5, 1930, pp. 65-68.
- Volckmann, Hans, “Der neue Einäscherungssofen System Volckmann-Ludwig,” in: *Zentralblatt für Feuerbestattung*, Vol. 3, No. 4, 1931, pp. 56-59.
- Volckmann, Hans, “Das Volckmann-Ludwig-Verfahren und die Kesslerschen Richtlinien,” in: *Zentralblatt für Feuerbestattung*, Vol. 6, No. 8, 1934, pp. 122-127.
- Volckmann, H., K. Ludwig, “Erwiderung auf den diesbezüglichen Aufsatz von Mag. Oberbaurat F. Hellwig in No. 25 vom 20. Juli 1931,” in: *Gesundheits-Ingenieur*, Vol. 54, No. 41, 1931, p. 616.
- von Engerth, Karl, *Fortschritte der Feuerbestattung in Deutschland. Vortrag, gehalten in der Hauptversammlung des Vereines der Feuerbestattung “Die Flamme” in Wien am 19. Februar 1892*. Verlag von Moritz Perles, Vienna 1892.
- von Engerth, Karl, *Die Feuerbestattung*. Im Selbstverlage des Verfassers, Vienna 1897.
- Vorstand des Vereines für Feuerbestattung zu Frankfurt a. M., “Elektro-Krematorien,” in: *Phoenix. Blätter für fakultative Feuerbestattung und verwandte Gebiete*, Vienna, XXIII. Vol., No. 10, 1910, pp. 399-401.
- Wegmann-Ercolani, *Ueber Leichenverbrennung als rationellste Bestattungsart*. Cäsar Schmidt, Zürich 1874.
- Weigt, K., *Almanach der Feuerbestattung*. Selbstverlag des Verfassers, Hanover 1909.
- Weinisch, Theodor, *Die Feuerbestattung im Lichte der Statistik*. Buchdruckerei J. Bollmann, Zinsdorf 1929.
- Weiss, Konrad, “Der erste deutsche elektrisch beheizte Einäscherungssofen im Krematorium Erfurt,” in: *Gesundheits-Ingenieur*, Vol. 57, No. 37, 15 September 1934, pp. 453-457.
- Weiss, Konrad, “Die Entwicklung des elektrisch beheizten Einäscherungssofen im Krematorium Erfurt,” in: *Gesundheits-Ingenieur*, 60. Vol., No. 11, 1937, pp. 159-162.
- Widmann, Max, *Die Feuerbestattung. Ein Wort der Aufklärung*. Im Auftrag der schweizer. Feuerbestattungsvereine verfasst. Burgdorf 1938.
- Wolfer, H., “Der neue ‘Volckmann-Ludwig’-Einäscherungssofen im Stuttgarter Krematorium,” in: *Gesundheits-Ingenieur*, Vol. 55, 1932a, No. 13, pp. 151-154, 1932b, No. 14, pp. 162-165.

5.2. Subject Listing

5.2.1. Modern Cremation

5.2.1.1. Bibliographies on Modern Cremation

- Cobb, John Storer, *A Quarter Century of Cremation in North America*. Knight and Millet, Boston, 1901.
- “Essai d’une bibliographie des ouvrages, brochures et journaux se rapportant à la crémation, aux usages funèbres, aux cimetières, etc. chez les différents peuples anciens et modernes,” in: de Cristophoris 1890, pp. 163-200.
- Heil, Karl, *Die Feuerbestattungs-Literatur*. Selbstverlag der Feuerbestattungsvereine Deutscher Sprache. Königsberg i. Pr. 1930.
- Lange, Martina, Holger Schutkowski, Susanne Hummel, Bernd Herrmann, *A Bibliography on Cremation / Leichenbrand – Bibliographie, Pact*, Vol. 19, Conseil d’Europe, Strasbourg 1987.
- Müller, Rudolph, “Ueber Leichenverbrennung.” Reprint from: *Medizinische Jahrbücher*, Vienna, Vol. 199, No. 1, 1883, pp. 73-82; Italian translation: “Sulla cremazione die cadaveri,” in: *Annali universali di medicina e chirurgia*, Vol. 268, 1st Semester 1884, Milan, Fratelli Rechiedei Editori, 1884, pp. 177-228.
- The John Crerar Library, *A List of Books, Pamphlets and Articles on Cremation*. Including the Cremation Association of America Collection. Printed by order of the Board of Directors, Chicago 1918.

5.2.1.2. History of Modern Cremation

- “A Discussion on the Disposal of the Dead. In the Section of Public Medicine at the Annual Meeting of the British Medical Association held in Bournemouth, July, 1891,” in: *The British Medical Journal*, 19. September 1891, pp. 627-631.
- Beutinger, E., *Handbuch der Feuerbestattung*. Carl Scholze Verlag, Leipzig 1911.
- Cobb, Augustus G., *Earth-Burial and Cremation: The History of Earth-Burial with its Attendant Evils, and the Advantages Offered by Cremation*. G.P. Putnam’s Sons, New York/London, 1892.
- Coletti, Francesco, *Memoria sulla incinerazione dei cadaveri*, Padua, 1857.
- “Crémation,” in: *Revue d’hygiène et de police sanitaire*, No. 11, 1889, pp. 788-792.
- “Crémation,” in: *Revue générale d’administration*, vol. I, January-April 1892, pp. 395-400.
- de Cristoforis, Malachia, *Etude pratique sur la crémation moderne*. Imprimerie Treves Frères, Milan 1890.
- de Pietra Santa, Prosper, *La crémation des morts en France et à l’étranger*. Librairie J.-B. Baillièrre et fils, Paris 1874.
- de Pietra Santa, Prosper, “Chronique de la crémation,” in: *Journal d’hygiène*, No. 590, 12 janvier 1888a, pp. 13-16 ; No. 592, 26 janvier 1888b, pp. 37-39 ; No. 593, 2 février 1888c, pp. 49-51.
- de Pietra Santa, Prosper, *Modern Cremation*. Publication de la Société Française d’Hygiène. Au bureau de la Société. Paris 1889.
- de Pietra Santa, Prosper, de Nansouty, “La crémation,” in: *Le génie civil*, 1881, No. 8, pp. 169-172; No. 9, pp. 193-195; No. 10, pp. 229-231; No. 11, pp. 256-258; No. 12, pp. 281-283, 15 February-15 April 1881.
- du Mesnil, O., “L’exposition et le congrès d’hygiène et de sauvetage de Bruxelles en 1876,” in: *Annales d’hygiène publique et de médecine légale*, 1877, série 2, No. 47, pp. 42-58.
- du Mesnil, O., “Le monument crématoire du cimetière de l’est. La crémation à Paris,” in: *Annales d’hygiène publique et de médecine légale*, 1888, série 3, No. 19, pp. 77-81.
- Eassie, William, “Cremation in its Bearing upon Public Health,” in: *The British Medical Journal*, 1 August 1874, pp. 134-138.
- Eassie, William, *Cremation of the Dead*. London, 1875.
- Enciclopedia Italiana*, entry “cremazione,” vol. XI, Rome 1949, p. 825.

- Erichsen, Hugo, *The Cremation of the Dead Considered from an Æsthetic, Sanitary, Religious, Historical, Medico-Legal, and Economical Standpoint*. D.O. Haynes & Company, Detroit, 1887.
- Davies, Douglas J., Lewis H. Mates (eds.), *Encyclopedia of Cremation*, Ashgate, London 2005.
- Faber, Heinrich, *Ein neues Krematorium für Wien/Die letzte Wohnung*. Diplomarbeit, Technische Universität Wien, 1981.
- Fischer, Norbert, *Vom Gottesacker zum Krematorium – Eine Sozialgeschichte der Friedhöfe in Deutschland seit dem 18. Jahrhundert*. Cologne/Weimar/Vienna, 1996.
- Goppelsroeder, Friedrich, *Ueber Feuerbestattung*. Druck und Verlag von Wenz u. Peters, Mühlhausen i. Els., 1890.
- Gorini, Paolo, *Sulla purificazione dei morti per mezzo del fuoco. Considerazioni, sperimenti e proposte*. Presso Natale Battezzati Editore, Milan, 1876.
- Grimm, Jacob, *Über das verbrennen der leichen. Eine in der academie der wissenschaften am 29. november 1849 von Jacob Grimm gehaltne [sic] vorlesung*. Berlin. Gedruckt in der druckerei der akademie der wissenschaften 1850. Ferd. Dümmler's buchhandlung. Große Brockhaus, *Der*, 1930, entries “Krematorium” (pp. 581f.) & “Feuerbestattung” (pp. 187f.).
- Guilbert, Edward A., “Cremation or earth burial, which?” in: *Public Health Papers and Reports*, Vol. 21, 1895, pp. 201-216.
- Heldwein, Johannes, *Die Geschichte der Feuerbestattung und deutsche Krematorien*. Franzmathes Verlag, Frankfurt am Main 1931.
- Houzeau, M., “Note sur la crémation des corps,” in: *Précis analytique des travaux de l'Académie des Sciences, Belles-Lettres et Arts de Rouen pendant l'année 1880-1881*. Rouen, Imprimerie d'Espérance Cagniard, 1882, pp. 135-141.
- Huber, Walter, *Die Feuerbestattung ein Postulat kultureller Entwicklung und das St. Galler Krematorium*. Selbstverlag des Verfassers, St. Gallen 1903.
- Küchenmeister, Friedrich, *Ueber Leichenverbrennung*. Vortrag gehalten am 8. April 1874 zum Besten des Neustädter Gymnasial-Stipendienfonds. Verlag von Ferdinand Enke, Erlangen 1874.
- Küchenmeister, Friedrich, *Die Feuerbestattung. Unter allen zur Zeit ausführbaren Bestattungsarten die beste Sanitätspolizei des Bodens und der sicherste Cordon gegen Epidemien*. Verlag von Ferdinand Enke, Stuttgart 1875.
- Lacassagne, A., P. Dubuisson, “Crémation,” in: *Dictionnaire encyclopédique des sciences médicales*, vol. 23, CRE-CRU, Paris, 1874, pp. 5-91.
- “La crémation,” in: *La Science Illustrée*, vol. V, 1890, premier semestre, No. 118, pp. 209f.
- “La crémation à Paris. Son état actuel,” in: *L'année scientifique et industrielle*, Vol. 34 (1890), Paris, 1891, pp. 419.
- “La crémation des morts à Paris,” in: *La Science Illustrée*, vol. I, 1888, premier semestre, p. 111.
- “La crémation des morts et l'édifice crématoire du Père-Lachaise,” in: *La Science Illustrée*, vol. I, 1888, premier semestre, pp. 12-14.
- 422.
- “La prima cremazione in Milano,” in: *Annali universali di medicina e chirurgia*. Series 1, vol. 235, fascicolo 703, January 1876, pp. 90-93.
- “La seconda cremazione a Milano,” in: *Annali universali di medicina e chirurgia*. Series 1, vol. 235, fascicolo 706, April 1876, pp. 290-292.
- Maccone, Luigi, *Storia documentata della cremazione presso i popoli antichi ed i moderni con speciale riferimento alla igiene*. Istituto Italiano d'Arti Grafiche, Bergamo 1932.
- Meyers Grosses Konversations-Lexicon*, 6th ed., 1905, entry “Leichenverbrennung,” pp. 362-364.
- Meyers Lexikon*, 7th ed., 1926, entry “Feuerbestattung,” pp. 644-646.
- Müller, Rudolph, “Ueber Leichenverbrennung.” Reprint from: *Medizinische Jahrbücher*, Vienna, Vol. 199, No. 1, 1883, pp. 73-82; Italian translation: “Sulla cremazione die cadave-

- ri," in: *Annali universali di medicina e chirurgia*, Vol. 268, 1st Semester 1884, Milan, Fratelli Rechiedei Editori, 1884, pp. 177-228.
- Nagel, Robert, *Wege und Ziele der modernen Feuerbestattung*. Verlag Wilhelm Ruppmann, Stuttgart 1922.
- Nagel, Robert, *Die Vorzüge der Feuerbestattung*. Selbstverlag des Verfassers, Vienna 1931.
- Ortloff, Hermann, *Gleichberechtigung der Feuer- und Erdbestattung. Anhang: Das Verbrennungssystem Rich. Schneider, vorm. Dresden, jetzt Berlin*. Felix Dietrich, Leipzig 1907.
- Pauly, Max, *Die Feuerbestattung*. Verlagsbuchhandlung von J.J. Weber, Leipzig 1904.
- Phoenix. Blätter für wahlfreie Feuerbestattung und verwandte Gebiete*, Vienna 1913, No. 1, p. 32.
- Pini, Gaetano, "Sulla cremazione dei cadaveri," in: *Annali di chimica applicata alla medicina cioè alla farmacia, alla tossicologia, all'igiene, alla fisiologia, alla patologia e alla terapeutica*. Series 1, vol. 226, No. 678, December 1873, pp. 529-550.
- Pini, Gaetano, *La crémation en Italie et à l'étranger de 1774 jusqu'à nos jours*. Ulrich Hoepli Editeur Libraire, Milan 1885.
- Polli, Giovanni, "La cremazione del cadavere del cav. Alberto Keller," in: *Annali di chimica applicata alla medicina cioè alla farmacia, alla tossicologia, all'igiene, alla fisiologia, alla patologia e alla terapeutica*. Serie 3, vol. 62, January 1876a, pp. 5-14.
- Polli, Giovanni, "Cremazione Pozzi," in: *Annali di chimica applicata alla medicina cioè alla farmacia, alla tossicologia, all'igiene, alla fisiologia, alla patologia e alla terapeutica*. Serie 3, vol. 62, No. 4, April 1876b, pp. 248-250.
- Polli, Giovanni, "Terza cremazione di un cadavere umano in Milano," in: *Annali di chimica applicata alla medicina cioè alla farmacia, alla tossicologia, all'igiene, alla fisiologia, alla patologia e alla terapeutica*. Serie 3, vol. 64, No. 3, March 1877, pp. 191f.
- Probst, C.O., "Report of the Committee on the Disposal of the Dead," in: *Public Health Papers and Reports*, Vol. 21, 1895, pp. 177-191.
- Préfecture du Département de la Seine. Direction des Affaires Municipales. *Note sur la crémation à Paris au 1^{er} novembre 1893*.
- Reber, B., "Un crématoire du temps de la révolution française," in: *Société de crémation de Genève*, Bulletin VIII, Geneva, Imprimerie Centrale, 1908, pp. 26-29.
- Reimann, W., *Aufklärungen über die Feuerbestattung*. Selbstverlag des Herausgebers, Berlin 1925.
- Rochard, Jules, "La crémation," in: *Revue des Deux Mondes*, Year LX, Vol. XCVIII, 1890, pp. 916-944
- Rolants, M.E., "État actuel de la crémation des cadavres," in: *Revue d'hygiène et de police sanitaire*, No. 32, 1910, pp. 1109-1126.
- Salomon, Georges, "État actuel de la crémation en France," in: *Revue d'hygiène et de police sanitaire*, No. 15, 1893, pp. 520-535.
- Schnitzer, Joseph, *Die Religions-psychologische Grundlage der Feuerbestattung*. Selbstverlag der Genossenschaft Luzerner Feuerbestattung, Munich 1933.
- Schuchhardt, Carl, "Die Anfänge der Leichenverbrennung," in: *Sitzungsberichte der Preussischen Akademie der Wissenschaften*. Philosophisch-Historische Klasse, 1920, pp. 499-521.
- Schumacher, Fritz, *Die Feuerbestattung*. J.M. Gebhardt's Verlag, Leipzig 1939.
- Sircar, Robin, *Untersuchung der Emissionen aus Einäscherungsanlagen und der Einsatzmöglichkeiten von Barrierenentladungen*. Doctoral thesis presented at Martin-Luther Universität Halle-Wittenberg on 28 June 2002.
- Stadtvorstand Gotha (ed.), *Gedenkschrift zum 50-jähr. Bestehen des Krematoriums in Gotha*, Gotha 1928.
- Tatzl, Johann, *Krematorium und Friedhofsgestaltung für den Stadtfriedhof Bruck an der Mur*. Diplomarbeit WS 1984-85. Technische Universität Graz.
- Thompson, Henry, *Cremation. The Treatment of the Body after Death*. Smith, Elder, & Co., London, 1884.

- Thompson, Henry, "Observations on cremation and death registration," in: *The British Medical Journal*, 25 March 1889a.
- Thompson, Henry, *Die moderne Leichenverbrennung*. Fischer's Medicinische Buchhandlung H. Kornfelds, Berlin 1889b.
- Trusen, J.P., *Die Leichenverbrennung als die geeignetste Art der Todtenbestattung oder Darstellung der verschiedenen Arten und Gebräuche der Todtenbestattung*. Verlag von Wilhelm Gotti, Korn, Breslau 1855.
- Vallin, E., "Une séance de crémation à Milan," in: *Revue d'hygiène et de police sanitaire*, No. 2, 1880, pp. 854-865.
- Verband der Feuerbestattungs-Vereine Deutscher Sprache, *II. Jahrbuch*, Vereinsbuchdruckerei, Pymont 1912.
- Verband der Feuerbestattungs-Vereine Deutscher Sprache, *III. Jahrbuch*, Druck von Carl Wull, Heilbronn a. N. 1913.
- Verband der Feuerbestattungs-Vereine Deutscher Sprache, *IV. Jahrbuch*, Königsberg i. Pr. 1928a.
- Verband der Feuerbestattungs-Vereine Deutscher Sprache, *V. Jahrbuch*, Königsberg i. Pr. 1930.
- Verein für Feuerbestattung Berlin (ed.), *Eine moderne Feuerbestattung erläutert an einem dem Verein für Feuerbestattung in Berlin gehörigen Modell eines Krematoriums*. Berlin 1897.
- von Engerth, Karl, *Fortschritte der Feuerbestattung in Deutschland. Vortrag, gehalten in der Hauptversammlung des Vereines der Feuerbestattung "Die Flamme" in Wien am 19. Februar 1892*. Verlag von Moritz Perles, Vienna 1892.
- von Engerth, Karl, *Die Feuerbestattung*. Im Selbstverlage des Verfassers, Vienna 1897.
- Wegmann-Ercolani, *Ueber Leichenverbrennung als rationellste Bestattungsart*. Cäsar Schmidt, Zürich 1874.
- Weigt, K., *Almanach der Feuerbestattung*. Selbstverlag des Verfassers, Hanover 1909.
- Widmann, Max, *Die Feuerbestattung. Ein Wort der Aufklärung*. Im Auftrag der schweizer. Feuerbestattungsvereine verfasst. Burgdorf 1938.

5.2.1.3. Legislation on Cremations

- "Amtliches. Bau und Betrieb von Krematorien," in: *Die Wärmewirtschaft*, Vol. 2, No. 7, 1925, pp. 107f.
- "Amtliches. Betr. Ofenanlage in Krematorien," in: *Die Wärmewirtschaft*, Vol. 4 No. 3, 1927, p. 51.
- Gesetz über die Feuerbestattung. Vom 15. Mai 1934*. Reichsgesetzblatt, Vol. 1934, Teil I, pp. 380-381.
- Lohmann, W., *Gesetz, betreffend die Feuerbestattung, vom 14. September 1911 nebst Ausführungsanweisung vom 29. September 1911*. J. Guttentag Verlagsbuchhaltung, Berlin 1912.
- Marcuse, O., *Die wichtigsten Bestimmungen der deutschen Landesgesetze über Feuerbestattung nebst dem Entwurf eines Reichsgesetzes*, in: *V. Jahrbuch des Verbandes der Feuerbestattungs-Vereine Deutscher Sprache*. Königsberg i. Pr. 1930.
- Richardson, Aubrey, *The Law of Cremation*. Reeves & Turner, London, 1893.
- Roland, Hans, "Zur Einführung des Reichsgesetzes über die Feuerbestattung," in: *Die Feuerbestattung*, Vol. 12, No. 3, 1942, p. 62.
- "Verordnung zur Durchführung des Feuerbestattungsgesetzes vom 10. August 1938." *Reichsgesetzblatt*, Vol. 1938, Teil I, pp. 1000f.

5.2.1.4. Statistics on Cremations in Germany and Elsewhere

- "60 Jahre Feuerbestattung in Deutschland (Eine statistische Skizze)," in: *Die Feuerbestattung*, Vol. 12, 1940, No. 1, pp. 8f.

- “60 Jahre Feuerbestattung in Europa,” in: *Phoenix. Zeitschrift des Vereines der Freunde der Feuerbestattung Die Flamme in Wien*, 50. Vol., No. 1, 1937, pp. 6-9.
- “Cremation. Progress of Cremation,” *The British Medical Journal*, 6 February 1909, pp. 349ff.
- “Die deutschen Krematorien im Jahre 1938,” in: *Die Feuerbestattung*, Vol. 12, 1940, p. 13.
- “Die Feuerhallen der Ostmark,” in: *Phoenix. Blätter für wahlfreie Feuerbestattung und verwandte Gebiete*, Vienna, 50. Vol., 1939, p. 7.
- “Einäscherungen im Grossdeutschland,” in: *Phoenix. Blätter für wahlfreie Feuerbestattung und verwandte Gebiete*, Vienna, Vol. 12, 1940, pp. 20 & 29.
- Helbig, Erwin, “Die deutschen Krematorien im Jahre 1939,” in: *Die Feuerbestattung*, Vol. 12, 1940, No. 3, pp. 28-31.
- Ichok, G., “La crémation,” in: *Revue d'hygiène et de médecine préventive*, No. 52, 1930, pp. 41-53.
- Ichok, G., “L'action sanitaire à l'étranger. La crémation à l'étranger,” in: *Revue d'hygiène et de médecine préventive*, No. 53, 1931, pp. 677-691.
- “Progress of the cremation,” *The British Medical Journal*, 5 March 1910, pp. 579ff.
- “Statistisches. Europäische Länder mit den Verhältniszahlen der Einäscherungen zu den Gestorbenen im Jahre 1938,” in: *Die Feuerbestattung*, Vol. 11, 1939.
- “Tabelle der europäischen Länder mit den Verhältniszahlen der Einäscherungen zu den Gestorbenen in den Jahren 1939 bis 1942,” in: *Die Feuerbestattung*, Vol. 16, No. 2, 1944, p. 17.
- “The Progress of the Cremation,” *The British Medical Journal*, 25 April 1914, pp. 926ff.
- Weinisch, Theodor, *Die Feuerbestattung im Lichte der Statistik*. Buchdruckerei J. Bollmann, Zinsdorf 1929.

5.2.1.5. Germany's Debate on the Process of Cremation

- Arbeitsgemeinschaft für Brennstoffersparnis, e.V., Berlin, “Bau und Betrieb von Krematorien. Gutachten,” in: *Die Wärmewirtschaft*, Vol. 1, 1924, No. 8, pp. 119f.
- Arbeitsgemeinschaft für Brennstoffersparnis, e.V., Berlin, “Bau und Betrieb von Krematorien,” *Die Wärmewirtschaft*, Vol. 2, 1925, No. 6, pp. 89-91.
- Arbeitsgemeinschaft für Brennstoffersparnis, e.V., Berlin, “Bau und Betrieb von Krematorien. Erwiderung auf den Einspruch des Verbandes der Preussischen Feuerbestattungsvereine vom 9. Oktober 1925 gegen den Erlass des Herrn Ministers des Innern II T 2015 – vom 24. Oktober 1924,” in: *Die Wärmewirtschaft*, Vol. 3, 1926a, No. 1, pp. 9-12.
- Arbeitsgemeinschaft für Brennstoffersparnis, e.V., Berlin. “Zur Frage der Krematorienbeheizung in Preussen,” in: *Die Wärmewirtschaft*, Vol. 3, 1926b, No. 6, pp. 95f.
- Arbeitsgemeinschaft für Brennstoffersparnis, e.V., Berlin. “Zur Frage der Krematorienbeheizung in Preussen,” in: *Die Wärmewirtschaft*, Vol. 3, 1926c, No. 7, pp. 105f.
- Arbeitsgemeinschaft für Brennstoffersparnis e.V., Berlin, “Mitteilungen,” in: *Die Wärmewirtschaft*, Vol. 4, No. 3, 1927, pp. 47f.
- Hellwig, Friedrich, “Vom Bau und Betrieb der Krematorien,” in: *Gesundheits-Ingenieur*, Vol. 54, 1931a, No. 24, pp. 369-374; No. 25, pp. 395-399.
- Hellwig, Friedrich, “Entgegnung zu vorstehenden Ausführungen,” in: *Gesundheits-Ingenieur*, Vol. 54, No. 41, 1931b.
- Volckmann, H., K. Ludwig, “Erwiderung auf den diesbezüglichen Aufsatz von Mag. Oberbaurat F. Hellwig in No. 25 vom 20. Juli 1931,” in: *Gesundheits-Ingenieur*, Vol. 54, No. 41, 1931, p. 616.

5.2.1.6. Cremation Technology

5.2.1.6.1. General Theoretical and Construction Principles of Cremation

- DeHaan, J.D., S.J. Campbell, S. Nurbakhsh, "Combustion of fat and its implications for the consumption of human bodies in fires," in: *Science & Justice*, Vol. 39, No. 1, 1999, pp. 27-38.
- Fleck, H., "Beitrag zur Beantwortung der Frage von Leichenverbrennung," in: *Zeitschrift für Epidemiologie*, Vol. I, 1874, pp. 161-169.
- Freygang, Paul, "Leichenverbrennung," in: Otto Lueger, *Lexikon der gesamten Technik und ihrer Hilfswissenschaften*. Deutsche Verlags-Anstalt, Stuttgart and Leipzig, vol. 6, 1908, pp. 120-127.
- Freygang, Paul, "Leichenverbrennung," in: Otto Lueger, *Lexikon der gesamten Technik und ihrer Hilfswissenschaften*. Ergänzungsband zur zweiten Auflage. Deutsche Verlags-Anstalt, Stuttgart and Leipzig, vol. 9, 1914, pp. 475-480.
- Georgius, "Neuere Leichenverbrennungstechnik," in: *Gesundheits-Ingenieur*, Vol. 46, No. 5, 1923, pp. 555-559.
- Grossdeutscher Verband der Feuerbestattungsvereine e.V., *Richtlinien für den Bau und Betrieb von Öfen zur Einäscherung menschlicher Leichen*, Verlag des Grossdeutschen Verbandes der Feuerbestattungsvereine e.V, Berlin 1937.
- Grüder, Fritz, "Die neue Flammbestattung auf dem Friedhof in Berlin-Wilmersdorf," in: *Zentralblatt der Bauverwaltung*, Vol. 42, No. 75, 16 September 1922, pp. 449-451.
- Heepke, Wilhelm, *Die Leichenverbrennungs-Anstalten (die Krematorien)*. Verlag von Carl Marhold. Halle a. S. 1905b.
- Hellwig, Friedrich, "Vom Bau und Betrieb der Krematorien," in: *Gesundheits-Ingenieur*, Vol. 54, 1931a, No. 24, pp. 369-374; No. 25, pp. 395-399.
- Hellwig, Friedrich, "Vom Bau und Betrieb der Krematorien," in: *Zentralblatt für Feuerbestattung*, Vol. 4, No. 1, 1932a, pp. 8-14.
- Hellwig, Friedrich, "Vom Sarg zur Urne," in: *Zentralblatt für Feuerbestattung*, Vol. 4, 1932b, pp. 37-43.
- Kämper, Hermann, "Der Umbau der Leichenverbrennungsöfen und die Einrichtung von Leichenkühlräumen auf dem Hauptfriedhof der Stadt Dortmund," in: *Gesundheits-Ingenieur*, Vol. 64, No. 12, 1941, pp. 171-176.
- Keller, Hans, *Mitteilungen über den Betrieb des Krematoriums Biel von 1927 bis 1945*. BFG Bieler Feuerbestattungs-Genossenschaft in Biel, Jahresbericht pro 1945a.
- Kessler, Richard, "Entwicklung und Zukunftswege der Einäscherungstechnik," in: *Zentralblatt für Feuerbestattung*, Vol. 3, No. 6, 1931b, pp. 83-89.
- Kessler, Richard, *Richtlinien für den Bau von Öfen zur Einäscherung menschlicher Leichen. Neue Fortschritte im Einäscherungssofenbau*. Veröffentlichungen des Grossdeutschen Verbandes der Feuerbestattungsvereine No. 5, Königsberg 1932.
- Kessler, Richard, "Die wärmewirtschaftliche Ausnutzung der Abgase bei Einäscherungsöfen," in: *Zentralblatt für Feuerbestattung*, Vol. 5, No. 2, 1933a, pp. 21-26.
- Kessler, Richard, "Richtlinien für den Bau von Öfen zur Einäscherung menschlicher Leichen aufgestellt vom Grossdeutschen Verbande der Feuerbestattungsvereine," in: *Zentralblatt für Feuerbestattung*, Vol. 5, No. 6, 1933b, pp. 87-93.
- Kori, Hans, "Bau und Betrieb von Krematorien. Neue Wege und Ziele," in: *Die Wärmewirtschaft*, Vol. 1, No. 8, 1924, pp. 115-119.
- Kori, Hans, GmbH. Berlin, *Einäscherungssofen System "Kori"* (Publicity leaflet from the late 1920s).
- Krapner, Hans, "Neuere Erkenntnisse und Erfahrungen beim Betrieb von Einäscherungsöfen." reprint from: *Städtehygiene* 8/1970, Uelzen.
- Krapner, Hans, Franz Puls, "Die chemische Vorgänge bei einer Einäscherung," reprint from: *Städtehygiene* 8/1970, Uelzen.
- Kristen, "Ausbrennversuche an Schornsteinen," in: *Wärmewirtschaftliche Nachrichten für Hausbau, Haushalt und Kleingewerbe*, Vol. 6, 7 No., 1933, pp. 83-85.

- Lebrasseur, M., "Tirage naturel et tirage mécanique des appareils thermiques," in: *Gesundheits-Ingenieur*, Vol. 45, No. 5, 1922 (review), pp. 56f.
- Löffler, Rudolf, "Die wichtigen Verbrennungs-Oxydationsvorgänge," in: *Die Volks-Feuerbestattung*, Vol. 1, No. 7/8, 1926, pp. 3f.
- Peters, A., "Winke für den Betrieb von Einäscherungsanlagen," in: *Zentralblatt für Feuerbestattung*, Vol. 2, No. 4, 1930, pp. 56-58.
- Quehl, Viktor, "Feuerbestattung und Einäscherungsöfen," in: *Gesundheits-Ingenieur*, Vol. 59, No. 38, 1936, pp. 559-561.
- Ruppmann, Wilhelm, *Der Feuerbestattungssofen System Ruppmann*, company brochure, 1910.
- Schetter, Gebhard, Henning Burk, *Das Krematorium Dresden. Ein Beispiel für umweltgerechte Einäscherung unter betriebswirtschaftlichen Gesichtspunkten*. Friedhofskultur, year 96, October 2006 (PDF).
- Schläpfer, Paul, *Über den Bau und Betrieb von Kremationsöfen*. Separatdruck aus dem Jahresbericht des Verbandes Schweizer Feuerbestattungsvereine, Zürich 1937.
- Schläpfer, Paul, "Betrachtungen über den Betrieb von Einäscherungsöfen," in: *Schweiz. Verein von Gas- und Wasserfachmännern Monatsbulletin*, XVIII. Vol., No. 7, 1938, pp. 147-160.
- Schulze-Manitius, Hans, "Moderne Feuerungsroste," in: *Feuerungstechnik*, Vol. XXIII, No. 8, 1935, pp. 86-90.
- Storl, Richard, "Ein neuer, den Richtlinien Kesslers entsprechender Einäscherungssofen," in: *Zentralblatt für Feuerbestattung*, Vol. 6, No. 5, 1934, pp. 72-75.
- Storl, Richard, "Die technische Einrichtungen neuzeitlicher Krematorien," in: *Die Feuerbestattung*, Vol. 11, No. 1, 1939.
- "Technical aspects of cremation," *The British Medical Journal*, 23 February 1946, p. 286.
- ter Linden, A.J., "Feuerräume und Feuerraumwände," in: *Feuerungstechnik*, XXIII, Vol., No. 2, 1935, pp. 14-20.

5.2.1.6.2. *Thermal Balance of Coke-Fired Cremation Furnaces*

- Fichtl, "Wärmewirtschaft in Krematorien," in: *Die Wärme – Zeitschrift für Dampfkessel und Maschinenbetrieb*, Vol. 17, No. 34, 1924, pp. 394-397.
- Heepke, Wilhelm, "Die neuzeitlichen Leicheneinäscherungsöfen mit Koksfeuerung, deren Wärmebilanz und Brennstoffverbrauch," in: *Feuerungstechnik*, XXI. Vol., No. 8. pp. 109-111; No. 9, pp. 123-128, 1933.
- Peters, A., H. Tilly, "Die Wirtschaftlichkeit von Anlagen zur Einäscherung menschlicher Leichen," in: *Die Wärmewirtschaft*, Vol. 3, No. 11, 1926, pp. 176-178.
- Tilly, H., "Versuch einer rechnermässigen Erfassung der Vorgänge bei der Einäscherung menschlicher Leichen," in: *Die Wärmewirtschaft*, Vol. 3, No. 8, 1926a, pp. 134-136.
- Tilly, H., "Luftüberschuss und Brennstoffverbrauch bei der Einäscherung menschlicher Leichen," in: *Die Wärmewirtschaft*, Vol. 3, No. 12, 1926b, pp. 190f.
- Tilly, H., "Ueber die Wirtschaftlichkeit von Anlagen zur Einäscherung menschlicher Leichen," in: *Die Wärmewirtschaft*, Vol. 3, No. 9, 1926c, pp. 143-145.
- Tilly, H., "Über die Einäscherung menschlicher Leichen," in: *Die Wärmewirtschaft*, Vol. 4, No. 2, 1927, pp. 19-25.

5.2.1.6.3. *Scientific Cremation Experiments*

- Bohnert, Michael, Thomas Rost, Stefan Pollak, "The Degree of Destruction of Human Bodies in Relation to the Duration of the Fire," in: *Forensic Science International*, Vol. 95, 1998, pp. 11-21.
- du Mesnil, O., "Le monument crématoire du cimetière de l'est. La crémation à Paris," in: *Annales d'hygiène publique et de médecine légale*, 1888, série 3, No. 19, pp. 77-81.

- Jones, E.W., "Factors Which Affect the Process of Cremation. Third Session." Extract from the Cremation Society of Great Britain's *Annual Cremation Conference Report, 1975*, pp. 77-87.
- Keller, Hans, *Mitteilungen über Versuche am Ofen des Krematoriums in Biel*. Bieler Feuerbestattungs-Genossenschaft in Biel. Jahresbericht pro 1927/28, Biel 1928.
- Keller, Hans, "Versuche an einem Feuerbestattungs-ofen." Sonderabdruck aus der Zeitschrift *Archiv für Wärmewirtschaft und Dampfkesselwesen*, Vol. 10, 1929, No. 6, pp. 1-3.
- Keller, Hans, *Ursache der Rauchbildung bei der Kremation*. Bieler Feuerbestattungs-Genossenschaft in Biel. Jahresbericht pro 1944. Biel 1945b.
- Kessler, Richard, "Rationelle Wärmewirtschaft in den Krematorien nach Massgabe der Versuche im Dessauer Krematorium," in: *Die Wärmewirtschaft*, Vol. 4, 1927, No. 8, pp. 134-140; No. 9, pp. 148-159; No. 10, pp. 165-169; No. 11, pp. 177-181.
- Kessler, Richard, "Rationelle Wärme-Wirtschaft in Krematorien unter besonderer Berücksichtigung der Leuchtgasfeuerung," in: *Verband...* 1930, pp. 133-143.

5.2.1.6.4. Gas-Fired Cremation Furnaces

- Feischner, "Die Einäscherungsöfen mit Gasfeuerung im Krematorium Berlin-Treptow," in: *Technische Monatsblätter für Gasverwendung*, Vol. 6, No. 2, 1930/31, p. 22.
- Henzi, R., "Die Zürcher Einäscherungsöfen mit Gasfeuerung," in: *Schweiz. Verein von Gas- und Wasserfachmännern*, XIV. Vol., No. 3, 1934, pp. 63-66.
- Klatte, Günther, "Krematoriumsöfen mit Gasfeuerung," in: *Industriegas*, No. 3, 1931, pp. 63-66.
- Manskopf, H., "Gas als Brennstoff für Einäscherungsöfen," in: *Das Gas- und Wasserfach*, Vol. 76, No. 42, 1933, pp. 772-775.
- Repky, "Der Umbau koksgefeuerter Kremationsöfen auf Leuchtgasbeheizung," in: *Gesundheits-Ingenieur*, Vol. 55, No. 42, 1932, pp. 506-509.
- Sausse, "Gasgefeuerte Einäscherungsöfen," in: *Technische Monatsblätter für Gasverwendung*, Vol. 6, No. 2, 1930/31, pp. 21-23.

5.2.1.6.5. The Volckmann-Ludwig Furnace

- Deutsches Reich. Reichspatentamt. Patentschrift No. 506627. Klasse 24d. Gruppe 1. Ausgegeben am 6. September 1930c. Tag der Bekanntmachung über Erteilung des Patents: 28. August 1930. Dipl.-Ing. Hans Volckmann und Dipl.-Ing. Karl Ludwig in Hamburg. *Verfahren und Vorrichtung zur Einäscherung*.
- Kessler, Richard, "Der neue Einäscherungs-ofen System Volckmann-Ludwig," in: *Zentralblatt für Feuerbestattung*, Vol. 3, No. 3, 1931a, pp. 34-40.
- Prüfer, Kurt, "'Ein neues Einäscherungsverfahren.' Eine Entgegnung," in: *Die Flamme*, Berlin, Vol. 48, 1931a, pp. 5f.
- Prüfer, Kurt, "Ein neues Einäscherungsverfahren," in: *Die Urne*, Vol. 4, No. 3, March 1931b, pp. 27-29.
- Schirm, E., "Feuerbestattungsöfen ohne Zusatzfeuerung," in: *V.D.I. Zeitschrift*, Vol. 76, No. 4, 1932.
- Stort, "Der menschliche Körper als Heizstoff," in: *Die Umschau in Wissenschaft und Technik*, No. 26, 1931, pp. 513f.
- Volckmann, Hans, "Ein neues Einäscherungsverfahren," in: *Zentralblatt für Feuerbestattung*, Vol. 2, No. 5, 1930, pp. 65-68.
- Volckmann, Hans, "Der neue Einäscherungs-ofen System Volckmann-Ludwig," in: *Zentralblatt für Feuerbestattung*, Vol. 3, No. 4, 1931, pp. 56-59.
- Volckmann, Hans, "Das Volckmann-Ludwig-Verfahren und die Kesslerschen Richtlinien," in: *Zentralblatt für Feuerbestattung*, Vol. 6, No. 8, 1934, pp. 122-127.
- Volckmann, H., K. Ludwig, "Erwiderung auf den diesbezüglichen Aufsatz von Mag. Oberbaurat F. Hellwig in No. 25 vom 20. Juli 1931," in: *Gesundheits-Ingenieur*, Vol. 54, No. 41, 1931, p. 616.

Wolfer, H., "Der neue 'Volckmann-Ludwig'-Einäscherungssofen im Stuttgarter Krematorium," in: *Gesundheits-Ingenieur*, Vol. 55, 1932a, No. 13, pp. 151-154, 1932b, No. 14, pp. 162-165.

5.2.1.6.6. *Electric Cremation Furnaces*

Jeanson, "Die elektrische Einäscherung in Theorie und Praxis," in: *Zentralblatt für Feuerbestattung*, Vol. 7, No. 8, 1935, pp. 118-122.

Keller, G., *Die Elektrizität im Dienste der Feuerbestattung*. Aktiengesellschaft Brown, Boveri & Cie, Baden (Schweiz). Sonderabdruck aus den Brown Boveri Mitteilungen A.G., No. 6/7 1942.

Keller, Hans, *Der elektrische Einäscherungssofen im Krematorium Biel*. Bieler Feuerbestattungs-Genossenschaft in Biel. Jahresbericht pro 1933. Biel 1934.

Keller, Hans, "Die Einäscherungssofen mit elektrischer Aufheizung im Krematorium in Biel," in: *Zentralblatt für Feuerbestattung*, Vol. 7, No. 5, 1935a, pp. 65-70.

Keller, Hans, *Der elektrifizierte Ofen im Krematorium Biel*. Graphische Anstalt Schühler A.G., Biel 1935c.

Phoenix. Blätter für wahlfreie Feuerbestattung und verwandte Gebiete, Vienna 1938, No. 2, p. 18.

Siedek, Egon, "Die Einäscherung von Leichen auf elektrischem Wege," in: *Phoenix. Blätter für fakultative Feuerbestattung und verwandte Gebiete*, Vienna, XXII. Vol., No. 10, 1909, p. 429.

Vorstand des Vereines für Feuerbestattung zu Frankfurt a. M., "Elektro-Krematorien," in: *Phoenix. Blätter für fakultative Feuerbestattung und verwandte Gebiete*, Vienna, XXIII. Vol., No. 10, 1910, pp. 399-401.

5.2.1.6.7. *Energy Consumption of Gas-Fired and Electric Furnaces*

Keller, Hans, "Wärmeverbrauch des mit Gas und mit Elektrizität geheizten Krematoriumsofens," in: *Zentralblatt für Feuerbestattung*, Vol. 7, No. 12, 1935b, p. 176.

Jordan, H., H. Deringer, "Wärmeverbrauch des mit Gas und mit Elektrizität geheizten Krematoriumsofens," in: *Die Feuerbestattung*, VII. Vol., No. 1, 1936, p. 16.

5.2.1.6.8. *Cremation Technology in Japan*

Dönitz, W., "Technik der Leichenverbrennung in Japan," in: *Deutsche Medicinische Wochenschrift*, Vol. II, No., 1876, pp. 377-379.

"La crémation au Japon," in: *Nice-médical*, Vol. 7, No. 6, March 1883, p. 94.

"La crémation au Japon," in: *Annales d'hygiène publique et de médecine légale*, 1900, série 3, No. 43, pp. 380f.

Olshausen, O., "Die Leichenverbrennung in Japan," in: *Zeitschrift für Ethnologie*, 40. Vol., 1908, pp. 100-106.

Pallester, Paul, *Mitteilungen über die Feuerbestattung in Japan*. Verlag des Vereines der Freunde der Feuerbestattung "Die Flamme" in Wien. Vienna 1912.

5.2.1.7. Patents

Bundesrepublik Deutschland. Deutsches Patentamt. Patentschrift No. 861731. Klasse 24d.

Gruppe 1. Ausgegeben am 5. Januar 1953. Martin Klettner, Recklinghausen, ist als Erfinder genannt worden. J.A. Topf & Söhne, Wiesbaden. *Verfahren und Vorrichtung zur Verbrennung von Leichen, Kadavern und Teilen davon*. Patentiert im Gebiet der Bundesrepublik Deutschland vom 24. Juni 1950 ab.

Deutsches Reich. Reichspatentamt. Patentschrift No. 324252. Klasse 24d. Gruppe 1. Ausgegeben am 24. August 1920. J.A. Topf & Söhne in Erfurt. *Sargeinführvorrichtung für*

- Verbrennungsöfen mit heb- und senkbarem Fahrgestell für Sargträger.* Patentiert im Deutschen Reiche vom 24. April 1915 ab.
- Deutsches Reich. Reichspatentamt. Patentschrift No. 331628. Klasse 24d. Gruppe 1. Ausgegeben am 11. Januar 1921. Adolf Marsch in Gera, Reuss. *Schachtofen zur gleichzeitigen Einäscherung einer grösser Anzahl von Menschenleichen oder Tierkadavern.* Patentiert im Deutschen Reiche vom 30. September 1915 ab.
- Deutsches Reich. Reichspatentamt. Patentschrift No. 493042. Klasse 24d. Gruppe 1. Ausgegeben am 5. März 1930a. J.A. Topf & Söhne in Erfurt. *Vorrichtung zum Nachverbrennen der Rückstände in Leichenverbrennungsöfen.* Patentiert im Deutschen Reiche vom 24. März 1929 ab.
- Deutsches Reich. Reichspatentamt. Patentschrift No. 494136. Klasse 24f. Gruppe 10. Ausgegeben am 19. März 1930b. J.A. Topf & Söhne in Erfurt. *Ausfahrbarer Schlackenrost für mit Unterwind betriebene Feuerungen.* Patentiert im Deutschen Reiche vom 22. August 1928 ab.
- Deutsches Reich. Reichspatentamt. Patentschrift No. 561643. Klasse 24d. Gruppe 1. Ausgegeben am 17. Oktober 1932 (Viktor Quehl in Gera). Umgeschrieben auf: J.A. Topf & Söhne, Erfurt. 17.5.1934. *Feuerbestattungsöfen mit drehbaren Rosten.* Patentiert im Deutschen Reiche vom 15. April 1931 ab.
- Deutsches Reich. Reichspatentamt. Patentschrift No. 576135. Klasse 24f. Gruppe 12 02 1560. Ausgegeben am 20. Mai 1933a. J.A. Topf & Söhne in Erfurt. *Düsenplattenrost.* Patentiert im Deutschen Reiche vom 27. August 1931 ab.
- Deutsches Reich. Reichspatentamt. Patentschrift No. 638582. Klasse 24d. Gruppe 1. Ausgegeben am 19. November 1936. (Wilhelm Basse in Hamburg). Umgeschrieben auf: J.A. Topf & Söhne, Erfurt. 27.11.1937. *Einäscherungsöfen.* Patentiert im Deutschen Reiche vom 20. November 1936 ab.
- Deutsches Reich. Reichspatentamt. Patentschrift No. 659405. Klasse 24d. Gruppe 1. Ausgegeben am 4. Mai 1938a. Hans Geerhardt in Erfurt ist als Erfinder benannt worden. J.A. Topf & Söhne in Erfurt. *Beschickungseinrichtung für Einäscherungsöfen.* Patentiert im Deutschen Reiche vom 20. November 1936 ab.
- Deutsches Reich. Reichspatentamt. Patentschrift No. 669645. Klasse 24d. Gruppe 1. Ausgegeben am 31. Dezember 1938b. Firma Wilhelm Ruppmann in Stuttgart. Tag der Bekanntmachung über die Erteilung des Patents: 8. Dezember 1938. *Leichenverbrennungsöfen.* Patentiert im Deutschen Reiche vom 23. Juni 1936 ab.
- Kaiserliches Patentamt. Patentschrift No. 218581. Klasse 24d. Ausgegeben den 8. Februar 1910. Max J. Kergel in Beuthen, O.-S. *Leichenverbrennungsöfen mit Rekuperator.* Patentiert im Deutschen Reiche vom 4. Oktober 1908 ab.
- Kaiserliches Patentamt. Patentschrift No. 244887. Klasse 24d. Ausgegeben den 20. März 1912. Lawson Henry Giddings in Pasadena, Calif. *Elektrischer Leichenverbrennungsöfen.* Patentiert im Deutschen Reiche vom 11. April 1911 ab.
- Kaiserliches Patentamt. Patentschrift No. 257576. Klasse 24d. Ausgegeben den 13. März 1913a. Gebr. Körting Aktiengesellschaft in Linden b. Hannover. *Leichenverbrennungsöfen mit Ölfeuerung.* Patentiert im Deutschen Reiche vom 30. Juni 1911 ab.
- Kaiserliches Patentamt. Patentschrift No. 258066. Klasse 24d. Ausgegeben den 28. März 1913b. Friedrich Siemens in Berlin. *Leicheneinäscherungsöfen mit Regeneratoren und einem Gaserzeuger.* Patentiert im Deutschen Reiche vom 18. August 1911 ab.
- Kaiserliches Patentamt. Patentschrift No. 263725. Klasse 24d. Ausgegeben den 6. September 1913c. Bunzlauer Werke Lengerdorff & Comp. in Bunzlau i. Schles. *Verfahren und Vorrichtung zur Einäscherung von Leichen mit Verbrennungsgasen und Lufterhitzer mit einer Wärmequelle.* Patentiert im Deutschen Reiche vom 6. Juli 1911 ab.
- Kaiserliches Patentamt. Patentschrift No. 279830. Klasse 24d. Ausgegeben den 29. Oktober 1914. Wilhelm Buess in Hannover. *Leichenverbrennungsöfen mit Öl- oder Gasfeuerung mit einem unter dem schräg abfallenden Verbrennungsraum liegenden Aschenaufnahmebehälter.* Patentiert im Deutschen Reiche vom 22. August 1913 ab.

- Kaiserliches Patentamt. Patentschrift No. 284163. Klasse 24d. Ausgegeben den 12. März 1915. Wilhelm Sauerland in Dresden. *Einäscherungsofen mit an der einen Stirnseite mit dem Verbrennungsraum verbundenem Gaserzeuger und einem Regenerator*. Patentiert im Deutschen Reiche vom 19. Dezember 1912 ab.
- Topf, J.A., & Söhne, Erfurt. Patentanmeldung. 26.10.1942a. "Kontinuierlich arbeitender Leichen-Verbrennungsofen für Massenbetrieb."
- Topf, J.A., & Söhne, Erfurt. Patentanmeldung. 16.11.1942b. "Luftgekühlte Rostplatten für mechanische Vorschubroste."

5.2.1.8. Mass Cremations (Epidemics and Battlefields)

- "Aus der nichtdeutschen Bewegung. Pardubitz," in: *Blätter für wahlfreie Feuerbestattung und verwandte Gebiete*, Vienna, Vol. XXVIII, No. 4, 1915, Column 126.
- "Aus der nichtdeutschen Bewegung. Zsolna," in: *Blätter für wahlfreie Feuerbestattung und verwandte Gebiete*, Vienna, Vol. XXVIII, No. 2, Column 40.
- Barrier, M., Georges Salomon, "La crémation des cadavres sur les champs de bataille," in: *Revue d'hygiène et de police sanitaire*, No. 37, 1915, pp. 545-588.
- Bugless, John D., "Cremation as a Safeguard against Epidemics," in: *Public Health Papers and Reports*, Vol. 10, 1884, pp. 140-144.
- Bundesrepublik Deutschland. Deutsches Patentamt. Patentschrift No. 861731. Klasse 24d. Gruppe 1. Ausgegeben am 5. Januar 1953. Martin Klettner, Recklinghausen, ist als Erfinder genannt worden. J.A. Topf & Söhne, Wiesbaden. *Verfahren und Vorrichtung zur Verbrennung von Leichen, Kadavern und Teilen davon*. Patentiert im Gebiet der Bundesrepublik Deutschland vom 24. Juni 1950 ab.
- Coletti, Francesco, "L'incenerimento dei cadaveri sul campo di battaglia," con una "Nota di G. Polli," in: *Annali di chimica applicata alla medicina cioè alla farmacia, alla tossicologia, all'igiene, alla fisiologia, alla patologia e alla terapeutica*. Serie 3, vol. 51, fascicolo 3, settembre 1870, pp. 160-167.
- "Cremation in Great Britain," *The British Medical Journal*, 14. January 1905, p. 99.
- Créteur, M., "La pratique de la crémation des cadavres sur les champs de bataille de Sédan en 1871," in: *Revue d'hygiène et de police sanitaire*, No. 37, 1915, pp. 558-563.
- Deutsches Reich. Reichpatentamt. Patentschrift No. 331628. Klasse 24d. Gruppe 1. Ausgegeben am 11. Januar 1921. Adolf Marsch in Gera, Reuss. *Schachtofen zur gleichzeitigen Einäscherung einer grösser Anzahl von Menschenleichen oder Tierkadavern*. Patentiert im Deutschen Reiche vom 30. September 1915 ab.
- Dechambre, A., "La crémation des morts sur les champs de bataille," in: *Gazette hebdomadaire de médecine et de chirurgie*, série 2, vol. 7, 29 juillet 1870a, pp. 465f.
- Dechambre, A., "Encore la crémation des morts," in: *Gazette hebdomadaire de médecine et de chirurgie*, série 2, vol. 7, 1er septembre 1870b, pp. 545f.
- Duroux, Charles, *Essai sur l'assainissement des champs de bataille*. Thèse pour le doctorat en médecine. Typographie A. Viollet, Paris 1878.
- "Einführung der Feuerbestattung in Mexico," in: *Blätter für wahlfreie Feuerbestattung und verwandte Gebiete*, Vienna, XXI. Vol., No. 1, 1908, p. 10.
- "Eingabe vom 20. Februar 1902 wegen Verbrennung von Pestleichen." An den Deutschen Reichstag, Addendum II.
- "Feuerbestattung auf dem Schlachtfelde," in: *Blätter für wahlfreie Feuerbestattung und verwandte Gebiete*, Vienna, XXVII. Vol., No. 12, 1914, Column 402.
- "Feuerbestattung im Kriege," in: *Blätter für wahlfreie Feuerbestattung und verwandte Gebiete*, Vienna, XXVII. Vol., No. 12, 1914, Columns 386f..
- Fröhlich, H., "Zur Gesundheitspflege auf den Schlachtfeldern," in: *Deutsche Militärärztliche Zeitschrift*, No. 1-4, Januar-April 1872, pp. 39-116.
- Grober, "Zur Feuerbestattung im Kriege," in: *Deutsche medizinische Wochenschrift*, 24 September 1914, p. 1781.

Lanyi, "Ueber die Verbrennung der Leichen am Schlachtfelde," in: *Allgemeine Militärärztliche Zeitung*, 12 April 1874, pp. 91-95.

Marmier, Fernand, *Utilité de la crémation des cadavres à la suite des grandes batailles et épidémies*. Thèse pour le doctorat en médecine. A. Parent, Imprimeur de la Faculté de médecine, Paris 1876.

Marsch, Adolf, "Masseneinäscherung von Kriegerleichen im Felde als Schutz gegen Seuchengefahr und später fühlbar werdende Verkehrshindernisse," in: *Phoenix. Blätter für wahlfreie Feuerbestattung und verwandte Gebiete*, Vienna, XXX. Vol., No. 2, 1917, pp. 35ff.

Pein, Théodore, *Essai sur l'hygiène des camps de bataille*. Paris, Librairie JB. Baillière et Fils, 1873.

Roth, Wilhelm, "Desinfektionsarbeiten auf Schlachtfeldern," in: Lex Roth, *Handbuch der Militärgesundheitspflege*, 1872, pp. 548-558.

Schultz-Schultzenstein, "Luftverpestung im Felde und deren Verhütung," in: *Allgemeine Militärärztliche Zeitung*, No. 46, 1870, pp. 364-367.

Topf, J.A., & Söhne, Erfurt. Patentanmeldung. 26.10.1942a. "Kontinuierlich arbeitender Leichen-Verbrennungsofen für Massenbetrieb."

5.2.1.9. Waste and Carcass Incinerators

Bollettino Ufficiale della Regione Liguria, Part II, No. 15 of 8 April 1992.

Heepke, Wilhelm, *Die Kadaververnichtungsanlagen*. Verlag von Carl Marhold, Halle a. S. 1905a.

Heinemann, Ferdinand, "Ein neuer Verbrennungsofen für Friedhofsabraum," in: *Gesundheits-Ingenieur*, Vol. 63, No. 16, 1940, pp. 189f.

Kori, Hans, GmbH., Berlin, *Verbrennungsofen für Abfälle aller Art* (leaflet from the 1930s). Regione Liguria, Dipartimento ambiente e territorio, *Servizio Gestione ciclorifiuti*. Genoa, 29 December 1998.

Topf, J.A., & Söhne, Erfurt, *Topf Abfall-Vernichtungs-Ofen* (brochure of 1940).

5.2.1.10. Company Brochures

BBC Brown Boveri Elektro-Kremationsöfen.

Equipements de crémation Tabo.

Ferbeck & Vincent, *Fours de crémation Modulaires, type C 411*.

Heinicke Feuerungs- und Schornsteinbau, *H.R. Heinicke Einäscherungsofen*, undated commercial brochure.

Industrial Equipment & Engineering Co. Ener-Tek II Cremator.

Kremationsöfen, System Ruppmann Typ 070/3.

Topf, J.A., & Söhne, Erfurt, *Öfen für Krematorien System Topf* (brochure of 1926).

Topf, J.A., & Söhne, Erfurt, *Topf Abfall-Vernichtungs-Ofen* (brochure of 1940).

5.2.1.11. Manuals, Dictionaries and Encyclopedias

Bordoni, Ugo, *Tecnologia del calore. Collana Trattato generale teorico pratico dell'arte dell'ingegnere civile, industriale ed architetto*. Casa Editrice dottor Francesco Vallardi, Milan 1918.

Brockhaus der Naturwissenschaften und der Technik. F.A. Brockhaus, Wiesbaden 1958.

Cantagalli, Alberto, *Nozioni teorico-pratiche per i conduttori di caldaie e generatori di vapore*. G. Lavagnolo Editore, Turin 1940.

Colombo, Gusieppe, *Manuale dell'ingegnere civile e industriale*, Hoepli, Milan 1916 and 1926.

Enciclopedia Curcio di Scienza e Tecnica. Armando Curcio Editore, Rome 1973.

Enciclopedia della Scienza e della Tecnica. Mondadori, Milan 1963.

Enciclopedia Italiana, Rome 1949.

- Forest Products Laboratory (ed.), *Wood Handbook: Wood as an Engineering Material*, U.S. Department of Agriculture, Madison, Wis., 2010;
www.fpl.fs.fed.us/documnts/fplgtr/fplgtr190/chapter_04.pdf.
- Fornasini, Giulio, *Generatori di vapore*. Briano Editore, Genoa 1960.
- Giua, Michele, Clara Giua-Lollini, *Dizionario di chimica generale e industriale*. Unione Tipografico-Editrice Torinese, Turin 1948.
- Große Brockhaus, Der*, 1930.
- “Hütte” des Ingenieurs Taschenbuch. Verlag von Wilhelm Ernst und Sohn, Berlin, Vol. I: 1931; Vol. IV: 1938.
- Manuale dell'ingegnere Nuovo Colombo*. Hoepli, Milan 1990.
- McPhee, S., M. Papadakis, L. Tierney, *Current Medical Diagnosis and Treatment*, vol. 47, McGraw-Hill Professional, New York 2008
- Meyers Grosses Konversations-Lexicon*, 6th ed., 1905.
- Meyers Handbuch über die Technik*. Bibliographisches Institut, Mannheim 1964.
- Meyers Lexikon*, 7th ed., 1926.
- Pierini, Ferdinando, *La conduzione dei generatori di vapore*. A.N.C.C., Rome 1977.
- Recknagel-Sprenger, *Taschenbuch für Heizung, Lüftung und Klimatechnik*. R. Oldenbourg, Munich 1959.
- Salvi, Giuliano, *La combustione. Teoria e applicazioni*. Tamburini Editore, Milan 1972.

5.2.2. Topf & Söhne, Erfurt

5.2.2.1. General Company Information

- Assmann, Aleida, Frank Hiddemann, Eckhard Schwarzenberger (eds.), *Firma Topf & Söhne – Hersteller der Öfen für Auschwitz. Ein Fabrikgelände als Erinnerungsort?*, Campus Verlag, Frankfurt/New York, 2002.
- Boegl, Ludwig, *Deutschland Städtebau. Erfurt*. Bearbeitet im Auftrage des Magistrats Erfurt. “Dari” Deutscher Architektur- und Industrie-Verlag, Berlin-Halensee 1922.
- Deutsches Reichs-Adressbuch für Industrie, Gewerbe Handel*. Buch II: Adressen-Verzeichnis. Ausgabe 1940. Druck: Buch- und Tiefdruck Gesellschaft m.b.H., Berlin.
- Die Grossunternehmen im Deutschen Reich*. Band 7: Handbuch der Ges. m.b.H. mit einem Kapital ab RM 500 000 einschl. der Kom.-Ges., Off. Handels-Ges. und Einzelfirmen der gleichen Größenordnung. 1941. Verlag Hoppenstedt & Co., Berlin C 2.
- Einwohnerbuch der Stadt Erfurt 1931/32*. Bearbeitet und herausgegeben von Gebr. Richters Verlagsanstalt, Erfurt, unter Mitarbeit der Behörde und Gemeinden.
- Gutsche, Willibald (ed.), *Geschichte der Stadt Erfurt*. Hermann Böhlau Nachfolger, Weimar 1986.
- Majewska, Justyna, “Technicy “ostatecznego rowiązania”. Topf & Söhne – konstruktorzy pieców dla Auschwitz”, *Zagłada Żydów: studia i materiały*, No. 13 (2017), pp. 854-859.
- Schüle, Annegret, *Industrie und Holocaust: Topf & Söhne – Die Ofenbauer von Auschwitz*, 2n ed., Wallstein Verlag, Göttingen, 2011.
- van Baar, Annika, Wim Huisman, “The Oven Builders of the Holocaust,” *British Journal of Criminology*, Vol. 52, No. 6 (2012), pp. 1033-1050.

5.2.2.2. The Topf Cremation Furnaces

- “Elektrisch betriebener Topf-Einäscherungsofen. D.R.P. angem.,” in: *Zentralblatt für Feuerbestattung*, Vol. 7, No. 6, 1935, pp. 88-90.
- Etzbach, Hugo, *Der technische Vorgang bei einer Feuerbestattung*. Druck Johannes Friese, Cologne 1935.
- Jakobskötter, Rudolf, “Die Entwicklung der elektrischen Einäscherung bis zu dem neuen elektrisch beheizten Heisslufteinäscherungsofen in Erfurt,” in: *Gesundheits-Ingenieur*, Vol. 64, No. 43, 1941, 579-587.

- Reichenwallner, Balduin, *Tod und Bestattung*. Katakomben-Verlag/Balduin Reichenwallner, Munich 1926.
- Stenger, Heinrich, "Ergebnisse mit einem gasbeheizten Einäscherungssofen neuer Bauart," in: *Gesundheits-Ingenieur*, Vol. 62, No. 2, 1939, pp. 17f.
- Topf, J.A., & Söhne, Erfurt, *Öfen für Krematorien System Topf* (leaflet of 1926).
- Weiss, Konrad, "Der erste deutsche elektrisch beheizte Einäscherungssofen im Krematorium Erfurt," in: *Gesundheits-Ingenieur*, Vol. 57, No. 37, 15 September 1934, pp. 453-457.
- Weiss, Konrad, "Die Entwicklung des elektrisch beheizten Einäscherungssofen im Krematorium Erfurt," in: *Gesundheits-Ingenieur*, 60. Vol., No. 11, 1937, pp. 159-162.

5.2.2.3. Crematoria with Topf Furnaces

- "Das Hanauer Krematorium," in: *Zentralblatt für Feuerbestattung*, Vol. 2, No. 4, 1930, p. 62.
- "Das Krematorium zu Hirschberg in Preussisch-Schlesien," in: *Phoenix. Blätter für wahlfreie Feuerbestattung und verwandte Gebiete*, Vienna, Vol. XXVIII, No. 10, 1915, pp. 296-298.
- "Deutschlands neueste Feuerehrungshalle in Lauscha," in: *Zentralblatt für Feuerbestattung*, Vol. 7, No. 1, 1935, p. 10.
- "Die Hirschberger Feuerhalle," in: *Phoenix. Blätter für wahlfreie Feuerbestattung und verwandte Gebiete*, Vienna, XXIX. Vol., No. 4, 1916, pp. 97-104.
- "Köln erhält ein Krematorium," in: *Zentralblatt für Feuerbestattung*, Vol. 7, No. 2, 1935, p. 27.
- "Krematorium Forst (Lausitz)," in: *Zentralblatt für Feuerbestattung*, Vol. 2, No. 4, 1930, p. 60.

5.2.2.4. Topf Patents and Patent Applications

See the general patent listing at 5.2.1.7. and Appendix 1.4.

5.2.3. Holocaust History

- Blumental, Nachman, *Dokumenty i materiały*. Wydawnictwa Centralnej Żydowskiej Komisji Historycznej w Polsce, Łódź 1946, 2 volumes.
- Czech, Danuta, *Kalendarium der Ereignisse im Konzentrationslager Auschwitz-Birkenau 1939-1945*. Rowohlt Verlag, Reinbek bei Hamburg 1989.
- Czuj, Tadeusz, Czesław Kempisty, "Spopielanie zwłok więźnów obozu Gross-Rosen w komunalnym krematorium Legnicy w latach 1940-1943," in: *Biuletyn Głównej Komisji Badania Zbrodni Hitlerowskich w Polsce*, Vol. XXVII, 1977, pp. 106-119.
- Długoborski, Waclaw, Franciszek Piper (eds.), *Auschwitz 1940-1945. Studien zur Geschichte des Konzentrations- und Vernichtungslagers Auschwitz*, Verlag des Staatlichen Museums Auschwitz-Birkenau. Oświęcim, 1999.
- Gauss, Ernst (ed.), *Grundlagen zur Zeitgeschichte. Ein Handbuch über strittige Fragen des 20. Jahrhunderts*. Grabert-Verlag, Tübingen 1994.
- Gauss, Ernst (ed.), *Dissecting the Holocaust. The Growing Critique of "Truth" and "Memory"*, Theses & Dissertations Press, Capshaw, Ala., 2000.
- Graf, Jürgen, Carlo Mattogno, *Concentration Camp Majdanek: A Historical and Technical Study*. 3rd edition, The Barnes Review, Washington, D.C., 2012/Castle Hill Publishers, Uckfield, 2016.
- Gutman, Yisrael, Michael Berenbaum (eds.), *Anatomy of the Auschwitz Death Camp*. Indiana University Press, Bloomington and Indianapolis 1994.
- Höss, Rudolf, *Commandant of Auschwitz: The Autobiography of Rudolf Hoess*, The World Publishing Company, Cleveland/New York, 1959.
- Internationales Lagerkomitee Buchenwald (ed.), *Konzentrationslager Buchenwald. Bericht des internationalen Lagerkomitees Buchenwald*. Thüringer Volksverlag, Weimar, undated (but 1949).

- Kogon, Eugen, *Der SS-Staat. Das System der deutschen Konzentrationslager*. Verlag Karl Alber, Munich 1946.
- Kommunistischen Partei Deutschlands (ed.), *Das war Buchenwald! Ein Tatsachenbericht*. Verlag für Wissenschaft und Literatur, Leipzig, undated.
- Kryl, Miroslaw, "Deportacja więźniów terezynskiego getta do obozu koncentracyjnego na Majdanku w 1942 roku," in: *Zeszyty Majdanka*, vol. XI, 1983.
- Kubica, Helena, "Kinder und Jugendliche im KL Auschwitz," in: Długoborski/Piper 1999, Vol. II, pp. 251-351.
- Langbein, Hermann, *Der Auschwitz-Prozess. Eine Dokumentation*. Europa Verlag, Vienna, Frankfurt, Zürich 1965, 2 volumes.
- Leuchter, Fred A., *An Engineering Report on the Alleged Execution Gas Chambers at Auschwitz, Birkenau and Majdanek, Poland*, Fred A. Leuchter, Associates, Boston, Mass., April 1988.
- Leuchter, Fred A., Robert Faurisson, Germar Rudolf, *The Leuchter Reports: Critical Edition*, 5th ed., Castle Hill Publishers, Uckfield 2017.
- Łukaszewicz, Zdzisław, "Obóz koncentracyjny i zagłady Majdanek," in: *Biuletyn Głównej Komisji Badania Zbrodni Niemieckich w Polsce*, Vol. 4, 1948, pp. 63-105.
- Marsalek, Hans, *Die Geschichte des Konzentrationslagers Mauthausen. Dokumentation*, Österreichische Lagergemeinschaft Mauthausen, Vienna, 1980.
- Mattogno, Carlo, *Le camere a gas di Auschwitz. Studio storico-tecnico sugli "indizi criminali" di Jean-Claude Pressac e sulla "convergenza di prove" di Robert Jan van Pelt*. Effepi, Genoa 2009.
- Mattogno, Carlo, "Origins and Functions of the Birkenau Camp", *Inconvenient History*, Vol. 2, No. 2, 2010, <http://www.inconvenienthistory.com/2/2/3113>.
- Mattogno, Carlo, *I verbali degli interrogatori sovietici degli ingegneri della Topf. Le dichiarazioni di Kurt Prüfer, Karl Schultze, Fritz Sander e Gustav Braun su "camere a gas" e forni crematori di Auschwitz: analisi storico-tecnica*. Effepi, Genoa, 2014.
- Mattogno, Carlo, *The Central Construction Office of the Waffen-SS and Police Auschwitz*. 2nd ed., Castle Hill Publishers, Uckfield, 2015.
- Mattogno, Carlo, *Special Treatment at Auschwitz. Origin and Meaning of a Term*, 2nd ed., Castle Hill Publishers, Uckfield, 2016.
- Mattogno, Carlo, "Auschwitz: The End of a Legend," in: G. Rudolf (ed.), *Auschwitz: Plain Facts—A Response to Jean-Claude Pressac*, 2nd ed., Castle Hill Publishers, Uckfield, 2016a, pp. 131-212.
- Mattogno, Carlo, *The Real Case for Auschwitz*, 3rd ed., Castle Hill Publishers, Uckfield 2019.
- Mattogno, Carlo, *Auschwitz: Trasporti, Forza, Mortalità*. Effepi, Genoa, 2019a.
- Mattogno, Carlo, *Le farneticazioni di Robert Jan van Pelt sui forni crematori di Auschwitz-Birkenau*, Effepi, Genoa, 2020.
- Mattogno, Carlo, Thomas Kues, Graf, Jürgen, *Sobibór. Holocaust Propaganda and Reality*. 2nd ed., Castle Hill Publishers, Uckfield 2020.
- Nyiszli, Miklos, *Im Jenseits der Menschlichkeit. Ein Gerichtsmediziner in Auschwitz*. Dietz Verlag, Berlin 1992.
- Piper, Franciszek, "Das Nebenlager Blechhammer," in: *Hefte von Auschwitz*, Wydawnictwo Panstwowego Muzeum w Oswiecimiu, Vol. 10, 1967, pp. 19-39.
- Piper, Franciszek, *Die Zahl der Opfer von Auschwitz*. Verlag des Staatlichen Museums in Oświęcim, 1993.
- Piper, Franciszek, "Gas Chambers and Crematoria," in: Gutman/Berenbaum 1994, pp. 157-182.
- Pressac, Jean-Claude, *The Struthof Album: Study of the Gassing at Natzweiler-Struthof of 86 Jews Whose Bodies Were to Constitute a Collection of Skeletons*. The Beate Klarsfeld Foundation, New York 1985.
- Pressac, Jean-Claude, *Auschwitz: Technique and Operation of the Gas Chambers*. The Beate Klarsfeld Foundation. New York 1989.

- Pressac, Jean-Claude, *Les crématoires d'Auschwitz. La machinerie du meurtre de masse*. CNRS Editions, Paris 1993.
- Pressac, Jean-Claude, *Le macchina dello sterminio. Auschwitz 1941-1945*. Feltrinelli, Milan 1994.
- Rudolf, Germar (ed.), *Dissecting the Holocaust. The Growing Critique of "Truth" and "Memory,"* 2nd ed., Theses & Dissertations Press, Chicago 2003.
- Rudolf, Germar, Carlo Mattogno, *Auschwitz Lies: Legends, Lies, and Prejudices on the Holocaust*, 4th ed., Castle Hill Publishers, Uckfield., 2017
- Schnabel, Raimund, *Macht ohne Moral. Eine Dokumentation über die SS*. Röderberg-Verlag, Frankfurt/Main 1957.
- Staatliches Museum Auschwitz (ed.), *Sterbebücher von Auschwitz*. K.G. Saur. Munich 1995, 3 volumes.
- Terezínská Iniziativa (ed.), *Terezínská Pamětní Kniha*, Terezínská Iniziativa Melantrich, 1995.
- van Pelt, Robert Jan, *The Case for Auschwitz. Evidence from the Irving Trial*, Indiana University Press. Bloomington and Indianapolis, 2002.

6. Indices

6.1. Names

This index contains only names of individuals of importance in the context of the present study which appear in the main text. In SMALL CAPS: designers, manufacturers and patent holders of crematoria and cremation systems; in *italics*: executives and employees of the company J.A. Topf & Söhne, Erfurt. Page numbers of entries in footnotes are set in italics.

- **A** —
 Anstett, Elisabeth: 19
 ASEA BROWN BOVERI: 157
 Assmann, Aleida: 11
- **B** —
 Barrier, M.: 151
 Bartels, Herbert: 167
 BASSE, WILHELM: 186
 BECK, GEBRÜDER: 40, 52, 54, 64, 65, 77, 78, 98, 102-104, 115, 136-138, 298-300, 335, 338, 388
 Bertani, Agostino: 46
 Beugless, John D.: 147
 Beutinger, Emil: 41, 43, 44, 52, 53, 100, 334
 Bischoff, Karl, SS
Hauptsturmführer: 218, 219, 221-223, 225-232, 235, 236, 238, 240-243, 291, 295, 342, 343, 346-348
 Blumental, Nachman: 414
 Bode, military doctor: 145
 Bohnert, Michael: 301
 Boos, Friedrich, Comp.: 352, 353
 Bordoni, Ugo: 28, 36, 41, 370
 BOURRY: 55
Braun, Gustav: 165-168
 BROWN BOVERI & CIE: 74, 95, 96, 105, 106, 157, 158, 380
 Brück, August, *Kapo*: 238
 BRUNETTI, Lodovico: 48
 BUESS, WILHELM: 60
 BUNZLAUER WERKE
 LENGERSDORFF & Co.: 59
 Burk, Henning: 159
- **C** —
 CADET, A.: 49
 Cantagalli, Alberto: 42, 370
 Castiglioni, Pietro: 46
 Cobb, Augustus G.: 141
 Cobb, John Storer: 140
 Coletti, Francesco: 46
 Collmener Schamottewerke GmbH: 213, 218, 219
 Colombo, Gusieppe: 43, 303, 354, 380
 CONLEY: 57
 Créteur, Louis, chemist: 144, 145, 146
 Créteur, M.: 144
 Czech, Danuta: 11, 238, 246, 344
 Czuj, Tadeusz: 409
- **D** —
 D'Arrest, military doctor: 145
 DAVIES: 55, 56
 Davies, Douglas J.: 11, 31, 33
 Dawidowski, Roman, Polish expert: 337-339, 399
 de Cristoforis, Malachia: 48, 149
 de Pietra Santa, Prosper: 33, 48
 Deana, Franco, engineer: 11, 19
 Dechambre, A.: 146
 DeHaan, J.D.: 30
 Dejaco, Walter, SS
Untersturmführer: 229, 232
 Deringer, H.: 97
 DIDIER (STETTIN): 64, 77, 78, 90, 338, 388, see also SCHNEIDER-DIDIER and
- STETTINER
 SCHAMOTTEFABRIK
 DIDIER-WERKE: 198, 405-407
 Dolinskii, Soviet expert: 337
 Dorovius, E., engineer: 52
 DOWSON & MASON: 108
 Dreyfus, Jean-Marc: 19
 Du Jardin, G.: 46, 48
 du Mesnil, O.: 48, 49, 50
 Dubuisson, P.: 46
 Duroux, Charles: 144
- **E** —
 Eassie, William: 47, 48
 Eicke, Theodor, SS
Gruppenführer: 208, 409
 Eirenschmalz, Franz, SS
Standartenführer: 227
 EMCH & CO.: 91, 94, 104, 105
 ENER-TEK: 158
 ENGLE SANITARY & CREMATION CO. DES MOINES: 55
Erdmann, Paul: 165, 166, 293, 295
 Erichsen, Hugo: 55, 62, 143
 Ertl, Fritz, SS
Untersturmführer: 233
 Etzbach, Hugo: 175
- **F** —
 FEIST, GEORG: 150, 154
 FERBECK & VINCENT: 158
 FICHET: 49, 54, 100, 101
 Fichtl, engineer: 111
 Fischer, Norbert: 11
 Fleck, Dr. H.: 29, 30, 51
 Fornasini, Giulio: 326
 Freygang, Paul: 55, 101
 Fröhlich, H.: 143, 144

— G —

Gauss, Ernst: 12, 15
 GEBRÜDER BECK: see BECK, GEBRÜDER; see also KLINGENSTIERNA-BECK
 Geerhardt, Hans: 188
 Georgius: 56
 GIDDINGS, LAWSON HENRY: 61
 Giua, Michele: 23, 29, 36
 Giua-Lollini, Clara: 23
 Glodek, Aleksander: 416
 GORINI, PAOLO: 47-51, 154
 Grabner, Maximilian, SS
Untersturmführer: 220, 228
 Graf, Jürgen: 12, 330, 336, 340, 394
 Granata, Russell: 12
 Grigor'ev, Soviet expert: 330, 333
 Grimm, Jakob: 46
 GROSSKOPF, LUDWIG & Co.: 415
 Grzybowski, Jan: 321
 Guilbert, Edward A.: 47
 GUZZI, PALAMEDE: 50

— H —

Haase, Erich: 209
 Hartmann & Braun, Comp.: 89
 Heepke, Wilhelm, engineer: 28, 29, 36, 41, 43, 52, 78, 109, 115, 122, 124, 125, 127, 155, 304, 318, 353, 355, 364, 369
 Heinemann, Ferdinand: 380
 HEINICKE, H.R.: 78, 82, 85, 86, 156, 354
 Helbig, Erwin: 140
 Hellwig, Friedrich, engineer: 83, 84, 94, 110, 388
 Henzi, R.: 91, 92
 Hiddemann, Frank: 11
 Himmeler, Heinrich: 15, 236, 409, 413, 414, 416
 Holik (Holick), Martin.: 233, 245-247
 Höss, Rudolf, SS
Obersturmbannführer: 238, 245, 246, 251, 291, 338, 339, 350
 Huber, Walter: 33, 143
 Huisman, Wim: 19
 Huta Hoch- und Tiefbau A.G., Comp.: 233, 234, 251

— I —

Ichok, G.: 141-143
 IGNIS-HÜTTENBAU A.G.: 15, 17, 297, 387, 400, 407, 408
 INDUSTRIAL EQUIPMENT & ENGINEERING CO.: 158

— J —

Jährling, Rudolf: 237, 238, 240, 242, 250, 375, 376
 Jakobskötter, Rudolf, engineer: 182, 183, 348, 361, 417
 Janisch, Josef, SS
Untersturmführer: 234, 245
 Jankowski, Stanisław: 338
 Jones, E.W.: 14, 108, 300, 306, 335
 Jordan, H.: 97
 Jothann, Werner, SS
Obersturmführer: 245, 246

— K —

Kammler, Hans, SS
Brigadeführer: 222, 223, 225, 227, 229, 236, 237, 295, 296, 342, 345-347
 Kämper, Hermann: 98
 Kazantsev, Smersh captain: 168
 Keller, Alberto: 47, 48
 Keller, G.: 96, 97
 Keller, Hans, engineer: 73-75, 77, 95-97, 111, 315, 335, 360, 361, 370, 379, 380
 Kempisty, Czesław: 409
 KERGEL, MAX J.: 59, 169
 Kessler, Richard, engineer: 14, 34, 41, 65, 66, 70-75, 77, 83, 90, 96, 98, 99, 102, 109, 110, 126, 132, 297-300, 303, 311, 312, 315, 334, 335
 Kirschnek, Hans, SS
Unterscharführer: 226, 234, 237, 239, 240, 242, 244, 348
 KLETTNER, MARTIN: 33, 98, 177, 193, 408
 KLINGENSTIERNA: 40, 52-54, 100, 109, 115, 136, 334, 335
 Knös, R.: 54, 169

Koch, Wilhelm: 216, 219, 220, 233, 235, 242, 245, 248, 433
 Koehler, Robert, Comp.: 223-227, 233, 234, 240-244, 246, 261
 Kogon, Eugen: 209
 KOPP, G.: 49
 KORI, HANS: 15-17, 62, 63, 78, 137, 138, 147, 148, 155, 198, 276, 290, 297, 306, 312, 316, 317, 320, 321, 324, 327, 330, 333, 336, 337, 339, 354, 368, 378, 387-390, 392, 394, 397, 398, 407
 KÖRTING AG: 60
 Kraupner, Hans, engineer: 31
 Krauze, Soviet expert: 330
 Kristen: 387
 Kryl, Miroslaw: 400
 Kubica, Helena: 340
 Kubitz, Comp.: 399
 KUBORN & JACQUES: 50
 Küchenmeister, Friedrich: 33, 46, 51, 146
 Kues, Thomas: 340

— L —

Lacassagne, A.: 46
 LAGÉNARDIÈRE: 49
 Langbein, Hermann: 344
 Lante, military doctor: 144
 Lanyi: 146
 Lavrushin, Soviet expert: 337
 Lebrasseur, M., Prof.: 41, 42
 Lehmann, civilian employee: 239
 Lenzner, SS *Sturmbannführer*: 316, 394
 Leonard, L.G.A.: 300
 Leuchter, Fred A.: 158
 Liebehenschel, Arthur, SS
Obersturmbannführer: 222, 238, 245, 414, 416
 Lippert, civilian employee: 237
 Locatelli, Anna Pozzi: 48
 Löffler, Rudolf: 31
 Lohmann, W.: 62, 127
 Lubitz, Heinz, SS
Unterscharführer: 225
 LUDWIG, KARL, engineer: 81, 83, 85

— M —

Maccone, Luigi: 33, 48, 143, 153
 Machemehl, Max: 167
 Majewska, Justyna: 19
 Mann, Günter: 168
 Manskopf, H.: 85, 98, 354
 Marcuse, O.: 127
 Marmier, Fernand: 144
 MARSCH, ADOLF: 151, 152, 154, 290
 Mates, Lewis H.: 11, 31, 33
 Mattogno, Carlo: 11, 12, 16, 17, 19, 168, 218, 221, 228, 233, 314, 322, 324, 330, 336, 340, 342, 347, 350, 394
 McPhee, S.: 361
 Mehr (*Mähr*), Albert: 218, 219
 Mersch, Heinrich: 165, 166
 Messing, Heinrich: 239, 433, 434
 Möckel, Karl Ernst, SS
Obersturmbannführer: 228
 Moleschott, Jakob, Prof.: 46
 Morawa, Mieczysław, *Kapo*: 238
 Mühling, Paul: 64
 Mulka, Robert, SS
Hauptsturmführer: 226
 MULLER & FICHET: see FICHET
 Mussfeldt, Erich, SS
Hauptscharführer: 321

— N —

Nagel, Robert: 45, 101, 335
 Nestripke, SS *Sturmmann*: 347

— O —

Ortloff, Hermann: 52

— P —

Palitsch, Boriwoje: 405
 Pallester, Paul: 143
 Papadakis, M.: 361
 Pauly, Max: 46, 47
 Peters, A.: 64, 77
 Pierini, Ferdinando: 23
 Pini, Gaetano: 47, 48, 148
 Piper, Franciszek: 11, 340, 409
 Plüttsch, Comp.: 219, 220, 245

POLLI, GIOVANNI: 47, 48
 POLLI-CLERICETTI: 47, 48, 56
 Pollok, Josef, SS
Oberscharführer: 222, 225
 Pressac, Jean-Claude: 11, 12, 224, 228, 232, 267, 277, 297, 343, 345, 347, 416
 Probst, C.O.: 47, 140
 PROMETHEUS: 57
Prüfer, Kurt: 14, 83, 164, 165, 167, 168, 215, 229-237, 239-245, 247, 253, 266, 280, 288, 291, 294, 296, 312-314, 340, 345, 374, 375, 381, 382, 407, 417

— Q —

QUEHL, VIKTOR: 174, 185

— R —

Reber, B.: 46
 Reclam, Karl, Prof.: 46
 Reichenwallner, Balduin: 169
 Repky: 98
 REY: 50
 REY, CAPTAIN: 150
 Richter, Hermann, Prof.: 46
 Rochard, Jules: 47
 Roland, Hans: 414
 Rolants, M.E.: 48, 141, 142
 Roth, Wilhelm: 51, 145, 146
 ROTHENBACH & Co.: 56
 Rudolf, Germar: 12, 350
 RUPPMANN, WILHELM: 35, 45, 54, 73, 78, 90, 100, 101, 136-138, 159, 335, 379, 388

— S —

Salomon, Georges: 47, 151
 Salvi, Giuliano: 23, 24, 25, 41, 43, 124, 380
Sander, Fritz: 164-166, 168, 174, 191, 288-290, 292, 293, 295, 312, 322, 323, 414
 SAUERLAND, WILHELM: 57
 Schamottefabrik Stettin: see Didier (Stettin)
 Schetter, Gebhard: 159
 Schiller, Friedrich: 167
 Schlachter, August, SS
Untersturmführer: 214-219

Schläpfer, Paul, Prof.: 30, 31, 40, 70, 93, 94, 102, 109, 110, 298, 324
 Schmidt, Hermann: 166
 Schmidt, Kurt: 166
 Schnabel, Reimund: 292
 SCHNEIDER, RICHARD: 136-138, 147, 150, 388, see also SCHNEIDER-DIDIER
 SCHNEIDER-DIDIER: 38, 52, 53, 99, 100, 109, 334, 335, 388
 Schuchhardt, Carl: 46
 Schüle, Annegret: 19, 163, 167, 288
 Schuler, Otto, Comp.: 236
Schultze, Karl: 14, 164, 165, 168, 239, 313
Schultz-Schultzenstein: 146
 Schulze-Manitius, Hans: 315
 Schumacher, Fritz: 85, 129, 176, 181
 Schwarzenberger, Eckhard: 11
 Seidler, Fritz August, SS
Obersturmführer: 212
 Shatanovski, Soviet interrogator: 312
 Shuer, Soviet expert: 337
 SIEMENS, FRIEDRICH: 40, 46, 48, 51, 52, 58, 62, 100, 109, 110, 136, 146, 147, 291, 334, 338
 Siemens-Halske, Comp.: 88, 89
 SIMON & BOURRY: 55
 Sircar, Robin: 158
 Stenger, Heinrich: 313
 STETTINER
 SCHAMOTTEFABRIK A.G.: 64, 78, 137, 138
 Storl, Richard: 90, 405
 Streichardt, Hans: 168
 Swiszcowski, Stefan: 221, 224

— T —

TABO: 158, 300
 Tauber, Henryk: 338
 Telyaner, Soviet expert: 330, 333
 ter Linden, A.J.: 315, 326
 Thilenius, D.: 46
 Thompson, Henry: 47, 141
 Tierney, L.: 361

Tilly, H., engineer: 64, 65,
112, 115, 354
TOISUL & FRADET: 65, 100,
101, 137
TOPF & SÖHNE: *passim*
Topf, Albert: 163
Topf, Ernst Wolfgang: 163,
164, 165, 168, 177, 231,
232, 266, 374
Topf, Gustav: 163
Topf, Johann Andreas,
founding father: 163
Topf, Ludwig: 163, 165, 168,
177, 231, 232, 266, 374
Topf, Ludwig (Wilhelm
Louis): 163
Topf, Max Julius Ernst: 163
Trusen, J.P.: 46

— V —
Vallin, E.: 48
van Baar, Annika.: 19
van Pelt, Robert Jan: 11, 19
VENINI, GIUSEPPE: 49, 51, 55
VOLCKMANN, HANS: 81-85
VOLCKMANN-LUDWIG: 72,
78, 84, 85, 90, 98, 99, 105,
156, 174, 175, 179, 182,
354, 403, 407
von Engerth, Karl: 52

— W —
W. MÜLLER. Co.: 78, 79, 102
Walther & Co.
Dampfkesselwerk, Comp.:
352
Wassner, SS
Unterscharführer: 301

Weinisch, Theodor: 139
Weiss, Konrad: 180-182, 379
Weyl, Th.: 147, 148, 387
Willing, August: 203, 319,
349, 367
Wirths, Eduard, SS
Hauptsturmführer: 238
Wirtz, SS *Sturmbannführer*:
229
Witalski, Karl: 416
Wolfer, H.: 85, 89, 90

— Z —
Zagorul'onii, Soviet colonel:
168
Žmirov, Soviet colonel: 168
Zuntz, Prof.: 113

6.2. Concentration Camps

Auschwitz: *passim* 367, 370, 371, 376, 378,
397
Bergen-Belsen: 388, 398
Birkenau: *passim*
Blechhammer: 388, 398
Buchenwald: 12, 16, 200,
207-210, 232, 233, 238,
266, 267, 270, 273, 274,
280, 290, 306, 314, 374,
409, 415
Dachau: 12, 13, 16, 78, 79,
102, 203-207, 276, 388,
389, 391, 393-395, 407
Dora-Mittelbau: 388, 398
Ebensee: 388, 389
Flossenbürg: 388, 389
Gross-Rosen: 16, 17, 266,
288, 388, 398, 399, 409,
415
Gusen: 12-17, 203, 204, 206,
207, 252, 261, 287, 297,
301-304, 306, 311-313,
319, 320, 339, 349, 353,
354, 357, 362, 363, 366,
367, 370, 371, 376, 378,
397
Heidelager: 250
Krakow (Plaszów): 212, 250
Lemberg: 250
Lublin-Majdanek: 14, 17,
250, 297, 316, 320, 321,
327, 329, 330, 333, 334,
336, 337, 341, 388, 389,
394, 395, 398, 407
Majdanek: see Lublin-
Majdanek
Mauthausen: 12, 16, 199,
200, 203, 204, 205, 207,
233, 251, 252, 254, 258,
259, 262, 267, 277, 286,
287, 294, 297, 322, 349,
388, 391, 392, 409, 415
Natzweiler-Struthof: 388,
398, 416
Neuengamme: 388, 390, 398
Ravensbrück: 388, 397
Sachsenhausen: 14, 15, 208,
297, 327, 330, 333, 335-
337, 388, 391, 394-396,
398, 407, 409, 410, 412,
415
Struthof: see Natzweiler-
Struthof
Stutthof: 14, 17, 297, 327,
333, 335, 337, 343, 347,
388, 391-393, 398, 407,
414
Terezín (ghetto): 12, 14, 15,
17, 297, 317, 400, 402, 404,
407, 408, 417, 425, 426
Theresienstadt (ghetto): see
Terezín (ghetto)
Trawniki: 250
Trzebinia (Trzebinka): 388,
398
Vught: 388, 398
Warsaw: 250
Westerbork: 14, 15, 297,
306, 307, 311, 312, 317,
319, 337, 339, 340, 354,
378, 388, 419
Wewelsburg: 107, 409

6.3. Crematorium Locations (Civilian)

— A —

Aarau: 102
 Albstadt-Ebingen: 157
 Altenburg: 138
 Apolda: 138
 Arnstadt i.Th.: 138, 171
 Augsburg: 137
 Aussig: 139

— B —

Baden-Baden: 137
 Baltimore, Md.: 55, 140
 Berlin-Gerichtsstrasse: 137, 354
 Berlin-Treptow: 65, 84, 137
 Berlin-Wilmersdorf: 90, 114, 123, 127, 137
 Bern: 97
 Bernburg: 138
 Biel (Biene): 35, 41, 45, 73, 74, 95-97, 102, 105, 106, 361, 379, 380
 Bielefeld: 107, 138, 409
 Birmingham: 141
 Boston, Mass.: 55, 140
 Bradford: 141
 Brandenburg: 138
 Braunschweig: 137
 Bremen: 136
 Bremerhaven: 138
 Breslau: 138
 Brussels: 164
 Brûx: 139
 Buffalo, N.Y.: 55, 140

— C —

Celle: 138
 Chemnitz: 136
 Chicago, Ill.: 140
 Cincinnati, O.: 55, 140
 Coburg: 136
 Cologne: 138
 Croydon: 95
 Cuxhaven: 138

— D —

Danzig: 137
 Darlington: 141
 Darmstadt: 137
 Davenport, Ia.: 55, 140
 Davos: 102
 Dessau: 56, 65, 84, 103, 104, 110, 137, 298, 334, 335

Detroit, Mich.: 140
 Döbeln: 138
 Dortmund: 98, 114, 137, 177
 Dresden: 46, 137, 159, 164
 Duisburg: 138
 Düsseldorf: 138

— E —

Eisenach: 136
 Eisfeld: 138
 Eisleben: 138
 Erfurt: 95, 137, 164, 171, 172, 178-180, 335, 348, 349, 379, 417
 Essen: 95, 138
 Esslingen: 137

— F —

Flensburg: 138
 Forst: 138
 Frankfurt a.M.: 137
 Frankfurt a.O.: 138
 Freiberg i.S.: 138
 Freiburg i.Br.: 137, 164
 Friedberg i. Hes.: 137
 Fürstenberg: 138

— G —

Gera: 137, 313
 Gießen: 138, 171
 Glasgow: 141
 Gleiwitz: 138, 409
 Göppingen: 137
 Görlitz: 137
 Gotha: 40, 47, 52, 100, 109, 115, 136, 163, 334
 Graz: 139
 Greifswald: 137
 Grünberg i.Schl.: 137, 171
 Guben: 138, 171

— H —

Hagen i.W.: 137, 388
 Halle a.d.S.: 137, 164, 173
 Hamburg-Ohlsdorf: 53, 82-87, 98, 99, 136, 156, 182, 354
 Hamburg-Öjendorf: 156
 Hanau: 138
 Hanover: 137, 173
 Harrogate: 95
 Heidelberg: 52, 136
 Heilbronn: 136

Hildburghausen: 138
 Hirschberg i.Schl.: 137, 164, 174
 Höchst a.M.: 138, 171
 Hof: 138
 Hull: 108, 141

— I —

Ilford: 141
 Ilmenau: 137, 171, 173

— J —

Jena: 52, 56, 136

— K —

Karlsbad: 139
 Karlsruhe: 136
 Kassel: 138
 Kiel: 137
 Kolberg: 138
 Königsberg i.Pr.: 137
 Konstanz: 137
 Krefeld: 137

— L —

Lahr: 136, 138
 Lancaster, Pa.: 55, 62, 140
 Landau: 138
 Langensalza: 138
 Lauscha: 138
 Leeds: 141
 Leicester: 141
 Leipzig: 137
 Liegnitz: 138, 155, 409
 Lindau: 138
 Linz: 139
 Liverpool: 141
 London Golders Green: 141
 Los Angeles, Cal.: 140
 Lübeck: 137
 Lucerne: 102
 Ludwigsburg: 138
 Lugano: 102

— M —

Magdeburg: 137, 171
 Mainz: 52, 136
 Manchester: 55, 141
 Mannheim: 136
 Meiningen: 137
 Meissen: 138
 Milan: 47, 48

Moscow-Donskoye: 142,
164, 170, 171
Mühlhausen: 138
Munich: 137

— N —

Naumburg: 138
Neuchâtel: 102
New York: 140
Nordhausen: 138
Nordheim: 157
Nuremberg: 137

— O —

Offenbach a.M.: 52, 136
Olten: 102
Osnabrück: 138

— P —

Paris (Père-Lachaise): 49, 51,
54, 100, 142, 311, 313, 319,
340
Pforzheim: 137
Philadelphia, Pa.: 55, 140
Pittsburgh, Pa.: 55, 140
Plauen i.V.: 137
Pössneck: 137
Potsdam: 138

— Q —

Quedlinburg: 138

— R —

Reichenbach: 138
Reichenberg: 139
Reutlingen: 137
Riolo: 49
Rostock: 138
Rudolstadt i.Th.: 137
Ruislip: 108
Rüti: 102

— S —

Saalfeld: 138
Saarbrücken: 138
Salzburg: 139
San Francisco, Cal.: 140
Schaffhausen: 102
Schneidemühl: 138
Schwenningen: 138
Schwerin: 138, 388
Selb i.B.: 138
Semil: 95
Sheffield: 141
Solothurn: 102
Sondershausen: 138
Sonneberg i.Th.: 137
St. Gallen: 97, 102, 106, 157
St. Louis, Mo.: 140
Stettin: 138
Steyr: 139, 409
Stuttgart: 85, 86, 99, 101,
105, 136, 335

Suhl: 137, 171, 174
Swinburne Island, N.Y.: 140

— T —

Tilsit: 137
Tokyo: 143
Troy, N.Y.: 140
Tuttlingen: 138, 157

— U —

Ulm: 136

— V —

Vienna: 139

— W —

Washington, D.C.: 47, 49,
55, 62, 140
Waterville: 140
Weimar: 137, 173, 208, 409
Weissenfels a.S.: 138, 388
Wetzlar: 138
Wiesbaden: 137, 177
Wilhelmshaven: 138, 171
Working: 141

— Z —

Zittau: 137
Zürich: 91-93, 104, 105, 109,
157
Zwickau: 137

HOLOCAUST HANDBOOKS

This ambitious, growing series addresses various aspects of the “Holocaust” of the WWII era. Most of them are based on decades of research from archives all over the world. They are heavily referenced. In contrast to most other works on this issue, the tomes of this series approach its topic with profound academic scrutiny and a critical attitude. Any Holocaust researcher ignoring this series will remain oblivious to some of the most important research in the field. These books are designed to both convince the common reader as well as academics. The following books have appeared so far, or are about to be released. Compare hardcopy and eBook prices at www.findbookprices.com.

SECTION ONE:

General Overviews of the Holocaust

The First Holocaust. The Surprising Origin of the Six-Million Figure.

By Don Heddesheimer. This compact but substantive study documents propaganda spread prior to, during and after the FIRST World War that claimed East European Jewry was on the brink of annihilation. The magic number of suffering and dying Jews was 6 million back then as well. The book details how these Jewish fundraising operations in America raised vast sums in the name of feeding suffering Polish and Russian Jews but actually funneled much of the money to Zionist and Communist groups. 5th ed., 200 pages, b&w illustrations, bibliography, index. (#6)



neued much of the money to Zionist and Communist groups. 5th ed., 200 pages, b&w illustrations, bibliography, index. (#6)

Lectures on the Holocaust. Controversial Issues Cross Examined.

By Germar Rudolf. This book first explains why “the Holocaust” is an important topic, and that it is essential to keep an open mind about it. It then tells how many mainstream scholars expressed doubts and subsequently fell from grace. Next, the physical traces and documents about the various claimed crime scenes and murder weapons are discussed. After that, the reliability of witness testimony is examined. Finally, the author argues for a free exchange of ideas on this topic. This book gives the most-comprehensive and up-to-date overview of the critical research into the Holocaust. With its dialogue style, it is easy to read, and it can even be used as an encyclopedic compendium. 3rd ed., 596 pages, b&w illustrations, bibliography, index. (#15)

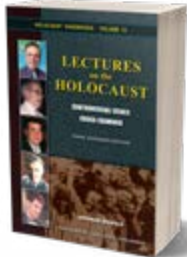

exchange of ideas on this topic. This book gives the most-comprehensive and up-to-date overview of the critical research into the Holocaust. With its dialogue style, it is easy to read, and it can even be used as an encyclopedic compendium. 3rd ed., 596 pages, b&w illustrations, bibliography, index. (#15)

Breaking the Spell. The Holocaust, Myth & Reality.

By Nicholas Kollerstrom. In 1941, British Intelligence analysts cracked the German “Enigma” code. Hence, in 1942 and 1943, encrypted radio communications between German concentration camps and the Berlin headquarters were decrypted. The intercepted data



Pictured above are all of the scientific studies that comprise the series *Holocaust Handbooks* published thus far or are about to be released. More volumes and new editions are constantly in the works. Check www.HolocaustHandbooks.com for updates.

refutes the orthodox “Holocaust” narrative. It reveals that the Germans were desperate to reduce the death rate in their labor camps, which was caused by catastrophic typhus epidemics. Dr. Kollerstrom, a science historian, has taken these intercepts and a wide array of mostly unchallenged corroborating evidence to show that “witness statements” supporting the human gas chamber narrative clearly clash with the available scientific data. Kollerstrom concludes that the history of the Nazi “Holocaust” has been written by the victors with ulterior motives. It is distorted, exaggerated and largely wrong. With a foreword by Prof. Dr. James Fetzer. 5th ed., 282 pages, b&w ill., bibl., index. (#31)

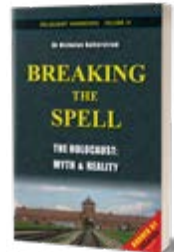

Debating the Holocaust. A New Look at Both Sides.

By Thomas Dalton. Mainstream historians insist that there cannot be, may not be, any debate about the Holocaust. But ignoring it does not make this controversy go away. Traditional scholars admit that there was neither a budget, a plan, nor an order for the Holocaust; that the key camps have all but vanished, and so have any human remains; that material and unequivocal documentary evidence is absent; and that there are serious problems with survivor testimonies. Dalton juxtaposes the traditional Holocaust narrative with revisionist challenges and then analyzes the mainstream’s responses to them. He reveals the weaknesses of both sides, while declaring revisionism the winner of the current state

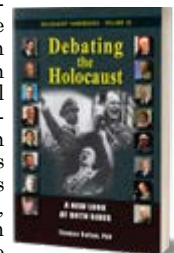

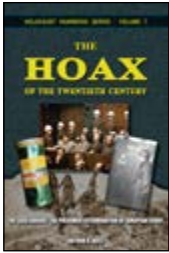

of the debate. 4th ed., 342 pages, b&w illustrations, bibliography, index. (#32)

The Hoax of the Twentieth Century. The Case against the Presumed Extermination of European Jewry. By Arthur R. Butz. The first writer to analyze the entire Holocaust complex in a precise scientific manner. This book exhibits the overwhelming force of arguments accumulated by the mid-1970s. Butz's two main arguments are: 1. All major entities hostile to Germany must have known what was happening to the Jews under German authority. They acted during the war as if no mass slaughter was occurring. 2. All the evidence adduced to prove any mass slaughter has a dual interpretation, while only the innocuous one can be proven to be correct. This book continues to be a major historical reference work, frequently cited by prominent personalities. This edition has numerous supplements with new information gathered over the last 35 years. 4th ed., 524 pages, b&w illustrations, bibliography, index. (#7)

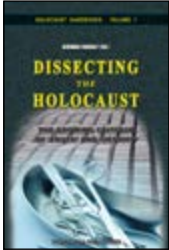

Dissecting the Holocaust. The Growing Critique of 'Truth' and 'Memory.' Edited by GERMAR RUDOLPH. *Dissecting the Holocaust* applies state-of-the-art scientific techniques and classic methods of detection to investigate the alleged murder of millions of Jews by Germans during World War II. In 22 contributions—each of some 30 pages—the 17 authors dissect generally accepted paradigms of the “Holocaust.” It reads as excitingly as a crime novel: so many lies, forgeries and deceptions by politicians, historians and scientists are proven. This is the intellectual adventure of the 21st Century. Be part of it! 3rd ed., 635 pages, b&w illustrations, bibliography, index. (#1)

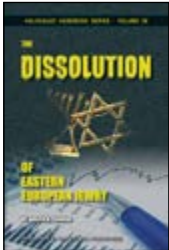

The Dissolution of Eastern European Jewry. By Walter N. Sanning. Six Million Jews died in the Holocaust. Sanning did not take that number at face value, but thoroughly explored European population developments and shifts mainly caused by emigration as well as deportations and evacuations conducted by both Nazis and the Soviets, among other things. The book is based mainly on Jewish, Zionist and mainstream sources. It concludes that a sizeable share of the Jews found missing during local censuses after the Second World War, which were so far counted as “Holocaust victims,” had either emigrated (mainly to Israel or the U.S.) or had been deported by Stalin to Siberian labor camps. 2nd ed., foreword by A.R. Butz, epilogue by GERMAR RUDOLPH containing important

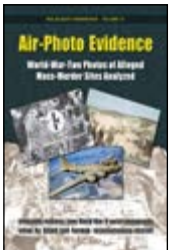

updates; 224 pages, b&w illustrations, bibliography (#29).

Air-Photo Evidence: World-War-Two Photos of Alleged Mass-Murder Sites Analyzed. By GERMAR RUDOLPH (editor). During World War Two both German and Allied reconnaissance aircraft took countless air photos of places of tactical and strategic interest in Europe. These photos are prime evidence for the investigation of the Holocaust. Air photos of locations like Auschwitz, Majdanek, Treblinka, Babi Yar etc. permit an insight into what did or did not happen there. The author has unearthed many pertinent photos and has thoroughly analyzed them. This book is full of air-photo reproductions and schematic drawings explaining them. According to the author, these images refute many of the atrocity claims made by witnesses in connection with events in the German sphere of influence. 6th edition; with a contribution by Carlo Mattogno. 167 pages, 8.5”x11”, b&w illustrations, bibliography, index (#27).

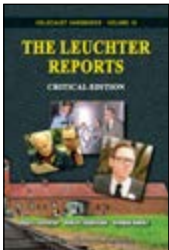

The Leuchter Reports: Critical Edition. By Fred Leuchter, Robert Faurisson and GERMAR RUDOLPH. Between 1988 and 1991, U.S. expert on execution technologies Fred Leuchter wrote four reports on whether the Third Reich operated homicidal gas chambers. The first on Auschwitz and Majdanek became world-famous. Based on various arguments, Leuchter concluded that the locations investigated could never have been “utilized or seriously considered to function as execution gas chambers.” The second report deals with gas-chamber claims for the camps Dachau, Mauthausen and Hartheim, while the third reviews design criteria and operation procedures of execution gas chambers in the U.S. The fourth report reviews Pressac's 1989 tome about Auschwitz. 4th ed., 252 pages, b&w illustrations. (#16)



Bungled: "The Destruction of the European Jews". Raul Hilberg's Failure to Prove National-Socialist "Killing Centers." By Carlo Mattogno. Raul Hilberg's magnum opus *The Destruction of the European Jews* is an orthodox standard work on the Holocaust. But how does Hilberg support his thesis that Jews were murdered *en masse*? He rips documents out of their context, distorts their content, misinterprets their meaning, and ignores entire archives. He only refers to “useful” witnesses, quotes fragments out of context, and conceals the fact that his witnesses are lying through their teeth. Lies and deceptions permeate Hil-

berg's book, 302 pages, bibliography, index. (#3)

Jewish Emigration from the Third Reich. By Ingrid Weckert. Current historical writings about the Third Reich claim state it was difficult for Jews to flee from Nazi persecution. The truth is that Jewish emigration was welcomed by the German authorities. Emigration was not some kind of wild flight, but rather a lawfully determined and regulated matter. Weckert's booklet elucidates the emigration process in law and policy. She shows that German and Jewish authorities worked closely together. Jews interested in emigrating received detailed advice and offers of help from both sides. 2nd ed., 130 pages, index. (#12)

Inside the Gas Chambers: The Extermination of Mainstream Holocaust Historiography. By Carlo Mattogno. Neither increased media propaganda or political pressure nor judicial persecution can stifle revisionism. Hence, in early 2011, the Holocaust Orthodoxy published a 400-page book (in German) claiming to refute "revisionist propaganda," trying again to prove "once and for all" that there were homicidal gas chambers at the camps of Dachau, Natzweiler, Sachsenhausen, Mauthausen, Ravensbrück, Neuengamme, Stutthof... you name them. Mattogno shows with his detailed analysis of this work of propaganda that mainstream Holocaust hagiography is beating around the bush rather than addressing revisionist research results. He exposes their myths, distortions and lies. 2nd ed., 280 pages, b&w illustrations, bibliography, index. (#25)

SECTION TWO: Specific non-Auschwitz Studies

Treblinka: Extermination Camp or Transit Camp? By Carlo Mattogno and Jürgen Graf. It is alleged that at Treblinka in East Poland between 700,000 and 3,000,000 persons were murdered in 1942 and 1943. The weapons used were said to have been stationary and/or mobile gas chambers, fast-acting or slow-acting poison gas, unslaked lime, superheated steam, electricity, Diesel-exhaust fumes etc. Holocaust historians alleged that bodies were piled as high as multi-storied buildings and burned without a trace, using little or no fuel at all. Graf and Mattogno have now analyzed the origins, logic and technical feasibility of the official version of Treblinka. On the basis of numerous documents they reveal Treblinka's true identity as a mere transit

camp. 3rd ed., 384 pages, b&w illustrations, bibliography, index. (#8)

Belzec: Propaganda, Testimonies, Archeological Research and History. By Carlo Mattogno. Witnesses report that between 600,000 and 3 million Jews were murdered in the Belzec Camp, located in Poland. Various murder weapons are claimed to have been used: Diesel-exhaust gas; unslaked lime in trains; high voltage; vacuum chambers; etc. The corpses were incinerated on huge pyres without leaving a trace. For those who know the stories about Treblinka this sounds familiar. Thus the author has restricted this study to the aspects which are new compared to Treblinka. In contrast to Treblinka, forensic drillings and excavations were performed at Belzec, the results of which are critically reviewed. 142 pages, b&w illustrations, bibliography, index. (#9)

Sobibor: Holocaust Propaganda and Reality. By Jürgen Graf, Thomas Kues and Carlo Mattogno. Between 25,000 and 2 million Jews are said to have been killed in gas chambers in the Sobibór camp in Poland. The corpses were allegedly buried in mass graves and later incinerated on pyres. This book investigates these claims and shows that they are based on the selective use of contradictory eyewitness testimony. Archeological surveys of the camp are analyzed that started in 2000-2001 and carried on until 2018. The book also documents the general National-Socialist policy toward Jews, which never included a genocidal "final solution." 2nd ed., 456 pages, b&w illustrations, bibliography, index. (#19)

The "Operation Reinhardt" Camps Treblinka, Sobibór, Belzec. By Carlo Mattogno. As an update and upgrade to the Volumes 8, 9 and 19 of this series, this study has its first focus on witness testimonies recorded during the World War II and the immediate post-war era, many of them discussed here for the first time, thus demonstrating how the myth of the "extermination camps" was created. The second part of this book brings us up to speed with the various archeological efforts made by mainstream scholars in their attempt to prove that the myth based on testimonies is true. The third part compares the findings of the second part with what we ought to expect, and reveals the chasm that exists between archeologically proven facts and mythological requirements. 402 pages, illustrations, bibliography, index. (#28)

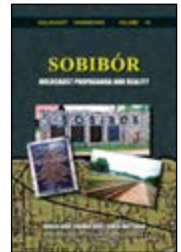
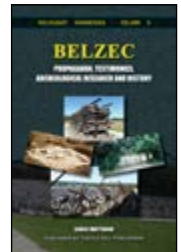
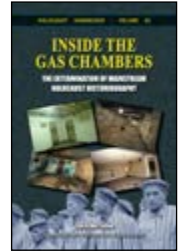
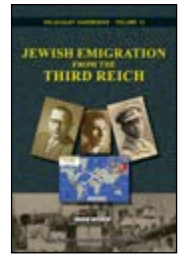

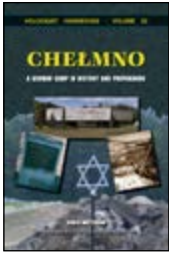

Chelmno: A Camp in History & Propaganda. By Carlo Mattogno. At Chelmno, huge masses of Jewish prisoners are said to have been gassed in “gas vans” or shot (claims vary from 10,000 to 1.3 million victims). This study covers the subject from every angle, undermining the orthodox claims about the camp with an overwhelmingly effective body of evidence. Eyewitness statements, gas wagons as extermination weapons, forensics reports and excavations, German documents—all come under Mattogno’s scrutiny. Here are the uncensored facts about Chelmno, not the propaganda. 2nd ed., 188 pages, indexed, illustrated, bibliography. (#23)

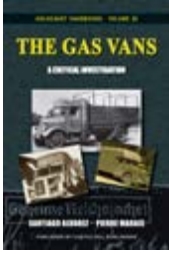

The Gas Vans: A Critical Investigation. By Santiago Alvarez and Pierre Marais. It is alleged that the Nazis used mobile gas chambers to exterminate 700,000 people. Up until 2011, no thorough monograph had appeared on the topic. Santiago Alvarez has remedied the situation. Are witness statements believable? Are documents genuine? Where are the murder weapons? Could they have operated as claimed? Where are the corpses? In order to get to the truth of the matter, Alvarez has scrutinized all known wartime documents and photos about this topic; he has analyzed a huge amount of witness statements as published in the literature and as presented in more than 30 trials held over the decades in Germany, Poland and Israel; and he has examined the claims made in the pertinent mainstream literature. The result of his research is mind-boggling. Note: This book and Mattogno’s book on Chelmno were edited in parallel to make sure they are consistent and not repetitive. 398 pages, b&w illustrations, bibliography, index. (#26)



The Einsatzgruppen in the Occupied Eastern Territories: Genesis, Missions and Actions. By C. Mattogno. Before invading the Soviet Union, the German authorities set up special units meant to secure the area behind the German front. Orthodox historians claim that these units called *Einsatzgruppen* primarily engaged in rounding up and mass-murdering Jews. This study sheds a critical light onto this topic by reviewing all the pertinent sources as well as material traces. It reveals on the one hand that original war-time documents do not fully support the orthodox genocidal narrative, and on the other that most post-“liberation” sources such as testimonies and forensic reports are steeped in Soviet atrocity propaganda and are thus utterly unreliable. In ad-

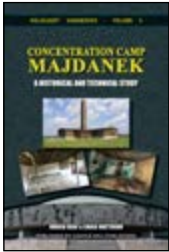

dition, material traces of the claimed massacres are rare due to an attitude of collusion by governments and Jewish lobby groups. 2nd ed., 2 vols., 872 pp., b&w illustrations, bibliography, index. (#39)

Concentration Camp Majdanek. A Historical and Technical Study. By Carlo Mattogno and Jürgen Graf. At war’s end, the Soviets claimed that up to two million Jews were murdered at the Majdanek Camp in seven gas chambers. Over the decades, however, the Majdanek Museum reduced the death toll three times to currently 78,000, and admitted that there were “only” two gas chambers. By exhaustively researching primary sources, the authors expertly dissect and repudiate the myth of homicidal gas chambers at that camp. They also critically investigated the legend of mass executions of Jews in tank trenches and prove it groundless. Again they have produced a standard work of methodical investigation which authentic historiography cannot ignore. 3rd ed., 358 pages, b&w illustrations, bibliography, index. (#5)

Concentration Camp Stutthof and Its Function in National Socialist Jewish Policy. By Carlo Mattogno and Jürgen Graf. Orthodox historians claim that the Stutthof Camp served as a “make-shift” extermination camp in 1944. Based mainly on archival resources, this study thoroughly debunks this view and shows that Stutthof was in fact a center for the organization of German forced labor toward the end of World War II. 4th ed., 170 pages, b&w illustrations, bibliography, index. (#4)

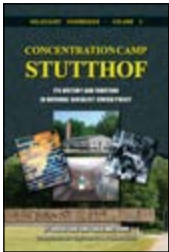

SECTION THREE: Auschwitz Studies

The Making of the Auschwitz Myth: Auschwitz in British Intercepts, Polish Underground Reports and Post-war Testimonies (1941-1947). By Carlo Mattogno. Using messages sent by the Polish underground to London, SS radio messages sent to and from Auschwitz that were intercepted and decrypted by the British, and a plethora of witness statements made during the war and in the immediate postwar period, the author shows how exactly the myth of mass murder in Auschwitz gas chambers was created, and how it was turned subsequently into “history” by intellectually corrupt scholars who cherry-picked claims that fit into their agenda and ignored or actively covered up literally thousands of lies of “witnesses” to make their narrative look credible. 2nd edi-

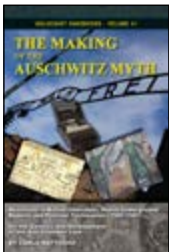

tion, 514 pp., b&w illustrations, bibliography, index. (#41)

The Real Case of Auschwitz: Robert van Pelt's Evidence from the Irving Trial Critically Reviewed. By Carlo Mattogno. Prof. Robert van Pelt is considered one of the best mainstream experts on Auschwitz. He became famous when appearing as an expert during the London libel trial of David Irving against Deborah Lipstadt. From it resulted a book titled *The Case for Auschwitz*, in which van Pelt laid out his case for the existence of homicidal gas chambers at that camp. This book is a scholarly response to Prof. van Pelt—and Jean-Claude Pressac, upon whose books van Pelt's study is largely based. Mattogno lists all the evidence van Pelt adduces, and shows one by one that van Pelt misrepresented and misinterpreted every single one of them. This is a book of prime political and scholarly importance to those looking for the truth about Auschwitz. 3rd ed., 692 pages, b&w illustrations, glossary, bibliography, index. (#22)

Auschwitz: Plain Facts: A Response to Jean-Claude Pressac. Edited by Germar Rudolf, with contributions by Serge Thion, Robert Faurisson and Carlo Mattogno. French pharmacist Jean-Claude Pressac tried to refute revisionist findings with the “technical” method. For this he was praised by the mainstream, and they proclaimed victory over the “revisionists.” In his book, Pressac's works and claims are shown to be unscientific in nature, as he never substantiates what he claims, and historically false, because he systematically misrepresents, misinterprets and misunderstands German wartime documents. 2nd ed., 226 pages, b&w illustrations, glossary bibliography, index. (#14)

Auschwitz: Technique and Operation of the Gas Chambers: An Introduction and Update. By Germar Rudolf. Pressac's 1989 oversize book of the same title was a trail blazer. Its many document reproductions are still valuable, but after decades of additional research, Pressac's annotations are outdated. This book summarizes the most pertinent research results on Auschwitz gained during the past 30 years. With many references to Pressac's epic tome, it serves as an update and correction to it, whether you own an original hard copy of it, read it online, borrow it from a library, purchase a reprint, or are just interested in such a summary in general. 144 pages, b&w illustrations, bibliography. (#42)

The Chemistry of Auschwitz: The Technology and Toxicology of Zyklon B and the Gas Chambers – A Crime-Scene Investigation. By Germar Rudolf. This study documents forensic research on Auschwitz, where material traces and their interpretation reign supreme. Most of the claimed crime scenes – the claimed homicidal gas chambers – are still accessible to forensic examination to some degree. This book addresses questions such as: How were these gas chambers configured? How did they operate? In addition, the infamous Zyklon B can also be examined. What exactly was it? How does it kill? Does it leave traces in masonry that can be found still today? The author also discusses in depth similar forensic research conducted by other scholars. 4th ed., 454 pages, more than 120 color and over 100 b&w illustrations, bibliography, index. (#2)

Auschwitz Lies: Legends, Lies and Prejudices on the Holocaust. By Carlo Mattogno and Germar Rudolf. The fallacious research and alleged “refutation” of Revisionist scholars by French biochemist G. Wellers (attacking Leuchter's famous report), Polish chemist Dr. J. Markiewicz and U.S. chemist Dr. Richard Green (taking on Rudolf's chemical research), Dr. John Zimmerman (tackling Mattogno on cremation issues), Michael Shermer and Alex Grobman (trying to prove it all), as well as researchers Keren, McCarthy and Mazal (who turned cracks into architectural features), are exposed for what they are: blatant and easily exposed political lies created to ostracize dissident historians. 4th ed., 420 pages, b&w illustrations, index. (#18)

Auschwitz: The Central Construction Office. By Carlo Mattogno. Ever since the Russian authorities granted western historians access to their state archives in the early 1990s, the files of the Central Construction Office of the Waffen-SS and Police Auschwitz, stored in a Moscow archive, have attracted the attention of scholars who are researching the history of this most infamous of all German war-time camps. Despite this interest, next to nothing has really been known so far about this very important office, which was responsible for the planning and construction of the Auschwitz camp complex, including the crematories which are said to have contained the “gas chambers.” This emphasizes the importance of the present study, which not only sheds light into this hitherto hidden

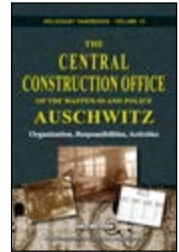
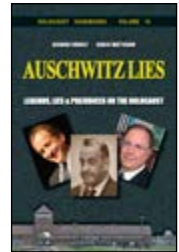
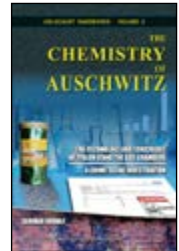
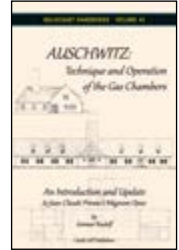



aspect of this camp's history, but also provides a deep understanding of the organization, tasks, and procedures of this office. 2nd ed., 188 pages, b&w illustrations, glossary, index. (#13)

Garrison and Headquarters Orders from the Auschwitz Camp. By Germar Rudolf and Ernst Böhm. A large number of all the orders ever issued by the various commanders of the infamous Auschwitz camp have been preserved. They reveal the true nature of the camp with all its daily events. There is not a trace in these orders pointing at anything sinister going on in this camp. Quite to the contrary, many orders are in clear and insurmountable contradiction to claims that prisoners were mass murdered, such as the children of SS men playing with inmates, SS men taking friends for a sight-seeing tour through the camp, or having a romantic stroll with their lovers around the camp grounds. This is a selection of the most pertinent of these orders together with comments putting them into their proper historical context. 185 pages, b&w ill., bibl., index (#34)

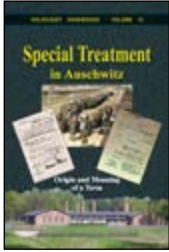

Special Treatment in Auschwitz: Origin and Meaning of a Term. By Carlo Mattogno. When appearing in German wartime documents, terms like "special treatment," "special action," and others have been interpreted as code words for mass murder. But that is not always true. This study focuses on documents about Auschwitz, showing that, while "special" had many different meanings, not a single one meant "execution." Hence the practice of deciphering an alleged "code language" by assigning homicidal meaning to harmless documents – a key component of mainstream historiography – is untenable. 2nd ed., 166 pages, b&w illustrations, bibliography, index. (#10)



Healthcare at Auschwitz. By Carlo Mattogno. In extension of the above study on *Special Treatment in Auschwitz*, this study proves the extent to which the German authorities at Auschwitz tried to provide health care for the inmates. Part 1 of this book analyzes the inmates' living conditions and the various sanitary and medical measures implemented. Part 2 explores what happened to registered inmates who were "selected" or subject to "special treatment" while disabled or sick. This study shows that a lot was tried to cure these inmates, especially under the aegis of Garrison Physician Dr. Wirths. Part 3 is dedicated to this very Dr. Wirths. His reality refutes the current stereotype

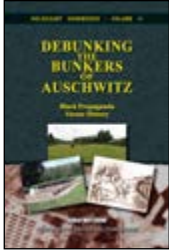

of SS officers. 398 pages, b&w illustrations, bibliography, index. (#33)

Debunking the Bunkers of Auschwitz: Black Propaganda vs. History. By Carlo Mattogno. The "bunkers" at Auschwitz, two former farmhouses just outside the camp's perimeter, are claimed to have been the first homicidal gas chambers at Auschwitz specifically equipped for this purpose. With the help of original German wartime files as well as revealing air photos taken by Allied reconnaissance aircraft in 1944, this study shows that these homicidal "bunkers" never existed, how the rumors about them evolved as black propaganda created by resistance groups in the camp, and how this propaganda was transformed into a false reality. 2nd ed., 292 pages, b&w ill., bibliography, index. (#11)

Auschwitz: The First Gassing, Rumor and Reality. By Carlo Mattogno. The first gassing in Auschwitz is claimed to have occurred on Sept. 3, 1941 in a basement. The accounts reporting it are the archetypes for all later gassing accounts. This study analyzes all available sources about this alleged event. It shows that these sources contradict each other about the event's location, date, the kind of victims and their number, and many more aspects, which makes it impossible to extract a consistent story. Original wartime documents inflict a final blow to this legend and prove without a shadow of a doubt that this legendary event never happened. 3rd ed., 190 pages, b&w illustrations, bibliography, index. (#20)



Auschwitz: Crematorium I and the Alleged Homicidal Gassings. By Carlo Mattogno. The morgue of Crematorium I in Auschwitz is said to be the first homicidal gas chamber there. This study investigates all statements by witnesses and analyzes hundreds of wartime documents to accurately write a history of that building. Where witnesses speak of gassings, they are either very vague or, if specific, contradict one another and are refuted by documented and material facts. The author also exposes the fraudulent attempts of mainstream historians to convert the witnesses' black propaganda into "truth" by means of selective quotes, omissions, and distortions. Mattogno proves that this building's morgue was never a homicidal gas chamber, nor could it have worked as such. 2nd ed., 152 pages, b&w illustrations, bibliography, index. (#21)



Auschwitz: Open-Air Incinerations. By Carlo Mattogno. In spring and summer of 1944, 400,000 Hungarian Jews were deported to Auschwitz and allegedly murdered there in gas chambers. The Auschwitz crematoria are said to have been unable to cope with so many corpses. Therefore, every single day thousands of corpses are claimed to have been incinerated on huge pyres lit in deep trenches. The sky over Auschwitz was filled with thick smoke. This is what some witnesses want us to believe. This book examines the many testimonies regarding these incinerations and establishes whether these claims were even possible. Using air photos, physical evidence and wartime documents, the author shows that these claims are fiction. A new Appendix contains 3 papers on groundwater levels and cattle mass burnings. 2nd ed., 202 pages, b&w illustrations, bibliography, index. (#17)

The Cremation Furnaces of Auschwitz. By Carlo Mattogno & Franco Deana. An exhaustive study of the early history and technology of cremation in general and of the cremation furnaces of Auschwitz in particular. On a vast base of technical literature, extant wartime documents and material traces, the authors can establish the true nature and capacity of the Auschwitz cremation furnaces. They show that these devices were inferior makeshift versions of what was usually produced, and that their capacity to cremate corpses was lower than normal, too. This demonstrates that the Auschwitz crematoria were not evil facilities of mass destruction, but normal installations that barely managed to handle the victims among the inmates who died of various epidemics ravaging the camp through its history. 2nd ed., 3 vols., 1201 pages, b&w and color illustrations (vols 2 & 3), bibliography, index, glossary. (#24)

Curated Lies: The Auschwitz Museum's Misrepresentations, Distortions and Deceptions. By Carlo Mattogno. Revisionist research results have put the Polish Auschwitz Museum under pressure to answer this challenge. In 2014, they answered with a book presenting documents allegedly proving their claims. But they cheated. In its main section, this study analyzes their "evidence" and reveals the appallingly mendacious attitude of the Auschwitz Museum authorities when presenting documents from their archives. This is preceded by a section focusing on the Auschwitz Museum's most-coveted asset: the alleged gas chamber inside the Old Crematorium, toured every

year by well over a million visitors. *Curated Lies* exposes the many ways in which visitors have been deceived and misled by forgeries and misrepresentations about this building committed by the Auschwitz Museum, some of which are maintained to this day. 2nd ed., 259 pages, b&w illustrations, bibliography, index. (#38)

Deliveries of Coke, Wood and Zyklon B to Auschwitz: Neither Proof Nor Trace for the Holocaust. By Carlo Mattogno. Researchers from the Auschwitz Museum tried to prove the reality of mass extermination by pointing to documents about deliveries of wood and coke as well as Zyklon B to the Auschwitz Camp. If put into the actual historical and technical context, however, as is done by this study, these documents prove the exact opposite of what those orthodox researchers claim. 184 pages, b&w illust., bibl., index. (#40)

SECTION FOUR: Witness Critique

Elie Wiesel, Saint of the Holocaust: A Critical Biography. By Warren B. Rutledge. The world's first independent biography of Elie Wiesel shines the light of truth on this mythomaniac who has transformed the word "Holocaust" into the brand name of the world's greatest hoax. Here, both Wiesel's personal deceits and the whole myth of "the six million" are laid bare for the reader's perusal. It shows how Zionist control of the U.S. Government as well as the nation's media and academic apparatus has allowed Wiesel and his fellow extremists to force a string of U.S. presidents to genuflect before this imposter as symbolic acts of subordination to World Jewry, while simultaneously forcing school children to submit to Holocaust brainwashing by their teachers. 3rd ed., 458 pages, b&w illustration, bibliography, index. (#30)

Auschwitz: Eyewitness Reports and Perpetrator Confessions. By Jürgen Graf. The traditional narrative of what transpired at the infamous Auschwitz Camp during WWII rests almost exclusively on witness testimony. This study critically scrutinizes the 30 most-important of them by checking them for internal coherence, and by comparing them with one another as well as with other evidence such as wartime documents, air photos, forensic research results, and material traces. The result is devastating for the traditional narrative. 372 pages, b&w illust., bibl., index. (#36)

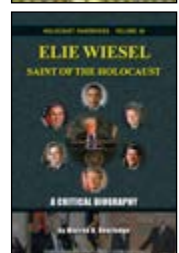
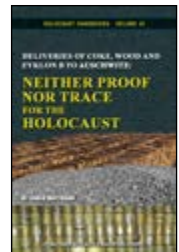



Commandant Auschwitz: Rudolf Höss, His Torture and His Forced Confessions. By Carlo Mattogno & Rudolf Höss. From 1940 to 1943, Rudolf Höss was the commandant of the infamous Auschwitz Camp. After the war, he was captured by the British. In the following 13 months until his execution, he made 85 depositions of various kinds in which he confessed his involvement in the “Holocaust.” This study first reveals how the British tortured him to extract various “confessions.” Next, all of Höss’s depositions are analyzed by checking his claims for internal consistency and comparing them with established historical facts. The results are eye-opening... 2nd ed., 411 pages, b&w illustrations, bibliography, index. (#35)

An Auschwitz Doctor’s Eyewitness Account: The Tall Tales of Dr. Mengele’s Assistant Analyzed. By Miklos Nyiszli & Carlo Mattogno. Nyiszli, a Hungarian physician, ended up at Auschwitz in 1944 as Dr. Mengele’s assistant. After the war he wrote a book and several other writings describing what he claimed to have experienced. To this day some traditional historians take his accounts seriously, while others reject them as grotesque lies and exaggerations. This study presents and analyzes Nyiszli’s writings and skillfully separates truth from fabulous fabrication. 2nd ed., 484 pages, b&w illustrations, bibliography, index. (#37)

Rudolf Reder versus Kurt Gerstein: Two False Testimonies on the Belzec Camp Analyzed. By Carlo Mattogno.

Only two witnesses have ever testified substantially about the alleged Belzec Extermination Camp: The survivor Rudolf Reder and the SS officer Kurt Gerstein. Gerstein’s testimonies have been a hotspot of revisionist critique for decades. It is now discredited even among orthodox historians. They use Reder’s testimony to fill the void, yet his testimonies are just as absurd. This study thoroughly scrutinizes Reder’s various statements, critically revisits Gerstein’s various depositions, and then compares these two testimonies which are at once similar in some respects, but incompatible in others. 216 pages, b&w illustrations, bibliography, index. (#43)

Sonderkommando Auschwitz I: Nine Eyewitness Testimonies Analyzed. By Carlo Mattogno. To this day, the 1979 book *Auschwitz Inferno* by former Auschwitz inmate and alleged *Sonderkommando* member Filip Müller has a great influence both on the public perception of Auschwitz and on historians trying to probe this camp’s history. This book critically analyzes Müller’s various post-war statements, which are full of exaggerations, falsehoods and plagiarized text passages. The author also scrutinizes the testimonies of eight other former *Sonderkommando* members with similarly lacking penchants for exactitude and truth: Dov Paisikovic, Stanislaw Jankowski, Henryk Mandelbaum, Ludwik Nagraba, Joshua Rosenblum, Aaron Pilo, David Flammenbaum and Samij Karolinski. 300 pages, b&w illust., bibliography, index. (#44)

Future Projects

The following projects are in various stages of research/writing/editing/translation. The titles listed and the contents summarized are tentative. These projects do not have timelines yet:

The Dachau Concentration Camp. By Carlo Mattogno. Dachau is one of the most-notorious Third-Reich camps. It’s about time revisionists gave it their full attention.

Sonderkommando Auschwitz II: The False Testimonies by Henryk Tauber and Szlama Dragon. By Carlo Mattogno. These two witnesses are held in high esteem among the orthodoxy for their tales about Auschwitz: Tauber on Crema II and Dragon on the “bunkers.” This study dispels the notion that these witnesses’

tales are worth any more than the paper they are written on.

Mis-Chronicling Auschwitz: Danuta Czech’s Flawed Methods, Misrepresentations and Deceptions in Her Auschwitz Chronicle. By Carlo Mattogno. Danuta Czech’s *Auschwitz Chronicle* is a reference book for the history of Auschwitz. Mattogno has compiled a long list of misrepresentations, outright lies and deceptions contained in it. This mega-fraud needs to be retired from the ranks of Auschwitz sources.

The Real Auschwitz Chronicle: A Documented Day-to-Day History. By Carlo Mattogno. Nagging is easy, doing a better job is the real challenge. In contrast to Danuta Czech’s 1990 *Auschwitz Chronicle*, this book reveals the true history of the Auschwitz Camp based on documented facts, not on rumors, lies and propaganda.



For current prices and availability, and to learn more, go to www.HolocaustHandbooks.com – by simply scanning the QR code to the left. Published by Castle Hill Publishers, PO Box 243, Uckfield, TN22 9AW, UK

BOOKS BY AND FROM CASTLE HILL PUBLISHERS

Below please find some of the books published or distributed by Castle Hill Publishers in the United Kingdom. For our current and complete range of products visit our web store at shop.codoh.com.

Thomas Dalton, *The Holocaust: An Introduction*

The Holocaust was perhaps the greatest crime of the 20th Century. Six million Jews, we are told, died by gassing, shooting, and deprivation. But: Where did the six-million figure come from? How, exactly, did the gas chambers work? Why do we have so little physical evidence from major death camps? Why haven't we found even a fraction of the six million bodies, or their ashes? Why has there been so much media suppression and governmental censorship on this topic? In a sense, the Holocaust is the greatest murder mystery in history. It is a topic of greatest importance for the present day. Let's explore the evidence, and see where it leads.

128 pp. pb, 5"×8", ill., bibl., index

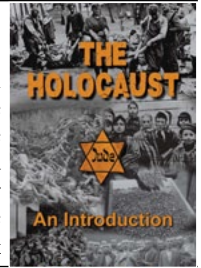

Carlo Mattogno, *Auschwitz: A Three-Quarter Century of*

Propaganda: Origins, Development and Decline of the "Gas Chamber" Propaganda Lie

During the war, wild rumors were circulating about Auschwitz: that the Germans were testing new war gases; that inmates were murdered in electrocution chambers, with gas showers or pneumatic hammer systems; that living people were sent on conveyor belts directly into cremation furnaces; that oils, grease and soap were made of the mass-murder victims. Nothing of it was true. When the Soviets captured Auschwitz in early 1945, they reported that 4 million inmates were killed on electrocution conveyor belts discharging their load directly into furnaces. That wasn't true either. After the war, "witnesses" and "experts" repeated these things and added more fantasies: mass murder with gas bombs, gas chambers made of canvas; carts driving living people into furnaces; that the crematoria of Auschwitz could have cremated 400 million victims... Again, none of it was true. This book gives an overview of the many rumors, myths and lies about Auschwitz which mainstream historians today reject as untrue. It then explains by which ridiculous methods some claims about Auschwitz were accepted as true and turned into "history," although they are just as untrue.

125 pp. pb, 5"×8", ill., bibl., index, b&w ill.

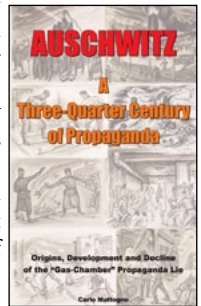

Wilhelm Stäglich, *Auschwitz: A Judge Looks at the Evidence*

Auschwitz is the epicenter of the Holocaust, where more people are said to have been murdered than anywhere else. At this detention camp the industrialized Nazi mass murder is said to have reached its demonic pinnacle. This narrative is based on a wide range of evidence, the most important of which was presented during two trials: the International Military Tribunal of 1945/46, and the German Auschwitz Trial of 1963-1965 in Frankfurt.

The late Wilhelm Stäglich, until the mid-1970s a German judge, has so far been the only legal expert to critically analyze this evidence. His research reveals the incredibly scandalous way in which the Allied victors and later the German judicial authorities bent and broke the law in order to come to politically foregone conclusions. Stäglich also exposes the shockingly superficial way in which historians are dealing with the many incongruities and discrepancies of the historical record.

3rd edition 2015, 422 pp. pb, 6"×9", b&w ill.

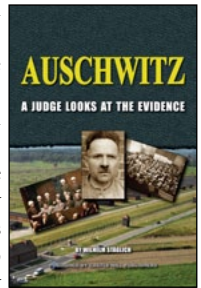

Gerard Menuhin: *Tell the Truth & Shame the Devil*

A prominent Jew from a famous family says the "Holocaust" is a wartime propaganda myth which has turned into an extortion racket. Far from bearing the sole guilt for starting WWII as alleged at Nuremberg (for which many of the surviving German leaders were hanged) Germany is mostly innocent in this respect and made numerous attempts to avoid and later to end the confrontation. During the 1930s Germany was confronted by a powerful Jewish-dominated world plutocracy out to destroy it... Yes, a prominent Jew says all this. Accept it or reject it, but be sure to read it and judge for yourself!

The author is the son of the great American-born violinist Yehudi Menuhin, who, though from a long line of rabbinical ancestors, fiercely criticized the foreign policy of the state of Israel and its repression of the Palestinians in the Holy Land.

4th edition 2017, 432 pp. pb, 6"×9", b&w ill.



For prices and availability see www.shop.codoh.com or write to: CHP, PO Box 243, Uckfield, TN22 9AW, UK

Robert H. Countess, Christian Lindtner, Germar Rudolf (eds.),

Exactitude: Festschrift for Prof. Dr. Robert Faurisson

On January 25, 1929, a man was born who probably deserves the title of the most-courageous intellectual of the 20th Century and the early 21st Century: Robert Faurisson. With bravery and steadfastness, he challenged the dark forces of historical and political fraud with his unrelenting exposure of their lies and hoaxes surrounding the orthodox Holocaust narrative. This book describes and celebrates the man, who passed away on October 21, 2018, and his work dedicated to accuracy and marked by insubmission.

146 pp. pb, 6"×9", b&w ill.

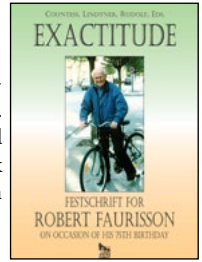

Cyrus Cox, ***Auschwitz – Forensically Examined***

It is amazing what modern forensic crime-scene investigations can reveal. This is also true for the Holocaust. There are many big tomes about this, such as Rudolf's 400+ page book on *The Chemistry of Auschwitz*, or Mattogno's 1200-page work on the crematoria of Auschwitz. But who reads those doorstops? Here is a booklet that condenses the most-important findings of Auschwitz forensics into a nutshell, quick and easy to read. In the first section, the forensic investigations conducted so far are reviewed. In the second section, the most-important results of these studies are summarized, making them accessible to everyone. The main arguments focus on two topics. The first centers around the poison allegedly used at Auschwitz for mass murder: Zyklon B. Did it leave any traces in masonry where it was used? Can it be detected to this day? The second topic deals with mass cremations. Did the crematoria of Auschwitz have the claimed huge capacity claimed for them? Do air photos taken during the war confirm witness statements on huge smoking pyres? Find the answers to these questions in this booklet, together with many references to source material and further reading. The third section reports on how the establishment has reacted to these research results.

124 pp. pb., 5"×8", b&w ill., bibl., index

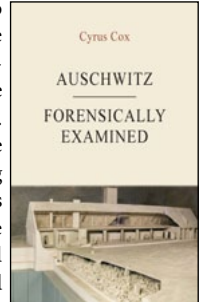

Steffen Werner, ***The Second Babylonian Captivity: The Fate of the Jews in Eastern Europe since 1941***

"But if they were not murdered, where did the six million deported Jews end up?" This is a standard objection to the revisionist thesis that the Jews were not killed in extermination camps. It demands a well-founded response. While researching an entirely different topic, Steffen Werner accidentally stumbled upon the most-peculiar demographic data of Byelorussia. Years of research subsequently revealed more and more evidence which eventually allowed him to substantiate a breathtaking and sensational proposition: The Third Reich did indeed deport many of the Jews of Europe to Eastern Europe in order to settle them there "in the swamp." This book, first published in German in 1990, was the first well-founded work showing what really happened to the Jews deported to the East by the National Socialists, how they have fared since, and who, what and where they are "now" (1990). It provides context and purpose for hitherto-obscure and seemingly random historical events and quite obviates all need for paranormal events such as genocide, gas chambers, and all their attendant horrors. With a preface by Germar Rudolf with references to more-recent research results in this field of study confirming Werner's thesis.

190 pp. pb, 6"×9", b&w ill., bibl., index

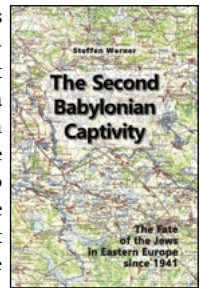

Germar Rudolf, ***Holocaust Skepticism: 20 Questions and Answers about Holocaust Revisionism***

This 15-page brochure introduces the novice to the concept of Holocaust revisionism, and answers 20 tough questions, among them: What does Holocaust revisionism claim? Why should I take Holocaust revisionism more seriously than the claim that the earth is flat? How about the testimonies by survivors and confessions by perpetrators? What about the pictures of corpse piles in the camps? Why does it matter how many Jews were killed by the Nazis, since even 1,000 would have been too many? ... Glossy full-color brochure. PDF file free of charge available at www.HolocaustHandbooks.com, Option "Promotion". This item is *not* copyright-protected. Hence, you can do with it whatever you want: download, post, email, print, multiply, hand out, sell...

15 pp., stapled, 8.5"×11", full-color throughout

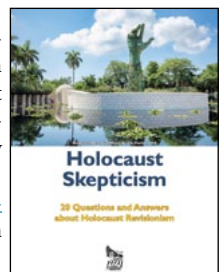

For prices and availability see www.shop.codoh.com or write to: CHP, PO Box 243, Uckfield, TN22 9AW, UK

Germar Rudolf, **Bungled: "Denying the Holocaust"** How Deborah Lipstadt Botched Her Attempt to Demonstrate the Growing Assault on Truth and Memory

With her book *Denying the Holocaust*, Deborah Lipstadt tried to show the flawed methods and extremist motives of "Holocaust deniers." This book demonstrates that Dr. Lipstadt clearly has neither understood the principles of science and scholarship, nor has she any clue about the historical topics she is writing about. She misquotes, mistranslates, misrepresents, misinterprets, and makes a plethora of wild claims without backing them up with anything. Rather than dealing thoroughly with factual arguments, Lipstadt's book is full of *ad hominem* attacks on her opponents. It is an exercise in anti-intellectual pseudo-scientific arguments, an exhibition of ideological radicalism that rejects anything which contradicts its preset conclusions. **F for FAIL**

2nd ed., 224 pp. pb, 5"×8", bibl., index, b&w ill.

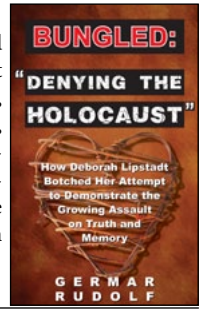

Carolus Magnus, **Bungled: "Denying History"**. How Michael Shermer and Alex Grobman Botched Their Attempt to Refute Those Who Say the Holocaust Never Happened

Skeptic Magazine editor Michael Shermer and Alex Grobman from the Simon Wiesenthal Center wrote a book in 2000 which they claim is "a thorough and thoughtful answer to all the claims of the Holocaust deniers." In 2009, a new "updated" edition appeared with the same ambitious goal. In the meantime, revisionists had published some 10,000 pages of archival and forensic research results. Would their updated edition indeed answer all the revisionist claims? In fact, Shermer and Grobman completely ignored the vast amount of recent scholarly studies and piled up a heap of falsifications, contortions, omissions, and fallacious interpretations of the evidence. Finally, what the authors claim to have demolished is not revisionism but a ridiculous parody of it. They ignored the known unreliability of their cherry-picked selection of evidence, utilizing unverified and incestuous sources, and obscuring the massive body of research and all the evidence that dooms their project to failure. **F for FAIL**

162 pp. pb, 5"×8", bibl., index, b&w ill.



Carolus Magnus, **Bungled: "Debunking Holocaust Denial Theories"**. How James and Lance Morcan Botched Their Attempt to Affirm the Historicity of the Nazi Genocide

The novelists and movie-makers James and Lance Morcan have produced a book "to end [Holocaust] denial once and for all." To do this, "no stone was left unturned" to verify historical assertions by presenting "a wide array of sources" meant "to shut down the debate deniers wish to create. One by one, the various arguments Holocaust deniers use to try to discredit wartime records are carefully scrutinized and then systematically disproven." It's a lie. First, the Morcans completely ignored the vast amount of recent scholarly studies published by revisionists; they didn't even mention them. Instead, they engaged in shadowboxing, creating some imaginary, bogus "revisionist" scarecrow which they then tore to pieces. In addition, their knowledge even of their own side's source material was dismal, and the way they backed up their misleading or false claims was pitifully inadequate. **F for FAIL.**

144 pp. pb, 5"×8", bibl., index, b&w ill.

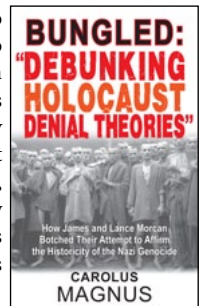

Joachim Hoffmann, **Stalin's War of Extermination 1941-1945**

A German government historian documents Stalin's murderous war against the German army and the German people. Based on the author's lifelong study of German and Russian military records, this book reveals the Red Army's grisly record of atrocities against soldiers and civilians, as ordered by Stalin. Since the 1920s, Stalin planned to invade Western Europe to initiate the "World Revolution." He prepared an attack which was unparalleled in history. The Germans noticed Stalin's aggressive intentions, but they underestimated the strength of the Red Army. What unfolded was the cruelest war in history. This book shows how Stalin and his Bolshevik henchman used unimaginable violence and atrocities to break any resistance in the Red Army and to force their unwilling soldiers to fight against the Germans. The book explains how Soviet propagandists incited their soldiers to unlimited hatred against everything German, and he gives the reader a short but extremely unpleasant glimpse into what happened when these Soviet soldiers finally reached German soil in 1945: A gigantic wave of looting, arson, rape, torture, and mass murder...

428 pp. pb, 6"×9", bibl., index, b&w ill.

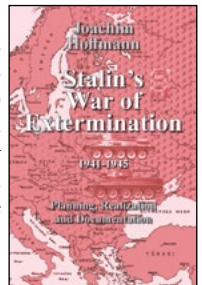

Udo Walendy, *Who Started World War II: Truth for a War-Torn World*

For seven decades, mainstream historians have insisted that Germany was the main, if not the sole culprit for unleashing World War II in Europe. In the present book this myth is refuted. There is available to the public today a great number of documents on the foreign policies of the Great Powers before September 1939 as well as a wealth of literature in the form of memoirs of the persons directly involved in the decisions that led to the outbreak of World War II. Together, they made possible Walendy's present mosaic-like reconstruction of the events before the outbreak of the war in 1939. This book has been published only after an intensive study of sources, taking the greatest care to minimize speculation and inference. The present edition has been translated completely anew from the German original and has been slightly revised.

500 pp. pb, 6"×9", index, bibl., b&w ill.

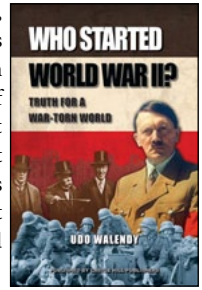

Germar Rudolf: *Resistance Is Obligatory!*

In 2005 Rudolf, a peaceful dissident and publisher of revisionist literature, was kidnapped by the U.S. government and deported to Germany. There the local lackey regime staged a show trial against him for his historical writings. Rudolf was not permitted to defend his historical opinions, as the German penal law prohibits this. Yet he defended himself anyway: For 7 full days Rudolf gave a speech in the courtroom, during which he proved systematically that only the revisionists are scholarly in their approach, whereas the Holocaust orthodoxy is merely pseudo-scientific. He then explained in detail why it is everyone's obligation to resist, without violence, a government which throws peaceful dissidents into dungeons. When Rudolf tried to publish his public defence speech as a book from his prison cell, the public prosecutor initiated a new criminal investigation against him. After his probation time ended in 2011, he dared publish this speech anyway...

2nd ed. 2016, 378 pp. pb, 6"×9", b&w ill.

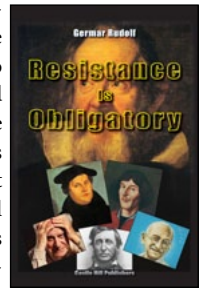

Germar Rudolf, *Hunting Germar Rudolf: Essays on a Modern-Day Witch Hunt*

German-born revisionist activist, author and publisher Germar Rudolf describes which events made him convert from a Holocaust believer to a Holocaust skeptic, quickly rising to a leading personality within the revisionist movement. This in turn unleashed a tsunami of persecution against him: lost his job, denied his PhD exam, destruction of his family, driven into exile, slandered by the mass media, literally hunted, caught, put on a show trial where filing motions to introduce evidence is illegal under the threat of further prosecution, and finally locked up in prison for years for nothing else than his peaceful yet controversial scholarly writings. In several essays, Rudolf takes the reader on a journey through an absurd world of government and societal persecution which most of us could never even fathom actually exists in a "Western democracy"...

304 pp. pb, 6"×9", bibl., index, b&w ill.



Germar Rudolf, *The Day Amazon Murdered History*

Amazon is the world's biggest book retailer. They dominate the U.S. and several foreign markets. Pursuant to the 1998 declaration of Amazon's founder Jeff Bezos to offer "the good, the bad and the ugly," customers once could buy every title that was in print and was legal to sell. However, in early 2017, a series of anonymous bomb threats against Jewish community centers occurred in the U.S., fueling a campaign by Jewish groups to coax Amazon into banning revisionist writings, falsely portraying them as anti-Semitic. On March 6, 2017, Amazon caved in and banned more than 100 books with dissenting viewpoints on the Holocaust. In April 2017, an Israeli Jew was arrested for having placed the fake bomb threats, a paid "service" he had offered for years. But that did not change Amazon's policy. Its stores remain closed for history books Jewish lobby groups disapprove of. This book accompanies the documentary of the same title. Both reveal how revisionist publications had become so powerfully convincing that the powers that be resorted to what looks like a dirty false-flag operation in order to get these books banned from Amazon...

128 pp. pb, 5"×8", bibl., b&w ill.

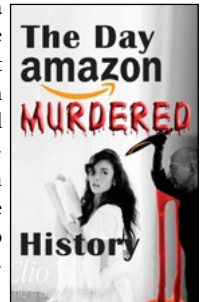

Thomas Dalton, *Hitler on the Jews*

That Adolf Hitler spoke out against the Jews is beyond obvious. But of the thousands of books and articles written on Hitler, virtually none quotes Hitler's exact words on the Jews. The reason for this is clear: Those in positions of influence have incentives to present a simplistic picture of Hitler as a blood-thirsty tyrant. However, Hitler's take on the Jews is far more complex and sophisticated. In this book, for the first time, you can make up your own mind by reading nearly every idea that Hitler put forth about the Jews, in considerable detail and in full context. This is the first book ever to compile his remarks on the Jews. As you will discover, Hitler's analysis of the Jews, though hostile, is erudite, detailed, and – surprise, surprise – largely aligns with events of recent decades. There are many lessons here for the modern-day world to learn.

200 pp. pb, 6"×9", index, bibl.



Thomas Dalton, *Goebbels on the Jews*

From the age of 26 until his death in 1945, Joseph Goebbels kept a near-daily diary. From it, we get a detailed look at the attitudes of one of the highest-ranking men in Nazi Germany. Goebbels shared Hitler's dislike of the Jews, and likewise wanted them totally removed from the Reich territory. Ultimately, Goebbels and others sought to remove the Jews completely from the Eurasian land mass—perhaps to the island of Madagascar. This would be the “final solution” to the Jewish Question. Nowhere in the diary does Goebbels discuss any Hitler order to kill the Jews, nor is there any reference to extermination camps, gas chambers, or any methods of systematic mass-murder. Goebbels acknowledges that Jews did indeed die by the thousands; but the range and scope of killings evidently fall far short of the claimed figure of 6 million. This book contains, for the first time, every significant diary entry relating to the Jews or Jewish policy. Also included are partial or full transcripts of 10 major essays by Goebbels on the Jews.

274 pp. pb, 6"×9", index, bibl.



Thomas Dalton, *The Jewish Hand in the World Wars*

For many centuries, Jews have had a negative reputation in many countries. The reasons given are plentiful, but less-well-known is their involvement in war. When we examine the causal factors for wars, and look at their primary beneficiaries, we repeatedly find a Jewish presence. Throughout history, Jews have played an exceptionally active role in promoting and inciting wars. With their long-notorious influence in government, we find recurrent instances of Jews promoting hard-line stances, being uncompromising, and actively inciting people to hatred. Jewish misanthropy, rooted in Old Testament mandates, and combined with a ruthless materialism, has led them, time and again, to instigate warfare if it served their larger interests. This fact explains much about the present-day world. In this book, Thomas Dalton examines in detail the Jewish hand in the two world wars. Along the way, he dissects Jewish motives and Jewish strategies for maximizing gain amidst warfare, reaching back centuries.

197 pp. pb, 6"×9", index, bibl.



Thomas Dalton, *Eternal Strangers: Critical Views of Jews and Judaism through the Ages*

It is common knowledge that Jews have been disliked for centuries. But why? Our best hope for understanding this recurrent ‘anti-Semitism’ is to study the history: to look at the actual words written by prominent critics of the Jews, in context, and with an eye to any common patterns that might emerge. Such a study reveals strikingly consistent observations: Jews are seen in very negative, yet always similar terms. The persistence of such comments is remarkable and strongly suggests that the cause for such animosity resides in the Jews themselves—in their attitudes, their values, their ethnic traits and their beliefs.. This book addresses the modern-day “Jewish problem” in all its depth—something which is arguably at the root of many of the world's social, political and economic problems.

186 pp. pb, 6"×9", index, bibl.

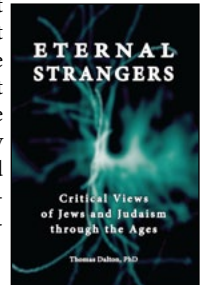

Thomas Dalton, *Streicher, Rosenberg, and the Jews: The Nuremberg Transcripts*

Who, apart from Hitler, contrived the Nazi view on the Jews? And what were these master ideologues thinking? During the post-war International Military Tribunal at Nuremberg, the most-interesting men on trial

For prices and availability see www.shop.codoh.com or write to: CHP, PO Box 243, Uckfield, TN22 9AW, UK

regarding this question were two with a special connection to the “Jewish Question”: Alfred Rosenberg and Julius Streicher. The cases against them, and their personal testimonies, examined for the first time nearly all major aspects of the Holocaust story: the “extermination” thesis, the gas chambers, the gas vans, the shootings in the East, and the “6 million.” The truth of the Holocaust has been badly distorted for decades by the powers that be. Here we have the rare opportunity to hear firsthand from two prominent figures in Nazi Germany. Their voices, and their verbatim transcripts from the IMT, lend some much-needed clarity to the situation.

330 pp. pb, 6”x9”, index, bibl.

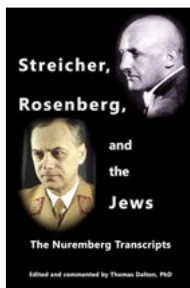

The Queen versus Zündel: *The First Zündel Trial: The Transcript*

In the early 1980s, Ernst Zündel, a German immigrant living in Toronto, was indicted for allegedly spreading “false news” by selling copies of Richard Harwood’s brochure *Did Six Million Really Die?*, which challenged the accuracy of the orthodox Holocaust narrative. When the case went to court in 1985, so-called Holocaust experts and “eyewitnesses” of the alleged homicidal gas chambers at Auschwitz were cross-examined for the first time in history by a competent and skeptical legal team. The results were absolutely devastating for the Holocaust orthodoxy. Even the prosecutor, who had summoned these witnesses to bolster the mainstream Holocaust narrative, became at times annoyed by their incompetence and mendacity. For decades, these mind-boggling trial transcripts were hidden from public view. Now, for the first time, they have been published in print in this new book – unabridged and unedited.

820 pp. pb, 8.5”x11”

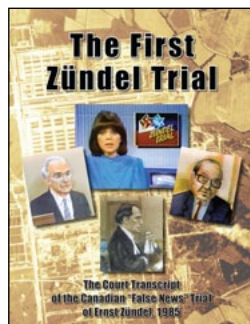

Barbara Kulaszka (ed.), *The Second Zündel Trial: Excerpts from the Transcript*

In 1988, German-Canadian Ernst Zündel was on trial for a second time for allegedly spreading “false news” about the Holocaust. Zündel staged a magnificent defense in an attempt to prove that revisionist concepts of “the Holocaust” are essentially correct. Although many of the key players have since passed away, including Zündel, this historic trial keeps having an impact. It inspired major research efforts as expounded in the series *Holocaust Handbooks*. In contrast to the First Zündel Trial of 1985, the second trial had a much greater impact internationally, mainly due to the *Leuchter Report*, the first independent forensic research performed on Auschwitz, which was endorsed on the witness stand by British bestselling historian David Irving. The present book features the essential contents of this landmark trial with all the gripping, at-times-dramatic details. When Amazon.com decided to ban this 1992 book on a landmark trial about the “Holocaust”, we decided to put it back in print, lest censorship prevail...

498 pp. pb, 8.5”x11”, bibl., index, b&w ill.

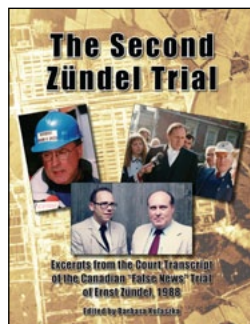

Gerard Menuhin: *Lies & Gravy: Landmarks in Human Decay – Two Plays*

A long time ago, in a galaxy far, far away, the hallucination of global supremacy was born. Few paid it any attention. After centuries of interference, when the end is in sight, we’re more inclined to take it seriously. But now, we have only a few years of comparative freedom left before serfdom submerges us all. So it’s time to summarize our fall and to name the guilty, or, as some have it, to spot the loony. Sometimes the message is so dire that the only way to get it across is with humor – to act out our predicament and its causes. No amount of expert testimony can match the power of spectacle. Here are a few of the most-telling stages in the chosenites’ crusade against humanity, and their consequences, as imagined by the author. We wonder whether these two consecutive plays will ever be performed onstage...

112 pp. pb, 5”x8”

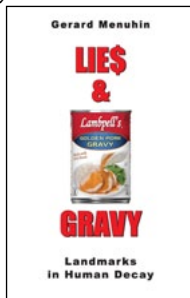

For current prices and availability see book-finder sites such as www.findbookprices.com; learn more at <https://shop.codoh.com> by simply scanning the QR code to the left with your smart device.

Published by Castle Hill Publishers, PO Box 243, Uckfield, TN22 9AW, UK

CARLO MATTOGNO & FRANCO DEANA

The
**CREMATION
FURNACES
of
AUSCHWITZ**

A TECHNICAL AND HISTORICAL STUDY

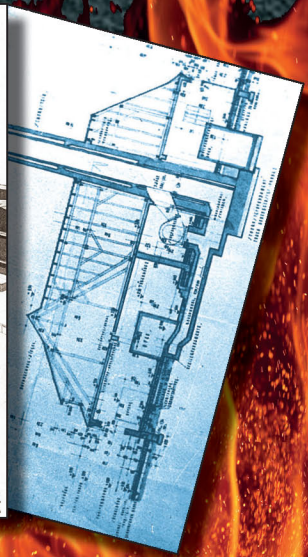
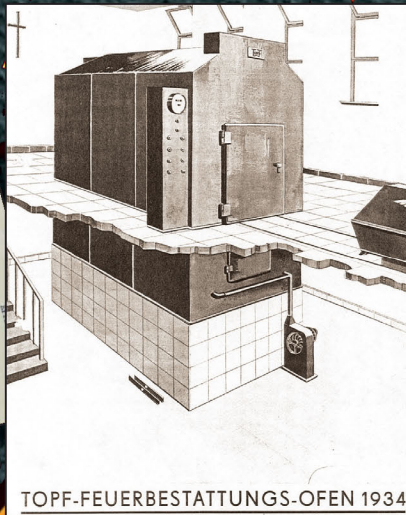
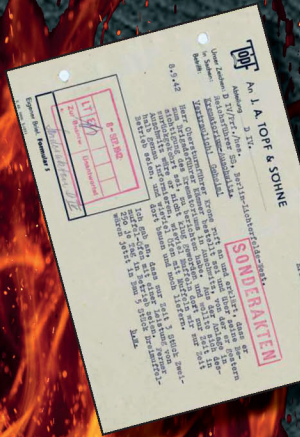

PART 2: DOCUMENTS

PUBLISHED BY CASTLE HILL PUBLISHERS

THE CREMATION FURNACES OF AUSCHWITZ, PART 2

The Cremation Furnaces of Auschwitz

A Technical and Historical Study

Part 2: Documents

By Carlo Mattogno

With Contributions by Dr.-Ing. Franco Deana



Castle Hill Publishers
P.O. Box 243, Uckfield, TN22 9AW, UK
October 2021

HOLOCAUST HANDBOOKS, Volume 24:

Carlo Mattogno:

The Cremation Furnaces of Auschwitz: A Technical and Historical Study.

Part 2: Documents

With Contributions by Dr.-Ing. Franco Deana

Uckfield, East Sussex: CASTLE HILL PUBLISHERS

PO Box 243, Uckfield, TN22 9AW, UK

2nd, revised edition, October 2021

Originally published in Italian in 2011 as *I forni crematori di Auschwitz: Studio storico-tecnico*, by Effepi, Genoa. Translated from the Italian by Henry Gardner and Germar Rudolf

ISSN: 1529-7748

Part 1: History and Technology

ISBN: 978-1-59148-936-8 (hardcover)

ISBN: 978-1-59148-275-8 (paperback)

Part 2: Documents

ISBN: 978-1-59148-935-1 (hardcover)

ISBN: 978-1-59148-276-5 (paperback)

Part 3: Photographs

ISBN: 978-1-59148-934-4 (hardcover)

ISBN: 978-1-59148-277-2 (paperback)

Published by CASTLE HILL PUBLISHERS

Manufactured worldwide

© by Carlo Mattogno 2011, 2015, 2021

Distribution worldwide by:

Castle Hill Publishers, PO Box 243

Uckfield, TN22 9AW, UK

<https://shop.codoh.com>

Set in Times New Roman

www.HolocaustHandbooks.com

Cover Illustrations: left: file memo by Engineer Kurt Prüfer of the Topf Company regarding the capacity of the Auschwitz cremation furnaces (Document 249); center: promotional brochure by the Topf Company for its electric and gas-fired cremation furnace (Document 140); right: blueprint (cross section) for a new crematorium at the Auschwitz camp (the later Crematorium II at Birkenau; Document 224).

Contents

Part 1: History and Technology (separate book)

Preface to the First Edition

Preface to the Second Edition

Unit I: Modern Cremation

1. The Cremation
 - 1.1. General Principles of Combustion Technology
 - 1.2. The Chemical Processes during Cremations
 - 1.3. The Cremation Process
2. Cremation Technology of Coke-Fired Furnaces
 - 2.1. Structure and Operation
 - 2.2. General Theoretical and Structural Principles
3. Origin and Development of Modern Cremation Furnaces
4. Cremation Experiments in Germany in the 1920s
5. Technical Developments of Cremation Furnaces in Germany in the 1930s
 - 5.1. Furnaces with Coke-Fed Gasifiers
 - 5.2. Furnaces Heated with City Gas
 - 5.3. Electrically Heated Furnaces
6. The Duration of the Cremation Process
 - 6.1. Cremation Furnace with a Coke-Fed Gasifier
 - 6.2. Cremation Furnace with Briquette-Fed Gasifier
 - 6.3. Cremation Furnace Heated with Gas
 - 6.4. Cremation Furnace Fired Electrically
7. Heat Balance of a Coke-Fed Cremation Furnace
8. Legal, Ethical and Professional Standards for Cremations in Germany
9. Cremation Statistics
 - 9.1. Statistics for Germany (1878-1939)
 - 9.2. Statistics of Other Countries
10. Mass Cremation for Hygienic and Sanitary Purposes
11. Notes on Present-Day Cremation Furnaces

Unit II: J.A. Topf & Söhne

1. Historical Notes on the Topf & Söhne Company
2. The Topf Cremation Furnaces for Civilian Use
 - 2.1. The Cremation Furnace with a Coke-Fed Gasifier
 - 2.2. The Gas-Fired Cremation Furnace
 - 2.3. The Cremation Furnace with Electrical Heating
3. The Topf Patents of the 1920s and 1930s
4. Topf Waste Incinerators
5. Topf Cremation Furnaces for Concentration Camps
 - 5.1. The Coke-Fired Cremation Furnace with One Muffle
 - 5.2. The Oil-Fired Mobile Cremation Furnace with Two Muffles
 - 5.3. The Coke- or Oil-Fired Cremation Furnace with Two Muffles

- 5.4. The Coke-Fired Cremation Furnace with Two Muffles Placed Opposite Each Other
6. The Topf Co. and the Construction of the Cremation Furnaces at Auschwitz-Birkenau
 - 6.1. The Furnaces of Crematorium I at Auschwitz
 - 6.2. The Furnaces of Crematoria II and III at Birkenau
 - 6.3. The Furnaces of Crematoria IV and V at Birkenau
7. Structure and Operation of the Topf Cremation Furnaces at Auschwitz-Birkenau
 - 7.1. The Coke-Fired Double-Muffle Furnace Auschwitz Type
 - 7.2. The Coke-Fired Triple-Muffle Furnace
 - 7.3. The Coke-Fired 8-Muffle Furnace
 - 7.4. The Plans for Mass Cremations at Auschwitz-Birkenau
8. The Duration of the Cremation Process in the Topf Furnaces at Auschwitz-Birkenau
 - 8.1. The Documents
 - 8.2. Richard Kessler's Cremation Experiments
 - 8.3. The List of Cremations in the Gusen Crematorium
 - 8.4. The List of Cremations at the Westerbork Crematorium
 - 8.5. Conclusions
9. The Cremation Capacity of the Cremation Furnaces at Auschwitz-Birkenau
 - 9.1. Continuous Operation of the Furnaces
 - 9.2. Concurrent Cremation of Several Corpses
 - 9.3. Soviet and Polish Technical Investigations
 - 9.4. Maximum Theoretical Cremation Capacity
 - 9.5. Normal Cremation Capacity
 - 9.6. Discussion of the *Zentralbauleitung* Letter of 28 June 1943
 - 9.7. The Durability of Refractory Lining
 - 9.8. The Effective Equivalent Operating Time of the Birkenau Cremation Furnaces
 - 9.9. The Auschwitz-Birkenau Crematoria in the General Operation of the Camp
10. Heat Balance of the Topf Furnaces at Auschwitz-Birkenau
 - 10.1. Remarks on the Method Used
 - 10.2. Technical Data
 - 10.3. Heat Balance of the Double-Muffle Furnace at Gusen
 - 10.4. Heat Balance of the Double-Muffle Furnace at Auschwitz
 - 10.5. Remarks on the Heat Balance
 - 10.6. Heat Balance of the Topf Triple-Muffle Furnace
 - 10.7. Heat Balance of the Topf 8-Muffle Furnace
 - 10.8. Observations on the Coke Consumption of the Triple- and 8-Muffle Furnaces
 - 10.9. A Comparison with the Kori Furnace at the Westerbork Camp and the Kori Slaughterhouse Furnaces
 - 10.10. Some Thermal Aspects of the Triple-Muffle Furnace
 - 10.11. On Claims of Flaming Chimneys
11. The Cremation Furnaces Built by Other German Companies: Kori, Ignis-Hüttenbau and Didier
 - 11.1. Historical Remarks Concerning the H. Kori Co. of Berlin
 - 11.2. The Coke-Fired Kori Cremation Furnaces for the Concentration Camps

- 11.3. The Oil-Fired Kori Cremation Furnaces for the Concentration Camps
- 11.4. The Oil-Fired Cremation Furnaces Built by Ignis-Hüttenbau A.G. at the Terezín Crematorium
- 11.5. The Didier Cremation Furnaces for Concentration Camps
- 11.6. Comparison of the Designs by Kori, Ignis-Hüttenbau, Didier and Topf
- 12. The Topf Furnaces and Regulations on Cremations in Greater Germany at the Outset of World War II

Appendices

- 1. Tables
 - 1.1. List of Cremations at the Westerbork Crematorium
 - 1.2. List of Cremations at the Terezín Crematorium
 - 1.3. Summary of the Topf Company's Activities at Auschwitz-Birkenau
 - 1.4. Patents (and Patent Applications) by J.A. Topf & Söhne
 - 1.5. Patent Applications by Department "DE" of J.A. Topf & Söhne
- 2. Glossary
- 3. Symbols
- 4. Abbreviations of Archive Names
- 5. Bibliography
 - 5.1. Alphabetical Listing
 - 5.2. Subject Listing
- 6. Indices
 - 6.1. Names
 - 6.2. Concentration Camps
 - 6.3. Crematorium Locations (Civilian)

Part 2: Documents (this book)

	page
List of Documents	9
I. Civilian Cremation Furnaces	31
II. TOPF, Civilian Activities	150
III. TOPF, Correspondence with the SS	263

Part 3: Photographs (separate book)

- I. Photographs 1-35: Gusen
- II. Photographs 36-50: Dachau
- III. Photographs 51-85: Mauthausen
- IV. Photographs 86-110: Auschwitz Main Camp
- V. Photographs 111-215: Buchenwald
- VI. Photographs 216-235: Auschwitz-Birkenau
- VII. Photographs 236-332: Kori Cremation Furnaces
- VIII. Photographs 335-344: Kori Furnaces in Other Camps
- IX. Photographs 345-362: Terezín
- X. Photographs 363-365: Urns

- XI. Photographs 366-367: Stoking Tools
- XII. Photographs 368-370: Cremation Experiments
- XIII. Color Documents from Part 2

List of Documents

	page
List of Documents	9
I. Civilian Cremation Furnaces	31
Document 1: W. RUPPMANN coke-fired cremation furnace at Biel (1911).	31
Document 2: W. RUPPMANN coke-fired cremation furnace at Biel (1911). Fig. 3: vertical section V-V; Fig. 4: section along the post-combustion chamber. Source: as Doc. 1, p. 22.	32
Document 3: Standard dimensions of the cremation chamber and the coffin. Source: W. Heepke, <i>Die Leichenverbrennungs-Anstalten (Die Krematorien)</i> . Verlag von Carl Marhold. Halle a.S., 1905, p. 59.....	33
Document 4: A 1799 project for a French crematorium. Source: B. Reber, <i>Un crématoire du temps de la Révolution française</i> , in: <i>Société de crémation de Genève. Bulletin VIII</i> . Geneva, Imprimerie Centrale, 1908, p. 29.....	34
Document 5: A 1799 project for a French crematorium. Source: as Doc. 4.....	34
Document 6: POLLI gas-fired cremation furnace. Source: Wegmann-Ercolani, <i>Ueber Leichenverbrennung als rationellste Bestattungsart</i> . Cäsar Schmidt, Zurich, 1874, illustration outside of text.	35
Document 7: Fig. 4: POLLI-CLERICETTI gas-fired cremation furnace in a fancy urn shape. Source: M. De Cristoforis, <i>Etude pratique sur la crémation</i> . Imprimerie Treves Frères, Milan, 1890, p. 68.....	35
Document 8: Figs. 8 & 9: CADET cremation furnace. Source: as Doc. 7, p. 77.	36
Document 9: Fig. 10: MULLER-FICHET coke-fired cremation furnace. Source: as Doc. 7, p. 79.....	36
Document 10a & b: Figs. 11 & 12: LAGENARDIERE cremation furnace. Source: as Doc. 7, p. 80.....	37
Document 11a through c: GORINI direct-combustion cremation furnace. Fig. 13: vertical section; Fig. 14: horizontal section; Fig. 15: chimney damper. Source: as Doc. 7, pp. 83f.....	37
Document 12: GORINI direct-combustion cremation furnace, inaugurated on 15 December 1887 at the crematorium of the Père-Lachaise Cemetery in Paris. Source: “La crémation des morts et l’édifice crématoire du Père-Lachaise”, in: <i>La Science Illustrée</i> , vol. I, année 1888, premier semestre, p. 13.	38
Document 13: VENINI coke-fired cremation furnace. Source: G. Pini, <i>La crémation en Italie et à l’étranger de 1774 jusqu’à nos jours</i> . Ulrich Hoepli Editeur Libraire, Milan, 1885, illustration outside of text.	38
Document 14: REY direct-combustion cremation furnace. Source: as Doc. 7, p. 100.....	39
Document 15, 15a (below): KUBORN-JACQUES mobile cremation furnace. Source: as Doc. 13, p. 140.....	39

	page
Document 16: GUZZI coke-fired cremation furnace. Source: as Doc. 7, p. 104.....	40
Document 17: SPASCIANI-MESSMER coke-fired cremation furnace. Longitudinal section. Source: as Doc. 7, p. 106.....	40
Document 18: TOISUL-FRADET coke-fired cremation furnace. Fig. 89: vertical section; Fig. 90: longitudinal Section a-b; Fig. 91: horizontal section. Source: as Doc. 17b, p. 101.....	43
Document 19: TOISUL-FRADET coke-fired cremation furnace. Source: Préfecture du Département de la Seine. Direction des Affaires Municipales. Note sur la crémation à Paris au 1 ^{er} novembre 1893, drawing outside text.	44
Document 20: SIEMENS experimental coke-fired cremation furnace. Source: F. Küchenmeister, <i>Die Feuerbestattung</i> . Verlag von Ferdinand Enke, Stuttgart, 1875, illustration outside text.	44
Document 21: SIEMENS coke-fired cremation furnace at the Gotha Crematorium (1878). Source: as Doc. 17b, p. 104.	45
Document 22: SIEMENS coke-fired cremation furnace at the Gotha Crematorium (1878). Source: William Eassie, <i>Cremation of the Dead</i> . London, 1875, drawing outside text.	46
Document 23: Vertical section of the Gotha Crematorium showing the funeral hall and the cremation furnace. Source: William Eassie, <i>Cremation of the Dead</i> . London, 1875, drawing outside text.	47
Document 24: KLINGENSTIERNA coke-fired cremation furnace, original model. Source: as Doc. 7, p. 114.....	48
Document 25: GEBRÜDER BECK-DOROVIVUS coke-fired cremation furnace. Source: K. Weigt, <i>Almanach der Feuerbestattung</i> . self-published, Hannover, 1909, p. 46.	49
Document 26: KLINGENSTIERNA-BECK coke-fired cremation furnace. Fig. 95: longitudinal section; Fig. 96: vertical section; Fig. 97: horizontal section at the height of the hearth; Fig. 98: horizontal section at the height of the cremation chamber. Source: as Doc. 17b, p. 108.	50
Document 27: R. SCHNEIDER coke-fired cremation furnace. Source: F. Schumacher, <i>Die Feuerbestattung</i> . J. M. Gebhardt's Verlag, Leipzig, 1939, p. 23.	51
Document 28: W. RUPPMANN coke-fired cremation furnace. Fig. 100: longitudinal section; Fig. 101: horizontal section at the height of the cremation chamber. Source: as Doc. 17b, p. 114.....	52
Document 29: KNÖS coke-fired cremation furnace. Longitudinal section. Source: as Doc. 17b, p. 118.....	54
Document 30: FICHET cremation furnace, inaugurated on 19 January 1891 at the crematorium of the Père-Lachaise Cemetery in Paris. Source: as Doc. 19, drawing outside text.	56
Document 31: TOISUL-FRADET gas-fired cremation furnace. Fig. 107: horizontal section at the height of the cremation chamber; Fig. 108: longitudinal section. Source: as Doc. 17b, p. 123.	57
Document 32: ROTHENBACH & CO. naphtha-fired cremation furnace (Swiss	

	page
Patent No. 86533). Fig. 1: longitudinal section; Fig. 2: vertical section. Source: Georgius, "Neuere Leichenverbrennungstechnik," in: <i>Gesundheits-Ingenieur</i> , 46. Jg., 1923, Heft 5, p. 56.	58
Document 33: PROMETHEUS experimental electric cremation furnace. Source: Phoenix. <i>Blätter für wahlfreie Feuerbestattung und verwandte Gebiete</i> , Vienna, 1910, Nr. 10, p. 399.	59
Document 34: CONLEY electric cremation furnace (U.S. patent no. 988862, 1911). Source: as Doc. 32, p. 57.....	60
Document 35: "Cremation furnace with a regenerator and a gas generator connected at the front to the combustion chamber." W. SAUERLAND Patent No. 284163, of 12 March 1915. Fig. 1: longitudinal section; Fig. 2: vertical section; Fig. 3: horizontal section.....	61
Document 36: "Cremation furnace for corpses with regenerator and gas generator" (Leicheneinäscherungsöfen mit Regeneratoren und einem Gaserzeuger). Patent F. SIEMENS, no. 258066, of 18 August 1911. Fig. 1: longitudinal section; Fig. 2: vertical section along the cremation chamber; Fig. 3: vertical section along the hearth.	62
Document 37: "Cremation furnace for corpses with regenerator recuperator" (Leichenverbrennungsöfen mit Rekuperator). Patent M.J. KERDEL, no. 218581, of 4 October 1908. Fig. 1: longitudinal section; Fig. 2: horizontal Section A-A along the cremation chamber.....	63
Document 38: "Procedure and device for the cremation of corpses with combustion gases and heated air with a heat source" (Verfahren und Vorrichtung zur Einäscherung von Leichen mit Verbrennungsgasen und erhitzter Luft mit einer Wärmequelle). Patent of BUNZLAUER WERKE LENGERSDORFF & COMP., No. 263725, of 6 September 1913. Fig. 1: vertical section.....	65
Document 39: "Naphtha-fired Cremation Furnace for Corpses" (Leichenverbrennungsöfen mit Ölfeuerung). Patent GEBRÜDER KÖRTING AKTIENGESELLSCHAFT in Linden, No. 257576, of 30 June 1911.	68
Document 40: "Naphtha- or gas-fired cremation furnace for corpses with an ash receptacle beneath the slanted cremation chamber" (Leichenverbrennungsöfen mit Öl- oder Gasfeuerung mit einem unter dem schräg abfallenden Verbrennungsraum liegenden Aschenaufnahmebehälter). Patent W. BUSS, no. 279830, of 22 August 1913. Fig. 1: longitudinal section.....	69
Document 41: "Electric cremation furnace for corpses" (Elektrischer Leichenverbrennungsöfen). Patent L.H.GIDDINGS, No. 244887, of 11 April 1911.	71
Document 42: GEBRÜDER BECK coke- or gas-fired cremation furnace at the Dessau Crematorium: thermotechnical improvement to closures by engineer R. Kessler (1926). Source: R. Kessler, "Rationelle Wärmewirtschaft in den Krematorien nach Massgabe der Versuche im Dessauer Krematorium," in: <i>Die Wärmewirtschaft</i> , 1927, no. 8, p. 136; original air flap; Fig. 2: improved air flap; Fig. 3: original introduction damper; Fig. 4: improved damper; Fig. 5 (see Doc. 43, top left):	

	page
original damper of the smoke conduit; Fig. 6 (Doc. 43, top right): improved damper.	72
Document 43: as above. Operational furnace instruments. Fig. 7: control levers of the shutters and doors; Fig. 10: thermotechnical devices for controlling the combustion. Source: as Doc. 42, p. 137.....	73
Document 44: as above. Fig. 8: rear parts of the gas burners; Fig. 9: Gauges for CO and CO ₂ , and for draft and gas pressure. Source: as Doc. 42, p. 138.	74
Document 45: as above. Fig. 11: control lever; Fig. 12: Instruments' Position; Fig. 13: electric switch board of the air compressor. Source: as Doc. 42, p. 139.	75
Document 46: as above. Location and arrangement of sensors and gas nozzles. Source: as Doc. 42, no. 9, p. 149.....	76
Document 47: as above. Cremation experiment with coke, conducted on 5 January 1927 by Engineer R. Kessler. Chart of furnace condition. Source: as Doc. 42, no. 9, p. 154.....	78
Document 48: as Doc. 47. Temperature chart. Source: as Doc. 42, no. 9, p. 155.	80
Document 49: as above. Cremation experiment with briquet, conducted on 12 January 1927 by engineer R. Kessler. Chart of furnace condition. Source: as Doc. 42, no. 9, p. 156.....	81
Document 50: as Doc. 49. Temperature chart. Source: as Doc. 42, no. 9, p. 157.	82
Document 51: as above. Cremation experiment with gas, conducted on 1 November 1926 by engineer R. Kessler. Chart of furnace condition. Source: as Doc. 42, no. 9, p. 150.....	83
Document 52: as Doc. 51. Temperature chart. Source: as Doc. 42, no. 9, p. 151.	84
Document 53: Cremation furnace of the crematorium at Biel as used by engineer H. Keller for his cremation experiments in 1927. Fig. 1: longi- tudinal Section A-B; Fig. 2: vertical Section C-D; Fig. 3: horizontal Section E-F; Fig. 4: horizontal Section G-H. Source: H. Keller, "Versu- che an einem Feuerbestattungsofen," special reprint from the journal Archiv für Wärmewirtschaft und Dampfkesselwesen, 1929, no. 6, p. 1.....	85
Document 54: Chart of cremation experiments conducted by Engineer H. Keller in the electric BROWN, BOVERI & CO. furnace at the Biel Crema- torium on 2 October 1940. Hourly exhaust-gas volume expelled by the exhaust fan during the cremation; first data set. Source: H. Keller, "Ursache der Rauchbildung bei der Kremation," in: Bieler Feuerbe- stattungs-Genossenschaft in Biel, Jahresbericht pro 1944. Biel, 1945, illustration outside text.....	86
Document 55: as Doc. 54, second data set.....	87
Document 56: as above, experiments of 25 January 1943. Hourly exhaust-gas volume expelled by the exhaust fan during the cremation. Source: as Doc. 54.....	88

	page
Document 57: as above, experiments of 2 and 6 January 1943. Exhaust-gas analysis during the cremation. Source: as Doc. 54.	89
Document 58: as above, experiments of January 1943. Temperature chart. Source: as Doc. 54.	90
Document 59: perfected BECK coke-fired cremation furnace (early 1930s). Fig. 1: longitudinal section; Fig. 2: vertical section; Fig. 3: horizontal section at the height of the cremation-chamber grate. Source: W. Heepke, "Die neuzeitlichen Leicheneinäscherungsöfen mit Koksfeuerung, deren Wärmebilanz und Brennstoffverbrauch," in: <i>Feuerungstechnik</i> , XXI. Jg., 15 August 1933, no. 9, p. 124.	91
Document 60: perfected DIDIER coke-fired cremation furnace (early 1930s). Fig. 1: longitudinal section; Fig. 2: vertical section; Fig. 3: horizontal section at the height of the cremation-chamber grate. Source: as Doc. 59, p. 125.	92
Document 61: "Procedure and device for cremation" (<i>Verfahren und Vorrichtung zur Einäscherung</i>). Patent H. VOLCKMANN and L. LUDWIG, no. 506627, of 30 October 1928. Fig. 1: longitudinal section along the cremation chamber; Fig. 2: horizontal section along the cremation chamber.	93
Document 62: VOLCKMANN-LUDWIG gas-fired cremation furnaces at the Hamburg crematorium (prototype). Source: R. Kessler, "Der neue Einäscherungsöfen System Volckmann-Ludwig," in: <i>Zentralblatt für Feuerbestattung</i> , 1931, no. 3, p. 34.	94
Document 63: VOLCKMANN-LUDWIG gas-fired cremation furnaces: design of combustion-air intake. Source: Stort, "Der menschliche Körper als Heizstoff," in: <i>Die Umschau in Wissenschaft und Technik</i> , 1931, no. 26, p. 513.	94
Document 64: as above (standard model). Fig. 1: longitudinal section; Fig. 2: vertical section. Source: as Doc. 27, p. 24.	95
Document 65: as above. Longitudinal section. Source: H. Manskopf, "Gas als Brennstoff für Einäscherungsöfen," in: <i>Das Gas- und Wasserfach</i> , 1933, no. 42, p. 773.	95
Document 66: as above, device at the Stuttgart Crematorium (1931). Fig. 1: longitudinal Section g-h; Fig. 2: vertical Section c-d; Fig. 3: horizontal Section a-b; Fig. 4: vertical Section e-f. Source: H. Wolfer, "Der neue 'Volckmann-Ludwig'-Einäscherungsöfen im Stuttgarter Krematorium," in: <i>Gesundheits-Ingenieur</i> , 1932, no. 13, p. 151.	96
Document 67: "Corpse-Cremation Furnace" (<i>Leichenverbrennungsöfen</i>). Patent W. RUPPMANN, No. 669645, of 23 June 1936. Fig. 1: vertical section (cremation chamber and combustion-air intake system); Fig. 2: longitudinal section (cremation chamber and construction system of the grate).....	97
Document 68: E. EMCH & Co. gas-fired cremation furnace at the Zürich Crematorium (1932). Vertical and longitudinal sections (cremation chamber and recuperator). Source: R. Henzi, "Die Zürcher Einäsche-	

	page
rungsöfen mit Gasfeuerung,” in: Schweiz. Verein von Gas- und Wasserfachmännern, Zürich, March 1934, no. 3, p. 64.	98
Document 69: E. EMCH & CO. gas-fired cremation furnace at the Zürich Crematorium (1935). Vertical and longitudinal sections (cremation chamber and recuperator). Source: P. Schläpfer, “Betrachtungen über den Betrieb von Einäscherungsöfen,” in: Schweiz. Verein von Gas- und Wasserfachmännern, Zürich, July 1938, no. 7, p. 150.	99
Document 70 & 71: Fig. 9: Chart of 5 cremations conducted on 30 November 1932 in Furnace II at the Zürich Crematorium. “Variation of CO ₂ content, muffle temperature and combustion-gas temperature in the flue of Furnace II during 5 cremations.” Fig. 10: Chart of 8 cremations conducted on 27 February 1936 in Furnace III at the Zürich Crematorium. “Variation of CO ₂ content, muffle temperature and combustion-gas temperature in the flue of Furnace III during 8 cremations.” Source: as Doc. 69, p. 156.	100
Document 72: Fig. 11: “Flue-gas losses in kcal/minute and in % of the amount of heat concurrently added by combustion as a function of the CO ₂ contents of the combustion gas”. Source: as Doc. 69, p. 156.	101
Document 73: Thermal balance of Furnaces II and III at the Zürich Crematorium. “Variation of the caloric needs per cremation as a function of the number of cremations per day”. Source: as Doc. 69, p. 157.	102
Document 74: E. EMCH & CO. electric cremation furnace (1930). Vertical section. Source: F. Hellwig, “Vom Bau und Betrieb der Krematorien,” in: Gesundheits-Ingenieur, 1931, no. 25, p. 397.	103
Document 75: Fig. A: vertical section of the old W. RUPPMANN coke-fired cremation furnace at Biel; Fig. B: vertical section of the BROWN, BOVERI & CO experimental electric cremation furnace. Source: H. Keller, “Der elektrische Einäscherungsöfen im Krematorium Biel,” in: Bieler Feuerbestattungs-Genossenschaft in Biel, Jahresbericht pro 1933. Biel, 1934, p. 5.	104
Document 76: A (bottom): horizontal section of the old W. RUPPMANN coke-fired cremation furnace at Biel; B (top): horizontal section of the BROWN, BOVERI & CO experimental electric cremation furnace. Source: as Doc. 75.	105
Document 77: BROWN, BOVERI & CO electric cremation furnace (standard model). “Schematic representation of an electric cremation furnace with related recuperator, fresh air and flue gas fan.” G. Keller, “Die Elektrizität im Dienste der Feuerbestattung,” Aktiengesellschaft Brown, Boveri & Cie, Baden (Switzerland); special reprint of Brown Boveri Mitteilungen, no. 6/7, 1942, p. 3.	106
Document 78: Temperature chart of 3 cremations in a coke-fired cremation furnace. Source: as Doc. 59, no. 8, p. 110.	107
Documents 79 & 80: Top: temperature chart of 5 cremations conducted on 26 October 1933 in Furnace III (E. EMCH & CO.) at the Zürich Crematorium. Bottom: temperature chart of 7 cremations conducted on 27 October 1933. Source: as Doc. 68, p. 66.	108

	page
Documents 81 & 82: Fig. 6: Temperature chart of 5 cremations conducted on 23 October 1931 in the VOLCKMANN-LUDWIG gas-fired cremation furnace at the Stuttgart Crematorium. Fig. 7: Temperature chart of 5 cremations conducted on 30 October 1931 in the same furnace. Source: as Doc. 66, no. 14, p. 163.	109
Document 83: Temperature chart of a cremation conducted on 24 April 1934 in the BROWN, BOVERI & CO. electric cremation furnace at the Biel Crematorium. Source: as Doc. 75, p. 13.	110
Document 84: Temperature chart of 2 cremations conducted on 19 April 1934 in the same furnace as above. Source: <i>ibid.</i> , p. 14.	111
Document 85: Fig. 2 (left): Temperature chart of a metallic-coil recuperator; Fig. 3 (right): Temperature chart of 4 cremations conducted in 1942 in the BROWN, BOVERI & CO. electric cremation furnace at the St. Gallen Crematorium. Source: as Doc. 77, p. 4.	111
Document 86-1a: List of cremations at the Bielefeld Crematorium (5-23 December 1941). Source: Sennefriedhof Bielefeld.	112
Document 87: Duration of a cremation as a function of the temperature in a modern gas-fired cremation furnace. Source: E.W. Jones, "Factors which affect the process of cremation." Extract from the Cremation Society of Great Britain's Annual Cremation Conference Report, 1975, p. 88.	118
Document 88: Fig. 6: Behavior of wall temperature in a badly insulated muffle at various points of heating it up. Source: as Doc. 69, p. 154.	119
Document 89: Fig. 7: Behavior of wall temperature in a well-insulated muffle at various points of heating it up. Source: as Doc. 69, p. 155.	120
Document 90: Coke consumption per cremation for several consecutive cremations. Source: P. Schläpfer, "Ueber den Bau und den Betrieb von Kremationsöfen." Special reprint from the Jahresbericht des Verbandes Schweizer. Feuerbestattungsvereine, Zürich, 1937, p. 36.	121
Document 91: Article by engineer Wilhelm Heepke, "Die neuzeitlichen Leicheneinäscherungsöfen mit Koksfeuerung, deren Wärmebilanz und Brennstoffverbrauch", in: Feuerungstechnik, XXI. Jg., 15 August 1933, no. 8, pp. 123-128.	122
Document 92a: "Ordinance for the Implementation of the Cremation Act" of 10 August 1938. Source: Reichsgesetzblatt, Jahrgang 1938, Teil I, pp. 1000f.	128
Document 93: Field cremation furnace, system FRIEDRICH SIEMENS. Source: as Doc. 20, illustration outside text.	130
Document 94: FEIST apparatus for mass cremations. Source: as Doc. 7, p. 126.	131
Document 95: ADOLF MARSCH shaft cremation furnace for mass cremations; vertical section. Source: "Masseneinäscherung von Kriegerleichen im Felde als Schutz gegen Seuchengefahr und später fühlbar werdende Verkehrshindernisse." Phoenix. Blätter für wahlfreie Feuerbestattung und verwandte Gebiete, Vienna, XXX. Jg., 1917, Nr. 2, columns 39f.	131

	page
Document 96: “Shaft furnace for the simultaneous cremation of a larger number of human corpses or animal carcasses” (Schachtofen zur gleichzeitigen Einäscherung einer grösseren Anzahl von Menschenleichen oder Tierkadavern). Patent ADOLF MARSCH, No. 331628, of 30 September 1915. Fig. 1: vertical section; Fig. 4: a load of 9 cadavers; Fig. 5: loading grate.	133
Document 97: FEIST furnace for mass cremations (standard model). Source: W. Heepke, <i>Die Kadaver-Vernichtungsanlagen</i> , Verlag von Carl Marhold, Halle a.S., 1905, p. 46.	135
Document 98: H. KORI cremation furnace for incinerating animal carcasses and slaughterhouse refuse. Source: as Doc. 97, p. 39.	135
Document 99: H. KORI cremation furnace for incinerating animal carcasses and slaughterhouse refuse at Liegnitz. Source: as Doc. 97, p. 41.	136
Document 100: H. KORI cremation furnace for incinerating animal carcasses and slaughterhouse refuse for combined operation (connected to the flue of a boiler system). Source: as Doc. 97, p. 44.	136
Document 101: H.R. HEINICKE gas-fired cremation furnace, system VOLCKMANN-LUDWIG. Longitudinal section. Source: Heinicke Feuerungs- und Schornsteinbau, H.R. Heinicke Einäscherungsöfen, undated commercial brochure.	137
Document 102: ASEA BROWN BOVERI electric cremation furnace, operating principle. Documents 102-104b were kindly provided by that company....	138
Document 103: ASEA BROWN BOVERI electric cremation furnace, model RK1-S.	139
Document 104a: Cremation hall equipped with two ASEA BROWN BOVERI electric cremation furnaces.	142
Document 105: FERBECK-VINCENT gas-fired cremation furnace, Model C411. Source: <i>Fours de crémation. Modulaires, Type C 411</i> . Undated promotional brochure kindly provided by that company.	144
Document 106: TABO gas-fired cremation furnace. Source: <i>Equipements de crémation Tabo</i> . Undated advertising brochure kindly provided by that company.	145
Document 107: ENER-TEK II gas-fired cremation furnace. Source: Fred A. Leuchter, <i>An Engineering Report on the Alleged Execution Gas Chambers at Auschwitz, Birkenau and Majdanek Poland</i> , Fred A. Leuchter, Associates, Boston, Mass., April 5, 1988, p. 122.	146
Document 108: Multi-storey furnace (Etagenofen, left) and flat-bed furnace (Flachbettöfen, right) with market share in Germany (73.9% versus 26.1%). Source: R. Sircar, “ <i>Untersuchung der Emissionen aus Einäscherungsanlagen und der Einsatzmöglichkeiten von Barrierenentladungen</i> ,” PhD thesis, University of Martin-Luther, Halle-Wittenberg, 28 June 2002, p. 14.	147
Document 109: RUPPMANN cremation furnace (without smoke filter). Source: G. Schetter, H. Burk, “ <i>Das Krematorium Dresden. Ein Beispiel für umweltgerechte Einäscherung unter betriebswirtschaftlichen</i> ”	

Gesichtspunkten,” Friedhofskultur, Jg. 96, October 2006, in PDF, p. 5. 148 page

II. Topf, Civilian Activities	150
Document 110: The founders of the company J.A. Topf & Söhne: J.A. Topf and his sons Julius and Ludwig. Source: Stadtarchiv Erfurt, 5/411 A-76. ..	150
Document 111: Description of the Topf Company’s activities. Source: Deutschlands Städtebau: Erfurt, Bearbeitet im Auftrage des Magistrats von Stadtbaurat Boegl, Erfurt. “Dari”, Deutscher Architektur- und Industrie-Verlag. Berlin-Halensee, 1922.....	151
Document 112: The German crematoria as of 1927. Source: IV. Jahrbuch des Verbandes der Feuerbestattungs-Vereine Deutscher Sprache 1928. Herausgegeben zum 22. Verbandstage am 4. bis 8. Juli in Bremen vom Verbandsvorstande. Königsberg Pr., 1928, pp. 82-87.....	152
Document 113: “Cremation Furnaces for Crematoria, System Topf.” Advertisement from just before Word War I. Source: III. Jahrbuch des Verbandes der Feuerbestattungs-Vereine Deutscher Sprache. Druck von Carl Wull, Heilbronn a. N., 1913, p. 175.....	157
Document 114: “Topf Cremation Furnaces.” Advertisement from the early 1930s. Source: R. Nagel, Die Vorzüge der Feuerbestattung. self-published, Vienna, 1931, p. 27.....	157
Document 115: “Topf Cremation Furnaces.” Advertisement from the early 1930s. Source: V. Jahrbuch des Verbandes der Feuerbestattungs-Vereine Deutscher Sprache. Königsberg Pr. 1930.	158
Document 116: “Mechanical Cremation Furnaces for Operation with Electricity, Gas and Coke”. Advertisement from the mid-1930s. Source: www.topfundsoehne.de.	158
Document 117: Advertisements by various companies active in the cremation sector at the beginning of the 20th century. Source: II. Jahrbuch des Verbandes der Feuerbestattungs-Vereine Deutscher Sprache. Vereinsbuchdruckerei, Pyrmont 1912, p. 147.....	159
Document 118: “Cremation Furnaces System Ruppmann.” Advertisement from just before Word War I. Source: as Doc. 113, p. 176.	159
Document 119: “The Cremation Furnace System Ruppmann.” Advertising brochure published around 1918.	160
Document 120: “Cremation Furnace System Ruppmann.” Advertisement from the early 1930s. Source: as Doc. 114, p. 28.....	162
Document 121: “Cremation Facilities System Ruppmann.” Advertisement from the early 1930s. Source: as Doc.114, p. 29.....	162
Document 122: “Cremation devices” by GEBRÜDER BECK and “Cremation Furnaces System RICHARD SCHNEIDER.” Advertisement from the early 20th Century. Source: as Doc. 117, p. 146.	163
Document 123: “Cremation Devices” by GEBRÜDER BECK. Advertisement from the early 20th Century. Source: as Doc. 113, p. 172.....	163
Document 124: “Cremation Furnaces System RICHARD SCHNEIDER.” Advertisement from the early 20th Century. Source: as Doc. 113, p.	

	page
173.	164
Document 125: "Cremation furnaces as well as all industrial furnaces" by Danubia A.G. Advertisement from the early 1930s. Source: as Doc. 114, p. 30.....	164
Document 126: Cremation Furnaces System JULIUS SCHMALZ. Advertisements from the early 1930s. Source: as Doc. 114, p. 31.....	165
Document 127: Cremation Furnaces System FRANZ CARL W. GAAB. Advertisement from the early 20th Century. Source: as Doc. 113, p. 174.	165
Document 128: Photo of the Topf engineer Kurt Prüfer probably dating to the 1930s. Source: www.topfundsoehne.de.	165
Document 129: "A Novel Cremation Procedure". Article by Kurt Prüfer. Source: Die Urne, 4. Jg., Nr. 3, March 1931, pp. 27-29.....	166
Document 130: "Topf around the world" during the 1930s. Source: www.topfundsoehne.de.....	168
Document 131: Technical departments of the Topf Company during the 1940s. Source: Stadtarchiv Erfurt, 5/411 A 174.	169
Document 132: General structure of the Topf Company during the 1940s. Source: Stadtarchiv Erfurt, E, 5/411 A 163.	174
Document 133: TOPF coke-fired cremation furnace (early 1920s). Source: B. Reichenwallner, Tod und Bestattung. Katakomben-Verlag/B. Reichenwallner, Munich, 1926, p. 27.	187
Document 134: "Furnaces for Crematoria System TOPF". Promotional brochure of 1926.	188
Document 135: TOPF gas-fired cremation furnace, Model 1934. Source: H. Etzbach, Der technische Vorgang bei einer Feuerbestattung. Johannes Friese, Cologne, 1935, p. 4.	194
Document 136: "Gas-fired Cremation Furnace System J.A. TOPF & SÖHNE"; new model. Source: F. Schumacher, Die Feuerbestattung. J.M. Gebhardt's Verlag, Leipzig, 1929, p. 26.....	195
Document 137: Letter from the municipal administration of Wiesbaden to the Topf Company of 19 December 1949 regarding improvement work done by chief engineer Klettner. Document kindly submitted by J.M. Boisdefeu.	196
Document 138: Letter from the Topf Company of 6 April 1948 to the city commandant's office, First Lieutenant Proskurin, Stadtarchiv Erfurt, 5/411 A 100.....	197
Document 139: TOPF electric cremation furnace as installed at the Erfurt Crematorium in 1933. Fig. 2: longitudinal section. Fig. 6: sketch of the combustion-air channels. Source: K. Weiss, "Der erste deutsche elektrisch beheizte Einäscherungsöfen im Krematorium Erfurt," in: Gesundheits-Ingenieur, 57. Jg., Nr. 37, 1934, pp. 453, 455.	198
Document 140: First TOPF electric- and gas-fired cremation furnace of 1934. Source: Stadtarchiv Erfurt, 4/411 A 97.....	199
Document 141: as above.	200

	page
Document 142: Temperature chart for cremations conducted on 17 and 18 April 1934 in the first TOPF electric cremation furnace at the Erfurt Crematorium. Source: as Doc. 139, p. 456.	201
Document 143: Second TOPF electric cremation furnace at the Erfurt Crematorium of 1936. Fig. 1: longitudinal section. Fig. 2: vertical section. Fig. 3: horizontal Section c-d. Fig. 4: horizontal Section e-f. Source: K. Weiss, "Die Entwicklung des elektrisch beheizten Einäscherungsofens im Krematorium Erfurt," in: <i>Gesundheits-Ingenieur</i> , 60. Jg., Nr. 11, 1937, p. 159.	202
Document 144: as above, longitudinal section. Source: R. Jakobskötter, "Die Entwicklung der elektrischen Einäscherung bis zu dem neuen elektrisch beheizten Heissluft-Einäscherungsofen in Erfurt," in: <i>Gesundheits-Ingenieur</i> , 64. Jg., Nr. 43, 1941, p. 581.	203
Document 145: as above, vertical section. Source: as Doc. 144, p. 582.	204
Document 146: Temperature curves of two cremations conducted in the second TOPF electric cremation furnace at the Erfurt Crematorium (1936 or 1937). Source: as Doc. 143, p. 160. a: first cremation; b: second cremation. The other curves indicate the temperature of the combustion air and that of the spent gases.	205
Document 147: Vertical section of the second (and third) TOPF electric cremation furnace at the Erfurt Crematorium. Source: as Doc. 144, p. 583.	205
Document 148: Charts of three cremations conducted in the third TOPF electric cremation furnace at the Erfurt Crematorium of 1939. Source: as Doc. 144, p. 586.	206
Document 149: TOPF electric cremation furnace. Standard model of the late 1930s. Source: as Doc. 144, p. 587.	207
Document 150: Patent J.A. Topf & Söhne in Erfurt, No. 324252. "Device for the introduction of the coffin for cremation furnaces with support cart that can be raised and lowered." 24 April 1915. Source: Deutsches Patentamt.	208
Document 151: Patent J.A. Topf & Söhne in Erfurt, No. 493042. "Device for post-combustion of residues in corpse-cremation furnaces." 13 February 1930. Source: Deutsches Patentamt.	212
Document 152: Patent Viktor Quehl in Gera, No. 561643, transferred to J.A. Topf & Söhne on 17 May 1934. "Cremation furnace with tiltable grates." Source: Deutsches Patentamt.	215
Document 153: Patent Wilhelm Basse in Hamburg, No. 638582, transferred to J.A. Topf & Söhne on 27 November 1937. "Incineration furnace." Source: Deutsches Patentamt.	218
Document 154: Patent J.A. Topf & Söhne in Erfurt, No. 659405. "Loading device for incineration furnaces." 7 April 1938. Source: Deutsches Patentamt.	222
Document 155: J.A. Topf & Söhne in Erfurt, patent application for "Continuously operating corpse-combustion furnace for large-scale operation." 4	

	page
November 1942. Source: Deutsches Patentamt.	225
Document 156: Patent J.A. Topf & Söhne in Erfurt, No. 494136. “Retractable slag-grate for hearths with air feed from below.” 6 March 1930. Source: Deutsches Patentamt.	233
Document 157: Patent J.A. Topf & Söhne in Erfurt, No. 576135. “Plate-grate with nozzles.” 20. April 1933. Source: Deutsches Patentamt.	236
Document 158: Patent J.A. Topf & Söhne in Erfurt, No. 587149. “Process and furnace for the recovery of lead and pieces of wires from cables.” 12 October 1933. Source: Deutsches Patentamt.	239
Document 159: Patent application J.A. Topf & Söhne in Erfurt of 16 November 1942. “Air-cooled grate plate for mechanical push grate.” Source: Deutsches Patentamt.	243
Document 160: Patent J.A. Topf & Söhne, Wiesbaden, No. 861731. “Process and device for the combustion of corpses, carrion, or parts thereof.” 24 June 1950. Source: Deutsches Patentamt.	249
Document 161: Maschinenfabrik J.A. Topf & Söhne, Erfurt, “Topf Waste Incinerator.” Promotional brochure of 1940. Source: RGVA, 502-1-327, pp. 161-164a.....	254
Document 162: TOPF gas-, naphtha- or coke-fired waste incinerator, Model AV. Source: www.topfundsoehne.de	262
III. TOPF, Correspondence with the SS	263
Document 163a: J.A. Topf & Söhne Drawing No. D 58173 of 6 January 1941 coke-fired “single-muffle cremation furnace” for the SS New Construction Office of the Concentration Camp Mauthausen. Longitudinal vertical section; Source: BAK, NS 4/Ma 54. Numbers added by the author. See text of Part 1 for details.	263
Document 164: “Cost estimate,” by J.A. Topf & Söhne of 6 January 1941 for the SS New Construction Office of Mauthausen Concentration Camp regarding a single- or double-muffle coke-fired cremation furnace. Source: Bundesarchiv Koblenz, NS 4/Ma 54.....	265
Document 165: Mobile cremation furnace system Topf.” Source: www.topfundsoehne.de	270
Document 166: TOPF naphtha-fired mobile cremation furnace. Source: www.topfundsoehne.de	271
Document 167: TOPF naphtha-fired mobile double-muffle cremation furnace. Source: www.topfundsoehne.de	271
Document 168: Bill of lading of 12 December 1940 to the SS New Construction Office of Concentration Camp Mauthausen about the parts for a TOPF naphtha-fired mobile double-muffle cremation furnace. Source: Bundesarchiv Koblenz, NS 4/Ma 54.....	272
Document 169: Invoice from J.A. Topf & Söhne of 5 February 1941 for the delivery of one TOPF naphtha-fired mobile double-muffle cremation furnace to the SS New Construction Office of Concentration Camp Mauthausen. (Rechnung Nr. D 41/107). Source: Bundesarchiv Koblenz,	

	page
NS 4/Ma 54.	274
Document 170: Forced-draft chimney with centrifugal fan. Source: A. Cantagalli, <i>Nozioni teorico-pratiche per i conduttori di caldaie e generatori di vapore</i> . G. Lavagnolo Editore, Turin 1940, p. 90.	276
Document 171: "Cost estimate" by J.A. Topf & Söhne of 21 December 1939 for the SS New Construction Office of the Buchenwald Concentration Camp regarding a coke- or naphtha-fired double-muffle cremation furnace. Document NO-4448.	277
Document 172: Drawing by J.A. Topf & Söhne D 56570 of 21 December 1939 "Naphtha-fired double-muffle cremation furnace" for the Buchenwald Concentration Camp. Document NO-4444.	281
Document 173: Crematorium of the Buchenwald Concentration Camp (December 1939). Document NO-4444.	284
Document 174: Drawing of the crematorium at Buchenwald Camp (January 1940). Document NO-4445.	285
Document 175: Crematorium at the Płaszów Camp. Number and date illegible. Source: www.topfundsoehne.de	286
Document 176: Report by SS-Oberscharführer Pollok of 30 May 1942 on the damage to the chimney of Crematorium I at Auschwitz Main Camp. Source: RGVA, 502-1-312, p. 64.	287
Document 177: Static calculations for the new chimney for Crematorium I at Auschwitz performed by R. Koehler on 20 June 1942. Source: RGVA, 502-1-316, pp. 44-46a.	288
Document 178 (top and bottom): Drawing by R. Koehler of the new chimney for Crematorium I at Auschwitz for the Central Construction Office. 20 June 1942. Source: RGVA, 502-2-23, p. 17.	292
Document 179: Drawing by R. Koehler of the flue ducts to the new chimney for Crematorium I at Auschwitz for the Central Construction Office. 11 August 1942. Source: RGVA, 502-2-23, p. 18.	293
Document 180: Summary of labor performed during the construction of the new chimney for Crematorium I at Auschwitz Main Camp (Schornstein-Krematorium BW. 11). 7 December 1942. Source: RGVA, 502-1-318, p. 5.	294
Document 181: Report by SS-Oberscharführer Pollok to the head of the Central Construction Office of 6 July 1942 on the danger of collapse of the old chimney of Crematorium I at Auschwitz. Source: RGVA, 502-1-312, p. 31.	295
Document 182: Letter from the head of the Central Construction Office to the camp commandant of 13 August 1942 about the damaging of the new chimney of Crematorium I at Auschwitz. Source: RGVA, 502-1-312, p. 27.	296
Document 183: Letter from the head of the Central Construction Office to the head of the garrison administration of 16 July 1943 regarding the suspension of activities at Crematorium I at Auschwitz. Source: RGVA, 502-1-324, p. 1.	297

	page
Document 184: Drawing of the Birkenau Camp. October 1941. (Location sketch of Construction Objects BW 21 and 22 “Einfriedigung”, fences). Source: RGVA, 502-1-235, p. 13.....	298
Document 185: Section enlargement of the “Lay-out plan of the PoW camp at Auschwitz, Upper Silesia, Plan No. 885,” drafted by SS-WVHA on 5 January 1942. Source: RGVA, 502-2-95, p. 7.	299
Document 186: Order confirmation by J.A. Topf & Söhne to the SS Construction Office at Auschwitz of 4 November 1941 regarding 5 coke-fired triple-muffle cremation furnaces for Crematorium II at Birkenau with auxiliary equipment and a waste incinerator. Source: RGVA, 502-1-313, pp. 81-83.	300
Document 187: “File memo” by SS-Untersturmführer Ertl of 21 August 1942. Source: RGVA, 502-1-313, pp. 159f.	303
Document 188: Final accounting to J.A. Topf & Söhne of November 1943 regarding the construction of 5 triple-muffle cremation furnaces for Crematorium II at Birkenau. Source: RGVA, 502-2-26, pp. 226-228.	305
Document 189: Final accounting to J.A. Topf & Söhne of November 1943 regarding the construction of 5 triple-muffle cremation furnaces for Crematorium III at Birkenau. Source: RGVA, 502-2-26, pp. 211-213.	309
Document 190: Copy of a letter from the SS business manager at the Higher SS- and Police Leader’s office of the Government General of 16 August 1943 regarding TOPF cremation furnaces ordered for Mogilev (one-and-a-half 8-muffle furnaces). Source: WAPL, Central Construction Office, 268, p. 132.....	313
Document 191: Letter from the Head of Constructions of the Trawniki Camp to the Central Construction Office of the Lublin Concentration Camp of 2 September 1943 regarding the Topf furnaces of the Mogilev Contract. Source: WAPL, Central Construction Office, 268, p. 147.....	314
Document 192: First list of day wages of the Huta Company for initial work performed at the construction site of Crematorium IV from 23 September to 3 October 1942. Source: RGVA, 502-2-54, p. 45.....	315
Document 193: “Cost Estimate” by J.A. Topf & Söhne of 13 November 1940 regarding the second TOPF coke-fired double-muffle cremation furnace for Crematorium I at Auschwitz. Source: RGVA, 502-1-327, pp. 168-172.	316
Document 194: “Cost Estimate” by J.A. Topf & Söhne of 1 November 1940 regarding a TOPF coke-fired double-muffle cremation furnace for the SS New Construction Office of Concentration Camp Mauthausen. Source: Bundesarchiv Koblenz, NS 4/Ma 54.....	319
Document 195: “Cost Estimate” by J.A. Topf & Söhne of 30 April 1941 regarding a TOPF coke-fired single- or double-muffle cremation furnace for the SS New Construction Office of Mauthausen Concentration Camp. Source: Bundesarchiv Koblenz, NS 4/Ma 54.	322
Document 196: “Cost Estimate” by J.A. Topf & Söhne of 31 October 1941 regarding a TOPF coke-fired double-muffle cremation furnace for	

	page
Concentration Camp Mauthausen. Source: Bundesarchiv Koblenz, NS 4/Ma 54.	325
Document 197: Bill of lading by J.A. Topf & Söhne to the SS New Construction Office Auschwitz of 17 January 1941 regarding the parts of the second TOPF coke-fired double-muffle cremation furnace for Crematorium I at Auschwitz. Source: RGVA, 502-1-327, pp. 201-203.	328
Document 198: "Cost Estimate" by J.A. Topf & Söhne of 25 September 1941 regarding the third TOPF coke-fired double-muffle cremation furnace for Crematorium I at Auschwitz. Source: RGVA, 502-2-23, pp. 264-267.	331
Document 199: Bill of lading by J.A. Topf & Söhne to the SS New Construction Office Auschwitz of 21 October 1941 regarding the parts of the third TOPF coke-fired double-muffle cremation furnace for Crematorium I at Auschwitz. Source: RGVA, 502-1-312, pp. 104-105.	334
Document 200: "Final Invoice" of J.A. Topf & Söhne back-dated to 16 December 1941 regarding the third TOPF coke-fired double-muffle cremation furnace for Crematorium I at Auschwitz. Source: RGVA, 502-2-23, pp. 261-261a.	336
Document 201: Bill of lading by J.A. Topf & Söhne to SS Construction Office Gusen of 12 January 1943 regarding the parts for a TOPF coke-fired double-muffle cremation furnace. Source: Bundesarchiv Koblenz, NS 4/Ma 54.	338
Document 202: Drawing by J.A. Topf & Söhne No. D 57253 "Coke-fired cremation furnace and foundation plan," 10 June 1940. Drawing of the first furnace for Crematorium I at Auschwitz. Source: Bundesarchiv Koblenz, NS 4/Ma 54.	341
Document 203: "List of materials for a TOPF double-muffle cremation furnace" for the SS New Construction Office of Gusen Camp on 23 January 1943. Source: Bundesarchiv Koblenz, NS 4/Ma 54.	346
Document 204: Drawing by J.A. Topf & Söhne No. D 57999 of Crematorium I at Auschwitz. 30 November 1940. Source: RGVA, 502-1-312, p. 135.	347
Document 205: Drawing by J.A. Topf & Söhne No. D 59042 "Installation of a cremation facility for Concentration Camp Auschwitz." 25 September 1941. Drawing relating to the third cremation furnace of Crematorium I at Auschwitz. Source: APMO, Negative No. 20818/1.	348
Document 206: Drawing by Central Construction Office No. 1241 "Inventory Plan of Building No. 47a, Construction Object 11. Crematorium." 10 April 1942. RGVA, 502-2-146, p. 21.	350
Document 207: Drawing by Central Construction Office No. 1434 of 3 July 1942 regarding the new chimney: "Construction of a new chimney at Crematorium B.W. 11 at Auschwitz Concentration Camp." Rework of Drawing No. 1241. Source: J.C. Pressac, <i>Les crématoires d'Auschwitz. La machinerie du meurtre de masse</i> . CNSR Editions, Paris 1993, document 8.	354
Document 208: Bill of lading by J.A. Topf & Söhne to the SS Construction	

	page
Office of Gusen Camp of 24 February 1943 regarding square bars for the gasifier grate. Source: Bundesarchiv Koblenz, NS 4/Ma 54.	357
Document 209: J.A. Topf & Söhne, "Operating instructions for the 'Topf' forced-draft device." 26 September 1941. Source: APMO, BW 11/1, p. 2.	358
Document 210: J.A. Topf & Söhne, "Operating instructions for the Topf coke-fired double-muffle cremation furnace." 26 September 1941. Source: APMO, BW 11/1, p. 3.	359
Document 211: Page 5 of the "Explanatory report for the preliminary draft of the new construction of the PoW camp of the Waffen-SS Auschwitz, Upper Silesia" of 30 October 1941. Source: RGVA, 502-1-233, p. 20.	360
Document 212: Page 6 of the "Explanatory report for the preliminary draft of the new construction of the PoW camp of the Waffen-SS Auschwitz, Upper Silesia" of 30 October 1941. Source: RGVA, 502-1-233, p. 27.	361
Document 213: "Bill of lading" by J.A. Topf & Söhne to the Central Construction Office at Auschwitz of 16 April 1942 regarding "Parts of TOPF triple-muffle furnaces" for Crematorium II at Birkenau. RGVA, 502-1-313, pp. 167-170.	362
Document 214: "Bill of lading" by J.A. Topf & Söhne to the Central Construction Office at Auschwitz of 18 June 1942 regarding "Parts of 5 TOPF triple-muffle furnaces" for Crematorium II at Birkenau. Source: RGVA, 502-1-313, pp. 165f.	366
Document 215: "Final Invoice" of J.A. Topf & Söhne of 27 January 1943 regarding 5 triple-muffle furnaces (and the waste incinerator) of Crematorium II at Birkenau. Source: RGVA, 502-2-26, pp. 230-230a.	368
Document 216: "Final Invoice" of J.A. Topf & Söhne of 27 May 1943 regarding 5 triple-muffle furnaces of Crematorium III at Birkenau. Source: RGVA, 502-2-26, pp. 215-215a.	370
Documents 217 (top) & 217a (bottom): TOPF coke-fired triple-muffle cremation furnace. Top: Vertical section. Bottom: Longitudinal section of a lateral muffle. Labeled by Carlo Mattogno based on the drawing by J.A. Topf & Söhne No. D 57253.	372
Document 218: as above, horizontal section.	373
Documents 219 (top) & 220 (bottom): as above, horizontal section. Top: vertical section, design of the combustion-gas ducts. Bottom: as above, Bottom: Longitudinal section of the side muffle.	374
Document 221: Project of the new crematorium at Auschwitz (future Crematoria II/III at Birkenau). Drawing No. 933 by the Central Construction Office of 19 January 1942. Source: APMO, Negative No. 20957.	375
Document 222: Project of the new crematorium at Auschwitz (future Crematorium II/III at Birkenau). Drawing No. 933 by the Central Construction Office of 19 January 1942. Source: APMO, Negative No. 20818/4.	376
Document 223: as above, horizontal section. Layout of the smoke ducts and the chimney. Source: APMO, Negative No. 520.	378
Document 224: as above, vertical section through the chimney. Drawing Nr.	

	page
933 by the Central Construction Office of 19 January 1942. Labeled by the author. Source: APMO, Negative No. 518.	379
Document 225a (top): Compare the TOPF waste incinerator MV (see Doc. 161) with Document 255b (bottom): the cremation furnace for large-scale operation invented by Fritz Sander (see also Doc. 155).	380
Document 226: Invoice of Topf No. 1314 of 23 August 1943 for the Central Construction Office at Auschwitz regarding the waste incinerator of Crematorium III. Source: RGVA, 502-1-327, pp. 13-13a.	381
Document 227: "Operating instructions for the TOPF coke-fired triple-muffle cremation furnace." Source: M. Nyiszli, <i>Im Jenseits der Menschlichkeit. Ein Gerichtsmediziner in Auschwitz</i> . Dietz Verlag, Berlin 1992, p. 33.	383
Document 228: "Cost Estimate" by J.A. Topf & Söhne for the Central Construction Office at Auschwitz of 12 February 1942 regarding a simplified TOPF coke-fired triple-muffle cremation furnace. Source: APMO, BW 30/34, pp. 27,32,29 (sic).	384
Document 229: Simplified TOPF coke-fired triple-muffle cremation furnace. Horizontal section. Labeled by Carlo Mattogno.	387
Document 230: "Cost Estimate" for a Topf wood-fired eight-muffle cremation furnace of the Mogilev Contract of 16 November 1942. Source: RGVA, 502-1-313, pp. 72-76.	389
Document 231: "Bill of lading" by J.A. Topf & Söhne to the Central Construction Office at Auschwitz of 8 September 1942 regarding two eight-muffle cremation furnaces. Source: RGVA, 502-1-313, pp. 143-143a.	392
Document 232: "Final Invoice" No. 380 by Topf of 5 April 1943 regarding the delivery of two eight-muffle cremation furnaces. Source: RGVA, 502-1-314, pp. 29-29a.	394
Document 233: "Final Invoice" No. 322 by Topf of 12 July 1944 back-dated to 23 April 1943 regarding cast-iron doors, insulation material and gasifier grates. Source: RGVA, 502-1-327, p. 22.	395
Document 234: Project Crematorium IV/V at Birkenau. Drawing No. 1678 (r) by the Central Construction Office of 14 August 1942. Source: APMO, Negative No. 20946/6.	396
Document 235: Project Crematorium IV/V at Birkenau. Drawing No. 2036 by the Central Construction Office of 11 January 1943. Source: APMO, Negative No. 6234.	397
Document 236: Project Crematorium IV/V at Birkenau. Drawing No. 2036(p) by the Central Construction Office of 11 January 1943. Source: APMO, Negative No. 20818/10.	399
Document 237: Anchoring parts for one Topf eight-muffle furnaces from the Mogilev Contract. List compiled by J.A. Topf & Söhne on 4 September 1942. Source: RGVA, 502-1-313, p. 141.	400
Document 238: Author's sketch of the TOPF coke-fired eight-muffle furnaces of Crematoria IV and V at Birkenau. Arrangement of the furnaces (Ofen), gasifiers (Generator) and smoke ducts.	401

	page
Document 239: as above. Horizontal section.....	401
Document 240: as above. Longitudinal section through the pair of external muffles. Based on Drawing No. D 58173 by J.A. Topf & Söhne. Numbers by the author. See text of Part 1 for details.....	402
Document 241: Composite photograph based on the TOPF double-muffle cremation furnace at Gusen Camp illustrating the structure of the Topf eight-muffle furnace.....	402
Document 242: Letter from Engineer Fritz Sander of J.A. Topf & Söhne from 14 September 1942. Source: www.topfundsoehne.de	403
Document 243: Letter from the head of the Central Construction Office Bischoff to the Camp Commandant Höss of 12 February 1943 regarding “Crematorium VI”. APMO, BW 30/34, p. 80.....	408
Document 244: “Ringofen” (ring furnace) for the sintering of bricks. Source: “Hütte” des Ingenieurs Taschenbuch, Berlin, 1938, vol. IV, p. 740.	409
Document 245: Last page of a cost estimate by J.A. Topf & Söhne of 1 April 1943 for the Central Construction Office at Auschwitz regarding a “cremation furnace”. Source: R. Schnabel, <i>Macht ohne Moral. Eine Dokumentation über die SS. Röderberg-Verlag, Frankfurt/Main, 1957</i> , p. 351.	410
Document 246: Letter from J.A. Topf & Söhne to the SS New Construction Office of the Mauthausen Concentration Camp of 1 November 1940 regarding a cost estimate for a TOPF coke-fired double-muffle cremation furnace. Source: Bundesarchiv Koblenz, NS 4/Ma 54.....	411
Document 247: Letter from J.A. Topf & Söhne to the SS New Construction Office of Mauthausen Concentration Camp of 9 July 1941. Source: SW, LK 4651.	413
Document 248: Letter from Bischoff to Kammler of 28 June 1943. Source: RGVA, 502-1-314, p. 14a.	414
Document 249: File memo by Kurt Prüfer of 8 September 1942. Source: http://veritas3.holocaust-history.org/auschwitz/topf/	416
Document 250: Summary table of data derived from cremation experiments conducted by engineer R. Kessler on 5 January 1927 at the Dessau Crematorium (coke-fired).	417
Document 251: Graph of the mean muffle temperature in the course of cremation experiments conducted by Engineer R. Kessler on 5 January 1927 at the Dessau Crematorium (coke-fired).	417
Document 252: Summary of the cremation process in a modern cremation furnace. Source: Douglas J. Davies, Lewis H. Mates (eds.), <i>Encyclopedia of Cremation</i> , Ashgate, London, 2005, p. 133.....	418
Document 253: Condition of a corpse after thirty minutes of cremation. Source: Michael Bohnert, Thomas Rost, Stefan Pollak, “The degree of destruction of human bodies in relation to the duration of the fire,” in: <i>Forensic Science International</i> , 95, 1998, p. 15.	419
Document 254: as above, after forty minutes. Color reproductions of these photos can be found at the end of Part 3 of this study.....	419

	page
Document 255: List of cremations at the Gusen Crematorium between 26 September and 12 November 1941. Source: ÖDMM, Archiv, B 12/31.....	420
Document 256: Explanatory table of the data contained in the list of cremations at the Gusen Crematorium (Document 255).....	421
Document 257: List of cremations conducted at the Westerbork Crematorium between 4 June and 1 July 1943. Source: ROD, C[64]392	422
Document 258: as above, cremations on 7 June 1943. Source: ROD, C[64]392.....	423
Document 259: Stoking tools. Source: A. Cantagalli, <i>Nozioni teorico-pratiche per i conduttori di caldaie e generatori di vapore</i> . G. Lavagnolo Editore, Turin 1940, p. 110.	424
Document 260: Operational results for eight carcass-destruction furnaces built by the Kori Co. Source: W. Heepke, <i>Die Kadaververnichtungs-Anlagen</i> . Verlag von Carl Marhold. Halle a. S. 1905, p. 43.....	424
Document 261: Letter from Hans Kori to the headquarters of Lublin Camp of 4 February 1944. Source: APMM, sygn. VI-9a, vol. 1, p. 27.....	425
Document 262: "Guidance chart for determining the cremation time of corpses in various crematoria as a function of temperature" as prepared by the Soviet Commission of Inquiry about the Lublin-Majdanek Camp. Source: GARF, 7021-107-9, p. 247.	426
Document 263: Letter from the Central Construction Office at Auschwitz to the Construction Office of the Stutthof Camp of 10 July 1942. Source: RGVA, 502-1-272, p. 168.....	427
Document 264: "File memo" by Jährling of 17 March 1943. Source: APMO, BW 30/7/34, p. 54.	428
Document 265: Experiment to burn out soot deposits in a chimney. Temperature chart. Source: Kristen, "Ausbrennversuche an Schornsteinen," in: <i>Wärmewirtschaftliche Nachrichten für Hausbau, Haushalt und Kleingewerbe</i> , 6. Jg., Nr. 7, April 1933, p. 84.	429
Document 266: Promotion leaflet by the H. KORI COMPANY, Berlin 1927, regarding incinerators for waste and all kinds of refuse. Source: APMM, sygn. VI-9a, vol. 1.....	430
Document 267: Promotion leaflet by the H. KORI COMPANY, Berlin 1927, regarding incinerators for all kinds of refuse. Source: APMM, sygn. VI-9a, vol. 1.....	432
Document 268: Promotion leaflet by the H. KORI COMPANY, Berlin 1937. Source: APMM, sygn. VI-9a, vol. 1.....	434
Document 269: "Cremation Furnace System 'Kori' at the Crematorium of the City of Hagen/Westfalia." Promotion leaflet of 1927. Source: APMM, sygn. VI-9a, vol. 1.....	435
Document 270: "Cremation Furnace System 'Kori' at the Crematorium of the Capital City of Schwerin." Promotion leaflet of 1927. Source: APMM, sygn. VI-9a, vol. 1.....	436
Document 271: Letter from the H. KORI COMPANY to Engineer Waller at Office CIII of SS WVHA dated 18 May 1943. Source: KfSD, 660/41.....	438

	page
Document 272: Draft of crematorium at Neuengamme Concentration Camp. Drawing No. 8998 by KORI of 6 February 1941. Source: GARF, 7445-2-125, p. 90.	440
Document 273: Draft for cremation furnaces at Dachau Concentration Camp. Drawing No. 9122 by KORI of 12 May 1942. Source: GARF, 7445-3-125, p. 91.....	441
Document 274: Drawing of the cremation furnaces for Sachsenhausen Concentration Camp prepared by the Soviet Commission of Inquiry in June 1945. Source: GARF, 7021-104-3, p. 5. A: top view of the ovens; B: front view; C: lateral view (right side of the fourth furnace).....	442
Document 275: Sketch of the cremation furnaces at Sachsenhausen Concentration Camp, prepared by the Soviet Commission of Inquiry in June 1945. Source: GARF, 7021-104-3, p. 6. A: longitudinal vertical section of the furnaces; B: horizontal section. Labeled by the author.....	443
Document 276a: Sketch of H. KORI coke-fired double-muffle cremation furnace at Stutthof Concentration Camp; front view. Soviet drawing of 1945. GARF, 7021-106-4, p. 26.	445
Document 277: "Cremation facility for Lublin PoW Camp." Kori Drawing No. 9080 of 31 March 1942. Source: GARF, 7445-2-125, p. 89.....	446
Document 278: Sketch of the crematorium at Lublin Concentration Camp. Cross section (top) and longitudinal section with front view of the furnaces (bottom). Drawing by the Polish-Soviet Commission of Inquiry of August 1944. Source: GARF, 7021-107-9, p. 252.....	447
Document 279: Sketch of the cremation furnaces at Lublin Concentration Camp. Drawing by the Polish-Soviet Commission of Inquiry of August 1944. Source: GARF, 7021-107-9, p. 254. Labeled by the author.....	448
Document 280: Sections through one of the cremation furnaces at Lublin Concentration Camp. Drawing by the Polish-Soviet Commission of Inquiry of August 1944. Source: GARF, 7021-107-9, p. 254. 280/2. Labeled by the author.....	449
Document 281: Floor plan of the crematorium at Lublin Concentration Camp showing the flue ducts. Drawing by the Polish-Soviet Commission of Inquiry of August 1944. Source: GARF, 7021-107-9, p. 252. 281/2. Labeled by the author.....	450
Document 282: Crematorim at Lublin Concentration Camp, longitudinal section showing the flue ducts. Drawing by the Polish-Soviet Commission of Inquiry of August 1944. Source: GARF, 7021-107-9, p. 252. Labeled by the author.....	451
Document 283: as above, angular perspective. Source: GARF, 7021-107-9, p. 255.	452
Document 284: KORI Furnace at Lublin Concentration Camp: sketch of the water heating device. Source: Z. Łukaszkiwicz, "Obóz koncentracyjny i zagłady Majdanek," in: <i>Biuletyn Głównej Komisji Badania Zbrodni Niemieckich w Polsce</i> , 1948, pp. 80f.....	453
Document 285: KORI naphtha-fired cremation furnace in the crematorium at	

	page
Trzebinia Concentration Camp. Drawing by the Institute of Heat and Fuel Technology at the Mining Academy of Cracow. Source: APMO, Negative No. 6671.....	454
Document 286: “Operating Instruction for Cremations” for the naphtha-fired KORI Furnace. Source: ROD, C[64]392.....	456
Document 287: Letter from DIDIER-WERKE AG to Boriwoje Palitsch of 25 August 1943. Document USSR-64.....	457
Document 288: “Cremation Facility for the Belgrade SS.” Drawing by Didier-Werke No. 0.913 of 23 August 1943. Source: GARF, 7445-2-125, p. 92.....	459
Document 289: List of names of the corpses cremated at the Terezín Ghetto’s crematorium on 11 October 1943. Source: PT, A 1194, p. 33.	460
Document 290: Numerical summary of cremations conducted at the Terezín Crematorium on 11 October 1943. Source: PT, A 1 194, p. 32.....	461
Document 291: Registry No. 6 of the Terezín Crematorium, spanning from 1 July to 15 November 1943. Source: PT, A 1194, p. 1.....	462
Document 292: Official form for the cremation of an inmate’s corpse. Stutthof Concentration Camp, 6 December 1944. Source: AMS, I-IIIC-2.....	463
Document 293: Official form for the cremation of an inmate’s corpse. Auschwitz Concentration Camp. Source: N. Blumental, <i>Dokumenty i Materiały</i> , Lodz, 1946, vol. I, pp. 106f.....	465
Document 294: Registry of the crematorium at Stutthof Concentration Camp, March 1944 (extract). Source: AMS, I-II-9.....	466
Document 295: Official form informing family members of a deceased inmate about the death and cremation of their relative. Source: AMS, I-VD-1.	466
Document 296: “Shipment of urn” by Mauthausen Concentration Camp. 7 October 1941. Source: ÖDMM, 3 12/49.	467
Document 297: Letter from Topf to the SS New Construction Office at Auschwitz of 3 June 1940 offering urns, an imprinting device for the urn lids, and fireclay markers. Source: RGVA, 502-1-327, pp. 226f.	468
Document 298: Letter from the Head of the Political Department of Auschwitz Concentration Camp to the camp’s SS New Construction Office of 29 April 1941 about storing urns with the ashes of deceased inmates. Source: RGVA, 502-1-314, p. 1.....	470
Document 299: Political Department of Auschwitz Concentration Camp. Order of 100 urn boxes from the SS New Construction Office’s carpentry workshop of 6 January 1941. Source: RGVA, 502-2-1, p. 29.	470
Document 300: “Labor time card” of 27 November 1941 on the manufacture of 50 shipping boxes for urns. Source: RGVA, 502-2-1, p. 34.	472

I. Civilian Cremation Furnaces

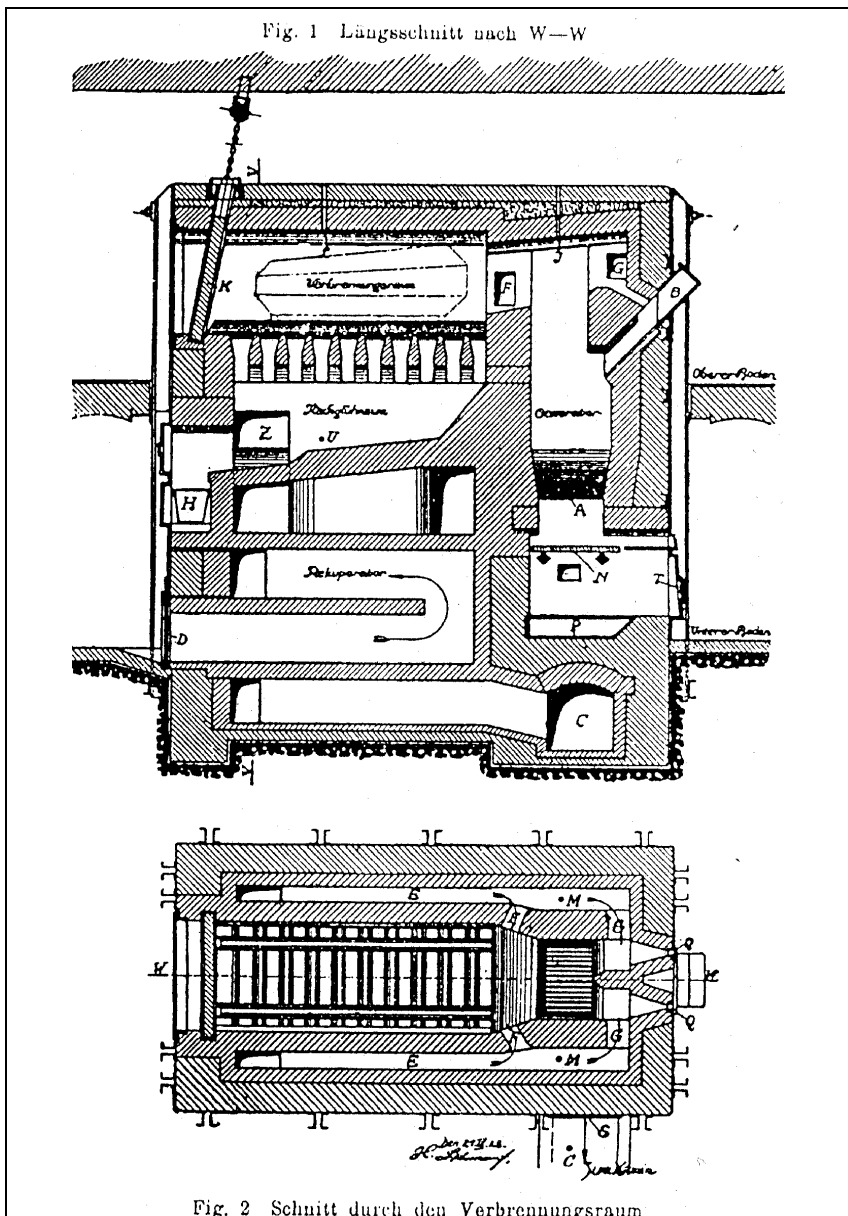

Document 1: W. RUPPMANN coke-fired cremation furnace at Biel (1911).

Fig. 1: vertical section W-W; Fig. 2: section through the cremation chamber.
Source: H. Keller, *Mitteilungen über Versuche am Ofen des Krematoriums in Biel. Bieler Feuerbestattungs-Genossenschaft in Biel (Schweiz). Jahres-Bericht 1927/28. Biel, 1928, p. 21.*

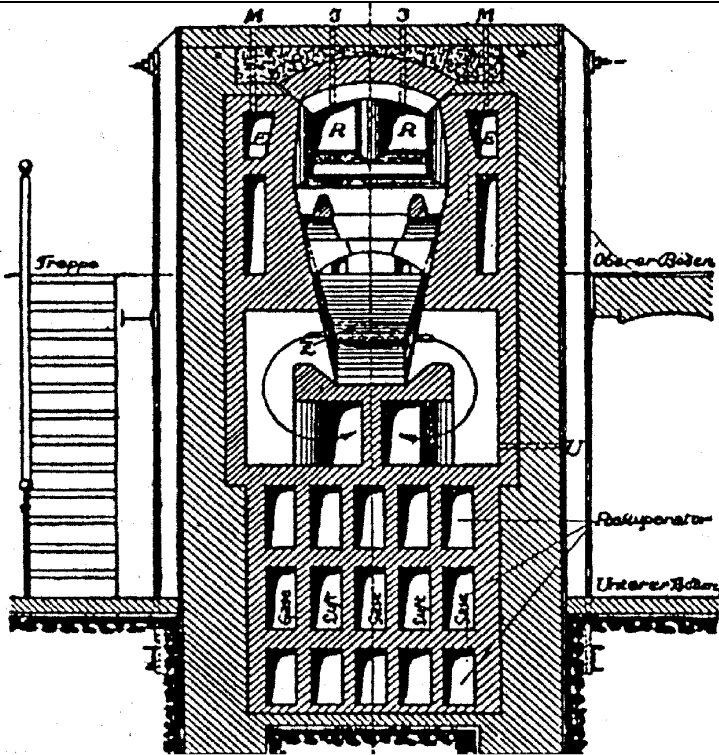

Fig. 3 Querschnitt nach V—V

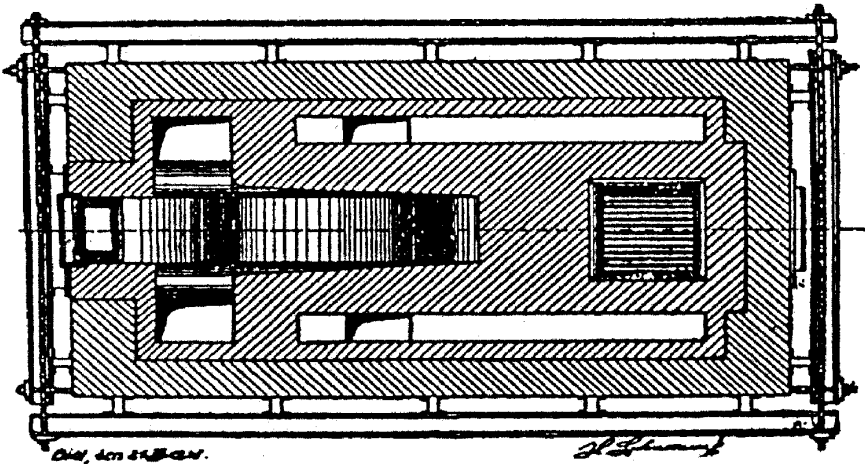

Fig. 4 Schnitt durch den Nachglühraum

Document 2: W. RUPPMANN coke-fired cremation furnace at Biel (1911). Fig. 3: vertical section V-V; Fig. 4: section along the post-combustion chamber. Source: as Doc. 1, p. 22.

— 59 —

Der Sarg ist zu bemessen (Abb. 12)

mit einer äusseren maximalen Breite von 750 mm

" " " " Höhe " 720 "

" " " " Länge " 2250 "

Verschiedene Krematorien-Verwaltungen bestimmen sogar nur:

die äussere maximale Höhe zu 700 und 650 mm und

" " " " Länge " 2000 mm,

welche Maße aber als zu knapp anzusehen sind.

Man kann Holz- und Metallsärge verwenden.



Abb. 12. Sarg- und Verbrennungskammerprofile; grösste Sarglänge 2250 mm, mittlere Kammerlänge 2500 mm.

Zur Erleichterung des Verbrennungsprozesses soll der Holzsarg aus leichtem Holz wie von Tanne oder Pappel hergestellt werden. Die Stärke der Holzbretter kann betragen:

höchstens 18 mm für den Unterteil und

" 15 " " " Deckel.

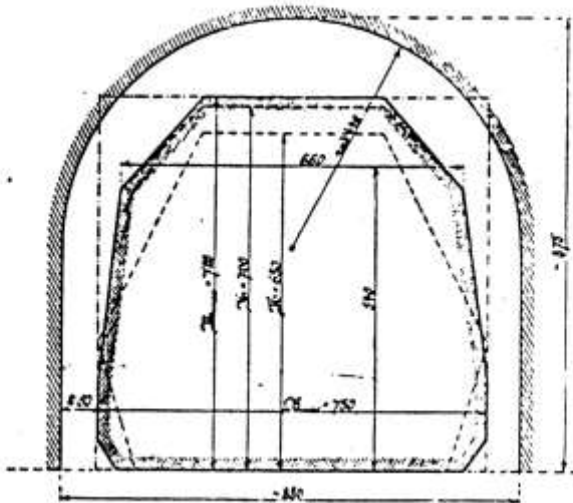
Zum Zusammenfügen der Bretter sind keine Nägel, sondern Holzpflocke von ebensolchem weichen Holze zu verwenden; auch sind Metallbeschläge fortzulassen.

Metallsärge sollen aus 1 mm starkem Zinkblech vorgefertigt werden. Um während des Transportes Deformationen

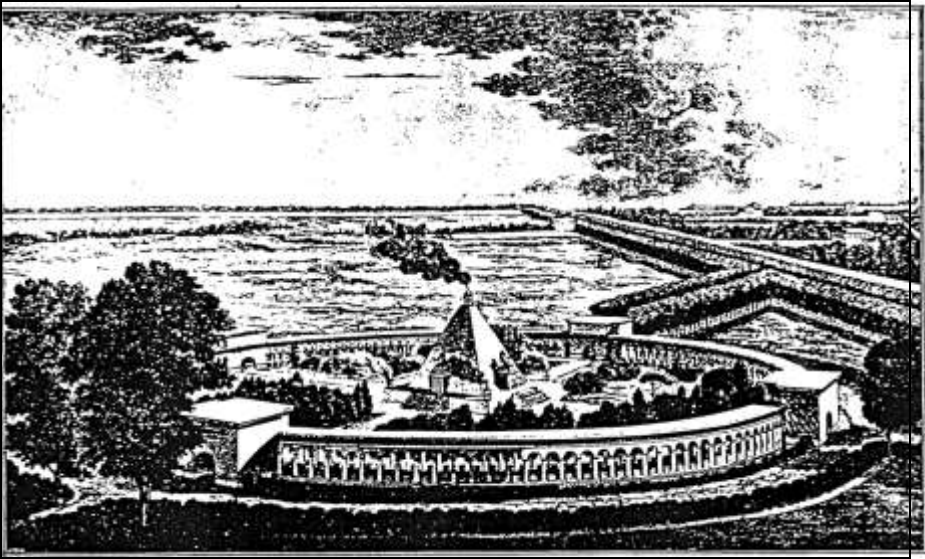

Document 4: A 1799 project for a French crematorium. Source: B. Reber, Un crématoire du temps de la Révolution française, in: Société de crémation de Genève. Bulletin VIII. Geneva, Imprimerie Centrale, 1908, p. 29.

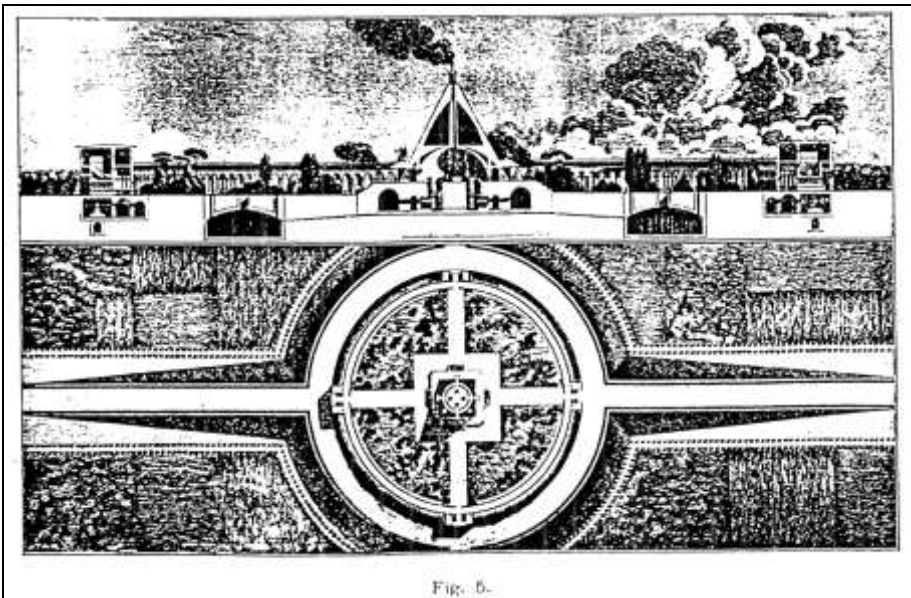

Document 5: A 1799 project for a French crematorium. Source: as Doc. 4.

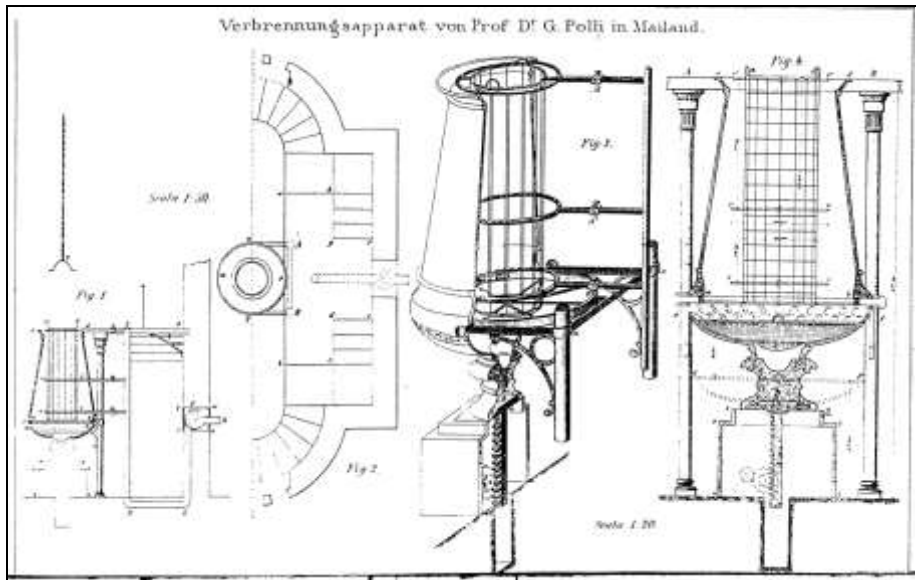

Document 6: POLLI gas-fired cremation furnace. Source: Wegmann-Ercolani, Ueber Leichenverbrennung als rationellste Bestattungsart. Cäsar Schmidt, Zurich, 1874, illustration outside of text.

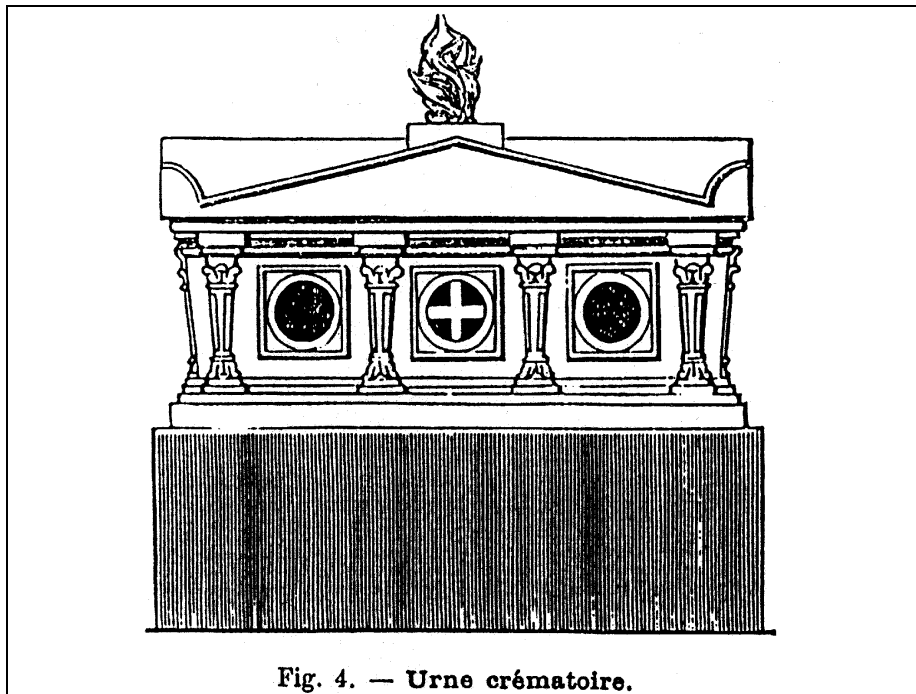
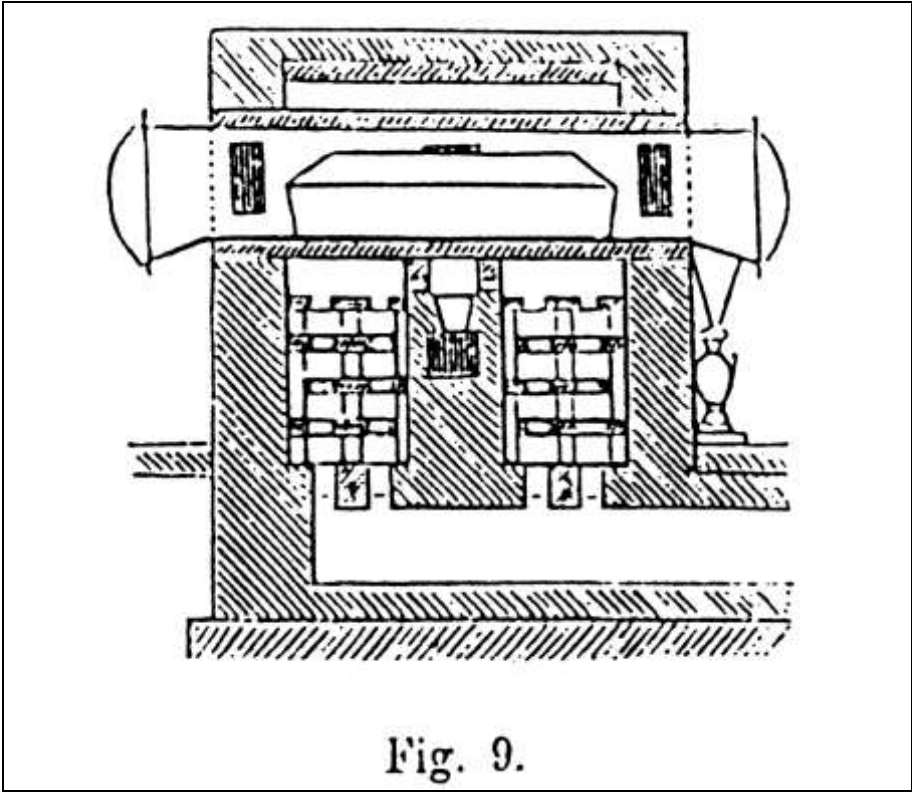
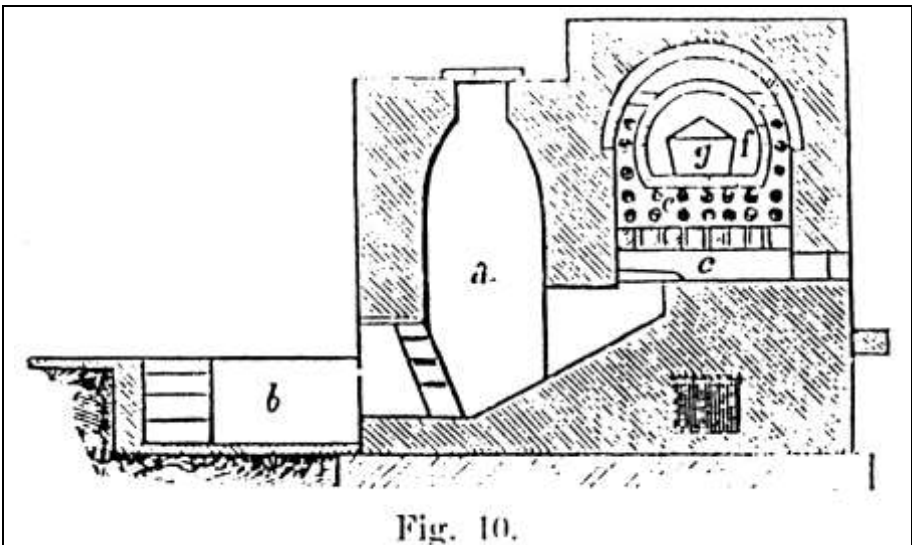

Fig. 4. — Urne crématoire.

Document 7: Fig. 4: POLLI-CLERICETTI gas-fired cremation furnace in a fancy urn shape. Source: M. De Cristoforis, Etude pratique sur la crémation. Imprimerie Treves Frères, Milan, 1890, p. 68.



Document 8: Figs. 8 & 9: CADET cremation furnace. Source: as Doc. 7, p. 77.



Document 9: Fig. 10: MULLER-FICHET coke-fired cremation furnace. Source: as Doc. 7, p. 79.

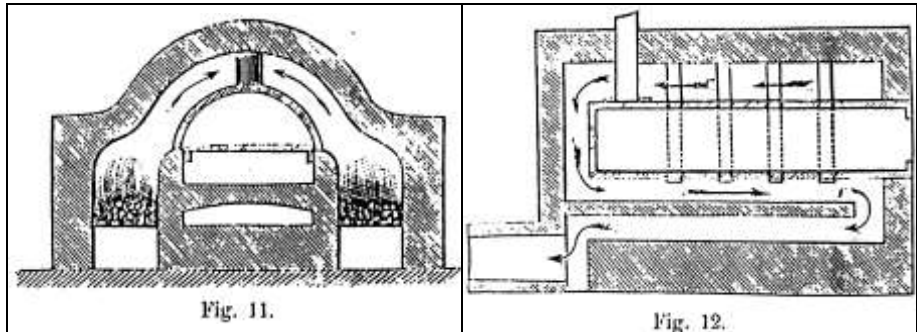

Document 10a & b: Figs. 11 & 12: LAGENARDIERE cremation furnace. Source: as Doc. 7, p. 80.

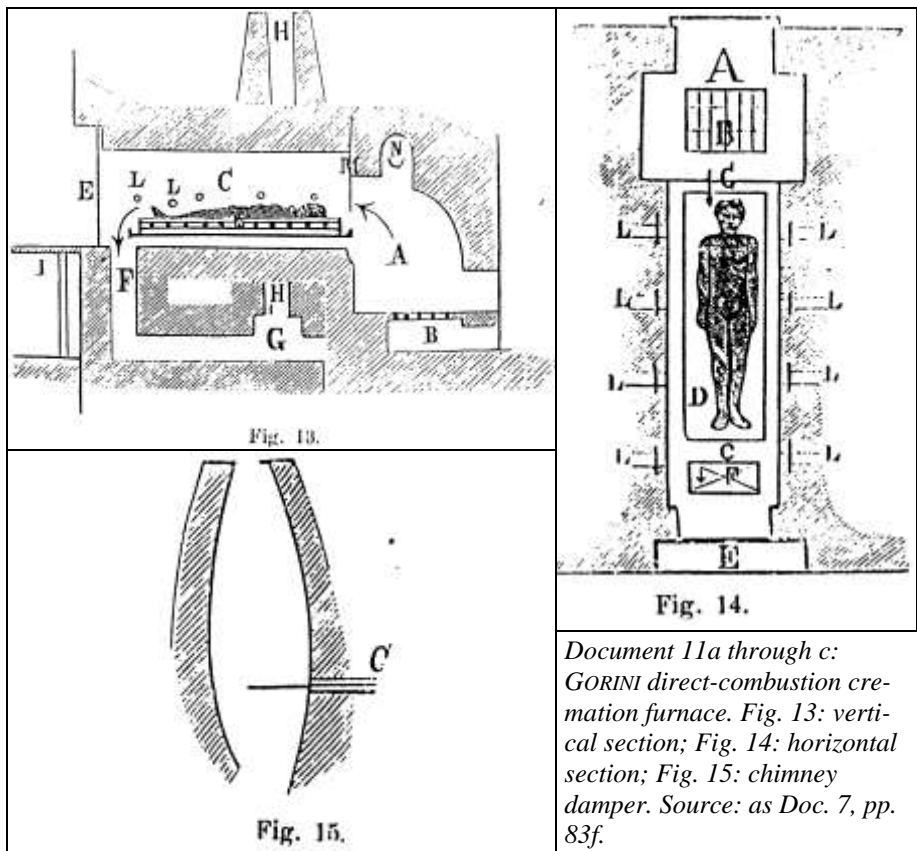

Document 11a through c: GORINI direct-combustion cremation furnace. Fig. 13: vertical section; Fig. 14: horizontal section; Fig. 15: chimney damper. Source: as Doc. 7, pp. 83f.

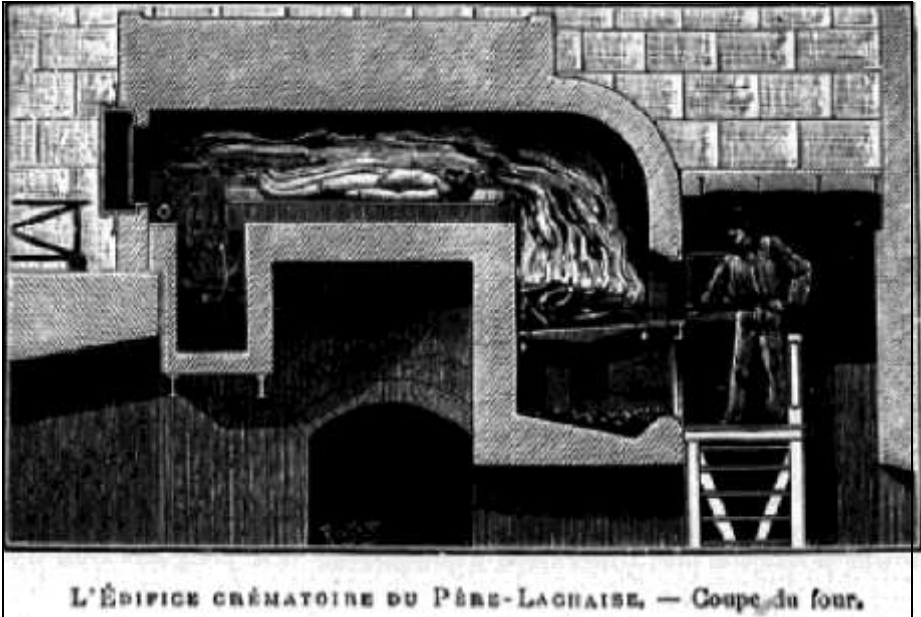

Document 12: GORINI direct-combustion cremation furnace, inaugurated on 15 December 1887 at the crematorium of the Père-Lachaise Cemetery in Paris. Source: "La crémation des morts et l'édifice crématoire du Père-Lachaise", in: La Science Illustrée, vol. I, année 1888, premier semestre, p. 13.

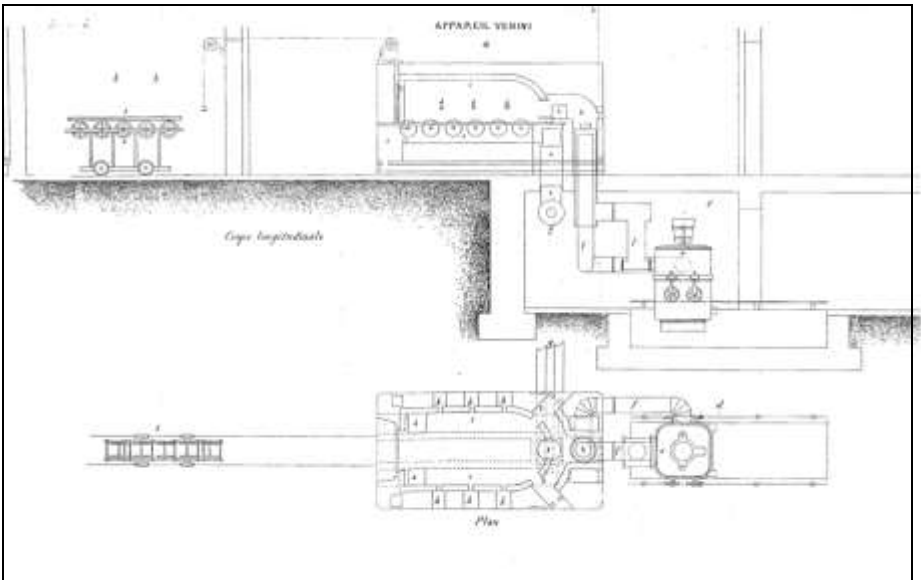

Document 13: VENINI coke-fired cremation furnace. Source: G. Pini, La crémation en Italie et à l'étranger de 1774 jusqu'à nos jours. Ulrich Hoepli Editeur Libraire, Milan, 1885, illustration outside of text.

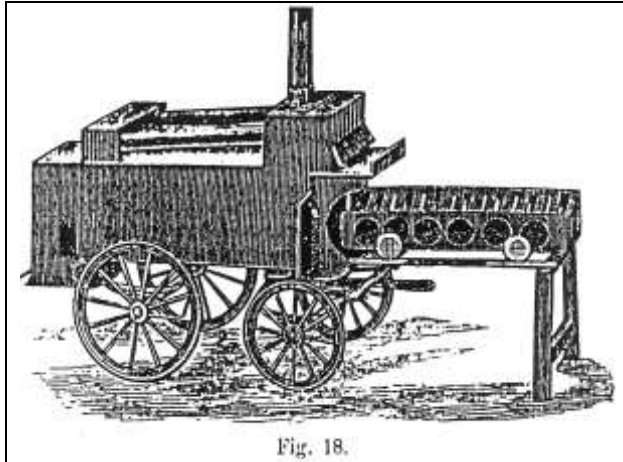

Document 14: REY direct-combustion cremation furnace. Source: as Doc. 7, p. 100.

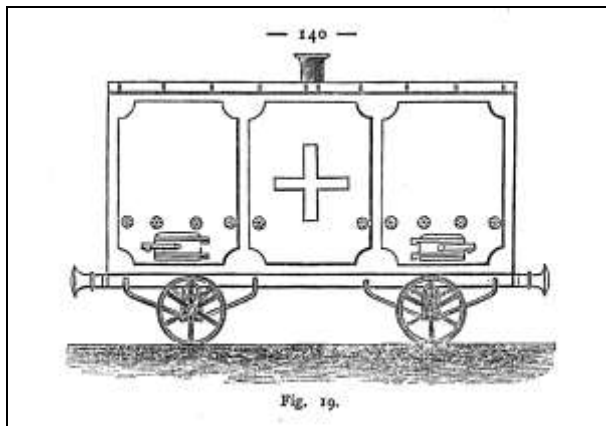

Document 15, 15a (below): KUBORN-JACQUES mobile cremation furnace. Source: as Doc. 13, p. 140.

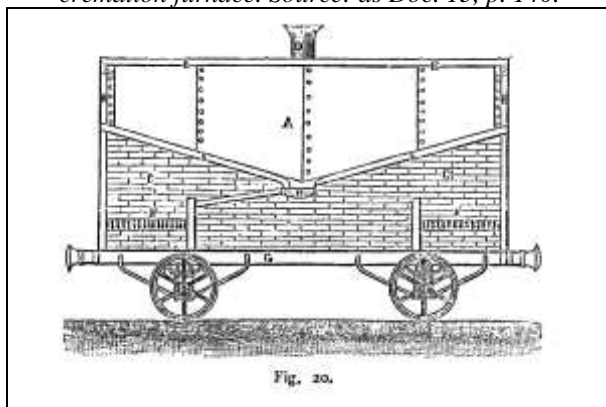

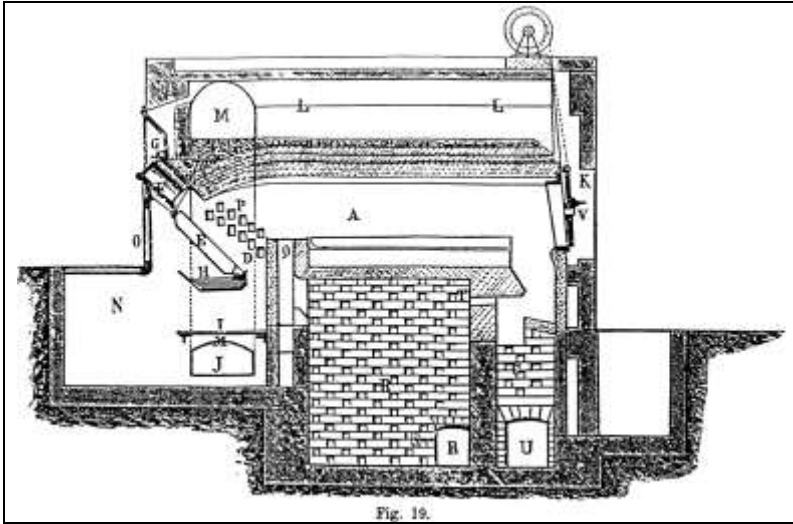

Fig. 19.

Document 16: *GUZZI coke-fired cremation furnace. Source: as Doc. 7, p. 104.*

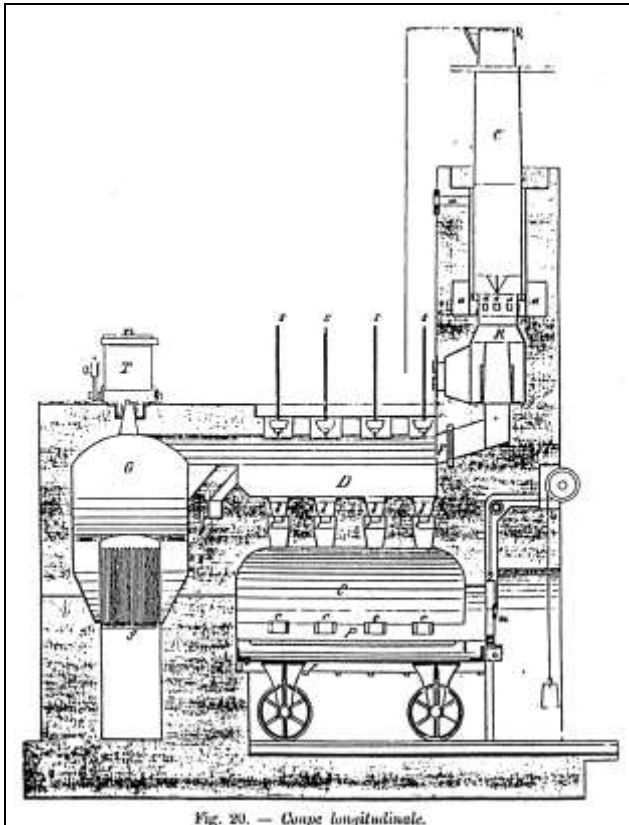
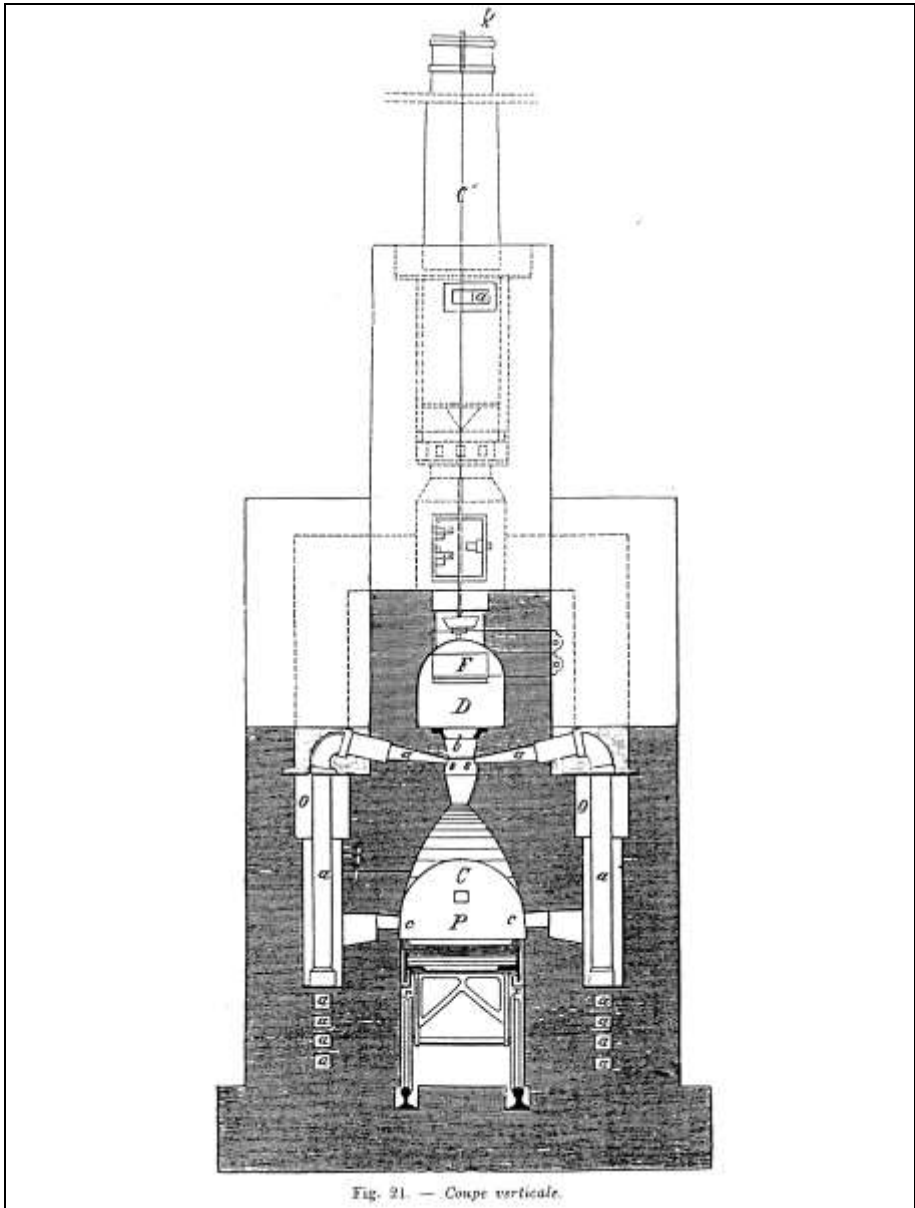
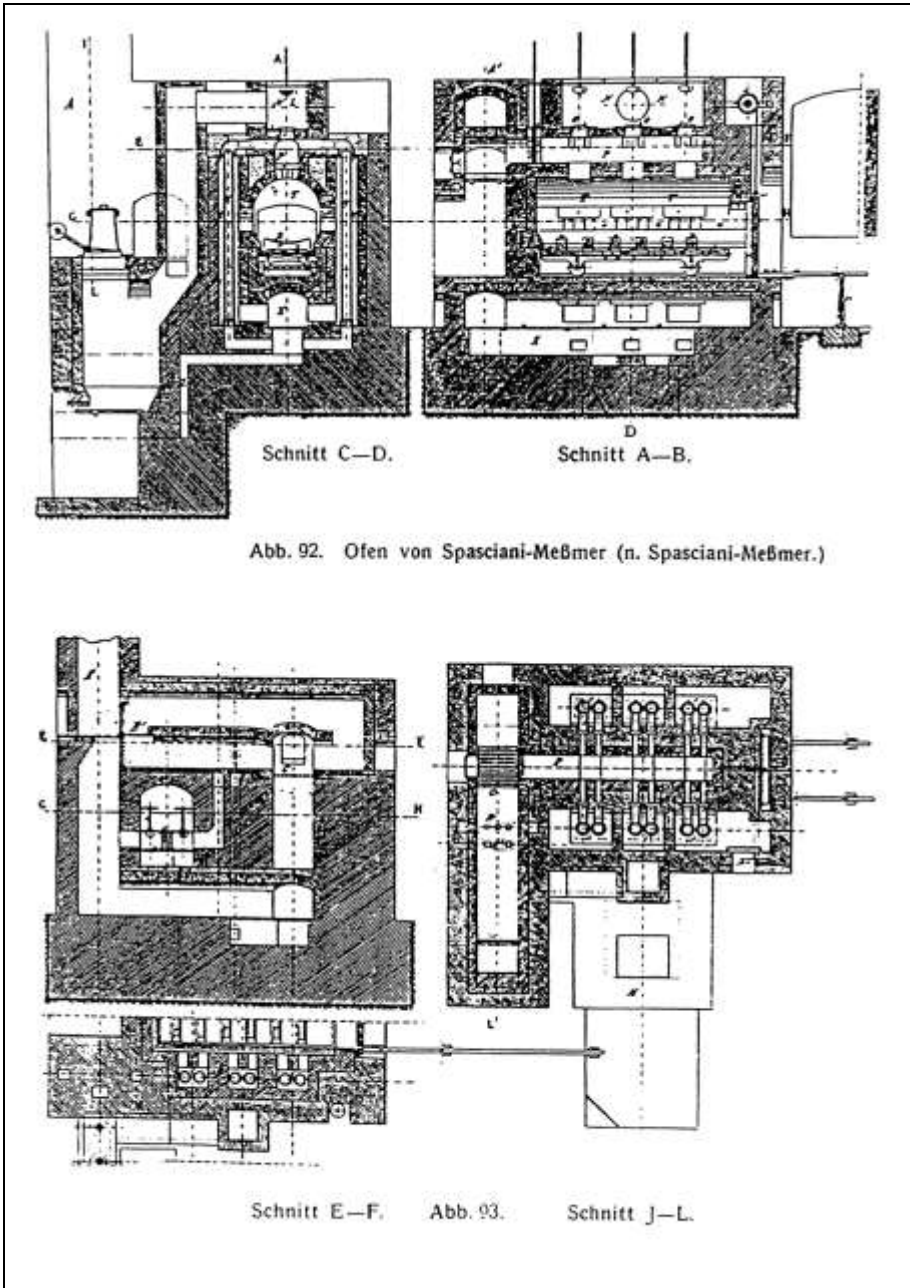

Fig. 20. — Coupe longitudinale.

Document 17: *SPASCIANI-MESSMER coke-fired cremation furnace. Longitudinal section. Source: as Doc. 7, p. 106.*



Document 17a: SPASCIANI-MESSMER coke-fired cremation furnace. Vertical section. Source: as Doc. 7, p. 107.



Document 17b: SPASCIANI-MESSMER coke-fired cremation furnace. Fig. 1: Section C-D; Fig. 2: Section A-B; Fig. 3: Section E-F; Fig. 4: Section J-L. Source: E. Beutinger, Handbuch der Feuerbestattung. Carl Scholtze Verlag, Leipzig, 1911, p. 102.



Abb. 89. Querschnitt.
Ofen von Toisul-Fradet, Paris



Abb. 90. Längenschnitt a—b.

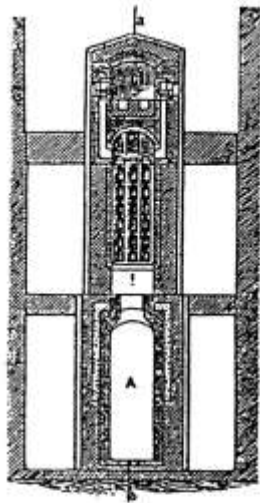

Abb. 91. Horizontalschnitt g h i j k l.

Document 18: TOISUL-FRADET coke-fired cremation furnace. Fig. 89: vertical section; Fig. 90: longitudinal Section a-b; Fig. 91: horizontal section. Source: as Doc. 17b, p. 101.

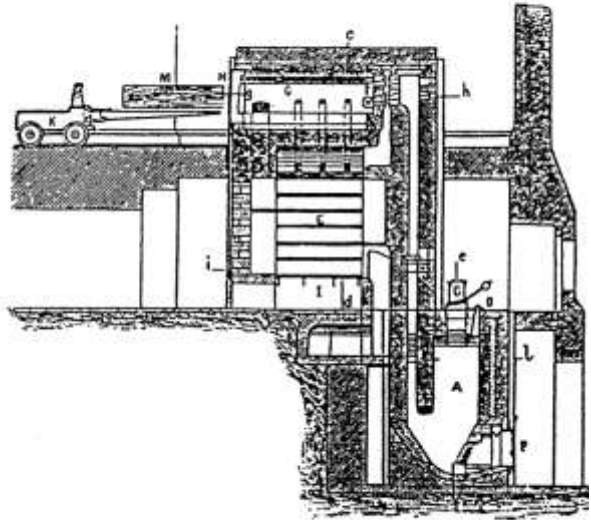

Document 19: TOISUL-FRADET coke-fired cremation furnace. Source: Préfecture du Département de la Seine. Direction des Affaires Municipales. Note sur la crémation à Paris au 1^{er} novembre 1893, drawing outside text.

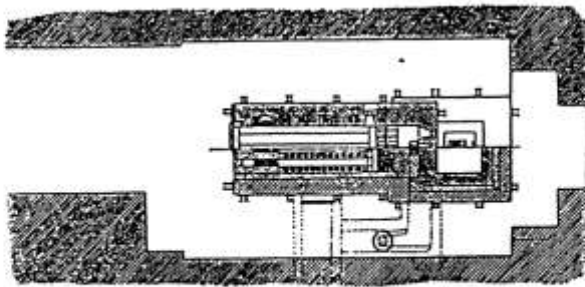
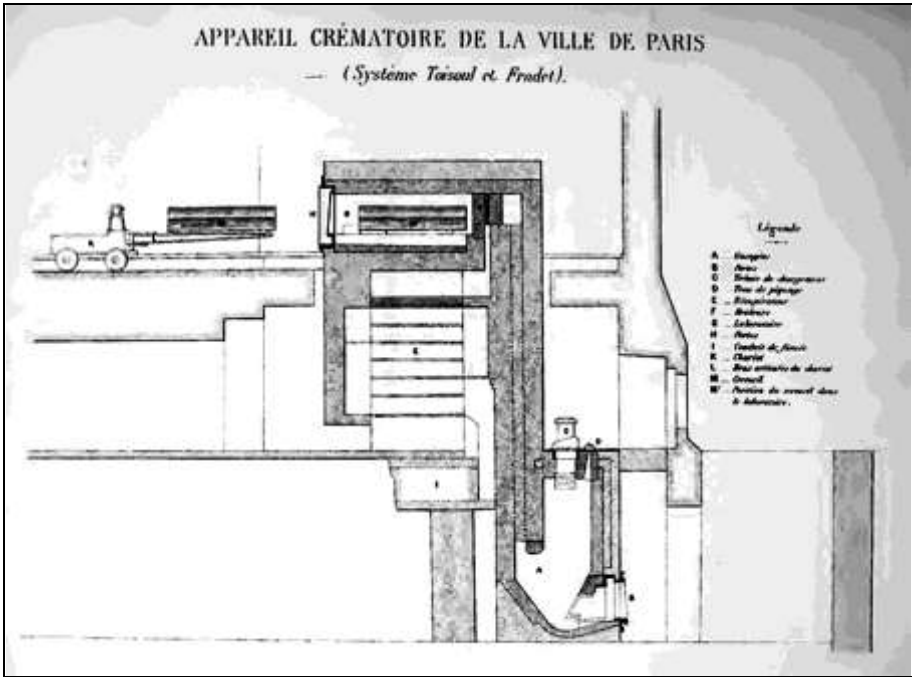
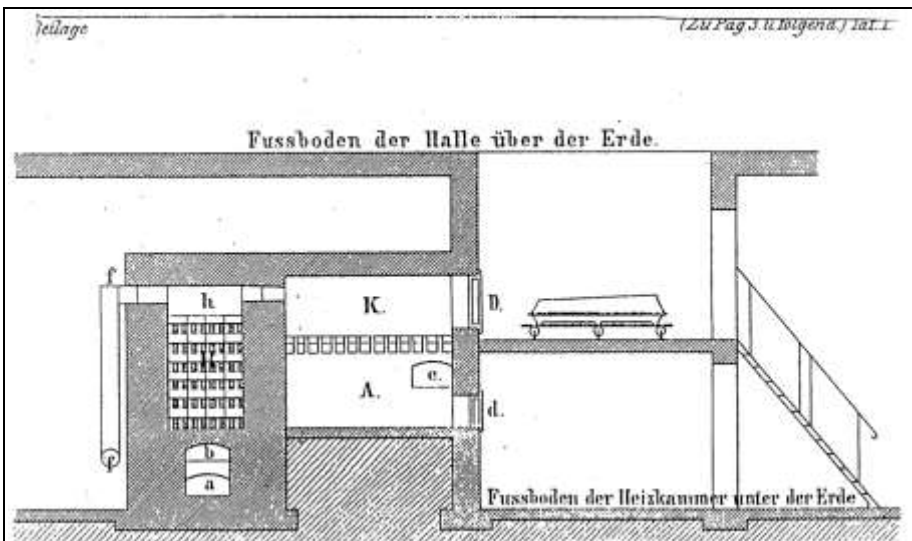

Document 20: SIEMENS experimental coke-fired cremation furnace. Source: F. Küchenmeister, *Die Feuerbestattung*. Verlag von Ferdinand Enke, Stuttgart, 1875, illustration outside text.

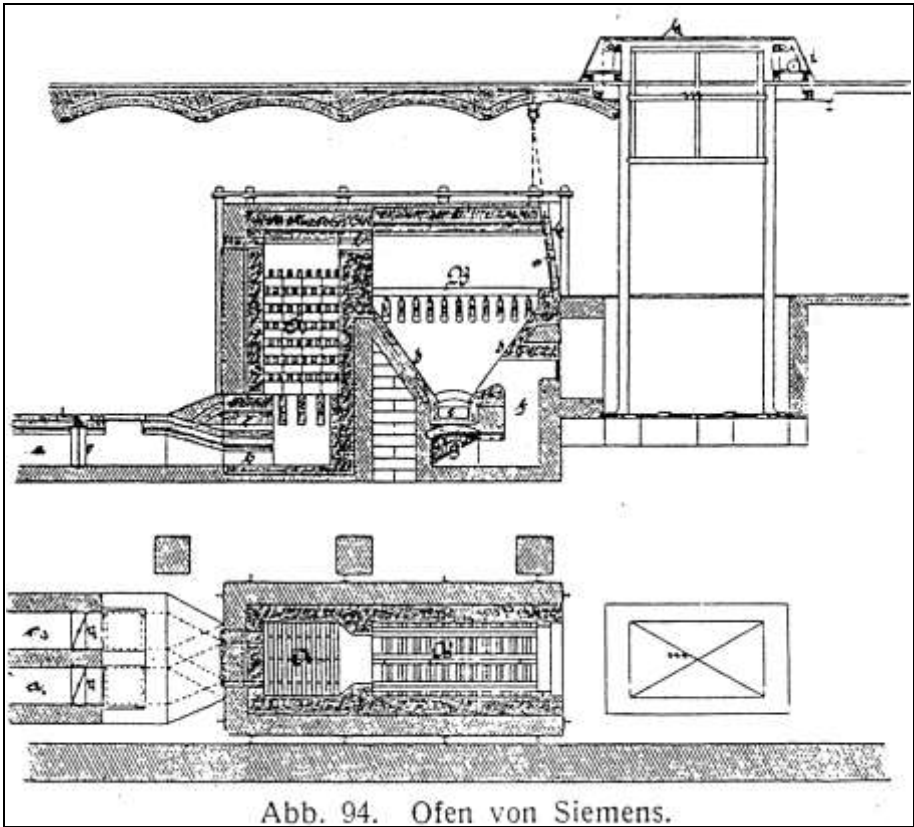

Document 21: SIEMENS coke-fired cremation furnace at the Gotha Crematorium (1878). Source: as Doc. 17b, p. 104.

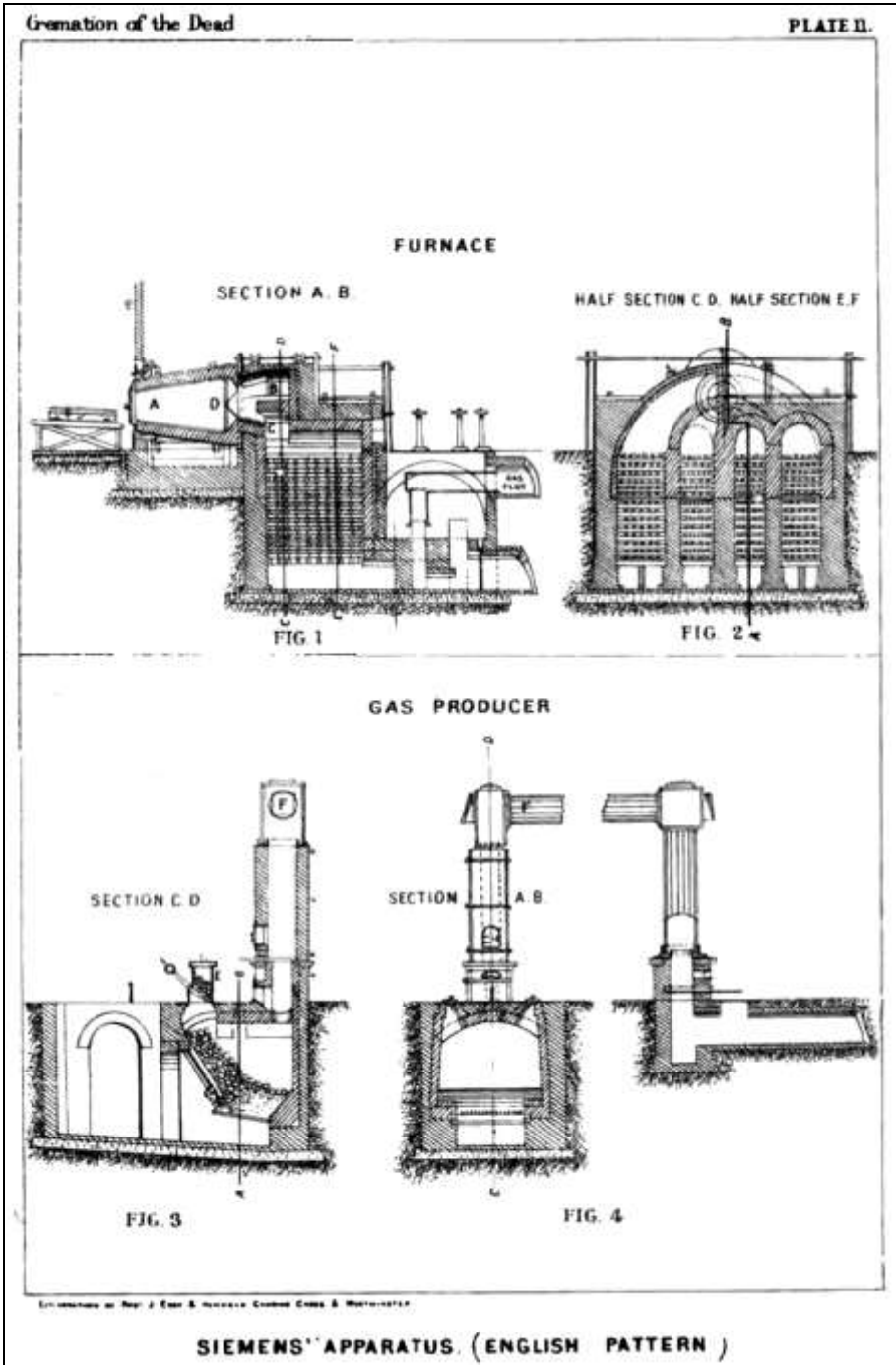

Document 22: SIEMENS coke-fired cremation furnace at the Gotha Crematorium (1878). Source: William Eassie, *Cremation of the Dead*. London, 1875, drawing outside text.

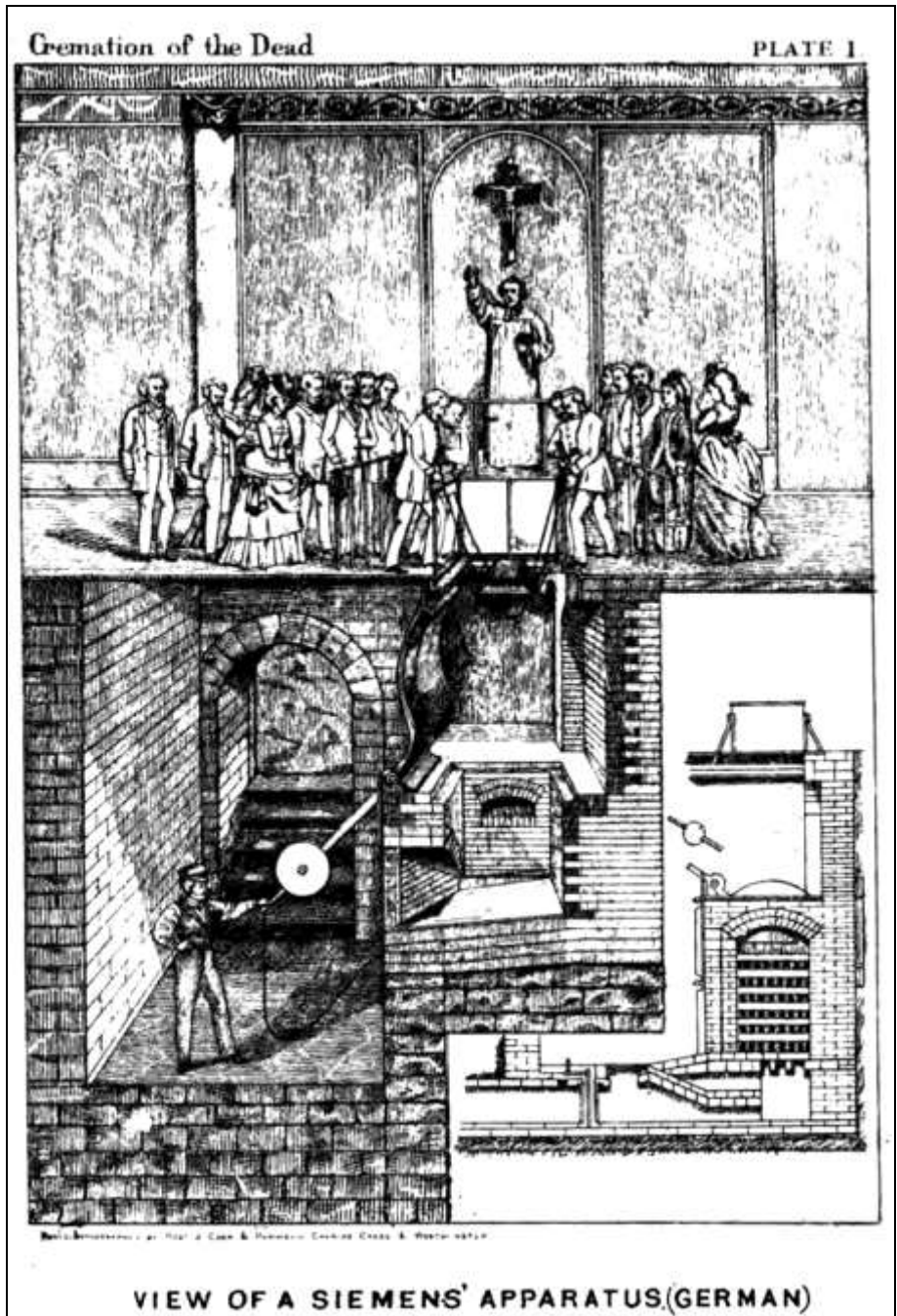

Document 23: Vertical section of the Gotha Crematorium showing the funeral hall and the cremation furnace. Source: William Eassie, Cremation of the Dead. London, 1875, drawing outside text.

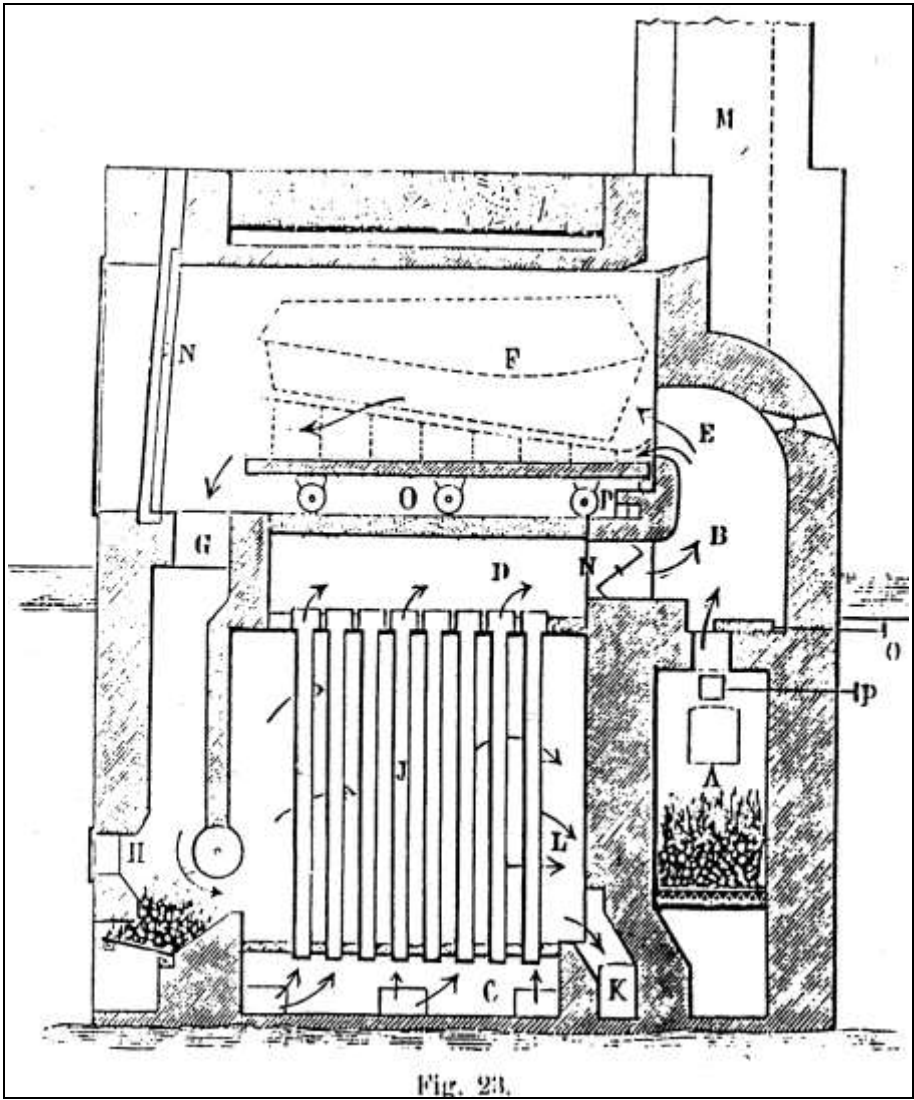

*Document 24: KLINGENSTIERNA coke-fired cremation furnace, original model.
Source: as Doc. 7, p. 114.*

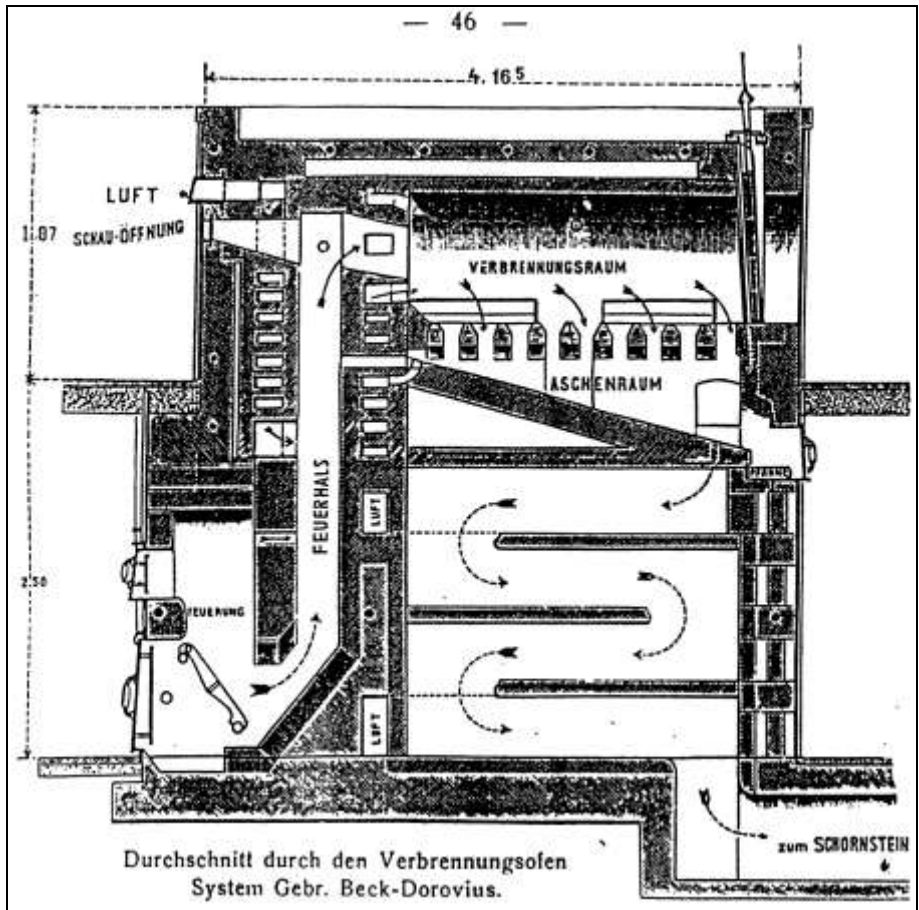

Document 25: *GEBRÜDER BECK-DOROVIVUS* coke-fired cremation furnace. Source: K. Weigt, *Almanach der Feuerbestattung*, self-published, Hannover, 1909, p. 46.

Abb. 95—98. Der Einäscherungsofen System Klingenstierna-Beck.



Abb. 95. Längenschnitt durch den Ofen.



Abb. 96. Querschnitt.

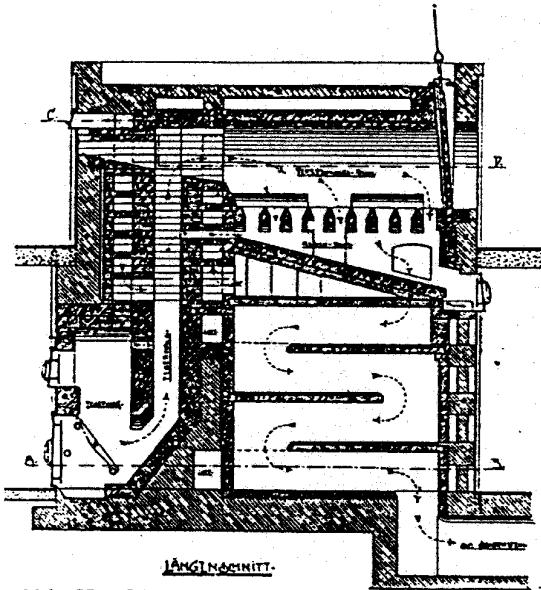

Abb. 97. Grundriß in der Höhe der Feuerung

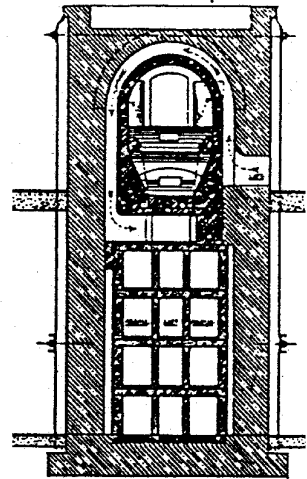

Abb. 98. Grundriß in der Höhe des Verbrennungsraumes.

Document 26: KLINGENSTIERNA-BECK coke-fired cremation furnace. Fig. 95: longitudinal section; Fig. 96: vertical section; Fig. 97: horizontal section at the height of the hearth; Fig. 98: horizontal section at the height of the cremation chamber.

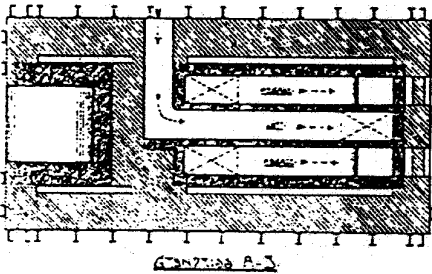
Source: as Doc. 17b, p. 108.

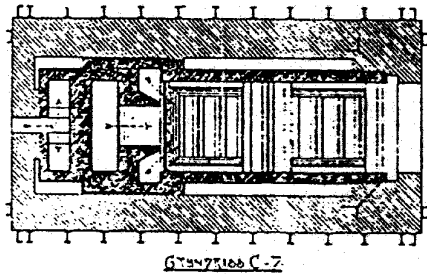
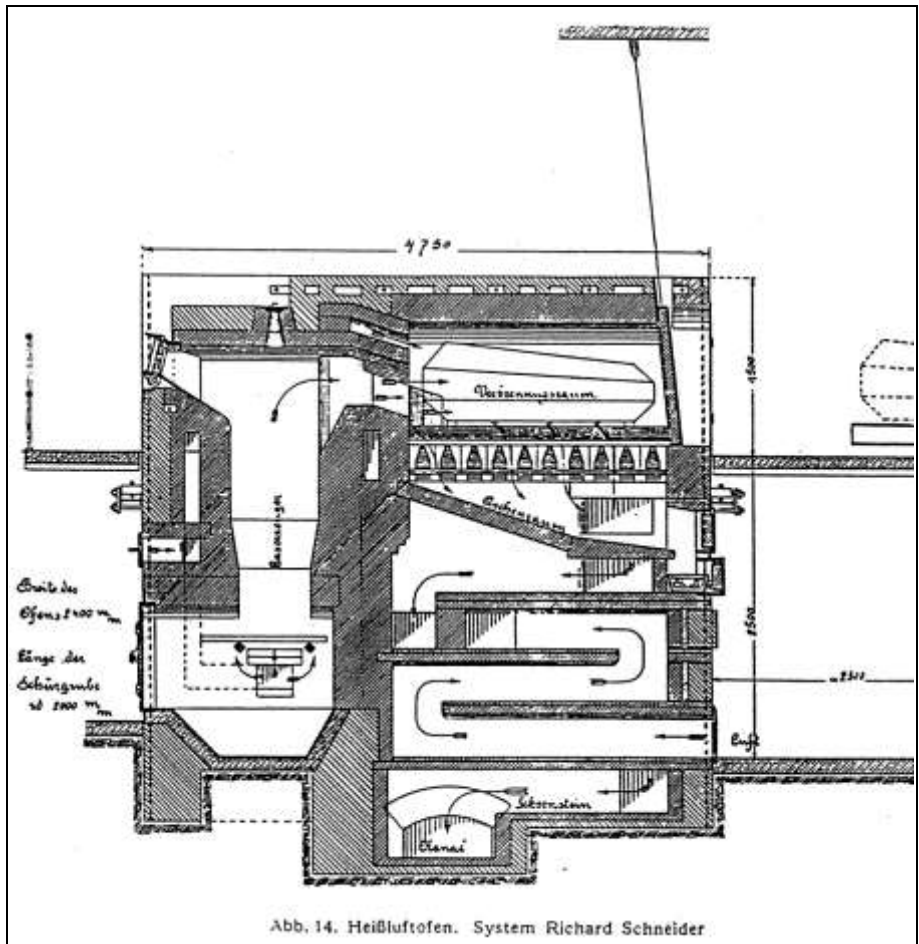

Document 27: R. SCHNEIDER coke-fired cremation furnace. Source: F. Schumacher, Die Feuerbestattung. J. M. Gebhardt's Verlag, Leipzig, 1939, p. 23.

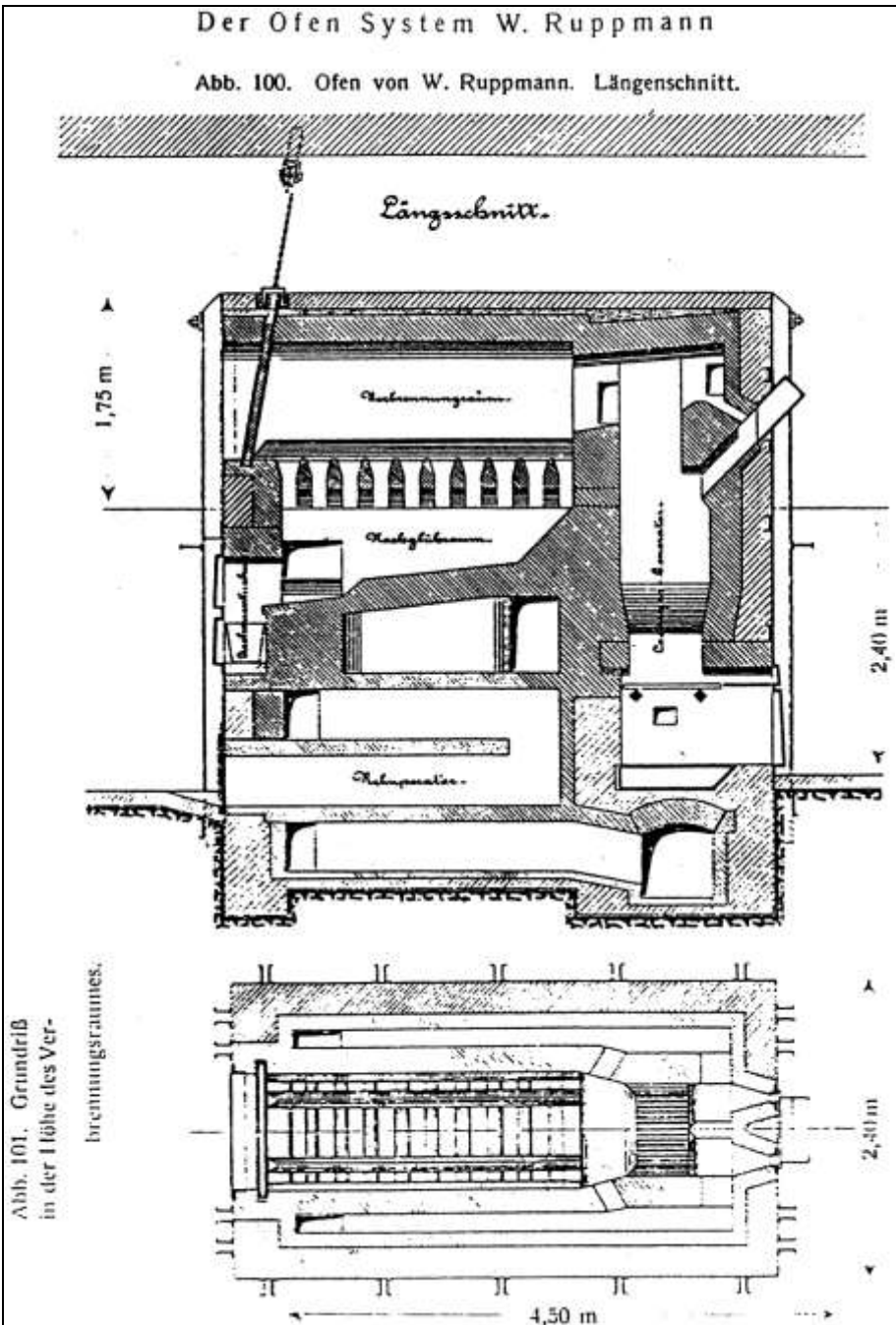

Document 28: W. RUPPMANN coke-fired cremation furnace. Fig. 100: longitudinal section; Fig. 101: horizontal section at the height of the cremation chamber.

Source: as Doc. 17b, p. 114.



Abb. 102. Querschnitt.



Abb. 103. Grundriß durch den Nachöhlraum

Document 28a: W. RUPPMANN coke-fired cremation furnace. Fig. 102: vertical section; Fig. 103: horizontal section along the post-combustion chamber. Source: as Doc. 17b, p. 115.

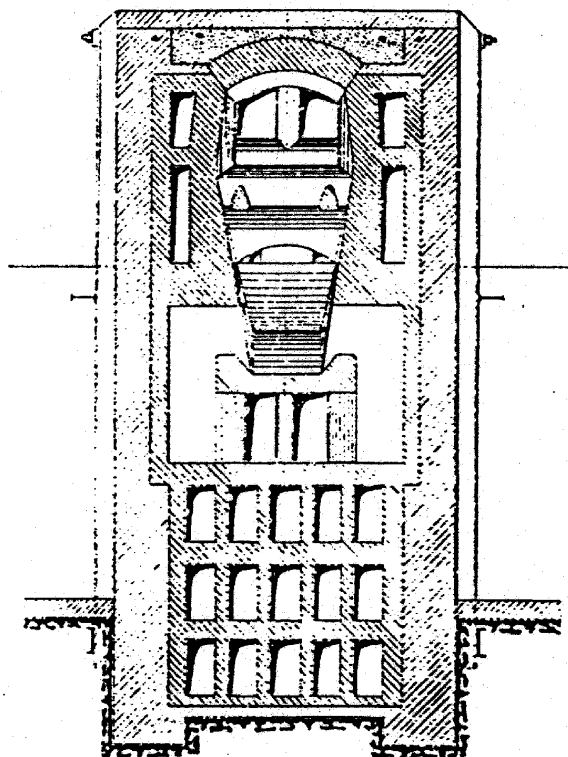

Document 29: KNÖS coke-fired cremation furnace. Longitudinal section. Source: as Doc. 17b, p. 118.

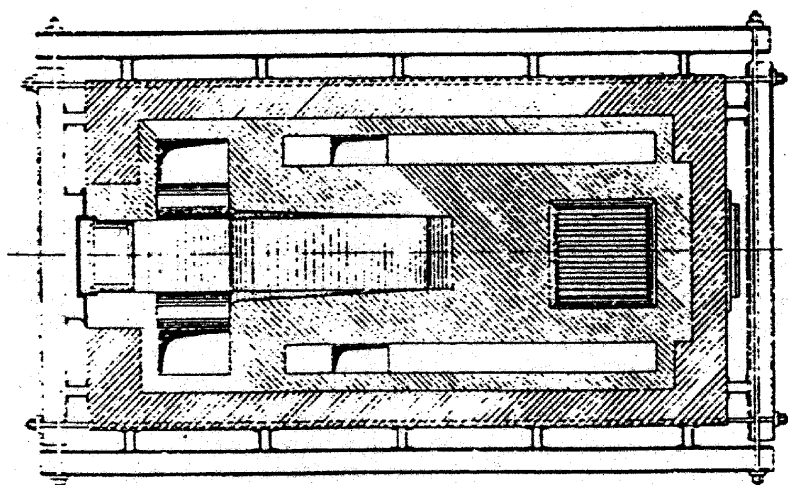
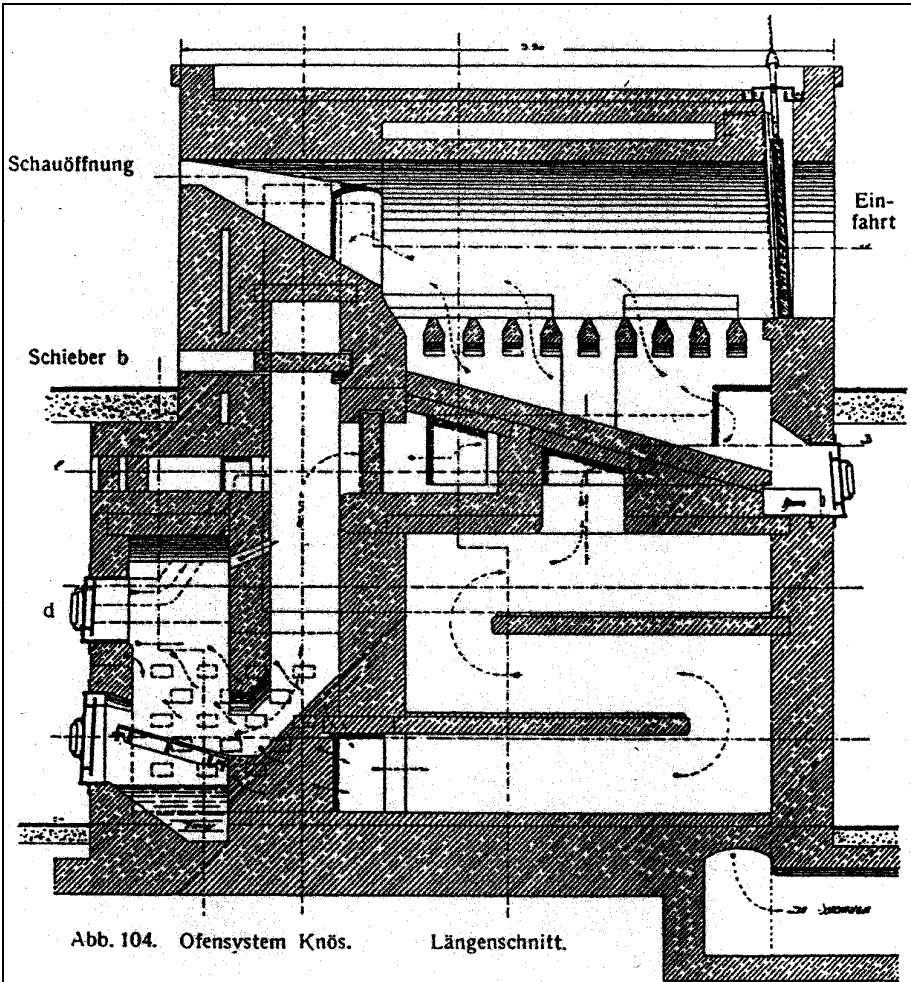

Abb. 105. Grundriß A—B durch den Einäscherungsraum.



Abb. 106. Grundriß C—D.

Document 29a: KNÖS coke-fired cremation furnace. Fig. 105: horizontal Section A-B along the cremation chamber; Fig. 106: horizontal Section C-D.

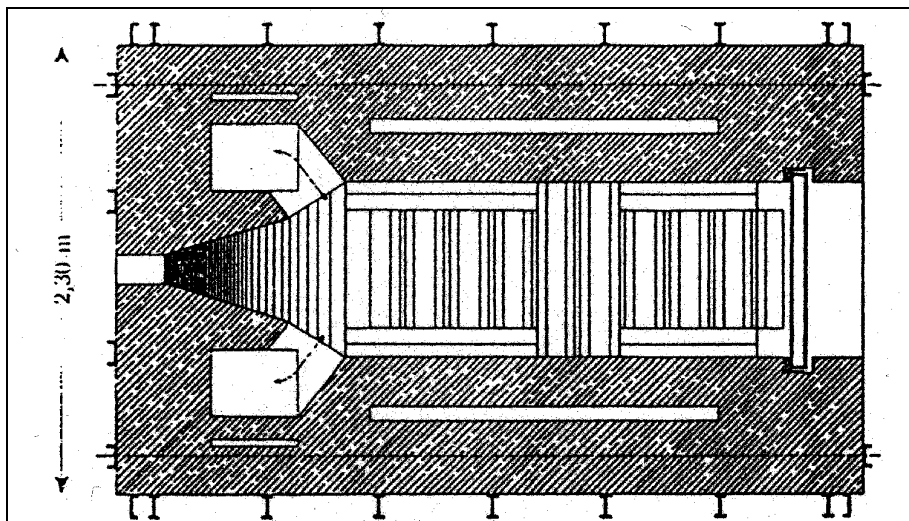

Document 30: FICHET cremation furnace, inaugurated on 19 January 1891 at the crematorium of the Père-Lachaise Cemetery in Paris. Source: as Doc. 19, drawing outside text.

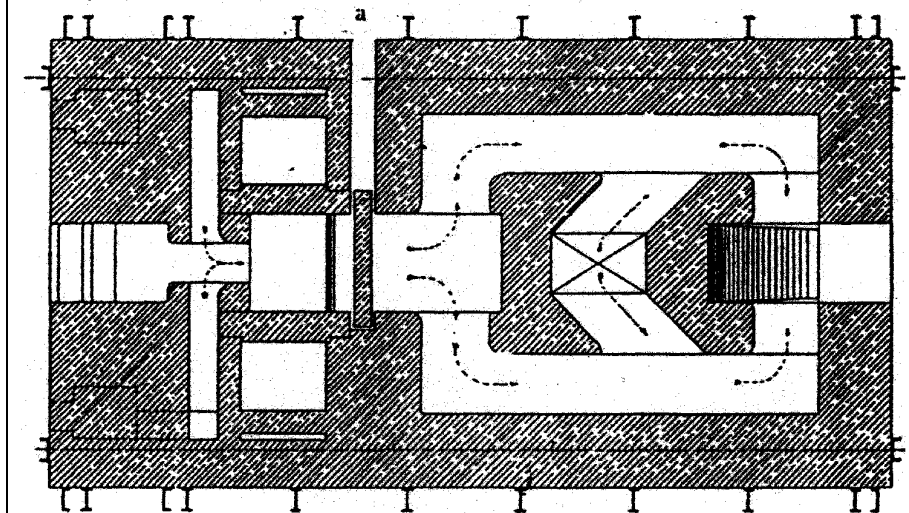
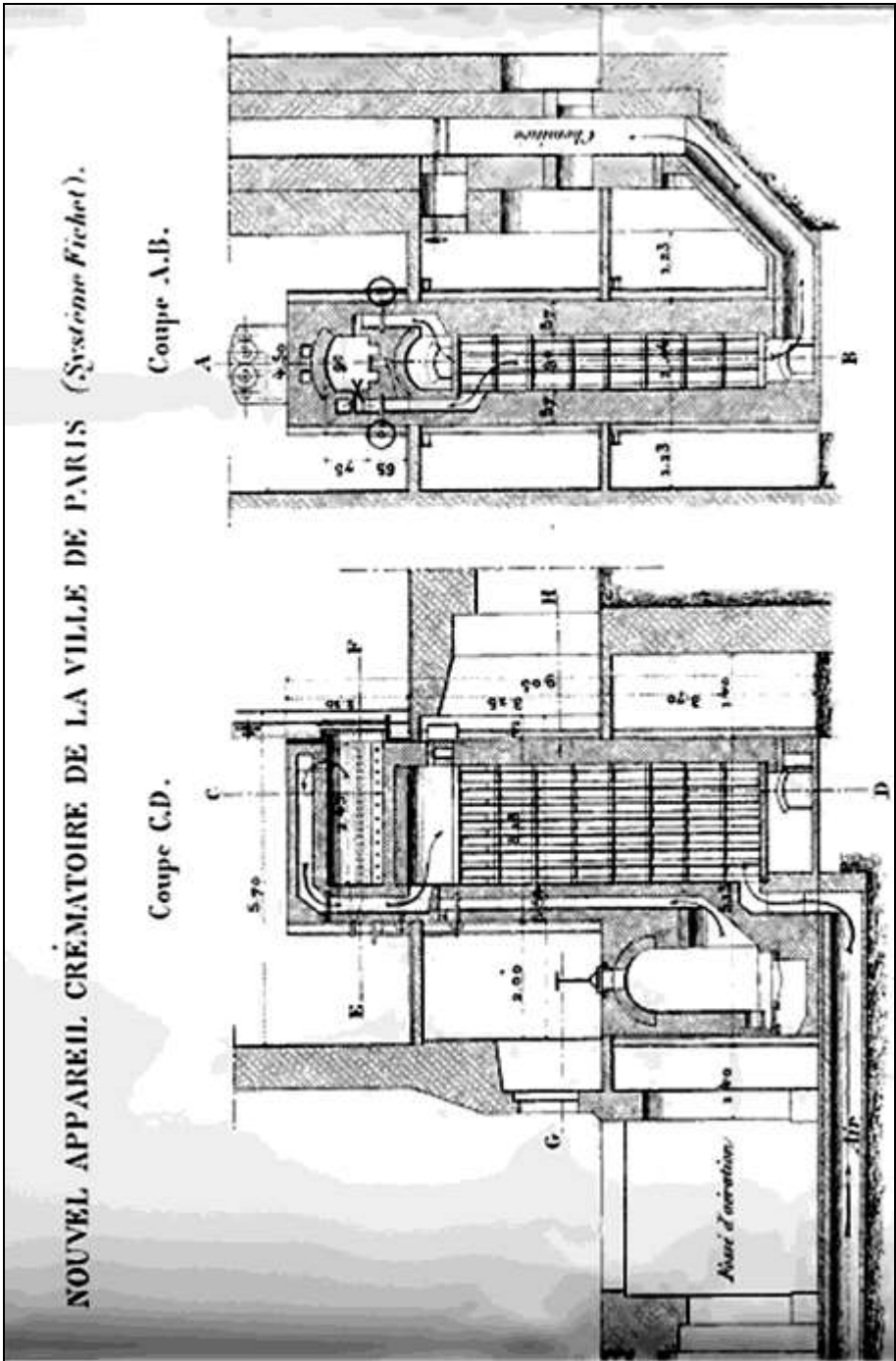

Abb. 107. Grundriß in der Höhe des Einäscherungsraumes.



Abb. 108. Längenschnitt des Leuchtgasofens Toisul und Fradet.

Document 31: TOISUL-FRADET gas-fired cremation furnace. Fig. 107: horizontal section at the height of the cremation chamber; Fig. 108: longitudinal section.

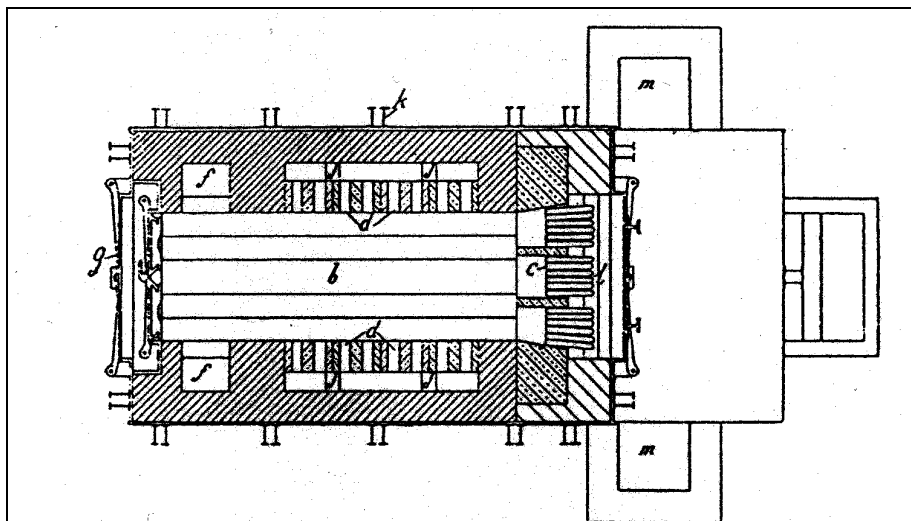
Source: as Doc. 17b, p. 123.

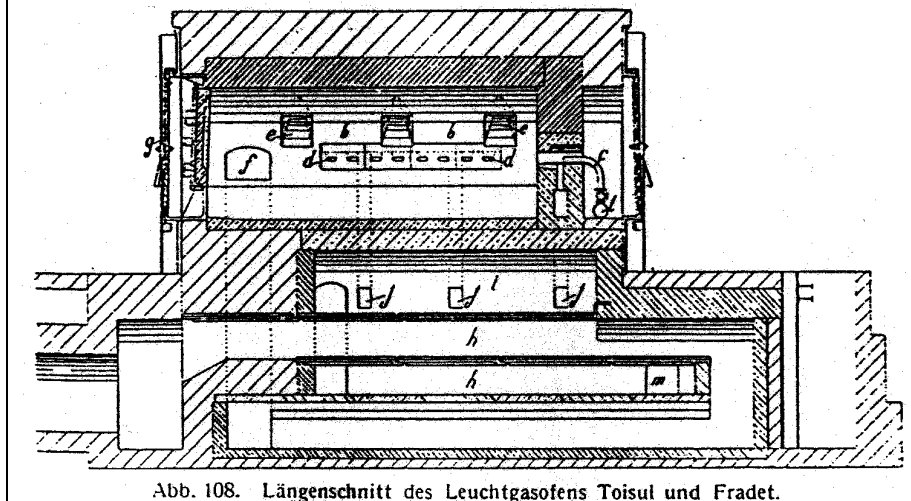

Abb. 1. Leichenverbrennungs-Ofen von Rothenbach & Co.,
Bern, Schweizer. Patent 86533. (Längsschnitt.)

Abb. 2.
Querschnitt zu Abb. 1.

Document 32: ROTHENBACH & CO. naphtha-fired cremation furnace (Swiss Patent No. 86533). Fig. 1: longitudinal section; Fig. 2: vertical section. Source: Georgius, "Neuere Leichenverbrennungstechnik," in: Gesundheits-Ingenieur, 46. Jg., 1923, Heft 5, p. 56.

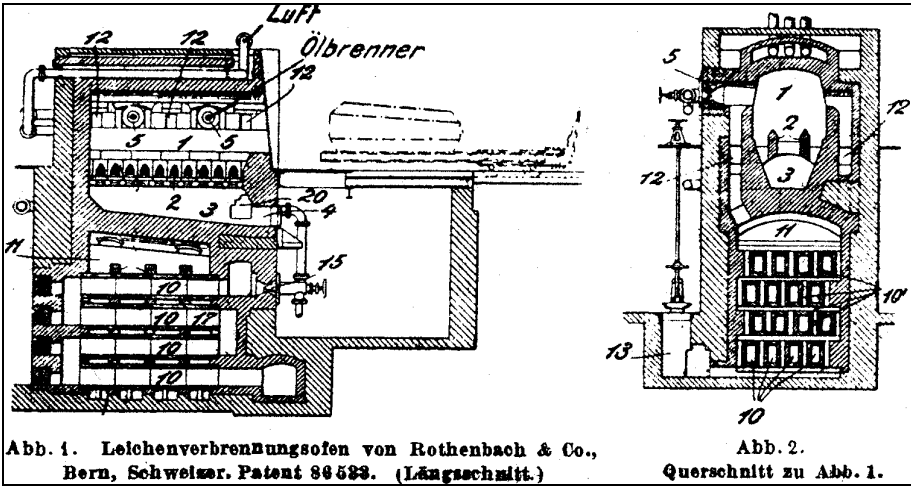
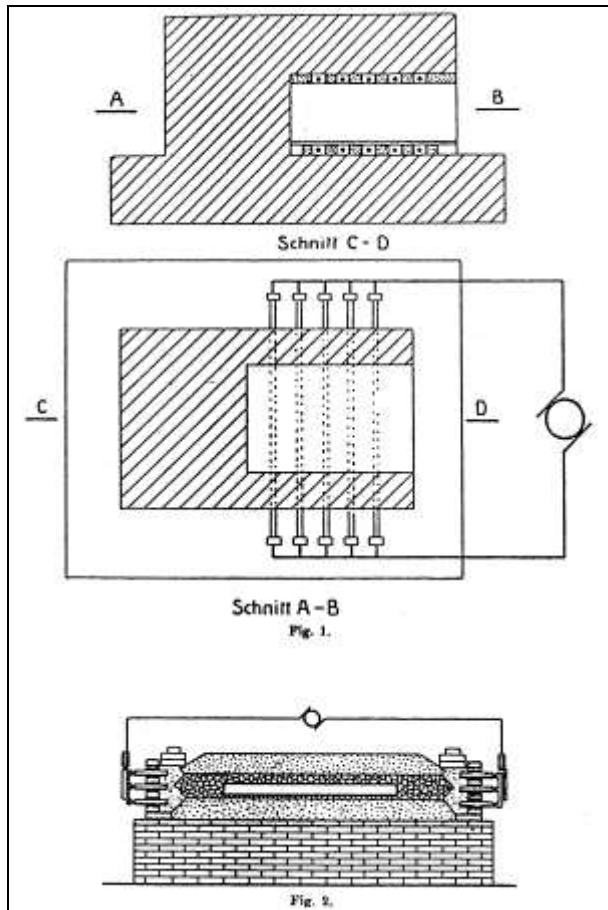

Document 33: PROMETHEUS experimental electric cremation furnace. Source: Phoenix. Blätter für wahlfreie Feuerbestattung und verwandte Gebiete, Vienna, 1910, Nr. 10, p. 399.



Abb. 6. Leichenverbrennungsöfen von Conley, amerikan. Patent 988 862.
(Längsschnitt.)



Abb. 7. Querschnitt zu Abb. 6.

Document 34: CONLEY electric cremation furnace (U.S. patent no. 988862, 1911).
Source: as Doc. 32, p. 57.

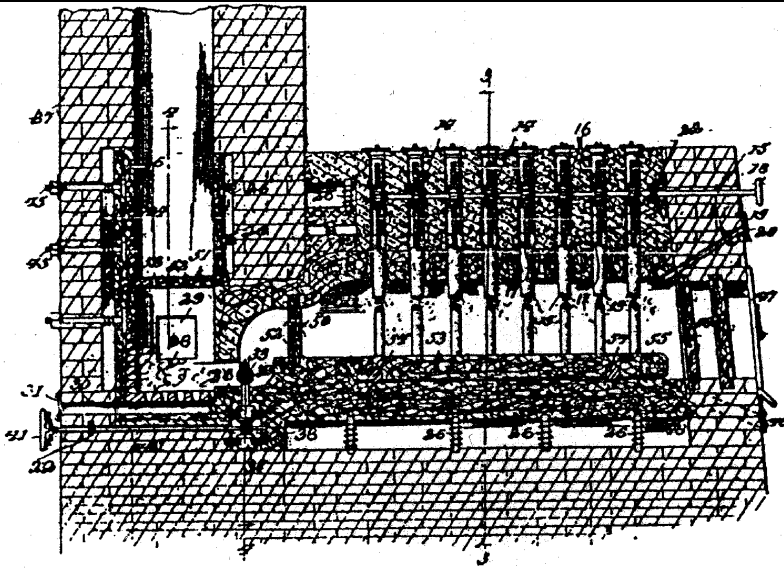

Document 35: "Cremation furnace with a regenerator and a gas generator connected at the front to the combustion chamber." W. SAUERLAND Patent No. 284163, of 12 March 1915. Fig. 1: longitudinal section; Fig. 2: vertical section; Fig. 3: horizontal section.

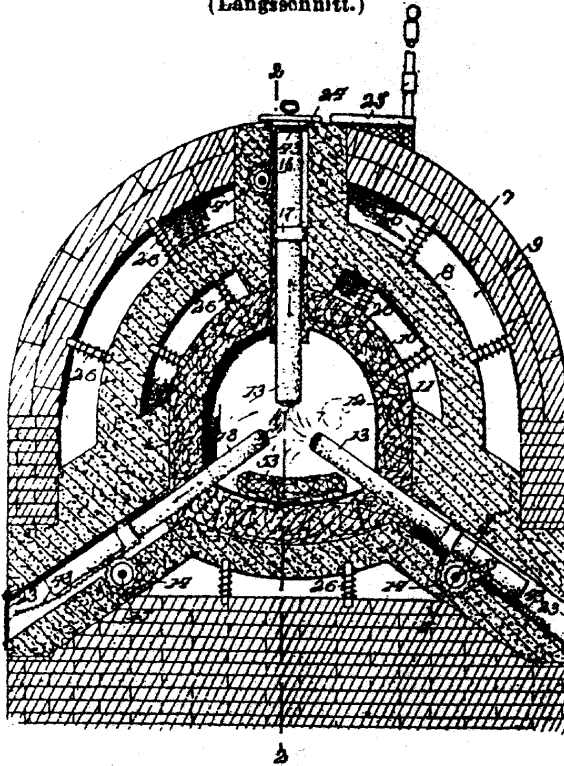
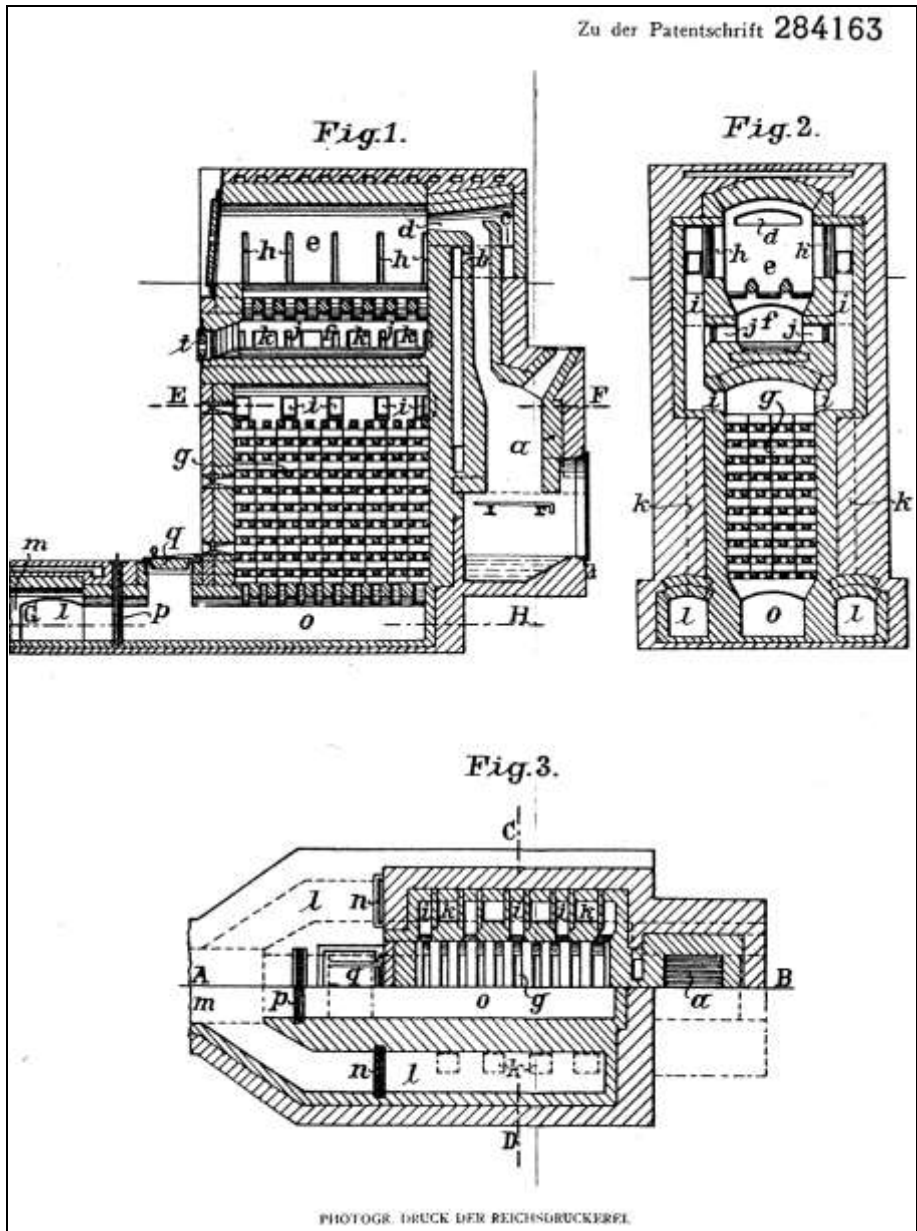
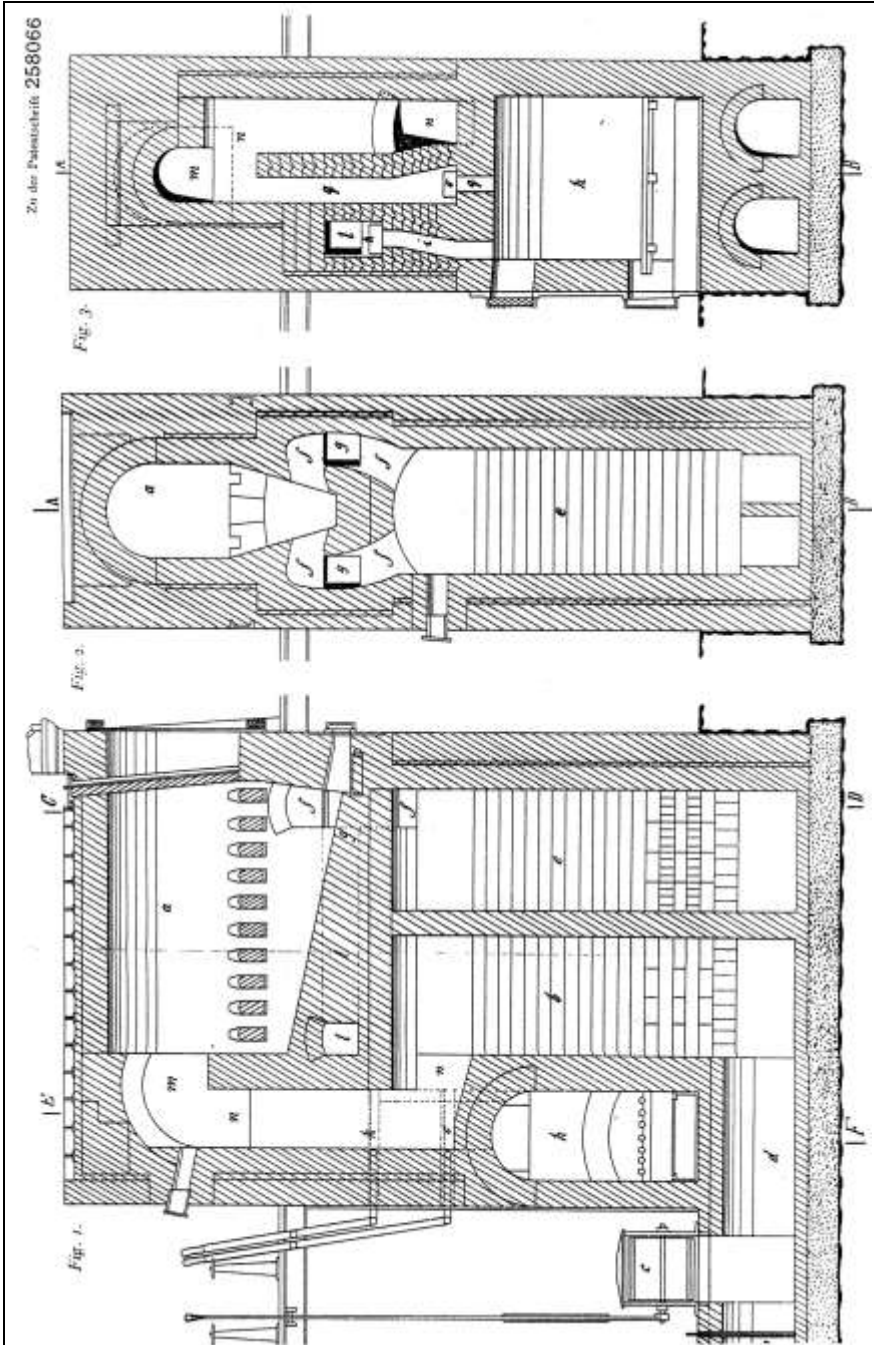

Document 36: "Cremation furnace for corpses with regenerator and gas generator" (*Leicheneinäscherungsöfen mit Regeneratoren und einem Gaserzeuger*). Patent F. SIEMENS, no. 258066, of 18 August 1911. Fig. 1: longitudinal section; Fig. 2: vertical section along the cremation chamber; Fig. 3: vertical section along the hearth.

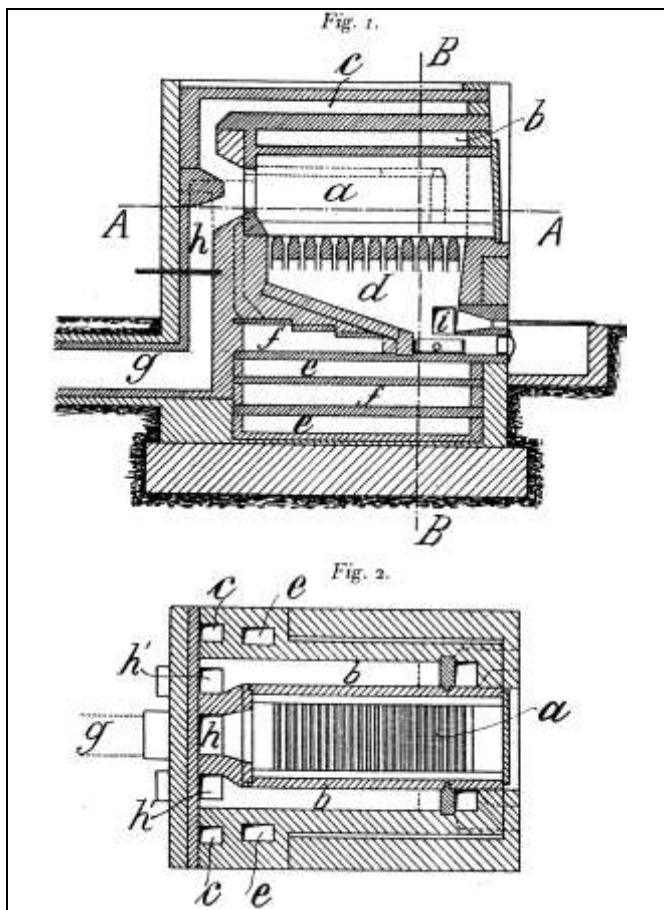

Document 37: "Cremation furnace for corpses with recuperator recuperator" (*Leichenverbrennungssofen mit Recuperator*). Patent M.J. KERGEL, no. 218581, of 4 October 1908. Fig. 1: longitudinal section; Fig. 2: horizontal Section A-A along the cremation chamber.

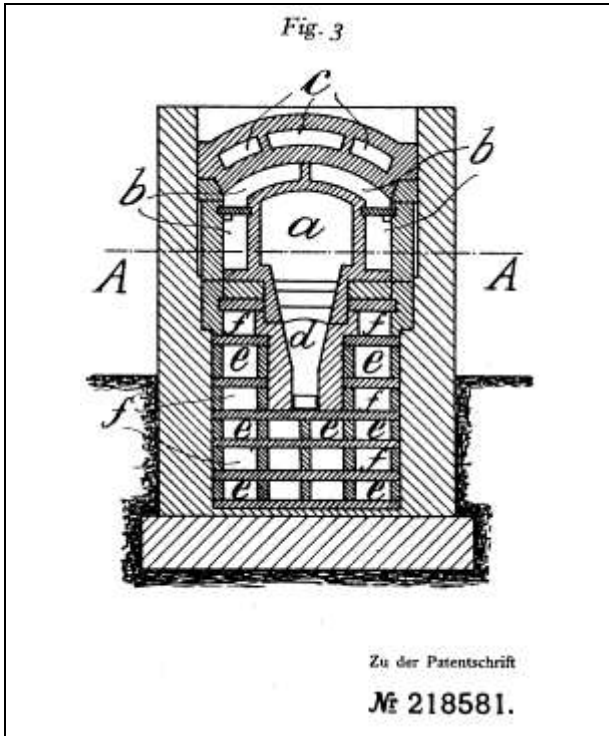

Document 37a: as above. Fig. 3: vertical Section B-B.

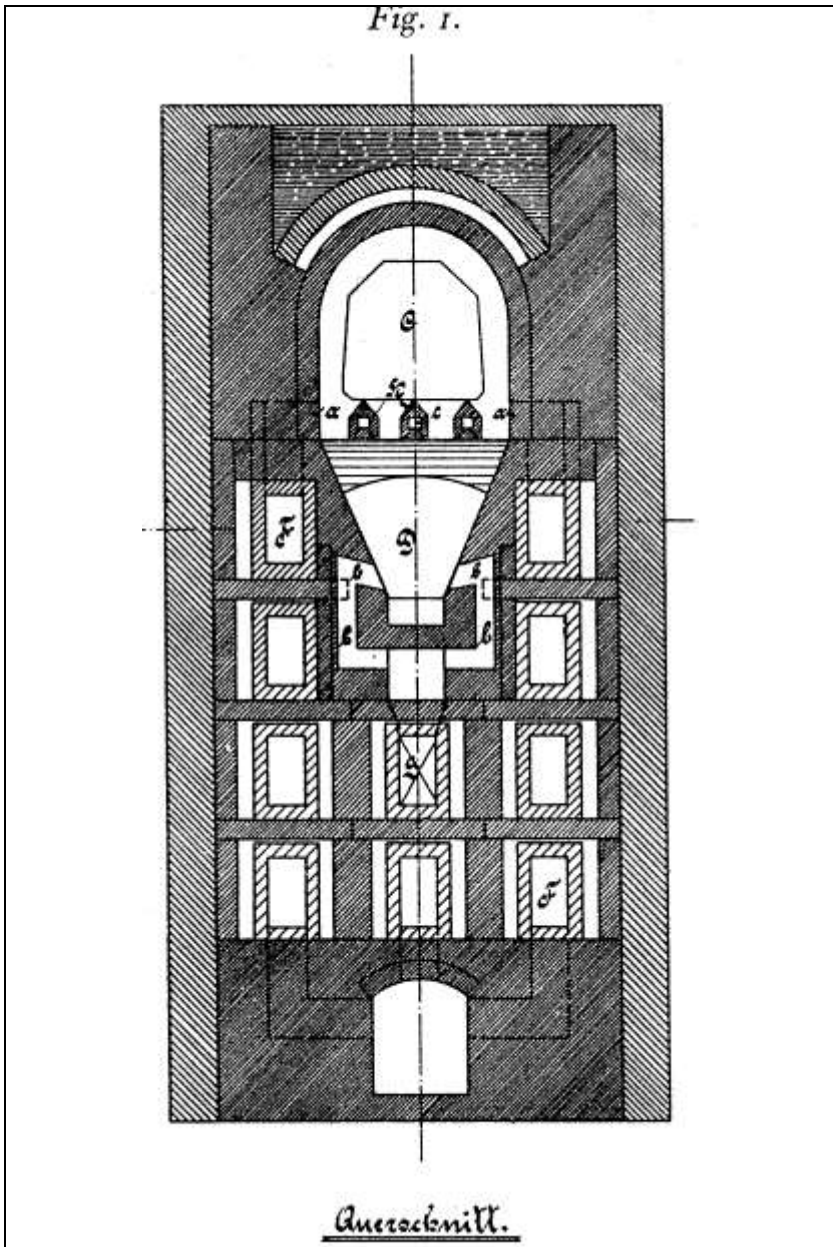

Document 38: "Procedure and device for the cremation of corpses with combustion gases and heated air with a heat source" (*Verfahren und Vorrichtung zur Einäscherung von Leichen mit Verbrennungsgasen und erhitzter Luft mit einer Wärmequelle*). Patent of BUNZLAUER WERKE LENGERSDORFF & COMP., No. 263725, of 6 September 1913. Fig. 1: vertical section.

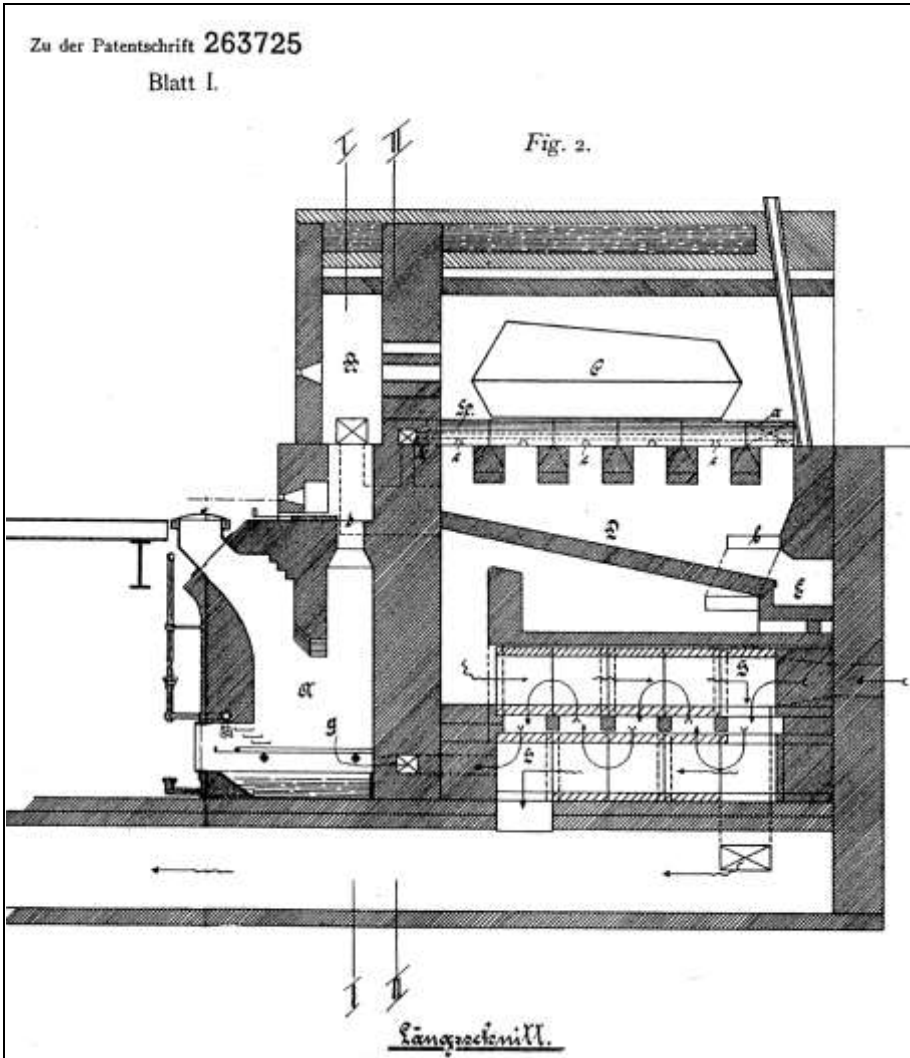

Document 38a: as above. Fig. 2: longitudinal section.

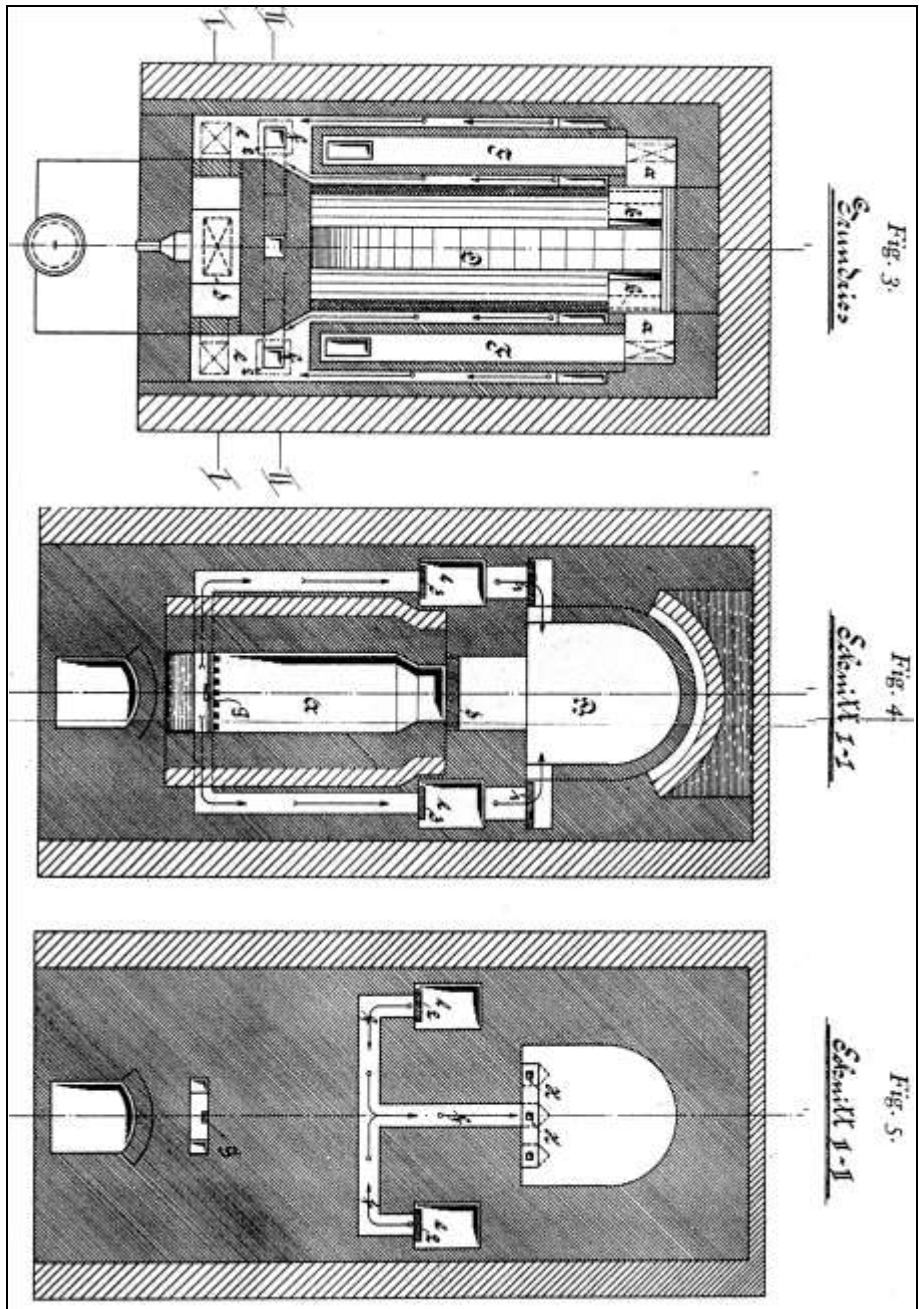

Document 38b & c: as above. Fig. 3: horizontal section. Fig. 4: vertical Section I-I along the gasifier; Fig. 5: vertical Section II-II along the combustion-air channel and the smoke flue.

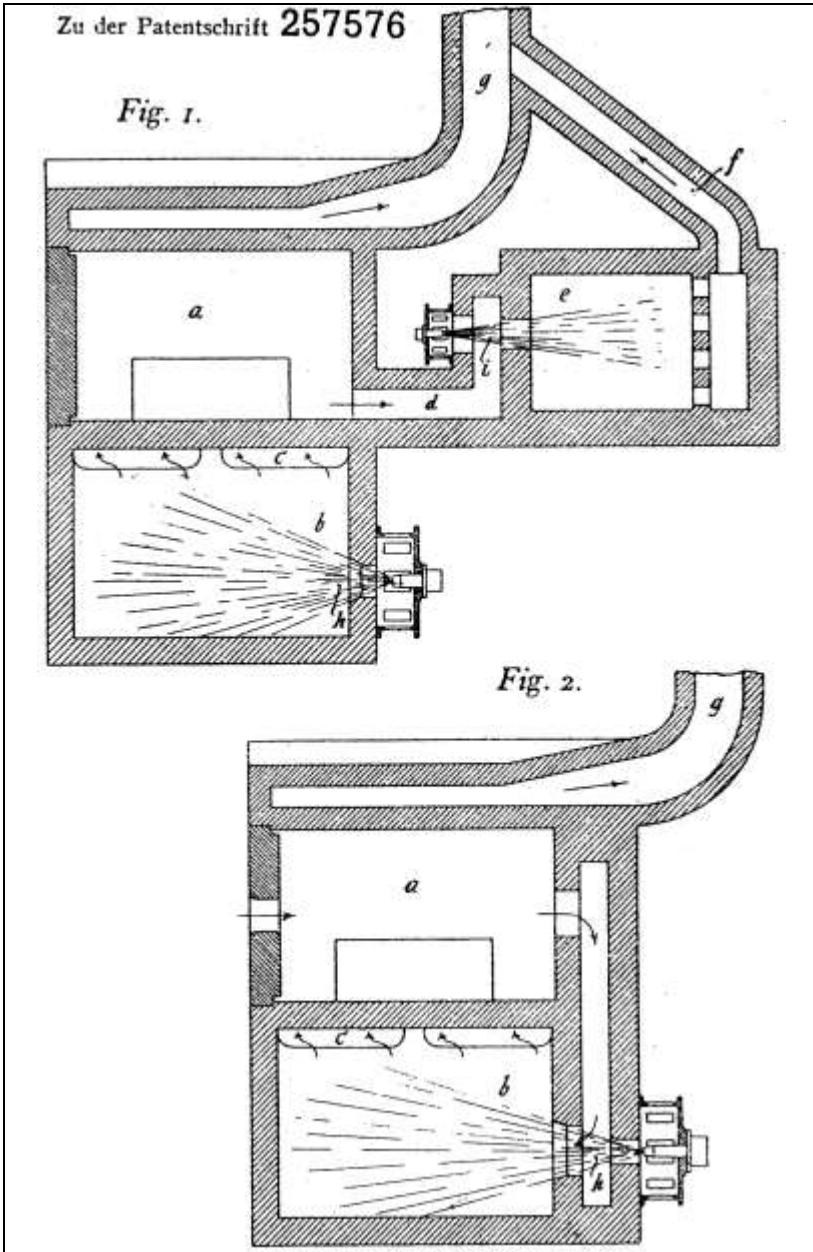

Document 39: "Naphtha-fired Cremation Furnace for Corpses" (*Leichenverbrennungsofen mit Ölfeuerung*). Patent GEBRÜDER KÖRTING AKTIENGESELLSCHAFT in Linden, No. 257576, of 30 June 1911.

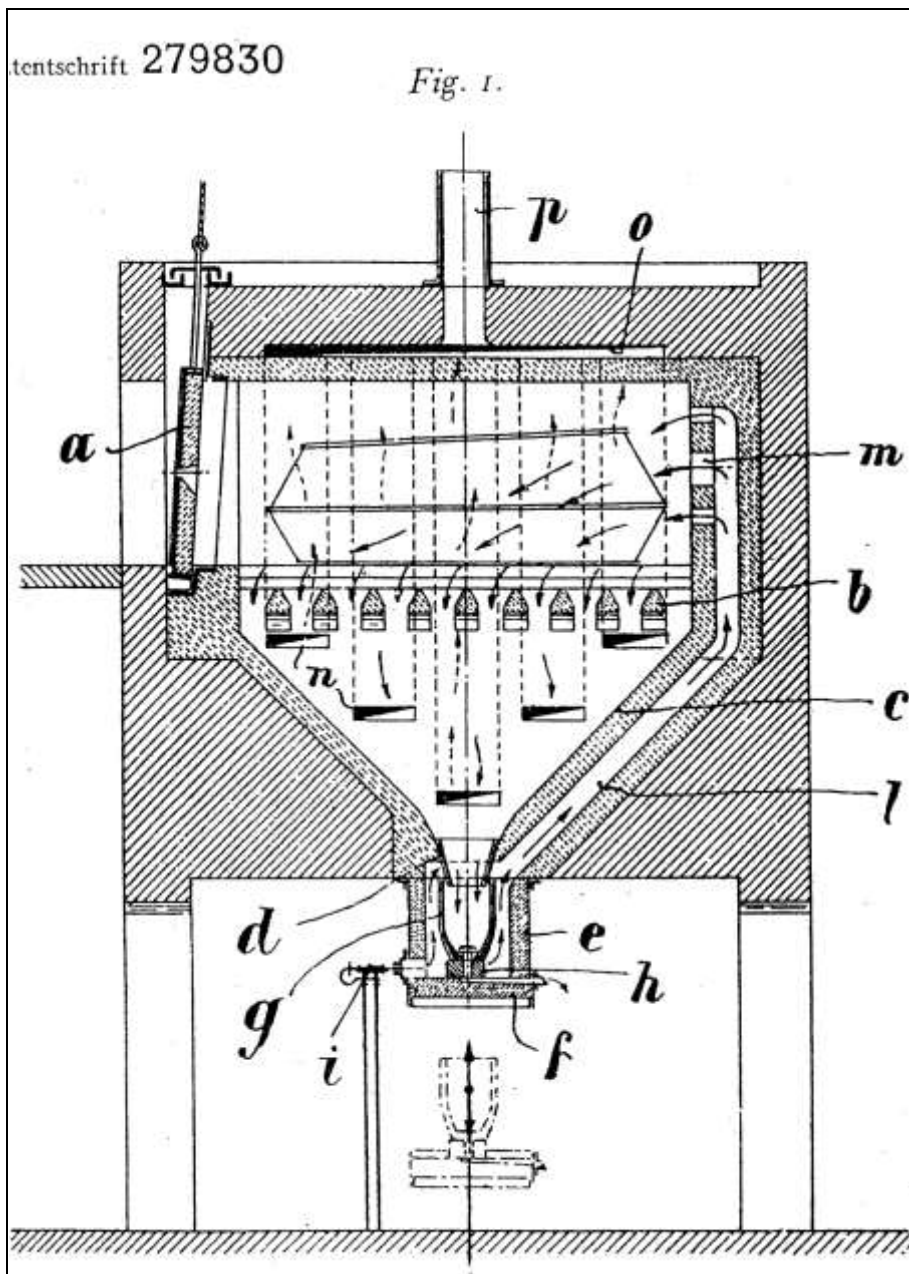

Document 40: "Naphtha- or gas-fired cremation furnace for corpses with an ash receptacle beneath the slanted cremation chamber" (*Leichenverbrennungsofen mit Öl- oder Gasfeuerung mit einem unter dem schräg abfallenden Verbrennungsraum liegenden Aschenaufnahmebehälter*). Patent W. BUSS, no. 279830, of 22 August 1913. Fig. 1: longitudinal section.

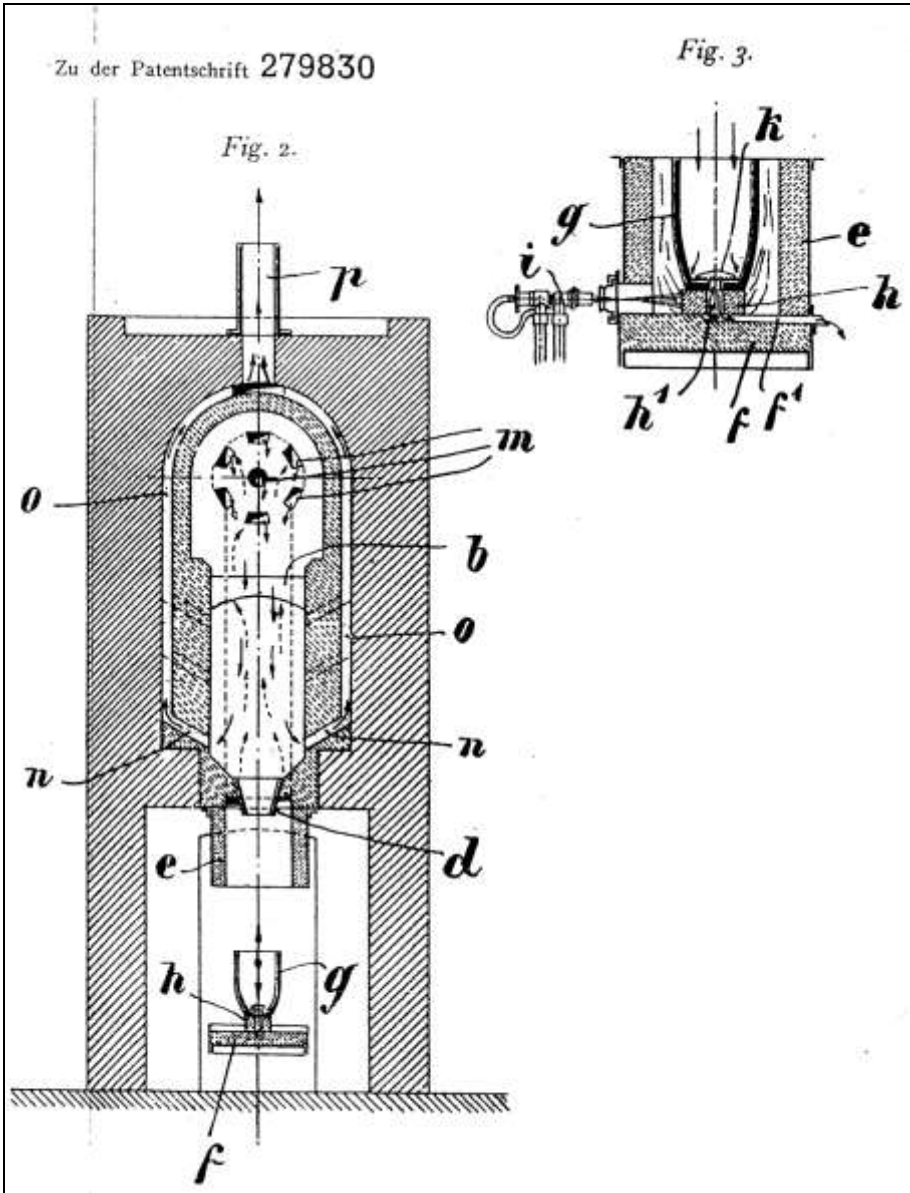

Document 40a: as above. Fig. 2: vertical section; Fig. 3: crucible with burner.

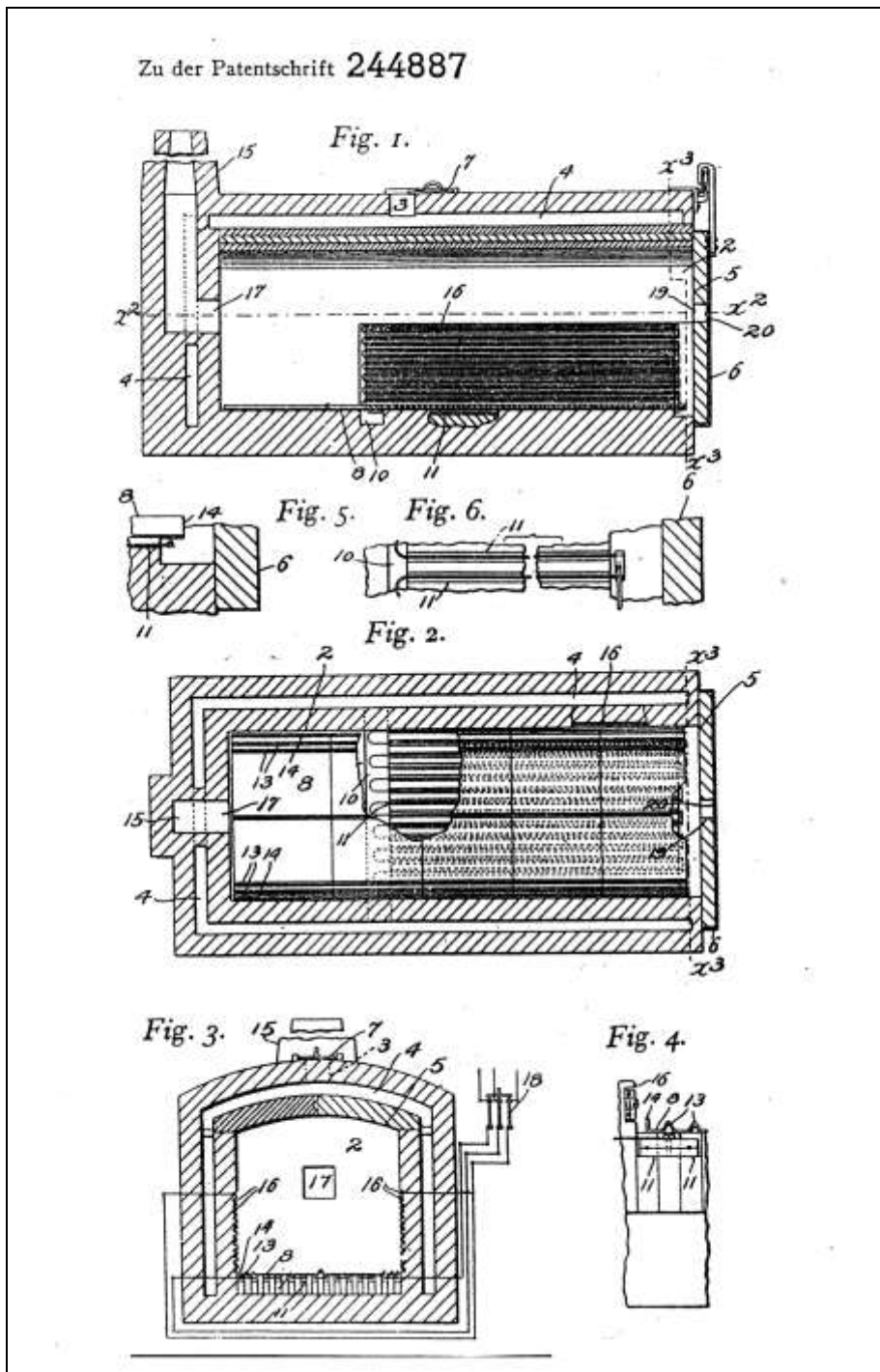

Document 41: "Electric cremation furnace for corpses" (*Elektrischer Leichenverbrennungsofen*). Patent L.H.GIDDINGS, No. 244887, of 11 April 1911.

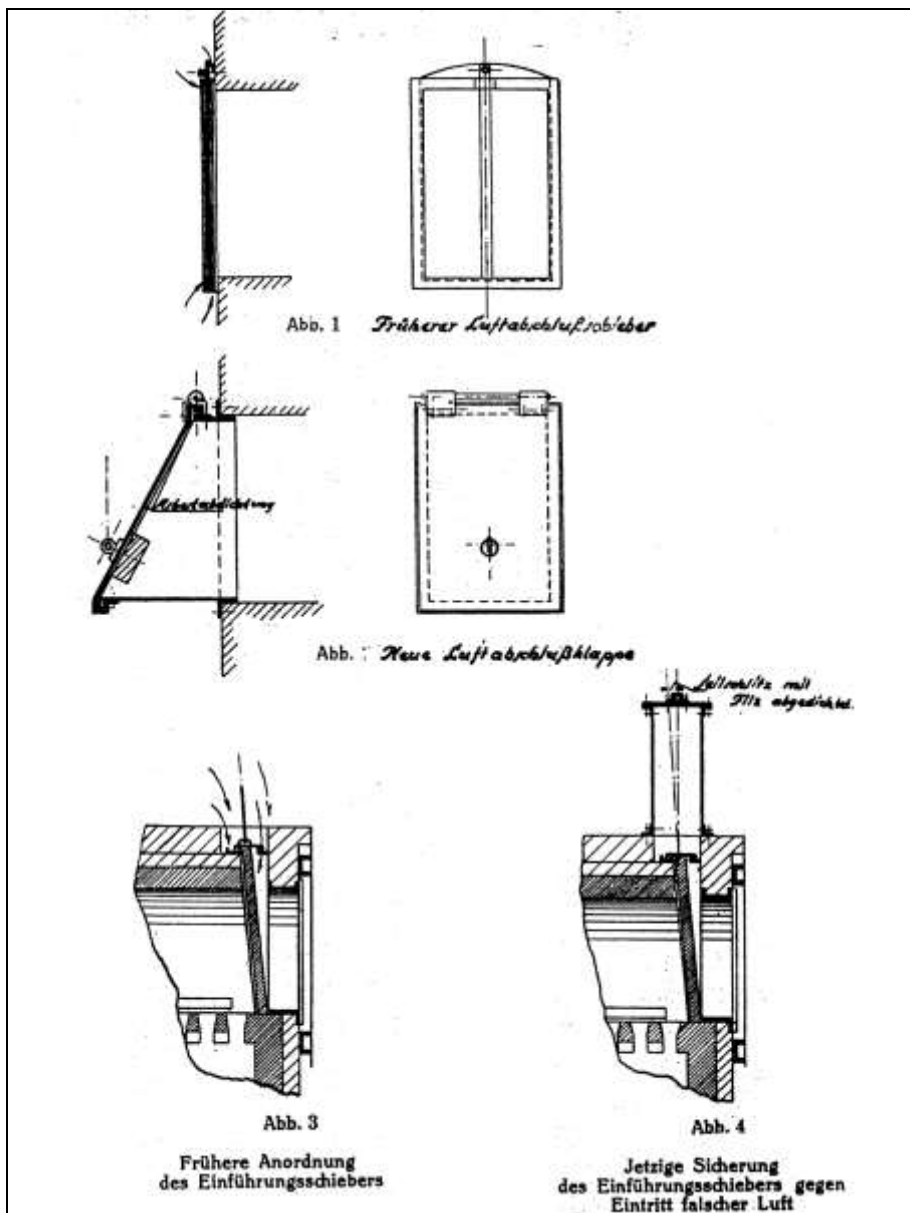

Document 42: *GEBRÜDER BECK* coke- or gas-fired cremation furnace at the Dessau Crematorium: thermotechnical improvement to closures by engineer R. Kessler (1926). Source: R. Kessler, "Rationelle Wärmewirtschaft in den Krematorien nach Massgabe der Versuche im Dessauer Krematorium," in: *Die Wärmewirtschaft*, 1927, no. 8, p. 136; original air flap; Fig. 2: improved air flap; Fig. 3: original introduction damper; Fig. 4: improved damper; Fig. 5 (see Doc. 43, top left): original damper of the smoke conduit; Fig. 6 (Doc. 43, top right): improved damper.

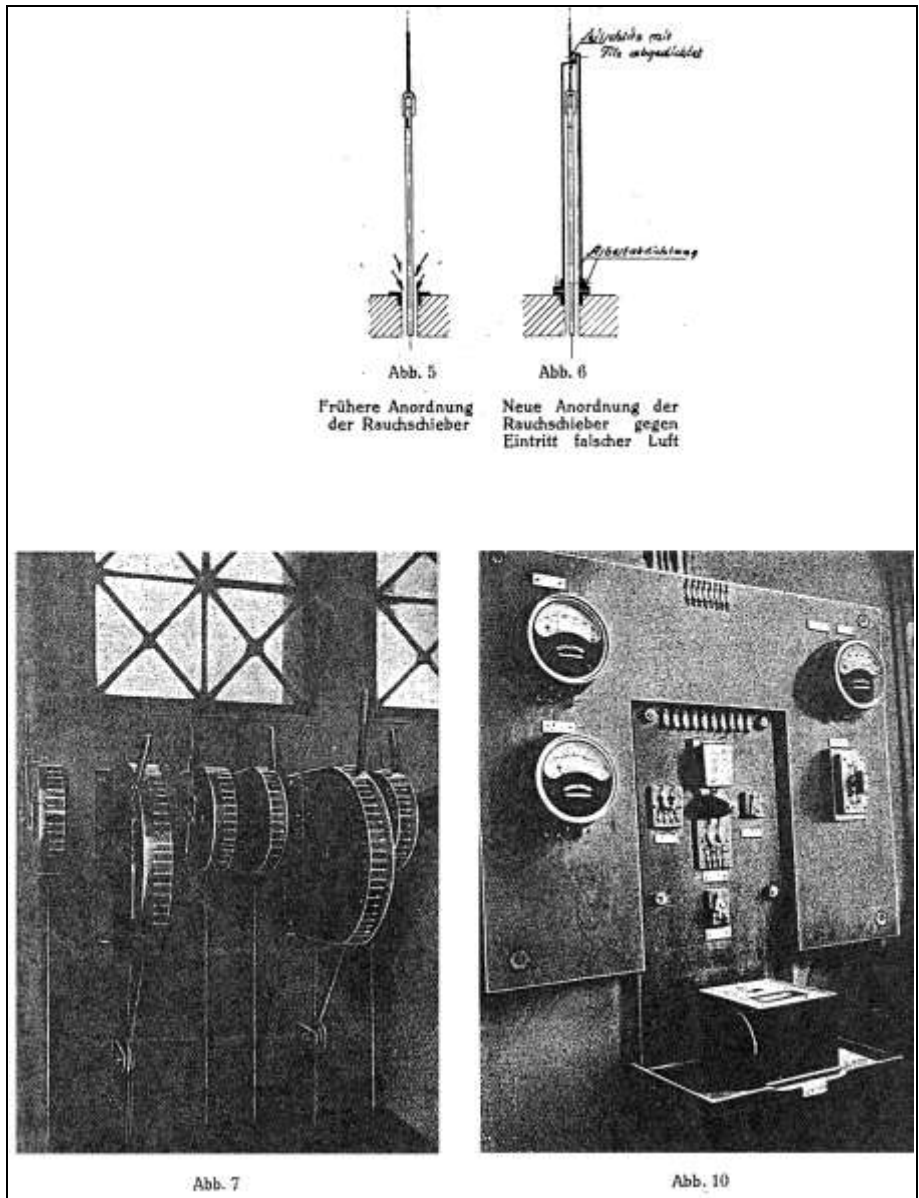

Document 43: as above. Operational furnace instruments. Fig. 7: control levers of the shutters and doors; Fig. 10: thermotechnical devices for controlling the combustion. Source: as Doc. 42, p. 137.



Abb. 8



Abb. 9

Document 44: as above. Fig. 8: rear parts of the gas burners; Fig. 9: Gauges for CO and CO₂, and for draft and gas pressure. Source: as Doc. 42, p. 138.

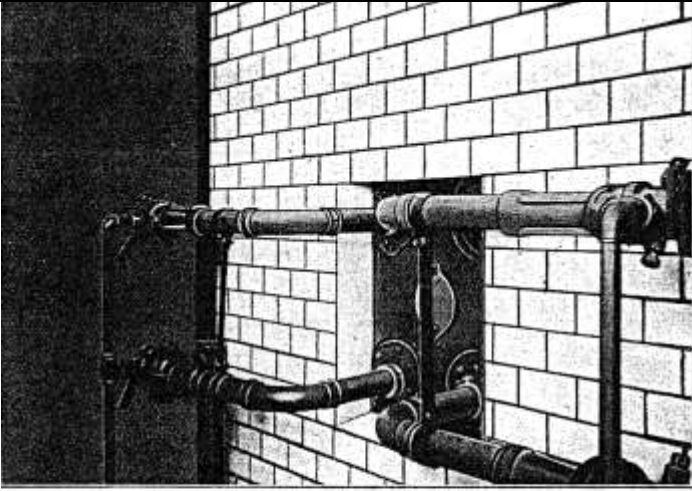

Document 45: as above. Fig. 11: control lever; Fig. 12: Instruments' Position; Fig. 13: electric switch board of the air compressor. Source: as Doc. 42, p. 139.

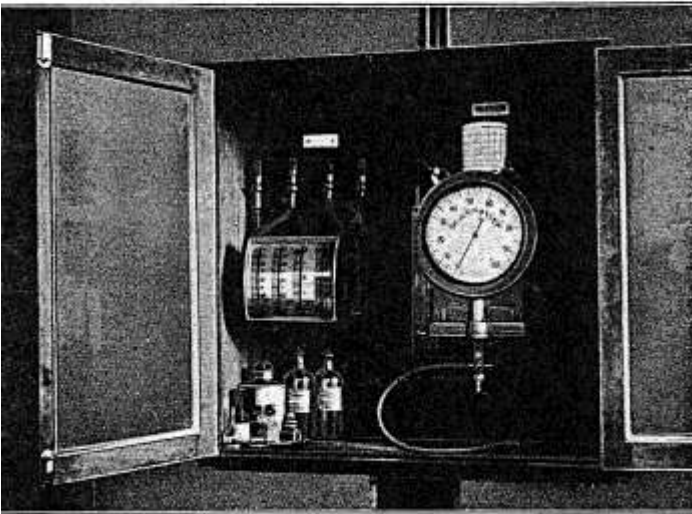
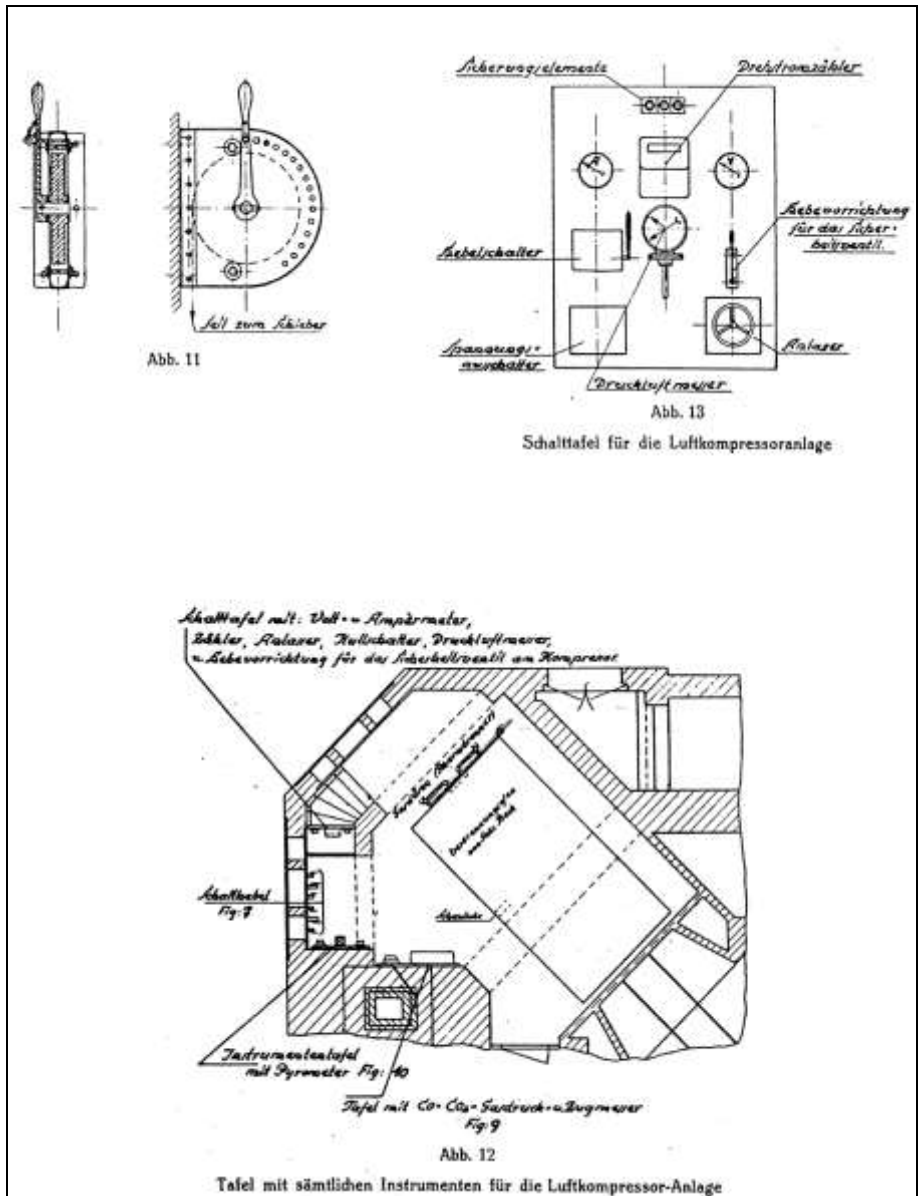
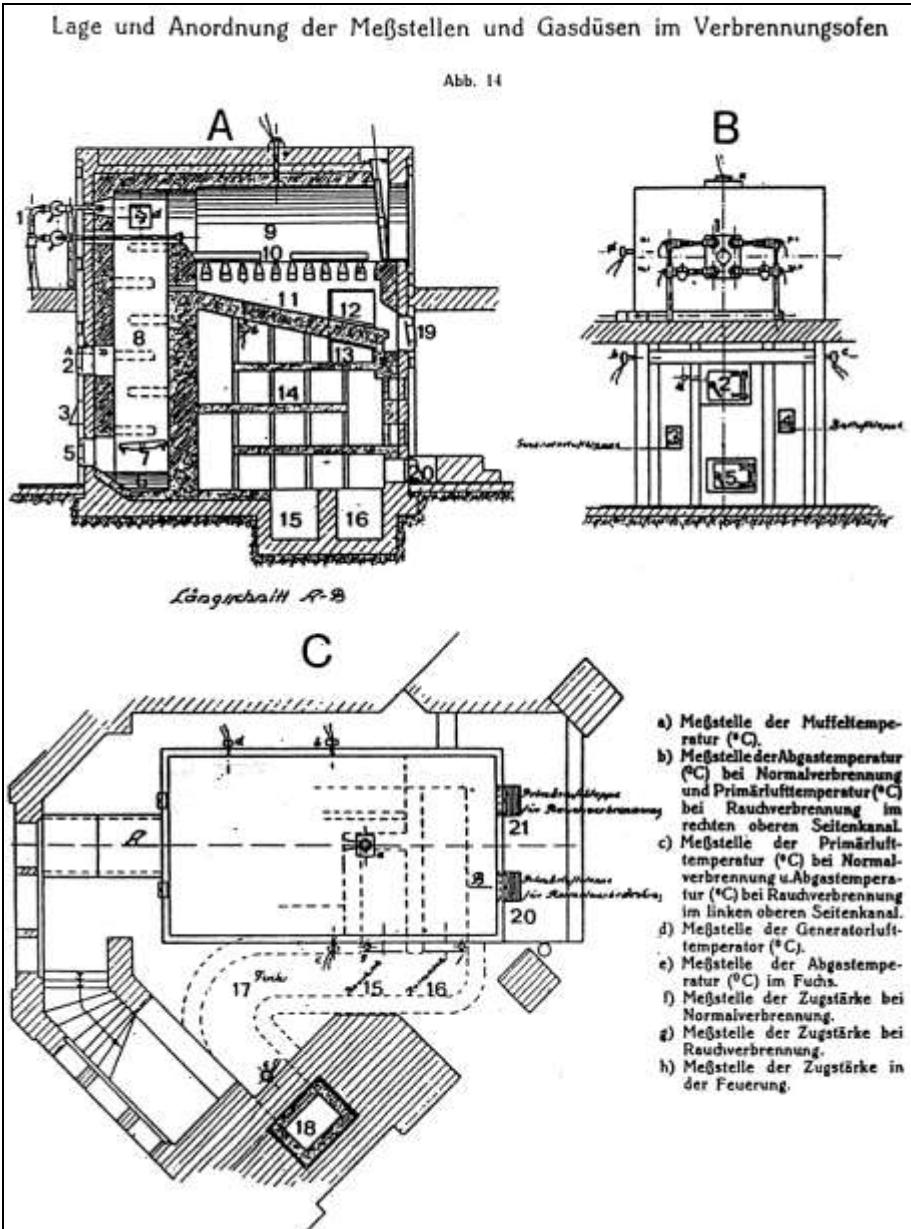

Document 46: as above. Location and arrangement of sensors and gas nozzles.

Source: as Doc. 42, no. 9, p. 149.

- A Vertical section
 B Rear side
 C Horizontal section
 1 Gas burner
 2 Feeding door of the gasifier
 3 Adjustable air vent of the gasifier

- 4 *Adjustable air vent of the hearth*
 - 5 *Hearth door (ash chamber)*
 - 6 *Water basin*
 - 7 *Hearth grate*
 - 8 *Gasifier*
 - 9 *Muffle*
 - 10 *Muffle grate*
 - 11 *Inclined plane of post-combustion chamber*
 - 12f. *Lateral upper left-hand channel connecting the post-combustion chamber to the recuperator (12: inlet; 13: outlet)*
 - 14 *Recuperator*
 - 15 *Discharge channel for the smoke combustion and smoke valve*
 - 16 *Discharge channel for normal combustion and normal valve*
 - 17 *Flue duct*
 - 18 *Chimney*
 - 19 *Ash-chamber door (to take out the ashes of the corpse)*
 - 20 *Adjustable air vent for normal combustion*
 - 21 *Adjustable air vent for combustion of smoke*
 - a *Measuring point for muffle temperature (°C)*
 - b *Measuring point of discharge gas temperature (°C) during normal combustion and of primary air temperature (°C) during combustion of smoke in lateral upper-right-hand channel*
 - c *Measuring point of primary air temperature (°C) during normal combustion and of discharge-gas temperature (°C) during combustion of smoke in lateral upper-left-hand channel*
 - d *Measuring point of temperature of gasifier air*
 - e *Measuring point of temperature of discharge gas (°C) in flue duct*
 - f *Measuring point of draft in normal combustion*
 - g *Measuring point of draft in combustion of smoke*
 - h *Measuring point of draft in hearth*
-

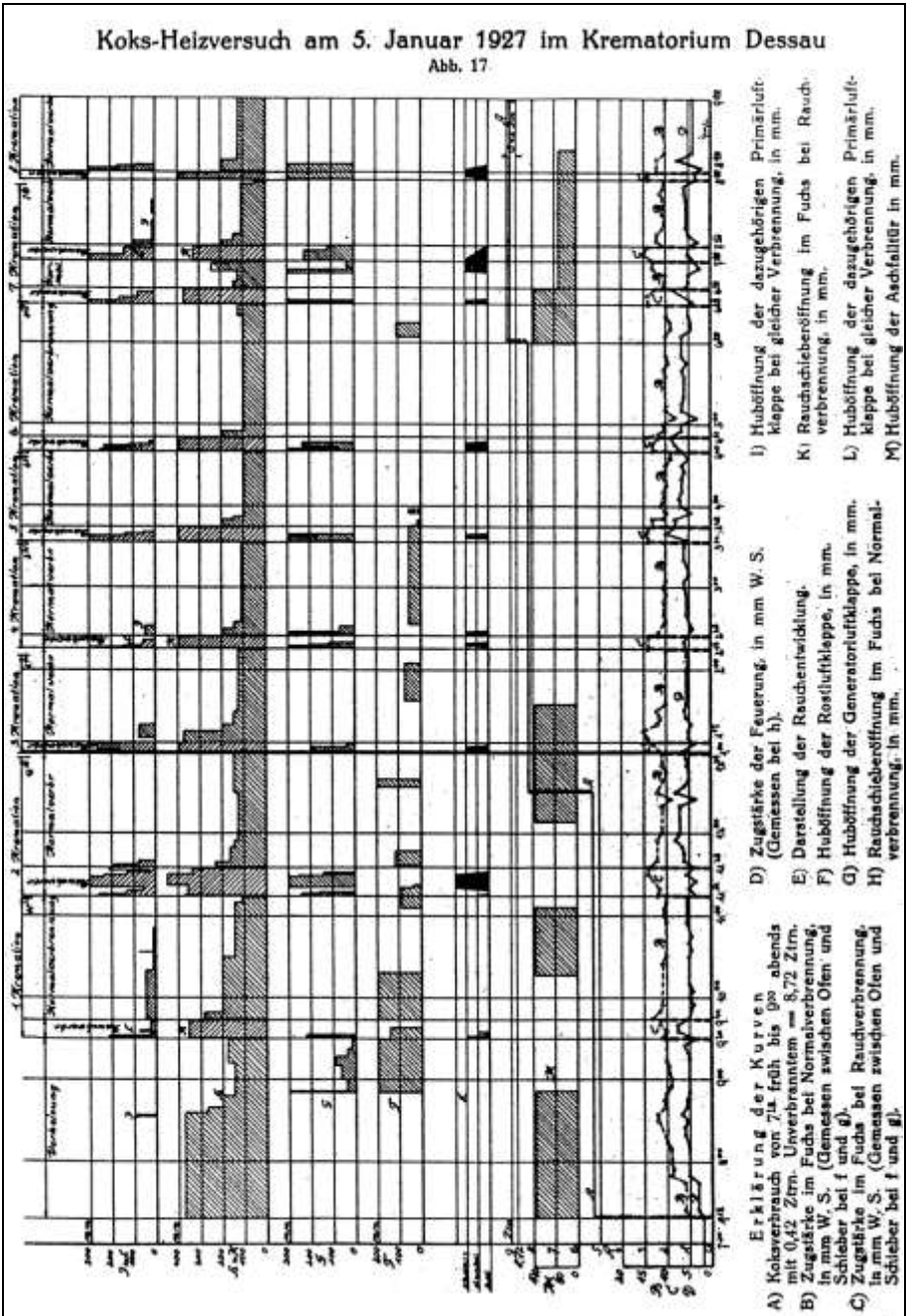

Document 47: as above. Cremation experiment with coke, conducted on 5 January 1927 by Engineer R. Kessler. Chart of furnace condition. Source: as Doc. 42, no. 9, p. 154.

The horizontal gives the duration of the various phases of the preheating (Vorheizung) of the furnace and of the subsequent eight cremations, for each one of which is

shown the combustion of smoke (Rauchverbrennung) and the normal combustion.

The vertical axis shows the measured property (from bottom to top):

0-20 Pressure difference in mm water column (= 0.1 mbar)

1-9 Zentner (= 50 kg) of coke loaded into gasifier

A Consumption of coke between 7:18 a.m. and 9 p.m. with 0.42 Zentner of in-combustibles: 8.72 Zentner (= 436 kg)

B Draft in the flue duct during normal combustion, in mm water column (measured between the furnace and the damper at f and at g)

C Draft in the flue duct during combustion of smoke, in mm water column, (measured between the furnace and the damper at f and at g)

D Draft of the hearth, in mm water column (measured at h)

E Indication of type of smoke (hell: light, dunkel: dark, schwarz: black)

F Opening of air vent for air feed to hearth, mm

G Opening of air vent for air feed to gasifier, mm

H Opening of smoke damper in flue duct during normal combustion, mm

I Opening of the corresponding smoke damper during same combustion, mm

K Opening of smoke damper during combustion of smoke, mm

L Opening of corresponding air vent of primary air during same combustion, mm

M Opening of ash-chamber door (hearth), in mm

The above figures refer to the vertical cross section of the corresponding openings and dampers

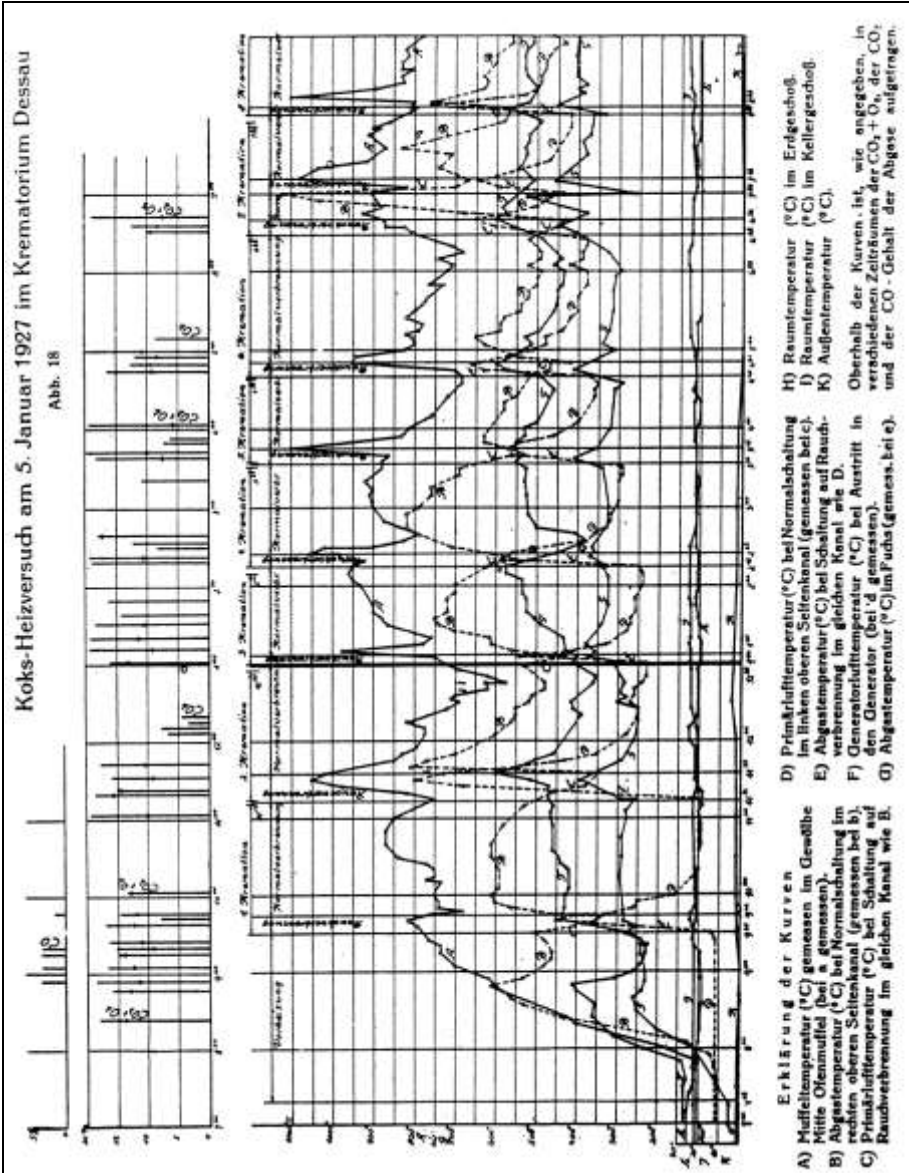

Document 48: as Doc. 47. Temperature chart. Source: as Doc. 42, no. 9, p. 155. The horizontal axis gives the duration of the various preheating and cremation phases, as in the previous chart. The vertical axis shows the temperatures:

- A Temperature of the muffle (°C) measured in the center of the vault of the muffle of the furnace (measured at a).
- B Temperature of the discharge gas (°C) in normal mode, in the lateral upper right-hand channel (measured at b).
- C Temperature of primary air (°C) during smoke combustion mode, in the same channel as in B.
- D Temperature of primary air (°C) during normal mode in lateral upper left-hand channel (measured at c).

E Temperature of discharge gas (°C) during smoke combustion mode, in the same channel as in D.

F Temperature of gasifier air (°C) at outlet of gasifier (measured at d).

G Temperature of discharge gas (°C) in flue duct (measured at e).

H Room temperature (°C) on ground floor.

I Room temperature (°C) in basement.

K Outside temperature (°C).

Above the temperature chart, we have indicated the CO₂ + O₂ content, the CO₂ content and partly the CO content at various times of the preheating and cremation phases.

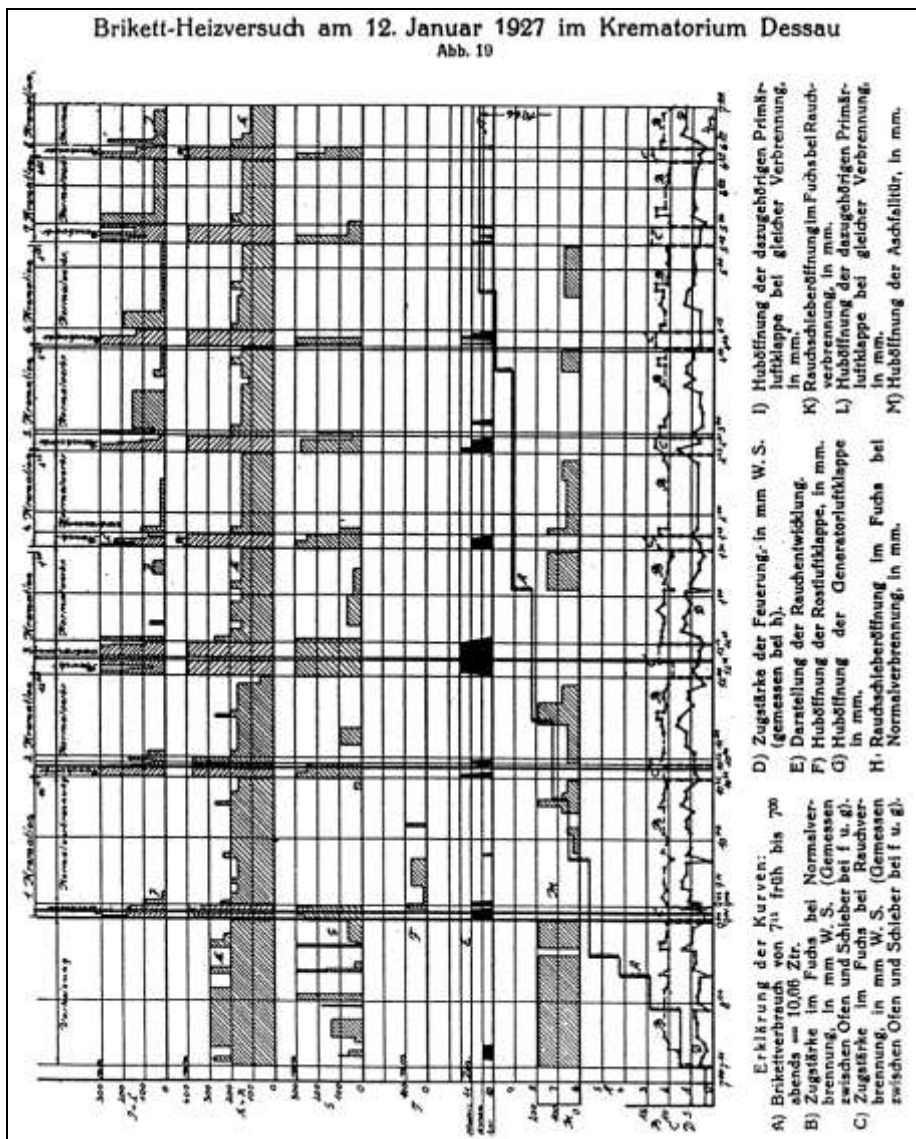

Document 49: as above. Cremation experiment with briquet, conducted on 12 January 1927 by engineer R. Kessler. Chart of furnace condition. Source: as Doc. 42, no. 9, p. 156.

Brikett-Heizversuch am 12. Januar 1927
im Krematorium Dessau

Abb. 20

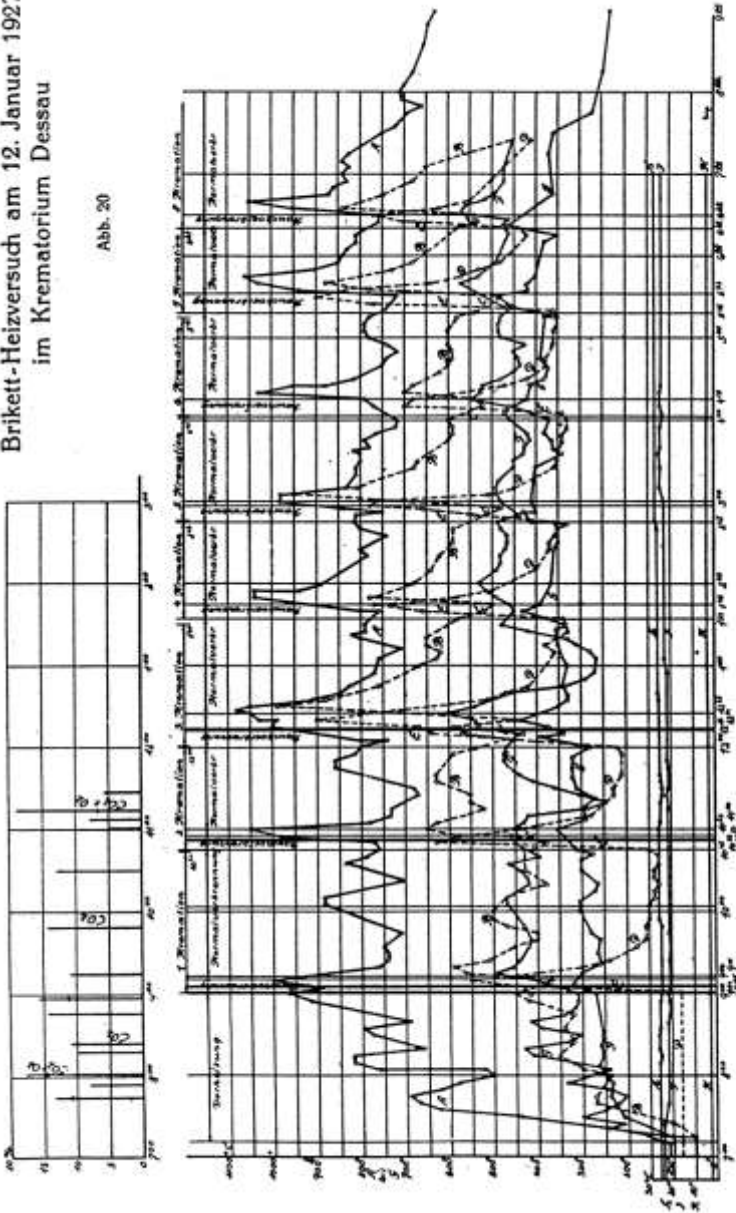

Erklärung der Kurven:
 A) Mitte Ofenmüffel (bei a gemessen).
 B) Abgastemperatur (°C) bei Normalchaltung im rechten oberen Seitenkanal (gemessen bei b).
 C) Primärlufttemperatur (°C) bei Schaltung auf Raubverbrennung im gleichen Kanal wie B.
 D) Primärlufttemperatur (°C) bei Normalchaltung im linken oberen Seitenkanal (gemessen bei c).
 E) Abgastemperatur (°C) bei Schaltung auf Raubverbrennung im gleichen Kanal wie D.
 F) Generatorlufttemperatur (°C) bei Austritt in den Generator (bei d gemessen).
 G) Abgastemperatur (°C) im Fuda (gemessen bei e).
 H) Raumtemperatur (°C) im Erdgeschoß.
 I) Raumtemperatur (°C) im Kellergeschoß.
 J) Raumtemperatur (°C) im Erdgeschoß.
 K) Raumtemperatur (°C) im Kellergeschoß.

Document 50: as Doc. 49. Temperature chart. Source: as Doc. 42, no. 9, p. 157.

Gas-Heizversuch am 1. November 1926 im Krematorium Dessau

Abb. 15

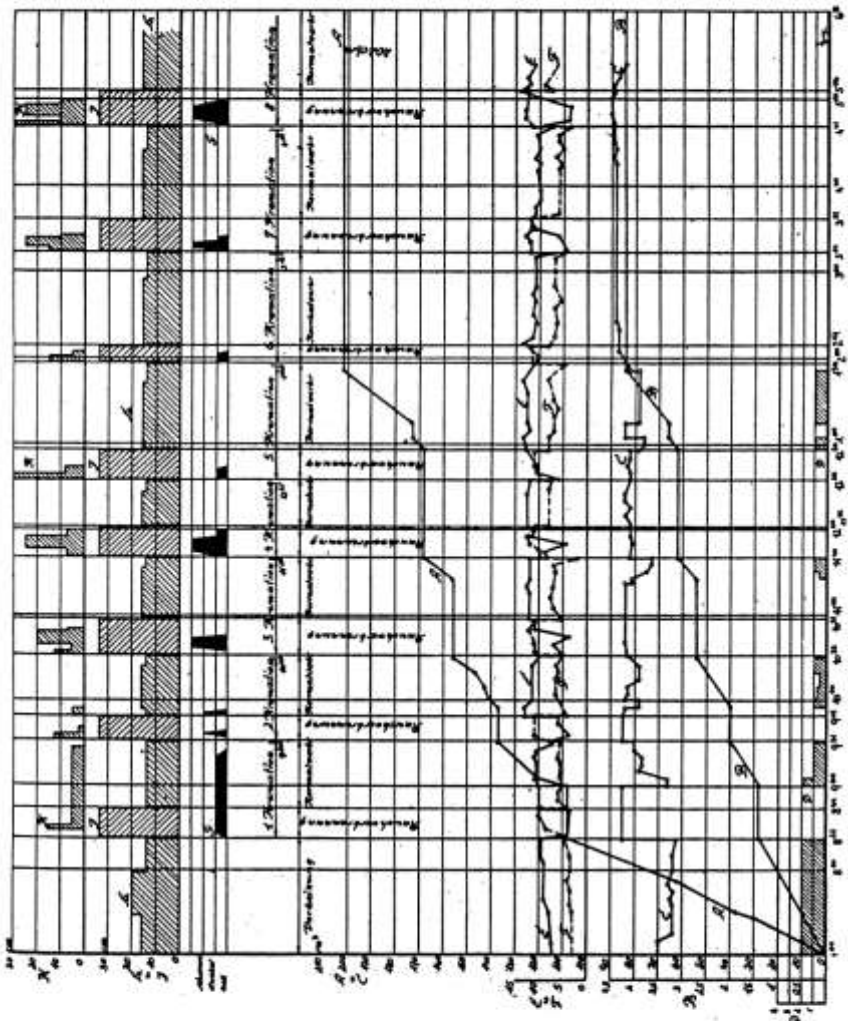

Erklärung der Kurven.

- A) Gasverbrauch in cbm. (Verbraucht sind 202 cbm Gas).
- B) Kraftverbrauch des Kompressors in KW. (Verbraucht sind 4,2 KW Strom).
- C) Gasdruck in mm W. S.
- D) Zahl der in Betrieb gewesen Düsen.
- E) Zugstärke im Fuchs bei Normal-Verbrennung, in mm W. S. } Gemessen zwischen Ofen und
- F) Zugstärke im Fuchs bei Rauch-Verbrennung, in mm W. S. } Schieber bei f) und g).
- G) Darstellung der Rauchentwicklung.
- H) Rauchschieberöffnung im Fuchs bei Normal-Verbrennung, in cm.
- I) Rauchschieberöffnung im Fuchs bei Rauch-Verbrennung, in cm.
- K) Generator-Luftschieberöffnung, in cm.

Document 51: as above. Cremation experiment with gas, conducted on 1 November 1926 by engineer R. Kessler. Chart of furnace condition. Source: as Doc. 42, no. 9, p. 150.

Gas - Heizversuch am
1. November 1926 im
Krematorium Dessau

Abb. 10

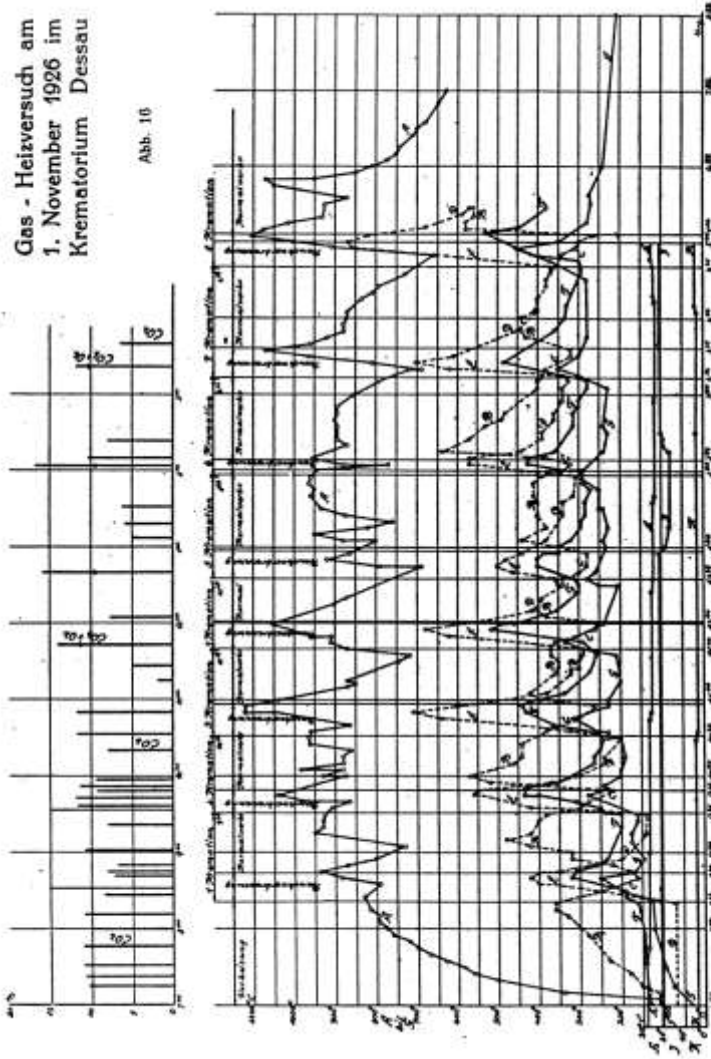

Erklärung der Kurven
 A) Mufftemperatur (°C) gemessen im Gewölbe Mitte Ofenmauer (bei a gemessen).
 B) Abgastemperatur (°C) bei Normalschaltung im rechten oberen Seitenkanal (gemessen bei b).
 C) Primärlufttemperatur (°C) bei Schaltung auf Rauchverbrennung im gleichen Kanal wie bei B.
 D) Primärlufttemperatur (°C) bei Normalschaltung im linken oberen Seitenkanal (gemessen bei c).
 E) Abgastemperatur (°C) bei Schaltung auf Rauchverbrennung im gleichen Kanal wie D.
 F) Generatorlufttemperatur (°C) bei Austritt in den Generator (bei d gemessen).
 G) Abgastemperatur (°C) im Fuchs (gemessen bei e).
 H) Raumtemperatur (°C) im Erdgesch. (gemessen bei f).
 I) Raumtemperatur (°C) im Kellergesch. (gemessen bei g).
 J) Außentemperatur (°C).
 Oberhalb der Kurven ist, wie angegeben, in verschiedenen Zeitstrichen der CO_2 -Gehalt der Abgase aufgetragen.

Document 52: as Doc. 51. Temperature chart. Source: as Doc. 42, no. 9, p. 151.

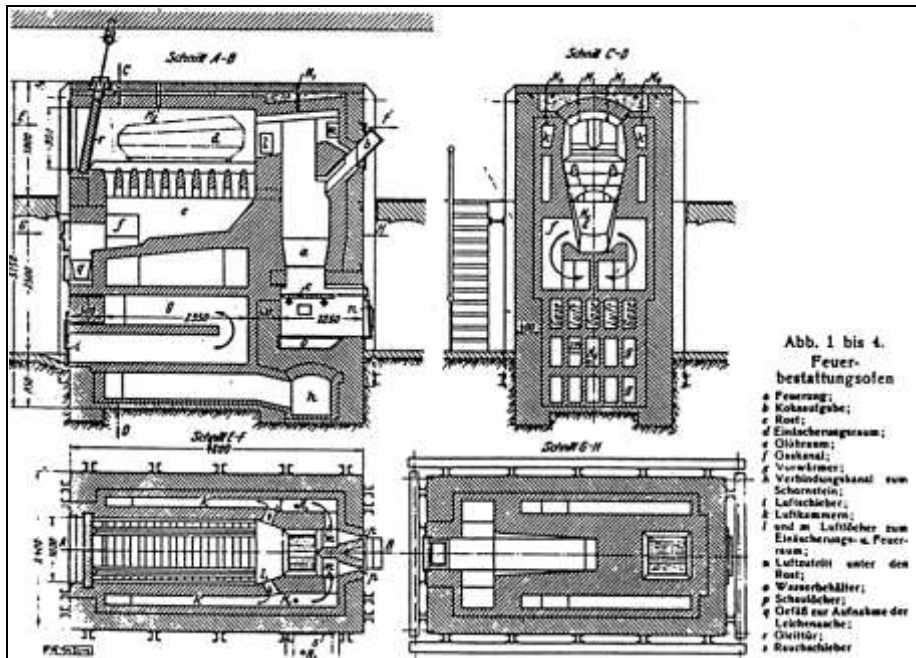

Document 53: Cremation furnace of the crematorium at Biel as used by engineer H. Keller for his cremation experiments in 1927. Fig. 1: longitudinal Section A-B; Fig. 2: vertical Section C-D; Fig. 3: horizontal Section E-F; Fig. 4: horizontal Section G-H. Source: H. Keller, "Versuche an einem Feuerbestattungs-ofen," special reprint from the journal *Archiv für Wärmewirtschaft und Dampfkesselwesen*, 1929, no. 6, p. 1.

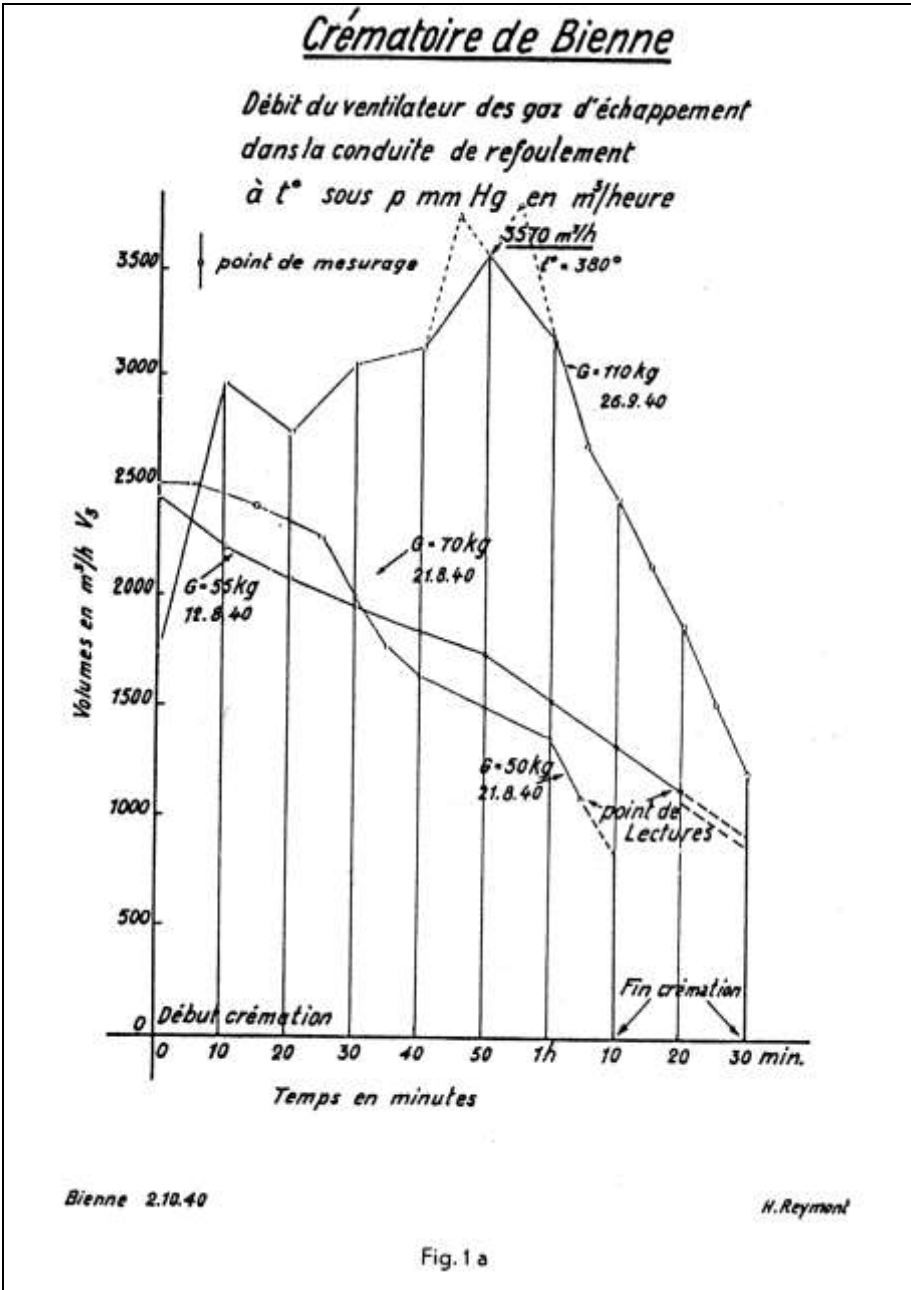

Document 54: Chart of cremation experiments conducted by Engineer H. Keller in the electric BROWN, BOVERI & CO. furnace at the Biel Crematorium on 2 October 1940. Hourly exhaust-gas volume expelled by the exhaust fan during the cremation; first data set. Source: H. Keller, "Ursache der Rauchbildung bei der Kremation," in: *Bieler Feuerbestattungs-Genossenschaft in Biel, Jahresbericht pro 1944. Biel, 1945, illustration outside text.*

Krematorium Biel.

Fördermenge des Abgasventilators
im Saugstutzen
bei t° und b^{mm}/m QS in m^3/h .

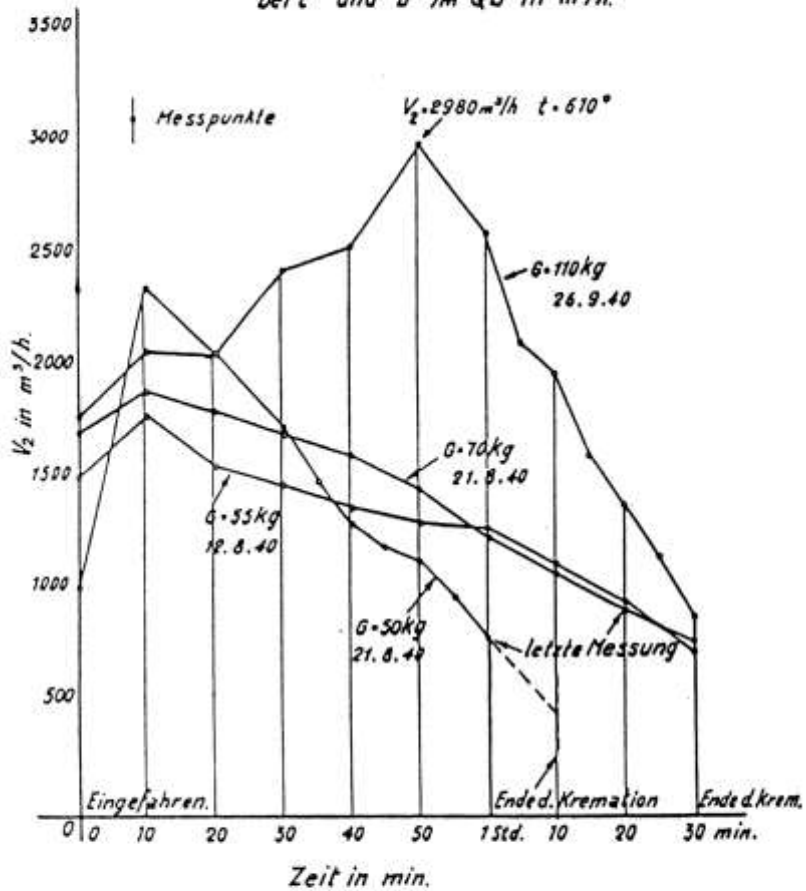

Biel. 2. 10. 40

Stürml.

Fig. 1b

C. Crématoire de Bienne.

Débit du ventilateur de gaz d'échappement
dans la conduite de refoulement
à 2° sous p mm. Hg. en m³/h

— points de mesure

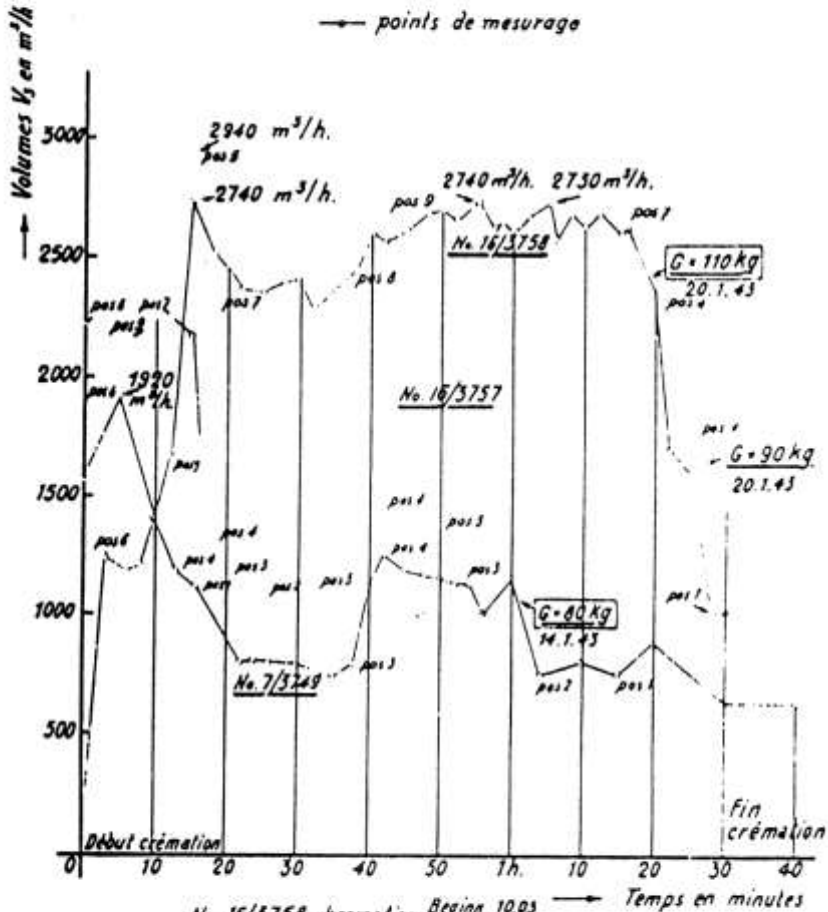

No. 16/3758	kremation	Beginn 10.03	Ende 11.30
No. 15/3757	kremation	Beginn 14.18	Ende 15.50
No. 7/3749	Kremation	Beginn 02.8	Ende 10.15

Bienne 25.1.43

Gerluch CSTR

Fig. 2

Document 56: as above, experiments of 25 January 1943. Hourly exhaust-gas volume expelled by the exhaust fan during the cremation. Source: as Doc. 54.

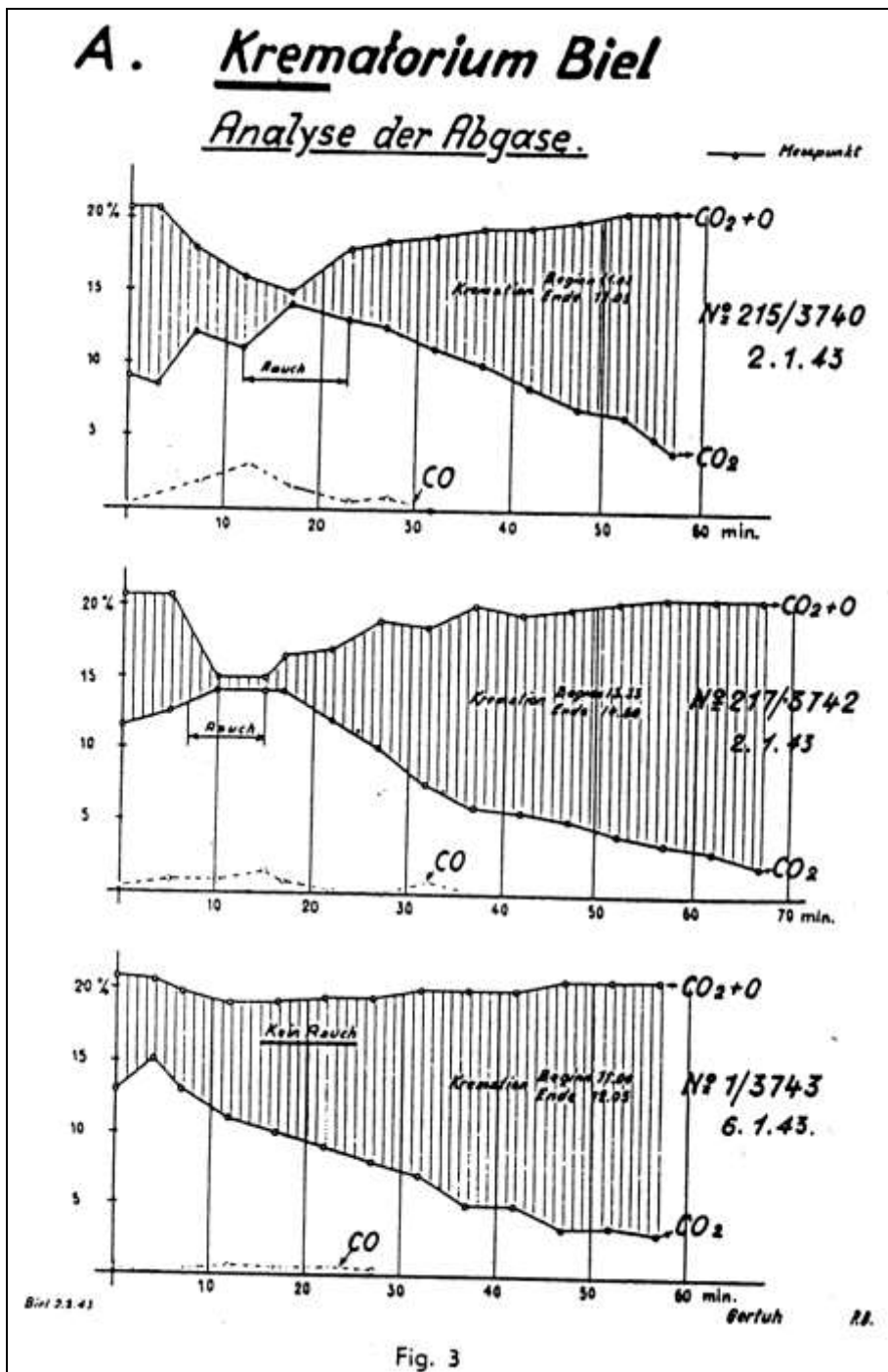

Document 57: as above, experiments of 2 and 6 January 1943. Exhaust-gas analysis during the cremation. Source: as Doc. 54.

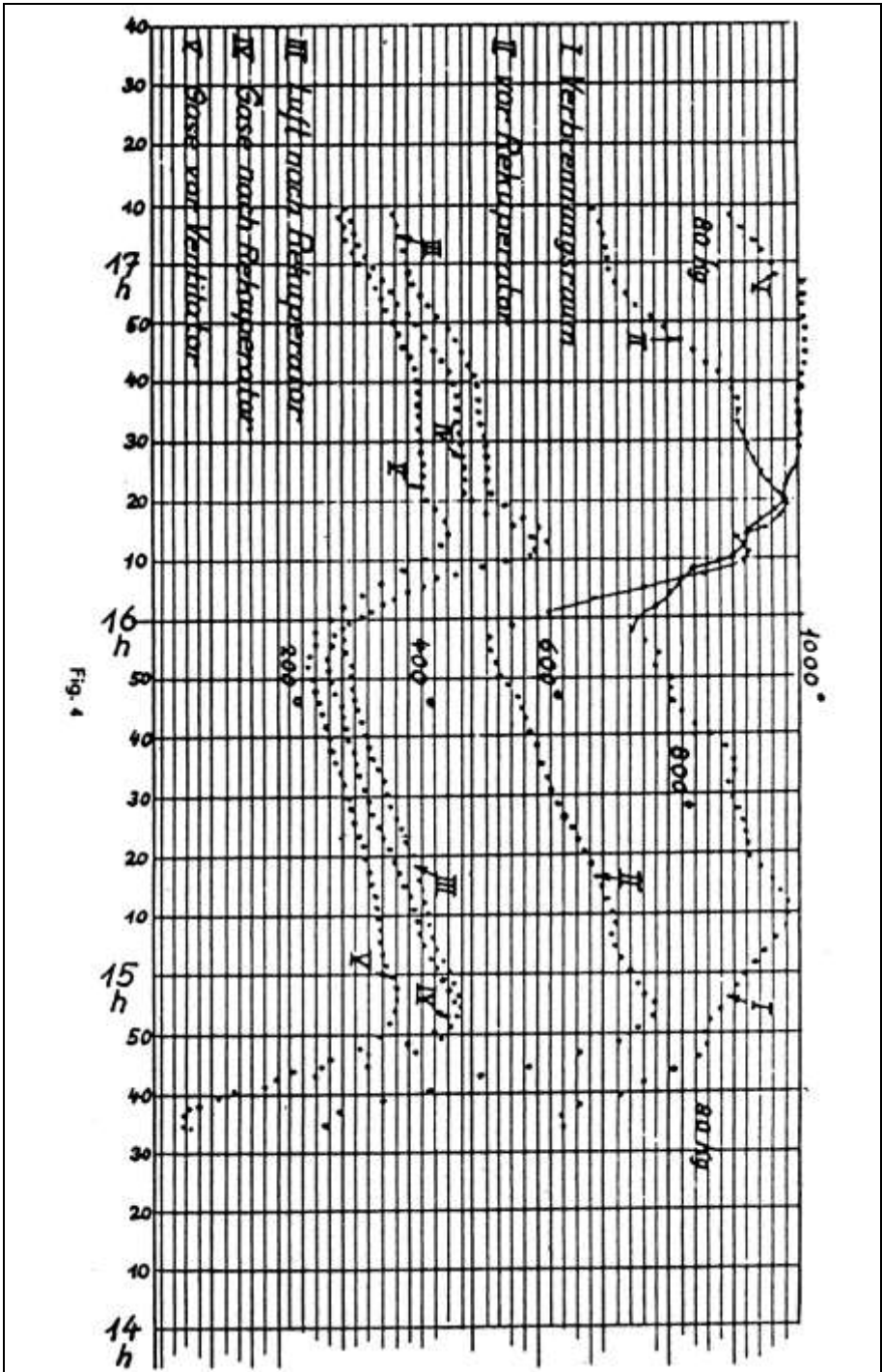
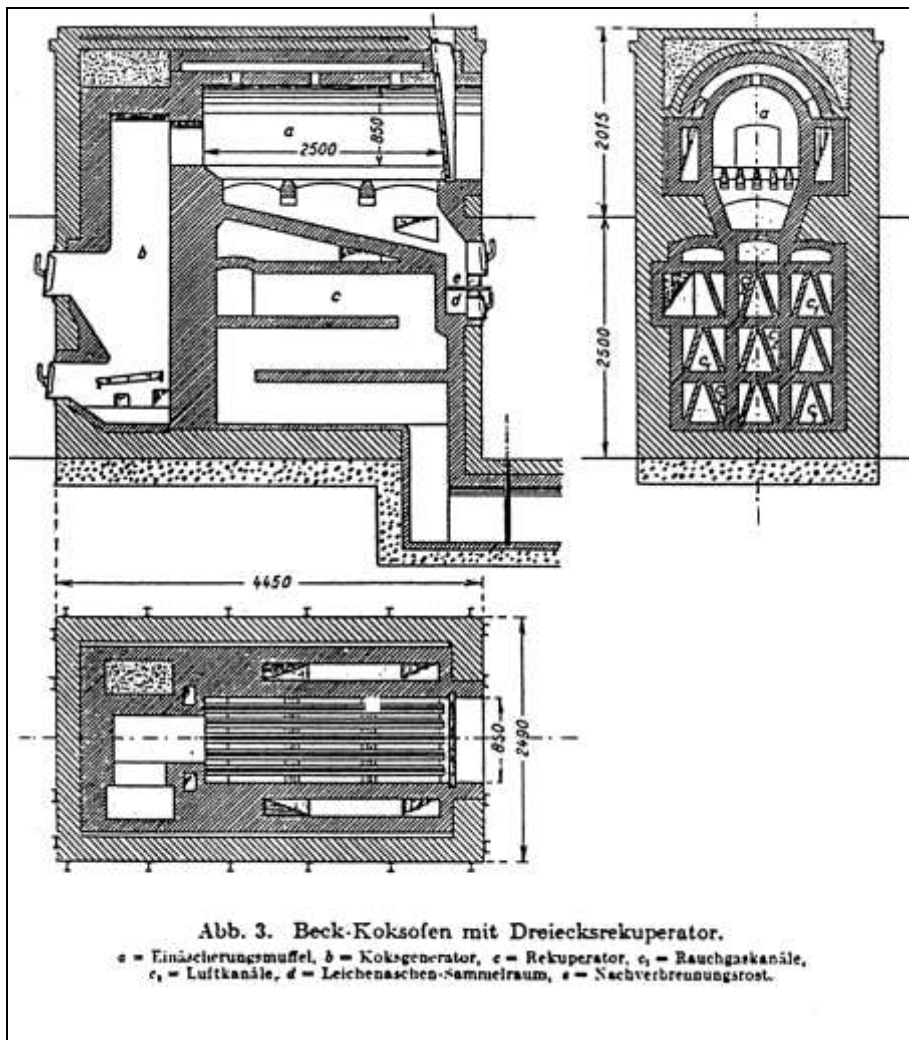
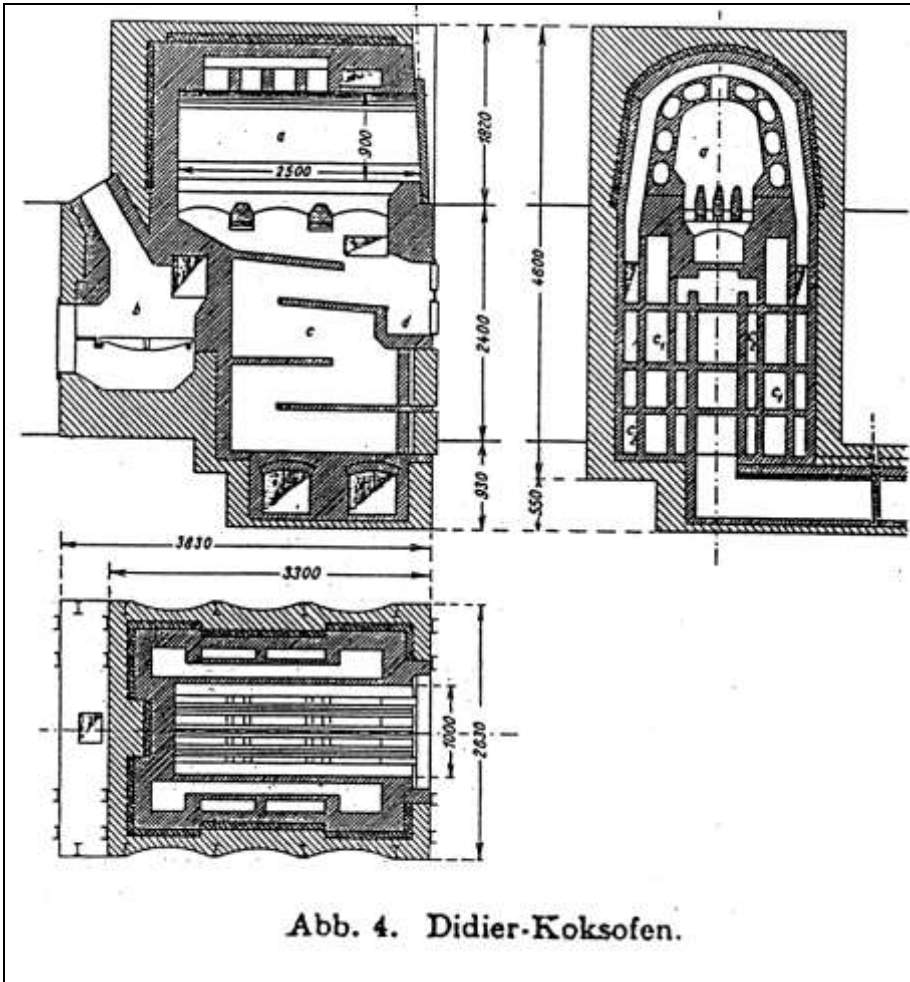

Fig. 4

Document 58: as above, experiments of January 1943. Temperature chart. Source: as Doc. 54.



Document 59: perfected BECK coke-fired cremation furnace (early 1930s). Fig. 1: longitudinal section; Fig. 2: vertical section; Fig. 3: horizontal section at the height of the cremation-chamber grate. Source: W. Heepke, "Die neuzeitlichen Leicheneinäscherungsöfen mit Koksfeuerung, deren Wärmebilanz und Brennstoffverbrauch," in: Feuerungstechnik, XXI. Jg., 15 August 1933, no. 9, p. 124.



Document 60: perfected DIDIER coke-fired cremation furnace (early 1930s). Fig. 1: longitudinal section; Fig. 2: vertical section; Fig. 3: horizontal section at the height of the cremation-chamber grate. Source: as Doc. 59, p. 125.

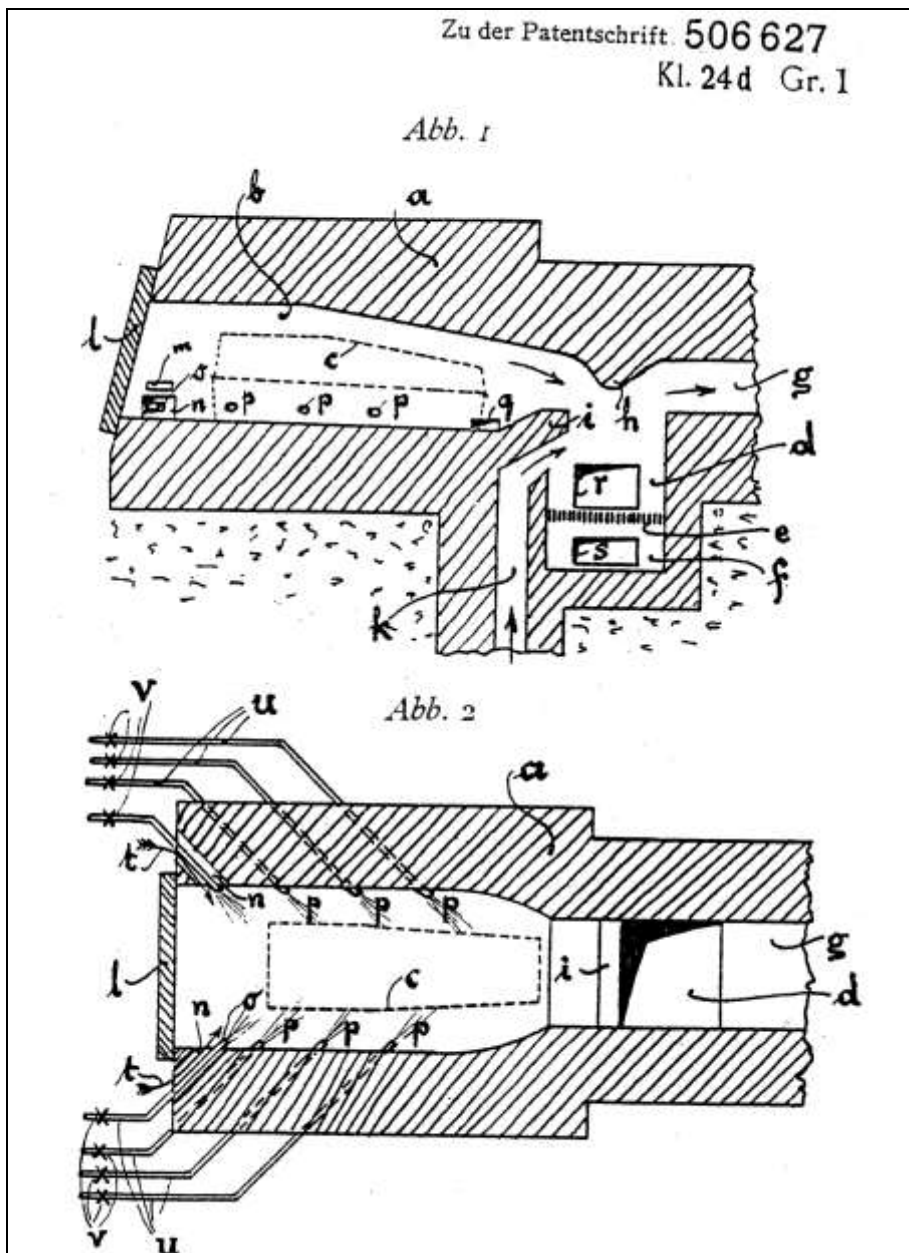

Document 61: "Procedure and device for cremation" (Verfahren und Vorrichtung zur Einäscherung). Patent H. VOLCKMANN and L. LUDWIG, no. 506627, of 30 October 1928. Fig. 1: longitudinal section along the cremation chamber; Fig. 2: horizontal section along the cremation chamber.

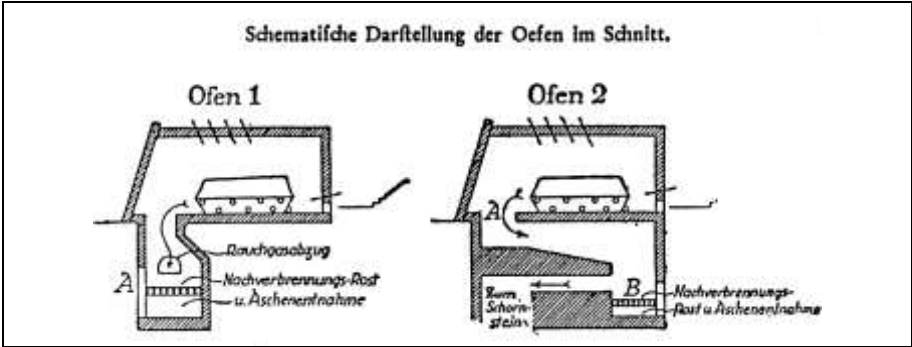

Document 62: VOLCKMANN-LUDWIG gas-fired cremation furnaces at the Hamburg crematorium (prototype). Source: R. Kessler, "Der neue Einäscherungs-Ofen System Volckmann-Ludwig," in: *Zentralblatt für Feuerbestattung*, 1931, no. 3, p. 34.

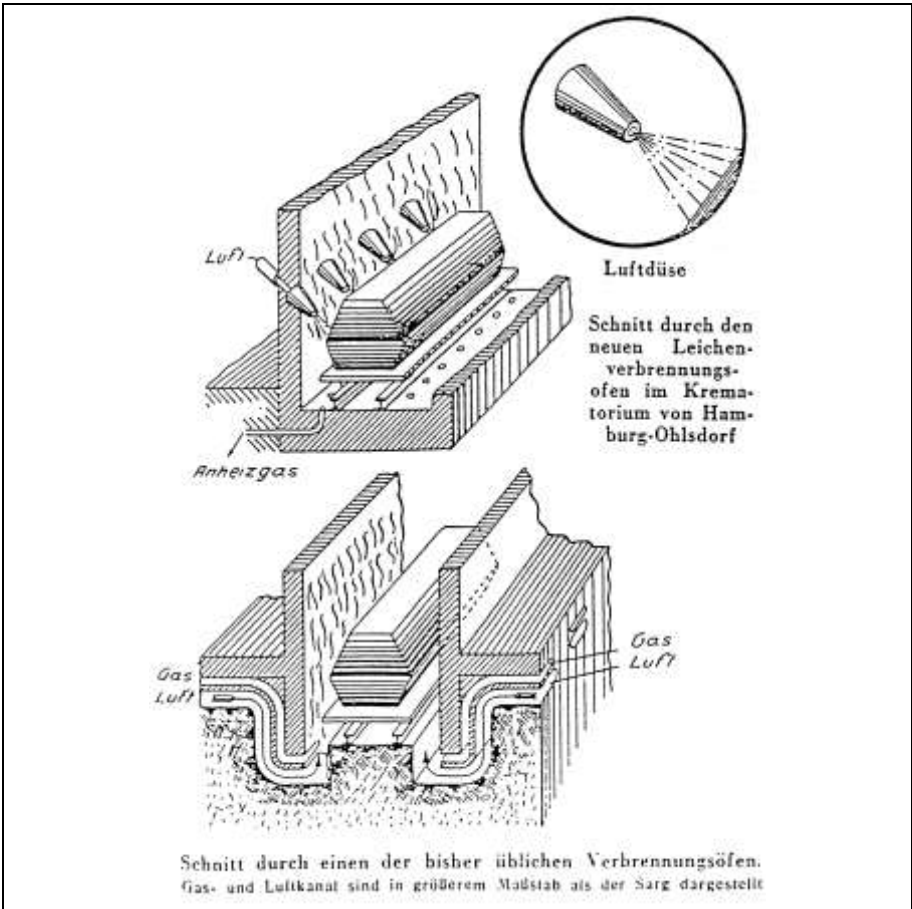

Document 63: VOLCKMANN-LUDWIG gas-fired cremation furnaces: design of combustion-air intake. Source: Stort, "Der menschliche Körper als Heizstoff," in: *Die Umschau in Wissenschaft und Technik*, 1931, no. 26, p. 513.

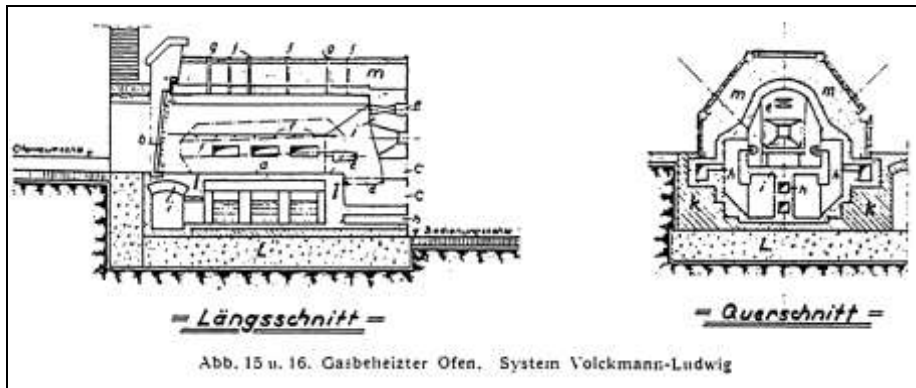

Document 64: as above (standard model). Fig. 1: longitudinal section; Fig. 2: vertical section. Source: as Doc. 27, p. 24.

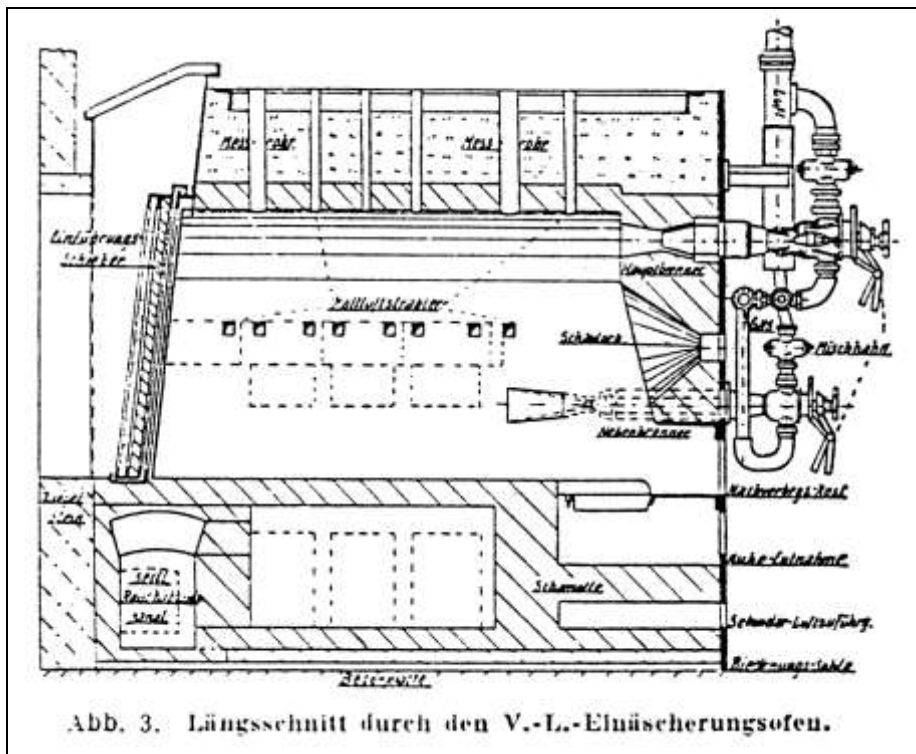

Document 65: as above. Longitudinal section. Source: H. Manskopf, "Gas als Brennstoff für Einäscherungsöfen," in: *Das Gas- und Wasserfach*, 1933, no. 42, p. 773.

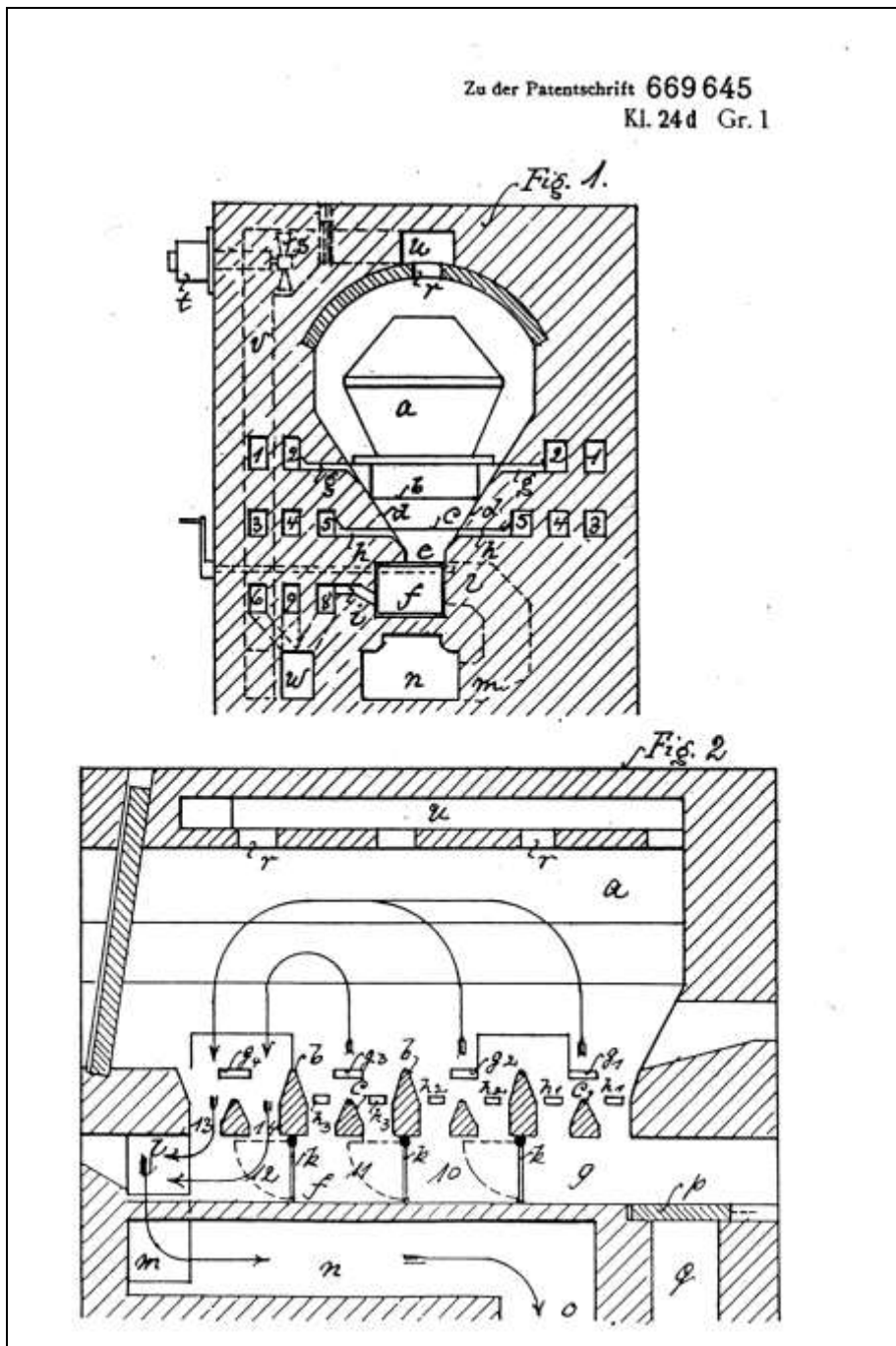

Document 67: "Corpse-Cremation Furnace" (Leichenverbrennungsofen). Patent W. RUPPMANN, No. 669645, of 23 June 1936. Fig. 1: vertical section (cremation chamber and combustion-air intake system); Fig. 2: longitudinal section (cremation chamber and construction system of the grate).

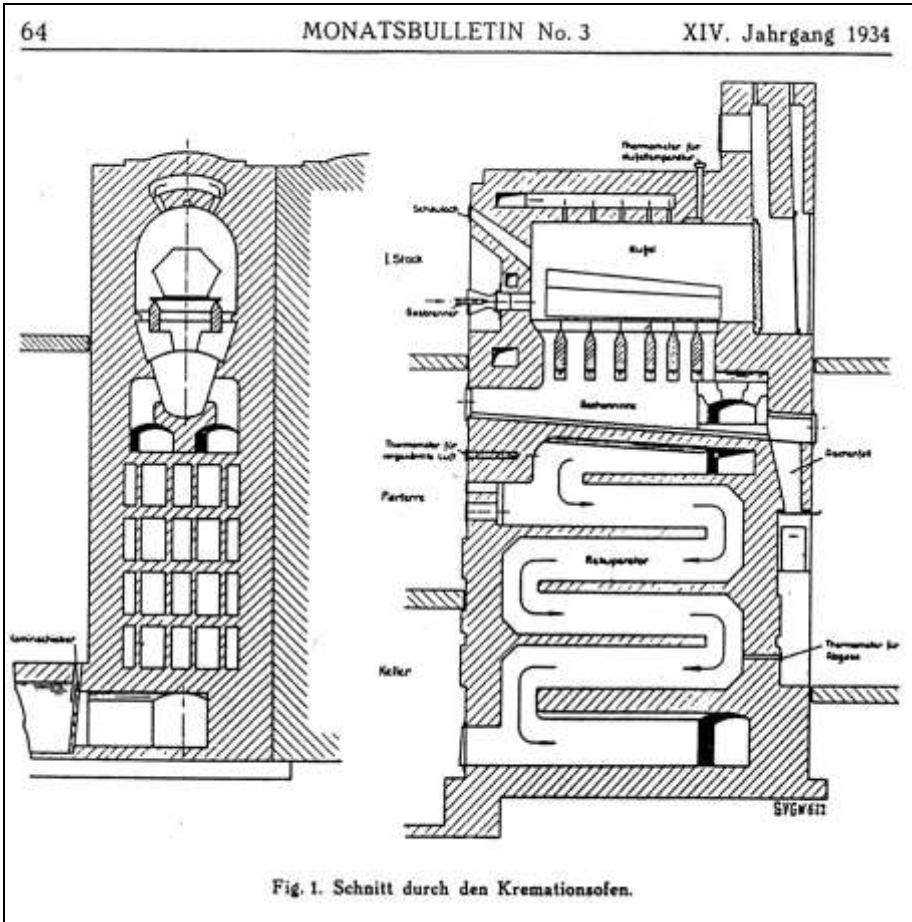

Document 68: E. EMCH & Co. gas-fired cremation furnace at the Zürich Crematorium (1932). Vertical and longitudinal sections (cremation chamber and recuperator). Source: R. Henzi, "Die Zürcher Einäscherungsöfen mit Gasfeuerung," in: Schweiz. Verein von Gas- und Wasserfachmännern, Zürich, March 1934, no. 3, p.

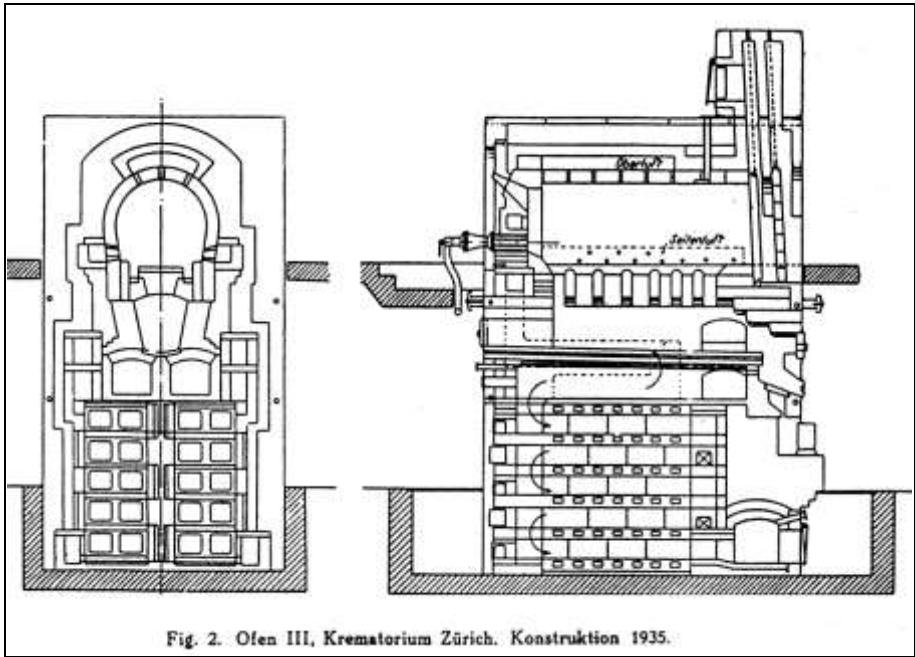

Fig. 2. Ofen III, Krematorium Zürich. Konstruktion 1935.

Document 69: E. EMCH & CO. gas-fired cremation furnace at the Zürich Crematorium (1935). Vertical and longitudinal sections (cremation chamber and recuperator). Source: P. Schläpfer, "Betrachtungen über den Betrieb von Einäscherungsöfen," in: Schweiz. Verein von Gas- und Wasserfachmännern, Zürich, July 1938, no. 7, p. 150.

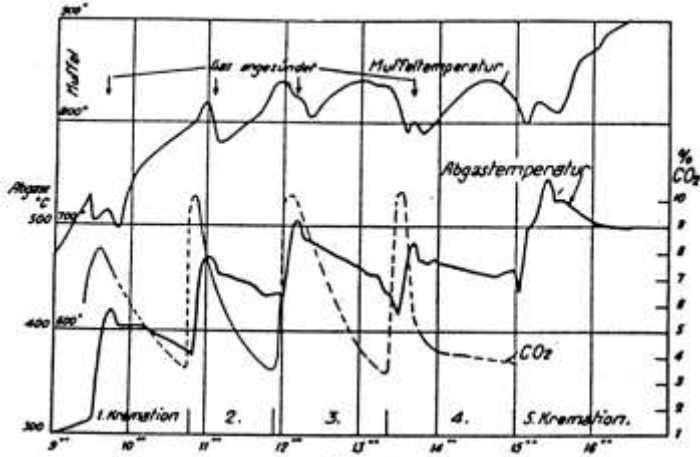

Fig. 9.

Aenderung des Kohlensäuregehaltes, der Muffeltemperatur und der Abgastemperatur im Fuchs des Ofens II während 5 Kremationen.

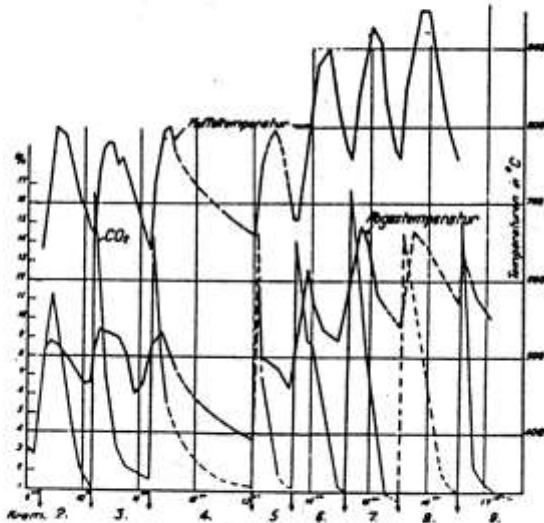
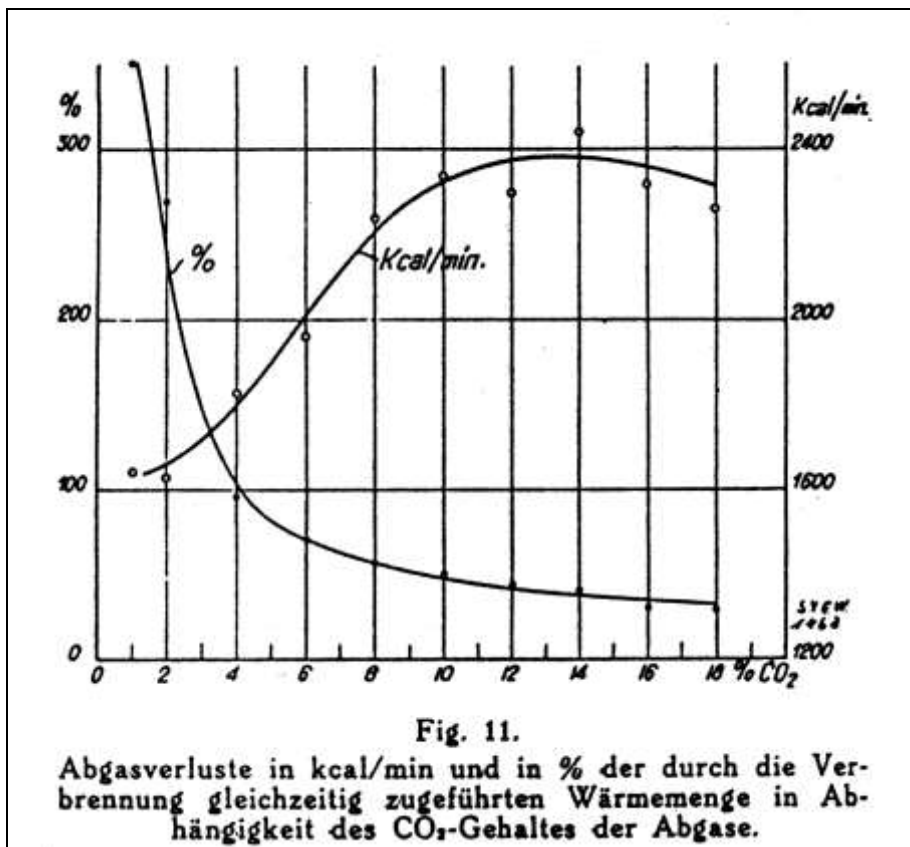

Fig. 10.

Aenderung des Kohlensäuregehaltes, der Muffeltemperatur und der Abgastemperatur im Fuchs des Ofens III während 8 Kremationen.

Document 70 & 71: Fig. 9: Chart of 5 cremations conducted on 30 November 1932 in Furnace II at the Zürich Crematorium. "Variation of CO2 content, muffle temperature and combustion-gas temperature in the flue of Furnace II during 5 cremations." Fig. 10: Chart of 8 cremations conducted on 27 February 1936 in Furnace III at the Zürich Crematorium. "Variation of CO2 content, muffle temperature and combustion-gas temperature in the flue of Furnace III during 8 cremations."

Source: as Doc. 69, p. 156.



Document 72: Fig. 11: "Flue-gas losses in kcal/minute and in % of the amount of heat concurrently added by combustion as a function of the CO₂ contents of the combustion gas". Source: as Doc. 69, p. 156.

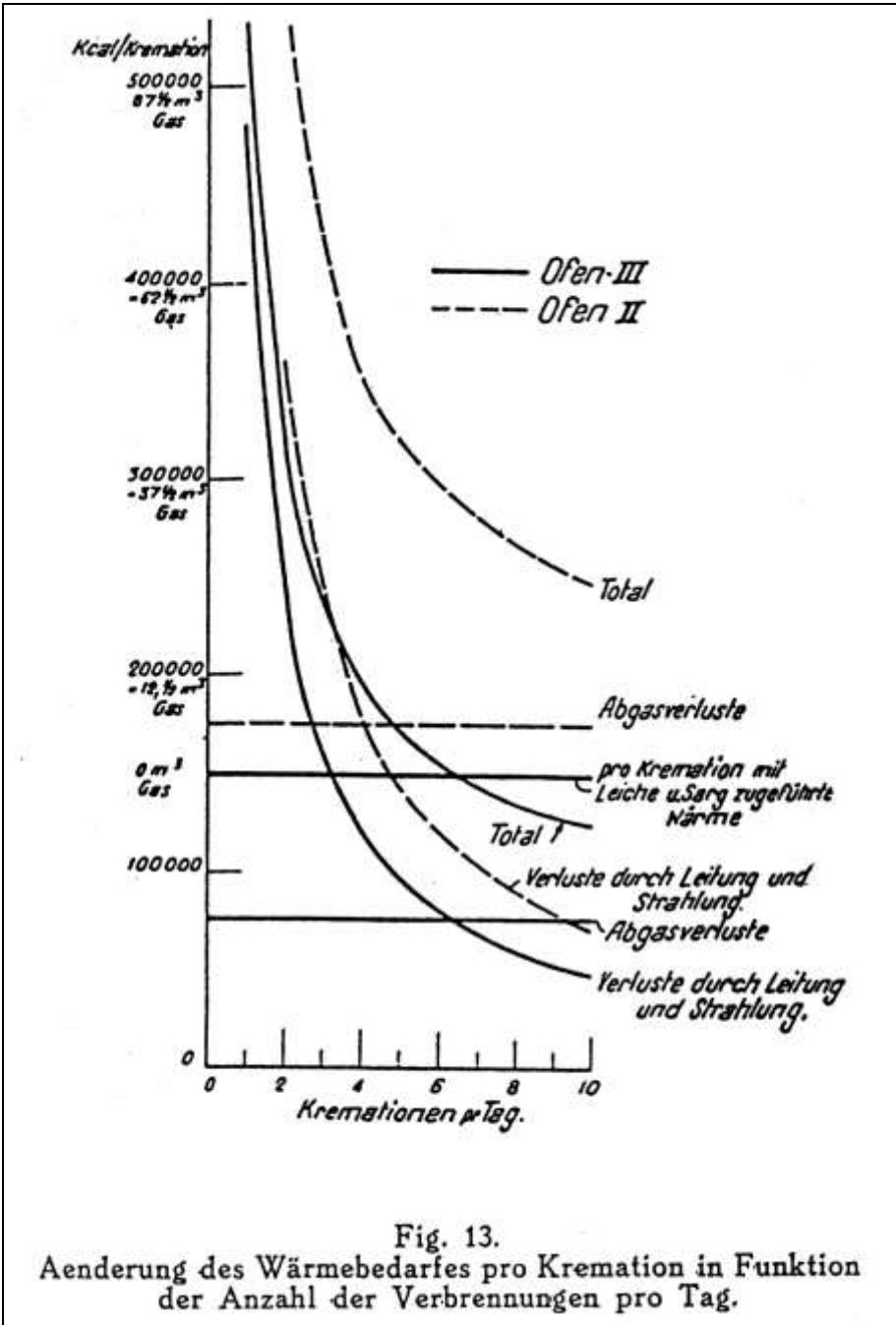

Fig. 13.
 Aenderung des Wärmebedarfes pro Kremation in Funktion
 der Anzahl der Verbrennungen pro Tag.

Document 73: *Thermal balance of Furnaces II and III at the Zürich Crematorium.*
 "Variation of the caloric needs per cremation as a function of the number of cremations per day". Source: as Doc. 69, p. 157.



Abb. 13. Elektrischer Ofen.

Document 74: E. EMCH & Co. electric cremation furnace (1930). Vertical section.
Source: F. Hellwig, "Vom Bau und Betrieb der Krematorien," in: *Gesundheits-Ingenieur*, 1931, no. 25, p. 397.



Document 75: Fig. A: vertical section of the old W. RUPPMANN coke-fired cremation furnace at Biel; Fig. B: vertical section of the BROWN, BOVERI & CO experimental electric cremation furnace. Source: H. Keller, "Der elektrische Einäscherungsofen im Krematorium Biel," in: Bieler Feuerbestattungs-Genossenschaft in Biel, Jahresbericht pro 1933. Biel, 1934, p. 5.

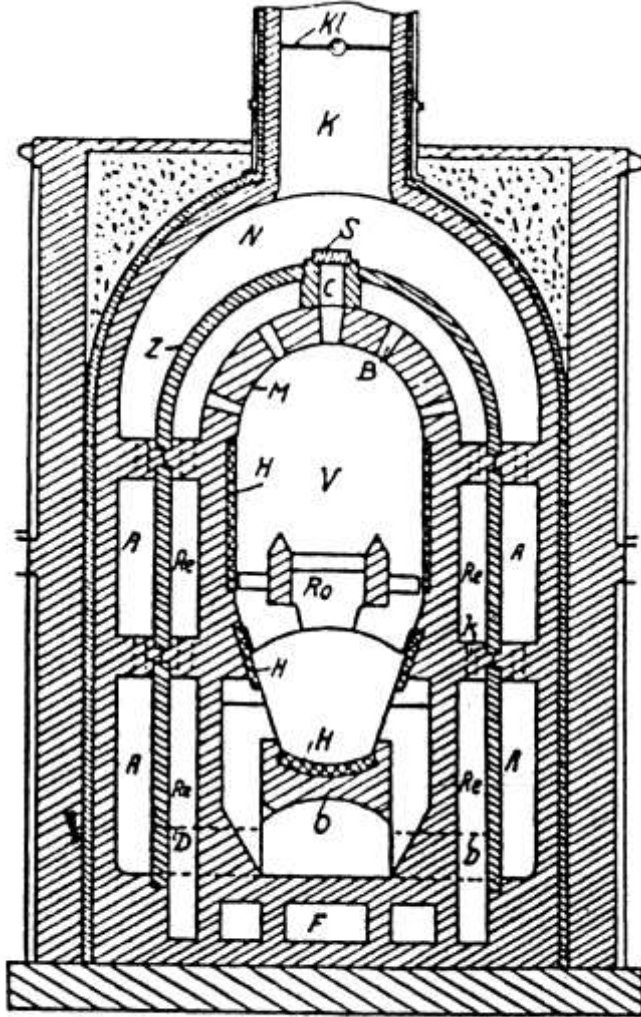
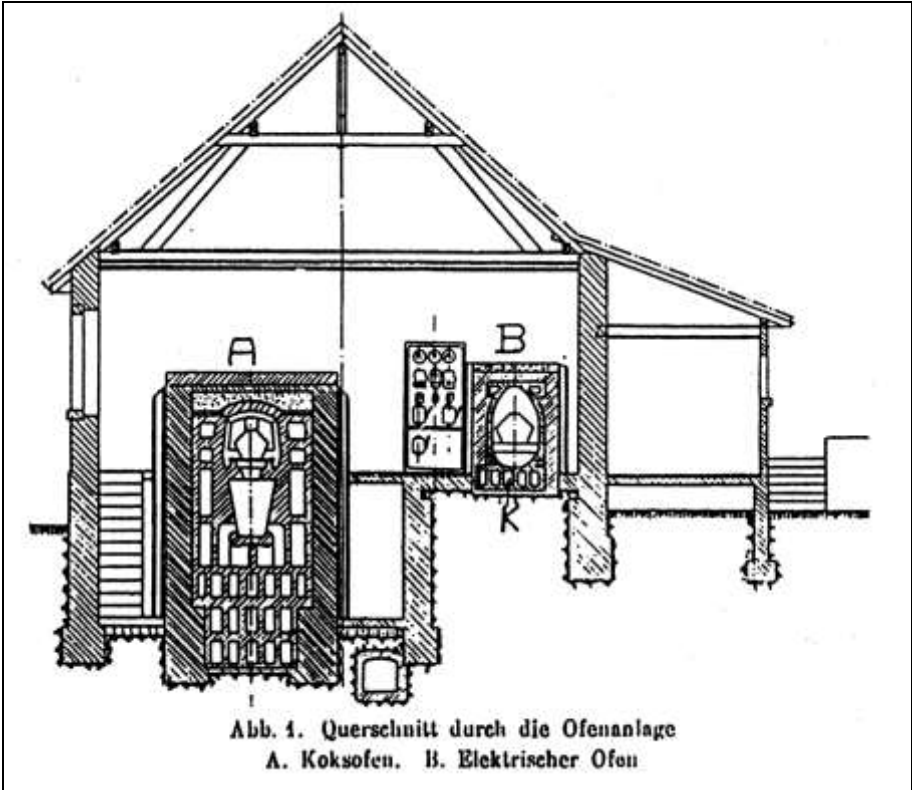
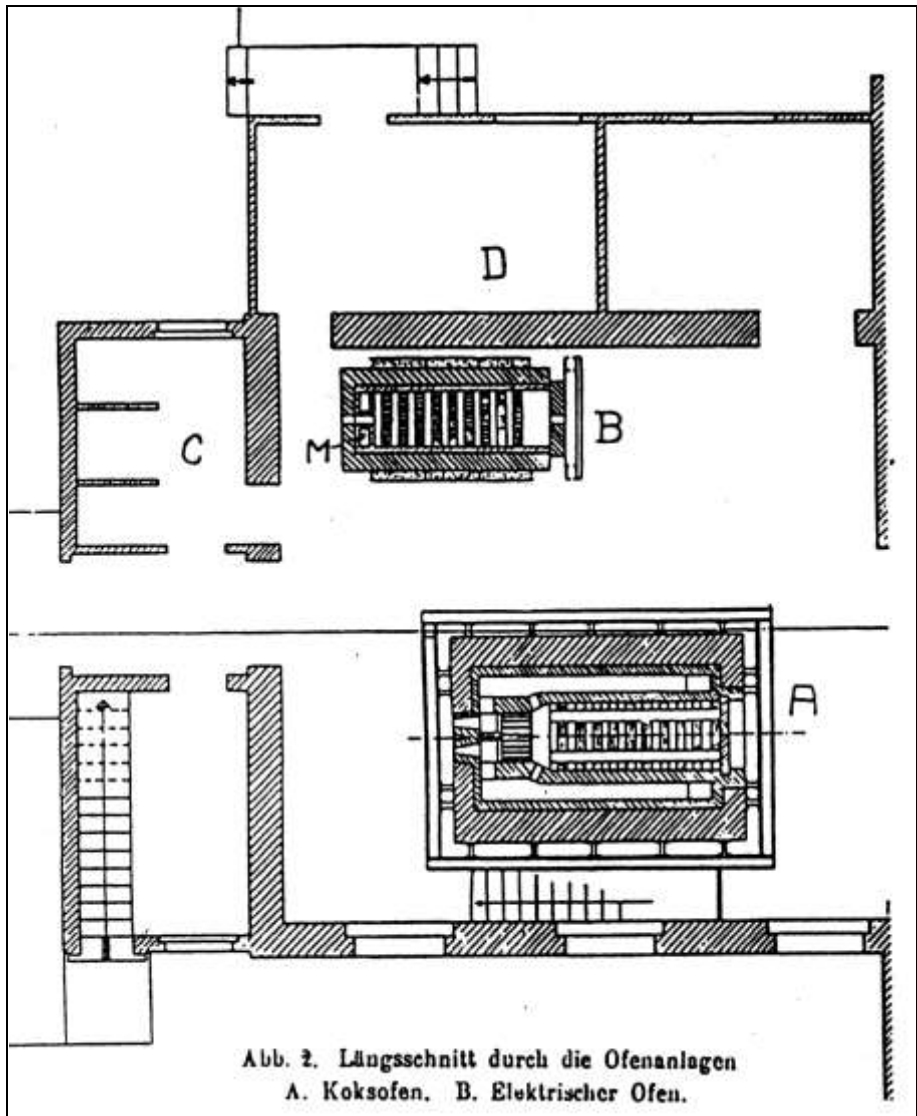

Document 76: A (bottom): horizontal section of the old W. RUPPMANN coke-fired cremation furnace at Biel; B (top): horizontal section of the BROWN, BOVERI & Co experimental electric cremation furnace. Source: as Doc. 75.

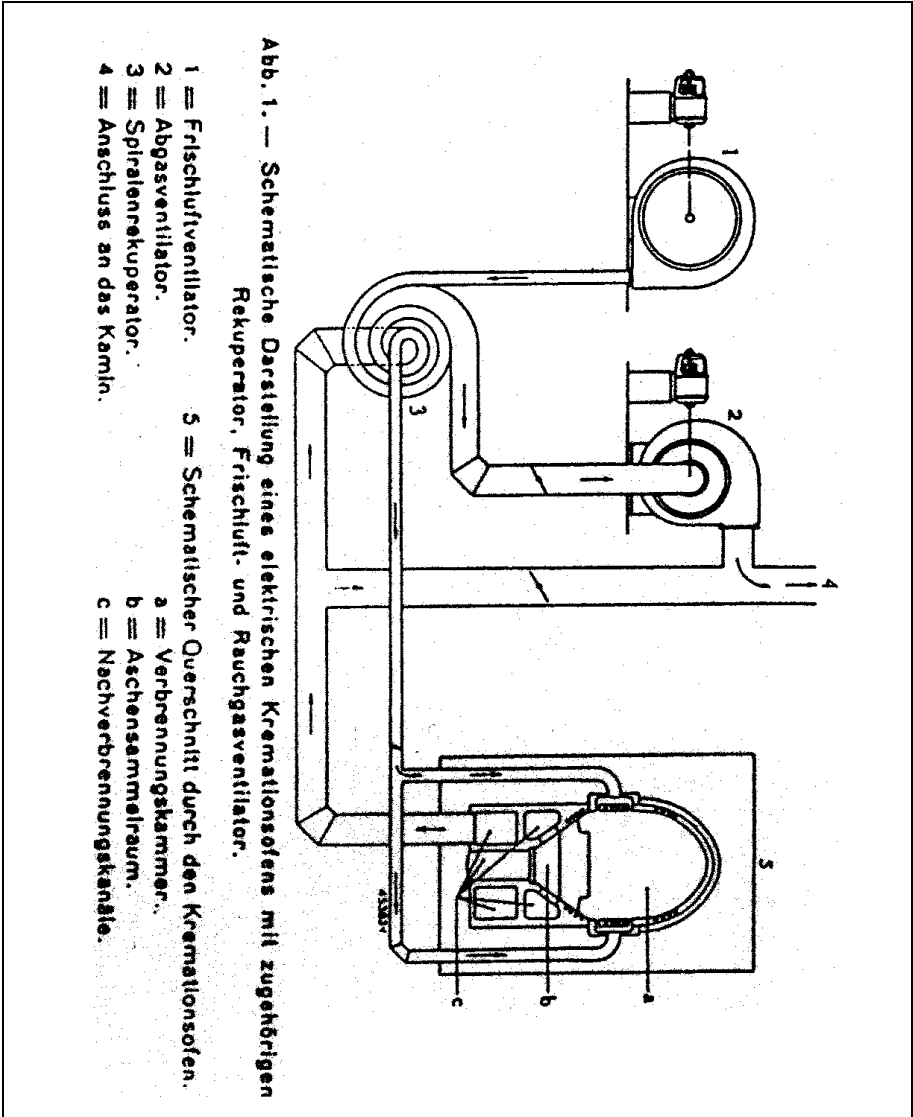

Document 77: BROWN, BOVERI & Co electric cremation furnace (standard model).

“Schematic representation of an electric cremation furnace with related recuperator, fresh air and flue gas fan.” G. Keller, “Die Elektrizität im Dienste der Feuerbestattung,” Aktiengesellschaft Brown, Boveri & Cie, Baden (Switzerland); special reprint of Brown Boveri Mitteilungen, no. 6/7, 1942, p. 3.

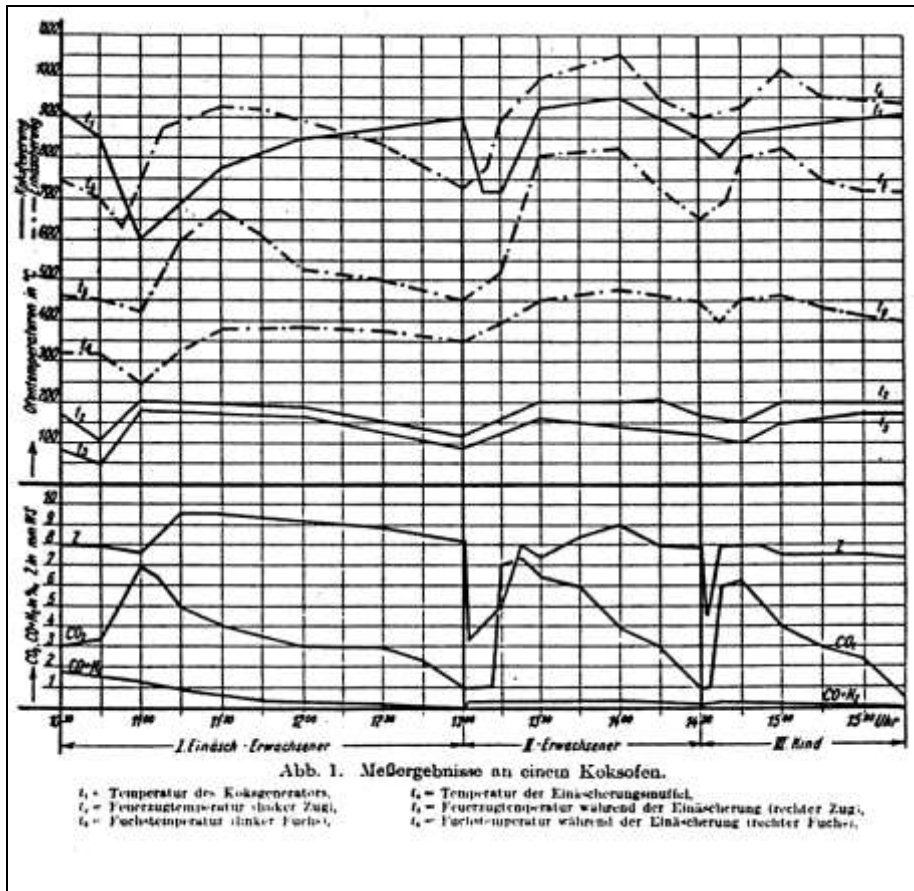

Document 78: Temperature chart of 3 cremations in a coke-fired cremation furnace. Source: as Doc. 59, no. 8, p. 110.

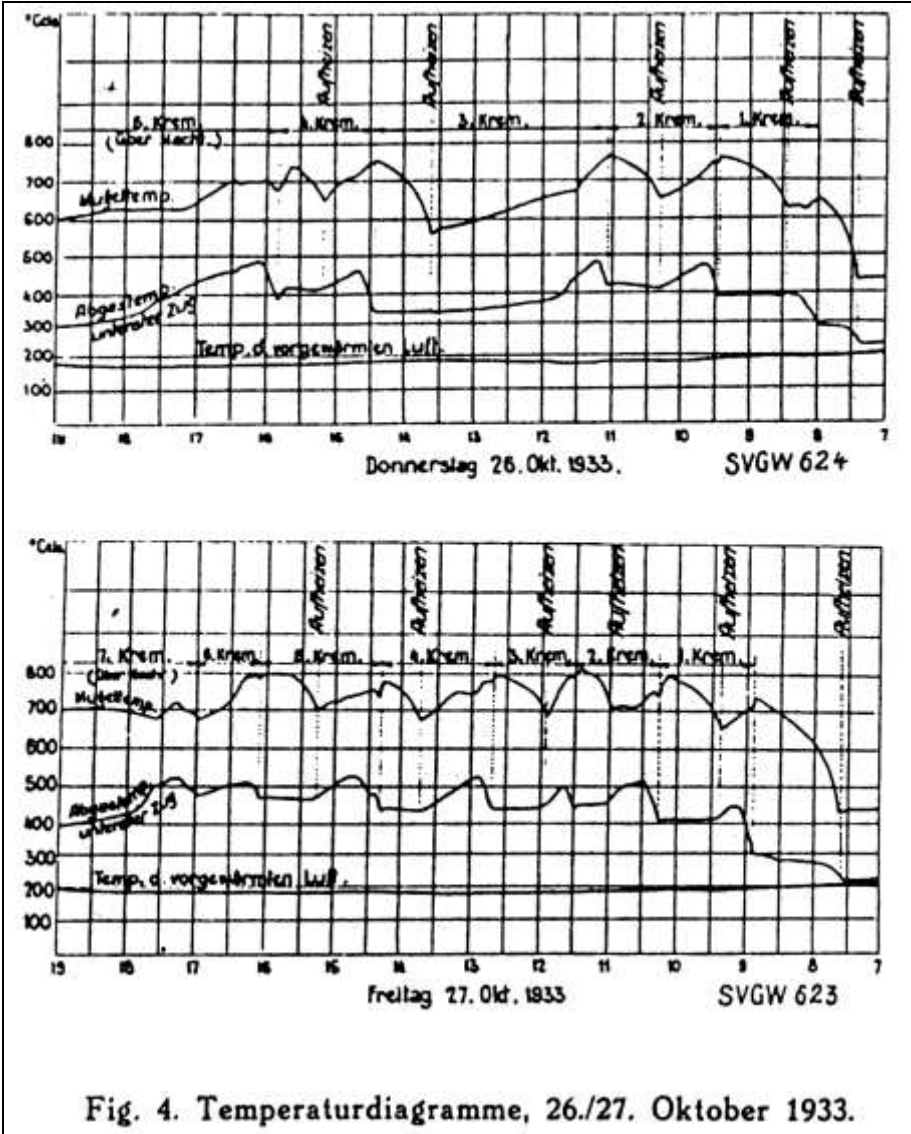

Fig. 4. Temperaturdiagramme, 26./27. Oktober 1933.

Documents 79 & 80: Top: temperature chart of 5 cremations conducted on 26 October 1933 in Furnace III (E. EMCH & Co.) at the Zürich Crematorium. Bottom: temperature chart of 7 cremations conducted on 27 October 1933. Source: as Doc. 68, p. 66.



Abb. 6. Tagesdiagramm vom 23. Okt. 1931 vor Erreichung des Beharrungszustandes. (5 Einäscherungen).



Abb. 7. Tagesdiagramm vom 30. Okt. 1931 nach Erreichung des Beharrungszustandes. (5 Einäscherungen).

Documents 81 & 82: Fig. 6: Temperature chart of 5 cremations conducted on 23 October 1931 in the VOLCKMANN-LUDWIG gas-fired cremation furnace at the Stuttgart Crematorium. Fig. 7: Temperature chart of 5 cremations conducted on 30 October 1931 in the same furnace. Source: as Doc. 66, no. 14, p. 163.

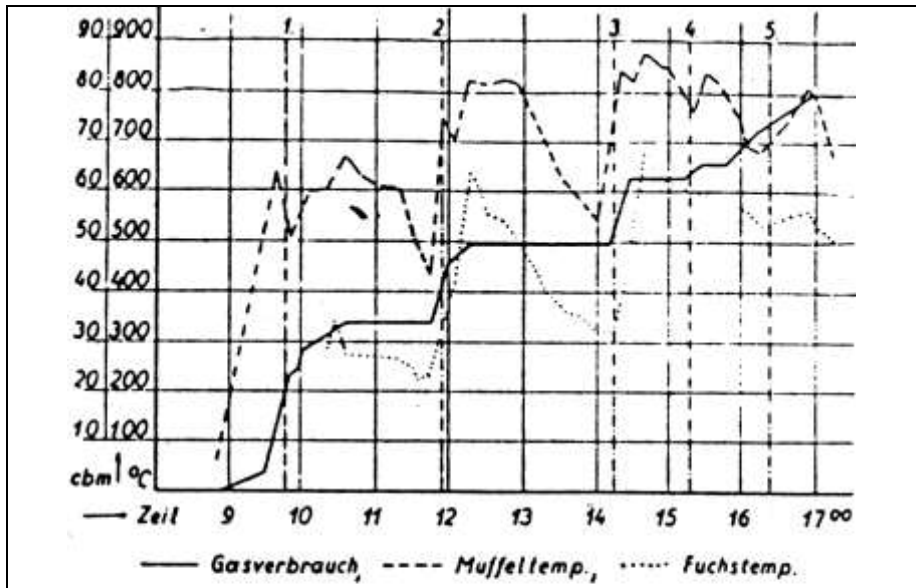

Abb. 4. Krenation vom 24. April 1934

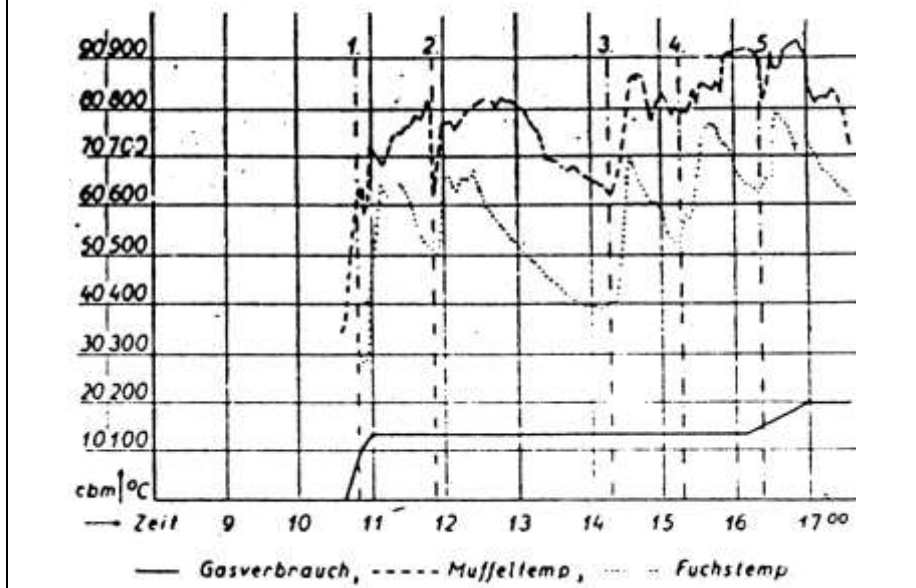
Die Abbildungen 4 und 5 zeigen den Verlauf der Temperaturen an 6 verschiedenen Messtellen. Es bedeuten:

- Kurve 1: Temperatur im Verbrennungsraum,
- Kurve 2: Temperatur im Nachverbrennungskanal,
- Kurve 3: Temperatur der Abgase nach dem Ofen und vor dem Rekuperator,
- Kurve 4: Temperatur der Abgase nach dem Rekuperator,
- Kurve 5: Temperatur der Verbrennungsluft nach dem Rekuperator,
- Kurve 6: Temperatur der Verbrennungsluft nach den Heizspiralen und vor Eintritt in den Verbrennungsraum.

Document 83: Temperature chart of a cremation conducted on 24 April 1934 in the BROWN, BOVERI & CO. electric cremation furnace at the Biel Crematorium. Source: as Doc. 75, p. 13.

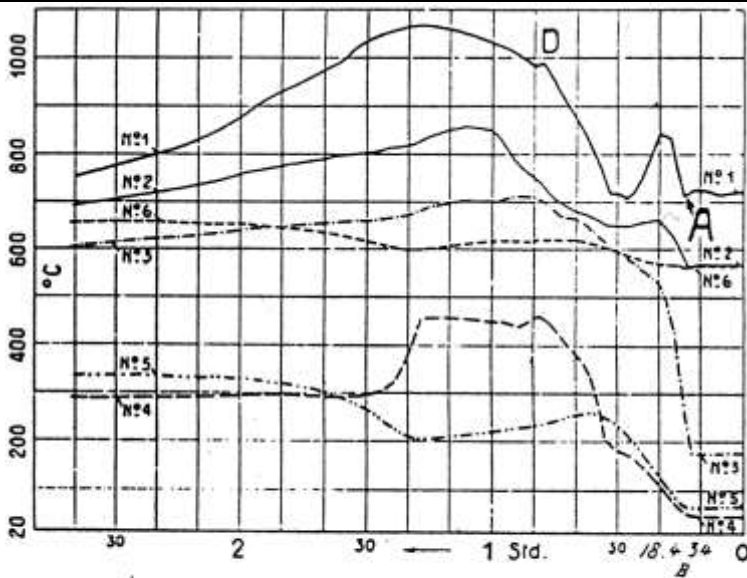
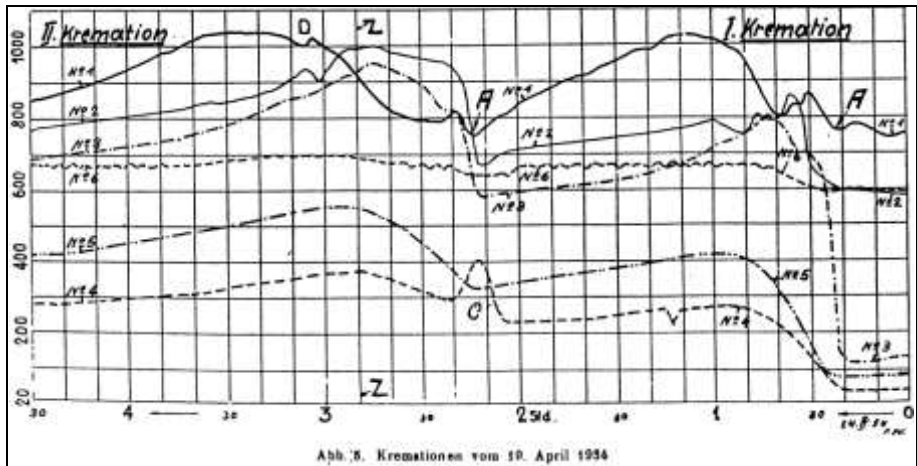

Document 84: Temperature chart of 2 cremations conducted on 19 April 1934 in the same furnace as above. Source: *ibid.*, p. 14

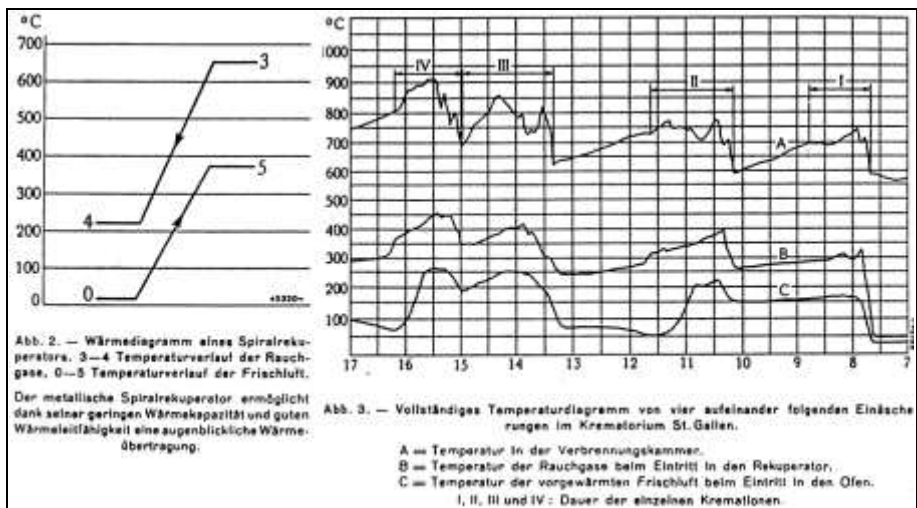

Document 85: Fig. 2 (left): Temperature chart of a metallic-coil recuperator; Fig. 3 (right): Temperature chart of 4 cremations conducted in 1942 in the BROWN, BOVERI & CO. electric cremation furnace at the St. Gallen Crematorium. Source: as *Doc. 77*, p. 4.

Ep. Nr.	Zahl und Vorname des Verstorbenen (Bei Frauen auch Geburtsname)	Geburtsdag	Todesdag	Erster Wohnort	Stand oder Beruf	Bemerkungen
		Geburtsort	Todesort			
1	2	3	4	5	6	7
1288	Tuchhorn Germann	2. 7. 1857 Bielefeld	26. 11. 1941 Bielefeld	Bielefeld	Kaufm. Angest.	ms.
1289	Kogemann Friedr. Hermann Kunze	20. 1. 1905 Altenhof	7. 12. 1941 Wewelsburg	Wewelsburg	Kaufm. Angest.	
1290	Blazewicz Wladyslaw	25. 2. 1912 Kamieny Kry. Litauen	1. 12. 1941 Wewelsburg	Wewelsburg	Kand. med.	Kath.
1291	Fordemann geb. obleyer Gylbergson	6. 4. 1898 Friedenoy	29. 11. 1941 Ladderbaum	Bad Salzungen	Lehrer	ms.
1292	Plumk Thoden Friedrich	20. 7. 1880 Hiel	16. 11. 1941 Bad Salzungen	Hofend	Ubersetzer	ms.
1293	Hallmeyer Karl	29. 1. 1857 Radborgen	1. 12. 1941 Hansberge / Porta	Hansberge	Sanitätsrat Dr. med.	ms.
1294	Karjische Konrad Kaufm.	18. 1. 1897 Königswist	2. 12. 1941 Wewelsburg	Wewelsburg	Kaufmann	Kath.
1295	Pöhlke Karl	24. 5. 1899 Hittelwalde	2. 12. 1941 Wewelsburg	Wewelsburg	Reiniger	Kath.
1296	Pöck Kunze	27. 1. 1873 Witten	2. 12. 1941 Bielefeld	Bielefeld	Zuführer	K.
1297	Sedisch Anton	10. 4. 1892 Leinwardorf Wewelsburg	2. 12. 1941 Bielefeld	Bielefeld	Arbeiter	

Document 86-1a: List of cremations at the Bielefeld Crematorium (5-23 December 1941). Source: Sennfriedhof Bielefeld.

Z. B. Bestimmungst. Form. Nr. 217. 12/1944
Brosch.

Zobedurfsache	Tag der Einschmelzung	Auf- schmelzungstag mit Nummer der Einschmelzung- urkunde	Bezeichnung oder Bestimmung der Asche Tag, Monat, Jahr, Ort	Eintragung des Belegungsdatums der Aschenreste
	Stunde der Einschmelzung			
	8	10	11	12
Gipspulver	5. 12. 1944 11 ⁰⁰	7. 12. 1944 261	10. 12. 1944 Kriegsgef. - Remberg	
	5. 12. 1944 4 ⁰⁰	7. 12. 1944 262	15. 12. 1944 Kammgriffel	
Ärger. i. Bismutgriffel	5. 12. 1944 10 ⁰⁰	7. 12. 1944 263	15. 12. 1944 Kriegsgef. im Lager Lachenhansen	
Haras, mus	5. 12. 1944 13 ⁰⁰	7. 12. 1944 264	10. 12. 1944 Kriegsgef. im Lager Lachenhansen	
Gipspulver	5. 12. 1944 10 ⁰⁰	265	Kriegsgef. im Lager Lachenhansen	
Altkorn. Gipspulver	5. 12. 1944 17 ⁰⁰	5. 12. 44 266	10. 12. 1944 Kriegsgef. im Lager Lachenhansen	
Altkorn. Gipspulver	6. 12. 1944 8 ⁰⁰	6. 12. 1944 267	6. 1. 1945 Kriegsgef. im Lager Lachenhansen	
Altkorn. Gipspulver	10. 12. 1944 10 ⁰⁰	6. 12. 1944 268	6. 1. 1945 Kriegsgef. im Lager Lachenhansen	
	16. 12. 1944 11 ⁰⁰	9. 12. 1944 269	Kammgriffel	
Gipspulver	10. 12. 1944 14 ⁰⁰	9. 12. 1944 270	11. 12. 1944 Kriegsgef. Bilshof-Lichter	

Document 86-1b: continued.

Op. Nr.	Zu und Vorname des Verstorbenen (Bei Frauen auch Geburtsname)	Geburtsdag	Todesdag	Exakte Wohnort	Stand oder Beruf	Bran- schien
		Geburtsort	Todesort			
1	2	3	4	5	6	7
271 1298	Bode Anthon	18. 10. 1859 Eggenp.	5. 12. 1941 Minden	Minden	Oberbauführer, ma.	
272 1299	Böhmner Paul	26. 9. 1910 Bochum	9. 12. 1941 Wewelsburg	Wewelsburg	Arbeiter	Kauf.
273 1300	Bräutigam Paul	9. 12. 1907 Berlin	9. 12. 1941 Wewelsburg	Wewelsburg	Kaufmann	ma.
274 1301	Bratkowski Lazarus Anton	17. 5. 1909 Thorn	10. 12. 1941 Wewelsburg	Wewelsburg	Heilpf.	Kauf.
275 1302	Brannica Ignaz	27. 1. 1910 Harg Landfeldt	10. 12. 1941 Wewelsburg	Wewelsburg	Landw. Arb.	Kauf.
276 1303	Schulderer Wilhelm	19. 4. 1897 Feldmark Bellen	9. 12. 1941 Wewelsburg	Wewelsburg	Arbeiter	Kauf.
277 1304	Schickel Hans	17. 4. 1887 Liegnitz	8. 12. 1941 Wewelsburg	Wewelsburg	Arbeiter	ma.
278 1305	Sandmann Klaus	22. 11. 1894 Barum / W.	12. 12. 1941 Bielefeld	Wolfenbüttel	Dr. med.	ma.
279 1306	Schickel August	26. 5. 1881 Oldenburg (Dürkum)	12. 12. 1941 Bielefeld	Bielefeld	Rechner	ma.
280 1307	Schäfer Joseph	7. 2. 1914 Oppely Oberfl.	11. 12. 1941 Wewelsburg	Wewelsburg	Diplom.	Kauf.

Document 86-2a: continued.

Dr. Reichsanzeiger Gesetz Nr. 12/1940 Deutsch				
Leberkrankheit	Tag der Einschlebung	Ein- schlebungstag und Nummer der Ge- nehmigungsur- kunde	Belegung oder Bezeichnung der Kiste	Kategorie der Belegungsart der Kiste
	Stunde der Einschlebung		Tag, Monat, Jahr, Ort	
8	9	10	11	12
Cholera	10.12.1941 16 ⁰⁰	10.12.1941 271	12.12.1941 Kriegsgefängnis Königsberg	
Leberentzündung	15.12.1941 9 ⁰⁰	15.12.1941 272	24.12.1941 Kriegsgefängnis Sachsenhausen	✓
Grippe	15.12.1941 10 ⁰⁰	15.12.1941 273	6.1.1942 Konzentrationslager Sachsenhausen	
Grippe	15.12.1941 12 ⁰⁰	15.12.1941 274	3.1.1942 Kriegsgefängnis Sachsenhausen	✓
Cholera - Darmblutfluss	15.12.1941 14 ⁰⁰	15.12.1941 275	6.1.1942 Konzentrationslager Sachsenhausen	
Cholera - Darmblutfluss	15.12.1941 15 ⁰⁰	15.12.1941 276	6.1.1942 Konzentrationslager Sachsenhausen	
Leberentzündung	15.12.1941 16 ⁰⁰	15.12.1941 277	6.1.1942 Konzentrationslager Sachsenhausen	
Blutruhr durch Morgengrippe	15.12.1941 8 ⁰⁰	15.12.1941 278	20.12.1941 Kriegsgefängnis Sachsenhausen	
Phlegmone d. l. Fußes Sepsis	17.12.1941 9 ⁰⁰	17.12.1941 279	28.12.1941 Kriegsgefängnis Sachsenhausen	
Cholera - Darmblutfluss	17.12.1941 11 ⁰⁰	17.12.1941 280	6.1.1942 Konzentrationslager Sachsenhausen	

Document 86-2b: continued.

Dfs. Nr.	Zu- und Vorname des Verstorbenen (Bei Frauen auch Geburtsname)	Geburtsdag	Todesdag	Letzter Wohnort	Stand oder Beruf	Rang- stellung
		Geburtsort	Todesort			
1	2	3	4	5	6	7
221 1308	Wolter Kurt	29. 3. 1913 Frankenburg / 1907	10. 12. 1941 Wewelsburg	Wewelsburg	Arbeiter	ms.
222 1309	Drach Gerd	31. 5. 1914 Genf (Suisse)	10. 12. 1941 Wewelsburg	Wewelsburg	Textilspinner	ms.
223 1310	Gille Günther	2. 9. 1904 Danzig	12. 12. 1941 Wewelsburg	Wewelsburg	Postler	ms.
224 1311	Dittigeb Ludwig	15. 1. 1919 Frankfurt a. M.	15. 12. 1941 Wewelsburg	Wewelsburg	Lehrer	ms.
225 1312	Wandersche Kurt	26. 5. 1896 Glabitz	15. 12. 1941 Wewelsburg	Wewelsburg	Textilarbeiter	Helf.
226 1313	Grasack Paul	6. 3. 1912 Bern	12. 12. 1941 Wewelsburg	Wewelsburg	Textilarbeiter	Helf.

Document 86-3a: continued.

 Reichsanstalt für den Völkischen Beobachter Nr. 13/1944 * Berlin				
Krankheitsart	Tag der Einlieferung		Belagerung oder Verletzung der Röhre Tag, Monat, Jahr, Ort	Erhebung des Belagerungsprotokolls der Röhrenstelle
	Stunde der Einlieferung	Auslieferungstag und Nummer der Überwachungsstunde		
8	9	10	11	12
Gangpflanz	18.12.1944 125	18.12.1944 287	10.12.1944 Frankfurt am Main Frankfurt 9.12.44	/
Katheter d. Zungen	18.12.1944 130	18.12.1944 288	6.1.1945 Zungenkatheterlager Lachowbrunn	
Wangenzahn Zahnfleischentzündung	18.12.1944 155	18.12.1944 283	24.12.1944 Zahnfleischentzündung Lachowbrunn	/
Zungenkatheterkopf	18.12.1944 165	18.12.1944 284	24.12.1944 Zungenkatheterkopf Frankfurt 1.12.	/
Diabetes	18.12.1944 175	18.12.1944 285	6.1.1945 Zungenkatheterlager Lachowbrunn	
Leberleiden	22.12.1944 90	22.12.1944 286	10.12.1944 Frankfurt Frankfurt	/
Gegen die die Malariaerkrankung mit dem Zungenkatheter d. Zungenkatheter Kopf nicht befreit.			Zungenkatheter 22.12.44 für Zungenkatheter 2. Kottmann Zungenkatheter	

Document 86-3b: continued.

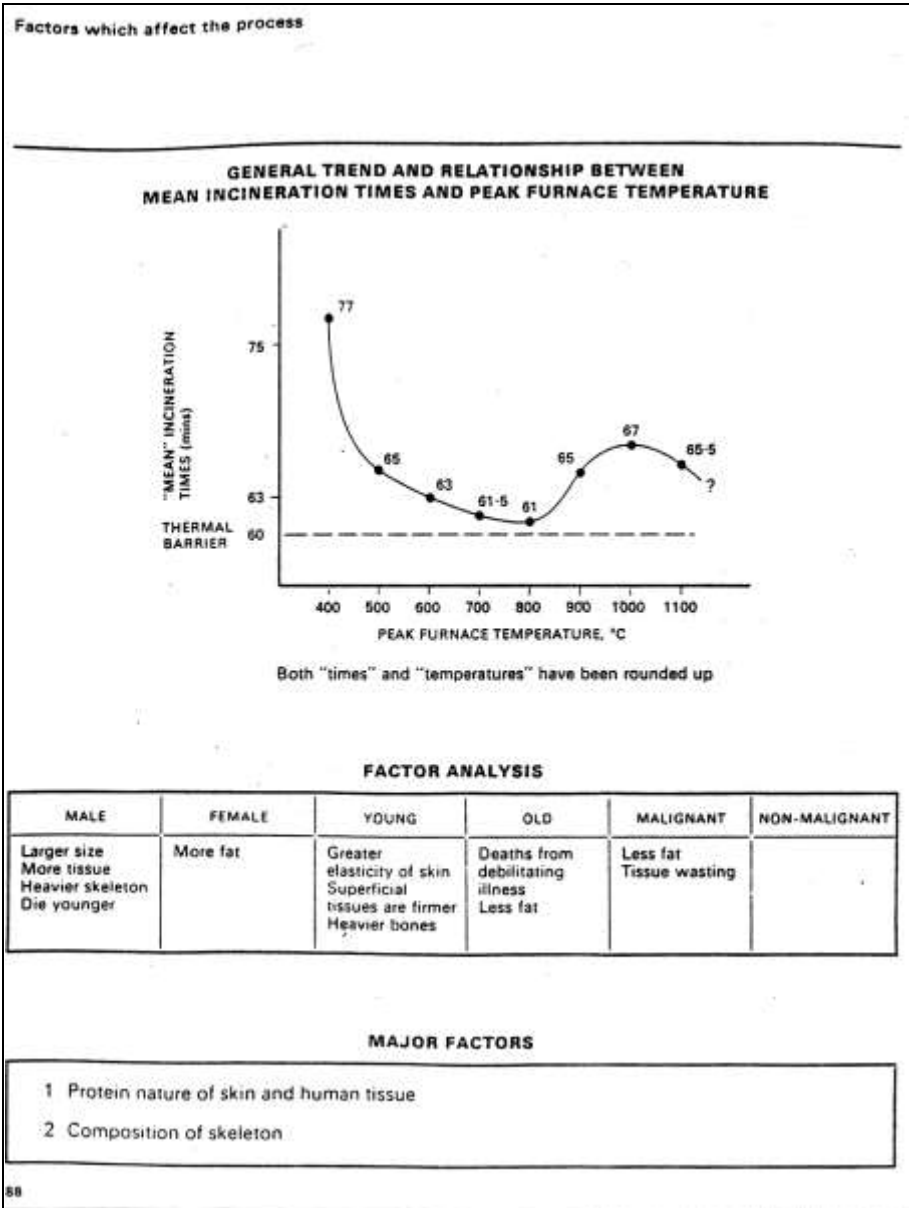

Document 87: Duration of a cremation as a function of the temperature in a modern gas-fired cremation furnace. Source: E.W. Jones, "Factors which affect the process of cremation." Extract from the Cremation Society of Great Britain's Annual Cremation Conference Report, 1975, p. 88.

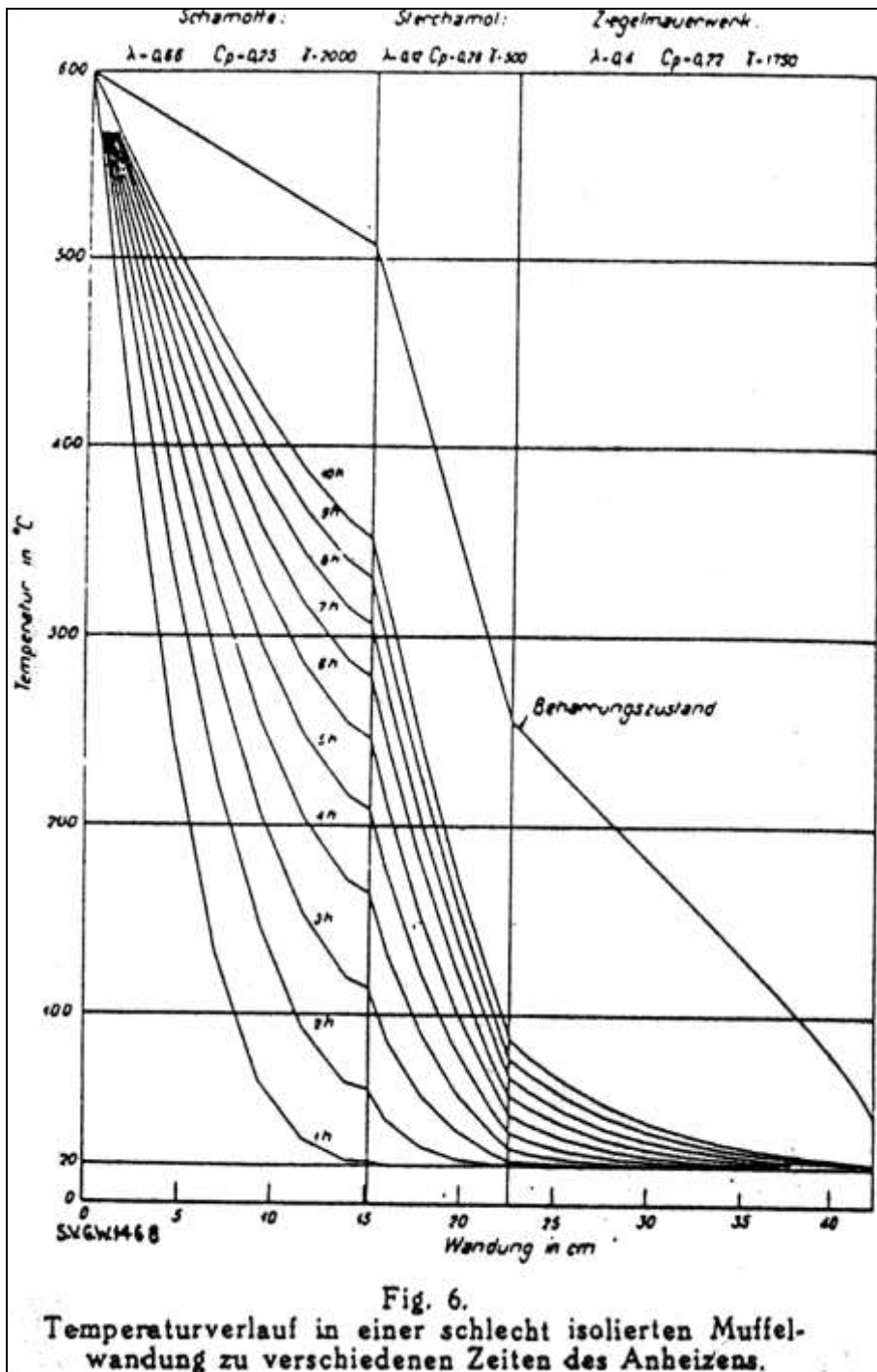

Fig. 6.
Temperaturverlauf in einer schlecht isolierten Muffel-
wandung zu verschiedenen Zeiten des Anheizens.

Document 88: Fig. 6: Behavior of wall temperature in a badly insulated muffle at various points of heating it up. Source: as Doc. 69, p. 154.

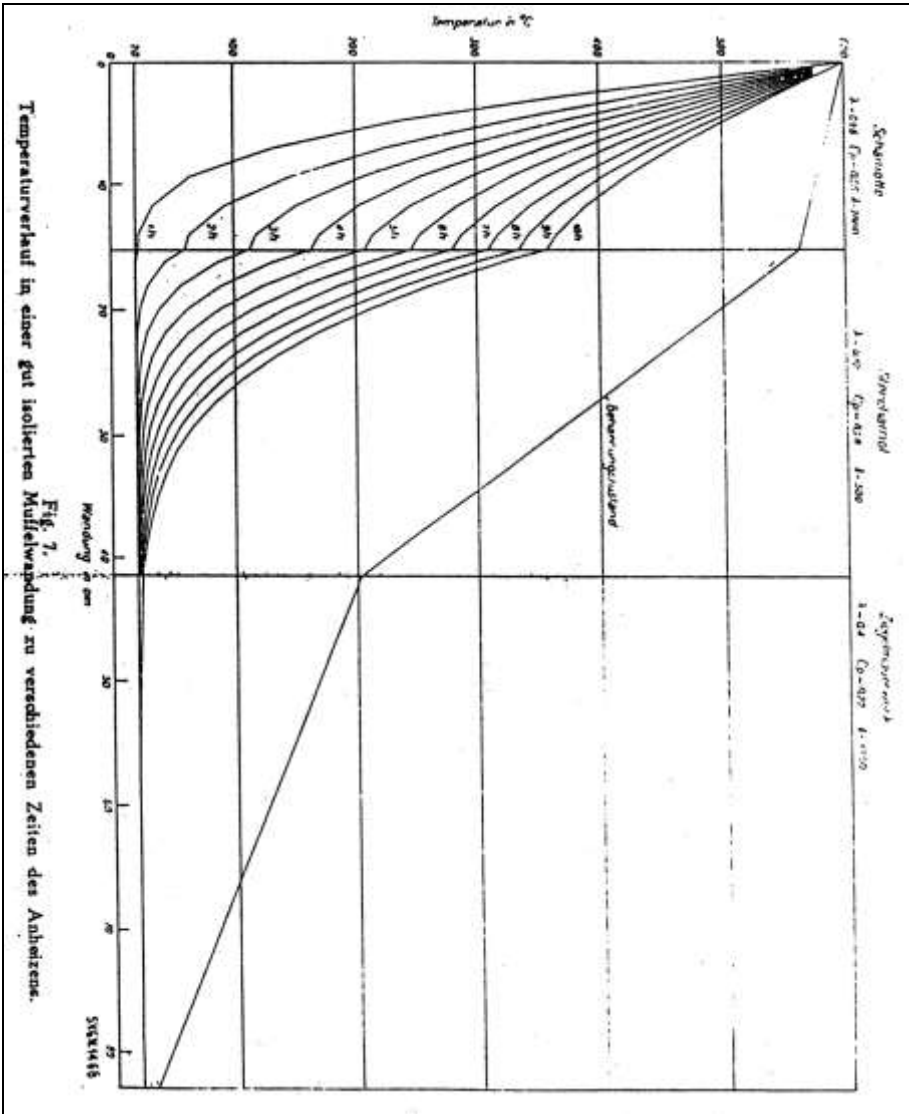
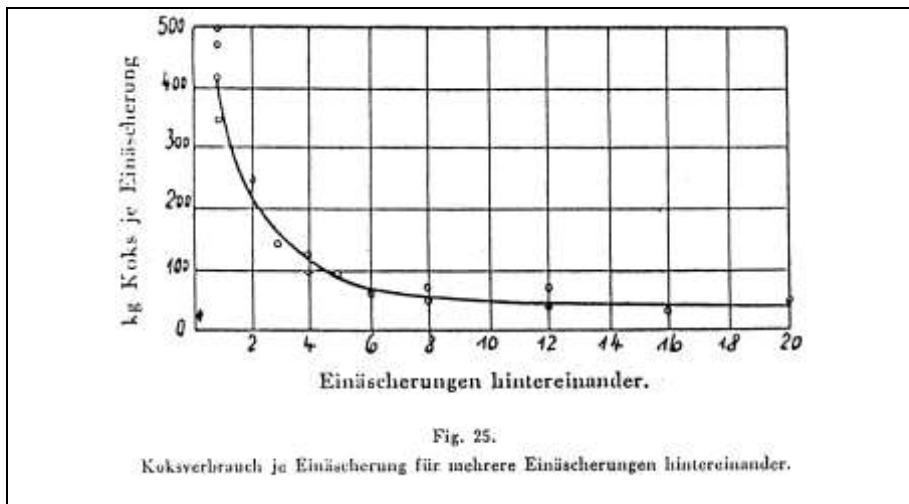
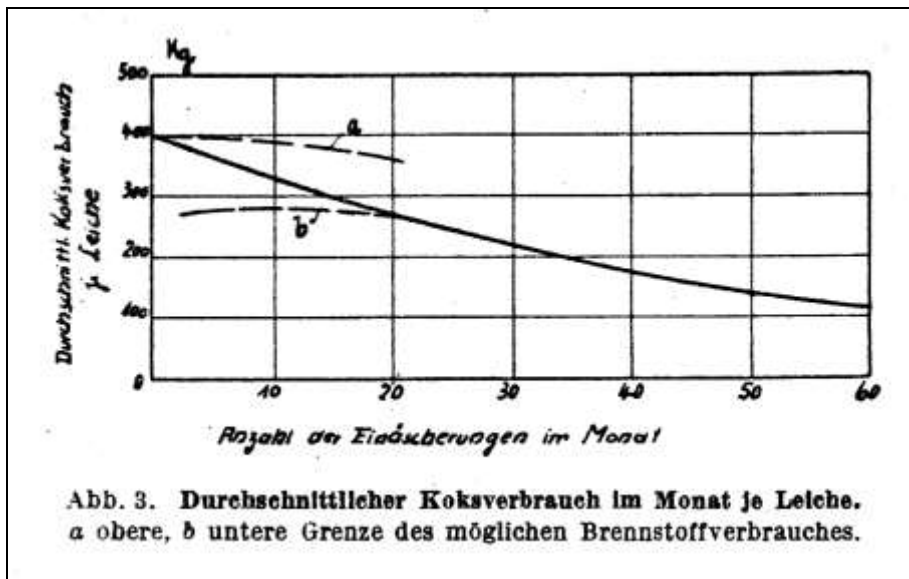

Fig. 7. Temperaturverlauf in einer gut isolierten Muffelwandung zu verschiedenen Zeiten des Anheizens.

Document 89: Fig. 7: Behavior of wall temperature in a well-insulated muffle at various points of heating it up. Source: as Doc. 69, p. 155.



Document 90: *Coke consumption per cremation for several consecutive cremations.* Source: P. Schläpfer, "Ueber den Bau und den Betrieb von Kremationsöfen." Special reprint from the Jahresbericht des Verbandes Schweizer. Feuerbestattungsvereine, Zürich, 1937, p. 36.



Document 90a: *Monthly average coke consumption per corpse as a function of the number of cremations per month. (a) and (b) give the maximum and minimum fuel consumption, respectively.* Source: *ibid.*

oberliegenden Seite der Ofenwand in einem außen abgeschlossenen Gehäuse eine elektrische Birne an, deren in den (den geworfene Lichtstrahlen durch eine vorgehaute Linse verstärkt werden.

Abschließend sei noch auf das Beobachtungsfenster von Mahon hingewiesen. Dasselbe ist mit einer dauernd und unmittelbar der Wärmestrahlung des Ofens ausgesetzten feuerfesten Scheibe versehen, wobei nicht nur die betreffende Scheibenoberfläche, sondern auch die dem Ofeninnern zugewandten Scheibenkanten vollständig oder doch mit nur geringen Unterbrechungen der Wärmestrahlung unterliegen. Dadurch soll eine ungleichmäßige Erwärmung der Scheibe und das damit verbundene Auftreten von Wärmespannungen, insbesondere an den Rändern der Scheibe vermieden werden. Die Befestigung der Scheibe an der dem Ofeninnern zugewandten Seite erfolgt statt durch die sonst üblichen Leisten — wie Abb. 5 zeigt — mittels schmaler, aus dem Rahmen vor-

springender Flächen, die sich nur auf kleine Teile der unmittelbar bestrahlten Scheibenoberfläche gewissermaßen punktförmig aufliegen. Die Scheiben können auch durch die Rahmenfläche selbst gehalten werden, indem diese unter einem spitzen Winkel zur unmittelbar bestrahlten Scheibenoberfläche gestellt werden und so die dem Ofeninnern zugewandten Scheibenkanten lediglich berühren, aber nicht überdecken (Abb. 6). Das Mahonsche Beobachtungsfenster besteht aus zwei halbthermenen Glasplatten und aus einer zwischen diesen mit Abstand angeordneten gefärbten Glasplatte. Letztere ist aus mehreren Glasstreifen zusammengesetzt, wobei die aneinanderstoßenden Streifenkanten schiefwinklig abgebragt sind. Durch eine solche Unterteilung wird die Oberflächenspannung verringert. Gleichzeitig werden etwa auftretende Verzerrungen in der Scheibe ausgeglichen, ohne daß sich dabei in der Scheibe Spalte bilden können. [249]

Die neuzeitlichen Leicheneinäscherungsöfen mit Koksfeuerung, deren Wärmebilanz und Brennstoffverbrauch.

Von Wilhelm Heepke, Mittweida.

Mit sechs Abbildungen.

Inhaltsangabe: Entwicklung der Feuerbestattung. Bisheriges feuerungstechnisches Schrifttum. Direkte und indirekte Einäscherung; Regeneratoren und Rekuperatoren. Schwierigkeiten für die Berechnung, starke Temperaturschwankungen. Der Koksöfen mit Rekuperator. Wärmebedarfsangaben, Wärmegevinns, Wärmeverluste, Brennstoffaufwand. Die Erhebungsgröße für eine Einäscherung.

(Schluß von Seite 111.)

Einen Überblick über das ineinandergreifen der verschiedenen Verbrennungsprozesse gibt das Wärmedigramm Abb. 2, dessen Zahlenwerte in der späteren Entwicklung ihre Erklärung finden. Die verschiedenen Wärmebeträge W , die sich durch den Einäscherungsprozeß ergeben, sind in Abb. 2 als Prozentverhältnisse des Brennstoffnutzeffektes verrechnet und durch die strichpunktierten Linien markiert. Für den ersten Koksverbrennungsprozeß kommen die Wärmeverluste mit voller Linien-signatur in Frage.

Sieht man von dem alten Gothaer Ofen ab, der zudem zuerst mit böhmischer Braunkohle gefeuert wurde, so kommt als neuzeitliche Bauart nur der Koksöfen mit Rekuperator in Betracht; letzterer ist aus Schamottesteinen aufgebaut. Die ersten Beck-Öfen der 90er Jahre waren nach dem Klingensierne-System mit gußeisernen Luftrekuperatorröhren ausgerüstet. Bemerkenswert ist hierfür, daß in der Eisenhüttenindustrie zur Zeit wieder eine Neigung zur Verwendung von Metallröhrenrekuperatoren vorliegt. In der neuesten Beckischen Bauart Abb. 3 ist die Zerlegung der bisherigen Rechtecks-Rekuperatorkanäle

in patentierte Dreiecksquerschnitte c_1 und c_2 beachtenswert, ebenso auch die Vergrößerung der Rauchgaskanalquerschnitte c_3 auf Kosten der Luftkanalquerschnitte c_4 bei dem Didier-Ofen Abb. 4. Diese Maßnahmen gehen darauf hinaus, die Kanalquerschnitte den Durchflußmengen und besonders



Abb. 2. Wärmedigramm des Koksöfens.

Document 91: Article by engineer Wilhelm Heepke, "Die neuzeitlichen Leicheneinäscherungsöfen mit Koksfeuerung, deren Wärmebilanz und Brennstoffverbrauch", in: *Feuerungstechnik*, XXI. Jg., 15 August 1933, no. 8, pp. 123-128.

den anfallenden großen Rauchgasmengen zwecks Verringerung des Rauches genauer anzupassen. Durch den Beckischen Dreieckrekuperator werden Lufterhitzungen bis 800° und mehr erzielt. Als weitere Neuerung ist die Anbringung mehrfacher Kanalmündungen für die Leichenverbrennungsluft in dem Deckengewölbe der Sargmuffel anzusehen.

Der Beck-Ofen hat den Vorrang, daß die Feuer gases von vorn nach hinten gezogen werden. Beim Öffnen des Hauptschiebers zur Einführung des Sarges können also keine Gase

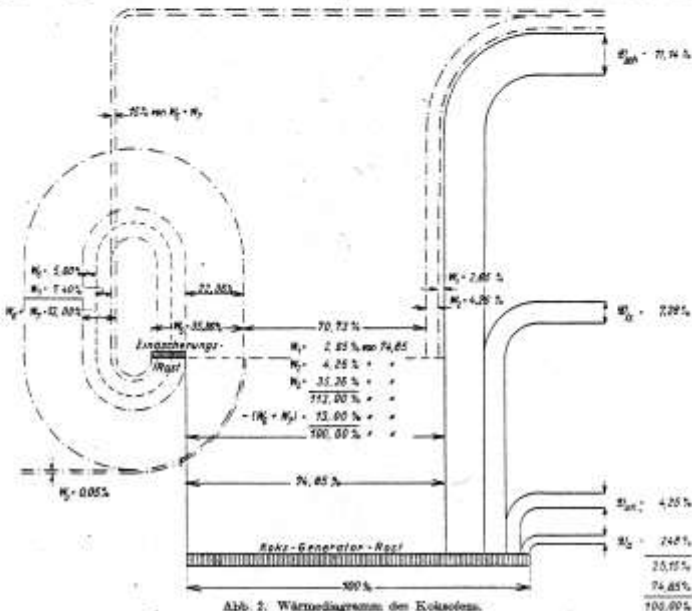
Um nun zu einer Rechnung zu kommen, müssen von Schwankungen der Wärmemengen und Temperaturen abgesehen, nur bestimmte Normal-, Maximal- oder Minimalwerte, wie sie passend erscheinen, zugrunde gelegt werden.

Das Gewicht der Leiche einer erwachsenen Person kann 70–100 kg betragen. Hiervon entfallen 65% auf den Wassergehalt und somit 35% auf die Trockensubstanz, von der 5% Unverbrennbares (Asche) sind. Die 36–5 = 30% brennbare Substanz setzt sich zusammen aus 12% Fett, 18% Eiweißstoffen und 3% sonstigen chemischen Stoffen oder aus 52% C, 7% H, 25% O, 1% S und 17% N. Danach erhält man bei Voraussetzung eines mittleren Leichengewichtes von 0,5 (70 + 100) = 85 kg als brennbares Leichengewicht 0,5 · 85 = 25,5 kg, welches besteht aus:

0,12 · 85 = 10,20 kg Fett
0,18 · 85 = 15,30 kg Eiweiß
0,03 · 85 = 2,55 kg Sonstige
28,05 kg
oder:
c = 0,65 · 25,5 = 16,575 kg C
h = 0,07 · 25,5 = 1,785 kg H
o = 0,23 · 25,5 = 5,865 kg O
s = 0,01 · 25,5 = 0,255 kg S
n = 0,17 · 25,5 = 4,335 kg N
28,80 kg

Für eine derartige brennbare Masse, die in ihrer Zusammensetzung einem festen Brennstoff gleichkommt, besteht eine Luftüberschusszahl $m = \frac{20,5}{13}$. Nach praktischen Messungen kann $CO_2 = 12\%$ gesetzt werden, somit $m = \frac{20,5}{12} = 1,71$.

Zur vollkommenen Verbrennung dieser Bestandteile ist eine wirkliche Verbrennungsluftmenge nötig von:

$$L = m \cdot \frac{2,67c + 8h + s - o}{0,30}$$

$$= 1,71 \cdot \frac{2,67 \cdot 16,575 + 8 \cdot 1,785 + 0,255 - 5,865}{0,30}$$

$$= 220,365 \approx 220 \text{ m}^3 \text{ von } 0^\circ \text{ und } 760 \text{ mm.}$$

Die Temperatur t in der Sargmuffel soll erfahrungsgemäß und auf Grund von genauen Versuchen nicht unter $\sim 800^\circ$ sinken und nicht über 1000° steigen, damit eine möglichst vollkommene Verbrennung und völlig ausgeglichene weiße Asche gewonnen wird. Bei $t > 1000^\circ$ würde zwar die Verbrennung rascher vor sich gehen, Gasen würden aber die Knochen schwarz und hart werden. Es soll daher $t = 900^\circ$ angenommen werden.

Die Luft wird im Rekuperator vor der Anfangs- oder Raumtemperatur $t_0 = 10^\circ$ auf $t_1 = 350^\circ$ vorgewärmt. Es wird dabei $t = 350^\circ$ vorausgesetzt, da die Entzündungstemperatur des Sargholzes bei $225\text{--}350$ liegt. Es ist dann für die Luft noch eine Wärmemenge vorzusehen von:

$$W_1 = 0,31 \cdot L \cdot (t - t_1) = 0,31 \cdot 220 (900 - 350)$$

$$= 37510 \approx 38000 \text{ kcal.}$$

Die in der Leiche enthaltene 65proz. Wassermenge von $q = 0,65 \cdot 85 = 55,25 \text{ kg}$ ist ebenfalls auf $t = 900^\circ$ zu bringen, das heißt in Sattendampf von 100° zu verwandeln und danach bis auf 900° zu überhitzen. Mit einer Erzeugungswärme $i = 840 \text{ kcal/kg}$ bei 1 ata und $c_p = 0,48 \text{ spez}$. Überhitzungswärme ergibt sich ein für diese Wasserverdampfung erforderlicher Wärmehaushalt von:

$$W_2 = q \cdot [i + c_p(t - t_0)] = 55,25 [640 + 0,48(900 - 10)]$$

$$= 58963 \approx 60000 \text{ kcal.}$$



Abb. 2. Beck-Eckofen mit Dreieckrekuperator.
 a = Einleuchtungsöffn., b = Kesselraum, c = Heizkörper, d = Rauchgasbehälter, e = Luftkanal, f = Leichenablagekanäle, g = Nachverbrennungsraum.

in den Heizraum austreten. Ist die Asche auf die unter dem Sargrost liegende schiefe Ebene gefallen und noch mit einigen brennbaren Teilen durchsetzt, so wird sie auf den Nachverbrennungsrost e gezogen, wo sie in sich restlos verbrennt. Hiernach wird dieser Rost gekippt, infolgedessen die Asche in den darunter befindlichen Aschenbehälter d fällt. Der Didier-Ofen ist eine für größere Krematorien und für Dauerbetrieb vorgesehene schwere Ofenbauart. Für Anstalten mit nur wenigen Einäscherungen in der Woche wird der Ofen in seinem Unterbau durch Fortlassen von ein oder zwei Rekuperatorzügen niedriger gehalten, wodurch das Anheizen schneller vor sich geht. Man hat bei den Didier-Öfen ferner die Möglichkeit, die aus der Muffel a abziehenden Feuer gases vor Eintritt in den Rekuperator c noch mit durch die Heizzüge der Muffel b ziehen und so an Brennstoff für das Aufheizen der Muffel a für die Einäscherung der nächsten Leiche zu sparen. Durch die Trennung von Generator b und Muffel a ist die Feuerführung für das Anwärmen der Muffel so gehalten, daß Abgase aus der Feuerung während der Einäscherung selbst in den Einäscherungsraum nicht gelangen können.

Das Unverbrennbare, die 5% Knochen von $0,06 \cdot 85 = 4,25$ kg Gewicht, wird während des Einäscherungsprozesses bei 0,2 spez. Wärme eine Wärmemenge:

$$W_2 = 0,2 \cdot 4,25 (900 - 10) = 740,5 = \sim 800 \text{ kcal}$$

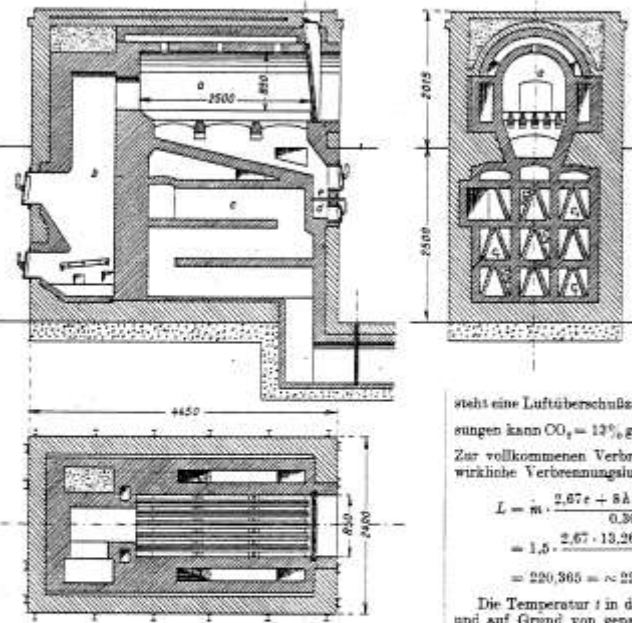
hinden, die mit Herausnahme der Asche aus dem Schemmelbehälter als Verlust zu buchen ist.

Das Schemmteufutter des Oberbaues des Ofens mit Muffel, Rost, Kanälen und Aschesammelraum kann mit $\sim 3 \text{ m}^3$ angenommen werden, besitzt also bei 1800 kg/m^3 spez. Gewicht ein

Gewicht $G_2 = 3 \cdot 1800 = 5400 \text{ kg}$. Die Temperatur dieses Schemmteufutteres beträgt nach Messversuchen etwa $\theta = 800^\circ$, so daß bei einer spez. Wärme von 0,21 für die Erwärmung dieses Ofenoberbaues von 10° auf 800° aufzubringen sind:

$$W_3 = c_p \cdot G_2 (\theta - t_0) = 0,21 \cdot 5400 \cdot (800 - 10) = 895860 = \sim 900000 \text{ kcal.}$$

Der untere Ofenteil mit dem Rekuperator umfaßt $\sim 4 \text{ m}^3$ Schemmteufutter, hat also ein Gewicht von $G_2 = 4 \cdot 1800 = 7200 \text{ kg}$. Unter Voraussetzung ungünstig niedriger Verhältnisse treten die Heizgase mit $T_1 = 600^\circ$ in den Rekuperator und verlassen ihn durch den Fuchs mit $T_2 = 200^\circ$. Hiermit sind gegeben:

die mittlere Rauchgastemperatur zu:

$$T_m = \frac{T_1 + T_2}{2} = \frac{600 + 200}{2} = 400^\circ,$$

die mittlere Lufttemperatur zu:

$$t_m = \frac{t_2 + t_1}{2} = \frac{10 + 350}{2} = 180^\circ.$$

Mit $\lambda = \frac{1}{2}$ Schemmteufutter der Rekuperatorwände, also $= 0,065 \text{ m}$ Stärke; $\lambda =$ Wärmeleitzahl der Schemmteufutter, $= 0,60$ bei $400 - 500^\circ$; $\alpha =$ Wärmeübergangszahl für rauhe Wandoberfläche, $= 9,0$ bei $v = 5 \text{ m/s}$ Geschwindigkeit (nach Jürges)

wird die Wärmedurchgangszahl der Rekuperatorwände:

$$k = \frac{1}{\frac{1}{\alpha} + \frac{s}{\lambda} + \frac{1}{\alpha}} = \frac{1}{\frac{1}{9} + \frac{0,065}{0,6} + \frac{1}{9}} = 0,33 = 3,33 \text{ kcal/m}^2 \text{ }^\circ\text{C h.}$$

Damit erhält man die beiden Oberflächentemperaturen der Rekuperatorsteine zu:

$$\theta' = T_m - (T_m - t_m) \frac{k}{\alpha} = 400 - (400 - 180) \frac{3,33}{9} = 318^\circ,$$

$$\theta'' = t_m + (T_m - t_m) \frac{k}{\alpha} = 180 + (400 - 180) \frac{3,33}{9} = 262^\circ.$$

und die mittlere Stein Temperatur:

$$\theta_m = \frac{\theta' + \theta''}{2} = \frac{318 + 262}{2} = 290^\circ.$$

Da $\alpha = \alpha' = \alpha'' = 9,0$ gesetzt ist, so muß auch sein:

$$\theta_m = \frac{T_m + t_m}{2} = \frac{400 + 180}{2} = 290^\circ.$$

Mit $\theta_m = \sim 300^\circ$ sind dann für die Anwärkung des Rekuperators erforderlich:

$$W_4 = c_p \cdot G_2 \cdot \theta_m = 0,21 \cdot 7200 \cdot 300 = 453600 = \sim 454000 \text{ kcal,}$$

die zur Erhöhung der Lufttemperatur von 10° auf 350° dienen. Da nun die Ofentemperatur über der Entzündungstemperatur des Sargmaterials liegt, so werden bei Einführen des Sarges dieser wie auch danach die Leiche unter Einwirkung der heißen Luft bzw. deren Sauerstoffes ab bald zur Verbrennung kommen.



Abb. 4. Düiser-Kreuzöfen.

Der Einäscherungsarg hat ein Gewicht von $G_2 = 40 \text{ kg}$ und könnte bei $H_u = 3000 \text{ kcal/kg}$ des Holzes eine Wärmemenge $H_u \cdot G_2 = 3000 \cdot 40 = 120000 \text{ kcal}$ entwickeln. Diese ganze Wärmemenge darf jedoch nicht als Gewinn eingesetzt werden. Durch den Anstrich, das Sargfüllmaterial, die Leichenbekleidung u. dgl. wird der Effekt um 33% herabgedrückt, so daß als Wärmegehalt durch die Sargverbrennung nur verbleiben:

$$W_5 = 120000 - 0,33 \cdot 120000 = 80400 = \sim 80000 \text{ kcal.}$$

Da die brennbare Substanz der Leiche aus denselben organischen Bestandteilen besteht wie ein fester Brennstoff, so läßt sich die bei der Verbrennung der Leiche entwickelte Wärmemenge nach der üblichen Verbandsformel bestimmen zu:

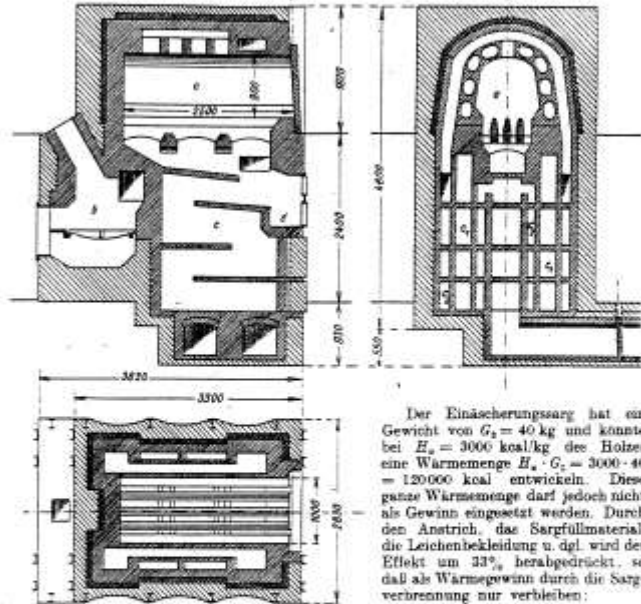
$$W_6 = 8100 \cdot c + 29000 \left(k - \frac{\sigma}{8} \right) + 2500 s - 600 \cdot \varphi = 8100 \cdot 13,26 + 29000 \left(1,785 - \frac{5,865}{8} \right) + 2500 \cdot 0,255 - 600 \cdot 55,25 = 103402 \text{ kcal.}$$

Rechnet man mit dem Fettbestandteil der Leiche und nimmt den Heizwert des Fettes mit 8000 kcal/kg und den der Erwei- und übrigen Stoffe mit 1500 kcal/kg an, so erhält man:

$$W_7 = 8000 \cdot 10,2 + 1500 (12,75 + 2,55) = 104550 \text{ kcal.}$$

Man kann aber auch zur Ermittlung von W_7 bewährte Erfahrungswerte von tierischen Verbrennungsöfen heranziehen. In derartigen guten Öfen rechnet man mit einem Kohle- oder Koksverbrauch von $0,350 - 0,375 \text{ kg}$ zum Verbrennen von

1949
reuerungslehre
Jahrgang XXI, Heft 3

1 kg Fleisch in 1 Minute. Mit $\eta = 0,5$ und $H_u = 7000$ kcal/kg für Koks wird:

$$W_f = 0,5 \cdot 7000 \cdot 0,350 \cdot 85 = 104125 \text{ kcal.}$$

Man kann mithin endgültig setzen:

$$W_f = 105000 \text{ kcal.}$$

Für die Verbrennung einer 85-kg-Leiche ist also nach vorstehendem Erfahrungswert eine Verbrennungsdauer von 85 Minuten = 1 Stunde und 25 Minuten nötig. Dies ist eine Zeit, die auch in den neuesten Leicheneinschierungsöfen vorauszusetzen ist.

Für eine erste Einschierung mit Hochheizen des kalten Ofens erhält man nunmehr folgende Wärmebilanz:

Aufzuwendende Wärmemengen:

für Erwärmung der Einschierungsluft	W ₁ = 36000 kcal
für Wasserverdampfung	W ₂ = 60000 "
für Eiswasserwärmung der Asche	W ₃ = 400 "
für Erwärmung des oberen Ofenteils	W ₄ = 900000 "
für Erwärmung des unteren Ofenteils	W ₅ = 454900 "
Σ (W₁ + W₅) = 1452800 kcal	

Erzeugende Wärmemengen:

durch Verbrennung d. Sauges	W ₆ = 80000 kcal
durch Verbrennung d. Leiche	W ₇ = 105000 "
W₆ + W₇ = 185000 kcal	

Somit liegt für eine erste Einschierung ein Wärmebedarf vor $W_f = 1267800$ kcal

Als Brennstoff kommt Koks als Gas- oder Hüttenkoks in Frage. Für nachstehende Berechnung wird ein Zeichenkoks zugrunde gelegt, dessen chemische Analyse ergeben hat:

C = 78,84; H = 0,51; O = 1,0; S = 0,91; W = 8,21; A = 10,53%

Dafür findet sich der untere theoretische Heizwert zu:

$$H_u = 81C + 290 \left(H - \frac{O}{8} \right) + 25S - 6W$$

$$= 81 \cdot 78,84 + 290 \left(0,51 - \frac{1,00}{8} \right) + 25 \cdot 0,91 - 6 \cdot 8,21$$

$$= 6471,18 \approx 6470 \text{ kcal/kg.}$$

Zur Bestimmung des Nutzeffektes bzw. Wirkungsgrades η sind die Wärmeverluste des Ofens zu erfassen, die sich aus dem Schornsteinverlust, dem Verlust durch Leitung und Strahlung, durch unvollkommene Verbrennung und durch Herdrückstände (Asche) zusammensetzen. Für diese Ermittlung werden Zahlenwerte benutzt, die durch Versuche und Erfahrungen mit obigem Brennstoff gefunden wurden. Teilweise muß natürlich für diese Darstellung auf Mittelwerte zurückgegriffen werden. Gefunden wurden: die Fuchstemperatur $T_f = 200^\circ$, die Raumtemperatur beim Anheizen $t_a = 10^\circ$ und nach Inbetriebsetzen $t_r = 20^\circ$, die Analysenwerte des Heißgases (Rauchgases) $CO_2 = 13$, $O_2 = 7,5$, $CO = 0,5$, $H_2 = 0,4$, $CH_4 = 0,3$ und $N = 70,5$ Vol.-%, die Koksaschenmenge einer ersten Heizung $A' = 12$ kg mit Analysenwerten $C_s = 47,8$, $H_s = 0,1$, $S_s = 1,6$ und Unverbranntes 50,5%, also Unverbranntes und noch Brennbares in der Asche: $U_s = (C_s + H_s + S_s) = 47,8 + 0,1 + 1,6 = 49,5\%$.

Der Heizwert von U_s war nach der Verbrennungsuntersuchung in der Berthelot-Mahlertschen Bombe $H_{us} = 3650$ kcal/kg.

Hiermit erhält man als Schornsteinverlust:

$$Q_{sm} = \left[0,32 \frac{C}{0,536 \cdot CO_2} + 0,0048 (9H - W) \right] (T_f - t_a) \frac{100}{H_u}$$

$$= \left[0,32 \frac{78,84}{0,536 \cdot 13} + 0,0048 (9 \cdot 0,51 + 8,21) \right] (200 - 10) \frac{100}{6470}$$

$$= 10,80\%$$

Oder mit dem Volumen der trockenen Verbrennungsgase:

$$R_v = \frac{0,01 \cdot C}{0,236 \cdot CO_2 + CO + CH_4} = \frac{0,01 \cdot 78,84}{0,236 \cdot 13 + 0,5 + 0,3}$$

$$= 10,7 \text{ m}^3/\text{kg}$$

und der mittleren spez. Wärme der Rauchgase:

$$\epsilon_{pm} = 0,318 + 0,000046(T_f - t_a) = 0,318 + 0,000046(200 - 10) = 0,327.$$

zu:

$$Q_{sm} = \frac{R_v \cdot \epsilon_{pm} \cdot (T_f - t_a) \cdot 100}{H_u} = \frac{10,7 \cdot 0,327 (200 - 10) \cdot 100}{6470}$$

$$= 10,30\%$$

Oder mit dem Luftüberschuß $w_1 = 1,5$ im Generator, dem Rauchgasgewicht:

$$R_g = 1,4 \frac{w_1 H_u}{1000} = 1,4 \frac{1,5 \cdot 6470}{1000} = 13,57 \text{ kg.}$$

dem Ausstrahlungsverhältnis $s = 0,15$, der spez. Wärme der Gase $c = \approx 0,24$ und dem Wirkungsgrad des Generators $\eta = \approx 0,90$, der Feuer-temperatur zu:

$$T = t_a + \eta \frac{H_u(1-s)}{R_g \cdot c}$$

$$= 10 + 0,90 \frac{6470(1-0,15)}{13,57 \cdot 0,24}$$

$$= 1516 \approx 1500^\circ$$

und damit nach Abb. 5 mit den genauen spez. Wärmen von $c = 0,282$ bei $T = 1500^\circ$ und $\epsilon_f = 0,235$ bei $T_f = 200^\circ$ zu:

$$Q_{sm} = \frac{T_f \cdot \epsilon_f}{T \cdot c} \cdot 100$$

$$= \frac{200 \cdot 0,235}{1500 \cdot 0,282} \cdot 100$$

$$= 11,14\%$$

Oder schließlich nach Siebert zu:

$$Q_{sm} = 0,70 \frac{T_f - t_a}{CO_2} = 0,70 \frac{200 - 10}{13} = 10,50\%$$

Der Verlust durch unverbrannte Gase (unvollkommene Verbrennung) entsteht durch den Gehalt der Abgase an Unverbranntem als CO und CH₄ und ist bestimmt zu:

$$Q_{un} = \frac{R_v (3050 \cdot CO + 2580 H_2)}{H_u} = \frac{10,7 (3053 \cdot 0,5 + 2580 \cdot 0,4)}{6470}$$

$$= 4,25\%$$

oder angenähert nach Brauns zu:

$$Q_{un} = \frac{70 \cdot (CO + H_2)}{CO_2 + CO + H_2} = \frac{70 \cdot (0,5 + 0,4)}{13 + 0,5 + 0,4} = 4,33\%$$

Den Verlust durch Herdrückstände (Asche, Schlacke) erhält man mit obigen Angaben und mit einer vorläufigen Annahme des Brennstoffverbrauches (nach Erfahrungen) von $B = \approx 300$ kg zu:

$$Q_s = U_s \cdot \frac{A' \cdot 8100}{B \cdot H_u} = 49,5 \cdot \frac{12 \cdot 8100}{300 \cdot 6470} = 2,48\%$$

Oder:

$$Q_s = \frac{A' \cdot H_u \cdot 100}{B \cdot H_u} = \frac{12 \cdot 3650 \cdot 100}{300 \cdot 6470} = 2,26\%$$

Der Verlust durch Wärmeleitung und -strahlung des Ofens muß vielfach als Restglied in die Bilanzrechnung eingesetzt werden. Hier läßt er sich jedoch mit Hilfe der Wärmedurchgangsgleichung erfassen.

Der ganze freistehende Ofenmauerklotz besitzt eine Außenfläche von $F = 90$ m². Die mittlere Temperatur der Innenwände kann mit $\theta_m = \frac{\theta + \theta_w}{2} = \frac{800 - 300}{2} = 550^\circ$

angesetzt werden. Für die Wärmedurchgangszahl gilt mit $\alpha_1 = \alpha_2 = 7$ (Innenwand) nach Abb. 6:

$$k = \frac{1}{\frac{1}{\alpha_1} + \frac{s_1}{\lambda_1} + \frac{s_2}{\lambda_2} + \frac{s_3}{\lambda_3} + \frac{1}{\alpha_2}} = \frac{1}{\frac{1}{7} + \frac{0,12}{0,70} + \frac{0,010}{0,60} + \frac{0,38}{0,45} + \frac{1}{7}} = \frac{1}{1,317} = 0,76 \text{ kcal/m}^2\text{°C h.}$$

In $z = 3$ Stunden Anheizzeit des Einschierungsofens nach Erreichen des Generatorbarrungsstandes ist der Wärmeverlust durch den Ofenmauerklotz:

$$W_a = k \cdot F \cdot (\theta_a - t_a) z = 0,76 \cdot 90(550 - 20) \cdot 3 = 108736 \text{ kcal}$$

oder:

$$\frac{W_a \cdot 100}{B \cdot H_a} = \frac{108736 \cdot 100}{300 \cdot 6476} = 5,60\%$$

Rechnet man hierzu noch 30% für die rechnerisch nicht zu erfassenden, aber immerhin bedeutenden Wärmeverluste



Abb. 6. Bestimmung der Wärmedurchgangszahl k .

durch Falschluft und Undichtigkeiten im Mauerwerk, in Klappen und Schiebern, so wird:

$$\alpha_a = 1,3 \cdot 5,60 = 7,28\%$$

Alle vorstehenden Prozentwerte der Wärmeverluste beziehen sich auf das Prozentverhältnis von H_a .

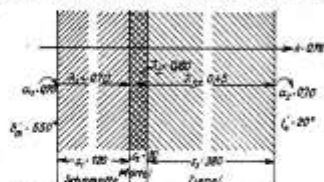
Mit dem Größtwerte der ermittelten Prozentsätze wird dann der Gesamtnutzeffekt (siehe auch Abb. 2):

$$100 - (\alpha_{a1} + \alpha_{a2} + \alpha_{a3} + \alpha_{a4}) = 100 - (11,14 + 4,25 + 2,46 + 7,28) = 100 - 25,13 = 74,85 = \sim 75\%$$

und der Wirkungsgrad:

$$\eta = 0,75.$$

also der wirkliche Heizwert des Kokes:

$$\eta H_a = 0,75 \cdot 6476 = 4850 \text{ kcal/kg.}$$

Für eine erste Einschierung ist mithin der Brennstoffaufwand:

$$B_1 = \frac{W_1}{\eta H_a} = \frac{1267800}{4850} = 262 \text{ kg.}$$

Für Öfen schwerer Bauart erhöhen sich C und G_1 und damit W_a und W_1 derart, daß B_1 auf 300-400 kg und mehr steigt.

Für eine zweite anschließende Einschierung sind aufzubringen einmal die Wärmemengen für die Verbrennungsluftvorwärmung, Wasserverdunstung und Aschenabsorptionswärme mit:

$$W_1 + W_2 + W_3 = 38000 + 60000 + 800 = 98800 \text{ kcal,}$$

dann $\sim 30\%$ für Deckung der Wärmeverluste des Ofens, hervorgerufen durch Absorption, Leitung, Strahlung, Falschluft, Sargenführung, Klappen und Schieber usw., also:

$$0,30 (W_1 + W_2) = 0,30 (98000 + 454000) = 406200 \text{ kcal.}$$

Durch die Sarg- und Leichenverbrennung werden:

$$W_4 + W_5 = 80000 + 165000 = 245000 \text{ kcal}$$

erzeugt, von welcher Wärmemenge $\sim 15\%$ mit den Abgasen durch den Schornstein als Verlust entweichen.

Somit stehen zur Verfügung:

$$0,85 (W_1 + W_2) = 0,85 \cdot 185000 = 157280 \text{ kcal.}$$

Für die zweite Einschierung sind also aufzubringen:

$$W_{II} = (98800 + 406200) - 157280 = 347750$$

und:

$$B_{II} = \frac{W_{II}}{\eta H_a} = \frac{347750}{4850} = 72 \text{ kg.}$$

Da sich mit jeder weiteren Betriebsstunde der Wärmeverlust durch die Absorption des Ofenmauerwerkes verringert, und zwar so weit, bis schließlich ein gewisser Beharrungsstand eingetreten ist, so kann man für weitere anschließende Betriebsstunden auf Grund von Erfahrungen und Messungen den Prozentsatz dieses Wärmeverlustes gleichmäßig herabsetzen bis zu der untersten Beharrungsgrenze von $\sim 15\%$.

Zahlentafel I.

Anlage	Kessel	Koksvorrat in kg für					Bemerkungen
		Beschreibung	Einschierung				
			1.	2.	3.	4.	
Arnsdorf	Gas	190-270	234-314	von zwei Leichen an einem Tage		Unregelmäßiger Betrieb. Abwärme für Kapselheizung.	
Berlin-Wilmsdorf	Gas	350-52	52	52	50,50	Dauerbetrieb.	
Chemnitz	Gas	280	80	50	40,40	Dauerbetrieb. Heizversuche Heepke	
Dessau	Hütten	265	180	zusammen 35		Heizversuche Kessler.	
Erfurt	Gas	182,5	87,5	112,5	110,60	Nicht täglich in Betrieb.	
Halle	Hütten	175-290	je 90				
Hannover	Hütten	etwa je 100	im Durchschnitt			Unregelmäßiger Betrieb.	
Hirschberg	Hütten	150	100	50	50,50	Saugzuganlage.	
Mainz	Gas	270	300	50	50,50	Modernisierter Ofen I unterbrochener Betrieb	
		400	200	100	100	Aher Ofen II	
München	Gas	300-210	62	62	62,62	—	
Weimar	Gas	je 135	im Durchschnitt			Nur Dienstag und Freitags in Betrieb.	

Für anschließende dritte bis fünfte Einschierung kommt man etwa mit dem Mittel zwischen 30 und 15%, also mit $\sim 22\%$ aus, so daß man erhält:

$$W_{III} = 0,22 (W_1 + W_2) + (W_3 - W_4 + W_5) = 0,85 (W_1 + W_2) = 0,22 \cdot 1354000 - 98800 - 157250 = 239430 \text{ kcal}$$

und:

$$B_{III} = \frac{W_{III}}{\eta \cdot H_a} = \frac{239430}{4850} = 49,4 = \sim 50 \text{ kg.}$$

Von der fünften oder sechsten Einschierung an wird der Beharrungsstand des Ofens in seiner Verlustwärmeabgabe annähernd erreicht sein, so daß man von jetzt an unbedenklich mit dem unteren Grenzwert von 15% rechnen darf. Somit gelten dann für eine weitere n te Einschierung:

$$W_n = 0,15 \cdot 1354000 + 98800 - 157250 = 144630 \text{ kcal}$$

und:

$$B_n = \frac{W_n}{\eta \cdot H_a} = \frac{144630}{4850} = 30 \text{ kg.}$$

Alle diese Rechnungsergebnisse decken sich gut mit praktischen Erfahrungen. In vielen Krematorien wird mit einem täglichen oder jährlichen Durchschnittswert je nach der Inanspruchnahme der Anstalten gerechnet. So findet man für eine erste Einschierung einschließlic Anheizen:

$$B = 175-275 \text{ kg für einen normalen mittleren Ofen,}$$

$$= 300-450 \text{ kg für einen schweren Ofen mit Dauerbetrieb,}$$

$$= 75-90 \text{ kg für eine weitere anschließende Einschierung.}$$

Wegen der Verrechnungen des Brennstoffverbrauches über eine längere Betriebszeit hin seitens der Krematorienverwaltungen finden sich nur wenig feste Werte für den Koksverbrauch für die einzelnen aufeinanderfolgenden Einschaltungen. Diese Werte lassen sich nur durch Heizversuche gewinnen. In vorstehender Zahlentafel I ist eine diegenüßliche beschränkte Übersicht gegeben. Die Hochheizzeit ist mit $\approx 2-3$ Stunden, die Einschaltungszeit mit $\frac{2}{3} (= 1\frac{1}{3})$ Stunden vorzusetzen. Von der Angabe der Ofensysteme ist abichtlich Abstand genommen.

Die größte Zahl der Einschaltungen im Koksolen hat sich im Jahre 1930 im Berlin-Wilmersdorfer Krematorium mit 3784 ergeben, also bei 52 Jahreswochen und 6 wöchentlichen Arbeitstagen im Durchschnitt täglich zu $\frac{3784}{52 \cdot 6} = \approx 12$; hier-

für wurden 35 kg für jede Einschaltung verrechnet.

Für die zu erhebende Gebühr für eine Leicheneneinschaltung kann natürlich nicht nur ein mittlerer Koksverbrauch herangezogen werden, sondern es müssen auch alle anderen Unkosten des Krematoriumsbetriebes prozentuale Berücksichtigung finden und dann aus der Jahresbilanz der Preis für eine Einschaltung festgelegt werden. Zieht man zum Beispiel

Obemittelter Verhältnisse herbei, so kommt man zu folgender Aufstellung:

Im Jahre 1930 sind im Chemitzer Krematorium 1753 Leichen eingescharrt und dafür 128 t Koks verbraucht worden. Somit entfällt auf eine Einschaltung ein Koksverbrauch von 128000 : 1753 = 73 kg. Damit erhält man folgende Verrechnung:

73 kg Koks bei 100 kg zu 3 RM	2.20 RM.
Anfuhr für 100 kg zu 0,38 RM	0.27 "
Anfuhrgeld	0.13 "
Aschenabfuhr	0.18 "
6 Heizer-Lohnstunden je 1.20 RM	7.20 "
(4 Heizer \times 48 Wochenstunden \times 32 Jahreswochen = 10008 Arbeitsstunden; 10008 : 1753 = 6 Heizer-Lohnstunden je Einschaltung)	
Von 7,20 RM. 25% für Versicherung usw.	1.80 "
	<hr/>
	11.70 RM.
Davon 15% für Ofenabnutzung	1.75 "
Aschenabspül	1.46 "
Herminiumbenutzung	6.80 "
4 Trägerstunden je 1 RM.	4.00 "
	<hr/>
	28.10 RM.
Davon 30% für Verwaltungsstellen	8.40 "
	<hr/>
Somit Durchschnittspreis für eine Einschaltung	36.50 RM.

[178]

Umschau.

Über das Mischen verschiedener Heizgase für die Stadtversorgung. Das genaue Mischen verschiedener Gase zwecks Herstellung eines völlig konstanten Stadtgases ist heute von großer Bedeutung, und zwar namentlich für die amerikanischen Gaswerke, deren außer Steinkohlengas, Wassergas und Generatorgas auch noch Naturgas, ferner Abfallgase der Ölfabrikation, Butan, Propan usw. zur Verfügung stehen. Die Herbeiführung dieses in three Zusammensetzung so verschiedenen Gase für die Abgabe an Städte hat an die Mischtechnik bisher unbekannte Anforderungen gestellt. Früher hat man beim Mischen verschiedener Gase nur wenig auf die Einhaltung genauer Mengenverhältnisse geachtet, weil man sich über die Bedeutung einer konstanten Gasbeschaffenheit nicht im Klaren war. Heute weiß man dagegen überall in der Gasindustrie, was wichtig die Unveränderlichkeit des Heizwertes, des spezifischen Gewichtes und der anderen Brenneigenschaften des Stadtgases ist. In Amerika beträgt der Heizwert des Stadtgases in der Regel 4450—5039 kcal/m³, und zwar ist das Gasgesellschaften die Einhaltung eines bestimmten Heizwertes meist von einer speziellen Kommission vorgeschrieben.

Die Gasgesellschaften haben zur Ausübung oder zur Anschaffung zuverlässiger Meß- und Kontrollgeräte beträchtliche Mittel aufgewendet, so daß man heute überall selbständige Kalorimeter, Heizwertprüfer, Dichtschreiber und andere Kontrollgeräte benutzt. Die Consolidated Gas Electric Light & Power Co., die die Stadt Baltimore und deren Umgebung mit Gas versorgt, verleiht z. B. an ihre Abnehmer ein Gas, das aus Kokergas, Ölfabrikergas und selbst-erzeugtem karburierten Wassergas besteht. Die von auswärtig bezogenen beiden Gase werden häufig in schwankenden Mengen und mit wechselndem Heizwert geliefert, trotzdem ist es dem Gaswerk gelungen, durch entsprechenden Zusatz von Wassergas, das mehr oder weniger stark karburiert wird, dauernd ein gleichmäßig zusammengesetztes Mischgas in das Rohrnetz zu speisen. Der Heizwert des abgegebenen Gases beträgt im Monatsdurchschnitt 4450 kcal/m³, wobei die Schwankungen für jede Einzellesung im Mittel nur 10 kcal unter oder 100 kcal über diesem Wert liegen. Das spezifische Gewicht des Mischgases schwankt zwischen 0,55 und 0,63 (auf Luft = 1 bezogen).

Zur Erzielung dieser gleichmäßigen Gasbeschaffenheit werden im Gaswerk die 3 Einzelgase genauestens gemessen und mit Hilfe zahlreicher Kontrollgeräte auf ihren Heizwert und ihr spezifisches Gewicht untersucht, ebenso das Mischgas vor dem Eintritt in das Rohrnetz. Im Originalaufsatz wiedergegebene Meßinstrumente zeigen die Schwankungen im Heizwert und im spezifischen Gewicht der Einzelgase sowie die völlig gleichmäßige Beschaffenheit des Stadtgases. Zur Ausföhrung der Messungen werden registrierende Thermo-Kalorimeter sowie Renkrex-Dichtschreiber verwendet, deren Anzeigen durch häufige Vergleichsmessungen mit Standardinstrumenten von sorgfältig ausgebildeten Leuten systematisch kontrolliert werden.

Das Kokergas wird von einem Stahlwerk in der Umgebung durch eine 15 Meilen lange Rohrleitung dem Gaswerk zugeführt. Die Gaslieferungen schwanken zwischen 17000 und 23000 m³/h, der Heizwert des Gases zwischen 4570 und 4750 kcal/m³ und das spezifische Gewicht zwischen 0,37 und 0,40. Das Ölfabrikergas wird aus dem Gaswerk von Schwefelwasserstoff befreit und darauf mit dem gewöhnlichen Gase gemischt. Das Raffineriegas wird ebenfalls aus 5 Meilen lange Rohrleitung von einer benachbarten Ölfabrik bezogen, und zwar in einer Menge von 2250—3400 m³/h, sein Heizwert

beträgt 13250—13800 kcal/m³ und seine Dichte 0,85—1,0. Auch dieses Gas wird auf dem Gaswerk von Schwefelwasserstoff befreit, ehe es den anderen Gasen zugegeben wird. Die eigene Wassergasanlage des Werkes muß instande sein, den Tagesbedarf von durchschnittlich 650000 m³ im Sommer und von 1,3 Mill. m³ im Winter zum Teil, im Notfalle aber auch vollständig zu decken, und zwar muß dieses Gas durch den oben erwähnten Anforderungen entsprechen. Zu diesem Zweck sind 30 dreistufige Wassergas-Einheiten, Bauart Lewis, vorhanden, die eine ausreichende Reserve bilden, selbst wenn die Lieferung von Kokergas- oder Raffineriegas ausbleiben sollte. Der Heizwert des Wassergases läßt sich durch Verändern der eingesparten Ölmenge in weiten Grenzen regeln, desgleichen das spezifische Gewicht durch geeignete Einstellung der Periode bei der Gaszeugung. Die einzige Verunreinigung der 3 Gase erfolgt in einem Feld-Wascher, so dem zugleich das Nachtblin aus dem Gas ausgewaschen wird, sowie in 4 großen Gasethälern. [J. H. Wolf, Ch. Met. Engg. 88, 1931, S. 576—581.]

Feuerfeste Massen als Anstrich-, Reparatur- und Aufbaumaterial. Um höher beanspruchte feuerfeste Anstrichungen von Feueröfen und Ofen längere Zeit hindurch betriebsfähig zu halten, ist man in neuerer Zeit mehr und mehr zur Verwendung von Stannionsmassen übergegangen, welche in verschiedensten Zusammenstellungen entsprechend der Art der Beanspruchung angeboten werden. Grundsätzlich unterscheidet man zwischen sogenannten Schutzüberzügen einerseits und den Flick- und Aufbaumassen andererseits. Während erstere — wie der Name schon sagt — zum Schutz des Mauerwerks als Überzug in verhältnismäßig dünner Schicht aufgetragen werden, nimmt man mit den Flickmassen meist Reparaturen an vorzeitig abgeplatzten Stellen des Mauerwerks vor. Der Vorteil bei der Verwendung von Schutzüberzügen und Flickmassen liegt vornehmlich in ihrer billigeren Anwendung, da man bedeutend geringere Mengen dieses Materials im Vergleich zu einer Reparatur trotz höherem Preis sich ersparen niedriger stellen. Eine für genannte Zwecke besonders geeignete Masse wird unter dem Handelsnamen „Pyro“ auf dem Markt gebracht. Als Schutzüberzug auf einem Mauerwerk angewandt, bewirkt diese Masse eine wesentliche Verlangsamung der Lebensdauer des Mauerwerks. Außer ihrer hohen Feuerbeständigkeit zeichnet sich Pyro-Masse auch durch eine große Widerstandsfähigkeit gegen chemischen Angriff von Schmelzen und Flugschlack der Feueröfen aus. Die Anwendung erfolgt in der Weise, daß man die pulverförmige in trockenem Zustand angefeuchtete Masse mit Wasser zu einem dünnflüssigen Brei anrührt, welchen man mit Hilfe einer Bürste auf das feuerfeste Mauerwerk aufträgt. Der Verbrauch dieser Masse ist sehr sparsam, da für einen Quadratmeter Mauerwerkfläche nur etwa 8 kg benötigt werden. Bei einem Preis von nur 0,27 RM. pro kg stehen die Kosten in sehr günstiger Verhältnis zur Verlangsamung der Betriebsfähigkeit des Mauerwerks. Wegen der chemischen Unempfindlichkeit der Pyro-Masse wird ein hinmüt verbleibendes Mauerwerk vor Schmelzenkorrosionen bewahrt.

¹⁾ Vertrieb durch L. Gorges Söhne, Halle a. d. Saale.

Verordnung

zur Durchführung des Feuerbestattungsgesetzes *).
Vom 10. August 1938.

Auf Grund des § 10 des Gesetzes über die Feuerbestattung vom 15. Mai 1934 (Reichsgesetzbl. I S. 380) wird verordnet:

§ 1

Die vor Inkrafttreten des Gesetzes auf Formblatt eines Feuerbestattungsvereins abgegebene, eigenhändig unterschriebene Erklärung, durch die der auf Feuerbestattung gerichtete Wille bekundet ist, bleibt, auch wenn sie nicht eigenhändig geschrieben ist, wirksam.

§ 2

(1) Die Polizeibehörde des Einäscherungsortes hat über alle von ihr genehmigten Feuerbestattungen, gegebenenfalls für jede selbständige Anlage gesondert, ein Verzeichnis zu führen, in das unter fortlaufenden Nummern einzutragen sind:

1. Zu- und Vorname des Verstorbenen,
2. Geburtsort und Geburtsort,
3. Todesort und Sterbeort,
4. letzter Wohnort,
5. Stand oder Beruf,
6. Konfession,
7. Todesursache,
8. Tag und Stunde der Einäscherung,
9. Ausstellungstag und Nummer der Genehmigungsurkunde,
10. Beisetzungsart der Aschentreste,
11. Änderungen des Beisetzungsortes der Aschentreste (§ 10 Abs. 2).

(2) Das Verzeichnis ist mit den der Genehmigung zugrunde liegenden Bescheinigungen und Nachweisen 30 Jahre nach der letzten im Verzeichnis erfolgten Eintragung aufzubewahren.

§ 3

(1) Die nach § 3 Abs. 2 Nr. 2 des Gesetzes vorgeschriebene amtsärztliche Bescheinigung ist durch den für den Sterbeort oder für den Ort der Einäscherung zuständigen Amts- oder Gerichtsarzt nach anliegendem Muster auszustellen.

(2) Die obersten Landesbehörden können, soweit nötig, zur Vornahme der Leichenschau und zur Ausstellung der Bescheinigung auch andere Ärzte ermächtigen, die die amtsärztliche Prüfung als Kreis-, Bezirks- oder Gerichtsarzt besanden oder an einem Sonderlehrgang mit Erfolg teilgenommen haben, durch den die für die gerichtliche Leichenschau erforderlichen Kenntnisse vermittelt werden, oder die bereits vor Inkrafttreten des Gesetzes mit Wahrnehmung dieser Verpflichtungen betraut waren.

*) Betrifft nicht das Land Österreich.

§ 4

Bei Leichen, die aus dem Ausland zur Einäscherung eingeliefert werden, entscheidet die Polizeibehörde des Einäscherungsortes, ob der gemäß den Bestimmungen des Internationalen Abkommens über Leichenbeförderung ausgestellte Leichenpaß für den Nachweis der Todesursache ausreicht. Etwa bestehende Zweifel sind durch Vornahme der amtsärztlichen Leichenschau gemäß § 3 Abs. 2 Nr. 2 des Gesetzes zu klären.

§ 5

Die auf Feuerbestattung gerichtete Willensbekundung kann widerrufen werden. Der Widerruf muß einwandfrei nachgewiesen werden; als einwandfrei nachgewiesen gilt der Widerruf insbesondere dann, wenn er in einer der Formen des § 4 Abs. 1 bis 3 des Gesetzes erklärt ist.

§ 6

Für die Feuerbestattungsanlage muß eine Leichenhalle vorhanden sein, in der die Leichen vor der Einäscherung untergebracht werden können. Außerdem muß ein Raum für die Vornahme der Leichenschau zur Verfügung stehen, der die für diesen Zweck erforderlichen Einrichtungen zu enthalten hat.

§ 7

Die Feuerbestattungsanlage und deren Betrieb unterliegen der Aufsicht der Polizeibehörde des Ortes, in dem die Anlage sich befindet. Der Betrieb regelt sich nach einer von der obersten Landesbehörde zu genehmigenden Betriebsverordnung, in der auch die Gebühren festzusetzen sind.

§ 8

Der für den Betrieb der Feuerbestattungsanlage verantwortliche Leiter ist von der die Aufsicht führenden Polizeibehörde ausdrücklich in Pflicht zu nehmen.

§ 9

Die Einäscherung darf erst erfolgen, wenn die schriftliche Genehmigung der Polizeibehörde des Einäscherungsortes (§ 3 des Gesetzes) dem für den Betrieb der Feuerbestattungsanlage verantwortlichen Leiter vorgelegt worden ist. Die Einäscherung ist innerhalb dreimal 24 Stunden nach erfolgter polizeilicher Genehmigung vorzunehmen. Kann die Frist nicht eingehalten werden, so hat der für den Betrieb der Feuerbestattungsanlage verantwortliche Leiter unter Angabe des Grundes der Verzögerung bei der Polizeibehörde eine Verlängerung der Frist zu beantragen.

§ 10

(1) Der für die Feuerbestattungsanlage verantwortliche Betriebsleiter hat die Einäscherung sowie die Beisetzung oder Befundung der Aschentreste unverzüglich der zuständigen Polizeibehörde mitzuteilen. Hierbei sind anzugeben: Zu- und Vorname des Eingeseherten, Nummer und Ausstellungstag der polizeilichen Genehmigungsurkunde, Zeitpunkt der Ein-

äscherung sowie Zeit und Ort der Beisetzung der Aschenteile, im Falle ihrer Versendung Anschrift, unter der die Aschenteile versandt worden sind. Der Versand von Aschenteilen darf erst erfolgen, wenn dem Betriebsleiter eine Bescheinigung der Friedhofsverwaltung über die Genehmigung zu ihrer Beisetzung vorliegt.

(2) Sind die Aschenteile zwecks Beisetzung nach einem anderen Orte versandt worden, so hat die Friedhofsverwaltung oder die Polizeibehörde dieses Ortes der Vollziehbehörde des Einäscherungsortes die erfolgte Beisetzung anzuzeigen. Auch eine Versendung bereits beigelegter Aschenteile ist der Vollziehbehörde des Einäscherungsortes mitzuteilen.

(3) Die Auszubildung der Aschenteile an die Angehörigen oder deren Beauftragte, auch zwecks Beisetzung an einem anderen Orte, ist vorbehaltlich der Ausnahme im § 9 Abs. 3 des Gesetzes nicht zulässig.

(4) Die Ruhefrist für die Aschenteile beträgt 20 Jahre, wenn für die Erdbestattung am gleichen Orte eine Ruhefrist von 20 Jahren oder mehr vorgezogen ist; in allen übrigen Fällen ist die Ruhefrist für Aschenteile mindestens auf den als Ruhefrist bei Erdbestattungen am gleichen Orte vorgegebenen Zeitraum zu bemessen. Nach Ablauf der Ruhefrist sind die alsdann noch vorhandenen und als solche erkennbaren Aschenteile und ihre Behältnisse in einer Gemeinschaftsgrabstelle dem Erdboden einzuverleiben.

§ 11

(1) Über die in der Feuerbestattungsanlage vorgenommenen Einäscherungen ist ein Verzeichnis nach beigelegtem Muster (Einäscherungsverzeichnis) zu führen. Das Verzeichnis ist am Ende jedes Kalenderjahres abzuschließen und mit dem von der Polizeibehörde geführten Verzeichnis (§ 2) abzugleichen.

(2) Das Einäscherungsverzeichnis mit den ihm zugrunde liegenden Genehmigungsurkunden ist 30 Jahre nach der letzten im Verzeichnis erfolgten Eintragung aufzubewahren.

§ 12

(1) Die Leichen sind in den Särgen oder Einäscherungssärgen einzuschließen, in denen sie zur Feuerbestattungsanlage gelangen. Die Säрге müssen aus dünnem Holz oder Zinkblech bestehen und frei von Metallbeschlägen sein. Nach darf zur Abdichtung der Fugen nicht verwendet werden. Als Unterlage für die Leiche sowie als Füllmasse für etwaige Rissen sind Säge- oder Hobelspäne, Holzwole oder Torfmoos zu benutzen. Die Auskleidung des Sarges sowie die Bekleidung der Leiche kann in der üblichen Weise erfolgen, doch sind zur Befestigung der Auskleidung Metallstifte und zum Schließen der Kleidung Nadeln, Haken oder Ösen unzulässig, dagegen einfache umspinnene Knöpfe gestattet.

(2) Der Reichsminister des Innern kann zur Herstellung von Särgen sowie als Unterlage für die

Leiche und als Füllmasse für die Rissen an Stelle der im Abs. 1 genannten Stoffe auch andere Stoffe zu lassen.

§ 13

In jeder Einäscherungskammer darf jeweils nur eine Leiche einzageschert werden. An den Särgen ist vor der Einbringung in den Verbrennungsofen ein durch die Ofenbühne nicht zerstörbares Schild anzubringen, auf welchem die Nummer, unter der die Eintragung in das Einäscherungsverzeichnis erfolgt ist, sowie der Name der Feuerbestattungsanlage deutlich sichtbar eingeschlagen sein muß. Die Aschenteile jeder Leiche sind mit dem Nummernschild in einem widerstandsfähigen, dauerhaften, luft- und wasserdichten Behältnis zu sammeln, das durch eine amtlich bestellte Person zu verschließen ist. Der Deckel des Behältnisses ist mit einem feststehenden, dauerhaften Schild zu versehen, das in deutlicher geprägter Schrift folgende Angaben zu enthalten hat:

1. die mit dem Einäscherungsverzeichnis und dem Nummernschild in der Asche übereinstimmende Einäscherungsnummer,
2. Zu- und Vorname sowie Stand des Verstorbenen,
3. Ort, Tag und Jahr seiner Geburt,
4. Ort, Tag und Jahr seines Todes,
5. Ort und Tag der Einäscherung.

§ 14

(1) Die durch die amtärztliche Leichenschau entstehenden Kosten sind nach den Mindestsätzen der Gebühreordnung für amt- oder gerichtsarztliche Verdichtungen zu berechnen. Außerdem sind die notwendigen Reisekosten zu erstatten. Die entstehenden Kosten fallen dem Bestattungspflichtigen zur Last.

(2) Soweit für das polizeiliche Genehmigungsverfahren Gebühren erhoben werden, sollen sie den Betrag von drei Reichsmark nicht übersteigen.

§ 15

(1) Diese Verordnung tritt mit dem auf die Verkündung folgenden Tage in Kraft.

(2) Gleichzeitig treten außer Kraft:

- die Verordnung zur Durchführung des Feuerbestattungsgesetzes vom 26. Juni 1934 (Reichsgesetzbl. I S. 519),
- die Verordnung über die Änderung der Verordnung zur Durchführung des Feuerbestattungsgesetzes vom 16. Oktober 1936 (Reichsgesetzbl. I S. 884) und
- die Zweite Verordnung über die Änderung der Verordnung zur Durchführung des Feuerbestattungsgesetzes vom 13. Oktober 1937 (Reichsgesetzbl. I S. 1132).

Berlin, den 10. August 1938.

Der Reichsminister des Innern

In Vertretung
Dr. Studart

Verzeichniss
der in der Feuerbestattungsanlage zu _____
im Kalenderjahr _____ vorgenommenen Einäscherungen

Uhr. Nr. (Einäscherungsnummer)	Ge- und Nachname des Verstorbenen	Behördenangabe und Geburtsort	Geburtsdatum und -ort	Religiöse Bekenntnisart	Stand und Beruf	Residenzort	Schicksalsurtheil	Tag und Stunde der Einäscherung	Wasch- und Einwickelungsort des Leichnams	Verfahrensweise der Einäscherung (z.B. mittel, klein, etc.)	Bestimmung des Aschensackes
1	2	3	4	5	6	7	8	9	10	11	12

9Hr. 126 — 24. der Reichsgr. 13. August 1935
1000
Beilage 2

Document 92b: Reproduction of a cremation register. Annex to the “Ordinance for the Implementation of the Cremation Act.” Source: *ibid.*, p. 1003.

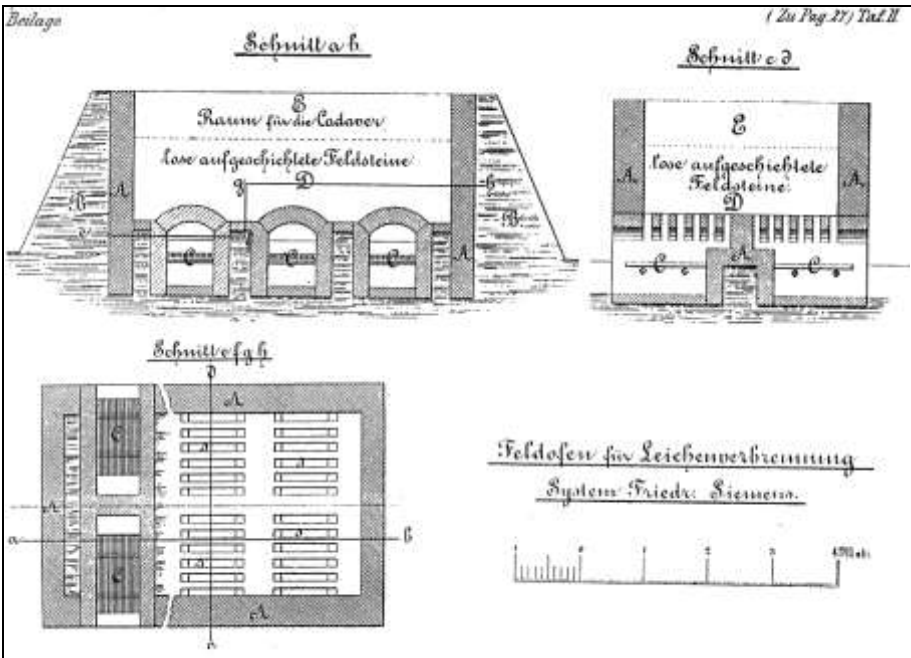

Document 93: Field cremation furnace, system FRIEDRICH SIEMENS. Source: as Doc. 20, illustration outside text.

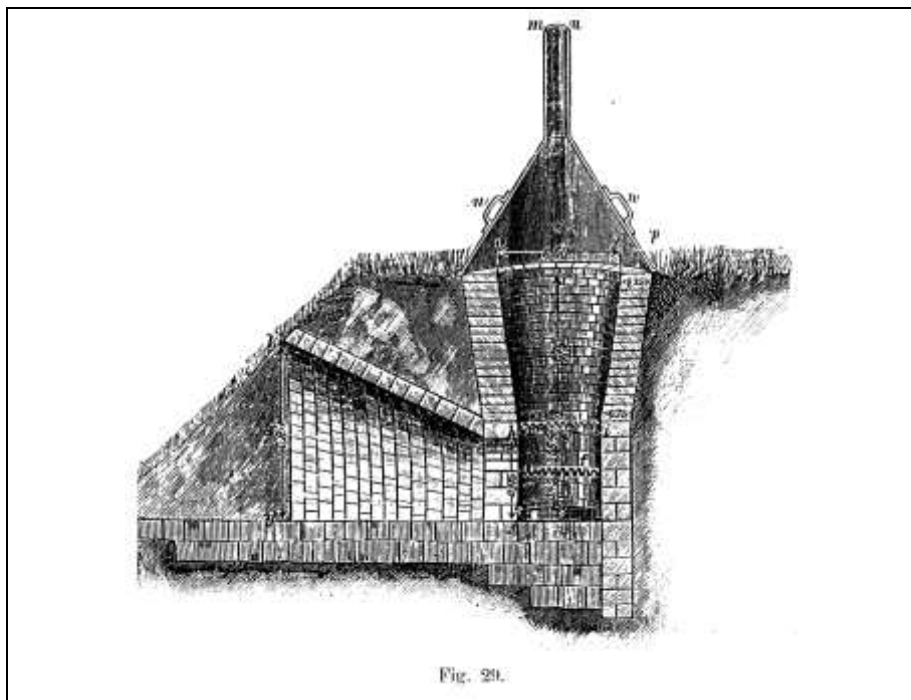

Document 94: FEIST apparatus for mass cremations. Source: as Doc. 7, p. 126.

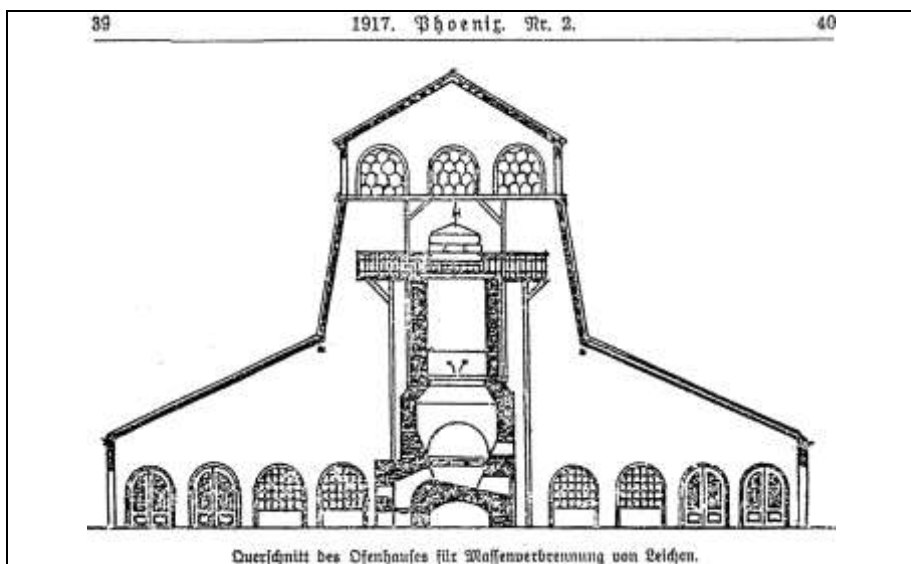

Document 95: ADOLF MARSCH shaft cremation furnace for mass cremations; vertical section. Source: "Masseneinäscherung von Kriegerleichen im Felde als Schutz gegen Seuchengefahr und später fühlbar werdende Verkehrshindernisse," Phoenix. Blätter für wahlfreie Feuerbestattung und verwandte Gebiete, Vienna, XXX. Jg., 1917, Nr. 2, columns 39f.

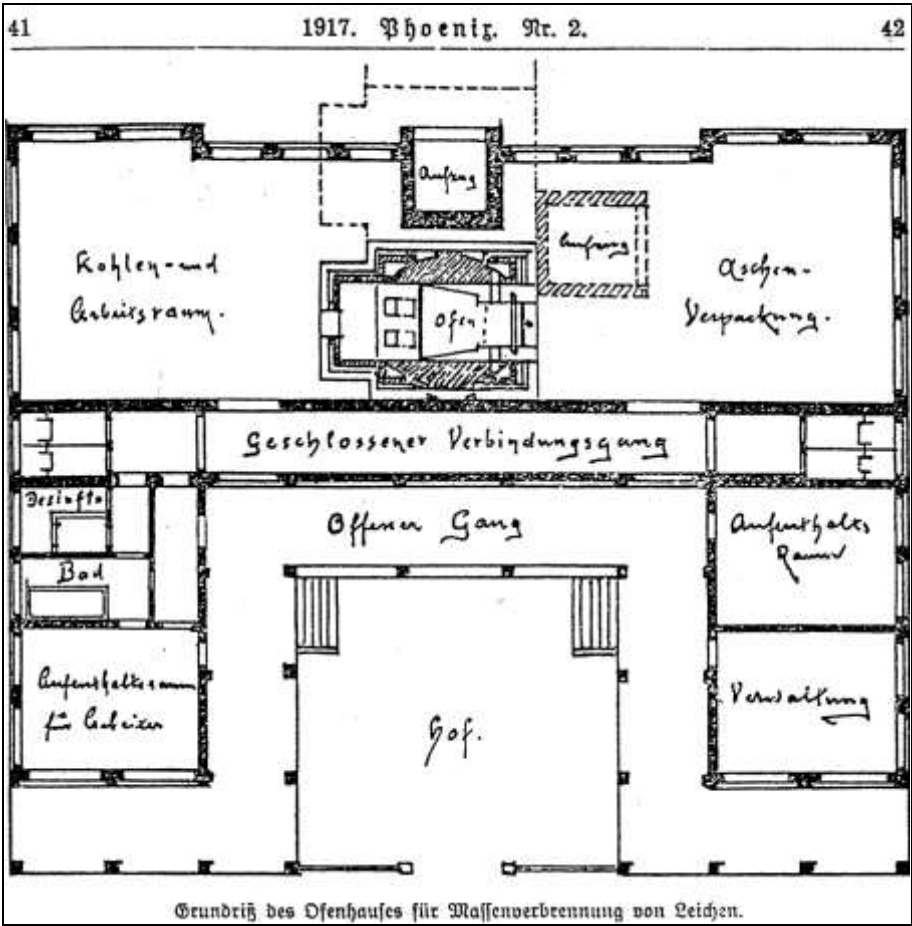

Document 95a: as above, horizontal section. Source: *ibid.*, columns 41f.

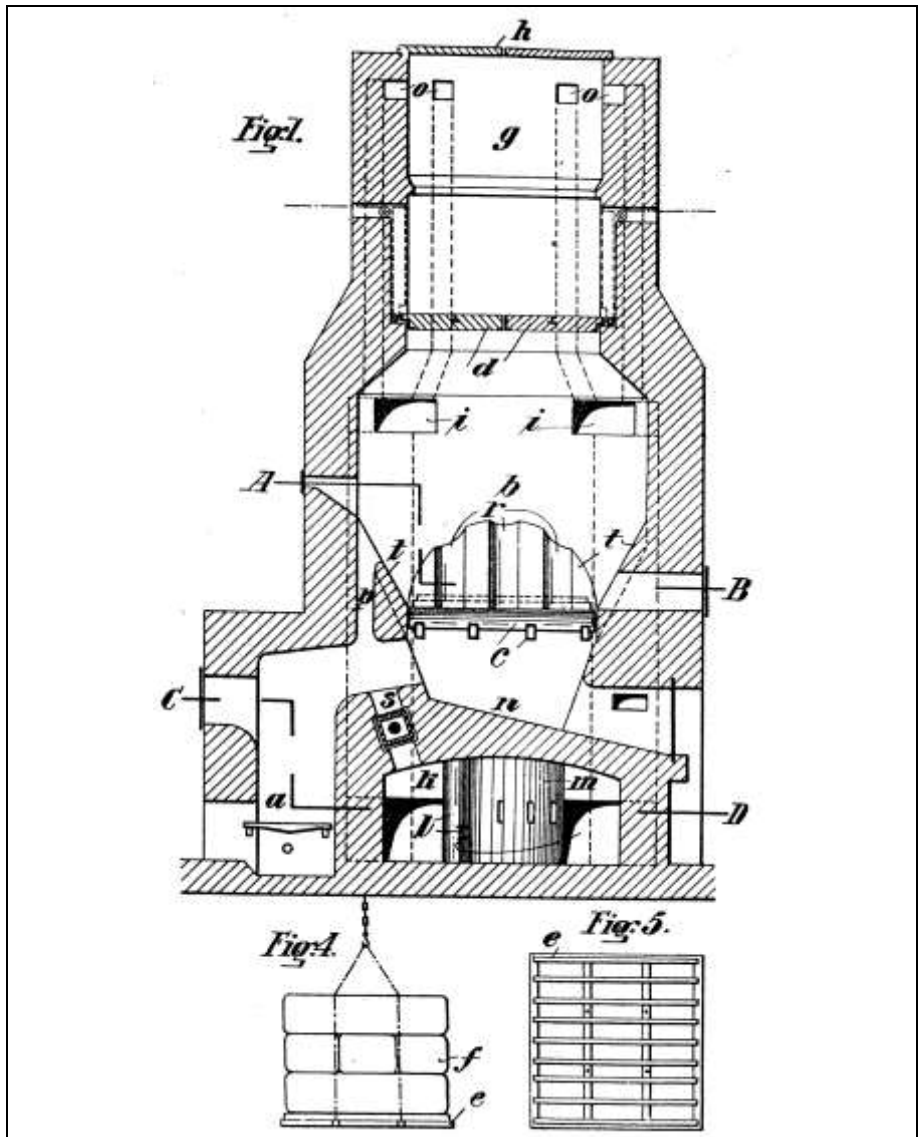

Document 96: "Shaft furnace for the simultaneous cremation of a larger number of human corpses or animal carcasses" (Schachtofen zur gleichzeitigen Einäscherung einer grösseren Anzahl von Menschenleichen oder Tierkadavern). Patent ADOLF MARSCH, No. 331628, of 30 September 1915. Fig. 1: vertical section; Fig. 4: a load of 9 cadavers; Fig. 5: loading grate.

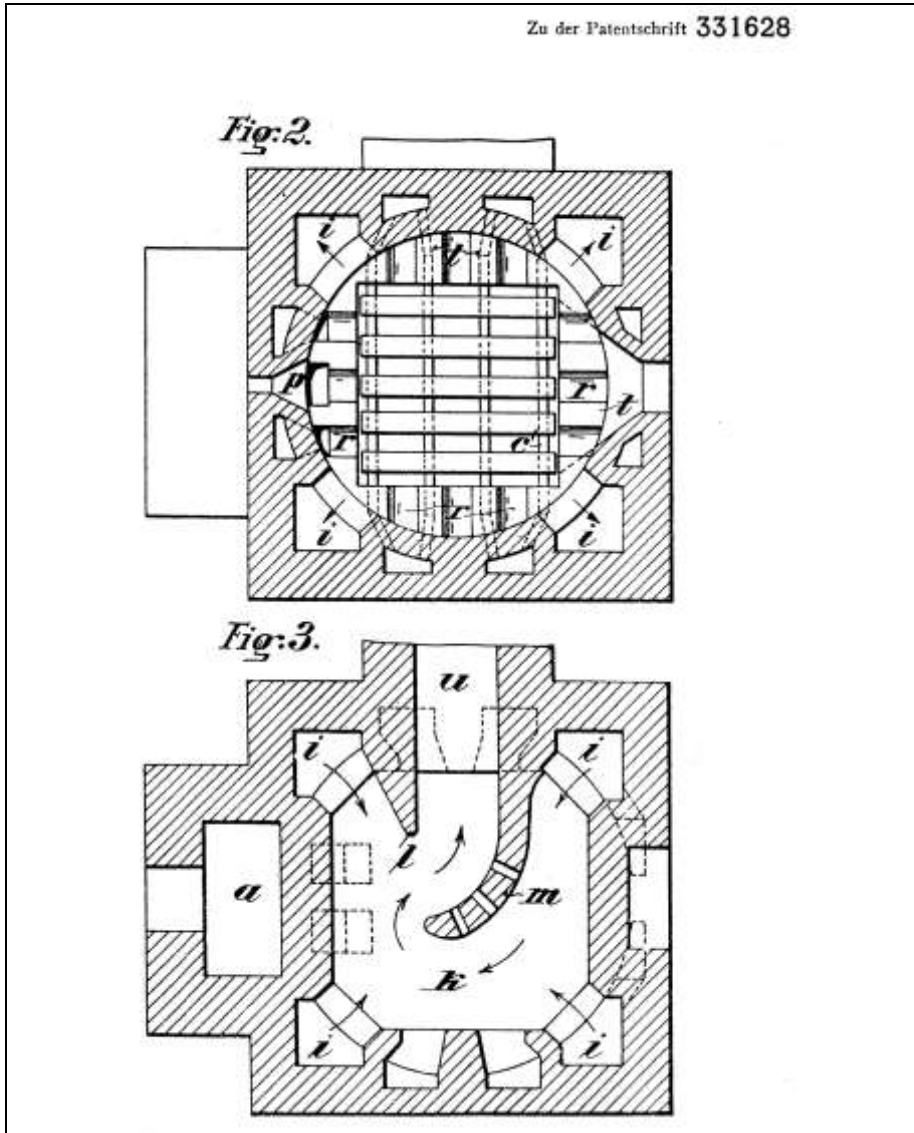

Document 96a: as above. Fig. 2: horizontal section along Line A-B of Fig. 1; Fig. 3: horizontal section along Line C-D of Fig. 1.

- Figure 1 (Doc. 96) is an axial section of the furnace.
- Figure 2 (Doc. 96a) is a section of the base along Line A-B, in Figure 1.
- Figure 3 (Doc. 96a) is a section of the base along Line C-D, in Figure 1.
- Figure 4 (Doc. 96) represents a pile of corpses constituted by three layers of three corpses each placed one on top of the other.
- Figure 5 (Doc. 96) shows the wooden grate on which the pile of corpses is arranged and on which it is introduced into the furnace.



Abb. 7

Document 97: FEIST furnace for mass cremations (standard model). Source: W. Heepke, Die Kadaver-Vernichtungsanlagen, Verlag von Carl Marhold, Halle a.S., 1905, p. 46.



Document 98: H. KORI cremation furnace for incinerating animal carcasses and slaughterhouse refuse. Source: as Doc. 97, p. 39.

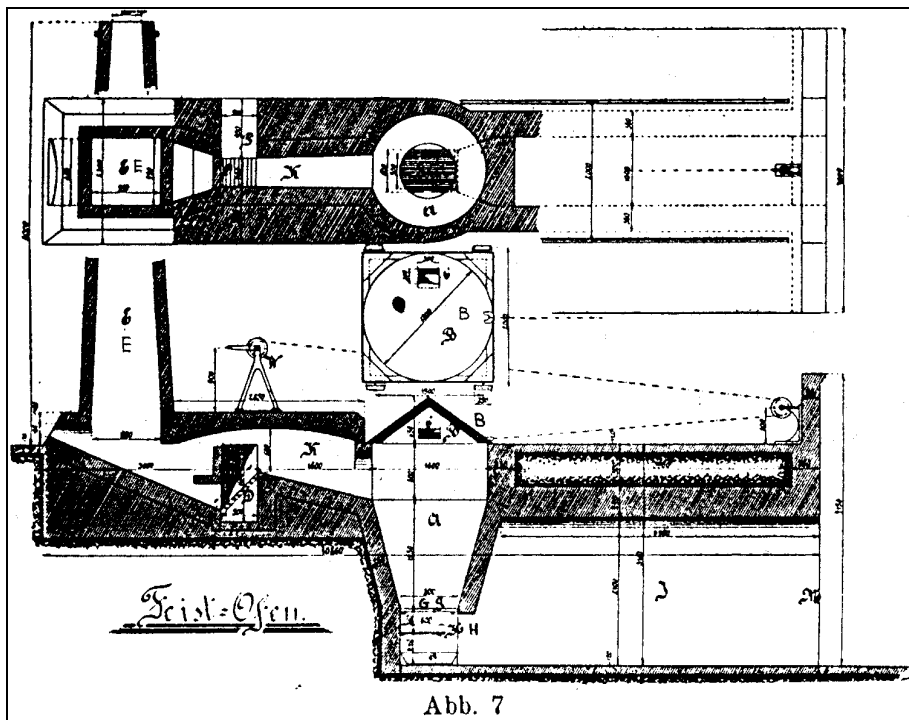
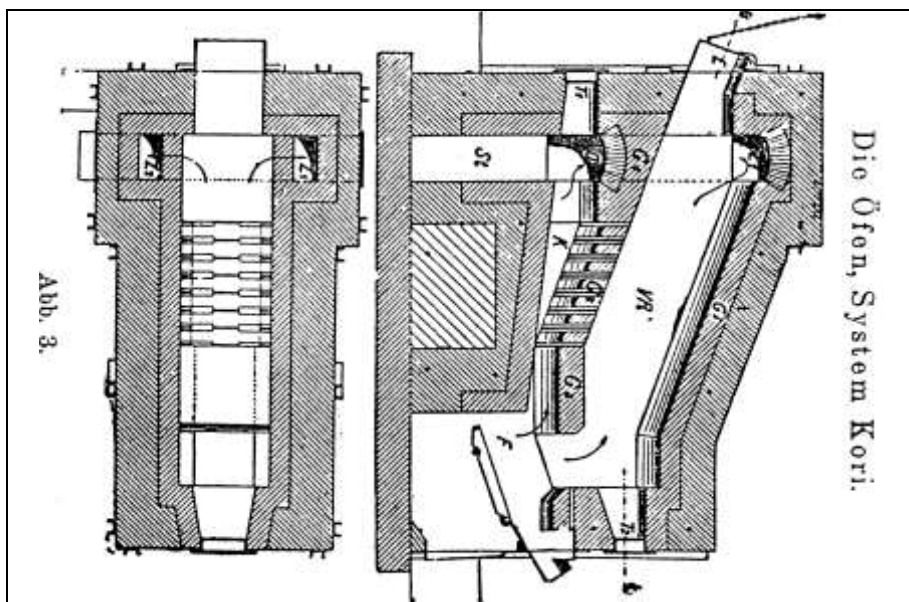
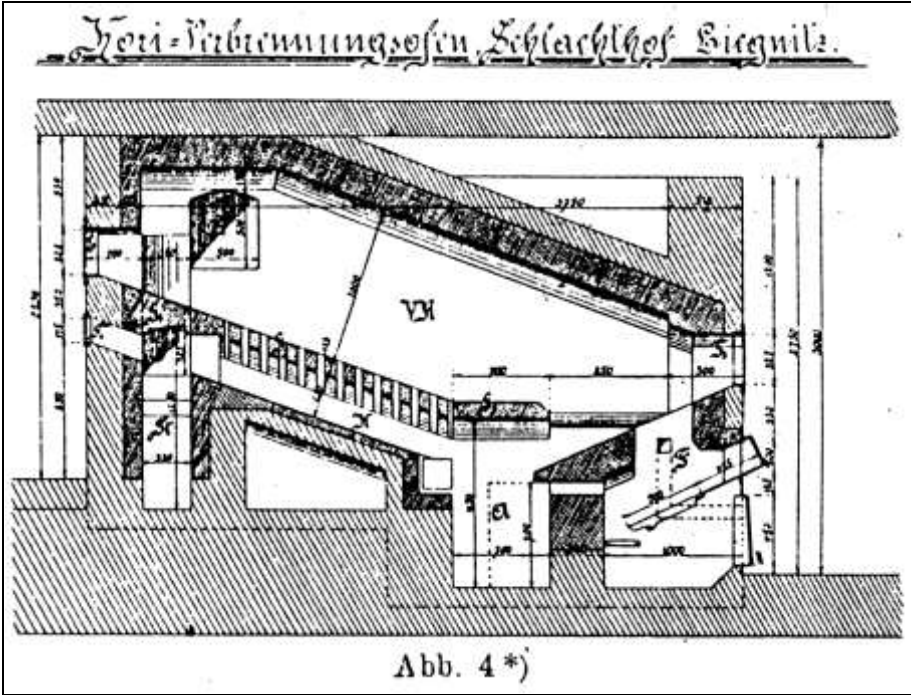

Document 99: H. KORI cremation furnace for incinerating animal carcasses and slaughterhouse refuse at Liegnitz. Source: as Doc. 97, p. 41.

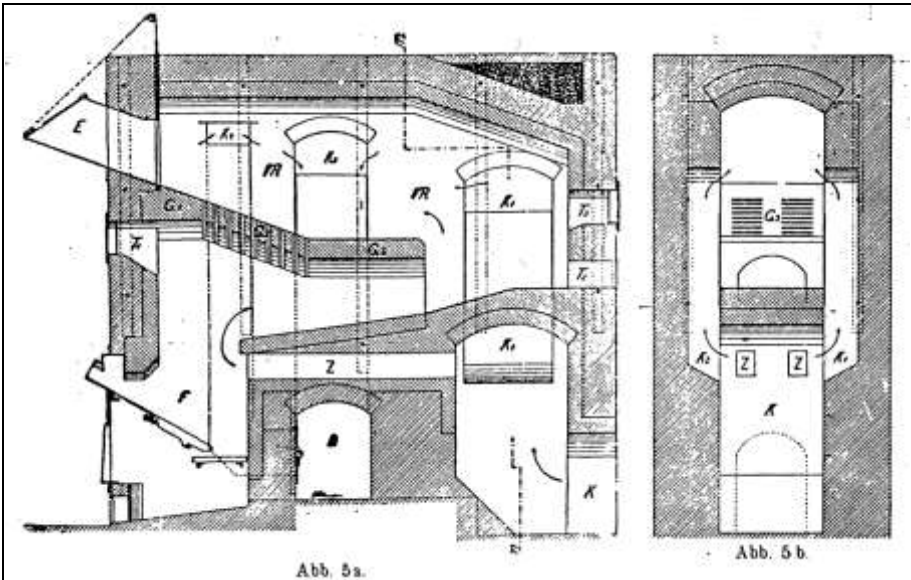

Document 100: H. KORI cremation furnace for incinerating animal carcasses and slaughterhouse refuse for combined operation (connected to the flue of a boiler system). Source: as Doc. 97, p. 44.

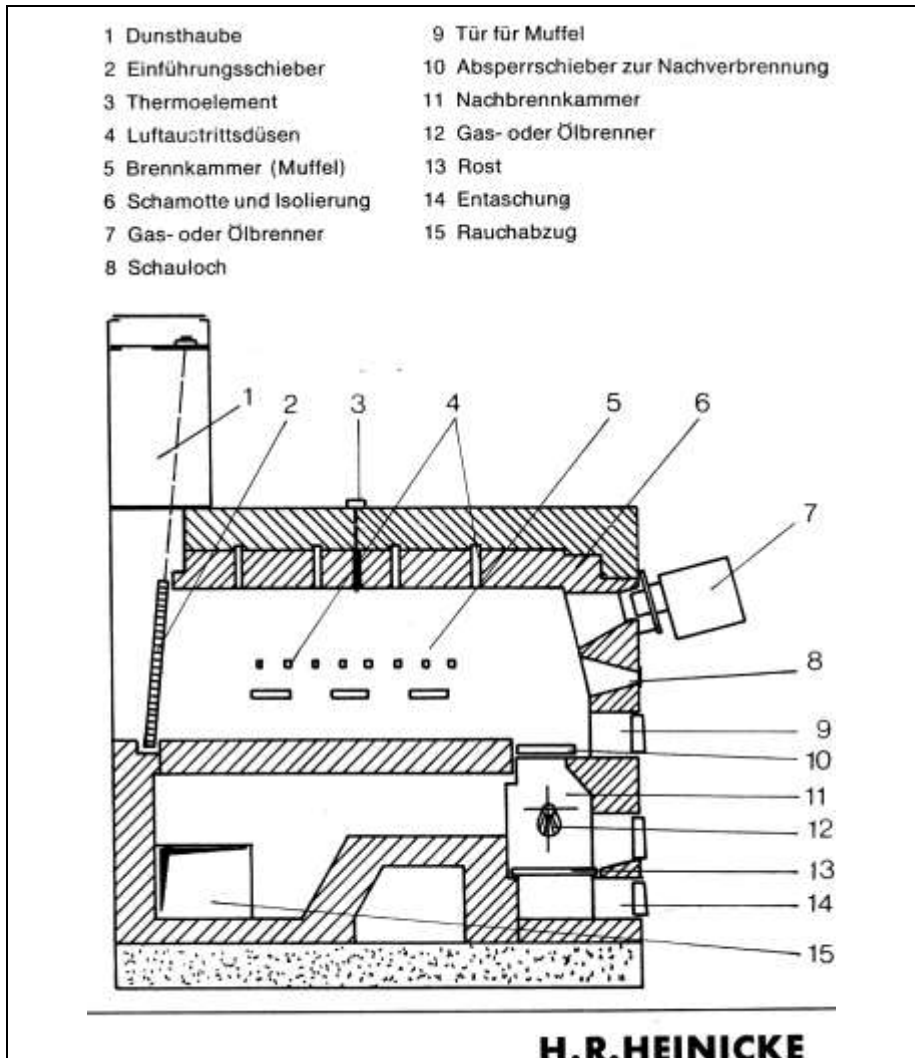

Document 101: H.R. HEINICKE gas-fired cremation furnace, system VOLCKMANN-LUDWIG. Longitudinal section. Source: Heinicke Feuerungs- und Schornsteinbau, H.R. Heinicke Einäscherungsofen, undated commercial brochure.

1: Extraction hood; 2: Introduction door; 3: Thermocouple; 4: Exit air vents; 5: Combustion chamber (muffle); 6: Refractories and insulation; 7: Gas or naphtha burner; 8: Inspection hole; 9: Muffle damper; 10: Closure of post-combustion chamber; 11: Post-combustion chamber; 12: Gas or naphtha burner; 13: Grate; 14: Ash removal; 15: Smoke discharge.

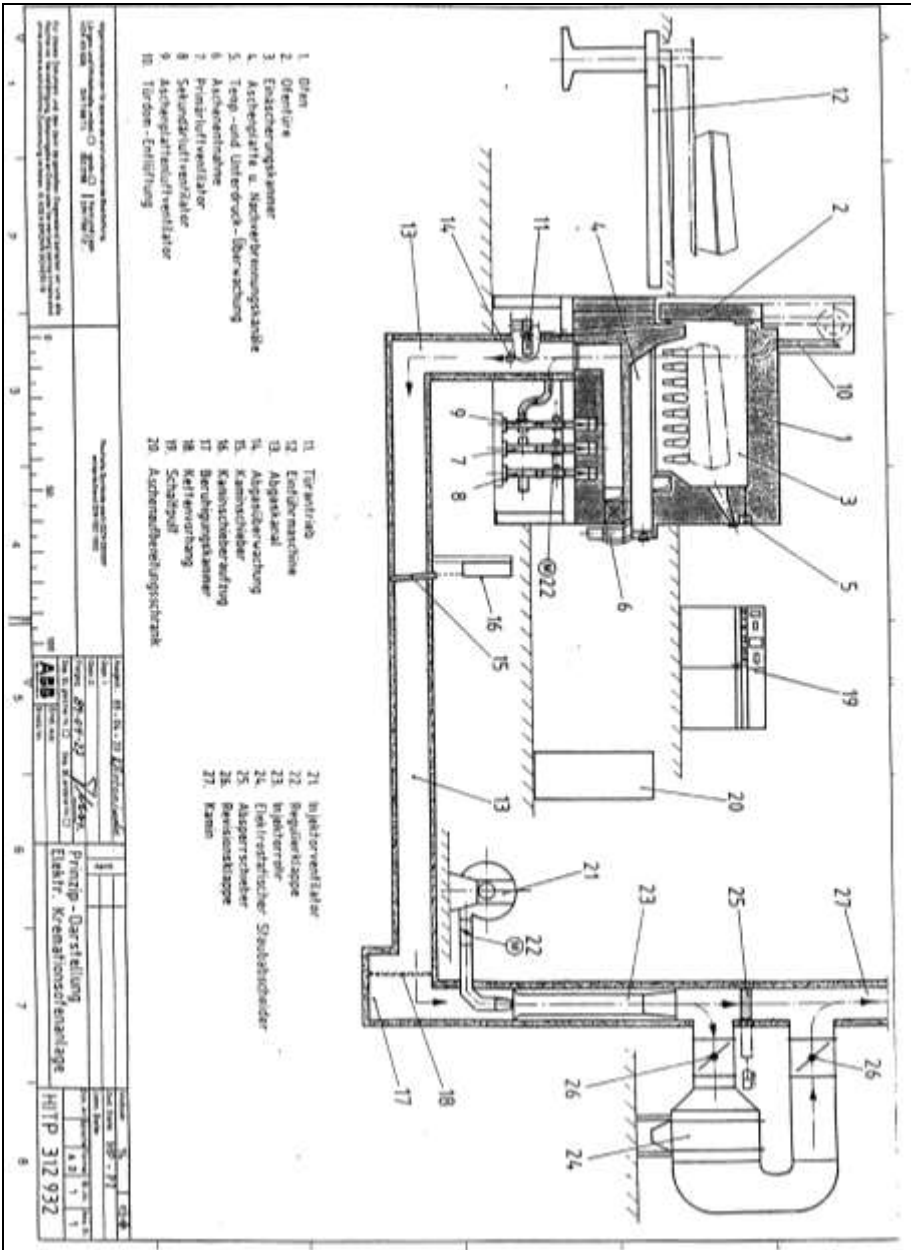

Document 102: ASEA BROWN BOVERI electric cremation furnace, operating principle. Documents 102-104b were kindly provided by that company.

1: Furnace; 2: Furnace door; 3: Cremation chamber; 4: Ash plate and post-combustion channels; 5: Observation of temperature and of draft; 6: Ash removal; 7: Blower for primary air; 8: Blower for secondary air; 9: Blower for air on ash plate; 10: Cupola: deaeration; 11: Door control; 12: Introduction trolley; 13: Discharge gas channel; 14: Observation of discharge gas; 15: Chimney damper; 16: Chimney-damper-raising device; 17: Damping chamber; 18: Chain curtain; 19: Electricity-control board; 20: Ash-preparation cabinet; 21: Injector blower; 22: Control valve; 23: Injector tube; 24: Electrostatic dedusting device; 25: Closure; 26: Inspection port; 27: Chimney

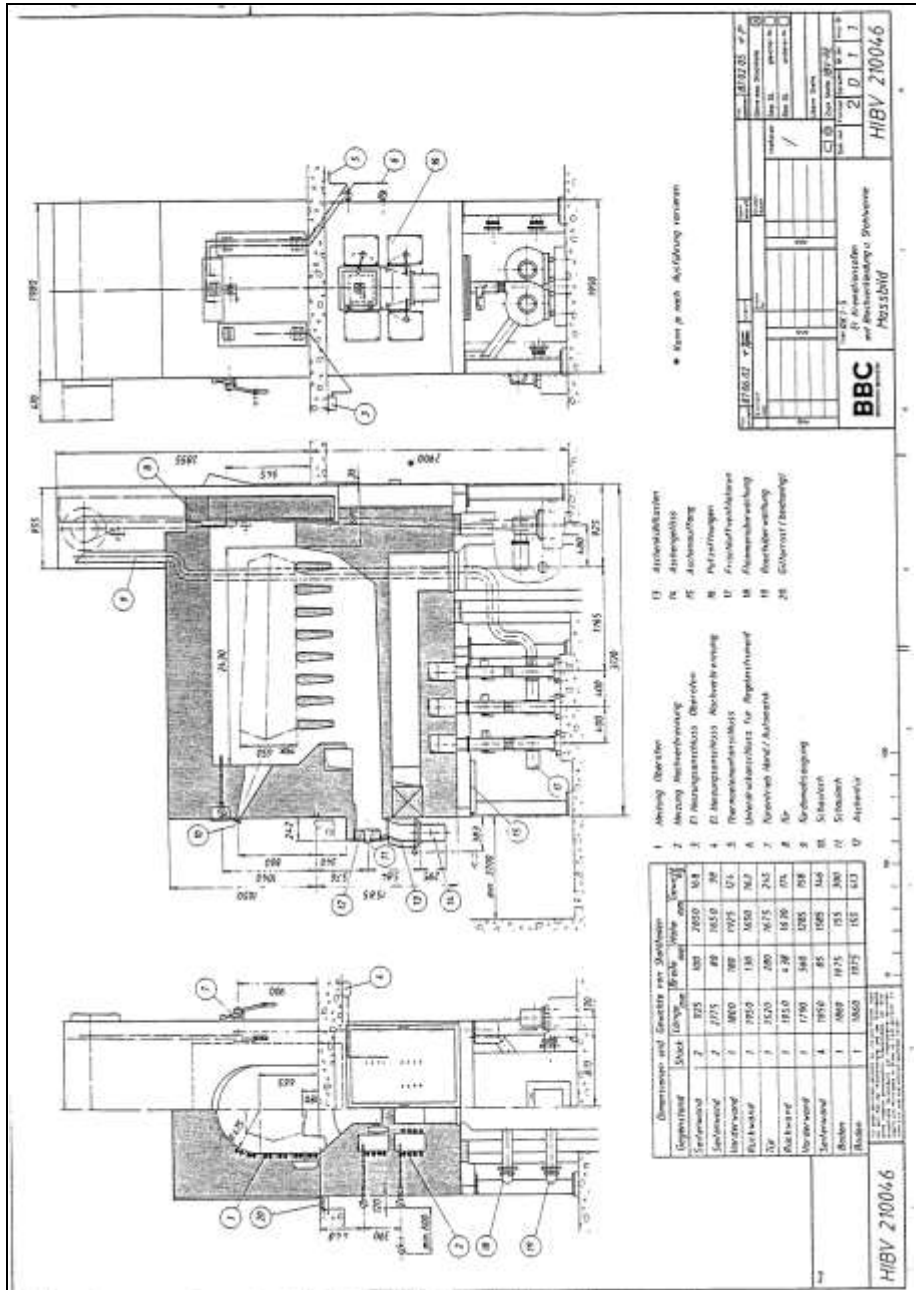

Document 103: ASEA BROWN BOVERI electric cremation furnace, model RK1-S.

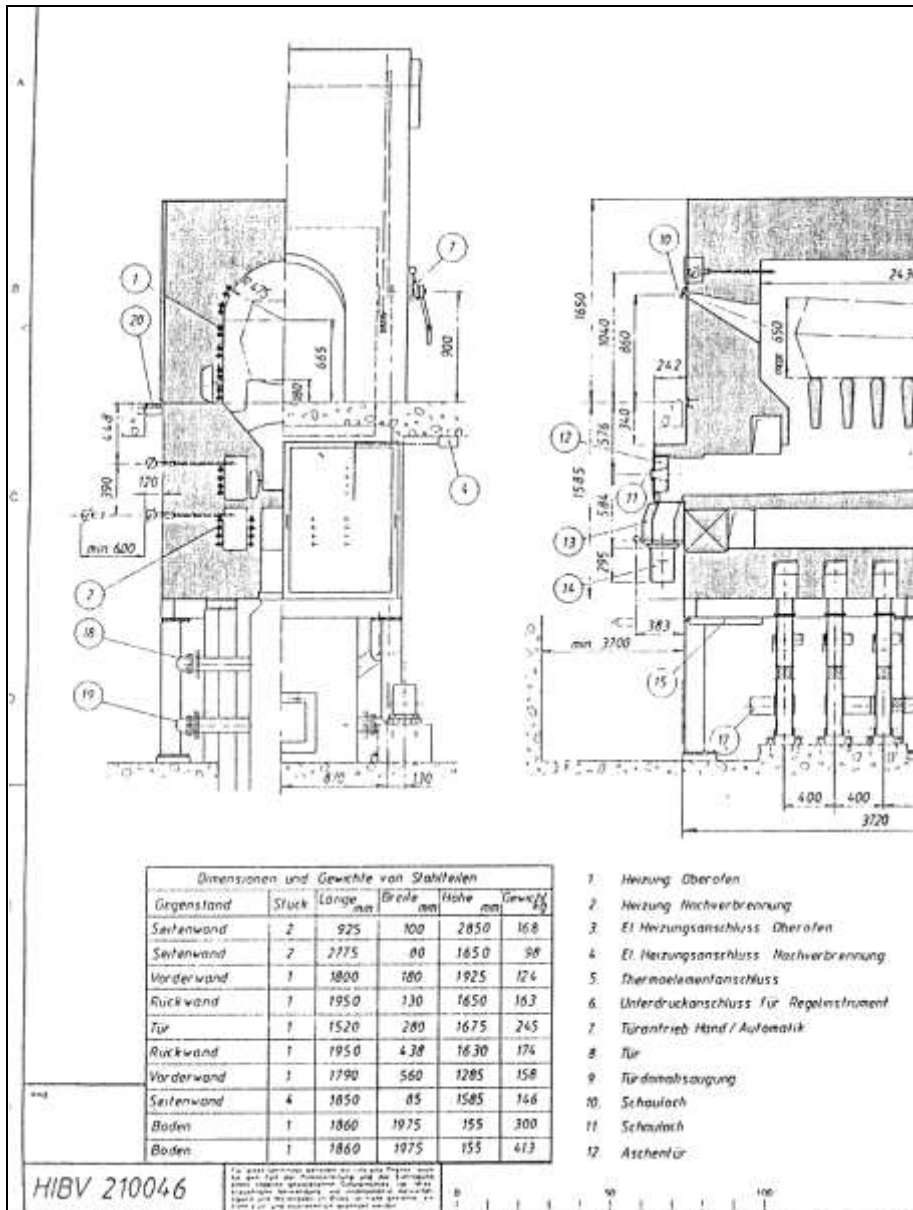

Document 103a: Doc. 103 enlarged, left-hand half.

CONCEPTION MONOBLOC

- ① Porte d'introduction
- ② Commande manuelle de secours
- ③ Brûleur de préchauffage
- ④ Tuyères de soufflage
- ⑤ Porte de service
- ⑥ Brûleur de post-combustion
- ⑦ Foyer secondaire
- ⑧ Grille mobile
- ⑨ Broyeur incorporé
- ⑩ Urne
- ⑪ Circuit de réchauffage d'air
- ⑫ Tableau de commande

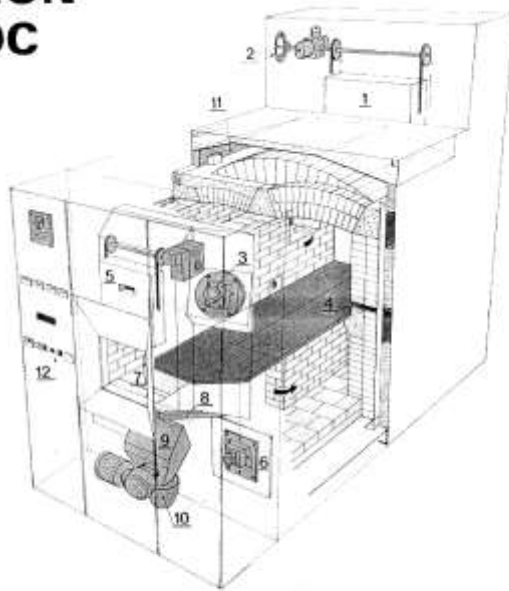

SES AVANTAGES :

- Le four est entièrement construit dans notre usine de Gaillon puis séché et testé sur plate-forme d'essais. L'ensemble des équipements et les séquences de fonctionnement et de sécurité sont ainsi complètement contrôlés et vérifiés avant livraison. Il ne reste plus à effectuer sur site que les branchements de combustible et d'électricité.
- Cette conception, permettant la livraison sur site d'un ensemble complet, améliore la qualité finale du matériel, réduit la durée des travaux sur site et les aléas de montage et de mise en route. De plus, elle limite considérablement les perturbations qu'un chantier de cette nature peut apporter sur l'exploitation d'un crématorium.



Four C 411 en cours de fabrication

Four C 411 sur la plate-forme d'essai

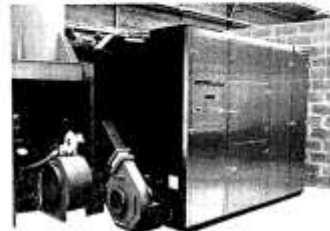

Document 105: FERBECK-VINCENT gas-fired cremation furnace, Model C411.

Source: Fours de crémation. Modulaires, Type C 411. Undated promotional brochure kindly provided by that company.

1: Introduction door; 2: Manual emergency control; 3: Preheating burner; 4: Air-feed tubes; 5: Manhole; 6: Post-combustion burner; 7: Secondary hearth; 8: Mobile grate; 9: Built-in grinder; 10: Urn; 11: Air-heating circuit; 12: Control panel.

LA CONCEPTION DU FOUR TABO

L'ossature métallique,

renforcée du four est réalisée à partir de profilés également utilisés pour la distribution de l'air primaire, secondaire et tertiaire.

La structure réfractaire et isolante,

du four est constituée de 3 parties essentielles :

- la chambre de crémation
- les chambres de mélange
- la chambre de post-combustion

De la chambre de crémation,

les gaz issus de l'autocombustion sont, selon un procédé exclusif, intimement mélangés à l'air secondaire dans la double paroi du four pour permettre un processus pyrolytique contrôlé par la sonde à oxygène, l'air tertiaire et le brûleur dans la chambre de post-combustion.

L'utilisation de réfractaires denses,

contenant de 42 % à 64 % d'alumine, de matériaux isolants modernes, et de l'échangeur de chaleur introduit par TABO, assurent une crémation parfaite dans des conditions économiques d'exploitation.

Les équipements électriques,

mécaniques et thermiques sont regroupés de façon rationnelle et facilement accessibles du côté service.

L'utilisation de brûleurs,

industriels permet de déplacer les ventilateurs dans un local approprié.

La conception,

du four TABO permet indifféremment son assemblage sur place ou en usine.

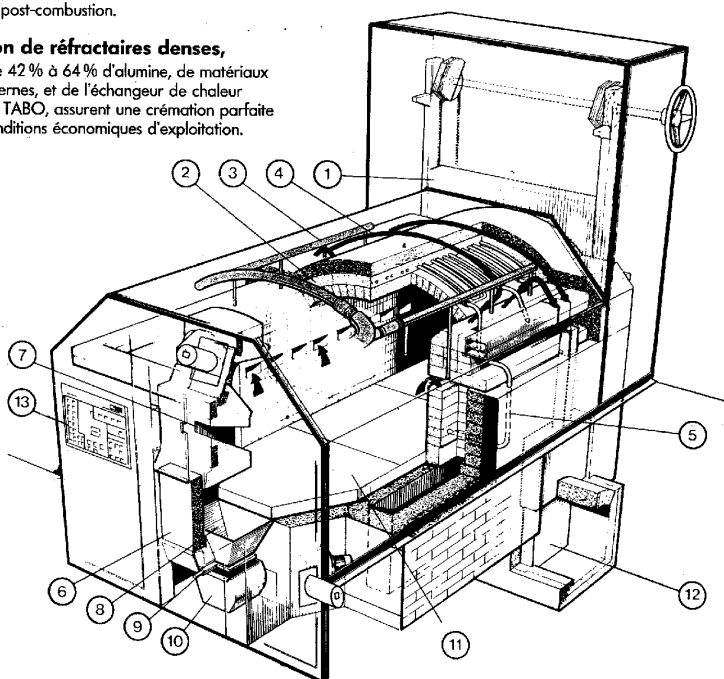

- | | | | |
|--------------------------------------|-----------------------------|-------------------------|--------------------------|
| 1. Porte d'introduction | 3. Air secondaire | 7. Lucarne d'inspection | 11. Sole du four |
| 2. Voûte de la chambre de combustion | ● Air primaire (supérieur) | 8. Trémie | 12. Registre |
| emmagasinage de la chaleur | 5. Air primaire (inférieur) | 9. Grille mobile | 13. Commande gaz ou fuel |
| 6. Porte de service | | 10. Cendrier | |

Document 106: TABO gas-fired cremation furnace. Source: Equipements de crémation Tabo. Undated advertising brochure kindly provided by that company.

1: Introduction door; 2: Vault of the combustion chamber, heat accumulation; 3: Secondary air; 4: Primary air (upper); 5: Primary air (lower); 6: Manhole; 7: Inspection window; 8: Funnel; 9: Mobile grate; 10: Ash container; 11: Oven floor; 12: Register (smoke damper); 13: Gas or oil supply.

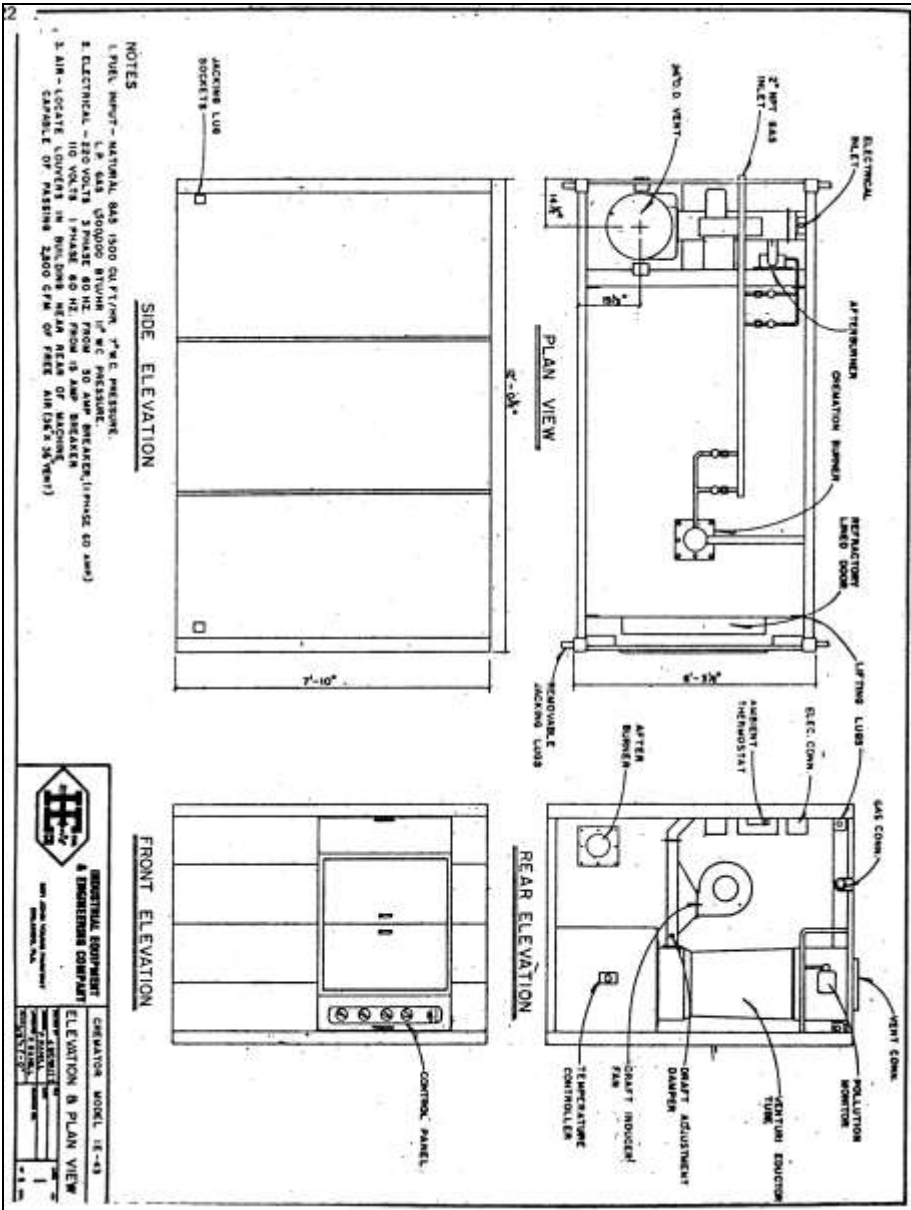

Document 107: ENER-TEK II gas-fired cremation furnace. Source: Fred A. Leuchter, An Engineering Report on the Alleged Execution Gas Chambers at Auschwitz, Birkenau and Majdanek Poland, Fred A. Leuchter, Associates, Boston, Mass., April 5, 1988, p. 122.

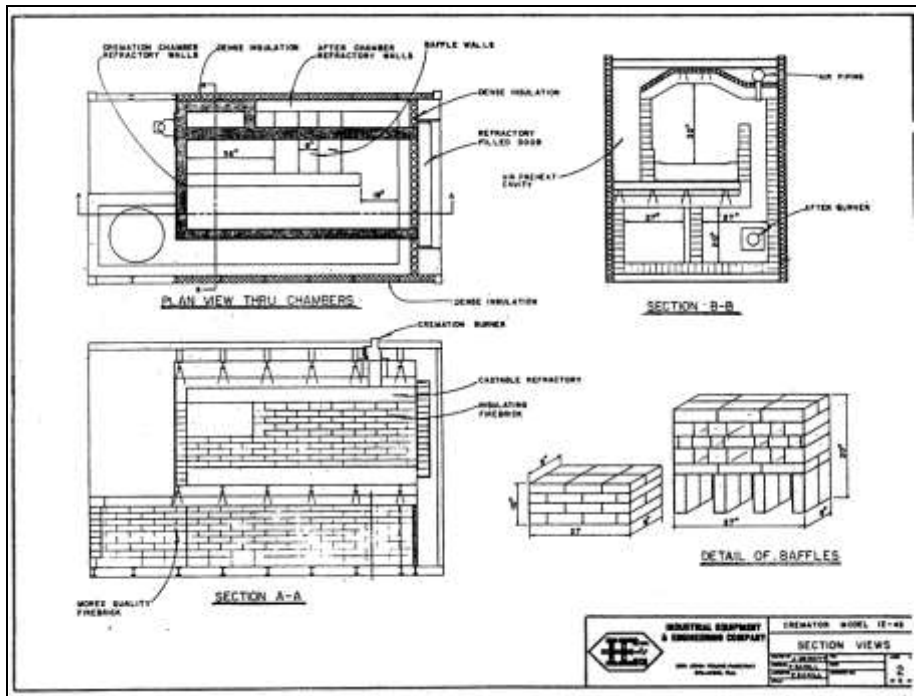

Document 107a: as above, p. 123

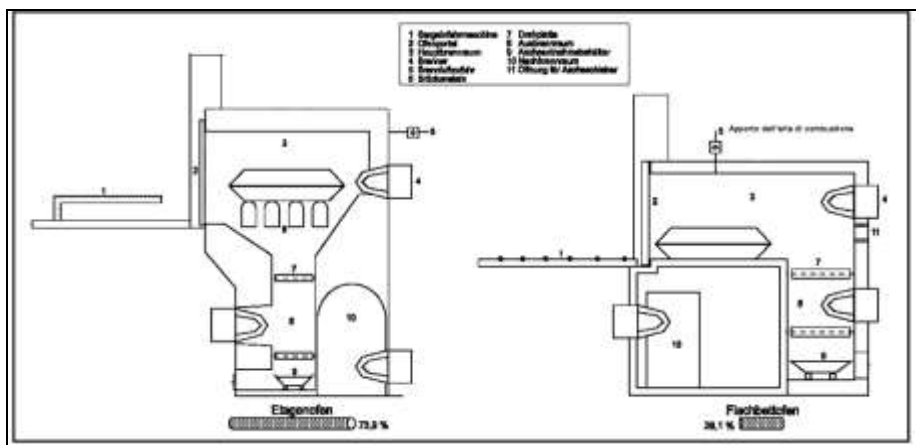

Document 108: Multi-storey furnace (*Etagenofen*, left) and flat-bed furnace (*Flachbettofen*, right) with market share in Germany (73.9% versus 26.1%). Source: R. Sircar, "Untersuchung der Emissionen aus Einäscherungsanlagen und der Einsatzmöglichkeiten von Barrierentladungen," PhD thesis, University of Martin-Luther, Halle-Wittenberg, 28 June 2002, p. 14.

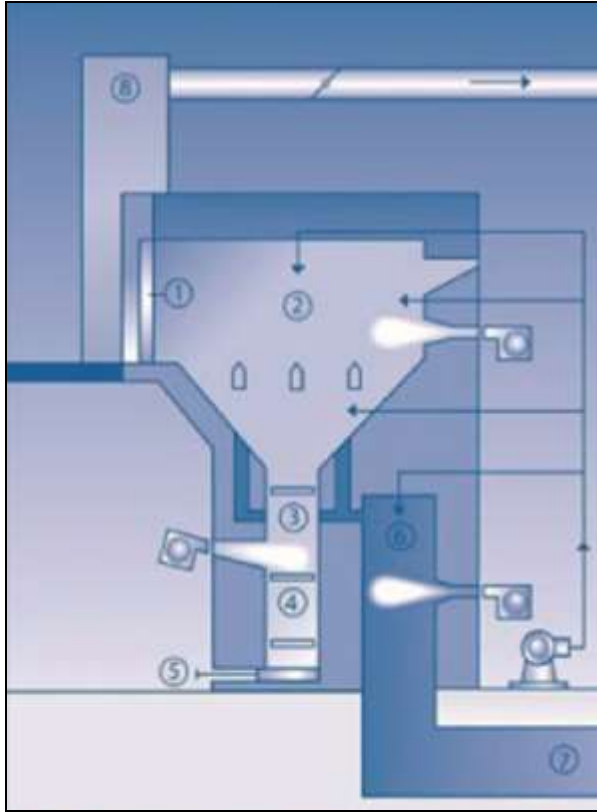

Document 109: RUPPMANN cremation furnace (without smoke filter). Source: G. Schetter, H. Burk, "Das Krematorium Dresden. Ein Beispiel für umweltgerechte Einäscherung unter betriebswirtschaftlichen Gesichtspunkten," Friedhofskultur, Jg. 96, October 2006, in PDF, p. 5.



tt therm-tec
 P.O. BOX 1105, TUALATIN, OREGON 97062
 30525 S.W. CIPOLLI ROAD, SHERWOOD, OREGON 97140
 (800) 292-9163 or (503) 625-1575 FAX (503) 625-6161
 E-MAIL: tt@thermtec.com

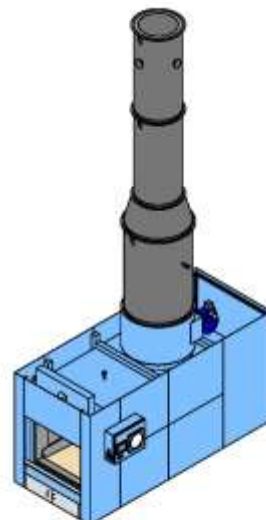

MODEL SQC-400

- Latest Design For Efficient Cremation. Not A "Hot Hearth" Design.
- Backed By Over 30 Years Of Combustion Technology.
- Main Burner Positioned For Direct Flame Contact To Case.
- Rapid Heat Up And Cool Down Cycles. Low Noise Operation.
- Tile Floor For Ease Of Replacement. Low Replacement Cost.
- Refractory Lined Stack For Longevity.
- Low Load Height Of 21". Design To Be Used With "Church Truck". No Need For Elevating Table.
- 220 Volts, 40 Amp, 60 Hz, Low 2.7 Horse Power.
- Natural Gas. Operating @ 2 to 5 Lbs. @ 3.9 Million BTU's
- 1.5 Seconds Dwell Time In Final Combustion Chamber

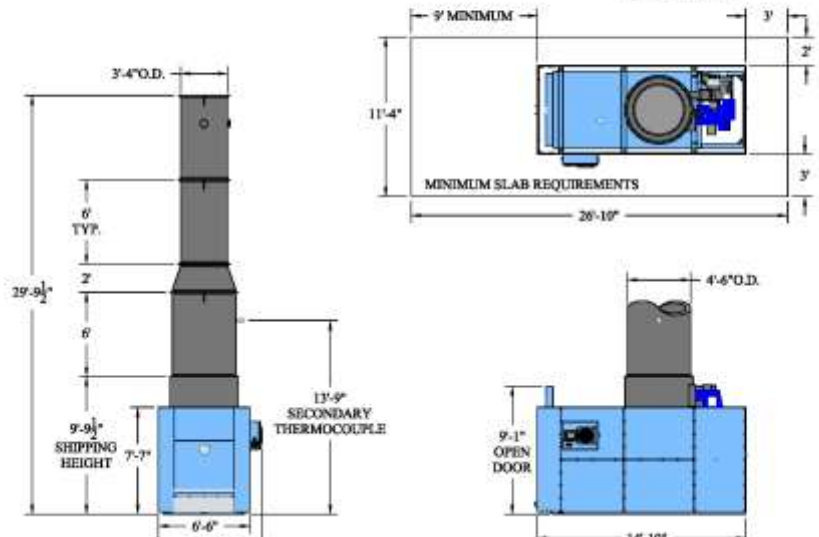

Document 109a: THERM-TECH gas-fired cremation furnace at Tualatin, Oregon, USA. Source: http://thermtec.com/sites/default/files/pdf-library/SQC-400_SPECS.pdf.

II. TOPF, Civilian Activities



Document 110: The founders of the company J.A. Topf & Söhne: J.A. Topf and his sons Julius and Ludwig. Source: Stadtarchiv Erfurt, 5/411 A-76.

J. A. Topf & Soehne

Maschinenfabrik • Feuerungstechnisches Baugeschäft

Feuerungstechn. Laboratorium • Eigene Versuchsanstalt

ERFURT

*

Die Firma wurde im Jahre 1878 durch Herrn J. A. Topf gegründet, der sich bereits vorher lange Zeit mit der Verbesserung industrieller Feuerungen eingehend befaßt hatte, nachdem er auf Grund seiner Tätigkeit als Brauerei-Fachmann zu der Ueberzeugung gelangte, daß das unwirtschaftliche Arbeiten der in dieser Zeit angewendeten Feuerungen eine Verbesserung der damals vorhandenen Einrichtungen erforderlich machte. In seinen Säbellen waren ihm tatkräftige Mitarbeiter erstunden, so daß das Gebiet der Feuerungstechnik durch Zusammenarbeit des Chemikers mit dem Techniker erfolgreich bearbeitet werden konnte.

In den beiden Hauptabteilungen für Entwurf und Ausführung zeitgemäßer Dampfkessel-Anlagen sowie die Einrichtung kompletter Mälzereien sind die darin behandelten Gebiete in einer Weise gepflegt worden, daß es der Firma gelungen ist, sich nicht nur in Europa, sondern auch in allen übrigen Erdteilen einen Namen zu verschaffen.

Das Arbeitsgebiet der Abteilung für Dampfkessel-Anlagen umfaßt den Entwurf und die Ausführung aller feuerungstechnischen Bestandteile, die auf die Nutzwirkung und Leistungsfähigkeit solcher Anlagen maßgebenden Einfluß ausüben. Es sind dies insbesondere:

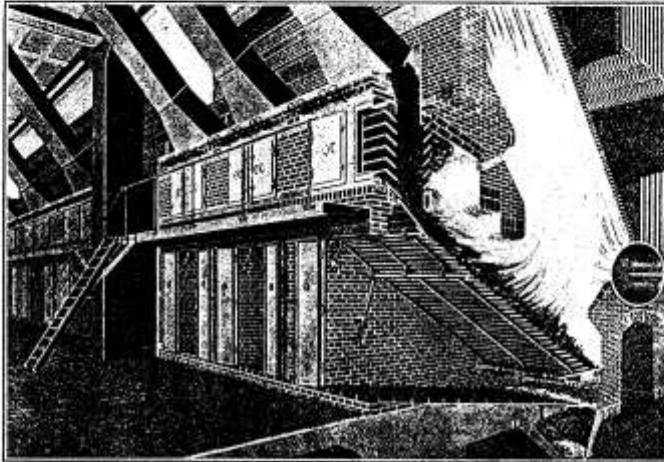

Topfsche Halbkugelsäuerung mit selbstem Vorwärtsgang an einem Stützrohr

Document 111: Description of the Topf Company's activities. Source: Deutschlands Städtebau: Erfurt, Bearbeitet im Auftrage des Magistrats von Stadtbaurat Boegl, Erfurt. "Dari", Deutscher Architektur- und Industrie-Verlag, Berlin-Halensee, 1922.

Übersicht über die				
Lfd. Nr.	Ort	Tag der Eröffnung	Anzahl der vorhan- denen Öfen	Ofensystem und Bauirma
1	Gotha	10. 12. 78	2	1) Friedrich Siemens, Dresden 2) Richard Schneider, Dresden
2	Heidelberg	22. 12. 91	1	Klingenstierna (Gebr. Beck), Offenbach a. M.
3	Hamburg	10. 11. 92	2	Richard Schneider, Dresden
4	Jena	14. 2. 98	2	Klingenstierna (Gebr. Beck), Offenbach a. M.
5	Offenbach a. M.	7. 12. 99	1	Klingenstierna (Gebr. Beck), Offenbach a. M.
6	Mannheim	20. 2. 01	1	Richard Schneider, Dresden
7	Eisenach	20. 1. 02	1	Richard Schneider, Dresden
8	Mainz	3. 5. 03	2	Klingenstierna (Gebr. Beck), Offenbach a. M.
9	Karlsruhe	25. 4. 04	1	Richard Schneider, Dresden
10	Heilbronn	26. 6. 05	1	Klingenstierna (Gebr. Beck), Offenbach a. M.
11	Ulm	1. 1. 06	2	1) Klingenstierna-Beck } 2) Gebrüder Beck } Offenbach a. M.
12	Chemnitz	15. 12. 06	2	1) Richard Schneider, Dresden 2) Gebr. Beck, Offenbach a. M.
13	Bremen	24. 2. 07	2	1) Klingenstierna-Beck, Offenbach a. M. 2) Alfred Schmidt, Bremen
14	Stuttgart	0. 4. 07	2	1) Klingenstierna-Beck, Offenbach a. M. 2) Wilhelm Ruppmann, Stuttgart
15	Coburg	12. 11. 07	2	Gebr. Beck, Offenbach a. M.
16	Pößneck	18. 10. 08	1	Gebr. Beck, Offenbach a. M.
17	Zittau	1. 4. 09	1	Rich. Schneider, Techn. Ofenbaubüro, Berlin
18	Baden-Baden	25. 10. 09	1	Gebr. Beck, Offenbach a. M.
19	Zwickau	1. 11. 09	2	Gebr. Beck, Offenbach a. M.
20	Leipzig	1. 1. 10	3	R. Schneider, Stettiner Chamotte-Fabrik
21	Lübeck	15. 5. 10	2	Gebr. Beck, Offenbach a. M.
22	Dessau	18. 5. 10	2	1) Toisul & Fradet, Paris 2) Gebr. Beck, Offenbach a. M.
23	Gera	12. 6. 10	2	Gebr. Beck, Offenbach a. M.
24	Reutlingen	1. 1. 11	1	Wilhelm Ruppmann, Stuttgart
25	Dresden	22. 5. 11	3	2) R. Schneider, Stettiner Chamotte-Fabrik 1) J. A. Topf & Soehne, Erfurt
26	Göppingen	8. 10. 11	1	Wilhelm Ruppmann, Stuttgart
27	Meiningen	8. 10. 11	1	Gebr. Beck, Offenbach a. M.
28	Weimar	14. 12. 11	2	1) R. Schneider, Stettiner Chamotte-Fabrik 2) J. A. Topf & Soehne, Erfurt
29	Sonneberg i. Th.	20. 12. 11	1	Gebr. Beck, Offenbach a. M.
30	Hagen i. W.	16. 9. 12	2	1) Custodis, Düsseldorf 2) Kori, Berlin
31	Frankfurt a. M.	12. 10. 12	2	R. Schneider, Stettiner Chamotte-Fabrik
32	Berlin Gerichtsstr.	28. 11. 12	3	R. Schneider, Stettiner Chamotte-Fabrik

Document 112: The German crematoria as of 1927. Source: IV. Jahrbuch des Verbandes der Feuerbestattungs-Vereine Deutscher Sprache 1928. Herausgegeben zum 22. Verbandstage am 4. bis 8. Juli in Bremen vom Vorstandsvorstande. Königsberg Pr., 1928, pp. 82-87.

deutschen Krematorien.

Reine Baukosten des Gebäudes bzw. der durch den Ofeneinbau not- wendigen Um- bauten	Kosten der Ofenanlage	Einäsche- rungsziffer 1927	Einäsche- rungen seit Eröffnung	Gebühren für die Einäscherung nebst Ausschmückung und Beleuchtung der Trauerhalle sowie Orgelspiel	Lfd. Nr.
70 000,—	1) 12 000,— 2) 18 000,—	793	17 977	Einheim. 30,— Fremde 38,—	1
34 153,—	9 537,—	134	4 306	92,—	2
132 512,—	28 400,—	3139	25 889	6,— bis 90,—	3
10 000,—	20 000,—	749	9 057	90,50	4
6 500,—	10 500,—	331	5 779	50,—	5
25 000,—	12 000,—	468	6 375	60,—	6
124 223,—	13 503,—	401	4 996	40,—	7
160 000,—	22 000,—	265	6 920	70,—	8
80 000,—	11 500,—	199	3 710	unentgeltlich	9
32 000,—	11 000,—	114	1 611	70,—	10
33 000,—	} 22 000,—	192	4 170	102,50	11
220 000,—	} 21 000,—	1392	16 313	unentgeltlich	12
225 000,—	} 30 000,—	1169	15 844	48,—	13
250 000,—	1) 10 000,— 2) 11 500,—	1040	12 482	20,50	14
12 500,—	23 305,—	205	5 132	III. Klasse 55,—	15
17 000,—	10 500,—	125	2 325	23,00	16
114 500,—	11 750,—	323	5 916	80,—	17
100 000,—	11 694,—	86	1 614	140,— bis 300,—	18
100 000,—	20 500,—	578	5 301	40,—	19
1 130 149,—	30 000,—	2048	22 638	57,—	20
47 000,—	20 500,—	153	1 946	103,—	21
105 000,—	1) 16 500,— 2) 10 000,—	624	3 439	57,—	22
50 000,—	20 000,—	746	6 883	47,—	23
21 640,—	10 027,—	56	446	75,—	24
1 000 000,—	} 2) 24 975,— 1) 18 300,—	2945	23 184	III. Klasse 34,50	25
54 300,—	10 000,—	44	778	50,—	26
31 000,—	10 000,—	153	1 733	170,— einschl. Sarg und Überführung	27
25 000,—	1) 9 000,— 2) 14 000,—	271	3 410	II. Kl. 180,— einschl. Sarg u. Überführ.	28
33 700,—	13 688,—	178	1 955	84,—	29
140 000,—	} 12 000,—	237	1 413	75,—	30
76 960,—	39 800,— einschl. Versen- kungsapparat	552	3 903	25,— bis 305,—	31
—	—	6126	54 526	40,—	32

Document 112: continued.

Lfd. Nr.	Ort	Tag der Eröffnung	Anzahl der vorhandenen Oefen	Ofensystem und Baufirma
33	München	28. 11. 12	2	R. Schneider, Techn. Ofenbaubüro, München
34	Wiesbaden	19. 12. 12	2	R. Schneider, Stettiner Chamotte-Fabrik
35	Nürnberg	15. 5. 13	2	Wilhelm Ruppmann, Stuttgart
36	Berlin-Treptow	23. 6. 13	2	Gebr. Beck, Offenbach a. M.
37	Tilsit	9. 9. 13	1	R. Schneider, Stettiner Chamotte-Fabrik
38	Eßlingen	1. 10. 13	1	Wilhelm Ruppmann, Stuttgart
39	Greifswald	20. 10. 13	1	Gebr. Beck, Offenbach a. M.
40	Görlitz	28. 11. 13	1	R. Schneider, Stettiner Chamotte-Fabrik
41	Freiburg i. Br.	15. 4. 14	1	J. A. Topf & Soehne, Erfurt
42	Darmstadt	10. 10. 14	1	Gebr. Beck, Offenbach a. M.
43	Danzig	15. 10. 14	2	R. Schneider, Stettiner Chamotte-Fabrik
44	Augsburg	25. 5. 15	1	Wilhelm Ruppmann, Stuttgart
45	Braunschweig	1. 7. 15	2	R. Schneider, Stettiner Chamotte-Fabrik
46	Hirschberg i. Schl.	22. 8. 15	1	J. A. Topf & Soehne, Erfurt
47	Krefeld	4. 10. 15	1	R. Schneider, Stettiner Chamotte-Fabrik
48	Halle a. d. S.	23. 12. 15	2	J. A. Topf & Soehne, Erfurt
49	Kiel	14. 2. 16	1	Gebr. Beck, Offenbach a. M.
50	Friedberg i. Hessen	15. 3. 17	1	Gebr. Beck, Offenbach a. M.
51	Pforzheim	2. 8. 17	1	Wilhelm Ruppmann, Stuttgart
52	Plauen i. V.	1. 2. 18	1	R. Schneider, Stettiner Chamotte-Fabrik
53	Königsberg i. Pr.	5. 12. 18	2	Wilhelm Ruppmann, Stuttgart
54	Konstanz	15. 5. 20	1	Gebr. Beck, Offenbach a. M.
55	Rudolstadt i. Th.	15. 6. 21	1	R. Schneider, Stettiner Chamotte-Fabrik
56	Bin.-Wilmersdorf	11. 5. 22	2	R. Schneider, Stettiner Chamotte-Fabrik
57	Ilmenau	22. 10. 22	1	J. A. Topf & Soehne, Erfurt
58	Hannover	24. 2. 23	2	J. A. Topf & Soehne, Erfurt
59	Erfurt	4. 4. 23	2	J. A. Topf & Soehne, Erfurt
60	Subl	11. 8. 23	1	J. A. Topf & Soehne, Erfurt
61	Magdeburg	22. 11. 23	2	J. A. Topf & Soehne, Erfurt
62	Grünberg i. Schl.	5. 1. 24	1	J. A. Topf & Soehne, Erfurt
63	Dortmund	24. 5. 24	2	J. A. Topf & Soehne, Erfurt
64	Arnstadt i. Th.	1. 10. 24	1	J. A. Topf & Soehne, Erfurt
65	Guben	19. 11. 24	1	J. A. Topf & Soehne, Erfurt
66	Selb i. B.	7. 2. 25	1	J. A. Topf & Soehne, Erfurt
67	Bernburg	17. 2. 25	1	J. A. Topf & Soehne, Erfurt
68	Stettin	17. 2. 25	2	1) R. Schneider, Stettiner Chamotte-Fabrik 2) desgl. (verbesserte Konstruktion)
69	Apolda	16. 4. 25	1	J. A. Topf & Soehne, Erfurt
70	Wilhelmshaven	11. 2. 26	1	J. A. Topf & Soehne, Erfurt
71	Breslau	12. 4. 26	1	Gebr. Beck, Offenbach a. M.
72	Cassel	21. 5. 26	1	J. A. Topf & Soehne, Erfurt
73	Höchst a. M.	1. 6. 26	1	J. A. Topf & Soehne, Erfurt
74	Liegnitz	8. 7. 26	1	J. A. Topf & Soehne, Erfurt
75	Gießen	7. 8. 26	1	J. A. Topf & Soehne, Erfurt
76	Brandenburg (H.)	17. 10. 26	1	J. A. Topf & Soehne, Erfurt
77	Weißenfels a. S.	7. 2. 27	1	Kory, Berlin
78	Tuttlingen	14. 8. 27	1	Wilhelm Ruppmann, Stuttgart

Document 112: continued.

Reine Baukosten des Gebäudes bzw. der durch den Ofeneinbau not- wendigen Um- bauten	Kosten der Ofenanlage	Einäsche- rungskilfer 1927	Einäsche- rungen seit Eröffnung	Gebühren für die Einäscherung nebst Aus schmückung und Beleuchtung der Trauerhalle sowie Orgelspiel	Lfd. Nr.
—	—	1083	8 228	nach 6 Kl. gestuft	33
35 000,—	26 500,—	381	3 593	133,—	34
230 000,—	20 000,—	532	4 880	100,—	35
—	—	4020	24 970	40,—	36
102 000,—	8 000,—	30	582	74,— bis 90,—	37
20 600,—	12 800,—	83	894	26,—	38
64 500,—	6 000,—	62	685	60,—	39
120 000,—	8 800,—	258	2 358	35,— bis 95,—	40
100 000,—	—	110	1 315	81,—	41
85 000,—	10 000,—	106	1 025	60,— bzw. 70,—	42
150 000,—	26 500,—	614	3 320	—	43
—	11 000,—	74	719	53,75	44
201 800,—	22 400,—	923	5 610	29,50	45
125 000,—	13 300,—	182	1 626	62,—	46
76 230,—	11 500,—	255	1 395	70,—	47
850 000,—	17 000,—	689	4 791	45,—	48
88 000,—	9 450,—	240	1 633	70,—	49
50 000,—	9 617,67	50	513	Einheim. 30,— Auswärtige 50,—	50
—	15 000,—	194	1 261	105,—	51
678 500,—	9 500,—	479	2 731	60,—	52
1 300 000,—	50 000,—	409	3 059	55,— bis 176,—	53
Inflation	Inflation	58	293	48,— bis 58,—	54
desgl.	desgl.	255	1 126	83,— bis 87,—	55
desgl.	desgl.	3581	17 426	40,—	56
desgl.	desgl.	133	672	50,—	57
desgl.	desgl.	627	1 739	46,—	58
desgl.	desgl.	589	2 075	71,70	59
desgl.	desgl.	110	471	55,—	60
desgl.	desgl.	930	2 586	70,—	61
desgl.	desgl.	27	87	70,— bis 80,—	62
desgl.	desgl.	363	887	63,— bzw. 66,—	63
52 000,—	—	199	620	103,—	64
—	12 000,—	220	491	60,—	65
105 500,—	—	162	439	80,—	66
55 000,—	14 000,—	240	500	—	67
70 000,—	Stft. d. Ofen- baufirma	307	701	27,—	68
—	—	153	321	36,—	69
24 900,—	14 850,—	63	101	45,—	70
225 000,—	12 500,—	377	552	56,—	71
—	14 000,—	148	215	53,—	72
—	15 000,—	32	49	65,—	73
44 040,—	12 000,—	81	121	73,—	74
60 000,—	14 200,—	76	104	50,—	75
400 000,—	16 000,—	213	255	62,—	76
—	—	62	62	40,— u. 21,50	77
150 000,—	21 500,—	16	16	—	78

Document 112: continued.

Lfd. Nr.	Ort	Tag der Eröffnung	Anzahl der vorhandenen Ofen	Ofensystem und Baufirma
79	Eisfeld	29. 9. 27	1	J. A. Topf & Soehne, Erfurt
80	Ludwigsburg	22. 10. 27	1	Wilhelm Ruppman, Stuttgart
81	Hildburghausen	27. 10. 27	1	J. A. Topf & Soehne, Erfurt
82	Freiberg i. S.	2. 3. 28	1	Gebr. Beck, Offenbach a. M.
83	Quedlinburg	10. 3. 28	1	J. A. Topf & Soehne, Erfurt

Durch nachträglichen Ofeneinbau wurden Friedhofskapellen in Krematorien umgewandelt in Jena, Offenbach, Eisenach, Reutlingen, Göppingen, Weimar, Sonneberg i. Th., Frankfurt a. M., München, Wiesbaden, Pforzheim, Konstanz, Ilmenau, Erfurt, Suhl, Magdeburg, Grünberg, Arnstadt i. Th., Bernburg, Stettin, Apolda, Wilhelmshaven, Liegnitz, Gießen, Weisensfels, Eisfeld, Ludwigsburg und Quedlinburg.

Als Heizmaterial verwenden die meisten deutschen Krematorien Koks (Gas-, Kammerofen-, Zechen-, Schmelz-, Hütten-, Grob-, Destillations-Koks), Braunkohle und Koks vermischt findet in Gotha Verwendung. Koks und Holz werden verfeuert in Göppingen, Eßlingen, Freiburg i. Br. — Mit Gas werden Krematoriumsofen beheizt in Dessau, Dresden, Ludwigsburg und Freiberg i. Sa.

Reine Baukosten des Gebäudes bzw. der durch den Ofeneinbau notwendigen Umbauten	Kosten der Ofenanlage	Einäschersziffer 1927	Einäscherrungen seit Eröffnung	Gebühren für die Einäscherung nebst Ausschmückung und Beleuchtung der Trauerhalle sowie Orgelspiel	Lfd. Nr.
21 300,—	13 700,—	7	7	73,—	79
47 000,—	18 000,—	7	7	50,—	80
24 000,—	13 000,—	10	7	50,—	81
145 000,—	13 500,—	—	—	200,—	82
30 000,—	13 519,—	—	—	70,—	83
		45 752,—	389 138,—		

Die Zeitdauer der Einäscherung schwankt zwischen 45 Minuten bis zu 3 Stunden. An Koks werden verbraucht $1\frac{1}{2}$ bis $8\frac{1}{2}$ Zentner für die Einäscherung, an Gas 33 bis 260 cbm. Die gewaltigen Unterschiede der Zahlen sind dadurch zu erklären, daß seitens der Krematorien zwischen der Hochheizung des Ofens und der Nachheizung des noch warmen Ofens bei den Zahlenangaben nicht unterschieden worden ist.

Die Tabelle verdanken wir zum größten Teile dem Volksfeuerbestattungsverein V. V. a. G. in Berlin, der den Nachdruck gütigst gestattete. Für die Zwecke des Jahrbuchs wurde die Tabelle vereinfacht und zeitgemäß ergänzt, z. T. unter Benutzung der Statistik der „Deutsche Flamme“.

**Einäscherungsöfen für
Krematorien**

System Topf



**Modernste Konstruktion
Kontinuierlicher Betrieb.**

Topf konstanter Temperaturhöhe gehaltene Verbrennungsluft
 und daher schnellste Einäscherung. Vollkommene Ver-
 brennung mittels hocherhitzter atmosphärischer
 Luft. Vollständig rauch- und geruchlos.
 Hygienisch einwandfreier Betrieb. Ge-
 ringster Brennstoffaufwand.
 Einfachste Bedienung.



J. A. Topf & Söhne, Erfurt
 Maschinenfabrik □ Feuerungstechnisches Baugeschäft.

**TOPF'sche
Feuerbestattungs-Öfen**



entsprechen allen neuzeitlichen
Anforderungen bezüglich rauch-,
geruch- u. geräuschlosem Betrieb

Umbau bestehender Anlagen
nach neuesten Erfahrungen,
auch besonders für Gasbeheizung

Über 60 Öfen seit 1922 ausgeführt
 bzw. in Auftrag erhalten, demnach fast sämt-
 liche neubauten Krematorien ausgestattet

-

Wir liefern ferner für die Einsegnungshallen
Luftheizungs-Anlagen
 (Ausnutzung der Rauchgase)

-

Fordern Sie
kostenlos und unverbindlich Vorschläge, Projekte und
Rentabilitäts-Berechnungen sowie Ingenieurbesuch!

J. A. TOPF & SÖHNE, ERFURT
 Maschinenfabrik, feuerungstechnisches Baugeschäft

Document 113: "Cremation Furnaces for Crematoria, System Topf." Advertisement from just before Word War I. Source: III. Jahrbuch des Verbandes der Feuerbestattungs-Vereine Deutscher Sprache. Druck von Carl Wull, Heilbronn a. N., 1913, p. 175.

Document 114: "Topf Cremation Furnaces." Advertisement from the early 1930s. Source: R. Nagel, Die Vorzüge der Feuerbestattung, self-published, Vienna, 1931, p. 27.

**Topf'sche
Feuerbestattungsöfen**

entsprechen allen neuzeitlichen Anforderungen
bezüglich rauch-, geruch- u. geräuschlosem Betrieb

 Umbau bestehender Anlagen nach
neuesten Erfahrungen, auch
besonders für Gasbeheizung

Neueste Aufträge: Potsdam, Köllberg, Pöbneck, Sondershausen

Fürden Sie kostenlos und unverbindlich Vorschläge, Projekte und Kostabilitätsberechnungen oder Ingenieurbesuch

J. A. TOPF & SÖHNE, ERFURT
Maschinenfabrik, feuerungstechnisches Baugeschäft



Feuer-
bestattungs-
anstalt der
Stadt Dresden
Verwaltungs-
stelle:
Städtisches
Bestattungs-
amt

Document 115: "Topf Cremation Furnaces." Advertisement from the early 1930s. Source: V. Jahrbuch des Verbandes der Feuerbestattungs-Vereine Deutscher Sprache. Königsberg Pr. 1930.



**Mechanische
Feuerbestattungsöfen**
für elektrischen, Gas- und Steinkohlebetrieb

entwerfen allen neuzeitlichen Anforderungen
bezüglich rauch-, geruch- und geräuschlosem
Betrieb. — Fortfall des Schürgeräts

In den letzten 10 Jahren
allein über 60 Öfen ausgeführt,
bzw. in Auftrag erhalten

Umbau bestehender Anlagen nach neuesten
Erfahrungen, besonders für Gas- und elek-
trischen Betrieb.

Fürden Sie kostenlos und unverbindlich Vorschläge, Projekte und Kostabilitätsberechnungen oder Ingenieurbesuch

J. A. Topf & Söhne
Maschinenfabrik, feuerungstechn. Baugeschäft
Erfurt Gründ. 1876



Document 116: "Mechanical Cremation Furnaces for Operation with Electricity, Gas and Coke". Advertisement from the mid-1930s. Source: www.topfundsoehne.de.

<p>Kremationsofenbau- Gesellschaft</p> <p>BERLIN SW. 47, Museumstr. 26. SAARBRÜCKEN 1, Paul-Marie-Str. 14.</p> <p>Wird sich zur Ausführung kompletter Kremation-Anlagen mit 1. kaminlosen Öfen für beschleunigte absolut rauch- und geruch- losen Verbrennung; — 2. hydraulischer Vererdung und isochlorer Sargführung direkt von der Versenkung in den Ofen. Vieltach ges. gesch. — bestens empfohlen.</p>	<p>Feuerbestattungs-Öfen System RUPPMANN</p> <p>seit Jahren bewährte Konstruktion. Sicherer, ästhetischer, durchaus rauch- und geruch- freier Betrieb.</p> <p>Einsicherung in glühendem Luftstrom. Anlagen im In- und Auslande im Betrieb. Ausführliche Druck- sachen stehen zu Diensten.</p> <p>Wilhelm Ruppmann, Stuttgart.</p>
<p>Öfen für Feuerbestattung eigenen Systems für Oel- und für Koksfeuerung fast unter Garantie</p> <p>Dr. Ernst Asbrand, Technisches Bureau für die chemische Industrie HANNOVER-LINDEN Fernsprecher 3662.</p> <p>Spezialität: Ölfeuerungen, Generatorfeuerungen u. Ofenbau.</p>	<p>Schornsteinbau Custodis G. M. B. H.</p> <p>∴ Düsseldorf ∴</p> <p>Einäufrierungsöfen Komplette Anlagen</p>
<p>Feuerbestattungs-Öfen System RUPPMANN</p> <p>mit bestem bewährte Konstruktion. Sicherer, läß- liches, durchaus rauch- und geruchlos Betrieb Einsicherung in glühendem Luftstrom. Anlagen im In- und Auslande im Betrieb. Ausführliche Drucksa- chen stehen zu Diensten.</p> <p>F. Holmeister «Frankfurt a. M. Steinwerke, Harigstein-Dreherei</p> <p>Spezialität: Asche-Urnen.</p> <p>« Eine große Anzahl Modelle sofort lieferbar. » Kataloge. Preislisten. Telegr.-Adr.: Syenitwerk Holmeister, Frankfurt/Main. Tel. 781, Amt 1.</p>	

Document 117: Advertisements by various companies active in the cremation sector at the beginning of the 20th century. Source: II. Jahrbuch des Verbandes der Feuerbestattungs-Vereine Deutscher Sprache. Vereinsbuchdruckerei, Pyramont 1912, p. 147.

Document 118: “Cremation Furnaces System Ruppmann.” Advertisement from just before World War I. Source: as Doc. 113, p. 176.

WILHELM RUPPMANN-STÜTTGART
IM KONIGLICHEN BERGWERK-UND HÜTTENWESEN
 MINISTERIUM ZU BERLIN, VEREINIGUNG
 DEUTSCHER HÜTTENMÄNNER

Der

Feuerbestattungs-Ofen

SYSTEM RUPPMANN

beruht auf dem Prinzip, die Verbrennung in rein atmosphärischer und hochkonzentrierter Luft, praktisch sauerstoff- und gewöhnlich vor sich gehend zu lassen, so dass dem betreffenden Eingeblichen in vollständigster Weise Rechnung getragen wird.

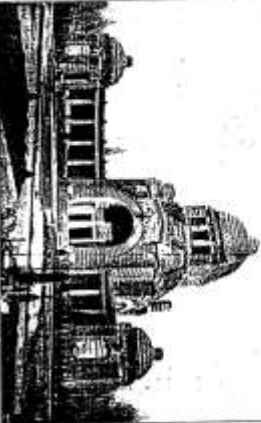

Achtung! Der Kesselstein aus dem Pflug-Friedhof in Stuttgart, Professor Schäfer in Stuttgart, Der zweite Verwesungsstadium wurde der Firma WILHELM RUPPMANN abgeliefert.

Die in allen Teilen sorgfältig durchgeführte, auf 26-jähriger wissenschaftlicher Erfahrung beruhende Konstruktion, die gewöhnlich selbständige und die anschließende Verwendung zweckentsprechender Materialien gewährleisten die guten Eigenschaften eines zeitgemäßen Verbrennungsstoffs!

Vollkommene Verbrennung in rein glühender Luft ohne Einwirkung von Feuergasen aus der Feuerung!

Garabschlosser, vollständig, durchsichtiger, sicherer und selbständiger Betrieb!

Einliche Stationen! □ Kurze Verbrennungszeit! □ Geringster Kohlenverbrauch!

Feuerbestattungs-Ofen
SYSTEM RUPPMANN

ausgestattet, welche auf neuzeitlicher Grundzüge konstruiert sind und selbst, gut besetzten Arrangements ausgesetzt ist, die eine leichte, bequeme und sichere Bedienung in jeder Hinsicht ermöglichen. Der Generatorraum ist in seinen Dimensionen so bemessen, dass er die nötige Kohlenmenge fasst, welche notwendig ist, um den Verbrennungs- und Nachbrennungsraum normalermaßen, d. h. wenn der Ofen durchgehend ist, innerhalb 3 Stunden von etwa 300' auf 950 bis 1000° Celsius hochzubringen.

Der Generatorraum

schließt sich oben direkt an den Generator an. Er entspricht dem vom Kongress für Feuerbestattungsgesellschaften festgelegten Dimensionen, ist 2500 mm hoch, 1450 mm breit und 950 mm hoch und bietet somit genügend Raum für die größte vorkommende Größe von 2250 mm Länge, 750 mm Breite und 720 mm Höhe (Ausnahmefälle).

Verbrennungsraum

Der auf geduldeter, Existenzdauer konstruierter Ofen wird Anfang 1929 wieder von der Firma WILHELM RUPPMANN, STÜTTGART

Feuerbestattungs-Ofen

SYSTEM RUPPMANN

Koks-Generator - Gassteuerung

Der Ofen ist mit einer handelsüblichen

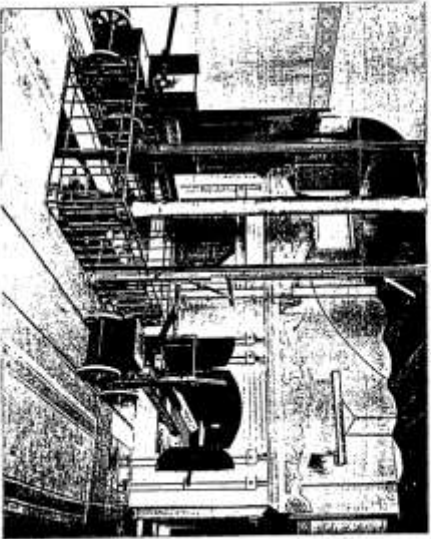

Kochzeit der Stuttgarter Ober-Abzug.

Feuerbestattungs-Ofen
SYSTEM RUPPMANN

ausgestattet, welche auf neuzeitlicher Grundzüge konstruiert sind und selbst, gut besetzten Arrangements ausgesetzt ist, die eine leichte, bequeme und sichere Bedienung in jeder Hinsicht ermöglichen. Der Generatorraum ist in seinen Dimensionen so bemessen, dass er die nötige Kohlenmenge fasst, welche notwendig ist, um den Verbrennungs- und Nachbrennungsraum normalermaßen, d. h. wenn der Ofen durchgehend ist, innerhalb 3 Stunden von etwa 300' auf 950 bis 1000° Celsius hochzubringen.

Der Generatorraum

schließt sich oben direkt an den Generator an. Er entspricht dem vom Kongress für Feuerbestattungsgesellschaften festgelegten Dimensionen, ist 2500 mm hoch, 1450 mm breit und 950 mm hoch und bietet somit genügend Raum für die größte vorkommende Größe von 2250 mm Länge, 750 mm Breite und 720 mm Höhe (Ausnahmefälle).

Verbrennungsraum

Der auf geduldeter, Existenzdauer konstruierter Ofen wird Anfang 1929 wieder von der Firma WILHELM RUPPMANN, STÜTTGART

Document 119: "The Cremation Furnace System Ruppmann." Advertising brochure published around 1918.

Der Sarg wird mit Handwagen oder meist mechanischer Eintragsvorrichtung eingehoben und automatisch auf einen Schamottemotorschieber voran der Wagen sofort wieder zurückgeführt wird.

Zum Verschluss des Verbrunnungsraumes dient ein zweiflügeliger, in Eisen armierter, vollständig gasdicht abschließender Schamotte-Schieber. Ausserdem wird als Abschluss nach aussen noch ein schwerer Winkelrahmen mit zweiflügeliger Türe in Kunstschieberarbeit angebracht. Unter dem Verbrunnungsraum ist ein

Nachtglühraum

angeordnet, auf dessen Herd die durch den Schamotterot fallenden Aschenreste des menschlichen Körpers ausgehen.

Vom Nachtglühraum aus gelangen die Feuerzäse in eine wärmeausgleichend wirkende Rückkammer, durch welche der Herd des ersteren auch von unten gründlich beheizt wird, worauf die Abgase in den Rekuperator einströmen.

Einer der wichtigsten Orientale ist der

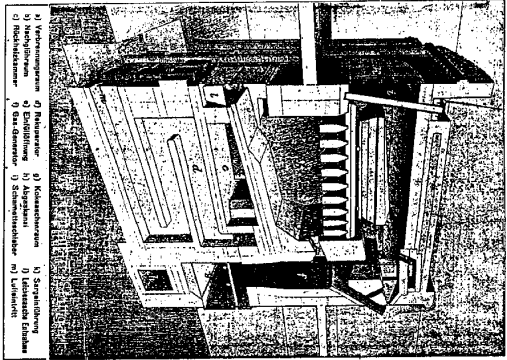

1) Verbrunnungsraum 2) Rekuperator 3) Rückkammer 4) Nachtglühraum 5) Schamotte-Schieber 6) Feuerzäse 7) Abgasrohr 8) Abgasrohr 9) Abgasrohr 10) Abgasrohr

Rekuperator System Ruppmann

welcher durch eine grössere Zahl enger Luftröhren und weiter Feuerkanäle nebeneinander gebildet wird. Derselbe dient dazu, die Abhize des Ofens, soweit praktisch irgend möglich zur Verwertung der Verbrunnungsruß auszunutzen.

Bei dem im Gegenstromprinzip arbeitenden Ruppmannschen Rekuperator wird die Luft in enge Beabnung mit den glühenden Schamotte-Wänden gebracht, wodurch allein die Gewähr für hohe Erhitzung grösserer Luftmengen geboten ist.

Um auch die nach aussen dringende Strahlwärme des oberen Verbrunnungsraumes für die Verbrunnungsruß zu gewinnen wird letztere zu beiden Seiten des Verbrunnungsraumes hin- und hergeleitet und dann als hochtemperierte Luft in den Gasbrenner, gleichmässig verteilt, eingeführt.

Der gesamte Ofen ist äusserst kräftig konstruiert und wird durch nur eigenes, gutgeschultes Baupersonal unter Verwendung erstklassiger Materialien sorgfältig aufgebaut und solid verankert. Zur genauen Einregulierung des Ofenbetriebs sind verschiedene Schieber in bewährter Anordnung eingebaut.

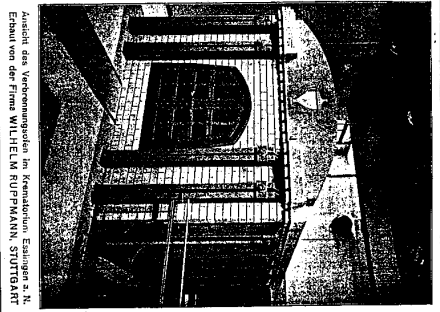

Ansicht des Verbrunnungsraumes im Krematorium Esslingen a. N. Erbauung von der Firma WILHELM RUPPMANN, STUTTGART

Allgemeines.

Die Verbrunnung spielt sich in der Weis ab, dass nach Einführung des Sarges der Körper infolge Einwirkung der Strahlwärme aufgelöst und in Gasform überführt wird. Die dabei erzeugten Gase werden in glühendem Luftstrom vollständig zur Verbrunnung gebracht.

Da bei Beginn des Einäscherungsprozesses die Kostbildung im Generator (2 Stunden vor einer Kremation wird kein Brennstoff mehr nachgeliefert) bis auf einen kleinen glühenden Rest verzehrt ist, werden keine Gase und Flammen im Generator mehr entwickelt. Der Körper kommt demzufolge mit inerdewelichen Feuer-gasem überhaupt nicht in Berührung, wird vielmehr in rein glühender Luft verzehrt, welche in reichlicher Menge von maltem Rekuperator geliefert wird.

Mein Ofensystem bietet dadurch die sicherste Gewähr für eine vollständig einwandfreie Feuerbestattung in denkbar ästhetischster Form.

Die sich im Nachtglühraum sammelnden Aschereste verfallen auf dessen Herd zu rein weisser Asche, welche nach Verlauf von 2 Stunden dem Ofen entnommen werden kann. Die Dauer der Verbrunnung beträgt normal 1 1/4 - 1 3/4 Stunden.

Ausgeführte Anlagen:

- AUGSBURG, BERN, BIEL, ESSLINGEN, GÖPFINGEN, KÖNIGSBERG, LUGANO
- PFORZHEIM, NÜRNBERG (2 Oden), REUTLINGEN, STUTTGART, WINTERTHUR.

Ingenieurbesuch und Projekt-Ausarbeitung bereitwillig und kostenlos. Gegenbenfalls wird die vollständige Ofenanlage in bereits vorliegende Baupläne eingezeichnet. Eigene Qualitäts-Schamotte-Werke. *** Eigens, geschultes Baupersonal. Eigene Armaturen-Werkstätten.

ABTEILUNG II: SCHAMOTTEWARENFABRIK VAIHINGEN 4/FILDERN
ABTEILUNG III: WERKSTÄTTE FÜR OFENBAU-ARMATUREN UND EISENKONSTRUKTIONEN

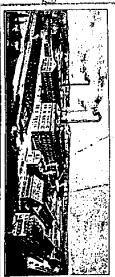

Qualitäten für grösste Dauerbeanspruchung

<p><u>Feuerbestattungsöfen</u> <u>System Ruppmann</u></p> <p>Neueste patentierete Konstruktion für Leuchtgas, Öl oder Koks</p> <p>Das neue patentierte Einäscherungsverfahren nach „System Ruppmann“ zeichnet sich aus durch <u>geringsten Brennstoffverbrauch, Verkürzung der Einäscherungszeit und rauch- u. geruchlosen Betrieb.</u></p> <p>Feuerbestattungsöfen System Ruppmann sind in nachgenannten Krematorien in Betrieb: <i>Augsburg, Bern, Biel, Bremerhaven, Chur, Effingen, Goppingen, Kiel, Königsberg, Lugano, Ludwigsburg, Nürnberg, Pforzheim, Reutlingen, Stuttgart, Winterthur.</i></p> <p>Anfragen erbeten an: Wilhelm Ruppmann -- Stuttgart Postfach 54</p>	<p>Für <u>Kremationsanlagen</u> <u>System Ruppmann</u></p> <p>liefern ich sämtliche maschinelle Zubehöre:</p> <p><u>Sargeinführungs-Wagen mit Handbetrieb</u> Automatische Sargeinführung mit elektrischem Antrieb Sargversenkungseinrichtungen, elektrisch oder hydraulisch angetrieben Komplette Sauganlagen (geräuschloser Betrieb) Entlüftungsanlagen Anlagen zur Ausnützung der Abwärme Sämtliche Kontroll- und Meßapparate Komplette Entwürfe und Dispositionsanlagen für Krematorien</p> <p>Anfragen erbeten an: Wilhelm Ruppmann -- Stuttgart Postfach 54</p>
---	--

Document 120: “Cremation Furnace System Ruppmann.” Advertisement from the early 1930s. Source: as Doc. 114, p. 28.

Document 121: “Cremation Facilities System Ruppmann.” Advertisement from the early 1930s. Source: as Doc. 114, p. 29.

Die Ausführung von

Apparaten zur Feuerbestattung

nach Klingensierna-Beck'schem, dem in Deutschland am meist verbreitetsten System, mit natürlichem oder Saugzug, mit Kohlgas-, Leuchtgas- oder Ölföuerung, übernimmt die hierzu allein berechnigte Firma:

Gebrüder Beck, Offenbach a. M.
Spezialgeschäft für Feuerbestattungsanlagen.

Bisher ausgeführte Apparate:

Heldelberg	Bremen 2 Oefen	Ulm 2 Oefen	Lübeck
Offenbach	Chemnitz	Pößneck	Gera 2 Oefen
Bergen i. Norw.	Mühlbrunn	Zwickau	Stockholm
Mainz 2 Oefen	Coburg 2 Oefen	Stuttgart	Illfelingen
Baden-Baden	Jena 2 Oefen	Sonneberg	

Ausarbeiten von Projekten, Voranschlägen etc.
Übernahme von mechanischen Einföhrungsvorrichtungen

Feuerbestattungs-Öfen

System RICH. SCHNEIDER

das beste und bewährteste, daher verbreitetste System der Welt, über 45 Ausführungen, baut unter Garantieleistung:

Bureau für technische Feuerungsanlagen
Rich. Schneider
Stettin G. m. b. H. Schwarzer Damm 15a

Verbrennung nur vermittelst glühender Luft, vollkommen rauch- und geruchlos.
Einfachster und billigster Betrieb.

Document 122: "Cremation devices" by GEBRÜDER BECK and "Cremation Furnaces System RICHARD SCHNEIDER." Advertisement from the early 20th Century. Source: as Doc. 117, p. 146.

Die Ausführung von

Apparaten zur Feuerbestattung

nach Klingensierna-Beck'schem System, dem in Deutschland am meist verbreitetsten System, mit natürlichem oder Saugzug, mit Kohlgas-, Leuchtgas- oder Ölföuerung, übernimmt die hierzu allein berechnigte Firma:

Gebrüder Beck, Offenbach a. M.
Spezialgeschäft für Feuerbestattungsanlagen.

Bisher ausgeführte bezw. in der Ausführung begriffene Apparate in folgenden Städten:

Heidelberg	Chemnitz
Jena (2 Oefen)	Baden-Baden
Offenbach a. M.	Zwickau (2 Oefen)
Mainz (2 Oefen)	Gera (2 Oefen)
Heilbronn	Lübeck (2 Oefen)
Ulm a. D. (2 Oefen)	Meiningen
Stuttgart	Sonneberg
Bremen (2 Oefen)	Berlin-Treptow (2 Oefen)
Coburg (2 Oefen)	Greifswald
Bergen in Norwegen	Darmstadt
Pößneck	Friedberg

Ausarbeiten von Projekten, Voranschlägen etc.
Übernahme von mechanischen Einföhrungsvorrichtungen.

Document 123: "Cremation Devices" by GEBRÜDER BECK. Advertisement from the early 20th Century. Source: as Doc. 113, p. 172.

Bureau für technische Feuerungs-Anlagen
Rich. Schneider
Stettin G. m. b. H. Schwarzer Damm 13a
 erbaut unter Garantieleistung

Feuerbestattungs-Oefen
 System Rich. Schneider.
 Es ist dies das beste, bewährteste, daher verbreitetste System der Welt.
50 Ausführungen

Hamburg (2 Oefen)	Braunschweig
Manheim	Görlitz
Berlin	Crefeld
Eisenach	Kopenhagen
Karlsruhe	Christiana
München (2 Oefen)	Serf
Speyer (Oefen)	Basel (2 Oefen)
Chemnitz	St. Gallen
Zürich	Bern
München	Lausanne
Leipzig (3 Oefen)	La Chaux de Fonds
Dresden (2 Oefen)	Rauu
Weimar	Davos
Frankfurt a. M. (2 Oefen)	Valencia
Wiesbaden (2 Oefen)	S. Francisco (5 Oefen)
Berlin (2 Oefen)	Oakland (2 Oefen)
Tilsit	Mexico City (2 Oefen)

Die Verbrennungen erfolgen nur vermittelt glühender Luft, rauch- und geruchlos.
 Ausser den obengenannten Oefen-Anlagen liefern wir auch die Berg-Einrichtungs-Vorrichtungen, sowie die bei den meisten Ereratoren nützigen Versenkungen.
 Auskünfte, Projekte und Kostenvorschläge stehen zu Diensten.

Danubia A. G.
 FÜR GASWERKS-BELEUCHTUNGS- U. MESSAPPARATE
WIEN, XIX.
KROTTENBACHSTRASSE 82-88

Einäscherungsöfen

sowie sämtliche

Industrieöfen

mit Gas-, Öl- und elektrischer Feuerung

Document 124: "Cremation Furnaces System RICHARD SCHNEIDER." Advertisement from the early 20th Century. Source: as Doc. 113, p. 173.

Document 125: "Cremation furnaces as well as all industrial furnaces" by Danubia A.G. Advertisement from the early 1930s. Source: as Doc. 114, p. 30.

ING. JULIUS SCHMALZ
 TECHNISCHES BÜRO FÜR PROJEKTIERUNG UND AUSFÜHRUNG:
 INDUSTRIEÖFEN, FABRIKSCHORNSTEINE, KESSELEN-ANLAGEN

OLMUTZ 6
 TELEPHON NR. 853

LEICHTVERBRENNUNGSEINRICHTUNGEN EIGENEN SYSTEMS
 BESTE FIRMA DER TSCHECOSLOWAKEI

SICHERE ÖFENBAUTEN IN FOLGENDEN ORTEN:
 PRAG, MAHR., OSTRAU, PARDUBITZ, B. BUDWES, NYMBURK
 IN OLMUTZ EIN ÖFEN FÜR LEUCHTGASFEUERUNG

FEUERUNGSTECHNIK
 SPEZIAL-BAUUNTERNEHMUNG GES. M. B. H.
 WIEN, IX., GRÜNE TORGASSE 2

Abteilung: Schornstein- und Industrieofenbau
 Bau von KREMATORIUMSÖFEN (Bauart Schmalz) für Koks-, Gas- und Rohölfeuerung.

Ausgeführten Anlagen:
 Böhm.-Budweis, Mähr.-Osterau, Nymburk, Pardubitz, Prag u. a. m.

WILHELM WOLLMANN
 KUPFER-URNEN-ERZEUGUNG
 WIEN, X., VAN DER NOLLGASSE NR. 96 - TELEPHON R-12-5-41

INGENIEUR
FRANZ CARL W. GAAB
 DÜSSELDORF-OBERKASSEL
 TEL. GR. - ADL. - INGENIEUR GAAB/DÜSSELDORF-OBERKASSEL

BÜRO FÜR TECHNISCHE FEUERUNGS-ANLAGEN
 PROJEKTIERUNG / BAUAUSFÜHRUNG
 UND INBETRIEBSETZUNG VON
KREMATORIEN



Eigene Entwürfe für Beisetzungs- und Urnen-Hallen
 Eigenes Ofensystem bester Konstruktion für Koks-,
 Gas- und Ölfteuerung, sowie mit natürlichem oder mit
 Saugzug
 Ensäuerung nur in glühender Luft
 Vermeldung von Rauch und Geruch

Document 126: Cremation Furnaces System JULIUS SCHMALZ. Advertisements from the early 1930s. Source: as Doc. 114, p. 31.

Document 127: Cremation Furnaces System FRANZ CARL W. GAAB. Advertisement from the early 20th Century. Source: as Doc. 113, p. 174.



Document 128: Photo of the Topf engineer Kurt Prüfer probably dating to the 1930s. Source: www.topfundsoehne.de.

Die Urne

Zeitschrift zur Förderung der Feuerbestattung
Monatliches Insertions-Organ

Verantwortlicher Schriftleiter: Hermann Findelen, Meissen
Für den Anzeigenenteil: Bruno Thieme, Meissen, Fernruf 2884
Zuschriften für den textlichen Teil sind an Herrn Findelen,
Meissen, Melzerstraße 3, zu richten.



Nachrichtenblatt des Feuerbestattungsvereins
Meissen und Umgebung

mit seinen Ortgruppen Weinböhla, Coswig, Lommatzsch,
Nossen, Riesa und deren Umgebung. Eingetragener Verein
Geschäftsstelle: Paul Schröder, Meissen, Neugasse Nr. 1511
Fernsprecher Amt Meissen Nr. 3117

Redaktionelle Einsendungen und Inserate bis spätestens 20. jeden Monats erbeten. **Insertionspreis:** 1 Feld (65:35 mm) 5 RM.

Der Verein ist politisch und kirchlich neutral

Nr. 3

Meissen, März 1931

4. Jahrgang

Ein neues Einäscherungsverfahren.

Da wir unsere Leser von dem neuen Einäscherungsverfahren bereits unterrichtet haben, müssen wir zwecks Klärung der Frage auch die Gegenseite zu Worte kommen lassen, ohne zur Sache selbst Stellung zu nehmen. Dies ist zunächst noch eine Angelegenheit der Fachleute. Die Schriftleitung.

Im „Zentralblatt für Feuerbestattung“ Jahrgang 1930 No. 5 erschien ein Aufsatz des Herrn Oberbaudipl.-Ing. Volkmann Hamburg, über „Ein neues Einäscherungsverfahren“, auf den im Interesse der Feuerbestattungs-Sache näher eingegangen werden muß.

Zunächst, wer ist der Verfasser, der den Nichteingeweihten als der ideale neutrale Verfechter einer neuzeitlichen Entwicklung der Feuerbestattungs-Öfen erscheinen muß, wenn ihm die inneren Zusammenhänge nicht bekannt sind. Herr Oberbaudipl.-Ing. Volkmann ist dienstlich Dezernent für die Feuerbestattung in Hamburg und mit Herrn Dipl.-Ing. Ludwig Usternecker eines Patentes über ein Einäscherungsverfahren. Beide versuchen das Patent zu verwenden und zwar gegen eine Vergütung, wie sie auf diesem Gebiete nicht üblich war (pro Jahr wurde eine Mindestlizenz von 30000 RM verlangt).—

Der Titel des Artikels ist irreführend, denn „Ein neues Einäscherungsverfahren“ steht nicht zur Debatte, wenn der Verfasser nicht wesentliche Punkte verschweigt. Daß man die Einäscherung mit möglichst geringem Luftüberschuß ausführt, ist allgemein bekannt und ergibt sich schon aus dem Bestreben, den Gasverbrauch niedrig zu halten und mit geringen Zug auszukommen. Die Idee ist also durchaus nicht neu und wenn man bisher auf Methoden, wie sie in Hamburg angewendet werden, verzichtet hat, so geschah dies wohl aus dem Bestreben heraus, die Feuerbestattung nicht auf die Stufe der Cadaververmichtung sinken zu lassen, sondern hierbei nicht allein den Brennstoff-Verbrauch, sondern vor allem Gründe der Hygiene und der Pietät zu berücksichtigen. Daß letzteres in Hamburg nicht ausreichend geschieht, ergibt sich schon daraus, daß während der Einäscherungsvorganges ein Gasrohr bis an die schwer verbrennbare Körperstelle herangeschoben und letztere mit Druckluft angeblasen werden. Ein weiterer Kommentar hierzu ist wohl überflüssig.

Der Verfasser nimmt das Verdienst für sich in Anspruch, daß seine Untersuchungen den Nachweis erbracht hätten, von der Vergleichbarkeit der wirtschaftlichen Grundsätze für Einäscherungs- und andere Öfen. Wenn der Verfasser diese Übertragbarkeit der für die Wirtschaftlichkeit maßgebenden Grundsätze tatsächlich herausgefunden hätte, so wäre das keine überwältigende Entdeckung. Man muß aber sehr vorsichtig sein, wenn man Krematoriumsbetriebe mit industriellen Feuerungen, oder mit Kadaver-Verdichtungsöfen von Standpunkte der Wirtschaftlichkeit in Vergleich setzt. Der Vergleich wird aber ganz bedenklich im punkto Luftüberschuß, also vom rein

technischen Gesichtspunkte, denn man kann selbstverständlich die Einäscherung einer Leiche mit dem Betriebe eines Industrieofens nicht vergleichen, weil die Materie zu große Verschiedenheiten aufweist.

Auf Seite 66 Absatz 1 weist der Verfasser darauf hin, daß in den Öfen der bekannten Systeme die Verteilung der Verbrennungsluft insofern mangelhaft wäre, als öfters gerade dort Luftmangel herrsche, wo Sauerstoff dringend benötigt würde und an anderen Stellen zum Schaden der Wärme-Ökonomie ein Überschuß daran festzustellen sei. Das führt der Verfasser auf eine bei den Industrie-Öfen bzw. Feuerungen beobachtete Erscheinung nämlich die mangelhafte Durchmischung der Feuer-gase mit der Verbrennungsluft zurück. Die Darstellung der laminaren Strömungen - paralleles nebeneinanderfließen von Feuer-gasen und Verbrennungsluft - ist praktisch ganz abwegig. In einem Einäscherungsöfen treten durch die vielen Umlenkungen der Strömungsrichtung ganz überwiegend turbulente Strömungen auf, die ein genügendes Durcheinandermischen der Gase zur Folge haben.

Im Absatz 2 geht der Verfasser näher auf den Verbrennungsvorgang selbst ein. Er behauptet, nach Zerfallen des Sarges verschlechtere sich die Luftzufuhr zur Leiche und damit deren Verbrennung, deshalb, weil von da ab der in der Muffel für die Luft verfügbare Raum ungleich größer geworden sei und mit fortschreitender Einäscherung weiter wachse. Dieser Satz zeugt von ganz verschwommenen feuerungstechnischen Kenntnissen. Es müßte eine Explosion, also eine blitzschnelle Verbrennung stattfinden, wenn man nicht im Stande sein sollte, das Luftquantum, welches dem Sargrollen entspricht, genügend schnell zu ersetzen. Außerdem hat ja der Sarg von vornherein auch Luftinhalt!

Am meisten anfechtbar ist der folgende Satz:

„Da aber von der durch die Muffel strömenden Luft nur ein verschwindend kleiner Teil mit der Leiche selbst in Berührung kommen kann, so muß die chemische Verbindung des Auflösungsprozesses notwendigerweise unvollkommen verlaufen und wir erhalten das Bild des rauchenden Schönsteins.“

Dies würde genau zutreffen, wenn man die Leiche auf eine massive Platte legt und Kühltluft (ohne Rekuperation) oben darüber streichen läßt. Dann ergibt sich naturgemäß ein Schwelen und kein Verbrennen. Das dürfte also die Erfahrungen sein, die man mit einem rostlosen Ofen ohne Rekuperation machen müßte.

Document 129: "A Novel Cremation Procedure". Article by Kurt Prüfer. Source: Die Urne, 4. Jg., Nr. 3, March 1931, pp. 27-29.

Etwas ganz anderes ist es, wenn die Leiche in jedem Stadium der Einsäuerung allseitig von Feuertgasen umspült wird, weil sie auf einem Rost liegt, und wenn man dafür sorgt, daß diese Feuertgase einen Überschuß von Luft haben, der zur restlosen Verbrennung der aus der Leiche selbst entwickelten Kohlen-Wasserstoffe ausreicht. Warum soll man das der Muffel zurückführende Luftquantum nicht genau regulieren können?

Es wird behauptet, daß in Hamburg 3500 Einsäuerungen vorgenommen worden sind mit einem Gasverbrauch von insgesamt nur 100 cbm Gas. Dies muß zunächst bestritten werden,

denn nach den Aussagen, die mir in Hamburg persönlich durch 2 den Ofen bedienende Heizer völlig unabhängig von einander gegeben worden sind, werden im allgemeinen ca 7 cbm Gas zugesetzt, vielleicht auch etwas mehr.

Um diese Frage zu prüfen, muß man sich etwas eingehender mit dem Problem befassen, ob eine menschliche Leiche so viel brennbare Bestandteile enthält, daß bei kontinuierlichem Betriebe des Ofens nach dem Anheizen und Erreichung des Beharrungszustandes keine Wärmezufuhr von außen notwendig ist. Nach mehreren medizinischen Autoren enthält der menschliche Körper durchschnittlich:

Wasser	65 $\frac{1}{2}$ % d. h. bei 70 kg Körpergewicht	45 kg
Fett	12 $\frac{1}{2}$ %	8,4 kg
Eiweißstoffe	15 $\frac{1}{2}$ %	10,6 kg
and. chem. Stoffe	3,5 $\frac{1}{2}$ %	9,5 kg
Asche	4,5 $\frac{1}{2}$ %	3,2 kg
	Sa. 100 $\frac{1}{2}$ %	Sa. 69,7 kg

Es läßt sich danach leicht errechnen, daß allein der Fettgehalt mit einem Heizwert von 7500 WE ausreichen müßte, um das Wasser zu verdampfen und die übrigen Teile auf Entflammungstemperatur zu erwärmen, wenn keine Ausstrahlung nach außen in Frage kommt. Es kann also in Krematorien, bei denen die Einsäuerungen laufend hintereinander erfolgen und bei guter Isolierung der Ofenwände zur Herabminderung der Wärmeverluste mit nur ganz geringem Gaszusatz gerechnet werden.

Das ist aber durchaus nichts neues, denn diese Erfahrung ist schon lange in Krematorien mit kontinuierlichem Betriebe gemacht worden.

Wenn die Behauptung der Einsäuerung ohne jeden Gaszusatz zutreffen sollte, so müßte die Abgastemperatur — Raumtemperatur sein, was wohl ernstlich ein Feuerungsstechniker nicht behaupten wird, denn die unvermeidlich Abgasverluste und die beim Einführen des Sarges einströmende kalte Luft sind gewisse Passivposten in der Wärmebilanz, die sich nicht umgehen lassen.

Ich hatte übrigens Gelegenheit, den Hamburger Ofen nach eingeholter Genehmigung zu besichtigen und mehreren Einsäuerungen beizuwohnen und knüpfte hieran noch folgende Bemerkungen.

Im Einsäuerungsraume befindet sich ein kleiner Ofen, der nach erhaltener Erklärung den Versuchsofen darstellt, lerner ein in Bau befindlicher Ofen, der bis zur halben Muffelhöhe fertiggestellt ist. Der neu im Bau befindliche Ofen weicht in seiner Konstruktion erheblich von dem ersten ab, ist also ebenfalls wieder ein Versuchsofen, weil damit meines Erachtens Betriebserfahrungen noch nicht vorliegen.

Im Großen und Ganzen bietet der Hamburger Ofen, abgesehen von dem Wegfall der Rekuperation nicht viel neues, sondern er ist in seinen Einzelheiten vielfach von Konkur-

renzen entlehnt. Weshalb sind die Herren Volkmann und Ludwig bei dem im Bau befindlichen Ofen von der in ihrer Patentschrift gekennzeichneten Bauart bereits wieder abgekommen, denn davon ist nicht mehr viel übrig geblieben? Doch wohl nur deshalb, weil der Versuch nicht restlos glücklich ist, wie man erwartet hat! Der erste Ofen ist mit einem engen Rost versehen, während bei dem zweiten noch nicht fertigen Ofen statt des Rostes eine Schamotteplatte vorgesehen ist, welche letztere nahezu das einzige ist, was von der patentierten Einrichtung noch beibehalten ist.

Der neueste Ofen hat am Kopflende 4 Stück Hochdruckbrenner, wie dies andere Systeme schon lange vorgesehen und an der Seite 2 senkrecht zur Muffel stehende Brenner (sogenannte Sperrbrenner); letztere sind in der Schweiz bereits seit 1918 angeordnet (siehe Patentschrift von Ludwig Heller, RBl, Patentnummer 81680). Diese Einrichtung ist also alles andere als neu!

Anfallend ist, daß bei dem letzten Ofen die Einführung der Luft von oben nach unten angewendet ist, eine Anordnung, die der Verfasser in Spalte 4 seines Artikels als mißglückten Versuch einer anderen Firma verurteilt.

Diese vorerst verurteilte neuerdings aber angewendete Anordnung „vom Muffelgewölbe etwas geneigt, sonst senkrecht zur Leiche Luft zuzuführen“ ist von der Firma J. A. Topf & Söhne, Erfurt, bereits bei zahlreichen Ofen angewendet, ebenso der für den Hamburger Ofen angewendete Nachverbrenungsrost.

Wenn in Hamburg angestrebt worden ist, eine rauchfreie Verbrennung zu erreichen, so muß dieser Versuch als gescheitert angesehen werden, denn es konnte bei der Besichtigung ein zeitweise sehr starke Rauchenwicklung beobachtet werden, wie sie bei draßbüßler bewährten Topf'schen Ofen nicht auftreten.

Die Einsäuerung einer Leiche nimmt in Hamburg durchschnittlich 80—90 Minuten in Anspruch, sodaß auch in dieser Hinsicht ein Fortschritt nicht zu verzeichnen ist.

Alles in Allem muß ich sagen, daß der Hamburger Ofen den Erwartungen, die ich nach den sensationellen Veröffentlichungen gestellt hatte, nicht entspricht.

K. P.

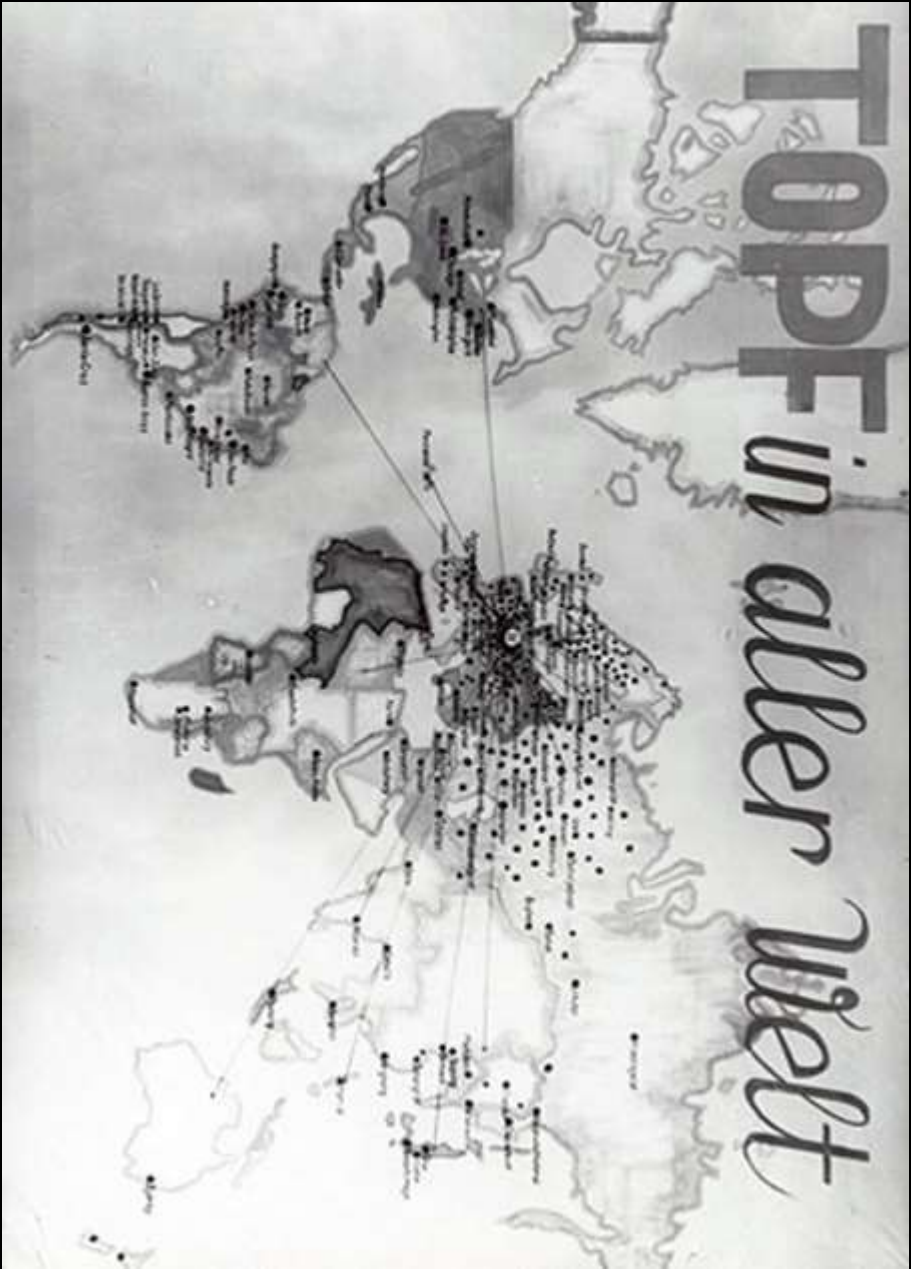

Document 130: "Topf around the world" during the 1930s. Source: www.topfundsoehne.de.



Seite: 1

GETREIDEPFLEGE-ANLAGEN

Abteilung A

- 1 Topf-Trockner für Getreide und Körner, einschl. Rohrleitungen für Luft und Staub, sowie Zyklon. (Arbeitsweise kontinuierlich).....
- 2 Trocknungs-Anlagen, Spezial, einschl. Rohrleitungen für Luft und Staub, sowie Zyklon. (Arbeitsweise periodisch).....
- 3 Silo-Begasungsanlagen.....
- 4 Silo-Belüftungsanlagen.....
- 5 Boden-Belüftungsanlagen.....
- 6 Ersatzteile.....
- 7 Bezogene Gegenstände (laut Liste).....
- 8 Montagen.....

HEIZUNG · LÜFTUNG · GEBLÄSEBAU

Abteilung B

- 9 Saugzuganlagen (und einzelne selbstgebaute Gebläse)
- 10 Luftverbesserungsanlagen (Klima, Räume-Be-u. Entlüftung)
- 11 Luftheizungsanlagen.....
- 12 Späne- und Staubabsauganlagen.....
- 13 Schornstein- und Dachaufsätze, bis 1000 mm (drehbar und feststehend).....
- 14
- 15 Ersatzteile.....
- 16 Bezogene Gegenstände (laut Liste).....
- 17 Montagen.....

STAHLBAU

Abteilung C

- 18 Stahlkonstruktionen.....
- 19 Behälterbau.....
- 20 Montagen.....

Betrittsk.-Nummern Einteilung



Seite: 2

KESSELHAUS u. FEUERUNGSBAU

Abteilung -DI

- 21 Planrostfeuerungen.....
- 22 Halbmechanische Feuerungen.....
- 23 Sonstige Feuerungen.....
- 24 Rostbeschicker.....
- 25 Einzelne Rostteile, Feuerungsarmaturen.....
- 26 Überhitzer, F.A.V. und Anderes eigener Bauart.....
- 27 Dampfkessel, Economiser und Zubehör
(ohne Einmauerung).....
- 28 Einmauerungen und sonstige Bauarbeiten für DI.....
- 29 " " " " für DII.....
- 30 Sonstige Ersatzteile
(ohne Roststäbe und Feuerungsguss).....
- 31 Bezogene Gegenstände (laut Liste).....
- 32 Schlosser-Montagen.....
- 33 Auswärts vergebene Arbeiten.....

TOPF-ROST BAU

Abteilung DII

- 34 Vollmechanische Feuerungsanlagen(ohne Einmauerung)
- 35 Einzelne Rostteile ,Feuerungsarmaturen.....
- 36 Bezogene Gegenstände (laut Liste).....
- 37 Schlosser-Montagen.....

INDUSTRIESCHORNSTEINBAU

Abteilung DIII

- 38 Industrie-Schornsteinbau zum Festpreis.....
- 39 Rauchkanäle zum Festpreis.....
- 40 Zeitlohnarbeiten.....
- 41 Auswärts vergabene Arbeiten(Festpreis u. Zeitlohn)

OFENBAU

Abteilung DIV

- 42 Krematorien(komplett).....
- 43 Vernichtungsöfen,Rückgewinnungsöfen(komplett).....
- 44 Ersatzteile.....
- 45 Bezogene Gegenstände (laut Liste).....
- 46 Maurer-Montagen.....
- 47 Schlosser-Montagen.....

Betrifft: K.-Nummern-Einteilung



Seite: 3

MALZWEIßBAU
Abteilung EI

- 48 Weichen, Umpump- u. Belüftungseinrichtungen...
- 49 Grünmalzpflüge, Kippwagen, Tennenwender.....
- 50 Keimtrommeln, einschl. Rohrleitungen aller Art
- 51 Keimkasten, Wender, " " "
- 52 Plandarren (Kompletter Neu- u. Umbau).....
- 53 Vertikaldarren (Kompletter Neu- u. Umbau).....
- 54 Einzelne Darrwender, Abräumer.....
- 55 Einzelne Lüftungs- und Heizapparate,
für Plan- und Vertikaldarren.....
- 56 Einzelne Rostbeschicker für Darren, Pfannen...
- 57 Einzelne Darrhorden, Durchstosstüren,
für Plan- und Vertikaldarren.....
- 58 Einzelne Darrhauben ab 600 mm ϕ
- 59 Einzelne Ventilatoren,
für Plan- und Vertikaldarren.....
- 60 Sämtliche mechanische Transporte
für Gerste, Grünmalz und Malz
- 61 Malzschrotereien, Malzkühler, Malzrumpfe
- 62 Vorwärmer
- 63 Einzelne Rostteile und Feuerungsarmaturen.....
- 64 Ersatzteile (kleineren Umfangs ohne FeuersGuss)
- 65 Bezogene Gegenstände (laut Liste).....
- 66 Schlosser-Montagen
- 67 Maurer - Montagen und Bauarbeiten
- 68 Sudhaus- und Kühlschiffeinrichtungen
(ohne Einmauerung).....

Betrieff: K. - Nummern-Einteilung



SPEICHERBAU

Abteilung E II

- 69. Komplette Speichieranlagen, einschl. Rohrleitungen mit Zyklon ohne das Filter.....
- 70. Einzelne Einrichtungsteile, einschl. Rohrleitungen mit Zyklon ohne das Filter.....
- 71. Einzelne Bodenspeicher-Einrichtungen für Gerste...
- 72. Malzsilos(Massiv), Mischapparate.....
- 73.
- 74. Ersatzteile.....
- 75. Bezogene Gegenstände(laut Liste).....
- 76. Montagen.....

LUFTFÖRDER-ANLAGEN

Abteilung E III

- 77. Komplette Pneumatische-Förderanlagen und Einzelorgane für Körner.....
- 78. Komplette Pneumatische-Förderanlagen und Einzelorgane für andere Schüttgüter.....
- 79. Ersatzteile.....
- 80. Bezogene Gegenstände(laut Liste).....
- 81. Montagen.....

KORNBEARBEITUNGS-ANLAGEN

Abteilung E IV

- 82. Komplette und Einzelne Kornreinigungs-, Sortier- und Entstaubungsanlagen, einschl. Rohrleitungen (Holz oder Eisen) mit Zyklon oder Staubkammer, jedoch ohne die Förderorgane.....
- 83. Komplette und Einzelne Malzreinigungs-, -Putz- und -Poliermaschinen, einschl. Rohrleitungen (Holz oder Eisen) mit Zyklon, jedoch ohne die Förderorgane.....
- 84. Druckfilter und Saugschlauchfilter für Kornstaub (aus Abteilung E I, E II, E IV).....
- 85. Mühleneinrichtungen, einschl. Holzelevatoren für alle Abteilungen.....
- 86.
- 87. Ersatzteile.....
- 88. Bezogene Gegenstände (laut Liste).....
- 89. Montagen.....

Betrifft: K. Nummern-Einstellung



MECHANISCHE FÖRDERANLAGEN

Abteilung F

- 90 Bekohlungsanlagen.....
- 91 Entaschungsanlagen.....
- 92 Transportanlagen für sonstige Güter.....
- 93 Ersatzteile.....
- 94 Bezogene Gegenstände (laut Liste).....
- 95 Montagen.....

ABTEILUNG BETRIEB

- 96 Sonderfertigungen.....
- 97 Abfälle und Altmaterial.....
- 98 Maschinen, Anlagen, Vorrichtungen, Lehren,
Werkzeuge und dergl. für eigenen Bedarf
- 99 Reparaturen und Instandsetzungen
grösseren Umfangs.....

Betrifft: K.-Nummern Einteilung

Ordnungs- nummer	Gegenstand	Anzahl der Akten	Bemerkung
II/1	<u>GESCHÄFTSINHABER</u> <u>GESCHÄFTSLEITUNG</u> <u>BETRIEBSFÜHRUNG</u> LE/ET		
2	<u>SEKRETARIAT</u> (Hauptverbindungsstelle der Führung des Betriebes) Postleitstelle/Sonderaktenstelle/Reiseplan- stelle/Tagesprogrammstelle der Betriebs- führer/Besuch- und Besprechungsstelle/Konfer- renzstelle/Bekanntmachungsstelle/Rundschrei- benstelle/Korrespondenzstelle/Protokoll- stelle für Entscheidungen und Anordnungen/ Berichtsstelle für Geschäfts- und Betriebs- geheimnisse/Ernennungen/Beauftragungen/ Personenausweis- und Paßstelle		Handakten- stelle
2 a	<u>Vorschlagsregisterstelle</u> Verwaltung der Auswertungen und Präziden- stelle		
2 b	<u>Sozialstelle "Ludwig-Topf-Fonds"</u> Innerbetriebliche Unterstützungen/Renten/ Pensionierungen		
2 c	<u>Stelle Außenspenden</u> Beiträge für außerbetriebliche Soziale Zwecke		
3	<u>VERBINDUNGSTELLE DER BETRIEBSFÜHRUNG</u> <u>GEFOLGSCHAFTSABTEILUNG</u> Stelle für Bewerbung und Anstellung/ Arbeitsbuchstelle/Abrechnung/Sozialversiche- rungstelle/Gefolgschaftshauptregister (Lohn- und Gehaltsempfänger) Aufteilungsregister/ Kriegsversehrtenregister/Beurlaubungs-, Ab- und Anmeldestelle (Passierschein) Personal- aktenstelle/Familienstandmeldestelle/Ausland- reisepaßstelle		Handakten- stelle Kartei- stelle

Document 132: General structure of the Topf Company during the 1940s. Source: *Stadarchiv Erfurt, E, 5/411 A 163.*

Ordnungs- Nummer	Gegenstand	Anzahl der Akten	Bemerkung
II/4	<u>Betriebsobmann</u> Büro für Betreuung		Handakten- stelle
5	<u>Wirtschaftsstelle</u> Werkküche/Genußmittellagerstelle/Einkella- rungsstelle/Gemeinschaftsraum/Stelle Büro- reinigung/Reinigungsmaterialverwaltung		Handakten- stelle, Karteistelle
6 a	<u>Gartenstelle</u> Landwirtschaftliche und gärtnerische Nutzung der Freiflächen Dreysesstraße Nennenrain		Handakten- stelle
6 b	<u>Gartenstelle</u> Hirnzigenweg		
7	<u>Werbeabteilung</u> Bücherei/Fachzeitschriften/Drucksachen/ Inserate/Fotoarchiv/Dokumentenarchiv		Handakten- stelle, Karteistelle
8	<u>Fotolabor</u> und Lagerstelle für Negativ und Positiv		Karteistelle
9	<u>AUSLANDABTEILUNG</u> <u>Protokollstelle/Auslandpreisprüfstelle/</u> <u>Kundenkorrespondenzstelle/Auslandangebot-</u> <u>und Auftragverwaltung/Vortragstelle/Aus-</u> <u>landprovisionsvorprüfstelle/Auslandmarkt-</u> <u>beobachtung/Auslandvertreterkorrespondenz/</u> <u>Verwaltungskorrespondenz/Prüfungs- und Vor-</u> <u>prüfstellen der sämtlichen Wirtschafts- und</u> <u>Fachgruppen</u>		Handakten- stelle, Karteistelle
10	<u>HAUPTSTELLE ALLGEMEINE VERWALTUNG</u> (Verbindungsstelle der kaufmännischen Abteilungen)		Handakten- stelle
11	<u>Verwaltungskostenprüfstelle</u> <u>Plankostenstelle</u>		Karteistelle
12	<u>Provisionsprüfstelle</u>		

Document 132: continued.

Ordnungs- Nummer	Gegenstand	Anzahl der Akten	Bemerkung
II/13	<u>Finanzstelle</u> Zahlungsmittelbereitstellung/Bonitätsbeobachtung/Liquiditätsbeobachtung		
14	<u>Devisenstelle</u>		Handakten- stelle
15	<u>Rechtstelle</u> (Prozessbeobachtung und Verwaltung)		Handakten- stelle
16	<u>Steuerstelle</u> (Finanzamt)		Handakten- stelle
17	<u>Versicherungsstelle</u> (Sach- und Personenversicherung)		Handakten- stelle
18	<u>Kaufmännische Lehrlingsausbildung</u> Nachwuchslenkung und Auslese		
19	<u>Allgemeine Registratur</u>		Handakten- stelle
20	<u>Telefonstelle</u> (Besuchsanmeldestelle)		
21	<u>Schreibstellen</u> (Schreibmaschinenkräfte sämtlicher Abteilungen)		
22	<u>Postausgangsstelle</u>		
23	<u>Papier- und Drucksachenlagerstelle</u>		

Document 132: continued.

Ordnungs- Nummer	Gegenstand	Anzahl der Akten	Bemerkung
II/24	<u>HAUPTVERBINDUNGSSTELLE DER GESCHÄFTSLEITUNG FÜR AUFTRAGVERPFLICHTUNGEN</u> (Planungsstelle der Erzeugung/Korrespondenz- und <u>Protokollstelle</u> sämtlicher Beschaf- fungsbehörden und Dienststellen/Reichs- anzeigerauswertung) <u>STELLE GENERALPLAN</u>		
25	<u>Kontingentsstelle</u> für Roh- und Hilfsstoffe.		Handakten- stelle, Karteistelle
26	<u>Hauptmaterialstelle</u> (Hauptmaterialplanung) Rohmaterial, Halbfertigteile und Bezogene Gegenstände		
27	<u>Hauptterminstelle</u> (Hauptterminplanung/Fertigungs-Quartalplan)		
28	<u>Registerstelle</u> Unsere dynamischen Register: 1.) Hauptregister Anfragen-Eingang (Inland) 2.) Hauptregister Anfragen-Eingang (Ausland). 3.) Nebenregister für Anfragenabwick- lung der 12 Technischen Abteilungen 4.) Hauptregister Auftragbestand 5.) Nebenregister der Auftragsabwick- lung der 12 Technischen Abteilungen 6.) Hauptregister Fabrikanelieferung 7.) Hauptregister Warenausgang 8.) Nebenregister Warenrücklauf 9.) Nebenregister Warenrücksendungen 10.) Hauptregister Montageabwicklung der 12 Technischen Abteilungen 11.) Hauptregister M-Bestellungen 12.) Hauptregister MR-Bestellungen		

Document 132: continued.

Ordnungs- Nummer	Gegenstand	Anzahl der Akten	Bemerkung
	<p>13.) Hauptregister V-Bestellungen</p> <p>14.) Hauptregister Rechnungseingang</p> <p>15.) Hauptregister Rechnungsausgang</p> <p>16.) Aufteilungsregister der Auftragswerte (Wirtschaftsgruppen)</p> <p>17.) Aufteilungsregister im Erzeugungskatalog (Anfrage- und Auftragbestand)</p> <p>18.) Provisionsregister</p> <p>19.) Register der OO-Aufträge und Gutschriften</p> <p>20.) Finanzplan II (Voraussichtliche Zahlungseingänge)</p> <p>21.) Finanzplan III (Voraussichtliche Zahlungsverpflichtungen)</p> <p>22.) Register Fabrikplanungen</p> <p>23.) Register der Betriebseigenen Bestellungen und Aufträge</p> <p>24.) Register der Besucher</p> <p>25.) Reiseplanregister</p> <p>26.) Register Sonderberichte (Übergaben, Abnahmen, Auswertungen)</p> <p>27.) Register Verbrauch Wirtschaftsstelle</p> <p>28.) Register Verbrauch Schreibstellen</p> <p>29.) Register Inventar (Mobilien)</p> <p>30.) Register Kohle- und Energieverbrauch</p>		
29	<p><u>Stelle Statistik</u></p> <p>Meldewesen für Hauptausschüsse, Sonderausschüsse, Arbeitsausschüsse/Wirtschafts- und Fachgruppen/Gauarbeitsamt/Arbeitsamt/Gauwirtschaftskammer/Innere Statistik/Rüstungsobmann/Wehrkreisbeauftragter</p>		
30	<p><u>Grundstückstelle</u></p> <p>(Verwaltung der Grundstücke)</p>		
31	<p><u>Inventarstelle</u></p> <p>(Verwaltung des Inventars)</p>		

Document 132: continued.

Ordnungs- Nummer	Gegenstand	Anzahl der Akten	Bemerkung
II/32	<u>Fabrikplanung</u> (Verwaltung der Projektierungen des Betriebes)		
33	<u>BETRIEBSABRECHNUNG</u> Kostenprüfstelle/Kontenplanstelle/Bewer- tungsstelle/Inventurstelle/Gemeinkosten- prüfstelle/Wirtschaftlichkeitsstatistik		Handakten- stelle, Kartei- stelle
34	<u>Betriebsbuchführung</u>		Lagerbe- standskartei
35	<u>Stelle Rechnungsprüfung</u>		
36	<u>Stelle Nachkalkulation</u>		
37	<u>Allgemeine Lohnabrechnung</u> Arbeitsbuchstelle/Socialversicherungs- stelle/Urlaubs- und Krankheitsverwaltung/ Personenkarteistelle (Lohnempfänger)		
38	<u>HAUPTBUCHHALTUNG</u> Finanzbuchführung/Bilanzstelle		Handakten- stelle
39	<u>Handkasse</u>		
40	<u>RECHNUNGSSTELLE</u>		Handakten- stelle
41	<u>HAUPTEINKAUF</u> Anfrage und Bestellung(Lieferanten)		Handakten- stelle, Kartei- stelle
42	<u>BAUEINKAUF</u> Anfrage und Bestellung(Lieferanten)		Handakten- stelle, Karteistelle
43	<u>VERSAND</u>		Handakten- stelle
43 a	Stelle Fahrwesen		
43 b	Stelle Versandlager		
43 c	Garage		

Document 132: continued.

Ordnungs- Nummer	Gegenstand	Anzahl der Akten	Bemerkung
II/44	<u>HAUPTVERBINDUNGSTELLE</u> <u>BETRIEBSPÜHRUNG - BETRIEB</u> <u>BETRIEBSDIREKTION</u> Betriebsleitung/Betriebssekretariat/ Meldewesen Rüstungskorralnde und Wehr- bezirke/Fabrik-Einsatzstelle/Betriebs- konferenzstelle/Stelle Bauaufsicht (Urbau - Neubau)		Handakten- stelle Kartei- stelle
45	<u>Stelle Betriebseinrichtung</u> Betriebs-Ingenieur/Reparaturstelle/ Eigene Maschinenmontage/Überwachung betriebseigener Anlagen/Instandhaltung/ Maschinen- und Werkzeugkarteistelle		Handakten- stelle
46	<u>Betriebsverwaltung</u> Verbindungstelle der Ausländereinsatz- verwaltung/Arbeitskraftanforderung/ Fabrikreinigung		Handakten- stelle, Kartei- stelle
47	<u>Lehrwerkstatt</u> Stelle Lehrlingsausbildung Facharbeiternachwuchsförderung/ Anlernmaßnahmen/Umschulung		Handakten- stelle, Kartei- stelle
48	<u>Hauptlagerverwaltung</u> Dispositions-Karteistelle		Handakten- stelle
48 a	Hauptlagerstellen		
48 b	Zwischenlagerstelle		
48 c	Baulagerstelle		
48 d	Hof- und Transportstelle		
48 e	Brennstofflager		
49	<u>Betriebsinspektion</u> Werkstellen (Fertigungsstellen) Stelle Unfallverhütung/Stelle Leistungssteigerung/Qualitätsprüfung/ Abnahme		Handakten- stelle
50	<u>Wohlager und Küche</u> Lagerführer/Züchenleiter/Zwischen- lagerstelle		Handakten- stelle, Kartei- stelle

Document 132: continued.

ORGANISATION DER UNTERNEHMUNG	KATALOG DER SONDERAKTEN		
	J. A. TOPF & SÖHNE GESCHÄFTSLEITUNG		
	<div style="border: 1px solid black; height: 50px; width: 100%;"></div>		Katalog Blatt Nr. 8
Ordnungs- Nummer	Gegenstand	Anzahl der Akten	Bemerkung
II/S1	<u>Werkpörförner</u>		Handakten- stelle, Karteistelle
52	<u>Werksanitätsstelle</u>		Handakten- stelle, Karteistelle
53	<u>ARBEITSVORBEREITUNG</u> Planungsstelle des Betriebes (Verbindungsstelle des Generalplanes) <u>Plankostenstelle</u>		Handakten- stelle, Dispositi- onskartei- stelle
54	Stelle <u>Lohn</u> Lohnvorkalkulation (Akkord) Lohngruppenverwaltung		Kartei- stelle
55	Stelle <u>Material</u> Materialauszug und Bereitstellung/ Kleimaterial und Gußbestellung		Kartei- stelle
56	Stelle <u>Termin</u> Fertigungsterminkontrolle		Kartei- stelle
57	Stelle <u>Konstruktion</u> (Verbindungsstelle der Technischen Abteilungen) Einzellisten- und Stücklistenaufbereitung/ Zeichnungsbereitstellung		Kartei- stelle
58	Stelle <u>Vorrichtung</u> (Vorrichtungs-Konstruktion und Rau- verbereitung)		Kartei- stelle
59	<u>MONTAGEABTEILUNG</u> <u>Technische Stelle</u>		Handakten- stelle, Disposi- tionskar- teistelle
59 a	Montagestellenleitung		
59 b	Terminstelle		
59 c	Ausrüstung		
59 d	Inspektion		
59 e	Einsatzstelle		

Ordnungs- Nummer	Gegenstand	Anzahl der Akten	Bemerkung
II/60	<u>Montageabteilung</u>		Handakten- stelle,
60 a	<u>Abnahmestelle</u>		Kartei- stelle
60 b	Zusammenbau/Montagefertigprüfung		
	Montagematerialverbereitung und Werkzeuginstandhaltung		
61	<u>Montageabteilung</u>		Handakten- stelle,
	Verwaltungs- und Abrechnungsstelle		Kartei- stelle
62	<u>TECHNISCHE VERWALTUNG</u>		Handakten- stelle,
	(Zentralstelle der Technischen Geschäftsleitung/Verbindungs- stelle der Technischen Abteilungen)		Kartei- stelle
	<u>Protokollstelle</u>		
	Hauptstelle Technische Organisation und Zentrale Ausrichtung/Technische Mitteil- ungsstelle/Stelle Rationalisierung des Fabrikationsprogramms/Stelle Spezialisierung und Aktivierung des Erfahrungspotentials der 12 Technischen Abteilungen/ Stelle Unterlieferungsprogramm der gesamten Industrie/Katalog der Bezogenen Gegenstände/ Katalog der Halbfertigfabrikate/ Stelle Eigenerzeugungskatalog/Stelle Technischer Außenwettbewerb/Stelle Inner- betriebliche Vorschlagsauswertung/Technische Zeichner Anlernung/Spezialisierung und Nachwuchsförderung der Technischen Abteilungen/Über- und innerbetriebliche Technische Schulung/Technisches Ausstel- lungswesen/Technische Schrifttumauswertung/ Auswertung Technischer Verordnungen		
63	<u>Normenstelle</u>		Handakten- stelle,
	Typisierung/Normung/Verknormenkatalogstelle/ Zeichnung- und Stücklistenprüfstelle		Kartei- stelle
64	<u>Entwicklungsstelle</u>		Handakten- stelle,
	Erfahrungsauswertungsstelle der Technischen Abteilungen/Vorschlagsauswertung/Neukonstruk- tionen		Kartei- stelle

Ordnungs- Nummer	Gegenstand	Anzahl der Akten	Bemerkung
II/55	<u>Versuchstation</u>		Handakten- stelle, Kartei- stelle Handakten- stelle, Kartei- stelle
66	<u>Preisstelle</u> Vorkalkulationsprüfstelle für Maschinen- bau, Stahlbau und Bauunternehmung/ <u>Normalisierungsstelle Fragebogen, Angebots- text und Gewährleistungen/Preisbuch- stelle für Eigenerzeugung und Bezogene Gegenstände</u>		
67	<u>Fotokopier</u>		Handakten- stelle, Karteistelle
68	<u>Lichtpausstelle</u>		Handakten- stelle, Karteistelle
69	<u>Zeichnungsregistratur</u>		Handakten- stelle, Karteistelle
70	<u>ELEKTROSTELLE</u> Projektierung, Ausführung und Entwicklung für die Technischen Abteilungen/Prüfungs- und Kontrollstelle des eigenen Betriebs		Handakten- stelle, Karteistelle
71	<u>PATENTSTELLE</u> Patent anmeldungs- und Bearbeitungsstelle/ Patentverwaltung/Laufende Patentprüfung/ Einspruchsstelle		Handakten- stelle, Kartei- stelle
72	<u>AUSSENSTELLEN</u> Technische Zweigbüros		Handakten- stelle
73	<u>AUSSENSTELLEN</u> Technische Vertretungen		Handakten- stelle
74	<u>Technische Abteilung A</u> (Getreidopflegetechnik-Apparatebau) Veranschlagung/Projektierung/Konstruktion/ Ausführung/Montageplanung		Handakten- stelle, Kartei- stelle

Document 132: continued.

Ordnungs- Nummer	Gegenstand	Anzahl der Akten	Bemerkung
II/75	<u>Technische Abteilung B</u> (Lüftungs- und Heizungsbau Entstaubungsanlagen) Veranschlagung/Projektierung/Konstruktion/ Ausführung/Montageplanung		Handakten- stelle, Kartei- stelle
76	<u>Technische Abteilung C</u> (Stahlbau) Veranschlagung/Projektierung/Konstruktion/ Ausführung/Montageplanung		Handakten- stelle, Kartei- stelle
77	<u>Technische Abteilung D I</u> (Dampfessel-Anlagen, Feuerungsbau, Einmauerung) Veranschlagung/Projektierung/Konstruktion/ Ausführung/Montageplanung		Handakten- stelle, Kartei- stelle
78	<u>Technische Abteilung D II</u> (Feuerungsbau, Mech. TOPF-Rost) Veranschlagung/Projektierung/Konstruktion/ Ausführung/Montageplanung		Handakten- stelle, Kartei- stelle
79	<u>Technische Abteilung D III</u> (Schornsteinbau) Veranschlagung/Projektierung/Konstruktion/ Ausführung/Montageplanung		Handakten- stelle, Kartei- stelle
80	<u>Technische Abteilung D IV</u> (Ofenbau) Veranschlagung/Projektierung/Konstruktion/ Ausführung/Montageplanung		Handakten- stelle, Kartei- stelle
81	<u>Technische Abteilung E I</u> (Elektreibau) Veranschlagung/Projektierung/Konstruktion/ Ausführung/Montageplanung		Handakten- stelle, Kartei- stelle

Document 132: continued.

Ordnungs- Nummer	Gegenstand	Anzahl der Akten	Bemerkung
11/02	<u>Technische Abteilung E II</u> (Speicherbau) Veranschlagung/Projektierung/Konstruktion/ Ausführung/Montageplanung		Handakten- stelle, Kartei- stelle
83	<u>Technische Abteilung E III</u> (Luftförderanlagen) Veranschlagung/Projektierung/Konstruktion/ Ausführung/Montageplanung		Handakten- stelle, Kartei- stelle
84	<u>Technische Abteilung E IV</u> (Kornbearbeitungs-Maschinen) Veranschlagung/Projektierung/Konstruktion/ Ausführung/Montageplanung		Handakten- stelle, Kartei- stelle
85	<u>Technische Abteilung F</u> (Mechanische Förderanlagen) Veranschlagung/Projektierung/Konstruktion/ Ausführung/Montage		Handakten- stelle, Kartei- stelle
86	<u>HAUPTSTELLE VERKAUF - KORRESPONDENZ</u> (Verbindungsstelle der Zwölf Tech- nischen Abteilungen) Stelle Inland-Angebotkorrespondenz und Auftragsannahme/Angebotsausstattung/ Inland-Angebot- und Verkaufsbericht/Reise- bericht-Verwaltung/Inland-Angebot- und Besuchsterminstelle/Stelle Referenzen- listen/Kundenanerkennung/Kundenreklama- tion/Konkurrenzbeobachtung/Inlandmarks- beobachtung		Handakt en- stelle, Kartei- stelle Kunden- kartei- stelle

Document 132: continued.

Ordnungs- Nummer	Gegenstand	Anzahl der Akten	Bemerkung
II/87	<u>Hauptstelle Sonderfertigung</u>		Handakten- stelle, Kartei- stelle
87 a	Arbeitsplanung		
87 b	Fertigungsleitung		
87 c	Kontrolle		
87 d	Abnahme		
88 a	<u>Sonderfertigung L I</u> (Fertigungsmeldungen)		
88 b	<u>Sonderfertigung L II</u> (Fertigungsmeldungen)		
88 c	<u>Sonderfertigung H</u> (Fertigungsmeldungen)		
89	<u>Sonderprogramme</u> (Planungen und Ausführungen)		

Document 132: continued.

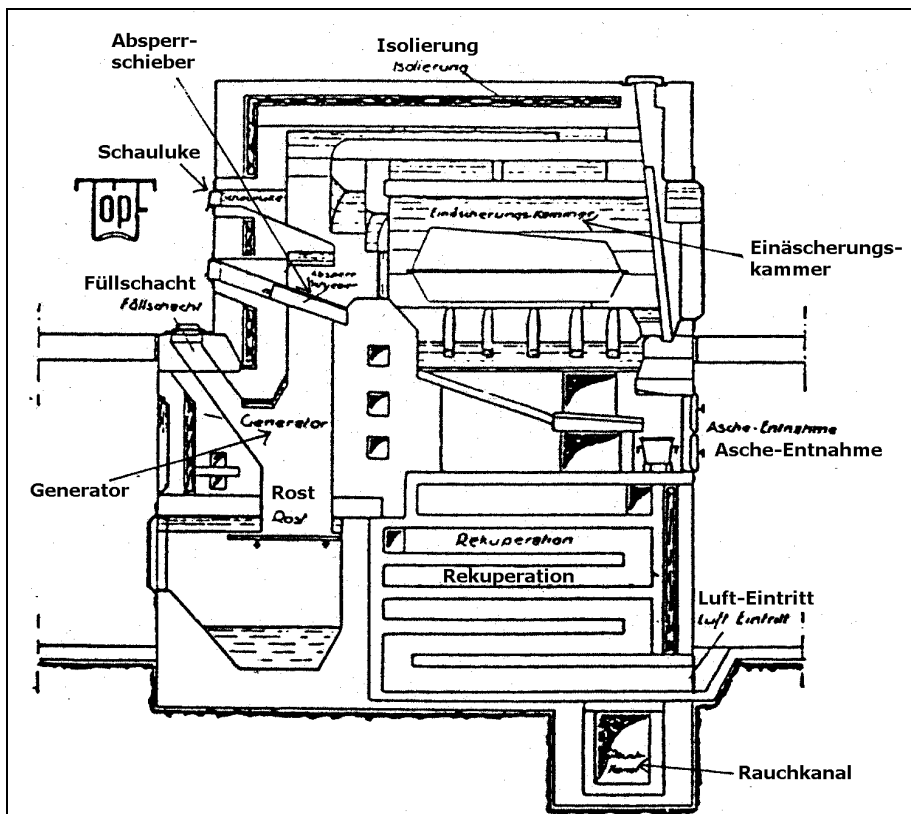

Document 133: TOPF coke-fired cremation furnace (early 1920s). Source: B. Reichenwallner, *Tod und Bestattung. Katakomben-Verlag/B. Reichenwallner, Munich, 1926, p. 27.*

Isolierung: thermal insulation; Schauluke: inspection hole; Einäscherungskammer: cremation chamber; Absperrschieber: damper closing duct from gasifier to cremation chamber; Füllschacht: coke-loading shaft; Generator: gas generator/gasifier; Asche-Entnahme: ash-extraction door; Rost: gasifier grate; Rekuperation: recuperator; Luft-Eintritt: air access to the recuperator; Rauchkanal: smoke duct.

ÖFEN FÜR KREMATORIEN

System Topf



Krematorium Halle a. d. Saale



J.A.TOPF & SOEHNE
ERFURT

Maschinenfabrik und feuerungstechnisches Baugeschäft

Document 134: "Furnaces for Crematoria System TOPF". Promotional brochure of 1926.



Der Feuerbestattungssofen System „Topf“ ist das Ergebnis nahezu fünfzigjähriger Erfahrungen auf feuerungstechnischem Gebiet und ist sowohl für direkte als auch indirekte Einäscherung geeignet. Der Ofen besteht aus dem Koksgenerator mit Umleitung der Kohlenoxydgase, dem für sich abgeschlossenen Einäscherungsraum (Muffel) und dem darunter angeordneten Kanalsystem (Rekuperator), welches für die Vorwärmung der für die Einäscherung erforderlichen Luft dient (siehe Abb. 2). Diese vorgewärmte Luft kommt mit den Rauchgasen nicht in Berührung, denn die Luftkanäle sind von den Rauchkanälen vollkommen getrennt, sodaß also die Einäscherung bei indirektem Betrieb tatsächlich mit reiner atmosphärischer Luft, welche nur auf dem Wege zur Muffel hochgradig erhitzt wird, erfolgt.



Abbildung 1. Krematorium Erfurt, Einsegnungshalle
Ausfahren des Sarges in Höhe des Einführfußbodens (ohne Versenkung)

Zwischen dem inneren und äußeren Ziegelmauerwerk wird über die ganze Länge und Höhe des Ofens eine starke Isolierschicht aus Kieselgursteinen angeordnet, durch welche die Wärmeausstrahlung auf ein Mindestmaß beschränkt wird. Bei der Durchbildung unserer neuesten Konstruktion haben wir gerade in dieser Hinsicht unsere wärmewirtschaftlichen Erfahrungen entsprechend verwertet. Die sich hieraus ergebenden Vorteile kommen hauptsächlich dann zur Geltung, wenn ein Ofen nicht täglich benutzt wird. Die Kieselgur-Isolierschicht hält den Ofen noch lange Zeit warm und bei Wiederinbetriebsetzung wird entsprechend weniger Heizmaterial benötigt. Außerdem verkürzt sich auch die Hochbeizungsdauer ganz bedeutend.

Das Außenmauerwerk des Ofens wird nach dem bewährten Topfschen Bogensystem ausgeführt und zwar in der Weise, daß das Mauerwerk in Form stehender Gewölbe zwischen kräftigen Winkel- und J-Eisen-Trägern eingespannt wird. Diese Bauart gewährleistet eine sehr lange Lebensdauer und vermeidet Rissebildungen, die sonst infolge der hohen Temperaturen leicht auftreten würden. Die Armaturen werden aus feuerbeständigem Guß hergestellt.

In den letzten Jahren haben wir für eine ganze Reihe kleinerer Städte Feuerbestattungsanlagen im Anschluß an bereits vorhandene Einsegnungshallen oder dergl. errichtet. Diese Anordnung, bei der in den meisten Fällen auch keine Versenkungsvorrichtung notwendig ist, gibt allen den Städten, die die Errichtung eines besonderen Krematoriums aus finanziellen Gründen immer wieder zurückstellen mußten, nunmehr die Möglichkeit, sich eine Einäscherungsanlage mit verhältnismäßig geringen Mitteln zu schaffen. Nach diesem Prinzip sind die Krematorien in:

Erfurt (siehe Abb. 1)
 Grünberg
 Guben
 Höchst a. M.
 Jlmeneau
 Magdeburg
 Suhl (siehe Abb. 3—5)

gebaut worden.



Abbildung 2. Längsschnitt durch den Ofen

Neuerdings ordnen wir zur Ausnutzung der Abgase Lufterhitzer an; das sind Apparate, die in den Fuchs kurz vor dem Schornstein eingebaut werden. Sie bestehen aus einem Wärmeaustauschkörper mit einer großen Anzahl sogenannter Taschen, in denen Rauchgase und Luft separat zirkulieren, ein davor geschalteter Ventilator saugt Frischluft an und drückt dieselbe durch die Lufttaschen. Durch die danebenliegenden Taschen werden die Rauchgase geleitet, die Luft wird auf diese Weise erwärmt und kann in Rohrleitungen nach der Einsegnungshalle geführt werden und dient gleichzeitig zur Heizung der Letzteren. Hierdurch wird eine besondere Zentralheizungsanlage überflüssig. Abgesehen davon, daß sich die Anschaffungskosten viel niedriger als diejenigen eines besonderen Heizkessels stellen, entstehen durch den kleinen Ventilator so verschwindend geringe Betriebskosten, daß die Heizung fast kostenlos möglich ist.



Abbildung 6. Krematorium Hannover

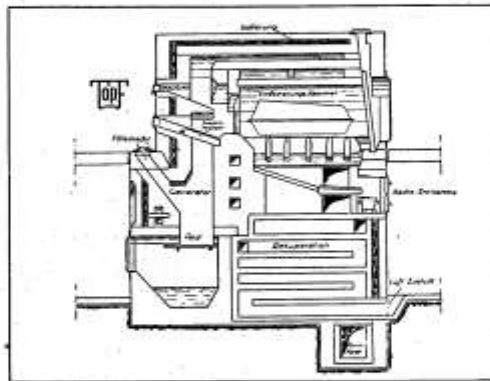

1926

im Bau befindliche Krematorien mit Topf-schen Einäscherungsöfen sowie der dazu-gehörigen maschinellen Anlagen:

Wilhelmshafen	1 Ofen
Gießen	1 Ofen
Moskau	2 Öfen

Seit 1922 haben wir also 28 Öfen ausgeführt bezw. in Auftrag erhalten, eine bisher unübertroffene Leistung.



Abbildung 7. Krematorium Hannover
Haupteinsegnungshalle

TOP



Abbildung 8



Abbildung 9

TOP

Die Abbildungen 8 und 9 stellen die Friedhofskirche des Donakoji-Friedhofes in Moskau dar, in die z. Zt. von uns

2 Feuerbestattungsöfen

eingebaut werden.

TOP



Der Stadtdirektor
Arnstadt i. Th.
 Abteilung IV.

Arnstadt, den 10. Februar 1925.

Firma J. A. Topf & Soehne, Erfurt.
 Am 1. Oktober 1924 ist der von der Firma J. A. Topf & Soehne in Erfurt ausgeführte Einäscherungsapparat übergeben und in Betrieb genommen worden. Bis heute haben 57 Einäscherungen stattgefunden. Die Einäscherungen finden unregelmäßig statt, deshalb ist die Hochheizungsdauer und der Kokerverbrauch für die einzelnen Verbrennungen nicht gleichmäßig. Als Heizmaterial findet Gaskoks Verwendung. Die Hochheizung des Ofens erfolgt in 2-2½ Stunden.
 Wenn Anzeichen bis zur Hochglut und reuelosen Verbrennung ist folgender Kokerverbrauch festgestellt worden:

Bei Einäscherung eines Leichnams 169-260 kg ^{1 stochl. Hochglut}
 von 2 Leichen an einem Tage 234-314 kg ^{1 stochl. Hochglut}
 Die Einäscherungen erfolgen rasch und geräuschlos in einem Zeitraum von ½ bis 1½ Stunde für jede Leiche. Der 180 m hohe, von der Firma J. A. Topf & Soehne erbaute Schornstein gibt zu Einwirkungen keinerlei Veranlassung. Dasselbe gilt von der Veranzugsverrichtung, die gleichfalls von der Firma hergestellt ist.
 In Verbindung mit dem Kanal für die Abführung der Gase von Einäscherungsöfen nach dem Schornstein ist von der Fa. J. A. Topf & Soehne eine Lutterhörsanlage für die Behälter der Friedhöfkapelle eingeholt worden. Die Lufttemperatur an den Austrittsöffnungen in der Kapelle beträgt durchschnittlich 50° C. Bei Einäscherungen ist die Kapelle ohne jeden Aufwand für Brennstoffe in kurzer Zeit erwärmt.

Das Friedhofamt.
 gez.: Unterschrift.

Garten- und Friedhofamt
 der Stadt Erfurt.

Erfurt, 25. Juni 1925.

Firma J. A. Topf & Soehne, Erfurt.
 Am 11. April 1923 wurde die von der Firma J. A. Topf & Soehne ausgeführte Einäscherungsanlage mit zwei Öfen in Betrieb genommen. In dieser Zeit bis zum heutigen Tage sind in ganzen 700 Einäscherungen erfolgt.
 Nach zweijähriger Benutzung der Öfen sind Betriebsleistungen bislang nicht aufgetreten.
 Infolge der besonderen Bauart der Öfen und ihrer guten Isolierung sind sehr geringe Temperaturschwankungen zu verzeichnen, was auf die Haltbarkeit des Mauerwerkes von großem Einfluß ist. Schäden irgendwelcher Art sind bis jetzt nicht festgestellt worden. Die außerordentlich einfache Bedienung der Öfen verdient hervorgehoben zu werden.
 Leider sind die Verbrennungsöfen noch nicht täglich in Benutzung. Infolgedessen ist die Menge an Verbrennungsmaterialien für eine Leiche noch nicht gänzlich feststehend.

Nach den gemachten Aufzeichnungen ist bislang unter Verwendung von Gaskoks, gerechnet vom Anzeichen bis zur Hochglut, reuelose Verbrennung und Herausnahme der Asche, unter Berücksichtigung daß die Öfen nicht täglich geheizt werden, ein Verbrauch festgestellt:

- | | | | |
|----|---|-----|---|
| 1. | Bei Einäscherungen von 1 Leiche an einem Tage 3½ Ztr. Gaskoks | 5 | " |
| 2. | " " " " " " " " " " " " | 7½ | " |
| 3. | " " " " " " " " " " " " | 9 | " |
| 4. | " " " " " " " " " " " " | 10½ | " |
| 5. | " " " " " " " " " " " " | 10½ | " |
| 6. | " " " " " " " " " " " " | 10½ | " |
| 7. | " " " " " " " " " " " " | 10½ | " |

Die Einrichtung des Typischen Systems gestattet es, daß die Einäscherungen vollständig rasch und geräuschlos erfolgen.
 Die Höchstleistung einer Einäscherung beträgt 1½ Stunde.
 Das städtische Garten- u. Friedhofamt
 gez.: Unterschrift.

Der Stadtdirektor
 der Landeshauptstadt (Baumst.)

Weimar, 30. Mai 1925.

Firma J. A. Topf & Soehne, Erfurt.
 Auf Ihre Ansuchen vom 22. d. Mts. teilen wir Ihnen mit, daß der von Ihnen in hiesigen Krematorium erbaute Einäscherungsapparat bis jetzt gut bewahrt. Die Einäscherungen finden, um den Betrieb wirtschaftlicher zu gestalten, bei Dienstaufg. und Freitage statt. Die Hochheizungsdauer beträgt 2-3 Stunden, die Zeit einer Einäscherung 1-1½ Stunde. Zu den letzten 24 Einäscherungen wurden im Durchschnitt je 2,7 hl Gaskoks verbraucht (einschl. Hochheizung).

Beigedrohter.
 gez.: Unterschrift.

Verwaltung des
Gertrauden-Friedhofes.

Halla a. d. S., 7. Oktober 1924.

Firma J. A. Topf & Soehne, Erfurt.
 Auf Ihr Schreiben vom 3. d. Mts. bestätigen wir Ihnen gern, daß die im Jahre 1915 von Ihnen erbaute Einäscherungsanlage bisher zu unserer vollsten Zufriedenheit gearbeitet haben. Die Anlage ist am 15. 12. 1915 in Betrieb genommen und sind bis heute in beiden Öfen zusammen 2670 Leichen eingeeäschert. Zur Erzielung einer Temperatur von 1000-1100 Grad Cels. benötigen wir beim vorher kalten Ofen ca. 3½ bis 4 Ztr. Hölzkohle, während zum Hochheizen des in Betrieb befindlichen Ofens nur 1 Ztr. der gleichen Brennstoffe benötigt werden. Die Leichendauer der Einäscherung richtet sich nach der Körpergröße des Verstorbenen und Beschaffenheit des Sarges, sie beträgt hier ½ bis 1½ Stunde.
 gez.: Unterschrift.

Städtische Betriebswerke.
 Heizungs- u. Maschinenwesen.

Hannover, 10. Oktober 1924.

Firma J. A. Topf & Soehne, Erfurt.
 Auf Ihr Schreiben vom 3. d. Mts. teilen wir Ihnen mit, daß der Betrieb sich in unserem Krematorium noch nicht so entwickelt hat, um über die Verbrennungsöfen ein Zeugnis ausstellen zu können, wie es für Sie erwünscht ist. Wir können vorläufig nur bestätigen, daß wir mit den geleierten Öfen zufrieden sind und nach den bisher vorgenommenen 300 Verbrennungen keine wesentlichen Abnutzungen festgestellt haben. Infolge der unregelmäßigen Benützung werden vorläufig für jede Verbrennung noch 100 Kilo Zedernkoks verbraucht. Wir hoffen, daß nach Fertigstellung der ganzen Basisanlage die Benutzung der Öfen eine stärkere werden und damit auch die Brennstoffmenge geringer wird.
 Jedenfalls sind wir mit den Öfen so zufrieden, daß wir auf die schon wiederholt an uns gerichteten Anfragen stets empfehlend Auskunft gegeben haben.
 gez.: Unterschrift.

Der Stadtgemeindevorstand.
 Stadtbauamt.

Ilmenau i. Th., 2. August 1924.

Firma J. A. Topf & Soehne, Erfurt.
 Wunschgemäß bestätigen wir Ihnen gern, daß wir mit der von Ihnen im Jahre 1922 errichteten Ofenanlage in hiesigen Krematorium zufrieden sind. Die Anlage hat sich in bezug auf die Vorschriften der Leichenverbrennung und einer sparsamen Wärmewirtschaft sehr gut bewährt. Eine Geruchbelästigung der Anwohner ist bei sachgemäßer Bedienung des Ofens bis heute noch nicht eingetreten. Trotz teilweiser starker Inanspruchnahme des Ofens haben sich bisher keine Mängel an der Anlage gezeigt.
 gez.: Unterschrift.

Verein für Feuerbestattung e. V.
 Suhl.

Suhl, 30. Oktober 1923.

Firma J. A. Topf & Soehne, Erfurt.
 Wir bestätigen gern, daß wir mit der von Ihrer Firma in unserem Krematorium ausgeführten Anlage in technischer Hinsicht zufrieden sind. Der Ofen arbeitet gut und bedarf eines verhältnismäßig geringen Kokerverbrauchs. Die Arbeitsweise der Saugzuganlage ist vorzüglich und mit dieser verbunden betätigt sich auch der Schornstein besonders befriedigend. Die Ausführung der ganzen Einäscherungsanlage ist in exakter Weise erledigt worden.
 gez.: Unterschrift.

Magistrat
 zu Hirschberg i. Schl.

Hirschberg, 26. Mai 1923.

Firma J. A. Topf & Soehne, Erfurt.
 Auf Ihr Schreiben vom 19. d. Mts. bestätigen wir Ihnen, daß der im Jahre 1914 gelieferte Einäscherungsapparat zur Zufriedenheit arbeitet. Die Bedienung ist bequem und einfach. Die Konstruktion hat sich gut bewährt. Bezüglich der Ausführung haben sich bis jetzt keine Mängel gezeigt.

As Koks werden verbraucht:
 Für die erste Einäscherung 5 Zentner
 " " zweite " 3 " "
 " " dritte " 1 " "
 " " vierte " 1 " "
 Die Einäscherungsdauer beträgt ca. 1½ Stunde. Für die Hochheizung sind 2-3 Stunden erforderlich. Der Generatorschieber wird bei einmaliger Hochheizung geschlossen. Da aber bei Dauerinäscherungen bei jeder weiteren Einäscherung Hochschüttungen erfolgen müssen, muß auch der Generatorschieber geöffnet werden.
 gez.: Unterschrift.

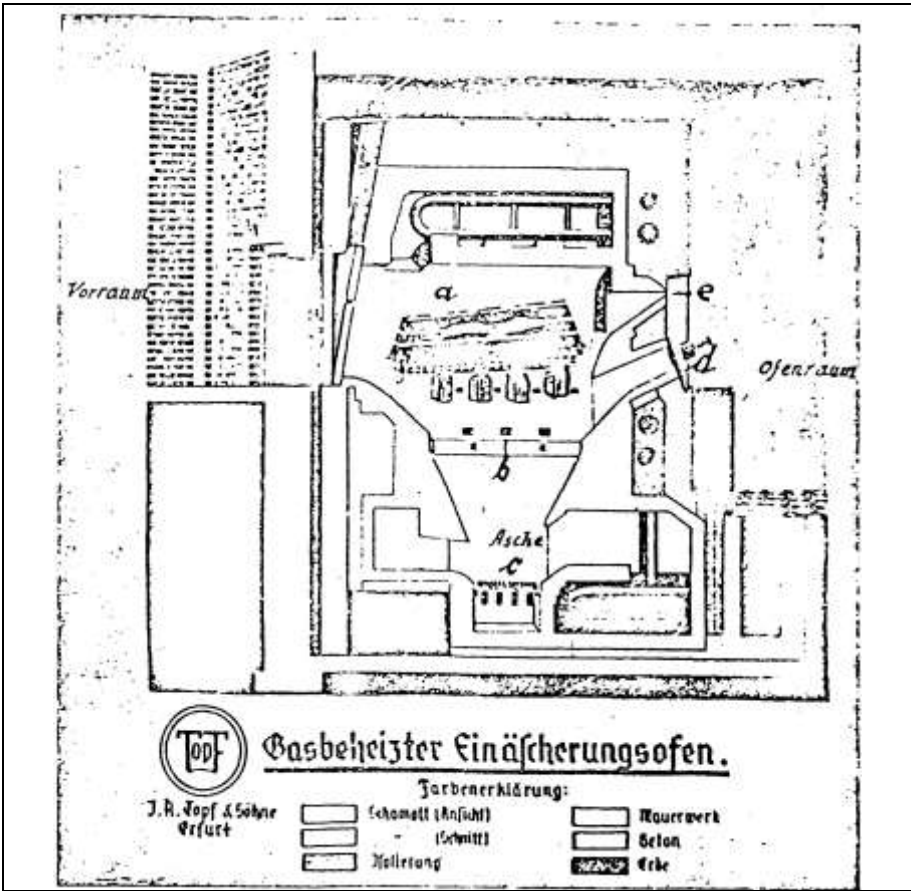

Document 135: TOPF gas-fired cremation furnace, Model 1934. Source: H. Etzbach, *Der technische Vorgang bei einer Feuerbestattung*. Johannes Friese, Cologne, 1935, p. 4.

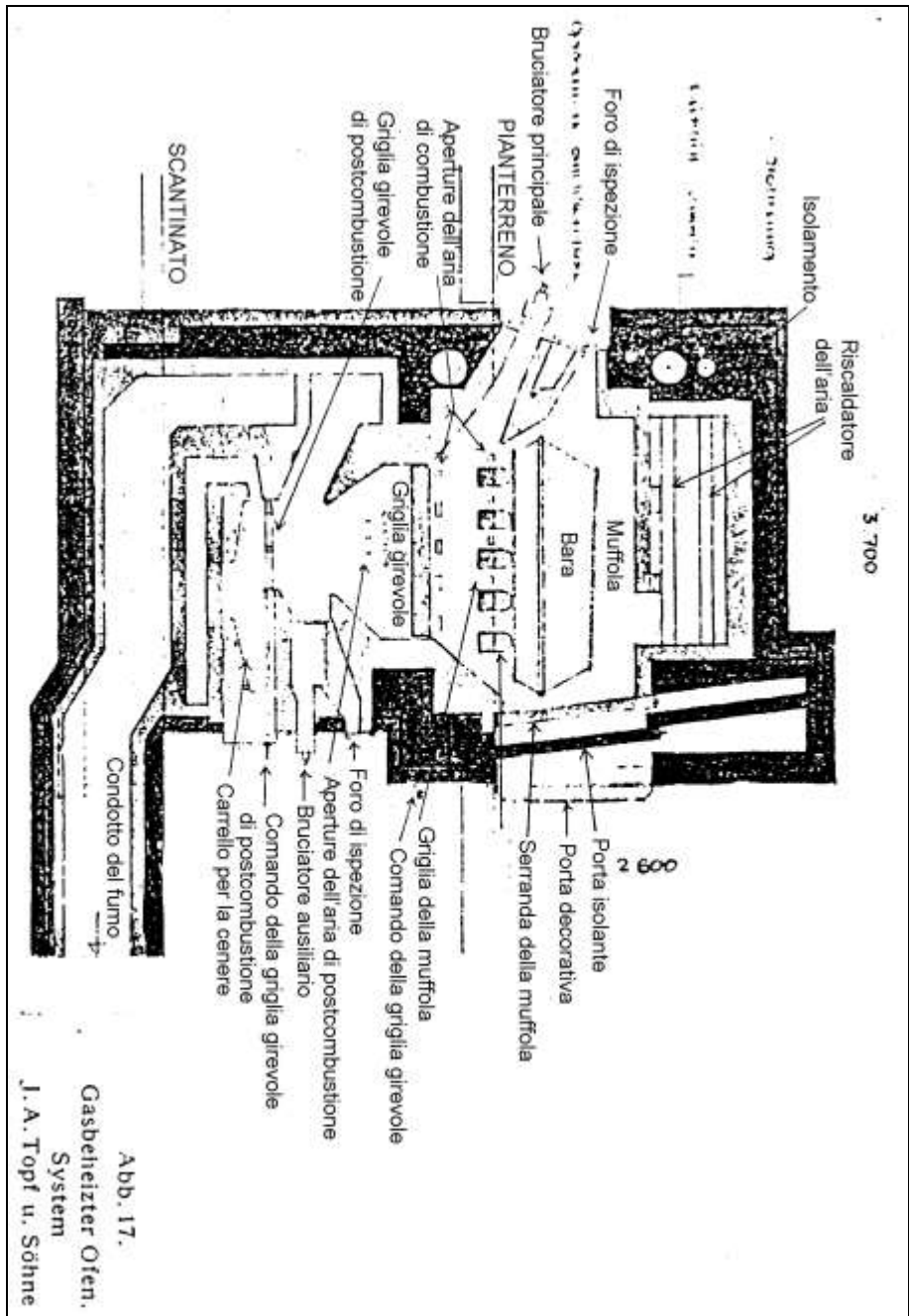

Document 136: "Gas-fired Cremation Furnace System J.A. TOPF & SÖHNE"; new model. Source: F. Schumacher, *Die Feuerbestattung*. J.M. Gebhardt's Verlag, Leipzig, 1929, p. 26.

Fotokopier: 12/49

Magistrat
Der Oberbürgermeister
der Stadt Wiesbaden
Städt. Hochbau- u. Maschinenamt

Der Beauftragte der Stadt Wiesbaden Magistrat Firma A. Topf u. Söhne Landeseigener Betrieb <u>Erfurt</u> Sorberweg	Jernruf: Gemeindefnummer 59561	Postfachkonto: Stadt Wiesbaden Nr. 226 Straßfurt a. M.
--	--------------------------------------	---

Bei Antwortschreiben
bitte Tgl.-Nr. angeben.

Ihr Zeichen	Ihr Schreiben vom	Tage
		19.12.1949

41/3

Betreff Einäscherungsöfen.

*Es wird Ihnen hiermit bestätigt, dass Herr Obering. Klettner den vorgesehenen Umbau des Einäscherungsöfens in 2 1/2 Wochen durchgeführt und hierbei Verbesserungen nach Ihren neuesten Erfahrungen berücksichtigt hat. Herr Klettner hat den Ofen im Betrieb vorgeführt und nach dreitägigem Probebetrieb mit insgesamt 16 Einäscherungen zu unserer vollen Zufriedenheit heute übergeben. Die Leistung des Ofens, insbesondere hinsichtlich des erforderlichen Brennstoffverbrauches, übertraf alle Erwartungen. Am dritten Tage nach Inbetriebnahme wurden bereits Einäscherungszeiten von 40 Minuten erzielt ohne jeglichen Brennstoffverbrauch ausser dem für das Anheizen erforderlichen.

Es steht Ihnen frei, den Ofen Interessenten nach vorheriger rechtzeitiger Anmeldung vorzuführen.

Eine Veröffentlichung vorstehenden Schreibens ohne vorherige diessseitige Genehmigung ist nicht gestattet.

Im Auftrage:
hail

WMA

Document 137: Letter from the municipal administration of Wiesbaden to the Topf Company of 19 December 1949 regarding improvement work done by chief engineer Klettner. Document kindly submitted by J.M. Boisdefeu.

An die Stadtkommandantur, Oberlt. Proskurin 6.4.48 -2-

Ascherungsöfen sind in jedem Falle in Verbindung mit den bestehenden Friedhofsanlagen bzw. Einäscherungshallen eingerichtet worden.

Diese Gesichtspunkte gelten in der heutigen Zeit mehr denn je, was das grosse Interesse aller Stadtverwaltungen an den Einäscherungsöfen beweist.

Bezüglich des Falles Wiesbaden teilen wir Ihnen mit, dass Lieferungen von unserem Werke **n i c h t** erfolgen, die Anlage wird nur nach unserem Plan gebaut. Wir haben im Februar dieses Jahres eine vorläufige Bauzeichnung angefertigt, die aber eine Änderung erfahren hat. Die endgültige Bauzeichnung wird gegenwärtig ausgearbeitet. Irgendwelche Zeichnungen zu diesem Bauvorhaben sind bei uns **n i c h t** in den Betrieb gegeben und ist dieses auch garnicht notwendig, weil unser Erfurter Werk für eine Fabrikation **n i c h t** in Anspruch genommen wird. Alle Lieferungen und Fertigungen sind aus der Westzone vorgesehen. Unsere Leistung bezieht also in diesem Falle in der Ingenieurarbeit. Es liegt ein Bestellschreiben der Stadtverwaltung in Wiesbaden vor, das aber nicht endgültig ist. Von uns aus ist das Geschäft noch nicht verbucht und auch die Auftragsannahme noch nicht schriftlich bestätigt.

Die Bearbeitung dieses Projektes ist bei uns eine rein kommerzielle Angelegenheit, da wir auf Verdienst zur Aufrechterhaltung unserer Firma angewiesen sind und bei Ablehnung unsere Firma mit dem Projekt eine Konkurrenzfirma -wahrscheinlich aus dem Westen - beauftragt würde mit dem Resultat, dass das Geschäft unserer Firma und damit der Ostzone verloren geht.

Den Einäscherungsöfenbau bearbeiten in erster Linie der Techniker Günter Mann unter Leitung von Herrn Ingenieur Hans Streichardt.

Eine Verpflichtung zur Meldung derartiger Aufträge, gleich sie aus der Ost- oder Westzone stammen, oder die Einhaltung

-b.w.-

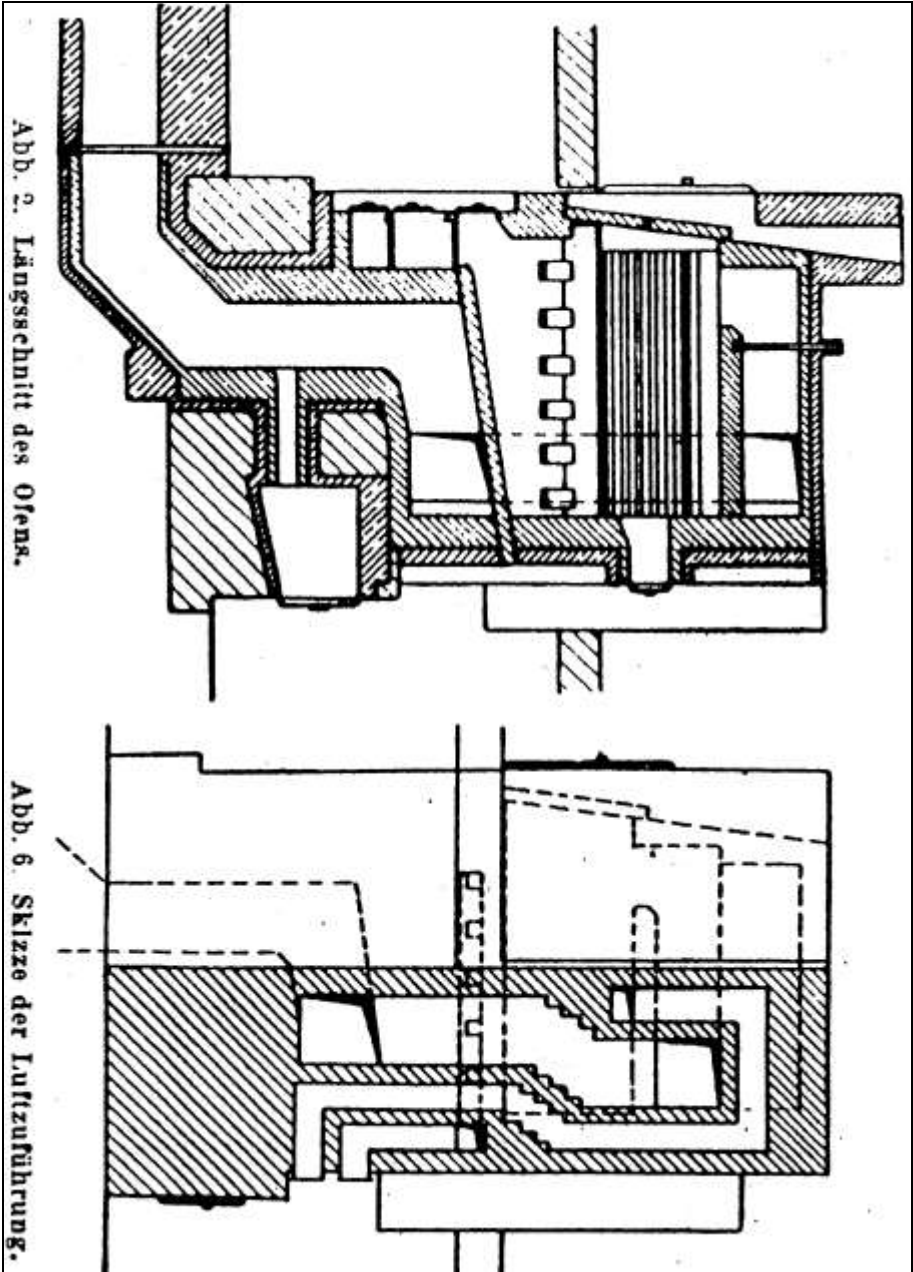

Document 139: TOPF electric cremation furnace as installed at the Erfurt Crematorium in 1933. Fig. 2: longitudinal section. Fig. 6: sketch of the combustion-air channels. Source: K. Weiss, "Der erste deutsche elektrisch beheizte Einäscherungs-ofen im Krematorium Erfurt," in: *Gesundheits-Ingenieur*, 57. Jg., Nr. 37, 1934, pp. 453, 455.

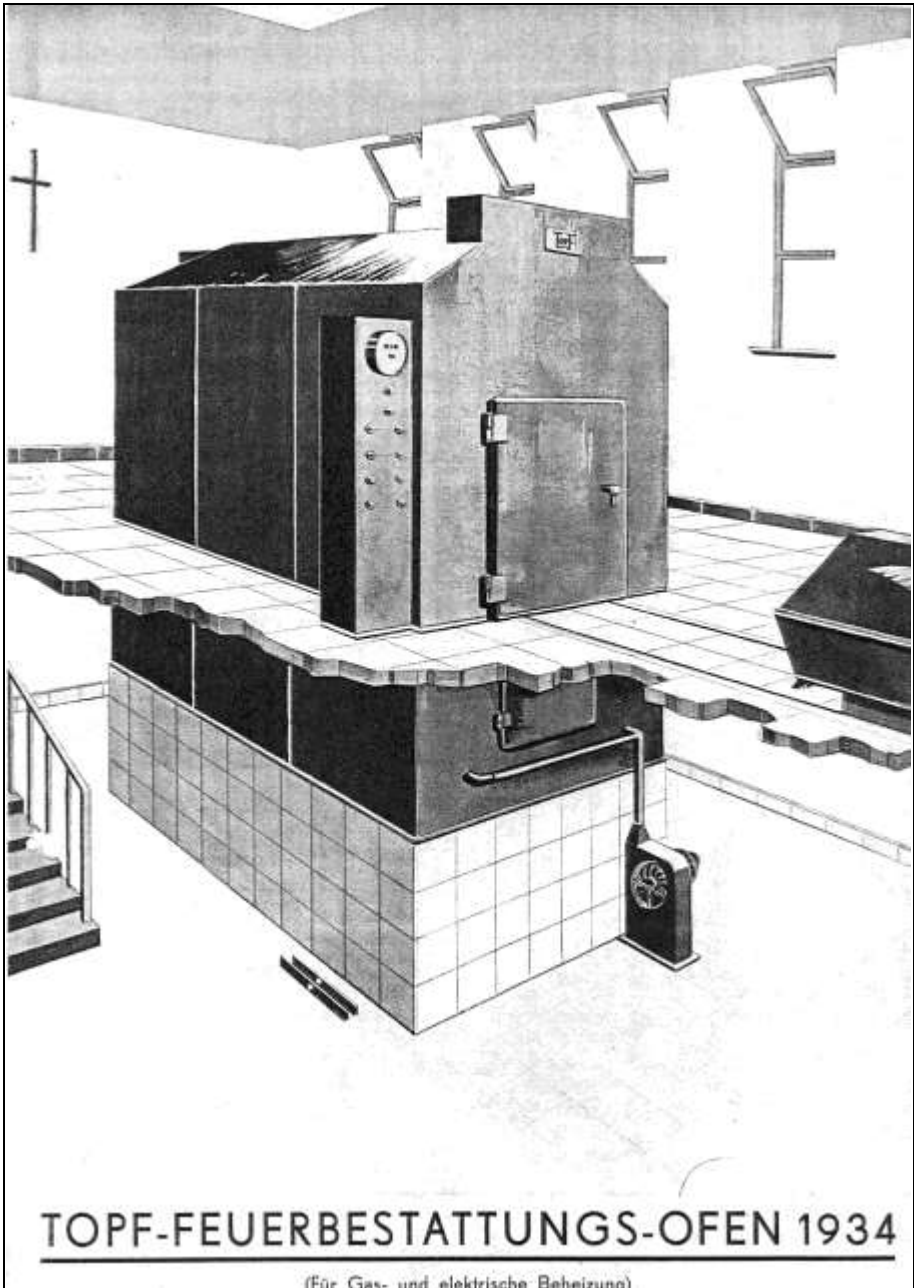

Document 140: First TOPF electric- and gas-fired cremation furnace of 1934.

Source: Stadtarchiv Erfurt, 4/411 A 97.

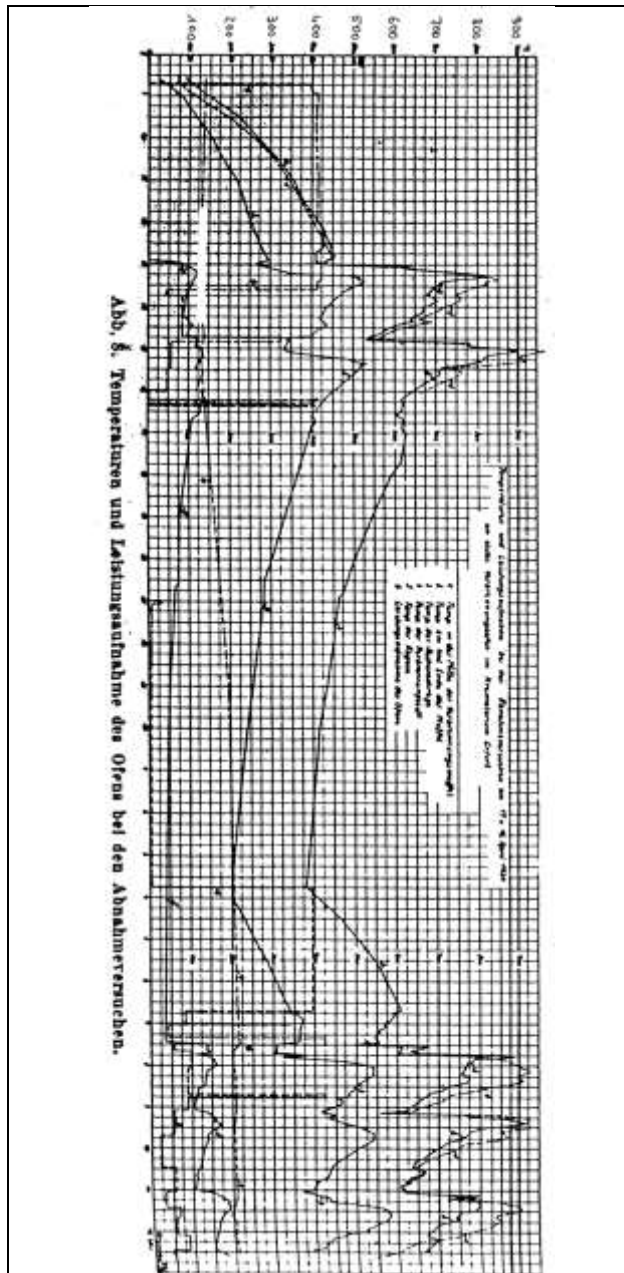

Document 142: Temperature chart for cremations conducted on 17 and 18 April 1934 in the first TOPF electric cremation furnace at the Erfurt Crematorium.

Source: as Doc. 139, p. 456.

Graphs from top to bottom: 1: temperature at the center of the muffle; 2: temperature in the rear portion of the muffle; 3: temperature of the inclined ash plane; 4: temperature of the combustion air; 5: temperature of the flue gases; 6: power consumption.

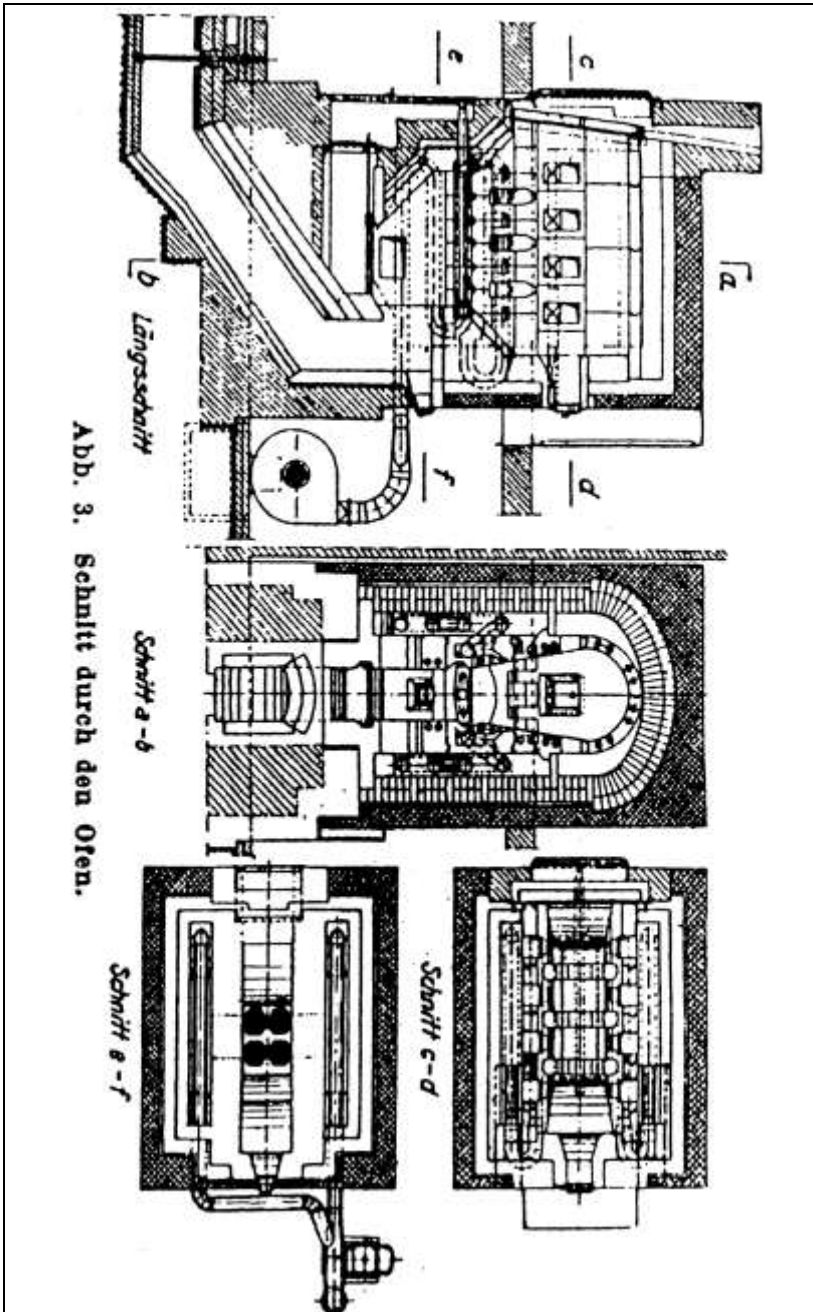

Document 143: Second TOPF electric cremation furnace at the Erfurt Crematorium of 1936. Fig. 1: longitudinal section. Fig. 2: vertical section. Fig. 3: horizontal Section c-d. Fig. 4: horizontal Section e-f. Source: K. Weiss, "Die Entwicklung des elektrisch beheizten Einäscherungsofens im Krematorium Erfurt," in: *Gesundheits-Ingenieur*, 60. Jg., Nr. 11, 1937, p. 159.

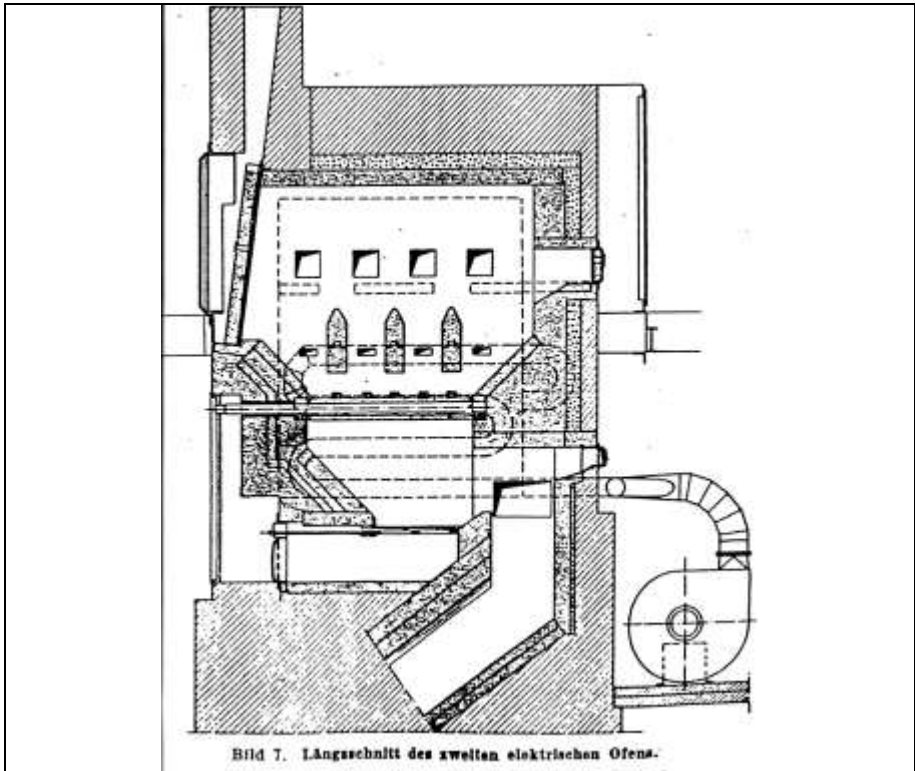

Document 144: as above, longitudinal section. Source: R. Jakobskötter, "Die Entwicklung der elektrischen Einäscherung bis zu dem neuen elektrisch beheizten Heissluft-Einäscherungsöfen in Erfurt," in: Gesundheits-Ingenieur, 64. Jg., Nr. 43, 1941, p. 581.

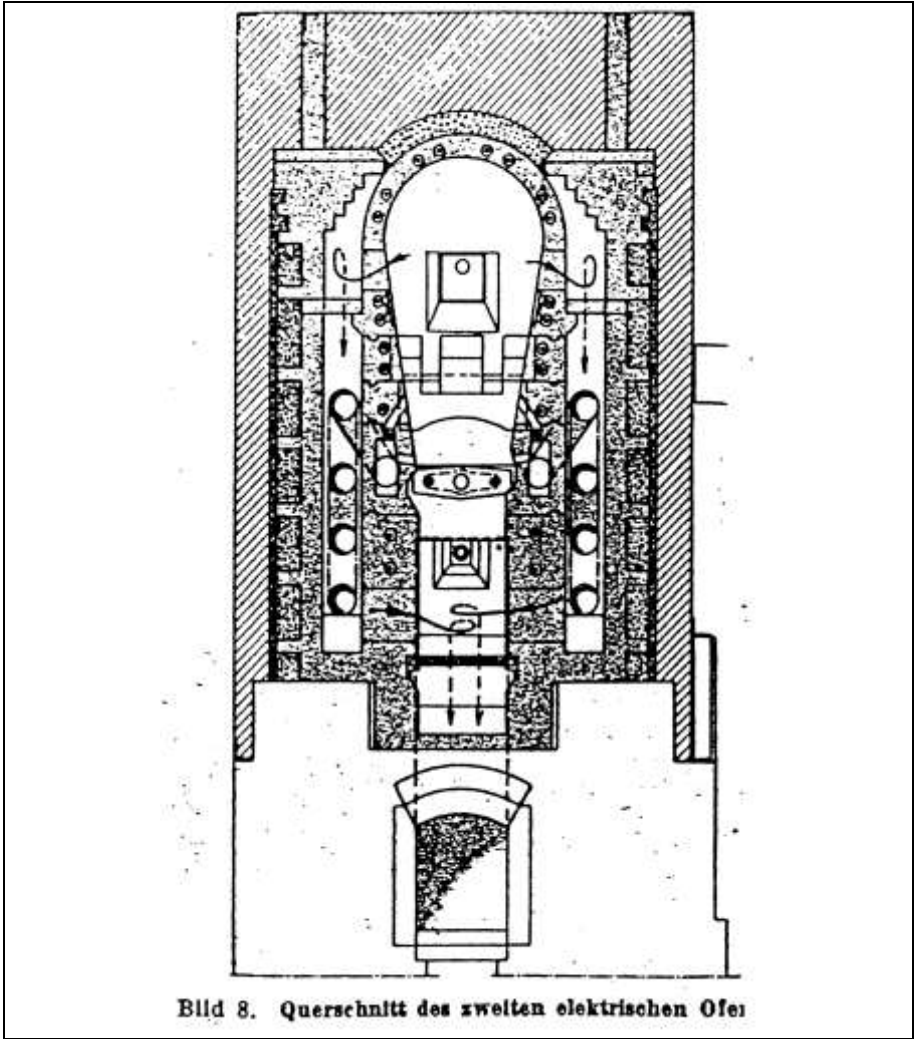

Document 145: as above, vertical section. Source: as Doc. 144, p. 582.



Abb. 5. Temperaturkurven.

Document 146: Temperature curves of two cremations conducted in the second TOPF electric cremation furnace at the Erfurt Crematorium (1936 or 1937). Source: as Doc. 143, p. 160. a: first cremation; b: second cremation. The other curves indicate the temperature of the combustion air and that of the spent gases.



Document 147: Vertical section of the second (and third) TOPF electric cremation furnace at the Erfurt Crematorium. Source: as Doc. 144, p. 583.

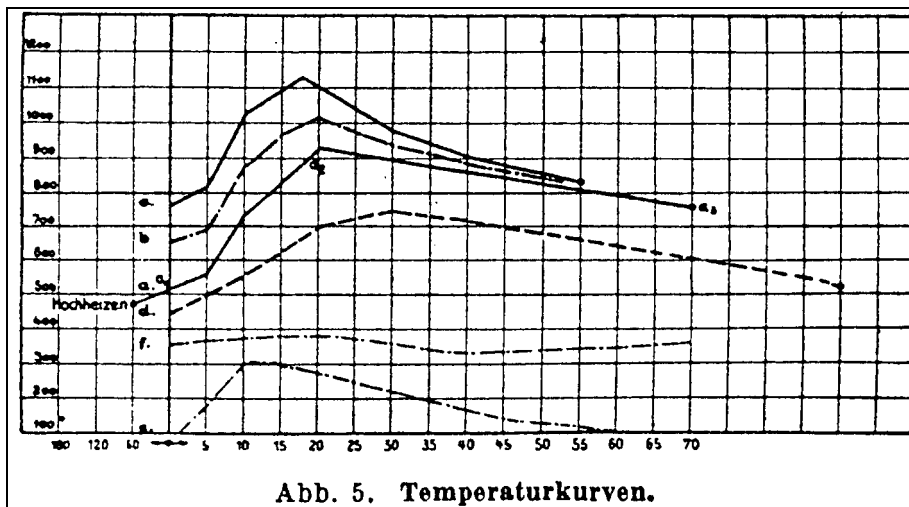
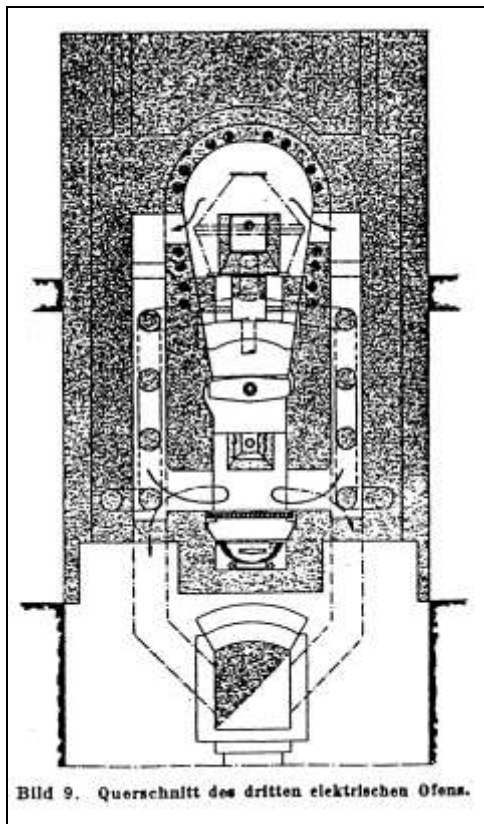

Bild 14. Zeitlicher Verlauf, Zug und Wärmegrade von 3 hintereinander folgenden Einäscherungen.

Document 148: Charts of three cremations conducted in the third TOPF electric cremation furnace at the Erfurt Crematorium of 1939.

Source: as Doc. 144, p. 586.

In the upper chart, the vertical axis shows the draft in mm water column; the curves depict the course of the cremations. Letter a indicates the beginning of the cremation, b the end of the combustion of the coffin, and c the end of the combustion of the solid parts of the corpse. The temperatures shown at the top are those at the beginning of each cremation.

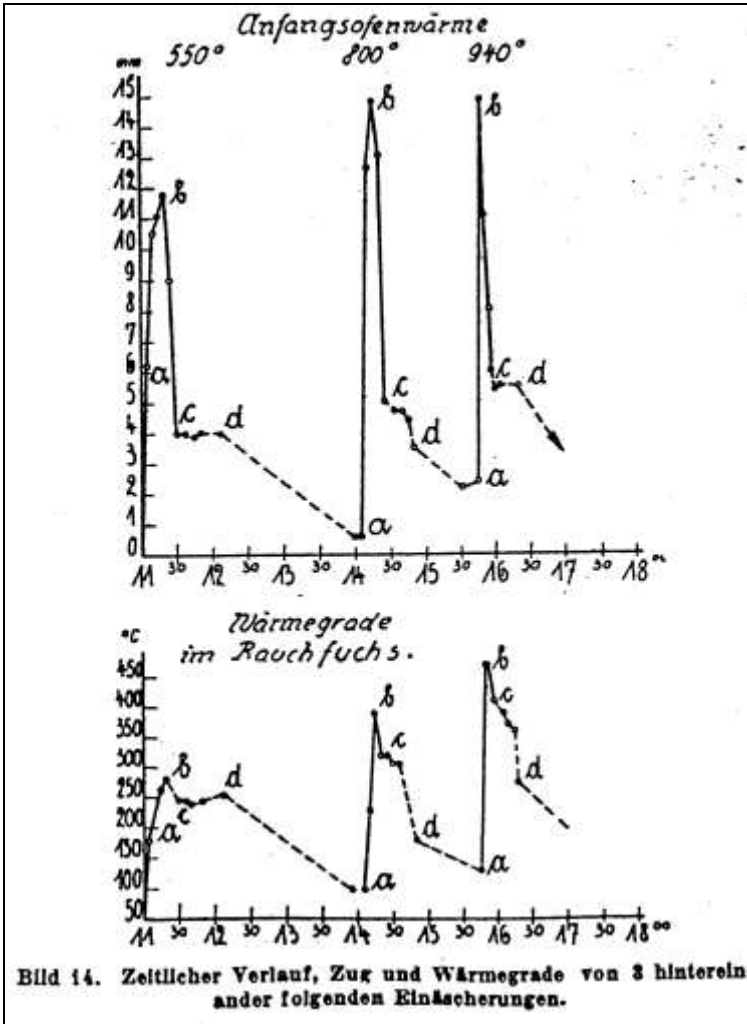
The lower chart refers to the temperature of the spent gases in the flue-gas channel.

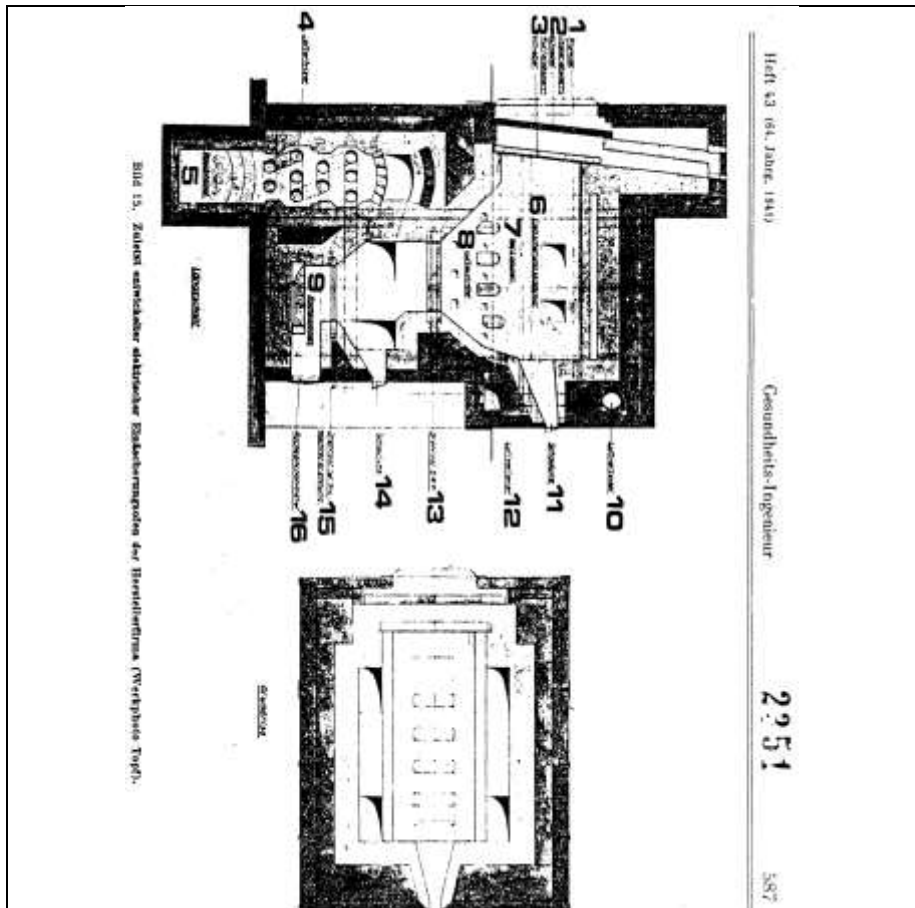

Document 149: TOPF electric cremation furnace. Standard model of the late 1930s.

Source: as Doc. 144, p. 587.

1. Prunktür: decorative muffle door; 2. Isolierabsperrierschieber: insulating closing slider; 3. Muffelabsperrierschieber: muffle's closing damper; 4. Lufterhitzer: air heater; 5. Rauchkanal: smoke duct; 6. Einäscherungskammer: cremation chamber; 7. Heizspulen: heating coils; 8. Lufteintritte: openings of combustion-air channels; 9. Aschewagen: ash cart; 10. Luftverteiler: combustion-air distributor; 11. Schauluke: inspection hole; 12. Luftverteiler: combustion-air distributor; 13. Drehrost DRP: patented tiltable grate; 14. Schauluke: inspection hole; 15. Drehrost für die Nachverbrennung: tiltable grate for post-combustion; 16. Ascheentnahmetür: ash-removal door.

DEUTSCHES REICH

Eigentum
des Reichspatentamts



AUSGEBEEN
AM 24. AUGUST 1920

REICHSPATENTAMT
PATENTSCHRIFT

— № 324252 —
KLASSE 24 d *Gr. 1*

J. A. Topf & Söhne in Erfurt.

Sargeinführvorrichtung für Verbrennungsöfen mit heb- und senkbarem Fahrge-
stell für den Sargträger.

Patentiert im Deutschen Reiche vom 24. April 1915 ab.

Die Erfindung bezieht sich auf Sargeinführ-
vorrichtungen, bei denen ein heb- und senk-
bares Fahrge-
stell für den zur Einführung in
den Ofen dienenden Sargträger zur Verwendung
5 kommt. Sie bezweckt eine Erhöhung der
Betriebsicherheit derartiger Vorrichtungen
durch Anwendung möglichst einfacher und
sicher wirkender Antriebsmittel, die von einer
einigen Antriebswelle aus bewegt werden
10 können. Diese Mittel sind im wesentlichen
dadurch gekennzeichnet, daß ein entsprechend
der Hin- und Rückfahrt des Sargträgers in
entgegengesetzten Drehrichtungen bewegtes
Antriebsvorgelege einerseits mit einer auf die
15 Fahrge-
stellhebe- und senkvorrichtung unmittel-
bar einwirkenden Zahntrieb-
stange, andererseits
mit einer Zugvorrichtung verbunden ist, die
einen zwischen zwei Anschlüssen des fahr-
baren Sargträgers hin und her bewegten Mitnehmer
30 besitzt. Diese Teile wirken in der Weise
zusammen, daß während der toten Bewegung
des Mitnehmers der Zugvorrichtung zwischen
den Anschlüssen des Sargträgers die Trieb-
stange verschoben und dadurch die Hub- und Senk-
35 vorrichtung betätigt wird, jedoch beim Auf-
treffen des Mitnehmers auf einen der An-
schläge und damit bei beginnender Fahr-
bewegung des Sargträgers die Zahnstange in
ihrer jeweiligen Grenzstellung bis zur Beendi-
40 gung der Fahrtbewegung in Ruhe bleibt. Ferner
sind auf der Vorgelegeachse durch den Sargträ-
ger bewegte Zughebel zum selbsttätigen Öffnen

und Schließen der Ofenschieber während der
Fahrtbewegung angebracht.

Die Zeichnung zeigt in Umrissen ein Aus-
45 führungsbeispiel der Erfindung in Fig. 1 in
der Seitenansicht und in Fig. 2 und 3 in
senkrechten Schnitten nach den Linien X-X
und x-x, (Fig. 1).

Die Hub- und Senkvorrichtung für das
50 Fahrge-
stell besteht aus vier paarweise unter
dem Fahrge-
leis H angebrachten doppelarmigen
Hebeln K, deren feste Drehpunkte K¹ sich
am Aufstellgerüst A befinden. Die kürzeren
Hebelenden tragen das Gleis, während die
45 längeren durch Gelenke C mit der oberen
Achse einer Rollenführung R¹ für die Zahn-
trieb-
stange verbunden sind. Die Rollenfüh-
rung R¹ ist in einem Gerüststrahlen senkrecht
verschiebbar und trägt ein infolge der Hebel-
55 verbindung gleichmäßig auf das Fahrge-
stell einwirkendes Gegengewicht L. Ihre Verschiebung
und das dadurch mittels der Hebelübertragung
bewirkte Heben und Senken des Fahrge-
stells erfolgt durch eine Trieb-
60 stange Q mit einer winkligen Verlängerung S
ausgebildet ist. Letztere wirkt als schiefe
Ebene für die Rollenführung R¹ und veranlaßt
daher beim Verschieben der Stange das Heben
oder Senken des Fahrge-
stells. Die Stange 60
gleitet außerdem an beiden Enden in Grad-
führungen R. Der Antrieb erfolgt in weiter
unten näher beschriebener Weise durch die
von Hand oder mechanisch betriebene Vor-

Document 150: Patent J.A. Topf & Söhne in Erfurt, No. 324252. "Device for the introduction of the coffin for cremation furnaces with support cart that can be raised and lowered." 24 April 1915. Source: Deutsches Patentamt.

gelegewelle *B* mittels einer Punktverzahnung *P* an der die Zugvorrichtung für den fahrbaren Sargträger *F* betätigenden Vorgelege *T*.

Die Zugvorrichtung wird von dem über Rollen *M* und die Trommel *T* geführten nachspannbaren Zugglied *D* gebildet, welches nicht fest mit dem Sargträger *F* verbunden, sondern frei beweglich durch zwei in bestimmtem Abstände voneinander liegende Schlitze *O* am Sargträger hindurchgeführt ist. Die Schlitzflächen wirken gleichzeitig als Anschläge für einen zwischen beiden liegenden, am Seil befestigten Mitnehmer *N* für den Sargträger. Mitnehmer und Anschläge können auch in anderer geeigneter Weise ausgebildet sein. Der Weg, den der Mitnehmer zwischen den beiden Anschlägen zurückzulegen hat, entspricht der Länge der Verschiebung der Triebstange *Q*, *S*.

Das Zusammenwirken der Hub- und Senkvorrichtung mit der Zugvorrichtung für den fahrbaren Sargträger geht durch Vermittelung des Vorgeleges wie folgt vor sich: Während die Triebstange durch den Zahntrieb vorgehoben und infolgedessen unter Senkung der langen Hebelenden *K* das ganze Fahrgestell angehoben wird (siehe die punktierten Stellen in Fig. 1), bewegt sich der Mitnehmer *N* frei zum gegenüberliegenden Anschlag *O* des Sargträgers. Sobald er auf diesen trifft, ist die Verschiebung der Triebstange zu Ende und wird dadurch aufgehoben, daß die Zähne der Vorgeletrommel an jedem Ende der entsprechend lang bemessenen Verzahnung *Q* auf eine lose Zahnfalle *q* treffen, die durch Ausweichen eine Weiterverschiebung der Stange im gleichen Sinne verhindert, dagegen ein Verschieben im jeweiligen entgegengesetzten Sinne gestattet. Nach Stillsetzung der Stange wird der fahrbare Sargträger *F* mit Hilfe des gegen den betreffenden Anschlag wirkenden Mitnehmers *N* in die Ofenöffnung eingefahren und dadurch der Sarg über den Rost der Einäscherungskammer gebracht. Diese Bewegung wird, eben so wie die Rückbewegung, durch Erdanschläge *h* des Gleises *H* begrenzt. Nachdem so der Sargträger eingefahren ist, wird das Vorgelege in entgegengesetzter Richtung gedreht, so daß sich der Mitnehmer *N* wieder frei zum anderen Anschlag *O* zurückbewegt, während gleichzeitig die Triebstange *Q*, *S* zurückverschoben und dadurch unter Hebung der langen Hebelenden *K* das ganze Fahrgestell gesenkt und hierbei der Sarg auf den Rost gesetzt wird. Inzwischen ist der Mitnehmer zum anderen Anschlag zurückgelangt, so daß, unter Stillsetzung der Triebstange in vorangegebener Weise, der Sargträger wieder in die Anfangsstellung zurückgefahren wird.

Auf der Vorgelegewelle ist lose drehbar noch ein Hebel *W* mit Rollen *V* am oberen Ende gelagert. Beim Vorfahren des Sarg-

trägers *F* werden die Hebel *W* zur Seite gedrängt, wobei die Rollen *V* an den unteren Flächen des die Gegengewichte des Sargträgers *F* tragenden Eisengerüsts entlang gleiten (siehe strichpunktierte Stellung in Fig. 1). Der auf diese Weise hervorgerufene Ausschlag der Hebel *W* wird durch Seil- oder Kettenzug auf eine Rolle *Y* übertragen, auf deren Achse *Z* die Seilscheibe *Y* zur Bewegung des unter Gewichtswirkung stehenden Seilzuges für die Ofenschieber sitzt. Durch diese Einrichtung wird bewirkt, daß die Ofenschieber mit Beginn des Sargträgervorschubes schnell geöffnet und sofort nach Wiederausritt des Fahrgestells aus dem Ofen schnell geschlossen werden.

PATENT-ANSPRÜCHE:

1. Sargeinführvorrichtung für Verbrennungsöfen, mit heb- und senkbarem Fahrgestell für den Sargträger, dadurch gekennzeichnet, daß ein entsprechend den Fahrrichtungen des Sargträgers (*F*) bewegtes Antriebsvorgelege (*B*, *T*, *P*) durch eine Zahntriebstange (*Q*, *S*) auf die Hub- und Senkvorrichtung (*R*¹, *C*, *K*) für das Fahrgestell (*H*, *F*) und durch ein, mit einem zwischen Anschlägen (*O*) des Sargträgers (*F*) hin und her bewegten Mitnehmer (*N*) versehenes Zugglied (*D*) auf den Sargträger (*F*) einwirkt, derart, daß während der toten Bewegung des Mitnehmers (*N*) zwischen den Anschlägen (*O*) die Triebstange (*Q*, *S*) verschoben und dadurch die Hub- und Senkvorrichtung (*R*¹, *C*, *K*) in Tätigkeit gesetzt wird, während beim Auftreffen des Mitnehmers (*N*) auf einen der beiden Anschläge (*O*) die Triebstange (*Q*, *S*) in ihrer jeweiligen Grenzstellung bis zur Beendigung der Fahrbewegung ausgeschaltet wird.

2. Ausführungsform nach Anspruch 1, dadurch gekennzeichnet, daß das Vorgelege (*B*, *T*, *P*) einerseits durch Punktverzahnung (*P*) auf eine Zahnstange (*Q*) einwirkt, die mittels einer schrägen Verlängerung (*S*) eine das Fahrgleis (*H*) tragende Knickhebelanordnung (*K*, *C*) zum Heben und Senken des Gleises bewegt und an den Triebenden beweglichen Zahnflanken (*q*) zur Begrenzung ihrer Weiterbewegung in gleicher Richtung besitzt, andererseits mit einer Zugvorrichtung (*T*, *D*) verbunden ist, deren Seil oder Kette (*D*) einen Mitnehmer (*N*) trägt, der sich während der Bewegung der Hubvorrichtung (*R*¹, *C*, *K*) leer zwischen zwei Anschlägen (*O*) des Sargträgers (*F*) bewegt.

3. Ausführungsform nach Anspruch 1 und 2, dadurch gekennzeichnet, daß auf der Vorgelegewelle (*B*) lose drehbar ein

5

oder mehrere Hebel (*W, V*) angebracht sind, die durch eine Zugvorrichtung (*Y, Y'*) mit den Ofenschiebern in Verbindung stehen und durch den Sargträger (*F*) bzw. das Fahrgestell bewegt werden, um während

des Sargeinführens kurz vor Eintritt des Sarges in den Ofen das schnelle Öffnen und gleich nach Wiederaustritt des Sargträgers aus dem Ofen das schnelle Schließen der Schieber selbsttätig zu bewirken.

10

Hierzu 1 Blatt Zeichnungen.

Document 150: continued.

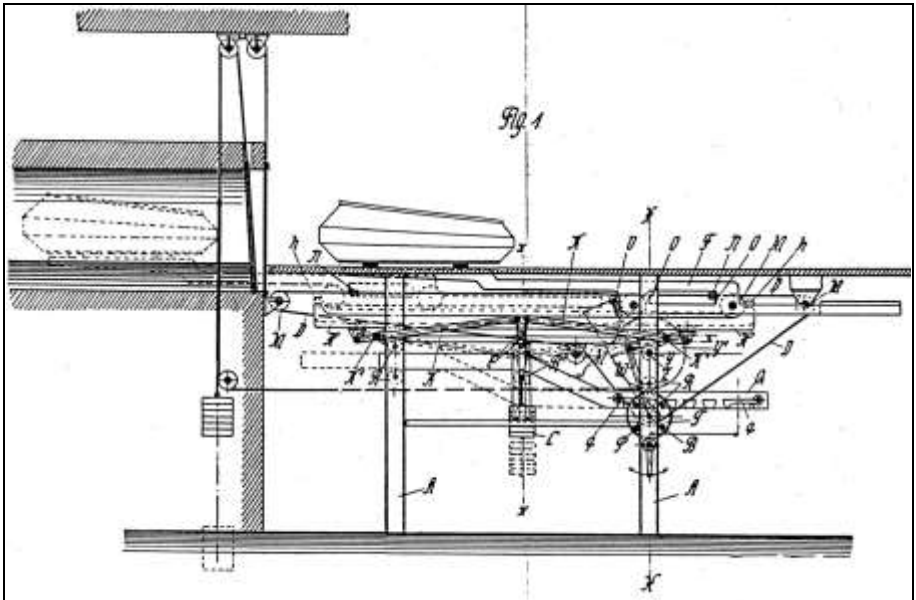

Document 150: continued.

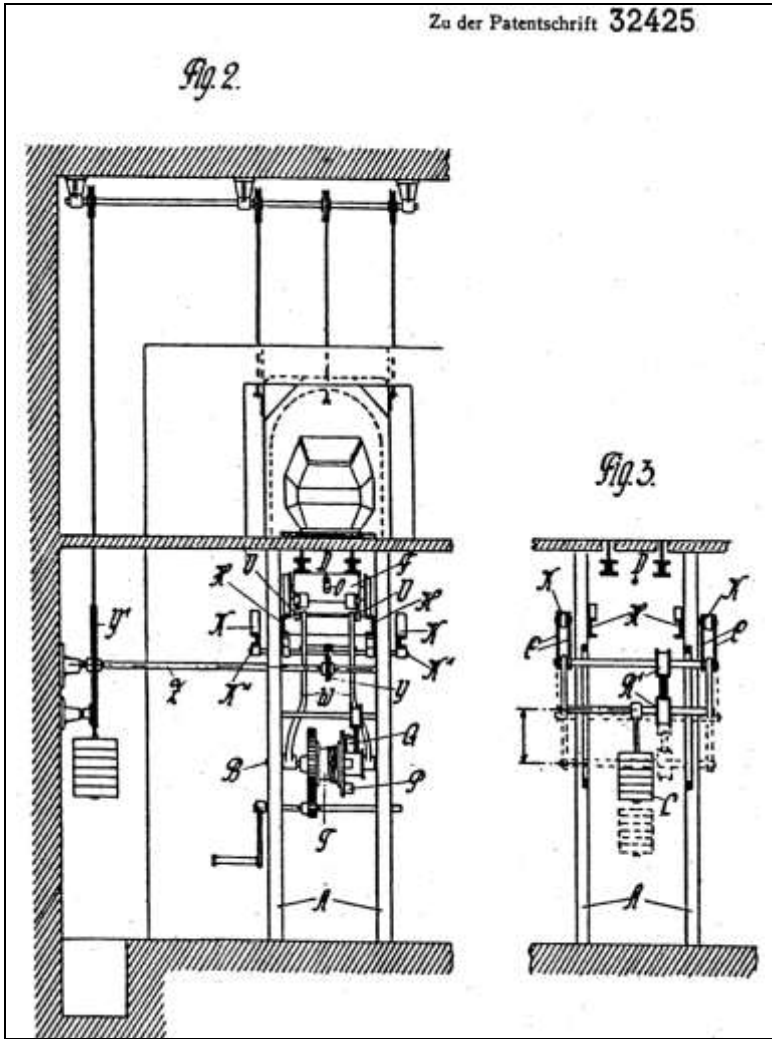

Document 150: continued.



Document 151: Patent J.A. Topf & Söhne in Erfurt, No. 493042. "Device for post-combustion of residues in corpse-cremation furnaces." 13 February 1930. Source: Deutsches Patentamt.

493 042

J. A. Topf & Soehne in Erfurt

Vorrichtung zum Nachverbrennen der Rückstände in Leichenverbrennungsöfen

Patentiert im Deutschen Reiche vom 24. März 1929 ab

Die Erfindung bezieht sich auf eine Vorrichtung zum Nachverbrennen der Rückstände in Leichenverbrennungsöfen, hauptsächlich zu dem Zweck, die mit der Leichenasche sich mischende Holzasche zu verbrennen. Von bekannten Nachverbrennungseinrichtungen unterscheidet sich der Erfindungsgegenstand dadurch, daß der am Ende der geeigneten Sohle des Aschenfalls angeordnete, herausnehmbare 5 Sammelbehälter für die Verbrennungsrückstände mit einem Siebboden versehen und über der Mündung einer regelbaren Verbrennungsluftzuleitung aufgestellt ist. Diese Anordnung besitzt den Vorzug der Einfachheit. Des weiteren ist über dem Sammelbehälter unterhalb der seitlichen Gasabzüge ein den Aschenfall des Ofens gegen den Behälter absperrender gasdurchlässiger Schieber angeordnet, wodurch bei unmittelbar aufeinanderfolgenden Einäscherungen die währenddessen im Sammelbehälter noch der Nachverbrennung ausgesetzten Rückstände von denen der nächsten Einäscherung getrennt gehalten werden können.

Die Zeichnung zeigt schematisch ein Ausführungsbeispiel in Abb. 1 im Längsschnitt durch den Ofen. Abb. 2 ist eine Stirnansicht der zur Nachverbrennung dienenden Vorrichtung.

Am Vorderende des Ofens ist unterhalb des Aschenfalls *f* ein Behälter *a* eingebaut, der mit einem Siebboden *b* und einer unterhalb desselben einmündenden Verbrennungsluftzuleitung *c* versehen ist. Letztere ist durch Klappen *d* o. dgl. regelbar.

Die Verbrennungsrückstände werden kurz vor Beendigung des Einäscherungsvorganges in den Behälter *a* eingeholt und unterliegen

dem dort einer Nachverbrennung, wobei die Abgase durch die seitlichen Abzüge *g* des Ofens entweichen.

Damit in den Behälter *a* nicht zugleich die Rückstände aus zwei aufeinanderfolgenden Einäscherungen gelangen können, ist über dem Behälter *a* unterhalb der Abzüge eine ausziehbare Absperrplatte *e* angebracht, durch die der Behälter gegen den Aschenfall *f* abgeschlossen werden kann. Diese Platte ist gasdurchlässig, z. B. fein gelocht, in der Weise, daß wohl die Nachverbrennungsgase abziehen, aber keine Rückstände aus dem Aschenfall *f* in den Behälter *a* gelangen können. Infolgedessen kann mit einer weiteren Einäscherung begonnen werden, bevor die Nachverbrennung der Rückstände aus der vorhergehenden Einäscherung im Behälter *a* beendet ist.

PATENTANSPRÜCHE:

1. Vorrichtung zum Nachverbrennen der Rückstände in Leichenverbrennungsöfen, dadurch gekennzeichnet, daß der am Ende der geeigneten Sohle des Aschenfalls (*f*) angeordnete, herausnehmbare Sammelbehälter (*a*) mit einem Siebboden (*b*) versehen und über der Mündung einer regelbaren Verbrennungsluftzuleitung (*c*, *d*) aufgestellt ist.
2. Vorrichtung nach Anspruch 1, dadurch gekennzeichnet, daß über dem Sammelbehälter unterhalb der seitlichen Gasabzüge (*g*) ein den Aschenfall des Ofens gegen den Behälter absperrender gasdurchlässiger Schieber (*e*) angeordnet ist.

Hierzu 1 Blatt Zeichnungen

BERLIN. GEDRUCKT IN DER REICHENBERGERSTR.

Document 151: continued.

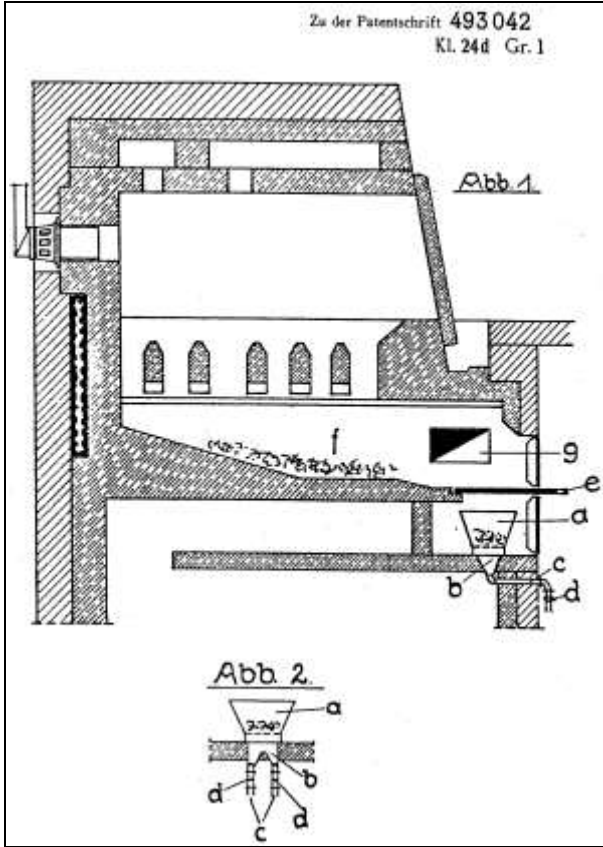

Document 151: continued.

DEUTSCHES REICH



AUSGEGEBEN AM
17. OKTOBER 1932

REICHSPATENTAMT
PATENTSCHRIFT

№ 561 643
KLASSE 24d GRUPPE 1
Q 1735 V/24d

Tag der Bekanntmachung über die Erteilung des Patents: 29. September 1932

~~Viktor Quehl in Gera~~

umgeschrieben auf:
J.A. Topf & Söhne,
Erfurt. 17.5.1934.

Feuerbestattungsöfen mit drehbaren Rosten

*Eigentum
des Reichspatentamts*

Document 152: Patent Viktor Quehl in Gera, No. 561643, transferred to J.A. Topf & Söhne on 17 May 1934. "Cremation furnace with tiltable grates." Source: Deutsches Patentamt.

561 643

Viktor Quehl in Gera

Feuerbestattungsöfen mit drehbaren Rosten

Patentiert im Deutschen Reiche vom 15. April 1931 ab

Bei den bisherigen Feuerbestattungsöfen sind die den Sarg und die einzuäschernden Leichenteile tragenden Ofenteile — der Muffel- und der Aschenrost — als feststehende 5 Ofenteile ausgeführt.

Dies hat den Nachteil, daß die Leichenteile nach ihrer Einäscherung mittels eines Kratzgerätes von diesen Ofenflächen heruntergescharrt werden müssen. Ein derartiges Ein- 10 greifen in den Einäscherungsvorgang entspricht nicht einer würdigen Form der Feuerbestattung. Weiterhin wird beim Einbringen des Kratzgerätes in den Ofen durch das Öffnen von Türen ein beträchtlicher Wärmever- 15 lust durch die einströmende kalte Luft hervorgerufen. Auch treten leicht Beschädigungen des glühenden Mauerwerkes durch die eisernen Kratzgeräte ein.

Nach der Erfindung wird die Anwendung 20 von Kratz- und Schürgeräten dadurch vermieden, daß der den Sarg tragende Muffelrost und der dazugehörige Aschenrost von außen schwenkbar um eine oder mehrere Achsen angeordnet sind, wobei die Roste in mehrere 25 einzeln abschwinkbare Flächen mit beliebiger Achsenanordnung unterteilt sein können.

Es ist dadurch die Möglichkeit gegeben, ohne Zuhilfenahme von Kratz- und Schürgeräten je nach Fortgang der Einäscherung

die verbleibenden Einäscherungsreste von 30 außen ohne Öffnen des Ofens durch einfaches Abschwenken der Flächen ganz oder teilweise von dem Muffelrost und dem Aschenrost zu entfernen.

In der Zeichnung ist ein Ausführungsbei- 35 spiel der Erfindung dargestellt. Es sind bezeichnet mit m der um eine Achse a drehbare Muffelrost, mit b der in einzelne, für sich schwenkbare Flächen f unterteilte Aschenrost, wobei die Flächen f um die Einzelachsen e 40 geschwenkt werden können.

Der Erfindungsgegenstand kann in einzelnen Teilen auch anders ausgebildet sein, solange das Wesen der Erfindung, die drehbare 45 Ausbildung des Muffel- und des Aschenrostes, gewahrt bleibt.

PATENTANSPRÜCHE:

1. Feuerbestattungsöfen mit drehbaren 50 Rosten, dadurch gekennzeichnet, daß der den Sarg und die einzuäschernden Teile tragende Muffelrost und der Aschenrost von außen schwenkbar angeordnet sind.

2. Feuerbestattungsöfen nach Anspruch 1, 55 dadurch gekennzeichnet, daß der Muffelrost und der Aschenrost in mehrere einzeln abschwinkbare Flächen unterteilt sind.

Hierzu 1 Blatt Zeichnungen

Document 152: continued.

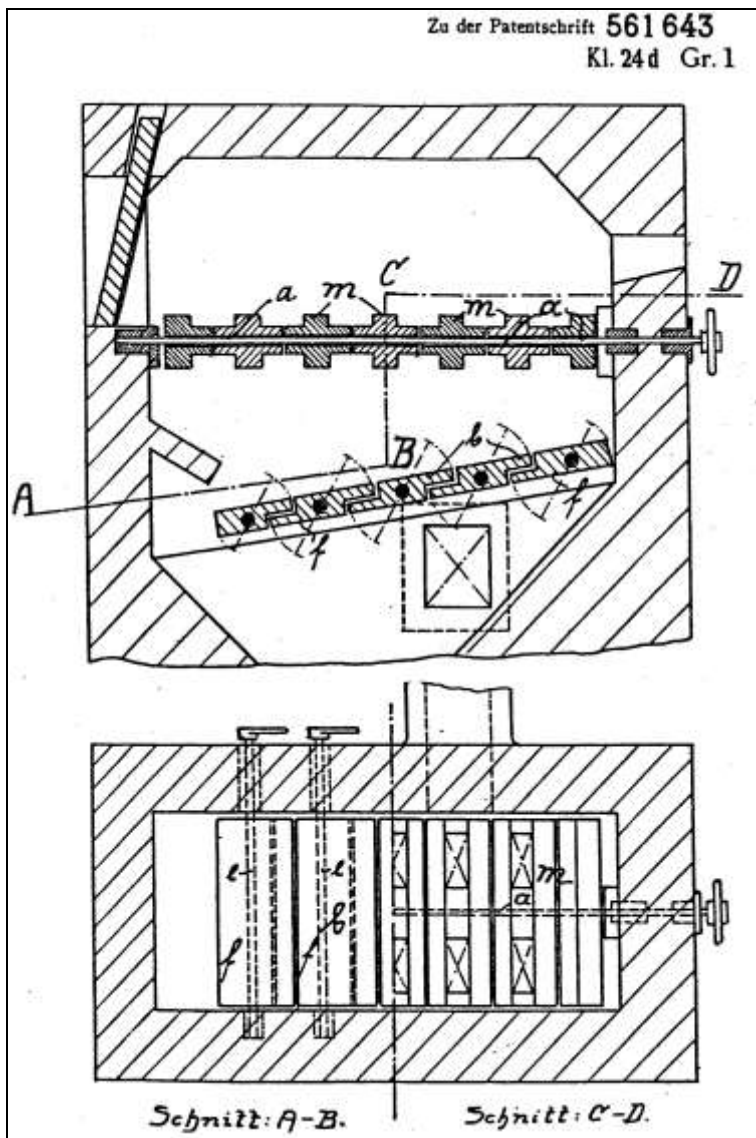

Document 152: continued.

DEUTSCHES REICH



AUSGEGEBEN AM
19. NOVEMBER 1936

REICHSPATENTAMT

PATENTSCHRIFT

№ 638582

KLASSE 24d GRUPPE 1

B 162300 V124d

Tag der Bekanntmachung über die Erteilung des Patents: 29. Oktober 1936

Wilhelm Basse in Hamburg

umgeschrieben auf:
J.A. Topf & Söhne,
Erfurt. 27.11.1937.

Einäscherungsöfen

Patentiert im Deutschen Reiche vom 9. September 1933 ab

Gegenstand der vorliegenden Neuerung ist eine Einrichtung an Einäscherungsöfen, und es soll damit u. a. erreicht werden, daß durch eine besondere Zuführung der Verbrennungsluft die Verbrennung verbessert wird.

Das Zuführen der Luft bei Einäscherungsöfen mit Rost oder geschlossener Grundplatte ist bekanntlich mit Mängeln verbunden, und zwar sind diese Mängel durch die Feuerführung im Einäscherungsraum begründet, die sich aus der konstruktiven Gestaltung der Platte oder des Rostes ergibt. Die Grundplatte hat infolge ihrer Geschlossenheit den Vorteil der Wärmespeicherung. Sie hat aber dabei den großen Nachteil, daß die Verbrennungsluft nicht zu den mittleren Teilen des Verbrennungsgutes gelangen kann, weil der Zerfall desselben nur außen stattfindet, wo der Sauerstoff Zutritt hat. Da der Sarg mit seinen mittleren Teilen fest auf der Grundplatte aufliegt, ist dort die Verbrennung eine unvollkommene bzw. verlangsamte. Diesen Nachteil vermeidet der Rost. Hiermit ist es möglich, die Luft auch zur Mitte des verbrennenden Sarges zu leiten und damit die Einäscherung zu beschleunigen. Aber auch hierbei zeigten sich Nachteile:

1. Weil der Rost offen ist, werden die Strömungsverhältnisse der Heizgase in der Muffel nicht mehr beherrscht.
2. während der Einäscherung der mittleren, schwerer verbrennenden Teile des Einäscherungsgutes strömt weiterhin durch die seitlichen Öffnungen des Rostes nutzlos Luft zu, die den Ofen abkühlt,
3. der Rost hat eine geringe Wärmespeicherfähigkeit.

Man hat indessen auch Ofen mit geschlossener Grundplatte gebaut, bei denen die Zuführung der Verbrennungsluft mittels Düsen geschieht, die von der Seite wie von oben auf den Verbrennungsgegenstand gerichtet sind.

Diese Art der Luftzuführung ist schon erheblich wirksamer, jedoch besteht auch hier der Nachteil, daß der Einäscherungsgegenstand zunächst nur oben und an den Seiten von der Verbrennungsluft umspült wird, die Luftzuführung an der Unterseite des Einäscherungsgegenstandes fehlt dagegen. Gerade an dieser Stelle ist aber die Luftzuführung besonders wirksam, weil die dort entstehenden Flammen um den ganzen Einäscherungsgegenstand herumschlagen und diesen so in Flammen vollkommen einhüllen.

Die Erfindung sieht daher vor, die Verbrennungsluft durch in der Grundplatte angebrachte Düsen zuzuführen. Die Grundplatte ist deshalb mit talförmigen Vertiefungen ausgerüstet, so daß sie eine rostartige Oberfläche erhält. In die Vertiefungen zwischen den Rostbalken münden die Luftdüsen.

Zweckmäßig wird die Bodenplatte aus einzelnen Steinen aufgebaut, die durch ihre Form und in ihrer Gesamtheit der Platte die rostartige Gestalt geben. Zwecks Unterbringung der Preßluftleitungen versieht man die Steine innen mit einer Aushöhlung. Die Luftzuführung zu den Düsen kann so ausgebildet sein, daß jede Düse einzeln regelbar ist. Auch

5

10

15

20

25

30

35

40

45

50

55

60

65

70

Document 153: Patent Wilhelm Basse in Hamburg, No. 638582, transferred to J.A. Topf & Söhne on 27 November 1937. "Incineration furnace." Source: Deutsches Patentamt.

638 582

kann man die Düsen zu diesem Zweck zu Gruppen zusammenfassen.

Bei der Anordnung nach der Erfindung erzeugt die ausströmende Preßluft unter dem Sarg eine kräftige Flammenbildung, wodurch die Rostplatte die stärkste Beheizung erfährt und die Wärme infolge der geschlossenen Ausführung der Bodenplatte gut gespeichert wird. Letzteres ist insofern von Wichtigkeit, als hierdurch die Dauer der nachfolgenden Einäscherungen wesentlich abgekürzt wird.

In der Zeichnung ist ein Ausführungsbeispiel dargestellt.

Fig. 1 ist ein senkrechter Schnitt durch den Ofen, und

Fig. 2 ist eine Draufsicht auf die Grundplatte.

Es bezeichnen darin *a* die die Rostplatte bildenden Steine, *b* den Unterbau der Ofenkonstruktion, *c* die Muffelwände, *d*, *d*₁ die Preßluftleitungen, *e* die dazugehörigen Konusabdichtungen, *f* die in den Steinen ausgesparten Luftkanäle, *g* die zum Ausströmen der Luft bestimmten Düsenlöcher.

In Fig. 2 sind die Steine mit den Ziffern 1 bis 20 bezeichnet.

Die Formsteine sind in der hier gezeigten Ausführungsart zu beiden Seiten dachförmig abgeschragt, so daß hierdurch die rostartige Gestalt der Bodenplatte erzeugt wird. In die talförmigen Vertiefungen zwischen den einzelnen Steinen münden die in letzteren angebrachten Luftdüsen, und zwar sind diese so eingerichtet, daß die ausströmende Luft unmittelbar auf den Verbrennungsgegenstand trifft. Hierin liegt die Erzielung der wirksamsten und zugleich sparsamsten Ausnutzung der Verbrennungsluft. Die Luftdüsen sind überdies zweckmäßig versetzt zueinander angeordnet, so daß die Luftzufuhr zum Brenngut eine vollkommene und gleichmäßige ist.

Die Einrichtung bietet noch den Vorteil, daß infolge der an den schräg liegenden Flächen der Rostplatte befindlichen Mündun-

gen der Düsen einer etwa durch das darüberliegende Brenngut entstehenden Verstopfung vorgebeugt wird. Die Lage der Düsen kommt insofern noch zu statten, als man dieselben bei der Aschenentnahme sämtlich anstellen und damit die feine Flugasche, die dann vom Schornsteinzug angesogen wird, fortblasen kann.

Die in den Steinen befindliche kanalartige Aushöhlung *f* kann sich (Fig. 2) auf die Länge nur eines Steines, wie z. B. bei Stein 6 und 10, erstrecken, jedoch auch zugleich auf mehrere Steine, wie etwa bei Stein 1 und 5 bzw. Stein 13 und 17.

Als Preßluftzuleitung kann in jedem dieser Fälle nur eine einzige Leitung *d*₁ dienen, während natürlich jeder einzelne Stein noch seinen eigenen Anschluß an die Luftzuleitung haben muß.

Die einfach herzustellenden Formsteine können bei etwaiger Ausbesserung, bedingt durch Abbrand oder mechanische Beschädigung (Absetzen des Sarges), leicht einzeln ausgewechselt werden, ohne daß der Verband der Rostplatte dadurch gelockert wird.

PATENTANSPRÜCHE:

1. Einäscherungsöfen mit den Einäscherungsraum unten abschließender Bodenplatte und mit Luftdüsen, die auf den Einäscherungsgegenstand gerichtet sind, dadurch gekennzeichnet, daß die aus Formsteinen (*a*) bestehende Bodenplatte eine rostartige Oberfläche besitzt, und daß in die Vertiefungen zwischen den Rostbalken die Luftdüsen (*g*) münden.
2. Einäscherungsöfen nach Anspruch 1, dadurch gekennzeichnet, daß die Formsteine (*a*) zwecks Unterbringung der Preßluftleitungen (*f*) hohl ausgebildet sind.
3. Einäscherungsöfen nach Anspruch 1 und 2, dadurch gekennzeichnet, daß die Luftdüsen (*g*) einzeln oder gruppenweise regelbar angeordnet sind.

Hierzu 1 Blatt Zeichnungen

Document 153: continued.

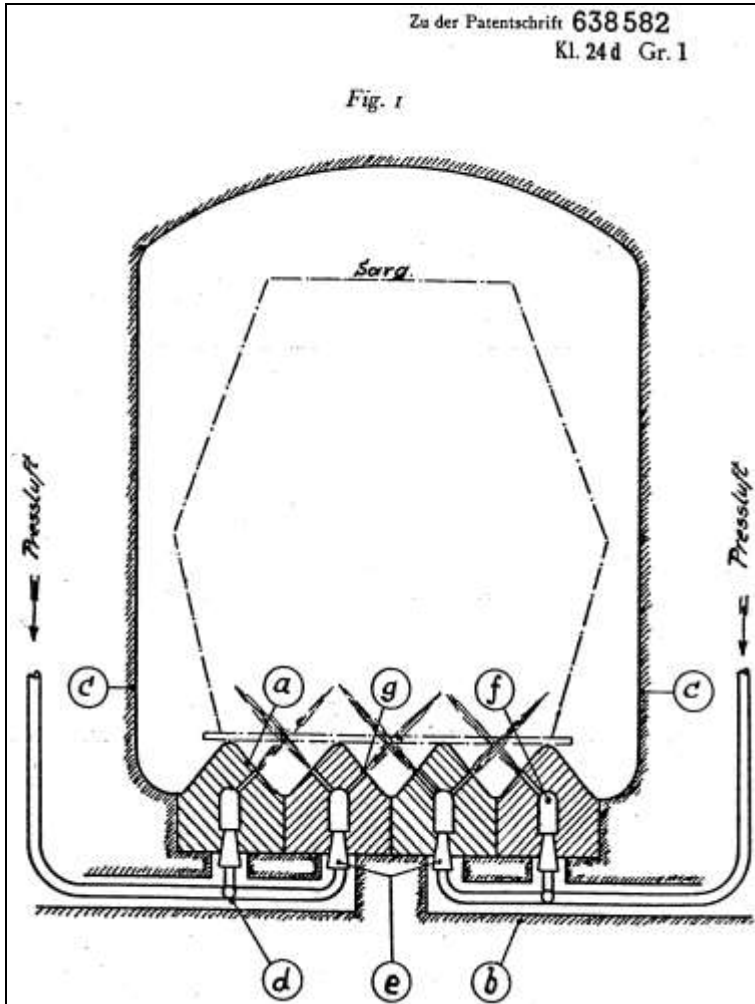

Document 153: continued.

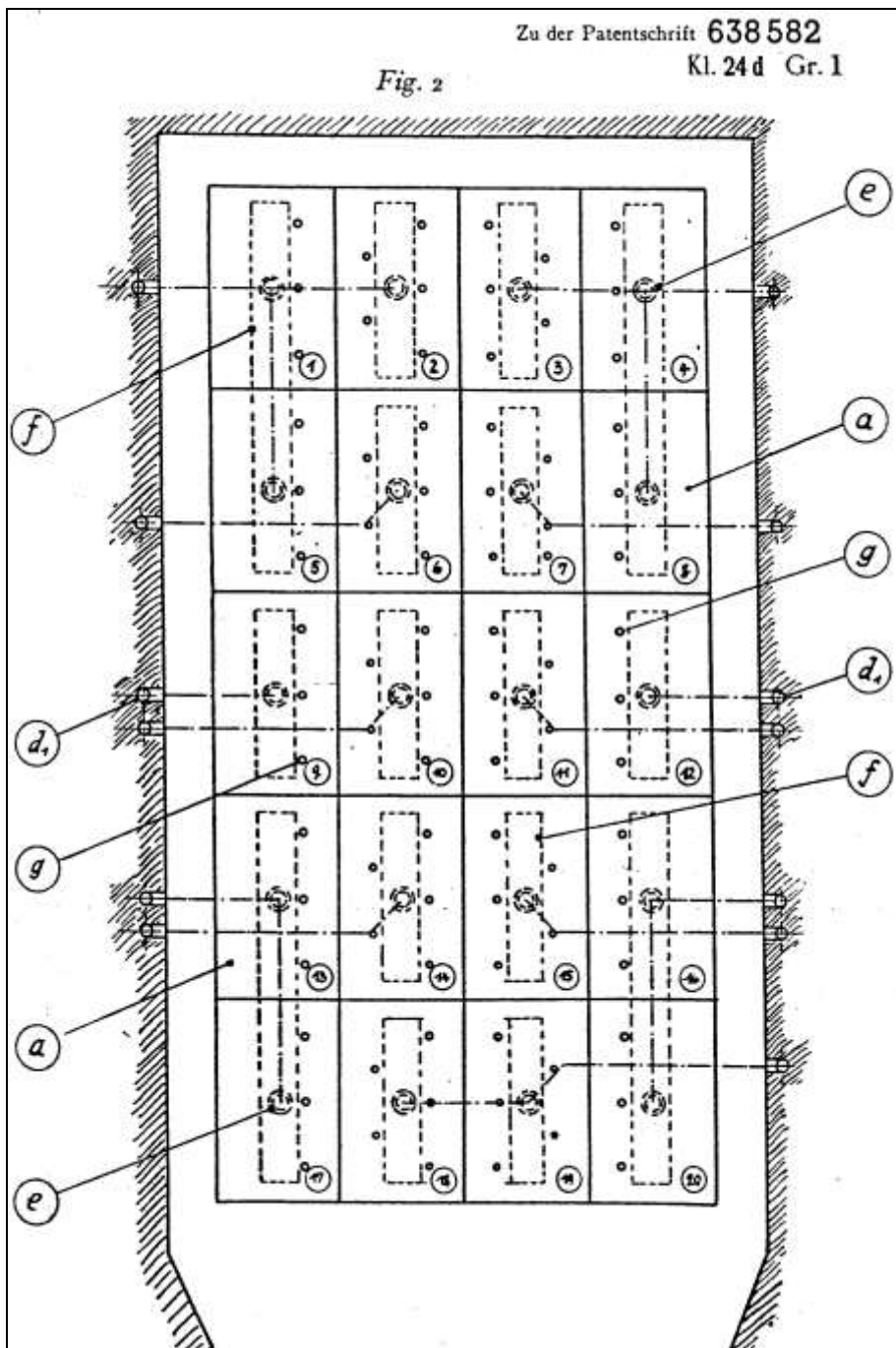

DEUTSCHES REICH



AUSGEGEBEN AM
4. MAI 1938

Eigentum
Reichspatentamt

REICHSPATENTAMT
PATENTSCHRIFT

№ 659405
KLASSE 24d GRUPPE I
T 47769 V/24d

Tag der Bekanntmachung über die Erteilung des Patents: 7. April 1938

* **Hans Geerhardt in Erfurt** *

ist als Erfinder benannt worden.

J. A. Topf & Söhne in Erfurt

Beschickungseinrichtung für Einäscherungsöfen

Document 154: Patent J.A. Topf & Söhne in Erfurt, No. 659405. "Loading device for incineration furnaces." 7 April 1938. Source: Deutsches Patentamt.

659 405

J. A. Topf & Söhne in Erfurt

Beschickungseinrichtung für Einäscherungsöfen

Patentiert im Deutschen Reiche vom 20. November 1936 ab

Gegenstand der Erfindung ist eine Beschickungseinrichtung für Einäscherungsöfen mit am Sargeinführungswagen befestigter Sargtragplatte, durch die alle Mängel, die zur Zeit sowohl hinsichtlich der Vorbereitung als auch der Ausführung der Sargeinführung bestehen, beseitigt werden sollen. Durch die Erfindung können in Fortfall:

1. das Auflegen von Holzplatten oder Eisenstäben auf die Tragarme des Wagens,
2. das Aussparen der Roststeine für die Tragarme des Wagens,
3. das Entfernen der Sargfüße, vor der Einführung des Sarges in den Ofen,
4. das Festhalten des Sarges (beim Herausziehen der Tragplatte aus dem Ofen), durch dahintergelegte Stempel, gleich welcher Art, mechanisch oder von Hand.

Die Erfindung ist im wesentlichen dadurch gekennzeichnet, daß mit dem Wagen eine Sargtragplatte verbunden ist, auf der eine zweite, verschiebbare Platte angeordnet ist, die bei Einführung des Sarges das hintere Sargende stützt und sowohl ein erschütterungsfreies Absetzen des Sarges auf dem Rost als auch das freie Herausziehen der Tragplatte ermöglicht.

Die Zeichnung zeigt ein Ausführungsbeispiel in Abb. 1 in Ansicht, Abb. 2 ist ein Querschnitt durch die beiden Tragplatten. Abb. 3 bis 6 zeigen schematisch den Vorgang der Sargeinführung und der Entfernung der Tragplatte aus dem Ofen.

Mit einem von Hand bewegbaren Wagen *a* ist in bekannter Weise eine heb- und senkbare längere Sargtragplatte *b* fest verbunden, die eine zweite auf ihr verschiebbare kürzere Platte *c* trägt. Das Vorderende *g* der

Haupttragplatte *b* ist unter Beibehaltung einer ebenen Oberfläche so gestaltet, daß es nicht unter der Hilfsplatte *c* hindurchgezogen werden kann.

Der Sarg wird so auf die Platten gestellt, daß der hintere Sargteil *d* auf die obere Platte *c* zu stehen kommt, während der Vorderteil *e* etwas über die Haupttragplatte *b* übersteht (Abb. 3). In dieser Lage wird der Sarg in den Ofen eingefahren (Abb. 4). Darauf wird die Platte *b* gesenkt, bis sie sich dicht über dem Ofenrost *f* befindet und der Vorderteil des Sarges sich auf den Rost stützt (Abb. 5). Bei dem nun folgenden Herausziehen der Tragplatte *b* aus dem Ofen bleibt die Lage der Hilfsplatte *c* infolge des auf ihr ruhenden Gewichts des hinteren Sargendes unverändert, bis sie durch das vordere Ende *g* der Platte *b* nach vorn gezogen und dadurch aus dem Ofen mit herausgenommen wird (Abb. 6). Da die Platte *c* nur dünn ist, macht das hintere Sargende beim Hervorziehen der Platte nur eine ganz geringe Senkbewegung. Der Sarg wird also im ganzen ohne Erschütterung auf den glatten Rost aufgesetzt.

PATENTANSPRUCH:

Beschickungseinrichtung für Einäscherungsöfen mit am Sargeinführungswagen befestigter Sargtragplatte, dadurch gekennzeichnet, daß auf der Tragplatte (*b*) verschiebbar eine kürzere Platte (*c*) angeordnet ist, die beim Einfahren und Absetzen des Sarges auf den Rost das hintere Sargende stützt und beim Zurückziehen der Platte (*b*) durch deren vorderes Ende (*g*) mit herausgenommen wird.

Hierzu 1 Blatt Zeichnungen

Document 154: continued.

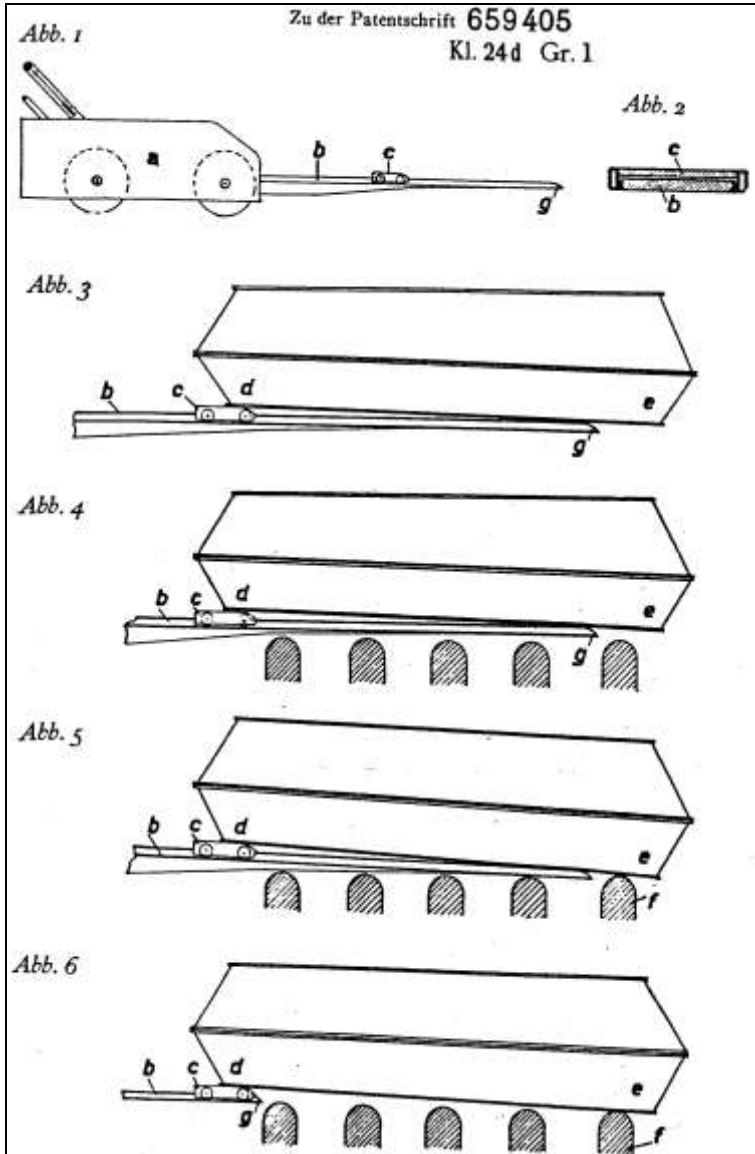

Document 154: continued.

<p>J. A. TOPF & SÖHNE ERFURT</p> <p>EMFÄNGER <i>L 58 240</i></p> <p>Reichspatentamt, Berlin NW 61</p>	<p>Zweitachr. RA 1780198 - 511.42</p> <p>TAG BLATT</p> <p>4.11.42 1</p> <p>402804</p> <p>2715</p>
<p><u>Beschreibung</u></p> <p>(Anlage 2 zum heutigen Antrag)</p> <p><u>Kontinuierlich arbeitender Leichen-Verbrennungsöfen</u></p> <p><u>für Massenbetrieb.</u></p>	
<p>In den durch den Krieg und seine Folgen bedingten Sammelagern der besetzten Ostgebiete mit ihrer unvermeidbar hohen Sterblichkeit ist die Erdbestattung der großen Menge verstorbenen Lagerinsassen nicht durchführbar. Einerseits aus Mangel an Platz und Personal, andererseits wegen der Gefahr, die der näheren und weiteren Umgebung durch die Erdbestattung der vielfach an Infektionskrankheiten Verstorbenen unmittelbar und mittelbar droht.</p>	
<p>1</p>	
<p>Es besteht daher der Zwang, die ständig anfallende große Anzahl von Leichen durch Einkäscherung schnell, sicher und hygienisch einwandfrei zu beseitigen. Dabei kann natürlich nicht nach den für das reichsdeutsche Gebiet geltenden gesetzlichen Bestimmungen verfahren werden. Es kann also nicht jeweilig nur 1 Leiche eingekäschert und der Einkäscherungsprozess kann nicht ohne Nach- und Zusatzheizung durchgeführt werden. Vielmehr müssen fortlaufend gleichzeitig mehrere Leichen gemeinsam eingekäschert werden und während der Gesamtdauer des Einkäscherungsprozesses müssen die Flammen und die Feuergase auf die eingekäscherten Leichen unmittelbar einwirken. Eine Scheidung der Asche der mehreren, gleichzeitig eingekäscherten kann nicht erfolgen, die Leichenasche kann nur gemeinsam verwahrt werden. Man kann somit bei den Vorrichtungen, die zur vorgeschilderten Beseitigung der Leichen dienen, nicht von einer "Einkäscherung" sprechen, sondern es handelt sich tatsächlich um eine Leichenverbrennung.</p>	
<p>Zur Durchführung dieser Verbrennung - und zwar nach oben nach vorgeschilderten Gesichtspunkten - wurden bisher in einzelnen derartigen Lagern eine Anzahl Mehrfach-Stoffel-Öfen aufgestellt, die naturgemäß periodisch beschickt werden und arbeiten</p>	
<p>- 2 -</p>	

Document 155: J.A. Topf & Söhne in Erfurt, patent application for "Continually operating corpse-combustion furnace for large-scale operation." 4 November 1942. Source: Deutsches Patentamt.

 J.A. TOPF & SÖHNE ERFURT

TAG

BLATT

4.11.42

2

Reichspatentamt, Berlin NW 61

102005

217-16

Infolgedessen befriedigen diese Öfen noch nicht voll, denn die Verbrennung geht in diesen noch nicht schnell genug vor sich, um die laufend anfallende große Anzahl von Leichen in möglichst kurzer Zeit zu beseitigen.

Letzteres kann nur geschehen durch Öfen, die kontinuierlich beschickt werden können und dann ebenso arbeiten. Zu denken wäre z.B. an solche in Form von Tunnel-Öfen. Bei diesen würden die zu verbrennenden Leichen je am vorderen Ende eines langgestreckten inwendig beheizten Tunnels auf eine bewegte Auflagevorrichtung aufgegeben werden, die sich in der Längsrichtung durch den Ofen hindurchbewegt, dabei die Leichen durch eine Anheiz-Kone in die Verbrennungskone führt und am hinteren Ende des Ofens die Leichenmasse austrägt. Einer solchen Konstruktion steht aber die bei anderen Gelegenheiten oft festgestellte Schwierigkeit entgegen, zu bewegendende Metallteile, die der Einwirkung von Feuer oder Rauchgasen ausgesetzt sind, auf die Dauer beweglich zu erhalten, auch wenn - wie im vorliegenden Fall - die bewegten Teile soweit als irgend möglich mit Schamotte- oder sonstigen feuerfesten Material verkleidet würden. Außerdem bereitet es Erschwernisse, bei Feuerungsanlagen, die - wie auch im angenommenen Fall - mit Zug, also mit verschiedenen Luft- bzw. Gasdruck in den einzelnen Teilen arbeiten, die bewegten Teile gegen die feststehenden so wie notwendig abzudichten. Ferner wäre ein ständiger Kraftbedarf zum Antrieb der bewegten Auflagevorrichtung notwendig. Schließlich wäre auch die Aenderung der Rauchgaszüge usw. unstattdlich, so das aus allen vorgenannten Gründen Tunnel-Öfen für Leichenverbrennung nicht zu empfehlen sind.

Um die vorgenannten Nachteile von Muffel- und Tunnel-Öfen zu vermeiden, dagegen aber alle Vorteile der kontinuierlichen Beschickung und Arbeitsweise auch bei Leichenverbrennungsöfen, verbunden mit bestmöglicher Ausnutzung des erforderlichen Brennmaterials, zu erreichen, schlägt die Erfindung einen kontinuierlich arbeitenden Ofen vor, bei welchem unter Fortfall von in Feuer zu bewegendenden Konstruktionsteilen die Fortbewegung der an oberem Ende des

J.A. TOPF & SÖHNE ERFURT

TAG BLATT

4.11.42 3

Reichspatentamt, Berlin NW 61

2717 002806

Ofens eingeführten Leichen innerhalb des Ofens selbsttätig erfolgt. Die Leichen gleiten durch eigene Schwerkraft auf entsprechend geneigten und geförnten Unterlagen in den behielten Ofen hinein und dann weiter herab, geraten auf diesem Wege ins Brennen, um schließlich an geeigneter Stelle des Ofeninneren auszubrennen und zu veraschen.

Fig.1 zeigt ein Ausführungsbeispiel in senkrechtem Schnitt.
Fig.2 ist ein Schnitt nach A-B, Fig.1.

Die Erfindung sieht beispielsweise einen Ofen mit mehreren in der Längsrichtung gegen die Waagerechte geneigten inneren Gleitbahnen vor - in der Zeichnung sind davon drei a, a', a'' angenommen -, die sich sack-artig aufeinander folgen. Jede Gleitbahn besteht aus mehreren Schamotte-Längsbalken b, die zur besseren Haltbarkeit durch darunter angeordnete Gesülberippen c unterstützt sind. Zwischen den Schamotte-Längsbalken b sind Quertragsteine d angeordnet, so daß jede Gleitbahnförmig restartig ausgebildet ist. Die Schamotte-Längsbalken b lagern mit ihrem oberen Ende in Umfassungsmauerwerk e des Ofens, mit dem unteren in entsprechenden Schamotte-Mauerwerk-Querbögen f. Die oberen Gleitbahnen sind je von einem in der Längsrichtung ebenfalls gegen die Waagerechte geneigten Beckengewölbe g überspannt, das mit Durchbruchsöffnungen versehen ist. Die Abdeckung über dem vorderen Teil der obersten Gleitbahn erhält keine Durchbruchsöffnungen.

Oben, wo am Ofen eine entsprechende Plattform h oder dergl. angeordnet ist, befindet sich am Anfang der obersten Gleitbahn a eine genügend weite Einführöffnung i, die normalerweise stets durch eine in den Vorraum ausweichende, selbstschließende Klapptür k verschlossen ist. Durch diese Einführöffnung werden die zu verbrennenden Leichen quer zur Längsrichtung des Körpers auf die oberste Gleitbahn a aufgegeben. Um diese Aufgabe zu ermöglichen, ist der Ofen mit entsprechender Lichterbreite ausgeführt. Die seitlichen Abstände der Einföhrung für

J.A. TOPF & SÖHNE ERFURT

TAG BLATT

4. 11. 42 4

Reichspatentamt, Berlin SW 61

einzelnen zu verbrennenden Leichen in dem Ofen richten sich nach dem Ablauf der Gesamtverbrennung, die ja durch die Eigenart des Ofens möglichst beschleunigt werden soll.

An unteren Ende der ersten Gleitbahn *a* schließt sich an der Umkehrstelle in entgegengesetzter Neigung die zweite Gleitbahn *a1* an, an diese die nächste *a2* und am Fuße der letzten ist der waagrecht liegende Schamotte-Ausbrennrost *l* mit der darunter vorgesehenen Asche-Sammelkammer *n* angeordnet. Vor diesem Ausbrennrost wird die Feuerung *m* untergebracht, die entweder als Planrost-, Treppenrost-, Generator-, Gas-, Öl- oder sonstiger Feuerung ausgeführt werden kann, je nach dem Brennmaterial, welches verheißt werden muß. Die Flammen- bzw. Heißgasführung ist so angeordnet, daß sowohl der Ausbrennrost *l* als auch die bestartig ausgebildeten Gleitbahnen *a*, *a1*, *a2* und alle durchbrechenden Deckengewölbe *g* den Flammen und Heißgasen den Durchgang von unten nach oben ermöglichen. An oberem Ende des Ofens, der Einführöffnung *i* gegenüber, liegt die Austrittsöffnung *o* für die abzuleitenden Rauchgase, die dort in geeigneter Weise in den Schornstein *p* eintreten. Die Rauchgase können natürlich vor dem Eintritt in den Schornstein auch erst durch einen in der Zeichnung nicht mit dargestellten Rauchgas-Luftvorwärmer entsprechender Bauart geleitet werden, um die darin enthaltene Wärme zum Vorwärmen der Verbrennungsluft auszunutzen.

Die zu verbrennenden Leichen sind also auf ihrem Weg durch den Ofen ständig den Einwirkungen der ihrer Bewegungsrichtung entgegenstreichenden Flammen bzw. Heißgase ausgesetzt. Durch seitlich verschiebbare und ebenso bedienbare, an den Umkehrstellen unter dem unteren Ende der oberen Gleitbahnen *a*, *a1*, angeordnete mehrteilige Schamotte-Schieber *q* kann eine Reinigung oder Unterbrechung des Leichendurchganges durch den Ofen erfolgen. Ferner kann durch entsprechend angeordnete Hochschlößöffnungen *r* bei einem evtl. Festbacken oder Festkleben der Verbrennungsobjekte von außen nachgeholfen werden. Asche, die beim Verbrennungsvergang innerhalb des Ofens anfällt, soll

 J.A. TOPF & SÖHNE ERFURT		TAG	BLATT
EMFÄNGER <u>Reichspatentamt, Berlin SW 61</u>		4.11.42	5
		2719	782800

soweit wie möglich durch die Öffnungen der Gleitbahnen a, a1, a2, und Deckengewölbe g nach unten bis zur Asche-Sammelkammer n durchfallen. Asche, die sich unterwegs evtl. auf der Rückseite von Mauerwerksteilen der durchbrochenen Deckengewölbe g oder sonstwo absetzt, kann durch entsprechende Asche-Reinigungsöffnungen s nach außen abgezogen werden. Die Hauptasche sammelt sich unter dem Ausbrennrost l der schon erwähnten Asche-Sammelkammer m wo sie an ihrer Oberfläche auch dauernd der Einwirkung der Feuer-gase unterliegt, so daß evtl. noch nicht ganz ausgebrannte Reste der Verbrennungsobjekte auch in diesem Ascheraum nach- und ausbrennen können. Durch entsprechend angeordnete, nach dem Ofeninneren offene Luftzuführungskanäle t wird auf dem gesamten Wege der Verbrennungsobjekte durch den Ofen für ausreichende Zufuhr von Luft zur Förderung des Verbrennungsvorganges der Leichen gesorgt. Diese Luft kann vor dem Eintritt in das Ofeninnere auch in einem in der Zeichnung nicht mit dargestellten Rauchgas-Luftvorwärmer vorgewärmt werden. Die Zufuhr sowohl der kalten als auch der vorgewärmten Luft kann auch unter Druck erfolgen, um eine ständige gute Durchwirbelung der Rauchgase zu erreichen.

Der Ofen kann an den Stellen, wo in der Zeichnung Fig.1 Nachstoßöffnungen r angeordnet sind, auch mit je noch einer Einführöffnung i mit selbstschließender Klapptür k versehen werden, um - von dort anzuordnenden Plattformen aus - den Ofen auch nur teilweise beschicken zu betreiben zu können, wobei je nach dem Umfang des Teilbetriebes der eine oder beide mehrteilige Schotte-Schieber q geschlossen werden.

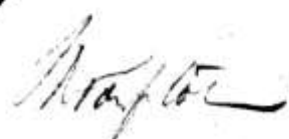

Document 155: continued.

Zweitschrift

J.A. TOPF & SÖHNE ERFURT

TAG BLATT

IMPFANGER

4.11.42 2 1

Reichspatentamt, Berlin SW 61

5 8 2 4 0

~~713389~~
2720Patentansprüche.

- 1.) Kontinuierlich arbeitender Leichen-Verbrennungsofen für Massenbetrieb, dadurch gekennzeichnet, daß in diesem mehrere, in der Längsrichtung gegen die Waagerechte geneigte reartartig ausgebildete Gleitbahnen (a, a1, a2) angeordnet sind, die sich sack-artig aufeinander folgen und auf denen die zu verbrennenden Leichen, die durch eine obere Einführöffnung (1) aufgegeben werden, infolge ihrer eigenen Schwere in den Ofen hinein- und dann herabgleiten, bei dem selbsttätigen Durchgang durch den Ofen - von den ihrer Bewegungsrichtung entgegenstreichenden Feuergasen her in Brand geraten, um auf dem am Ende der untersten Gleitbahn (a2) angeordneten Ausbrennrost (1) auszubrennen und zu veraschen.
- 2.) Ofen nach Anspruch 1.), dadurch gekennzeichnet, daß die Gleitbahnen je aus mehreren Schamotte-Längsbalken (b) mit dazwischen angeordneten Quertragsteinen (d) bestehen, wobei die Balken (b) durch darunter angeordnete Stützrippen (c) unterstützt sind.
- 3.) Ofen nach Anspruch 1.) und 2.), dadurch gekennzeichnet, daß die oberen Gleitbahnen (a, a1) durch mit Durchbruchsöffnungen versehene Deckengewölbe (g) überspannt sind.
- 4.) Ofen nach Anspruch 1.) - 3.), dadurch gekennzeichnet, daß über jedem Deckengewölbe (g) Asche-Abzugöffnungen (e) angeordnet sind.

 J. A. TOPF & SÖHNE ERFURT	TAG BLATT
EMPFÄNGER <u>Reichspatentamt, Berlin NW 61</u>	4.11.42 2
	2721 70210
<p>5.) Ofen nach Anspruch 1.7 und 2.), dadurch gekennzeichnet, daß an den Umkehrstellen unter dem unteren Ende der oberen Gleitbahnen (a, a') seitlich zu verschiebende und ebenso zu bedienende Schamotte-Schieber (q) zur Stauung oder Unterbrechung des Leichendurchganges angeordnet sind.</p> <p>6.) Ofen nach Anspruch 1.) - 4.), dadurch gekennzeichnet, daß im Bereich der Gleitbahnen Kanäle (t) für Zusatzluft ausmünden.</p> <p>7.) Ofen nach Anspruch 1.) - 6.), dadurch gekennzeichnet, daß an Stelle der Nachstoßöffnungen (r) Einführöffnungen (i) mit selbstschließender Klapptür (k) vorgesehen werden, um von dort anzuordnenden Plattformen aus den Ofen auch nur teilweise beschicken und betreiben zu können.</p>	
<p style="text-align: center;">-----</p> <p style="text-align: right;"><i>W. Topf</i></p>	

Document 155: continued.

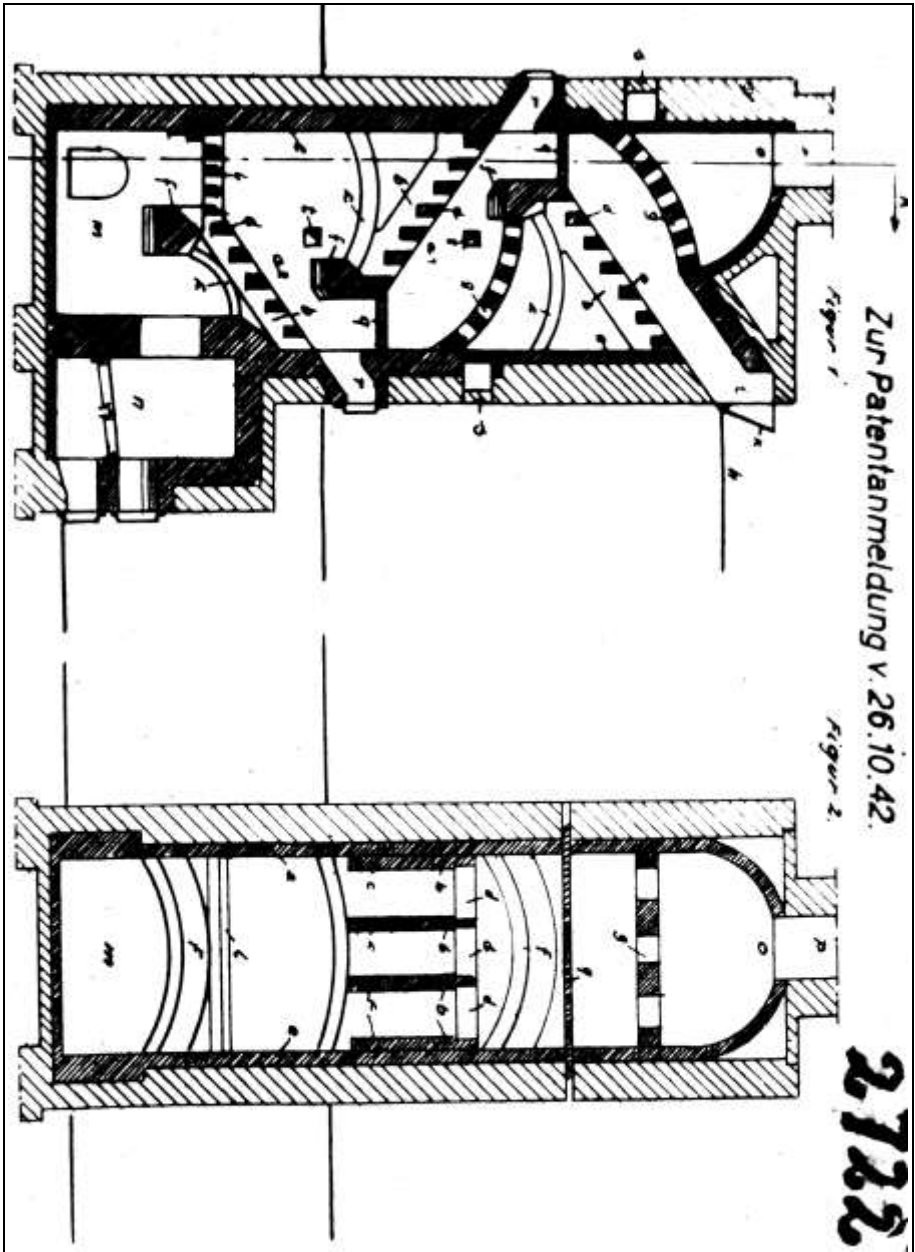

Document 155: continued; schematic drawing of the furnace.



Document 156: Patent J.A. Topf & Söhne in Erfurt, No. 494136. "Retractable slag-grate for hearths with air feed from below." 6 March 1930. Source: Deutsches Patentamt.

494 136

J. A. Topf & Soehne in Erfurt

Ausfahrbarer Schlackenrost für mit Unterwind betriebene Feuerungen

Patentiert im Deutschen Reiche vom 22. August 1928 ab

Für Unterwindfeuerungen mit hoher Brennleistung ist es besonders wichtig, daß diese auch während des Abschlackens des Rostes erhalten bleibt. Dies ist aber nur dann möglich, wenn der Verbrennungsvorgang auch während des Abschlackens nicht gestört wird, was eintritt, wenn der Unterwind während des Abschlackens abgestellt werden muß.

Gegenstand der Erfindung ist ein ausfahrbarer Schlackenrost, welcher ein schnelles Abschlacken während des Betriebes gestattet, ohne daß hierbei der Unterwind abgestellt zu werden braucht. Zu diesem Zweck ist am hinteren Ende des ausfahrbaren Schlackenrostes eine Abschlußplatte angelenkt. Durch das Ausfahren des Schlackenrostes, welches von Hand oder mechanisch erfolgen kann, wird am hinteren Rostende ein breiter Spalt freigelegt, durch welchen hindurch die Rückstände schnell in den unterhalb des Schlackenplanrostes befindlichen Schlackenschacht abströmen können, wobei sie über die dabei schräg stehende Abschlußplatte abrutschen. Diese Abschlußplatte verhindert hierbei ein unmittelbares Überströmen von Luft aus dem Windraum unterhalb des Rostes durch den freigelegten Spalt in den Feuerraum hinein. Ein Abstellen des Windes während des Abschlackens ist also nicht erforderlich.

Die Anordnung einer zweiten Abschlußplatte am vorderen Schlackenrostende ermöglicht es, den Windraum unterhalb des Schlackenrostes vom Hauptwindraum unterhalb des Brennrastes zu trennen. Beide Windräume können also unter verschiedenen Druck gesetzt werden. Ist beispielsweise der Schlackenrost aus irgend einem Grunde zu stark bedeckt, so kann man, um einen schnellen, guten Ausbrand zu erzielen, den Luftdruck unterhalb des Schlackenrostes verstärken, ohne gleichzeitig den Druck unterhalb des Brennrastes steigern zu müssen. Umgekehrt kann man bei schwach bedecktem Schlackenrost, beispielsweise unmittelbar nach dem Abschlacken, den Winddruck unterhalb des Schlackenrostes vermindern oder ganz abstellen, um hierdurch unwirtschaftlichen Luftüberschuß zu vermeiden. Es ergibt sich also durch die Anordnung der beiden Abschlußplatten eine sehr günstige Zonenregulierung der

Luftzufuhr getrennt für den Brennrast und Schlackenrost.

Die Abbildung zeigt ein Ausführungsbeispiel der Erfindung. Es bedeutet r den Hauptrost und s den Schlackenrost, an welchen hinten die Abschlußplatte a und vorn die Abschlußplatte b angelenkt ist. Wird der Schlackenrost s von Hand oder mechanisch durch die Zugstange x in der Pfeilrichtung nach links ausgefahren, so kommen die Abschlußplatten in die punktierte Lage a' und b' . In diesem Falle stürzt die sich vorher auf dem Schlackenrost s befindliche Schlacke nach dem Schlackenschacht t ab, wobei sie über die Abschlußplatte a abrutscht. Gleichzeitig verhindert diese Abschlußplatte a ein Überströmen von Wind aus dem Raum h unterhalb des Rostes r durch den vom Schlackenrost freigelegten Spalt in den Feuerraum f .

Die am vorderen Schlackenrostende angelenkte Platte b trennt den Hauptwindraum h unterhalb des Brennrastes r von dem Windraum unterhalb des Schlackenrostes s . Beide Windräume erhalten eine gesonderte Luftzufuhr, wobei der Winddruck in jeder Zone unabhängig voneinander durch Drosselorgane d bzw. c eingestellt werden kann.

PATENTANSPRÜCHE:

1. Ausfahrbarer Schlackenrost für mit Unterwind betriebene Feuerungen, dadurch gekennzeichnet, daß am hinteren Ende des Schlackenrostes eine über die ganze Rostbreite reichende, sich unten auf eine Querwand des Aschenfalles stützende Abschlußplatte (a) angelenkt ist, welche bei ausgefahrenem Schlackenrost verhindert, daß Luft aus dem Windraum (h) durch die Öffnung für den Schlackenrost unmittelbar in den Feuerraum tritt.

2. Ausfahrbarer Schlackenrost nach Anspruch 1 mit getrennten Windräumen unter dem Hauptrost und dem Schlackenrost, dadurch gekennzeichnet, daß auch am vorderen Ende des Schlackenrostes eine solche Abschlußplatte (b) angelenkt ist, welche den besonderen Windraum unterhalb des Schlackenrostes vom Hauptwindraum unterhalb des Hauptrostes abgrenzt.

Hierzu 1 Blatt Zeichnungen

Document 156: continued.

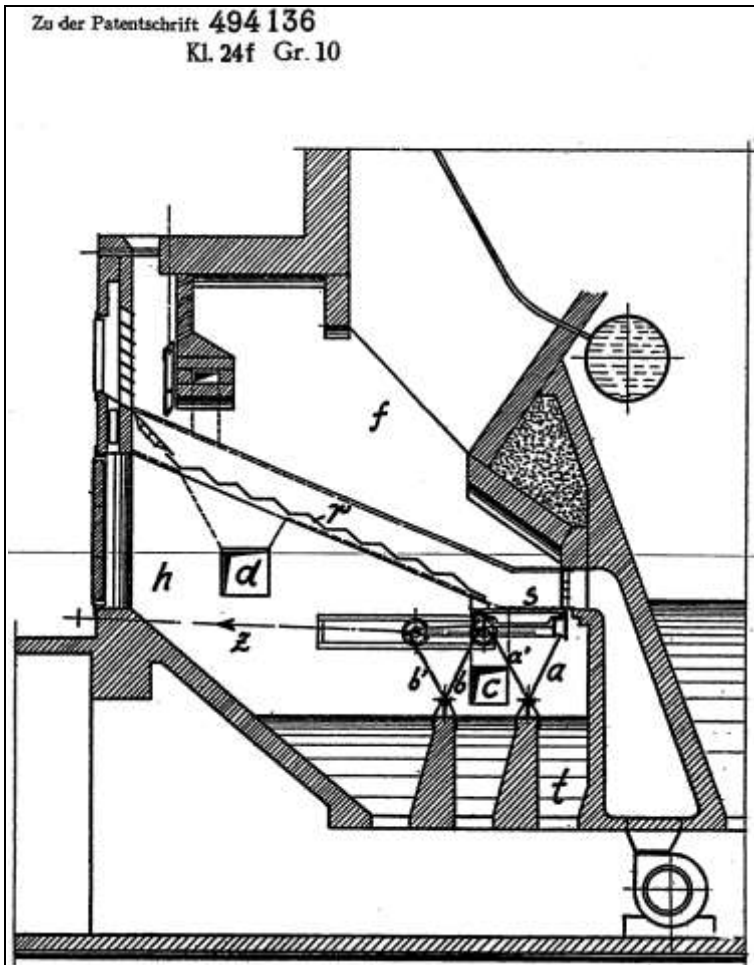

Document 156: continued.

DEUTSCHES REICH



AUSGEGEBEN AM

24.5.1933.

 REICHSPATENTAMT
 PATENTSCHRIFT

№ 576 135

KLASSE 24f GRUPPE 1202

T39364 V/24f

Tag der Bekanntmachung über die Erteilung des Patents: 20. April 1933

J. A. Topf & Söhne in Erfurt

Düsenplattenrost

Patentiert im Deutschen Reiche vom 27. August 1931 ab

Die Erfindung bezieht sich auf einen Düsenplattenrost für feinkörnigen Brennstoff, bei dem die in gegenläufig bewegten Querreihen nebeneinanderliegenden Platten sich an den vorderen, der Brennstoffzufuhr zugekehrten Enden auf schwingende Querträger und an den anderen Enden auf die in der nächstfolgenden Reihe liegenden Platten stützen.

Bei derartigen Rosten müssen die Platten im kalten Zustand mit einem gewissen Spiel verlegt werden, damit sie sich bei der Erwärmung unbehindert ausdehnen können und Verklemmungen im Betriebe vermieden werden. Andererseits nötigt die Verwendung feinkörnigen Brennstoffes dazu, besondere Mittel vorzusehen, die einen Durchfall des Brennstoffes zwischen den einzelnen Platten verhüten.

Gemäß der Erfindung werden schalenförmige Auffangkörper vorgesehen, welche die Stoßfugen seitlich benachbarter Rostplatten nach unten abdecken, sich am vorderen Ende auf die für die zugeordneten Rostplatten vorgesehenen Querträger und am hinteren Ende, ebenso wie die Platten, auf die folgenden Platten stützen. Diese Auffangkörper werden durch seitliche Zapfen mitgenommen, welche in Ausschnitte hineinragen, die durch nach unten vorspringende, den Querträger umfassende Lappen der Platten gebildet werden.

Bei Rosten mit über die ganze Rostlänge durchlaufenden Roststäben ist es an sich bereits vorgeschlagen worden, unter den im wesentlichen T-förmig ausgebildeten eigent-

lichen Roststäben Auffangkörper derart anzuordnen, daß zwischen Roststäben und Auffangkörpern Spalte zum Durchtritt der Verbrennungsluft belassen wurden, wobei ein Rostdurchfall verhindert wird. Von diesen bekannten Auffangkörpern wird in Anwendung auf Düsenplattenroste Gebrauch gemacht, bei denen die Platten in gegenläufig bewegten Querreihen nebeneinanderliegend angeordnet sind.

Die Erfindung ist durch die Zeichnungen in schematischer Weise dargestellt, und zwar ist

Abb. 1 ein Längsschnitt durch den Rost,

Abb. 2 ein Querschnitt nach Linie A-B in Fig. 1,

Abb. 3 ein in größerem Maßstab gehaltenen Querschnitt durch die benachbarten vorderen Enden zweier Düsenplatten und einen der Stoßstelle zugeordneten Auffangkörper.

Der Düsenplattenrost besitzt Reihen von aufeinanderfolgenden Platten *a*, *b*, *c*, die sich mit den nach der Brennstoffzufuhr zugekehrten Enden auf um Querwellen *d* schwingende Querträger *e* stützen, mit den anderen nasenförmigen Enden *n* aber sich auf die Rücken der nächstfolgenden Plattenreihe auflegen. Jede einzelne Plattenreihe *a*, *b*, *c* besteht aus einer Vielzahl von nebeneinanderliegenden Platten *a*¹, *a*², *a*³... Die einzelnen Rostrahmen sind in nicht-Gegenstand der Erfindung bildender Weise an gegenläufig bewegte Stangen derartig angeschlossen, daß bei einer Vorwärtsbewegung der Plattenreihen *a*, *c* usw. die darzwischen angeordneten

576 135

Plattenreihen *b* usw. eine Rückwärtsbewegung ausführen, und umgekehrt.

Um den Platten die Möglichkeit einer Wärmeausdehnung ohne Gefahr von Verklemmung zu geben, sind sie im kalten Zustand in der aus Abb. 3 für die Platten *a*¹, *a*² ersichtlichen Weise mit einem gewissen Spiel *s* verlegt. Um einen dauernden Brennstoffverlust durch den Spalt *s* zu verhüten, sind unter der Stoßfuge schalenförmige Auffangkörper *f* von U-förmigem Querschnitt gelegt, die sich mit ihrer Unterseite am vorderen Ende auf die Querträger aufliegen, auf denen auch die zugehörigen Platten aufruhem, während die hinteren Enden, ebenso wie die Rostplatten, auf dem Rücken der folgenden Plattenreihe aufliegen. Die Auffangkörper besitzen seitliche Zapfen *z*, die in Ausschnitte hineinragen, welche durch nach unten vorspringende Lappen *l* der Rostplatten gebildet sind, mit denen diese den Querträger umfassen, wodurch sie mitgenommen werden.

PATENTANSPRUCH:

Düsenplattenrost für feinkörnigen Brennstoff, bei dem die in gegenläufig bewegten Querreihen nebeneinanderliegenden Platten sich an den vorderen, der Brennstoffzufuhr zugekehrten Enden auf schwingende Querträger und an den anderen Enden auf die in der nächstfolgenden Reihe liegenden Platten stützen, dadurch gekennzeichnet, daß schalenförmige Auffangkörper (*f*), die in an sich bekannter Weise die Stoßfugen (*s*) seitlich benachbarter Rostplatten nach unten abdecken, am vorderen Ende sich auf die Querträger (*e*) für die zugeordneten Platten, am hinteren Ende ebenso wie diese auf die folgenden Platten stützen, wobei sie durch seitliche Zapfen (*z*), welche in durch nach unten vorspringende, den Querträger umfassende Lappen (*l*) gebildete Ausschnitte hineinragen, mitgenommen werden.

Hierzu 1 Blatt Zeichnungen

Document 157: continued.

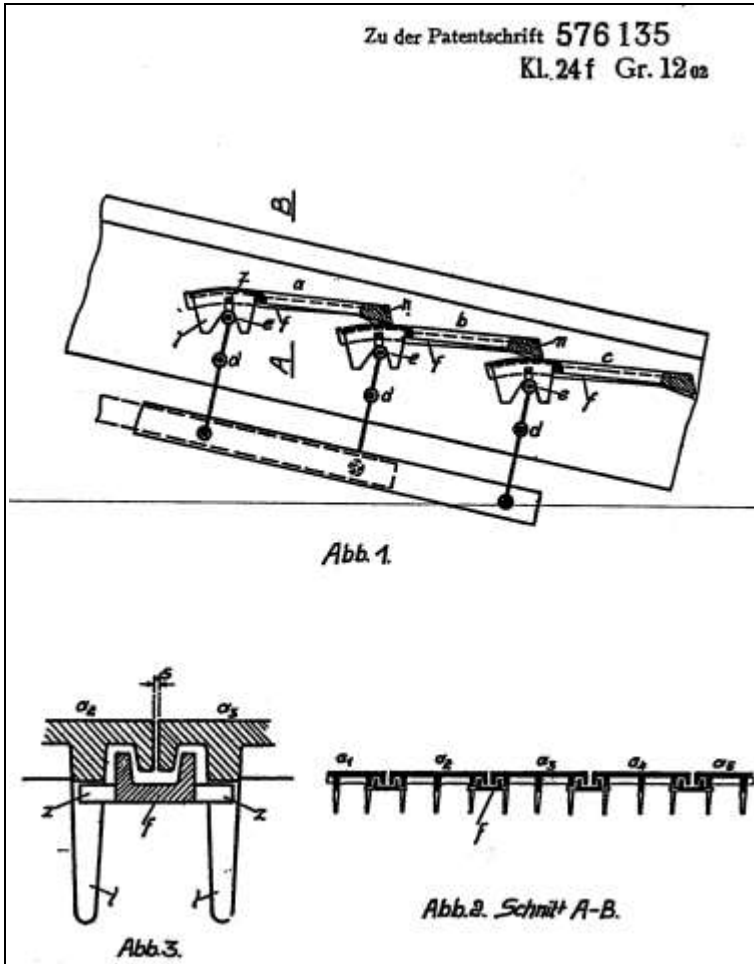

Document 157: continued.

DEUTSCHES REICH

Bibliothek
Bur. Ind. Eigendom
20 DEC. 1933



AUSGEGEBEN AM
31. OKTOBER 1933

REICHSPATENTAMT
PATENTSCHRIFT

№ 587 149

KLASSE 40a GRUPPE 1500

T 41416 VI/40a

Tag der Bekanntmachung über die Erteilung des Patents: 12. Oktober 1933

J. A. Topf & Söhne in Erfurt

Verfahren und Ofen zur Zurückgewinnung von Blei und Kupferdraht aus Kabeln

Patentiert im Deutschen Reiche vom 29. September 1932 ab

In Betrieben, in welchen alte Kabel und Kabelreste anfallen und sich ansammeln, macht sich neuerdings das Bestreben geltend, diese Reste und alten Kabel abzubrennen, um die Metalle zurückzugewinnen.

5 Bisher wurden zu diesem Zweck offene Feuerstellen errichtet, über welche ein Blech gelegt wurde. Auf diesem wurden die Kabel stückweise aufgeschichtet und infolge der Er-
10 hitzung von unten her zunächst abgebrannt und dann in flüssiges Blei und Kupferdraht zerlegt. Das Blei floß in einen danebenstehenden Bleikessel, der noch besonders beheizt wurde. Durch die hierbei frei werden-
15 den Bleidämpfe wurden die Bedienungsmannschaften vielfach gesundheitlich schwer geschädigt. Die gewonnenen Kupferdrähte waren teilweise noch stark mit Bleikräuze be-
20 haftet, auch kam das Blei unsauber in den Bleikessel. Der Gewinn an Metall war ungenügend.

Nach der Erfindung soll die Zurückgewinnung der Metalle durch unmittelbares Abbrennen der Kabel in einem geschlossenen
25 Ofen ohne besondere Feuerung erfolgen. Hierzu wird der Ofen der nachstehend beschriebenen Bauart verwendet.

Eine Ausführungsform des Ofens ist in Fig. 1 im Längsschnitt und in Fig. 3 im Hori-
30 zontalschnitt dargestellt. Fig. 2 zeigt eine Abbrennplatte im Querschnitt.

In den Ofen sind schräg liegende Abbrennplatten *a* eingebaut, auf welchen die durch die Aufgabeeöffnung *i* eingeführten Kabel durch

Abfallwachsdraht in Brand gesetzt werden. 3
Dadurch werden gleichzeitig die Schamotte-
wandungen *b* und auch die Abbrennplatten *a*
selbst so weit erwärmt, daß die Bestandteile
aus Papier und Jute verbrennen. Bei der Ver-
4 brennung dieser Bestandteile wird so viel
Wärme entwickelt, daß der Bleimantel der
Kabel schmilzt und der Kupferdraht frei wird.
Das geschmolzene Blei läuft von den geneigt
angeordneten Abbrennplatten *a* in eine dahinter-
liegende Bleirinne *c*, deren Auslauf nach
4 außen hin ebenfalls schräg gelagert ist. Unter
dem Rinnenauslauf ist ein von den Abgasen
beheizter außen angebauter Bleikessel *d* ange-
ordnet (Fig. 3), in welchem das flüssige
Blei gesammelt wird. Innerhalb des Ofens ist
5 eine Abdeckplatte *k* über der Bleirinne *c* vor-
gesehen, damit beim Herausziehen des Kupfer-
drahtes nicht Schmutz in die Rinne ge-
langt und dauernd freier Ablauf für das Blei
gewahrt bleibt.

Die in der Mitte vertieften oder als flache
Rinnen ausgebildeten Abbrennplatten *a* haben
seitliche Abweiser *g*, wodurch das fließende
Blei in die Mitte der Brennbahn geführt
(Fig. 2) und somit das seitliche Schamotte-
6 mauerwerk nicht beschädigt wird.

Der von Blei und Jute befreite Kupferdraht
wird über die Abbrennplattenbahn *a* nach
unten auf einen innerhalb des Ofens angeord-
neten Abklopfrost *g* gezogen, hier von dem
6 noch anhaftenden Blei und sonstigen Rück-
ständen befreit und dann durch die der Auf-
gabeeöffnung gegenüberliegenden Entnahme-

Document 158: Patent J.A. Topf & Söhne in Erfurt, No. 587149. "Process and furnace for the recovery of lead and pieces of wires from cables." 12 October 1933.

Source: Deutsches Patentamt.

587 149

öffnung *k* mittels eines Schürhakens aus dem Ofen entfernt.

In der Zwischenzeit werden frische Kabel durch die Aufgabe *i* weiter zugelegt, so daß
 5 der Ofen dauernd auf Temperatur und somit in Betrieb gehalten wird. Durch die Aufeinanderfolge der Teile *a*, *c* und *g* und das Gegenüberliegen der Öffnungen *i*, *k* wird ein ununterbrochener Betrieb sowie ein gutes und
 10 geschütztes Bedienen des Ofens ermöglicht. Die gebildeten Abgase steigen von den Abbrennplatten *a* nach oben in einen seitwärts angeordneten Kanal *m*, werden in diesem schräg nach unten gezogen, gehen um eine
 15 Sperrmauer *n* herum unter die Bleirinne *c*, streichen um den Bleikessel *d* herum, um das Blei flüssig zu halten und gelangen dann unter den Aschensack *p* zum Schornstein *o*. Durch diesen langen Weg werden die Abgase voll
 20 und wärmewirtschaftlich ausgenutzt.

PATENTANSPRÜCHE:

1. Verfahren zur Rückgewinnung von
 25 Blei und Kupferdraht aus Kabeln, dadurch gekennzeichnet, daß die organische Substanz der Kabel in einem nicht beheizten geschlossenen Ofen abgebrannt und das abgeschmolzene Blei und der entbleite
 30 Kupferdraht getrennt aus dem Ofen entfernt werden.

2. Ofen zur Ausführung des Verfahrens nach Anspruch 1, dadurch gekennzeichnet, daß hinter einer Aufgabeöffnung (*i*) für die Kabel geneigt liegende Abbrennplatten
 35 (*a*) angeordnet sind, auf welchen die Kabel unmittelbar entzündet werden und an welche hintereinander eine mit Überdeckung (*k*) versehene Bleisammelrinne (*c*), die in einen außen befindlichen Bleikessel
 40 (*d*) mündet, und eine der Aufgabeöffnung (*i*) gegenüberliegende Entnahmeöffnung (*h*) für den Kupferdraht anschließen.

3. Ofen nach Anspruch 2, dadurch gekennzeichnet, daß die Abbrennplatten (*a*)
 45 in der Mitte vertieft oder als flache Rinnen ausgebildet sind.

4. Ofen nach Anspruch 2, dadurch gekennzeichnet, daß die Abbrennplatten (*a*) mit seitlichen Abweisern (*g*) zum Schutze
 50 des Mauerwerkes gegen korrodierende Wirkung des Bleies versehen sind.

5. Ofen nach Anspruch 2, dadurch gekennzeichnet, daß zwischen Bleisammelrinne (*c*) und Entnahmeöffnung (*h*) ein
 55 Abklopfrost (*e*) zur Reinigung des Kupferdrahtes innerhalb des Ofens angeordnet ist.

6. Verfahren zum Betriebe des Ofens nach Anspruch 2, dadurch gekennzeichnet,
 60 daß der Bleikessel (*d*) von den Abgasen des Ofens beheizt wird.

Hierzu 1 Blatt Zeichnungen

Document 158: continued.

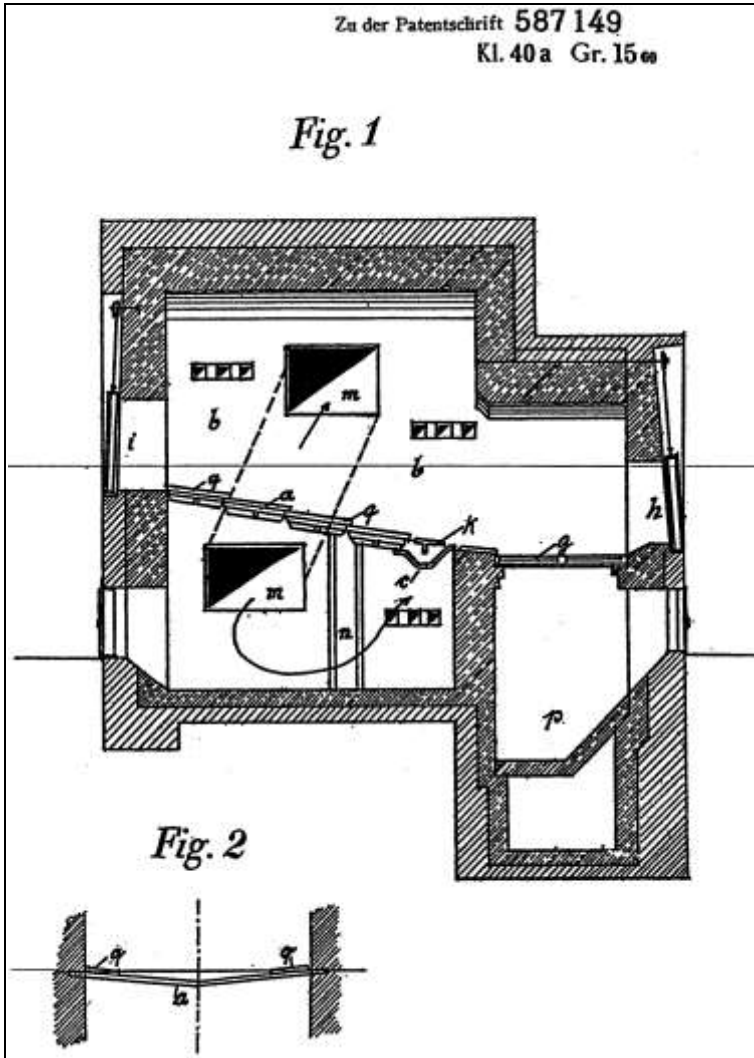

Document 158: continued.

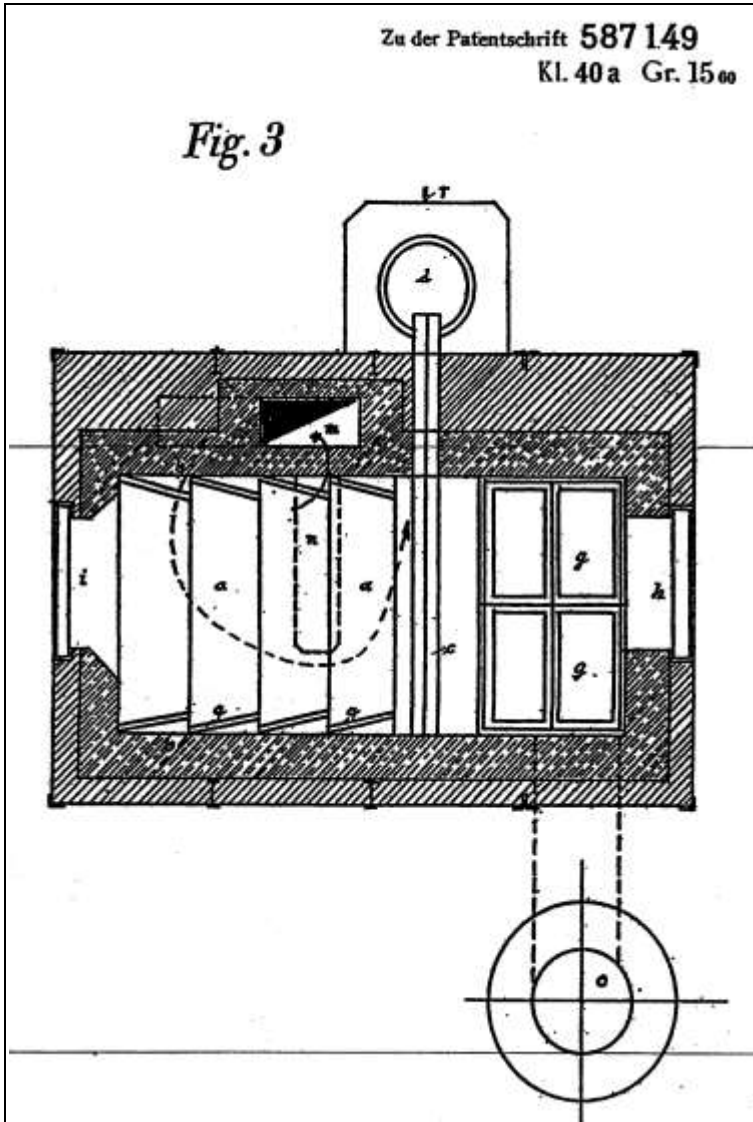

Document 158: continued.

Zweitschrift.

PA 789491 17.11.42
TAG BLATT

J.A.TOPF & SÖHNE ERFURT

16.11.42 1

EMFFANGER:

Reichspatentamt, Berlin SW 61 002700

Beschreibung.

Luftgekühlte Rostplatten für mechanische Verschubroste.

In jeder Feuerung ist meist der Rostbelag dem größten Verschleiß unterworfen. Je nach der Brennstoffsorte und den dadurch bedingten Verbrennungs-Temperaturen ist die Lebensdauer des Rostbelages verschieden, gleichzeitig spielt auch die Bauart des Rostes eine wesentliche Rolle. Gut bediente Roste aus Roststäben besitzen meist eine verhältnismäßig lange Lebensdauer, wenn die Verbrennungsluft durch Kühlrippen so zweckmäßig geführt wird, daß eine gleichmäßig gute Kühlung der Roststäbe über die durch diese gebildete Gesamtrostfläche gewährleistet ist. Dabei ist es gleichgültig, ob die Verbrennungsluft durch natürlichen oder künstlichen Zug angesaugt oder auch als Unterwind - also mit Pressung - zugeführt wird.

Werden dagegen die Roste aus mit Düsen für den Luftdurchtritt versehenen Rostplatten hergestellt - was bei mechanischen Verschubrosten überwiegend der Fall ist -, so wird eine gleichmäßig gute Kühlung der Gesamtrostfläche in Frage gestellt, weil die bei diesen Rosten stets als Unterwind mit Pressung zugeführte Verbrennungsluft infolge der stufenförmigen Anordnung und der bisher allgemein üblichen Ausbildung der Rostplattenkörper kaum mit deren Köpfen in Berührung kommt. Infolgedessen werden naturgemäß die Köpfe der Rostplatten, die ja außerdem den höchsten Temperaturen ausgesetzt sind, stets zuerst zerstört. Wegen dem dadurch bedingten stärkeren Materialverbrauch und den laufenden hohen Instandsetzungskosten waren daher mechanische Verschubroste für die Verbrennung von hochwertigen Brennstoffen bisher nicht geeignet.

Die Rostplattenkörper müssen also so ausgebildet sein, daß in jeder Stellung dieser auch deren Köpfe von der Verbrennungsluft zwangsläufig kühlend bespült werden, bevor diese Luft durch vorgesehene Düsen in den Feuerraum tritt. Die Erfindung gewährleistet durch besondere Ausbildung der Rostplattenkörper und

Document 159: Patent application J.A. Topf & Söhne in Erfurt of 16 November 1942. "Air-cooled grate plate for mechanical push grate." Source: Deutsches Patentamt.

J. A. TOPF & SÖHNE ERFURT

TAG BLATT

16.11.42 2

EMPFANGER

Reichsententamt, Berlin SW 61

002702

dadurch bewirkte zwangsläufige Führung der Verbrennungsluft eine gleichmäßig gute Kühlung der Gesamtrostfläche - insbesondere auch der Rostplatten-Köpfe - auch bei mechanischen Vorschubrosten. Da außerdem je nach Bedarf außer der Verbrennungsluft noch Zusatz-Kühlluft zur nachhaltigeren Kühlung des Rostbelages zugeführt werden kann, ist es möglich, Vorschubroste auch mit hochwertigen Brennstoffen zu betreiben.

Um Zusatz-Kühlluft zur nachhaltigeren Kühlung des Gesamtrostbelages anwenden zu können, ist ferner in an sich bekannter Weise eine Unterteilung des Raumes unter diesem in einzelne Zonen vorgesehen, die sich außerdem für eine wirtschaftliche Feuerführung vorteilhaft auswirkt.

In der Zeichnung zeigt Abb. 1 einen Querschnitt durch einen luftgekühlten Vorschubrost mit Zonenunterteilung und abwechselnd feststehenden und beweglichen Rostbelagereihen. Während Abb. 2 die Rostplatte einer feststehenden Rostbelagereihe in der Draufsicht wiedergibt, stellt Abb. 3 einen Schnitt quer durch diese Rostplatte und Abb. 4 einen Schnitt parallel zur Rostplattenoberfläche dar. Abb. 5 zeigt den gleichen Schnitt durch die Rostplatte einer beweglichen Rostbelagereihe.

Gemäß Abb. 1 besteht jede Zone aus einem Luftsammelkasten a mit durchgehenden zweiteiligen Einbauten b und c . Über jedem Luftsammelkasten a befindet sich je eine bewegliche Rostplattenreihe d und eine dergleichen feststehende e . Vom Gehäuse aus tritt die Luft durch die Öffnung f in den oberen Teil b der Einbauten des Luftsammelkastens a und von dort in den Raum unter dem Rostbelag. Hier teilt sich die Luftmenge, und zwar tritt ein Teil durch die Öffnungen g (Abb. 4) der feststehenden Rostplattenreihe e und der andere Teil durch die Öffnungen h (Abb. 5) der beweglichen Rostplattenreihe d in den Rostbelag selbst ein. Aus den Abbildungen 4 und 5 ist der weitere Weg dieser Luftteilungen ersichtlich, der in beiden Fällen die Luft zwangsläufig über die Fläche jedes Rostplattenkörpers und insbesondere an dem

J.A. TOPF & SÖHNE ERFURT
TAGBLATT

MPFANGEE

16.11.42

3

Reichspatentamt, Berlin SW 61.

002703

Köpfen der Rostplattenreihen kühlend vorbeiführt. Bei den feststehenden Rostplattenreihen e tritt die Luft durch die Öffnungen i und bei den beweglichen Rostplattenreihen d durch die Öffnungen k wieder aus den Kanälen der Rostplatten aus, abzüglich der Luftmengen, welche als Verbrennungsluft durch die Luftdüsen l - Abbildungen 2 und 3 - in den Feuerraum tritt. Die Anordnung der Luftdüsen l erfolgt zweckmäßig in den Luftabführenden Kanälen, also hinter der an den Rostplatten-Köpfen befindlichen Umlenkung, da so etwaiger Rostdurchfall leicht durch die Zusatz-Kühlluft ausgetragen wird. Nach Verlassen des Rostbelages wird die Zusatz-Kühlluft in dem unteren Teil e der Einbauten des Luftsammelkastens a gesammelt, von wo sie dann durch die an dessen Ende befindliche Öffnung m ins Freie treten oder - da sie vorgewärmt ist - durch das Gebläse rückgesaugt und vom Neuen verwendet werden kann. Etwas mitgerissener Rostdurchfall wird im Raum n des Luftsammelkastens a ausgeschieden und durch Ascheabnahme-Vorrichtungen o von dort abgesaugt, ohne daß an dieser Stelle Luft austreten kann.

Um für jede Zone die Verbrennungsluftmenge einstellen zu können, wird an der Austrittsöffnung m im unteren Teil e der Einbauten des Luftsammelkastens a eine (nicht gezeichnete) Drosselklappe angeordnet. Wird diese Klappe z.B. ganz geöffnet, so dient die gesamte Luftmenge nur zur Kühlung des Rostbelages, weil die Öffnungen m dem Luftdurchtritt weniger Widerstand entgegensetzen, als die Luftaustritts-Düsen l des Rostbelages. Ist die Klappe dagegen nahezu geschlossen, so ist fast die gesamte Luftmenge gezwungen, durch die Düsen l zu treten und damit der Verbrennung zu dienen. Diese Einstellmöglichkeit gestattet für jede Zone das Verhältnis zwischen Zusatz-Kühlluftmenge und Verbrennungsluftmenge festzulegen. Dabei muß jedoch mit Rücksicht auf den Rostdurchfall stets so viel Zusatz-Kühlluft austreten, daß sich die Kanäle der Rostplatten nicht mit Asche oder Kohleteilchen zusetzen können.

Die durch Anwendung der Erfindung nachgewiesene Möglichkeit, mechanische Vorschubreste auch mit hochwertigen Brennstoffen

- 4 -

Document 159: continued.

J. A. TOPF & SÖHNE ERFURT	TAG	BLATT
#FANGER	16.11.42	4
<u>Reichspatentamt, Berlin NW 61</u>	002704	
<p>zu betreiben, hat in der Jetztzeit besondere Bedeutung. In den Zeiten der Belieferung mit gleichbleibenden Brennstoffen, herrschte das Bestreben vor, Leistung und Wirkungsgrad einer Feuerung bei Verwendung einer bestimmten Kohlenart zu steigern. Heute gilt es dagegen, die Brennstoff-Grundlage einer Feuerung so zu verbreitern, daß der Feuerungsbetrieb auch mit ursprüng- lich nicht vorgesehenen Brennstoffen durchgeführt werden kann und dabei doch noch gute Wirkungsgrade zu erreichen sind. Die Erfindung gestattet, Verschieb-Feuerungen nach jeder Richtung hin mit einem großen Spielraum in Bezug auf den Brennstoff zu betreiben und gewährleistet dabei durch die Verwendung des be- schriebenen Restbelages in Verbindung mit der Konstruktions- einen Feuerungsbetrieb mit hochprozentigem Wirkungsgrad. Voraus- setzung ist natürlich, daß sich ein Brennstoff überhaupt zur Verbrennung auf einem mechanischen Verschiebrost eignet.</p>		

Document 159: continued.

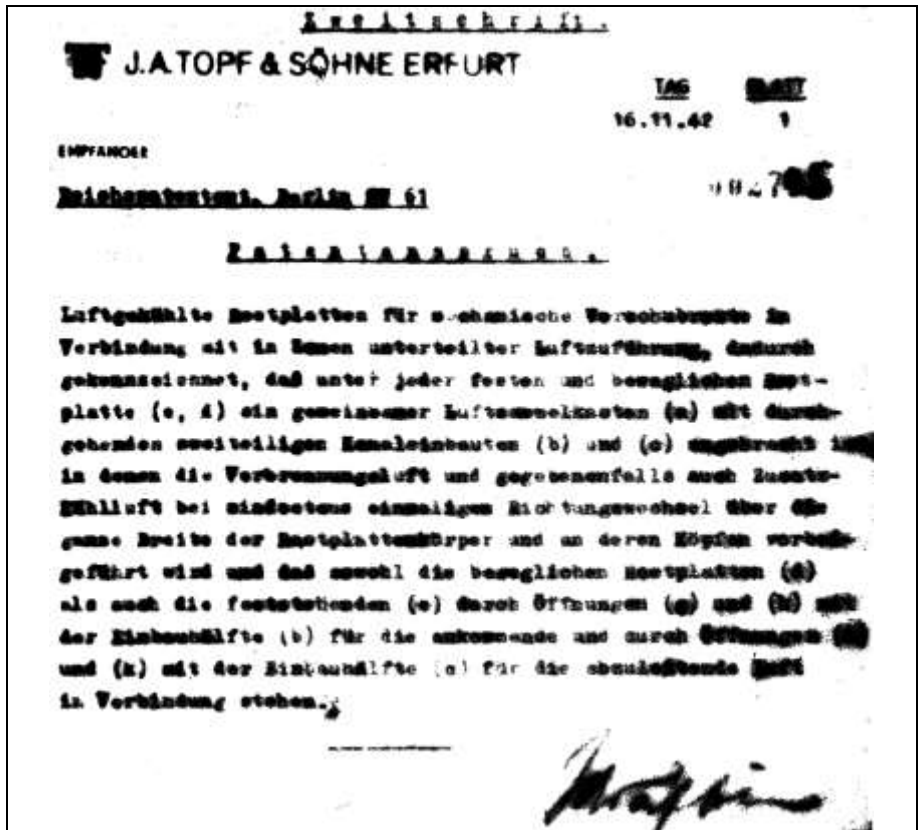

Document 159: continued.

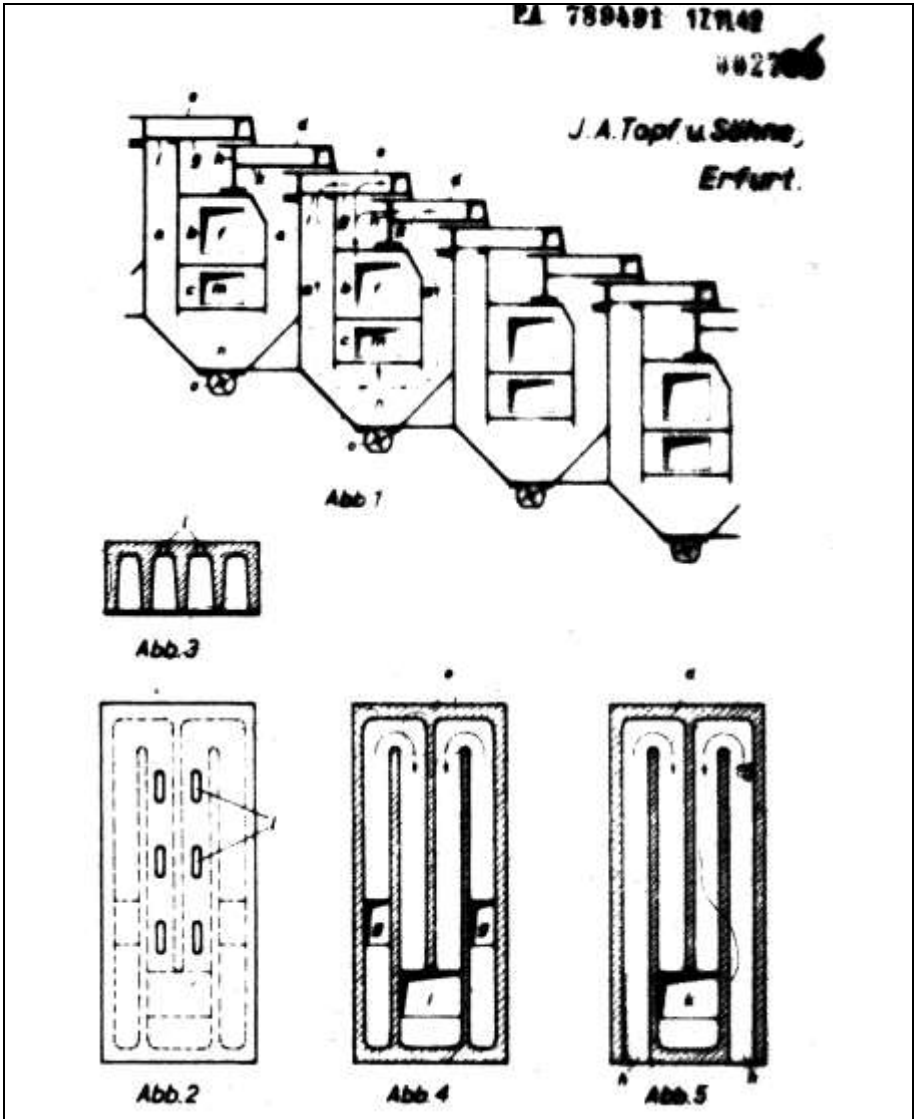

Document 159: continued.

Ertelt auf Grund des Ersten Überleitungsgesetzes vom 8. Juli 1949

(WzGBL S. 175)

BUNDESREPUBLIK DEUTSCHLAND



AUSGEGEBEN AM
5. JANUAR 1953

DEUTSCHES PATENTAMT

PATENTSCHRIFT

Nr. 861 731

KLASSE 24 d GRUPPE 1

T 1562 V/24 d

Martin Klettner, Recklinghausen
ist als Erfinder genannt worden

J. A. Topf & Söhne, Wiesbaden

Verfahren und Vorrichtung zur Verbrennung von Leichen,
Kadavern und Teilen davon

Patentiert im Gebiet der Bundesrepublik Deutschland vom 24. Juni 1950 an

Patentanmeldung bekanntgemacht am 31. Oktober 1951

Patenterteilung bekanntgemacht am 13. November 1952

Die Erfindung betrifft ein Verfahren zur Verbrennung von Leichen, Kadavern und Teilen davon durch rekuperativ erhitze Verbrennungsluft und eine Vorrichtung zur Durchführung des Verfahrens.

5 Fast alle bisher bekanntgewordenen Einäscherungsverfahren verwenden im Rekuperativverfahren erhitze Luft als Verbrennungsluft für die Verbrennung der Leichen. In der gleichen Weise wie bei allen
10 Verbrennungsvorgängen in der Wärmetechnik soll der Verbrennungsprozeß durch die Vorwärmung der Luft thermisch auf eine höhere Stufe gehoben und damit die Verbrennungstemperatur gesteigert werden.

Der Heizwert einer Leiche bzw. ihr Brennwert wurde bisher grundsätzlich nach dem Fettgehalt der
15 Leiche beurteilt. Die im Fettkörper der menschlichen Leiche enthaltenen CH (Kohlewasserstoff)-Verbin-

dungen (Fette) weisen zum Teil eine sehr niedrige Zündtemperatur auf und verbrennen bei höchsten Temperaturen. Dagegen ist es bisher nicht gelungen, die im Eiweißkörper in Verbindung mit N (Stickstoff) enthaltenen CH-Verbindungen bei Fehlen von reinen Fettkörpern und damit reinen CH-Verbindungen exotherm zu verbrennen. Der Eiweißkörper setzt mit seinem relativ hohen N-Gehalt (etwa 25 %) seiner
20 Verbrennung heftigsten Widerstand entgegen. Seine Zündtemperatur liegt bei etwa 800° C.

Bei bisher erreichten Lufttemperaturen von 400 bis 500° C konnte somit die im Eiweißkörper enthaltene Stickstoffkomponente in ihrer die Verbrennung hemmenden Wirkung nicht aufgehoben werden.

30 Erfahrungsgemäß vermag erst die Einwirkung von Luft von 800 bis 900° die Trennung des N von den

Document 160: Patent J.A. Topf & Söhne, Wiesbaden, No. 861731. "Process and device for the combustion of corpses, carrion, or parts thereof." 24 June 1950.

Source: Deutsches Patentamt.

861 731

2 CH-Verbindungen zu vollziehen, trotzdem es sich auch im Eiweißkörper nicht um eine chemische Verbindung von N + CH handelt, sondern nur um eine jener lockeren Verbindungen von N, wie sie dieser, als sehr träge bekanntes Gas, vielfach eingelagert. Daß bei der Ausschaltung des N auch eine gewisse Wärmemenge verbraucht wird, ist anzunehmen. Jedoch wird aber niemals der große Wärmeverbrauch auftreten, der notwendig ist, um N aus einer festen chemischen Verbindung frei zu machen. Es werden auch bei der Verbrennung der CH-Verbindungen im Eiweißkörper nahezu die Wärmemengen frei, welche bei der Verbrennung von reinen CH-Verbindungen ihrer Zusammensetzung entsprechend entbunden werden.

15 Für eine menschliche Leiche von etwa 70 kg Gewicht, einem Gehalt von etwa 12 kg C, etwa 2 kg H₂ und etwa 0,5 kg P, bei etwa 55,5 kg H₂O + N errechnet sich ein Mindestkalorienwert von etwa 160 000 WE, wozu noch die Sargverhüttungswärme zu rechnen ist.

Das endgültige Ziel in der Kremation mußte demnach sein, die jeweilige notwendige Verbrennungsluftmenge ohne zusätzliche Wärmezufuhr, lediglich unter Ausnutzung der Abgase auf 800 bis 900° zu erhitzen, um die im Eiweißkörper enthaltenen beträchtlichen, aber an N gebundenen CH-Mengen restlos zu verbrennen und durch Freiwerdung dieser Wärmemengen die Verbrennung jeder menschlichen Leiche ohne zusätzliche Wärmezufuhr zu ermöglichen.

30 Mittels des Einäscherungsverfahrens gemäß der Erfindung ist dieses Ziel erreicht. Es werden nicht nur die notwendigen Wärmemengen für die Verdampfung und den Abtransport des Wassers in der Leiche verfügbar, sondern auch diejenigen für das Verbrennen und Verscharren der Leiche selbst. Abzüglich der Wärmemengen, die im Abgas verlorengehen, verbleiben noch immer bedeutende Wärmemengen disponibel für das Hochheizen des Ofens bzw. die Erhaltung seines Beharrungszustandes.

40 Ein eingangs erwähntes Verfahren wird gemäß der Erfindung derart durchgeführt, daß die Leiche mit dem Sarg in einer Muffel auf einem Balkenrost so lange der Einwirkung eines unter Aufwand von Brennstoff rekuperativ beheizten Luftstromes und/oder der Strahlungseinwirkung erhitzter Muffelwände ausgesetzt wird, bis der in Brand geratene Sarg und die durch die Verdampfung ihres Wassergehaltes brennfähig gewordene Leiche zerfällt, und daß die Teile auf einem darunter befindlichen kleinen Ausbrennrost mit der auf 800 bis 900° C rekuperativ, hauptsächlich durch die Verbrennungswärme der Leichtenteile erhitzten erforderlichen Verbrennungsluftmenge exotherm verbrennen, wobei die sich bildenden Verbrennungsgase von oben nach unten durch den Ausbrennrost abströmen und sich zwecks vollständiger Verbrennung der flüchtigen Bestandteile mit unter dem Ausbrennrost zugeführter heißer Verbrennungsluft mischen, und daß die Verbrennungsgase unmittelbar in den 60 Rekuperator geleitet werden, in welchem sie ihren Wärmeinhalt an die Verbrennungsluft abgeben, so daß die Verbrennung ohne weiteren Aufwand an Brennstoff unterhalten wird.

Die Abbildung zeigt einen Ofen zur Durchführung des Verfahrens.

65 Die den Sarggrößen angepaßte und in den Normalmaßen ausgeführte Muffel A ist als Verbrennungsraum nur so lange wärmewirtschaftlich wirksam, wie der Muffelraum von den Verbrennungsgasen voll ausgefüllt wird. Der bisherige ausschließlich in der Muffel durchgeführte Verbrennungsprozeß muß Trocknungsprozeß werden und als solcher beendet sein, sobald nach Verbrennen des Sarges und Abfallen des Kopfes und der Gliedmaßen die nur aus zwei Steinen bestehende Rostanlage die Teile des Rumpfes selbsttätig 75 in den kleinen über der Drehplatte liegenden eigentlichen Verbrennungsraum B durchfallen läßt. Dauer dieses Prozesses in der Muffel 20 bis 30 Minuten.

In diesem kleinen Verbrennungsraum kommt die auf 800 bis 900° C erhitzte Luft innig mit den noch unverbrannten Eiweißstoffen in Berührung, trennt N von den CH-Verbindungen und bringt CH bei Temperaturen bis über 1200° C restlos zur Verbrennung. Dieser eigentliche Verbrennungsprozeß dauert 20 bis 15 Minuten. Die Drehplatte kann gedreht werden, und die gesamten Aschereste fallen zum Nachglühen in den dritten Verbrennungsraum auf den Ascherost C.

Die notwendige Verbrennungsluft wird in einem aus Schamottesteinen gemauerten oder metallischen Lufterhitzer D auf 800 bis 900° C erhitzt. Beim Anfahren des Ofens liefert ein Heißluftgasbrenner E Verbrennungsgase von 1200 bis 1300° C für das Hochheizen des Lufterhitzers. Die Heißluft wird regelbar in die Muffel, über der Drehplatte und unter dem Ascherost zugeführt. Auch der Heißluftgasbrenner wird vom Lufterhitzer mit Luft von max. 600° C beliefert.

Sobald der Ofen Beharrungszustand erreicht hat, wird der Gasbrenner abgestellt, und die Beheizung des Lufterhitzers erfolgt nur durch die gleichfalls sehr heißen Abgase insbesondere während der eigentlichen Verbrennungsphase auf der Drehplatte, bei der die Eiweißkörper lebhaft verbrennen.

Die gesamte Einäscherungsdauer wird durch das neue Einäscherungsverfahren bis 45, oft bis 30 Minuten reduziert.

Die Qualität der Asche kennzeichnet diese als vollkommen verbrannt, keimfrei und von so mäßigem Volumen, daß die normale Urne selten ganz gefüllt wird.

PATENTANSPRÜCHE:

1. Verfahren zur Verbrennung von Leichen, Kadavern und Teilen davon durch rekuperativ erhitzte Verbrennungsluft, dadurch gekennzeichnet, daß die Leiche mit dem Sarg in einer Muffel auf einem Balkenrost so lange der Einwirkung eines unter Aufwand von Brennstoff rekuperativ beheizten Luftstromes und/oder der Strahlungseinwirkung erhitzter Muffelwände ausgesetzt wird, bis der in Brand geratene Sarg und die durch die Verdampfung ihres Wassergehaltes brennfähig gewordene Leiche zerfällt, und daß die Teile auf einem darunter befindlichen kleinen Ausbrennrost mit der auf 800 bis 900° C rekuperativ, haupt- 115

861 731

3

sächlich durch die Verbrennungswärme der Leichenteile, erhitzten erforderlichen Verbrennungsluftmenge exotherm verbrennen, wobei die sich bildenden Verbrennungsgase von oben nach unten durch den Ausbrennrost abströmen und sich zwecks vollständiger Verbrennung der flüchtigen Bestandteile mit unter dem Ausbrennrost zugeführter heißer Verbrennungsluft mischen, und daß die Verbrennungsgase unmittelbar in den Rekuperator geleitet werden, in welchem sie ihren Wärmehalt an die Verbrennungsluft abgeben, so daß die Verbrennung ohne weiteren Aufwand an Brennstoff unterhalten wird.

2. Ofen zur Verbrennung von Leichen, Kadavern und Teilen davon mit rekuperativ erhitzter Verbrennungsluft mit unter dem Balkenrost einer Muffel befindlichen abklapp- oder einfahrbarem Ausbrennrost zur Durchführung des Verfahrens nach Anspruch 1, dadurch gekennzeichnet, daß der Balkenrost nur aus zwei Balken besteht und über einen Trichterboden angeordnet ist, dessen

Böschungsfächen zur Beförderung der Sarg- und Leichenteile auf den aufklapp- oder einfahrbaren Ausbrennrost dienen und daß über dem Ausbrennrost Zuführungsöffnungen für die Erstluft und in dem Raum unterhalb des Ausbrennrostes der Verbrennungsgasabzug in den Rekuperator, ein Heißluftgasbrenner zur zeitweisen Beheizung des Rekuperators und Öffnungen zur Zuführung von Zwiitluft angeordnet sind und sein Boden einen ebenfalls abklappbaren, entsprechend der fortgeschrittenen Verbrennung kleineren Ausglührost bildet, so dem ebenfalls Heißluftzuführungsöffnungen führen.

3. Ofen nach Anspruch 2, dadurch gekennzeichnet, daß der Feuerraum mit einer verhältnismäßig dünnen Auskleidung von geringer Wärmekapazität ausgestattet ist und von einer starken Isolierschicht umgeben ist.

Angezogene Druckschriften:
Deutsche Patentschrift Nr. 669 645.

Hierzu 1 Blatt Zeichnungen

Document 160: continued.

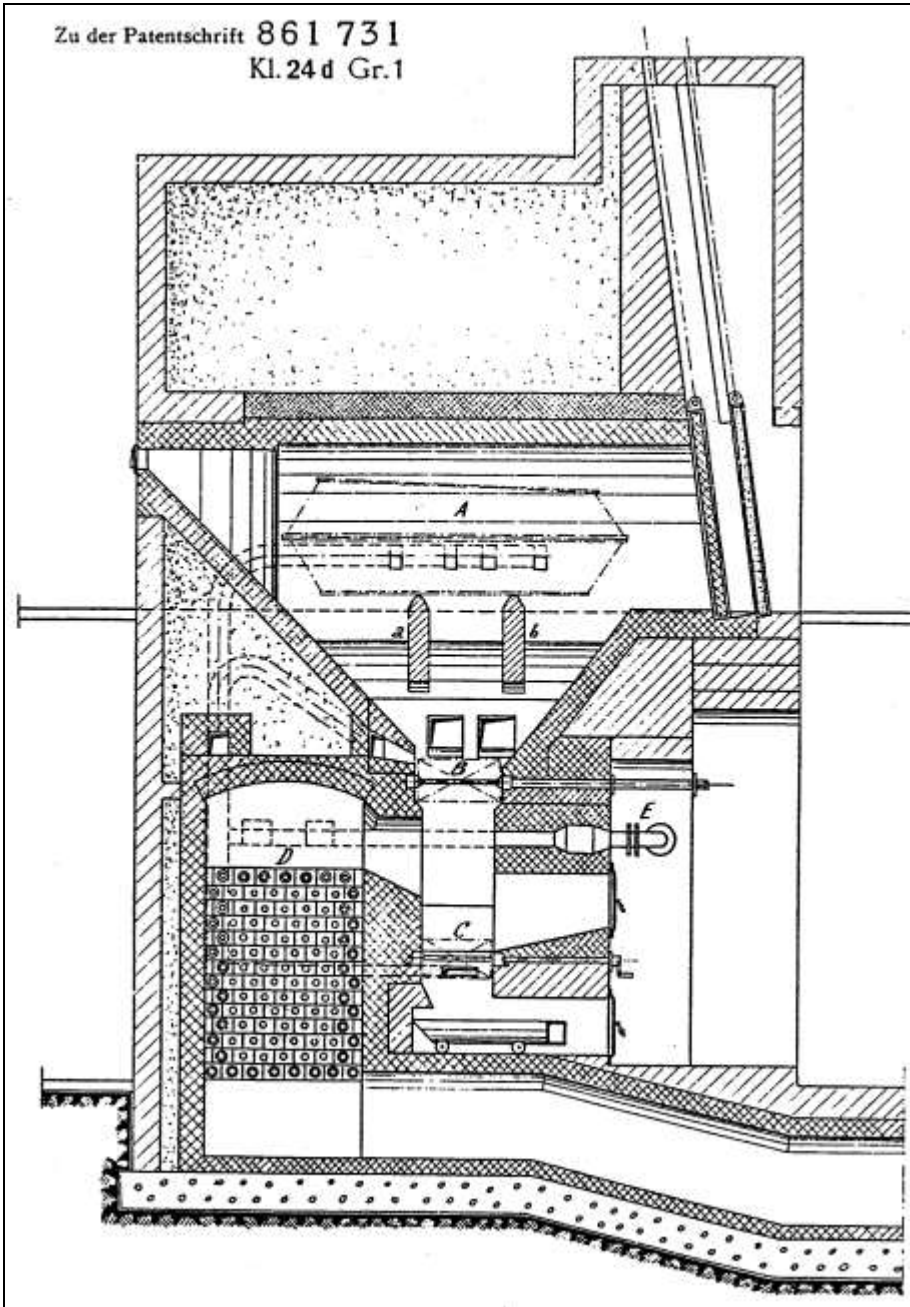

Document 160: continued.

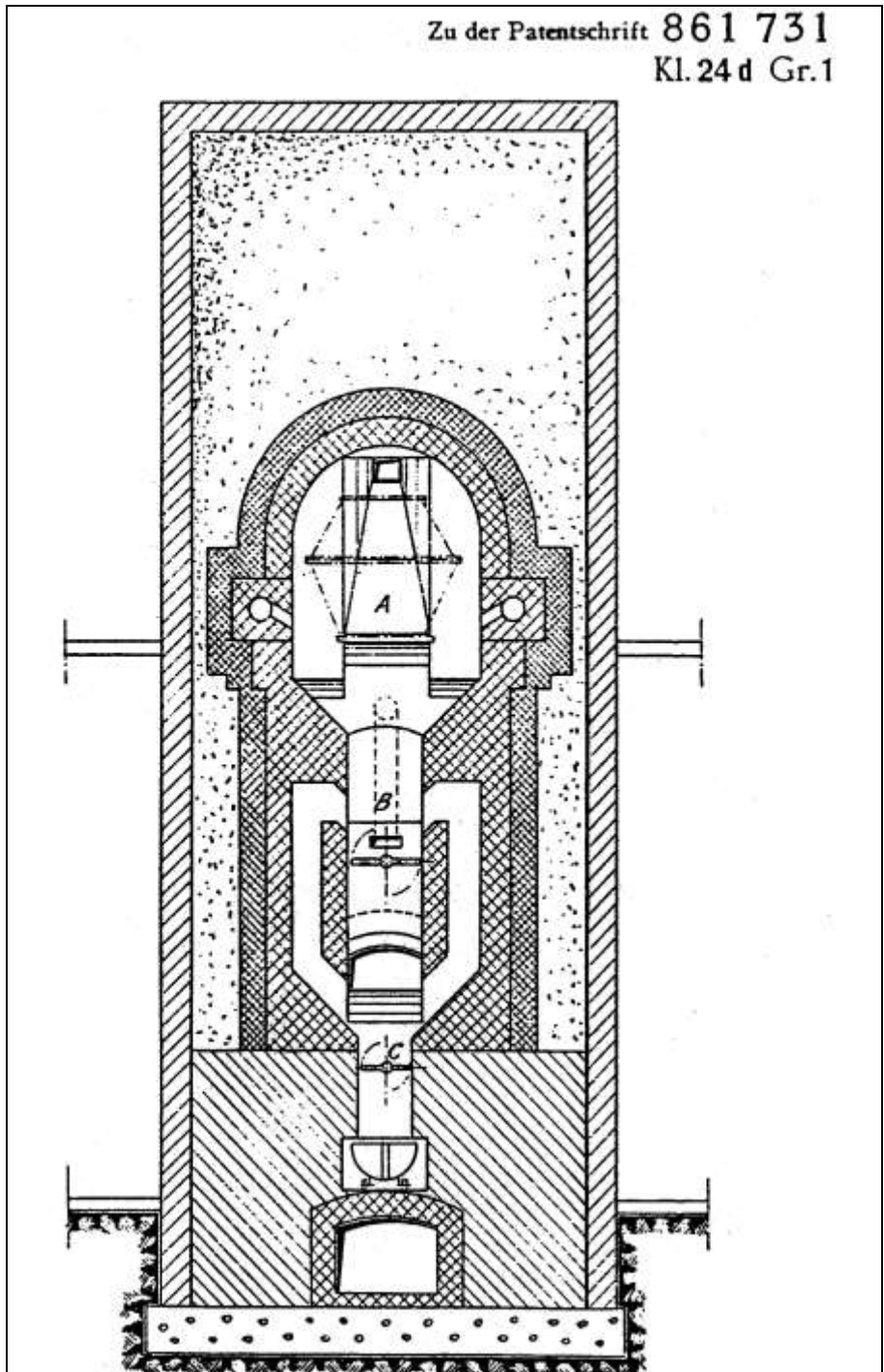

Document 160: continued.

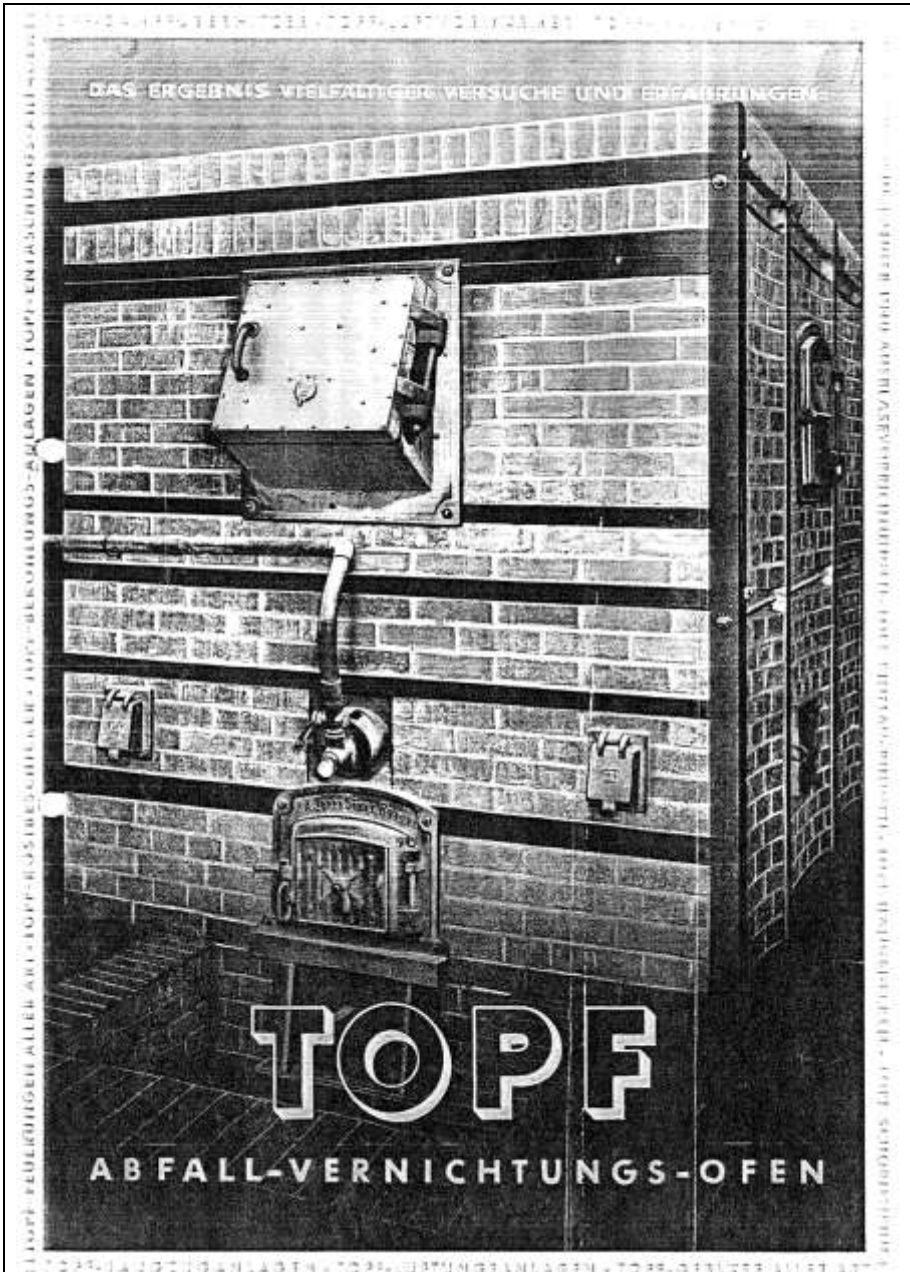

Document 161: Maschinenfabrik J.A. Topf & Söhne, Erfurt, "Topf Waste Incinerator." Promotional brochure of 1940. Source: RGVA, 502-1-327, pp. 161-164a.

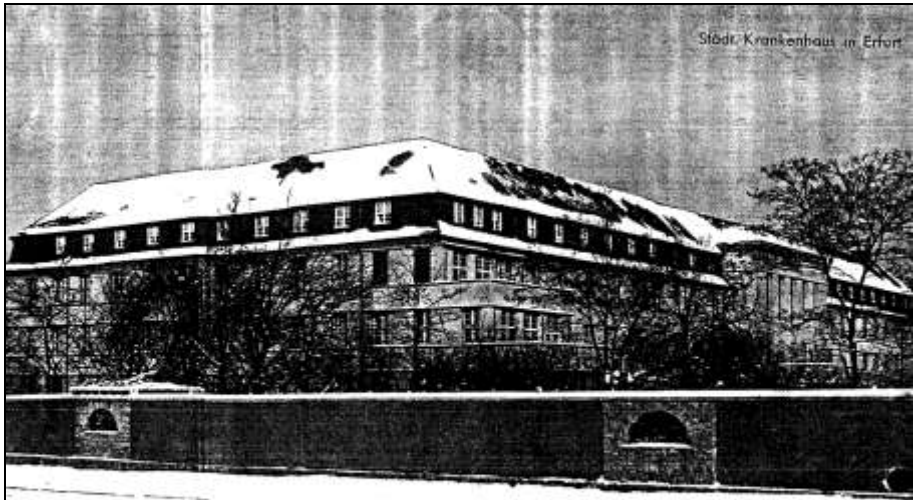

VOLKSGESUNDHEIT UND HYGIENE

sind der Ausgangspunkt für die überaus sorgfältige Behandlung der Spezialfragen, die unsere **Abteilung Ofenbau** seit Jahrzehnten bearbeitet. Unsere Spezialöfen dienen demnach dem Ziel, der Verbreitung von Krankheiten wirksam zu begegnen.

Vorbeugen ist besser . . .

Die technisch-wissenschaftlichen Erkenntnisse und umfassenden praktischen Erfahrungen haben es uns ermöglicht, eine restlose Vernichtung der Krankheitskeime in den Krankenabfällen, Mull und ähnlichen Stoffen durch die reinigende Kraft des Feuers zu erreichen.

TOFF-OFENBAU

Hierbei kamen uns zugute unsere 60 jährigen Erfahrungen auf dem Gebiete des Feuerungsbaues und der Wärmewirtschaft. Die Güte unserer Spezialkonstruktionen zeigt sich an der geruch-

losen, rauchschwachen Verbrennung und an der weitgehenden Ausnutzung des Brennstoffs, d. h. an der wärmewirtschaftlich einwandfreien Arbeitsmethode, die sich im Betrieb dieser Ofenanlagen auswirkt.

TOFF-Abfallvernichtungsöfen – für Gas-, Kohle-, Öl- oder Elektrobeheizung – arbeiten demnach nicht nur hygienisch einwandfrei, sondern überaus wirtschaftlich.

Krankenhaus-Abfallvernichtung

Immer mehr gehen die Krankenhäuser, Kliniken und auch Privatsanatorien dazu über, **Spezialofenanlagen zur Vernichtung von Krankenabfällen**, Verbandsresten, Amputationsteilen anzuwenden. (Der Dampfkessel der Heizungsanlage ist hierfür nicht geeignet.) Die Ofen beanspruchen nur wenig Platz und eine geringe Wartung; sie eignen sich somit ebenso für die kleineren wie auch für die großen Anstalten.

INDUSTRIELLE ABFALLWIRTSCHAFT

Die Anwendung von Spezialofenanlagen für die Abfallvernichtung in großen Industriebetrieben ist im Laufe des letzten Jahrzehnts im starken Fortschreiten; erfordert doch die Lagerung z. B. von anfallendem Müll viel Platz und wirkt sich in unhygienischer Weise aus. Die Abfuhr des Gutes kostet Arbeitskraft, Zeit und Geld. Die Verbrennung des Mülls hilft also sparen und stellt die Möglichkeit dar, die dabei anfallende Abgaswärme zur Warmwasserbereitung oder Raumheizung auszunutzen.

Erhaltung der Werte

Der Vierjahresplan hat uns gelehrt, die Erfassung auch kleinster Mengen wertvollen Rohstoffes vorzusehen. Es geht deshalb nicht nur um die Vernichtung des Abfalls, sondern auch um die Erhaltung der in diesen Abfällen vorhandenen Werte, die zusammengenommen für die Volkswirtschaft von Bedeutung sind.

Über die industrielle Bedeutung dieser Abfallvernichtung innerhalb der Betriebe hinaus – hat die Abfallverwertung für Staatsbetriebe, Versorgungsbetriebe und Gemeindeverwaltungen eine ständig wachsende Bedeutung erlangt. Aus diesen Erfordernissen sind unsere Spezialkonstruktionen entstanden, die eine überaus vielseitige Anwendung erfahren • Einige dieser Ofentypen:

1. Der Kabel-Abbrennofen

erzielt eine restlose Rückgewinnung der wertvollen Metalle. Der Abbrennofen ist so konstruiert, daß er dabei gleichzeitig Kupfer und Blei trennt.

2. Der Müll-Verbrennungsofen

findet bei Gemeindeverwaltungen Anwendung. (Die Asche ergibt ein gutes Düngemittel.)

3. Der Kranz-Verbrennungsofen

ist ein wertvoller Helfer für Friedhofsverwaltungen. Die großen Mengen Kränze, die im Laufe eines Jahres anfallen und deren Lagerung Schwierigkeiten macht, werden schnell beseitigt. Die Asche kann ebenfalls zur Düngung verwendet werden. Das Metall der Bindedrähte wird zurückgewonnen.

4. Der Matratzen-Verbrennungsofen

ermöglicht sparsame und hygienische Vernichtung bei gleichzeitigem Rückgewinnen der in der Matratze enthaltenen Metalle.

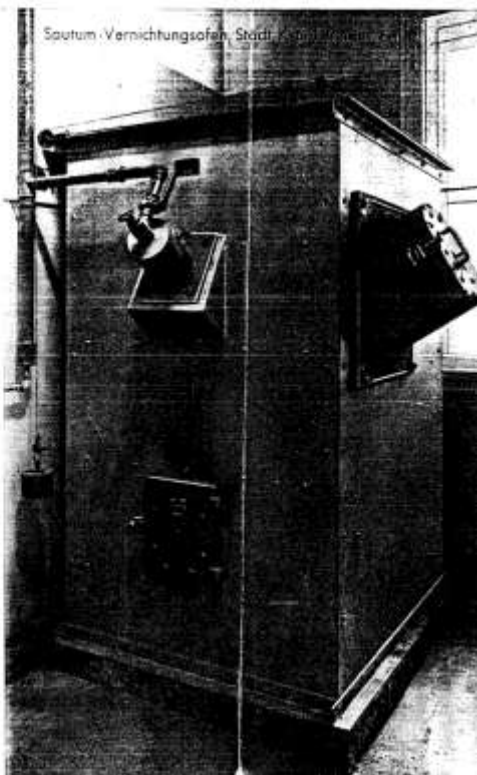

Document 161: continued.

VIER TOPF-OFENTYPEN

Der Abfall-Vernichtungs-ofen AV 1

Abb. 1

Ist leicht unterzubringen. Er eignet sich daher besonders für wissenschaftliche Institute, kleinere Krankenhäuser, Sanatorien, Kliniken und Entbindungsanstalten. Er vernichtet äußerst rauch- und geruchsschwach Amputationsteile, Versuchstiere und Krankenabfälle. Dieser Ofen ist ähnlich dem Sputum-Vernichtungs-ofen mit Schmiedeeisen ummantelt. Er ist mit Schamottesteinen ausgemauert und mit Kieselgur isoliert. Der Aufgabekasten A hat einen seitlich aufgehenden isolierten Türverschluss. Unter dem Kasten ist die Feuerung C mit Aschefalle D. Der Brennraum B erhält an der Rückwand als Abschluß eine Schamotte-Gitterwand, hinter dem der Abgaskanal E angeordnet ist. Der Rauchkanalschieber F schließt ihn außerhalb der Ofen-Ummantelung vom Schornstein ab und regelt die Zugstärke.

Der Abfall-Vernichtungs-ofen AV 2

Abb. 2

Leichte Bedienung, schnellste Vernichtung der Abfälle bei geringem Brennstoffverbrauch, rauch- und geruchsschwach arbeiten. Für mittlere Krankenhäuser, Kliniken, Hotels und dergleichen sehr geeignet. Diese Type besteht aus einem Ziegelsteingehäuse, das die Schamottemauerung und die Isolierung fest umschließt. Der Aufgabekasten A kann entweder oben auf dem Ofen angebracht werden, oder er tritt an die Stelle der Verschlusstür V (Type AV3). Unter dem Brennraum B liegt der von der Feuerung C aus beheizte Schamotteroast B 1. Dieser Rost nimmt nasse und andere schwer brennbare Abfälle auf. Mittels des Drehrostes D lassen sich die Aschereste leicht in den Ascheraum E befördern. Der Abgaskanal mit dem Fuchs F ist hinter einem Schamotte-Gitterwerk G angebracht. Der Schieber H schließt den Kanal ab. In dem Abgaskanal können Luftherzter-Rohre zur Heißluft-Erzeugung oder Rohrschlangen für die Warmwasser-Bereitung eingebaut werden.



ABBILDUNG 1

■ Schamotte ■ Isolierung ■ Ziegelstein



ABBILDUNG 2

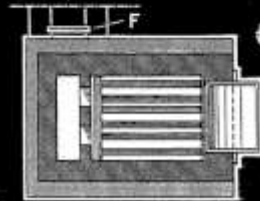
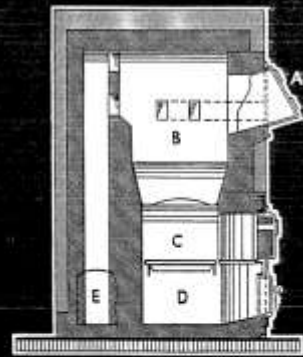

VIER TOFF-OFENTYPEN

 PLANTZWEIGLEITER VERBODEN
 ARCHIVUM

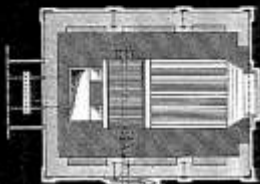
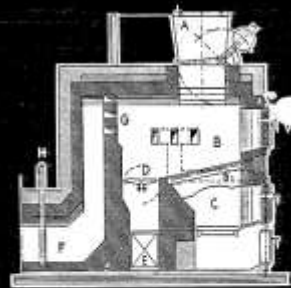
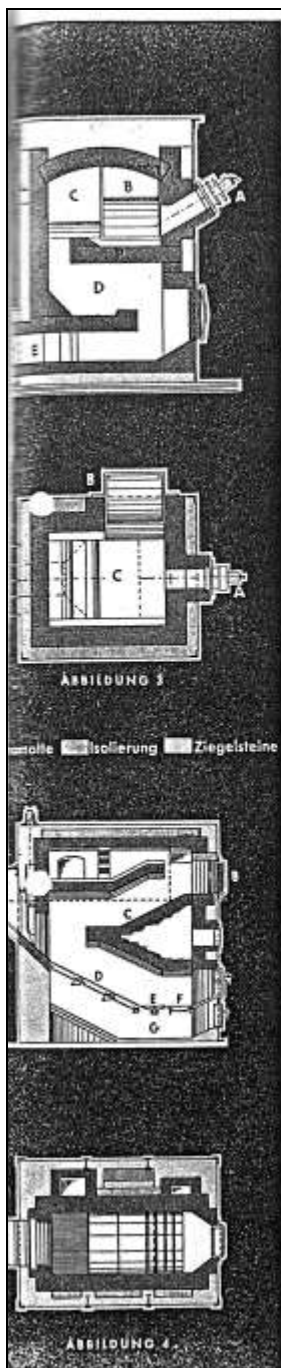
Der Sputum-Vernichtungssofen SV

Abb. 3

ist mit Schmiedeeisen umkleidet. Dieser Mantel schützt das Ofeninnere vor Beschädigung. Gleichzeitig sind an ihm der Gasbrenner A und der Aufgabekasten B angebracht. Die Schamotteplatte P trennt den Verbrennungsraum C vom Nachverbrennungsraum D und dem zum Schornstein führenden Rauchgaskanal E. Die zu vernichtenden Papp-Sputum-Gefäße werden durch den Aufgabekasten auf die Schamotteplatte gebracht, auf der sie verbrennen. Der Nachverbrennungsraum gewährleistet einen guten Ausbrand der Abgase und damit einen rauch- und geruchsschwachen Betrieb • Der Rauchkanalschieber F, der außerhalb der Ofen-Ummantelung angebracht ist, dient dem Regeln der Zugstärke. Zwischen Blechmantel und Schamotte-mauerung wird eine Isolierung aus Kieselgur angebracht. Diese unterbindet die Wärmeausstrahlung.

Der Müll-Verbrennungssofen MV

Abb. 4

vernichtet bei geringem Brennstoffverbrauch schnell, sicher, rauch- und geruchsschwach den täglich anfallenden Müll in Kaufhäusern, Industriewerken, Hotels, Markthallen usw. Der Ofen hat einen Backsteinmantel mit einer starken schmiedeeisernen Verankerung. Eine kleine Hilfsfeuerung F heizt den Ofen vor der Verbrennung hoch • Das nasse Müllgut wird durch die Tür B auf den Schamoterost C und der trockene Müll durch den Kasten A auf den Rost D geschüttet. Der Drehrost E befördert nach dem Brand die Ascherückstände leicht nach dem Aschefall G.

Wert und Leistungsfähigkeit der TOFF-Ofen werden in einem Bericht gekennzeichnet:

„In den letzten 4 Wochen sind von der Städtischen Straßenreinigung ungeheure Berge von alten Sofas und Matratzen angeliefert worden, die schnellstens und zwar in 24 stündiger Schicht verbrannt werden mußten. In der Zeit hat unser Ofen dauernd binnen 24 Stunden 120 – 130 Matratzen eingeschert und dabei riesige Mengen Drahtsprungfedern ans Licht gebracht.“

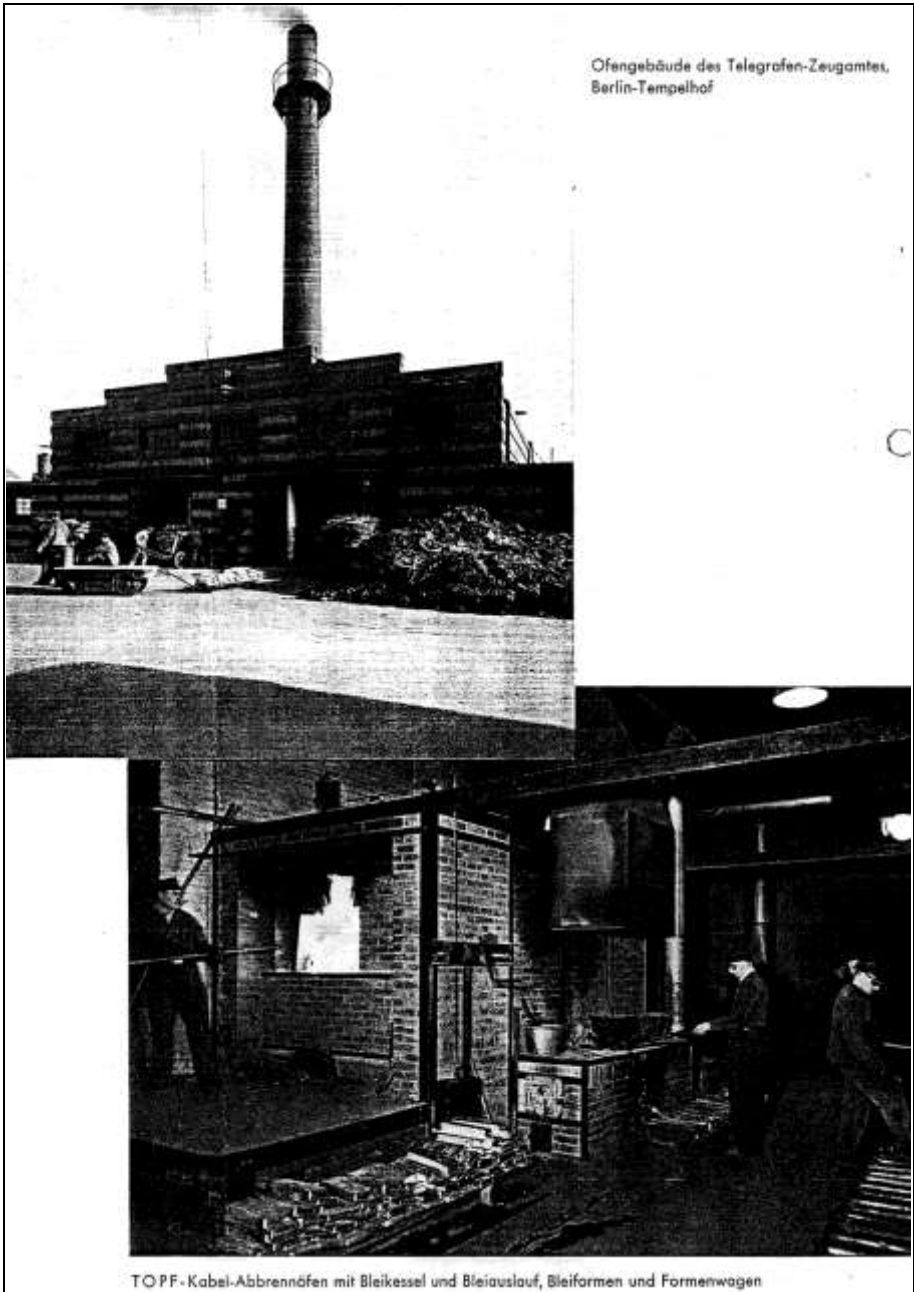

Document 161: continued.

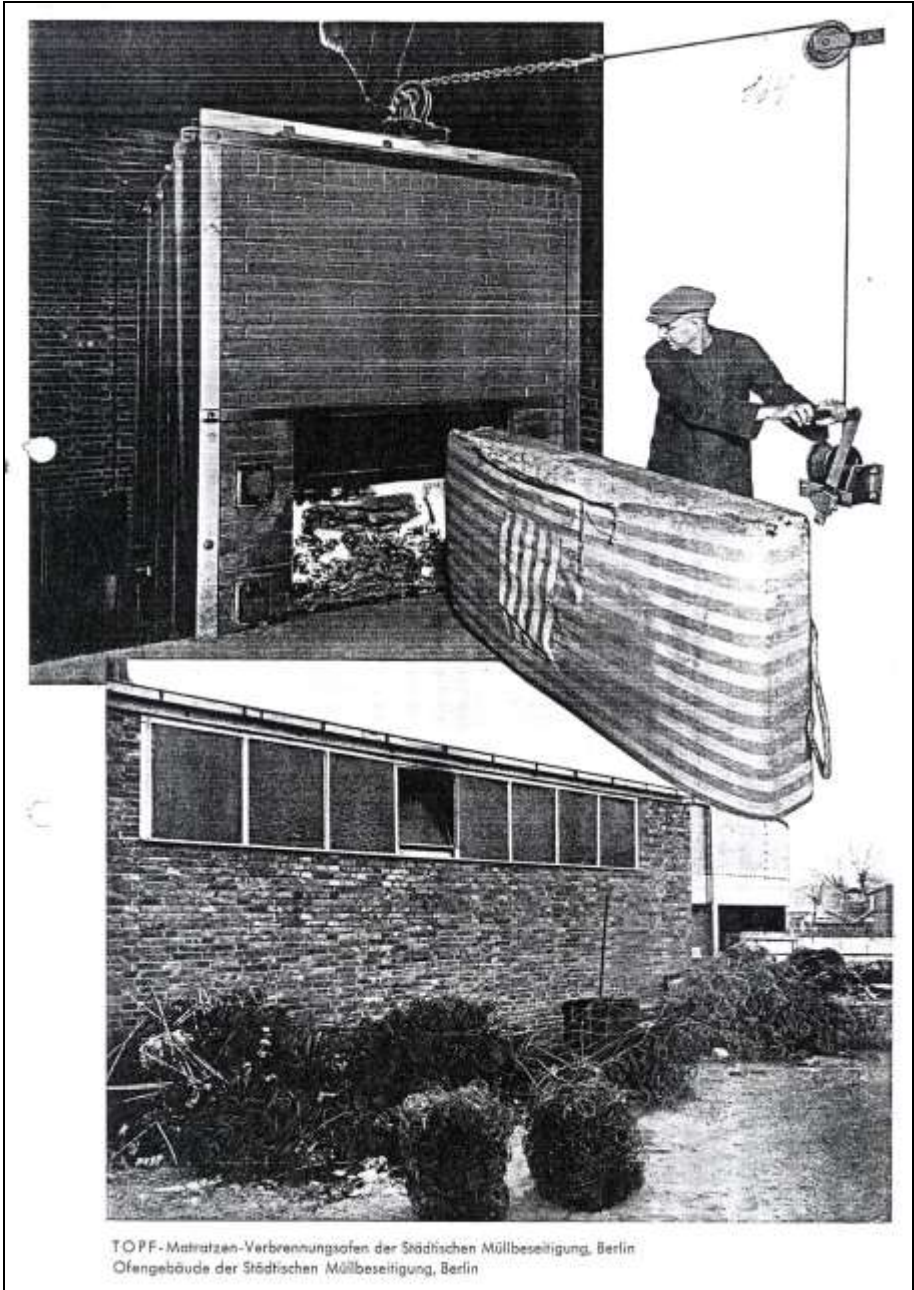

TOPF-Matratzen-Verbrennungssofen der Städtischen Müllbeseitigung, Berlin
Ofengebäude der Städtischen Müllbeseitigung, Berlin

Document 161: continued.

EINIGE BESTELLER VON TOPF-ANLAGEN ZUR ABFALLVERNICHTUNG

Krankenhaus Friedberg
 Heil- und Pflegeanstalt Frankenthal
 Krankenhaus Ilmenau/Thür.
 Rotes Kreuz Athen/Griechenland
 Universitätsklinik Göttingen
 Heilanstalt des Johannitarordens (Sorge)
 Horz
 Lungenheilstätte Römheld
 Lungenheilstätte Bad Berka
 Stadtkrankenhaus Eisenach
 Elisabeth-Krankenhaus Frankfurt/Main
 Städt. Krankenhaus Erfurt
 Kreis-Krankenhaus
 Sondershausen
 Landesheilanstalt Stad-
 roda
 Krankenhaus Lucken-
 walde
 Städt. Krankenhaus Erfurt
 Krankenhaus Fürsten-
 walde
 Katholisches Krankenhaus
 Erfurt
 Krankenhaus Delmenhorst
 Evang. Krankenhaus
 Oberhausen
 Kreis-Krankenhaus
 Milbitz/Gera
 Städt. Krankenhaus Athen/
 Griechenland
 Medizinische Klinik
 Heidelberg
 Friederikenstift Hannover
 Krankenhaus Passau
 Knappschaftskrankenhaus
 Eisleben
 Kreis-Krankenhaus Annaberg/Dresden
 Krankenhaus Hof/Bayern
 Sanatorium Sonnenblick Marburg
 Landeskrankenhaus Meiningen
 Kreis-Krankenhaus Hameln
 Landeskrankenhaus Rudolstadt
 Landeskrankenhaus Gotha
 Landeskrankenhaus Pößneck
 Kaiser-Wilhelm-Institut Berlin-Dahlem
 Vinzenz-Krankenhaus Berlin
 Knappschaftskrankenhaus Leopoldshill-
 Staßfurt
 Landesversicherungsanstalt Weimar für
 Bad Colberg
 Heil- und Pflegeanstalt Eichstedt

Chirurgische Universitätsklinik Heidelberg
 Krankenhaus Neustadt/Haard
 Kreis-Krankenhaus Schweinfurt
 Krankenhaus Harburg
 Universitätsklinik Leipzig
 Karl-Olga-Krankenhaus Stuttgart
 Staatl. Frauenklinik Dresden
 Städt. Hautklinik Bremen
 Landeskrankenhaus Coimbra/Portugal
 Ruhrknappschaft Bochum
 St. Joseph-Hospital Wuppertal-Eberfeld

St.-Medwigs-Krankenhaus Berlin
 Chirurgische Universitätsklinik Heidelberg
 Mercedes Büromaschinenfabrik Zella-
 Mehlis
 Reichsbahndirektion Erfurt
 Meierl C. Bolle, A. G., Berlin
 Burghotel „Kyffhäuser“, Bad Franken-
 hausen
 Rothenburg „Kyffhäuser“, Bad Franken-
 hausen
 Rathfeld „Kyffhäuser“, Bad Frankenhausen

EIN ZEUGNIS



Fichtel & Sachs,
 Schweinfurt
 Primus A. G., Stockholm-
 Essingen
 M. Schaefer A. G. für Peru,
 Bern
 Oberpostdirektion Erfurt
 Oberpostdirektion
 Pasing/München
 Oberpostdirektion Berlin/
 Tempelhof
 Neumayer A. G., Nürnberg
 Kabelwerk Reinhausen,
 Wuppertal-Ronsdorf
 Land- und Seekabelwerke
 Köln-Nippes
 Kupfer- und Drahtwerke
 Osnabrück
 Oberpostdirektion Karlsruhe
 Telegrafenzugamt Berlin
 Städt. Schlachthof Erfurt
 Staatl. Veterinär Unter-
 suchungsamt
 Landsberg/W.
 Staatl. Veterinär Untersuchungsamt Breslau
 Gaswerk Elbtal, Radebeul/Dresden
 Staatl. Veterinär Untersuchungsamt
 Frankfurt/Main
 Georg-Speyer-Haus, Frankfurt/Main
 Schlachthof Frauenfeld/Schweiz
 Staatl. Veterinär Untersuchungsamt
 Potsdam
 Staatl. Veterinär Untersuchungsamt
 Königsberg/Pr.
 Staatl. Veterinär Untersuchungsamt
 Schleißheim
 Staatl. Veterinär Untersuchungsamt Berlin
 Staatl. Veterinär Untersuchungsamt
 Nürnberg



MASCHINENFABRIK
J. A. TOPF & SÖHNE · ERFURT
 FEUERUNGSTECHNISCHES BAUGESCHAFT, ABTEILUNG OFENBAU

Document 161: continued.

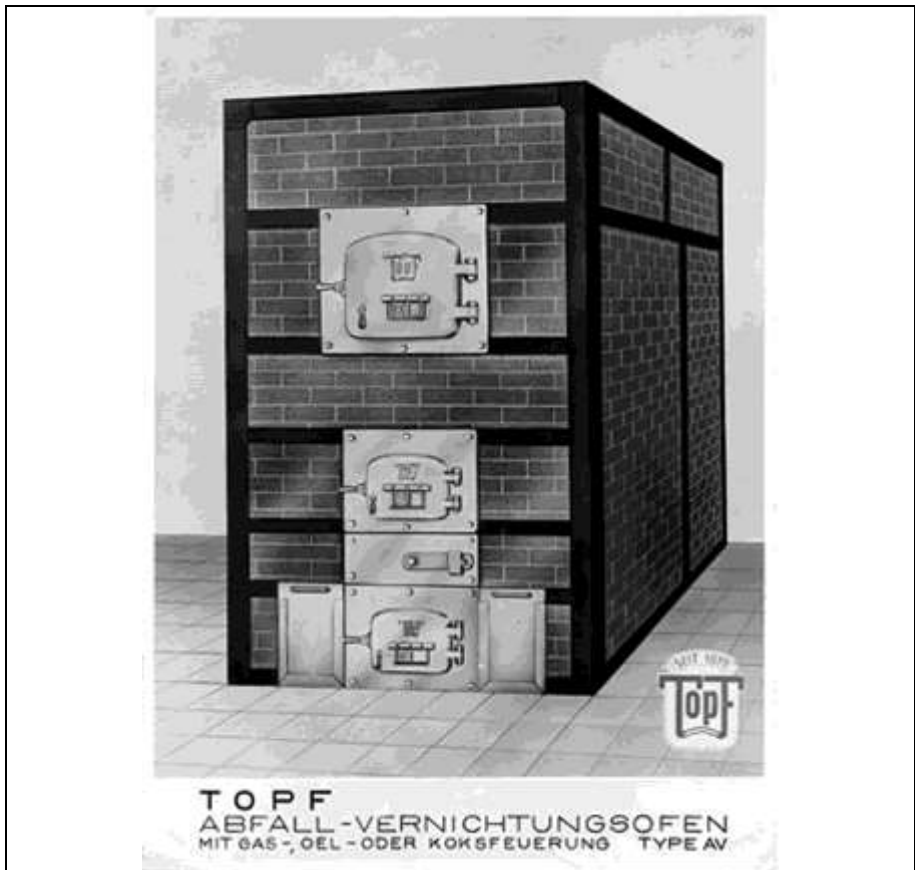

Document 162: TOPF gas-, naphtha- or coke-fired waste incinerator, Model AV.

Source: www.topfundsoehne.de.

III. TOPF, Correspondence with the SS

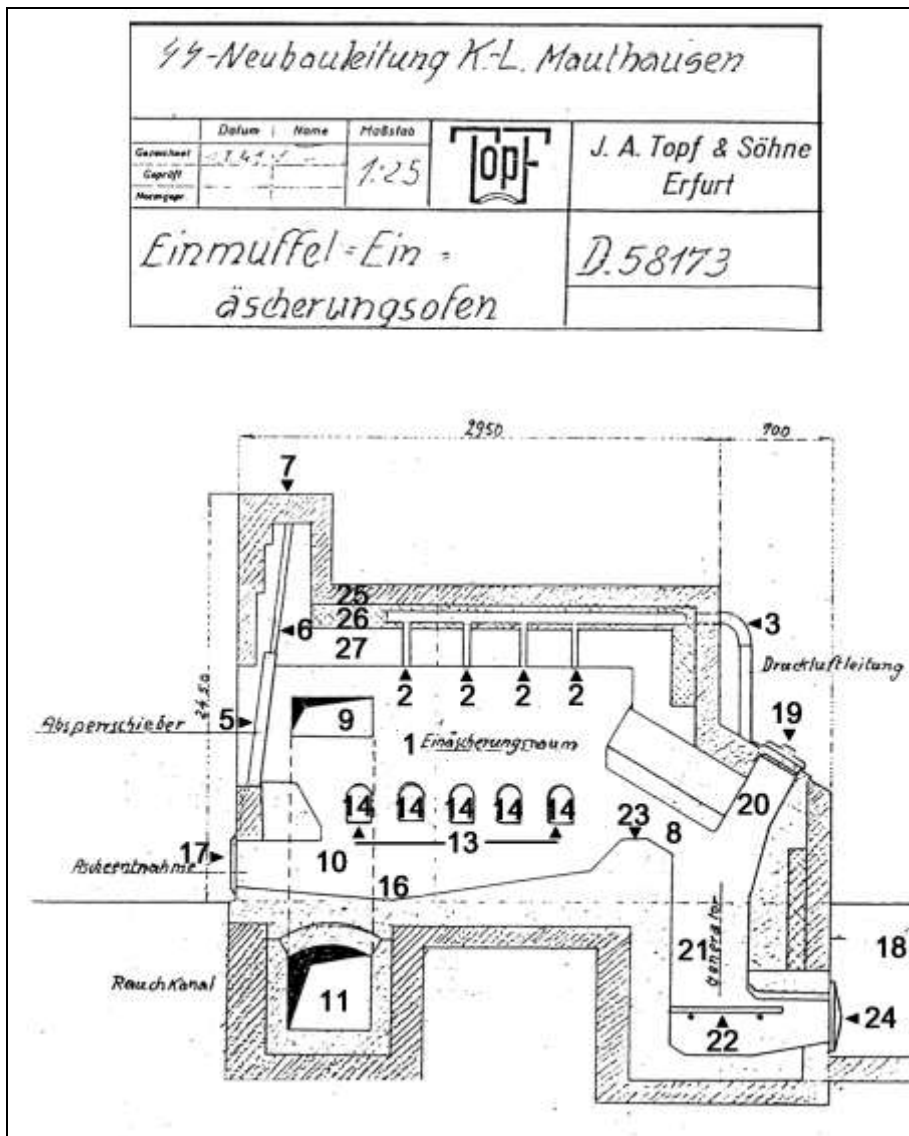

Document 163a: J.A. Topf & Söhne Drawing No. D 58173 of 6 January 1941 coke-fired "single-muffle cremation furnace" for the SS New Construction Office of the Concentration Camp Mauthausen. Longitudinal vertical section; Source: BAK, NS 4/Ma 54. Numbers added by the author. See text of Part 1 for details.

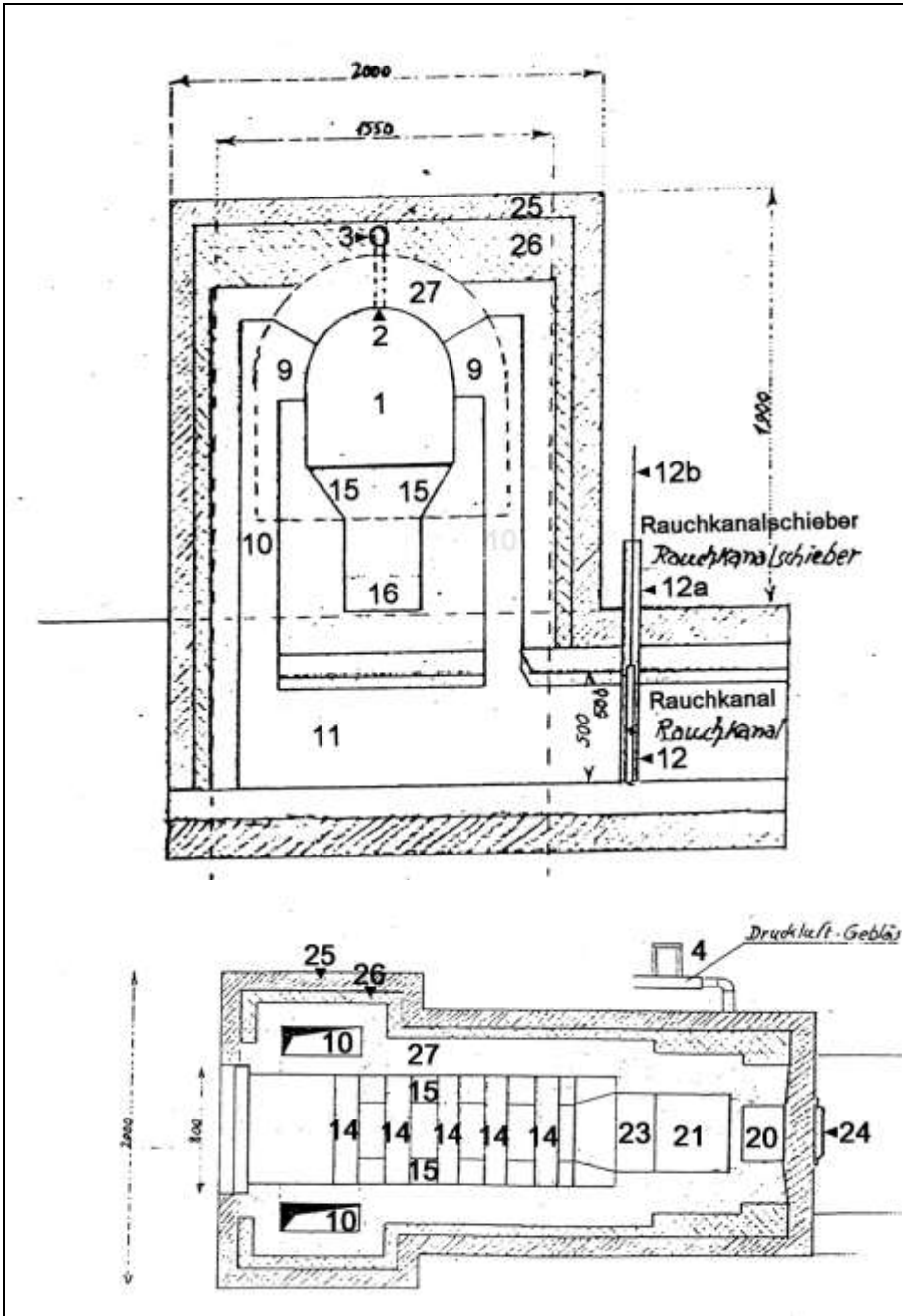

Document 163b & c: as above. Top: transverse vertical section through the smoke flue; bottom: horizontal section at the height of the grate. Numbers added by the author. See text of Part 1 for details.

J. A. TOPF & SÖHNE	
MASCHINENFABRIK UND FEUERUNGSTECHNISCHES BAUGESCHÄFT	
<p>UNSER ARBEITSGEBIET: Entwurf und Ausführung vollständiger Kessel-Büser Verbesserungen u. Umbauen bei nicht wirtschaftlicher Dampfherzeugung</p>	<p>60 JAHRE GEGR. Topf 1878</p>
<p>Abteilung DI Wärmewirtschaftliche Unter- suchungen und fädinämische Beratung Wärmeanlagen Eigen-Herstellung und Liefe- rung sämtlicher wärmetechn. Anlagen, Apparate und Vor- richtungen Topf-Spezial-Feuerungen für alle Brennstoffe: Steinkohle, Braunkohle, Schmelzkohle, Torf, Saggspläne, Holz usw. Vollmechanische Topf-Roste Halbmeh. Topf-Feuerungen Topf-Wurfbeschicker „Ballist“ Topf-Spezial-Roststöße Feuerungsmotoren Ofenfeuerungen für sämtliche industrielle Betriebe Vorwärmer, Lufterhitzer, Dampfüberhitzer, Flugische- Ausblase-Vorrichtungen Zugverdrückungsanlagen Einmauerungen von Dampf- kesseln von industriellen Feuer- ungen bis zu den größten Abmessungen usw. Industrie-Schornsteinbau bis zu den größten Abmessungen Schmelzöfene Schornsteine Industrie-Ofenbau mit Abblö- ckung, Müllverbrennung, Kabelverwertung, Verwendung Feuerbeständige-Einrich- tungen mit moderner elek- trischer- oder Gas-Beheizung</p>	<p>ERFURT POSTFACH 550g FABRIK UND VERWALTUNG DREYSESTRASSE 7g DRAHTWORT TOFFWERKE ERFURT FERNRUUF 25/25 25/26 25/27 25/28</p>
<p>Abteilung DII Sämtliche Transmiss-Anlagen Mechanische Beköhlung und Entstäubung</p>	<p>UNSERE ABTEILUNG: D/Prf. ANGEBOT Nr. 40/1159. HAUSAPPARAT Nr. 123. DATUM: 6.1.41.</p>
<p>Abteilung DIII Lüftungstechnische Anlagen für Industrie's Betriebe Bäder sanitarien, Gasstätten etc. Absauganlagen für Staub, Späne etc. Eismaschinen Verfahrensbau</p>	<h2 style="margin: 0;">Kosten-Anschlag</h2>
<p>Abteilung EIII Feuerliche Filteranlagen für Kohle, Asche, Chemikalien, Geräde und alle anderen artigen Schmutzpart.</p>	<p>Titl. Leichsführer SS, Hauptamt Haushalt u. Bauten, SS-Neubauleitung KL <u>Mauthausen.</u></p>
<p>Abteilung C Eisenstrukturbau und Be- leuchtung</p>	<p>Besitz: 1 koksbeheizten T o p f - Einäscherungs- ofen mit einer Einäscherungskammer <u>wahlweise:</u> 1 koksbeheizten T o p f - Einäscherungs- ofen mit doppelter Einäscherungskammer 1 T o p f - Seugzug-Anlage</p>
<p>Abteilung</p>	<p>Aufgabe: Prf./Hes. Capitl: 11</p>
<p>Abteilung</p>	<p>Die Spezialfabrik für feuerungstechnische Anlagen TOPF hat Zehntausende von TOPF-Feuerungen geliefert. Hervorragende sechzigjährige Spezialerfahrungen. Eigene Versuchstation und feuerungstechnisches Laboratorium. Untersuchung von Brennstoffen, Asche, Speisewasser. Eigene Lehrheizer.</p>

Document 164: "Cost estimate," by J.A. Topf & Söhne of 6 January 1941 for the SS New Construction Office of Mauthausen Concentration Camp regarding a single- or double-muffle coke-fired cremation furnace. Source: Bundesarchiv Koblenz, NS 4/Ma 54.

J. A. TOPF & SOHNE ERFURT		2. Blatt des Kostenanschlages vom 6.1.41.		
		für <u>Bauhausen.</u>		
lfd. Nr.	Anzahl	Gegenstand der Veranschlagung		
1).		<p>Lieferung eines koksbeheizten <u>T o p f - Einäscherungs-Ofens mit einer Muffel und Druckluft-Anlage,</u></p> <p>wozu folgende Arbeiten und Lieferungen gehören:</p> <p>Fundament zum Ofen und Rauchkanal müssen bauseitig nach unseren Angaben ohne Kosten für uns durchgeführt werden.</p> <p>Zum Mauerwerksmantel Ziegelsteine, Sand, Kalk und Zement. Die besten Steine werden zur Verblendung herausgesucht.</p> <p>Das erforderliche Schamottematerial, bestehend aus Normal-, Form- und Keilsteinen und Monolitstampfmasse, sowie dem dazu gehörigen Mörtel.</p> <p>Zur Isolierung des Ofens die erforderlichen Kieselgursteine, Schlackenwolle und Kieselgurmörtel.</p> <p>Die schmiedeeisernen Verankerungseisen, bestehend aus T-, U- und Winkel-Eisen, Ankern, Schrauben und Muttern.</p> <p>Die guß- und schmiedeeisernen Armaturen, wie:</p>		
	1	schmiedeeiserne Muffelabsperrschieber-Einbindung, die mit Monolit ausgestampft wird, einschließlich den erforderlichen gußeisernen Rollen, Drahtseil und einer Handwinde,		
	6	gußeiserne Luftkanalverschlüsse,		
	1	gußeiserne Ascheentnahmetür,		
	1	gußeiserner Generatorfüllschachtverschluss,		
	2	schmiedeeiserne Aschebehälter,		
	1	gußeiserne Feuertür,		
	1	schmiedeeiserner Planrost aus Vierkantstäben mit Rost-Auflager,		

Document 164: continued.

J. A. TOPF & SOHNE ERFURT		3. Blatt des Kostenanschlages vom 6.1.41.			
T		für Mauthausen.			
Lfd. Nr.	Anzahl	Gegenstand der Veranschlagung			
	die	erforderlichen Schürgeräte,			
	1	Druckluft-Anlage, bestehend aus dem Druckluft-Gebläse mit 1,5 PS-Drehstrom-Motor, direkt gekuppelt, und der erforderlichen Rohrleitung,			
	1	schmiedeeisernes Leicheneinführungs-Vorrichtung, bestehend aus dem Sargeinführungswagen und den erforderlichen Laufschiennen,			
		<u>Montage des Ofens.</u>			
		Monteurgestellung zum Bau des Ofens, einschließlich Reisekosten, Tagelöhner, einschließlich der sozialen Abgaben.			
		Preis Pos. 1).	RM		5 996.--
		Kennziffergewicht: 1 750 kg.			
<u>Wahlweise:</u>	2).	1			
		koksbeheizter T o p f - Einäscherrungs-Ofen mit Doppelmuffel und Druckluft-Anlage,			
		<u>wozu folgende Lieferungen und Arbeiten gehören:</u>			
		Fundament zum Ofen und Rauchkanal müssen beuseitig nach unseren Angaben ohne Kosten für uns ausgeführt werden.			
		Zum Mauerwerksmantel Ziegelsteine, Sand, Kalk und Zement. Die besten Steine werden zur Verblendung herausgesucht.			
		Das erforderliche Schamottesmaterial, bestehend aus Normal-, Form- und Keilsteinen und Monolitstampfmasse, sowiedem dazu gehörigen Mörtel.			
		Zur Isolierung des Ofens die erforderlichen Kieselgursteine, Schlackenwolle und Kieselgurmörtel.			

Document 164: continued.

J. A. TOPF & SOHNE ERFURT		4. Blatt des Kostenschlages vom 6.1.41.	
		Nr. Mauthausen.	
Lfd. Nr.	Anzahl	Gegenstand der Veranschlagung	
		Die schmiedeeisernen Verankerungs-Eisen, bestehend aus T-, U- und Winkel-Eisen, Ankern, Schrauben und Muttern.	
		Die guß- und schmiedeeisernen Armaturen, wie:	
	2	gußeiserne Einführungs-Türen mit gußeisernen Rahmen. Die Innenseiten der Türen werden mit Monolitstampfmasse ausgestampft,	
	6	gußeiserne Luftkanalverschlüsse,	
	4	gußeiserne Ascheentnahmetüren,	
	2	gußeiserne Generatorfülltüren,	
	2	schmiedeeiserne Aschebehälter,	
	2	schmiedeeiserne Rauchkanalschieberahmen mit Monolit ausgestampft, einschließlich der erforderlichen Rollen, Drahtseile und Gegengewichte,	
die		erforderlichen Schürgeräte,	
	2	gußeiserne Feuertüren,	
	2	Flanroste,	
	1	Druckluft-Anlage, bestehend aus dem Druckluft-Gebläse mit 1,5 PS-Drehstrom-Motor, direkt gekuppelt, und der erforderlichen Rohrleitung.	
		<u>Montage des Ofens.</u>	
		Monteurgestellung zum Bau des Ofens, einschließlich der Reisekosten, Tagelöhner, einschließlich der sozialen Lasten.	
	1	schmiedeeiserne Leicheneinführungsvorrichtung, bestehend aus dem Sargeinführungswagen und dem schmiedeeisernen Verschlebewagen mit den erforderlichen Laufschielen.	
		Preis Pos. 2).	
		Kennziffergewicht: 2 600 kg.	
			RM 7 053.--

Document 164: continued.

J. A. TOPF & SOHNE ERFURT		5. Blatt des Kostenanschlages vom 6.1.41. für Mauthausen.			
Lfd. Nr.	Anzahl	Gegenstand der Veranschlagung			
3).	1	<p><u>T o p f - Saugzug-Anlage</u> für ca. 4 000 cbm Abgase, bestehend aus: 1 Saugzug-Gebläse mit 3 PS-Drehstrom-Motor und Anlasser, mit dem erforderlichen Saug- und Druck-Stutzen und einer Drehklappe, die den Saug- vom Druckraum trennt. Preis Pos. 3).</p> <p>Unserem Monteur müssen während der Bauzeit zwei Hilfskräfte, ohne Kosten für uns, zur Verfügung gestellt werden.</p> <p>Lief.Bed.A. 60.6.40. 1 000. L 0204.</p>	RM	1 250.--	

Document 164: continued.

Deutsches Patent

Fahrbarer Verbrennungsofen System „Topf“

(siehe Abbildung 1 und 2)



Abbildung 3. Längsschnitt.

Der nachstehend beschriebene Ofen ist fahrbar eingerichtet, wodurch er den Vorzug hat, daß er unmittelbar an das Ver-
brennungsobjekt herangefahren werden kann. Der Ofen ist be-
sonders für Großgrundbesitzer und Viehhändler in weiten Stie-
pen unentbehrlich, da in der
Hauptsache an Tränkstellen ge-
fallenes Vieh sofort vernichtet werden kann, ohne dasselbe erst
weit zu transportieren.

Die Vorzüge dieses Ofens sind
leichte und bequeme Beförde-
rungsweise, leichte Bedienung,
große Haltbarkeit und stabiles
Fahrgestell. Der Kessel wird
innen mit La Schamottemateri-
alies ausgekleidet, daher ge-
ringe Ausstrahlung. Dieser Ofen
kann auch mit Öl- und Gas-
feuerung eingerichtet werden.

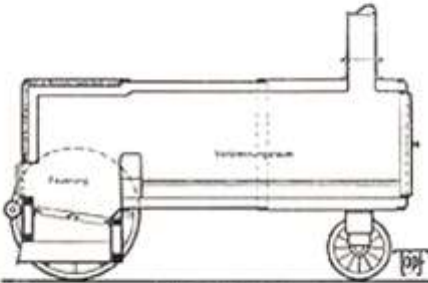

Abbildung 4. Querschnitt.

J. A. TOPF & SÖHNE · ERFURT
MASCHINENFABRIK U. FEUERUNGSTECHNISCHES BAUGESCHAFT
 Feuerungstechnisches Laboratorium / Eigene Versuchsstation
 Telegramm-Adresse: Topfwerke · Fernsprecher Nr. 2352, 2353, 2354 u. 2355

Document 165: Mobile cremation furnace system Topf." Source:
www.topfundsoehne.de.

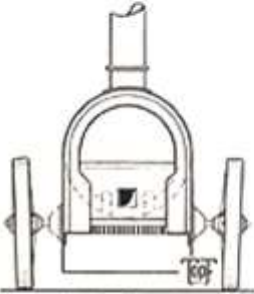
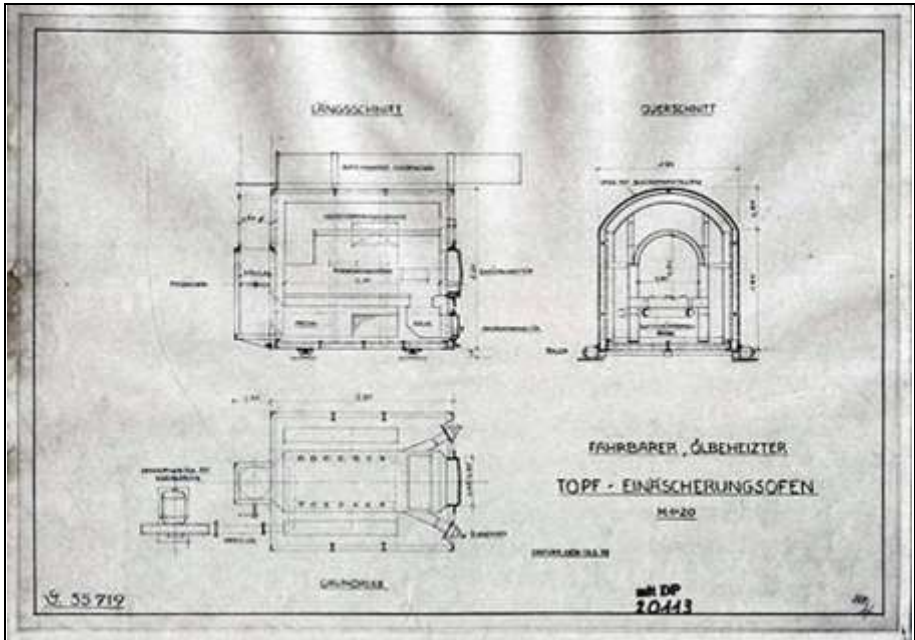

Document 166: TOPF naphtha-fired mobile cremation furnace.
Source: www.topfundsoehne.de.

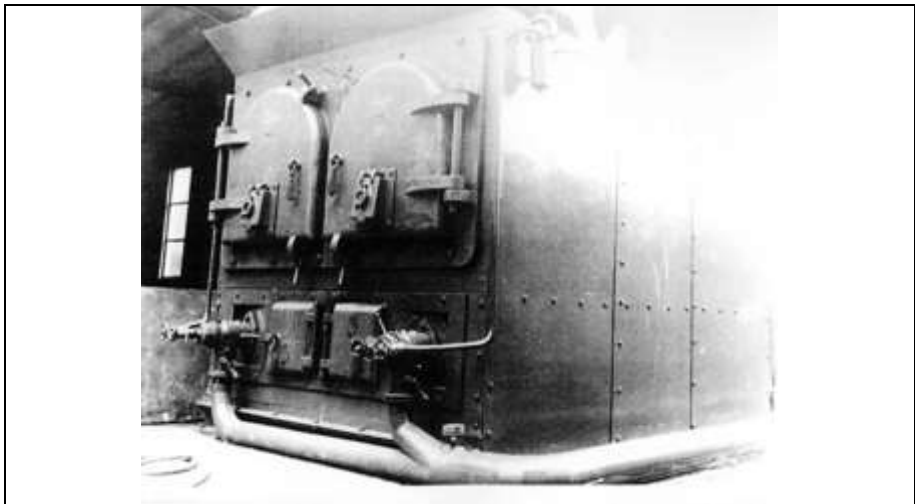

Document 167: TOPF naphtha-fired mobile double-muffle cremation furnace.
Source: www.topfundsoehne.de.

Expedition	Versand	Fakturiert	Comm. Budh.	Kontrolle	Montagebureau	Kalkulation
na.						
J. A. Topf & Söhne Maschinenfabrik Feuerungstechnischer Baugeschäft  Erfurt			Auftrag Nr. 4o D263 Der Reichsführer SS , Hauptamt Haushalt und Beuten , SS- Neubauleitung K.L. Mauthausen Mauthausen/Oberdonau			
den <u>12.12.</u> 19 <u>40</u>						
Hierdurch teilen wir Ihnen mit, daß wir heute folgende Sendung auf dem Weg brachten: p. Weg Weg — Eilgut nach Station: St. Georgen a.d. Gusen / Oberdonau an Lager Unterkunft Gusen.						
2541 Wagon Nr. 34512 Stuttg.			J. A. Topf & Söhne Versandabteilung			
Signum	Fabrik-Nr.	Art der Verpackung	Stückzahl	Gegenstand	Gewichte in kg	
					Netto	Brutto
J.A.T.&S.				<u>Teile zum Einäscherungs-Ofen</u>		
	96788	1 lose	1	fahrbarer Einäscherungs-Ofen mit 2 Muffeln	2833	2833
		2 "	2	Rohre		
		1 "	1	Blechrohr 120 ø mit 2 Krümmern	8,5	8,5
		1 "	1	desgl. "	10,5	10,5
		1 "	1	Wagen für die Gebläse-Station mit 3 Gebläsen 120/520, 120/300 u.	637	637
	96669			400 K. sowie 3 el. Motoren 5,5 PS.		
	96666			1,5 PS. 380V., 3 PS. 380V.		
	96625	2 lose	2	Blechrohre 120 ø	11	11
		1 "	1	Blechstützen 280/430	43,5	43,5
	96788	4 "	4	Schürgeräte	17	17
		1 "	1	Aschekasten	13	13
Übertrag					3572,5	

Document 168: Bill of lading of 12 December 1940 to the SS New Construction Office of Concentration Camp Mauthausen about the parts for a TOPF naphtha-fired mobile double-muffle cremation furnace. Source: Bundesarchiv Koblenz, NS 4/Ma

Etzeliste Nr. 1				Auftrag Nr.		
Signum	Fabrik-Nr.	Art der Verpackung Koll.-zahl	Stückzahl	Gegenstand	Gewichte in kg	
					Netto	Brutto
J.A.I.&S.				Übertrog		3573,5
	97644	1 lose	1	Rahmen mit Rollen zur Einführungs- vorrichtung	47,5	47,5
		1 "	1	Einführungswanne	41	41
	21242	4 "	4	Ge. Feuerthüren 350/280	188	188
		4 "	4	Ge. Luftkanalverschlüsse 108/128	30	30
		20 "	20	Viereckeisen 30/30, 600 lg.	84	84
		4 "	4	desgl. 640-lg.	18	18
		4 "	4	Formsteine	36	36
H e i l e n d	97338	1 "	1	Blechstützen	62	62
		1 "	1	kon. Blechrohr	28,5	28,5
	22564	1 Verschl.	6 Qm.	Asbestplatten	23	26,5
	21267	6 lose	6	Monolit-Roststeine 750 lg.	176	176
		8 "	8	Monolit-Platten 500/600 /100	408	408
	21878	2 Kisten	²⁵⁰ 225	Kg. Schlackenwolle	250	286
		4 Säcke				
	97055	1 Kerten	1	Ölstand	0,3	5
	96788			div. Schrauben	2	2
				div. Dichtungen	0,1	
					500	

Document 168: continued.

J. A. TOPF & SÖHNE

MASCHINENFABRIK

GELDBERECHNUNG
 REICHSBANK-
 GIBEBKONTO 254
 DEUTSCHE BANK, ERFURT
 DRESDNER BANK, ERFURT
 POSTSCHECKENKONTO
 ERFURT 1792

Neubauleitung
 19 FEB. 1941
 K. L. Mauthausen

B. Nr. 3742	Bearb.	Erl. 822
----------------	--------	-------------

DRACHENWORT
 TOPFWERKE ERFURT
 FERNRUUF
 2523 2526 2527 2528 2529
CODES
 BUD. MASSE CODE
 A.B.C. CODE
 STAUBT & HUMDIUS

Rechnung Nr. D 41/107

An den
 für Herrn Reichsführer S.S. Hauptamt
 Haushalt und Bauten
Berlin - Lichterfelde - West

ERFURT, 5.2.1941
 POSTFACH 352
 FABRIK UND VERWALTUNG
 DREYSESTRASSE 7 1/2
 Fol. 79/66
Juwetschrift
 Schr.

Auftrag Nr. 40 D 264	<p><u>betr.: Konzentrationslager Mauthausen.</u></p> <p>Lieferung eines fahrbaren Ringescher- ungsOfens mit 2 Muffeln, bestehend aus:</p> <p>dem schmiedeeis. Ofenmantel mit Unterstüztungsgerüst und Rollen- gestell, schmiedeeis. unlegbaren Schornstein von 4 m Höhe, Saug- zugeanlage, Schamotteausmauerung und Isolierung, den guss- und schmiedeeis. Ofenarmaturen und der Oelbrenneranlage, im übrigen lt. Beschreibung in uns. Kosten- anschlag vom 29.2.1940</p> <p>Anbau von zwei Koksgeneratoren an den fahrbaren Doppelkuffel- einischerungsOfen und zwar:</p> <p>Lieferung von:</p> <p>1.000 Schamotte Normal- und Keil- steinen S.K. 34</p> <p>500 kg Schamotte-Mörtel</p>	<p>8.950,—</p> <p>380,—</p> <p>Übertrag: 9.330,—</p>
-----------------------------------	--	---

Hieron entfallen RE
 auf Fracht und Versicherungen § 5 Abs.
 4 des U. St. G.

- 2 -

Document 169: Invoice from J.A. Topf & Söhne of 5 February 1941 for the delivery of one TOPF naphtha-fired mobile double-muffle cremation furnace to the SS New Construction Office of Concentration Camp Mauthausen. (Rechnung Nr. D 41/107). Source: Bundesarchiv Koblenz, NS 4/Ma 54.

J. A. Topf & Söhne Erfurt		2. Blatt der Rechnung vom 5.2.1941 Nr. 107	
		für den Herrn Reichsführer S.S., <u>Berlin - Lichterfeld/West</u>	
		Auftrag Nr. 40 D 264	Übertrag
	450 Isoliersteinen	163,—	
	200 kg Isoliermörtel		
	4 gusseis. Feuer- und Aschetüren schamottegefüllt	180,—	
	20 schmiedeeis. Vierkantstäben mit Auflagerisen für die Gene- ratorroste	51,—	
	4 gusseis. Luftkanalverschlüssen	28,—	
	Änderungsarbeiten an der schmie- deeisernen Ummantelung des Ofens und an den Verankerungseisen	100,—	
	Verpackung und Frachten frei Mauthausen, gem. ans. Kostenan- schlag vom 1.10.1940	262,—	10.114,—
	Gestellung unseres Montörs Willing in der Zeit vom 26.12.40 bis 4.2.41 zum Anbauen der Generatoren lt. be- scheinigten Tagelohnzetteln		
	31 Reisestunden a 2,—	62,—	
	267 Arbeitsstunden a 2,—	134,—	
	48 x Überstundenzuschlag a 0,50	24,—	
	38 x Sonntagsstundenzuschlag a 1,—	38,—	
	29 Tage Auslösung a 7,—	203,—	
	Reisegeld Erfurt-Mauthausen-Dachau	46,80	
	Auslagen, Werkzeugtransport etc.	13,60	521,40
		Reichsmark	10.635,40
durch: <u>S.S. Neubauleitung K.Z-L-</u> <u>Mauthausen.</u>			

Document 169: continued.

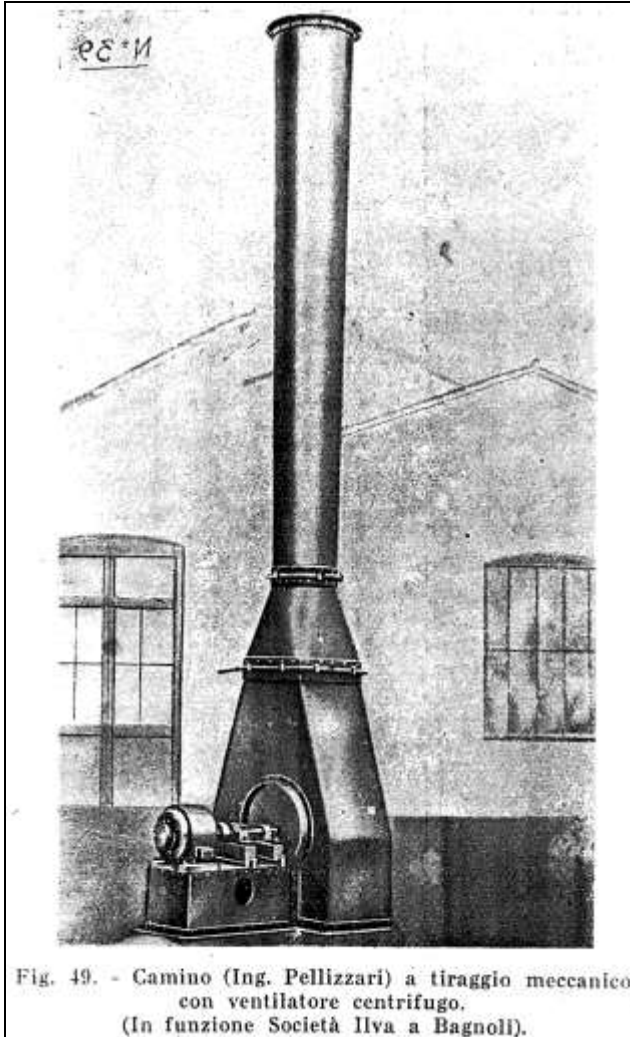

Document 170: Forced-draft chimney with centrifugal fan. Source: A. Cantagalli, Nozioni teorico-pratiche per i conduttori di caldaie e generatori di vapore. G. Lavagnolo Editore, Turin 1940, p. 90.

J. A. TOPF & SÖHNE
MASCHINENFABRIK UND FEUERUNGSTECHNISCHES BAUGESCHÄFT

NO-4448

UNSER ARBEITSGEHET:
 Entwerf und Ausführung
 vollständiger Kesselhäuser
 Vorwärmanngen u. Umwärmanngen
 bei allen unterschiedlicher
 Dampfleistungen

Abteilung DI
 Wasserkocherische Umwärmungen und technisches
 Bauwesen
 Wasserkocher
 Dampfmaschinen und Liefer-
 ungen allerhand technischer
 Anlagen, Apparate und Ver-
 richtungen

Topf-Spezial-Feuerungen für
 alle Brennstoffe: Steinkohle,
 Braunkohle, Schmelzkohle, Torf,
 Steingut, Holz usw.

Wasserkocherische Topf-Heize
 Maltmahl, Topf-Feuerungen
 Topf-Werkstätten für „Biller“
 Topf-Spezial-Brennstoffe
 Feuerungsanlagen

Öfenanlagen für stehende
 Industrie-Betriebe
 Vorwärmanngen, Luftanlagen,
 Dampfmaschinen, Flugzeug-
 Antriebe, Verdichtungen
 Zugverstärkungsanlagen

Brennvorrichtungen von Dampf-
 maschinen und industriellen Feuer-
 ungen bis zu den größten
 Abmessungen von
 Industrie-Schmelzöfen bis zu
 den größten Abmessungen
 Schmelzöfene Schmelzöfen
 Industrie-Öfenbau auf alle An-
 forderung, Metallbearbeitung,
 Kalkbrennung, Vererdung
 Feuerbestattungs-Anrich-
 tungen mit moderner ab-
 wärmanngen- oder Gas-Behaltung

Abteilung DII
 Sechsbau Transport-Anlagen
 Mechanisches Bauwesen und
 Erzeugung

Abteilung DIII
 Lüftungstechnische Anlagen
 für industrielle Betriebe, Be-
 reitungen, Öfenanlagen von
 Abgasanlagen für Stahl,
 Spinn usw.
 Öfenanlagen
 Verdichtungen

Abteilung EIII
 Pneumatische Feueranlagen
 für Kohle, Asche, Chemisches,
 Getreide und alle lufttechni-
 schen Schüttgüter

Abteilung C
 Eisenstrukturreisen und Be-
 lehrungen

60 JAHRE

 Hauptamt Buchhalt. u. Besten
 u. Neubauleitung Buchenwald
 Buchenwald 13. JAN. 1940
 B. Nr. 3765/39
Kosten-Anschlag

ERFURT
 POSTWACH 222,
 PARK- UND VERWALTUNG
 BOHNESTRASSE 74

BRANNTUCH
 TOPFWERKE ERFURT
ERFURT
 BUNDESTRASSE 10

UNSERE ANSTALTEN:
D/PT.

ANLAGE Nr.
39/1306

NAHMAKTARAT Nr.

DATUM:
21. 12. 1939.

An die
**SS-Neubauleitung des
 KL-Buchenwald,**
W. I. H. F.

**1 Öl- oder kohlebeheizter Topf-
 Ringbohrungs-Ofen mit Doppelmuffel
 und Druckluft-Anlage, sowie
 Zugverstärkungs-Anlage.**

Angebot: **PT/20.**
 Datum:

Die Spezialfabrik für feuerungstechnische Anlagen TOPF
 hat Zahnzusende von TOPF-Feuerungen geliefert.
 Hervorragende sechzigjährige Spezialerfahrungen.
 Eigene Versuchsstation und feuerungstechnisches Laboratorium.
 Untersuchung von Brennstoffen, Asche, Spelmasse.
 Eigene Lehrmeister.

Document 171: "Cost estimate" by J.A. Topf & Söhne of 21 December 1939 for the SS New Construction Office of the Buchenwald Concentration Camp regarding a coke- or naphtha-fired double-muffle cremation furnace. Document NO-4448.

Lit. Nr.	Anzahl	Gegenstand der Veranschlagung
<p>A. Topf & Söhne Erfurt  2. Blatt des Kostenschätzung von 21.12.39. für Weimar. NO-4448</p>		
		<p><u>Ein Öl- oder koksbeheizter Einkammerofen mit Druckluftanlage und Rauchkanal, eine Saugzug-Anlage,</u></p> <p><u>hierzu gehören:</u></p> <p>Der Mauerwerksmantel, bestehend aus normalen Ziegelsteinen, wovon die besten Steine zur Verblendung des Ofens herausgesucht werden, einschließlich des erforderlichen Zementkalkes und Sandes, das Schamottmaterial bestehend aus Normal-, Form- und Keilsteinen, der Monolit-Stampfmasse und dem Schamottmörtel, insgesamt ca. 10 200 kg für Schamotte-Material.</p> <p>Die schmiedeeisernen Verankerungseisen, bestehend aus T-, U- und Winkelisen, Ankern, Schrauben und Muttern, insgesamt ca. 800 kg.</p> <p>Die guß- und schmiedeeisernen Armaturen, bestehend aus:</p> <p>2 Stück gußeisernen Einführungstüren mit gußeisernen Rahmen, die Innenseiten der Türen werden mit Monolitmasse ausgestampft,</p> <p>2 gußeisernen Ascheentnahmetüren,</p> <p>3 gußeisernen Luftkanalverschlüssen,</p> <p>1 gußeisernen Rauchkanalschieber in luftdicht schließender Führungshülse laufend, einschließlich Rollen, Drahtseil und Gegengewicht,</p> <p>2 Stück schmiedeeisernen Aschebehälter</p> <p>Die erforderlichen Schürgeräte.</p> <p>1 Druckluftgebläse direkt gekuppelt mit einem 1,5 PS Drehstrom-Motor und die erforderliche Rohrleitung.</p>

Document 171: continued.

Lfd. Nr.	Anzahl	Gegenstand der Veranschlagung		
<p>L. A. Topf & Söhne Erfurt</p> <p>3. Blatt des Kostenvoranschlags vom 21.12.39.</p> <p>Weimar. NO-4448</p>				
		<p>Ölbrenner-Anlage, bestehend aus:</p> <p>2 Stück Ölbrennern von je 6 bis 25 kg/3,</p> <p>2 Stück Absperrventilen,</p> <p>2 Stück Handflügelpumpen,</p> <p>2 Stück Winddruckmessern,</p> <p>1 Druckluftgebläse mit einem 2½ PS-Motor, direkt gekuppelt, der erforderlichen Öl-Zu- und Rücklaufleitung,</p> <p>1 Ölbehälter für 250 Liter Öl.</p> <p>1 schmiedeeiserne Leicheneinführungs-Vorrichtung. Gesamtgewicht ca. 1325 kg.</p> <p><u>Montage des Ofens:</u> Die Monteurstellung (5 Mann) zum Bau des Ofens einschließlich der sozialen Abgaben, Tagelöhner und Reisekosten. Ostellung eines Ingenieurs zur Baukontrolle und Inbetriebnahme des Ofens. Frachten und Anfahrkosten frei Arbeitsetelle Buchenwald. Preis Position I RM. 7.755,-</p>		
II.		<p><u>Eine Topf-Saugpumpe-Anlage</u> für ca. 4000 ckm Abgase mit 3 PS-Drehstrom-Motor und Anlasser, mit Saug- und Druckstutzen und einer Drehklappe, die den Saug- vom Druckraum trennt. Gesamtgewicht ca. 260 kg Preis Position II RM. 1.250,-</p>		

A. Tepl & Söhne
Erfurt

 Nr. **Weimar.**

4. Mit der Kostenschätzung von **27.250.99.**

NO-4448

U.N. Nr.	Anzahl	Gegenstand der Veranschlagung			
		<p>Unsere Monteure müssen während der Bauphase drei Mann als Helfer ohne Kosten für uns gestellt werden. Für die vorstehend aufgeführten guß- und schmiedeeisernen Armaturen benötigen wir eine Kesselsiffer mit dem Zusatzzeichen "I", die uns bei Auftragserteilung sofort bekanntgegeben werden muß.</p>			
		<p>Lieferungsbedingungen A. 60.8.39.1000.Gr.</p>			

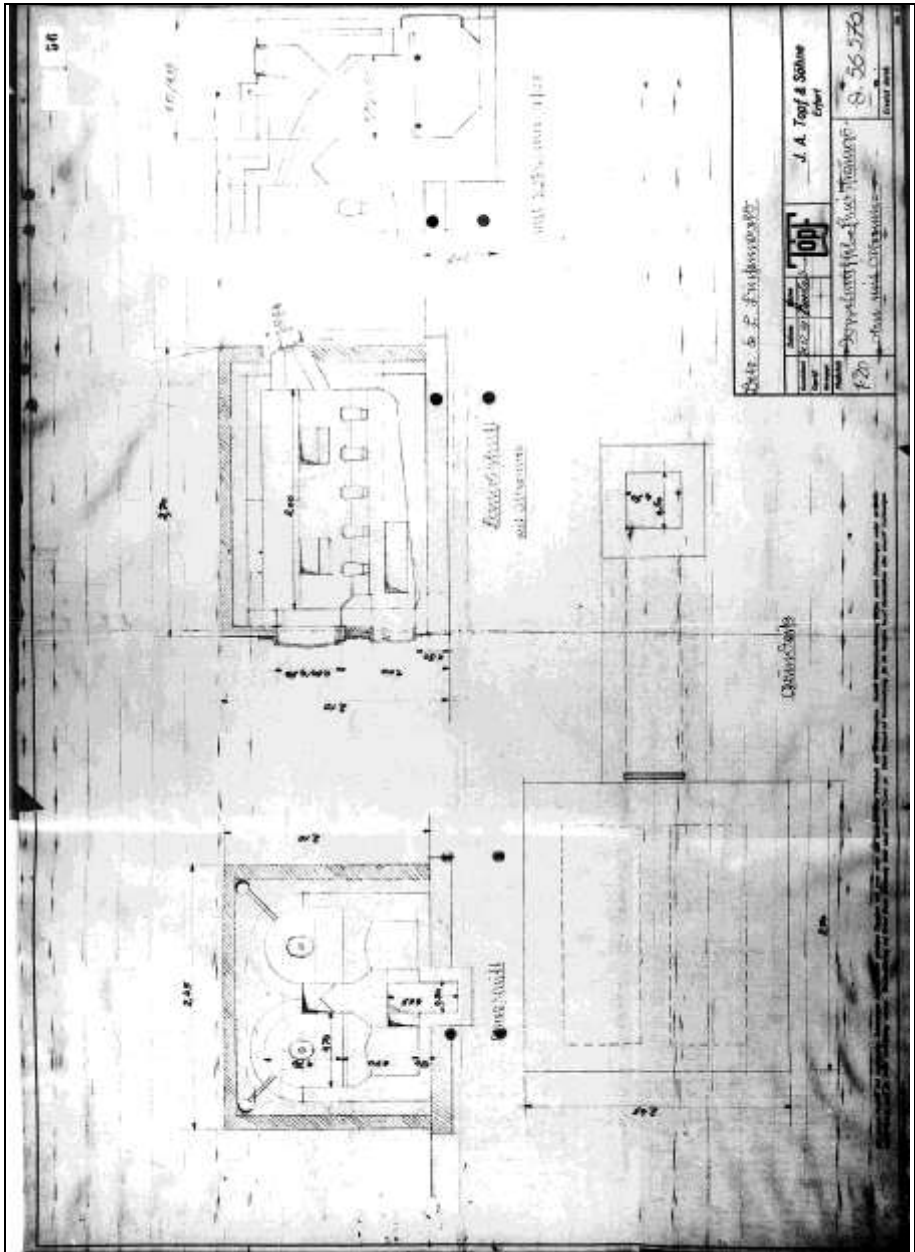
Document 171: continued.



Document 172: Drawing by J.A. Topf & Söhne D 56570 of 21 December 1939 "Naphtha-fired double-muffle cremation furnace" for the Buchenwald Concentration Camp. Document NO-4444.

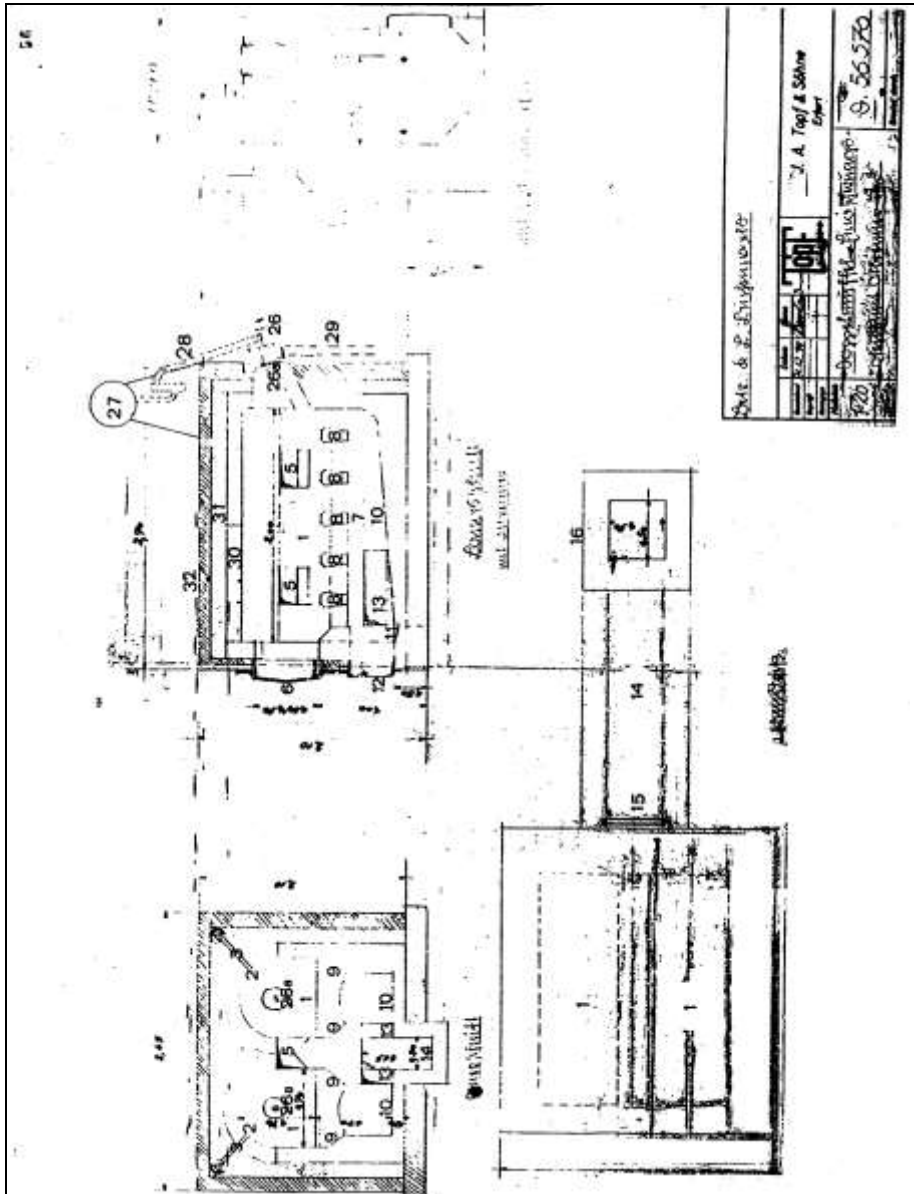

Document 172a: as above, detail; numbers added; see text of Part 1.

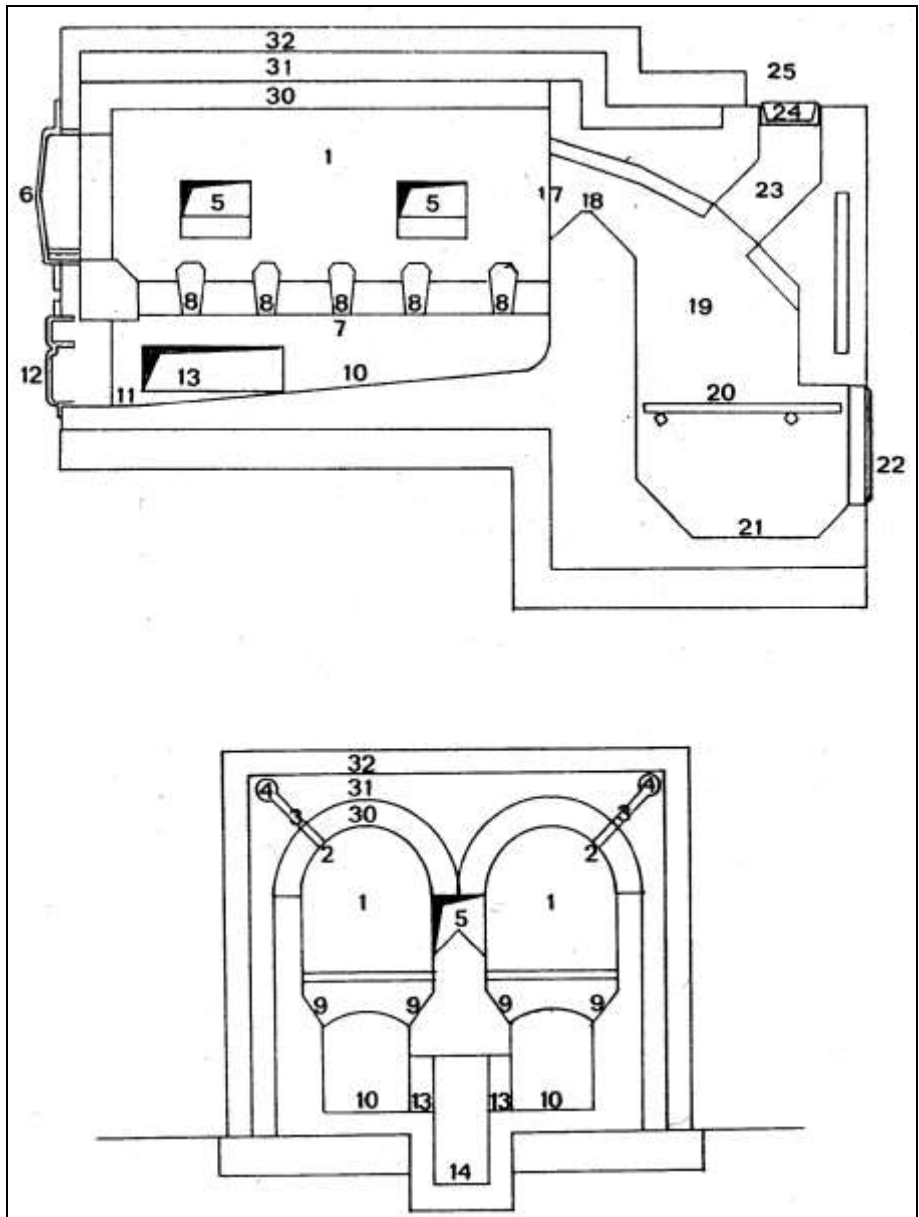

Document 172-b & c: as above, redrawn details with numbers added; longitudinal (top) and trans Płaszów verse vertical section (bottom). See text of Part I.

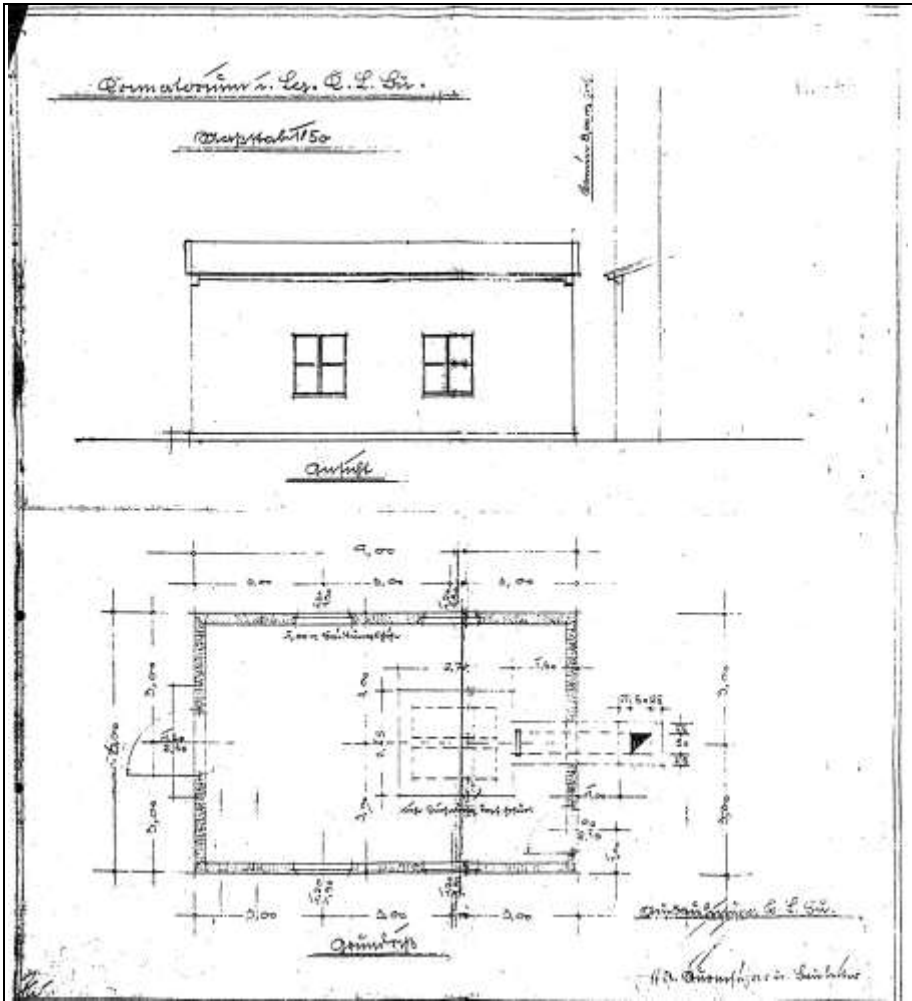

Document 173: Crematorium of the Buchenwald Concentration Camp (December 1939). Document NO-4444.

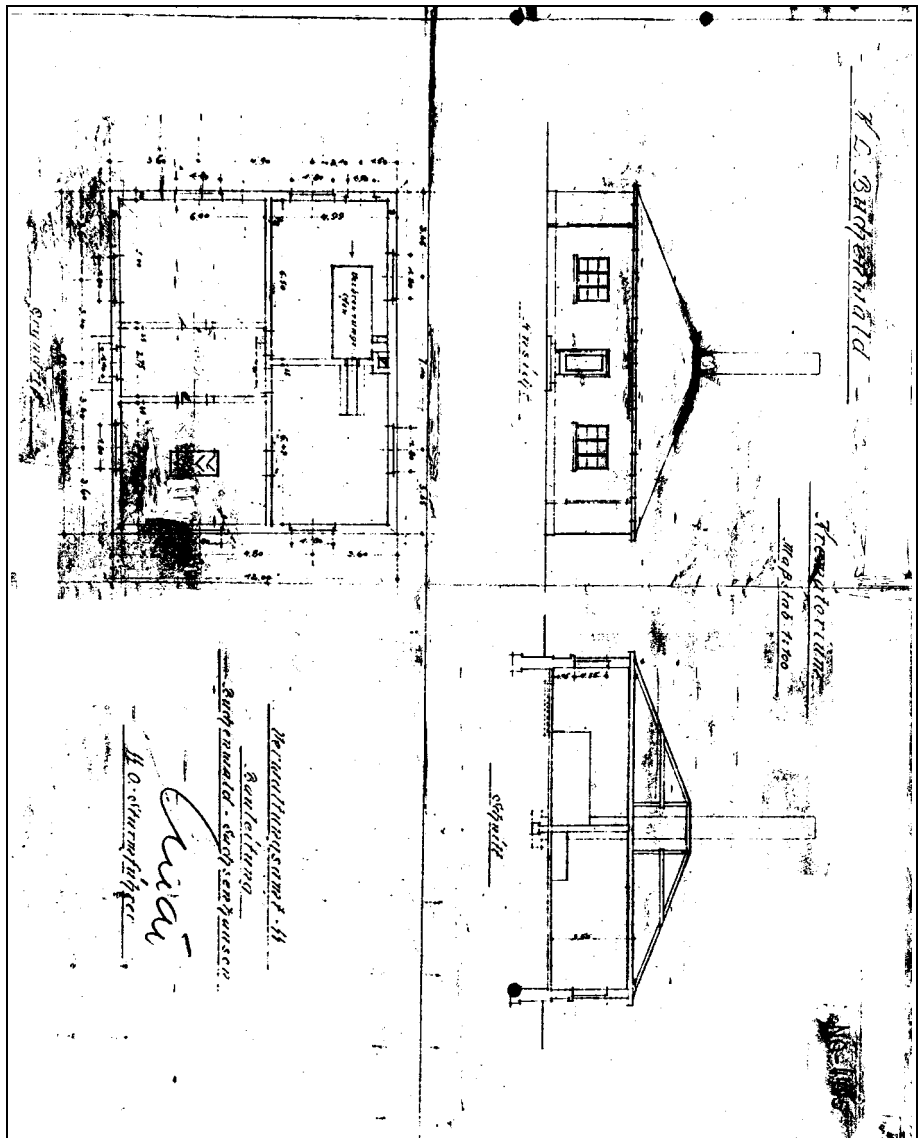

Document 174: Drawing of the crematorium at Buchenwald Camp (January 1940). Document NO-4445.

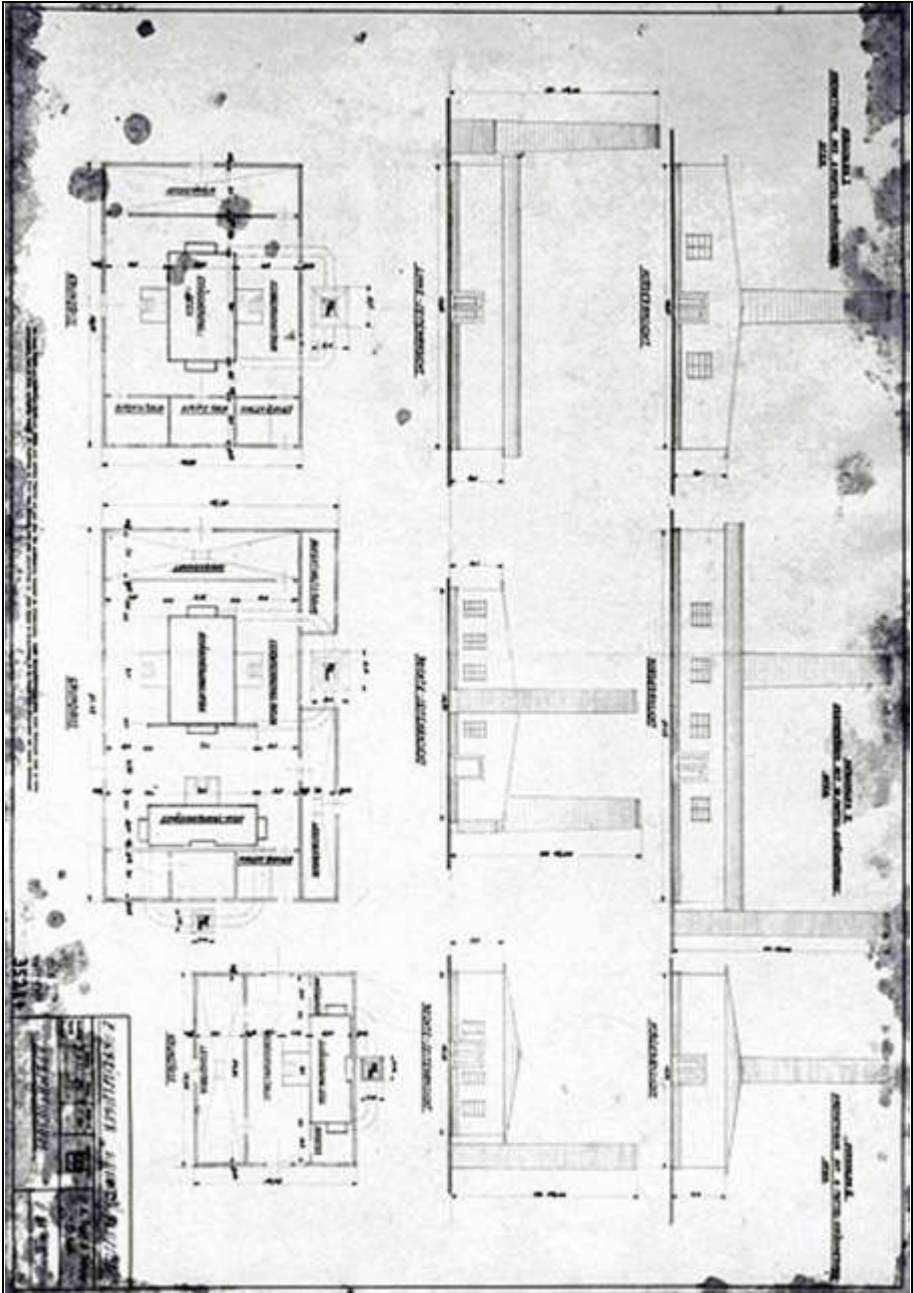

Document 175: Crematorium at the Płaszów Camp. Number and date illegible.

Source: www.topfundsoehne.de.

2. d. A.

gestrichen
Entf.

Bericht.

des SS-Oberh. P o l l o k in der Eigenschaft als
Sachbearbeiter für baupolizeiliche Angelegenheiten.

Am Schornstein des Krematoriums im K.L. Auschwitz hat sich der Kamineinband gelöst. Dieses ist auf eine unsachgemäße Ausführung, sowie teilweise Überhitzung des Schornsteines zurückzuführen. Die Einbände sind nicht dem Zweck entsprechend als Rahmen ausgebildet und sind deshalb unwirksam. Da der Schornstein bereits starke Risse aufweist, die zwar äußerlich wieder verfügt, im Mauerwerk meines Erachtens nach noch vorhanden sind, besteht die Gefahr, dass der Schornstein bei stärkerem Wind einstürzen kann. Um unabsehbare Folgen zu vermeiden, bitte ich den Leiter der Zentralbauleitung veranlassen zu wollen, dass sofort Massnahmen getroffen werden, um die Mängel zu beseitigen. Dabei wäre zu beachten, dass alle Einbände entfernt und durch Rahmeneinbände sach- und handwerksgemäß ersetzt werden.

Auschwitz, den 30-Mai. 1942

Pollok

SS-Oberscharführer.

Kenntnis genommen:

Auschwitz, den 30.5.42

Lil
SS-Unterstuf.(S)

Pollok

Land Polizei Auschwitz Q...

Polizeiführer	Eingang:	St...
	30. MAI 1942	2472/42
1. Abt.	2. Abt.	3. Abt.
4. Abt.	5. Abt.	6. Abt.

Document 176: Report by SS-Oberscharführer Pollok of 30 May 1942 on the damage to the chimney of Crematorium I at Auschwitz Main Camp. Source: RGVA, 502-1-312, p. 64.

94 A

Standfestigkeitsberechnung eines gemauerten Schornsteins

von $h = 15$ m Höhe über Gelände und $2r_0 = 1,20$ m oberer lichter Weite.

Bauherr: **Zentralbauleitung der Waffen SS und Polizei in Auschwitz O/S.**

Bauunternehmer: _____

Bauort: **Lager Auschwitz** Dampfkesselnummer: _____

Der Schornstein dient zum Betriebe einer _____ Anlage.

Berechnungsgrundlagen:

Grundlagen für die Ausführung freistehender Schornsteine DIN 1056, Blatt 1-2 u. DIN 1057 (Ausg. 1940). Erläuterung des Vordrucks in: H. Jahr, Die Fabrikschornsteine. 8. Auflage, Verlag Otto Hammerschmidt, Hagen i. W., 1940.

Abmessungen und Baustoffe:

(vgl. anliegende Zeichnung Nr. _____ vom _____ 19__)

Schiff

Schiffhalbmesser an der Mündung: innen $r_0 = 0,60$ m; außen $R_0 = 0,84$ m

Unterer innerer Schiffhalbmesser $r = 0,85$ m
 Unterer äußerer Schiffhalbmesser $R = 1,09$ m

Die Schiffhöhe $h_s = 12$ m
 Die Halbmessenzunahme für 1 m Höhe beträgt $0,04$ m

Mauerwerk: $h'_s = 12$ m - Ziegel; Ziegel-Druckfestigk.: $\sigma_1 = 150$ kg/cm²; Mauerwerks-Druckfestigk.: $\sigma_3 = 7$ kg/cm²

Mauerwerk: $h''_s =$ _____ - Ziegel; Ziegel-Druckfestigk.: σ_2 kg/cm²; Mauerwerks-Druckfestigk.: σ_3 kg/cm²

laut beil. Prüfungszeugnis. Mörtelmischungsverhältnis = Raunteile Zement zu = Rtl. Kalk zu **1:3** Rtl. Sand.

Mauerwerks-Raumgewicht: $\gamma_1 = 1800$ kg/m³; größte zulässige Druckspannung: $\sigma_{d.zul} = 7$ kg/cm²

Mauerwerks-Raumgewicht: $\gamma_2 =$ _____ kg/m³; größte zulässige Druckspannung: $\sigma_{d.zul} =$ _____ kg/cm²

Sockel

Höhe: $h_1 = 3$ m

Mauerwerk: _____ - Ziegel

Querschnittsform: außen: **Quadrat**; innen: _____

Ziegel-Druckfestigkeit: $\sigma_2 = 150$ kg/cm²; Mauerwerks-Druckfestigkeit: $\sigma_3 = 7$ kg/cm²; Mörtelmischungsverhältnis: **1:3** Rtl. Zement zu _____ Rtl. Kalk zu _____ Rtl. Sand; Mauerwerks-Raumgewicht: $\gamma = 1800$ kg/m³

größte zulässige Druckspannung: $\sigma_{d.zul} = 7$ kg/cm²

Grundbau

Form der Sohlenfläche: **qm**; Tiefe: $h_2 = 2,6$ m; Baustoff: _____ - Beton, Mischungsverhältnis = **1:6**

Mauerwerk: **normal** - Ziegel, Mörtelmischung = **1:4:13**; Raumgewicht: $\gamma = 1800$ kg/cm³

größte zulässige Druckspannung für Mauerwerk: $\sigma_{d.zul} = 10$ kg/cm²; desgl. für Beton: $\sigma_{d.zul} = 25$ kg/cm²

Isoliermantel

Höhen: **4,60** m; **12** m; _____ m; _____ m; _____ m

Wandstärken: **12** cm; **12** cm; _____ cm; _____ cm; _____ cm

Baustoff: **Schamott** - Ziegel; Raumgewicht: $\gamma = 1900$ kg/cm³

Normalziegel - Ziegel; Raumgewicht: $\gamma = 1800$ kg/cm³

Erläuterung zur Berechnung des Schornsteins:

- Gewichtsberechnung.** Das Gewicht einer Trommel (Schiff- oder Sockelteil von gleicher Wanddicke) ist $G = x \cdot d \cdot z \cdot (R_0 + r) \cdot \gamma$ kg, wobei d die Wanddicke, z die Trommelhöhe und R_0 und r den äußeren oberen bzw. inneren unteren Trommelhalbmesser bedeuten. Außerdem ist bei Kreisquerschnitt $x = \pi = 3,1416$, bei Achtecken $x = 3,314$, bei Quadraten $x = 4,00$.
- Windlastberechnung.** Ist h (in m) die Schornsteinhöhe über Gelände, dann ist die Windlast, bezogen auf 1 m² Achsschnittfläche $w = 120 + 0,6 \cdot h$ (in kg/m²). Ist ferner bei runden Schornsteinen $n = 0,67$, bei achteckigen $n = 0,71$, bei viereckigen $n = 1,0$, dann ist der gesamte Winddruck auf die Säule $W = n \cdot w \cdot F$ und das Winddruckmoment $M = W \cdot s$, wenn F die senkrechte Querschnittfläche und s den Abstand des Schwerpunktes derselben über der betrachteten Lagerfuge bezeichnen.

Nachdruck, auch auszugsweise, verboten. Erläuterungen dazu sind enthalten in Jahr: Die Fabrikschornsteine 8. Auflage 1940. Verlag Otto Hammerschmidt, Hagen i. Westf.

- 1,1111 942

Document 177: Static calculations for the new chimney for Crematorium I at Auschwitz performed by R. Koehler on 20 June 1942. Source: RGVA, 502-1-316, pp. 44-46a.

Rauminhalte und Eigenlasten			B
Bezeichnung des Schornsteinzeils (Schalt, Futterabsatz, Sockel, Grundbau)	Ansatz für den Reuminhalt z. B.: $V = \pi \cdot d^2 \cdot (R_0 + r)$ in m ³ vgl. Verdrick A, Erläuterung I	Rauminhalt in m ³	Gewicht der einzelnen Schornsteinzeile in kg
Absatz I.	4x12x0,25 (0,84+0,85)	20,281800	36,504
			G w = 36,504
Sockel	4x3x0,38 (1,22+0,90)	9,671800	17,406
			G 1 = 17,406
Isoliermantel Mauerwerk	4,08x0,12x12	5,871800	10,584
Schamott	(4,08x0,12x4,6)+(0,9x0,9x0,12)+ +(0,38x0,7x0,6x4)	2,991900	5,681
			G 2 = 16,265
werk Fundamentmauer	4x1,6x0,52x(1,41+0,93)-(0,6x0,7x 0,51x2)	7,201800	12,960
Fundamentbeton	3,6x3,6x1	12,962200	28,512
			G 3 = 41,472
	Insgesamt:	G o =	111,547

Berechnung der Fugenspannungen		
Für jeden Schornsteinquerschnitt ist h die Höhe des darüberliegenden Schornsteinlaufes in m. Für die Mündung des Schornsteines ist $R_0 = 0,84$ m, $r_0 = 0,60$ m.		
Für nebenbezeichn. Schornsteinsteile ist	Säule über Fuge I, h = 12 m	Säule über Fuge , h = m
Unterer äußerer Halbmesser R in m	$(0,04 \times 12 + 1,70) : 2 = 1,09$	
Unterer innerer Halbmesser r in m	$1,09 - 0,25 = 0,84$	
1. Gewicht G über der Fuge in kg	$4 \times 12 \times 0,25 (0,84 + 0,85) \times 1800 = 36.504$	
2. Windlast W in kg	$125 (0,84 + 1,09) \times 12 = 2.895$	
Windlastmoment M in kgm	$42 (1,09 + 1,68) \times 12^2 = 16.753$	
3. Ausschl. des Druckmittelpunktes: $a = \frac{M}{G}$ in m	$\frac{16753}{36504} = 0,45$	
4. Der betracht. Querschn. F in m ²	$4 (1,09^2 - 0,85^2) = 1,88$	
5. Kleinste Kernweite k in m	$0,236 \times 1,09 (1 + \frac{0,85}{1,09}) = 0,42$	
6. Zulässige Größe des Ausschlages = zweite Kernweite e	$0,55 \times 1,09 + 0,34 \times 0,85 = 0,89$	
Da a kleiner ist als e, so ist die Bedingung erfüllt, daß sich die Fugen nicht weiter als bis zur Schwerpunktschse öffnen.		
7. Pressung durch Eigengewicht $\sigma_g = G : (F \cdot 10000)$ in kg/cm ²	$\frac{36504}{18800} = 1,94$	
8. Hilfs-spannungen in kg/cm ²	$\sigma'' = \sigma_g (1 + \frac{a}{k}) = 1,94 (1 + \frac{0,45}{0,42}) = 4,01$	
	$\sigma' = \sigma_g (1 - \frac{a}{k}) = 1,94 (1 - \frac{0,45}{0,42}) = 0,14$	
9. Größe Kantenpress. in kg/cm ² $\sigma_m = \sigma'' + \sigma' (\frac{a-k}{a-k})^2$	$4,01 + 0,14 (\frac{0,45-0,42}{0,89-0,42})^2 = 4,01$	
10. Zulässige Kantenpress. in kg/cm ² $\sigma_g = 0,40 \quad \sigma_{dazul} = 0,15 h'$	$0,4 \times 7 + 0,15 \times 12 = 4,60$	
Für nebenbezeichn. Schornsteinsteile ist	Säule über Fuge II, h = 3 m	Säule über Fuge , h = m
Unterer äußerer Halbmesser R in m	$(0,04 \times 3 + 2,18 + 26) = 1,28$	
Unterer innerer Halbmesser r in m	$1,28 - 0,38 = 0,90$	
1. Gewicht G über der Fuge in kg	$4 \times 3 \times 0,38 (1,22 + 0,9) \times 1800 = 17406$	
2. Windlast W in kg	$95 \times 2,44 \times 3 = 695$	
Windlastmoment M in kgm	$16753 + 3 \times (2895 + 695) = 26479$	
3. Ausschl. des Druckmittelpunktes: $a = \frac{M}{G}$ in m	$\frac{26479}{53910} = 0,49$	
4. Der betracht. Querschn. F in m ²	$4 \times (1,28^2 - 0,90^2) = 3,32$	
5. Kleinste Kernweite k in m	$0,236 \times 1,28 (1 + \frac{0,90}{1,28}) = 0,45$	
6. Zulässige Größe des Ausschlages = zweite Kernweite e	$0,55 \times 1,28 + 0,34 \times 0,90 = 1,01$	
Da a kleiner ist als e, so ist die Bedingung erfüllt, daß sich die Fugen nicht weiter als bis zur Schwerpunktschse öffnen.		
7. Pressung durch Eigengewicht $\sigma_g = G : (F \cdot 10000)$ in kg/cm ²	$\frac{17406}{33200} = 1,62$	
8. Hilfs-spannungen in kg/cm ²	$\sigma'' = \sigma_g (1 + \frac{a}{k}) = 1,62 (1 + \frac{0,49}{0,45}) = 3,38$	
	$\sigma' = \sigma_g (1 - \frac{a}{k}) = 1,62 (1 - \frac{0,49}{0,45}) = 0,15$	
9. Größe Kantenpress. in kg/cm ² $\sigma_m = \sigma'' + \sigma' (\frac{a-k}{a-k})^2$	$3,38 + 0,15 (\frac{0,49-0,45}{1,01-0,45})^2 = 3,53$	
10. Zulässige Kantenpress. in kg/cm ² $\sigma_g = 0,40 \quad \sigma_{dazul} = 0,15 h'$	$0,4 \times 10 + 0,15 \times 3 = 4,45$	

Beanspruchung der Grundbausohle		D
Tiefe des Grundbaues $h_1 =$	2,60 m	erbaubogen: Der Grundbau besteht aus dem Inhalte der Bodensohle und dem Inhalte der Pyramide und Stufen abzüglich der Ausparungen. Der Inhalt der Pyramide ist $= \frac{1}{3} h^2 (R_2^2 + R_1^2 + r_1^2)$, wenn h die Höhe der Pyramide, R_2 und r_1 die Halbmesser der eingeschriebenen Kreise des unteren und oberen Querschnittes der Pyramide sind. Ist $W =$ Windlast und $M =$ Windlastmoment auf den Säulenschaft, $W_1 =$ Windlast und $M_1 =$ Windlastmoment auf die Sockelssohle, so ist das auf die Grundbausohle wirkende Windlastmoment $M_2 = M_1 + h_1 (W + W_1)$ Hat der Schornstein keinen Sockel, so ist $M_2 = M + h_2 W$ Die kleinste Kernweite der Grundplatte beträgt bei: quadr. Form $k_2 = 2,118 \cdot D$ achteck. „ $k_2 = 2,122 \cdot D$ runder „ $k_2 = 2,125 \cdot D$
Durchmesser der runden oder Abstand zweier gegenüberliegender Seiten der eckigen Grundplatte $D =$	3,60 m	
1. Fläche der Grundbausohle $F_1 =$	12,96 m ²	
Inhalt des Grundbaues $V_1 =$	20,16 cbm	
$G_1 =$ Schüttgewicht =	36.504,- kg	
$G_2 =$ Inste-Behälter $\left\{ \begin{array}{l} \text{Leergewicht} = \dots \text{ kg} \\ \text{gefüllt } J = m^3 = \dots \text{ kg} \end{array} \right.$	17.406,- kg	
$G_3 =$ Sockelgewicht =	16.265,- kg	
$G_4 =$ Isoliermantel =	41.472,00 kg	
$G_5 =$ Grundbaugewicht =	111.647,00 kg	
$G_6 =$	35.813 kgm	
2. Gesamt-Schornsteingewicht $\Sigma G =$	111.647,00 kg	
3. Windmoment, bezogen auf die Grundbausohle $M_1 = 26.479 + 2,6(2.895 + 695)$	35.813 kgm	
4. Der Ausschlag des Druckmittelpunktes von der Mitte ist: $a_2 = \frac{M_2}{\Sigma G} = \frac{35.813}{111.647}$	0,32 m	
5. Die kleinste Kernweite der Grundplatte ist: $k_2 = 0,118 \times 3,6$	0,42 m	
Da $a_2 < k_2$, hebt sich die Grundplatte nicht vom Boden ab!		
6. Beanspruchung durch Eigenlast: $\sigma_0 = \frac{G \text{ (in kg)}}{F \text{ (in m}^2) \cdot 10000} = \frac{111.647}{129.600}$	0,86 kg/cm ²	
7. Randspannung an der Windschattenseite: $\sigma_2 = \sigma_0 \left(1 + \frac{a_2}{k_2}\right) = 0,86 \left(1 + \frac{0,32}{0,42}\right) = 1,50$	1,50	
Art des Baugrundes:	2	
Zulässige Bodenbeanspruchung: σ_{zul}	2 kg/cm ²	
Erklärung		
Bauherr und Bauausführender übernehmen die Gewähr dafür, daß die in der Standfestigkeitsberechnung eingesetzten Gewichte mit der Wirklichkeit übereinstimmen und die zu verwendenden Baustoffe hinsichtlich ihrer Güte und Fähigkeit unseren Angaben entsprechen und technisch richtig angewandt werden.		
den 19	Myslowitz	den 20. Juni 42.
Der Antragsteller:	Der Bauunternehmer:	
	Ing. Robert Koehler Bauunternehmer Myslowitz Schlageterstraße 13	

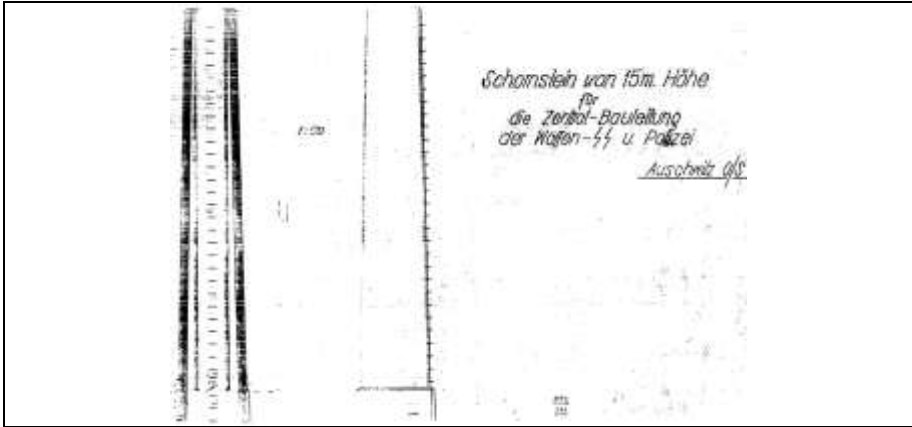

Document 178 (top and bottom): Drawing by R. Koehler of the new chimney for Crematorium I at Auschwitz for the Central Construction Office. 20 June 1942.
Source: RGVA, 502-2-23, p. 17.

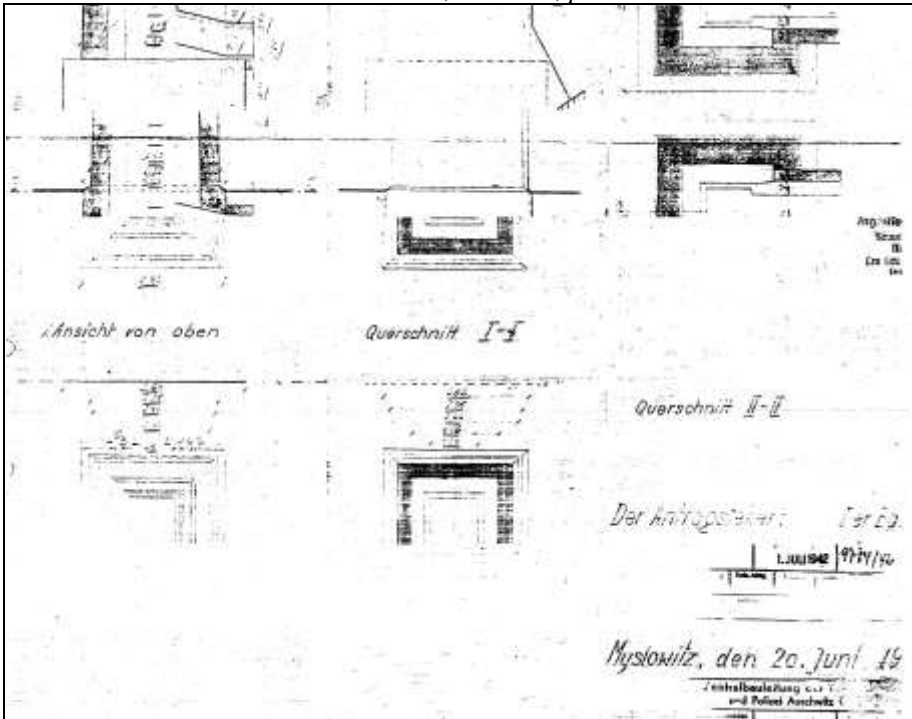

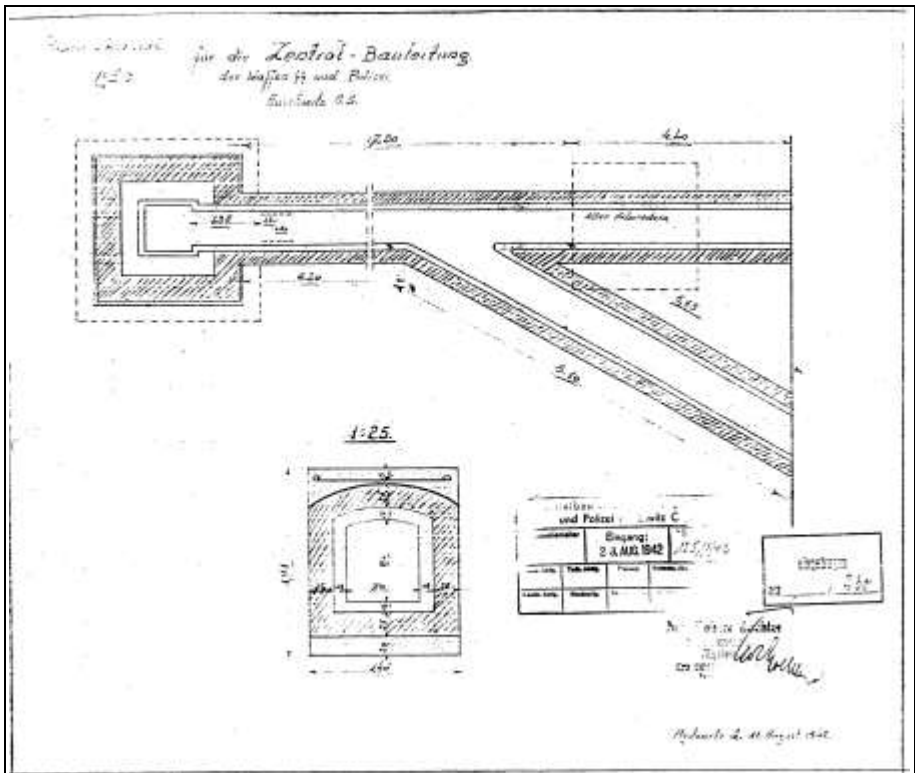

Document 179: Drawing by R. Koehler of the flue ducts to the new chimney for Crematorium I at Auschwitz for the Central Construction Office. 11 August 1942. Source: RGVA, 502-2-23, p. 18.

Schornstein - Krematorium I
BW. 11.

Baubeginn 12.6.1942
Bau beendet 8.8.1942

Monat	Hällinger	Leibensätze
12. Juni	258	18
Juli	290	45
8. August	140	30
Zusammen:	688	123

Leistungsummen:
Hällinger: $688 \times 11 = 7568 \text{ St.}$
Leibensätze: $123 \times 11 = 1353 \text{ St.}$

Materialverbrauch

25000 Stk	Ziegelsteine
6,00 m ³	Meißelkalk
200 Fass	Zement
31000 Kt	Schaumtöpfe
3700 Kt	Schmelztiegel
6 1/2 Stk	Meißeln
6 Stk	Rührer
3 Stk	Öl
10 Stk	Brennöl
12 Rollen	Sackpappe
50 Kt	Feuert.

7. 11. 42.

Document 180: Summary of labor performed during the construction of the new chimney for Crematorium I at Auschwitz Main Camp (Schornstein-Krematorium BW. 11), 7 December 1942. Source: RGVA, 502-1-318, p. 5.

Bftgb.Nr. 10 000/42/Po/Ha.

B e r i c h t

des H -Oberscharführer Pollok in der Eigenschaft
als Sachbearbeiter für baupolizeiliche Angelegenheiten.

Bei der baupolizeilichen Überwachung der Bauarbeiten am Krematorium wurde festgestellt, daß der alte Schornstein in der Horizontal- sowie Vertikalrichtung neue Risse erhalten hat, die zum Einsturz des Schornsteines führen müssen. Dieses ist darauf zurückzuführen, daß der Schornstein weiterhin übermäßig beansprucht wurde, trotzdem die Zentralbauleitung der Waffen- H und Polizei mit Schreiben vom 4. Juni 1942 Bftgb.Nr. 8195/42/Po/Qu. an die Kommandantur des K.L. die Benützung desselben verboten hat.

Ich bitte den Dienststellenleiter der Zentralbauleitung die weitere Benützung des Schornsteines erneut zu verbieten und veranlassen zu wollen, daß der Schornstein sofort abgetragen wird, da sonst unabsehbare Folgen entstehen können.

Auschwitz, den 6. Juli 1942

K. J. Lu H -Umsf (1)
6.7.42

 H -Oberscharführer

Kennlinie genommen:

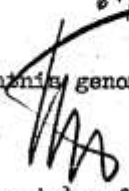
 H -Hauptsturmführer (S)

Document 181: Report by SS-Oberscharführer Pollok to the head of the Central Construction Office of 6 July 1942 on the danger of collapse of the old chimney of Crematorium I at Auschwitz. Source: RGVA, 502-1-312, p. 31.

13. August 1942

Bftgb. - Nr. 11775 /42/K1/MU 54/11

Betr.: K.L. Auschwitz, neue Schornsteinanlage Krematorium

Bezug: Telefongespräch zwischen H-Hstuf. (S) Bischoff und
H-Hstuf. Mulka am 12.8.1942, 12⁰⁰ Uhr

Anlg.: - . -

An die
Kommandantur des K.L.A u s c h w i t z O/S.

Auf Grund o.a. Telefongespraches wurde der Kommandantur mitgeteilt, dass durch das zu rasche Ausheizen der neuen Schornsteinanlage des Krematoriums (essind alle 3 Öfen in Betrieb) bereits Schäden am Mauerwerk aufgetreten sind.

Da die Inbetriebsetzung der 3 Verbrennungsöfen noch vor Erhärtung des Kaminmauerwerkemörtels in vollem Umfange erfolgte, muss jede weitere Verantwortung für das Bauwerk abgelehnt werden.

Der Leiter der Zentralbauleitung
der Waffen-~~H~~ und Polizei Auschwitz

H
H-Hauptsturmführer (S) L
902

Document 182: Letter from the head of the Central Construction Office to the camp commandant of 13 August 1942 about the damaging of the new chimney of Crematorium I at Auschwitz. Source: RGVA, 502-I-312, p. 27.

16. Juli 1943

32 695 /43/K1/Go

Betr.: Baracken für die politische Abteilung - BW 92 -
Besuz: persönliche Rücksprache zwischen Ostuf. Grabner und
 Ostuf. (P) Kirschneck
Anl.: keine

An den Leiter der
 SS-Standortverwaltung
 SS-Ostuf. 8 o k i

K.L. Auschwitz

Die hiesige Dienststelle teilt mit, dass der Standortplatz der beiden Baracken für die politische Abteilung, insbesondere der Schweizer Baracke, von der Voraussetzung ausgehend festgesetzt wurde, dass das Krematorium I seinen Betrieb vollständig einstellen wird, wie dies auch bei der o.a. Rücksprache von SS-Ostuf. Grabner vernichtet wurde.

Nachdem die Arbeiten an den Baracken fast beendet sind, wurde festgestellt, dass das Krematorium trotzdem neuerdings in Betrieb genommen wurde.

Die leichte Entzündbarkeit dieser Bauwerke verlangen die Ausserbetriebsetzung des Krematoriums-I, widrigenfalls für sich daraus ergebende Feuerschäden jede Verantwortung abgelehnt werden muss.

Der Leiter der Zentralverwaltung
 der öffentlichen und politischen Angelegenheiten
 in Auschwitz

SS-Sturmabführer

Verteilt an
 Register
 Hauptstadt
 Standort

Document 183: Letter from the head of the Central Construction Office to the head of the garrison administration of 16 July 1943 regarding the suspension of activities at Crematorium I at Auschwitz. Source: RGVA, 502-1-324, p. 1.

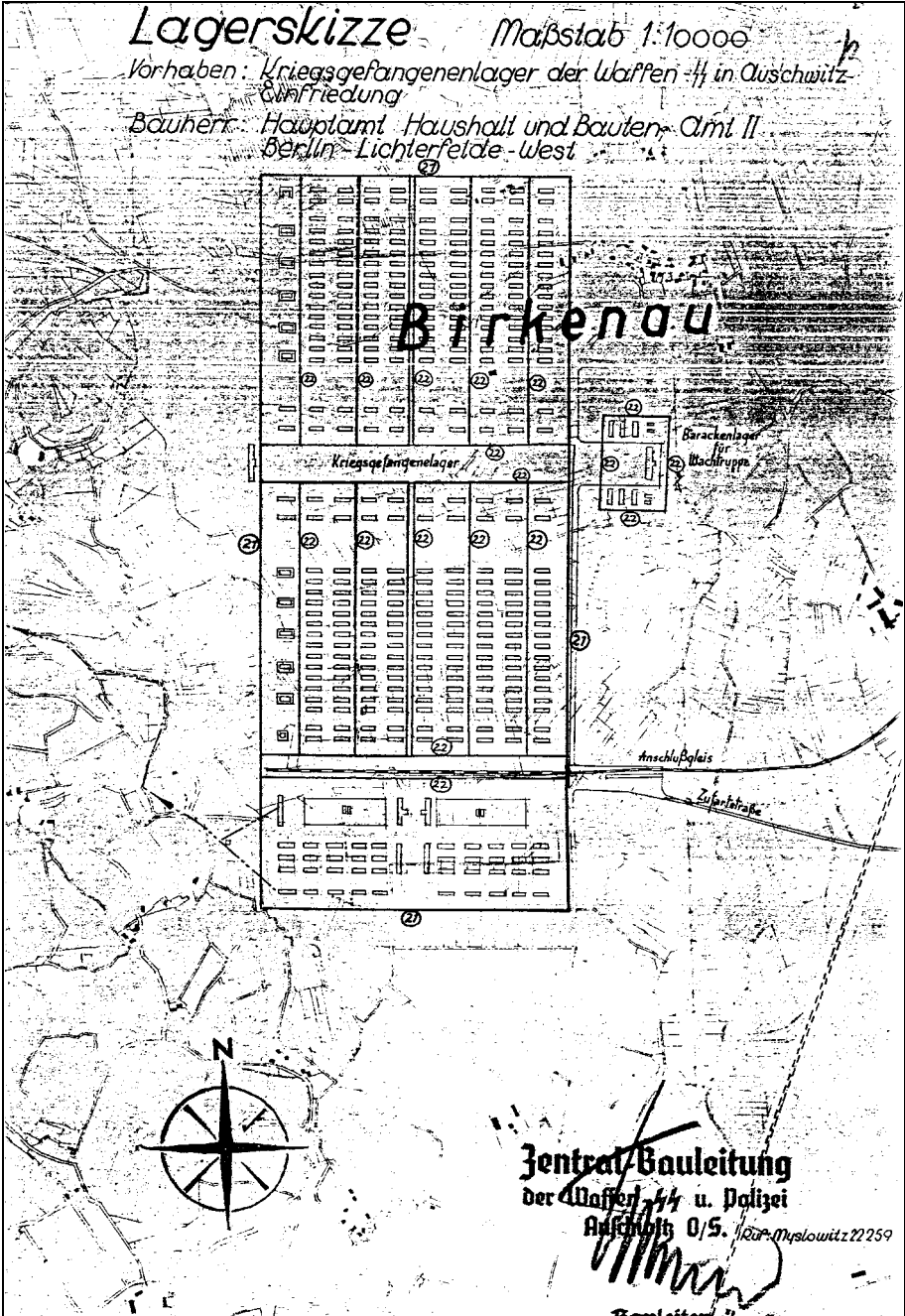

Document 184: Drawing of the Birkenau Camp. October 1941. (Location sketch of Construction Objects BW 21 and 22 "Einfriedigung", fences). Source: RGVA, 502-1-235, p. 13.

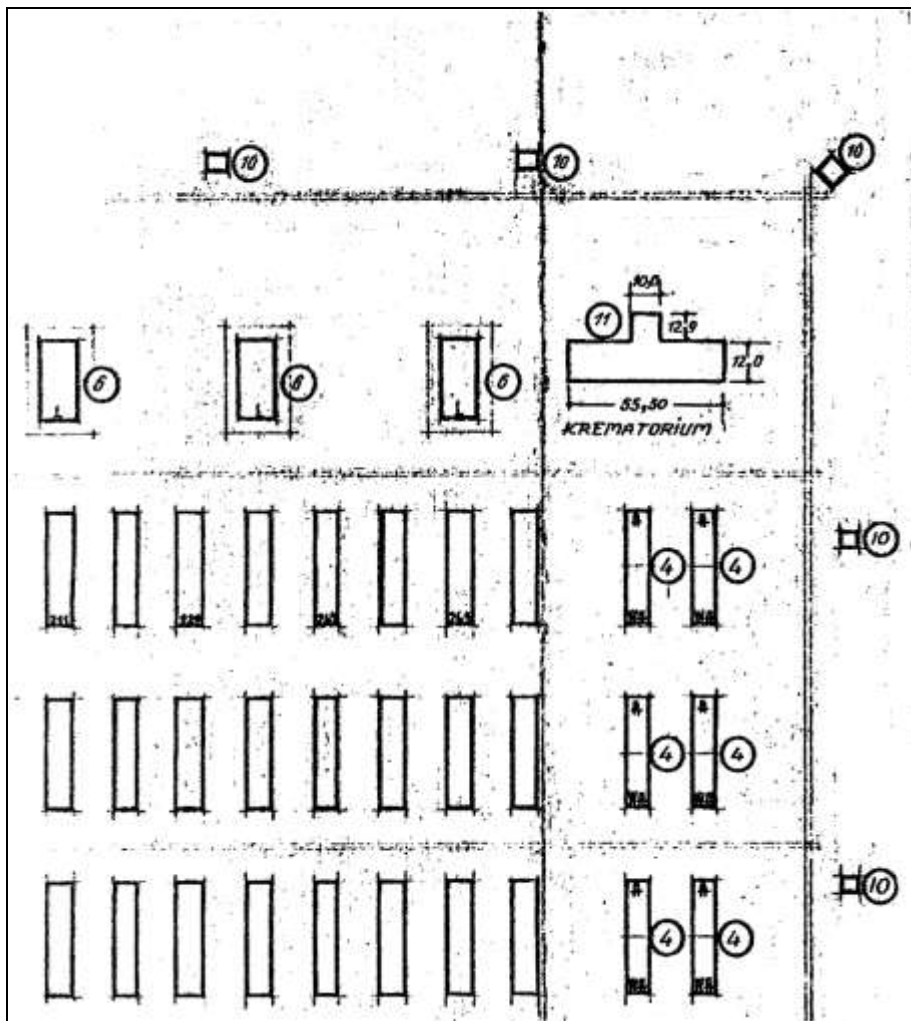

Document 185: Section enlargement of the "Lay-out plan of the PoW camp at Auschwitz, Upper Silesia, Plan No. 885," drafted by SS-WVHA on 5 January 1942. Source: RGVA, 502-2-95, p. 7.

by Arnold Erdt
J. A. TOPF & SÖHNE
 M A S C H I N E N F A B R I K

81

GEGR.  1878

COPIE
 IND. MOSE-COOS
 A. S. COOP
 SAUDT & HUNDIUS

An die
 Bauleitung der Waffen-SS
 und Polizei,
Auschwitz /G.-S.

ERFURT, 4. 11. 41.
 POSTFACH NR. 2
 FABRIK UND VERWALTUNG
 DEYERSTRASSE 7a
 hes.

BEZUGLICH
 Ihr Schreiben v. 22. 10. 41,
 Bestellung von Topf-Dreimuffel-Öfen, Saugzug-Anlagen
 und Topf-Müllverbrennungs-
 Öfen.

HIER ZEICHEN
 Bftg.-Nr. 215/
 41 Ho.

UNSERE ABTEILUNG
 D IV/Prf.
 Auftrag Nr. 41/2249/L.

Wir danken Ihnen bestens für den uns erteilten Auftrag
 auf Lieferung von

5 Topf-Dreimuffel-Einsäuerungs-Öfen mit
 Druckluft-Anlage
2 Sarg-Einührungs-Vorrichtungen mit
 Schienen-Anlage für 5 Öfen
3 Topf-Saugzug-Anlagen
1 Topf-Müll-Verbrennungs-Öfen
 Rauchkanal-Anlage.

Den Auftrag nehmen wir an aufgrund unseres beiliegenden
 Kostenschlages und dessen Bedingungen zum Gesamtpreise
 von RM 51 237.--

Unsere Lieferung:

a) Für die 5 Topf-Dreimuffel-Einsäuerungs-Öfen die gesamten
 Schamotte- und Isoliermaterialien, die guß- und schmiede-
 eisernen Armaturen, die Druckluft-Anlagen mit Motoren
 und die Kosten zweier Monteure für die Beaufsichtigung
 der Bauarbeiten.

W. A. 1100 1. 11. 1941 (111)

Document 186: Order confirmation by J.A. Topf & Söhne to the SS Construction Office at Auschwitz of 4 November 1941 regarding 5 coke-fired triple-muffle cremation furnaces for Crematorium II at Birkenau with auxiliary equipment and a waste incinerator. Source: RGVA, 502-1-313, pp. 81-83.

 J.A. TOPF & SÖHNE ERFURT

TAG BLATT

4.11.41. -2-

EMPFANGER

Bauleitung der Waffen-SS und Polizei,
Auschwitz /Q.-S.

82

- b) Die 2 Sarg-Einführungs-Vorrichtungen mit Verschiebewagen, einschließlich der Schienen-Anlage für die 5 Stück Einzelsicherungs-Öfen.
- c) Die 3 Topf-Saugzug-Anlagen mit Motoren und die Monteurstellung zum Einbau der Anlagen.
- d) Für die Topf-Müll-Verbrennungs-Anlage die gesamten Schamotte- und Isoliermaterialien, einschließlich der guß- und schmiedeeisernen Armaturen, einschließlich Stellung eines Monteurs zur Beaufsichtigung der Bauarbeiten.
- e) Zur Rauchkanal-Anlage die gesamten Schamottmaterialien und Stellung eines Monteurs.

Bauseitige Lieferung:

Zu den Öfen und der Rauchkanal-Anlage die gesamten Mauer-materialien, wie Ziegelsteine, Sand, Kalk und Zement, deren Mengen aus dem Kostenanschlag zu ersehen sind, sowie auch die gesamten, schmiedeeisernen Verankerungs-Eisen kostenlos für uns.

Ferner stellen Sie unseren Monteuren ohne Kosten für uns genügend Helfer zur Verfügung.

Die von uns vorgesehene Bauzeit für die Anlagen darf 8 Wochen nicht überschreiten, da wir die Stellung unserer Leute nur für diese Zeit berechnet haben. Sollte die vorgesehene Bauzeit überschritten werden, sind die abgeleisteten Stunden im Tagelohn zu verrechnen.

Da die fortgeschrittene Jahreszeit den Bau der Öfen in ungeheizten Räumen nicht zuläßt, so wollen Sie für baldige Erstellung des Ofenraumes und für Heizung desselben Sorge tragen.

J.A.TOPF & SÖHNE ERFURT

TAG BLATT

4.11.41. -3-

EMPFANGER

Bauleitung der Waffen-SS und Polizei,
Auschwitz /C.-S.

83

Lieferzeit:

Die von Ihnen gewünschte Lieferzeit von 3 Monaten für die Öfen werden wir versuchen einzuhalten. Dabei ist Voraussetzung, daß in der Materialbeschaffung keine Stockung eintritt und uns keine weiteren Arbeitskräfte entzogen werden.

Wir benötigen 6 Frachtbriefe mit den erforderlichen Vermerken Ihrerseits, um deren baldige Zustellung wir Sie bitten.

Kennziffer:

Wir bitten, dafür zu sorgen, daß die Bekanntgabe einer solchen über 17 600 kg schnellstens erfolgt.

Zeichnungen:

Für die Erstellung der Ofenfundamente sowie zur Anfertigung der Verankerungs-Eisen erhalten Sie von uns in Kürze die erforderlichen Zeichnungen.

Der Gesamtplan mit eingezeichneten Öfen, Rsuchkanal- und Entlüftungs-Anlage, desgleichen eine Ofenzzeichnung des Dreimuffel-Ofens liegt bei.

Ausführung:

Erwähnen möchten wir, daß die Einscherungskammern in den Öfen jetzt größer gebaut werden als bei den bisherigen Öfen. Hierdurch wollen wir eine größere Leistung erreichen. Aus dem gleichen Grunde haben wir auch statt 2 Saugzug-Anlagen deren 3 vorgesehen, dabei aber auch berücksichtigt, daß gefrorene Leichen zur Einscherung gelangen, die mehr Heizmaterialaufwand bedingen, wodurch die Abgasmenge sich erhöht.- Wir sichern Ihnen die Erstellung einer sachgemäßen und gut arbeitenden Anlage zu und empfehlen uns mit

Heil Hitler!

Anlagen:

1 Kostenanschl.
2-fach,
Eisenaufteilg. } ?
Aufstellungen. }
2 Zeichng.D 59 320 u.D 59 091,
1 Zeichn.D 59 090. 1 Zeichn.D 59 090.

Document 186: continued.

Bftgb.Nr. 11 415 /42/Er/Ha.

89/30

Revisanden!

159

Aktenvermerk

Beitrag: Anwesenheit von Obering. Prüfer der Fa. Topf u. Söhne Erfurt, bezüglich Ausbau der Einöcherungsanlagen im K.G.L. Auschwitz

Vorgang: Herr Ing. Prüfer sprach am 19.8.1942 um 14,00 Uhr bei hiesiger Dienststelle vor, um über den Einbau von 5 Stück 3 Muffel-Einöcherungsöfen im Krematorium des K.G.L. und Neuanlage von 2 Stück 3 Muffelöfen in einfacher Bauweise lt. Plan Nr. D 59 - 570 und Nr. D 59 599 die erforderlichen Einzelheiten zu besprechen.

Hierbei wurde folgendes festgelegt:

- 1.) Spätestens 26. - 27. August trifft der Monteur Holik aus Fuchenwald hier ein, der Monteur Koch in ca. 14 Tagen. Mit dem Aufbau der 5 Stück 3 Muffelöfen im K.G.L. wird sofort begonnen. Die Fa. Köhler Kyslowitz führt die Ausmauerung der Öfen und Fuchse, sowie die Errichtung des Schornsteines lt. Plänen und Angaben der Fa. Topf u. Söhne durch.
- 2.) Bezüglich Aufstellung von je 2 Dreimuffelöfen bei den "Badeanstalten für Sonderaktionen" wurde von Ing. Prüfer vorgeschlagen, die Öfen aus einer bereits fertiggestellten Lieferung nach Mogilew abzuzweigen und wurde sogleich der Dienststellenleiter welcher beim "Wirtschafts-Verwaltungshauptamt in Berlin anwesend war, hiervon tel. in Kenntnis gesetzt und gebeten, das weitere veranlassen zu wollen.
- 3.) Bezüglich Errichtung eines 2. Krematoriums mit 5 Dreimuffelöfen, sowie Be- und Entlüftungsanlagen muß erst das Ergebnis der bereits laufenden Verhandlungen mit dem Reichsicherheitshauptamt bezügl. Zuteilung von Kontingente abgewartet werden.

- 2 -

Document 187: "File memo" by SS-Untersturmführer Ertl of 21 August 1942.

Source: RGVA, 502-1-313, pp. 159f.

- 2 -

150

- 4.) Nach Auschwitz wurden von der Pa. Topf u. Söhne irrtümlich die Teile eines Doppelmuffel-Einäscherungs-Ofens gesandt, welche jedoch für Neuhausen bestimmt waren.

*Ofen geht nach
Handlungen
zurück!*

Ing. Prüfer schlägt vor, den Ofen hier zur Aufstellung zu bringen. Die fehlenden 2 Einführtüren und 2 Asche-entwärtmetüren können inzwischen der Lieferung der 5 Dreimuffel-Einäscherungsöfen entnommen werden.

- 5.) Die Schäden in dem neu gemauerten Schornstein für das bestehende Krematorium wurden gemeinsam mit Herrn Köhler und $\frac{1}{4}$ -Unterscharführer Kirschnek besichtigt und die zu ergreifenden Maßnahmen besprochen. - Da das Schornsteinfutter infolge der großen Hitze arbeitet, muß es oben frei durchgehen und darf nicht mit dem Außenmantel fest verbunden sein.

- 6.) Am Donnerstag den 20. August 1942 wurde gemeinsam mit $\frac{1}{4}$ -Strm. Janisch u. Herrn Köhler die Baustelle des 5 Dreimuffelofens im K.G.L. besichtigt, und die erforderlichen Einzelheiten durchbesprochen.

- 7.) Ing. Prüfer bat um schriftlichen Auftrag über die Lieferung der 2 Stück 3 Muffel- und den Doppelmuffel-Einäscherungsöfen, sowie um baldige Mitteilung, ob die Öfen der Lieferung Mogilew abgezweigt werden können.

*29.8.42 tel. 8.) Zum Antransport des fehlenden Schamotte- und sonstigen
Kein Profen Sondermaterialies sind der Pa. Topf u. Söhne sogleich 10 Fracht-
gaben, daß briefe einzusenden.*

*2 Stück 3 Muffelöfen aus Lieferung Mogilew
abgezweigt werden können.
Der Profen hätte mit, sonst über die $\frac{1}{4}$ -Strm.
Lieber bereits mitgeteilt habe.*

lll
 $\frac{1}{4}$ -Unterscharführer (S)

lll
Kontrolliert genommen:

lll
 $\frac{1}{4}$ -Hauptsturmführer (S)

Auschwitz, den 21. August 1942.

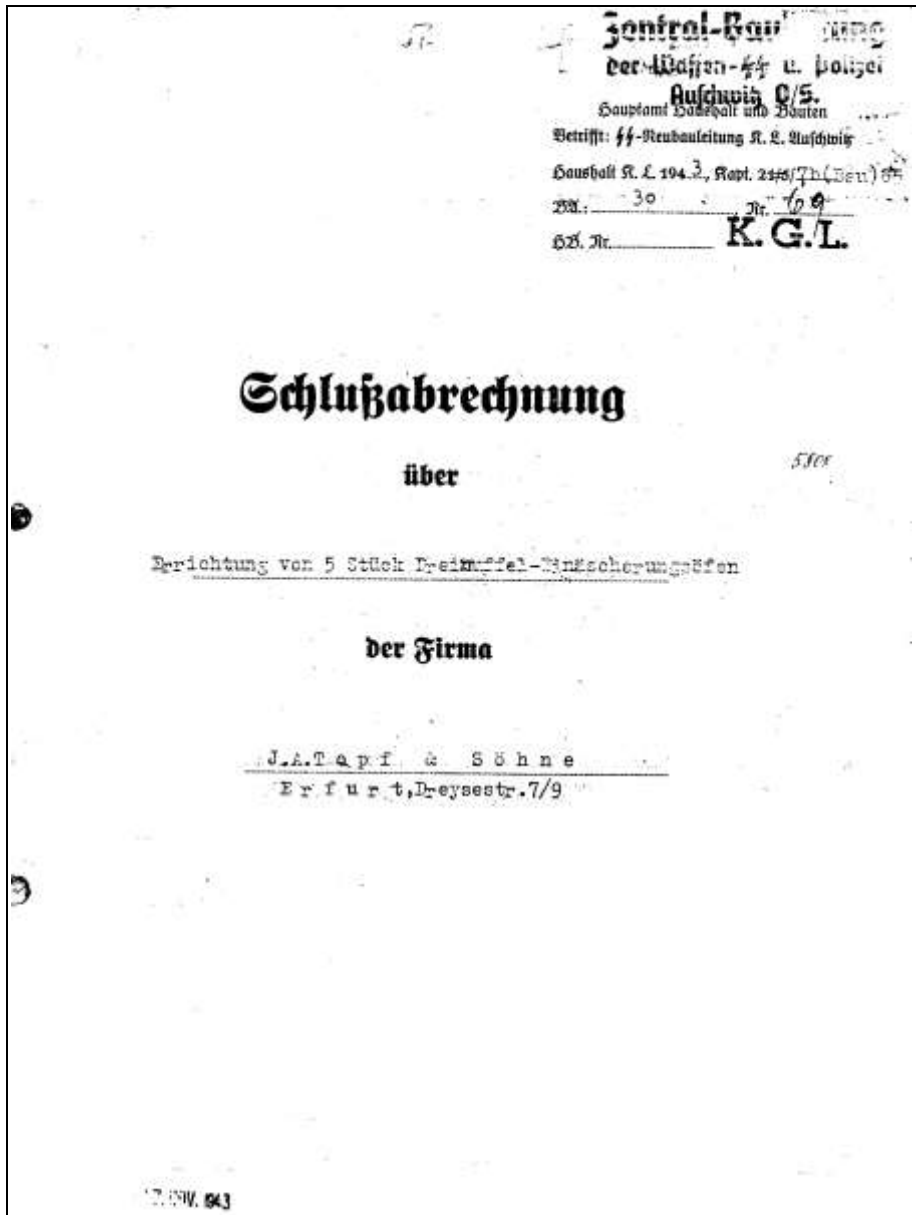

Document 188: Final accounting to J.A. Topf & Söhne of November 1943 regarding the construction of 5 triple-muffle cremation furnaces for Crematorium II at Birkenau. Source: RGVA, 502-2-26, pp. 226-228.

Zentral-Bauleitung
der Waffen-SS u. Polizei
Auschwitz O/S.

Bauvorhaben: _____
Baushalt: 1943. Kap.: 01/75 Tit.: (Bau)03
Baumerk (BW): 30 = Krematorium II
Bausgabebuch Seite: _____ Nr. **69**

Auftrag
Schlußrechnung zum Vertrag Nr. 715/41

Auftrag Vertrag vom <u>22.10.41</u>	Summe RRM <u>51.237,-</u> ✓
Nachtrag vom _____	Summe RRM _____
Nachtrag vom _____	Summe RRM _____
Nachtrag vom _____	Summe RRM _____
Nachtrag vom _____	Summe RRM _____
Nachtrag vom _____	Summe RRM _____
Nachtrag vom _____	Summe RRM _____
Nachtrag vom _____	Summe RRM _____
Nachtrag vom _____	Summe RRM _____
Nachtrag vom _____	Summe RRM _____
	RRM <u>51.237,-</u> ✓

Summe der Schlußrechnung (Unterbeleg 3) RRM 47.532,- ✓

hierauf sind laut beigefügter Zusammenstellung geleistet an
Abschlagszahlungen (Unterbeleg 1) RRM 40.000,- ✓

mithin noch RRM 7.532,- ✓ auszuzahlen.

Im Garantieleistungsverzeichnis vorgemerkt Seite: _____ laufende Nr. _____

Richtig und festgestellt!

Auschwitz, den 11. November 1943

Der Leiter der Zentralbauleitung
der Waffen-SS und Polizei Auschwitz

[Handwritten Signature]

-Oberbauleiter- (P)

ff-Vormblatt - Bau - 15 . Schlußrechnung zum Vertrag * . Waffen-SS-Behördenamt Kassel (1941.)

Die A 4

Verzeichnis der geleisteten Abschlagszahlungen
auftrag
zum Vertrag-Nr. 715/41

Laufende Nr.	Anweisungs- Datum	gebucht bei		Summe RM	Kasse-Beleg Nr.
		BW 30 Bausausgabebuch Seite	Nr.		
1.	13.2.42	2	1	25.000,-	
2.	17.9.42	1	1	15.000,-	
				40.000,-	

U-Beleg Nr.: 1

44 = Stammbuch — 200 — 16 Verzeichnis der Abschlagszahlungen — 11011

Gewerbsteuereinnahme Rechnungsjahr 19 43
Ausgabe

Die Kasse der Bauinspektion der Waffen- und
Polizei Reich-Dst. wird angewiesen,
den Betrag von 7.532,- R.M. — Pf.
wörtlich Sieben tausend fünf hundert
zwei und dreissig R.M. — Pf.
sogleich an H. A. Goff & Söhne Erlauf
auszuzahlen und wie folgt zu verbuchen:
anzurechnen
bei Kap 2/26 Tit Bau 65 in Ausgabe R.M. 7.532,00

Einnahme
Zwischen dem 11. November 19 43

Der Leiter der Bauinspektion W. Ma

Jr. W. Ma

W-Unterstuermführer (F)

R.M. 7.532,- sind durch

Reichsbank giro

Conto Nr. 8934432

bezahlt am 22. 11. 43

W. Ma

W. Ma

W-Unterstuermführer

W-Oberscharführer

Einnahme 7.532 R.M. — Pf.
Ausgabe

D. u. A. D. Seite 19 nr. 417/50



Document 189: Final accounting to J.A. Topf & Söhne of November 1943 regarding the construction of 5 triple-muffle cremation furnaces for Crematorium III at Birkenau. Source: RGVA, 502-2-26, pp. 211-213.

Zentral-Bauleitung
der Waffen-~~u~~ u. Polizei

Bauvorhaben Reifung 3/5

Bauschalt: 1943. Kap. 21/75 Tit. 10/155

Bauwerk (BW): 30a = Werkstatt III

Bauausgabebuch Seite: 42
K.G.L.

Auftrag
Schlußrechnung zum Vertrag Nr. 274

Antrag		
Vertrag vom	26.10.42	Summe RM 53.702,- ✓
Nachtrag vom	_____	Summe RM _____
Nachtrag vom	_____	Summe RM _____
Nachtrag vom	_____	Summe RM _____
Nachtrag vom	_____	Summe RM _____
Nachtrag vom	_____	Summe RM _____
Nachtrag vom	_____	Summe RM _____
Nachtrag vom	_____	Summe RM _____
Nachtrag vom	_____	Summe RM _____
Nachtrag vom	_____	Summe RM _____
Nachtrag vom	_____	Summe RM _____
		RM 53.702,- ✓

Summe der Schlußrechnung (Unterbeleg 3) RM 53.702,- ✓

hierauf sind laut beigefügter Zusammenstellung geleistet an

Abchlagszahlungen (Unterbeleg 1) RM 32.500,- ✓

mithin noch RM 21.202,- ✓ ausbezahlen.

Im Garantieleistungsverzeichnis vorgemerkt Seite: _____ laufende Nr. _____

Richtig und festgestellt!

Auschwitz, den 11. November 1943.

Der Leiter der Zentralbauleitung
der Waffen-~~u~~ und Polizei Auschwitz



17. NOV. 1943

ff-Formblatt - Bau - 13 . Schlußrechnung zum Vertrag * . Weisenhoss-Buchdruckerei Kassel. (1941.)

Verzeichnis der geleisteten Abschlagszahlungen
zum Vertrag Nr. 274

	Bauende Nr.	Anweisungs- Datum	gebucht bei		Summe	Kasse-Beleg Nr.
			BW	Bankausgabebuch		
			Soll	Haben		
	1.	4.12.42	1	1	27.000,-	✓
	2.	8.12.42	2	1	5.500,-	✓
					<u>32.500,-</u>	✓

K-Beleg Nr.: /

ff-Formblatt — Bau — 16 . Verzeichnis der Abschlagszahlungen* . Waisenhaus-Buchdruckerei Kassel. (1941.)

Document 189: continued.

114
52

U
Abschrift
höhere
-und Polizeiführer
Generalgouvernement
SS Wirtschaftler

Krakau, den 16. Aug. 1943.
Aussenring 118
Sammel-Nr. 15080

As. 6/C 2/2a Ka./Ls.

Betr. Einäscherungsöfen für Krematorium
Bezug *Kreis der SS Wirtschaftler Verwaltung Hauptstadt*
Auf Ab. Nr. vom 10. 8. 43

Aufgabe: —

Verhiler

An die Zentralbauleitung der Waffen SS u. Pol.	Heidelager
" " " " " " " "	Krakau
" " " " " " " "	Leuberg
" " " " " " " "	Lublin
" " " " " " " "	Warschau
" " Bauleitung der Waffen SS u. Pol.	Mogilev

Denn Auf. Ab. Nr. St. 3. 36. 1^{te} Einäscherungsöfen - 12 Muffeln zur Verfügung.

Die dortige Dienststelle wird eine zugehörige Meldung des Bedarfs geben, falls ein Weiteres dort vorliegen sollte. Fehlensfalls ist erforderlich. Früh 1. 9. 43. Vorhanden sind hierfür nicht erforderlich.

Der Gruppenleiter O- Bauwesen
gez. SS Hauptbauaufseher

Zbiory AP w Lublinie

Document 190: Copy of a letter from the SS business manager at the Higher SS- and Police Leader's office of the Government General of 16 August 1943 regarding TOPF cremation furnaces ordered for Mogilev (one-and-a-half 8-muffle furnaces). Source: WAPL, Central Construction Office, 268, p. 132.

263
147

Trawniki, den 2. Sept. 1943.

Betr. Einäscherungsöfen für Krematorium
 Bez. Verteiler des SS Wirtschafters in Krakau v. 16.8.43.
 Az. 6/R C 2 / 2a / Ma / La.
 Anlage: 1

An die Zentralbauleitung
 der Waffen SS u. Polizei

L u b l i n

Anliegend wird der Verteiler des SS Wirtschafters zurück-
 gesandt. Ein Krematorium ist im hiesigen Lager nicht vorhanden.
 Dieser Zustand wurde bereits öfters beanstandet. Die Errichtung
 eines Krematoriums wäre jedoch dringend erforderlich. Ob aller-
 dings die dem Amt C. 3 zur Verfügung stehenden ~~Topf~~-Einäscher-
 ungs Öfen für Trawniki in Frage kommen könnten, müsste von
 dort entschieden werden.

Ji

Zbiery AP w Lublinie

Document 191: Letter from the Head of Constructions of the Trawniki Camp to the Central Construction Office of the Lublin Concentration Camp of 2 September 1943 regarding the Topf furnaces of the Mogilev Contract. Source: WAPL, Central Construction Office, 268, p. 147.

HUTA		Tagelohnliste Nr. 1											
vom 23. September		bis zum 3. Oktober 1942.											
Bau Nr. 4 Krematorium IV in Auschwitz 2. Klammerringarbeiten u. Aufarbeiten.													
Vorname	Zunamen	Beschäftigt als	Datum							Bezeichnung der Arbeit			
			Mi	Do	Fr	Sa	So	Mn	Di				
						23	24	25	26				
Lies	Pamula	Pol.				5	10	10	8		33	Aufarbeiten Aufhängen u. auf	
Anna	Felbert	Wt.				5	5				10	aus 24.2. ab Aufarbeiten des	
Julia	Josteph	"				5	5				10	Fingerringe u. 100 Aufarbeiten	
Karl	Morock	"				5					5		
Wenzl	Wegisch	Pa				5	5	10	8		25		
											15		
												Pol. = ✓ 91 Std. ✓	
												Don. = ✓ 28 " ✓	
												Mer. = ✓ 252 " ✓	
												Verbrauchtes Material, An- und Abfuhr = 16.6.43.	
						27	28	29	30	1	2	3	Nachgerechnet am 16.6.43.
Lies	Pamula	Pol.		10	10	10	10	10	8		58	heim Spackel u. Untergrundarbeiten	
Aug	Wegansch	Wt.		10	10	10	10	10	11		58	Fingerringe bekorieren	
Jul	Morock	"		10	10	10	10	10	11		58	Waffenlager gelassen form	
Jul	Kozusa	"		10	10	10	10	10	11		58	Klammerring 7 100 Aufarbeiten	
Aug	Zemba	"		10	10	10	10	10	11		58		
Auffrüstung		den	5. Oktober		1942.								
Der Polier		Anerkannt											
Huta		Schypol 44 Ham.											
Kamtionen gegen die Richtigkeit des Inhalts dieser Liste müssen innerhalb einer Woche geltend gemacht werden.													

Document 192: First list of day wages of the Huta Company for initial work performed at the construction site of Crematorium IV from 23 September to 3 October 1942. Source: RGVA, 502-2-54, p. 45.

<h1>J. A. TOPF & SÖHNE</h1>		
MASCHINENFABRIK UND FEUERUNGSTECHNISCHES BAUGESCHÄFT		
<p>UNSER ARBEITSBEREICH: Spezial- und Ausführung vollständiger Kesselhäuser Verbesserungen u. Umbauten bei nicht wirtschaftlicher Dampfherzeugung</p>	<p>60 JAHRE </p>	<p>ERFURT POSTFACH 2220, FABRIK UND VERWALTUNG DREYSESTRASSE 7/8</p> <p>GRANDWORT TOFFWERKE ERFURT</p> <p>FERNUMF 25125 25126 25127 25128</p>
<p>Abteilung D I Wärmeökonomische Unter- suchungen und fachmännische Beratung Wärmebrennen Eigen-Herstellung und Liefe- rung sämtlicher wärmetechn. Anlagen, Apparate und Vor- richtungen</p> <p>Topf-Spezial-Feuerungen für alle Brennstoffe: Steinkohle, Braunkohle, Schmelzschlacke, Torf, Sägespäne, Holz usw.</p> <p>Vollmechanische Topf-Roste Halbmeh. Topf-Feuerungen Topf-Wurfbeschicker „Ballist“ Topf-Spezial-Roststäbe Feuerungsmotoren</p> <p>Ölfeuerungen für sämtliche industrielle Betriebe</p> <p>Vorwärmer, Lufterhitzer, Dampfüberhitzer, Flugische- Ausblase-Vorrichtungen Zugverdrängungsanlagen</p> <p>Einmauerungen von Dampf- kesseln von industriellen Feuer- ungen bis zu den größten Abmessungen usw.</p> <p>Industrie-Schornsteinbau bis zu den größten Abmessungen Schmelzeisene Schornsteine</p> <p>Industrie-Ofenbau zur Abfallver- richtung, Müllverbrennung, Kabelverwertung, Vercoakung</p> <p>Feuerbestimmungs-Einrich- tungen mit moderner elek- trischer- oder Gas-Beheizung</p>	<h2>Kosten-Anschlag</h2>	<p>UNSERE ABTEILUNG: D/Prf.</p> <p>ANGABEN N.: 40/999.</p> <p>HAUSAPPARAT N.: 123.</p> <p>DATUM: 13.11.40.</p>
<p>Abteilung D II Sämtliche Transportanlagen Mechanische Beköpfung und Ermaschung</p>	<p>Titl. 7</p> <p>Reichsführer SS, Chef der deutschen Polizei, Hauptamt Haushalt und Bauten, SS-Neubauleitung KL Auschwitz, Auschwitz /OS. =====</p>	
<p>Abteilung D III Lüftungsmechanische Anlagen für industrielle Betriebe, Bade- anstalten, Gaswännen usw. Absaugeanlagen für Staub- löse usw. Gedämmungen Ventilationsbau</p>	<p>Besitt: 1 koksbeheizten T o p f - Doppel-muffel-</p> <p>Einäscherungs-Ofen mit Druckluft-Anlage.</p> <p><u>Durch Herrn Oberingenieur Prüfer !</u></p>	
<p>Abteilung E III Neuzeitliche Förderanlagen für Koble, Asche, Chemikalien Geräte und alle unterstütz- enden Schüttgüter</p>	<p>Aufgabe: Prf/Hes.</p> <p>Gesamt: </p>	
<p>Abteilung C Eisenkonstruktionen und Be- schweißarbeiten</p>	<p>Die Spezialfabrik für feuerungstechnische Anlagen TOPF hat Zehntausende von TOPF-Feuerungen geliefert. Hervorragende sechzigjährige Spezialerfahrungen. Eigene Versuchstation und feuerungstechnisches Laboratorium. Untersuchung von Brennstoffen, Asche, Speisewasser. Eigene Lehrheizer.</p>	

Document 193: "Cost Estimate" by J.A. Topf & Söhne of 13 November 1940 regarding the second TOPF coke-fired double-muffle cremation furnace for Crematorium I at Auschwitz. Source: RGVA, 502-1-327, pp. 168-172.

J. A. TOPF & SOHNE ERFURT		2. Blatt des Kostenanschlages vom 13.11.40.	
		für KL, Auschwitz /OS.	
Lfd. Nr.	Anzahl	Gegenstand der Veranschlagung	
1		<p>koksbeheizter T o p f - Einäscherungs-Ofen mit Doppelmuffel und Druckluft-Anlage,</p> <p>-----</p> <p>wozu folgende Lieferungen und Arbeiten gehören:</p> <p>Fundament zum Ofen und Rauchkanal müssen bauseitig, nach unseren Angaben, ohne Kosten für uns ausgeführt werden.</p> <p>Zum Mauerwerkamantel Ziegelsteine, Sand, Kalk und Zement. Die besten Steine werden zur Verblendung herausgesucht.</p> <p>Das erforderliche Schamottematerial, bestehend aus Normal-, Form- und Keilsteinen und Monolitstampfmasse, sowie dem dazu gehörigen Mörtel.</p> <p>Zur Isolierung des Ofens die erforderlichen Kieselgursteine, Schlackewolle und Kieselgurmörtel.</p> <p>Die schmiedeeisernen Verankerungs-Eisen, bestehend aus T-, U- und Winkel-Eisen, Ankern, Schrauben und Muttern.</p> <p>Die guß- und schmiedeeisernen Armaturen, wie:</p>	
2		gußeiserne Einführungs-Türen mit gußeisernen Rahmen. Die Innenseiten der Türen werden mit Monolitstampfmasse ausgestampft,	
6		gußeiserne Luftkanalverschlüsse,	
4		gußeiserne Ascheentnahme-Türen,	
2		gußeiserne Generatorfüll-Türen,	
2		schmiedeeiserne Aschebehälter,	

Document 193: continued.

J. A. TOPF & SOHNE ERFURT		3. Blatt des Kostenschlages vom 13.11.40.	
		für KL, Auschwitz /OS.	
Ud. Nr.	Anzahl	Gegenstand der Veranschlagung	
	2	schmiedeeiserne Rauchkanalschieber- rahmen, mit Monolit ausgestampft, einschließlich der erforderlichen Rollen, Drahtseile und Gegengewich- te,	
	die	erforderlichen Schürgeräte,	
	2	gußeiserne Feuer-Türen,	
	2	Planroste,	
	1	Druckluft-Anlage, bestehend aus dem Druckluft-Gebläse mit 1,5 PS-Dreh- strom-Motor, direkt gekuppelt und der erforderlichen Rohrleitung.	
		<u>Montage des Ofens.</u> Monteurgestellung zum Bau des Ofens, einschließlich der Reisekosten, Tage- gelder, sowie einschließlich der so- zialen Lasten.	
	1	schmiedeeiserne Leichen-Einführungs- Vorrichtung, bestehend aus dem Sarg- einführungs-Wagen und dem schmiede- eisernen Verschiebe-Wagen mit den er- forderlichen Laufschielen.	
		Frachten frei Auschwitz /OS.	
		P r e i s für den Ofen:	Reichsmark 7 753.--
		<u>Kennziffergewicht:</u> 2 600 kg Eisen.	=====
		500 3 100	
		Unserem Monteur müssen während der Bauzeit mehrere Hilfskräfte, ohne Kosten für uns, zur Verfügung gestellt werden.	
		<i>Wichtigste Bedingung: keine Störung der Arbeit, keine Verzögerung.</i>	
		Lief.Bed.A. 60.6.40. 1 000. L 0204.	

Document 193: continued.

J. A. TOPF & SÖHNE

MASCHINENFABRIK UND FEUERUNGSTECHNISCHES BAUGESCHÄFT



UNSER ARBEITSGEBIET:

Entwurf und Ausführung vollständiger Kesselhäuser Verbesserungen u. Umbausen bei nicht wirtschaftlicher Dampfleistung

Abteilung D I

Wärmeisolierte Untersuchungen und fachmännische Beratung

Wärmeblöden Eigen-Herstellung und Lieferung sämtlicher wärmetechn. Anlagen, Apparate und Vorrichtungen

Topf-Spezial-Feuerungen für alle Brennstoffe: Steinkohle, Braunkohle, Schmelzkohle, Torf, Sägespäne, Holz usw.

Vollmechanische Topf-Roste

Halbmech. Topf-Feuerungen

Topf-Wurfbeschicker „Ballist“

Topf-Spezial-Roststäbe

Feuerungsmotoren

Offenfeuerungen für sämtliche industrielle Betriebe

Vorwärmer, Lufterhitzer,

Dampfüberhitzer, Fluggasde-

Ausblase-Vorrichtungen

Zugverstärkungsanlagen

Einmauerungen von Dampf-

kesseln von industriellen Feuer-

ungen bis zu den größten

Abmessungen usw.

Industrie-Schornsteinbau bis zu

den größten Abmessungen

Schmelzeisenerne Schornsteine

Industrie-Ofenbau zur Ablösch-

richtung, Müllverbrennung,

Kabelverlegung, Verrohrung

Feuerbeständige Einrich-

tungen mit moderner elek-

trischer oder Gas-Beheizung

Abteilung D II

Sämtliche Transport-Anlagen

Mechanische Beküpfung und

Entsorgung

Abteilung D III

Lokungreduzier-Anlagen

zu industriellen Betrieben, Boden-

wäscher, Dampfer usw.

Abgasanlagen für Staub,

Späne usw.

Klimaanlagen

Verfahrenbau

Abteilung E III

Pneumatische Förderanlagen

für Kohle, Erz, Gestein, etc.

Chemische und mechanische

Umbauarbeiten

Abteilung C

Einrichtungen für die Be-

heizung

ERFURT

POSTFACH 552g
FABRIK UND VERWALTUNG
DREYESTRASSE 7g

DRAHTHUT

TOFFWERKE ERFURT

ERNHILF

25125 25126 25127 25128

UNSERE ABTEILUNG:

D/Prf.

ANGEBOT Nr.
40/964.

HAUSSAPFAT Nr.
123.

DATUM:
1.11.40.

Kosten-Anschlag

Titl.
Der Reichsführer SS,
Chef der Deutschen Polizei,
Hauptamt Haushalt u. Beuten,
SS-Neubauleitung KL
Mauthausen.

Best: Lieferung eines koksbeheizten Topf - Bin-
sicherungs-Ofens mit Doppelmuffel und Druck-
luft-Anlage,
1 Topf - Zugverstärkungs-Anlage.

Prf/Mes.

Aufgesetzt:

Geprüft:

Die Spezialfabrik für feuerungstechnische Anlagen TOPF

hat Zehntausende von TOPF-Feuerungen geliefert.

Hervorragende sechszwanzigjährige Spezialerfahrungen.

Eigene Versuchstation und feuerungstechnisches Laboratorium.

Untersuchung von Brennstoffen, Asche, Speisewasser.

Eigene Lehrstätte

Document 194: "Cost Estimate" by J.A. Topf & Söhne of 1 November 1940 regarding a TOPF coke-fired double-muffle cremation furnace for the SS New Construction Office of Concentration Camp Mauthausen. Source: Bundesarchiv Koblenz, NS 4/Ma 54.

J. A. TOPF & SOHNE ERFURT		2. Blatt des Kostenschlages vom 1.11.40.	
		für KL, Mauthausen.	
Ud. Nr.	Anzahl	Gegenstand der Veranschlagung	
	1	<p>koksbeheizter Topf - Einäscherungs-Ofen mit Doppelmuffel und Druckluft-Anlage,</p> <p>-----</p> <p>wozu folgende Lieferungen und Arbeiten gehören:</p> <p>Zum Mauerwerkamantel Ziegelsteine, Sand, Kalk und Zement. Die besten Steine werden zur Verblendung her- ausgesucht.</p> <p>Das erforderliche Schamottenmaterial, bestehend aus Normal-, Form- und Keilsteinen und Monolitstampfmasse, sowie dem dazu gehörigen Mörtel.</p> <p>Zur Isolierung des Ofens die erforderlichen Kieselgursteine, Schlackenwolle und Kieselgurmörtel.</p> <p>Die schmiedeeisernen Verankerungs-Eisen, bestehend aus T-, U- und Winkel-Eisen, Ankern, Schrauben und Muttern.</p> <p>Die guß- und schmiedeeisernen Arma- turen, wie:</p>	
	2	gußeiserne Einführungs-Türen mit gußeisernen Rahmen. Die Innenseiten der Türen werden mit Monolitstampfmasse ausgestampft,	
	6	gußeiserne Luftkanalverschlüsse,	
	4	gußeiserne Asche-Entnahme-Türen,	
	2	gußeiserne Generatorfülltüren,	
	2	schmiedeeiserne Aschebehälter,	
	2	schmiedeeiserne Rauchkanalschieber- rahmen mit Monolit ausgestampft, einschließlich der erforderlichen Rollen, Drahtseile und Gegengewichte,	
	die	erforderlichen Schürgeräte,	
	2	gußeiserne Feuer Türen,	
	2	Planroste,	

Document 194: continued.

J. A. TOPF & SOHNE ERFURT		3. Blatt des Kostenschlages vom 1.11.40.		
		für KL, Mauthausen.		
Lfd. Nr.	Anzahl	Gegenstand der Veranschlagung		
1		Druckluft-Anlage, bestehend aus den Druckluft-Gebläse mit 1,5 PS Drehstrom-Motor, direkt gekoppelt und der erforderlichen Rohrleitung. <u>Montage des Ofens.</u> Monteurgestellung zum Bau des Ofens, einschließlich der Reisekosten, Tagelöhner, und einschließlich der sozialen Lasten.		
1		schmiedeeiserne Leichen-Einführungs-Vorrichtung, bestehend aus dem Sargeinführungs-Wagen und dem schmiedeeisernen Verschiebe-Wagen mit den erforderlichen Laufschielen. Frachten und Anfahrkosten frei Mauthausen. P r e i s für den Ofen:	Reichsmark	7 753.-- ✓
1		<u>T o p f - Saugzug-Anlage</u> für ca. 4 000 cbm Abgase, bestehend aus: 1 Saugzug-Gebläse mit 3 PS-Drehstrom-Motor und Anlesser, mit dem erforderlichen Saug- und Druck-Stützen und einer Drehklappe, die den Saug- vom Druckraum trennt. P r e i s für die Anlage:	Reichsmark	1 250.-- ✓
		Unseren Monteur muß während der Bauzeit ein bis zwei Hilfskräfte ohne Kosten für uns zur Verfügung gestellt werden.		9003
		Lief. Bed. A. 60.6.40. 1 000. L 204.		<i>geprüft: Mauthausen 11.11.40</i> <i>gich</i>

		<u>A b s c h r i f t .</u> J.A.Topf & Söhne, Erfurt. DRUCKF.				
Lfd. Nr.	Stück-Zahl	Gegenstand	Einheits-Preis		Geldbetrag	
			RM	h	RM	h
		<u>BAX/8a Häftlings-Reviergebäude. Übertrag</u> <u>Kl. Mauthausen.</u>				
I.		Lieferung eines koksbeheizten T o p f -Einäscherungs- Ofens mit einer Muffel und Druckluft-Anlage, wozu folgende Arbeiten und Lieferungen gehören: Fundament zum Ofen und Rauchkanal müssen bauseitig nach unseren Angaben ohne Kosten für uns durchgeführt werden. Zum Mauerwerksmantel Ziegelsteine, Sand, Kalk und Zement. Die besten Steine wer- den zur Verblendung herausgesucht. Das erforderliche Schamottmaterial, bestehend aus Normal-, Form-, und Keil- steinen und Monolitstampfmasse, sowie dem dazu gehörigen Mörtel. Zur Isolierung des Ofens die erforder- lichen Kieselgutsteine, Schlackenwolle und Kieselgummörtel. Die schmiedeeisernen Verankerungs-Eisen, bestehend aus T-, U- und Winkel-Eisen, Ankern, Schrauben und Muttern. Die guß- und schmiedeeisernen Armaturen, bestehend aus ;				
	1	schmiedeeisernen Muffelabsperrschie- ber-Einbindung, die mit Monolit ausge- stampft wird, einschliesslich den erforderlichen gußeisernen Rollen, Drahtseil und einer Handwinde,				
	6	gußeisernen Luftkanalverschlüssen,				
	1	gußeisernen Ascheentnahmetür,				
	1	gußeisernen Generatorfüllschacht- verschluss,				
	2	schmiedeeisernen Aschebehältern,				
	1	gußeisernen Feuertür,				
	1	schmiedeeisernen Planrost aus Vierkant- stäben mit Rost-Auflager, den erforderlichen Schürgeräten,				
	1	Druckluft-Anlage, bestehend aus dem Druckluft-Gebläse mit 1,5 PS- Drehstrom- Motor, direkt gekuppelt, und der er- forderlichen Rohrleitung,				
		<u>Übertrag</u>				

Document 195: "Cost Estimate" by J.A. Topf & Söhne of 30 April 1941 regarding a TOPF coke-fired single- or double-muffle cremation furnace for the SS New Construction Office of Mauthausen Concentration Camp. Source: Bundesarchiv Koblenz, NS 4/Ma 54.

		- 2 -				J. A. Topf & Söhne, Erfurt.			
Lfd. Nr.	Stück-Zahl	Gegenstand	Einheits-Preis		Geldbetrag				
			RM	RM	RM	RM			
	1	<p style="text-align: right;"><u>Übertrag</u></p> <p>schmiedeeisernen Leicheneinführungs-Vorrichtung, bestehend aus den Sargeinführungswagen und den erforderlichen Laufschielen.</p> <p><u>Montage des Ofens.</u></p> <p>Monteurgestellung zum Bau des Ofens, einschliesslich Reisekosten, Tagegelder, einschliesslich der sozialen Abgaben.</p> <p>Preis Pos. I) RM</p> <p>Kennziffergewicht: 1.900 kg</p>			5.996.	—			
II)	1	<p style="text-align: center;"><u>Wahlweise:</u></p> <p>koksbeheizter Topf - Einäscherungs-Ofen mit Doppelmuffel und Druckluft-Anlage,</p> <hr/> <p>wozu folgende Lieferungen und Arbeiten gehören:</p> <p>Fundament zum Ofen und Rauchkanal müssen bauseitig nach unseren Angaben ohne Kosten für uns ausgeführt werden.</p> <p>Zum Mauerwerksmantel Ziegelsteine, Sand, Kalk und Zement. Die besten Steine werden zur Verblendung herausgesucht.</p> <p>Das erforderliche Schamottmaterial, bestehend aus Normal-, Form- und Keilsteinen und Monolitstampfmasse, sowie dem dazu gehörigen Mörtel.</p> <p>Zur Isolierung des Ofens die erforderlichen Kieselgursteine, Schlackenwolle und Kieselgutmörtel.</p> <p>Die schmiedeeisernen Verankerungs-Eisen, bestehend aus T-, U- und Winkel-Eisen, Ankern, Schrauben und Müttern.</p> <p>Die guss- und schmiedeeisernen Armaturen, bestehend aus:</p>							
	2	gusseisernen Einführungs-Türen mit gusseisernen Rahmen. Die Innenseiten der Türen werden mit Monolitstampfmasse ausgestampft,							
	6	gusseisernen Luftkanalverschlüssen,							
	4	gusseisernen Aschenentnahmetüren,							
	2	gusseisernen Generatorfülltüren,							
		<u>Übertrag</u>							

H-Zertrauftrag 22.8.33az. 22.8.33az. (Zuss. 22.8.33az) 1933

Document 195: continued.

		- 3 -		J.A. Topf & Söhne, Erfurt.		
Lfd. Nr.	Stück-Zahl	Gegenstand	Einheits-Preis		Geldbetrag	
			RM	ℳ	RM	ℳ
		<u>Übertrag</u>				
	2	schmiedeeisernen Aschebehältern, schmiedeeisernen Rauchkanalschieber- rahmen, mit Monolit ausgestampft, ein- schliesslich der erforderlichen Rollen, Drahtseile und Gegengewichte, den erforderlichen Schürgeräten, 2 gusseisernen Feuertüren, 2 Planrosten, 1 Druckluft-Anlage, bestehend aus dem Druckluft-Gebläse, mit 1,5 PS-Drehstrom- Motor, direkt gekuppelt und der erforder- lichen Rohrleitung. <u>Montage des Ofens.</u> Monteurgestellung zum Bau des Ofens, einschliesslich der Reisekosten, Tage- gelder, einschliesslich der sozialen Lasten.				
	2					
	2					
	2					
	1					
	1	schmiedeeiserne Leicheneinführungs- Vorrichtung, bestehend aus dem Sarg- einführungswagen und dem schmiedeeisernen Verschiebewagen mit den erforderlichen Laufschienen. Preis Pos II).	RM		7.089. —	
		Kennziffergewicht: 2.700 kg				
III)	1	<u>T o p f - Saugzug-Anlage</u> für ca. 4000 cbm Abgase, bestehend aus: 1 Saugzug-Gebläse mit 3 PS-Drehstrom- Motor und Anlasser, mit dem erforderlichen Saug- und Druckstutzen und einer Dreh- klappe, die den Saug-vom Druckraum trennt. Preis Pos. III).	RM		1.250. —	
		Kennziffergewicht: 650 kg. Lieferzeit: Ca. 3 Monate nach Eingang der Materialien. Unserem Monteur müssen während der Bau- zeit 3 Hilfskräfte, ohne Kosten für uns, zur Verfügung gestellt werden. Lief.Bed.A.60.11.40. 1000. L. o2o4. <u>Preise geprüft!</u>				
		//-Unterschriftführer u. Bauleiter.				
		<u>Für die Richtigkeit der Abschrift:</u> <u>Mauthausen, den 30. April 1941.</u>				
		<u>Übertrag</u>				

Document 195: continued.

J. A. TOPF & SÖHNE
M A S C H I N E N F A B R I K

GEGR. **TOPF** 1878

AN DER
CODIS
LUD. MOSSÉ-CODE
A. & C. CODE
STAUDT & HUNDIUS

2 NOV 1941
K. L. I
E. No. 121
D. No. 121

DEANHEWERT
TOPFWERKE ERFURT
FERNLE
25125 25126 25127 25128
GELDVERKEHR
REICHSBANK
D. FÜR DEN
POSTSCHICKENSTADT
ERFURT 1941

An den
Reichsführer SS,
Chef der Deutschen Polizei,
Hauptamt Haushalt und Bauten,
SS-Bauleitung KL Mauthausen,
und Bauabschnitt A.-L.Gusen,
Mauthausen-Oberdonau.

ERFURT, 31.10.41.
POSTFACH 888,
FABRIK UND VERWALTUNG
GREYSESTRASSE 7/9

hes.
UNSERE ABTEILUNG:
D IV/Prf ✓

BETRIFFT: **IHR ZEICHEN**
Ihr Schreiben v. 16.10.41, N/L.-W.
Nr. 3 718, Einäscherungs-Ofen,
Ihren Bestellschein Nr. 474,
Bauabschnitt BWG/25.

K o s t e n a n s c h l a g
auf

1 koksbeheizten Topf-Einäscherungs-Ofen
mit Doppelmuffel und Druckluft-Anlage
sowie der Einführungs-Vorrichtung.

Document 196: "Cost Estimate" by J.A. Topf & Söhne of 31 October 1941 regarding a TOPF coke-fired double-muffle cremation furnace for Concentration Camp Mauthausen. Source: Bundesarchiv Koblenz, NS 4/Ma 54.

J. A. TOPF & SOHNE ERFURT		2. Blatt des Kostenanschlages vom 31.10.41.	
		für Kauthausen-Oberdonsau.	
Lfd. Nr.	Anzahl	Gegenstand der Veranschlagung	
		<p>1 koksbeheizter Topf-Binäscherungs-Ofen mit Doppelmuffel und Druckluft-Anlage sowie der Einführungs-Vorrichtung.</p> <p>wozu folgende Lieferungen und Arbeiten gehören:</p> <p>Fundament und Rauchkanal müssen bauseitig, nach unseren Angaben, ohne Kosten für uns ausgeführt werden.</p> <p>Zum Mauerwerksmantel Ziegelsteine, Sand, Kalk und Zement. Die besten Steine werden zur Verblendung herausgesucht.</p> <p>Das erforderliche Schamottematerial, bestehend aus Normal-, Form- und Keilsteinen und Monolitstampfmasse, sowie dem dazu gehörigen Mörtel.</p> <p>Zur Isolierung des Ofens die erforderlichen Kieselgursteine, Schlackenwolle und Kieselgurmörtel.</p> <p>Die schmiedeeisernen Verankerungs-Eisen, bestehend aus T-, U- und Winkel-Eisen, Ankern, Schrauben und Muttern.</p> <p>Die guß- und schmiedeeisernen Armaturen, wie:</p>	
	2	gußeiserne Einführungs-Türen mit gußeisernen Rahmen. Die Innenseiten der Türen werden mit Monolitstampfmasse ausgestampft,	
	6	gußeiserne Luftkanalverschlüsse,	
	4	gußeiserne Asche-Entnahmetüren,	
	2	gußeiserne Generator-Fülltüren,	
	2	schmiedeeiserne Aschebehälter,	

Document 196: continued.

J. A. TOPF & SOHNE ERFURT		3. Blatt des Kostenanschlags vom 31.10.41.	
		für Mauthausen-Oberdonau.	
Ufd. Nr.	Anzahl	Gegenstand der Veranschlagung	
	2	schmiedeeiserne Rauchkanal-Schieber- rahmen, mit Konolit ausgestampft, einschließlich der erforderlichen Rollen, Drahtseile und Gegenge- wichte,	
	die	erforderlichen Schürgeräte,	
	2	gußeiserne Feuertüren,	
	2	Planroste,	
	1	Druckluft-Anlage, bestehend aus dem Druckluft-Gebläse mit 1,5 PS-Drehstrom- Motor, direkt gekuppelt, und der erforderlichen Rohrleitung.	
		<u>Kontage des Ofens.</u>	
		Monteurgestellung zum Bau des Ofens, einschließlich der Reisekosten, Tagegelder, sowie einschließlich der sozialen Lasten.	
	1	schmiedeeiserne Leichen-Einführungs- Vorrichtung, bestehend aus dem Sarg- Einführungs-Wagen und dem schmiede- eisernen Verschiebe-Wagen mit den er- forderlichen Laufschielen.	
		Preis für den Ofen:	RM 7 350.--√
		Kennziffergewicht: <u>2.820</u> kg.	
		Unserem Konteur müssen während der Bauzeit mehrere Hilfskräfte, ohne Kosten für uns, zur Verfügung ge- stellt werden.	
		Lief.Bed.A. 60.5.41. 2 000. L 0204.	

Bl. 1. 48. 900. Cr.

Expedition	Versand	Fakturist	Comm. Buchh.	Kontrolle	Montagebureau	Kalkulation
	G.					<i>W</i>

J. A. Topf & Söhne
 Maschinendabrik
 Feuerungstechnisches Baugeschäft
 Erfurt
 den 17. Januar 1941

Auftrag Nr. 40D 263, 1090, 892
 An der Reichsführer SS
Hauptamt Haushalt und Bauten
SS-Neubauleitung K.L. Auschwitz
Auschwitz O/S. (Oswiecim)

Hierdurch teilen wir Ihnen mit, daß wir heute folgende Sendung auf den Weg brachten: p. ~~Waggon~~ Frachtgut — ~~EMW~~ nach Station: Auschwitz O/S. (Oswiecim) *(Kiliberlauf)*

Waggon-Nr. 152799 Deutsch G. **J. A. Topf & Söhne**
Versandabteilung

Signum	Fabrik Nr.	Art der Verpackung		Stückzahl	Gegenstand	Gewichte in kg	
		Kolli-zahl				Netto	Brutto
J.A.T.&S.					<u>Teile zum Einäscherungssofen, 2 M</u>		
	22293	6	lose	6	U- Eisen NP 12, je 1950 lg.		
		4	"	4	I - Eisen NP 12, je 1950 lg.		
		2	"	2	Winkelseisen 50/5, je 2780 lg.		
		2	"	2	desgl. je 2400 lg.		
		4	"	4	desgl. je 1070 lg.		
		4	"	4	desgl. 80/8, je 1070 lg.		
		4	"	4	desgl. 40/4 je 1232		
		4	"	4	desgl. 60/6 je 800 lg.		
		2	"	2	Flacheisen 100/10 mit 4 Rollen		Gewicht siehe nächste
		2	"	2	Einführungstüren 600/600 i.L.		Seite
		2	"	2	Feuertüren 280/350		
		24	"	14	Rundisen-Anker 19 ø		
		2	"	2	Feuertüren 280/350		
		2	"	2	Winkelseisen 80/8, je 1650 lg.		
		1	"	1	T - Eisen 80/80, 1650 lg.		
		1	"	1	Flacheisen 50/8, 2500 lg.		

794. 12. 40. 809. 1. 011. Hierzu 2 Einzelliste

Document 197: Bill of lading by J.A. Topf & Söhne to the SS New Construction Office Auschwitz of 17 January 1941 regarding the parts of the second TOPF coke-fired double-muffle cremation furnace for Crematorium I at Auschwitz. Source: RGVA, 502-1-327, pp. 201-203.

Einzeliste Nr. 1		Auschwitz		Auftrag Nr. 202		
Signum	Fabrik-Nr.	Art der Verpackung	Stückzahl	Gegenstand	Gewichte in kg	
					Netto	Brutto
J.A.T.&S.				ferner		
	22293	2 lose	2	Rauchkanalschieber 350/600		
		2 "	2	Gehäuse dazu		
		6 "	6	Luftkanalverschlüsse 108/128		
		2 "	2	Aschebehälter 350/320		
		2 "	2	Schürgeräte ca. 3000 lg.		
		30 "	30	Vierkanteisen 40/40 je 630 lg.		
		34 "	34	desgl. je 740 lg.	2036	2036
		1 "	1	Rohrleitung 120/124		
		1 "	1	Siederohr 82/89 ϕ , 1560 lg.		
		1 "	1	desgl. 1660 lg.		
		2 "	2	Füllschachtverschlüsse		
		10 "	10	Laufschienen 50/50/5 mit Ankern		
		1 Vschl. 2		Asbestplatten 5 mm stark	10,5	14
		13		Papiersäcke Schlackenwolle	500	500
		2		* Monolit		
		1 Stoff sack		Monolit	117	117
	22515	10 lose	10	Schamotte - Roststeine 560 lg.	460	460
	22469	1 "	1	Gebläse 120/300 mit Elektro-Motor S0 37/2, 5,5 PS	90	90
		1 Kiste	4	Steinschrauben 3/8 x 150	0,5	81
			1	Sterndreieckschalter	4	
	22293		4	Schamotte-Steine für Feuertür	48	
			1	Drahtseil 10 ϕ , 10 m lg.	3,5	
			4	Seilkauschen, 8 Klemmen	1,5	
				div. Schrauben u. Scheiben	8	
Übertrag					3181	

JAN. 1941

T. 104, S. 10. 2000. II.

Document 197: continued.

Einzeliste Nr. 2				auschwitz		Auftrag Nr. 203		
Signum	Fabrik-Nr.	Art der Verpackung Kollizahl	Stückzahl	Gegenstand	Gewichte in kg			
					Netto	Brutto		
J.A.T.&S.				Übertrag:		3181		
	22293	- Kiste	8	Steinschrauben 3/4", 250 lg.	5			
			4	Steinschrauben 3/8 x 100	0,5			
	98265		4	Seilrollen 150/125 ø	6,5			
	20809	1 Kiste	1	kompl. Beschriftungs-Apparat		12		
Gesamtgewicht:						3193		

Heilrand								
21. JAN. 1945								

J. A. TOPF & SÖHNE -4. OKT. 1941
 MASCHINENFABRIK UND FEUERUNGSTECHNISCHES BAUGESCHÄFT

GEGR.  1878

CODES
 RUD. MOSSF-CODE
 A. & C. CODE
 STAUDT & HUNDIUS

BEAHTWORT
 TOPFWERKE ERFURT
 FEHRLEIF
 25123 25126 25127 25128 25129
 GELDVORKEHR
 REICHSBANK
 GIBOKONTO
 POSTSCHECKKONTO
 ERFURT 1792

An den
 Reichsführer SS
 und Chef der deutschen Polizei,
 Bauleitung Waffen-SS,
Auschwitz /O.-S.

ERFURT, 25.9.41.
 POSTFACH 3503,
 FABRIK UND VERWALTUNG
 DREYSESTRASSE 7,

BETRIFFT: IHR ZEICHEN: UNSERE ABTEILUNG: **DIV**
Einäscherungs-Ofen. - Prof. 7

K o s t e n a n s c h l a g
 auf

einen koksbeheizten Topf-Einäscherungs-Ofen mit Doppelmuffel und Druckluft-Anlage.

25.9.1941
 Eingang:
 25.9.1941

Planungs-Abt. | Hochbau-Abt. | Tiefbau-Abt. | Bau-Abt.
 Leitung-Abt. | Abt. | Abt. | Abt.

Document 198: "Cost Estimate" by J.A. Topf & Söhne of 25 September 1941 regarding the third TOPF coke-fired double-muffle cremation furnace for Crematorium I at Auschwitz. Source: RGVA, 502-2-23, pp. 264-267.

J. A. TOPF & SOHNE ERFURT		2. Blatt des Kostenschlages vom 25.9.41.	
		für Auschwitz /O.-S.	
Lfd. Nr.	Anzahl	Gegenstand der Veranschlagung	
		<p><u>1 Koksbeheizter Topf-Einäscherungs-Ofen mit Doppelmuffel und Druckluft-Anlage.</u></p> <p>wozu folgende Lieferungen und Arbeiten gehören:</p> <p>Fundament zum Ofen und Rauchkanal müssen bauseitig nach unseren Angaben ohne Kosten für uns ausgeführt werden.</p> <p>Zum Mauerwerksmantel Ziegelsteine, Sand, Kalk und Zement. Die besten Steine werden zur Verblendung herausgesucht.</p> <p>Das erforderliche Schamotte-material, bestehend aus Normal-, Form- und Keilsteinen und Monolitstampfmasse, sowie dem dazugehörigen Mörtel.</p> <p>Zur Isolierung des Ofens die erforderlichen Kieselgursteine, Schlackenwolle und Kieselgurmörtel.</p> <p>Die schmiedeeisernen Verankerungs-Eisen, bestehend aus T-, U- und Winkel-Eisen, Ankern, Schrauben und Muttern.</p> <p>Die guß- und schmiedeeisernen Armaturen, wie:</p>	
	2	gußeiserne Einführungstüren mit gußeisernen Rahmen. Die Innenseiten der Türen werden mit Monolitstampfmasse ausgestampft,	
	6	gußeiserne Luftkanalverschlüsse,	
	4	gußeiserne Ascheentnahmetüren,	
	2	gußeiserne Generatorfülltüren,	
	2	schmiedeeiserne Aschebehälter,	
	2	schmiedeeiserne Rauchkanalschieberahmen, mit Monolit ausgestampft, einschließlich der erforderlichen Rollen, Drahtseile und Gegengewichte,	

68. 2. 41. 1000. L. 0004. 0200

Document 198: continued.

J. A. TOPF & SOHNE ERFURT		3. Blatt des Kostenauftrages vom 25.9.41. für Auschwitz /O.-S.		
Ud. Nr.	Anzahl	Gegenstand der Veranschlagung		
die		erforderlichen Schürgeräte,		
2		gußeiserne Feuertüren,		
2		Planroste,		
1		Druckluft-Anlage, bestehend aus dem Druckluft-Gebläse mit 1,5 PS-Drehstrom-Motor, direkt gekuppelt, und der erforderlichen Rohrleitung.		
		<u>Montage des Ofens.</u>		
		Monteurgestellung zum Bau des Ofens, einschließlich der Reisekosten, Tagegelder, einschließlich der sozialen Lasten.		
1		schmiedeeiserne Leicheneinführungsvorrichtung, bestehend aus dem Sargeinführungswagen und dem schmiedeeisernen Verschlebewagen mit den erforderlichen Laufschielen, einschließlich einer Drehscheibe.		
		Preis des Ofens:	RM	7 332.--/
		Kennziffergewicht: 2 870 kg.		
		Der Preis gilt ab Werk Erfurt, ohne Verpackung, einschließlich Monteurgestellung.		
		Für die Dauer der Montage sind unserem Monteur hauseitig, kostenlos für uns, drei Helfer zur Verfügung zu stellen.		
		Lief.Bed.A. 60.5.41. 2 000. L 0204.		

RS. X. 41. 11/23. L. 001 07/25

J. A. TOPF & SOHNE
 Maschinenfabrik
 Feuerungstechnisches Baugeschäft

ERFURT, den 21. Oktober 1941

Versandanzeige

Der Reichsführer SS Hauptamt Haushalt und Bauten
 SS-Neubauleitung A.L. Auschwitz
Auschwitz O/S.

Hierdurch teilen wir Ihnen mit, daß wir heute folgende Sendung auf den Weg
 brachten: p. Waggon — ~~Friedrich-Ebert-Station~~ nach Station:
Auschwitz O/S. Anschlußgleis
Waggon-Nr. 43225 München (G)

franko

J. A. TOPF & SOHNE
 VERBANDSABTEILUNG

Signum	Unserm Auftrag-Nr.	Art der Verpackung Kollizahl	Stückzahl	Gegenstand	Gewichte in kg	
					Netto	Brutto
J.A.T.&S.	41/1980/1			Teile zum koksbeheiztem TOPF-Doppelmuffel-Einscherungssofen.		
	23131	2 lose	2	Winkelleis. 90/9, 2000 lg.	62	62
		4 "	4	" 80/8, 1235 lg.	47	47
		2 "	2	Einführungstüren 600/600	425	425
		4 "	4	Winkelleis. 50/5, 1235 lg.	19	19
		2 "	2	Feuertüren 280/350	90	90
		1 "	1	Winkel 50/5, 2330 lg.	8,5	8,5
		6 "	6	Luftkanalverschlüsse 108/126	50	50
		1 "	2	Winkelleis. 60/6, 1945 lg vernietet	24,5	24,5
		13 "	13	Rundeisen-Anker 16 ϕ	55	55
		4 "	4	L-eisen NP 12, 2000 lg.	90	90
		6 "	6	Winkelleis. 50/5, 824 lg.	18	18
		2 "	2	Winkelleis. 90/9, 2000 lg.	56	56
		2 "	2	" 50/5, 1130 lg.	8	8
		1 "	1	Flacheisen 70/10, 2520 lg.	13	13
		2 "	2	Winkelleis. 80/8, 1600 lg.	30	30
		2 "	2	desgl.	30,5	30,5
		4 "	4	" 50/5, 1235 lg.	19,5	19,5
		2 "	2	Feuertüren 280/350	90	90
		1 "	1	Flacheis. 70/10, 2520 lg.	13	13
		4 "	4	" 80/8, 790 gestr. lge.	19	19
		2 "	2	Füllschachtverschlüsse 270/340 i.l.	126	126

1. OKT. 1941

Übertrag

Hierzu 1 4224

Document 199: Bill of lading by J.A. Topf & Söhne to the SS New Construction Office Auschwitz of 21 October 1941 regarding the parts of the third TOPF coke-fired double-muffle cremation furnace for Crematorium I at Auschwitz. Source: RGVA, 502-1-312, pp. 104-105.

Einzelliste Nr. 1				Auftrag Nr. 1.5		
Signum	Fabrik-Nr.	Art der Verpackung Koll.-zahl	Stückzahl	Gegenstand	Gewichte in kg	
					Netto	Brutto
J.A.T.&S.				Übertrag		1294
	23131	2 lose	2	Flacheis. 70/10, 770 lg.	8	8
		2 "	2	Flacheisen-Bügel mit je 2 Seilrollen	27	27
		2 "	2	Rauchkanalschieber-Rahmen	19	19
		2 "	2	" Gehäuse	34	34
		2 "	2	Gegengewichte 240 ϕ	72	72
		2 "	2	Aschebehälter	12	12
		2 "	2	Schürgeräte	12	12
		30 "	30	Vierkanteisen 40/40, 630 lg.	255	255
		4 "	4	" " 740 lg.	37	37
		3 "	3	Blechrohr-Leitungsstücke 120 16	46	46
		10 "	10	Schamotte-Roststeine K 6 650 lg.	440	440
	23133	10 "	10	Laufschienen f.d.Einführwagen	83	83
		1 "	1	Verschiebewagen	100	100
		1 "	1	Einführwagen mit Abstreifer	303	303
		6 "	6	Gegengewichte 300/190/210	264	264
	23238	1 "	1	Gebälse 120/300 mit Drehstrommotor 1,5 PS	50	50
	27410	10 lose	10	Schamotte-Roststeine K 6a, 650 lg.	440	440
	23131	1 lose	1	Eisen NP 12, 2000 lg.	22,5	22,5
	23131	1 Kiste	2	Firmenschilder	0,1	30
			10	Drahtseil 10 ϕ mit Kauschen u. Klemmen	5	
				div. Schrauben	16	
						3548,5

						30.10.41

K.L. Auschwitz
Bauleitung

Betr. Neubau K.L. Auschwitz
Haushalt K.L. **1942** Kap.
Genehmigungsverfügung vom 31.8.42
Kostenanschlag vom 3.7.42 mit R.H.
Titel _____ Prof. _____
Auftrag Nr. _____ vom _____ mit R.H.
Vertrag Nr. _____ vom _____ mit R.H.

Bauleitung: K.L. Auschwitz
Sanabschnitt 4 Nr. 5
Hauptbuch Nr. _____
Art der Vergabung:
Freihändig
~~_____~~
~~_____~~

Kasse: _____
Kontibel _____ Titel _____
Beleg Nr. _____

13 JUL 1942
Mez
2696

Schlus-Rechnung
(Umlagebescheid 0 an Kunden)

der Firma J.A. Topf & Söhne Erfurt
betr. K.L. Auschwitz
Kontofonte: Reichsbank-Girokonto. 75/851
Postfach-Konto: Erfurt 1792

J.A. TOPF & SÖHNE, ERFURT
[Signature]
Erfurt, den 16.12. 1941
schd.

Raum für
Finanzstempel
u. Unterschrift

Ab. Nr.	Ab. Nr. des Kostenanlasses	Zeit der Ausführung der Arbeit	Menge	Gegenstand	Geldbetrag			
					im einzelnen		im ganzen	
					R.H.	N.	R.H.	N.
				über				
				Lieferung und Errichtung eines koks-beheizten Topf- Doppelmuffel- Ein-Ischerungsöfen ohne Fundament und Rauchkanal und zwart...				
				Lieferung der Ziegelsteine und der Mörtelmaterialien für den Mauerkmantel, der erforderlichen Schamottmaterialien, der Monolitstampfmasse, der Kieselgursteine, des Kieselgurmörtels und der Schlackenwolle zur Isolierung des Ofens, der schmiedeeis. Verankerung, der guss- u. schmiedeeis. Ofenarmaturen sowie der Druckluftanlage bestehend aus Druckluftgebläse mit Drehstrommotor und der erforderlichen Rohrleitung.				
				Gestellung eines Monteurs einschl. dessen Reisekosten, Tagelöhner und d.w.				

10 JUL 1942 *[Signature]*

Document 200: "Final Invoice" of J.A. Topf & Söhne back-dated to 16 December 1941 regarding the third TOPF coke-fired double-muffle cremation furnace for Crematorium I at Auschwitz. Source: RGVA, 502-2-23, pp. 261-261a.

Zf. Nr.	Zf. Nr. des Stoffanlasses	Zf. Nr. der Ausführung der Arbeit	Menge	Gegenstand	Gelbbetrag			
					im einzelnen		im ganzen	
					RM	Sp	RM	Sp
				sozialen Lasten zur Errichtung des Ofens.				
				Lieferung einer schmiedeeis. Leichen-einführungsvorrichtung bestehend aus Sargeinführungswagen, Verschiebewagen Laufschienen und Drehscheibe.				
				Im übrigen nach Massgabe unseres Kostenanschlages vom 25.9.41 und uns. Auftragsannahmeschreiben vom 25.9.1941.			7332.	—
				Fracht auf die ab Erfurt verladenen Eisenteile, lt. Frachtbrief vom 21.10.41			186.	10 /
				- Abschlagszahlung v. 31.1.42			7518.	10 /
							3650.	— /
				- Abzug wegen nicht gelieferter Drehscheibe			3868.	10 /
							82.	— /
							3786.	10
				uns. Auftr.-Nr. 41 D 1980				
				uns. Rechnungsnr. 2363				
				An den				
				Herrn Reichsführer SS				
				Chef der deutschen Polizei				
				Hauptmann Haushalt und Bauten				
				K.L.				
				<u>A u s c h w i t z / O . S .</u>				

Fachtechnisch richtig!

Aufdruck, d. 13.7.1942

K. Reichsführer

Reichsführer

16/1000
Nachgerechnet am 17.7.42

Gebäudeamt, 18.7.42

Festgestellt am 31.8.40

W. M. L.

SS-Untersturmführer

Document 200: continued.

J. A. TOPF & SÖHNE Maschinenfabrik Feuerungstechnische Bauunternehmung		S.	12. Januar 1943	3
		ERFURT, den		194
An die		Ablegen <i>Versandanzeige</i>		
An die		<i>Versandanzeige</i>		
Befreiung der Waffen-SS u. Polizei Gusen b. St. Georgen a. d. Elbe, Oberdonau		der Waffen-SS und Polizei		
001569		14 JAN 1943		
Gusen b. St. Georgen a. d. Gusen / Oberdonau				
Hierdurch teilen wir Ihnen mit, daß wir heute folgende Sendung auf den Weg brachten: 2 Waggon - Frachtwagen, 7 Eilwagen, 1 Expresswagen mit St. Georgen a. d. Gusen / Oberdonau mit Wehrmacht-Fracht-				
brief				
Ihr Schrb. v. 30.11.42 Az: T/S-B, 1257 a/42 Ihre Transport-Anmeldg. Nr. 1849 v. 26.11.42		J. A. TOPF & SÖHNE VERSANDABTEILUNG		

Signum	Unsere Auftrag-Nr.	Art der Verpackung Kolliz- zahl	Stück- zahl	Gegenstand	Gewichte in kg	
					Netto	Brutto
J.A.T.&S.	41/2215/1 Febr. Nr. 27 741			Teile zum Doppelmuffel-Ein- sicherungssofen: <u>Verankerung:</u>		
		2 lose	2	Winkelleisen 90/9 x 2000 mm		
		4 "	4	" 80/8 x 1235 "		
		4 "	4	" 50/5 x 1235 "		
		1 "	1	" 50/5 x 2330 "		
		2 "	2	" 60/6 x 1945 "		
		1 "	1	Rundeisenanker 16 mm Ø, 2520 mm lang		
		4 "	4	I-Eisen NP 12, je 2000 mm lg.		
		6 "	6	Winkelleisen 50/5 x 824		
		2 "	2	" 90/9 x 2000 "		
				mit Knotenblechen		
		4 "	4	Rundeisenanker 16 mm Ø, je 2850 mm lang		
		2 "	2	desgl. je 2840 mm lg.		
		2 "	2	Winkelleisen 50/5 x 1130 mm		
		6 "	6	Rundeisenanker 16 mm Ø, je 2570 mm lang		
		1 "	1	Flecheisen 70/10 x 2520 mm		
		2 "	2	Winkelleisen 80/8 x 1600 "		
		1 "	2	desgl. vernietet		
		4 "	4	" 50/5 x 1235 mm		
		1 "	1	Flecheisen 70/10 x 2520 mm		
		4 "	4	desgl. 80 x 10 x 790 mm gestr. lg.		

T.M. S. 42. 10100. L. 011 Hierzu 2 Beil. 1/2

Document 201: Bill of lading by J.A. Topf & Söhne to SS Construction Office Gusen of 12 January 1943 regarding the parts for a TOPF coke-fired double-muffle cremation furnace. Source: Bundesarchiv Koblenz, NS 4/Ma 54.

Beiblatt Nr. <u>1</u>		Auftrag Nr. _____				
Signum	Unsere Auftrag-Nr.	Art der Verpackung Kollizahl	Stückzahl	Gegenstand	Gewichte in kg	
					Netto	Brutto
J.A.T.&S.	<u>41/2215/1</u>					
	<u>Febr. Nr.</u>	2 lose	2	Flacheisen 70/10 x 770 mm lg.		
	<u>27 741</u>	2 "	2	" 100/10 x 1220 " gestr. Länge mit 4 Wellen 20 mm Ø x 100 mm lang		
		1 "	1	I-Eisen NP 12, 2000 mm lang mit Knotenblech		
				Gesamtgewicht vorstehender Teile	600	600
		2 "	2	Wähmen zu den Raauhkanalschiebern	19	19
		2 "	2	Hülsen dazu ✓	38	38
		2 "	2	Gegengewichte ✓	88	88
		2 "	2	Aschebehälter ✓	14	14
		2 "	2	Schürgeräte ✓	13	13
		30 "	30	Vierkanteisen 40/40 x 630 mm	225	225
		4 "	4	desgl. je 740 mm lang	34	34
		1 "	1	Blechrohrleitung (Blechrohr n. Krümmer)	23	23
		2 "	2	Siederohre 89/82 mm Ø, 1060 und 1660 mm lang	28	28
		<u>41/1980/1</u>				
	<u>Febr. Nr.</u>	2 "	2	g.e. Einführtüren 600/500 mm i. L., 1 x r., 1 x lks.	443	443
	<u>27 395</u>	4 "	4	g.e. Feuertüren 280/350 mm	176	176
		6 "	6	Luftkanalverschlüsse 108/126 mm	47	47
	<u>41/2215/1</u>					
	<u>Febr. Nr.</u>	2 "	2	" Einführtüren 600/600 mm i. L. 1 x r., 1 x links	443	443
	<u>27 736</u>	6 "	6	" Luftkanalverschlüsse 108/126 mm	47	47
		2 "	2	" Füllschechtverschlüsse 270/340 mm i. L.	128	128
		4 "	4	" Feuertüren 280/350 mm	176	176
	<u>27 743</u>	10 "	10	Laufschienen zum Einführwegen	38	38
		1 "	1	Verschiebewagen ✓	91	91
		1 "	1	Einführungswegen ✓	182	182
		1 "	1	Blech 480/2765 mm gestr. Lg. mit 2 Stegblechen	72	72
		6 "	6	Blechkästen ✓	24	24
		1 "	1	Abstreifer ✓	41	41
				Uebertrag		3040

Document 201: continued.

Beiblatt Nr. 2		Auftrag Nr.					
Signum	Unsere Auftrag-Nr.	Art der Verpackung		Stück- zahl	Gegenstand	Gewichte in kg	
		Koli- zahl				Netto	Brutto
I.A.T.&S.	42/1050/3				Uebertrag		3040
	Stüchl. Nr.	32	lose	32	Vierkanteisen 30/30 x 600 mm	128	128
	44 Bl. 1						
	41/2215/1	1	"	1	Gebläse Nr. 120/300 mit El. Motor 380 Volt, 1,5 PS	50	50
Febr. Nr.	27 735						
	41/1052	1	"	1	Gebläse Nr. 450 für Motor- Antrieb	269	269
"	26 674	1	"	1	Drückstutzen	40	40
		2	"	2	Winkelisen mit Flocheisen- Ankern	7	7
		1	"	1	Gegenrahmen 500/350 mm l.	7	7
		1	"	1	Hauchkanalschieber	74	74
		1	"	1	Gegengewicht 210 mm \varnothing	28	28
	25 762	1	"	1	Gebläse Nr. 120/590 mit El. Motor 1,1 PS, 380 Volt	118	118
	41/2215/1						
"	27 742	20	"	20	Schamotte-Roststeine K 6 a	740	740
	41 D. lc52	1	Kiste	4	Steinschrauben 3/8" x 200 mm	1	78
"	26 716			4	Streifen Kraftregelplatte	0,5	
				1	Sterndreieckschalter	2	4
	26 674			6	Steinschrauben 1/2" x 150	1	
				1	Sterndreieckschalter	2	3
					div. Schrauben		1
				1	Trichter m. Rohr		0,5
				1	g.e. Seilrolle, Fig. 2		1,5
				1	Drahtseil 6,5 m, 6 mm \varnothing		1
				1	g.e. Seilrolle Fig. 2		2,5
				8	m Asbestschnur 8 mm \varnothing		0,3
	41/2215/1			10	m Drahtseil, 10 mm \varnothing		3,5
"	27 741			2	Firmenschilder		0,1
					div. Schrauben		17
"	27 74336			4	g.e. Seilrollen 125/150 mm \varnothing		6,5
				2	nebel		3
				16	Sechsk.Schraub. 3/4" x 50 mm		4
	41/1980/1			4	Seilrollen 150/125 mm \varnothing		6,5
"	27 395			2	g.e. nebel Mod. 19 829		3
							4579

Document 201: continued.

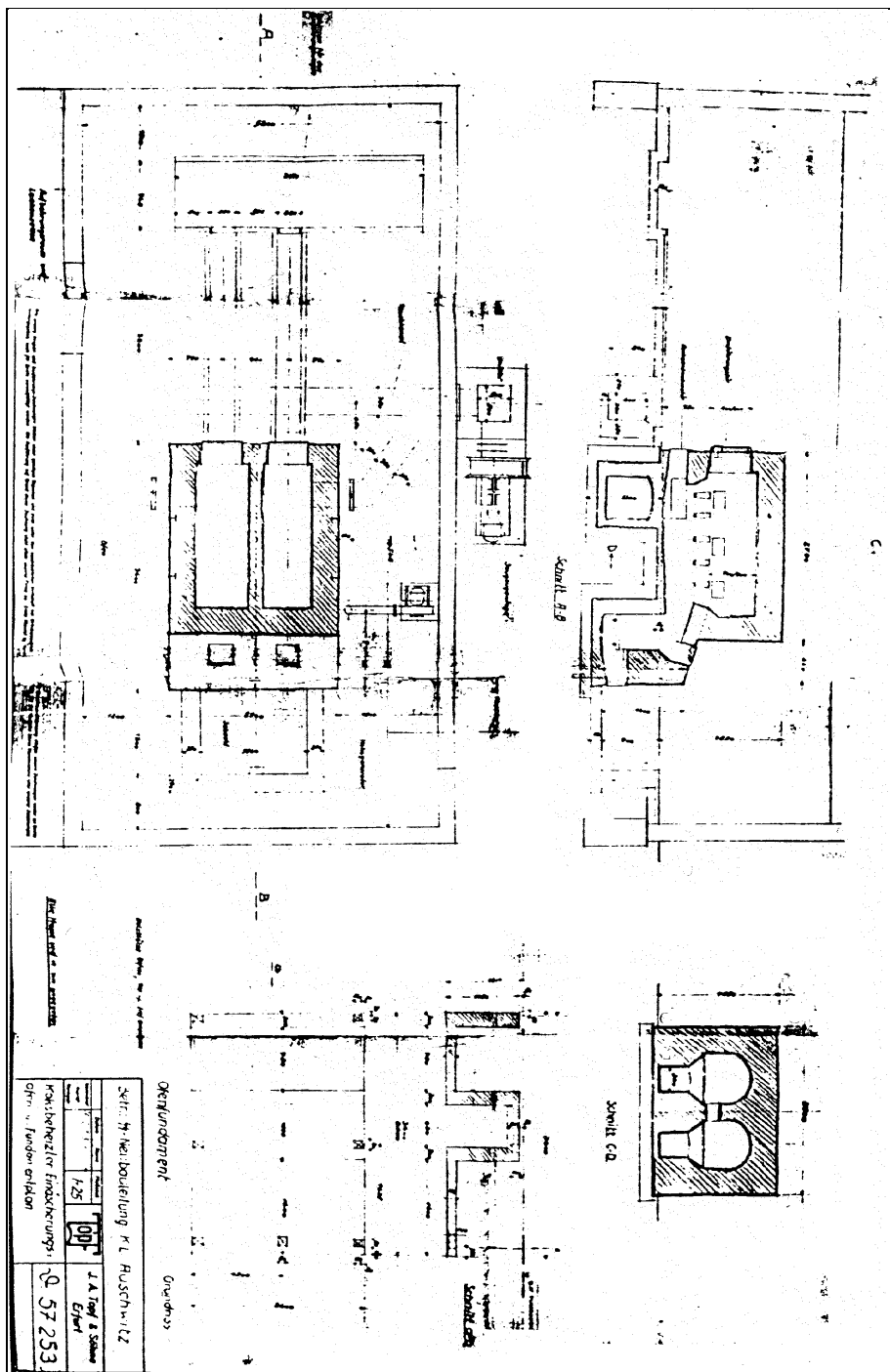

Document 202: Drawing by J.A. Topf & Söhne No. D 57253 "Coke-fired cremation furnace and foundation plan," 10 June 1940. Drawing of the first furnace for Crematorium I at Auschwitz. Source: Bundesarchiv Koblenz, NS 4/Ma 54.

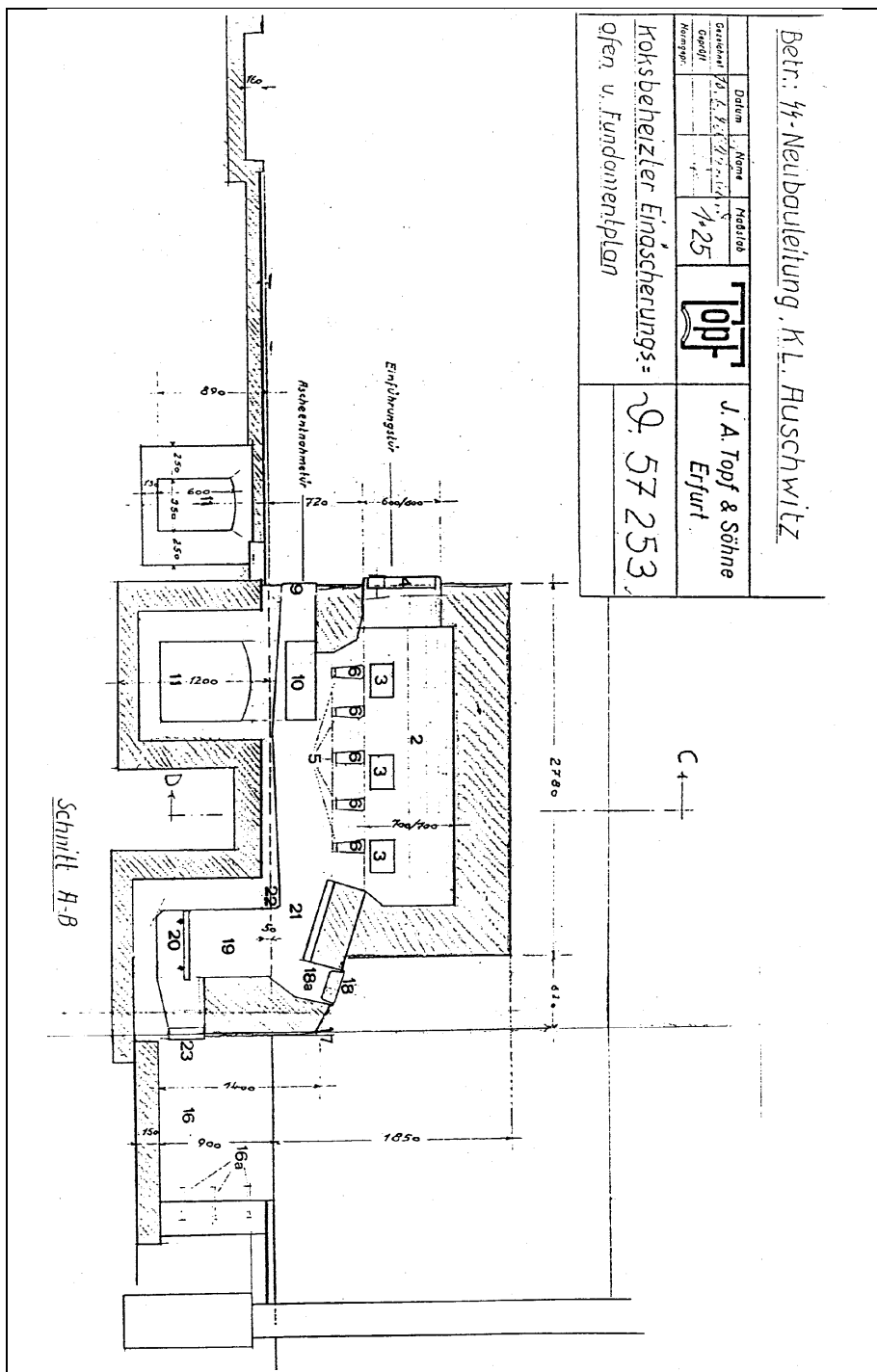

Document 202a: as above, longitudinal section.

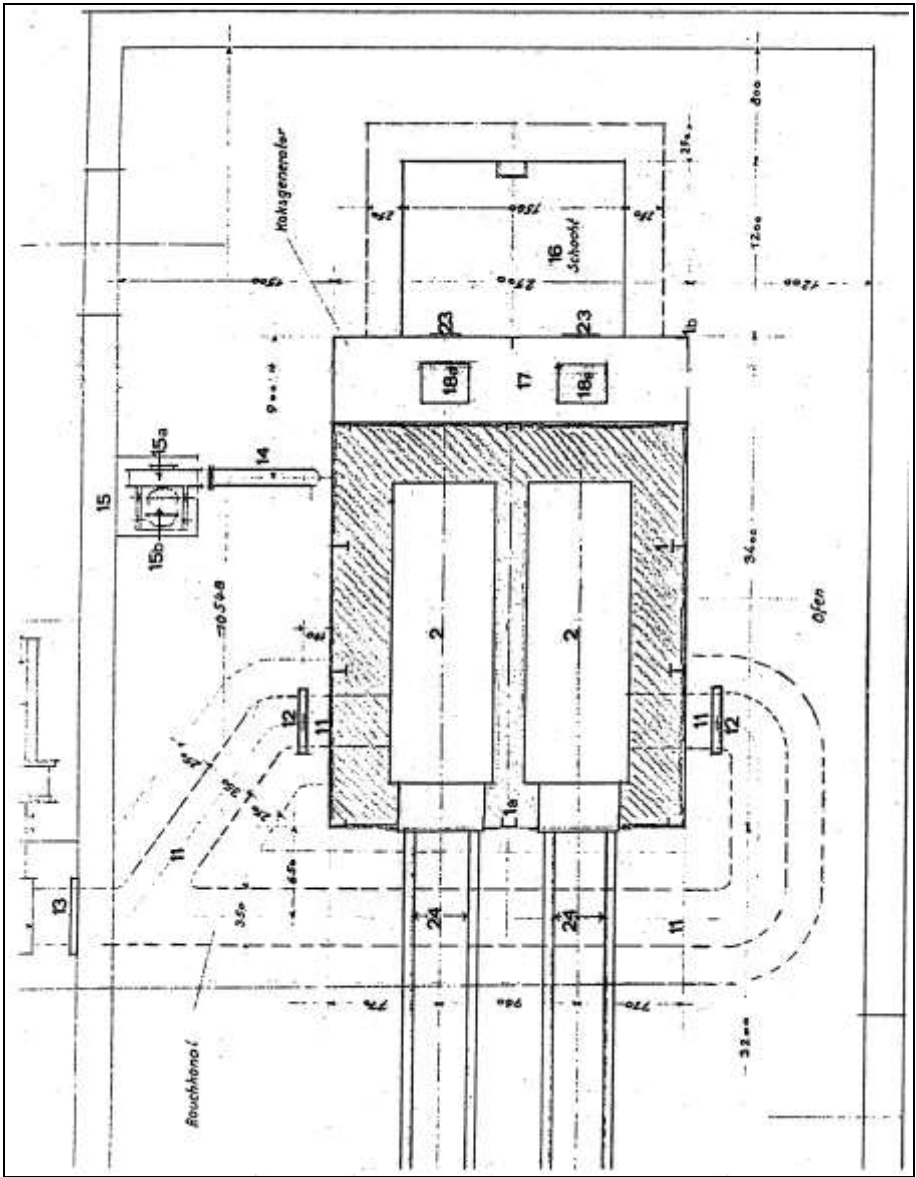

Document 202b: as above, horizontal section. Numbers added by Carlo Mattogno.
See text of Part 1 for details.

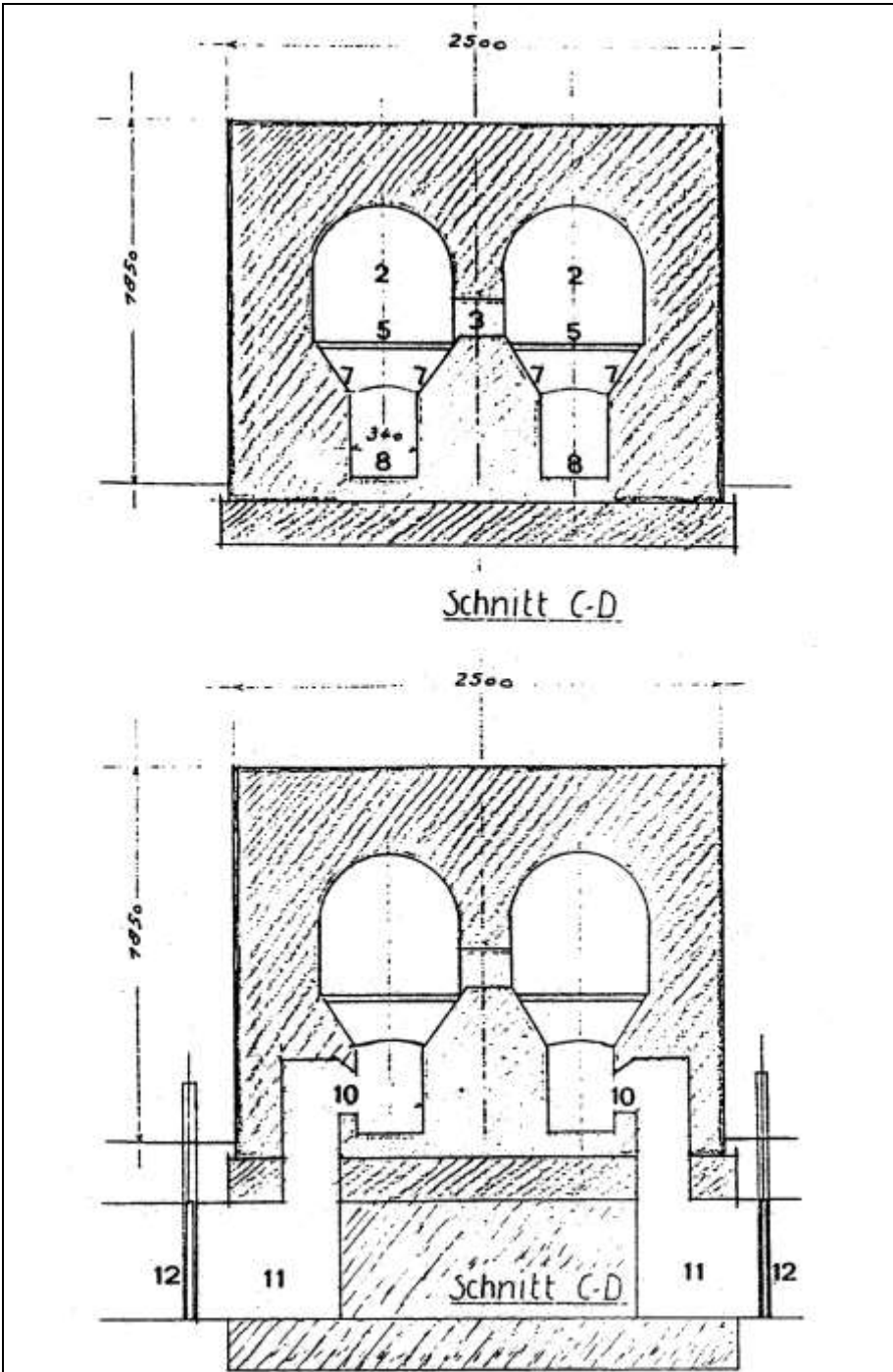

Document 202c & d: as above, vertical sections. 202d (bottom): section through the flue ducts. Numbers added by Carlo Mattoigno. See text of Part 1 for details.

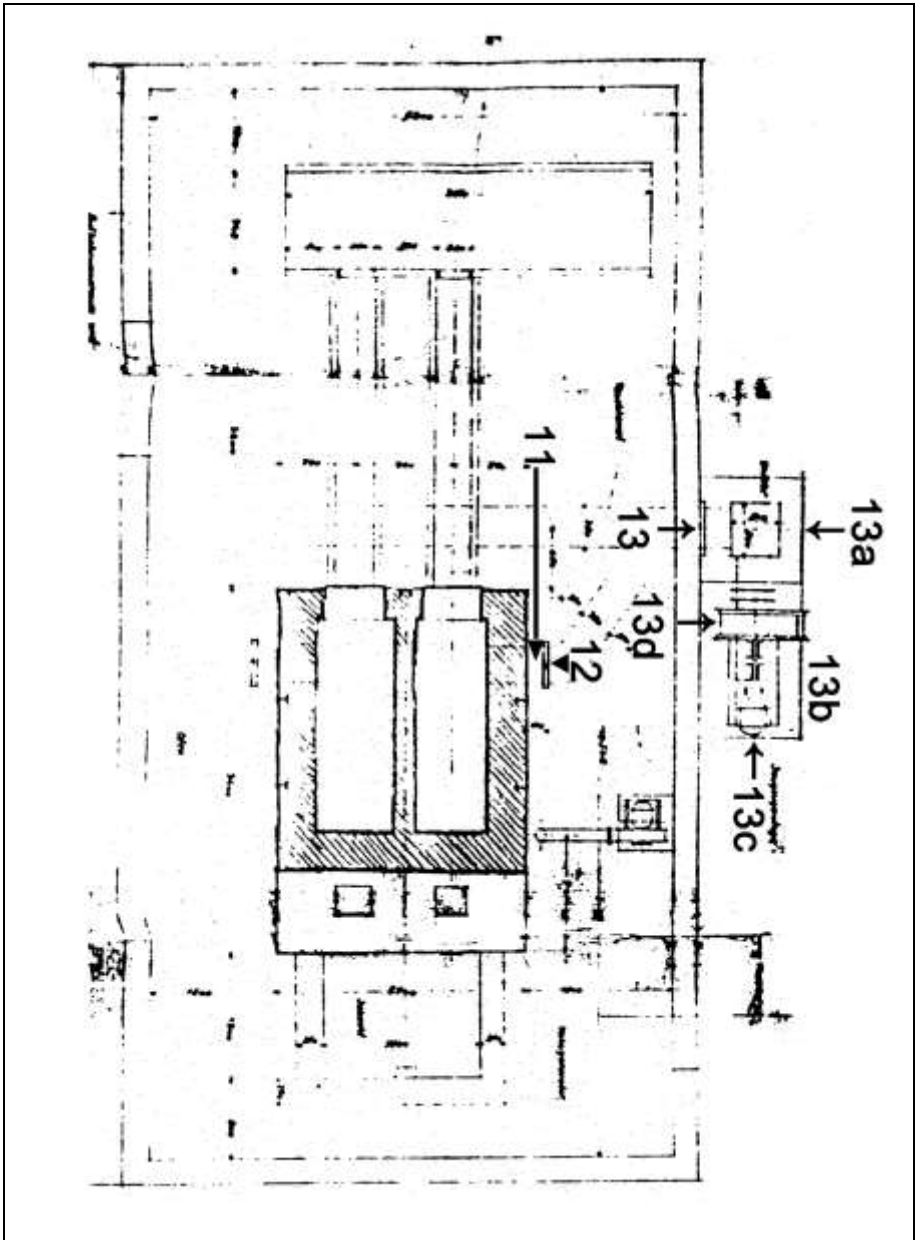

Document 202e: as above, setup of the chimney. Numbers added by Carlo Mattoigno. See text of Part 1 for details.

TOPF J.A.TOPF & SÖHNE ERFURT		<u>TAG</u>	<u>BLATT</u>
		23.1.43.	-1-
EMPFANGER	<u>Bauleitung der Waffen-SS und Polizei, Gusen bei St. Georgen.</u>		
D IV/Prf./bes.			
AUFSTELLUNG			
der Materialien zu einem Topf-Doppel- Einscherungs-Ofen.			
	1 Sargeinführungswagen, ✓		
	1 Verschiebewagen, ✓		
	2 große gusseiserne Einführtüren,		
	2 gusseiserne Ascheentnahmetüren,		
	2 gusseiserne Füllschachtverschlüsse,		
<i>100.00</i>	800 Stück Schamotte-Normalsteine SS, 1/1.		
	800 " " " " A,		
	500 " " " Keilsteine SS, ✓	<i>nicht vorhanden</i>	
	400 " " " " A,	<i>nicht vorhanden</i>	
	1 400 kg Schamottemörtel,	<i>(Hammelmühle (kg) 1080)</i>	
?	2 500 kg Monolitstampmasse,	<i>(Menschelwerk (kg) 2150)</i>	
✓	1 300 Stück weiße Kieselgursteine (Isoliersteine),		
✓	400 kg Isoliermörtel.	<i>1150 kg in 23.1.43. vorhanden</i>	

Handwritten signatures

Document 203: "List of materials for a TOPF double-muffle cremation furnace" for the SS New Construction Office of Gusen Camp on 23 January 1943. Source: Bundesarchiv Koblenz, NS 4/Ma 54.

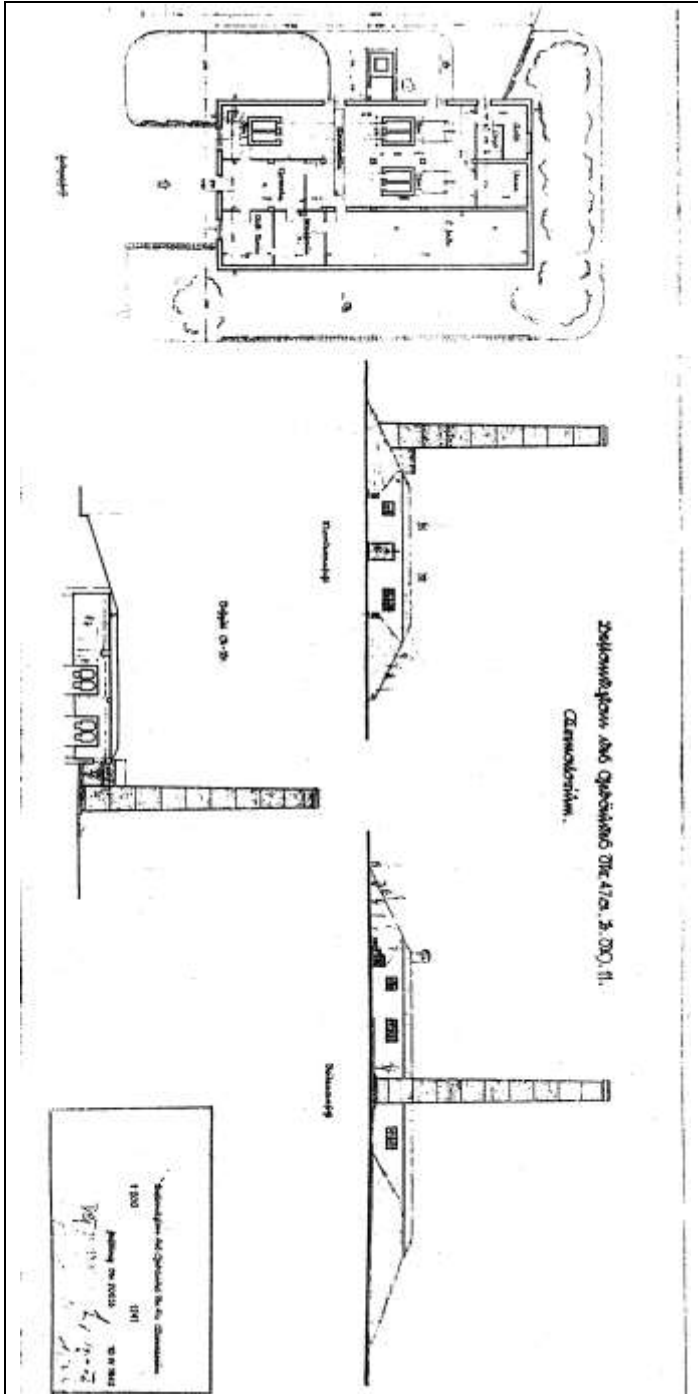

Document 206: Drawing by Central Construction Office No. 1241 "Inventory Plan of Building No. 47a, Construction Object 11. Crematorium." 10 April 1942. RGVA, 502-2-146, p. 21.

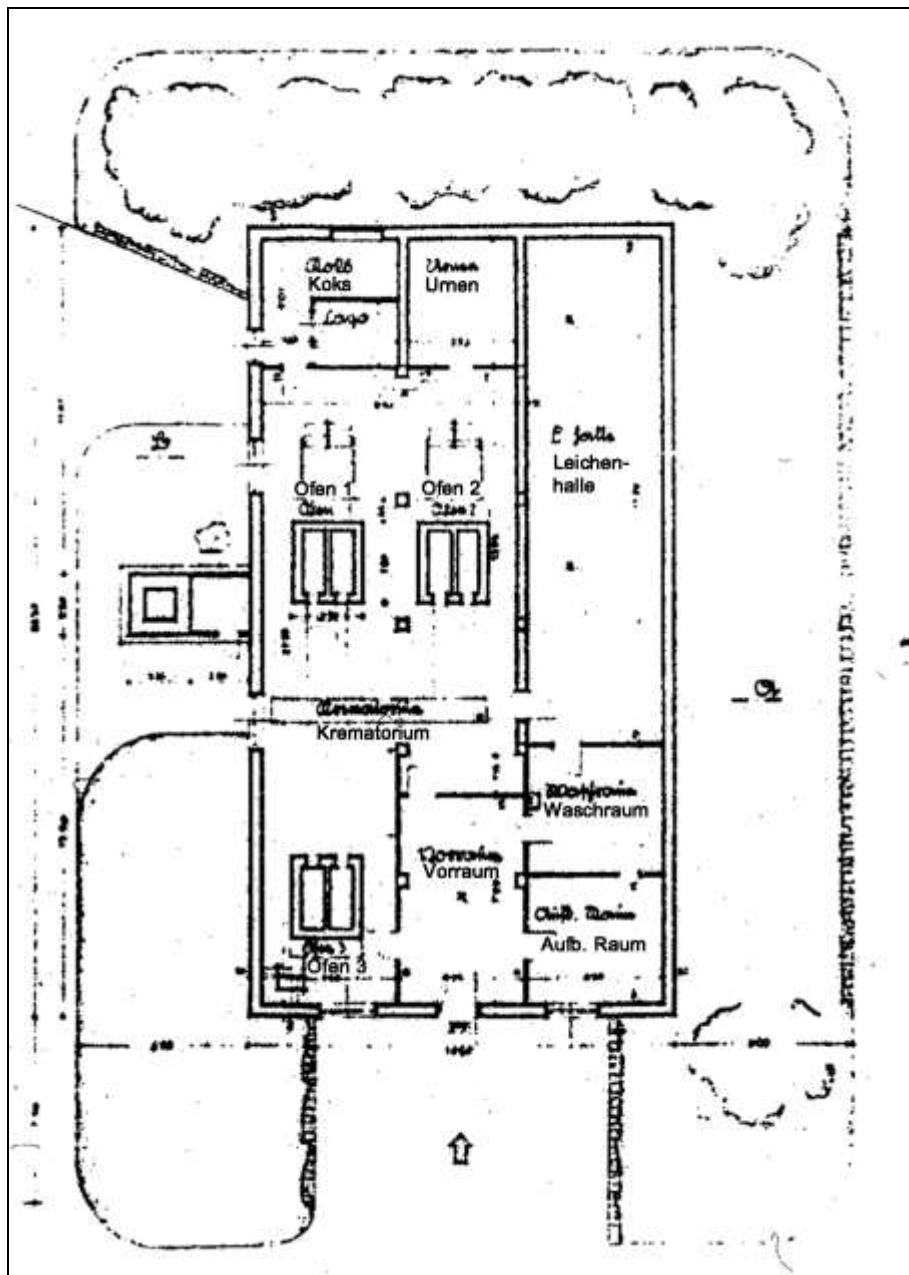

Document 206a: as above, section enlargement with floor plan, labeled by the author. Koks: coke; Urnen: urns; Ofen: furnace; Leichenhalle; morgue; Waschraum; washroom; Vorraum: Vestibule; Aufb[ahrungs]-Raum: examination room

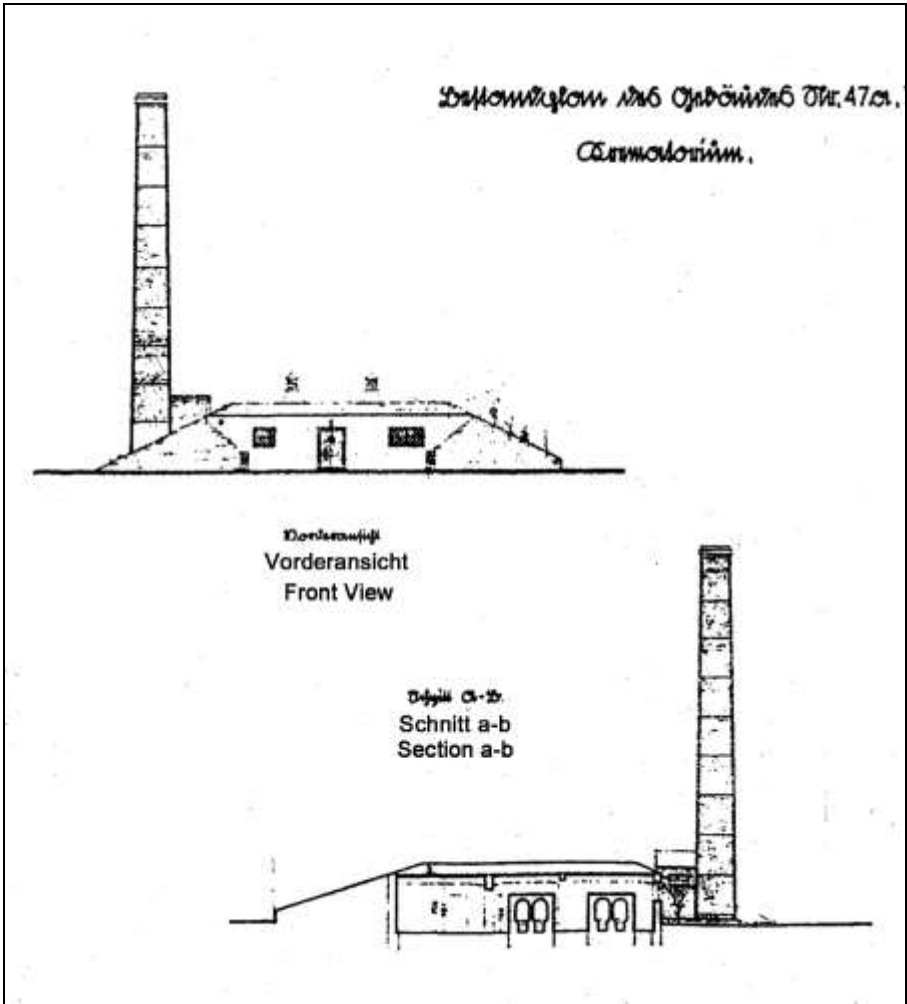

Document 206b: as above, section enlargements with front view (top) and vertical cross section (bottom), labeled by the author.

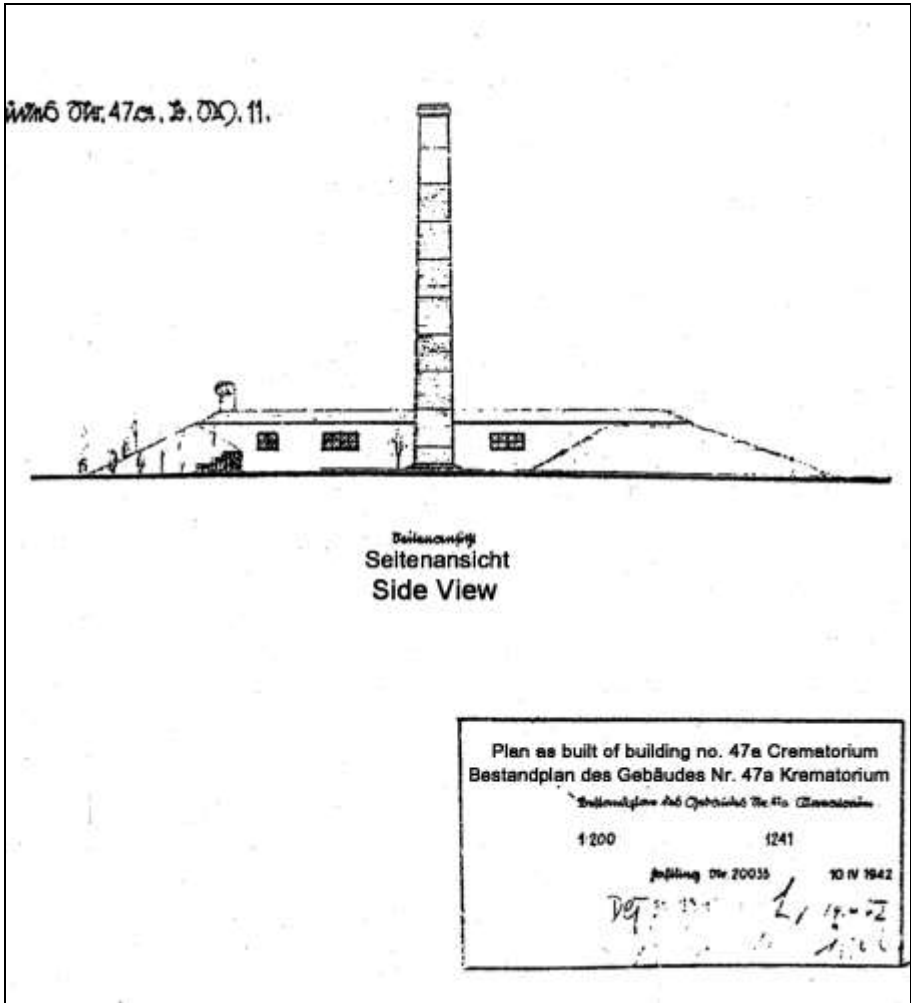

Document 206c: as above, section enlargements with side view, labeled by the author.

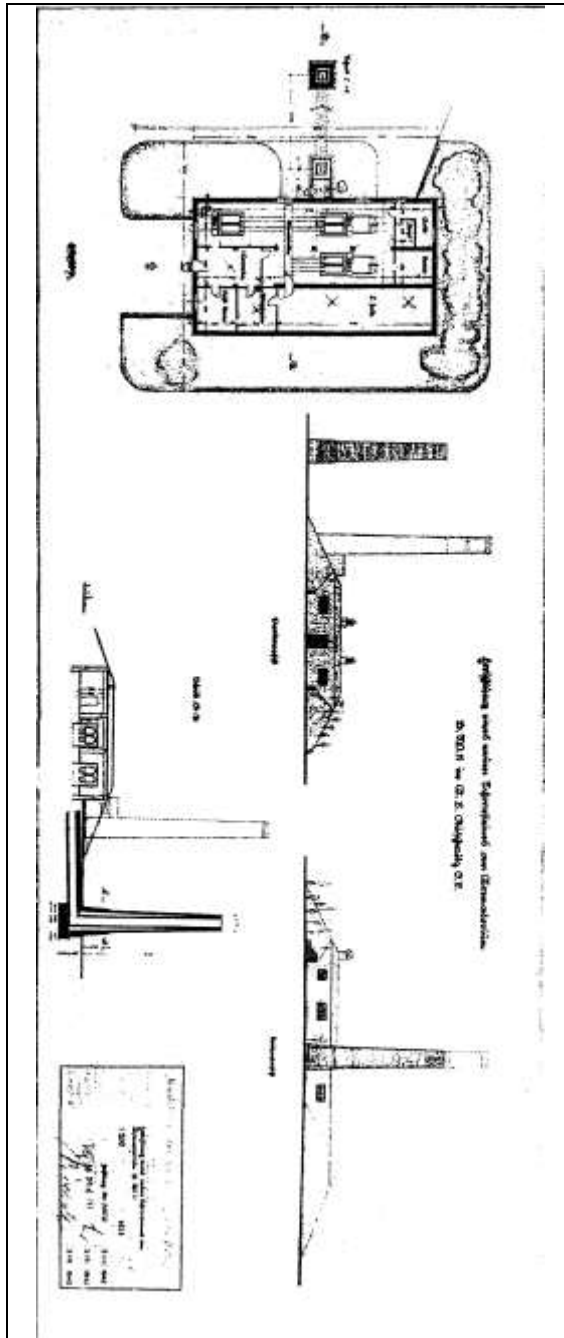

Document 207: Drawing by Central Construction Office No. 1434 of 3 July 1942 regarding the new chimney: "Construction of a new chimney at Crematorium B.W. II at Auschwitz Concentration Camp." Rework of Drawing No. 1241. Source: J.C. Pressac, Les crématoires d'Auschwitz. La machinerie du meurtre de masse. CNSR Editions, Paris 1993, document 8.

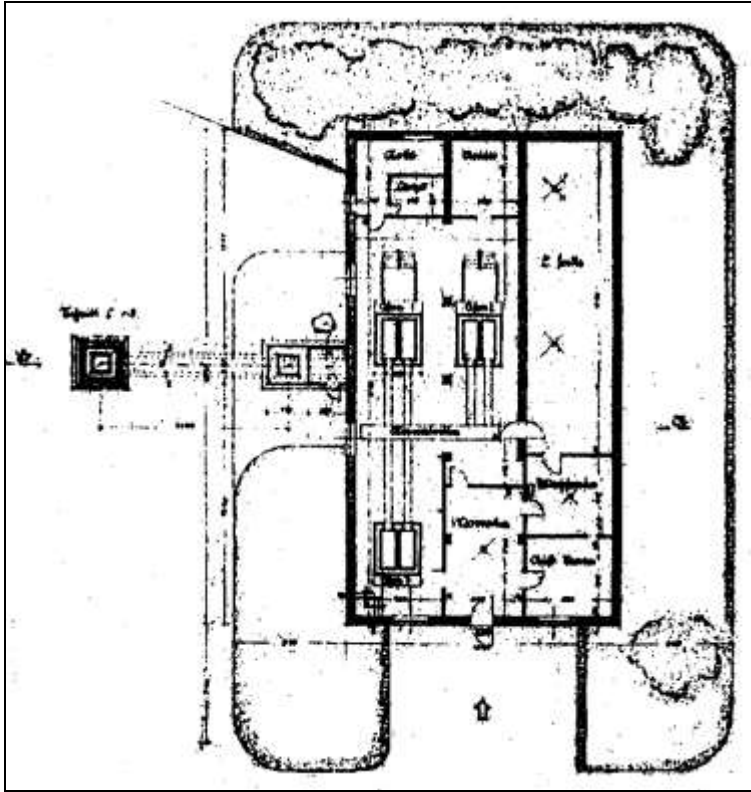

Document 207a: as above, section enlargements with floor plan.

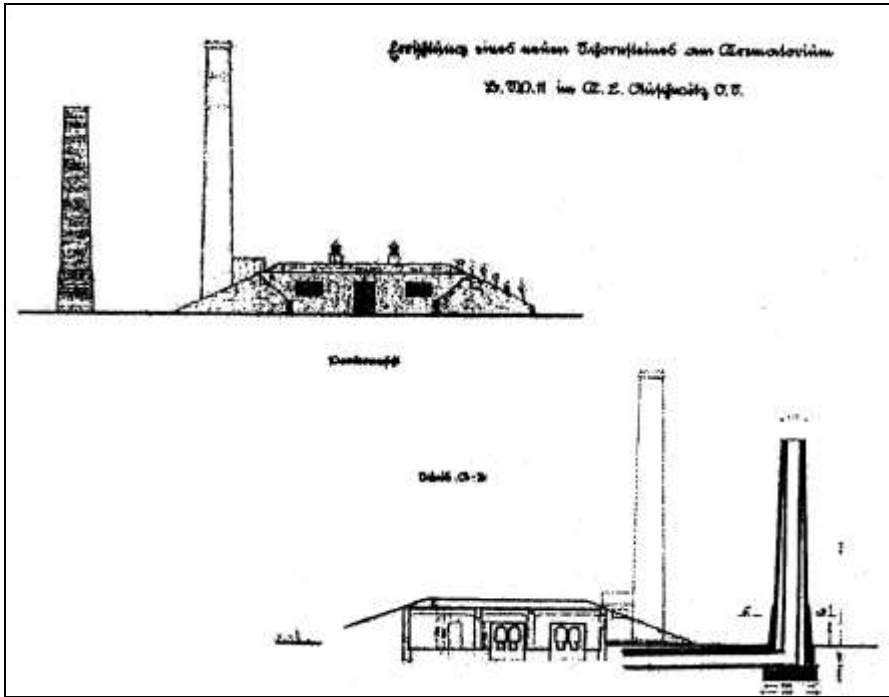

Document 207b: as above, section enlargements with front view (top) and vertical cross section (bottom).

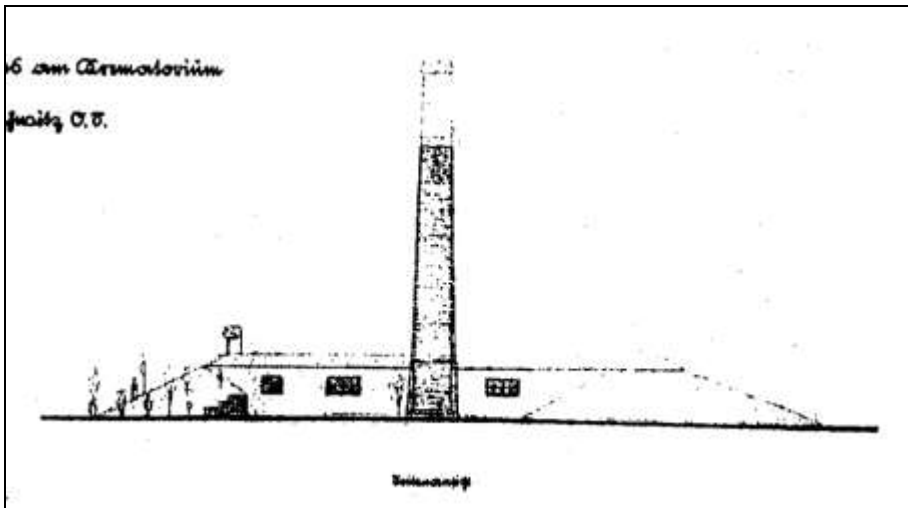

Document 207c: as above, section enlargements with side view.

J. A. TOPF & SÖHNE
 Maschinenfabrik
 Feuerungstechnische Bauunternehmung

TOPF

24. Februar 1943

Bestimmung des Empfängers: Polizei
 Gutsen b. St. Georgen a.d. Saufen, Oberdonau

001956 / -2 MARZ 1943

Adressen: Anzahl: Art: Menge:

Versandanzeige

Der Reichsführer SS und Chef der Deutschen Polizei
 Hauptamt Haushalt und Bauten - SS-Bauleitung Konzentrationslager Mauthausen - Bauabschnitt A.L. - Gusen
 Mauthausen / Oberdonau

Hierdurch teilen wir Ihnen mit, daß wir heute folgende Sendung auf den Weg brachten: p. Waggon - Frachtgut - Eilgut - Express - Krabwagen nach Station: St. Georgen (Gusen) an die Bauleitung der Weissen-SS und Polizei

Ihr Bestellschein Nr. 474 vom 16.10.41

J. A. TOPF & SÖHNE
 VERBANDSABTEILUNG

Signum	Unsere Auftrag-Nr.	Art der Verpackung		Stückzahl	Gegenstand	Gewichte in kg	
		Kolli-zahl				Netto	Brutto
J.A.T.&S.	41/2215/1						
1/30	Stüchtl. Nr.	30	lose	30	Vierkenteisen 40/40 x 630 mm	235	235
31/34	42 Bl. 1	4	"	4	desgl. 740 mm lang	37	37
					als Generator-Roststäbe		272

Hierzu Beiblätter

Document 208: Bill of lading by J.A. Topf & Söhne to the SS Construction Office of Gusen Camp of 24 February 1943 regarding square bars for the gasifier grate.
 Source: Bundesarchiv Koblenz, NS 4/Ma 54.

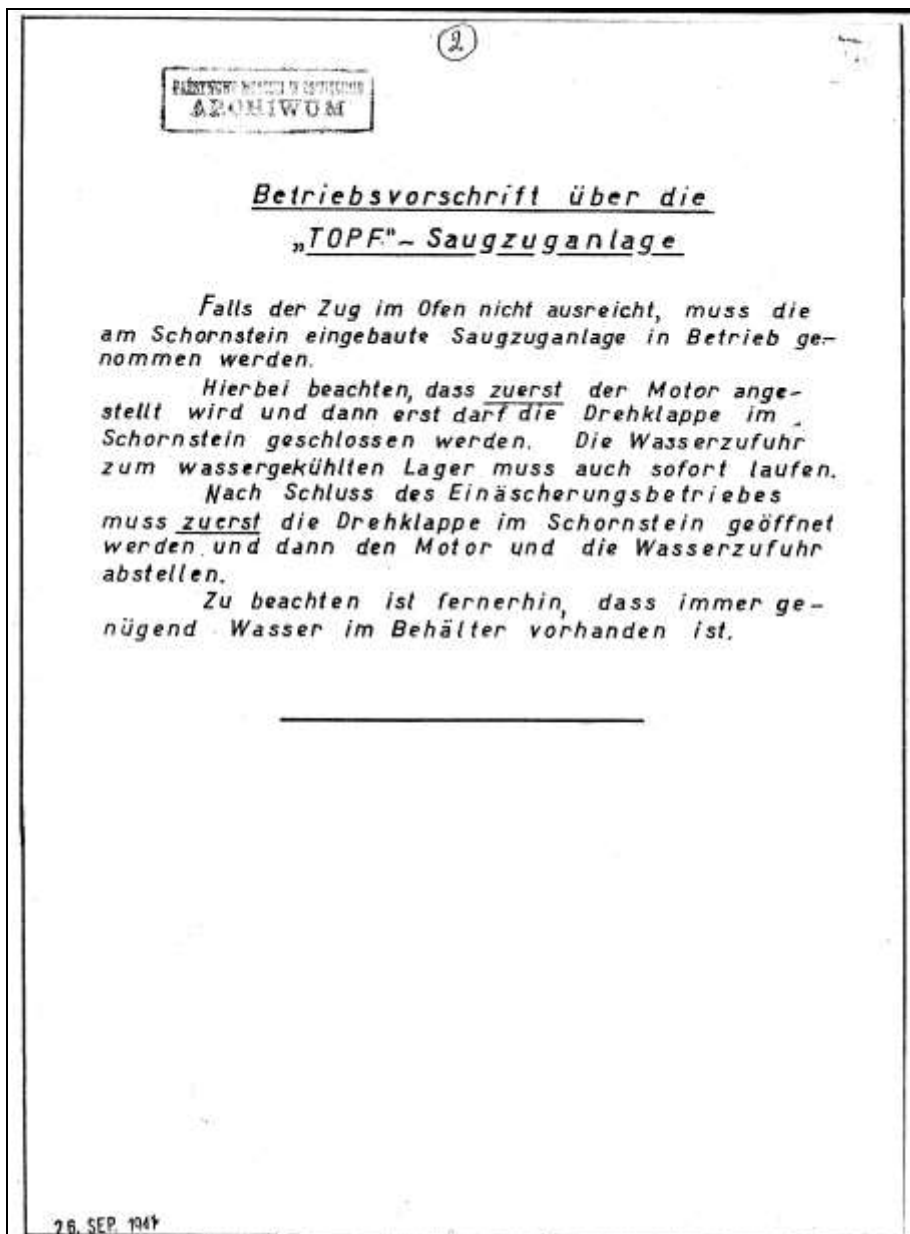

Document 209: J.A. Topf & Söhne, "Operating instructions for the 'Topf' forced-draft device." 26 September 1941. Source: APMO, BW 11/1, p. 2.

③

FABRIKWERKE AUSCHWITZ W. GOSSELER
AROHIVUM

Betriebsvorschrift des
koksbeheizten Topf-Doppelmuffel-Einäscherungs ofen.

272100

Vor Beschickung der beiden Koksgeneratoren mit Koks müssen die beiden Rauchkanalschieber am Ofen geöffnet werden, desgl. auch der Hauptrauchkanalschieber bzw. die Drehklappe am Schornstein.

Nunmehr kann in den beiden Generatoren Feuer angefacht und unterhalten werden, hierbei beachten, dass die Sekundärverschlüsse rechts und links der Ascheentnahmetüren (Koksgenerator) geöffnet sind.

Nachdem die Einäscherungskammer gut rotwarm (ca 800°C) ist können die Leichen hintereinander in die beiden Kammern eingefahren werden.

Jetzt ist es zweckmässig das seitwärts am Ofen stehende Druckluftgebläse anzustellen und ca 20 Minuten laufen zu lassen. Hierbei ist zu beobachten, ob zuviel oder zu wenig Frischluft in die beiden Kammern eintritt.

Die Regulierung der Frischluft erfolgt durch die Drehklappe die sich in der Luftröhrlleitung befindet. Weiterhin müssen die rechts und links der Einführtüren angeordneten Lufteintritte, halb geöffnet werden.

Sobald die Leichenteile vom Schamotterrost nach der darunter liegende Ascheschräge gefallen sind, müssen diese mittels der Kratze nach vorn zur Ascheentnahmetür gezogen werden. Hier können diese Teile noch 20 Minuten zum Nachverbrennen lagern. Dann wird die Asche in den Aschebehälter gezogen und zur Abkühlung beiseite gestellt.

Zwischendurch werden neue Leichen in die Kammern nach einander eingeführt.

Die beiden Koksgeneratoren müssen von Zeit zu Zeit mit Brennstoff beschickt werden.

Jeden Abend muss der Generatorrost von den Koksschlacken befreit und die Asche herausgenommen werden.

Zu beachten ist ferner, das nach Betriebsabschluss, sobald der Generator leer gebrannt ist und Glutteile nicht mehr vorhanden sind, alle Luftschieber und Türen desgl. auch die Rauchkanalschieber am Ofen geschlossen sein müssen um den Ofen nicht auszukühlen.

Nach jeder Einäscherung steigt die Temperatur im Ofen. Daher bitte beachten, dass die Innentemperatur nicht über 1100°C kommt (Weissglut). Diese Temperatursteigerung kann durch Lufteinblasen verhindert werden.

26. SEP. 1941

Document 210: J.A. Topf & Söhne, "Operating instructions for the Topf coke-fired double-muffle cremation furnace." 26 September 1941. Source: APMO, BW 11/1, p. 3.

- 5 -

Barackenlager: Für Wachtruppe (1 Bataillon) werden 6 Luftwaffenbaracken, 1 Wirtschaftsbaracke, 1 Waschbaracke und 1 Abortbaracke aufgestellt. Die Baracken erhalten elektr. Licht, Wasseranschluss und Ofenheizung.
(Die Lieferung der Baracken wurde vom Hauptamt Haushalt und Bauten Amt II zugesagt, jedoch sind diese bis heute noch nicht eingetroffen).-

Lagerhaus: Ausserhalb des Lagers am Anschlussgleis für Lebensmittel-lagerung mit Rampe. Planung noch nicht durchgeführt.

Nebenanlagen: Die Wasserversorgung erfolgt durch 3 eigene Brunnenanlagen mit Pumpanlage für Nutzwasser und 3 Brunnen für Trinkwasser. Die Beseitigung der Abwässer erfolgt durch je 3 Leitungen an der Breitseite des Lagers. Über den Abflusleitungen sind die Wasch- und Abortbaracken angeordnet. Die 3 Leitungen werden zusammengefasst, die Abwässer in 3 Frischwasserklärgruben geklärt und durch einen Vorflutgraben zur Weichsel geführt.-Die Stromzufuhr erfolgt von der Dachpappenfabrik in Birkenau bis zum Transformator im Quarantänelager - Eingangsgebäude als Freileitung, von dort wird der Strom in Kabel weitergeführt.
Die Lagereinfriedung besteht aus ca 3,20 m hohen Betonpfosten in 3,50 m Abstand, an welcher der mit 2000 Volt Hochspannung geladene Stacheldraht angebracht wird. Um ein Untergraben des Drahtzaunes zu verhindern, wird eine Erdsicherung eingebaut.

Anschliessend wäre zu bemerken, dass die neue Zufahrtsstrasse vom K.L. die Reichsbahn schienengleich durchkreuzt. Diesbezügliche Verhandlungen mit der Reichsbahn sind im Gange, ebenso bezüglich des Gleisanschlusses.-

Arbeitsbetriebe: Infolge des grossen Belages (125000 Gefangene) wird ein Krematorium errichtet. Es enthält 5 Stück Muffelöfen mit je 3 Muffeln für 2 Mann, sodass in einer Stunde 60 Mann eingäschert werden können. Ausserdem wird ein Leichenkeller und 1 Müllverbrennungsofen erstellt. Das Krematorium gelangt auf dem Gelände des K.-L. zur Aufstellung.

- 6 -

Document 211: Page 5 of the "Explanatory report for the preliminary draft of the new construction of the PoW camp of the Waffen-SS Auschwitz, Upper Silesia" of 30 October 1941. Source: RGVA, 502-1-233, p. 20.

- 6 -

2

Zusammenstellung:

I. Bauten:	3460.000,- 3.500.000.00	Rmk.	
II. Aussenanlagen:	2.700.000.00 2.678.500,-	"	
<hr/>			
C.) Bauten und Aussenanlagen:	6.178.500,- 6.200.000.00	Rmk.	
<hr/>			
32 <u>D.) Gerät und besondere Betriebs-</u> <u>einrichtungen:</u>			
a.) Kucheneinrichtungen für die Wirtschaftsgebäude 14 Anlagen a 20.000.00 Rmk.	z.b.N.	280.000.00 Rmk.	
b.) Revierbaracken: 15 2 Baracken a 15.000.00 "	z.b.N.	225.000,- 30.000.00 "	
c.) Geräte und Maschinen für Gefangenearbeit	z.b.N.	165.000,- 160.000.00 "	
<hr/>			
D.) Geräte und besondere Betriebs- einrichtungen:		670.000,- 470.000.00 Rmk.	
<hr/>			
33 <u>E.) Hilfsbetriebe:</u>			
HW 30 Krematorium mit 5 Verbrennungs- Muffelöfen. Planung noch nicht genehmigt. Krematorium, Gesamtkosten	z.b.N.	650.000.00 Rmk.	
<hr/>			
HW 31 Prov. Bäckerei mit 4 Backöfen für direkte Feuerung. Planung noch nicht durchgeführt Prov. Bäckerei, Gesamtkosten	z.b.N.	180.000.00 Rmk.	
<hr/>			
E.) Hilfsbetriebe:	Gesamtsumme:	830.000.00 Rmk.	

- 7 -

Document 212: Page 6 of the "Explanatory report for the preliminary draft of the new construction of the PoW camp of the Waffen-SS Auschwitz, Upper Silesia" of 30 October 1941. Source: RGVA, 502-1-233, p. 27.

J. A. TOPF & SÖHNE
Maschinenfabrik
Feuerungstechnisches Baugeschäft

ERFURT, den 16. April 1942

Versandanzeige

An die Zentral-Bauleitung der Waffen SS und Polizei
Konzentrationslager Auschwitz
Auschwitz O/S.

Hierdurch teilen wir Ihnen mit, daß wir heute folgende Sendung auf den Weg
brachten: p. Waggon — nach Station:
Auschwitz O/S.
Waggon-Nr. 4.627o3-B.M.B.

J. A. TOPF & SÖHNE
VERBANDSLEITUNG

Signum	Unsere Auftrag-Nr.	Art der Verpackung Kollizahl	Stückzahl	Gegenstand	Gewicht in kg	
					Netto	Brutto
J. A. T. & S.	41/2249/1			Teile zu den Topf-Dreimuffel- Öfen:		
	27621	10 lose	10	Einführtüren 600/600 mm i.l. 7 rechts, 3 links	2290	2290
		28/ " "	28	Feuertüren 280 x 350 i.l.	1274	1274
		28 " "	28	Einsatz-Schamottesteine dazu	228	228
		41 " "	41	Luftkanalverschlüsse 108/128	307	307
		6 " "	6	Füllschachtverschlüsse 270 x 340 i.l.	402	402
		14 lose	14	Seilrollen 150/125 ø	23	23
		5 " "	5	Rauchkanalschieber 600 x 700 mm i.l.	525	525
		2 " "	2	Feuertüren 250 x 250 mm	48	48
		9 " "	3	Fuchseinsteigeschachtver- schlüsse 450 x 510 i.l. (Rahmen mit Doppeldeckel)	266	266
		1 lose	1	zweifl. Feuertür 600 x 600	123	123
		1 " "	1	Reinigungstür 390 x 510 i.l.	29	29
	27974	3 " "	3	Rauchkanalschieber 1200 x 800 - Führungshülsen	348	348
		3 " "	3	Schieberplatten 1250 x 840	432	432
	28089	5 lose	5	Gebläse Nr. 275 M, 2 x rechts 3 x links, mit je 1 Dreh- strommotor 3 PS, n=1420 /Min. 380 Volt	460	460
				Übertrag		6755

18. APR. 1942

Hierzu Beiblätter

Document 213: "Bill of lading" by J.A. Topf & Söhne to the Central Construction Office at Auschwitz of 16 April 1942 regarding "Parts of TOPF triple-muffle furnaces" for Crematorium II at Birkenau. RGVA, 502-1-313, pp. 167-170.

Beiblatt Nr. 1		Auftrag Nr. 70				
Signum	Unsere Auftrag-Nr.	Art der Verpackung Koll.-zahl	Stückzahl	Gegenstand	Gewichte in kg	
					Netto	Brutto
I.A.T.&S.	41/2249/1			Übertrag		6755
	6	10 lose	5	Rohrleitungen, je 2teilig aus Blechröhr 140 lg u. Siederöhr 82 lg	380	380
	27989	2 lose	2	Einführungswagen X	588	588
		12 "	12	Blechkülsen 300/190/210 für die Gegengewichte	60	60
	27995	2 "	2	Verschiebewagen X	180	180
		15 "	15	Laufschienen (U 6,5 350 lg.	43	43
		30 "	30	" (Winkel 50/50/5, 2800 lg.	330	330
		10 "	10	desgl. 560 lg.	25	25
		7 "	7	" 4000 lg.	112	112
		1 "	1	" 3100 lg.		
		2 "	2	" 3900 lg.	70	70
		2 "	2	" 2900 lg.		
		1 "	1	" 800 lg.		
	41/1980/1			<u>Verankerung. usw.</u>		
	27405	2 lose	2	Winkelleis. 90/9, 2000 lg.		70
		4 "	4	" 80/8, 1235 lg.		
		4 "	4	" 50/5, 1235 lg.		
		1 "	1	" 50/5, 2330 lg.		
		1 "	2	" 60/6, 1945 lg.		
				zus. genietet		
		13 "	13	Rundeisensanker 16 p		
		4 "	4	I-eisen NP 12, 2000 lg.		
		6 "	6	Winkelleis. 50/5, 824 lg.		
		2 "	2	" 90/9, 2000 lg.		
		2 "	2	" 50/5, 1130 lg.		
		1 "	1	Flacheis. 70/10, 2520 lg.		
		2 "	2	Winkelleis. 80/8, 1600 lg.		
		1 "	1	Flacheis. 70/10, 2520 lg. ✓		
		1 "	2	Winkelleis. 80/8, 1600 lg. verschweißt		
		4 "	4	Winkelleis. 50/5, 1235 lg.		
		4 "	4	Flacheisen 80/10, 790 lg.		
		2 "	2	" 70/10, 770 lg.		
		2 "	2	" 100/10, 1220 lg.		
		1 "	1	I-eisen NP 12, 2000 lg.		
				Übertrag		8543

104. K. H. 3000 1.011

Gewicht
s. nächste
Seite

Beiblatt Nr. 2		Auftrag Nr. 107				
Signum	Unsere Auftrag-Nr.	Art der Verpackung Koll.-zahl	Stückzahl	Gegenstand	Gewichte in kg	
					Netto	Brutto
J.A.T.&S.	27405			Übertrag		8543
		2	lose	2 Rauchkanalschieber 350 x 600		
				Rahmen zum Ausmauern		
		2	"	2/ Eülisen (Gehäuse)		
		2	"	2/ Gegengewichte 240. ϕ , 250 lg.		
		2	"	2/ Aschebehälter 320 x 350		
		2	"	2/ Schürgeräte ca. 3000 lg.		
		30	"	30/ Vierkantseisen 40/40, 630 lg.		
		4	"	4/ " " 740 lg.		
		1	"	1/ Rohrleitung 120 ϕ + 89 ϕ Gewicht:	1041	1041
					50	50
	27419	1	lose	1/ Laufschiene 50/5, 2030 lg.		
		1	"	1/ " " 3870 lg.		
		1	"	1/ " " 480 lg.		
		1	"	1/ " " 500 lg.	87	87
		2	"	2/ " (U 6,5, 350 lg.		
		4	"	4/ " " 50/5, 3000 lg.		
		1	"	1/ Verschiebewagen X	90	90
		1	"	1/ Einführungswagen X	186	186
		1	"	1/ Auflegeblech dazu	72	72
		6	"	6/ Gegengewichtskasten	28	28
		1	"	1/ Abstreifer	38	38
	41D 314					
	26957	1	lose	1/ Gebläse Nr. 550 mit Cont-Motor 3 PS	236	236
		1	lose	1/ Konsol aus Winkelseisen	40	40
		1	"	1/ Druckstutzen	85	85
		5	"	5/ Rohre 180 ϕ , 1600 - 1970 lg.	37	37
		1	"	1/ Rohr 300 ϕ , 1900 lg. ✓	18	18
		2	"	2/ " " 950 lg.	13	13
		8	"	8/ " " 225 ϕ	44	44
		2	"	2/ " " 550 ϕ , ca. 950 lg	25	25
		8	"	8/ " " 400 ϕ "	165	165
		3	"	3/ " " 350 ϕ , "	23	23
		4	"	4/ " " 250 ϕ "	20	20
		10	"	10/ " " 225 ϕ , "	52	52
		5	"	5/ " " 180 ϕ "	20	20
		4	"	4/ " " 300 ϕ "	26	26
				Übertrag		10939

Beiblatt Nr. 3		Auftrag Nr. 130				
Signum	Unsere Auftrag-Nr.	Art der Verpackung Kollizahl	Stückzahl	Gegenstand	Gewichte in kg	
					Netto	Brutto
J.A.T.&S.	41D 314 26957			Übertrag		10939
		6 lose	6	versch. Abzweigstutzen	43	43
		12 "	12	" Krümmer	36	36
		18 "	18	Kohrschellen	38	38
		19 "	19	Sickenschelle.	11	11
		1 Kiste	1	Sterndreieckschalter	4	82
				div. Schrauben	1	
	41/1980		2	Steinschraubel 5/8", 200 lg	1	
	27419			div. Schrauben	1	
	27405		10	lfdm. Drahtseil 70 ø mit Kauschen u. Klemmen	5	
			2	Firmenschilder	0,1	
				div. Schrauben & Scheiben	16	
	41/2249		20	Sechskantschr. 5/16 x 20	0,5	
	28089		20	Steinschrauben M10 x 100	1	
	27621		4	Fl.-Anker	1	
			112	Sechskantschr. 3/4" x 50	33,2	
						11149
						=====
				<i>Produktaktion in Hongkong</i>		
				<i>20. 4. 42.</i>		
				<i>1, 9. 1944.</i>		

384 x 6 45. 2000 1.0211

J. A. TOPF & SÖHNE
 Maschinenfabrik
 -Feuerungstechnisches Baugeschäft-

ERFURT, den 12. Juni 1942

Versandanzeige

An die Zentral-Bauleitung der Waffen SS und Polizei
 Konzentrationslager Auschwitz **YFM**
Auschwitz O/S.

Hierdurch teilen wir Ihnen mit, daß wir heute folgende Sendung auf den Weg
 brachten: p. Waggon ~~xxxxxxx~~ nach Station:
Auschwitz o/S.

Waggon-Nr. 93413 Erfurt X ~~xxxxxxx~~

J. A. TOPF & SÖHNE
 VERSANDABTEILUNG

Signum	Unsere Auftrag-Nr.	Art der Verpackung	Stück- zahl	Gegenstand	Gewicht in kg	
					Netto	Brutto
J.A.T.&S.				betr.: <u>Teile zu den 5 Topf- Dreifachmuffel-Ofen:</u>		
	41/2249/1 27621	5 lose	5/	Einführungen 600/600 i.l. 2 x links, 3 x rechts	1105	1105
		15 "	15	Luftkanalverschlüsse 108/128	120	120
		4 "	4	Rüllschachtverschlüsse 270 x 340 mm i.l.	268	268
		1 "	1	Rauchkanalschieber 600/700	99	99
		6 "	2	Ruchseinsteigeschachtver- schlüsse 450 x 570 i.l. (Rahmen mit Doppeldeckeln)	179	179
	9	2 lose	2	Winkelleis. 50/5, 500 lg.	4	4
		3 "	3	Kettenrollen mit Mauerbolzen	17	17
		3 "	3	Schneckenrad-Handwinden	42	42
	8 u. 7	2 lose	2	Gebläse 625D, 2x5 rechts, o.	1490	1490
		1 "	1	desgl. 1x5 links, Mo- tor	775	775
		3 "	3	Druckstutzen 870/595 auf 1600/870	435	435
		1/ Kiste	6	Fasser-Zu-u. Abflußrohre	4,5	
				div. Schrauben u. Steinschr.	15	
	9		4	Steinschrauben M12 x 200	1	
			3	Seilrollen m. Mauerbolzen	5,5	
			12	Steinschrauben M12 150 lg.	1,5	
			3	kalibr. Ketten 8 mm je 4 m	4	
				Übertrag		
						4534 Beilblätter

796. 2. 42. 9000. I. 0211

20. JUN 1942

Document 214: "Bill of lading" by J.A. Topf & Söhne to the Central Construction Office at Auschwitz of 18 June 1942 regarding "Parts of 5 TOPF triple-muffle furnaces" for Crematorium II at Birkenau. Source: RGVA, 502-1-313, pp. 165f.

Beiblatt Nr. 1		Auftrag Nr. 111				
Signum	Unsere Auftrag-Nr.	Art der Verpackung Kell- zahl	Stück- zahl	Gegenstand	Gewichte in kg	
					Netto	Brutto
J.A.T. & S.	41/2249/1 9	---Kiste	3	Übertrag Drabtseile 8 mm ϕ mit Klemmen u. Kauschen	3,5 0,5	4534
	27621		40	Sechsk.-Schrauben 3/4" x 50	11	
	41/2249/1 43		4	Zum Müllverbrennungssofen. Steinschrauben 5/8", 200	1	
			2	Schlüsselbolzen 12 ϕ ,	0,2	61
		1 lose	1	Aschedrehrost m. Welle 1585 lg.	25	25
		2 "	2	Klotzlager 50 Bohrg.	10,5	10,5
		1 "	1	Gasrohr 2", 450 lg.	2,5	2,5
		3 "	3	Rostplatten 350/275	42	42
		2 "	2	Flacheisen 60/25, 900 lg.	20	20
		1 "	1	Rutschplatte 700/250	24	24
		1 "	1	Rahmen für den Aufgabe-Ver- schlußdeckel	7	7
		1 "	1	Riffelblechdeckel m. Scharnier	22	22
		35 "	35	Roststäbe 700 lg. glatt Mod. 15156	200	200
					4948	

UNTERSUCHT
MATERIALERHALTEN
MATERIALERHALTUNG
29. 6. 42
MOSCHAU
M: 6164.

+

30x 41, 500 1.0211
20. JUN 1942

K. G. L.

Bauherrn: H. L. Gumbert, Mess. I. Bauwerk (BW): 70 K. G. I.

Haushalt: Häfen 77 1942 Kap. 21.20 III. Jan. 1943 Bauausgabebuch Seite Nr.

Genehmigungsübertragung vom 1.11.42 z. 1.1.43

Art der Vergebung:
(Stützpreisverfahren vermeiden) -2100 143

Noten(vor)anschlag vom 13. 11. 42 Abschnitt C
Kostenanschlag Veranschlagte Nr. 4 41.41 = 57237-2042
Auftrag Nr. 775/42 vom 22.10.42 mit 57237.- RM
Betrag Nr. 775/42 16 vom 22.10.42 mit 57237.- RM

freihändig
bezeichnete Ausschreibung
öffentliche Ausschreibung

Unsere Rechnungs-Nr. 69

Einzel- / Teil- / Schluß-Rechnung Nr.
(Stützpreisverfahren ist zu vermeiden)

der Firma: J.A. Topf & Söhne Erfurt Name
des Auftraggebers
Stützpreismessung

betr. Waffen-SS Auschwitz **J. A. TOPF & SÖHNE, ERFURT**
1. Hauptgeschäftsbereich, Feuerwerkstechnisches Hauptgeschäft

Bankkonto der Firma: Reichsbank-Giro 851 Erfurt den 27. Januar 1943

Postfach-Konto der Firma: Erfurt 1792 1943

Leistungs	Leistende Nr. des Notenan- schlages	Zeit der Aus- führung der Arbeiten	Menge	Gegenstand	Geldbetrag	
					im einzelnen	im ganzen
				<u>Nr. 30 - <i>Stützpreisverfahren I</i></u>		
				<u>41 D 2249</u>		
				<u>Errichtung von 5 Stück Dreimuffel-Einäscherungsöfen und zwar:</u>		
				<u>Lieferung der Schamottenormal-Keil- und Formsteine des Schamottenörtels und der Monolitstampfmasse zur Herstellung des feuerfesten Ofenmauerwerks</u>		
				<u>der Schlackenwolle, Kieselgursteine und des Isoliermörtels zum Isolieren der Öfen,</u>		
				<u>der guss-u. schmiedeeis. Ofenarmaturen und der Druckluftanlagen lt. Beschreibg. in uns. Kostenschlag vom 4.11.41 Pos. I.</u>		
				<u>Gestellung uns. Monteure zur Beaufsichtigung der Bauarbeiten an den Öfen, einschl. der Tagegelder, Reisekosten und sozialen Abgaben</u>		
				<u>Aufuhr der Baustoffe vom Werk Erfurt zum Bahnhof Erfurt <u>20378.-</u></u>		<u>31.890.-</u>
				<u>Lieferung von 2 Sargeinführungsvorrichtungen bestehend aus je einem Sargeinführungswagen, dem Verschleppwagen und der Schienenanlage für 5 Einäscherungsöfen</u>		<u>1.780.-</u>
				<u>Übertrag:</u>		<u>33.670.-</u>

31. JAN 1943

ff-Formblatt - Bau - 13 „Einzel- / Teil- / Schluß-Rechnung“, Titelblatt, Werkbuch-Buchdruckerei Kassel (1941.)
Zuschnitt 12a - 10/14/1941

U. Böing Nr.: 3

Document 215: "Final Invoice" of J.A. Topf & Söhne of 27 January 1943 regarding 5 triple-muffle furnaces (and the waste incinerator) of Crematorium II at Birkenau. Source: RGVA, 502-2-26, pp. 230-230a.

Einzelnbr. Nr.	Umsätze Nr. des Rollen- und Idioms	Zeit der Ausführung der Arbeiten	Menge	Gegenstand	Gelbbetrag		
					im eingetragenen RM 1.302	im eingetragenen RM 1.302	
				Übertag:		33.670.- ✓	
				<u>Lieferung von:</u> 10000 Schamottenormalsteinen SK30 3000 " Keilsteinen " 7000 kg " Mortel 1 2 und Gestellung unseres Monteurs zur Herstellung der Rauchkanalanlage		4.049.- ✓	
				<u>Lieferung von 3 Topfsaugzugenanlagen bestehend aus je</u> 1 Saugzugeschliesse zur Förderung von stündl. 40 000 cbm Rauchgasen gegen 30 cm w3 Gesamtpressung mit 2 angesetzten Saugstutzen, 1 Druckstutzen 1 Rauchkanalabsperrschleier G.9. 1,2 m, mit luftdichtschiessender Führungsnäse, Rollen, Drahtseil und Handwinde 1 Drehstrommotor für 380 Volt, 50 Per., tropfwassergeschützt, K. 15 PS mit Seileifringanker, Vollastanlasser u. Bolzenpufferanpplung Gestellung uns. Monteurs zum Einbauen à 3.016.- <u>Errichtung eines Müllverbrennungs Ofens und zwar: Lieferung</u> der Schamotte-Normal-Keil und Formsteine, des Schamottemörtels u. der Monolitstampfmasse, der Klebeigsteinsteine, des Isoliermörtels u. der Schlackenwolle zur Herstellung und Isolierung des feuerfesten Ofenmauerwerks. der guss- und schmiedeeis. Ofenarmaturen, des schmiedeeis. Aufgabekastens und des Rauchkanalschiebers Gestellung uns. Monteurs z. Beaufsichtigung der Bauarbeiten. Entsendung ein. Ingenieurs zur Inbetriebnahme gem. uns. Kostenschlag vom 4.11.41 B.uss. Sachz. v. 4.11.41. Betr. Bestelle. v. 22.11.41 an Herrn Reichsführer SS-Hauptamt-Haushalt u. Beuten-Neuschleisung K.L. Auschwitz Bstg. Nr. 217/41-Ho. <i>In Abschrift für 1 Bauverwalter v. 16.4.42</i>		9.048.- ✓	
						4.474.- ✓	
						51.221.- ✓	
						3.505.- ✓	
						47.536.- ✓	
Fachtechnisch richtig! Aufschreib. d. 9. d. 4.3. <i>Jahnke</i>					Festgestellt auf AM 17.5.42 <i>[Signature]</i>		Beträufte Nachgerechnet am <i>[Signature]</i>

Baubehörden: <i>K.L. Birkenau, Neu. I K.S.L.</i>		Baumeck (BW) <i>K.S.L.</i>	
Haushalt <i>Stäffen-77</i> 1943 Kap. 21/70 Tit. (gen) 0-		Bauausgabebuch Seite Nr.	
Genehmigungserfügung vom <i>1.11.41 u. 12.11.41</i>		Mit der Bescheinigung (Stützpunktbescheinigung) Konzentrationslager Auschwitz Verwaltung freiländiger beschränkter Tätigkeit vom 1. JUNI 1943 bis 1. JUNI 1943 <i>Handleistung</i>	
Kosten(vor)anschlag vom <i>13.11.42</i> Abschnitt <i>C</i>			
Auftrag Nr. <i>274</i> vom <i>26.10.42</i> mit <i>53702.- RM</i>		Erfurt, den 27. Mai 19 43	
Betrag Nr. <i>274</i> vom <i>26.10.42</i> mit <i>53702.- RM</i>		Einzel-/Teil-/Schluß-Rechnung Nr. 728 <small>(Schlußrechnung ist zu streichen)</small> Name der Firmensitz und Stammort J. A. TOPF & SÖHNE, ERFURT <i>M. H. ...</i>	
der Firma J. A. Topf & Söhne Erfurt		betr. Zentralblt.g. Auschwitz	
Bankkonto der Firma: Reichsbankgiro 851		Postcheck-Konto der Firma: Erfurt 1792	

Belegart	Cau- Terde Nr.	Laufende Nr. des Rechnen- schlages	Zeit der Aus- führung der Arbeiten	Anzahl	Gegenstand	Gelbbetrag			
						im einzelnen		im ganzen	
						RM	RM	RM	RM
					<i>Nr. 30 A - Krematorium I</i>				
					42 D 1454				
					Errichtung von 5 Stck. Dreimuffel- Einäscherungsöfen und zwar:				
					Lieferung der Schamotte-Normal- Keilund Formsteine des Schamotte- mörtels und der feuerfesten Stampf- masse zur Herstellung des feuer- festen Ofenmauerwerks, Lieferung der Isolierstoffe zum Isolieren der Öfen.				
					Lieferung der guss-u. schmiedeei- sernen Ofenarmaturen und der Druckluftanlagen, der Verankerungs- teile für das Ofenmauerwerk und je einer Leicheneinfuhrvorrichtung als Trage ausgebildet, mit Füh- rungsrollen und Befestigungseisen versehen, frei Bahnhof Erfurt				
					Gestellung unseres Monteurs zur Beaufsichtigung der Bauarbeiten im übrigen lt. uns. Angebot v. 30.9.42. uns. Schro. v. 30.9.42				
					Lieferung und Einbau von 3 Topf- Saugzuganlagen bestehend aus je				
					<u>Übertrag:</u>				
						7830		39150	
								39.150	

ff-Formblatt - Bau - 13 (Einzl-/Teil-/Schluß-Rechnung) - Titelblatt. Waisenhaus-Subordinari Kasel (1941) Dr. A.4
 Document 216 - Belegart

U-Beleg Nr.: 3

Document 216: "Final Invoice" of J.A. Topf & Söhne of 27 May 1943 regarding 5 triple-muffle furnaces of Crematorium III at Birkenau. Source: RGVA, 502-2-26, pp. 215-215a.

Zu- lenbe Nr.	Contende Nr. des Referen- am- schlages	Zeit der Aus- führung der Arbeiten	Menge	Gegenstand	Gelbbetrag	
					im einzelnen R.M. 1.34	im ganzen R.M. 1.34
				1 Saugzugesbläse mit eingebauten Saugstutzen, 1 Druckstutzen, 1 Rauchkanalabsperrschieber mit Rollen, Drentseil und Handwinde 1 Drentsmotor mit Scaleiffringanker N. ca. 15 PS für 380 Volt 50 Per. 1 Vollgasanlasser 1 elastisch- isolierenden Bolzenpufferkupplung.		39150. ✓
			12880	Gestellung unseres Monteurs zum Herstellung einer Rauchkanalanlage für die 5 Einäscherungsöfen und zwar Lieferung der erforderlichen Schamottenormal- u. Keilsteine und des nötigen Schamottenörtels Gestellung unseres Monteurs zur Überwachung der Bauarbeiten an den Rauchkanälen, gemäss uns. Angebot vom 30.9.u. uns. Schrb.v. 30.9.42	3016. →	9048. ✓
				Betr. Ihre Bestellg. v. 26.10.42 Bestg.Nr. 1649642/ Jäh/Lp. K.L.Auschwitz K.G.L.-Zweites Krematorium.		5504. → 53702. →
				Nachgerechnet am 11.11.43 <i>Gais</i>		Sollsumme

Fachtechnisch richtig!
Auschwitz, d. 9.11.43.
(Signature)
20.11.43.

Festgestellt auf BM 53702.-
(Signature)
K.L.Auschwitz

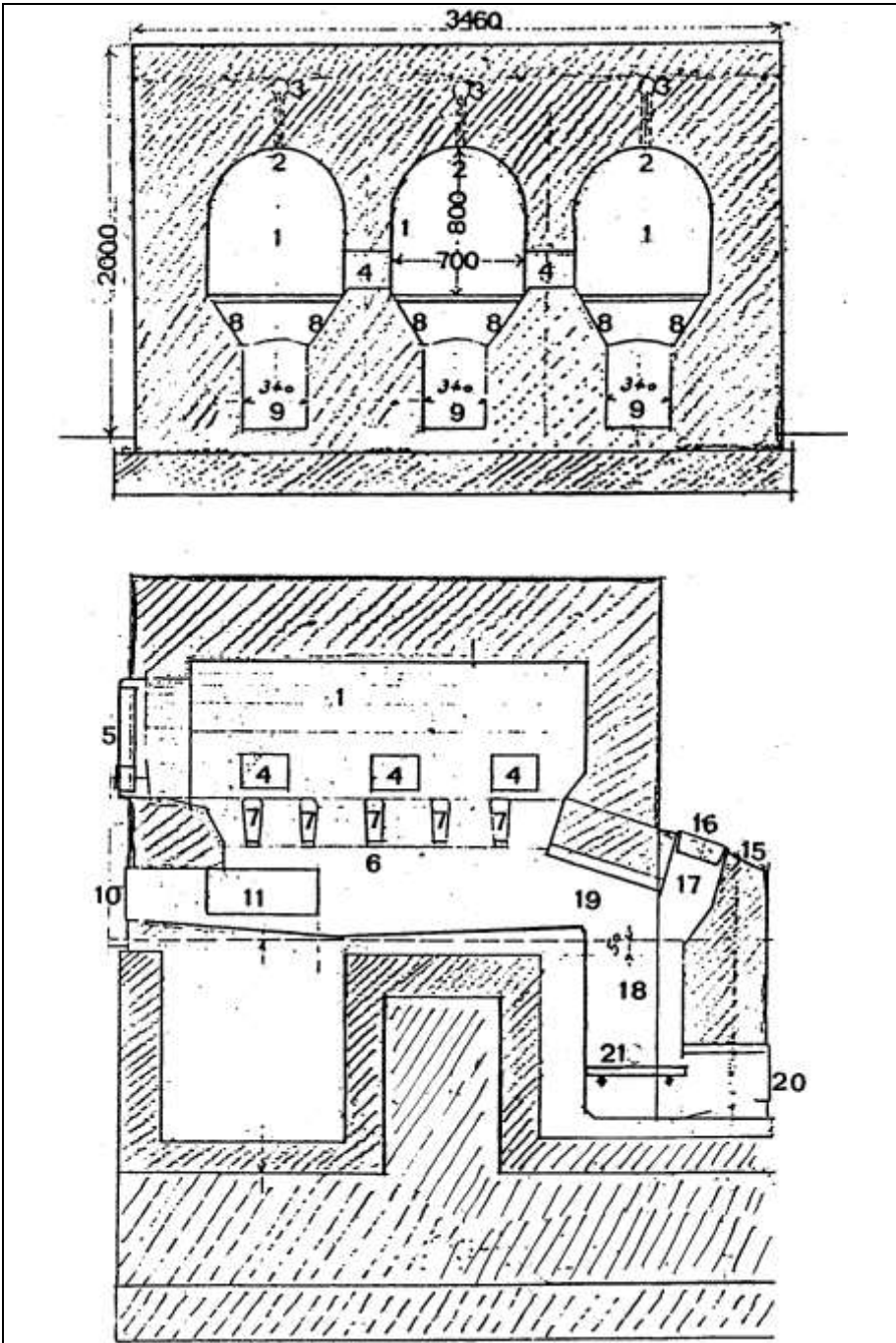

Documents 217 (top) & 217a (bottom): TOPF coke-fired triple-muffle cremation furnace. Top: Vertical section. Bottom: Longitudinal section of a lateral muffle. Labeled by Carlo Mattogno based on the drawing by J.A. Topf & Söhne No. D 57253.

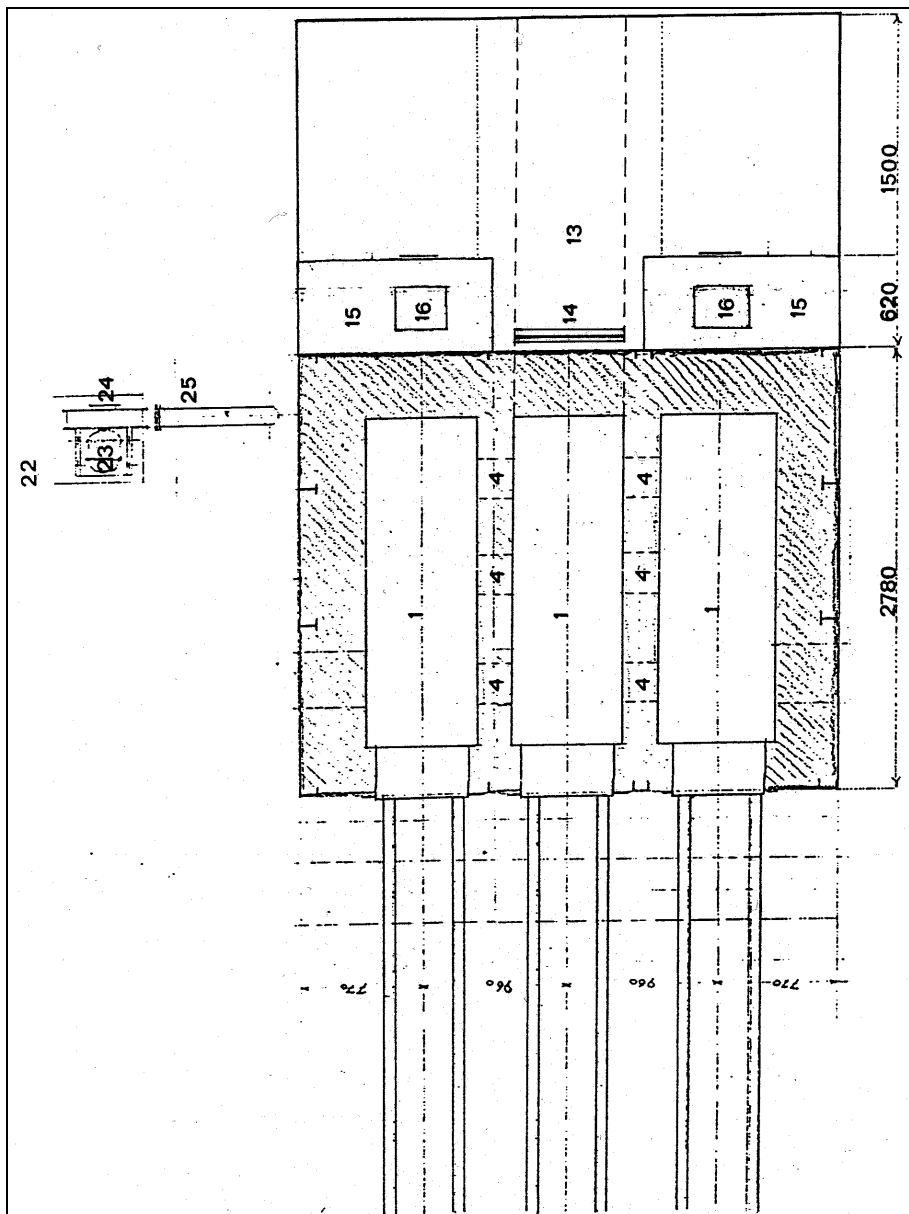

Document 218: as above, horizontal section.

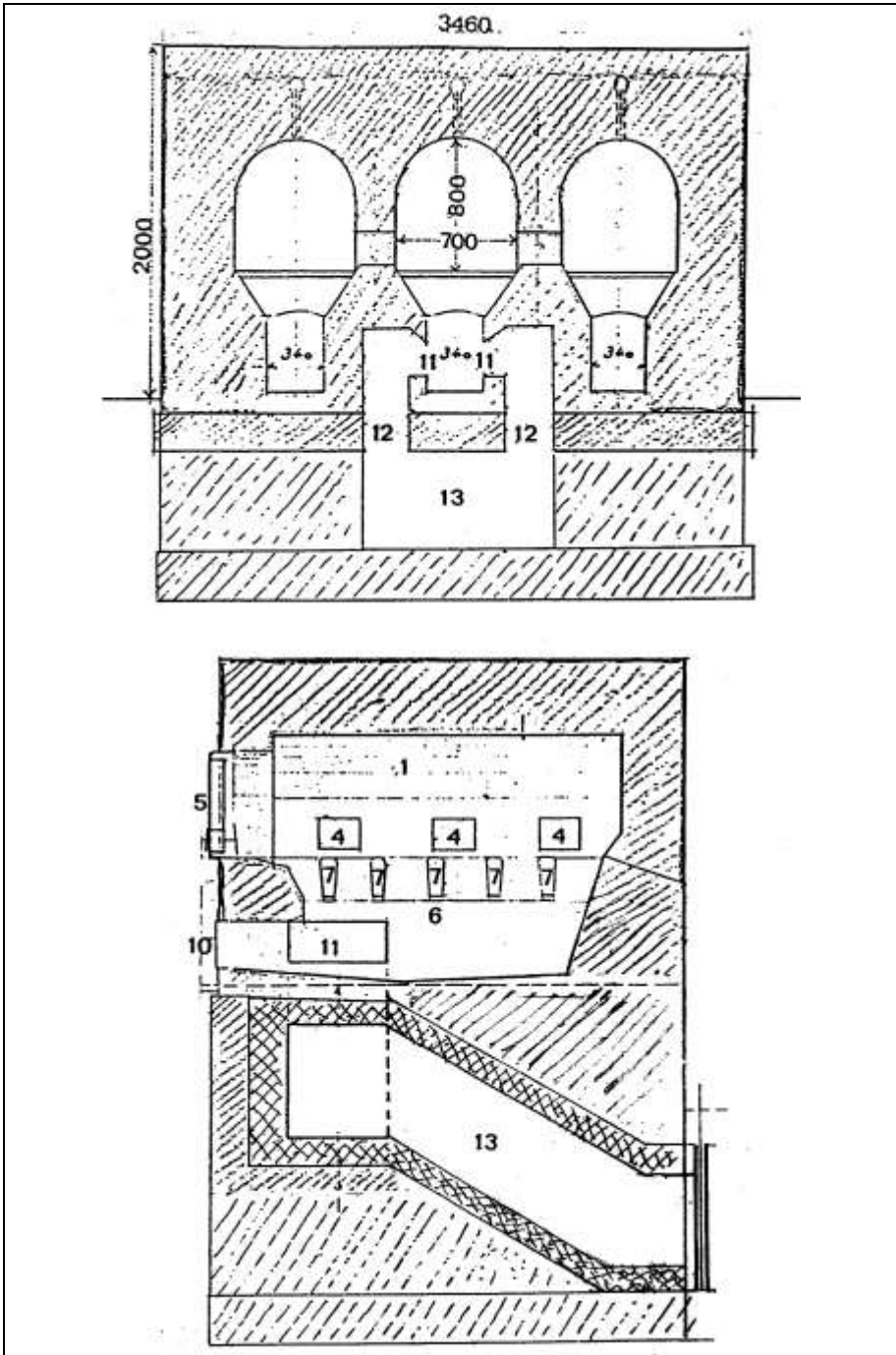

Documents 219 (top) & 220 (bottom): as above, horizontal section. Top: vertical section, design of the combustion-gas ducts. Bottom: as above, Bottom: Longitudinal section of the side muffle.

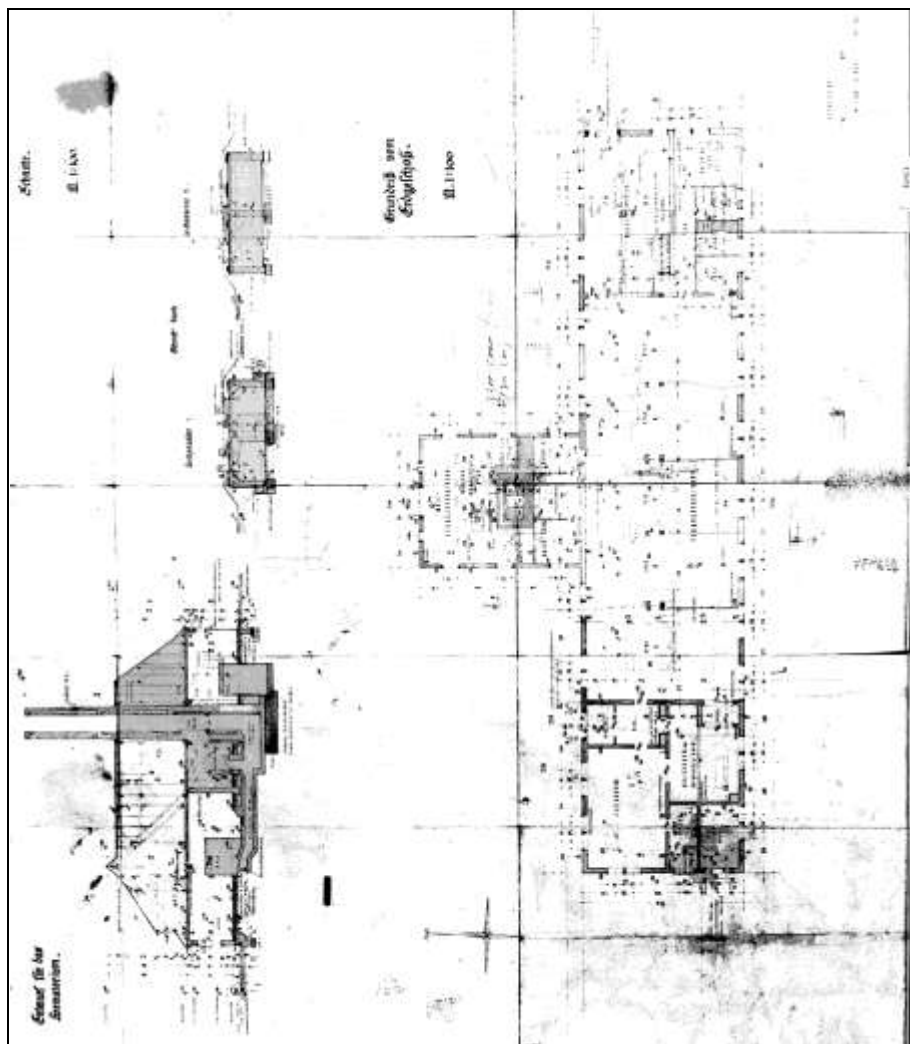

Document 221: Project of the new crematorium at Auschwitz (future Crematoria II/III at Birkenau). Drawing No. 933 by the Central Construction Office of 19 January 1942. Source: APMO, Negative No. 20957.

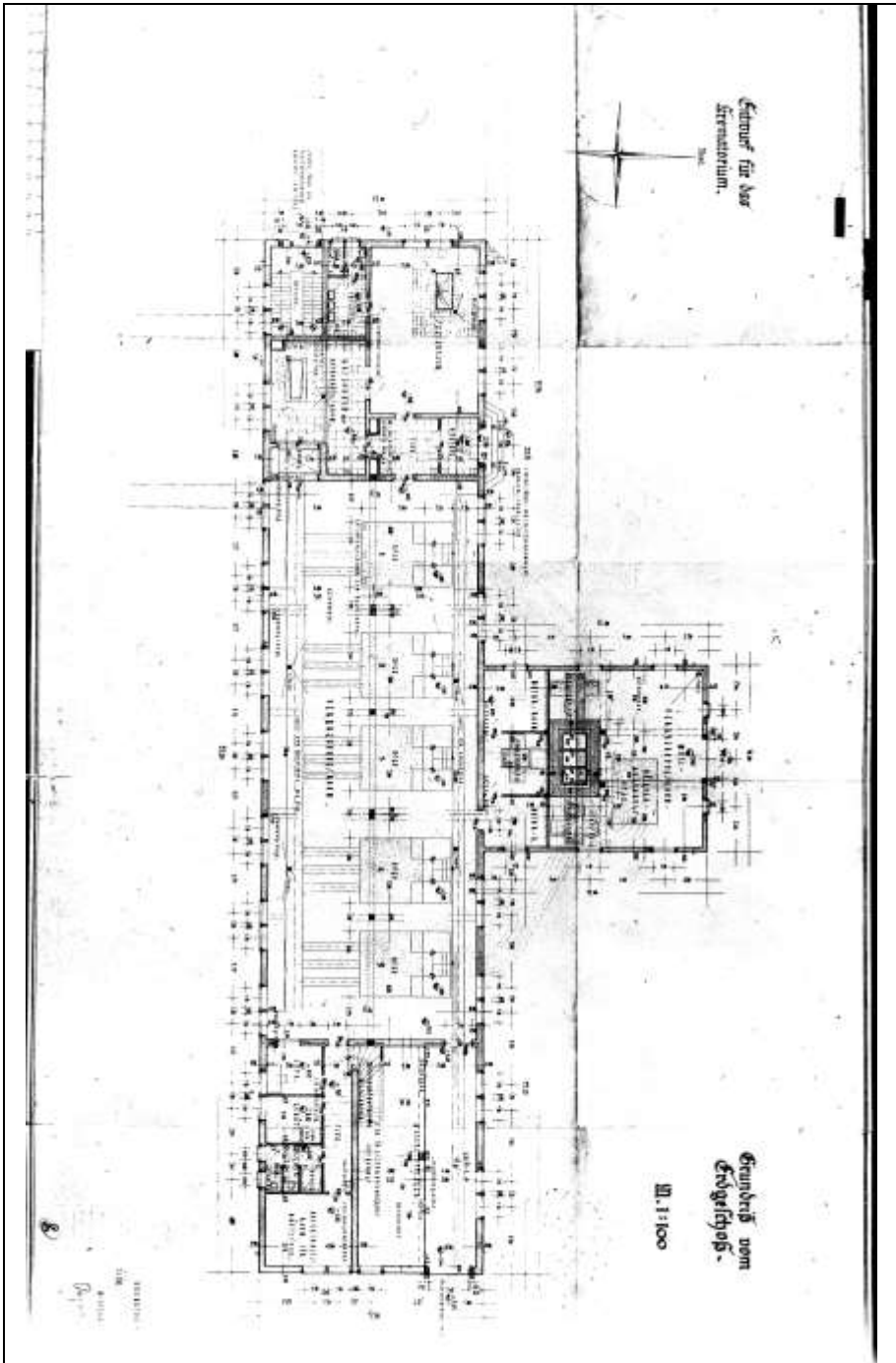

Document 222: Project of the new crematorium at Auschwitz (future Crematorium II/III at Birkenau). Drawing No. 933 by the Central Construction Office of 19 January 1942. Source: APMO, Negative No. 20818/4.

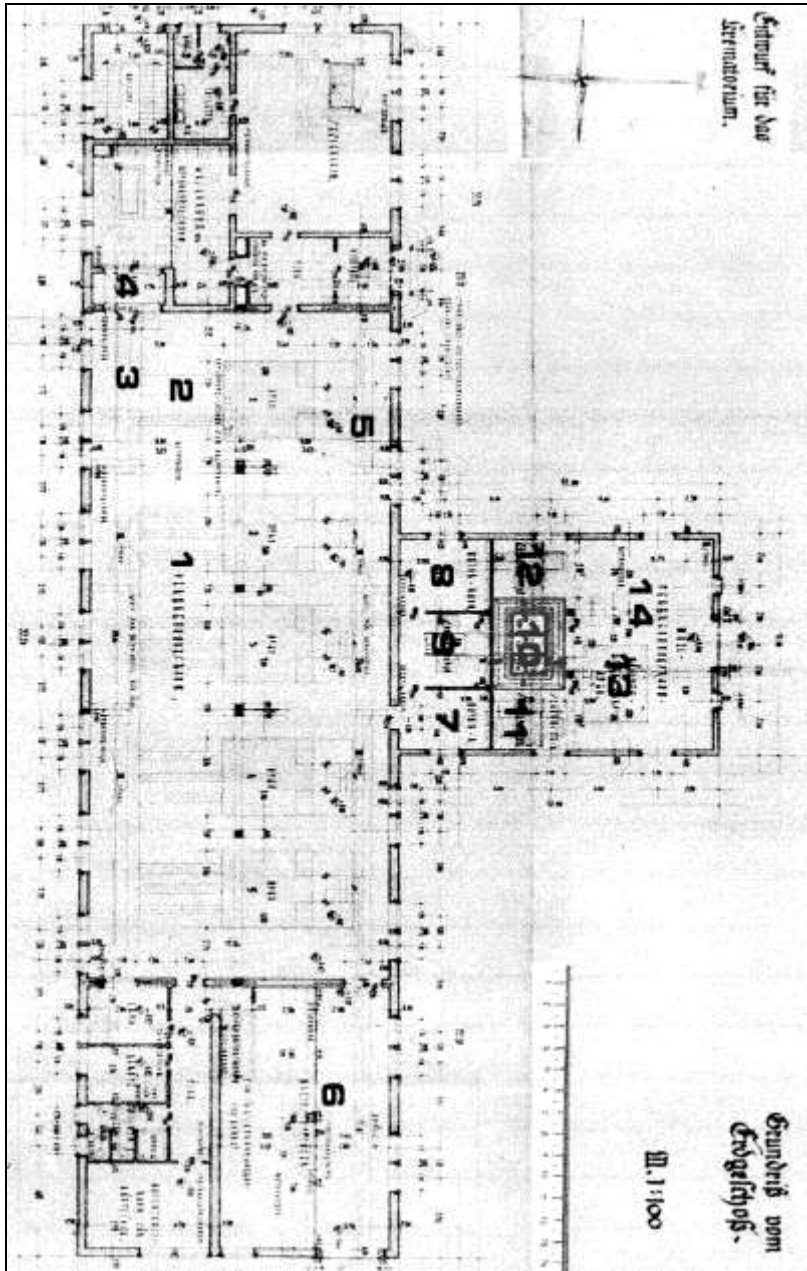

Document 222a: as above, section enlargement with labels by the author. For a description see text in Part I.

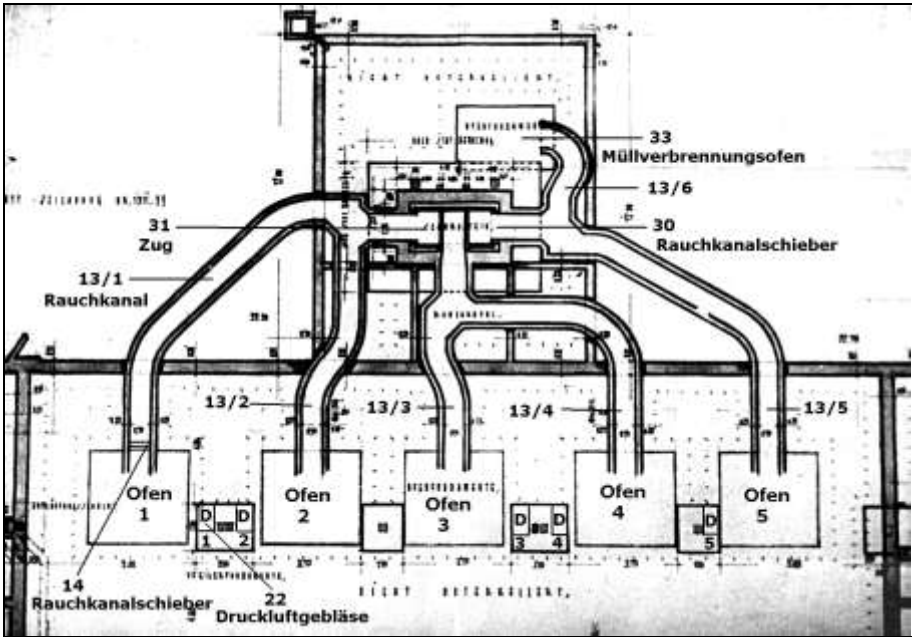

Document 223: as above, horizontal section. Layout of the smoke ducts and the chimney. Source: APMO, Negative No. 520.

1-5: Ofen=furnace; 13/1-6: smoke ducts/flues; 14: Rauchkanalschieber=smoke duct damper; 22 (D1-5): Druckluftgebläse=combustion-air blower; 30: Rauchkanalschieber=chimney's smoke duct damper; 31: Zug=chimney duct; 33: Müllverbrennungs-ofen=waste incinerator.

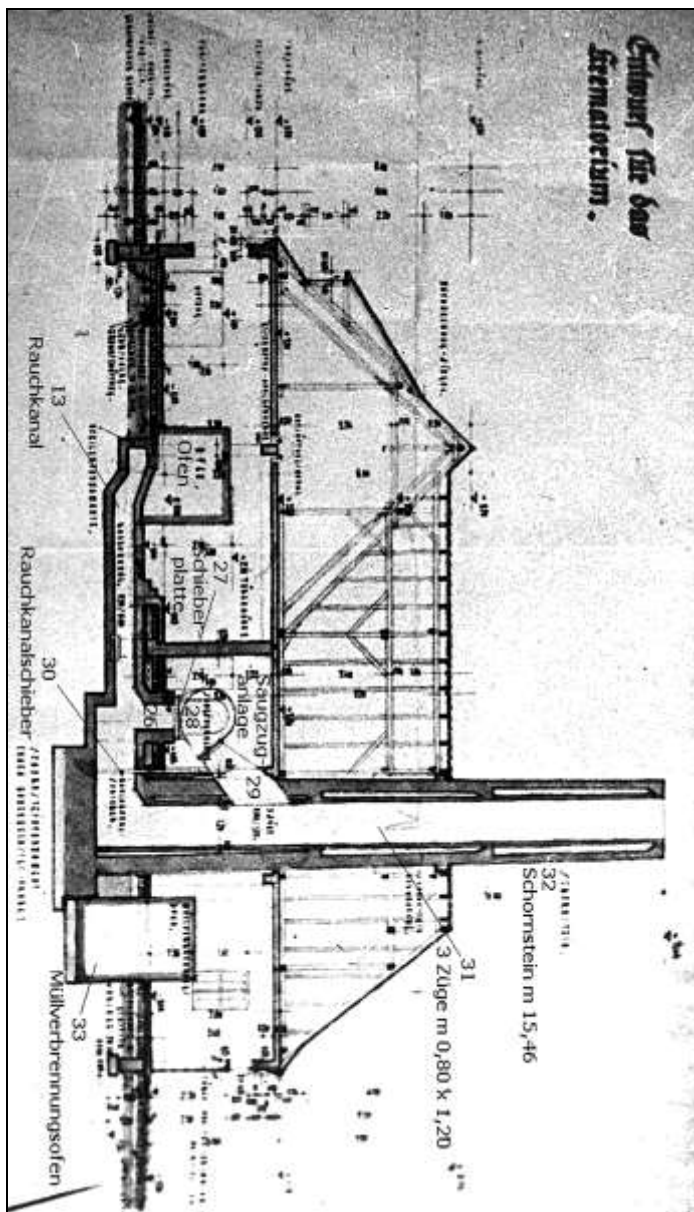

Document 224: as above, vertical section through the chimney. Drawing Nr. 933 by the Central Construction Office of 19 January 1942. Labeled by the author.

Source: APMO, Negative No. 518.

Ofen=furnace; 13: Rauchkanal=smoke duct/flue; 26: connection channel of the force-draft blower; 27: closing plate of the force-draft blower's connection channel; 28: Saugzuganlage=forced-draft device; 29: connection shaft of forced-draft blower with chimney; 30: Rauchkanalschieber=chimney's smoke-duct damper; 31: 3 Züge= 3 chimney ducts; 32: Schornstein=chimney; 33: Müllverbrennungsofen=waste incinerator.

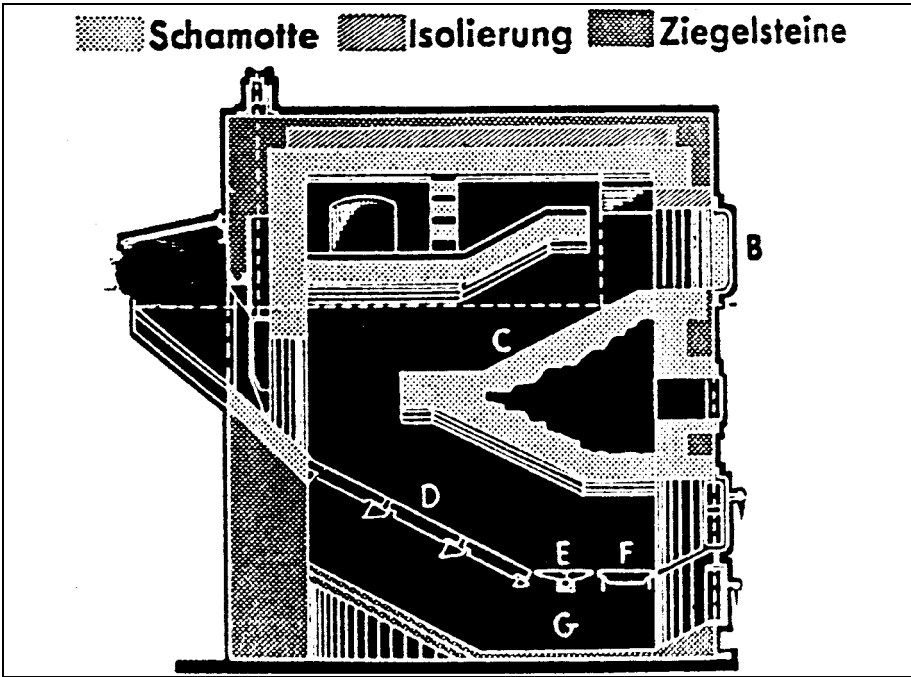

Document 225a (top): Compare the TOPF waste incinerator MV (see Doc. 161) with Document 255b (bottom): the cremation furnace for large-scale operation invented by Fritz Sander (see also Doc. 155).

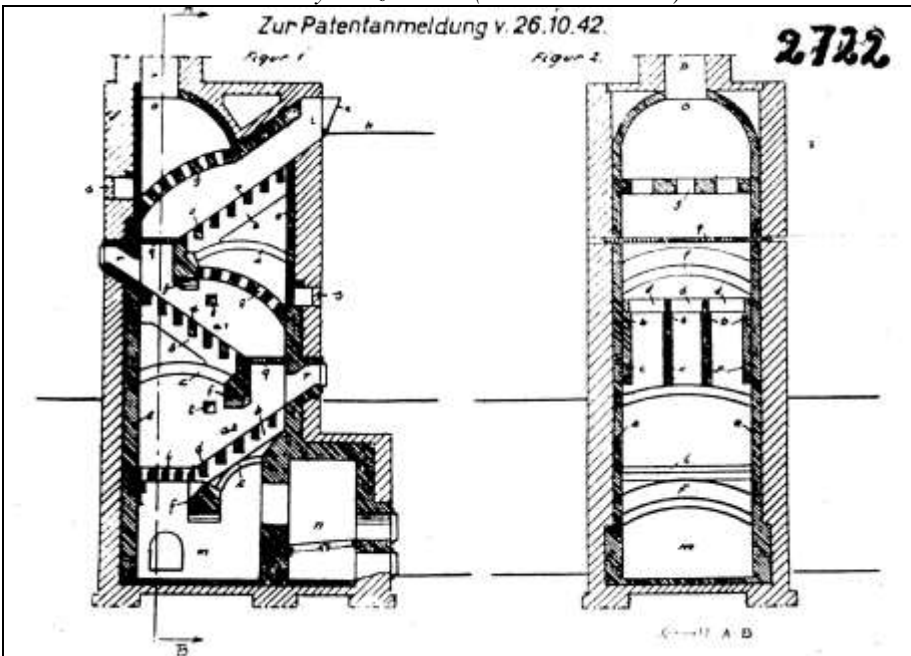

<p>Firma oder Dienststelle (mit Unterschrift versehen):</p> <p>I. A. TOPF & SÖHNE, ERFU <i>Handwritten signature: I. A. Topf</i></p>	<p>Abschrift!</p> <p>Unterzeichn. Nr. _____</p> <p>Bauvorhaben: _____</p> <p>Haushalt: _____ Kap.: _____ Tel.: _____</p> <p>Genehmigungsverfügung vom: _____</p> <p>Kosten (Vorausanschlag) vom: _____</p> <p>Auftrag Nr.: _____ vom _____ mit _____ RM</p> <p>Vertrag Nr.: _____ vom _____ mit _____ RM</p> <p>Bauwerk (BW) _____</p> <p>Bausausgabebuch Seite: _____ Nr. _____</p> <p>Freihändige Vergabung</p> <p>beschränkte Ausschreibung</p> <p>öffentliche Ausschreibung</p>				
<p>Anschrift des Empfängers:</p> <p>An die Zentral-Bauleitung der Waffen-SS und Polizei</p> <p>Auschwitz / Ost-Oberschles.</p>	<p>Ort: Erfurt, 23.8.43. Stadt: Dreysestr. 7/9</p>				
<p>Einzel- / Teil- / Schluß- Rechnung Nr. 1314 Unser Hausnr. 132 Unsere Auftrags-Nr. u. Zeichen 43 D 150</p>					
<p>Unsere Reichsbetriebs-Nr. _____</p>	<p>Ihre bestellende Dienststelle _____</p>	<p>Geduldigungsgruppe _____</p>	<p>Ihre Bestellung Nr. (liegt) _____</p>		
<p>Reisewaren-Nr. _____</p>		<p>Zeit der Lieferung, Versandtag _____</p>			
<p>Versandangaben</p>					
<p>Nr. des Kost.-An.</p>	<p>Gegenstand</p>	<p>Menge</p>	<p>Preis je Einheit</p>	<p>Betrag</p>	<p>Raum ! Vermerke</p>
	<p>Lieferung und Errichtung eines Topf-Müllverbrennungsofens im Krematorium III und zwar:</p> <p>Lieferung der</p> <p>a) zum Mauerwerksamtel nötigen Ziegelsteine und sonstigen Baustoffe erfolgt für uns kostenfrei durch die Bauleitung.</p> <p>b) der erforderlichen Schamotte-Normal-, Keil- und Formsteine, der Schamotteplatten, des Schamotte-Mörtels und der feuerfesten Stampfmasse für das feuerfeste Ofenmauerwerk,</p> <p>der notwendigen Schlackenwolle zur Isolierung des Ofens,</p> <p>c) der schmiedeeis. Ofenverankerung, der guß- u. schmiedeeis. Ofenarmaturen lt. Beschreibung in uns. Kostenanschlag vom 5.2.43</p> <p>d) Gestellung eines Monteurs zur Beaufsichtigung der Bauarbeiten (Lohn-u. Tagegelder) soziale Abgaben und anteilige Reisekosten</p>				

Document 226: Invoice of Topf No. 1314 of 23 August 1943 for the Central Construction Office at Auschwitz regarding the waste incinerator of Crematorium III. Source: RGVA, 502-1-327, pp. 13-13a.

Nr.	Nr. des Kopf-An.	Gegenstand	Menge	Preis je Einheit	Betrag	Summ f. Verweise
		e) Entsendung eines Ingenieurs zur Inbetriebnahme des Ofens,				
		f) Anlieferung der Baustoffe frei Versandstation, gem. uns. Kosten- anschlag und uns. Schrb.v.5.2.43y			5.791.--	
		<u>Ihre Zahlungen:</u>				
		31.8.1943 RM 2.900.-- ✓				
		29.11.1943 RM 2.891.-- ✓				
		RM 5.791.-- ✓				
		***** ✓				

Document 226: continued.

BETRIEBSVORSCHRIFT

des koksbeheizten Töpf-Dreimuffel-

Einäscherungsofen

Vor Beschickung der beiden Koksgeneratoren mit Koks muss der Rauchkanalschieber am Ofen geöffnet werden.

Nunmehr kann in den beiden Generatoren Feuer angefacht und unterhalten werden, hierbei ist zu beachten, dass die Sekundärverschlüsse rechts und links der Ascheentnahmetüren (Koksgeneratoren) geöffnet sind.

Nachdem die Einäscherungskammern gut rotwarm (ca. 800°C.) sind können die Leichen hintereinander in die drei Kammern eingefahren werden.

Jetzt ist es zweckmässig das seitwärts am Ofen stehende Druckluftgebläse anzustellen und ca. 20 Minuten laufen zu lassen. Hierbei ist zu beobachten, ob zuviel oder zu wenig Frischluft in die drei Kammern eintritt.

Die Regulierung der Frischluft erfolgt durch die Drehklappe die sich in der Luftrohrleitung befindet. Weiterhin müssen die rechts und links der Einführtüren angeordneten Lufteintritte halb geöffnet werden.

Sobald die Leichenteile vom Schamotterrost nach der darunter liegende Ascheschräge gefallen sind, müssen diese mittels der Kratze nach vorn zur Ascheentnahmetür gezogen werden. Hier können diese Teile noch 20 Minuten zum Nachverbrennen lagern. Dann wird die Asche in den Aschebehälter gezogen und zur Abkühlung beiseite gestellt.

Zwischendurch werden neue Leichen in die Kammern nach einander eingeführt.

Die beiden Koksgeneratoren müssen von Zeit zu Zeit mit Brennstoff beschickt werden.

Jeden Abend müssen die Generatorroste von den Koks-schlacken befreit und die Asche herausgenommen werden.

Zu beachten ist ferner, das nach Betriebsschluss, sobald die Generatoren leer gebrannt und Glutteile nicht mehr vorhanden sind, alle Luftschieber und Türen, desgl. auch der Rauchkanalschieber am Ofen geschlossen sein müssen um den Ofen nicht auszukühlen.

Nach jeder Einäscherung steigt die Temperatur im Ofen. Daher bitte beachten, dass die Innentemperatur nicht über 1000°C. kommt (Weissglut).

Diese Temperatursteigerung kann durch Luftblasen verhindert werden.

27

Abschrift/Go

J. A. T o p f und S ö h n e

An die
Zentral-Bauleitung der Waffen-SS
und Polizei,
Auschwitz /Ost-OS.

Erf

Betrifft: Ihre Zeich. Uns. ~~Abteilung~~: D IV
Krematorium, — Prf.
Einäschungs-Ofen

K o s t e n a n s c h l a g

auf

Lieferung von 2 Stück Dreimuffel-Ein-
äschungs-Ofen und Herstellung des
Schornsteinfutters mit Reinigungstr.

Document 228: "Cost Estimate" by J.A. Topf & Söhne for the Central Construction Office at Auschwitz of 12 February 1942 regarding a simplified TOPF coke-fired triple-muffle cremation furnace. Source: APMO, BW 30/34, pp. 27,32,29 (sic).

J.A.Topf u.Söhne Effurt		Abschrift/Go	2.Blatt des Kostenanschlages v. 12.2.42			
Pos.	Stückzahl	Gegenstand	Einheits-Preis		Geldbetrag	
			xx	xx	xx	xx
I).	1	<u>koksbeheizter Einäscherungs-Ofen mit 3 Muffeln,</u> wozu folgende Arbeiten und Lieferungen gehören: Das erforderliche Schamottematerial, bestehend aus Normal-, Form- und Keilsteinen und der Monolitstampfmasse sowie dem dazugehörigen Mörtel. Zur Isolierung des Ofens die erforderlichen Kieselgursteine, Schlackenwolle und Kieselgurmörtel. Die guss- und schmiedeeisernen Armaturen, wie:				32
	3	schmiedeeiserne Absperrschieber, die mit Monolitstampfmasse ausgestampft werden, einschließlich eines Riffelblech-Belages an der Vorderseite des Schiebers und Einrichtung einer Schauluke,				
	6	gusseiserne Kettenrollen,				
	6	gusseiserne Lager,				
	3	gusseiserne Wandwinden für je 500 kg Tragkraft,				
	die	erforderlichen Drahtseile und 4 Ketten für die Schieber,				
	10	gusseiserne Luftkanalverschlüsse,				
	5	gusseiserne Ascheentnahmetüren, schamottegefüllt,				
	1	gusseiserner Generator-Füllschachtverschluss, mit Isolierkappe				
	2	schmiedeeiserne Aschebehälter,				
	1	gusseiserner Rauchkanalschieber, in luftdicht schließender Führungshülse laufend, einschließlich Rollen, Drahtseil und Gegengewicht,				
	die	erforderlichen Schürgeräte für den Generator,				
	der	Planrost, bestehend aus schmiedeeisernen Vierkant-Eisen, einschliesslich den Auflager-Eisen,				

Document 228: continued

3. Blatt des Kostenanschlages vom 12.2.42						
Pos.	Stück- zahl	Gegenstand	Einheits- Preis		Geldbetrag	
			RM	RM	RM	RM
	1	<p>schmiedeeiserne Sarg-Einführungs- vorrichtung, bestehend aus einer Trage und 6 Stück Laufrollen mit Befestigungs-Eisen,</p> <p>Monteurgestellung zum Bau des Ofens und Stellung eines Ingenieurs zur Abnahme des Ofens.</p> <p>Preis Pos. I) für 1 Ofen RM 7.106,-- Preis Pos. I) für 2 Ofen RM</p>			29	14.212,--
II)	Das	<p><u>Schamottefutter für den Schornstein</u> bis zu 6 m Höhe und 12 cm Stärke.</p> <p>1 400 Schamottenormalsteine SK 30, 700 kg Schamottenörtel M 2 1 gusseiserne Einsteige- und Reinigungstür.</p> <p>Preis Pos. II) RM</p>				440,--
	0	<p>Die zum Ofen erforderlichen Ver- ankerungs-Eisen sind nach unserer Zeichnung bauseitig, ohne Kosten für uns, zu stellen. Weiter sind bauseitig, kostenlos für uns, zu liefern: Für jeden Ofen</p> <p>ca. 4 000 Stück Ziegelsteine, 6 cbm Mauersand, 1 200 kg Kalk 500 kg Zement.</p> <p>Diese Materialien gehören zum Mauerwerksmantel.</p> <p>Für die Dauer der Montage sind unserem Monteur bauseitig, kostenlos für uns, 3 - 4 Helfer zur Verfügung zu stellen.</p> <p>Kennsiffergewicht insgesamt: 3450 kg</p> <p>Die Preise unseres Angebotes gelten ab Werk, ohne Verpackung.</p> <p>Lief.Bed.A. 60.5.41 2 000. L 02041.</p>				

Document 228: continued

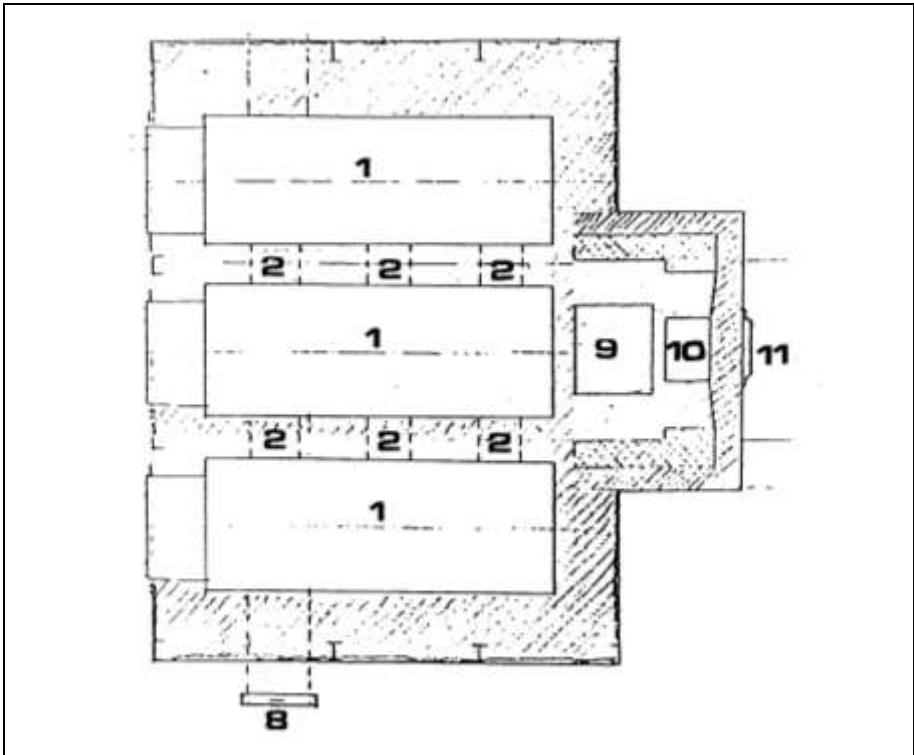

Document 229: Simplified TOPF coke-fired triple-muffle cremation furnace. Horizontal section. Labeled by Carlo Mattogno.

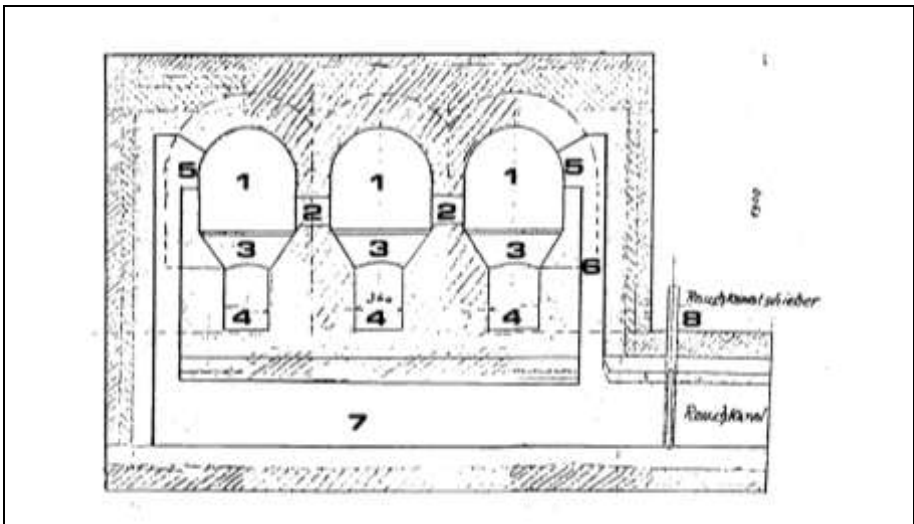

Document 229a: as above; vertical section through the combustion-gas ducts.

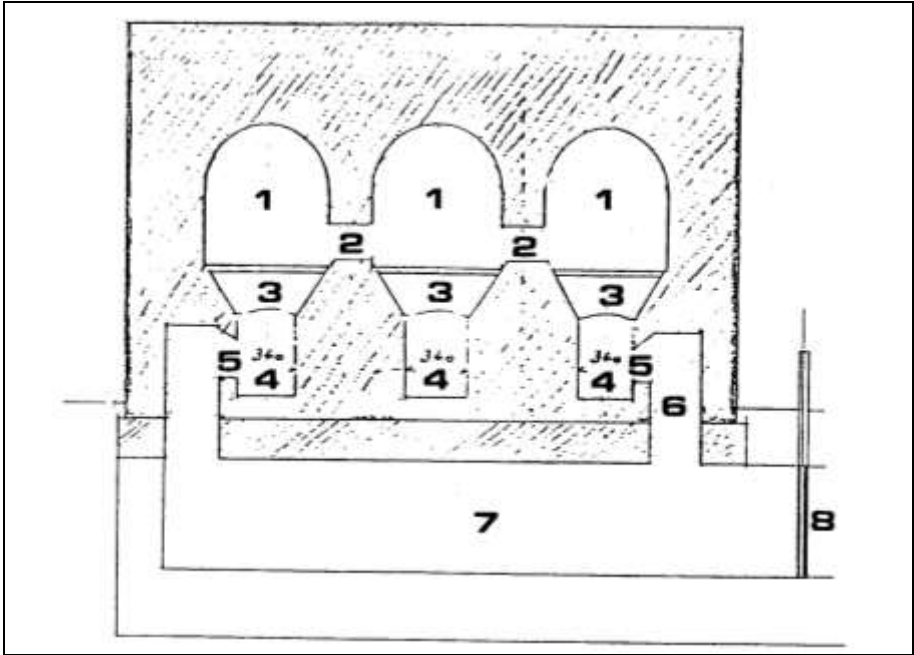

Document 229b: as above, alternative design of combustion-gas ducts.

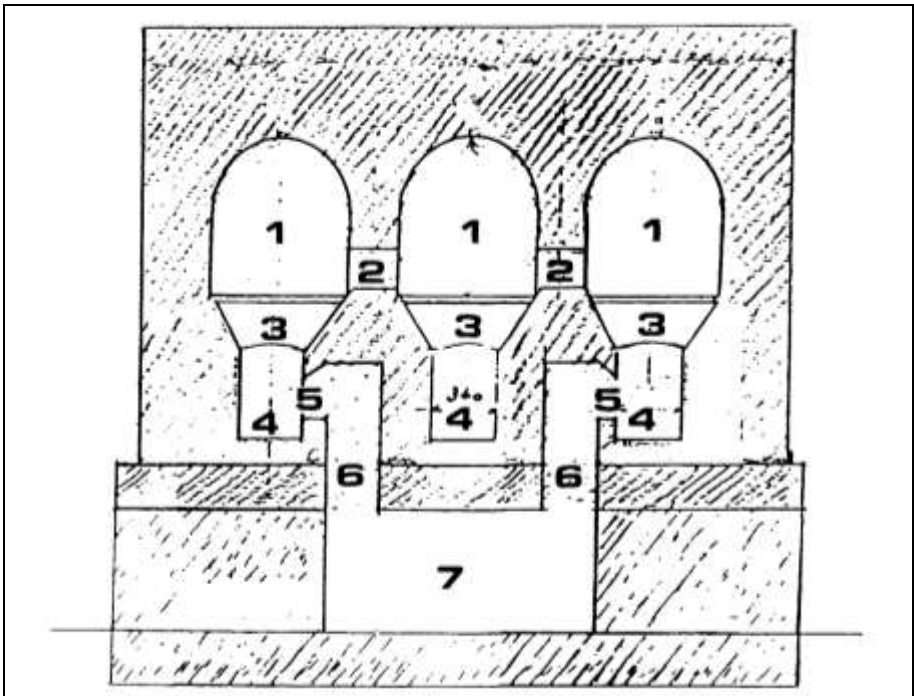

Document 229c: as before, another alternative design for the ducts.

J. A. TOPF & SÖHNE

MASCHINENFABRIK UND FEUERUNGSTECHNISCHES BAUGESCHÄFT



BERECHNUNG
TOPFWERK ERFURT
REKURD
2575 2535 2527 2528 2529
CODE 1
EUD. MOBILE CODE
A. & C. CODE
STAUDT & HUNDIUS
DILDVREIHE
RECHENKUNDE
DREHSTREIFEN
POSTSCHECKENK. O.
ERFURT 1792

An die
Zentral-Bauleitung der
Waffen-SS und Polizei,
Auschwitz / Ost-Oberschl.

Topf/Werke

ERFURT, 16.11.42
POSTFACH 509
FABRIK UND VERWALTUNG
DREYSEKASSE 7a
hes.

BETRIFF:
Uns. Angeb. Nr. 42/98e2/1.

IBR BEZUGS:
1795e/42/Jäh./Ip.

UNSERE ABRECHNUNG: D IV
Prf. ✓

Zentralbauleitung der Waffen-SS und Polizei Auschwitz O.S.				
Direktionsleiter		Eingang:		Seitennummer
		18. NOV. 1942		18472/42
Techn. Abt.	Techn. Abt.	Planung	Verwaltung	Techn. Abt.
Techn. Abt.	Techn. Abt.	Techn. Abt.	Techn. Abt.	Techn. Abt.

Kostenanschlag

über

einen Topf-Achtmuffel-Einsicherungs-

Ofen.

TOPF-FEUERUNGSANLAGEN HABEN WELTRUF

Document 230: "Cost Estimate" for a Topf wood-fired eight-muffle cremation furnace of the Mogilev Contract of 16 November 1942. Source: RGVA, 502-1-313, pp. 72-76.

J. A. TOPF & SOHNE
ERFURT

2. Blatt des Kostenanlasses vom 16.11.42.

für Auschwitz.

Lfd. Nr.	Anzahl	Gegenstand der Veranschlagung			
		<u>Lieferung und Bau eines Tonf-Achtmuffel-Einsicherungs-Ofens,</u>			
		wozu gehören:			
	Zum	Mauerwerksmantel			
		ca. 9 000 Stück Ziegelsteine (Normalformat),			
		ca. 14 m ³ Mauer sand,			
		ca. 3 000 kg Mauer kalk,			
		ca. 500 kg Zement.			
		(Diese Materialien sind unseren Monteuren kostenlos zur Verfügung zu stellen.)			
	Die	Schamottematerialien, und zwar:			
		1 600 Stück Schamottekeilsteine SK 33/34,			
		3 000 Stück Schamottenormalsteine SK 33/34,			
		1 500 Stück Schamottenormalsteine SK 32,			
		3 000 kg Schamottemörtel II,			
		35 Stück Schamotteterost-Formsteine,			
		35 Stück Schamotteformsteinplatten,			
		2 000 kg Monolitstampfmasse.			
	Die	guss- und schmiedeeisernen Armaturen, wie:			
	4 ✓	Holzfeuerungen, bestehend aus den gusseisernen Schrägrosten, den gusseisernen Planrosten, den Füllschachtdeckeln aus Riffelblech mit Verstärkungs-Risen und den schmiedeeisernen Auflager-Eisen für die Roste,			
	2 ✓	gusseiserne Rauchkanalschieber, in luftdicht schließender Führungshülse laufend, einschließlich Rollen, Drahtseile und Gegengewichte,			
	8 ✓	schmiedeeiserne Muffelabsperreschieber mit Ketten und Aufhänge-Eisen (diese Schieber werden mit Monolit ausgestampft),			
	10000 ✓	kg Kieselgur-Isolierfüllmasse,			

45 3 41.1 000 1.226 (204)

Document 230: continued.

Uz. Nr.	Anzahl	Gegenstand der Veranschlagung		
	16 ✓	gusseiserne Kettenrollen und die hierfür erforderlichen gusseisernen Lager mit schmiedeeisernen Wellen.		
	2 ✓	schmiedeeiserne Schürgeräte, bestehend aus Kratze und Schür-Eisen,		
	die ✓	erforderlichen Drahtseile, Ketten- und Seilrollen sowie Gegengewichte,		
	die ✓	Unterstützungs-Eisen zur Befestigung der Ketten- und Seilrollen,		
	4 ✓	schmiedeeiserne Aschekästen mit Verstärkungs-Eisen und je 2 Handgriffen,		
	20 ✓	gusseiserne Luftkanalverschlüsse,		
	8 ✓	gusseiserne Ascheentnahmehülen, schamottegefüttert, mit Rahmen und Spiral-Handgriffen,		
	2 ✓	Sarg-Einführvorrichtungen, bestehend aus je einer schmiedeeisernen Trage, den Laufrollen mit Befestigungs-Eisen für jede Kuffel.		
		<u>Monteursstellung</u> zum Bau des Ofens, einschließlich der Tagelöhner, sozialen Abgaben und der Reisekosten.		
		Preis des Ofens:	RM	12 972,-
		<u>Kennziffergewicht:</u> 3 000 kg.		
		Der Preis gilt für Lieferung frei Bahnwagen Erfurt.		
		Unserem Monteur müssen während der Bauzeit des Ofens genügend Helfer, ohne Kosten für uns, zur Verfügung gestellt werden. Bei Eintreffen auf der Baustelle müssen die Ofenfundamente bauseitig erstellt sein. Wünschen Sie zur Erstellung der Ofenfundamente unsere Monteure zur Beaufsichtigung, würden wir diese im Tagelohn gegen entsprechende Berechnung stellen.		
		<i>[Handwritten signature]</i> Lief. Bed. A. 60.1.42. 5 000. L/0211.	fachtechnisch richtig	

J. A. TOPF & SOHNE
 Maschinenfabrik
 Feuerungstechnisches Baugeschäft

S. ERFURT, den 8. September 1942

An die **Versandanzeige**
 Zentral-Leitung der Waffen - SS und Polizei

Auschwitz
 Ost-Oberschlesien

Hierdurch teilen wir Ihnen mit, daß wir heute folgende Sendung auf den Weg
 brachten: p. Waggon ~~mit 2 Stück 23 Erfurt~~ nach Station:
Auschwitz

Waggon Nr. 82 505/France **J. A. TOPF & SOHNE**
 mit ~~2 Stück 23 Erfurt~~ **VERSANDABRECHNUNG**

Signum	Unsere Auftrag-Nr.	Art der Verpackung Koll- zahl	Stück- zahl	Gegenstand	Gewichte in kg	
					Netto	Brutto
J.A.T.&S.	11/2435/1		2	kompl. Achtmuffel-EinAsche- rungsöfen, bestehen aus:		
	Stückl.Nr.					
	42 Bl. 2	16 lose	16 ✓	g.e. Feueröfen 280/350 mm	736	736
		24 "	24 ✓	Luftkanalverschlüsse 108/126 mm, Mod.311 a	180	180
		16 "	16 ✓	Luftkanalverschlüsse	232	232
		4 "	4 ✓	Rauchkanalschieber, be- stehend aus: (800 mm hoch, 700 mm breit) :		
		4 "	4 ✓	Hulsen	280	280
		4 "	4 ✓	g.e. Schieber	342	342
		4 "	4 ✓	Schieberstangen	8	8
		1 Bund	8 ✓	Seilrollen Fig. 2	13	13
		17 lose	17 ✓	g.e. Kettenräder, 210 mm Teilk.r., 35 mm Abg.	90	90
	28 162	16 "	16 ✓	Muffelsperrschieber	736	736
	42 Bl. 1	4 "	4 ✓	Einfahrtregan	204	204
	" 8	15 "	15 ✓	Seilrollen mit Stütze	60	60
	26 551	2 "	2 ✓	g.e. Deckel, Modell 9973 z. Generatorfüllschachtverschluss	23	23
	42 Bl. 5	8 "	8 ✓	Verschlussdeckel für die Generatoren	252	252
		4 "	4 ✓	Winkelleisen 60/60/6, je 2300 mm lang	44	44
	" 3	4 "	4 ✓	Aschebehälter aus Blech	24	24
		4 "	4 ✓	Schürgeräte	22	22
				Uebersrag		

794. 2. KL. NR. 1.024, 1. SEP. 1942

Hierzu **Beibitzer**

Document 231: "Bill of lading" by J.A. Topf & Söhne to the Central Construction Office at Auschwitz of 8 September 1942 regarding two eight-muffle cremation furnaces. Source: RGVA, 502-1-313, pp. 143-143a.

Beiblatt Nr. 1		Auftrag Nr.				
Signum	Unser Auftrag-Nr.	Art der Verpackung Kgl.-zahl	Stückzahl	Gegenstand	Gewichte in kg	
					Netto	Brutto
I.A.T. & S.	41/2435/1			Uebertrag		3245
	Stüchl. Nr.	4	lose	4 ✓ Schürstangen	13	13
	42 Bl. 3	8	"n	8 ✓ Gasrohre 2", je 1250 mm lang	44	44
		8	"	8 ✓ Winkelleisen 80/80/100 ", je 1250 mm lang	100	100
		105	"	105 ✓ g.e. Planroststäbe, je 600 mm lang, Modell 15 377	525	525
		235	"	235 ✓ g.e. Schrägroststäbe, je 940 mm lang, Modell 8735	1504	1504
	" 4 g	16	"	16 ✓ g.e. Seilrollen 152/190 mm Ø Fig. 6	114	114
		16	"	16 ✓ Vierkanteisen 70/25 mm, je 1200 mm lang	272	272
	Diech- Trommel	250		250 Vierkanteisen-Bügel MAXX mm je 150 mm gestr. Länge	131	133
		8	lose	8 ✓ Vierkanteisen 60/60 mm, je 1200 mm lang	256	256
		8	"	8 ✓ U-Eisen NP 10, je 2600 mm lg.	636	636
	1 Kiste	16		16 Winkelleisen 60/60/8 mm, je 150 mm lang	16	343
		265		265 Vierkanteisenbügel 10/10 mm, je 260 mm gestr. Länge	47	
		64		64 Steinschrauben 3/4" x 250 mm mit Muttern	39	
		16		16 Seilkeuschen } f. Drahtseil	0,5	
		16		16 Beckzahnklemmen } 8 mm	2	
		65		65 Seilkeuschen } f. Drahtseil	3	
		65		65 Beckzahnklemmen } 10 mm	10	
	" 6	32		32 Winkelleisen 100/50/8 mm, je 180 mm lang	35	
		16		16 Rollen 40 mm Ø, je 510 mm lg.	80	
		32		32 Rollen 60 " " " 50 " "	34	
		32		32 blanke Scheiben 43	2	
		32		32 Stellringe 42 mit Schrauben	7,5	
		64		64 Steinschrauben 16 mm Ø, je 170 mm lang n. Muttern	22	
	16 Bl. 2	5		5 Stern dreieckschalter f. Motor 3 PS	20	
	42 " 9	20	Seck	20 Tonelitz	1000	1000
	" 26	60	lose	60 geshm. Poststeine 140/250/650 mm	4000	4000
	" 9	40		40 gegl. 120/250/850 mm	4000	4000
		30		30		12196

Handwritten notes:
 26. 9. 1942
 M. O. H. H. H.

1914 - 8. 1. 2000 1021111 SEP. 1942

Abschrift!

Umsatz-Nr.

Rechnung Nr. 322

Umsatz-Nr. 132

Umsatz-Nr. 42 D 1422

Ort Erfurt, 23.3.43

Strasse Hauptstrasse

Drayestr. 7/9

Unsere Rechnungs-Nr.	Ihre bestellende Dienststelle	Bestellungs-Nr.	Ihre Bestellung Nr. / Tag
Rechnungs-Nr.	Zeit der Leistung, Versandtag		

Versandspesen

Nr.	Nr. des Post. Ak.	Gegenstand	Menge	Preis je Einheit	Betrag	Bem. (Vermerke)
		Wir lieferten am 25.1. bzw. 19.3.43 4 gußeis. Türen mit gußeisernen Rahmen, Spiralhandgriffen für Schamottefütterung			360.--	
		7500 kg Schlackenwolle anstelle von 5000 Isoliersteinen und 1200 kg Schlackenwolle			1218.--	
		4 Generatorroste aus Kanteisen 40/40 je 1200 mm lang,			1680.--	
		gem. uns. K.A.v.2.9. und uns. Schreiben vom 22.9.42 betr. Ihre Bestellung vom 15.9.42.			3.258.--	
		Ihre Zahlung vom 2.2.1944				
		RM 3.258.-- ✓				

1944

Bestell-Nr.

Postbest-Nr.

H-Formblatt - Rev. - 12 „Einzel-/Teil-/Schluß-Rechnung“ - Treibler, Wiesinger-Walzenbau-Druck, Kassel/Wilhelmsstraße
Formblatt 10a - Anlagenteil

Dr. A 4

Document 233: "Final Invoice" No. 322 by Topf of 12 July 1944 back-dated to 23 April 1943 regarding cast-iron doors, insulation material and gasifier grates. Source: RGVA, 502-1-327, p. 22.

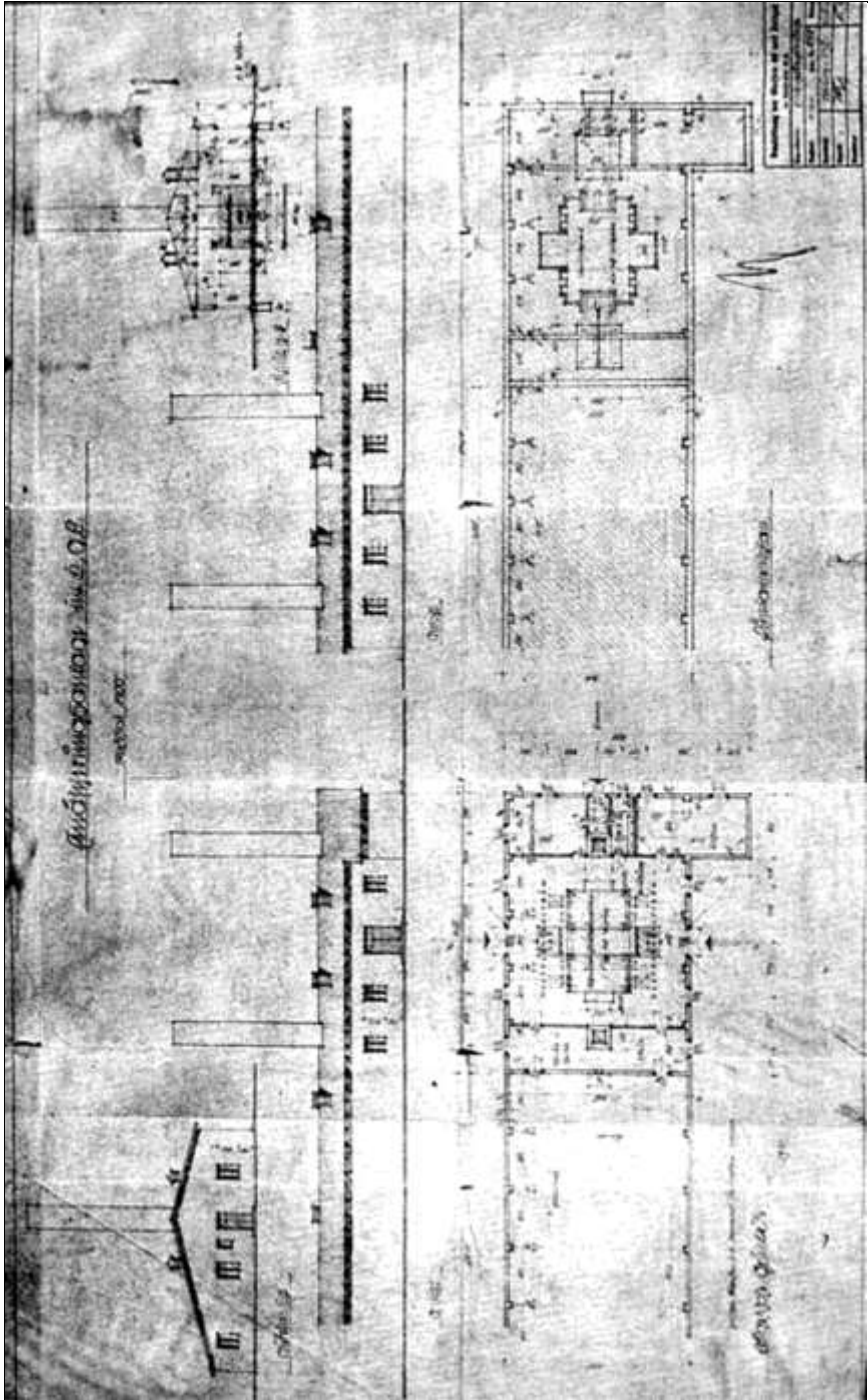

Document 234: Project Crematorium IV/V at Birkenau. Drawing No. 1678 (r) by the Central Construction Office of 14 August 1942. Source: APMO, Negative No. 20946/6.

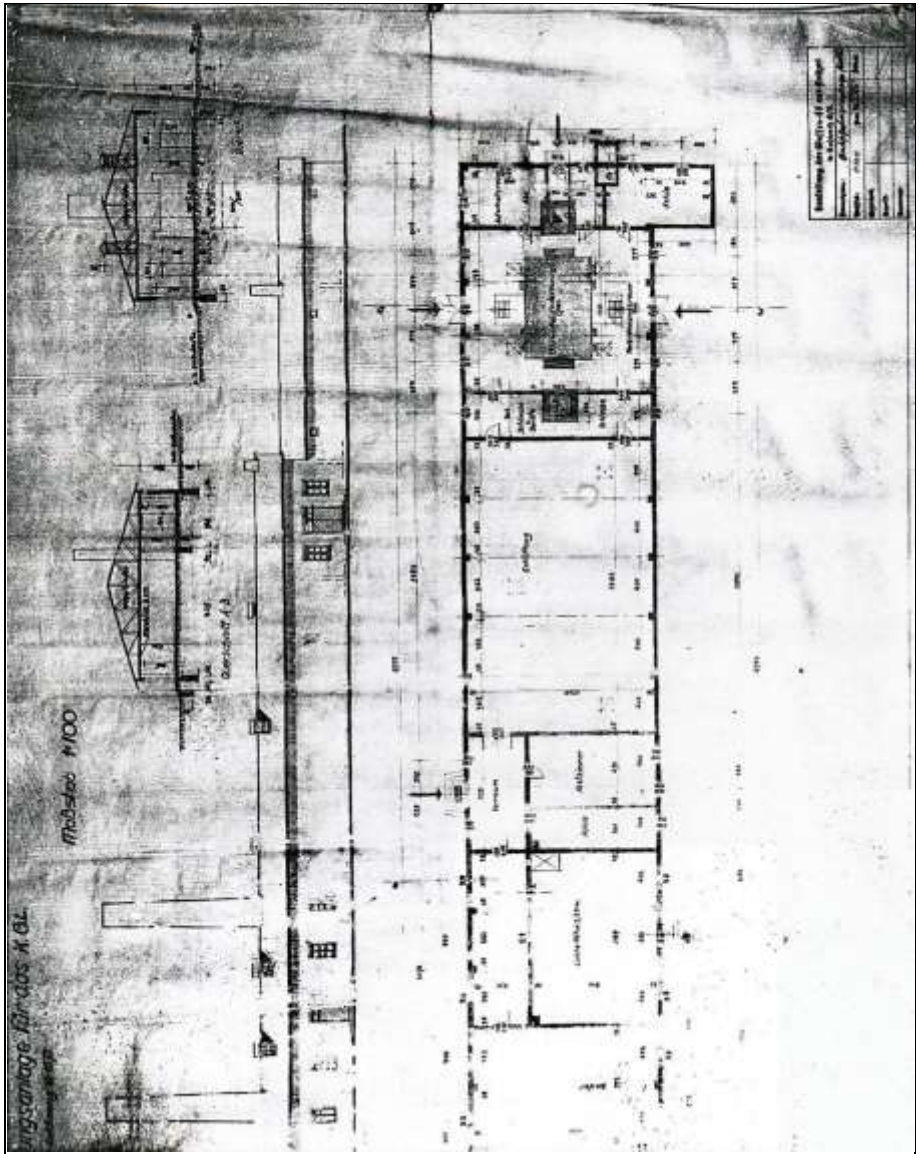

Document 235: Project Crematorium IV/V at Birkenau. Drawing No. 2036 by the Central Construction Office of 11 January 1943. Source: APMO, Negative No. 6234.

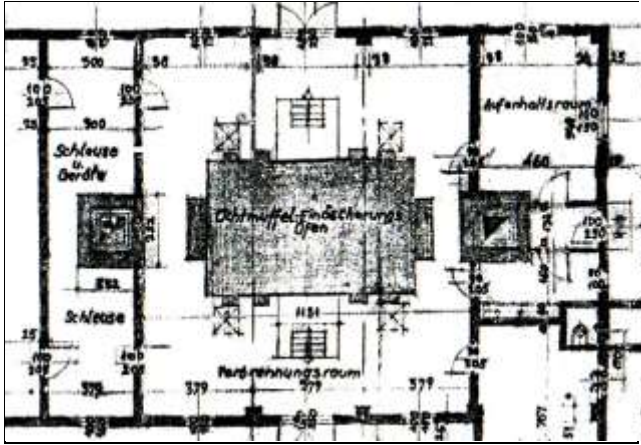

Document 235a: as above, section enlargement showing the eight-muffle furnace.

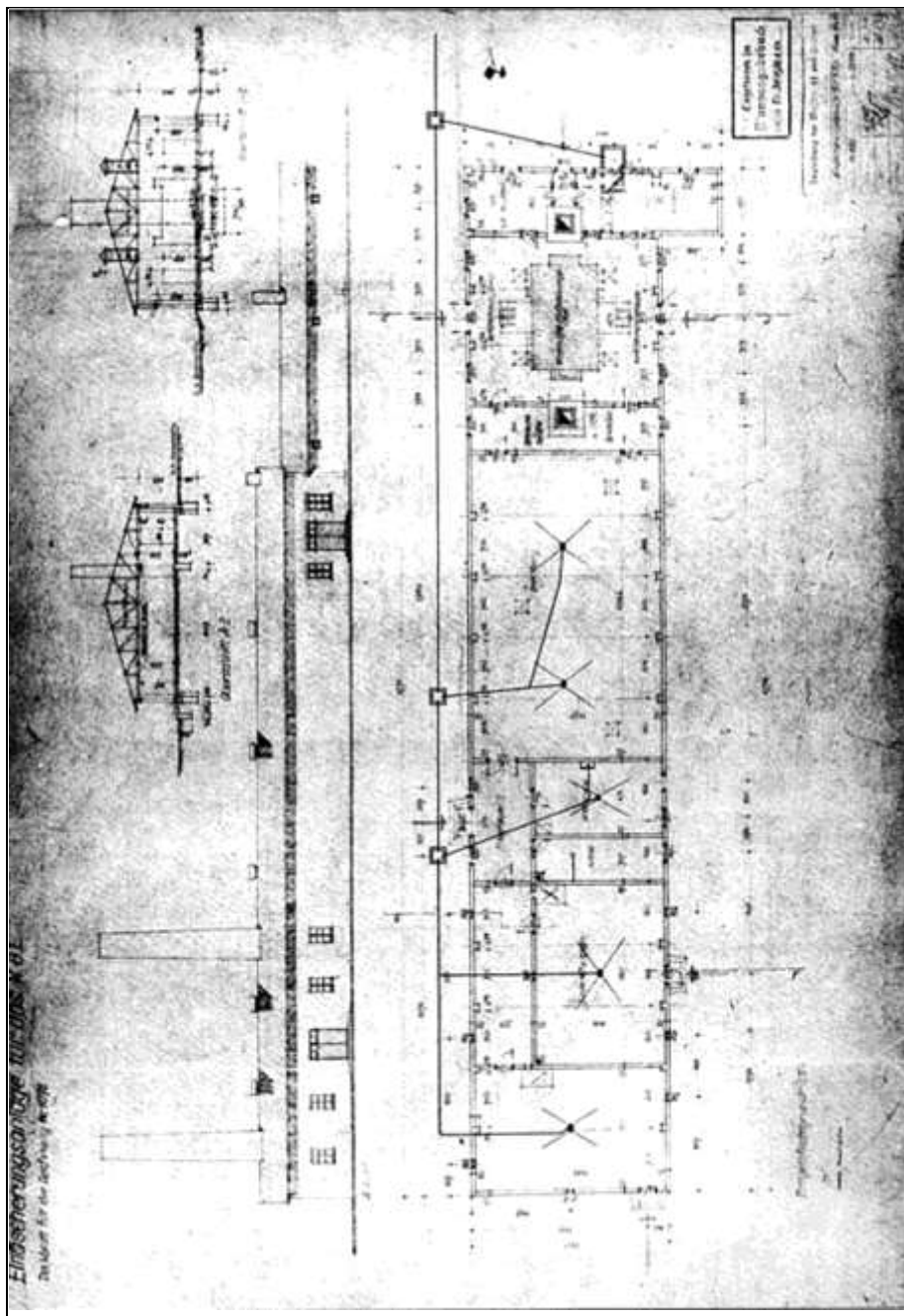

Document 236: Project Crematorium IV/V at Birkenau. Drawing No. 2036(p) by the Central Construction Office of 11 January 1943. Source: APMO, Negative No. 20818/10.

AUFTRAG NR. 412435 1.1		Kennwort <i>Mogilew</i> 149		Anzahl der Abträge				
Grupp.	Werk	STÜCKLISTE NR. 42		Besteller <i>Central-Bauleit. d. Waffen-F.</i>				
				Ort <i>Hirschowitz</i>				
Stückzahl	Bezeichnung und Bemerkung	Lfd. Nr.	Zählheft-Nr. oder Matr.-Nr.	Teil	Verfügt	Material-Nr. oder Bauteil-Nr.	Buch. Gew.	Bem.
4	h 100x100x10, L.Nr. je 2990 lg	65	360129	1	51.00.12			
2	J N°12 je 2290 lg	70	-	2	"			
4	h 100x100x10, C.Nr. je 2545 lg	71	-	3	"			
4	h 70x70x9, 2450 lg	72	-	4	"			
4	h " " " 2450 "	73	-	5	"			
2	h " " " 2060 "	74	-	6	"			
2	h " " " 2060 "	75	-	7	"			
8	h 60x60x8, je 70 lg, an Winkel Teil 3 anschraublösen	76	-	8	"			
4	Rundanker 240, je 3225 lg, an jedem Ende 100 7m lg. Gewinde M.24 anschneiden	77	-	9	"			
6	Rundanker 240, je 4480 lg, an jedem Ende 100 7m lg. Gewinde M.24 anschneiden	78	-	10	"			
2	Brennschlüßler A 10 x 455, Din 1180 mit Rostschweißenden	79	Din 1180	11	51.36.13			
20	rote Muttern M.24	80	-	12	51.36.13			
68	Sechskantschrauben M.16, je 50 lg	81	-	13				
24	Sechskantschrauben M.16, je 40 lg	82	-	14				
<p><i>Obige Teile sind in ihrer Anzahl nur für einen 8-Muffel offen angegeben.</i></p>								
<p>J.A. Topf & Söhne, Erfurt Maschinenfabrik Feuerungstechnischer Versuchsbau Gebr. 1911-1970</p>								
Übertrag:								
Topf Name Geschrieben <i>J.A. Topf</i> Geprüft Namegeprüft Akzept. Übersichtzeichnung Hauptgeplant		Gegenseite: <i>Frankenburg</i> zu einem 8-Muffel-Ofen				Abnahme: Tag Lfd. Nr. Name Unterschrift Stichtag		

Document 237: Anchoring parts for one Topf eight-muffle furnaces from the Mogilev Contract. List compiled by J.A. Topf & Söhne on 4 September 1942. Source: RGVA, 502-1-313, p. 141.

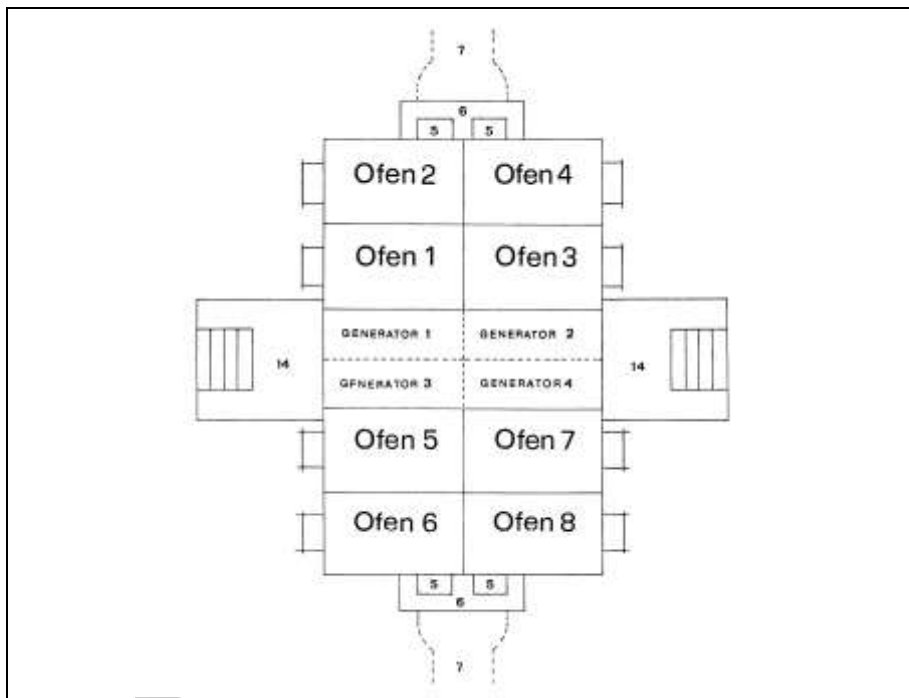

Document 238: Author's sketch of the TOPF coke-fired eight-muffle furnaces of Crematoria IV and V at Birkenau. Arrangement of the furnaces (Ofen), gasifiers (Generator) and smoke ducts.

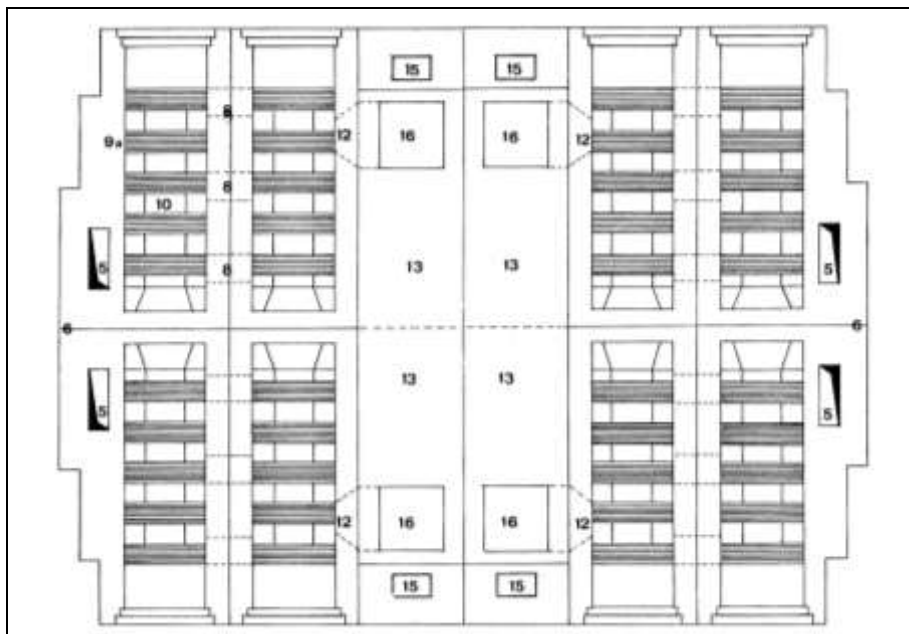

Document 239: as above. Horizontal section.

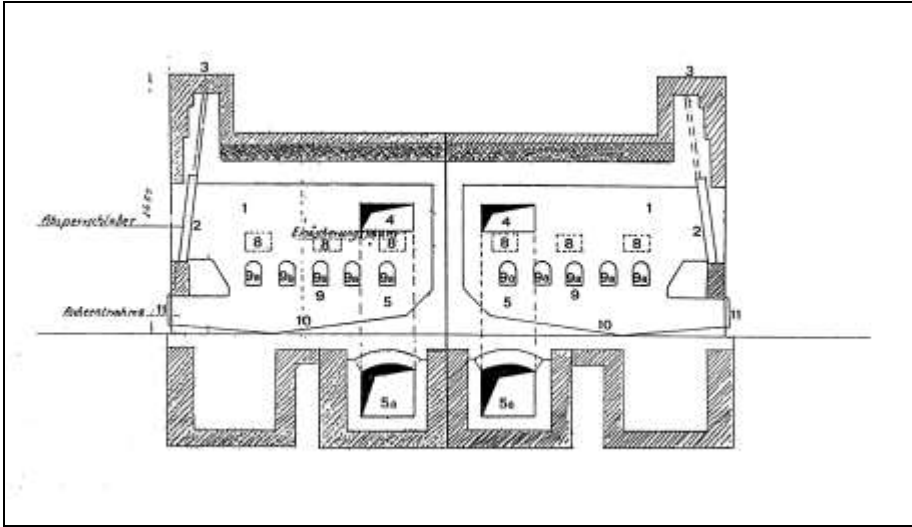

Document 240: as above. Longitudinal section through the pair of external muffles. Based on Drawing No. D 58173 by J.A. Topf & Söhne. Numbers by the author. See text of Part I for details.



Document 241: Composite photograph based on the TOPF double-muffle cremation furnace at Gusen Camp illustrating the structure of the Topf eight-muffle furnace.

An *an* J. A. TOPF & SÖHNE *Blatt* 37

Abteilung Geschäftsleitung.

Unser Zeichen: D/Sa./hes. Erfurt, den 14.9.42.

In Sachen: Einäscherungs-Öfen für Konzentrationslager.

Betrifft: Neukonstruktion. **SONDERAKTEN** *Dr. Fritz Sander*

Der starke Bedarf an Einäscherungs-Öfen für Konzentrationslager - der in letzter Zeit besonders deutlich für Auschwitz in Erscheinung getreten ist, und der laut Bericht des Herrn Prüfer wieder zu seiner Bestellung auf 7 Stück Dreimuffel-Öfen führte - veranlasste mich zu einer Prüfung der Frage, ob das bisherige Ofensystem mit Muffel für obengenannte Stellen von dem die richtige ist. Meiner Ansicht nach geht in den Muffel-Öfen die Einäscherung nicht schnell genug vor sich, um eine große Anzahl von Leichen in wünschenswert kurzer Zeit zu beseitigen. Man hilft sich also mit einer Vielzahl von Öfen bzw. Muffeln und mit einem Vollstopfen der einzelnen Muffel mit mehreren Leichen, ohne aber damit die Grundursache, nämlich die Mängel des Muffelsystemes, zu beheben.

Diese Mängel der Muffel-Öfen, die auch durch Zusammensetzung zu Vielmuffel-Öfen (Drei- bzw. Aacht-Muffelöfen) und durch das gleichzeitige Belegen der einzelnen Muffeln mit mehreren Leichen nicht aufgehoben werden, sind m.E. folgende:

- 1). Unterbrochener Betrieb.
Jede Muffel muss in bestimmten Zeiträumen neu gefüllt, gereinigt, dann wieder gefüllt und wieder gereinigt werden, und so setzt sich das Spiel während der Dauer des Ofenbetriebes fort. Zu jedem Spiel muss jedesmal die vordere Einführtür geöffnet und die Leichen müssen von vorn durch diese Tür in die Muffel eingeschoben werden. Während der Dauer dieser Handlung zieht kalte Luft in die Öfen ein, kühlt die Muffel ab, was die Haltbarkeit dieser herabsetzt, und verursacht außerdem Wärmeverluste, die jedesmal durch erhöhten Brennstoff-Aufwand ersetzt werden müssen.
- 2). Schwierigkeiten der Einföhrung.
Es ist jedenfalls eine harte und unangenehme Arbeit, die Leichen in der Längs-

L.S.W.

Eigener Brief. **Formular 4**

11. 41. 2000. 1-0011

Document 242: Letter from Engineer Fritz Sander of J.A. Topf & Söhne from 14 September 1942. Source: www.topfundsoehne.de.

richtung der Muffel in diese einzuführen, namentlich wenn in die Muffel immer gleichzeitig mehrere Leichen hineingepackt werden müssen. Auch werden dabei Beschädigungen des doch immerhin empfindlichen Muffelmauerwerkes auf die Dauer nicht zu vermeiden sein.

3). Großer Platzbedarf der Mehrmuffel-Öfen.

In bezug auf die Grundfläche nehmen die Mehrmuffel-Öfen ziemlichen Raum ein und bedingen zu ihrem Aufbau eine erhebliche Materialmenge. Außerdem müssen die zu verbrennenden Leichen jedesmal vor die Einführöffnung der betr. Muffel transportiert, also auf eine ganze Anzahl solcher Stellen verteilt werden. Solche sind somit über die gesamte Grundfläche des Einsäckerungsraumes verstreut. Das Gleiche gilt bedingt auch für das Heizmaterial.

Zur Behebung vorgenannter Nachteile und als meiner Ansicht nach ideale Lösung bezüglich Bauart eines Einsäckerungs-Ofens für die Zwecke eines Konzentrationslagers sehe ich einen solchen mit kontinuierlicher Beschickung und für ebensolchen Betrieb an. Vorteilhaft wäre z.B. ein derartiger Ofen in Form eines Tunnel-Ofens. Dabei würden die einzusäckernden Leichen am vorderen Ende eines langgestreckten, inwendig beheizten Tunnels auf eine bewegte Auflage-Vorrichtung aufgegeben werden, die sich längs durch den Ofen hindurchzieht, die Leichen durch eine Anheizzone in die Verbrennungszone führt und am Schluss die Asche austrägt. Demgegenüber steht aber die oft erwiesene Unmöglichkeit, irgendwelche Eisenteile auf die Dauer im Feuer beweglich zu erhalten, auch wenn, wie im vorliegenden Falle, die bewegten Teile oben naturgemäß mit Schamotte verkleidet würden. Außerdem wäre ein ständiger Kraftbedarf zum Bewegen der beispielsweise als Doppelkette ausgebildeten bewegten Auflage-Vorrichtung notwendig. Schließlich wäre die Anordnung der Rauchgaszüge usw. kompliziert, sodass aus allen vorgenannten Gründen diese Anordnung ausscheiden würde.

Wenn also ein Ofen kontinuierlich beschickt und betrieben werden soll, so muss - um im Feuer zu bewegende Konstruktionsteile zu vermeiden - die Bewegung der eingeführten Leichen innerhalb des Ofens selbsttätig durch die natürliche Schwerkraft erfolgen. ~~Statt~~ Die Leichen müssen also auf entsprechend geneigten und geformten Unterlagen in den Ofen hinein und durch diesen hindurchgleiten, auf diesem Wege in's Brennen geraten und schließlich an einer geeigneten Stelle ausbrennen und veraschen. Ich habe einen entsprechenden Entwurf ausgearbeitet, der 3 Gleitbahnen vorsieht, die zickzackartig aufeinander folgen und rostartig ausgebildet sind. Oben, am Anfang der obersten



Fortsetzung

Datum
14.9.42.Blatt
-2-

Bericht von Herrn Sander

betr.: Einäscherungs-Öfen für Konzentrationslager.

Gleitbahn befindet sich eine genügend weite Einführöffnung, die normalerweise stets durch eine geeignete, nach innen ausweichende Klapptür geschlossen ist. Durch diese Einführöffnung werden die einzusähernden Leichen so aufgegeben, dass sie quer zur Längsrichtung des Körpers auf die erste Gleitbahn gelangen. Um die Quereinführung zu ermöglichen, ist der Ofen mit 1,9 m lichter Breite vorgesehen. Am Ende der ersten Gleitbahn schließt sich an der Umkehr, in entgegengesetzter Neigung, die zweite Gleitbahn an, an dieser die dritte und am Fuße letzterer ist der wagerechtliegende Ausbrennrost vorgesehen. Vor diesem wird die Feuerung angeordnet, die entweder als Planrost-, Treppenrost-, Generator-, Öl- oder sonstige Feuerung ausgeführt werden kann, je nach dem Brennmaterial, welches verheizt werden muss. Die Flammen- bzw. Heizgas-Führung ist so gedacht, dass alle Gleitbahnen und sonstigen Auflagen, die ja, wie oben gesagt, rostartig ausgebildet sind, den Flammen und Rauchgasen von unten bis oben den Durchgang ermöglichen. Die Einäscherungs-Objekte sind also auf dem ganzen Weg durch den Ofen den Einwirkungen der Flammen bzw. Heizgasen ausgesetzt. Ebenfalls am oberen Ende des Ofens, der Einführöffnung gegenüber, liegt die Austrittsöffnung für die abzuleitenden Rauchgase, die dort in geeigneter Weise in den Schornstein eintreten können.

Durch entsprechend angeordnete Nachstoßöffnungen kann bei einem eventuellen Festbrennen oder Festklemmen der Einäscherungs-Objekte von außen nachgeholfen werden. Asche, die beim Verbrennungs-Vorgang innerhalb des Ofens anfällt, soll, soweit möglich, durch die Öffnungen der Gleitbahnen und sonstigen Auflagen nach unten durchfallen. Solche Asche, die sich unterwegs eventuell auf der Rückseite durchbrochener Gewölbe und sonstwo absetzt, soll durch entsprechende Asche-Reinigungsöffnungen nach außen abgezogen werden. Die Hauptasche sammelt sich unter dem Ausbrennrost in einer entsprechend großen Aschekammer, die an ihrer Oberfläche auch dauernd der Einwirkung der Heizgase unterliegt, sodass auch noch nicht ausgebrannte Reste der Einäscherungs-Objekte in diesem Ascheraum noch nach- und austrennen können.

Eigener Brief
Formular 5D.S.

S. 41. 100 Bl. 1.0211

Ein Ofen dieser Bauart würde also ununterbrochen arbeiten, d.h., die zu verbrennenden Leichen würden oben - ohne Störung des Verbrennungsvorganges - in entsprechenden zeitlichen Zwischenräumen aufgegeben, auf dem Weg durch den Ofen sünden, brennen, ausbrennen und veraschen, und in Form ausgebrannter Asche in der Aschekammer unter dem Ausbrennrost landen. Dabei bin ich mir vollkommen klar darüber, dass ein solcher Ofen als reine Vernichtungs-Vorrichtung anzusehen ist, dass also die Begriffe Pietät, Aschetrennung sowie jegliche Gefühlsmomente vollständig ausgeschaltet werden müssen. All das ist aber wohl auch schon jetzt bei dem Betriebe mit zahlreichen Muffel-Öfen der Fall. Es liegen eben in den KZ-Lagern besondere kriegsbedingte Umstände vor, die zu derartigen Verfahren zwingen.

Ein erschwerender Umstand beim Betrieb der von mir vorgeschlagenen Neukonstruktion gegenüber den bisherigen Muffel-Öfen liegt lediglich darin, dass der neue Ofen höher bauen würde, und dass die Einäscherungs-Objekte infolgedessen erst auf eine gewisse Höhe gebracht werden müssten. Ich betrachte diesen Umstand jedoch nicht als so schwerwiegend, & um deswegen die Neukonstruktion nicht vorzuschlagen, weil sich das Hochbringen der Leichen jedenfalls durch eine entsprechende Vorrichtung - entweder einen Aufzug einfachster Konstruktion oder eine schiefe Ebene - ausgleichen lässt und in keinem Verhältnis zu den zu erwartenden Vorteilen des neuen Ofens steht.

Eine weitere Erschwernis, die allerdings nur bei den ersten Ausführungen eintreten ^{wird} ~~mag~~, ist die, dass eine ganze Anzahl Schamotteformsteine und demzufolge Modelle für solche gebraucht werden, weil selbstverständlich im Innern des Ofens Eisenteile soviel als irgend tunlich vermieden werden müssen. Vorläufig habe ich lediglich oben, im kühleren Teil des Ofen-Innern, neben einigen Querformeisen, einen schweren gusseisernen Hohlbalken als Stütze für ein Gewölbe vorgesehen. Auch dieser kann aber voraussichtlich noch durch eine Formstein-Konstruktion ersetzt werden. Der sonstige Aufwand an Eisen ist nicht erheblich und beschränkt sich auf gusseiserne Armaturen und eine in Stahlkonstruktion auszuführende Einführ-Vorrichtung, sodass für letztere neue Modelle nicht angefertigt werden brauchen. Die erforderliche kräftige Mauerwerksverankerung muss natürlich auch bei diesem Ofen vorgesehen werden.

Herr Prüfer, mit dem ich über die Angelegenheit bereits gesprochen habe, bezweifelt, dass die Leichen selbsttätig durch den Ofen gleiten, weil nach seinen Beobachtungen an normalen Einäscherungs-Öfen in Krematorien angebrannte Leichenteile selbst auf stark

33



Fortsetzung

Datum
14.9.42.

Blatt
-3-

Bericht von Herrn Sander
betr.: Einischerungs-Öfen für Konzentrationslager.

geneigten Flächen zum Anbacken neigen. Ich kann diese Befürchtung nicht teilen, soweit solche aber zurecht besteht, könnte sie sicher durch die Wahl eines anderen Rutschwinkels behoben werden. Vorläufig habe ich für alle 3 Gleitbahnen eine Neigung von 35 Grad gegen die Wagerechte vorgesehen, weil erfahrungsgemäß bei diesem Rutschwinkel auch schwieriges Brennmaterial selbst rutscht. Außerdem ist ja zu beachten, dass im Maße der fortschreitenden Verbrennung den durch den Ofen gleitenden Leichen immer an dem unteren Ende der Gleitbahn die Stütze entzogen wird. Das Schwerkraft liegt somit immer am oberen Teil der Gleitbahn und drückt die auf dieser lagernde Schicht von oben her nach.

Mit Rücksicht auf die eingangs gemachten Darlegungen ist anzunehmen, dass die infragekommenden Behördenstellen auch andere Ofenbaufirmen wegen Lieferung gut und schnell arbeitender Einischerungs-Öfen in Bewegung setzen. Auch bei diesen wird daher die Frage nach der günstigsten Bauart derartiger Öfen für vorgenannte Zwecke geprüft werden. Ich muss also voraussetzen, dass diese Frage jetzt allseitig aufgerollt wird, und dass daher auch in anderen Ofenbaufirmen Gedanken für neue Bauarten derartiger Öfen auftauchen. Aus diesem Grunde halte ich es für dringend notwendig, meinen Vorschlag zum Patent anzumelden, damit wir uns die Priorität sichern.

Außerdem halte ich es für wünschenswert, die Neukonstruktion einmal gründlich durchzuarbeiten, da sich dabei sicher noch mancher Vorteil herausholen lässt. Z.B. könnte ein derartiger Ofen auch als Doppel-Ofen ausgebildet werden, mit der Feuerung an beiden Enden und dem oder den Schornsteinen in der Mitte. Will man auf die anerkannten verbrennungstechnischen Vorzüge der Muffel nicht verzichten, so kann der Raum über dem Ausbrennrost auch als Muffel ausgebildet werden. Diese würde dann an einer Längsseite offen sein und durch letztere von der untersten Gleitbahn her beschickt werden. Die Muffel würde dann für eine Beschleunigung des Ausbrandes sorgen und damit zu einem noch schnelleren Durchlass durch den Gesamt-Ofen mit beitragen.



Eigener Brief
Formular 5

4.45. 100 Bl. L.0111



mtly. Anmerkung Bst 30.30
 12. Februar 1943.

80

Bftgb.Nr. 22447/43/20/Schu.

Betr.: Krematorium VI.

Bezug: - ohne -

Anl.: 1 Klammer.

An den

Lagerkommandanten

† - Obersturabannführer H ö s s

Auschwitz O/S!

Unter Bezugnahme auf die Unterredung des Unterfertigten und des Ingenieur P r i f e r von der Firma Topf und Söhne am 29.1.43 wurde die Planung eines 6. Krematoriums (eine offene Verbrennungskammer mit den Ausmaßen von 43,75 x 3,76 m) in Erwägung gezogen. Die Zentralbauleitung hatte daraufhin die Firma Topf und Söhne beauftragt, einen Entwurf für diese offene Verbrennungsstätte anzufertigen, der in der Anlage beigelegt wird.

Sollte der Bau dieses 6. Krematoriums durchgeführt werden, so wird gebeten, einen entsprechenden Antrag durch die Amsgruppe D an die Amsgruppe C zu stellen.

Bei einer eventuellen Durchführung dieser Anlage sind ausser den jetzt im Einsatz befindlichen Arbeitskräften neue Arbeitskräfte durch die Kommandantur zur Verfügung zu stellen. Es sind hierzu erforderlich:

150 Häftlingsmaurer

200 Häftlingsbauhilfsarbeiter.

Die Durchführung der Baumaßnahme ist abhängig von der Gestellung vorerwähnter Arbeitskräfte.

Der Leiter der Zentralbauleitung
 der Waffen-† und Polizei Auschwitz.

Verteiler:

†-Ustuf. Pollok

†-Ustuf. Janisch

†-Ustuf. Kirschneck

Registatur (Akt Krematorium KGL BW 30)

† - Sturabannführer. *f*

Document 243: Letter from the head of the Central Construction Office Bischoff to the Camp Commandant Höss of 12 February 1943 regarding "Crematorium VI".

APMO, BW 30/34, p. 80.

Man rechnet auf 1 m² Brennraum 300 NSt. Bei 60 m Brennkannlänge und Schornsteinauszug von 3 bis 5 mm WS beträgt der tägliche Feuerfortschritt etwa 6 m.

Ofenleistung nach der Näherungsformel: $L = q \cdot l \cdot 300/10$.

Dabei ist L Tagesleistung in NSt.,
 q Querschnitt des Brennkannals [m²],
 l Länge des Brennkannals [m].

Ein langer Brennkannal beansprucht stärkeren Zug als ein kurzer. Kohlenverbrauch etwa 150 kg Steinkohlen je 1000 NSt.

Empfindliches Gut muß langsam gebrannt werden. abwechselnd mit einem Überschuß von sauerstoffreicher

Luft (oxydierend) und mit einem Mangel an Sauerstoff (reduzierend) zu brennen. Besonders beim Brennen von Eisenschmelzlinkern ist dies wichtig, weil durch reduzierendes Brennen das schwer schmelzbare Eisenoxyd in das leicht schmelzende Eisenoxydul übergeführt wird und dieses den dunklen Metallglanz des Klinkers erzeugt.



Abb. 17. Ringofen (rd. 1/1000 nat. Größe).



Abb. 18. Ziegelei mit Zick-Zack-Ofen und Kammerrockner (rd. 1/100 nat. Größe).

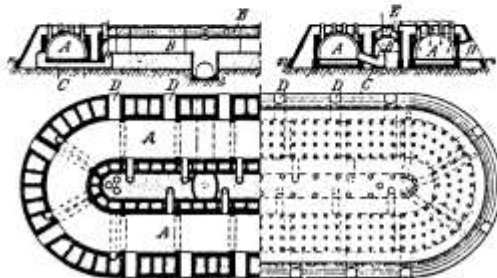

Abb. 19. Tunnelofen.

nach jedem Brande müssen die Wände so weit abgekühlt werden, daß das Arbeiten im Ofen erträglich wird. Das bedeutet Wärmeverluste, und außerdem sind nur schwer die erforderlichen Arbeiter hierfür zu beschaffen. Beide Übel-

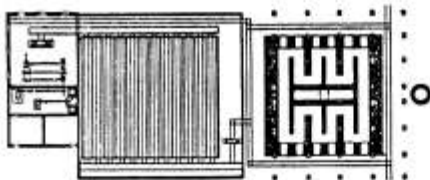
Verfärbungen. Aus den Rauchgasen können auf dem frischen und kühlen Einsatz H₂O und SO₂ niedergeschlagen und dadurch Verfärbungen erzeugt werden. Um dies zu verhindern, leitet man angewärmte, reine Luft aus den Kühlkammern des Ofens hinter dem Feuer in besonderen Schmauchkanälen (Abb. 17, E) an der Feuerzone

des Ringofens vorbei in die vorderen, zwischen Papierschiebern abgeschlossenen Abteile. Vgl. Vormauersteine S. 742.

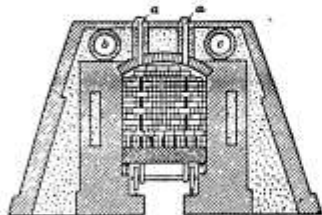
Zickzacköfen, Abart des Ringofens (Abb. 18), beansprucht wenig Raum und hat weniger Wärmeverluste durch Strahlung.

Man kann im Zickzackofen schnell brennen und deshalb mehr Wärme aus den Kühlkammern zu Trockenzwecken entnehmen.

In den bisher genannten Öfen wird das Gut im Brennkannal selbst durch menschliche Arbeitskräfte eingesetzt und ausgebracht;

D 133**Kostenvoranschlag der Fa. Topf
für einen Verbrennungsöfen, 1943****I. A. Topf & Söhne
Erfurt****Kostenanschlag vom 1. 4. 43**

für Auschwitz

Lfd. Nr. Anzahl Gegenstand der Veranschlagung

- 1 gußeiserner Rauchkanalschieber mit Rollen, Drahtseil
und Handwinde,
die erforderlichen Schürgeräte,
Monteurstellung
zum Bau des Ofens, einschließlich Reisekosten, Tage-
gelder und sozialer Abgaben.

Preis des Ofens: **RM 25 148,-**
Kennziffergewicht: 4037 kg

Während des Baues sind unseren Monteuren genügend
Helfer, kostenlos für uns, zur Verfügung zu stellen. Die
gesamten Mauermaterialien, wie Ziegelsteine, Sand,
Kalk und Zement, müssen rechtzeitig auf der Baustelle
zur Verfügung stehen; diese Materialien sind uns eben-
falls kostenlos beizustellen. Es handelt sich um:

- ca. 19 000 Stück Ziegelsteine,
ca. 20 cbm Mauersand,
ca. 800 kg Zement,
ca. 6 000 kg Kalk.

Der Preis für den Ofen gilt frei Bahnwagen verladen
ab Station.

ppa. I. A. Topf & Söhne
gez.: zwei Unterschriften
(vermutlich: Sender, Erdmann)

Lief. Bed. A. 60. I. 42 5000 L/0211

Document 245: Last page of a cost estimate by J.A. Topf & Söhne of 1 April 1943 for the Central Construction Office at Auschwitz regarding a "cremation furnace". Source: R. Schnabel, Macht ohne Moral. Eine Dokumentation über die SS. Röderberg-Verlag, Frankfurt/Main, 1957, p. 351.



Document 246: Letter from J.A. Topf & Söhne to the SS New Construction Office of the Mauthausen Concentration Camp of 1 November 1940 regarding a cost estimate for a TOPF coke-fired double-muffle cremation furnace. Source: Bundesarchiv Koblenz, NS 4/Ma 54.

 J.A. TOPF & SÖHNE, ERFURT

TAG BLATT
1.11.40. -2-

EMFFANGER

Reichsführer SS, Neubauleitung KL,
M a t h a u s e n.

Escherung kommen können.

Damit Sie die Vorarbeiten zum Bau des Ofens jetzt schon treffen können, übersenden wir Ihnen gleichfalls einen Abzug unserer Zeichnung D 57 253.

Wir bitten um Erteilung Ihres geschätzten Auftrages.

Heil Hitler !
J. A. TOPF & SÖHNE

ppa.



i.V.



Anlagen:

- 1 Kostenanschlag,
- 1 Zeichnung D 57 253,
- 1 Aufstellung.

J. A. TOPF & SOHNE
 MASCHINENFABRIK UND FEUERUNGSTECHNISCHES BAUGESCHÄFT

CODES
 SUP. MOSE-CODE
 A.B.C. CODE
 STAUBT & HUNDIUS

GEGR. **TOPF** 1878

BEANTWORT
 TOPFWERKE ERPFURT
 FERNLEUF
 224 25 2576 2327 2318 2319
 GELDERKASSE
 REICHSBANKE
 GIBRICHTO
 POSTSCHECKKONTO
 ERPFURT 1792

SS-Neubauleitung
 18. JULI 1941
 K. L. Mauthausen
 P 728

An den
 Reichsführer S.S., Chef
 der deutschen Polizei
 Hauptamt Haushalt und Bauten
 S.S. Neubauleitung Mauthausen

Mauthausen /Oberdonau

BETRIEFF:
 Ihr Schreiben vom 9.7.41 N/L. - Sc.
Einäscherungs-Ofen.

ERPFURT, den 14.7.1941

FABRIK UND VERWALTUNG
 GREYSSTRASSE 74
 18.

UNSERE ABTEILUNG: **D IV/Erfr.**

IHR ZEICHEN

Im Verfolg unseres oben angeführten Schreibens übersenden wir Ihnen wunschgemäß eine Bedienungs-Vorschrift in dreifacher Ausfertigung mit der Bitte, eine hiervon im Ofenraum an sichtbarer Stelle aufzuhängen. Die beiden anderen können Sie zu Ihren Akten nehmen.

*fr. Falle 1943
 würden im gleichen Ofen in 10 Minuten bis zu 300 Leichen verbrannt.*

In dem kesselsbeheizten TOPF-Doppelmuffel-Einäscherungs-Ofen können in ca. 10 Stunden 30 bis 36 Leichen zur Einäscherung gelangen. Vorstehende Anzahl kann ohne weiteres taglich zur Einäscherung kommen, ohne den Ofen zu überlasten. Es schadet auch nichts, wenn der Betrieb es erfordert, dass Tag und Nacht Einäscherungen hintereinander vorgenommen werden. Die Tatsache besteht, dass die Schamottenmaterialien länger halten, wenn im Ofen dauernd gleichmäßige Temperatur herrscht.

Wir hoffen, mit Verstatendem bestens gedient zu haben und empfehlen uns Ihnen inzwischen.

Heil Hitler!

GGA J. A. TOPF & SOHNE

Herrn Widmann

Document 247: Letter from J.A. Topf & Söhne to the SS New Construction Office of Mauthausen Concentration Camp of 9 July 1941. Source: SW, LK 4651.

28. Juni 1943. ^{040/b}
 14a

31550/Ja./No.-

Betr.: Fertigstellung d. Krematoriums III

Besug: ohne

Anl.: -/-

An das

Wirtschafts-Verwaltungs-
 hauptamt, Amtsgruppenchef G
 Brigadeführer u. Generalmajor
 Dr.-Ing. K a m m l e r
 Berlin- Lichterfelde. - West

Unter den Eichen 126 - 135

Melde die Fertigstellung des Krematoriums III mit dem
 26.6.1943. Mithin sind sämtliche befohlenen Krematorien fertig-
 gestellt.

Leistung der nunmehr vorhandenen Krematorien
bei einer 24 stündigen Arbeitszeit :

<u>1.) altes Krematorium I</u>		
5 x 2 Muffelöfen	340	Personen
<u>2.) neues Krematorium I.K.G.L. II</u>		
5 x 3 Muffelöfen	1440	Personen
<u>3.) neues Krematorium III</u>		
3 x 3 Muffelöfen	1440	Personen
<u>4.) neues Krematorium IV.</u>		
8 Muffelöfen	768	Personen
<u>5.) neues Krematorium V.</u>		
8 Muffelöfen	768	Personen
Insges. bei 24 stündiger Arbeitszeit	4756	Personen

Verteiler:

Akt - ~~Janick~~ *Baum*,
 " - Kirschnek
 Registratur K.G.L. BW. 30

Der Leiter der Zentralbauleitung

der Waffen- und Polizei Auschwitz

Sturmabführer.

Document 248: Letter from Bischoff to Kammler of 28 June 1943. Source: RGVA, 502-1-314, p. 14a.

28. Juni 1943. 090/16
14a

31550/Ja./No.-

Betr.: Fertigstellung d. Krematoriums III
Besugi: ohne
Anl.: -/-

An das
 #-Wirtschafts-Verwaltungshauptamt, Antigruppenchef G
 #-Brigadeführer u. Generalmajor
 Dr.-Ing. K a m m l e r
 Berlin- Lichtenfelde. - West

Unter den Richten 126 - 135

Melde die Fertigstellung des Krematoriums III mit dem 26.6.1943. Mithin sind sämtliche befohlenen Krematorien fertiggestellt.

Leistung der nunmehr vorhandenen Krematorien bei einer 24 stündigen Arbeitszeit :

<u>1.) altes Krematorium I</u>		
3 x 2 Muffelöfen	340	Personen
<u>2.) neues Krematorium i.K.G.L. II</u>		
3 x 3 Muffelöfen	1440	Personen
<u>3.) neues Krematorium III</u>		
3 x 3 Muffelöfen	1440	Personen
<u>4.) neues Krematorium IV.</u>		
8 Muffelöfen	768	Personen
<u>5.) neues Krematorium V.</u>		
8 Muffelöfen	768	Personen
Insges. bei 24 stündiger Arbeitszeit	4756	Personen

Verteiler:
 Akt - *Baum*
 " - Kirschnek
 Registratur K.G.L. Bf. 30
Jehring

Der Leiter der Zentralbauleitung
 der Waffen- und Polizei Auschwitz
 #-Sturmbannführer.

Document 248a: Letter from Bischoff to Kammler of 28 June 1943. Source: www.topfundsoehne.de.

TOPF An J. A. TOPF & SOHNE Erfurt , den 8.9.42.
 Abteilung: D IV.

Unser Zeichen: D IV/Erfr./hes.
 in Sachen: Reichsführer SS, Berlin-Lichterfelde-Wggt.
 Betrifft: Krematorium-Auschwitz.
Vertraulich! Geheim!

SONDERAKTEN

8.9.42 Herr Obersturmführer Krone ruft an und erklärt, dass er zum Brigadeführer Kämmer bestellt sei und über seine Besichtigung des Krematoriums in Auschwitz, von der er gestern zurückgekehrt sei, zu berichten habe. Aus der Anlage in Auschwitz wäre er nicht klug geworden und wollte sich deshalb genau informieren, wieviel Muffeln dort zur Zeit in Betrieb seien, und wieviel Ofen mit Muffeln wir zur Zeit dort bauen und noch liefern.

Ich gab an, dass zur Zeit 3 Stück Zweimuffel-Ofen mit einer Leistung von 250 je Tag in Betrieb seien. Ferner wären jetzt in Bau 5 Stück Dreimuffel-

Dr.W.

8-SEP.1942	
LT	Efr
Zur Beantwortung	Quantität

Sonderakten D IV

Eigener Brief, Formular 5
 1 41 100 1.001

Document 249: File memo by Kurt Prüfer of 8 September 1942. Source: <http://veritas3.holocaust-history.org/auschwitz/topf/>.

Ofen mit einer täglichen Leistung von 300. Zum Versand können heute und in den nächsten Tagen die von Mogilew abgezweigten 2 Stück Achtmuffel-Ofen mit einer Leistung von je 300 täglich.

Herr K. erklärte, dass diese Anzahl von Muffeln noch nicht ausreichend sei; wir sollen noch weitere Ofen schnellstens liefern.

Es ist daher zweckmäßig, dass ich am Donnerstag Vormittag nach Berlin käme, um mit Herrn K. über weitere Lieferungen zu sprechen. Ich soll Unterlagen über Auschwitz mitbringen, damit nun endgültig einmal die dringenden Rufe verstummen würden.

Den Besuch für Donnerstag habe ich zugesagt.

Document 249: continued.

Cremation #	2	3	4	5	6	7	8
1	780 °C	820 °C	9 min.	690 °C	16 min.	870 °C	75 min.
2	750 °C	1050 °C	16 min.	780 °C	52 min.	820 °C	56 min.
3	700 °C	980 °C	12 min.	750 °C	20 min.	960 °C	68 min.
4	950 °C	1050 °C	9 min.	800 °C	24 min.	920 °C	62 min.
5	880 °C	1100 °C	12 min.	830 °C	20 min.	830 °C	–
6	690 °C	950 °C	10 min.	800 °C	24 min.	830 °C	44 min.
7	800 °C	930 °C	16 min.	820 °C	36 min.	1080 °C	40 min.
8	810 °C	1100 °C	13 min.	800 °C	24 min.	830 °C	40 min.
Mean Values	795 °C	997.5 °C	12½ min.	784.75 °C	27 min.	892.5 °C	55 min.

Columns

- 2: Initial temperature.
- 3: Maximum temperature during coffin incineration.
- 4: Duration of coffin incineration.
- 5: Temperature at the beginning of corpse cremation.
- 6: Duration of corpse water evaporation.
- 7: Maximum temperature during corpse cremation.
- 8: Duration of the cremation until the maximum temperature of corpse cremation (main combustion phase).

Document 250: Summary table of data derived from cremation experiments conducted by engineer R. Kessler on 5 January 1927 at the Dessau Crematorium (coke-fired).

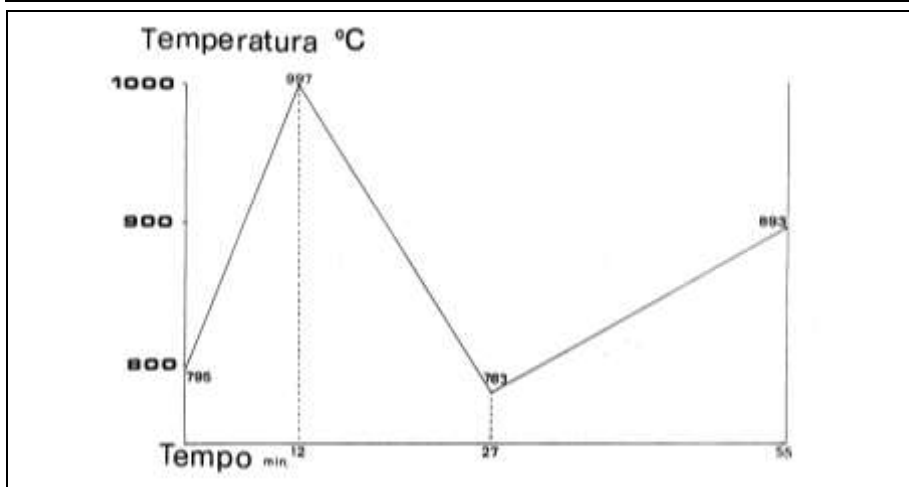

Document 251: Graph of the mean muffle temperature in the course of cremation experiments conducted by Engineer R. Kessler on 5 January 1927 at the Dessau Crematorium (coke-fired).

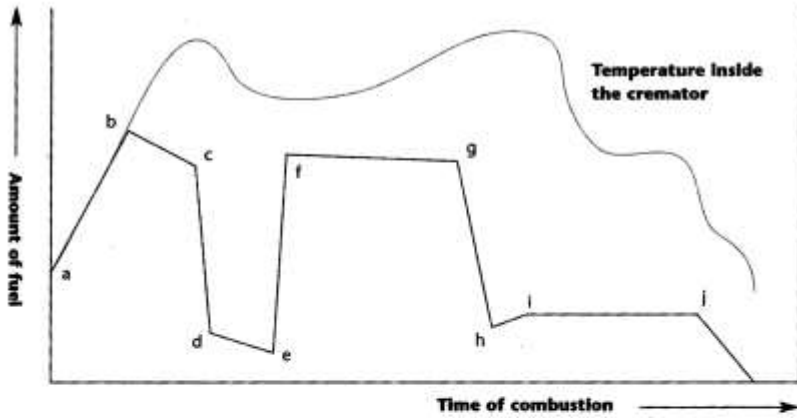

Figure 1 Phases of cremation combustion

Table 1 Combustion characteristics in each phase

Phases	Time (minutes)	Conditions	Phenomena
(1) a-b	0-2	Combustion begins.	The coffin is burning.
(2) b-c	2-6	The temperature inside the cremator is rising.	Moisture within the corpse is evaporating.
(3) c-d	6-7	The temperature inside the cremator is controlled.	The corpse begins to burn (dissolving due to heat).
(4) d-e	7-11	The corpse is burning.	Full-scale combustion.
(5) e-f	11-13	The corpse is burning.	Flammable parts have been burnt out.
(6) f-g	13-34	The corpse is burning.	The belly and loin parts are burning.
(7) g-h-i	34-38	The temperature is declining.	The belly and loin parts are burning.
(8) i-j	38-60	Heat preservation.	The corpse is burnt out.

Document 252: Summary of the cremation process in a modern cremation furnace.
 Source: Douglas J. Davies, Lewis H. Mates (eds.), *Encyclopedia of Cremation*, Ashgate, London, 2005, p. 133.



Document 253: Condition of a corpse after thirty minutes of cremation. Source: Michael Bohnert, Thomas Rost, Stefan Pollak, "The degree of destruction of human bodies in relation to the duration of the fire," in: Forensic Science International, 95, 1998, p. 15.



Document 254: as above, after forty minutes. Color reproductions of these photos can be found at the end of Part 3 of this study.

Uhr	Datum	Leichen	Kamen Koks	Uhr	Datum	Leichen	Kamen Koks
10 ^h - 6			16	10 ^h - 0			346
3 ^h - 8	26.9.41.	20	16	10 ^h - 13			
12 ^h - 11			12	11 ^h - 14	4.11.41	49	23
2 ^h - 11				11 ^h - 15			
10 ^h - 14	29.9.41.	14	12	10 ^h - 21			250
11 ^h - 16				10 ^h - 23			
3 ^h - 18				15 ^h - 22	5.11.41	45	22
11 ^h - 20	1.10.41.	25	20	11 ^h - 23			
7 ^h - 20				10 ^h - 24			
10 ^h - 13	3.10.41.	11	13	11 ^h - 26	6.11.41	57	34
2 ^h - 15				11 ^h - 27			
2 ^h - 15	6.10.41.	25	20	10 ^h - 28			
7 ^h - 2				11 ^h - 29			
2 ^h - 10	8.10.41.	12	10	11 ^h - 30	7.11.41.	94	45
2 ^h - 11				11 ^h - 31			
8 ^h - 11	10.10.41	21	16	10 ^h - 1			
10 ^h - 13				10 ^h - 2			
7 ^h - 16				11 ^h - 3			
11 ^h - 8	13.10.41.	33	16	11 ^h - 4			
10 ^h - 12				11 ^h - 5			
11 ^h - 8	14.10.41.	19	14	11 ^h - 6			
11 ^h - 20				11 ^h - 7			
11 ^h - 20	15.10.41	23	16-13	11 ^h - 8	8.11.41	72	35
11 ^h - 18				10 ^h - 24			
				10 ^h - 25			
	26.10.41	20	14	11 ^h - 29			
	27.10.41	30	17	11 ^h - 30			
	28.10.41	30	18	10 ^h - 9	9.11.41.	34	19
	29.10.41	23	14	10 ^h - 16			
	30.10.41.	26	17	11 ^h - 19			
				10 ^h - 8			
				11 ^h - 9	10.11.41.	30	14
				11 ^h - 10			
				11 ^h - 11			
				11 ^h - 12			
				11 ^h - 13	11.11.41	58	33
				11 ^h - 14			
				11 ^h - 15			
				11 ^h - 16			
				11 ^h - 17			
				11 ^h - 18			
				11 ^h - 19			
				11 ^h - 20			
				11 ^h - 21			
				11 ^h - 22			
				11 ^h - 23			
				11 ^h - 24			
				11 ^h - 25			
				11 ^h - 26			
				11 ^h - 27			
				11 ^h - 28			
				11 ^h - 29			
				11 ^h - 30			
				11 ^h - 31			
				11 ^h - 1			
				11 ^h - 2			
				11 ^h - 3			
				11 ^h - 4			
				11 ^h - 5			
				11 ^h - 6			
				11 ^h - 7			
				11 ^h - 8			
				11 ^h - 9			
				11 ^h - 10			
				11 ^h - 11			
				11 ^h - 12			
				11 ^h - 13			
				11 ^h - 14			
				11 ^h - 15			
				11 ^h - 16			
				11 ^h - 17			
				11 ^h - 18			
				11 ^h - 19			
				11 ^h - 20			
				11 ^h - 21			
				11 ^h - 22			
				11 ^h - 23			
				11 ^h - 24			
				11 ^h - 25			
				11 ^h - 26			
				11 ^h - 27			
				11 ^h - 28			
				11 ^h - 29			
				11 ^h - 30			
				11 ^h - 31			
				11 ^h - 1			
				11 ^h - 2			
				11 ^h - 3			
				11 ^h - 4			
				11 ^h - 5			
				11 ^h - 6			
				11 ^h - 7			
				11 ^h - 8			
				11 ^h - 9			
				11 ^h - 10			
				11 ^h - 11			
				11 ^h - 12			
				11 ^h - 13			
				11 ^h - 14			
				11 ^h - 15			
				11 ^h - 16			
				11 ^h - 17			
				11 ^h - 18			
				11 ^h - 19			
				11 ^h - 20			
				11 ^h - 21			
				11 ^h - 22			
				11 ^h - 23			
				11 ^h - 24			
				11 ^h - 25			
				11 ^h - 26			
				11 ^h - 27			
				11 ^h - 28			
				11 ^h - 29			
				11 ^h - 30			
				11 ^h - 31			
				11 ^h - 1			
				11 ^h - 2			
				11 ^h - 3			
				11 ^h - 4			
				11 ^h - 5			
				11 ^h - 6			
				11 ^h - 7			
				11 ^h - 8			
				11 ^h - 9			
				11 ^h - 10			
				11 ^h - 11			
				11 ^h - 12			
				11 ^h - 13			
				11 ^h - 14			
				11 ^h - 15			
				11 ^h - 16			
				11 ^h - 17			
				11 ^h - 18			
				11 ^h - 19			
				11 ^h - 20			
				11 ^h - 21			
				11 ^h - 22			
				11 ^h - 23			
				11 ^h - 24			
				11 ^h - 25			
				11 ^h - 26			
				11 ^h - 27			
				11 ^h - 28			
				11 ^h - 29			
				11 ^h - 30			
				11 ^h - 31			
				11 ^h - 1			
				11 ^h - 2			
				11 ^h - 3			
				11 ^h - 4			
				11 ^h - 5			
				11 ^h - 6			
				11 ^h - 7			
				11 ^h - 8			
				11 ^h - 9			
				11 ^h - 10			
				11 ^h - 11			
				11 ^h - 12			
				11 ^h - 13			
				11 ^h - 14			
				11 ^h - 15			
				11 ^h - 16			
				11 ^h - 17			
				11 ^h - 18			
				11 ^h - 19			
				11 ^h - 20			
				11 ^h - 21			
				11 ^h - 22			
				11 ^h - 23			
				11 ^h - 24			
				11 ^h - 25			
				11 ^h - 26			
				11 ^h - 27			
				11 ^h - 28			
				11 ^h - 29			
				11 ^h - 30			
				11 ^h - 31			
				11 ^h - 1			
				11 ^h - 2			
				11 ^h - 3			
				11 ^h - 4			
				11 ^h - 5			
				11 ^h - 6			
				11 ^h - 7			
				11 ^h - 8			
				11 ^h - 9			
				11 ^h - 10			
				11 ^h - 11			
				11 ^h -			

Date dd/mm	kg of coke	corpse	kg/corpse	min	min/corpse	kg coke/hr
26/09	960	20	48.0	275	28	105
29/09	720	14	51.4	165	24	131
01/10	1,200	25	48.0	105	8	343
03/10	780	11	70.9	165	30	142
06/10	1,200	25	48.0	155	12	232
08/10	600	12	50.0	115	19	157
10/10	960	21	45.7	210	20	137
13/10	960	23	41.7	255	22	113
14/10	840	19	44.2	120	13	210
15/10	960	23	41.7	120	10	240
Totals/Avg	9,180	193	49.0	1,685	19	163
26/10	840	20	42.0	?	?	?
27/10	1,020	30	34.0	?	?	?
28/10	1,080	30	36.0	?	?	?
29/10	840	23	36.5	?	?	?
30/10	1,020	26	39.2	?	?	?
Totals/Avg	4,800	129	37.2	–	–	–
31/10	2,100	63	33.3	960	30	66
01/11	1,260	38	33.2	525	28	72
02/11	1,260	42	30.0	325	15	116
03/11	1,140	42	27.1	420	20	81
04/11	1,380	49	28.2	552	23	75
05/11	1,320	45	29.3	315	14	126
06/11	2,040	57	35.8	730	26	84
07/11	2,700	94	28.7	1,065	23	76
08/11	2,100	72	29.2	1,110	31	57
09/11	1,140	34	33.5	465	27	74
10/11	840	30	28.0	160	11	158
11/11	1,920	58	33.1	740	26	78
12/11	1,500	53	28.3	610	23	74
Totals/Avg	20,700	677	30.6	7,977	24	78

Columns:

- 1: Date of cremations.
- 2: Total coke consumption (in kg).
- 3: Total number of cremations.
- 4: Mean coke consumption per cremation (in kg).
- 5: Total time (in minutes) of each day according to the times recorded in the first column of Document 255.
- 6: Mean duration of each cremation (in minutes), assuming that the time recorded in Column 5 refers to cremations.
- 7: Coke throughput of each gasifier (in kg/hr), assuming that the time recorded in Column 5 refers to cremations.

Document 256: Explanatory table of the data contained in the list of cremations at the Gusen Crematorium (Document 255).

1943 bis 31.5		Kohlenverbrauch 1850 kg		Kohlenvorrat 150 kg.					
1943 Tag	Pochzeit Begin Ende		Verbrennung Zeit		Kohlen verbrauch kg	Kohlen Vorrat kg	Anmerkungen		
4/6	7.30	13.30	6	230-235	150	0	wegen Kohlenmangel muss die Verbrennung gestoppt werden weil sonst Koffen.		
4/6						1700			
7/6	7.20	17.50	13	236-248	150	1550			
11/6	7.30	13.00	6	249-254	120	1430			
15/6	7.20	13.10	8	255-262	140	1290			
16/6	16.30	17.30	1	263	20	1270			
18/6	7.30	14.00	7	264-270	180	1090			
22/6	7.30	13.30	6	271-276	160	930			
25/6	7.30	14.-	8	277-284	160	770			
28/6	7.15	15.00	11	285-295	185	585			
1/7	7.15	16.00	12	296-308	160	425			
							1090		
							11500		
							2690	1550	
								2370	
								2185	
							21/6. 1600 kg. Kohlen		

Document 257: List of cremations conducted at the Westerbork Crematorium between 4 June and 1 July 1943. Source: ROD, C[64]392

Krematorium

7/6-43 Abraham, Rüdelsheim, Herbornstr.

No	vom	bis	Kohlenverbrauch
	7 ²⁰	8 ²⁰	9 ³⁰ 60 kg
1	8 ²⁰	9 ²⁰	
2	9 ¹⁰	10 ⁰⁰	
3	10 ⁰⁰	10 ⁴⁵	
4	10 ⁴⁵	11 ³⁰	12 ⁰⁰ 50 kg
5	11 ³⁰	12 ²⁰	
6	12 ¹⁰	12 ⁵⁰	
7	12 ⁵⁰	13 ²⁵	
8 X	12 ⁵⁰	13 ²⁵	
9	13 ²⁵	14 ³⁵	14 ⁰⁰ 40 kg
10	14 ²⁵	15 ²⁵	
11	15 ²⁵	16 ²⁵	
12 X	15 ²⁵	16 ²⁵	
13	16 ²⁵	17 ⁰⁰	

7.6.43. *[Signature]*

Document 258: as above, cremations on 7 June 1943. Source: ROD, C[64]392

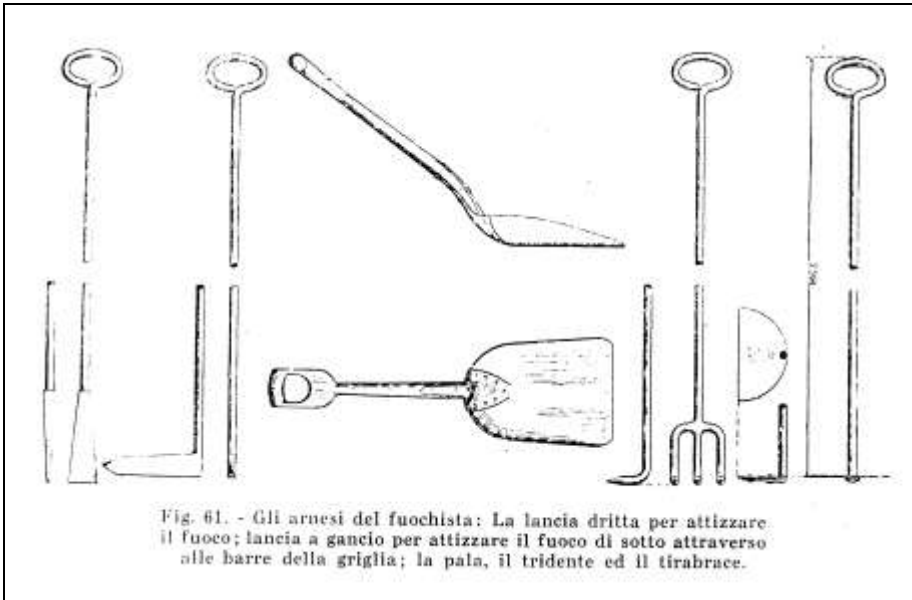

Document 259: Stoking tools. Source: A. Cantagalli, Nozioni teorico-pratiche per i conduttori di caldaie e generatori di vapore. G. Lavagnolo Editore, Turin 1940, p. 110.

Tabelle III.

Ausführung nach Abb.	Form-Nr. des Ofens	Ausmaße des Mauerwerks			Innenmaße des Verbrennungsraumes		Füllungsvermögen des Ofens bei einmaliger Füllung kg	Steinkohlenverbrauch bei voller Füllung kg	Dauer des Prozesses bei voller Füllung Stunden	Gewicht des Ofens kg
		Breite mm	Länge mm	Höhe mm	Breite mm	Länge mm				
3a und 3b	1a	1160	2460	2200	400	1700	250	110	5	950
	1b	1290	2460	2200	530	1700	310	130	6	1000
	2a	1290	2850	2500	530	2100	370	150	7	1200
	2b	1420	2850	2500	660	2100	450	170	8	1275
	3a	1420	3240	2800	660	2500	540	200	9,5	1475
	3b	1550	3240	2800	790	2500	650	225	10,5	1575
	4a	1550	3630	3100	790	2900	750	255	12	1875
	4b	1680	3630	3100	920	2900	900	300	13,5	2000
6a und 6b	1	900	1810	2000	400	860	70	50	4	675
	2	1030	1810	2100	530	860	100	60	5	700

Document 260: Operational results for eight carcass-destruction furnaces built by the Kori Co. Source: W. Heepke, Die Kadaververnichtungs-Anlagen. Verlag von Carl Marhold. Halle a. S. 1905, p. 43.

Odpis Ablage 27

Abschrift!

Hans Kori, G.m.b.H. Berlin, den 4.2.44
 Grossrauchheizungen

An die
 Kommandantur des Kriegsgefangenen
 Lager der Waffen-SS und Polizei
Lublin

Betrifft: Krematorium

In Ergänzung unseres heutigen Berichtes über den Betrieb der Einäscherungsöfen im Konz.-Lagers Lublin, lassen wir Sie noch wissen, dass der Brennstoffbedarf beim Betrieb stationärer Krematorien bei guter Betriebsbeobachtung auf einen sehr geringen Verbrauch zurückgebracht werden kann; denn das Verbrennungsgut selbst trägt ja im wesentlichen durch seine gute Brennbarkeit zu einer Brennstoffersparnis bei, wenn die Temperatur im Verbrennungsraum des Krematoriums sich um 700 ° bewegt.

Für die Bereitstellung von Brennmaterial für eine bestimmte Heizperiode kann man annehmen, dass zum Erhitzen eines Ofens 50 kg. Koks und für jede Einäscherung 25 kg Koks gebraucht werden. Daraus ergibt sich ein Tagesbedarf von 10 Einäscherungen (d.h. rund 300 kg.). Es ist dabei unbekannt, ob man nur mit Koks arbeitet, oder mit einem Gemisch von Koks und Steinkohle. Im letzten Falle wird man 150 kg zu 150 kg verfahren. Mit einer gleichen Brennstoffmenge von 300 kg für einen Tagesbetrieb lassen sich auch ohne weiteres ca 20 Einäscherungen erledigen, wenn man von Einseleinführungen Abstand nimmt.

In der Erwartung, dass Ihnen mit unserem heutigen Gedient ist, zeichnen wir mit

Heil Hitler
 Hans Kori G.m.b.H.

Die Richtigkeit der Abschrift bescheinigt
 Lublin, den piosq. okrągła z napisami: Waffen -
 Konzentrationlager Lublin

podpis nieczytelny
 SS-Oberstabsführer

Za zgodności
 Przewodniczący
 OMI. Kom. Bad. i Spr. Sędziowskich
 w Lublinie
 / Jan Grzybowski
 Prokurator Sądu Apelacyjnego

*for file
 H. J.*

Document 261: Letter from Hans Kori to the headquarters of Lublin Camp of 4 February 1944. Source: APMM, sygn. VI-9a, vol. 1, p. 27.

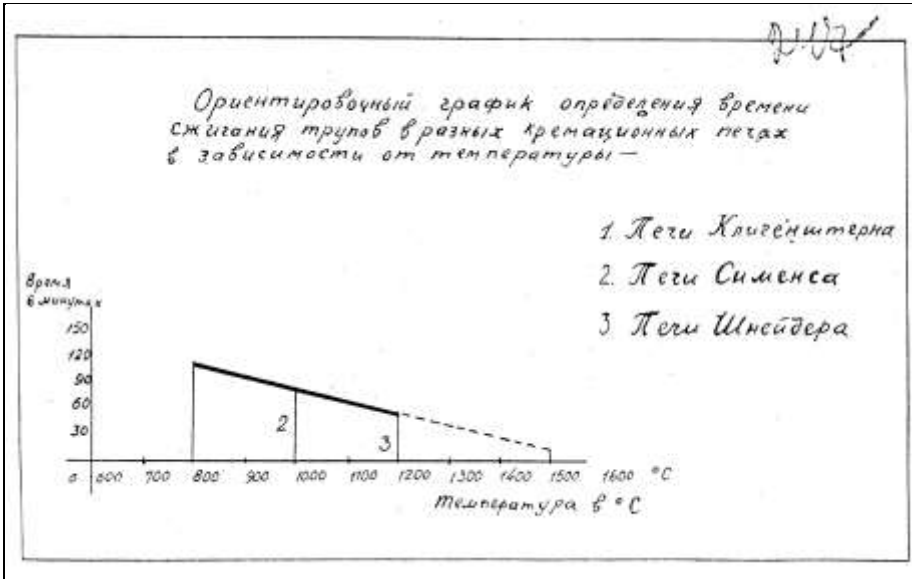

Document 262: "Guidance chart for determining the cremation time of corpses in various crematoria as a function of temperature" as prepared by the Soviet Commission of Inquiry about the Lublin-Majdanek Camp. Source: GARF, 7021-107-9, p. 247.

10. Juli 1942

Bftgb.Nr. 10225/42/Er/Wa.

Einschreiben

Betr.: Neubau eines Krematorium für das K.L. Stutthof
 Bezug: Dort. Schreiben vom 15.6.42 Tgb.Nr. 281/42/Wa./D./1
 Anlg.: 8 Pläne

An die

Bauleitung der Waffen-#
 und Polizei

Stutthof - Danzig

In der Anlage werden die Pläne für ein Krematorium für
 30.000 Häftlinge überreicht. Die Anlage ist mit 5 Stück
 Dreimaßel-Verbrennungsöfen ausgerüstet. Nach Angabe der Firma
 Topf & Söhne Erfurt dauert eine Verbrennung ca. 1/2 Stunde.
 Die Keller wurden deshalb gehoben, da an der Baustelle ein
 hoher Grundwasserstand ist.

Bezüglich der technischen Einrichtungen wird anheim gestellt,
 sich mit der Firma Topf & Söhne Erfurt in Verbindung zu setzen.

Der Leiter der Zentralbauleitung
 der Waffen-# und Polizei Auschwitz

#-Hauptsturmführer (S) 4

Document 263: Letter from the Central Construction Office at Auschwitz to the Construction Office of the Stutthof Camp of 10 July 1942. Source: RGVA, 502-1-272, p. 168.

Bfzgb.: 24 757/43/JH/Ln

Auschwitz, am 17.3.1943

Aktenvermerk

Betr.: Schätzung des Loksverbrauches für Krematorium II EGL
nach Angaben der Pn. Topf u. Söhne (Erbauer der Fen)
vom 11.3.43.

10 Feuerungen = 350 kg/stdl.

in 12 Std. = 12 · 350 = 4 200 kg. 2 Krematorien demnach 8 400 kg.

Bei Dauerbetrieb vermindert sich diese Menge wesentlich, sodass
mit 2/3 der Menge gerechnet werden kann. Für Krematorium II u.

III demnach Verbrauch in 12 Stunden = $\frac{350}{3} \cdot 12 \cdot 2 = 2800 \cdot 2 = \frac{5600}{\text{kg}}$

Krematorium IV + VI

mit je 4 Feuerungen = 8 Feuerungen zusammen =

$\frac{35 \cdot 4 \cdot 12}{3} \cdot 2 = 1120 \cdot 2 = \underline{2240 \text{ kg in 12 Stunden (1 Tagesbet.)}}$

Krematorium II = 2 800 kg
" III = 2 800 "
" IV = 1 120 "
" V = 1 120 "

zus. = 7 840 kg in 12 Std.(1 Tagesbetr.)

Dies sind Spitzenleistungen! Ein Jahresbedarf lässt sich nicht
angeben, da vorher nicht bekannt ist, wieviel Stunden bzw. Tage
geheizt werden muss.

Verteiler:
2 Verwaltung KL
? Sachbearbeiter
1 Registr. BW 30 KKL
2.2.43

WÄRMEWIRTSCHAFTLICHE
NACHRICHTEN VI. Jg. 1932/33 Heft 7







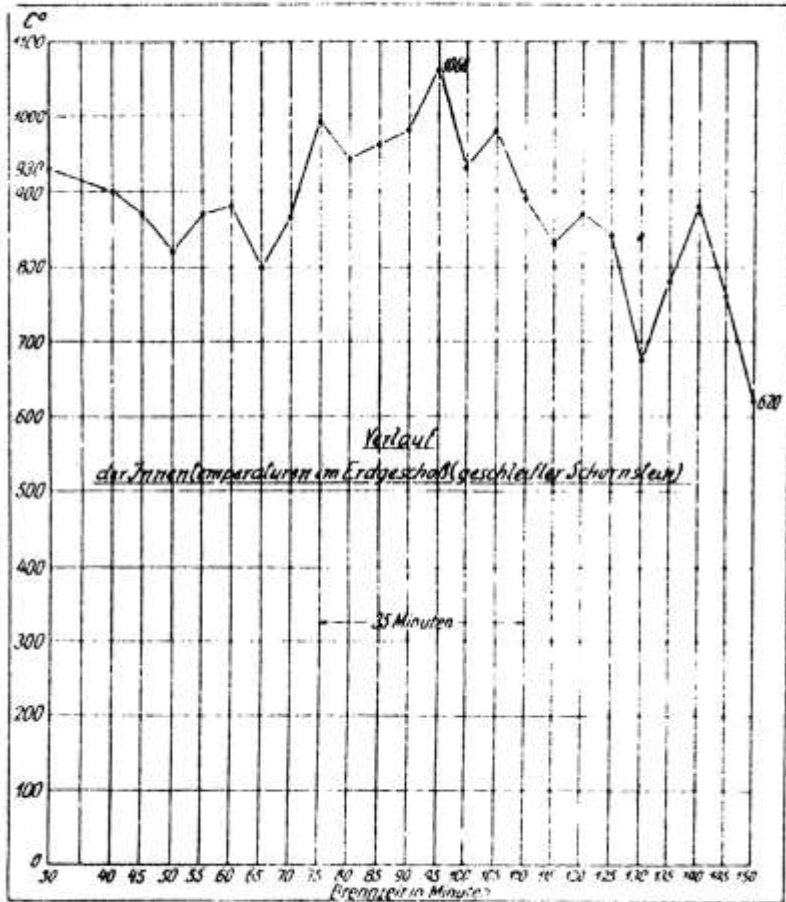

Abb. 1.

Document 265: Experiment to burn out soot deposits in a chimney. Temperature chart. Source: Kristen, "Ausbrennversuche an Schornsteinen," in: Wärmewirtschaftliche Nachrichten für Hausbau, Haushalt und Kleingewerbe, 6. Jg., Nr. 7, April 1933, p. 84.

H.KORI GMBH

BERLIN W 57 · DENNEWITZSTRASSE 35

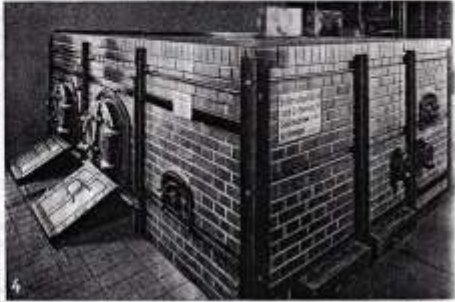
Gegründet im Jahre 1887 Telegramme Kori Berlin Fernruf, Sammel-Nr. 82 Litzow 5464 Feinstechkant Berlin Nr. 31339 Deutsche Bank und Disconto-Gesellschaft Dresdner Bank Dep.-Kassa 51

KORI Die älteste Spezialfirma für Bau und vollständige Lieferung von **Einzel-Verbrennungsöfen für Müll und Abfälle aller Art**

Document 266: Promotion leaflet by the H. KORI COMPANY, Berlin 1927, regarding incinerators for waste and all kinds of refuse. Source: APMM, sygn. VI-9a, vol. 1.

TYPENBEZEICHNUNG UND VERWENDUNGSZWECKE DER KORI-ÖFEN

KORI-Ofen Typus I Ia II IIa IV V IX X finden Verwendung

für kleine, mittlere und große Krankenhäuser, Kliniken, Lazarette, Spitäler, Ambulanzen, medizinische, hygienische und wissenschaftliche Institute, Desinfektionsanstalten sowie für Heil-, Pflege- und Irrenanstalten, Seuchenstationen, Frauenkliniken und Sanatorien zum Verbrennen von Krankenhausabfällen aller Art, Verbandstoffen, Sputum, Operations- und Anputationsreste, Leichenteilen, Versäuerungen sowie Küchenabfällen, Speiseresten, Blasen, Kehricht und Gartenabraum.

KORI-Ofen Typus I Ia III IIIa V X finden Verwendung

für kleine, mittlere u. große Schlachthöfe, Viehhöfe, Veterinärinstitute, tierärztliche Hochschulen, Gestüte, Zoologische Gärten, Abdeckereien, Fischereihäfen, Konservenfabriken zum Verbrennen von Schlachthausabfällen aller Art, Konfakates, Groß- und Kleintierkadavern, Sorten und sonstigen tierischen Rückständen, auch breiigen und flüssigen Abgängen, sowie Stallmist und Dampf.

KORI-Ofen Typus IV V XI XII finden Verwendung

für gewerbliche Großbetriebe, Waren- und Kaufhäuser, Lebensmittelgeschäfte, Konsumvereine, Büro-, Bank- und Geschäftshäuser, Behörden, Zollämter, Fabrik- und industrielle Betriebe, Hotels, Restaurants und Vergnügungsalen, Säle und Versammlungshallen zum Verbrennen von Büro- und Fabrikationsabfällen der verschiedensten Art, Papier- und Packmaterial, Emballagen, trockenen und feuchten Lebensmittel- und Küchenabfällen, Kehricht, Hafabraum usw.

KORI-Ofen Typus IV V VI VII VIII finden Verwendung

für Markthallen und Märkte, Ausstellungshallen, Messegelände, Gefängnisse und Strafanstalten, Kasernen, Truppenübungsplätze und Barackenlager, Wohnungsblocks und Siedlungen, Flughäfen, Bahnhöfe, Hafenanlagen, Fischereihäfen, Kläranlagen, Friedhöfe zum Verbrennen von trockenem, feuchtem und gemischtem Abfallmaterial, wie verdorbene Fleischabfälle, Fische, Obst und Gemüsereste, wie auch Küchenabfälle, Kehricht und sonstiger Abraum, wie z. B. verrottete Kränze und Blasen auf Friedhöfen, Papierabfälle und Emballagen, Hausmüll aller Art.

KORI-Ofen Typus XI XII finden Verwendung

als Klein-Müllverbrennungsöfen für Büros, Gesundheitsämter, Finanzämter sowie für Einzelhaushaltungen

zum Verbrennen von Papierabfällen, Akten, Zeichnungen und Dokumenten sowie von Küchen- und sonstigen Hausabfällen. Alles soweit unverwertbar.



Die Abbildungen auf der Titelseite dieses Prospektes stellen dar:
 Bild 1: Ansicht einer Verbrennungsanlage, mit weißes Glasfenster verbleidet. Bild 2: Außenansicht einer Verbrennungsanlage, verbundener Betriebscharakter. Bild 3: Freistehende Feuertiegelanlage mit eigener Schornstein. Bild 4: Ansicht einer Verbrennungsanlage, gefüllte Handmitzelle. Bild 5: Verbrennungsanlage mit abgeschlossener Wasserverarbeitung

ARCHIVUM
 PANITZKI
 5000. VI-90. Vol. 1

Berlin 1898
Ausstellung von Rotes Kreuz





Berliner
Gewerbe-Aus-
stellung 1896



Berlin 1899
Ausstellung für Krankenpflege

H. KORI G. m. BERLIN
h. H.

Telegr.-Adr.: Kori-Berlin 57 **W 57, Denneowitzstraße 35** Fernspr.: B 2 Lützow 2430

Technisches Büro und Fabrik für Entwurf und vollständige Lieferung von
Verbrennungsöfen für Abfälle aller Art
Einäscherungsöfen für Krematorien
Glüh-, Schmelz- u. Härteöfen, Kesseleinmauerungen, Schornsteinbau

Über die Notwendigkeit und Zweckmäßigkeit der Abfallverbrennung braucht heute kein Wort mehr gesagt zu werden.

Nachdem von uns im Laufe von über 40 Jahren Tausende der verschiedenartigsten Verbrennungsöfen geliefert wurden, die überall zur größten Zufriedenheit arbeiten, darf unseren Apparaten unbefangenes Vertrauen entgegengebracht werden.

Durch schnelle, sichere, einwandfreie, in Anlage und Betrieb gleich billige Beseitigung und restlose Vernichtung aller Art von Abfällen erfüllen unsere Verbrennungsöfen sowohl die Forderungen der öffentlichen Gesundheitspflege, als alle Ansprüche eines wirtschaftlichen Betriebes, der durch die Ausnutzung der Abgase für Warmwasser-Bereitungen, Bäder oder für andere Zwecke wesentlich gesteigert wird.

Unsere Verbrennungsöfen
finden daher mit größtem Vorteil Verwendung für:

1. Medizinische, bakteriolog., Hygien. u. z. wissenschaftliche Institute.
2. Kliniken, Lazarette, Kranken-, Irren-, Heil- und Pflegeanstalten.
3. Sanatorien, Bade- und Kuranstalten, Genesungsheime, Heilstätten.
4. Veterinär-Institute, tierärztliche und landwirtschaftliche Hochschulen.
5. Schlachthöfe und Viehhöfe, Abdeckereien, Gestüte, Serum- und ähnliche Institute.
6. Markthallen, Fischereihöfen, Konservfabriken, Konservvereine und dergleichen.
7. Friedhöfe, Desinfektionsanstalten, Kläranlagen, Seuchenstationen.
8. Kasernen, Festungen, Truppenübungsplätze, Barackenlager, Werften.
9. Gefängnisse, Straf-, Erziehungs- und andere geschlossene Anstalten.
10. Kauf-, Waren- und Geschäftshäuser, Bank-, Büro- und Verwaltungsgebäude.
11. Fabriken, Werkstätten, industrielle Anlagen, Hüttenwerke usw.
12. Hotels, Restaurants, Vergnügungslöke, Theater, Zoologische Gärten.
13. Messgelände, Ausstellungshallen, Bahnhöfe, Hafenanlagen, Märkte und dergl.

sowie für alle möglichen anderen Zwecke.

Im ganzen haben wir bisher etwa 3500 Verbrennungsöfen geliefert.

Überall, wo regelmäßig Abfälle entstehen, die wegen ihrer gesundheitsgefährlichen Eigenschaften eine schnelle Vernichtung verlangen oder deren regelmäßige Abfuhr und anderweitige Unterbringung laufende Ausgaben verursacht, bilden unsere Verbrennungsöfen das beste Hilfsmittel, allen Ansprüchen der Hygiene zu genügen. Dabei erweist sich die Verbrennung auch wirtschaftlich als das billigste Verfahren, weil die Anlagekosten der Öfen gering sind, die Bedienung einfach und der Kohlenverbrauch so mäßig ist (bzw. ganz fortfällt), daß die Unterhaltungs- und Betriebsausgaben gar keine Rolle spielen.

Nachstehend sind einige der gebräuchlichsten Ofentypen kurz erwähnt und besprochen, Ausführliche Drucksachen und Kostenausschlüsse stehen gern zur Verfügung.

ARHIWUM
PAŃSTWOWEGO MUZEJ
NA MADANKU
Sygn. VI-9a, vol. 1

Document 267: Promotion leaflet by the H. KORI COMPANY, Berlin 1927, regarding incinerators for all kinds of refuse. Source: APMM, sygn. VI-9a, vol. 1.

425

Typen IV, IVa, V u. VI. Öfen mit doppelten Verwertungskammern.

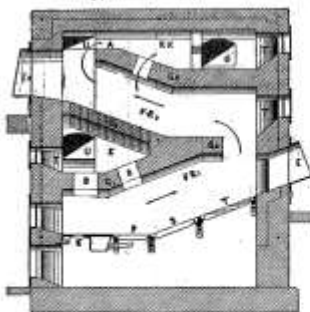

Fig. 6

In Pflegeanstalten, Heilanstalten usw. handelt es sich in der Regel um die Verwertung von Kehricht, Müll und Wirtschaftsabfällen, doch kommen durch den Krankenhausbetrieb auch Verbandstoffe, Amputationsreste, Leichenteile usw. in Frage. Will man diese Abfälle getrennt vom Müll verbrennen, so erhält der Ofen die aus Fig. 6 ersichtliche Ausführung mit zwei übereinander liegenden Kammern. Meistens wird diese Ausführungsform auch dort verwendet, wo gleichzeitig feuchtes und trockenes Material verbrannt werden muß. Die zwei Einwürfe E_1 und E_2 können auch an derselben Stirnseite des Ofens liegen. Eine Nebenfeuerung zur Nachverbrennung der Rauchgase wird seitlich am Ofen angebaut, der sich konstruktiv den jeweiligen Bedürfnissen anpassen läßt.

Bei Type IV für Waren- und Geschäftshäuser, Banken, Fabriken usw. fällt meist die obere Verwertungskammer fort. Dafür werden häufig Heißwasserspiralen eingebaut.

Bei Type VI für Markthallen und dgl. wird die Sohle der unteren Kammer mit durchbrochenem Gewölbe versehen.

Type VII, VIII. Öfen für Desinfektionsanstalten, Friedhöfe usw.

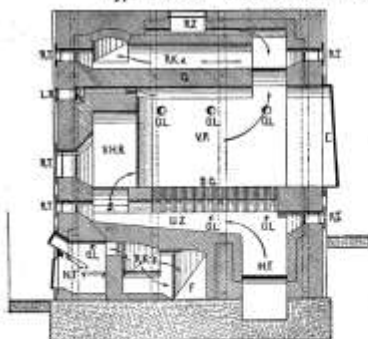

Fig. 7

Wie Fig. 7 zeigt, besteht der Verbrennungsraum aus einer Kammer mit horizontaler Sohle mit durchbrochenen Schamottesteinen DG. Darunter liegt die Hauptfeuerung HF, deren Flamme durch den Unterzug U2 und die Schlitze des Gewölbes DG hindurchzieht und die Abfälle von allen Seiten in Feuer hüllt. Eine reichliche Zuleitung hochheißer Verbrennungsluft erfolgt durch die Oberluftöffnungen O1, die alle sich bildenden Gase und Dämpfe verzehrt. — In dem Rauchabzugskanal RK, und den anschließenden senkrechten Zügen ist den abziehenden Gasen Zeit gelassen, vollkommen auszubrennen. Unten vereinigen sich die Züge im Rauchkanal RK, in der hinteren Stirnseite des Ofens ist die Nebenfeuerung NF eingebaut zur Nachverbrennung der Gase. Hinterlassen die Rückstände, wie z. B. bei Friedhofsmüll (Type VIII), zurückgehalten, glühenden Bindedraht, so wird eine Kühlkammer angeordnet.

Type IX. Verbrennungsöfen für Wohngebäude und Kleinbetriebe.

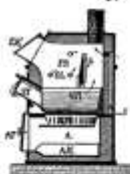

Fig. 8

Das Bestreben, Hausmüll und Kehricht auf dem Wege der Verbrennung zu beseitigen, wie es in England seit langen Jahren geschieht, hat auch auf dem Kontinent zum Bau zentraler Müllverbrennungs-Anstalten geführt. Allerdings haben sich diese nicht überall bewährt, weil die Beschaffenheit des Mülls sehr verschieden, und die Nachfrage nach den Schlackenrückständen gering ist. Auch hängt die Rentabilität davon ab, welche Unkosten die Abfuhr bisher verursachte. Diese Umstände trugen dazu bei, daß manche Müllverbrennungs-Anstalten stillgelegt wurden.

Um aber die hygienischen Vorteile der Verbrennung nicht preisgeben und die Abfuhr und Unterbringung des Mülls zu entlasten, könnten — abgesehen von all den auf Seite 1 erwähnten Fällen — auch in Wohn- und Einzelhäusern, vor allem mit Zentralheizung, kleine Müllverbrennungsöfen aufgestellt werden. Es würde sich dann die Abfuhr auf Asche und Schlacke der Küchen, Zentralheizung und des Verbrennungsöfens, sowie der unverbrennlichen Abfälle beschränken und so zur Entlastung der allgemeinen Abfuhr wesentlich beitragen.

Einen solchen kleinen Verbrennungsöfen für Einzelhäuser stellt Fig. 8 dar, der in verschiedenen Größen, bis 300 Liter Fassungsraum, geliefert wird. — Für größere Gebäude käme Type IV in Frage.

X. Verbrennungsöfen mit Gasbetrieb.

Während in der Regel für den Betrieb der Verbrennungsöfen (sofern überhaupt ein Brennstoffzusatz nötig ist) feste Brennstoffe Verwendung finden, werden die Verbrennungsöfen Type IX sehr vielfach auch für Leuchtgasbeheizung geliefert, wegen der reinlichen und bequemeren Handhabung und der streifen Betriebsbereitschaft. Aber auch größere Öfen haben wir, und zwar mit bestem Erfolge, mit Gasfeuerung versehen, nur ist dann die Bauart den veränderten Anforderungen anzupassen. Jedenfalls bietet der Gasbetrieb in vielen Fällen Vorteile, die sich allmählich noch weiter ausgestalten lassen.

H. Kori GmbH., Berlin W 35



1887 **50** 1937

Dennewitzstraße 35

Fernruf: Saumnrnummer 325444

Drahtwort: Kori-Berlin 35

Gegründet 1881

Kaloifer



Bild 1

Verbrennungsöfen



Bild 2

Einäscherungsöfen



Bild 3

Müllschluckor



Bild 4

Kundendienst

Von allen obengenannten Anlagen in 50jähriger Tätigkeit Tausende von Ausführungen zur vollen Zufriedenheit. Auch nach Übergabe Kontrolle der von uns ausgeführten Anlagen durch alten Stamm zuverlässiger Mitarbeiter. Drucksachen, Empfehlungen, Angebote, Einzelverschläge kostenlos. Auf Wunsch unverbindlicher Ingenieurbesuch.

Sonderdruck aus dem Firmen-Katalog, Jahrgang 7

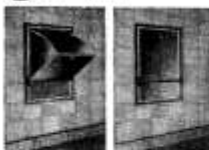
Abteilung Heizung

Sammelheizung, Warmwasserbereitung

Alle Heizungsarten von der Stockwerkheizung bis zur Pumpen-Warmwasser- und Fernheizung, Heizungsanlagen für Siedlungen, Villen, Wohn- und Geschäftshäuser, Hotels, Industriebauten und öffentliche Gebäude aller Art. Erste Empfehlungen bei Behörden, Architekten und Privaten.

Luftheizungs-Anlagen

insbesondere Großraum-Heizungen für Hallen, Sport- und Festräume, Säle, Werkstätten, Garagen usw. Hersteller der Kori-Kalorifere (Luftheizerapparate, s. Bild 1), verschiedene Bauarten und Größen für alle Zwecke und Größenverhältnisse (u. a. Stadt- und Festhalle Götrow).

Besondere Vorzüge: Hohe Wärmeleistung bei geringem Platzbedarf; kräftige Bauart (schamotteausgemauert Guß), daher lange Lebensdauer; weitgehende Heizgasausnutzung, daher mäßiger Brennstoffverbrauch.

Kirchenheizungen

Führendes Unternehmen auf diesem Sondergebiet. Viele Hunderte von Anlagen jeden Umfanges im In- und Ausland, in Form von Kaloifer- oder Dampf-Luftheizung mit oder ohne Ventilatorbetrieb, Niederdruck-Dampfheizung oder Einzelöfenheizung, Vorschläge und Beratung kostenlos.

Einzelöfen

Kori-Öfen jeder Art und Größe mit und ohne Mantel oder eingemauert. Bewährt für Schulen, kleine Kirchen, Kasernen, Lazarette, Gefängnisse, Werkstätten, Fabriken, Turnhallen, Versammlungssäle, Baracken usw.

Lüftungs- und Trockeneinrichtungen — Abwärme-Verwertung Zubehörteile

aller Art für Heizungs- und Lüftungsanlagen: Kessel, Heizkörper, Warmwasserspeicher, Dampfwaschabbeiter, Ventile, Hähne, Pumpen, Gitter usw.

Abteilung Feuerung

Müll- und Abfall-Verbrennungsöfen (Bild 2)

Der bewährte Kori-Ofen ist das Hilfsmittel für rasche, billige und gesundheitsunschädliche Beseitigung aller denkbaren Abfälle. Wirtschaftlichkeit durch Ersparnis der Abfuhr sowie durch Rauchgasausnutzung für Warmwasserbereitung usw. Tausende von Öfen geliefert für:

Wissenschaftliche Anstalten, Krankenhäuser, Hotels und Gaststätten, Groß-Wohnhäuser, Bürogebäude, Fabriken, Waren- und Kaufhäuser, Konsumvereine, Kasernen, Strafanstalten, Barackenlager, Schlacht- und Viehhöfe, Abderkerien, Markthallen, Fischereihäfen, Lagerhallen, Bahnhöfe, Ausstellungsgebäude, Friedhöfe, Kläranlagen, Entkeimungsanstalten.

Einäscherungsöfen für Feuerbestattung (Bild 3)

Reformoten Bauart Kori, bedeutende Ersparnis an Anlage- und Betriebskosten. Befeuert mit festen Brennstoffen oder Gas. Betriebsfertige Lieferung einschl. Zubehör, Bewährte Saug- und Vorrichtungen eigener Bauart.

Industrieöfen

Glüh-, Schmelz-, Härte- und Emailöfen, Muffel-Öfen, Trocken-Öfen.

Kesseleinmauerungen und Schornsteinbau

Müllschluckanlagen (Bild 4)

Staub- und geruchssichere Verschlässe eigener Bauart. Für die bekanntesten Großbauten Berlins und im Reich geliefert. Besondere Schlucker für Müll, Asche, Papier und Wäsche. Verlangen Sie Vorschläge und Drucksachen.

Einäscherungsöfen System „Kori“

im
Krematorium der Stadt Hagen/Westf.

**Außenansicht des Krematoriums
auf dem Friedhof im Stadtteil
Delstern.**

Diese Einäscherungsstätte wurde 1906 als erste in Preußen erbaut und nach langem Kampf mit den Gegnern der Feuerbestattung im Jahre 1912 in Betrieb genommen.

Unterhalb der Andachtshalle befindet sich der Einäscherungsraum mit 2 Kori-Öfen, die an den links sichtbaren freistehenden Schornstein angeschlossen sind.



**Ansicht der beiden Kori'schen
Einäscherungsöfen.**

Im Vordergrund ist die Sargver-senkungs-einrichtung erkennbar, mit links und rechts angeordneter Sargeinführung.

Der rechts sichtbare offene Ofen wurde im Jahre 1906 als Ersatz für einen Ofen älterer Bauart erstellt. 3 Jahre später ließ die Verwaltung auch den 2. Ofen nach System Kori umbauen.

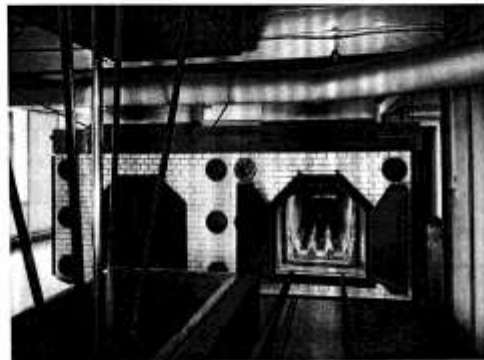

Die Einäscherungsöfen System Kori sind in konstruktiver Beziehung seit Jahren bahnbrechend, vor allem durch wesentliche Verbesserung des Rekuperators und Wegfall des früher erforderlichen Tiefkellers, wodurch eine erhebliche Verbilligung erzielt wurde. Neuerdings werden die Kori-Öfen mit bestem Erfolg auch für Gasbetrieb eingerichtet.

H. KORI G. M. B. H., BERLIN W 57

Telefon: Sammelnummer Lützow 5464

Dennowitzstr. 35

Document 269: "Cremation Furnace System 'Kori' at the Crematorium of the City of Hagen/Westfalia." Promotion leaflet of 1927. Source: APMM, sign. VI-9a, vol. 1.

Einäscherungs-System „Kori“

im
Krematorium der Hauptstadt Schwerin

Außenansicht des Krematoriums
auf dem Schweriner Friedhof.



Dieser moderne Ziegelrohbau enthält im niedrigen Bauteil — vorn ganz rechts — die Feuerbestattungsanlage, System „Kori“. Im Turmbau sind untergebracht der Schornstein für zwei Einäscherungsöfen und die Entlüftungsschächte.

Ansicht vom Kori-Einäscherungs-
ofen mit Sargeinführungswagen.

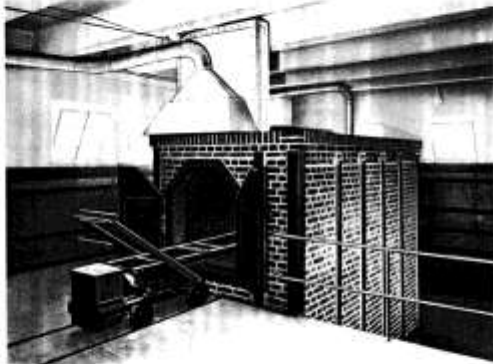

Dieser Reformofen ist sowohl für Kokageneratorbetrieb als auch für Gasfeuerung eingerichtet. Er besitzt einen nach neuzeltlichen Erfahrungen konstruierten Rekuperator, der gleichzeitig als Wärmespeicher dient. Der aus steilen Chamottewangen gebildete Asch-Sammelraum endet am tiefsten Punkt auf einem Nachgüßrost.

Durch geschickte Gruppierung der Sargkammer mit Aschraum und Rekuperator erdrierte sich der kostspielige Tiefkeller beim Bau des Ofenraumes. Die Anordnungsfrage für die Einäscherungsöfen, von denen zunächst nur einer zur Ausführung kam, wurde räumlich und technisch vorbildlich gelöst.
(Siehe auch Grundriß- und Schnittdarstellung auf besonderem Blatt.)

H. KORI G. M. B. H., BERLIN W 57

Telefon: Sammelnummer Lützow 5464

Dennewitzstr. 35

Document 270: “Cremation Furnace System ‘Kori’ at the Crematorium of the Capital City of Schwerin.” Promotion leaflet of 1927. Source: APM, sygn. VI-9a, vol. 1.

Einäscherungssofen System „Kori“

im
Krematorium der Hauptstadt Schwerin



Abb. 1 — Grundriß

1 — Schürstand — 2 — Sargeführungs- und Bedienung-Raum — 3 — Veraschung — 4 — Maschinenraum — 5 — Leichenkleiderin — 6 — Einkleideraum — 7 — Flur — 8 — Sargkammer — 9 — Infektionsraum — 10 — Sezierraum
a — Veraschungssofen — b — Reserwasofen — c — Kompressor — d — Antriebsmotor für die Hebebühne — e — Drehscheiben für die Gleisanlage — f, g — Motor und Ventilator für die Be- und Entlüftung — h — Be- und Entlüftungsleitung

Abb. 2 — Längsschnitt durch das Krematorium

Maßstab 1:300

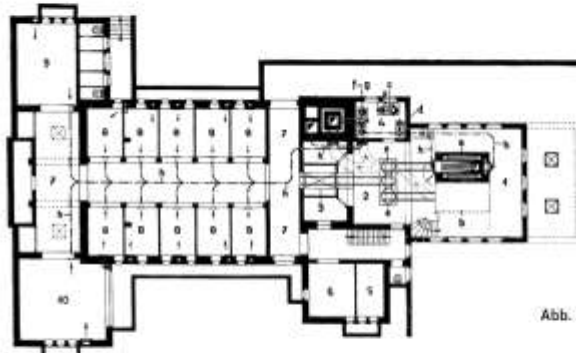
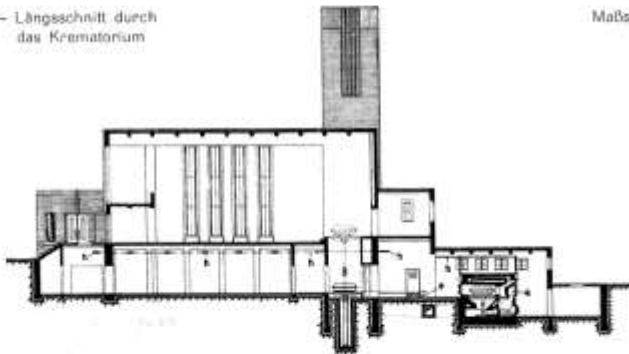

a — Veraschungssofen — e — Gleisanlage für Sargeinführung — h — Be- und Entlüftungsleitung — b — Veraschungsanlage

H. KORI G. M. B. H., BERLIN W 57

Telefon: Sammelnummer Lützow 5464

Dennewitzstraße 35

H. KORI G.m.b.H.
 Technisches Büro und Fabrik
 für
 Abfallverbrennungsöfen aller Art
 und vollständige Verbrennungsganlagen
 Kesselraumwärmungen - Schornsteinbau
 Gask-, Schmelz-, Metall- und Wärmöfen, sowie
 sämtliche Feuerungsanlagen der Metallindustrie
 Einscherungsöfen für Chromatosen

Postfach: Schmöder, 239404
 Telegramm: Kori-Berlin 28
 Postbank-Konto: Berlin 21200
 Bank-Konto: Dresdner Bank Berlin, Depotkassen 21
 Potsdamer Straße 111
 Filialbüro- und Geschäftsbüro: Berlin

V.-au./T. BERLIN W 35, den 18. Mai 1943.
 D. 1111111111

Abteilung: III
 Schriftl. B. R. F.
 W. v. theer
 VZP
 Schriftl. B. R. F.
 CIII/CIII/CIII/CIII/CIII/CIII/CIII/CIII/CIII/CIII

1445 (47)

von Reichsführer der SS und
 des Deutschen Polizei
 VZP des Herrn Dipl. Ing. Waller
 Berlin, Nichtenfeld-Str.
 unter den Eichen 120-130.

1943

Betrifft: Krepatorien

Im verfolg der mit Ihnen gehaltenen mündlichen Rücksprache wegen der Beschaffung einer Einscherungsanlage in einfacher Ausführung bringen wir Ihnen unseren Reform-Einscherungsöfen mit Kohlenfeuerung in Vorschlag, die sich bisher in der Praxis bestens bewährt haben. - Wir bringen für denselben in Aussicht genommene neuverhoben zwei Stück Einscherungsöfen in Vorschlag, empfehlen aber, durch Rückfrage nochmals festzustellen, ob diese beiden Öfen für den Bedarf ausreichend sind. Auch ist noch die Offenordnungsfrage klarzustellen, weil davon die Ausführung der Armaturteile sowie des Verankerungsgerippes abhängig ist. Die Offenanlage ist möglichst in einem abgeschlossenen Raum unterzubringen und an einen evtl. vorhandenen Schornstein anzuschließen. - Falls ein Aufstellungsraum bereits in Aussicht genommen ist, bitten wir Sie, uns hiervon einen Plan zuzusenden, damit wir Ihnen einen brauchbaren Anordnungsverzicht unterbreiten können. Den erforderlichen Platzbedarf der Öfen mit Bedienungs- und Schürstand können Sie aus den beigefügten Zeichnungen ersehen. Die Zeichnung - J.Nr. 8998 - veranschaulicht die Anordnung von zwei Öfen, wogegen nach der Zeichnung - J.Nr. 9122 - für den neuverhoben Dachten vier Öfen zur Ausführung gekommen sind. Eine weitere Zeichnung: St. JEF J.Nr. 9080 zeigt Ihnen die Anlage Lublin mit fünf Einscherungsöfen und zwei eingebauten Heißkammern.

Was nun die Anschaffungskosten für zwei Krepatorien anbetrifft, so bieten wir Ihnen diese wie folgt an:

1) 2 Stück Reform-Einscherungsöfen neuester Konstruktion mit gewölbter Burgkammer und horizontaler Aschenrutsche einschließlich der gesamten Armaturteile, den Einführungs-, Bedienungs- und Reinigungsstufen, der Luftrosetten, den Feuerungsgarnituren für die Hauptfeuerung und dem Ausgüßrost, dem vollständigen Verankerungsgerippe aus kräftigen Winkelstahlschienen und U-Stahlschienen mit Ankerstangen, verbleibenden Bauteilen, tragfähigen Beton- und Normstahlgewindestift, Verankerungs- und Hinterschraubungsschrauben, Mauerwerk und Zement sowie mit der gesamten Montage durch unseren Montage-Conteur unter Anstellung sämtlicher Hilfskräfte je RM. 4.500,-

Falls die Aufstellung des zweiten Ofens im Anschluß an die erste Montage erfolgt, ermäßigt sich der Preis für den zweiten Ofen auf RM. 3.000,-

1943

Document 271: Letter from the H. KORI COMPANY to Engineer Waller at Office CIII of SS WVHA dated 18 May 1943. Source: KfSD, 660/41.

- 2 -

In diesen Betrag sind jedoch die Kosten für Fracht und Rohlgeld der Materialien frei Verwendungsstelle sowie die Reisekosten für den Konteur und Heißeisegenoss sowie Landzulage nicht enthalten. Diese Kosten würden wir gesondert zum besonderen Nachweis in Anrechnung bringen.

ebenso schliesst unser Angebot aus die baulichen Nebenarbeiten am Aufstellungsort, wie Erdaushub, Umlenkcement, Herstellung des Ofenaufstellungsraumes sowie die Rauchkanäle von den weifen bis zum Schornstein und den Schornstein selbst.

Sobald die Anordnungsfrage für die Ofenanlage klargestellt worden ist, reichen wir Ihnen aber gern ein Sonderangebot über die Herstellung der Rauchkanäle nach.

Für die Einführung der Leichen in die Verbrennungskammer der Öfen bieten wir Ihnen noch zusätzlich an:

- 1) 2 Stück Einsicherungswagen, muldenförmig ausgebildet, mit Rollen und Handgriffen, per Stück RM.160,-- RM.320,--
- 2) 2 Stück rollenböcke zur Auflagerung der Einführungswagen, per Stück RM.75,-- * 150,--
RM.150,--

Für den Effekt der zu liefernden Einsicherungsofen sowie für deren Stabilität, auch für die Lieferung nur bester Materialien und Ausführung tadelloser Arbeiten übernehmen wir die volle Garantie.

Die Lieferung der gußeisernen Armaturen und Verankerungsteile sowie der Schamotteformsteine kann kurzfristig erfolgen, falls uns hierfür ein Wehraechtfrachtbrief zur Verfügung gestellt wird.

Für die Lieferung der eisernen Ofenteile benötigen wir pro Ofen 1460 kg, also für zwei weifen 2920 kg. Die Eisenanforderungsscheine hierfür finden Sie beigeschlossen.

Ihren weiteren Nachrichten gern gewärtig, empfehlen wir uns Ihnen bestens mit

Hell Hitler 1
H. KORB
1944

17/3
32

Anlagen: 3 Zeichnungen - J.Nr.8998, J.Nr.9122, J.Nr.9080 -
Eisenanforderungsscheine

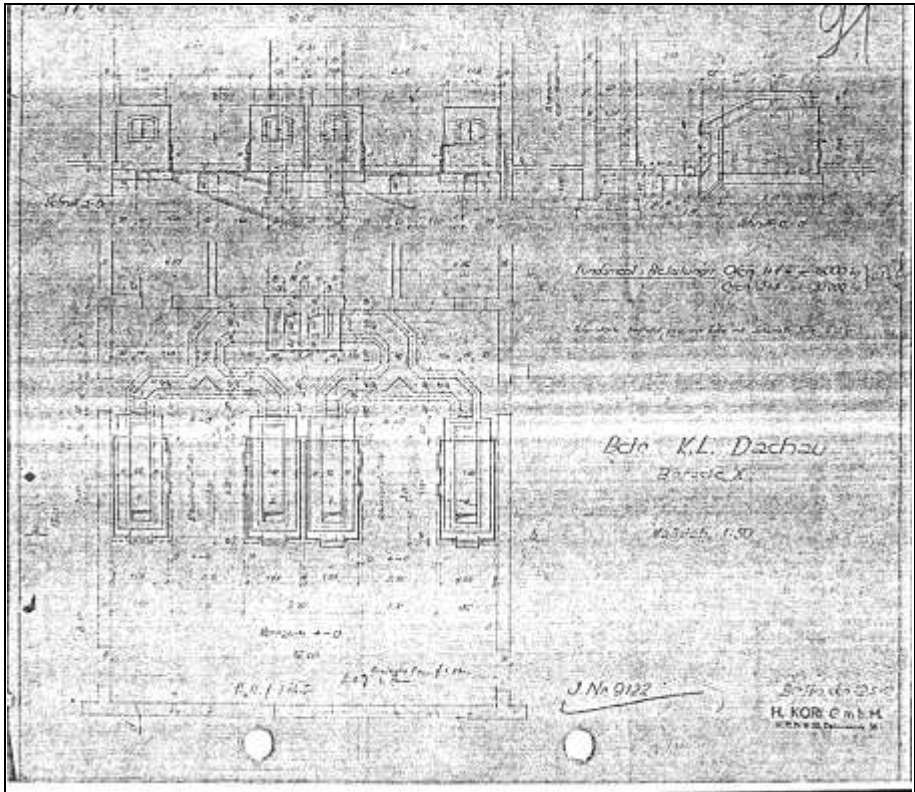

Document 273: Draft for cremation furnaces at Dachau Concentration Camp. Drawing No. 9122 by KORI of 12 May 1942. Source: GARF, 7445-3-125, p. 91.

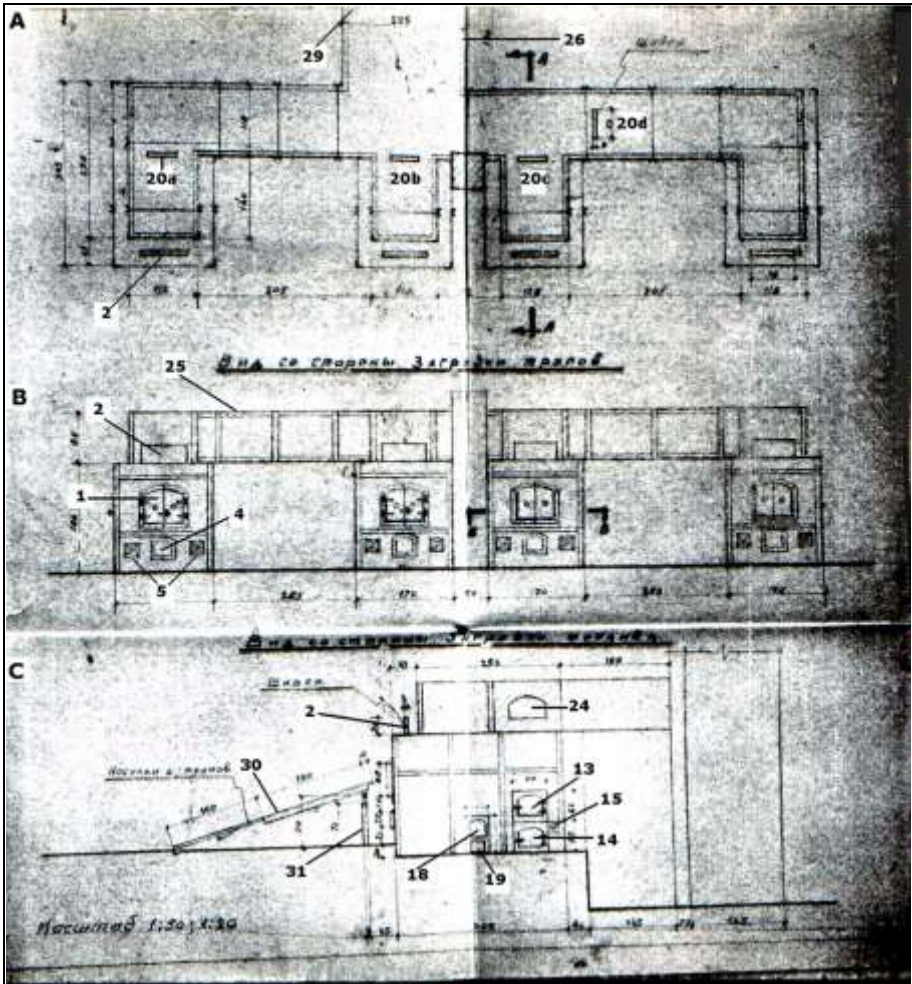

Document 274: Drawing of the cremation furnaces for Sachsenhausen Concentration Camp prepared by the Soviet Commission of Inquiry in June 1945. Source: GARF, 7021-104-3, p. 5. A: top view of the ovens; B: front view; C: lateral view (right side of the fourth furnace).

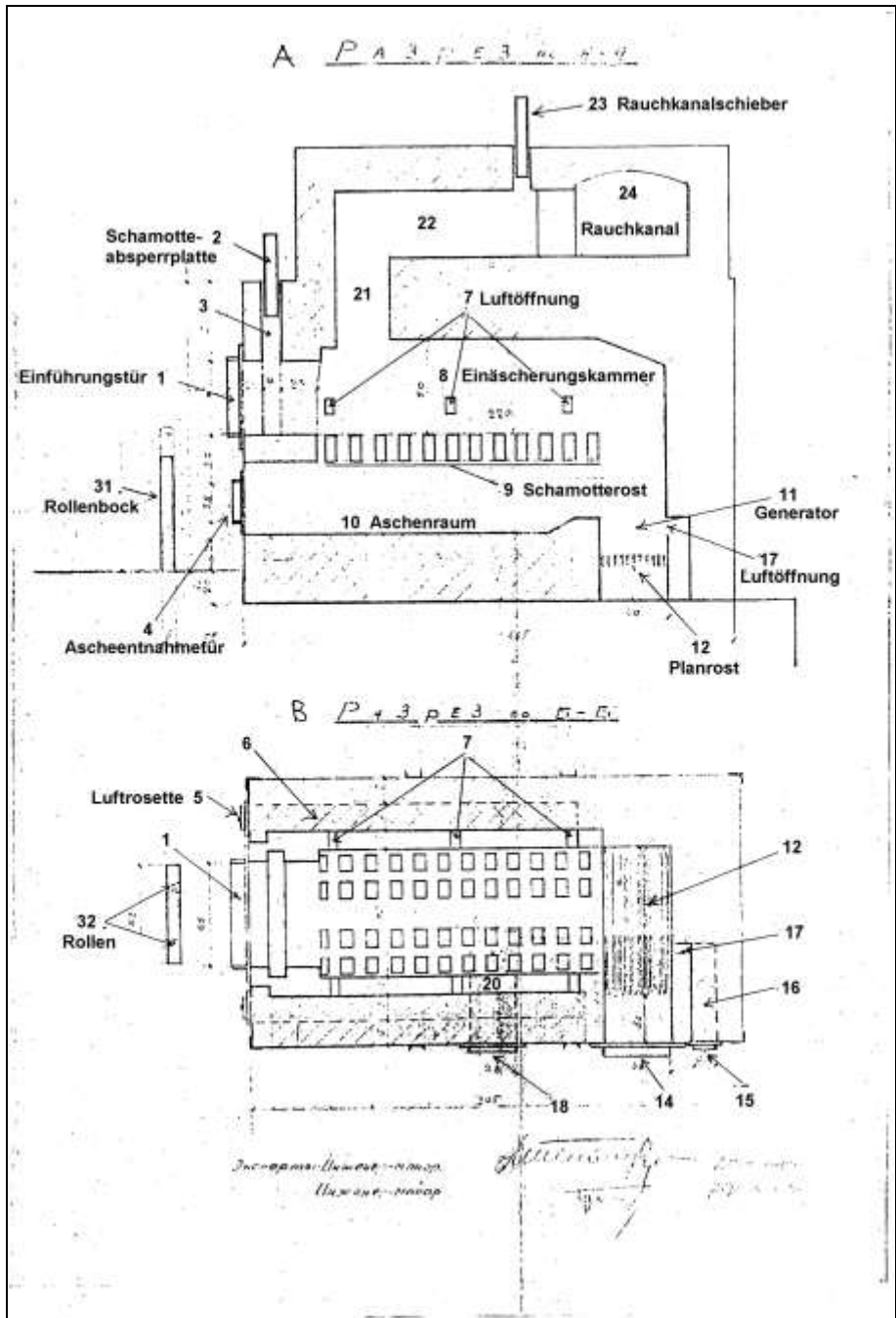

Document 275: Sketch of the cremation furnaces at Sachsenhausen Concentration Camp, prepared by the Soviet Commission of Inquiry in June 1945. Source: GARF, 7021-104-3, p. 6. A: longitudinal vertical section of the furnaces; B: horizontal section. Labeled by the author.

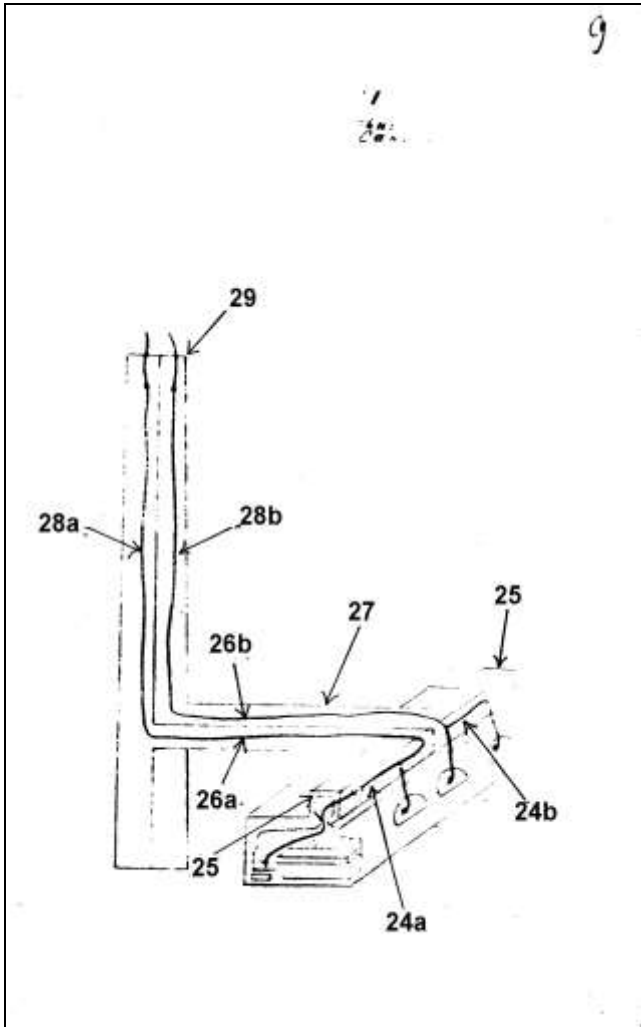

Document 275a: Sketch of the KORI Furnaces' smoke-duct system in the crematorium at Sachsenhausen Camp, drawn by the Soviet Commission of Inquiry in June 1945. Source: GARF, 7021-104-3, p. 29. Numbers added by the author.

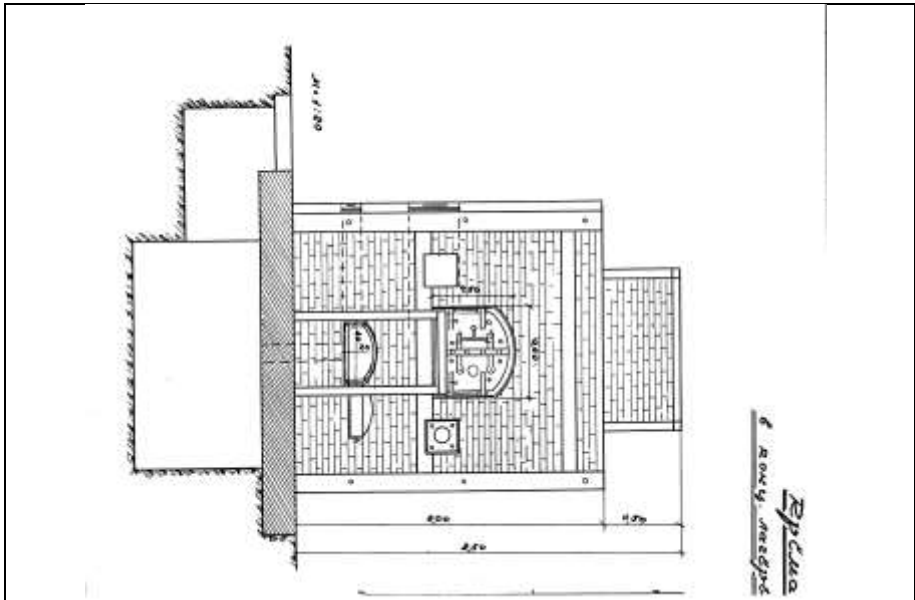

Document 276a: Sketch of H. KORI coke-fired double-muffle cremation furnace at Stutthof Concentration Camp; front view. Soviet drawing of 1945. GARF, 7021-106-4, p. 26.

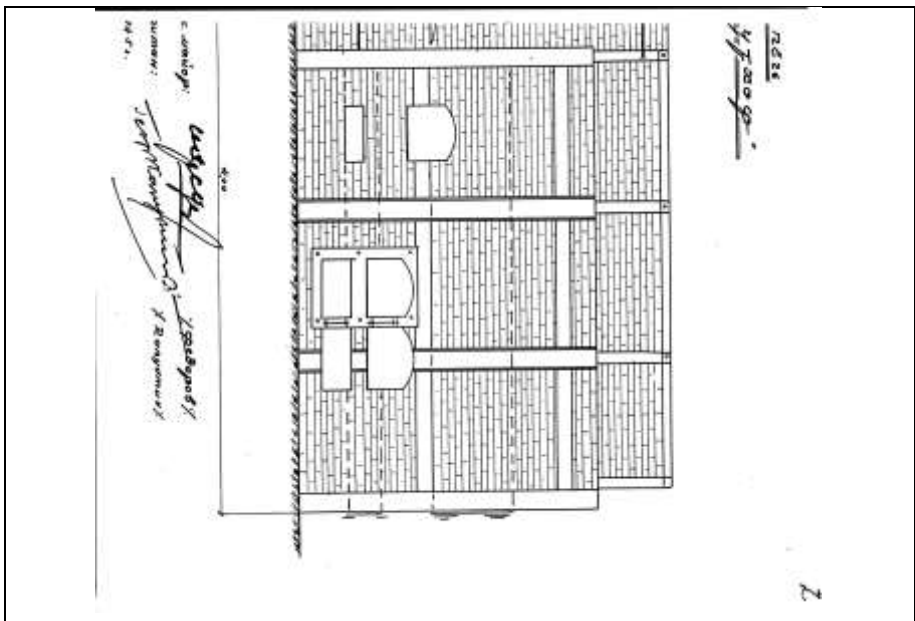

Document 276b: as above, side view.

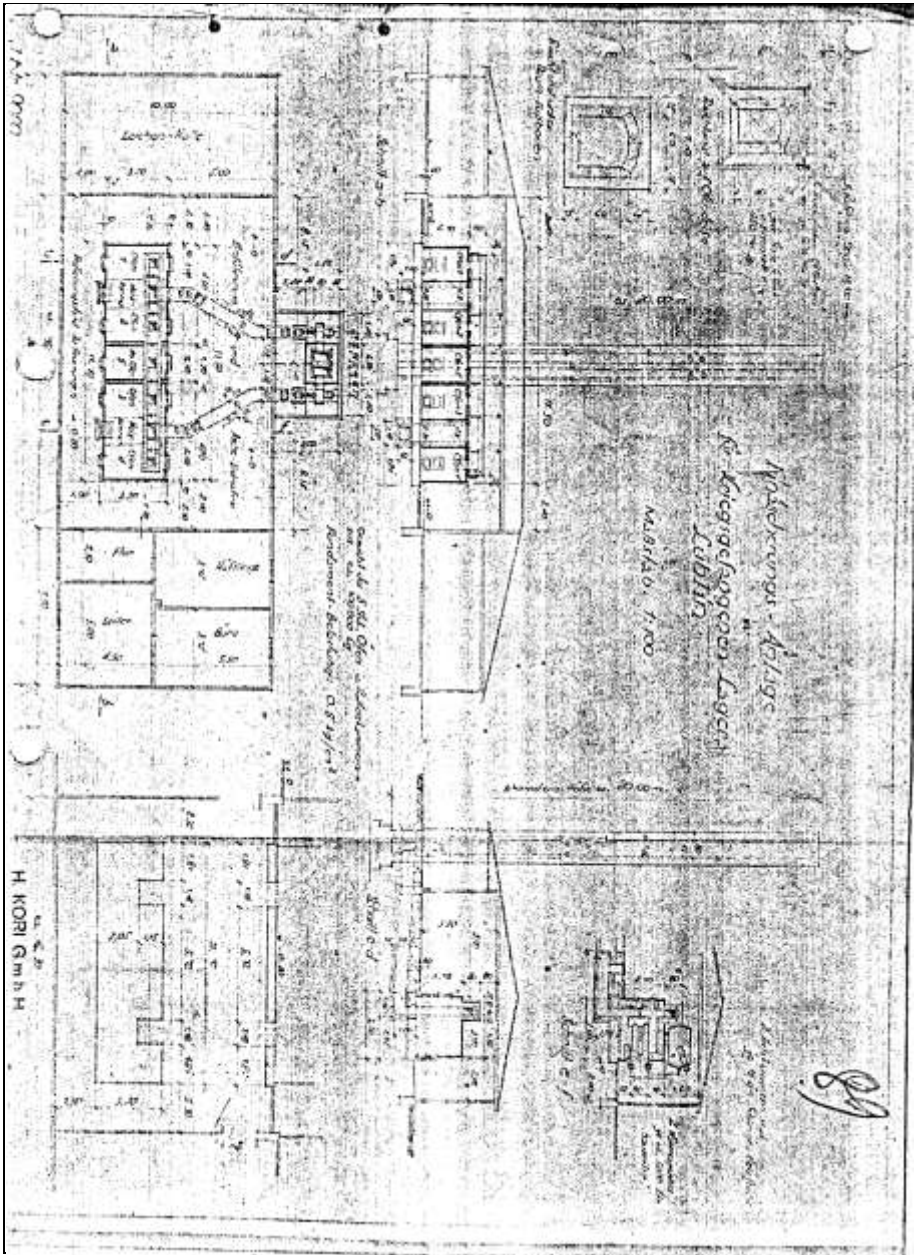

Document 277: "Cremation facility for Lublin PoW Camp." Kori Drawing No. 9080 of 31 March 1942. Source: GARF, 7445-2-125, p. 89.

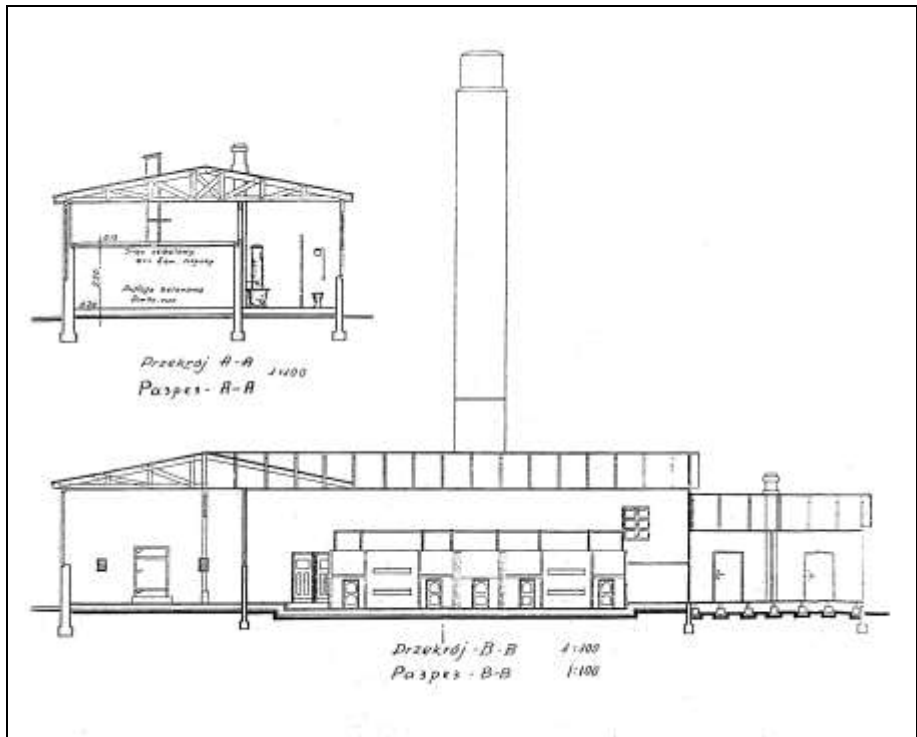

Document 278: Sketch of the crematorium at Lublin Concentration Camp. Cross section (top) and longitudinal section with front view of the furnaces (bottom). Drawing by the Polish-Soviet Commission of Inquiry of August 1944. Source: GARF, 7021-107-9, p. 252.

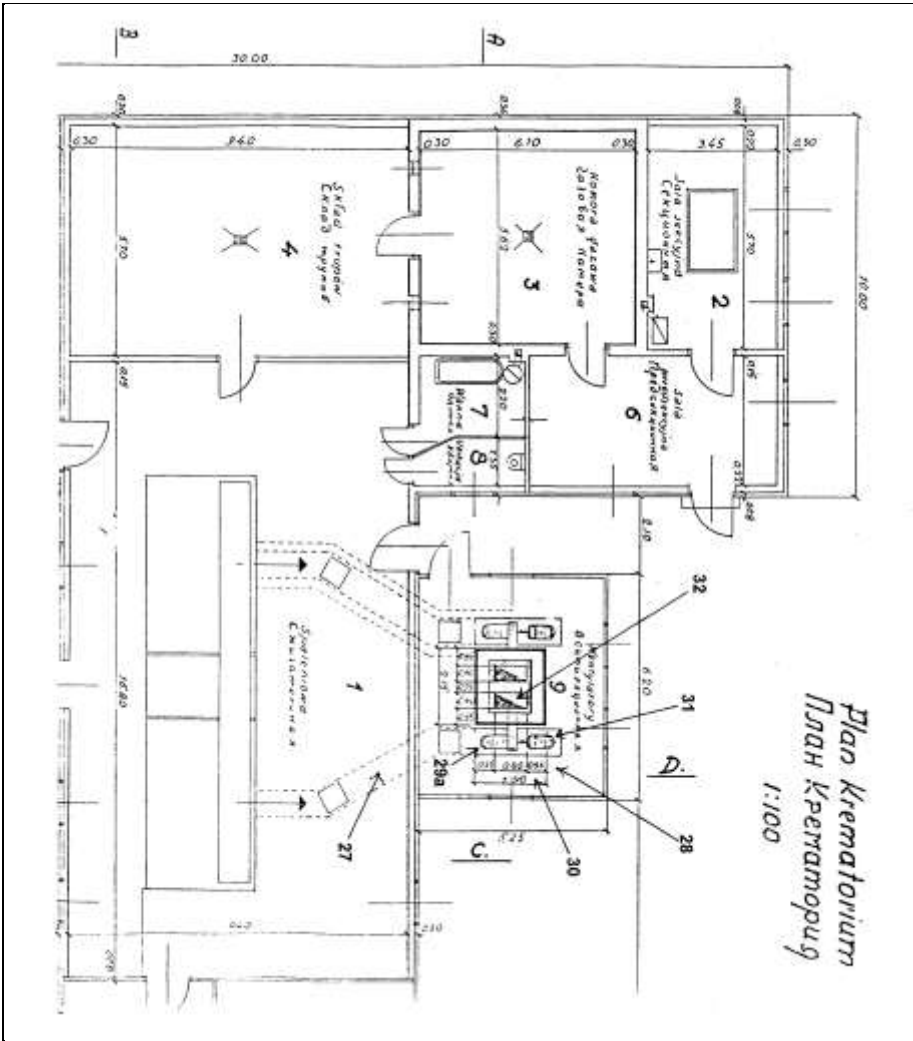

Document 281: Floor plan of the crematorium at Lublin Concentration Camp showing the flue ducts. Drawing by the Polish-Soviet Commission of Inquiry of August 1944. Source: GARF, 7021-107-9, p. 252. 281/2. Labeled by the author.

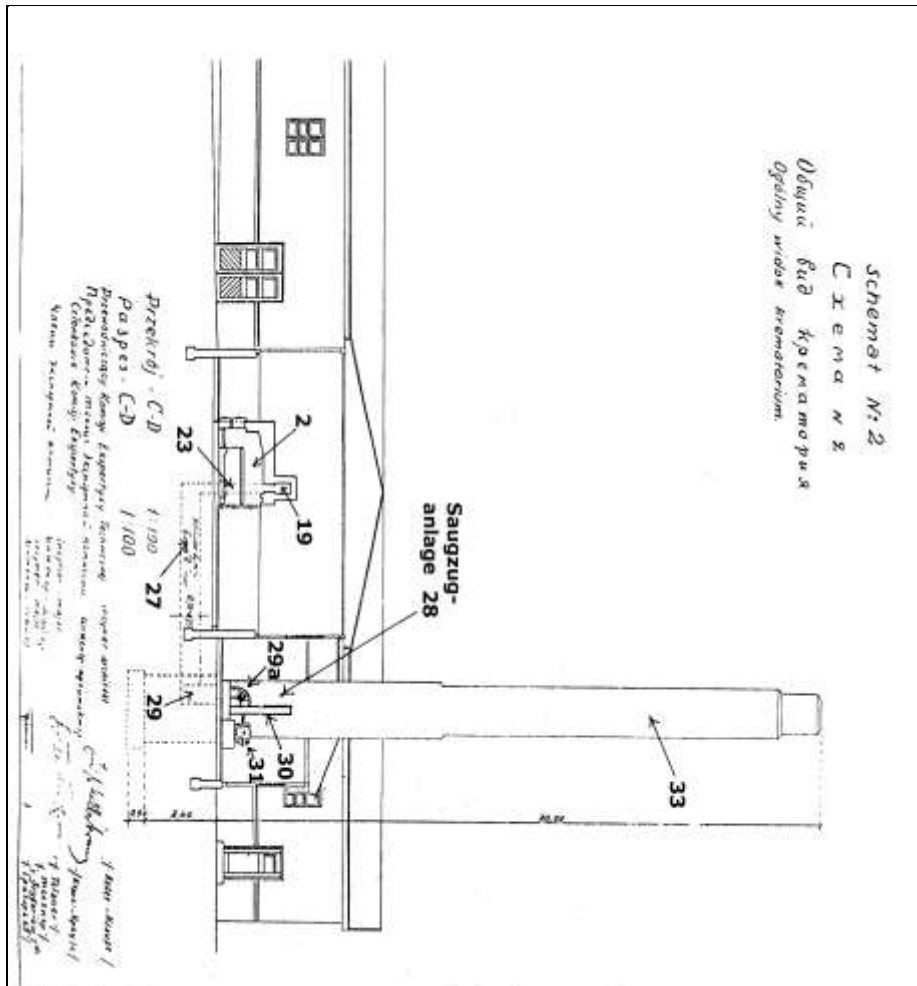

Document 282: Crematorium at Lublin Concentration Camp, longitudinal section showing the flue ducts. Drawing by the Polish-Soviet Commission of Inquiry of August 1944. Source: GARF, 7021-107-9, p. 252. Labeled by the author.

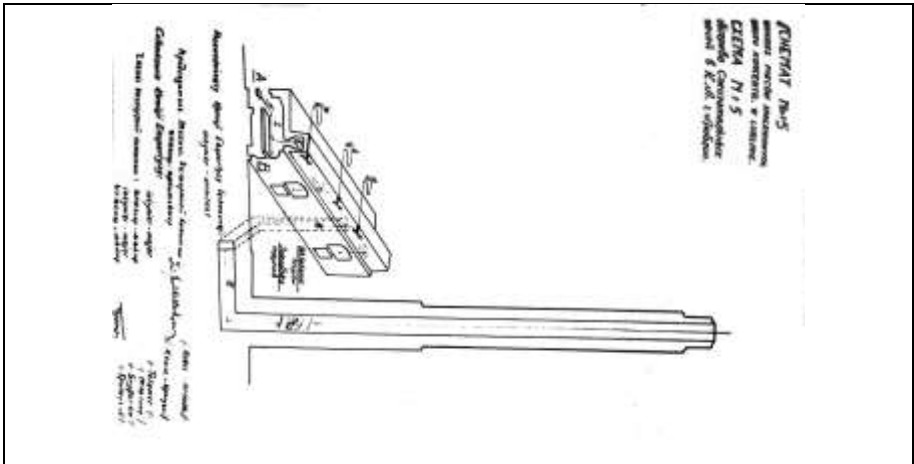

Document 283: as above, angular perspective. Source: GARF, 7021-107-9, p. 255.

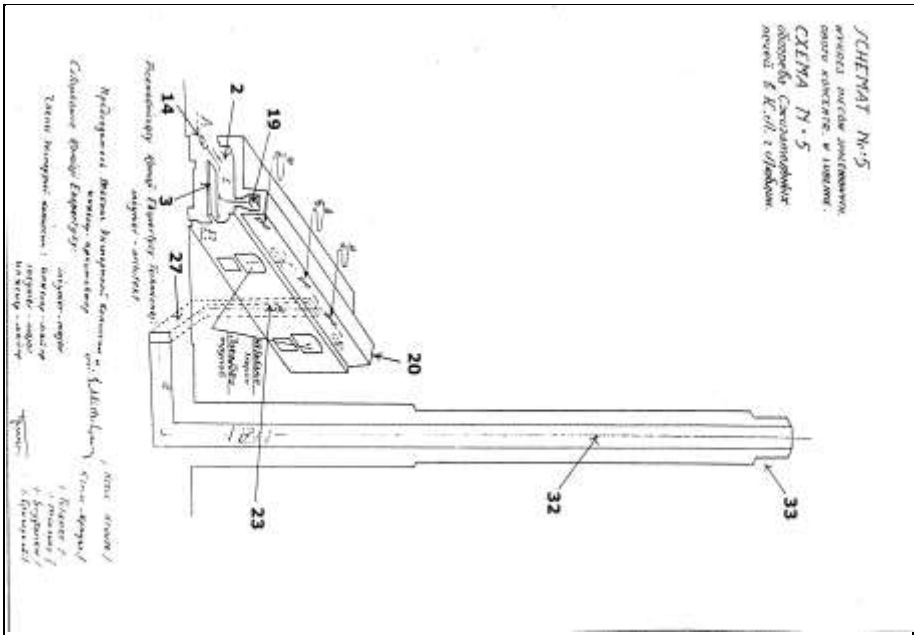

Document 283a: as above, labeled by the author. See text of Part 1 for details.

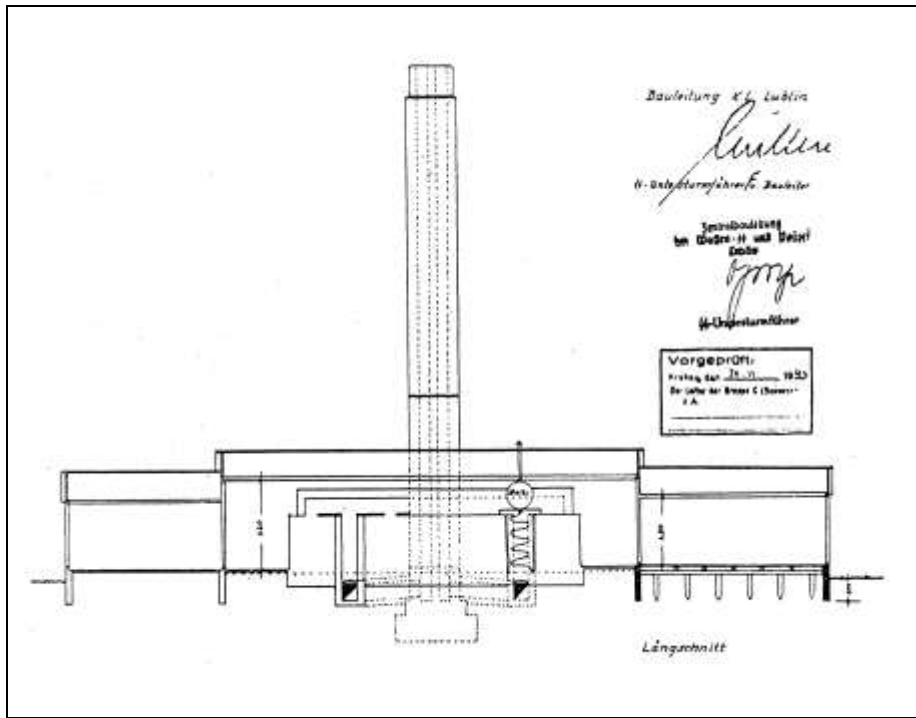

Document 284: KORI Furnace at Lublin Concentration Camp: sketch of the water heating device. Source: Z. Łukaszewicz, "Obóz koncentracyjny i zagłady Majdanek," in: *Biuletyn Głównej Komisji Badania Zbrodni Niemieckich w Polsce*, 1948, pp. 80f.

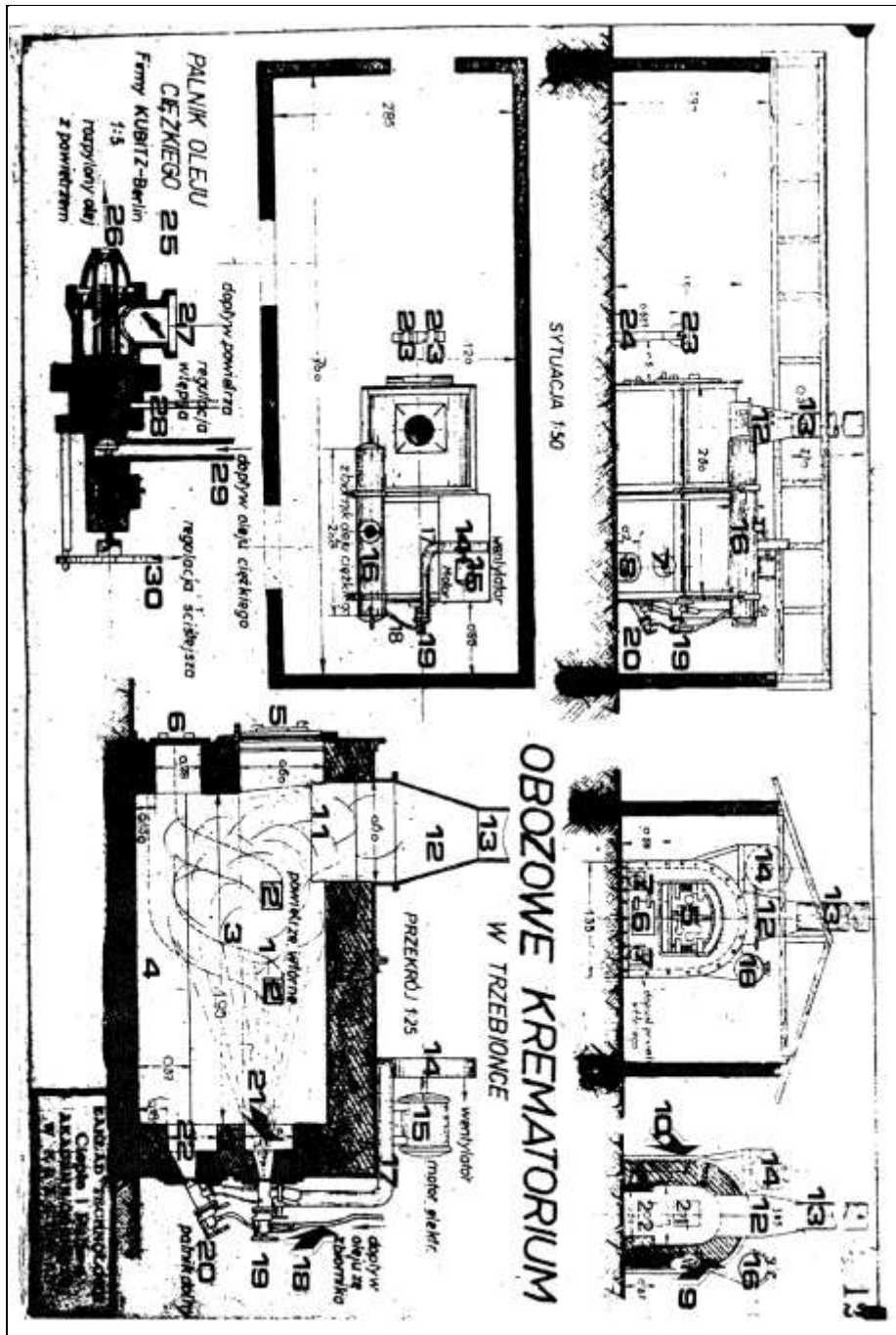

Document 285a: as above, labeled by the author.

BETRIEBSVORSCHRIFT

für die

EINSICHERUNG

Anzünden der Brenner:

A. Ist der Ofen noch warm und ist die Brenneinstellung seit dem letzten Betrieb nicht verändert worden, so ist neue Brenneinstellung, gleichen Brennstoff vorausgesetzt, meist nicht erforderlich.

Anzünden erfolgt in nachstehender Reihenfolge:

- 1.) Ventilator anlassen.
- 2.) Luftklappe am Brenner schliessen.
- 3.) Absperrventil für Öl öffnen.
- 4.) Brennende Lunte einführen.
- 5.) Luftklappe öffnen.

Sobald Zündung erfolgt, Luftklappe langsam schliessen bis Flamme nicht mehr zurückschlägt, sondern ohne Rauchentwicklung gleichmässig brennt. Sollte Zündung nicht gleich erfolgen, Regulierventil bei stehendem Regulierhebel etwa ein viertel Umdrehung nach links drehen, dann wenn Brenner gezündet hat, langsam wieder nach rechts zurückdrehen. Ist der Ofen bereits warm geworden, versuchen mehr Luft zu geben, also Luftklappe mehr öffnen. Nach 5 Minuten Luftrossen am Ofen etwa 3 cm öffnen.

B. Ist der Ofen kalt, oder war die Brenneinstellung verändert, so muss die Einstellung der Brenner folgendermassen erfolgen:

- 1.) Querhub auf ungefähr Mitte stellen.
- 2.) Ventilator anlassen.
- 3.) Luftklappe am Brenner schliessen.
- 4.) Regulierhebel ungefähr senkrecht stellen.
- 5.) Regulierventil oben um ca. 2 unten um ca. 1 1/2 Umdrehungen öffnen.
- 6.) Brennende Lunte einführen.
- 7.) Absperrventil für Öl öffnen.
- 8.) Luftklappe ganz öffnen.

Wenn Zündung nicht sofort erfolgt, Regulierventil noch etwas aufdrehen. Nach Zünden einige Minuten später soweit schliessen bis Flamme noch gut brennt. Raucht die Flamme, dann Querhub etwas in Richtung "zu" stellen. Ist der Brenner einige Minuten im Betrieb, ist der Regulierhebel ganz nach rechts bis zum Anschlag zu stellen. Brennt die Flamme gut, dann Regulierhebel mit Regulierventil kuppeln. Eventuell Flamme nochmals mit Querhub regulieren, falls bei Grosserstellung Rauchentwicklung eintritt. Wenn Flamme stossweise erloscht und wieder zündet (zurückschlägt), ist zuviel Luft vorhanden. Luftklappe dann soweit schliessen, bis Flamme ruhig brennt. Ist der Ofen warm geworden, kann die Luftklappe weiter geöffnet werden. Nach 5 Minuten Luftrossen am Ofen etwa 3 cm öffnen.

Breite von ca 2000 mm erhalten. Wir haben aus diesem Grunde den uns vorliegenden Entwurf für das Gebäude entsprechend ergänzt und überreichen Ihnen anbei ein Skissenblatt No. 0913 in welchem wir die erforderlichen Mindestmaße einzeichnen haben. Damit Sie in der Lage sind schnellstens ein Vorangebot ausarbeiten teilen wir Ihnen mit, dass für einen Ofen benötigt werden:

- 1100 Kg Weibsteine Segerkegel 33
- 6500 " Normalsteine
- 1000 " Schornsteinortel
- 5000 Stück gewöhnliche Ziegelsteine für das Ofenausgemauertwerk
- 100 Kg Kalk
- 3,8 cbm Sand
- 2,- " Lehm

An Eisenteilen:

- 500 Kg " " zur Verankerung
- 80 " Rundisenanker
- 85 " Hufeisenschieberfassung mit Gegengewichten und Seilrollen
- 40 " Rauchschieberfassung mit Gegengewichten und Seilrollen
- 25 Kg 2 Luftschieber
- 200 " je eine Feuer-, Schlack-, und Aschennahmetür
- 25 " Schürstangen
- 10 " " " " "
- 100 " gusseiserne Hotstäbe
- 80 " Rostauflegerbalken.

Hierzu können die gleiche Menge für den 2. Ofen und die Materialien für den Rauchkanal und Schornstein. Auch der Rauchkanal und der untere Teil des Schornsteines ca 3-4 m hoch muss mit Schornsteinteilen ausgeklüftet werden. Hierfür genügt allerdings eine geringere Sorte. Die Feuerung der Ofen wird so eingerichtet, dass neben Koks auch Kohle oder Holz verfeuert werden kann.

Hochofnungsvoll
Hüttenwerke A.G.

Handwritten signatures and initials

Anlage

Du je ova fotokopija verni originali koji se nalazi u arhivi Drzavnog Kogizivlja i razvijanja stozina rukovodila i njihovih podataka o pogrebnim i gasnim komorama u Auschwitzu u promisljeni arhivi nasadne redakcije u Beogradu oktobra 1944. - OTZAVI

2. Avgusta 1945
Beograd



Prosednik Drzavnog Kogizivlja
Dr. Dusan Stokichovic
Profesor

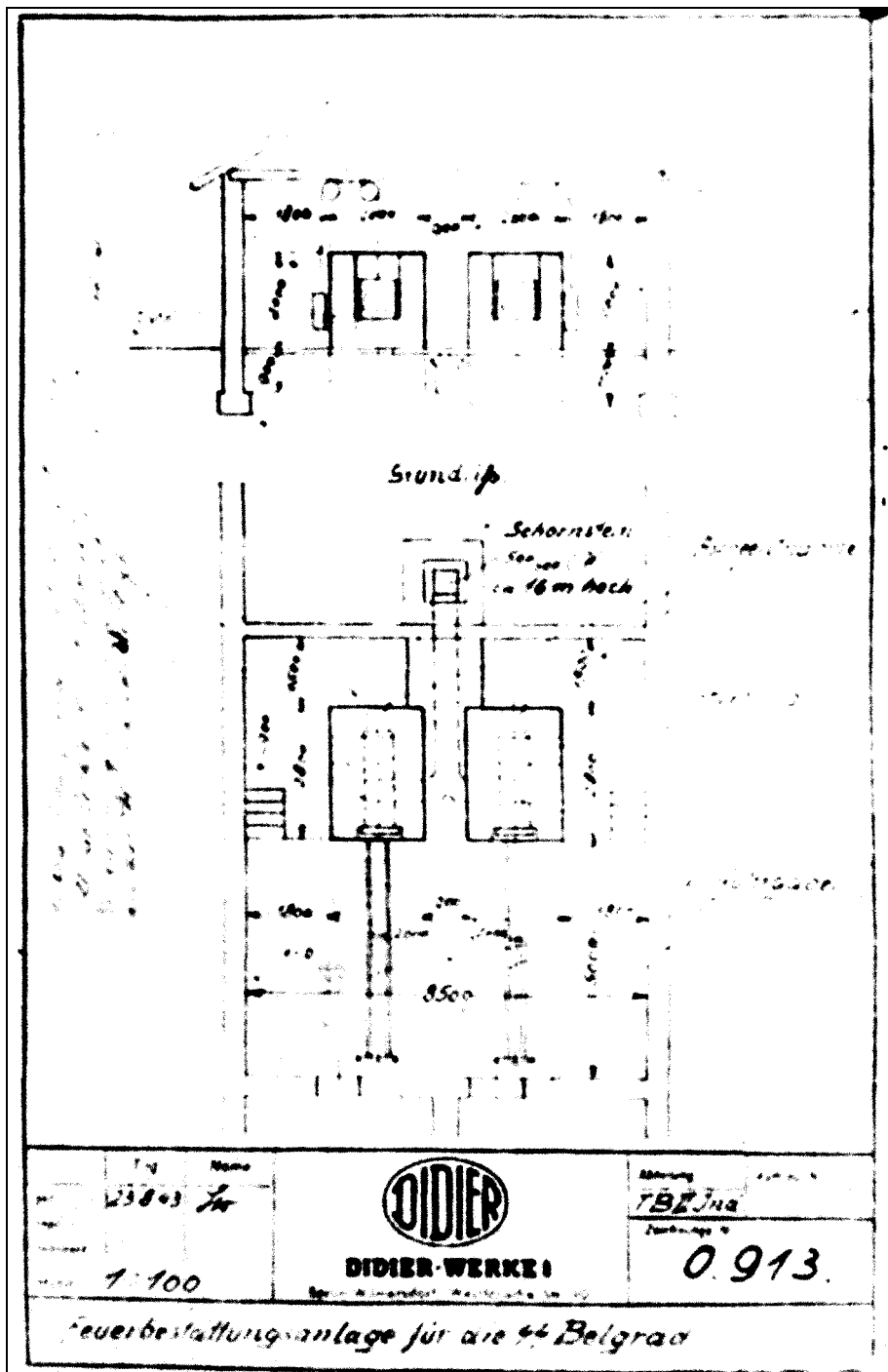

Document 288: "Cremation Facility for the Belgrade SS." Drawing by Didier-Werke No. 0.913 of 23 August 1943. Source: GARF, 7445-2-125, p. 92.

GHETTO THERESIENSTADT Krematorium		PAMÁNIK TĚŽKŮ KOPIE PRO STUDIJNÍ ÚČELY COPY FOR STUDY PURPOSES		H 1194		38		
				Ofen Nr. IV		Datum 11.10.43		
Lfd. Nr.	Z e i t			Temperatur °C			Name u. Vorname	Sarg Nr
	Be- ginn	Ende	Dauer	Be- ginn	Ende	Max		
1	6 ⁰⁰	6 ³⁰	30	50	IT		Hirsch Rosalie	19668
2	6 ³⁰	7 ⁰⁰	30	50	IT		Absberg Jenny	19669
3	7 ⁰⁰	7 ³⁰	30	0	/		Wasserkilling Gisela	19670
4	7 ³⁰	8 ⁰⁵	35	50	IT		Abeles Alois	19671
5	8 ⁰⁵	8 ⁴⁰	35	/	/		Witz Amalie	19672
6	8 ⁴⁰	9 ¹⁵	35	/	/		Heinemann Georg	19673
7	9 ¹⁵	9 ⁵⁰	35	/	/		Herz Therese	19674
8	9 ⁵⁰	10 ²⁵	35	S	IT		Falkenstein Moses	19675
9	10 ²⁵	11 ⁰⁰	35	/	/		Ichelheimer Hannchen	19676
10	11 ⁰⁰	11 ³⁵	35	S	IT		Beer Richard	19677
11	11 ³⁵	12 ¹⁰	35	/	/		Hirschel Paula	19678
12	12 ¹⁰	12 ⁴⁵	35	/	/		Herrmann Freide	19679
13	12 ⁴⁵	13.00	15	/	/		Badrian Emanuel	19680
14.	13.00	13.35	35	S.	IT		Goldschmidt Pauline	19681
15.	13.35	14.10	35	SV.	IT		Reichler Ida	19682
16.	14.10	14.45	35	/	/		Jacoby Flora	19683
17.	14.45	15.20	35	S.	IT		Manni No 59. K.F.	19684
18.	15.20	15.55	35	/	/		Süss Josefine	19685
19.	15.55	16.30	35	/	/		Salus Paul	19686
20.	16.30	17.05	35	/	/		Bleim Lina	19687
21.	17.05	17.30	30	S.	IT		Onler Dr. Felix	19688
22.	17.30	18.00	30	/	/		Butmann Rosa	19689
23.	18.00	18.30	30	S.	IT		Schwartz Selma	19690
24.	18.30	19.00	30	/	/		Oppenheimer Rosa	19691
25.	19.00	19.30	30	S.	IT		Ruhm Felix	19692
26.								✓

Document 289: List of names of the corpses cremated at the Terezín Ghetto's crematorium on 11 October 1943. Source: PT, A 1194, p. 33.

32

GHETTO THERESIENSTADT
Krematorium

Datum 11.10.43

Ofen Nr.	Schicht von bis	Einges. Leichen		Ölverbrauch l	Heizer	Helfer	Kontrolle
		Lfd. Nr.	Anzahl				
1							
2							Puh
3							
4	6 ⁰⁰ - 13 ⁰⁰ 13 - 20	1-13 14-25	13 12	✓ 0	Ryger/alt. Brennmeister Fischhof	Mauses	3 3.
			25				

562-TA-42/r

Document 290: Numerical summary of cremations conducted at the Terezín Crematorium on 11 October 1943. Source: PT, A 1 194, p. 32.

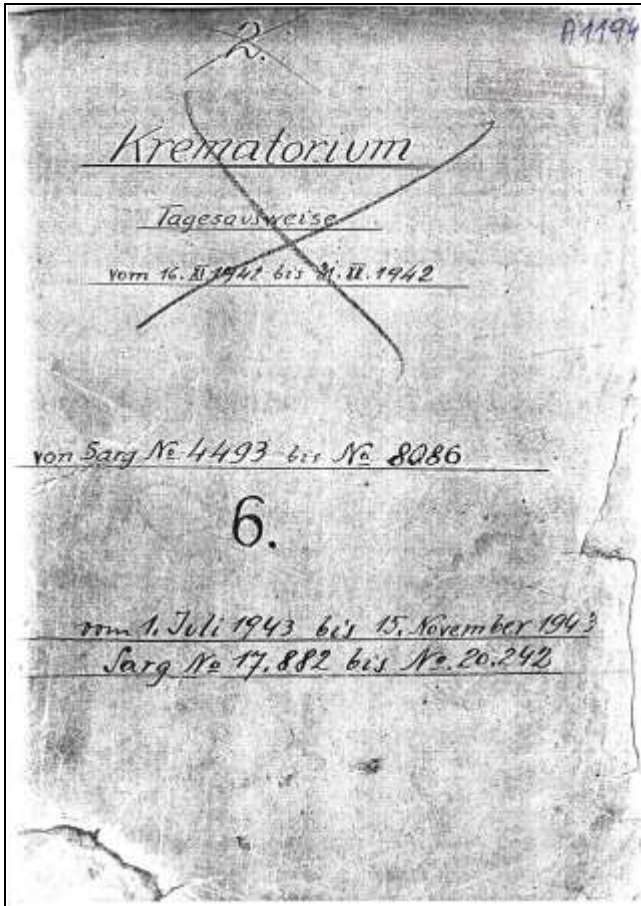

Document 291: Registry No. 6 of the Terezín Crematorium, spanning from 1 July to 15 November 1943. Source: PT, A 1194, p. 1.

43

Konzentrationslager Stutthof
Kommandantur

Nr. der Totenliste 187/18/44

Verstorbene Person :

1. **Familienname:** 1 (Eine) unbekannte
Vornamen (Rufname unterstreichen): ?
 Geburtsort: ? Geburtsdatum: ?
 Letzter Wohnort: ?
 Beruf: ?
 Sterbedatum: 5 Dezember 1944 um 11:30 Uhr
 Sterbeursache: Flex-allgemeine Körperschwäche

2. **Standesamt**

Sterbeschein.

Unter Nr. _____ des Sterberegisters ist eingetragen worden, dass der

am _____ 194 um _____ Uhr _____ mittags zu _____
 verstorben sei.

den _____ 194

Der Standesbeamte.

Siegel

3. **Amtsärztliche Bescheinigung.**

Nach Besichtigung der Leiche am - 6. DEZ. 1944 194 wird hierdurch amtlich
 bescheinigt, dass der vorstehend Genannte an Flex-allgemeiner
Körperschwäche (Sterbeursache)
 gestorben ist. Auf Grund der Leichenschau hat sich ein Verdacht nicht ergeben, dass der
 Verstorbene eines nichtnatürlichen Todes gestorben sei.

Stutthof

den - 6. DEZ. 1944 194

U. L.
 44-Übersetzermeister M



Document 292: Official form for the cremation of an inmate's corpse. Stutthof Concentration Camp, 6 December 1944. Source: AMS, I-IIIC-2.

W⁵⁴

4. Hier sind keine Umstände bekannt, die auf Herbeiführung des Todes durch strafbare Handlung schliessen lassen.
 (§ 3 Abs. 2 Ziff. 3 des Gesetzes über Feuerbestattung vom 15. Mai 1934.)
Stutthof, den **6. Dezember** 194**4**.

Staatliche Kriminalpolizei
 I. 1. *W. Min*
SS-Untersuchungsführer

Konzentrationslager **Stutthof** **Stutthof**, den **6. Dez.** 194**4**.
 Kommandantur

5. An
 den Leiter des Krematoriums
 Die Einäscherung der Leiche ist innerhalb 24 Stunden durchzuführen.

W. Min
SS-Stabschef u. Kommandant

Eingeschert am *1. Dec* 194**4**.
H. Rant
SS-Untersuchungsführer

KL 50/443 200.000

Document 292: continued.

Konzentrationslager
Kommandantur
Nr der Totenliste

Verstorbene Personen:

1. Familienname
Vornamen (Rufname unterstreichen): —
Geburtsort Geburtsdatum
Letzter Wohnort
Beruf
Sterbedatum
Sterbeursache
2. Standesamt

Sterbeschein

Unter Nr..... des Sterberegisters ist eingetragen worden,
dass der..... am..... 194..... um
Uhr..... mittags zu..... verstorben sei.
..... den..... 194.....

Siegel

Der Standesbeamte.

106

3. Antragsärztliche Bescheinigung

Nach Besichtigung der Leiche am..... 194..... wird hierdurch
amtlich bescheinigt, dass der vorstehend Genannte am.....
(Sterbeursache) gestorben ist. Auf Grund des Leichensehen hat
sich ein Verdacht nicht ergeben, dass der Verstorbene eines nicht-
natürlichen Todes gestorben sei.

..... den....., 194.....

4. Hier sind keine Umstände bekannt, die auf Herbeiführung des
Todes durch strafbare Handlung schliessen lassen.
(§ 3. Abs. 2. Ziffer 3. des Gesetzes über Feuerbestattung vom 15.
Mai 1934).

..... den....., 194.....

Staatliche Kriminalpolizei.

Konzentrationslager Mauthausen
Krematorium

Mauthausen, den 7. Oktober 1941

578

11/4

Betreff: Urnenversand

Bezug: dort. Schr. v. 4.10.41

Anlagen: keine

An

Unterkunft Gasen, Abtlg. Krematorium
H - Uscha. Wassner

Bei Durchsicht der für Steyr hergerichteten Urnen ergeben sich nachstehende Beanstandungen :

fälschlich nicht aufgeführt , aber doch zu verschicken ist :

3347 (Polen-Jude)	
3499 (Spanier)	Dortige Liste ist entspr.
3625 zum Aufrunden auf 300 Stück	zu ändern und die Urnen
3626 "	von den hergerichteten weg-
	zunehmen oder hinzuzutun.

das ~~pa~~ aufgeführt und nicht zu verschicken ist :

3438 (AZR.)	
3551 (D.R.-Jude)	
3618 (Protekt.-Jude)	
3619 (" ")	

✓

Document 296: "Shipment of urn" by Mauthausen Concentration Camp. 7 October 1941. Source: ÖDMM, 3 12/49.

 J.A. TOPF & SÖHNE, ERFURT

TAG 3.6.40. ⁴²BLATT -2-

EMPFANGER

SS-Neubauleitung, KL, Auschwitz /0.-8.

I Beschriftungs-Apparat,

bestehend aus dem Holzsetzkasten
und dem schmiedeeisernen Apparat,
einschließlich der Typen zur Be-
schriftung, also komplett,

zum Preise von RM 150.-- ✓

Bei Bestellung dieser Teile bitten wir um Übermitte-
lung einer gültigen Kennziffer für das III.Quartal 40
über 310 kg.

Wir bitten um Ihre geschätzte Auftragserteilung und
empfehlen uns Ihnen

Heil Hitler !

opa. J.A. TOPF & SÖHNE

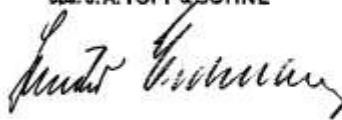

Konzentrationslager Auschwitz
Politische Abteilung

Auschwitz, den 29. April 1941.

Az.: 14 f 5 /4.41/ Cu.

Betr.: Urnenaufbewahrung.
Bezg.: RP-H, d. Insp. d. Konz. Lager vom 16.4.1941.
und Anordnung des Kommandanten des KL. Au.
Anlg.: keine.

An die
Neubauleitung des KL.-Au.,
Auschwitz.

30. APR. 1941

Laut Verfügung des Insp. d. Konz. Lager im Einvernehmen des R.S.H.-
Amtes sollen die Urnen der verstorbenen Häftlinge in einem der
hiesigen Gebäude untergebracht werden. Der Kommandant hat deshalb
angeordnet, dass hierfür ein Bodenraum im Reviergebäude eingerich-
tet wird. Damit die Urnen in diesem Raum ordnungsgemäß unterge-
bracht werden können, ist erforderlich, dass entsprechende Regale
aufgestellt und kleine Veränderungen vorgenommen werden.
Es wird gebeten, einen Fachmann abzustellen, der die Besichtigung
des Raumes vornimmt und die erforderlichen Vorbereitungen trifft.
Der Leiter der Politischen Abteilung
[Signature]
1-Untersturmführer und Krim.-Sekt.

Document 298: Letter from the Head of the Political Department of Auschwitz Concentration Camp to the camp's SS New Construction Office of 29 April 1941 about storing urns with the ashes of deceased inmates. Source: RGVA, 502-1-314, p. 1.

Schiff: Wesseling-Bremsterium		Wärfung 11° 8'		29	
100 Stück Urnenboxen		194.41		vom 6.1.41	
48-	m²	Lohn	10%	8.16	101.52
3-	kg	Wage	15%	52	1.56
1-	l.	Material			3.67
				104.72	106.76
250 Leuchtmittel a 0.05 = 12.50				Lohn	10.50
4 Messer a 0.2 = 0.80					10.50
20.50				Rab.	132.94
					10.12
Ablegen!					

Document 299: Political Department of Auschwitz Concentration Camp. Order of 100 urn boxes from the SS New Construction Office's carpentry workshop of 6 January 1941. Source: RGVA, 502-2-1, p. 29.

195 3346

Anforderung Nr. _____

Auschwitz, den 5. Februar 1941

von Politische Abteilung / Krematorium

Es wird benötigt

dringend

100 Stück

Urnenkisten

Der Reichsführer-SS
Haus- und Haushalt und Bauten
SS-Neubauleitung A. C. Auschwitz

[Signature]
Oberscharführer u. Bauleiter

Unterschrift [Signature]
SS-Unterkunftsführer

Anschaffung bzw. Abgabe genehmigt <u>[Signature]</u>	zur Abgabe an <u>[Signature]</u>
---	-------------------------------------

10011

Document 299a: Political Department of Auschwitz Concentration Camp. Order of 100 urn boxes from the SS New Construction Office's carpentry workshop of 5 February 1941. Source: RGVA, 502-2-1, p. 46.

Bauleitung der Waffen-~~SS~~
und Polizei
Auschwitz OS.-Oswiecim

Auftrag Nr. 1009
Auschwitz, den 27. 11. 41.

Arbeitskarte

An die

Tischlerei _____	Zimmerei
Schlosserei _____	Betonkolonne
Installateure _____	Malerei
Elektriker _____	Glaserei
Maurer _____	Dachdecker

Für Krematorium ✓
ist folgende Arbeit auszuführen:

Versandkästen Urnen nach Angabe
Krematorium

50 Stück 26 x 19 x 19 cm **Ablegen!**

50 Stück 26/19/19 cm groß

Angefangen: 20. 11. 41. Beendet: 20. 11. 41.

10 ~~100~~ 1005 Facharbeiterstunden 4

Hilfsarbeiterstunden	
Schweißerstunden	

100 1005

Document 300: "Labor time card" of 27 November 1941 on the manufacture of 50 shipping boxes for urns. Source: RGVA, 502-2-1, p. 34.

HOLOCAUST HANDBOOKS · VOLUME 24

CARLO MATTOGNO & FRANCO DEANA

The
**CREMATION
FURNACES
of
AUSCHWITZ**

A TECHNICAL AND HISTORICAL STUDY



PART 3: PHOTOGRAPHS

PUBLISHED BY CASTLE HILL PUBLISHERS

THE CREMATION FURNACES OF AUSCHWITZ, PART 3

The Cremation Furnaces of Auschwitz

A Technical and Historical Study

Part 3: Photographs

By Carlo Mattogno

With Contributions by Dr.-Ing. Franco Deana



Castle Hill Publishers
P.O. Box 243, Uckfield, TN22 9AW, UK
October 2021

HOLOCAUST HANDBOOKS, Volume 24:

Carlo Mattogno:

The Cremation Furnaces of Auschwitz: A Technical and Historical Study.

Part 3: Photographs

With Contributions by Dr.-Ing. Franco Deana

Uckfield, East Sussex: CASTLE HILL PUBLISHERS

PO Box 243, Uckfield, TN22 9AW, UK

2nd, revised edition, October 2021

Originally published in Italian in 2011 as *I forni crematori di Auschwitz: Studio storico-tecnico*, by Effepi, Genoa. Translated from the Italian by Henry Gardner and Germar Rudolf

ISSN: 1529-7748

Part 1: History and Technology

ISBN: 978-1-59148-936-8 (hardcover)

ISBN: 978-1-59148-275-8 (paperback)

Part 2: Documents

ISBN: 978-1-59148-935-1 (hardcover)

ISBN: 978-1-59148-276-5 (paperback)

Part 3: Photographs

ISBN: 978-1-59148-934-4 (hardcover)

ISBN: 978-1-59148-277-2 (paperback)

Published by CASTLE HILL PUBLISHERS

Manufactured worldwide

© by Carlo Mattogno 2011, 2015, 2021

Distribution worldwide by:

Castle Hill Publishers, PO Box 243

Uckfield, TN22 9AW, UK

<https://shop.codoh.com>

Set in Times New Roman

www.HolocaustHandbooks.com

Cover Illustrations: top: the reconstructed crematorium at the Lublin-Majdanek Camp (Photo 285); right: Crematorium I at the Auschwitz Main Camp (Photo 86); bottom: cremation furnace on the foundations of the former cremation hall at the Groß-Rosen Camp (Photo 332); left: the new crematorium ("Baracke X") at the Dachau Camp (Photo 248).

Table of Contents

Part 1: History and Technology (separate book)

Preface to the First Edition

Preface to the Second Edition

Unit I: Modern Cremation

1. The Cremation
 - 1.1. General Principles of Combustion Technology
 - 1.2. The Chemical Processes during Cremations
 - 1.3. The Cremation Process
2. Cremation Technology of Coke-Fired Furnaces
 - 2.1. Structure and Operation
 - 2.2. General Theoretical and Structural Principles
3. Origin and Development of Modern Cremation Furnaces
4. Cremation Experiments in Germany in the 1920s
5. Technical Developments of Cremation Furnaces in Germany in the 1930s
 - 5.1. Furnaces with Coke-Fed Gasifiers
 - 5.2. Furnaces Heated with City Gas
 - 5.3. Electrically Heated Furnaces
6. The Duration of the Cremation Process
 - 6.1. Cremation Furnace with a Coke-Fed Gasifier
 - 6.2. Cremation Furnace with Briquette-Fed Gasifier
 - 6.3. Cremation Furnace Heated with Gas
 - 6.4. Cremation Furnace Fired Electrically
7. Heat Balance of a Coke-Fed Cremation Furnace
8. Legal, Ethical and Professional Standards for Cremations in Germany
9. Cremation Statistics
 - 9.1. Statistics for Germany (1878-1939)
 - 9.2. Statistics of Other Countries
10. Mass Cremation for Hygienic and Sanitary Purposes
11. Notes on Present-Day Cremation Furnaces

Unit II: J.A. Topf & Söhne

1. Historical Notes on the Topf & Söhne Company
2. The Topf Cremation Furnaces for Civilian Use
 - 2.1. The Cremation Furnace with a Coke-Fed Gasifier
 - 2.2. The Gas-Fired Cremation Furnace
 - 2.3. The Cremation Furnace with Electrical Heating
3. The Topf Patents of the 1920s and 1930s
4. Topf Waste Incinerators
5. Topf Cremation Furnaces for Concentration Camps
 - 5.1. The Coke-Fired Cremation Furnace with One Muffle

- 5.2. The Oil-Fired Mobile Cremation Furnace with Two Muffles
- 5.3. The Coke- or Oil-Fired Cremation Furnace with Two Muffles
- 5.4. The Coke-Fired Cremation Furnace with Two Muffles Placed Opposite Each Other
6. The Topf Co. and the Construction of the Cremation Furnaces at Auschwitz-Birkenau
 - 6.1. The Furnaces of Crematorium I at Auschwitz
 - 6.2. The Furnaces of Crematoria II and III at Birkenau
 - 6.3. The Furnaces of Crematoria IV and V at Birkenau
7. Structure and Operation of the Topf Cremation Furnaces at Auschwitz-Birkenau
 - 7.1. The Coke-Fired Double-Muffle Furnace Auschwitz Type
 - 7.2. The Coke-Fired Triple-Muffle Furnace
 - 7.3. The Coke-Fired 8-Muffle Furnace
 - 7.4. The Plans for Mass Cremations at Auschwitz-Birkenau
8. The Duration of the Cremation Process in the Topf Furnaces at Auschwitz-Birkenau
 - 8.1. The Documents
 - 8.2. Richard Kessler's Cremation Experiments
 - 8.3. The List of Cremations in the Gusen Crematorium
 - 8.4. The List of Cremations at the Westerbork Crematorium
 - 8.5. Conclusions
9. The Cremation Capacity of the Cremation Furnaces at Auschwitz-Birkenau
 - 9.1. Continuous Operation of the Furnaces
 - 9.2. Concurrent Cremation of Several Corpses
 - 9.3. Soviet and Polish Technical Investigations
 - 9.4. Maximum Theoretical Cremation Capacity
 - 9.5. Normal Cremation Capacity
 - 9.6. Discussion of the *Zentralbauleitung* Letter of 28 June 1943
 - 9.7. The Durability of Refractory Lining
 - 9.8. The Effective Equivalent Operating Time of the Birkenau Cremation Furnaces
 - 9.9. The Auschwitz-Birkenau Crematoria in the General Operation of the Camp
10. Heat Balance of the Topf Furnaces at Auschwitz-Birkenau
 - 10.1. Remarks on the Method Used
 - 10.2. Technical Data
 - 10.3. Heat Balance of the Double-Muffle Furnace at Gusen
 - 10.4. Heat Balance of the Double-Muffle Furnace at Auschwitz
 - 10.5. Remarks on the Heat Balance
 - 10.6. Heat Balance of the Topf Triple-Muffle Furnace
 - 10.7. Heat Balance of the Topf 8-Muffle Furnace
 - 10.8. Observations on the Coke Consumption of the Triple- and 8-Muffle Furnaces
 - 10.9. A Comparison with the Kori Furnace at the Westerbork Camp and the Kori Slaughterhouse Furnaces
 - 10.10. Some Thermal Aspects of the Triple-Muffle Furnace
 - 10.11. On Claims of Flaming Chimneys
11. The Cremation Furnaces Built by Other German Companies: Kori, Ignis-Hüttenbau and Didier

- 11.1. Historical Remarks Concerning the H. Kori Co. of Berlin
- 11.2. The Coke-Fired Kori Cremation Furnaces for the Concentration Camps
- 11.3. The Oil-Fired Kori Cremation Furnaces for the Concentration Camps
- 11.4. The Oil-Fired Cremation Furnaces Built by Ignis-Hüttenbau A.G. at the Terezín Crematorium
- 11.5. The Didier Cremation Furnaces for Concentration Camps
- 11.6. Comparison of the Designs by Kori, Ignis-Hüttenbau, Didier and Topf
12. The Topf Furnaces and Regulations on Cremations in Greater Germany at the Outset of World War II

Appendices

1. Tables
 - 1.1. List of Cremations at the Westerbork Crematorium
 - 1.2. List of Cremations at the Terezín Crematorium
 - 1.3. Summary of the Topf Company's Activities at Auschwitz-Birkenau
 - 1.4. Patents (and Patent Applications) by J.A. Topf & Söhne
 - 1.5. Patent Applications by Department "DE" of J.A. Topf & Söhne
2. Glossary
3. Symbols
4. Abbreviations of Archive Names
5. Bibliography
 - 5.1. Alphabetical Listing
 - 5.2. Subject Listing
6. Indices
 - 6.1. Names
 - 6.2. Concentration Camps
 - 6.3. Crematorium Locations (Civilian)

Part 2: Documents (separate book)

List of Documents

- I. Civilian Cremation Furnaces
- II. Topf, Civilian Activities
- III. Topf, Correspondence with the SS

Part 3: Photographs (this book)

	page
List of Photographs	9
I. Photographs 1-35: Gusen	25
II. Photographs 36-50: Dachau	43
III. Photographs 51-85: Mauthausen	51
IV. Photographs 86-110: Auschwitz Main Camp.....	69
V. Photographs 111-215: Buchenwald.....	82
VI. Photographs 216-235: Auschwitz-Birkenau.....	137
VII. Photographs 236-332: KORI Cremation Furnaces	149
A. Photographs 236-247: Mauthausen	149
B. Photographs 248-269: Dachau.....	155

C. Photographs 270-284: Stutthof, Coke-Fired Furnace.....	166
D. Photographs 285-317: Majdanek, Coke-Fired Furnace.....	174
E. Photographs 318-327: Majdanek, Naphtha-Fired Furnace.....	193
F. Photographs 328-329: Stutthof, Naphtha-Fired Furnace.....	199
G. Photographs 330-331: Trzebinia	200
H. Photograph 331a: Blechhammer	201
I. Photographs 332-334: Groß-Rosen	202
VIII. Photographs 335-344: KORI Furnaces in Other Camps	205
IX. Photographs 345-362: Terezín.....	212
X. Photographs 363-365: Urns	226
XI. Photographs 366-367: Stoking Tools.....	228
XII. Photographs 368-370: Cremation Experiments	230
XIII. Color Documents from Part 2	233

List of Photographs

	page
Photograph 1: Original furnace body made of coated sheet metal with added masonry gasifiers at both sides.	25
Photograph 2: Cremation muffles.	26
Photograph 3: Ash doors of the muffles. At the sides the original combustion-air-intake holes.	26
Photograph 4: The furnace's left-hand gasifier with coke-loading door and the gasifier's primary air-intake door (with the shutter missing).	27
Photograph 5: Left-hand gasifier: Inside view, with the first opening connecting it to the left-hand muffle. The refractory brickwork shows evidence of fusion. (For two similar images, see Photographs 315f., which were placed later out of order.)	27
Photograph 6: Left-hand gasifier's primary air intake.	28
Photograph 7: Left-hand gasifier: slag/ash-removal door and service pit.	28
Photograph 8: The furnace's right-hand gasifier with coke-loading door and the gasifier's primary air intake.	29
Photograph 9: Right-hand gasifier: coke-loading door.	29
Photograph 10: Right-hand gasifier: primary air-intake door, ash-removal door and service pit.	30
Photograph 11: Left-hand muffle door: outside.	30
Photograph 12: Left-hand muffle door: inside.	31
Photograph 13: Right-hand muffle door: outside.	31
Photograph 14: Right-hand muffle door: inside.	32
Photograph 15: Left-hand muffle.	32
Photograph 16: Left-hand muffle: ash compartment with two openings connecting it to the gasifier.	33
Photograph 17: Left-hand muffle: inside.	33
Photograph 18: Left-hand muffle: ash compartment. Visible at the bottom left is the first opening connecting it to the gasifier.	34
Photograph 19: Left-hand muffle: Vaulted muffle ceiling with the outlet of one of the pipes connected to a blower.	34
Photograph 20: Left-hand muffle: partition wall with inter-muffle openings.	35
Photograph 21: Right-hand muffle.	35
Photograph 22: Right-hand muffle: to the left the partition wall with three inter-muffle openings.	36
Photograph 23: Right-hand muffle: detail of the partition wall with inter-muffle openings.	36
Photograph 24: Right-hand muffle: inside.	37
Photograph 25: Right-hand muffle: rear wall with opening for the flue gas.	37

	page
Photograph 26: Right-hand muffle: Vaulted muffle ceiling with the outlet of one of the pipes connected to a blower.....	38
Photograph 27: Right-hand muffle: ash compartment with an opening connecting it to the gasifier.....	38
Photograph 28: Right-hand muffle: lateral wall of muffle and ash compartment with an opening connecting it to the gasifier.	39
Photograph 29: Left-hand gasifier.....	39
Photograph 30: Right-hand gasifier.....	40
Photograph 31: The rear of the furnace with chimney (right-hand side).....	40
Photograph 32: The rear of the furnace with chimney going through the ceiling (right-hand side).	41
Photograph 33: The rear of the furnace with chimney (left-hand side).....	41
Photograph 34: The rear of the furnace with chimney (left-hand side) with an access door to a pilot flame at the chimney's base. The circular sheet metal welded to the chimney's base closes the original opening for a forced-draft blower.	42
Photograph 35: Upper side of the furnace (from the right).	42
Photograph 36 (top) and 36a (bottom): Original furnace body of coated sheet metal with masonry gasifiers added to its sides.....	43
Photograph 37: Original furnace body with left-hand masonry gasifier. The furnace body (with muffle doors, ash doors and original combustion-air-intake holes bolted shut by two discs) is the same as that at the Gusen Concentration Camp. The gasifier sports the large coke-loading door and the small doors for the primary air to the hearth (bottom) and the primary air to the gasifier (top). The ash door is located in the service pit closed by the grate visible at the foot of the gasifier	44
Photograph 38: Original furnace body with right-hand masonry gasifier.	44
Photograph 39: Left-hand gasifier: large coke-loading door (right), small doors for the primary air to the hearth (bottom) and the primary air to the gasifier (top).	45
Photograph 40: Inside of the right-hand muffle with muffle grate.....	45
Photograph 41: Vaulted ceiling of the left-hand muffle; to the right: outlets of pipes connected to the blower.....	46
Photograph 42: Vaulted ceiling of the right-hand muffle; to the left: outlets of pipes connected to the blower.....	46
Photograph 43: Muffle doors.	47
Photograph 44: Outside of left-hand muffle door.....	47
Photograph 45: Rear of the furnace, right-hand side. At the top of the gasifier, the rear part of the original oil tank sticks out, which was recklessly walled-in. The furnace's original body is mounted on metal wheels.	48
Photograph 46: Rear side of the furnace seen from the right: Fuel tank (top left) and metal wheels of the furnace body (bottom).....	48
Photograph 47: Rear view of the furnace; base of the chimney with an open service door at the right-hand side. The square metal sheet welded to the	

	page
chimney's bottom closes the opening for the original forced-draft blower.....	49
Photograph 48: Central part of the chimney.	49
Photograph 49: Top part of the chimney.	50
Photograph 50: Left-hand side of the furnace; background: open service door for the pilot flame at the chimney's base.	50
Photograph 51. Furnace front.	51
Photograph 52 & 53: Left-hand muffle. On the left muffle wall four holes for introducing combustion air can be seen. The grate bars are visible beneath the corpse-introduction stretcher.	52
Photograph 54: Left-hand muffle with four holes for introducing combustion air.	53
Photograph 55: Right-hand muffle. On the right muffle wall four holes for introducing combustion air can be seen.	53
Photograph 56: as above.	54
Photograph 57: Combustion-air channel of the left-hand muffle, closed with the door visible in the next photograph.	54
Photograph 58: Door for the combustion-air channel of the left-hand muffle.....	55
Photograph 59: Door for the combustion-air channel of the right-hand muffle.....	55
Photograph 60: Vaulted ceiling of the left-hand muffle; outlets of pipes connected to the blower.	56
Photograph 61: Vaulted ceiling of the right-hand muffle; outlets of pipes connected to the blower.	56
Photograph 62: Right-hand muffle; the three inter-muffle openings can be seen to the left.	57
Photograph 63: Left-hand muffle; the three inter-muffle openings can be seen to the right.	57
Photograph 64: as above, close-up.	58
Photograph 65: as above, close-up.	58
Photograph 66: The muffle doors	59
Photograph 67: Left-hand muffle door, inside, and stretcher.	59
Photograph 68: Left-hand muffle door, outside.....	60
Photograph 69: Left-hand muffle with open ash door.	60
Photograph 70: Right-hand muffle with open ash door.	61
Photograph 71: Ash chamber of the right-hand muffle.	61
Photograph 72: Ash chamber of the left-hand muffle; at the top the bars of the muffle grate. On the left in the rear part of the wall are two small square openings of a combustion-air intake connected to a channel which opens on the left side of the furnace (see Photos 73f.). In front of those openings is the large opening of the flue-gas outlet; to the right the large opening connects to the ash receptacle of the right-hand muffle.	62
Photograph 73: Left side of the furnace: Door of the combustion-air-intake channel whose channel leads into the ash chamber of the left-hand muffle.	62
Photograph 74: as above, close-up.	63

	page
Photograph 75: Rear side of the furnace with the gasifiers.	63
Photograph 76: Air pipe originally connected to a blower.	64
Photograph 77: Rear side of the furnace with the gasifiers and service pit.	64
Photograph 78: Rear side of the furnace with the gasifiers sporting the coke-loading doors (top) the ash-chamber doors (large door at center bottom) and the combustion-air-intake doors (bottom, small doors).	65
Photograph 79: as above; coke-loading door of the gasifier heating the right-hand muffle.	65
Photograph 80: as above, the gasifiers' ash-chamber doors.	66
Photograph 81: as above; the left-hand combustion-air-intake door.	66
Photograph 82: Grate of the left-hand gasifier (viewed from the rear).	67
Photograph 83: Loading system of the right-hand muffle: rod mounted to the frame, movable roller device, and stretcher for the corpse.	67
Photograph 84: as above, left-hand muffle.	68
Photograph 85: as above, viewed from top: the movable roller device on which the bars of the corpse stretcher rests.	68
Photograph 86: Crematorium I or Old Crematorium at the Auschwitz Main Camp. The chimney is a post-war reconstruction.	69
Photograph 87: Furnace no. 1 with two corpse-introduction carts.	69
Photograph 88: as above.	70
Photograph 89: as above.	70
Photograph 90: Furnace no. 2. The reconstruction omitted the transverse anchor bars and the combustion-air-intake channels next to the muffle doors; in addition, the muffle doors were reversed. Compare Photo 51.	71
Photograph 91: as above.	71
Photograph 92: Furnace no. 1: inside of a muffle. The masonry was artificially blackened.	72
Photograph 93: Furnace no. 2: grate of the left-hand muffle.	72
Photograph 94: Furnace no. 2: inside the right-hand muffle.	73
Photograph 95: as above; grate of the right-hand muffle.	73
Photograph 96: Furnace no. 1, right-hand side. Original doors of combustion-air channels. The Polish reconstructions did not include those channels. The number, type and position of the doors are also wrong. The larger door originally belonged to an eight-muffle furnace, and the smaller door was located lower. Cf. Photo 73.	74
Photograph 97: Furnace no. 1, rear side. The furnaces were reconstructed without gasifiers. The gasifiers' coke-loading doors are therefore necessarily in the wrong position over those of the ash-chamber doors. See Photo 78.	75
Photograph 98: Furnace 2, rear: same reconstruction errors as for Furnace no. 1.	75
Photograph 99: Furnace 2: original gasifier grate with seven longitudinal bars and two transverse bars.	76
Photograph 100: Ruins of the foundations of Furnace no. 3: service pit and the	

	page
gasifier hearths seen from the top.	76
Photograph 101: as above, seen from the rear: original grate of the left-hand gasifier and the two transverse support bars of the right-hand grate. The bar with the rollers, originally attached to the ceiling, was used to operate the furnace's two flue dampers.	77
Photograph 102: Ruins of furnace no. 3: flue-duct opening of the left-hand muffle.	77
Photograph 103: Ceiling of the furnace hall: ventilation opening over Furnace no. 1.	78
Photograph 104: Roof of Crematorium I: The two ventilation chimneys of the cremation furnaces (black and grey).	78
Photograph 105: Transverse rails and rotating platform (turntable).	79
Photograph 106: Turntable for corpse cart.	79
Photograph 107: Crematorium I at Auschwitz: cremation-furnace parts stored in the former coke-storage room.	80
Photograph 108: as above.	80
Photograph 109: as above.	81
Photograph 110: Commemorative plaque in the furnace hall of Crematorium I.	81
Photograph 111: SS photo of the TOPF coke-fired triple-muffle furnaces at Crematorium II at Birkenau. APMO, microfilm no. 287.	82
Photograph 112: TOPF triple-muffle cremation furnaces in the Crematorium at Buchenwald Concentration Camp.	82
Photograph 113: SS photo of the TOPF coke-fired triple-muffle furnaces at Crematorium II at Birkenau. APMO, microfilm no. 290.	83
Photograph 114: TOPF triple-muffle cremation furnaces in the Crematorium at Buchenwald Concentration Camp.	83
Photograph 115: SS photo of the TOPF coke-fired triple-muffle furnaces at Crematorium II at Birkenau. APMO, microfilm no. 290.	84
Photograph 116: TOPF triple-muffle cremation furnace in the Crematorium at Buchenwald Concentration Camp.	84
Photograph 117: as above, coke- or naphtha-fired furnace, front view.	85
Photograph 118: as above, left-hand front view.	85
Photograph 119: as above.	86
Photograph 120: as above, right-hand front view.	86
Photograph 121: as above, right-hand side.	87
Photograph 122: as above, coke-fired-only model (no oil tank on top).	87
Photograph 123: as above, left-hand front view.	88
Photograph 124: as above, close-up of the furnace's left half.	88
Photograph 125: as above, right-hand front view.	89
Photograph 126: as above, left-hand rear view, with coke-loading door of the gasifier.	89
Photograph 127: as above, door of the left-hand muffle.	90
Photograph 128: Muffle door from a TOPF triple-muffle cremation furnace	

	page
previously installed in either Crematorium II or III at Birkenau.	90
Photograph 129: TOPF coke-fired triple-muffle cremation furnace at Buchenwald Concentration Camp. Interior of the left-hand muffle door.	91
Photograph 130: same location as above, interior of the left-hand muffle of the TOPF coke- and naphtha-fired triple-muffle cremation furnace.	91
Photograph 131: as above; in the left-hand wall four openings of combustion- air channel are visible; below this the remnants of the muffle-grate bars and the walls slanted toward the ash chamber; in the back at the bottom is the opening to the gasifier.	92
Photograph 132: as above; the apex of the vaulted ceiling sports four square openings which open into tubes supplying the muffle with combustion air.	92
Photograph 133: as above, close-up.	93
Photograph 134: as above, right-hand muffle wall with rectangular openings connecting this side muffle to the center muffle.	93
Photograph 135: as above, central muffle. Both side walls have three rectangular openings connecting it to the side muffles.	94
Photograph 136: as above, close-up.	94
Photograph 137: as above, showing five of the rectangular inter-muffle openings, four square openings in the ceiling and one in the back wall for combustion-air supply.	95
Photograph 138: as above, rectangular inter-muffle openings in the right-hand muffle wall.	95
Photograph 139: as above; right-hand muffle. Foreground: the stretcher of the corpse-introduction cart. The opening of the naphtha burner can be seen in the wall in the background.	96
Photograph 140: Coke-fired triple-muffle furnace, left-hand muffle. Left wall: square openings of the combustion-air feed. Bottom: wall sloping into the ash chamber). Center bottom: opening to the gasifier. Right-hand wall: rectangular inter-muffle openings. The muffle-grate bars have been ripped out.	96
Photograph 141: as above, left-hand muffle wall sloping into the ash chamber with bottom rear opening into the gasifier.	97
Photograph 142: as above, right-hand wall with rectangular openings to center muffle.	97
Photograph 143: as above, vaulted muffle ceiling with square openings for combustion-air supply.	98
Photograph 144: as above, center muffle, right-hand wall with rectangular openings to the right-hand muffle.	98
Photograph 145: as above, right-hand muffle, left-hand wall with rectangular openings to the center muffle.	99
Photograph 146: as above, vaulted muffle ceiling with square openings for combustion-air supply.	99
Photograph 147: as above, right-hand square openings of the combustion-air feed. Bottom: muffle grate.	100

	page
Photograph 148: TOPF coke- or naphtha-fired triple-muffle cremation furnace. Right-hand muffle. Doors closing the combustion-air channels of the muffle (top) and of the ash chamber (bottom).	100
Photograph 149: as above, the muffle's combustion-air-supply channel.	101
Photograph 150: as above, left-hand muffle. To the left of the large muffle door: doors closing the combustion-air channels of the muffle (top) and of the ash chamber (bottom).	101
Photograph 151: as above, the muffle's combustion-air-supply channel.	102
Photograph 152: as above, the ash chamber's combustion-air-supply channel.	102
Photograph 153: as above, both doors of the combustion-air channels.	103
Photograph 154: combustion-air-channel door with the Topf insignia, close-up. .	103
Photograph 155: TOPF coke-fired triple-muffle cremation furnace. Front-side service pits with the left and center muffle's ash doors.	104
Photograph 156: as above, central muffle's ash chamber with the two lateral openings to the flue duct and a combustion-air-supply hole in the back.	104
Photograph 157: as above, ash chamber of the right-hand muffle.	105
Photograph 158: TOPF triple-muffle cremation furnaces; right-hand rear view with the gasifier's coke-loading doors (top) and ash doors in the service pit (bottom).	105
Photograph 159: as above, left-hand rear view.	106
Photograph 160: TOPF coke- or naphtha-fired triple-muffle cremation furnace. Rear view, left-hand muffle. Naphtha burner (top) and the gasifier's coke- loading door (bottom).	106
Photograph 161: as above.	107
Photograph 162: as above, with opened coke-loading door.	107
Photograph 163: as above, view through the coke-loading door into the gasifier. .	108
Photograph 164: as above; inside of the gasifier. The masonry shows signs of fusion.	108
Photograph 165: as above; the gasifier's ash-chamber door (bottom) and the door of the gasifier's combustion-air channel (top right).	109
Photograph 166: as above, close-up of the gasifier's combustion-air channel.	109
Photograph 167: as above, view into the gasifier's ash chamber with the grate.	110
Photograph 168: as above, central muffle. Crank operating the smoke-duct damper (top) and the door to the muffle's rear combustion-air channel (bottom).	110
Photograph 169: as above; doors to the muffle's (top) and the ash chamber's combustion-air channel (bottom).	111
Photograph 170: as above; close-up of the muffle's combustion-air channel.	111
Photograph 171: as above; close-up of the ash chamber's combustion-air channel.	112
Photograph 172: as above; cement counter weight of the smoke-duct damper.	112
Photograph 173: as above, right-hand muffle. The gasifier's ash-chamber door (bottom) and the door of the gasifier's combustion-air channel (top left).	113

	page
Photograph 174: as above; view into the gasifier's ash chamber with the grate. ...	113
Photograph 175: Topf coke-fired triple-muffle cremation furnace. Rear view, right-hand muffle: the gasifier's ash-chamber door (bottom) and its combustion-air-channel door (top left)	114
Photograph 176: as above, left-hand muffle: the gasifier's ash-chamber door (bottom) and its combustion-air-channel door (top right).	114
Photograph 177: as above; view into the gasifier's ash chamber with the grate. ...	115
Photograph 178: as above, front view, central muffle. The lowered movable roller device. The device is threaded through the mounting bar, can pivot vertically and move horizontally.	116
Photograph 179: as above, movable roller device put into place for operation.....	117
Photograph 180: as above, view into the muffle across the rollers.	117
Photograph 181: Corpse-introduction cart, left-hand side.....	118
Photograph 182: Corpse-introduction cart, right-hand side.....	118
Photograph 183: Corpse-introduction cart, rear view.....	119
Photograph 184: Corpse-introduction cart, rear view, bottom part with wheels. ...	119
Photograph 185: view across the corpse-introduction cart with stretcher inside the muffle.....	120
Photograph 186: Corpse-introduction cart, viewed from below. Edges of the loading stretcher running on the rollers.	120
Photograph 187: as above, close-up.	121
Photograph 188: Blowers located between the two furnaces.	121
Photograph 189: The furnaces' combustion-air blower, front view; the left tube feeds the furnace fueled with either coke or naphtha, the right tube the coke-fired one (see Photo 188).....	122
Photograph 190: as above, rear view.....	122
Photograph 191: as above, close-up.	123
Photograph 192: Blower tube connected to the furnace fueled with either naphtha or coke. At the tube's end, close to the furnace's wall, sits a valve for regulating the air flow.	123
Photograph 193: Blower tube connected to the coke-fired furnace.....	124
Photograph 194: Tube from the combustion-air blowers to the furnaces; butterfly valve in the right-hand tube for regulating the air flow.	124
Photograph 195: Combustion-air blower for the oil burner of the furnace fueled with either naphtha or coke. Rear view.	125
Photograph 196: as above, front view.	125
Photograph 197: as above, right-side rear view, with the combustion-air blower in the background.	126
Photograph 198: as above, left-side rear view with tube running into the furnace.	126
Photograph 199: as above, tube detail.	127
Photograph 200: as above.....	128
Photograph 201: as above, right-side rear view; tube connection with naphtha	

	page
burner.....	129
Photograph 202: TOPF coke- or naphtha-fired triple-muffle cremation furnace; nafta tank, rear view.....	130
Photograph 203: as above, left-side view.....	130
Photograph 204: as above, rear view, naphtha burner of the left-hand muffle; connected to the naphtha burner are from above, the tube feeding oil from the naphtha tank, and from below, the tube from the combustion-air blower...	131
Photograph 205: Rear view of the two TOPF triple-muffle cremation furnaces.....	131
Photograph 206: A U.S. soldier in front of the central muffle of the TOPF coke- or naphtha-fired triple-muffle cremation furnace at the Buchenwald Camp. U.S. Army photo of 1945.....	132
Photograph 207: Crematorium at Buchenwald Concentration Camp.....	132
Photograph 208: as above, close-up.....	133
Photograph 209; as above; hatch of the corpse chute into the underground morgue.....	133
Photograph 210: as above; basement morgue, wooden corpse chute.....	134
Photograph 211: as above; on the back wall, on the right, the manual controls for operating the freight elevator.....	134
Photograph 212: as above, freight elevator, front.....	135
Photograph 213: as above, rear.....	135
Photograph 214: as above, elevator door in the cremation hall, ground floor.....	136
Photograph 215: as above; elevator cage viewed from the cremation hall above...	136
Photograph 216: Ruins of the furnace hall of Crematorium II (direction east- west).....	137
Photograph 217: as above; rails for the corpse-introduction cart.....	138
Photograph 218: as above.....	138
Photograph 219: as Photo 216; rails for the corpse-introduction cart to the first three furnaces and location of the transverse rails for the turntable (direction east-west).....	139
Photograph 220: as above; direction west-east.....	140
Photograph 221: as Photo 219; hole with the foundation of the chimney.....	140
Photograph 222: Ruins of Crematorium V. Wrought-iron frame of the TOPF eight-muffle furnace and service pit. Polish photo of May 1945. APMO, negative no. 21334/141.....	141
Photograph 223: as above, viewed from the other side. APMO, negative no. 21334/83.....	141
Photograph 224: as above; right-hand (northern) service pit. Polish photo of May 1945. The man with the hat is the Polish investigating judge Jan Sehn. APMO, negative no. 21334/82.....	142
Photograph 225: as above; APMO, negative no. 21334/81.....	142
Photograph 226: as before. Ash-chamber doors of the northwestern pair of muffles. Foreground: iron tools (pokers, scrapers) and square grate irons of the gasifiers.....	143

	page
Photograph 227: as above, ash chamber's door frame of the muffle located in the north-western corner. Visible on the right is the door of the ash chamber's combustion-air channel.	143
Photograph 228: Ruins of Crematorium V (1997). Wrought-iron frame of the Topf eight-muffle furnace (direction west-east).	144
Photograph 229: as above, direction south-north.	144
Photograph 230: as above; behind the iron frame: access ladder to the gasifier's service pit.....	145
Photograph 231: as above. Detail of the northern gasifier's frame irons (direction south-north). The two brackets visible below were used for mounting the gasifier's hearth door.	145
Photograph 232: as above. South service pit and access ladder.	146
Photograph 233: Ruins of Crematorium V (1997). Ruins of the two chimneys of the Topf eight-muffle furnace: north chimney in the foreground, south chimney in the background.....	147
Photograph 234: Ruins of Crematorium IV (1991). Gasifier's service pit (direction north-south).	148
Photograph 235: as above. Framework fragments of the TOPF eight-muffle furnace in the foreground (direction north-south).....	148
Photograph 236: front view.	149
Photograph 237: as above, close-up of the corpse-introduction stretcher.	149
Photograph 238: as above, right-hand side; in the wall the chimney damper.	150
Photograph 239: Inside the muffle.	150
Photograph 240: as above; left-hand muffle wall with opening for the combustion-air supply.	151
Photograph 241: as above, close-up of combustion-air-supply holes.....	151
Photograph 242: as above, right-hand side.....	152
Photograph 243: ash chamber seen through the ash-chamber door.....	152
Photograph 244: rear view.	153
Photograph 245: left-hand side view; the gasifier's coke-loading door (top) and ash door (bottom).....	153
Photograph 246: gasifier grate.	154
Photograph 247: Information sign on the support column of the furnace hall stating in German, French, Russian and Italian: "First cremation facility. This first Mauthausen cremation facility was operating from 4 May 1940 until 3 May 1945.".....	154
Photograph 248: New crematorium building at Dachau Camp ("Baracke X").....	155
Photograph 249: Three of the four cremation furnaces.	155
Photograph 250: The fourth furnace, muffle door.....	156
Photograph 251: as above, ash-chamber door and ash receptacle in the ash chamber; to either side: combustion-air inlets; foreground: metal stand with rollers for the corpse-introduction stretcher.....	156
Photograph 252: as above, close-up of the muffle door.	157

	page
Photograph 253: Second furnace, inside the muffle; left-hand side with three opening for combustion-air supply.	157
Photograph 254: as above, right-hand side.	158
Photograph 255: Fourth furnace, front view: metal housing of the muffle door's corpse-retaining plate made of refractory clay; wire rope, pulley and counterweight for its operation.	158
Photograph 256: as above.	159
Photograph 257: First furnace, right-hand side: two doors of the auxiliary hearth (center bottom): coke-loading door (rear center), and main-ash-chamber door of the main gasifier (rear bottom).	159
Photograph 258: Rear view of Furnaces nos. 2 through 4 (front to back).	160
Photograph 259: Rear view of the first furnace; inspection door of the vertical smoke duct. Wire and pulleys for operating the smoke-duct damper, visible in Photo 258 on the floor at the bottom of the furnace.	160
Photograph 260: First furnace, the auxiliary gasifier's service doors: loading door (top) and ash-chamber door (bottom).	161
Photograph 261: Coke-loading door of the main gasifier.	161
Photograph 262: Ash-chamber door of the main gasifier.	162
Photograph 263: View into the main gasifiers.	162
Photograph 264: View through the main gasifier's ash-chamber door onto the coke grate.	163
Photograph 265: Second furnace, front view. Muffle with stretcher and lowered corpse-retaining plate made of fireclay.	163
Photograph 266: as above.	164
Photograph 267: First furnace. Muffle without stretcher and raised refractory corpse-retaining plate.	164
Photograph 268: as above, close-up of muffle with corpse grate.	165
Photograph 269: Staff at the new crematorium at work. SS photo of 1944.	165
Photograph 270: The furnaces after the war in 1945.	166
Photograph 271: The furnace in 1997 in the crematorium reconstructed by the Poles.	166
Photograph 272: The inside of the left-hand muffle.	167
Photograph 273: The ash chamber of the left-hand muffle. Top: underside of the muffle's grate bars. On the left wall in the rear: opening connecting it with the auxiliary hearth. All the way at the back: the gasifier's pit.	167
Photograph 274: The inside of the right-hand muffle.	168
Photograph 275: as above, ash chamber.	168
Photograph 276: Right-hand furnace. To the left: coke-loading door (center) and ash door (bottom) of the auxiliary gasifier. Center: double-leaf coke-loading door of the main gasifier with the ash-chamber door beneath.	169
Photograph 277: Inside the right-hand furnace's main gasifier viewed through the ash-chamber door. The hearth's grate has been damaged, with only four remaining bars merely leaning against the outer support bar.	169

	page
Photograph 278: as above, seen through the coke-loading door. 1: door frame; 2: muffle; 3: muffle grate; 4: gasifier pit; 5: ash chamber.	170
Photograph 279: Inside of the muffle seen through the main gasifier's coke-loading door. In the right-hand wall: openings for combustion-air supply. Top in the background: the opening of the smoke-gas outlet.	170
Photograph 280: Left-hand furnace; doors of the auxiliary gasifier.	171
Photograph 281: as above. View into the auxiliary gasifier. Background: the wall of the muffle's ash chamber. Foreground: the end of an iron bar from the auxiliary hearth grate.	172
Photograph 282: as above. The muffle's ash chamber seen through the auxiliary gasifier's ash-chamber door.	172
Photograph 283: Right-hand furnace, inside of the auxiliary gasifier with the muffle's ash chamber wall in the background and the muffle grate above.	173
Photograph 284: as above; right-hand wall of the muffle's ash chamber as seen from the auxiliary gasifier's ash chamber; top: vaulted muffle-grate bars.	173
Photograph 285: Polish reconstruction of the crematorium at the former Lublin-Majdanek Concentration Camp.	174
Photograph 286: The cremation furnace after Soviet capture in July 1944.	174
Photograph 286a: as above, section enlargement: the crematorium ruins.	175
Photograph 286b: as above; the furnaces.	175
Photograph 286c: as above.	176
Photograph 287: Row of cremation furnaces with five muffles, front view.	176
Photograph 288: as above, first furnace from the left.	177
Photograph 289: as above; first recuperator.	177
Photograph 290: as above, second furnace from the left.	178
Photograph 291: as above, third furnace from the left.	178
Photograph 292: as above, fourth furnace from the left.	179
Photograph 293: as above, second recuperator.	179
Photograph 294: as above, fifth furnace from the left.	180
Photograph 295: as above, close-up of the muffle.	180
Photograph 296: The center furnace, close-up of the muffle.	181
Photograph 297: Vaulted ceiling of the first muffle; in the side walls the openings of the combustion-air-supply channels can be seen.	181
Photograph 298: as above, second muffle.	182
Photograph 299: as above, third, center muffle.	182
Photograph 300: as above, fourth muffle.	183
Photograph 301 as above, fifth muffle.	183
Photograph 302: Vertical duct of the flue-gas outlet.	184
Photograph 303: Access door to the post-combustion area.	184
Photograph 304: Ash-extraction door with the first bar of the post-combustion grate visible.	185
Photograph 305: Right-hand rear view of the five-furnace device.	185

	page
Photograph 306: as above, from the left-hand side.....	186
Photograph 307: as above.....	186
Photograph 308: as above. Hot-water pipes of the recuperator.	187
Photograph 309: Front view from the right-hand side. The brick structure at top contains the smoke duct, with an inspection door on the side.....	188
Photograph 310: as above, smoke duct with inspection door.	188
Photograph 311: The gasifier grate.....	189
Photograph 312: as above.....	189
Photograph 313: Inside of a furnace seen from the gasifier's coke-loading door. Foreground: the gasifier; behind it: the ash chamber with the ash doors in the background; above that: the muffle's fireclay grate; top: the muffle.	190
Photograph 314: as above; bottom: the ash chamber with the ash-chamber- access door in the background; above that: the muffle's fireclay grate; top: the muffle.	190
Photograph 315: Inside of the gasifier of the TOPF furnace at the Gusen Concentration Camp. The refractory lining shows extensive fusion.....	191
Photograph 316: as above.	191
Photograph 317: Sign displayed in the crematorium of the Lublin Concentration Camp stating in five languages: "The crematorium was built in autumn 1943. It was fueled with coke. The bodies were cremated at a temperature of about 700°C. The daily yield was about 1000 bodies."	192
Photograph 318: front view of the furnace.	193
Photograph 319: as above; top: the muffle door; bottom center: ash-chamber door; bottom left and right: combustion-air inlets.....	193
Photograph 320: Inside of the muffle. Bottom: the refractory grate; on the back wall: the main burner's nozzle; on the side walls: openings of the combustion-air-supply channels.....	194
Photograph 321: as above; the vaulted muffle ceiling with the smoke-duct opening in the foreground.	194
Photograph 322: as above; the refractory grate; bottom: ash-chamber door.	195
Photograph 323: Ash chamber; top: the underside of the muffle's refractory grate; background: the auxiliary burner's nozzle.	196
Photograph 324: left-hand side of the furnace.	197
Photograph 325: as above. In the upper part of the furnace can be seen the combustion-air pipe for the burners (left), the support bars for the fan and its motor (center), and the base of the chimney (right).	197
Photograph 326: right-hand side; bottom right: side inspection door beneath a combustion-air inlet.	198
Photograph 327: rear view; combustion-air pipe with main (center) and auxiliary burners (bottom).....	198
Photograph 328: The furnace right after the camp's Soviet capture in 1945.....	199
Photograph 329: The furnace as exhibited in the camp museum in June 1997. © Carlo Mattogno	199

	page
Photograph 330: Front view of the furnace. The interior of the furnace was completely destroyed. At the top the conical chimney (center), the blower (left) and the naphtha tank (right).	200
Photograph 331: Right-hand side of the furnace with the naphtha tank in the foreground.	200
Photograph 332: Furnace on the foundations of the former cremation hall.	202
Photograph 333: Front view. In the foreground the stand with the two rollers for introducing the stretcher.	202
Photograph 333a: rear view. Top left: naphtha tank; below it: combustion-air inlet and access door; top right: combustion-air pipes; rear end: main (top) and auxiliary burner (bottom).	203
Photograph 333b: as above. The air pipes were originally connected to a blower installed on the shelf to the right.	203
Photograph 334: Interior. The introduction stretcher moved with four metal rollers on two angle irons. The opening in the back wall housed the main burner. The refractory lining has been completely removed.	204
Photograph 335: KORI coke-fired cremation furnace at the Flossenbürg Camp. Source: http://commons.wikimedia.org/wiki/File:Crematory_oven_-_Flossenbürg.jpg	205
Photograph 336: KORI coke-fired cremation furnace at the Ebensee Camp. Source: www.profit-over-life.org/teachers_guide/austria/mauthausen_kz/mauthausen-ebensee_crematorium.html	205
Photograph 337: Ruins of the KORI coke-fired cremation furnace at the Sachsenhausen Concentration Camp. Source: http://snapeatrepeat.com/tag/sachsenhausen-concentration-camp/ , now removed.	206
Photograph 338: KORI coke- and naphtha-fired cremation furnace at the Ravensbrück Concentration Camp. Source: http://mmlorusso.blogspot.com/2011/03/his-will-is-our-hiding-place-cont.html	206
Photograph 339: KORI naphtha-fired cremation furnace at the Bergen-Belsen Concentration Camp. Source: http://galleryhip.com/bergen-belsen-liberation.html , now removed.	207
Photograph 340: KORI naphtha-fired cremation furnace at the Dora-Mittelbau Concentration Camp. Source: http://commons.wikimedia.org/wiki/File:210509_Krematorie_Dora_Mittelbau_01.JPG	208
Photograph 341: KORI naphtha-fired cremation furnace at the Natzweiler-Struthof Concentration Camp. Source: http://commons.wikimedia.org/wiki/File:Natzweiler-Struthof_krematorium.JPG	209
Photograph 342: KORI naphtha-fired cremation furnaces at the Neuengamme Concentration Camp. Source: www.kz-gedenkstaette-neuengamme.de/typo3temp/pics/5f467c62d5.jpg , now removed.	210

	page
Photograph 343: KORI naphtha-fired cremation furnaces at the Sachsenhausen Concentration Camp. Source: Sachsenhausen, Kongress-Verlag, Berlin 1962, p. 84.....	210
Photograph 344: KORI naphtha-fired cremation furnace at the Vught Concentration Camp. Source: http://ww2today.com/wp-content/uploads/2014/11/vught-crematoria.jpg	211
Photograph 345: The four furnaces viewed from above. On the right-hand wall, top, are the naphtha tanks.....	212
Photograph 345a: as above, viewed from eye level. Source: https://commons.wikimedia.org/wiki/File:Terez%C3%ADnCreatorium.jpg	212
Photograph 346: Left-hand furnace of the front pair, front view, with the corpse-introduction cart.	213
Photograph 347: as above; left-hand side and rear of the furnace.	213
Photograph 348: as above, rear view.	214
Photograph 349: as above; on the right, next to the wall, is the naphtha preheater behind a long scraper.....	215
Photograph 350: Right-hand furnace of the front pair, rear view, naphtha burner.	216
Photograph 351: Left-hand furnace of the front pair, rear view; the three service doors: for the muffle (top), the post-combustion chamber (center) and the ash chamber with the ash receptacle (bottom).	217
Photograph 352: as above; the muffle's inside seen from its rear service door. In the foreground the front part of the corpse-introduction cart.....	218
Photograph 353: as above, with the introduction cart pulled out. In the foreground, the shaft of the scraper to move cremation remains.	218
Photograph 354: as above; inside of the post-combustion chamber seen through its rear service door.	219
Photograph 354a: as above; close-up.....	219
Photograph 355: as above; inside of the ash chamber seen through its rear service door, with the corroded iron ash container.	220
Photograph 356: Forced-draft blower of the front pair of furnaces, with suction duct (left), chimney duct (center) and the motor (right). In the background left and right the two combustion-air blowers.....	220
Photograph 357: as above, side view.....	221
Photograph 358: Combustion-air blower for the left-hand furnace of the front pair.	222
Photograph 359: Closing damper of the right-hand furnace of the rear pair of furnaces.	222
Photograph 360: left-hand furnace of front pair, front view; the damper's steel cable and pulley attached to the ceiling.	223
Photograph 361: Left-hand furnace of the rear pair, front view, with the corpse-introduction cart.	224
Photograph 361a: Left-hand furnace of the front pair, front view, with the	

	page
corpse-introduction cart.....	224
Photograph 362: Rough wooden coffin for cremation, left of the above furnace. .	225
Photograph 363: Urns stored in a showcase of the Lublin-Majdanek Camp Museum.	226
Photograph 364: Urns stored in a showcase of the Buchenwald Concentration Camp Museum.....	226
Photograph 364a: as above, close-up.	227
Photograph 365: Urns found in the crematorium of the Natzweiler-Struthof Concentration Camp in 1945. Source: Jean-Claude Pressac, <i>The Struthof Album</i> , Beate Klarsfeld Foundation, New York, 1985. p. 56.....	227
Photograph 366: Stoker tools in the crematorium of Stutthof Concentration Camp (June 1997): two stokers and a scraper. © Carlo Mattogno.	228
Photograph 367: as above, close-up.	229
Photograph 368: Combustion experiment of animal fat conducted by the author on 21 October 1994.	230
Photograph 369: as above, 10 January 1995.	231
Photograph 370: as above.....	232
Document 253: Condition of a corpse after thirty minuts of cremation. Source: Michael Bohnert, Thomas Rost, Stefan Pollak, “The degree of destruction of human bodies in relation to the duration of the fire,” in: <i>Forensic Science International</i> , 95, 1998, p. 15.	233
Document 254: as above, after forty minutes.	233

I. Photographs 1-35: Gusen

TOPF double-muffle mobile cremation furnace, fueled with naphtha, converted to a stationary, coke-fired furnace at Concentration Camp Gusen. July 1991. © Carlo Mattogno for all photographs.



Photograph 1: Original furnace body made of coated sheet metal with added masonry gasifiers at both sides.



Photograph 2: Cremation muffles.



Photograph 3: Ash doors of the muffles. At the sides the original combustion-air-intake holes.



Photograph 4: The furnace's left-hand gasifier with coke-loading door and the gasifier's primary air-intake door (with the shutter missing).



Photograph 5: Left-hand gasifier: Inside view, with the first opening connecting it to the left-hand muffle. The refractory brickwork shows evidence of fusion. (For two similar images, see Photographs 315f., which were placed later out of order.)



Photograph 6: Left-hand gasifier's primary air intake.



Photograph 7: Left-hand gasifier: slag/ash-removal door and service pit.



Photograph 8: The furnace's right-hand gasifier with coke-loading door and the gasifier's primary air intake.



Photograph 9: Right-hand gasifier: coke-loading door.



Photograph 10: Right-hand gasifier: primary air-intake door, ash-removal door and service pit.

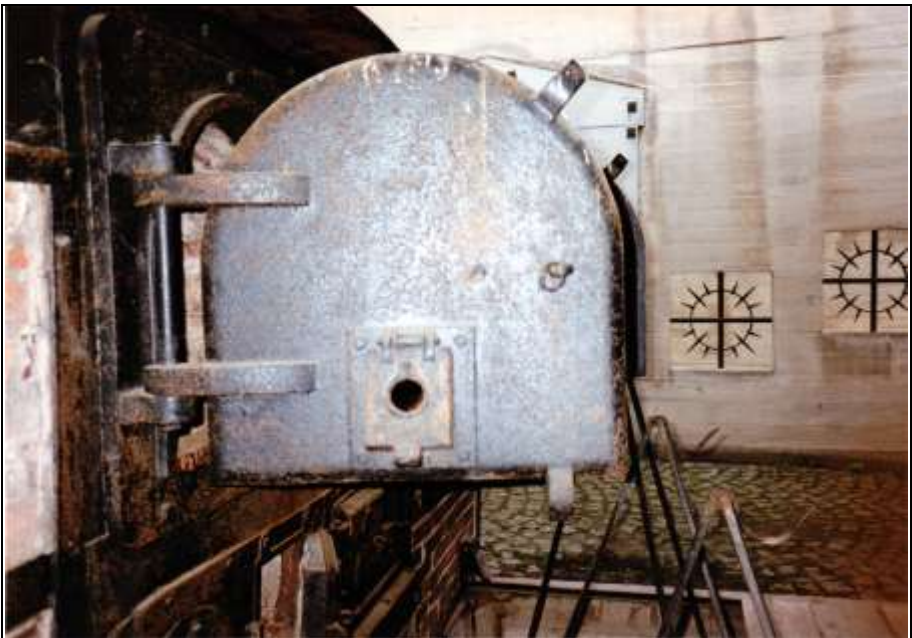

Photograph 11: Left-hand muffle door: outside.



Photograph 12: Left-hand muffle door: inside.



Photograph 13: Right-hand muffle door: outside.



Photograph 14: Right-hand muffle door: inside.



Photograph 15: Left-hand muffle.



Photograph 16: Left-hand muffle: ash compartment with two openings connecting it to the gasifier.



Photograph 17: Left-hand muffle: inside.



Photograph 18: Left-hand muffle: ash compartment. Visible at the bottom left is the first opening connecting it to the gasifier.



Photograph 19: Left-hand muffle: Vaulted muffle ceiling with the outlet of one of the pipes connected to a blower.



Photograph 20: Left-hand muffle: partition wall with inter-muffle openings.



Photograph 21: Right-hand muffle.



Photograph 22: Right-hand muffle: to the left the partition wall with three inter-muffle openings.



Photograph 23: Right-hand muffle: detail of the partition wall with inter-muffle openings.



Photograph 24: Right-hand muffle: inside.



Photograph 25: Right-hand muffle: rear wall with opening for the flue gas.



Photograph 26: Right-hand muffle: Vaulted muffle ceiling with the outlet of one of the pipes connected to a blower.



Photograph 27: Right-hand muffle: ash compartment with an opening connecting it to the gasifier.



Photograph 28: Right-hand muffle: lateral wall of muffle and ash compartment with an opening connecting it to the gasifier.



Photograph 29: Left-hand gasifier.



Photograph 30: Right-hand gasifier.



Photograph 31: The rear of the furnace with chimney (right-hand side).



Photograph 32: The rear of the furnace with chimney going through the ceiling (right-hand side).



Photograph 33: The rear of the furnace with chimney (left-hand side).



Photograph 34: The rear of the furnace with chimney (left-hand side) with an access door to a pilot flame at the chimney's base. The circular sheet metal welded to the chimney's base closes the original opening for a forced-draft blower.



Photograph 35: Upper side of the furnace (from the right).

II. Photographs 36-50: Dachau

TOPF double-muffle mobile cremation furnace, fueled with naphtha, converted to a stationary, coke-fired furnace at Concentration Camp Dachau. December 1990. © CARLO MATTOGNO for all photographs.



Photograph 36 (top) and 36a (bottom): Original furnace body of coated sheet metal with masonry gasifiers added to its sides.





Photograph 37: Original furnace body with left-hand masonry gasifier. The furnace body (with muffle doors, ash doors and original combustion-air-intake holes bolted shut by two discs) is the same as that at the Gusen Concentration Camp. The gasifier sports the large coke-loading door and the small doors for the primary air to the hearth (bottom) and the primary air to the gasifier (top). The ash door is located in the service pit closed by the grate visible at the foot of the gasifier



Photograph 38: Original furnace body with right-hand masonry gasifier.



Photograph 39: Left-hand gasifier: large coke-loading door (right), small doors for the primary air to the hearth (bottom) and the primary air to the gasifier (top).



Photograph 40: Inside of the right-hand muffle with muffle grate.



Photograph 41: Vaulted ceiling of the left-hand muffle; to the right: outlets of pipes connected to the blower.



Photograph 42: Vaulted ceiling of the right-hand muffle; to the left: outlets of pipes connected to the blower.



Photograph 43: Muffle doors.



Photograph 44: Outside of left-hand muffle door.



Photograph 45: Rear of the furnace, right-hand side. At the top of the gasifier, the rear part of the original oil tank protrudes, which was walled-in. The furnace's original body is mounted on metal wheels.



Photograph 46: Rear side of the furnace seen from the right: Fuel tank (top left) and metal wheels of the furnace body (bottom).



Photograph 47: Rear view of the furnace; base of the chimney with an open service door at the right-hand side. The square metal sheet welded to the chimney's bottom closes the opening for the original forced-draft blower.



Photograph 48: Central part of the chimney.



Photograph 49: Top part of the chimney.



Photograph 50: Left-hand side of the furnace; background: open service door for the pilot flame at the chimney's base.

III. Photographs 51-85: Mauthausen

TOPF coke-fired double-muffle cremation furnace at Concentration Camp Mauthausen. December 1990. © Carlo Mattogno for all photographs.



Photograph 51. Furnace front.



Photograph 52 & 53: Left-hand muffle. On the left muffle wall four holes for introducing combustion air can be seen. The grate bars are visible beneath the corpse-introduction stretcher.





Photograph 54: Left-hand muffle with four holes for introducing combustion air.



Photograph 55: Right-hand muffle. On the right muffle wall four holes for introducing combustion air can be seen.



Photograph 56: as above.



Photograph 57: Combustion-air channel of the left-hand muffle, closed with the door visible in the next photograph.



Photograph 58: Door for the combustion-air channel of the left-hand muffle.



Photograph 59: Door for the combustion-air channel of the right-hand muffle.

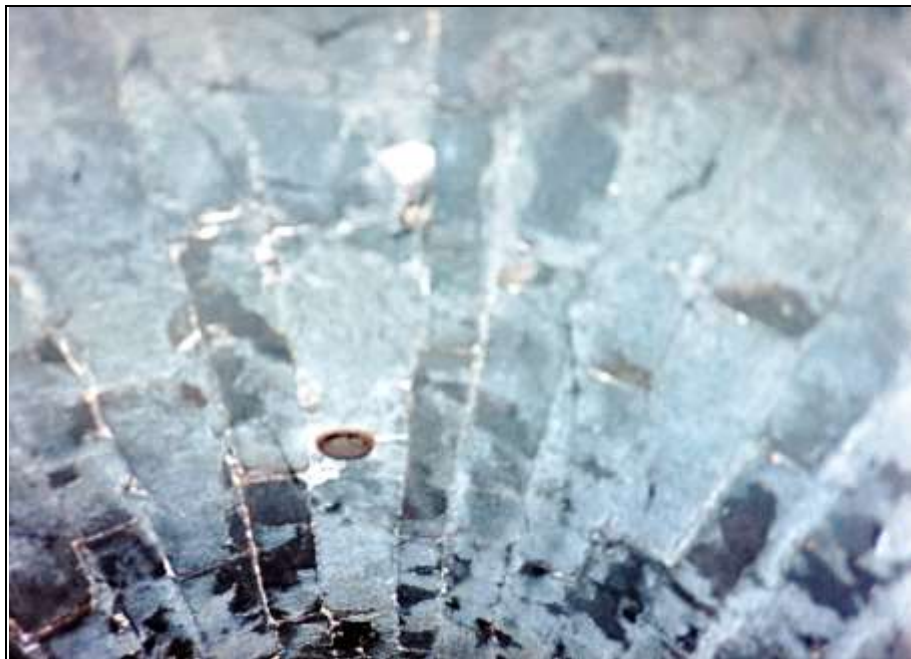

Photograph 60: Vaulted ceiling of the left-hand muffle; outlets of pipes connected to the blower.



Photograph 61: Vaulted ceiling of the right-hand muffle; outlets of pipes connected to the blower.



Photograph 62: Right-hand muffle; the three inter-muffle openings can be seen to the left.



Photograph 63: Left-hand muffle; the three inter-muffle openings can be seen to the right.



Photograph 64: as above, close-up.



Photograph 65: as above, close-up.



Photograph 66: The muffle doors

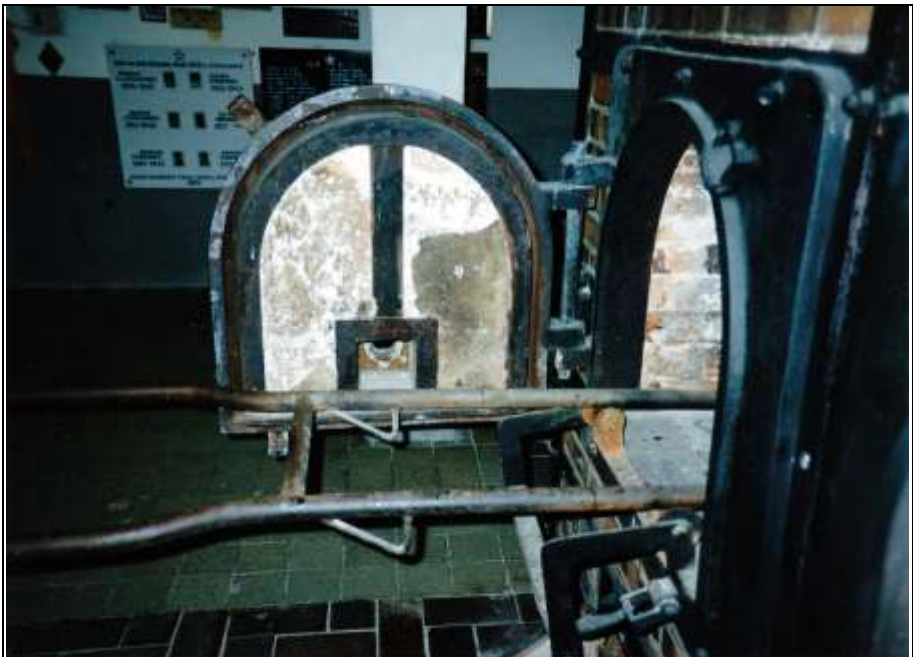

Photograph 67: Left-hand muffle door, inside, and stretcher.



Photograph 68: Left-hand muffle door, outside.



Photograph 69: Left-hand muffle with open ash door.



Photograph 70: Right-hand muffle with open ash door.



Photograph 71: Ash chamber of the right-hand muffle.



Photograph 72: Ash chamber of the left-hand muffle; at the top the bars of the muffle grate. On the left in the rear part of the wall are two small square openings of a combustion-air intake connected to a channel which opens on the left side of the furnace (see Photos 73f.). In front of those openings is the large opening of the flue-gas outlet; to the right the large opening connects to the ash receptacle of the right-hand muffle.



Photograph 73: Left side of the furnace: Door of the combustion-air-intake channel whose channel leads into the ash chamber of the left-hand muffle.



Photograph 74: as above, close-up.



Photograph 75: Rear side of the furnace with the gasifiers.



Photograph 76: Air pipe originally connected to a blower.



Photograph 77: Rear side of the furnace with the gasifiers and service pit.



Photograph 78: Rear side of the furnace with the gasifiers sporting the coke-loading doors (top) the ash-chamber doors (large door at center bottom) and the combustion-air-intake doors (bottom, small doors).



Photograph 79: as above; coke-loading door of the gasifier heating the right-hand muffle.



Photograph 80: as above, the gasifiers' ash-chamber doors.



Photograph 81: as above; the left-hand combustion-air-intake door.



Photograph 82: Grate of the left-hand gasifier (viewed from the rear).



Photograph 83: Loading system of the right-hand muffle: rod mounted to the frame, movable roller device, and stretcher for the corpse.



Photograph 84: as above, left-hand muffle.



Photograph 85: as above, viewed from top: the movable roller device on which the bars of the corpse stretcher rests.

IV. Photographs 86-110: Auschwitz Main Camp

TOPF coke-fired double-muffle cremation furnaces at Crematorium I at Auschwitz Main Camp (postwar reconstruction). July 1992. © Carlo Mattogno for all photographs.



Photograph 86: Crematorium I or Old Crematorium at Auschwitz Main Camp. The chimney is a post-war refabrication.



Photograph 87: Furnace No. 1 with two corpse-introduction carts.



Photograph 88: as above.



Photograph 89: as above.



Photograph 90: Furnace No. 2. The refabrication omitted the transverse anchor bars and the combustion-air-intake channels next to the muffle doors; in addition, the muffle doors were reversed. Compare Photo 51.



Photograph 91: as above.



Photograph 92: Furnace No. 1: inside of a muffle. The masonry was artificially blackened.



Photograph 93: Furnace No. 2: grate of the left-hand muffle.



Photograph 94: Furnace No. 2: inside the right-hand muffle.



Photograph 95: as above; grate of the right-hand muffle.



Photograph 96: Furnace No. 1, right-hand side. Original doors of combustion-air channels. The Polish refabrications did not include those channels. The number, type and position of the doors are also wrong. The larger door originally belonged to an eight-muffle furnace, and the smaller door was located lower. Cf. Photo 73.



Photograph 97: Furnace No. 1, rear side. The furnaces were re-fabricated without gasifiers. The gasifiers' coke-loading doors are therefore necessarily in the wrong position over those of the ash-chamber doors. See Photo 78.



Photograph 98: Furnace No. 2, rear: same refabrication errors as for Furnace no. 1.



Photograph 99: Furnace No. 2: original gasifier grate with seven longitudinal bars and two transverse bars.



Photograph 100: Ruins of the foundations of Furnace No. 3: service pit and the gasifier hearths seen from the top.



Photograph 101: as above, seen from the rear: original grate of the left-hand gasifier and the two transverse support bars of the right-hand grate. The bar with the rollers, originally attached to the ceiling, was used to operate the furnace's two flue dampers.



Photograph 102: Ruins of Furnace No. 3: flue-duct opening of the left-hand muffle.



Photograph 103: Ceiling of the furnace hall: ventilation opening over Furnace No. 1.



Photograph 104: Roof of Crematorium I: The two ventilation chimneys of the cremation furnaces (black and grey).



Photograph 105: Transverse rails and rotating platform (turntable).



Photograph 106: Turntable for corpse cart.



Photograph 107: Crematorium I at Auschwitz: cremation-furnace parts stored in the former coke-storage room.



Photograph 108: as above.



Photograph 109: as above.



Photograph 110: Commemorative plaque in the furnace hall of Crematorium I.

V. Photographs 111-215: Buchenwald

TOPF coke-fired triple-muffle cremation furnace (one fueled with naphtha) at Concentration Camp Buchenwald. July 1991. © Carlo Mattogno for all photographs (unless stated otherwise).

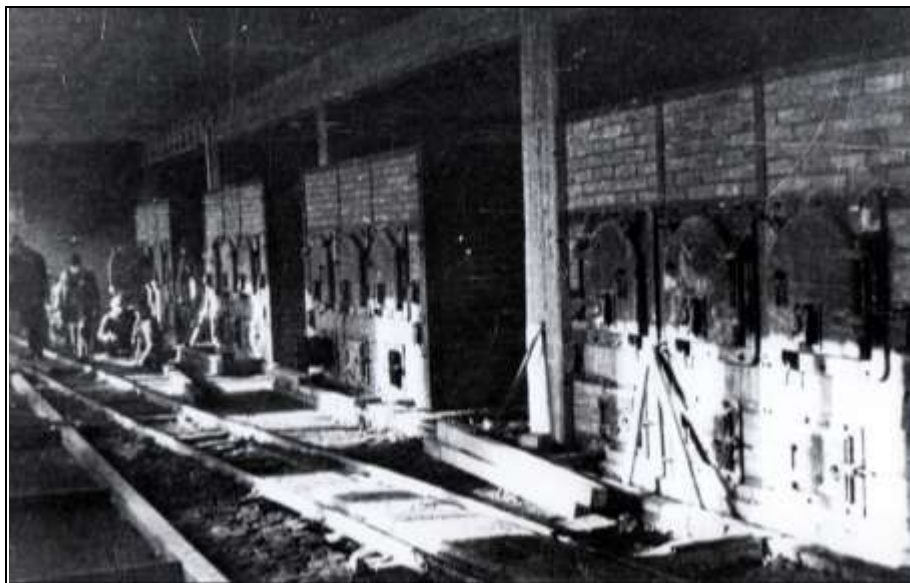

Photograph 111: SS photo of the TOPF coke-fired triple-muffle furnaces at Crematorium II at Birkenau. APMO, Microfilm No. 287.



Photograph 112: TOPF triple-muffle cremation furnaces in the crematorium at Buchenwald Concentration Camp.

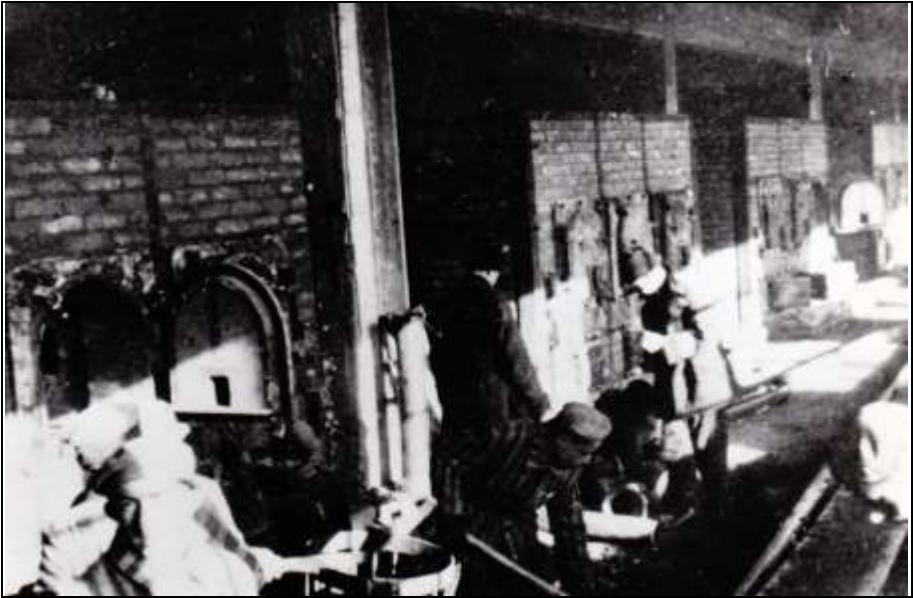

Photograph 113: SS photo of the TOPF coke-fired triple-muffle furnaces at Crematorium II at Birkenau. APMO, Microfilm No. 290.



Photograph 114: TOPF triple-muffle cremation furnaces in the crematorium at Buchenwald Concentration Camp.



Photograph 115: SS photo of the TOPF coke-fired triple-muffle furnaces at Crematorium II at Birkenau. APMO, Microfilm No. 290.



Photograph 116: TOPF triple-muffle cremation furnace in the crematorium at Buchenwald Concentration Camp.



Photograph 117: as above, coke- or naphtha-fired furnace, front view.



Photograph 118: as above, left-hand front view.



Photograph 119: as above



Photograph 120: as above, right-hand front view.



Photograph 121: as above, right-hand side.



Photograph 122: as above, coke-fired-only model (no oil tank on top).



Photograph 123: as above, left-hand front view.



Photograph 124: as above, close-up of the furnace's left half.



Photograph 125: as above, right-hand front view.



Photograph 126: as above, left-hand rear view, with coke-loading door of the gasifier.

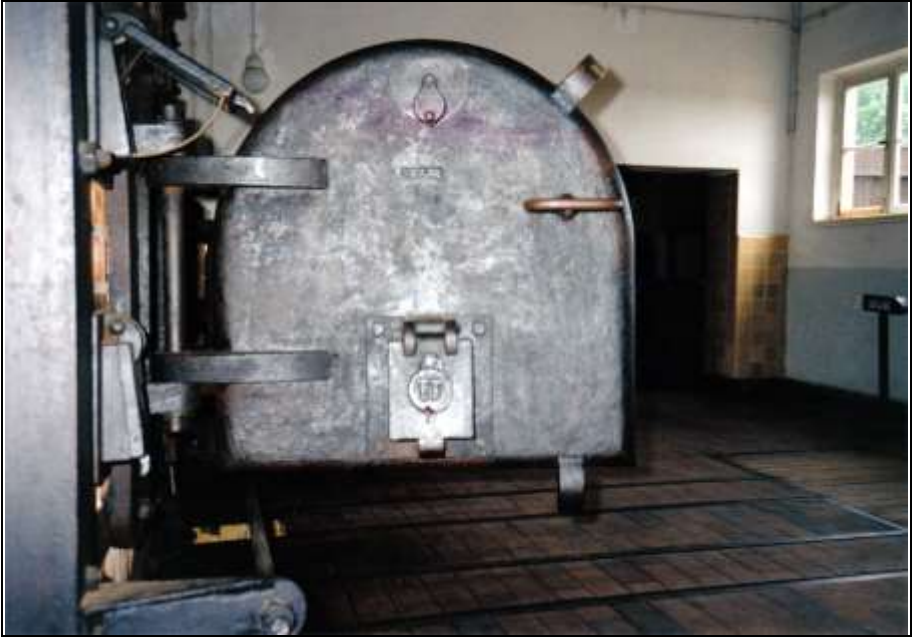

Photograph 127: as above, door of the left-hand muffle.



Photograph 128: Muffle door from a TOPF triple-muffle cremation furnace previously installed in either Crematorium II or III at Birkenau.



Photograph 129: TOPF coke-fired triple-muffle cremation furnace at Buchenwald Concentration Camp. Interior of the left-hand muffle door.



Photograph 130: same location as above, interior of the left-hand muffle of the TOPF coke- and naphtha-fired triple-muffle cremation furnace.



Photograph 131: as above; in the left-hand wall four openings of combustion-air channel are visible; below this the remnants of the muffle-grate bars and the walls slanted toward the ash chamber; in the back at the bottom is the opening to the gasifier.



Photograph 132: as above; the apex of the vaulted ceiling sports four square openings which open into tubes supplying the muffle with combustion air.



Photograph 133; as above, close-up.



Photograph 134: as above, right-hand muffle wall with rectangular openings connecting this side muffle to the center muffle.



Photograph 135: as above, central muffle. Both side walls have three rectangular openings connecting it to the side muffles.



Photograph 136: as above, close-up.



Photograph 137: as above, showing five of the rectangular inter-muffle openings, four square openings in the ceiling and one in the back wall for combustion-air supply.



Photograph 138: as above, rectangular inter-muffle openings in the right-hand muffle wall.



Photograph 139: as above; right-hand muffle. Foreground: the stretcher of the corpse-introduction cart. The opening of the naphtha burner can be seen in the wall in the background.



Photograph 140: Coke-fired triple-muffle furnace, left-hand muffle. Left wall: square openings of the combustion-air feed. Bottom: wall sloping into the ash chamber). Center bottom: opening to the gasifier. Right-hand wall: rectangular inter-muffle openings. The muffle-grate bars have been ripped out.



Photograph 141: as above, left-hand muffle wall sloping into the ash chamber with bottom rear opening into the gasifier.



Photograph 142; as above, right-hand wall with rectangular openings to center muffle.



Photograph 143: as above, vaulted muffle ceiling with square openings for combustion-air supply.



Photograph 144: as above, center muffle, right-hand wall with rectangular openings to the right-hand muffle.



Photograph 145: as above, right-hand muffle, left-hand wall with rectangular openings to the center muffle.



Photograph 146: as above, vaulted muffle ceiling with square openings for combustion-air supply.



*Photograph 147: as above, right-hand square openings of the combustion-air feed.
Bottom: muffle grate.*



*Photograph 148: TOPF coke- or naphtha-fired triple-muffle cremation furnace.
Right-hand muffle. Doors closing the combustion-air channels of the muffle (top)
and of the ash chamber (bottom).*



Photograph 149: as above, the muffle's combustion-air-supply channel.



Photograph 150: as above, left-hand muffle. To the left of the large muffle door: doors closing the combustion-air channels of the muffle (top) and of the ash chamber (bottom).



Photograph 151: as above, the muffle's combustion-air-supply channel.



Photograph 152: as above, the ash chamber's combustion-air-supply channel.



Photograph 153: as above, both doors of the combustion-air channels.



Photograph 154: combustion-air-channel door with the Topf logo, close-up.



Photograph 155: TOPF coke-fired triple-muffle cremation furnace. Front-side service pits with the left and center muffles' ash doors.



Photograph 156: as above, central muffle's ash chamber with the two lateral openings to the flue duct and a combustion-air-supply hole in the back.



Photograph 157: as above, ash chamber of the right-hand muffle.



Photograph 158: TOPF triple-muffle cremation furnaces; right-hand rear view with the gasifier's coke-loading doors (top) and ash doors in the service pit (bottom).



Photograph 159: as above, left-hand rear view.



Photograph 160: TOPF coke- or naphtha-fired triple-muffle cremation furnace. Rear view, left-hand muffle. Naphtha burner (top) and the gasifier's coke-loading door (bottom).



Photograph 161: as above.



Photograph 162: as above, with opened coke-loading door.



Photograph 163: as above, view through the coke-loading door into the gasifier.



Photograph 164: as above; inside of the gasifier. The masonry shows signs of fusion.



Photograph 165: as above; the gasifier's ash-chamber door (bottom) and the door of the gasifier's combustion-air channel (top right).



Photograph 166: as above, close-up of the gasifier's combustion-air channel.



Photograph 167: as above, view into the gasifier's ash chamber with the grate.



Photograph 168: as above, central muffle. Crank operating the smoke-duct damper (top) and the door to the muffle's rear combustion-air channel (bottom).



Photograph 169: as above; doors to the muffle's (top) and the ash chamber's combustion-air channel (bottom).



Photograph 170: as above; close-up of the muffle's combustion-air channel.



Photograph 171: as above; close-up of the ash chamber's combustion-air channel



Photograph 172: as above; cement counterweight of the smoke-duct damper.



Photograph 173: as above, right-hand muffle. The gasifier's ash-chamber door (bottom) and the door of the gasifier's combustion-air channel (top left).



Photograph 174: as above; view into the gasifier's ash chamber with the grate.



Photograph 175: Topf coke-fired triple-muffle cremation furnace. Rear view, right-hand muffle: the gasifier's ash-chamber door (bottom) and its combustion-air-channel door (top left).



Photograph 176: as above, left-hand muffle: the gasifier's ash-chamber door (bottom) and its combustion-air-channel door (top right).



Photograph 177; as above; view into the gasifier's ash chamber with the grate.



Photograph 178: as above, front view, central muffle. The lowered movable roller device. The device is threaded through the mounting bar, can pivot vertically and move horizontally.



Photograph 179: as above, movable roller device put into place for operation.



Photograph 180: as above, view into the muffle across the rollers.



Photograph 181: Corpse-introduction cart, left-hand side.

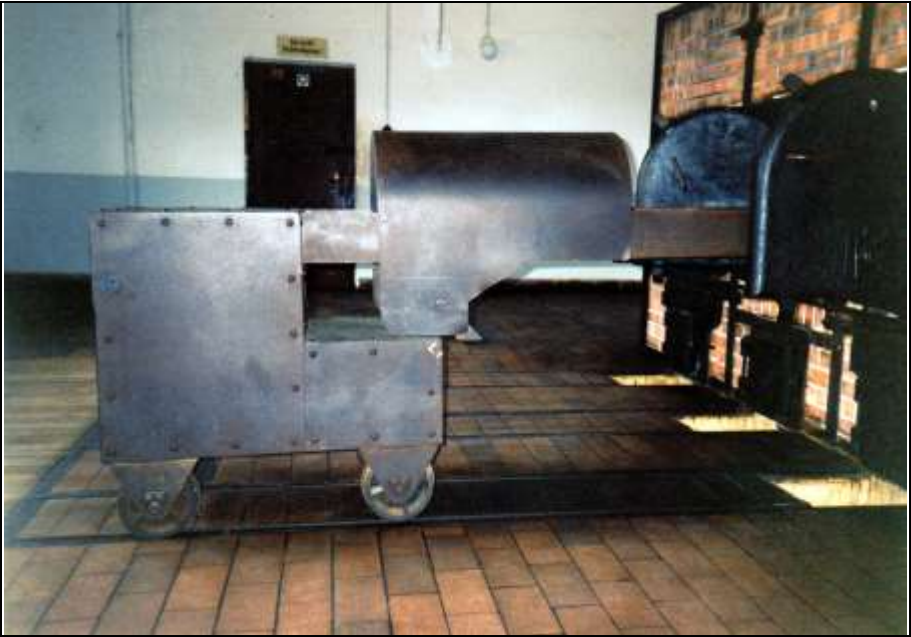

Photograph 182: Corpse-introduction cart, right-hand side.



Photograph 183: Corpse-introduction cart, rear view.



Photograph 184: Corpse-introduction cart, rear view, bottom part with wheels.



Photograph 185: view across the corpse-introduction cart with stretcher inside the muffle.



Photograph 186: Corpse-introduction cart, viewed from below. Edges of the loading stretcher running on the rollers.



Photograph 187: as above, close-up.



Photograph 188: Blowers located between the two furnaces.



Photograph 189: The furnaces' combustion-air blower, front view; the left tube feeds the furnace fueled with either coke or naphtha, the right tube the coke-fired one (see Photo 188).



Photograph 190: as above, rear view.



Photograph 191: as above, close-up.



Photograph 192: Blower tube connected to the furnace fueled with either naphtha or coke. At the tube's end, close to the furnace's wall, is a valve for regulating the air flow.



Photograph 193: Blower tube connected to the coke-fired furnace.



Photograph 194: Tube from the combustion-air blowers to the furnaces; butterfly valve in the right-hand tube for regulating the air flow.



Photograph 195: Combustion-air blower for the oil burner of the furnace fueled with either naphtha or coke. Rear view.



Photograph 196: as above, front view.



Photograph 197: as above, right-side rear view, with the combustion-air blower in the background.



Photograph 198: as above, left-side rear view with tube running into the furnace.



Photograph 199: as above, tube detail.



Photograph 200: as above.



Photograph 201: as above, right-side rear view; tube connection with naphtha burner.



Photograph 202: TOPF coke- or naphtha-fired triple-muffle cremation furnace; naphtha tank, rear view.



Photograph 203: as above, left-side view.



Photograph 204: as above, rear view, naphtha burner of the left-hand muffle; connected to the naphtha burner are from above, the tube feeding oil from the naphtha tank, and from below, the tube from the combustion-air blower.



Photograph 205: Rear view of the two TOPF triple-muffle cremation furnaces.



Photograph 206: A U.S. soldier in front of the central muffle of the TOPF coke- or naphtha-fired triple-muffle cremation furnace at Buchenwald Camp. U.S. Army photo of 1945.



Photograph 207: Crematorium at Buchenwald Concentration Camp.



Photograph 208: as above, close-up.



Photograph 209; as above; hatch of the corpse chute into the underground morgue.



Photograph 210: as above; basement morgue, wooden corpse chute.



Photograph 211: as above; on the back wall, on the right, the manual controls for operating the freight elevator.



Photograph 212: as above, freight elevator, front.



Photograph 213: as above, rear.



Photograph 214: as above, elevator door in the cremation hall, ground floor.



Photograph 215: as above; elevator cage viewed from the cremation hall above.

VI. Photographs 216-235: Auschwitz-Birkenau

Ruins of the Crematoria II through V at the Birkenau Camp. 1991-1992. © Carlo Mattogno for all photographs (unless stated otherwise).



Photograph 216: Ruins of the furnace hall of Crematorium II (direction east-west).



Photograph 217: as above; rails for the corpse-introduction cart.



Photograph 218: as above.



Photograph 219: as Photo 216; rails for the corpse-introduction cart to the first three furnaces and location of the transverse rails for the turntable (direction east-west).



Photograph 220: as above; direction west-east.



Photograph 221: as Photo 219; hole with the foundation of the chimney.



Photograph 222: Ruins of Crematorium V. Wrought-iron frame of the TOPF eight-muffle furnace and service pit. Polish photo of May 1945. APMO, Negative No. 21334/141.



Photograph 223: as above, viewed from the other side. APMO, Negative No. 21334/83.



Photograph 224: as above; right-hand (northern) service pit. Polish photo of May 1945. The man wearing a hat is the Polish investigating judge Jan Sehn. APMO, Negative No. 21334/82.



Photograph 225: as above; APMO, Negative No. 21334/81.

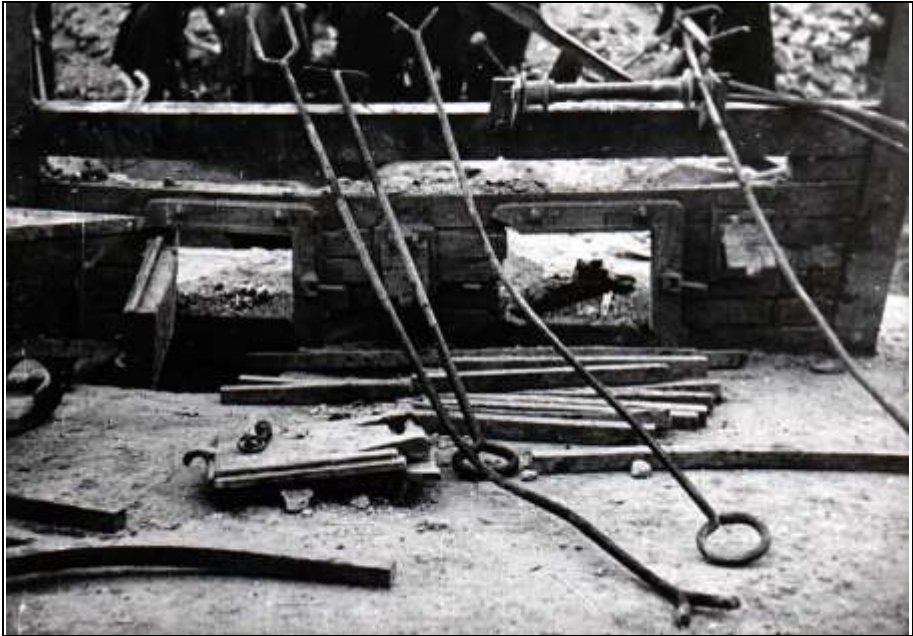

Photograph 226: as before. Ash-chamber doors of the northwestern pair of muffles. Foreground: iron tools (pokers, scrapers) and square grate irons of the gasifiers.



Photograph 227: as above, ash chamber's door frame of the muffle located in the north-western corner. Visible on the right is the door of the ash chamber's combustion-air channel.



Photograph 228: Ruins of Crematorium V (1997). Wrought-iron frame of the Topf eight-muffle furnace (direction west-east).



Photograph 229: as above, direction south-north.



Photograph 230: as above; behind the iron frame: access ladder to the gasifier's service pit.



Photograph 231: as above. Detail of the north gasifier's frame irons (direction south-north). The two brackets visible below were used for mounting the gasifier's hearth door.



Photograph 232: as above. South service pit and access ladder.



Photograph 233: Ruins of Crematorium V (1997). Ruins of the two chimneys of the Topf eight-muffle furnace: north chimney in the foreground, south chimney in the background.



Photograph 234: Ruins of Crematorium IV (1991). Gasifier's service pit (direction north-south).



Photograph 235: as above. Framework fragments of the TOPF eight-muffle furnace in the foreground (direction north-south).

VII. Photographs 236-332: KORI Cremation Furnaces

A. Photographs 236-247: Mauthausen

Coke-fired cremation furnace at Concentration Camp Mauthausen.
December 1990. © Carlo Mattogno for all photographs.



Photograph 236: front view.



Photograph 237: as above, close-up of the corpse-introduction stretcher.



Photograph 238: as above, right-hand side; in the wall the chimney damper.



Photograph 239: Inside the muffle.



Photograph 240: as above; left-hand muffle wall with opening for the combustion-air supply.



Photograph 241; as above, close-up of combustion-air-supply holes.



Photograph 242: as above, right-hand side.



Photograph 243: ash chamber seen through the ash-chamber door.



Photograph 244: rear view.



Photograph 245: left-hand side view; the gasifier's coke-loading door (top) and ash door (bottom).



Photograph 246: gasifier grate.



Photograph 247: Information sign on the support column of the furnace hall stating in German, French, Russian and Italian: “First cremation facility. This first Mauthausen cremation facility was operating from 4 May 1940 until 3 May 1945.”

B. Photographs 248-269: Dachau

Coke-fired cremation furnace at Concentration Camp Dachau. December 1990. © Carlo Mattogno for all photographs.



Photograph 248: New crematorium building at Dachau Camp ("Baracke X")



Photograph 249: Three of the four cremation furnaces.



Photograph 250: The fourth furnace, muffle door.



Photograph 251: as above, ash-chamber door and ash receptacle in the ash chamber; to either side: combustion-air inlets; foreground: metal stand with rollers for the corpse-introduction stretcher.



Photograph 252: as above, close-up of the muffle door.



Photograph 253: Second furnace, inside the muffle; left-hand side with three openings for combustion-air supply.



Photograph 254: as above, right-hand side.



Photograph 255: Fourth furnace, front view: metal housing of the muffle door's corpse-retaining plate made of refractory clay; wire cable, pulley and counterweight for its operation.



Photograph 256: as above.

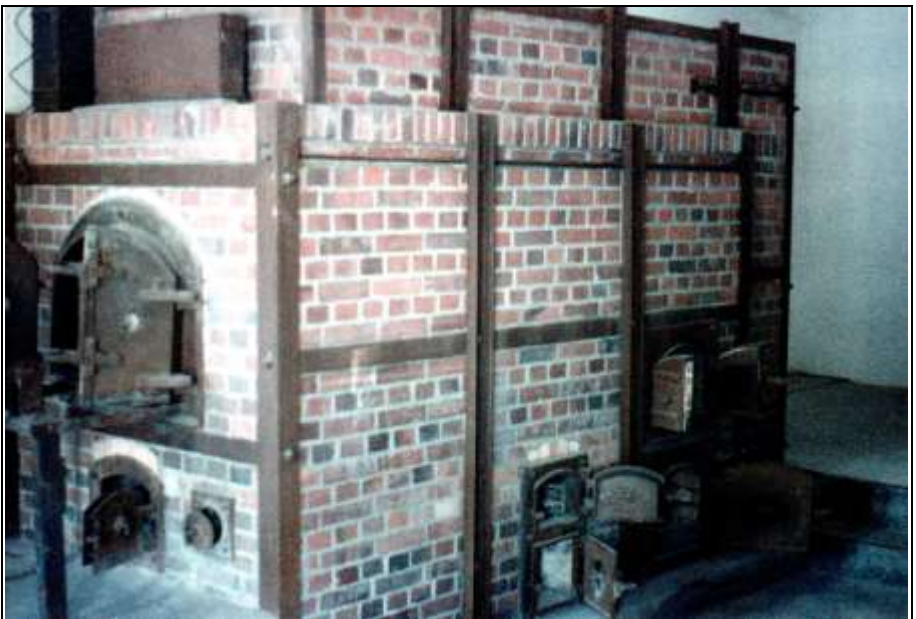

Photograph 257: First furnace, right-hand side: two doors of the auxiliary hearth (center bottom): coke-loading door (rear center), and main-ash-chamber door of the main gasifier (rear bottom).



Photograph 258: Rear view of Furnaces Nos. 2 through 4 (front to back).



Photograph 259: Rear view of the first furnace; inspection door of the vertical smoke duct. Wire cable and pulleys for operating the smoke-duct damper, visible in Photo 258 on the floor at the bottom of the furnace.



Photograph 260: First furnace, the auxiliary gasifier's service doors: loading door (top) and ash-chamber door (bottom).



Photograph 261: Coke-loading door of the main gasifier.



Photograph 262: Ash-chamber door of the main gasifier.



Photograph 263: View into the main gasifiers.



Photograph 264: View through the main gasifier's ash-chamber door onto the coke grate.



Photograph 265: Second furnace, front view. Muffle with stretcher and lowered corpse-retaining plate made of fireclay.



Photograph 266: as above.



Photograph 267: First furnace. Muffle without stretcher and raised refractory corpse-retaining plate.



Photograph 268: as above, close-up of muffle with corpse grate.



Photograph 269: Staff at the new crematorium at work. SS photo of 1944.

C. Photographs 270-284: Stutthof, Coke-Fired Furnace

Coke-fired cremation furnace at Concentration Camp Stutthof. June 1997. © Carlo Mattogno for all photographs except No. 270.

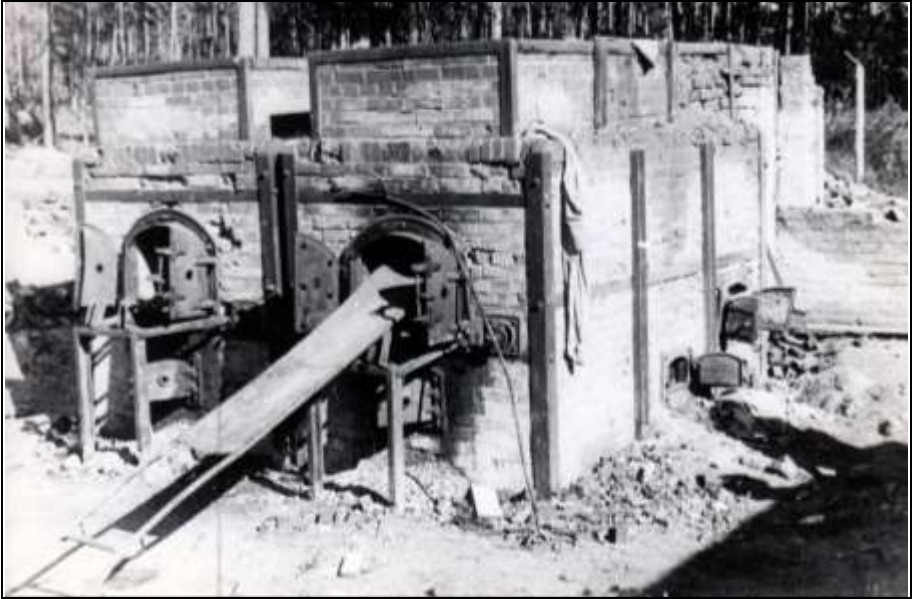

Photograph 270: The furnaces after the war in 1945.



Photograph 271: The furnace in 1997 in the crematorium refabricated by the Poles.



Photograph 272: The inside of the left-hand muffle.



Photograph 273: The ash chamber of the left-hand muffle. Top: underside of the muffle's grate bars. On the left wall in the rear: opening connecting it with the auxiliary hearth. All the way at the back: the gasifier's pit.



Photograph 274: The inside of the right-hand muffle.



Photograph 275: as above, ash chamber.



Photograph 276: Right-hand furnace. To the left: coke-loading door (center) and ash door (bottom) of the auxiliary gasifier. Center: double-leaf coke-loading door of the main gasifier with the ash-chamber door beneath.



Photograph 277: Inside the right-hand furnace's main gasifier viewed through the ash-chamber door. The hearth's grate has been damaged, with only four remaining bars merely leaning against the outer support bar.

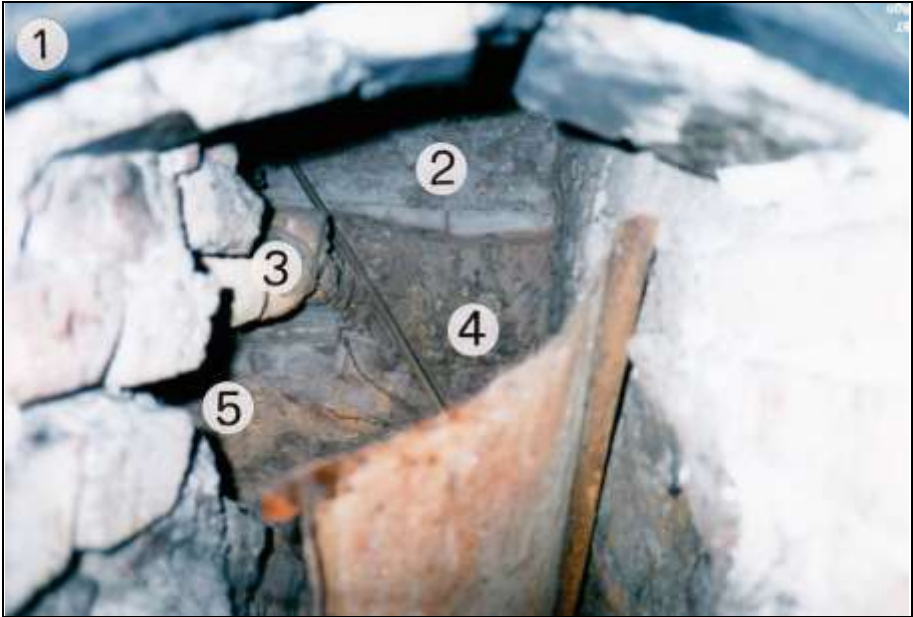

Photograph 278: as above, seen through the coke-loading door. 1: door frame; 2: muffle; 3: muffle grate; 4: gasifier pit; 5: ash chamber.



Photograph 279: Inside of the muffle seen through the main gasifier's coke-loading door. In the right-hand wall: openings for combustion-air supply. Top in the background: the opening of the smoke-gas outlet.



Photograph 280: Left-hand furnace; doors of the auxiliary gasifier.



Photograph 281: as above. View into the auxiliary gasifier. Background: the wall of the muffle's ash chamber. Foreground: the end of an iron bar from the auxiliary hearth grate.



Photograph 282: as above. The muffle's ash chamber seen through the auxiliary gasifier's ash-chamber door.



Photograph 283: Right-hand furnace, inside of the auxiliary gasifier with the muffle's ash chamber wall in the background and the muffle grate above.



Photograph 284: as above; right-hand wall of the muffle's ash chamber as seen from the auxiliary gasifier's ash chamber; top: vaulted muffle-grate bars.

D. Photographs 285-317: Majdanek, Coke-Fired Furnace

Coke-fired cremation furnace at Concentration Camp Lublin (Majdanek).
July 1991. © Carlo Mattogno for all photographs except No. 286.



Photograph 285: Polish refabrication of the crematorium at the former Lublin-Majdanek Concentration Camp.

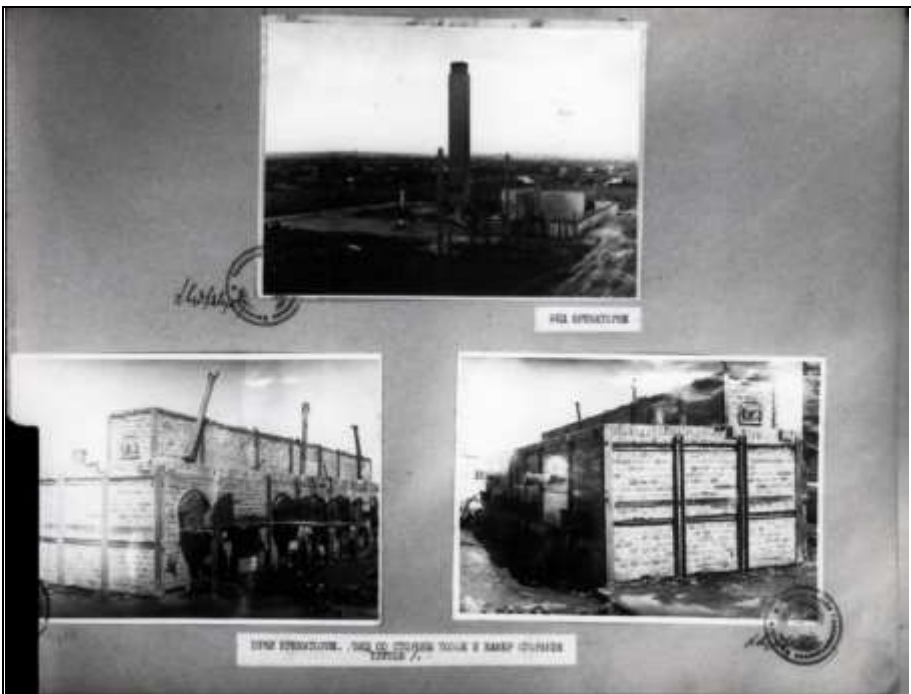

Photograph 286: The cremation furnace after Soviet capture in July 1944.



Photograph 286a: as above, section enlargement: the crematorium ruins.

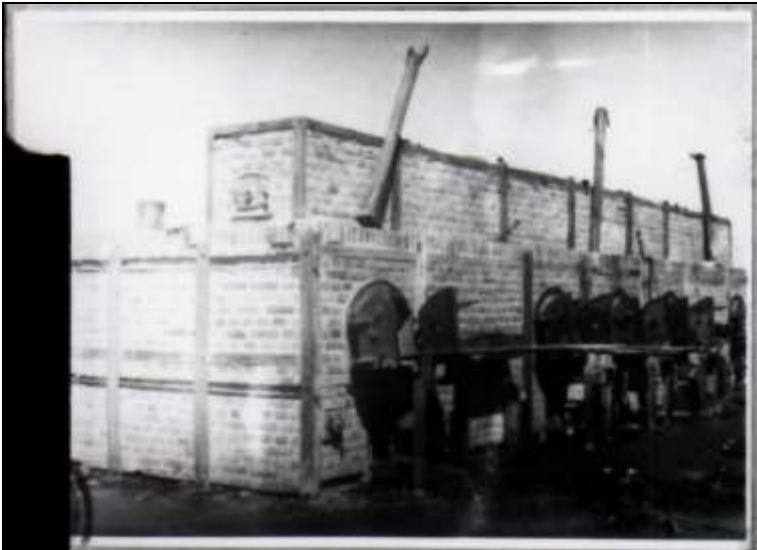

Photograph 286b: as above; the furnaces.



Photograph 286c: as above



Photograph 287: Row of cremation furnaces with five muffles, front view.



Photograph 288: as above, first furnace from the left.



Photograph 289: as above; first recuperator.



Photograph 290: as above, second furnace from the left.



Photograph 291: as above, third furnace from the left.



Photograph 292: as above, fourth furnace from the left.



Photograph 293: as above, second recuperator.



Photograph 294: as above, fifth furnace from the left.



Photograph 295: as above, close-up of the muffle.



Photograph 296: The center furnace, close-up of the muffle.



Photograph 297: Vaulted ceiling of the first muffle; in the side walls the openings of the combustion-air-supply channels can be seen.



Photograph 298: as above, second muffle.



Photograph 299: as above, third, center muffle.



Photograph 300: as above, fourth muffle.



Photograph 301 as above, fifth muffle.



Photograph 302: Vertical duct of the flue-gas outlet.



Photograph 303: Access door to the post-combustion area.



Photograph 304: Ash-extraction door with the first bar of the post-combustion grate visible.



Photograph 305: Right-hand rear view of the five-furnace device.



Photograph 306: as above, from the left-hand side.



Photograph 307: as above.



Photograph 308: as above. Hot-water pipes of the recuperator.



Photograph 309: Front view from the right-hand side. The brick structure at top contains the smoke duct, with an inspection door on the side.



Photograph 310: as above, smoke duct with inspection door.



Photograph 311: The gasifier grate.



Photograph 312: as above



Photograph 313: Inside of a furnace seen from the gasifier's coke-loading door. Foreground: the gasifier; behind it: the ash chamber with the ash doors in the background; above that: the muffle's fireclay grate; top: the muffle.



Photograph 314: as above; bottom: the ash chamber with the ash-chamber-access door in the background; above that: the muffle's fireclay grate; top: the muffle.



Photograph 315: Inside of the gasifier of the TOPF Furnace at Gusen Concentration Camp. The refractory lining shows extensive fusion.



Photograph 316: as above.

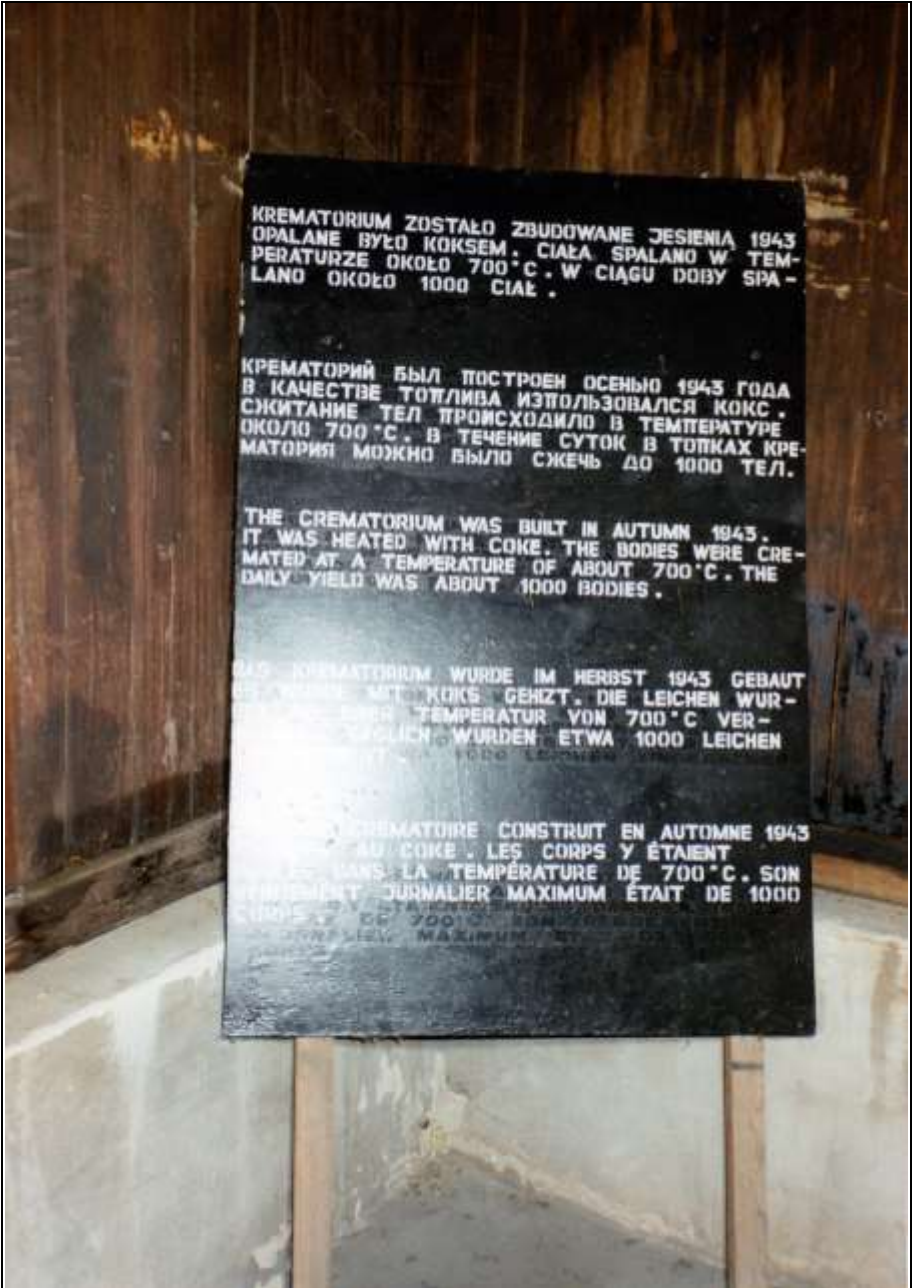

Photograph 317: Sign displayed in the crematorium of Lublin Concentration Camp stating in five languages: “The crematorium was built in autumn 1943. It was fueled with coke. The bodies were cremated at a temperature of about 700°C. The daily yield was about 1000 bodies.”

E. Photographs 318-327: Majdanek, Naphtha-Fired Furnace

Naphtha-fired cremation furnace at Concentration Camp Lublin (Majdanek).
July 1991. © Carlo Mattogno for all photographs.



Photograph 318: front view of the furnace.



Photograph 319: as above; top: the muffle door; bottom center: ash-chamber door; bottom left and right: combustion-air inlets.



Photograph 320: Inside of the muffle. Bottom: the refractory grate; on the back wall: the main burner's nozzle; on the side walls: openings of the combustion-air-supply channels.



Photograph 321: as above; the vaulted muffle ceiling with the smoke-duct opening in the foreground.



Photograph 322: as above; the refractory grate; bottom: ash-chamber door.



Photograph 323: Ash chamber; top: the underside of the muffle's refractory grate; background: the auxiliary burner's nozzle.



Photograph 324: left-hand side of the furnace.



Photograph 325: as above. In the upper part of the furnace can be seen the combustion-air pipe for the burners (left), the support bars for the fan and its motor (center), and the base of the chimney (right).



Photograph 326: right-hand side; bottom right: side inspection door beneath a combustion-air inlet.



Photograph 327: rear view; combustion-air pipe with main (center) and auxiliary burners (bottom).

F. Photographs 328-329: Stutthof, Naphtha-Fired Furnace

Naphtha-fired cremation furnace at Concentration Camp Stutthof.



Photograph 328: The furnace right after the camp's Soviet capture in 1945.



Photograph 329: The furnace as exhibited in the camp museum in June 1997.

© Carlo Mattogno

G. Photographs 330-331: Trzebinia

Naphtha-fired cremation furnace at Trzebinia Subcamp. October 1991. © Carlo Mattogno.



Photograph 330: Front view of the furnace. The interior of the furnace was completely destroyed. At the top the conical chimney (center), the blower (left) and the naphtha tank (right).



Photograph 331: Right-hand side of the furnace with the naphtha tank in the foreground.

H. Photograph 331a: Blechhammer



Photograph 331a: Naphtha-fired cremation furnace at Blechhammer Subcamp. Source:

https://commons.wikimedia.org/wiki/File:Arbeitslager_Blechhammer_-_krematorium1.jpg.

I. Photographs 332-334: Groß-Rosen

Naphtha-fired cremation furnace at Concentration Camp Groß-Rosen. March 1999. © Carlo Mattogno for all photographs.



Photograph 332: Furnace on the foundations of the former cremation hall.



Photograph 333: Front view. In the foreground the stand with the two rollers for introducing the stretcher.



Photograph 333a: rear view. Top left: naphtha tank; below it: combustion-air inlet and access door; top right: combustion-air pipes; rear end: main (top) and auxiliary burner (bottom).



Photograph 333b: as above. The air pipes were originally connected to a blower installed on the shelf to the right.



Photograph 333c: rear view, main (top) and auxiliary burner (bottom)



Photograph 334: Interior. The introduction stretcher moved with four metal rollers on two angle irons. The opening in the back wall housed the main burner. The refractory lining has been completely removed.

VIII. Photographs 335-344: KORI Furnaces in Other Camps



Photograph 335: KORI coke-fired cremation furnace at the Flossenbürg Camp. Source: http://commons.wikimedia.org/wiki/File:Crematory_oven_-_Flossenbürg.jpg.



Photograph 336: KORI coke-fired cremation furnace at Ebensee Camp. Source: www.profit-over-life.org/teachers_guide/austria/mauthausen_kz/mauthausen-ebensee_crematorium.html.



Photograph 337: Ruins of the KORI coke-fired cremation furnace at Sachsenhausen Concentration Camp. Source: <http://snapeatrepeat.com/tag/sachsenhausen-concentration-camp/>, now removed.



Photograph 338: KORI coke- and naphtha-fired cremation furnace at Ravensbrück Concentration Camp. Source: <http://mmlorusso.blogspot.com/2011/03/his-will-is-our-hiding-place-cont.html>.



Photograph 339: KORI naphtha-fired cremation furnace at Bergen-Belsen Concentration Camp. Source: <http://galleryhip.com/bergen-belsen-liberation.html>, now removed.



Photograph 340: KOR1 naphtha-fired cremation furnace at Dora-Mittelbau Concentration Camp. Source:

http://commons.wikimedia.org/wiki/File:210509_Krematorie_Dora_Mittelbau_01.JPG



Photograph 341: KORI naphtha-fired cremation furnace at Natzweiler-Struthof Concentration Camp. Source: http://commons.wikimedia.org/wiki/File:Natzweiler-Struthof_krematorium.JPG.



Photograph 342: KORI naphtha-fired cremation furnaces at Neuengamme Concentration Camp. Source: www.kz-gedenkstaette-neuengamme.de/typo3temp/pics/5f467c62d5.jpg, now removed

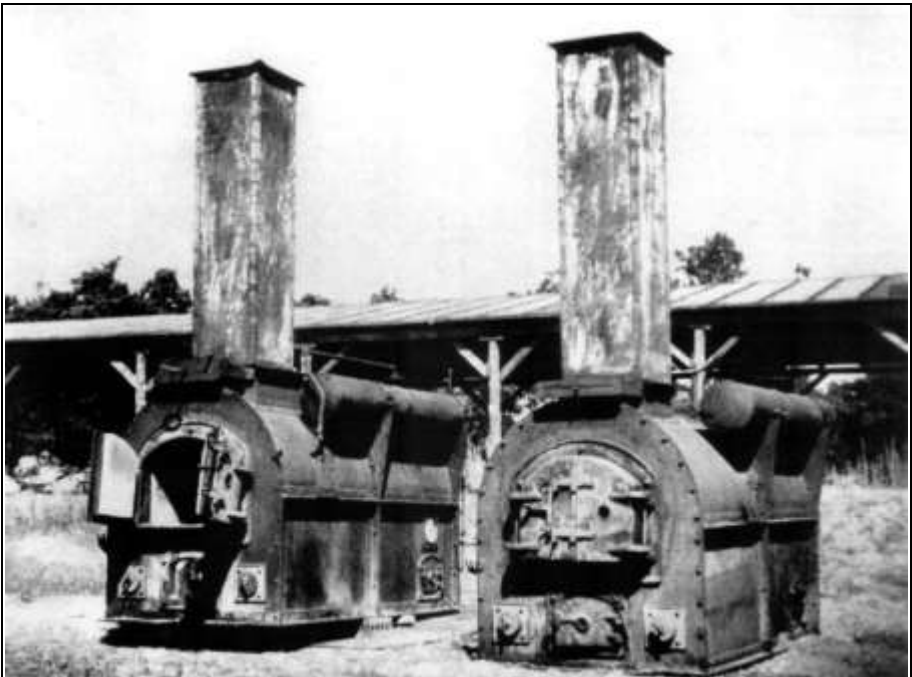

Photograph 343: KORI naphtha-fired cremation furnaces at Sachsenhausen Concentration Camp. Source: Sachsenhausen, Kongress-Verlag, Berlin 1962, p. 84.



Photograph 344: KORI naphtha-fired cremation furnace at Vught Concentration Camp. Source: <http://ww2today.com/wp-content/uploads/2014/11/vught-crematoria.jpg>.

IX. Photographs 345-362: Terezín

IGNIS-HÜTTENBAU naphtha-fired cremation furnaces at Terezín Ghetto.
February 1999. © Carlo Mattogno, unless stated otherwise.



Photograph 345: The four furnaces viewed from above. On the right-hand wall, top, are the naphtha tanks.



Photograph 345a: as above, viewed from eye level. Source:

<https://commons.wikimedia.org/wiki/File:Terez%C3%ADnCrematorium.jpg>.



Photograph 346: Left-hand furnace of the front pair, front view, with the corpse-introduction cart.

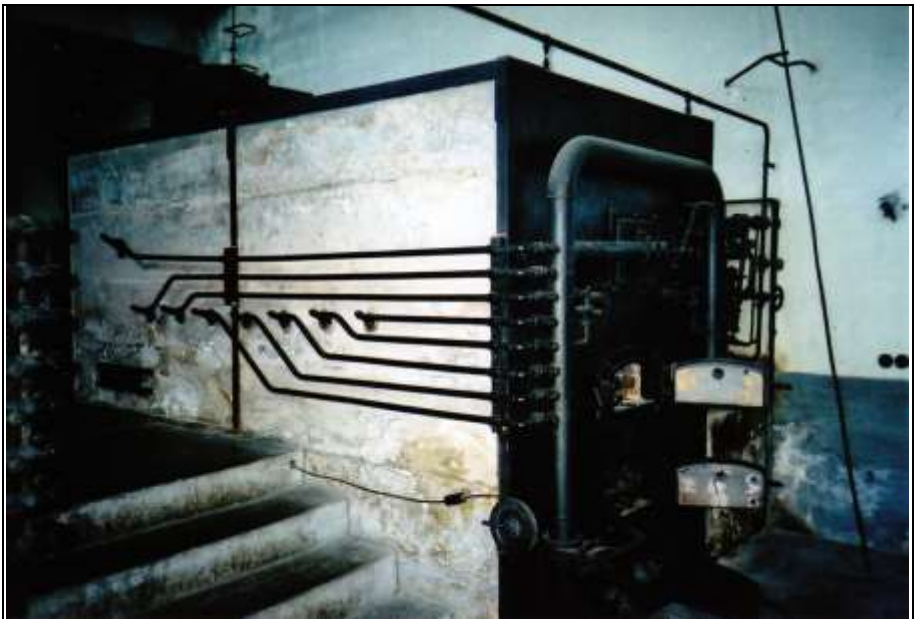

Photograph 347: as above; left-hand side and rear of the furnace.



Photograph 348: as above, rear view.



Photograph 349: as above; on the right, next to the wall, is the naphtha preheater behind a long scraper.



Photograph 350: Right-hand furnace of the front pair, rear view, naphtha burner.



Photograph 351: Left-hand furnace of the front pair, rear view; the three service doors: for the muffle (top), the post-combustion chamber (center) and the ash chamber with the ash receptacle (bottom).



Photograph 352: as above; the muffle's interior seen from its rear service door. In the foreground the front part of the corpse-introduction cart.



Photograph 353: as above, with the introduction cart pulled out. In the foreground, the shaft of the scraper to remove cremation remains.



Photograph 354: as above; inside of the post-combustion chamber seen through its rear service door.



Photograph 354a: as above; close-up.



Photograph 355: as above; inside of the ash chamber seen through its rear service door, with the corroded iron ash container.



Photograph 356: Forced-draft blower of the front pair of furnaces, with suction duct (left), chimney duct (center) and the motor (right). In the background left and right the two combustion-air blowers.



Photograph 357: as above, side view.



Photograph 358: Combustion-air blower for the left-hand furnace of the front pair.



Photograph 359: Closing damper of the right-hand furnace of the rear pair of furnaces.



Photograph 360: left-hand furnace of front pair, front view; the damper's steel cable and pulley attached to the ceiling.



Photograph 361: Left-hand furnace of the rear pair, front view, with the corpse-introduction cart.



Photograph 361a: Left-hand furnace of the front pair, front view, with the corpse-introduction cart.



Photograph 362: Rough wooden coffin for cremation, left of the above furnace.

X. Photographs 363-365: Urns

Cremation urns at the concentration camps. © Carlo Mattogno, unless stated otherwise.



Photograph 363: Urns stored in a showcase of the Lublin-Majdanek Camp Museum.



Photograph 364: Urns stored in a showcase of the Buchenwald Concentration Camp Museum.



Photograph 364a: as above, close-up.



*Photograph 365: Urns found in the crematorium of Natzweiler-Struthof Concentration Camp in 1945. Source: Jean-Claude Pressac, *The Struthof Album*, Beate Klarsfeld Foundation, New York, 1985. p. 56.*

XI. Photographs 366-367: Stoking Tools



Photograph 366: Stoking tools in the crematorium of Stutthof Concentration Camp (June 1997): two stokers and a scraper. © Carlo Mattogno.



Photograph 367: as above, close-up.

XII. Photographs 368-370: Cremation Experiments

Cremation experiments with animal fat. © Carlo Mattogno



Photograph 368: Combustion experiment with animal fat conducted by the author on 21 October 1994.



Photograph 369: as above, 10 January 1995.



Photograph 370: as above.

XIII. Color Documents from Part 2



Document 253: Condition of a corpse after thirty minuts of cremation. Source: Michael Bohnert, Thomas Rost, Stefan Pollak, "The degree of destruction of human bodies in relation to the duration of the fire," in: Forensic Science International, 95, 1998, p. 15.



Document 254: as above, after forty minutes.