

KORN N.O., P. 35
 TOBIAS GEN.
 H. A. ALEXANDER-NOTES
 ELZAS-D.J.C., P. 93
 ELZAS MN., P. 8

AARONS I

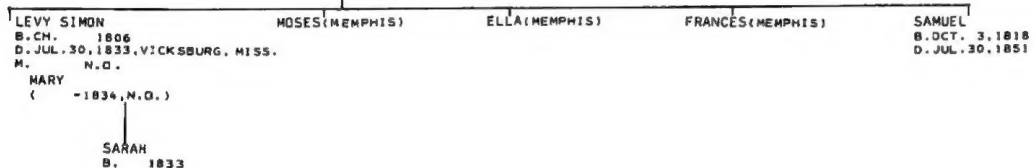
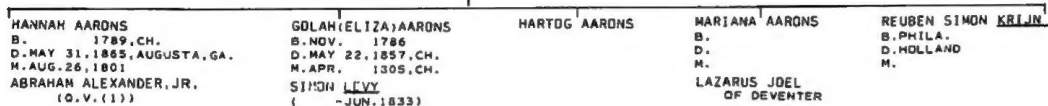
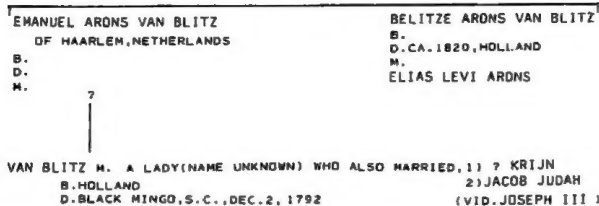

ABENDANONE-COHEN DELMONTE

ELZAS-M.N. P. 8
 SHEARITH ISRAEL REC.
 WILL OF GRACE ABENDANONE (JRM)
 WILL OF JOSEPH ABENDANONE
 GRACE ABENDANONE MS. (AJA)
 ST. THOS. CEMETERY REC.
 GA. COLONIAL DAMES-EARLY EPITAPHS
 MORTUARY REC. OF GA.
 SHEPTALL MSS.
 SALLEY-MARRIAGE NOTICES
 IN CH. COURIER
 MISC. VII JHSE
 PAJHS 21, P. 43

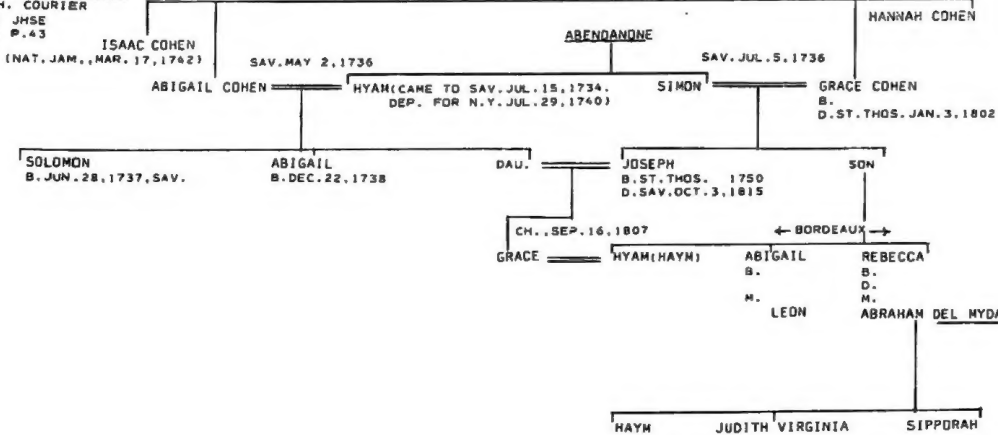
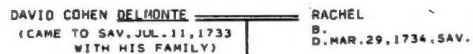

B'NAI JESH. REC.
 SHEARITH ISRAEL REC.

AARONS II

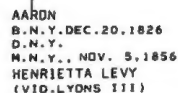
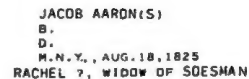

SHEARITH ISRAEL REC.

AARONS III

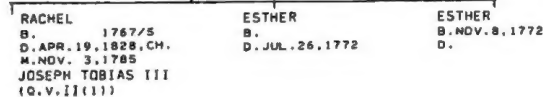

AARONS IV

N. Y. CENSUS 1856

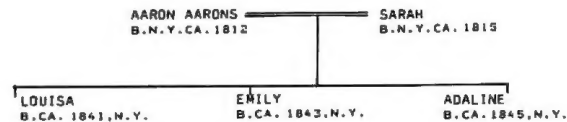

ABRAHAM (1)

ELIZABETH PLAUNT

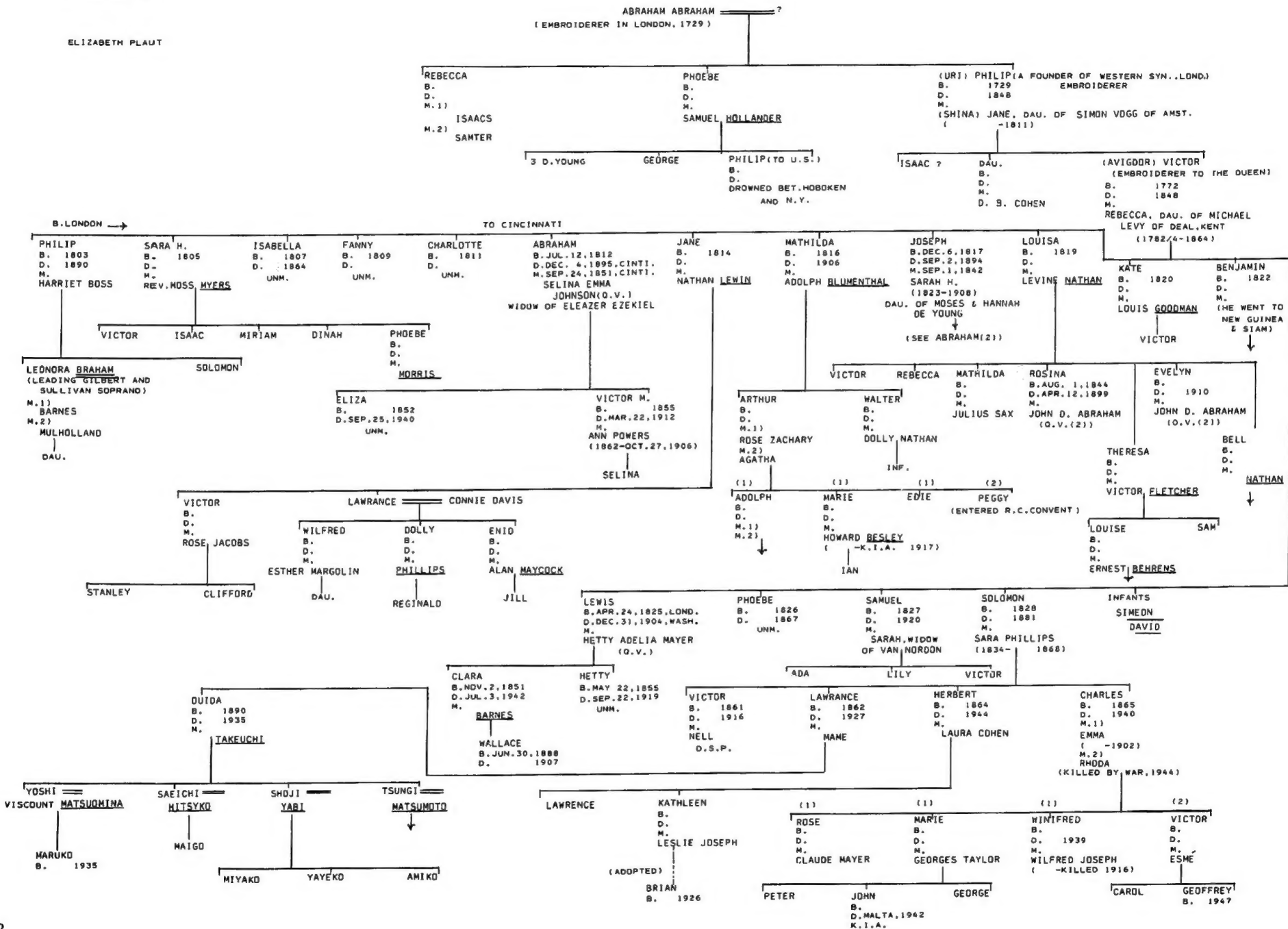

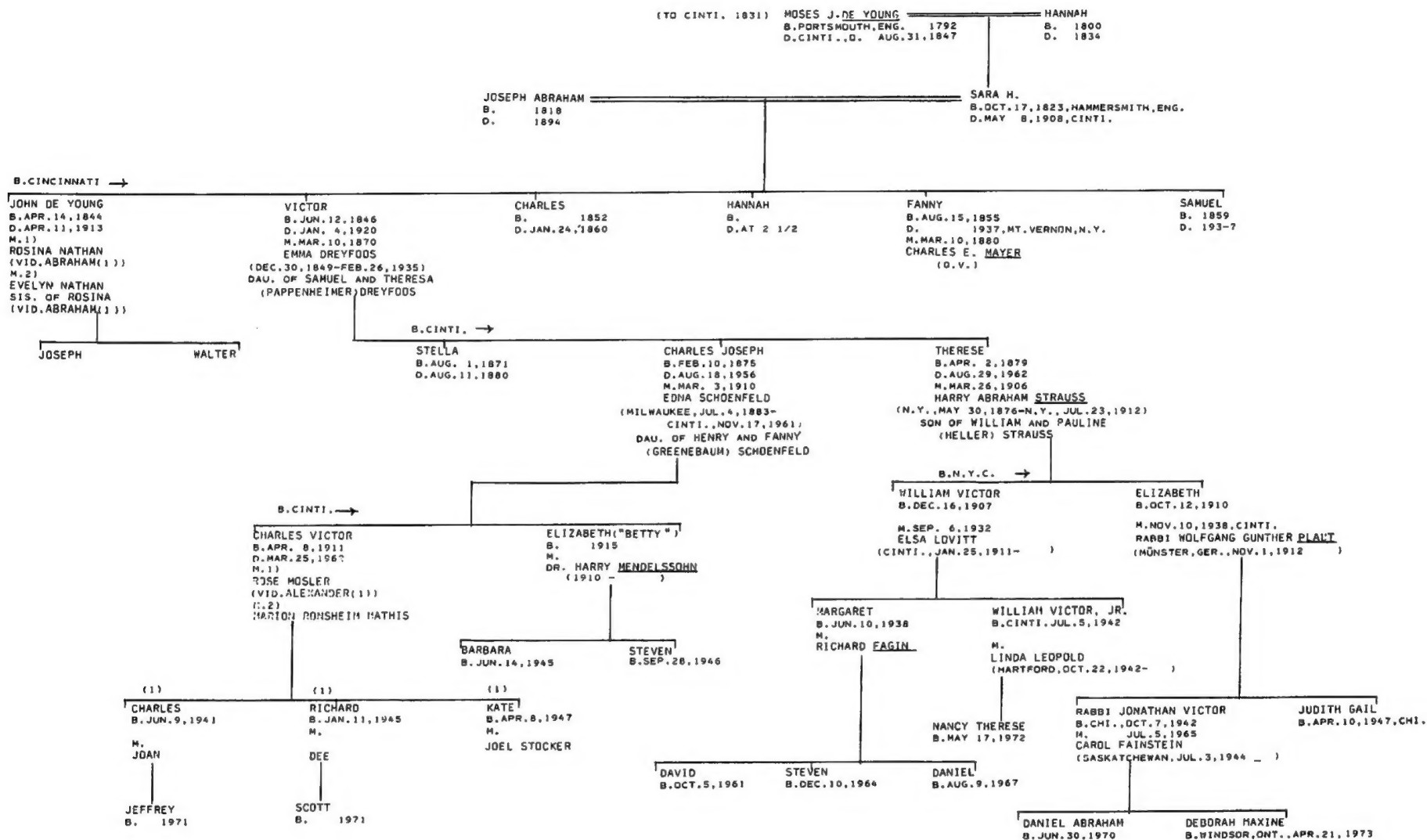

ABRAHAMS I (N.Y.)

ROSENWAIKE
AMER. DAILY ADV.
KRAUS-SANDOR(AJA)
PAJMS.V.27.P.150F.
GRINSTEIN...JEW. COMMUNITY OF N.Y.
POOL-PORTRAITS...
ELZAS-OJC P.77
ELZAS MSS.(NYHS)
SHEARITH ISRAEL REC.

RABBI ISAAC ABRAHAMS
(CALLED "ISAAC BRISKER"
I.E. OF BREST-LITOVSK)

ESTHER
B.
D.AUG.29,1766

(BROTHER OR COUSIN)

EMANUEL (FREEMAN, N.Y., JAN. 4, 1757
TOBACCONIST & DISTILLER)
B. 1748, LOND.
D. JAN. 24, 1802
M.
BILAH
(-CH. MAR. 1794)
(HE CAME TO AMERICA, 1757)

ABRAHAM ISAAC
B. 1720
D. N.Y. AUG. 10, 1796
M.
ELKALY ESTHER LOUZADA (O.V.)

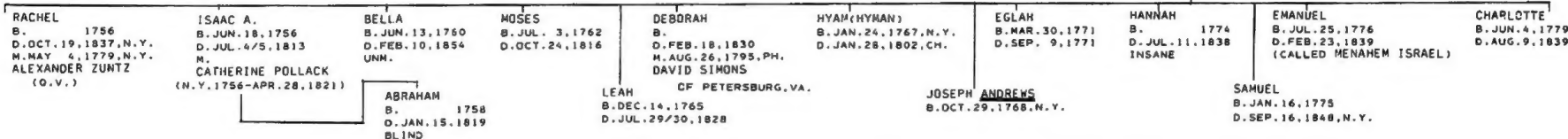

ABRAHAMS III ABRAMS (S.C.)

A.L. MARSH
MRS. J.R. MCDAVID
EDGAR M. KAHN
KRAUS-SANDOR COLL. (AJA)
FAM. HIST. OF BENJAMIN MORDECAI (AJA, PH.)
DAR LINEAGE BOOKS
ELZAS-OJC, P. 40
SHEARITH ISRAEL REC.

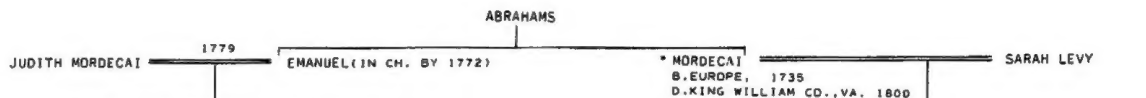

THIS GENERATION CHANGED NAME TO ABRAMS

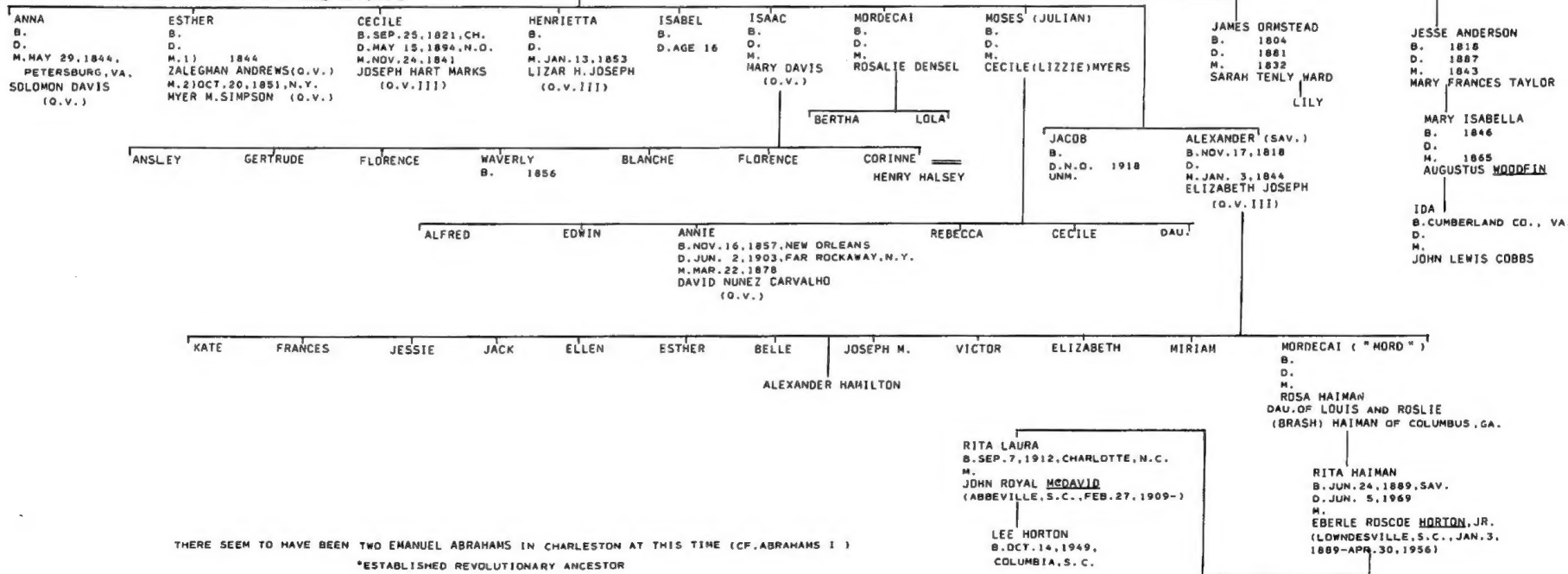

THERE SEEM TO HAVE BEEN TWO EMANUEL ABRAHAMS IN CHARLESTON AT THIS TIME (CF. ABRAHAMS I)

*ESTABLISHED REVOLUTIONARY ANCESTOR

ABRAHAMS FAMILY BIBLE
(MRS. EDMUND H. ABRAHAMS)
LAWRENCE L. FALK GEN.
H.A. ALEXANDER-ALEXANDER
KRAUS-SANDOR COLL.
JACOB ISAACKS MS. (MAP)
ELZAS MSS. (NYHS)
ELZAS M.N., P. 43
FLORENCE ABRAHAMS
B.H. LEVY

ABRAHAM
HEZEKIEL
D.
D. DEC. 1847, HASTADT (HASTEDT NEAR BREMEN)
H.
APP. 8, 1829, CH.
ALEXANDER HEZEKIEL ABRAHAMS
B. JUN. 18, 1801, BERKHOFF, NEAR BREMEN
D. OCT. 16, 1871, S.C.
HANNAH MOSES
(O.V. III (1))

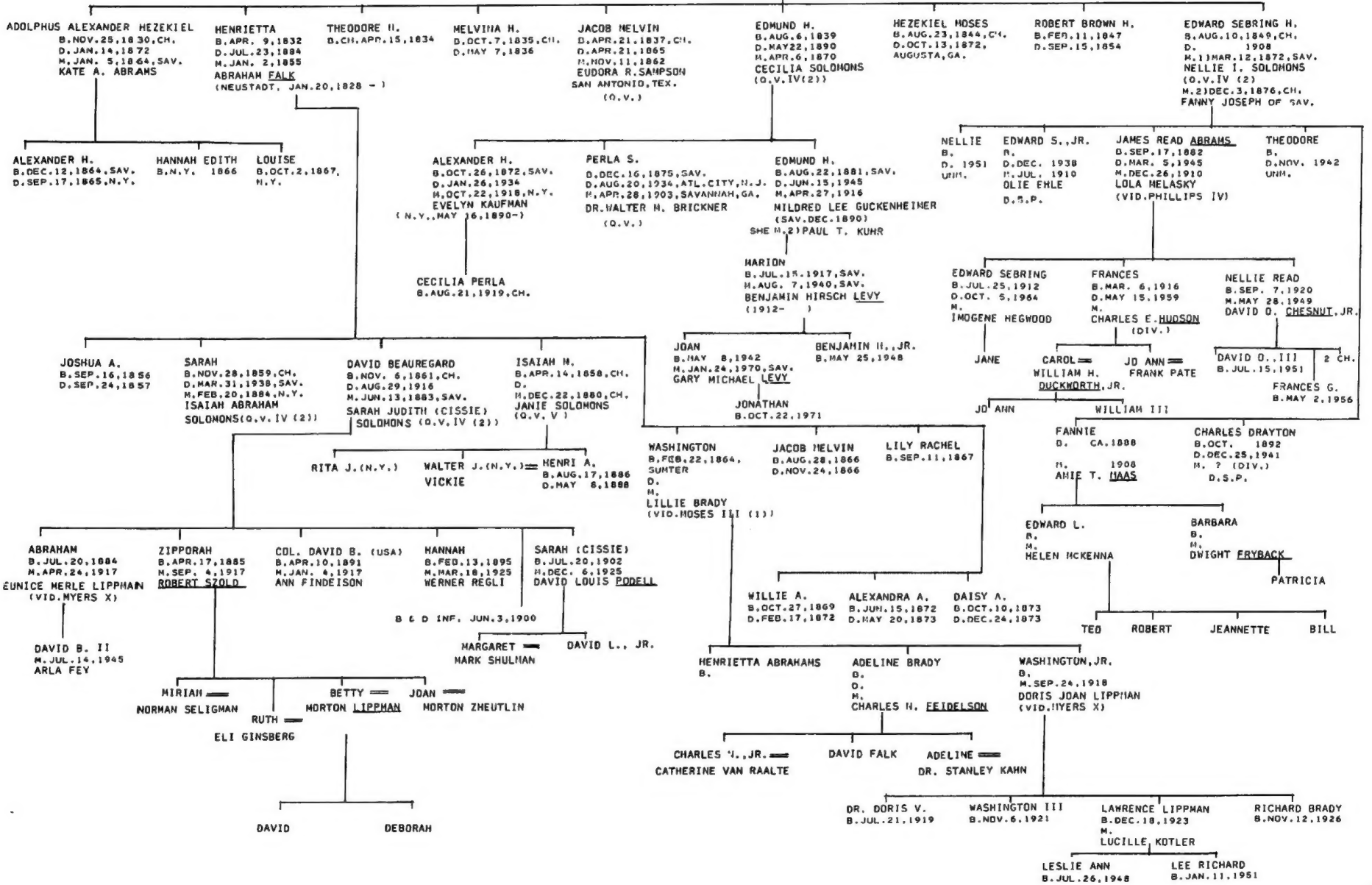

ABRAHAMS IV (NEW YORK)

KRAUS-SAMDOOR COLL.
PAJHS, V. 27, P. 74, 110F.
ELZAS, H. N. P. 12
SHEARITH ISRAEL REC.
STANLEY F. JACOBS
R'NAI JESHURIM REC.
BARBER-H. Y. MARRIAGES
N. Y. 1850 CENSUS

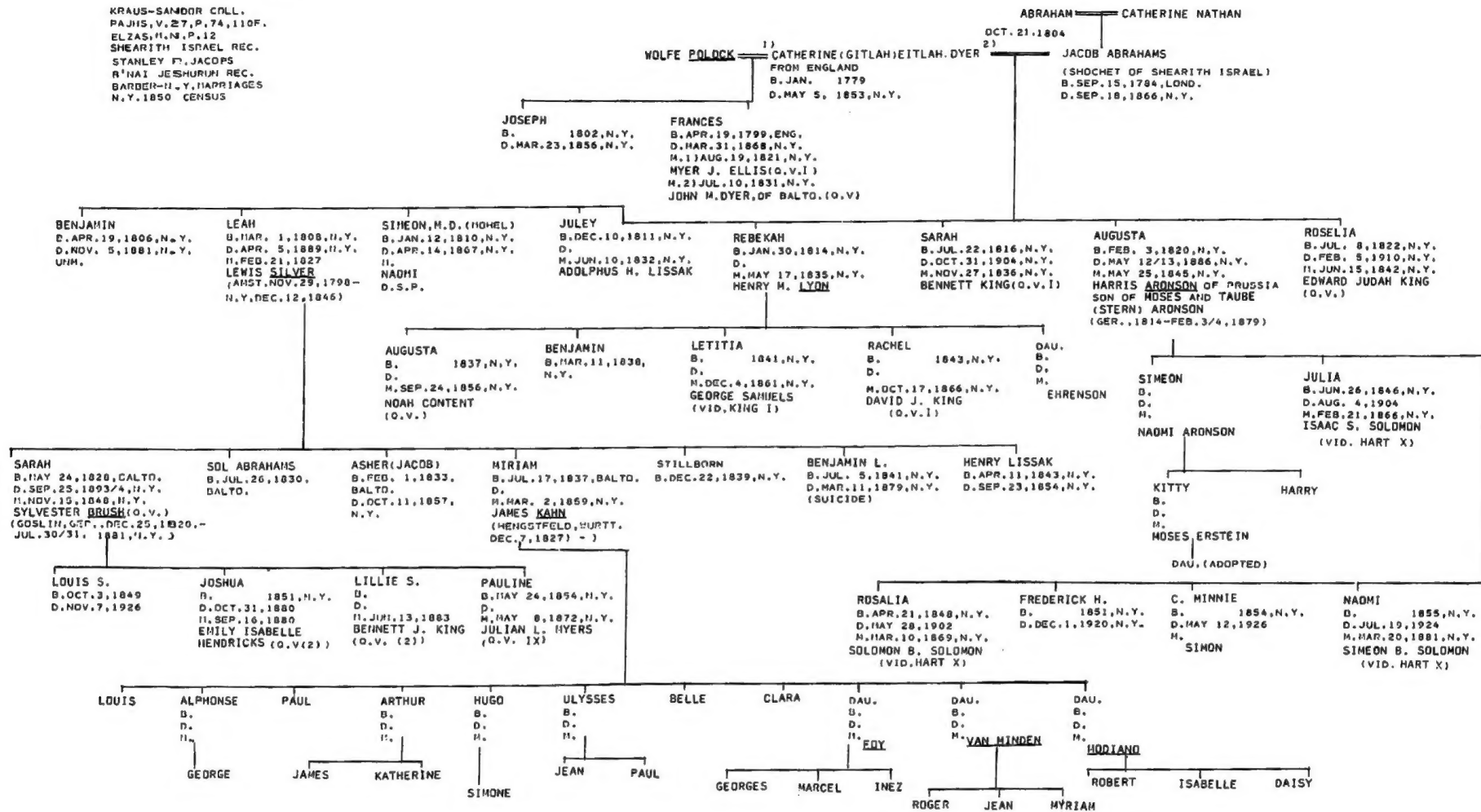

ABRAHAMS V

PAJHS V. 19, P. 118
POOL-PORTRAITS...

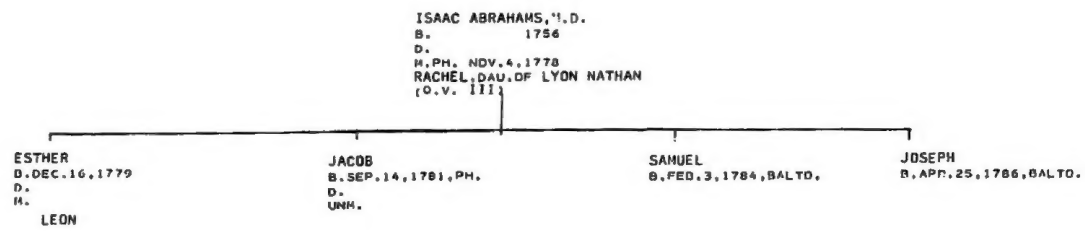

ABRAHAMS VI

O.J.C.
WILL OF MOSES NUNES
WILL OF ABRAHAM & ISAAC ABRAHAMS
SHEFT ALL MSS.
SHEARITH ISRAEL REC.

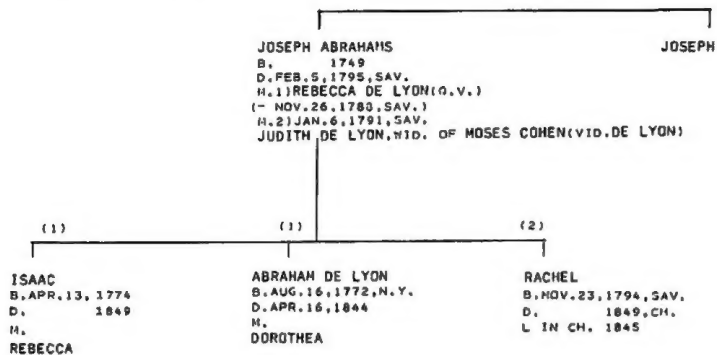

ABRAHAMS VII

E-L

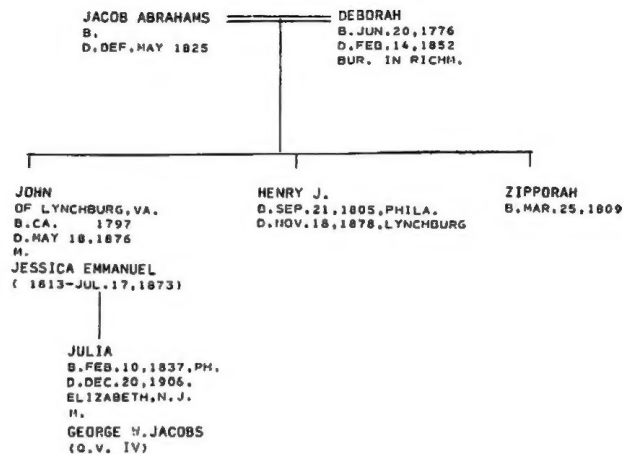

ADOLPHUS

KRAUS-SANDOR COLL.
PAJHS V. 2, P. 62F.
PAJHS V. 10, P. 165
AJHG LXI, 119F.
MISC. V. 11 #535
NYGDR 104, 79
POOL- PORTRAITS...
SHEARITH ISRAEL REC.

RAPHAEL ADOLPHUS

BENJAMIN OR EPHRAIM REINE
B. BONN, GERMANY
D. BEF. 1759
M.

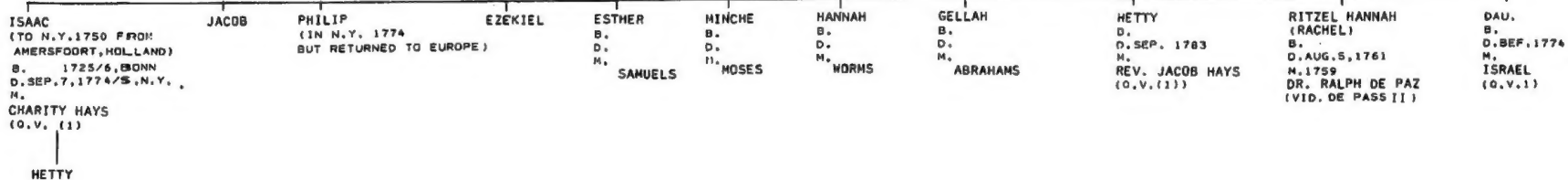

AARON ALEXANDER (OF VICKSBURG, ATLANTA, PHILA., & COLUMBUS, GA.)
 B. MAR. 7, 1812, CH.
 D. JUN. 1, 1876, ATLANTA
 M. MAR. 5, 1836, CH.
 SARAH MOSES
 (Q.V. III (1))
 (SEE PRECEDING PAGE)

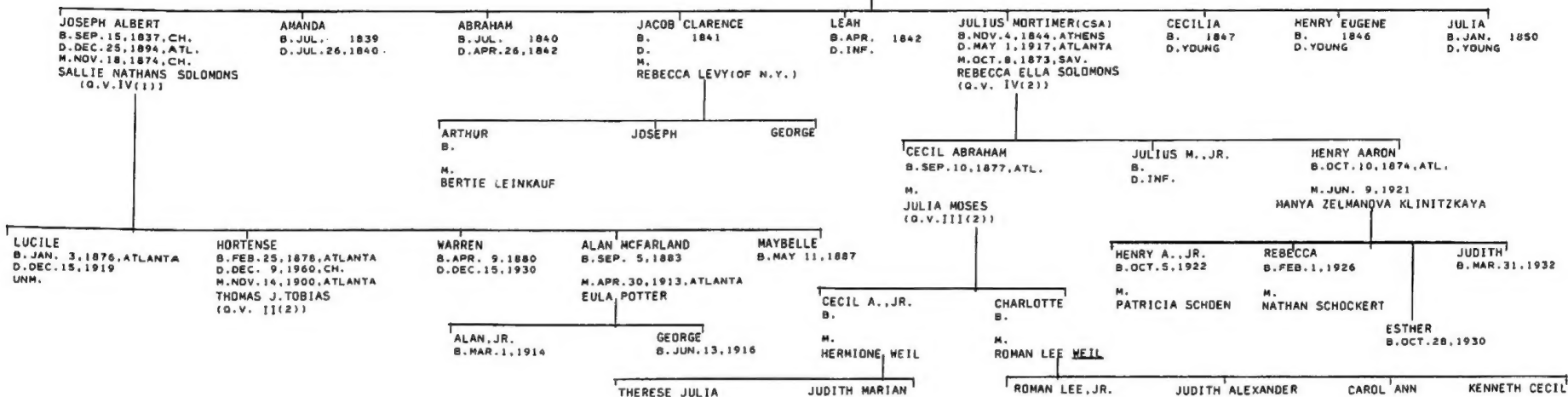

JOHN F. ALEXANDER
 JON STEDMAN
 ABBOTT L. MOFFAT

ALEXANDER ALEXANDER OF COLUMBIA, S.C.
 B. ENG. 1793/1800
 D. COLUMBIA, JAN. 19, 1857
 M.
 SARAH HARRIS SAMPSON
 (VID. HARRIS II)

ALEXANDER II

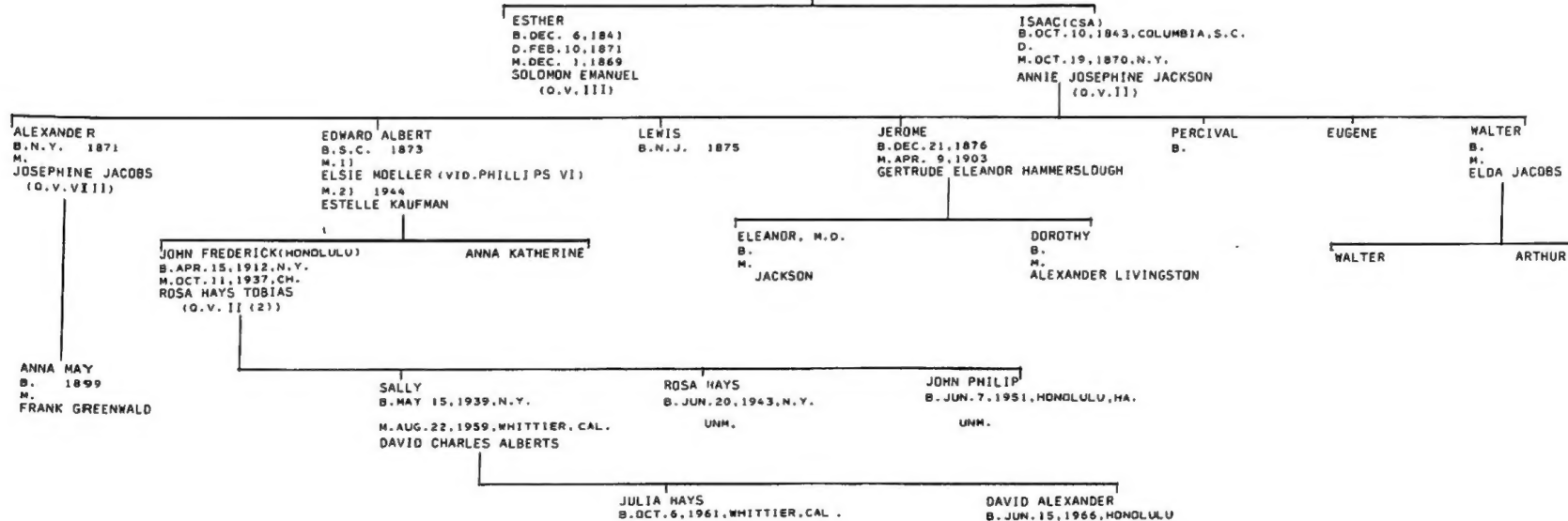

ALLEN

ALLEN GEN.
 JEWISH ENCYCLOPEDIA, V. 8, P. 59
 MORAIS-JEWS OF PHILA.
 KRAUS-SANDOR COLL.
 MICKVE ISRAEL REC.
 SHEARITH ISRAEL REC.
 FLORENCE ABRAHAMS

PETER SMILERS B. 1740 A'ELIA CLARKE B. 1742
 D. 1799 D. 1803

LEWIS ALLEN B. 1762 A'ELIA B. STATEN ISL. 1767
 D. NOV. 5, 1811 / MAR. 1, 1815 D. PHILA. JUL. 16, 1834
 CAME FROM ENGLAND, 1805

LEWIS, JR. B. LONDON JAN. 21, 1793
 D. PHILA. NOV. 4/5, 1841
 M. DEC. 10, 1823
 ANNA MARKS (O.V.)

HARRIET B. D. M. AUG. 28, 1822
 MORRIS B. COHEN

ESTHER B. 1798, ENG. D. DEC. 15, 1872, N.Y. (BUR. PH)
 M. MAY 20, 1821
 ABRAHAM MITCHELL (O.V.)

MARIA B. 1799 D. NOV. 26, 1848
 M. NOV. 16, 1825
 JUDAH L. HACKENBURG (O.V.)

JACOB B. N.Y. JUN. 16, 1825

AMELIA JOHAVETH B. 1824 D. JUN. 27, 1856
 M. SEP. 6, 1846
 MITCHELL, A. MITCHELL (O.V.)

LEWIS MARKS B. PHILA. AUG. 5, 1827 D. MAR. 6, 1870
 M. JUN. 11, 1851
 MIRIAM ARNOLD (O.V.)

HENRY SAMSON B. OCT. 11, 1828, PH. D. MAR. 3, 1903, N.Y.
 M. FEB. 23, 1859, N.Y.
 ROSALIE HENDRICKS (O.V.) D.S.P.

MICHAEL MITCHELL B. NOV. 24, 1830, PH. D. M. NOV. 7, 1866, N.Y.
 JULIA SPANIER (O.V.)
 (MOVED TO HANOVER, GER., 1874.)

BENJAMIN WOLFF B. MAY 5, 1833 D. INF.

CHARLES CHAUNCEY OF N.Y. B. JUN. 4, 1835, PH. D. APR. 30, 1906, N.Y.
 M. JUN. 19, 1872, N.Y.
 LOUISE SONDHEIM (NOV. 4, 1853, N.Y. - JUN. 12, 1930, N.Y.)
 DAU. OF NATHAN & CAROLINE LDEWI SONDHEIM

ALFRED HART B. D. NOV. 16, 1864, PH. EMMA WETZLER (LIVED IN LONDON)

GRACE AMELIA B. N.Y. SEP. 29, 1857 M. 1889
 DR. JACOB WINTER

LEWIS S., M.D. B. N.Y. JAN. 4, 1872 M. MINNA RUBEN, OF HAMBURG

CLARENCE MITCHELL B. JUL. 28, 1875, HANOVER D. APR. 9, 1933, PH. M. DEC. 2, 1909
 BERNADINE HIRSCHFELDT

ANNA FLORENCE B. 1882 M. 1907
 DR. EMIL LEVY OF POHERANIA

FLORENCE LILLIAN ZILLAH BEATRICE B. N.Y. DEC. 25, 1868

LEO B. 1897 M. 1923
 HANNIE SCHWABE

ANNIE B. 1894 M. 1) 1919
 HEINRICH FEINGOLD M. 2) ERNST LANDSBERGER

ELLY B. 1890 M. 1910
 HANS KORNBLUH

GABRIELE B. 1924

ERNST B. 1918

FRED B. 1910

RUTH EVELYN B. 1912, N.Y. M. MAY 2, 1943, N.Y.
 JOSHUA VIVIAN FIOANQUE

MICHAEL B. 1916

ROSALIE B. MAR. 26, 1874 D. M. NOV. 7, 1893
 DR. CHARLES HAY

WALTER CHARLES B. OCT. 6, 1875 M. 1919
 WINONA WILKINS

HENRY HATHAI B. DEC. 25, 1876 M. 1917
 ADELE STRAUSS

FLORINE B. FEB. 14, 1881 M. 1903
 ALFRED JULIUS LYONS OF SURINAM

CAROLINE B. NOV. 16, 1883 M. 1904
 LIONELLO PERERA (JUN. 5, 1871 -

CHARLES CRAIG B. MAR. 20, 1921

HENRY GREEP B. 1924

ROSALIE A. B. 1905 M. 1924
 HERVIN L. LANE

ROGER A. B. 1915

HERVIN L., JR.

ERNST MORITZ B. 1908

PETER B. 1909

EVA B. 1910

WOLFGANG B. 1915

EDGAR D. 1916

HANS HENRY B. 1900 M. 1924
 FANNIE SIMON

HIRJAH B. 1901 M. 1924
 DR. OTTO ASCHER

KURT B. 1905

FRITZ B. 1907

ERNST B. 1911

CLAUS B. 1927

GERHART B. 1926

CHARLES ALLEN B. 1904

NINA B. 1907

LIONEL CANTONI B. 1909

GEORGE A. B. 1911

LYDIA B. 1917

LEWIS IV B. AUG. 4, 1852 D. NOV. 11, 1909
 M. 1887
 HANNAH EIHANUEL (A WIDOW)

ALICE B. FEB. 6, 1854 D. JAN. 25, 1859

FRANCES B. APR. 8, 1855 D. JUN. 8, 1889
 DR. NOISE DE FORD

AMELIA JOHAVETH B. 1856 D. 1935
 UNM.

CLARENCE B. 1857 D. 1930
 UNM.

ANNA B. 1859 D. 1944
 UNM.

JULIUS B. 1862 D. INF. 1864

ROSALIE HAY B. MAY 1, 1866 D. JUN. 18, 1872

LEWIS V

ALICE ROSALIE B. 1890

MIRIAM ALLEN B. 1888 M. 1) 1916
 ARHISTEAD COLLIER M. 2) 1921
 MAYNARD SHIPLEY

ALLEN VANARD B. 1893

DOROTHY OETTINGER

DORIS JEAN

ROBERT O.

BARBARA FRANCES

E-L, P. 286
R.S., MOH. REC.
KRAUS-SANDOR COLL.
ST. CHARLES, P. 134 F.
ANCKER HS.
ELZAS HSS.

ELZAS D. J. C.
MICKVE ISRAEL REC.
SHEARITH ISRAEL REC.
D.A.R.
FLO. ABR.
HENRY SCHWABACHER

(RICHMOND) ADOLPH ANCKER
B. ENG.

HETTY PETTIGREW
(O.V.)

ANCKER (1)

HART B. 1872 D. M. DRINAH DE YOUNG (-1906)
MITCHELL B. 1805 D. MAR. 9, 1853 M. MAR. 16, 1831 ADALIA PHILLIPS (VID. PETTIGREW) (SEE BELOW)
HENRY C. B. 0. DEC. 23, 1806 D. JUL. 20, 1839 CINCINNATI UNH.
ABBY B. D. SEP. 2, 1888 WASH., D.C. M. NOV. 8, 1823 ELIAS MAYER (O.V.)
JACOB B. SEP. 25, 1808 D. MAY 23, 1837 JULIA PHILLIPS (VID. PETTIGREW) (SEE BELOW)
GUSTAVUS V. B. D. M. 11 APR. 1, 1841 ABIGAIL SAHPSON (O.V.)
SAMUEL P. B. 1817 D. 1903 M. 1853 CATHERINE HYAMS (O.V., (2))
JUDITH B. D. INF. UNM.
GERTRUDE B. D. INF.
SARAH B. D. M. OCT. 14, 1841 HENRY ROSENHAN (O.V.)
ELIAS B. 1826 D. APR. 5, 1852 CINCINNATI UNH.
ALFRED B. D. M. LYDIA DAVIS

VIRGINIA B. SEP. 27, 1837, RICHMOND D. M. SEP. 9, 1857, PEORIA, ILL. HENRY SCHWABACHER
HETTY B. JULIUS KLYMAN
HARIA B. MOSES DEMUTH
ABBY B. GEORGE KLYMAN
BELLA B. JOHN WAND
HENRY B. HART EDWARD BESSIE MEYER
ABIGAIL B. CAROLINE LOEB
MOSES B. SARAH KAHN
SAMUEL P., JR. B. 1857 D. 1885 M. 1
GUSTAVUS B. M. 1
PINKNEY B. M.
MITCHELL B. LEAH ADELSHEIMER
CLOTHILDE B. M. SAMUEL P., JR. ANNA MURPHY

HETTIE B. DEC. 8, 187 D. JUL. 22, 1948 M. DEC. 3, 1890 N. SAMUEL REICHMAN
FLORENCE B. LED
HART B. REBECCA EMILY B. JAN. 4, 1842 D. AUG. 30, 1843
JOSEPH THEODORE B. MAY 11, 1843 D. JUL. 28, 1844
THEODORE B. D. JUL. 1855 INF.
VIRGINIA B. 1860 D. 1944 M. JAN. 2, 1888, PH. ALFRED SCHLESINGER
KATHERINE P. B. OCT. 13, 1890, MUSKOGEE, OKLA.
FRANCES ELEANOR B. JAN. 21, 1894, KANSAS CITY, MO.
MILTON B. 1895 D. APR. 19, 1959 M. 1 MARY ADELE GOODMAN
SAMUEL P., JR. B. ANNA MURPHY
KATIE B. 1883 D. OCT. 8, 1887
MARY MAGDALENE B. 1886 D. JAN. 2, 1889
LILIAN ELIZABETH B. MAY 15, 1887 D. AUG. 7, 1887
GUSTAVUS VASA B. DEC. 17, 1888
THERESA DOROTHEA B. DEC. 1, 1890
LAURENCE B. THERESA ROTHENBURG
CAROLINE ROSE B. LORIS B. GEORGE ROSSKAH
GAIL B. 1946
NANCY B. 1948
GEORGE ANCKER B. 1953

ALAN J. B. 1899
VIRGINIA ROSE B. AUG. 20, 1893 D. NOV. 29, 1973 M. DEC. 6, 1911 JOSEPH DANIEL PRICE
STANLEY T. B. AUG. 16, 1969 DOROTHY JONES
EDWARD B. ROSE KAPLAN
LOUIS B. J. MALVERN, JR. B. MARJORIE GARRETT
FLORA B. DAVID FRANKEL D.S.P.
JOEL
CHRISTINE MARK
JOSEPH D. JR. B. SEP. 30, 1912, N.Y. M. 1 MARJORIE (D.V.) M. 2 MARJORIE (STAMPLETON) TAYLOR
BETSY JANE B. APR. 3, 1916 D. AUG. 23, 1952 M. AUG. 14, 1940 MURRAY J. COHEN
SARAH (SALLY) ANN B. AUG. 29, 1919 D. APR. 29, 1945 DR. MERTON P. STRAHL D.S.P.
PEGGY RUTH B. JUL. 25, 1925 M. JAN. 30, 1944 JOSEPH GILINSON
MARSHA ANN B. JUL. 21, 1948 M. MAY 29, 1972 JOHN M. O'CONNOR
BETSY JANE B. OCT. 30, 1954
PATRICIA HELEN B. APR. 28, 1945, N.Y. M. ELI SILVERSTEIN
JACK B. DEC. 26, 1967, MARYLAND
MICHAEL B. JUL. 27, 1971, MARYLAND
JAMES BARNET B. NOV. 14, 1942 D. DEC. 1965 JACQUELYN HANDLER
BARRY B. JAN. 13, 1967 PETER B. NOV. 20, 1969
NED LYDIA AARON
JAKE HENRIETTA SALZENSTIEN
ALBERT MARY SUPERA
JULIUS LOUIE FANNY GUNDELFINGER
LOUIS LANNY
MAUD JOSEPH WIEL
BETZ HYRON GREISHEIM

ANCKER (2)
MITCHELL ANCKER B. 1805 D. MAR. 9, 1863 (SEE ANCKER (1))
ADELIA PHILLIPS (VID. PETTIGREW)
JULIA PHILLIPS (VID. PETTIGREW)
MAY 23, 1837
JACOB ANCKER B. SEP. 1808 D.
JACOB JR. B. D. M. KATE
ADELIA B. MAR. 30, 1847 D. MAR. 10, 1927 M. FEB. 2, 1887 REV. HYER ELKIN (O.V. 1)
ARTHUR
ABRAHAM PHILLIPS B. D. M. ELIZA FRANCES JAMES
ADOLPH B. APR. 30, 1841 D. APR. 2, 1842
RACHEL B. D. M. ADOLPH BITTERMAN
JACK B. M. KAHN
JULIA B. M. HARRY LOWENTHAL
DELIA B. M. KAHN
DE WITT CLINTON JAMES
MITCHELL
PHILIP OTHERS

ADOLPH B. D. REM. JAN. 3, 1869, PH. HARY (MIRIAM) MCALLISTER (CONVERT TO JUDAISM)
HITCHELL B. PH. NOV. 7, 1863
ISABEL
JACOB B. FEB. 3, 1834, N.Y. D. M. ANNA HALTON CHARLES
ELIZABETH P. B. D. M. PHILIP RUSSELL (O.V.)
EDWARD B. D. M. LIZZIE
GEORGE B. 1840 D. 1913 M. 1872 VIRGINIA CALLANAH (1851-1883)
EVA
ELIAS
ISABEL
CHARLES B. CINCINNATI, 1838 D. PH. FEB. 13, 1869
CLARA
CAROLINE B. 1878 D. 1897 M. FRANK S. VAN GIESEN (1872-1914)
VIRGINIA SAV. JAMES RANDALL WINBURN

JOSEPH ANDREWS N.Y.AUG.9,1794 SALLIE SALOMON
B. 1753,STRASBOURG (O.V.(1))
D.OCT.31,1824,PHILA.

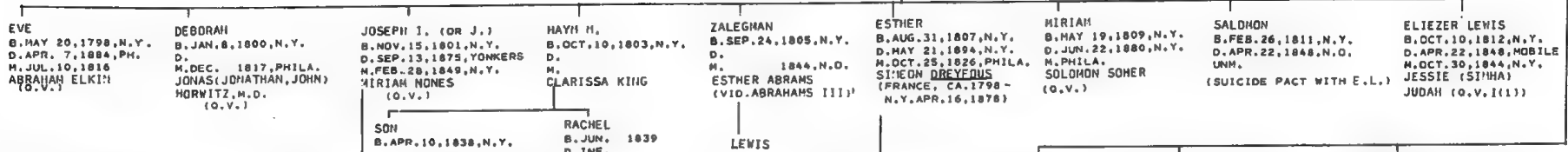

U.S.CENSUS 1850,N.Y.C. WILL OF JOSEPH ANDREWS MORAIS-JEWS OF PHILA, P.445 PAJMS V.6,P.110;V.12, P.118 CHARTER & BY LAWS OF... HICKVE ISRAEL,P.11 CONSTITUTION OF FEMALE HEBREW BENEVOLENT SOCIETY,PHILA. LIST OF SUBSCRIBERS KRAUS MS. M1.REC. SHEARITH ISRAEL REC. PH.D.M. JANE HUTKIN ALFRED REYSON, JR. MRS. JOSEPH LYON ANDREWS

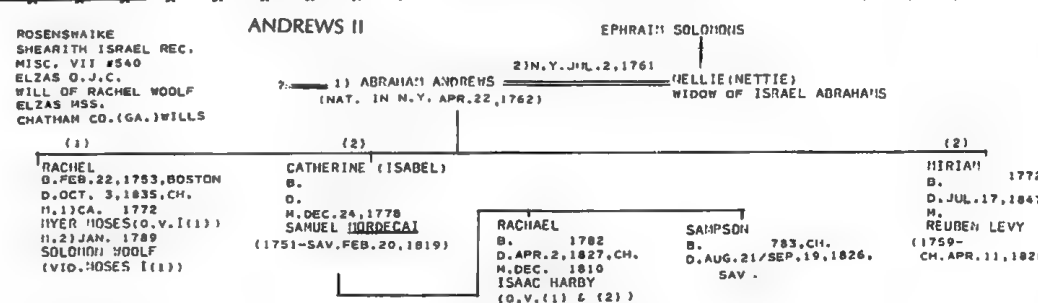
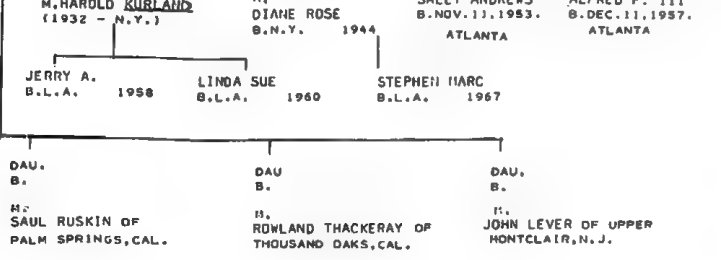
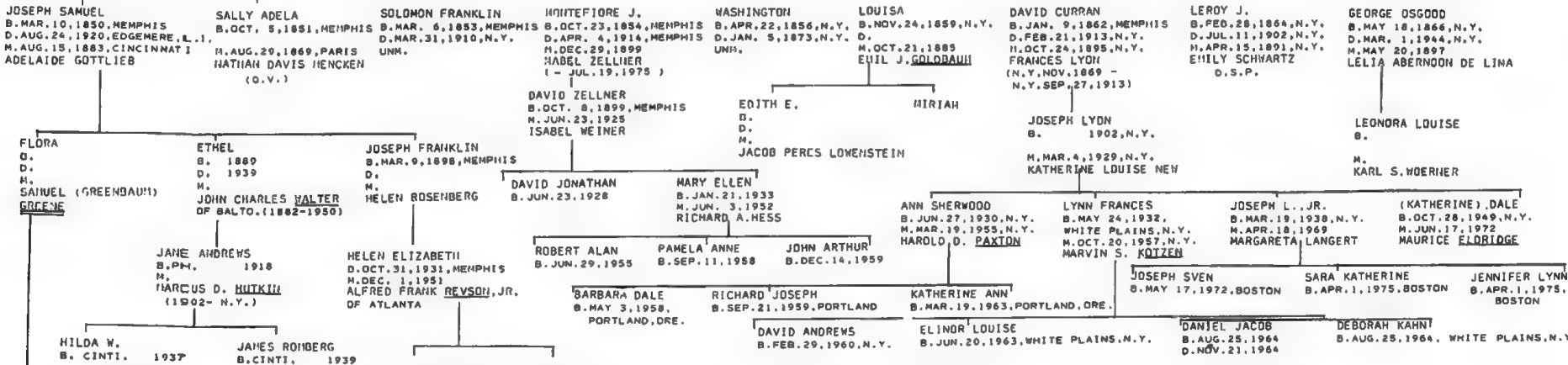
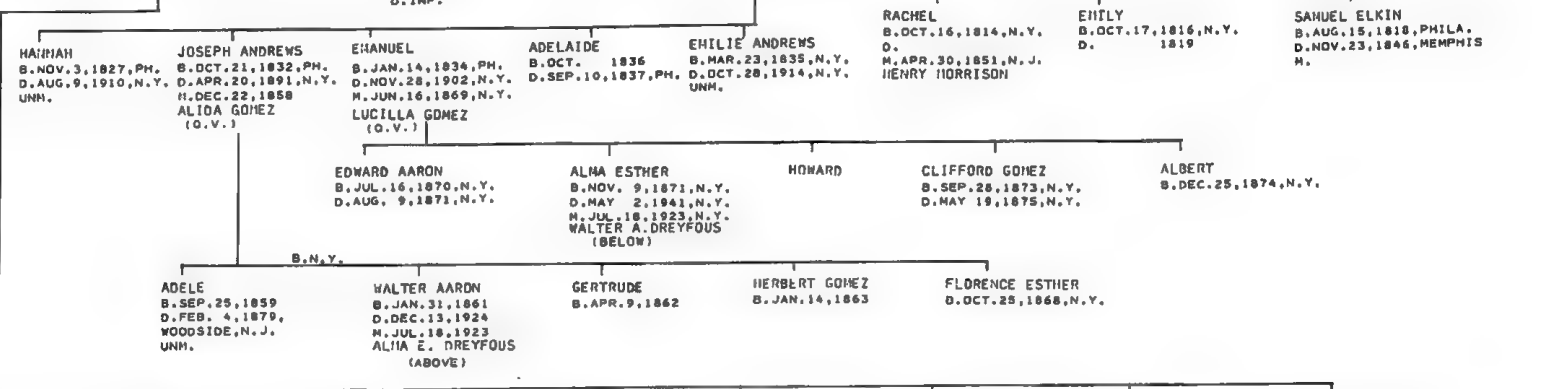

1
2
3
4

AJYB, 5666, P. 36
KRAUS-SANDOR COLL.
ARNOLD FAMILY REC. (PHOTOSTAT IN AJA)
HICKVE ISRAEL REC.
FAMILY HIST. OF BENJ. HORDECAI (PHOTO, AJA)
FLORENCE ABRAHAMS

HAYER (CAME TO U.S., 1798)
B. DEC. 1, 1785
D. NOV. 24, 1860
M. MAY 9, 1822
FANNY WOLF (O.V.I.)

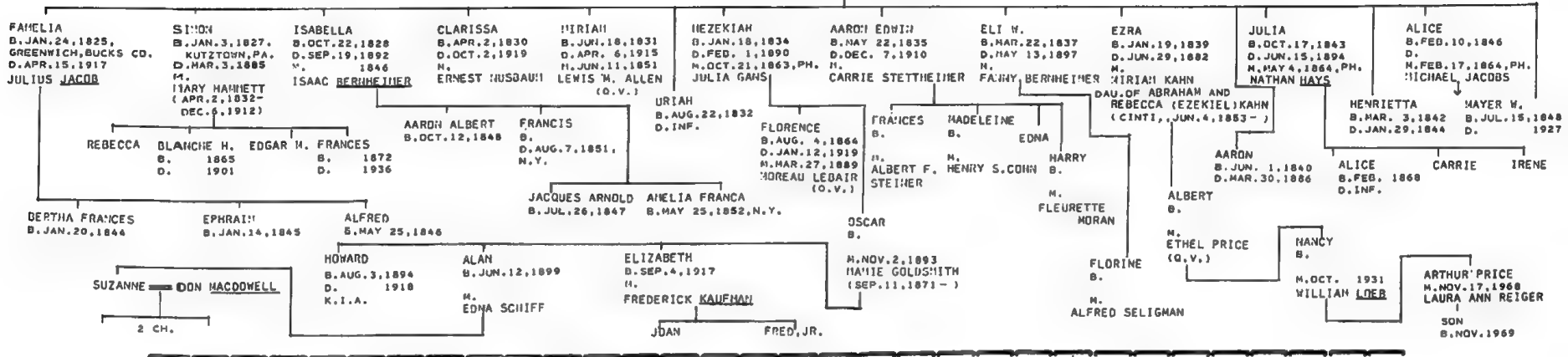

J.R. COHEN
W.V., P. 490
NDRAIS-JEWS OF PHILA.
JACKSON GEN. (AJHS)
MRS. H.S. CARTER
SHEARITH ISRAEL REC.
FLORENCE ABRAHAMS
FEDERAL ST. CEM.

JOSEPH W. ASCH
B. JUL. 12, 1802, POLAND
D. JUN. 22, 1866, PH.
M. AUG. 4, 1830
CLARISSA ULIAN

ROSES H.
B. POLAND
D. PH. JUN. 16/17, 1829

ASCH

WILL OF ESTHER AZUBY (JR MARCUS COLL.)
ELZAS-D. J.C., P. 83

AZUBY

ROSALIE
B. 1853
D. 1853
M. FEB. 16, 1853
GEORGE KING OF N.Y.

MYER, D. D. S. (CIVIL WAR)
B. OCT. 24, 1831, PH.
D. FEB. 16, 1890, N.Y.
UNM.

MORRIS JOSEPH, M. D.
B. JUL. 4, 1833, PH.
D. 1890
UNM.
(CIVIL WAR)

ESSTIE (REBECCA)
B. OCT. 19, 1837, PH.
D. JAN. 8, 1916, N.Y.
M. 11
WILLIAM SHOYER (O.V.I.)
M. 2 SEP. 29, 1869, PH.
AUGUSTUS BENJAMIN ELFELT
(VID. CADET)

MITCHELL J.
B. APR. 15, 1841, PH.
D. NOV. 20, 1888, N.Y.
M.
MANUELA JACKSON AVEZZANO
(VID. JACKSON I)
IRMA CLARA = **HENRY CULVER**
B. JAN. 8, 1875, N.Y.
D. APR. 1953,
ST. AUGUSTINE, FLA.

AMST. TO CH. 1784

ABRAHAM AZUBY (CHARLESTON
B. 1738, HOLLAND
D. FEB. 10, 1805, CH.
M.
ESTHER
(1754-MAY 30, 1805, CH.)

ESPERANCA TABAR

CHARLES J.
B. MAR. 23, 1835, N.Y.
D. MAY 13, 1873, PH.
UNM.

B'NAI JESH, REC.
KRAUS-SANDOR COLL.
SHEARITH ISRAEL REC.
JON STEDMAN (1850 CENSUS)

ISRAEL BACH

HANNAH
B. GER. 1828
D. SEP. 21, 1872
M. FEB. 26, 1851, N.Y.
HENRY LEWIS
(O.V.I.)

JOSEPH BACH
B. GER. 1816

ELLEN LEWIS (O.V.I.)
B. FEB. 11, 1820/2

BACH

ELLEN DOROTHY
B. 1847
D. 1847
M. 11
CARL SANDERS
M. 2
PERRY
M. 3
HENRIE CART
(2)
PATRICIA

AMELIA
B. N.Y. 1847
D. 1847
M.
SAMUEL LAVENBERG

JULES
B. N.Y. 1849
D. 1849
M.
CLARA EPSTEIN

HENRY H.
B. 1849
D. 1849
UNM.

ALBERT
B. 1849
D. 1849
M. NOV. 24, 1885
ALICE HENDRICKS
(O.V. II)

JUSTINE ELLEN
B. OCT. 12, 1886
D. SEP. 21, 1915
M. 11
OTTO L. KOSCHERAK

ALBERT, JR.
B. OCT. 28, 1887
D. 1940
M. 11
HAZEL BLUIH
OF MACON, GA.
M. 2
RUTH POLLOCK
OF JACKSONVILLE

HENRY MICHAEL II
B. FEB. 4, 1891, N.Y.
M. JAN. 22, 1934
HAUDE NATHAN
(1891-1961)

LINDA ELLEN
B. 1942

ANDREW ROBERT
B. 1947

MARY HENDRICKS
B. 1949

M. GEORGE R. VISIGLIO, JR.

MILORED
B. 1916

H. HAROLD K. SIMON

ROGER HENDRICKS
B. 1942

DONALD HENDRICKS
B. 1945

HANCOY JEAN
B. 1948
M.
DAVID ROGER FULTON

JUSTINE ELLEN
B. 1918

M. GOTCHEAU LEVI

JOHN DELANO

ALICE HENDRICKS
B. 1942

PETER MICHAEL
B. 1945

M. BARBARA BRISSON

HENRY H. III
B. OCT. 3, 1915

IRENE BRONSTEIN

ROBERT ELLEN ACKERMAN

BAMBERGER

PRIOR TO 1881: JACOB BAMBERGER
FAMILY BIBLE

DAVID BAMBERGER

WOLF BAMBERGER
B.
D. OCT. 18, 1850
W.
KEILAH
(- DEC. 14, 1835)

MOSES
B. 1805(1804?)
D. AUG. 3, 1882

ABRAHAM
B. OCT. 9, 1808, HESSDORF, BAVARIA
D. FEB. 15, 1887, BALTIMORE
M. JAN. 24, 1841
BABETTE STRAUS
(DEC. 25, 1814-MAR. 28, 1891,
CAME TO U.S., 1839)

CAROLINE
B. JUL. 25, 1843
D.
M. SEP. 27, 1863
JULIUS BOWMAN
(- JAN. 20, 1901)

BETSY
B. DEC. 5, 1845
D.
M. MAR. 18, 1865
WILLIAM BAUMGARTEN
(- JUL. 23, 1903)

JACOB
B. JUL. 18, 1848, BALTIMORE
D. JUN. 4, 1908, BALTIMORE
M. FEB. 24, 1878
SOPHIE HERMAN
(OCT. 12, 1854-JUL. 8, 1933,
BALTIMORE)

WILLIAM
B. JAN. 29, 1851
D.
M. NOV. 12, 1871
SARAH BOOKMAN

EVA
B. JUN. 23, 1853
D. APR. 5, 1902, N.Y.C.
M. JUN. 12, 1881
ISAAC UNGER
(- APR. 1, 1892)

WILLIAM BURK
B. AUG. 18, 1879, LYNCHBURG, VA.
D. AUG. 30, 1934, BALTIMORE
M. OCT. 12, 1902
GUSSIE ERLANGER
(BALTIMORE, OCT. 19, 1882 -
OCT. 24, 1968, N.Y.C.)

MINDELLE
B. AUG. 14, 1881, BALTIMORE
D. MAR. 3, 1957, ST. LOUIS
M. JUN. 16, 1908
JULIUS BENEDIT CERF
(MAR. 25, 1880-JAN. 29, 1945)

MIRAM NAPHTALI
B. OCT. 21, 1883
D. FEB. 1, 1884

RIFKA S. (PEGGY)
B. MAY 5, 1885
D. OCT. 2, 1934
M. JAN. 12, 1909
MEYER ERLANGER
(JUN. 21, 1878-MAY 30, 1960)

BEATRICE
B. MAY 19, 1891, BALTIMORE
D. JUL. 3, 1965, COLUMBUS, OHIO

ROSE HERMAN
B. JAN. 23, 1898
D. MAY 29, 1899

BERNARD JACOB
B. MAY 30, 1904, BALTIMORE
M. JUN. 14, 1932
ETHEL KRAUS
(DEC. 27, 1908, N.Y.C.)
(VID. SULZBERGER I)

RUTH
B. JAN. 15, 1913, BALTIMORE
M. AUG. 23, 1942
EDWARD BRADFELD
(APR. 6, 1914, N.Y.C.)

HENRY
B. JUN. 1, 1935, ALBANY, N.Y.
M. JUN. 21, 1959
SHEILA LISTER (LIFSCHITZ)
(SEP. 23, 1935, N.Y.C.)

DAVID
B. OCT. 14, 1940, ALBANY, N.Y.
M. JUN. 8, 1965
CAROLA BERL
(APR. 11, 1943, HITCHIN, ENGLAND -)

STEVEN BERNARD
B. JAN. 1, 1969, N.Y.C.

MICHAEL
(D. INFANCY)

JUDITH
B. APR. 19, 1963, NORWOOD, MASS.

MIRIAM
B. FEB. 26, 1966, NORWOOD, MASS.

EINHORN MARR. REC.
 AJYB, 5666, P. 39
 KOHN-BARNET FAMILY TREE
 CAROLYN K. BLUMENTHAL
 GATES STERN

JACOB WOLF **HAMBURGER** ESTHER KRAFT
 B. 1795 B. 1794
 D. 1884 D. 1878

(TO U.S. 1832) MEYER BARNET REBECCA
 B. 1815 B. 1825
 D. 1893 D. 1905

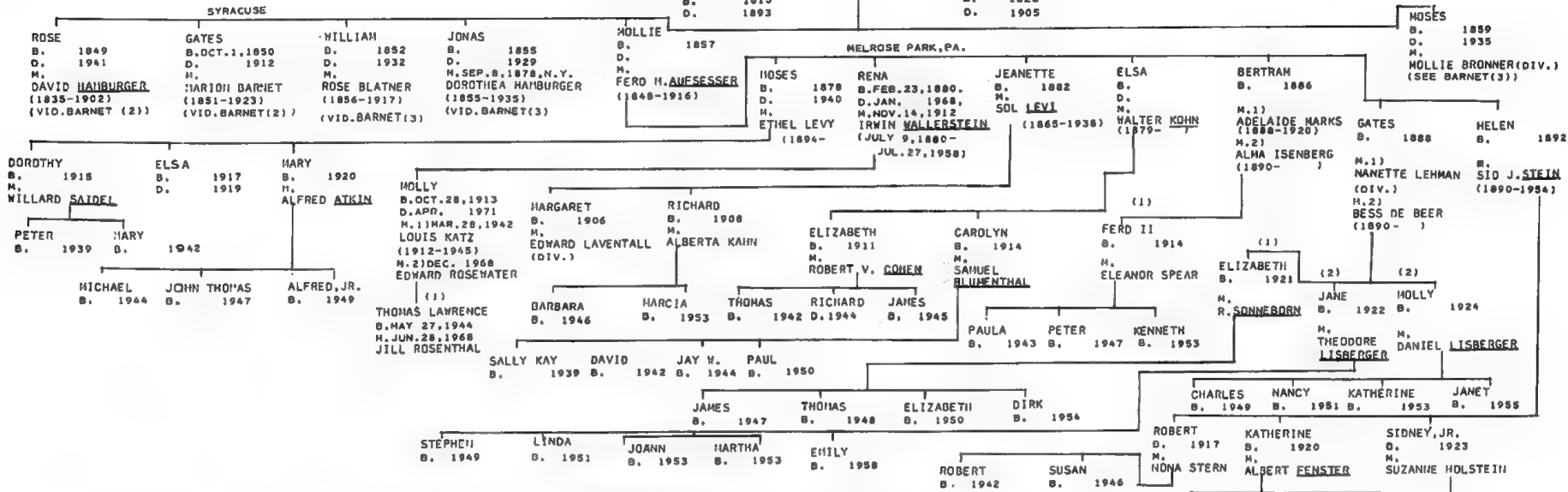

BARNET (2)

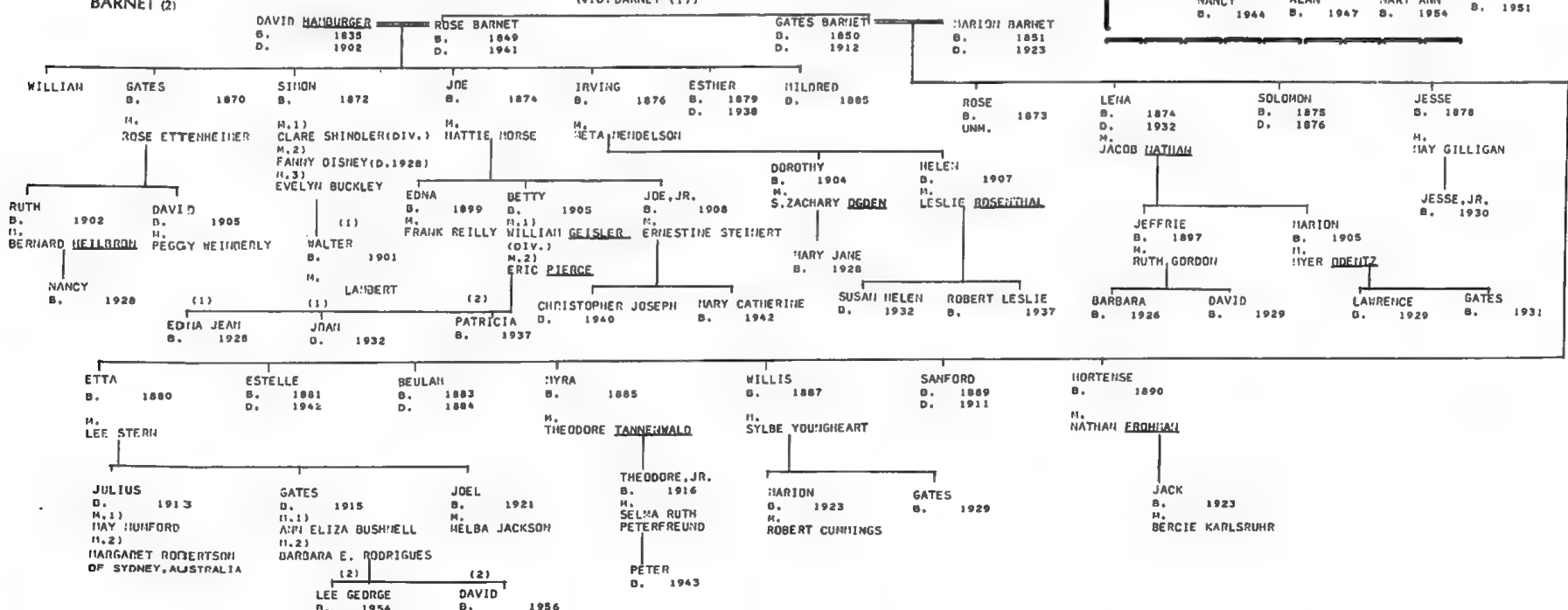

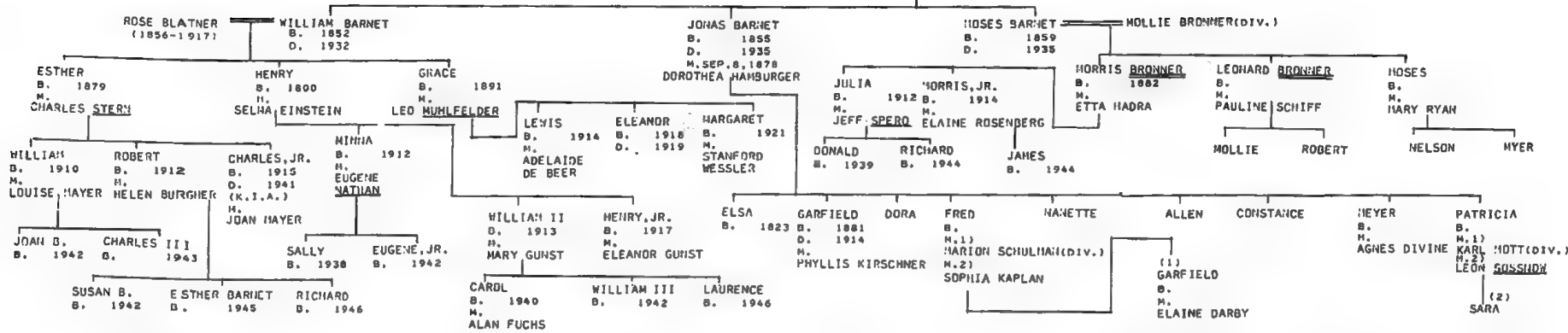

SHEARITH ISRAEL REC.

ARRAMIAH BARNETT
B. 1744
D. JUN. 18, 1820, N.Y.

RITCHA
B. 1754
D. FEB. 13, 1828, N.Y.

BARNETT I

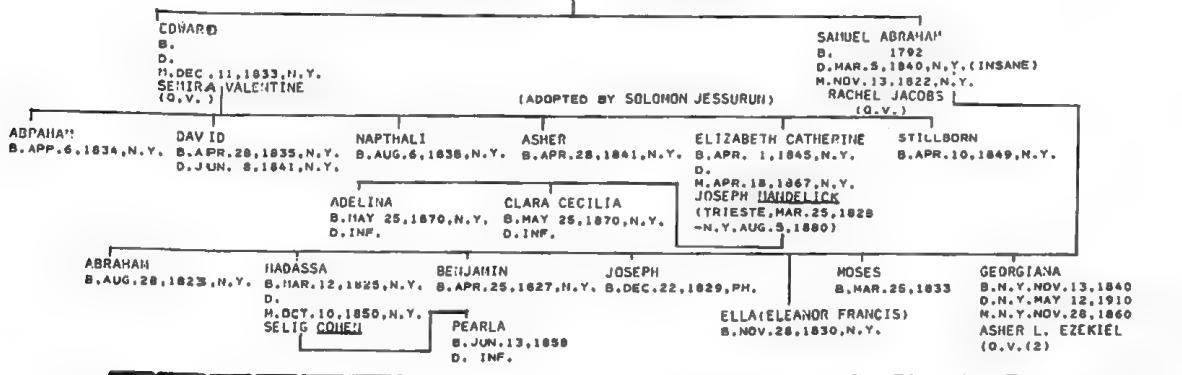

B'NAI JESH, REC.

1) DAVID BARNETT
B. N.Y., AUG. 11, 1826

2) N.Y., AUG. 30, 1832
GITLA ALEXANDER
(VID. DELMAR)

SHEVA
B. N.Y., AUG. 31, 1828
HYMAN LYONS

BARNETT III

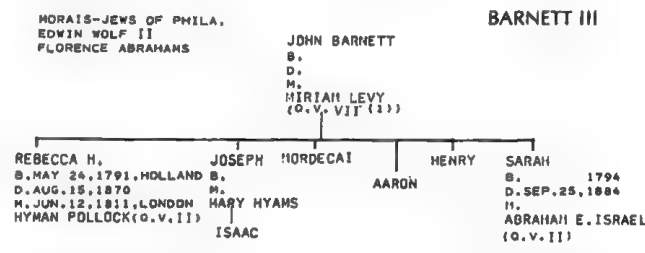

BARNETT IV

LAZARUS BARNETT (IN PH.)
B. HOLLAND
D. LOND. MAR. 26, 1797

SUSANA HAYER

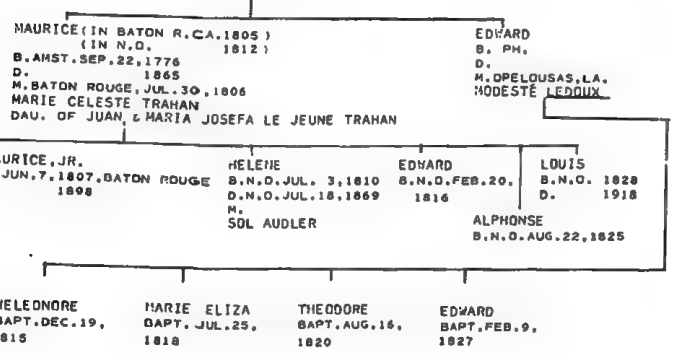

BARNETT V

KRAUS-SANDOR COLL.
MORAIS-JEWS OF PHILA.
MARKS FAMILY REC. (PHOTO. IN AJA)
MICKVE ISRAEL REC.

ISSACHAR (HA-COHEI)

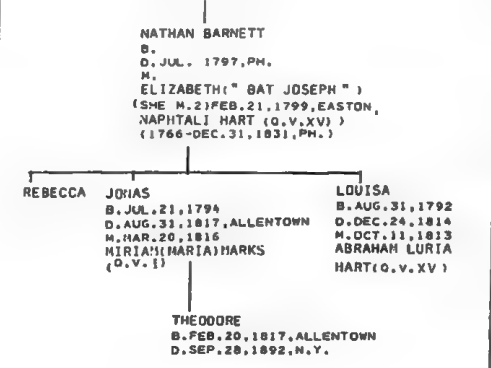

BARNETT VI

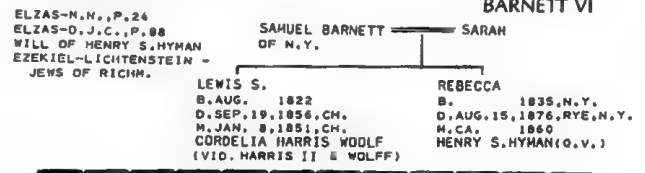

BARNETT VII

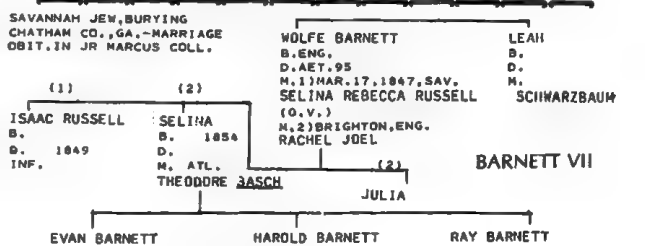

WILL OF JACOB BARRETT
 HAROLD MOISE
 ELZAS MSS.
 D.-J.-C.
 M.N.

BARRETT

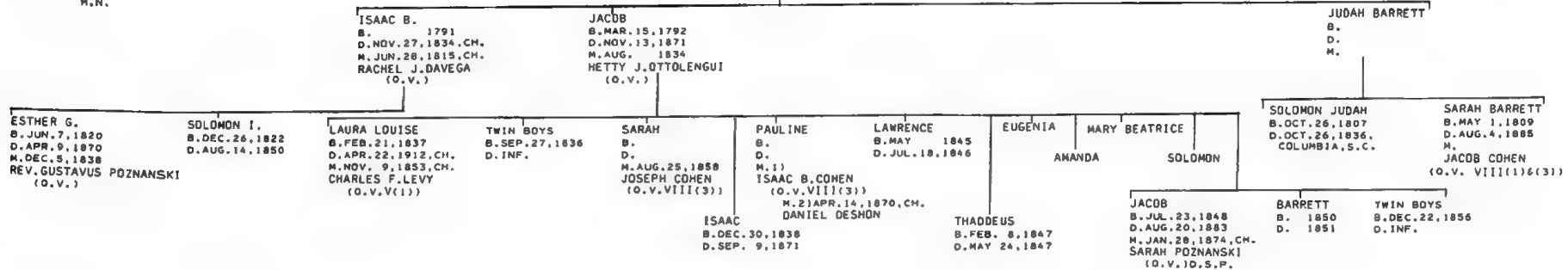

JON STEDMAN
 ELZAS MSS.
 O.-J.-C.
 M.N.
 SHEARITH ISRAEL REC.
 N.Y. TIMES OBIT.

SIGISMUND BARUC

NANETTE

BARUC

N.Y. TIMES 10/6/63
 ELZAS M.N.
 FLORENCE ABRAHAMS
 KRAUS-SANDOR COLL.
 DAR LINEAGE BOOKS
 U.J.E. V.2

BERNARD OR BENJAMIN BARUCH

BARUCH I

CHARLESTON, OCT. 10, 1855
 BERNARD S.
 B. DEC. 4, 1828, GER.
 D. OCT. 20, 1904, N.Y.

MATHILDA R. OPPENHEIM
 (O.V. (1))

NANNIE
 B. AUG. 16, 1856
 D. MAR. 9, 1861

EMMIE
 B. 1858
 D.
 M.
 HERMAN BAHR
 OF FRANKFURT

RACHEL M.
 B. 1860
 D.
 M.
 SIMON BERLIN

CATHERINE O.
 B. 1863
 D.
 M.
 ALEX MENKE

MATHILDA REBECCA
 B. 1865

SIMON, M.D. (SURGEON, C.S.A.)
 B. JUL. 29, 1840, SCHWERSENZ, POLAND
 D. 1921, N.Y.
 M.
 (ISA) BELLE WOLFE
 (O.V. II)

HERMAN, OF CAMDEN
 B.
 D.
 M. MAY 5, 1874 OF G'T'N
 DEBORAH SAMPSON
 (O.V.)

BERNARD MANNES
 B. AUG. 19, 1870, CAMDEN, S.C.
 D. JUN. 20, 1965
 M. OCT. 20, 1897
 ANNIE GRIFFEN
 (- JAN. 16, 1938)

HERMAN BENJAMIN
 B. APR. 28, 1872, CAMDEN, S.C.
 D. MAR. 15, 1953
 M.
 ROSEMARIE EMPASSE

SAILING WOLFE
 B. FEB. 1, 1874, CAMDEN
 D. JUN. 14, 1962
 M. JUN. 1, 1901, HOUSTON
 LEONORE PRINCE, OF GALVESTON

HARTWIG
 B. 1876
 D. MAR. 1, 1953
 M. 1)
 ANALIE RAYNOR, OF BALTO.
 M. 2)
 ARLINE LENOX,
 OF HARTFORD, CONN.

SIMONA
 B. 1901
 M.
 MEYERS

AMALIE
 B. 1902
 M.
 PERRY BELMONT FRANK

HARTWIG, JR.

PERRY B., JR.
 B.
 M.
 JOANNE SCHNECK (DIV.)

BERNARD M., JR.
 B. 1901
 M. 1932, GENEVA
 BEATRICE MANN
 OF LONDON

RENEE WILCOX
 B. JUN. 1905
 M.
 H. ROBERT SAMSTAG

ISABELLE WILCOX
 B.
 D. AUG. 25, 1964

ROBERT PARKS
 B. 1908
 M. NOV. 22, 1934
 JEANETTE DE FOREST CANDEE
 BAYSHORE, N.Y. OCT. 5, 1963

MARINA
 B. 1914/5
 INF.
 SYMMERS

SAILING, JR.
 B. JUN. 7, 1904, ELBERON, N.J.

DONALD
 B. JUN. 24, 1910, WEST END, N.J.

KEVIN DAU.

ELZAS-JEW. GEN. AT COLUMBIA, S.C.

JOSEPH BARUCH HANCHEN

BARUCH II

BERNHARD
 B. 1844
 D. JUN. 17, 1879, CH.

ALBERT
 B.
 D.
 M.
 FREDERICKA COHEN
 (LIEBENAU, GER. JAN. 20, 1848-
 CH., MAR. 28, 1878)

ADDLPH MICHAELIS
 B. SCHWERSENZ, MAY 18, 1847
 D. CHESTER, S.C. NOV. 13, 1868

ERNESTINA
 B. SCHWERSENZ, NOV. 30, 1849
 D. CHARLOTTE, N.C. APR. 24, 1880
 UNN.

BENJAMIN I

E.N.A.
ST. THOS. CEM.
ST. THOS. HARR.
EDGAR KAHN
PAJMS, 12, P. 67
ELZAS MSS.
MYANS FAMILY REC.
MRS. J. M. FORGOTSON

PHILIP BENJAMIN
(IN ST. EUSTATIUS BY 1744)

HANNAH DE LEON (MIDWIFE AND HEALER IN ST. EUSTATIUS)
B. 1715
D. FEB. 7, 1783, ST. EUSTATIUS

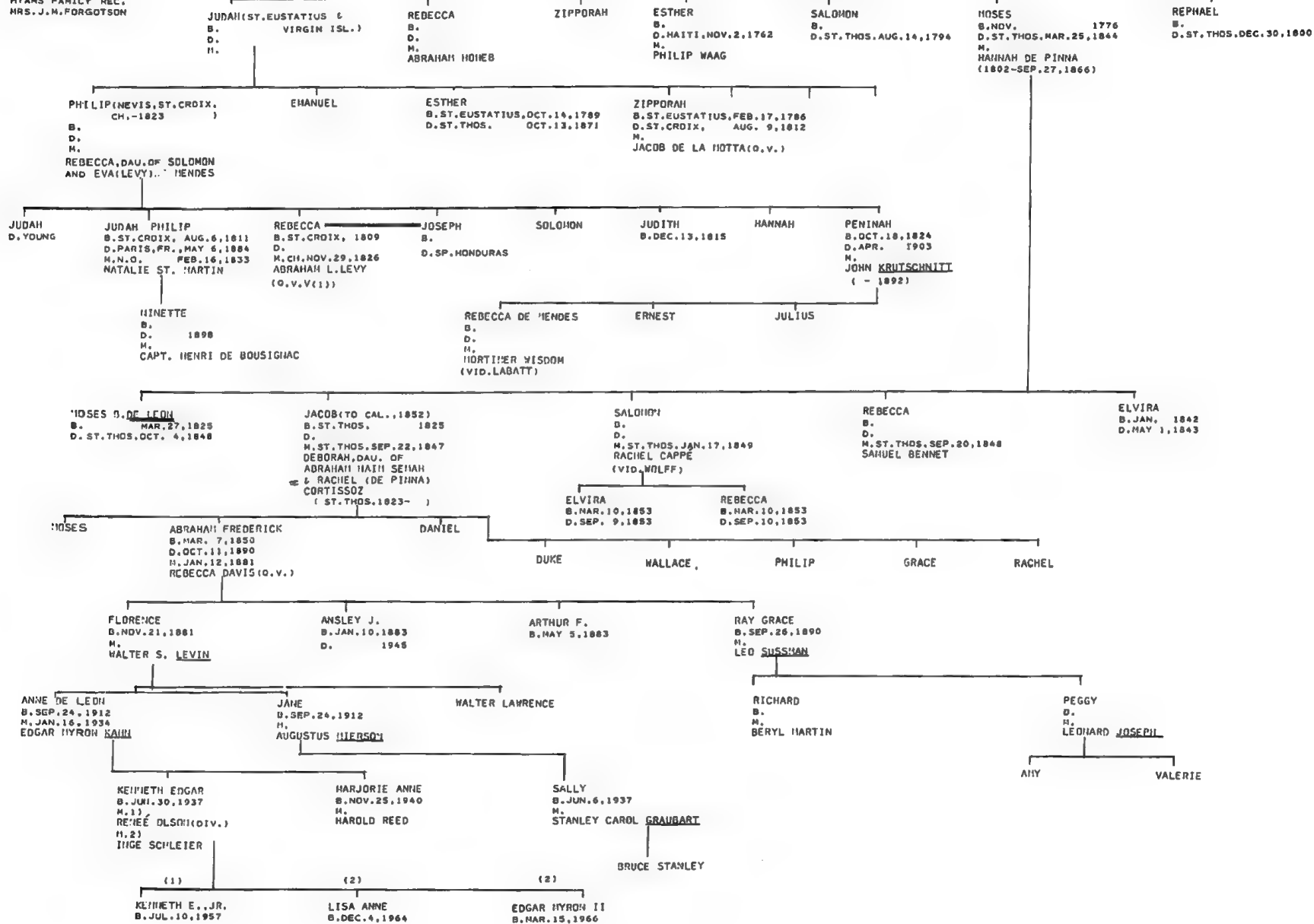

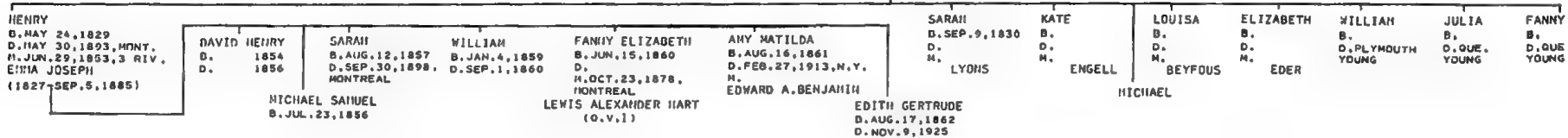

KRAUS-SANDOR COLL. SHEARITH ISRAEL REC. N.Y. CENSUS 1855

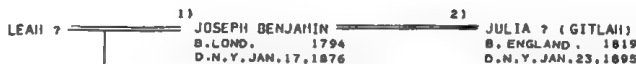

BENJAMIN II (N.Y.)

LEWIS
B. JAN. 10, 1825, LOND.
D. FEB. 27, 1874, BERGEN, N. J.
M. JUL. 28, 1852, N. Y.
ZIPPORAH PHILLIPS
(O. V. 1 (2))

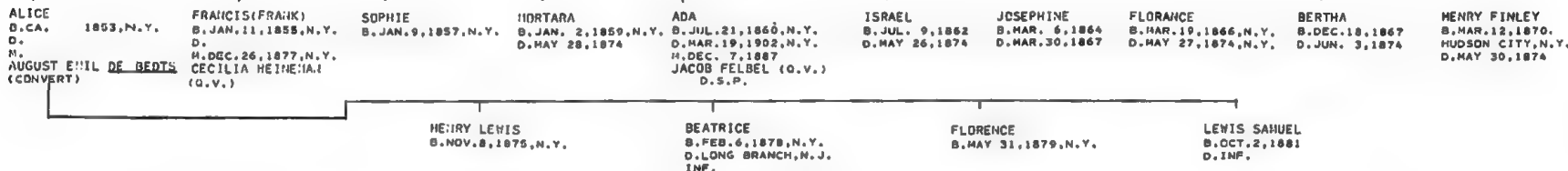

ELIAS H.N., P. 9
WILL OF SAMUEL BENSACKEN
B. N. KET.
ROSENWAIKE
KORN-N. O.

BERLANDINA-BENSACKEN

BENZAKEN

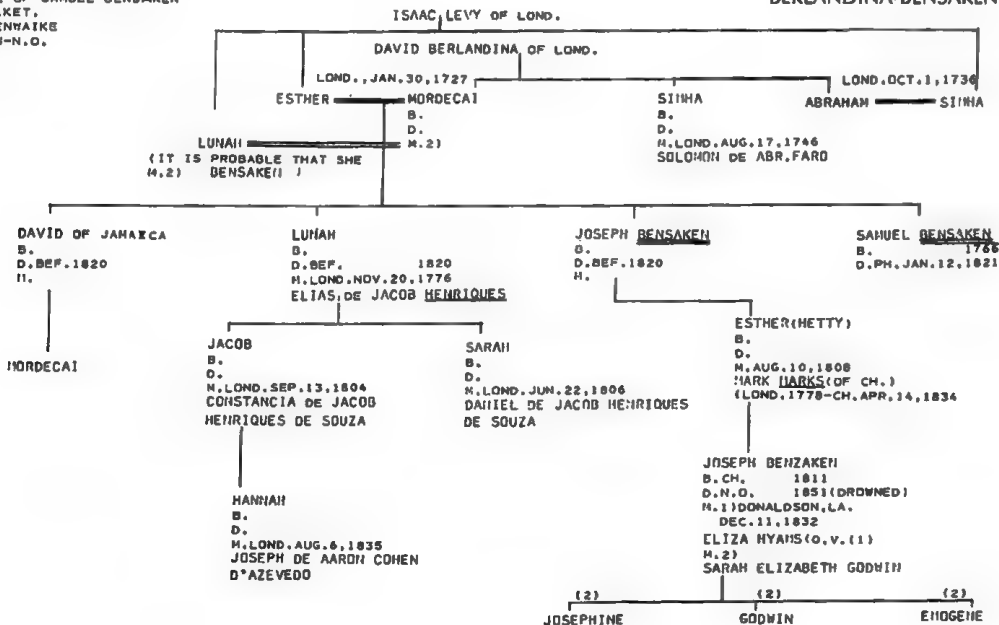

PAJMS, V. 27, P. 152
PAJMS, V. 6, P. 109
AJMO, LVI, P. 193F
WILL OF ESTHER BENZAKEN
(OPPENHEIM COLL., AJMS)

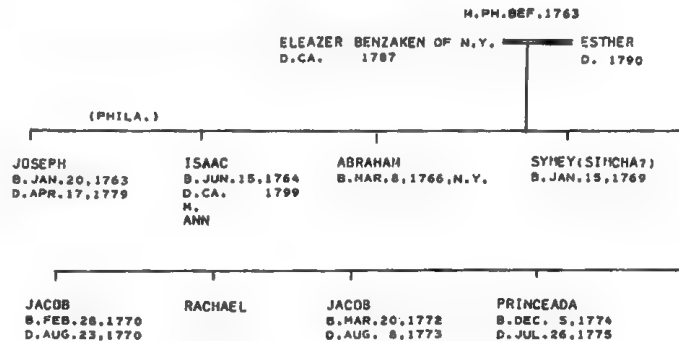

BERNHEIM I (PHILA.)

SANFORD MOSS HSS.
NICKVE ISRAEL REC.
R.S.MOH.REC.

SANSON BERNHEIM IDA

HORRIS (CAME TO U.S., 1846)
B. JUN. 26, 1823, HECHINGEN, GER.
D. JAN. 1, 1878, PHILA.
M. SEP. 5, 1849, PHILA.
JULIA MOSS (G.V. 2)

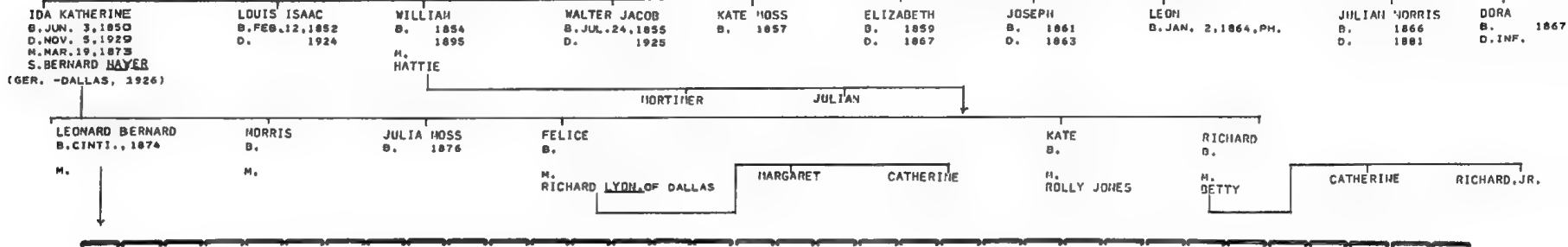

BERNHEIM II (CINTI.)

EZEKIEL FAMILY REC. (ESTHER PINCUS)

SAMUEL BERNHEIM

B.
D. PROVIDENCE, R. I.
M. JAN. 8, 1866, RICHMOND
ROSETTA EZEKIEL (G.V. 11)

B. CINCINNATI →

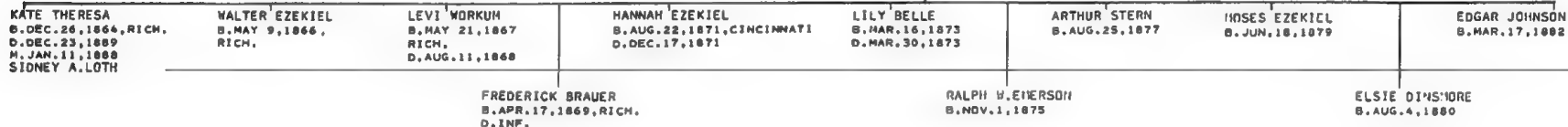

STANLEY R. JACOBS
KRAUS-SANDOR COLL.
EDWIN WOLF II
NICKVE ISRAEL REC.
HYER SOLIS-COHEN
FLORENCE ABRAHMS

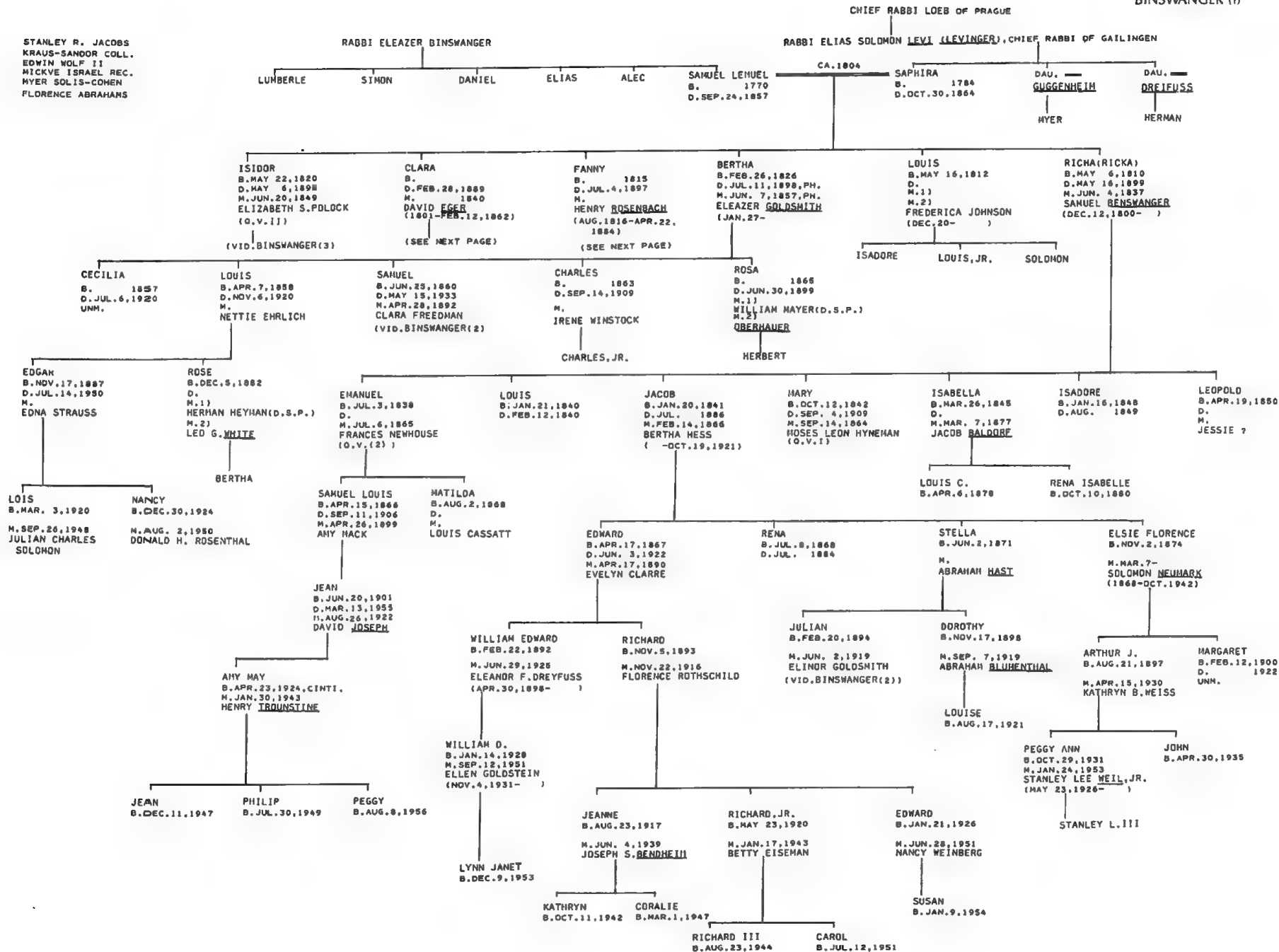

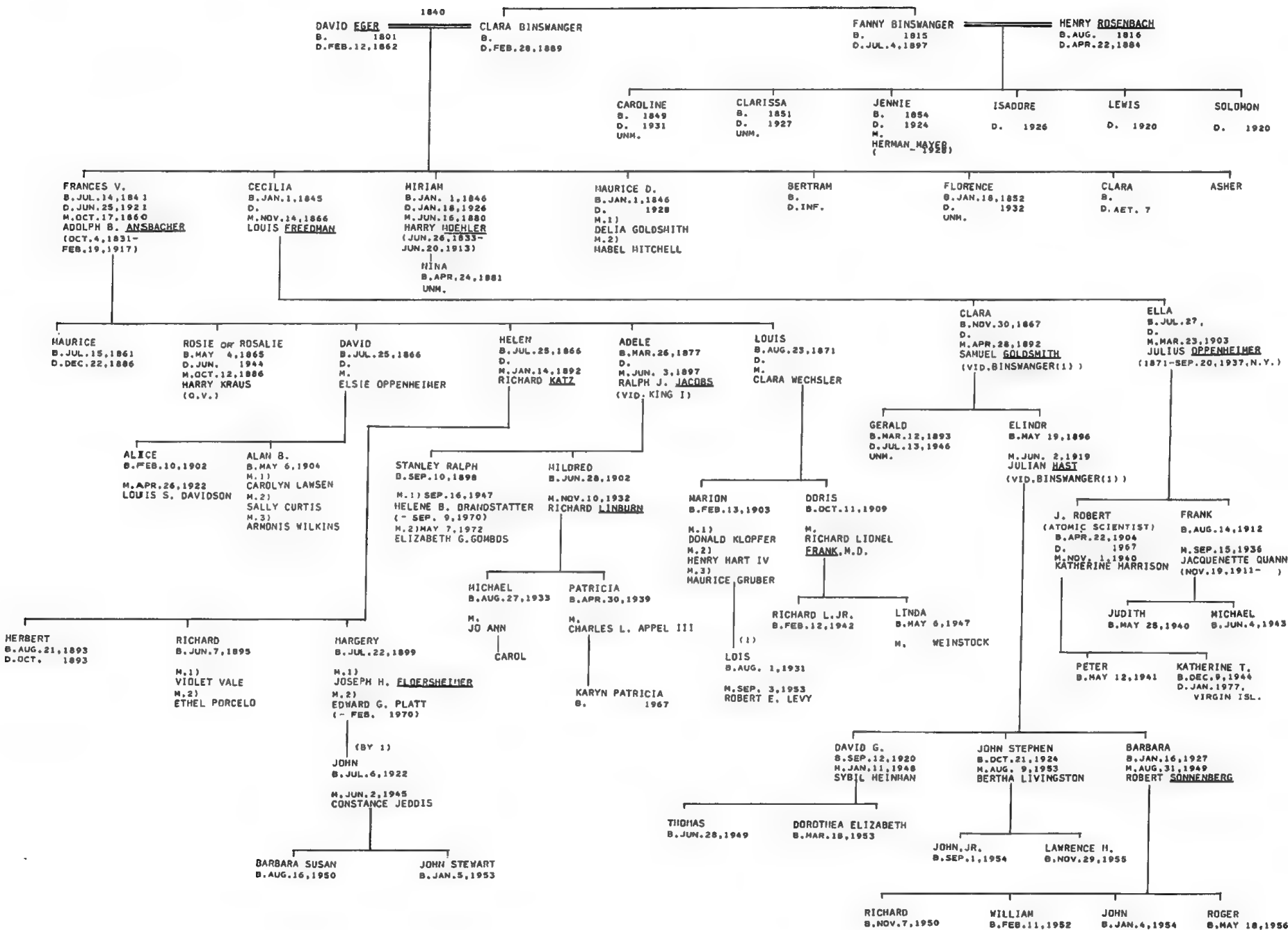

JUN. 20, 1849

ISIDOR BINSWANGER
B. MAY 22, 1820
D. MAY 6, 1890
(V.D. BINSWANGER (1))

ELIZABETH SOPHIA POLOCK
(O.V. 11)

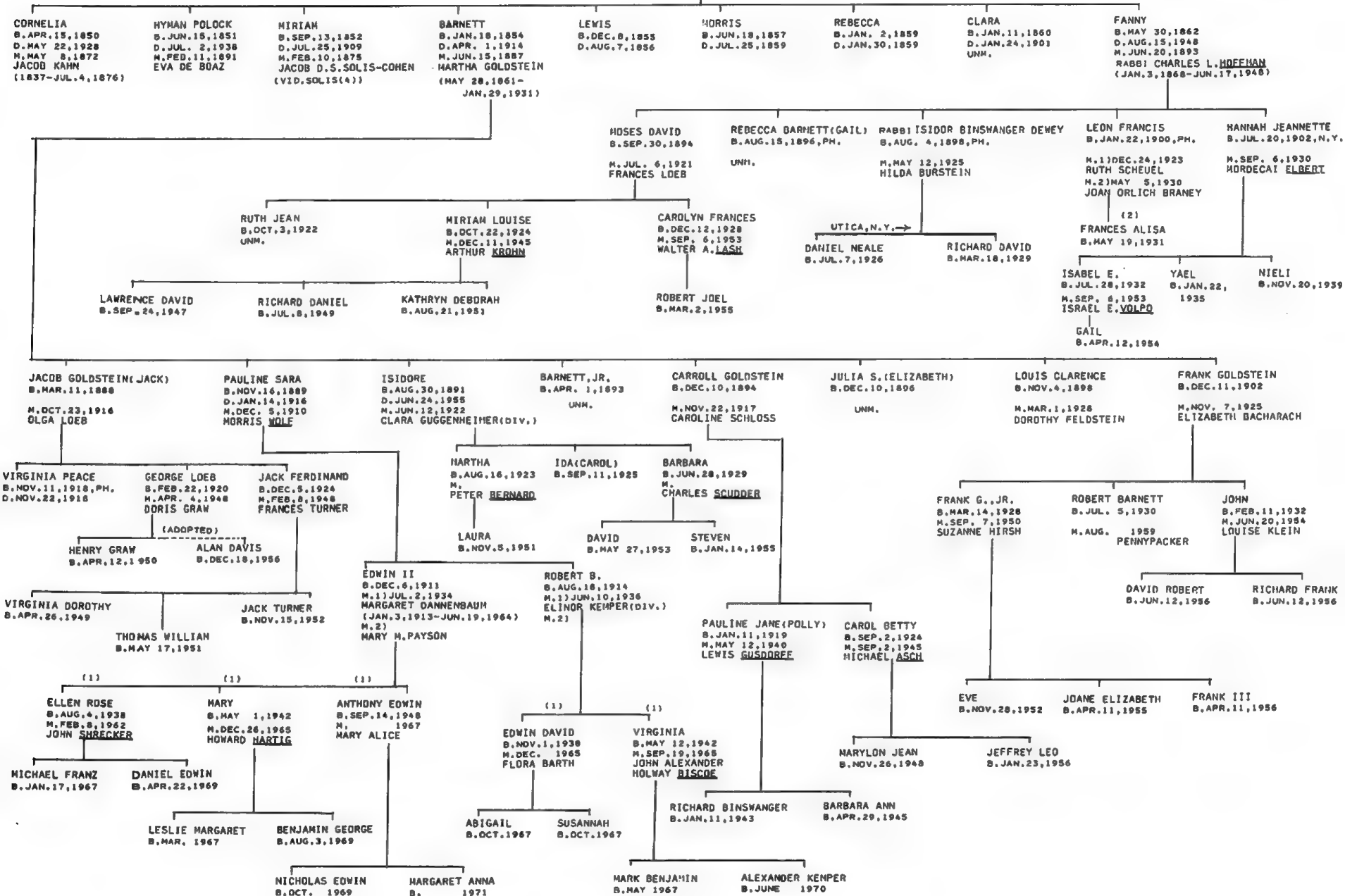

BLOCH

ANKER MS.
KRAUS MS.
ST. CHARLES, FIG. 21

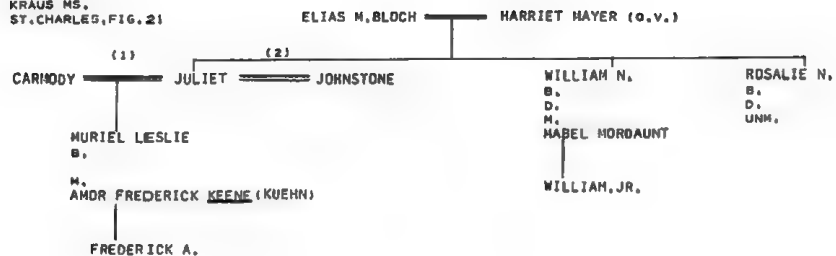

BLOCK I

PAJHS, V. 22, P. 195

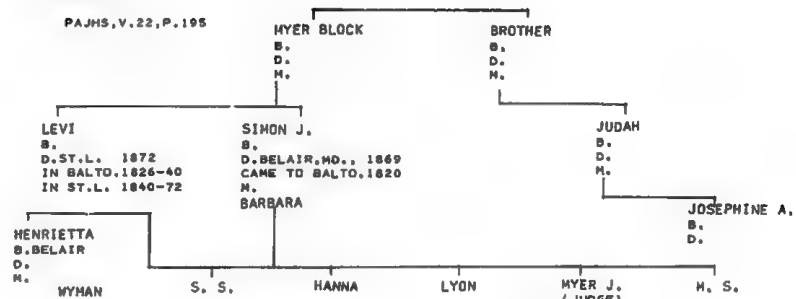

BLOOMINGDALE

FLORENCE ABRAHAMS
NICKVE ISRAEL REC.

EVA EZEKIEL 1) CHARLES BLOOMINGDALE 2) CARDLINE ELFELT
B. 1825 B. AUG. 1, 1814 (VID. CADET)
D. SEP. 3, 1858 D. APR. 5, 1903

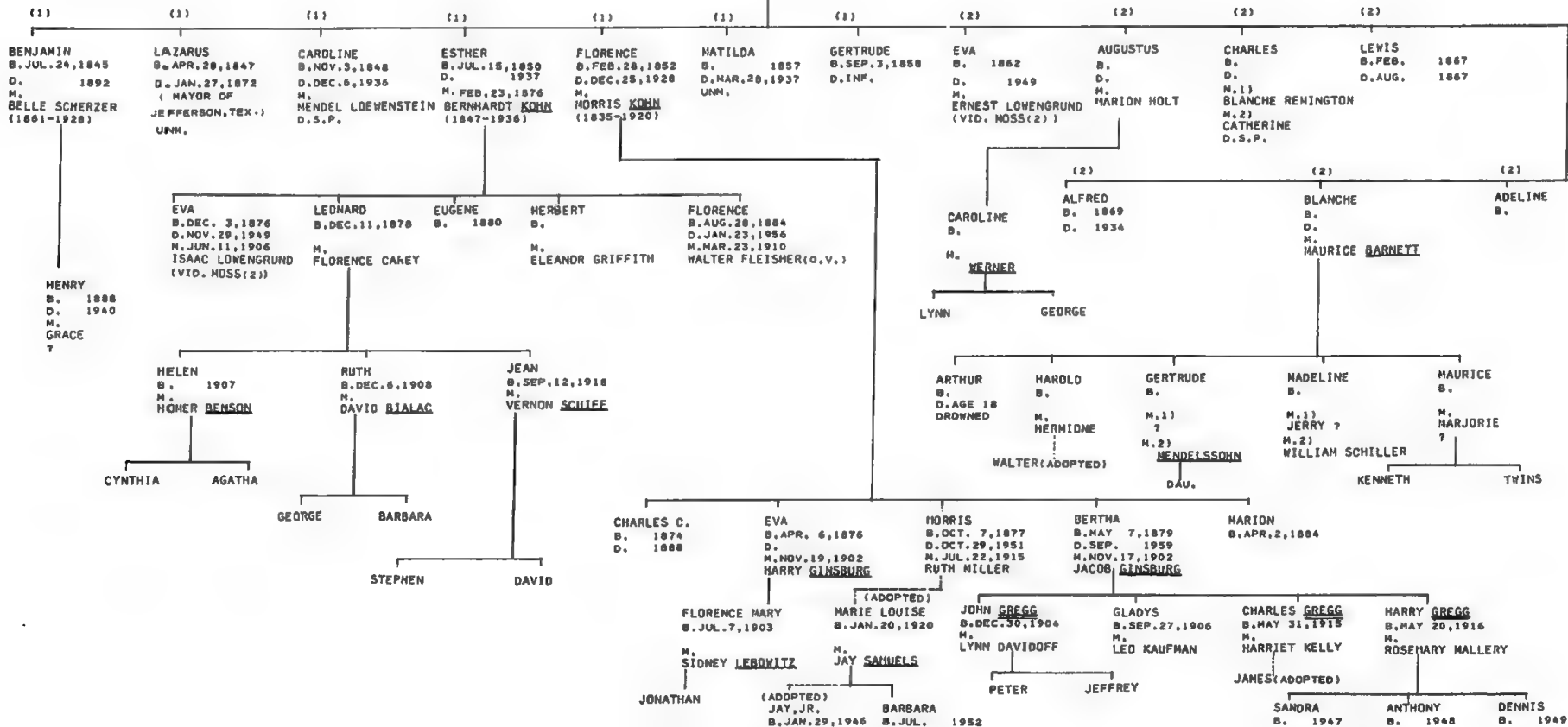

KRAUS-SANDOR COLL.
E.-L.
PAJHS 8, P. 53
PAJHS 27, P. 70
HILL OF SIMON BLOCK, JR. (JRM)
BALTO.-COMEN-ETTING CEM.
ROSA HAYER GRANT
PAULINE BOOKER CARTER

(BLOCK)

ABRAHAM (RICHMOND, 1810
CHARLOTTESVILLE, VA.
WASHINGTON, ARK., 1823-)
B. BOHEMIA, JAN. 20, 1780
D. N.O. MAR. 17, 1857
M. N.Y. OCT. 2, 1811
FRANCES ISAAH ISAACS
(G.V.V)

ELIEZER
B. ROUSNTY, BOHEMIA, 1792
D.
M.
ABIGAIL DE PAZ
(VIO. DE PASS II)

LOUISA
B.
D.
M. OCT. 11, 1829
ABRAHAM JONAS
(G.V.)

ELINDR
B.
D.
M. MAY 4, 1829
PHINEAS NOSES
(G.V. III(1))

SIMON, JR. (RICHMOND, VA.
CAPE GIRARDEAU, MO.)
B.
D. MO., CA. 1825
M.
SUSAN

DELIA
B.
D.
M.
PENEAS BLOCK

NOSES

ABBY

LOUISA

ZALMA

ROSANNA

RACHEL

ZIPPORAH

VIRGINIA

JULIANA

FRANCES

EMMELINE

ROSALIE
B.
D.
M.
GEORGE JONAS
(G.V.)

SARAH
B.
D.
M.
CHARLES HENRY
JONAS (G.V.)

JOSEPHINE
B.
D.
M.
BENJAHIN F.
JONAS (G.V.)

ELEANOR
B.
D.
M.
HENRY LABATT

HERMAN (DEL RIO, TEX.)
B. JUNE 1841
D.
M.

LOUISA SALDHE
B. JUN. 4, 1846
D. MAR. 8, 1847, BALTO.

SAHSON OF
SAN ANTONIO, TEX.

HESTER
B. RICH. 1813
D. ARK. 1887
M. WASHINGTON, ARK.,
FEB. 21, 1833
DR. BENJAHIN J. JETT

SIMON
B. VA. 1815
D. ARK. 1833

ROSINA
B. VA. 1816
D. M. FEB. 14, 1838
EDWARD BRITTIN
OF CONN. & N.O.

ISAACS
B. VA. 1817
D. ARK. 1828

AUGUSTUS
B. VA. 1818
D. CA. 1896
LUCIA JONAS
(G.V.)

HENRY
B. VA. 1820

DAVID
B. VA. FEB. 12, 1823
D. ARK. DEC. 21, 1865
M. WASH., ARK.,
MAR. 11, 1848
ALHERA CLARK TRIMBLE
(V. 1823-)

VIRGINIUS
(BRYAN CITY, TEX.)
B. LA.
D.
M. 1)
LEONDRA TUNSTALL
M. 2) SEP. 3, 1868
SARAH TUNSTALL
(SISTER OF LEONDRA)
2 CH.

EUGENE
B. ARK. 1828

JULIET PAULINE
B. ARK. SEP. 2, 1831
D. WASHINGTON, ARK.,
M. JUL. 29, 1858
ORVILLE JENNINGS
OF LITTLE ROCK, ARK.
(ME. 1826 -)
B. ARK.

ELLEN
B. ARK. 1833
D. UNM.

LAURA
B. SEP. 20, 1835
D. OCT. 14, 1853

SOLOMON

E. B. 1853

EARNEST
B. 1855

DR. CHESTER (LITTLE ROCK)
B. 1857

ROSINA
B. 1849
D. 1908
M. WASH., ARK.,
DEC. 15, 1870
JOEL DYER CONWAY, SR.

ABRAHAM
B. 1851
D. WASH., ARK. 1901
UNM.

WALTER TRIMBLE
D. AFTER 1876, N.O.

FRANCES
B. 1855
D. 1916
M. BUR, TEXARKANA
W.
WILLIAM DAVIES
JOHNSON

ESTELLE
B. 1859
D. 1886
BUR, WASH., ARK.

ELLEN (NELLIE)
M. GEORGE ALSTEN (D.S.P.)

JULIET
B. 1864
D. 1917
M. WASH., ARK. 1887
PAUL ROBERT BOOKER

PAULINE

JACOB MONRDE CARTER

BERTHA
B. N.O. FEB. 4, 1857
D. N.O. OCT. 28, 1918
M. CA. 1887
PHINEAS H. HAYER (G.V.)

FREDERICK
B.
D.
UNM.

DORA
B.
D.
UNM.

GUSTAVE
B.
D.
M.
ANNA CONWAY OF N.O. #

LOUISE
B.
D.
UNM.

ABRAHAM (N.O.)
B.
D.
M.
EMMA SHAW

FRANCES (FANNIE)
B.
D.
UNM.

FLORA
B.
D.
M. MAR. 6, 1865
COL. RICHARD GAINES OF
ARROW ROCK, MO.

ABRAHAM LUDLOW
B. JAN. 1, 1840
D. WASHINGTON, ARK.,
OCT. 22, 1840

WILLIAM ISAACS
B. FEB. 19, 1844
D. WASHINGTON, ARK.,
NOV. 27, 1846

CELESTE
B.
D. N.O.

ADELE
B.
D.
M.
DR. ALLAN EUSTIS OF N.O.

MAHIE

MARSHALL

FLORA

MIDDLECOFF

ROSE

WILLIAM CLAYTON OF EL PASO, TEX.

EDWIN D.
B. ARK. 1836
D.
M. DEC. 2, 1868
IRENE ROYSTON

BENJAHIN P.
B. ARK. 1838
D.
M.
LULIE WRIGHT BELT

EUGENE

WILLIAM AUGUSTUS
B. ARK. 1846
D.
M. FEB. 25, 1875
KATE GREEN

SEVIER
B. ARK. 1852
D. 1899
M.
LULA BROOKS

CHARLES
B. ARK.
(WICKES, ARK.)

ROSE
B.
D.
M. SEP. 22, 1864
JAMES J. GAINES

ALHEDIA
B. 1850
D. 1929
M. 1)
M. 2)
WILLIAM SAMUEL
RAINEY

MARY
B.
D.
M. JULY 12, 1871
WALTER C. CARRINGTON

EMMA
B.
D.
M. SEP. 4, 1865
JOHN N. MORGAN

3 OTHERS

BOMEISLER

NICKVE ISRAEL REC.
R.S.MOM REC.
W.W.
MORAISS-JEWS OF PHILA.
FLORENCE ABRAHAMS

NATHAN LOEBL BOMEISLER
(NAPOLEONIC SOLDIER)

REBECCA HELLER

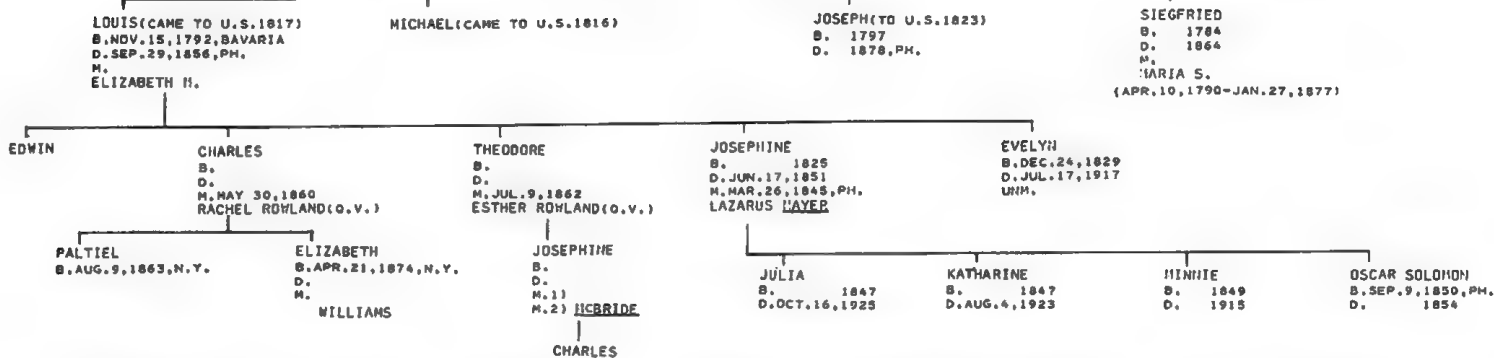

FONSECA BRANDON

LEANDER C. LEVY
BEVIS MARKS REC.
KRAUS-SANDOR COLL.
HENDRICKS GEN.
SHEARITH ISRAEL REC.

DAVID ISRAEL BRANDON
OF LONDON

JOSEPH DA FONSECA

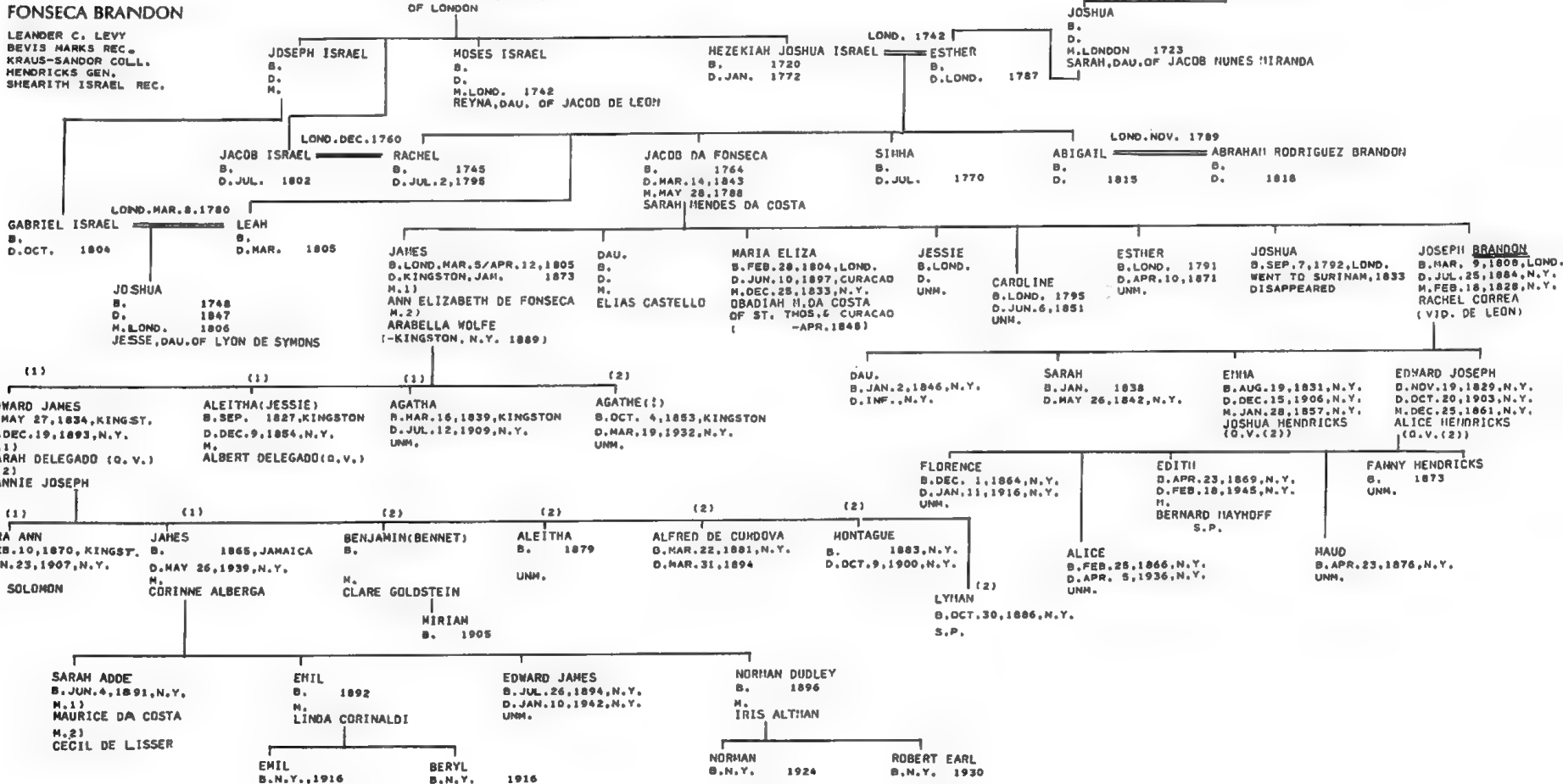

P.B.H. ROSENWAIKE KRAUS-SANDOR COLL. AARON LEVY CALENDAR(AJHS) N.Y.WILLS,V.3 E.M.SHILSTONE MSS. & SH. POOL-PORTRAITS. MICKVE ISRAEL REC. SHEARITH ISRAEL REC.

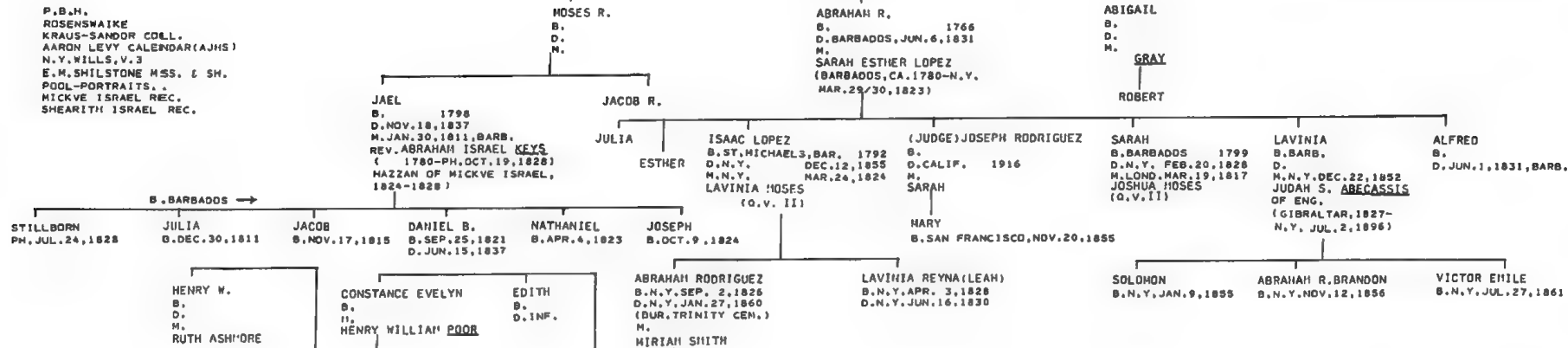

JOHN BRAUER(CHRISTIAN) SARAH? BRAUER

EZEKIEL FAMILY REC.(ESTHER PINCUS)

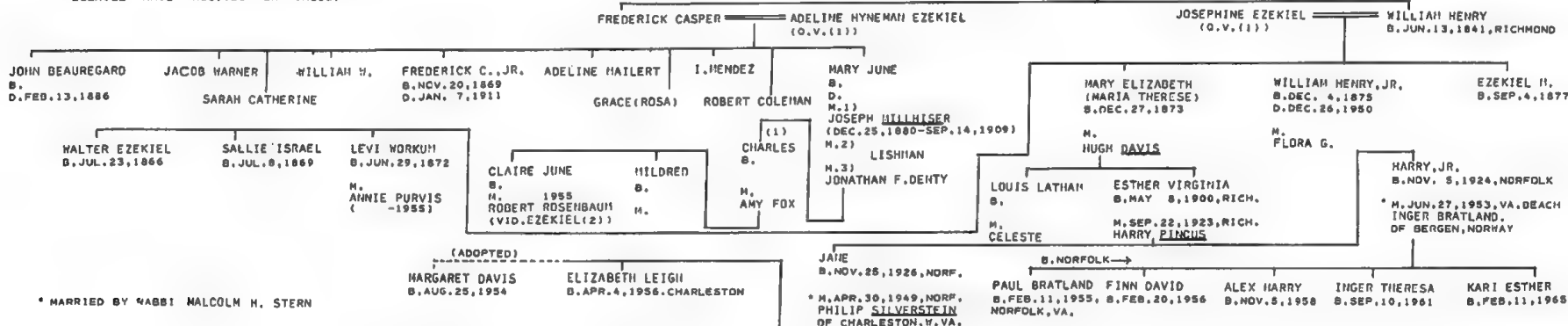

BRICKNER

SAHUEL BRICKNER HENRIETTA NEWMAN

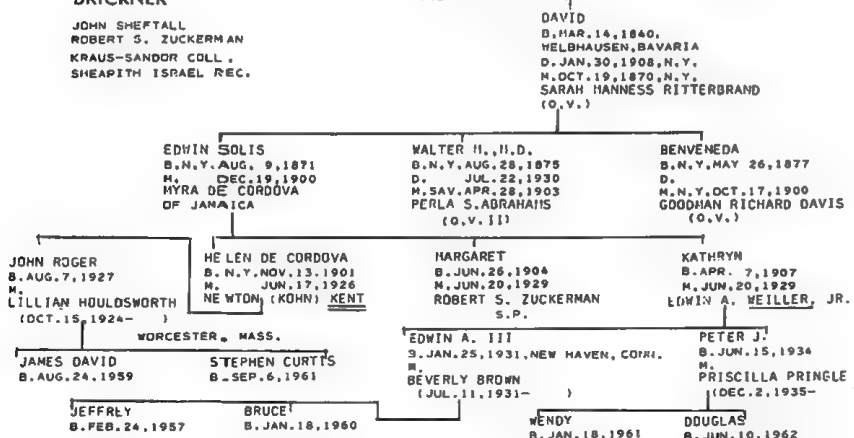

BRUSH

STANLEY R. JACOBS (JOSHUA) SCHAJE BRUSH SARAH, sis. OF DAVID KRULECK(VID. KING I) KRULSCHIK

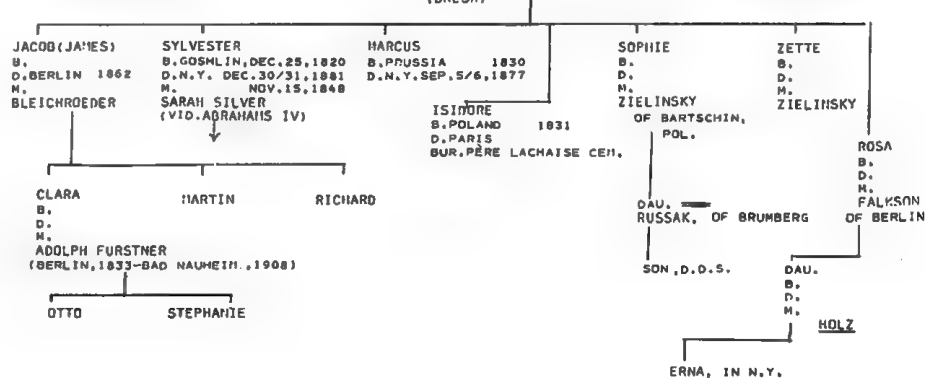

BUSH

AJHO LXI, P. 67
N.G.S.O 54, P. 38
MISC. VII #502
COHEN-ETTING MS.
SHEFTALL MSS.
BUSH BIBLE (ROSENBAACH COLL.)
B. JACOBS MOHEL REC.
KRAUS-SANDOR COLL.

J.E.V. 3, P. 443
MORAIS-HEWS OF PH., P. 401
PHILIPSON-LETTERS OF REBECCA
GRATZ, P. 457
SAVANNAH JEW. BURYING GROUND
MICKVE ISRAEL REC.
SPRUCE ST. CEMETERY REC.
W.W.P. 425

MATHIAS BUSH
B. PRAGUE, MAY 10, 1722
D. PHILA., MAR. 29, 1790
M. 1)
TABITHA HEARS (O.V.)
M. 2) 1764
REBECCA MYERS-COHEN
(O.V. I)

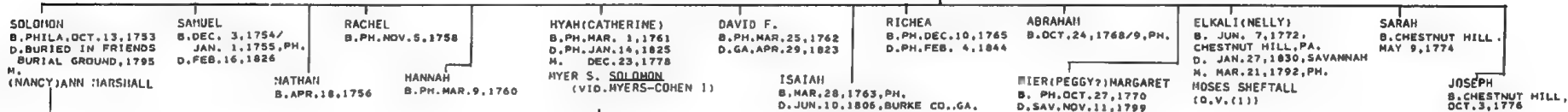

CADET

R. S. MOH. REC.
MICKVE ISRAEL REC.
MORAIS-JEWS OF PH., P. 71
PAJHS V. 31, P. 154
ELZAS MSS.
ALLEN GEN.
FLORENCE ABRAHAMS

SIMON DE LYON CADET
B. LYONS, FR. 1784
D. PH. MAR. 8, 1845
M.
FRANCES (TINA) (1766- JUN. 2, 1865)

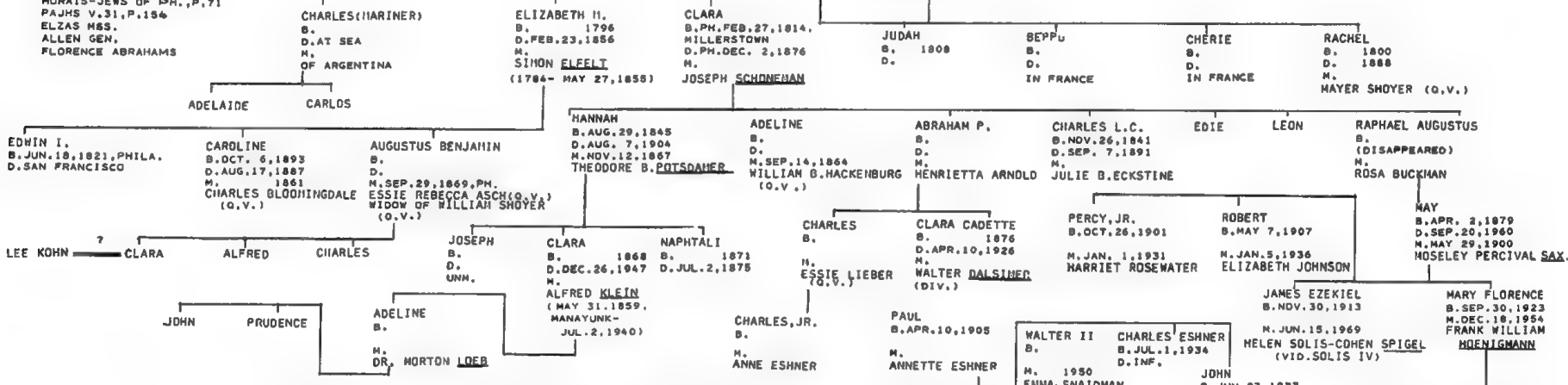

CANTER

MOBILE CEM. REC.
ROSENWAIKE
E. N. A.
1790 & 1820 CENSUS
SAY. BURIAL GROUND (WPA)
SHEFTALL MS.
WILL OF JOSHUA CANTER
WILL OF RACHEL CANTER
GRACE ABENDANNE
RACHEL DE LA MOTTA
MARR. CONVEYANCES
ELZAS-D. J. C., P. 29
M. N., P. 7 MS5.
POOL-PORTRAITS, P. 136P.
GEO. H. TUCKER
JOHN SHEFTALL

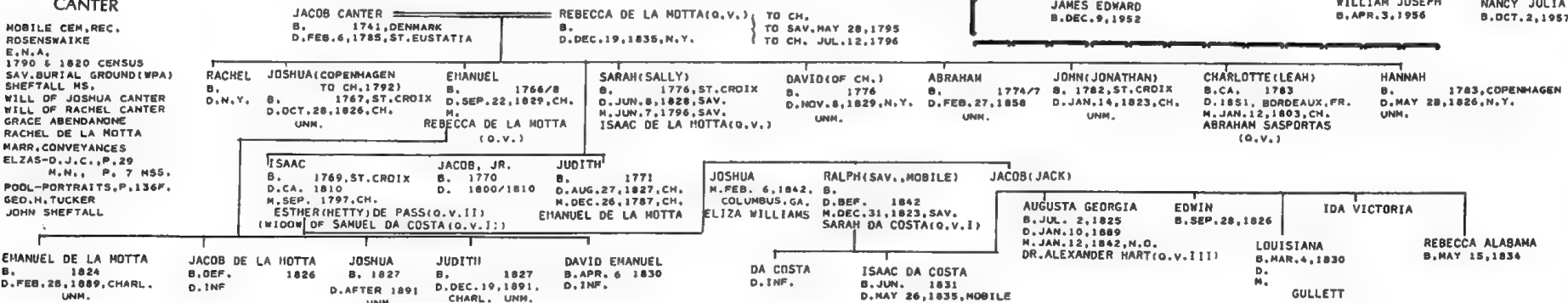

DAVID NUNEZ CARDOZO

ISAAC RODRIGUEZ LEON

JACOB NUNES NAVARO

OBITS. IN N.Y. TIMES
D.C. SEIXAS BIBLE
MISC.VI,P.108
A.J.V.B. V.41,P.25F
J.E. V. 3,P.576
U.J.E. V. 3,P.38F
KRAUS MS.
GOLDSTONE MS.
M.I. REC.
ENCYC. OF VA. BLDG. V.4,P.553
MICHAEL HART CARDOZO IV
ELZAS MSS. (NYHS)

RICH. NEWS-LEADER
TRACHTENBERG J.R. COHEN
G.J.C.
SAV. JEW. BURYING GROUND
WILL OF DAVID N. CARDOZA (AJA)
BEVIS HARKS REC.
SHEARITH ISRAEL REC.
FLORENCE ABRAHAMS

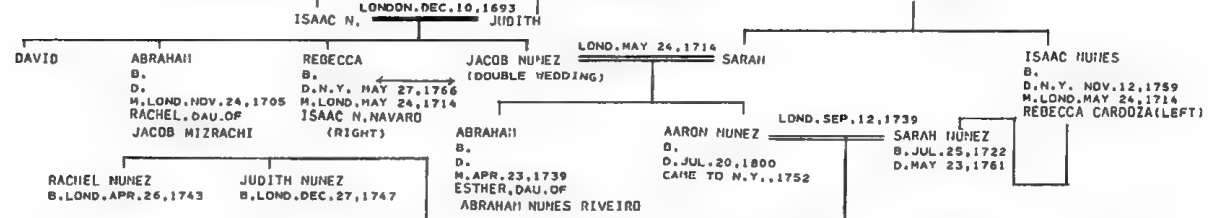

B. EASTON, PA.

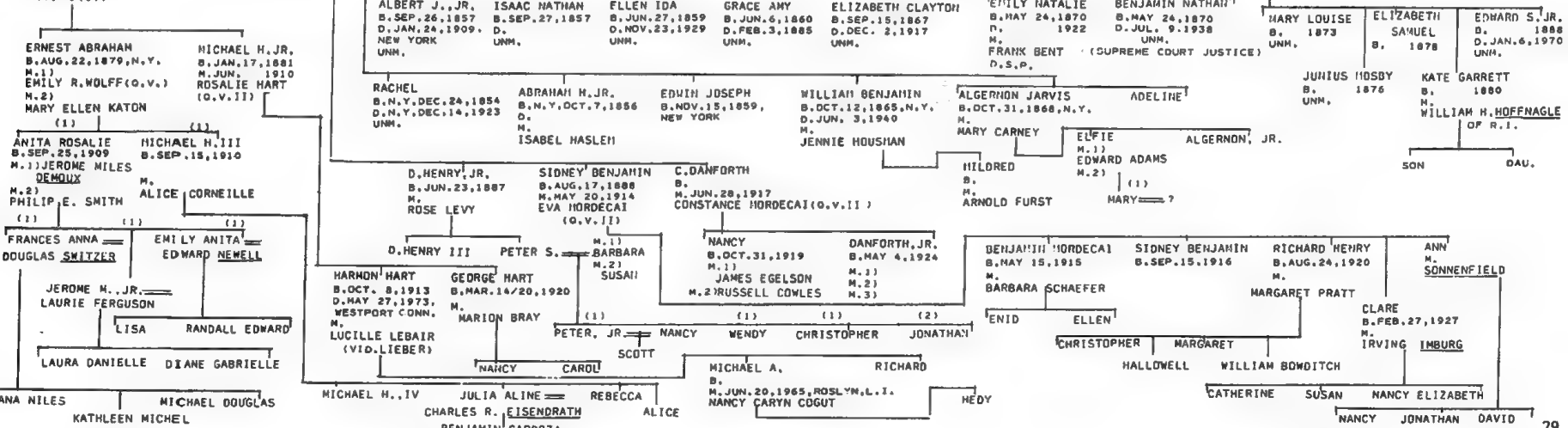
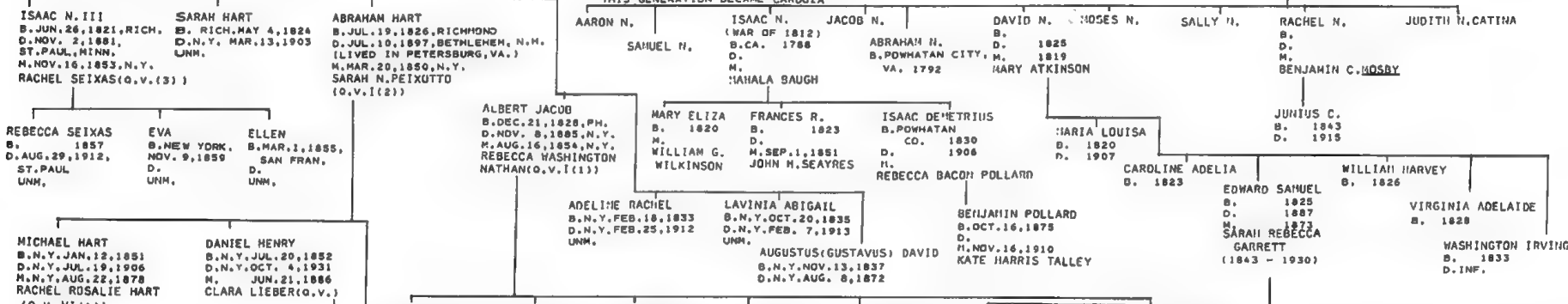
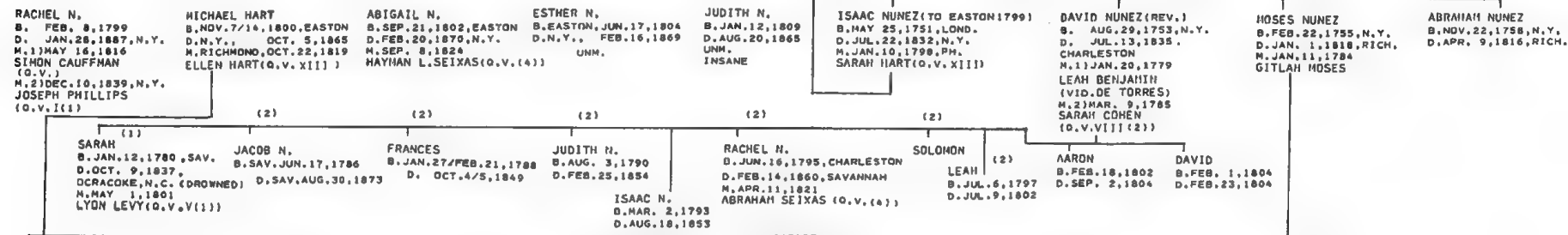

CARVALHO

P.B.H.
B.W.KORN
WILL OF EMANUEL
FLORENCE ABRAHMS
U.J.E. V.3,P.54F.
KRAUS-SANDOR COLL.
PAJHS V.27,P.463
MICKVE ISRAEL REC.
ELZAS-M.N.,P.20
ELZAS-O.J.C.,P.46
MRS.HARRY COHN
BEVIS MARKS REC.
SHEARITH ISRAEL REC.
KORN-CARVALHO'S
'INCIDENTS OF TRAVEL'
MYER SOLIS-COHN

BENJAMIN RODRIGUES MOREIRA
OF LONDON

SARAH
B.
D. PHILA. JAN. 24, 1831

LOND. 1790

EHANUEL NUNES
B. NOV. 14, 1770 LOND.
D. MAR. 20, 1817, PHILA.
D.S.P.
HAZAN IN BARBADOS,
CHARLESTON AND PHILA.

ISAAC NUNES
B.
D.
M. LOND. AUG. 1803
(A CONVERT)

DAVID NUNES
B. LOND. 1784
D. BALTO. 1860
M. CH. 1814
SARAH D'AZEVEDO
(O.V.)

REBECCA
B.
D.
M. OCT. 1800 LOND.
MOSES DE DAVID
HENRIQUES BASSAN

BATSHEBA
B. AUG. 3, 1768, LOND.

SOLOMON NUNES
B. APR. 27, 1815, CH.
D. MAY 21, 1897, N.Y.
M. OCT. 15, 1845, PHILA.
SARAH MIRIAM SOLIS
(O.V. (2))

EMANUEL NUNES
B. MAR. 22, 1817, CH.
D. MAR. 13, 1883, N.Y.
M. DEC. 1, 1841, CH.
CAROLINE A. WOLFF
(VID. WOLFF)

DAVID NUNES
B. SEP. 23, 1842
D. NOV. 19, 1843, CH.

ISAAC WOLFF NUNES
B. FEB. 19, 1848

ISAAC
B. JUN. 1835
D. DEC. 25, 1835, PH.

JULIA
B. JUL. 4, 1819, CH.
D. JAN. 22, 1897, N.Y.
UNN.

SARAH
B. SEP. 1823
D. NOV. 13, 1842,
BARBADOR

MIRIAM N.
B. NOV. 10, 1838, PH.
D. MAR. 25, 1910, N.Y.
M. NOV. 7, 1866, PH.
ISADOR OSORIO
(ST. THOS. MAR. 12, 1840-
N.Y. JAN. 2, 1914)

DAVID NUNES
B. SEP. 29, 1848, PH.
D. JUN. 29, 1925,
NEW ROCHELLE, N. Y.
M. MAR. 22, 1878
ANNIE ABRAHMS
(VID. ABRAHMS III)

CHARITY SOLIS
B. APR. 12, 1853, BALTO.
D. APR. 5, 1945, NEW ROCHELLE
M. NOV. 15, 1876, N.Y.
ADOLPH MARSHUETZ
(DEHMELSDORF, BAV.
JUL. 23, 1840)

JULES CARVALHO

SOPHIE
B.
UNN.

SARAH NUNES
B.
UNN.

SOLOMON NUNES
CARVALHO
B.
M. 1907
ROSEMARY STANISLAUS
HURRAY

ETHEL
B.
UNN.

JACOB SOLIS
B. SEP. 23, 1852, CH.
D. MAR. 13, 1937, LAWRENCE, L. I.
M.
SUZANNE WALKER
(CONVERT)

SOLOMON SOLIS
B. BALTO. JAN. 1856
D. APR. 12, 1942
M. MAY 1895
HELEN CUSACK

G. STACK = HELEN

DAU. = FRANK H. CRESHORE

LESLIE
RUSSELL NUNES
B. NOV. 1885
D. IN AUTO ACC.
M.
JEWESS

ADELE
B.
D. 1958, WASHINGTON, D.C.
M.
MAJ. ERNEST G. FRENCH

BERTRAM NUNES
B. MAY 1879
D.
M.
JESSICA PIERCE

BERTRAM N. JR.

DAYTON
D. AGE 1

CURTIN BALTON
PIERCE
B. JUN. 28, 1932
MELBA WYCKOFF

MAIE
B. MAY 19, 1882
M. 1901
CARL F. STURHANN
(GER. -)

CLAIRE
B.
M. HERBERT A. WEILLER
(-SARASOTA, CA. 1967)

ELLEN
B. CA. 1870, BROOKLYN
D. NOV. 12, 1954, N.Y.
UNN.

J. NEWTON
B. SEP. 24, 1876
D. APR. 1948
M.
HATTIE FULD

VIOLETTE AINE
B. JUN. 15, 1916, LOND.
M.
GEORGE F. DAVIS
2 CH.

1 DAU.
GEOFFREY ERNEST
B. NOV. 25, 1919, DUBLIN
M. ?
JONATHAN 3 OTHERS

MARSHALL
B. SEP. 1956

DAVID M. II
B. MAY 25, 1940
ANNETTE PHILBRICK

JOAN
B. SEP. 1930
M. MCNUTT

HERBERT CARL
B. D. CA. 1939

EDWARD MARSHALL
B. MAY 1905/6
M. 1929
LOUISE DAILEY

ADOLPH G.
B. JUN. 26, 1908, N.Y.
M. AUG. 4, 1933
ISABELLE BAIRD

RITA J.
B. AUG. 1916
M. ROBERT L. SPEARS

WILLIAM BAIRD
B. JAN. 16, 1936

RICHARD JONES
B. MAY 30, 1942

SON SON

CAUFFMAN

LOXLEY MS. (PA. HIST. SOC.)
U.S. CENSUS, 1800
M. ROSENBAUM-THE JEWS OF PH., P. 17.
SHEARITH ISRAEL REC.

JOSEPH CAUFFMAN
D. 1720
D. PH. FEB. 10, 1807
M.

SIMON
B.
D.
M. MAY 16, 1816
RACHEL N. CARDOZA (O.V.)

SARAH CARDOZA
B. APR. 17, 1817
D. MAR. 1, 1896, PARIS
M. NOV. 14, 1838, N.Y.
GERSHON DRUCKER

ESTHER CARDOZA
B. NOV. 30, 1820, RICH.
D. FEB. 9, 1895, N.Y.
BURIED PHILA.
M. AFTER 1850
ELIAS OPPENHEIMER
(PH. JUL. 8, 1832-
N.Y. JAN. 2, 1916)

CLARA
B. 1821, RICH.
D. FEB. 14, 1880, N.Y.
UNN.

MICHAEL
B. N.Y. DEC. 10, 1839

EDWARD
B. N.Y. AUG. 1, 1842

CLARA
B. N.Y. OCT. 30, 1843

ELEAZER (STIEGHUND)
B. N.Y. SEP. 24, 1845
D. N.Y. JUL. 8, 1846

AUGUSTA
B. N.Y. OCT. 10, 1848

ANNA
B. N.Y. JUN. 17, 1841

HENRY
B. N.Y. JUN. 29, 1847

CLAVA

AJMO LVII, P. 65
MISC. VII #543
W.W.
MICHAEL GRATZ LETTER BK. (AJNS)
OPPENHEIM (AJMS)

MOSES CLAVA
B.
D.
M.

(NATURALIZED LANCASTER,
SEPT. 12/24, 1762)

BENJAMIN MOSES
B.
D. MAR. 16, 1785, PHILA.
M.
(A XIAN IN CHURCH)

(GLUCESTER, N.J. 1755
HT. MOLLY, N.J.
TO PHILA. 1774)

N.G.S.O XLIX,P.43
 KRAUS-SANDOR COLL.
 ELZAS,H.N.P.14
 E.COHEN GEN.
 MICKVE ISRAEL REC.
 MARYLAND HIST.MAG.V.18,
 MRS.ALBERT H.COHEN
 FLORENCE ABRAHAMS
 FEDERAL ST.CEN.
 R.S.MOH.REC.

COHEN, OF SWANSEA, WALES

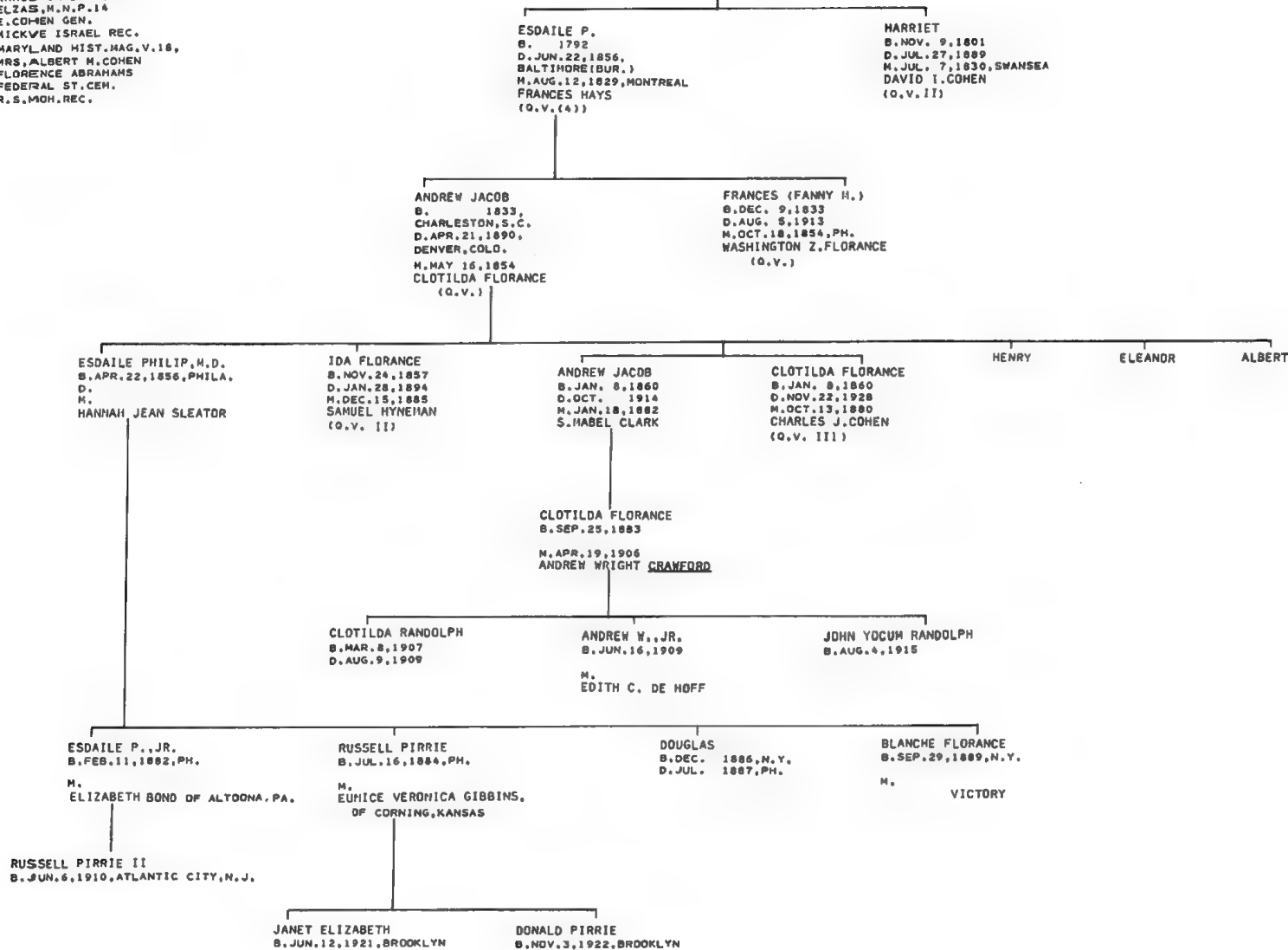

COHEN II (BALTO.)

MORDECAI FAM. BTBLE
WILL OF JACOB I. COHEN
WOLF-WHITEMAN-JEWS OF PHILA.
MD. HIST. MAG., V. 18, PP. 357-376
V. 19, PP. 54- 77
N. G. S. O. XLIX, P. 43
M. I. REC.
U. J. E. V. 3, P. 233F.
KRAUS MS.
MYERS MS.
JEWS OF RICHM. PASSIM.
SHEARITH ISRAEL REC.
MYER SOLIS-COHEN
COHEN-ETTING MSS.
N. Y. 1855 CENSUS
B'NAI JESH. REC.

MEYER COHEN
B. OBERDORFF, CA. 1700

JACOB

JOSHUA COHEN, OF OBERDORFF, GERHANY
B. 1720
D. FEB. 7, 1771, OBERDORFF

PESLAH
B. 1723
D. AUG. 26, 1797

AUG. 1782, PH. (1) (2) PH. NOV. 3, 1807

BRISTOL, ENG., DEC. 21, 1786

ELIZABETH (ESTHER) WHITLOCK
B. 1744
D. AUG. 22, 1804
WIDOW OF NOSES MORDECAI
(O.V. I (1))

JACOB I.
B. OBERDORFF, GER. 1744/7
D. PHILA. OCT. 9, 1823
REV. SOLDIER, LUSHINGTON'S
BRIGADE, S. C.

RACHEL JACOBS
(VID. NUWEZ)

ISRAEL I.
B. OBERDORFF, GER. 1750/1
D. JUL. 29, 1803
(CAME TO RICHMOND
SEP. 21, 1787)

JUDITH I. SOLOMON
B. 1766
D. APR. 5, 1837

JOSHUA
B. RICH. JUN. 28, 1788
D. RICH. SEP. 12, 1788

SOLOMON I.
B. 1791
L. IN RICHMOND

PHILIP I.
B. APR. 17, 1793, RICH.
D. SEP. 30, 1852, NORF.
M. JAN. 25, 1826, NORF.
AUGUSTA MYERS (TO N.Y. 1853)
(O.V. II)

MARIA I.
B. SEP. 30, 1794, RICH.
D. JUN. 23, 1821, BALTO.

MENDES I.
B. MAY 25, 1796, RICH.
D. MAY 7, 1879, BALTO.

BENJAMIN I.
B. SEP. 17, 1797, RICH.
D. SEP. 20, 1845, BALTO.
M. DEC. 15, 1819

KITTY ETTING
(O.V.)

DAVID I.
B. APR. 30, 1800, RICH.
D. JUL. 4, 1847, BALTO.
M. JUL. 7, 1830, SWANSEA
HARRIET COHEN (O.V. I)

JOSHUA I., M.D.
B. RICH. AUG. 30, 1801
D. BALTO. NOV. 4, 1870

EDWARD I.
B. RICH. NOV. 19, 1802
D. RICH. JUL. 23, 1803

JACOB I.
B. RICHMOND, SEP. 30, 1789
D. BALTIMORE, APR. 6, 1869
UNM.

ISRAEL
B. SEP. 12, 1820
D. JUN. 3, 1875
M. OCT. 3, 1850
CECILIA E. LEVY
(O.V. V (2))

SOLOMON ETTING
B. FEB. 16, 1822
D. DEC. 17, 1878
M. AUG. 30, 1842
ANNA MARIA DENNY

JOHN JACOB
B. FEB. 9, 1823
D. MAY 10, 1825

BENJAMIN
B. NOV. 4, 1824
D. INF.
DEC. 9, 1825

RACHEL ETTING
B. OCT. 14, 1825
D. SEP. 28, 1913
UNM.

MARIA
B. AUG. 18, 1830
D. SEP. 14, 1905
M. OCT. 4, 1854
JOHN HINTON LOPEZ (O.V. I (2))

KATE FRANCES
B. FEB. 25, 1832
D. MAY 18, 1890
UNM.

EDWARD
B. NOV. 15, 1835, BALTO.
D. JAN. 18, 1888, PA.
M. DEC. 5, 1855
CAROLINE MYERS
(O.V. I) D.S.P.

GEORGIANA
B. FEB. 1, 1834
D. DEC. 15, 1903
UNM.

ELIZA EMORY
B. APR. 18, 1837
D. INF.
MAY 27, 1837

BENJAMIN I.
B. FEB. 21, 1852, BALT.
D. AUG. 10, 1915, VICTORIA, B.C.
M. MAY 19, 1881, PORTLAND, ORE.
SALLY ELLA HARPER
D.S.P.

MARIA
B. APR. 25, 1853
D. INF.

GEORGIE
B. NOV. 11, 1856
D. MAY 14, 1871
UNM.

JOSHUA I.
B. JUN. 25, 1860
D. NOV. 17, 1885, L.A.
UNM.

ANNA MARIA
B. APR. 11, 1863
D. MAY 24, 1891, SAV.
M. OCT. 8, 1890
ABRAHAM WITIS (O.V.)

SOLOMON ETTING
C. JUN. 26, 1843
D. AUG. 8, 1847,
HARPER'S FERRY

BENJAMIN DENNY
B. SEP. 13, 1845, PH.
D. JUL. 23, 1847

GEORGE
B. NOV. 14, 1847.
HARPER'S FERRY
D.
M. 1) DEC. 25, 1866
HANNAH JEAN WEAVER
M. 2) FEB. 2, 1874
EMILY ELIZABETH
MONTGOMERY

ANNA MARIA
B. JUL. 27, 1849, PH.
D. OCT. 3, 1914
M. 1) MAR. 1876
BENJAMIN LUTHER LELAND
M. 2) CA. 1884
JOHN A. HALL (DIV.)
M. 3) MAR. 12, 1898
CLAUS VAN MEEDEN

HERBERT
B. MAR. 9, 1851,
CHESTER, PA.
D. INF.

KITTY
B. JUL. 19, 1854
D. JAN. 19, 1856

ELEANOR SEPTIMA
B. FEB. 17, 1858
UNM.

(1) EDWARD

(2) FREDERICK GEORGE

(2) EVA

(2) REIDER

(1) LT. BARNEY
B. NOV. 17, 1878
M.
META CLARA ?

(1) SOLOMON ETTING

HAY, DAVID MENDES
B. DEC. 7, 1826, NORF.
D. MAR. 28, 1891, N.Y.
M. DEC. 5, 1879, N.Y.
MATILDA STERN (O.V. I)

ELIZA M.
B. SEP. 13, 1829, NORF.
D. MAR. 28, 1904, N.Y.
UNM.
(TO N.Y. 1853)

ARTHUR M.
B. MAY 13, 1833, BALTO.
D. JAN. 3, 1885, N.Y.
UNM.

CHARLES
B. FEB. 24, 1835, BALTO.
D. AUG. 18, 1836, BALTO.

ALFRED M.
B. JAN. 14, 1837, BALTO.
D. SEP. 20, 1858, MOBILE

ADELINE MYERS (TO N.Y. 1855)
B. MAY 25, 1839, NORF.
D. MAR. 28, 1889, N.Y.
M. JAN. 10, 1872, N.Y.
DAVID STERN (O.V. I)

HENRY, M.D.
B. APR. 17, 1828, NORF.
D. OCT. 6, 1868, N.Y.
UNM.

VIRGINIA
B. APR. 22, 1831, NORF.
D. JUN. 23, 1834, BALT.

MENDES
B. MAY 4, 1831
D. AUG. 13, 1915
M. OCT. 18, 1845, N.Y.
JUSTINA HATHAN
(O.V. I (1))

EMILY CLARA
B. AUG. 3, 1866, N.Y.
D. SEP. 18, 1903
UNM.

CATHERINE
B. OCT. 3, 1833
D. AUG. 18, 1898
M. JAN. 3, 1872
CHARLES D. MEYERS
(1813-1884)

MIRIAM C.
B. DEC. 28, 1873
D. SEP. 3, 1900
UNM.

MIRIAM
B. SEP. 5, 1835
D. MAR. 3, 1891
UNM.

MARGARET
B. FEB. 20, 1837
D. AUG. 3, 1902
UNM.

BERTHA
B. APR. 12, 1838
UNM.

JACOB I.
B. NOV. 5, 1841
D. JAN. 22, 1920
M. OCT. 14, 1868
ELLEN MORDECAI
(1837-1915)
(O.V. III)

DAVID I.
B. SEP. 14, 1870
D. JUN. 20, 1871

ALAN H. III
B. AUG. 17, 1920

REBECCA
B. SEP. 25, 1844
D. JUN. 13, 1899
M. FEB. 8, 1865
EUGENE J. JACKSON
(O.V. I)

ALAN MORDECAI
B. JAN. 21, 1872
D. SEP. 6, 1913
M. 1891
EMILY JOHNSTON (DIV.)

ALAN H., JR.
D. FEB. 2, 1895
M. JAN. 2, 1920
ELIZABETH DORIS BUDA

FEDERAL ST. CEM.
N.Y., 1855 CENSUS
W.W., P. 395
PAJMS V. 9, P. 36
PAJMS V. 27, P. 486
PAJMS V. 31, P. 255
UJE V. 3, P. 249F.
KRAUS MS,
COHEN LETTERS (JRM)
N.Y. WILLS
CLIPPING FROM AMERICAN STATIONER (JRM)
SAMUEL-YATES G. (AJA)
COHEN G. (AJA)
SHEARITH ISRAEL REC.
COHEN FAMILY FACTS & FAIRY TALES
OBIT. IN PHILA. DAILY NEWS 4/3/57

ROSE BARNET (1) JOSEPH COHEN (2) ENG. HANNAH MOSES
B. ELBERFELD, WESTPHALIA, 1745/46 B. 1800
D. LONDON, AUG. 1, 1822 D.
CAME TO U.S. 1768
RET'D TO ENGLAND

(1) (2) (2) (2)
SOLDMON JUDITH RACHEL LEWIS J. (LEVY) (TO N.Y. CA. 1835)
B. LONDON 1782 B. LANCASTER, PA. JUL. 23, 1800
D. JAN. 24, 1854 M. D. MAIDA VALE, ENG. APR. 14, 1868
M. HARY ISAACS (SOPHIA ANDRADE (LOND. 1810-LOND. FEB. 20, 1870))
(-APR. 30, 1861)

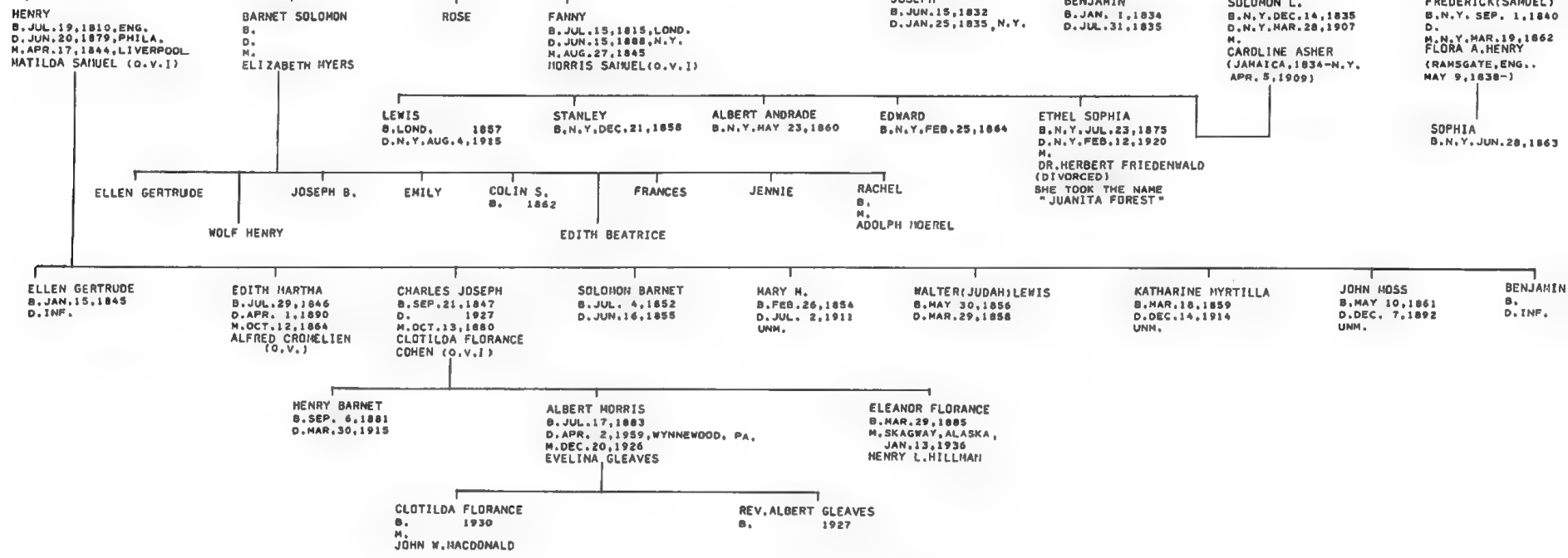

VALENTINE'S MANUAL
PAJMS V. 27, P. 75
POOL-PORTRAITS...
SHEARITH ISRAEL REC.
MICKVE ISRAEL REC.
MYER SOLIS-COHEN

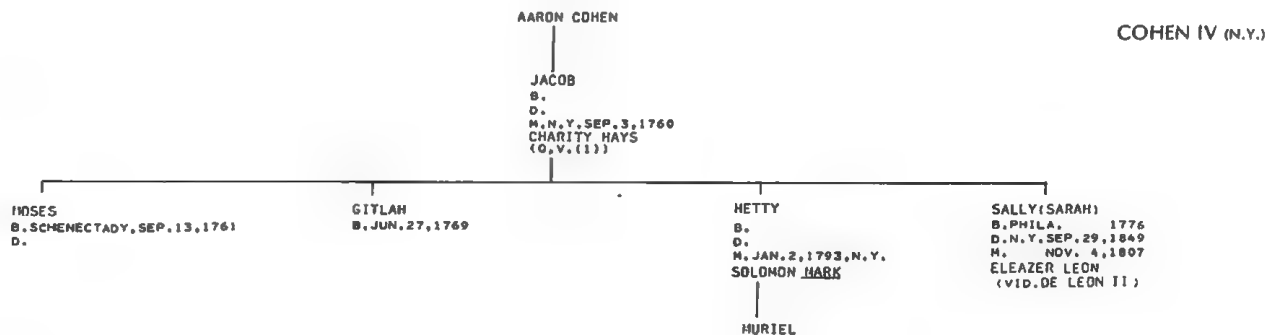

COHEN V (N.Y.)

MRS. DAVID GOODMAN
 B'NAI JESH REC.
 NORFOLK HEB. CEM.
 KRAUS-SANDOR COLL.
 SHEARITH ISRAEL REC.

ALFRED LYONS OF VIENNA ———— LADY SARAH HYATT (CONVERT)

JACOB COHEN ———— ERNESTINE (ESTHER)
 L. IN ENGLAND

DINAH SYMONS
 OF LONDON

SAMUEL (FURRIER, PARTNER OF
 JOHN D. PHILLIPS (O.V. VI)
 D. CAME TO U.S. 1832)

CHARLES
 B. LOND. 1811
 D. JUL. 1860, N.Y.
 M. AUG. 4, 1841, N.Y.
 PRISCILLA PHILLIPS (O.V. VI)

ELIZABETH
 B.
 D.
 UNM.

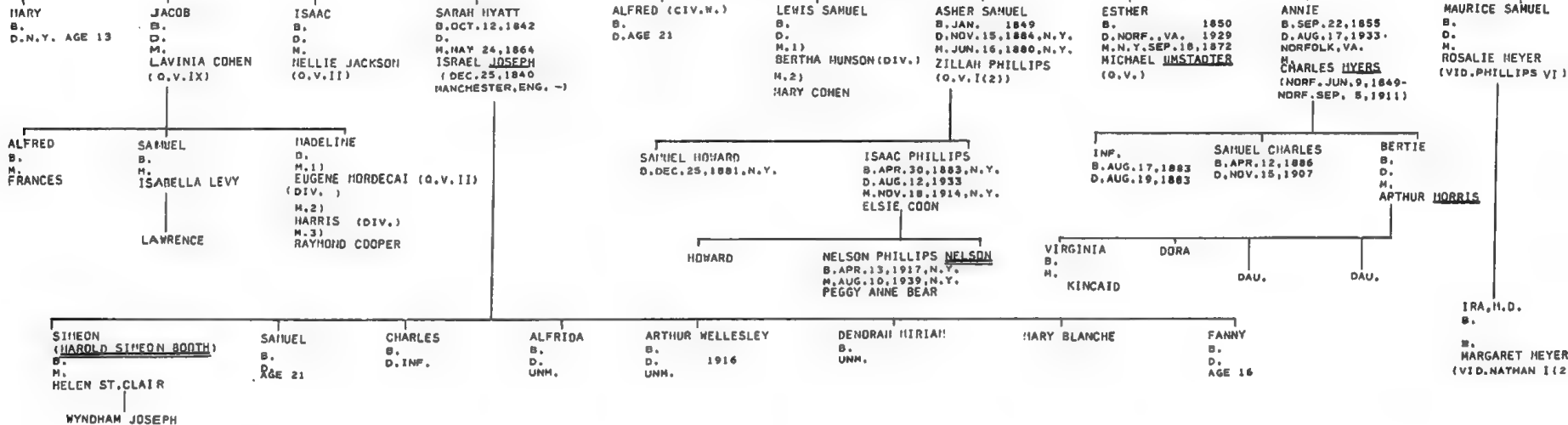

COHEN VI (S.C.)

CHARLES WHITEHEAD (COHEN FAMILY BIBLE)
 KRAUS-SANDOR BOOKS
 MORAIS-JEWS OF PHILA., P. 44
 JEW CEM. AT GEORGETOWN (ELZAS HSS.)
 D.A.R. LINEAGE BOOKS
 A.J.Y.B. 5666, P. 48
 ELZAS H.N.
 ELZAS O.J.C.

FISHEL COHEN ———— SARAH
 OF WARTHA, POLAND

REV. HARTWIG COHEN
 B. WARTHA, POL. NOV. 14, 1784
 D. WINNSBORO, S.C. OCT. 12, 1861
 INTERIM HAZAN, NICKVE ISRAEL
 HAZAN BETH ELOHIM, (1818-23)

MAR. 24, 1824, CH.

DEBORAH MARKS
 (O.V. IV)

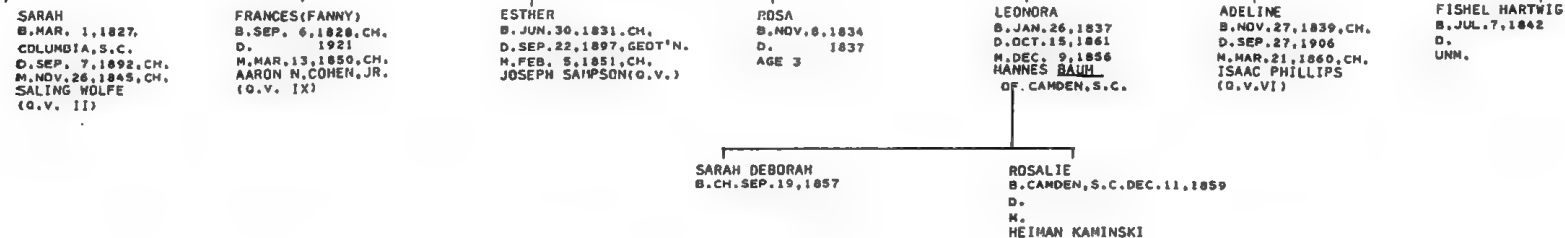

MOISE-JEW.CEN.AT SUMTER
HART-RECORDS OF FAMILIES OF HART E COHEN
LAZARUS GEN.
HARR. CONVEYANCES
RAISIN FAMILY
WILL OF RACHEL HART
UJE V.3,P.251F.
ST.CHARLES,P.89
KRAUS MS.
MOSES GEN.(AJA)
ELZAS MS.
ELZAS M.N.,P.14F.
ELZAS O.J.C.
SAMUEL-YATES G.(AJA)
SHEARITH ISRAEL REC.

IN CH. BY 1788

DEC.1795

MORDECAI COHEN
B.ZAKOSEC,POL AND 1763
D.CHARLESTON,JUL.8,1848

LEAH LAZARUS
(O.V.II)

ELIZA B. 1800 D.OCT.7,1811
CORNELIA B.NOV.20,1805 D.SEP.19,1886,PH. M.APR.1,1840 BEHJ.DORES LAZARUS (O.V.II)

LUCRETIA B. 1807 D.AUG.8,1888 M.NOV.19,1834 THOMAS WHITLOCK MORDECAI (O.V.II)(1)(3)

HARX EDWIN B.JUL.25,1810,CHARLESTON D.FEB.24,1882,SUMTER M.NOV.14,1838 ARHIDA HARBY(O.V.II)

DAVID DANIEL B.NOV.16,1802,CH. D.JUN.25,1860 M.FEB.17,1830 MARY HART(O.V.VI (1))

MARX E.,JR.,H.D.(CSA) B.CHARLESTON,DEC.3,1839 D. MAR.19,1865 BATTLE OF BENTONSVILLE, N.C. UNM.

CAROLINE B. D. M.CANAJOHARIE,N.Y. AUG.18,1883 JOSEPH P. JOACHIMSEN

ELIZA B.NOV.25,1842,CH. D.SEP.26,1926,SUMTER M.NOV.27,1878,SUMTER A.DE LEON MOSES (O.V.II(3))

OCTAVIA B.OCT.12,1844, CHARLESTON D.MAR.16,1936,SUMTER M.JAN.11,1871 ALTAHONT MOSES (O.V.II(2))

HERBERT B.JUL.27,1846 D.DEC.19,1847 INF. B.6 D. APR.20,1848

LEE(LEAH) B.SEP.9,1849 D.OCT.21,1918 M.MAY 11,1869 JACOB DE LA HOTTA HARBY (O.V.II)

ARHIDA B.OCT.18,1855,CH. D.NOV.17,1913,FLUSHING,N.Y. H.NOV.24,1880,SUMTER SOLOMON EHAUOL OF GEORGETOWN,S.C. (O.V.III)

WILL OF DAVID DANIEL

MICHAEL B. D. YOUNG.

DAVID DANIEL, JR. B. MAR. 17, 1832, CH. D. JAN. 31, 1890, N. Y. M. MAR. 23, 1870, N. Y. GERTRUDE H. SAMUEL (O.V.I)

ROSALIE L. B. 1832 D. DIJON, FR. JUN. 22, 1893 UNM.

MARY JANE B. AUG. 20, 1834 D. SEP. 7, 1856 UNM.

ASHER D. B. MAY 28, 1838, CH. D. OCT. 10, 1904, CH. M. NOV. 8, 1865, N. Y. MIRIAM HART (O.V.VI (1))

MCDOUFF B. APR. 7, 1840

DOUGLAS B. NOV. 5, 1875

FANNY B. JUL. 29, 1873

INEZ B. APR. 21, 1871 M. POLLOCK

FRANK DAU.

ISABEL B. APR. 12, 1876 D. OCT. 24, 1945 D. S. P.

GORDA C. DODD B. APR. 11, 1852 D. JUL. 3, 1944

MARRIAGE CONVEYANCES I, 210
WILLS OF SOLOMON, CECILIA AND AARON COHEN (JRM)
KORN-N.O. JOHN H. SHEPTALL
ALICE LANDRUM
HAROLD MOISE
ROSENWAIKE
KRAUS-SANDOR COLL.
PAJHS V.12,P.57
ELZAS-JEWS OF S.C.,P.48
ELZAS O.J.C.
ELZAS M.N.
ELZAS MSS.
ELZAS-NEW JEW.CEN. OF B.E.
CHATHAM CO.,GA,WILLS
SAV.JEWISH BURYING GROUND
SHEARITH ISRAEL REC.
SAMUEL-HIST.6GEN.SAMUEL-YATES
POULSON'S DAILY ADVERTISER

(1) APR.1763

REV. MOSES COHEN B. 1709, ENGLAND D. APR. 19, 1762, CH. IN CH. BY 1750

DINAH COMGILE OR CONGUE

JOSEPH DAVID

COHEN VIII (1)

ABRAHAM B. 1739 D. DEC. 10, 1800, GEORGETOWN, S.C. UNM. REV. SOLDIER

JACOB B. 1741 D. DEC. 16, 1808 UNM. REV. SOLDIER

ISAAC B. D. CA. 1787 M. JUDITH LYON (SEE NEXT P.)

ESTHER B. 1748 D. DEC. 8, 1826, GEORGETOWN, S.C. M. MORDECAI MYERS (O.V.III)

SOLOMON (TORY) D. OCT. 13, 1757 D. MAY 23, 1835, GEORGETOWN M. MAR. 1796, CH. BELLE (BELLA) MOSES (O.V.II(1))

RACHEL D. M. NATHANS

BELLE B. D. M. ABRAH MYERS (O.V.III)

B. GEORGETOWN →

DIVINAH B. APR. 21, 1787 D. FEB. 17, 1874 M. DEC. 14, 1803 ISAAC HINIS (O.V.I)

MOSES B. MAY 1, 1790 D. INF. SEP. 4, 1790

ISAAC B. JAN. 18, 1794 D. SEP. 22, 1800

JACOB B. NOV. 5, 1796 D. JUN. 13, 1871, CH. M. 1) FEB. 19, 1816 RACHEL LOPEZ (O.V.II(2)) M. 2) SARAH BARRETT (O.V.V) (VID. COHEN VIII(3))

SARAH HENRIETTA B. FEB. 28, 1799 D. JUN. 19, 1886 M. 1) JCA. 1820 MORIDCAI MYERS (O.V.III) M. 2) ROBERT PHILLIPS (O.V.II)

SOLOMON B. AUG. 15, 1802 D. AUG. 14, 1875, SAV. M. NOV. 30, 1836, PH. MIRIAM GRATZ MOSES (O.V.II)

ELEANOR B. D. MAR. 9/10, 1871, MEMPHIS M. JAN. 23, 1818 AARON LOPEZ, H. D. (O.V.II(2))

CECILIA B. NOV. 10, 1807 D. DEC. 9, 1863 UNM.

JOSEPH (USN) B. AUG. 16, 1810 D. FEB. 3, 1830 K. IN A DUEL

OCTAVUS B. FEB. 3, 1814 D. DEC. 7, 1876 M. OCT. 16, 1837 HENRIETTA YATES LEVY (O.V.XI)

GRATZ (C.S.A.) B. 1845 D. MAR. 19, 1865 UNM. K.I.A.

BELLE B. D. M. FRANCIS C. O'DRISCOLL OF SAVANNAH

MIRIAM GRATZ B. JUN. 25, 1850 D. JUN. 6, 1931 M. JAMES TROUP BENT

FANNY YATES B. MAY 30, 1840, SAV. D. M. JAN. 23, 1867, SAV. HENRY TAYLOR

GEORGINA BRYANT B. DEC. 23, 1841 D. JUL. 3, 1909 M. AFTER 1863 CLAVIUS PHILLIPS (O.V.III)

OCTAVUS B. JUL. 19, 1843 D. JAN. 10, 1887 M. EINHA LOUISE PHILLIPS (O.V.III)

HENRIETTA B. APR. 30, 1846 D. JUL. 22, 1853

JOSEPH CECIL B. OCT. 25, 1848 D. JUN. 20, 1854

FANNY B. M. JOHN HUNTER

BELLE B. M. FRANK BATTEY

EDITH B. M. WRIGHT HUNTER

AIMEE

GRATZ COHEN B. SEP. 24, 1881 D. JUN. 1, 1932

OCTAVUS B. M. PING

ETHEL B. M. FERGIUS HALL

SALVADOR

OCTAVUS PHILLIPS B. AUG. 20, 1884 D. NOV. 12, 1885 INF.

MARION (MIRIAM) GRATZ B. NOV. 12, 1883 D. JUN. 22, 1953 UNM.

OPHELIA K. B. NOV. 14, 1886 D. SEP. 16, 1873, BRUNSWICK, GA. UNM.

JAMES T. B. OCT. 15, 1882 D. APR. 4, 1887

HAMMOND FRANK O'DRISCOLL LENORA JEANNE BELLE AIMEE HORACE ALICE EDITH WILLIAM HENRY JOHN HAROLD EDITH

COHEN VIII (2)

JOHN M. SHEFTALL

ISAAC COHEN
B. 1748
D.C.A. 1787
(SEE PRECEDING P.)

JUDITH LYON
B. 1748
D.NOV. 1816, CH.

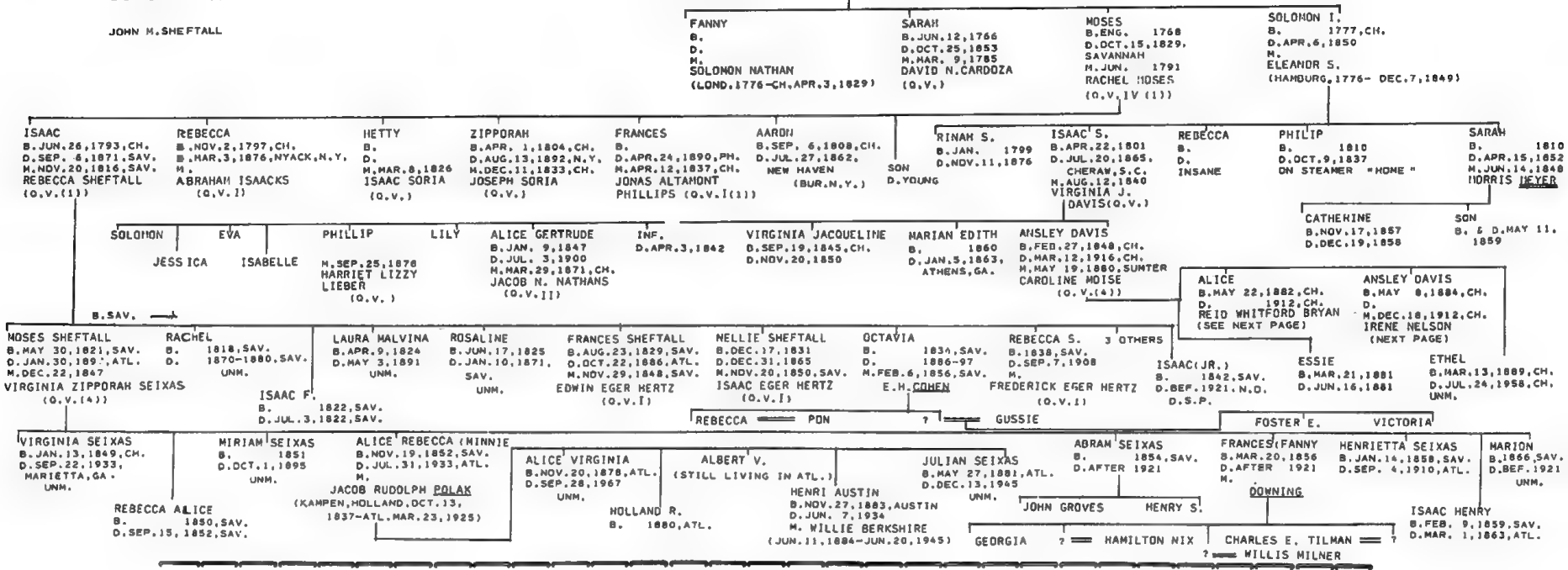

COHEN VIII (3)

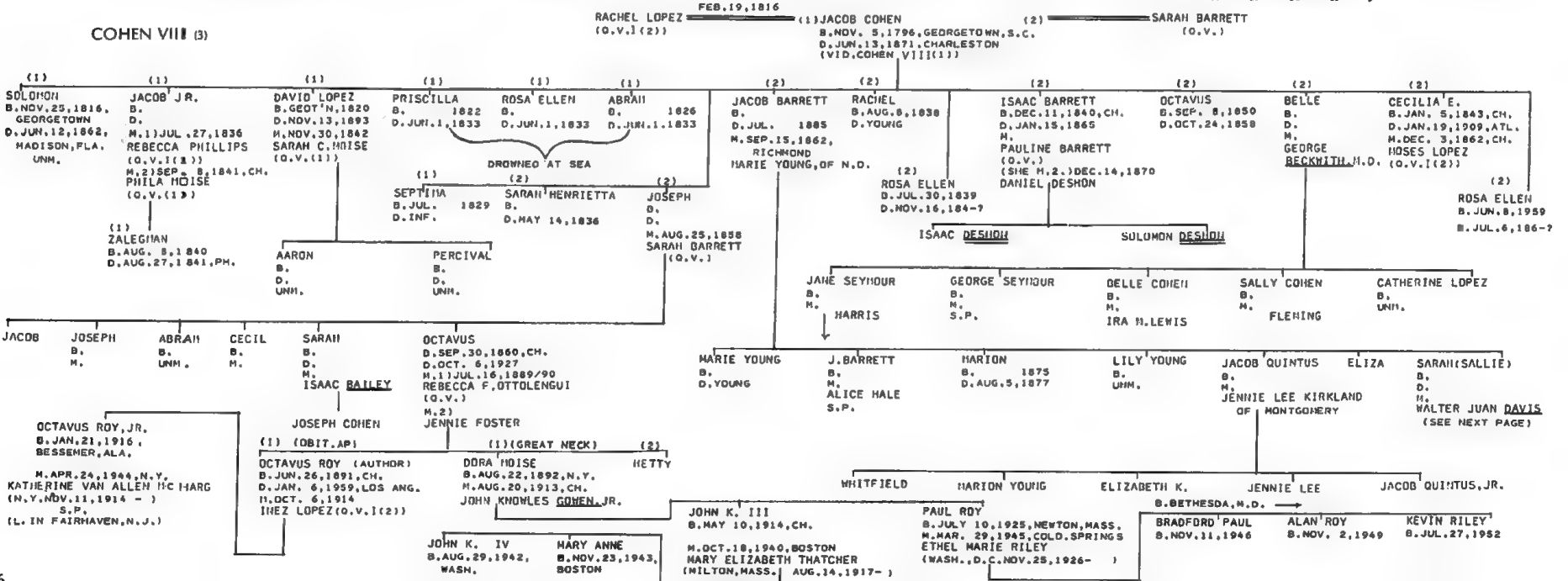

ANSLEY DAVIS COHEN
(SEE PRECEDING PAGE) CAROLINE HOISE
(O.V. (4))

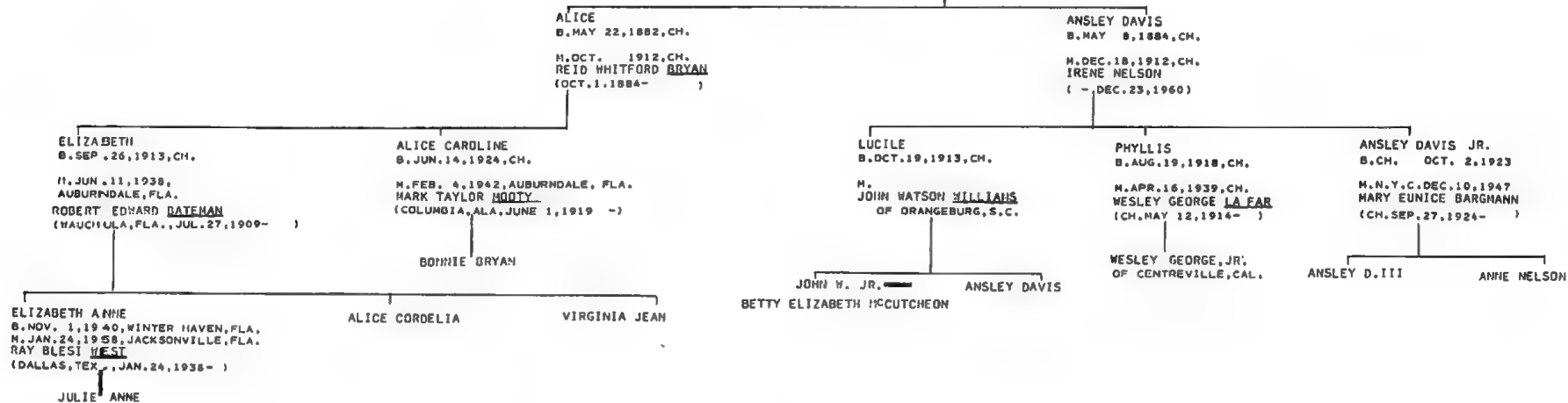

SARAH (SALLIE) COHEN
(SEE PRECEDING PAGE) WALTER JUAN DAVIS

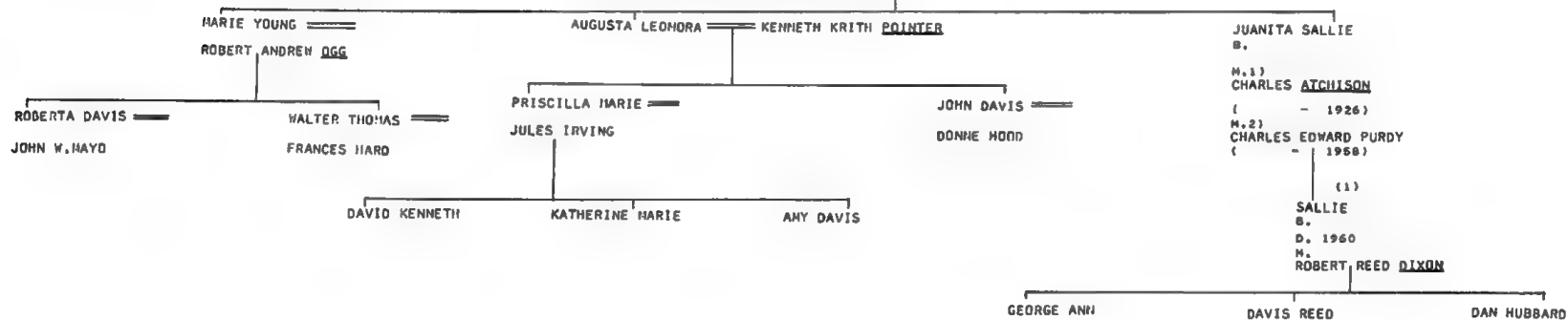

COHEN IX (S.C.)

CHARLES WHITEHEAD
ELIAS FAMILY BIBLE
KRAUS-SANDOR COLL.
ELZAS MSS.
ELZAS M.N.
ELZAS O.J.C.
D.A.R. LINEAGE BOOKS
SHEARITH ISRAEL REC.
FLORENCE ABRAHAMS

AARON NATHAN COHEN
B. LOND. 1777
D. COLUMBIA, S.C. AUG. 19, 1862

RACHEL
B. AUG. 1790
D. NOV. 3, 1851/0

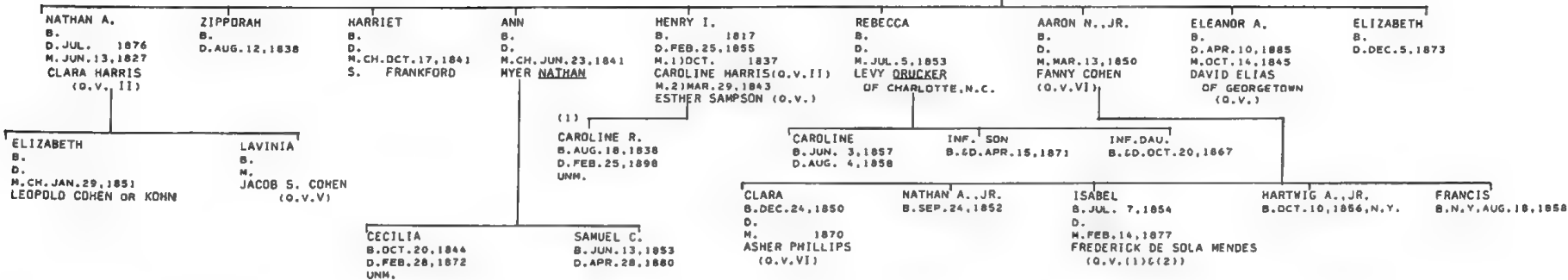

COHEN X (1) (CH. & N.Y.)

AARON LOPEZ MSS. (JRM)
ABBOT L. MOFFAT
KORN N.O.
B'NAI JESH. REC.
A. J. D., P. 183
HAROLD MOISE
PAJMS V. 27, P. 167
KRAUS MS.
WILL OF JACOB JACOBS (JRM COLL.)
ELZAS MSS.
ELZAS O.J.C.
ELZAS M.N.
EMANUEL FAM. REC. (JRM COLL.)
SHEARITH ISRAEL REC.
MOORE, ETC. - MEN OF THE SOUTH

URI (COHEN)

GERSHON (1748) m. REBECCA SARZEDAS (O.V.) (1779)
D. CH. JAN. 24, 1802
CAME TO AMERICA, 1772

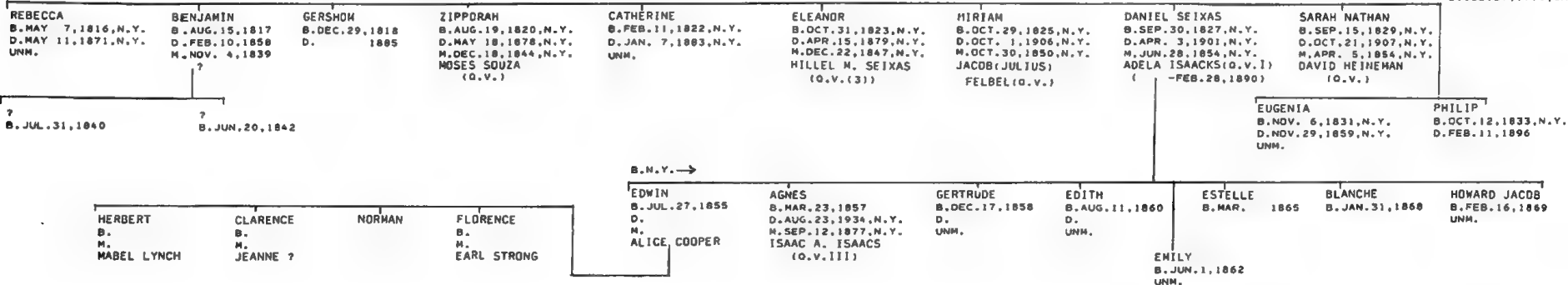
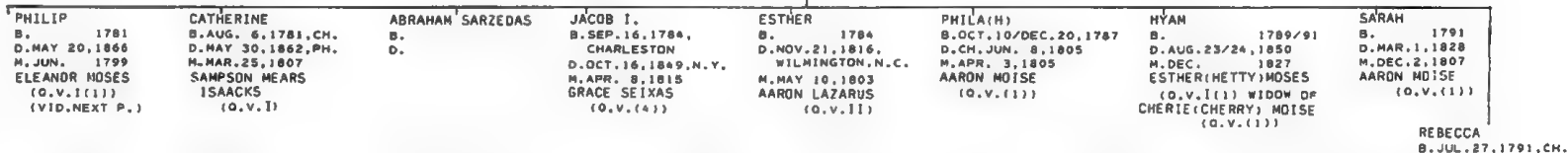

PHILIP COHEN
B. 1781
D. MAY 20, 1866
(VID. PRECEDING PAGE)

ELEANOR MOSES
(O.V. I (1))

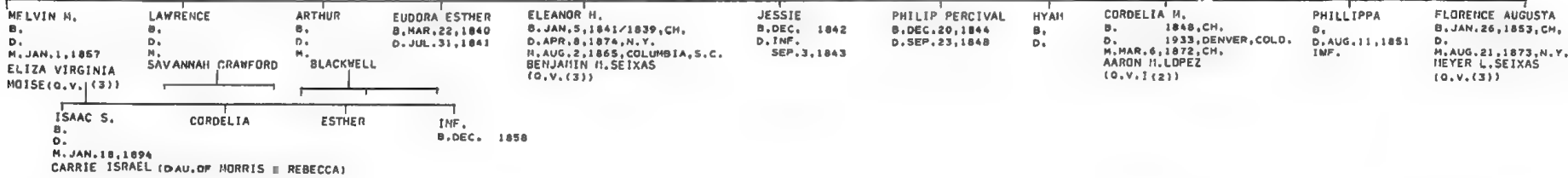
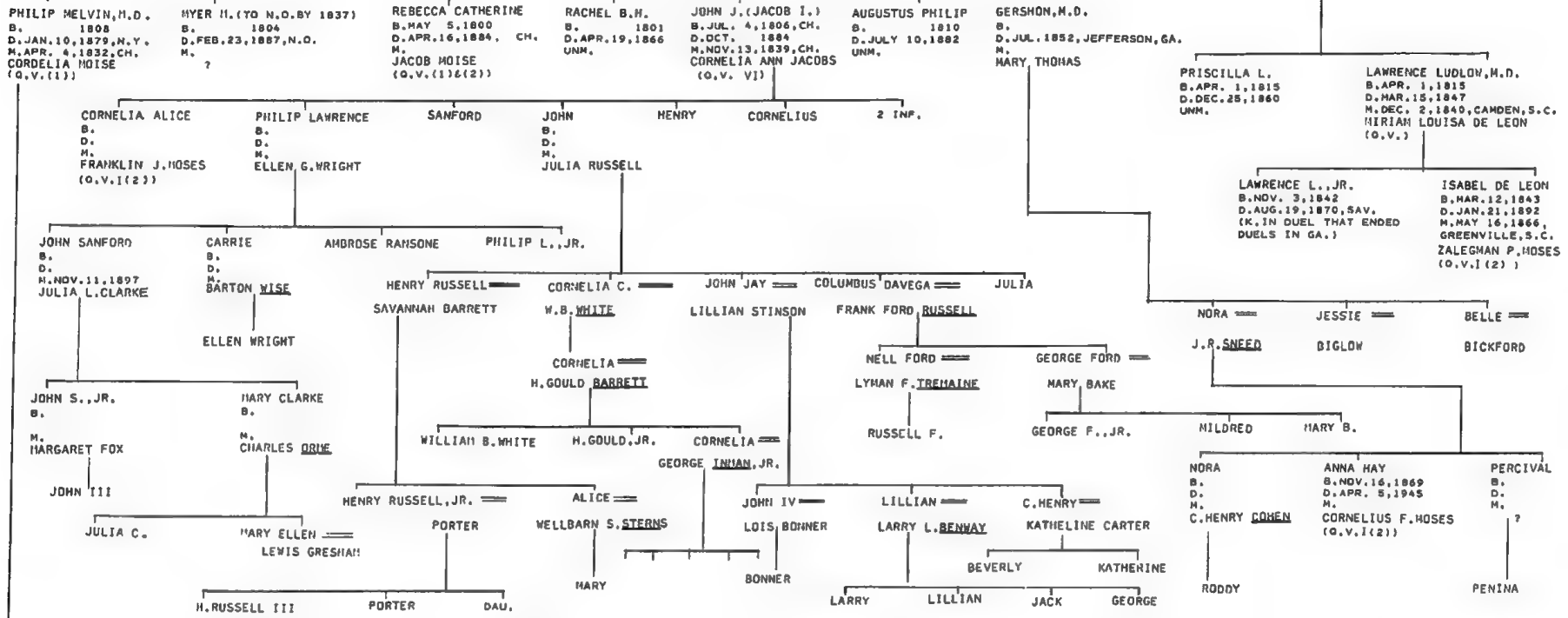

ELZAS D. J. C., P. 5, 6
KORN-THE JEWS & NEGRO SLAVERY...
ROTH-RISE OF PROVINCIAL JEWRY
CHATHAM CO., GA., HARR. REC.

MOSES COHEN OF BRISTOL, ENG.

COHEN XI

JON STEDMAN (1850 CENSUS)
B'NAI JESH. REC.
GRINSTEIN P. 590

COHEN XII

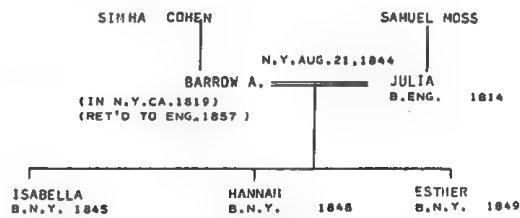
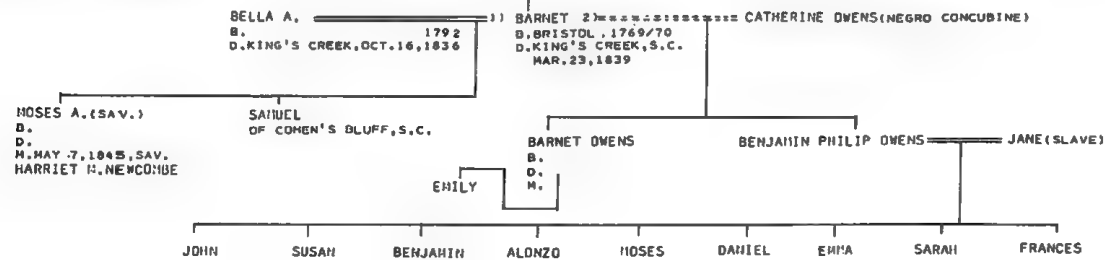

COLEMAN

DAR LINEAGE BOOKS
FLORENCE ABRAHAMS
R.S.MOH.REC.

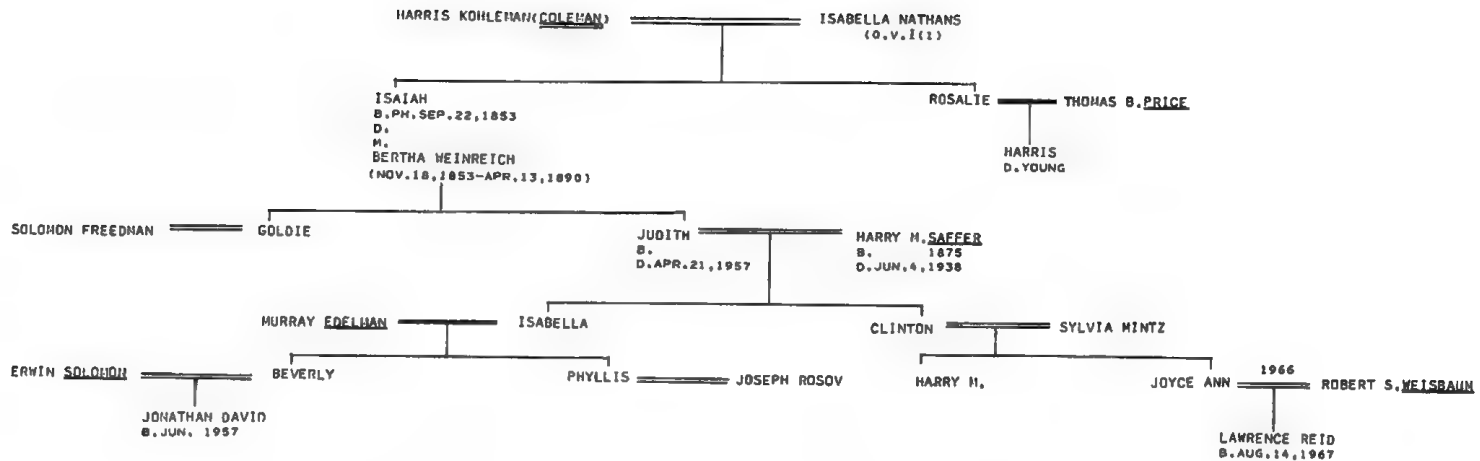

CONTENT

JON STEDMAN (1850 CENSUS)
B'NAI JESH, REC.
KRAUS-SANDOR COLL.
DAVIS-HIST. OF R.S.
SUPPLE GEN.
OBIT. IN N.Y. TIMES 2/9/1944

CONTENT OF HOLLAND

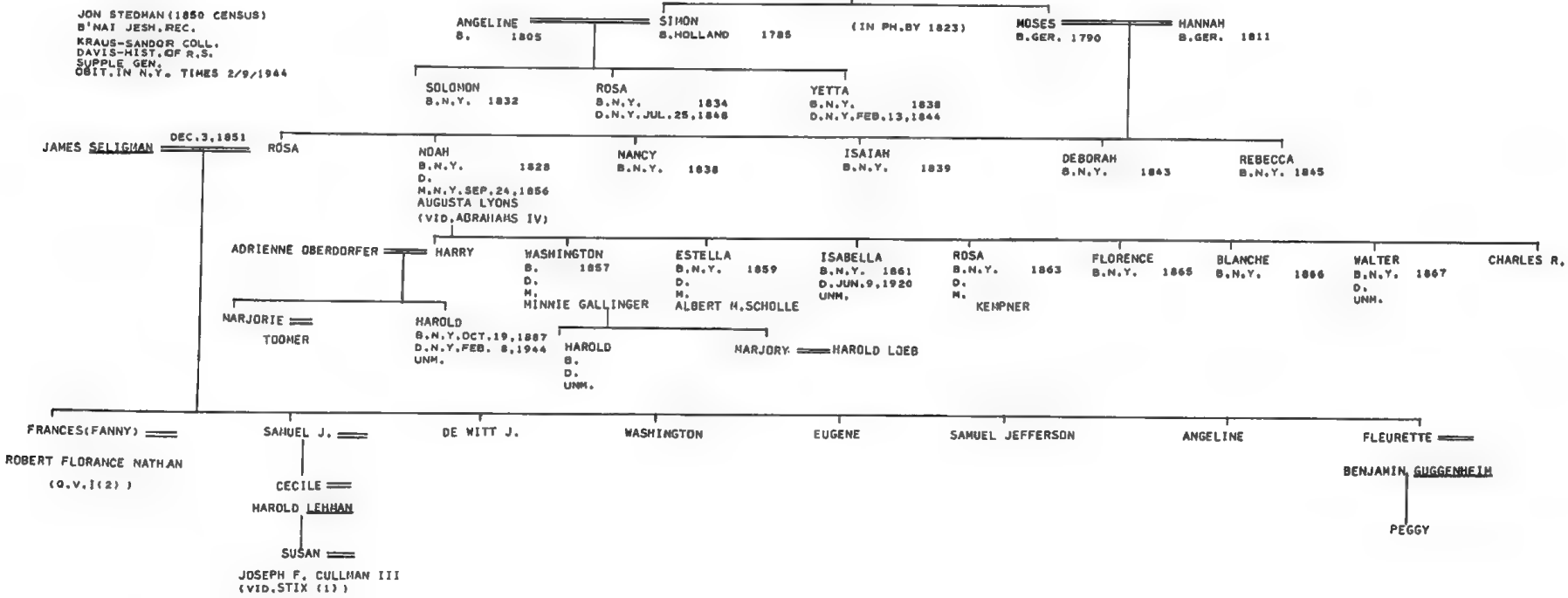

KORN N.O.
B'NAI JESH.REC.
DAVID J.SLENKER
JULIEN D.SAKS
KRAUS-SANDOR COLL.
HICKVE ISRAEL REC.
JRW COLLECTION
SHEARITH ISRAEL REC.
SPRUCE ST.CEM.
SAMUEL-YATES GEN.
FLORENCE ABRAHAMS
MYER SOLIS-COHEN

JACOB NATHAN(S)

ADELINE(DR ADELIA)
OF AMSTERDAM

(1)

DAVID CROMELIEN
B.HOLLAND, APR. 3, 1780/1
D.PH. DEC.28, 1843

(2) CA.1811

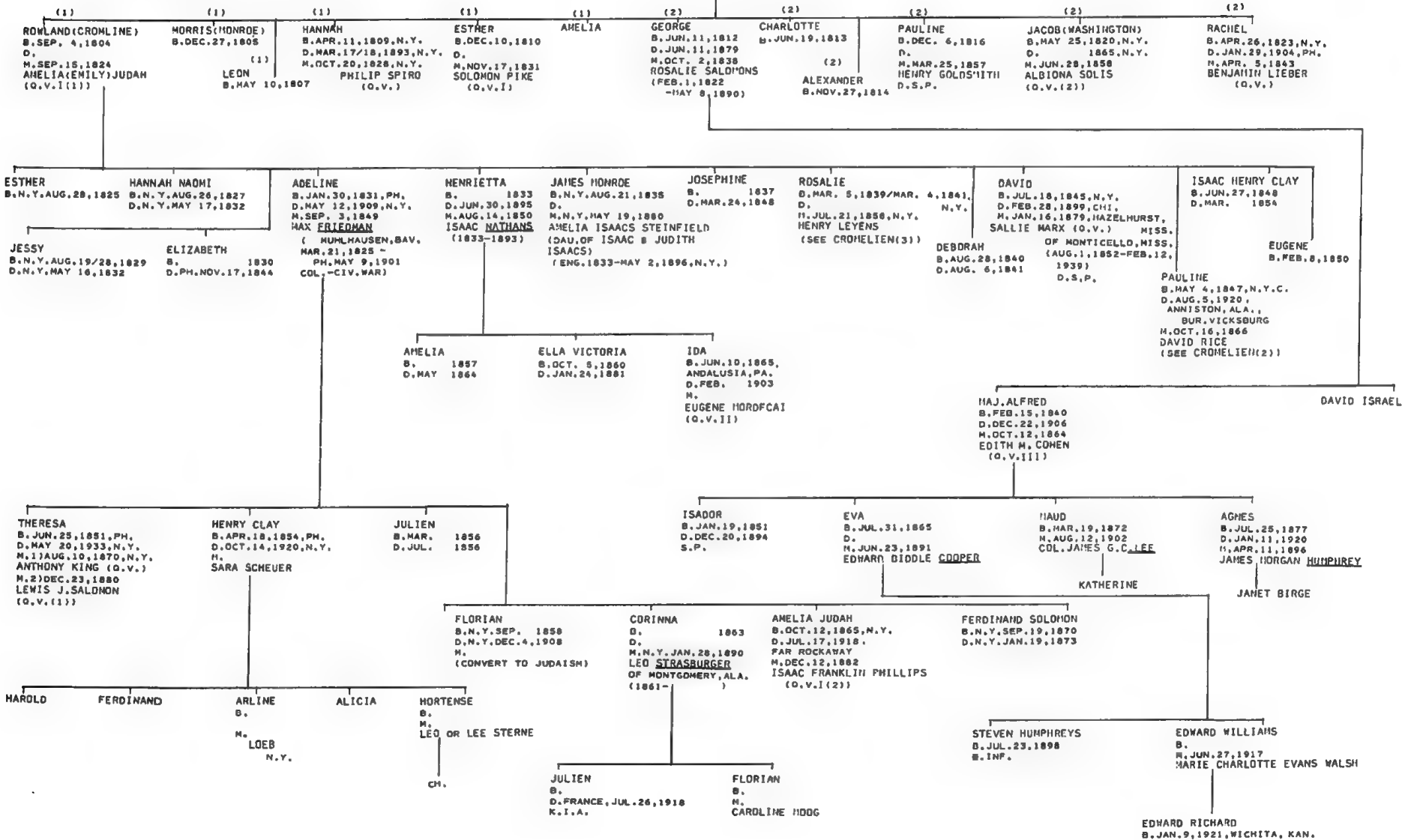
HENRIETTE
B.LEYDEN, AUG.25, 1788/9
D.PH. AUG.10, 1858/9

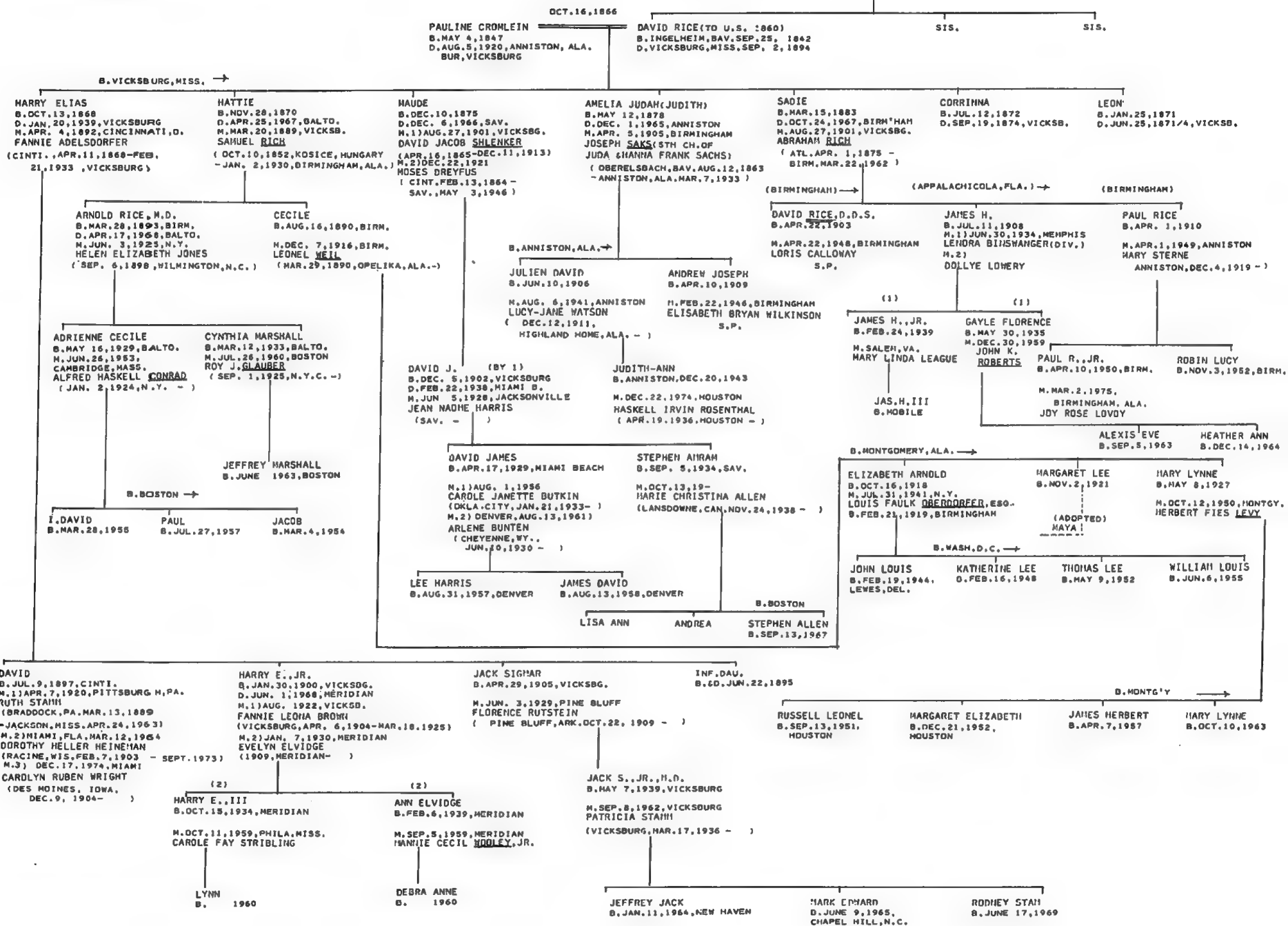

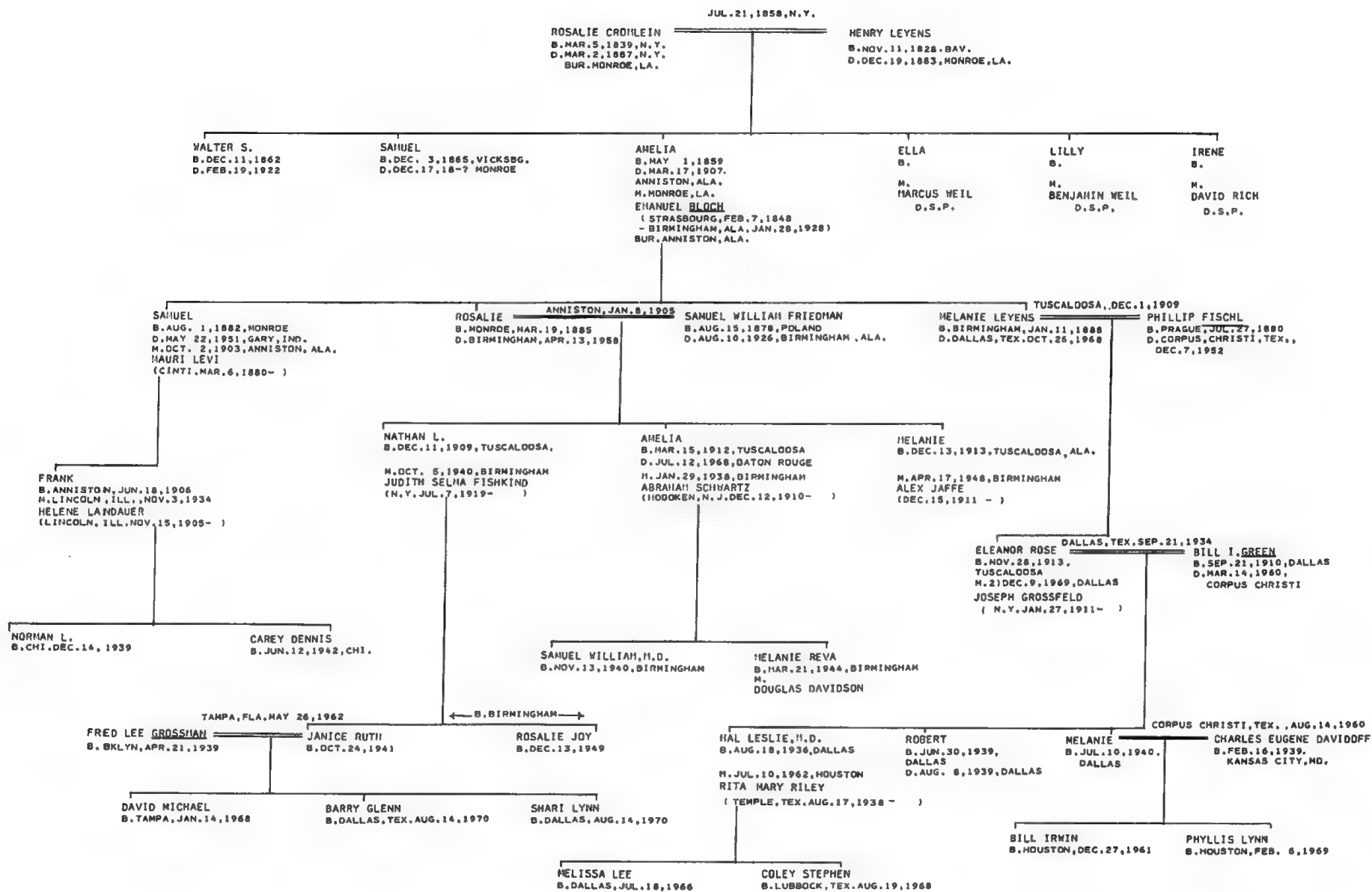

DA COSTA I

BEVIS MARKS REC.
SHEFTALL MSS.
PAJMS 19, PP. 51, 76
38, P. 98F.
KRAUS-SANDOR COLL.
ANCKER DAR LINEAGE
ELZAS-JEWS OF S.C., PT. 2, P. 54
D.J.C.
M.N.
WILLS OF LEAH PIMENTA, SARAH
DA COSTA, AND MOSES MOLINA
U.S. 1790 CENSUS
REZNIKOFF, P. 48
A.J.D., PP. 53 F., 439
E.S. SALLEY-M.N.
KORN-JEWS OF MOBILE, N.O.
MISC. VI

ISAAC DA COSTA

JACOB COHEN

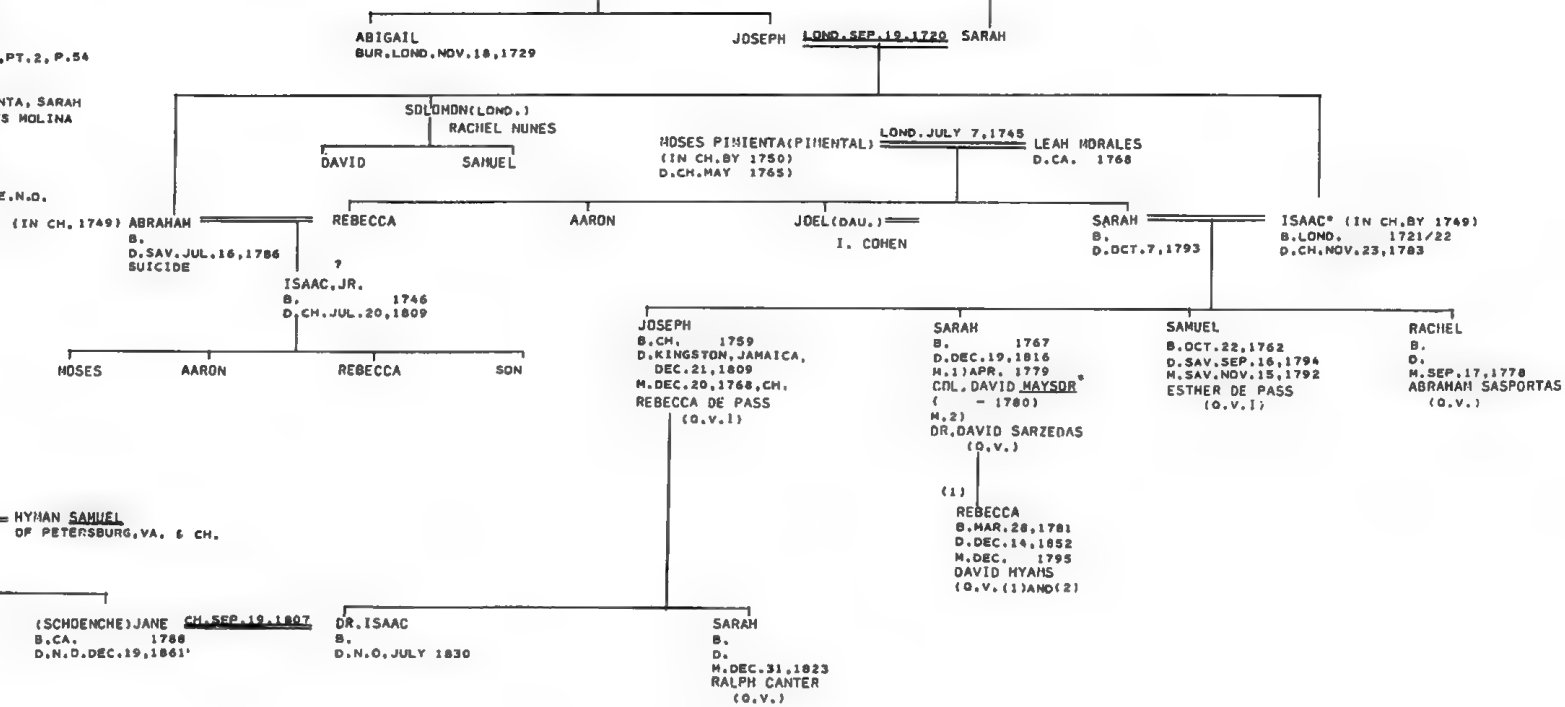

AARON ALEXANDER
OF HAMBURG, GER.

REBECCA and HYMAN SAMUEL
OF PETERSBURG, VA. 6 CH.

SAMUEL
B. PETERSBURG, VA. 1790

(SCHOENCHE) JANE (CH. SEP. 19, 1807;
B. CA. 1788
D. N. D. DEC. 19, 1861')

DR. ISAAC
B. D. N. O. JULY 1830

SARAH
B. D. DEC. 31, 1823
RALPH CANTER
(O.V.)

* ESTABLISHED REVOLUTIONARY ANCESTOR

DA COSTA II

E. N. A.
MRS. F. I. VANDERCOOK
PAJMS 42, P. 278
32, P. 56

(ISAAC) DA COSTA OF PORTUGAL

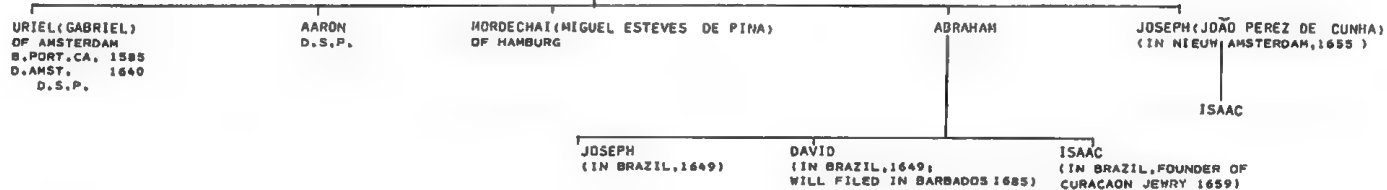

JRM COLL.
ELZAS MSS.
O.J.C.
M.N.
HAROLD NOISE

(TO CH. CA. 1788)

MOSES DAVEGA
B. CA. 1760
D. CH. JUL. 27, 1833

SOL
D. GIBRALTAR, 1771
D. CH. JAN. 19, 1828

DAVEGA

ISAAC
B. DEC. 25, 1796
D. JAN. 21, 1835 AT SEA
M. JUN. 28, 1815, CH.
GRACE LABATT
(O.V.)

RACHEL J.
B. 1801
D. AUG. 15, 1865, MONTREAL
(BUR. CH.)
M. JUN. 28, 1815, CH.
ISAAC BARRETT
(O.V.)

← DOUBLE WEDDING →

MOSES
B. APR. 2, 1816
D. MAR. 19, 1836

DAVID
B. FEB. 2, 1818
D. CHERAN, S.C.
SEP. 1, 1822

BENJAMIN FRANKLIN
B. JUL. 4, 1819

ABRAHAM
B. NOV. 25, 1823
D.
M. JUL. 2, 1857
ELIZA J. HCCURE

ISAAC (LAWYER CH., N.Y.)
B. JUN. 28, 1825
D.
M. CH. SEP. 9, 1857
MRS. SARAH J. MOSES

COLUMBUS, N.D.
B. DEC. 23, 1829/30
D. JUL. 14, 1862
II.

AMANDA
B. AUG. 14, 1831
D. OCT. 24, 1838

DORA
B.
D.
M.
ISAIAH EZRA MOSES
(O.V. III(1))

SELINA
B.
D. NOV. 7, 1886
M. OCT. 12, 1881, CH.
HERMAN LEIDLDOFF

SOLOMON BARRETT
B. FEB. 5, 1865, N.Y.
D. N.Y.
M. MAY 1886, N.Y.
CORDELIA ALICE SEIXAS
(O.V. (3))

ISAAC DAVEGA
B.
D.
M.
REBECCA LOUISE MOSES
(O.V. III(3))

ABRAM

MARIE

SADIE DELMONTE

BRYAN FORSTER

HARRY SIDNEY
B. JUL. 19, 1887, N.Y.
M. JAN. 1, 1914, N.Y.
DOROTHY WILHELMINA ROTH
(OCT. 9, 1895, BROOKLYN -)

MARIE LOUISE
ROBERT H. ROSS

FRANCES CELESTINE
VINCENT CODLEY

BYRON DAVEGA

BYRON R.

VINCENT, JR.

ROSLYN LOUISE
MORTON H. WEIDENFELD
(WIDEN)
OF FOREST HILLS, N.Y.

VIRGINIA
ROBERT SILVERS
OF WESTBURY, N.Y.

RICHARD
HOPE WEISS OF CAL.

RICHARD SON

MORTON D. ANDREW GERALD

DAVID D. RONALD JUDITH

SONOMA, CAL.

GROTON, CONN.

MYSTIC, CONN.

DOROTHY
B. NOV. 6, 1914, BROOKLYN
M. JUN. 16, 1940, N.Y.
WILLIAM BECKER
(NEWARK, N.J., JUN. 22, 1918 -)

RUTH
B. APR. 2, 1918, N.Y.
M. 11 JUN. 26, 1940, N.Y.
DAVID BOLTON (BOLSTEIN)
(NOV. 12, 1913 -) DIV.
M. 2 JAN. 6, 1951, GROTON, CONN.
GILMAN CARLTON GUNN, JR.
(APR. 20, 1923, WOODSTOCK, VT. -)

PATRICIA ANNE
B. JUN. 19, 1924, N. CALDWELL, N.J.
M. DEC. 15, 1945, N.Y.
GEORGE EDWARD BUTCHER, JR.
(OCT. 8, 1919, KENOVA, W. VA. -)

SANDRA JOAN NANCY GWEN JEFFREY WILLIAM

(1) DAVID BARRETT
B. MAR. 17, 1943, WASH. D.C.

(1) MICHAEL DEAN GUNN
B. MAR. 14, 1944, HALIFAX, N.S.

(1) BRUCE DENNIS (BERT) GUNN
B. SEP. 14, 1946, NEW ROCHELLE, N.Y.

(2) GLEN HARRY
B. SEP. 20, 1957,
NEW LONDON, CONN.

CHRISTINE LYNN

GREGORY SCOTT

THOMAS JAY

DAVID (1)

FLORENCE ABRAHAMS
FEDERAL ST. CEM.
MICH. JEW. HIST. JUN. 1963, P. 156F.
MRS. E. MILLER
KRAUS-SANDOR COLL.
JR MARCUS COLL.
ELZAS MISS.
MALCHELOSSE-JUIFS CANADIENNE
SHEARITH ISRAEL REC.
HART FAMILY REC. (MS.AJA)
ABRAHAM JOSEPH DIARY

EZEKIEL SAMUEL OF R. I.

(IN MONTREAL BY 1763)

LAZARUS DAVID
(ELEAZER B. DAVID)
D. SWANSEA, WALES, 1734
D. MONTREAL, OCT. 22, 1776

PHOEBE SAMUEL
B. ARNHICK, ENG. 1736/7
D. MONTREAL, OCT. 10, 1786

R. I. 1761

(WINDSOR, ONT.)

BRANDELE ABIGAIL (BRANDY)
B. MAY 13/25. 1762, N.Y.
D. JUN. 19, 1801, MONTREAL
M. 1778
ANDREW HAYS
(O.V. (4))

CAPT. DAVID (ON BRIT. ARMY WAR OF 1812)
B. MONTREAL, OCT. 14, 1764
D. MONT. NOV. 30, 1824
M. UNM.

SAMUEL
D. OCT. 22, 1766
D. JAN. 3, 1824/FEB. 3, 1822
M. SEP. 5, 1810
SARAH HART
(O.V. (1))

LT. MOSES (WAR OF 1812)
B. OCT. 4, 1767
D. SEP. 26, 1814,
SANDWICH, ONT.
M. 1812
CHARLOTTE HART
(O.V. (1))

FRANCES (FANNY)
B. AUG. 6, 1770
D. 1838/9
M. SEPT. 3, 1793
LT. MEYER MICHAELS (WAR OF 1812)
(VID. HAYS (1))

COL. ELEAZAR
B. JUN. 8, 1811, MONTREAL
D. FEB. 1, 1887,
COAT COOK, P.O.
M.
ELIZA LOCK WALKER
(SEE DAVID (2))

AARON HART, J.D.
B. MONT. OCT. 9, 1812
D. NOV. 5, 1882
M. OCT. 12, 1836
CATHERINE JOSEPH
(O.V. (1))

LT. MOSES SAMUEL
B. NOV. 15, 1816
D. FEB. 2/3, 1854
M. NOV. 4, 1846, N.Y.
GERTRUDE VIRGINIA
JOSEPH (O.V. (1))

PHOEBE
B. SEP. 19, 1818, MONT.
D. APR. 9, 1903, N.Y.
M. NOV. 21, 1849
AARON EZEKIEL HART
(O.V. (1))

FRANCES (FANNY) MICHAELS
B. OCT. 6, 1820
D. FEB. 28, 1844
M. JAN. 4, 1842
JONATHAN THEODORE HART
(O.V. (1))

SOPHIA
B. JUL. 11, 1822
D. SEP. 3, 1866
M. NOV. 18, 1846,
MONTREAL
ABRAHAM JOSEPH
(O.V. (1))

SAMUEL
B. JUL. 12, 1823
D. JUL. 23, 1823
YOUNGEST

MOSES ELEAZER
B. MAR. 10, 1813
D. OCT. 1, 1892
M. (1) NOV. 15/25, 1846
ROSINA FLORENCE (O.V. (1))
M. 21 1872
ADA ABRAHAM'S
OF BRISTOL, ENG.

B. MONTREAL →
AUGUSTUS
B. DEC. 14, 1847
D. FEB. 7, 1850, ST. JOHNS,
LOWER CANADA

LAURENS JOSEPH
B. DEC. 29, 1848
D. SAN RAFAEL, CAL. 1878
M. (ON DEATH-BED) OCT. 18, 1878
JENNIE BETTY

EDITH
B. OCT. 5, 1850, ST. JOHN'S, CAN.
D. AUG. 29, 1864, N.Y.

ISOLINE
B. OCT. 3, 1853,
ST. JOHN'S, CAN.
D. JAN. 1, 1944, N.Y.
M. JUN. 25, 1873, N.Y.
LAFAYETTE GRAFF
OF FT. WAYNE, IND.

(1)
CHARLOTTE
B. 1848
D. 1853

(1)
NINA
B. DEC. 1847, LOND.
D. DEC. 8, 1853,
MONTREAL

(1)
ARTHUR MEREDITH (FLORENCE)
B. OCT. 5, 1849
D. UNM.

CLARENCE LAFAYETTE
B. N.Y. SEP. 3, 1874
M. JUL. 12, 1899
FLORENCE BRIMSON OF TORONTO
(OPERA SINGER "MME. TORONTO")
S.P.

STANLEY
B. AUG. 18, 1876
M.
ELLA HAAS OF ST. LOUIS

GERTRUDE VIRGINIA
B. N.Y. MAY 24, 1915
M. N.Y. MAR. 3, 1946
GERALD E. HERRNSTADT

JOHN DAVID

ROGER STANLEY

LESLIE
B. OCT. 21, 1880
M.
IRENE BRANDON
S.P.

MONTREAL

B. THREE RIVERS →

(MOSES) EDHUND
B. MONT. NOV. 30, 1844
D. JAN. 25, 1846

FANNY
B. APR. 13, 1846
D. FEB. 22, 1907
UNM.

ROBERT SULLIVAN (SULLY)
B. JUL. 16, 1847
D. OCT. 14, 1914
M. MAY 26, 1885
FRANCES J. LITTLE
DAU. OF WATSON LITTLE
OF L'ORIGINAL, QUE.

ESDAILE COHEN
B. FEB. 22, 1849, MONT.
D. MAY 29, 1890, CROMA, N.Y.
M. MAY 26, 1880 ON DEATHBED
FANNY E. HERCHINGER
N.Y.C.
DAU. OF S. HERCHINGER

JOSEPH
B. MONT. AUG. 1, 1850
D. INF.
AUG. 9, 1850

HARLINE
B. JUL. 17, 1851
D. DEC. 29, 1927
M. JUN. 5, 1907
LUDWIG RUBEN
(METROPOLITAN OPERA
IMPRESARIO) D.S.P.

SAMUEL
B. AUG. 8, 1837,
MONTREAL
D. OCT. 22, 1883,
BROOKLYN
M. MAR. 19, 1867, N.Y.
CLAUDINE JOSEPH
(O.V. (1))

HENRY
B. SEP. 11, 1838
D. INF.
SEP. 16, 1839

SARAH HATILDA
B. JUN. 14, 1842
D. FEB. 15, 1921, MONT.
M. MAR. 21, 1876
DAVID A. HART
(O.V. (1))

TUCKER
B. OCT. 5/6, 1843, 3 RIV.
D. OCT. 5. 1891, YONKERS
M. APR. 3, 1872, N.Y.
(MINNIE) MIRIAM PHILLIPS
(O.V. (2))

MONTE DAVID
B. FEB. 6, 1840, MONTREAL
D. MAY 31, 1874, MONTREAL

B. ST. LOUIS
ARTHUR
B. MAY 9/8, 1870, ST. LOUIS
D. MAY 5/7, 1903, N.Y.
UNM.

ARTHUR MONTROSE
B. NOV. 29, 1868
D. INF. DEC. 2, 1868

CATHERINE GERTRUDE (KITTY)
B. NOV. 24, 1872, MOBILE
D. JAN. 7, 1945, N.Y.
M. APR. 28, 1892, N.Y.
FRANK Q. HENDRICKS
(O.V. (1))

VIRGINUS ANDREW
B. NOV. 25, 1873, MOBILE
D. INF.
JUN. 13, 1874

CLAUDE
B. MAR. 13, 1875, N.Y.
D. INF.
AUG. 12, 1875

ELIZABETH
B. JAN. 16, 1878, N.Y.
D. INF.
APR. 15, 1878

CARYL DOUGLAS BRADSHAW
B. JUL. 26, 1886,
L'ORIGINAL, QUE.
D. INF. SEP. 28, 1886

GWENDOLINE LILLIAN
B. JAN. 16, 1886,
BROCKVILLE, QUE.
M. APR. 6, 1912
GUSTAVE A. VORSCHER

WATSON CUTHBERT
B. APR. 7, 1890,
BARRIE, ONT.
D. (1) DOROTHY HAN
M. 21 ADA (1937)

HAROLD SPRY
B. OCT. 17, 1892
M.
GLADYS
CUTHBERT OF SEPT ISLES,
M.

HENRY (HARRY) PERCY
B. FEB. 9, 1873, N.Y.
D. FEB. 7, 1932, N.Y.
M. JUL. 17, 1924, N.Y.
META HART LEVIN
(O.V. (1))

JONAS HILLARD
B. NOV. 22, 1874, N.Y.
D. MAY 3/JUL. 19, 1875,
CATSKILL, N.Y.
UNM.

HABEL
B. MAY 3, 1876, N.Y.
D. JUN. 22, 1920, N.Y.
UNM.

BERTRAM
B. JUN. 11, 1879
N.Y.
M. 11
M. 2

EDNA
B. OCT. 22, 1880
D. OCT. 27, 1933
N.Y.
UNM.

WALTER PHILLIPS
B. APR. 28, 1886, N.Y.
M. JUN. 28, 1911
EDITH OLLENDORF
DAU. OF JACOB OLLENDORF

ESTHER ROSALIE
B. OCT. 2, 1890, N.Y.
M. CHARLES ASCHMAN

SON
MILDRED
TUCKER HENRY
B. JAN. 22, 1915

ROBERT HARVIN
B. APR. 1, 1916

ARTHUR MILLARD
B. FEB. 4, 1920

DAVID (2)

CAPT. CHARLES WALKER

COL. ELEAZER DAVID
B. JUN. 8, 1811
D.
(ABOVE)

ELIZA LOCK WALKER
B. 1811/2
D. FEB. 1, 1887, COAT COOK, P.O.

MAJ. HARRIS

GERTRUDE SOPHIA
B. APR. 6, 1840
D. M. APR. 4, 1861
CAPT. THOMAS HOWARD

ARTHUR MAHARD
B. JAN. 29, 1842,
MAHARONECK, N.Y.
D. AUG. 18, 1869
UNM.

GOLDA ADELA
B. JAN. 13, 1846, PISA, ITALY
D. M. APR. 30, 1866
JOHN S. DYDE

CARLO GRIMALDI
B. AUG. 5, 1847, PARIS, FR.
D. INF. JUL. 5, 1848, ST. CROIX

HILDA EDNA
B. OCT. 13, 1850, MONTREAL
D. MAR. 24, 1858, MONTREAL

ALEYDA ELIZA MINIFRED
B. JUL. 29, 1852, MONTREAL
O. MAR. 3, 1917
M. FEB. 20, 1873
JOHN J. FISKE

4 SONS
5 DAUS.

ANY LILLIAN ERNESTINE
B. OCT. 8, 1854, MONT.
D. MAR. 31, 1858

ELIZA EVELYN (MINNIE)
B. APR. 13, 1860

T. PALMER
4 SONS
2 DAUS.

ERNEST WILFRED
B. OCT. 29, 1843,
NEW ROCHELLE, N.Y.
D. NOV. 26, 1862
MONTREAL

6 SONS
2 DAUS.

FLORENCE
HARRY THOMSON
HIGGINBOTHAM

MARIETTA BEATRICE
B. FEB. 28, 1849, ST. THOS.
D. MAR. 19, 1858, MONTREAL

(? DEC. 1868 - JUL. 10, 1905)

B'NAI JESH, REC.
 JON STEDMAN
 KRAUS-SANDOR COLL.
 SHEARITH ISRAEL REC.
 KORN N.O.

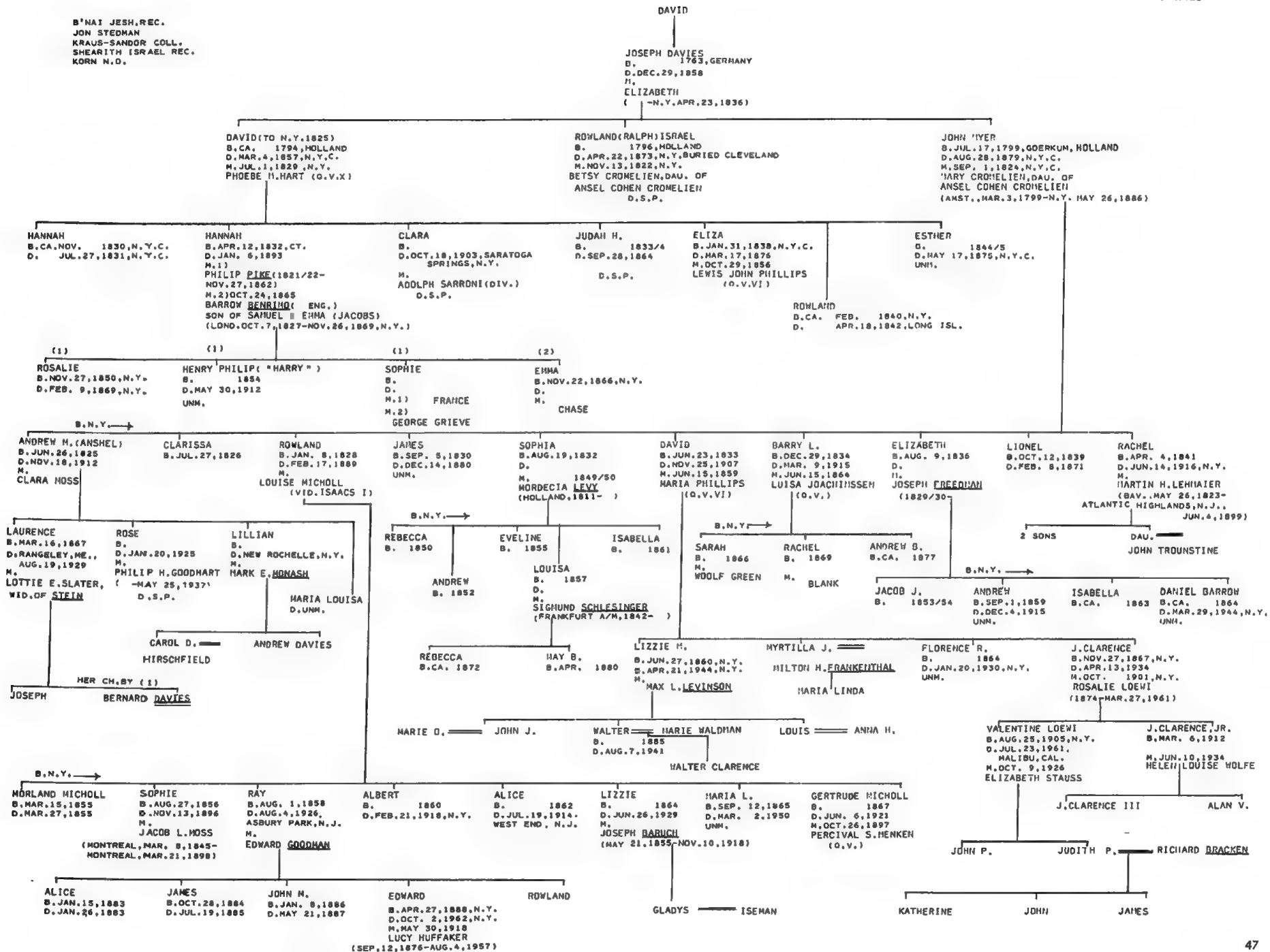

DAVIS I (1) (VA.)

BETH SHALOME KEY.
BETH AMADAN KEY.
EDGAR M. KAHN
MAXWELL WHITEMAN
PAJHS 33,P.6
KRAUS-SANDOR COLL.
FLORENCE ABRAHAMS

JON STEDMAN(1850 CENSUS)
E. H. P. 290F.
AMY STEWART HSS. (AJA)
MARKS FAMILY REC. (AJA)
B'NAI JESH. REC.

FAMILY HIST. OF BENJAMIN MORDECAI (AJA)
ELZAS HSS.
M.N.
SHEARITH ISRAEL REC.
HAROLD MOISE
SUMTER CEM.

DAVID DAVIS
B. LOND. 1750/65
D. 1833

ESTHER MORDECAI
B. 1744
D. JULY 26, 1844

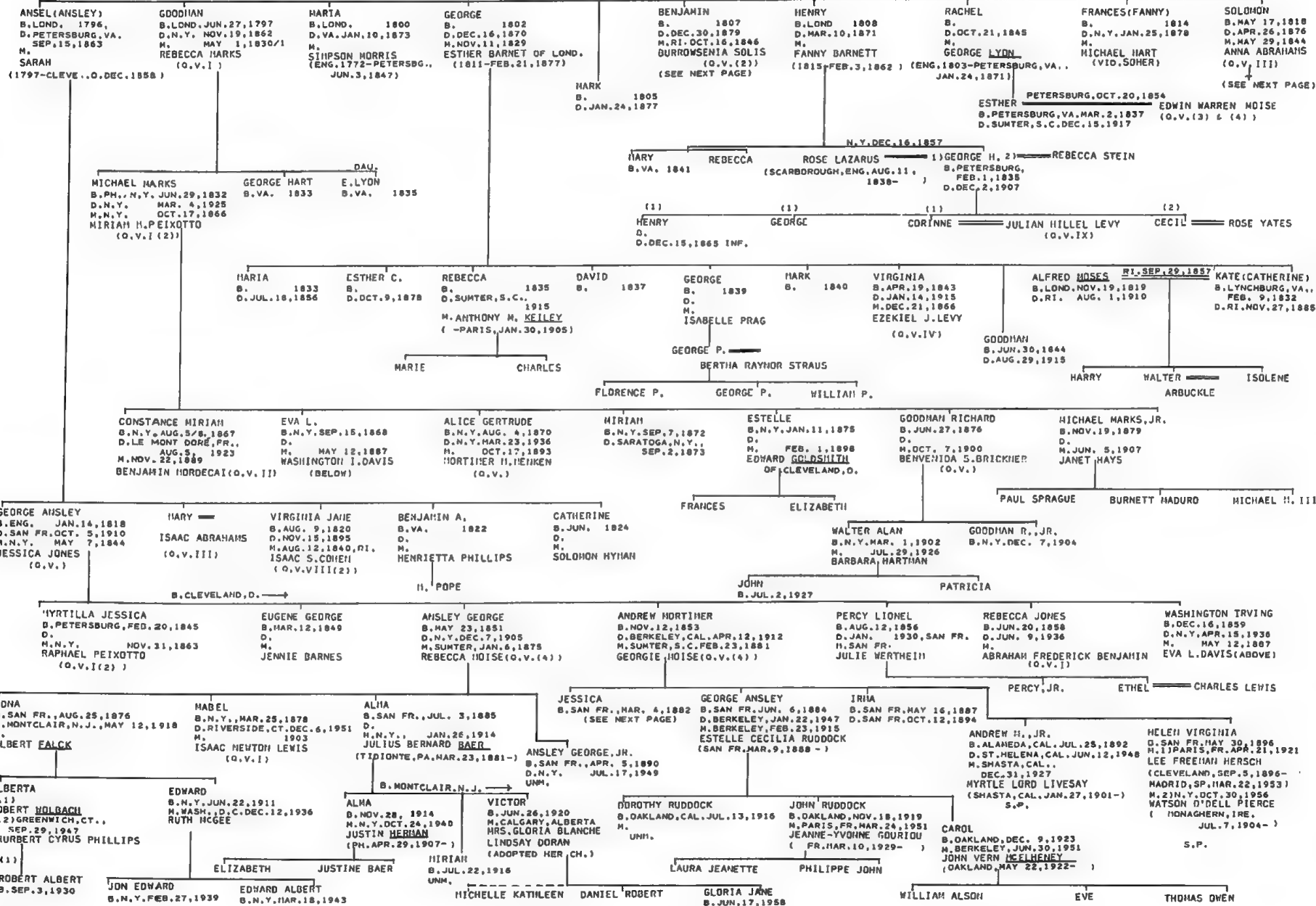

(SEE PRECEDING PAGE)

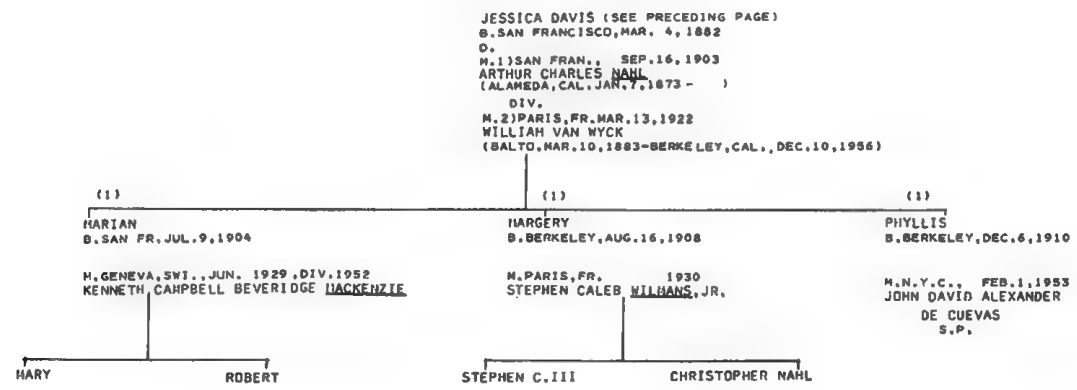
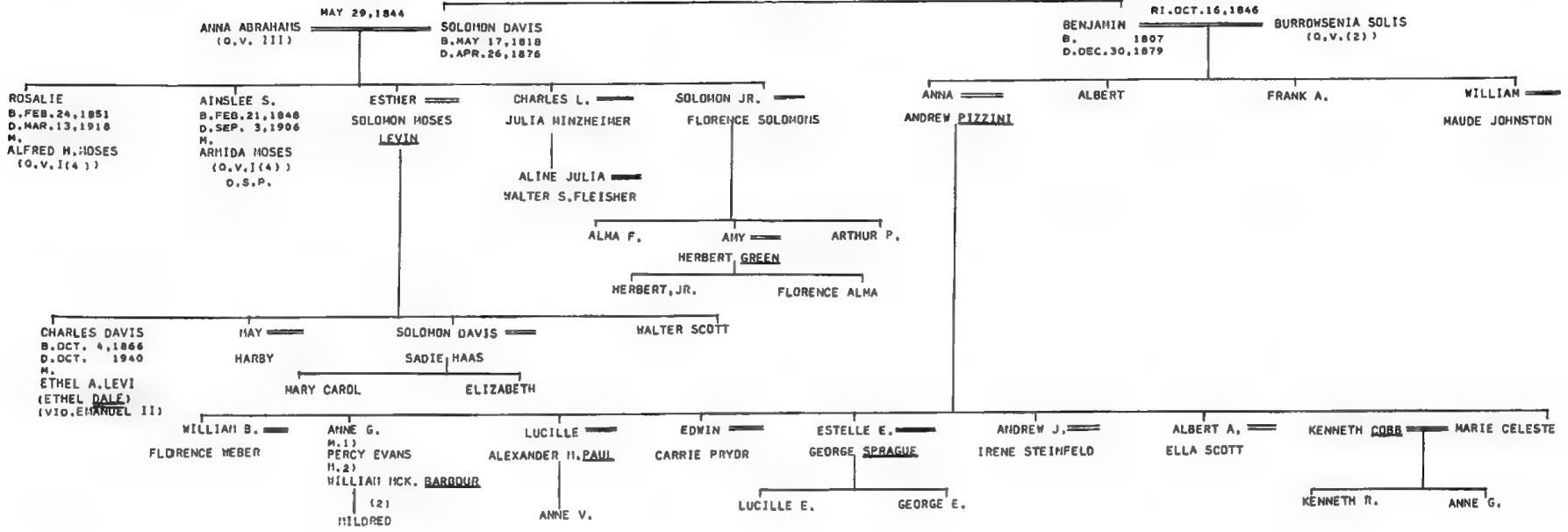

DAVIS II

JON STEDMAN

BENJAMIN DAVIDS (PRAGER)
(IN N.Y. BY 1816)

SARAH
B.C.A. 1750
D.APR. 10, 1835, N.Y.

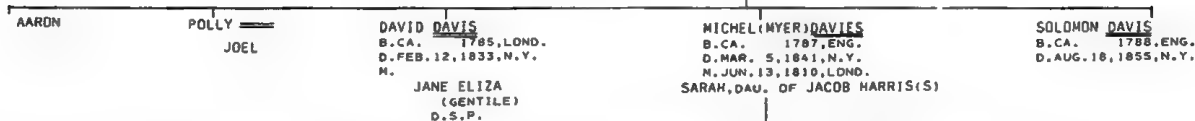

THIS GENERATION DAVIS

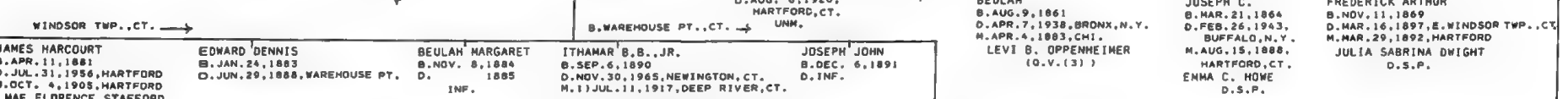
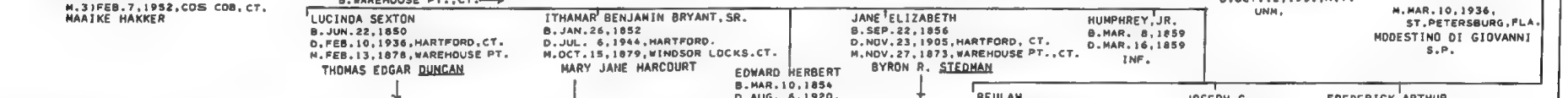
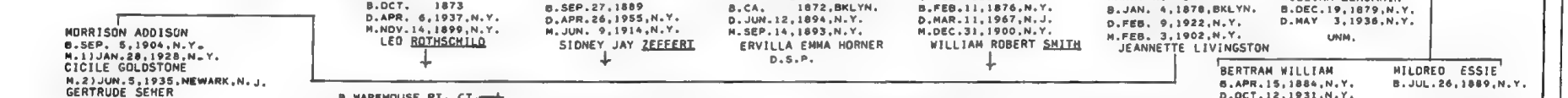
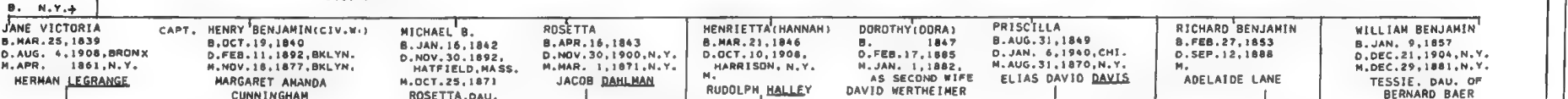
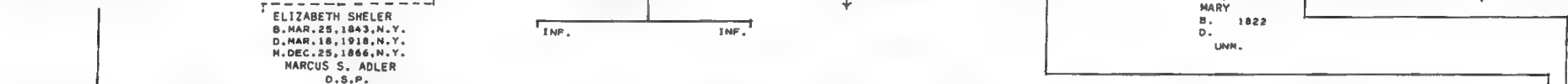
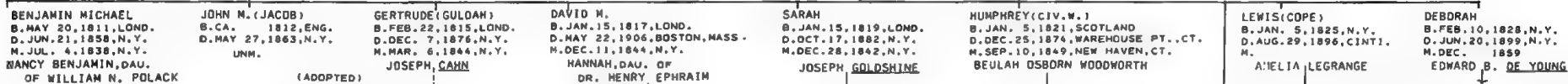

BEVIS MARKS KET.
 PICCIOTTO
 ELZAS D.J.C.
 ST.THOS.REC.
 WILL OF RACHEL(SALOH)C.D'AZEVEDO
 SMILSTONE
 MRS.HARRY COHN REC.
 FLO. ABR.
 PAJHS V.19,197F,
 S.C.MARR. CONVEYANCES
 FEDERAL ST.CEN.

DANIEL COHEN D'AZEVEDO

HAHAM MOSES (OF LONDON)
 B.HOLLAND, 1720
 D.LOND.SEP. 1784
 M.1)LOND.NOV.12,1749
 SARA DE HAHAM MOSES GOMES DE MESQUITA
 M.2)LOND.FEB.23,1758
 SARA DE ABRAHAM HENRIQUES FARRO

(1) DANIEL B. D. M.LOND.MAY 26,1779
 ESTER RODRIQUES BRANDON

(2) ISAAC B. D.CH.JAN.5,1805
 M.LOND.FEB.11,1784
 RACHEL DE ABRAHAM SALOMI (1768-CH.JAN.22,1843)

(2) ESTHER B. D. M.LOND.AUG.26,1784
 DAVID DE ELIEZER BEN HAHU (BENJAMIN)

(2) BENJAMIN B. D.LOND.SEP.12,1820
 M.LOND.AUG. 5,1789
 JUDITH DE ABRAHAM DE PAZ

(2) RACHEL B. D. M.LOND.JUN.7,1786
 HENASSEH DE ISAAC DELGADO

(2) ABIGAIL D.LOND.APR. 8,1768
 M.LOND.FEB.15,1792
 ISAAC HAHU DE ABRAHAM DE JACOB DIAS

(2) SAHUEL B.LOND.MAR.4,1770
 REBECCA B.LOND.DEC.21,1771

(2) ARON B.LOND.APR.27,1773

SAHUEL ISAAC FINZI
 B. D. M. 1778
 RACHAEL AZULAY (BAR.JAN.7,1838)

SARAH B. D. M.CH. 1804
 JACOB ARES HOTTA (CUR.1781-CH.FEB.25,1839)

HANNAH SAMUELS B.OCT.28,1791,SURINAM
 D.MAY 28,1849,PHILA.

MOSES B.NOV.20,1790,LOND.
 D.NOV.11,1861,PH.

SARAH B.ENG. 1793
 D.PH.MAR.20,1864
 M.CH. 1814
 DAVID NUNES CARVALHO (O.V.)

DANIEL B.AUG.10,1799(?)
 D. 1816

ISAAC B.LOND.MAY 10,1799
 D.ST.KITTS,FEB.15,1864/S
 (BUR.ST.THOS.)
 M.ST. THOS.
 RACHEL WOLFF(O.V.)

ABIGAIL B.LOND.NOV.29,1808
 D.MAR.1,1869,BAR.
 M. MAR.26,1834
 ISAAC DE MOSES LORD (SURINAM,DEC.15,1807-
 UG.26,1850,BARBADOS)

SARAH B. JUN. 9,1798
 D.JAN.23,1857,PH.
 M.JAN.15,1834
 DANIEL DE MOSES LORD (1803-PH.AUG.23,1849)

ABRAHAM MAR.26,1834
 B.APR.16,1800
 D.JAN.8,1870,PH.

JUDITH B.MAR.6,1817
 D.APR.3,1885,PH.

BENJAMIN B.NOV. 2,1815
 D.MAY 28,1878,MARTINIQUE
 M.JUN.25,1843
 REYNA BENJAMINS (- ST.PIERRE,MARTINIQUE,JUL.10,1881)

DEBORAH B. D.SEP.15,1896,POST.

SOPHIA B.SEP. 5,1814,BARB.
 D.OCT.29,1879,PHILA.

SAMUEL ELIAS DANIELS B. 1808
 D.MAY 9,1853

MOSES B.AUG.20,1836
 D.SEP.25,1870,
 BARBADOS

DANIEL B.OCT.13,1840
 HERIAH B.AUG.22,1839

JANE (JUDITH) B. JUN.30,1840
 D. JUL. 7,1920
 UNM.

EDWARD S. B. JUN.29,1905
 D. DEC.21,1869

HONOR B.AUG.5,1875
 D. 1952
 M. J.W.L. CRAIGG

SAHUEL ELIAS B. JUL.19,1877

BLANCHE SOPHIA FINZI B.FEB.25,1878
 D. 1955
 M. ERNEST WALCOTT

JUDITH DEBORAH B.MAR.13,1884
 M. V. PARRAVICINDO

JULIUS (JOSHUA) B. JUN.16,1841
 D. AUG.14,1907
 M. FEB.20,1881
 HINNIE JAPETH (?) (NOV.29,1858-JAN.25,1924)

HANNAH SOPHIA (ANNA) OF BARBADOS B.APR.13,1845,BARB.
 D.APR. 6,1900,PH. UNM.

ALFRED BENJAMIN B.AUG.31,1847
 D. 1915
 M. FEB.22,1882
 FANNY HERZBERG (1863-JUL.9,1929)

FLEURETTE MIRIAN B.FEB.24,1853,BARB.
 D.DEC.30,1916,PHILA. UNM.

FLORENCE D'AZEVEDO B.FEB.22,1871
 M. EDWARDS

BENJAMIN D'AZEVEDO ELIAS B.OCT.11,1872
 D. PHILA.

CLARENCE D'AZEVEDO B.SEP.3,1887
 D. 1954

EDNA SOPHIA B.OCT.20,1883
 M. FEB.21,1907,PH.
 DAVID D. HYMAN

BLANCHE CAROLINE B.SEP.16,1885

ETHEL FLORENCE B.MAY 17,1889
 D.MAR.19,1924 UNM.

EDITH D'AZEVEDO B.MAR.12,1883
 M. JOSEPH C. ABRAHAM

FLEURETTE FINZI B. JUN. 2,1885
 M. SEP.28,1905
 HARRY REGINALD COHN

STANLEY D'AZEVEDO B.MAY 26,1887

STEPHEN W.H.D. B.OCT.14,18-?

HOSES FINZI B. DEC. 6,1834, BARBADOS
 D. NOV.17,1904, PH.

AMELIA ISAACS B. MARJORIE B. II. SHELTON SOSKIN

RICHARD DAVID B. NOV.6,1910

DOROTHY CLAIR B. DEC.27,1915
 M. SEP.11,1936
 HORTON SWEFFEL OF SAPIJUPA, OKLA.

LEONARD SPENSER SHAW B. NOV.27,1906
 M. OCT.13,1932, BALTO.
 HELEN SHAW, OF YORK, PA.

EDWARD DANIELS B. MAR.13,1911
 M. AUG. 3,1935
 ELIZABETH SENSBACH

SHEFTALL MSS.
 EGHONT
 BEVIS MARKS KET.

DE CRASTO

(ALL THREE ARRIVED IN SAV., JUL.11,1733)

REM.LOND.APR.9,1732 (1)

(2) SAV.MAR.15,1734

DAVID LOPEZ DE PASS ZIPPORAH JACOB LOPES DE CRASTO

RACHEL B.SAV. JUL.26,1736

JUDITH D.SAV. APR.2,1738

RALPH B.SAV. JUN.12,1739

BENJAMIN M. ST. THOS. JUL.9,1851
 RACHEL DE JACOB LINDO (AUG.31,1830-ST. THOS. JAN.11,1858)

JULIA B. D. ST. THOS. JUL.22,1865 UNM.

MOSES (CONFIRMED, ST. THOS., MAY 30,1844)
 M. ST. THOS. MAY 1,1858
 JULIA BENLISA (1838-ST. THOS. OCT.2,1866)

ALFRED (CONFIRMED, ST. THOS. APR. 9,1847)

ALEXANDER B. OCT.20,1856
 D. ST. THOS. MAY 8,1863

DE CORDOVA (1)

JON STEDMAN
A.J.A. XVII 1, 161F.
ENA
MORAIS--JEWS OF PH.
DAVIS--R'DEPH SHALOM
FLO. ABR.
CONEN--100 YEARS OF JEWRY
IN TEXAS
M.W.
DEVIS MARKS KET.
ANDRADE -- JEWS OF JAMAICA

ISAAC DE CORDOVA (OF CONSTANTINOPLE)

MOSES RAPHAEL (CONSTANTINOPLE TO AMST., CA. 1641)
B. D. AMST. 1649

JACOB HAI (IN BRAZIL)
D. AMST. 1712/14

LOND., APR. 5, 1702

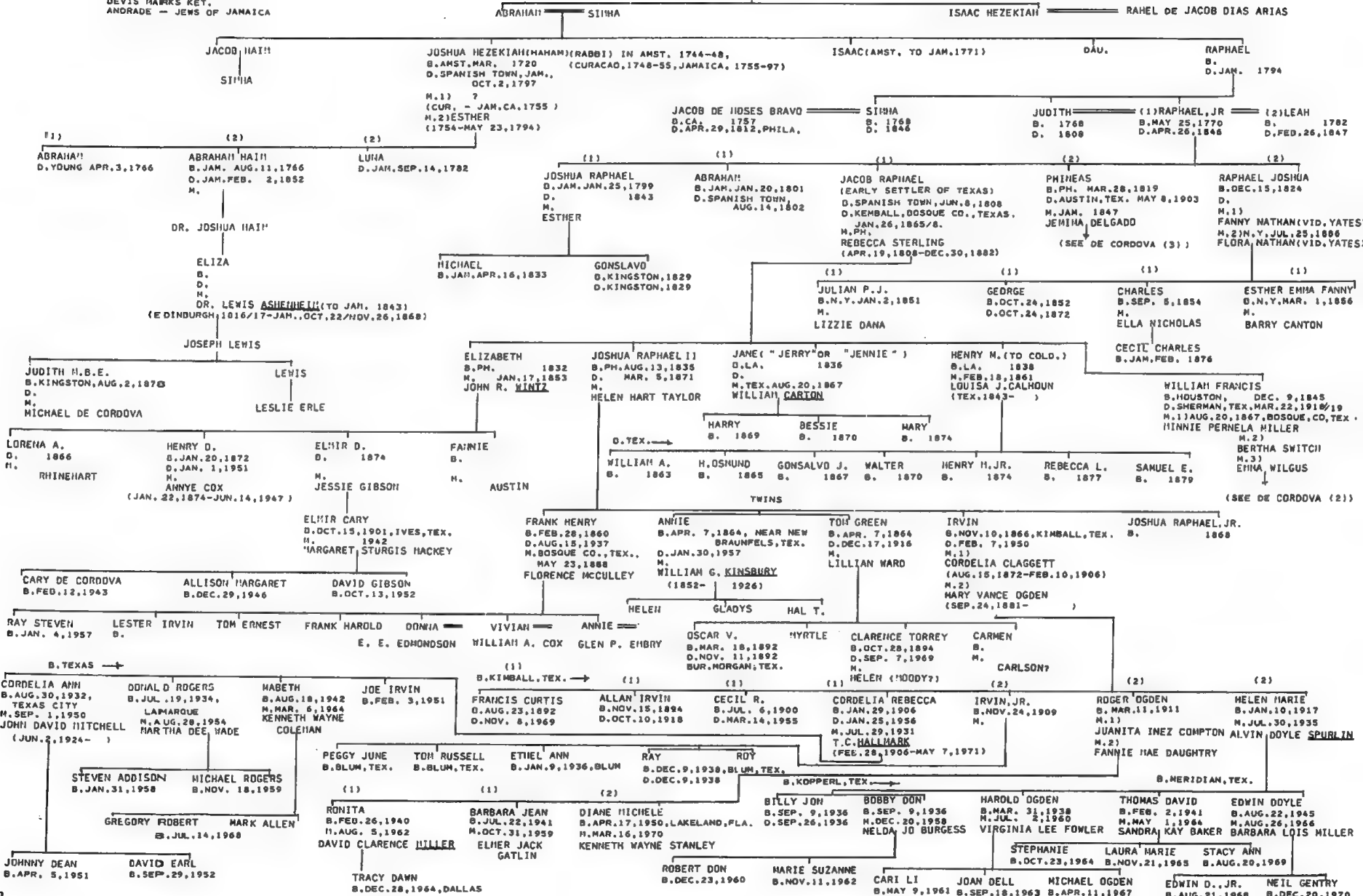

(SEE PRECEDING PAGE)

WILLIAM FRANCIS DE CORDOVA
 B. HOUSTON, TEX., DEC. 9, 1845
 D. SHERMAN, TEX., MAR. 22, 1918/9 (BUR. TISHINGO, OKLA.)
 M. 1) BOSQUE CO., TEX., AUG. 20, 1867
 MINNIE PERNELA MILLER
 M. 2)
 BERTHA SWITCH
 M. 3)
 EMMA WILGUS

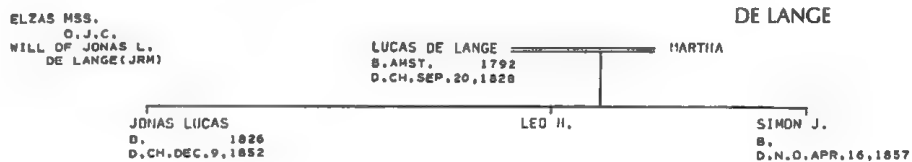
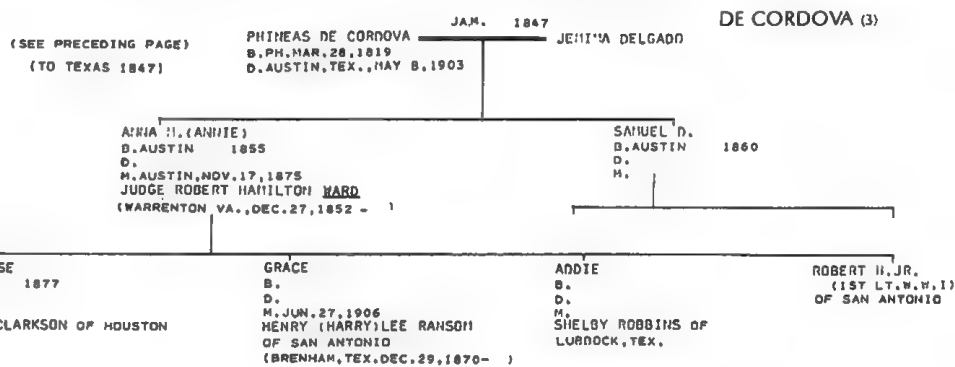
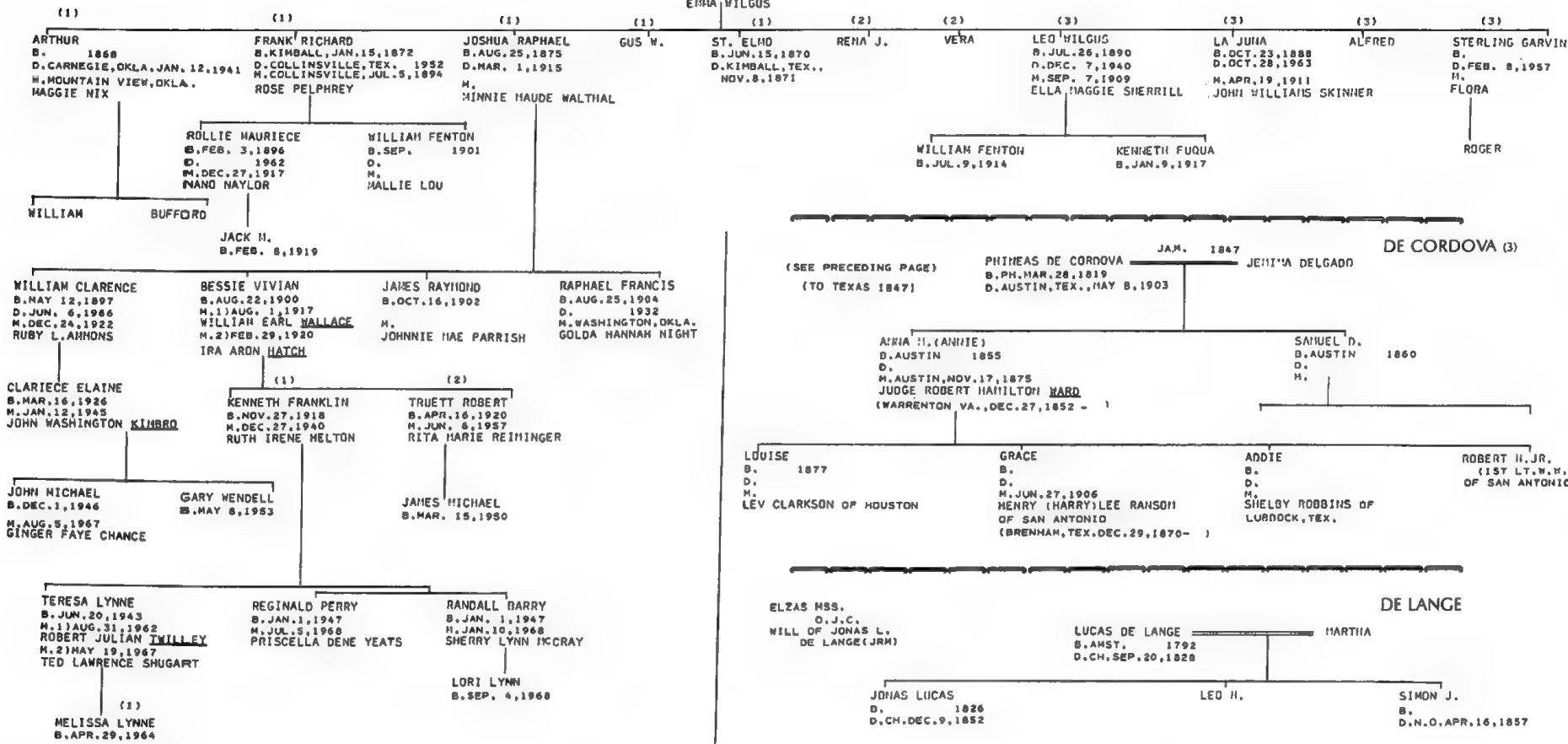

KRAUS-SANDOR
 SHEARITH ISR. REC.
 SAWYER'S WILLS
 ANDRADE

ISAAC DELGADO CLARA MILHADO
 B. KINGSTON, JAN. NOV. 23, 1838 (NIECE OF EZEKIEL ISAACS)
 D. D. KINGSTON, JAN. 1878
 (BENEFACTOR OF NEW ORLEANS)

DELGADO

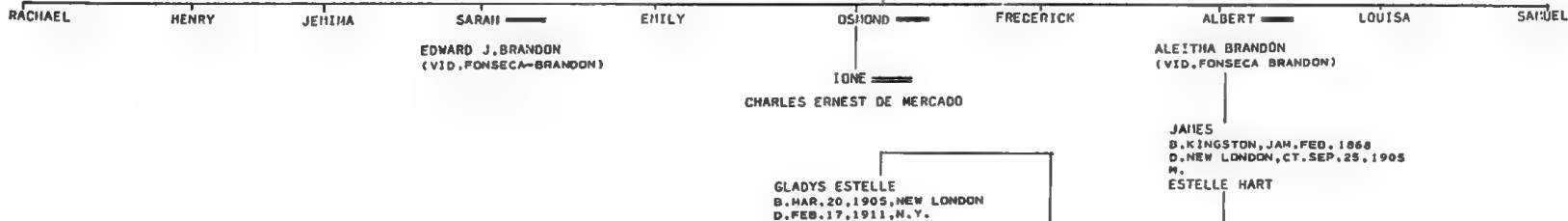

DE LA MOTTA

KRAUS-SANDOR
PAJHS V.19, PP. 00, 03
ELZAS HSS.
D.J.C.
M.N.

RAISIN HSS. (PHOTOSTAT AJA)
SHEARITH ISRAEL REC.
WILLS OF (ISA)BELLA L. PHILLIPS,
RACHEL DE LA MOTTA

ENA
GA. NEWSP.
ROSENAIKE
LAZARUS GEN. (T. J. TOBIAS)
SHEFTALL
BARBER-N.Y. MARR.
JOHN SHEFTALL

(IN ST. CROIX, JAM., SAV. (1785), CH.)

ISAAC DE LA MOTTA
B. 1726
D. CH. DEC. 12, 1794

SARAH
B. 1720
D. SAV. AUG. 16, 1790

JACOB DE LA MOTTA
ZIPPORAH BENJAMIN
(O.V.I)

ABRAHAM HISQUIRO DE LA MOTTA
D. ST. EUSTATIUS, MAY 10, 1742

JUDAH BENJAMIN
B. ST. T. MAY 26, 1811

ISAAC
B. SEP. 8, 1750
D. CH. JUN. 16, 1802
M. SAV. JUN. 9, 1796
SARAH CANTER
(O.V.)

REBECCA
B.
D. N.Y. DEC. 19, 1835
M.
JACOB CANTER
(O.V.)

SARAH (TO SAV. SEP. 16, 1768)
B. ST. CROIX, JAN. 29, 1754
D. SAV. NOV. 6, 1811
M. ST. CROIX, MAY 25, 1768
LEVI SHEFTALL
(O.V. (1))

MOSES
B. 1755
D. CH. DEC. 19, 1800

EMANUEL
B. ST. CROIX, NOV. 2, 1760
D. CH. MAY 17, 1821
M. CH. DEC. 26, 1787
JUDITH CANTER
(O.V.)

RACHEL
B. ST. CROIX, CA. 1768
D. MAY 11, 1786, CH.
M. CH. JUL. 3, 1784
ABRAHAM DE PASS
(O.V. II)
D.S.P.

REBECCA
B. 1798
D. FEB. 16, 1829
M. AUG. 24, 1820
AS HIS 2ND WIFE
LEVI S. DE LYON
(O.V.)

LEDNORA
B. APR. 1800
D. JAN. 29, 1819
M. MAR. 1, 1818
AS HIS 1ST WIFE
LEVI S. DE LYON
(O.V.)

(ATTORNEY) JACOB
B. CH. CA. 1801
D. N.Y. OCT. 23, 1856

JACOB CANTER, M.D.
B. SAV. FEB. 24, 1789
D. CH. FEB. 13, 1845
M. CH. APR. 29, 1835
CHARLOTTE LAZARUS
(O.V. II)

ISAAC
B. SAV. JAN. 16, 1791
D. SAV. 1793

SARAH
B. SAV. NOV. 1, 1792
D. CH. NOV. 12, 1817
ABRAHAM SHEFTALL
(O.V. (1))

CHARLOTTE
B. 1809, CHARL., S.C.
D. SAV. SEP. 7, 1833
UNM.

RACHEL
B. 1815, CHARL.
D. DEC. 7, 1874
UNM.

EMANUEL
B. SAV. 1803
D. N.Y. JUL. 27, 1838

CLARA
M.
SHEFTALL

HOFFMANN
JACOB EMANUEL
B. OCT. 1, 1836

JULIA
D. JUN. 11, 1839

JULIET

ISABEL
DR. WILLIAM PARRISH

BENJAMIN DORES, M.D.

BENJAMIN DORES, JR. WARING

DELMAR

SHEARITH ISRAEL REC.
U. S. CENSUS, 1850
B'NAI JESHURUN
PAJHS V. 27, P. XII
ANDRADE-JAMAICA, P. 56

KINGSTON, JAN. NOV. 13, 1768
REUBEN ALEXANDER SARAH JACOBS
B. KINGSTON, 1767
D. N.Y. MAY 3, 1843

SARAH ? (1) JACOB COUTIN(H)O DELHAR (2) N.Y. AUG. 8, 1831

BELVIDEN (BENVENIDA)
B. JAM. 1801

SON
B.
D.
M.
M.
ANIELIA
(JAM. 1789-)

GITLA
B.
D.
D.
M.
N.Y. AUG. 30, 1832
DAVID BARNET

MOSES
B. NOV. 18, 1834
D. N.Y. JAN. 27, 1835

ALEXANDER
B. AUG. 10, 1836
D.
M. N.Y. JUL. 17, 1861
EMILY JOSEPH
(O.V. I)

EMANUEL
B. JAN. 14, 1838

DAVID EUGENE
B. SEP. 12, 1841

FRANCES
B. JAM. 1811

SARAH
B. N.Y. 1833

WALTER
B. N.Y. MAY 28, 1862

EUGENE
B. N.Y. SEP. 6, 1864

HARRY
B. WASH. NOV. 11, 1866

FRANCES (FANNY)
B. GEORGETOWN, D.C.,
JUN. 22, 1868

ALGERNON PERCY
B. BROOKLYN, MAR. 3, 1870

WILLIAM

NAUD

DE LEDESMA

SH.
EGMONT
BEVIS MARKS KET.

REMARR. IN JUDAISH, LOND. APR. 16, 1727

(TO SAV. JULY, 1733) MOSES DE LEDESMA
B. PORTUGAL

ESTER
D. PORTUGAL

B. SAV. →

RALPH (ABRAHAM)
B. JUL. 25, 1733
(FIRST JEWISH CHILD B.
IN SAV.)

REBECCA
B. JUL. 12, 1735

RACHEL
B. JUL. 12, 1737

SAMUEL

DE MOLINA

SH.
EGMONT
BEVIS MARKS KET.

FERNANDO

REMARR. AS JEWS, LOND. DEC. 15, 1728

ABRAHAM DE MOLINA
B. PORTUGAL
(ARR. SAV. JUL. 11, 1733)

SARAH
(BOTH ARR. SAV. WITH JUDITH
CHILDREN, SEP. 18, 1736)

ESTHER

ISAAC

RACHEL

ANDRADE
ABBOT LOU HOFFAT
MOISE-JEW, CEM. AT SUMTER
ALICE LANDRUH
PAJHS V.19, P.81
PAJHS V.27, P.286
UJE V.3, P.498F.
KRAUS-SANGOR COLL.
ABRAHAM DE JACOB DE LEON BIBLE(AJA)
PERRY DE LEON FAMILY REC.(AJA)
ST.CHARLES, P.133F.
ELZAS HSS.
CHATHAN CO., GA. WILLS
ELZAS H.H.
ELZAS O.J.C.
HICKVE ISRAEL REC.
HENDRICKS GEN.
SHEARITH ISRAEL REC.
FED. ST. CEM.
S.C. HARR. CONVEYANCES
XIV, 296
O'NAI JESHURUN
MOISE FAMILY

ABRAHAM
B. MAY 8, 1702
D.
M. SPANISHTOWN, JAMAICA

MOSES
B.
D.
M.

JACOB

ABRAHAM

ABRAHAM
B. SEP. 21, 1734
D. DEC. 26, 1786
BUR. AT SPANISHTOWN
H.

MOSES
B. OCT. 3, 1736

ISAAC
B. NOV. 18, 1736

ESTHER
B. MAR. 19, 1740
D. JUL. /AUG. 1765

SARAH (ABIGAIL)
B. OCT. 29, 1743

JACOB
B. NOV. 3, 1746

REBECCA
B. SEP. 8, 1748

RACHEL
B. DEC. 30, 1749

DAVID
B. AUG. 19, 1751

(- JAN. 10, 1792)

JACOB
B. SEP. 7, 1764, JAM.
D. SEP. 29, 1820, COLUMBIA,
H. OCT. 4, 1789, N.Y. S.C.
HANNAH HENDRICKS
(O.V. I)

REBECCA
B. NOV. 16, 1765

SARAH
B. OCT. 4, 1768,
SPANISHTOWN
D. SEP. 8, 1841, N.Y.
M.
AARON CORREA

BENJAMIN
D. INF.

DAU.
B. JUL. 1, 1772
D. AT BIRTH

LEAH ABIGAIL
B. JAN. 15, 1779
D. INF.

RACHEL
B. DEC. 29, 1780
D. OCT. 11, 1811

ABIGAIL
B. NOV. 26, 1783, JAM.
D. NOV. 24, 1850, N.Y.
M. 1802
JOSEPH HENRIQUES
(O.V. II)

ESTHER
B. MAR. 11, 1785
D. NOV. 20, 1803

ABRAHAM
B. JUL. 15, 1790

ABRAHAM, M.D.
B. JUL. 16, 1790, PHILA.
D. NOV. 12, 1847, CAMDEN, S.C.
M. SEP. 27, 1815, PHILA.
BILHA (ISABELLA) JONES
(O.V.)

HORDECAT HENDRICKS
B. NOV. 12, 1791
D. OCT. 29, 1848, CHARLESTON
H.
REBECCA LOPEZ (O.V. I (2))

HENRIETTA
B.
D.
UNM.
(CONVERT TO XTY.)

LOUISA
B. 1795
D. JAN. 30, 1872, PH.
UNM.
B. COLUMBIA, S.C. →

ALMERIA
B. 1798/9, PH.
D. FEB. 28, 1882, PH.
M. NOV. 24, 1819, CH.
HAYIAN LEVY
(O.V. III)

REBECCA
B. 1801
D. JUL. 16, 1851
UNM.

ADELAIDE
B. SEP. 25, 1805, CH.
D. APR. 21, 1839, CAMDEN, S.C.
UNM.

URIAH
B. 1806
D. NOV. 19, 1883
UNM.

DAVID CAMDEN
B. MAY 6, 1816,
CAMDEN
D. SEP. 2, 1872,
SANTA FE
UNM.

DAU.
B. FEB. 1817
D. INF.

EDWIN
B. MAY 4, 1818
D. NOV. 30, 1891, N.Y.
M. AUG. 25, 1858,
SOMERSET, ENG.
ELLEN HARY NOULAN
OF ROTHGAR, IRE.
D. S.P. (-DEC. 5, 1891, N.Y.)

AGNES
B. APR. 9, 1817
D. FEB. 9, 1902,
WASH. D.C.
UNM.

MARIA LOUISA
B. 1820
D. OCT. 27, 1901
WASH. D.C.
UNM.

ADELINE HARY
B.
D. MAR. 23, 1877
WASH. D.C.
M. SEP. 29, 1852
WASH. D.C.
JOSEPH HENRY ADAMS OF BOST.
(BOST. JAN. 2, 1818 - BOST. NOV. 17, 1896)

THOMAS COOPER
B. MAY 21, 1839/7
D. MAR. 19, 1914
MOBILE
UNM. (AUTHOR)

ANNA
B. JUL. 24, 1816, CAMDEN
D. MAR. 26, 1888, CHATTANOOGA
M. NOV. 28, 1839, CAMDEN, S.C.
OLIVER H.P. MOSES
(O.V. I (3))

HENRIETTA
B. JUN. 12, 1826, CAMD.
D. JUN. 23, 1912, ATL.
M. NOV. 19, 1846
DAVID C. SETXAS (O.V. (4))

MIRIAM LOUISA
B. SEP. 16, 1822
D. DEC. 8, 1869, SUMTER
M. DEC. 2, 1840, CAMDEN
LAWRENCE L. COHEN
(O.V. X (2))

BENJAMIN HONES
B. SEP. 9, 1823, CAMDEN
D. OCT. 8, 1853,
MOBILE
UNM.

ISABEL HONES
D. 1828
D. FEB. 18, 1896,
BALTIMORE
UNM.

HARRISON HENDRICKS
B. APR. 24, 1829, CAMD.
D. JAN. 3, 1901, CH.
H. DEC. 17, 1851, CH.
CAROLINE AGNES MOISE
(O.V. (2))

HETTY
B. 1833
D. MAY 20, 1891
WASH. D.C.
UNM.

MARY
B.
D. APR. 6, 1862, N.Y.
UNM.

ALMERIA
B. 1839, CAMDEN
D. APR. 6, 1862, N.Y.
UNM.

AGNES
B. OCT. 26, 1852, CH.
D. DEC. 14, 1936, SUMTER
M. JUL. 26, 1876, CH.
FELIX J. MOSES
(O.V. III (2))

BENJAMIN
B. JAN. 5, 1854, CH.
D. BERKELEY, CAL. 1910
M.
ELINOR (NELL) JONES (WIDOW)

CAROLINE (LEHA)
B. OCT. 9, 1855, CH.
D. JUL. 12, 1942, SUMT.
M. FEB. 19, 1885, CH.
ROBERT SHELDRON
FORBES (NEXT P.)

ISADEL HONES
B. FEB. 9, 1858/9, CH.
D. SEP. 15, 1927,
ATLANTIC CITY, N.J.
M. NOV. 7, 1877, CH.
HARRISON MOISE
(O.V. (4))

HOISE
B. APR. 19, 1862, CH.
D. SEP. 1, 1866, CH.
UNM.

JACQUELINE
B. AUG. 28, 1863
D. JUN. 8, 1936,
BEECHURST, L.I.
M. JUN. 12, 1889, CH.
SAMUEL LITT KELLER
(NEXT P.)

HOISE
B. AUG. 28, 1867/9, CH.
D. JUN. 21, 1915, ATL.
M. JAN. 23, 1901, K.C.
IDA HAUDE HOISE
(O.V. (2))

EDWIN WARREN
B. AUG. 6, 1868, CH.
D. OCT. 9, 1918, N.Y.
M. JAN. 23, 1901, K.C.
FANNY ERRA HOISE
(O.V. (3))

MARIA
B. APR. 9, 1872, CH.
D. NOV. 11, 1953,
PADUA, ITALY
M. MAY 11, 1910
ROME, ITALY
ANTONIO NORDIO
(1865-1947)

ADOPTED BY STEP-FATHER
PAUL ANTHONY JONES DE LEON
B.
H. OCT. 23, 1907, SUMTER
MARIE HOISE (O.V. (4))

WALTER JONES DE LEON

ALBERT (ADRAH)
B. MAY 25, 1857, CH.
D. FEB. 4, 1940, SUMTER
H. OCT. 19, 1881, CH.
AMANDA MOISE
(O.V. (2))

MARGERY MAE
B. OCT. 7, 1902
NEW ORLEANS
D. MAR. 25, 1953, N.Y.
UNM.

ROGER HOISE
B. NOV. 15, 1904
ATLANTA
M. NOV. 1, 1935, ATL.
EUGENIA JOHN COBER
(1906-)

DOROTHY IRENE
B. SEP. 23, 1909
ATLANTA
M. 1) JUL. 26, 1935
CLARKSVILLE, GA.
JESSE ROY JOHNSTON, JR.
(ANNULLED)
2) 2) SEP. 4, 1936, ATL.
EDITH WILLIA KING
(1914)

HARRON DE LEON
B. JUL. 29, 1853, WASH.
D. OCT. 15, 1931, BOST.
H. BOSTON
GORDON PRINCE PAGE
(MEDFORD, MASS. NOV. 7, 1850-
KINGSTON, MASS. MAR. 3, 1893)
D. S.P.

JOSEPH HENRY JR.
B. DEC. 15, 1857, WASH.
D. AUG. 20, 1924, N.Y.
M. PLYMOUTH, MASS.
JUL. 18, 1893

ANNA WILHELMINE LINCKE
(TORONTO, NOV. 6, 1868
WEST TISBURY, MARTHA'S
VINEYARD, MASS. SEP. 11, 1947)

ABBOT LOU HOFFAT
B. N.Y. MAY 12, 1901

HARRON
B. NOV. 7, 1905, N.Y.

LAWRENCE DE LEON
B. OCT. 17, 1940, ATL.

KATHRYN ANN

(SEE NEXT P.)

DE LEON (2)

HARMON HENDRICKS DE LEON DEC. 17, 1851, CH.
 B. APR. 24, 1829, CAMDEN
 D. JAN. 3, 1901, CH.
 (SEE PRECEDING PAGE)

CAROLINE AGNES MOISE (G.V. (2))

ABBOT LOW MOFFAT B. N. Y. MAY 12, 1901 (SEE PRECEDING PAGE)

HARION ADAMS B. N. Y. NOV. 7, 1905

CAROLINE (LENA) B. OCT. 8, 1855, CH.
 D. JUL. 12, 1942, SUMTER
 M. FEB. 19, 1883, CH.
 ROBERT SHELDON FORBES (SYRACUSE, N. Y. DEC. 5, 1852-
 DEC. 23, 1911, MONTCLAIR, N. J.)

JACQUELINE B. AUG. 28, 1863, CH.
 D. JUN. 8, 1936, BEECHURST, N. Y.
 M. JUN. 12, 1889, CH.
 SAMUEL LITT KELLER (N. Y. JUN. 10, 1861-JUN. 28, 1946, SACRAMENTO, CAL.)

MARGUERITE SHELDON B. DEC. 13, 1885, CH.
 D. JUL. 20, 1941, GREENSBORO, N. C.
 M. AUG. 30, 1917, MONTCLAIR, N. J.
 LEMUEL HOMER HOLE (HURON, S. D., DEC. 4, 1874-
 GREENSBORO, N. C., AUG. 26, 1948)
 D. S. P.

JACK HAMILTON B. SEP. 1, 1887, HAYMARKET, VA.
 M. 11 APR. 14, 1924, SUMTER, S. C.
 WILLIE DELGAR (SUMTER, SEP. 15, 1896-
 SUMTER, FEB. 12, 1926)
 M. 21 APR. 24, 1929, GREENWOOD, S. C.
 RUTH OTHELLA MOORE (GREENWOOD, AUG. 5, 1900-

ROBERT BELMONT B. MAR. 13, 1892, WASH.
 M. JUN. 8, 1918
 BLOOMINGBURG, N. Y.
 CLAIRE LOUISA FRASER (BROOKLYN, DEC. 3, 1891-

BURNHAM B. APR. 9, 1927, N. Y.
 M. 11 JUL. 19, 1947, BETHSEDA
 (ARION PATRICIA ARTHUR (SAN DIEGO, MAY 6, 1926-)
 WILLIAM THOMAS LIFLAND
 M. MAY 29, 1954, WASH.
 H. 21 ELKTON, MD.
 TOROHO KURAIOTO

ANNA (HANCY) ADAMS B. MAR. 23, 1928, N. Y.
 M. MAY 29, 1954, WASH.
 WILLIAM THOMAS LIFLAND

JANE KERRIN B. FEB. 28, 1931
 UNM.

ELIZABETH PIERREPOINT R & D. JUL. 27, 1933
 PETERBOROUGH, N. H.
 INF.

AGNES DE LEON B. SEP. 18, 1891, SHEFFIELD, ALA.
 M. 11 APR. 23, 1914, N. Y.
 WILLIAM BUTLER KINSTLER (N. Y. AUG. 18, 1891-)
 M. 21 1937, NEVADA
 WILLIAM D. LONGLEY (DULUTH, MINN. AUG. 14, 1893-)

CAROL MOFFAT B. MAR. 21, 1955, WASH.

CHARLES COLEMAN D. MAY 14, 1957, PH.

JOHN KERIN D. MAY 14, 1959
 NEVILLY-SUR-SEINE, FR.

DAVID THOMAS B. APR. 17, 1961
 PRINCETON, N. J.

(1) MARGUERITE HEARTT B. APR. 26, 1925, SUMTER
 M. MAR. 18, 1945, GREENSBORO, N. C.
 GEORGE TURNER YOUNTZ (SOUTH MONT, N. C. FEB. 22, 1922-

(2) RUTH ANDERSON B. APR. 3, 1931, SUMTER
 M. DEC. 20, 1959
 GREENVILLE, S. C.
 JERRY DAVIS WYNN

LINDA MARGUERITE B. FEB. 9, 1949, GREENSBORO

JUDITH ANN B. OCT. 29, 1949

EDWARD BRIAN B. AUG. 13, 1952

(1) ABBOT LOW II B. FEB. 14, 1949, DOSTON
 M. JUN. 1, 1969, HARSHALL, MICH.
 ELAINE PHILLIPS (GERGER, TEX. AUG. 22, 1950-)

(1) ELLEN PIERREPOINT D. MAY 22, 1951, PDG.

(2) SUSAN ROBERTA B. LONG BEACH, CAL.
 AUG. 2, 1962

(2) NICHELE JAY B. FAIRFAX, VA.
 FEB. 8, 1966

ABBOT LOW III B. OCT. 6, 1969, SAN DIEGO

(1) JOHN CHRISTOPHER B. JUN. 11, 1918, FLUSHING, N. Y.
 M. FEB. 11, 1939, N. Y.
 CHRISTINA (TINA) KANAKOS (N. Y. AUG. 17, 1916-

MARGARET MARY B. DEC. 12, 1945, N. Y.

JOHN CHRISTOPHER B. JAN. 6, 1947
 SACRAMENTO, CAL.

KATHLEEN ANN B. AUG. 24, 1948
 SACRAMENTO, CAL.

CHRISTINE

GRETCHEN

WILLIAM CHARLES

DE LEON II

KRAUS-SANDOR COLL.
 SHEARITH ISRAEL REC.
 FLORENCE ABRAHAMS
 OLIVER STREETON

MOSES (DE) LEON B. 1775
 D. N. Y. SEP. 2, 1828
 M.
 ELIZABETH ? (ESTHER) BRAHMS (1772-JUL. 30, 1874)

JOSEPH M., M. D. B. OCT. 3, 1803
 D. MAR. 24, 1882, PH.
 UNM.

EVELINE B. APR. 3, 1805, N. Y.
 D. NOV. 27, 1869, N. Y.
 M. JUL. 23, 1823
 JOSEPH B. NONES (G. V.)

CAROLINE B. OCT. 10, 1797
 D. DEC. 23, 1875
 M. JUL. 27, 1825
 AARON B. NONES (G. V.)

ESTHER SERENA B. 1801
 D. 1872
 M.
 JOSEPH BRAND CLENCH (-FEB. 20, 1857)

2ND SON
 LEON MOSES OF ST. MARY'S, ONT.
 B. 1830
 D.
 M.
 EUNICE CRITTENDEN (1830-1924)

MARY BLANSHARD F. MUIRHEAD OF LONDON

ESTHER LEONORA B. 1870
 D. 1938
 M.

C. L. OLIVER B. 1911

SIR ARTHUR ERNEST STREETON

PAJHS V. 6, P. 126
 PAJHS V. 23, P. 150
 ST. CHARLES
 GOLDSTONE GEN.
 HENDRICKS GEN.
 OPPENHEIM COLL. (AJHS)
 PODL- PORTRAITS
 AM. JEW. ARCHIVES, V. 1, #2, P. 3
 WILL OF ABR. H. AJHQ LV/345

ABRAHAM (ARRIVED NEW AMSTERDAM. JAN. -MAR. 1655)
 D. AFTER 1676

MOSES DE LUCENA

MOSES KOSHER BUTCHER IN NEW AMST. OCT. 1657-APR. 1660

JACOB IN NEW AMST. 1656-78
 PEDDLER IN N. Y. AND HARTFORD

ABRAHAM HAIN DE LUCENA B. N. Y. AUG. 4, 1725
 M. N. Y. 1699
 RACHEL ?

(MADE FREEMAN JUL. 6, 1708
 PERM. SON OR GRANDSON OF ADDVE)
 HAZAN OF SHEARITH ISRAEL, 1700-20
 IN JAMAICA, 1713

SAMUEL B. N. Y. JAN. 2, 1711
 D. 1789, N. Y.
 FREEMAN IN N. Y. JUL. 3, 1759
 IN PHILA., 1740
 NEWPORT 1758-59

REBECCA B. JUL. 1713
 D. JUN. 28, 1801, N. Y.
 M. MAY 4, 1741
 HORDECAI GOMEZ (G. V.)

ESTHER (HESTER)

JUDITH

MOSES B. OCT. 30, 1723, N. Y. (?)

SHEFTALL
 BEVIS MARKS KET.#508
 COHEN-100 YEARS OF JEWRY IN TEXAS
 J.R.COHEN REC.
 MISC.VII 357
 S.C.MARR, CONVEYANCES
 GA, NEWSPAPER VITAL REC.
 JOHN SHEFTALL
 WILL OF SARAH DE LA MOTTA
 ELZAS OJC
 B'NAI JESHURUN

ABRAHAM DE LYON (LEAD) (ARR. SAV. JUL. 11, 1733)
 B. PORTUGAL
 O. BEF. 1761
 M. LOND. JUN. 5, 1732
 ESTHER NUNEZ (O.V.)

DE LYON

REBECCA B. LOND. 1733
 D. SAV. NOV. 26, 1788
 M. JOSEPH ABRAHAMS (O.V. VI)

RACHEL B. SAV. AUG. 2, 1734
 D. PH. SEP. 29, 1792
 M. EASTON, PA.
 HYER HART DE SHIRA (TEXEIRA)
 (VID. HART XIII)

SIPRA (ZIPPORAH) B. SAV. FEB. 10, 1738
 D. BALTO. APR. 6, 1806
 M. EASTON, PA.
 REV. HORDECAI H. HORDECAI (O.V. III)

ISAAC (CH.) B. SAV. JAN. 28, 1739
 D. M. CH. SEP. 1762
 RINAH TOBIAS (O.V. II (1))

ABIGAIL B. D. NOV. 20, 1803, PH.

DAU. B. D. BEF. 1784
 M. BAER LEVY (BARNET LAZARUS)

ESTHER B. SAV. AUG. 9, 1762
 D. M. SAV. SEP. 24, 1777
 BARNARD ROSES

JUDITH B. FED. 19, 1764
 D. CH. 1848
 M. 1) CH. FEB. 1779
 MOSES, SON OF LIEPMAN COHEN
 (1747-JUN. 28, 1790, SAV.)
 M. 2) SAV. JAN. 6, 1791
 HER AUNT'S WIDOWER
 JOSEPH ABRAHAMS (O.V. VI)

HANNAH (SAV. TO CH. CA. 1793)

ABRAHAM I B. D. SAV. OCT. 10, 1835
 M. 1) SAV. JUN. 1, 1785
 SARAH SHEFTALL (O.V. (1))
 M. 2) SAV. MAR. 21, 1827
 HANNAH SHEFTALL (O.V. (1))

ESTHER B. D. M. EASTON, DEC. 27, 1786
 ISAAC SIMONS

ELEAZER B. EASTON, FEB. 18, 1789

COL. ISAAC B. SAV. FEB. 12, 1766
 D. FED. 16, 1856

RINA B. DEC. 21, 1789
 D. SAV. MAR. 11, 1814
 UNM.

JUDGE LEVI SHEFTALL B. SAV. OCT. 23, 1791
 D. SAV. AUG. 28, 1863
 M. 1) MAR. 1, 1818
 LEONORA DE LA MOTTA (O.V.)
 M. 2) AUG. 26, 1820
 REBECCA DE LA MOTTA (O.V.)

ABRAHAM I B. SAV. APR. 18, 1793
 D. MAR. 27, 1840
 UNM.

BENJAMIN B. SAV. SEP. 20, 1796
 D. SAV. SEP. 13, 1802

JOSEPH B. OCT. 17, 1800
 D. OCT. 19, 1814

REBECCA B. SAV. NOV. 24, 1806
 D. JUL. 19, 1880
 M. EDWARD S. FULTON
 (- MAR. 18, 1871)

REINAH (RINAH) B. CH. SEP. 3, 1783
 D. CH. JUL. 21, 1853
 M. CH. DEC. 29, 1802
 DAVID HORDECAI (O.V. III)

BILAH B. SAV. AUG. 24, 1785

SARAH B. JUL. 7, 1787, CH.
 D. N.Y. APR. 16/17, 1874
 M. SAV. MAR. 26, 1806

JACOB B. SAV. APR. 6, 1795
 D. SAV. OCT. 13, 1795
 INF.

HANNAH (ANNA) B. SAV. NOV. 1, 1798
 D. JAN. 11, 1873
 UNM.

COL. LEONOREAH B. JAN. 21, 1819

LEONORA REBECCA B. SAV. JAN. 24, 1824
 D. GALVESTON, TEX. NOV. 2, 1888
 M. 1) ST. MARY'S, GA. JAN. 31, 1842
 LEVI CHARLES HARDY (O.V. (1))
 M. 2) EDWARD RANDALL, N.D.

ISAAC

JAMES WAYNE (WEST POINT CADET) B. DEC. 18, 1825
 D. SAV. FEB. 28, 1865
 M.

CLARENCE ABRAHAM B. 1829
 D. NOV. 10, 1856
 M. ST. MARY'S, GA. JAN. 31, 1854
 JOSEPHINE SEABROOK CURTIS

LEONORA B. SAV. 1849
 D. WILLIAM E. HORTIL

ELIZABETH JOSEPHINE B. 1851
 D. SEP. 1, 1857

REBECCA B. D. M. RICHARD W. RALSTON

ISAAC II.

LEONDREA D.

LEONORA DE LYON

REBECCA DE LA MOTTA

KRAUS-SANDOR COLL.
 PAJHS, V. 23, P. 149
 PODL. PORTRAITS...
 PAJHS, V. 5, P. 69
 PAJHS, V. 42, P. 277F
 TRANSACT JHSE, V. 13, P. 14
 WILL OF JOSEPH AJHO LV/33

BENJAMIN BUENO DE MESQUITA B. D. N.Y. 1683
 M. SARAH ?
 (- N.Y. OCT. 24, 1708)

1649-IN BRAZIL
 1660-65-IN JAMAICA
 1665-BANISHED WITH HIS TWO SONS
 1679-IN BARBADOS

(DOVALE) DERVAL RACHEL (D. FEB. 26, 1678, CUR.)

ABRAHAM OF NEVIS B. D. 1715

ESTHER B. D. BEF. 1708
 M. ISAAC GABAY FARR (IN N.Y. 1686-1708)

JOSEPH BUENO B. D. OCT. 1708
 D. S.P.

RACHEL IN N.Y.

SAUL D. YOUNG, 1708

BENJAMIN B. APR. 2, 1687

JACOB B. SEP. 18, 1694

SOLOMON B. NOV. 18, 1701

BUENO DE MESQUITA

DE PASS I

KRAUS-SANDOR COLL.
KIRKLAND-KENNEDY-HISTORIC
CAMDEN(S.C.)
KENDALL-HIST. OF NEW ORLEANS
ELZAS-D.J.C.
M.N.
MSS.
H.A.ALEXANDER-ALEXANDER FAMILY

DE PASS(PAZ) OF BORDEAUX

SOLOMON HEYDENFELDT
OF SILESIA

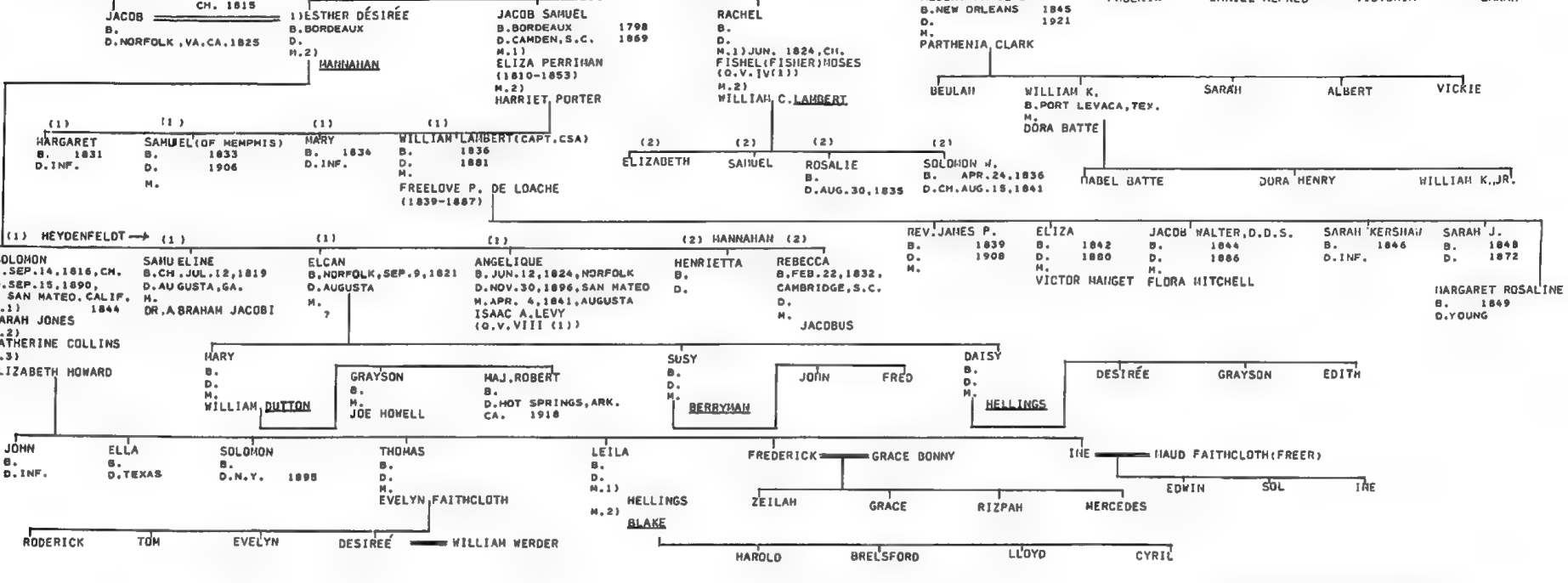

DE PASS II

CHEF TALL
CLEMENS-N. & S.C. MARR. REC.
ELZAS MN
MSS.
KRAUS-SANDOR COLL.
ROSENWAIKE
GA. NEWSPAPER VITAL REC.
FLO. ABR.
BEVIS MARKS KET.
MISC. VI (JWSE)

ABRAHAM ALVAREZ DE PASS

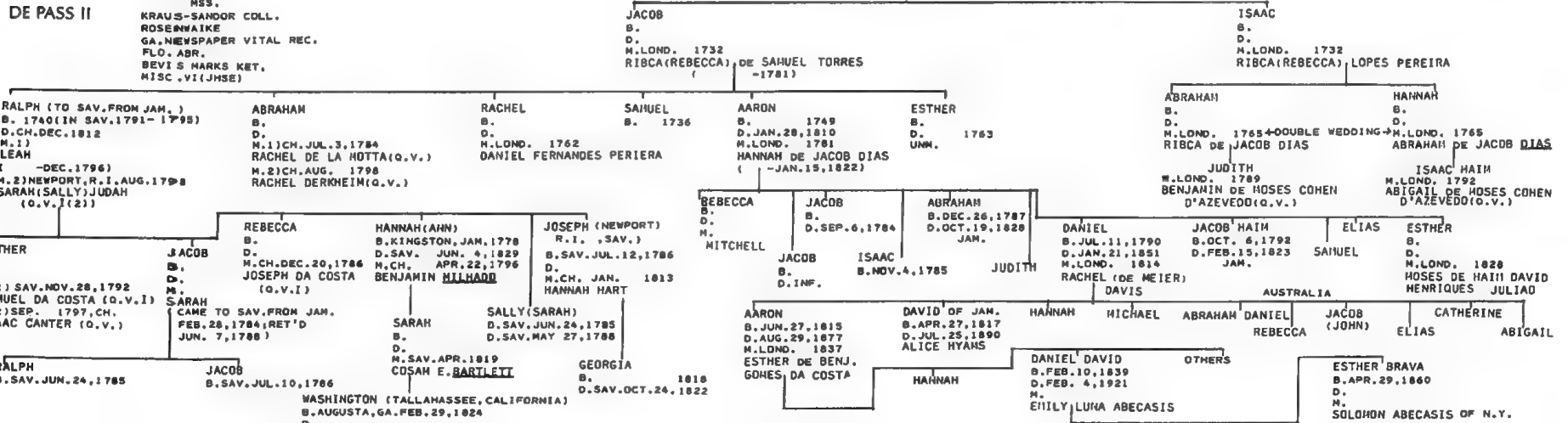

PAJHS, V.6, P.109F
 EZEKIEL-LICHTENSTEIN-JEWS
 OF RICHMOND, P.32F.
 ELZAS-M.N.P.7
 NICKVE ISRAEL REC.
 J.R. COHEN REC.
 ROSENSWAIKE

(MOHEL IN RICHMOND, VA., PETERSBURG, VA., & PH.)

MOSES
 MYER DERKHEIM SARAH
 B. 1748 B. 1754
 D. PHILA. AUG. 2, 1818 D. PHILA. SEP. 9, 1828

DERKHEIM

DAVID ELIZA MOSES RACHEL HORDECAI (HARCUS) ELIEZER ABRAH HAYER SALOMON
 B. FEB. 22, 1774 B. B. RICHMOND, MAY 9, 1788 B. RICHMOND, 1789 B. PETERSBURG, 1791 B. APR. 10, 1799

H. PEREIRA MENDES: A BIOG. (N.Y. 1938)
 KRAUS-SANDOR COLL.
 UJE V.3, P.500
 JE V.11, P.430F.
 PAJHS V.23, P.18 OF
 SHEARITH ISRAEL REC.
 BEVIS MARKS REC.
 WHO'S WHO IN AMERICA, 1952-53
 ANITA STEINBERG

ISAAC IBN DAUD
 BARUCH (9TH CENTURY NAVARRE) ALIAS DON BARTOLOME

DE SOLA (1)

MICHAEL IBN DAUD SHALOM IBN DAUD (10TH C.)
 B. SEVILLE, 1025 AARON (10TH C.)
 MICHAEL BEN MICHAEL HAI BEN MICHAEL (SEVILLE & LUCENA) MIRIAM, DAU. OF ISAAC IBN GIAT SOLOMON BEN MICHAEL

MICHAEL ISAAC ENOCH BEN HAI (11TH C. LUCENA-TUDELA) JOSEPH

ELIJAH
 ISAAC BEN ELIJAH (D. 1216)

JUDITH BENVENISTE DAVID DE SOLA ABRAHAM DE SOLA AARON ENRIQUE DE SOLA (D. SALAMANCA, 1280)

SON

JACOB

DON BARTOLOME (BARUCH) (13TH C. D. TOLEDO) SOLOMON

JACOB ALFONSO DE SOLA

SON

RABBI ELIJAH DE SOLA (B. GRANADA, 1420)

ISAAC (B. GRANADA, 1459; FLED TO PORTUGAL, 1492) BARUCH (BARTOLOME) B. 1461

GABRIEL DE SOLA

CARLOS (B. 1598; D. AMSTERDAM)

SON

(PORTUGAL, HOLLAND)

DAVID (TORTURED BY INQUISITION)
 B. HOLLAND, 1670
 D. ANSTERDAM 1797
 M. ANITA ALVAREZ

AARON (ESCAPED TO LOND., 1749)
 B. PORTUGAL
 D. HOLLAND
 M.

RACHEL REM. AMST. 1705

ISAAC (HAZAN IN LOND., 1690-1700)
 B. 1675
 D. 1734
 M. IN JUD. AMST. 1705

ABRAHAM (ASST. HAZAN, LOND. 1722,
 HAZAN, 1740)
 B. 1753
 D. LOND. AUG. 27, 1722
 (COUSIN) ABIGAIL, DAU. OF JOSEPH COHEN D'AZEVEDO

SAMUEL (ZERAHIAH?)
 B. B. D. M.

RAPHAEL SAMUEL MENDES JOSEPH MENDES (HAZAN IN LOND. 1749-1770)

LEA DE JOSEPH COHEN D'AZEVEDO MOSSHE

DAVID B. LISBON, 1727 D. ANSTERDAM 1797 M. SARAH JESSURUN D'OLIVEIRA OF ANSTERDAM (SEE DE SOLA (2))

ISAAC DE BENJ. B. 1728 D. M. (SEE DE SOLA (5))

JACOB B. LISBON, 1730 D. H. LEAH JESSURUN HENRIQUEZ

ELIAS B. D. M. FURTADO (D. LOND. 1811)

JOSHUA B. CURACAO, 1774 D. CURACAO, FEB. 9, 1839 M. 1) ESTHER HONSANTO (D. ST. T. MAR. 30, 1802) HANNAH ABINUN DE LIMA

BENJAMIN (HOLLAND) ABIGAIL ESTHER RACHEL

RACHEL B. 1732

BENJAMIN B. 1735 D. 1816

ABRAHAM B. LISBON, 1739 D. (L. IN AMSTERDAM)

LEAH COHEN HENRIQUEZ

JACOB B. CURACAO, 1800 D. CURACAO, JUN. 26, 1867

ELIAS B. 1801

HAIM B. CURACAO, 1810 D. ST. THOM. 1830

BENJAMIN B. 1810 D. 1882 M. HETTY ABINUN DE LIMA

OTHERS

ELIAS B. 1826 D. 1816

SARAH SENIOR

ABIGAIL C. HENRIQUEZ

JOSHUA D. 1828

HAIM SOLOMON B. 1832 D. M. SARAH A. DE LIMA

MOSES B. 1835 D. M. ROSALFINE OSORIO

BENJAMIN B. 1837 D. M. LEAH SENIOR

OTHERS

SAMUEL B. 1844 D. M. ROSALVINA JESSURUN

JACOB CHARLES B. 1865 D. M. LEAH DE SOLA (BELOW, LEFT)

ANITA B. 1866 D. M. ERNEST LURIA

HARRY B. 1869 D. M. DOLORES ERASO

FREDERICK B. 1871 D. M. ELEANOR DE SOLA (BELOW LEFT)

JACOB CHARLES DE SOLA (ABOVE RIGHT)

LEAH

JACOB B. NOV. 8, 1858, ST. T. D. NOV. 9, 1858, ST. T.

ELEANOR FREDERICK DE SOLA (ABOVE, RIGHT)

JOSHUA FRANCIS B. 1863 D. 1894

BENJAMIN EDWARD B. 1867 M. BEATRICE MYER

DE SOLA I (2)

FLORENCE ABRAHAMS
MRS. E. MILLER
LAWRENCE LANGNER'S
"MAGIC CURTAIN"

DAVID DE SOLA B.L. 1858DN. 1727
D. AMSTERDAM, 1797
(VID. DE SOLA (1))

SARAH JESSURUN D'OLIVEIRA
OF AMSTERDAM

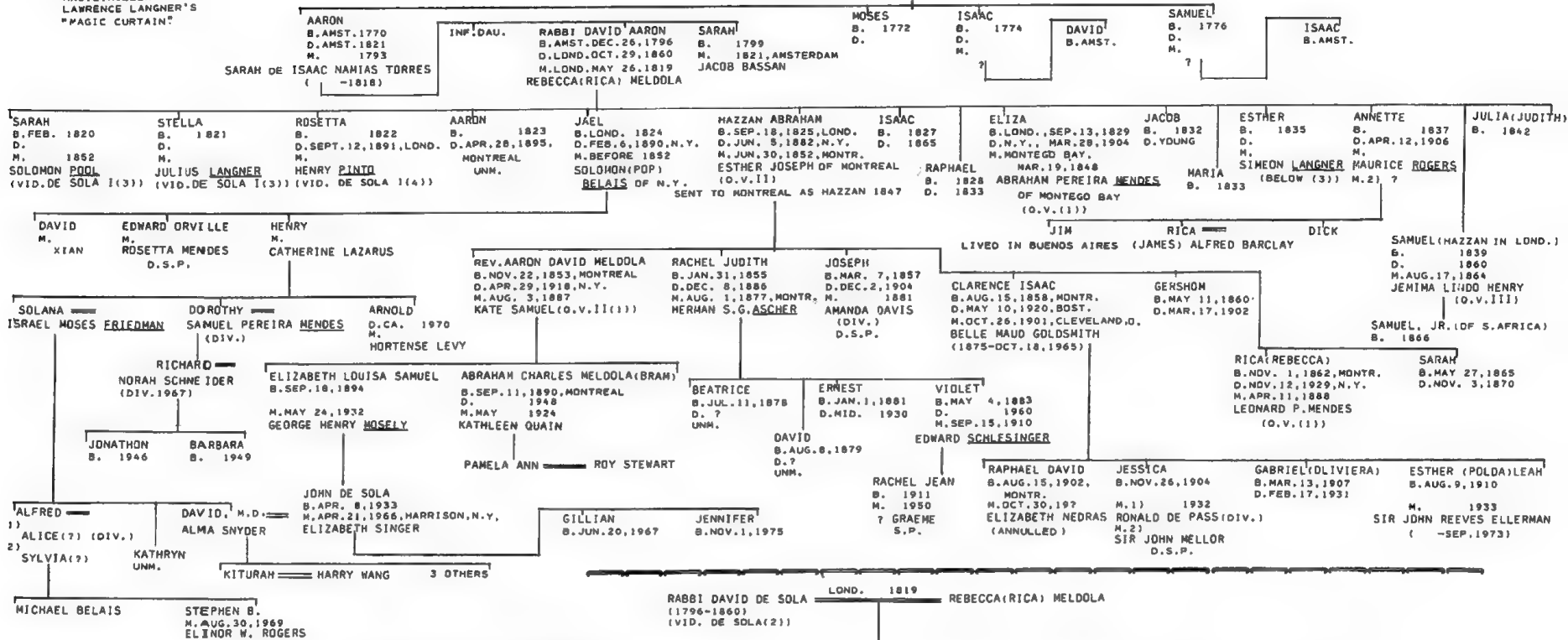

DE SOLA I (3)

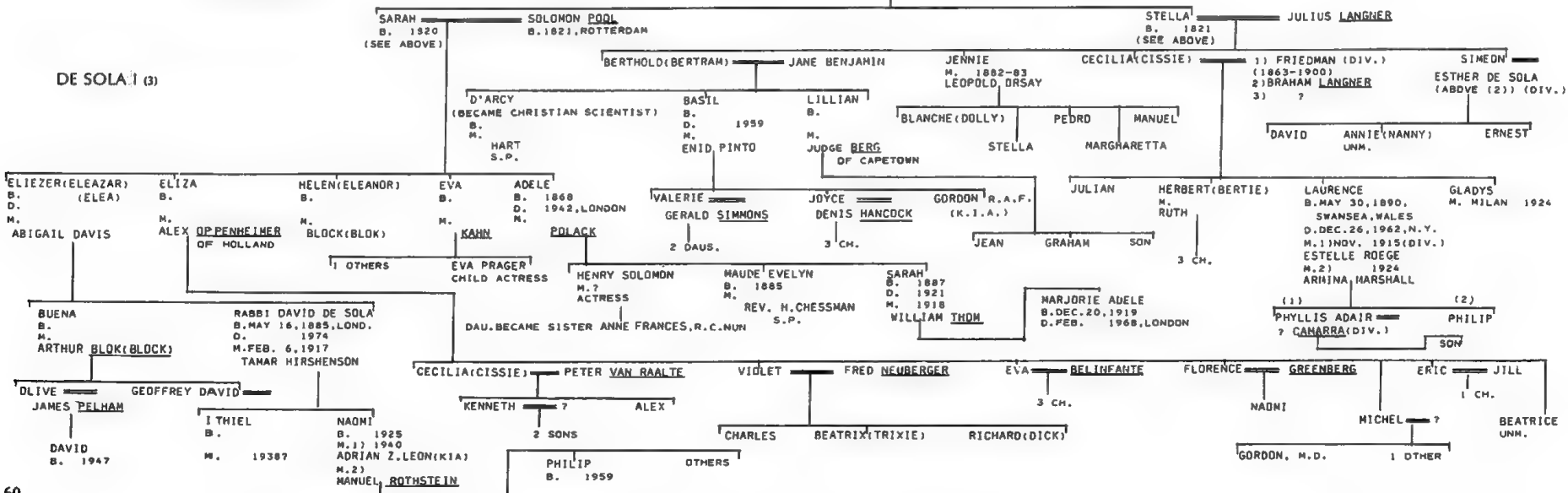

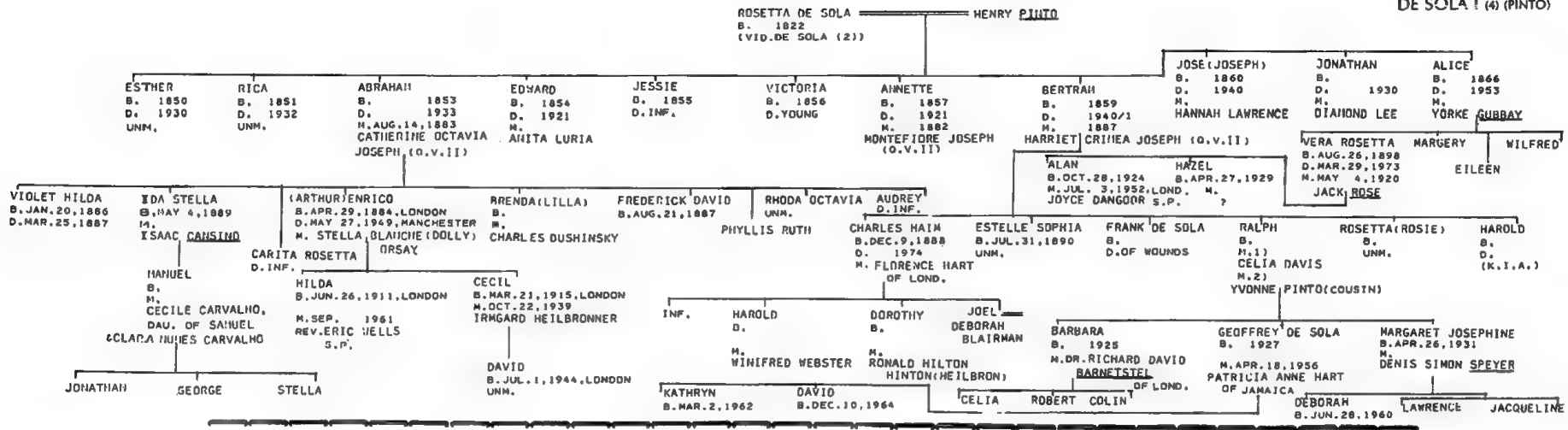

BENJAMIN DE SOLA B. 1733 (TO CUR. 1758) ABIGAIL HENRIQUEZ MORENO DE SOLA II (1)

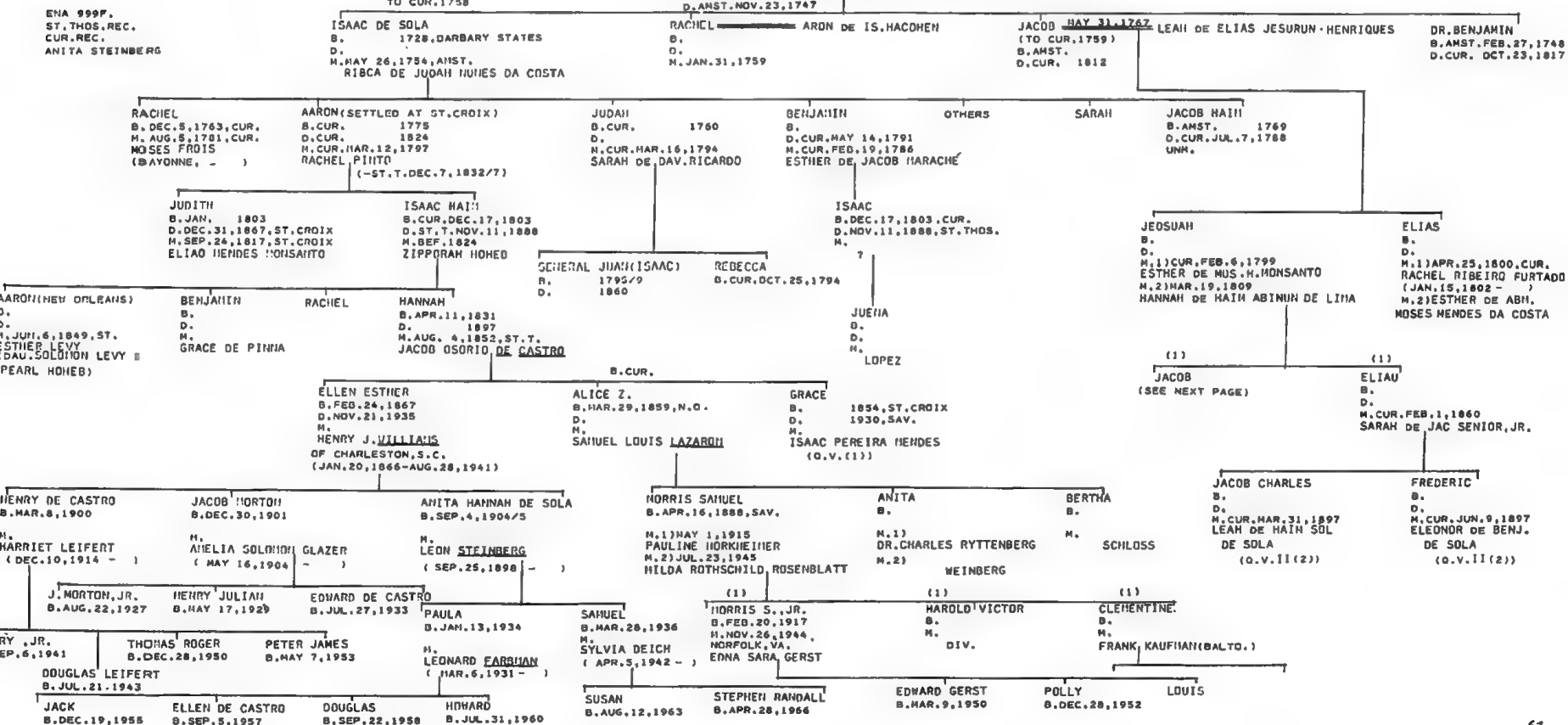

BENJAMIN B. D. M. CUR. JAN. 23, 1861
 HETTY DE ELIAU ABINUN DE LIMA
 JACOB CUR. JUN. 27, 1826
 LEAH DE SELOMOM COHEN HEIRIQUES

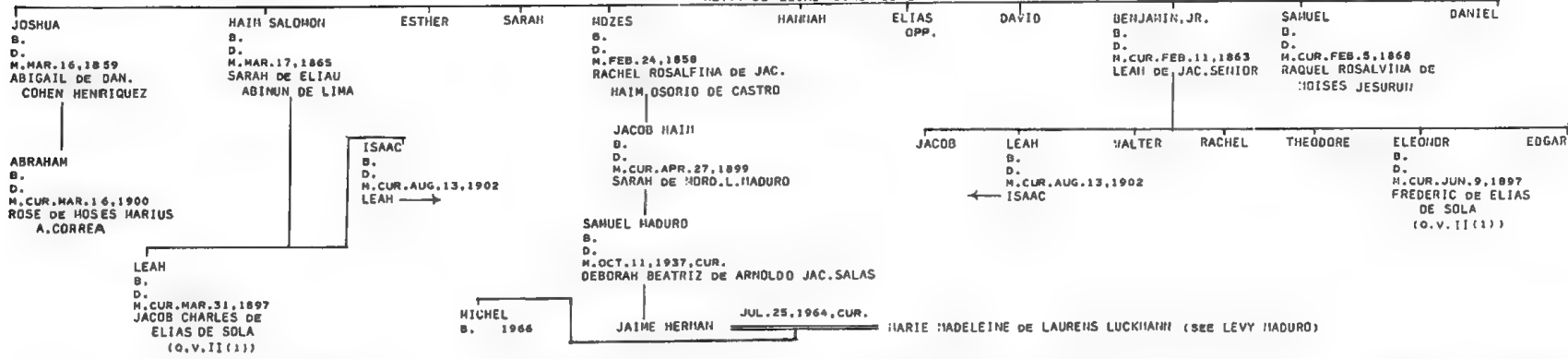

DE TORRES I

DE TORRES II

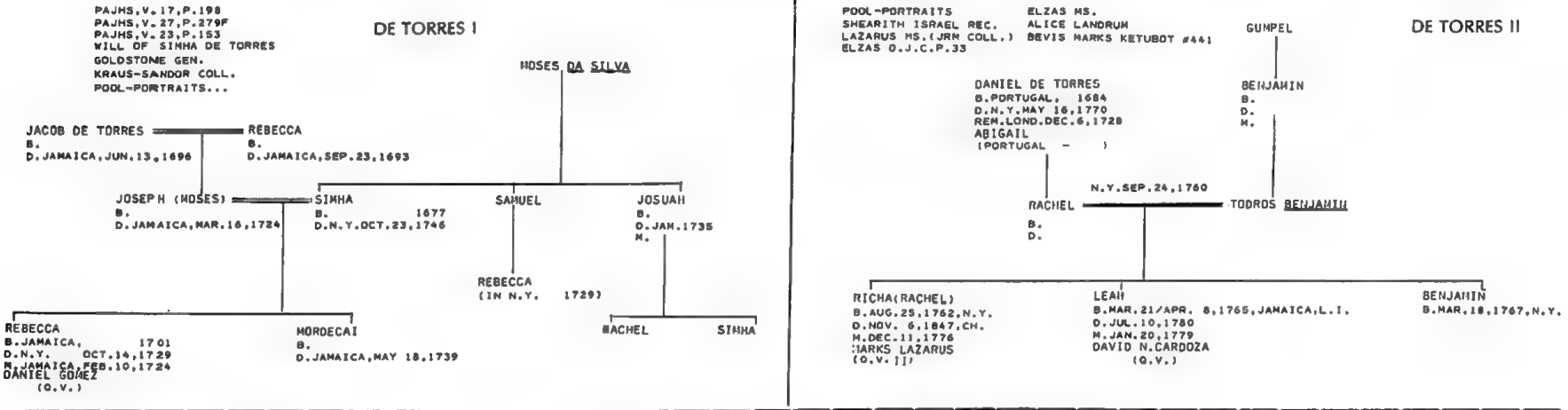

D. LEFKOWITZ-100 YEARS OF JEWRY IN TEXAS
 A. S. DREYFOUS-HEBREW CEM. NO. 1 OF GALVESTON (MIMED)
 A. GUTTMACHER-HIST. OF BALTO. HEB. CDNG.
 B'NAI JESHURUN

GERSHON BAR JEHUQA (DAVID NACHMANIDES)

DYER

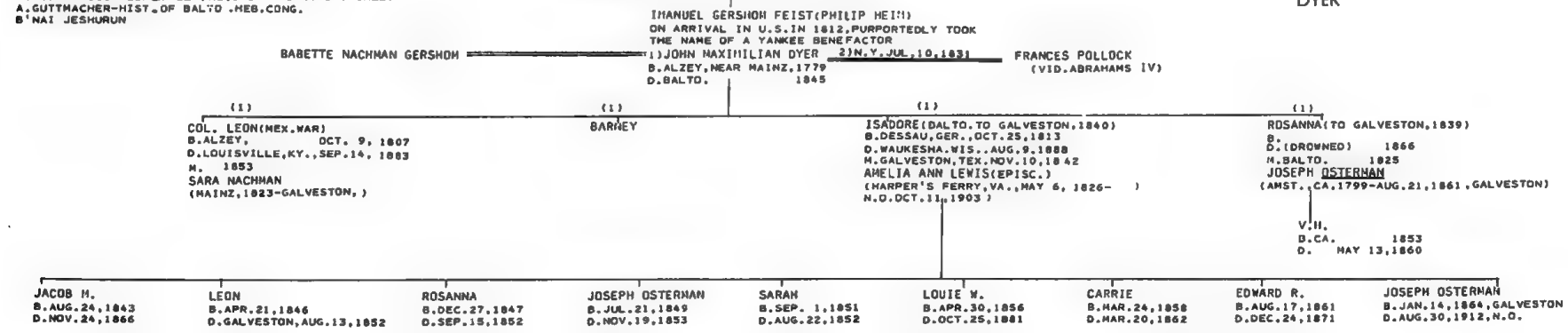

ELIAS FAMILY BIBLE
ELZAS MSS.
OJC.
MN.
JEW.CEM.AT COLUMBIA
STERLING PRICE ELIAS

(CAME TO CH.,CA,1830)

LEVY ELIAS
B.DEDESODORF,GER.1800
D.CH. DEC.30, 1877

ROSA L.
B.BAVARIA 1819
D.COLUMBIA,S.C.1868

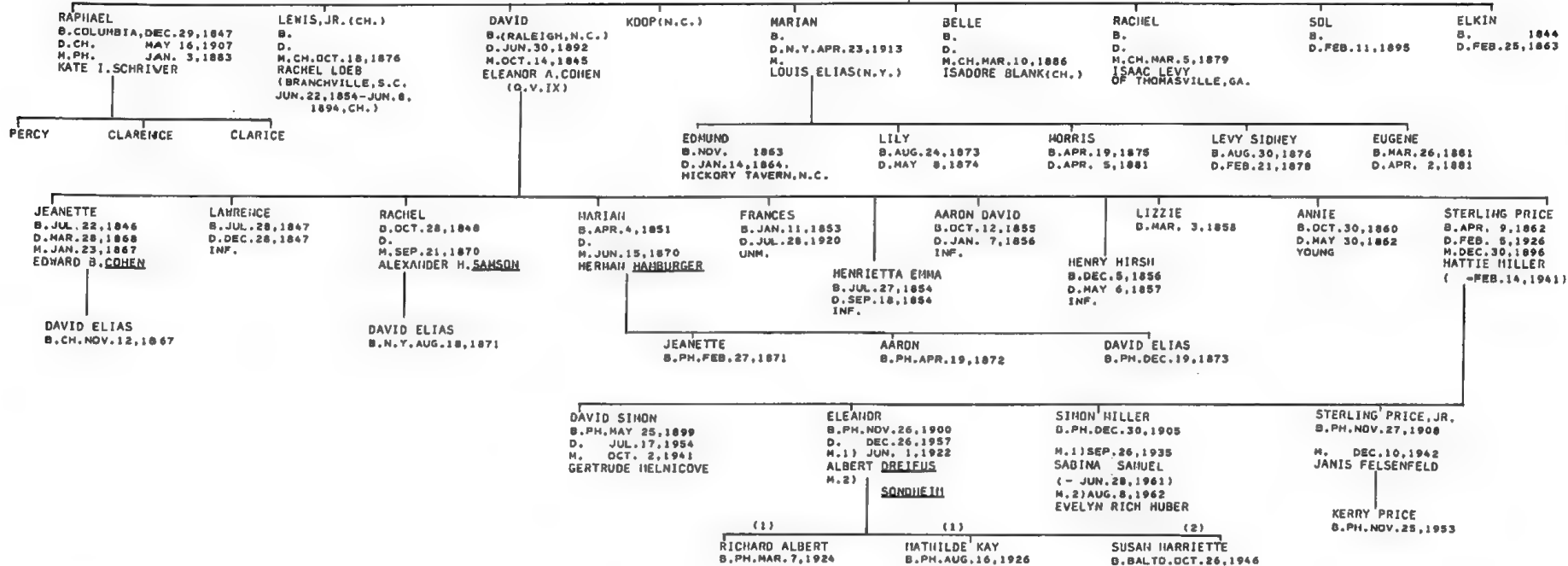

ELIZER

V.L.GUITERMAN MSS.
ELZAS MSS.
VITAL REC.OF R.I.,V.4
SPRAGUE-VITAL REC. OF NEWPORT(MS.NEHS)
STILES' MORTALITY REGISTER (TYPESCR.NEHS)
MISC.VII #548
ROSENWAIKE
AM.D.ADV.

(NAT.N.Y.,JUL.23,1763)

ISAAC ELIZER
OF NEWPORT,R.I.
D.CA. 1718/20
D.CH.JAN.2,1807

FEB.28,1758,NEWPORT

RICHE ISAACKS
(O.V.I)

D. NEWPORT →
ELEAZER
B.OCT. 7,1761,NEWPORT
D.SEP.20,1821,CH.
DROWNED "BELONGED TO A
ONCE WEALTHY FAMILY, NOW
EXTINCT." -ELZAS

HANNAH
B.MAY 21,1763
D.APR.25,1822,CIT.

BILLAH
B.JUL./JAN.17,1765

PRISCILLA
B.AUG.14,1767
D.CH.AUG.1796

MOSES
B.AUG.27,1772
D.

FRANCES(FANNY)
B.NOV.11,1774
D.AUG.11,1796,CH.

JOSIE

ELKIN I

ANKER MS.
 KRAUS MS.
 ST. CHARLES, P. 134F.
 A. J. Y. B. 5664, P. 51
 5677, P. 106

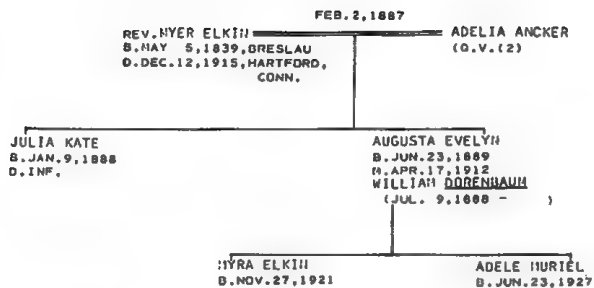
**ELKIN II**

KRAUS-SANDOR COLL.
 SALOMON FAMILY REC. (AJMS)
 PHILIPSON-LETTERS OF REBECCA
 GRATZ, P. 87
 NICKVE ISRAEL REC.
 SPRUCE ST. (PH.) CEMETERY REC.

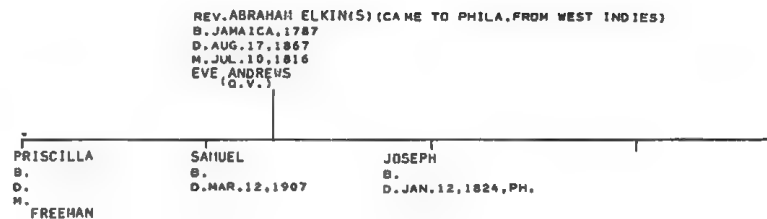
**ELLIS I**

LETTER OF AUGUSTA E. JOHNSON (AJMS)
 ELZAS MSS.
 ELZAS M.N.
 POOL-PORTRAITS...
 SHEARITH ISRAEL REC.
 BARBER, N.Y. MARR.

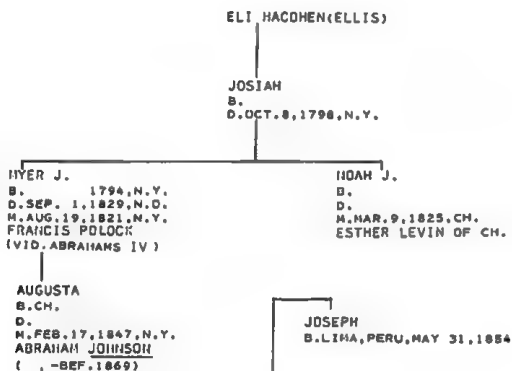
**ELLIS II**

NATHAN GEN.

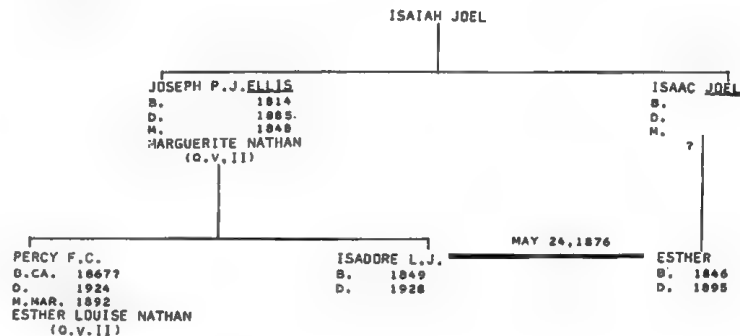
**EMANUEL I**

KRAUS SANDOR-COLL.
 EZEKIEL-LICHTENSTEIN-JEWS OF RICHMOND, P. 291
 WILL OF MARK EMANUEL
 (PETERSBURG, VA. WILLS)
 A. E. MARSH

MARK EMANUEL (CAME TO PETERSBURG, 1832)
 B. 1791, ENG.
 D. AUG. 12, 1851, PETERSBURG, VA.
 M.
 JULIET DAVIS

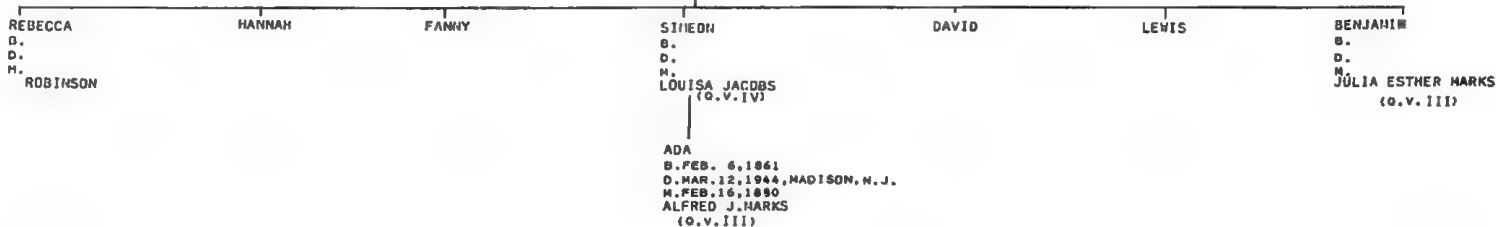

JHSE MISC. VI/192
J.E.V.9,P.678
AJYB V.2,P.533
MORALIS-JEWS OF PHILA.
JON STEIN
FLO ABR.

LEVY EMANUEL
B. WEISENDORF, GER. 1732 (IN PLYMOUTH BY 1763)
D.
M.

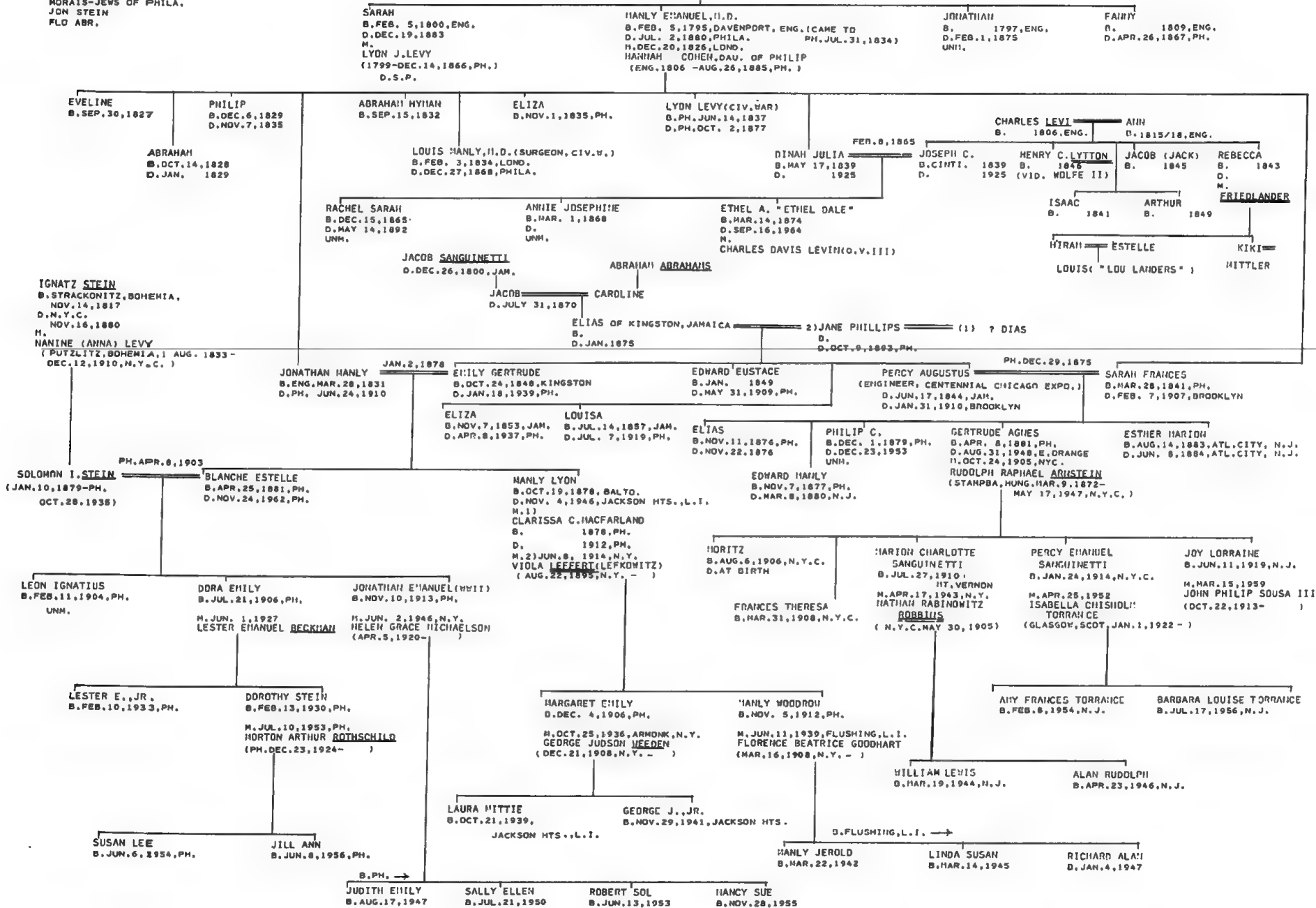

EMANUEL III

E.-L., P. 122
 PAJHS V. 27, P. 293
 KRAUS-SANDOR COLL.
 ELZAS MSS.
 O. J. C.
 M. N.
 JEWISH CEM. AT GEO'TN., S.C.
 JEWISH CEM. AT COLUMBIA, S.C.
 MOSES FAMILY REC. (JRM COLL.)
 N.Y. DEATHS (DAR)
 SHEARITH ISRAEL REC.
 MOISE-JEW. CEM. AT SUMTER

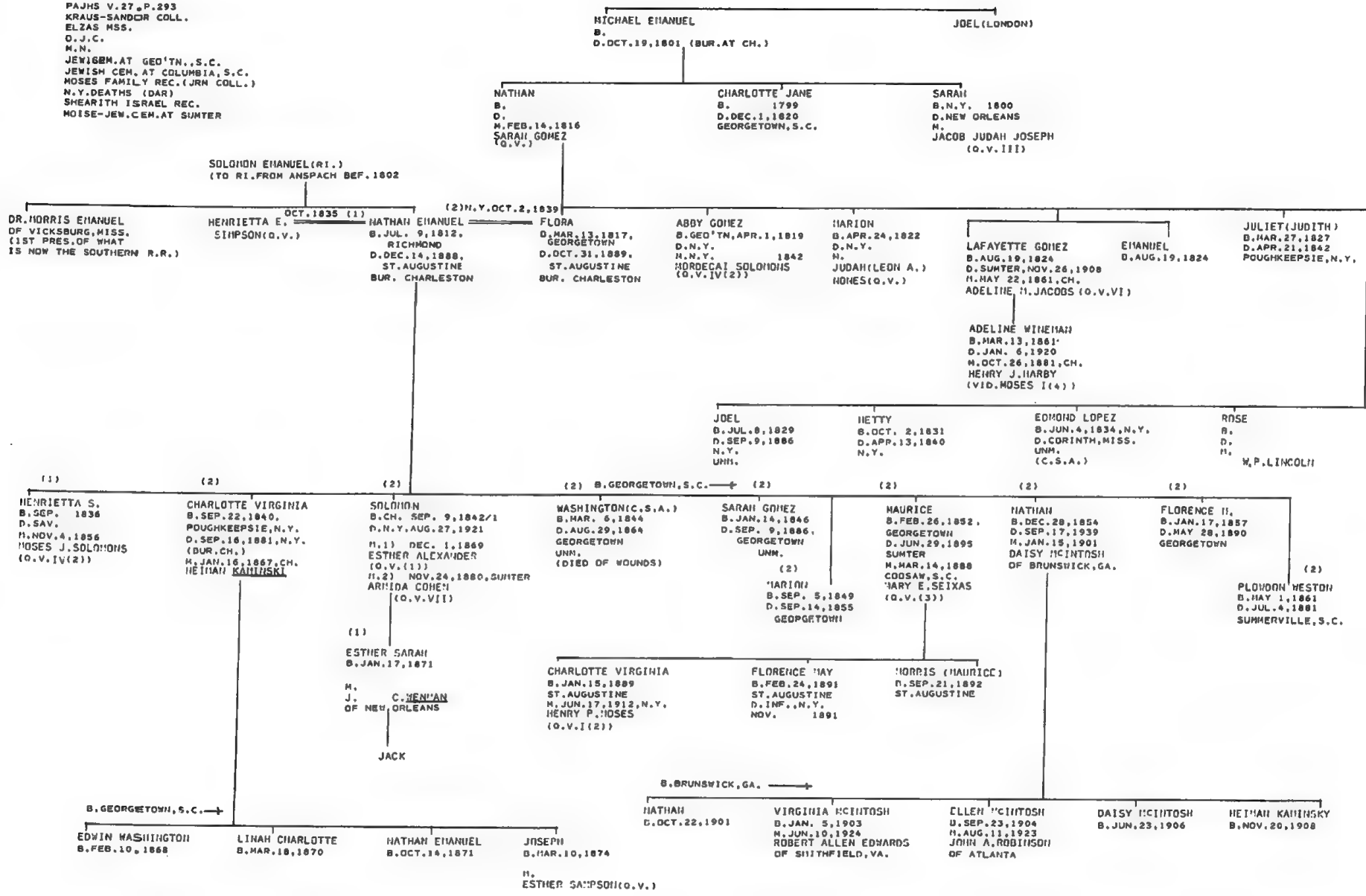

MERSHOWITZ-N.Y.WILLS(I, ADOLPHUS)
K.SCOTT-N.Y.POST BOY

N.Y. ADMIN.
PAJHS V.2,P.63FIV.9,P.30F
UJE V.4,P.186F.IV.5,P.255
MORAIS-JEWS OF PHILA.,P.393F.
PHILIPSON-LETTERS OF REBECCA GRATZ
KRAUS-SANDOR COLL.
MENDRICKS GEN.
CHATHAM CO.,GA.,MARRIAGE RECORDS
GRATZ REC.(DAR)
MARYLAND HIST.MAG. V.15,NO.1,PP.1-20
MICKVE ISRAEL REC.
ELZAS-JEW.CEMETERY AT GEORGETOWN
ELZAS M.N.
BARNET JACOBS HIGHEL REC.(PHOTO.AJA)
SHEARITH ISRAEL REC.
MYER SOLIS-COMEN
COMEN-ETTING CEM.REC.
J.R.COMEN REC.

REUBEN ETTING

JAN.5,1759

ASHER(NORTH CASTLE,WESTCHESTER CO.,N.Y.)
B.
D.SEP.APR.1752
M.
RACHEL JACOBS
(O.V.I)

ELIJAH
B.AUG.10,1724,FRANKFORT A/M.
D.JUL. 3,1778,YORK,PA.
(CAME TO YORK,1758;
NATURALIZED SEP.24/22,1765)

SHINAH SOLOMON
(VID.HYERS-COMEN I)
(CAME TO BALTO.IN SEP.1780
WITH 5 CHILDREN)

ESTHER(HETTY ASSER)

BE'JAH'IN(FREEHAN,N.Y.FEB.7,1769
"GOLDSMITH")

REUBEN
B. 1750/6
D.PH.AUG.29,1770

MOSES
B.
D.EASTON,1778

D. 1793
M.MAY 23,1764
DAVID HAYS(O.V.(1)&(2))

B. 1750/6
D.PH.AUG.29,1770

REUBEN
D.JUN. 6,1762,YORK
D.JUN. 3,1848,PH.
M.SEP.17,1794
FRANCES GRATZ
(O.V.(1))

SOLOMON
B.JUL.28,1764,YORK
D.AUG. 6,1847,BALTO.
M.1)SEP.1,1783
REYNA(RACHEL)SILHON(O.V.)
M.2)OCT.26,1791
RACHEL GRATZ(O.V.(1))

FANNY
D.OCT. 2,1766,YORK
D.JAN.20,1828
M.MAR. 7,1793
ROBERT TAYLOR
(1763-1803)
(SEE NEXT P.)

KITTY
B.SEP.15,1768
D.APR.12,1838
UNM.

HETTY
B.MAR. 4,1770
D.SEP.13,1847
UNM.

ELIZABETH
B.NOV.24,1772/4
D.DEC.27,1860,EMMITSBURG,MD.
M. 1795/6
ROBERT HICKLE
(SEE NEXT P.)

JOSEPH
B.NOV.17,1778,YORK
D. 1781
SALLY
B.SEP.12,1776
D.JUN. 2,1863
UNM.

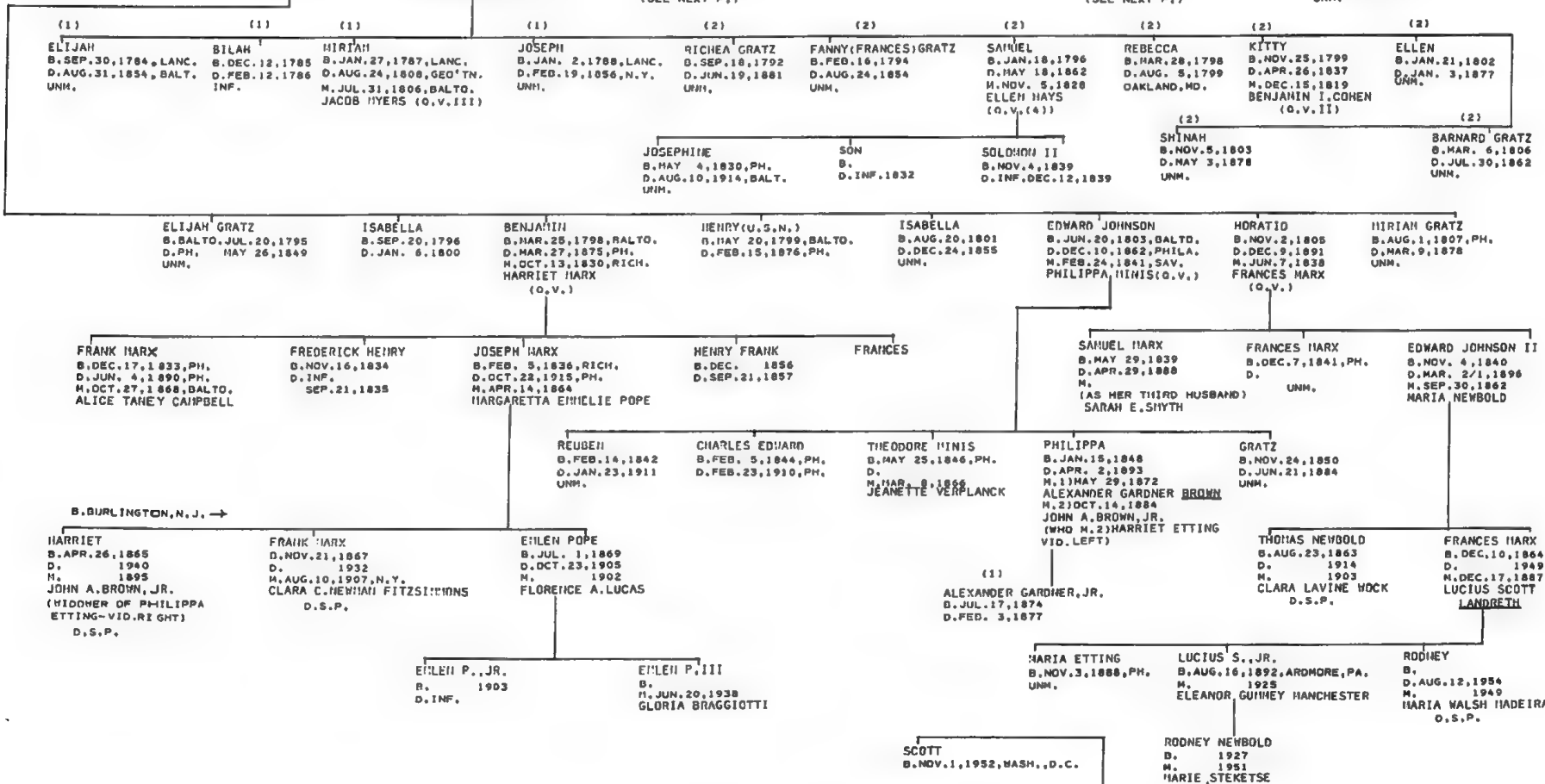

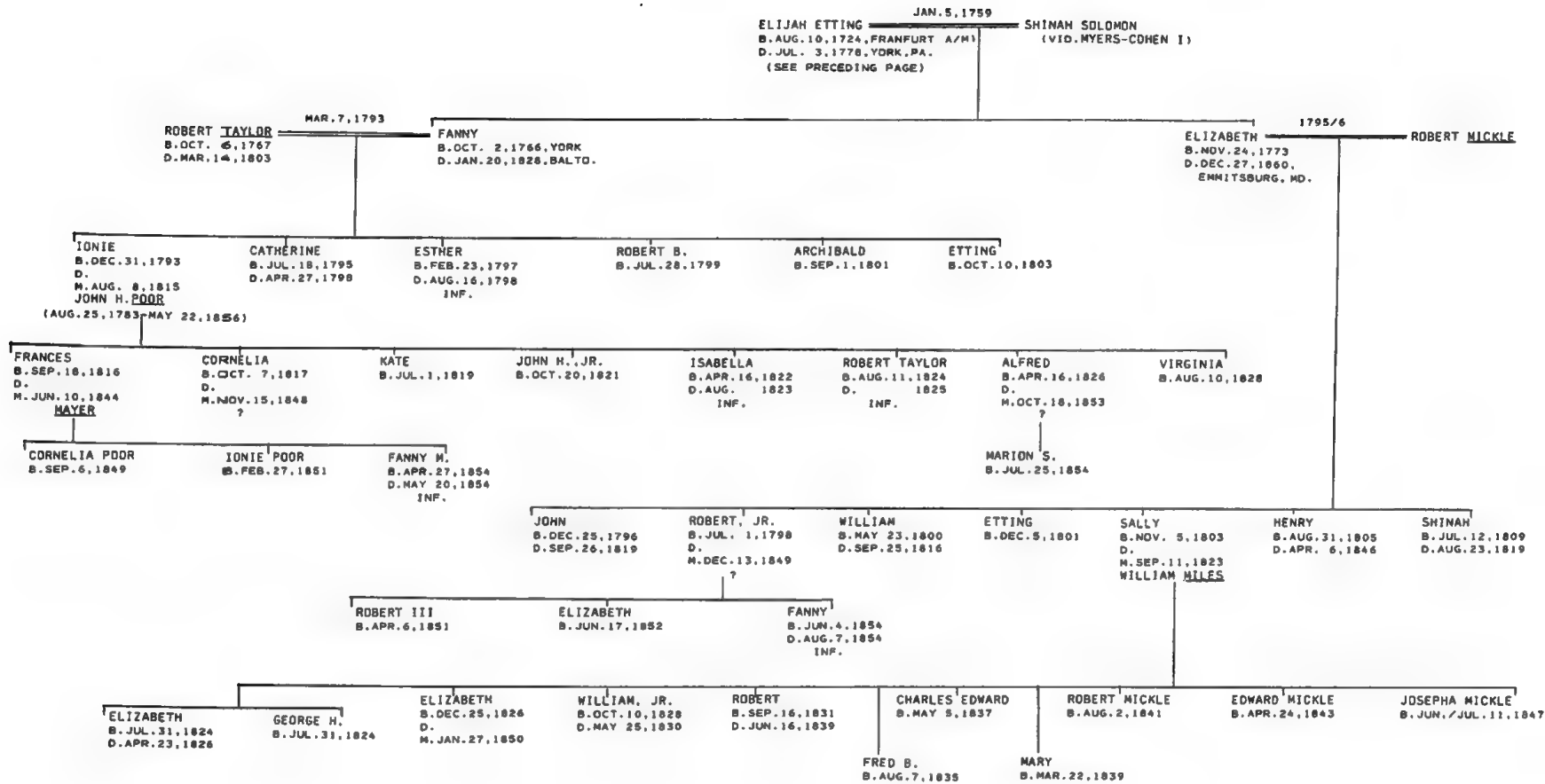

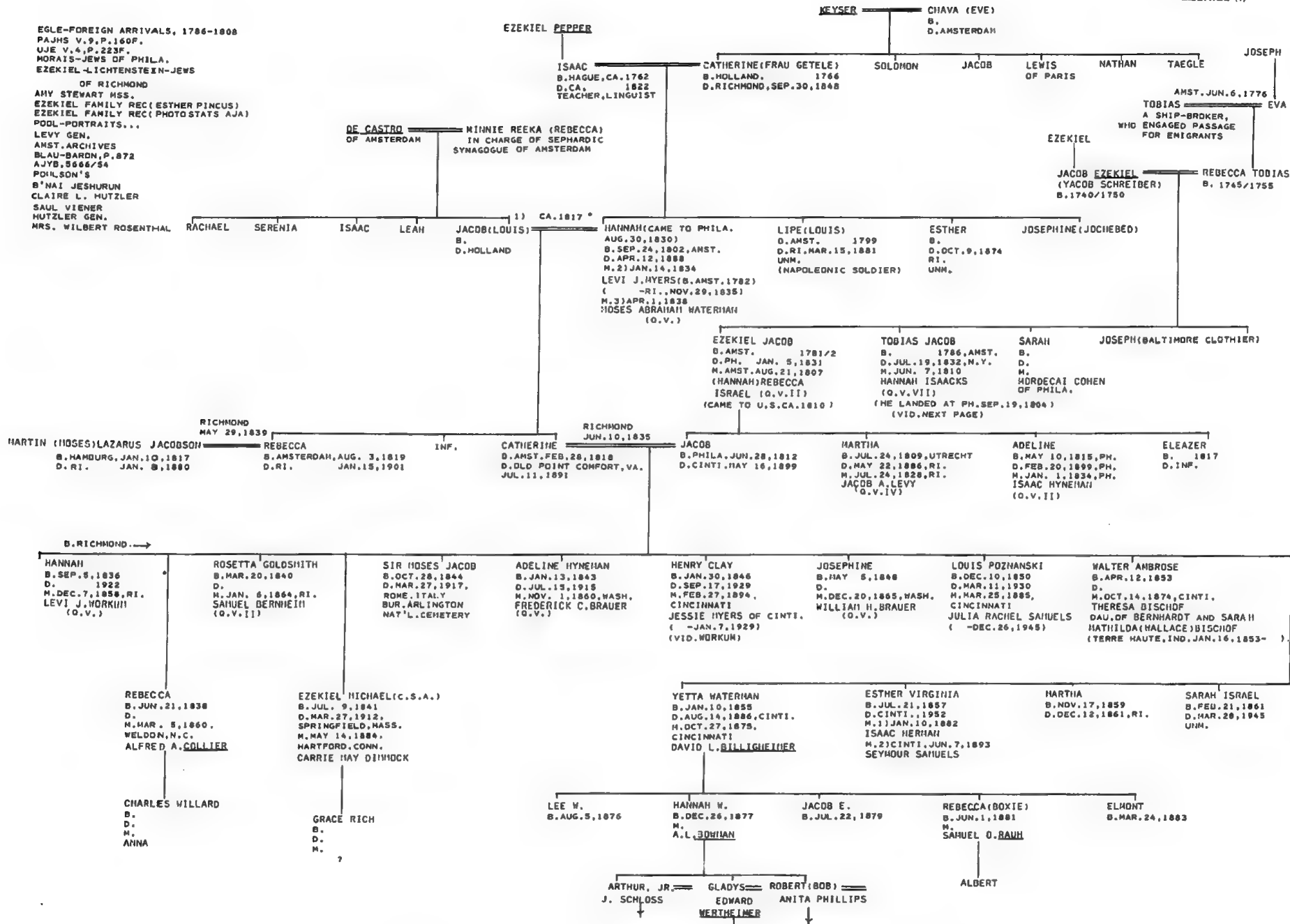

* NOTE:FAMILY RECORD DATES THE MARRIAGE OF JACOB (LOUIS) DE CASTRO AND HANNAH PEPPER,APR.13,1809,BUT THIS DATE IS IMPOSSIBLE,IF HANNAH'S BIRTH DATE IS CORRECT.

TOBIAS JACOB EZEKIEL (LANDED IN PHILA., SEP. 19, 1804)
 B. AMST. 1786 IN RICHMOND BY 1807
 D. N.Y., JUL. 19, 1832
 M. JUN. 7, 1810
 HANNAH ISAACKS (O.V.VII)
 (SEE PRECEDING PAGE)

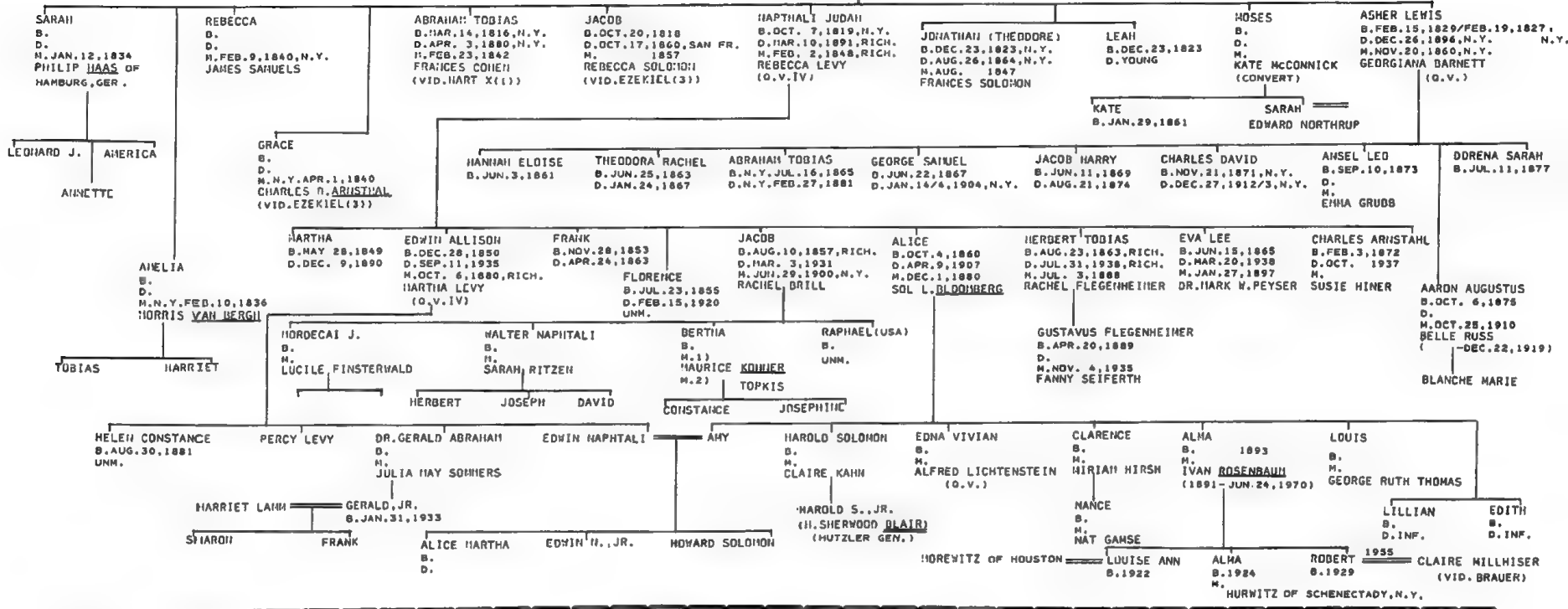

EZEKIEL (3)

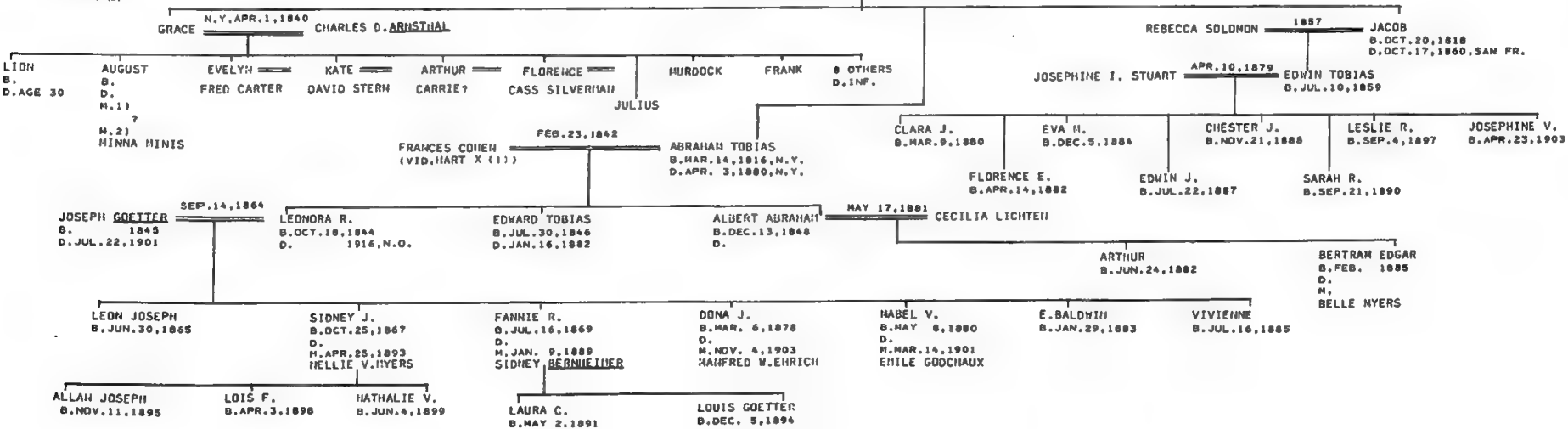

U.J.E.
HORAIJ-JEWS OF PHILA.
C.J.TELLER-TELLER FAMILY
IN AMERICA
FLORENCE ABRAHAMS

BENJAMIN WULF FLEISHER
B. 1810
D. 1845
M.
HARRIET TUCHNER
(1810-1903)

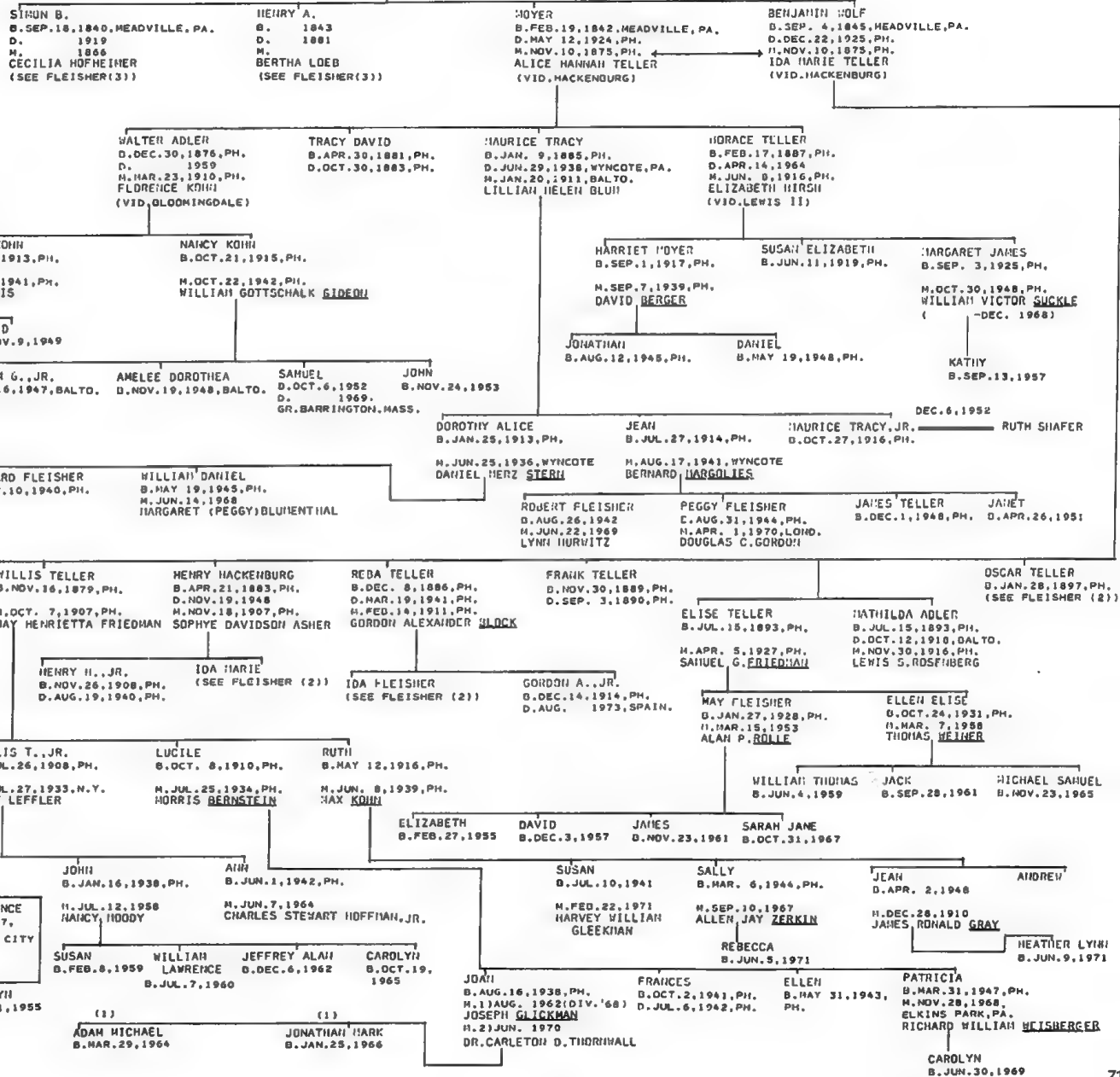

BENJAMIN WOLF FLEISHER
 B. SEP. 6, 1845, MEADVILLE, PA.
 D. DEC. 22, 1925, PH.

NOV. 10, 1875, PH.

IDA MARIE TELLER
 (VID. HACKENBURG)

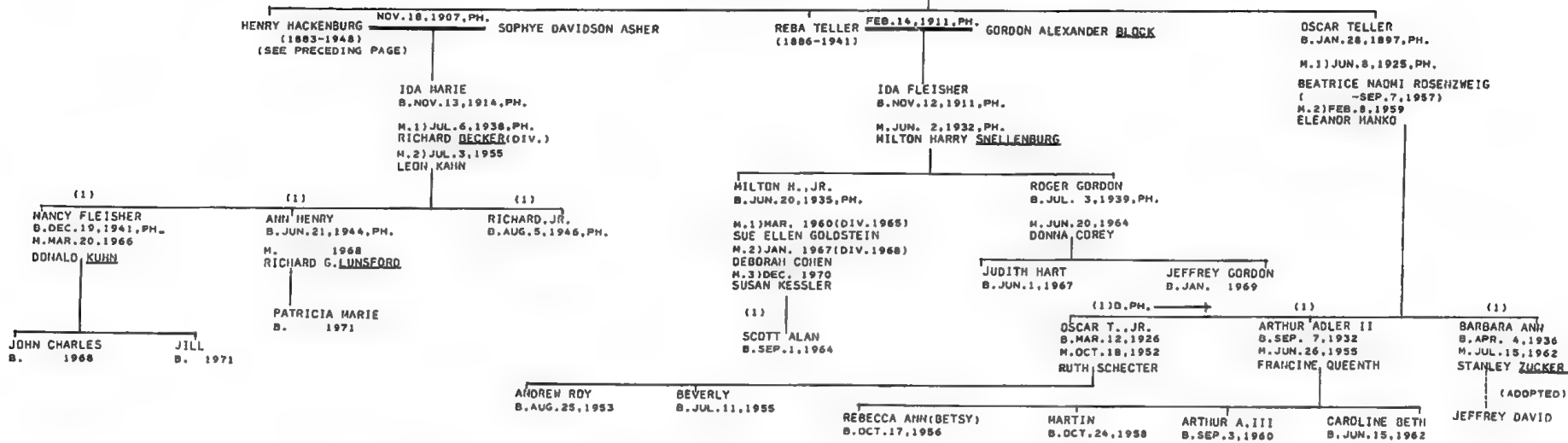

FLEISHER (3)

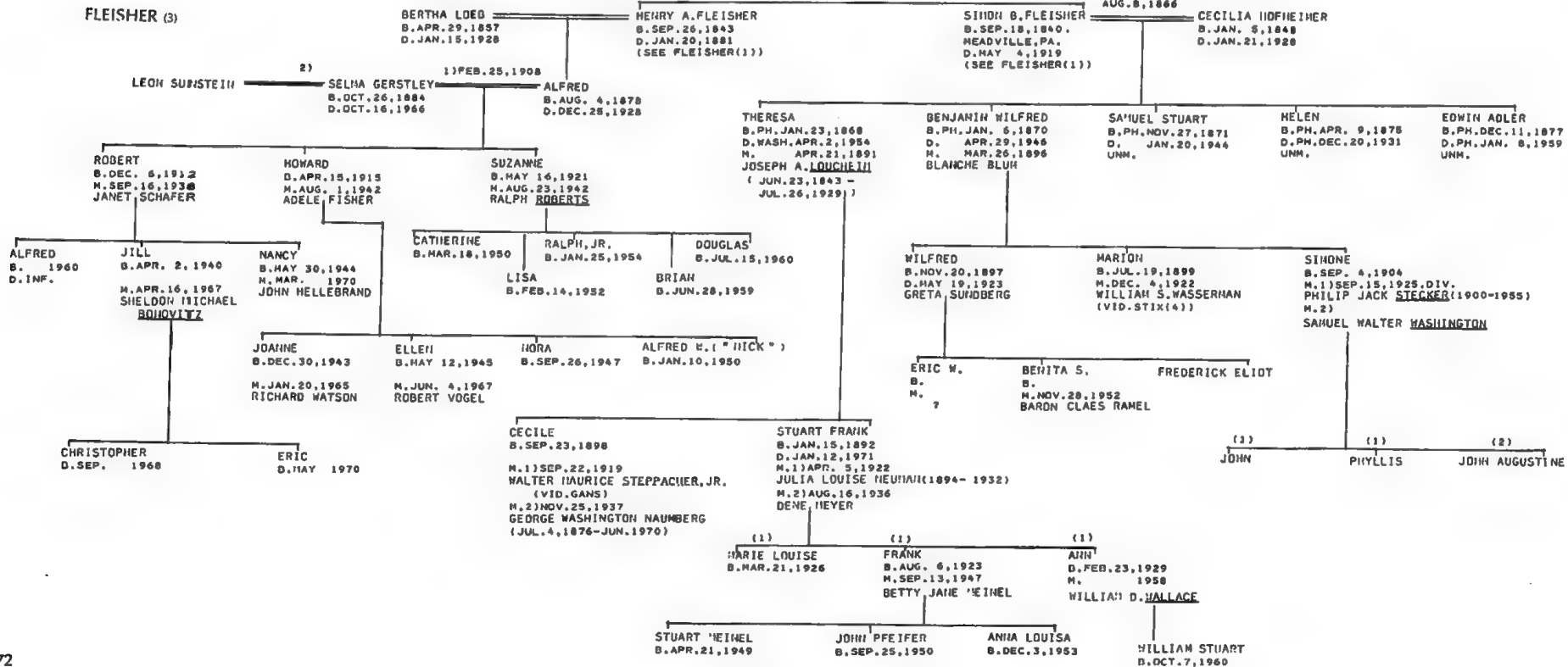

KRAUS-SANDOR COLL.
SHEARITH ISRAEL REC.

FELBEL

JACOB (JULIUS) FELBEL
B. OCT. 15, 1823, GER.
D. NOV. 2, 1904, N.Y.
M. OCT. 30, 1850
HIRIAH COHEN
(G.V. X(1))

GRACE
B. OCT. 19, 1851, BOSTON
D. MAR. 23, 1893, N.Y.
UNM.

ROSALIE
B. AUG. 23, 1853, N.Y.
D. OCT. 6, 1934
M.
EDWIN J. ISAACS

VICTOR

ISADOR
B.
D.
M.
TESSIE HYMAN FREEHAN
D.S.P.

JACOB
B. 1857, N.Y.
D. DEC. 12, 1938, N.Y.
D. DEC. 7, 1887
ADA BENJAMIN
(G.V. III)

FRANK JULIUS
B. DEC. 29, 1889, N.Y.
D. OCT. 4, 1918, FRANCE
K.I.A.

EUGENIE
B. NOV. 16, 1859
D.
M. JUN. 1, 1881
HENRY C. ISAACS
(G.V. III)

DINAH BLANCHE
B. JUL. 1862, N.Y.
D. JUL. 23, 1864, N.Y.

GERTRUDE
B. APR. 13, 1864, N.Y.
D. JAN. 17, 1938, N.Y.
UNM.

HENRY
B. SEP. 2, 1866, N.Y.
D. JUL. 19, 1867, N.Y.

FONSECA

ISAAC GRANTED 1000 ACRES IN JAN. SEP. 26, 1676

JACOB FONSECA RIBCA
OF NEW YORK AND JAMAICA
B.
D. CA. 1729
PERH. JAMAICA.

ISAAC ABRAHAM JOSEPH RACHEL ESTHER JUDITH SARAH
B.
D.
M. LOND. FEB. 6, 1730
ESTER DE SIMON HALPHON

FLORANCE

J.E. V.8,P.664
 KRAUS-SANDOR COLL.
 ELZAS,M.N. P.13
 ELEANOR COHEN GEN.(AJA)
 MICKVE ISRAEL REC.
 MRS. ALBERT M. COHEN
 SHEARITH ISRAEL REC.
 FLORENCE ABRAHAMS
 FED.ST.CEN.
 KORN N.O.
 F.BASIL GUEDAL LA
 RODEPH SHALOM NOM.REC.
 EVELYN MILLER

(PERH.ZACCARIA LEVY OF BROAD ST.BLDGS.
 EMDEN,LOND.19 DEC.1766)

ZACHARIAH LEVY
 (CHANGED NAME TO FLORANCE)
 B.
 D.NEW ORLEANS,NOV.15,1832
 (DENTIST IN CHARLESTON,1802;
 LIVED ALSO IN KY.,TENN.)
 (TO N.O..1827/28)

SARAH LEVY

JACOB LEVY (IN N.O. BY 1825)
 B. APR. 17, 1803
 D. SEP. 4, 1867, PH.
 M.
 HANNAH LEVY
 (VID. LYONS III)

WILLIAM (PHILA.)
 B. JAN. 28, 1805, CH.
 D. JUL. 15, 1882, PH.
 M. SEP. 17, 1834, N.Y.
 MYRTILLA SEIXAS
 (O.V. (2))

LEWIS
 B.
 D.
 UNM.

LAVINIA
 B.
 D.

HENRY (IN N.O. BY 1830)
 B.
 D.
 M.
 MARY LEVY
 (VID. LYONS III)

BENJAMIN (NEW ORLEANS)
 B.
 D.
 M. AUG. 3, 1836, N.Y.
 REBECCA KURSHEEDT
 (O.V.)

ROSIANA
 CH. APR. 27, 1827

AUDLER
 DR. E. H.
 OF AUGUSTA, GA.

SOLOMON
 (IN CH. 1824; N.O. 1827)
 B.
 D.
 M. N.O.
 HELENE BARNETT
 (O.V.)

HYER

WILLIAM
 B.
 D.
 M.
 RUTH ?
 (XIAN)

THEODORE J.
 B. JUL. 2, 1836, NEW OR.
 D. SEP. 28, 1914, PH.
 M. MAY 22, 1860, N.Y.
 ROSALIE NATHAN
 (O.V. I (1))

SELINA
 B.
 M. 1) SEP. 5, 1855
 PHILIP A. MOISE
 (O.V. (2))
 M. 2)
 LE COMTE DE L'ANNE
 ET DE LA GEORGETTE

CORINNA
 B. MAR. 3, 1839, NEW OR.
 D. OCT. 1, 1863, N.Y.
 M.
 EUGENE J. JACKSON
 (O.V. I)

ANNIE AUGUSTA
 B. MAR. 27, 1842, PH.
 D. NOV. 18, 1878, CH.
 H. JAN. 5, 1859, PH.
 ISRAEL ROBERT W. NATHAN
 (O.V. I (1)) & (2))

LUCIEN GERSHON
 B. AUG. 13, 1845, PH.
 D. JUN. 25, 1898, N.Y.
 M. SEP. 11, 1867, N.Y.
 EMILY ISAACS
 (O.V. II)
 O.S.P.

LAVINIA
 B.
 D.
 M.
 JAMES G.B. WILLIAMS

HENRY
 B.
 D.
 M.
 SON

LOUIS (CIV. W.)
 B.
 D. 1863
 (CSA)

MYRTILLA
 B. JUN. 16, 1839
 D. MAR. 8, 1896
 M.
 ISAAC LIONEL CRAVCOUR
 (JUN. 14, 1825 - JUL. 25, 1886)

ROWENA
 B. OCT. 29, 1842, NEW OR.
 D.
 M. 1872, LOND.
 JOSEPH GUEDALLA
 OF LONDON (1847-)

CLAUDE
 B.
 D. 1885
 UNM.

ERNEST TOURD
 B. JUL. 30, 1854
 D. JUL. 1918
 UNM.

MYRTILLA
 B. MAR. 5, 1861, PH.
 D. MAY 26, 1954
 M.
 HENRY H. HENDRICKS
 (O.V. (2))

WILLIAM HERBERT
 B. FEB. 1, 1863, PH.
 D. INF.

LILLIAN H.
 B. 1864, SAV.
 D. APR. 5, 1939, PH.
 UNM.

EUSTACE LEE
 B. PHILA. AUG. 1, 1866
 M.
 MARY EDWARDS

ROSALIE
 B. MAR. 27, 1870, PH.
 D. OCT. 26, 1876, N.Y.

EMILY
 B. MAR. 27, 1870, PHILA.

JUDAH FLORANCE
 B. 1873

ABRAHAM HERBERT
 B. 1874

RUTH AGNES
 B. 1878

EUSTACE LEE, JR. ROSALIE MARY JOHN SALLY

CLARENCE
 B.
 D. YOUNG

ARTHUR
 B. OCT. 29, 1861
 D. DEC. 29, 1873

SARAH
 B.
 D.
 M.
 JOSEPH GIVEL

MYRTLE

EDYTHE
 D.
 M.
 HERBERT CARR
 (SEE PRECEDING PAGE)

LAVINIA
 B. MAY 26, 1828, N.O.
 D.
 M. OCT. 22, 1851, PH.
 ABRAHMINIS (O.V.)

ROSINA
 B. FEB. 11, 1827, N.O.
 D. DEC. 8, 1850.
 TEIGNMOUTH, ENG.
 M. NOV. 15, 1846
 MOSES E. DAVID
 (O.V. (1))

WASHINGTON ZACHARIAH
 B. MAR. 29, 1829 / NOV. 29,
 1829, NEW OR.
 D. JUL. 18, 1881
 M. OCT. 18, 1854, PH.
 FRANCES COHEN (O.V. I)

CLOTILDA
 B. FEB. 22, 1832, NEW OR.
 D. MAR. 30, 1915, PH.
 M. MAY 16, 1854
 ANDREW J. COHEN (O.V. I)

BLANCHE
 B. NEW OR. 1836
 D. PH. NOV. 20, 1863
 M.
 CARL TEVIS
 (DIV.)

FLORIAN HART
 B. AUG. 30, 1838, N.O.
 D. MAY 18, 1899, N.Y.
 M. NOV. 7, 1860, N.Y.
 SARAH HENDRICKS
 (O.V. (1))

EDWIN JACOB
 B. JAN. 25, 1843, PH.
 D.
 M.
 AUGUSTA STEARNS

FLORA
 B.
 D.
 M.
 GEN. HENRY GDUGET
 DE LONDRES

EMMA
 B.
 D.
 UNM.

MARGARET
 B.
 D.
 M.
 J. SMITH PERGUSON

ROSINA
 D. JUL. 18, 1857

BLANCHE
 D. NOV. 20, 1863

LILY
 B. 1869
 D. 1888

ESDAILE
 B.
 D.
 M.
 ANNA STIRLING

FANNY
 B.
 D.
 M.
 SPENCER HEAD

FLORIAN
 B.
 D.
 M.
 MINNIE DUNN

WRIGHT (1) HAY (2) JOHN POLK

EDWIN JACOB
 B. DEC. 2, 1868, N.Y.
 D. MAY 7, 1872, N.Y.

TWIN
 B. DEC. 2, 1868, N.Y.
 D. INF.

DAISY
 B. JAN. 21, 1870
 UNM.

SYLVIA
 B. JAN. 24, 1874, N.Y.
 D. NOV. 2, 1937, N.Y.
 M.
 THEODORE H. JOSEPH
 (O.V. I)

JAMES (W. W. I)
 B. 1882
 D. MAR. 2, 1917,
 FRANCE

JOHN DUNN ESDAILE

JAMES MURRAY KAY FLORANCE

CHRISTOPHER PETZELT FRANCES FREDERICK WORK

MARJORIE DOROTHY BARBARA

FRANCES

ABIGAIL FRANKS LETTERS
 WOLF-WHITEMAN
 ALFRED D. SUMBERG
 FLO. ABR.
 UJE, V. 4, P. 416F.
 JE, V. 5, P. 497
 HORAISS-JEWS OF PH., P. 35F.
 PAJHS, V. 4, P. 197F.
 V. 5, P. 7F.
 V. 10, PP. 121, 213F.
 V. 26, PP. 78F, 261F.
 V. 27, PP. 376, 472.
 KRAUS-SANDOR COLL.
 ROTH-THE GREAT SYMAGOGUE, P. 62F.
 N.Y.G. 6B.R. 104/79

GOLDSTONE GEN.
 DAVIDSON GEN.
 PA. MAGAZINE, V. 34, P. 253F.
 POOL-PORTRAITS
 MICKVE ISRAEL REC.
 SHEARITH ISRAEL REC.
 R. J. D'AREY HART
 SALOMON FAMILY REC.
 J. R. ROSENBLUM
 MISC. VI
 MISC. VII
 J. R. COHEN REC.
 FOSTER M. PALMER

AARON FRANKS

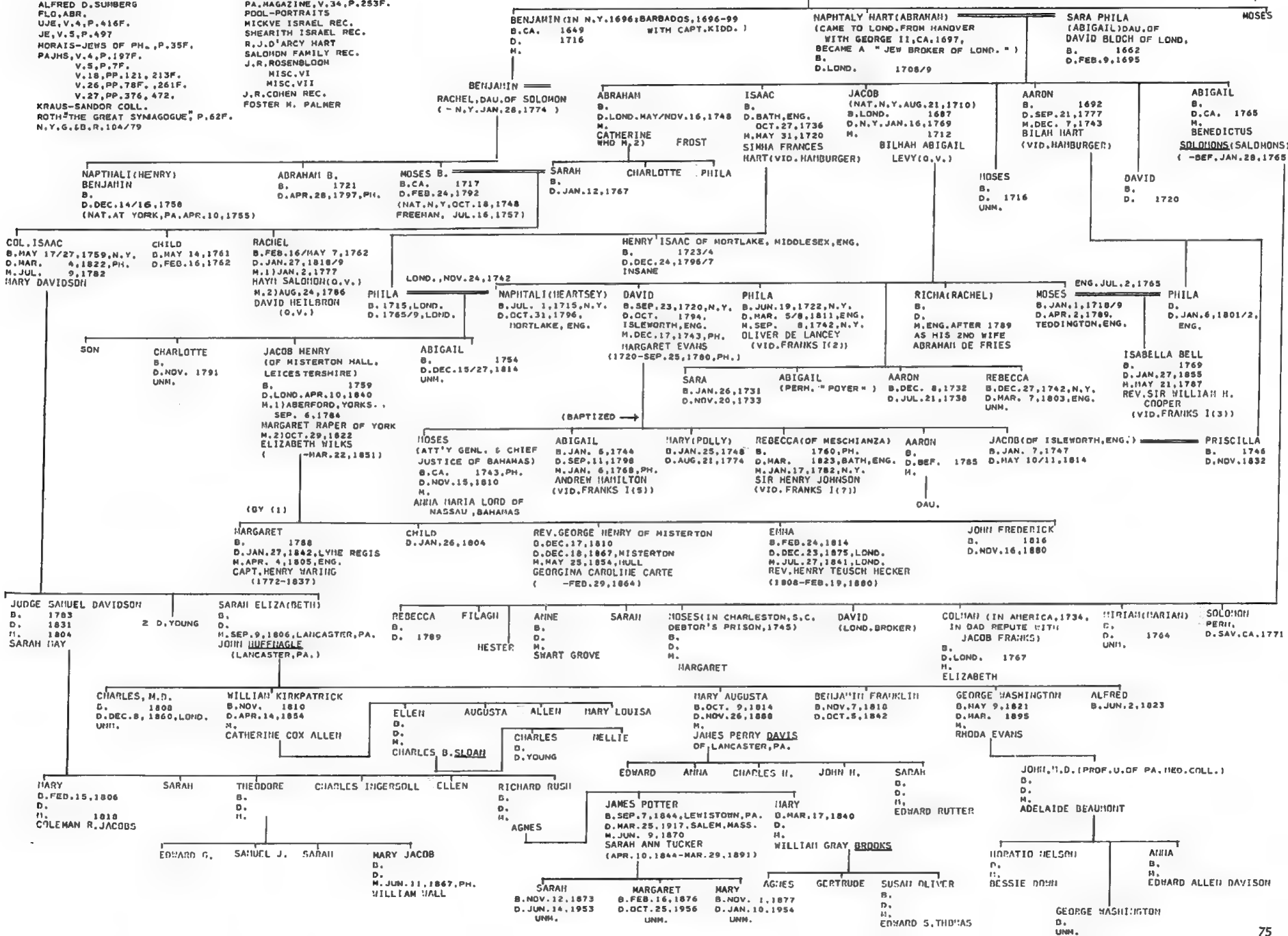

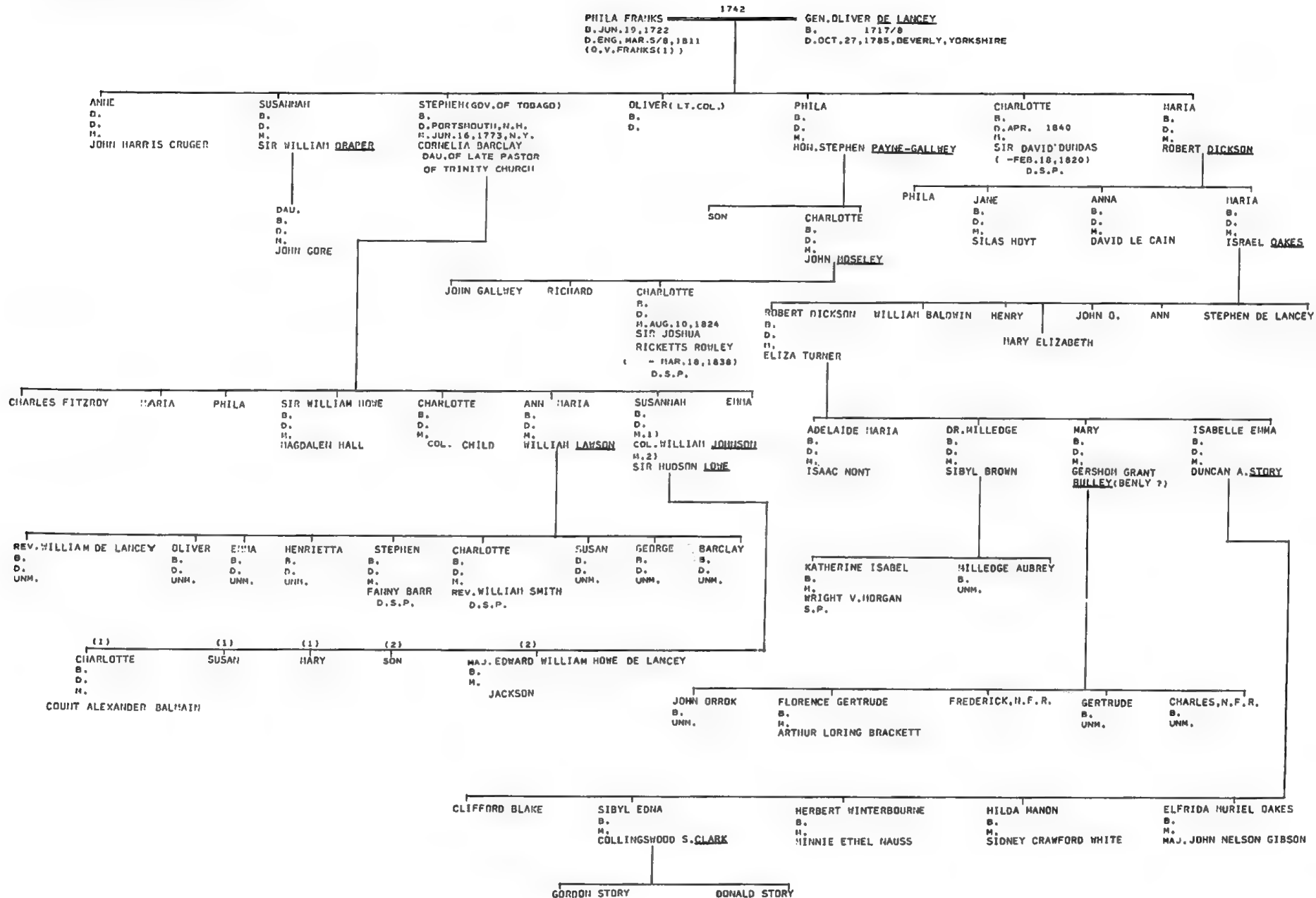

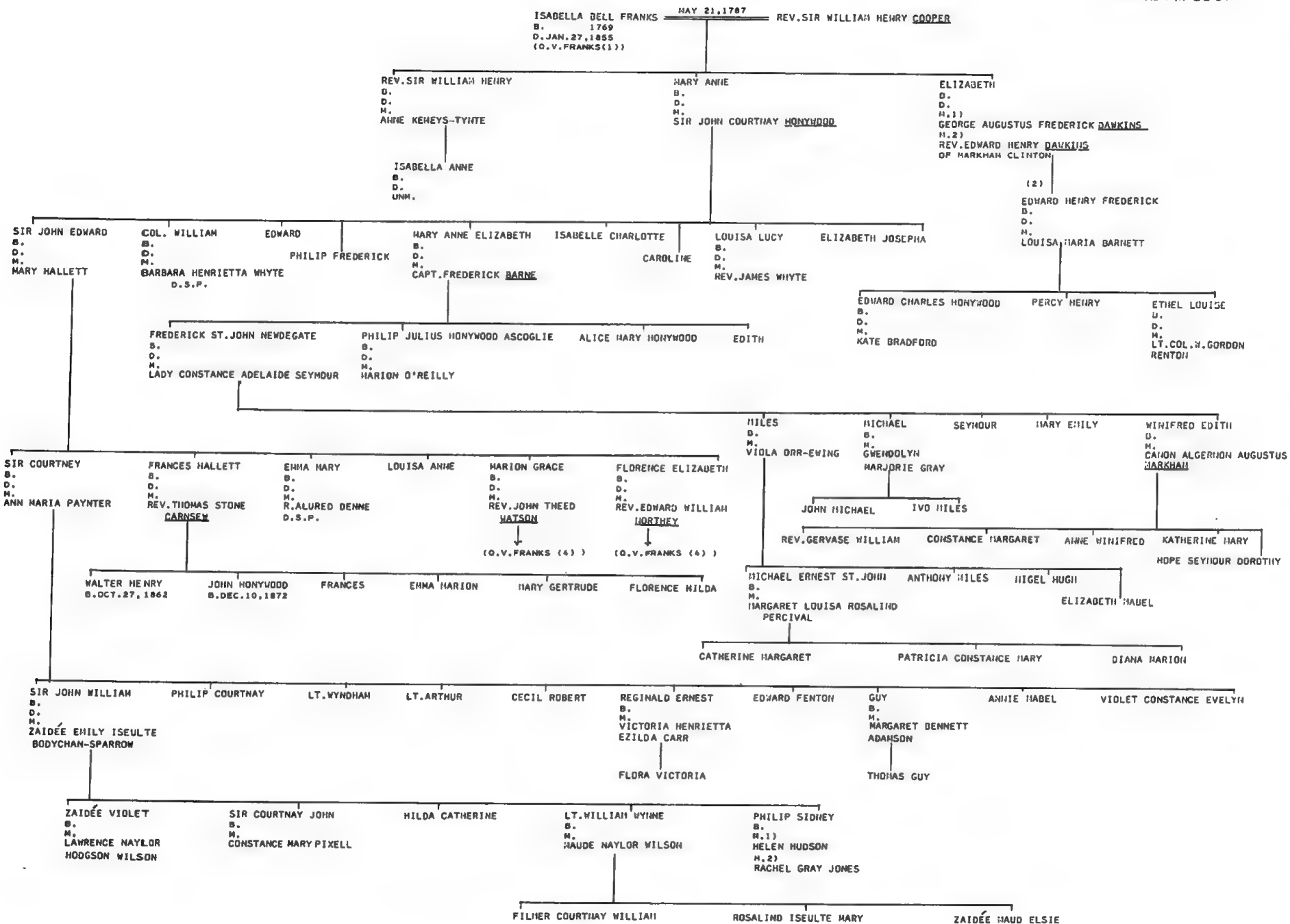

FRANKS I (4) WATSON, NORTHEY

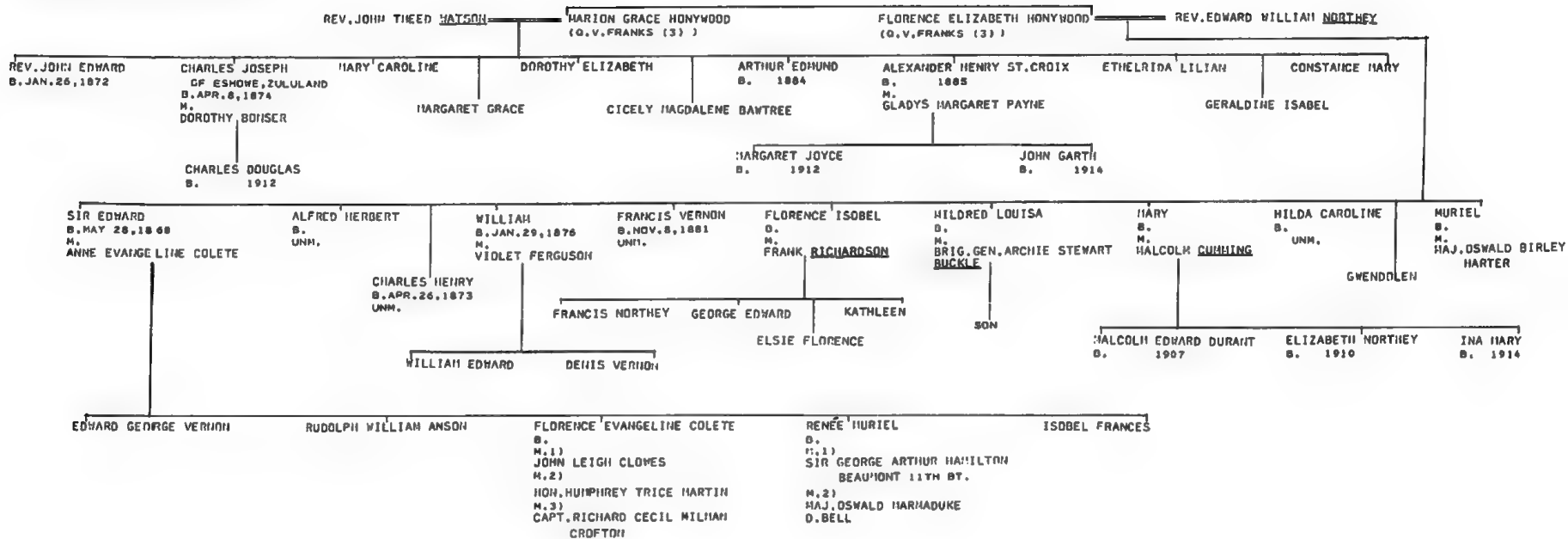

ABIGAIL FRANKS
B. JAN. 6, 1744
D. SEP. 11, 1798
(O.V. FRANKS (1))

JAN. 6, 1768

ANDREW HAMILTON III
B. JAN. 12, 1742/3
D. NOV. 25, 1784

FRANKS I (5) HAMILTON

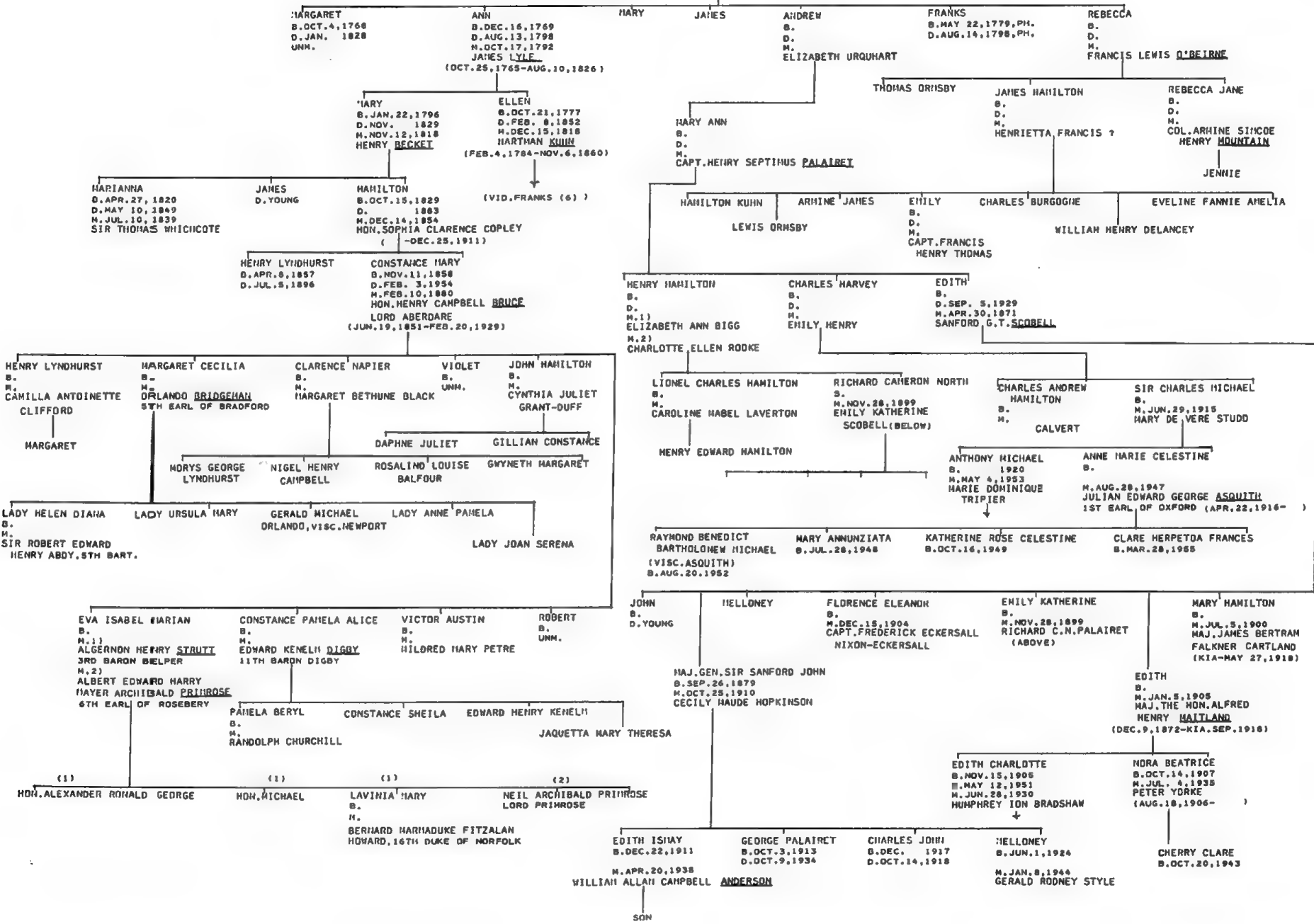

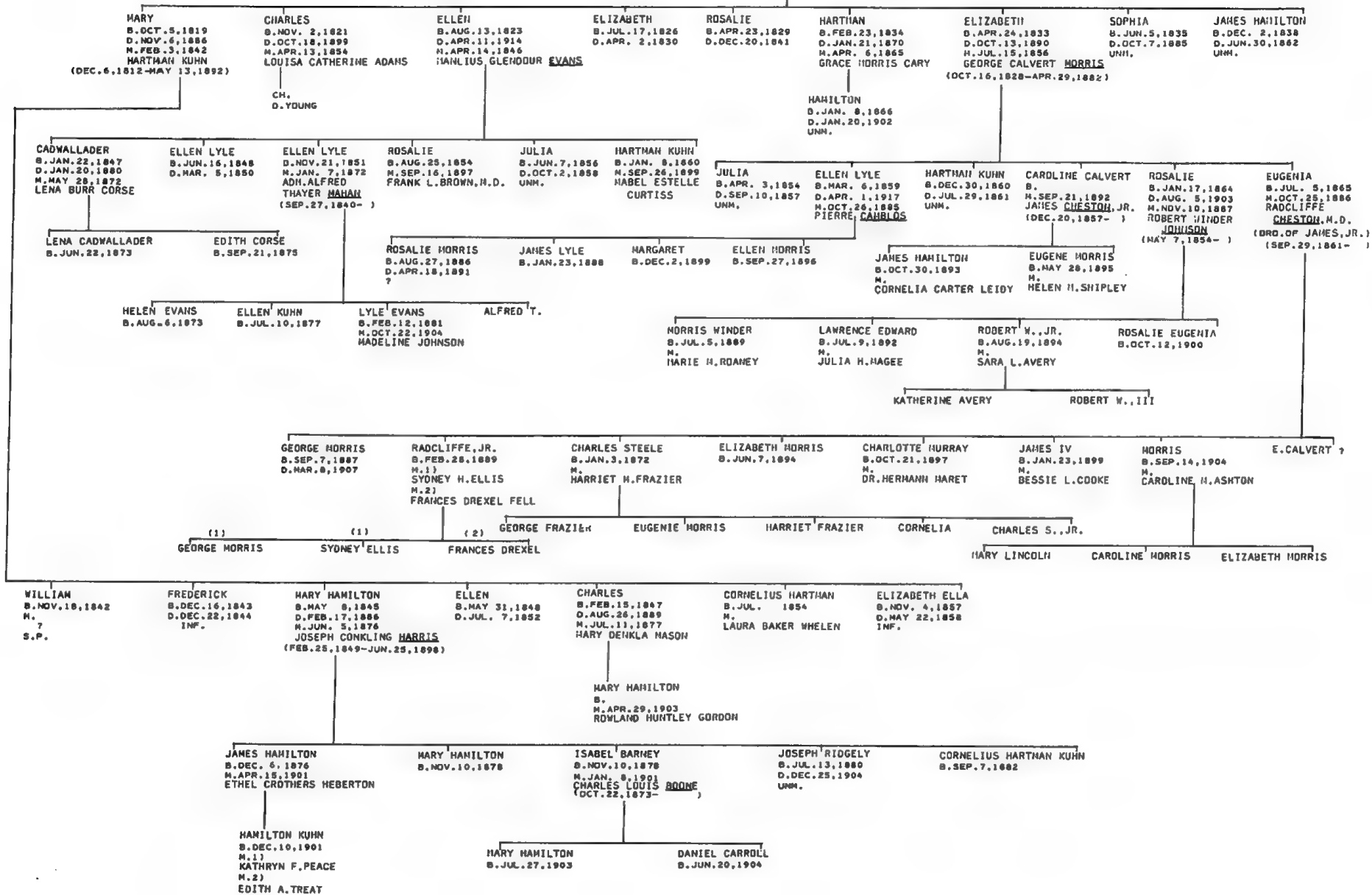

JAN. 17, 1882
 REBECCA FRANKS B.P.H. 1760
 D.BATH, ENG. MAR. 1823
 (O.V. FRANKS (1))
 SIR HENRY JOHNSON B. 1748
 D. 1835

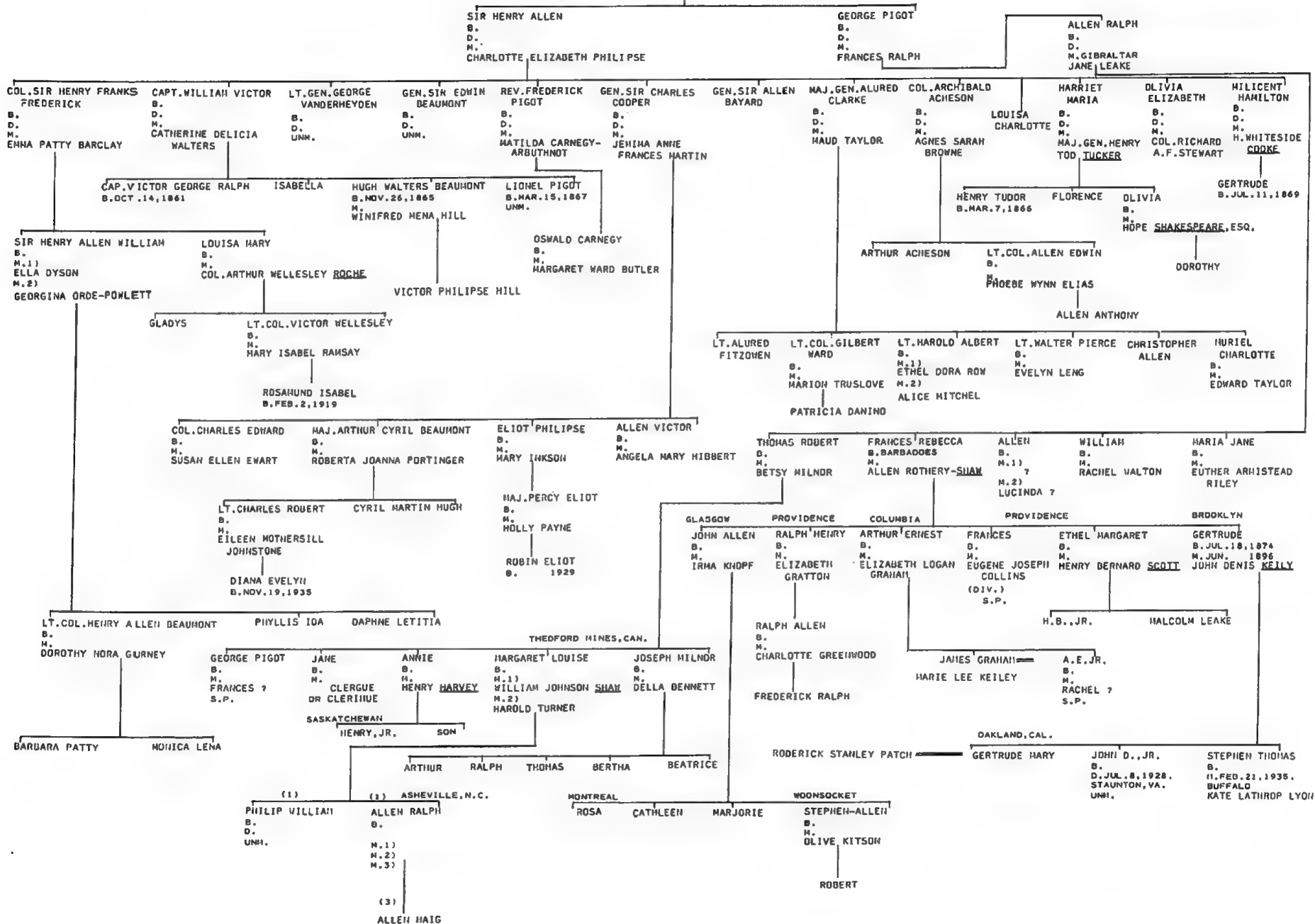

FRANKS II

ADMIN. OF DAVID S. FRANKS
WOLF-WHITEHAN
MARCUS-AJD. P. & SF.
U.S. CENSUS, PHILA. 1790
FLO. ABR.
D.N.B.

JOHN FRANKS, OF PH., QUEBEC, HALIFAX

DAVID SALISBURY (SOLEBURY)
B. PH. CA. 1742
D. PH. OCT. 7, 1793 (YELLOW FEVER)
(BUR. CHRIST EPISC. CHURCHYARD
TO PREVENT PAUPER'S BURIAL)
M. ?

REBECCA
(IN PH. 1799)

JOHN, JR.
(IN MONTREAL, 1799)

MOSES (REV.)
(IN PH. 1790; WEST IND. 1799)

WILLIAM CAMPBELL HARY SON

BENJAMIN GOLDSMID JESSIE SOLOHONS

GEORGE HACKENZIE STUART
MARY BABINGTON

LIONEL PRAGER
B. LOND. 1797
D. 1866

ELIZA FRANCES
B. 1799
D. 1844

EDWARD MOSES GOLDSMID ROSE

HARY
B. JAN. 2, 1849
D. JUL. 21, 1900

FREDERIC JOHN
B. AUG. 19, 1818
D. JAN. 12, 1908

JESSY SARAH
B. 1816
D. 1888

HENRY EDWARD
B. MAY 9, 1813
D. JAN 3, 1855, CAIRO, EGYPT

ELIZA HARY B. 1929 D. 1929	CATHERINE FRERE B. 1934 D. 1934	GEORGE STUART B. 1856 D. 1935 M. 1900 FRANCES EHELINE ROWSELL	EVERARD VAUGHAN B. 1857 D. 1914 M. BLANCHE	JESSIE HERON B. 1863 D. 1942 M. 1894 AUGUSTUS WHITESTONE (SEP. 15, 1866-JAN. 16, 1941) D.S.P.	PATRICIA STUART B. 1864 D. FEB. 1941 M. JUN. 9, 1904 SIR ROBERT VAUGHAN D.S.P.	ALBERT EDWARD WILLIAMSON B. OCT. 6, 1846, BOMBAY, IND. D. MAR. 26, 1904, PARIS, FR. M. 1879 IDA STUART HENDRIES (JUN. 30, 1859-FEB. 7, 1929)	BARTLE GEORGE B. 1846 D. CA. 1930 M. 1874 AMY REYNOLDS	FREDERICK LESTOCK B. MAY 31, 1850 D. 1877 EMMA BLANCHE HARRISON (-1927)	ARTHUR POWYS WILLOUGHBY B. FEB. 13, 1852 D. SEP. 27, 1894 M. MARION BEYER	FRANCES CAROLINE ELPHINSTONE B. 1855 D. OCT. 9, 1894
----------------------------------	---------------------------------------	---	---	--	--	--	--	--	--	--

FRANCIS FREDERICK
B. 1903

FREDERICK

BARTLE HENRY SEATON
B. MAY 30, 1875
D. 1902

CECIL ALBERT
B. OCT. 6, 1877
D. JUN. 4, 1878

GUY
B. JAN. 9, 1883

REGINALD

GLADYS HELEN RACHEL
B. APR. 4, 1879
D. JAN. 8, 1965
M. FEB. 9, 1898
LOUIS SAMUEL MONTAGUE
2ND BARON SWATHLING

MURIEL ETHEL CARMEL
B. MAY 10, 1881
D. FEB. 20, 1943
M. (AS HIS 2ND WIFE) 1910 (DIV.)
LESLIE HADEN-GUEST
1ST BARON, HADEN-GUEST

GHENDOLYN BEATRICE
B. JUN. 13, 1884
D. AUG. 15, 1884

LIONEL FREDERICK
B. SEP. 30, 1880
M. 1907
ALLISON MARGUERETTA DODD

BEATRICE
B. SEP. 14, 1885
D. 1952

GRACE
B. SEP. 9, 1887

STUART ALBERT SAMUEL
3D BARON SWATHLING
B. DEC. 19, 1898
M. 1) APR. 21, 1925 (DIV. 1942)
MARY VIOLET LEVY
M. 2) AUG. 13, 1945
JEAN MARCIA LUTH-MARSHALL
(AUG. 14, 1909-)

EVEN EDWARD SAMUEL
B. MAR. 29, 1901
M. JUN. 14, 1923
IRIS RACHEL SOLOHON
(MAY 9, 1903-)

IVOR GOLDSMID SAMUEL
B. APR. 23, 1904
M. JAN. 10, 1927
EILEEN HELLSTERN

JOYCE IDA JESSIE
B. JAN. 10, 1909
M. AUG. 15, 1941
OLIVER HARRY FREST

DAVID
B. 1911
D. 1937
(KIA-SP. CIVIL WAR)

PETER
B. 1913
M. 1945
JEANNETTE PAULINE HINDES

ANGELA
B. NOV. 27, 1965
M. 1948
ORLANDO MARTINEZ

JEREMY PETER SAMUEL
B. DEC. 24, 1927
M. JUL. 29, 1955
GWEN ELLEN INGLEDEW

JENNIFER IRIS RACHEL
B. MAR. 20, 1931

CHRISTOPHER
B. FEB. 5, 1948

NICHOLAS
B. MAY 5, 1951

ELISSA
B. JAN. 10, 1953

RACHEL MARY
B. MAR. 13, 1956

SARAH RUTH
B. APR. 29, 1958

SIMON JOSEPH SAMUEL
B. JUN. 18, 1959

DENIS CHARLES SAMUEL
B. AUG. 6, 1928
M. DEC. 4, 1951
FRANCOISE CHRISTIANNE (NINETTE) DREYFUS
(OCT. 28, 1927-)

JEAN HARY
B. AUG. 8, 1929
M. NOV. 28, 1951
LINTHORN TREVOR HIGHET
(JUN. 1, 1921-)

ANTHONY TREVOR SAMUEL
B. AUG. 3, 1931
M. JUN. 26, 1962
DEIRDRE BRIDGET SENIOR

GEORGINA MARY
B. APR. 15, 1963

ROBERT ANTHONY SAMUEL
B. AUG. 5, 1965

CHARLES EDGAR SAMUEL
B. FEB. 20, 1954

FIONA YVONNE
B. NOV. 11, 1952

NICOLA MARY
B. NOV. 8, 1956

CLARE JOANNA
B. AUG. 9, 1956

PAUL LINTHORN
B. MAY 11, 1958

STEPHANIE JANE
B. NOV. 20, 1963

KATZ-BETH EL STORY
EVELYN MILLER
MARCUS A.J.D.

GREEN BAY 1817
THÉRÈSE DE GUÈRE 1) (HALF-BREED OF GREEN BAY, WIS.)
JACOB FRANKS 2) HARY (POLLY) SOLOMONS
D. ENG. CA. 1766 (O.V.I.)
D. NOV. 18, 1840

WILLIAM B. D. JUL. 27, 1813 FT. GEORGE, QUE. K.I.A.
MARY D. M. SEP. 1814 THOMAS H. MCNAMARA
JOHN JAMES
GEORGE B. D. OCT. 8, 1816 M. ELIZABETH ?
RACHEL
REBECCA
JOHN (GREEN BAY, WIS.) B. DEC. 6, 1779, MONTREAL D. FEB. 11, 1846, GREEN BAY M. THERESA RANKIN

MORAIS-JEWS OF PH., P. 267 F.
RODEPH SHALOM MOHEL REC.
EDNA HELLMAN
FLG. ABR.
A. J. Y. B.
NISTY. OF J. E. S.
FEDERAL ST. CEM.
U. J. E.

GANS, OF NATZINGEN, WESTPHALIA

GANS

SOLOMON (TO U.S., 1834) B. AUG. 10, 1804, NATZINGEN D. APR. 3, 1896, PH. M.
HESES B. NOV. 14, 1811 D. NOV. 1, 1885 M.
HEYER B. APR. 28, 1814 D. SEP. 10, 1884 M.
DANIEL B. FEB. 7, 1818 D. NOV. 18, 1867 D. S. P.
JOSEPH B. SEP. 10, 1820 D. SEP. 6, 1896 M.
CAROLINE (L. IN GER., 1892) B. HEUSTADT M.

BETTI LEBERMAN (O.V.)
JEANETTE (JUN. 15, 1826 - MAY 10, 1915)
BERTHA (BAV. JUL. 24, 1833 - SEP. 13, 1891)
SIMEON B. APR. 25, 1853
JULIA B. 1857 D. DEC. 17, 1940
CORNELIA B. 1861 D. JUL. 7, 1929
DAVID S. B. 1872 D. AUG. 10, 1916
STILLBORN
SIGMUND J. B. 1875 D. NOV. 30, 1926 M. JENNIE E. (1868-1921)

JULIA B. D. N. Y. M. PH. JUN. 22, 1870 LEOPOLD BERNHEIMER
EHANUEL B. PH. NOV. 25, 1853 D. PH. JUL. 1, 1893
CARRIE B. PH. FEB. 10, 1856 D. PH. APR. 19, 1950 M. JUN. 23, 1875
LOUIS B. PH. FEB. 9, 1858 D. YOUNG
HESES B. PH. JAN. 23, 1860 D. YOUNG
JACOB (CHARLES) B. SEP. 12, 1862 D. APR. 15, 1865
LEAH B. JAN. 5, 1866 D. SEP. 15, 1958 M. OCT. 8, 1888/9 WALTER MAURICE STEPPACHER (DEC. 24, 1859 - JAN. 29, 1919)
SIGMUND H. B. 1869 D. FEB. 20, 1952 UNM.

HELENE B. PH. MAR. 16, 1877 D. N. Y. MAY 24, 1960 CHARLES WAXELBAUM D. S. P.
BLANCHE B. DEC. 23, 1879 D. FEB. 29, 1921 M. STANLEY FOLZ (1878 - NOV. 2, 1954)
CLARENCE B. 1881 D. OCT. 29, 1954
ALIA VENDIG B. 1883 D. NOV. 23, 1948
CECILE LOUCHEIN (VID. FLEISHER (2) SEP. 23, 1919
WALTER H., JR. B. JUL. 16, 1890 D. APR. 5, 1936
LESTER B. JUL. 1, 1892
RUTH (DOLLY) STEINBACH D. JUN. 1, 1897
WALTER M. III B. JUL. 26, 1920 M. APR. 6, 1951 MARJORIE DOLWIG
JOHN B. APR. 29, 1923 M. JUL. 24, 1948 JOHANNE PENDLETON
DORIS B. APR. 6, 1927 M. JUN. 4, 1949 ROBERT JUDELL
LESTER, JR., H. D. B. APR. 12, 1921 M. NOV. 24, 1950 LEWIS AFFELDER
HILDRED B. JUL. 30, 1923 M. JUN. 20, 1949 WILLARD R. BONNIT

GEORGE B. OCT. 29, 1906 D. MAY 12, 1950 UNM.
CLARENCE, JR. B. 1912 D. 1934 (SUICIDE)
CHARLES B. 1915 M. CAROLYN CUMMINS (-1971)
BRIAN B. FEB. 8, 1951
JILL B. MAY 24, 1953
LEE B. MAY 26, 1956
LYNN B. FEB. 25, 1953
WALTER H. IV B. SEP. 26, 1955
DEBRA B. APR. 26, 1951
TERRY B. AUG. 21, 1953
ANDREA B. MAR. 14, 1957
NANCY S.
DAVID F.
ANDREW B. DEC. 25, 1958
HILLARD, JR.

JULIA B. DEC. 27, 1838 D. NOV. 6, 1934 M. OCT. 21, 1863 HEZEKIAH ARNOLD (O.V.)
LEON (MAJ. CSA) B. 1839 D. JAN. 17, 1911 M. THERESA E. (1853-1911, PH.)
AARON B. JUN. 4, 1841, PH. D. APR. 29, 1918 M. CAROLINE HOCHSTADTER (HECHINGEN, BAV. JAN. 31, 1845 - FEB. 27, 1930)
EMMA B. D. M. ALBERT HOCHSTADTER
CLARENCE B. MAR. 27, 1857

WALTER SIMON B. AUG. 6, 1867 D. APR. 28, 1930 UNM.
HILTON HENRY B. DEC. 14, 1870 D. SEP. 29, 1942 UNM.
BERTIE B. JAN. 8, 1878 D. APR. 30, 1913
GEORGE WASHINGTON OAKS-OAKES B. JAN. 8, 1861 D. N. Y. OCT. 26, 1931
LEONARD, H. D. ?
EDNA
HARRY
SIDNEY
LEONARD, JR.
HILDRED HORSE
DAU.

SIGMUND LEON, H. D. B. PH. DEC. 15, 1874 D. HAINES LANDING, ME. AUG. 25, 1931 M. ADELE
PEARL B. PH. 1876 D. PH. 1877
JOSEPHINE B. PH. DEC. 1879 D. PH. MAY 21, 1943 M. LEWIS STEINHARDT, H. D. (1878 - MAR. 3, 1950, ELKINS PARK, PA.)
DAU.
HOWARD
WALTER
GEORGE W., JR. B. OCT. 1909
JOHN BERTRAM OAKES (EDITOR OF N.Y. TIMES) B. APR. 23, 1913 M. OCT. 24, 1945 MARGERY CAROLINE HARTMAN
ANDRA
ALISON HARTMAN
CYNTHIA
JOHN HARTMAN
STILLBORN 1906
THERESA B. M. 1) 1931 M. 2) MARTIN WEISS (DIV.) M. 2) STANLEY BERG
DANIEL B. PH. M. MAR. 1971 BIRD
(ADOPTED)
JOSEPHINE B. N. Y. M. JUN. 1971 JOHN ROSENTHAL

GOLDSCHMIDT

KAUS-SANDOR COLL.
WILL OF SAMUEL B.H. JUDAH

JOHN MEYER GOLDSCHMIDT
B. SEP. 24, 1801, HAMBURG, GER.
D. SEP. 21, 1877
CAME TO N.Y., 1832

JUN. 6, 1838

CELESTINE JUDAH
(O.V. I (1))

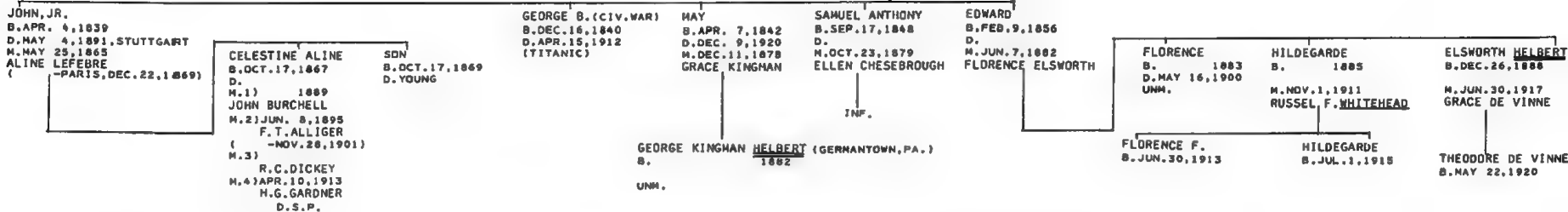

GOLDSMITH

ISAAC H. GOLDSMITH
B. ROTTERDAM 1774
D. CH. SEP. 26, 1821

FRANCES (FANNY) PHILLIPS
(O.V. IV)

ELZAS MRS.
M. N.
NEW JEW. CEM. OF BETH ELOHIM
D. J. C.

JRM COLL.
FLORENCE ABRAHAMS
ROSENWAIKE

CATHERINE
B. D.
M. FEB. 2, 1838
SAMUEL SAMPSON
(O.V.)

MOSES
B. OCT. 25, 1815, CH.
D. JUN. 28, 1884, CH.
M. JUN. 23, 1837
ELEANOR ALEXANDER
(O.V. (1))

JOSEPH J.
B. D. AET. 35, BOSTON

REBECCA
B. D. AUG. 1882
M. JAN. 1839
JOSEPH SAMSON (OF LIVERPOOL)
(LOND.)

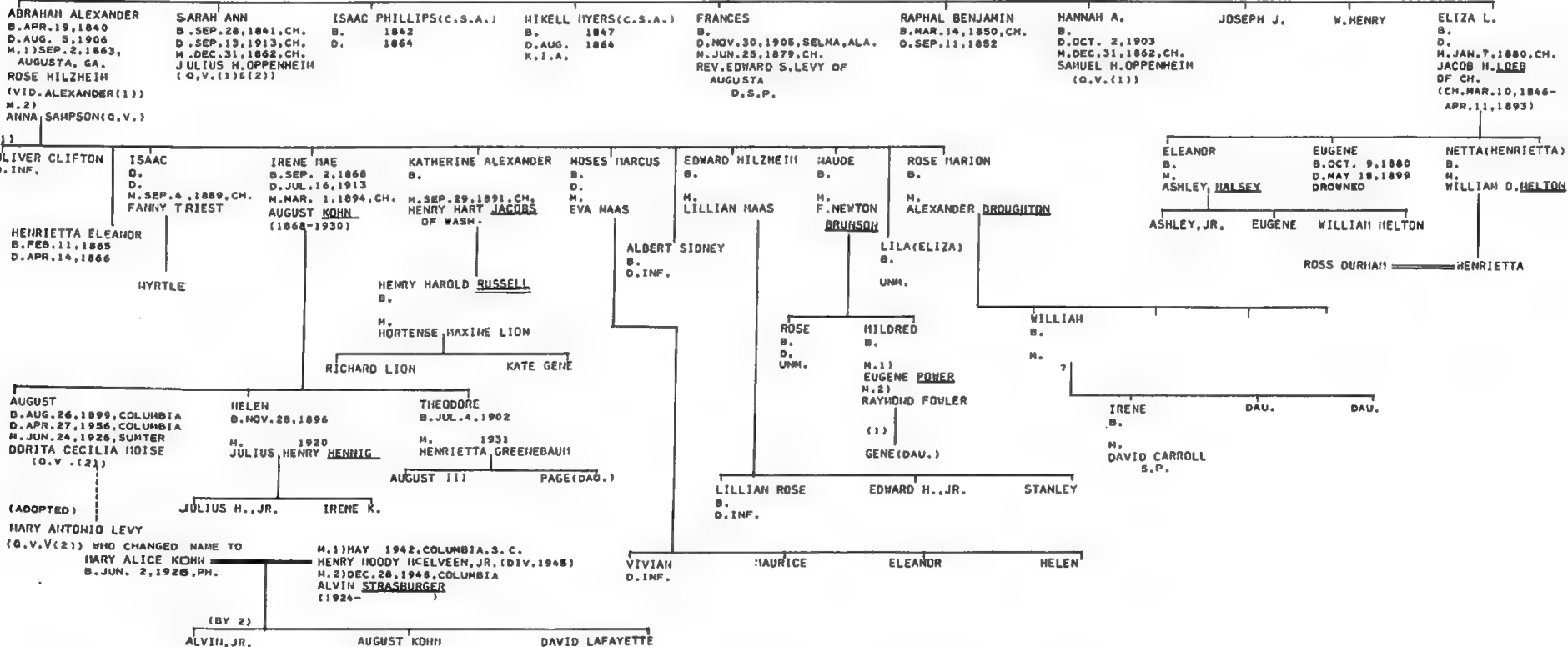

ISAAC GOMEZ ESTHER

D.SPAIN
D.FRANCE

N.Y. 1695

LEONORA (ELLENOR)
B. 1663
D. JUL. 24, 1740
UNM.

DAU.
(LEGHORN, ITALY)

1) LUIS (LEWIS)
B. MADRID 1654/60
D. N.Y. MAR. 31, 1740
(ENDEN, APR. 18, 1705, FREEMAN, FEB. 12, 1706)

ESTHER MARQUES (O.V.)
(MARCHAZE)

K. SCOTT - N.Y. POST - 80Y
HERSHKOWITZ - WILL S (LOUIS, MORDICIA,
DAVID, ISAAC, BENJAMIN,
HOSES, DANIEL, MATTATHIAS
EMANUEL - PRECIOUS STONES
PAJHS, V. 13, P. 139 F.
V. 17, P. 197 F.
V. 27, P. 279 F.
JE V. 6, P. 41.
UJE V. 5, P. 49 F.
ST. CHARLES, P. 131
KRAUS - SANDOR CDLE.
GOLDSTONE GEN.
POOL - PORTRAITS
JRM COLL.
SHEARITH ISR. REC.
MISC. VII
ENA
SHILSTONE
N.Y. WEEKLY MUSEUM
AMER. DAILY ADVERTISER
NYGR, APR. 1971, P. 98
ELZAS D.J.C.

(1) JACOB (ENDEN, DEC. 29, 1714)
B. BARBADOS 1688
DIAT SEA 1722
UNM.

(1) MORDICIA (ENDEN, DEC. 29, 1714)
B. BARBADOS 1688
(FREEMAN JUN. 7, 1715)
D. N.Y. NOV. 1, 1750
M. 1)
HESTER RACHEL CAHPOS
(MAR. 1695 - SEP. 29, 1736)
M. 2) N.Y. MAY 4, 1741
REBECCA DE LUCEHA (O.V.)

(2) DANIEL (ENDEN, DEC. 29, 1714)
B. JUN. 23, 1695
(FREEMAN, JUL. 16, 1751)
D. JUL. 28, 1780, PH.
M. 1) FEB. 10, 1724, JAMAICA
REBECCA DE TORRES (O.V.)
M. 2) 1733, CURACAO
ESTHER DE GABRIEL ALEVY
(MAY 31, 1753)

(2) DAVID (ENDEN, DEC. 29, 1714)
B. AUG. 14, 1697
D. JUL. 15, 1769
M.
REBECCA DE LEON (SILVA)
(OF BARBADOS - SEP. 1761)
O.S.P.

(2) ISAAC
B. JUL. 13, 1705
D. AUG. 28, 1770
M. 1738
DEBORAH DE LEON
(SIS. OF REBECCA)
(BARBADOS, NOV. 24, 1712 -
AUG. 8, 1801)

(2) BENJAMIN
B. APR. 11, 1710/11
D. AUG. 8, 1772
M. 1)
ESTHER RACHEL NUNES
(BARBADOS, 1717 - NOV. 15, 1733)
M. 2)
ESTHER ABIGAIL
(BARBADOS, 1723 - SEP. 25, 1743, BARB.)

(1) JOSEPH
B. 1729
D. SEP. 26, 1734

(1) HOSES DANIEL
B. MAY 29, 1728
D. APR. 12, 1789, N.Y.

MAY 14, 1755

ESTHER
B. AUG. 8, 1739,
BARBADOS
D. AUG. 7, 1822,
N.Y.

DAVID
B. OCT. 15, 1761
D. INF.

HOSES
B. FEB. 1741
D. APR. 28, 1743,
BARBADOS

SARAH
B. FEB. 8, 1763
D. INF.

HATTATHIAS
B. 1742/3
D. MAY 5, 1781
BUR. PHILA.

RACHEL
B. D. APR. 16, 1776,
NEWARK, N.J.

(1) HOSES MORDICIA
B. JAN. 2, 1716
D. BEF. 1744
M. JAMAICA

(1) ISAAC
B. JUL. 14, 1718
D. NOV. 9, 1764,
CURACAO
M. CURACAO 1748
RIBCA DE JACOB
DE DAVID JESURUN

(1) JACOB
B. 1730
D. SEP. 8, 1763, N.Y.
INSANE

(2) ABRAHAM
B. 1742
D. SEP. 12, 1808
UNM.

(2) HOSES MORDICIA (JR.)
B. JAN. 23, 1744/5
D. MAY 29, 1826
M.
ESTHER LOPEZ
(O.V. I (1))

(2) RACIEL
B. CA. 1739
D. JAN. 22, 1809, ENG.
M. JUL. 4, 1770, N.Y.
ABRAHAM WAAGE
(O.V.)

(2) EVE ESTHER
B. 1743
D. JUN. 24, 1775
M. JUN. 30, 1762
URIAH HENDRICKS
(O.V. (1))

(2) DANIEL
B. MAR. 13, 1759
D. AUG. 27, 1784
UNM.

(2) ISAAC
B. MAR. 23, 1763
D. SEP. 1, 1764

(2) ISAAC (JR.)
B. JUL. 28, 1768, N.Y.
D. DEC. 5, 1831, N.Y.
M. MAY 26, 1790
ABIGAIL LOPEZ
(O.V. I (1))

REBECCA (REBCA)
B. MAY 10, 1761
D. OCT. 12, 1762

JOSEPH DE TORRES
B. FEB. 14, 1766
D. APR. 2, 1769

HESTER
B.
D.
M.
S. FLAMENGO

JACOB

SOLOMON NUNES
B. 1759
D. OCT. 25, 1804
M.
ABIGAIL DE BENJ.
DE NEHASSE PEREIRA
(DEC. 1758 - FEB. 12, 1774)

AARON LOPEZ
B. WILMINGTON, N.C.
D. JUL. 28, 1860,
BULL'S FERRY, N.J.
M. MAY 20, 1821
HETTY (HENRIETTA)
HENDRICKS (O.V. (1))

HIRIAM (HARIE)
B. D.
M. FEB. 26, 1817
SAMUEL PEIXOTTO
(O.V. I (2))

MORDECAI
B. OCT. 20, 1786

LEWIS
B. 1795
D. NOV. 15, 1827
AT SEA
UNM.

DEBORAH
B. JAN. 13, 1766
D. OCT. 5, 1783
BUR. PHILA.
UNM.

ISAAC
B. JUN. 24, 1767
D. DEC. 4, 1810
UNM.

ESTHER
B. JUL. 19, 1768
D. SEP. 1807, VA.
M. FEB. 10, 1798, N.Y.
EDWARD WEEKS, JR.
SON

BENJAMIN
B. SEP. 11, 1769
D. AUG. 14, 1828
M. SEP. 13, 1797, N.Y.
CHARLOTTE HENDRICKS
(O.V. (1))

SEBANA
B. N.Y. SEP. 27, 1770
D. YOUNG

MOSES
B. N.Y. JAN. 19, 1772
D. INF.

HETTY (ESTHER)
B. MAR. 24, 1791
D. NOV. 22/29/31, 1871
M. FEB. 1, 1815
SOLOMON SEIXAS
(O.V. (4))

HOSES
B. 1794
D. 1795

SARAH
B. SEP. 12, 1793
D. APR. 5, 1852,
CHARLESTON
M. FEB. 14, 1816
NATHAN EMANUEL
(O.V. III)

CYTHIA
B. MAR. 16, 1795
D. NOV. 1, 1874
M. Y. INSANE

HARY ANN (HARIANNE)
B. MAR. 3, 1799
D. NOV. 15, 1847, N.Y.
M. JUN. 29, 1836, N.Y.
JOSHUA LOPEZ
(O.V. I (1))

RACHEL
B. AUG. 9, 1800,
HARLEM
D. MAR. 3, 1881, N.Y.
M. 1) FEB. 3, 1819
AARON JUDAH
(O.V. I (1))
M. 2)
WOOD

JULIET
B. AUG. 18, 1802,
BLOOMINGDALE
D. FEB. 26, 1891,
N.Y.
M. JUN. 13, 1832
GUSTAVUS I. PESOA
(O.V.)

HOSES EMANUEL
B. JAN. 18, 1804, N.Y.
D. APR. 11, 1878

ESTHER
B. N.Y.
M. CURACAO, 1782
JACOB DE HOSES
DE CASTRO

MORDECAI
B. CURACAO, NOV. 1750

HORRIS
B. OCT. 13, 1817
D. AUG. 26, 1823

RACHEL
B. APR. 6, 1827,
CURACAO
D. JUL. 3, 1858,
PLEASANTVILLE, N.Y.
M. APR. 20, 1853, N.Y.
HOSES L.H. PEIXOTTO II
(O.V. I (2))

ABIGAIL
B. NOV. 24, 1829, CUR.
D. APR. 28, 1861, N.Y.
M. MAR. 24, 1858, N.Y.
JACOB EPSTEIN
(MAR. 13, 1831
ALTENSCHONBACK, GER. -)
SON
B. N.Y. APR. 18, 1861

ESTHER HATHILDA
B. 1798
D. DEC. 6, 1893
N.Y. INSANE

HATHIAS
B. D.
D. JUN. 19, 1833
NEW ORLEANS
K. IN DUEL

RACHEL LOUISE
B. AUG. 1804
D. JAN. 20, 1809

EHELINE
B. JAN. 15, 1809
D.
M.
NATHAN ADOLPHUS

HETTY MARIA
B. MAR. 7, 1822, N.Y.
D. DEC. 9, 1869, N.Y.
M. 1) SEP. 26, 1841
MYNAN N. HART
(O.V. VI (1))
M. 2) AUG. 1, 1861, N.Y.
JOSHUA E.P. LAZARUS
(VID. HART VI (2))

LEWIS (WILMINGTON, N.C.)
B. JUL. 18, 1823
D. OCT. 15, 1828
AT SEA
BUR. ST. AUGUSTINE, FLA.

ROSELANE (ROSALIE)
B. APR. 6, 1825, N.Y.
D. AUG. 16, 1890, N.Y.
M. OCT. 26, 1853
GERSHON S. NATHAN
(O.V. I (1))

JOSHUA (HORATIO) HORACIO, H.D.
B. FEB. 26, 1827,
BELLEVILLE, N.J.
D. APR. 22, 1909, N.Y.
M. AUG. 16, 1873
HARRIET ALEXANDER
(N.Y. AUG. 8, 1851 - N.Y. SEP. 2, 1937)

JOSEPH EDWIN
B. FEB. 22, 1829
D. FEB. 16, 1897, N.Y.
M.
HARGUERITE (LEAN) RYAN
(CONVERT)
(IRELAND, 1838 - NOV. 28, 1906)

ALIDA
B. N.Y. APR. 4, 1833
D. N.Y. DEC. 25, 1907
M. N.Y. DEC. 22, 1858
JOSEPH A. DREYFOUS
(VID. ANDREWS)

LUCILLA
B. N.Y. MAY 31, 1842
D.
M. N.Y. JUN. 14, 1869
EMANUEL DREYFOUS
(VID. ANDREWS)

HERNIONE

MOSES LEWIS
B. 1817
D. OCT. 12, 1822

CHILDREN CONVERTED WITH MOTHER, FEB. 3, 1871

HADELAIN
FRANCES
B. CA.
D. JUL. 3, 1878, N.Y.
EUGENE W. HOCK

JOSEPH EDWIN
B. CA.
D. JUL. 11, 1926
FRANKLIN, N.Y.

LOUIS LOPEZ
B. CA.
1864

ROSALIE RUTH
B. N.Y. MAR. 1, 1871

GOMEZ II

GUST MARK
GLORIA LOUISE FLOWERS
N.Y. WEEKLY MUSEUM

ABR., RICH., & ARNEY
SAILED FROM N.Y. TO BORDEAUX 1922

ABRAHAM GOMEZ OF BORDEAUX N.Y. DEC. 27, 1907 RICHIA (RACHEL) HENDRICKS

ARNEY (ERNEST)
B.
D.
M.

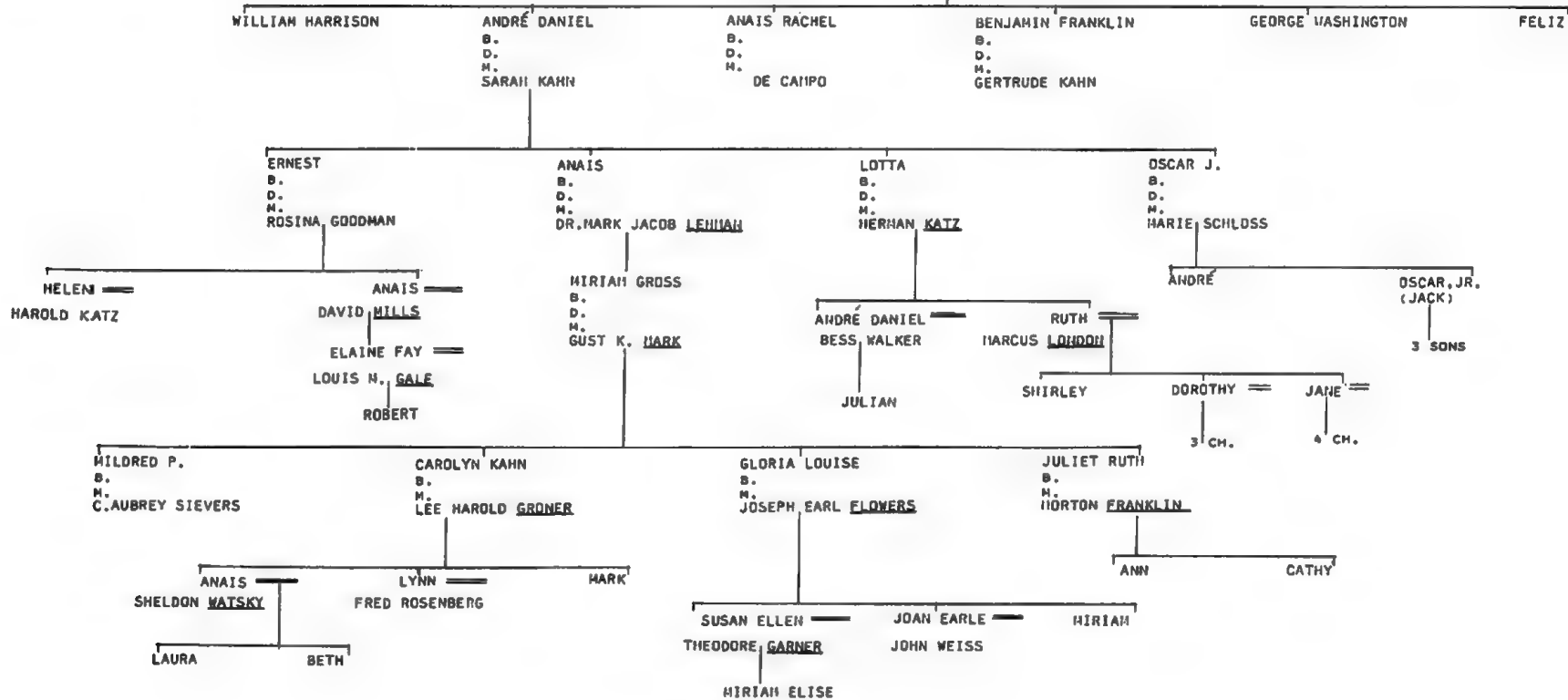

DAR LIBRARY & LINEAGE BOOKS
 BARNARD JACOBS MOHEL REC. (PHOTO, A.J.A.)
 FLORENCE ABRAHAMS
 MISC. VI, #545
 COHEN-ETTING GEN.
 W.W.
 BYERS-B & M. GRATZ
 ORGLER, BLOCH, GRATZ GEN.
 GIST-CARY GEN.
 N.Y. TIMES, SEPT. 8, 1974

J.E. V.6, P.83
 U.J.E. V.5, P.317
 A.J.Y.B. 5687, P.193F
 PHILIPSON-LETTERS OF REBECCA GRATZ
 PAJHS V.23, P.1F.
 MORAIS-JEWS OF PHILA., P.270
 KRAUS-SANDOR COLL.
 WILL OF JACOB HENRY (JRM COLL.)
 WICKVE ISRAEL REC.
 ROTH-ANGELO-JEWISH LETTERS
 GRATZ CLIPPING (DAR)
 FISH-RELIGIOUS FUNCTIONARIES
 (MS.AJHS)

RABBI ZEV WOLF
 RABBI JACOB (KOPPEL) BLOCH
 RABBI JONATHAN
 B. CRACOW, CA. 1640
 D. LANGENDORF, SILESTIA,
 APR. 22, 1722

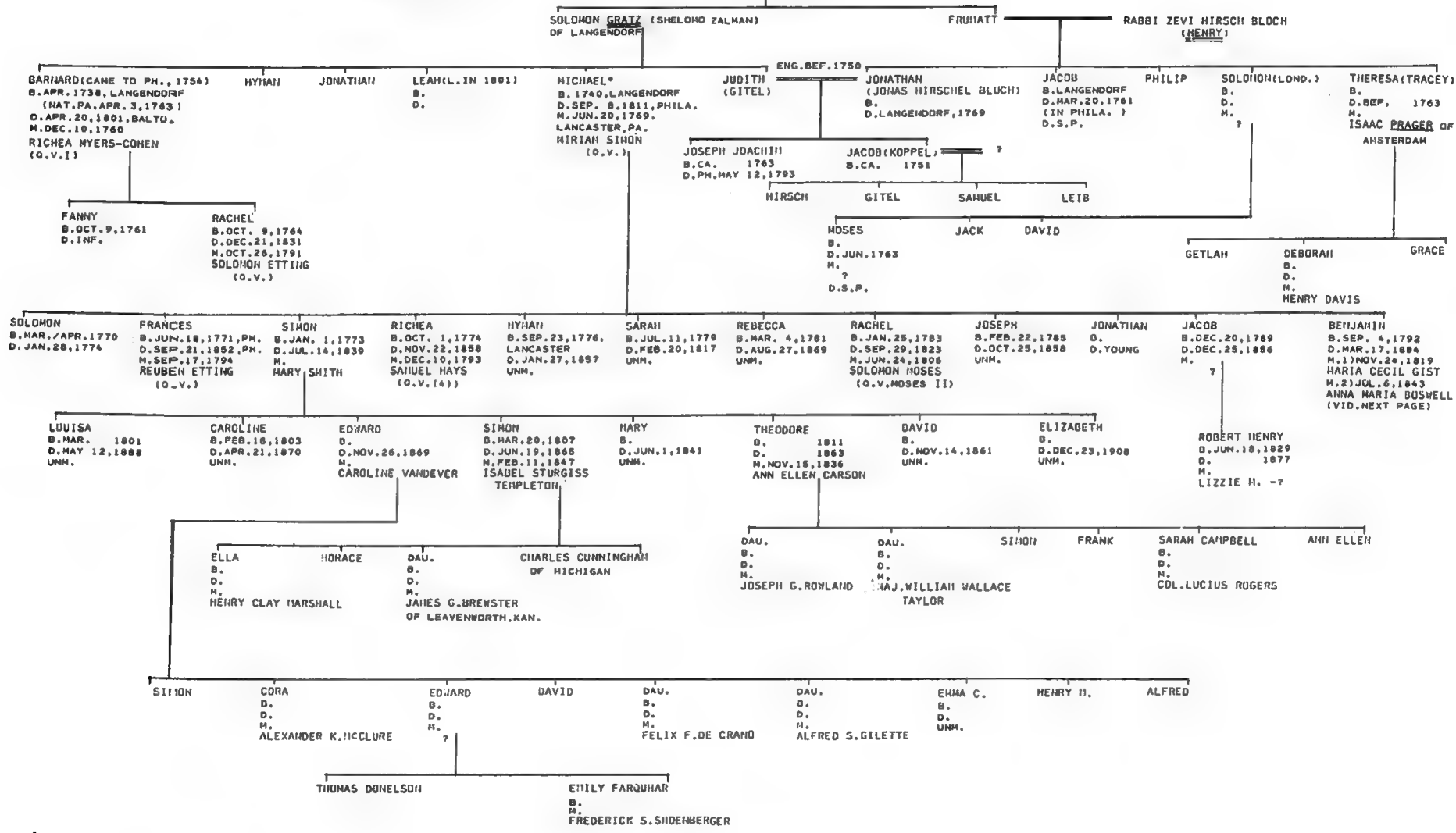

*ESTABLISHED REVOLUTIONARY ANCESTOR

MARIA CECIL GIST NOV. 24, 1819 (1) BENJAMIN GRATZ 2) JUL. 6, 1843 ANNA MARIA BOSWELL
 B. 1797 (OF LEXINGTON, KY.)
 D. 1841 B. SEP. 4, 1792
 D. MAR. 17, 1884
 (SEE PRECEDING PAGE)

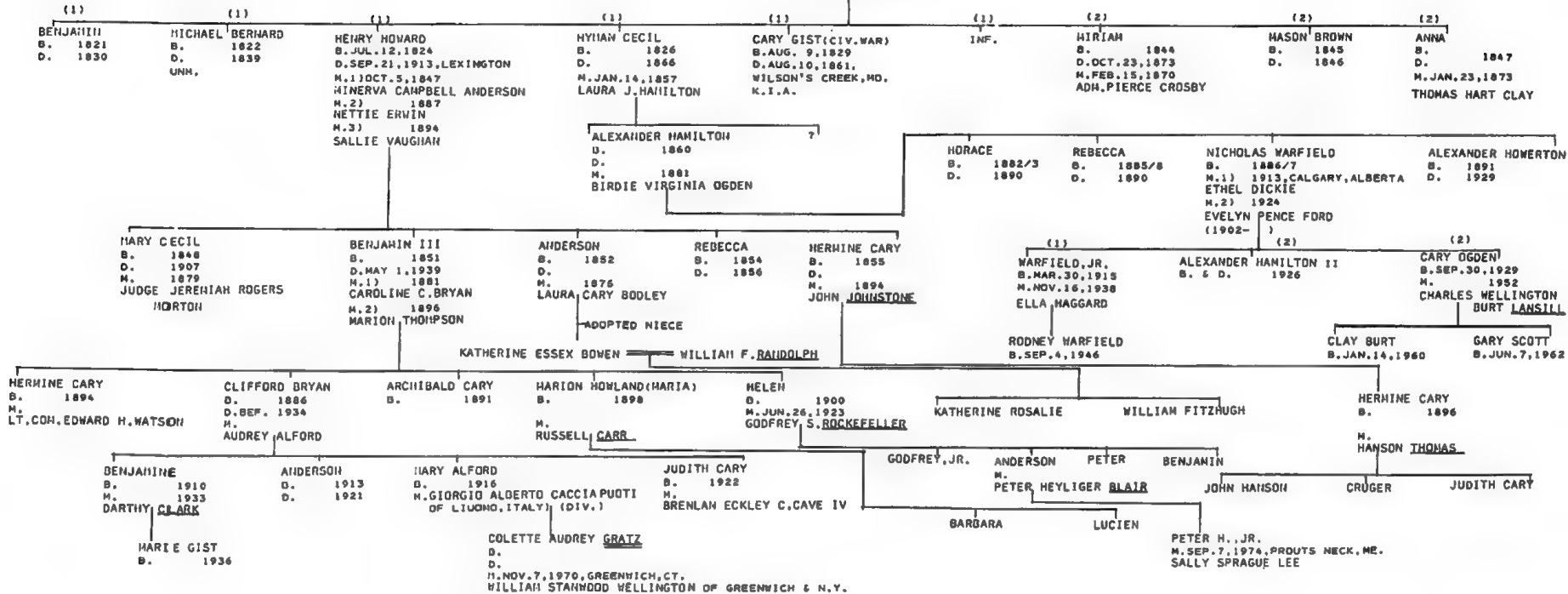

HAAS

KRAUS-SANDOR COLL.
 SHEARITH ISRAEL REC.
 SARAH SADOWSKY

BENJAMIN P. HAAS CHRISTINA

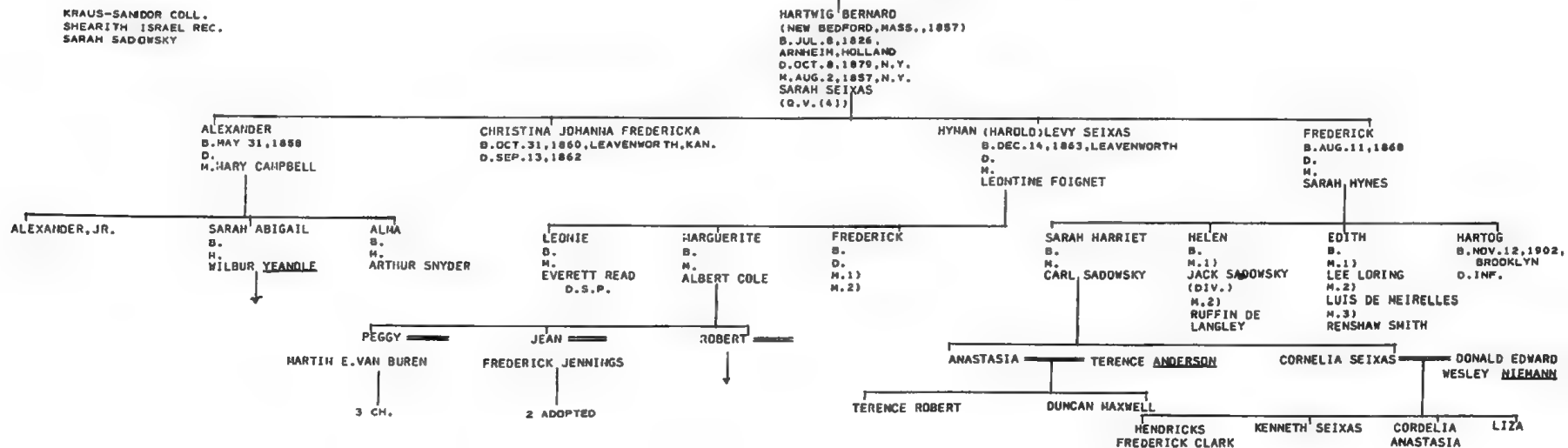

UJE
GUGGENHEIMER FAMILY 8116
SYDNEY CONE-GUGGENHEIMER
EDNA L.LICHTENFELS-THE GUGGENHEIMER FAMILY TREE
EZEKIEL-LICHTENSTEIN
A.J.Y.B. 5665
LYNCHBURG COURT RECS.
CILLA G.NUSBAUM
U.S.CENSUS-LYNCHBURG, 1850, 1860
WHO'S WHO IN WORLD JEWRY.

BROTHERS OR COUSINS

DOLZE BACHARACH
B. 1785
D. FEB. 4, 1855

ABRAHAM GUGGENHEIMER
B. 1779, GER.
D. MAR. 26, 1864

SIGMUND
B. 1812
D. 1844

1) KLARA ?
B. JUN. 13, 1818
D. DEC. 5, 1906, KRUMBACH, BAV.
(FORMERLY HURBAN)

2) LANDAUER

B. MURBEN, BAV. →

CILLI
B. JAN. 25, 1834
D. AUG. 8, 1872, NEWPORT, R.I.
M. AUG. 3, 1853, MURBEN
NATHANIEL SIDNEY
GUGGENHEIMER
(BELOW & NEXT PAGE)

MAX ("JR.")
B. MAY 19, 1842
D. AUG. 28, 1912, N.Y.
M. JAN. 10, 1877, RI.
BERTHA ROSENBAUM
(VID. MYERS X)

SIMON (TO CAL.)
B. D.
D. M.

CARL
B. D.
D. OCT. 22, 1906, STUTTGART

BLANCHE — SIDNEY IGSTADTER

JUN. 1, 1904, LOND.
CECILE ISABEL
B. OCT. 22, 1877, LYNCHBURG
D. AUG. 13, 1906, ADIRONDACK, N.Y.

EDWARD FULLERTON MILLIKEN
D. NOV. 10, 1906, N.Y.

B. MURBEN, BAV. →

CAESAR (SÜSSKIND)
B. JAN. 26, 1806
D. DEC. 21, 1856.
GILMORE'S MILL, VA.
M. HENRIETTA OBERMAYER
(SEE NEXT PAGE)

SAMUEL
M. ELEANORA STEINHART

MAX
B. 1821
D. M.
FRANCES (FANNY)?
(1829-)

FANNY
B. JAN. 1, 1813
D. JUL. 25, 1878
M. SIGMUND MYERS
(O.V.X)

(TO R.I. AUG. 1837) SOLOMON
B. DEC. 27, 1814
D. OCT. 17, 1848.
LYNCHBURG, VA.
M. THERESE
(1827-)

SARA
B. 1853
D. M.
SIG. ROSENBERG

MOSES B.

CLARA
B. AUG. 27, 1855

LILLY

SEYMOUR
M. CLARA AUERBACH

HARRY

NEWTON

ALBERT

HATTIE
M. ARTHUR WIENER

DELIA
B. 1860
D. 1946
M. ADOLPH LEWYN
(1858-1909, GER.)

RITA
M. WARREN AUERBACH

SEYMOUR
M. BLANCHE SPIEGELBERG

IRMA
B. DEC. 22, 1882, N.Y.
D. M. 1)
ALLEN MILTON BERNSTEIN
(NOV. 23, 1884-JUN. 18, 1951)
M. 2)
G. RICHARD DAVIS

OSWALD
B. M.
AGNES MAAS

(1) CHARLES
B. JUL. 20, 1909

(1) ALINE
B. MAR. 25, 1914
M. 1) JUL. 15, 1935
JOSEPH LOUGHHEIM
M. 2) MAR. 1954
EERO SAARINEN

(1) PETER LEWYN
B. JAN. 22, 1919
M. JUL. 15, 1945.
WIESBADEN, GER.
SHIRLEY DOWD
(JAN. 13, 1918-)

JOHN
B. 1928
D. 1940

TON
B. 1930
M. ANNE SALFIELD

ALFRED THOMAS

(1) DONALD
B. JUN. 6, 1937

(1) HARRY ALLEN

(2) EAMES

RANDOLPH
B. JUL. 20, 1848, LYNCHBURG
D. 1907, NYC
M. 1875
ELIZA KATZENBERG

CHARLES
M. MINNIE SCHAEFER

HARRY
M.

ADELE
M. PHILIP LEWISOHN

CHARLES, JR.

RANDOLPH
B. JUN. 2, 1932
ELINDOR COLEMAN
(APR. 11, 1912, N.Y.)

SOPHIE
M. UNTERMEYER

CHARLES

RANDOLPH II

NATHANIEL SIDNEY
B. JUN. 21, 1817
D. JAN. 16, 1866.
LYNCHBURG, VA.
M. AUG. 3, 1853
CILLI GUGGENHEIMER
(ABOVE)
(SEE NEXT PAGE)

HENRY
M. YETTA SPRINGER

SIMON
B. D.
M. JAN. 14, 1863, RI.
FREDRICA LOWENBERG

SELIGHAN
M. KLARA BARBIER

LENAH
M. ? HEYMANN

MARCUS
M. LAURA SHIRE

DORA
M. AUGUST REISER

ALVIN

ROSE
M. JOSEPH WALTERS

HERBERT
M. LENA MATER

HENRY
M. SYLVIA LESSER

CAESAR

MIRIAM
M. PAUL GIERASCH

HENRIETTE

STEPHEN
M. NINA RUDMAN

PAULA

MATTHEW PAUL

JUDAN

DAVID

LEO
M. PAULINE GUGGENHEIMER
(VID. NEXT PAGE)

DORA
M. SOLOMON JAEHA

MILTON
M. BESLAH SPRINGER LEVI

MELVILLE

HARRY

ALFRED
M. REBECCA LEVINE

FRANK
M. EDNA MAE ?

SUZANNE

JOHN (W.W.II)
D. K.I.A.

JANE
M. GEORGE GREENBERGER

JOHN

RUTH

CLAIRE
M. ALEX SCHLESINGER

ROBERT

CILLI
M. FRITZ SPRINGER

DORA
M. JULIUS DFTINGER

ROSE
M. JACOB HOCHSTADTER

GERTRUDE
M. FRITZ KOHN

PIERRE DANIELLE

CHARLOTTE
M. JACQUES BLOCH

RALPH

ALEX

FRED
M. BEATRICE HAMMER

LYNN EVE

ELIZABETH

ARTHUR
M. MARION KOHN

ROBERT

GUGGENHEIMER (2)

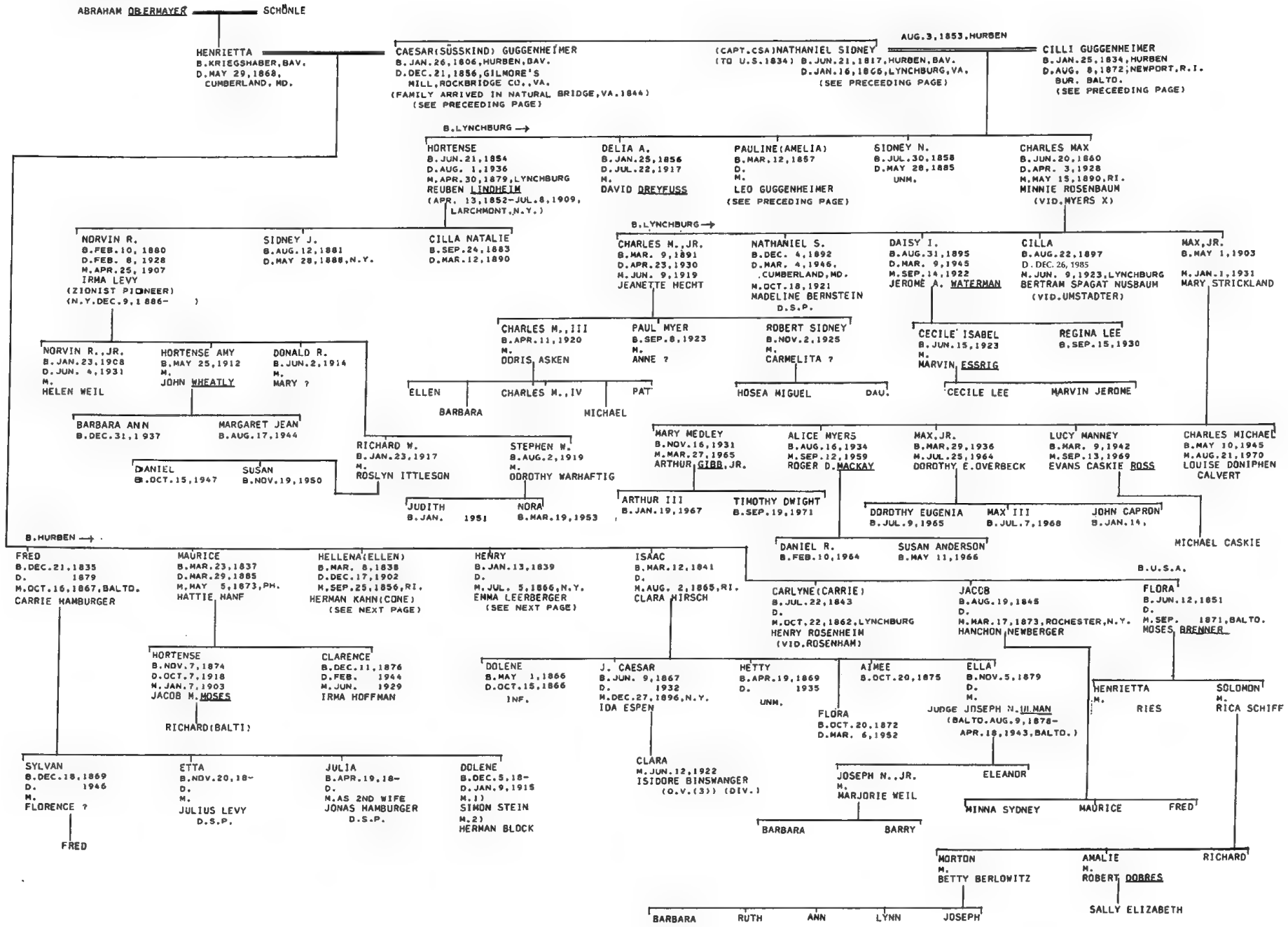

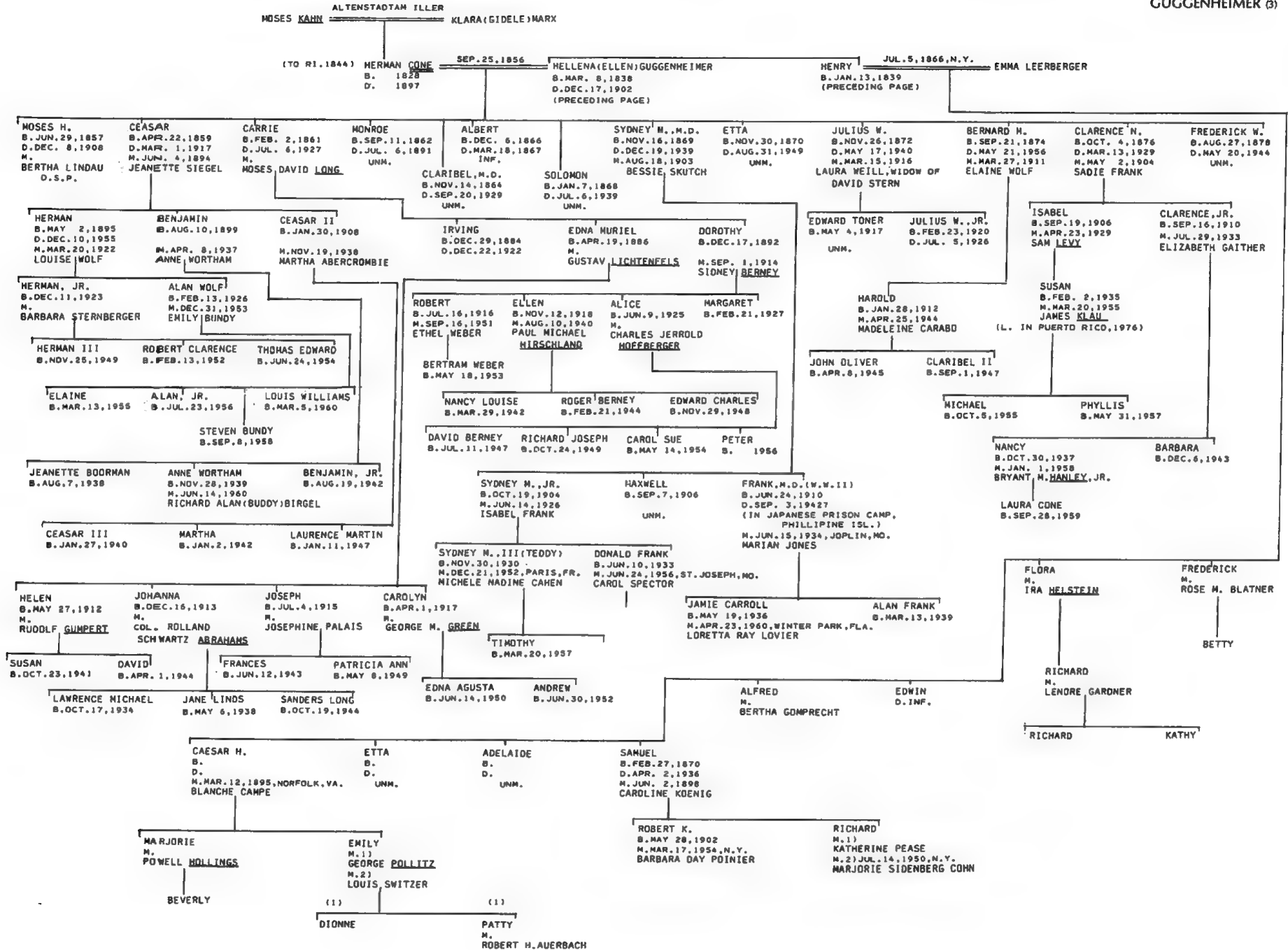

HACKENBURG

MORAIJ-JEWS OF PHILA.
ALLEN GEN.
NICKVE ISRAEL REC.
C.J.TELLER-TELLER FAMILY IN AMERICA
W.W. P.490
PAJHS,V.28,P.282,310

JUDAH LAZARUS HACKENBURG NOV.16,1825 MARIA ALLEN (O.V.)
B.COOLENTZ 1788
D. 1862

JACOB ELEAZER B. 1826 D.DEC. 1827
REBECCA ALLEN B.JUN.16,1832,PH. D.APR. 1,1902,PH. M.FEB. 2,1852,PH. DAVID TELLER (KIRSCHMEIH,BAY.FEB.18,1824--PHILA.OCT.10,1905)
ISAAC E.
GERSHON B.MAY 1835 O.FEB.12,1836
LEWIS ALLEN B. 1832 D.FEB.23,1836
WILLIAM BOWER B.JUN. 2,1837,PH. D.JUN.27,1818,PH. M. 1864 ADELINE SCHONEIMAN (VID.CADET)
HENRY B. 1839 D.JUN.5,1849

IDA MARIE B.DEC. 2,1853,WILM. D.FEB. 3,1897,PH. M.NOV.10,1875,PH. BENJAMIN FLEISHER (O.V.(1))
ALICE HANNAH B.DEC. 4,1864,WILM,N.C. D.DEC.20,1934,PH. M.NOV.10,1875,PH. MOYER FLEISHER (O.V.(1))
FRANK B.OCT.20,1856,WILM. D.JUN.14,1924,PH. M.SEP.18,1888,WILKES BARRE,PA. GETTA LONG (WILKES BARRE DEC.20,1864--
LOUIS ALLEN B.SEP.5/6,1858,PH. D.DEC.19,1921,PH. M.OCT. 9,1893,PH. HELEN ROME (N.Y.JUN.3,1867--PH.JUL.17,1942) D.S.P.
OSCAR BOWER B.NOV.10,1860,PH. D.JUL.26,1919,PH. UNM.
JULIUS LAZARUS B.MAY 19,1863,PH. D.JAN.21,1929,PH. M.JAN. 7,1914,PH. LAURA SPIELBERGER (PH.NOV.25,1877--
ADELINE HACKENBURG B.SEP. 9,1865,PH. D.AUG.10,1932,PH. M.OCT. 25,1892,PH. ALFRED HAYER,M.D. (PH.NOV.4,1861--PH.SEP.13,1960)
WILLIAM HACKENBURG B.AUG.30,1867,PH. M.FEB.14,1895,PH. JULIA ESPEN (PH.JUL.16,1871--
SOLOMON B.MAR.20,1870,PH. D.AUG.20,1912,PH. UNM.
FRANK LONG B.APR.21,1896,PH. UNM.
JEROME LONG B.JUL.29,1890,WILKES-BARRE M.NOV.29,1925,N.Y. REGINA ADELAIDE WEINBURGH
JEAN LONG B.JUN.3,1927,N.Y.
OSCAR BOWER B.MAY 12,1916,PH. M.FEB.15,1948,PH. ESTELLE ELAINE SIMON
REBECCA TELLER B.AUG.5,1893,PH. UNM.
FANNY ESPEN B.FEB.18,1896,PH. D.JUN.14,1941,PH.
IDA B.MAY 13,1898,PH.

HAMBURGER-MOSES-LEVY-HART

KRAUS-SANDOR COLL.
ROTH-THE GREAT SYN.,P.68
BEVIS MARKS REC.I,P.30N.
MURIEL CHESLER ANDRADE
MISC.III & VII.

MOSES HAMBURGER

LEBLE MOSES CALLED MOSES LEVY OF BRESLAU
MICHAEL LEVY
HARTWIG MOSES CALLED NAPHTALI HART OF BRESLAU
GLÜCKEL OF HAMELN
HARCUS (HORDECAI HAMBURGER) FREUDCHEN HAMELN
THIS GENERATION CALLED LEVY
BENJAMIN WOLF (ARR.LOND.1670) B. HAMBURG, 1664 D.LONDON, 1704 M.1 (SISTER OF MRS. MOSES LEVY) M.2) LOND. DEC.22,1684 MITCHELE (HENDEDLE, ISABEL) HEILBUTH (VID.HELBERT)
SOLOMON SELIGMAN D. 1738
ISAAC
LEAH
HINDELE
BILAH
FRANDELE
THIS GENERATION CALLED HART
JOCHABED D. 1797
JUDITH D. 1785
MOSES (NAT.LOND.NOV.10,1721) B.BRESLAU, 1676 D.LOND.NOV.19,1756 M. PRUDENCE HEILBUTH (VID.HELBERT)
SOLOMON D.JAN.12,1760 M. RACHEL ISAACS
MARGOLES D. 1788 M. SIMON LAZARUS OF GOZLAR (IN LOND.1697) (- LOND.1764)
ZIPPORAH M. HEIR WAAG(E) (O.V.)
AARON (RABBI URI PHOEBUS) B.BRESLAU 1670 D.LOND.NOV.21,1756 M. DAU. OF RABBI SAHUEL B. URI, SHERAGO PHOEBUS
MENACHEN B. 1686 D.OCT.14,1708
ABIGAIL (GOLLY) B. 1700 D. M. MOSES ADOLPHUS
ELIAS B. 1702 D.JAN.14,1750
LOND. JUN. 2, 1727
JUDITH B. 1706 D.JAN.20,1803
HYAM (NAT.LOND.NOV.16,1721) B. 1710 D.OCT.18,1738,BATH UNM.
BILAH B. D.JUL.6,1748 M.DEC.7,1743 AARON FRANKS (O.V.I(1))
RACHEL M. 1750 M. MICHAEL ADOLPHUS
ISABELLA M. JACOB ADOLPHUS
SIMHA FRANCES B. 1705 D.JAN.18,1754 M.MAY 31,1720 ISAAC FRANKS (O.V.I(1))
ABRAHAM B. D.DEF. 1756 M. 7 (AARON (TO JAMAICA, CA.1780)
SUSANNA
REBECCA (1)
SIMON MOSES (2) JACOBUS D.LOND. 1764
SUSANNAH MOSES D. 1768
BENJAMIN B. 1728 D. 1749/50
ISABELLA B. 1731 D.MAR. 1754 M.APR.25,1753 HON.LOCKHART GORDON D.S.P.
OTHERS D. INF.
HESTER D. 1764
NAPHTALI HART MYERS (O.V.VI)

PAJHS V.2,P.147
 PAJHS V.32,P.46F.
 UJE V.5,P.213
 MOSES GEN.
 HARBY GEN.
 WILL OF HENRY HARBY(JRN COLL.)
 HARBY REC.(JRN COLL.)
 WILL OF ABRAHAM COHEN(JRN COLL.)
 ELZAS MS.
 OJC.
 DAR LINEAGE
 MOISE-JEW.CEM.AT SUMTER
 WILL OF GRACE ABENDANDONE
 WILL OF A TOBIAS HARBY
 JANE L. RAISIN
 KORN-N.O.,P. 82F.

ISAAC HARBY (LAPIDARY TO EMPEROR OF MOROCCO) FRANGIPANI

HARBY

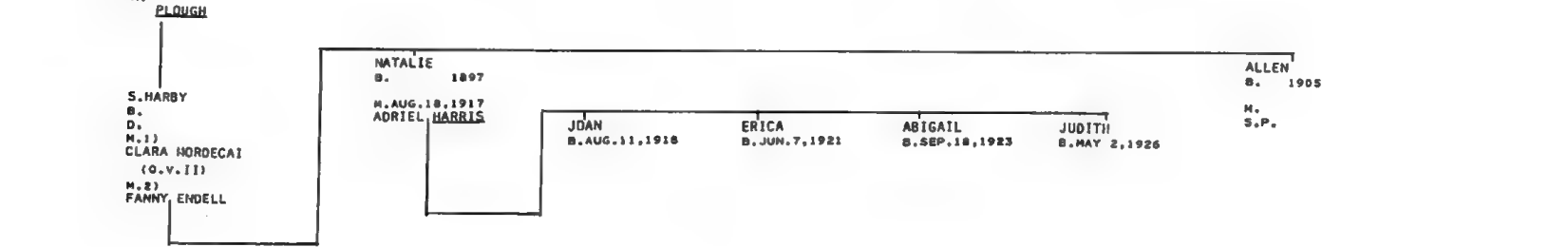
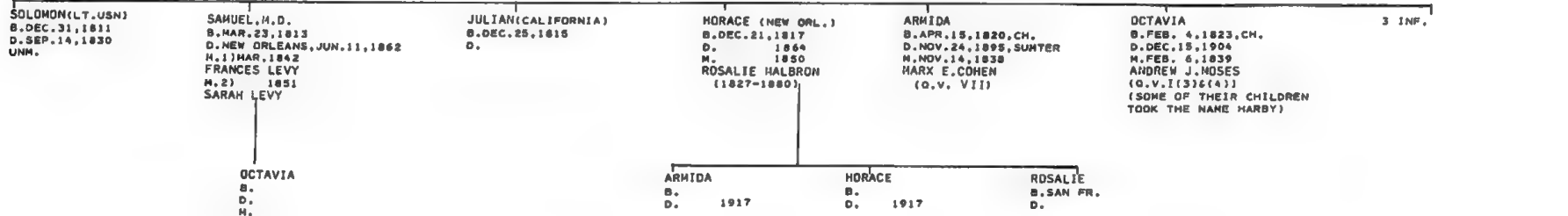
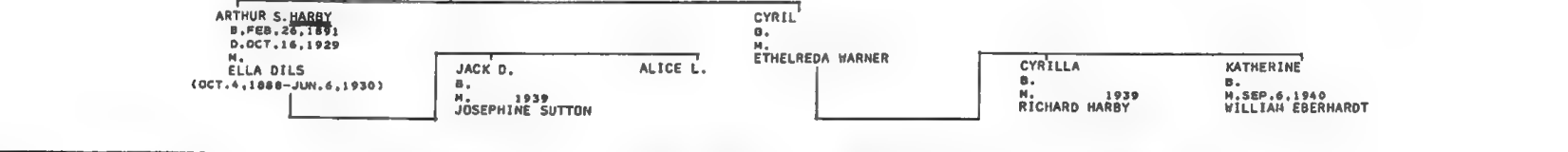
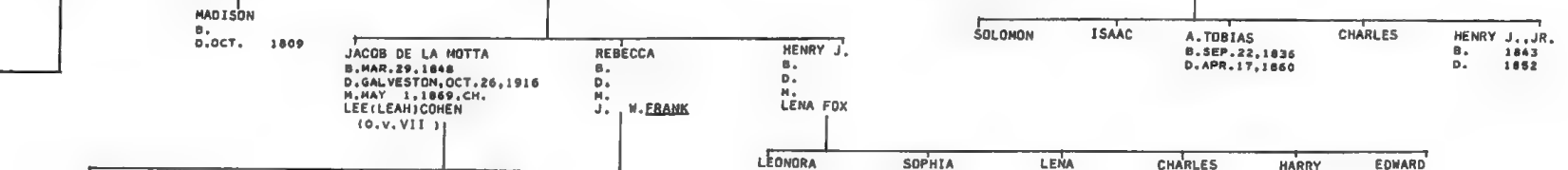

HARRIS I

MOSS-HARRIS GEN.
NATHAN GEN.
NATHAN GEN. (AJA)
ELZAS MSS.
SAUL VIENER (GOODMAN BIBLE)
KORN-JEWS OF N.O.
EGON WOLFF

ABRAHAM HARRIS
B. 1735
D. JAN. 29, 1827, LOND.
M.

HYAM (HYMAN) (TO CH. 1800; N.O., 1825)
B. 1764/74, ENG.
D. JUN. 1, 1828, N.O.
M. 1799(?), LOND.
CATHARINE NATHAN
(O.V. II)

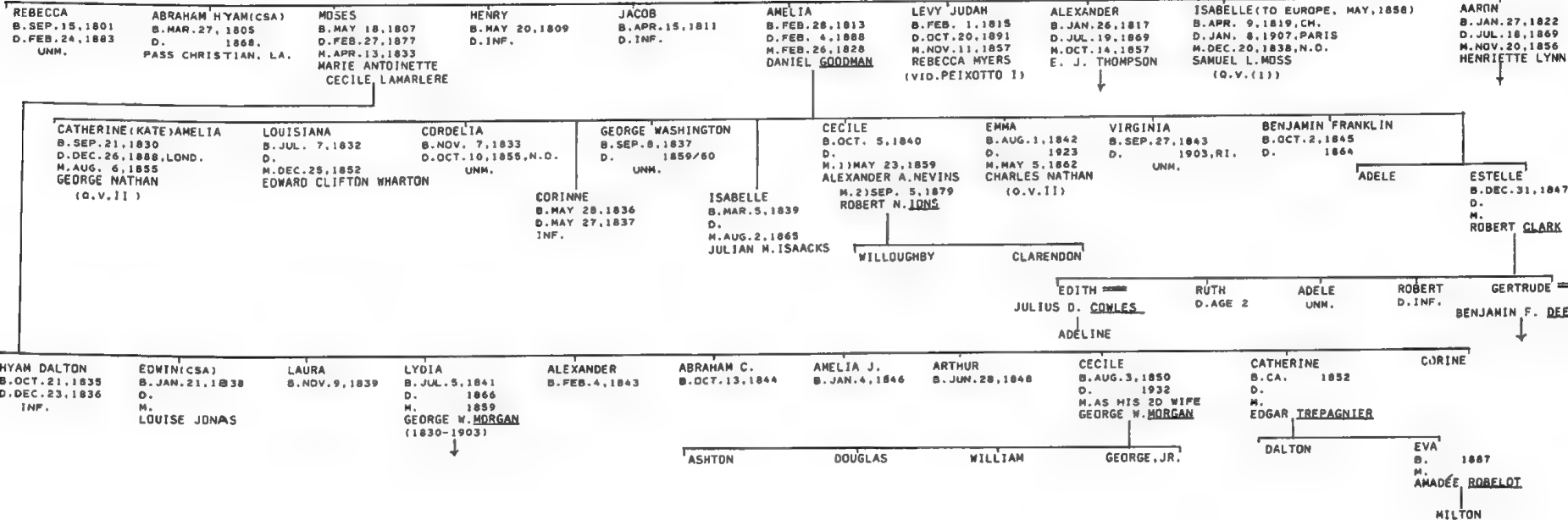

HARRIS II

ELZAS-JEWS OF S.C.
M.N.
O.J.C.
JOHN F. ALEXANDER

JACOB HARRIS, JR. (TO CH. CA. 1797)
B. 1766, HOLLAND
D. JAN. 9, 1837, CH.
M.
A- ?
(ENG. 1779-DEC. 27, 1840)

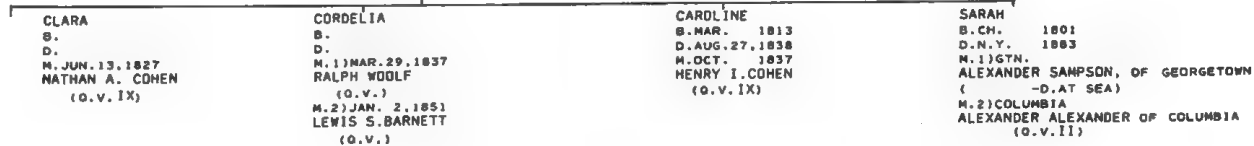

VALENTINE'S MANUAL
FAJHS, V.4, P.215F,
V.27, P.490P.
UJE, V.5, P.223F.
KRAUS-SANDOR COLL.
N.Y. MARRIAGES
MALCHLOSSE-LES JUIFS...
MICKVE ISRAEL REC.
SHEARITH ISRAEL REC.
HART FAMILY REC. (MS.AJA)
FLO, ABR.
EVELYN MILLER
N.Y. WEEKLY MUSEUM

M.H. HART VS. BENJAMIN HART 1849
DOROTHEA HART CORR. MCCORD MUS.
FANNY JOSEPH DIARY

(EZEKIEL) HART JUDAH (O.V.III)

HART I (1) CANADA

AARON (MOSHE URI B. YEHEZKEL)
SEIGNEUR DE BECANCOUR, OUE.
B. AUG. 16, 1724, LOND.
D. DEC. 28, 1800, TROIS RIVIERES, OUE.
M. JAN. 14, 1768, LOND.
DOROTHEA CATHERINE JUDAH
(O.V.III)

NAPHTALI JOSEPH
(O.V.II)

ESTHER SOLOMONS (O.V.I)

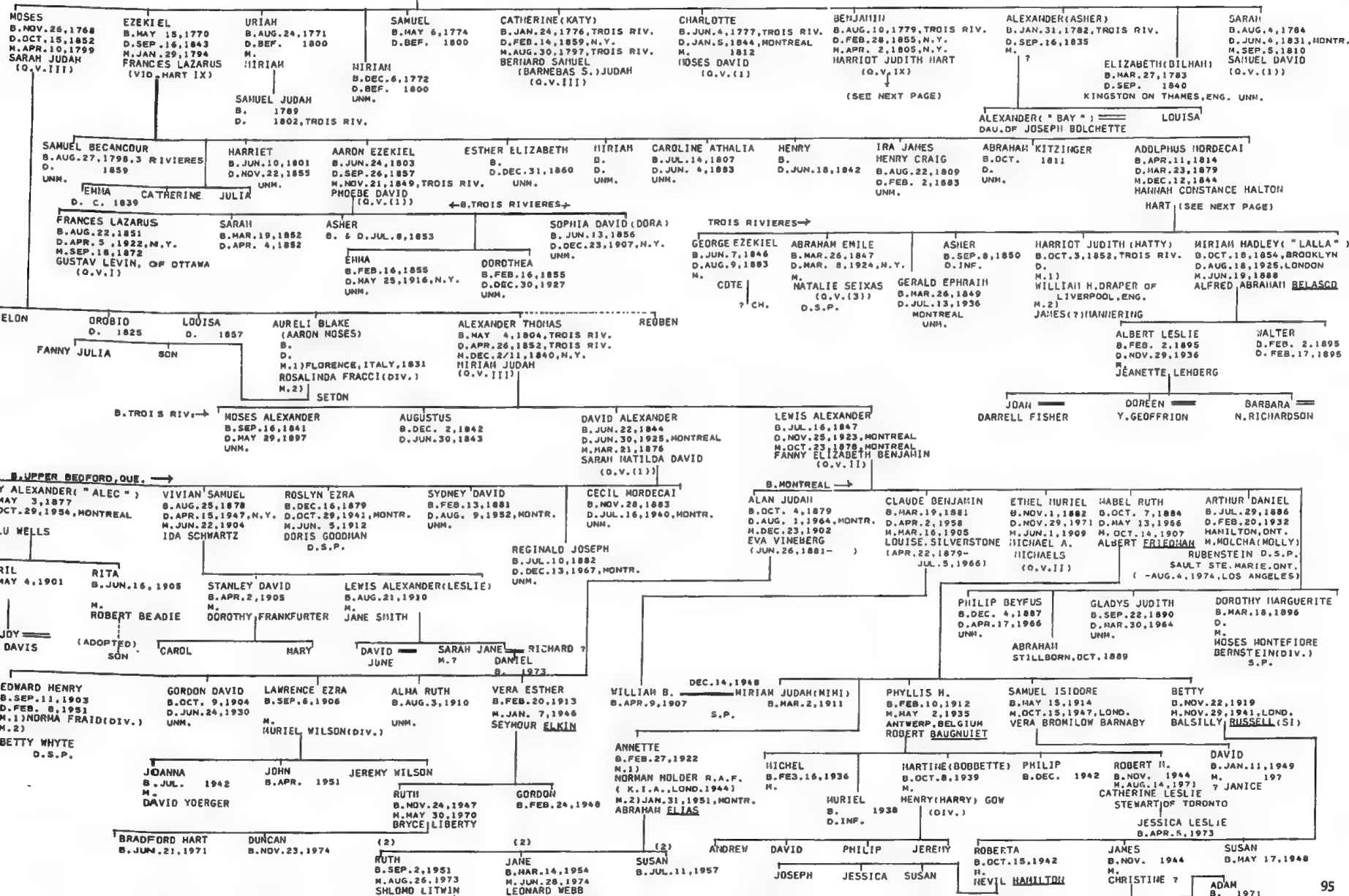

HART I (2) CANADA

BOSTON DIRECTORY OF 1850
 HARRIOT HART VS. BENJAMIN HART 1849
 ST. MARTIN'S PARISH RECORDS, ST. MARTINSVILLE, GA.
 B.G.SACH, HISTORY OF THE JEWS IN CANADA

APR. 2, 1805, N.Y.
 BENJAMIN HART
 B. AUG. 10, 1779, TROIS RIV.
 D. FEB. 28, 1855, N.Y.
 (SEE PRECEDING PAGE)

HARRIOT JUDITH HART
 (G.V.-IX)

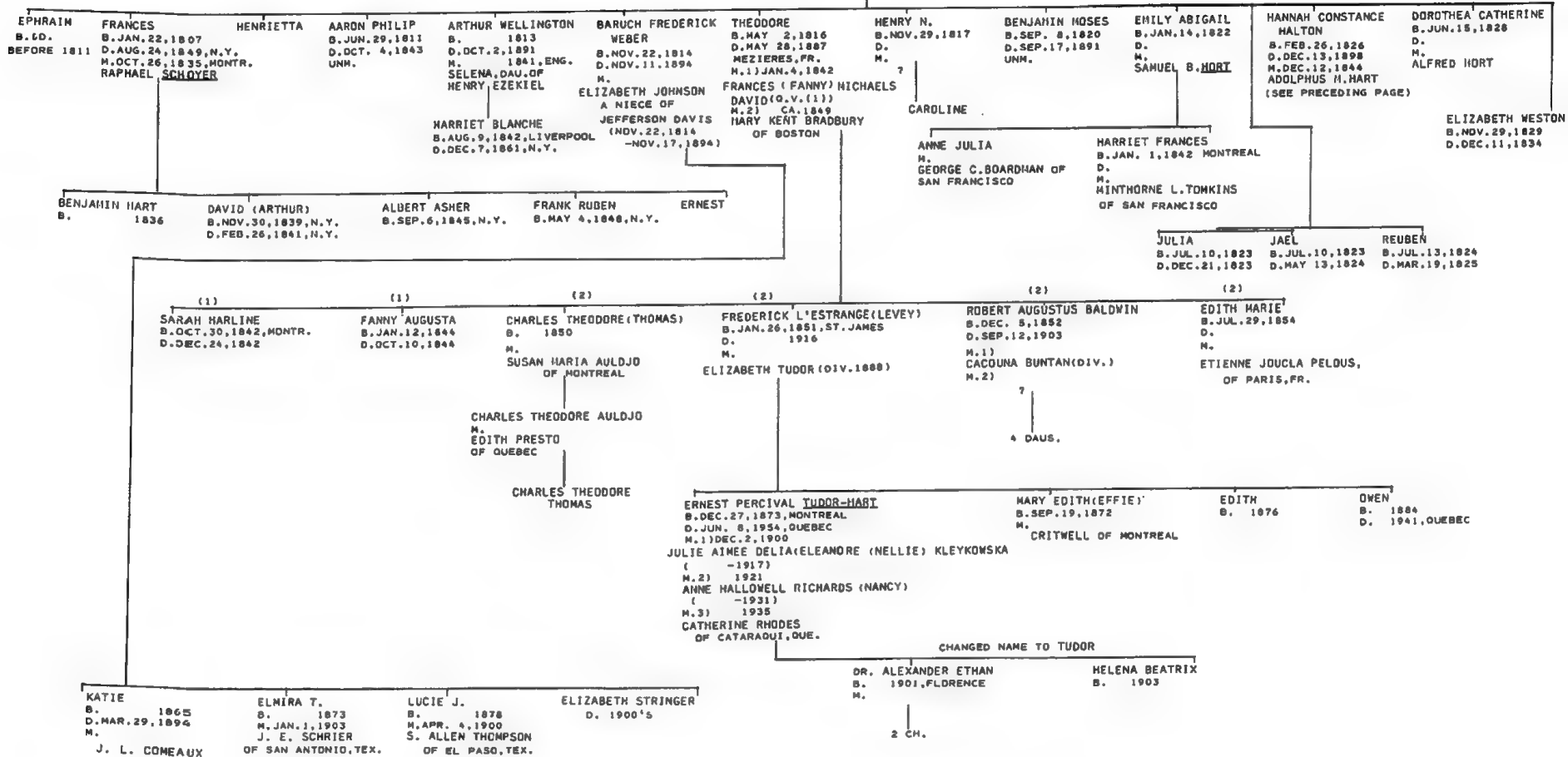

U.S. CENSUS 1860
PAJHS V. 27, PP. 110, 164
V. 32, P. 99F.
UJE V. 5, P. 225
KRAUS-SANDOR COLL.
SHEARITH ISRAEL REC.
THE OLD MERCHANTS, P. 119F.

MEMACH HART
1799 (1) (2) AUG. 13, 1806
CATHERINE BRETT BERNARD (TO U.S. 1777) REBECCA B. SEIXAS
B. DEC. 25, 1763, LONDON B. (O.V. 41)
D. JUL. 19, 1855, N.Y.

HART II (N.Y.)

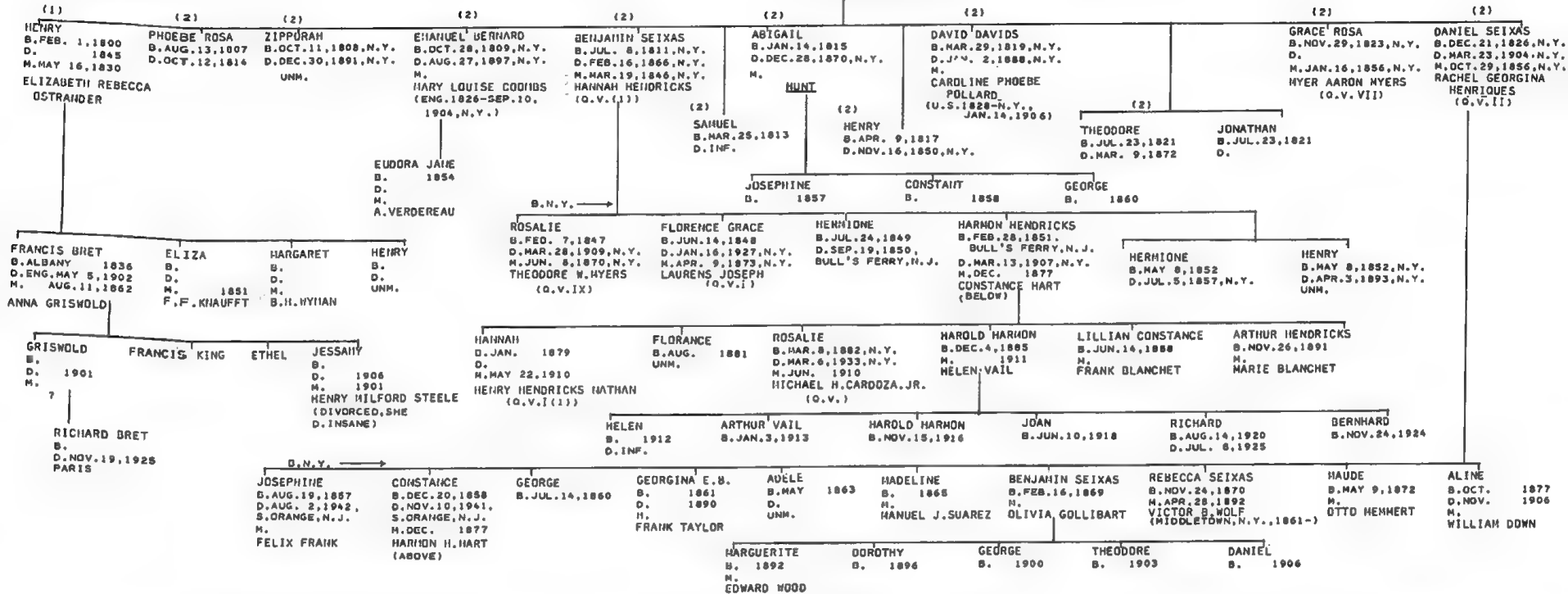

HART III (CHARLESTON, NEW ORLEANS)

WILLS OF PHILIP, ALEXANDER & HART M. HART
(JRM COLL.)
ELZAS MSS. OJC.
KORN-N.D.

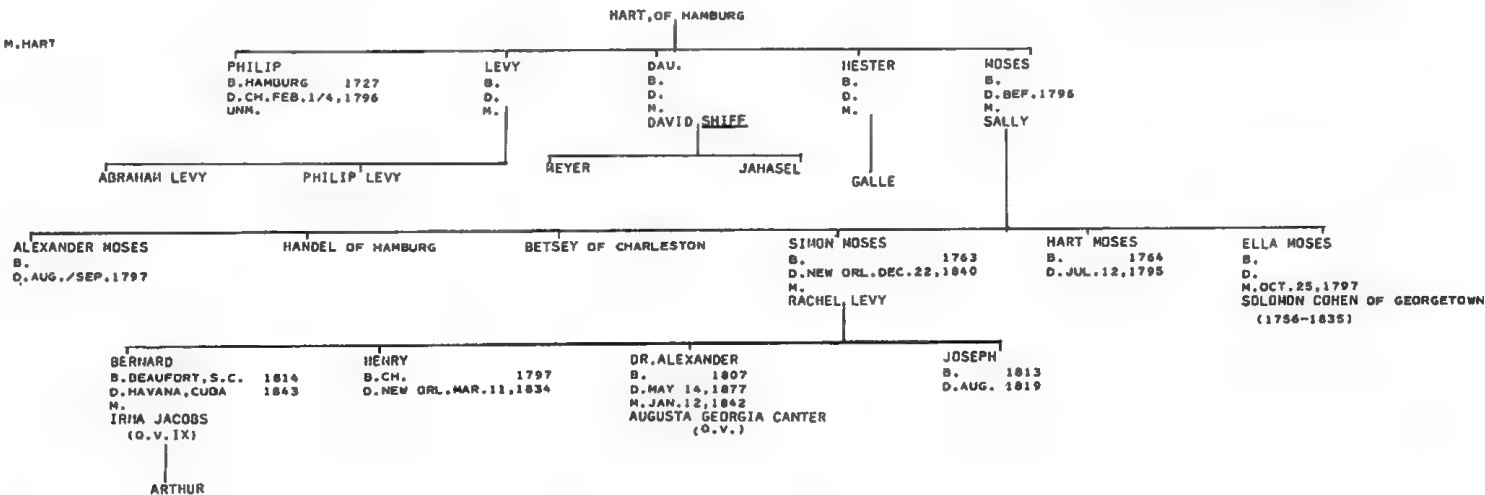

HART IV (PHILA. & N.Y.)

ADMINISTRATION OF NATHAN HART
PAJMS, V. 27, P. 110
KRAUS MSS.
KORN-N.O.
U.S. CENSUS, 1850 (N.Y.C.)

N.Y. DEATHS (DAR)
SHEARITH ISRAEL REC.
HART MS. IN DAR
MRS. M.S. CARTER

JACOB (NAPHTALI) HART
B. GERHANY, (FURTH) 1746
CAME TO AMERICA, 1775
D. MAY 9, 1822, N.Y.
BUR. NEW BOWERY CEM.

LEAH NATHAN
(O.V. III)

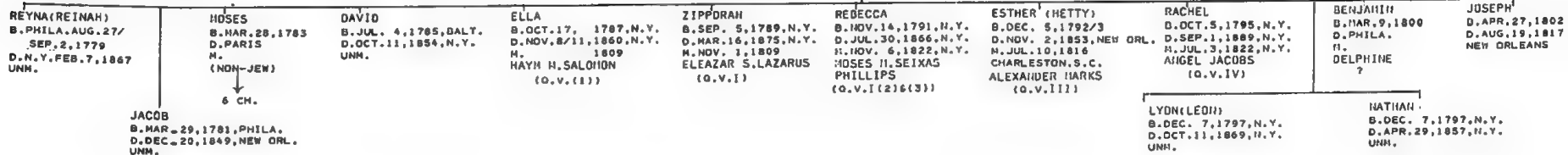

HART V (CHARLESTON, S.C.)

KRAUS MS.
LOPEZ LETTERS
CLEMENS-N. & S. CAROLINA MARRIAGE REC.
ELZAS MSS. (NYHS)
SHEFTALL MSS.

MOSES HART OF THE HAGUE = ESTHER

FRANCES
B. JUL. 1740
D. OCT. 25, 1820
BEAUFORT, S.C.
M. OCT. 28, 1761, CH.
HORDECAI SHEFTALL
(O.V. I)

JOSHUA
B.
D. JUL. 10, 1787, CH.
(IN CH., BY 1761)

REBECCA
D.
D. SEP. 20, 1788,
SPANISHTOWN, JAMAICA

RICHEA
B.
D.
M. NOV. 18, 1777
ABRAHAM H. SEIXAS
(O.V. I)

ESTHER
(HESTER)

SHANKEY
B. JUN. 5, 1766, CHARLESTON
D. JAN. 24, 1804
M. OCT. 19, 1795, CHARLESTON
ABRAHAM (ADRAH) JACOBS
(O.V. I)

HART VI (1) (CHARLESTON, S.C.)

HART OF MANNHEIM

DAU. OF JOSEPH, OF MANNHEIM
(O.V. JOSEPH IV)

U.S. CENSUS 1850 (N.Y.C.)

KRAUS MS.
WILLS OF DANIEL, BELLA & HYNON
HART (JRM COLL.)
PAJMS V. 27, P. 77
ELZAS MSS.
O.J.C.
M.N.
NEW JEWISH CEM. OF BETH ELOHIM
SHEARITH ISRAEL REC.
WILL OF RACHEL HART
SHEFTALL MSS.
MIRIAM COHEN-RECORD OF HART & COHEN FAMS.
(TYPESCR. - T.J. TOBIAS)
ABBOT LDW MOFFAT

MOISE-MOISE FAM.
JANE L. RAISIN

JOSEPH
(LIVING IN 1811)

HANNAH (HANEL)
OF MANNHEIM

SAMUEL
B. BERSTADT, MANNHEIM
D.
M.

NATHAN
B. CA. 1784
D. 1840
M. DEC. 2, 1807
RACHEL HART
(SEE NEXT PAGE)

DANIEL
B. MANNHEIM
D. CH. MAY 1811
(SEE NEXT PAGE)

BELLA (CAME TO CH. 1785)
B. LOND. 1742
D. CH. NOV. 6, 1851

MIRIAM
B. 1752
D. FEB. 7, 1815
M.
ISRAEL JOSEPH
(O.V. IV)

HANNAH (1)
D. 1761
D. JUN. 26, 1850
M. 21, 1792, SAV.
ISRAEL DELIEBEN
(BOHEMIA, 1748-JAN. 29, 1807, CH.)
M. 3 MAR. 1813
MOSES DAVIS
(COBLENTZ, 1759-DEC. 31, 1843, CH.)

HYNDON
B.
D. CH. NOV. 2, 1791

HORDECAI LEVY = HARY, DAU. LIEPHAN COHEN
(VID. DE LYON)

SAMUEL NATHAN
B. SEP. 10, 1808
D. DEC. 20, 1880
M.
ISABEL LAZARUS'
(VID. NEXT PAGE)

HARY
B. MAR. 13, 1811
D. OCT. 25, 1861
M. FEB. 17, 1839
DAVID D. COHEN
(O.V. VII)

JANE
B. FEB. 1816
D. OCT. 21, 1865
M. DEC. 18, 1839
HORDECAI H. LEVY
(O.V. XIII)

HYNAN N.
B. MAR. 5, 1816, CH.
D. MAR. 15, 1859, N.Y.
M. SEP. 26, 1841, N.Y.
HETTY HARRIA GOMEZ
(O.V. I)

EUDORA H.
B. OCT. 4, 1843, CH.
D. DEC. 5, 1874, N.Y.
M. NOV. 6, 1867, N.Y.
GRATZ NATHAN
(O.V. I (1))

LEWIS
B. JUL. 1846
D.
M.
ANNIE
?

NATHAN
B. DEC. 18, 1848, CH.
D. JUL. 12, 1897, N.Y.
UNH.

RACHEL ROSALIE
B. SEP. 14, 1851, N.Y.
D. JAN. 31, 1881, N.Y.
M. AUG. 22, 1878, N.Y.
MICHAEL RUIEZ CARDOZA
(O.V. I)

FRANCES ISABEL
B. MAR. 27, 1857, N.Y.
D. DEC. 7, 1942, N.Y.
UNH.

DANIEL SAMUEL
B. FEB. 1, 1839, CH.
D. APR. 15, 1877, CH.
M. DEC. 17, 1860, CH.
PRISCILLA LOPEZ
(O.V. I (2))

HIRAH
B. MAY 2, 1840, CH.
D. M. NOV. 8, 1865, N.Y.
M. APR. 4, 1899, CH.
ASHER D. COHEN
(O.V. VII)

NATHAN SAMUEL
B. DEC. 1, 1841, CH.
D. M. DEC. 27, 1871, N.Y.
M. ADELAIDE FANNY
SAMUEL (O.V. I)

JOSHUA L.
B. NOV. 21, 1843
D. SEP. 10, 1901
M. MAR. 26, 1884, N.Y.
HYRTILLA FLORANCE
JACKSON (O.V. I)

HYRTILLA
B. MAR. 27, 1885
M.
JACK SHYDER

ILIA
B. NOV. 27, 1885
D. INF. MAY 3, 1885

HENRIETTA
B. NOV. 21, 1843
D. DEC. 5, 1860
UNH.

HENRY
B. 1845
D. FEB. 9, 1865
COLUMBIA, S.C.

ROSETTA
B.
D. UNH.

JANE WARNER
B. JUL. 24, 1851
D. OCT. 7, 1874
M. DEC. 18, 1872, CH.
ALBERT LAZARUS
(APR. 5, 1848-OCT. 21, 1879)
(O.V. II)

ISRAEL DANIEL
B. NOV. 3, 1861, CH.
D. JUN. 20, 1901, BEAUFORT, S.C.
M. APR. 4, 1899, CH.
ROSALIE LEVY
(O.V. VI (1))

CATHERINE
B. JAN. 9, 1863
D. GREENVILLE, S.C.
D. MAY 10, 1932, CH.
UNH.

SAMUEL N. JR.
B. JAN. 15, 1865, GREENVILLE, S.C.
D. SEP. 1917, COLUMBIA, S.C.
M. APR. 18, 1891, SEMINOLE, S.C.
CAROLINE AUGUSTA SOLOMONS
(SEMINOLE, S.C. APR. 4, 1862-
AUG. 15, 1927, DENMARK, S.C.)

DAVID LOPEZ
B. AUG. 6, 1866, CH.
D. M. JUN. 4, 1890, CH.
LAURA L. LEVY
(O.V. VI (1)) D.S.P.

ISABEL
B. JAN. 15, 1868, CH.
D. UNH.

IDA
B. SEP. 24, 1869, CH.
D. AUG. 31, 1929, N.Y.
UNH.

HARY
B. NOV. 26, 1871, CH.
D. NOV. 25, 1922, N.Y.
UNH.

JACQUELINE HARBY
B. NOV. 7, 1900, CH.
D. APR. 29, 1954, CH.
M. MAR. 17, 1915, CH.
ROBERT ALEXANDER JONES
(SALKEHATCHIE, S.C. SEP. 1889
-APR. 29, 1954, CH. 3 D.S.P.)

PRISCILLA
B. JAN. 23, 1892, SEMINOLE, S.C.
D. NOV. 19, 1913, ESTILLE, S.C.
JOHN WESLEY CRUM
(DENMARK, S.C. JAN. 1, 1889 -)

DOROTHY EHER
(BELTON, S.C.)
B. MAY 16, 1893, COOSAW, S.C.
UNH.

CAROLINE SOLOMONS
B. SEP. 11, 1894
M. JUL. 18, 1916
WESLEY WILLINGHAM MORRISON

HENRY
B. MAR. 19, 1873
D. FEB. 25, 1874

FANNY
B. DEC. 30, 1874

MORRIS
B. MAY 31, 1877

NINA
B. AUG. 12, 1882

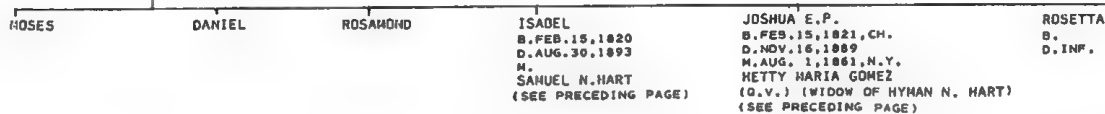
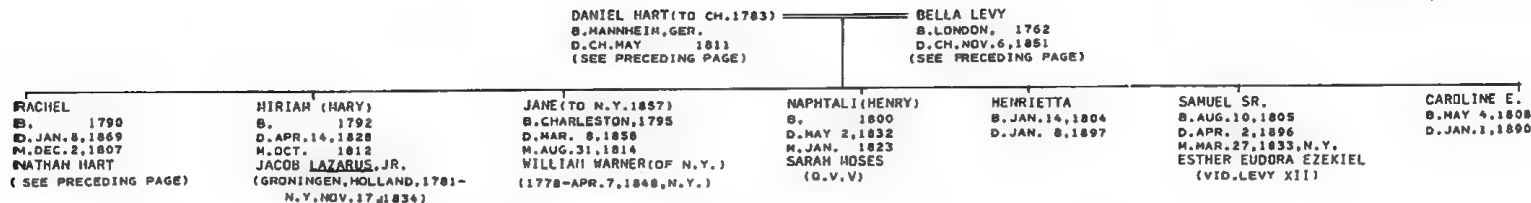

HART VII (LONDON, N. Y., & ST. EUSTATIUS)

KRAUS-SANDOR COLL.
 NEWPORT HISTORICAL MAG. V. 3 & 4
 ADMIN. OF AARON HART (K. SCOTT)
 E. N. A. P. 1050 F.
 HERSHKOWITZ-WILLS (AARON HART)

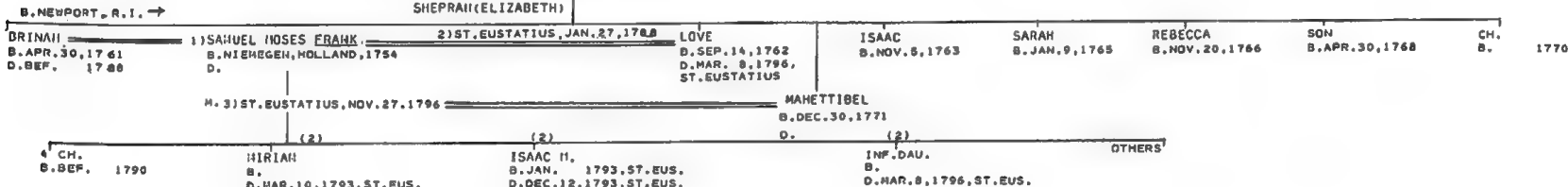

HART VIII (PHILA.)

MORAIS-JEWS OF PH., P. 53 F., 337
 KRAUS MS.
 MICKVE ISRAEL REC.
 FLD ABR.
 FEDERAL ST. CEM.
 PH. BUR. OF HEALTH REC., (HSP)

TSEBI

BILLAH
 B. JUL. 1730
 D. PH. NOV. 6, 1815

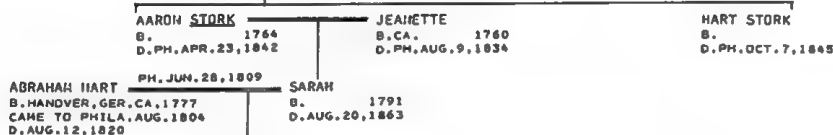

HART IX (N.Y.)

VALENTINE'S MANUAL
 N.Y. WEEKLY MUSEUM
 AMERICAN DAILY ADVERTISER
 PAJHS V. 4, P. 215F.
 PAJHS V. 27, P. 49F.
 UJE V. 5, P. 223F.
 KRAUS-SANDOR COLL.
 GENEALOGICAL SOC. OF PA. (JRH COLL.)

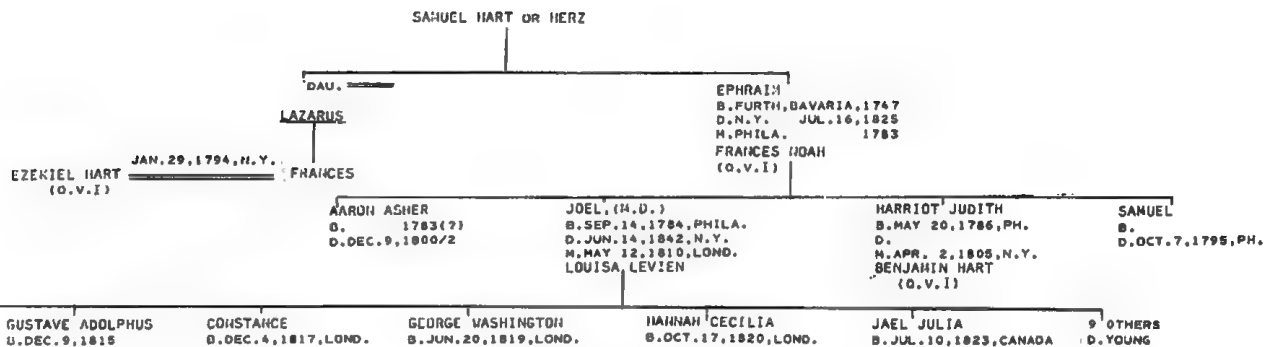

HART XI (PA.)

KRAUS-SANDOR COLL.

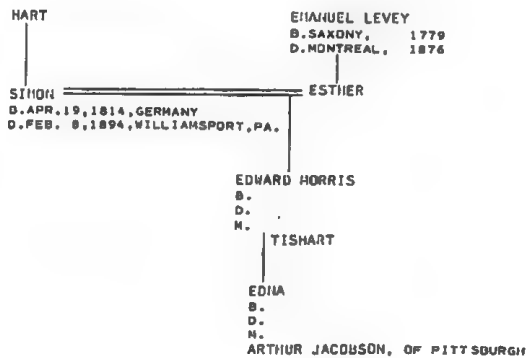

HART XII (CONN. & NEWPORT)

KRAUS-SANDOR COLL.
 PAJHS V. 38, P. 87F.
 NEWPORT HISTORICAL MAG.

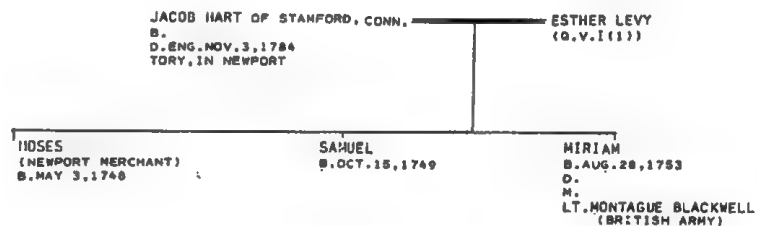

R.J.D'ARCY HART
 AMY STEWART FAMILY REC.
 GRINSTEIN-JEW. COMMUNITY OF N.Y.
 B'NAI JESHURUN REC.
 KORN-N.D.
 IRVING KATZ
 HART-WORKUM REC. (AJA)
 JON STEDMAN
 N.Y. CENSUS, 1855
 KRAUS-SANDOR COLL.
 U.J.E.V. 5, P. 228
 FLO. ABR.
 WILL OF JOHN I. HART
 AJYB, 5666/67

HERTZ JUDAS (NAPHTALI HART) OF NIEDERWEISEL, WETTERAU

(SILVERSMITH IN PORTSMOUTH, ENG.) REV. JUDAH HART
 B. 1741/2
 D. OCT. 23, 1827

HANNAH

COHEN
 OF PORTSEA, ENG.
 D. N. O. 1838

JACOB SHANOH/SIAHNOU
 OF LONDON

BENJAMIN
 D. JUN. 24, 1792, LOND.
 D. FEB. 5, 1858, N. O.

RACHEL
 B. JUN. 7, 1796, LOND.
 D. SEP. 29, 1843, N. O.

MOSES HENRY JOHN I. 1786, PORTSMOUTH
 B. 1741/2
 D. AUG. 30, 1863, GRAVESEND BAY, N. Y.
 M. ENG.
 HARIA LEVY (O. V. XV)
 (SEE NEXT PAGE)

REV. ALEXANDER (HAZZAN AT B'NAI JESHURUN)
 B. 1777, PORTSMOUTH
 D. FEB. 12, 1839, N. O.
 M. 1) PORTSMOUTH
 PAULINE MOSES
 N. 2) JUL. 26, 1836, N. Y.
 BETSY LEVY KOKERHOT
 (O. V.)
 N. O. DEC. 26, 1838

BY (1) →

REV. PHINEAS A. (HAZZAN AT B'NAI JESHURUN)
 B. 1786, PORTSMOUTH
 D. DEC. 18, 1833, PH.
 REBECCA LEVY
 (O. V. VII (2))

YITLAH (JULIA)
 B. 1786, PORTSMOUTH
 D. AGE 75
 N. FEB. 24, 1850, N. Y.
 MORRIS LUBLEY

HANNAH
 B. 1786, PORTSMOUTH
 D. JUN. 2, 1830, N. Y.
 LOUIS LEVY
 (PRES. SHARAVY TEFILA, N. Y.)
 (DEC. 25, 1800-JAN. 30, 1878)

AMELIA
 B. 1802, ENG.
 D. FEB. 14/15, 1865
 M. MAY 7, 1833, N. Y.
 DAVID SANSON
 (O. V.)

BLUHE
 B. PORTSEA, 1810
 D. N. D. SEP. 13, 1862
 M. N. Y. SEP. 4, 1839
 BENJAMIN LEVY

ISAAC
 B. JUL. 30, 1814/5, PORTSM.
 D. JAN. 11, 1890, DETROIT

JULIA
 B. MAY 16, 1819, ENG.
 D. MAR. 15/23, 1906, DETROIT

JACOB (CIV. W.)
 B. CA. 1829
 CHARLOTTE, N. C.
 D. JUL. 30, 1862
 (K. I. A. AT 2ND
 BATTLE OF MANASSAS)

DOHAH
 B. 1829
 D. FEB. 23, 1878, N. O.
 JOHN FORCHEIMER

FRANCES
 B. FEB. 11, 1821
 D. MAR. 16, 1899
 M. FEB. 23, 1842
 ABRAHAM EZEKIEL
 (O. V. (2) & (3))

SARAH
 M. 1)
 LOVIN
 M. 2)
 MANUEL GOLDSMITH

LEWIS
 B. JUL. 25, 1831

ISAAC
 B. APR. 14, 1832

BENJAMIN
 B. AUG. 7, 1833
 D. AUG. 14, 1906, N. Y.

ELIZA BETSY
 B. NOV. 25, 1834

EDWARD
 B. MAR. 30, 1837
 D. JAN. 14, 1920, N. Y.

BELLE H.
 ROSA JULIA
 B. SEP. 5, 1877, N. Y.
 D. MAY 8, 1896, N. Y.

ALEXANDER (MAJOR, CSA)
 B. OCT. 1, 1839, N. D.
 D. SEP. 21, 1911, NORFOLK, VA.
 M. AUG. 15, 1866, RI.
 LEONORA LEVY
 (O. V. IV)

SIDNEY ABRAM
 B. OCT. 25, 1841, N. D.
 D. APR. 28, 1908, GRAND RAPIDS
 M. FEB. 14, 1870, LAFAYETTE, IND.
 FANNIE, DAU. OF MOSES AMBERG
 (LAFAYETTE, IND., MAY 14, 1850-)

ELIZABETH
 B. JUL. 26, 1843, N. D.
 D. DEC. 29, 1928, CINTI.
 DAVID WORKUM

KATE
 B. JUL. 19, 1847
 D. OCT. 22, 1874
 UNM.

HATHAH (SAN ANTONIO)
 B. AUG. 17, 1849
 D. BETTIE HOLLIS

SIMEON
 B. JUL. 7, 1851
 D. M. NOV. 2, 1881
 HENRIETTE BROTH
 OF FLINT, MICH.

GEORGE
 D. DEC. 2, 1853
 D. OCT. 7, 1904
 M. APR. 5, 1887
 CLARA

FANNIE
 B. DEC. 8, 1855
 D. SEP. 24, 1903
 M. SEP. 22, 1885
 AS HIS SECOND WIFE
 LEE AMBERG
 OF CINTI.
 (WIDOWER OF HER
 SISTER HENRIETTA)

SALLIE
 B. JAN. 23, 1858
 D. JUL. 6, 1859, N. D.

HEMRIETTA
 B. JAN. 22, 1860
 D. AUG. 22, 1883, CINTI.
 M. DEC. 26, 1882, DETROIT
 LEE AMBERG OF
 CINCINNATI

MORRIS
 B. OCT. 20, 1845

RACHEL
 B. OCT. 20, 1845
 D. M. SEP. 3, 1866, DETROIT
 HEYER HALEE OF
 SAN ANTONIO

MIRIAM
 EDWARD SYKES
 OF N. Y.

IDA
 D. DEC. 29, 1884
 D. M.
 SIDNEY SILBERMAN
 (-1929, DETROIT)

ARTHUR
 B. DEC. 31, 1887
 CLARA
 B. FEB. 1887
 M. HUGO SOMMERICH OF N. Y.

IRVIN
 ELOISE
 B. JAN. 15, 1887

FLORENCE
 B. NOV. 1892
 D. MAY 21, 1902

MOSES A.
 B. JUN. 21, 1872
 D. APR. 20, 1915

WALTER EMMANUEL
 B. JUL. 2, 1874
 D. M. JUN. 7, 1909
 ALICE VICTOR

BLANCHE J.
 B. GRAND RAPIDS,
 DEC. 22, 1876

SIDNEY A., JR.
 B. DEC. 6, 1878
 D. M. NOV. 3, 1902
 BESSIE WALTERS

WALTER, J. R.
 B. JUN. 13, 1910

HENRIETTA VICTOR
 B. MAR. 12, 1912

JOHN ALAN
 B. APR. 5, 1925

HENRIETTA
 B. SEP. 25, 1867
 D. M. FEB. 1887
 FREDERICK GOLDSMITH

ALEX
 B. FEB. 5, 1869

HENRY
 B. AUG. 17, 1874

LILLIE
 B. AUG. 4, 1877
 D. M.
 JESSIE D. DOPPEHEIMER

HENRY H. SILLS
 GOLDYE LEVY

JOHN A. SILLS
 JOSEPHINE WELT

ALLEN B.

JOHN S.

JANE E.

SIDNEY A. III
 B. SEP. 7, 1903
 D. FEB. 23, 1904

FRANCES ELIZABETH
 B. NOV. 23, 1904

JULIAN
 B. JUL. 16, 1907

BLANCHE ALICE
 B. JAN. 29, 1909

ANNIE

HENRY J.

LAWRENCE

GERTRUDE
 B. SEP. 26, 1867
 D. SEP. 20, 1945
 M. 1) OCT. 29, 1888
 GEORGE D. LEVY
 (O. V. IV)
 M. 2) DEC. 14, 1910
 AS HIS 2ND WIFE
 CHARLES F. WEST

ALBERT L.
 B. JAN. 4, 1870
 D. OCT. 13, 1928
 M. OCT. 25, 1904
 IDA HARGOLIUS

ETHEL
 B. SEP. 4, 1906

LOUIS ALEXANDER
 B. OCT. 25, 1913

AMY COLEMAN
 B. MAY 20, 1873
 D. SEP. 10, 1954, NORFOLK
 M. NOV. 13, 1916
 AS HIS 2ND WIFE
 OSCEOLA OLAR STEWART

ALEXANDER HART
 B. JAN. 29, 1918
 D. NOV. 2, 1931

MORACE BEVERLY
 B. OCT. 7, 1879
 D. 1948, NORFOLK
 H. OCT. 3, 1915
 HAE HOODALL
 (SEPARATED)

JOHN I. HART MARIA LEVY
 B. 1786, PORTSMOUTH, ENG. (O.V.XV)
 D. AUG. 30, 1863, GRAVESEND BAY, N.Y.
 (SEE PRECEDING PAGE)

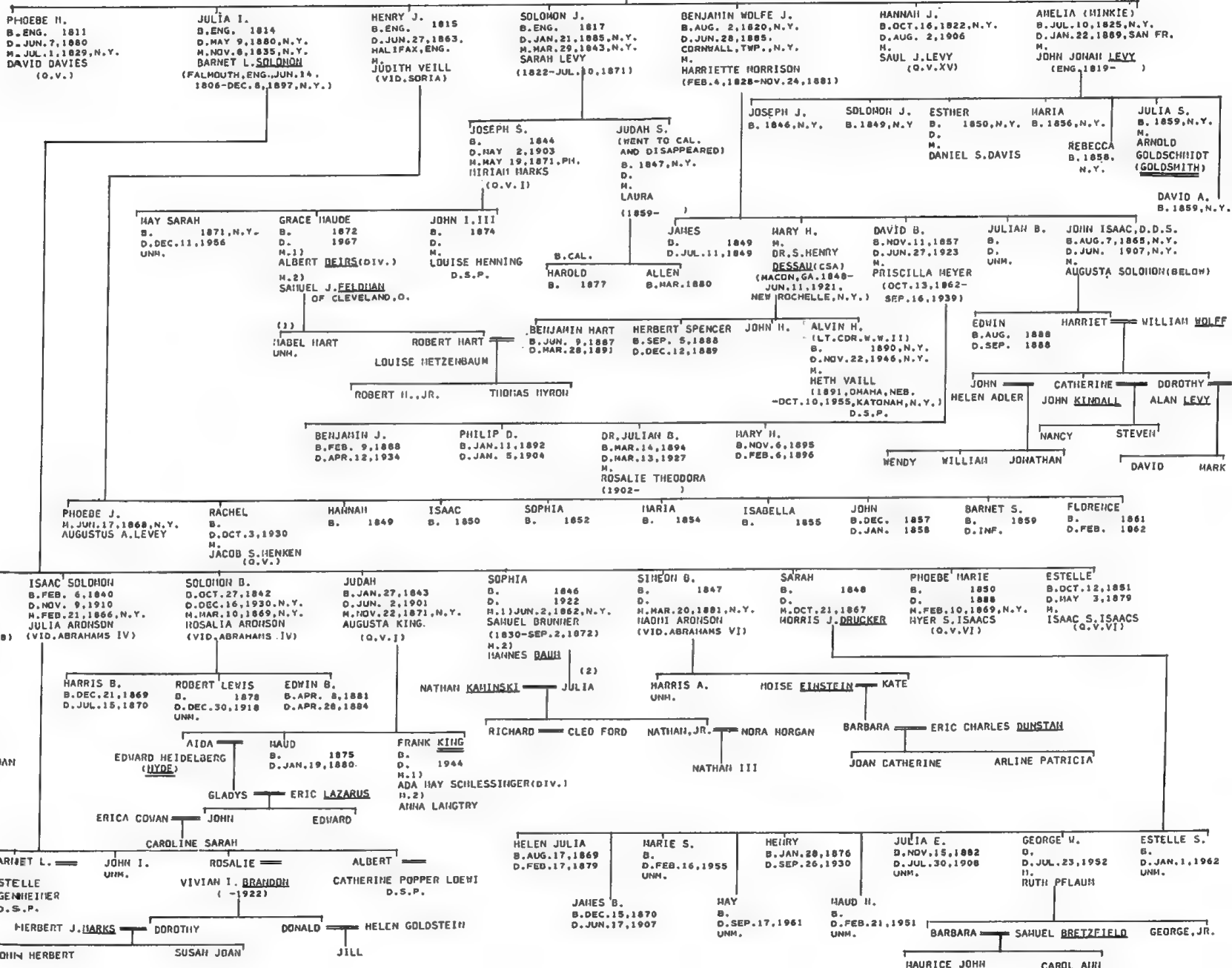

PAJHS, V. 8, P. 133
 V. 28, P. 266F.
 V. 35, P. 236
 ANCKER MS.
 MORAIS-JEWS OF PHILA... P. 52F.
 J.E. V. 3, P. 576
 ST. CHARLES, P. 133F.
 GENEALOGICAL SOCIETY OF PA. MS.
 (PHOTOSTAT, JRM)
 LEVY FAMILY GEN. (EDWIN WOLF II)
 MICKVE ISRAEL REC.
 FLORENCE ABRAHAM'S
 BARNET JACOBS MOHEL REC. (AJA)
 LEVY FAMILY REC. (PA. H.S.)
 SHARATH ISRAEL REC.
 FED. ST. CEH.
 MISC. VIII (1850A)
 RODEPH SHALOM MOHEL REC.
 RODEPH SHALOM MARR. REC.
 TRACHTENBERG

(NAT. PA. APR. 22, 1764) HYER HART DE SHIRA (TEXEIRA)
 B.
 D. PHILA. AUG. 14, 1797
 [A FOUNDER OF EASTON, PA. CA. 1750]

RACHEL DE LYON
 (O.V.)

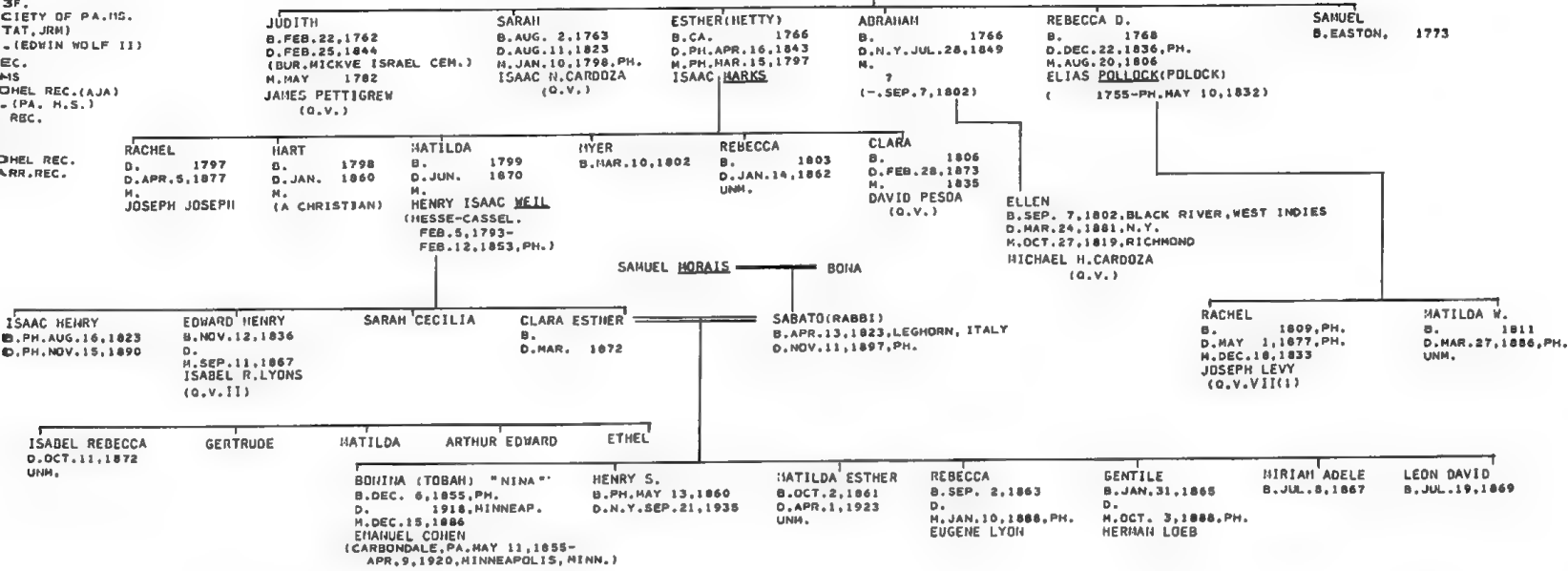

TRACHTENBERG
 J.R. COHEN
 J.E. V. 6, P. 240F.
 MORAIS-JEWS OF PHILA., P. 29
 KRAUS-SANDOR COLL.
 PAJHS V. 8, P. 127F.
 DAR LINEAGE BOOKS
 MICHAEL MARKS MS. (EDITH ROSENTHAL)

R. J. MOSES AUTOBIOG. (JRM COLL.)
 MICKVE ISRAEL REC.
 FED. ST. CEM.
 ESTHER SCHWARTZ
 ROSENWAIKE
 C. H. UNGER OBIT.
 N.Y. TIMES, APR. 4, 1967

LEAH HARKS (O.V. I)

(1) MICHAEL HART B. 1738, GERMANY
 D. MAR. 23, 1813, EASTON, PA.

(2) ESTHER COHEN (VIO. LURIA)

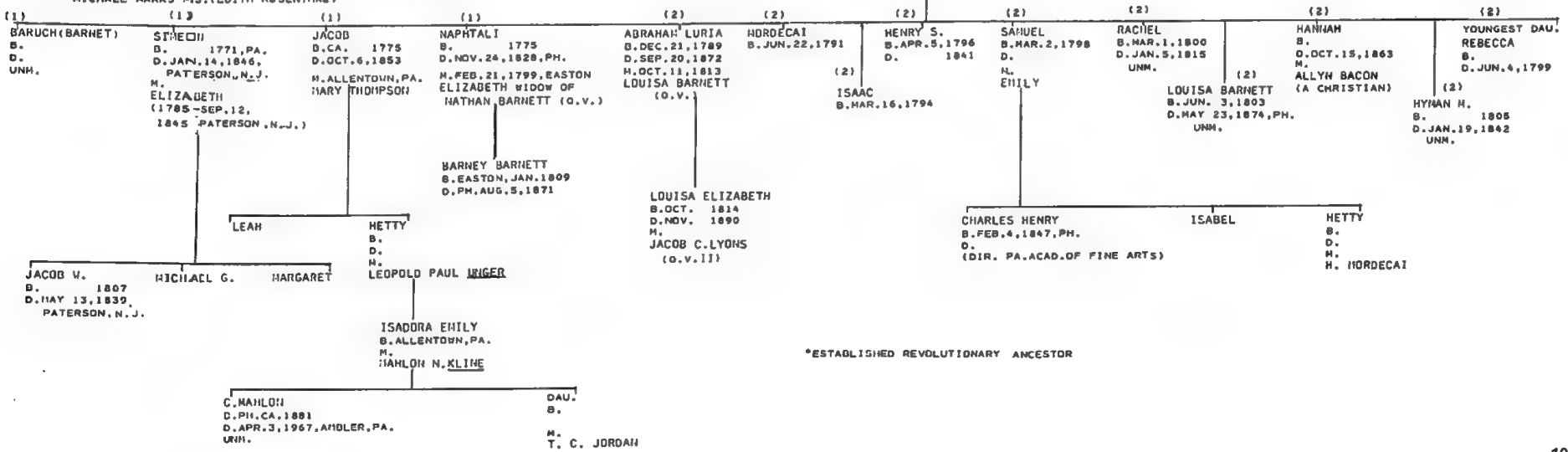

*ESTABLISHED REVOLUTIONARY ANCESTOR

HAYS (1)

HERSKOWITZ HILLS(JUDAH, MICHAEL, YITLAIH)
A.J.Y.B, 5666/67
VALLENTINE'S MANUAL
SHEFTALL MSS.

SOLOMON HAYS

MICHAEL (JECHEIL)
B. HOLLAND
D. AUG. 1740

PHILIPSON-LETTERS OF REBECCA GRATZ
NICKVE ISRAEL REC.
SULZBERGER GEN.

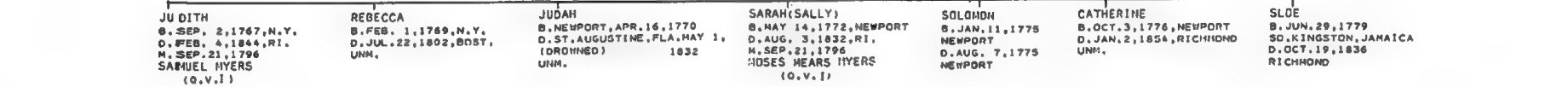
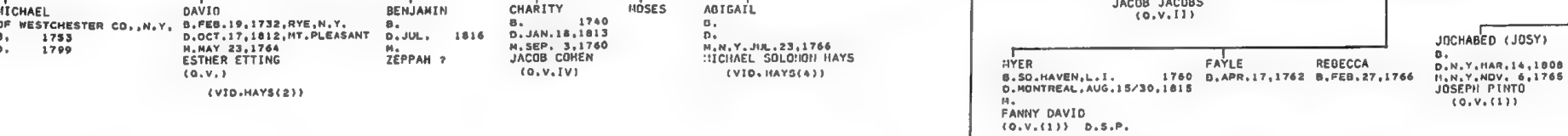
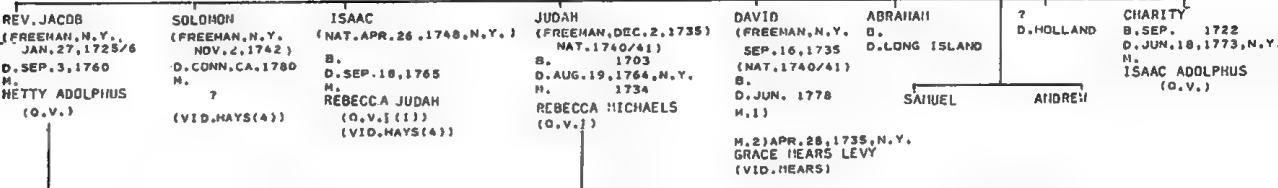

HAYS (2)

DAVID HAYS, JR. ESTHER ETTING
(SEE HAYS (1)) (O.V.)

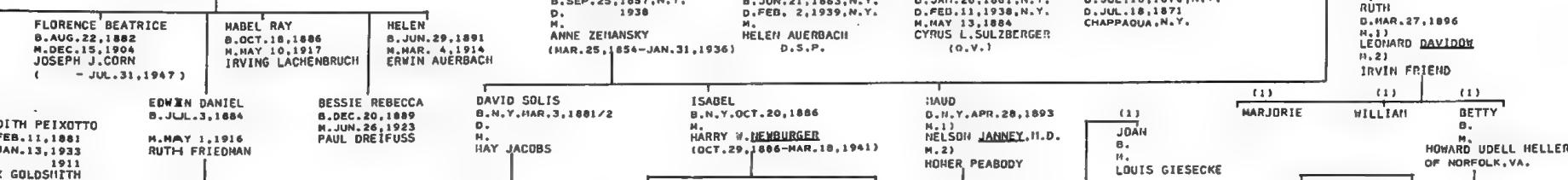
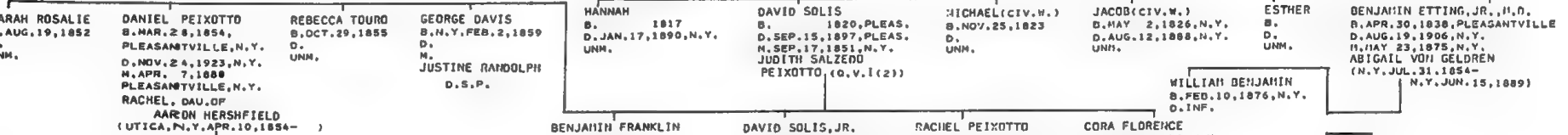
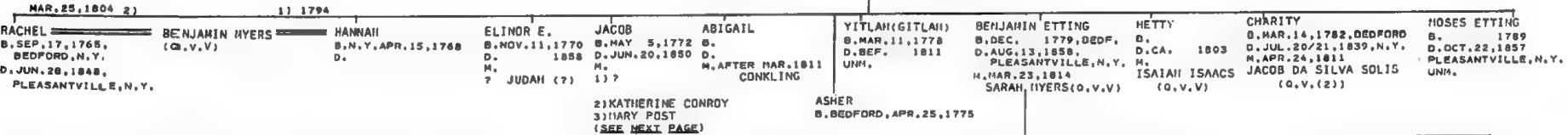

(1) JAN. 14, 1798

JACOB HAYS*
(SEE PRECEDING PAGE)

2) CATHERINE CONROY OF N.Y.
(1776-FEB. 20, 1812)
3) MARY POST
(1788 N.Y.-)

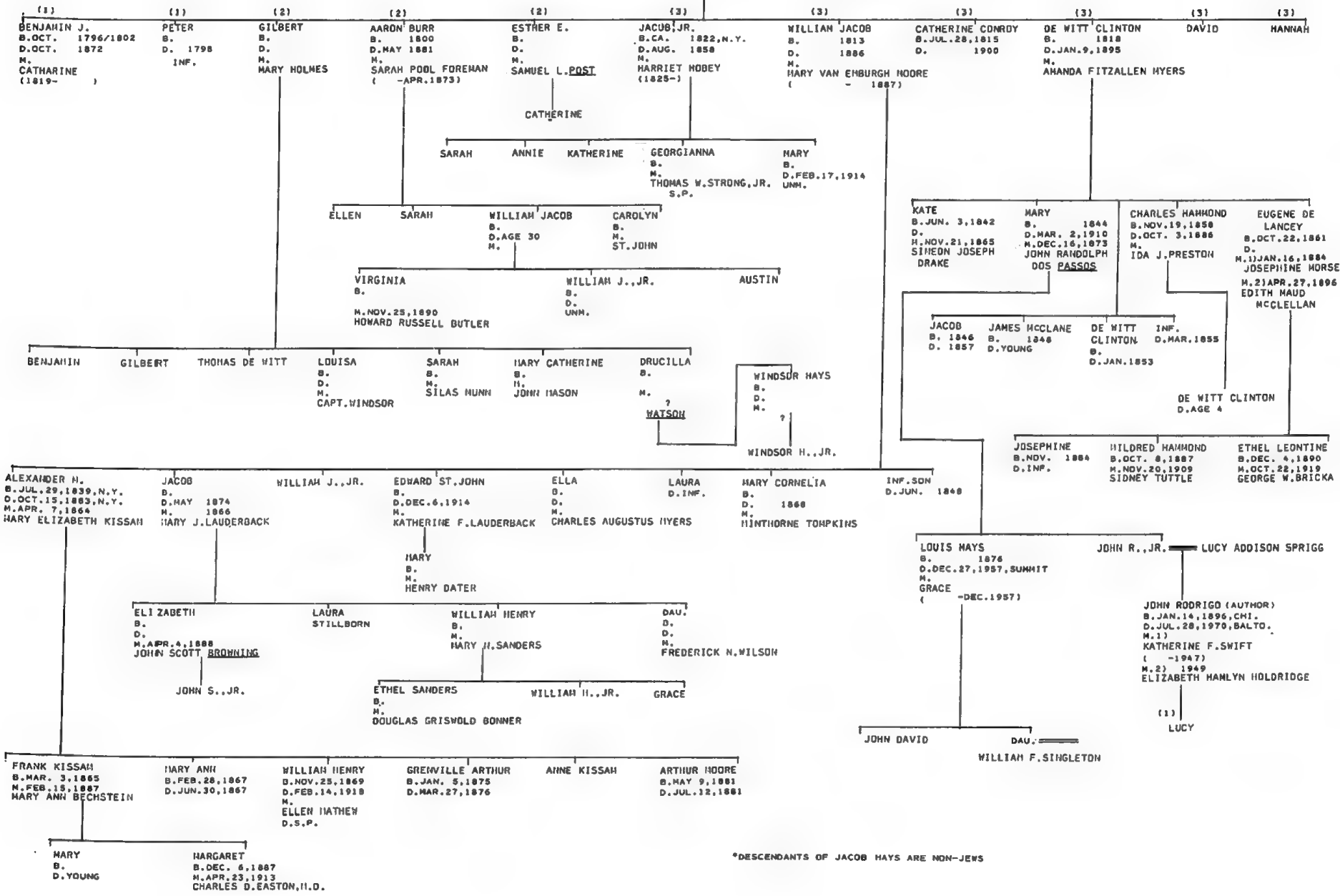

*DESCENDANTS OF JACOB HAYS ARE NON-JEWS

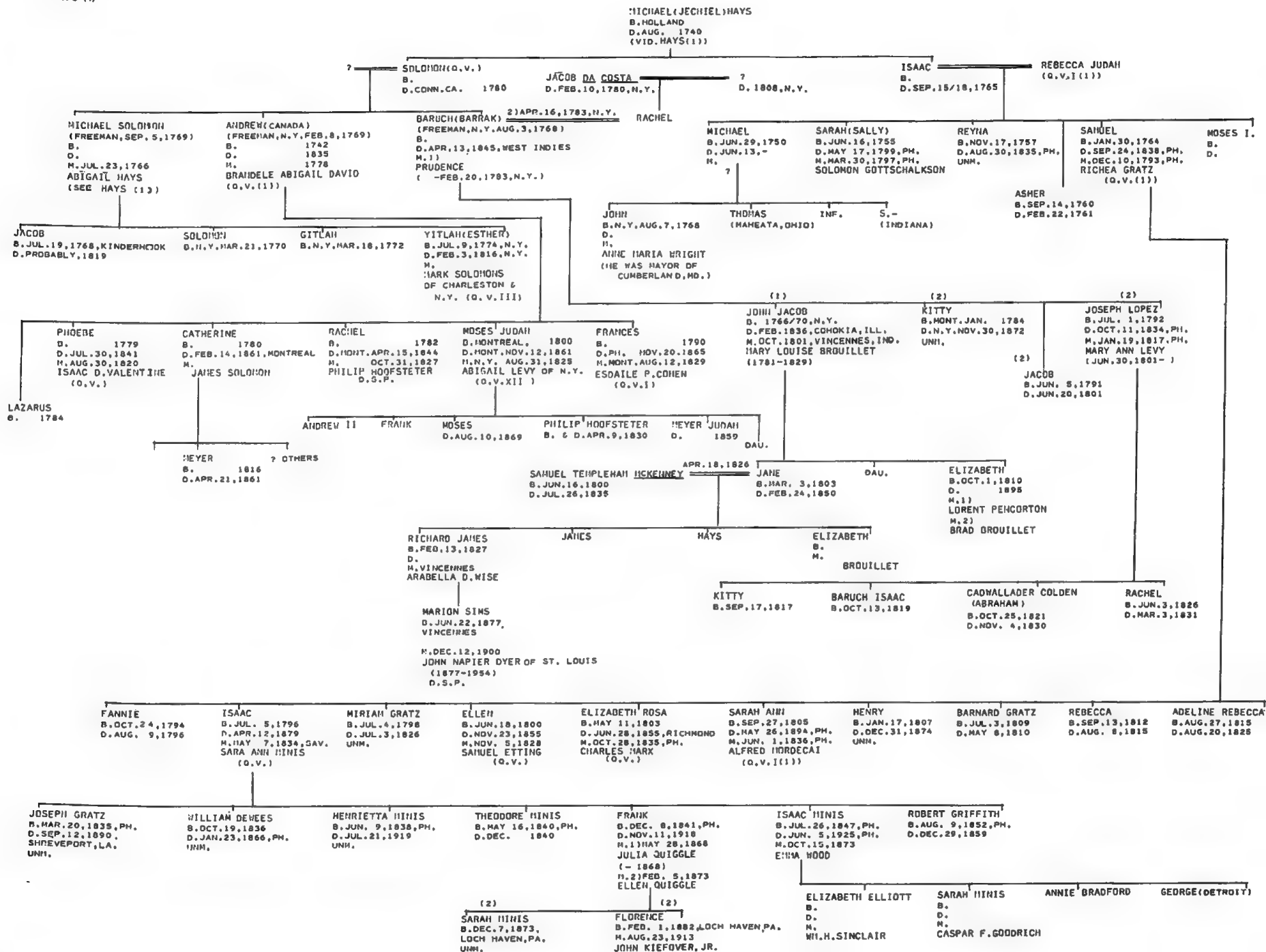

GRINSTEIN-RISE OF JEW. COMMUNITY OF N.Y.
 NORFOLK, VA. - COURT RECORDS
 HEBREW CEMETERY
 FOREST LAWN CEMETERY
 MABEL S. HECHT
 LESTER S. SHERRICK
 DAVID H. GOODMAN

NINA _____
 B. 1803, HAMBURG
 D. BEFORE 1866

1) REV. JONAS HECHT _____
 B. 1803, HAMBURG
 D. MAY 27, 1899, NORFOLK, VA.
 (TO U.S. BEFORE 1838; HAZZAN AT N.Y.
 -ANSHE CHESED, NORFOLK-OHEF SHOLOM)

JETTCHEN (HENRIETTA, JANE)
 B. AUG. 1, 1826, BADEN
 D. MAY 27, 1909, NORFOLK

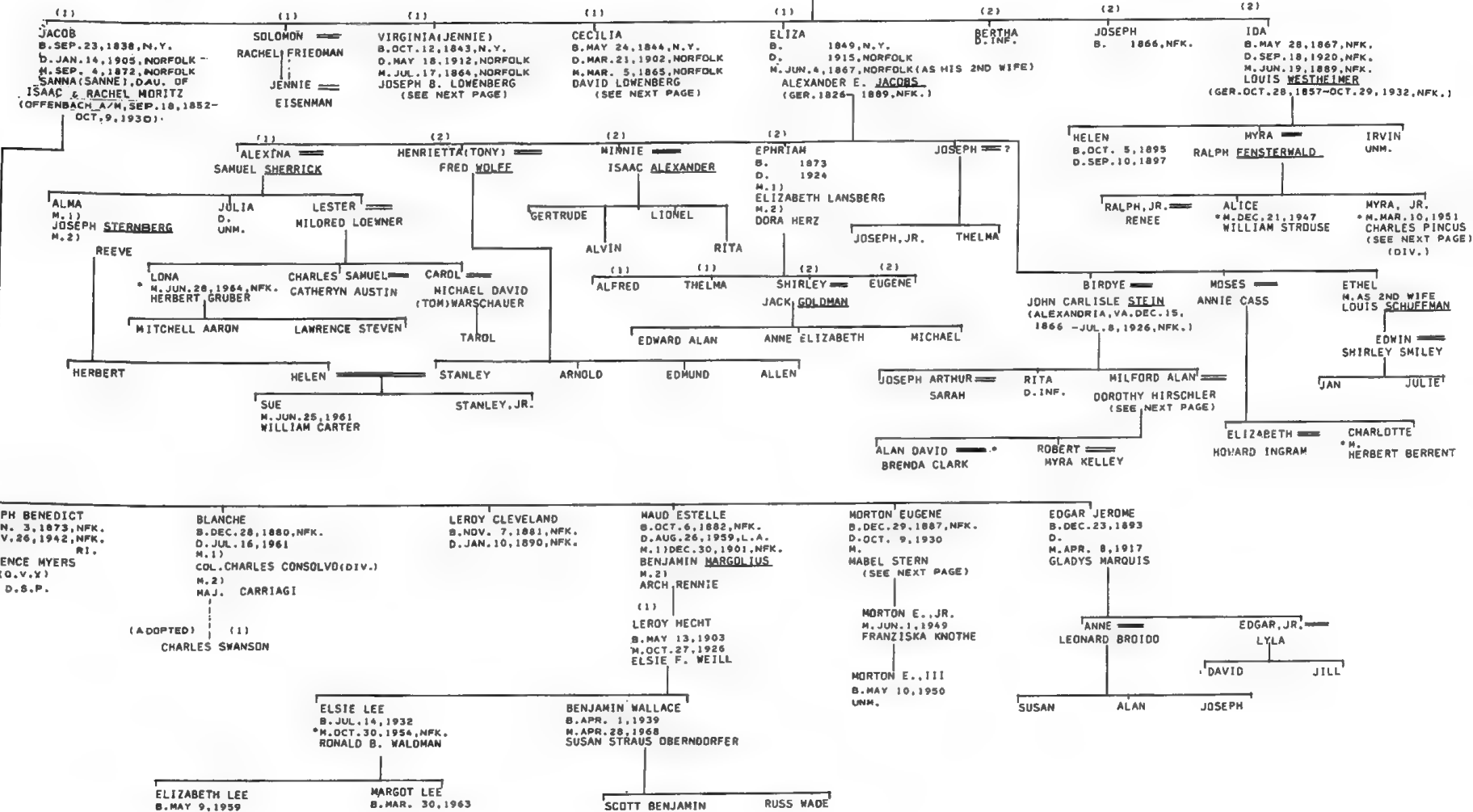

*MARRIED BY MALCOLM H. STERN

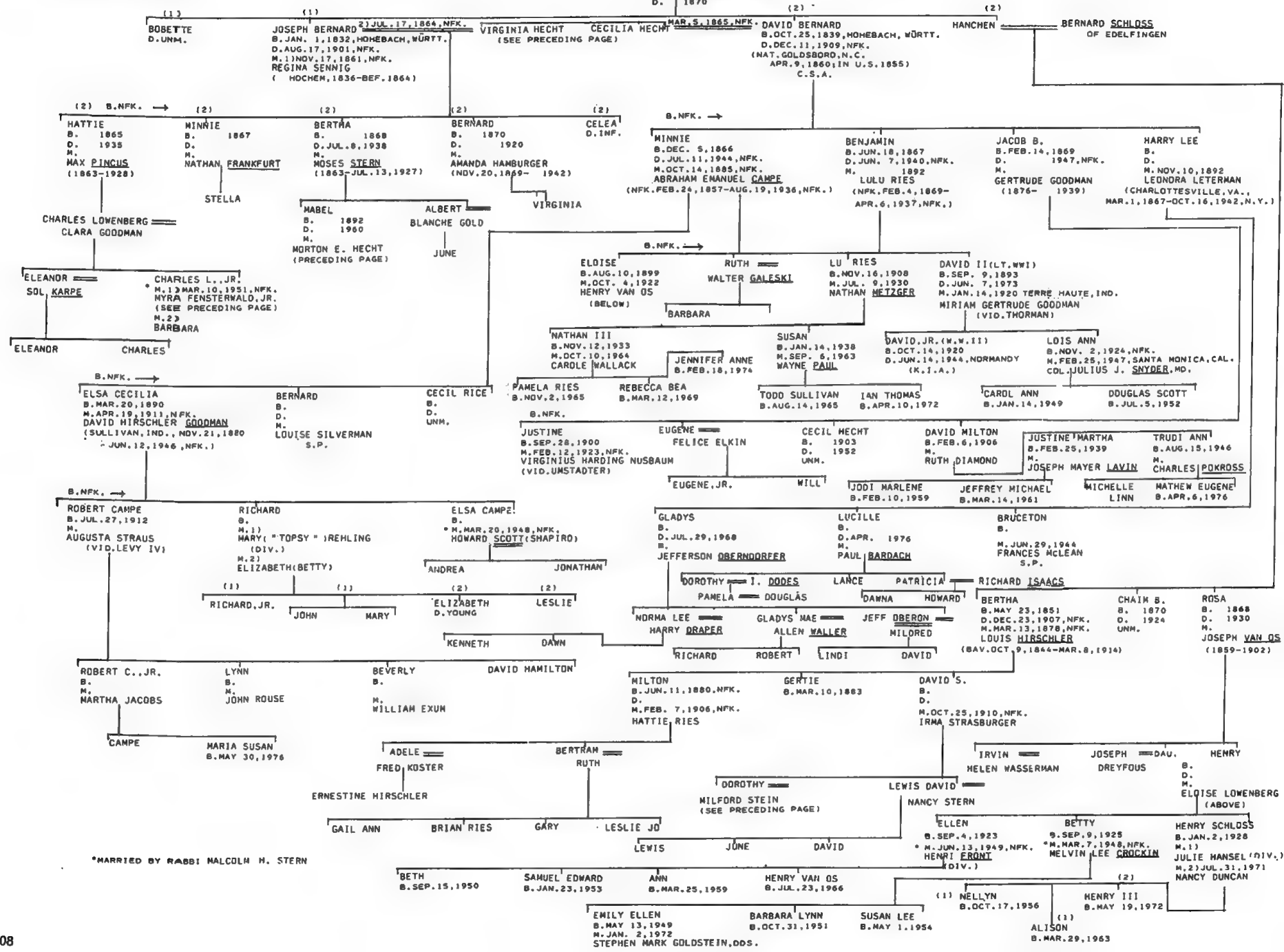

*MARRIED BY RABBI MALCOLM H. STERN

SALOMON FAMILY REC. (AJHS)
MICKVE ISRAEL REC.

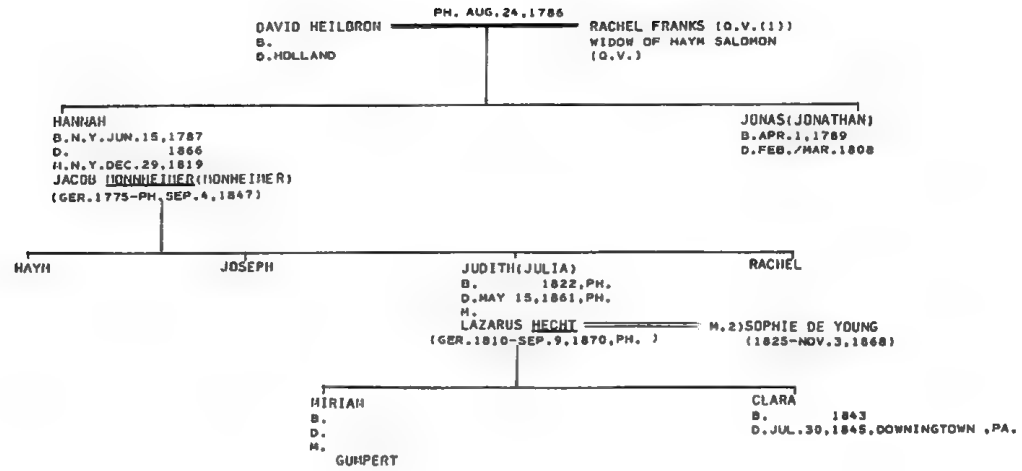

KRAUS-SANDOR COLL.
SHEARITH ISRAEL REC.
FLD. ABR.
WHO'S WHO IN AMERICA (JAMES D. DUCHTERLONEY)

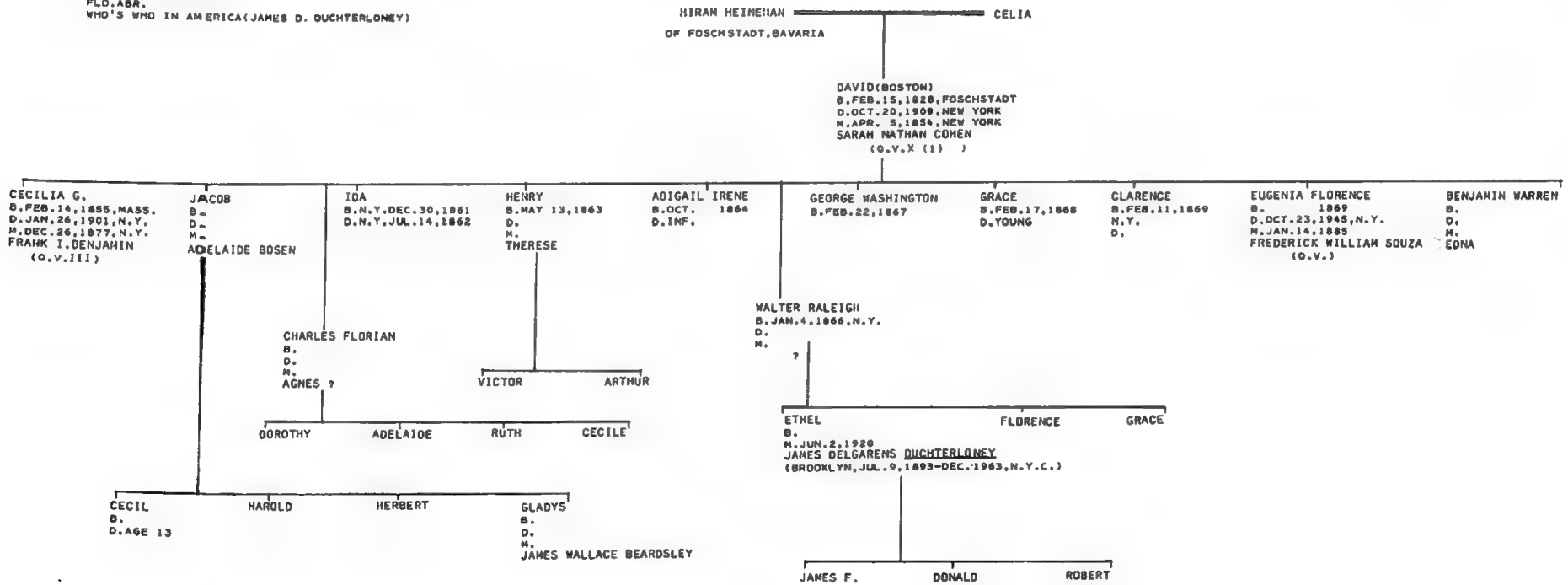

HENDRICKS (1)

PAJHS V.13,P.139
V.27,PP.206,387
V.31,P.260

J.E. V.6,P.346
U.J.E. V.5,P.314
KRAUS-SANDOR COLL.
ST. CHARLES P.131
GOLDSTONE HS. (PHOTO, AJA)
HENDRICKS GEN.
GEN. SOC. OF PA. (JRM)
ROTH-ANGLO-JEWISH LETTERS
POOL- PORTRAITS...
FLO. ABR.
SHEARITH ISRAEL REC.
WHITMAN-COPPER FOR AMERICA
MISC. VI, P.177F.
ROSENSWAIKE
N.Y. TIMES-OBIT OF MONTAGUE NAPHTALI
ABBOT LOW HOFFPAT
HELEN ROSE KLAUSNER

(MEMBER OF LOND. GREAT SYN.)

CHAI: HENDRICKS OF HOLLAND

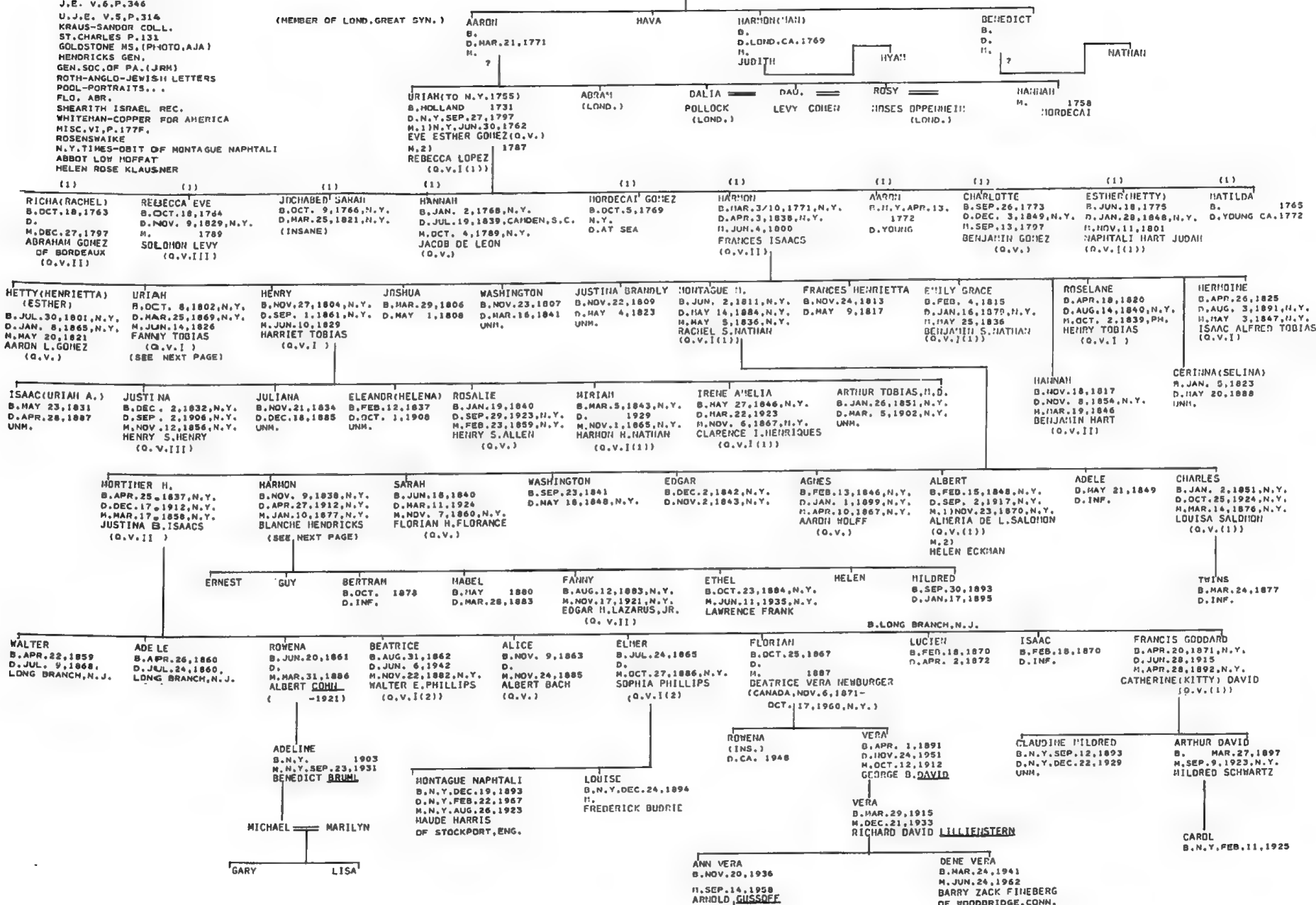

HENRIQUES I (1)

FLD.ABR.
ELZAS HISS.
SHEARITH ISRAEL REC.
MISC.VII(#441)
U.S.CENSUS,1880,N.Y.
N.Y.-IMMIGRATION & NATURALIZATION REC.(AJHS)
D'NAI JESHURUN REC.

ABRAH HENRIQUES QUIXANO SARAH

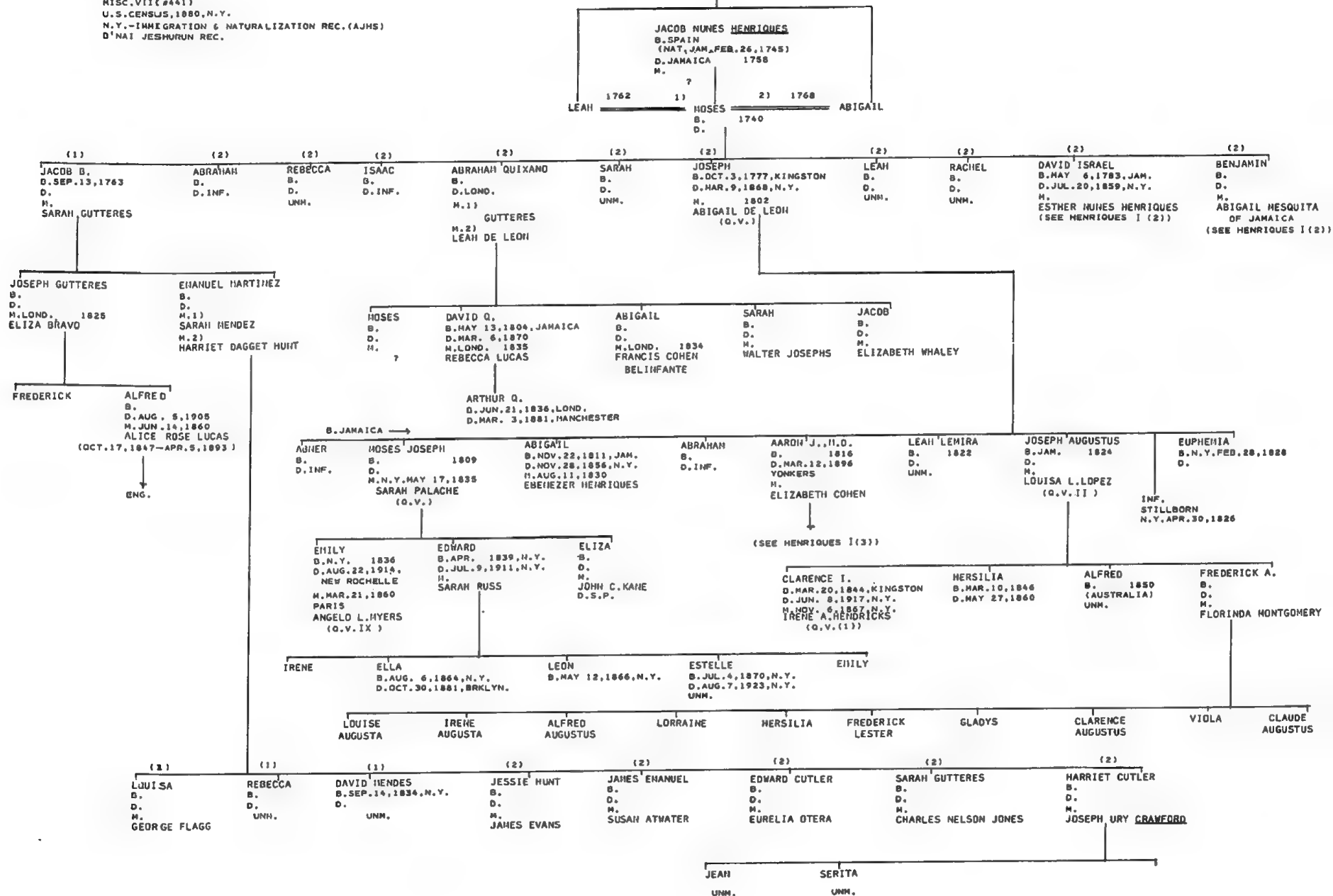

ESTHER NUNES HENRIQUES
B. JAMAICA 1792
D. N.Y. JAN. 7, 1864

DAVID ISRAEL
B. MAY 6, 1783, JAMAICA
D. JUL. 20, 1859, N.Y.

BENJAMIN
B.
D.

ABIGAIL MESQUITA
OF JAMAICA

HOSES
D.
D.
M. 1) N.Y. NOV. 2, 1836
REBECCA HENRIQUES
(BELOW)
M. 2)
MONTEFIORE

JOSEPH
B.
D.
M.
MONTEFIORE

RACHEL
B.
D.
M.
DR. IFFLA

ABIGAIL

ABRAHAM
B.
D.
UNM.

MATHANIEL
B.
D.
UNM.

EDMUND
B.
D.
M.

CORDELIA
B.
D.
M.
FORD

(1)
EDWARD
B. N.Y. APR. 4, 1839

(2)
DAVID

(2)
AMOS

B. KINGSTON →

B. N.Y. →

ABIGAIL
B. DEC. 1814
D. MAR. 17, 1880, N.Y.
M. OCT. 1, 1834, N.Y.
GEORGE HENRIQUES
(O.V. II)

HOSES
B. JAN. 1815/7
D. OCT. 3, 1891
UNM.

REBECCA
B. 1819
D.
M. N.Y. NOV. 2, 1836
HOSES HENRIQUES
(ABOVE)

AARON
B. 1821
D.
M.
(MRS.) BRENNAN

ALEXANDER
B. 1822
D. N.Y. OCT. 30, 1845
UNM.

HORATIO
B. MAY 15, 1826
D.
UNM.

EUDORA
B. APR. 26, 1828
D. MAR. 25, 1908
UNM.

DECIMA ADELINE
B. DEC. 13, 1829
D. INF.

ELIZA VICTORIA
B. MAY 14, 1834
D.
M. JAN. 7, 1857, N.Y.
ALBERT F. LEWIS
(O.V. I)

JOSEPHINE LUHA
B. MAR. 19, 1836
D. JUN. 11, 1856, ST. THOMAS
M. FEB. 20, 1855, N.Y.
ELIAS WOLFF
(O.V.)

EUGENIA
B. APR. 10, 1824
D. JUN. 17, 1863, N.Y.
M. SEP. 13, 1848, N.Y.
FREDERICK SALMONSON
(LOND. JAN. 22, 1811 -
N.Y. OCT. 17, 1849)

ALBERT WASHINGTON
B. OCT. 12, 1831, N.Y.
D. AUG. 27, 1894, BRKN.
M.
ZITELLA DE LA MOTTA

FREDERICK WALEY
B. JUN. 14, 1849, N.Y.
D. SEP. 9, 1921, N.Y.
M.
LILLIE WARNER
(O.V. I)

ZITELLA
B. NOV. 1869,
BROOKLYN
D. INF.

REBECCA LINDO
B. OCT. 24, 1871, BRKN.
D. MAR. 2, 1876, BRKN.

EUDORA
B. BRKN. SEP. 25, 1874
D. BRKN. MAR. 29, 1877

IDNA LAURETTA
B. MAR. 4, 1876, BRKN.
D. INF.

CHARLES THEODORE
B. JAN. 1878, BRKN.
D. INF.

HYMAN COHEN — LEAH

HENRIQUES I (3)

N.Y. FEB. 16, 1859

AARON J. HENRIQUES, M.D.
B. 1816, JAMAICA
D. MAR. 12, 1896, YONKERS, N.Y.
(SEE HENRIQUES I (1))

ELIZABETH
B. N.Y. 1837

HERBERT DE LEON
B. JAN. 17, 1860, N.Y.
D. DEC. 29, 1893, YONKERS
UNM.

HENRY ALPHONSO, M.D.
B. N.Y. SEP. 21, 1861
M.
ALICE DAKLEY

NINA LOUISE
B. N.Y. DEC. 24, 1862

EDGAR
B. N.Y. AUG. 16, 1864
M.
KALANI DAVIS

EUGENE
B. N.Y. JUL. 21, 1866
M.
LILLIAN HARROW

LORENZO JOSEPH
B. N.Y. SEP. 24, 1868
D. INF.

ARTHUR
B.
M.
VALENTINE LAWRENCE

EUGENIE

CHARLOTTE

HERBERT DE LEON HORACE FULLER KATHRYN
B.
M.
ROBERT CRESSWELL

MADELEINE

HENRIQUES II

U.S. CENSUS, N.Y., 1850
 SHEARITH ISRAEL REC.
 N.Y. CENSUS 1855
 N.Y. IMMIGRATION & NATURALIZATION REC. (AJHQ)
 F.J. DALLETT

MOSES HENRIQUES
 (JAMAICA TO N.Y., 1826)
 B. LOND., MAR. 26, 1784
 D. N.Y., FEB. 11, 1857

SARAH
 B. KINGSTON

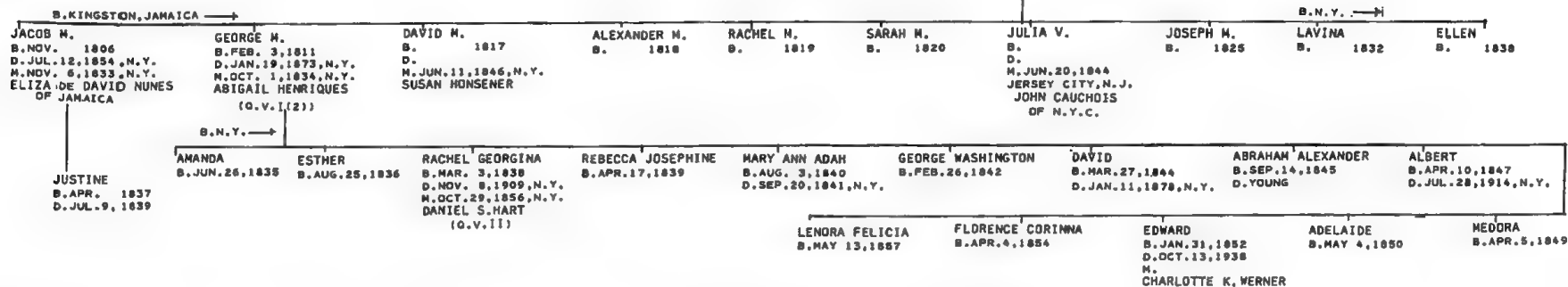
**HENRIQUES III**

SHEFTALL MSS.
 EGMONT
 BEVIS MARKS KEY. #390F.

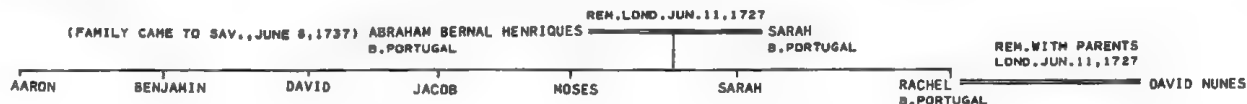
**HELBERT**

MISC. VI
 ROTH-THE GREAT SYNAGOGUE, P. 65
 BEVIS MARKS REC., V. I, P. 30N
 KRAUS-SANDOR COLL.

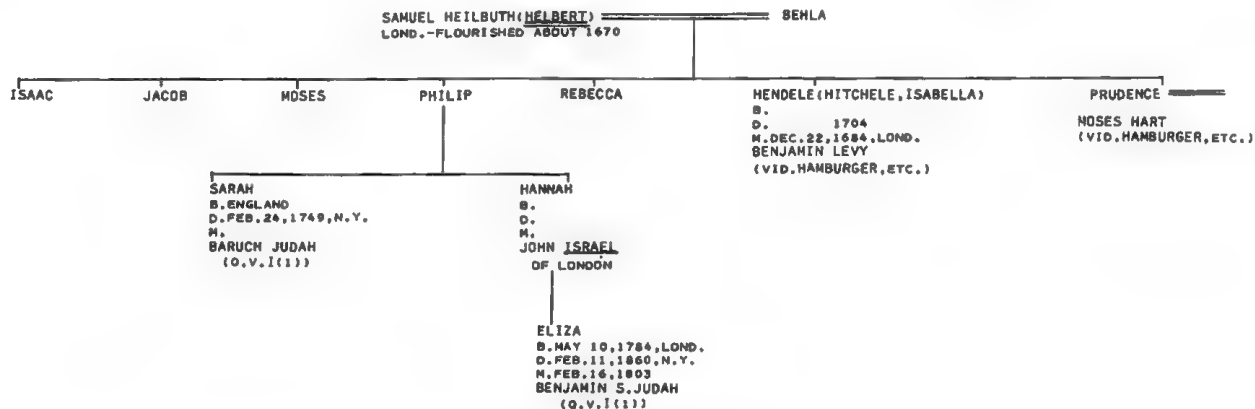
**HENRY I**

PAJHS, V. 27, P. 349
 ELZAS MSS.
 SHEFTALL MSS.
 WILL OF JACOB P. HENRY
 MRS. GEORGE C. LEWIS

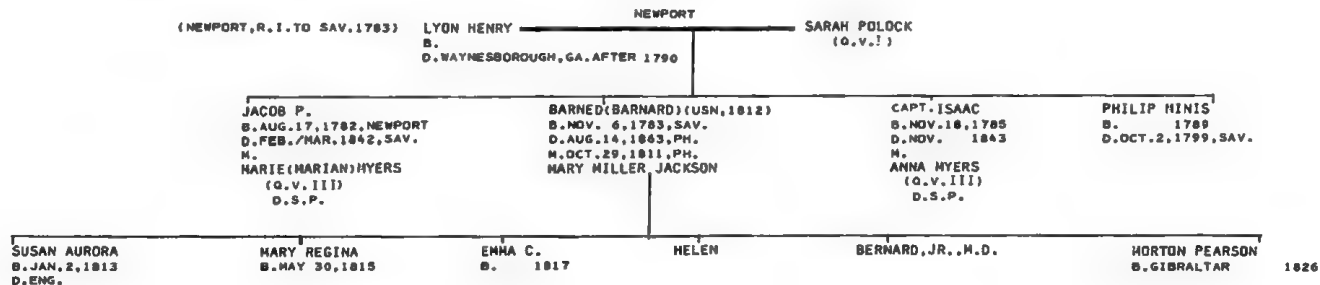

POSTAL-KOPPHAN-JEWISH TOURIST'S GUIDE
ELZAS MS.
ELZAS D.J.C.
WILL OF JUDITH J.HENRY(JRM COLL.)
WILL OF AMELIA HENRY
ROSENWAIKE

JOEL HENRY (ANN)AMELIA
B. 1755,CH.
D. JUN.25,1825,CH.

CATHERINE 1 JACOB 2) ESTHER
(OF CH.AND N.CAROLINA) B.BEAUFORT,N.C. 1707
D.SEP.4,1812 (LEAVING HUSBAND AND THREE CHILDREN) D.CH. JUL.16,1823

ESDRA, OF BORDEAUX, FR.

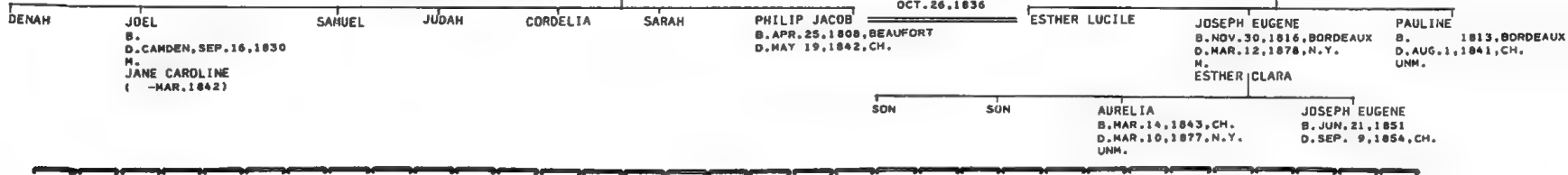

HENDRICKS GEN.
KRAUS-SANDOR COLL.
SHEARITH ISRAEL REC.
FLORENCE ABRAHAMS

ABRAHAM LOEW ALICE ALEXANDER

(THIS GENERATION CALLED HENRY)
REBECCA B. 1703 D. 1864 UNM.
ABRAHAM B. 1791 D. 1832 UNM.
ALEXANDER B. 1791 D. 1832 UNM.
EDWARD (ELIAS) B. NOV. 1794 D. FEB. 24, 1873 M. SEP. 16, 1835 SARAH LINDO (AUG. 6, 1814-AUG. 16, 1868)ISRAEL B. RAMSGATE, ENG. 1796 D. RAMSGATE, JAN. 15, 1858 M. JAN. 25, 1826 AMELIA ISAACS (1798-FEB. 4, 1868, LOND.)

ELIZABETH MOSES B. 1760 D. 1811
LEVI (JUDAH) ABRAHAM B. 1752 D. 1847

MICHAEL LEDN B. 1840 D. 1890
FLORA B. 1837 D. 1898
ALICE B. 1830 D. 1898
FREDERICK COHEN
HOSEA ALEXANDER ISRAEL MONTEFIORE

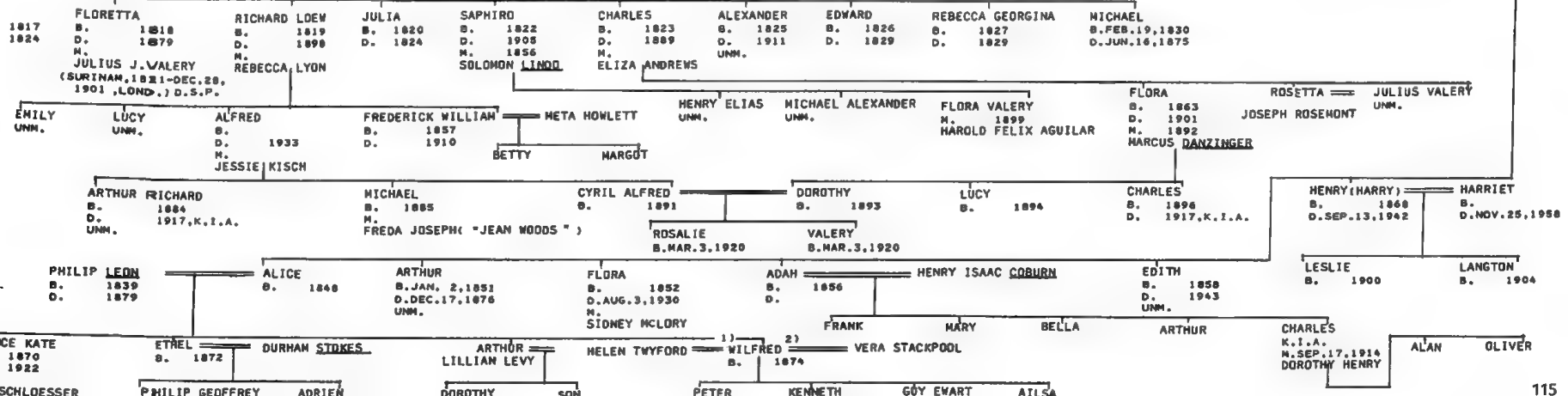
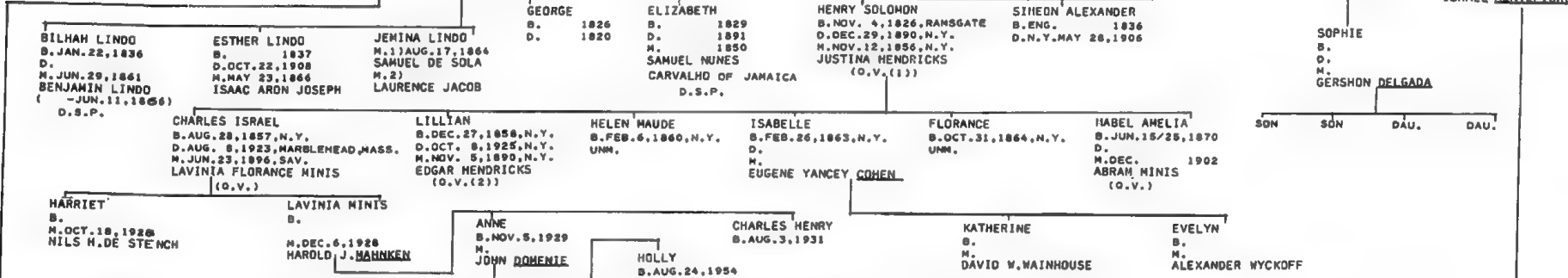

HERMANN
KORN-N.O.

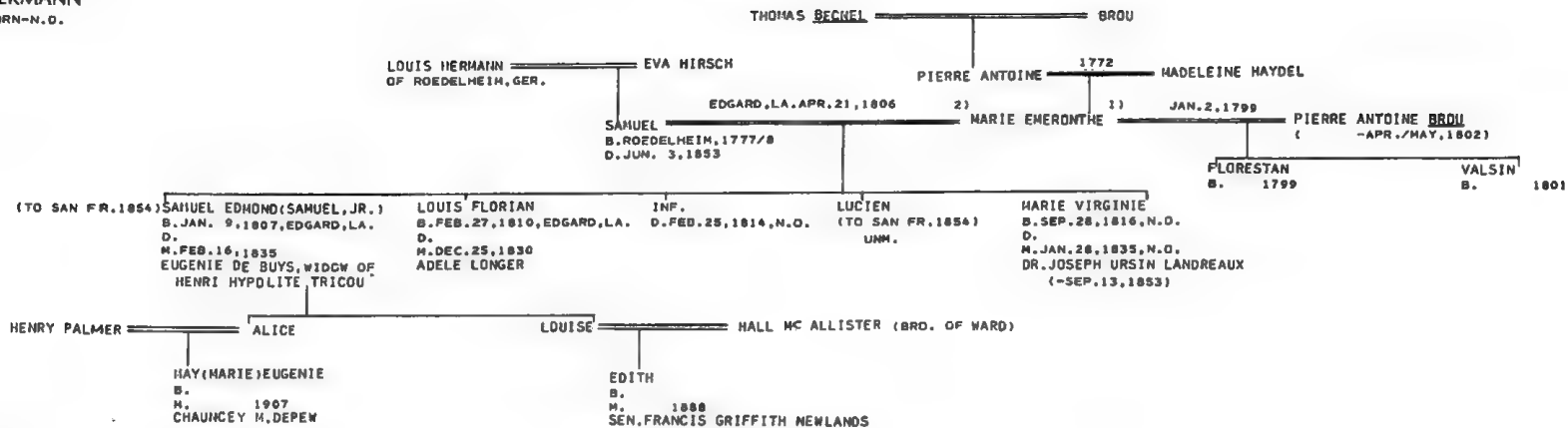

HERZOG
GOLDSTONE GEN.

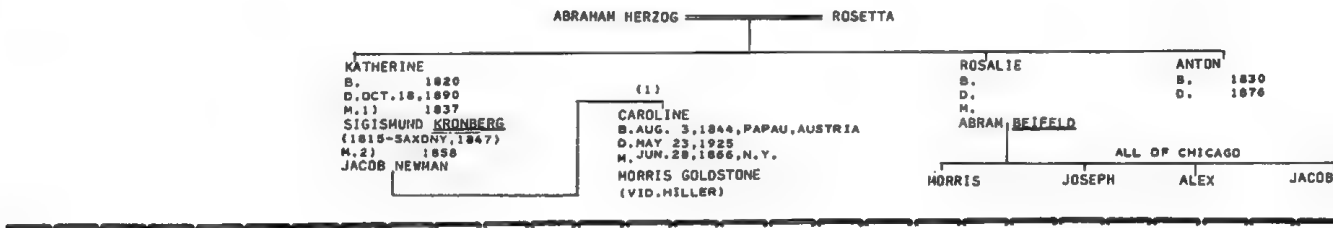

HILLER (GOLDSTONE)
GOLDSTONE MS. (PHOTOSTAT AJA)

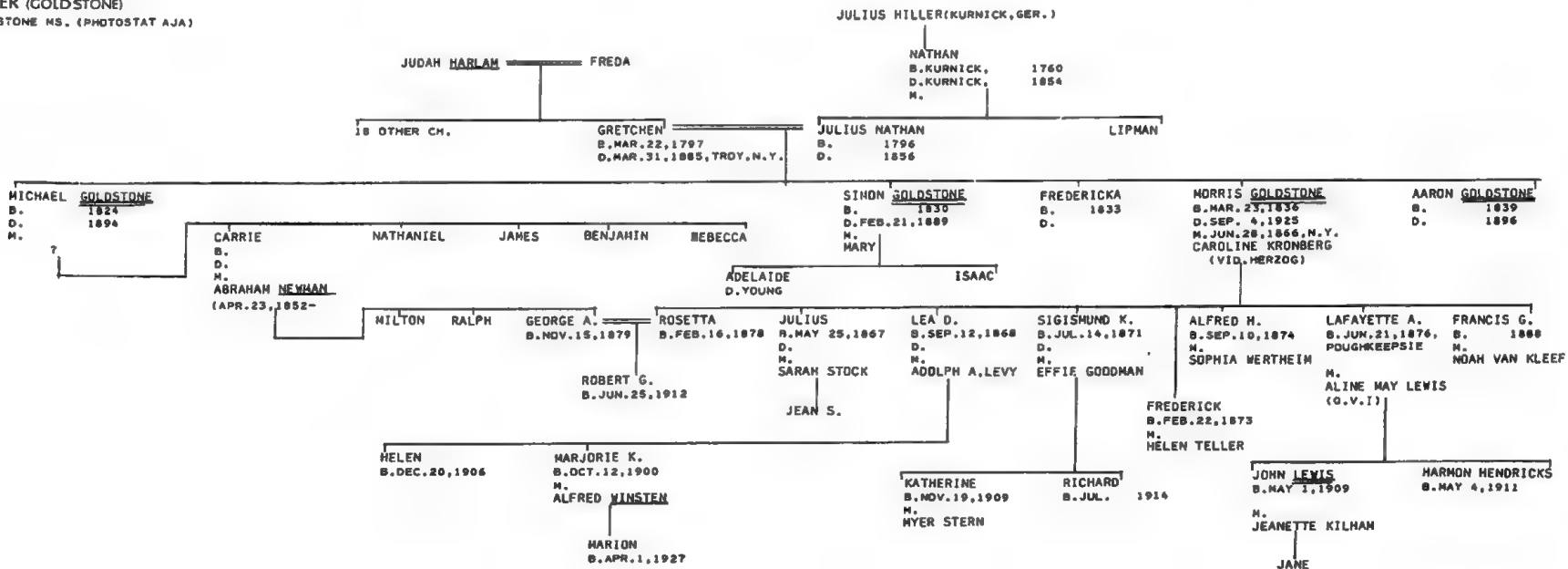

JOHN MCKAY SHEFTALL
ELZAS-CEM.OF CONG.BERTH SHALOME
MS.
NEW JEWISH CEM.OF BETH ELOHIM
D.J.C.
M.N.
SAVANNAH JEWISH BURYING GROUND
MRS.W.A.MOORE

JACOB(EGERHART?)HERTZ CH.SEP.12,1810
B.C.A. 1776
D.CH.OCT.23,1846

REBECCA MORDECAI
(O.V. I (1))

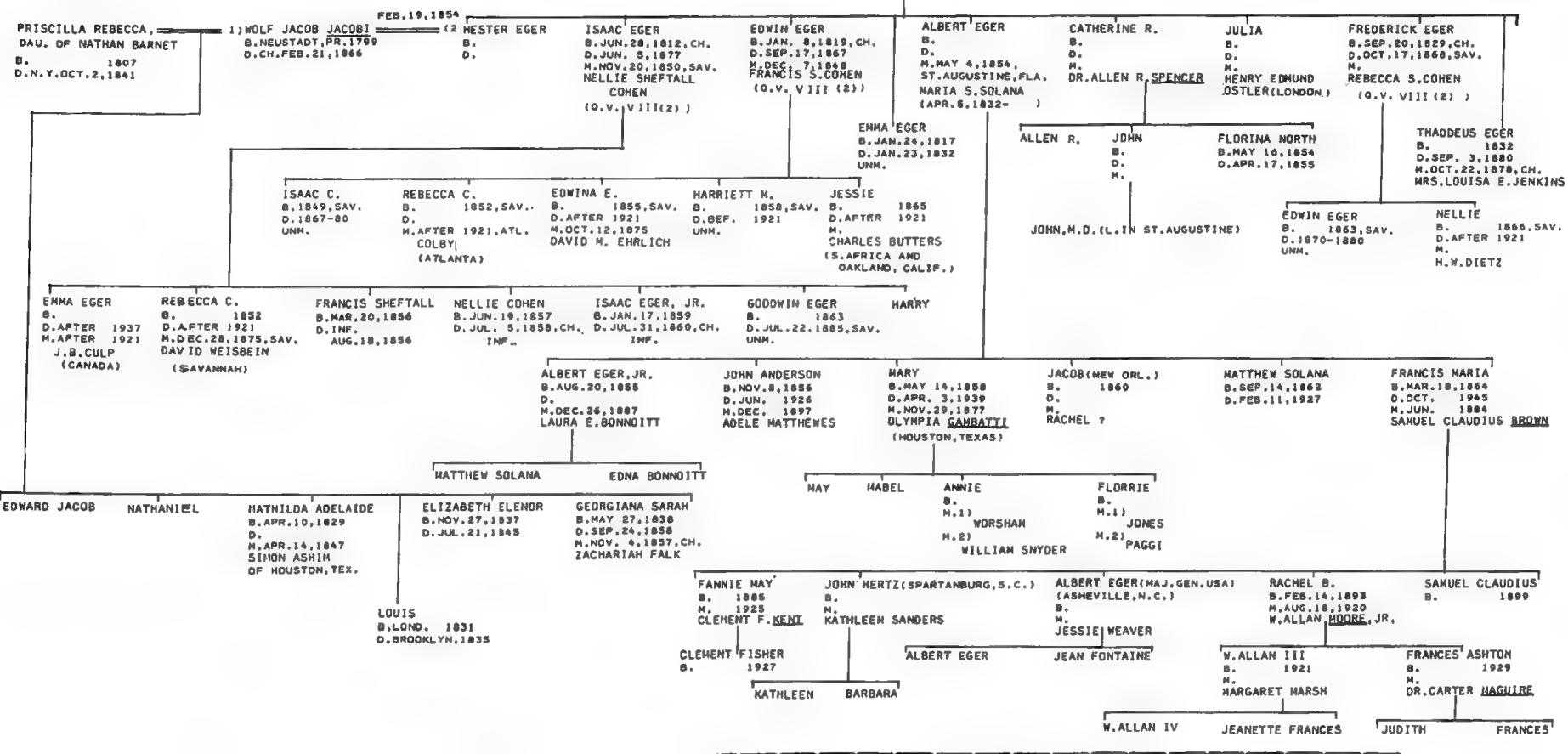

PAJMS, V. 2, P. 143
NGSO, VOL. 87, P. 219

HERTZ II

JOSEPH HERTZ, M. D.
B. D. EUROPE
(CAME TO U.S. 1832
SETTLED IN NACOGDOCHES, TEX.
1835 - IN MATCHEZ, MISS.)

HYMAN
D. MAY 19, 1833
(IN BOAT ACCIDENT BETWEEN
N.O. & MATCHITOCHE)

HERTZ III

SHEARITH ISRAEL REC.
ELZAS MS.

DANIEL HERTZ
OF HAMBURG, GER.

THEODORE
B. DEC. 15, 1816, HAMBURG
D. JAN. 18, 1894
M. NOV. 2, 1853, N.Y.
JESSY (SINHA) JUDAH ANDREWS
(VID. JUDAH I (1))

WILL OF MANDEL M. HERTZ (JRM COLL.)
ELZAS-D. J. C.
M. N.
ROSENWAIKE

HERTZ IV

ALEXANDER HERTZ
B. HILDESHEIM 1774
D. CH. MAR. 4, 1822

HANDEL MOSES HERTZ
B. HILDESHEIM 1778
D. CH. SEP. 25, 1840
M. ISABELLA
(CH. 1769 - JAN. 24, 1824)

SARAH N.
B. NOV. 2, 1804
D. MAY 15, 1865
M. NATHAN NATHANS
(O.V. I I)

HOHENFELS
 ROSENTHAL MS.
 EDWIN WOLF, 2ND
 MICKVE ISRAEL REC.
 RODEPH SHALOM HOHEL REC.

SELIG HOHENFELS
 B. GER. 1808
 D. PH. JAN. 6, 1852

ROSETTA (ROSA) LYONS
 (O.V.I.)

PH. DEC. 15, 1861

MIRIAM DINAH
 B. OCT. 16, 1842
 D. FEB. 5, 1872
 M. JUL. 9, 1862
 ELIAS P. LEVY
 (G.V.VII(1))

CLARA TELSCHEN
 B. MAR. 7, 1844
 D. AUG. 29, 1864
 UNM.

MOSES JULIUS
 B. JUN. 13, 1845
 D. INF.

MATILDA SARAH
 B. JUL. 23, 1847
 D. M.
 M. WALTER WALSH

EUGENE ISAAC
 B. APR. 5, 1849

ALBERT ASHER (ASHER S. HAYIN)
 B. MAY 14, 1851, PH.
 D. M.
 SARAH LEVY

WALTER, JR.

ROBERT

ROSALIE
 B. D. M.
 M. LEON BREIDENBACH

RUTH

MIRIAM
 B. D. M.
 M. SAMUEL WEIMAN

SELMA

LESLIE

CLARA
 B. D. M.
 M. GOLDSTEIN

DORA

EDNA

HORWITZ

FLO. ABR.
 U. J. E. V. S. P. 461
 KRAUS MS.
 MRS. M. S. CARTER

JONAS (JONATHAN, JOHN) HORWITZ, M.D.
 B. D. BALTO. 1852

PHILA. DEC. 1817

DEBORAH ANDREWS
 (O.V.)

ORVILLE
 B. D. M.
 M. MARIA GROSS

BENJAMIN FRANKLIN
 B. D. M.
 M. LOUISE E. GROSS

SAMUEL GROSS

BENJAMIN F., JR.

EUGENE, M.D.

ADELE
 B. D. M. 11
 M. FRANCES BARNES STEVENS
 M. 2) AUG. 10, 1908
 BEVERLY M. ROBINSON

PHINEAS JONATHAN, M.D.
 B. MAR. 3, 1822, BALTO.
 D. SEP. 28, 1904
 M. NOV. 2, 1854, BALTO.
 CAROLINE NORRIS

THEOPHILUS BYRON, M.D.
 B. D. M.
 M. MARY R. BARROLL

MARY BARROLL

CARDLYN NORRIS

FLORENCE GROSS
 B. D. M.
 M. EDWARD KEY

LOUISE GROSS
 B. D. M.
 M. AS 2ND WIFE
 JUN. 4, 1889

HALLER GROSS
 B. D. FEB. 2, 1932
 M. 1) JAN. 28, 1891
 (DIV. 1907)

ALICE GROSS
 B. D. M.
 M. DUKE D'ASSERGIO

THEODORE
 B. SEP. 24, 1856
 D. DEC. 13, 1877

ORVILLE, M.D.
 B. JUN. 26, 1860
 D. JAN. 28, 1913

THOMAS LLOYD NORRIS
 B. SEP. 13, 1863
 D. JUN. 22, 1900

JOHN MEREDITH READ
 B. JAN. 27, 1865
 D. INF.

AMELIA READ (LEILA)
 B. AUG. 26, 1866
 D. 1912
 M. MAY 23, 1894
 S. FRANKLIN SHARPLESS

GEORGE QUINTARD
 B. FEB. 3, 1860
 D. DEC. 14, 1916
 M. MAY 23, 1901
 MARIAN NEWHALL

WILLIAM CHRISTIAN
 BULLITT (HE M. 1)
 JAN. 1886. EMILY TATHEM

CLAUDE A. C. PONSONBY
 M. 2) MAY 6, 1908
 RONALD GEORGE BROOKE
 (SEP. 25, 1866-NOV. 28, 1930)

JOSEPH PARKER
 B. JUN. 26, 1858
 D. JUL. 13, 1860

CAROLINE NORRIS
 B. SEP. 17, 1861
 D. JUL. 1, 1862

CAROLINE NORRIS III
 B. 1902
 D. 1908

PETER ORVILLE
 B. NOV. 20, 1909
 D. M. SEP. 18, 1934, RADNOR, PA.
 NATALIE DULLES

(1)

(2)

(2)

(1)

(1)

(1)

JOHN C.

WILLIAM C., JR.
 B. JAN. 25, 1891

M. 1) A. ERNESTA DRINKER
 M. 2) ANNE NOEN LOUISE BRYANT (WIDOW OF SILAS REED)

ORVILLE HORWITZ
 B. JUL. 30, 1894
 M. NOV. 15, 1916
 SUSAN B. INGERSOLL

HAROLD ASHLEY CURZON
 B. OCT. 6, 1891
 D. JUL. 22, 1950
 M. AUG. 23, 1941
 RUTH MARGARET HILLER

ERIC
 B. APR. 28, 1893
 D. OCT. 17, 1894

MOYRA BLANCHE MAY DIANA
 B. DEC. 3, 1901
 M. 1) FEB. 11, 1932, DIV. 1945
 HANS MENNING
 M. 2) MAY 14, 1947
 MAURICE HERIOT NICOLLS
 (-MAR. 24, 1954)

SARAH HALLER
 B. OCT. 12, 1944

JANE CAROLINE
 B. AUG. 10, 1946

JOHN ASHLEY CHARLES
 B. SEP. 2, 1948

JONATHAN
 B. JUN. 12, 1938

GEORGE DULLES

MARIAN NEWHALL
 B. M. 1)
 LLOYD MORRIS COATES, JR.
 M. 2) JUN. 7, 1958
 JAMES McILHENNY WINTERSTEEN

ANNE
 B. 1924
 M. 1) CASPER TOWNSEND
 M. 2) NICHOLAS DUKE BIDDLE
 M. 3) 1944
 RODERIC O'FERRAIL

RITA S.
 B. M. JOHN L. McGLENAHAN

JOHN CHRISTIAN
 B. M. NOV. 1954
 LELIA MYERS WARDWELL
 (VID. MYERS I)

ORVILLE H., JR.
 B. M. SHELBY THAYER

PETER RONALD

JACQUELINE HALLER

MOYRA CHRISTINE

SUSAN S.

JOHN S.

ORVILLE H. III THAYER

HUNT

EZEKIEL-LICHTENSTEIN JEWS OF RICHM.
 SHEARITH ISRAEL REC.
 BETH SHALOME HARR. REC.

EMANUEL HUNT
 B. AMSTERDAM
 D. RICHMOND
 AGE 103

DINAH
 B. AMSTERDAM
 D. RICHMOND
 AGE 93

SOLOMON EMANUEL HUNT
 B. AMST. 1792
 D. MAY 7, 1846
 M. MAY 15, 1827, N.Y.
 RACHEL C. PEIXOTTO

ABRAHAM S.
 B. 1834
 D. RICH. AUG. 22, 1855

CHARLES
 B. D. M.
 M. SARAH E. LYON
 (O.V.I.)

DAU.
 B. M.
 M. F. I. BAUGHAN

BELLA
 B. D. M.
 M. DAVID EPSTEIN
 1852, RI.

DINAH
 B. N.Y. FEB. 11, 1864

(TO AMERICA, 1767) MOSES HYAMS — JUDITH ISAACKS
 B. POLAND D. AUG. 17 B. GERMANY

ANCKER MS.
 PAJHS V. 27, P. 154
 LOUIS GINSBERG
 N.L. HYMAN
 ELZAS M.N.
 JEW. CEM. AT CAMDEN, S.C.
 JEW. CEM. AT COLUMBIA, S.C.
 MSS.
 NEW JEW. CEM. OF BETH ELZHIM
 D. J. C.
 MRS. JAMES M. FORGOTSON
 WILLS OF CAROLINE (N.T.) HYAMS
 MOSES D. HYAMS
 SOLOMON HYAMS (JRM COLL.)
 HYAMS FAMILY REC. (AJA)
 N.O. BIRTHS
 ROSENWAIKE
 SALLY-MARR. NOTICES IN CH. COURIER
 JEW. CEM. AT NATCHEZ, MISS.
 KEN WELLS
 KORN-N.D.

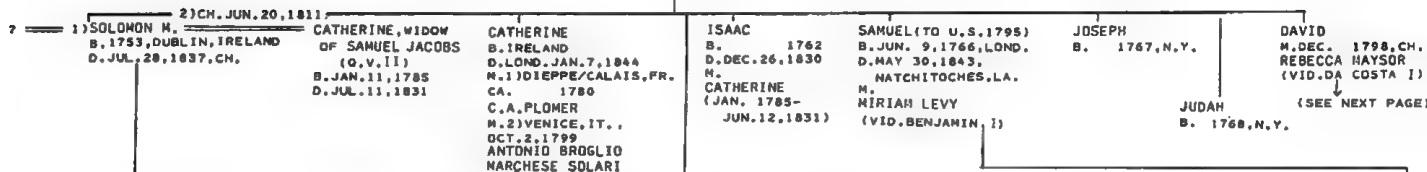

HONTAGUE JACKSON MAR. 2, 1811 HANNAH
 ABRAHAM ESTHER JOSEPH ETIENNE TOURNE
 B. JUL. 1813 B. 1814, CH. NOV. 28, 1837 B. FRANCE, 1807
 D. AUG. 7, 1814 D. 1896, N.O.

JAMES BINAGHI
 B. MAR. 20, 1842, N.O.

MOSES, H.D. LEAH MORDECAI 1797 HENRY 1793, LOND. HANNAH (ANNIE) JULIA DAVID SOLOMON 1840 SARAH
 B. LDND. D. CH. SEP. 26, 1817 D. MAY 16, 1852, N.O. D. JUN. 6, 1813, CH. D. 1890, K.C. M. OCT. 10, 1840 M. JUN. 25, 1807
 M. N. 1838, CH. LEVY SOLDMDN (G.V.) CARLINE MATILDA THOMPSON RALPH ISRAEL RICARDO
 JUDITH (CH. DEC. 17, 1796 - NOV. 5, 1883, N.O.) WILLIAM PALMEDO

BAU. LEAH DAU. ADELINE MARY MORDECAI ISAAC ROBERT H.P. HANNAH RACHAEL
 B. D. DEC. 6, 1891, SAN ANTONIO, TEX. M. JAN. 8, 1848 M. NOV. 1, 1848 M. SEP. 5, 1828, CH. B. 1827 D. MAY 15, 1916, SAN ANTONIO, TEX. B. CH.
 D. MAY 18, 1841, CH. ELIAS C. POLLOCK COLUMBIA, JUL. 1826 (APR. 11, 1889) D. FEB. 17, 1907, NATCHEZ, MISS. M. H. ALEXANDER NORDHAUS D. SAN ANTONIO, TEX.
 JUDAH BENSADON (VID. JACOBS I) FRANCES LEVI M. DEC. 21, 1849 D. NOV. 24, 1852 JOSEPHINE (G.V. III) JOSEPHINE MORRIS OF GALVESTON (JAN. 25, 1869-) AGE 85 YEARS, 6 MOS.
 (VID. JACOBS I) DAVID LEVY MARY C. CLOTILDA GEORGE HANNAH FLORINE HENRY FRANKLIN JEFFERSON DAVIS
 B. MAY 22, 1858 ELLA CARSON DAVID LEVY MARY C. B. AUG. 4, 1859 B. SAN ANTONIO, 1936 D. SAN ANTONIO, 1950 B. OCT. 9, 1870 B. N.O. 1851 OF SAN ANTONIO
 D. MAY 11, 1875 D. JUN. 12, 1905, JOHNSTON, S.C. HENRY STRAUS MAHIE JOSEPHINE CHARLES DENISON GEORGE E., JR. OF ST. LOUIS HENRY H. MORRIS OF JACOB MORRIS ALEXANDER
 B. OCT. 25, 1855 B. OCT. 11, 1941 B. MAR. 25, 1871 D. OCT. 12, 1923 M. B. N.O. 1851 OF JACOB MORRIS

VIOLA STRAUS SARAH (SALLY) ALEXANDER ALEXANDER EDDIE DAU. DAU. DAU. DAU.
 ABRAHAM ALEXANDER HENRY MORDECAI HYAMS ERICKA MORRIS ALEXANDER EDNA WELLS
 (APR. 19, 1852-DEC. 9, 1920) B. MAY 30, 1887 D. APR. 24, 1888 B. NOV. 20, 1888 D. FEB. 21, 1909 M. LOUIE BROWN MORRIS ALEXANDER EDNA WELLS
 HARRY MORTIMER JOSEPH IRMA ETTA FRANKLIN LEVISON HALLE LUCILLE MORRIS ALEXANDER EDNA WELLS
 MILDRED HASKELL STEPHANIE HARRIET KATHERINE CONNALLY L. D. TUCKER CAMPBELL
 JOHN BLAIR SMITH MOSES KOCSIUSKO JUDITH CAROLINE ELIZA ELEAZER LEVY SAMUEL MYERS (COL. CSA) ANDREW JACKSON
 B. APR. 8, 1798 B. MAY 13, 1800 B. AUG. 18, 1802 B. MAR. 10, 1808 B. SEP. 26, 1810 B. SEP. 16, 1813 B. JAN. 29, 1818
 D. AUG. 18, 1836 D. AUG. 10, 1840 D. FEB. 1825 D. OCT. 31, 1837, N.D. D. JUL. 9, 1860 D. NATCHITOCHESS, LA. D. 1870, N.O.
 POINTE COUPEE, LA. BARCELONA, SPAIN UNM. DONALDSON VILLE, LA. JOSEPH B. MARKS (VID. BENZAKEN) M. GAINIE

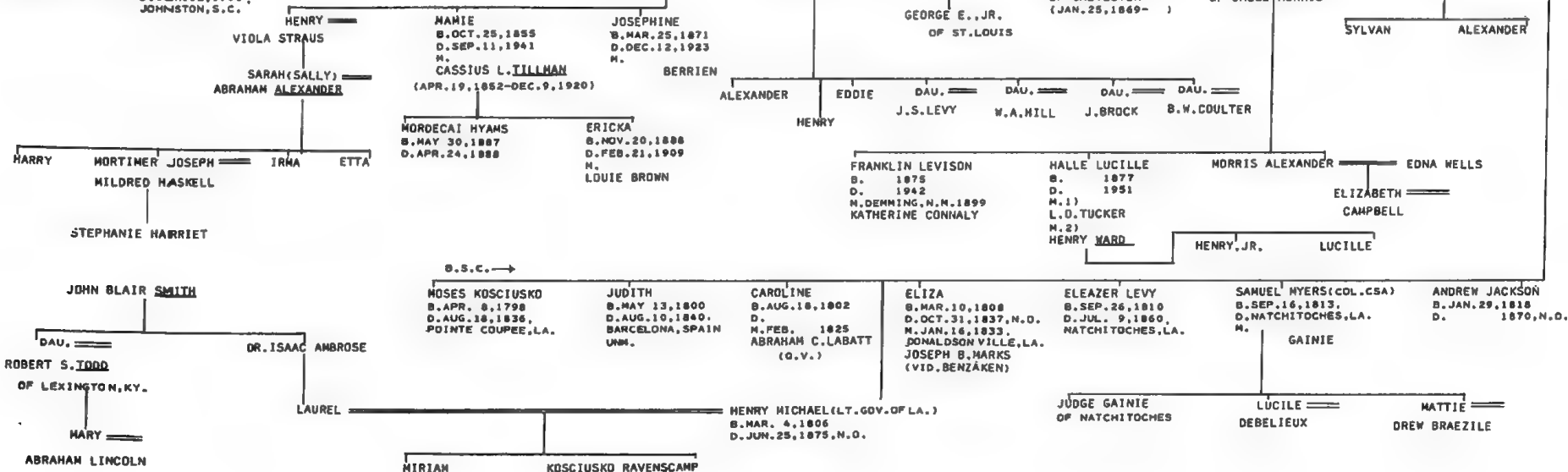

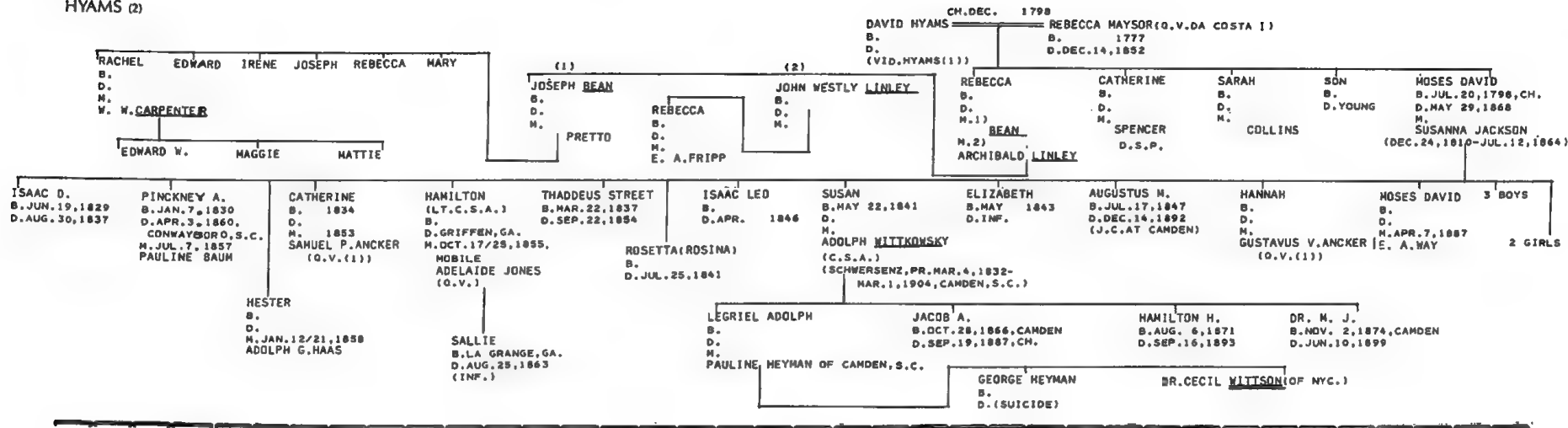

ISAACS (ISAACS I)

PAJHS V. 27, PP. 349, 372, 416 V. 32, P. 125 V. 33, P. 202F.
 UJE V. 3, P. 598F.
 KRAUS-SANDOR COLL.
 MORATIS-JEWS OF PH., P. 241F
 NICKVE ISRAEL REC.
 POOL-PORTRAITS...
 JR MARCUS COLL.
 BARBER-N.Y. DEATHS
 JACOB ISAACS MS. (DAR)
 ELZAS MSS.
 MICHAEL MARKS MS.
 SHEARITH ISRAEL REC.
 WILL OF JACOB (D. 1831)
 N.Y. WEEKLY MUSEUM MISC. VII (8312)
 B'NAI JESHURUN REC.
 KORN-MOBILE
 ARNOLD-VITAL REC. OF R. I.
 FEDERAL ST. CEMETERY

(NAT. N.Y. JUN./JUL. 1741)

ABRAHAM ISAACKS S. EMDEN, GERMANY D. SEP. 24, 1743, N.Y. (CAME TO N.Y. 1697/8; MADE FREEMAN, AUG. 6, 1723)
 HANNAH HEARS B. D. N.Y. 1745

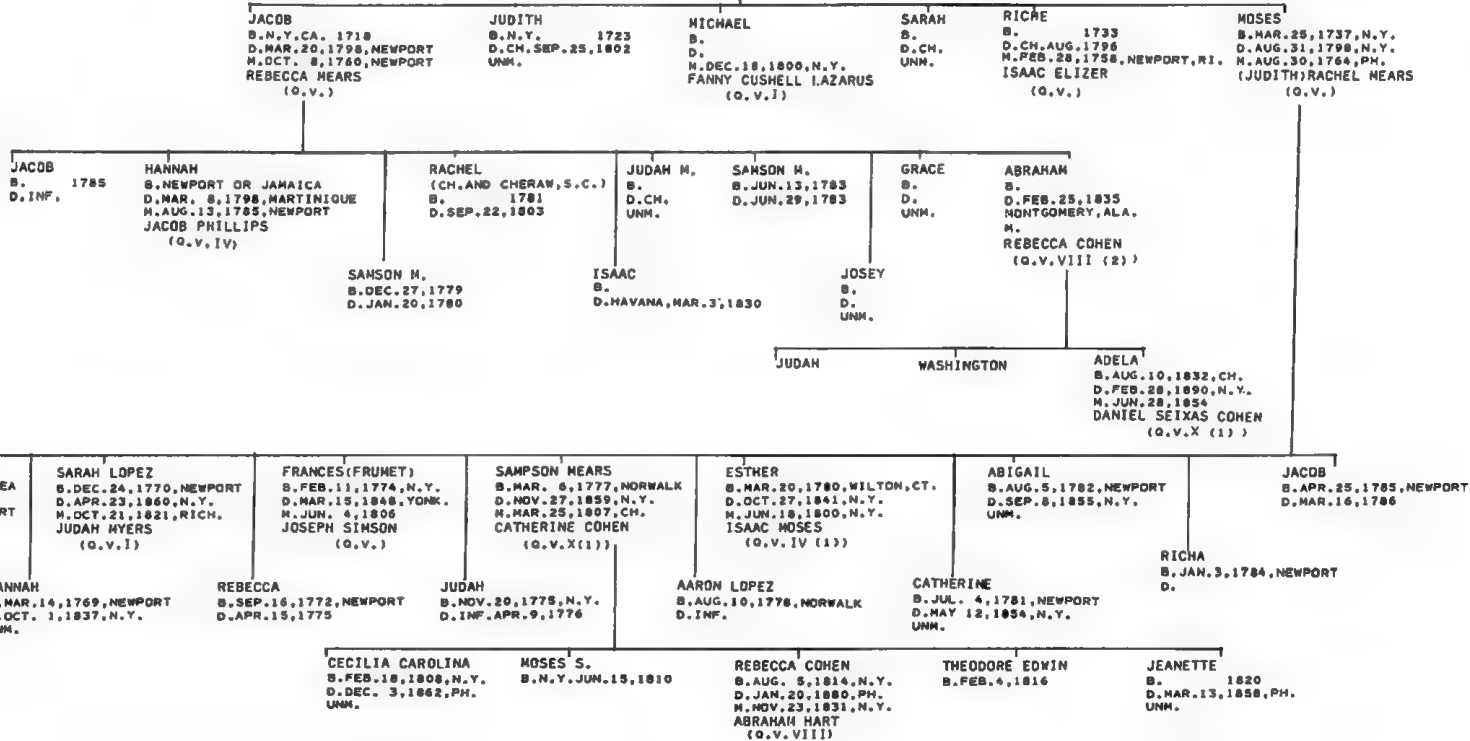

U.S.CENSUS,1860(N.Y.), 1880(N.Y.)
 MISC.VI,P.190
 PAJHS, V.46,P.102F.
 BETH SHALOME HARR, REC.
 LEVY GEN.
 KRAUS-SANDOR COLL.
 FLD.ABR.
 EZEKIEL-LICHTENSTEIN- JEWS OF RICHH.
 WILL OF HENRY HYMAN
 SHEARITH ISRAEL REC.

ABRAHAM MOSES MARY HARRIS

JOSEPH(JOUSEL)MOSES

(TO ENG.1700,SETTLED AT PLYMOUTH)

SAMUEL HYMAN
 B. 1771,KELIN,BOHEMIA
 D.NOV.25,1836/ APR.1839

ELIZABETH(BETSY)
 B. DEC.11,1835

(VID.MOSS(1))

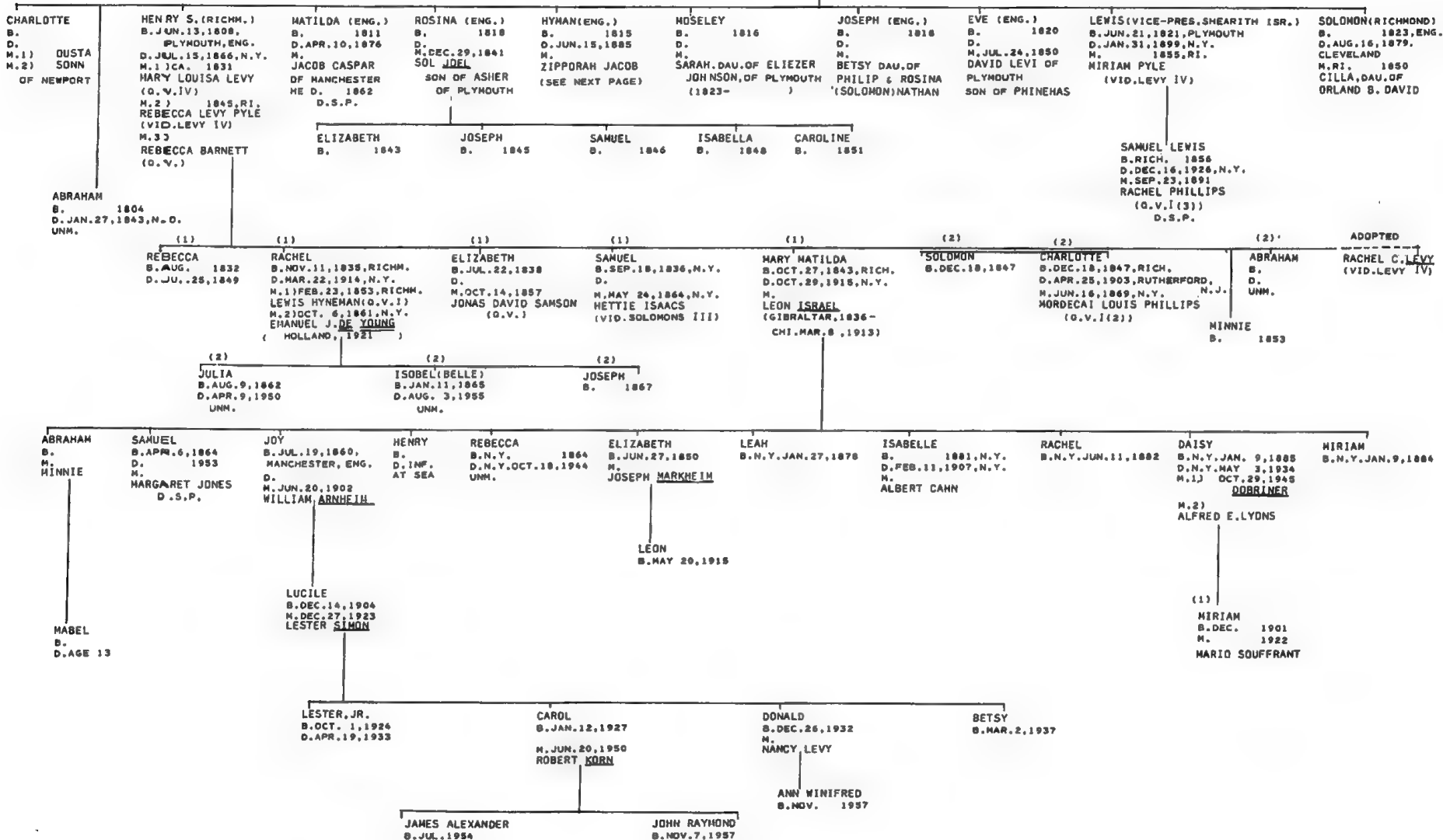

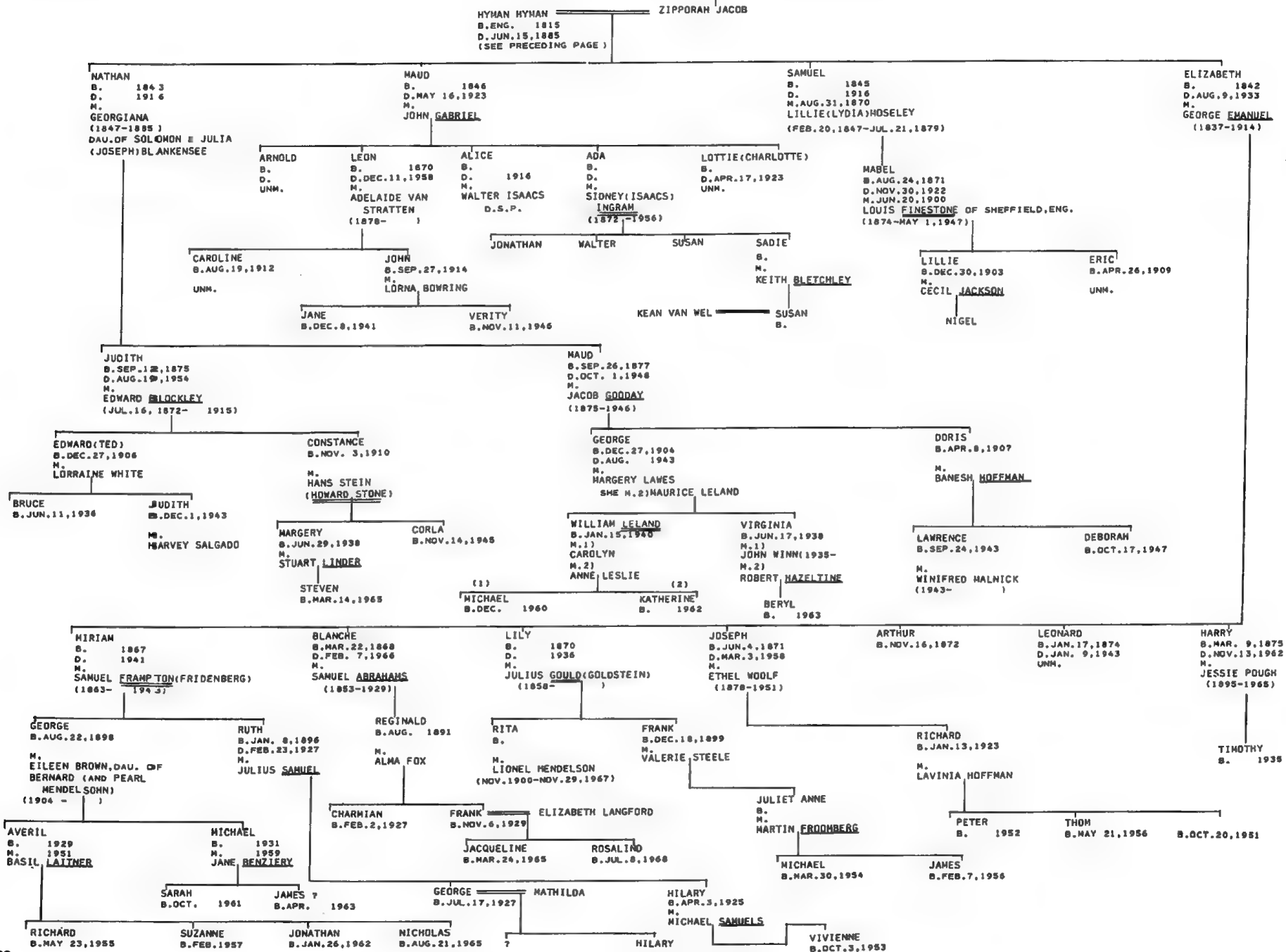

J.R. COHEN REC.
 FEDERAL ST. CEM.
 UJE V.5,P.516
 J.E. V.6,P.513
 MORAIS-JEWS OF PHILA.
 KRAUS-SANDOR COLL.
 BETH AHABAH(RICHM.)MARRIAGE REC.
 MICKVE ISRAEL REC.
 FLO.ABR.
 FISH-AARON LEVY
 SPRUCE ST.CEN.REC.
 MYER SOLIS-COHEN

ELIAS HYNEMAN 1765
 B.HOLLAND,
 D.PHILA.JUL.11,1845

RACHEL POLLOCK OR LEVY
 (VID.LEVY VII (1))

HYNEMAN I

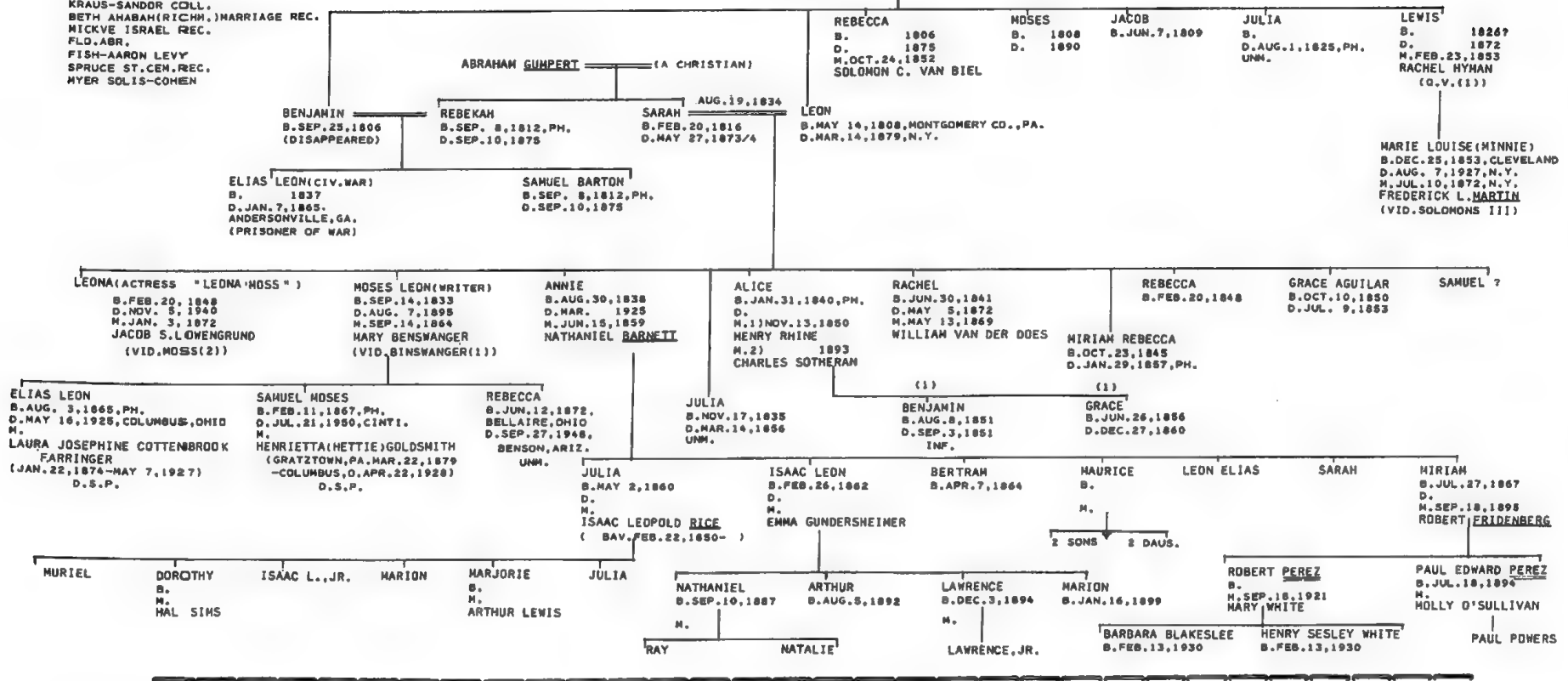

HYNEMAN FAMILY REC.(PHOTOSTAT,AJA)
 ANY STEWART MS.
 KRAUS-SANDOR COLL.
 MICKVE ISRAEL REC.
 FLORENCE ABRAHAM S
 RODEPH SHALON HARR,REC.
 PHILA.BOARD OF HEALTH (MSP)

SIMON LUCAS HYNEMAN (KLEEBURG)
 B.GERMANY, 1765
 D. JAN.4,1849

HYNEMAN II

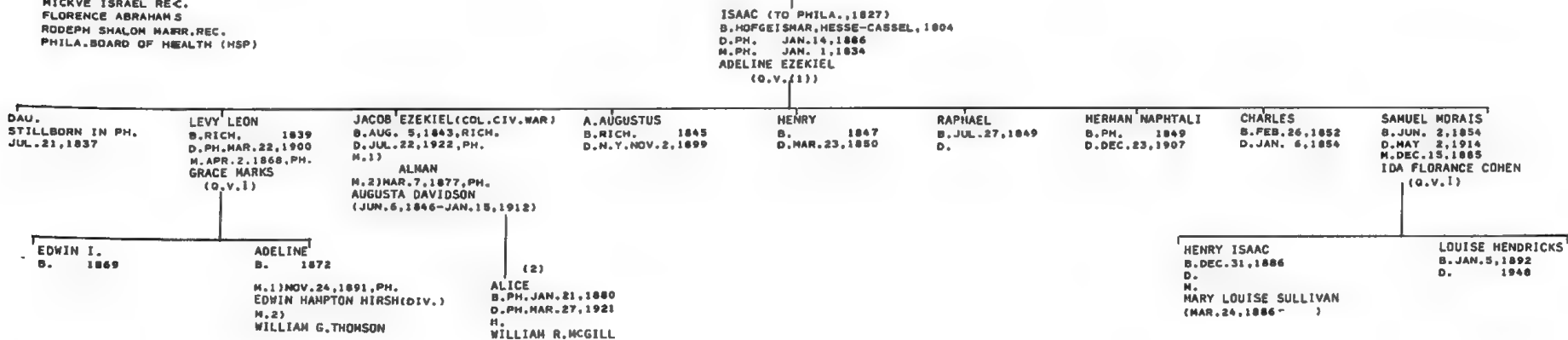

ISAACS II

PAJHS, V.12, P.167
 V.23, P.151
 V.33, P.210
 AJHO, V.LXI, P.115^N
 KRAUS-SANDOR COLL.,
 ST. CHARLES, P.126
 POOL-PORTRAITS...
 HENDRICKS GEN.
 GOLDSTONE GEN.
 ELZAS-JEUS OF S.C., PT.2, P.10
 AMER. JEW. ARCHIVES, V.3, #1.
 HERSHKOWITZ-WILLS; SOLOMON ISAACS
 JOSHUA ISAACS

(SOLOMON) ISAACS REBECCA ? (L. IN N.Y. 1695)

JOSEPH
 B. 1659 (IN N.Y. 1691; FREEMAN, AUG. 23, 1698)
 D. N.Y. MAY 25, 1737 (KOSHER BUTCHER; K. WILLIAM'S WAR)

SOLOMON (OF FREEMOLD, N.J., BOSTON & CH.)
 B. D.CH. 1757
 ASHER B. D. M. ?
 JOSHUA B. D. JUL. 1744 M. DEC. 1741 HANNAH (HINDLAH) LEVY (G.V. I, (1))
 JUDITH
 REBECCA B. D. M. 1722, WILTON, CONN. JOSEPH SIMSON (G.V.)
 RACHEL

JACOB KING (G.V. III) (2) MARY (1) SOLOMON B. D. N.Y. 1793 (YELLOW FEVER)
 JOSHUA B. SEP. 17, 1744, GRENADA, W.I. D. FEB. 16, 1810, N.Y. M. MAR. 28, 1781, LANCASTER, PA. (JUSTINA) BRANDLY LAZARUS (G.V. III)
 GRACE B. BEP. 1744 D. OCT. 13, 1781, JAMAICA, L.I. N. NATHAN HART
 NYER B. JUN. 2, 1779 D. AUG. 16, 1779

JOSEPH B. MAR. 21, 1782, LANCASTER, PA. D. JUL. 20, 1783
 FRANCES B. JUN. 9, 1783, LANCASTER, PA. D. MAY 1, 1854, N.Y. M. JUN. 4, 1800, N.Y. HARMON HENDRICKS (G.V. (1))
 SOLOMON J. B. FEB. 26, 1786, N.Y. D. JAN. 13, 1855, N.Y. M. MAY 21, 1829, N.Y. ELKALEH KURSHEEDT (G.V.)
 GRACE B. MAY 13, 1788, N.Y. D. JUN. 14, 1848, N.Y. UNM.
 SAMPSON B. N.Y. AUG. 29, 1790 D. INF. AUG. 10, 1791
 HANNAH B. JUL. 7, 1792, N.Y. D. NOV. 17, 1867, N.Y.

BRANDLY LAZARUS D. JUN. 12, 1830, BELLEVILLE, N.J. D. FEB. 3, 1833
 JOSHUA B. N.Y. JUN. 26, 1832 D. N.Y. APR. 24, 1883
 GUSTAVUS JOSEPH B. OCT. 7, 1836, N.Y. D. DEC. 9, 1910, N.Y. EUGENIA VAN DUZER D. S.P.
 JUSTINA BRANDLY (JESSIE) B. FEB. 16, 1839, N.Y. D. JUL. 18, 1885, N.Y. M. MAR. 17, 1858, N.Y. HORTIMER HENDRICKS (G.V. (1))
 MOSES MONTEFIORE B. N.Y. FEB. 20, 1841 D. N.Y. JUN. 1, 1902
 FRANCES ZELHIRA B. NOV. 28, 1842, N.Y. D. MAY 19, 1916, N.Y. M. FEB. 21, 1866, N.Y. CHARLES NOE BENJAMIN WEITZER M. 2) CHARLES C. EDEY
 EMILY HANNAH B. JAN. 26, 1845, N.Y. D. OCT. 22, 1918, N.Y. M. SEP. 11, 1867, N.Y. LUCIEN G. FLORANCE (G.V.)
 WASHINGTON SAMPSON B. OCT. 27, 1847, N.Y. D. SEP. 13, 1919, N.Y. UNM.
 GERTRUDE ADELAIDE B. MAY 10, 1851, N.Y. D. MAY 28, 1912, N.Y. M. OCT. 11, 1871, N.Y. DAVID LIEBER (G.V.)
 VIRGINIA GRACE B. NOV. 6, 1834 D. NOV. 14, 1881, N.Y.
 JESSIE LEONORE B. OCT. 7, 1866, N.Y. D. MAR. 3, 1918, N.Y. M. APR. 15, 1891, N.Y. MICHAEL DE MERCADO (KINGSTON, 1847-)
 EUGENE NOE B. JAN. 25, 1868

ISAACS III (1)

SPRUCE ST. (PH.) CEM.
 SHEARITH ISRAEL REC.
 ISAACS FAMILY BIBLE
 JON STEDMAN
 MICKVE ISRAEL REC.
 RALPH COLTON
 B'NAI JESHURUN REC.
 P. B. H.
 KRAUS-SANDOR COLL.
 LEVY GEN.

GATZEL ISAAC PRONT (VAN BRUNT)
 B. AMST. 1749(?) (CONTRACT SURGEDN ON "BON HOMME RICHARD", 1779)

(TO BOSTON, 1830) ISAAC GERRAT PRONT (GEORGE ISAACS) B. 1772 D. PH. DEC. 22, 1842
 RACHEL SARAH ? B. D. ROCHESTER, N.Y. BEF. 1864

AARON (ISAACS) TO BOSTON, PH. GALVESTON, ATLANTA) B. AMST. DEC. 25, 1801 D. PH. JAN. 16, 1878 M. RI. MAR. 10, 1824 ESTHER LEVY (G.V. IV) (SEE NEXT PAGE)
 BRINA (TO U.S. 1824 L. IN PH.) SOLOMON ISAAC(S); B. AMST. D. M. HANNAH, DAU. OF LEVY AND LEA MEYERS
 HATILDA B. D. M. N.Y. JAN. 22, 1834 MOSES ABRAHAMS INF. DAU. D. PH. JUL. 1835
 BRENDILLA B. D. M. AS 2ND WIFE SOLOMON FRIEDENBERG (TO U.S. 1827)
 JULIUS MITCHELL (OF BUFFALO) DENA HART
 ISAAC A. B. OCT. 8, 1825, BOSTON D. MAR. 14, 1897, N.Y. M. FEB. 11, 1846 MARY PYLE (VID. LEVY IV) (DEC. 5, 1828, N.Y. - JAN. 20, 1873) M. 2) SEP. 12, 1877, N.Y. AGNES COHEN (G.V. X(1))
 DAU. B. 1832 D. PH. JUN. 4, 1835
 ISAAC A. SOLOMON B. JAN. 1836 D. SEP. 4, 1837, PH.
 LEWIS B. JAN. 1836 D. SEP. 4, 1837, PH.
 INF. DAU. D. PH. JUL. 31, 1845
 BRINDELLA B. PH. AUG. 29, 1847

AARON CLARENCE B. APR. 11, 1849, CLEVELAND D. SEP. 3, 1901, N.Y. M. OCT. 29, 1873, N.Y. MARY CONSTANCE JACKSON (G.V. I)
 REBECCA B. OCT. 21, 1850, CLEVELAND D. M. 1) LENA BISHOFF M. 2) SALLY RAPHAEL
 ALBERT M. B. AUG. 15, 1852, CLEVE. D. JAN. 20, 1923, CHI. M. 1) EDNA B. MAR. 25, 1882 M. DOUD
 HENRY CLAY B. MAY 12, 1855, CLEVE. D. APR. 13, 1916, N.Y. M. JUN. 1, 1881 EUGENIE FELBEL (G.V.)
 ETHEL MIRIAM B. NOV. 1, 1883 D. JUN. 23, 1931 M. JAN. 5, 1911 ARCHIBALD SOUZA SEIXAS (G.V. (4))
 WALTER SCOTT B. MAR. 30, 1857, CLEVELAND D. M. ESSIE ISAACS (SEE NEXT PAGE)
 CLIFFORD B. SEP. 16, 1879, NYACK, N.Y. D. APR. 1955 UNM.
 ERNEST R. B. MAY 22, 1883, NYACK, N.Y. D. NOV. 21, 1941 M. NOV. 4, 1909 HELEN ROTHSCHILD
 EUGENE JACKSON B. N.Y. NOV. 18, 1874 D. N.Y. FEB. 27, 1929 M. LOLA TISHMAN
 ALBERT B. APR. 12, 1876 D. N.Y. AUG. 1903 KITTY
 CLARENCE B. OCT. 16, 1885 D. OCT. 17, 1938, N.Y. M. APR. 2, 1908 ALMA HENDRICKS (DIV.) (G.V. (2))
 HENRY B. FEB. 2, 1909 DOROTHY B. JUL. 5, 1911 M. ALLEN HERBERT
 BARBARA GAY
 ROBERT B. NOV. 16, 1910 M. OCT. 12, 1940 GLADYS STRONGIN
 EDWIN B. MAR. 19, 1913 M. MAR. 11, 1944 MARION RYDOLM
 ALBERT B. NOV. 13, 1920 UNM.
 CARL B. OCT. 8, 1946, N.Y. LAURIE B. JUL. 16, 1948, N.Y.
 VINCENT B. APR. 6, 1944 PETER B. MAY 10, 1948

AARON ISAACS
B. AMST. DEC. 25, 1801
D. PH. JAN. 16, 1878
(SEE PRECEDING PAGE)

ESTHER LEVY
(O.V. IV)

(GALVESTON)

RACHEL CORNELIA B. MAY 10, 1827
D. M. LOEB OF DAYTON, O.

ABRAHAM B. SEP. 14, 1828
D. M. JAN. 12, 1859, PH.
CORNELIA, DAU. OF
TOBIAS MYER
D.S.P.

GEORGE 1829
D. 1925, N.Y.
M. FEB. 7, 1856, RI.
FRANCES PYLE
(VID. LEVY IV)

JACOB LEVI B. JUN. 24, 1832, PH.
D. OCT. 10, 1912, ST. L.
M. 1) OCT. 5, 1858
EMILIE (AMELIA) LOEB
(FEB. 15, 1840-AUG. 7, 1882)
M. 2) JUN. 1, 1884
CAROLINE NEWARK
(JUN. 1, 1853-NOV. 14, 1929)

LEWIS B. APR. 21, 1834
D. AUG. 31, 1835, PH.

MARY LOUISE B. APR. 17, 1836, PH.
D. JAN. 6, 1923, OMAHA
M. JAN. 1, 1862, ATLANTA

ISABELLE ISAAC REIS
MARCUS CORNELIUS CLARISSA
B. MAY 25, 1846, PH.
D. MAR. 17, 1922
JACKSONVILLE, FLA.
N. SEP. 7, 1870, N.Y.
SIGISMUND RITZMOLLER
(NEUSTADT, GER., FEB. 2, 1835-
MAR. 4, 1897, JACKSONVILLE)

OLIVIA B. SEP. 1, 1852
D. APR. 22, 1921
M. OCT. 27, 1869, N.Y.
MOSES HENRY SHWARTZ
(BERLIN, JUN. 11, 1857-
AUG. 5, 1878, GALVESTON)

SAMUEL B. D. ST. L. AGE 83
M. 1)
BERTHA GRABENHEIMER
M. 2)
BERTHA ALTHEIMER

(1) AARON B. INF.
D. INF.

(1) REBECCA B. JUL. 13, 1860
D. APR. 28, 1868

(1) ESTHER B. DEC. 11, 1861, ST. L.
D. FEB. 1937
M. 1865
MEYER GOLOSNIH
(DEC. 25, 1845-JUL. 22, 1891)

ESTHER K. B. JUL. 28, 1869, CINTI.
D. FEB. 23, 1939, OMAHA
M. JUN. 29, 1898, CINTI.
RABBI FREDERICK COHN
(ATTLEBORO, MASS. AUG. 24, 1875-MAR. 5, 1940, OMAHA)

IRVING C. IRWIN ESTHER B. 1873, JACKSONVILLE, FLA.
D. 1955, SAN FR.

REBECCA MYER JACOBS RUTH ESTHER
D. INF. D. INF. RALPH COHEN

RALPH, JR. PHYLLIS
PEGGY PATSY

AMELIA B. JUN. 29, 1888
M. S. HARTLEY WHEATLEY

ROSE B. OCT. 25, 1889
D. OCT. 23, 1959
M. 1) NOV. 26, 1914
PHILIP HENRY MORTIMER
(DIV. MAR. 1917)
M. 2) APR. 18, 1923, ST. L.
THOMAS WILLIAMS COX

B. FT. WAYNE, IND. MADELEINE ISABEL B. JUN. 26, 1900
RALPH FREDERICK COLTON B. NOV. 5, 1901
M. JUL. 17, 1930, N.Y.
ELSIE FLORENCE GERRARD
(N.Y. SEP. 15, 1903-)

MILDRED ESTHER CLARA B. MAR. 21, 1904
M. BENJAMIN LEWIS HERZBERG
(CHI. MAY 6, 1897-)

DAVID B. 50.
JUL. 12, 1923

ESTHER ("BOBBIE") B. NOV. 7, 1924
M. WILLIAM JOHN MEYER

ROBERT ADRIENNE SUSAN
B. APR. 28, 1932 B. APR. 21, 1935 B. MAY 28, 1941
M. JUL. 1, 1956 M. AUG. 19, 1956
ROBERTA FALK ALBERT ERLEBACHER
(CHI. AUG. 23, 1935-) (GER. FEB. 27, 1935-)

STEPHEN B. NOV. 12, 1957
RAPID CITY, S.D.

BETH LYNN B. NOV. 1, 1960, CHI.

JOSEPH RACHAELE ESTHER ALBERT RALPH MAE W.
GILBERT STEINHAU FELSENTHAL RALPH SMITH
JACKSONVILLE

ALEXANDER VAN BRUNT OLIVER CORNELIUS
B. JUN. 24, 1871, N.Y. C. B. SEP. 9, 1881
D. JUL. 28, 1940. D. MAR. 20, 1959, CHI.
M. JAN. 7, 1907, BALTO. D. JAN. 2, 1932, N.Y.
JULIA WEIGLIN BROFMAN (BALTO. OCT. 28, 1874-)

JOSEPH SILVERSTONE
B. APR. 8, 1880
D. JAN. 2, 1932, N.Y.
UNM.

JEANNE ?
M. 2)
FAY FISH
M. 3) DEC. 1, 1949
ZELLA CHERRY CURTIS
(ADOPTED SON OF (13))
RICHARD
B. APR. 23, 1941

SUSANNE BROFMAN
B. FEB. 14, 1911, JACKSONVILLE
M. JAN. 7, 1935, JACKSONVILLE
LEWIS JAY SCHAUL, JR.

(1) EUGENE B. SEP. 25, 1864
D. FEB. 8, 1931
M. JAN. 22, 1888
MATILDA EINSTEIN
(APR. 29, 1864-
JAN. 8, 1933)

(1) BENJAMIN FRANKLIN B. DEC. 31, 1868, ST. L.
D. JUL. 7, 1937, ST. L.
M. 1) 1892
M. 2) DEC. 3, 1901
MAY BERNICE MEYER
(PINE BLUFF, ARK., MAY 13, 1873-)

(1) FLORENCE B. JUN. 23, 1872
D. SEP. 25, 1944
M. 1)
SYLVAN HAAS (DIV. 1905)
M. 2) JUL. 5, 1922
HENRY KLEIN

(1) CORNELIA NEWARK B. JUL. 18, 1885
D. DEC. 13, 1901
M. 1) MAR. 14, 1899
FERDINAND HAROLD BACH
M. 2) AUG. 7, 1919
SIGMUND UFFENHEIMER

(2) AUGUSTA AGNES B. SEP. 30, 1886, ST. L.
D. OCT. 18, 1954, CAL.
M. 1) SEP. 8, 1915
ARYE BUDTANSKY
(HARRY BORTIN)
(RUSSIA, JUL. 3, 1881-)

(2) FRANCES LOUIS B. JAN. 4, 1889
M. 1) DEC. 5, 1919
MARK SILVERSTONE
(LOND., MAR. 26, 1871)
M. 2) SEP. 11/12, 1937
DR. LEON FEINSTEIN

JACOB LOEB B. MAR. 28, 1889, ST. L.
D. AUG. 11, 1950, CAL.
M. 1) FEB. 8, 1916, ST. L.
MARION HARRIS
M. 2) JUL. 7, 1946, L.A.
BERTHA SHUCART SCHWARTZ

ANY LOEB B. AUG. 20, 1890
SOPHIE RUTH B. MAR. 18, 1892, ST. L.
M. JAN. 18, 1922, ST. L.
HELVAN ELI SCHLOSS

RODALIND B. AUG. 24, 1902, ST. L.
M. JUN. 3, 1924, ST. L.
EDGAR GUY LEHMAN

EDGAR G., JR. B. FEB. 19, 1926
JOHN MICHAEL B. DEC. 28, 1927
PLEASANT HILL, ILL.
M. MAR. 22, 1958
PAULA SUE WIETERS
(FEB. 6, 1931-)

JOHN H., JR. B. MAY 8, 1960
BETHESDA, MD.

CAROL SYLVA B. JAN. 28, 1908, ST. L.
M. NOV. 5, 1925
KINGSTON, N.Y.
BERTEL D. HONNE II
(DIV.)

HARRY, JR. B. AUG. 11, 1916
BROOKLYN
M. DEC. 24, 1939
DORIS RUTH VAN SANT

JOSEPH LEONARD B. APR. 30, 1918, ST. L.
M. 1) NOV. 27, 1947
MILDRED DONN H. 2)
1961

BARBARA B. SEP. 4, 1959

MARY ELLEN B. SEP. 2, 1920
M. 1) JUN. 29, 1941
JACK CARL OPPENHEIMER (DIV.)
M. 2) MAY 25, 1957
ENDOCH PHILIP SAYRE
(HUMBOLDT, IOWA, APR. 19, 1924-)

MARCIA FRANCES B. APR. 29, 1924
M. AUG. 1948
DANIEL BRANDEIS WOLF
(ST. L. AUG. 29, 1922-)

MARK ALEXANDER B. NOV. 2, 1950, INDIANAPOLIS
JUDITH ANN B. JUL. 12, 1956,
MEMPHIS

JOHN D. INF.
AMY B. DEC. 2, 1925
M. SEP. 6, 1951, ST. L.
JOSEPH PASTERNAK

MELVIN E., JR. B. MAY 10, 1927
M. 1) SEP. 24, 1952, TOLEDO
BARBARA GANS
M. 2) APR. 13, 1957,
ST. CHARLES, MO.
SHIRLEY HAY SCHAEFER JONES

JOHN MICHAEL B. DEC. 28, 1927
PLEASANT HILL, ILL.
M. MAR. 22, 1958
PAULA SUE WIETERS
(FEB. 6, 1931-)

JOHN H., JR. B. MAY 8, 1960
BETHESDA, MD.

FLORENCE B. AUG. 14, 1927
M. AUG. 21, 1948
RALPH MONTELEONE

BETTY LOU B. JUN. 6, 1933
WILLIAM BEHRINGER

JEFFREY B. FEB. 24, 1953
ELISE RACHAEL B. MAY 25, 1954

MELISSA CAROL B. NOV. 17, 1959

SYLVIA RUTH B. NOV. 22, 1941

WILLIAM WALLACE B. MAY 9, 1948

DAVID BRUCE B. JUN. 21, 1943

BARBARA CAROL B. MAR. 11, 1942
M. JUN. 16, 1958
GERALD JOSEPH FITZGERALD

SARAH B. APR. 16, 1959

CAROLYN WILSON B. DEC. 28, 1921
M. AUG. 11, 1940
ROBERT H. HARGROVE

DAVID NEWARK B. NOV. 22, 1925

STEVEN JACOB B. APR. 26, 1953, MEMPHIS

LOUIS WILLIAM B. DEC. 28, 1916
M. AUG. 20, 1936, SALT LAKE CITY
ALENE PARSONS

SUSAN B. APR. 24, 1921
M. DEC. 5, 1942, ST. L.
LEONARD KREVITZ

ROBERT HARRIS B. JUL. 6, 1922
M. NOV. 12, 1942
ELIZABETH GROVER

EUGENE LOEB II B. APR. 7, 1925
JEANNE

WILLIAM BRADFORD B. CORA, WYO. 1958
ROBIN ANN B. 1961

MICHAEL TINDOTHY B. APR. 16, 1959

KALMAN B. AUG. 2, 1870
D. OCT. 30, 1941, MONTGOMERY
M. 1907
ELLA KLEIN
(MONTGOMERY, SEP. 1887-)

OLIVIA JEANNE B. MAY 22, 1909
D. INF.

ALFRED HENRY B. SEP. 22, 1909
M. SEP. 29, 1940, CINTI.
AUDREY LEVY

MARIAN JUNE B. JUN. 10, 1918
M. JUN. 16, 1940, CINTI.
RABBI DUDLEY WEINBERG

REBECCA B. APR. 15, 1947

STEVEN DONALD B. SEP. 30, 1949

ANN AUGUSTA B. JAN. 21, 1954

MARION ALENE B. MAR. 26, 1940
M. RAY HARDELL

JAMES ROBERT B. 1961

LEONARD CHARLES, JR. B. FEB. 2, 1944, ST. L.

JAMES GARY B. DEC. 13, 1954, L.A.

MINIFRED MARION B. SEP. 18, 1946, L.A.

PETER S. B. MAY 4, 1975

OLIVIA B. JAN. 6, 1908
D. MAY 22, 1936
M. JAN. 18, 1930
SEYMOUR A. LISS

LEO B. JUL. 30, 1917, WOODHURST, N.Y.
M. 1945, MERIDIAN, MISS.
ELSIE FEIBELMAN

KALMAN, JR. B. SEP. 25, 1921
M. JUN. 26, 1943
MONTGOMERY
GLORIA HAAS

OLIVIA ROSE B. AUG. 26, 1947

JOHN FOREST B. AUG. 1950

RUTH ELIZABETH B. OCT. 17, 1956

RICHARD B. 1944

ELLEN K. B. 1946, MEMPHIS

ALLEN LESLIE B. SEP. 30, 1945

AVROM MICHAEL B. OCT. 12, 1943, FT. KNOX, KY.

MYRA RUTH B. MAY 14, 1950, BOSTON

JONATHAN DAVID B. OCT. 19, 1951, BOSTON

ISAACS IV

N.Y. TIMES MAG. 4/8/23
THE OLD MERCHANTS, P. 317
VITAL RECORDS FROM GA. NEWSPAPERS
UJE, V. 5, P. 593
KRAUS MS.

MARY RUMSEY (A CHRISTIAN)
B. 1705
D. JAN. 16, 1770

MAR. 7, 1725

RALPH ISAACS
B.
D. NORWALK, CONN.

(EXCEPT FOR SOME LEGAL
AND BUSINESS ASSOCIATIONS
BETWEEN RALPH AND AARON ISAACS
THERE IS NOTHING TO SHOW
THAT RALPH WAS JEWISH)

AARON ISAACS CA. 1750
B. AUG. 15, 1724, HAMBURG
D. SEP. 11, 1798, EASTHAMPTON, L. I.
(INSCRIBED ON HIS TOMBSTONE:
"AN ISRAELITE IN WHOM
THERE IS NO GUILF")

MARY HEDGES (A CHRISTIAN)
B. SEP. 11, 1720, EASTHAMPTON, L. I.
D. SEP. 14, 1808, EASTHAMPTON, L. I.

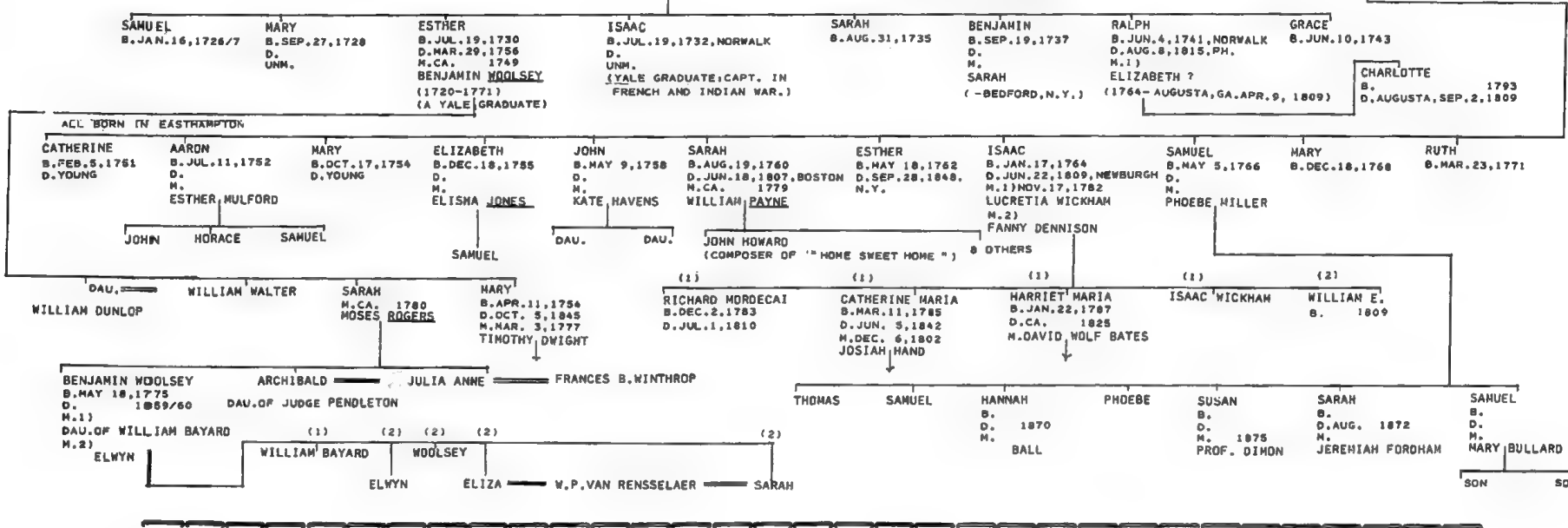

ISAACS V

KRAUS-SANDOR COLL.
WILL OF JACOB COHEN (JRM COLL.)
WILL OF DAVID ISAACS (ALBE HARLE CD., VA. CH.)
MARRIAGE RECORDS (ALB. CD., VA. CH.)
EZEKIEL-LICHTENSTAMIN-JEWS OF RICHM.
RICHMOND, VA. ARGUS
KORN-JEWS & NEGRO SLAVERY

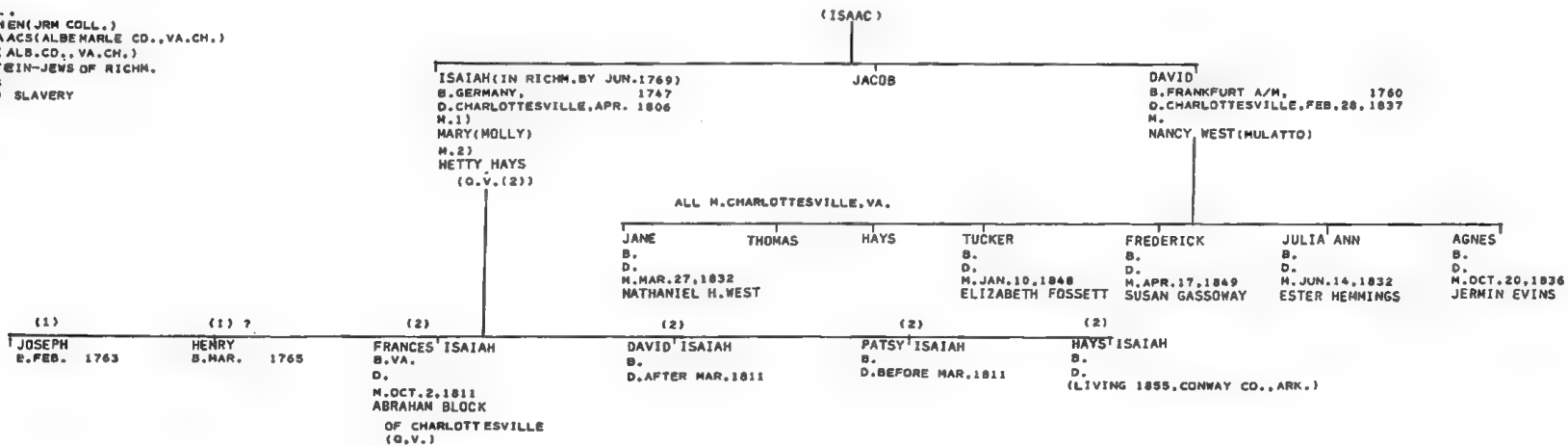

UJE V.5,P.594F.
 KRAUS-SANDOR COLL.
 PHILIP BRODY
 PLO.ABR.
 N.Y.CENSUS,1955
 SOLDMON GEN.
 U.S.CENSUS,1960 (N.Y.)
 LEON L.WATTERS
 WHO'S WHO IN AMER.JEWRY 1955
 CAROL SHARLIN LEVY
 JEAN FARLEY MCLAUGHLIN LEVY

HYER SAMUEL ISAACS OF LEEUWARDEN, NETHERLANDS

JACOB SYMONS OF LOND.

ISAACS VI

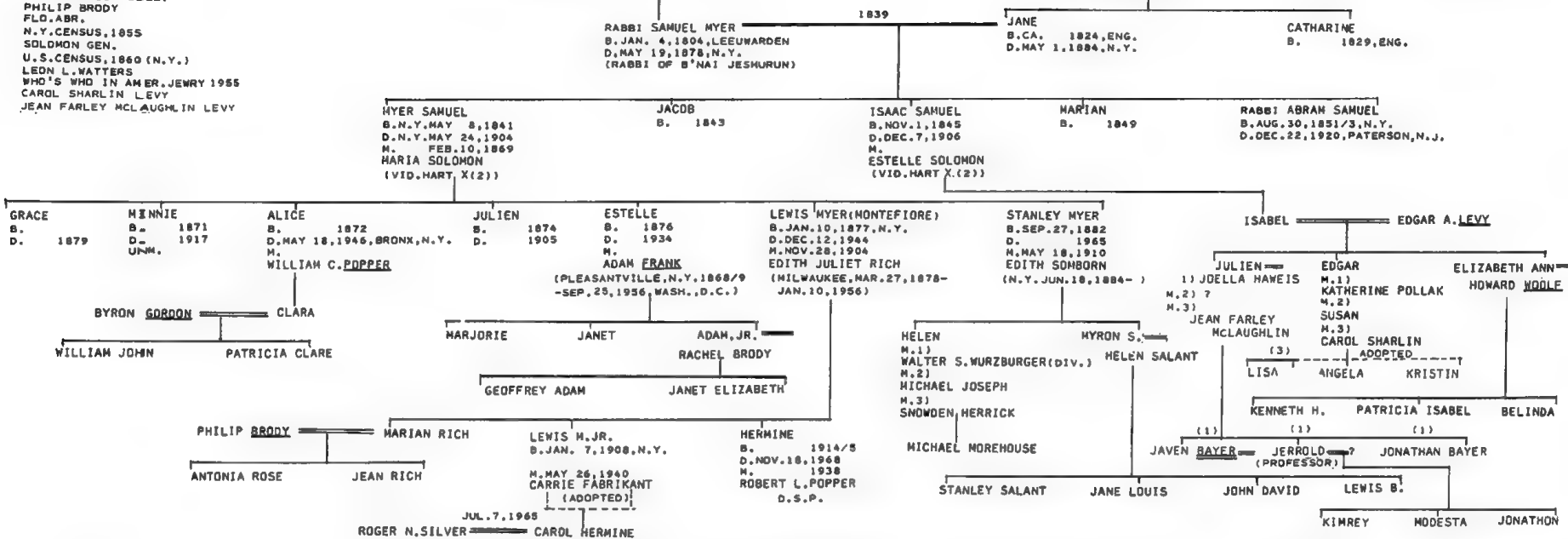

ROSENWAIKE
 PAJMS, V. 50, P. 51
 B'NAI JESHURUN REC.

(FREEMAN, N.Y. AUG. 21, 1770)
 (TO N.Y. CA. 1759)

ABRAHAM ISAACS
 B. AMST. 1737
 D. MAR. 20, 1815

JANETTE

ISAACS VII

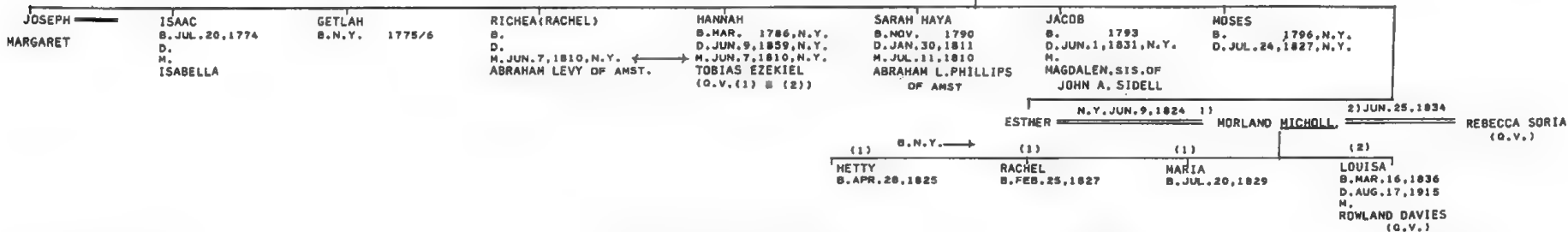

N.Y. CENSUS, 1855
 B'NAI JESHURUN REC.

ISAAC

JACOB KAHN/COHEN

ISAACS VIII

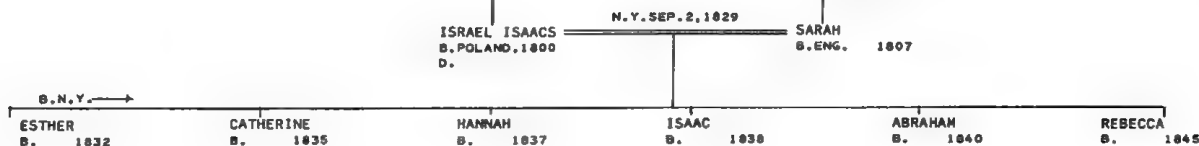

ISRAEL I

UJE V.5,P.619
MORAIS-JEWS OF PH.
ELZAS MS.
DAR LINEAGE BOOKS
FLORENCE ABRAHANS
MISC.VII,#511

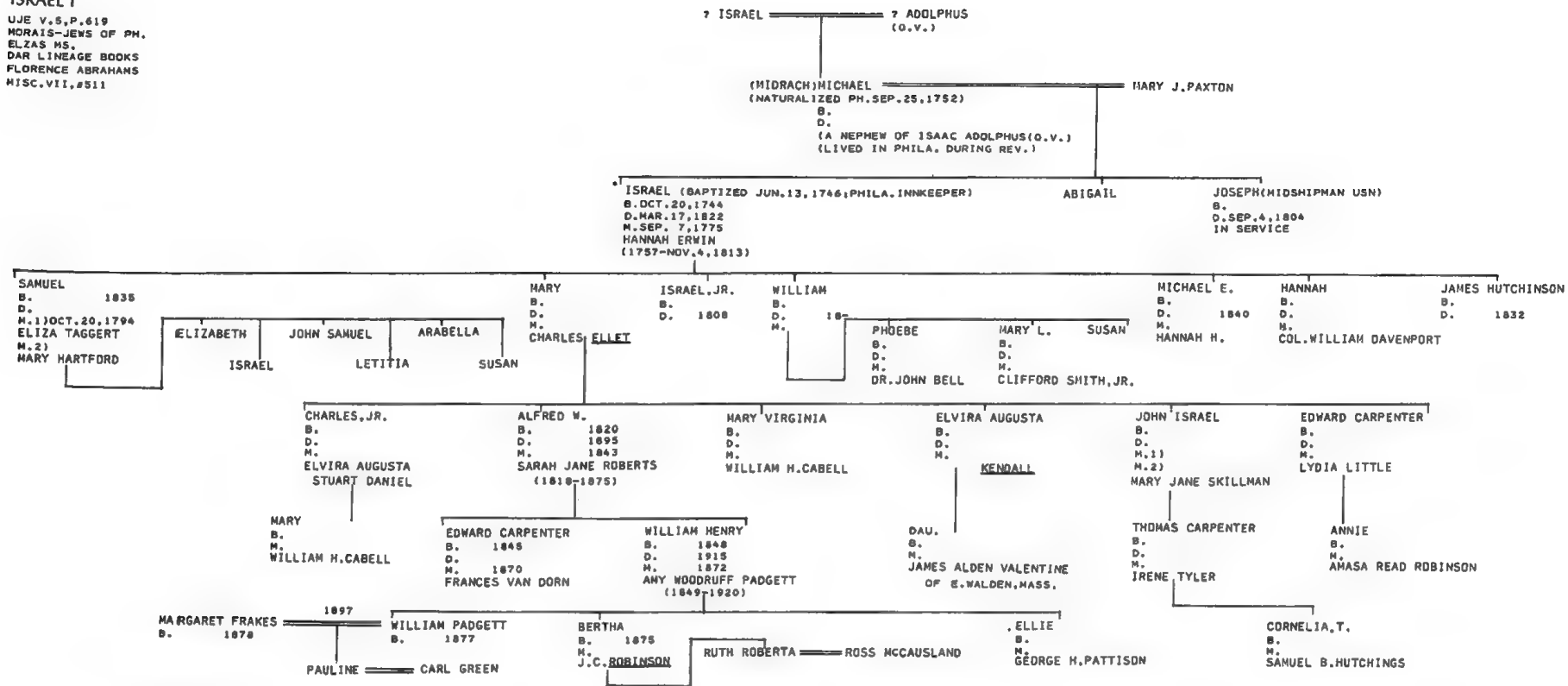

* ESTABLISHED REVOLUTIONARY ANCESTOR

ISRAEL II

PAJMS V.6,P.109
DAVIS-HIST. OF CONG. RODEPH SHALOM, P. 37
MORAIS-JEWS OF PHILA.
MICKVE ISRAEL REC.
HYNEMAN FAMILY REC. (PHOTO, AJA)
EGLE-... FOREIGN ARRIVALS
EZEKIEL-LICHTENSTEIN-JEWS OF RICHM.
EZEKIEL FAMILY REC.
POULSON'S
PBH

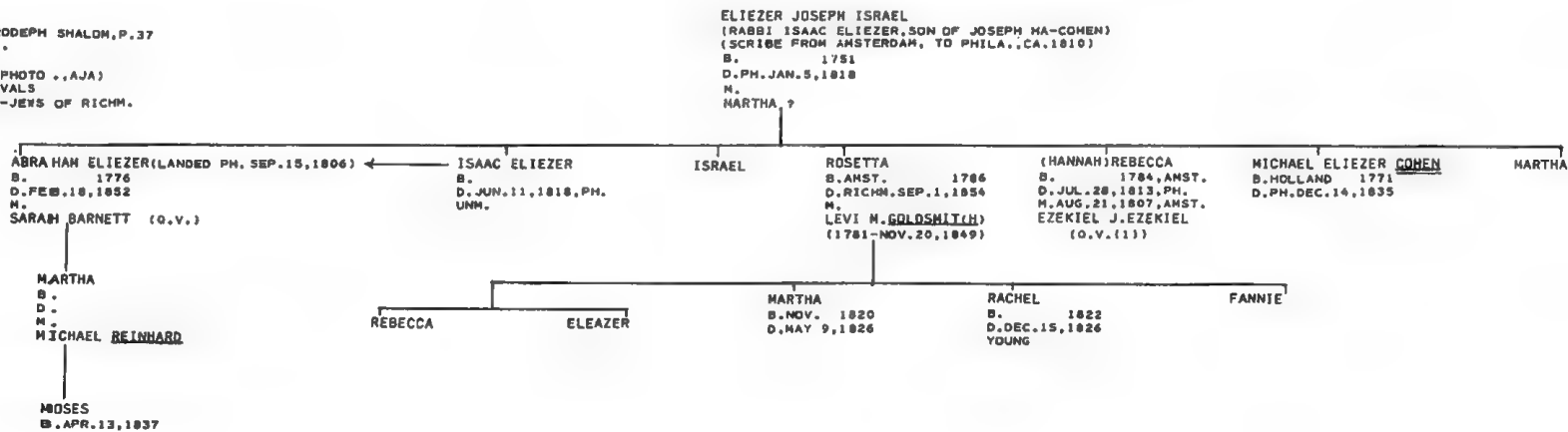

WILLS OF JOSEPH A., MARY (JON STEDMAN)
 JACKSON GENEALOGY (AT AJHS)
 KRAUS COLL.
 GOLDBERG-MAJOR NOAH', P. 219F.
 U. J. E., V. 6, P. 4
 MARYLAND HIST. MAG., V. 19, P. 76
 SHEARITH ISRAEL REC.
 FLORENCE ABRAHAMS
 SAWYER-N.Y. WILLS
 U.S. CENSUS
 N.Y. CENSUS, 1855
 ELZAS-OJC

(JACOB)

PHILLIPS

THIS GENERATION CALLED JACKSON

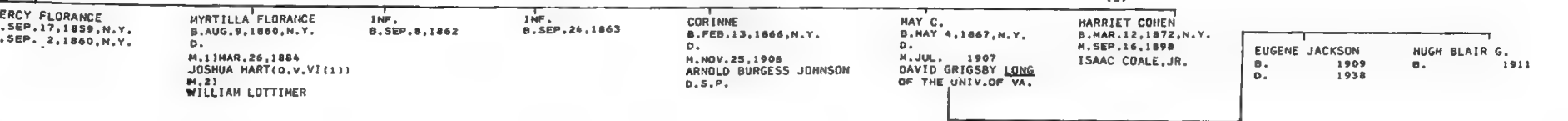
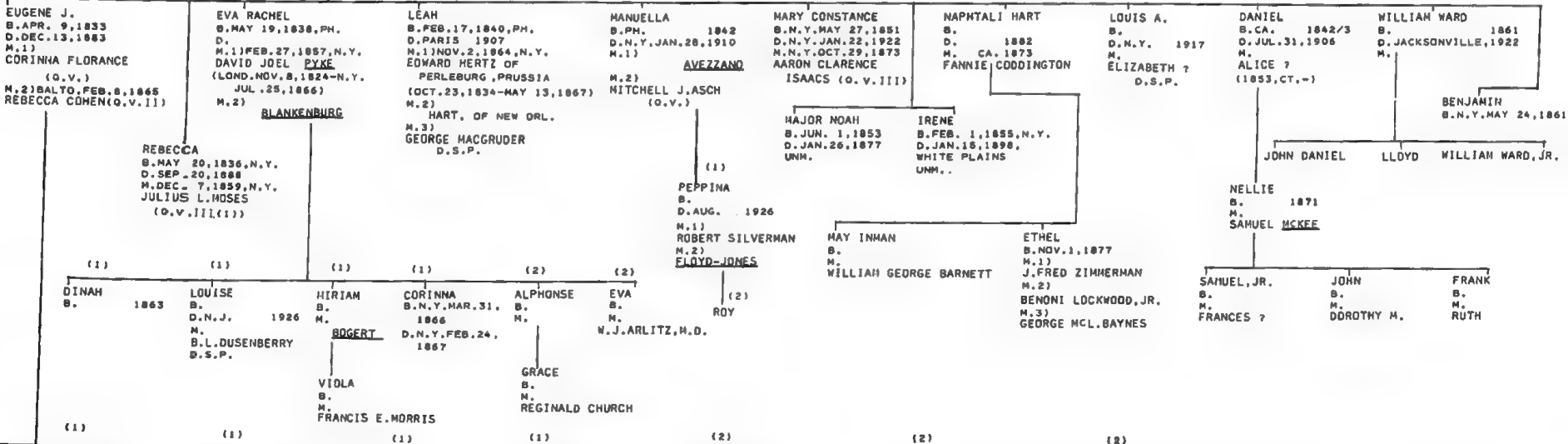
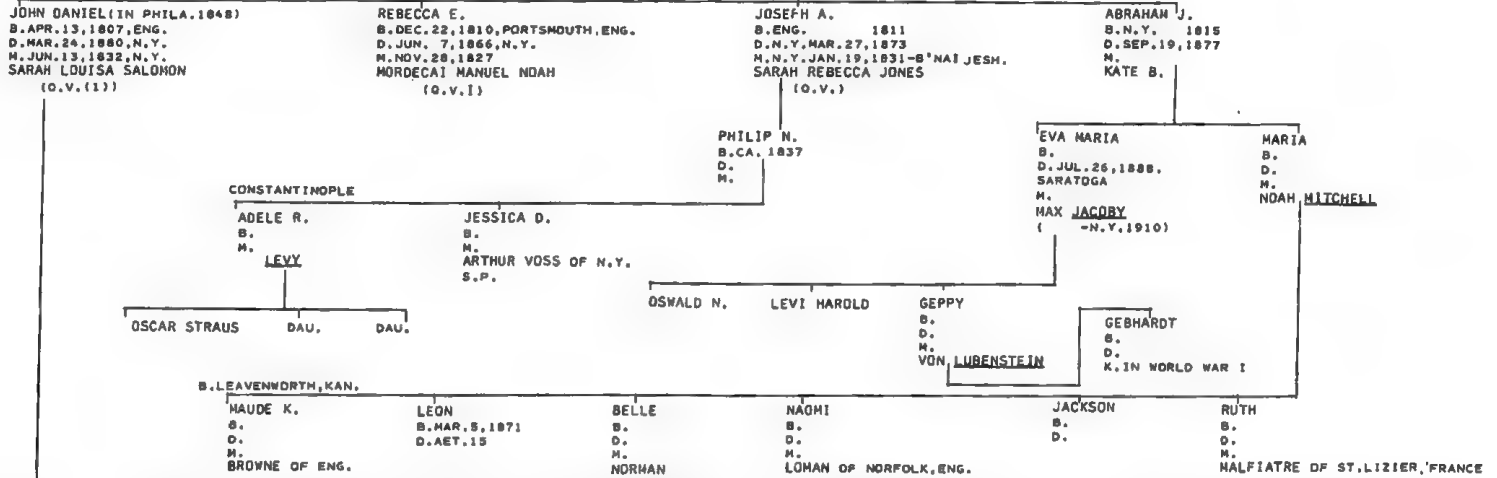

JACKSON II

KRAUS-SANDOR COLL.
SHEARITH ISRAEL REC.
B'NAI JESHURUN REC.
FLO. ABR.
JON STEDMAN

JOSEPH JACKSON
B. ENG. NOV. 1791/2
D. U.S. 1854

LOND. NOV. 30, 1814

HANAH ABRAHAMS
B. LOND. AUG. 1797
D. N.Y. FEB. 22, 1875

JOHN
B. PORTSMOUTH, ENG. 1796
D. N.Y. MAY 1853
M.
HARTHA

ABRAHAM B. APR. 3, 1825
AMELIA B. APR. 1, 1830
D. M. 11
HANNAH M. 2
ROSETTE, DAU. OF HENRY RITTERBAND (ENG. 1828-JUL. 24, 1878, N.Y.)
ELIAS B. JUL. 24, 1832
ELEAZER B. OCT. 13, 1834
DAVID B. JUN. 28, 1838
M. MAY 10, 1849, N.Y.
JACOB COHEN

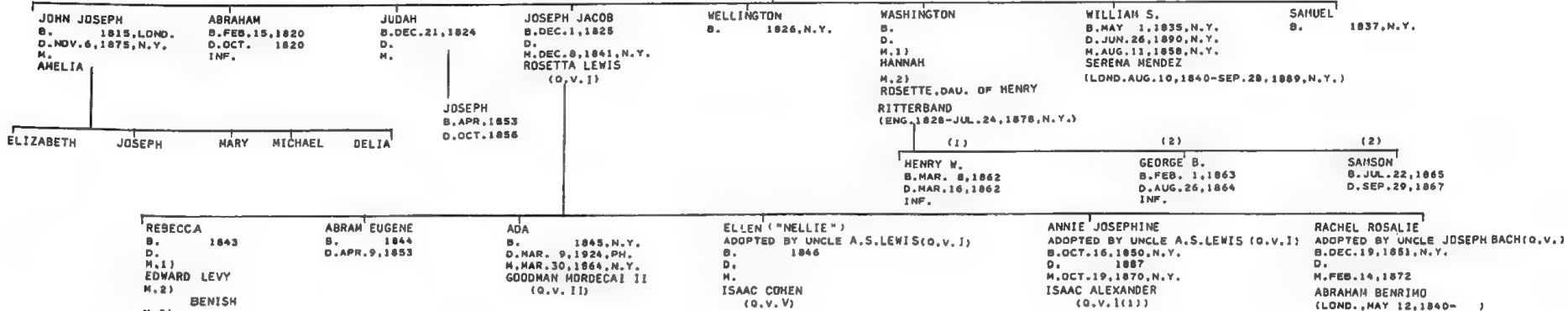

JACKSON III

JON STEDMAN

REV. JOHN MILLER (PIKE CO., PA.) - REV. WAR.
(TO U.S. CA. 1787) SOLOMON HENRY JACKSON B. LOND. D. FEB. 13, 1846 (EDITOR, PUBLISHER, PRINTER)
HELEN ("ANNIE") MILLER B. D. CA. 1815

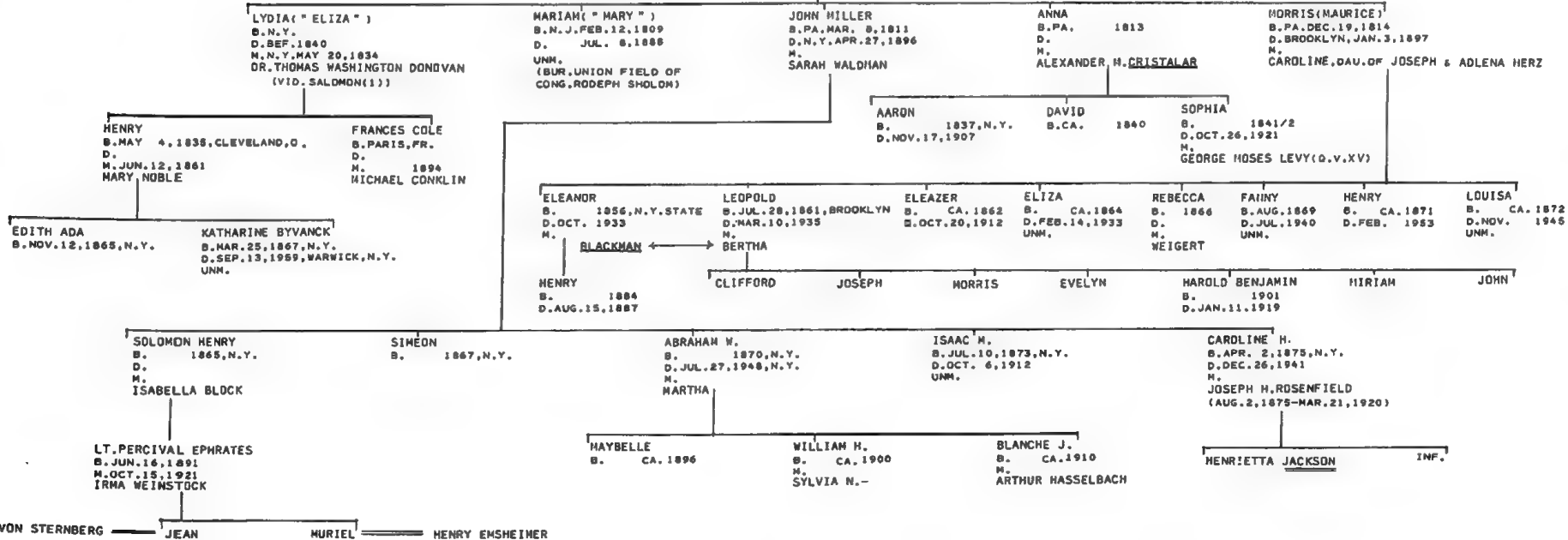

K.SCOTT-N.Y.ADMINS.
KORN-JEWS OF N.O.
U.S.CENSUS,1860
KORN-JEWS OF MOBILE

PAJMS V.18,P.101
PAJMS V.27,P.151F.
KRAUS-SANDOR COLL.
POOL-PORTRAITS...
CLEMENS-N.& S.CAR.MARRIAGE RECORDS
WILL OF SAMPSON SIMSON
(OPPENHEIM COLL.AJMS)
NYHS COLL.
WILLS OF ESTHER SHEFTALL,
GRACE ABENDANDNE(JRM)
N.Y.DEATHS
SHEARITH ISRAEL REC.
ELZAS MS.

(RIBI) RAPHAEL

JACOB SCHWAB, OF AMSTERDAM

JACOBS I

REBECCA HADASSAH = BENJAMIN JACOBS (IN N.Y. BEFORE 1720)
B. 1661
D.N.Y.OCT.13,1739

RAPHAEL (RALPH)
B.AUG. 9,1711
D.SEP.16,1796,N.Y.
M.
SARAH SIMSON
(O.V.)

RACHEL = ASHER ETTING(O.V.)

BENJAMIN (CHARLESTON)
B.AUG.31,1744,HOLLAND
D.JAN.31,1824,N.Y.

JOSEPH
B.FEB. 1,1746
D.DEC.24,1831,N.Y.
M.
BILHAH POLOCK(O.V.I)

ABRAHAM (ABRAM)
B.JUL. 31,1755
D.APR. 1,1834,N.Y.
M.OCT.19,1785,CH.
SHANKEY HART
(O.V.V)

JUDITH HADASSAH
B.JUL. 9,1759/O
D.DEC.25,1832,N.Y.
M.
MANUEL MYERS
(O.V.VIII)

SARAH
B.JUL.29,1786,CH.
D.DEC.18,1861,N.Y.
UNM.

SON
B.JAN.17,1788
D.JAN.22,1788

FRANCES
B.FEB. 2,1789
KINGSTON,JAMAICA
D.NOV.23,1874,N.Y.
UNM.

GEORGIANA (JUDITH)
B.MAR.27,1791,SAV.
D.JUL. 2,1859,N.Y.
UNM.

RACHEL
B.FEB.20,1793,SAV.
D.NOV.18,1870,N.Y.
M.NOV.13,1822,N.Y.
SAMUEL A.BARNETT
(O.V.)

MARIA (RITCHA)
B.APR.26,1795,SAV.
D.AUG. 4,1876,N.Y.
UNM.

PERLA
B.JUN.28,1798
WASHINGTON,GA.
D.JUL.10,1798

AUGUSTA
B.AUG.20,1799
AUGUSTA,GA.
D.AUG. 4,1800

RAPHAEL (RALPH ABRAHAM)
B.NOV.21,1801,SAV.
D.JAN.23,1802

ABIGAIL
B.
D.MAR.19,1847,MOBILE
M.FEB.11,1818,N.Y.
JACOB BENSADON

DR. JOSEPH (N.ORLEANS)
B.JAN.9,1819,N.Y.
D.DEC.2,1871,N.D.

JUDAH (CH.)
B.
D.JUL.16,1882,N.O.
M.MAY, 1841
LEAH HYAMS(O.V.II)

ISABELLA INF.
B.APR. 8,1842.
D.OCT.28,1843
WALTERSDROUGH,S.C.

RAPHAEL (RALPH)
B.JAN.23,1782
D.APR.23,1845
NEW ORLEANS

ISAAC
B. 1783
D.SEP.15,1784

FRANCES POLOCK
B.JUN.30,1784
NEWPORT,R.I.
D.JUL.22,1887,N.Y.
M.APR.15,1807
AARON JOSEPH(S)
(-LOUISVILLE,
AUG.1,1831)

BENJAMIN
B.MAY 26,1786

AARON R.

PAJMS V.27,P.150F.
ELZAS-JEWS OF S.C.
O.J.C.
M.N.
WILL OF JACOB JACOBS
(BLAU & BARON,P.104F.)
SHEARITH ISRAEL REC.

(CH.,SAV.)

JACOB JACOBS
B. 1742
D.NOV. 1,1797,CH.
M.NOV.21,1775
CATY HAYS(O.V.I)
WIDOW OF ABRAHAM SARZEDAS(O.V.)

DAVID JACOBS
B.
D.APR.24,1771,ST.EUSTATIA
M.DEC. 2,1761,N.Y.
RICHARD SIMSON
(O.V.)

JACOBS II

SARAH
B.SEP.21,1762,N.Y.
D.SEP.20,1763,N.Y.
INF.

JACOB
B.AUG.26,1764,N.Y.

SAMUEL
B.FEB. 8,1767,N.Y.
D.SEP.18,1810,CH.
M.APR. 1805,CH.
CATHERINE
(JAN.11,1788-JUL.11,1831
SHE M.2)
SOLOMON M.HYAMS
(O.V.II)

YITLAH
B.FEB.14,1769,N.Y.

RACHAEL (TO ENG.)

WILL OF BENJAMIN JACOBS (N.Y.ABSTRACTS)
KRAUS-SANDOR COLL.
POOL-PORTRAITS...
SHEARITH ISRAEL REC.
SAYYER-N.Y,WILLS
MD,WILLS
ROSENSWAIKE

GOMPERS ISRAEL

(JACOBS)

JACOBS III

HANNAH
B.SURINAM 1743
D.N.Y.AUG.20,1825

BENJAMIN
B.SURINAM, 1738
D.N.Y.DEC.15,1811

LEVI

SARAH
B.SURINAM
D.JUL.12,1849,N.Y.
M.
GOMPERS SALMONS GOMPERS
(SURINAM,1768/72-FEB.13,1831,N.Y.)
(NATURALIZED 9 SEP.1802)

DAU.
B.
D.
M.
EZEKIEL BARENT EZEKIEL
OF SURINAM

JACOB
B.
D.
M.
ISRAEL BENJAMIN
B.SURINAM 1781
(NATURALIZED 25 NOV.1803)

BENJAMIN, JR.

JULIA

BETSY (BATHSHEBA)
B. 1781
D.N.Y.MAR.1,1817

BENJAMIN

REBECCA
B.SURINAM
D.
M.JUL.4,1819
HOSES RUDEN
(O.V.)

DAVID I.

SAMUEL
B.
D.N.Y. 1814

HANNAH
B. 1790/2
D.N.Y.FEB.13,1826
UNM.

SOLOMON
B.APR.7,1797
D.MAR.2,1844
SURINAM
M.

(ADOPTED)

JACQUES RUDEN
(O.V.)

SARAH

GOMPERS S.

JACOBS IV

SHEARITH ISRAEL REC.
B'NAI JESHURUN REC.
N.Y.CENSUS, 1855

MYER SOLIS-COHEN
KRAUS-SANDOR COLL.
HART MS. (DAR)

ANGEL JACOBS
B. APR. 12, 1795, DARTMOUTH, ENG.
D. JUN. 13, 1850, N.Y.

RACHEL HART
(O.V. IV)

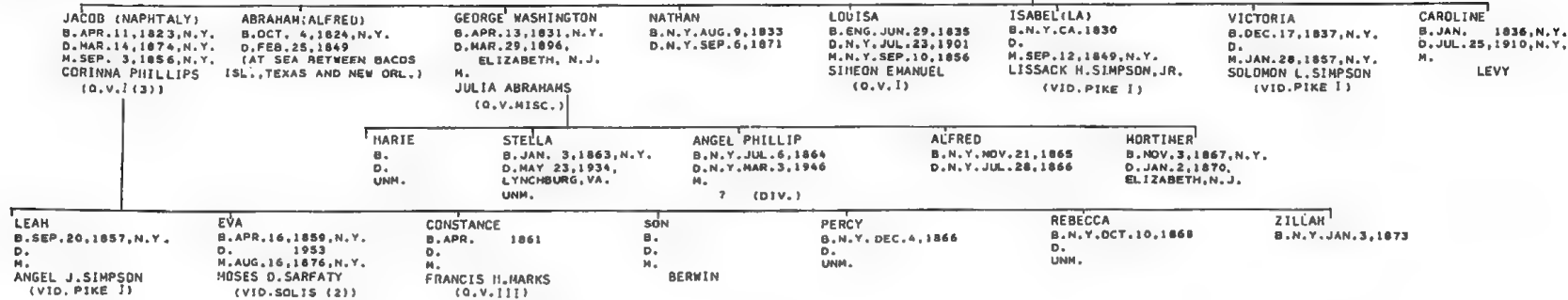

JACOBS V (1)

W.M.
U.S.CENSUS, 1790, 1850
AJHQ, LVII/24FF.
MRS. HUGH BRENEHAN
CARRINGTON WILLIAMS
MISCELLANIES VII, #546
#562
ROSENWAIKE

KRAUS-SANDOR COLL.
EZEKIEL-LICHTENSTEIN-JEWS OF RICH.
WILL OF SOLOMON JACOBS (JRM)
BARNET JACOBS MOHEL REC.
PAJHS V.16, P.74F.
VA. MARRIAGE BONDS
S.A. MOSS-MOSS-HARRIS GENEALOGY
SPRUCE ST. (PH.) CEMETERY REC.
HENRY V. HOAGLAND
MISCELLANIES VII, #546

CLARA C. PA. 1761

1) BERNARD (BARENT, BEAR) JACOBS 2)

CA. 1770, PA.

2) JUDICA 1)

3) ISAAC LEVY

(ARR. PH. FROM ROTTERDAM OCT. 7, 1755;
NAT. IN PA. APR. 3, 1763)
B. HOLLAND CA. 1735
D. PA. 1766

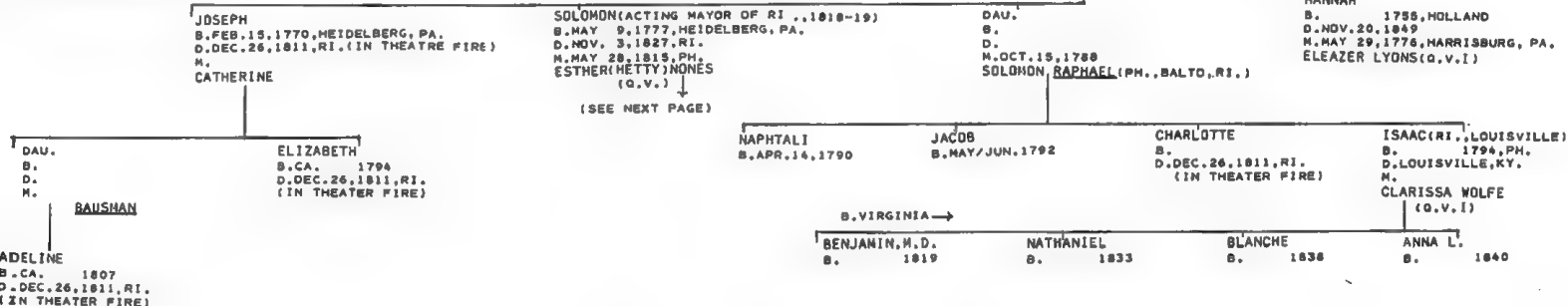

JACOBS VI

ELZAS MS.
M.N.
NEW JEW. CEM. OF BETH ELOHIM
O.J.C.
FLO. ABR.
LAZARUS GEN. (T. TOBIAS)
KRAUS-SANDOR COLL.

FEB. 17, 1817, CH.
COL. MYER JACOBS
B. JAN. 11, 1791, ENG.
D. NOV. 20, 1861, CH.
REBECCA LAZARUS
(O.V. II)

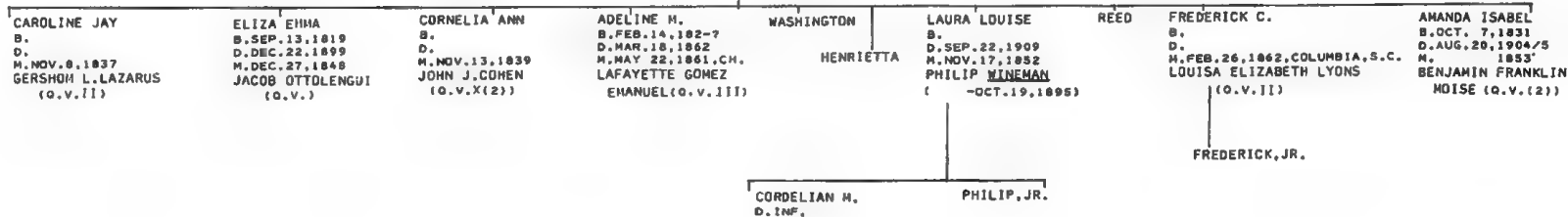

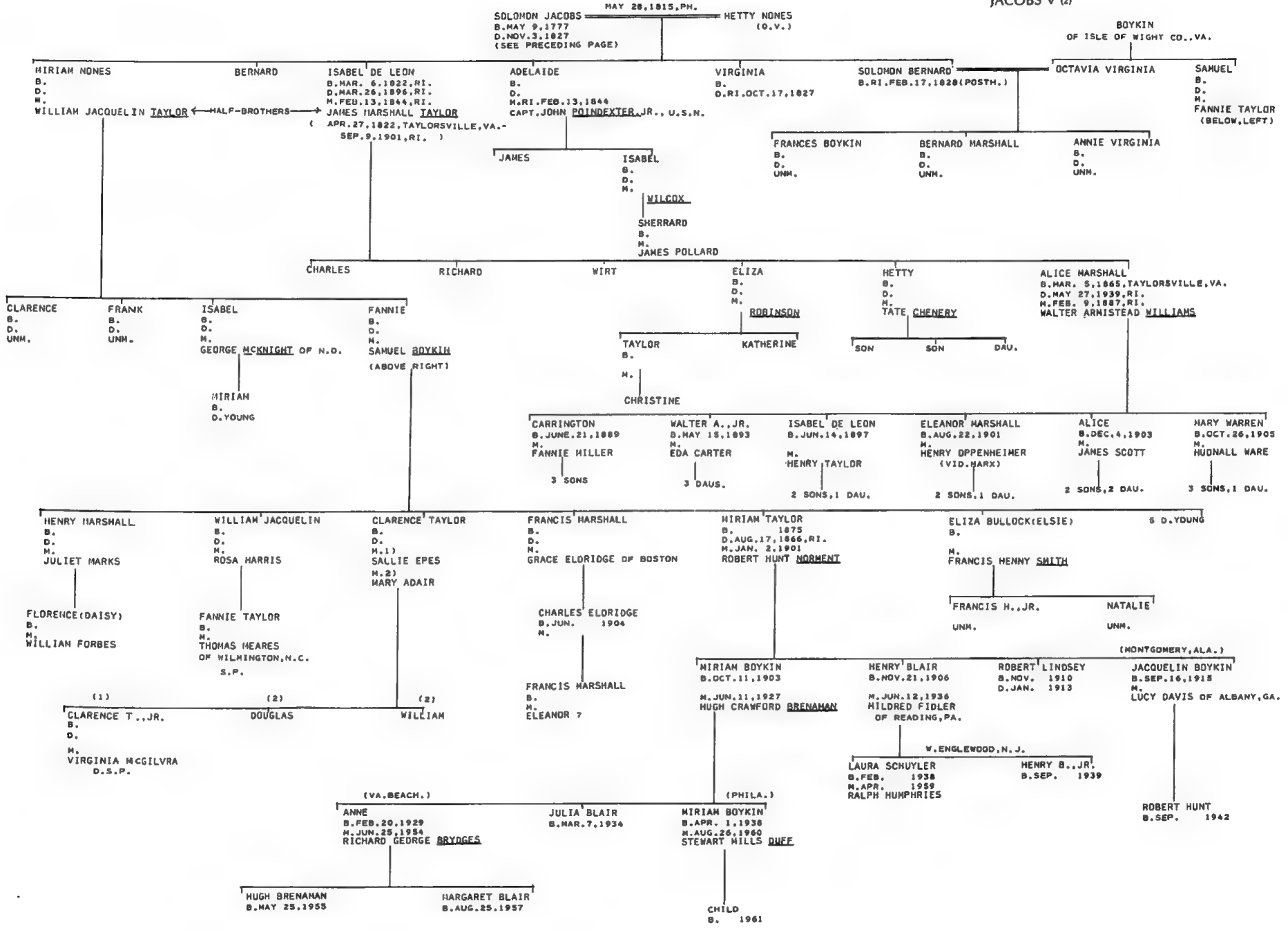

JACOBS VII

LEVY GEN.
JE VII, P. 45
AMY STEWART MSS. (A.J.A)
BETH SHALOME HARR. REC.
FLD. ABR.
ELZAS-NEW JEW. CEM. OF BETH ELOHIM
B'NAI JESHURUN REC.
ELIZABETH WEIL JACOBS

EZEKIEL-LICHTENSTEIN-JEWS OF RI.
ANDRADE-JEWS OF JAMAICA
RALPH F. COLTON

(JAMAICA) XENY JACOBS

B.
D.
M.
RACHEL MESQUITA

JACOB GARCIA (DE PAZ)

B.
D.
M.
ESTHER BRANDON

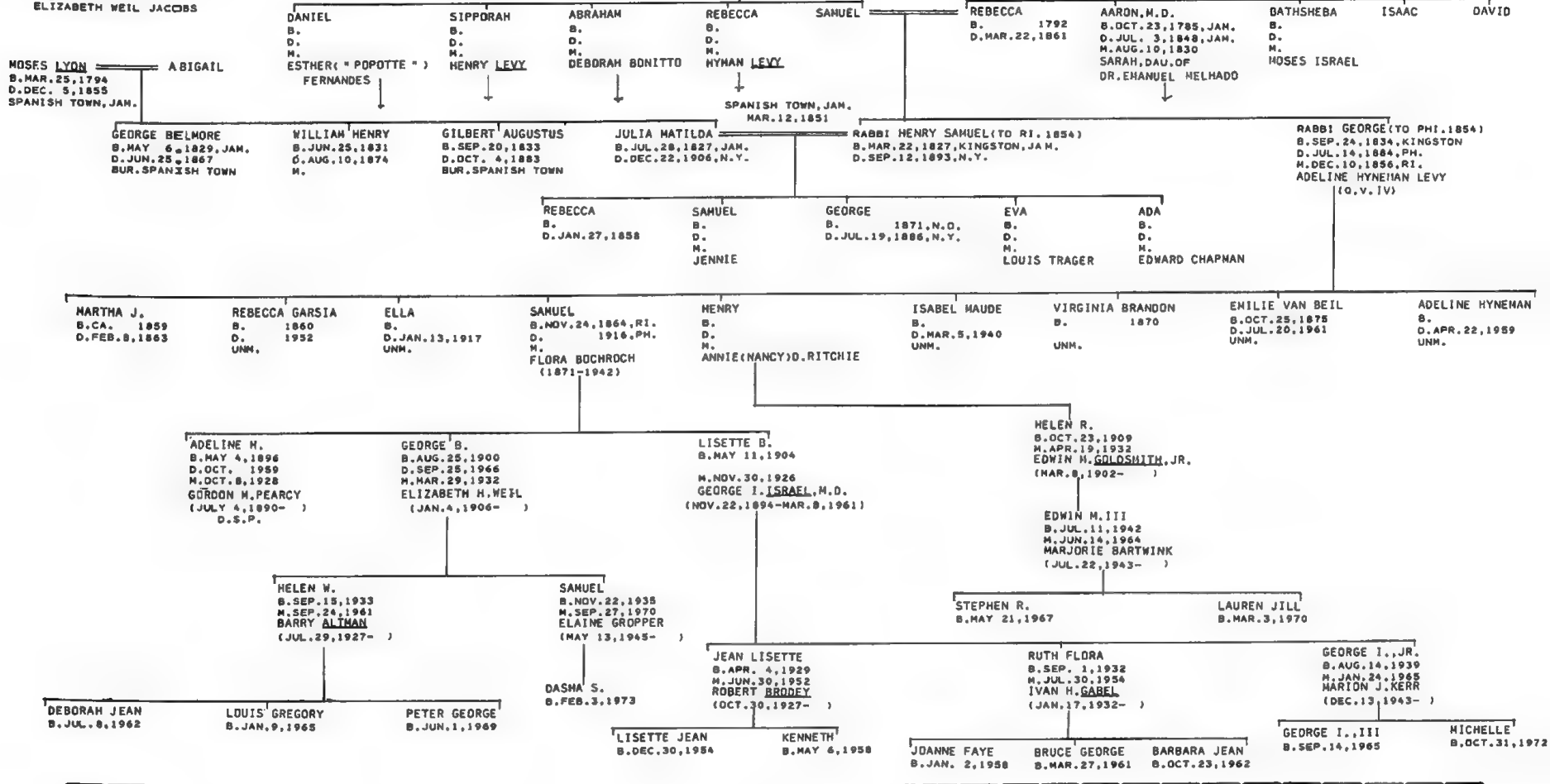

JACOBS VIII
KRAUS-SANDOR COLL.

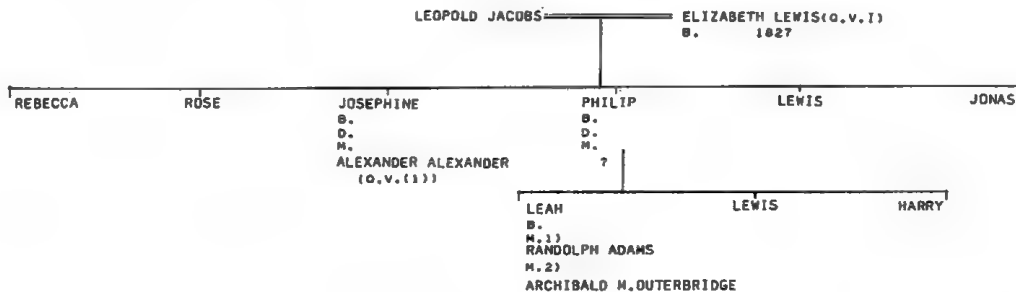

(MEMACHEH)MANIS JACOBS (IN N.O. BEFORE 1812)
S. AMST. CA. 1782
D. N. O. SEP. 24, 1839
M. 1)
M. 2) N.O. 1826
ANGELIQUE CHARLOTTE JACINTHE, WIDOW OF DENIS VERNEUILLE
(PARIS, FR. 1781/82-AUG. 4, 1851, N.O.)

THOMAS JACOBS OF ST. DENIS, QUE. B. D. M. FEB. 26, 1781, QUEBEC ANGELIQUE MASSE
SAMUEL OF ST. DENIS B. D. 1786
MARIE JOSETTE AUDET LAPOINT (2) DR. JEAN BAPTISTE PIEUTORD (2) PELAGIE PERRON (1) 1758 B.C.A. 1739
B.C.A. 1731 D.MAR. 1818
SAMUEL, JR. B. D. 1764 1824
MARIE GENEVIEVE (POLLY) B. D. M. CAPT. STANISLAUS VIGNEAU
MARIANNE (MARIE ANNE)
JAMES LEVY
JEAN BAPTISTE B. AFTER 1775

(1) IRMA B.C.A. 1816 D. M. BERNARD HART (O.V. III)
(2) THERESE
(2) FELIX

MOSES JACOBS B. 1749 D. JAN. 13, 1802, BALTO.
ESTHER

JACOB RACHEL JOHN SARAH MICHAEL B. 1792 D. SEP. 22, 1804, BALTO. BENJAMIN CHARLOTTE JULIET

PAJMS V. 2 V. 8, P. 46F. JE. VII, P. 222F. UJE. VOL. 6, P. 169F. AMER. ISRAELITE, FEB. 21, 1957, P. 6. ELIZ. PLAUT JOHNSON GEN.

PHINEAS ISRAEL JOHNSON (PORTSMOUTH, ENG. TO CONNELLSVILLE, IND., 1817)

DAVID ISRAEL (CONNELLSVILLE, IND., 1818 CINCINNATI, O. 1820) B. CA. 1795 D. JUN. 15, 1842 M. MAY 16, 1816, ENG. ELIZA DAVIS

(OHIO ASSEMBLYMAN)

(SONGWRITER)

EDWARD ISRAEL B. PORTSMOUTH, ENG. FEB. 14, 1817 D. GOLIAD, TEX. MAR. 27, 1836 UNM.
HENRY DAVID (MEX. WAR) B. CONNELLSVILLE, IND. FEB. 21, 1819 D. CAL. UNM.
FLEURETTE M. NOV. 1867 MORRIS POWERS
ELI ZA D. M. 1) ISAAC SIMON (-1881) M. 2) 1882 GEORGE LOUIS
EDWARD I. ELEANOR MOSES
SELINA DOUGLAS
SIMEON MOSES B. 1859, CINTI. D. M. DEC. 7, 1893 GERTRUDE (GETTIE) COHEN (VID. WORKUM I)
FREDERICK AUGUSTUS, JR. BELLE LEVY
SAMUEL J. LOUISA DAVIS
DAVID I. ESTHER ROSENHAUS ? D.S.P.
JAMES W. B. APR. 23, 1830, CINTI. D. OCT. 1889, CINTI. M. KATE V. NELSON D.S.P.
EDGAR M. B. NOV. 5, 1836, CINTI. D. DEC. 8, 1893, C. M. LAURA LOUIS
ELIZA ROSENSTEEL DAVID FANNY STURM ? SAMUEL J. ROSENFELD
LOUIS DOROTHY HELLER LOUISE EMILY
MARY LOUISE LOUIS KAUFMAN
LOUISE EMILY JOHN MACK SAMUEL J. SEINSHEIMER
DAVID LOUISE EMILY
SON DAU.
FRED L. EDGAR M.
MAY CUNNINGHAM CECILIA POLLOCK
EDGAR M. MARGARET ? D.S.P. EDGAR N. LAWRENCE

JOACHIMMSEN
KRAUS-SANDOR COLL.,
SHEARITH ISRAEL REC.,
UJE IV.P.279
U.S.CENSUS 1850
B'NAI JESHURUN REC.

JOACHIMMSEN OF Breslau

RACHEL

B.
D. Breslau, DEC. 9, 1832

PHILIP GOLDSMID

BETSY

B. 1759
D. N.Y. OCT. 7, 1848

(TO U.S. 1849) RABBI ISAAC FERNBACH
OF LOEWENBERG, PRUSSIA
B.
D. BEF. 1874

TERNINA PINSK
B. AUG. 2, 1794, Breslau
D. MAY 12, 1874, N.Y.

LOUIS
B. APR. 24, 1791, Breslau
D. MAY 26, 1870, N.Y.
(CAME TO N.Y. NOV. 4, 1831)

JOHANNA
B. NOV. 30, 1798, GER.
D. FEB. 10, 1859, N.Y.

PHILIP JOSEPH
B. NOV. 19, 1816, Breslau
D. JAN. 6, 1890, N.Y.
M. AUG. 31, 1842, N.Y.
PRISCILLA GODFREY
(ENG. SEP. 18, 1824 - N.Y. JUL. 24, 1893)

SARAH
B.
D. SEP. 28, 1855,
HOUSTON, TEXAS
M. APR. 15, 1839, N.Y.
ABRAHAM G. LEVY, JR.

BERTHA
B. GER. JUN. 22, 1821
D. N.Y. FEB. 25, 1880
M. N.Y. OCT. 18, 1843
MORRIS MICHAELIS, M.D.
(DETMOLO, OCT. 18, 1811 - N.Y.
JUN. 23, 1893)

ADELAIDE
B. GER. JUL. 7, 1827
D. N.Y. DEC. 12, 1911
M. N.Y. JAN. 24, 1847
JACOB LITHAUER

B. HARTFORD, CONN.

ISAAC
B. SEP. 24, 1848

JOHANNA
B. MAR. 11, 1850

SARA
B.
D.

M. 12 JAN. 1876
SIMON N. SONNHEIM
(O.V.)

ALL BECAME JOACHIMMSEN

BERTHA JOACHIMMSEN
B. N.Y. SEP. 14, 1849
D.
M. N.Y. MAY 9, 1871
MORRIS GOODHART
(AMST. AUG. 6, 1838 -)

LEWIS L.
B. N.Y. JAN. 7, 1840
D. N.Y. MAY 30, 1845

RACHEL
B. MAY 29, 1841, N.Y.
D. OCT. 18, 1842

HENRY
B. N.Y. AUG. 12, 1844
SDN
B. NOV. 1842

LUISA
B. N.Y. FEB. 19, 1846
D. N.Y. OCT. 21, 1919
M. JUN. 15, 1864, N.Y.
BARRY DAVIES
(O.V.)

JOSEPH J.
B. AUG. 18, 1847,
PORTCHESTER, N.Y.
D.
M. FEB. 24, 1875, N.Y.
SARAH MYERS

HANNAH
B. 1845

LAWRENCE GEORGE
B. N.Y. APR. 15, 1872

MORRIS, JR.
B. JAN. 25, 1874

WM. ALFRED
B. N.Y. MAR. 16, 1875

AUGUSTUS CHARLES
B. N.Y. APR. 23, 1876
D. INF.

PRISCILLA ESTELLE
B. 1878

N.Y. OCT. 18, 1866

HENRY (ARCHITECT)
B. APR. 17, 1830,
LOEWENBERG
D. 1893, N.Y.

HENRIETTA JULIA
B. N.Y. JAN. 25, 1845
D.

JOANNA
B. N.Y. OCT. 11, 1846
D. N.Y. SEP. 6, 1912
M. N.Y. APR. 2, 1873
JACOB S. RITTERBAND
(O.V.)

SARA ELIZABETH
B. N.Y. OCT. 2, 1848
D. N.Y. JAN. 6, 1929
M. N.Y. SEP. 6, 1876
JULIUS MICHAELIS
(DETMOLO, WESTPHALIA,
MAR. 3, 1841 - N.Y. FEB. 6, 1912)

ADELE
B. N.Y. JUL. 22, 1850

BRENLAH
B. N.Y. JUL. 2, 1852

PHILIP
B. 1857
D. N.Y. NOV. 24, 1860

ISABELLA
B. N.Y. 1858
D. N.Y. AUG. 22, 1911
UNM.

ELIEZER (LUDWIG)
B. N.Y. AUG. 17, 1863

REBECCA ALICE
B. N.Y. JUN. 29, 1877

JONAS

CINTI.-UNITED JEW. GEN. REC.
JRM COLL.,
FLD. ABR.,
ROTH-RISE OF PROVINCIAL JEWRY
KORN-JEWS OF N.O.
MRS. RICHARD H. GRANT
KRAUS-SANDOR COLL.,
PAJMS V. 8, P. 44F.
V. 17, P. 123F.

BENJAMIN JONAS OF EXETER, ENG.
D. MAY 14, 1846

ANNIE EZEKIEL
B. EXETER 1772
D. CINTI. FEB. 26, 1851

ABRAHAM

EZEKIEL B. ABRAHAM
OR
ABRAHAM EZEKIEL
B. 1729?
D. NOV. 20, 1799, PORTSMOUTH, ENG.

SARAH
B. 1736
D. 1806

JOSEPH, (OF CINCINNATI)
(CAME TO U.S., 1816)
B. EXETER, 1792
D. MOBILE, MAY 5, 1869
M. 1) PH. DEC. 10, 1823
RACHEL SEIXAS (O.V. (2))
M. 2) LOND. OCT. 17, 1838
HARTHA OPPENHEIM
(1800- 1867)

SARAH
B. CA. 1795
D. CINTI. NOV. 5, 1846
M.
MORRIS MOSES
(O.V. III (1))

ABRAHAM
B. EXETER, 1801
D. QUINCY, ILL. JUN. 1864
M. 1)
LUCY ORAH SEIXAS (O.V. (2))
M. 2) OCT. 11, 1829
LOUISA BLOCK (O.V.)

SAMUEL
B. 1801
D. 1838
M. 1)
JOSEPHINE BLOCK
(O.V.)

BENJAMIN
?

EZEKIEL ABRAHAM
B. 1757
D. 1806
M.
REBECCA

14 OTHERS EDWARD HARRIET BARUH
B. TEIGNMOUTH, DEVON, JAN. 18, 1798
D. N. D. JAN. 4, 1822
M. N. D. NOV. 20, 1820
TERESA BARBARIN

(1) SON
B. FEB. 1825
D. INF.

(2) CHARLES HENRY
B. 1832
D.
SARAH BLOCK
(O.V.)

(2) LUCIA
B. 1830
D. CA. 1901/2
M.
AUGUSTUS BLOCK
(O.V.)

(2) SAMUEL ALROY
(ED. ABERDEEN, MISS.
"EXAMINER")
B. 1838
M.

(2) BENJAMIN FRANKLIN
B. JUL. 19, 1834
D.
M.
JOSEPHINE BLOCK
(O.V.)

(2) JULIAN
(YAZOO, MISS.)
B. 1836
D.
M.
UNM.

(2) ANNE ELIZABETH
B. 1842
D.
M.
REV. T. B. WELLS

(2) ROSALIE
B. 1848
D.
M.
ADLPH MEYER
(LA. CONGRESSMAN)

(2) GEORGE
B. 1840
D.
M.
EDWARD

(2) EDWARD
(CIV. WAR, COL. USA)
B. 1844

BENJAMIN FRANKLIN EDWIN

LOUISE
B. 1858
D. 1867
M.
OSCAR NIXON, JR.

JOSEPH B.
B. 1858
D. 1867
M.

CHARLES HENRY, JR.
B.
D.
M.
ALINE GIBBS

ISABELLE
B.
D.
M. 1)
EUGENIO RUIZ
M. 2)
FRANK BETHUNE

(1) B. D. YOUNG

(1) B. D. INF.

(2) ANNIE
B. SEP. 4, 1839
D.
M.
ABRAHAM MOSES
(O.V. III (1) (6) (3))

(2) ROSETTA
B. NOV. 8, 1841
D. JAN. 1, 1917
M. APR. 15, 1863
MONTEFIORE J. MOSES
(O.V. III (2))

(2) MICHAEL BENJAMIN
B. NOV. 18, 1843
D. UNM.

(2) SARAH
B. FEB. 14, 1846
D.
M.
HERMAN D. OPPENHEIM
(O.V. (1))

KRAUS-SANDOR COLL.
MORAIS-JEWS OF PH., P. 331F.
ROSENTHAL MS.
MARKS FAMILY REC. (AJA)
MICKVE ISRAEL REC.

JONES I

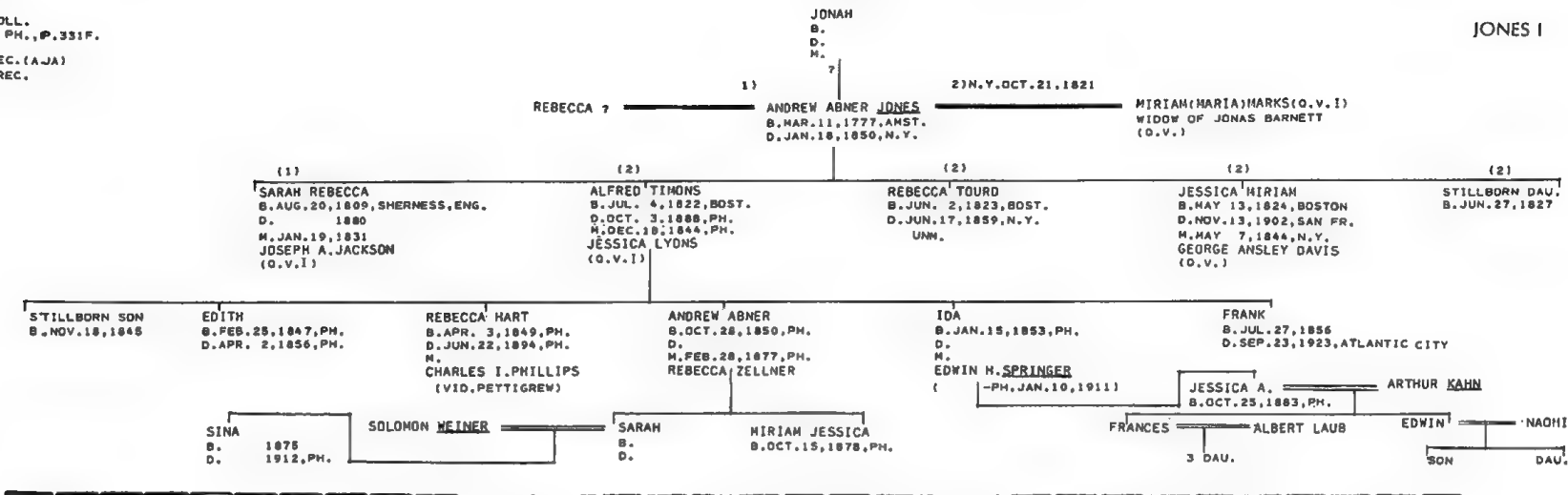

KORN-JEWS OF MOBILE
WILL OF SAMUEL JONES
ELZAS-G.J.C.

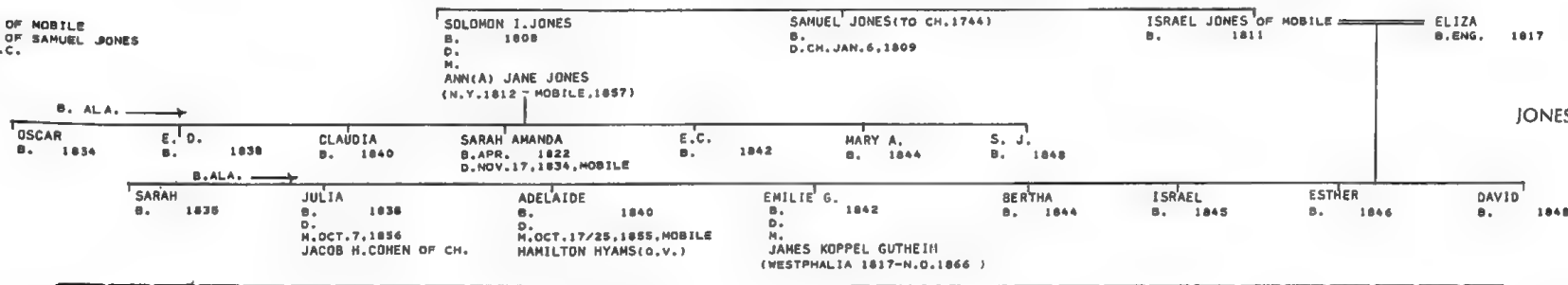

JONES II

KRAUS-SANDOR COLL.
EZEKIEL-LICHTENSTEIN-JEWS OF RICHM.
LETTERS OF RUPERT L. JOSEPH
R. J. D'ARCY HART
SHEARITH ISRAEL REC.
ROSENWAIKE

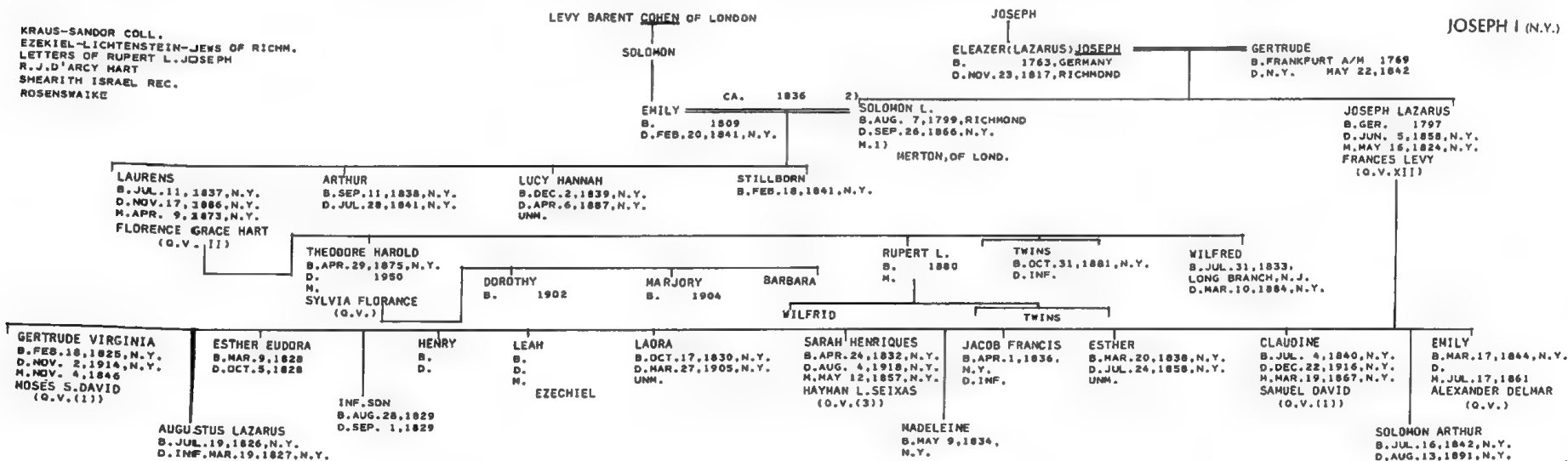

JOSEPH II (CANADA)
 J.R.M.
 MRS. E. MILLER
 PAJMS V.1, P. 117F.
 UJE V.6, P. 194
 KRAUS-SANDOR COLL.
 GRATZ CLIPPING (DAR)
 MALCHELOSSE-LES JUIFS CANADIENNE ...
 SHEARITH ISRAEL REC.
 FLORENCE ABRAHAMS

NAPHTALI JOSEPH HART
 B. AMSTERDAM (O.V. I)

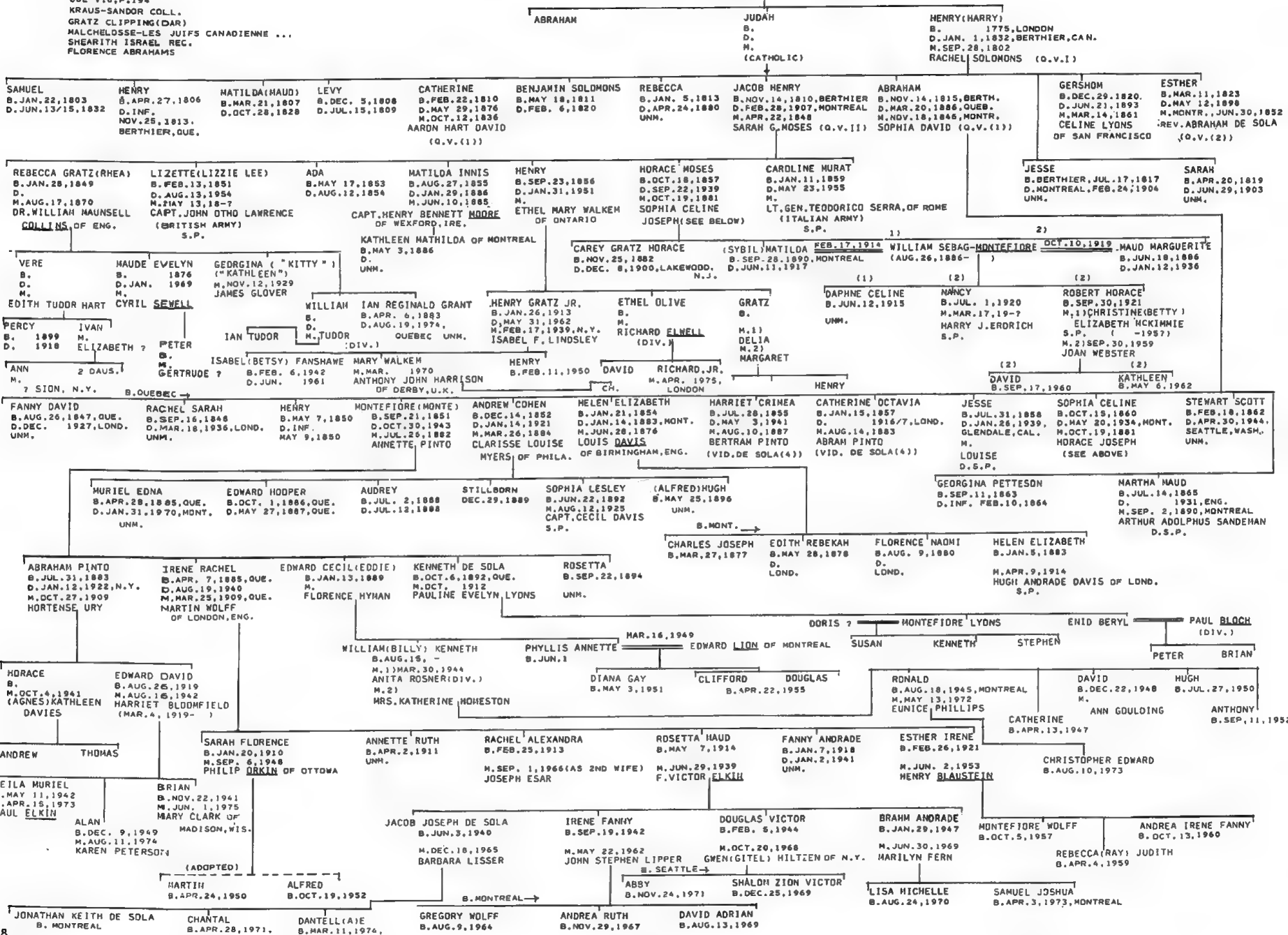

ELZAS MS.
M.N.
NEW JEW. CEMETERY
AT GEORGETOWN, S.C.
D.J.C.
M.A. ALEXANDER-ALEXANDER FAMILY
FLO. ABR.
NATCHEZ CEMETERY (JULIEN SAKS)

JOSEPH STEGG
LIZER JOSEPH
B. MANNHEIM, GER. 1762
D. GEORGETOWN, S.C. JUN. 25, 1827

JACOB JUDAH
(VID. AARONS)
SARAH
B. 1776
D. GEO'TN. OCT. 8, 1820

JOSEPH III

ELEANOR
B. NOV. 9, 1794, BLACK MINGO, S.C.
D. FEB. 6, 1856, SAV.
M. MAY 5, 1814
ISRAEL SOLOMONS
(O.V. IV (1) & (2))

MOLCIE (MOLSEY)
B. D. AUG. 16, 1835, CH.
M. JAN. 11, 1819
SAMPSON SOLOMONS
(O.V. IV (1))

JACOB JUDAH
B. D. SARAH EHAUEL
(O.V. III)

JOSEPH
B. D. M. MAR. 1822
FRANCES ALEXANDER
(O.V. I)

SARAH
B. D. UNM.

CHARLOTTE
B. D. UNM.

ISABELLE
B. D. M. LEVY L. JOSEPH

CLARA
B. D. UNM.

ELIZABETH
B. D. M. JAN. 3, 1844
ALEXANDER ABRAMS
(VID. ABRAHAMS III)

LIZAR H.
B. D. M. JAN. 13, 1853
HENRIETTA ABRAMS
(VID. ABRAHAMS III)

FRANCES
B. D. M. JUL. 30, 1851
MOSES JOSEPH SOLOMONS
(O.V. IV (2))

SARAH
B. D. 1823
D. DEC. 2, 1824
GEO'TN

EMILY
B. D. M. MAR. 15, 1842

ANNABEL (ISOBEL)
B. D. N.

NATHANS

JACOB JUDAH (CSA)
B. GEO'TN
D. APR. 7, 1862
(2D BATTLE OF SHILOH)

MOLCIE
B. MAY 5, 1841, CH.
D. NOV. 26, 1910,
BOSTON, MASS.
(BUR. NATCHEZ)

JOSEPHINE
B. AUG. 22, 1836, CH.
D. NOV. 12, 1906.

HENRIETTA
B. D. M.

JAMES NATHANS

SALLIE
B. MAY 1, 1874
D. JAN. 13, 1881

HILDA
B. AUG. 26, 1876
D. DEC. 30, 1880

ISAAC LOMENBERG
N. JUN. 3, 1873
(HECHINGEN, HDENZOLLERN,
MAR. 7, 1837-SEP. 7, 1888)

EVERY J.

JEFFERSON

ELZAS MS.
M.N.
O.J.C.

JOSEPH, OF MANNHEIM, GERMANY

JOSEPH IV

WILL OF MANUEL JOSEPHSON

JOSEPH

JOSEPHSON

ISRAEL JOSEPH
B. MANNHEIM 1733
D. CH. JUN. 9, 1804
M.
HENRIETTA ABRAMS
MIRIAM (LEVY (VID. HART VI (1)))

MIRIAM (MARY)
B. 1791
D. APR. 15, 1863, SUMTER
M. FEB. 1809
LEVY MOSES (O.V. III (1))

JUDAH (LONDON)
B. D. M.

JOSEPH

HOSES (MANNHEIM)
B. D. M.

SOLOMON

KATEY
B. D. M.

SOLOMON HOSES
GUNDERSHEIN

SERKA
B. D. M.

DANIEL
B. D. M.

HART, OF MANNHEIM
(O.V. VI (1))

MANUEL JOSEPHSON
B. 1729, GER.
D. JAN. 30, 1796, PH.
M. 1759
RACHEL (RITZEL) JUDAH
D. S.P. (O.V. I)

AARON
B. D. M.

HORDECAI
B. D. M.

4 SISTERS

(IN N.Y., 1700 IN BROOKHAVEN, CONN., 1708
MADE FREEMAN IN N.Y. JAN. 10, 1715/6)

JUDAH LEIB, OF Breslau

JUDAH I (1)

DAR LINEAGE BK. XCVI, P. 254
FLORENCE ABRAHMS
SHEARITH ISRAEL REC.
MYER SOLIS-COHEN
PAJMS V. 11, P. 184
PAJMS V. 21, P. 6
PAJMS V. 27, P. 286
J.E. V. 7, P. 331
U. J. E. V. 6, P. 231
KRAUS-SANDOR COLL.
SOLOMONS MS. (JRM)
POLY-PORTRAITS...
WILL OF SAMUEL B. H. JUDAH
WILL OF BELLA JUDAH
WILL OF ISAAC JUDAH
ROSENWAIKE
U.S. CENSUS, 1790, 1820
HORDECAI FAMILY BIBLE

BARUCH JUDAH
B. Breslau, 1678/9
D. N.Y. JAN. 12, 1774
M. 1
RACHEL JOCHANAN, OF Breslau
M. 2
SARAH HELBERT, OF LONDON
(ENG. - N.Y. FEB. 24, 1749)
(O.V.)

JACOB
B. D. JUN. 20, 1783

REBECCA
B. 1727/5
D. PH. MAR. 24, 1817

ISAAC HAYS
(O.V. (1) & (4))

SAMUEL
B. AUG. 19, 1728, N.Y.
D. OCT. 19, 1781, PH.

JESSIE JONAS
(LOND. 1736/8-N.Y.
MAY 8, 1818)

HILLE (HILLIARD)
(FREEMAN IN N.Y.
JAN. 8, 1784)

BILAH
(SEE NEXT PAGE)

RACHEL (RITZEL)
B. 1732
D. PH. JAN. 17, 1797

MANUEL JOSEPHSON
M. JUN. 1789.
D. S.P. (O.V.)

HOSES
B. 1735
D. N.Y. SEP. 28, 1822
UNM.
(FREEMAN, N.Y. AUG. 3, 1788)

URIAH JUDAH
B. D. M.

ABRAHAM
B. 1715
D. N.Y. SEP. 2, 1784
M.

DAVID (ENTERED UNIV. OF PA., 1760)

BENJAMIN S.
B. OCT. 6, 1760

AMELIA
B. SEP. 12, 1761
D. APR. 22, 1849
UNM.

SARAH
B. DEC. 14, 1763, N.Y.
D. OCT. 12, 1795,
PATERSON, N.J.
M. OCT. 22, 1794
SAMUEL MYERS (O.V. I)

CARY JEKUTHIEL
B. SEP. 14, 1766, N.Y.
D. FEB. 7, 1837, N.Y.
UNM.

JACOB SAMUEL
B. OCT. 7, 1767, N.Y.
D. JUN. 20, 1783, PH.
UNM.

RACHEL
B. MAY 11, 1772
D. FEB. 6/8, 1836
UNM.

NAPHTALI HART
B. JUN. 1/6, 1774
D. SEP. 16, 1855, N.Y.
M. NOV. 11, 1801
ESTHER (HETTY) HENDRICKS
(O.V. (1))

AARON
B. JUN. 20, 1778, N.Y.
D. JUN. 28, 1834
M. FEB. 3, 1819
RACHEL R. GOMEZ
(O.V.)

WALTER JONAS (FALK)
B. APR. 4, 1778, N.Y.
D. SEP. 15, 1798, N.Y.
UNM.

SARAH
B. OCT. 6, 1762
D. INF.

REBECCA
B. JUL. 12, 1765
D. DEC. 19, 1846, N.Y.
UNM.

RACHEL
B. SEP. 1768
D. APR. 29, 1770

BELLA
B. SEP. 29, 1770
D. JAN. 16, 1847, N.Y.
UNM.

FANNY (FRUMET)
B. MAY 6, 1771
D. FEB. 14, 1833
UNM.

DE WITT CLINTON
B. D. M.

RICHEA
D. INF.

RICHEA ANN
B. 1814
D. JUN. 1, 1857, N.Y.
M. NOV. 1, 1843
THEODORE J. SEIXAS (O.V. (2))

SAMUEL N.
B. OCT. 8, 1803
D. MAR. 2, 1849
M. JAN. 10, 1844
MIRIAM HATHAN
(O.V. I (1))

HENRIETTA
B. D. S. BEND, IND.
UNM.

AMELIA (EMILY)
B. JUN. 30, 1806, N.Y.
D. JUN. 13, 1877, N.Y.
M. SEP. 15, 1824
ROWLAND CROWLINE
(O.V.)

ADELINE
B. 1809
D. FEB. 17, 1851

URIAH HENDRICKS
B. JUN. 20, 1810
D. M. 1) JUL. 27, 1836
GERTRUDE SIMONSON
(A CONVERT)
(1812-MAY 9, 1842)

HORATIO
B. JUN. 13, 1837, N.Y.

ANNA
B. 1839
D. M. 1868 (AS HIS 2ND WIFE)
WASHINGTON SHARRETT
(1831- 1911)

SAMUEL B. HELBERT
B. FEB. 14, 1804, N.Y.
D. JUL. 21, 1876, N.Y.
M.

HENRIETTA
B. MAY 4, 1806
D. OCT. 1, 1868, N.Y.
UNM.

AMELIA
B. APR. 5, 1808
D. NOV. 11, 1863
UNM.

HARIA
B. AUG. 7, 1810
D. MAY 9, 1899
STEPHEN C. RICHARD

CELESTINE
B. JUN. 25, 1813
D. NOV. 19, 1898
M. JUN. 6, 1838
JOHN MYER GOLDSCHMIDT
(O.V.)

JOHN JACOB
B. APR. 17, 1816
D. DEC. 2, 1829
UNM.

CARY JEKUTHIEL
B. MAY 17, 1819
D. JAN. 5, 1850
UNM.

JESSY (SIHWA)
B. FEB. 17, 1822
D. NOV. 17, 1913
M. 1) OCT. 30, 1844
M. 2) NOV. 2, 1853, N.Y.
THEODORE HERTZ
(O.V. III)

WALTER HENRY
B. MAR. 30, 1825
D. FEB. 14, 1852, N.Y.
UNM.

EHANUEL
B. D. AT SEA, 1839

PHILIPPINE EUDORA
B. 1832
D. 1899
M. JUN. 9, 1852
FREDERICK W. VON STADE
OF ALTONA, GER.

FREDERICK, JR.
B. 1855
D. 1934

GEORGE
B. APR. 25, 1828, N.Y.
D. MAY 16, 1854, N.Y.
UNM.

GERTRUDE
B. ELIZABETH, N.J.
D. M.
ANDREW HAGAMAN

JUDAH I (2)

HILLEL (HILLIARD) JUDAH (SEE PRECEDING PAGE) NEW EBERDAIN JUN. 1759 ABIGAIL SEIXAS (O.V. (1))

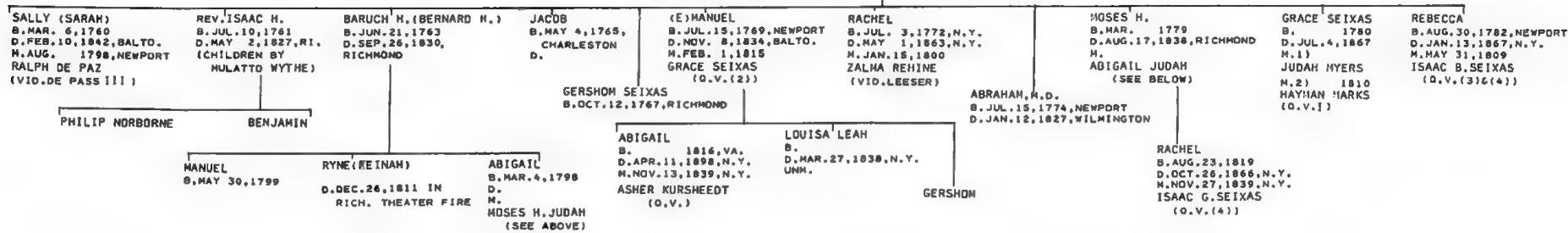

JOHN DICKSON NEEL
GA. NEWSPAPER
JUDAH GEN.
PAJMS V. 27, P. 151
Y. 21, P. 150
WILL OF MOSES JUDAH
WILL OF MICHAEL JUDAH
BARBER-N.Y. MARRIAGES
KORN-THE JEWS OF MOBILE

JUDAH II (1) (CHRISTIAN)

REV. MICHAEL JUDAH (OF NORWALK, CONN.) B. D. N.Y. 1786

MARTHA RAYMOND B. JAN. 5, 1734/5

DAVID (OF WESTPORT, CONN.) CHARITY BENNETT
B. D. 183 J M. 1) CA. 1780 ESTHER TAYLOR

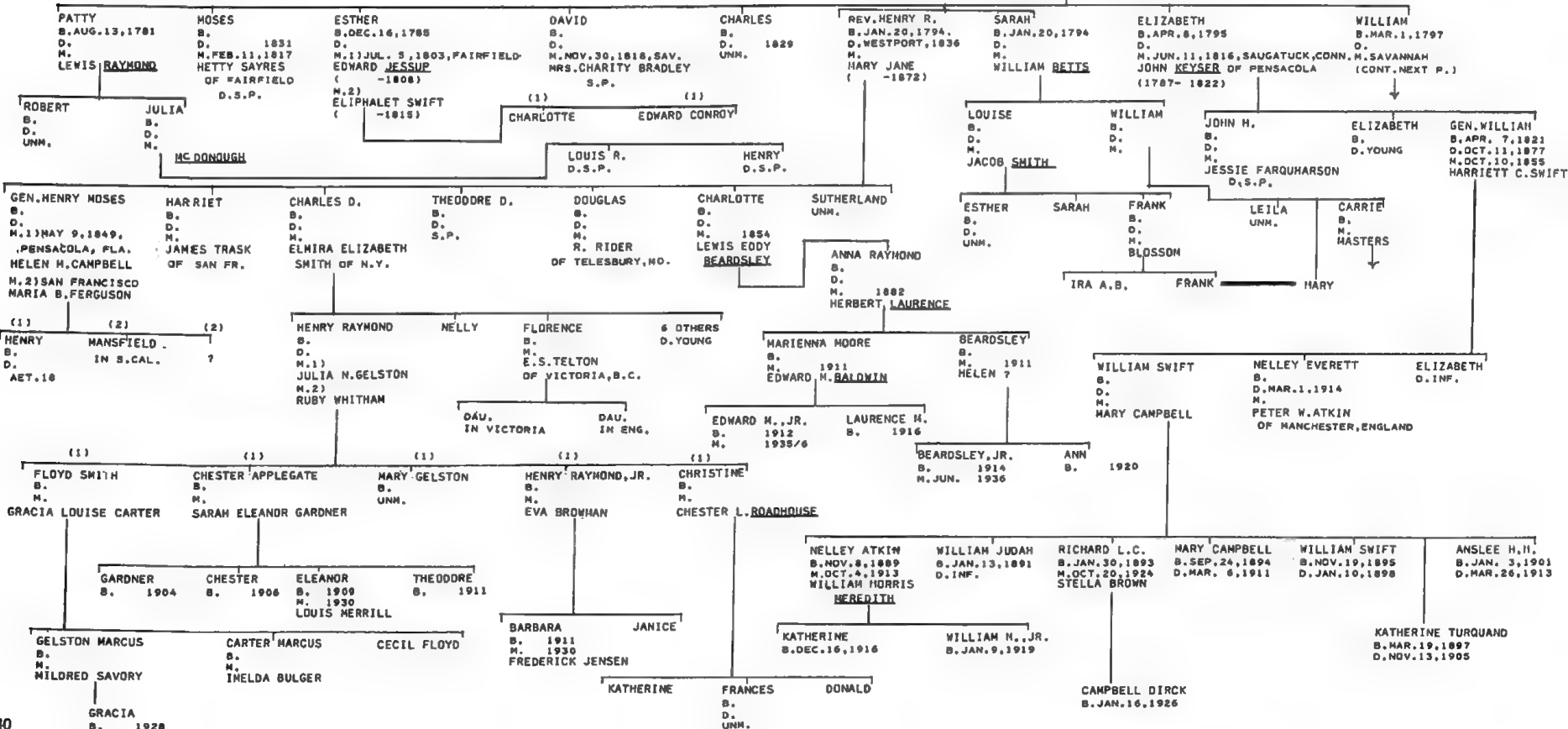

WILLIAM JUDAH ?
 B. MAR. 1, 1797
 D.
 L. IN SAVANNAH
 (SEE PRECEDING P.)

WILLIAM HENRY
 B. SEP. 9, 1829
 D. NOV. 9, 1880
 M. JUN. 12, 1854, WARRINGTON, FLA.
 ELODIE CAMPBELL OF PENSACOLA
 (DEC. 2, 1831-)

FRANCIS
 B.
 D.
 UNM.

FANNY
 B.
 D.
 M.
 CLARENCE KNOWLES

DUNLOP
 B.
 D.
 UNM.

CONSTANCE
 B.
 M.
 JESSE DRAPER OF ATLANTA
 S.P.

CLARENCE, JR.
 B.
 M.
 MARY HELEN WOODY OF ATLANTA

CONSTANCE
 MARIAN

URIAH

(IN MONTREAL 1780) JUDAH ABRAHAM OR ABRAHAM JUDAH OF Breslau MFR. OF PAINTER'S MATERIALS
 DAU. (EZEKIEL) HART (O.V.I)

JUDAH III (1)
 (N.Y., MONTREAL, INDIANA)

E.L. JUDAH GEN. (AJA)
 EVELYN MILLER
 J.E. V. 7, P. 331
 U.J.E. V. 6, P. 231
 KRAUS-SANDOR COLL.
 SOLOMONS MS.
 SHEARITH ISRAEL REC.
 HART FAMILY REC. (MS. AJA)
 MCCORKLE FAMILY REC. (DAR)
 U.S. CENSUS, 1790
 KATZ-BETH EL STORY
 MISC. VII
 J.R. COHEN REC.

(NATURALIZED N.Y.
 JUNE 18, 1799, DRUGGIST)

B. NEW BRUNSWICK, N.J.

ISAAC (SEE NEXT PAGE) URIAH B. 1714 D. SEP. 2, 1782 (SEE NEXT PAGE) SAMUEL (FREEMAN "MERCH" N.Y. FEB. 9, 1769) B. 1725 D. N.Y. 1789 M. LOND. CA. 1776/1775 ELIZABETH EZEKIEL (1755- FEB. 7, 1838) MARIAN (HIRIAM/HAY) B. 1779/80 D. M. H. DAVID HANUEL DOROTHY CATHERINE B. 1747, PORTSMOUTH, ENG. D. AUG. 16/16, 1827 AARON LOND. JAN. 14, 1768

BERNARD SAMUEL (BARNEBAS S.) B. JUN. 8, 1777, LONDON D. MAY 21, 1831, N.Y. M. AUG. 30, 1797, TROIS RIVIERES CATHERINE HART (O.V.I) ABRAHAM, M.D. B. D. BALTD, OR SAV. UNM. CATHERINE B. JAN. 1, 1788, N.Y. D. JUL. 30, 1860, N.Y. UNM. HANNAH (ANNIE/NANCY) B. OCT. 1766 D. MAR. 8/16, 1856, PH. M. NOV. 1, 1789 GERSHOM M. SEIXAS (O.V. I) (1821) CATHERINE B. JAN. 1, 1768, LOND. D. MAR. 29, 1852, N.Y. M. JUL. 29, 1801, N.Y. LEVY SOLOMONS (O.V. I) DOROTHEA ELIZA B. 1763 D. OCT. 19, 1823, MONTREAL M. 11 JUL. 18, 1781, MONTREAL CHAPMAN ABRAHAM OR ABRAHAM CHAPMAN (-1783) M. 23 MAR. 22, 1787 MOSES HYERS (O.V. I)

SAMUEL B. JUL. 18, 1799, N.Y. D. APR. 20, 1869, VINCENNES, IND. M. JUN. 22, 1825, Piqua, OHIO HARRIET BRANDON AARON HART B. JUL. 15, 1801 D. APR. 20, 1836, N.Y. UNM. JONATHAN B. DEC. 1, 1803 D. M. EDWARD B. FEB. 13, 1806 D. JUL. 18, 1883, N.Y. UNM. MIRIAM B. OCT. 27, 1807 D. JUN. 12, 1887, MONTREAL M. DEC. 2, 1840, N.Y. ALEXANDER THDHAS HART (O.V. I) ABRAHAM B. MAR. 19, 1810 D. FEB. 26, 1825 INSANE UNM. ALFRED N. B. JUL. 2, 1812 D. MAR. 20, 1858 M. (A CATHOLIC) WASHINGTON B. SEP. 28, 1814 D. DEC. 16, 1853, N.Y. UNM. LOUISA C. L. D. MAR. 25/27, 1838 UNM.

HARY L. B. AUG. 4, 1845, N.Y. D. MAR. 16, 1878, N.M. UNM.

CAROLINE B. FEB. 22, 1829 D. AUG. 20, 1849 M. MAR. 11, 1847 DR. JOHN R. MANTEL HARRIET B. D. M. WILLIAM H. BREVOORT OF VINCENNES JOHN H. B. MAUDE EMISSION

CATHERINE B. DEC. 24, 1830 D. JAN. 1876 VINCENNES M. JUN. 5, 1850 LAZARUS NOBLE ALICE B. APR. 28, 1837 D. DEC. 5, 1915 M. MAY 20, 1863 FRANKLIN CLARKE NAHIE B. O. YOUNG FRANKLIN B. LUCINDA BRANDON OF VINCENNES JOHN H. B. D. M. ? SAMUEL BRANDON B. DEC. 26, 1845 D. M. NOV. 15, 1871 EIMA C. BURNET CHARLES B. B. 1872 B. 1875 D. M. 1898 EDITH REYNOLDS NOBLE BRANDON B. SEP. 7, 1851 D. DEC. 10, 1918 M. KATE HUTCHINSON

HENRY SON NAMES CHANGED TO BRANDON U.S. AMBASSADOR TO FRANCE

EMILY JANE B. M. 1919 GEORGE L. BAYARD REYNOLD S. B. M. HELEN FISHER OF NEW CASTLE, PA. CHARLES B., JR. NOBLE BRANDON, JR. B. APR. 23, 1864, CHI. M. DOROTHY PATTERSON OF DAYTON, OHIO HELEN B. M. NOV. 5, 1915 CARL SCHONEMAN OF MILWAUKEE

(SEE PRECEDING PAGE)

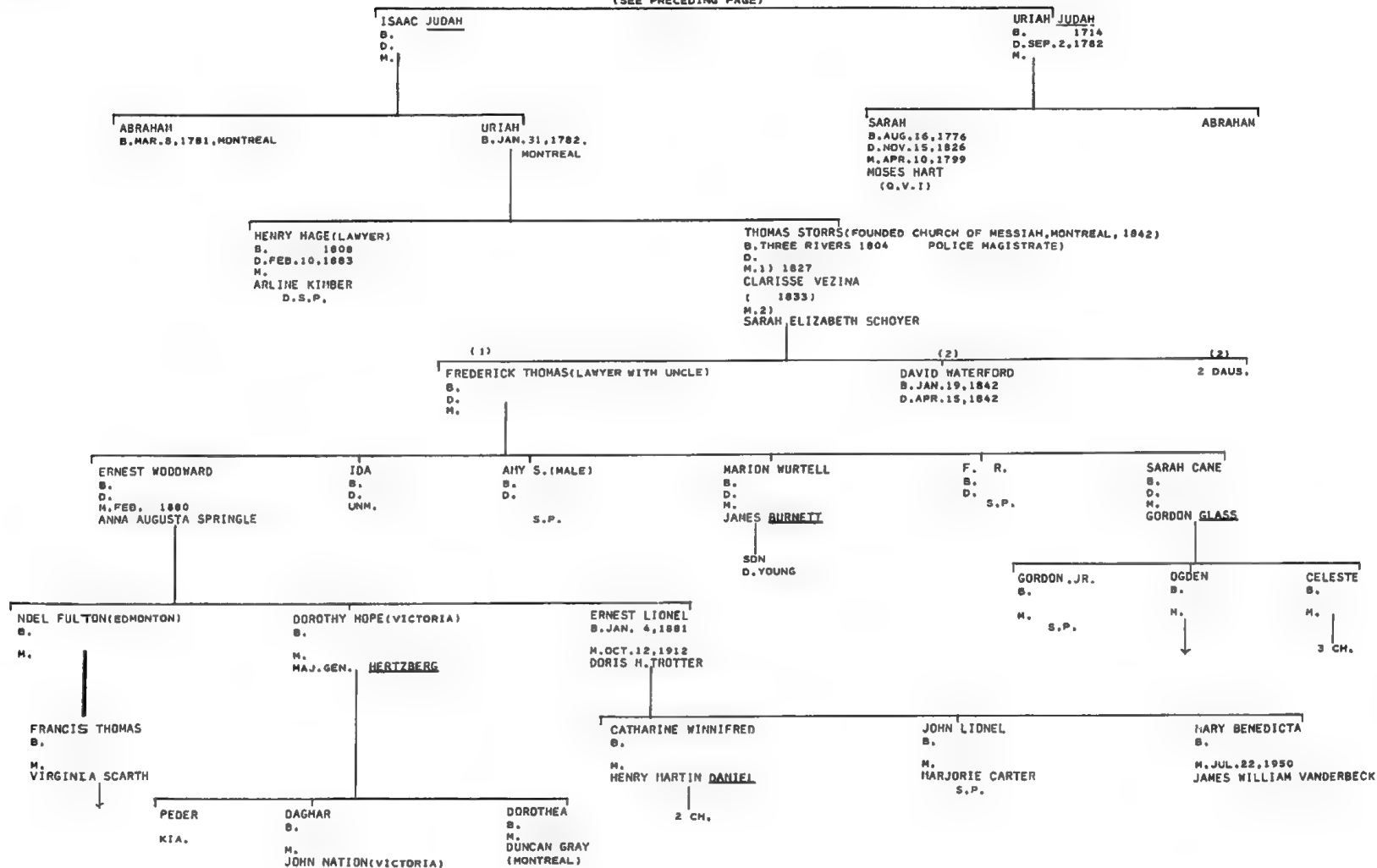

ANKER MS.
KRAUS MS.
ST. CHARLES, FIG. 21

SAMUEL KAUFMAN
B. BINGEN, GER.

ROSALIE HAYER
(O.V.)

KAUFMAN

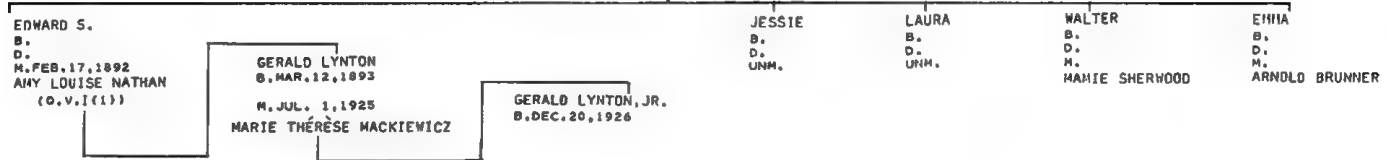

HARNO H. KAYTON
HISTORY OF THE KAYTON FAMILY
BERNARD KAYTON
NORFOLK HEBREW CEMETERY
NORFOLK COURT RECS.

HERZ KOETHEN OF GELNHAUSEN, HESSE
AMALY-KOETHEN ?
(CAME TO U.S. WITH SONS)

KAYTON

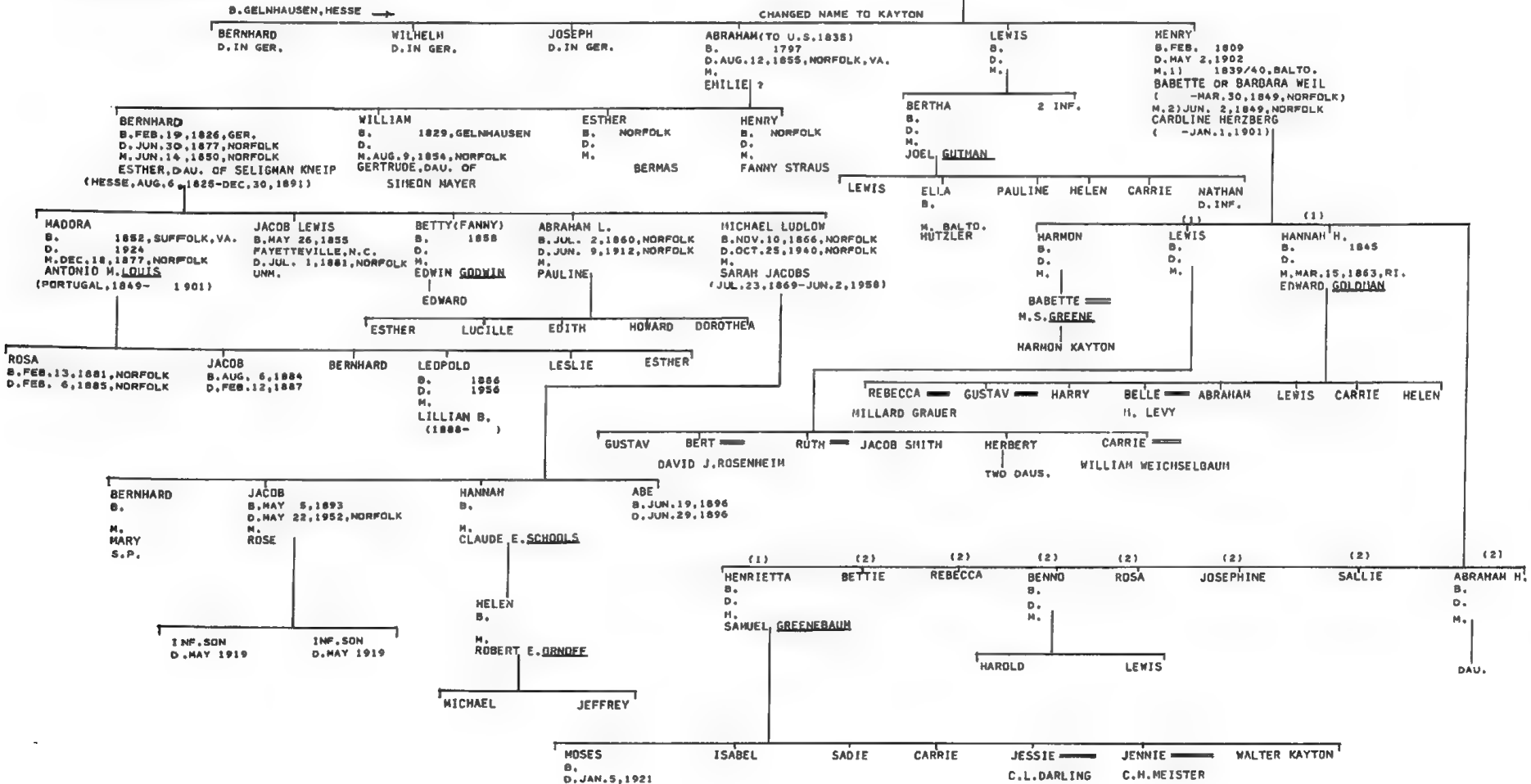

KING I

B'NAI JESHURUN REC.
KRAUS-SANDOR COLL.
SHEARITH ISRAEL REC.
STANLEY R. JACOBS
GRACE K. KOENIGSWERTHER

SPRINZE (SOPHIA) — 1) DAVID KRULSCHIK (KROLECK) — 2) HANNZH
OF MORAVANA-GOSLIN, PRUSSIAN POSEN

SARAH — SCHAJE BRUSH
(Q.V.)

ALL CHANGED NAME TO KING; ALL B. GOSLIN, PRUSSIAN POSEN

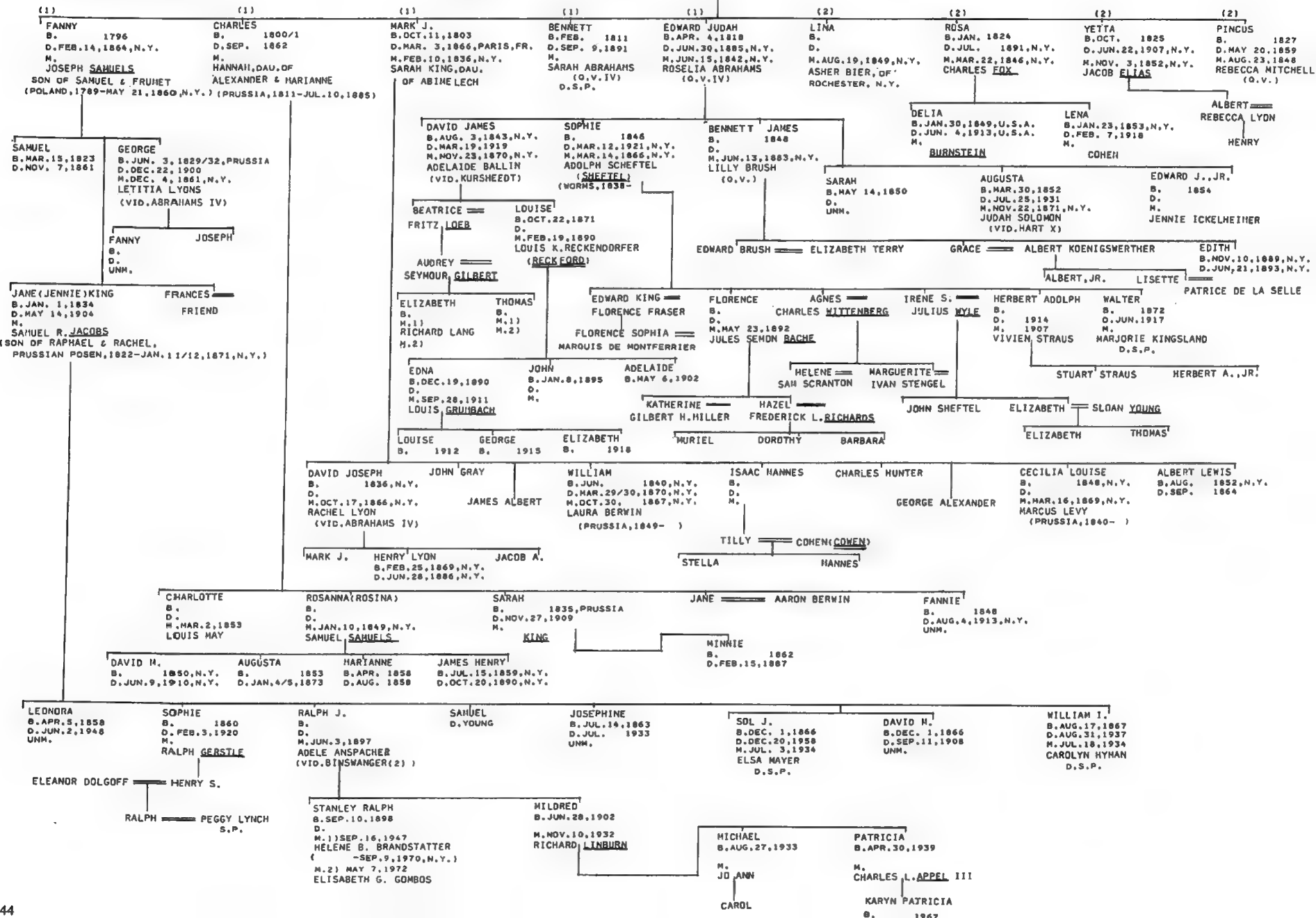

KRAUS-SANDOR COLL.
EZEKIEL-LICHTENSTEIN
MICKVE ISRAEL REC.

KING II

JACOB KING 1774
B. 1774
D. RICH. OCT. 22, 1824

MARY WIDOW OF SOLOMON ISAACS
(O.V. I)

ISAAC 1799
B. 1799
D. PH. NOV. 6, 1824
(" RICHMOND MERCHANT ")

ELIEZER 1804
B. APR. 1804
D. INF.

JUDAH 1805
B. OCT. 18, 1805
D. INF.

KRAUS-SANDOR COLL.
SHEARITH ISRAEL REC.
DARBY G. LIVINGSTON
NFK. COURT RECORDS
TUCKER-NFK. MARRIAGE BONDS

(NFK., 1850; N.Y., 1870) HENRY KING
B. CA. 1799

HINDA (HANNAH) AARON

KING III

B. NACKEL, PRUSSIA →

LEOPOLD 1823
B. 1823
D. MAR. 12, 1876, N.Y.

HENRIETTA 1830
B. 1830
D. SEP. 14, 1905, VA.
M. AUG. 6, 1850, NFK.

ANTHONY 1834/6
B. DEC. 24, 1834/6
D. DEC. 28, 1876
M. AUG. 10, 1870, N.Y.
THERESA FRIEDMAN
(VID. CROMELIEN)

DAVID LIVINGSTON MEYER
SARAH COHN
JAN. 24, 1872, N.Y.

FLORA
B. NFK.
D. N.Y.

JOSEPH LEVY

HARRY 1872
B. 1872
D. M.
RUBINSTEIN

HATTIE LILLIAN LEON HENRY ISADORE BEATRICE GOLDIE EDWIN
JOSEPH ADLER HYMAN SCHLOR MRS. WEINBERGER SOPHIE FELDBLUM IDA SIMON NATHAN FRIEND BEN LECHTMAN LOTTIE WINTERS

KORN-JEWS OF N.O.

SIMON BELLA

KOHN

OCT. 27, 1778, PETERSBURG, BOHEMIA
(NATHAN SCHIMM) NATHAN KOHN KIWI/EVA LOBL
B. BOHEMIA, JAN. 18, 1831

B. BOHEMIA →

LOWY 1802
B. 1802
M. JAN. 26, 1802
RACHEL FELDSTEIN

SIMON 1781
B. 1781
D. M.

SAMUEL (TO L.A. BY 1806) 1783
B. 1783
D. MAY 18, 1853, PARIS, FR.

SELIGMAN 1786
B. 1786

JOACHIM 1800
B. 1800
D. 1886, PARIS, FR.
M. JUN. 22, 1834, N.O.
MARIE THALIE MARTIN

HERMANN 1806
B. 1806

JOSEPH 1808
B. 1808

CARL (TO N.O. 1830/1) 1830
B. 1830
D. AUG. 27, 1895, N.O.
M. JUN. 27, 1850, N.O.
CLARA, DAU. OF MAUNSELL WHITE

EDOUARD 1825
B. BOHEMIA, 1825
D. M.
VON EMBDEN

SAMUEL ARTHUR 1835
B. NOV. 13, 1835, N.O.
D. 1909/10, PARIS

JOSEPH GUSTAVE 1837
B. MAR. 18, 1837, N.O.
D. SEP. 7, 1906

AMELIE ARMAND MICHEL 1842
B. 1842
(IN N.O. 1842)

ISAAC HEINE 1828
(UNCLE OF HEINRICH)
D. OCT. 18, 1828

ALPHONSE MILTENBERGER
CELESTE DORFVIELLE

MARIE CELESTE AMELIE 1832
B. 1832

MARIE ALICE 1875
B. 1875
D. M. 1) 1875
DUC DE RICHELIEU
M. 2) ALBERTO
PRINCE OF MONACO

KRAUS-SANDOR COLL. (AJA)
AMERICAN JEWISH YR. BK. V. 47, P. 526

MARCUS MORDECAI KRAUS (KROUSE) 1792
B. DEMMELSDORF, BAVARIA, 1792
D. CINCINNATI, DEC. 29, 1845

RACHEL FRANK 1799
B. LUTHERISCH, MEILINGSTADT, BAV. 1799
D. CINCINNATI, FEB. 8, 1883

KRAUS

WILLIAM 1823
B. OCT. 15, 1823, DEMMELSDORF
D. MAY 22, 1899, N.Y.
M. OCT. 2, 1850, CIN'TI.
MINNIE LAUER
(DEMMELOD, NOV. 5, 1831 -
WEST END, N.J. AUG. 12, 1913)

CELIA 1829
B. 1829
D. M.
HERMANN MACK

MARCUS (MAX) 1829
(IN HUNTSVILLE, ALA.)
B. JAN. 11, 1829
D. M.
LENA STROMBERG

HENRIETTA 1863
B. SEP. 5, 1863
D. M.
ISAAC ABRAHAM SIMM

MAX WILLIAM 1888
B. NOV. 9, 1888, CIN'TI
D. M. OCT. 10, 1888, N.Y.
CARRIE MAY ADLER

HARRY 1886
B. 1886
D. M. OCT. 12, 1886
ROSIE OR ROSALIE ANSBACHER
(VID. BINSWANGER (2))

BELLE 1861
B. AUG. 26, 1861
D. M.
HENRY P. SONDHEIM

MATHILDA 1861
B. 1861
D. M.
HERMAN ADLER

STELLA 1899
B. 1899
D. M.
PERCY W. LANSBURGH

WALTER MAX, M.D. 1889
B. AUG. 25, 1889, N.Y.
D. AUG. 22, 1944, N.Y.
M. 1) MAY 5, 1917
MARIAN F. NATHAN
(O.V. I (2))
M. 2) DEC. 29, 1929
INES HEFFES ADES OF PARIS

HAUDE ROSALIE 1887
B. JUL. 21, 1887, N.Y.
D. DEC. 4, 1953
M. 1) ARISTO W. SLOAN
M. 2) AL PACH
M. 3) HARRY IRVING
D. S. P.

WILLIAM 1893
B. AUG. 26, 1893, N.Y.
D. APR. 2, 1920, N.Y.

EDITH JANE

JOHN WALTER 1918
B. FEB. 5, 1918

FRANCIS VAN PRAAG 1920
B. MAR. 13, 1920

KOKERNOT

JON STEDMAN
KORN-JEWS OF N.O.

(TO N.O. 1817) LEVI MOSES KOKERNOT

1) BETSY VAN DER BEUGEL
(TO N.O.CA. 1820)

2) N.Y. JUL. 26, 1836

ALEXANDER HART
(O.V. X 11)

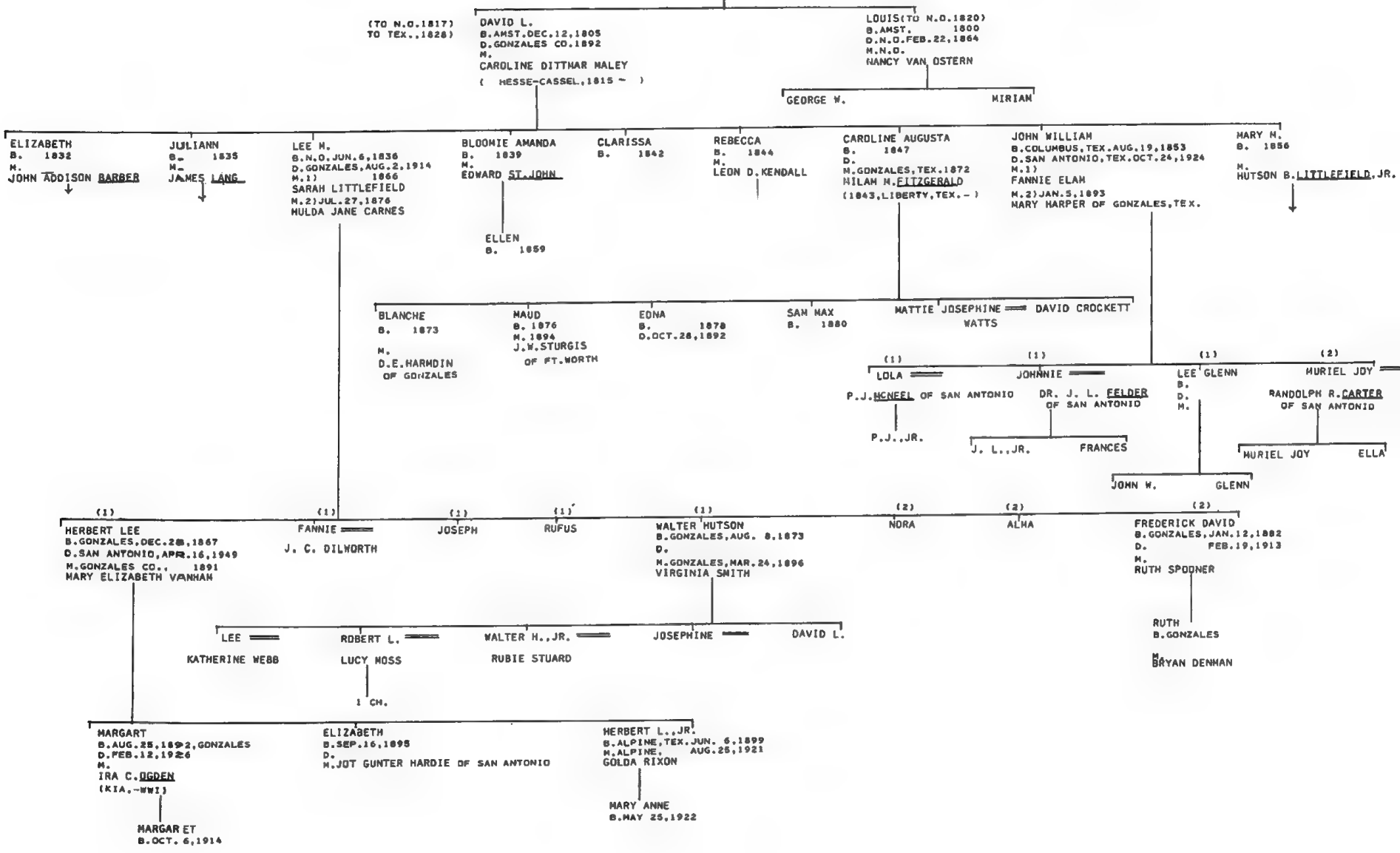

PAJHS V.31,P.273F.
PAJHS V.33,P.189F.
UJE V.6,P.491
KRAUS-SANDOR COLL.
G.M.SEIXAS MS.(JRM)
SHEARITH ISRAEL REC.
N.Y.CENSUS,1855
US CENSUS,1860(J.STEDMAN)
ABIGAIL HOFFMANN

(CAME TO BOSTON,N.Y.,1796) ISRAEL BAER KURSHEEDT
B.GERMANY,APR. 6,1766
D.N.Y. APR.30,1852

JAN.18,1804

SARAH ABIGAIL SEIXAS
(O.V.(2))

KURSHEEDT

ELKALEH B.N.Y.DEC.18,1805 D.N.Y.DEC.27,1883 M.N.Y.MAY 21,1829 SOLDMON J. ISAACS (O.V.II)	ASHER B.NOV.17,1808,N.Y. D.JUL.25,1893,N.Y. M.NOV.13,1839 ABIGAIL JUDAH (O.V.I (2))	ALEXANDER B.JUN. 7,1811,N.Y. D.APR.19,1884,N.Y. M.)CA.NOV.1839 THERESA SEIXAS M.23 1867 GRACE GUEDALLA (WIDOW OF HIS BROTHER GERSHOM) D.S.P.	ISAAC MENDES B.JUN. 3,1814 D.JAN. 7,1886 M.)CA.NOV.1839 HANNAH DUKE (KINGSTON,JAM.JUN.6, 1804- NOV.25,1876)	ANNA AUGUSTA B.CA. 1815,VA. D.FEB.23,1876,LOND. M. BENJAMIN WODLEY HART (ENG.CA.1812- OCT.30,1893,LOND.)	GERSHOM B.RICH.JAN. 1817 D.LOND.MAY 7,1863 M. GRACE GUEDALLA	REBECCA B.MAR.29,1819 D.DEC.28,1875,NEW ORL. M.AUG. 3,1836 BENJAMIN FLORANCE (O.V.)	HIRIAH B.JUL.20,1821,RICH. D.JUN. 3,1866,N.Y. M.SEP.24,1846,N.Y. EUGENE S.BALLIN (PRUSSIA,JAN.18,1817- JUN. 23,1885)
---	--	---	---	--	--	--	--

JEANETTE
B.APR.29,1807
D.DEC.25,1901
UNM.

EDWIN ISRAEL
B.MAR.25,1838
D.FEB.21,1906
M.AUG.15,1866.
RICHH.
SARAH LEVY
(O.V.IV)

LUDWIG EUGENE
B.N.Y.AUG.4,1847

FREDERICK EUGENE
B.N.Y.AUG.15,1849

ADELAIDE
B.AUG. 3,1851,N.Y.
D.NOV.27,1895
M.NOV.23,1870,N.Y.
DAVID JAMES KING
(O.V.)

EDWIN ISRAEL
B.N.Y.OCT.28,1853
D.N.Y.OCT.15,1857

OSCAR EUGENE
B.N.Y.NOV.19,1856

EDITH
B.MAY 2,1867
UNM.

LAWRENCE G.
B.AUG.14,1868
D.INF.

MYRTLE
B.OCT. 9,1871
D.OCT.24,1919
M.SEP. 2,1908
FREDERICK SACKETT
CHESEBRO

LILIAN
B.JUL.14,1873
D.AUG. 5,1894
UNM.

HILDA
B.JUL.12,1878
UNM.

EDWIN MENDEZ
B.JUL.1,1882
M.APR.1,1911
JENNIE DE FOREST CARPENTER

IRMA
B.NOV.10,1875
UNM.

ETHEL
B.OCT.30,1880
D.SEP. 7,1902,
LYNN,N.C.
UNM.

EDWIN MENDEZ, JR.
B.JAN.30,1913

HELEN MAXWELL
B.JUL.13,1919

B.N.Y. →

MANUEL AUGUSTUS
B.AUG.14,1840
D.OCT.30,1923,
BRONXVILLE
UNM.

ALEXANDER E.
B.AUG.26,1843
D.OCT.19,1895
M.
IDA HESS

FREDERICK ADOLPH
B.SEP.23,1845
D.OCT.14,1906,PARIS
UNM.

GRACE ELOISE
B.DEC.4,1847
D.APR.7,1935
WHITE PLAINS,N.Y.
UNM.

ISRAEL BAER
B.APR.29,1852
D.MAR. 8,1897
DENVER,COLO.
UNM.

LIONEL JUDAH
B.JUL.30,1856
D.FEB.24,1932,VENTNOR,N.J.
M.MAR.24,1913
BESSIE KURTZ SCHELLENBURG
SAMUELS D.S.P.

MOSES MONTEFIORE
B.NOV.27,1858
D.
M.FEB. 9,1911
JENNIE SCHELLENBURG

GERSHOM MENDES
B.NOV.27,1858
D.APR. 4,1899,
N.Y.

SIMEON ROLAND
B.FEB.24,1860
D.JUN.24,1927,N.Y.
UNM.

EDMUND BARUCH
B.MAY 18,1861
D.
M.)MAY 21,1889
ENMA FRANZEB
M.2)OCT.10,1910
ANNA KENT
D.S.P.

JESSIE CONSTANCE
B.NOV.25,1881
M.
HARVEY E.MILLER

ALBERT EDWARD
B.JUL.13,1869
M.1)JAN. 5,1914
MARY VALIQUETTE
M.2)JUN.17,1922
MARY S.DARGAN,DAU.OF JAMES
(-KINGSTON,N.Y.AUG.20,1929)

SERENA
B.FEB.18,1850
D.MAR. 3,1935,
WHITE PLAINS
UNM.

ALPHONSE HART
B.APR.23,1854
D.APR.26,1936.
WHITE PLAINS
UNM.

ABIGAIL GRACE
B.JUL.21,1912

NATHAN HOFFMAN
(JUN.2,1906-DEC.14,1962)

MONTE KURSHEEDT
B.NOV.25,1941
M.1)MARY LOU BLAKE
(DIV.)
M.2)STEFANIE REITZES
(DIV.)
S.P.

GEORGE SEIXAS
B.NOV.25,1941
M.1)MARY KAY JOHNSON
(DIV.)
M.2)EILEEN ABLE
(1)

JANE ABIGAIL
B.NOV.8,1947
UNM.

NATHAN RICHARD
B.AUG.8,1969

RACHEL KURSHEEDT
B.FEB.8,1971

ASHER CHARLES
B.MAR.1,1976

SHEARITH ISRAEL REC.

HOSS LAWRENCE OF LONDON
B.
D.

REYNA ANDRADE
B.LOND.CA. 1801
D.LOND.FEB.4,1871

LAWRENCE

JOHN M.
B.
D.OCT.19,1888,LIVERPOOL
M.
EMILY ?

BENJAMIN
B.AUG.18,1829,LOND.
D.DEC.20,1900,N.Y.
M.APR.12,1869,N.Y.
LOUISA ASHER
(JAMAICA,DEC.14,1836-)

MABEL LOUISE
B.N.Y.DEC.21,1872

HAUD
B.N.Y.MAY 2,1877

EDITH EMILY
B.OCT. 1875

PHINEAS
B.ENG. 1831
D.FEB.1,1918,
RICHMOND,ENG.
M.NOV.5,1862,N.Y.
KATE RUTH DIX
(CONVERT)

LAWRENCE
B.
D.AUG.12,1855
FRANCE

Laurie Philip
B.N.Y.MAY 28,1864

ALFRED HOSS
B.N.Y.FEB.22,1866
D.N.Y.OCT.29,1924

JOHN JACOB
B.N.Y.APR.14,1868
D.N.Y.JUN.19,1874

ROGER DIX
B.N.Y.APR.14,1868

RAYNOR ANDRADE
B.N.Y.NOV.19,1869

EDWIN ABRAHAM
B.N.Y. 1871

ARTHUR HOSS
B.N.Y.AUG. 24,1869

REYNA EMILY
B.N.Y.MAR.13,1861

ESTHER ELLA
B.N.Y.OCT.21,1862

BLANCHE
B.N.Y.AUG.26,1864

LOUISE
B.N.Y.DEC.8,1866

WALTON
B.N.Y.JAN.29,1869

AMY LILLIAN
B.LOND.FEB.9,1872

LABATT

NEW ORL. JCC
PAJMS. V. 2, P. 139F.
HYAMS MS. (JRM)
UJE. V. 6, P. 497
ELZAS MS.
M.N.
JEWS OF S.C.
DR. H.G. SIMON
MRS. JAMES M. FORGOTSON

(IN CH. BY 1800) DAVID LABATT
B. FRANCE
D. CHARLESTON, S.C.
CATHERINE ?
B. GER. 1773
D. N.O. JAN. 2, 1846

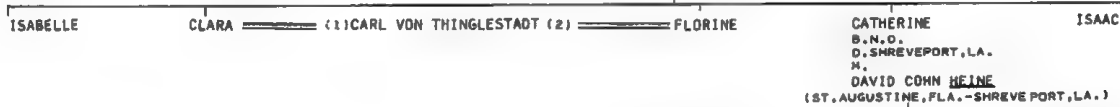
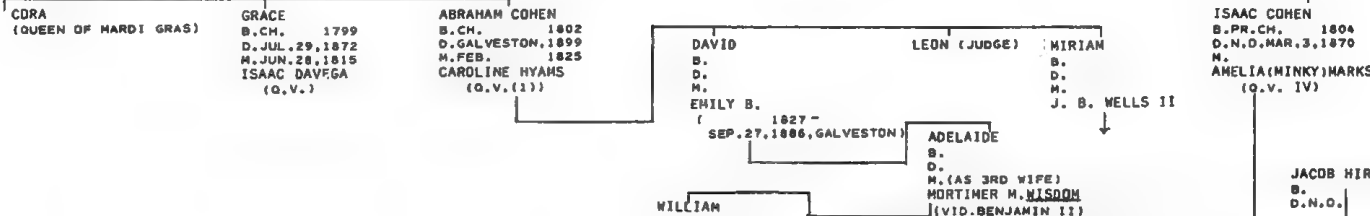

HENRY GERSON (CIV. WAR) CAROLINE KING

HARRIET
B. JUL. 5, 1860, MONROE, LA.
D. JUN. 16, 1936, N.O.

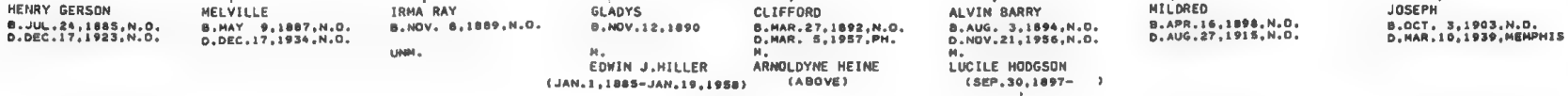

LAIB (LOEB) ¹⁾ ESTHER LIEBENSTEIN ²⁾ WEILER

(1) ELIZABETH (1) HENRY (1) ROSINA (1) SOLOMON (TO U.S. 1837) (2) SIMON (2) HERMAN
 B. D. M. NATHAN BECKER B. D. FEB. 1904, GRUNSTADT, BAV. B. OCT. 15, 1812, BAV. B. NOV. 19, 1893, LA PORTE, IND. B. OCT. 15, 1885, PH. B. JUL. 27, 1859, PH. B. DEC. 25, 1830
 D. MAR. 29, 1905, CH I. M. DEC. 17, 1884, N. Y. M. NOV. 28, 1869, LA PORTE, IND. M. AUG. 3, 1846, PH. SARAH LANG (BAV. MAR. 13, 1822-SEP. 1910) UNM. D. JUL. 27, 1904
 M. DEC. 30, 1852 ELLEN ULMAN (OCT. 20, 1828-AUG. 28, 1898)

JULIA B. JAN. 8, 1857 D. JUN. 10, 1937 M. MAR. 23, 1880 HENRY FERNBERGER (1851 - 1928)

SAMUEL FANNY CHARLES MAX MATILDA HENRY ALBERT
 B. AUG. 27, 1847, ERIE, PA. B. APR. 6, 1850, PH. B. FEB. 11, 1852, PH. B. JAN. 6, 1855, PH. B. DEC. 15, 1857, PH. B. FEB. 21, 1859, PH. B. FEB. 8, 1862, PH.
 D. MAR. 29, 1905, CH I. D. FRENCH LICK, IND. D. INF. D. JUL. 25, 1890, POCAHONTAS, VA. D. M. APR. 27, 1892, N. Y. D. M. NOV. 26, 1892, CH I.
 M. DEC. 17, 1884, N. Y. M. NOV. 28, 1869, LA PORTE, IND. M. DEC. 6, 1883, RT. KATE MEYER M. OCT. 15, 1885, IND. MICHAEL BLOCH EVA LILIENTHAL LILY (JAN. 19, 1866 -)
 MINNIE LIEBENSTEIN SAMUEL EDY (JAN. 12, 1858-NOV. 25, 1925)

ALVIN B. SEP. 20, 1885 MATILDA B. JUL. 28, 1890

B. POCAHONTAS, VA. → IRA B. NOV. 7, 1886 SIGMA B. SEP. 30, 1887 CLARENCE B. JUL. 20, 1889

NORRIS B. OCT. 9, 1860, PH. D. INF.

B. INDIANA → MAURICE B. JUN. 28, 1871 HERBERT B. JUN. 13, 1873 ARTHUR B. FEB. 21, 1877 WALTER B. MAR. 10, 1883 NORMAN B. OCT. 20, 1887
 D. M. JULIA D. S. P. ROBERT B. JUN. 21, 1879

HERMAN WEILER B. FEB. 11, 1882 D. JUL. 18, 1936 M. 1906 HORTENSE GANNENBAUM (-1887)
 PROF. SAMUEL WEILER B. JUN. 4, 1887 D. MAY 3, 1956 M. JUL. 12, 1922 EVE WALLERSTEIN (FEB. 21, 1896 -)

B. PH. → NELLIE VIRGINIA B. DEC. 8, 1884, PH. D. JAN. 9, 1965, PH. M. SEP. 14, 1911, PH. JACOB SAMUEL GOLDBAUM
 HERBERT M. B. JAN. 7, 1887 D. 1949 EDNA B. MAR. 26, 1888 D. 1892 WALTER JOEL B. JUL. 11, 1890 D. APR. 1967 M. 1) FEB. 1924 JEANNE MAHLER LOWENTHAL (DIV.) 1948 M. 2) ETHEL LOEB (-1974)

HENRY FERNE B. MAR. 28, 1909 UNM. EDWARD B. JUN. 4, 1925 M. JUN. 21, 1947 MARILYN FRIEDMAN (AUG. 13, 1927 -) JOHN MARSHALL B. SEP. 7, 1926 M. AUG. 11, 1950 LINDA MARGOLIES (DIV.) (MAY 1936 -)

RUTH DENE B. MAR. 22, 1919, PH. M. APR. 7, 1940 MILTON NEUFELD DIV. ERMA KATHERINE B. APR. 20, 1917, PH. M. JAN. 5, 1941, PH. HOWARD LEOPOLD (JUL. 25, 1909 -)

(1) JANET (2) DENE B. D. 1973

JOHN, JR. B. SEP. 1953 PETER BALDWIN B. 1955

LAWRENCE B. APR. 6, 1943 M. 1) NOV. 1, 1968 JAHNA FLESHER (DIV.) M. 2) AUG. 1972 CYNTHIA CASWELL
 DENE B. FEB. 16, 1946 ANDREW B. FEB. 25, 1948

EDWARD, JR. B. DEC. 15, 1948 ELLEN WEILER B. APR. 14, 1951 JAMES MOYER B. OCT. 20, 1955

LAZARUS I (N.Y.)

ST. CHARLES, P. 126
 KRAUS-SANDOR COLL.,
 AARON LEVY CALENDAR (A.JHS)
 WILL OF FANNY ISAACKS
 SHEARITH ISRAEL REC.
 POOL-PORTRAITS...
 N.Y. WEEKLY MUSEUM
 N.Y. CENSUS, 1855

ELEAZER

B.
 D.N.Y. 1777
 M.
 ?

MOSES LAZARUS

SAMUEL LAZARUS

B.
 D.N.Y. OCT. 11, 1798

MAR. 25/6, 1777 1)

FANNY CUSHELL
 B. 1749
 D.N.Y. AUG. 1, 1809

2) DEC. 18, 1800, N.Y.

MICHAEL ISAACKS
 (G.V.I)

ELEAZER SAMUEL
 B. FEB. 2, 1788
 D. MAR. 28, 1844, N.Y.
 M. NOV. 1, 1809
 ZIPPORAH HART
 (G.V.IV)

PERH. SAME PERSON

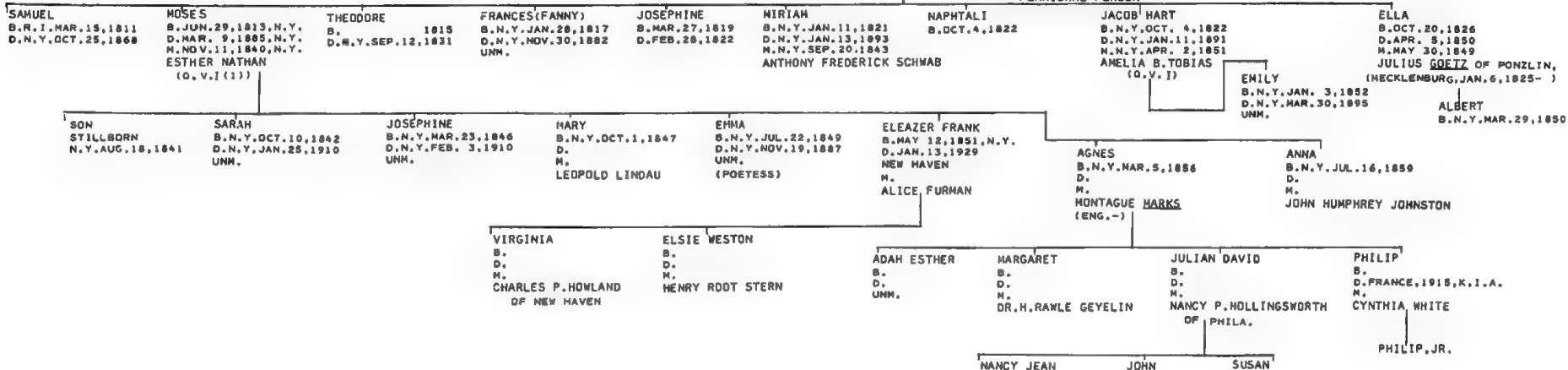

LAZARUS III

ST. CHARLES, P. 126
 KRAUS-SANDOR COLL.,
 POOL-PORTRAITS...
 N.Y. WEEKLY MUSEUM
 ROSENWATKE

ELEAZER (LAZARUS) (IN N.Y. 1748)
 B.
 D.
 M.
 ?

ISAAC COHEN, N.D. (LANCASTER, 1747)
 OF HAMBURG, GER.
 B.
 D.
 M.
 ?

ISAAC
 B.
 D. N.Y. APR. 25, 1779

SAMPSON
 B.
 D.

FRUMET (FANNY)
 B.
 D. N.Y. MAY 14, 1793

JUDAH

LEVY (LIVED IN MD.)
 B. 1722
 D. CORLEARS HOOK, N.Y.
 APR. 5, 1793

(JUSTINA) BRANDLY
 B. OCT. 16, 1752, MD.
 D. FEB. 16, 1825, N.Y.
 M. MAR. 28, 1781, LANCASTER
 JOSHUA ISAACKS, JR.
 (G.V.II)

LAZARUS IV

PAJHS V. 12, P. 119
 HOSS GEN.
 ELZAS MS.
 MICKVE ISRAEL REC.

ISAAC LAZARUS (PH., MOBILE)
 B.
 D.
 M.
 H. PH. MAY 10, 1805
 ESTHER LYONS
 (G.V.I)

HENRY (CH., MOBILE)
 B.
 D.
 M.
 LOUISA ?

HENRY
 B. MAR. 15, 1806, PH.
 D. OCT. 21, 1868, PARIS
 M. OCT. 7/9, 1835, PH.
 HERRIAM (MARY) HOSS
 (G.V.II)

REBECCA
 B. JAN. 12, 1808
 D.
 M. MAR. 17, 1830, PH.
 HARRIS ISAACKSON
 (-AUG. 14, 1839)

BERNARD
 B. 1827
 D. N.Y. APR. 8, 1832

GEORGE GAINES
 B. PH. JUL. 23, 1836

HENRY H. (ADOPTED BY UNCLE HENRY)
 B.
 D. FARMVILLE, VA. AUG. 31, 1890
 M. N.D. NOV. 13, 1855
 KATE MARKS

JRM COLL.
 DAR-HARBY HS.
 MOSES GEN.
 KRAUS-SANDOR COLL.
 ELZAS M.N.
 MS.
 D.J.C.
 WILL OF RACHEL D.LAZARUS
 ISABELLA **
 MICHAEL **
 JOSHUA **
 ADELINE **

REV. MAR PENSION REC.(NAT'L ARCH.)
 LAZARUS BIBLE(JANE L. RAISIN)
 LAZARUS GEN.(T. TOBIAS)
 DR. AARON S. RAISIN
 S.C. MARR. CONVEYANCES
 A.J.Y.B 5664/88
 J.B. HORDECAI MS.

(IN CH. BY 1749) MICHAEL LAZARUS

LAZARUS II (S.C.)

MARKS*
 B. FEB. 22, 1757, CH.
 D. NOV. 1, 1835, CH.
 M. DEC. 11, 1776, CH.
 RICH (RACHEL) BENJAMIN
 (VID. DE TORRES)

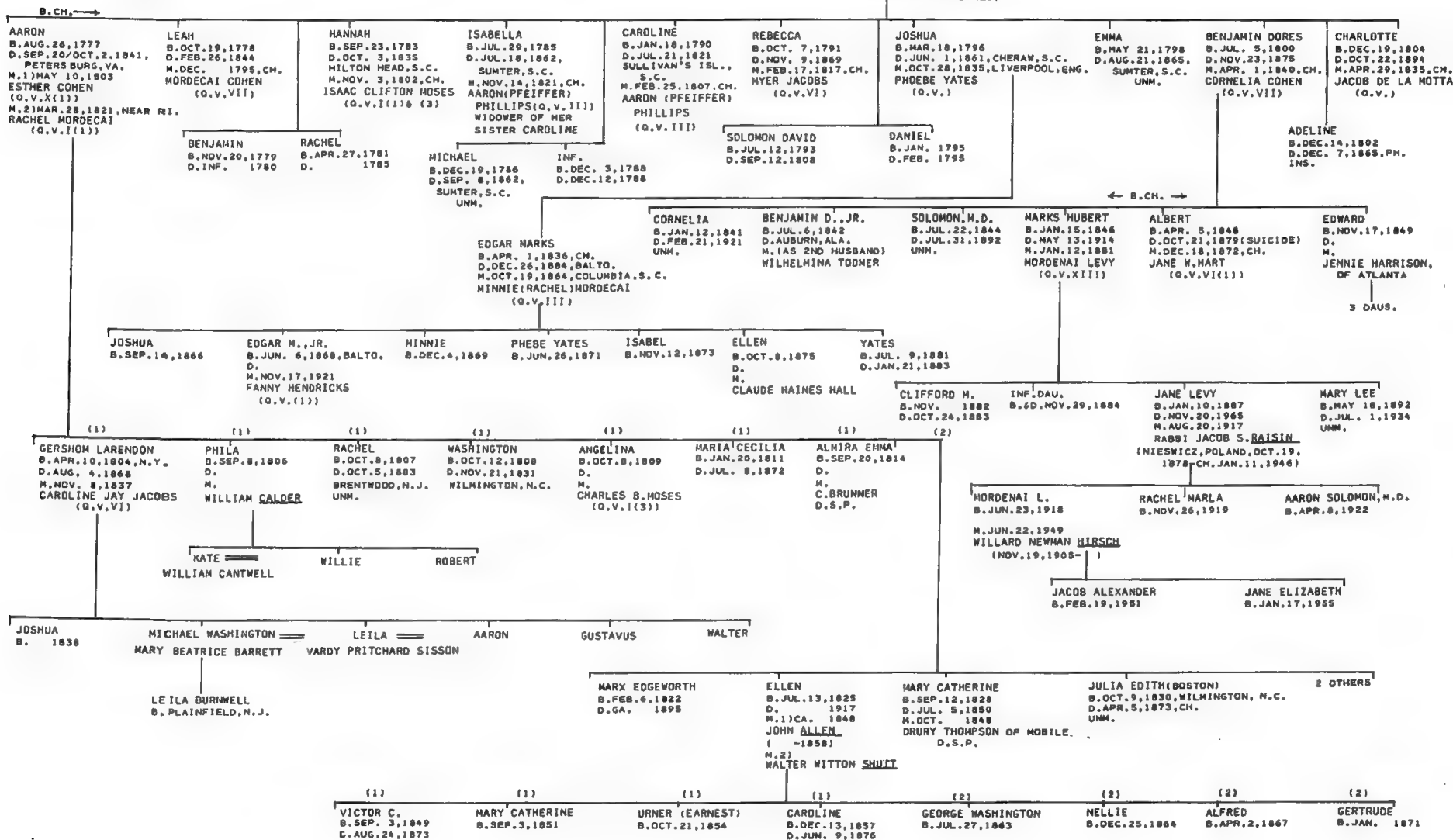

* ESTABLISHED REVOLUTIONARY ANCESTOR

LEBERMAN
 F. J. DALLET
 MT. SINAI CEM.
 CHELTON HILLS CREMATORY
 FLORENCE ABRAHAMS

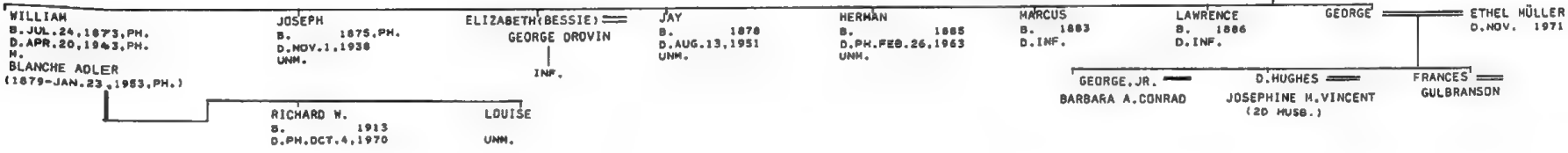
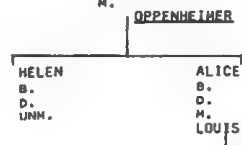
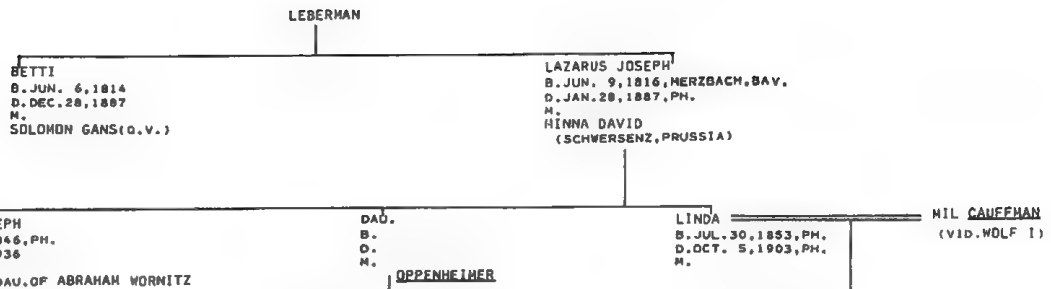

LEDESMA
 SH.
 EGMONT
 B. M. KET # 379

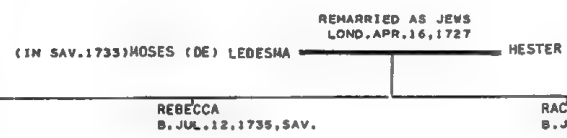

LEO
 KRAUS-SANBOR COLL.
 PAJHS, V. 10, P. 110
 GRINSTEIN, PASSIM
 SHEARITH ISRAEL REC.
 J.E. V. 7, P. 683
 N.Y. CENSUS 1855
 B'NAI JESHURUN
 RHODA ROYAL

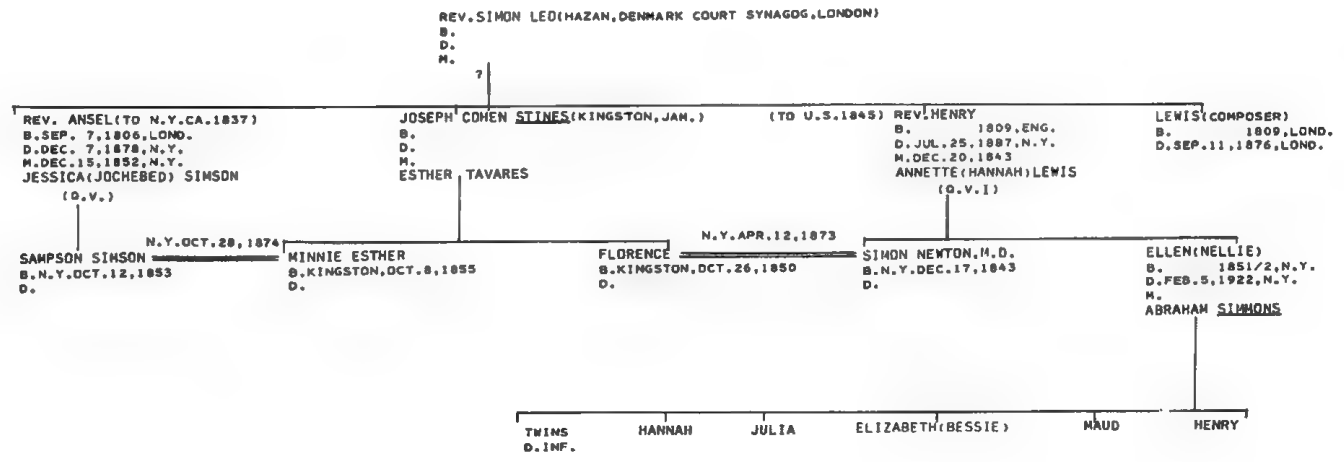

J.E. V.7, P.662F.
UJE V.6, P.558
JRM COLL.
MICKVE ISRAEL REC.

LEESER

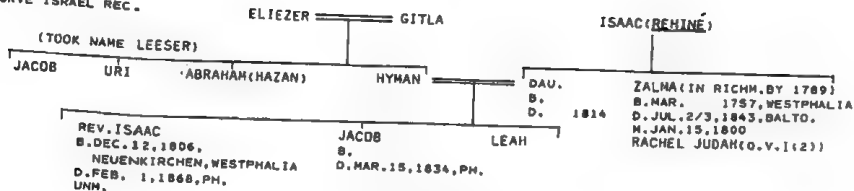

LEVINE

FLORENCE ABRAHAMS
FED. ST. CEM.

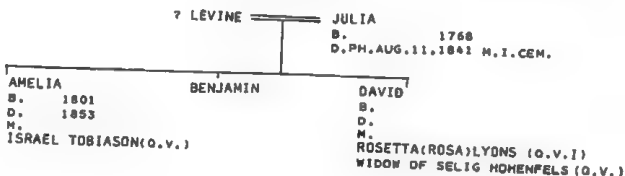

MRS. E. MILLER
KRAUS-SANDOR COLL.
SHEARITH ISRAEL REC.

JACOB I. LEVIN — FLORA

GUSTAV (OTTAWA, THREE RIVERS, N.Y.)
B. MAR. 26, 1841, GER.
D. JUL. 1, 1923, N.Y.
M. SEP. 18, 1872
FRANCES LAZARUS HART
(O.V. I)

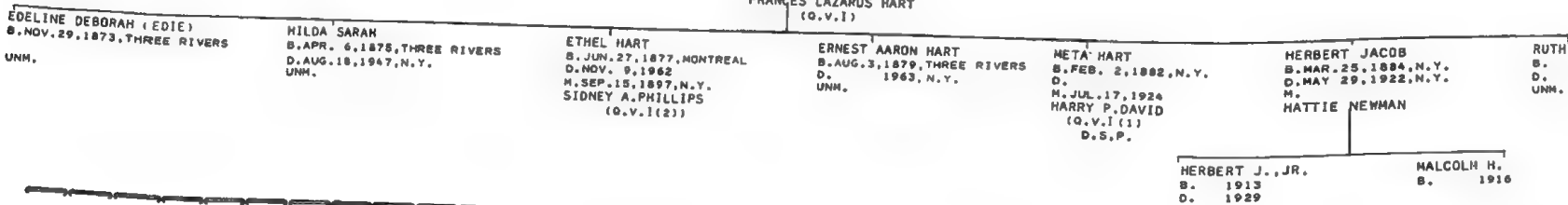

FLO. AGR.

SOLOMON MOSES LEVIN — ESTHER DAVIS (O.V.)

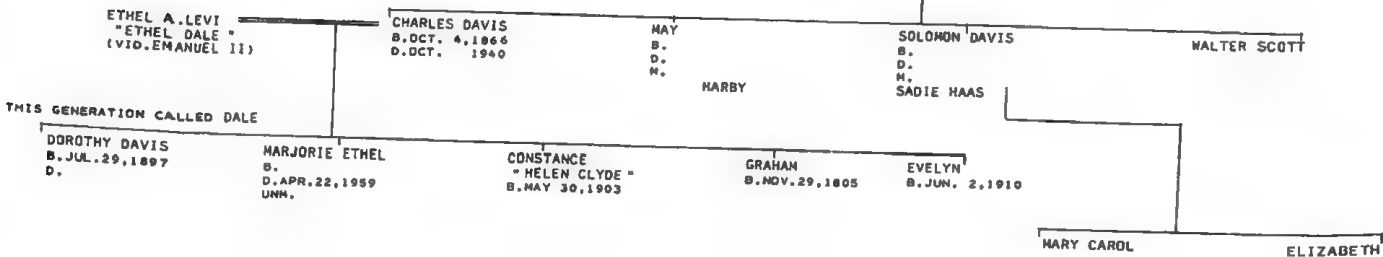

LEVIN II

ELZAS MS.
ELZAS JEW. CEMETERY AT COLUMBIA
ELZAS NEW JEW. CEM. AT CH.
ELZAS M.N.
ELZAS D.J.C.

LEWIS LEVIN, SR. (IN CH. 1808)
B. LOND. 1765
D. CH. OCT. 11, 1817
M. ?

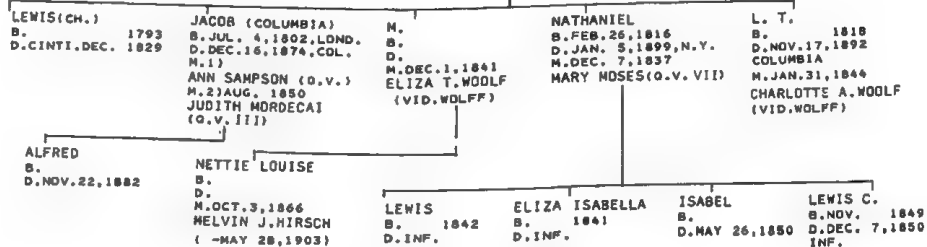

LEVIN I

LEVIN III

LEVY I (1)

FLO.ABR.
ELZAS-JEWS OF S.C., P.42
PAJHS, V.18, P.93F.
V.23, P.150, 158
V.27, P.161
V.33, P.210
V.34, P.60F.
V.38, P.87F.
J.E.V.8, P.59F.
KRAUS-SANDOR COLL.
TRANSACTIONS VII
ROSENSWAKE-BALTO.
PHILIP(PAT) WINSOR
F.J.DALLETT
HERSHKOWITZ-WILLS

N.Y.CALENDAR OF WILLS
WILLS OF ASHER, ISAAC,
NATHAN, HETTY
MARTHA, RACHEL
SAMSON, MOSES
GOLDSTONE GEN.
HENDRICKS GEN.
NICKVE ISRAEL REC.
ROTH-THE GREAT SYNAGOGUE
FRANKS LETTERS
N.Y.MARRIAGE BONDS
SOCIAL REGISTER
N.Y.TIMES OBITUARIES

ISAAC LEVY
B.
D.APR.26, 1695

BEILA
B.
D.APR.29, 1697

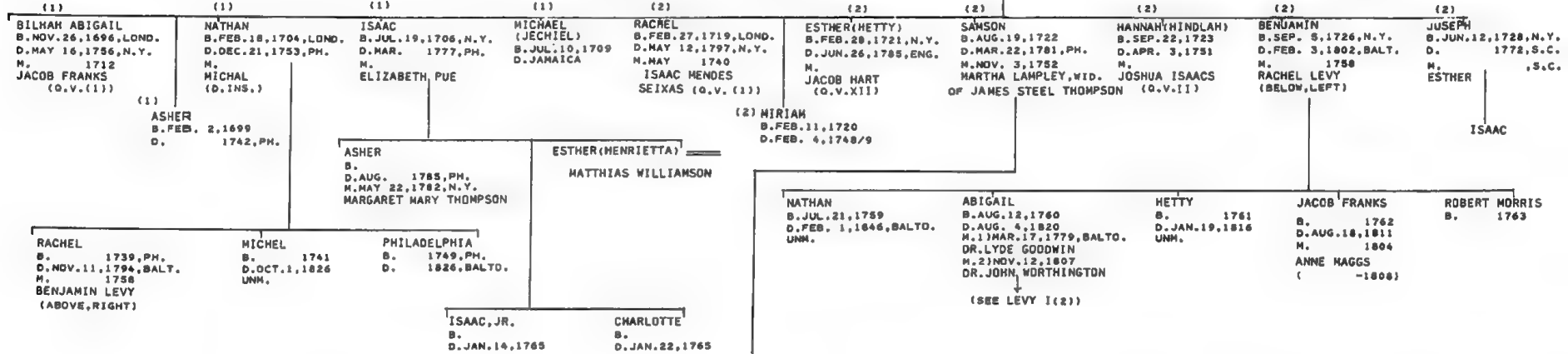
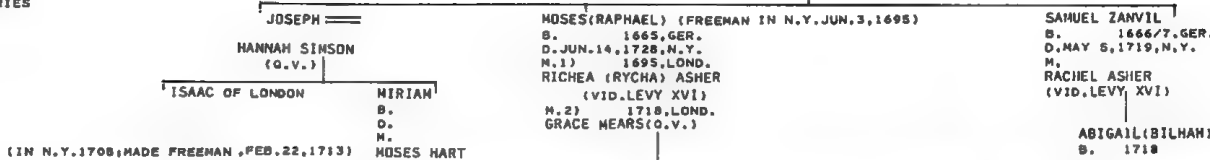

B.PH. →

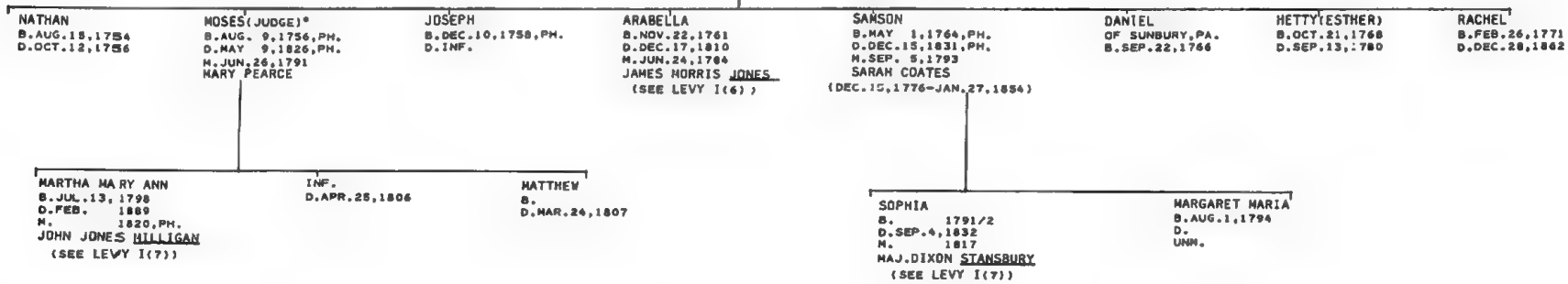

*ESTABLISHED REVOLUTIONARY ANCESTOR

LYDE GOODWIN PLEASANCE RIDGELY
 B. 1718
 D. 1755
 CAME FROM BRISTOL, ENG. TD
 BALTIMORE COL., M.D. CA. 1730

WILLIAM WORTHINGTON SARAH RISTEAU

LEVY I (2) GOODWIN

NOTE: PLACE NAMES IN PARENTHESIS ON THIS AND THE FOLLOWING PAGES
 INDICATE THAT THE INDIVIDUALS NAMED BELOW HAVE BEEN LOCATED
 IN THE SOCIAL REGISTER FOR THAT COMMUNITY.

DR. LYDE BALTO. MAR. 17, 1779 (1) ABIGAIL LEVY (2) BALTO. NOV. 12, 1807
 B. FEB. 4, 1754 D. AUG. 19, 1801 (SEE LEVY I (1)) DR. JOHN B. 1738 D. APR. 6, 1814

PLEASANCE B. FEB. 12, 1780 D. SEP. 29, 1837 M. JUN. 9, 1801 MICHAEL McBLAIR	RACHEL B. FEB. 1781 D. JUL. 1781	LIONEL LYDE B. NOV. 2, 1782 D. DEC. 2, 1845 M. DEC. 21, 1812 ELIZABETH AUGUSTA CAMPBELL (-SEP. 14, 1853)	CHARLES RIDGELY (CHANGED NAME TO CHARLES GOODWIN RIDGELY) B. JUL. 2, 1784 D. FEB. 4, 1848 M. DEC. 1, 1822 CORNELIA LOUISIANA LIVINGSTON (DEC. 24, 1802-MAR. 21, 1830)	BENJAMIN B. APR. 12, 1786 D. 1811 DROWNED	HENRY B. JUN. 18, 1787 D. JUN. 25, 1805	WILLIAM B. JUL. 4, 1789 D. JUN. 7, 1808 DROWNED	ELIZABETH B. OCT. 11, 1790 D. SEP. 24, 1826 M. JAN. 9, 1812 GEORGE PITT STEVENSON, JR. (SEE LEVY I (4))	THOMAS PARKIN B. OCT. 4, 1791 D. JAN. 14, 1820	MARIA B. SEP. 11, 1792 D. APR. 6, 1878 M. MAY 18, 1824 REV. FRANCIS WILLIAM PITT GREENWOOD (SEE LEVY I (4))	JAMES B. JUL. 31, 1794 D. AUG. 25, 1810	ROBERT MORRIS B. MAY 26, 1796 D. MAY 4, 1861 M. DEC. 6, 1821 ELIZABETH ANNE TAYLOR (-MAR. 30, 1862)
---	--	---	---	--	---	--	--	--	--	---	--

MARGARET MARIA B. N.Y. APR. 11, 1824 D. N.Y. NOV. 25, 1863 M. JUL. 2/19, 1846 JAMES SCHOTT (-MAY 26, 1860)	ELIZABETH AUGUSTA B. SEP. 10, 1825 D. JUL. 29, 1864 M. OCT. 14, 1852 WILLIAM HENRY HUNT (1824-FEB. 27, 1884)	CORNELIA ADELAIDE B. FEB. 12, 1827 D. OCT. 1857 M. JUL. 1, 1846 ST. GEORGE BROGHAN (-1861)	CORA B. OCT. 1828 D. JUL. 1829	WILLIAM TAYLOR B. SEP. 5, 1822 D. MAY 24, 1864	ABBY JOSEPHINE B. NOV. 1, 1824 D. JAN. 7, 1870 M. AUG. 27, 1846 WILLIAM LAW	MARY ELIZABETH B. OCT. 12, 1826 D. AUG. 17, 1905 M. SEP. 28, 1858 GEORGE C. LUDLOW	LIONEL LYDE B. APR. 4, 1828 D. DEC. 16, 1892, SAV. M. OCT. 8, 1879 ANNIE BOOTH	JULIA CLAYTON B. DEC. 10, 1831/2 D. M. AUG. 29, 1885 JARED WATERBURY SCUDDER (SEE LEVY I (5))	CHARLES RIDGELY B. APR. 10, 1842 D. MAY 19, 1894 M. OCT. 5, 1871 BELLE DE VRIES (1848-1916)	ALEXANDER TAYLOR B. AUG. 9, 1836 D. M. NOV. 11, 1863 MARY WAGER	FRANK GREENWOOD B. NOV. 13, 1844/5 D. JUL. 2, 1863 UNM.
---	---	---	--------------------------------------	--	---	--	--	---	--	--	--

CORNELIA LIVINGSTON B. MAY 9, 1847 LOCUST GROVE, KY. D. M. MAR. 31, 1869 OAKLAND, CALIF. HORATIO GEORGE HORNER	LUCY SERENA B. MAY 23, 1850 D. M. DEC. 11, 1866 SPENCER COCHRANE BROWNE	GEORGE B. MAR. 27, 1852	ELIZABETH AUGUSTA B. JUL. 30/31, 1854 D. M. MAR. 9, 1876, OAKLAND, CALIF. LT. DUNCAN KENNEDY	(BALTO. '50) ELIZABETH TAYLOR B. JUL. 24, 1872	WILLIAM DE VRIES B. SEP. 14, 1874	ELIZABETH TAYLOR B. SEP. 5, 1864	MARY WAGER B. JAN. 19, 1866 D. DEC. 6, 1873	LETITIA B. JAN. 31, 1868 D. M. NOV. 2, 1892 JAMES LANCASTER MORGAN
---	--	----------------------------	---	--	--------------------------------------	-------------------------------------	---	---

MARY SOPHIA B. S. FR. APR. 30, 1870	CORNELIA RIDGELY B. FEB. 23/25, 1868 D. JUN. 22, 1882	JOHN ROSS B. JUN. 14, 1870 D. JAN. 5, 1871	LUCY MITCHELL B. JAN. 30, 1873 D. M. SEP. 16, 1902 SYDNEY McMECHEN VAN WYCK	FLORENCE ELIZABETH B. SEP. 2, 1875	SPENCER C., JR. B. MAR. 1, 1885	JAMES L., JR. B. D. UNM.	HELEN RIDGELY B. MAY 26, 1896 D. M. JOHN HOLME BALLENTINE
--	---	--	--	---------------------------------------	------------------------------------	-----------------------------	---

RIDGELY B. JAN. 31, 1854 D. M. 1) NOV. 3, 1884 VIRGINIA DELANCEY KEARNEY M. 2) OCT. 16, 1901 MARGARITA CRESS	THOMAS B. MAY 16, 1855 D. M. APR. 14, 1888 HELEN JEWETT	RANDALL B. OCT. 30, 1856 D. JAN. 29, 1898 M. MAY 5, 1880 EMILIE RADCLIFFE	WILLIAM HENRY B. NOV. 5, 1857 D. M. AUG. 31, 1882 GERTRUDE UPSHUR	REAR ADM. LIVINGSTON B. NOV. 3, 1859 D. M. JUL. 7, 1892 CATHERINE HOWLAND HUNT	CORNELIA RIDGELY B. FEB. 4, 1861 D. M. NOV. 15, 1905 WILLIAM KELLEY NEWTON, M.D.	GAILLARD B. SEP. 8, 1862 D. M. OCT. 24, 1901 MARY GOODFELLOW
---	--	---	--	---	---	---

RIDGELY, JR. B. SEP. 16, 1887 M. JULIA DE F. CHENEY	VIRGINIA LIVINGSTON B. JUL. 19, 1890 D. INF.	VIRGINIA B. 1891	ELIZABETH RIDGELY B. JUL. 22, 1883	WILLIAM HENRY, JR. B. APR. 12/13, 1886	HELEN UPSHUR B. FEB. 28, 1889 M. BARNABY CONRAD	GERTRUDE LIVINGSTON B. NOV. 19, 1898	GAILLARD, JR. B. APR. 9, 1903	HENRY GOODFELLOW B. SEP. 22, 1907	ELEANOR B.	MARY C.	LIVINGSTON, JR. B. AUG. 12, 1894 M. CELIA PRATT
---	--	---------------------	---------------------------------------	---	---	---	----------------------------------	--------------------------------------	------------	---------	---

CHARLES RIDGELY B. NOV. 11/12, 1847, BALTO. D. JUL. 9, 1878 M. MAR. 30, 1872 ELLEN LINDSAY FISHER (JAN. 31, 1846-JAN. 22, 1916)	SCHUYLER LIVINGSTON B. DUNDAFF, PA. MAY 5, 1849 D. RICHM., VA. NOV. 10, 1878	REBECCA CORNELIA B. NOV. 24, 1850, N.Y. D. M. 1) SEP. 1, 1870, PH. WILLIAM ENGES SCHOTT M. 2) MAY 15, 1902 WILLIAM HENRY WETMORE	MARGARET LIVINGSTON B. SEP. 14, 1853 D. MAR. 10/11, 1856	RADCLIFFE B. SEP. 13, 1881 D. JAN. 10, 1886	WILLIAM HENRY B. SEP. 16, 1882 D. JAN. 10, 1886	GAILLARD B. JUL. 8, 1884 D. JAN. 21, 1886	FLORIDE LOUISA B. DEC. 8, 1887 M. CAPT. H. KENT HEWITT U.S.N.	NATALIE HAMMOND B. AUG. 13, 1889 M. HERBERT ROSS BAKER
--	--	---	--	---	---	---	--	--

JULIAN RIDGELY B. SEP. 7, 1874 D. JUL. 1880/AUG. 1881	CHARLOTTE B. OCT. 16, 1877 M. SEP. 28, 1904 WALTER COLES CABELL	MARGARET RIDGELY B. OCT. 5, 1872, PH. M. JUN. 14, 1905 WILLIAM ORDWAY PARTRIDGE	MARGARET LIVINGSTON (N.Y.) B. MAR. 6, 1909 M. WILLIAM A. H. BURDEN, JR.	FLORIDE	BETSY ROSS	ROBERT L.
---	--	--	---	---------	------------	-----------

LEVY I (3) McBLAIR

PLEASANCE GOODWIN
B. FEB. 12, 1880, BALTO.
D. SEP. 29, 1937, BALTO.
(SEE LEVY I (2))

JUN. 9, 1801

MICHAEL McBLAIR
B. CA. 1776
D. DEC. 19, 1861, BALTO.

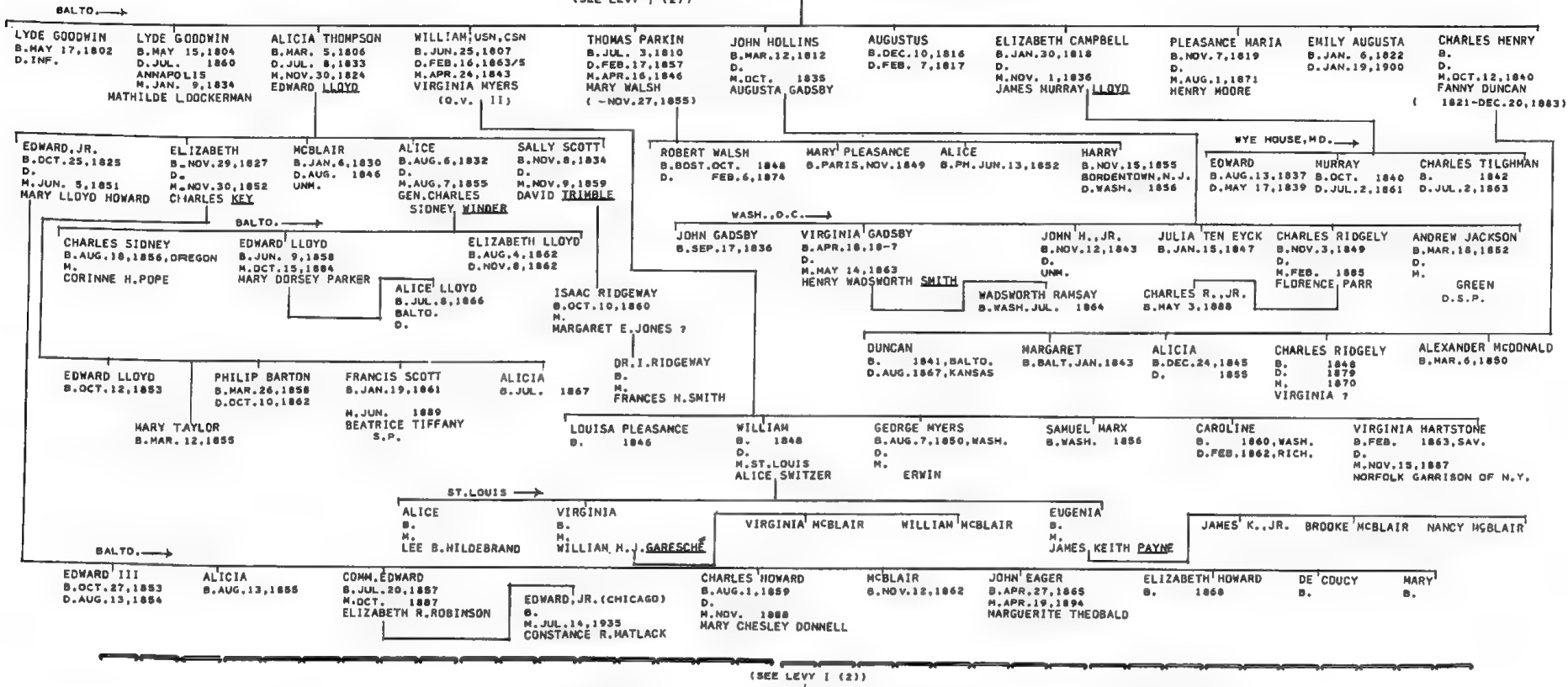

LEVY I (5) LAW, LUDLOW, SCUDDER

ABBY JOSEPHINE GOODWIN
B. NOV. 1, 1824, SAV.
D. JAN. 7, 1870, SAV.
M. AUG. 27, 1846, SAV.
WILLIAM LAW

MARY ELIZABETH GOODWIN
B. OCT. 12, 1826, SAV.
D. AUG. 17, 1905, NEW BRUNSWICK, N.J.
M. SEP. 28, 1859, NEW BRUNSWICK, N.J.
GEORGE C. LUDLOW

JULIA CLAYTON GOODWIN
B. DEC. 10, 1831, SAV.
D. ?
M. AUG. 29, 1855, NEW BRUNSWICK, N.J.
JARED WATERBURY SCUDDER

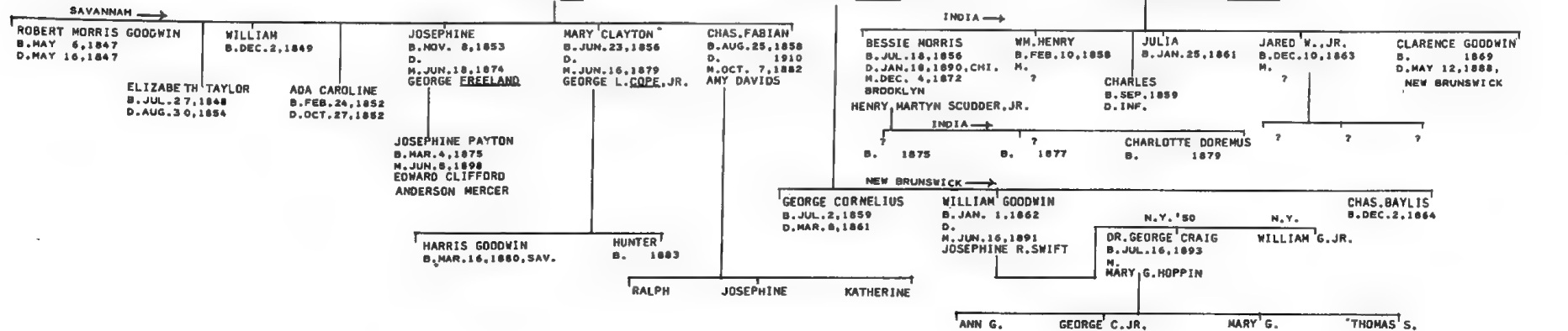

BALTO., JAN. 9, 1812

MAY 18, 1824

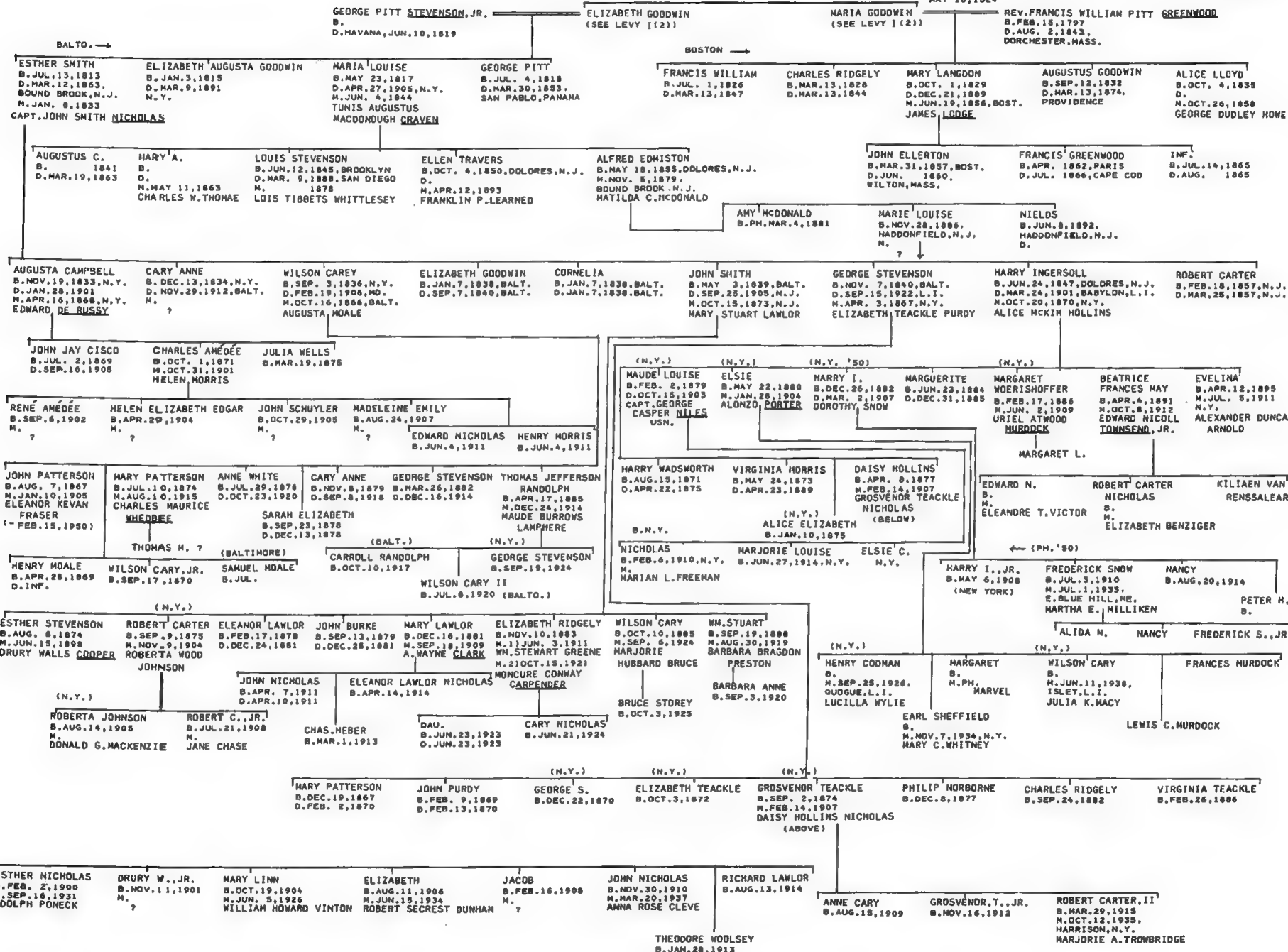

LEVY I (6) JONES

*GEN. OF THE MORRIS FAM. (PHOTO IN KR.)

ARABELLA LEVY
(SEE LEVY I (1))
B. NOV. 22, 1761
D. DEC. 17, 1810

JUN. 24, 1784
HARTHA LEVY
B. MAY 6, 1788
D. DEC. 27, 1849
M. MAR. 28, 1805
ROBERT ADAMS
(- FEB. 27, 1833)

JAMES MORRIS JONES, 1ST. LT. (REV.)^{*}
B. APR. 12, 1763

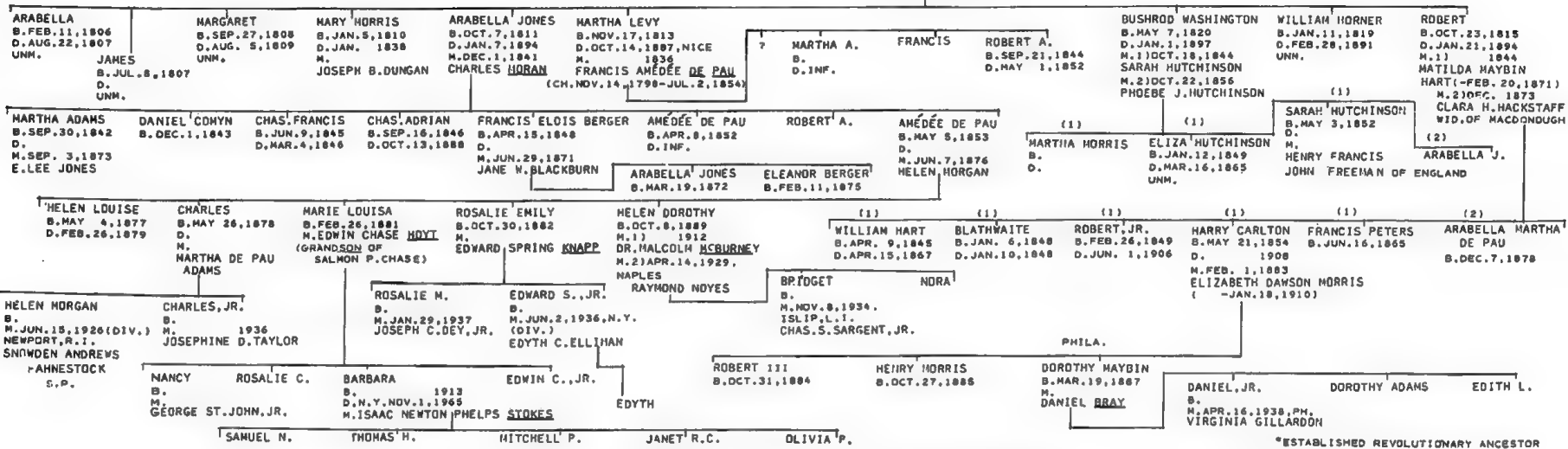

LEVY I (7) MILLIGAN, STANSBURY

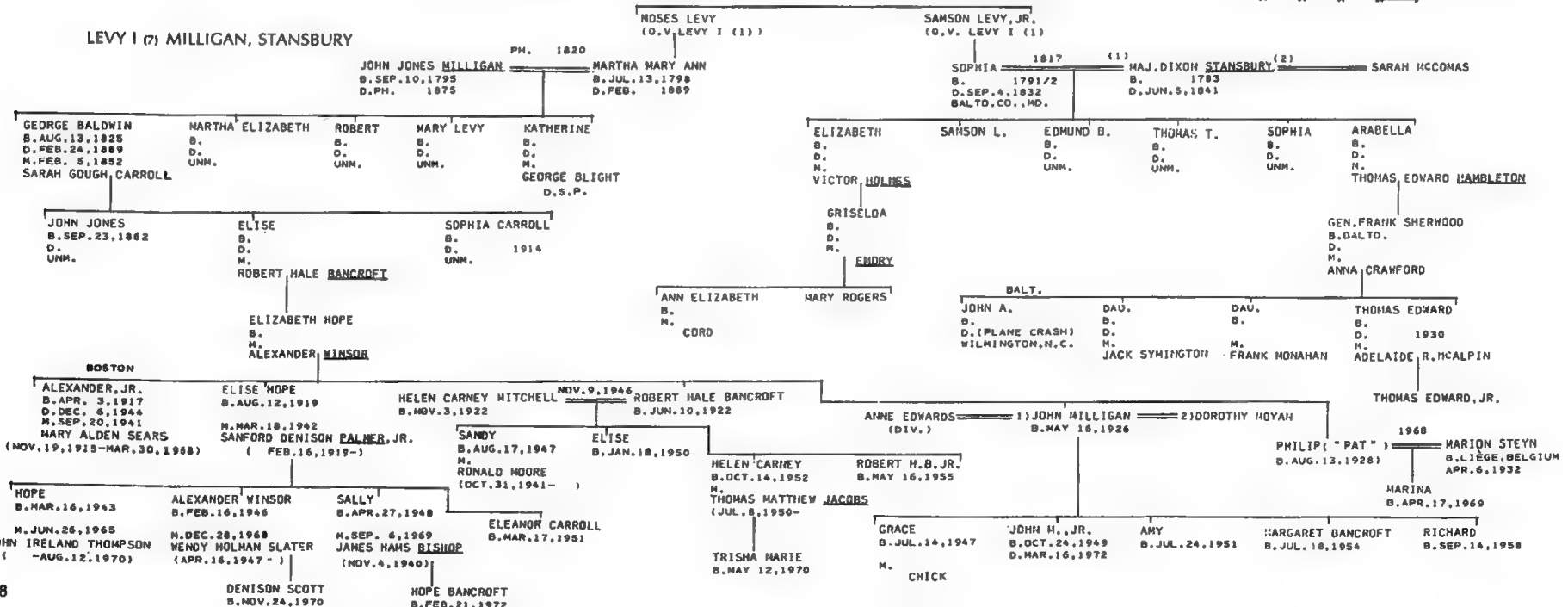

PAJMS, V. 12, P. 91
V. 27, P. 111
JON STEEDMAN
B'NAI JESHURUN REC.
KRAUS-SANDOR COLL.
ELZAS MS.

MICKVE ISRAEL REC.
SHEARITH ISRAEL REC.
FLO. ABR.
WILLS - JOSEPH M. LEVY
AMELIA LEVY
V. V. P. 198

ISAAC MICHAEL LEVY JUN. 1787, PH. RACHEL PHILLIPS (G.V. I (11))
B. 1755 D. 1812

LEVY II (PA.)

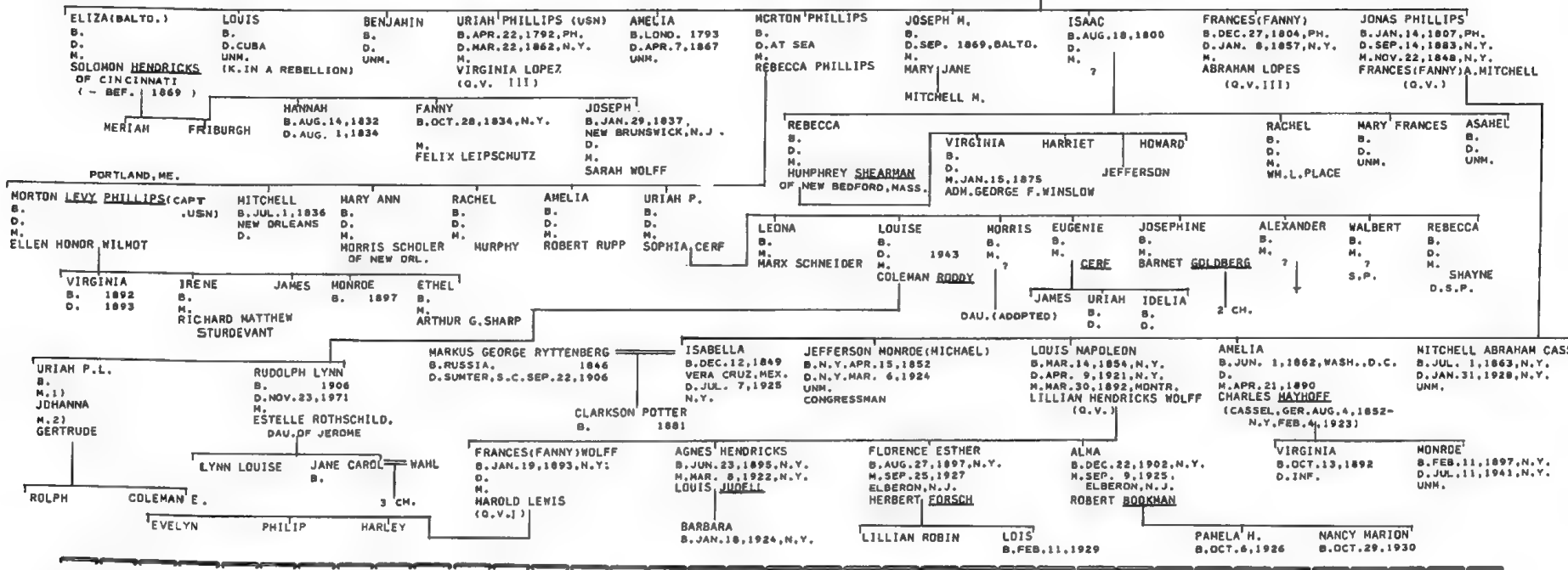

FEDERAL ST. CEM.
HERSHKOWITZ-WILLS
P. B. M.
POULSSON'S
JULIA MORDECAI MS.
TRANSACTIONS VII
MRS. RALPH NEWMAN
ELZAS-JEW. CEMETERIES AT
COLUMBIA, S. C.

PAJMS V. 4, P. 210
V. 27, P. 168F, 286, 336F
UJE, V. 8, P. 14
KRAUS-SANDOR COLL.
HENDRICKS GEN.
POOL-PORTRAITS...
AARON LEVY CALENDAR
N.Y. WILLS
SHEARITH ISRAEL REC.
ELZAS-M. N.

ISAAC HAIN
MOSES LEVY REYNA
OF FERNHOLZ, HANOVER

LEVY III (1) (N.Y.)

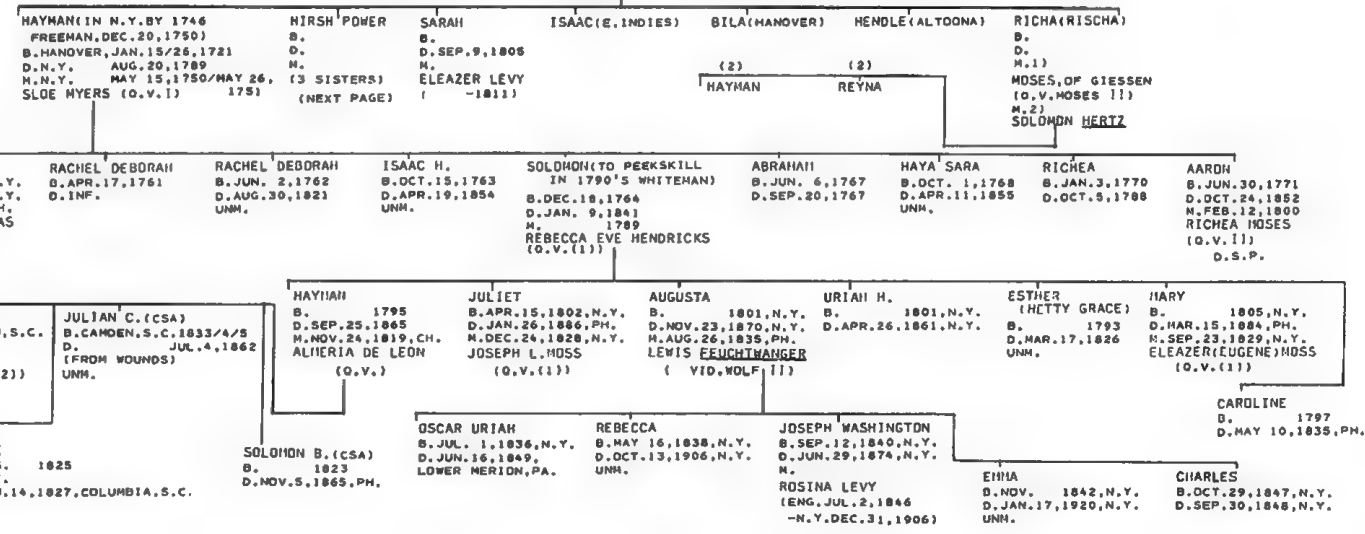

HARMON HENDRICKS
B. JUL. 1820
D. INF.
COLUMBIA, S. C.
JUN. 27, 1829

ROSALE ALICE
B. JAN. 1, 1824
D. FEB. 4, 1861
M. NOV. 5, 1849
DAVID SALDON (G.V. I (2))
(G.V. I (2))

REBECCA HENDRICKS
B. NOV. 29, 1832, CAMDEN, S. C.
D. SEP. 13, 1915, PH.
M. NOV. 5, 1856, PH.
JOHN SARUEL (G.V. I (2))
(G.V. I (2))

JULIAN C. (CSA)
B. CAMDEN, S. C. 1833/4/5
D. JUL. 4, 1862
(FROM WOUNDS)
UNM.

HAYMAN
B. 1795
D. SEP. 25, 1865
M. NOV. 24, 1819, CH.
ALIERIA DE LEON
(G.V. I)

JULIET
B. APR. 15, 1802, N. Y.
D. JAN. 26, 1886, PH.
M. DEC. 24, 1828, N. Y.
JOSEPH L. MOSS
(G.V. I (1))

AUGUSTA
B. 1801, N. Y.
D. NOV. 23, 1870, N. Y.
M. AUG. 26, 1835, PH.
LEWIS FEUCHTWANGER
(VIO. WOLF I)

URIAH H.
B. 1801, N. Y.
D. APR. 26, 1861, N. Y.

ESTHER (HETTY GRACE)
B. 1793
D. MAR. 17, 1826
UNM.

HARY
B. 1805, N. Y.
D. MAR. 15, 1884, PH.
M. SEP. 23, 1829, N. Y.
ELEAZER (EUGENE) MOSS
(G.V. I (1))

GEORGE
B. DEC. 1, 1820
D. JUN. 29, 1832

ALICE
B. AUG. 1825
D. INF.
JAN. 14, 1827, COLUMBIA, S. C.

SOLOMON B. (CSA)
B. 1823
D. NOV. 5, 1865, PH.

OSCAR URIAH
B. JUL. 1, 1836, N. Y.
D. JUN. 16, 1849,
LOWER MERIDON, PA.

REBECCA
B. MAY 16, 1838, N. Y.
D. OCT. 13, 1906, N. Y.
UNM.

JOSEPH WASHINGTON
B. SEP. 12, 1840, N. Y.
D. JUN. 29, 1874, N. Y.
M.
ROSINA LEVY
(ENG. JUL. 2, 1846
-N. Y. DEC. 31, 1906)

EMHA
D. NOV. 1842, N. Y.
D. JAN. 17, 1920, N. Y.
UNM.

CHARLES
B. OCT. 29, 1847, N. Y.
D. SEP. 30, 1848, N. Y.

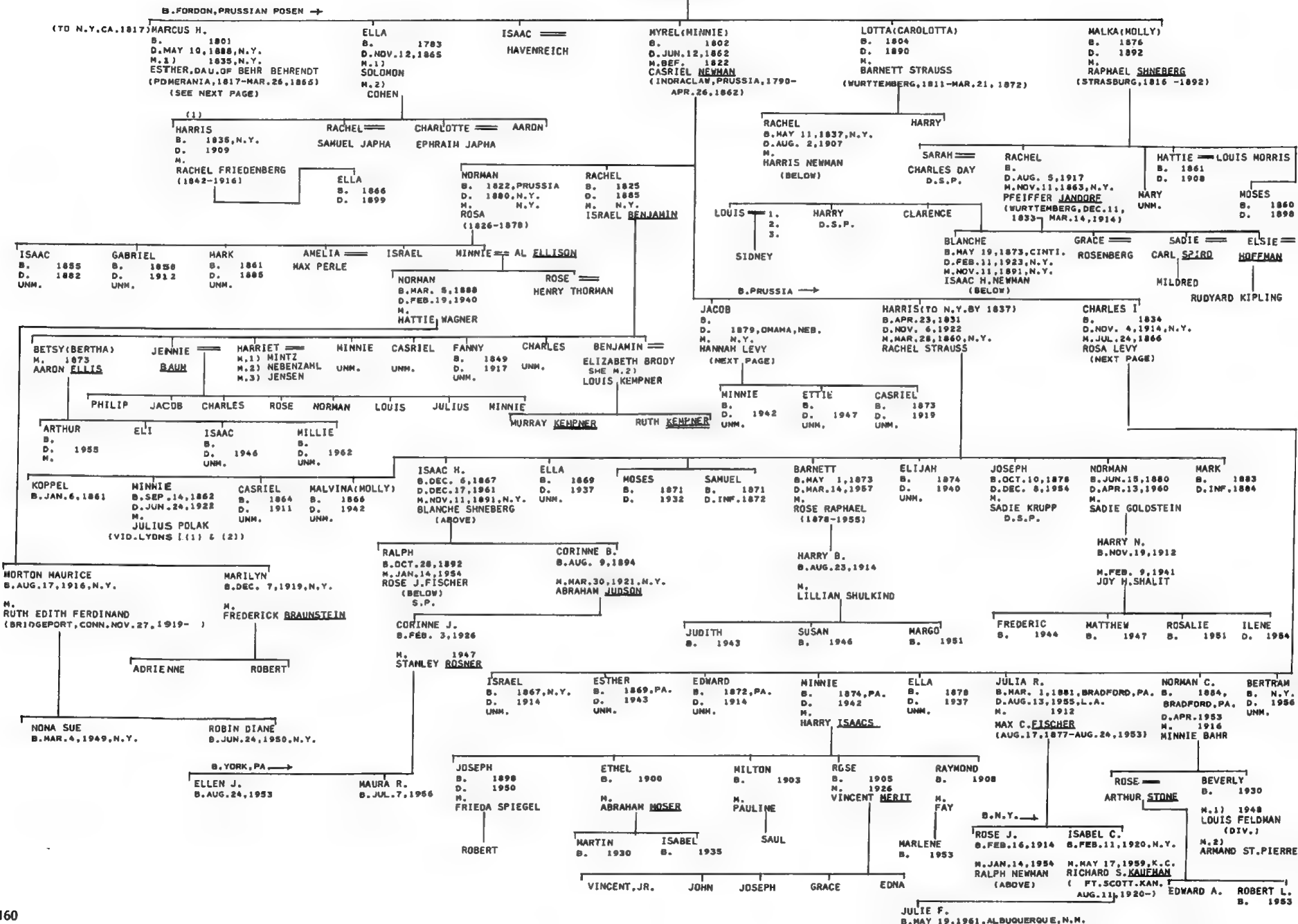

(10 N.Y.CA. 1817)

1835, N.Y.

MARCUS H. LEVY
 B. 1801, FORDON, PRUSSIA
 D. MAY 10, 1888, N.Y.
 (SEE PRECEDING PAGE)
 M. 2)
 M. 3)

1) ESTHER, DAU. OF
 BEHR BEHRENDT
 B. 1817, POMERANIA
 D. MAR. 26, 1865

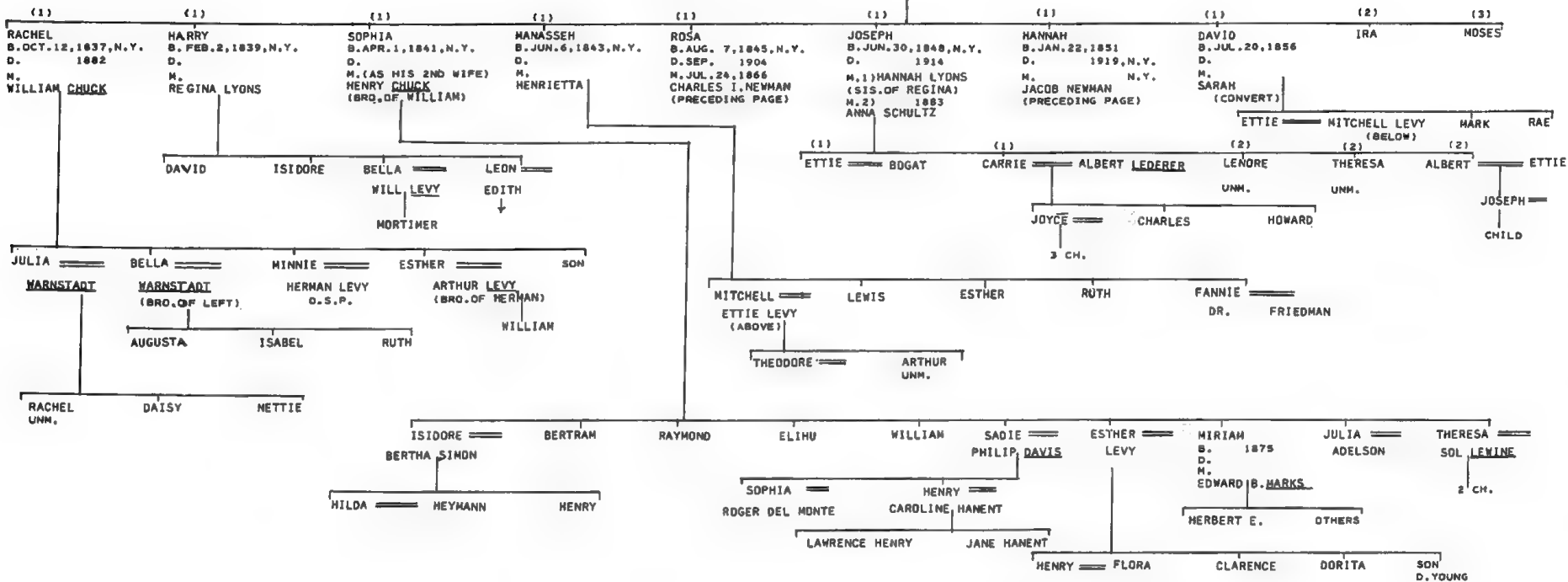

LEVY IV (RICHMOND)

PAJMS, XLVI, P. 101F.
CLARE L. HUTZLER
RALPH COLTON
AMY STEWART PAPERS
FLORENCE ABRAHAMS
EZEKIEL-LI CHTENSTEIN-JEWS OF RICHM.

RI. DAILY DISPATCH, 4/24/1878
ISAACS FAMILY REC.
FLO. ABR.
LEVY GEN.
BETH SHALOME MARR. REC.
VA. MARR. BONDS
MYER SOLIS-COHEN

(TO RICHM. 1818) ABRAHAM LEVY
B. AMST. 1769
D. RICHM. DEC. 27, 1852

RACHEL CORNELIA BERNARD
(SARAH RACHEL)
B. AMST.
D. RICHM. APR. 9/10, 1842

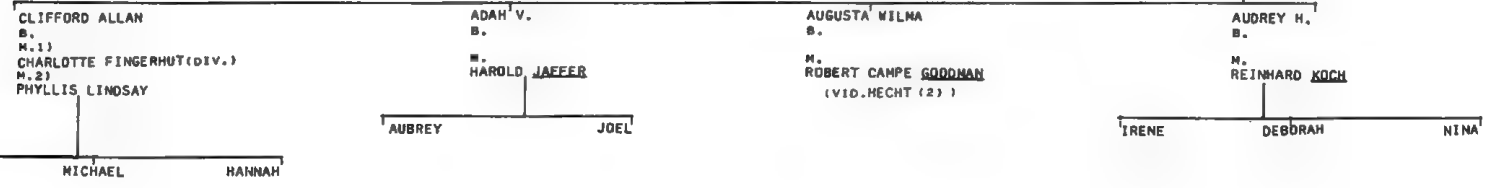
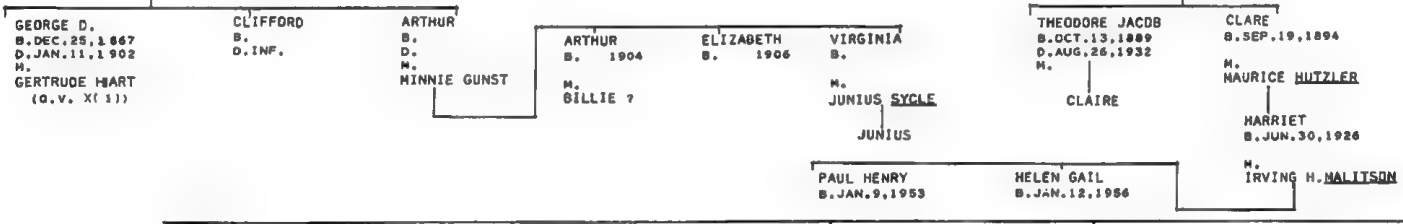
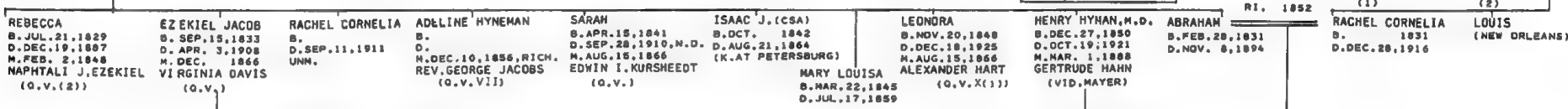
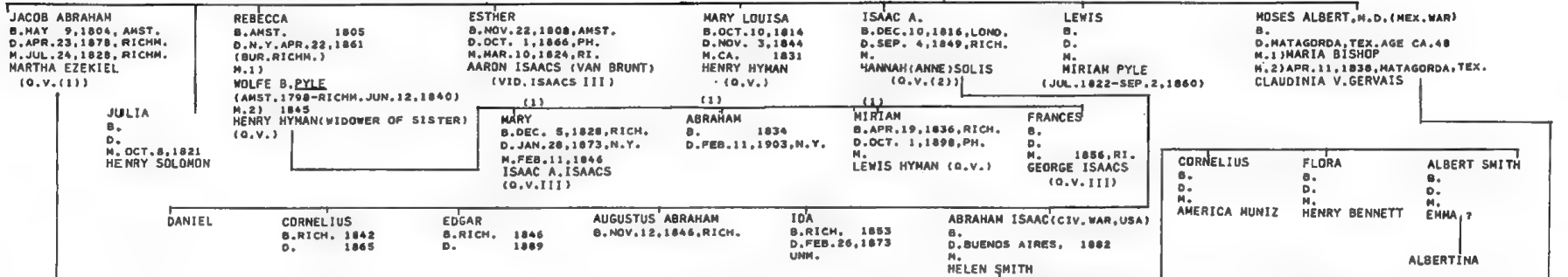

ADAM JÜDD MICHAEL HANNAH

H. MOISE-THE MOISE FAMILY
 FLO. ABR.
 ELZAS M.N.
 M.S.S.
 O. J. C.
 JRM COLL.
 WILL OF (ISA) BELLA L. PHILLIPS
 WILL OF RACHEL M. LEVY
 MORDEAI L. RAISIN
 ABBOT L. NOFFAT

MAXWELL WHITEMAN
 ESOUILINE HILL, GA. CEM. REC.
 KRAUS-SANDOR COLL.
 RAISIN COLL. (AJA)
 MOSS GEN.
 TOBIAS GEN.
 ROSENWAIKE

1790
 LEAH TOBIAS (O.V. II (1))
 MAY 1, 1801, CH.
 SARAH CARDOZO (O.V.)
 B. JUL. 1764, WOODLICH, ENG.
 D. MAR. 20, 1835, CH.
 (IN CH. BY 1785)

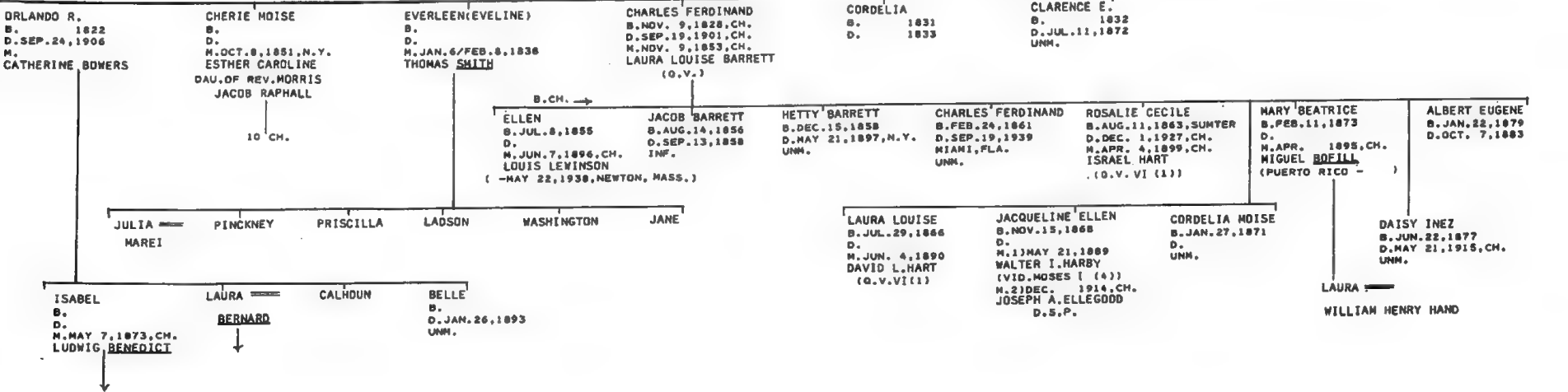
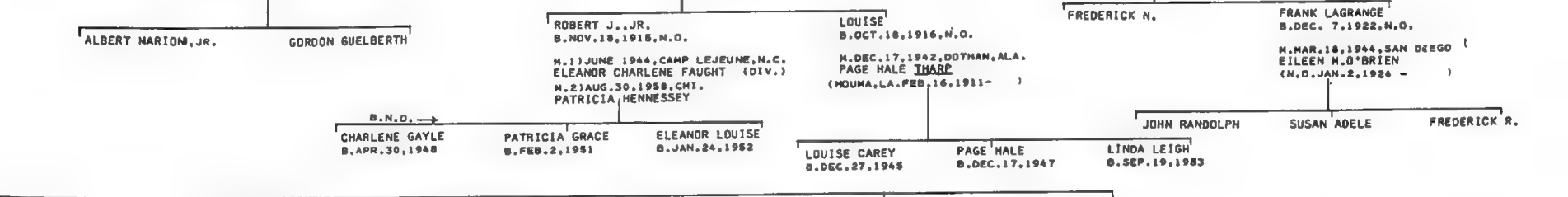
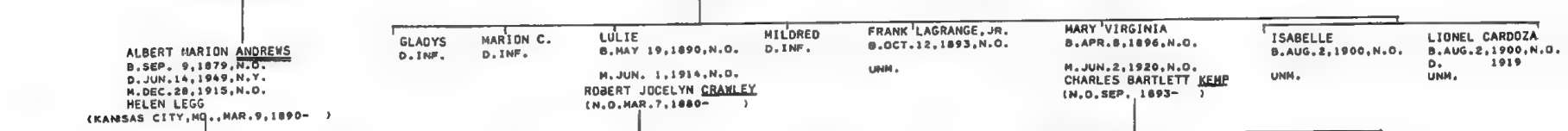
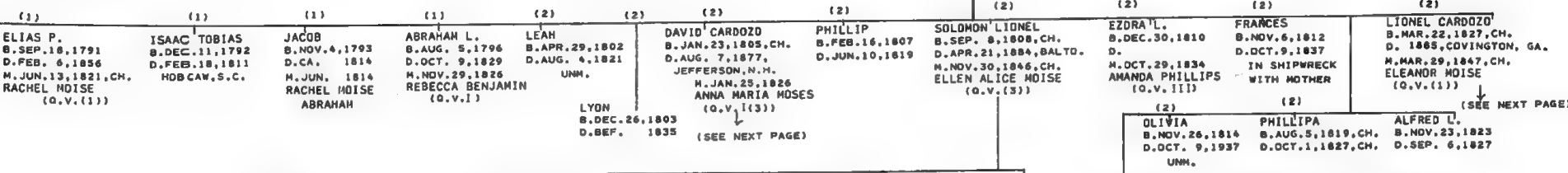

DAVID CARDOZA JAN. 25, 1826 ANNA MARIA MOSES (G.V. I (13))
 B. JAN. 23, 1805, CH. D. AUG. 7, 1877, JEFFERSON, N. H.
 LIONEL CARDOZA MAR. 29, 1847, CH. ELEANOR MOISE (G.V. I (11))

CECILIA ELIZA B. OCT. 3, 1830, CH. D. NOV. 14, 1916, BALTO M. OCT. 3, 1850, PH. ISRAEL COHEN (G.V. I (1))
 FANNY ENMA B. NOV. 30, 1831, CH. D. OCT. 25, 1925, N. C. M. SEP. 6, 1854, PH. COLUMBUS MOISE (G.V. I (1) & (3))
 CAROLINE AGNES B. D. SEP. 22, 1834
 SEPTIMA MARIA B. C. A. 1834 D. C. A. 1912 M. CAPT. CHARLES T. H. COLLIS
 DAVID C., JR. B. 1837 D. 1863
 SARAH HANNAH B. FEB. 16, 1838 D. JUL. 17, 1907, PH. M. EZRA I. MOSES (G.V. III (11))
 SOLOMON LAZARUS B. D. M. JAN. 10, 1894, SUNTER (THE) DORRA ALICE MOISE (G.V. (2))
 AMANDA OCTAVIA B. MAY 18, 1843 D. NOV. 23, 1897, PH. M. JAN. 5, 1885, PH. LUCIEN MOSS (G.V. (1))

LLOYD AMELIA EDWIN LEWIS CHARLES
 DONALD EGGLESTON EASTLAKE (-MAY 23, 1953, RIDLEY PARK, PA.)
 CAROLINE MOISE B. APR. 6, 1895, PH. D. MAY 25, 1922, PH.
 DAVID CARDOZA B. APR. 30, 1896, PH. M. OCT. 3, 1921 ADELE BOWES REEVES
 ALICE ELEANOR B. SEP. 6, 1917, PH. DONALD E., JR. B. SEP. 19, 1919, PH.
 HARY ANTONIA (ADOPTED AS MARY ALICE KOHN BY AUGUST KOHN, JR. (VID.) (GOLDSMITH) B. JUN. 2, 1926, PH. M. 1) MAY 1942, COLUMBIA, S. C. HENRY MOODY MCELVEEN, JR. (DIV. JUN. 1945) M. 2) DEC. 28, 1948, COLUMBIA, S. C. ALVIN STRASBURGER

LIONEL C., JR. B. MAY 22, 1847 (?), CH. D. SEP. 5, 1906, COLUMBUS, GA. ISABEL A. MOSES (G.V. IV (1))
 EDWARD B. LEVIE ALICE LANDIS PLACE (1847-1886)
 SARAH ADOLPH L. SANGER (1842-1894)
 DAVID C. M. 1) BREAUZ M. 2) BREAUZ D. S. P.
 COLUMBUS MOISE B. 1855 D. 1889 M. 1878 BELLE EVELYN SAUNDERS (MAR. 5, 1867-JUL. 29, 1887)
 ELEANOR MOISE M. 1) ALBERT M. LEVY (SEE PRECEDING PAGE) M. 2) FRED B. KING
 REBECCA FRANK L. PLACE
 LOUISA MOISE B. SEP. 1, 1867, N. O. D. SEP. 27, 1936, N. O. M. APR. 15, 1886, N. O. FRANK LAGRANGE LEVY (SEE PRECEDING PAGE)
 MARION BENNETT
 PERCIVAL R. B. DEC. 8, 1860 D. JAN. 31, 1884

ELEANOR HENRY SCHUMANN SANGER
 CLARA B. DEC. 26, 187-7, N. Y. D. M. NOV. 8, 1912, N. Y. LEONARD LINDSAY GLOVER (N. Y. SEP. 7, 1886-) D. S. P.
 SARAH LEO FRANK HAROLD
 MARIAN FRANCES B. APR. 20, 187-7, N. Y. D. M. NOV. 25, 1897, N. Y. JULIUS FRANK (OGDENSBURG, N. Y. JUL. 18, 18-67-)
 LIONEL C. B. JUL. 8, 1879 D. FEB. 20, 1881
 BELLE EVELYN HORNLEIN LIONEL
 INF. B. NOV. 25, 1882 D. NOV. 26, 1882
 IRMA B. JAN. 4, 1884 D. DEC. 6, 1904 UNM.
 EDNA B. SEP. 23, 1885, N. O. M. APR. 24, 1906, COLUMBUS, GA. GEORGE SYDNEY COBB (ENNIS, TEX., OCT. 11, 1878-)
 LITA SAUNDERS B. JUL. 14, 1887, N. O. D. JUL. 1947 M. WALTER SCOTT HERRILL

FREDERICK MILLER ETHEL LIONEL GERTRUDE
 EOLA FELL KATHERINE RICHARDSON
 FREDERICK, JR. JESSIE CARTER

EDWARD B., JR. LUCIOUS INF. WILLIAM AUBREY
 GRACE SHEPHERD LILLY SHEPHERD LIONEL B. FEB. 17, 1884, WACO, TEX. D. MAR. 21, 1906, CNTT.
 LUCIOUS, JR. LILLY
 EDWARD B. III JOSEPH L. JOHN AUBREY ALICE

ELEANOR CHARLOTTE B. APR. 15, 1900, OGDENSBURG M. APR. 9, 1924, OGDENSBURG EDGAR LOUIS SCHWARTZ (N. Y. MAR. 30, 1896)
 RICHARD LIDNEL ADOLPH SANGER
 GEORGE S., JR. B. MAR. 8, 1907, COLUMBUS, GA. M. NOV. 12, 1929, W. POINT, GA. LILLIAN SHANNON EDMONDSON (DALTON, GA. FEB. 28, 1908-)

LIONEL CLARENCE M. JERUSALEM CHRISTINA LARSON
 MARIAN FRANCES B. 1874, MUSCOGEE, GA. ARTHUR CRAWCOUR B. DEC. 27, 1880 D. SEP. 16, 1942 M. MARJORY HOKE SISK (1884-1929)
 REGINALD JOHNSTON B. JAN. 7, 1873 D. JUN. 4, 1873, N. O. INF.
 NILS J.
 JULIUS FRANK B. OCT. 27, 1925, N. Y. M. OCT. 31, 1954, OGDENSBURG NELDA MARGARET JENKINS (CANTON, N. Y., MAY 10, 1932-)
 SUSAN MARGARET
 MARIAN FRANCES B. JUL. 20, 1928, O' BURG. M. NOV. 1, 1958, O' BURG. JAY BERNARD CLASS
 LILLIAN MYRICK B. AUG. 31, 1930 M. MAR. 24, 1951 LAGRANGE DAVID ZIMRI CAUBLE, JR. (FAIRFIELD, ALA., APR. 24, 1925)
 EDNA SYDNEY B. JUL. 17, 1933 M. OCT. 26, 1957 LAGRANGE WILLIAM DU BERRY SMITH (BETHEL, N. C., FEB. 9, 1931-)
 SARAH OWEN B. FEB. 8, 1940
 WILLIAM D., JR.

ISABEL ADELINE B. FEB. 22, 1907 M. JUN. 9, 1927, COLUMBUS, GA. ALEXANDER ANDREW DDBAK (BUDAPEST, NOV. 30, 1898 -)
 ELLA HOKE B. SEP. 5, 1908, SHELBY, N. C. M. JUN. 7, 1928, COLUMBUS, GA. MYLES COLLIER STEWART (COLUMBUS, GA. OCT. 22, 1896-)
 ELEANOR MARJORIE B. JUN. 16, 1910 M. JUN. 29, 1931, COLUMBUS, GA. RICHARD WOODHOUSE JOHNSON, JR. (NORWICH, ENG. OCT. 30, 1889-)
 FRANCES MARIAN B. NOV. 13, 1912 M. JUL. 13, 1931, COLUMBUS, GA. WILLIAM JOSEPH DAVIDSON (ANNISTON, ALA. JUL. 19, 1909 -SEP. 30, 1948)
 INA AUGUSTA B. NOV. 12, 1917
 DAVID Z. III LILLIAN COBB EDNA SUE
 APR. 12, 1936, COLUMBUS, GA. SAUL PAUL SCHAPIRO (BALTO. JUL. 14, 1909-)
 SHIRLEY ADELINE MARGIE INA
 ALEXANDER A., JR. JOHN DANIEL ANNE HELEN
 KATHERINE ANN HOGAN (NORMAN, OKLA. JUL. 26, 1930-)
 SAN MARCOS, TEX. FEB. 7, 1951
 RICHARD CARDOZA ELEANOR LEIGHTON M. 1) 1958 WILLIAM COLLIER (KILLED 1960) M. 2) 1966 JAMES LOWE-DONNELL
 WILLIAM J., JR. FRANCIS MARIAN ARTHUR LIDNEL
 SYDNEY B. 1960 JAMES L., JR. B. 1968

SHELBY KATHERINE STEWART MARSHALL

MISC.VII #397
 HERSHKOWITZ WILLS,P.196F.
 KORN-BENJAMIN LEVY
 JEWS OF N.O.
 PAJHS V. 4,P.189(CORRECTED)
 PAJHS V.27,P.192F.,348F.
 PAJHS V.33,P.199F.
 PHILLIPS GEN.(JRH)
 V.L.GUTERMAN NOTES(KRAUS-SANDOR COLL.)
 VITAL RECORDS OF R.I., V.4
 GUTSTEIN-JEWS OF NEWPORT
 POOL-PORTRAITS...
 SHEARITH ISRAEL REC.
 ELZAS MS.

ISAAC LEVY

JUDITH? B. 1700/2 D.OCT.23,1788,NEWPORT
 BENJAMIN B. 1692,LOND. D.DEC.30,1787,NEWPORT
 MOSES(NAT.N.Y.APR.19,1743) B. 1704 D.JUN.18,1792,NEWPORT

HAIM(HIAM) B. 1739 D.JUL.12,1795 M.JUL.24,1768,NEWPORT
 GRACE HEARS (O.V.)

BILAH B. 1742 D.FEB.3,1781 UNM.

JOCEBED B.JAN.12,1746/7,N.Y. D.OCT.26,1828, N.Y. M.OCT. 3,1770,NEWPT.
 MOSES SEIXAS (O.V.(1))

SINEON B. 1748,NEWPT. D.DEC.23,1825,N.Y. M. HETTY LEVY(O.V.X)

JUDITH B.SEP. 4,1769,NEWPT. D.MAR.17,1833,N.Y. UNM.

MOSES B.MAR.4,1772 D.ENG. M. ROSETTA ALHOND OF BRISTOL,ENG.

JUDAH HEARS(USH) B.JUN.18,1778 D.OCT. 1813,HAVANA M.WILMINGTON,N.C.

JOCEBED B.DEC. 1797 D.FEB.28,1820 UNM.

BILHAH B. D. M. JOHN HART(N.Y.)

BENJAMIN LEVY(TO N.O.CA.1812) B. 1786,N.Y. D.JAN.10,1860,N.O. M. 1817,N.O.

HANNAH B. 1783,N.Y. D.JUL.5,1863,WASH. UNM.

JULIA B. 1789,N.Y. D.NOV.23,1862,WASH. M.JAN.11,1817,N.Y. JOHN SOLOMONS (O.V.II)
 MIRIAM(HARY) B. 1793,N.Y. D.FEB.29,1880,WASH. UNM.

HEARS

HENRY

JULIA

GEORGE

INF. D.MAR.1819

HENRY(ZEBY) B.MAY 7,1820

DAU. B.JAN.2,1827

ALEXANDER B.SEP.7,1818,N.O. D.FEB.7,1866,N.O.

(ISABEL)MATHILDA B.APR. 2,1820 D.JUL.22,1852 M.MAY 21,1840 ALBERT CHILDE AINSWORTH (- MAY 5,1851)

ALINE MARY B.CA. 1843 M. FREDERICK J. JORDY (1831 - 1900) D.S.P.

ANNIE ELIZABETH B. 1845 D.AUG.13,1860 POINT COUPEE,LA.

MARTIN LUTHER B. 1847 D.OCT.16,1876 M. AMELIA MARGUERITE RHODES

ANNE CORINNE

ALICE LOUISE

HARRY MARTIN

WHO'S WHO IN WORLD JEWRY
 CCR YEARBOOK
 FLD.ABR.
 KORN-JEWS OF N.O.
 MOISE-JEW GEN. AT SUMTER

KRAUS-SANDOR COLL.
 ELZAS MS.
 JRM COLL.

MAR.30,1839

LEVY IX (NEW ORLEANS)

JACOB LEVY(OF NEW ORLEANS) B.CH. D.

SARAH EDWITHA MARKS (O.V.I)

EUGENE HENRY B.GRAND GULF,MISS. 1840 D. M.1 ALMERIA EMMA MOSES (O.V.I(3)) M.2 MELINDA

JULIAN HILLEL B.AUG. 3,1843 D.FEB.27,1916 M. CORINNE DAVIS (O.V.(1))

JOSEPH CALHOUN(CSA) B. 1862 D. K.AT SMILDH

ROSALIE VIRGINIA B. 1845 D. 1930 M. PERRY MOSES (O.V.I(4)&(5))

MIRIAM GRACE B. D. UNM.

ADELE B.APR.2,1849 D.JUL.1,1920 M.SEP.3,1873,N.O. ANDREW J.MOSES, JR. (O.V.I(4))

EDMUND HYMAN B. D. YOUNG

BERTHA B. D. M. FREDERICK ALEXANDER BONITA

FLORA B. 1854 D. 1918 M. RUDOLPH BEER

GEORGE DAVIS

JULIAN

WAVERLY BERTRAM

DAU. D.INF.

CORINNE B. D. YOUNG

FREDERICK A.,JR. B. D. YOUNG

SARAH EDWITHA B. D. M. ISAAC C.MARK S.P.

WALTER

EDMOND

ALINE LUCILE

PEARL

DAISY B. D. YOUNG

(RABBI) CLIFTON HARBY B.JUN.21,1867,N.O. D.MAR.17,1962 M.1 SARAH LANG M.2) APR.28,1903 CORA BACHARACH

LUCIA DE L. B. D. UNM.

EUGENE HENRY, JR. B. D. M. CLARA MUNSCHWEIN

DANIEL DERONDA B. D. ADDIE L.C.MOSES (O.V.III(3))

EUGENIA

EVANGELINE

ALMERIA

CHARLES

INF

HELEN

ADELE RUCKER

EDWARD J. MARIE BAYLEY

ALICE JULIAN HILLER

SUSAN

ADELE

ALFRED E.

RICHARD J.

EUGENE HENRY = ALMERIA(HINNIE)MOSES (O.V.III(3))

ARTHUR EUGENE

LEVY VII (1) (PA.)

DAVIS-HIST. OF ROSEPH SHALOM
EDWIN WOLF II
FISH-AARON LEVY
LEVY MSS. (PA. HS)
ROSENTHAL MSS.
MORAIS-JEWS OF PHILA.
MYER SOLIS-COHEN
FED. ST. GEN.
P.B.H.
FLD.ABR.

PHILLIPS
SAMUEL
RACHEL PHILLIPS
B.
D. DEC. 23, 1910, PH.
D.S.P.

AARON
B. AMST. 1742
D. FEB. 28, 1815

DAU.
B.
D.
M.
MOSES HAYM POLLOCK OR LEVY

AARON LEVY, OF AMSTERDAM
B.
D.
M.
7

(TO U.S. 1801) JUN. 10, 1801, PH.
FANNY H. JOSEPH
B. 1796
D. JUL. 5, 1841

(TO U.S. 1796)
AARON LEVY, JR.
B. 1774
D. AUG. 3, 1852

(TO U.S. 1801)
RACHEL
B. 1781/7
D. JAN. 2, 1843
ELIAS HYNEMAN
(O.V.I.)

NIRIAH
B. 1814
M.
JOHN BARNETT
(O.V.)
BENJAMIN
B. D. FEB. 1, 1809, PENNA.

RACHEL POLLOCK
(VID. HART XIII)

DEC. 18, 1833/4
JOSEPH
B. DEC. 1, 1802, PH.
D. FEB. 4, 1885

REBECCA
B. MAY 14, 1804, PH.
D. AUG. 31, 1888
M. DEC. 13, 1833, PH.
PHINEAS HART
(O.V.X)

BENJAMIN
B. SEP. 14, 1806, PH.
D.
M.
EMMALINE RUNSEY

AARON (CIV. WAR)
B.
D.
M.
?

A. CHARLES
B. 1847
D. 1933
BARBARA WEIL

EMMALINE
B.
D.
M.
JONES

FANNY
MEHRLE (MURYA)
B. JUN. 6, 1809, PH.
D. FEB. 3, 1810

HANNAH
B. DEC. 19, 1810, PH.
D. DEC. 7, 1850
UNM. (INS.)

RASKY (RISCHKY
OR RICHA)
B. APR. 21, 1812, PH.
D. JUL. 25, 1846
(DISAPPEARED)

MOSES
B. NOV. 9, 1834
D. FEB. 6, 1835

ELIAS PHINEAS
B. FEB. 4, 1836
D. MAR. 2, 1891
M. 1) JUL. 9, 1862
MIRIAM DINAH HOHENFELS (O.V.)
M. 2)
CARRIE NEGBAUER

HYER SAMUEL (CIV. W.)
B. SEP. 12, 1839
D. APR. 8, 1909
SARAH J. SOUTHWALL
(SEE BELOW)

BENJAMIN FRANKLIN
B. MAY 8, 1837
D. APR. 15, 1920
M. JUN. 12, 1885
ELLEN FRANCES SMITH

REBECCA VIRGINIA
B. NOV. 2, 1841
D. 1926
M. JUL. 2,
SIGMUND DEUTSCH
(SEE BELOW)

BLANCHE
B. JUL. 10, 1848
D.
M. 1) JUN. 6, 1908
WILLIAM K. KARFORD
(JUN. 3, 1879-MAR. 6, 1931)
M. 2) DEC. 23, 1931
JOSEPH M. ROSS
(FEB. 18, 1882-)

ELIAS P. JR.
B. 1870
D. SEP. 1, 1872

BARTON EPLEY
B. FEB. 3, 1898
M. OCT. 5, 1936
WINIFRED V. REES
(APR. 26, 1886-)

FANNIE
B. JAN. 23, 1864
D.
M.
ELIAS H. LEVY
(SEE BELOW)

HYMAN JOSEPH
B. OCT. 2, 1865
D. JUL. 8, 1883
DROWNED

LOUIS MEYER
B. JUN. 14, 1867, PH.
D. JUL. 1, 1939, PH.
M. NOV. 26, 1896, PH.
HENRIETTA SCHWARTZ
(CONCORD, WIS. JUN. 16,
1869-PH. SEP. 6, 1946)

MIRIAM E. JOSEPH

CLARENCE PHINEAS
B. MAR. 23, 1869
D. NOV. 1939
M. 1)
LINDA EPLEY
(OCT. 1864-1914)
M. 2) NOV. 1917
MARY GRESHAM
(APR. 1874-MAY 20, 1984)

ELIAS P. JR.
B. 1870
D. SEP. 1, 1872

ELIAS P. JR.
B. 1870
D. SEP. 1, 1872

ELIAS P. JR.
B. 1870
D. SEP. 1, 1872

LEVY VII (2)

SARAH J. SOUTHWALL
B. 1848
D. QUAKERTOWN, PA. 1924
(CONVERT)

PH. NOV. 3, 1872
HYER SAMUEL LEVY (CIV. W.)
B. SEP. 12, 1839, PH.
D. APR. 8, 1909

(SEE ABOVE)
REBECCA VIRGINIA LEVY
B. NOV. 2, 1841
D. 1926

JUL. 2
SIGMUND DEUTSCH
B. AUSTRIA, 1841
D. 1906

ELIAS HENRY
B. PH. 1837
D. PH. DEC. 9, 1913
M. PH. MAR. 1, 1897
FANNIE LEVY
(SEE ABOVE)

JOSEPH H.
B. PH.
D. M.
IDA PAASCH

MIRIAM REBECCA
B. FEB. 13, 1872, PH.
D. MAR. 11, 1897

BENJAMIN
B. 1878
M. ALICE MURRAY

REBECCA
B.
M. THEODORE L. DE LAND

SAMUEL H.
B. AUG. 19, 1880
M. FEB. 28, 1915
TESSIE KIRK
(JUN. 19, 1884-)

CHARLES
B. 1882
M. MILLIE ?

MARTHA
B. 1884
M. FRANK PASSAMORE

ELEANOR
B. 1886
M. HARRY E. WELT

ISAAC
B. 1886
D. 1888

LOUIS HYER II
B. JAN. 24, 1900
D. JUL. 21, 1920

FANNY
D. YOUNG

DDROTHY
B. PH.
M. 1)
WILLIAM C. MCCLOUD
M. 2)
FRANK PITTS
M. 3)
CHARLES JOCHEN

EDWARD
MIRIAM E.
BENJAMIN, JR.
JOSEPH
B. M.
FRANCES

CHARLES J.
MYRA
ADELAIDE

SAMUEL EARL (WW II)
B. SEP. 1, 1916
M. OCT. 16, 1954
JANE CUTLER

MARIE ADELE
B. NOV. 21, 1918
M. MAY 8, 1948
WARREN, BRYANI (WW II)

OWEN
B. 1950

STEPHEN
B. 1952

BLANCHE E.
B. M.
OWEN J. MORRIS (WW II)
B. 1950

JUDY
B. 1950

WARREN
B. 1952

JOSEPH
B. OCT. 14, 1872, PH.
EMMA LANDSBURG
(1870-)

CHARLOTTE
B. MAR. 8, 1874, PH.
D. 1940
M. 1915
BENJAMIN VASEN
(1870-1920)

WILLIAM
B. PH.
M. JULIA KELLY

MORRIS
B.
M. HANNAH LOWENSTEIN

EDWARD
B.
M. BELLA ROSENBAUM

CLARA
BLANCHE
B. M.
ROCKISS

AARON
B.
UNM.

ALEXANDER
B.
M. ROSA ?

RACHEL
B.
M. JOSEPH NELSON

SIGMUND, JR.
B. DEC. 10, 1883, PH.
M. DEC. 23, 1912
MIRIAM L. - ?
(N. Y. FEB. 12, 1886-)

SARA JANE
B. JUN. 12, 1889, PH.
M. JUN. 16, 1910
WALTER EINK
(PH. 1891-PH. 1938)

CRESTON
B. 1895

EARL
B. 1896

VIOLET
B. 1898

CYRIL
B. 1902

SELMA
JOSEPH, JR.

ALEXANDER, JR.

JAMES

VIRGINIA

WALTER, JR.
B. AUG. 20, 1911, PH.
M. CELIA DOWNEY
(PH. 1910-)

MARY ANN
B. PH. 1939

JOHN
B. PH. 1941

WILLIAM MARCUS
B. JUL. 7, 1913, PH.
M. 1935
BETTY SULLIVAN
(PH. 1913-)

WILLIAM WALTER
B. PH. 1941
JOHN T.
B. PH. 1946

JOHN EDWARD
B. NOV. 21, 1914, PH.
M. 1933
SOPHIA CERPENSLEI
(EASTON, PA. 1915-)

REBECCA VIRGINIA
B. DEC. 2, 1915, PH.
M. OCT. 1945
EARL CHILSON SKILLMAN
(N. BRANCH, N. Y. 1904-)

FRANK MORRIS (W. W. II)
B. JUN. 27, 1918
D. JUN. 18, 1946

ROBERT
B. PH. 1920
M. IRENE COPPELS
(PH. 1921-)

SIGMUND
B. PH. 1920

CHARLOTTE R.
B. NOV. 22, 1923, PH.
M. JAN. 1951
BETTY HILL

RHODA MAY
B. PH. 1934
M. JAN. 1951
JOHN BIELMAN

JOHN, JR.
B. AUG. 11, 1936
PH.

BETTY JANE
B. MAR. 11, 1938, PH.

BARBARA L.
B. PH. 1945

WILLIAM FRANK
B. 1947

CAROL ANN
B. PH. 1943

LOUISE IRENE
B. 1947

DIANNE LYN
B. MAR. 1947, SOMERVILLE, N. J.

EARL C., JR.
B. 1949, SOMERVILLE, N. J.

JUDY
B. PH. 1952

LEWIS, JR.
B. PH. 1954

CHRISTINE
B. NOV. 1951

DONNA MARIE
B. 1953

JOHN, JR.
B. 1955

JUDY
B. PH. 1952

LEWIS, JR.
B. PH. 1954

ROSENWAIKE
KRAUS-SANDOR COLL. (AJA)
WILL OF SARAH LEVY (JRM)
CLARENCE H. COHEN
FLO. ABR.
SAMUEL LEVY MS. (JRM)
ELIAS MS.
D. J. C.

MATHAN LEVY
OF CHARLESTON
B. CA. 1758, HOLLAND
D. CH. JAN. 29, 1827

SARAH
B. ENG. 1781
D. CH. AUG. 13, 1822

LEVY VIII (1) (S.C.)

LEWIS
B. 1802
D. OCT. 19, 1866, AUGUSTA, GA.

MOSES
B. FEB. 19, 1803
D. JAN. 21, 1804

ISAAC A.
B. 1809, CH.
D. NOV. 9, 1871, AUGUSTA
M. APR. 4, 1841, AUGUSTA
ANGELIQUE HEYDENFELDT
(VID. DE. PASS I)

(JUDGE) SAMUEL
B.
D.
M. OCT. 24, 1845, HAMBURG, S. C.
HANNAH HENDRICKS
(VID. PHILLIPS IV)

ABRAM
B. 1820, HAMBURG, S. C.
D. SEP. 3, 1879
M.
ROSINA HENDRICKS
(VID. PHILLIPS IV)
(SEE BELOW)

N. ELCAN (CSA)
B. 1840, AUGUSTA
D. JUL. 30, 1864, PETERSBURG, VA.
K. I. A.

LT. JACOB R. (CSA)
B. 1846, AUGUSTA
D. FEB. 6, 1865, MUTTER'S RUN
K. I. A.

CELIA
B. AUGUSTA, 1849
D. SAN MATEO, CAL. 1922
UNM.

HENRY MARIAN
B. APR. 13, 1862, AUGUSTA
D. MAY 1, 1894, SAN MATEO
UNM.

WALTER HEYDENFELDT
B. APR. 1, 1854, AUGUSTA
D. MAY 29, 1900, SAN MATEO
M. AUG. 12, 1880, SAN FRAN.
BELLA GREENBERG

EDWIN
B. JUL. 8, 1854, AUGUSTA

ADELAIDE BETTY
B. MAR. 23, 1856, CASSVILLE, GA.
D. SEP. 29, 1929, ATLANTA
M. JAN. 1874, AUGUSTA, GA.
MOSES ASHER
(NEAR BERLIN, GER. APR. 12, 1851 -)

BARON H.
B. APR. 9, 1882, AUGUSTA
D.
M. MAR. 12, 1923, PITTSBURGH, PA.
ERNA FROMME
(MANSFIELD, D. MAY 21, 1900 -)

WALTER HEYDENFELDT, JR.
B. SEP. 18, 1881, SAN FR.

ANNETTE ANGELIQUE
B. SEP. 29, 1866, SAN FR.
M. SEP. 26, 1909
JEROME NORDLINGER BACHMAN

G. WASHINGTON
B. JUL. 20, 1847
D. OCT. 23, 1848

MELVIN CARTER
B. JAN. 30, 1849, AUGUSTA

CAROLINA TURD
B. AUG. 24, 1850
D. JUN. 7, 1852, AUGUSTA

ISIDORE HENDRICKS
B. MAY 18, 1852, AUGUSTA

B. ATLANTA →

LAURA HOPE
B. MAR. 4, 1924
M. 1)
MORRIS BENATOR (DIV.)
M. 2)
ELBERT EVERETT

BARON HENRY
B. MAY 27, 1928

EUGENE SAMUEL
B. MAY 5, 1928
M.
LAURIE LYNN
B. MAR. 11, 1958

ABRAHAM LEVY
B. 1820, HAMBURG, S. C.
D. SEP. 3, 1879
(SEE ABOVE)

ROSINA HENDRICKS
(VID. PHILLIPS IV)

LEVY VIII (2) (S.C.)

I. CLARENCE
B. JAN. 12, 1850, HAMBURG, S. C.
D. SEP. 23, 1897
M. FEB. 28, 1874
IDA BRADY
(DEC. 15, 1855 - JAN. 16, 1938)

J. WILLIE
B.
D.
M.
ADDIE SOLOMON

DR. MOSES S.
B.
M. MILDRED FERST

I. CLARENCE
B.
M. JEANNETTE, VICTOR

TRACY
B. INF.
M. MARY NEL MELTON

ELIZABETH
B.
M. JOSEPH A. PRICE

JACOB H.
B.
D.
M. ANNIE BROWN

ALICE
B.
D.
M. MATTHEW HARGUS

ROSA
B.
M. ALFRED BRILL

MATTHEW, JR.
B.
M. MARION BROOKS

SYMME
B.
M. SYMME

ESSIE
B.
M. MEYER MEYERS
D. S. P.

TILLIE
B.
D.
M. HERBERT BARNETT

ABRAHAM
B.
D.
M. HERBERT, JR.

LEAH
B.
D. INF.

JULIUS WILLIE
LA GREA VEALE

TRACY
MARY NEL MELTON

ELIZABETH
JOSEPH A. PRICE

BARBARA

JUDITH

TRACY, JR.

FRANK H.

JOSEPH, JR.

ISAAC
B.
M. FANNIE NEUBERGE

ABRAM
B.
M. INA MAY WEIL

PENA
B.
M. ?

ROSEBUD
B.
M. SIMON SORENTTRUE

ESSIE
B.
M. BENEDICT S. GOLDBERG

ABRAM
B. MAY 23, 1875, AUGUSTA, GA.
D. MAR. 14, 1937
M. JAN. 18, 1899
FANNY KOPPEL
(JAN. 2, 1871 - JUL. 10, 1954)

ADELINE BRADY
B. MAY 9, 1877, AUGUSTA, GA.
D. MAY 9, 1934
M. FEB. 13, 1901
ISAAC HARRIS COHEN
(NOV. 16, 1874 - APR. 16, 1938)

RALPH VICTOR
ANNA ERWIN FLEMING

ISAAC CLARENCE, JR.

JEAN WILLIAM

HENRY S.

ABRAM, JR.
B. JAN. 13, 1900
M. GLADYS LORING

LIONEL K.
B. AUG. 14, 1902
M. ELIZABETH HAYS

DOROTHY IDA
B. JAN. 29, 1904
M. LEON MORSE

LOIS CLARICE
B. SEP. 4, 1911
M. THEODORE J. JACOBWITZ

CLARENCE H.
B. NOV. 23, 1901
M. JUL. 23, 1933
RHODE BETTY GREEN

LEOPOLD I.
B. SEP. 19, 1904
M. MAR. 17, 1938
HELINE S. FINEMAN
(WIDOW)

ADRIAN
B. OCT. 3, 1905
M. JAN. 2, 1927
LEONA COHEN

IDA BEATRICE
B.
D. INF.

ABRAM III

CLAIRE
B.
M. FRANKEL

ALAN RICHARD

DAU.

DAU.

LOIS

PATSY

CHARLES

ANN CLAIRE

ELLEN SUE

BETTY ADELINE
B. NOV. 16, 1934
M. JUL. 17, 1954
HILMAR KLEEMAN

CLARENCE H., JR.
B. MAR. 16, 1938
(WIFE'S SON)

JOEL FINEMAN COHEN
B.

LEOPOLD I., JR.
B. APR. 2, 1937

M. SHIRLEY SHAPIRO

ADRIAN, JR.
B. AUG. 23, 1929
M. OCT. 28, 1951
LOIS PETASHNICK

JULIE

LEVY X (PHILLIPS & MENDES-SEIXAS)

ROSENWAIKE
MRS. ROBT. R. GRAUCH
KRAUS-SANDOR COLL.
ELIAS MS.
SHEARITH ISRAEL REC.
POOL-PORTRAITS...
SALLIE KENT PHILLIPS

JOSHUA LEVY
II.
D.BEF. 1807

HANNAH
B.
D.OCT. 8, 1772

JOHN PHILLIPS, CAPT. (BOSTON MERCH.)
B.
D.BEF. 1759

ANN
B.
D.BEF. 1759

DEACON WILLIAM ENGS

MENDES SEIXAS (BORDEAUX)

NETTY B. D. SIMOEN LEVY (Q.V.VI)

ISAAC B. NOV. 15, 1761, N.Y.

REBECCA B. D.OCT. 2, 1762

MOSES B. NOV. 20, 1763

JOHN PHILLIPS (COL. BRIT. MILITIA, TO CAN. 1759) B. BOST. SEP. 15, 1735 D. BEF. 1807

1) RACHEL 2) DEC. 28, 1807 B. MAR. 7, 1767, N.Y. D. FEB. 13, 1843 (BATON ROUGE)

JACOB B. MAY 22, 1759, BORDEAUX, FR. D. JUN. 22, 1821, N.Y. (CAME TO N.Y. 1794)

MOISE B. 1751 D. JUL. 11, 1817 (BUR. ST. PAUL'S, N.Y. CHURCHYARD)

BENJAMIN B. D. S.P.

ALL BAPTIZED IN QUEBEC, AUG. 29, 1793

PHILLIPS

MENDES-SEIXAS

WILLIAM B. NEWPORT, OCT. 9, 1789 D. QUEBEC, APR. 5, 1829

JOHN B. SEP. 5, 1787, NEWPT. D. OCT. 28, 1853, BATON ROUGE M. 1) SUSAN SOMMERS (GERMANTOWN, PA., AUG. 8, 1784 - BATON ROUGE, JUN. 17, 1846) M. 2) AUG. 18, 1847 LUCY MARIA WOODRUFF (AS HER 2ND HUSBAND) (FARMINGTON, CONN. JUL. 23, 1816 - JUL. 13, 1908, WARSAW, N.Y.)

ANN MARIA B. N.Y. JUN. 23, 1792 D. SEP. 5, 1828, ST. GEORGE, CAN.

ANGELICA SUSANNAH B. NOV. 13, 1793, QUEB. D. JUN. 9, 1818, ENG.

EDWARD (IN LA. 1825) B. JUN. 2, 1799 (IN N.Y. D. MAY 17, 1871, THOMASVILLE, GA. M. HULDAH S. SMITH

ANGELINA CECILIA B. OCT. 27, 1804 D. NOV. 13, 1880, THOMASVILLE, GA.

ADOLPHUS B. N.Y. 1809 D. NOV. 14, 1825, QUEBEC

M. 1) DEC. 24, 1830 PHINEAS FISHER M. 3) MAR. 20, 1855 HIS BROTHER SAMUEL FISHER

ANNE WILLIS B. D. M. PETER MCGLASHAN

EDWARD

ANGELINA B. D. M. THOMAS S. PAINE OF MILLEDGEVILLE, GA.

CHARLES (WAYCROSS, GA.) DAU. (MACON) EDWARD (JACKSONVILLE) ANNE B. D. M. ERNEST MANN OF WAYCROSS, GA.

(1) AMELIA JENNINGS B. OCT. 8, 1812 D. MAY 8, 1884 M. DEC. 10, 1832 ROBINSON MUMFORD (PAYETTEVILLE, N.C. FEB. 28, 1801 - PECAN GROVE, LA. SEP. 11, 1878)

(1) EDWARD FINLEY B. D. M. GERTRUDE OLIVIA JENNINGS

(1) ANGELINA L. B. NOV. 9, 1818 D. SEP. 29, 1834 M. JOHN R. WILLIAMS (CA. 1813-OCT. 30, 1837)

(1) CAROLINE B. DEC. 20, 1820, L.A. D. JAN. 1, 1868 M. NOV. 9, 1837, N.O. DANIEL BARLOW GORHAM (MAY 23, 1813-MAR. 11, 1855)

(1) WILLIAM DAVIS B. 1821/2, MISS. D. MAR. 19, 1895, LAKELAND, LA. M. OCT. 20, 1841, N. BATON ROUGE CAROLINE ELIZABETH POPE (OCT. 20, 1823-JAN. 24, 1866)

(1) ELIZA D. B. 1832 D. M. JAN. 12, 1853 HORACE R. VIBBERT (JAN. 20, 1825, N.Y. - JUN. 8, 1872)

(2) LUCY MATILDA B. FARMINGTON, CONN. SEP. 10, 1851 D. DEC. 11, 1918, OVERBROOK, PA.

DAU. SON

M. A. J. B. 1838 J. L. B. 1843 WILLIAM J. B. 1847 MUMFORD B. 1849 AMELIA B. 1850 CARRIE B. 1856

MARY ISETT B. BATON ROUGE, AUG. 1849 D. BATON ROUGE, JUN. 13, 1852

ADELENE B. M. ROBERT R. GRAUCH

(1) SUSAN MARION B. JUL. 12, 1842

(1) GERTRUDE B. 1844 D. SEP. 17, 1890, LAKELAND, LA. M. 1) DEC. 15, 1864, BATON ROUGE, LA. MARCUS MCCAUSLAND (JUN. 16, 1840) M. 2) ALFRED HEBRARD (-MAY 3, 1903)

(1) WILLIAM D. JR. B. APR. 14, 1846

(1) EDWARD FINLEY B. 1849 D. N. 1) JUN. 14, 1883, BATON ROUGE MARY BELL LOBDELL M. 2) HAMIE DAVID

(1) MARY JANE B. 1851 D. M. NOV. 15, 1870, FELICIANA, LA. JOSEPH M. HART OF E. BATON ROUGE

(2) CAROLINE B. 1853

AMELIA M. B. 1833 EDWARD R. B. 1835 JOHN PHILLIPS B. 1841 FRANCIS M. B. OCT. 8, 1842 D. APR. 4, 1911 M. ALICE HAILE. MARGARET ELLEN B. 1837

ROBINSON, JR. B. 1847 WALTER H. B. MAR. 1850 CAMILLA PAULFREY B. MAR. 5, 1854, BAYOU SARA D. JAN. 21, 1928

MARSHALL POPE B. JUL. 25, 1854, BATON ROUGE D. MAY 30, 1894, LAKELAND, LA.

NATHANIEL T. B. 1856 D. B. LULA TORRAS

ROBINSON MUMFORD B. MAY 29, 1862 D. OCT. 8, 1927, BATON ROUGE M. APR. 28, 1904, ROSEDALE, LA. SALLIE KENT (JAN. 9, 1876-NOV. 2, 1968, BATON ROUGE)

MARCUS B. 1869 D. YOUNG

ROBINSON MUMFORD B. JAN. 3, 1878 D. JAN. 22, 1928 M. FIDELIA MERRITT

NATHANIEL POPE B. JAN. 10, 1879 D. JAN. 12, 1951 M. UNM.

WILLIAM DAVIS, M.D. B. DEC. 2, 1883, FRANCISVILLE, LA. D. M. SEP. 9, 1913 MARY G. SCOTT OF LEXINGTON, MASS.

AMELIA J. OLLIE RABENHORST ALVIN PHILLIPS KAREN MARSHALL ANTHONY HUGH KERR

NELLIE PHILLIPS B. SEP. 4, 1889 D. NOV. 6, 1890

CAROL ELIZABETH B. JUN. 28, 1891 D. AUG. 10, 1958 M. DR. MARSHALL HARVEY GANDY (DEC. 6, 1886-JAN. 2, 1958)

SALLIE KENT B. JUN. 3, 1908

LELAH MERRITT B. JAN. 19, 1902 D. JUN. 4, 1954 M. WILLIAM STONE LEAHE

MARSHALL

CAMILLA PHILLIPS B. ED. SEP. 3, 1920

MARSHALL H., JR. B. MAY 16, 1922 D. MAY 25, 1922

KRAUS-SANDOR COLL.
 PAJHS, V. 19, PP. 85, 296
 ELZAS MS.
 PHILLIPS MS. (L. OF C.)
 WILL OF MOSES C. LEVY, JACOB C. LEVY
 SAMUEL-YATES GEN. (JRM)
 E. COHEN GEN. (JRM)
 HIST. OF SAMUEL-YATES FAMILY
 CHATHAM CO. (GA.) MARRIAGE REC.
 SAUL J. RUBIN

(TO U.S. 1785) MOSES CLAVA LEVY SARAH ?
 B. ZOBNAU, POLAND, 1750 B. 1767
 D. CH. MAR. 30, 1839 D. SAV. JUL. 16, 1858

LEVY XI

JACOB CLARISSE (OR CLAVIUS)
 B. DEC. 19, 1788, CH.
 D. JUN. 10, 1875, SAV.
 M. OCT. 21, 1817, LIVERPOOL, ENG.
 FANNY YATES (O.V.)

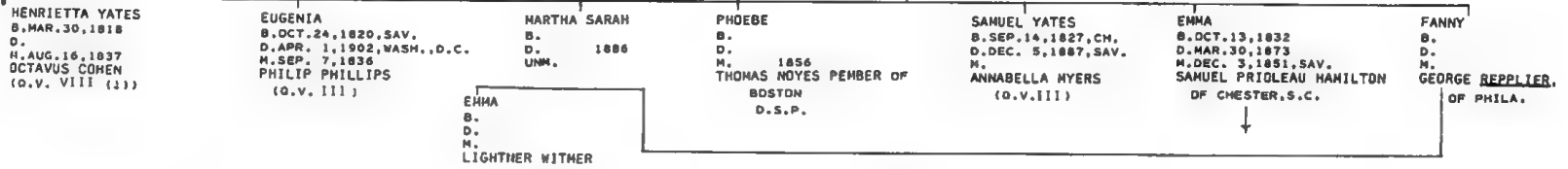

U.S. CIRCUIT CO. (N.Y. DIST. IMMIGR.)
 KRAUS-SANDOR COLL.
 SHEARITH ISRAEL REC.
 N.Y. WEEKLY MUSEUM
 POULSSON'S DAILY ADVERTISER

SIMON LEVY (PH., MONTREAL, IN CANADA, 1760)

LEVY XII

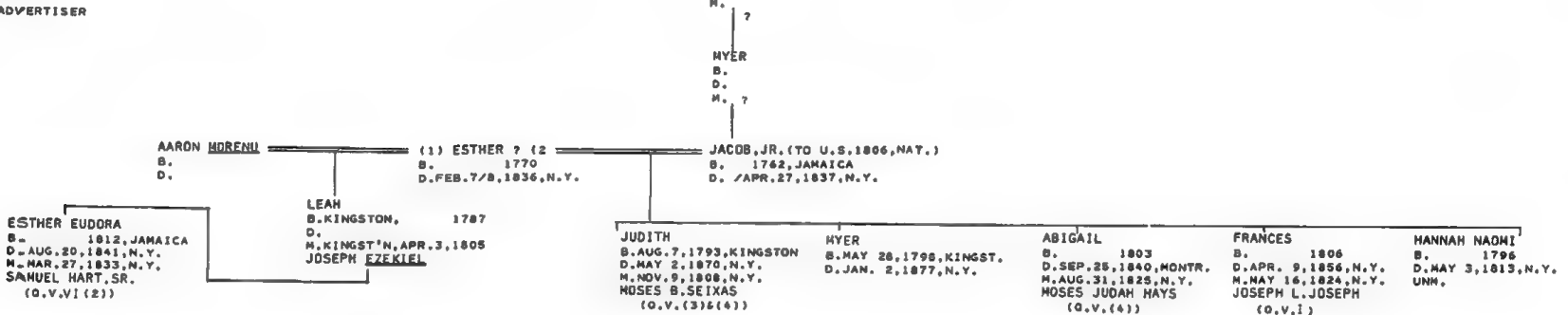

MS.
 O.J.C.
 ELZAS-NEW JEW. GEN. AT CH.
 KIRKLAND-KENNEDY-HISTORIC CAMDEN
 (S.C.) P. 406F.
 WILLS RACHEL HART
 SARAH LEVY
 JANE LEVY
 CH. MARR. CONVEYANCES XIV/277
 JANE L. RAISIN

SAMUEL LEVY SARAH MOSES
 B. 1746 B. 1839
 D. 1842 D.

MENACHEM LEVY

LEVY XIII

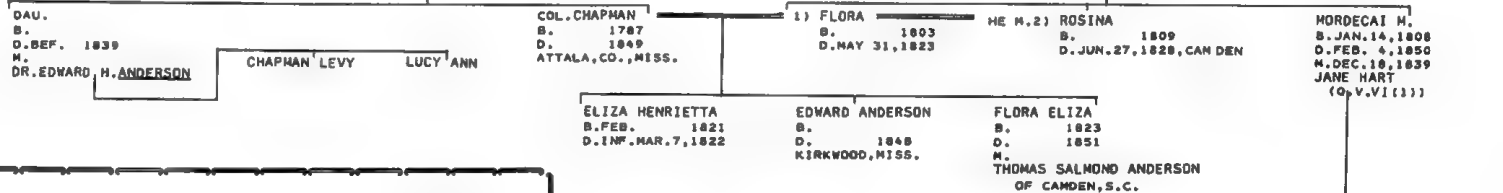

MOSS GEN.
 SHEARITH ISRAEL REC.
 BARBER N.Y. MARR.
 ALSO HS V. 7, P. 74

ASHER SAMUEL LEVY (SURINAM, PH.)
 B. D. M.

LEVY XIV

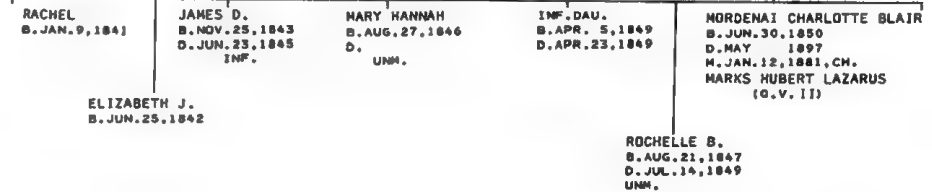

LEVY XV

JON STEDMAN
B'NAI JESHURUN REC.

ELIAKUM LEVY

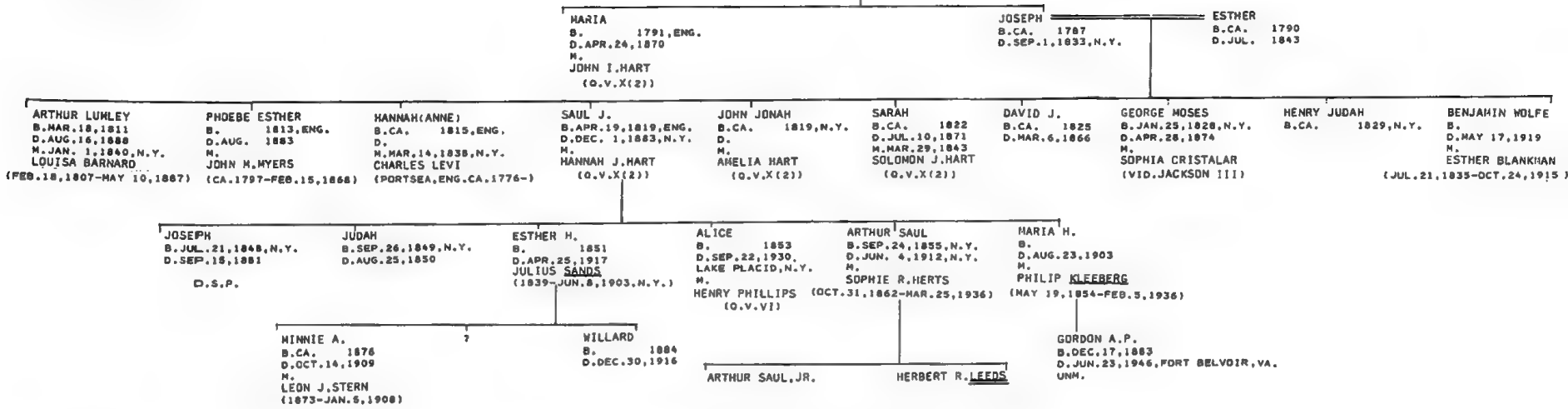

LEVY XVI

A. J. A. III, P. 7
XXVI, P. 66FF.
PAJMS XLIV, P. 93
POOL-PORTRAITS, P. 216F.
EHRENFRIED-BOSTON, P. 5 SF.
HERSHKOWITZ-WILLS, P. 6 SN

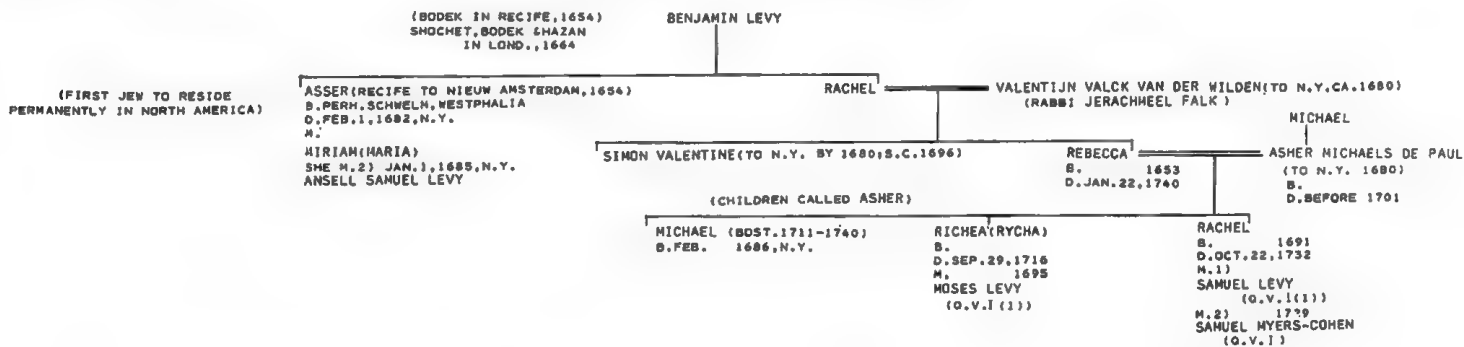

LEVY XVII

AJHG LVII, P. 49F.
LXI, P. 69FF.
MARCUS-EAJ II, P. 48
CAJ III, P. 1192
W.W., PP. 49, 64
ROSENSWAIKE-BALTO.
AJA, XII, P. 98F
ROTH-PROVINCIAL JEWRY, P. 89
DAVID A. BRENER

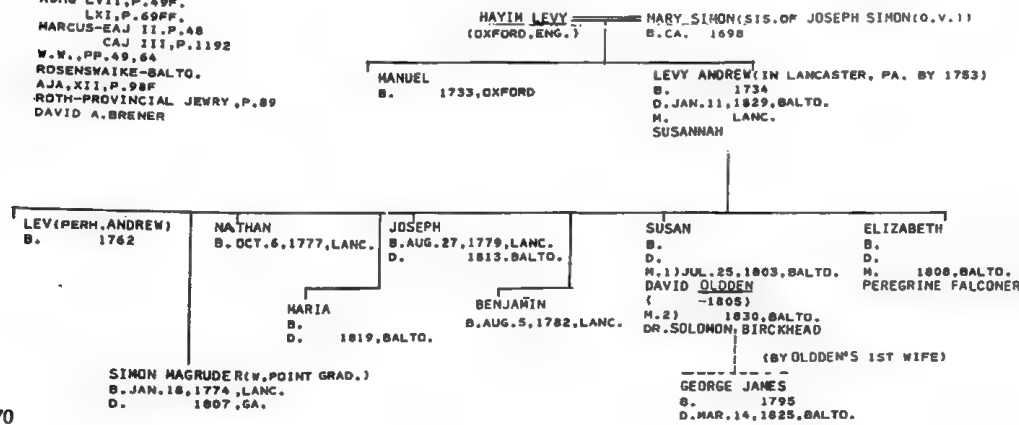

LEVY XVIII

HERSHKOWITZ-WILLS (P. 161F, 186F.)

(JACOB LEVY?)

ROSEY ISRAEL

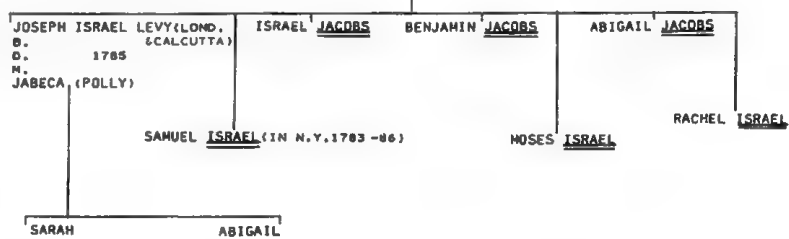

NAT'L CYCLOPAEDIA OF AMER. BIOG. V.9, P.342F.
 FLA. HIST. QUARTERLY V. 19, NO. 4, P. 319FF.
 PAJMS, V. 25, P. 1FF.
 U.S. DIST. CT., PH., REPORTS OF ALIENS, BK. 8., P. 163
 UJE, V. 3, P. 444 ST. THOS. REC.
 DAB V. 5, P. 24

LEVY XIX (YULEE)

SPRUCE ST. CEN. REC., P. 72
 MICKVE ISRAEL REC.
 KRAUS-SANDOR COLL.

LEVY XX

(ELIAS) LEVY

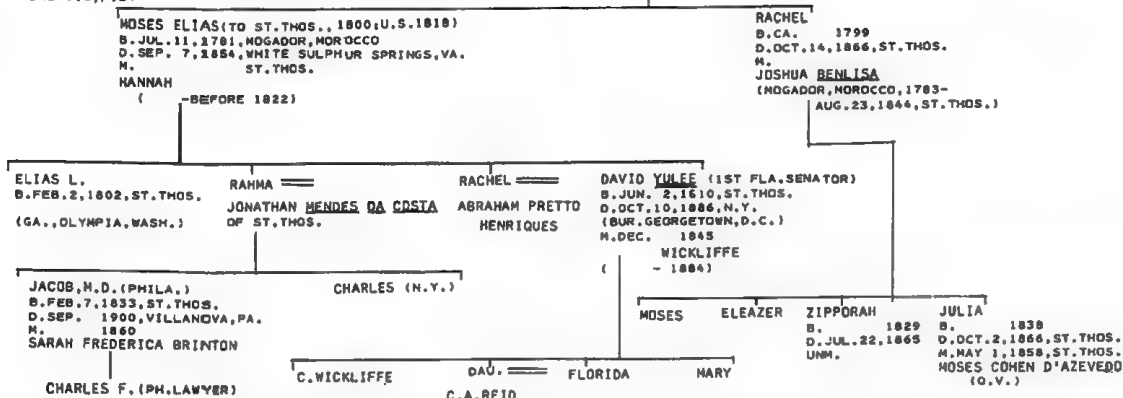

(JACOB) LEVY

ELIAS POLLOCK OF BALTIMORE

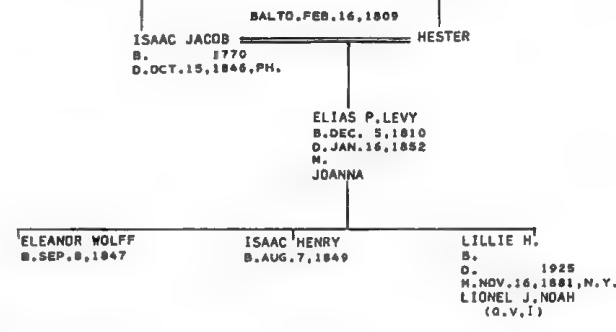

N.Y. CENSUS 1855
 JON STEDMAN
 B'NAI JESHURUN REC.
 KRAUS-SANDOR COLL.
 GOLDSTONE GEN.

SHEARITH ISRAEL REC.
 H. MOISE

(CAME TO N.Y., NOV. 24, 1832)

LONDON

LEWIS LEWIS
 B. 1795, GWINFE, CARMARTHEN, WALES
 D. N.Y. JUN. 17, 1861

SUSAN SOLOMAN
 B. 1794, LOND.
 D. DEC. 18, 1869, N.Y.

LEWIS I

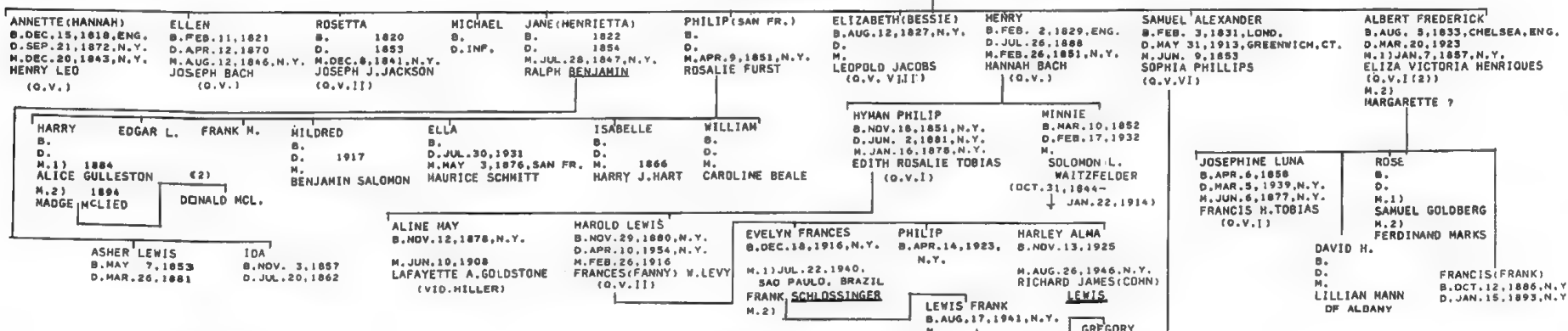

ADOPTED NIECES

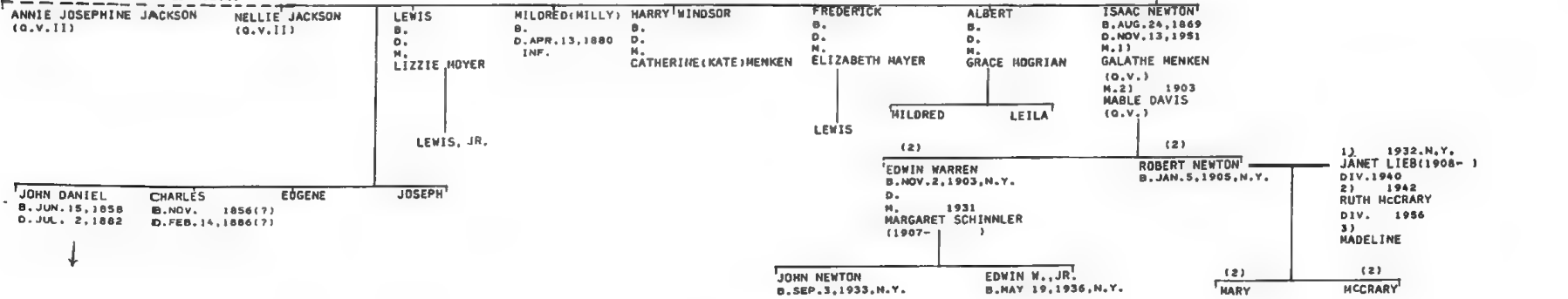

LEWIS II (1)

JANE KAUDERS
KORN-JEWS OF N.O.
MRS. STANLEY YARMUTH
FLD. ABR.
FEDORA S. FRANK
U.S. CENSUS 1880
ELIZABETH FLEISHER
PAJMS, V. 19, P. 195F.
SHEARITH ISRAEL REC.
HENDRICKS GEN.

HENRI LEWIS — JUDITH D'ISRAELI

MOSES SALMON, M.D.

TO U.S. 1777
(PVT., CAPT. CUTHBERT HARRISON'S TROOP, 1ST REGT.,
LIGHT DRAGOONS, SERVING UNDER LAFAYETTE)

DAVID
B. 1763, WURZBURG
D. MAY 8, 1839, N.O.

CA. 1809/10

RACHEL
B. DEC. 28, 1794, CH.
D. JAN. 8, 1831, CINTI.

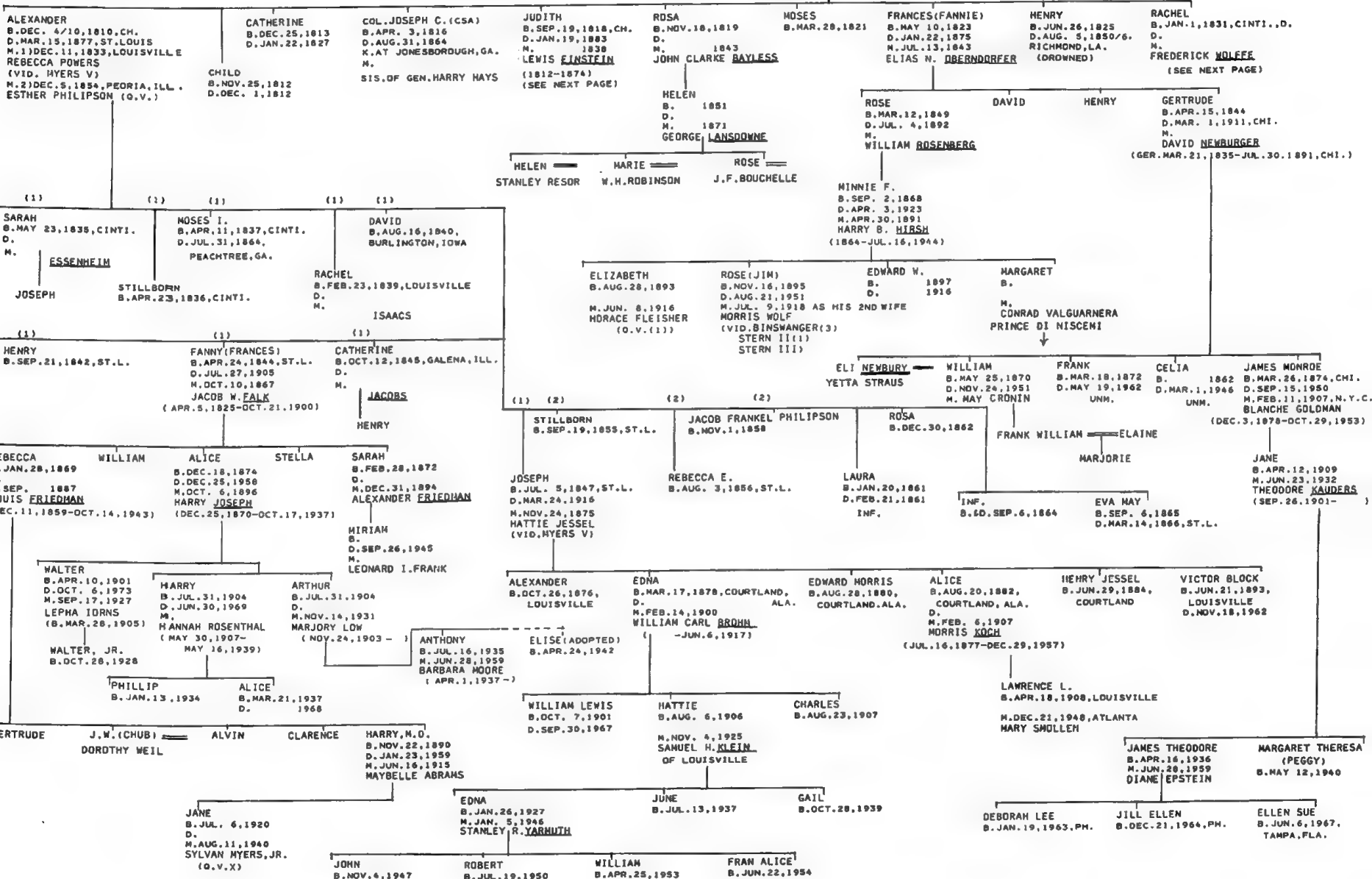

*ESTABLISHED REVOLUTIONARY ANCESTOR

DAVID LEWIS
B. 1763, WURZBURG
D. MAY 8, 1839, N.O.
(SEE PRECEDING PAGE)

RACHEL SALOMON
B. DEC. 20, 1794, CH.
D. JAN. 8, 1831, CINTI.

1838
LEWIS EINSTEIN
B. 1812
D. 1874

JUDITH
B. SEP. 19, 1918, CH.
D. JAN. 19, 1883

RACHEL
B. JAN. 1, 1831, CINTI.

FREDERICK WOLFFE

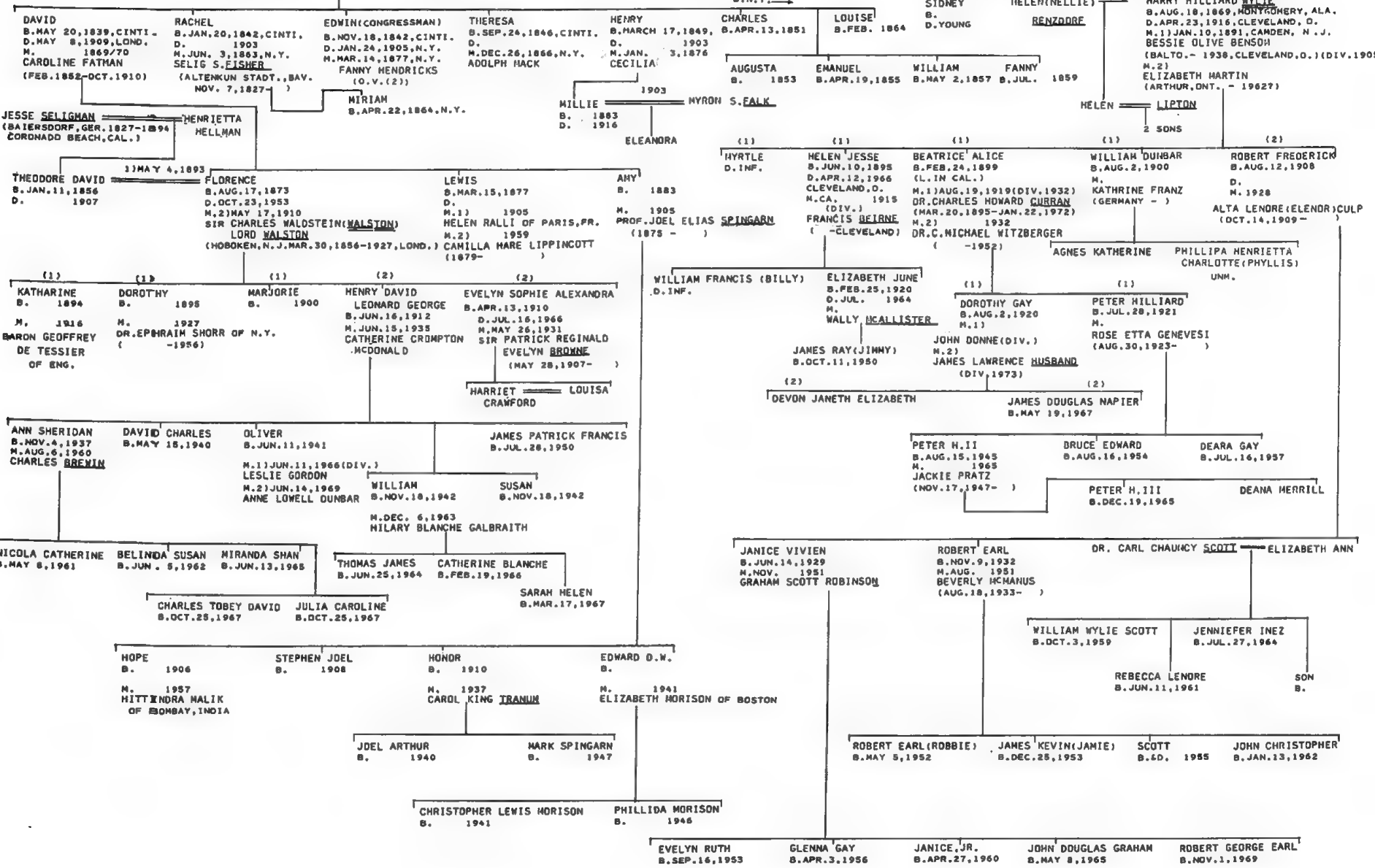

LICHTENSTEIN (VA.)
 WHO'S WHO IN AMERICAN JEWRY, 1965
 LICHTENSTEIN-THE VA. LICHTENSTEINS
 EZEKIEL-LICHTENSTEIN-THE JEWS OF RICHMOND, P. 301F.

LEIB LICHTENSTEIN PEARL
 L. AT FORDON, PRUSSIAN POL.
 D. AET. CA. 190

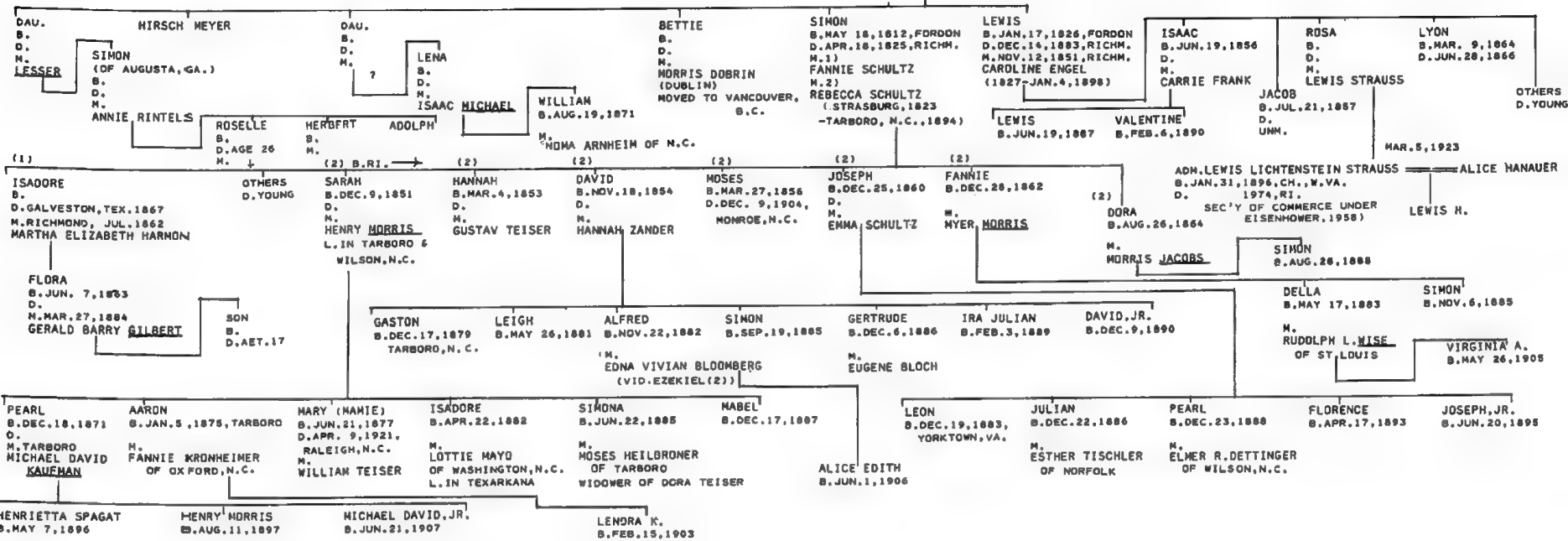

LIEBER (LEBAIR)

LIEBER FAM. BIBLE
 FLORENCE ABRAHAMS
 KRAUS-SANDOR COLL.
 MICKVE ISRAEL REC.

THIS GENERATION
 CHANGED NAME TO LIEBER (OR LEBAIR)

GEORGE LEVI (b. Dec. 18, 1855) and **JUDITH** (b. Jun. 1843) are the parents of the following children:

- CHARLES (N.Y.)** (b. ca. 1840) married **ANN LEVY** (b. ca. 1840).
- WALTER** (b. Dec. 11, 1891; d. Bournemouth, Eng. M. 1) married **ISADORE (ENG.)** (b. ca. 1890).
- ISADORE (ENG.)** (b. ca. 1890) married **LOUISA (ENG.)** (b. ca. 1890).
- MATILDA** (b. ca. 1840) married **ISAAC (CHI.)** (b. ca. 1840).
- JACOB (CIN'TI.)** (b. ca. 1840) married **BENJAMIN** (b. Feb. 26, 1819; d. Jan. 7, 1898, Portsmouth, Eng. M. 1).

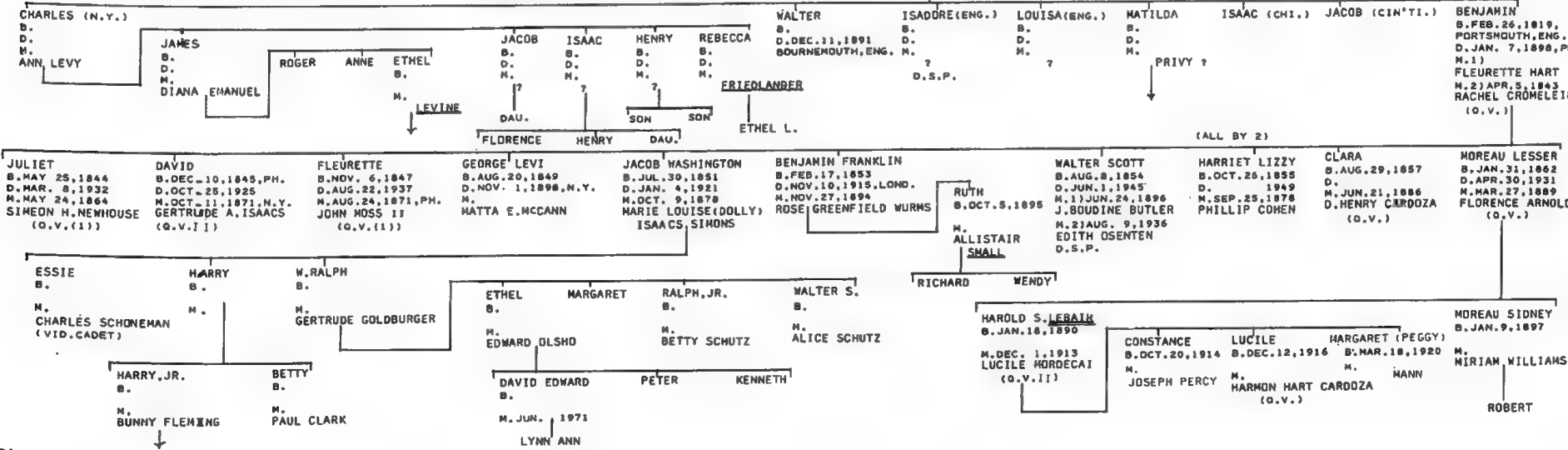

MSS.
D. J. C.
MARCUS-AJD, P. 4
REV. EZRA STILES- BILL OF
MORTALITY FOR NEWPORT, R. I., 1760-64
(TYPESCR. IN NENG.S.)
STILES-LITERARY DIARY
TRANSACTIONS JHSE, VII
KRAUS-SANDOR COLL.
PAJHS V. 2, P. 101
V. 10, P. 13
V. 23, P. 88F.
V. 35, P. 295, 303.
V. 27, P. 151F., 200F., 349F.
V. 42, P. 303
AARON M. LOPEZ REC.
MOISE-MOISE FAMILY
ABBOT L. MOFFAT
B. W. KORN
FLORENCE D. NORTHWAY
GOLDSTONE GEN.
POOL- PORTRAITS...
SHEARITH ISRAEL REC.
LOPEZ MS. (JRM.)
GUTSTEIN-JEWS OF NEWPORT
FLORENCE ABRAHAMS

ABRAHAM RODRIGUES DE RIVERA (FREEMAN IN N.Y. 1726. NAT. 1740/41)
B. SPAIN OR PORTUGAL
D. NEWPORT, JUL. 7, 1765
M. 1) PERH. LOND. 1712
PALOMBA, DAU. OF JACOB MIZRACHI
M. 2)
SARAH ? (D. IN CHILDBIRTH, AUG. 17, 1727, N.Y.)
M. 3)
? DE LUCENA

SISTER
1) DIEGO JOSE LOPEZ 2)
7 LOPEZ
ABRAHAM (MICHAEL) (PORTUGAL
NAT. N.Y. 1740/41,
TO NEWPORT ARR. JUL. 11, 1767)
B. 1711/14
D. MAR. 26, 1775, NEWPT.
M.
ABIGAIL (JOANNA) ?
(1685-MAR. 26, 1767)

DANIEL (1) NAT. N.Y. 1740/1
ISAAC (2) B. D. NEWPORT M. PERH. LOND. 1735
JACOB (2) (NAT. N.Y. MERCH. JAN. 21, 1746) B. 1717 D. FEB. 18, 1789, NEWPT.
RACHEL (2) B. D. OCT. 21, 1731, N.Y.
STILLBORN AUG. 17, 1727
REBECCA (2) B. D. OCT. 17, 1793 (CENSUS OF 1774 3 F & 3 M OVER 16 1 F UNDER 16)
MOSES (JOSE) (1) (N N.Y. 1727, FREEMAN, 28 JUL. 1741) B. 1706, LOND. D. APR. 6, 1767, NEWPT.
ABRAHAM (MICHAEL) (PORTUGAL NAT. N.Y. 1740/41, TO NEWPORT ARR. JUL. 11, 1767) B. 1711/14 D. MAR. 26, 1775, NEWPT. M. ABIGAIL (JOANNA) ? (1685-MAR. 26, 1767)

ABRAHAM (N.Y.) B. DEC. 1762, NEWPT. D. JAN. 10, 1823, N.Y. M. HANNAH LOPEZ (O.V. BELOW)
SARAH B. 1747, N.Y. D. JAN. 6, 1840, N.Y. M. AARON LOPEZ (O.V. RIGHT)
MOSES (DUARTE) B. PORTUGAL, 1739/44 D. N.Y. APR. 1, 1830, BUR. NEWPORT ("LAST JEW OF NEWPORT" LEFT FOR N.Y. OCT. 5, 1822) UNM.
SAMUEL (JOSE) B. 1743
DAU. D. MAR. 30, 1767
JACOB (JOAO) B. 1750 D. MAR. 18, 1822, NEWPORT UNM.
ELIZABETH B. D. PORTUGAL, 1755 M. LOPEZ

AARON (WILMINGTON, N.C.) B. AUG. 26, 1790 D. SEP. 1827
JACOB B. 1791 D. MAY 23, 1820, N.Y. UNM.
SARAH B. 1791 D. MAY 23, 1820, N.Y. UNM.
MANUEL B. 1796 D. FEB. 20, 1797

DAVID (JR.) B. NEWPT. 1750 D. JAN. 19, 1811/12, CH. M. 1)
DANIEL B. D. NEWPT.
ABIGAIL D. OCT. 10, 1792, NEWPORT
JACOB B. 1755 D. 1764
AARON (JR.) B. JAN. 1767
ABRAHAM B. D. ILL IN 1811
ISAAC B. MAY 1762 D. 1768
SARAH B. D. ILL IN 1811

DAU. DAU. DAU. DAU. SON (MURDERED) ABIGAIL (ANNA) B. PORTUGAL, 1726 D. MAY 14, 1762 (NEHZGR V. 62) STILES-MORTALITY REGISTER
1) AARON (EDWARD) B. PORTUGAL, 1731 D. MAY 28, 1782 DROWNED M. 2) SARAH RIVERA (O.V. LEFT)
HENRY (MOSES, JR.) B. 1746 D. SEP. 17, 1763
DAVID (GABRIEL) B. PORTUGAL D. DEC. 19, 1797, BOSTON

SON B. MAY, 1753
CATHERINE (SARAH) B. PORTUGAL D. M. MAR. 4, 1766, NEWPT. ABRAHAM PEREIRA HENDES (O.V. (1))
RACHEL B. 1758 D. AUG. 26, 1789
REBECCA B. 1760 D. FEB. 20, 1844, N.Y. M. 1787 URIAH HENDRICKS (O.V. (1))
MIRIAM (MARIA) B. D. JUL. 22, 1812, WILMINGTON N.C. M. NEWPT. 1805 JACOB LEVY OF WILMINGTON (- NEW ORL.)
DEBORAH B. D.
HANNAH B. 1767 D. MAR. 22, 1848, N.Y. M. ABRAHAM RIVERA (O.V. ABOVE)
JOSHUA B. MAR. 31, 1768 D. DEC. 31, 1845, N.Y. M. 1) MAR. 18, 1828 REBECCA TOURD (O.V.) M. 2) JUN. 29, 1836 MARY ANN (MARIANNE) GOMEZ (O.V.)
ABIGAIL B. 1771 D. AUG. 2, 1851, N.Y. (O.V.) ISAAC GOMEZ, JR. (O.V.)
JULIET B. 1772 D. MAR. 4, 1852, N.Y. M. DEC. 31, 1823, N.Y. JACOB LEVY (WIDOWER OF HER SISTER)
SAMUEL B. D. MAR. 1, 1831, N.Y. M. MAR. 4, 1806 JUDITH SEIXAS (O.V. (1))
ESTHER B. NEWPT. 1753 D. JAN. 3, 1811 M. MOSES GOMEZ (O.V. 2)
JOSEPH B. AUG. 1756/54 D. NOV. 22, 1822
JUDITH B. D. INF.
JACOB B. 1762 D. SEP. 27, 1762 INF.
JACOB B. D. INF.
SARAH ANN B. DEC. 1808 D. SEP. 1809
AARON EDWIN B. NOV. 11, 1838, N.Y. D. SEP. 13, 1872, N.Y.
DELIA B. 1773 D. NOV. 10, 1843, N.Y. UNM.
GRACIA B. D. MAY 12, 1839, N.Y. UNM.
SARAH B. SEP. 7, 1806, NEWPT.
AARON B. NOV. 20, 1807, NEWPT.

*NAMES IN PARENTHESES ARE MARRAND NAMES, DROPPED ON ARRIVAL IN AMERICA

DAVID LOPEZ B. MAR. 1750, NEWPT.
D. JAN. 15, 1811/12, CH.
(SEE PRECEDING PAGE)

PRISCILLA MOSES (O.V. I (1))

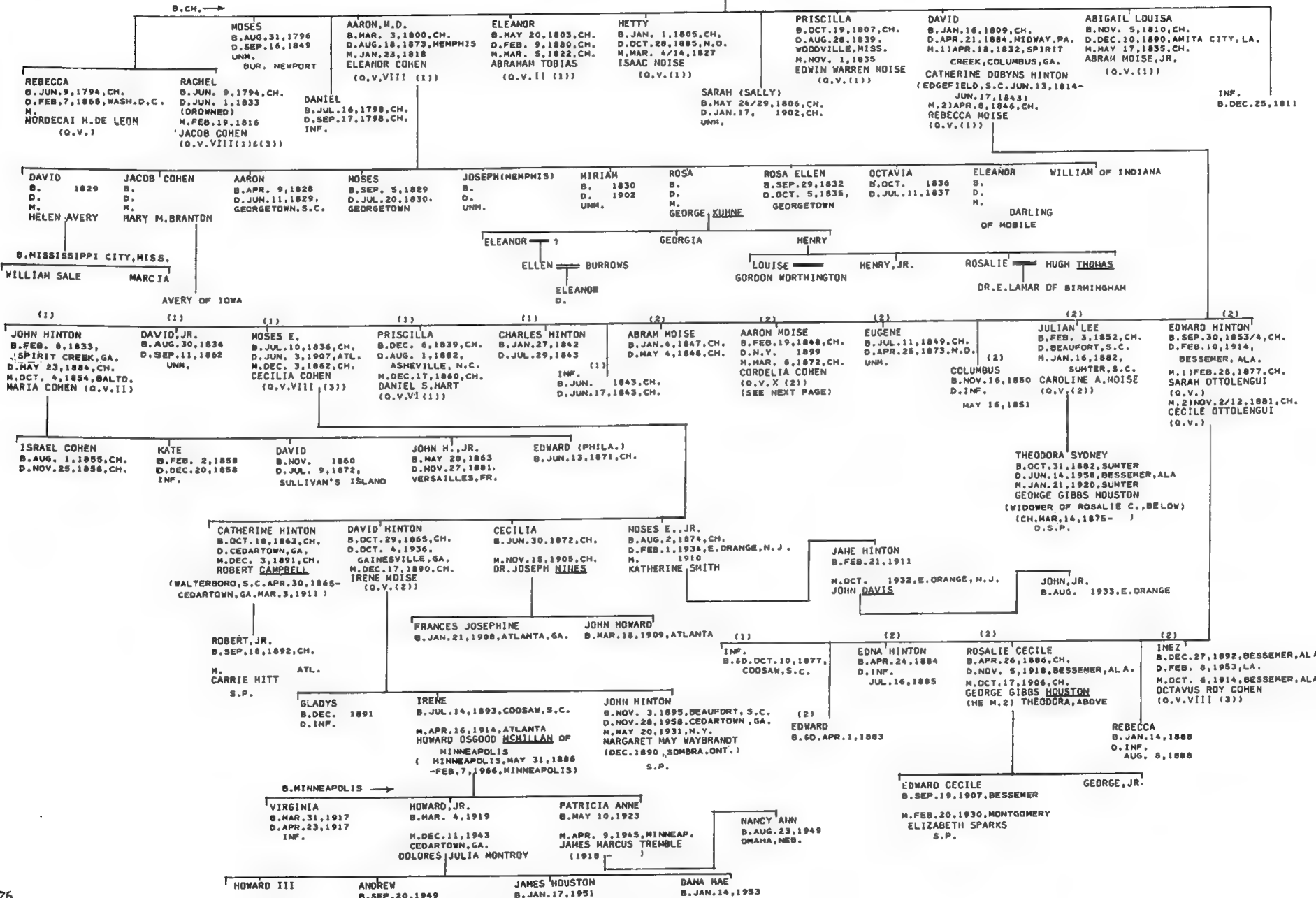

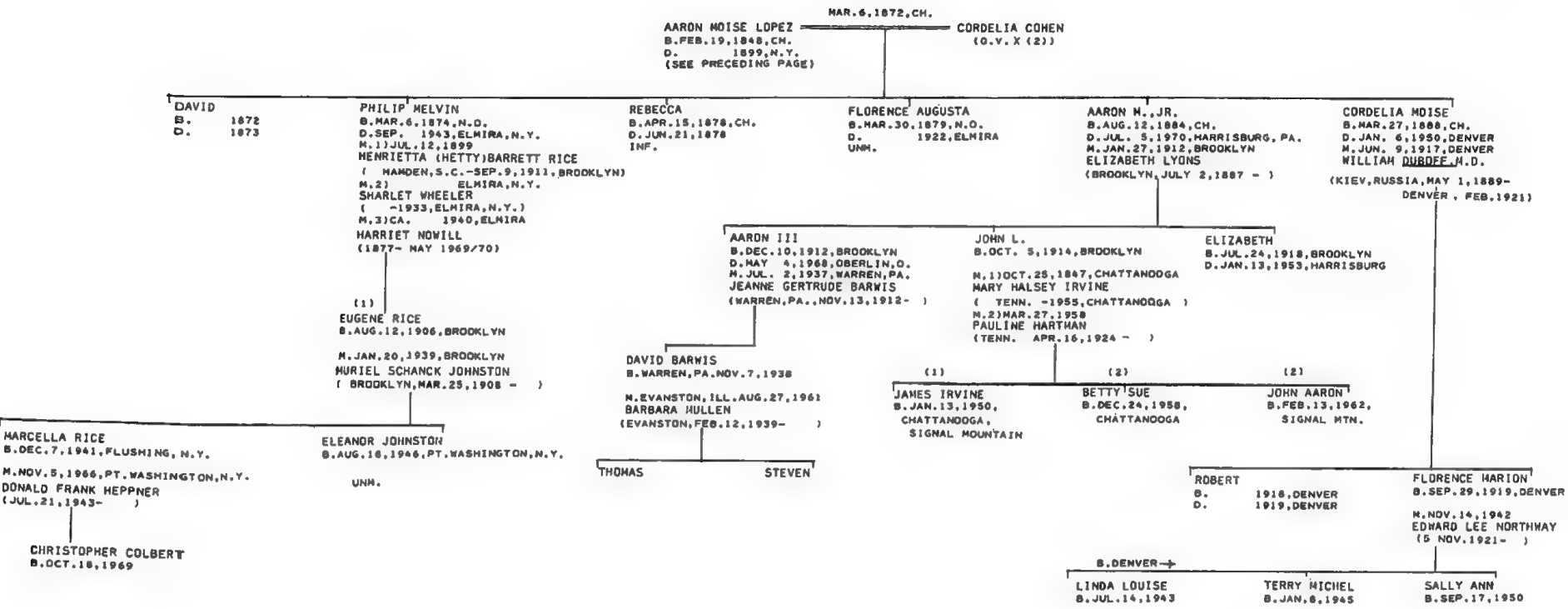

LOPEZ II (DA FONSECA)
 CUR.VITAL REC.
 MAY VAZ LOPEZ
 SHEARITH ISRAEL REC.
 ANDRADE-JEWS OF JAMAICA
 ENMANUEL-PRECIOUS STONES ,PP.153,206
 NETHERLANDS ANTILLES,P.890F.

DAVID NUNES DA FONSECA
 OCT.21,1676,AMST.
 HAHAM ELIAU LOPEZ
 B. 1648,HALAGA,SP.
 D.JUL.22,1713,CUR.
 (RABBI IN BARBADOS,1678-1695/6
 IN CUR. 1695/6-1713)
 RACHEL
 B. SEVILLE,SP.
 D.MAY 20,1699,CUR.

HAHAM=RABBI
 HAZZAN=READER
 RIBI=TEACHER
 SHOHET=KOSHER BUTCHER
 DE=CHILD OF

ALL S.BARBADOS AND MOVED WITH PARENTS TO CUR.; ALL DESCENDANTS NOT NAMED ELIAU ADDED DA FONSECA TO LOPEZ

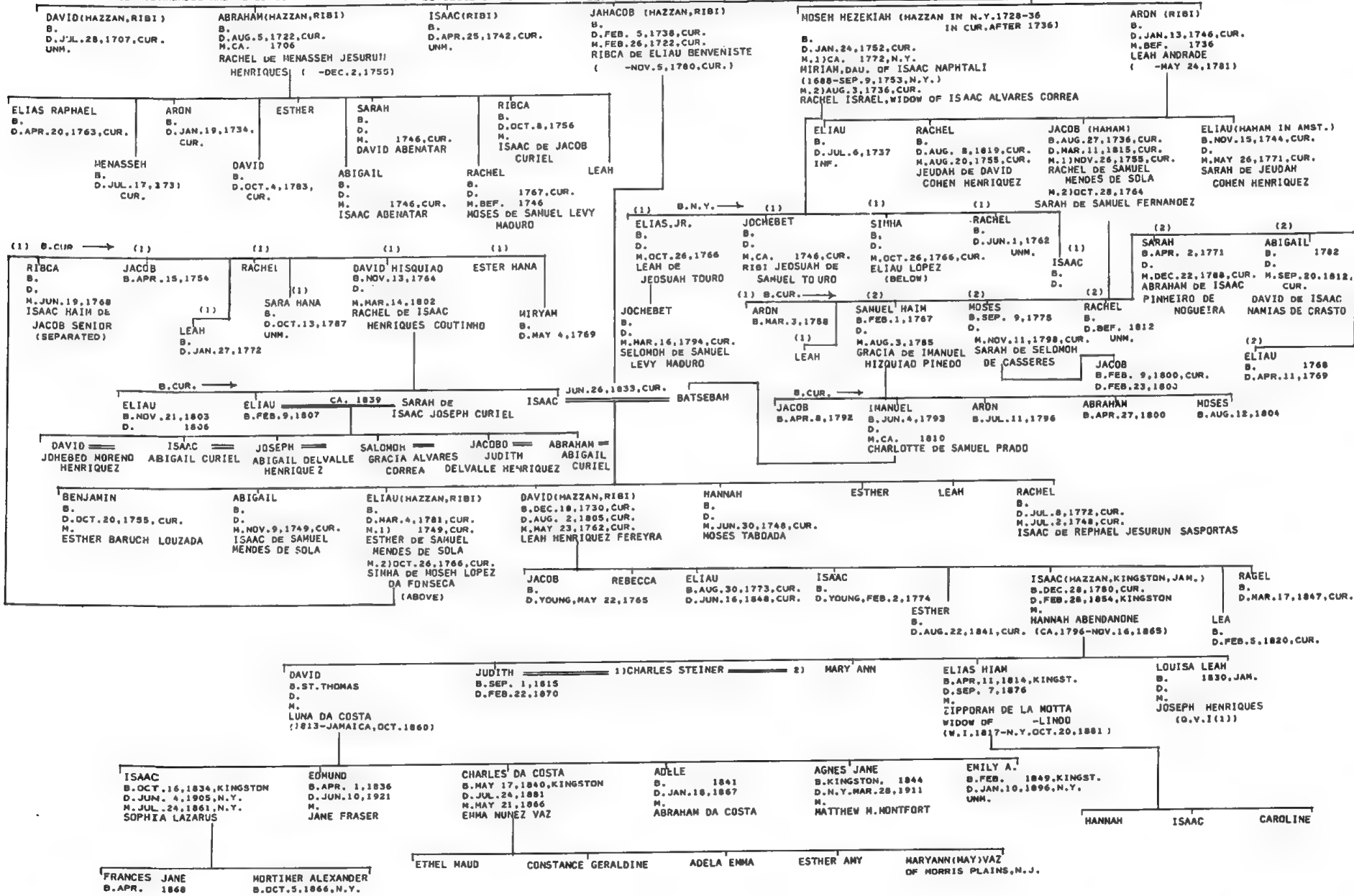

ELZAS MS.
SHEARITH ISRAEL REC.
WILL OF JOSEPH LEVY
ANDRADE-JEWS OF JAMAICA

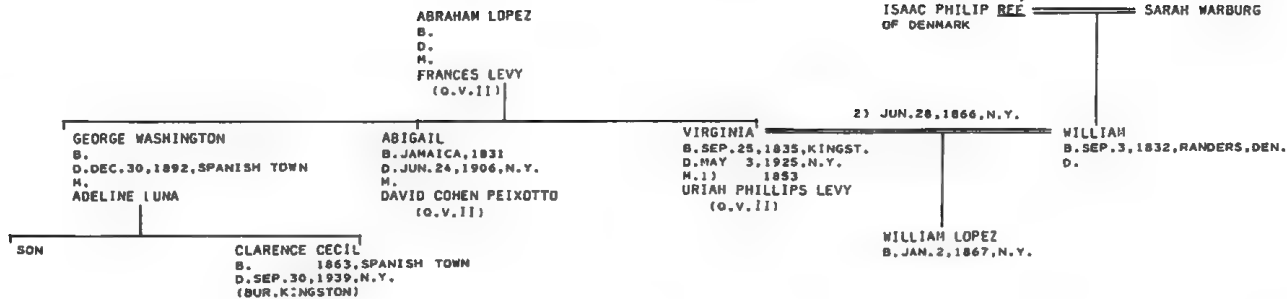

LORYEA

WILL OF ISAAC LORYEA
ELZAS MSS.
NW, p. 24
OJC, P. 95
MOISE-JEW, GEN. AT SUHTER

ISAAC LORYEA
B. COURLAND, RUSSIA, 1798
D. CH. MAR. 16, 1855

ESTHER

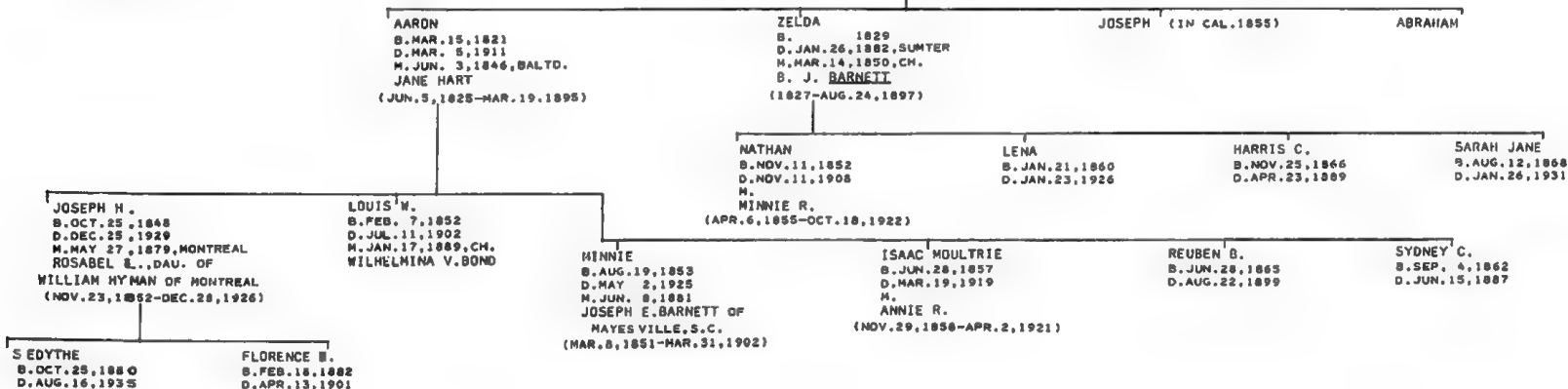

LOUZADA

SHEARITH ISRAEL ESCABDT
AJHQ LV, P. 347N.
KRAUS-SANDOR COLL.
PDDL-PORTRAITS ETCHED IN STONE
DONALD A. S. INCLAIR
SHEARITH ISRAEL REC.

JACOB LOUZADA (IN N.Y. BY 1727)
B.
D. JUN. 12, 1729, N.Y.
M. ?

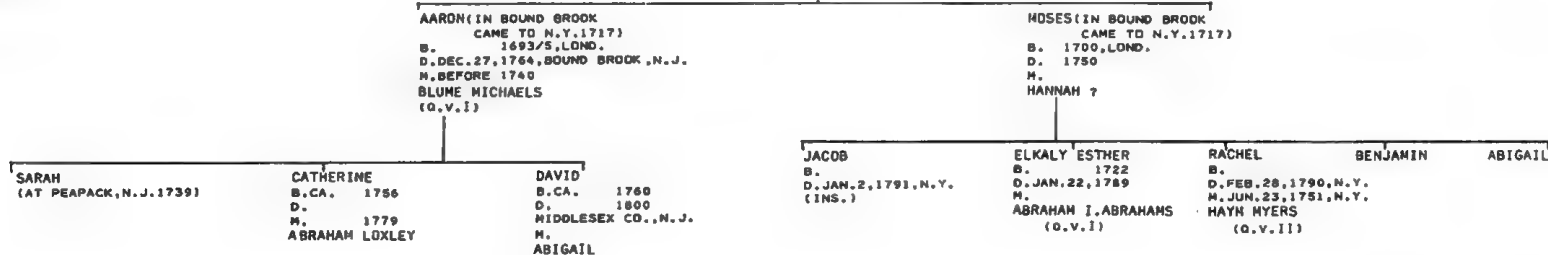

LURIA

J.R.COHEN REC.
BEVIS MARKS KETUBOT
MISC.JHSE.VI,P.22
PAJMS V.6,P.109
KRAUS-SANDOR COLL.
EZEKIEL-LICHTENSTEIN-JEWS OF RICHM.
LYONS MSS.(JRM) P.219F.
NDRAIS-JEWS OF PHILA.,P.18
ELZAS MS.
WILL OF JACOB COHEN(JRM)
MICKVE ISRAEL REC.
SHEARITH ISRAEL REC.
GAINES KENCAID
EGON WOLFF

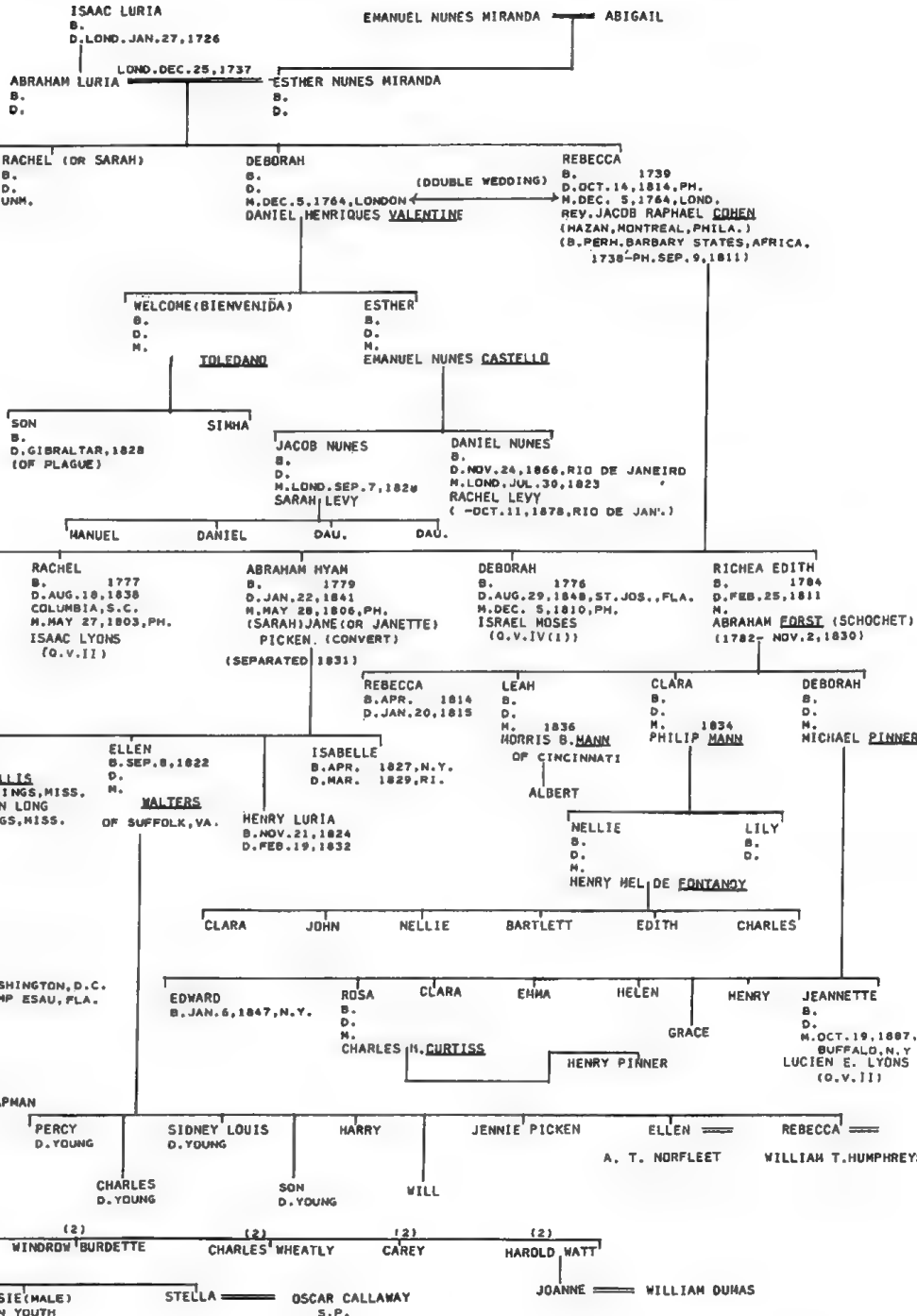

EZEKIEL-LICHTENSTEIN-JEWS OF RICHM.
VA. MARRIAGE ABSTRACTS
ROSENWAIKE

JACOB (POZNANSKI) LYON
B. 1777, PORNAK, POSEN, POL.
D. NOV. 29, 1851
M. 1)

M. 2)

M. 3)
ELIZA WHITE
(NORFOLK, JAN. 15, 1795--RICHMOND, DEC. 20, 1887)

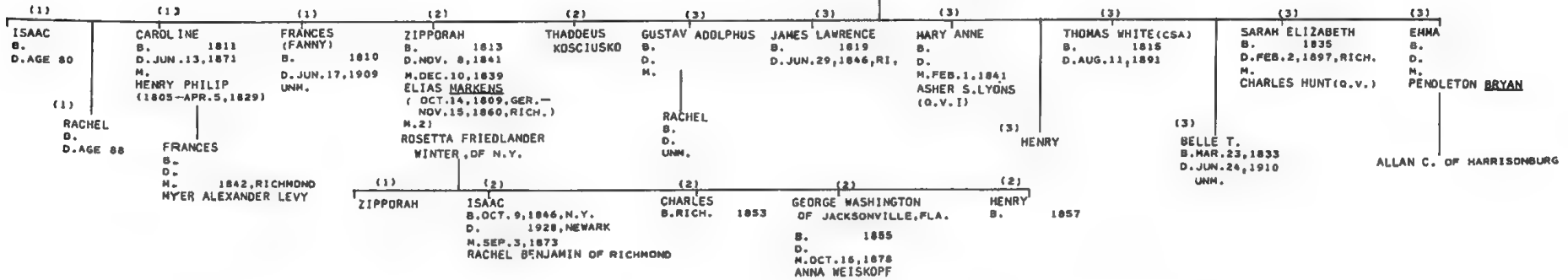

LYON II

KRAUS-SANDOR COLL.
SHEARITH ISRAEL REC.
FLORENCE ABRAHAMS
UJE

ROBERT LYON B. 1810 D. SEP. 1858

DINAH MAWSON

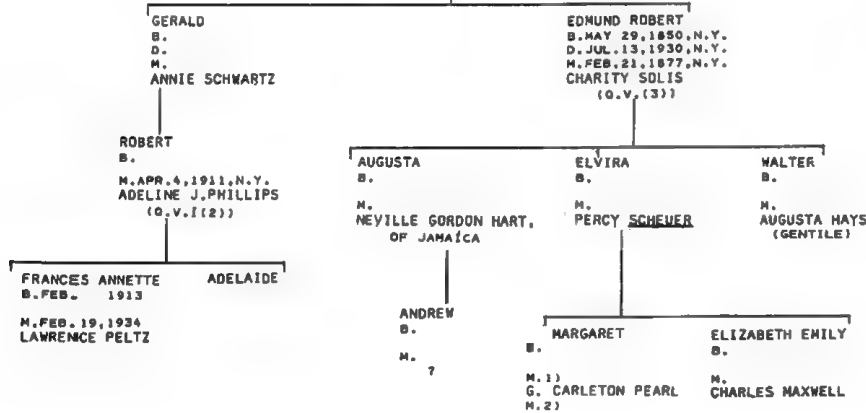

SHEARITH ISRAEL REC.

LYON III

ISAAC LYON B. D. M. ?

GEORGE (JUDAH) (N.Y.)

B. D. M.

CATHERINE ? (CONVERTED TO JUDAISM, APR. 8, 1821, BEFORE BIRTH OF HER SIXTH CHILD)



ELEAZER LYONS
B. HOLLAND, 1729
D. PH. OCT. 1, 1816

HANNAH LEVY
(VID. JACOBS V)

REBECCA
B. MAY 10, 1777, LANC.
D. AUG. 24, 1864, PH.
M. FEB. 19, 1797, PH.
JOHN MOSS (G.V. (1))

JUDAH ELEAZER
B. JUL. 17, 1779, PH.
D. AUG. 29, 1849, N.Y.
M. FEB. 29, 1804, N.Y.
MARY (HATJE ASSER) LEVY
(G.V. X:IV)

SAMUEL
B. OCT. 5, 1781, BALTO.
D. MAR. 17, 1858, PH.
M. 1) JUN. 29, 1810, SURINAM
DINAH (DIANA) LEVY
(1785-PH. SEP. 25, 1815)
M. 2) MAR. 14, 1821, PH.
SARAH MARKS (G.V. I)

URIAH
B. APR. 15, 1784, BALTO.
D. JUL. 3, 1832
M. SURINAM
MARY ANN ALEXANDER

ESTHER
B. DEC. 6, 1786, BALTO.
D. MAY 18, 1846
M. MAY 10, 1805, PH.
ISAAC LAZARUS
(G.V. IV)

NORDECAI
B. JUL. 23, 1792, SURIN.
D. JAN. 19, 1845
M. JUL. 23, 1812, BALTO.
MARY BAUSMAN
(1786-JUN. 25, 1820)

CATHERINE
B. JUL. 23, 1792, SURIN.
D. DEC. 9, 1868, PH.
M. AUG. 19, 1812, PH.
JACOB MOSS
(G.V. (1) B (2))

KRAUS-SANDOR COLL.
PAJMS V. 21, P. XXIII F.
ROSENTHAL MS.
HENRICKS GEN.
MOSS GEN.
MOSS-HARRIS GEN.
EZEKIEL-LICHTENSTEIN-JEWS OF RICHM.
HICKVE ISRAEL REC.
SHEARITH ISRAEL REC.
LYONS-MOSS MS. (PA. MS)
LETTER OF ELIAS P. LEVY 11/12/1885 (JRM)
LEVY GEN. (MRS. RALPH NEWMAN)

AUGUSTA, GA. →
ELLIS

ALEXANDER
D. CAL. 1865

DAU
D.
M.

EMANUELS
SON

ISABELLA
B. JUL. 3, 1813

LAWRENCE
B. MAR. 1, 1816

JUDAH
B. JUL. 13, 1818

(1)

(1)

(1)

(2)

(2)

ROSETTA (RDSA)
B. JUL. 6, 1812, SURINAM
D. FEB. 14, 1866, PH.
M. 1) DEC. 15, 1841, PH.
SELIG HOHENFELS (G.V.)
M. 2)
DAVID LEVINE (G.V.)

ELEAZER
B. DEC. 19, 1813,
SURINAM

ASHER S.
B. APR. 15, 1815, SUR.
D. K.C., MO.
M. FEB. 1/3, 1841, RICH.
MARY ANNE LYON
(G.V. I)

JESSICA
B. FEB. 4, 1822, PH.
D. SEP. 7, 1894, ATL. CITY
M. DEC. 18, 1844, PH.
ALFRED T. JONES (G.V.)

ANNIE
B. SEP. 17, 1827, PH.
D. JUN. 1, 1908, PH.
M. SEP. 17, 1856, PH.
EDWARD PINCUS
(HAMBURG, G. JUL. 20, 1817-
PH. SEP. 21, 1900)

ZIPPORAH ELLA
B. DEC. 6, 1841, PH.

SAMUEL JACOB
B. 1843
LOUISA C. W., VA.

FANNY
B. NOV. 1845,
LOUISA, C. H., VA.

KATE
B.
(BUR. RICH.)

SARAH
STILLBORN
JUL. 1, 1867, PH.

SAMUEL HENRY
B. SEP. 23, 1858, PH.
D. FEB. 25, 1915, HOUSTON
M. MAR. 7, 1896
ABBIE LEVY

FLORIAN
B. FEB. 25, 1861, PH.
D. MAY 28, 1931, PH.
M. NOV. 19, 1905, PH.
MARTHA TEWELES

WALTER
B. SEP. 9, 1863, PH.
D. APR. 28, 1932, PH.
UNM.

B. PARAMARIBO, SURINAM →

ASHER
B. DEC. 29, 1804, PH.
D. PARAMARIBO (?)

HENRY
B. OCT. 6, 1807
D. JUL. 9, 1849, BOST.
M. SEP. 29, 1842, PH.
ELIZABETH WOLF

SAMUEL
B. MAY 1, 1809

ELLIS (ELEAZER)
B. JUL. 10, 1811
D. DEC. 5, 1861, N.Y.
M.
SARAH POLAK
(SURINAM, OCT. 2, 1812-
N.Y. OCT. 17, 1891)

REV. JACQUES JUDAH
B. AUG. 25, 1813
D. AUG. 12, 1877, N.Y.
M. NOV. 23, 1842, RICH.
GRACE NATHAN
(G.V. I (1))

RUDDLPH
B. AUG. 5, 1816

ROSALIE
HANNAH

JOSEPH
PERH. HE
D. NOV. 17, 1839

RUTH
B. AUG. 28, 1897, PH.
D. NOV. 22, 1930, CAL.
M.

GRANT

LORRAINE

EDITH
B. AUG. 30, 1906

M. APR. 5, 1928
ALEXANDER ROSENTHAL

-----ADOPTED-----
BERNHARD FORJES ROBERT DORIS

EDWIN JACQUES
B. MAY 4, 1873, N.Y.
D. JAN. 12, 1926, SAN DIEGO
M. 1) APR. 14, 1910, N.Y.
GUELINA LAWRENCE BAKER
M. 2) JAN. 22, 1925
THEODOSIA SHANN

JULIUS JUDAH
B. OCT. 27, 1843, N.Y.
D. MAY 26, 1920, SAN DIEGO
M. MAY 8, 1872, N.Y.
CONSTANCE HENDRICKS
(G.V. (2))

SARAH
B. FEB. 13, 1845, N.Y.
D. JUN. 27, 1934, N.Y.
UNM.

ALFRED
B. NOV. 12, 1848, N.Y.
D. JUL. 14, 1915, N.Y.

ISABELLA
B. 1835
D. NOV. 5, 1840, N.Y.

MARY
B. FEB. 14, 1835, SUR.
D. MAR. 27, 1889, N.Y.
M. OCT. 28, 1854, N.Y.
DAVID JUDAH POLAK
(SUR., FEB. 26, 1826,
-N.Y. MAR. 12, 1910)

HANNAH
B. DEC. 29, 1840, N.Y.
D. OCT. 26, 1896, N.Y.
M. JUL. 6, 1873, N.Y.
HYMAN (CHOS) HORTON
(LOND. 1842-) (N.Y. OCT. 23, 1842-N.Y. NOV. 25, 1896)

ROSE
B. MAR. 5, 1845, RICH.
D. FEB. 20, 1897, N.Y.
M. AUG. 1, 1866, N.Y.
PHILLIP ISRAEL FELLEMAN

GERSHOM
B. FEB. 2, 1849, BOST.

ABIGAIL
B. NOV. 20, 1854, N.Y.

MICHAEL
B. MAY 2, 1874, NEWARK

BETSY
B. MAR. 5, 1867, N.Y.

ELEAZER
B. OCT. 17, 1868, N.Y.

ISRAEL
B. JUL. 22, 1870, N.Y.

GERSHOM
B. MAR. 25, 1872, N.Y.

DAVID
B. 1882, N.Y.
D. APR. 3, 1898, N.Y.

JUDAH
B. DEC. 3, 1857, N.Y.

ELLIS LYONS
B. MAY 23, 1860, PH.
D. JUN. 25, 1877, N.Y.

JACOB
B. NOV. 21, 1861, N.Y.

JULIUS
B.
D.
M.
MINNIE NEWMAN
(VID. LEVY III (2))

BENJAMIN F.
B. FEB. 3, 1864, N.Y.
D. AUG. 14, 1885, N.Y.

SARAH
B.
D.

S. MARKS
B. MAR. 30, 1867, N.Y.
D. AUG. 16, 1930

JUDITH
B. JAN. 25, 1870, N.Y.
D. MAY 18, 1871, N.Y.

RACHEL
B. FEB. 12, 1888
D. 1918
M.
HARRY MARKS
INF.
B. ED. 1918

DAVID
O. YOUNG

MIRIAM
B. APR. 29, 1896
D. SEP. 19, 1965
M.
IRVING CRAGER
(OCT. 8, 1894-JUN. 6, 1953)

RAYNOR
B. MAY 25, 1922
M. JUN. 18, 1944
BARNARD DANIELS

JONATHAN
B. JUL. 6, 1947
M. NOV. 1, 1970, CHI.
RONNA LUDGEN

MICHAEL
B. FEB. 16, 1951

MAILERT

BLAU & BARDON, P. 818FF.

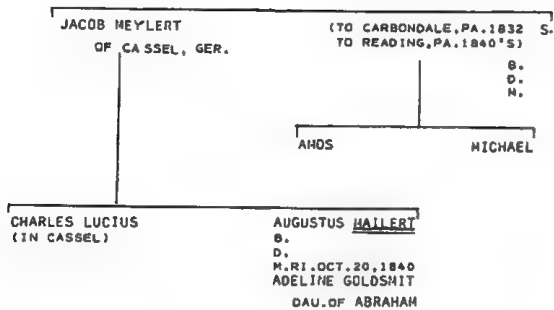

MAIRS

FLD. ABR.
ELZAS JEWS OF S.C.
M. N.
MS.
O. J. C.

(TO CH. CA. 1801) SIMON MAIRS
B. BUDINGEN, 1765
D. CH. DEC. 26, 1835/1831

ELIZABETH
B. 1769
D. FEB. 15, 1845

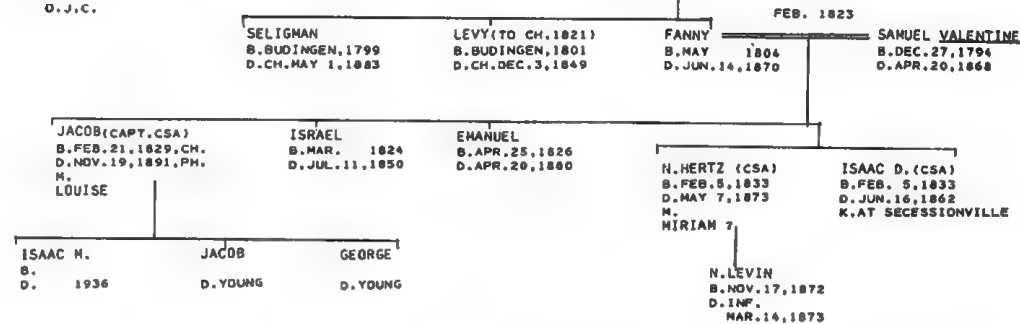

MARACHÉ

EMMANUEL, P. 839
ENA, PP. 172, 939
MAXWELL WHITEMAN
KRAUS-SANDOR COLL.
ELZAS MS.
MICKVE ISRAEL REC.
SHEARITH ISRAEL REC.
PAJMS, V. 21, PP. 58, 63
ROSENBLON-DICT. OF AMER.
POULSSON'S
JEW. BIOG.
W. W. P. 175
LONDON-MINIATURES, P. 13
NEHGR V. 29, P. 113

JAHACOB HARACHÉ
D. JUN. 30, 1735, CUR.

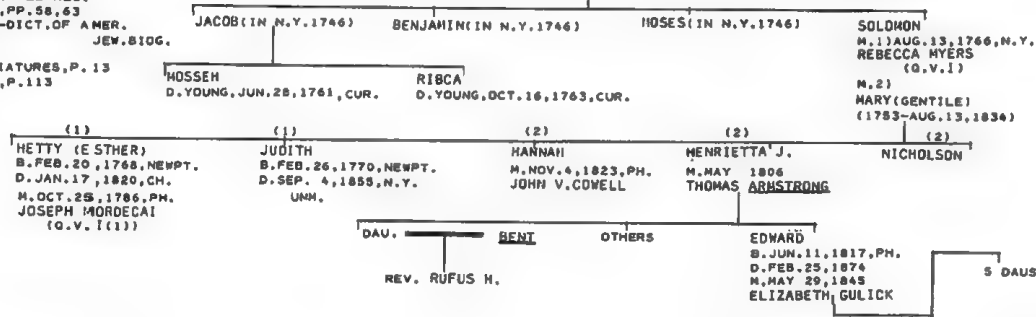

KRAUS-SANDOR COLL.
SHEARITH ISRAEL REC.

MARCHANT

HENRY MARCHANT

WILLIAM
B. NOV. 8, 1833, R. I.
D. FEB. 1, 1893, N. Y.
M.
RACHEL PHILLIPS
(G. V. I (2))

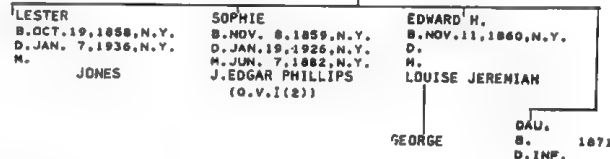

AMER. JEW. ARCHIVES, V. 3, NO. 2
AJMS COLL.
CUTLER, WM. RICH. ET AL. -
GEN. E FAMILY HIST.
N. Y. G. & BR. 38, P. 11
CONN. HIST. SOC.

MORDECAI MARKS (TO AMERICA, 1726, BAPT. STRATFORD, CONN.)
B. LOND. APR. 23, 1706
D. JAN. 8, 1771
M. 1 DEC. 1729
ELIZABETH HAWKINS (DERBY, CONN.)
M. 2
ELIZABETH YORIEU

MARKS II

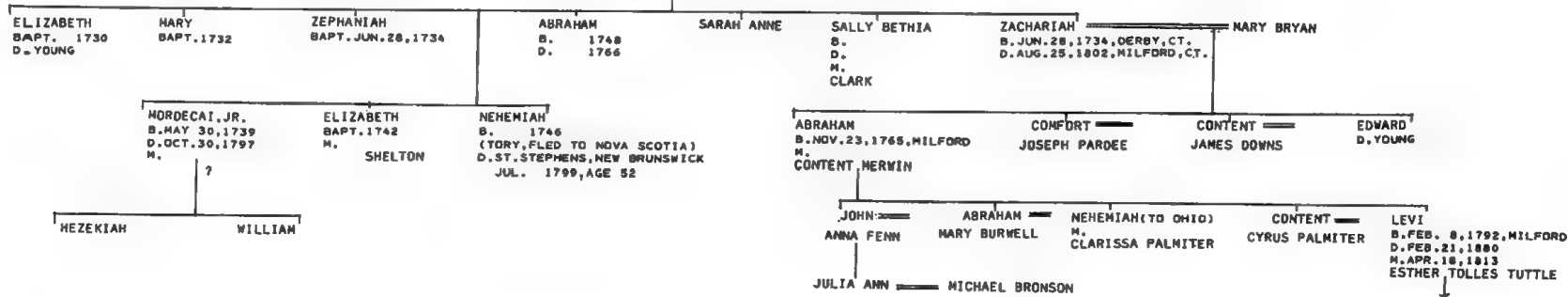

FLO.ABR.
MISC.JHSE VII
PHILA.PRESS 10/1/1912
ESSAYS IN AJM,P.113F.
TRACHTENBERG-JEWS OF EASTON
ROSENWAIKE
KRAUS-SANDOR COLL.
PAJHS, V.8,P.127F.
MORAIS-JEWS OF PHILA.,PP.241F.,331F.
ROSENTHAL MS.
AJA COLL.
ALLEN GEN.
ELZAS MS.
FLORENCE ABRAHAMS
BARNET JACOBS MOHEL REC.

FAMILY HISTORY OF BENJ. HORDECAI
WILL OF HENRY MARKS
WILL OF I.H. JUDAH
MICKVE ISRAEL REC.
SHEARITH ISRAEL REC.

MAYER MARKS
B.
D.
M.
? (D. MAY-JUN.1769)

MARKS I (PH. & RICHMOND)

(NATURALIZED, PA. 24 SEP. 1770)

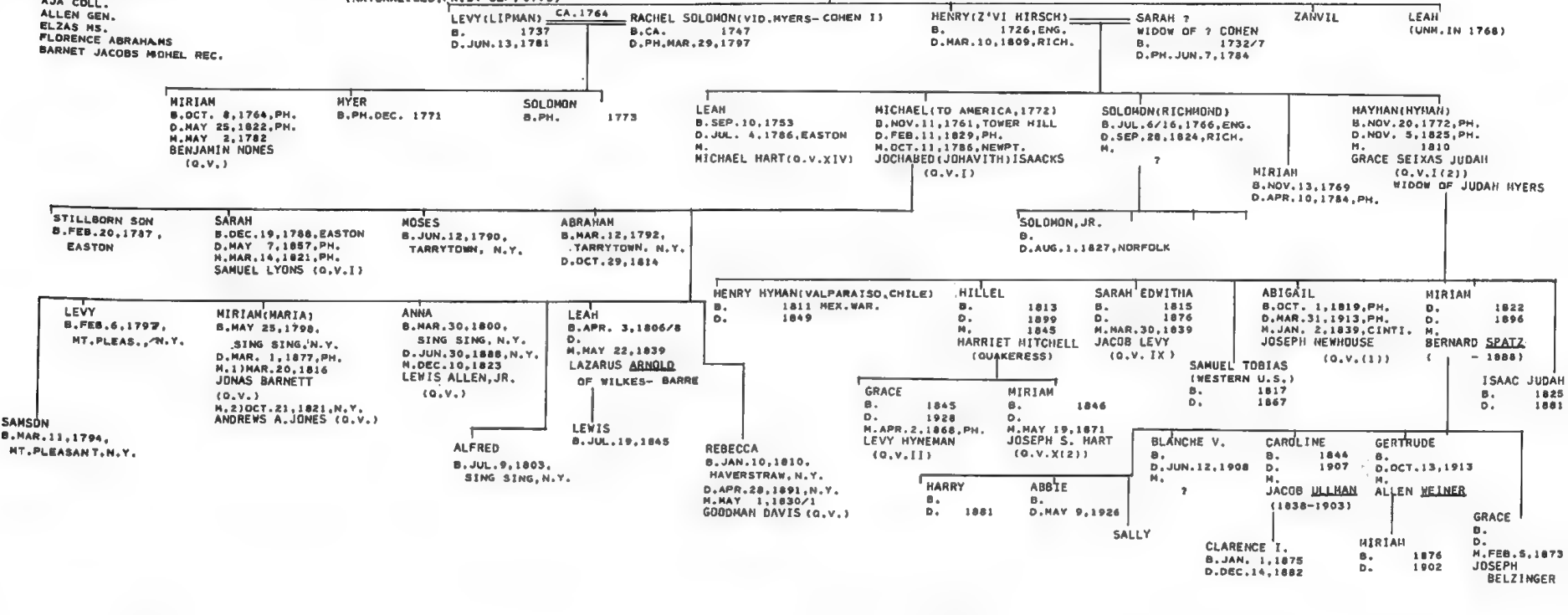

S.A.R. REC.
ELZAS MS.
D.A.R. REC.
WILL OF SAMPSON SIMONS
P.N.Y.H.S.
ROSENWAIKE
FLO.ABR.

MARKS IV

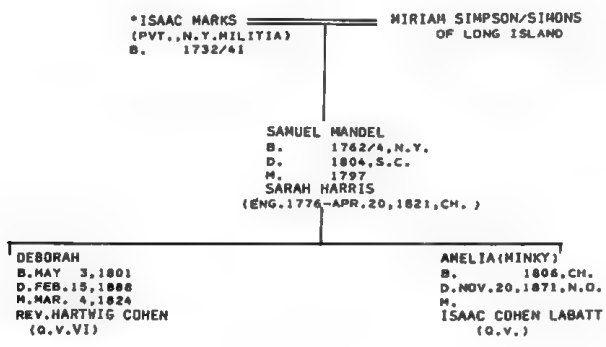

KORN-BARBADOS WILLS
KRAUS-SANDOR COLL.
PAJHS, V. 6, P. 10
V. 18, P. 120
V. 23, P. 148
POOL-PORTRAITS...
WILL OF JACOB R. MARQUES (TJHSE, V. 13, P. 86)
SHILSTONE
JOSHUA M.L. MADURO

MARQUES

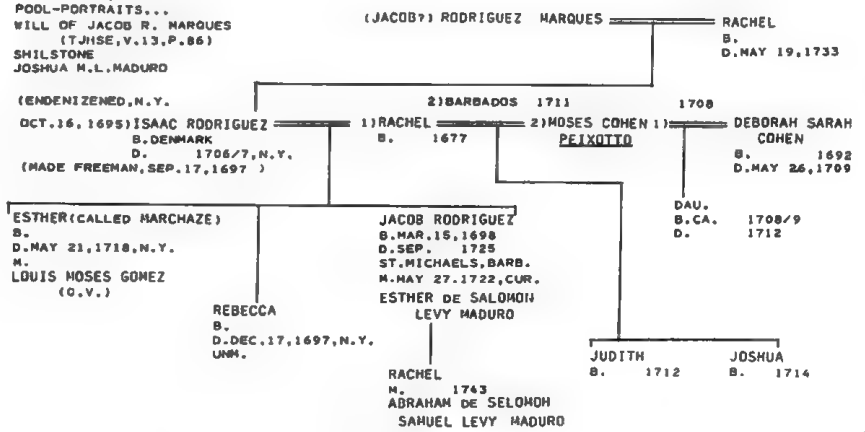

*ESTABLISHED REVOLUTIONARY ANCESTOR ; INCORRECTLY CALLED SON OF JACOB RODRIGUES (RIGHT)

MARKS III (NEW ORLEANS)

KRAUS-SANDOR COLL.
PAJMS, V.27,P.78,310
ELZAS MS.
D.J.C.
MN.

JEW.CEMETERIES AT COLUMBIA,S.C.
MURIEL S. CARTER
FAM.HISTORY OF BENJAMIN HORDECAI
WHO'S WHO IN WORLD JEWRY, 1955
ARTHUR E. MARSH
J.DREYFOUS GEN.

CA. 1786

(TO S.C.-1782) HUMPHREY (HORDECAI) MARKS ——— FRANCES ?
B.LONDON, 1760 B. 1763
D.COLUMBIA, S.C.,SEP.15,1838 D.MAR.29,1850

FREDERICK H. B. D.APY. 1850 REBECCA M. (OCT.17,1855)
ALEXANDER (WAR OF 1812) B.AUG. 4,1788,CH. D.SEP.14,1861,N.O. M.JUL.10,1816,CH. ESTHER HART (O.V.IV)
DR.ELIAS (CONVERT TO XTV.) B.DEC. 2,1790,CH. D.JUN.22,1886,WASH.,D.C. M.1MAY / JUNE 1816 JANE BARNHAM (BOSTON,ENG.1788-COLUMBIA, M.2) 1853 JUN.24,1827) JULIA PIERPONT WARNE
ISAAC B. 1798/6 D.MAR.12,1810
(1) (1) (1) (1)
FRANCES B.FEB.7,1817 D.INF. SEP.15,1817
EDWARD F. B. 1818 D.MAR.31,1830
BARNAM B.APR. 1822 D.NOY.5,1833
JOHN B. B.JUN.24,1827 D.DEC.26,1833

ISAAC N. JOSEPH HART B.JUN.29,1818,N.Y. D.JAN.22,30,1907,N.O. M.NOV.24,1841,CH. CECILIA ABRAMS (VID.ABRAHMS III)
MARION WASHINGTON
ALEXANDER (CSA) EDWIN B. 1838
THEODORE B. D. M.NOV.11,1857,COLUMBIA,S.C. OLIVIA POLOCK
FREDERICK DAVID
ELIZABETH (ELIZA) COL. B. D. M.MAY 7,1844 EHANUEL SAMPSON
ISABEL B. 1829 D.DEC.28,1833
LEONORA B.MAR. 3,1831 D.INF. DEC.23,1831
JULIA ESTHER B.ENG. 1818 D.JAN.1,1907 M. BENJAMIN EMANUEL (O.V.I)
FANNY B. D. M. PASEY

HAROLD KATHERINE B.JAN.14,1845,N.O. D.DEC. 7,1911,N.Y. M.JAN.11,1865,N.O. ALLEN L. HORDECAI (O.V.II)
ESTHER B.MAY 24,1846,N.O. D.JAN. 8,1916,N.O. M.FEB. 7,1866 ISAAC SCHERCK (POSEN,DEC.25,1833-FEB. 1,1889)
JOSEPH HARROD B.NOV. 1850 D.NOV. 1871 UMM.
HENRIETTA B.APR.14,1851 D.JUL. 1,1923 M.OCT.18,1870 LUDWIG JAFFE (1844)
ALFRED JACOBS B.DEC.11,1853,COL. D. M.FEB.16,1880 ADA EHANUEL (O.V.II)
FRANCES MARION B.AUG.10,1855 D.NOV.11,1914 M. CONSTANCE JACOBS (O.V.IV)
CECIL B. A.UG.20,1857 D. M.FEB.22,1899 RAL FOX (DEC.18,1870-)
IDA B.FEB.19,1865,COLUMBIA,S.C. N.O. M.MAR. 6,1899 RABBI MAX HELLER (JAN.31,1860,PRAGUE-MAR. 30,1929)

PAUL VERA GEORGE ARTHUR ELIOT MARSIL MABEL EDNA
CECILE RABBI JAMES GUTHEIM B.JAN. 4,1892,NEW ORL. D.DEC.19,1971 M.1)AUG.15,1917 JEAN BETTMAN(DIV.) M.2)DEC. 5,1952 HELEN RAUH BETTMAN(DIV.)
RUTH M.1) GEORGE LION COHEN M.2) ALBERT STEINER
ISAAC S. B.AUG.12,1893,N.O. M.MAR.25,1925 HILORED HARRIS
EDWARD M. THEO M.

HENRY JOSEPH B. 1867 D. 1933 M. TALLIE ALTHEIHER
LEWIS B. 1869/70 D.AUG.15,1943 M. NANCY BURKENROAD (1878-1954)
CECILIA B. 1871 M. RICHARD S. ALGUS
ERNESTINE B.APR.18,1877,N.O. D.NOV. 1,1932,MEMPH. M.OCT.18,1899 MORTIMER G. LIBERMAN (-FEB.11,1954)
ETHEL ALHA B. ANN(ESTHER) B. M. JOSEPH DAVIS M. J. STEPHEN MARKS II
STEPHEN III PEGGY ANN
ISAAC B. E. LEVING B. LEWIS B. M. HIRIAH FRIEDMAN M. ETHEL MANN M. FANNY KAHN M. LOUISE
FANNIE VERA B. 1899,N.O. D.AUG.15,19- M.NOV.15,1922 FELIX JULIUS DREYFOUS
JOSEPH MORTIMER CHARLES HONARD JANE CECILE

CARD VERA B. 1923,N.O. M.FEB.14,1946 FRED ELSEMAN, JR. (ATLANTA,1921-)
FELIX JOHN B. 1928,N.O. M. HELEN CLARE BARKER (1940-)
LESLIE HELENE B.NOV.2,1963
F. LEE B.DEC.28,1947 JONATHAN A. B.JAN.11,1956,BUFFALO,N.Y. THOMAS J. B.AUG.18,1958 NANCY V. B.OCT. 4,1960
(ADOPTED) (1) (1)
CECILIA L. THEODOR R. MARCUS JACQUELINE ADRIENNE
CLAIRE J. STANFORD J. WOLF MICHAEL STEPHEN SUSAN JO ANN
JOAN E.

FRIEDMAN-ANCESTRY OF LEE M. FRIEDMAN
PAJMS XLVII, 211F.

(CAME TO DAYTON, O.)

DAVID MARKS M. DAYTON
B. SCHWARZWALD, GER. S. MITTITZ, JUN. 27, 1817
SEP. 18, 1918 D. MAR. 30, 1874
D. OCT. 15, 1897

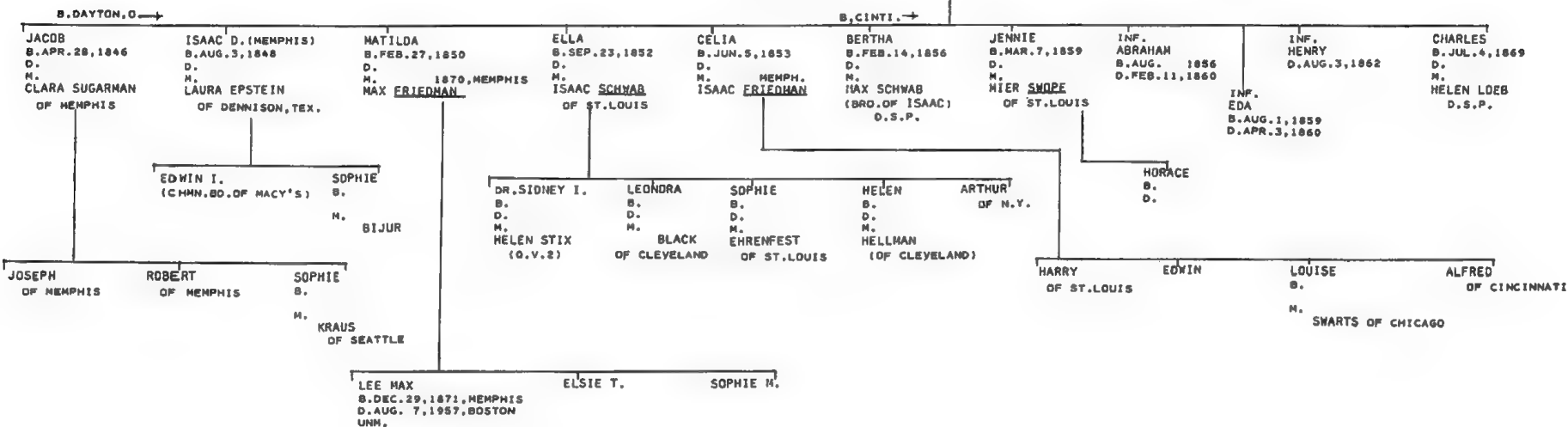

MARX J

AJHO, LIII, P. 291
 POULSON'S
 N.Y. WEEKLY MUSEUM
 BARBER - N.Y. MARR.
 LONDON-MINIATURES
 MOSES MYERS MSS.
 MORAIS-JEWS OF PH., P. 432
 EZEKIEL-LICHTENSTEIN
 MISC. TJHSE, I V
 NORFOLK VA. PILOT 1/6/58
 WILL OF EMMA MARX
 JOSEPH MARX
 SAMUEL MARX
 WILHELMINA MARX
 MIKVEH ISRAEL REC.
 N.Y. DEATHS
 J.B. MORDECAI

1770/3

JACOB MARX
 (COURT PHYSICIAN, ELECTOR
 OF HANOVER)
 B. 1743, GER.
 D. 1789, HANOVER

FRANCES
 B. 1750, GER.
 D. JUL. 8, 1819, RI.

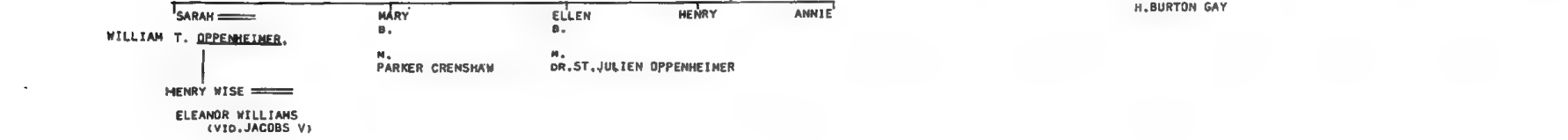
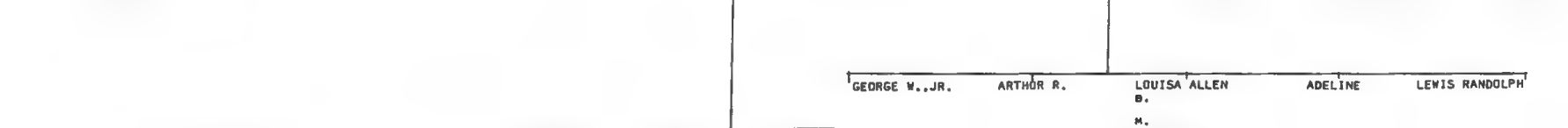
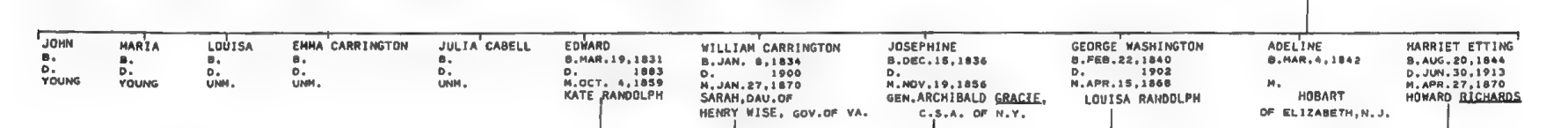
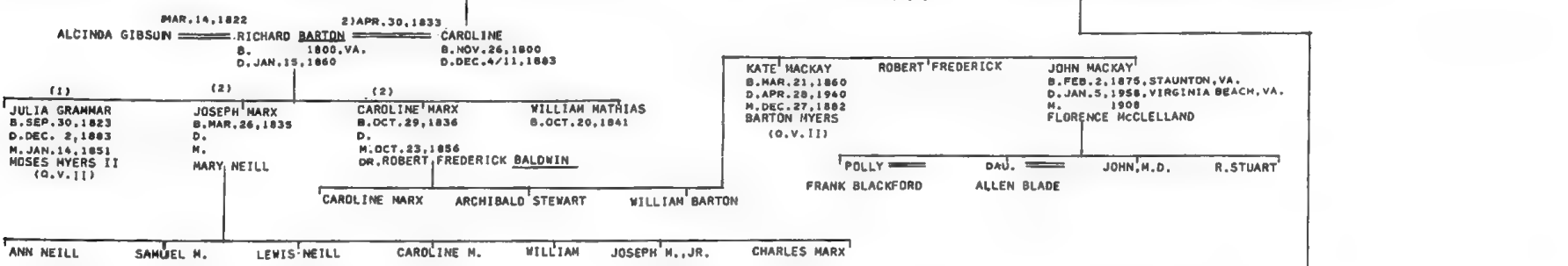
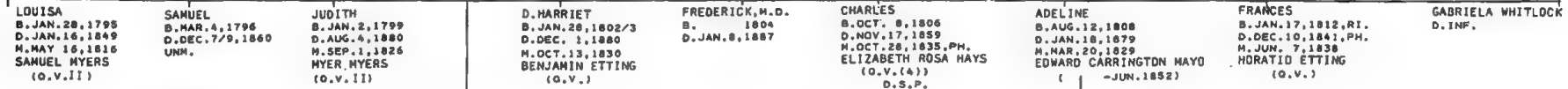
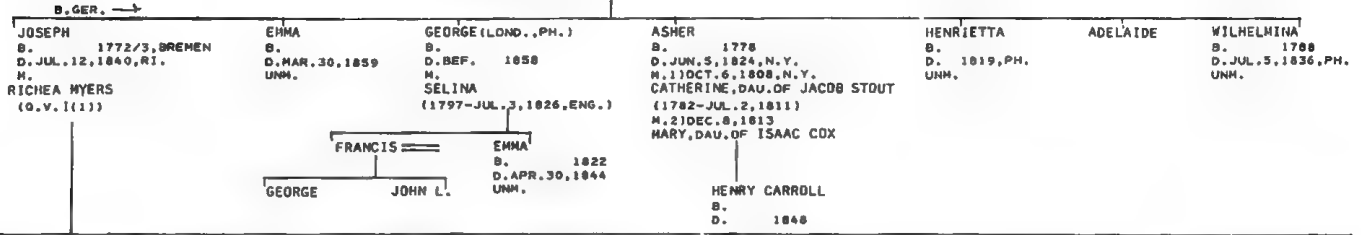

JULIEN SAKS

MAY 14, 1847, MONTICELLO, MISS.

(TO U.S. 1838) MOSES MARK
B. JAN. 1, 1825, ENGENHEIM, BAV.
D. DEC. 4, 1902, MISS.

MARIE ANN KLOTZ
B. JAN. 16, 1827, FRANCE
D. AUG. 18/21, 1884, MISS.

MOSES JOEL
B. INGENHEIM, BAV.

BETSY VAN RONKEL
B. KROENINGER, HOLLAND
(TO U.S. AT AGE 8)

PHILLIP
B. FEB. 4, 1848
D. DEC. 28, 1903
M.
SALLIE JOHNSON

FRANK
B. NOV. 5, 1850, MONTICELLO, MISS.
D. APR. 1, 1927, SHREVEPORT, LA.
M. SEP. 1909
VENIE SIMPSON

SALLY
B. AUG. 1, 1852, MONTICELLO
D. FEB. 12, 1939, CHI.
M. JAN. 18, 1879, HAZELHURST, MISS.
DAVID CROMLEIN
(G.V.)

REGENIA
B. JUN. 15, 1856, MONTICELLO
D. JAN. 6, 1931, HAZELHURST, MISS.
M. 1) FEB. 16, 1881, HAZELHURST, MISS.
HERMAN JACOBS
(JUN. 28, 1848 - JUL. 18, 1892)
M. 2) JAN. 5/6, 1900
DR. GABRIEL M. STURM

PIERRE
B. JUN. 13, 1862
D. AUG. 12, 1927
M. NOV. 24, 1900
BLANCHE HIRSCH

EDWIN MANDEL
B. DEC. 15, 18-
CANTON, MISS.
D. OCT. 12, 1936.
VICKSBURG, MISS.
M. DEC. 28, 1896
PAULINE (LENA) DAU. OF
JOSEPH EHLBERT
(GREENVILLE, ALA. 1873-
APR. 7, 1948, VICKSBURG)

(1)
MAUDE ELEANOR
B. APR. 27, 1883, HAZELHURST, MISS.
D. DEC. 19, 1966, HAZELHURST
UNM.

(1)
RAPHAEL (RALPH) ISAAC
B. AUG. 6, 1886, HAZELHURST
D. JUL. 6, 1941, MINEOLA, MISS.

MONROE, LA.
JUL. 29, 1919

BLANCHE MARGUERITE
B. FEB. 14, 1898, VICKSBURG

ELBERT
B. HAZELHURST
M. 1)
M. 2) FEB. 21, 1929, MERIDIAN, MISS.
TARRIS MAAS
(MERIDIAN, MAR. 2, 1906-)

RALPH I., JR. (CDR. USN)
B. JUL. 30, 1920, VICKSBURG
M. JUL. 4, 1947, ASHDOWN, ARK.
MINA MARGARET WHEELER
(DEKALB, TEX., OCT. 21, 1922)

EDWIN MERVIN
B. SEP. 6, 1923, VICKSBURG
D. NOV. 18, 1973, HOUSTON
M. 1) N.Y.
SHIRLEY HOFSTADLER
M. 2) SEP. 29, 1956
HORMA JEAN PARKER
(OCT. 21, 1930-)

HERMAN
B. MAY 1, 1926, VICKSBURG
M. 1953, AUSTIN, TEX.
EMMA BLOOMQUIST

(1)
NATALIE
B. JAN. 4, 1926, OHIO
M.
JOE GINSBERG

(2)
TARRIS
B. APR. 6, 1931, LAUREL, MISS.
M. AUG. 3, 1952, GALVESTON, TEX.
DONALD ROTHSCHILD
(FEB. 2, 1930-)

(2)
ELBERT, JR.
B. APR. 6, 1931,
LAUREL, MISS

MARGARET ELEANOR
B. OCT. 14, 1949, CORPUS CHRISTI
M. OCT. 20, 1973
JEFFREY THOMAS WOODS
(CHI., SEP. 11, 1948-)

WILLIAM CHARLES
B. OCT. 15, 1953, BETHESDA, MD.

(1)
ROBERT ALLEN
B. FEB. 1, 1947
D. MAY 26, 1962, TYLER, TEX.

(2)
CATHY DIANNE
B. SEP. 26, 1957, AUSTIN, TEX.

B. GALVESTON →
JACKY SUSTE RONNIE

J.R. MARCUS-MEMDIRS I, P. 261 F.
JULIEN SAKS
FLD. ABR.

MAYER II-FRANK

(TO N.O., 1833,
NATCHEZ, 1841)

APR. 25, 1835, N.O.

(JACOB) JOHN MAYER
B. MAY 14, 1806, LANDAU, BAV.
D. MAY 26, 1882, NATCHEZ, MISS.

JEANETTE REIS
B. FEB. 18, 1818, OBERNAI,
D. AUG. 12, 1883, NATCHEZ, MISS.

MAYER FRANK
B. SULZDORF, GER.

CARDLINE SACHS
B. SULZDORF, GER.

MAURICE
B. FEB. 2, 1836, N.O.
D. JUL. 8, 1873,
NATCHEZ, MISS.
M.

SIMON
B. 1839, N.O.
D. NOV. 20, 1905, NATCHEZ
M.
EMMA ROOS
(NATCHEZ, OCT. 11, 1847-
APR. 7, 193-, N.O.)

CARRIE (CAROLINE)
B.
D.
M. JAN. 27, 1864
JULIUS WEIS

OPHELIA
B. JUL. 21, 1845
D. APR. 6, 1871
M. JAN. 4, 1865
ISAAC LOWENBURG
(VID, HYANS)

HENRY
CLEMENTINE

ADELAIDE
THERESA

JOHN JR.
BENJAMIN

ELEANOR LOUISA
(ELLA)
HAE
D. YOUNG

JOSEPH EGGLESTON
JOHNSON

MELANIE
B. JAN. 16, 1849,
NATCHEZ
D. OCT. 17, 1931, N.O.

HENRY
B. APR. 6, 1836, GER.
D. NOV. 2, 1916, NATCHEZ

SOPHIE
BERNHARD FORSTER
(OF LONG ISLAND)

HERMAN
(DISAPPEARED)

ROSINA
ABRAHAM HINES OF PH.

HENNIE
B. FEB. 7, 1870, NATCHEZ,
D. JUL. 20, 1875, BEN LOMON,
MISS.

OPHELIA
B. SEP. 1876, NATCHEZ
D. OCT. 6, 1876, NATCHEZ

INF.
B. DEC. 16, 1877
D. DEC. 21, 1877

EMMA
SAMUEL ULLMAN

CARRIE
B. FEB. 1, 1869
D. OCT. 3, 1880

ROSALIE
B. SEP. 11, 1870
D. MAR. 2, 1871

FREDERICK
B. MAR. 7, 1872
D. MAR. 21, 1872

ERNEST
B. MAR. 29, 1873
D. OCT. 1, 1880

JOHN MAYER
B. FEB. 13, 1886, NATCHEZ
M. OCT. 20, 1914
LOUISE BETTMAN

DANIEL
B. MEHLSDORF, BAV.
(BECAME A PRIEST)

BERNHARDT
(GERMAN SOLDIER)
D. AET. 83, MUNICH

HANNAH
GERSON SAMUELS

ELEANORA
B. MAR. 28, 1879
D. MAR. 30, 1879

HENRY G.
B. MAR. 15, 1877
D. APR. 12, 1877

HENRIETTA HARY BERNHARD

HARY PATRICIA SUSAN
MELVILLE ROTHSCHILD, JR. SPITZ ABEL DAVIS

MAYER I

AJHO, LIX, P.368
 MAKOVSKY-THE PHILIPSONS
 ROSA MAYER GRANT
 ANCKER MS.
 KRAUS-SANDOR COLL.
 ST.CHARLES,P.134F.
 MORALS-JEWS OF PH.,P.536
 ELTZ. PLAUT

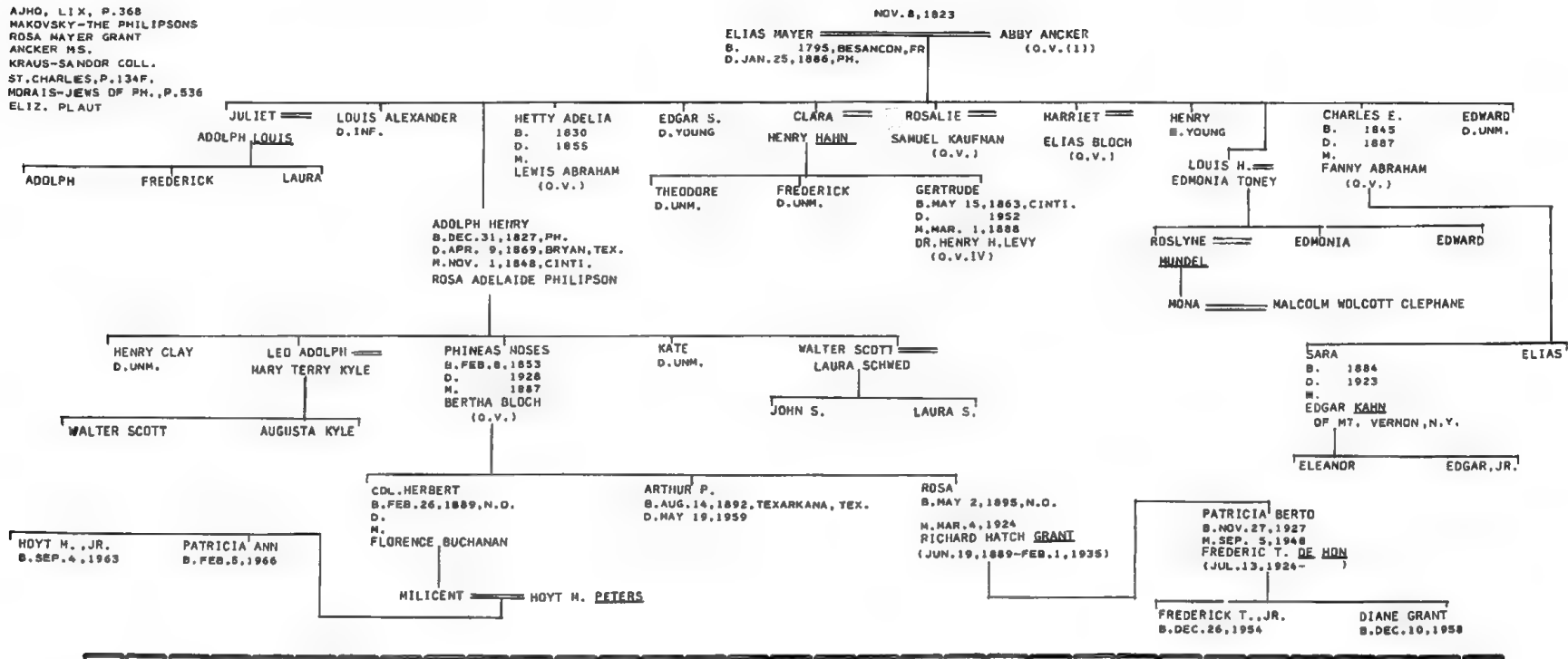

MEARS

PAJHS V. 11, P. 158
 V. 27, P. 372
 V. 33, P. 199F.
 AM. JEW. ARCHIVES, V. 1, NO. 2, P. 15F.
 MOSES GEN.
 KRAUS COLL.
 V.L. GUITERMAN NOTES (KRAUS)
 ADMINISTRATION ACT BOOK, SOMERSET HOUSE, 1711
 ROTH - "THE GREAT SYNAGOGUE" P. 26F.
 MYERS-HAYS-MORDECAI MSS. (VA. HIST. SOC.)
 H.A. ALEXANDER-ALEXANDER FAMILY
 E.N.A., P. 1055
 MISC. JHSE, VII

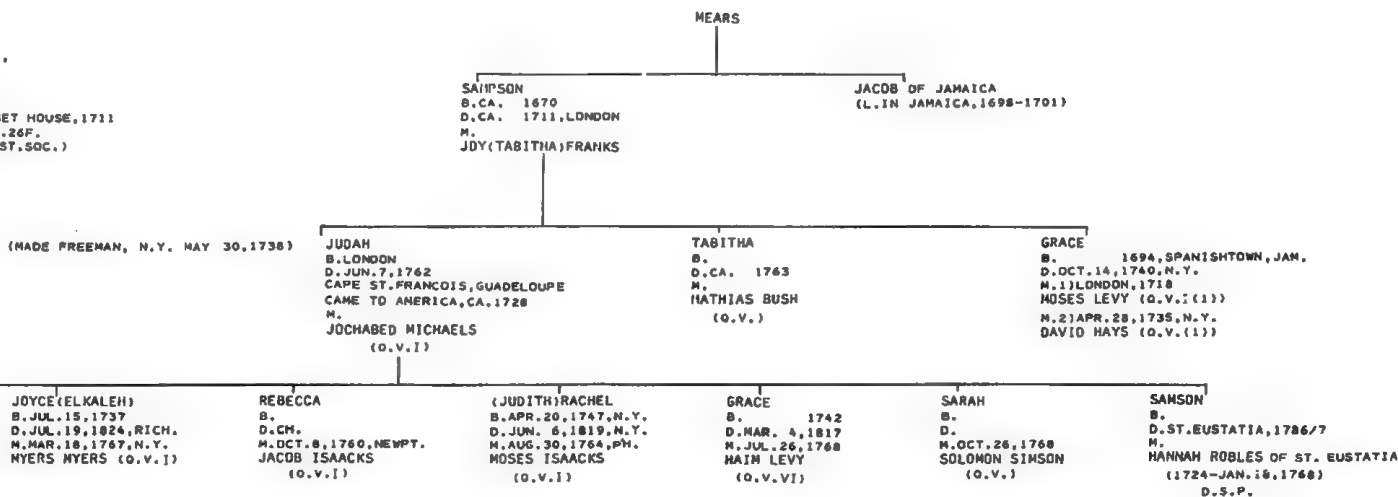

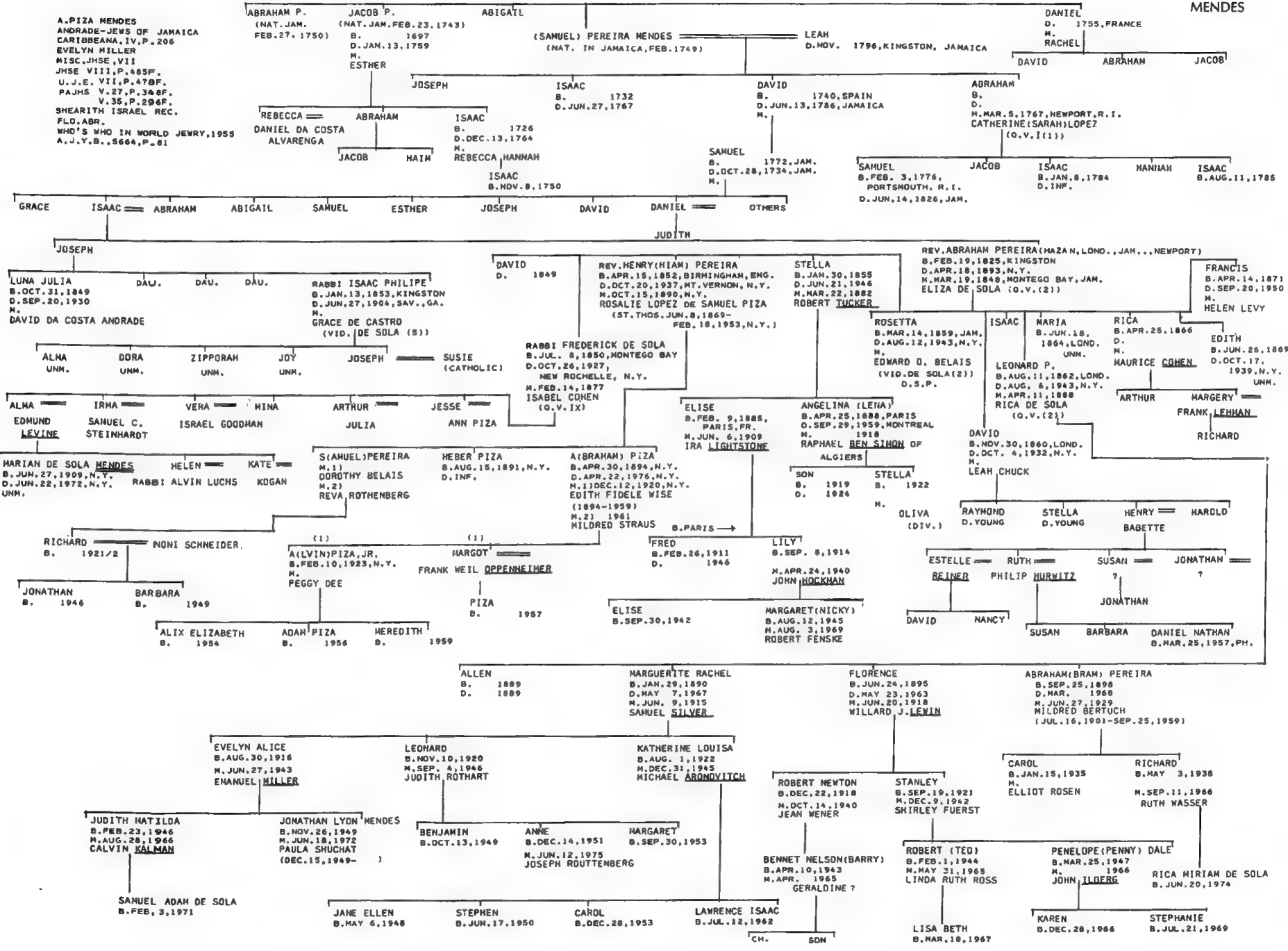

MENKEN-MORANGE

8th NAJ JESHURN REC.
 KRAUS-SANDOR COLL.
 MICKVE ISRAEL REC.
 SPRUCE ST. CEM. REC., PH.
 SHEARITH ISRAEL REC.
 JON STEDMAN
 LESSER-WEAVE A WREATH OF LAUREL
 MRS. JOSEPH LYON ANDREWS

DAVIS
 B. GERMANY
 D. CINCINNATI
 M.

BENJAMIN MORANGE — BELLA

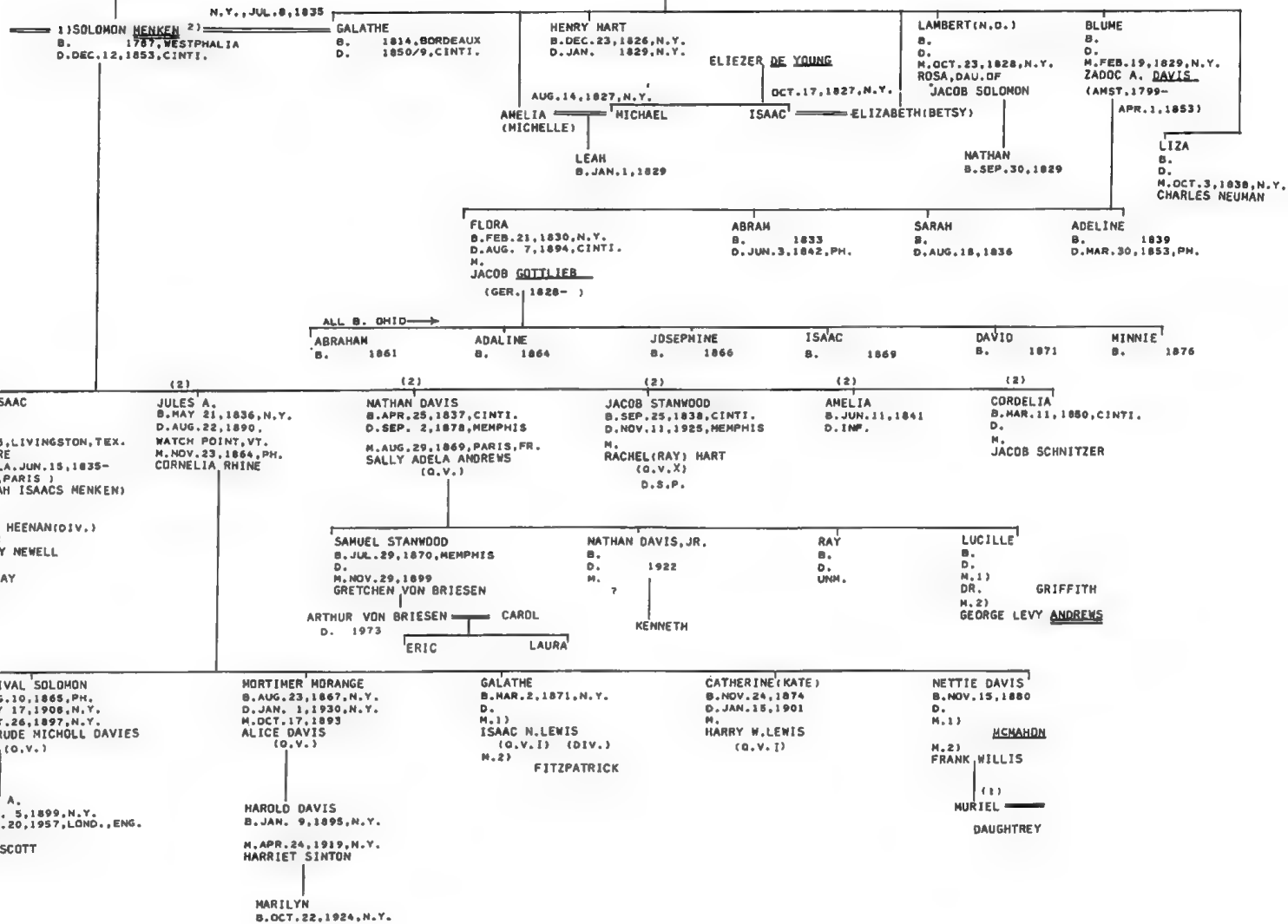

PAJHS, V. 23, P. 151
 V. 33, P. 199F.
 KRAUS-SANDOR COLL.
 THE SAINT CHARLES, P. 115F.
 POOL-PORTRAITS
 H.A.ALEXANDER-THE ALEXANDER FAMILY
 EMMANUEL-PRECIOUS STONES, P. 260FF.
 HERSHKOWITZ-WILLS, P. 59FF., 66

MICHAEL (JECHIEL) OF HERZFELD, GER.
 NOSES MIKAL (MICHAL, MICHAELS) (IN N.Y. BY 1707)
 B. AUG. 8, 1677, HERZFELD, GER.
 D. DEC. 8, 1740, CURACAO
 N.
 CATHARINE MACHAR
 (-BEF. 1740)

REBECCA
 B. 1707
 D. APR. 9, 1801, BOSTON
 M. 1734/5
 JUDAH HAYS
 (O.V. I)

RACHEL
 B. 1707
 D. AUG. 20, 1749, N.Y.
 M. I AFTER 1732
 AS HIS 2ND WIFE
 SAMUEL MYERS-COHEN
 (O.V. I)
 M. 2) 1744
 JACOB LEVY

JOCHABED
 JUDAH HEARS
 (O.V. I)

BLUME
 AARON LOUZADA
 (O.V. I)

MICHAEL
 D. MAR. 1737, N.Y.

MICHAELS II

HART MS. (AJA)
 FLORENCE ABRAHAMS
 MRS. E. MILLER

JOHN MICHAELS
 B.
 D.

SARAH MISELL
 B.
 D.

JUN. 1, 1909

MICHAEL A.
 B. DEC. 18, 1882,
 MONTREAL

ETHEL MURIEL HART
 (O.V. I)

EMMA CAROLINE (CARL)
 B. MAR. 29, 1910
 M. DR. FRED FRIEDMAN

JOHN LEWIS
 B. JUN. 20, 1911
 D. 1941
 K. I. A.
 UNM.

AMY BENJAMIN
 B. DEC. 13, 1913
 D. MAY 10, 1950, ONTARIO, CAL.
 M. OCT. 1939
 DR. FREDERICK WILLIAM CHARLES
 (OCT. 23, 1903- 1970)

DOROTHY REBECCA
 B. JUN. 7, 1915
 M. JUN. 30, 1941
 JAMES HOUGHTON

STEPHEN
 B. FEB. 28, 1940
 M. JUN. 1945
 GAIL KROPNICK

LINDA CAROL MICHAELS
 B. JUN. 22, 1944

FREDERICK (MICHAELS) DOUGLAS
 B. SEP. 11, 1951

DAVID WILLIAM
 B. SEP. 28, 1942

JOHN MICHAEL
 B. AUG. 28, 1948

MARION ELIZABETH
 B. NOV. 8, 1943
 M. SEP. 9, 1967
 FRANK WOODS
 S. P.

BARBARA JEAN
 B. SEP. 8, 1945

CRAIG EDWARD ARTHUR
 B. DEC. 6, 1970

DOUGLAS

STACY RUTH ANN
 B. MAR. 23, 1973

MITCHELL

J. E., V. 8, P. 59
 MORAIS-JEWS OF PHILA., PP. 50, 337F.
 ALLEN GEN.
 SHEARITH ISRAEL REC.
 MICKVE ISRAEL REC.
 FEDERAL ST. CEM.
 FLD. ABR.
 B'NAI JESHURUN REC.
 RODEPH SHALOM REC.

ABRAHAM MITCHELL
 B. LISSA, POLAND, 1798
 D. PH. NOV. 2, 1856
 (REINTERRED IN N.Y. 1901)

ESTHER ALLEN
 (O.V. I)

MAY 20, 1821

MITCHELL ALLEN
 B. FEB. 1, 1822, N.Y.
 D. MAY 22, 1875
 M. SEP. 16, 1848
 AMELIA JOHAVETH ALLEN
 (O.V. I)

FRANCES (FANNY) ALLEN
 B. AUG. 19, 1823, N.Y.
 D. JAN. 10, 1893, N.Y.
 M. NOV. 22, 1848, N.Y.
 JONAS PHILLIPS LEVY
 (O.V. II)

REBECCA
 B. MAR. 1825, N.Y.
 D. SEP. 2, 1918, N.Y.
 M. AUG. 23, 1848, N.Y.
 PINCUS KING
 (O.V. I)
 D. S. P.

LEWIS ALLEN
 B. JAN. 6, 1829
 D. OCT. 1, 1889, PH.
 M. 1860
 HYRTILLA EUDDRA HART
 (O.V. VIII)

HENRY

ANNA MARIA
 B. 1838, N.Y.
 D. DEC. 17, 1885, N.Y.
 M. NOV. 24, 1858
 SIMON LANDSBURG
 D. S. P.

MOSES
 B. SEP. 20, 1839, N.Y.
 D. NOV. 27, 1885, N.Y.

ELOISE MARIA
 B. SEP. 17, 1850
 D. APR. 28, 1908
 UNM.

LEWIS ALLEN
 B. JUL. 26, 1851, PH.
 D. APR. 13, 1919, N.Y.
 M.
 ROSE MANKIEWICZ

REBECCA ESTHER
 B. JUN. 1852, PH.
 D. JUL. 10, 1916, N.Y.
 UNM.

ANNA AMELIA
 B. APR. 1, 1854, PH.
 D. AUG. 14, 1921,
 NEW ROCHELLE, N.Y.
 UNM.

ESTELLE ZILLAH
 B. SEP. 28, 1861
 D. MAR. 8, 1936
 UNM.

IRVING ABRAHAM
 B. MAR. 20, 1864

CLARENCE

PERCIVAL ALLEN
 B. 1873
 D. MAY 18, 1902

MINIS

ABBOT L. MOFFAT
GA. NEWSPAPERS
MINIS MSS. (AJA)
POULSSON'S
SH.
J.E. V. 8, P. 597
U.J.E. V. 7, P. 568
PAJMS V. 10, P. 80F.
KRAUS-SANDOR COLL.
TOBIAS GEN.

ELZAS MS.
ELZAS M.N.
SAVANNAH JEW. BURYING GROUND
CHATNAM CO. (GA.) MARRIAGE REC.
CHATNAM CO. (GA.) WILLS
BIGG. SOUVENIR OF FLA. (GA.) P. 587
WILL OF ABRAHAM MINIS (JRM) (1754)
MARCUS-EARLY AMERICAN JEWRY
FLORENCE ABRAHAMS
NAT'L GEN. SOC. QUARTERLY

7 MINIS

SIMON (TO SAV. JUL. 11, 1733)
B.
D.
UNM.

ABRAHAM
B. 1691/6, ENG.
D. JAN. 13, 1757, SAV.

ABIGAIL
B. 1698/1701
D. OCT. 11, 1794, SAV.

B. SAV. →

LEAH
B. CA. 1726, ENG.
D. MAY 26, 1802, SAV.
UNM.

SAMUEL
B. OCT. 14, 1740
D. YOUNG

ESTHER
B. CA. 1731, ENG.
D. JUL. 4, 1793, SAV.

HINTS
B. AUG. 17, 1736
D. NOV. 5, 1771,
BEAUFORT, S.C.

JOSEPH
B. SEP. 14, 1738
D. SEP. 24, 1757

JUDITH
B. JUN. 24, 1742, SAV.
D. JAN. 30, 1826, SAV.
"OLDEST NATIVE OF GA."

HANNAH (ANNA)
B. JUN. 13, 1744
D. N. APR. 17, 1798, SAV.
DAVID LEION
(HAMBURG, GER.)
(DIV. AUG. 22, 1799)

SARAH (SALLY)
B. AUG. 7, 1748
D. OCT. 23, 1810, SAV.

PHILIP (URI) ('FIRST WHITE
CHILD CONCEIVED AND BORN IN GA. ')
B. JUL. 11, 1734, SAV.
D. MAR. 6, 1789, SAV.
M. JUL. 20, 1774, NEWPORT
JUDITH POLOCK (O.V. I)

ABIGAIL
B. APR. 8, 1775, SAV.
D. FEB. 28, 1835, GEORGETOWN, S.C.
UNM.

FRANCES (FANNY)
B. MAY 17, 1776, SAV.
D. SEP. 22, 1827, AT SEA
M. FEB. 12, 1794
LEVY MYERS (O.V. III)

ABRAHAM
B. FEB. 23, 1788, SAV.
D. AUG. 29, 1801, NEWPORT
UNM.

ISAAC (WAR OF 1812)
B. JUL. 30, 1780, CH.
D. NOV. 15, 1856, PH.
M. DEC. 14, 1803,
GEORGETOWN
DIVINA COHEN (O.V. V. III (1))

DAU.
B. JUL. 18, 1782, SAV.
D. JUL. 30, 1782, SAV.

ESTHER (HETTY)
B. NOV. 21, 1784/2, SAVANNAH
D. DEC. 2, 1864
UNM.

PHILLIPA (POSTHUMUS)
B. MAY 30, 1789, SAVANNAH
D. AUG. 23, 1865
UNM.

PHILIP, M.D.
B. JAN. 28, 1805, SAV.
D. NOV. 28, 1855, BALTO.
M.
SARAH A. LIVINGSTON,
OF N.Y.
(1807-1892)

HENRIETTA
B. FEB. 24, 1807, SAV.

SARA ANN
B. JUL. 5, 1811
D. M. MAY 7, 1834, SAV.
ISAAC HAYS
(O.V. (4))

PHILIPPA
B. FEB. 26, 1818
D. FEB. 5, 1881
M. FEB. 24, 1841
EDWARD J. ETTING
(O.V.)

ABRAM
B. NOV. 4, 1820
D. NOV. 6, 1889, N.Y.
M. OCT. 22, 1851, PH.
LAVINIA FLORANCE
(O.V.)

FRANCES (FANNY)
B. FEB. 11, 1822
D.
UNM.

THEODORE
B. AUG. 8, 1826, SAV.
D. FEB. 15, 1850, SAV.
M. JAN. 12, 1848, CH.
EMILY TOBIAS
(O.V. I (1))

MARIA
B. FEB. 23, 1829
D. AUG. 17, 1853
UNM.

REBECCA GRATZ
B. JUN. 30, 1830
D.
UNM.

CECILIA
B. NOV. 30, 1832
D.
UNM.

THEODORA SALLIE

ELEANOR

ELIZA
B. MAR. 22, 1809

EMILY
B. DEC. 27, 1815

ELLEN
B. JUL. 6, 1849
D. INF.
JUN. 11, 1850

ALICE
B.
D.
N.
NELSON DOE

PHILIP HENRY
B.
D.
M.
ROBERTA CLARK

ISAAC LIVINGSTON
B.
D.
UNM.

ANNIE
B.
D.
M.
MOLE OF BALTO.

LEILA LIVINGSTON
B.
D.
M.
SAMUEL EUGENE
POULTNEY OF BALTO.

CHARLES SPALDING
B.
D.

AUGUSTA MEDORA
B.
D.

JACOB FLORANCE
B. NOV. 12, 1852, PH.
D. M. 1)
LOUISA PORTER GILNER
M. 2)
MARY MASKELL

MARIA
B. DEC. 30, 1853
D.
UNM.

ROSINA FLORANCE
B. OCT. 5, 1855, PH.
D. INF., SAVANNAH

ISAAC
B. JAN. 30, 1857, SAV.
D. JUN. 19, 1893, N.Y.
M. MAY 9, 1886
EUGENIA P. MYERS
(O.V. III)

ABRAM
B. MAY 16, 1859
D. MAR. 30, 1939, SAV.
M. 1) OCT. 8, 1890
ANNA MARIA COHEN
(O.V. I)
M. 2) DEC. 9, 1902
HABEL A. HENRY
(O.V. III)

LAVINIA FLORANCE
B. JAN. 11, 1864
D. M. JUN. 23, 1896, SAV.
CHARLES I. HENRY
(O.V. III)

ESTELLE LIVINGSTON

EUGENE JOHN LIVINGSTON EDGAR CURZON

FLORANCE
B. JUN. 29, 1922
M. LEONARD MALL

CAROLINE
B. APR. 9, 1928
M. RAYMOND MAXIM REHN, JR.

FRANCES
B.
M. GUY EARLE

ISAAC, JR.
B. FEB. 9, 1887
M. LOUISE COHEN

CAROL EUGENE
B. DEC. 19, 1889
D. DEC. 27, 1953
M. SARA LONSBURG

ABRAM, JR.
B. NOV. 6, 1903
M. FLORENCE POWELL

HENRY PHILLIP
OF PRINCETON
B. JUN. 11, 1908
M. DOROTHEA HERTY

PHILIP LIVINGSTON
B.
D.
M.
GRACE ELLIOT MORRIS

NINA
B.
D.
M.
WILLIAM V. ELDER

SARAH
B.
D.
UNM.

ELIZABETH
B. SEP. 9, 1906, BALTO.

LEONARD WALTER ISAAC
B. JUN. 1953

GUY HARMAN
B. FEB. 23, 1950

RICHARD DAKIN
B. NOV. 11, 1953

CARD EDWARD
B.
M. MARGARET HANONEY

KIM

EUGENIA
B.
M. MAX FORMAN

LYNN

ROBERT POWELL
B. JAN. 4, 1943

HENRY HOLMES
B. AUG. 10, 1946

MARGUERITE ANNE
B. APR. 20, 1945

DOROTHEA
B. SEP. 4, 1940

SUSAN
B. APR. 23, 1942

HENRY P., JR.
B. SEP. 4, 1945

M. ROBIN ADAIR GANS

H. MOISE-THE MOISE FAMILY OF S.C.
 WILL OF ABRAHAM MOISE
 ISAAC MOISE
 RACHEL N. LEVY
 KRAUS-SANDOR COLL.
 ELZAS-M.N.
 O.J.C.
 MS.
 LOPEZ GEN.
 SNOWDEN-HIST. OF S.C., V.4
 BIOG. HIST. MEMOIRS OF L.A., V.2,
 FLO. ABR.
 MOISE-JEWISH CEM. AT SUMTER, S.C.
 ROSENWAIKE

(TO CH. FROM SANTO DOMINGO, 1791) ABRAHAM MOISE
 B. 1736, ALSACE
 D. MAY 8, 1809, CH.

ST. EUSTATIA, 1779

SARAH
 B. 1762
 D. APR. 15, 1842, CH.

MOISE (1)

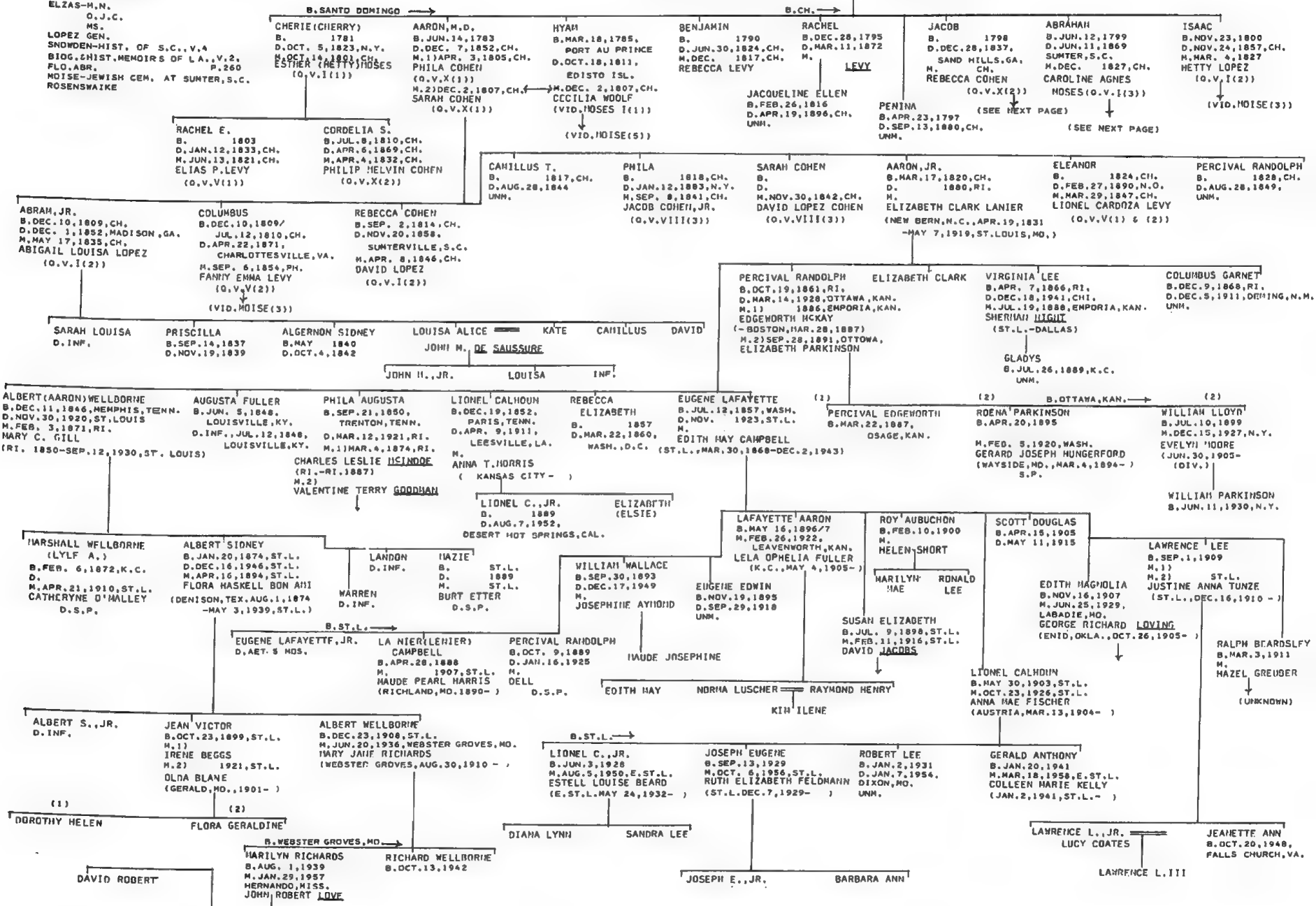

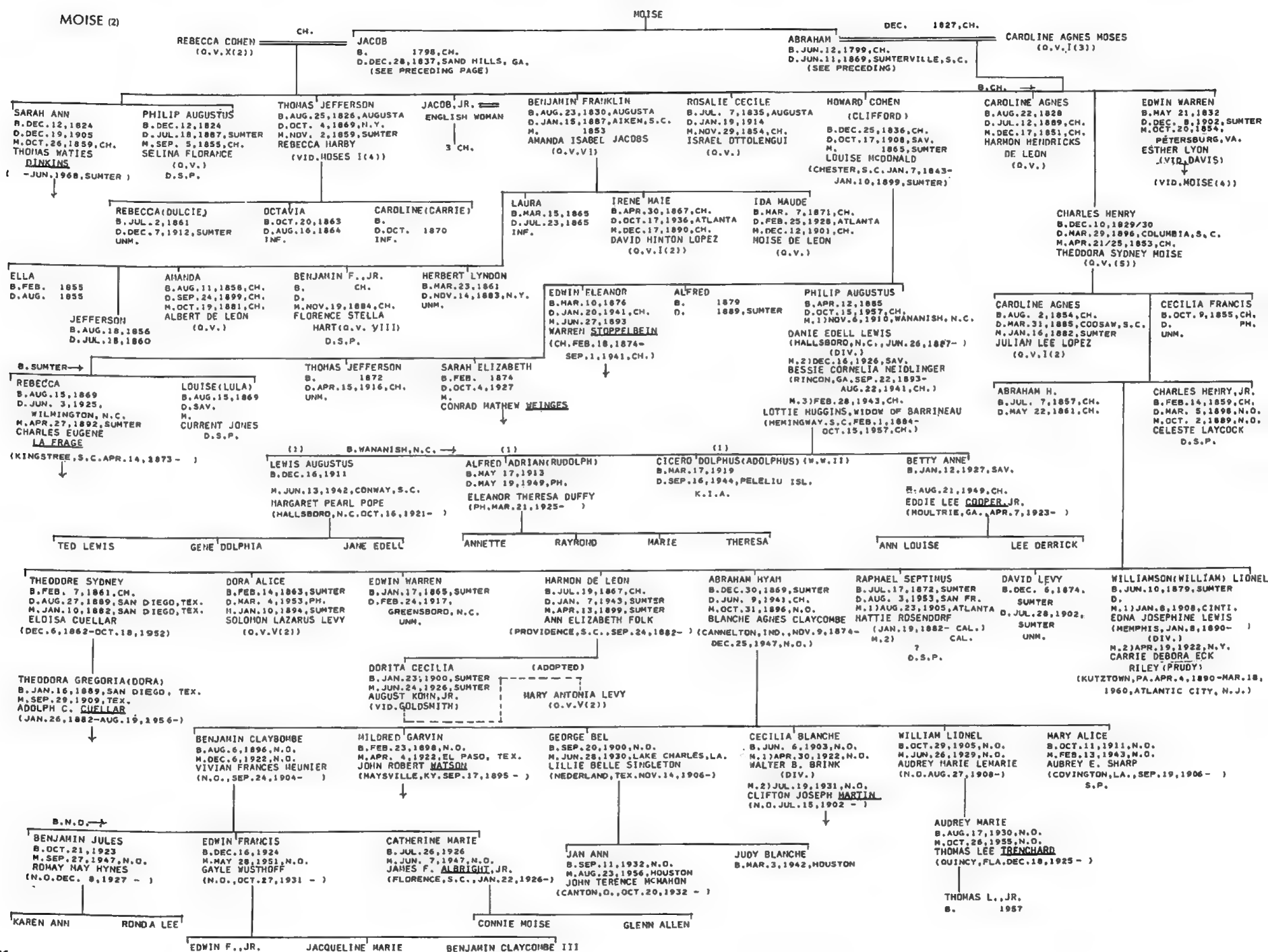

SEP. 20, 1854, PETERSBURG, VA.

(MAJOR, CSA) EDWIN WARREN MOISE
 B. MAY 21, 1832, CH.
 D. DEC. 8, 1902, SUMTER
 (VID. MOISE (2))

ESTHER LYON
 (VID. DAVIS)

B. SUMTER →

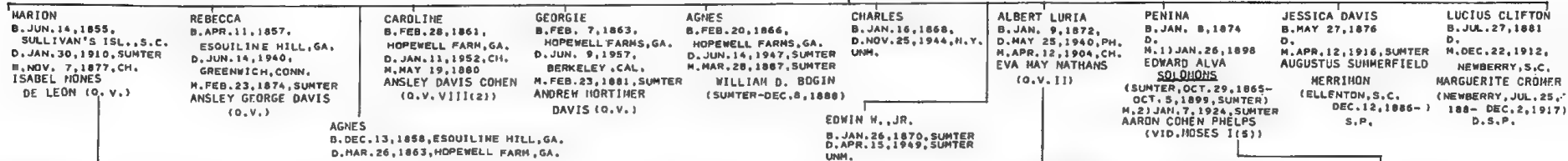

AGNES
 B. DEC. 13, 1858, ESOUILINE HILL, GA.
 D. MAR. 26, 1863, HOPEWELL FARM, GA.

EDWIN W., JR.
 B. JAN. 26, 1870, SUMTER
 D. APR. 15, 1949, SUMTER
 UNM.

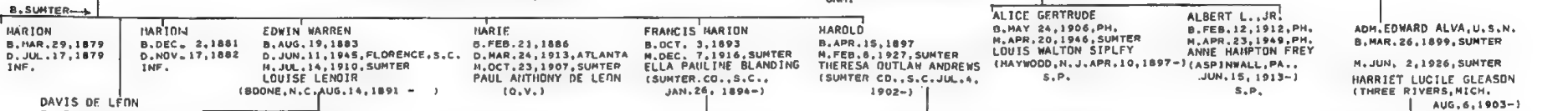

DAVIS DE LEON
 B. APR. 13, 1880
 D. NOV. 22, 1931, SUMTER
 M. OCT. 12, 1904, SUMTER
 ANITA HARBY
 (VID. MOSES (4))

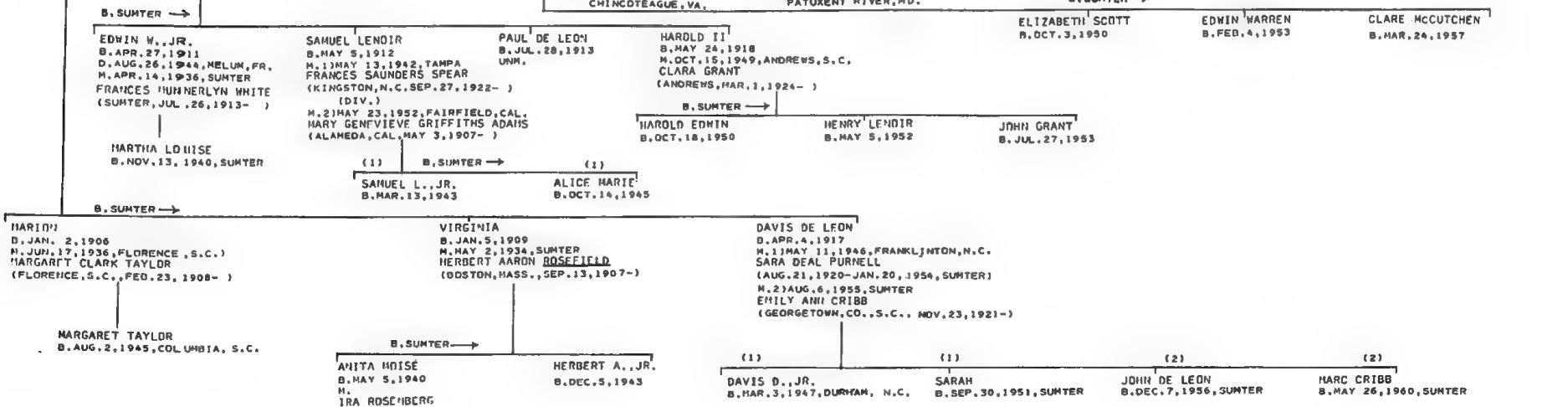
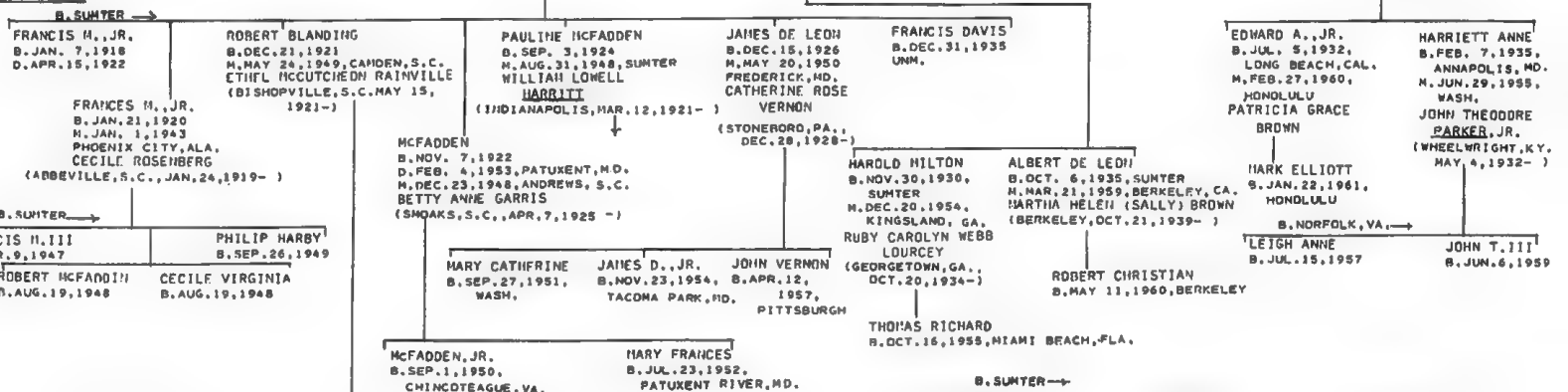

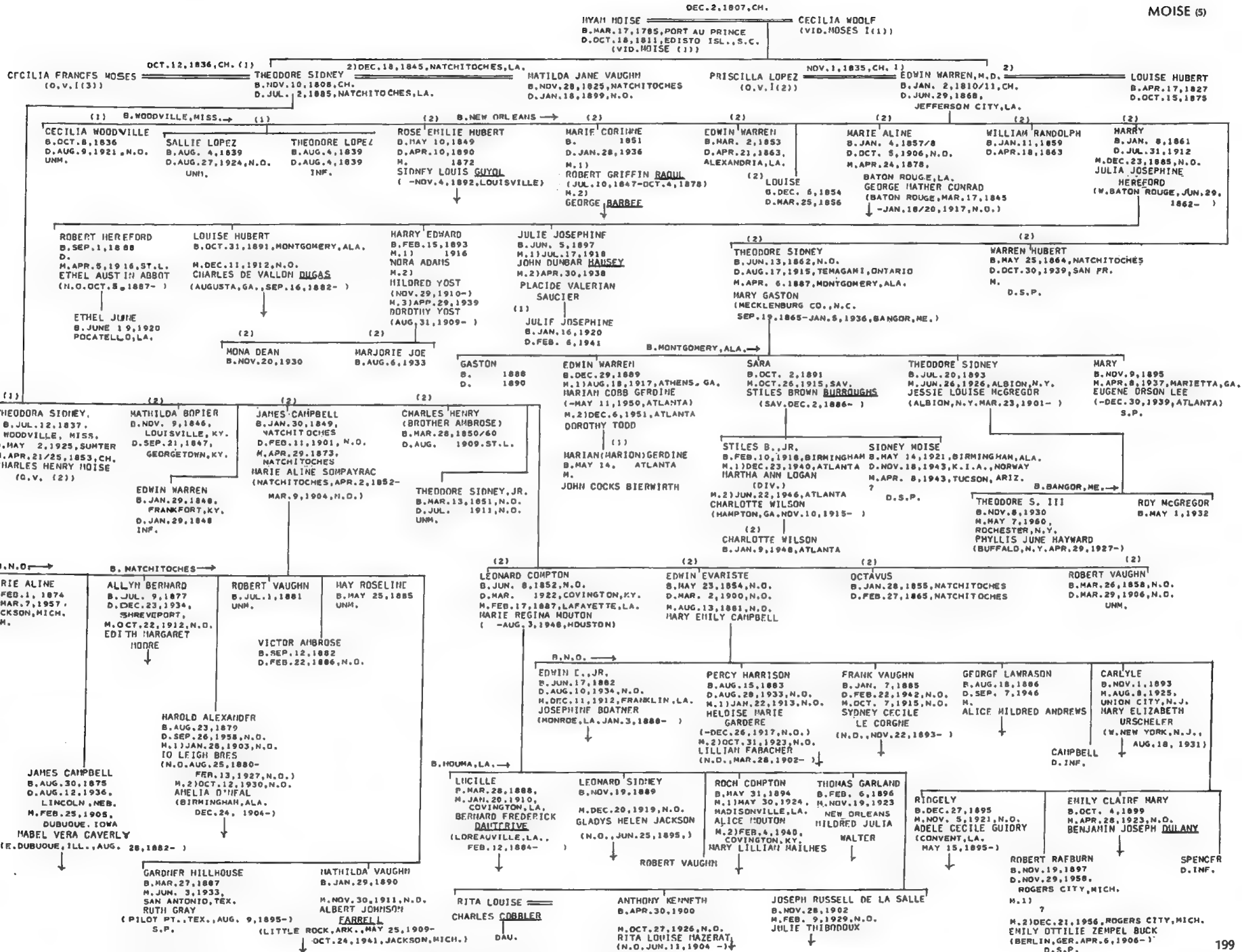

MORDECAI I (1)

J.E.V. 9, P. 10
 U.J.E. V. 7, P. 643F.
 MOSES MYERS FAMILY MSS.
 MOSES GEN.
 EZEKIEL-LICHTENSTEIN-
 "JEWS OF RICHMOND"
 ELZAS MSS. (NYHS)
 COHEN- RECORD OF THE
 MYERS-HAYS-MORDECAI FAMILIES
 VA. MAG. OF HIST. 681DG.
 OCT. 1941, PP. 364-373
 SPRUCE ST. (PHILA.) GEN. REC.
 MRS. ARTHUR KONZELMAN
 ELZAS M.N.
 ELZAS O., C.
 MISC. VII, P. 552
 PAJHS V. 6, P. 39F.
 PAJHS V. 11, P. 197F.

J.B. MORDECAI REC. (VA, H.S.)
 FEDERAL ST. CEM.
 POULSSON'S
 J.G. BULLOCH- "MEMOIR OF
 THE FAMILIES OF BELLINGER
 AND DE VEAUX"
 WILL OF JACOB I. COHEN
 MICKVE ISRAEL RECORDS
 RAISIN MSS. (AJA)
 MAGNOLIA CEM., MOBILE
 RICHMOND TIMES-
 DISPATCH, AUG. 13, 1971
 (OBIT.)

(TO AMERICA, CA. 1760
 NAT. PA. 23 SEP. 1764)

MORDECAI, OF BONN

ENGLAND
 MOSES MORDECAI
 B. 1707, BONN, GER.
 D. MAY 28, 1781, PHILA.

1) ELIZABETH (FSTHER) WHITLOCK
 B. 1744
 D. AUG. 22, 1804, RICH.
 (CONVERT)

2) PH. AUG. 28, 1782
 JACOB I. COHEN
 (O.V. II)

JACOB
 B. APR. 11, 1762, PHILA.
 D. SEP. 4, 1838, RICH.
 M. 1) JUN. 16, 1784
 JUDITH MYERS (O.V. I)
 M. 2) MAR. 21, 1798
 REBECCA MYERS (O.V. I)

JOSEPH
 B. NOV. 18, 1766, PH.
 O. JUL. 10, 1839
 M. OCT. 25, 1786, PH.
 ESTHER MARACHIE
 (O.V. I)

SALOMON JOSEPH
 B. MAR. 20, 1790, VA.
 D. 1843/50
 M. APR. 20, 1817,
 FRANKLIN, MD.
 ISABELLA JANE KINCAID
 (VID. MORDECAI I (3))

ISAAC
 B. NOV. 13, 1805
 D. UNK.

THOMAS WHITLOCK
 B. DEC. 25, 1806
 D. APR. 12, 1865
 M. NOV. 19, 1834
 LUCRETIA COHEN
 (O.V. VII)

ESTHER
 B. AUG. 5, 1811
 D. UNK.

ISAAC
 B. APR. 11, 1764, PH.
 D. M.
 M. ZIPPORAI RUSSELL
 (O.V.)

JUDITH
 B. VA.
 D. JUN. 4, 1820, CH.
 UNK.

REBECCA
 D. 1791/3
 D. MAY 15, 1833
 M. JACOB HERTZ
 (O.V. I)

HARRIET
 B. NOV. 10, 1810
 D. UNK.

JOHN SAMUEL ISAAC

(1)
 MOSES
 B. APR. 4, 1785, N.Y.
 D. SEP. 1, 1824
 SWEET SPRINGS, VA.
 M. 1) DEC. 9, 1817
 MARGARET LANE
 (- DEC. 11, 1821)
 M. 2) JAN. 6, 1824
 ANNE WILLIS LANE
 (SISTER OF 1)

(1)
 SAMUEL
 B. JUL. 24, 1786, N.Y.
 D. APR. 9, 1865, RAL.
 UNK.

(1)
 RACHEL
 B. JUL. 1, 1789,
 GOODCHLAND CO., VA.
 D. JUN. 23, 1838,
 PETERSBURG, VA.
 M. MAR. 21, 1821
 AARON LAZARUS
 OF WILMINGTON, N.C.
 (O.V. II)

(1)
 ELLEN
 B. NOV. 10, 1790, RI.
 D. OCT. 6, 1884,
 HAMPTON, VA.
 UNK.

(1)
 SALOMON, M.D.
 B. OCT. 10, 1792,
 PETERSBURG, VA.
 D. MAY 7, 1869,
 MOBILE
 N. APR. 22, 1824
 CAROLINE WALLER
 HE L. IN MOBILE, ALA.
 (SEE NEXT PAGE)

(1) ← WARRENTON, N.C.
 CAROLINE
 B. AUG. 27, 1794
 D. APR. 20, 1862,
 RALEIGH
 M. DEC. 19, 1820 (AS HIS
 ACHILLE PLUNKETT
 (FR. - JAN. 26, 1824)
 SHE DIED INSANE

(2)
 GEORGE WASHINGTON
 B. APR. 27, 1801
 D. FEB. 19, 1871, RAL.
 M. JUL. 1, 1853
 MARGARET CHEROBI
 UNK.

(2)
 ALFRED (MAJ. USA)
 (MEX. H.)
 B. JAN. 3, 1804
 D. OCT. 23, 1887, PH.
 M. JUN. 2, 1836, PH.
 SARAH HAYS
 (O.V. (4))

(2)
 AUGUSTUS
 B. OCT. 5, 1806
 D. JUL. 25, 1847
 M. MAR. 1835
 ROSINA URSULA
 YOUNG
 (SEE NEXT PAGE)

(2)
 ELIZA KENNEDY
 B. AUG. 10, 1809
 D. NOV. 8, 1861,
 RICHMOND
 M. NOV. 21, 1827
 SAMUEL H. MYERS
 (O.V. I)

(1)
 HENRY
 B. MAR. 25, 1819
 D. SEP. 22, 1875
 M. SEP. 3, 1845
 MARTHA HINTON

(1)
 (JUDITH) ELLEN
 B. APR. 14, 1820
 D. FEB. 6, 1916
 M. FEB. 4, 1850
 SAMUEL FOX MORDECAI
 (O.V. NEXT PAGE)

(1)
 JACOB
 B. NOV. 26, 1821
 D. AUG. 3, 1867
 UNK.

(2)
 MARGARET LANE
 B. OCT. 10, 1824
 D. 1910
 M. MAY 25, 1842
 JOHN DEVEREUX
 (- APR. 10, 1893)

LAURA
 B. JUN. 5, 1837
 D. JAN. 11, 1927
 UNK.

ROSA
 B. FEB. 1, 1839
 D. OCT. 21, 1936
 UNK.

ALFRED, JR., MAJ. GEN.
 B. JUN. 30, 1840, PH.
 D. WASH. D.C., JAN. 20, 1920
 M. 1) NOV. 1, 1866
 SALLY SANDFORD
 HAYNADIER
 M. 2) SEP. 6, 1892
 (ELHA) DORRA VARNEY

FRANK
 B. NOV. 10, 1841
 D. CA. 1843

EMMA
 B. NOV. 16, 1844
 D. INF.

MIRIAM GRATZ
 B. SEP. 7, 1843
 D. JUN. 29, 1923
 UNK.

MARGARET LANE
 B. APR. 18, 1848
 D. 1918
 M. NOV. 2, 1870
 DR. WILLIAM LITTLE
 OF RALEIGH

MOSES
 B. NOV. 12, 1852
 D. YOUNG
 JUN. 15, 1856

MARY WILLIS
 B. SEP. 17, 1858
 D.
 M. JAN. 12, 1881
 WILLIAM TURK

HARTHA ("PATTY")
 B. OCT. 16, 1860
 UNK.

(1)
 SARA HAYS
 B. JAN. 29, 1869
 D.
 M. JUN. 1, 1892
 COL. JOHN DAVID HILEY

(1)
 MARGARET SALDWIN
 B. DEC. 22, 1870
 D. INF.

(1)
 LAURA
 B. JUN. 26, 1872
 D.
 N. AUG. 1901
 MAJ. GEN. CHARLES PELOT
 SUMMERALL
 CHARLES P., JR.
 B. JUN. 16, 1903

(1)
 ALFRED III
 B. MAR. 28, 1874
 D. NOV. 1899
 UNK.

(1)
 WILLIAM HAYNADIER
 B. DEC. 25, 1875
 D. SEP. 8, 1893
 UNK.
 (ENGAGED TO JOHN BROOKER
 YOUNG, BRO. OF ROSINA URSULA)

MARGARET LANE
 B. JAN. 12, 1884
 M.
 GAVIN DORTCH

RUDDOLPH

HENRY MORDECAI
 B. JAN. 30, 1872

GEORGE
 B. NOV. 14, 1873

WILLIAM
 B. DEC. 1, 1875

ALBERT
 B. FEB. 4, 1878

BURKE HAYWOOD
 B. APR. 1880

JOHN DAVID, JR.
 B. MAY 15, 1893

SALLY HAYNADIER
 B. JAN. 16, 1895

NANCY CONDIT
 B. DEC. 10, 1896

ANNE LANE
 B. OCT. 1, 1843
 D. APR. 29, 1912

THOMAS POLLOCK (CSA)
 B. NOV. 8, 1845
 D. NOV. 23, 1912

CATHERINE JOHNSTON
 B. JUN. 27, 1846
 D.
 M. NOV. 9, 1881
 JOSEPH JENKINS HACKAY

ELLEN
 B. SEP. 1850
 D.
 M. SEP. 23, 1869
 COL. JOHN W. HUISDALE
 (- SEP. 1921)

MARGARET (META)
 B. DEC. 13, 1852
 D.
 M. DEC. 8, 1878
 SAMUEL ASHE

JOHN II
 B. JAN. 23, 1855
 D. MAY 1921
 UNK.

LAURA M.
 B. JUL. 28, 1859
 O. AUG. 4, 1904
 M.
 ARTHUR WINSLOW

HARY
 B. JAN. 6, 1862
 D.
 M.
 ARTHUR WINSLOW

THOMAS POLLOCK
 B. NOV. 15, 1882

CHARLES DESAUSSURE
 B. SEP. 22, 1884
 D.
 M.
 ELIZABETH DAVIS (BESSIE)
 MORDECAI
 (SEE NEXT PAGE)

MARGARET
 B. JUN. 15, 1886
 D.
 M.
 GEORGE L. JONES

JOSEPH
 B. FEB. 11, 1891

THOMAS SAMUEL
 B. MAY 7, 1880
 D. OCT. 26, 1896

JOHN DEVEREUX
 B. SEP. 12, 1882
 D. SEP. 12, 1885

MARGARET MORDECAI
 B. NOV. 1884
 D.
 M.
 SAHUEL STOCKARD OF
 WILMINGTON, N.C.

GEORGE DEVEREUX
 B. JUN. 1887

MARGARET DEVEREUX
 B. NOV. 26, 1872

SAMUEL J.
 B. MAR. 4, 1875

ELIZABETH CHRISTOPHER
 B. JUL. 5, 1877
 D.
 M. APR. 30, 1904
 DR. JOHN H. WINFREE
 OF RI.

JOHN WFTHORE
 B. AUG. 22, 1879

ELLEN THEODOSIA
 B. SEP. 6, 1881

AMNIE L.D.
 B. JAN. 5, 1883

JACOB MORDECAI (SEE PRECEDING PAGE)

CAROLINE WALLER APR. 22, 1824 SOLOMON M.D. (MOBILE, ALA.) B. OCT. 10, 1792, PETERSBURG, VA. D. MAY 7, 1869, MOBILE, ALA. AUGUSTUS MAR. 5, 1835, RI. B. OCT. 5, 1806, WARRENTON, N.C. D. JUL. 25, 1847, RI. ROSINA URSULA YOUNG B. MAR. 24, 1818 D. APR. 4, 1906

EDWARD RANDOLPH M.D. B. APR. 27, 1825 D. DEC. 23, 1866, MOBILE UNM. WILLIAM V. (CAPT. CSA) B. NOV. 15, 1826 D. MAR. 24, 1887 UNM. SAMUEL FOX B. DEC. 19, 1828 D. AUG. 22, 1852 UNM. MARY ELLEN B. AUG. 25, 1830 D. 1899 SCOTLAND NECK, N.C. H. JAN. 19, 1854 CHARLES BROUH OF MOBILE LAURA B. 1834 SUSAN ALICE B. OCT. 25, 1837 D. JACOB (JAMES) GRANVILLE (CAPT. CSA) B. DEC. 24, 1839 D. OCT. 15, 1870 M. APR. 24, 1867, MOBILE K.T.A. WALLER THOMPSON (2ND LT., CSA) B. OCT. 26, 1841 D. SEP. 22, 1863 CAROLINE GERTRUDE B. MAY 6, 1844 D. ARISTIDE LOUIS AUBERT

MARGARET LANE B. NOV. 25, 1850 D. N. NOV. 29, 1870 CALHOUN T. MOBEL (SAV. APR. 26, 1845-) SAMUEL FOX, JR. B. DEC. 12, 1852 D. DEC. 29, 1927 M. NOV. 9, 1875 BETTY GRIMES ELIZABETH DAVIS (BESSIE) B. NOV. 2, 1876 D. GEORGE WASHINGTON B. AUG. 14, 1878 HENRY LANE B. SEP. 24, 1882 BRYAN GRIMES D. INF. EDWARD WALLER B. APR. 14, 1885 ELLEN B. JUN. 14, 1887 D. MAR. 1917, RI. UNM. ALFRED B. DEC. 29, 1889 WILLIAM GRIMES B. JUL. 25, 1892 MARGARET LAHT B. JAN. 6, 1896

ELLEN B. OCT. 28, 1871 WILLIAM B. APR. 13, 1873 D. MAR. 10, 1896 ANIE VALCAU B. DEC. 31, 1875 D. M. MARGARET B. MAR. 19, 1879 MARY PENDELTON B. NOV. 8, 1884 JOHN B. NOV. 10, 1890 VAN SHARK ANTONY GERARD WILLIAM YOUNG (CSA) B. MAR. 28, 1836, RI. D. MAR. 25, 1900, RI. HELEN ALVES HORWOOD HARY BROOKE B. AUG. 15, 1837, RALEIGH D. INF. JOHN BROOKE B. OCT. 13, 1839 (K. IN A DUEL) REBECCA B. JAN. 9, 1842, RI. D. INF. GEORGE WASHINGTON (CSA) B. APR. 18, 1844, RI. D. JUN. 14, 1920, CAL. M. OCT. 28, 1876, BUENA VISTA, VA. LOUISE DIXON (SEP. 22, 1849-MAY 21, 1929) MARY BROOKE B. JUL. 28, 1846, RI. D. INF. AUGUSTA B. SEP. 30, 1847, RI. D. FEB. 5, 1939, RI. UNM.

ROSTINA B. SEP. 6, 1876 M. MAY 23, 1941, RI. UNM. WILLIAM HORWOOD B. DEC. 15, 1877 D. JUN. 10, 1878, RI. INF. JOHN BROOKE B. NOV. 8, 1878 D. M. SEP. 29, 1904 FAUQUIER CO., VA. HARY MAGILL RANDOLPH (JUN. 29, 1876-) AUGUSTUS B. DEC. 29, 1881 D. JUL. 1, 1911 SARANAC LAKE, N.Y. UNM. THOMAS HORWOOD B. FEB. 28, 1883 D. FEB. 24, 1949, RI. M. OCT. 22, 1936, RI. CHARLOTTE WILLIAMS HEADE D. S.P. GEORGE W., JR. B. SEP. 15, 1877 D. SEP. 23, 1944, SANTA CRUZ, CAL. M. DEC. 16, 1932, YUMA, ARIZ. IRENE VIOLET HODGKIN ANDERSON D. S.P. LOUISE B. JAN. 19, 1880 UNM. BROOKE FISHER B. FEB. 21, 1883 D. AUG. 11, 1971, MADERA, CAL. M. OCT. 5, 1918, LOUISVILLE, KY. CAROLINE IYERS PRESTON (VID. IYERS I) ETHEL FLEDA B. JUL. 29, 1889 M. JUN. 14, 1926 VICTOR LABADIE (DIV.) S.P. MARY RANDOLPH B. FEB. 13, 1906 M. MAY 20, 1940, RI. AS HIS 2ND WIFE THOMAS RUTHERFORD LE BARON GOODWIN S.P. WILLIAM YOUNG B. AUG. 17, 1907 D. JUN. 23, 1908. FAUQUIER CO., VA. INF. BERTHA LEE B. JUN. 22, 1909 M. SEP. 16, 1939, RI. HOWARD CLARK WILLETT OF WASH. (AUG. 23, 1912-) JOHN CLARK B. MAY 23, 1947, WASH. HELEN HORWOOD B. JAN. 21, 1911 M. NOV. 12, 1932, RI. ALLAN BERNARD FERGUSON, JR. (DIV.) ELIZABETH CITY, N.C. JOSEPH LAWRENCE LYLE (MAR. 3, 1900-) JOSEPH L., JR. B. OCT. 25, 1936, WASH. ROSINA URSULA B. SEP. 6, 1912, CHESTERFIELD CO., VA. M. DEC. 6, 1933. ELIZABETH CITY, N.C. JOSEPH LAWRENCE LYLE (MAR. 3, 1900-) CAROLINE PRESTON B. MAR. 11, 1920, SAN FR. CAL. D. MAR. 25, 1933, MADERA, CO., CAL. BARBARA COLQUHOUN B. NOV. 20, 1921 M. MAY 17, 1947, MADERA DE ROSSET IYERS OF CH. ELIZABETH BROOKE B. MAY 4, 1928 M. WISSLER OF HAWAII SUSAN DIXON B. NOV. 13, 1930 M. MYRICK OF WASH., D.C.

JOSEPH MORDECAI (PRECEDING PAGE)

ISABELLA JANE KINCAID B. CA. 1800 D. AFTER 1860 FRANKLIN, MO., APR. 20, 1817 SOLOMON JOSEPH B. MAR. 20, 1790, VA. D. BOONE CO., MO. 1843/50 THOMAS WHITLOCK NOV. 19, 1834, CH. B. DEC. 25, 1866 D. APR. 12, 1865 LUCRETIA COHEN (O.V.IX) LOUISE B. FEB. 9, 1819, HOWARD CO., MD. D. JUL. 28, 1836 JOSHUA STICE WASHINGTON B. MAR. 27, 1820, HOWARD CO. D. POLINA WILLIAM B. AUG. 23, 1823, HOWARD CO. D. RACHEL JONES ELIZABETH B. FEB. 24, 18-7 BOONE CO., MD. D. CALEB DAVID HARRIET B. DEC. 24, 1828, BOONE CO. D. JOHN N. FROST THOMAS B. AUG. 4, 1831, BOONE CO. D. AUG. 18, 1912 M. SEP. 16, 1857 ELIZABETH DIAI JOSEPHINE B. HINTON, MO. D. JOHN B. HINTON, MO. D. EDWARD HIGEE M. 2) NICHOLS ANS B. MAR. 11, 1860, HINTON, MO. O. JAN. 10, 1881 (K. IN DUEL) WILLIAM ANDERSON B. SEP. 15, 1867, HINTON D. DEC. 10, 1943 M. JAN. 26, 1888 ISABELLA CREASY (-OCT. 18, 1943) ELIZA B. HINTON D. M. NETTIE B. HINTON D. UNM. HARRY PRICE M. H. MARY PRICE

ARTHUR, JR. ETHEL ARTHUR KONZELMAN ISAAC WHITLOCK B. OCT. 1, 1840, CH. D. M. MAR. 14, 1866 LAURA H. TAYLOR CORNELIA B. APR. 1841 D. INF. LUCRETIA COHEN B. JAN. 7, 1842, CH. ESTHER COHEN B. JAN. 9, 1843, CH. CORNELIA B. SEP. 7, 1844, CH. D. AUG. 8, 1869 UNM. HARRIET B. FEB. 6, 1845, CH. D. JAN. 5, 1868 M. NOV. 21, 1867, CH. ISAAC WILLARD HIBSCU (-1925) THOMAS HOUTRIE B. MAR. 12, 1855, CH. D. M. 1) APR. 29, 1890 HANNAH MOSES (O.V. III(1)) M. 2) SEP. 17, 1893, NEWARK, N.J. GERTRUDE AGNES DAHL LEAH COHEN B. OCT. 12, 1836, CH. THOMAS WHITLOCK, JR. B. FEB. 1, 1839 D. APR. 11, 1861 SULLIVAN'S ISL., S.C. UNM. (C.S.A.) LAURA H. ZAIDEE VIVIAN B. 1868 D. APR. 7, 1878 CELIA J. B. 1870 LUCRETIA B. 1872

MORDECAI II (S.C.)

ELZAS M.S.
 ELZAS O.J.C.
 ELZAS JEW. CEMETERIES AT COLUMBIA, S.C.
 "FAM. HISTORY OF BENJ. MORDECAI"
 SHEARITH ISRAEL REC.
 MD. HIST. SOC. REC.
 SHEFTALL M.S.
 B'NAI JESHURUN REC.
 BARBARA L. SOSKIN
 S.C. MARRIAGE CONVEYANCES
 KRAUS-SANDOR COLL.

1) GERSHON COHEN 1785
 B. 1765, GER.
 D. AUG. 25, 1839, CH. ALEXANDER SOLOMONS
 B. 1756, POLAND
 D. JUL. 7, 1836, CH.

MIRIAM REBECCA 7 (1) GOODMAN (GOMEZ) MORDECAI 2) NOV. 1808 1) JANE 2) MICHAEL SIMPSON
 B. 1779 B. 1789 (O.V.)
 D. OCT. 9/10, 1808 D. (ARR. SAV. OCT. 21, 1801) D. MAR. 17, 1843

(1) INF. B. MAR. 17, 1802, SAV. (1) FRANCES (FANNY) B. MAY 8, 1804, CH. D. AUG. 12, 1858, COLUMBIA UNM. (2) BENJAMIN B. DEC. 3, 1809, CH. D. MAR. 30, 1893 M. NOV. 7, 1838 CLARA POLOCK (CH. DEC. 3, 1819-APR. 29, 1894, N.Y.) (2) ABRAHAM G. B. APR. 8, 1811 D. MAY 8, 1841 (2) CECILIA B. 1813 D. NOV. 6/7, 1833 WALTERBORD, S.C., UNM.

GOODMAN II B. SEP. 11, 1839 D. APR. 5, 1922 M. MAR. 30, 1864, N.Y. ADA JACKSON (O.V. I)
 ALLEN LEWIS (CSA) B. OCT. 25, 1841, COLUMBIA, S.C. D. FEB. 8, 1908, N.Y. M. JAN. 11, 1865, N.D. KATHERINE MARKS (O.V. III)
 LEON A. B. SEP. 25, 1843 D. APR. 24, 1925 UNM.
 FRANCES ("SISSY") B. OCT. 31, 1845 D. FEB. 20, 1927 M. FELIX GOTTSCHALK
 HENRY B. JUL. 1847 D. SEP. 13, 1920 M. AUG. 6, 1879 CORINNE HARRIS
 CECILE B. SEP. 28, 1848 D. HENRY M. WOOLF
 ANNIE B. APR. 6, 1853 D. CHARLES J. WILLIAMS
 ELIAS POLOCK B. FEB. 18, 1855 D. JUN. 9, 1858
 ARTHUR LEVY B. JUN. 6, 1856 D. JUL. 3, 1858

ALINE B. D. M. JOHN HOSELEY WALKER OF BALTO.
 HERBERT Q. OF BALTO.
 WALTER C. OF NEW YORK
 CLARA B. MAY 31, 1873, N.Y. D. JUN. 22, 1919 M. NOV. 11, 1896 S. HARBY PLOUGH (VTD. HARBY (2))

BENJAMIN B. DEC. 9, 1865, N.O. D. M. NOV. 20, 1889 CONSTANCE H. DAVIS (O.V.)

CECILIA EVA B. NOV. 15, 1868, N.Y. D. AUG. 14, 1890 UNM.

ROBERT E. LEE B. OCT. 19, 1870, N.Y. D. AUG. 5, 1923, FR. M. AUG. 1, 1905 NELLIE KING MOORE

EUGENE (YONKERS, N.Y.) B. D. M. 1) IDA NATHANS (VTD. CROMELIEN) M. 2) MADELINE COHEN (O.V. V)

EVA B. SEP. 14, 1890, N.Y. M. MAY 20, 1914 SIDNEY B. CARDOZO (O.V.)

LUCILE B. DEC. 2, 1891 M. DEC. 1, 1913 HAROLD LEBAIR (VTD. LIEBER)

CONSTANCE B. SEP. 23, 1895 M. JUN. 28, 1917, N.Y. C. DANFORTH CARDOZO (O.V.)

KATHERINE B. FEB. 17, 1899 M. OCT. 19, 1917, N.Y. CLARENCE LEE OF ROCHESTER, N.Y.

ALLEN LEWIS' B. NOV. 4, 1902 M. 1) APR. 18, 1928 ROSALIND REDLICH M. 2) OCT. 24, FLORENCE GOLDMAN

BARBARA B. AUG. 8, 1918 M. 1) APR. 5, 1938 JAMES N. BANKS M. 2) FEB. 20, 1952 RABBI SAMUEL D. SOSKIN (-1971, N.Y.) M. 3) 1972 PHILIP BERMAN (DIV.) M. 4)

BENJAMIN MORDECAI (WILLIAM) B. JAN. 29, 1920 M. ELAINE BRANLEY

KATHERINE B. APR. 27, 1926 M. MORTON HEYERS, JR. OF BUFFALO, N.Y.

(1) DOROTHY B. NOV. 19, 1929

(2) BENJAMIN MORDECAI

ANDREW LEE B. APR. 7, 1948

GAIL B. 1950

THOMAS B. 1956

(1) BARBARA B. NOV. 3, 1942

JEFFREY LEE B. AUG. 1946

TIMOTHY LEE B. SEP. 1951

M. AUG. 22, 1965 DAVID M. BRODSKY

KATHERINE B. APR. 12, 1967

PETER SAMUEL B. NOV. 12, 1970

SHEPTALL MSS.
 MRS. HAROLD GRADY
 MRS. C. A. WILLIAMS
 ROSENWAIKE-1820 CENSUS
 BALTO. CITY DIR.
 KRAUS-SANDOR COLL.
 MD. MAG. OF HIST.
 LYONS MS. (JRM)
 ELZAS MS.

D.A.R. REC.
 MORDECAI FAMILY BIBLE
 MD. HIST. SOC. REC.
 MISC. VII #561
 NORFOLK, VA. VITAL REC.
 GA. NEWSPAPERS
 AJHO, V. LVII, NO. 1, P. 24FF.

(IN AMERICA BY 1757)
 (NAT., PA. SEP. 23, 1765)

REV. MORDECAI MOSES MORDECAI
 B. JAN. 16, 1727, TELTZ, LITHUANIA
 D. JAN. 19, 1809, BALTO.

CA. 1761, EASTON, PA.

ZIPPORAH (SIPORA) DE LYON
 (O.V.)

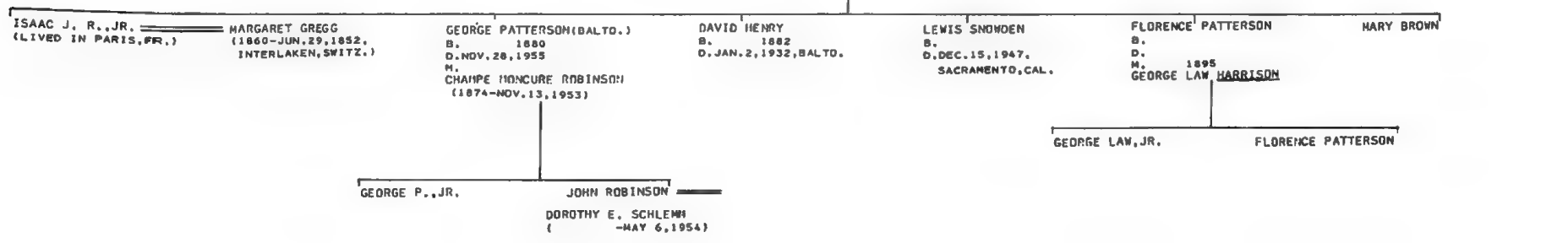
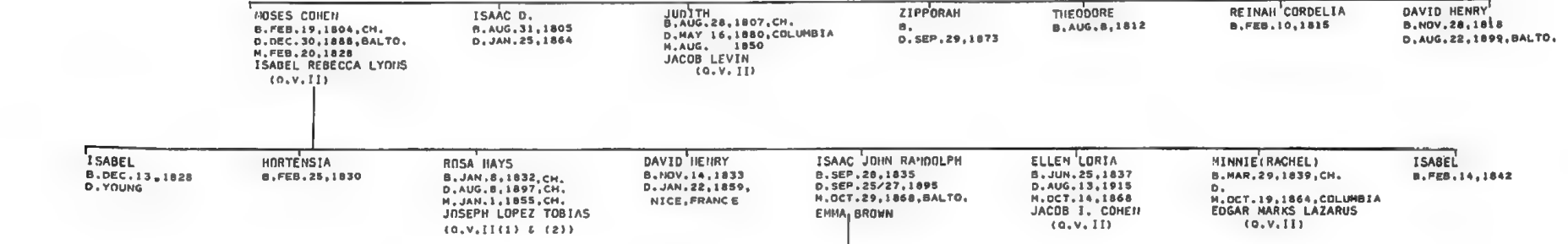
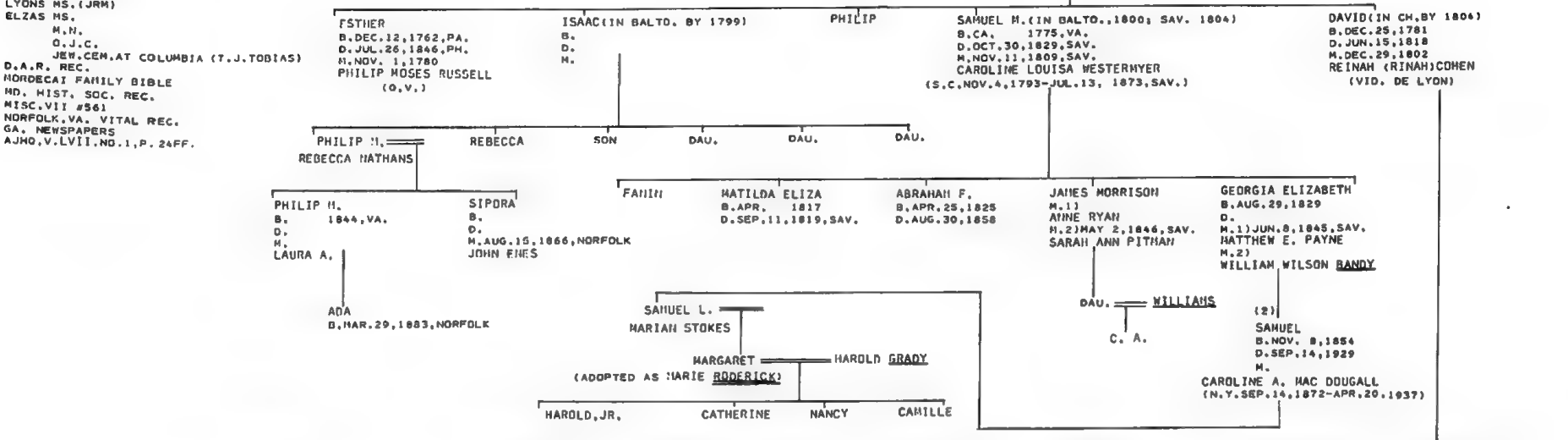

MORRISON

SALEM FIELDS CEM. (J. STEDMAN)
 KRAUS-SANDOR COLL.
 PAJHS, V. 27, P. 174
 SHEARITH ISRAEL REC.
 1870 CENS. (J. STEDMAN)

MOSES MORRISON
 B. 1791
 D. OCT. 19, 1869
 M.
 SARAH
 (1799-MAR. 15, 1872)

JOSEPH =
 SARAH

LEWIS M.
 B. JAN. 1, 1819, ENG.
 D.
 M. JAN. 15, 1851, N.Y.
 ROWENA NATHAN
 (O.V. 1(1))

EDWARD
 B. NOV. 11, 1821, LOND.
 D. JUN. 21, 1897
 M. AUG. 27, 1856, N.Y.
 ZIPPORAH SOHER
 (O.V.)

HENRY
 B. 1824, N.Y.
 D. CA. 1901
 M.
 JUDITH JULIA VEILL
 (VID. SORIA)

HARRIETTE
 B. FEB. 4, 1828
 D. NOV. 24, 1891
 M.
 BENJAMIN WOLFE J. HART
 (O.V. X(1))

ALICE
 B. 1857
 D. SEP. 28, 1881
 UNM.

ADELAIDE
 B.
 D. OCT. 11, 1908
 UNM.

LEWIS W.

ALICE M. =
 MORRIS SOLOMON ULMAN

EDWARD
 B.
 D.
 M.
 BEATRICE STEWART

MORRISON =
 KATHERINE VAN RENSSELAER

EDWARD STEWART

BEATRICE THERESA
 B.
 M. 1)
 HOPKINS
 M. 2)
 J. RUSSELL CRAIT

(1)
 ALAN

SARAH M.
 B. OCT. 9, 1851, N.Y.
 D. JUL. 6, 1918

JULIAN ISAAC
 B. FEB. 10, 1853, N.Y.
 D. OCT. 19, 1894, N.Y.

LEWIS, JR.
 B. JUL. 21, 1855, N.Y.
 D. AUG. 27, 1856, N.Y.

GRACE
 B. DEC. 19, 1856
 D. MAR. 6, 1859

FRANCES FREIDENBERG
 B. JUL. 7, 1858
 D. MAR. 31, 1866

ROSALIE
 B. NOV. 13, 1859
 D. DEC. 14, 1921
 M.
 BOYD

GERTRUDE
 B. MAR. 5, 1861

JOSEPHINE
 B. JUL. 15, 1862, N.Y.
 D. MAR. 20, 1863, N.Y.

CONSTANCE
 B. JAN. 13, 1869

FRANK HENRY
 B. MAY 27, 1870
 D. DEC. 31, 1906
 M. JAN. 10, 1903
 EDITH VIVIAN COPPE

HAROLD MOISE
SNOWDEN-HIST. OF S.C.
WILL OF RACHEL A.M. WOODLIF (JRM)
HARBY GEN. (JRH)
RAISIN MS. (AJA)
FLO. ABR.
COL. PERCIVAL S. MOSES
LAZARUS GEN. (T. J. TOBIAS)
MRS. ROBERT S. MIDDLEMAS
LUCY F. BERKMAN

KRAUS-SANDOR COLL.
ELZAS MS.
ELZAS D. J. C.
ELZAS M. N.
MOSES GEN. (AJA)
MOSES MS. (OAR)
ST. CHARLES, P. 84F.
SAV. JEW. BURYING GROUND
POOL- PORTRAITS...
MOISE- JEW. GEN. AT SUMTER
S.C. MARRIAGE CONVEYANCES
NGSO, V. 58, P. 130
V. 59, P. 50

7 FRANGIPINI 1) HYER MOSES 2) CA. 1772 1) RACHEL ANDREWS 2) JAN. 1789 SOLOMON WOODLIF
D. EUROPE, BEF. 1771 B. 1735, ENG. (O.V.)
D. FEB. 15, 1787, CH.

CECILIA
B. JAN. 2, 1789, CH.
D. FEB. 6, 1871, CH.
M. DEC. 2, 1807, CH.
HYAH MOISE (O.V. (1))

(1) REBECCA B. OCT. 2, 1768 D. DEC. 31, 1854, CH. M. 1787, CH. SOLOMON HARBY (O.V. (1))	(2) BELL (BELLA) B. 1862 M. MAR. 1786, CH. SOLOMON COHEN (O.V. VIII (1))	(2) PRISCILLA B. NOV. 19, 1775, CH. D. SEP. 19, 1866, CH. M. SEP. 20, 1793, CH. DAVID LOPEZ (O.V. I (1)(2))	(2) ELEANOR B. AUG. 1, 1778 D. MAY 15, 1857 M. JUN. 1799 PHILIP COHEN (O.V. X (1)(2))	(2) MAJ. HYER B. FEB. 12, 1779, CH. D. MAR. 20, 1833, N.Y. M. NOV. 2, 1803, PH. ESTHER PHILLIPS (O.V. I (1))	(2) ISAAC CLIFTON B. 1781 D. SEP. 3, 1834, NR. NEW HAVEN, CONN. M. NOV. 3, 1802 HANNAH LAZARUS (O.V. II)	(2) ESTHER (HETTY) B. 1784 D. APR. 18, 1860, CH. M. 1 OCT. 14, 1801, CH. CHERRY MOISE (O.V. (1)) M. 2 DEC. 1827 HYAH COHEN (O.V. X (1))
---	---	---	---	--	---	--

(2)
INF.
K. MAY 1780
(IN SIEGE OF CHARLESTON)
(SEE MOSES I (3))

FRANKLIN J.
B. AUG. 13, 1804, PH.
D. MAR. 6, 1877, COLUMBIA
M. 1828
JANE DORCAS McLENAHAN
OF CHESTERFIELD DIST., S.C.

REBECCA PHILLIPS
B. OCT. 1, 1806, CH.
D. DEC. 7, 1889, N.Y.
UNM.

MONTGOMERY
B. AUG. 27, 1808, CH.
D. DEC. 17, 1886, NEWBERRY, S.C.
M. OCT. 27, 1832
CATHERINE PHILLIPS
(O.V. I (1))

RACHEL WOODLIF
B. OCT. 8, 1811, CH.
D. JUN. 26, 1836, N.Y.
UNM.

HORTENSIA
B. JUL. 8, 1815, CH.
D. APR. 10, 1890, N.Y.
M. DEC. 31, 1834
JACOB L. SEIXAS
(O.V. (3))

(SEE NEXT PAGE)

ELIZA JANE
B. 1829
D. 1852
M. 1852
DR. THOMAS BAKER
O.S.P.

ROSALIE ESTHER AMN
B. 1831
D. 1862
M. AUG. 27, 1862
ROBERT SPAIN

REBECCA
B. 1837
D. 1855
M. THOMAS P. MIKELL

FRANKLIN J., JR.
(GOV. OF S.C. 1872-74)
B. SUMTER 1838
D. WINTHROP, MASS. 1905
M. EMMA BUFORD RICHARDSON

MARY
B. 1811
D. 1855
M. 1811
CHRISTOPHER C. BOWER
M. 2 WILLIAM NELSON TAFT
M. 3 DR. HENRY D. GEDDINGS

JANE
B. 1811
D. 1855
M. 1811
DR. SAMUEL CHANDLER BAKER
M. 2 HARRIET
M. 3 WILLIAM
EMMA
RICHARD
CLARENCE ANDERSON

EMMA
B. 1811
D. 1855
M. 1811
CHARLES BUFORD BRYCE
BUFORD
HENRY CURTIS

FRANKLIN (CQL. USMC)
MARIE A. RAUM
D.S.P.

FRANK
B. 1811
D. 1855
D. YOUNG

THOMAS
B. 1811
D. 1855
UNM.

FRANKLIN
B. 1811
D. 1855
M. LUCY TREZVANT
FRANKLIN
HANPIE HAAS
HENRIETTA
NANCY
FRANKLIN

JANE
B. 1811
D. 1855
UNM.

EMILY
B. 1811
D. 1855
M. FRANKLIN SPAIN
(SEE BELOW) BAKER

WILLIAM E.
B. 1811
D. 1855
M. MATTIE McVEE
WILLIAM
MARY THOMAS

HENRY (HARRY) JUDAH
B. 1811
D. 1855
M. HENRIETTA CAMPBELL BRYAN
HENRIETTA
M. 1 LYLE BROWN
M. 2 JOHN JONES

HENRY
B. 1811
D. 1855
M. BLANCHE, RICHBOURG

JANE RUFUS WILSON HENRY BLANCHE

FRANKLIN
B. 1811
D. 1855
M. EMILY MIKELL
(O.V. ABOVE)

ROBERT
B. 1811
D. 1855
D. YOUNG

JANE REBECCA ROBERT
B. 1811 D. 1855 B. 1811 D. 1855 D. 1855
D. YOUNG D. YOUNG D. YOUNG

FLORENCE BAKER
UNM.

CLARENCE, JR.

JENNIE BAKER
WILLIAM CAMPBELL HSSVAIN

EMMA BAKER
M. 1 REV. BERKELEY
M. 2 ALFRED PARKS CHAMBLIS

LUCY STONE JEANNIE BAKER

CLARENCE SAXLEY ALFRED P., JR.

FRANKLIN JAMES

RICHARD BRICE
CYNTHIA GRINSLEY
RICHARD B., JR.

HENRY
LONNIE HAKE
LONNIE BUFORD

OCT. 27, 1832

MONTGOMERY MOSES
B. AUG. 27, 1808, CH.
D. DEC. 17, 1886, NEWBERRY, S.C.

CATHERINE PHILLIPS
(O.V. I (1))

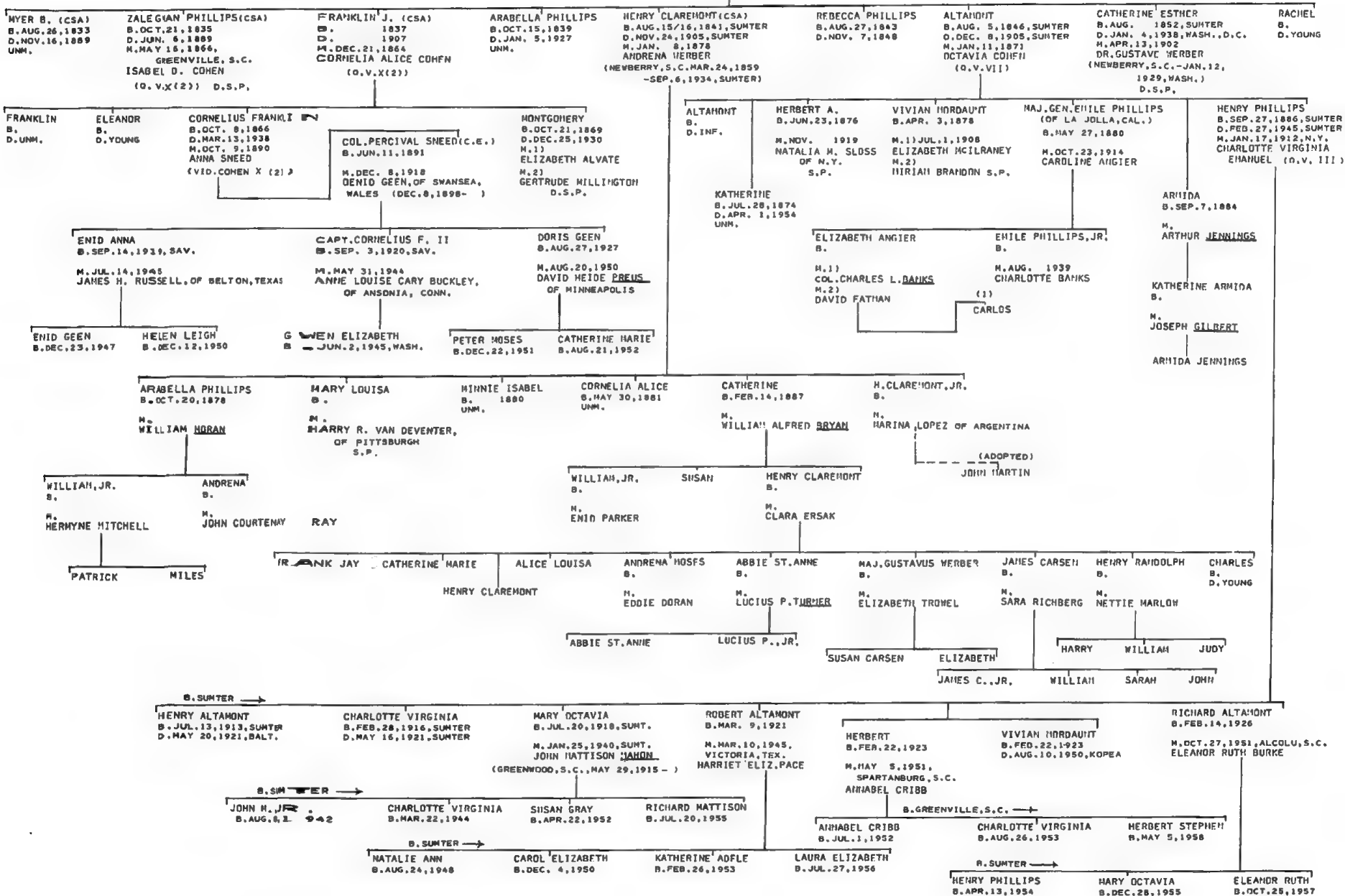

== DENOTES NAME CHANGE

NOV. 3, 1802
ISAAC CLIFTON MOSES
B. 1781
D. SEP. 3, 1834, NR. NEW HAVEN, CONN.
(VID. MOSES I (1))
HANNAH LAZARUS
(O.V. 11)

ANNA MARIA B. AUG. 30, 1805, CH. D. SEP. 3, 1899. ATLANTIC CITY, N. J. M. JAN. 25, 1826 DAVID CARDOZA LEVY (O.V. V (1) & (2))	CECILIA FRANCES B. AUG. 21, 1806, CH. D. APR. 7, 1844, N.O. M. OCT. 12, 1836, CH. THEODORE S. MOISE (O.V. (1))	CAROLINE AGNES B. JAN. 10, 1808, CH. D. DEC. 5, 1880 M. DEC. 1827, CH. ASRAHAI MOISE (O.V. (1) & (2))	CHARLES BROWN B. FEB. 15, 1810 D. JAN. 30, 1854 M. ANGELINA LAZARUS (O.V. II)	ELIZA MATILDA B. FEB. 17, 1812, CH. D. JUN. 4, 1892. ESQUILINE HILL, GA. M. JAN. 22, 1834, CH. RAPHAEL J. MOSES (O.V. IV (1))	DLIVER HAZARD PERRY B. NOV. 9, 1813, CH. D. SEP. 9, 1880, SUMTER M. NOV. 29, 1839, CAMDEN, S.C. ANNA DE LEON (O.V.)	ANDREW JACKSON B. JUL. 1815 D. APR. 3, 1877 M. FEB. 6, 1839, CH. OCTAVIA HARBY (O.V. (1)) (SEE BELOW)	PENINA SEPTIMA B. DEC. 4, 1821 D. JUL. 11, 1844 M. SOLOMON C. LEVY (O.V. V (1))	WILLIAMSON B. D. M. TEXAS ? OF MEXICO 10 CH.	ISAAC HARTHA
---	---	--	--	---	---	---	---	--	-----------------

MARY ALICE B. APR. 4, 1841, D. OAKLAND, S.C. D. M. OCT. 5, 1869, COLUMBUS, GA. ISAAC I. MOSES (O.V. III (1) & (3))	CHARLES B., JR. B. DEC. 17, 1848 D. SEP. 10, 1852	ANNA HARTIA B. D. M. JUN. 1, 1859, COLUMBUS, GA. ISRAEL H. HUNZEL (VID. MOSES IV (1) & (2))	ELIZA B. MAR. 16, 1848 D. AUG. 7, 1926, AUSTIN M. A.R. PAINTER	ALHERIA EINA B. JAN. 1, 1845, D. PENDELTON, S.C. D. N.Y. M. EUGENE H. LEVY (O.V. IX)	ADDIE CLIFTON B. D. M. JONES WEST	ISABEL A. B. 1820 D. SEP. 21, 1854
---	---	---	--	--	---	--

PERRY DE LEON (CSA) B. CH. 1841 D. WASH. D.C. 1922 UNM.	A. DE LEON B. JUL. 9, 1842, CH. D. MAY 18, 1901, SUMTER M. NOV. 27, 1878, SUMTER ELIZA COHEN (O.V. VII)	HARK EDWIN COHEN B. D. M. MARIE BACOAT	EDWARD LEON	PETER PIERRE	CHARLES CAROL	AZILE	PERRY, JR. (CSA) B. AUG. 26, 1844 D. SEP. 12, 1862, RICHMOND, VA. (FROM WOUNDS AT HALVERN HILL)	ANNA DE LEON B. D. M. KETCHAM D.S.P.	CHARLES DE LEON B. JUL. 1, 1854, SUMTER D. AUG. 12, 1876, SAV. UNM.	BENJAMIN CHARLES DE LEON B. D. M. KETCHAM D.S.P.	ISABEL
--	--	--	----------------	-----------------	------------------	-------	---	---	--	---	--------

ANDREW JACKSON MOSES
B. JUL. 1815
D. APR. 3, 1877
(SEE ABOVE)

FEB. 6, 1839

OCTAVIA HARBY
(O.V. 7)

MARX EDWIN, JR. DE LEON PETER B. ELLIOTT ST. P. CAROL CHARLES M. ELIZA M. MARION L.

JOSHUA L. (CSA) B. 1865 D. BLAKELY, ALA. K. T. A.	REBECCA HARBY B. FEB. 12, 1841 D. FEB. 13, 1918 M. NOV. 2, 1859 THOMAS J. MOISE (O.V. (2))	ISAAC HARBY B. AUG. 12, 1842 D. APR. 27, 1900	ALFRED HARBY B. D. M. ROSALIE DAVIS (O.V.) D.S.P.	PERRY B. APR. 13, 1844 D. 1916 M. ROSALIE V. LEVY (SEE NEXT PAGE)	HORACE HARRY B. JAN. 9, 1846 D. APR. 12, 1905 M. EMMA H. SOLOMONS (O.V. V)	ANDREW JACKSON, JR. B. JUN. 26, 1847 D. OCT. 16, 1911 M. SEP. 3, 1873, N.O. ADELE LEVY (O.V. IX)	OCTAVIA B. JAN. 22, 1849 D. AUG. 3, 1851	ARHIDA B. AUG. 11, 1850 D. OCT. 13, 1902 M. AINSLEE S. DAVIS (O.V.)	CECILE FRANCES B. MAR. 16, 1852 D. DEC. 1, 1919 M. HERMAN SCHWERIN (VID. SUARES)	OCTAVIA B. SEP. 14, 1853 D. DEC. 9, 1857	CAROLINE B. AUG. 23, 1855 D. CA. 1904 M. MONTEFIDRE J. MOSES (O.V. III (2))
--	---	---	--	--	---	--	--	---	---	--	--

EUNICE	KENNETH	BERENICE B. M. W. HOMANUS	JULIAN HARRY B. AUG. 1, 1857 D. M. JENNIE SUTHERLAND	HENRY J. HARRY B. DEC. 3, 1858 D. DEC. 26, 1938 M. 11 OCT. 26, 1881 ADELINE W. ENAHUEL (O.V. III) LUCY LADD	ALICE B. NOV. 14, 1883 D. AUG. 8, 1916 M. ROBERT SHELDR (MAR. 2, 1878 - MAY 1, 1903)	HAL W. B. M. DAISY BURGESS	ALINE B. M. LELAND HODGE	WALTER IRVING HARRY B. APR. 8, 1859 D. MAR. 5, 1915 M. 11 MAY 21, 1889 JACQUELINE E. LEVY (O.V. V (1)) M. 23 EDITH GANDY D.S.P.	ALBERT LURIA B. OCT. 1862 D. JUL. 7, 1891, N.Y. UNM.	JANE McCLELLAND B. NOV. 1866 D. OCT. 21, 1867	ANNA HARTIA (ANITA) B. JAN. 1865 D. JUL. 14, 1881, N.Y. UNM.
--------	---------	------------------------------------	--	--	---	-------------------------------------	-----------------------------------	--	---	---	---

WILLIAM GRAHAM B. 1949 D. M. LUCILE ISEMAN	ARHIDA DAVIS B. 1875 D. 1928 M. JOSHIAH WILLIAM BRUNSON	LILIAN B. M. N. J. MOSES	ADELE B. AUG. 6, 1878 D. SEP. 13, 1913 M. EUGENE FORSHIEE	ANDREW JACKSON III B. M. HUGHSON	ROSALIE VIRGINIA B. M. 1913, SUMTER WILFRED MCILTRIE MOSES (III (2))	HENRY B. M. JESSIE GYNN	GWYN	ALICE	ROBERT B. M. KATHERINE BELSER	ALICE HARBY	LUCY C.	ROBERT, JR.	KATHERINE
--	---	-----------------------------------	---	---	--	----------------------------------	------	-------	--	-------------	---------	-------------	-----------

HELEN B. OCT. 30, 1918 M. JUL. 30, 1940 LOUIS REGENSTEIN	ADELE MARIE B. AUG. 2, 1921 D. JAN. 7, 1950 M. AUG. 6, 1944 HITCHELL N. MILLER	WILLIAM GRAHAM, JR. B. JAN. 12, 1926 M. AUG. 30, 1946 RITA LEVENE	ROBIN LEIGH B. JAN. 18, 1948 M. JUN. 15, 1969 MICHAEL CUTSON	W. GRAHAM III B. OCT. 4, 1951	DANA LUCILE B. SEP. 28, 1957	ISAAC B. SUMTER D. SCARSDALE, N.Y. M. 1 MAY LEVIN (SEP. 23, 1871 - SEP. 22, 1920) ISABEL W. SOLOMONS	ANSLEY D. B. DEC. 8, 1876 D. JUN. 13, 1941 M. 1 DAISY GOLDSMITH	HORACE B. M. DAISY BOWMAN	JACKSON H. B. M. FREDDIE FARKUS
---	--	--	---	----------------------------------	---------------------------------	--	---	------------------------------------	--

HABEL B. JUN. 27, 1871 D. DEC. 20, 1878	MARY EMMA B. JUL. 5, 1874 D. NOV. 10, 1891	ANITA H. B. JUL. 19, 1881, SUMTER D. JAN. 7, 1950 M. OCT. 12, 1904 DAVID D. MOISE (O.V. (4))	VIRGINIA S. B. D. M. C. A. PRINCE	AUGUSTA I. B. M. W. R. SHELDR	ESTHER D. B. D. M. ELLSBREE	ROSALIE HAY B. SEP. 8, 1902 D. APR. 14, 1904 INF.	DONOVAN B. B. M. DAWES	HORACE DE LITCHFIELD	MARY ZELINE	JEANNE	HARGUERITE	SAMUEL	HORACE	JACKSON	BETTY	GERTRUDE A.
---	--	---	---	--	---	--	---------------------------------	----------------------	-------------	--------	------------	--------	--------	---------	-------	-------------

PERRY MOSES
B. APR. 13, 1844
D. 1916
(SEE PRECEDING PAGE)

ROSALIE VIRGINIA LEVY
(O.V. IX)

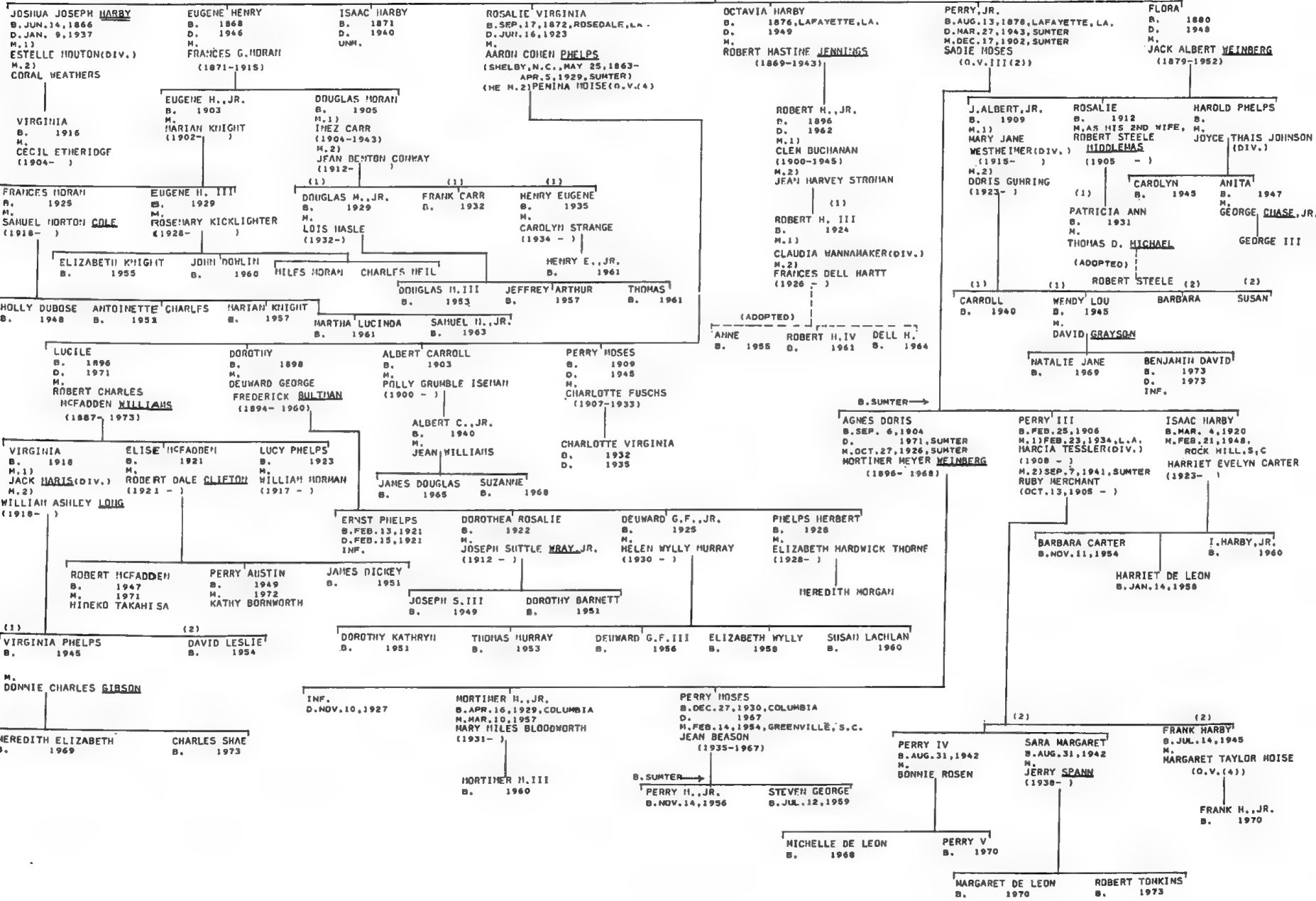

PAJHS V. 4, P. 210
 PAJHS V. 27, P. 168F, 1286, 33 6F.
 U.J.E. V. 8, P. 14
 COHEN FAMILY PAPERS
 HENDRICKS GENEALOGY
 AARON LEVY CALENDAR
 MOSS GEN.
 KRAUS COLLECTION
 SHEARITH ISRAEL REC.
 MISC. VII
 ROSENSWAIKE
 BARBER-N.Y. DEATHS
 EVELYN MILLER
 POULSON'S
 MRS. RALPH NEWMAN

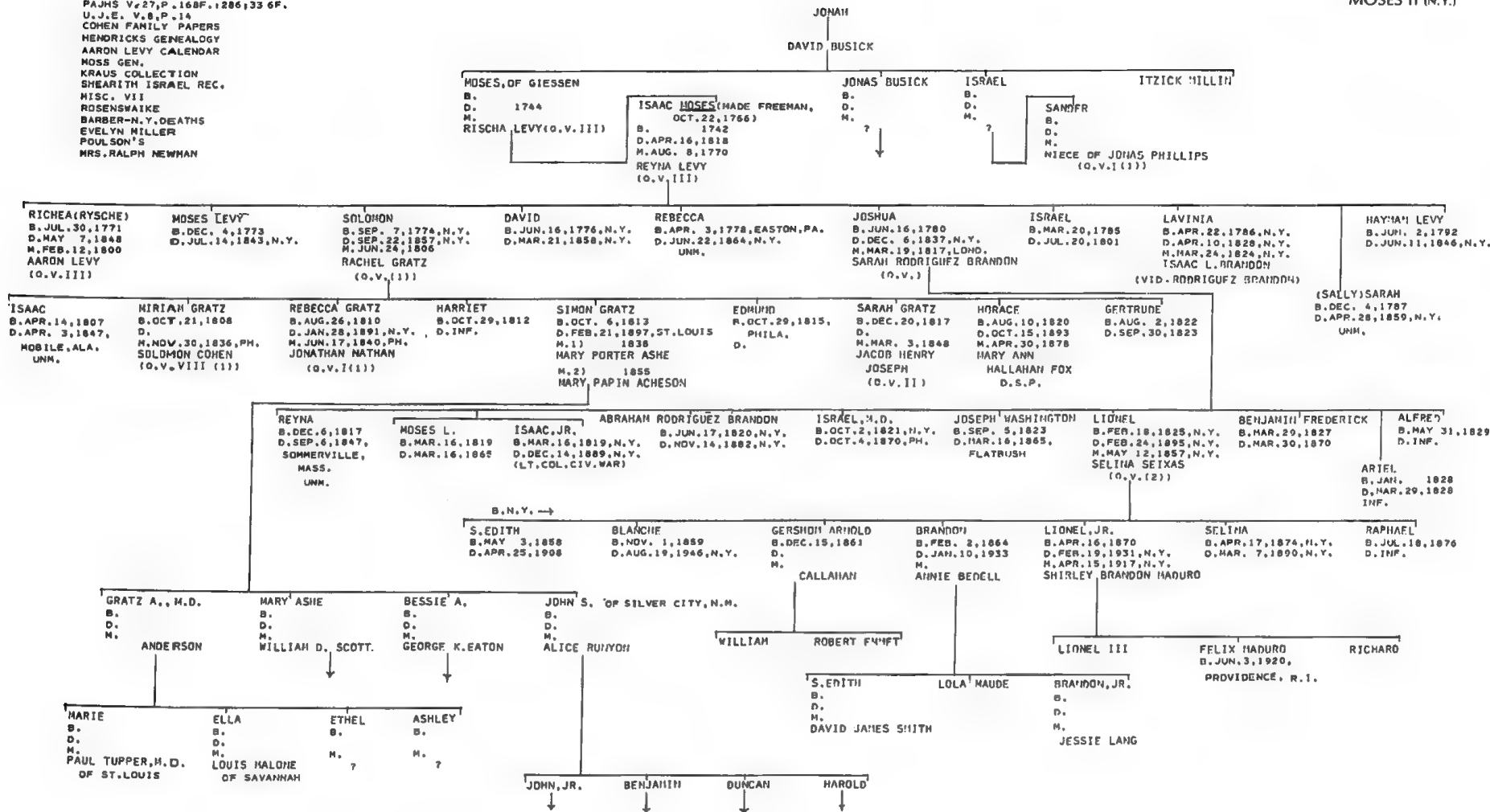

MOSES III (1)

FLO, ABR.
 HAROLD MOISE
 KRAUS-SANDOR COLL.
 PAJHS V.8, P.48F
 SHEARITH ISRAEL REC.
 JACOB ISAACHS HS. (DAR)
 ELZAS HS.
 D.J.C.
 M.N.I.
 NEW JEV. GEN. OF BETH ELOHIM
 H.A. ALEXANDER-ALEXANDER FAM.
 JACKSON-NOAH GEN. (AJHS)
 FALK GEN.
 ABRAHAMS FAMILY BIBLE
 LUCY F. BERKMAN

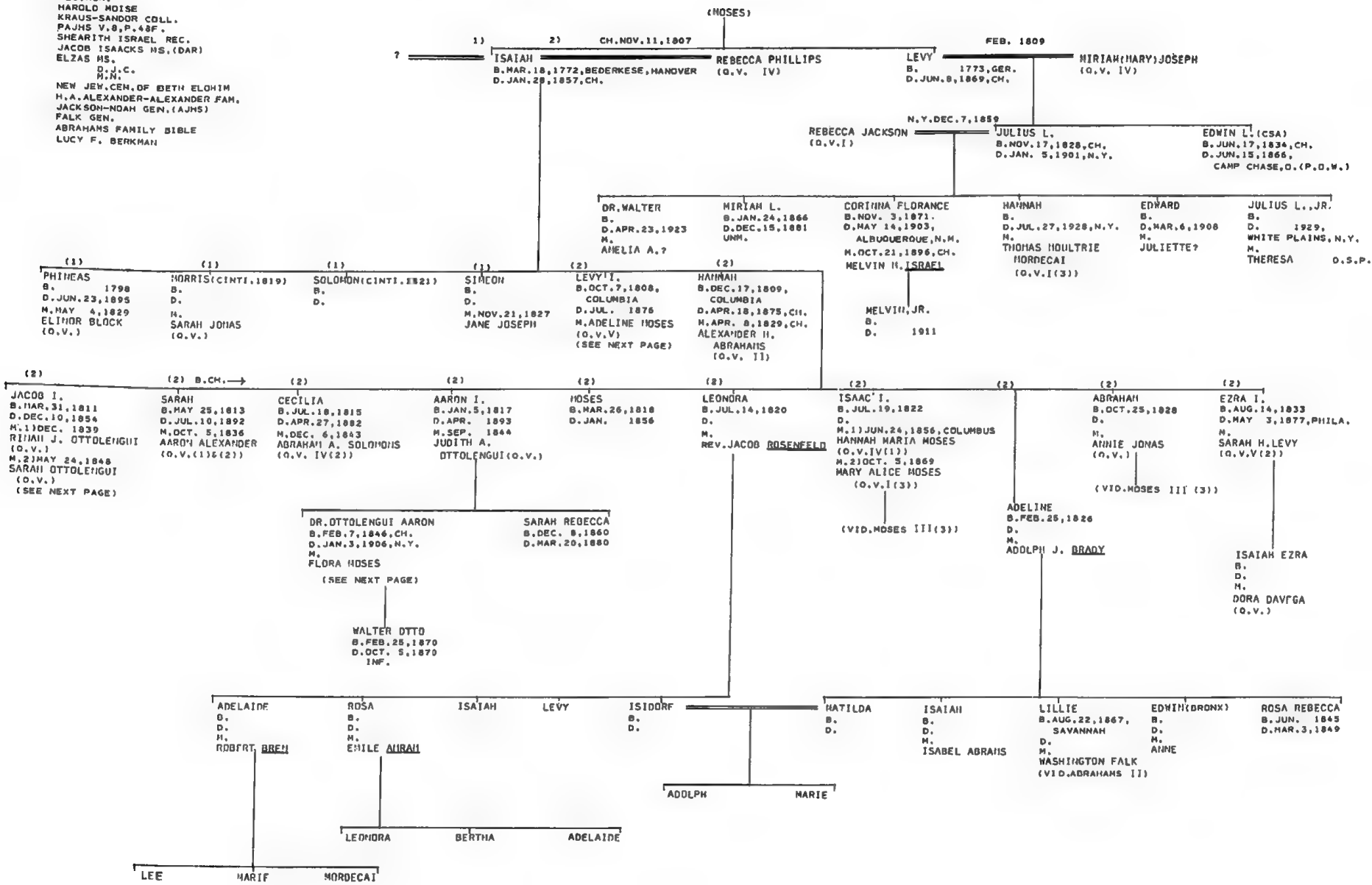

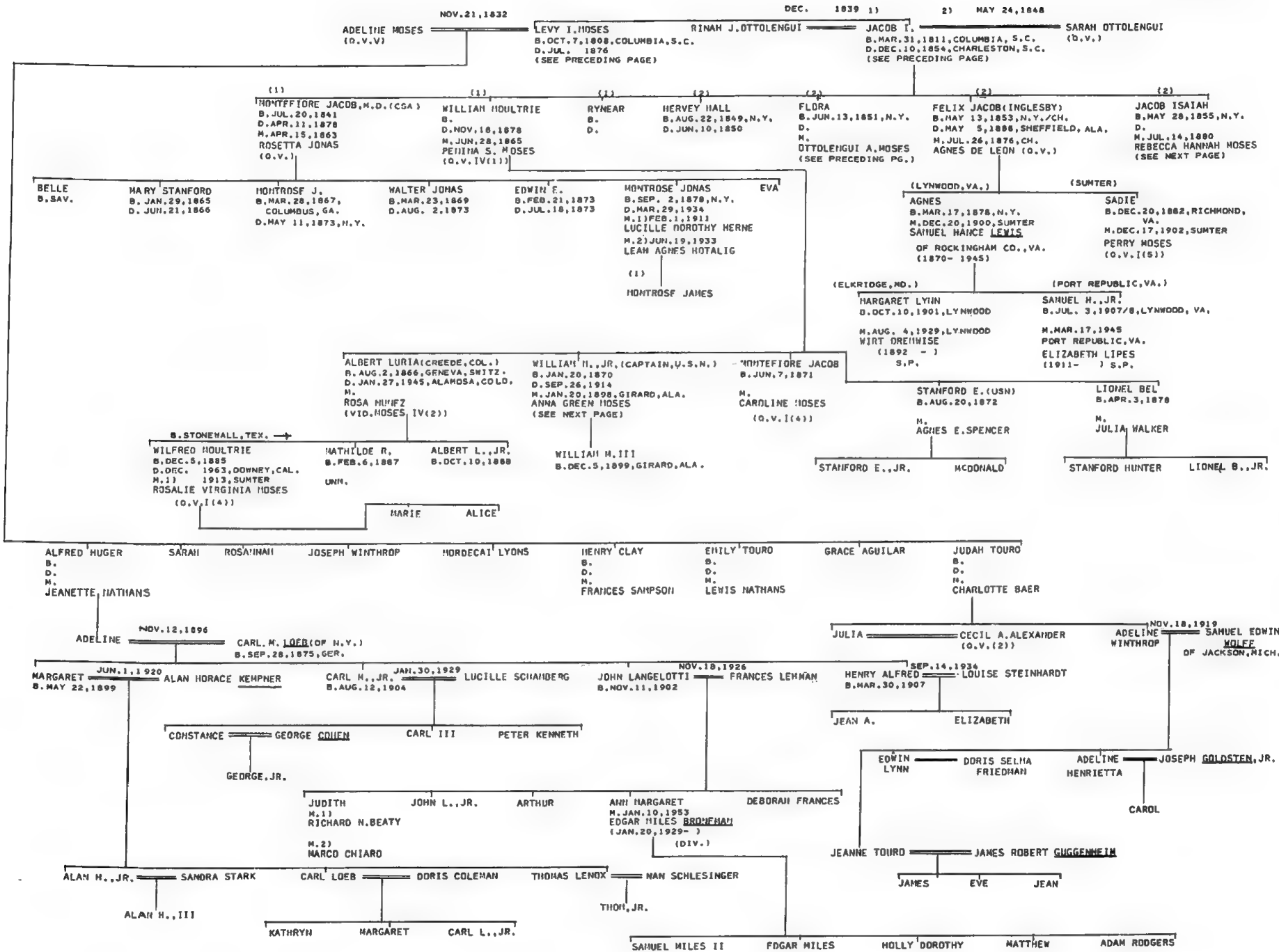

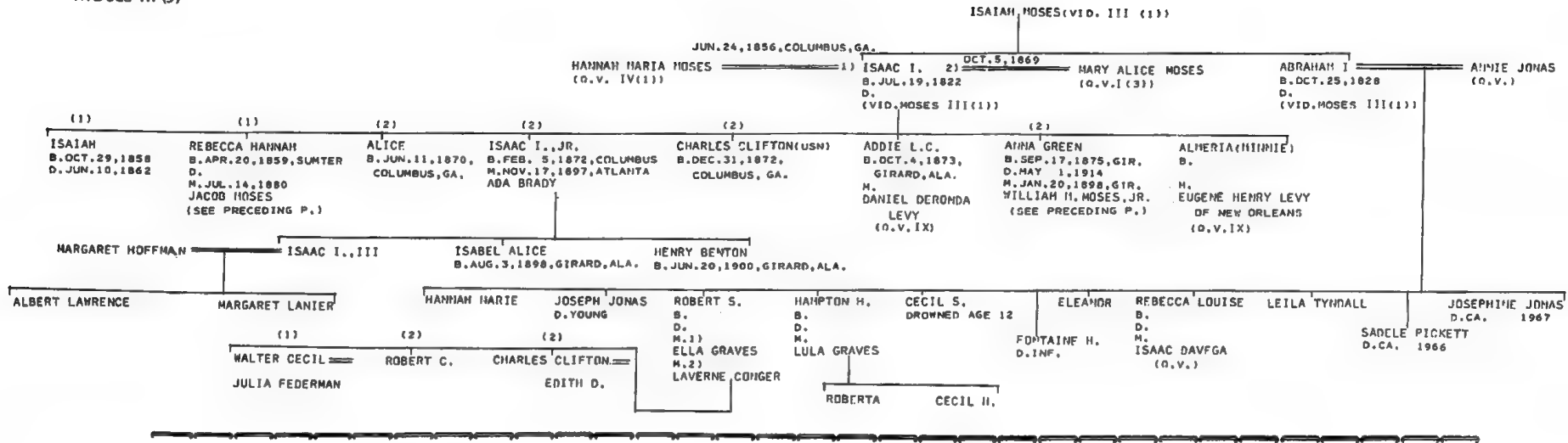

MOSES IV (1) (S.C.)

PAJMS V. 2, P. 49P.
V. 50, P. 56
UJE V. 8, P. 12F.
ST. CHARLES, P. 84F.
ELZAS MSS.
WILL OF DEBORAH MOSES
MOSES MSS. (JRM COLL.)
ELZAS-JEWS OF S.C.
ESQUILINE HILL, GA., CEM. REC. (JRM)
WILL OF ABRAHAM MOSES (JRM)
ROSENWAIKE
J.R. COHEN REC.
LUCY F. BERKMAN
L. SHEFTALL BIBLE
ELZAS M.N.

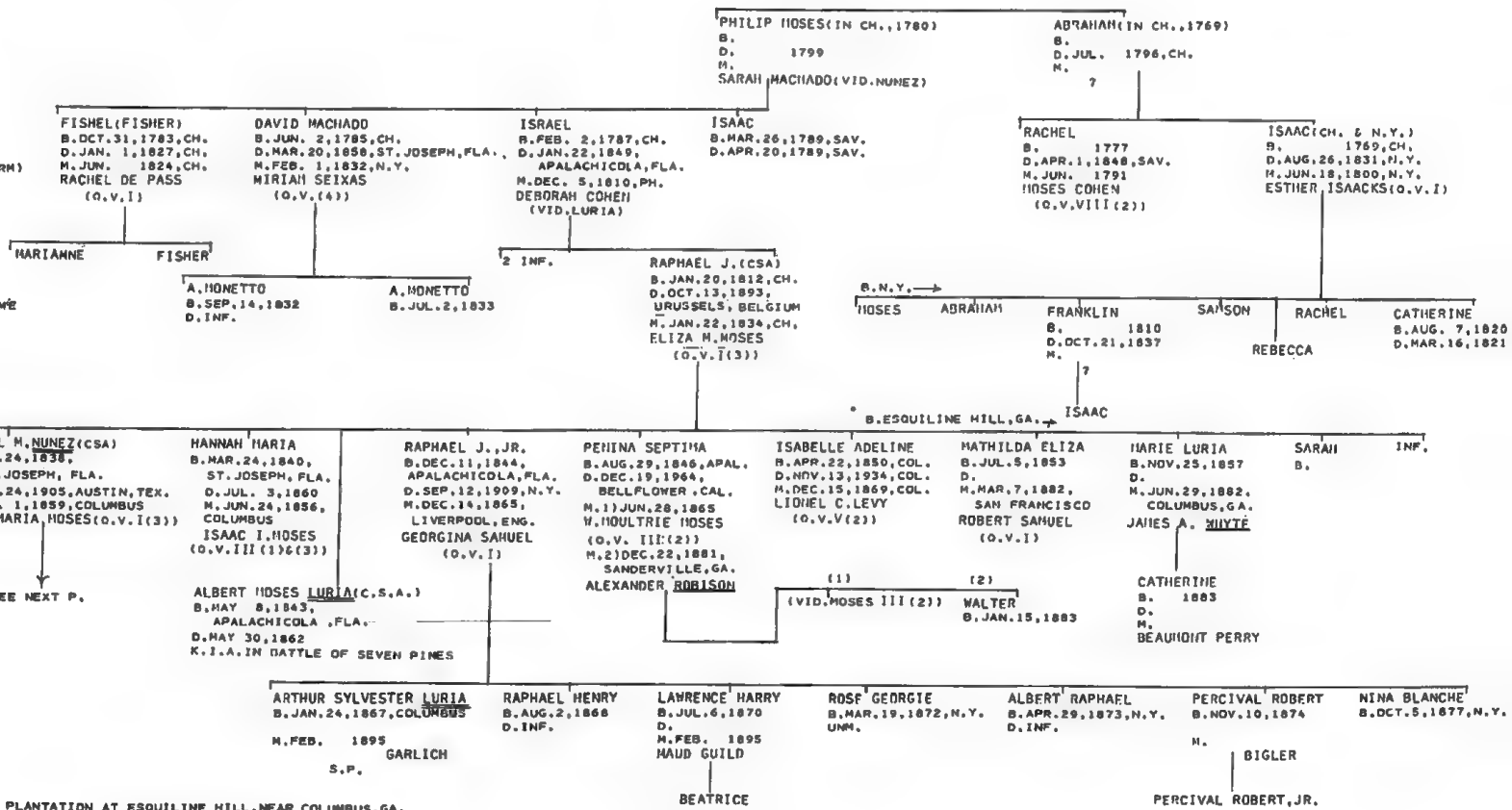

INDICATES CHANGE OF SURNAME

INDICATES FAMILY PLANTATION AT ESQUILINE HILL, NEAR COLUMBUS, GA.

JUN. 1, 1859, COLUMBUS, GA.
 ISRAEL MOSES NUNEZ B. OCT. 24, 1838, ST. JOSEPH, FLA.
 D. FEB. 24, 1905, AUSTIN, TEX.
 ANNA MARIA MOSES (D.V. I(3))

B. ESOUTLINE HILL, COLUMBUS, GA. →

CHARLES BROWN B. APR. 9, 1860 D. APR. 8, 1862 INF.	ALBERTA LURIA B. JUN. 23, 1862 D. JAN. 18, 1935, TEX.	AMIEE B. FEB. 28, 1864 D. AUG. 18, 1954, TULSA, OKLA. M. AUG. 29, 1880, STONEWALL, TEX. CHARLES H. HARPER (LA, 1861 -)	ROSA B. AUG. 15, 1866 D. M. FEB. 24, 1885, SAN ANTONIO ALBERT LURIA MOSES (D.V. III(2))	RAPHAEL H. B. NOV. 4, 1868 D. JUN. 27, 1924, AUSTIN, TEX. M. 11 MAR. 25, 1889 LIZZIE POWERS (- FEB. 2, 1897) M. 21 SEP. 17, 1899 AUSTIN, TEX. EIMA P. ANDER	CECILIA MARIA B. JUN. 16, 1871, HOPEWELL, GA. D. NOV. 19, 1959 M. MAR. 22, 1914, SAN ANTONIO SOL SILVERMAN (CZERNOWITZ, AUSTRIA, OCT. 18, 1855 - JUN. 7, 1934, AUSTIN)	FRANK B. DEC. 25, 1873 D. DEC. 28, 1873 INF.	DULCE B. MAY 25, 1875, FREDERICKSBURG, TEX. D. SEP. 20, 1888	DAVID EZRA B. AUG. 23, 1877, STONEWALL, TEX. D. JUN. 17, 1912, AUSTIN, TEX. M. DEC. 20, 1910, AUSTIN, TEX. VIOLA PICKLE	WILLIAMSON MOSES B. JAN. 17, 1883, STONEWALL D. JUL. 1938
---	---	--	--	--	--	---	---	--	---

B. STONEWALL, TEX. →

ANNA HARY B. JAN. 13, 1881 D. NOV. 19, 1962, AUSTIN H. MAR. 1, 1900 WALTER THOMAS GREEN	EDWARD NUNEZ B. MAY 10, 1882 D. JUL. 19, 1929 H. LULA	ALICE SARAH (LEA) B. JAN. 22, 1885 D. MAR. 26, 1945, AUSTIN M. JAN. 31, 1906, AUSTIN JAMES MORROE FAULK	(2)	RUTH B. JUL. 13, 1902, TAYLOR, TEX. D. JAN. 30, 1965, HOUSTON M. JUL. 14, 1927, TEMPLE, TEX. MABRY P. RYALS	(2)	ROY J. B. NOV. 24, 1904 M. 11 JUN. 19, 1933, AUSTIN, TEX. HOLLY SAMBLIN M. 21 JUN. 6, 1964 LOIS HARRIS	(2)	REON I. B. OCT. 28, 1909 M. 1928, GEORGETOWN, TEX. W. LESLIE JENKINS
---	---	---	-----	---	-----	--	-----	---

DORA IRENE B. DEC. 24, 1886 D. FEB. 18, 1972, TULSA M. 11 DEC. 2, 1909, AUSTIN SAM T. BROWN M. 21 1923 JAMES MARTIN McMULTY, JR.	RAPHAEL CORTEZ B. FEB. 27, 1888 D. AUG. 27, 1897	WILLIE OSCAR B. FEB. 12, 1889 D. APR. 21, 1974, AUSTIN M. MAY 22, 1918, DALLAS CALLIE ESTHER PANTHER	CLIFTON HENRY B. MAR. 8, 1891 D. SEP. 25, 1954, AUSTIN M. FEB. 10, 1913, WACO LEDNA GAGE	IDA MATHILDA B. JAN. 16, 1893 D. OCT. 31, 1919, TULSA M. FEB. 7, 1911, AUSTIN GUY H. LEWIS	CHARLEY PHILIP (JACK) B. OCT. 12, 1895 D. NOV. 6, 1959, TULSA M. FEB. 10, 1920, WACO NAN FARMER	DULCE CECILE B. OCT. 9, 1897, AUSTIN M. 11 JAN. 1, 1916, TAYLOR AUER MORRIS M. 21 AUG. 29, 1934 COLORADO SPR., COLO. ROY ELLIOTT BURKS	NAME CHANGED TO HUNIS ROY THOMAS B. JUN. 10, 1938 ROBERT PATRICK B. JAN. 18, 1939
--	--	--	--	--	---	--	---

B. AUSTIN →	W. LESLIE, JR. B. MAR. 1, 1929	RAPHAEL HENRY B. DEC. 28, 1930	DAVID NUNEZ B. NOV. 1, 1935
-------------	-----------------------------------	-----------------------------------	--------------------------------

MOSES V

ELZAS MS.
M.N.
D.J.C.
WILL OF MORDECAI LYON
U.S. CENSUS, 1870, N.Y.

JOSEPH MOSES
B. 1772
D. JUL. 5, 1814

RACHEL? ("NIECE OF MORDECAI LYON")
B. 1781
D. MAY 20, 1860

CATHERINE
B. 1802
D. DEC. 25, 1890, MONTGOMERY, ALA.
M. MAY 2, 1821
HERTZ WOLFF (FRITZ) OPPENHEIM
(D.V.)

MORDECAI
B. DEC. 1803
D. JUL. 14, 1805

SARAH
B. 1806
D. DEC. 4, 1825
M. JAN. 1823
NAPTALI H. HART
(D.V. V(2))

COL. HART J.
B. 1807
D. OCT. 2, 1860

HETTY
B. MAR. 7, 1812
D. MAR. 26, 1892
UNM.

ADELINE
B.
D. NOV. 1873
M. NOV. 21, 1832
LEVY I. MOSES
(D.V. III(2))

SHEARITH ISRAEL REG.
PAJMS V. 27, P. 152

LEVY MOSES (IMPRISONED AT JAM., L. I.)
B.
D.
H.
?

MOSES VI

B. JAMAICA, L. I., N.Y. →

LEAH
B. MAR. 3, 1760, JAM.

ISSACHAR
B. JUL. 3, 1762, N.Y.

INF. DAU.
B. JAN. 21, 1764, JAM.

DANIEL
B. JAN. 14, 1765, JAM.

MIRIAM
B. FEB. 15, 1767, JAM.

MOSES
B. SEP. 18, 1768, JAM.

JACOB
B. MAR. 1, 1770

1) SOLOMON MOSES, SR. 2)
B. AMSTERDAM, 1734
D. CH. JUN. 23, 1828

RACHEL MIRIAM (MARY)
B. 1754
D. SEP. 23, 1810

(1)
REUBEN
B. 1765, LOND.
D. MAY 26, 1850, CH.
M.
HAR'IAH
(1768 - NOV. 9, 1886)

(1)
PIER (POLLY ?)

(2)
SOLOMON, JR.
B. FEB. 22, 1783, LOND.
D. SEP. 20, 1857, CH.
M. NOV. 1815
ISABELLA MYERS
(1796 - SEP. 4, 1850)

(2)
SARAH
B. MAR. 1792
D. DEC. 18, 1869
M. MAY 31, 1809
ISAAC WOLFF (WOLFF)
(VID. WOLFF)

ELZAS MSS.
D.J.C.
S.C. WILLS
PAJMS V. 50, P. 56
ROSENSHAIKE

MOSES VIII

(IN CH. BY 1781) LYNN MOSES
B. 1748, AMST.
D. APR. 19, 1821, CH.

ABIGAIL

ISAAC L.
B. SEP. 1794
D. APR. 27, 1807

HESTER (HETTY)

DANIEL L.

MOSES L.
B.
D. JAN. 1856

ELZAS O.J.C.
M.N.
WILL OF RACHEL MIRIAM (MARY) MOSES (JRM)
WILL OF REUBEN MOSES (JRM)

MOSES VII

MARY
B. OCT. 24, 1819
D. APR. 3, 1887
M.
NATHANIEL LEVIN
(D.V. II)

MOSS (1)

ROSENWAIKE
R. S. MOHEL REC.
FLO. ABR.
POULSON'S
MORAI-S-JEWS OF PHILA.
MOSS GEN.
ROSENTHAL MS.
MICKVE ISRAEL REC.
SHEARITH ISRAEL REC.
MOSS-HARRIS-GEN.
SANFORD A. MOSS NOTES
HARRIET STRYKER-RODDA

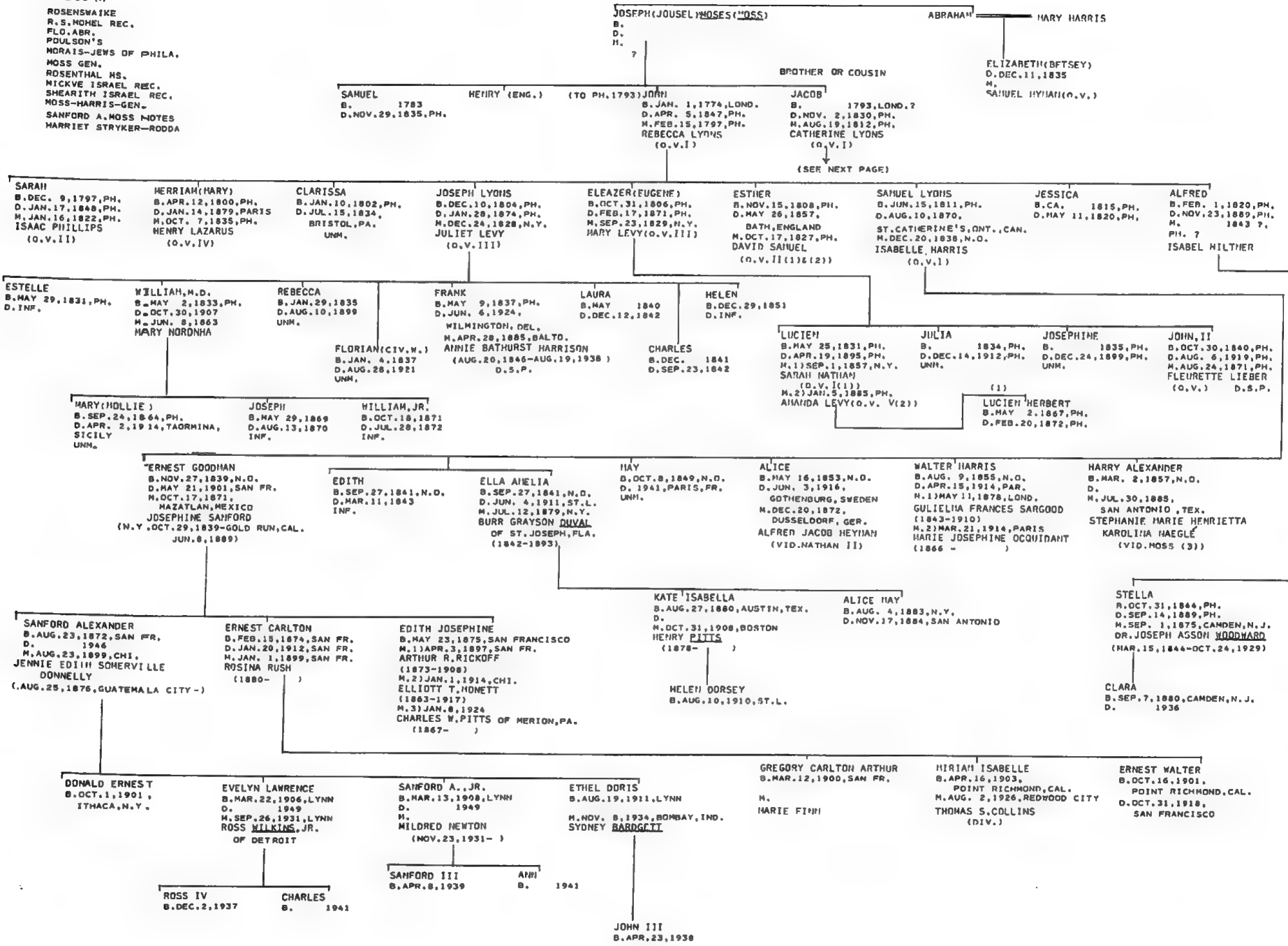

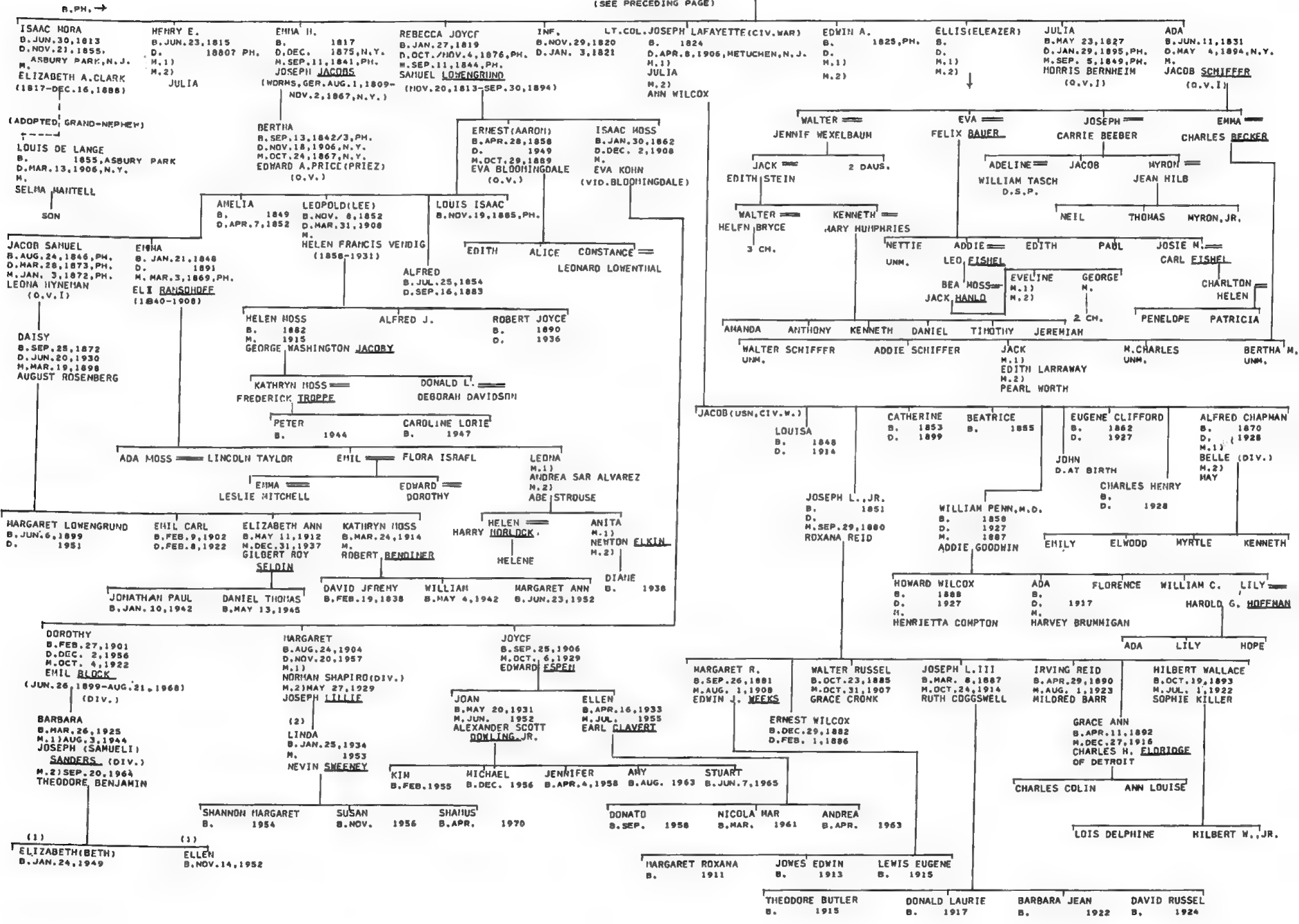

JUL. 30, 1885, SAN ANTONIO, TEX.

HARRY ALEXANDER MOSS
B. MAR. 2, 1857
D. [?]
(L. IN MEXICO CITY)
(SEE MOSS (1))

STEPHANIE MARIE HENRIETTA KAROLINA NAEGLE
B. DEC. 7, 1859, WICKRATH, PRUSSIA
D. JAN. 10, 1917, PACHUCA, MEXICO

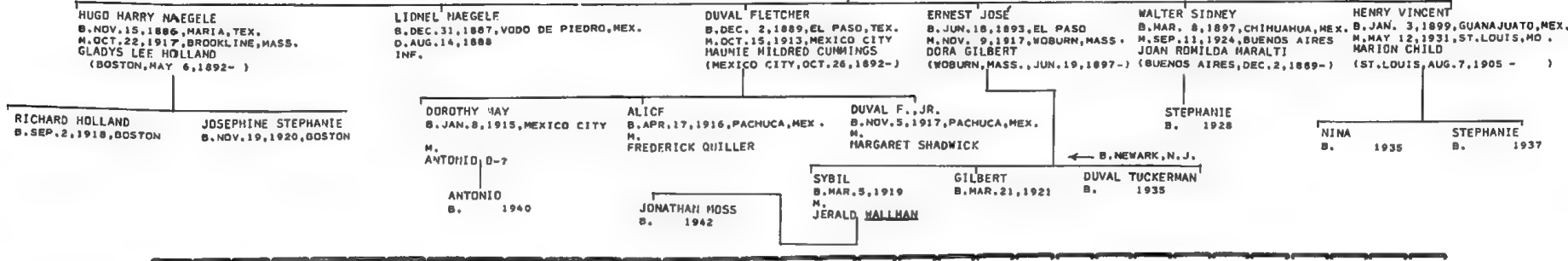

MYERS III (SAVANNAH)

MOSS GEN.
ELZAS MS.
ELZAS JEW. CEM. AT GEORGETOWN, S.C.
JRM COLL.
S.C. MARRIAGE CONVEYANCES
BARBER-N.Y. MARRIAGES
COOPER M. CUBBEDGE
KRAUS-SANDOR COLL.
PAJMS. V. 12, P. 47

HORDICAI HYERS
B. 1727
D. DEC. 16, 1788, GEORGETOWN, S.C.

ESTHER COHEN
(O.V. VIII (1))

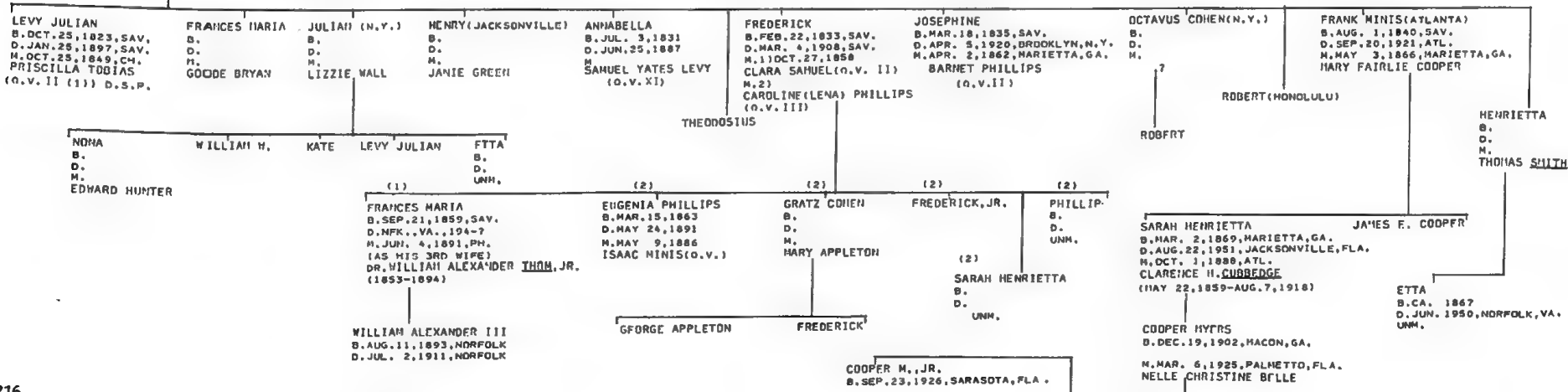
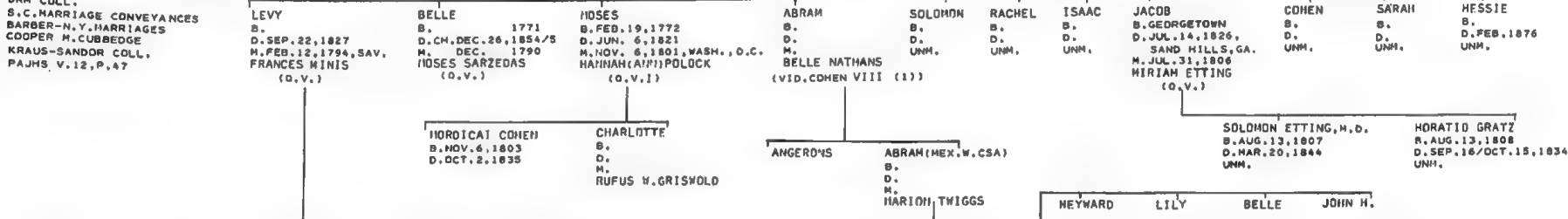

JULIA HORDECAI REC.
JOHN BROOKE HORDECAI (MS. V.A.M.S.)
MISC.VII
VALENTINE'S MANUAL
POOL-PORTRAITS
PAJHS V.11,P.155
V.27,P.151F-
V.33,P.203F-
AJHO V.53,P.292
V.56,P.116
KRAUS-SANDOR COLL.
NOSES MYERS MSS.
GOLDSTONE MS.
EZEKIEL-LICHTENSTEIN
AARON LEVY CALENDAR(AJHS)
SHEARITH ISRAEL REC.
FLO.ABR.
J.ROSENBAUM-MYER MYERS...
SIMSON MS.(JRM)

MYER
(IN N.Y. BY 1722)
(FREEMAN, MAY 12, 1723/24)
SOLOMON MYERS
B. BEF. 1700
D. CA. 1740, N.Y.

JOSEPH
JUDITH
B. 1696
D. FEB. 19, 1773, N.Y.

MYERS I

MYER (FREEMAN, APR. 29, 1745/6)
B. 1723
D. DEC. 12, 1795, N.Y.
M. 1) CA. 1753
ELKALEH MYERS-COHEN (O.V. I)
M. 2) MAR. 18, 1767
ELKALEH (JOYCE) HEARS (O.V.)

ASHER (FREEMAN, SEP. 30, 1755)
B. 1728
D. MAY 7, 1789
M.
CATHERINE (CATY) HEARS (O.V.)

JOSEPH
SLOE (SLOEY)
B. 1728, N.Y.
D. APR. 5, 1811, N.Y.
M. MAY 15, 1750/MAY 26, 1751
HAYHAI H. LEVY
(O.V. I)

SARAH
RACHEL
B. 1738
D. SEP. 29, 1810, BOSTON
M. AUG. 13, 1766, N.Y.
MOSES MICHAEL HAYS
(O.V. I)

REBECCA
B. 1738
D. AUG. 13, 1766, N.Y.
SOLOMON MARACHE

JUDAH
B. JUN. 3, 1761
D. JUN. 12, 1831, RI.
M. OCT. 21, 1821, RI.
SARAH LOPEZ ISAACKS
(O.V. I)

HOSES
D. AUG. 15, 1762

JOSEPH
B. MAY 24, 1764, N.Y.
D. SEP. 29, 1827, RI.
M.
ELIZABETH STUBBLEFIELD

SAHSON
B. FEB. 22, 1766

GABRIEL
B. MAR. 26, 1768
D. SEP. 11, 1770, N.Y.
INF.

SARAH
B. MAR. 29, 1770

NATHAN
B. FEB. 18, 1774

JOCHABED (JOHAVETH)
B. JUN. 21, 1775

SOLOMON HEARS
B. NOV. 30, 1753, N.Y.
D. NOV. 13, 1791
PETERSBURG, VA.

SAHUEL
B. APR. 16, 1755, N.Y.
D. AUG. 22, 1836, RI.
M. 1) OCT. 21, 1794, RI.
SARAH JINAH
(O.V. I (1))
M. 2) SEP. 27, 1796, BOSTON
JUDITH HAYS (O.V. I (1))

JOSEPH HEARS
B. SEP. 12, 1758
D. SEP. 10, 1817

JUDITH
B. MAY 8, 1762
D. JAN. 9, 1796
M. JUN. 16, 1784
JACOB HORDECAI
(O.V. I (1))

JUDAH
B. FEB. 2, 1763
D. INF.

RICHA
B. JUN. 10, 1769, N.Y.
D. MAR. 21, 1837, RI.
M.
JOSEPH HARK
(O.V. I)

HOSES HEARS
B. JAN. 14, 1771
D. SEP. 9, 1860
M. SEP. 21, 1796
SALLY HAYS
(O.V. I (1))

SAHSON HEARS
B. DEC. 5, 1772/3
D. AUG. 4, 1803, N.Y.
M.
(NON-JEWESS)

REBECCA HEARS
B. APR. 26, 1776
D. OCT. 1, 1863, RI.
M. MAR. 21, 1798
AS HIS 2ND WIFE
JACOB HORDECAI
(O.V. I (1))

BENJAMIN
B. MAY 2, 1778
D. SEP. 1, 1835, N.Y.
UNM.

AARON
D. DEC. 27, 1774
D. AUG. 18, 1778
INF.

HIRIAH
D. AUG. 16, 1775
INF.

COMMANDER JOSEPH (U.S.N., C.S.N.)
B. CA. 1802
D. MAR. 17, 1862
M. JAN. 31, 1838
RACHEL HAYS MYERS
(BELOW)

SAHUEL HAYS
B. JAN. 1, 1799
D. OCT. 2, 1849, RI.
M. NOV. 21, 1828
ELIZA KENNON HORDECAI
(O.V. I (1))

GUSTAVUS ADDLPHUS
B. AUG. 9, 1801
D. AUG. 20, 1869
M. OCT. 10, 1833
ANNIE AUGUSTA GILES
WIDOW OF CONWAY
(MAY 23, 1867)

REBECCA HAYS
B. MAR. 28, 1803
D. MAY 4, 1877
UNM.

HENRY, M.D.
B. FEB. 6, 1806
D. APR. 9, 1845
UNM.

ELLA C.
B. MAR. 15, 1808
D. JAN. 8, 1892
UNM.

RACHEL HAYS
B. MAR. 15, 1808
D. JUL. 7, 1862
M. JAN. 31, 1838
JOSEPH MYERS
(ABOVE)

AGNES

MAJ. EDUARD TROWBRIDGE DAHA (CSA)
B. JUL. 13, 1830, PETERSBURG
D. MAY 12, 1905, RI.
M. DEC. 2, 1856
FRANCES (FANNIE) COLQUHOUN TRIGG
(FEB. 26, 1836 - AUG. 8, 1899)

CARDLINE
B. DEC. 5, 1844, RI.
D. DEC. 11, 1928, WASH., D.C.
M. DEC. 6, 1865
EDWARD COHEN
(O.V. II)

MAJ. WILLIAM BARKSDALE (CSA)
B. DEC. 4, 1839
D. NOV. 5, 1873
M. DEC. 15, 1864
HATTY PAUL

JAMES HUE CONWAY
B. SEP. 26, 1865
D. MAR. 12, 1895

LELIA AUGUSTA
B. OCT. 4, 1868
D. M.
JOHN HILL HORGAN
OF BROOKLYN

ADELA PEGRAM
B. JUL. 15, 1870
D. M.
DR. RICHARD FROTHINGHAM
O'NEILL OF BOSTON

WENTWORTH PAUL
B. JUN. 13, 1872
D. JUL. 3, 1873
INF.

RACHEL ELLA
D. INF.

FANNIE COLQUHOUN
D. INF.

LILBURN TRIGG
B. SEP. 24, 1857
D. JUN. 12, 1934
UNM.

ELIZA KENNON
B. JAN. 18, 1860
D. NOV. 5, 1934
M. JAN. 18, 1888
WILLIAM CARRUTHERS PRESTON
OF LEXINGTON, VA.
(MAR. 1862-MAR. 1901)

EDMUND T. D., JR.
B. JAN. 9, 1862
D. OCT. 27, 1934
M. DEC. 15, 1887
GRACE ADAMS
(DEC. 6, 1869-DEC. 18, 1942)

FRANCES COLQUHOUN
B. JUN. 28, 1889
M. JUN. 5, 1912
JAMES HODDHALD WELLEDOR
(MAR. 7, 1886-OCT. 18, 1945)

ANNE HAYS
B. APR. 23, 1895, RI.
D. NOV. 25, 1971, RI.
M. APR. 29, 1920
DR. DANIEL D. TALLEY, JR.
(JUN. 24, 1882-1966)

LELIA MYERS
B. M. NOV. 1954
JOHN C. BULLITT
(VID. HORWITZ)

ALLEN II

HELEN ROGERS

LELIA
EDWARD ROGERS HARDWELL

RICHARD F., JR.
B. 1903

ELIZABETH RANDOLPH
B. DEC. 25, 1888
D. NOV. 12, 1928
UNM.

CARDLINE MYERS
B. NOV. 20, 1893
D. OCT. 2, 1974
(MEDERA, CAL.)
1918
BROOKE HORDECAI
(O.V. I (2))

THOMAS LEWIS
B. OCT. 25, 1897
M. JAN. 6, 1930
ANNE GORDON
BROCKENBROUGH
(APR. 27, 1902 -)

EDMUND MYERS
B. OCT. 9, 1898
D. MAR. 21, 1945
M. JUN. 23, 1923
JANE DAVES STRUDWICK
(JAN. 2, 1899 -)

FRANCES COLQUHOUN
B. JUN. 28, 1889
M. JUN. 5, 1912
JAMES HODDHALD WELLEDOR
(MAR. 7, 1886-OCT. 18, 1945)

ANNE HAYS
B. APR. 23, 1895, RI.
D. NOV. 25, 1971, RI.
M. APR. 29, 1920
DR. DANIEL D. TALLEY, JR.
(JUN. 24, 1882-1966)

LELIA MYERS
B. M. NOV. 1954
JOHN C. BULLITT
(VID. HORWITZ)

ALLEN II

HELEN ROGERS

LELIA
EDWARD ROGERS HARDWELL

RICHARD F., JR.
B. 1903

ELIZABETH RANDOLPH
B. DEC. 25, 1888
D. NOV. 12, 1928
UNM.

CARDLINE MYERS
B. NOV. 20, 1893
D. OCT. 2, 1974
(MEDERA, CAL.)
1918
BROOKE HORDECAI
(O.V. I (2))

THOMAS LEWIS
B. OCT. 25, 1897
M. JAN. 6, 1930
ANNE GORDON
BROCKENBROUGH
(APR. 27, 1902 -)

EDMUND MYERS
B. OCT. 9, 1898
D. MAR. 21, 1945
M. JUN. 23, 1923
JANE DAVES STRUDWICK
(JAN. 2, 1899 -)

FRANCES COLQUHOUN
B. JUN. 28, 1889
M. JUN. 5, 1912
JAMES HODDHALD WELLEDOR
(MAR. 7, 1886-OCT. 18, 1945)

ANNE HAYS
B. APR. 23, 1895, RI.
D. NOV. 25, 1971, RI.
M. APR. 29, 1920
DR. DANIEL D. TALLEY, JR.
(JUN. 24, 1882-1966)

LELIA MYERS
B. M. NOV. 1954
JOHN C. BULLITT
(VID. HORWITZ)

ALLEN II

HELEN ROGERS

LELIA
EDWARD ROGERS HARDWELL

RICHARD F., JR.
B. 1903

ELIZABETH RANDOLPH
B. DEC. 25, 1888
D. NOV. 12, 1928
UNM.

CARDLINE MYERS
B. NOV. 20, 1893
D. OCT. 2, 1974
(MEDERA, CAL.)
1918
BROOKE HORDECAI
(O.V. I (2))

THOMAS LEWIS
B. OCT. 25, 1897
M. JAN. 6, 1930
ANNE GORDON
BROCKENBROUGH
(APR. 27, 1902 -)

EDMUND MYERS
B. OCT. 9, 1898
D. MAR. 21, 1945
M. JUN. 23, 1923
JANE DAVES STRUDWICK
(JAN. 2, 1899 -)

FRANCES COLQUHOUN
B. JUN. 28, 1889
M. JUN. 5, 1912
JAMES HODDHALD WELLEDOR
(MAR. 7, 1886-OCT. 18, 1945)

ANNE HAYS
B. APR. 23, 1895, RI.
D. NOV. 25, 1971, RI.
M. APR. 29, 1920
DR. DANIEL D. TALLEY, JR.
(JUN. 24, 1882-1966)

LELIA MYERS
B. M. NOV. 1954
JOHN C. BULLITT
(VID. HORWITZ)

ALLEN II

HELEN ROGERS

LELIA
EDWARD ROGERS HARDWELL

RICHARD F., JR.
B. 1903

ELIZABETH RANDOLPH
B. DEC. 25, 1888
D. NOV. 12, 1928
UNM.

CARDLINE MYERS
B. NOV. 20, 1893
D. OCT. 2, 1974
(MEDERA, CAL.)
1918
BROOKE HORDECAI
(O.V. I (2))

THOMAS LEWIS
B. OCT. 25, 1897
M. JAN. 6, 1930
ANNE GORDON
BROCKENBROUGH
(APR. 27, 1902 -)

EDMUND MYERS
B. OCT. 9, 1898
D. MAR. 21, 1945
M. JUN. 23, 1923
JANE DAVES STRUDWICK
(JAN. 2, 1899 -)

FRANCES COLQUHOUN
B. JUN. 28, 1889
M. JUN. 5, 1912
JAMES HODDHALD WELLEDOR
(MAR. 7, 1886-OCT. 18, 1945)

ANNE HAYS
B. APR. 23, 1895, RI.
D. NOV. 25, 1971, RI.
M. APR. 29, 1920
DR. DANIEL D. TALLEY, JR.
(JUN. 24, 1882-1966)

LELIA MYERS
B. M. NOV. 1954
JOHN C. BULLITT
(VID. HORWITZ)

ALLEN II

HELEN ROGERS

LELIA
EDWARD ROGERS HARDWELL

RICHARD F., JR.
B. 1903

ELIZABETH RANDOLPH
B. DEC. 25, 1888
D. NOV. 12, 1928
UNM.

CARDLINE MYERS
B. NOV. 20, 1893
D. OCT. 2, 1974
(MEDERA, CAL.)
1918
BROOKE HORDECAI
(O.V. I (2))

THOMAS LEWIS
B. OCT. 25, 1897
M. JAN. 6, 1930
ANNE GORDON
BROCKENBROUGH
(APR. 27, 1902 -)

EDMUND MYERS
B. OCT. 9, 1898
D. MAR. 21, 1945
M. JUN. 23, 1923
JANE DAVES STRUDWICK
(JAN. 2, 1899 -)

FRANCES COLQUHOUN
B. JUN. 28, 1889
M. JUN. 5, 1912
JAMES HODDHALD WELLEDOR
(MAR. 7, 1886-OCT. 18, 1945)

ANNE HAYS
B. APR. 23, 1895, RI.
D. NOV. 25, 1971, RI.
M. APR. 29, 1920
DR. DANIEL D. TALLEY, JR.
(JUN. 24, 1882-1966)

LELIA MYERS
B. M. NOV. 1954
JOHN C. BULLITT
(VID. HORWITZ)

ALLEN II

HELEN ROGERS

LELIA
EDWARD ROGERS HARDWELL

RICHARD F., JR.
B. 1903

MYERS II

MYERS MSS.
 KRAUS-SANDOR COLL.
 PAJHS V.27,PP.74,150,152
 V.33,P.252FF.
 JOURNAL OF 5JHS, V.I
 TUCKER-NORFOLK MARRIAGE BONDS
 NORFOLK NEWSPAPERS
 SHEARITH ISRAEL REC.
 POOL-PORTRAITS
 WILL OF MOSES MYERS

EHIMENT E REPRESENTATIVE MEN OF VA. E D.C.
 EPITAPHS-HEB.CEMETERY,NORFOLK
 ELMWOOD CEMETERY ,NORFOLK
 EZEKIEL-LICHTENSTEIN
 QUEBEC GAZETTE,DEC.17,1767
 RICHMOND NEWSPAPERS
 ABRIDGED COMPENDIUM OF EARLY AM. FAMILIES
 MARY GRAHAM MYERS ANDREWS
 MISC.VII #537
 BARBER-N.Y.MARRIAGES

HYER
 (NATURALIZED,N.Y. JAN.16,1759) HYMAN HYERS JUN.23,1751,N.Y.
 B. HOLLAND RACHEL LOUZADA
 D. D.C. 1801 (O.V.)

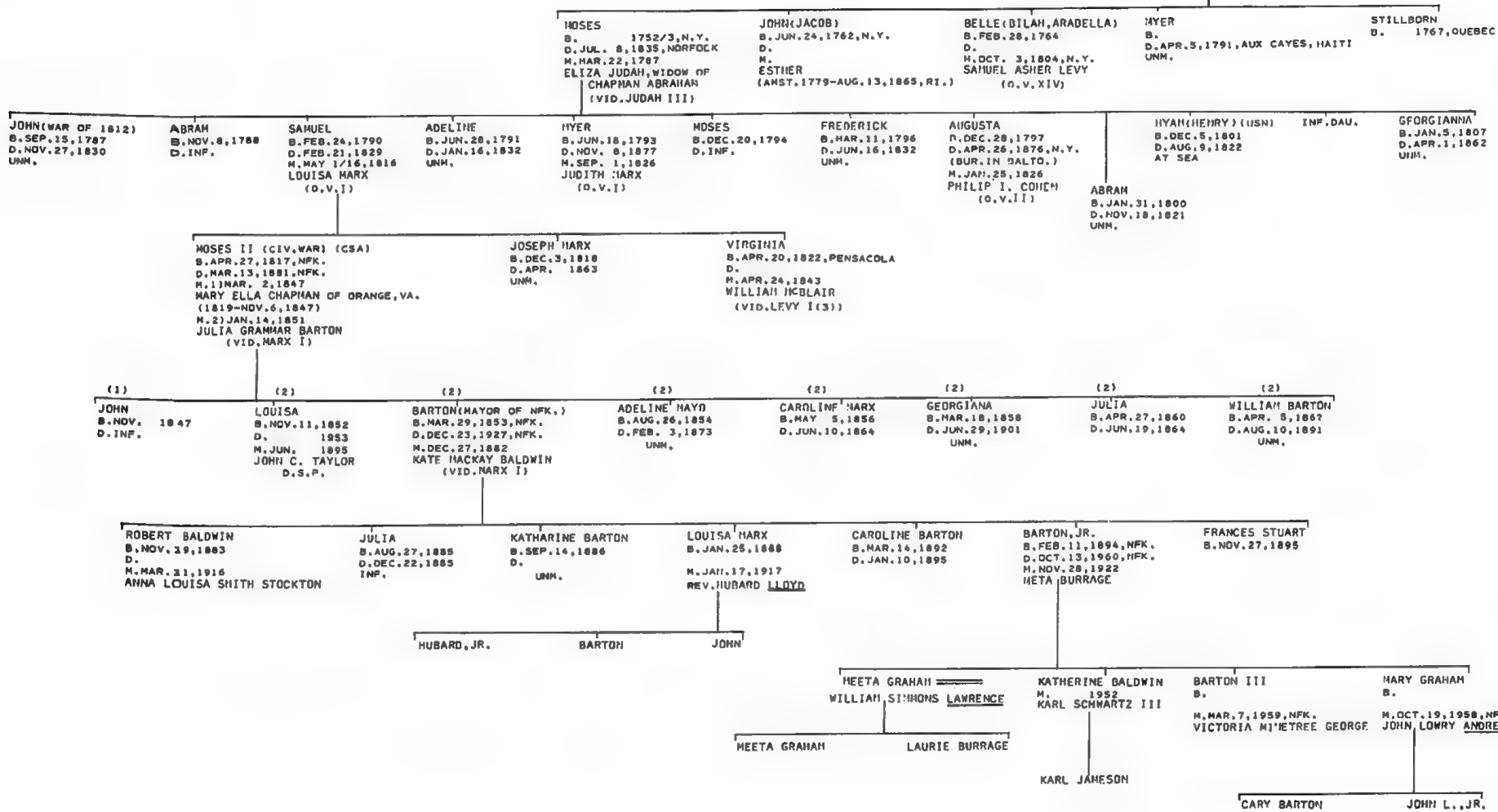

MYERS SOLIS-COHEM
 BETH SHALOME MARRIAGE REC. (AJA)
 EZEKIEL-LICHTENSTEIN
 MILDRED R. BRANDT, M. A. BRANDT II
 TOMBSTONES-NORFOLK, VA. HEBREW CEMETERY
 TUCKER-NORFOLK MARRIAGE LICENSES
 PORTSMOUTH, VA., MARRIAGE REC.
 FLO. ABR.

(NAPOLEONIC SOLDIER,
 TO NORFOLK, CA. 1828)

1812/14

EMANUEL J. MYERS
 B. HOLLAND,
 D. NORFOLK, VA., MAR. 22, 1871

EDEL (ADELINE) WATERMAN
 (O.V.)

MYERS IV

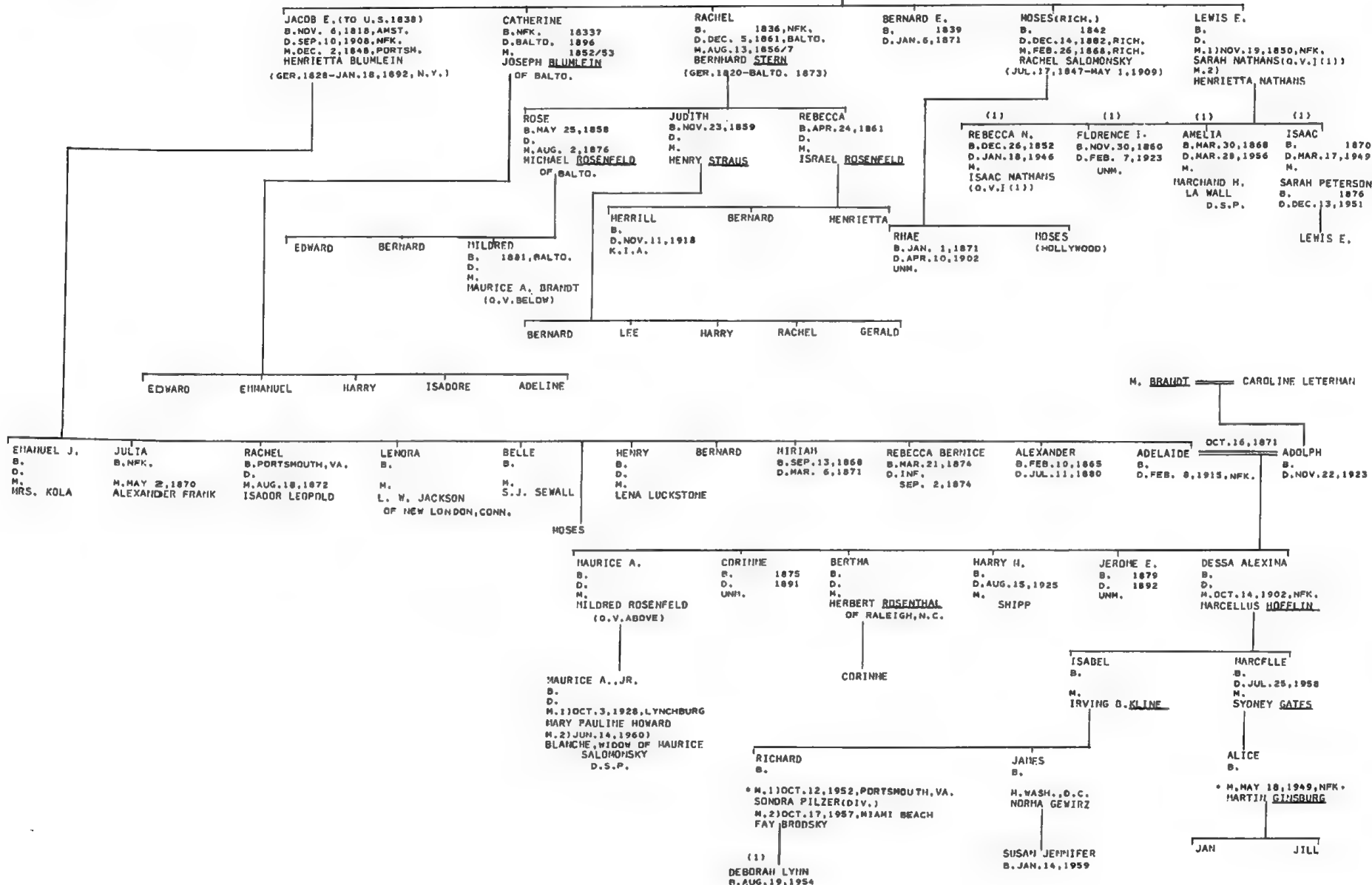

*MARRIED BY RABBI MALCOLM H. STERN

MYERS V

R.I.J.H.S.NOTES,V.V.P.144;
 V.VI
 PAJHS V.26,P.174F.
 V.27,PP.323,330
 POOL-PORTRAITS
 SHEARITH ISRAEL REC.
 SUMMER SOCIAL REGISTER,1949
 D.A.R. REC.ELAINE G. MYERS
 NEWPORT,R.I.CENSUS,3774
 JAMES-BIOG.SKETCHES OF
 THE BAILEY-MYERS-MASON FAMILY
 HORDECAI MYERS-REMINISCENCES
 MYER SOLIS-COHEN
 FEDORA S.FRANK
 GEORGE MONTGOMERY
 D'NAI JESHURUN REC.
 ROBERT S. ZUCKERMAN

HYER BENJAMIN
 OR BENJAMIN HYERS
 B.CA. 1723,HUNGARY
 D.NOV.20,1776,NEWPORT

RACHEL
 B.CA. 1735,AUSTRIA
 D.MAR.30,1801,N.Y.

THIS GENERATION CALLED HYERS

BENJAMIN
 B.DEC.14,1755,N.Y.
 D.DEC.11,1851,PLEASANTVILLE,N.Y.
 M.1) 1794
 HANNAH HAYS(O.V.(2))
 M.2)MAR.25,1804
 RACHEL HAYS(O.V.(2))

ABRAHAM POLLY

JUDITH
 B. D. 1783
 ALEXANDER MONTGOMERY
 (1754-1841)

S DAUS,

HAY HORDECAI(WAR OF 1812)
 (MAYOR OF SCHENECTADY,N.Y.)
 B.MAY 31,1776,NEWPORT
 D.JAN.20,1871,SCHENECTADY N.Y.
 M.JAN.24,1814,PLATTSBURGH
 CHARLOTTE BAILEY
 (PLATTSBURGH, OCT.12,1796- FEB.15,1848,N.Y.)

JOHN ALEXANDER SARAH
 B. 1792 B. 1791
 D. 1867 D. 1896

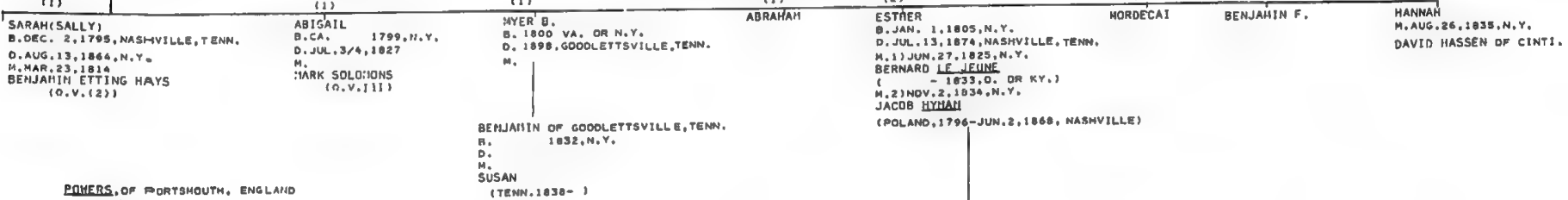
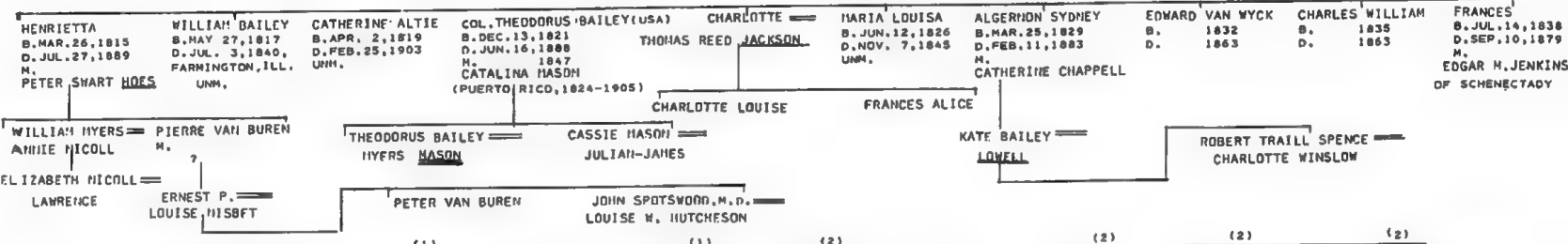

POWERS, OF PORTSMOUTH, ENGLAND

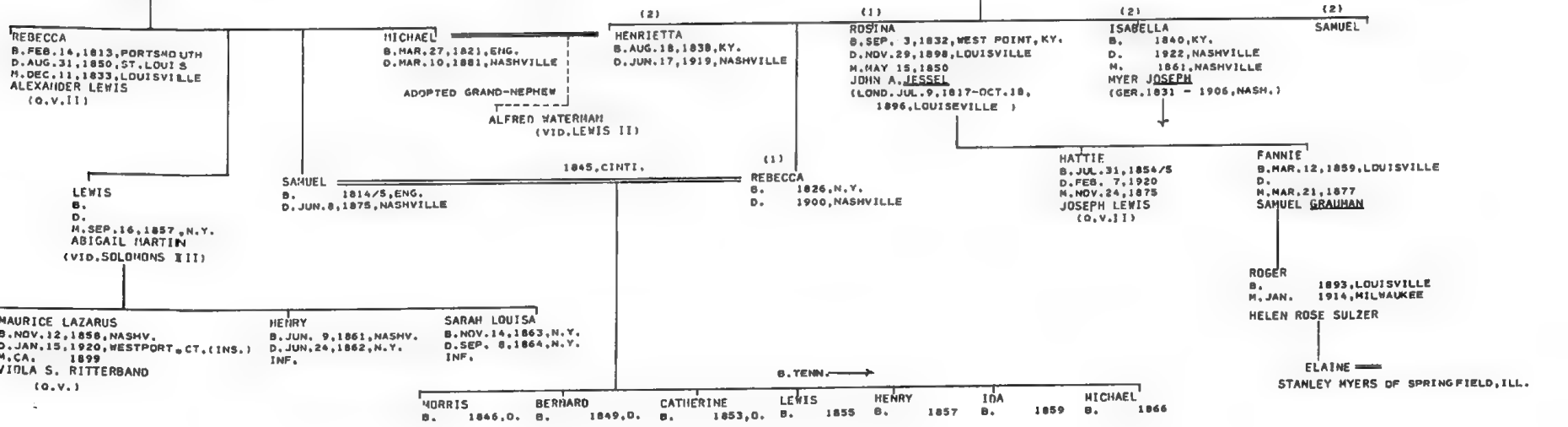

MYERS VI

ROTH-THE GREAT SYNAGOGUE, P.160
 POOL- PORTRAITS
 SHEARITH ISRAEL REC.
 FLD. ABR.
 MARCUS-A. J. D., P.6
 MISC. VII, #551
 BLAU & BARON II.606

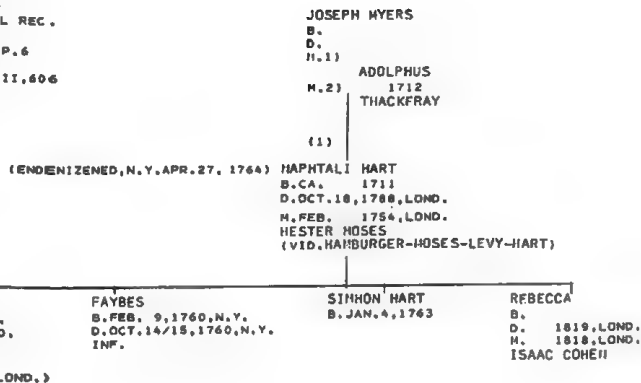

MYERS VIII

KRAUS-SANDOR COLL.
 AJA, V.1, NO.2, P.32
 WILL OF MANUEL MYERS
 MISC. VII

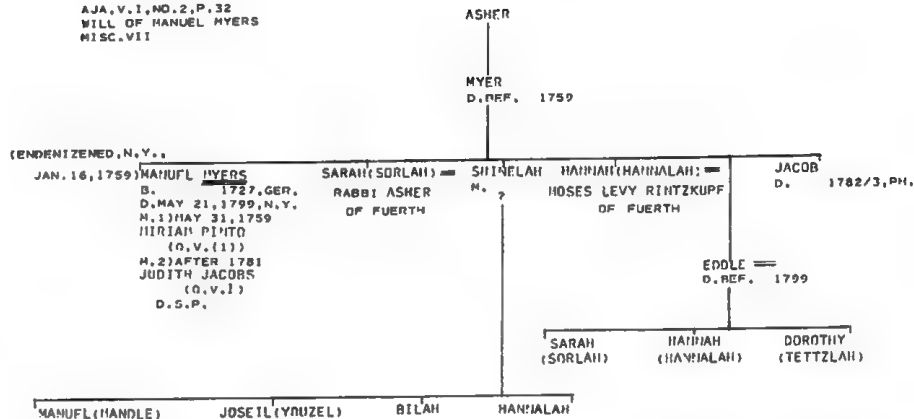

MYERS VII

KRAUS-SANDOR COLL.
 SHEARITH ISRAEL REC.
 EZEKIEL LICHTENSTEIN- JEWS OF RICHMOND

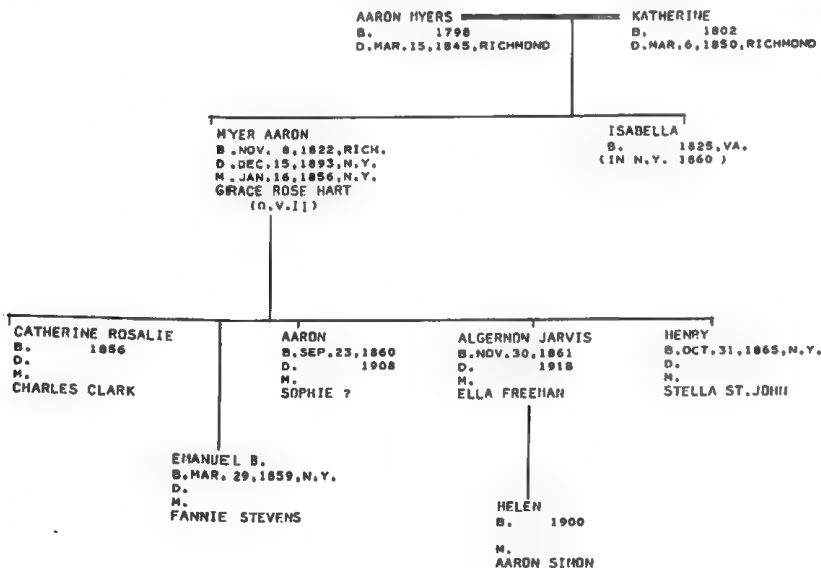

MYERS IX

KRAUS-SANDOR COLL.
 SHEARITH ISRAEL REC.

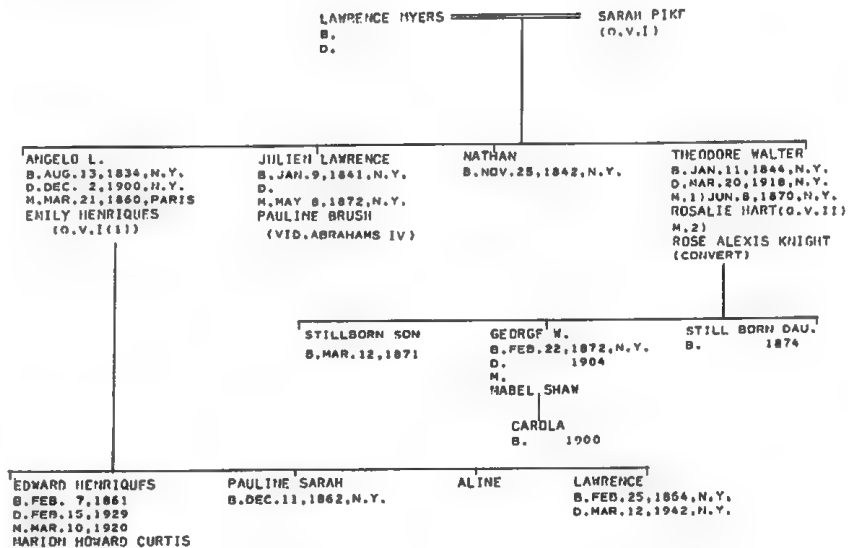

MYERS X

LUCILE S. MYERS
 EZEKIEL- LICHTENSTEIN IN
 CILLA G. NUSBAUM
 SYDNEY H. CONE, JR.
 SAUL VIENER
 NORFOLK-HEB. GEN.
 A. J. Y. B. (5663), P. 159
 ANNE P. MYERS
 ISAAC ROSENHEIM GEN.

CARDLINE WATERMAN
 B. NOV. 15, 1817, UHLFELD, BAV.
 D. JUL. 8, 1902, RI.

JOSEPH MYERS
 B. APR. 6, 1802, ILLEREICHEN, BAV.
 D. APR. 7, 1859, RI.
 (IN RI. BEF. 1836)

SIGMUND
 B. JUL. 8, 1808, ILLEREICHEN, BAV.
 D. JAN. 12, 1862, WARM SPRINGS, VA.
 M.
 FANNY GUGGENHEIMER
 (O. V.)

JOSEPH
 B. 1817, BAV.
 D. SEP. 17, 1885, RI.

SELIGMAN
 B. 1821, BAV.
 D. SEP. 9, 1885, RI.

ISABELLE
 B. SEP. 6, 1837, RI.
 D. MAR. 4, 1906
 M.
 MICHAEL ROSENBAUM
 (BAVARIA, MAR. 10, 1826-
 APR. 2, 1889, RI.)

ISADORE
 B. MAR. 2, 1841
 D. OCT. 31, 1872

HERMAN J.
 B. JUL. 27, 1843
 D. SEP. 8, 1901

B. R. I. →

BERTHA VARINA
 B. JAN. 18, 1857
 D. MAR. 3, 1927
 ST. PAUL, MINN.
 M. JAN. 10, 1877, RI.
 MAX GUGGENHEIMER, JR.
 (O. V.)

FLORENCE VIRGINIA
 B. JAN. 12, 1859
 D. [unclear]
 M. JAN. 10, 1883
 LAWRENCE LIPPMAN OF SAVANNAH

HORTON BEAUREGARD
 B. MAR. 6, 1861
 D. 1925
 M. OCT. 29, 1886
 IDA HUTZLER
 (O. V.)

MINNIE LEE
 B. JUN. 5, 1863
 D. NOV. 6, 1938
 M. MAY 15, 1890, RI.
 CHARLES M. GUGGENHEIMER
 (O. V.)

DAISY WISE ESTELLE
 B. NOV. 29, 1865
 D. OCT. 3, 1951
 M. DEC. 29, 1892
 AARON PRAG OF BALTO.

JOSEPH HANX
 B. JUL. 18, 1869
 D. 1928
 M. DEC. 22, 1891, RI.
 SARA H. STRAUS
 D. S. P.

SYDNEY BEALE
 B. SEP. 4, 1870
 M. FEB. 6, 1894, SAV.
 BERTHA ROSENHEIM
 (O. V.)

ADELE RITA
 B. MAR. 3, 1874
 D. [unclear]
 M. NOV. 11, 1896
 MOTZ PRAG OF BALTO.

IRMA BELLE
 B. NOV. 16, 1877
 D. [unclear]

CORINNE OMEGA
 B. JAN. 9, 1880
 D. 1973
 M.
 SIDNEY HIRSH
 (JUL. 23, 1874-
 DEC. 31, 1937)
 D. S. P.

EUNICE HERLE
 B. DEC. 24, 1883
 D. [unclear]
 M. APR. 24, 1917
 ABRAHAM FALK
 (VID. ABRAHAM II)

GLADYS RUTH
 B. NOV. 14, 1885
 D. [unclear]
 M. APR. 4, 1911
 LOUIS NEUBURGER
 (FEB. 23, 1882-)

DORIS JOAN
 B. FEB. 7, 1890
 D. [unclear]
 M. SEP. 24, 1918
 WASHINGTON FALK, JR.
 (VID. ABRAHAM II)

HERTON JOSEPH
 B. JAN. 6, 1888
 D. 1940
 M. [unclear]
 REBECCA BOWMAN

IVAN ISAAC
 B. MAR. 20, 1891
 D. JAN. 24, 1970
 M. [unclear]
 ALMA BLOOMBERG
 (VID. EZEKIEL (2))

FLORIBEL
 B. JUN. 13, 1893
 D. [unclear]
 EDGAR J. KAUFMAN
 (1890-1933)

ISABELLE DAISY
 B. DEC. 14, 1897
 D. [unclear]
 ADRIAN BENJAMIN

HEREDITH CHAMBERS
 B. SEP. 20, 1897
 M. 1) HILDA BLUMBERG
 M. 2) MARGARET
 PEGGY

INF. SON
 B. OCT. 22, 1872

INF. DAU.
 B. APR. 14, 1876

PHYLLIS
 B. JUN. 15, 1912
 D. [unclear]
 M. DEC. 19, 1937
 SOLOM LANDSBERGER

LOIS
 B. AUG. 13, 1914
 D. [unclear]
 M. JUN. 23, 1936
 MEYER SCHEIN

BILLY MAX
 B. JUL. 20, 1947
 VIRGINIA HATHENS

HERTON, JR.
 B. 1920

IDA HELEN
 B. 1916
 M. FERDINAND GOODMAN, JR.

EDGAR J.
 B. 1918
 D. 1939

DOROTHY IDA
 B. DEC. 6, 1894
 D. 1960
 M. WALTER HAHNERSLOUGH
 (1884-1964)
 D. S. P.

SYDNEY ROSS
 B. JAN. 8, 1896
 D. 1959
 M. 1) RUTH ZAGAT (DIV.)
 (1898-)
 M. 2) BETTY LAPAT (DIV.)
 (-1956)
 M. 3) DOROTHY NORWAY
 (1913-)
 M. 4) EDITH WHITEHEAD
 (1920-)

ALINE HAY
 B. MAY 1, 1897
 D. 1953
 UNM.

TESS
 B. DEC. 9, 1901
 D. 1947
 UNM.

BARBETTE
 B. MAY 7, 1942

ROBERT SOLOM
 B. MAY 12, 1945

STEPHEN
 B. SEP. 18, 1936

NANCY
 B. NOV. 18, 1945

LOUISE ANN
 B. 1922
 M. HOREWITZ OF HOUSTON, TEX.

ALMA
 B. 1924
 M. HURWITZ OF SCIENECTADY

ROBERT
 B. 1929
 M. CLAIRE HILLHEISER
 (VID. BRAUER)

INF.

DONALD
 B. 1922
 M. 1) HARRIET MURPHY
 (DIV.)
 (1937-)

KENNETH
 B. 1936
 M. LYNN FITZGERALD

BARBARA
 B. 1937
 D. 1941

NANCY MARTIN
 (1919-)

LAUREL
 B. 1962

EMILY
 B. 1965

FRANKLIN D. WILLIAM W. CHARLES A.
 B. 1944 B. 1947 B. 1953

BERTHA
 B. NOV. 4, 1833
 D. APR. 26, 1870
 UNM.

FRIEDA
 B. [unclear]
 D. [unclear]
 M. JACOB EDEL

KATE
 B. OCT. 1840, GER.
 D. DEC. 1872, RI.
 M. JUL. 29, 1863, LYNCHBURG
 ABRAHAM GOODMAN
 (APR. 1837-OCT. 13, 1888)

FRED S.
 B. MAR. 27, 1844
 D. MAY 26, 1912
 M. CLARA ETTENHEIMER
 OF ROCHESTER, N.Y.
 (JAN. 10, 1857-DEC. 13, 1947)

HERMAN NATHAN (MAYOR OF SAV.)
 B. BAV. JAN. 18, 1847
 D. [unclear]
 M. VIRGIE G. GERST
 (RI. MAY 15, 1867-)
 D. S. P.

SIGO
 B. [unclear]
 D. [unclear]
 M. NELLIE SIMMONS

DELIA
 B. [unclear]
 D. [unclear]
 M. JULIUS EDEL

ELFRIEDA = ALBERT = HERMAN
 LEF REINSBERG RIETTE LEVY

LEONORE = DELIA = ALBERT, JR.
 EMIL ROTJMAN RAYMOND RUFF

SUSAN = BARBARA = GARY

IRLEN = VIRGINIA = JULIUS
 DR. LOUIS JOELL IRA ROTJMAN DANYS GREENWALD

HOWARD
 B. JUL. 27, 1903

FREDERICK
 B. JUL. 9, 1908

FREDERIC S.
 B. OCT. 1, 1913, NFK.
 D. JUN. 20, 1970, VA. BEACH
 M. MAR. 15, 1943
 ANNE POORE OF LAGRANGE, GA.
 S. P.

SYLVAN, JR. (VAII)
 B. JUL. 29, 1917, NFK.
 M. AUG. 11, 1940, BOSTON
 JANE FRIEDMAN
 (VID. LEWIS II)

VALERIE
 B. MAY 27, 1924, NFK.
 M. MAR. 16, 1947, NFK.
 GEORGE ROTHSCHILD
 OF CHICAGO

CHARLES
 B. [unclear]

JAMES
 B. [unclear]

CATHY
 B. JUN. 6, 1943
 M. JUN. 27, 1965
 CARL HERMANN ROSE III

BRUCE HARRY
 B. APR. 23, 1948
 M. NOV. 27, 1971
 SALLY AVRIL HODGSON

JANE ELLIEN
 B. OCT. 30, 1947
 M. JUN. 27, 1970
 JOSEPH FERGUSON

JOHN STEPHAN
 B. AUG. 22, 1952

CARL H. IV
 B. DEC. 20, 1966

MICHELLE MEYERS
 B. OCT. 14, 1971

ROSENSWAIKE-BALTO.
 KRAUS-SANDOR COLL.
 PAJHS V.18,P.99F.
 V.19,PP.51,61
 V.20,P.107
 V.23,P.151F.
 V.33,P.209F.
 B.JACOBBS HOHEL REC.
 HORAI-S JEWS OF PH.,P.410F.
 ST.CHARLES
 MOSES GEN.
 MICKVE ISRAEL REC.
 SHCARITH ISRAEL REC.
 POOL- PORTRAITS
 MISC.VII
 AJA,V. XII,P.103F.
 MERSHKOWITZ-WILLS
 FEDERAL ST.CEM.

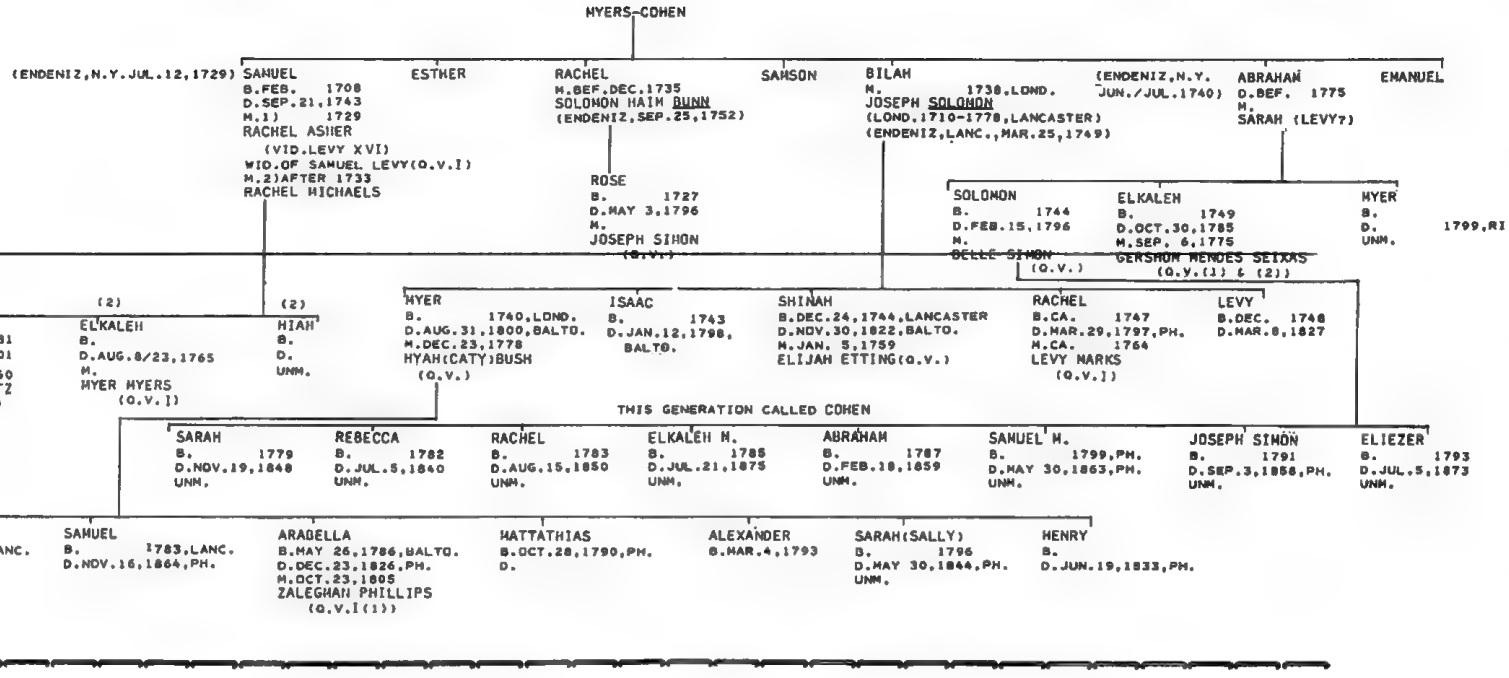

DAR LINEAGE BOOKS: 109,P.304;115,P.261
 MURIEL S. CARTER
 SHEARITH ISRAEL REC.
 B'NAI JESHURUN REC.

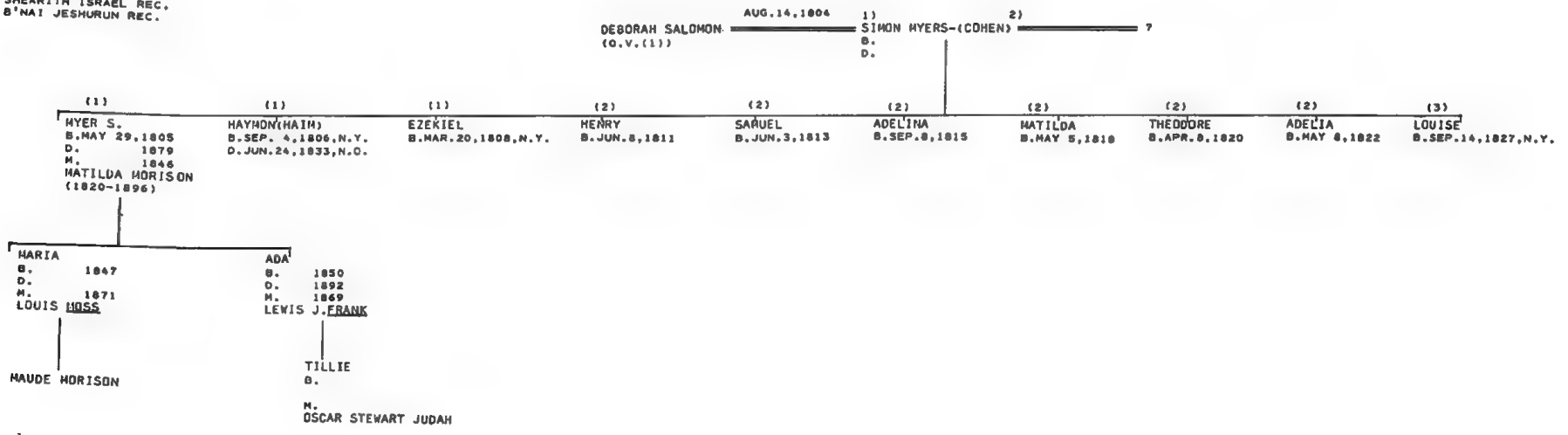

NAAR (1)

PA. ARCH., 2D SER., V. 3
 EDITH K. NICHOLAS
 KRAUS-SANDOR COLL.
 SHEARITH ISRAEL REC.
 AJHQ, V. 53, P. 373FF.
 ST. THOS. CEM. REC.
 E.N.A.
 J.M.L. MADURO

JAN. 20, 1800, ST. THOS.

(ARR. PH. FROM CAPE FRANÇOIS, HAITI, 1793)

JOSHUA NAAR
 B. OCT. 17, 1769, CURACAO
 D. MAR. 10, 1834/S. N.Y.

SARAH COHEN D'AZEVEDO

DAVID
 B. NOV. 10, 1800, ST. THOS.
 D. FEB. 24, 1860, ELIZABETH, N. J.
 M.
 SARAH COHEN D'AZEVEDO
 (SEE NEXT PAGE)

ABRAHAM D'AZEVEDO
 B. NOV. 8, 1802, ST. THOS.
 D. FEB. 4, 1858, ELIZABETH, N. J.
 M.
 RACHEL PRETTO

BENJAMIN
 B. AUG. 31, 1831, N. Y.
 SARAH PEIXOTTO
 (O.V. I (2))

DAVID PRETTO
 B. MAY 10, 1833, ST. THOS.
 D.
 M. NOV. 23, 1859, ELIZ., N. J.
 LEITA BAIZ
 (SEE NEXT PAGE)

SARAH SOPHIA
 B. JUN. 19, 1836, N. Y.
 D.
 M. SEBASTIAN HOSQUERON
 D. S. P.

ELEANOR
 B. DEC. 26, 1837, N. Y.
 D.
 M. FEB. 13, 1867, N. Y.
 ABRAHAM PRETTO
 (ST. THOS. OCT. 30, 1811 -)

ESTHER PRETTO
 B. JUL. 9, 1839, N. Y.
 D.
 M. HERMAN PEIXOTTO
 (O.V. I (2))

CAROLINE
 B. SEP. 18, 1846
 D.
 M. APR. 17, 1867
 JOSEPH L. HAAR
 (SEE NEXT PAGE)

REBECCA
 M. 1)
 MOSES D'A. NAAR
 (SEE NEXT PAGE)
 M. 2)
 ABRAHAM D'A. NAAR
 (BELOW)

RAPHAEL
 M. 1)
 PERLA HOHER
 (1843-JUN. 30, 1876)
 M. 2)
 JUDITH R. HAAR
 (BELOW)

CLARA
 D. UHM.

DAHIEL

REBECCA CLARENCE

ABRAHAM THEODORE NANETTE ADELAIDE GEORGE ADOLPH ADA RACHEL MIRIAM
 B. JAN. 14, 1871, ELIZABETH B. SEP. 12, 1860, ELIZ. B. JUL. 28, 1866

ALBERT SARAH R. (SADIE) FLORENCE GRACE ERNEST JOSPHINE

SARAH FRANCES
 B. DEC. 7, 1832, N. Y.
 D. NOV. 2, 1887, TRENTON
 M. 1) 1854, JAMAICA, W. I.
 EDWIN DE LEON
 (- 1856)
 M. 2) 1869
 ABRAHAM D'A. NAAR
 (SEE NEXT PAGE)

JOSHUA DAVID
 B. NOV. 9, 1834, N. Y.
 D. APR. 1876, ELIZ.
 M. 1863, ELIZ.
 MARY LOUISE PRICE
 (ELIZ. MAY 24, 1836 -
 MAY 8, 1926, N. Y.)

MOSES DANIEL
 B. SEP. 12, 1836, N. Y.
 D.
 M. BEATRICE HAURY
 AGNES
 FRED HOWELL

JUDITH ROSALIE
 B. 1838
 D.
 M. RAPHAEL NAAR
 (ABOVE)

GRACE JOSEPHINE
 B. 1840, JAN.
 D. UHM.

ABRAHAM D'AZEVEDO
 B. 1842, ELIZ.
 D. APR. 24, 1918, TRENTON
 M.
 REBECCA NAAR
 (ABOVE)

RAPHAEL PEIXOTTO
 B. 1845

HANANEL DE LEON
 B. SEP. 19, 1846
 D. MAY 29, 1858, ELIZ.

SAMUEL GREY
 O. UHM.

ISAAC LOPEZ
 MARY REICHER
 LILLIAN
 M. 1)
 JOSEPH GRIBBIN
 M. 2)
 TRENTON
 LARGE
 (1)
 FRANCIS HAROLD

FRANCES HANFRED NAAR
 HENRY BRENERMAN OF TRENTON

(1)
 EDWIN, JR.
 B. 1856, N. J.
 D. 1867, TRENTON

BENJAMIN
 B. 1864, ELIZ.
 D. 1914, N. Y.
 UHM.

TALBOT JACQUES
 B. JUL. 18, 1866, ELIZ.
 D. OCT. 6, 1944, N. Y.
 M. DEC. 12, 1891, NEWARK, N. J. →
 ZIPPORAH HAAR
 (SEE NEXT PAGE)

GEORGE H. (W. W. I)
 B. APR. 24, 1868, ELIZ.
 D. 1946, BATH, N. Y.
 M. DEC. 12, 1891, NEWARK
 ESTHER NAAR
 (SEE NEXT PAGE)

CHARLES H.
 B. JUL. 24, 1871
 D. SEP. 19, 1949, L. I.
 UHM.

WILLIAM PEIXOTTO
 B. JAN. 1, 1874
 D. MAR. 1952

DAVID D'AZEVEDO

WILLIAM JACQUES
 B. NOV. 14, 1898, N. Y.
 M. MAY 8, 1921, N. Y.
 MARY HAACK

HERBERT
 B. SEP. 1, 1908, N. Y.
 M. DEC. 21, 1948, N. Y.
 ETHEL SMITH
 S. P.

EDITH K.
 B. JAN. 16, 1910
 M. AUG. 12, 1926
 DIMITRI NICHOLAS

FRANCES H.
 B. JAN. 1892, N. Y.
 D. MAR. 1966, K. C.
 M. 1917, K. C.
 WILLIAM CIESLER

LESTER L.
 B. 1898
 D. 1949
 M. 1920, K. C.
 NETCALF

HENRY D.
 B. MAY 18, 1922, N. Y.
 M. 1944, N. Y.
 DOROTHY ?

ALFRED DIMITRI
 B. JUN. 24, 1927, N. Y.
 M. JUL. 29, 1960, SEATTLE
 LOIS ROHL

TALBOT JACQUES
 B. OCT. 22, 1929, N. Y.
 M. MAR. 2, 1954, N. Y.
 BLANDINA LA BOMBARDA

RICHARD DAVID
 B. MAR. 20, 1942
 D. MAR. 20, 1948

LESTER NETCALF
 B. 1922, K. C.

B. N. Y. →
 DAWN B. 1947 DARREL B. 1949 DEREK B. 1952

DAVID DIMITRI
 B. MAY 6, 1961, SEATTLE

TALBOT JACQUES II
 B. NOV. 15, 1954, N. Y.

OLIVIA DEBORAH
 B. JUL. 8, 1959, N. Y.

CA. 1806

JACOB BAIZ
B. SEP. 20, 1779, BAYONNE, FR.
D. DEC. 9, 1857, ST. THOS.

LEAH OLIVEIRA ISIDRO
B. AUG. 6, 1786, ST. THOS.
D. DEC. 17, 1839, ST. THOS.

DAVID NAAR
B. NOV. 10, 1800, ST. THOS.
D. FEB. 24, 1880, TRENTON, N. J.
(SEE PRECEDING PAGE)

SARAH COHEN D'AZEVEDO

ABRAHAM
B. SEP. 4, 1816, ST. THOS.
D. NOV. 1, 1887, BROOKLYN

SARAH MIRIAM
B. MAR. 23, 1822, ST. THOS.
D. JUN. 5, 1900, BROOKLYN

MOSES D.
B.
D. APR. 1856, PH. M.
REBECCA NAAR
(SEE PRECED. PAGE)

BENJAMIN
KATE STRYKER
ESTHER
D. UNM.

JOSEPH LEVI
B. OCT. 23, 1834, ELIZ.
D. SEP. 10, 1905, TRENTON
M. 1) APR. 17, 1867
CAROLINE NAAR
(SEE PRECED. PAGE)
M. 2) 1889, TRENTON
ADELE MIRIAM SEIXAS
(O.V. (1))

ABRAHAM D'A.
B. 1837, TRENTON
D. 1916, BKLYN.
M. 1869, TRENTON
SARAH FRANCES NAAR
(SEE PRECED. PAGE)

GRACE JUDITH
JAMES IRVING

ZIPPORAH
B. APR. 15, 1839, ELIZ.
D.
M. W.D. NAAR
EDGAR

JOSHUA
REBECCA BAIZ
(BELOW)
RACHEL
B. JAN. 1885, N.Y.
D. JUL. 7, 1910, N.Y.
UNM.

6 OTHERS

DAVID B. ALFRED THEODORE
 PARDO CORREA WILLIAM
 MADEL ALFREDA PERCY SEIXAS
 G.E. GRINES

ZIPPORAH
B. OCT. 12, 1871, TRENTON
D. MAR. 2, 1941, N.Y.
M. DEC. 21, 1891, NEWARK
TALBOT JACQUES NAAR
(SEE PRECED. P.)

ESTHER
B. OCT. 7, 1873, TRENTON
D. SEP. 1904, N.Y.
M. DEC. 21, 1891, NEWARK
GEORGE H. NAAR
(SEE PRECED. P.)

(1) HENRY KELSEY

(1) BEATRICE
B. 1870, TRENTON
D. 1937, TRENTON
M. 1892, TRENTON
JUAN PASCUAL
CAROLINE
B. 1895, TRENTON
M. HAVANA, CUBA
DECIDMOJO

(2) CONSTANCE
B. N.Y.
D. N.Y.
M. ?

(2) JOSEPH L.
B. N.Y.
M. 1) JOSSINING, N.Y.
M. 2) JOSSINING, H.Y.
3 SONS

(2) MILDRED
B. N.Y.
3 SONS

LEITA
B. MAY 10, 1839
D. M.
DAVID PRETTO NAAR
(SEE PRECED. PAGE)

JACOB
B. JAN. 19, 1843
D.
M. MAR. 11, 1868, ELIZ.
EMILY MENDES SEIXAS
(O.V. (1))

NANETTE (HAINAH)
B. JUN. 26, 1844
D. JUL. 28, 1928, ELIZ.
M. MAR. 11, 1868, ELIZ.
BENJAMIN PARDO MENDES SEIXAS
(O.V. (1))

RACHEL
B. NOV. 1, 1848
D. NOV. 14, 1848
INF.

DAVID NAAR
B. FEB. 19, 1850
D. NOV. 17, 1881, ELIZ.
INF.

JOSEPH LEVI
D. MAR. 10, 1882
D. M. JUN. 7, 1876, ELIZ.
MARY HEINEMAN

MOSES
B. SEP. 5, 1854

REBECCA
JOSHUA NAAR
(ABOVE)
ESTHER

ISAAC
B. JUL. 1, 1859
D. JUL. 19, 1859
INF.

SAMUEL
B. APR. 23, 1861
D. INF.

ZIPPORAH
B. SEP. 22, 1865

SARAH
B. JAN. 2, 1841
D. FEB. 17, 1856, ELIZ.
UNM.

AHITA
B. SEP. 1, 1869, BROOKLYN

NATHAN I (I) (N.Y.)

KRAUS-SANDOR COLL.
PAJHS, V. 4, P. 212
V. 27, P. 166
J.E. V. 9, P. 177
AJYB, 5665, P. 159F.
GOLDSTONE GEN.
HENDRICKS GEN.
U.S. CENSUS 1850
N.Y. TIMES, MAY 2, 1965 (ORIT.)
ANE NEBEL
MOSS GEN.
SHEARITH ISRAEL REC.
POOL-PORTRAITS...
FLORENCE ABRAHAMS
NATHAN FAMILY RIBLE

JUDAH NATHAN (ENGLAND)

B.
D.
M.
?
SIOBH(WILLIAMSBURG, RICHMOND, 1779; N.Y., 1773)
B. FROKE, SOMERSETSHIRE, ENG. 1746/50
D. SEP. 8, 1822, N.Y.
M. AUG. 29, 1780, PH.
GRACE SEIXAS (O.V. (1))

(ISAAC MENDES) SEIXAS

B. MAY 24, 1785, N.Y.
D. MAY 30, 1852, N.Y.
M. NOV. 30, 1808, N.Y.
SARAH SEIXAS (O.V. (4))

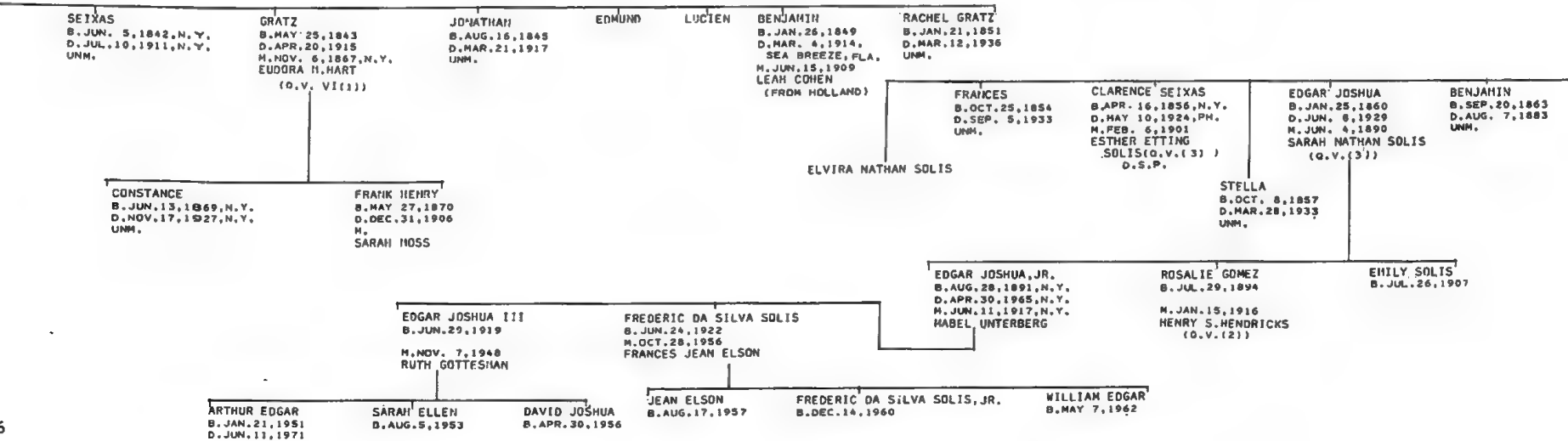
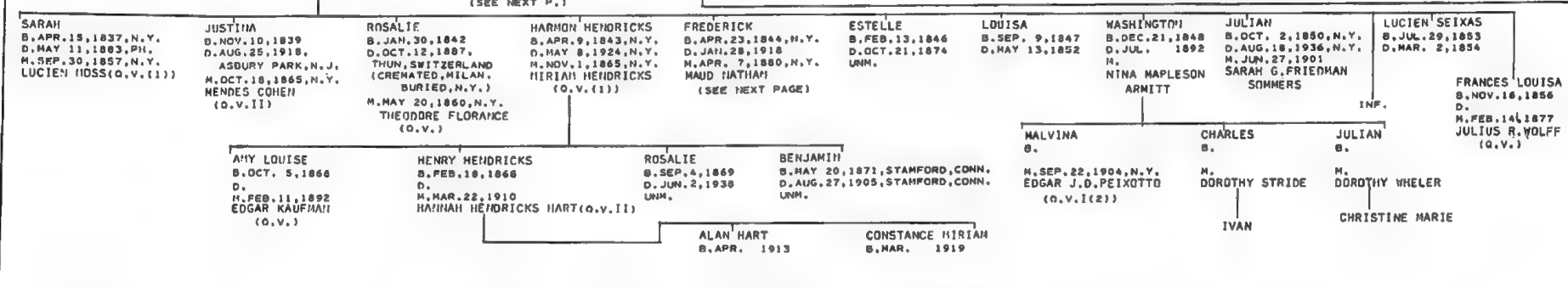
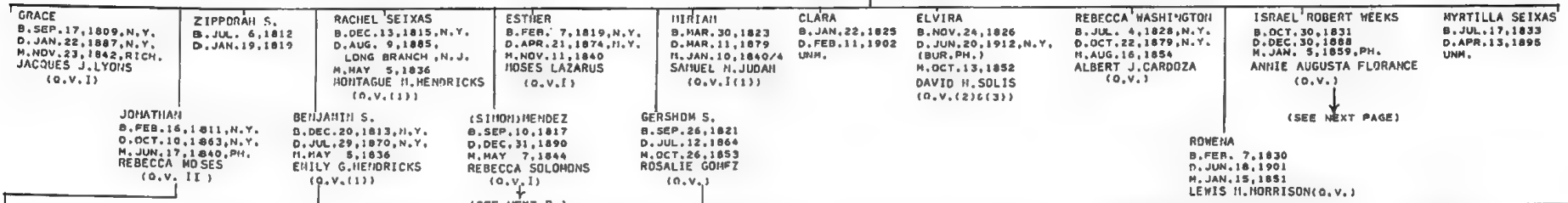

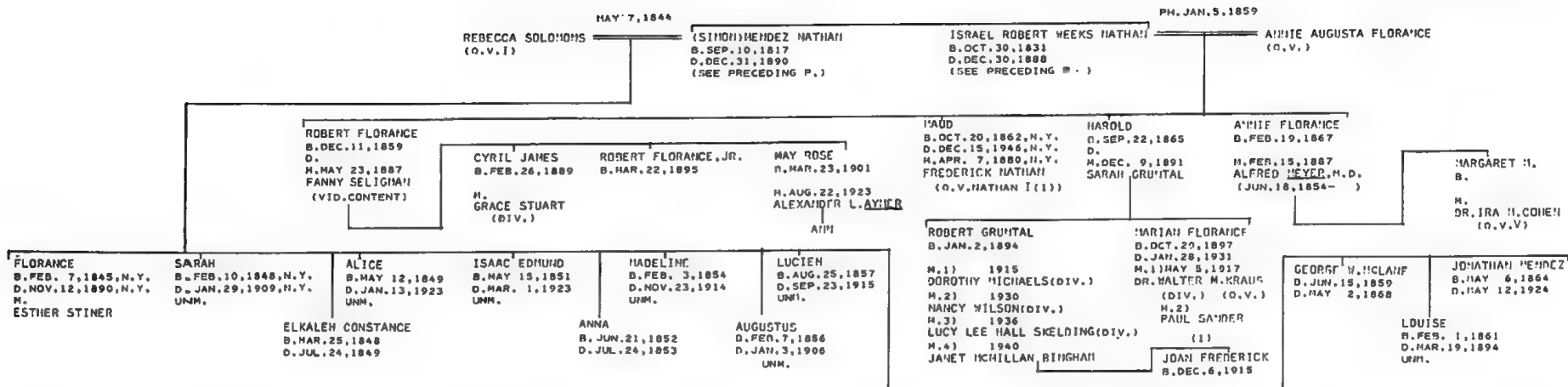

MISC. VII, #544
KRAUS-SANDOR COLL.
POOL-PORTRAITS...

(NAT., READING, PA. APR. 3, 1763) LYON NATHAN (SERVED AS SHAMMAS OF HICKVE ISRAEL, PH.)

NATHAN III

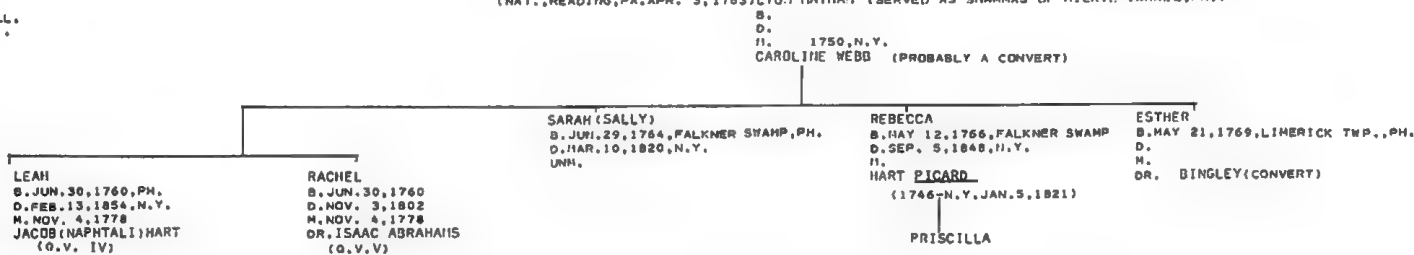

NATHAN IV

JACOB R. COHEN REC.
WOLF-WHITEMAN

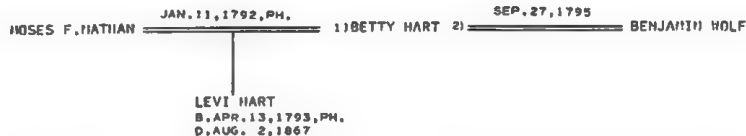

NATHAN I

ELZAS HSS. (NYHS)
D.J.C.
NATHAN GENEALOGIES(AJA)
MOSS-HARRIS GEN.
FLO.ADR.
EGON WOLFF
MOISE-JEWISH CEM.AT SUMTER

NATHAN THE SCRIBE OF AMSTERDAM

MOSES NATHAN
B. PROBABLY AMST.
D. LOND.
M. 1)
MILCO (AMELIA)
(-AUG. 11, 1808)
M. 2) SEP. 18, 1808
EAVE, DAU. OF SAMUEL OF MAYENCE

LEVY (CH.)

ISAAC LAHERT

DR. MATTHEW M. 1) M. 2) MARY BARROWS (AUNT OF CHARLES DICKENS)	RACHEL B. D. SEP. 25, 1842 M.	ESTHER B. DEC. 25, 1791 D. DEC. 8, 1860 M.	FEB. 5, 1812	JOSEPH (LOND., RID DE JANEIRO) B. AUG. 12, 1790, AMST. D. FEB. 15, 1876	JULIET B. 1774 D. NOV. 20, 1862 M. ABRAHAM ISAAC BOSS OF LOND.	NATHAN (LOND., BIRMINGHAM, & HAMBURG) B. 1776, AMST. D. MAR. 6, 1828 M. JULIA SOLOMAN	CATHARINE B. 1781, AMST. D. MAY 6, 1845, N.O. M. 1) 1799, LOND. M. 2) HYAM (HYAH) HARRIS (O.V. I)	ASHER MOSES (CH., N.D., & PARIS) B. 1785 D. 1863, N.O. M. MAR. 24, 1910, BATON ROUGE, LA. MARGUERITE DALTON (CH. 1788-JUL. 15, 1854)	HENRY (TO CH. CA. 1809) B. 1790, AMST. D. MAR. 25, 1837, CH.	AUG. 30, 1815	ESTHER B. 1789, CH. D. FEB. 18, 1871, N.O.
--	--	---	--------------	--	---	--	--	---	---	---------------	--

SOLONON BENNATON B. MAY 30, 1805 D. APR. 26, 1850	REV. MOSES NATHAN NATHAN B. OCT. 21, 1807 D. MAY 13, 1883, N.O.	AMELIA BENNATON B. AUG. 5, 1808 D. APR. 16, 1876 M.	ROSA NATHAN B. APR. 20, 1810 D. NOV. 15, 1878 M.	NATHAN B. FEB. 19, 1812 D. JAN. 16, 1872 M. MAR. 27, 1850 SARAH LINDO	HENRY NATHAN B. FEB. 19, 1812 D. DEC. 9, 1886	LOUISA NATHAN B. DEC. 21, 1813 D. DEC. 9, 1886	HEWTON BENNATON	BELLA NATHAN EMANUEL	MAURICE BENNATON B. 1824 D. APR. 14, 1899	HIRIAM NATHAN B. OCT. 10, 1825 D. 1900 M.	BERNARD B. 1789, CH. D. MAY 23, 1869 M. DEC. 1841 MARY ANN SUARES (O.V.)
---	--	--	---	---	---	--	-----------------	-------------------------	---	--	---

ADELF B. 1839 D. 1900 M.	JULIA ROSE B. 1842 D. 1878 M.	VALLENTINE	MEYHAN	SAUL BENNATON	JOSEPH BENNATON B. APR. 1, 1822 D. 1902? M.	SAHUEL NATHAN	JULIA B. 1855 D. M.
-----------------------------------	--	------------	--------	---------------	--	---------------	---------------------------

ARTHUR B. 1870 D. M. 1906 DOROTHY OF LLA LEVI (SEE RIGHT)	OSWALD B. 1865 D. 1909	DINAH R. LEVY	DARRELL B. 1872	ALFRED JACOB B. JUL. 15, 1845, GOTHENBERG, SWEDEN D. MAY 25, 1918, GOTHENBERG, SWEDEN M. DEC. 20, 1892, DUSSELDORF, GER. ALICE MOSS (O.V. I)	W. H. OF SAN PEDRO SULA, HONDURAS	DOROTHY BELLA B. 1881 D. 1936 M. 1906 ARTHUR HAES (SEE LEFT)
---	------------------------------	---------------	--------------------	--	---	---

HAROLD ERNEST B. NOV. 26, 1873 D. M. 1) JAN. 12, 1904, GOTHENB. DORA WERNER (GOTHENB. AUG. 27, 1874 - MAY 11, 1922, PARIS) M. 2) NOV. 26, 1927, MENTON, FR. RENEE HANNN (VITRE, FR., JUN. 24, 1897 -)	CARL ERIK B. JUL. 10, 1875 D. M. APR. 12, 1921, GOTHENB. MASCHA TAUSON (SWE. JUL. 29, 1888 -)	EDWARD JAMES B. APR. 2, 1877 D. MAR. 6, 1910, BERLIN UNH.	WALTER OSCAR B. SEP. 5, 1878 D. MAY 6, 1886, GOTHENB.	KURT ALFRED B. JUN. 2, 1880 D. M. OCT. 19, 1905, SAN FR. ETHEL IRENE COX (DUTCH FLAT, CAL. DEC. 21, 1875 -)	SIXTINE B. FEB. 28, 1884 D. SEP. 25, 1927, COPENHAGEN UNH.	GLADYS B. MAY 6, 1891 M. JUL. 23, 1921, BIDART, FR. GOSTA NYSTROEM (SWE. OCT. 13, 1890 -)
--	--	--	---	--	--	--

EILIN WERNER B. DEC. 10, 1904, PARIS D. DEC. 2, 1926, PARIS	PER WERNER B. DEC. 1908, PARIS M. RIPO, HERETINIA	ERIK JACOB IVAN B. MAR. 8, 1822, GOTHENB.	JOY B. MAY 5, 1922, HELSINKI	LILIANE B. MAY 8, 1924, PARIS	HONA B. MAY 30, 1927, GOTHENB.
---	---	--	---------------------------------	----------------------------------	-----------------------------------

HENRY B. MAR. 1807 D. 1878	REBECCA D. MAR. 4, 1813/5 D. FEB. 1, 1879	MOSES LEWIS B. MAY 27, 1814 D. MAR. 30, 1888 M.	HENRY B. SEP. 8, 1816 D. 1876?	SON D. AUG. 8, 1817	AMELIA B. NOV. 17, 1820 D. M. HERTON	GEORGE B. JUL. 27, 1824 D. JUN. 25, 1887, RIO DE JANEIRO KATE AMELIA GOODMAN (VID. HARRIS I)	CHARLES B. AUG. 4, 1825 D. NOV. 24, 1910 M. MAY 5, 1862 EMMA GOODMAN (VID. HARRIS I)	WILLIAM B. APR. 17, 1827	MARGUERITE B. JAN. 29, 1829 D. DEC. 31, 1899 M. 1848 JOSEPH P. J. ELLIS (O.V. I)	JOHN B. FEB. 29, 1830 D. MAY 19, 1837	14 OTHERS (1)
----------------------------------	---	--	--------------------------------------	------------------------	--	--	---	-----------------------------	---	---	---------------

AMELIA B. 1842 D. 1915 M. MAR. 18, 1874 EDGAR LINDO	ESTHER LOUISE B. MAY 5, 1867 D. JUL. 31, 1922 M. MAR. 1892 PERCY F. C. ELLIS (O.V. II)	LEWIS (LOND.) NYCR 5.	ALLEN CHAPMAN B. 1858 D. JAN. 5, 1922, RIO DE JANEIRO M. (A GENTILE)	HOWARD FRANCIS B. 1900 D. 1959, RIO
---	---	--------------------------	--	---

INF. B. JUL. 28, 1816	AMELIA B. JAN. 17, 1819 D. AUG. 4, 1895 UNH.	ISABELLE B. AUG. 19, 1820, CH. D. NOV. 19, 1897, SUMTER M. NOV. 27, 1839, CH. JACOB F. SUARES (O.V.)	MOSES HENRY B. NOV. 7/8, 1821, CH. D. JAN. 21, 1875, N.Y. M. CA. 1846 LEAH C. PEIXOTTO (O.V. I (1))	SAMUEL B. JUN. 23, 1824 D. SEP. 17, 1878, N.O. M. CA. 1846 SARAH C. PEIXOTTO (O.V. I (1))	ASHER B. JUN. 30, 1826? D. 1895?	HENRY (HYHAN) B. JUL. 15, 1828 D. MAY 3, 1865, N.O.	LEVY NATHAN FISHER B. MAY 25, 1833	SIMON B. MAY 5, 1835 D. MAY 17, 1875, N.O.
--------------------------	---	---	--	--	--	---	---------------------------------------	--

HENRY HUTCHISON B. SEP. 7, 1847 D. MAR. 22, 1902 M. NOV. 5, 1873, COLUMBIA, S.C. CORDELIA A. POLLOCK (VID. SUARES)	BELLE B. JAN. 15, 1876 D. JUL. 4, 1879
---	--

SPRUCE ST. CEM. REC. JACOB R. COHEN REC. KRAUS-SANDOR COLL. PAJHS V. 12, P. 180 NICKVE ISRAEL REC. DAR LINEAGE BOOKS NATHANS ISS (MRS. MELVIN FRANKLIN) WILL OF DAVID NATHANS (D. 1817) PHILIP M. RUSSELL NATHANS ISS. (HSP) FLD. ADR. RODEPH SHALOM REC. MYER SOLIS-COHEN FEDERAL ST. CEM. RUSSELL FAMILY BIBLE U.S. CENSUS 1790, 1800, 1820

BLAU & BARNH, VII, P. 697 MAXWELL (WHITEHAI) S'NAI JESHURUN REC. JOHN H. SHEFTALL POULSON'S

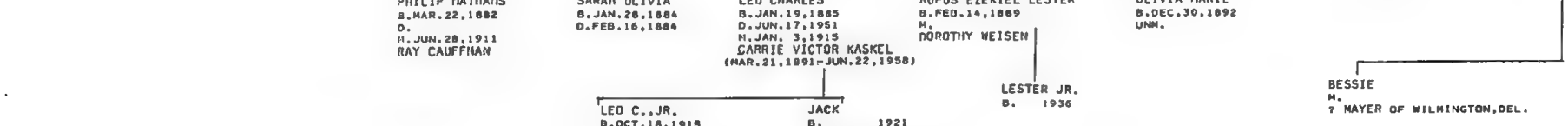
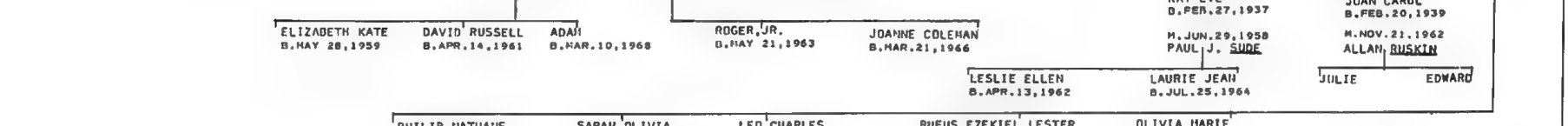
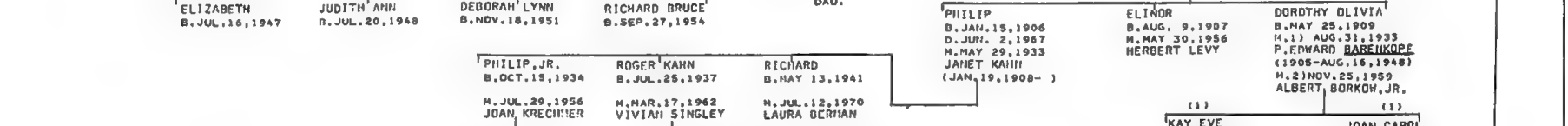
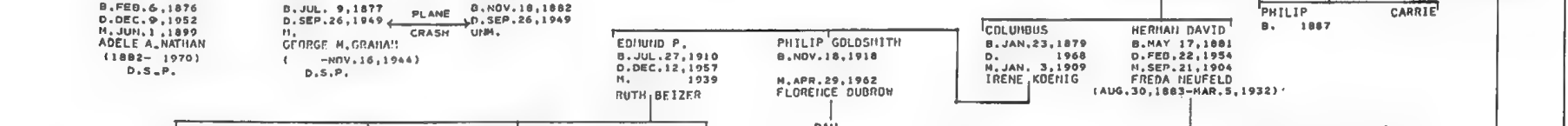
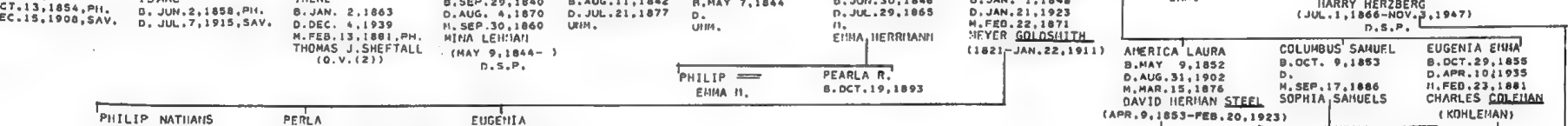
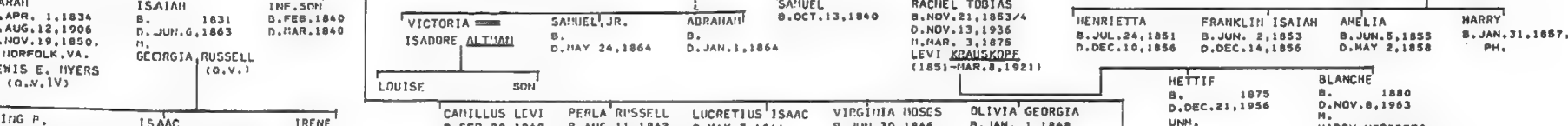
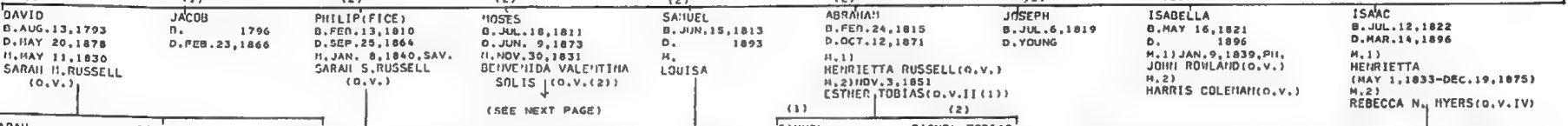
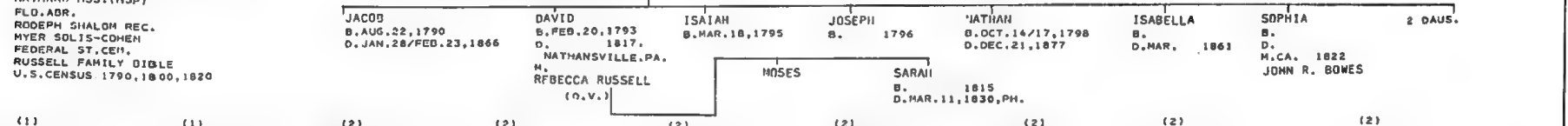
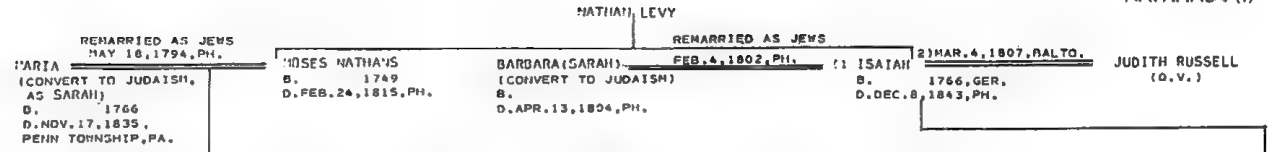

NATHANS I (2)
MRS. IRWIN L. BERNSTEIN

MOSES NATHANS
B. JUL. 16, 1811
D. JUN. 9, 1873
(SEE NATHANS I (1))

NOV. 23, 1831

BENVENIDA VALENTINA SOLIS
B. AUG. 25, 1815
D. JUN. 26, 1893
(O.V. (2))

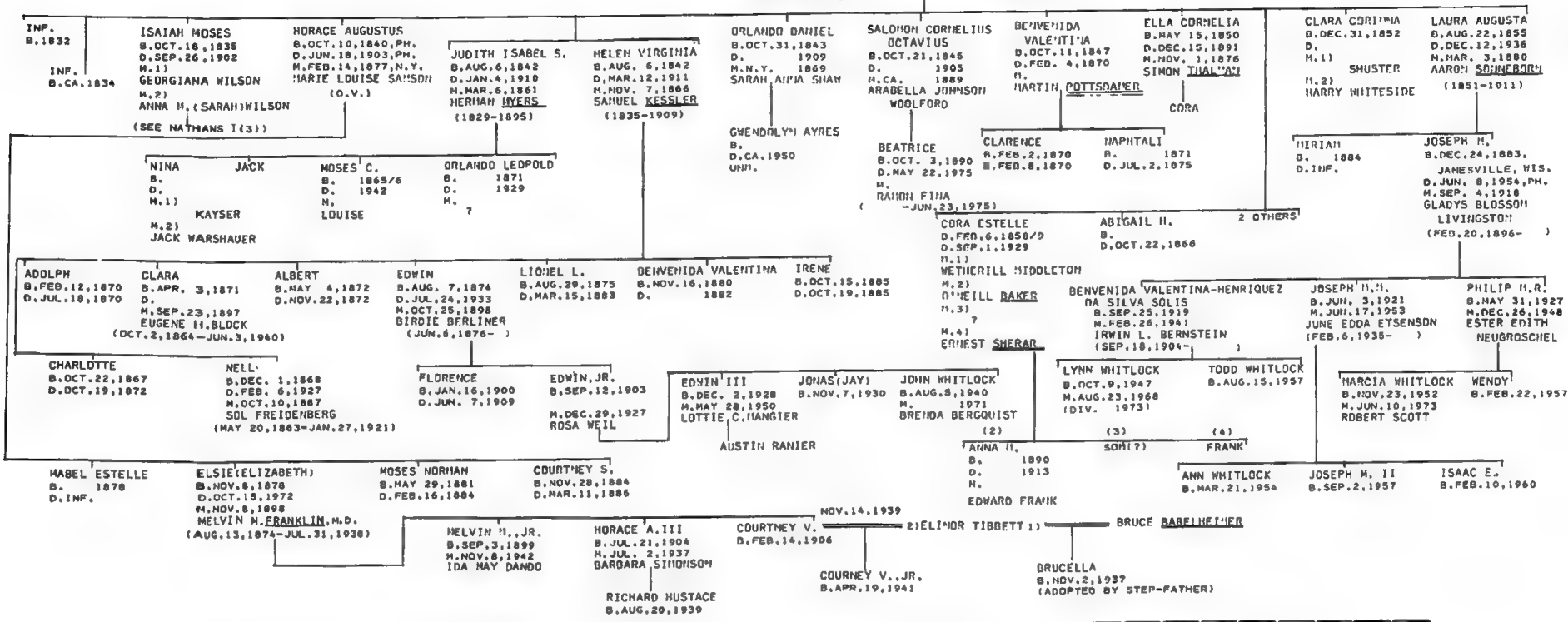

NATHANS I (3)

GEORGIANA WILSON = 1) ISAAH MOSES NATHANS 2) ANNA H. (SARAH) WILSON (CONVERT)
B. OCT. 18, 1835
D. SEP. 26, 1902
(SEE NATHANS I (2))
MAY 2, 1858

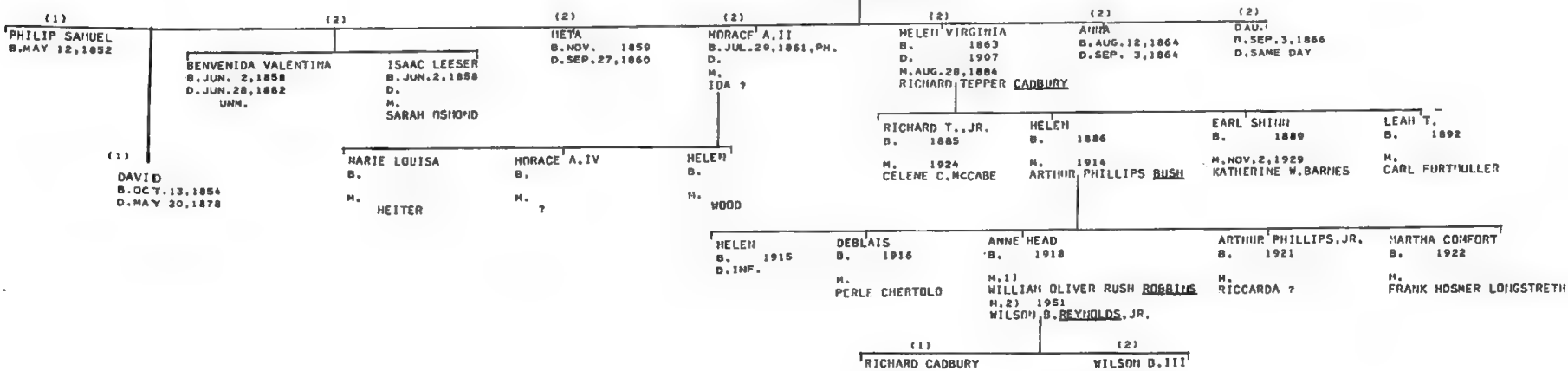

U.S.CENSUS, 1880 (J. STEDMAN)
 H. MOISE-THE MOISE FAMILY
 ELZAS-NEW, JEW. CEM. OF BETH ELOHIM
 MS.
 O. J. C.
 ALEXANDER MS. (AJA)
 WILL OF NATHAN NATHANS

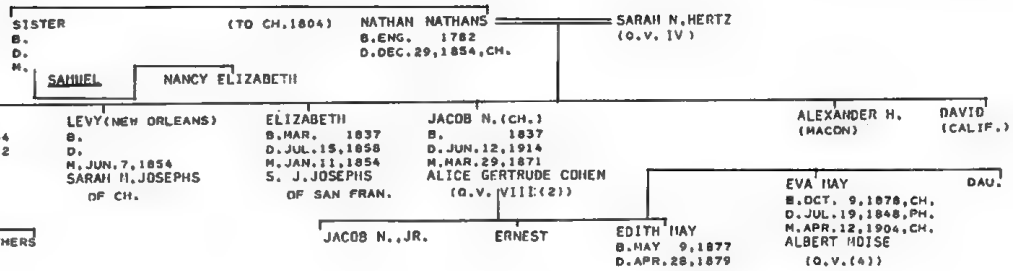

FEDERAL ST. CEM.
 AJYD 5666, P. 78
 JRM COLL.
 MICKVE ISRAEL REC.
 FLORENCE ABRAHAMS
 ALFRED D. SUMBERG
 RODEPH SHALOM REC.

NEWHOUSE (1)

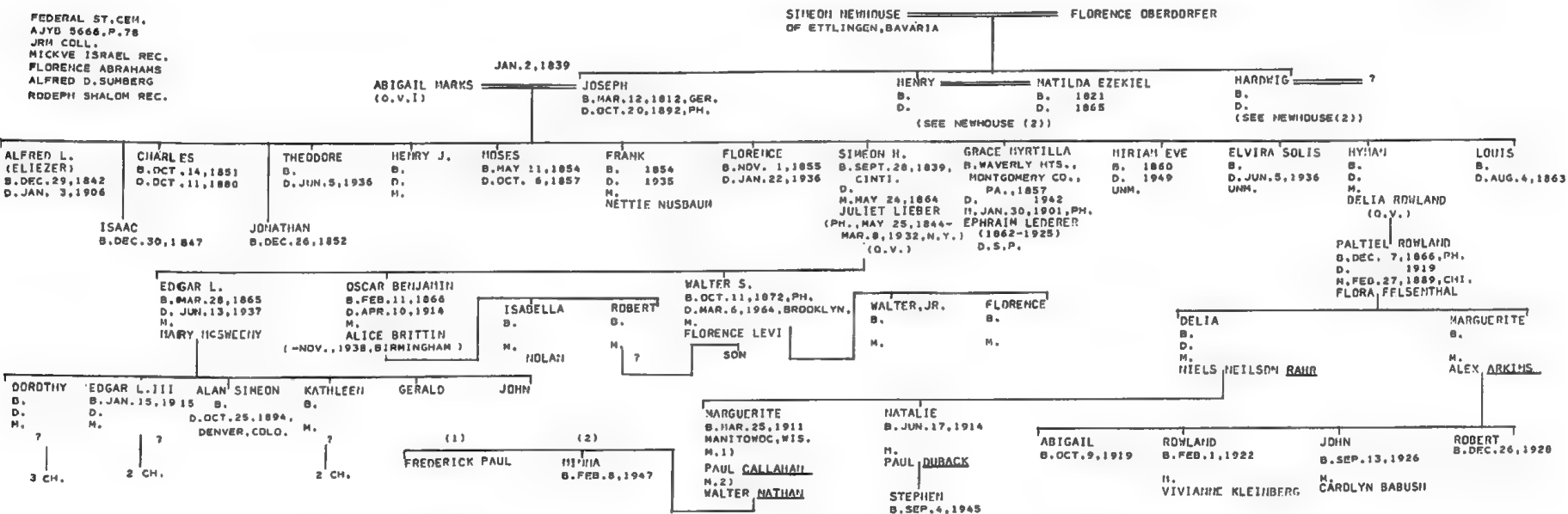

NEWHOUSE (2)

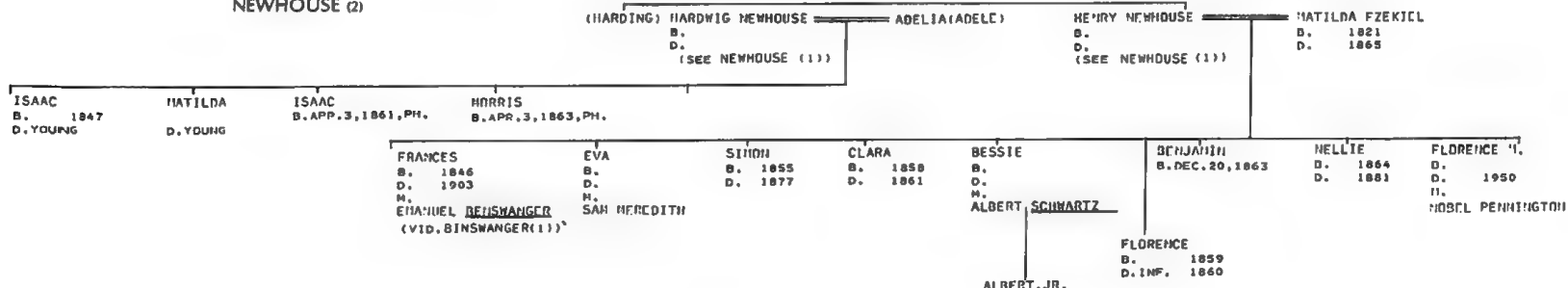

NOAH I

KRAUS-SANDOR COLL.
JE
UJE V. S. P. 227
GOLDRERG-MAJOR NOAH
JACKSON-NOAH GEN. (AJHS)
HICKVE ISRAEL REC.
SHEARITH ISRAEL REC.
W. GUNTHER PLAUT
POOL-PORTRAITS...
B'NAI JESHURUN REC.

HAJUEL NOAH (REV. WAR)
B. 1755, HANNEIM, GER.
D. JAN. 2/FEB. 22, 1822, N.Y.
M. AUG. 4, 1784, PH.
ZIPPORAH PHILLIPS
(O.V. I)

MORDECAI HANUEL
B. JUL. 14/19, 1785, PH.
D. MAR. 22, 1851, N.Y.
M. NOV. 26, 1827, N.Y.
REBECCA ESTHER JACKSON
(O.V. I)

JUDITH
B. MAR. 1789, N.Y.
D. AUG. 24, 1868, N.Y.
UNM.

MANUEL MORDECAI
B. DEC. 23, 1828, N.Y.
D. 1874, WASHINGTON, D.C.
UNM.

JACOB J. (ST. PAUL)
B. OCT. 6, 1830, N.Y.
D. WASH., 1874
M. 1)
ELIZA B.
M. 2)
ETTIE
(-N.Y., 1919)

ROBERT P. (ABRAHAM)
B. DEC. 4, 1832, N.Y.
D. 1901, N.Y.
M. 1)
MIRIAM SOLOMON
(-CA, 1927)
M. 2)
ELIZABETH DARLS

ZIPPORAH
B. JUL. 26, 1835, N.Y.
D. OCT. 11, 1890, N.Y.
M. NOV. 12, 1856, N.Y.
CHARLES L. (LAZARUS) LAWRENCE
(NOTTINGHAM, ENG. JUL. 4, 1833-
JUL. 15, 1890, N.Y.)

DANIEL JACKSON
B. AUG. 6, 1837, N.Y.
D. FEB. 24, 1846, N.Y.

HENRY
B. SEP. 16, 1839, N.Y.
D. MAY 18, 1895, N.Y.
UNM.

LIONEL J.
B. DEC. 25, 1843, N.Y.
D. SEP. 23, 1897, N.Y.
M. NOV. 16, 1881, N.Y.
LILLIE H. LEVY
(O.V. XX)

WALTER M.
B. SEP. 17, 1857, N.Y.
D. FEB. 28, 1920, WESTCHESTER, N.Y.
M. 1)
?
M. 2)
BLANCHIE
(WHO M. 2)
ELMER R. GRANDIN

PERCY
B. MAY 30, 1859, N.Y.
D. APR. 1924, N.Y.
M. IDA VAN BUREN
CATHERINE
B.
M. WICKESON

LIONEL PHIL
B. JUN. 6, 1863, N.Y.
D. JAN. 29, 1914, N.Y.
M. ?

CHARLES L., JR.
B. NOV. 23, 1868, N.Y.
D. JUL. 30, 1883,
WOODBURY, L.I.

LIONEL J., JR.
B. OCT. 28, 1884, N.Y.
M. MARGARET B.

FLORENCE
B. MAY 1859
D. M.
JUNIUS BRUTUS BOOTH

HIMMIE
RICHARD TURNER

EVA
COUNT ADRIAN DE FLEURY

ESMÉ
ROY

ROBERT L.
HARRY T.

(1)
HORACE H.
B. 1857

(1)
CARRIE
D. WASH.
M. VAN ANTHONP

(1)
WILLIAM H.
B. 1902
D. S.P.

(1)
JOHN
CLARA R. (WHO M. 2)
W. GRAY HAWLEY

(2)
BEATRICE
B. D. WASH., 1922
UNM.

BOYMAN DR. HOSEY BALDWIN

NOAH II

AJHO, V. LVI, P. 207^H
SHEARITH ISRAEL REC.
ROSENWAIKE

ELIAS NOAH
B. 1766, GER.
D. MAR. 21, 1824, N.Y.
M. ?

FRANCES
B. 1768
D. JUL. 11, 1843, N.Y.
(BUR. MONTREAL)
M. 1783, PH.
EPHRAIM HART
(O.V. IX)

SAMUEL (TO U.S. 1799)
B. JUL. 19, 1799, LOND.
D. MAR. 10, 1871, MT. PULASKI, ILL.

URIAH

NOAH III

WILLIAM GLOSSINGER NOAH
B. 1768, TESZCHEN, HUNGARY
D. NOV. 19, 1844, N.Y.

CATHERINE ?
B. 1772, LOND.
D. JUN. 4, 1849, N.Y.

SARAH
B. 1803
D. OCT. 26, 1830

RACHEL
B. ?
D. M. JUN. 19, 1834, N.Y.
SAMUEL MORRIS

B. N. Y. →
SARAH DEBORAH
B. MAR. 31, 1835
D. M. MAR. 14, 1852, UTICA, N.Y.
MARKS L. ABBAUAHS

MICHAEL
B. JAN. 15, 1838

ISAAC NOAH
B. DEC. 14, 1849

LYON
B. JAN. 5, 1853, N.Y.

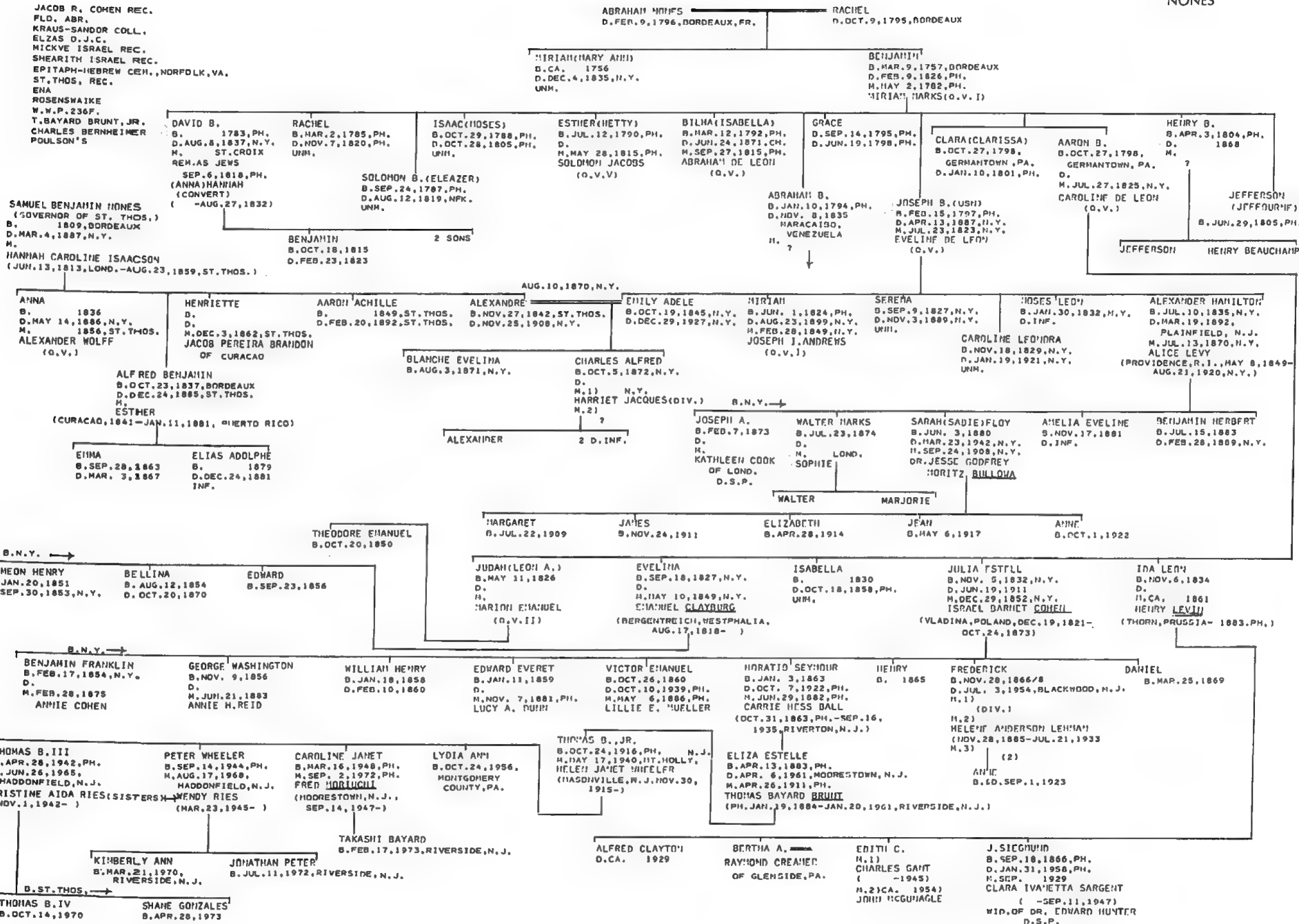

NUNEZ
 MIGRATION & SETTLEMENT (JMSE), P.63FF.
 SHEFTALL MSS.
 ELZAS NS.
 CHATHAM CO., GA. WILLS
 BEVIS MARKS REC.
 MICKVE ISRAEL REC.
 FLD, ABR.
 NGSO, V.54, P.43
 GA. NEWSPAPERS
 ROSENWAIKE
 MISC. V.VI
 KORN-THE JEWS & NEGRO SLAVERY

MANOEL HENRIQUES DE LUCENA
 B. CA. 1643, PORTUGAL
 D.
 M.1)
 M.2)

ANDRE DE SIQUEIRA
 B. CA. 1646, PORTUGAL

(MARIA CAETANA) (ZIPPORAH) (ARR. SAV. JUL. 11, 1733) REM. AS JEWS
 AUG. 8, 1726, LOND.

ANTONIO RIBEIRO
 SANCHEZ

ANNA
 SINÃO NUNES

DIOGO NUNES RIBEIRO
 (DR. SAHUEL NUNEZ)
 B. 1668, IDANHA A NOVA, BEIRA
 D. PROBABLY, CH.
 (ARR. SAV. JUL. 11, 1733)

GRACIA (REBECCA)
 B. CA. 1678, PORT.
 (ARR. SAV. NOV. 12, 1733)

THERESA EUGENIA
 SIQUEIRA

FRANCES SORRES DA VEIGA
 B. 1687, PORT.

DR. ANTONIO NUNES
 RIBEIRO SANCHEZ
 B. 1699, PENAMACOR, PORT.

MANOEL 3 OTHERS

MANOEL (HOSES)
 B. 1700, PORT.
 D. SEP. 6, 1787, SAV.
 M.1)
 M.2)
 ROSE (MULATTO)

ANDRE (DANIEL)
 B. 1710, PORT.
 D. SEP. 20, 1789, SAV.
 M. JAN. 21, 1767, SAV.
 PHILA HAYS
 (G.V. (1))
 D. S. P.

MARIA CAETANA (ZIPPORAH)
 B. 1714, PORT.
 D. NOV. 19, 1799, PH.
 M.1) 1733
 REV. DAVID MENDES NACHADO
 (TO SAV. NOV. 12, 1733)
 (PORT. 1695-NOV. 23/DEC. 4, 1747, N.Y.)
 M.2)
 ISRAEL JACOBS (TO PH. CA. 1739)
 (LOND. 1714-MAR. 3, 1810, PH.)

THERESA (ESTHER)
 B.
 D. JUL. 11, 1785, PA.
 M. JUN. 4, 1732, LOND.
 ABRAHAM DE LYON
 (G.V.)

IZABEL DE VEIGA
 CAETANA (RACHEL)
 RODRIGO (JACOB) SOARES
 DE BIVAR
 (1693 -)

INF. SON
 O. JAN. 12, 1727, LOND.

RODRIGO LOPES (JOSEPH)
 B. 1693-

(1) SON ROBERT (2) JAMES (2) ALEXANDER (2) FRANCES GALPHIN

JOSEPH PATIENCE (NEGRO CONCUDINE)
 B. CH.

(1) REBECCA
 B. NOV. 21, 1746, READING, PA.
 D. JUN. 25, 1831, PH.
 M. NOV. 10, 1762, HICKORY TOWN,
 PLYMOUTH, MONTGOMERY CO., PA.
 JDNAS PHILLIPS
 (G.V. (1))

(1) SARAH
 B. 1747
 D. MAR. 12, 1810, CH.
 M.
 PHILIP HOSES
 (G.V. (1))

(2) RACHEL
 B. 1754/60
 D. NOV. 1, 1821
 M. 1) OCT. 4, 1786, SAV.
 CUSHMAN POLACK (POLLOCK, POLLOCK)
 (- APR. 21, 1798, PH.)
 M. 2) NOV. 3, 1807, PH.
 JACOB I. COHEN
 (G.V. (1))

OTTOLENGUI

ELZAS M.N.
 MS.
 NEW JEWISH CEM. OF BETH ELOHIM
 D. J. C.
 WILL OF ABRAHAM OTTOLENGUI (JRM)
 B. A. RODRIGUES
 H. NOISE-THE NOISE FAMILY
 JEWISH CEM. AT SUMTER
 LAZARUS FAMILY BIBLE
 ROSENWAIKE
 SALLEY -M.N.

HORDECAI OTTOLENGUI RINAH
 B. ITALY D. 1794 B. GIDRALTAR D. 1810

ESTHER SARAH
 B. OCT. 5, 1808
 ISRAEL SOLOMONS
 (G.V. (1) & (2))

ABRAHAM
 B. SEP. 6, 1790, CH.
 D. DEC. 12, 1850
 M.
 SARAH JACOBS
 (JUL. 13, 1793-AUG. 1, 1864, SUMTER)

RINAH J. B. SEP. 27, 1813 D. INF. MORDECAI D. INF. JUDITH A. B. MAY 1, 1816 D. SEP. 1, 1883 M. SEP. 1844 AARDN I. HOSES (G.V. III (1) & (2)) ISAAC B. DEC. 1822, CH. D. JUN. 30, 1824, N.Y. HETTY J. D. MAY 8, 1818 D. FEB. 15, 1886 M. AUG. 1834 JACOB GARRETT (G.V.) JACOB B. JUL. 27, 1819 D. FEB. 5, 1900 M. DEC. 27, 1848 ELIZA MINA JACOBS (G.V. VI) REBECCA B. OCT. 1826 D. INF. SARAH M. MAY 24, 1848 JACOB I. HOSES (G.V. III (1) & (2)) WIDOWER OF HER SISTER RINAH HORDECAI H. D. INF. MIRIAM D. INF. ABRAHAM B. FEB. 1831 D. INF. ISRAEL B. NOV. 27, 1832, CH. D. JUN. 7, 1895 M. NOV. 29, 1854, CH. ROSALIE C. NOISE (G.V. (2)) DANIEL M. MAY 30, 1860, CH. HELEN ROSALIE RODRIGUEZ (G.V.)

ABRAHAM B. OCT. 16, 1849 D. JAN. 1, 1892

CORNELIA ALICE B. DEC. 22, 1851 D. MAR. 10, 1935 UNM.

ELIZA MINA B. DEC. 16, 1852 D. MAR. 24, 1895 M. APR. 26, 1876, CH. MARION W. DIBBLE

ABRAHAM B. DEC. 17, 1854 D. SEP. 24, 1894

BENJAMIN A. RODRIGUES, D.D.S. B. 1851, CH. D. JUL. 1937 M. MAY HALL (- JUL. 10, 1936)

HELEN C. M. JUL. 1, 1885, BROOKLYN ARTHUR HIRSCH OF N.Y.

ISRAEL LEF

SARAH B. AUG. 28, 1855 D. OCT. 10, 1877, COOSAW, S.C. M. FEB. 28, 1877, CH. EDWARD HINTON LOPEZ (G.V. I (2))

REBECCA FLORENCE B. OCT. 16, 1856 D. NOV. 17, 1938, CH. M. JUL. 16, 1889/90, CH. OCTAVUS COHEN (G.V. VIII (3))

CECILE B. FEB. 24, 1858 D. JAN. 7, 1936 M. NOV. 12, 1881, CH. EDWARD HINTON LOPEZ (G.V. I (2)) WIDOWER OF HER SISTER SARAH

JESSIE B. JUL. 9, 1861 D. FEB. 26, 1953, ASHEVILLE, N.C. UNM.

ELLA B. JUL. 7, 1863 D. SEP. 30, 1936, CH. UNM.

IDA B. FEB. 4, 1865 D. SEP. 5, 1865 INF.

ISRAEL, JR. B. SEP. 29, 1866 D. MAR. 6, 1927, ORANGE CO., VA. M. 1) MAR. 1, 1912 ANNA S. CHILDS (- 1919) M. 2) APR. 25, 1922 MARY R. CHILDS

ROSALIE B. JUL. 9, 1869 D. APR. 8, 1945, ASHEVILLE, N.C. INF. M. NOV. 12, 1905 THOMAS DIRCH ALLISON (1876-1946)

FRANKLIN NOISE B. MAR. 9, 1871 D. JUL. 15, 1871 INF.

AMANDA ISABEL B. APR. 3, 1874 D. JUL. 15, 1874 INF. DAISY B. MAR. 2, 1873 D. JUN. 4, 1873 INF.

MINA ALICE B. AUG. 26, 1879 B. MAY 8, 1960, ASHEVILLE, N.C. UNM.

INF. B. ED. OCT. 10, 1877, COOSAW, S.C.

FLORENCE DONBEY B. DEC. 10, 1859 D. APR. 7, 1928, CH. UNM.

(1) ROSALIE NOISE B. NOV. 3, 1914 M. 1947 MAJ. PHILIP DUKE

JFANNF B. SEP. 22, 1948, HONOLULU

(1) ROY EDWARD B. FEB. 17, 1916

ROSENSTEIN
E. J., V. 12, P. 1431 F.
ELZAS D. J. C.
MS.
OPPENHEIM MS. (JRM)
J. E. V. 9, P. 410; V. 12, P. 503
WILL OF HERTZ W. OPPENHEIM
SHEARITH ISRAEL REC.
F.L.D. APR.
OPPENHEIM FAMILY REC. (EMILY MEYER)
ROSENWAIKE
JON STEDMAN

SANDELE CARCASSONE

SAMUEL WOLFF OPPENHEIMER
OF VIENNA
B. 1630
D. MAY 3, 1703

ABRAHAM OPPENHEIM "ZUR KANNE"
B. WORMS
D. DEC. 2, 1692, HEIDELBERG
(BUR. MANNHEIM)

BLUME
D. 1683

ISSACHAR HA-LEVI BERMAN

EMANUEL
B.
D. 1721
M. ?
DAU. WOLF WERTHEIMER (RIGHT)

SIMON WOLFF (HANDOVER)
M. 1)
PRADE BEHRENS COHEN (O.V. RIGHT)
M. 2)
REBEKKA SHEFFRA REININGONUM (-NOV. 6, 1727)

DAVID OPPENHEIM
RABBI OF MORAVIA & BOHEMIA
B. WORMS, 1664
D. PRAGUE, SEP. 12, 1736

GNENDL
B.
D. JUN. 30, 1712

MOSES
B.
D. MAY 2, 1712

JACOB
B.
D. NOV. 26, 1771

LEHMAN
B.
WOLFF OPPENHEIM (O.V. BELOW)

PRADE
B.
D. AUG. 6, 1724, VIENNA

MIRIEL
B.
WIDOW OF NATHAN OPPENHEIM.

PHILIP HERSCHEL BOSING

SELIG COHEN

PHEBUS

JEUTE
B.
D. MAR. 3, 1786

GNENDL
B.
D. DEC. 26, 1734
UNM.

JOSEPH
B.
D. JUL. 22, 1739

TELZE

ISAAC

WOLF
DAU. OF EMANUEL OPPENHEIMER (LEFT)

SORCHEN
B.
D.
M.
MICHAEL DAVID

LEAH
B.
D. MAR. 13, 1772

MOSES
B.
D. MAY 23, 1781

SARAH ELIAS GOMPERTZ OF CLEVE

MAYER OF NICHOLSBURG
B.
D. 1759

NOAH SAMUEL
B.
D. 1721

SIMON JACOB
M. 1)
SARAH MIRIAM
DAU. OF MOSES DANKWERT (1698-OCT. 6, 1728)

EDEL
B.
D. APR. 14, 1783

KAPPEL GUMPEL OF WOLFENBUTTEL
WOLFF (1) JACHET MAY 20, 1767 (2) HALE

(2) LEISER DUSSELDORF

(2) PHILIP
M. 1)
DAU. OF GOTTSCHALK DUSSELDORF (-SEP. 7, 1803)

SARAH DAVID WOLFF HERZ OF HANBURG

MATHILDE MARCUS SAMSON HERZ OF HAMBURG

CHARLOTTE HELLWITZ OF COLOGNE

WOLFF
B.
D. APR. 12, 1797
M. 1)
MIRIEL BEHRENS COHEN (O.V. ABOVE)
M. 2)
GUTRAD (-SEP. 28, 1811)

HERTZ WOLFF (FRITZ)
B. 1786, HANOVER
D. JUN. 7, 1853, CH.
M. MAY 2, 1821, CH.
CATHERINE MOSES (O.V.V)

FREDERICKE DR. DETMOLD
HERMAN

RACHEL
D. UNM.

LISETTE SAMUEL BASSWITZ OF BERLIN

PHILLIPE HENRY COHEN OF HANOVER

DAU. DR. WOLFGANG STRASMAN

JACOB D. INF.
WOLFF
B. MAR. 2, 1822, CH.
D. MAR. 19, 1822 INF.

JOSEPH H. (CSA)
D. AUG. 31, 1901
HANNAH JOSEPH OF N.Y. (-JUN. 28, 1911)

SARAH GERTRUDE
D. MAR. 22, 1911, BERLIN (BUR. HANOVER)
M. CH.
MORRIS HAYER FROM HANOVER

SAMUEL HERTZ
D. APR. 9, 1910
M. DEC. 31, 1862
HANNAH A. GOLDSMITH (O.V.)

MATHILDA REBECCA
B. OCT. 31, 1830, CH.
D. APR. 16, 1877, N.Y.
M. OCT. 10, 1855
BERNARD S. BARUC (O.V.)

HENRY HERTZ (CSA)
D. AUG. 25, 1888

JULIUS HERTZ
B. NOV. 23, 1835, CH.
D. APR. 8, 1903, N.Y.
M. DEC. 31, 1862
SARAH ANN GOLDSMITH (O.V.)
(SEE NEXT PAGE)

EMILY FREDERIKA
B. OCT. 7, 1837, CH.
D. FEB. 9, 1920, MONTGOMERY, ALA.
M. FEB. 11, 1856/7
EMIL JOSEPH MEYER (BIELEFELD, PRUSSIA, SEP. 1, 1826-OCT. 15, 1857, CH.)

EDWIN HERTZ (CSA)
B. 1840
D. 1918

HERMAN DETMOLD
D. MAY 8, 1896
M. 1)
SARAH JONAS (O.V.)
M. 2)
MRS. M. L. PRESCOTT

CATHERINE BARROWDAIL BROWNE OF PH.

HERTZ W. JOSEPH

ADELE MORRIS MAYER OF BERLIN

REBECCA GUSTAVE FREUND OF BERLIN

EMIL JOSEPH
B. DEC. 21, 1857, CH. (POSTHUMOUS)
D. SEP. 29, 1930, MONTGOMERY, ALA.
M.
EDA HIRSCHFIELD

EMIL J. JR.
B. OCT. 8, 1886
D. AUG. 15, 1957
M. JUN. 19, 1917
MIRIAM BLUMENFELD

EDITH
B. APR. 26, 1888
D.

JOAN
B. JAN. 23, 1920
M. 1)
ROSEN
M. 2) MAY 23, 1956
JOHN CAIN

EMIL J. III
B. APR. 22, 1922
BARBARA ANN

BERNHARDT MEYER
B. JAN. 8, 3910
M. MAJORIE KOHLMAN

ROBERT EUGENE
B. FEB. 1, 1913

MATILDA REBECCA
B. FEB. 18, 1884
M. FEB. 12, 1908
BERNHARDT FRIEDMAN

EMILY
B. MAR. 25, 1885
D.

EDITH
B. APR. 26, 1888
D.

JOAN
B. JAN. 23, 1920
M. 1)
ROSEN
M. 2) MAY 23, 1956
JOHN CAIN

EMIL J. III
B. APR. 22, 1922
BARBARA ANN

JULIUS HERTZ OPPENHEIM
B. NOV. 23, 1835, CH.
D. APR. 5, 1903, N.Y. (SEE ABOVE)

SARAH ANN GOLDSMITH (O.V.)

OPPENHEIM (2)

ELEANOR E. (ELLEN)
B. OCT. 30, 1863
D. OCT. 28, 1944, CINTI.
M. FEB. 6, 1884, ATL.
JOSEPH A. MAGNUS (VID. ALEXANDER (1))

CATHERINE
B. APR. 15, 1865
D. APR. 14, 1866

MIKELL HEARS GOLDSMITH
B. FEB. 16, 1867, GA.
D. MAR. 18, 1929, N.Y.
M. JAN. 27, 1894, WERNERSVILLE, PA.
NEVADA (VADDIE) SMITH (APR. 16, 1865-OCT. 24, 1938)

RAPHALL BENJAMIN
B. NOV. 9, 1866, AUGUSTA
D. MAY 3, 1940, N.Y.
M. FEB. 9, 1892, SELMA, ALA.
HENRIETTA SCHULHOFFER (MAY 1, 1870-)

FERDINAND
B. FEB. 3, 1893, SELMA, ALA.
4. MAY 18, 1920, N.Y.
ESTHER DORIS HIRSCH (N.Y., NOV. 5, 1889-)

JULIUS HERTZ
B. NOV. 9, 1870, AUG.
D. OCT. 21, 1927
M. NOV. 30, 1905, N.Y.
GRETE KATZ

HERBERT
B.
D. YOUNG

LILIAN
B.
D. YOUNG

ISAAC PHILIP
B. NOV. 17, 1869
D. MAY 29, 1870
YOUNG

EMILY FRANCES
B. AUG. 12, 1876, ATL.
D. JAN. 20, 1923, N.Y.
M. NOV. 12, 1907, N.Y.
BERNARD KATZ (BRO. OF GRETE -LEFT)
D. S. P.

LOUIS MICHAEL
B. SEP. 2, 1898, N.Y.
M. JUN. 3, 1924, N.Y.
SYLVIA KLEVE

CLARENCE J.
B. SEP. 7, 1901, N.Y.
UNM.

JULIA GRACE
B. APR. 30, 1903, N.Y.
D. JUL. 2, 1945, N.Y.
M. JUL. 25, 1938
MORTIMOR LINDY D. S. P.

HERBERT SMITH
B. MAR. 26, 1906, N.Y.
M. JUL. 25, 1938
LILIAN ?

JUDITH NEVADA
B. MAR. 1939

MICHAEL
B. DEC. 1942

ALFRED PHILIP
B. JUL. 1, 1922, N.Y.
M. MAR. 3, 1946, N.Y.
SARAH ROSE BLUM

JUSTIN SABLE
B. AUG. 17, 1923, N.Y.
M. JUN. 26, 1949, N.Y.
JOYCE T. HARRITS

MONA HIRSCH
B. JUL. 3, 1925, N.Y.

ELLEN SUE
B. JUL. 30, 1926, N.Y.
M. NOV. 28, 1946, N.Y.
DAVID MICHAEL LIEBOWITZ

ANN MARCIA
B. DEC. 21, 1948, N.Y.

MICHAEL JULIAN
B. APR. 16, 1951, N.Y.

RUTH MAE
B. JUL. 1, 1935,
JAMAICA, N.Y.

PHYLIS
B. FEB. 1941

GAIL IRIS
B. SEP. 10, 1947,
MT. VERNON, N.Y.

JANET SUE
B. JUN. 15, 1952, N.Y.

JUDITH HEARS
B. NOV. 18, 1954,
GLEN OAKS, L. I.

OPPENHEIMER (1)

JON STEDMAN

SCHUTZJUDE DAVID **KAHN** B.C.A. 1759, GERMANY
D. DEC. 2, 1825, GEDERN

SCHIELE (SHEINA, JULIA) ABRAHAM
B. GERMANY
D. JUN. 28, 1836

JUDAH HA-COHEN

SCHÜTZJUDE ABRAHAM OPPENHEIMER
B.C.A. 1765, HESSE-DARMSTADT
D. JAN. 11, 1841, GEDERN

REINA (RACHEL)
B.C.A. 1774, HESSE-DARMSTADT
D. FEB. 1, 1838, GEDERN

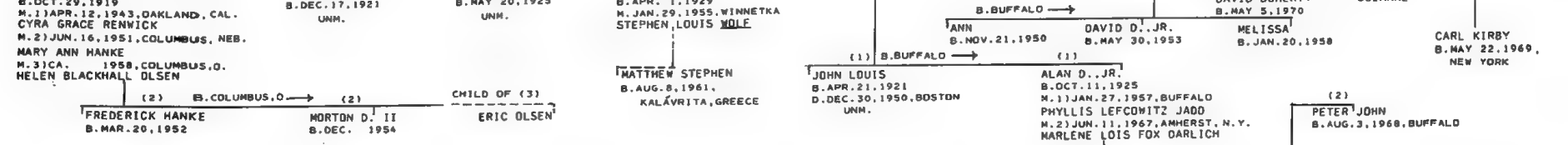
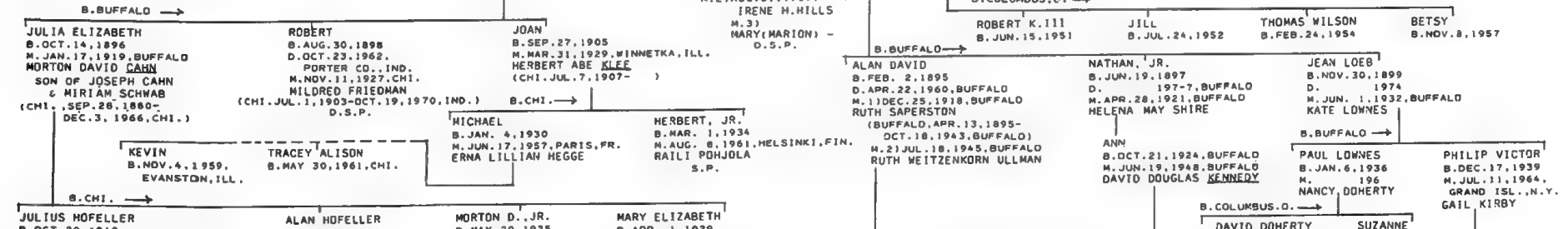
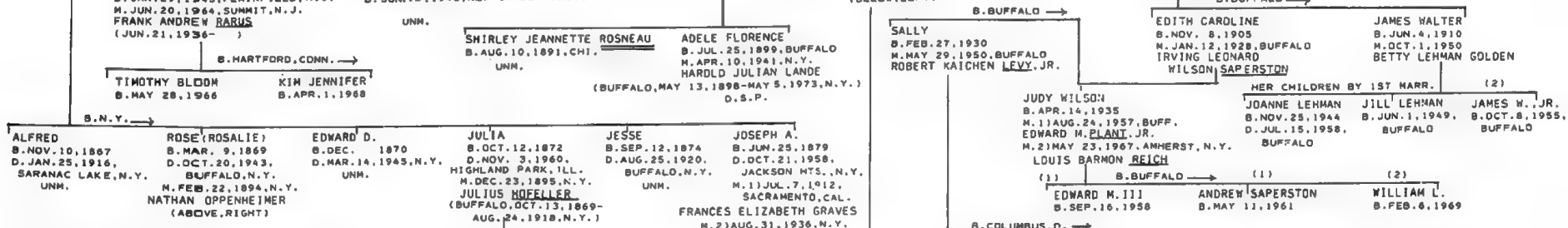
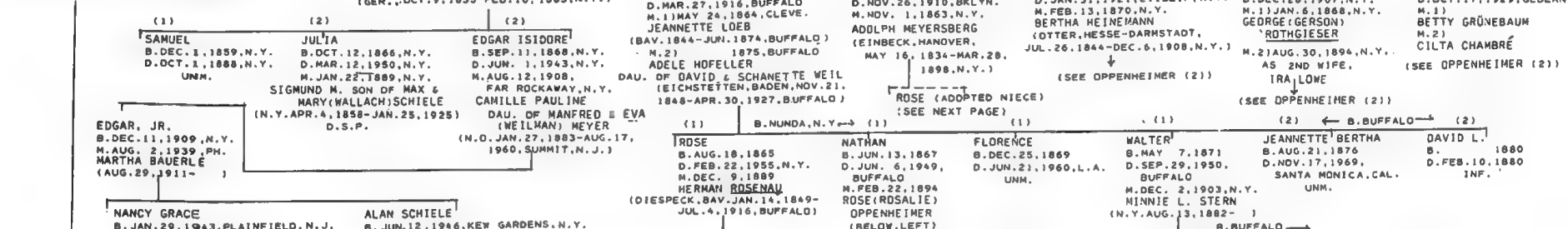
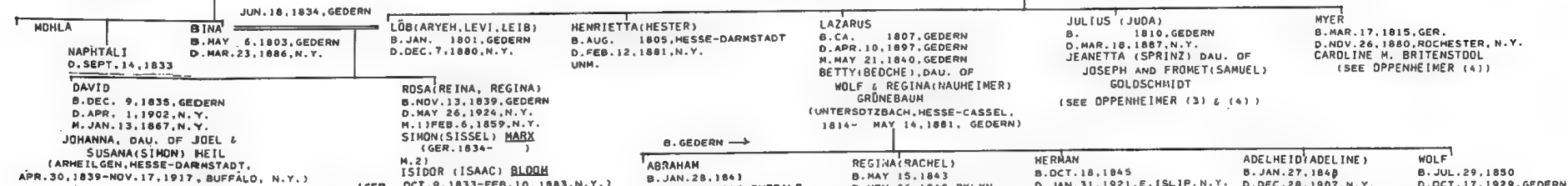

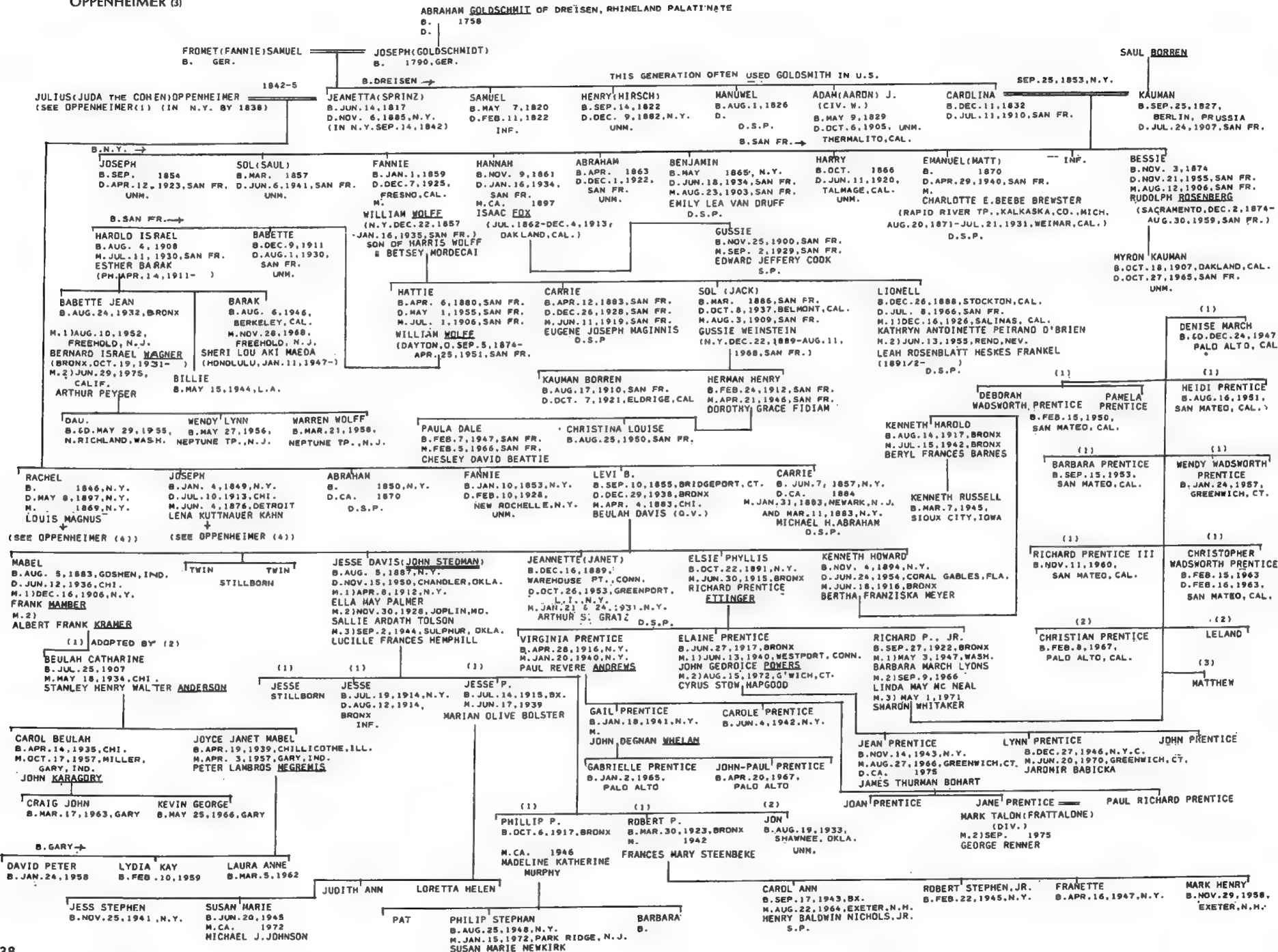

1842-5

JEANETTA (SPRINZ) GOLDSMITH JULIUS (JUDA THE COHEN) OPPENHEIMER
(SEE OPPENHEIMER (1) & (3))

MARCUS MAGNIUS ESTHER COHEN

RABBI SAMUEL KUTTNAUER CAROLINE MILLER

LOUIS (ELEAZER) 1869, N.Y.
(CIV. W., 1ST SGT.)
B. OCT. 10, 1830, HAMBURG
D. AUG. 8, 1909, N.Y.

RACHEL
B. 1846, N.Y.
D. MAY 8, 1897, N.Y.

JOSEPH
B. JAN. 4, 1849, N.Y.
D. JUL. 10, 1913, CHI.

LENA KUTTNAUER KAHN
B. FEB. 18, 1855, FRANKFURT, A/M
D. APR. 29, 1944, MANTENO, ILL.

HYERMEIER
B. MAR. 17, 1815, GER.
D. NOV. 26, 1880, ROCHESTER, N.Y.
M.
CAROLINE M. BRITENSTOOL
(GER. DEC. 5, 1818-DEC. 24,
1896, SYRACUSE, N.Y.)

MARCUS
B. JUN. 28, 1871
D. FEB. 7, 1874, N.Y.

ESTHER
B. FEB. 11, 1873
D. AUG. 4, 1913, N.Y.
UNM.

ABRAHAM (EDWARD) 3 D. INF.
B. OCT. 7, 1874
D. MAY 3, 1956,
HILLSIDE, N.J.
M. FEB. 21, 1904, N.Y.
MATILDA FINSIE, DAU. OF
AARON HENRY & MADELENA HAMBURGER FINSIE (GERMANY, CA. 1866-MARCH 15, 1934, BRONX)
D. S.P.

SADIE
B. NOV. 29, 1881
D. DEC. 11, 1946, N.Y.
M. APR. 14, 1915, BX.
AS HIS 3D WIFE
LEOPOLD S. SCHWERIN
(RUSSIA 1887 -)
D. S.P.

LILLIAN
B. OCT. 20, 1883
D. MAY 7, 1944, BX.
M. NOV. 3, 1914, N.Y.
SALOMON BOLKE
(RUSSIA 1887 -)
D. S.P.

MOSES (MURRAY)
B. JAN. 21, 1887
D. DEC. 26, 1943, N.Y.
M. MAR. 15, 1908
BELLE PLATZNER
D. S.P.

INF. D. AT BIRTH, MAR. 31, 1915

HER SON BY KAHN

RUTH
B. MAR. 8, 1905, N.Y.
M. FEB. 23, 1926, BKLYN.
IRVING SCHWARTZ
(STOROZHINETZ, BUKOVINA,
NOV. 15, 1902-)

LUCILLE
B. DEC. 27, 1909, BKLYN.
M. SEP. 3, 1935, BKLYN.
LEO JUDA SNIKOFF
(GRIGORIPLE, MOLDAVIA,
DEC. 18, 1908-)

ABRAHAM B.
B. 1877, DETROIT
D. JAN. 13, 1915.
EXCELSIOR SPRS., MO.
M. JUL. 22, 1907, CHI.
BERTHA MATT
(CA. 1879-)
D. S.P.

HATTYE H.
B. AUG. 6, 1879, DETROIT
M. JUN. 20, 1906, CHI. (DIV.)
PETER ALBERT COONEY
SON OF PETER AND ROSE
(RODGERS) COONEY
(CHI., DEC. 16, 1878-JUNE 1, 1944, CHI.)

CARRIE
B. SEP. 22, 1885, GOSHEN, IND.
D. SEP. 8, 1947, CHI.
M. 1) CA. 1905
M. 2) AUG. 29, 1925, CHI.
JOHN WILLIAM AUST
(CA. 1889 -)
D. S.P.

WILLIAM KAHN
B. FEB. 1874, DETROIT
D. NOV. 11, 1966, CHI.
M. 1)
M. 2) FLORA
(2)
SON

EDWARD MAGNUS
B. FEB. 24, 1930
M. NOV. 21, 1956,
BAYONNE
HELEN TOPILON
(BAYONNE, NOV. 22, 1934 -)

ALAN MAGNUS
B. FEB. 24, 1930
M. MAR. 8, 1964,
E. ORANGE, N. J.
GLADYS MALINA
S.P.

STEPHEN MAGNUS
B. MAR. 20, 1946, NEWARK
UNM.

JOSEPH RAYMOND
B. MAR. 23, 1909, CHI.
D. DEC. 20, 1966, S. HAVEN, MICH.
M. 1) NOV. 192-?,
WAUKEGAN, ILL.
VIRGINIA DOROTHY BROWN MANNING
M. 2) NOV. 2, 1939, CROWN PT., IND.
MARY CUTLER
M. 3) CA. 1958
EVELYN ?

ROSLYN LUCILLE
B. SEP. 25, 1912, CHI.
M. CA. 1937, CHI.
LE ROY J. CREAGAN
(CHI., FEB. 3, 1901-
AUG. 7, 1966, CHI.)
S.P.

ABRAHAM
B. SEP. 6, 1849, N.Y.
D. DEC. 1, 1914, CLEVELAND
M. JAN. 18, 1871, CLEVELAND
GUSSIE, DAU. OF ISAAC &
BETTIE (WEIL) WOLF
(CLEVELAND, JUN. 23, 1850-
JAN. 27, 1923, CLEVELAND)

LEVI
B. JUN. 1853, NUNDA, N.Y.
D. JAN. 11, 1932, SYRACUSE
M. FEB. 9, 1881, ROCHESTER
ETTA (LOUISE), DAU. OF
SOLDMAN H. & REGINA (ANFENGER)
GOLDBERG
(OSWEGO, N.Y. JAN. 28, 1859-
DEC. 27, 1921, SYRACUSE)
D. S.P.

ANDREW ERIC
B. OCT. 8, 1958

JANE CAROL
B. SEP. 15, 1959

SUZANNE WENDY
B. MAR. 1, 1965

(1)
RICHARD ALBERT
B. JUL. 8, 1930, CHI.
M. 1) OCT. 1, 1951, CHI.
MICALYN CELIA FLORENCE
M. 2) DEC. 23, 1955, CHI.
AUDREY ELLEN WHITAKER
M. 3) AUG. 4, 1961, L.A.
JOAN ROSELYN BRADY

ROSA
B. JAN. 1, 1872, WARSAW, N.Y.
D. MAY 23, 1935, HUNTINGTON, W. VA.
M. JUN. 24, 1900, CLEVELAND, O.
EMMANUEL ADOLPH REICH SON OF
JACOB & HANNAH GREENWALD REICH
(TOLCSVA, HUN., FEB. 13, 1867-SEPT. 17, 1965,
HUNTINGTON, W. VA.)

ALBERT
B. NOV. 8, 1874, WARSAW
D. OCT. 21, 1939, CLEVELAND
M. JUN. 21, 1923, CLEVELAND
STELLA BAER KRONTHAL DAU. OF
SOLDMAN & HANNAH RHEINHEIMER BAER
(CLEVE., OCT. 14, 1876-OCT. 31, 1947, CLEVE. HGTS.)
D. S.P.

STELLA
B. AUG. 19, 1878, WARSAW
D. MAY 19, 1926, CLEVELAND
UNM.

INF. SON
B. FEB. 10, 1884,
ROCHESTER, N.Y.

(1)
KEVIN RICHARD ALLEN
B. MAR. 2, 1953, CHI.

(2)
WALTER JULIAN MAXWELL
B. SEP. 22, 1956,
WINCHESTER, TENN.

(2)
VIRGINIA CARROLL MAXWELL
B. JAN. 28, 1958, CHI.

(2)
WILLIAM PATRICK MAXWELL
B. MAY 21, 1959,
WINCHESTER, TENN.

JACOB JEROME (JERRY) (PHILANTHROPIST)
B. JUN. 22, 1901, NEW HARTINSVILLE, W. VA.
D. DEC. 26, 1968, HUNTINGTON, W. VA.
M. DEC. 19, 1936, HUNTINGTON
MAYME RUTH ARRINGTON STRAIT
D. S.P.

PALACHÉ

SHEARITH ISRAEL REC.
PAJMS V.27,P.112

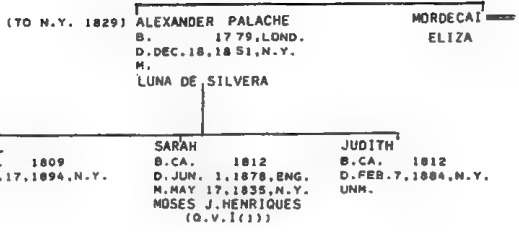

PEIXOTTO I (1)

KRAUS-SANDOR COLL.
CURACAD REC.
SHEARITH ISRAEL REC.
PAJMS V.27, PP.167,264,342
V.29,P.38
ST. CHARLES, P.131
GOLDSTONE MS. (AJA)
MARKS MS. (AJA)
NATHAN GEN. (AJA)
ELZAS-JEWS OF S.C.
JEWISH CEM. AT COLUMBIA
M.N.
MSS. (NYHS)
AJYB 5665, P.163
THELMA B. SCHLOSSBERG

HORTENSE PEIXOTTO BLUMBERG
REZNIKOFF-JEWS OF CH., P.290
FAMILY HIST. OF BENJ. MORDECAI
POOL-PORTRAITS
BEVIS MARKS REC.

SOLOMON C. PEIXOTTO REC.
AMST. MUNICIPAL ARCH.
EMMANUEL-PRECIOUS STONES
E.N.A.
ST. THOS. CEM. REC.
J.M.L. MADURO
ABE NEBEL
EDGAR KAHN
HELEN E. PEIXOTTO
STEVEN W. SIEGEL

PARDO

POOL-PORTRAITS
HERSHKOWITZ-WILLS
E.N.A.

JOSEPH PARDO (RABBI, VENICE (AMST.))
B. SALONIKA, OTTOMAN EMPIRE
D. OCT. 11, 1619, AMST.
M. ?

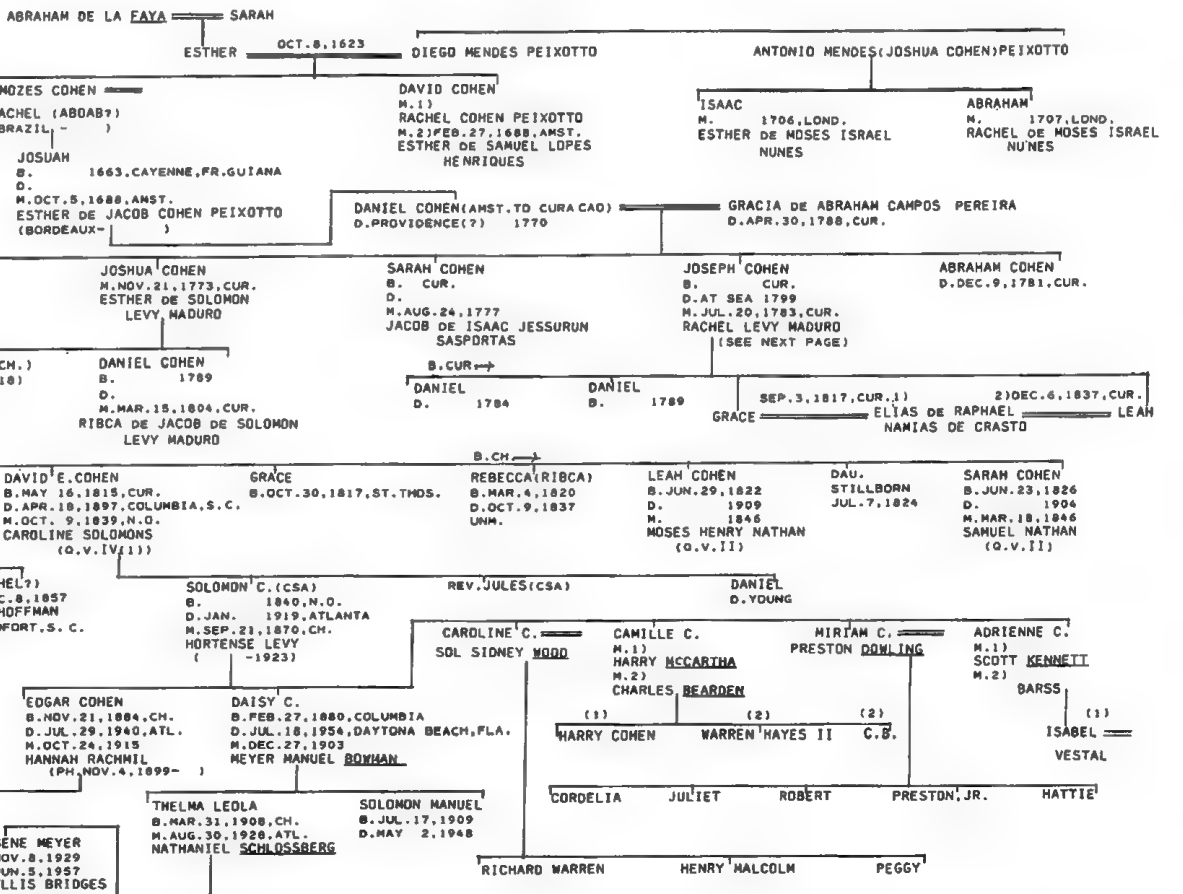
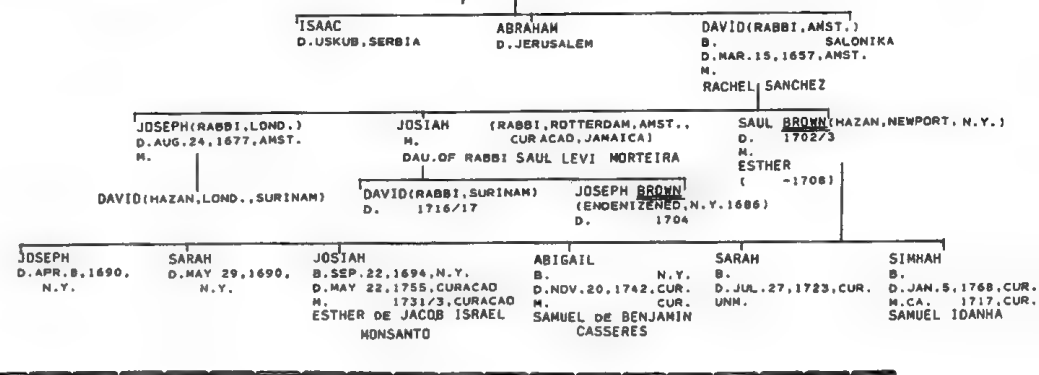

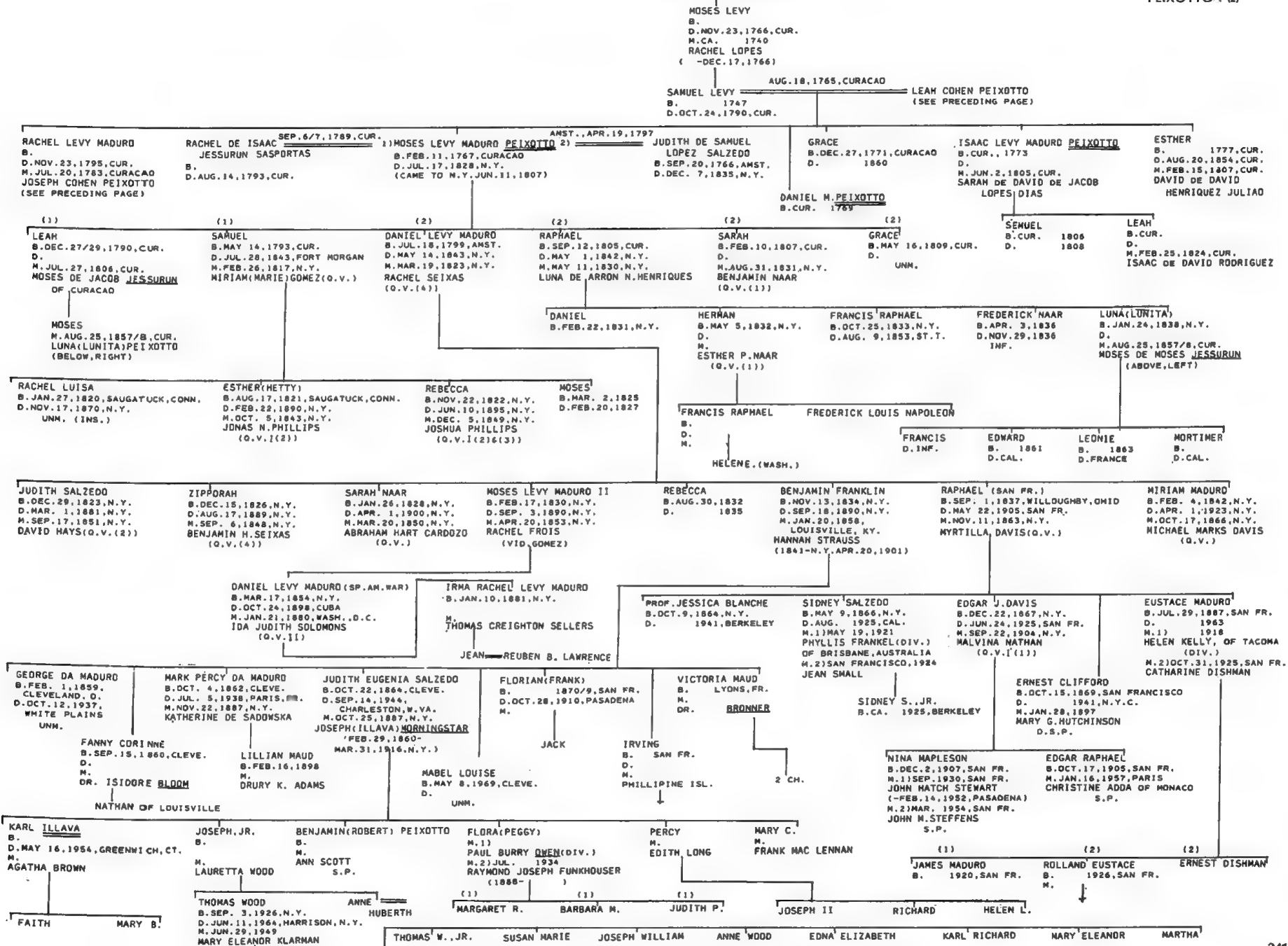

PEIXOTTO II

ELZAS HS.
SHEARITH ISRAEL REC.

DAVID COHEN PEIXOTTO
B. M. I. 1816
D. MAY 15, 1897
M.
ABIGAIL LOPEZ
(O. V. III)

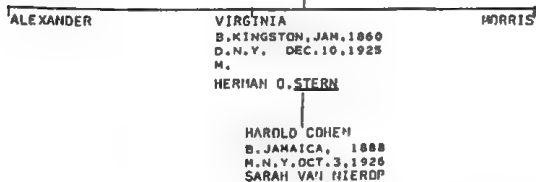

PEIXOTTO III

MORAIJS-JEWS OF PHILA.
MICKVE ISRAEL REC.
SHEARITH ISRAEL REC.
W. V. P. 488

ABRAHAM C. PEIXOTTO (JAM. TO PH. 1823)
B. 1774 (RET'D TO JAMAICA)
D.
M.
RACHEL ?
(-PH. FEB. 16, 1835)

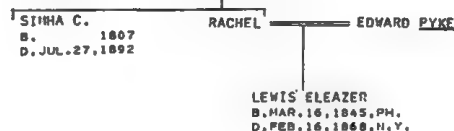

(RODRIGUES) PEREIRA

JOHN F. WYSHULLER
RIJH NOTES, PASSIIM

ABRAHAM RODRIGUES PEREIRA OF AMST.

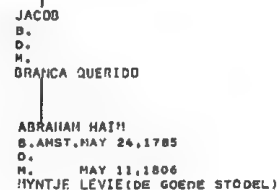

SALOMON (PEREIRA) (IN PROVIDENCE, R. I. BY 1839)
B. NOV. 17, 1809, AMST.
D.
M. MAY 23, 1838, AMST.
NIETJE HALBERSTAD

JUDA
B. MAY 7, 1812, AMST.
D.
M. OCT. 7, 1835
JUDIC MEYER DE HARK.

ARON
B. APR. 20, 1815, AMST.
D.
M. JUL. 10, 1835
RACHEL DE GROOT

SARAH
B. SEP. 1821, AMST.
D. NOV. 7, 1886, PROVIDENCE
M.
BERNARD MILKIAN
(O. V. I)

B CH. B. AMST.

B CH. B. AMST.



PESOA

WILL OF ISAAC PESOA
JACOB R. COHEN REC.
ANDRADE-JEWS OF JAMAICA
FEDERAL ST. CEN.
KRAUS-SANDOR COLL.
PAJHS V. 27, P. 292F.
MORAIJS-JEWS OF PHILA., P. 292F.
ELZAS HS.
MICKVE ISRAEL REC.
SHEARITH ISRAEL REC.
SPRUCE ST. (PH.) CEMETERY

APR. 13, 1796, PH.
ISAAC PESOA
B. FEB. 1762, KINGSTON, JAM.
D. DEC. 3, 1809, PH.

PHILA PHILLIPS
(O. V. I (1))

JACOB
B. 1765
D. OCT. 29, 1823, JAMAICA

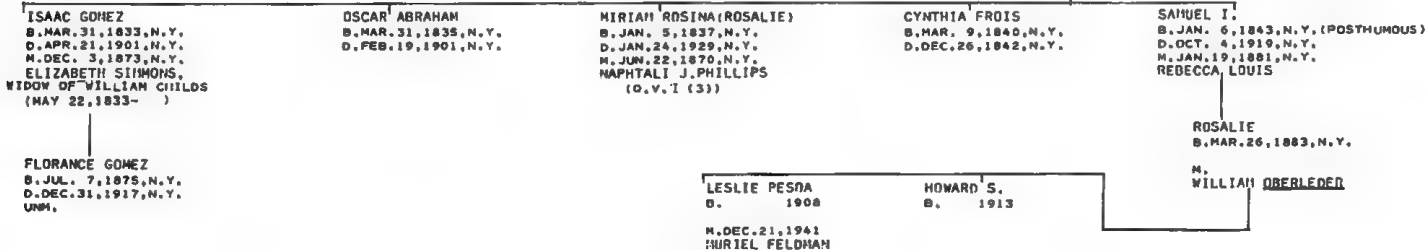
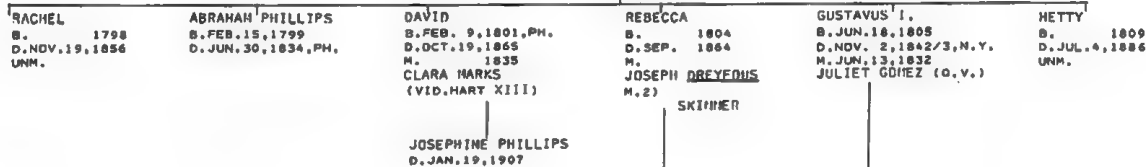

JACOB R. COHEN REC.
MICKVE ISRAEL REC.
P. B. H.
FEDERAL ST. CEMETERY
KRAUS MS.

FLO. ABR.
ST. CHARLES, P. 133F.
ANCKER MS.

(MEMBER OF SOC. OF CINCINNATI) JAMES PETTIGREW*
(LT., REV. WAR) B. 1756, SCOTLAND
D. OCT. 13, 1793, EASTON

MAY 1782

JUDITH HART
(VID. HART XIII)

PETTIGREW

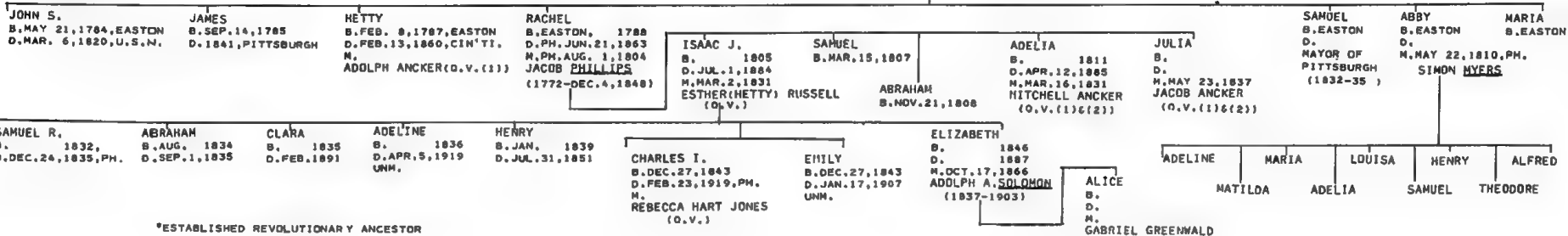

*ESTABLISHED REVOLUTIONARY ANCESTOR

KRAUS-SANDOR COLL.
J. E. V. 10, P. 3
PAJMS V. 2, P. 60F.
V. 27, PP. 165F, 277
MORAISS-JEWS OF PHILA.
ST. CHARLES, P. 86F.
PHILLIPS GEN. (JRM)
MOSES GEN. (AJA)
MICKVE ISRAEL REC.
SHEARITH ISRAEL REC.
DAR LINEAGE BOOKS
POOL-PORTRAITS...
SPRUCE ST. (PH.) CEM. REC.
FLO. ABR.

WILL OF JONAS PHILLIPS
JACOB R. COHEN REC.
BARBER - N.Y. MARRIAGES
ELIAS D. J. C.
U.S. CENSUS, 1850
N.Y. CENSUS, 1855
ROSENSWAIKE
POULSON'S
NGSO, V. 58, P. 134
B'NAI JESHURUN REC.

MOSES, OF FRANKFURT AM MAIN

PHILLIPS I (1) (N.Y.)

NAPHTALI JOSHUA VON STEIN
AARON PHAIBUSH (URI) PHILA

*JONAS PHILLIPS (TO CH., NOV. 1756) FREEMAN, RETAILER N.Y. FEB. 28, 1769
B. 1735, BUSECK, GERMANY (BUR. N.Y.)
D. JAN. 29, 1803, PH. M. NOV. 10, 1762, HICKORY TOWN, PLYMOUTH TOWNSHIP, MONTGOMERY CO., PA.
REBECCA HACHADD (VID. NUMEZ)

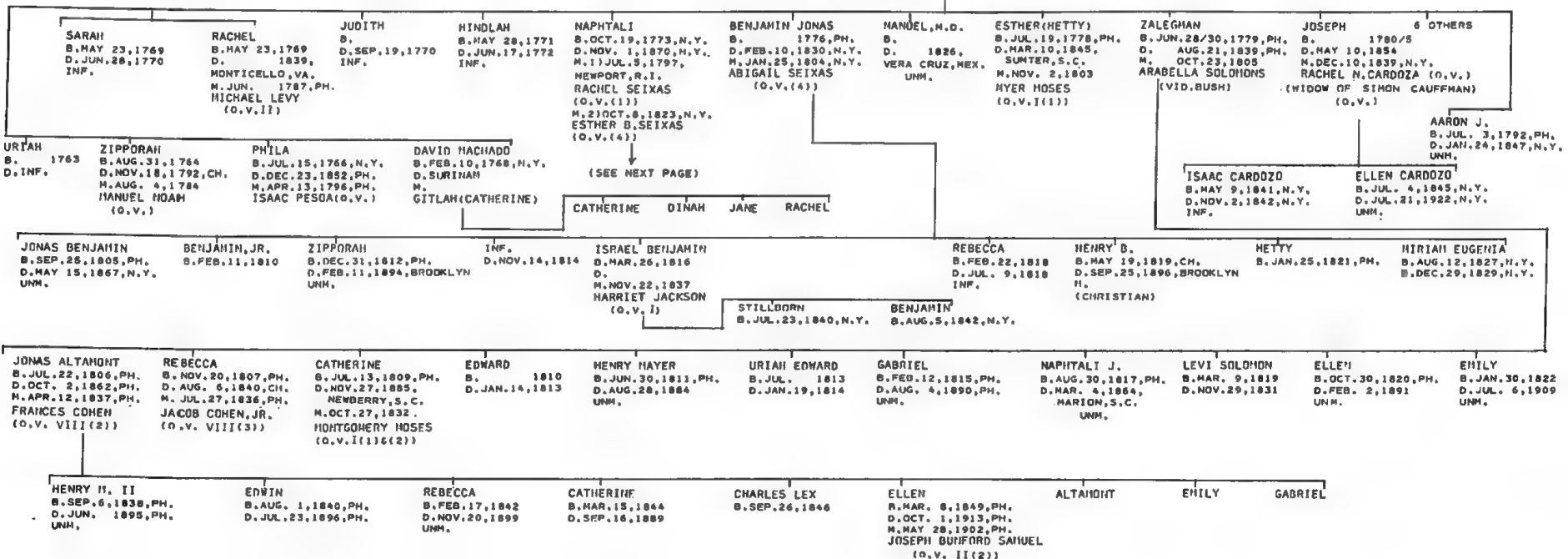

*ESTABLISHED REVOLUTIONARY ANCESTOR

JUL. 5, 1797, NEWPORT

OCT. 8, 1823, N.Y.

RACHEL SEIXAS
(O.V. (1))

HAPHTALI PHILLIPS
B. OCT. 19, 1773, N.Y.
D. NOV. 1, 1870, N.Y.
(SEE PRECEDING P.)

ESTHER B. SEIXAS
(O.V. (4))

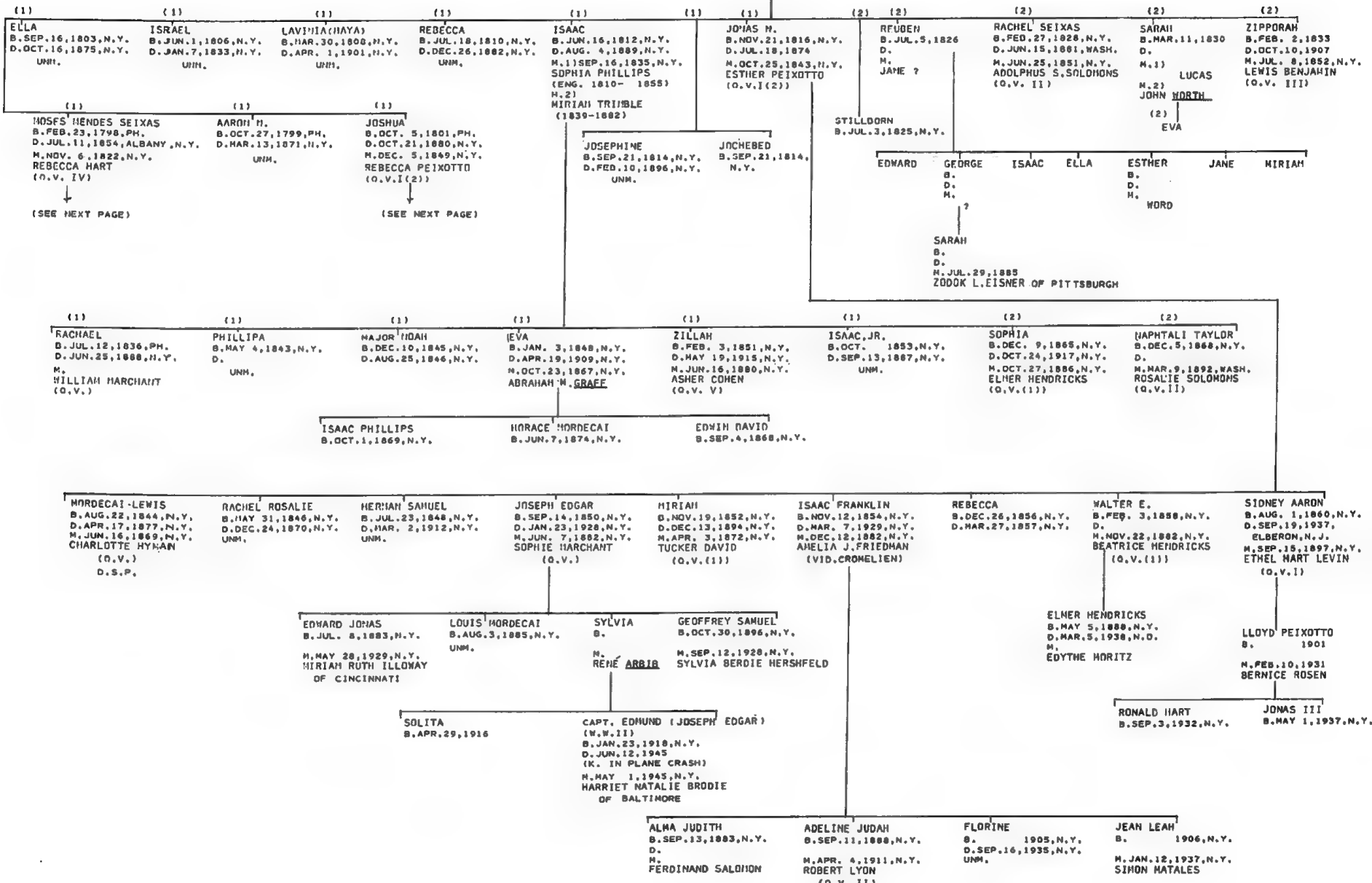

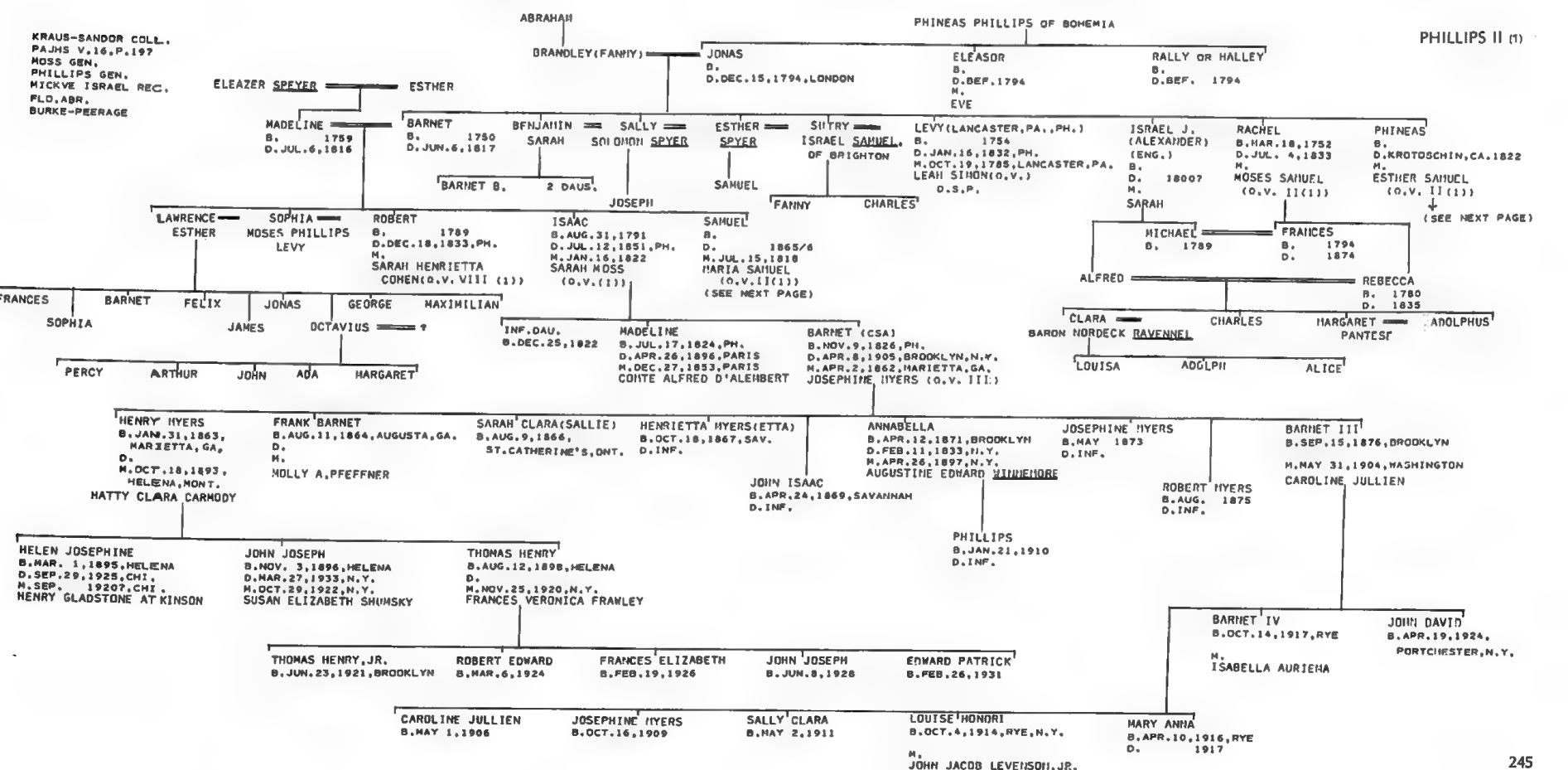
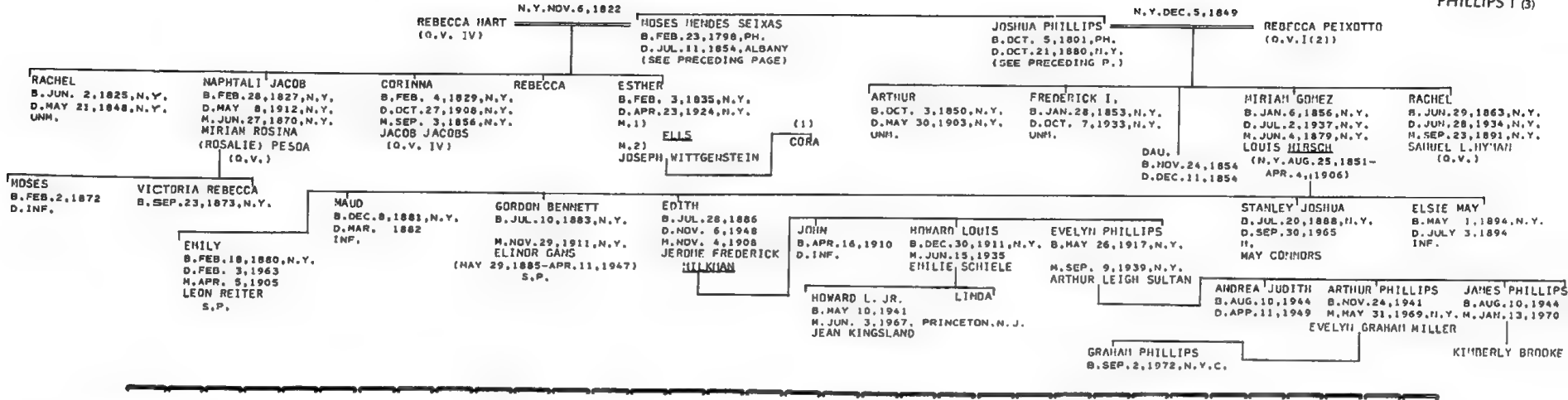

KRAUS-SANDOR COLL.
PAJHS V.12,P.119
SAMUEL-YATES GEN.
ELZAS MS.
ELZAS O.J.C.
HARRISON-BIOS.DICT.OF AMER.
CONGRESSMAN,P.1678

PHILLIPS MS(JRM)
PHILLIPS MS(LC)
JANE L.RAISEIN
SAUL J.RUBIN

CAROLINE LAZARUS (1) CH.FEB.25,1807
(O.V. II)

AARON(PFFIFFER) PHILLIPS (2) CH.NOV.14,1821
B.JAN.28,1780,ANSPACH
D.FEB.17,1834,CH.

ISABELLA LAZARUS (O.V. I)

PHILLIPS III (ALA.)

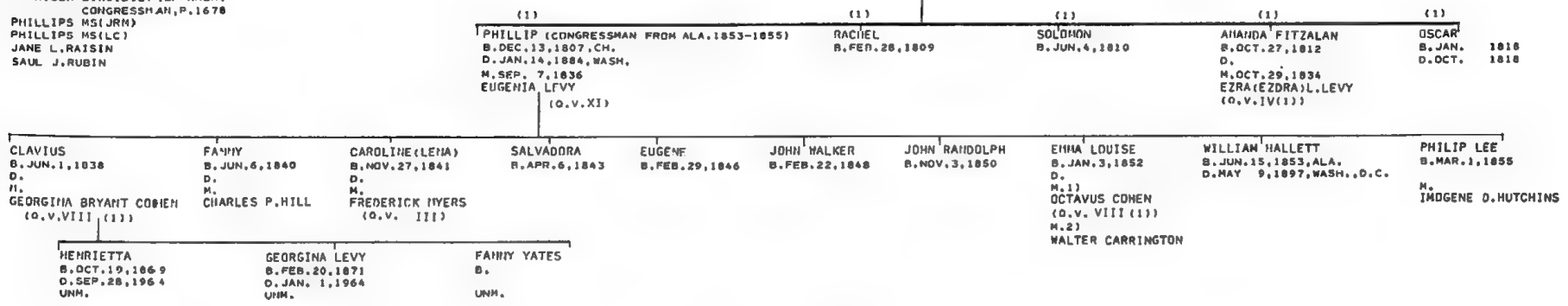

JACOB ISAACKS MS.(DAR)
KRAUS-SANDOR COLL.
PAJHS V.32,P.125
ALEXANDER MS.(JRM)
H.A.ALEXANDER-ALEXANDER
PLO.ABR.

NEWPORT, R.I., AUG.13, 1785

JACOB PHILLIPS (O.V. I)
B.CA. 1750,ENG.
D.CA. 1820,CH.

HANNAH ISAACKS (O.V. I)

PHILLIPS IV

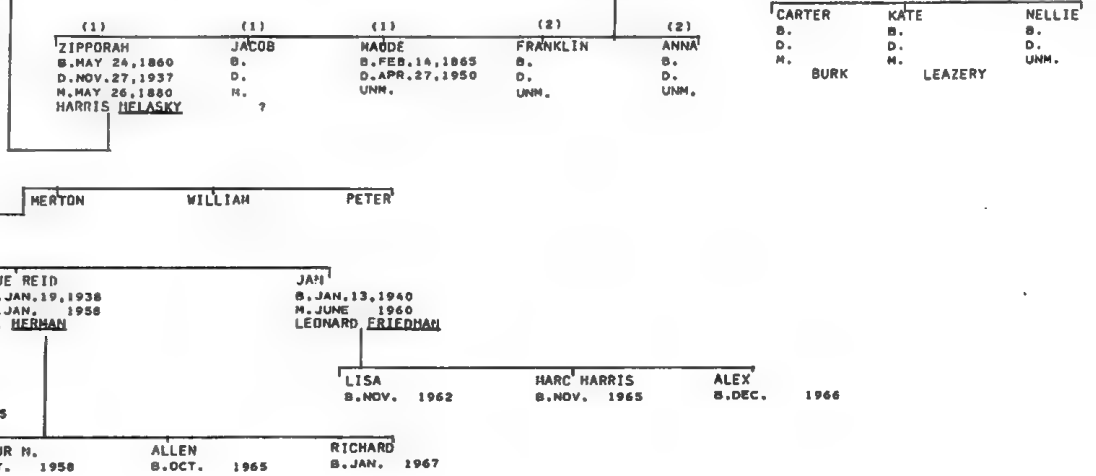
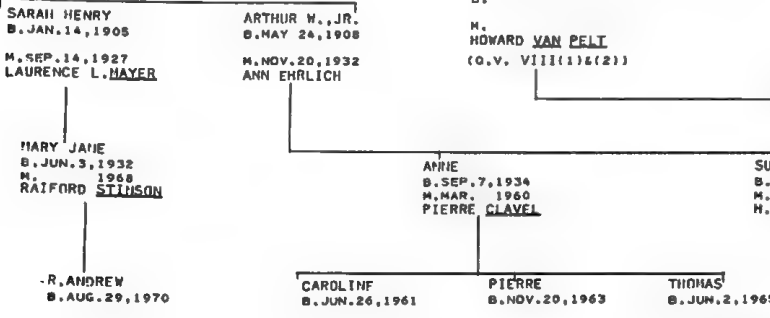
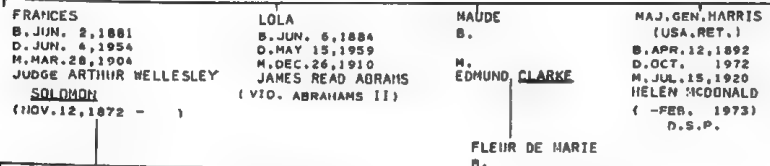
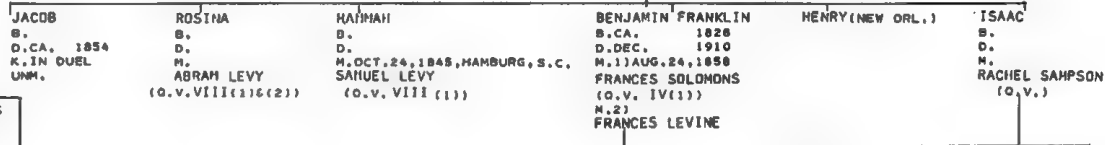

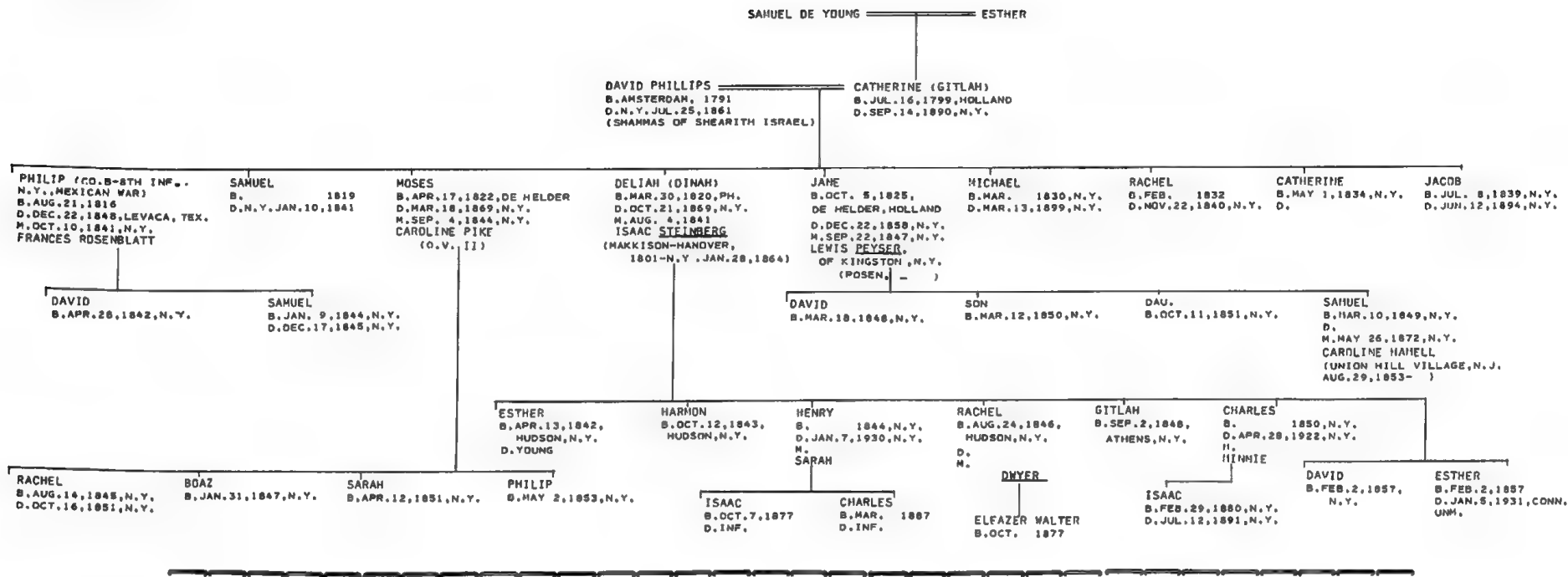

PHILLIPS VII (NEW ORLEANS)
KORN-JEWS OF N.O.

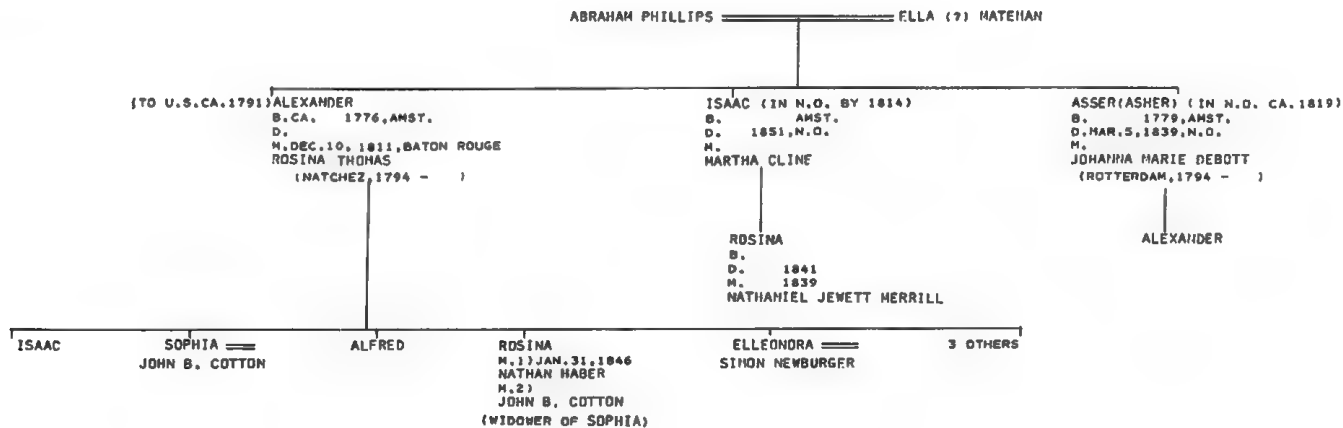

CHARLES WHITEHEAD
 JON STEDMAN
 U.S. CENSUS, 1880
 B'NAI JESHURUN REC.
 DAR LINEAGE BOOKS
 JOHN F. ALEXANDER

(TO U.S. 1833) JACOB DANIEL (JOHN D. PHILLIPS)
 B. 1808, LOND.
 O. FEB. 5, 1880, N.Y.
 M. DEC. 24, 1829, LOND.
 NATHILDA SIMMONDS
 (- JAN. 6, 1878, N.Y.)

HARRY

PRISCILLA
 M. AUG. 4, 1841, N.Y.
 CHARLES COHEN
 (O.V.V)

SON

LEWIS
 B. APR. 26/28, 1831, LOND.
 D. MAY 18, 1905, N.Y.
 H. OCT. 29, 1856, N.Y.
 ELTZA DAVIES
 (O.V.V)

HARY
 B. NOV. 4, 1832
 D. JUN. 30, 1884
 M. MAY 1853
 SIGMUND T. BEYER

SOPHIA
 B. MAR. 8, 1834
 D. JUL. 8, 1903,
 ELBERON, N.J.
 M. JUN. 9, 1853
 SAMUEL ALEXANDER LEWIS
 (O.V.I)

HENRIETTA
 B. JUL. 18, 1835
 D. NOV. 26, 1853, N.Y.
 UNM.

ISAAC
 B. NOV. 10, 1836, N.Y.
 D. MAY 14, 1889
 M. MAR. 21, 1860
 ADELINE COHEN
 (O.V.VI)

MARIA
 B. AUG. 10, 1838
 D. AUG. 26, 1888
 M. JUN. 15, 1859
 DAVID DAVIES
 (O.V.V)

SARAH
 B. FEB. 9, 1840
 D. DEC. 4, 1920
 M. JAN. 1866
 ISAAC KUHN
 OF DES MOINES

RACHEL KATE
 B. OCT. 4, 1842
 D. 1871
 FREDERICK HOELLER

CLARA
 B. MAY 12, 1843
 D. AUG. 15, 1867
 M. JAN. 1866
 ISAAC MEYER

HENRY
 B. AUG. 12, 1844, N.Y.
 D. OCT. 28, 1907, N.Y.
 M. JAN. 1872
 ALICE LEVY
 (O.V.V(1))

ASHER
 B. MAY 11, 1846
 D. 1870
 CLARA COHEN
 (O.V.IX)

ROSALIE = MAURICE SAMUFL COHEN (O.V.V)

RACHEL PHOEBE
 B. 1859
 D. MAY 11, 1867

DAVID L.
 B. JUN. 3, 1861, N.Y.
 D. MAR. 22, 1921, CHI.
 M.
 GERTRUDE KUHN (ABOVE, RIGHT)

MINNIE = W. ANDREWS SOHER (O.V.)

FLORENCE
 B. MAR. 3, 1864
 D. DEC. 16, 1912
 UNM.

HENRY L.
 B. JUN. 6, 1867
 D. JUL. 19, 1939,
 HYANNISPORT, MASS.
 M.
 GERTRUDE ABBOTT
 (AUG. 9, 1881 - MAY 3, 1965)

PHOEBE MARIA
 D. INF.

GERTRUDE
 B. SEP. 23, 1867
 D. JUN. 11, 1914
 M.
 DAVID L. PHILLIPS
 (BELOW, LEFT)

MARIE A.
 B. FEB. 3, 1875
 D. JUL. 1, 1967, N.Y.
 M.
 ALBERT MORRIS STEINERT
 (FEB. 5, 1868 - DEC. 15, 1927)
 (PROVIDENCE, R. I.)

LILLIAN M.
 B. JAN. 18, 1855
 M.
 EDWIN MAYER
 (ADOPTED)

EMMA
 D. 1925/6
 H. 11
 MALEY
 H. 2
 FITZSIMONS

HENRY (HARRY) PHILIP ELISE = HANNAH EDWARD ALBERT ALEXANDER (O.V.I)

MARIE KATHRYN LILLIAN ALICE MARIE
 B. JUL. 21, 1907 B. APR. 4, 1912 B. APR. 4, 1912
 D. AUG. 4, 1926, LAKE PLACID, N.Y. D. MAY 7, 1921, PROVIDENCE, R. I.

(2) ALLEN (2) RENNE MARIE

J. DUDLEY
 B. NOV. 23, 1885
 D. JUN. 10, 1959,
 WHITE PLAINS, N.Y.
 M.
 EDITH JOSEPH

EDNA = STFRN ROBERT W.
 B. OCT. 19, 1889
 D. NOV. 14, 1943,
 WHITE PLAINS, N.Y.
 M.
 SELMA WEIGEL

HELEN = FRANKS G. HARRJORIE = STERN LLOYD J.
 B. 1905
 D. MAR. 14, 1964
 M.
 ETHEL C.

ALLAN GEORGE W. RUTH LLOYD JAMES ANNE

DOROTHY = HARGARET = ELIZABETH
 WOLFF WEYER

ETHILIE
 B. JUN. 22, 1861
 D. M. SEP. 26, 1882, N.Y.
 MELVILLE H. REGENSBURGER
 (MAR. 1, 1850 - MAR. 28, 1926)

HARTWIG I.
 B. FEB. 17, 1863
 D. JAN. 15, 1920
 H. MAR. 21, 1899
 ESTELLE NEWELL

LEWIS
 B. AUG. 24, 1864
 D. AUG. 15, 1940
 UNM.

LEONORA (NONIE)
 B. JAN. 22, 1866, N.Y.
 D. OCT. 24, 1931
 UNM.

HENRIETTA
 B. JUL. 8, 1867, N.Y.
 D. OCT. 26, 1937
 UNM.

SAMUEL MENDEZ
 B. MAR. 9, 1871
 D. JUN. 1, 1900

JACOB CAMPBELL
 B. FEB. 27, 1873
 D. SEP. 23, 1948
 M. JUN. 8, 1909
 ?

BENJAMIN MCCREADY
 B. OCT. 25, 1875
 D. JAN. 19, 1940
 M. MAR. 29, 1905, N.Y.
 MAE BEEBER STIX
 (O.V.(1))

H. ADRIAN
 B. JUN. 27, 1900
 M. JUN. 27, 1922
 ISABEL

J. DONALD
 B. JUN. 29, 1906

ETHEL STIX
 B. AUG. 21, 1906, N.Y.
 M. APR. 25, 1927
 PAUL WHITEHEAD
 (JUL. 18, 1901 -)

CAROL ADALINE
 B. DEC. 25, 1911, N.Y.
 M. APR. 22, 1938
 STEPHEN P. PARKE

HENRY MELVILLE
 B. AUG. 10, 1883

IRVING PHILLIPS
 B. FEB. 10, 1886

JILL PHILLIPS
 B. 1946

BARBARY HARY
 B. 1950

CHARLES P.
 B. 1929
 M.
 MARY LAUB

DONALD
 B. 1956

MICHAEL
 B. 1959

LINDA

PIKE I

SHEARITH ISRAEL REC.
B'NAI JESHURUN REC.
N.Y. CENSUS, 1855

SOLOMON LEVY

MOSES PIKE

B.
D.
M.

?

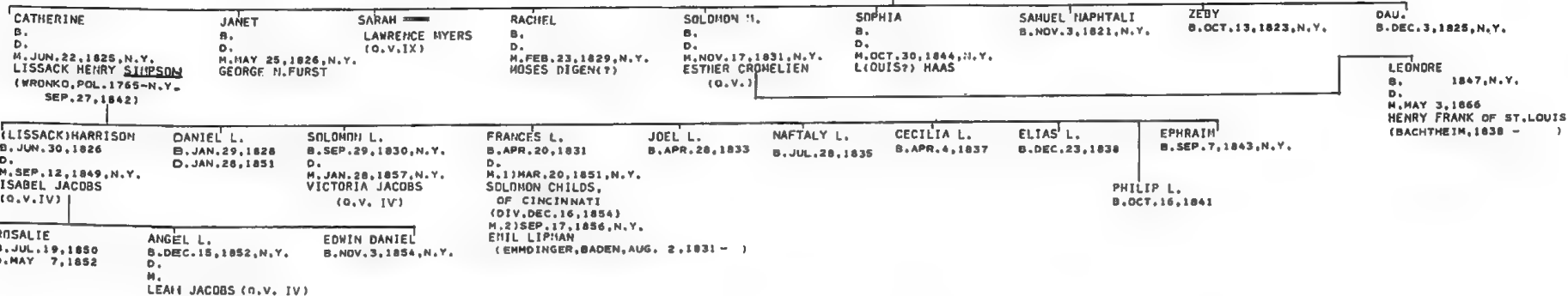

PIKE II

SHEARITH ISRAEL REC.

BOAZ PIKE RACHEL

B. D. BEF. 1844

DAVID

B.
D.
M.

EMANUEL

B. AUG. 21, 1820, AMST. D. DEC. 15, 1874, N.Y. M. JANE LYONS (O.V. III)

CARDLINE

B.
D.
M.

MOSES PHILLIPS (O.V. V)

BENJAHIN NACHMAN N.Y. 18 FEB. 1877 IDA

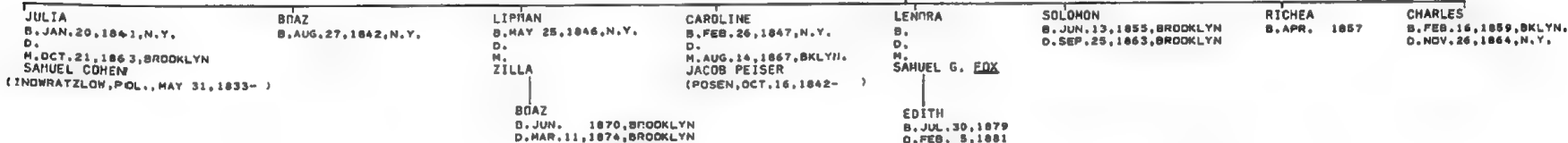

PINHEIRO

KRAUS-SANDOR COLL. PAJMS V. 23, P. 157 POOL- PORTRAITS HERSHKOWITZ-WILLS E. N. A. SWILSTONE

ABRAHAM PINHEIRO

OF AMST.

(MADE FREEMAN, N.Y., FEB. 2, 1695)

ISAAC

B. D. FEB. 17, 1710, N.Y. M. ESTHER (ELIZABETH) PINHEIRO

SARA HANA

B. D. SEP. 10, 1730, CUR. M. ISHAK HENDES GAMA (-JAN. 9, 1721, CUR.)

RACHEL (AMST.)

IN NEVIS 1708



(IN STAMFORD, CONN. BY 1725,
FREEMAN, N.Y., JUN. 21, 1743)

JUDAH HAYS REC.
N.Y. WEEKLY MUSEUM
KRAUS-SANDOR COLL.
PAJHS V. 2, P. 49
PAJHS V. 13, P. 113F.
PAJHS V. 38, P. 92F.
N.Y. DEATHS
ELZAS MS.
POOL-PORTRAITS...
EVANS-HIST. OF ROSS CO., OHIO
ORCUTT'S HIST. OF STRATFORD, CONN.
STRATFORD VITAL REC.
AMER. JEW. ARCHIVES, V. 1, NO. 2, P. 27F.
DAR LINEAGE BOOKS
BAILEY-EARLY CONN. MARRIAGES
PINTO FAMILY PAPERS

ABRAHAM PINTO
B. CA. 1697
D. CA. MAR. 1797

SARAH
B. DEC. 7, 1698
D. MAR. 8, 1785

ISAAC
B. JUN. 12, 1720
D. JAN. 17, 1791

RACHEL
B. APR. 3, 1722
D. OCT. 30, 1815
UMH.

JACOB
B. JAN. 26, 1724
D. 1806
M. 1) 1755
THANKFUL PECK,
OF NEW HAVEN
M. 2) ABIGAIL PECK
(SISTER OF THANKFUL)
(1748-1798)

JOSEPH
B. D. MAY 5, 1798, N.Y.
D. NOV. 6, 1765
JOCHABED (JOSY) HAYS
(D. V. (1))
SON

SOLOMON
B. FEB. 23, 1725/6
D. M. OCT. 4, 1762
ANNA GREEN

SAMUEL
B. MAR. 2, 1727/8
D. DEC. 7, 1764

HIRSH
B. JUN. 8, 1730
D. JUL. 1, 1781
M. MAY 31, 1759
SAMUEL MYERS
(D. V. VIII)

(1) ABRAHAM (REV. W.)
B. MAR. 8, 1757
D. DEC. 30, 1779
MARY GAULT,
OF BOSTON

(1) SOLOMON (REV. W.)
B. DEC. 29, 1758
D. MAR. 28, 1854
M. CLARISSA S.
(1788-1844)

(1) WILLIAM (REV. W.)
B. DEC. 16, 1760
D. N. D. 1847
M. 1) FANNY HAMILTON
M. 2) URANIA CLARK
M. 3) OCT. 3, 1816, N.Y.
LAURETTA PACKARD
(1796-1839)

(2) THANKFUL
B. DEC. 22, 1769

(2) SAMUEL
B. AUG. 18, 1771

(2) ISAAC (TO CHILLICOTHE, O.)
DEC. 1817
B. DEC. 21, 1777
D. JAN. 1, 1858, CHILLICOTHE
M. 1806, NEW HAVEN
MARIA HARSHALL (1789-1864)

(2) SARAH
B. FEB. 3, 1780

(3) CAROLINE
B. CONN. 1819
D. M. HARVEY HUBBELL

(3) AUGUSTA LAURETTA
B. D. M. JOHN LAURETTER

FRANCIS E.
B. D. M. ?

WILLIAM

DAU. HENRY M. (CHILLICOTHE)
B. JUN. 5, 1807, NEW HAVEN
D. DEC. 26, 1891, CHILLICOTHE
M. APR. 21, 1837, CHARLESTON, S.C.
ELIZABETH HUTCHISON
(MAY 26, 1817-DEC. 26, 1893)
(SEE BELOW)

JACOB ABRAHAM (PHILA.)
B. D. M. ELIZABETH KEEPERS (?)
(SEE BELOW)

SAMUEL (YELLOWBIRD, ARK.)
B. D. M. ELIZABETH RICHHART
(SEE BELOW)

MILES AUGUSTUS (ROSS CO., O.)
B. MAR. 6, 1832
D. 1905
M. MARGARET READE

ERNEST N. LUNA E.
DOLLIE M.

HORACE H. WARREN L.

LAWRENCE G.
B. MAY 25, 1865
D. M. 1902
M. IRENE I. HORREIS

ELSTIE M.

MINNIE E.

DR. ALVAH SHERMAN (OMAHA)
B. M. LABEL STERLING

ROWLAND O. SHERMAN

PINTO (SEE ABOVE)

PINTO (2)

HENRY MARSHALL
B. JUN. 5, 1807, NEW HAVEN
D. DEC. 26, 1891, CHILLICOTHE, O.
M. APR. 21, 1837, CHARLESTON, S.C.
ELIZABETH HUTCHISON
(MAY 26, 1817-DEC. 26, 1893)

JACOB ABRAHAM
B. D. M. ELIZABETH KEEPERS (?)

SAMUEL
B. D. M. ELIZABETH RICHHART

MARGARET S.
B. JAN. 13, 1838
D. OCT. 22, 1895
M. DEC. 28, 1859
M. J. GARCELAN

MARY M.
B. APR. 7, 1841
D. NOV. 4, 1881
M. NOV. 14, 1865
HUGH K.S. ROBINSON

MARIA LOUISE
B. JUN. 11, 1843
D. SEP. 15, 1878
M. NOV. 22, 1865
CHARLES H. SHULTZ

EMMA JANE
B. MAY 20, 1845
D. JUL. 4, 1876
M. SEP. 4, 1865
SAMUEL A. DENNING
(1841-1895)

CAROLINE RIPLEY
B. SEP. 20, 1847
D. NOV. 15, 1874
M. FEB. 23, 1871
A. MELVILLE BARD

HARRY HUTCHISON
B. FEB. 14, 1850
D. APR. 25, 1882
KATE PEEBLES SANKEY

ELIZA ELLEN
B. OCT. 2, 1851
D. SEP. 1852

LILLIAN
B. OCT. 21, 1853
D. M. APR. 19, 1881
JOHN S. ANDREWS

FLORA A.
B. FEB. 10, 1855

ROSE A.
B. MAY 28, 1857
D. M. FRANK A. EWING

ROBERT
B. MAY 28, 1857
D. AUG. 17, 1857

CARRIE PINTO
B. JAN. 21, 1869
D. MAY 3, 1929
M. FEB. 18, 1890
WALTER SPRAGUE STORY
(JUL. 23, 1868-)

AUSTIN PUTNAM
B. DEC. 19, 1890

ANNE
B. MAY 15, 1906
M. SEP. 3, 1931
HAROLD BRIEL

WILLIAM WALLACE
B. JUN. 17, 1897-

WILLIAM PHILIP
B. FEB. 2, 1941

MARIA
B. D. M. WOODRUFF

LAURA
B. D. M. RUSSELL

WILLIAM (CHICAGO)

ARTHUR (OMAHA)

FRANCES

CAD

SAMUEL, JR.
B. D. M. CHARLES WISEMAN

CHARLES

JACOB

WILLIAM

CLARENCE

BERTHA

IDA
B. D. M. JOHN FEINTON

POLOCK I

NEHGR V.62663
 MARCUS-STUDIES
 SHEFTALL MS.
 S.C.MARRIAGE CONVEYANCES
 GA.NEWSPAPERS
 ROSENWAIKE
 SHEARITH ISRAEL REC.
 KRAUS-SANDOR COLL.
 PAJHS V.27,P.348F.
 V.44,P.62

ARNOLD-VITAL REC.OF R.I.
 GUTSTEIN-JEWS OF NEWPORT
 ELZAS-JEWISH CEM,AT GEORGETOWN
 H.A.ALEXANDER-THE ALEXANDER FAMILY

(IN N.Y. BY 1720)

RABBI HYER

ISAAC POLOCK
 B.AUG.16,1790
 D.MAY 19,1764
 M.
 FANNY ISAACKS (O.V.I)
 (CA.1674-MAR.4,1764,NEWPORT)

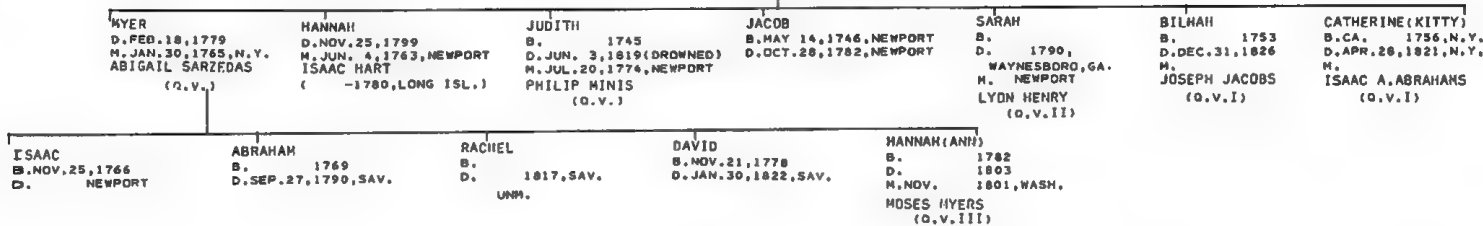

POLOCK II

KRAUS-SANDOR COLL.
 PAJHS V.17,P.217
 V.31,P.159
 MORAIS-JEWS OF PHILA.
 MICKVE ISRAEL REC.
 EDWIN WOLF II
 FLD.ABR.
 ISABELLA SACKEY
 MYER SOLIS-COHEN
 JACOB R.COHEN REC.
 ROSENWAIKE

POLOCK

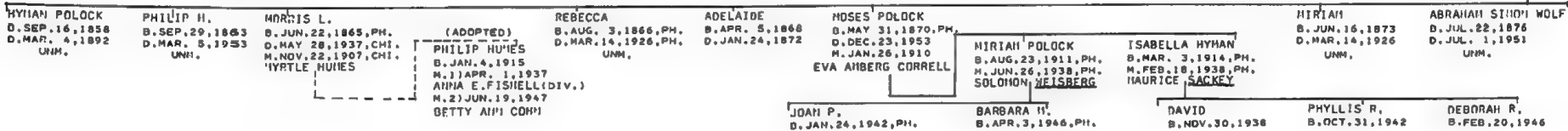
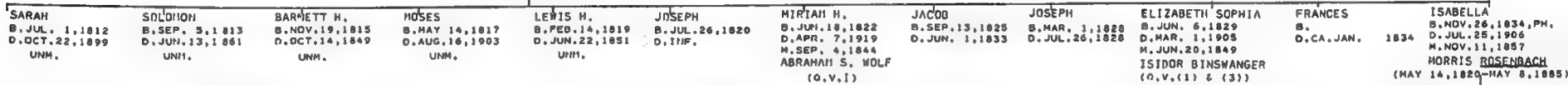
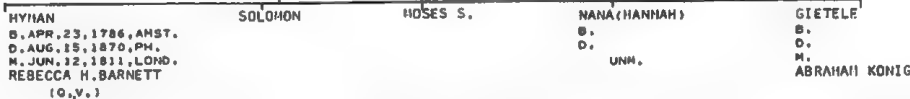
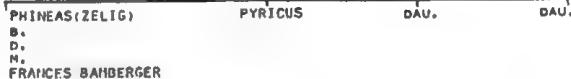

POZNANSKI

WILL OF ESTHER POZNANSKI
 KRAUS-SANDOR COLL.
 ELZAS MS.
 UJE V.8,P.612
 SHEARITH ISRAEL REC.
 AJHG V.LIV,P.431

JOSEPH POZNANSKI
 B.
 D.

SARAH
 B.
 D. JUN. 3, 1836, POLAND

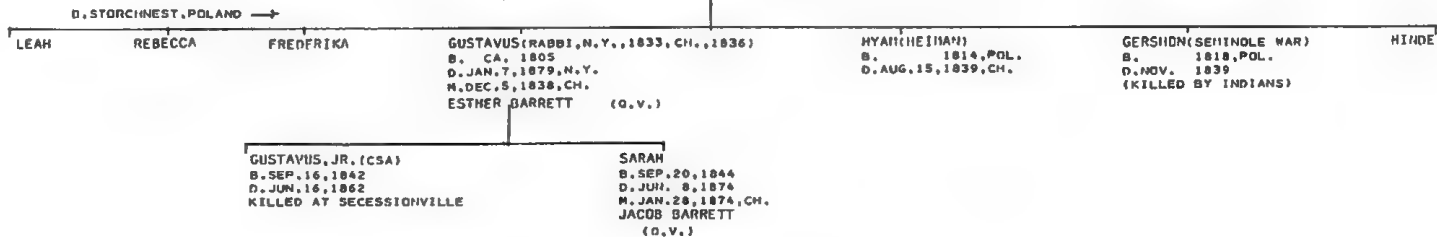

FLO. ARR.
HARRIET STRYKER-RODDA
SANFORD A. MOSS

ABRAHAM PREIZ
OF HAINZ, GER.

PRICE

EDWARD ALFRED PRICE
B. FEB. 16, 1840, HAINZ
D. NOV. 22, 1906, N.Y.
M. OCT. 24, 1867
BERTHA JACOBS
(VID. MOSS (2))

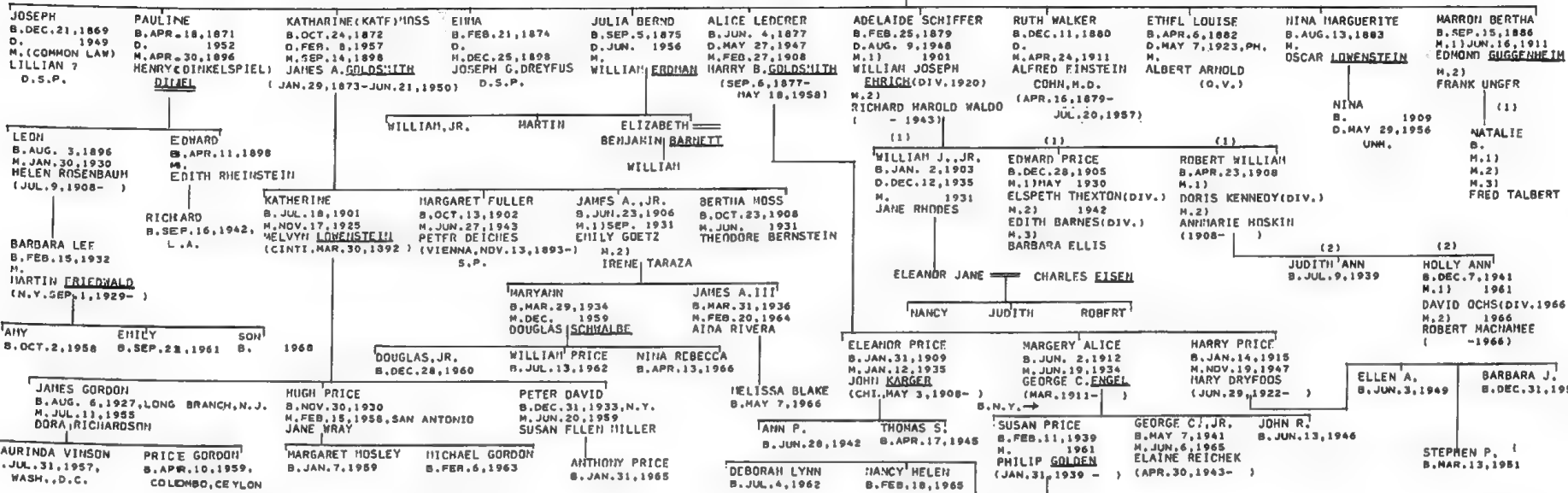

MORRIS RITTERBAND HANNAH LEON MANESS RITTERBAND OCT. 28, 1835, N.Y. B. 1809, POLAND D. SEP. 28, 1860, N.Y. BENVENEDA SOLIS (O.V. (2)) RITTERBAND

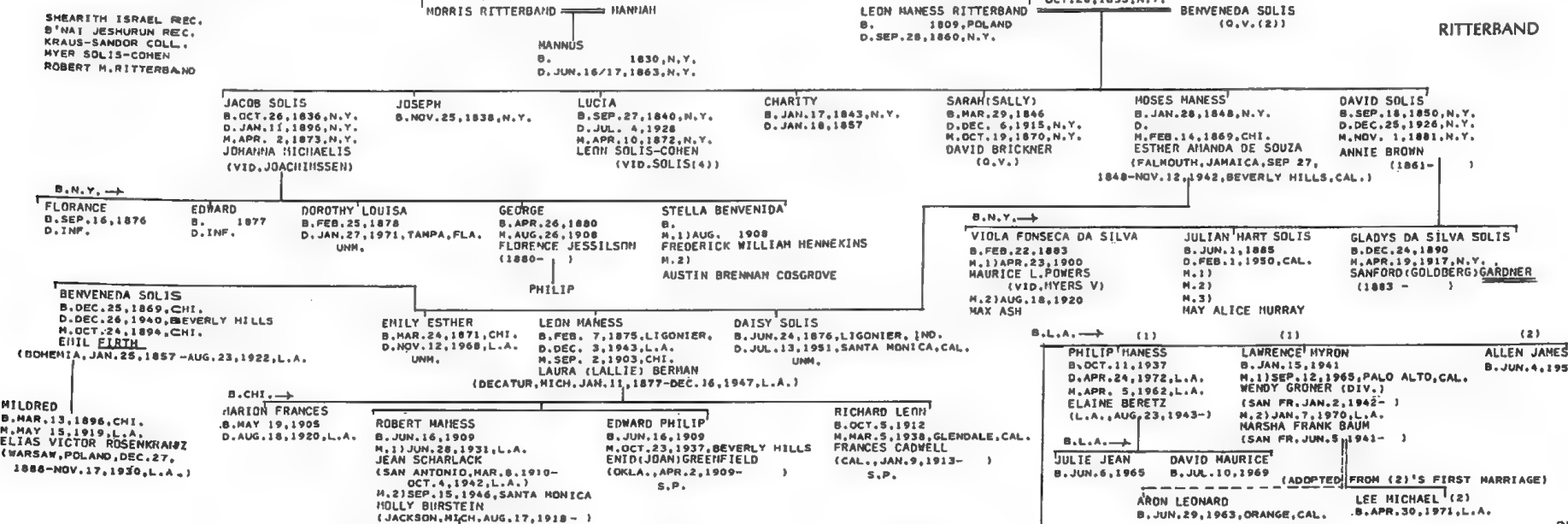

ANCKER MS.
KRAUS-SANDOR COLL.
ST. CHARLES, FIG. 21
RALPH E. BECKER
EZEKIEL-LICHTENSTEIN
I. ROSENHEIM GEN.

(TO U.S. 1836, NAT. APR. 10, 1844)

ISAAC ROSENHEIM
THERESA STRAUSS

HEINRICH (HENRY) ROSENHAM
B. OCT. 29, 1816
D.
M. OCT. 14, 1841
SARAH ANCKER
(O.V. (1))

(TO U.S., SEP. 1836)

ESTELLA DAVID JOHNSON
ISABEL HERMAN MYERS
ADELLA D. OCT. 30, 1847
INF.
CHARLES D. UNM.
JULIA WILLIAM KIEFER
LOUIS KATE-JOHNS RALSTON
JAMES D. UNM.
JULIUS D. YOUNG
FANNIE
3 D. YOUNG

SADIE
B. CINTI.
D.
M.
J. A. BURGETT

AMELIA
M. CA.
1862, RX.
ISAAC MEINHARD OF SAV.

HENRY (PARKERSBURG, W. VA.)
CARRIE GUGGENHEIMER
(O.)

JOSEPH M.
B. 1841
D. 1929
M.
AMELIA STERNBERGER
(1851-1912)

DAVID

REBECCA

HENRIETTA (YETTA)

LAZARUS
B. 1853
D. MAR. 29, 1854
INF.

SOPHIE
M. MAY 25, 1880, N.Y.
HENRY C. NATHAN

PHILIP
TILLIE STERNBERGER

ALICE
GUSTAVE MILLER

LUCILLE
WILLIAM WATERS

ANN
RALPH E. BECKER
OF WASH., D.C.

DE WITT
FLORETTE
B. 1877
M. 1)

ERNST ROSENFELD
(-CA. 1936)
M. 2)
ARTHUR STEIN

MIRIAM
B. 1870
D. 1872

BERTHA S.
B. 1872
D. 1939
M.
SYDNEY ROSENBAUM
(VID. MYERS X)

DAVID J.
B. 1873
D. 1958
M.
BERT KAYTON
(1874-1967)

LEE ROY
B. 1877
D. 1884

TESS R.
B. 1878
D. 1878
M.
HERBERT KAYTON
(1877-1969)

HERMAN
B. 1880
D. 1961
M.
ROSALIND RICH
(1880-1961)

ALBERT READE
B. 1889
D. 1966
M.
FRANCES LAPAT
(1886-)

NAME CHANGED TO KAYTON

ALLAN D.
B. 1900

ROBERT
B. 1904
M.
ELIZABETH KANN
(1905-)

JOHN H.
B. 1906
M.
SUZANNE JACOBS
(1909-)

RUTH
B. 1904
D. 1971
M.
ALLEN KAUFFMANN
(1893-1971)

MARGARET
B. 1909
M.
KURT APPEL
(1909-1973)

RICHARD H. RICH
B. 1901
M.
VIRGINIA LAZARUS
(1908-1957)

KATHERINE
B. 1906
M.
CHARLES RIESER
(1904-)

BETTY
B. 1920
M.
WILLIAM WAHLERT
(1911-) (DIV.)

JEAN A.
B. 1929
M.
EDWARD SONDER
(1928-)

DONALD J.
B. 1931
M.
MAJORIE KLEMPNER
(1935-)

BARBARA L.
B. 1935
M.
ROBERT TANDESKY

JOHN
B. 1931
M.
JANE SHAPIRO
(1941-)

JUDITH
B. 1944
M.
EUGENE KELLY
(1944-)

JOHN C.
B. 1937
M.
HELEN BRODY
(1939-)

ROSALIND R.
B. 1939
M.
RICHARD NEEDLE
(1937-)

DEBORAH
B. 1959

ANDREW
B. 1961

MARK
B. 1967

KAREN
B. 1966

DONNA
B. 1964

DAVE
B. 1969

ROBYN R.
B. 1963

DAVID J.
B. 1967

KAREN A.
B. 1956

LESLIE
B. 1959

JOAN
B. 1963

MARTAN
B. 1965

SUSAN
B. 1966

ELIZABETH
B. 1973

ROBYN R.
B. 1963

DAVID J.
B. 1967

DELIA
B. APR. 15, 1865

CHARLES
IDA SCHONBERG

CAESAR
MAY HOWARD

DAVID

LEON

NATHANIEL
ELLA
HENRY

ALBERT ROSS
M. 1)
ELSIE STEINER
M. 2)
MILDRED OETTINGER

(1)
RICHARD A.
B. 1952

(1)
JUDITH E.
B. 1955

(1)
ELIZABETH G.
B. 1956

VIRGINIA M.
B. 1962

RICHARD II
B. 1963

KATHERINE S.
B. 1965

MICHAEL P., JR.
B. 1967

ARLENE
SOL SACHS

ROBERT
MADELYN KATZKY

JOHN ROBERT

SYLVAN, M.D.
CLARA NEW

HENRIETTA
JACOB LEIBSON

MINNA
VICTOR JELENKO

NANETTE
JACOB LEIBSON (sic!)

RUSSELL

JOHN M. SHEFTALL
EZEKIEL-LICHTENSTEIN, P. 33
MORAIS-JEWS OF PH.
MICKVE ISRAEL REC.
DAR LINEAGE BOOKS
WILL OF P. M. RUSSELL (JRM)
FLD. ABR.
ELZAS M. N., P. 9
SHEFTALL MS.
SPRUCE ST. CEN. REC.

SHEARITH ISRAEL REC.
CHATHAM CO. MARR. REC.
ELSIE N. FRANKLIN
ROSENWAIKE
CHATHAM CO. MARR. ABSTRACTS
P. B. N.
B'NAI JESHURUN REC.
RUSSELL FAMILY BIBLE

(MOSES) ROESSEL OF OBERFELT, GER.

* PHILIP MOSES RUSSELL
B. JUL. 1747, PORTSMOUTH, ENG.
D. AUG. 11, 1830, GERMANTOWN, PA.
M. NOV. 1, 1780, PH.
ESTHER MORDECAI
(O. V. III)

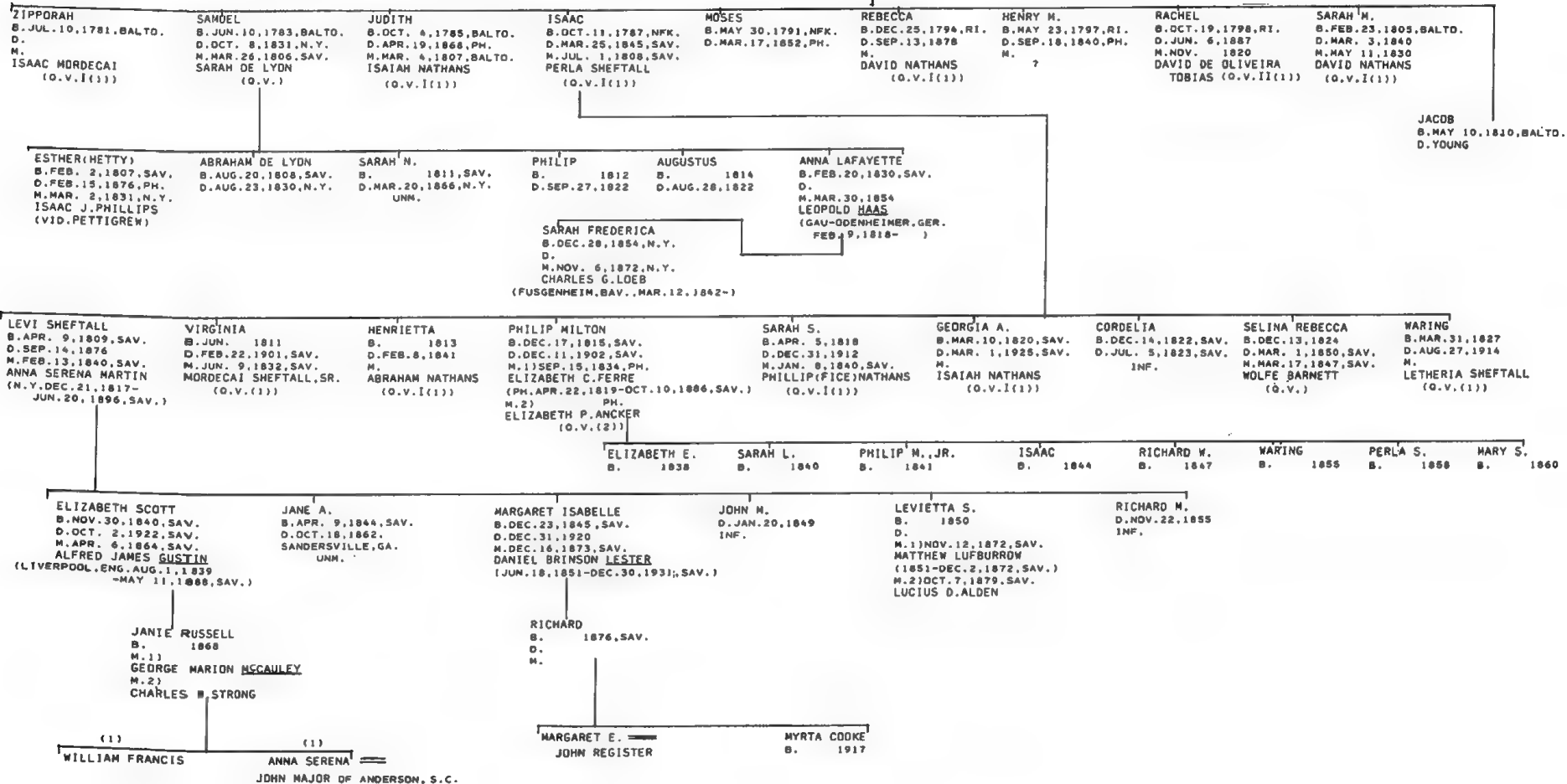

*ESTABLISHED REVOLUTIONARY ANCESTOR

KRAUS-SANDDR COLL.
JE V.9.P.671F.
PAJMS PASSIN
RUSSELL-HAYM SALOMON...
SALOMON FAM. REC. (A.JHS)
MURIEL SCHEFFER CARTER

POOL-PORTRAITS...
SHEARITH ISRAEL REC.
FERDINAND L.SDLOMON
JON STEDMAN

*HAYM SALOMON
B. LISSA, POLAND, 1740
D. PH. JAN. 6, 1785

RACHEL FRANKS
(O.V. I)

SALOMON (1)

EZEKIEL
B. JUL. 20, 1778, N.Y.
D. SEP. 27, 1821, N.D.
UNM.

SALLIE
B. OCT. 17, 1779, PH.
D. JUL. 29, 1845, N.Y.
M. AUG. 9, 1794, N.Y.
JOSEPH ANDREWS (O.V.)

DEBORAH
B. JAN. 12, 1783
D. SEP. 13, 1808, N.Y.
M. AUG. 14, 1804, N.Y.
SIMON MYERS-COHEN (O.V. I)

HAYM MOSES
B. APR. 23, 1785, N.Y.
D. FEB. 15, 1858, N.Y.
M. 1809
ELLA HART (O.V. IV)

DEBORAH (DELIA)
B. NOV. 29, 1809, N.Y.
D. FEB. 11, 1895, N.Y.
M. JUL. 15, 1840, N.Y.
AS HIS 2ND WIFE
DR. THOMAS WASHINGTON
DONOVAN (VID. JACKSON III)
(1812/3 - CA. 1889)

HAYM MOSES, JR.
B. MAY 31, 1812, N.Y.
D. OCT. 20, 1856, N.Y.
UNM.

SARAH LOUISA
B. NOV. 1, 1813, N.Y.
D. MAR. 14, 1879, N.Y.
M. JUN. 13, 1832, N.Y.
JOHN DANIEL JACKSON
(O.V. I)

EZEKIEL (EDWIN)
B. NOV. 26, 1815, N.Y.
D. OCT. 16, 1893, N.Y.
M.
ADELINE (LATER ADELAIDE)
CECILIA BEZEAU (PH. 1818-
N.Y. OCT. 25, 1866)

JOSEPH
B. JUL. 6, 1818, N.Y.
D. FEB. 23, 1821, N.Y.
M.
ALEXANDER DE C.
B. CA. 1849, N.D.
D. MAY 9, 1892, N.D.

DAVID
B. MAY 17, 1820, N.Y.
D. MAY 21, 1875, N.Y.
M. 1 NOV. 5, 1849, N.Y.
ROSALIE ALICE LEVY
(O.V. I)

RACHEL FRANKS
B. JAN. 13, 1823, N.Y.
D. SEP. 14, 1865
LAKE MADCAP, N.Y.
M. JUN. 14, 1848, N.Y.
MORTIZ (MORRIS) LEO
WOLF, M.D. (O.V. I)

JACOB
B. FEB. 1, 1825, N.Y.
D. OCT. 5, 1843, MOBILE, ALA.
UNM.

BENJAMIN FRANKLIN
B. SEP. 1, 1829, N.Y.
D. APR. 12, 1865, N.Y.
UNM.
SAMUEL NAPOLEON
B. SEP. 1, 1829, N.Y.
D.
M.
E. McDowell D.S.P.

AUGUSTA CAMILLA
B. 1837/5, N.Y.
D. OCT. 31, 1872, N.D.
M. SEP. 8, 1851, N.D.
ROBERT MILLS LUSHER
(CH. MAY 17, 1823 -
N.O. NOV. 22, 1890)
(SEE NEXT PAGE)

DELIA CECILIA
B. NOV. 28, 1836, MOBILE
D. NOV. 30, 1865, N.D.
M. JAN. 14, 1856, N.D.
OTTO HENRY KARSTENDIEK
(VEGESACK, BREMEN, APR. 21,
1823 - N.O. APR. 21, 1883)

LEWIS JOSEPH
B. SEP. 24, 1838, MOB.
D. MAY 4, 1925, FAR ROCKAWAY, L.I.
M. JAN. 23, 1880, N.Y.
THERESA FRIEDMAN
(VID. CROMELIAN)
(WIDOW OF ANTHONY
KING) (O.V.)

FERDINAND L.
B. 1888
SOPHIE HEILBRON
ALEXANDER, JR.
B. JUL. 23, 1882, N.Y.
D. AUG. 30, 1886, N.Y.

MATILDA ?
ALEXANDER, JR.
B. JUL. 23, 1882, N.Y.
D. AUG. 30, 1886, N.Y.

(1)
ALMERIA DE LEON
B. JUL. 12, 1851,
MOLLYWOOD, ALA.
D. JUL. 13, 1879, N.Y.
M. NOV. 22, 1870, N.Y.
ALBERT HENDRICKS
(O.V. I)

(1)
WILLIAM JONES
B. OCT. 9, 1852,
MOBILE, ALA.
D. DEC. 14, 1919, N.Y.
M.
HELEN FORBES LEWIS
(O.V. I)

(1)
ELLA
B. NOV. 24, 1853
D. JUL. 31, 1920
M. FEB. 2, 1882,
N.Y.
BUNFORD SAMUEL
(O.V. I) (2)

(1)
LOUISA
B. AUG. 7, 1857, PH.
D. MAR. 26, 1934, N.Y.
M. MAR. 14, 1876, N.Y.
CHARLES HENDRICKS
(O.V. I)

(2)
SIDNEY HENDRICKS
B. APR. 21, 1867, N.Y.
D.
M. 1
ESTELLE CAMPBELL
M. 2
MARIAN GIROUX POST

HENRY SALOMON
B. NOV. 6, 1856, N.O.
D. MAR. 5, 1909, N.O.
M. JAN. 20, 1886, N.O.
MARY M. SCHOMMER
(APR. 26, 1859 -
N.D. MAR. 23, 1937)

ADELAIDE ANNA
B. JAN. 8, 1856, N.O.
D. DEC. 14, 1939, N.O.
M. APR. 18, 1877, N.O.
JAMES JACKSON SCHMIDT
(VID. 2, 1852 - NOV. 24, 1920)

OTTO HAYM
B. DEC. 5, 1860, N.O.
D. JUN. 20, 1928, CINTI.
M. OCT. 1, 1884, CARLSLE, O.
MARY ELIZABETH CRAIG
(OCT. 17, 1864 - NOV. 13, 1943)

DELIA HELEN
B. MAY 11, 1862, N.O.
D. JUN. 21, 1917, GALV., TEX.
M. JUN. 14, 1884, N.O.
AUGUST EDWARD SCHEFFER
(N.O. NOV. 30, 1860 - HOUSTON,
FEB. 1, 1940)

LEWIS HUNTEMAN (HENRY)
B. JUL. 1, 1864, N.O.
D. OCT. 24, 1937, N.O.
M.
GEORGIANA MAGDALENE HOFFMAN
(OCT. 3, 1876 - N.O. DEC. 9, 1933)

(ADOPTED)
OTTO JAMES
B. APR. 7, 1885, N.O.
D. MAY 22, 1885, N.O.

MURIEL ADELAIDE
B. JUN. 12, 1886, N.O.
M. JUL. 1, 1920, ARDMORE, OKLA.
CLAIR FRED CARTER
(CANTON, KAN. JUL. 18, 1803 -)

LEWIS GEORGE
B.
M. 1 JAN. 1929
JANET THALL
M. 2
SUSANNAH DUNCAN
SAW OF ENGLAND

HERBERT
B.
M. OCT. 7, 1916
EDNA HELLER

ARTHUR K.
B. MAY 3, 1877
HORACE J. LANDAY

DAU.
HORACE, JR.

HARRY SCHOMMER
B. NOV. 15, 1886
D. NOV. 24, 1944
M. APR. 27, 1920
IRENE TRONDALE
(APR. 11, 1889 -)

EDWARD F.
B. APR. 10, 1888
M. SEP. 11, 1936
FRIEDA DORFER
WIDOW OF C. H.
THEBAULT, JR.
S.P.

MARIAN DELIA
B. NOV. 30, 1891
D. AUG. 8, 1913
UNM.

PEARL CELIA
B. OCT. 21, 1895
UNM.
VIOLET C.
B. OCT. 12, 1893
D. DEC. 8, 1894

LAWRENCE EDWARD
B. JUN. 2, 1885, N.O.
D. HOUSTON, 1886

CLAIR FRED CARTER
(CANTON, KAN. JUL. 18, 1803 -)

DAU.
STILLBORN
MAR. 14, 1922

CLAIRE FREDA
B. MAR. 15, 1923, GALVESTON
M. JAN. 10, 1942, GALVESTON
JAMES WILLIAM CARTER, M.D.
(EL PASO, SEP. 17, 1915 -)

ALGERNON

GERALDINE

MARJORIE CLARE
B. FEB. 28, 1923, N.O.
M.
JOHN STEPHEN PATIN

MARY LORRAINE
B. MAY 9, 1925, N.O.
M. JUN. 3, 1950, N.O.
IVOR JAMES WYNN
(HARVEY, N.D., -
APR. 18, 1928 -)

SHARON ANN
B. OCT. 2, 1951

DOREEN CLARE
B. DEC. 15, 1952

MARGUERITE LIONNE
B. JUL. 4, 1885, DETROIT
M. 1 FEB. 6, 1907, CINTI.
BILL GROSSIUS (D. 1911)
M. 2 LEXINGTON, KY.
GEORGE B. NEWLAND

VIRGINIA JACK
B. AUG. 31, 1913, CINCINNATI
B. NOV. 23, 1917, CINCINNATI
M. MAY 31, 1906, CIN.
EDWARD ACKERMAN
D.S.P.

LUCILLE HELEN
B. JUL. 17, 1889, CIN.
D. APR. 6, 1927, CIN.
M. MAY 31, 1906, CIN.
EDWARD ACKERMAN
D.S.P.

JEANETTE HORTENSE
B. MAR. 31, 1892, CINTI.
M. FEB. 22, 1909, NEWPT.
KENTUCKY
PRESTON LANGLEY

RICHARD PRESTON
B. OCT. 3, 1910, CIN.
M. 1
ELIZABETH FISKE
(D. 1940)
M. 2
BESSIE LOUISE ROE

(2)
RICHARD PRESTON, JR.
B. FEB. 11, 1947, CIN.

(2)
CRAIG ALLEN
B. SEP. 20, 1950,
CINTI.

VIOLET DELIA
B. JAN. 25, 1879, N.O.
D. MAR. 13, 1911, N.O.
M. APR. 9, 1902, N.O.
WILLIAM LOUIS BILLET

JAMES JACKSON, JR.
B. NOV. 30, 1882, N.O.
D. MAR. 29, 1944, N.O.
UNM.

IRVING FRANCIS
B. APR. 16, 1885, N.O.
D. AUG. 5, 1892, N.O.

HARRY ZIEGLER
B. AUG. 31, 1886, N.O.
D. OCT. 10, 1951,
SAN ANTONIO, TEX.

(1) MARY ANN BROWN
(2) JUNA ELAM
(3) LENA SHOFNER

EARLE E.
B. JUL. 31, 1890, N.O.
D. FEB. 6, 1953, N.O.
M. JUL. 31, 1928
FAITH FINLEY
M. 2
ISABELLE MCHARDY
SHERIDAN

ADELAIDE
B. SEP. 25, 1894, N.O.
D. MAR. 28, 1948, N.O.
M. FEB. 7, 1917, GALV.
FRANKLYN J. ALBRECHT

JAMES WILLIAM III
B. APR. 10, 1943,
DALLAS

GILBERT BRUCE
B. SEP. 26, 1946,
ROCHESTER, MINN.

RUSSELL HUNTEMAN
B. OCT. 24, 1949,
ROCHESTER, MINN.

MILDRED VIRGINIA
B. MAR. 11, 1904
M. JUN. 16, 1925
FRANK MELVILLE HERBY

INEZ LOUISE
B. MAY 29, 1907
D. MAR. 19, 1909

(1) CRAIG ZIEGLER, JR.
B. JUL. 30, 1909

(1) SULU MAE DOYLE
(2) WANDA MAE
CLEMENTSON

(1) RICHARD MORGAN
B. OCT. 25, 1911
M. OCT. 29, 1950
MILDRED WILLOWBY

(2) UNA ADELAIDE
B. AUG. 19, 1924
M. SEP. 24, 1942
WALTER EDWIN
JONES, JR.

(1) GRAYCE MALETHA
B. NOV. 13, 1930, N.O.

LILLIE HATTIES
B. FEB. 28, 1898, N.O.
M. FEB. 18, 1916
DAVID ALEXANDER
CASSE (JUL. 10, 1894 -)
ALVIN JOSEPH DESPOUEY
(JUL. 11, 1899 -) D.S.P.

ADELE DELILAH
D. JUL. 6, 1943, N.O.

LEWIS HENRY, JR.
B. DEC. 25, 1906, N.O.

FRANK M., JR.
B. APR. 6, 1927

PATRICIA ANN
B. NOV. 4, 1932

(1) PHILIP CRAIG
B. MAY 12, 1940

(2) CRAIG ZIEGLER, JR.
B. SEP. 14, 1953

RICHARD JEFFREY
B. JUL. 11, 1952

KAREN LEE
B. JUL. 24, 1953

FRANKLIN J., JR.
B. APR. 1, 1921, N.O.
M. OCT. 22, 1949, N.O.
ALTHEA RITA
RODRIQUEZ

ADELAIDE MAY
B. APR. 13, 1926, N.O.
M. BAY ST. LOUIS, MISS.,
1949
HENRY MAL HILFMAN, JR.

LILLIAN ETHEL
B. AUG. 21, 1922, N.O.
M. SEP. 6, 1939
WILBUR AUGUST JOHNSON
(JAN. 30, 1920 -)

MERIAM AMELIA
B. JUL. 24, 1917, N.O.

WELBUR CONRAD
B. SEP. 24, 1919, N.O.

*ESTABLISHED REVOLUTIONARY ANCESTOR (EAR)

AUGUSTA CAMILLA SALOMON N.O. SEP. 8, 1851
 B.N.Y. 1833/5
 D.N.O. OCT. 31, 1872
 (SEE PRECEDING P.)

ROBERT MILLS LUSHER
 B. CH. MAY 17, 1823
 D. N.O. NOV. 23, 1890

MARY ALICE B. AUG. 10, 1852, N.O. D. MAY 25, 1863, HOLMESVILLE, MISS.
 JOSEPH ARTHUR B. N.O. JUN. 1, 1854 D. N.O. MAY 24, 1856
 CECILIA ADELIZA B. MAR. 15, 1856, N.O. D. MAY 20, 1863, HOLMESVILLE, MISS.
 SON STILLBORN, 1858
 THERESA AUGUSTA B. N.O. APR. 26, 1859 D. N.O. SEP. 12, 1859
 JOHN ROBERT B. N.O. SEP. 5, 1860 D. N.O. DEC. 22, 1928 M. N.O. DEC. 21, 1886 NELLITA F. JOHNSON (CIN'TI. DEC. 21, 1866-MAR. 15, 1943, NO.)
 SON STILLBORN OCT. 31, 1872

ARTHUR ROBERT B. N.O. SEP. 10, 1887 M. 1) JUL. 1920 CARABEL MILES M. 2) 1938 LENA GEBKLE S.P.
 EARLE WISWELL B. N.O. JUL. 11, 1889 D. N.O. AUG. 15, 1919
 LILLIAN ALICE B. M. AUG. 1920 HAROLD BACKHOFF OF LOND.
 ROY HILLS B. JUL. 17, 1897, N.O. M. SEP. 11, 1920 STELLA HULIN
 ELEANOR LORRAINE B. NOV. 4, 1898, N.O. M. FEB. 28, 1920 DOMINIC HASTREITER
 JOHN ROBERT, JR. B. FEB. 22, 1900, N.O. M. JUN. 1919 MYRTLE WIGLEY
 LIONEL GUSTAVE B. N.O. MAR. 26, 1902 D. 1925 UNM.
 PATRICIA B. MAR. 5, 1922, BUDAPEST, HUNGARY M. L.S. LEE, JR.
 ROY HILLS, JR. (CAL.) B. N.O. 1922
 GLORIA B. N.O. 1925
 MARY JANE B. N.O. 1923 SUE ELEANOR B. N.O. 1931
 MYRTLE NELLITA B. N.O. 1922 M. LEWIS BONO
 JOHN ROBERT III B. N.O. 1923 M. MAVIS DAGELE
 GREGORY LEWIS B. DEC. 8, 1947 ROBERT JOHN B. AUG. 16, 1950
 KEITH MICHAEL B. NOV. 1, 1948 SCOTT JEARD B. JAN. 31, 1952
 JOEL B. APR. 17, 1953

SALVADOR

M.O. SALVADOR
 MISC. III, VII #231
 BEVIS MARKS KETUBOT
 ANGLO-JEWISH NOTABILITIES, PP. 118, 230
 J.E.V. 4, P. 290
 U.J.E.V. 9, P. 331
 PAJHS V. 9, P. 108
 V. 12, P. 57
 V. 38, P. 104
 SALVADOR GEN. (BRITISH USEUM)
 WILLS OF JOSEPH SALVADOR, ABIGAIL
 FLO. ABR.

FRANCIS SALVADOR (SPAIN TO PORTUGAL TO AMST.)

JOSEPH (JESSURUN RODRIGUES) ISAAC FRANCIS (JACOB) B. D. FEB. 27, 1736, LOND. M. ANNA DE ANTONIO MENDEZ (RACHEL MENDEZ DA COSTA)
 ABRAHAM REBECCA DA SILVA REBECCA
 FRANCIS (DANIEL) (NAT. LOND. APR. 24, 1719) B. AMST. D. OCT. 29, 1754, LOND. M. NOV. 21, 1708, LOND. RACHEL DE MOSES MENDES DA COSTA
 JOSHUA D. OCT. 15, 1741 SAMUEL ISAAC RACHEL FERNANDES NUNES OF AMST. (TO QUITO, ECUADOR) MANUEL RACHEL FERANDES NUNEZ

ABIGAIL D. CA. 1733 M. JUN. 22, 1730, LOND. JACOB PEREIRA DE PAIBA (TO S.C. 1784) JOSEPH B. JAN. 21, 1716, LOND. D. DEC. 29, 1786, CH. M. OCT. 15, 1738, LOND. LEONORA (RACHEL) DE ANTONIO LOPES, 3D BARON SUASSO (D. OCT. 10, 1766, TODTING, ENG.)
 REBECCA D. JUL. 1781 M. NOV. 16, 1742, LOND. MOSES DE JACOB MENDES DA COSTA
 JACOB D. APR. 21, 1749, LOND. M. DEC. 16, 1745, LOND. ESTHER DE MOSES PORTELLO DE QUIROS
 SARAH D. 1756 M. JUN. 3, 1750, LOND. MOSES DE JACOB DE MOSES FRANCO
 (NATURAL SON) JOSEPH LEWIS SALVADOR DE MORIENCOURT REBECCA (JUDITH) M. MAY 14, 1760, LOND. JOSHUA DE JACOB DE ABRAHAM MENDES DA COSTA ABIGAIL B. 1740 D. 1812 M. TEXEIRA DE MATTOS ELISEBAH MIRIAM D. JUN. 4, 1781 UNM. SUSANNAH SARAH JUN. 2, 1767, LOND. FRANCIS (TO S.C., DEC. 1773) (DANIEL JESSURUN RODRIGUES) D. 1747, LOND. D. AUG. 1, 1776, S.C. (SCALPED BY INDIANS) MOSES (THE HAGUE) SARAH SUASSO JACOB
 REV. JOHN LOVELL (JACOB) B. JUN. 20, 1771 (BAPT. 1780) D. DEC. 26, 1836, STAUNTON ON WYE, ENG. M. SEP. 7, 1810 FANNY PRATT ANNE (ESTHER) MARY (LEONORA)
 CAROLINE LEONORA FRANCES ANNE

CHARLES WHITEHEAD
ELZAS MS.
M.N.
JEWS OF S.C.
JEWISH CEM. AT GEORGETOWN
JEWISH CEM. AT COLUMBIA
U. J. E. V. 9. P. 341
ROSENWAIKE

AMELIA
B. 1800
D. AUG. 13, 1819

1) SAMUEL SAMPSON (TO GEORGETOWN, S.C. IN 1840'S)
B. 1789/91, BURY ST. EDMONDS, ENG.
D. AUG. 25, 1827, CH. M. 2)

(TO CH. 1817) JOSEPH SAMPSON
B. 1801, BURY ST. EDMONDS, ENG.
D. JAN. 1, 1830

1) ABIGAIL
2) APR. 1834 L. LEVY

ABIGAIL REBECCA
B. JUL. 4, 1823
D. JUL. 25, 1844
M. APR. 1, 1841
GUSTAVUS V. ANCKER
(O.V. (1))

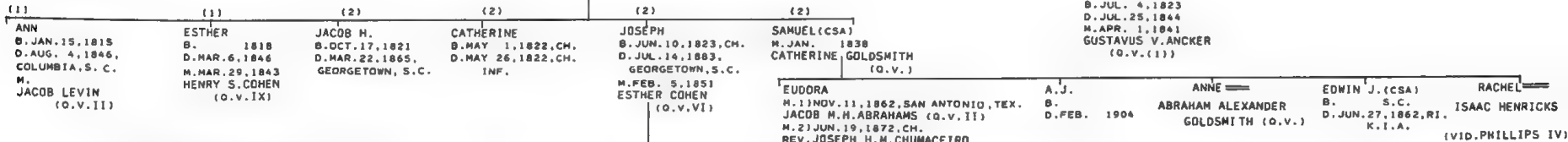

(THIS GENERATION IS SOMEWHAT QUESTIONABLE)

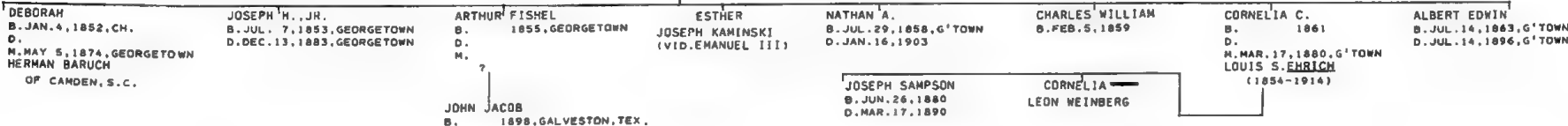

ELSIE NATHANS FRANKLIN
FLO. ABR.
N. Y. CENSUS, 1855
B'NAI JESHURUN REC.

JONAS SAMELSDORF RACHEL

(TO U.S. 1831)

DAVID SAMSON
B. 1806, BAVARIA
D. MAR. 3/4, 1866, N.Y.
M. MAY 7, 1833, N.Y.
AMELIA HART (O.V. X)

HANNAH
M. MAR. 6, 1850, N.Y.
MYER FLOERSHEIMER

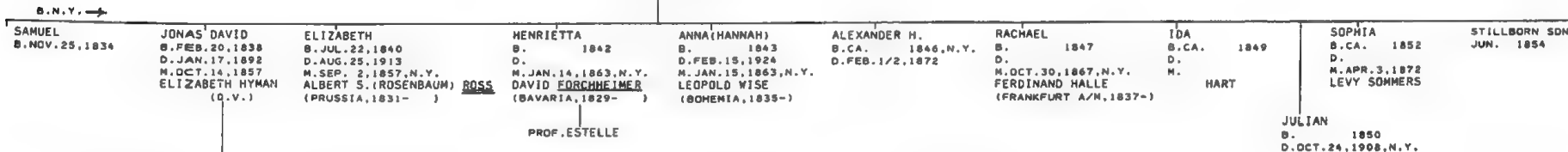

MARIE LOUISE B. SEP. 3, 1858 D. NOV. 7, 1947 M. FEB. 14, 1877, N.Y. HORACE AUGUSTUS NATHANS (O.V. I (2))

AMELIA B. FEB. 22, 1860 D. UNK.

HENRIETTA B. SEP. 14, 1862 D. APR. 28, 1918 M. EDWARD BION MURRAY

ADA B. APR. 29, 1864 D. DEC. 20, 1948 M. CHARLES BURTON BEARDSLEY OF VERMONT
MICHAEL

ROSALIE B. JUL. 22, 1867 D. JUN. 25, 1951 UNK.

EDWARD JOSEPH B. 1890 D. 1933 M. ANNA MAY BAUER (1896-1930)

JOSEPH EDWARD CAROL MAWSON THEODORE BION D. INF.

RONALD EDWARD MICHELE

SAMUEL I

SAMUEL-YATES GEN. (AJA)
 SAMUEL-HIST. & GEN. OF SAMUEL AND YATES
 FLD. ABR.
 EGDN WOLFF
 U.S. CENSUS, 1886

SAMUEL OF STRELITZ OR KISSINGEN

RALPH SAMUEL JUN. 14, 1769, LOND.
 POLLY LEVY
 B. NOV. 22, 1738, GER.
 D. JAN. 31, 1809, LIVERPOOL
 B. DEC. 8, 1745
 D. DEC. 17, 1803

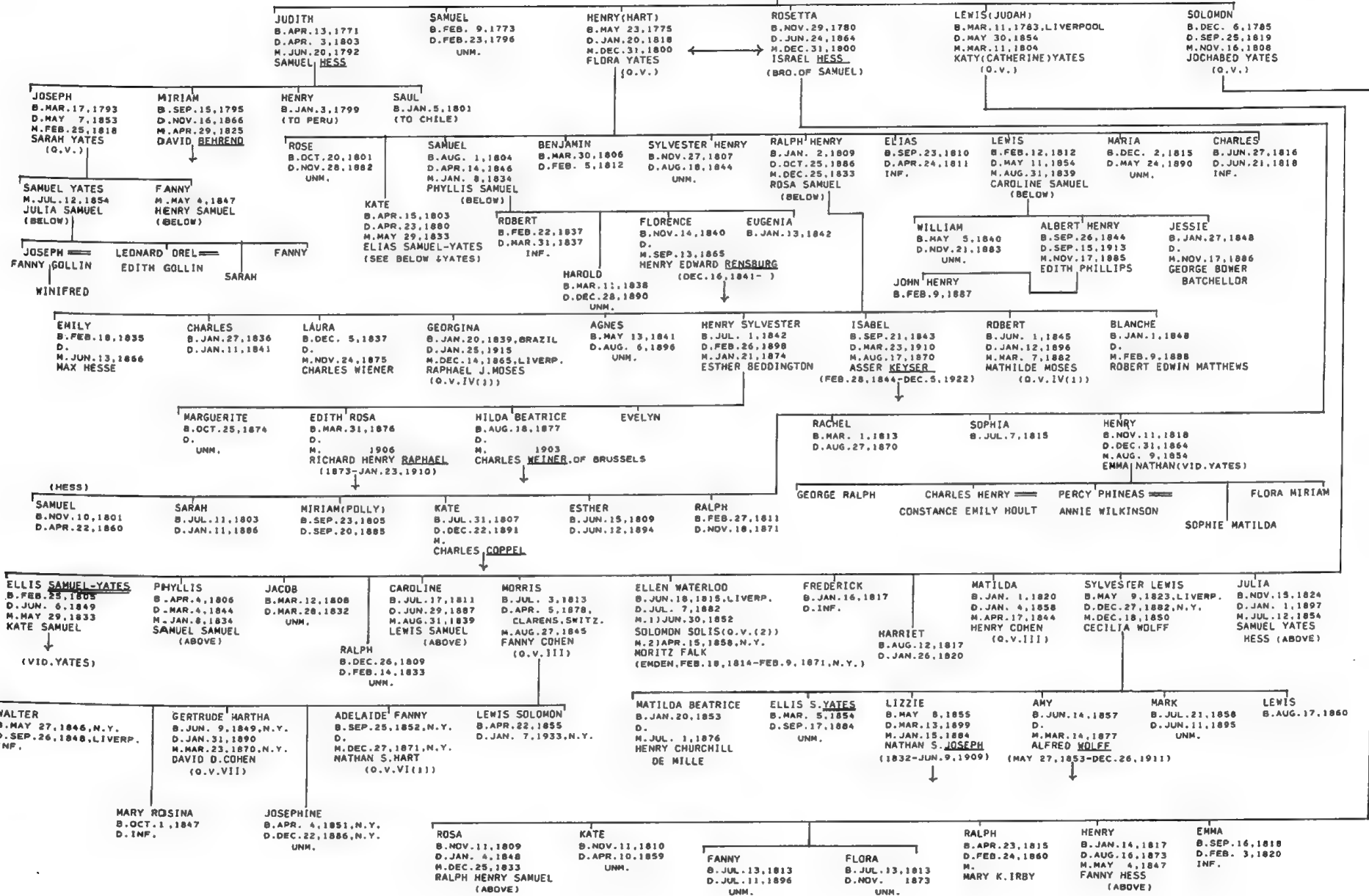

KRAUS-SANDOR COLL.
MOSS-SAMUEL GEN.
SAMUEL-REC. OF THE SAMUEL FAMILY
PHILA. SOCIAL REGISTER
J.E.V. 7, P. 454
N. ROSENSTEIN
FLD. ABR.
MORAIS-JEWS OF PHILA.

ISAAC OF KATZENELLEMEGEN

JUDAH MINZ OF PADUA
ABRAHAM MINZ OF PADUA

SAMUEL II (1) (GER., ENG., PHILA.)

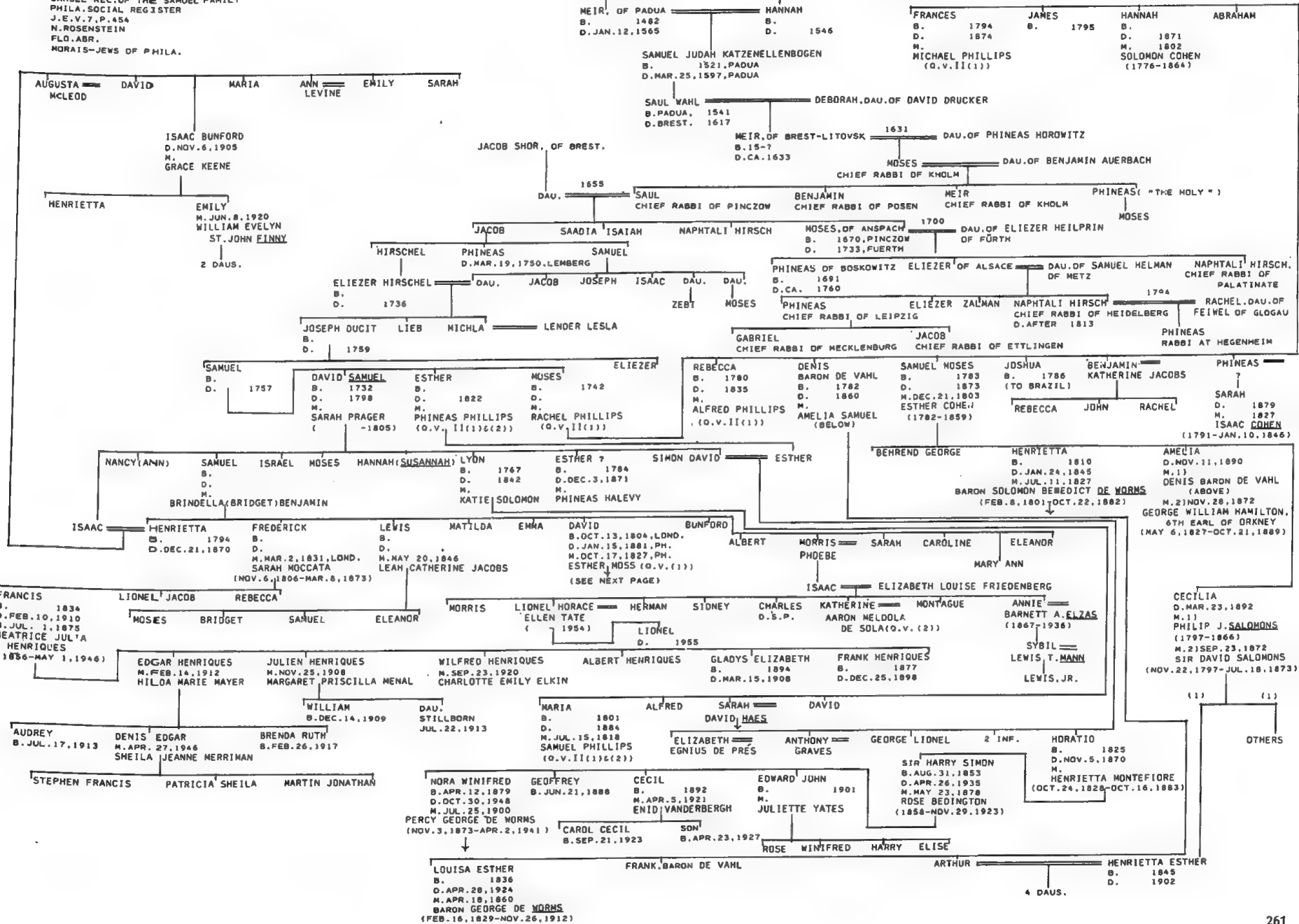

DAVID SAMUEL OCT. 17, 1827, PH. ESTHER MOSS (O.V. (1))
 B. OCT. 13, 1804, LOND.
 D. JAN. 15, 1881, PH.
 (SEE PRECEDING PAGE)

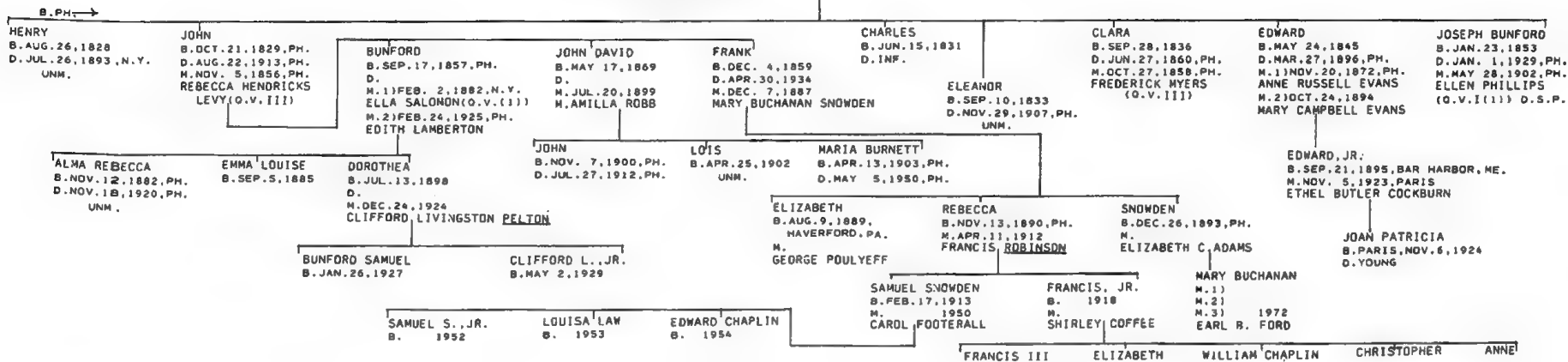

SARZEDAS

KRAUS-SANDOR
 PAJHS V. 12, P. 57
 ELZAS MS.
 SHEARITH ISRAEL REC.
 MYERS-HAYS-MORDECAI MS. (VA. H.S.)
 U.S. CENSUS, 1820
 EVELYN GREENBERG
 GA. NEWSPAPERS
 S.C. MARRIAGE CONVEYANCES
 MISC. VII #473, 474
 SHEFTALL MS.

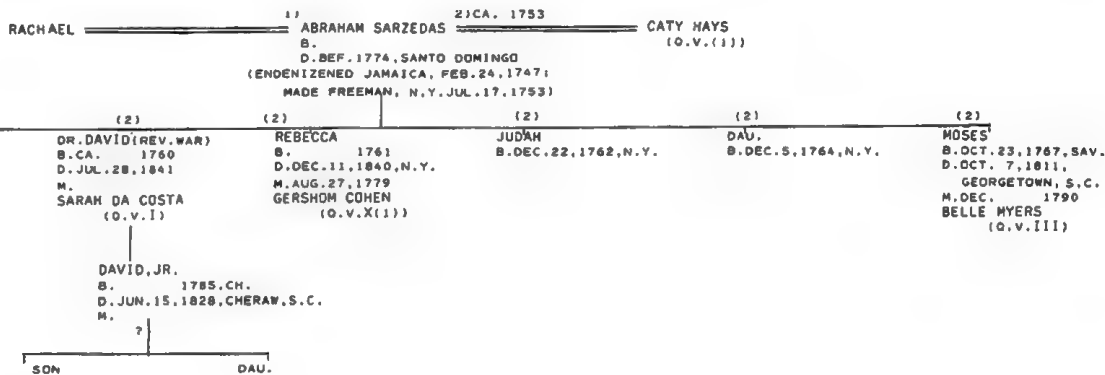

SASPORTAS

KRAUS-SANDOR COLL.
 PAJHS V. 19, P. 81
 V. 27, P. 304
 V. 29, P. 32F.
 ELZAS M.N., P. 7
 MS.
 WILL OF ABRAHAM SASPORTAS
 SHEARITH ISRAEL REC.
 SHEFTALL MS.

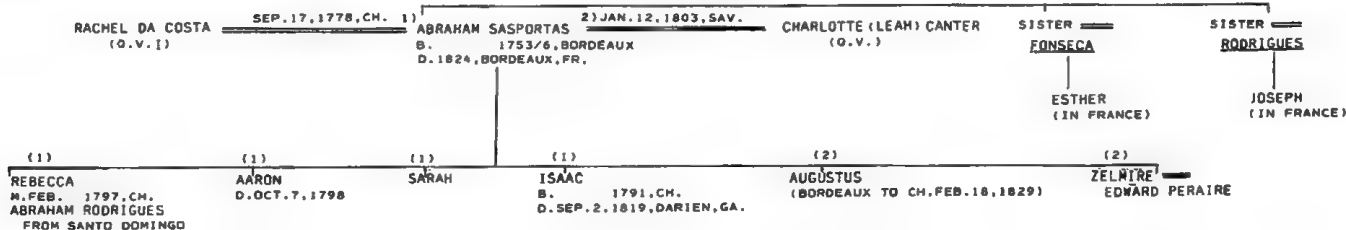

N.Y. WEEKLY MUSEUM
WILL OF DAVID C. SEIXAS
DAVID CARDOZA SEIXAS BIDDLE
BEVIS MARKS BIRTH REC.
BEVIS MARKS KETUBOT
MISC. VII. #214D, 502
HERSHKOWITZ-WILLS
J.E.V.9, P. 159
PAJHS V. 4, P. 201F.
V. 27, PASSIM

THE IMPROVEMENT ERA, FEB. 1936
KRAUS-SANDOR COLL.
SHEARITH ISRAEL REC.
FLD. ABR. 2
EDITH K. NICHOLAS
ELZAS O. J. C.
N.Y. TIMES OBIT. MAY 22, 1887
U.S. CENSUS, 1850
ROSENWAIKE
VICTORIA FAUTH SUTTON
RALPH COLTON
LILLIAN OISLANDER
JEANNE F. INGRAM
ALICE LANDRUM

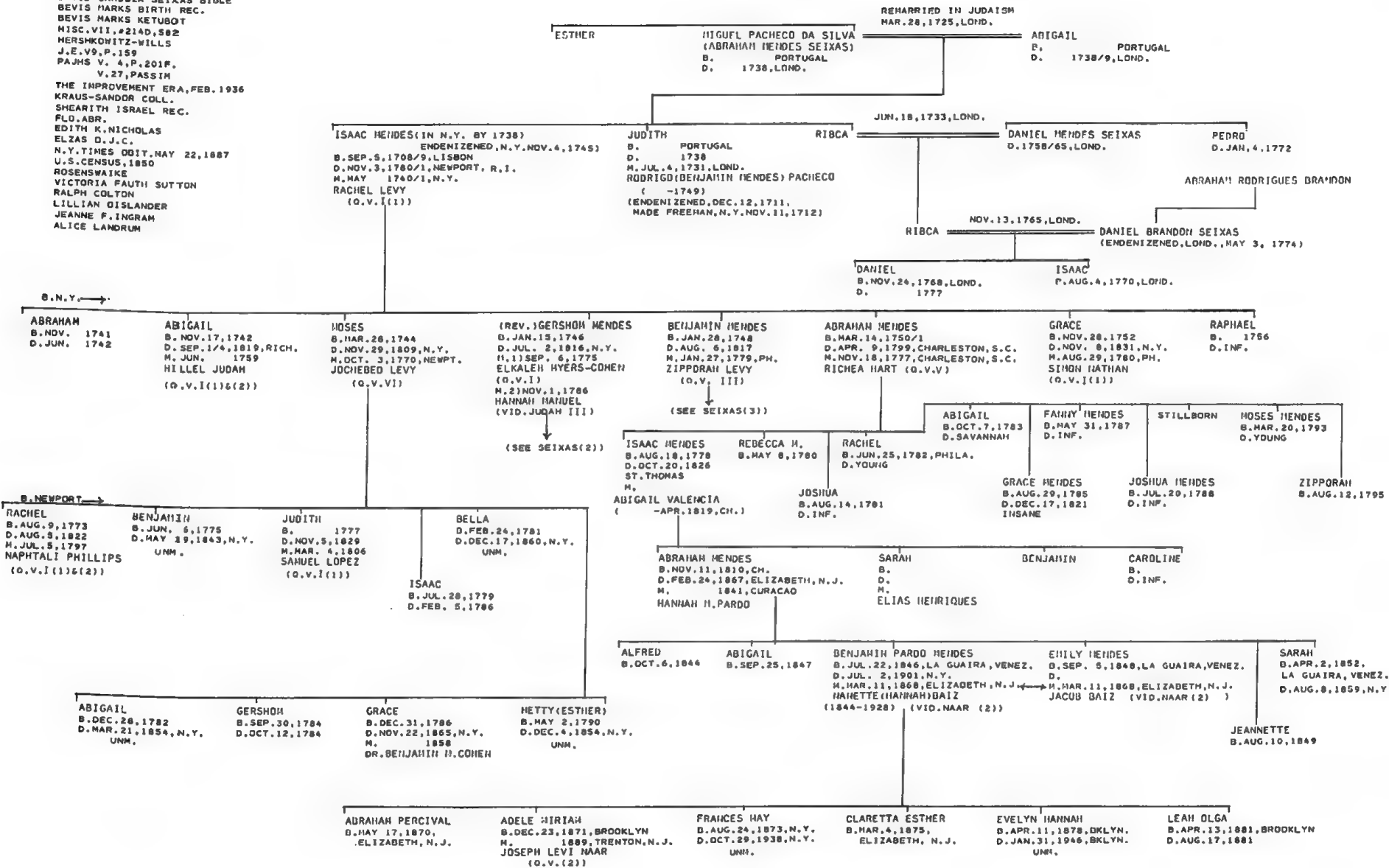

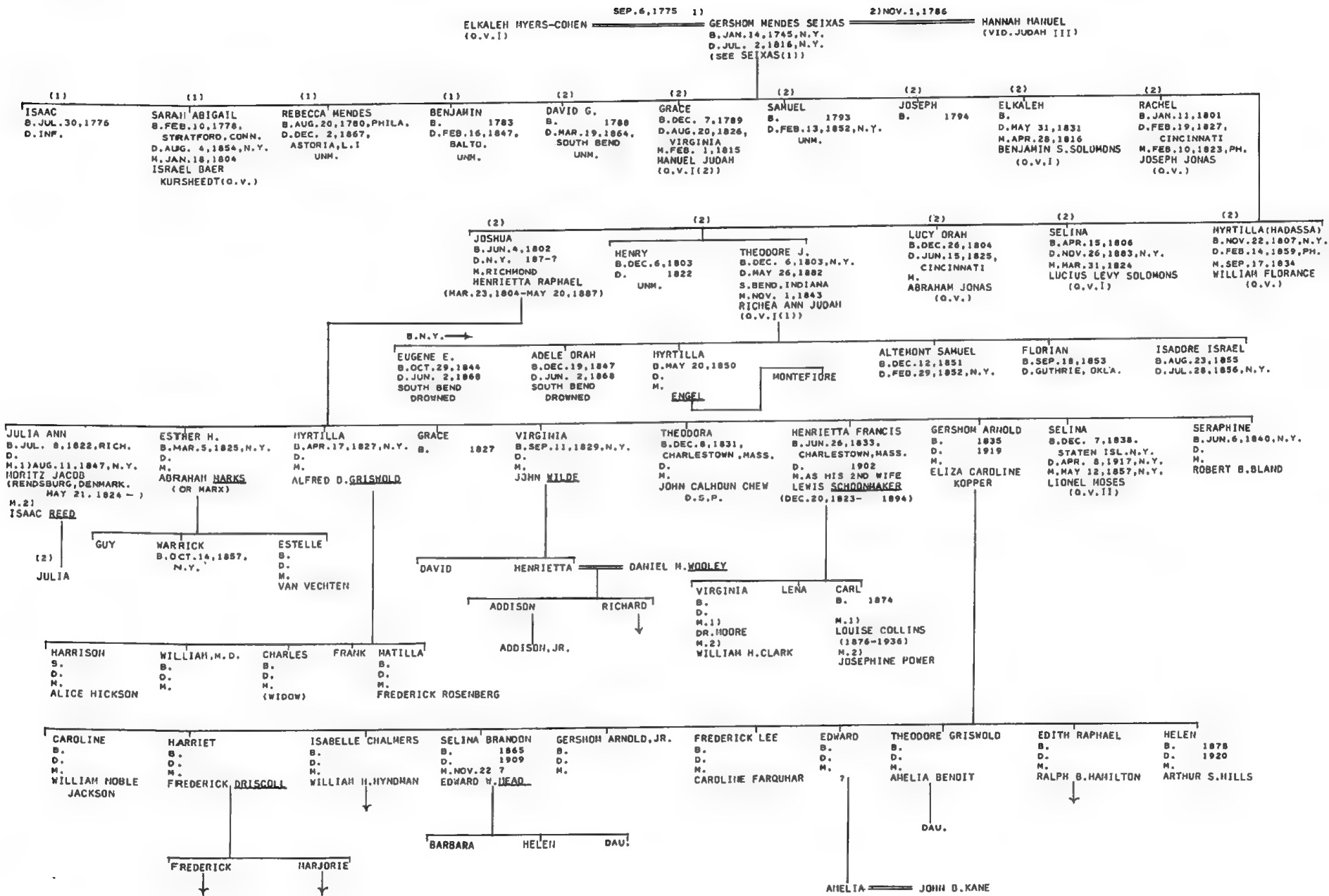

BENJAMIN MENDES SEIXAS
 B. JAN. 28, 1748, N.Y.
 D. AUG. 16, 1817
 (SEE SEIXAS (1))

JAN. 27, 1779, PH.

ZIPPORAH LEVY
 (O.V. III)

SEIXAS (3)

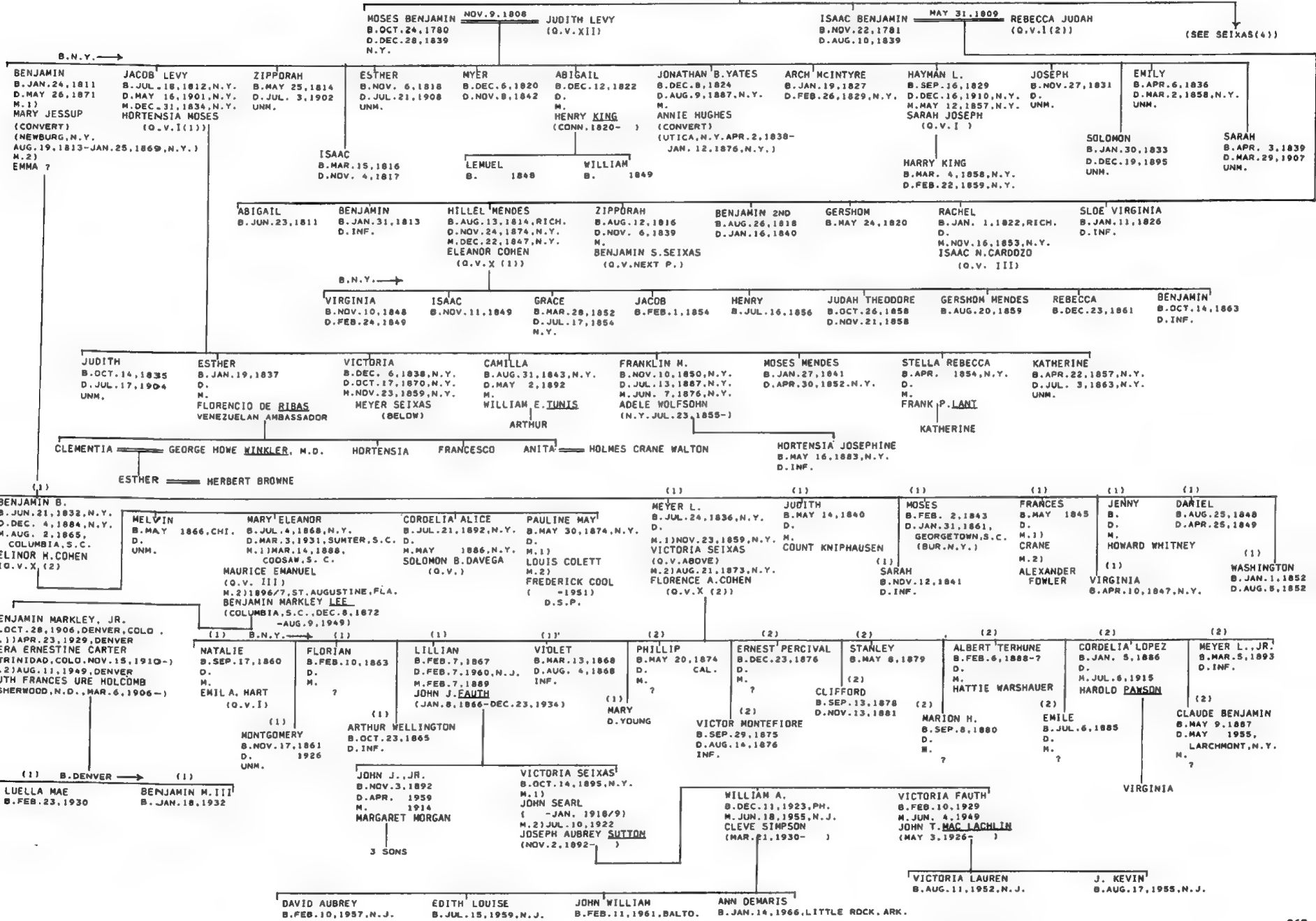

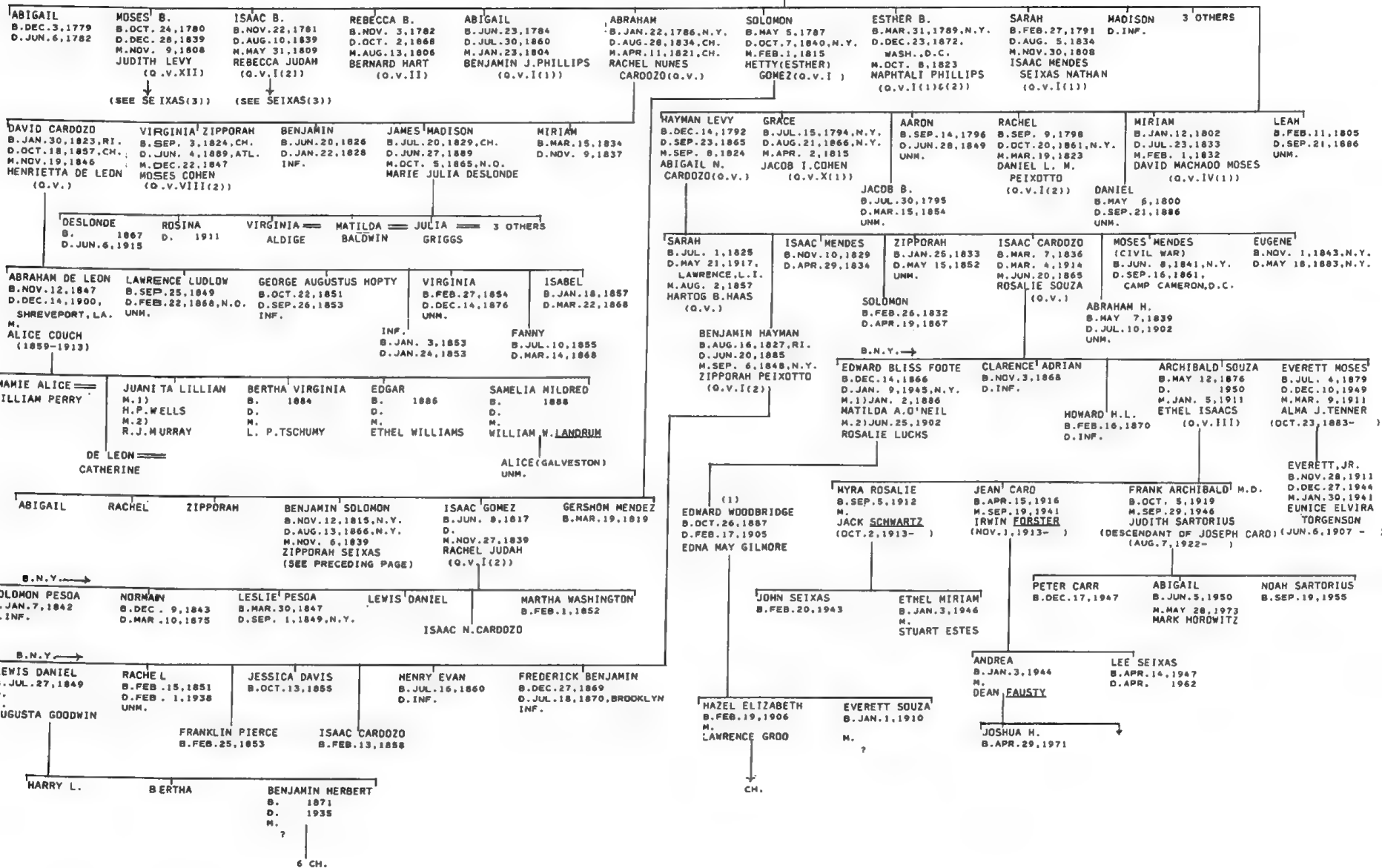

SHEFTALL MS.
JOHN MCK. SHEFTALL
KRAUS-SANDDR COLL.
PAJHS V.10.P.80FF.
V.17.P.167FF.
ELZAS-JEWS OF S.C.,PT.2,P.9
MSS.
SAVANNAH JEW.BURYING GROUND
CHATHAM CO. HARR. REC.
ABSTRACT OF WILLS,CHATHAM CO.
ROSENWATKE
81DG.SOUVENIR OF FLA. & GA.,
P.734.

MIKVEH ISRAEL(PH.JREC.
MICKVE ISRAEL(SAV.)REC.
WILLS:LEVI,ESTHER,PERLA SHEFTALL
DAR REC.OF M.E.HARBY
FLO.ABR.
CLARENCE SHEFTALL,JR.
LAUREL GROVE CEM.REC.
WILSON-ANNALS OF GA.,V.III
JACK COLEMAN
WALTER V.ARNOLD,JR.
LEVI SHEFTALL BIBLE

PERLA B. 1736, SAV. (CAME TO SAV., JUL. 11, 1733)
BENJAMIN SHEFTALL B. 1692, PRUSSIA D.OCT. 3, 1765
HANNAH SOLOMONS B. 1699, AMST. D.FEB. 21, 1772, SAV. (CAME TO SAV., OCT. 5, 1738)
LEVI B. DEC. 6, 1775, SAV.

(1) SHEFTALL B. AUG. 3, 1734 D. INF.
(1) MORDECAI (REV.) B. DEC. 2, 1735 D. JUL. 6, 1797, SAV. M. OCT. 28, 1761, CH. FRANCES HART (O.V.V.)
(2) LEVI B. DEC. 12, 1739 D. JAN. 26, 1809, SAV. M. MAY 25, 1768, ST. CROIX SARAH DE LA MOTTA (O.V.V.)
(2) SOLOMON B. AUG. 8, 1741 D. 1743 INF.

* SHEFTALL (REV.) B. SEP. 8, 1762 D. AUG. 15, 1849, SAV. UNM.
PERLA B. NOV. 11, 1763 D. NOV. 3, 1820. BEAUFORT, S.C. UNM.
ELIAS B. FEB. 18, 1765 D. MAR. 2, 1765, SAV. INF.
BENJAMIN B. OCT. 14, 1767 D. AUG. 8, 1794 AT SEA UNM.
MOSES, M.D. B. OCT. 12, 1769 D. JUN. 10, 1835, SAV. M. MAR. 24, 1792, PH. ELKALEH (NELLIE) BUSH (O.V.V.)
ESTHER B. SEP. 16, 1771 D. SEP. 27, 1828 UNM.

B. SAV. →
MORDECAI B. JAN. 6, 1793 D. NOV. 1, 1817 UNM.
DAU. B. FEB. 26, 1796 D. MAR. 8, 1796 INF.
DAU. B. FEB. 26, 1796 D. MAR. 12, 1796 INF.
REBECCA BENJAMIN B. MAY 24, 1798 D. APR. 19, 1881 M. NOV. 20, 1816, SAV. ISAAC CDHEN (O.V.VIII(2))
FRANCES B. 1800 D. OCT. 28, 1816 UNM.
MATHIAS BUSH B. SEP. 16, 1802 D. JUN. 5, 1803, SAV. INF.
PEGGY BUSH B. OCT. 31, 1804 D. NOV. 18, 1806, SAV. INF.
BENJAMIN B. JUN. 21, 1807 D. SEP. 12, 1807 INF.
PERLA B. SEP. 8, 1811 D. JAN. 19, 1897 M. NOV. 17, 1847, SAV. LIZAR SOLOMONS (O.V.IV(2))
MOSES, M.D. B. 1814 D. MAR. 7, 1850, CH. UNM.

SARAH B. NOV. 29, 1769, SAV. D. SEP. 26, 1825, SAV. M. JUN. 1, 1785, SAV. ABRAHAM DE LYON(O.V.V.)
HANNAH B. APR. 11, 1773, SAV. D. MAY 22, 1843, SAV. M. MAR. 11, 1827, SAV. AS HIS 2ND WIFE ABRAHAM DE LYON(O.V.V.)
LEVI B. OCT. 27, 1776, SAV. D. AUG. 6, 1796, CH. UNM.
ISAAC B. OCT. 16, 1779, CH. D. JUL. 19, 1780, CH. INF.
MORDECAI (SR.) B. DEC. 30, 1783, CH. D. JUN. 6, 1856, SAV. M. JUN. 9, 1832, SAV. VIRGINIA RUSSELL (O.V.V.)
PERLA B. FEB. 18, 1788, CH. D. JUN. 7, 1850, SAV. M. JUL. 3, 1808, SAV. ISAAC RUSSELL (O.V.V.)
ABRAHAM B. DEC. 2, 1793, SAV. D. DEC. 18, 1831, SAV. M. NOV. 12, 1817, CH. SARAH DE LA MOTTA (O.V.V.)
ABIGAIL MINIS B. FEB. 20, 1796, SAV. D. NOV. 23, 1871, SAV. M. JUL. 18, 1818, SAV. LEVY HART (1792-DEC. 8, 1853, SAV.)

BENJAMIN B. APR. 6, 1771, SAV. D. JUL. 19, 1835, SAV. M. ? (SEE SHEFTALL(4))
REBECCA B. FEB. 5, 1775, SAV. D. JUL. 12, 1777, SAV. INF.
RACHEL B. APR. 21, 1778, SAV. D. FEB. 6, 1781, CH. INF.
JUDITH B. JUN. 29, 1781, CH. D. 1854, SAV. UNM.
EMANUEL B. FEB. 16, 1786, SAV. D. APR. 23, 1818, SAV. M. ?
SOLOMON B. SEP. 9, 1791, SAV. D. JAN. 18, 1868, SAV. M. CLARA DE LA MOTTA (O.V.V.) (SEE SHEFTALL(3))

B. SAV. →
SOLOMON B. 1809 D. DEC. 16, 1832 UNM.
REBECCA B.C.A. 1810 D. JUL. 20, 1849, SAV. M. APR. 17, 1831, SAV. DANIEL SHANDLEY (1800-NOV. 3, 1843, SAV.) (MAR. 9, 1815-JAN. 29, 1857, SAV.) D.S.P.
EMANUEL B. OCT. 25, 1811 D. NOV. 19, 1875, SAV. M. NOV. 20, 1834, SAV. JANE L. THEISS (MAR. 9, 1815-JAN. 29, 1857, SAV.)
ELIZABETH B. 1814 D. FEB. 5, 1828
LEVI SHEFTALL B. 1821, SAV. D. APR. 18, 1887, SAV. UNM.
AMANDA MALVIANA B. MAR. 11, 1829 D. OCT. 5, 1846
EUGENIA MURTELLA B. D. M. DEC. 1, 1858, SAV. SAMUEL G. NATHANS (O.V.I(1))

B. SAV. →
THOMAS B. 1836 D. NOV. 7, 1836 INF.
CAROLINE E. B. 1838 D. SEP. 30, 1905, SAV. M. JUL. 16, 1856, SAV. WILLIAM T. HEIDT
JANE E. B. DEC. 7, 1843 D. DEC. 1, 1924 M. APR. 24, 1864, SAV. WILLIAM M. LANIER D.S.P.
LOUISA ANN B. JUL. 31, 1840 D. NOV. 8, 1853, SAV.
JAMES A. B. 1845(?) D. MAY 15, 1905 M. ROSALIE AMANDA WILKENS
EDWARD E. B. JUN. 26, 1845 D. OCT. 10, 1876 M. OCT. 31, 1872 MAGGIE M. RITTER
MARY W. B. AUG. 9, 1846 D. APR. 20, 1917 M. 1) APR. 23, 1866 SAMUEL H. BOWMAN M. 2) JUL. 3, 1894 ROBERT GODWIN CRAMER
HANNAH REBECCA B. 1849 D. MAR. 5, 1888 M. APR. 29, 1872 ROBERT GODWIN CRAMER
SARAH FLORENCE B. MAY 8, 1851 D. FEB. 13, 1899, SAV. M. JAN. 28, 1869, SAV. JAMES E. CREAMER
JOSEPHINE G. B. 1859 D. AUG. 14, 1891, SAV. UNM.
WILLIAM CRUMLEY B. 1855 D. DEC. 10, 1875, SAV. UNM.

B. SAV. →
DAISY MARY JANE B. 1874, SAV. D. APR. 6, 1912, SPARTANBURG, S.C. M. DEC. 7, 1891, SAV. SEABORN MARSHALL MACKENDREE
JOHN EMANUEL B. OCT. 1, 1871 D. NOV. 17, 1872 INF.
JAMES B. JUL. 20, 1874 D. MAY 6, 1889
GERTRUDE B. MAY 23, 1876 D. NOV. 22, 1883
CATHERINE B. JUL. 10, 1877 D. JUL. 22, 1877
TILLY B. JUL. 10, 1877 D. JUL. 18, 1877

MAY 25, 1768, ST. CROIX
 LEVI SHEFTALL B. DEC. 12, 1739, SAV.
 SARAH DE LA MOTTA (O.V.)
 D. JAN. 26, 1809, SAV.
 (SEE PRECEDING PAGE)

VIRGINIA RUSSELL JUN. 9, 1832, SAV. MORDECAI (SR.) B. DEC. 30, 1783, CH.
 (O.V.) D. JUN. 6, 1856, SAV.
 ABRAHAM NOV. 12, 1817, CH. SARAH DE LA MOTTA (O.V.)
 B. DEC. 2, 1795, SAV.
 D. DEC. 18, 1831, SAV.

B. SAV. →
 JUDITH B. FEB. 27, 1833 D. JUN. 18, 1836, SAV.
 SARAH VIRGINIA B. OCT. 16, 1835 D. JUN. 17, 1885, SAV. UNM.
 LAURA CORINNA B. JUN. 28, 1837 D. SEP. 11, 1854, SAV.
 LETHERIA HENRIETTA B. FEB. 19, 1842 D. MAY 6, 1923 M. MAR. 5, 1895, SAV.
 HENRY CLAY B. OCT. 11, 1844 D. NOV. 1, 1858
 BENJAMIN FRANKLIN, M.D. B. OCT. 6, 1848 D. JUL. 16, 1897, SAV. M. JAN. 26, 1881, SAV.
 THOMAS JEFFERSON B. MAY 2, 1854 D. DEC. 15, 1925, SAV. M. FEB. 13, 1881, PH.
 IRENE ELLA NATHANS (O.V. I (1))

B. SAV. →
 SARAH VIRGINIA B. JAN. 21, 1890 D. FEB. 20, 1920, GOLDSBORO, N.C. M. JAN. 18, 1907, SAV.
 MORDECAI B. AUG. 9, 1881 D. AUG. 25, 1939 M. MAY 15, 1906, SAV. (SEP. 23, 1886-JUN. 6, 1948)
 LAURA CORINNA B. FEB. 26, 1883 D. AUG. 16, 1962, RD ANDKE, VA.
 THOMAS JEFFERSON B. JUN. 4, 1885 D. M. GALVESTON, TEX.
 ESTELLE B. 1888 D. CA. 1969 M. JUN. 26, 1907, SAV.
 WARING RUSSELL B. NOV. 18, 1881, SAV. D. JUL. 30, 1941, SAV. UNM.
 GEORGIA NATHANS B. FEB. 1, 1886, SAV. D. FEB. 9, 1907, MACON, GA.
 ARTHUR E. MCWILLIAMS D.S.P.
 RAYMOND HARRIS B. JUL. 24, 1889 D. DEC. 11, 1955 M. JUL. 27, 1918, SAV.
 MINNIE MCCORKLE D.S.P.

B. SAV. →
 WALTER
 BENJAMIN FRANKLIN B. FEB. 27, 1907 D. MAR. 18, 1947, GAFFNEY, S. C. M. FEB. 19, 1934 NORMA KASSLER
 MORDECAI B. MAR. 26, 1902, SAV. EDWIN T. OF HOUSTON M. SEP. 15, 1945, TEHERAN, IRAN BENJAR MANSOOR (JOY)
 H. PAUL DUBLEY EMMA
 LETHERIA B. DEC. 23, 1915 M. ALFRED ELLIOTT
 LED CHARLES B. AUG. 18, M. FANNY (ADOPTED)
 WANDA WAYNE
 LEVI B. JAN. 30, 1819 D. MAR. 18, 1845, SAV. UNM.
 DE LA MOTTA B. APR. 11, 1823 D. JAN. 30, 1856, DUBLIN, GA. UNM.
 THOMAS CHARLTON B. OCT. 18, 1824 D. JAN. 16, 1825, SAV.
 EDWARD TATNALL B. MAR. 19, 1826 D. MAY 29, 1863, DUBLIN, GA. M. JAN. 8, 1857, THOMAS CO., GA.
 ANNIE GAILLARD COOPER (DEC. 10, 1840-DEC. 29, 1923, COLUMBUS, GA.)

STANLEY WARING B. APR. 20, 1938 M. APR. 25, 1956 BETTY EZELL
 MYRNA LEA B. MAR. 16, 1941 M. AUG. 17, 1963 ALAN EDWARD ROTHEFEDER
 BENJAMIN FRANKLIN B. MAY 1, 1947 M. NOV. 25, 1970 KAY WHITE
 EDWARD TATNALL B. NOV. 6, 1857, MADISON CO., FLA. D. AUG. 4, 1934, JACKSON, MISS.
 COOPER B. MAR. 7, 1860, DUBLIN, GA. D. APR. 4, 1947, DALLAS, TEX. M. JUN. 17, 1903, LONGVIEW, TEX.
 DE LA MOTTA B. JUN. 27, 1862, MADISON CO., FLA. D. AUG. 27, 1939, MARIETTA, GA. M. NOV. 9, 1887, PENSACOLA, FLA.
 KEMPER FISHER D.S.P.
 FLORIDA B. JAN. 8, 1864, MADISON CO., FLA. D. JUN. 15, 1864 INF.
 ESTHER WOOD CARLISLE
 TATHALL CARLISLE B. MAY 6, 1904, LONGVIEW, TEX. M. AUG. 11, 1927, BROOKHAVEN, MISS.
 ANNIE LEA WALLACE

STANLEY W., JR. B. MAY 6, 1957 PAMELA SUSAN B. APR. 2, 1961
 'ANNE SHEFTALL B. OCT. 29, 1965 ANDREW EMORY B. AUG. 6, 1968
 KATHY B. JUN. 10, 1972
 DE LA MOTTA B. JAN. 12, 1894 D. OCT. 20, 1963, HOUSTON, TEX. M. 1) M. 2) NOV. 1, 1923 ALICE FRANCES ELLIOTT

(1) CHARLES MILTON (2) DE LA MOTTA II B. AUG. 22, 1924 M. MAR. 7, 1943 AUDREY KELLEY (2) SARAH VIRGINIA B. SEP. 15, 1926 M. DEC. 13, 1944 JAMES H. LEMMON (2) MARY KATHERINE B. JAN. 5, 1943 M. AUG. 30, 1962 BRYAN C. BAKER
 LISA KAY B. APR. 4, 1962
 THOMAS EDWARD B. SEP. 14, 1928 M. DEC. 18, 1949 BETTIE ANN JORGENSEN
 DOROTHY JEAN B. JUL. 3, 1930 M. NOV. 17, 1956 GEORGE LEONARD GARRISON
 CAROLYN BABB B. JAN. 18, 1932 M. NOV. 15, 1958 JOHN CLEM PETERS

REBECCA JEAN B. JUN. 22, 1952 EDWARD CARLISLE B. JUL. 20, 1954 KATHRYN BABB B. JUL. 30, 1955
 TIMOTHY MARK B. JAN. 9, 1963 MARY LEA B. APR. 6, 1966

DE LA MOTTA III B. APR. 23, 1945 KIMBERLY B. AUG. 23, 1947 WILLIAM LAYNE B. AUG. 21, 1953 ALLYSON KELLEY B. OCT. 10, 1963
 MICHAEL EUGENE B. SEP. 8, 1958 LEANNE B. JUL. 17, 1960 PAUL EDWARD B. OCT. 1, 1961

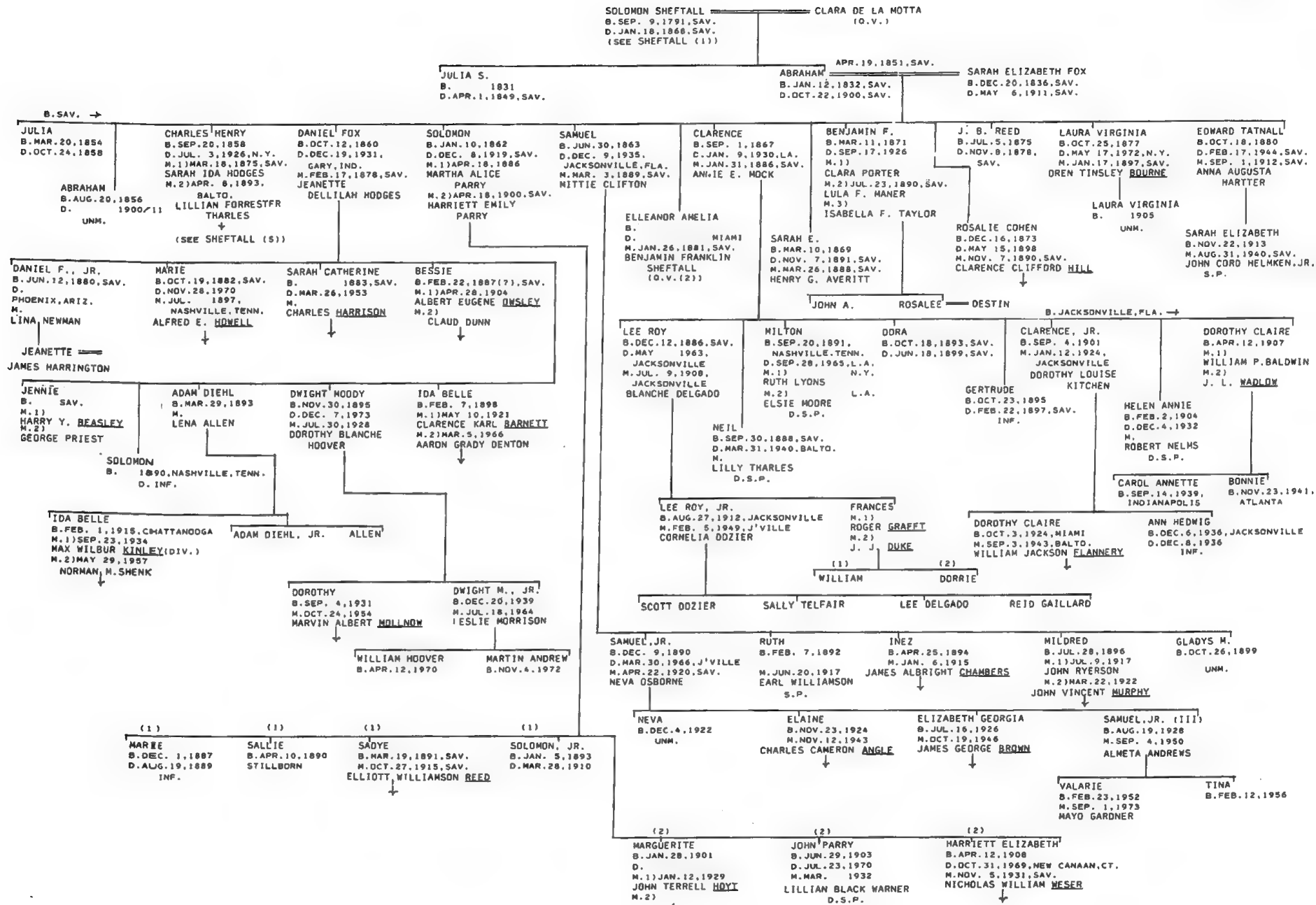

SHEFTALL (4)

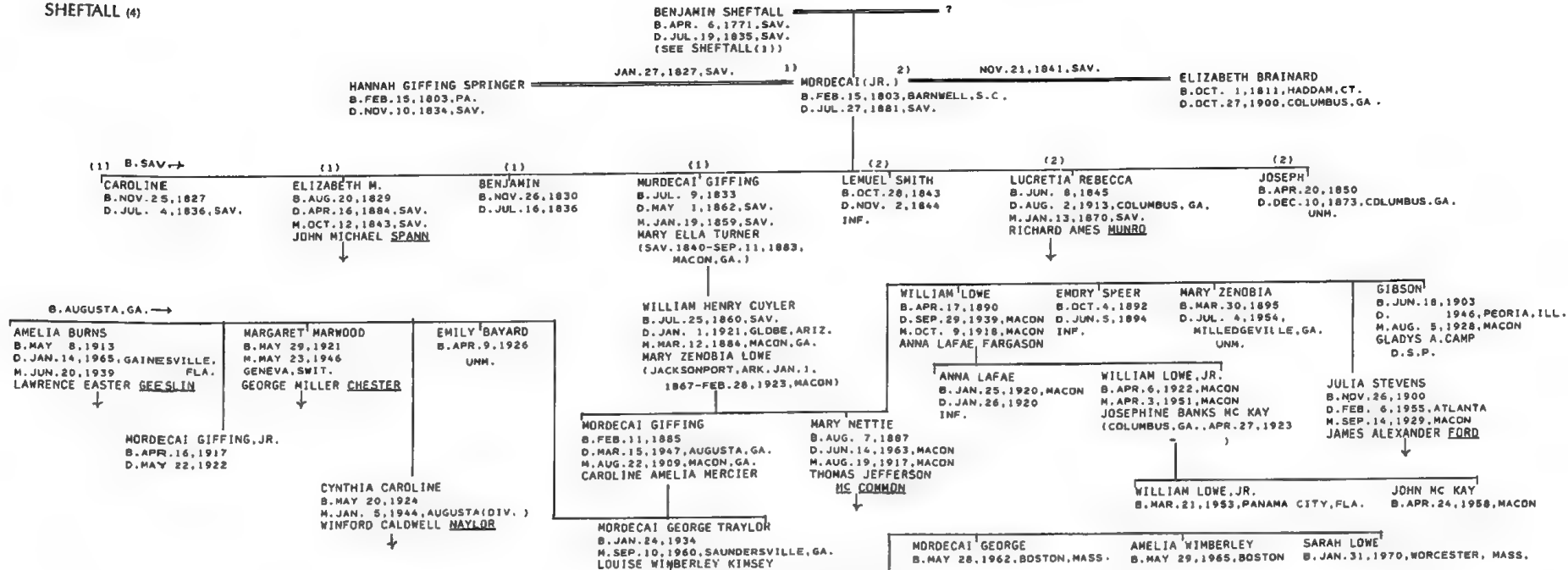

SHEFTALL (5)

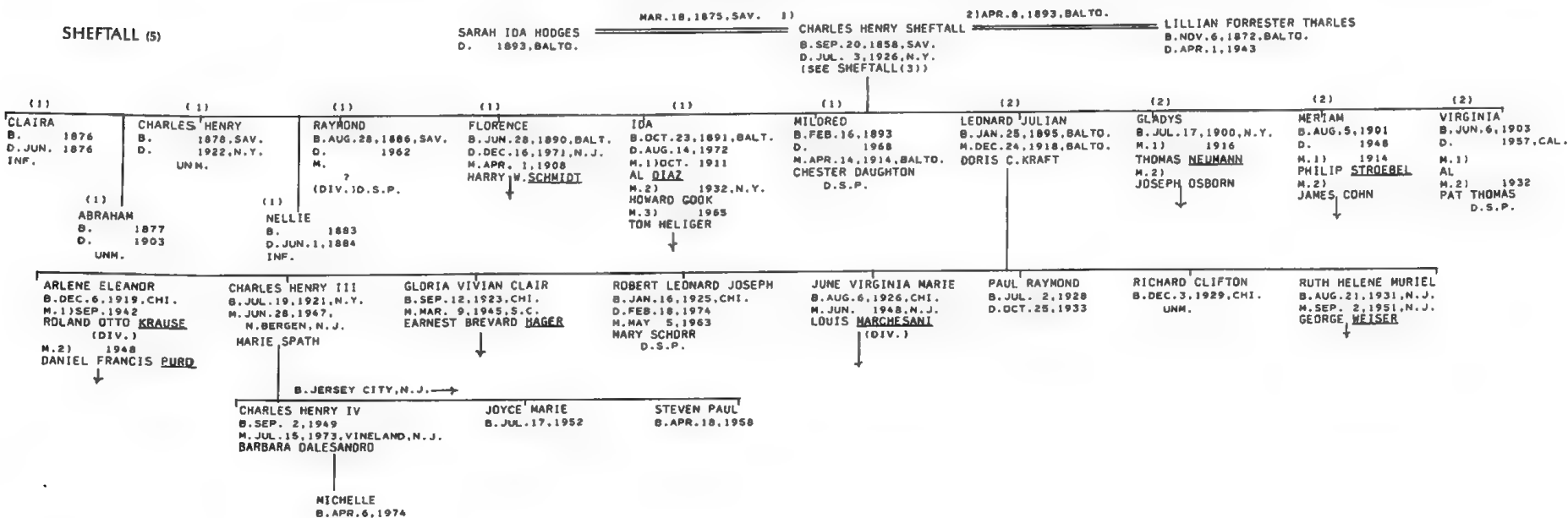

FLD.ABR.
SHEARITH ISRAEL REC.
MIKVEH ISRAEL REC.
RODEPH SHALOM MOHEL REC.
DAVIS-RODEPH SHALOM

(IN PH.BY 1820) MAYER SHOYER RACHEL CADET
B. 1773 (O.V.)
D.DEC.25, 1850,PH.

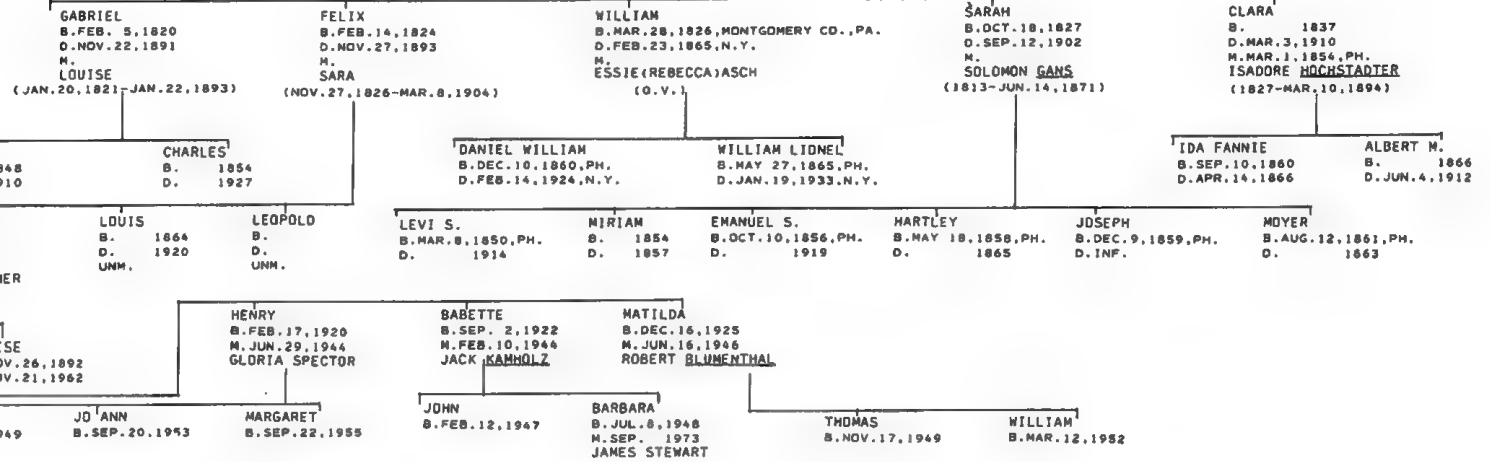

SIMON

SHEARITH ISRAEL REC.
MIKVEH ISRAEL REC.
SPRUCE ST.CEM.
B.JACOBS MOHEL REC.
AJA.V.XII,P.107
W.W.,P.49
KRAUS-SANDOR COLL.
PAJHS V.8,P.30F.
V.21,PP.154,156
V.27,P.155
V.31,P.241
AJMO,LXI,P.73
PHILIPSON-REBECCA GRATZ,P.42
DAVID A. BRENER

(IN LANCASTER, PA. 1735; NAT. MAR. 25, 1749) JOSEPH SIMON ROSE BUNN
B. 1712 (VIO. MYERS-COHEN I)
D. JAN. 24, 1804

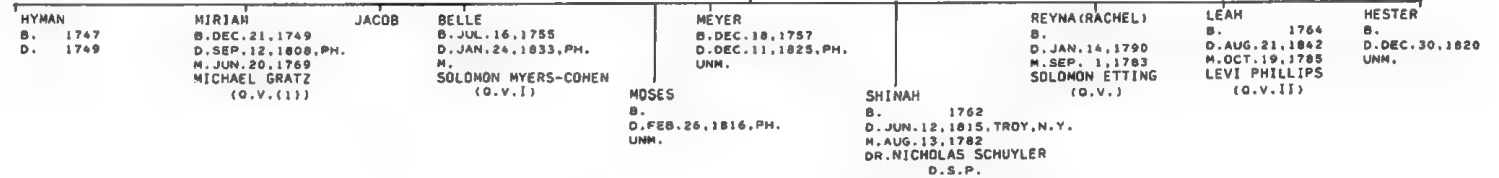

SIMONS

KRAUS-SANDOR COLL.
ELZAS-JEWS OF S.C.
MS.
O.J.C.
CHATHAM CO.(GA.)WILLS
WILL OF SAMPSON SIMONS (JRM)
MONTAGUE SIMONS
SAV.JEWISH BURYING GROUND

ISAAC SIMONS, OF LOND.

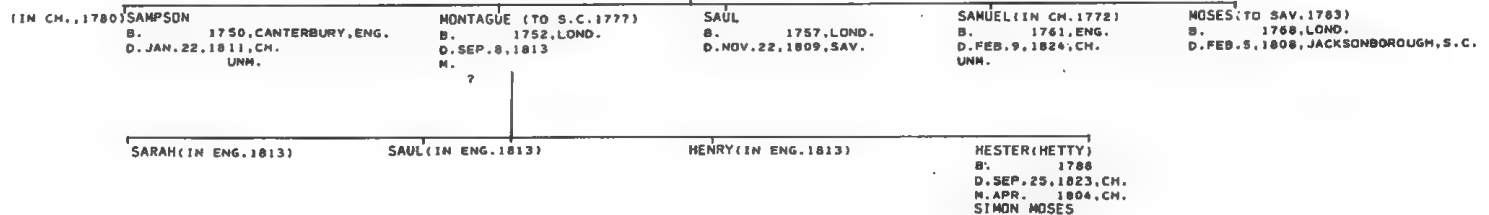

SIMPSON

ELZAS MS.
D.J.C.
SHEARITH ISRAEL REC.
A.L.NARSH

NANCY ? 1) MICHAEL SIMPSON 2)
B.MAY 1791 B. 1773
D.JUL.20,1817 D.SEP.14,1833
JACKSONBOROUGH,S.C.

JANE COHEN
WIDOW OF GOODMAN MORDECAI
(O.V.MORDECAI II)

CATHERINE B. 1806 D.FEB.27,1893.SAV. UNM.	ADELINE B.NOV. 6,1810 D.AUG.15,1852 UNM.	JOSEPH	HENRIETTA EUGENIA B. D.SEP.21,1836. GEORGETOWN, S.C. M.OCT. 1835 NATHAN EMANUEL (O.V.III)	ANNIE B. B.MAR.13,1820 D.JAN.26,1905,CH. UNM.	MYER H.(NEW ORLEANS) B. 1823,CH. D.NEW ORLEANS M.OCT.20,1851,N.Y. ESTHER ABRAMS (VID.ABRAMMS III; WIDOW OF ZALEGMAN ANDREWS (O.V.)	LEONARD B. D. M. (MRS.) STRAUS	REBECCA B. 1827 D.APR.19,1904 M.FEB.24,1857 DR.JOSEPH R.SOLOMONS (O.V.V)
--	---	--------	---	--	---	--	---

PERCY HENRY

SIMSON

SIMSON MS.(AJHS)
HERSHKOWITZ-WILLS.P.
N.Y.STATE CENSUS, 1855
PAJHS V.10,PP.109P.,34
V.25,P.88F.
V.27,P.371F.
V.33,P.202
AMER.JEW ARCHIVES.V.1,#2.P.33F.
POOL-PORTRAITS...
SHEARITH ISRAEL REC.
MISC.VII

(SIMSON)

GRACE B. D. M. SAMUEL PLONT OF BONN	ROSE B. D. M. MIRO KISER OF AMSTERDAM	NATHAN(IN N.Y.1704) B.GERMANY D.LONDON 1725 M.I) ? M.2) DYFIE ?	HANNAH B. D. M. JOSEPH LEVY (O.V.I)	SARAH B. D. M. ?
--	--	---	--	---------------------------

(CALLED SIMSON)

(HOLLAND TO N.Y.,1744)	FRUMET(FRANCES) B. D.N.Y.JUL.29,1772	SAMUEL B. D.HOLLAND BEF. 1744	ISAAC(LOND.)	JOSEPH (TO N.Y.1718;FREEMAN,FEB.1,1743) B. 1686,GER. D.NOV.1787,N.Y. M. 1722,WILTON,CONN. REBECCA ISAACS (O.V.II)
------------------------	--	-------------------------------------	--------------	--

JACOB LEVY

FIGLAH B. D. M.OCT.15,1769,N.Y. JOSEPH SIMONS	DAVID JACOBS (O.V.II)	N.Y.DEC.2,1761 1)	RICHARD B.HOLLAND D.	2)N.Y.NOV.20,1774	HART AARON B. D.N.Y.JAN.29,1777
---	--------------------------	-------------------	----------------------------	-------------------	---------------------------------------

SIMPSON, SR. B. 1725 D.AUG.29,1773,N.Y.	SARAH B. 1727 D.SEP.20,1762 M. RAPHAEL (RALPH) JACOBS (O.V.I)	SOLOMON B.SEP. 1738/22 D.JAN.17,1801,YONKERS,N.Y. M.OCT.26,1768 SARAH HEARS (O.V.)
---	--	---

SIMCHA B.MAY 4,1772, KINDERHOOK, N.Y.	REBECCA B.AUG.6,1774, KINDERHOOK, N.Y.	HANANEL B.NOV.22,1776,N.Y. D.JUN.23,1778	GERSHON B.JAN.29,1779
---	--	--	--------------------------

REBECCA B.SEP.19,1769,N.Y. D.FEB.22,1854,N.Y. M.JUN.18,1806 ABRAHAM N.ISAACS (O.V.I)	JOCHEBED(JOICE) B.SEP.14,1771 D.OCT.30,1814 UNM.	ELLEN(HELENA) B.MAY 6,1773 D.SEP.30,1819 UNM.	FRUMET B.JUL.25,1774 D.SEP. 1,1774	JOSEPH B. 1779 D.OCT.31,1842,N.Y. M.JUN. 4,1806 FRANCIS ISAACS (O.V.I)	SAMPSON, JR. B.JUN.30,1781, DANBURY, CONN. D.JAN. 7,1857,N.Y. UNM.
---	---	--	--	---	--

SOHER

KURN-N.D.
EDGAR M.KAHN
SALEM FIELDS CEM.(J.STEDMAN)
KRAUS-SANDOR COLL.
SHEARITH ISRAEL REC.

BENJAMIN HART (LOND.)
B.
D.
M.

(TO N.O.1822) SOLOMON SOHER 1828

SOLOMON B.MAY 8,1807	SARAH B. D.N.Y.MAY 20,1835	SAMPSON III	JESSICA(JOCHBED) B.FEB.13,1810,WESTCHESTER CO. D.FEB. 7,1886,N.Y. M.DEC.15,1852,N.Y. REV.ANSEL LEO (O.V.)
-------------------------	----------------------------------	-------------	--

MIRIAM ANDREWS (O.V.)

MICHAEL(LYNCHBERG,VA.) B.APR.20,1802,LOND. D.SEP.15,1861,LOUISVILLE,KY. M. FRANCES DAVIS(O.V.)	JOSEPH B.CA. 1830 D. UNM.	ZIPPORAH B.MAY 12,1831,N.Y. D.MAY 9,1898 M.AUG.27,1856,N.Y. EDWARD MORRISON (O.V.)	MOSES(MORRIS) B.JUN. 8,1834,N.Y. D.JAN.17,1873 M.NOV.22,1871,N.Y. ROSALIE ELIZA HENDRICKS (O.V.(2))	W.ANDREWS B.MAY 22,1836,ENG. D.FEB. 9,1901, ATLANTIC CITY,N.J. M. MINNIE PHILLIPS (O.V.VI)
--	------------------------------------	---	--	--

BENJAMIN LEWIS	GEORGE B. D. M. HELEN LITTLE	SARAH B. 1847,VA. D.AUG.21,1889,FRANCE UNM.	ALFRED B.SEP.26,1848, LYNCHBERG D.MAR.22,1864,N.Y.	DAVID B.MAR.30,1836, LYNCHBERG D.	ROSAIE B.N.Y.MAR.27,1829	MICHAEL	MARIE LEROY
----------------	--	--	---	--	-----------------------------	---------	-------------

HENRY
B.
D.
M. ?

ALENA
B.N.Y.OCT.20,1872
D.N.Y.JAN. 5,1873

VIOLET B.N.Y.JAN. 1884 D.N.Y.DEC.4,1887	LE ROY	RODNEY
---	--------	--------

BENJAMIN HARY FANNY IMOGENE
S.K.JONES BREASTED

PHILIP W. ERNEST W.

REZNIKOFF-JEWS OF CHARLESTON, PP. 49, 270
 JAMES M. FORGOTSON
 LOUIS GINSBERG

ISAAC
 (REVOLUTIONARY WAR)

LEVY (TO U.S., 1780)
 B. GERMANY, CA. 1754
 D. 1827

CHAPMAN
 B. 1769
 D. JUN. 28, 1849, NEW ORL.

LEVY
 B. FEB. 29, 1812, IN OR NEAR CH.
 D. 1886, MEXIA, TEXAS
 M. 1838 (?), CH.
 HANNAH (ANNIE) HYAMS
 (O.V. (1))

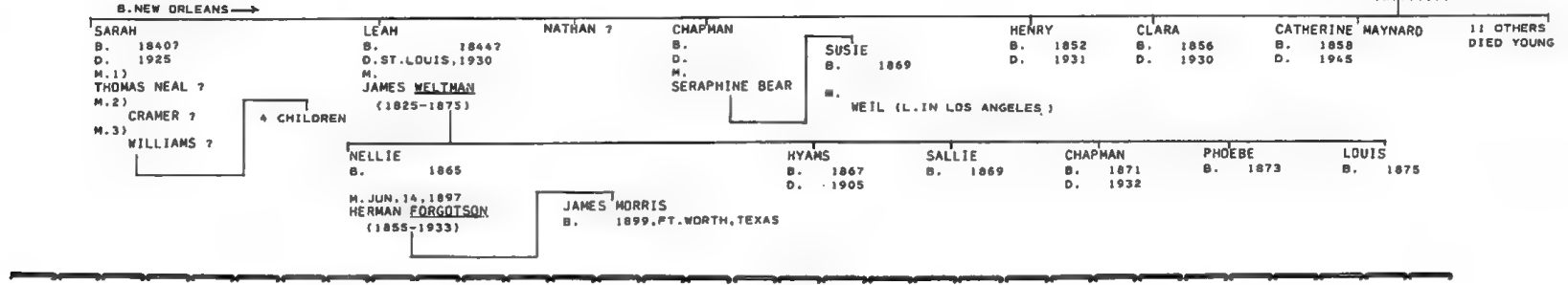

SOLIS (1)

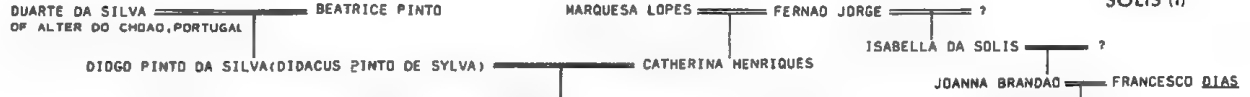

KRAUS-SANDOR COLL.
 HENDRICKS GEN.
 EZEKIEL-LICHTENSTEIN-JEWS OF RICHM., P. 290F.
 PLO. ABR.
 HICKVE ISRAEL REC.
 SHEARITH ISRAEL REC.
 BEVIS MARKS REC.
 MYER SOLIS-COHEN
 BETH SHALOME MARRIAGE REC

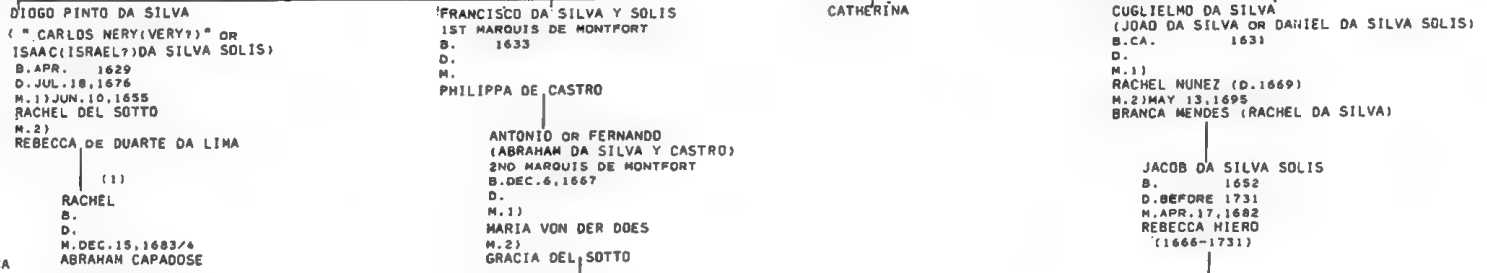

ÁSPAR MALUENDA Y BARBARON MARQUIS BARBARON B. D. M. ANTONIA DE PAZ CORDHEL Y FONSECA

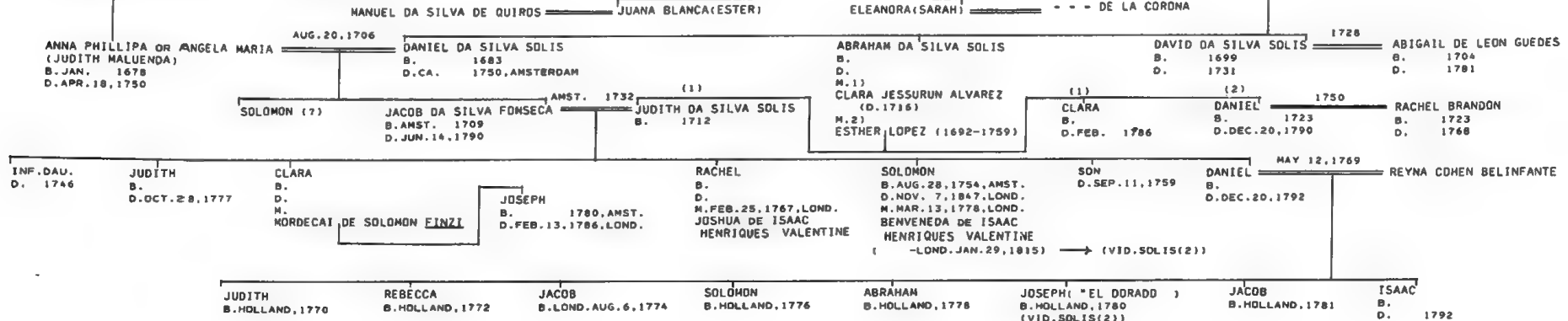

SOLIS (2)

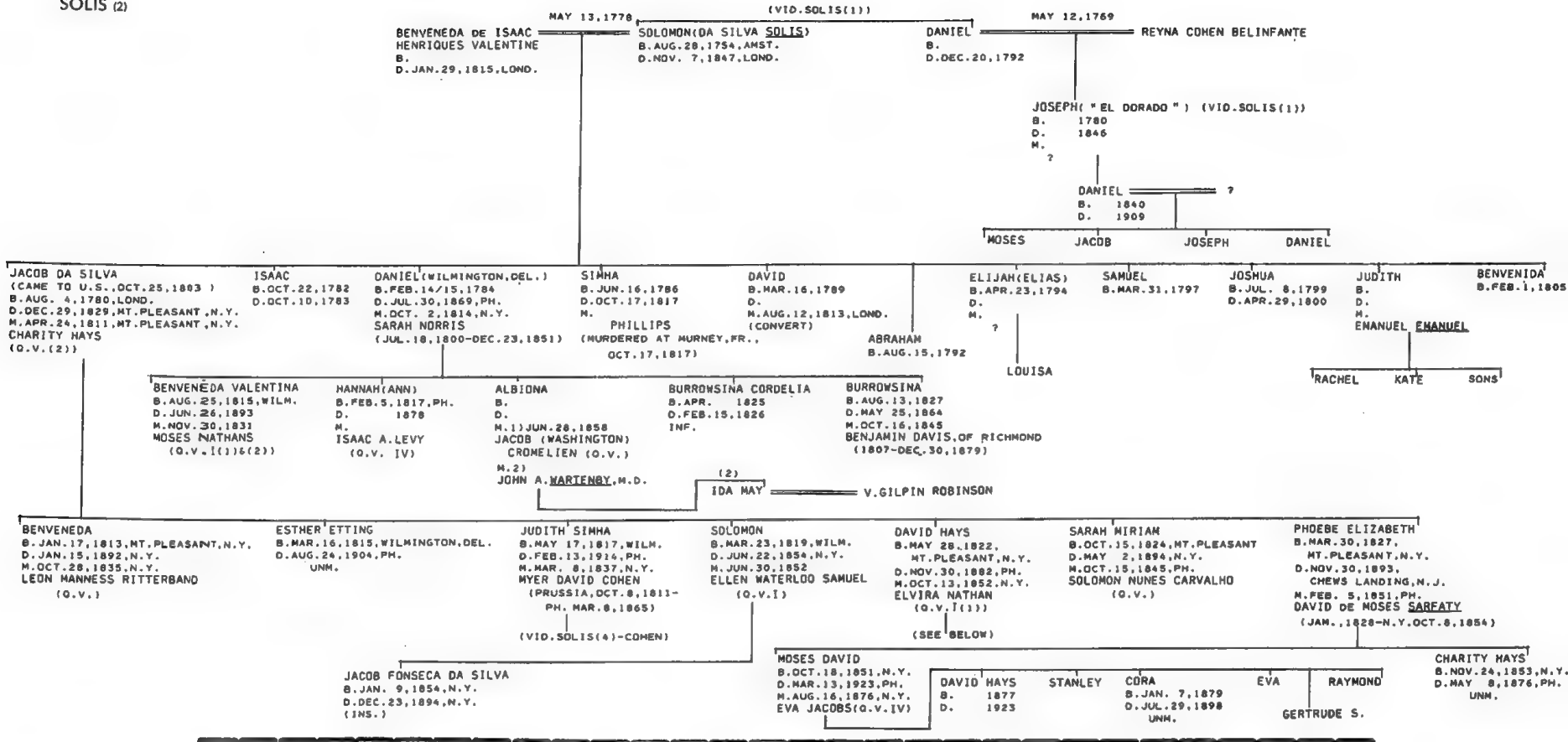

SOLIS (3)

N. Y., OCT. 13, 1852

DAVID HAYS SOLIS B. MAY 28, 1822, MT. PLEASANT, N.Y. D. NOV. 30, 1882, PH. (SEE ABOVE)

ELVIRA NATHAN (O.V. I (1))

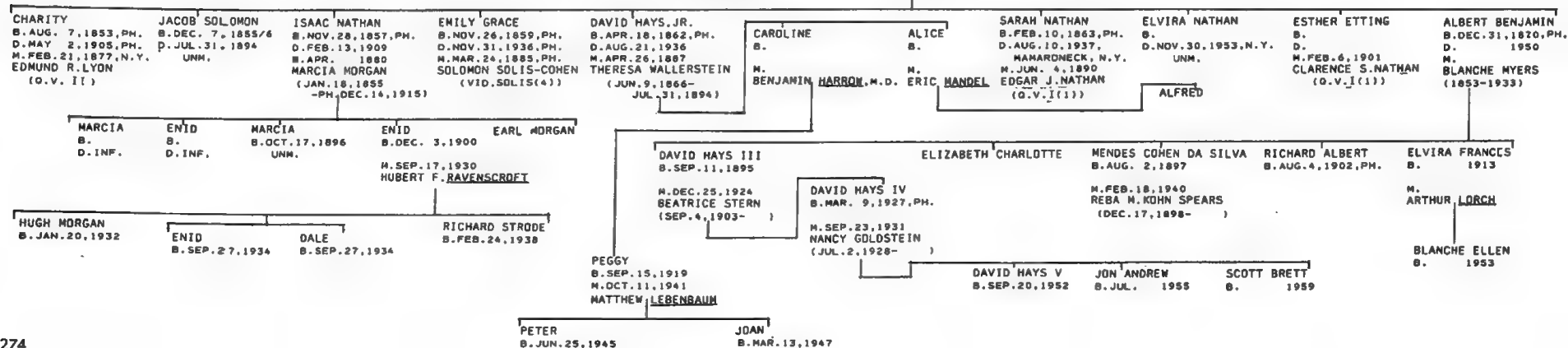

MYER DAVID COHEN N.Y. MAR. 8. 1837
B. PRUSSIA, OCT. 8, 1811
D. PH. MAR. 8, 1865

JUDITH SIMHA SOLIS
(VID. SOLIS (2))

(LAST NAMES IN BRACKETS)

JACOB DA SILVA, M.D. (SOLIS-COHEN) (CIV. WAR)
B. FEB. 28, 1838, N.Y.
D. DEC. 27, 1927, PH.
M. FEB. 10, 1875
MIRIAM BINSWANGER (O.V. (3))

LEON (CIV. W.) (SOLIS-COHEN)
B. OCT. 16, 1840, PH.
D. SEP. 19, 1884, PH.
M. APR. 10, 1872, N.Y.
LUCIA MANNESS RITTERBAND (O.V. (2))

CHARITY SOLIS (COHEN)
B. APR. 16, 1844, PH.
D. AUG. 15, 1943, PH.
UNM.

ISABEL EMANUEL (COHEN)
B. SEP. 17, 1848, PH.
D. AUG. 3, 1940, PH.
UNM.

DAVID SOLIS (COHEN)
B. OCT. 15, 1850, PH.
D. NOV. 19, 1928, PORTLAND, OREGON
M. APR. 4, 1894, PORT. BERTHA KAHN

ZITELLA ESTHER (COHEN)
B. JUL. 23, 1852, PH.
D. JAN. 23, 1932, PH.
UNM.

SALOME SOLIS (COHEN)
B. PH. D. PORTLAND, ORE.
M. NOV. 20, 1887
ALEXANDER BERNSTEIN (OCT. 10, 1859-OCT. 1, 1924)

SOLOMON, M.D. (SOLIS-COHEN)
B. SEP. 1, 1857, PH.
D. JUL. 12, 1948, PH.
M. MAR. 24, 1885, PH.
EMILY GRACE SOLIS (VID. SOLIS (3))

ISAAC LEESER (COHEN)
B. SEP. 3, 1861, PH.
D. PORTLAND, ORE.
M. SEP. 15, 1892
CELIA RAPHAEL (1862-JUN. 15, 1924)

JESSIE MYRA
B. JUN. 19, 1874, N.Y.
M. JOSEPH ALPHONSE LITELIER DE ST. GIUSTI HUDON DE BRAULIEU

GERTRUDE
B. MAY 30, 1880, N.Y.
D. SEP. 25, 1880, N.Y.

LEON MANNESS
B. AUG. 26, 1881
D. JUN. 4, 1944
M. SEP. 23, 1920
ELFRIDA COHEN (DEC. 24, 1888-)

LEON MYER
B. FEB. 9, 1890, PH.
M. IDA ?

JUDITH SIMHA
B. UNM.

SALOME SOLIS-COHEN
B. D. JUL. 17, 1926
UNM.

LEESER RAPHAEL SOLIS
B. OCT. 13, 1893
D. OCT. 6, 1920
UNM.

DAVID SOLIS II
B. MAY 13, 1899
D. M. JUL. 20, 1924
LILLIAN ARABELLE BATES (APR. 6, 1905-)

THEODORA BENVEDENA JUSTINE
B. OCT. 4, 1905, N.Y.
M. KENNETH JONES EARTH

GLADYS
B. N.Y. OCT. 1906
M. RICHARD SHINE

EMILY ELVIRA
B. MAR. 20, 1886, PH.
D. APR. 19, 1969, PH.
UNM.

DAVID HAYS
B. AUG. 21, 1888, PH.
M. JUN. 10, 1914
ERNA SULTAN

LEON, M.D.
B. JUN. 7, 1890, PH.
D. MAY 6, 1965, PH.
M. SEP. 30, 1917, PH.
MARIAN MANSBACH (NOV. 6, 1893-)

FRANCIS NATHAN
B. APR. 13, 1892, PH.
D. 1956
M. APR. 12, 1917
JULIA COLEMAN (APR. 25, 1894 - 1966)

BATES BATES
B. MAR. 27, 1927

DAVID SOLIS BATES
B. OCT. 22, 1928

HELEN
B. JUN. 2, 1915, PH.
M. 1) AUG. 31, 1939
HERBERT SPIGEL (-DEC. 16, 1951)
M. 2) JUN. 15, 1969
JAMES EZEKIEL SAX (VID. CADET)

DAVID HAYS, JR.
B. JUL. 15, 1917, PH.
M. JUN. 6, 1942
VIRGINIA R. KAUFMAN

LEON, JR.
B. FEB. 23, 1920, PH.
M. APR. 4, 1954
LITA CLAIRE HAHN

SOLOMON II
B. DEC. 24, 1921, PH.
M. MAY 5, 1943, PH.
BARBARA A. SAMUEL

MARJORIE GRACE
B. DEC. 8, 1921, PH.
M. APR. 10, 1941
IRA B. JOSEPH

FRANCIS ESTHER
B. AUG. 9, 1924, PH.
M. APR. 30, 1944
JOHN SCHULMAN, JR.

NANCY JOAN
B. MAR. 15, 1948

VIRGINIA MARTHA
B. FEB. 25, 1950

FRANK BENJAMIN
B. DEC. 27, 1943

ROBERT HAYS
B. JAN. 3, 1946
M. DEC. 26, 1971
SUSAN CATHERINE GRAY (JUN. 19, 1947-)

JAMES HERBERT
B. OCT. 2, 1951

ELIZABETH VIRGINIA (BETSY)
B. JAN. 15, 1947
M. JUL. 5, 1970
PETER RIZZA

KATHERINE EMILY (KATE)
B. DEC. 26, 1948
D. NOV. 23, 1973

DAVID HAYS, III

JOHN AGAS
B. NOV. 3, 1946

PAUL HENRY
B. MAR. 7, 1949

ELLEN SUE
B. DEC. 2, 1952

LAWRENCE KENNETH
B. DEC. 1, 1942

DONALD ROBERT
B. JAN. 9, 1947

THOMAS ALAN
B. DEC. 14, 1950

DEBRA ANN
B. DEC. 22, 1953

JUDITH SIMIRA
B. JUN. 14, 1876, PH.
D. OCT. 8, 1927, PH.
UNM.

MYER, M.D.
B. MAY 24, 1877, PH.
D. JAN. 8, 1960, PH.
M. FEB. 11, 1925
ROSEBUD L. TESCHNER (N.Y. JUN. 29, 1903-)

SOPHIA REBECCA
B. JUL. 28, 1879, PH.
D. SEP. 5, 1952
UNM.

MIRIAM FONSECA
B. JUL. 18, 1833
WEST CHESTER, PA.
D. MAY 30, 1970, PH.
UNM.

ROSALIE ISABEL
B. MAR. 27, 1887, PH.
D. APR. 25, 1887, PH.

ELINOR
B. AUG. 31, 1885, PH.
UNM.

BERTHA FLORENCE
B. APR. 20, 1889, PH.
UNM.

JACOB DA SILVA, JR.
B. JUN. 26, 1890, PH.
D. JUL. 8, 1968
M. DEC. 13, 1916
MARTON GIMBEL LABE (PH. MAR. 13, 1895-MAR. 28, 1962)

ESTHER
B. MAR. 15, 1892, PH.
D. JAN. 4, 1893

ISADORE BINSWANGER
B. SEP. 13, 1896, PH.
D. AUG. 26, 1925, PH.
UNM.

EDITH
B. SEP. 13, 1893, PH.
D. AUG. 23, 1964
UNM.

KATHE
B. JUL. 15, 1926, PH.
PH. FEB. 24, 1945

MARVIN E. JACOBY

GEORGE D. KELLER
APR. 6, 1943

MARY
B. SEP. 11, 1917

ANN
B. SEP. 8, 1923, PH.
APR. 14, 1946

CHARLES L. ROSENTHAL

DAVID ALEXANDER
B. APR. 28, 1948, PH.

EDITH SHARON
B. MAY 13, 1950, PH.

ALICE LOUISE
B. DEC. 26, 1952, PH.

MARY ANN
B. SEP. 8, 1947,
BINGHAMTON, N.Y.

JOHN CHARLES
B. JUL. 29, 1950,
BINGHAMTON, N.Y.

KATE
B. MAY 1, 1954

JULIE ANN
B. JAN. 12, 1943, PH.
M. DAVID KUHN

POLLY ELIZABETH
B. NOV. 5, 1945, PH.
M. DAVID HILDEBRAND (DIV.)

ADAM
B. MAY 9, 1951, PH.

SOLOMONS I (MONTREAL, ALBANY)

KRAUS-SANDOR COLL.
J.E. V. 11, P. 459F.
PAJMS, V. 27, PP. 151, 376
SOLOMONS MS. (AJA)
JRM COLL.
MALCHELOSSE-LES JUIFS...
POOL-PORTRAITS...
SHEARITH ISRAEL REC.
R.J.D'ARCY HART
KATZ-BETH EL STORY
FLD.ABR.
ROSENSWAIKE
BLAU-BARDON, P. 507F.
MRS. E. MILLER
MCCORD MUS.

ESTHER
B.
D.
M.
NOSES HART
(O.V. I)

EZEKIEL
B.
D. JUL. 1808
M.
ELIZABETH LOUISE DUBOIS

SON SOLOMONS
B.
D.
M. ?

SON SOLOMONS
B.
D.
M. ?

WILLIAM
B.
D.
M. ?

SOPHIE
B.
D.
M. JUL. 23, 1798
ISIDORE PELLETIER

(OTHERS)
EZEKIEL
B. MAY 26, 1799
D. MONROE, MICH.

ISAAC
B.
D.
M. MARY
(ELOPED, N.Y. 1760)

LUCIUS LEVY (TO CANADA
CA. 1760 FROM ALBANY, N.Y.)
B. DEC. 23, 1771, ENG.
D. MAY 18, 1792, MONTREAL
M. 11
N. 21 MAY 31, 1775
REBECCA FRANKS
(-MAR. 27, 1812)

(1) SARAH (SALLY) B. 1769/70 D. JUN. 13, 1812 M. NOV. 27, 1798 LONDON THOMAS MCCORD OF MONTREAL (VIO. JUDAH III)	(1) LEVY B. DEC. 23, 1771, MONTREAL D. JUN. 11, 1823, N.Y. M. JUL. 29, 1801, N.Y. CATHERINE MANUEL (VIO. JUDAH III)	(2) MARY (POLLY) B. MAR. 6, 1776 D. OCT. 1826 M. 1817 JACOB FRANKS (O.V. III)	(2) BENJAMIN B. MAY 16, 1777 D. JUL. 25, 1777 UNM.	(2) ELIZABETH (BETSY) B. DEC. 22, 1779 D. JUN. 1832 UNM.	(2) RACHEL B. DEC. 25, 1780 D. OCT. 9, 1855 M. SEP. 28, 1802/3 HENRY (HARRY) JOSEPH (O.V. II)	(2) CATHERINE (KITTY) B. SEP. 25, 1782 D. MAR. 28, 1851 M.	(2) REBECCA (BACKKY) B. NOV. 25, 1783 D. FEB. 17, 1789 UNM.	(2) JESSICA (JESSIE) B. SEP. 15, 1785 D. OCT. 23, 1853 UNM.	(2) BENJAMIN SAMUEL B. OCT. 25, 1786 D. MAY 13, 1831, MONTREAL M. APR. 28, 1816 ELKALEH SEIXAS (O.V. (2))	(2) FANNY B. JAN. 29, 1789 (2) HENRY B. 1787 D. 1865
--	--	---	--	--	---	--	---	---	--	--

(JUDGE) JOHN SAMUEL OF MONTREAL B. JUN. 27, 1801, IRELAND	WILLIAM KING OF QUEBEC CITY B. JAN. 8, 1804, IRELAND	LEVY B. 1818 D. MAY 23, 1892, MONT.	2 CH.	BENJAMIN B. APR. 1829 D. JUL. 6, 1829 UNM.	GERSHOM B. FEB. 6, 1823 D. NOV. 30, 1905 (BUR. MONTREAL) UNM.	REBECCA B. CANADA, 1822 D. MAR. 31, 1890, N.Y. M. MAY 7, 1844, N.Y. (SIMON) MENDES NATHAN OF N.Y. (O.V. I(1) & I(2))
---	---	---	-------	---	---	--

LEVY B. DEC. 23, 1826, ALBANY D. OCT. 16, 1843, NEW ORLEANS UNM.	JACOB B. NOV. 22, 1826, MONTREAL D. JAN. 15, 1827, MONTREAL	CATHERINE MANUEL B. NOV. 22, 1826, MONTREAL D. JAN. 15, 1829, MONTREAL	GERSHOM MENDES SEIXAS B. JUL. 4, 1828, MONTREAL D. JAN. 12, 1889 M. SAN FRANCISCO HANNAH MARKS (SEP. 2, 1835-AUG. 4, 1890)	LUCIUS LEVY (NAME CHANGED TO MOSES IN CHILDHOOD ILLNESS) B. JAN. 4, 1830, MONTREAL D. FEB. 7, 1883, N.Y.	SELINA SEIXAS B. NOV. 22, 1862 D. UNM.	GERTRUDE MARKS B. JUN. 30, 1866 D. NOV. 20, 1973	ADELE ROSA (PROF.) B. NOV. 7, 1868 M. FEB. 1895 MYER E. JAFFA	LEON MENDES B. SEP. 30, 1873 D. JAN. 14, 1900 UNM.	FRANK BENJAMIN B. MAY 1875 D. INF.
---	---	--	---	--	--	--	--	---	--

KATHERINE MAY B. FEB. 22, 1918, S.F. M. WESLEY WOODEN	EDITH MARIAN B. AUG. 17, 1920, S.F. M. BENJAMIN DOREMAN (1921, LOUISVILLE-)	KATHERINE MANUEL B. JUL. 28, 1897 M. MAR. 15, 1917 ARTHUR GERSTLE LILIENTHAL OF SAN FRANCISCO (1887-1965)	EDITH JOSEPHINE B. JAN. 21, 1904, S.F. M. STANLEY GREEN (1903-1968, S.F.)	MARIAN FRANK B. FEB. 21, 1907 (-1955) ARTHUR FRANKEN	EDWARD MOSS B. 1896 M. SYLVIA ROBERTS	AILEEN B. 1900 M. JUL. 1922 HILTON KATSKY (DIV.)	THEODORE SEIXAS B. JUL. 27, 1870 M. 1910 KATHERINE CHURCH BOTHWELL	ELEANOR SUSAN "TONI" B. 1911 M. 1 BENJAMIN JACKSON M. 2 BEN VOLCANI (1)	LEON HENRY B. 1915 DAVID SEIXAS B. 1913 (2)
---	--	--	--	---	---	--	---	---	---

WAYNE STANLEY B. 1943, S.F.	MARIANN B. 1949, S.F.	JOAN B. 1952, WOODLAND, CALIF.	RICHARD NATHAN B. 1947, S.F.	ROGER B. 1949, S.F.	ERIC B. 1963, D.C.	DEBORAH B. 1955, D.C.	DAVID B. 1957, D.C.	MICHAEL B. 1960, SAN FR.	LAURA B. 1962, S.F.	ANDREW B. 1961, B. 1957, D.C.	JOHN B. 1967	JOAN B. 1937, S.F. M. ROBERT SPITZLER	ROBERT	JOAN B. 1937, S.F. M. LAWRENCE H. JARMILA ?	KATHERINE YANNON B. D. YOUNG
--------------------------------	-----------------------------	--------------------------------------	---------------------------------	------------------------	-----------------------	--------------------------	------------------------	--------------------------------	------------------------	----------------------------------	-----------------	---	--------	--	---------------------------------

SOLOMONS II (N.Y. & WASH.)

KRAUS-SANDOR COLL.
PHILLIPS GEN. (JRM)
SHEARITH ISRAEL REC.
ROSENSWAIKE

SON SOLOMONS
B.
D.
M. ?

JOHN
B. DEC. 1789, LOND.
D. SEP. 19, 1858, N.Y.
M. JAN. 13, 1818, N.Y.
JULIA LEVY (O.V. VI)

RACHEL
B.
D.
M. HENRY JOSEPH HART
OF LONDON

SON B. JAN. 1823, N.Y. D. MAR. 11, 1823, N.Y. INF.	ADOLPHUS SIMSON B. OCT. 26, 1826, N.Y. D. MAR. 18, 1910, WASH. M. JUN. 25, 1851, N.Y. RACHEL S. PHILLIPS (O.V. I(2))	WELLINGTON B. D. M. SUSAN V. ATKINS	GERTRUDE B. D. M. JOHN CARNICK	THEODORE B. D. M. ANNIE (XIAN)	JOHN B. D. M. LILLIE (XIAN)	EVERT B. D. M. LOLA SEARLES	MARY JANE B. N.Y. 1818 D. WASH. NOV. 11, 1905 UNM.
---	---	--	---	---	--------------------------------------	--------------------------------------	---

IDA JUDITH B. APR. 3, 1852, N.Y. D. DEC. 15, 1933, WASH. M. JAN. 21, 1880, WASH. DANIEL L.M. PEIXOTTO (O.V. I(2))	ISABELLE B. DEC. 1, 1853, N.Y. D. DEC. 14, 1934, WASH. UNM.	HENRY B. SEP. 5, 1855, N.Y. D. MAR. 28, 1859, N.Y.	ZILLAH B. MAR. 11, 1857, N.Y. D. DEC. 10, 1917, WASH. UNM.	ALINE ESTHER B. FEB. 17, 1859, N.Y. D. MAR. 31, 1942, WASH. UNM.	EMMA B. DEC. 5, 1860, WASH. D. OCT. 28, 1939, WASH. UNM.	JULIA B. N.Y. OCT. 20, 1862	ALMA B. WASH. DEC. 25, 1864 D. WASH. FEB. 4, 1888 UNM.	ROSALIE B. APR. 25, 1866, WASH. D. FEB. 5, 1946, N.Y. M. MAR. 9, 1892, WASH. N. TAYLOR PHILLIPS (O.V. I(2))
--	--	--	---	---	---	--------------------------------	---	--

POOL-PORTRAITS...
SHEARITH ISRAEL REC.
FLORENCE ABRAHAMS
PAJHS V.27,P.7B
B'NAI JESHURUN REC.

NATHAN SOLOMON(S) (LOND.)

B.
D.
M.

?

MARK (SCHOCHET IN N.Y. & CH.)

B. 1763, LOND.
D. NOV. 15, 1830, N.Y.

M. 1)

YITLAH (ESTHER) HAYS

(O.V. (4))

M. 2)

ABIGAIL MYERS (O.V.V)

(-N.Y. JUL. 3/4, 1827)

(1)	(2)	(2)	(2)	(2)	(2)
SAMUEL B. CA. 1807, CH. D. MAY 11, 1874, N.Y.	HANNAH B. APR. 3, 1817, N.Y. D. JUN. 17, 1874, N.Y. M. OCT. 28, 1835, N.Y. JONAS ISAACS (TO US. 1828) (MANCHESTER, ENG. JAN. 12, 1810- NDV. 28, 1873, N.Y.)	ESTHER (HESTER) B. OCT. 5, 1819, N.Y. D. JUN. 22, 1908, N.Y. M. MAY 5, 1836, N.Y. LAZARUS Y. MARTIN (POLAND, 1802-N.Y. NDV. 12, 1877)	SAMSON B. JAN. 23, 1821, N.Y. D. JUL. 2, 1901, N.Y.	JONA ABRAHAM B. FEB. 23, 1823, N.Y.	INF. B. AUG. 7, 1825, N.Y.

PHILIP B. N.Y. AUG. 27, 1836	AMELIA B. N.Y. FEB. 19, 1843 D. M. N.Y. DEC. 24, 1862 JOSEPH HENRY STEINER (ZAUVE, AUSTRIA, SEP. 6, 1839 -)	HETTIE B. N.Y. NDV. 6, 1847 D. M. N.Y. MAY 24, 1864 SAMUEL HYMAN (O.V.)	SIMON B. APR. 29, 1837, N.Y. D. AUG. 17, 1890, N.Y.	ABIGAIL B. DEC. 11, 1838, N.Y. D. MAR. 9, 1926, N.Y. M. SEP. 16, 1857, N.Y. LEWIS POWERS OF NASHVILLE, TENN.	HENRY B. FEB. 14, 1842, N.Y.	MURRIS B. OCT. 1842 D. MAY 29, 1843, N.Y.	FREDERICK L. B. DEC. 14, 1847, N.Y. D. DEC. 21, 1935, SAN FRAN. M. JUL. 10, 1872, N.Y. MARIE LOUISE (MINNIE) HYNEMAN (O.V. I)
---------------------------------	---	--	---	---	---------------------------------	---	--

MAURICE LAZARUS B. NOV. 12, 1858, NASHVILLE, TENN. D. JAN. 15, 1920, WESTPORT, CONN. (INS.) M. CA. 1899 VIOLA S. RITTERBAND (O.V.)	HENRY B. JUN. 9, 1861, NASHVILLE D. JUN. 24, 1862, N.Y.	SARAH LOUISA B. NOV. 14, 1863, N.Y. D. SEP. 8, 1864, N.Y.	INF.	EMANUEL B. 1878, N.Y. D. AGE 6, LONDON	STELLA B. OCT. 30, 1873, N.Y. D. DEC. 22, 1874, N.Y.	HAROLD B. JAN. 9, 1886, N.Y. M. 1) ELSA ROSENBERG M. 2) MARY PAULINE KRENTZ	FLORENCE B. MAY 12, 1889, N.Y. D. APR. 17, 1917, N.Y. ERNST BAERWALD
--	---	---	------	--	--	--	---

SOLOMONS IV (1)

JUDITH ? ———— 1) SOLOMON 2) ?

KRAUS-SANDOR CDL L.
ELZAS MSS.
O. J. C.
M. N.
JEWS OF S. C.
WILL OF JOSEPH SOLOMONS (JRM)
ALEXANDER MSS. (A JA)
JACOB ISAACKS MS. (DAR)
HORTENSE PEIXOTTO BLUMBERG
M. A. ALEXANDER-ALEXANDER FAMILY

(1)	(1)	(?)	(2)	(2)
JOSEPH SOLOMON(S) B. AMSTERDAM M. JUDITH (JUDDY) STEP-DAU. OF PHILIP MOSES (- NDV. 21, 181-7)	ISRAEL SOLOMONS (TO GEORGETOWN, S. C., CA. 1800) B. 1770, AMST. D. AUG. 10, 1830, GTN. M. 1) OCT. 5, 1808 ESTHER SARAH OTTOLENGUI (O.V.) M. 2) MAY 5, 1814 ELEANOR JOSEPH (O.V. III) (SEE NEXT PAGE)	JUDY (AMSTERDAM)	SAMPSON (TO GEORGETOWN, 1817) B. 1794, AMST. D. SEP. 21, 1832, GTN./1833 M. JAN. 11, 1819 MOLCIE JOSEPH (O.V. III)	MOSES B. 1799 D. SEP. 1826

SOLOMON B. 1784 D. DEC. 13, 1836 M. AUG. 1805, CH. ALICE ABRAHAMS (O.V. III)	RACHAEL	AARON B. 1791, CH. D. MAR. 15, 1851, N. O.	SALLIE B. 1825 D. SEP. 22, 1828	ZIPPORAH MOLSEY B. AUG. 10, 1829 D. NOV. 28, 1890 M. MAR. 8, 1848 JOSEPH M. SOLOMONS (SEE NEXT PAGE)	SOLOMON SAMPSON B. AUG. 2, 1823, GTN. D. FEB. 15, 1904, GTN. M. 1) 1852 ESTHER NATHANS (O.V. III)	FRANCES B. JUL. 1827 D. OCT. 6, 1866, AUSTIN, TEX.. M. 1) FEB. 1, 1854 RAPHAEL MAYER M. 2) AUG. 24, 1859, ROME, GA. BENJAMIN F. HENDRICKS, OF AUSTIN, TEXAS (VID. PHILLIPS IV)
--	---------	--	---------------------------------------	---	--	--

FANNY B. CA. 1807	JOSEPH B. 1809 D. JUN. 1, 1832. GEORGETOWN	CARLINE B. OCT. 5, 1812 D. AUG. 29, 1887 M. OCT. 9, 1839, N. O. DAVID C. PEIXOTTO (O.V. I (1))	EMMA	SALLIE NATHANS B. APR. 19, 1854, CH. D. AUG. 24, 1933, ATL. M. NOV. 18, 1874, CH. JOSEPH A. ALEXANDER (O.V. (2))	SON B. 1860 D. JAN. 5, 1867	HORTENSE D. M. APR. 26, 1882, CH. LOUIS LE HARDY COHEN (OCT. 29, 1855-FEB. 10, 1902)	ZIPPORAH	CLARA
----------------------	---	---	------	---	-----------------------------------	--	----------	-------

ELZAS MS.
OJC
MN
JEWS OF S.C.
SAV. JEWISH BURYING GROUND
SOLOMONS FAMILY REC. (T.J. TOBIAS)
MOISE-JEWISH CEMETERY AT SUMTER

MARK SOLOMON(S) ————— RACHEL ?
B. 1787, GER. B. 1799
D. JUL. 25, 1837, SUMTER, S.C. D. FEB. 26, 1855, SUMTER

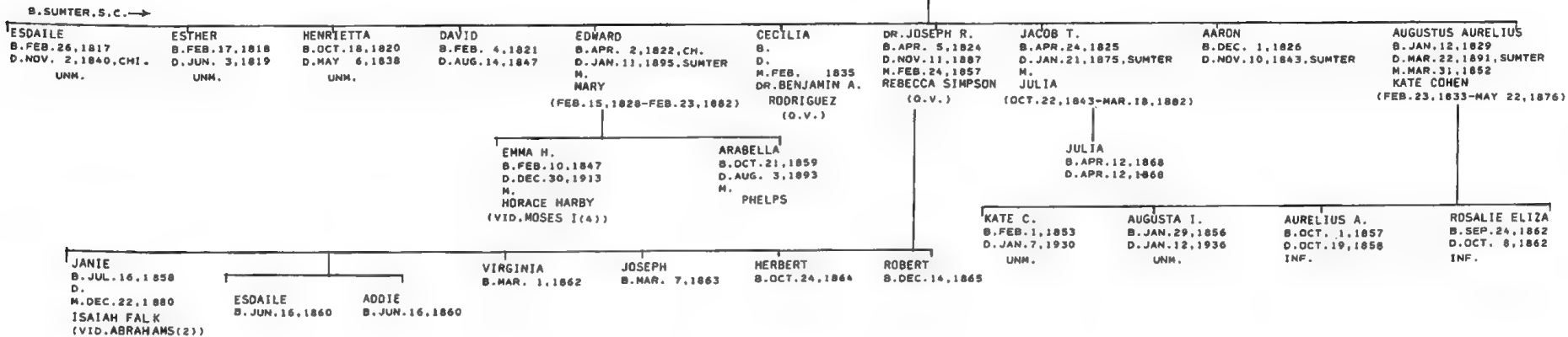

B'NAI JESHURUN REC.
N.Y. CENSUS, 1855

SONDHEIM

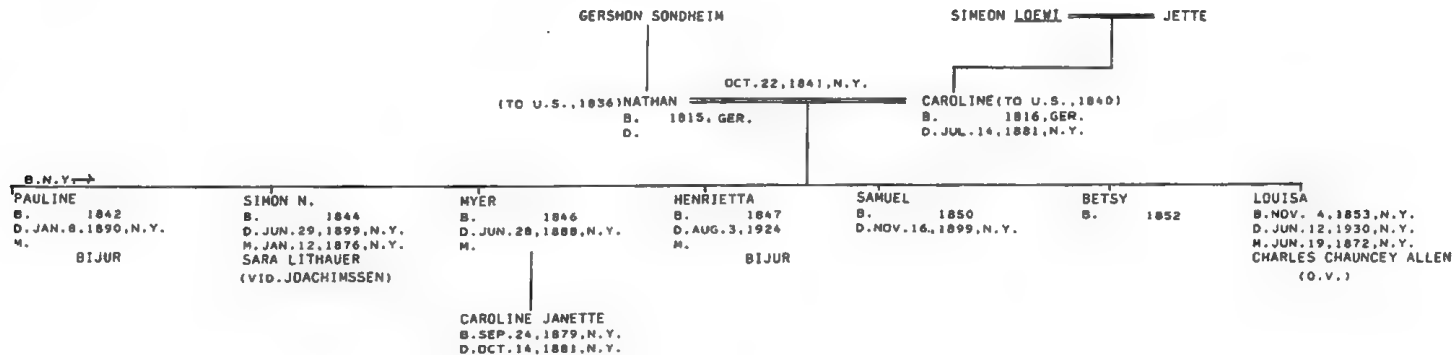

SORIA

B'NAI JESHURUN REC.
WILL OF AARON COHEN
POOL-PORTRAITS...
PAJHS V.27,P.47SF.
V.31,P.25BF.
SHEARITH ISRAEL REC.
JON STEDMAN

(TO N.Y.FROM ST.DDMINGO,CA.1794)AARON SORIA
B.FEB.22,1762,BORDEAUX
D.JAN.5/FEB.12,1852,N.Y.

RACHEL MENDEZ HEGA
B.DEC.25,1781,BORDEAUX
D.MAY 17,1837,N.Y.

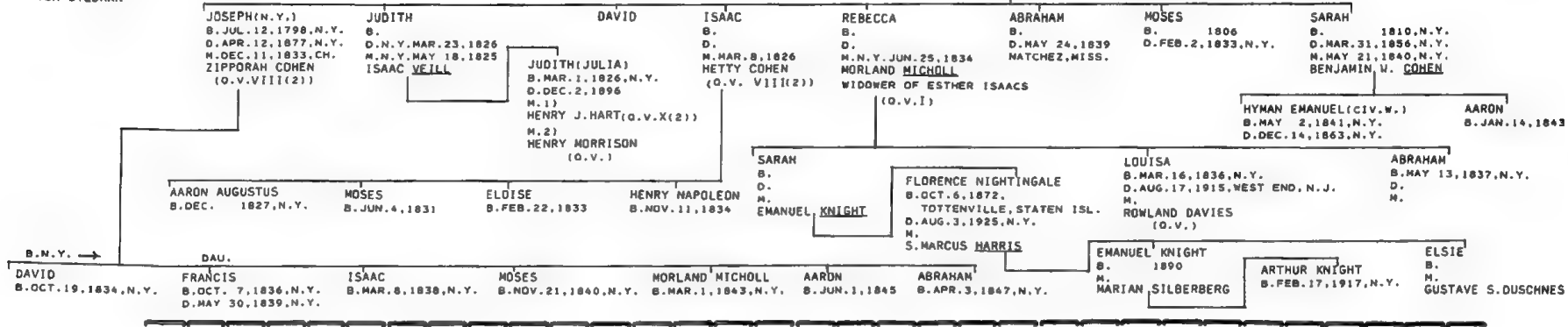

SAMUEL HENRIQUEZ SOUZA OF BAYONNE,FRANCE

B.
D.
M.

?

SAMUEL(TO U.S.,1823)
B.JAN. 1,1780,BAYONNE
D.SEP.27,1861,N.Y.
M. 1801,ROCHELLE,FRANCE
MINKELLA CERF
(LANDAU,PRUSSIA,1783-JAN.20,1858,N.Y.)

SOUZA

KRAUS-SANDOR COLL.
SHEARITH ISRAEL REC.
MICKVE ISRAEL REC.
FLORENCE ABRAHAMS

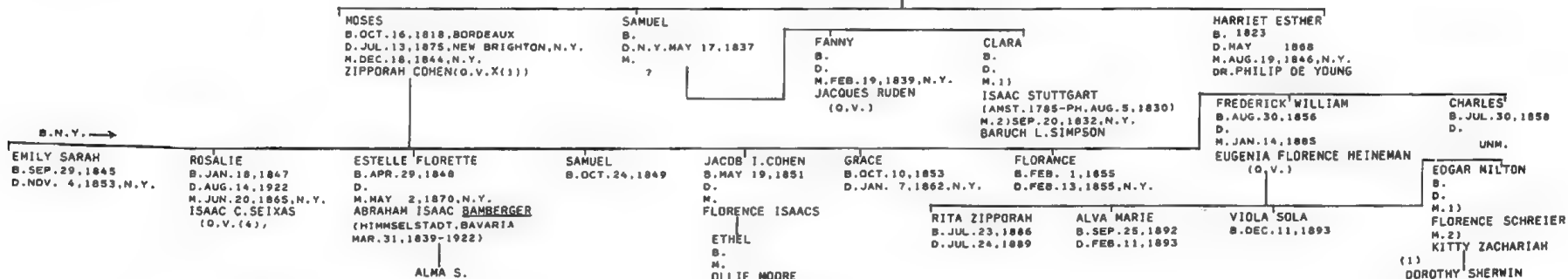

SPANIER

KRAUS SANDOR COLL.
SHEARITH ISRAEL REC.

LOUIS SPANIER(ALBANY,N.Y.)
B. 1803,WUNSDORF, HANOVER
D.DEC.11,1864,N.Y.

ROSALIE MEYERS

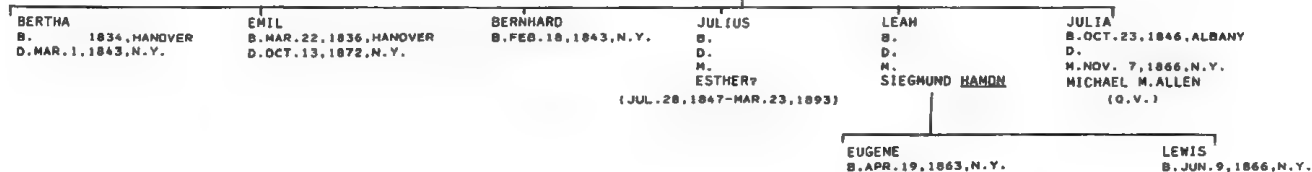

B'NAI JESHURUN REC.
FLD.ABR.
LEONORE R.ELKUS
PEGGY LEHMAN KORN
WHO'S WHO IN AMERICA,1952-3

JACOB SPIRO — HANNAH

PHILIP JACOB — HANNAH CROMELIEN
B. 1799, PRUSSIA (O.V.)
D. JUNE 1859, N.Y.

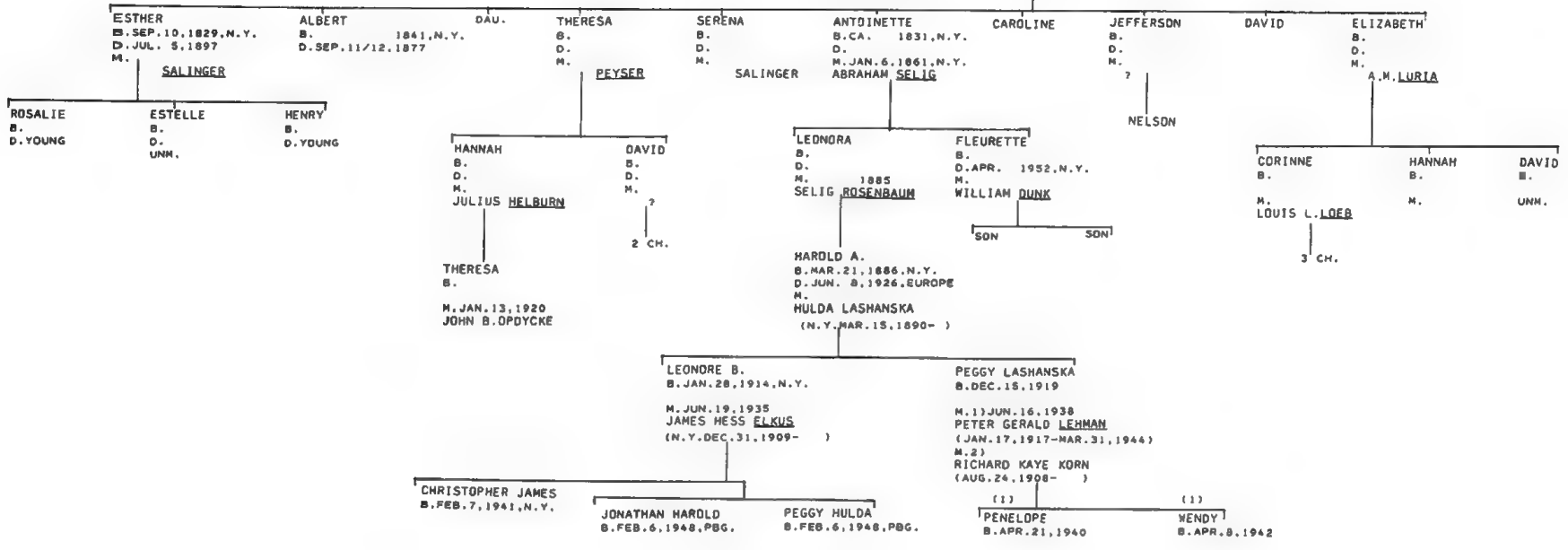

U. S. CENSUS, 1880 (J. STEDMAN)
MD. MAG. OF HIST. v. 19, P. 61
SHEARITH ISRAEL REC.
B'NAI JESHURUN REC.

JACOB KAUFMAN — HELLEN

JACOB STERN — JEANETTE
B. 1803, GER.
D. DEC. 17, 1891, N.Y.

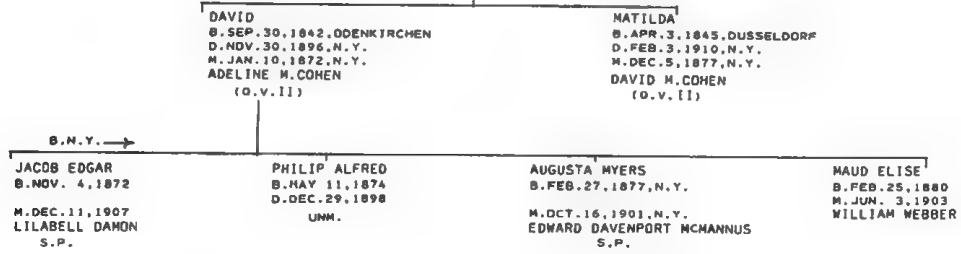

STERN I (N.Y.)

STERN II (1)

STERN FAMILY BIBLE
EPITAPHS, ADATH JESHURUN CEMETERY (PH.)
RODEPH SHALOM MOHEL REC.

MOSES STERN, OF SCHWETZING'EN, BADEN

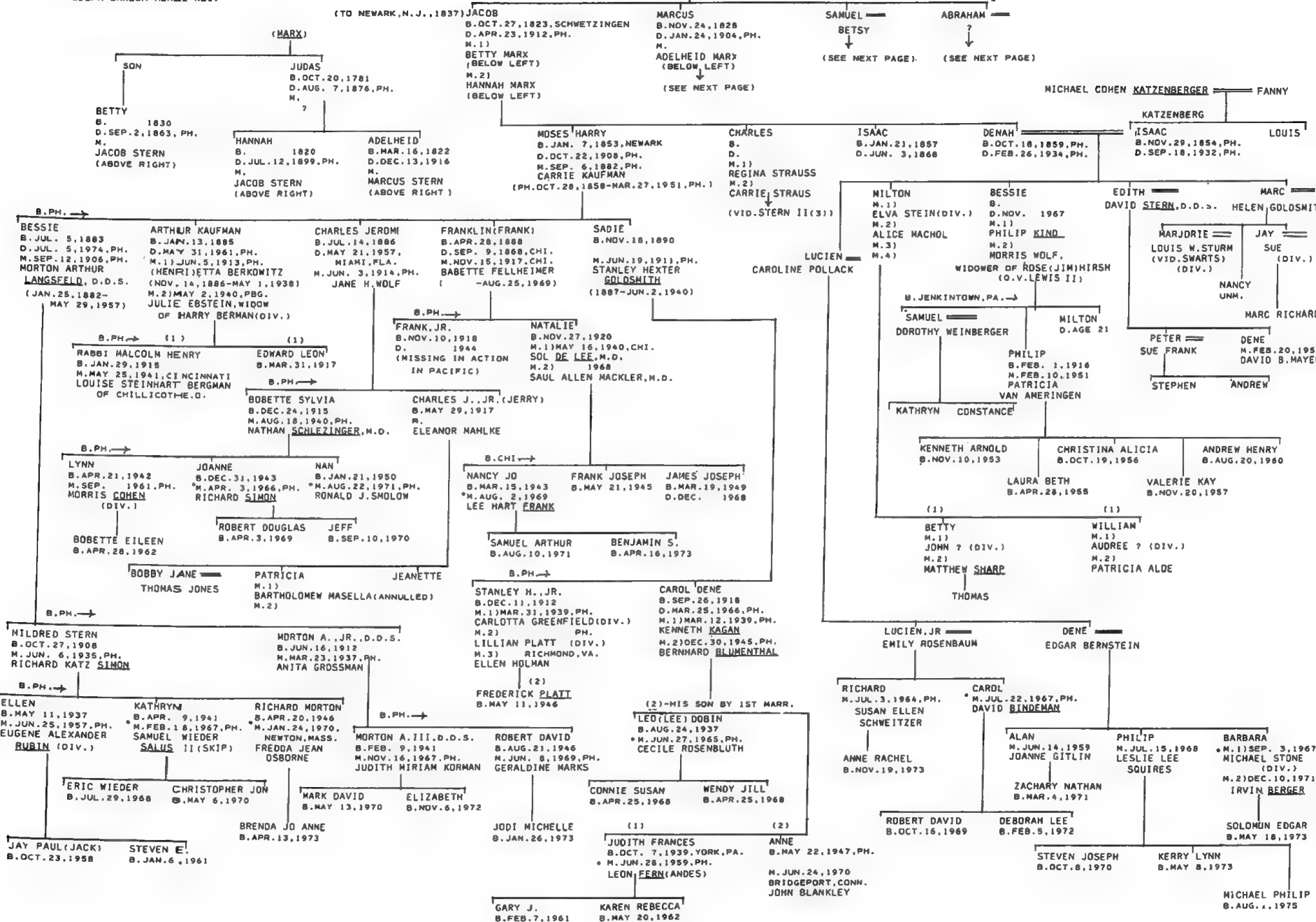

*MARRIED BY RABBI MALCOLM H. STERN

MOSES STERN (SEE PRECEDING PAGE)

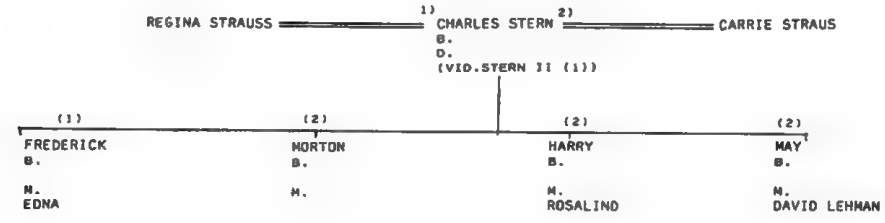
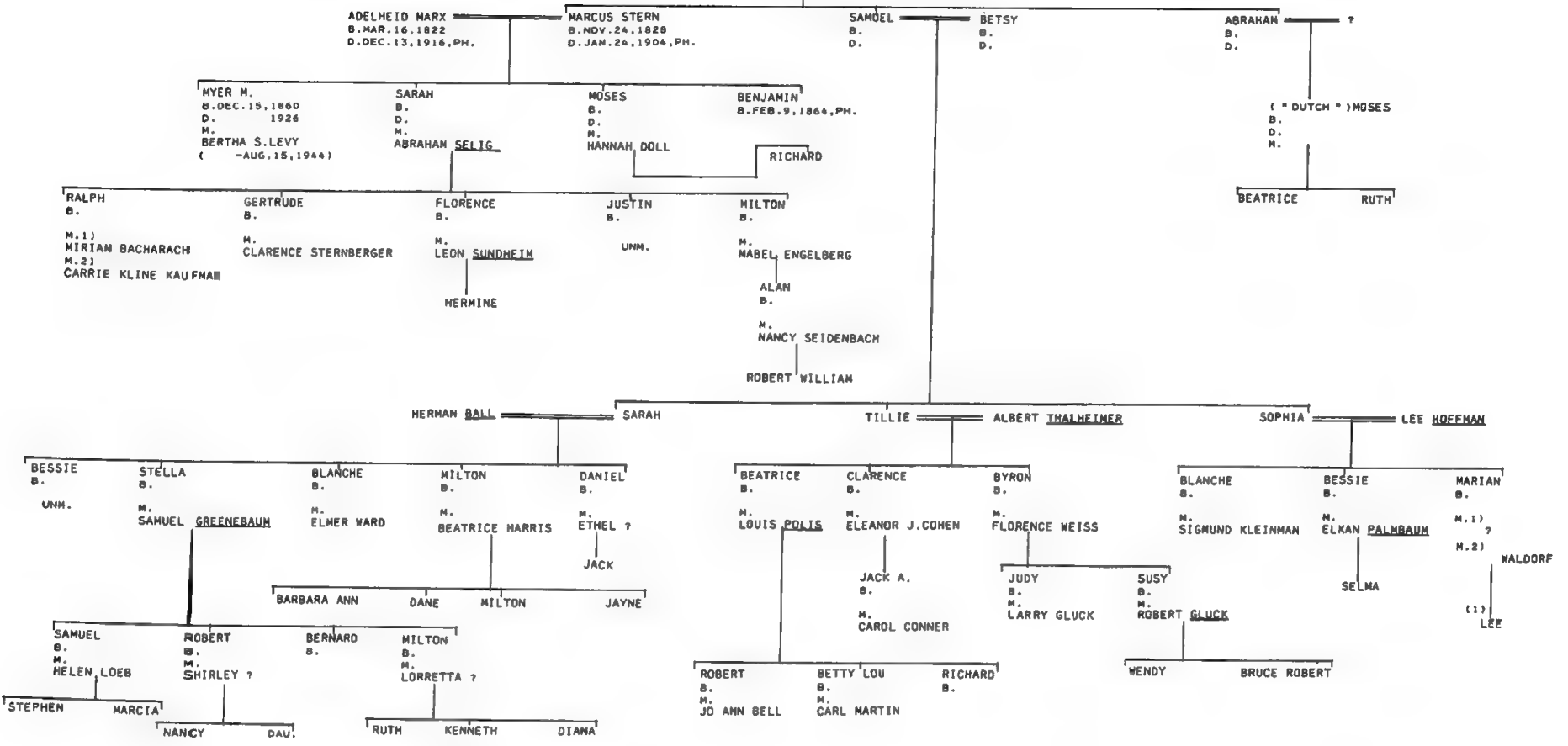

STERN III

FLO. ABR.
FRANCIS JAMES DALLET
TRACHTENBERG-CONSIDER THE YEARS
WHO'S WHO IN WORLD JEWRY 1965
AJYB 5666, P. 36:5702, P. 375 F.
RODEPH SHALOM MOHEL REC.
BABETTE W. STERN

LEVI
SIMON STERN OF MILTENBERG, BAV.
(TO U.S. 1822) JULIUS HENRIETTA ADLER
B. DEC. 4, 1804, GER. B. AUG. 26, 1815, MEHELSDORF, BAV.
D. 1870, PH. D. OCT. 15, 1897, PH.

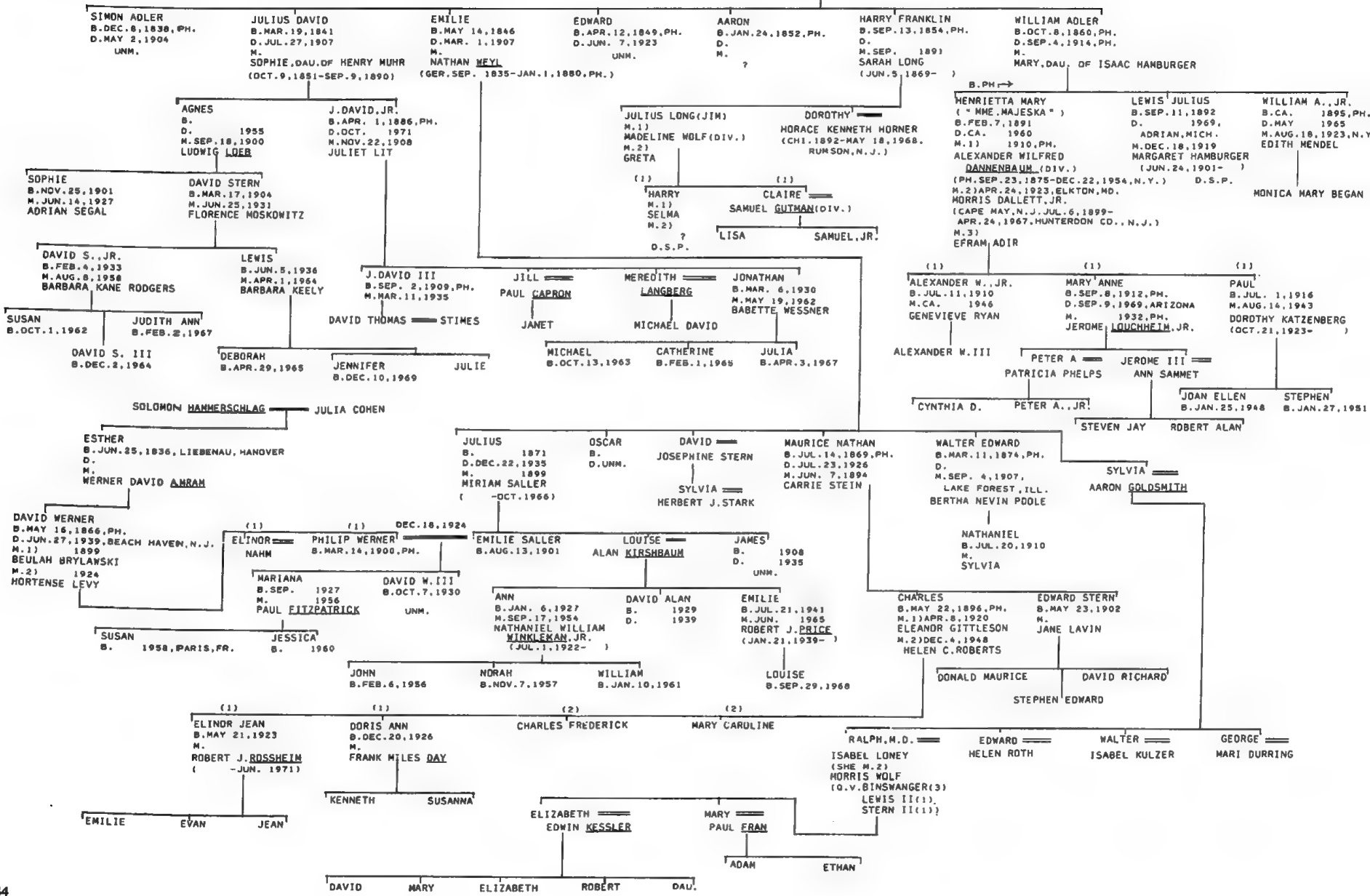

NOTE: D'DORF=DEMMELODORF

MICHAEL MOSES
B. 1708, GLENSDORF, BAV.

KORN-JEWS OF N.O.
MULLINS-FIRST CENSUS OF TEXAS

1) EMANUEL STERN
B. D. JUL. 25, 1828, N.O.
(IN N.O. BY 1824)

2) JEANETTE HUNT
B. D. JUL. 28, 1828, N.O.

LOUIS STIX-REMINISCENCES
RICE-STIX GEN. (REV. ED.)
SHEARITH ISRAEL REC.
CARL STERN
FLO. ABR.
MARY ELLEN GOODMAN
WHO'S WHO IN WORLD JEWRY, 1965
N.Y. TIMES OBIT.

SOLOMON

CAROLINE
B. 1739, GLENSDORF
D. M.
MOSES COHEN
(SCHNEIDACH, 1730-)

COSMAN
B. 1750, DEMMELODORF, BAV.
D. 1808, D'DORF.
M. RELIA
(D'DORF, 1756- 1820, D'DORF)

(RABBI OF D'DORF) AARON
B. 1750, SCHNEIDACH
D. DEC. 8, 1830, D'DORF
M.
CONENDAL MOSES
(GLENSDORF, 1752-1827, D'DORF)

(1) ADOLPHUS STERNE (TEXAS PIONEER)
B. APR. 15, 1801, COLOGNE, GER.
D. MAR. 27, 1852, N.O.
N. JUN. 2, 1828, NATCHITOCHEES, LA.
EVA CATHERINE ROSINE RUFF
(ESSLINGEN, WURTTENBERG, JUL. 23, 1810-)

(2) EMANUEL
B. 1822

(2) NANCY STEVENS
(REARED BY AN AUNT,
VAN OSTER)

(2) ISAAC
(REARED BY AN AUNT,
VAN OSTER)

STERN IV

SOLOMON STIX
B. APR. 2, 1788, D'DORF
D. AUG. 4, 1865, WESTWOOD, D.

NOV. 2, 1815
DEBORAH (DOROTHEA)
B. JAN. 18, 1795, SCHNEIDACH
D. JUN. 16, 1883, CINTI.

HENRY
MADELINE SULSBACHER
MOSES OF LEAVENWORTH, KAN.
D. UNM.

STIX (1)

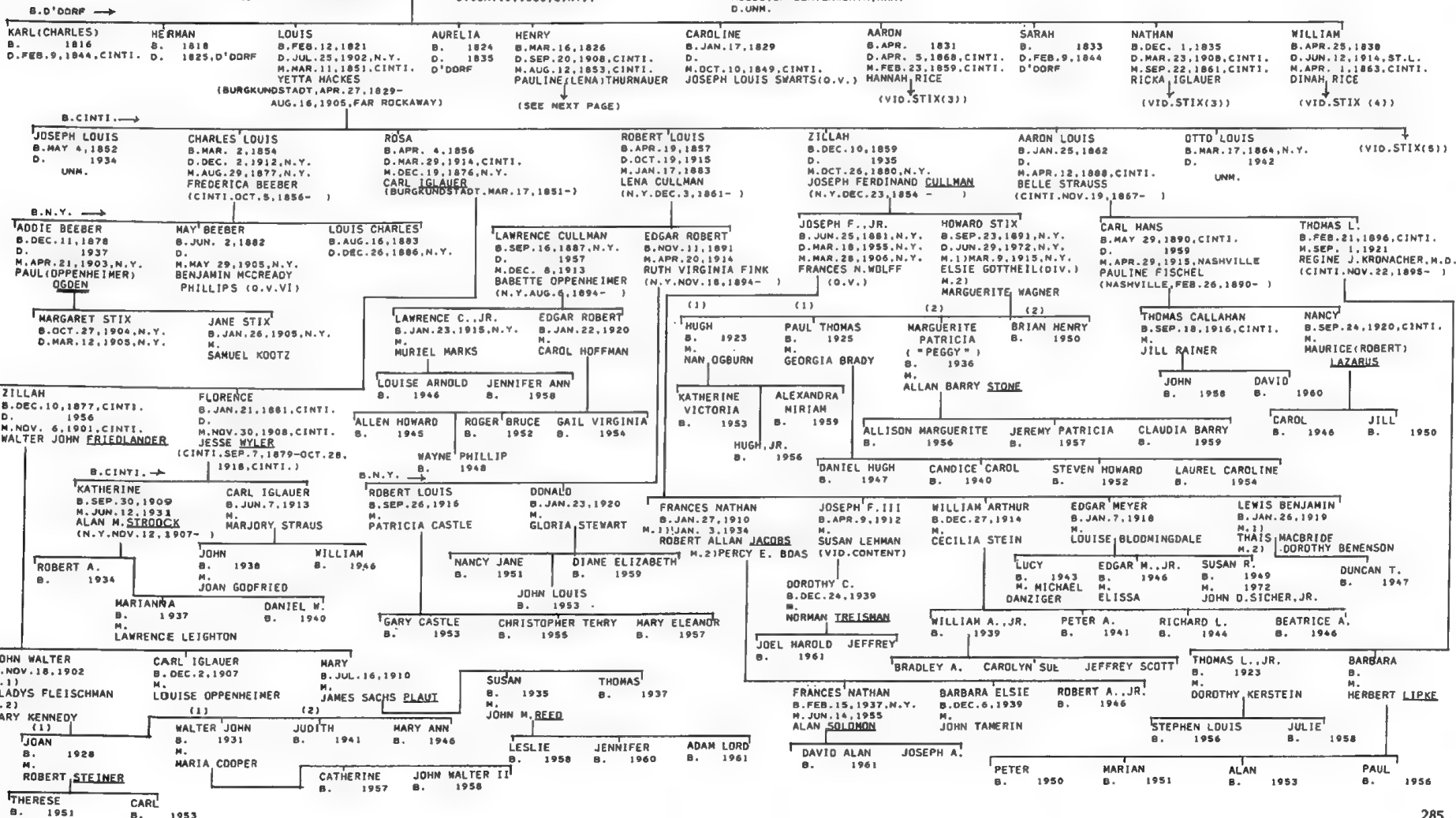

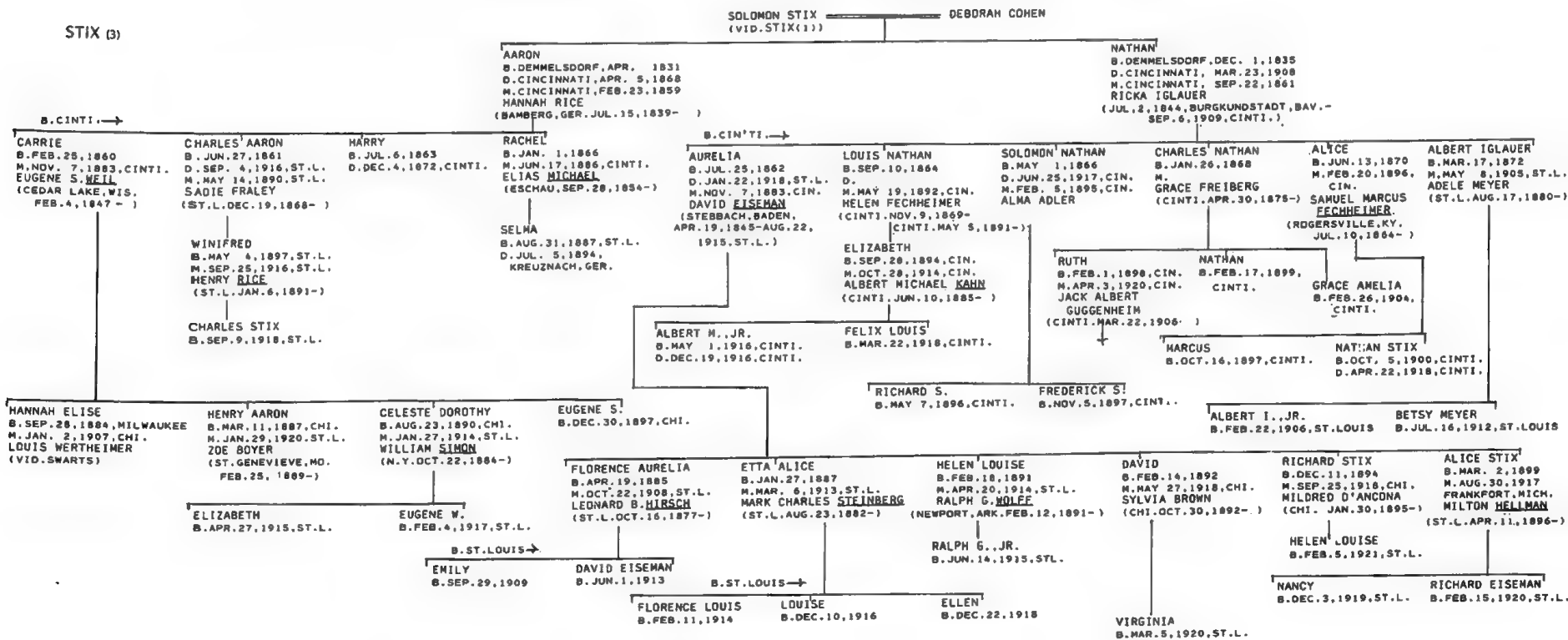
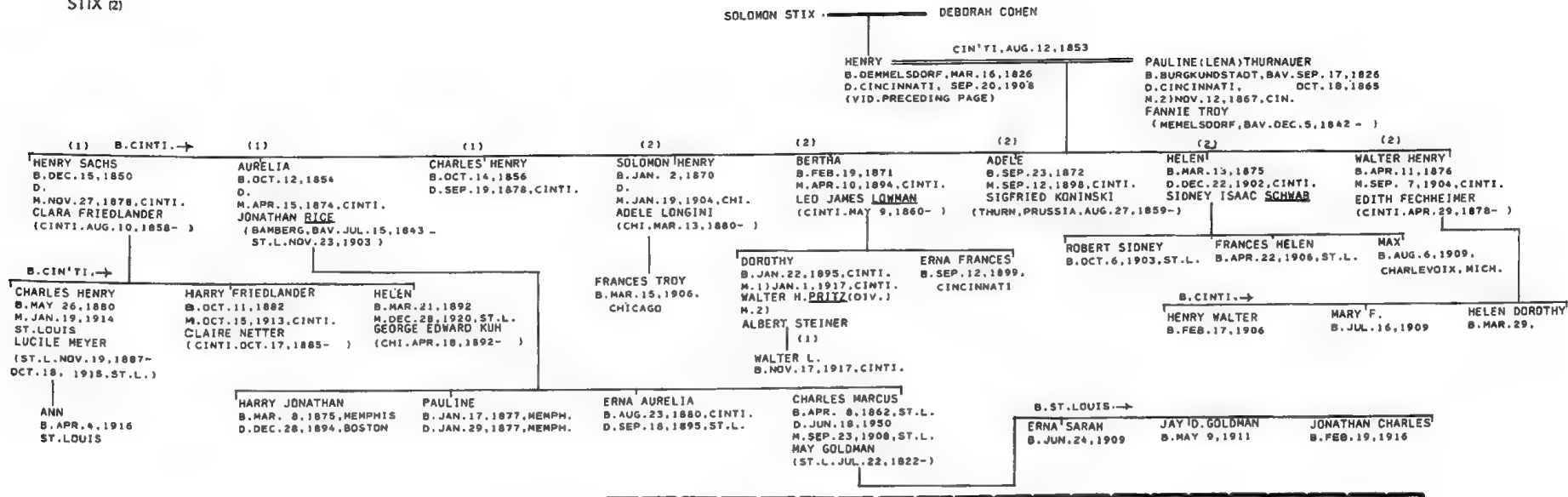

SOLOMON STIX ————— DEBORAH COHEN
(SEE STIX(1))

WILLIAM
B. APR. 25, 1838, DEMMELSDORF
D. JUN. 12, 1914, ST. LOUIS
M. APR. 1, 1863, CINCINNATI
DINAH RICE
(BAMBERG, BAV. JAN. 4, 1842- 1927)

B. CINTI. →

PAULINE B. MAR. 22, 1866, MEMPHIS D. M. APR. 14, 1886, ST. L. GEORGE MILIUS (CINTI. MAY 7, 1854-)
SOLOMON B. OCT. 30, 1867, MEMPH. D. FEB. 13, 1868, MEMPH.
RACHEL B. DEC. 21, 1869, D. M. OCT. 25, 1892, ST. L. LEON JACOB SCHWAB (GER. JUL. 16, 1863- MAR. 23, 1918, ST. L.)
AGNES B. JUL. 16, 1871, D. FEB. 13, 1875, CINTI.
CORA B. MAY 7, 1873, D. M. MAR. 9, 1895, ST. L. ABRAHAM FRIEDMAN (RECKENDORF, BAV. DEC. 25, 1862-)
EDITH B. NOV. 21, 1874, D. M. MAR. 22, 1899, ST. L. JOSEPH WASSERMAN (PH. JUL. 26, 1861-)
AARON B. JUL. 14, 1876, D. FEB. 9, 1879, CINTI.
ALMA B. OCT. 18, 1877, D. 1974, N. Y. M. APR. 23, 1909, ST. L. MILTON I. D. EINSTEIN (N. Y. MAR. 17, 1877- JAN. 31, 1968)
ERNEST WILLIAM B. NOV. 16, 1878, D. SEP. 28, 1955, ST. L. M. JAN. 7, 1907, PITTSBURGH ERMA KINGSBACKER (PBG. JUL. 29, 1884-)

B. ST. L. →

B. ST. L. →

B. ST. L. →

EVELYN B. JUN. 22, 1887, D. M. MAR. 17, 1913, ST. L. SIMON ROSENFELDER (ROCK ISLAND, ILL. MAR. 2, 1882-)
WILLIAM STIX B. DEC. 26, 1889
DOROTHY B. NOV. 20, 1894, D. NOV. 10, 1919, ST. L. SIDNEY WALTER KAUFMAN (N. Y. AUG. 1881-)
HELEN DINAH B. MAR. 6, 1896
JOHN STIX B. MAY 23, 1899, D. MAY 28, 1900
WILLIAM STIX B. JUL. 23, 1900
AGNES STIX B. SEP. 1, 1902
EDITH STIX B. FEB. 21, 1914
MARY SMALL B. DEC. 13, 1904, N. Y. M. RUSSELL WRIGHT
I. DAVID EASTON B. MAY 27, 1909
DOROTHY JANE B. MAY 8, 1914, SIOUX CITY, IO.
ROBERT A. B. AUG. 6, 1916, ROCK ISL., ILL.
KATHERINE B. NOV. 12, 1920, N. Y.
LEON JACOB, JR. B. OCT. 25, 1899, D. FEB. 19, 1936, M. 1928, MARJORIE MEYER (ADOPTED) LEON B. 1932
ALICE RACHEL B. MAR. 31, 1902, M. JUN. 21, 1928, LEON JONAS, M.D. (AUG. 22, 1887- SEP. 9, 1958)
ELLEN M. B. APR. 4, 1930, M. AUG. 18, 1954, ALBERT JOSEPH FELDMAN
LEON, JR. (LEE) B. OCT. 20, 1931, M. JAN. 6, 1963, WILLICENT SAAL (HER 2ND MARR.)
ELIZABETH B. JAN. 26, 1909, M. APR. 27, 1933, MERLE FAINSDO (MAY 2, 1903-)
WILLIAM II B. OCT. 5, 1911
ERNEST W. JR. B. APR. 27, 1916
THOMAS HOWARD B. JUL. 12, 1924, M. MAY 28, 1950, HAZEL ROSE SHERWIN
JOHN MORRIS B. NOV. 14, 1920
DAVID WILLIAM III DINAH
ELIZABETH STIX MARY LEWIS SUSAN SHERWIN MICHAEL SHERWIN

B. ST. L. →

B. PH. →

JAMES LEON B. JAN. 4, 1894, M. FEB. 25, 1920, ST. L. GELLA LANDMAN
WILLIAM STIX B. NOV. 24, 1896, M. FRANCES NEWMAN
RACHEL ANN B. JUN. 27, 1956, VA. (HER CH. BY 1)
DAVID JONAS B. APR. 19, 1950, PH. (HER CH. BY 1)
EMILY LOUISE B. MAY 7, 1960, PH.
MARGARET B. DEC. 13, 1899, M. FEB. 11, 1926, LIONEL FARADAY LEVY
WILLIAM STIX B. MAR. 24, 1901, M. DEC. 4, 1922, MARION FLEISHER (D. V. (2))
SON B. JAN. 4, 1903, D. JAN. 11, 1903
DINAH STIX B. OCT. 9, 1905, M. MORTON HOWARD
KATHERINE STIX B. FEB. 25, 1907, M. JAN. 4, 1932, SHELBY CULLOM DAVIS
DAVID SAAL B. OCT. 1, 1956
DANIEL SAAL B. JAN. 3, 1963
LEE ANN B. APR. 14, 1964
WILLIAM STIX B. DEC. 31, 1969

WILLIAM S. JR. B. MAR. 2, 1928, M. JUL. 27, 1951, CYNTHIA HERRMAN

LAURA NEWMAN B. FEB. 24, 1930, M. NOV. 30, 1952, JOHN ALLAN BLUMENFELD

RICHARD NEWMAN B. JAN. 7, 1935, M. 1962, RACHELLE HOLLANDER

WILLIAM S. III B. SEP. 14, 1954, ENID, OKLA.

DAVID HERMAN B. MAY 3, 1956, ENID, OKLA.

ANNE LAUER B. JUN. 25, 196- OKLA. CITY

WENDY B. JUN. 30, 1964, WASH., D.C.

JILL ANN B. SEP. 5, 1966, WASH., D.C.

B. ST. L. →

JOHN A. JR. B. MAR. 20, 1954
JANE ALICE B. JUN. 4, 1956
ANDREW DAVID B. MAR. 30, 1960
JAMES MARK B. NOV. 11, 1962
EMILY ANN B. OCT. 30, 1966
JAMES LEON, JR. B. DEC. 8, 1921, M. DEC. 17, 1949, MARGARET DALLOFF
ROGER B. DEC. 8, 1924, M. 1948, BETTY BAY
WALTER LANDMAN B. MAR. 28, 1929, M. 1956, GERALDINE KLING
JULIE BAY B. FEB. 24, 1950
BONNIE B. JUL. 1, 1953
BARBARA B. AUG. 26, 1957
ELLEN B. JUN. 20, 1958
CAROLINE B. MAR. 12, 1962
DIANE AMY B. DEC. 5, 1969

JOAN B. DEC. 13, 1899, M. FEB. 11, 1926, LIONEL FARADAY LEVY
LOUIS B. MAR. 24, 1901, M. DEC. 4, 1922, MARION FLEISHER (D. V. (2))
EDITH D. 1974
CAROL B. COLIN FRANKLIN
DAVID STACY ERICA
HANNAH WILLIAM SIDNEY HOWARD

JAMES L. III B. APR. 4, 1951

ELISE B. NOV. 28, 1954

PETER MARTIN B. JAN. 29, 1957

ROBERT LOUIS B. JAN. 29, 1957

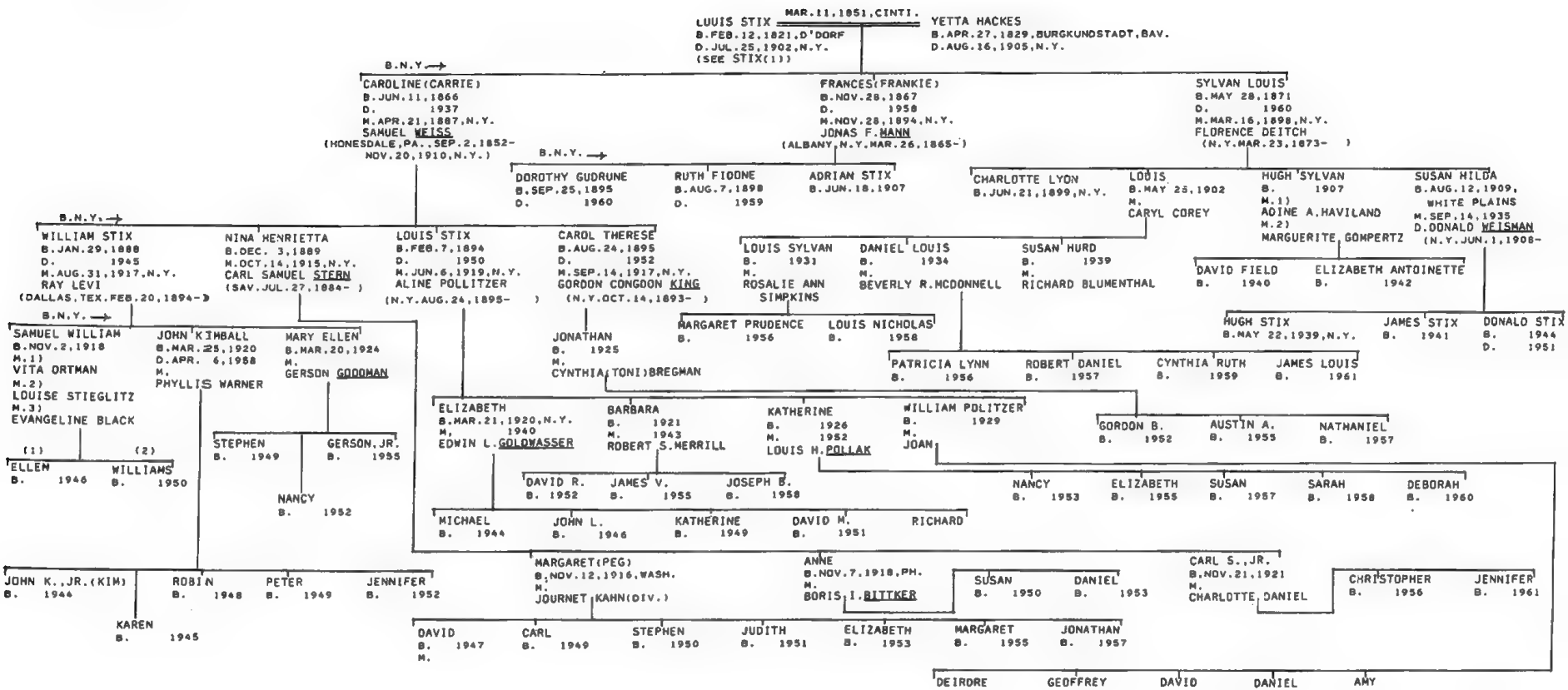

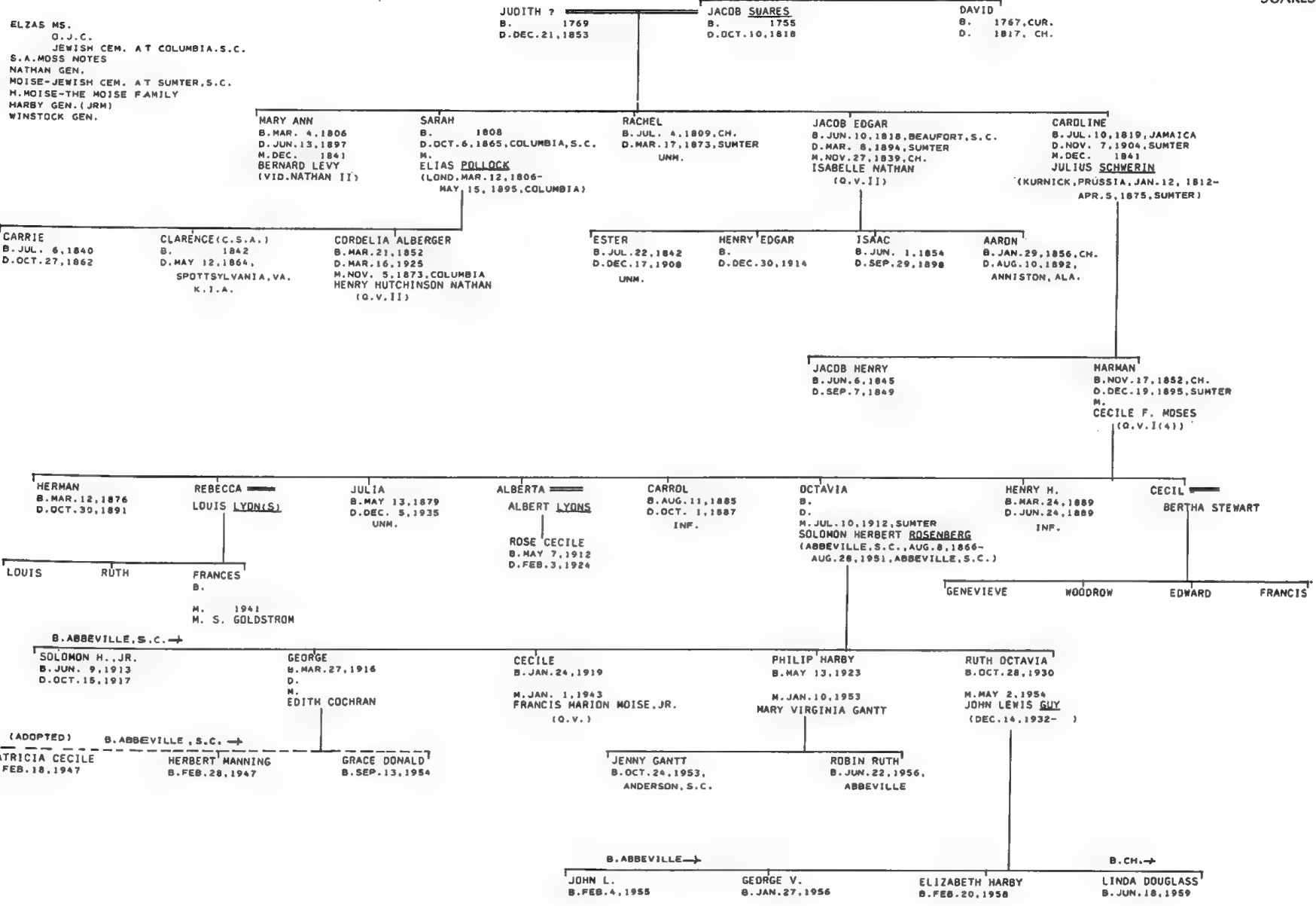

SULZBERGER (1)

J.E.V. 11, P. 584F.
 U.J.E. V. 10, P. 98F.
 AJVS, 5663, P. 200
 5666, P. 107F.
 5701, P. 24F.
 PAJVS, V. 20, P. 170F.
 KRAUS-SANDOR COLL.
 ROBERT SIMPSON (N.Y. TIMES)
 WHO'S WHO IN WORLD JEWRY, 1955
 FED. ST. GEN.
 FLD. ADR.
 FRIEDENWALD GEN.
 IPHIGENE OCHS SULZBERGER
 WHO'S WHO IN WORLD JEWRY, 1965

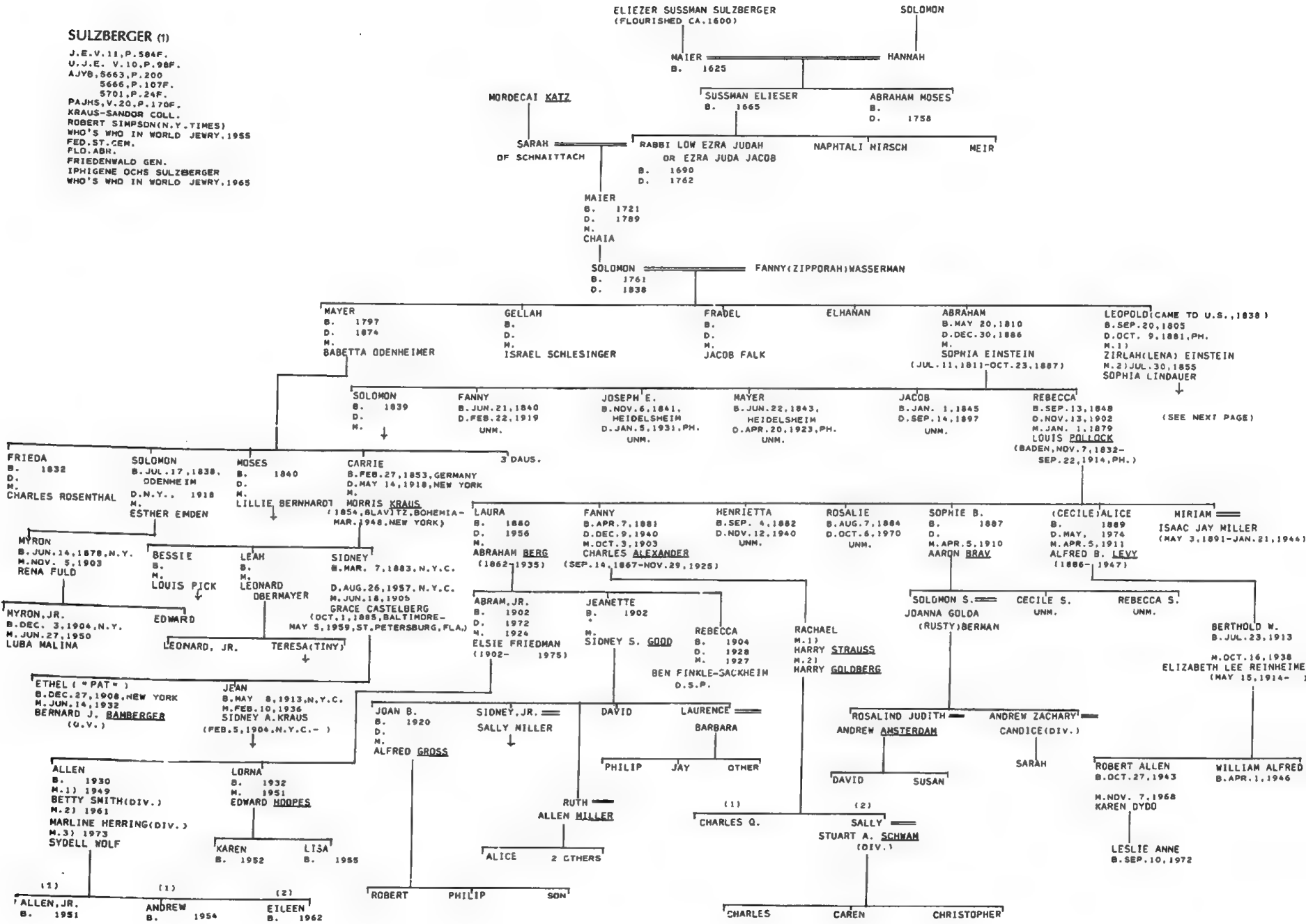

(SEE NEXT PAGE)

SELIGMAN LOB LINDAUER
B. 1750
D. 1839

SPRINZ GUMBEL
OF MASNENBACH

EINSTEIN

JUDA
B. 1797
D. 1863

MARIE
B. 1802
D. 1878

SOPHIA JUL. 30, 1855 2) LEOPOLD SULZBERGER 1)
B. SEP. 20, 1805
D. OCT. 9, 1881, PH.
(TO U.S. 1838)
(SEE PRECEDING PAGE)

ZIRLAW

(1) DAVID B. MAY 1, 1838, HEILDELSHEIM D. MAR. 15, 1910, PH. UNM.
(1) SARAH B. AUG. 27, 1839 D. 1928 M. OCT. 5, 1858 SAMUEL ADLER (CA. 1827-JAN. 12, 1867)
(2) SOLDRON L. B. FEB. 5, 1857, PH. D. M. CLARA FRANK
(2) CYRUS LEOPOLD B. JUL. 11, 1858, PH. D. APR. 30, 1932, N.Y. M. MAY 13, 1884 RACHEL P. HAYS (O.V. (2))
(2) ROSALIE DAVID ROSENHEIM
(2) FLORA

BELLE B. JUL. 24, 1859 D. DEC. 7, 1951 M. JUN. 4, 1879 JOSEPH HERZOG ROSE
CELIA B. 1932 M. S. MINZESHEIMER
CYRUS B. SEP. 13, 1863 D. APR. 7, 1940, PH. M. SEP. 1905, PH. RACHEL (RACIE) FRIEDENWALD (AUG. 5, 1872-MAR. 20, 1852)
MILTON B. PH. D. 1911
FRANK L. B. DEC. 3, 1887, CHI. D. M. NOV. 28, 1911 HELEN BECKER
LED B. 1885, N.Y. D. 1926, N.Y. M. BEATRICE JOSEPHI (SHE M. 2 ELI JACQUES KAHN)
ARTHUR HAYS B. SEP. 12, 1891, N.Y. D. DEC. 11, 1968, N.Y. M. NOV. 17, 1917 IPHIGENE BERTHA OCHS (CINTI., SEP. 19, 1892-)
DAVID HAYS B. 1897 M. FEB. 1921 LOUISE BLUMENTHAL
CYRUS ANNA 1930

SARAH B. 1906 M. WOLFE WOLFINSOHN (1902 -)
JUDITH B. 1933
KATE M. JUN. 4, 1946 EDWARD H. LEVI (CHI. JUN. 26, 1911 -) (U.S. ATTORNEY GENERAL)
ANN WOLFF
JEAN MELTZER
BEATRICE B. 1910 M. DR. LEONARD TRILLING
CYRUS L. B. OCT. 27, 1912, N.Y. M. JAN. 21, 1942 MARINA, TATIANA LADA
MARIAN EFFIE B. DEC. 31, 1918, N.Y. M. 1) JUL. 8, 1941, WHITE PLAINS, N.Y. DRVIL EUGENE DRYFOOS (N.Y. NOV. 8, 1912 - MAY 25, 1963, N.Y.) M. 2) JAN. 30, 1965 ANDREW HEISKELL (NAPLES, IT., SEP. 13, 1915 -)
RUTH RACHEL B. MAR. 12, 1921, N.Y. M. 1) JUN. 1, 1946, WHITE PLAINS, N.Y. BEN HALE GOLDEN (BARBOURVILLE, KY., DEC. 16, 1909 - 1970) M. 2) MAY 25, 1972, STAMFORD, CT. A. WILLIAM HOLMBERG, JR. (SEP. 18, 1923 -)
JUDITH PEIXOTTO B. DEC. 27, 1923, N.Y. M. 1) DEC. 22, 1946, WHITE PLAINS, N.Y. MATTHEW ROSENSCHEIN, JR. (N.Y. SEP. 5, 1922 -) M. 2) JAN. 31, 1958, N.Y. RICHARD N. COHEN (OCT. 28, 1923 -) M. 3) DEC. 26, 1972, N.Y. BUDD LEVINSON (NOV. 14, 1915 -)
ARTHUR OCHS ("PUNCH") B. FEB. 5, 1926 M. 1) JUL. 2, 1948 BARBARA GRANT (PARIS, FR. MAR. 31, 1928 -) M. 2) DEC. 19, 1956 CARL FOX FUHRMAN (N.Y. MAR. 23, 1927 -)

JOHN DAVID MICHAEL
MARINA BEATRICE B. M. JUN. 4, 1967, PARIS, FR. ADRIAN BERRY (SON OF LORD HARTWELL)
DAVID ALEXIS
JESSICA MARGARET B. FEB. 11, 1968
DANIEL HAYS COHEN B. AUG. 1, 1952, N.Y.
JAMES MATTHEW COHEN B. FEB. 17, 1954, N.Y.

JACQUELINE HAYS B. MAY 8, 1943, N.Y. M. JUL. 2, 1964, STAMFORD, CT. STUART PRINCE GREENSPON (AUG. 26, 1939 -)
ROBERT OCHS B. NOV. 4, 1944, N.Y. M. AUG. 31, 1964, N.Y. KATHERINE THOMAS (MAY 8, 1946 -)
SUSAN WARMS B. NOV. 5, 1946, N.Y.
CARDLYN DRYFOOS B. MAR. 30, 1963, N.Y.
MICHAEL STUART B. JUN. 24, 1971, N.Y.
JAMES DAVID B. MAR. 2, 1965, HANDVER, N. H.
VICTORIA ANN B. MAR. 2, 1967

(1) B. CHATTANOOGA, TENN. → (1) MICHAEL DAVID B. JUL. 15, 1949 M. AUG. 21, 1971, BRANFORD, CT. ANNE BARNES (MAR. 21, 1949 -) (1) LYNN IPHIGENE B. JAN. 17, 1952 M. JUN. 17, 1973, CHATTANOOGA, TENN. EDWARD ISHMAEL DOLNICK (NOV. 10, 1952 -) (1) ARTHUR SULZBERGER B. DEC. 8, 1956

(1) ARTHUR O., JR. B. SEP. 22, 1951, WHITE PLAINS, N.Y. M. MAY 24, 1975, TOPEKA, KAN. GAIL GREGG (1) KAREN ALDEN B. NOV. 6, 1952, WASH., D.C. (BY HER 1ST HUSBAND) CATHY JEAN B. JUL. 5, 1949 (2) CYNTHIA FOX B. JUN. 4, 1964, N.Y.

SWARTS

WHO'S WHO IN WORLD JEWRY .1955
 AJYB 47, P.529
 RICE-GENEALOGY OF THE STIX FAMILY(REVISED)

JOSEPH LOUIS SWARTS
 B.OCT.27,1818,OSTERBURG, BAV.
 D.
 M.OCT.10,1849,CINCINNATI
 CAROLINE STIX (O.V.(1))

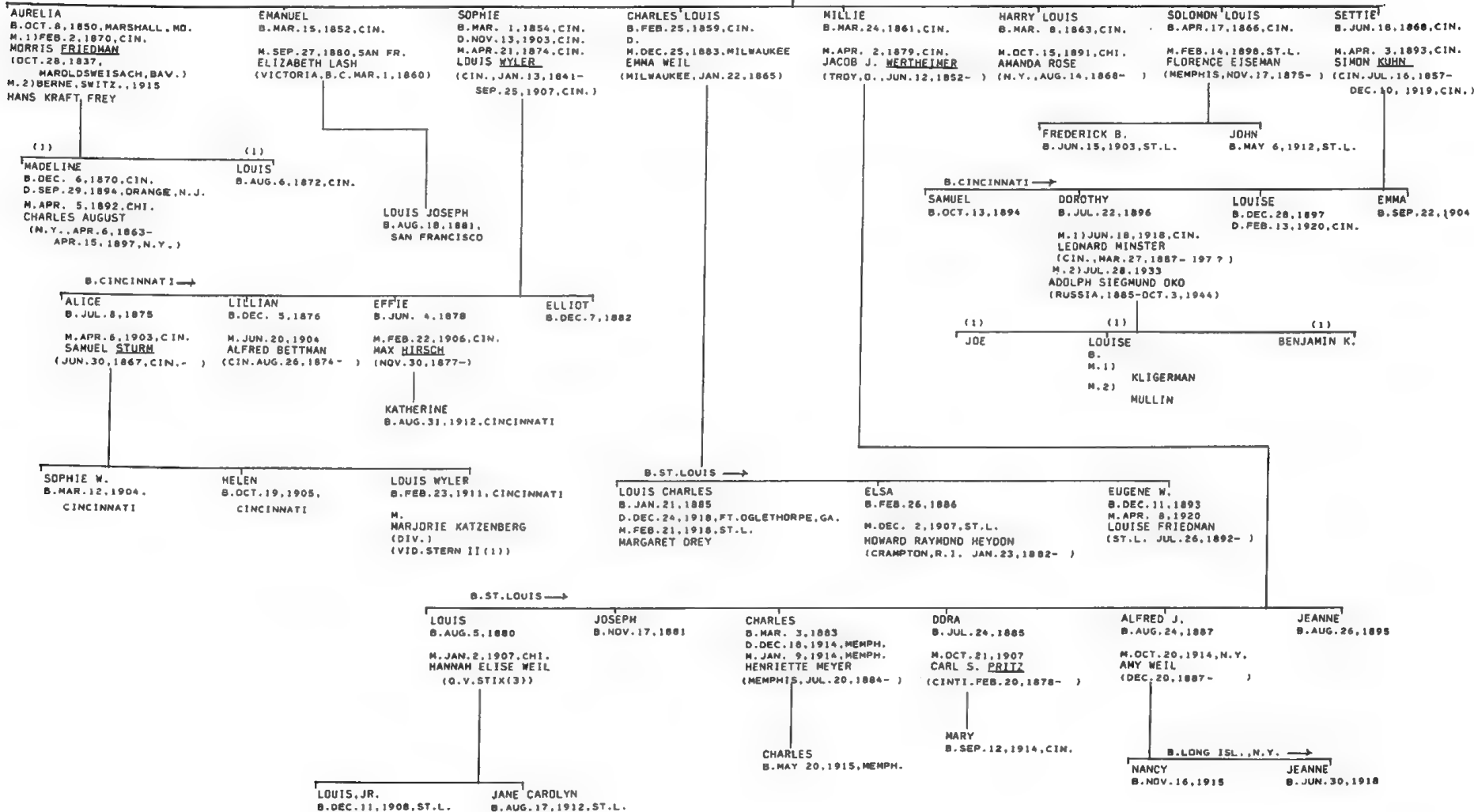

SIMPSON (TO DDDOPHON, MO., 1831; FIRST JEW IN CLEVELAND, O., 1837)
B. 1811, BAV.
D. 1881, CLEVELAND
M. REGINA KLEIN (1816-1885)

SAMUEL MYER ROSE

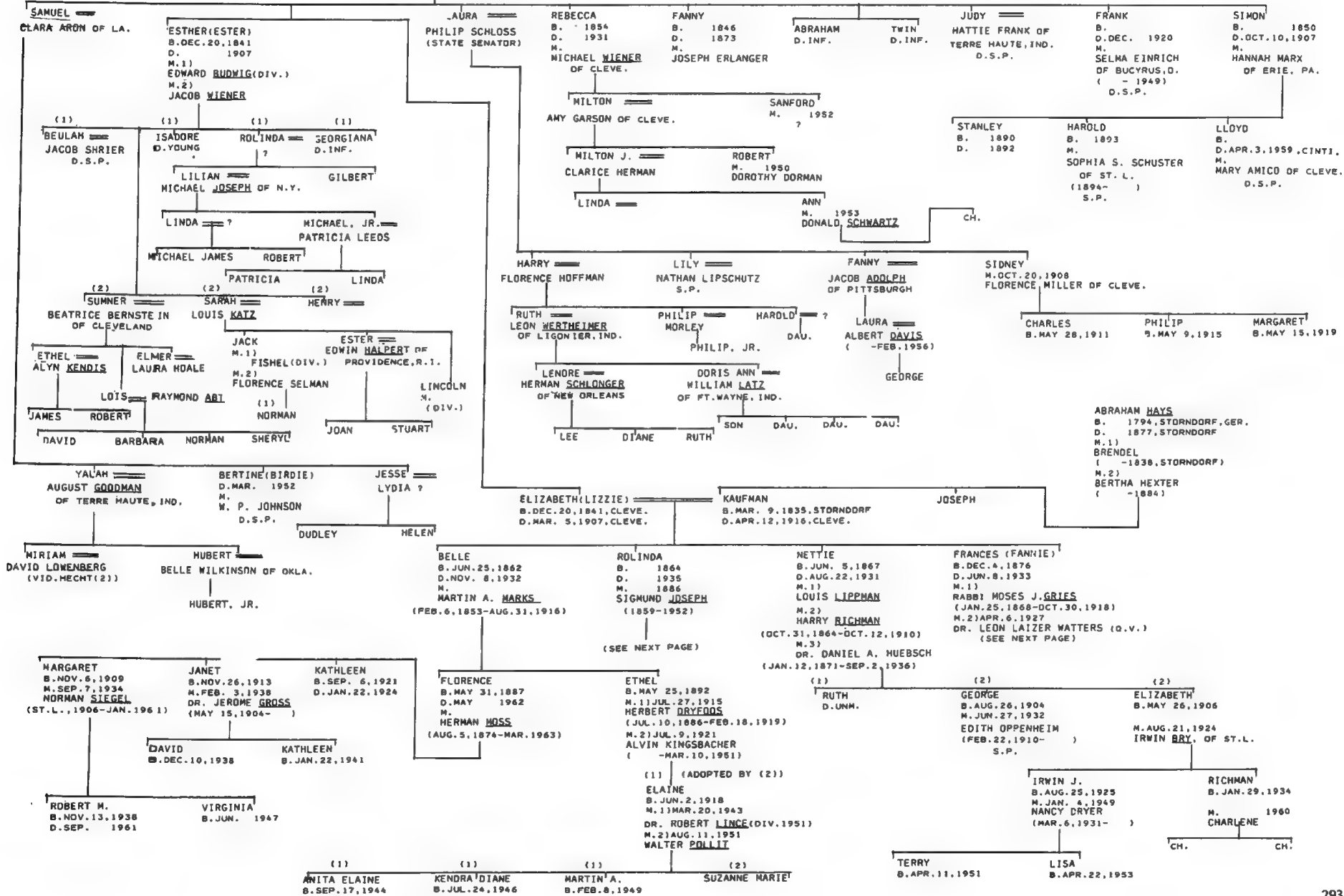

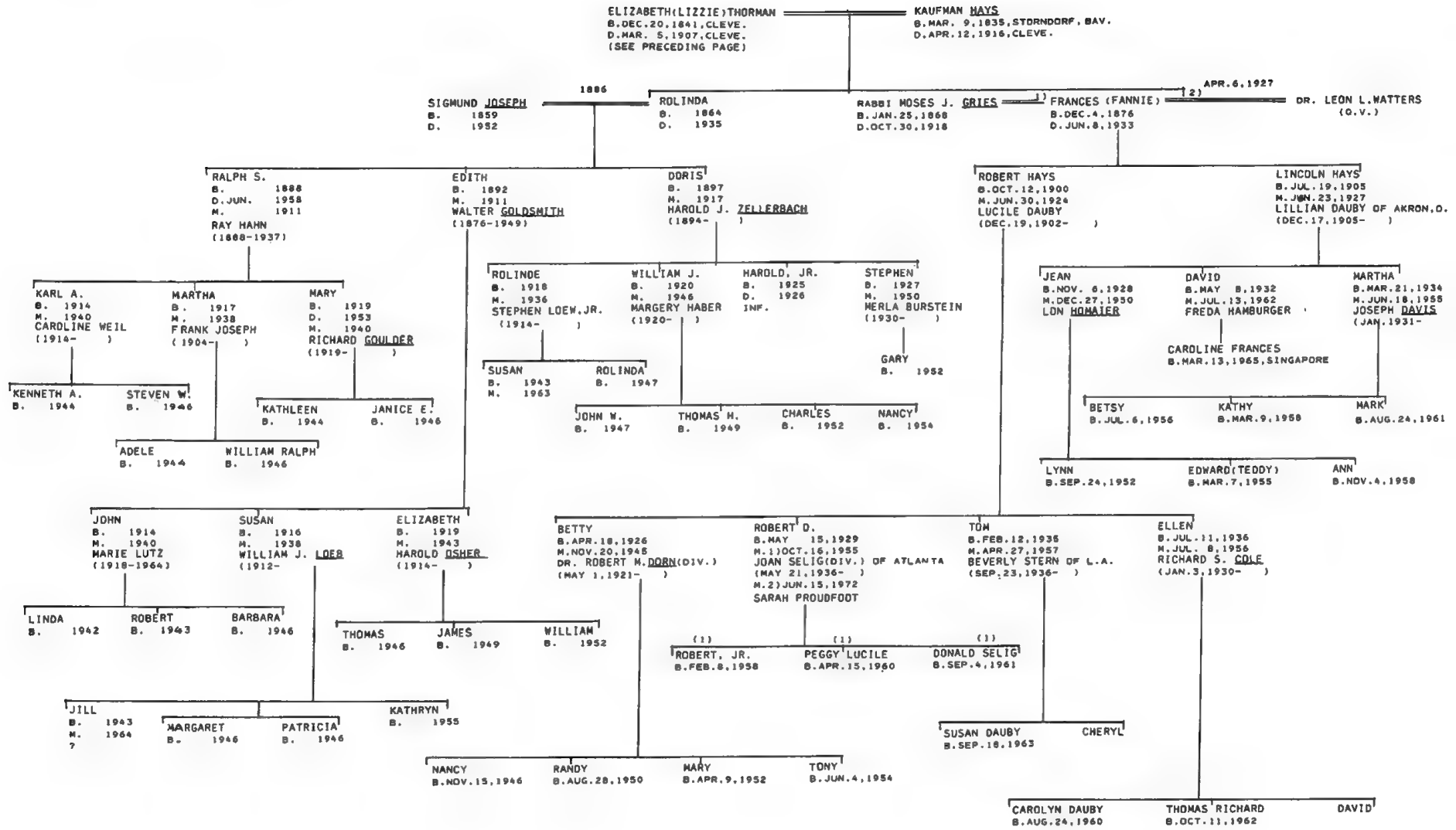

BERNHARDT LOUIS TIM
B. MAR. 20, 1813, HAMBURG, GER.
D. FEB. 7, 1872, PH.

FANNIE MARKSTEIN
B. DEC. 26, 1810, BUCHALBACH, BAV.
D. SEP. 3, 1887, LONG BEACH, N. J.

MOBILE, ALA.

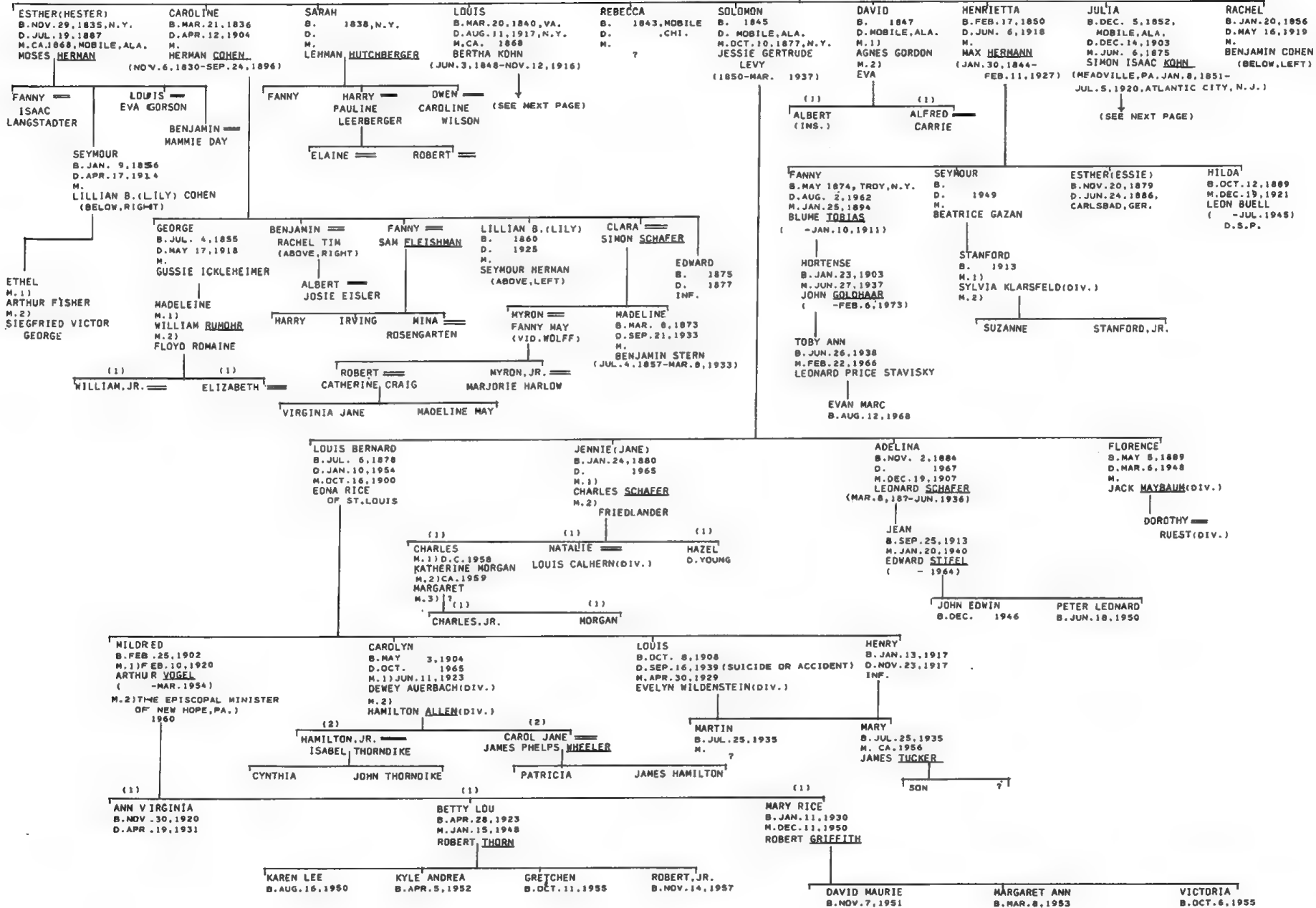

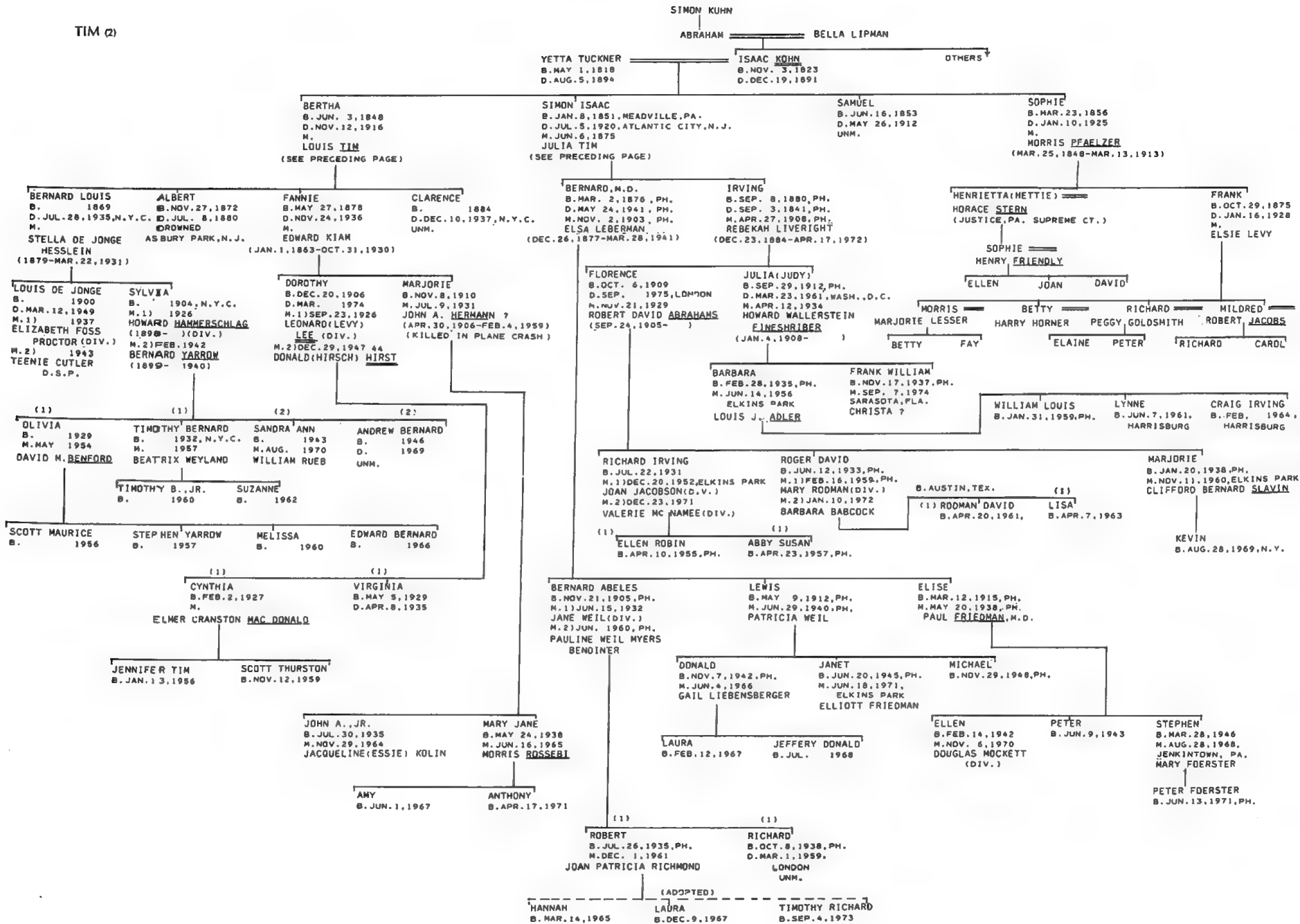

FLD. ABR.
 JOHN STEDMAN
 MISC. IV
 BARBER-N.Y. MARRIAGES
 KRAUS-SANDOR COLL.
 GOLDSTONE GEN. (AJA)
 HENDRICKS GEN. (JRM)
 SHEARITH ISRAEL REC.
 N.Y. CENSUS, 1855

(TOBIAS)

TOBIAS I (N.Y.)

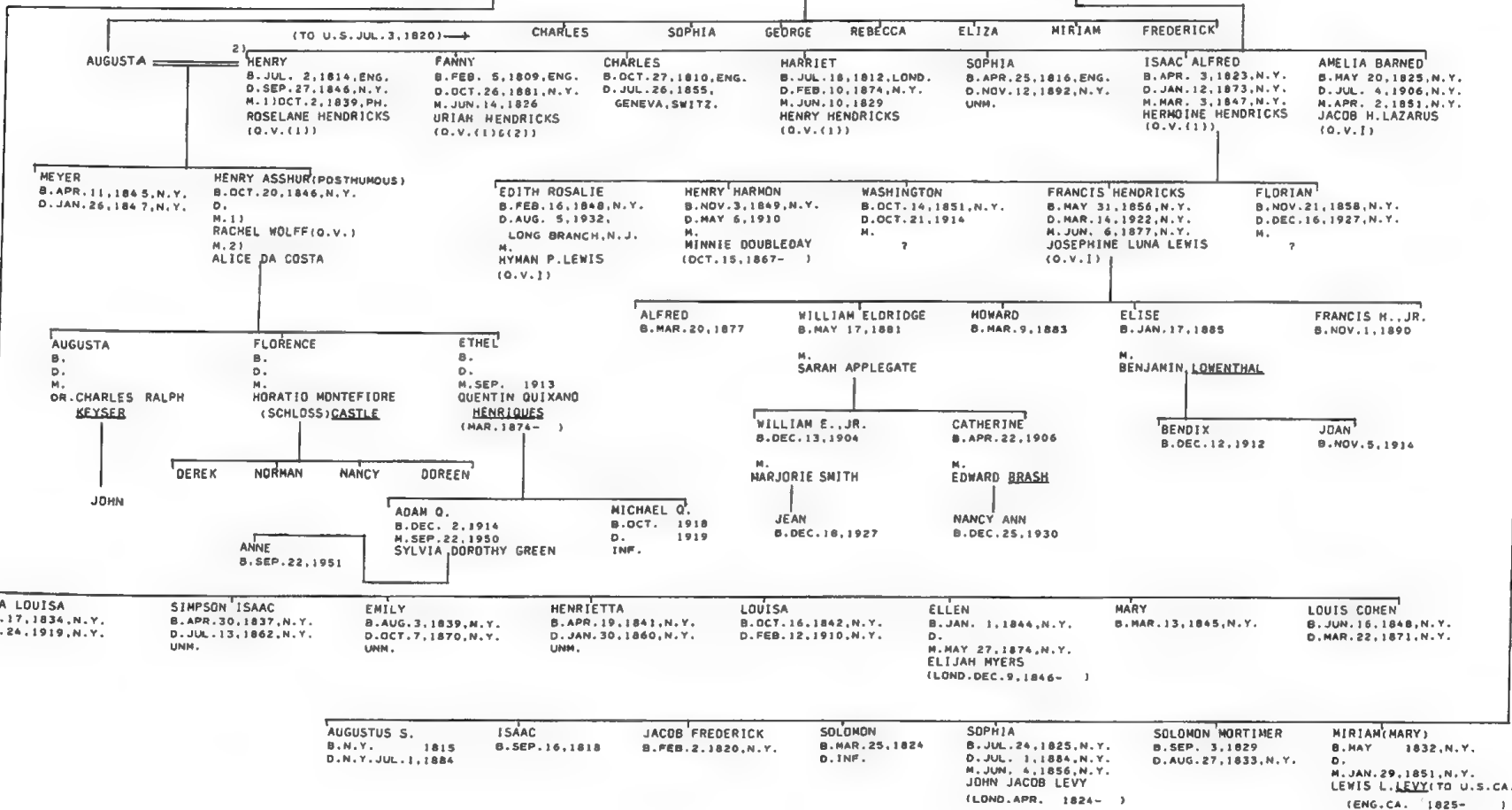
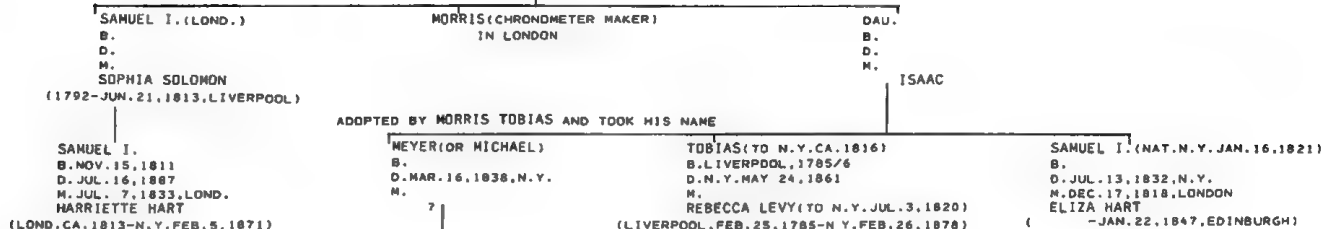

TOBIAS II (1) (CHARLESTON)

TOBIAS GEN. (KRAUS, A.J.A.)
TOBIAS BIBLE (IBID.)
KRAUS-SANDOR COLL.
PAJHS V. 12, P. 44; V. 10, P. 73
ELZAS-JEWS OF S.C.
-JEWS OF S.C., PT. 2, P. 8F.
M.N.
O.J.C.
MSS. (NYHS)

WILLS OF JUDITH, JACOB, AND ISAAC TOBIAS
LOPEZ GEN. (JRM)
CLEMENS-N.E.S.C. MARRIAGE REC.
SPRUCE ST. (PHILA.) CEMETERY REC.
SHEARITH ISRAEL REC.
T.J. TOBIAS

WILL OF JACOB OLIVEIRA
FATHER EDWIN C. TOBIAS
MISC. VII, #364
SH.
EGMONT, P. 91
MIKVEH ISRAEL REC.
P.B.H.
ABBOT LOW HOFFPAT
AMST. MUNICIPAL ARCHIVE
PHILA. PUBLIC LEDGER
(OBIT. JUN. 26, 1850)

JACOB LOPEZ D'OLIVEIRA
(CAME TO SAVANNAH, JUL. 11, 1733 WITH WIFE & CHILDREN)
B.
D. 1751/2, CH.
M. JUL. 15, 1717, AMST.
JUDICA (JUDITH) VELHA

DAVID TO SAV., JUL. 11, 1733

(NAT. S.C. FEB. 13, 1742)

JOSEPH TOBIAS
B. 1684
D. JAN. 29, 1761

LEAH
B. JAN. 1, 1715
D. SEP. 17, 1778, CH.

DAVID
B. NOV. 10, 1763
(DROWNED; BUR. SULLIVAN'S ISL.)

ISAAC
B. NOV. 11, 1734
(SHOT BY ACCIDENT)

MASDAD
B. APR. 1, 1740
D. FEB. 27, 1798

RINAH
B. JUN. 20, 1741
D. M.
ISAAC DE LYON
(O.V.)

JOSEPH II
B. MAR. 31, 1745
D. 1786 ?
M.
JUDITH
(- 1816)

JACOB
B. JUL. 18, 1747
D. NOV. 16, 1775
M. MAY 30, 1775
RACHEL DA COSTA
D.S.P.

JUDITH
UNM.

JOSEPH III
B. SEP. 3, 1764
D. APR. 4, 1810
M. NOV. 3, 1785
RACHEL AARDNS
(O.V.)

LEAH
B. JAN. 28, 1771
D. NOV. 25, 1799
M. JULY 1790
LYON LEVY
(O.V.V. (1))

ISAAC
B. JAN. 28, 1771
D. APR. 29, 1803
BUR. HOBCAW, S.C.

JOSEPH (IV)
B.
D.

JACOB
B. AUG. 5, 1786
D. JUL. 14, 1811
UNM.

RINA
B. SEP. 18, 1788
D. M.

SOLOMON
B. JAN. 15, 1791
D. M.
MARGARET MCMANUS

ABRAHAM
B. JUL. 30, 1793, CH.
D. JUN. 26, 1856, CH.
M. MAR. 5, 1822, CH.
ELEANOR LOPEZ
(O.V. I (2))

ISAAC
B. FEB. 10, 1796
D. JAN. 28, 1860
M. JUL. 1, 1824
ISABELLA COWEN
OF BEAUFORT, S.C.
(1807-DEC. 9, 1880)

JUDITH
B. APR. 15, 1798

MASDAD
B. MAR. 17, 1801
UNM.

DAVID DE OLIVEIRA
B. SEP. 9, 1804
D. APR. 26, 1874
M. NOV. 1820
RACHEL RUSSELL
(O.V.)

LEAH
B. SEP. 9, 1809, ASHEPOO, S.C.
D. M. 1)
HENRY J. HARBY (O.V. (1))
M. 2)
DR. L. COHEN

LEAH AMANDA
B. M.
M.
EDWIN NELSON OF PHILA.

JOSEPH FRANKLIN
B. 1826
D. 1902
M. 1850
MARY ANNA SENIFF
(1827-1899)

SON
B. 1853
D. 1871
SENIFF

JOSEPH F. TOBIAS
B. UNM.
(L.I. IN PHILA. 1954)

KATHLEEN
B. 1853
D. 1921
M. 1881
MONTAGU M.W. BAIRD
OF SCOTLAND
(1854-1915)

JOSEPH F.M.
B. 1884
D. 1917

STANLEY H.M.
B. 1890

ARTHUR WASHINGTON
B. MAY 17, 1852, CH.
M. AUG. 1873, CH.
MARY MCCULLOUGH

IDA URANIA
B. JAN. 16, 1854
D. 1919
UNM.

ASHLEY COWEN
B. AUG. 10, 1855, CH.
D. DEC. 8, 1919, CH.
M. JUL. 15, 1885, CH.
ELLA THERESA O'NEILL
(VID. TOBIAS II (3))

ISABELLA
B. JUL. 23, 1857, CH.
D. 1938
M. FEB. 13, 1882, CH.
C.W. ST. AMAND

ASHLEY
B. D. M.
JEANETTE

CHARLES REYNOLDS
B. JUN. 7, 1859
M. FEB. 11, 1885, N.Y.
ROSE WEBER

ELIZABETH
B. FEB. 15, 1887
D. DEC. 27, 1900

LEILA
B. JUL. 28, 1861, CH.
D. NOV. 20, 1935, CH.
M. SEP. 13, 1881
THOMAS B. CURTIS
(JUL. 13, 1856-
JUN. 28, 1909)

SOPHIE
B. MAY 10, 1889
M. FEB. 2, 1921
FREDERICK HANNE
(AUG. 28, 1866-)

ELIZABETH
B. JAN. 3, 1867, CH.
D. MAY 21, 1894
M. APR. 29, 1886, CH.
WILLIAM E. JENKINS
(1860-1936)

WILLIAM E. JR.
B. FEB. 14, 1892
D. MAR. 30, 1951
M. MAY 23, 1913
ELIZABETH DICENA
SMITH

PRISCILLA LOPEZ
B. DEC. 25, 1823, CH.
D. JUL. 29, 1902, SAV.
M. OCT. 25, 1849, CH.
LEVY J. MYERS
(O.V. III)

(SEE NEXT PAGE)

FANNY
B. MAY 5, 1856, CH.
D. MAY 23, 1922, N.Y.
UNM.

ABRAHAM
B. OCT. 7, 1857, CH.
D. SEP. 25, 1860, N.Y.

ELEANOR
B. MAY 16, 1859, N.Y.
D. MAY 8, 1941
UNM.

CHARLES
B. AUG. 5, 1860, N.Y.
D. DEC. 13, 1913, N.Y.
M.
ISABEL ROGERS
D.S.P. (DIV.)

SON
B. JAN. 8, 1862, N.Y.
D. INF.

EMILY
B. JUL. 8, 1863, N.Y.
D. NOV. 1, 1947, N.Y.
UNM.

EMELIE ELIZABETH
B. JAN. 19, 1917
M. SEP. 2, 1939
WILLIAM L. BEERY, JR.

WILLIAM E. III
B. SEP. 10, 1922

MARY ANNE
B. FEB. 19, 1929
M. AUG. 27, 1949
SAMUEL BYNUM COTHMAN

JAN. 1, 1855, CH.

JOSEPH LOPEZ TOBIAS
B. SEP. 3, 1825, CH.
D. MAR. 16, 1893, CH.
(SEE PRECEDING PAGE)

ROSA HAYS MORDECAI
(O.V. III)

ISABEL B. OCT. 20, 1855, CH. D. 1925, CH. UNM. ENG. TO ALBERT LAZARUS (O.V. I?) WHO DIED ACCIDENTALLY OF PISTOL SHOT.

ELEANOR B. SEP. 5, 1857, CH. D. SEP. 16, 1857, CH. INF.

HORTENSIA B. AUG. 17, 1858, CH. D. SEP. 8, 1860, CH.

DAVID HENRY B. JUN. 29, 1860, CH. D. SEP. 9, 1907, GREENVILLE, S.C. M. 1892, N.Y. TERESA FISHER (READING, PA. MAY 5 1876-1940, CAL.)

ABRAHAM B. APR. 28, 1862, COLUMBIA, S.C. D. SEP. 2, 1931, CH. UNM.

MOSES COHEN MORDECAI B. FEB. 3, 1866, CH. D. APR. 16, 1919, SAV. UNM.

THOMAS JEFFERSON B. MAY 3, 1868, CH. D. MAR. 16, 1937, CH. M. JUN. 8, 1918, TORONTO HORTENSE ALEXANDER (O.V. (2))

JOHN RANDOLPH B. MAY 10, 1871, CH. D. JUL. 2, 1949, SAV. M. JUL. 8, 1918, JESSIE MORNINGSTAR (ST. CATHERINE'S, ONT., JUN. 4, 1894-)

EDITH WINONA B. FEB. 10, 1893, N.Y. M. 1) 1912, COLUMBIA, S.C. BENJAMIN WESTLEY MITCHELL (AUBURN, ME. 1892-1964, CAL.) M. 2) H. A. RAYNE

DAVID HENRY, JR. B. APR. 5, 1895, N.Y. D. 1957, BERKELEY, CALIF. M. 1) 1928, SACRAMENTO, CALIF. JANE ROGERS (1901-1941) M. 2) 1952 MARGARET ELLIS S.P.

ARTHUR STANLEY B. FEB. 23, 1897, N.Y. D. 1951, N.Y. M. 1) 1924, N.Y. ISABEL WEBB (DIV.) M. 2) ELIZABETH D.S.P.

JEANNE TERESA B. JUN. 26, 1901, MT. VERNON, N.Y. D. 1966, SAN FR. UNM.

ISABEL B. JAN. 10, 1903, N.Y. D. 1962, CAL. M. AUG. 3, 1929, SAN DIEGO, CALIF. GEORGE LEWECK

WILLIAM RANDOLPH B. APR. 27, 1905, N.Y. D. APR. 21, 1926, GREENVILLE, S.C. UNM.

ISABEL DIANE B. MAR. 9, 1933

DAVID WESTLEY B. JAN. 28, 1913, COLUMBIA, S.C.

JOHN WESTLEY B. JAN. 20, 1915, SAN FR. D. MAR. 1918, SAN FR.

SALLIE ALEXANDER B. NOV. 27, 1901, CH. M. MAY 10, 1927, CH. ROBERT MCCORMICK FIGG, JR. (RADFORD, VA. OCT. 22, 1901-)

HORTENSE ALEXANDER B. AUG. 19, 1903, CH. D. DEC. 2, 1963, CH. UNM.

THOMAS JEFFERSON, JR. B. NOV. 12, 1906, CH. D. AUG. 31, 1970, CH. M. OCT. 27, 1934, ATL. ROWENA WILSON (WAYCROSS, GA. NOV. 6, 1912-DEC. 1975) SHE M. 2) RABBI ALLAN (ARSHISH

ROSA HAYS B. JAN. 3, 1914, CH. D. OCT. 14, 1967, HONOLULU M. OCT. 11, 1937, CH. JOHN F. ALEXANDER, OF N.Y. (O.V. II)

ROBERT III B. FEB. 24, 1928, CH. M. DEC. 26, 1959, ATLANTA, GA. MARY ELIZABETH JOHNSON (BIRM. ALA., SEP. 25, 1934-)

EMILY TOBIAS B. SEP. 11, 1931, CH. M. DEC. 20, 1951, CH. RICHARD DALLA MURA (PORTSMOUTH, N.H. AUG. 2, 1928-)

JEFFERSON TOBIAS B. NOV. 10, 1936, CH. M. MAY 27, 1961, CH. CATHERINE LOUISE COX (CH. AUG. 30, 1940-)

JUDITH B. JAN. 24, 1937, CH. M. JUN. 18, 1961, CH. RABBI MARTIN SIEGEL (BROOKLYN, MAY 27, 1933-)

DAVID LOPEZ B. MAR. 23, 1938, CH. M. JUN. 18, 1961, CH. RABBI MARTIN SIEGEL (BROOKLYN, MAY 27, 1933-)

ELEANOR ELIZABETH B. MAY 12, 1919, SAV. M. OCT. 24, 1942 EDWIN GEORGE REYNOLDS, JR. (NEW ROCHELLE, N.Y. JUN. 28, 1917- GREENWICH, CT. NOV. 2, 1964)

JESSIE RANDOLPH B. NOV. 16, 1922, SAV. M. NOV. 28, 1942, SAV. THOMAS MCKEE (ST. GEORGE, STATEN ISL., N.Y., MAR. 2, 1919-)

MARGARET B. FEB. 21, 1927, SAVANNAH

AMY ELIZABETH B. MAR. 2, 1961, DURHAM, N.C.

PAUL SETTLE B. JAN. 7, 1969, TAMPA, FLA.

SUSAN TRACY B. MAY 10, 1962, COLUMBIA, S.C.

CATHERINE EMILY B. MAR. 11, 1965, COLUMBIA

ROBERT MCCORMICK B. FEB. 28, 1967, CHARLOTTE, N.C.

SALLIE B. SEP. 24, 1953, CH.

KIMBERLY PAIGE B. NOV. 13, 1965, SAV.

AMY ELIZABETH B. MAY 20, 1969, SAV.

ANNE RANDOLPH B. MAR. 10, 1944, SAV. M. FEB. 27, 1965, SAV. ELLIOTT OLIVEROS EDWARDS (JACKSONVILLE, FLA., APR. 15, 1942-)

ELIZABETH SUTTON B. FEB. 22, 1947, SAV. M. FEB. 25, 1967, SAV. ROBERT LEE LA PRATT (ALMA, MICH. AUG. 29, 1943-)

EDWIN GEORGE, JR. B. JUN. 28, 1949, EL PASO, TEX. M. JUN. 27, 1970, SAV. CAROLINE ANNE SULLIVAN (SAV. APR. 24, 1950-)

FATHER E. C. TOBIAS

ASHLEY COWEN TOBIAS B. AUG. 19, 1855, CH. D. DEC. 8, 1919, CH. (VID. TOBIAS I) (1)

ELLA THERESA O'NEILL B. JUN. 8, 1860, CH. D. JUL. 1, 1932, CH.

RANDOLPH LOWE B. AUG. 29, 1944, SAV. UNM.

MARGARET ELEANOR B. 1947, ST. GEO., STATEN ISL. UNM.

SUSAN ELIZABETH M. AUG. 31, 1968 STEPHEN MARTIN

THOMAS LOWE B. JUN. 18, 1959, ST. GEO., STATEN I. UNM.

ASHLEY COWEN, JR. (OF COLUMBIA, S.C.) B. JUN. 20, 1886, CH. D. 1967, COLUMBIA M. 1) JUN. 4, 1912 ETHEL G. WIMNAUGH M. 2) URSULA CANTWELL

ELLA THERESA B. JAN. 28, 1889, CH. D. OCT. 16, 1919, CH. M. NOV. 11, 1916, CH. LOUIS S. LETELLIER

VERNON MULBERN B. MAR. 30, 1896, CH. D. NOV. 23, 1968, CH. M. FEB. 23, 1927, CH. EMILIE AGNES COMINS

ASHLEY COWEN III B. COLUMBIA, 1915 M. NEOMI NEWSOME

JOHN L. WIMNAUGH B. COLUMBIA, 1921 M. LOUISA ELLERBE

JAMES CANTWELL (2)

MARY EMILIE B. DEC. 8, 1927, CH. M. 1953, CH. JOHN BLODGETT STEBBINS

EDWIN CREIGHTON B. APR. 2, 1932, CH. D. 1975 (CATHOLIC PRIEST)

JAMES MAY B. JUN. 3, 1933, CH. M. SEP. 30, 1961, CH. OPAL S. WILKES (1936-)

JANIE E. B. FEB. 24, 1939, CH. M. JUL. 20, 1970, CH. MAJ. RALPH E. NAUMANN

JOHN B. JR. B. NOV. 11, 1954

GEORGE TOBIAS B. JAN. 24, 1956

ELIZABETH B. JUN. 22, 1965

EVE MARIE B. SEP. 27, 1962, CH.

EDWIN JAMES B. OCT. 30, 1963, CH.

ERIC WILKES B. SEP. 13, 1967, CH.

TOBIASON

FLO. ABR.
P.B.H.

ISRAEL TOBIASON
B. ENG. 1797
D. AUG. 23, 1865

AMELIA LEVINE
(Q.V.)

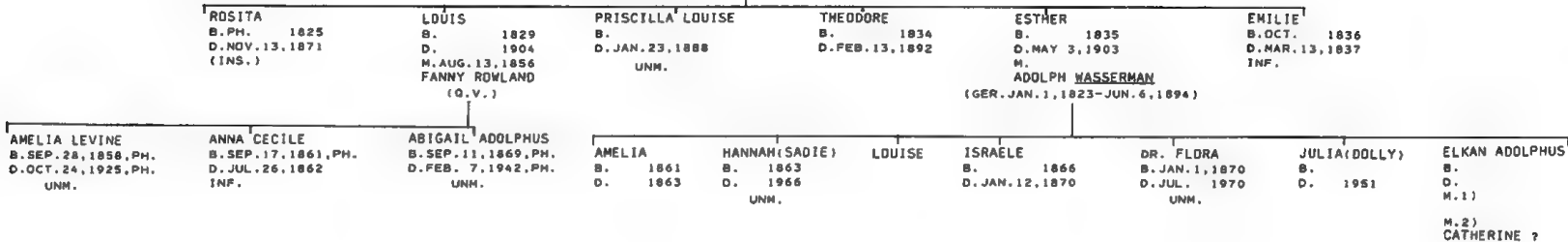

TOURO

PAJMS V. 13, P. 93F.
V. 27, P. 417F.
U. J. E., V. 10, P. 284F.
GUTSTEIN- JEWS OF NEWPORT
AARON LOPEZ (JUDAH TOURO)
SHEARITH ISRAEL REC.

ABRAHAM TOURO

RABBI ISAAC
B. 1738, HOLLAND
D. DEC. 8, 1783, KINGSTON, JAMAICA
M. JUN. 1773
REYNA (MALCHA) HAYS (Q.V. (1))
HE CAME TO AMERICA, 1760



VALENTINE

ELZAS MS.
POOL- PORTRAITS...
SHEARITH ISRAEL REC.
ROSENWAIKE

DAVID HENRIQUES VALENTINE
B. 1758, LONDON
D. APR. 16, 1837, N. Y.

ELIZABETH JEWEL (OR JUHEL)
B. OCT. 1759
D. JUL. 11, 1835, N. Y.

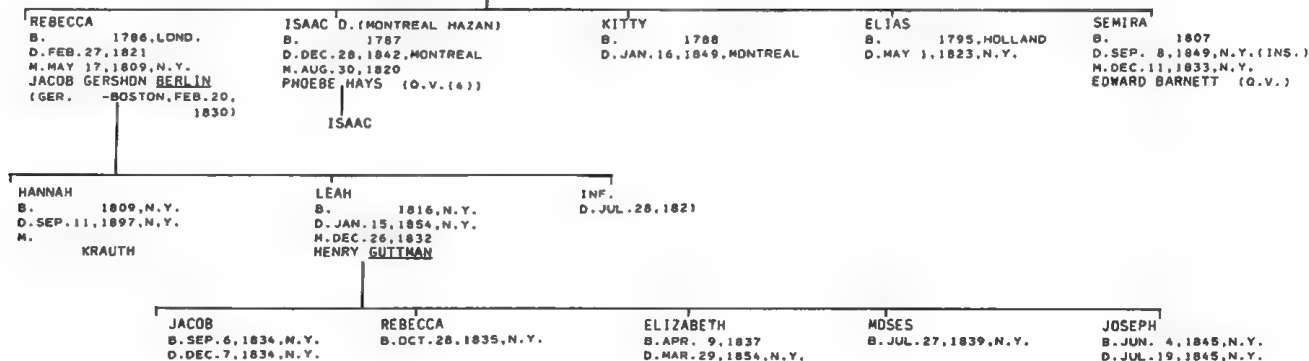

NORFOLK HEBREW CEMETERY
 NORFOLK CITY RECS.
 U.S. CENSUS, 1870
 NORFOLK CITY DIRECTORY
 REFORM ADVOCATE
 AJYB, 5666, P. 44
 5674, P. 269
 HOWARD STERN
 FLD. ABR.
 CILLA G. NUSBAUM

MICHAEL UMSTADTER BETTY
 OF HANOVER, GER.

MEIR LEVY (BETTIE)
 OF HESSE

(IN NORF., 1840) JACOB
 B. APR. 22, 1805, HANOVER
 D. MAY 30, 1872, NORF.

FANNY (FRUMET)
 B. 1814, HESSE
 D. NOV. 5, 1883, NORF.

CAROLINE (GENTL. KAILINE)
 B. 1806, HESSE
 D. JAN. 28, 1879, NORF.
 M. AARON L. GOLDSMITH
 (MAY 21, 1798-DEC. 18, 1881)

MINA (MENDEL)
 B. 1825/30, HESSE
 D. JAN. 27, 1898, NORF.
 M. MEYER SARLOUIS
 (BADEN, 1780/3-JUN. 8, 1867, NORF.)

HENRIETTA B. DEC. 13, 1841, MD.
 D. FEB. 7, 1877, NORF.
 M. FEB. 29, 1860, NORF.
 SAMUEL WOLF SELDNER
 (HAINSTADT, BADEN, 1832-
 JUN. 3, 1898, NORF.)

MICHAEL B. MAY 13, 1844, NORF.
 D. 1922
 M. SEP. 18, 1872, N.Y.
 ESTHER COHEN
 (O.V.V.)

SON B. NOV. 4, 1860, NORF.

BERTHA B. NOV. 27, 1862, NORF.
 D. DEC. 21, 1935, NORF.
 M. SEP. 15, 1886, NORF.
 FELIX L. GOLDSMITH
 (NOV. 2, 1862-OCT. 30, 1900)

AARON BEAUREGARD
 B. 1861
 D. 1935
 M. ROSE LOUCHHEIM
 (1872-1939)

MICHAEL B. JUL. 12, 1863
 D. DEC. 30, 1936

MIRIAM B. JUN. 16, 1873, NORF.
 D. 1957
 M. 1) SEP. 18, 1911
 RABBI DAVID BLAUSTEIN
 (LIDA, RUSSIA, MAY 5, 1866-
 AUG. 26, 1912, COLD SPRING, N.Y.)
 M. 2)
 RABBI SAMUEL GREENFIELD
 (KASCHAU, AUSTRIA, APR. 6, 1870-
 JUL. 11, 1937, N.Y.)
 D.S.P.

JACOB B. 1874, NORF.
 D. 1935, NORF.

DIANA MORRIS TURK
 EMILY

ISABELLA B. OCT. 10, 1843, BALTO.
 D. APR. 6, 1868, NORF.
 M. SOLOMON HAMBURGER
 (APR. 24, 1830-APR. 26, 1908)

BETTIE B. FEB. 1844, BALTO.
 D. OCT. 4, 1894, NORF.
 M. LEWIS NUS(S)BAUM
 (HESSDORF, GER. DEC. 4, 1830-
 DEC. 25, 1902, NORF.)

MOSES B. JUN. 24, 1848
 D. DEC. 5, 1884

BETTIE (BERTHA)
 B. JAN. 29, 1857
 D. FEB. 14, 1936
 M. (AS 2ND WIFE)
 JOSEPH WOLF SPAGAT
 (WONGROWITZ, PR. 1844-
 APR. 22, 1915, NORF.)

LESTER HENLY B. 1894
 D. 1920
 UNM.

HUBERT ALAN B. 1898
 D. 1899
 INF.

SAMUEL WINFRED B. 1901
 D. 1942
 UNM.

LEE FELIX B. OCT. 28, 1892
 D. NOV. 21, 1929

HORTENSE SAM HAVRE

MINNA EDWARD GOODMAN

LINA SAMUEL KERN
 BARBARA DOROTHY

FRANCES

BENJAMIN B. 1865, MD.
 D. 1923
 M. HUTCHINSON, KAN.

MAX VA.

SIDNEY LEON B. AUG. 14, 1870, NORF.
 D. DEC. 27, 1943, NORF.
 M. 1)
 HENNYE, DAU. OF JOSEPH W. SPAGAT (ABOVE)
 (FEB. 16, 1874-OCT. 21, 1929)
 M. 2)
 STELLA ULLMAN
 (JAN. 10, 1871-MAY 28, 1947)

MOSES B. NORF.
 D. NORF.
 M. MAIDIE GOLDSMITH

ISABEL

ALVINA GOLDBERG
 LEON NUSSBAUM

ELISE WRIGHT IV
 MESLEY PARKER

LINDA B. NORF.
 M. JUL. 29, 1958,
 WILLIAMSBURG, VA.
 GEORGE MANSBACH KAUFMAN
 (ADOPTED)
 EDWARD (TEDDY)

ELISE PARKER

ELISE HENRY CLAY
 HOFHEIMER II

LORIN NELSON BARBARA
 KEN JAY DAVID BARR

VIRGINIUS HARDING (BEE)
 B. SEP. 7, 1898, NORF.
 D. DEC. 17, 1958, NORF.
 M. JUSTINE LOWENBERG
 (NORF., SEP. 28, 1900-
 (VID. HECHT (2))

BERTRAM SPAGAT
 B. OCT. 5, 1895, NORF.
 D. NORF.
 M. JUN. 9, 1923, LYNCHBURG,
 CILLA GUGGENHEIMER (O.V. (1))
 (LYNCHBURG, VA. AUG. 22, 1897-DEC. 26, 1985)

ROBERT COLLIER
 B. FEB. 23, 1924
 M. DENVER, COLO.
 (BETTY) LOUISE SCHLOSS
 (DENVER, COLO. JUN. 3, 1924-)

SIDNEY LEON B. MAR. 9, 1925
 M. JUN. 1947, YOUNGSTOWN, O.
 FAITH WILKOFF
 (DEC. 23, 1925-)

VIRGINIUS H., JR.
 B. NOV. 21, 1927
 *M. APR. 23, 1949
 NANCY NORDLINGER
 (NORF.)

BERTRAM S., JR.
 B. MAY 11, 1924, NORF.
 M. SEP. 2, 1951, PATERSON, N.J.
 LOIS SILBERMAN
 (AUG. 19, 1931-)

CHARLES GUGGENHEIMER
 B. JUN. 2, 1926, NORF.
 M. NOV. 23, 1963, RI.
 BLANCHE BOWMAN
 (RI., JUN. 13, 1936-)

BETH SUSAN B. SEP. 29, 1953
 *M. JUL. 14, 1973, NORF.
 RAND MARSHALL CURTISS
 (CLEVELAND, JUN. 9, 1950-)

CHARLES SILBERMAN
 B. JAN. 15, 1957
 M. OCT. 12, 1985
 NANCY HORTON
 (MAR. 4, 1962-)

CHARLES G.
 B. MAY 13, 1965

JOHN MYERS
 B. MAR. 4, 1967

ROBERT C., JR.
 B. MAY 1, 1949
 *M. JUN. 27, 1971, NORF.
 MARLENE ACKERMAN

WILLIAM B. JUL. 29, 1955
 M. AUG. 28, 1983
 SHARON JEAN KURTZ
 (SEP. 4, 1949-)

CYNTHIA B. MAR. 31, 1949, NORF.
 M. JUL. 8, 1972, YOUNGSTOWN, O.
 STUART KATZ
 (JUL. 17, 1947-)

ALAN BEE
 B. NOV. 11, 1950, NORF.

LAURA MEREDITH B. APRIL 5, 1980

CATHERINE ASHLEY B. JUNE 13, 1983

MICHAEL ADAM B. FEB. 19, 1987

AMY CAROLINE B. OCT. 20, 1989

CHARLES STEPHEN "STEPHEN" B. JAN. 26, 1985

LEIGH MICHELLE B. SEP. 3, 1989

VALVERDE

TJHSE, V. 13, PASSIM
SHILSTONE
BARBADOS CENSUS, 1715
KORN-BARBADOS WILLS
PAJHS, V. 42, P. 395
POOL- PORTRAITS, P. 464
MISC. VII
S. M. KETUBOT

JACOB VALVERDE
(IN RECIFE, BRAZIL, 1649)

REBECCA
B. D. MAY 17, 1706, BARB.
AARDN NAVARRO
B. D. SEP. 23, 1685, BARB.

JACOB FRANCO NUNES (ENDENIZ, BARBADOS.)
B. 1646 OCT. 11, 1687
D. OCT. 27, 1726, BARB.
M. LUNA
(-APR. 9, 1706, BARB.)

ABRAHAM (RECIFE TO BARB., 1654)
B. (ENDENIZ, BARB. FEB. 1, 1696)
D. MAR. 3, 1707, BARB.
M. JAELE
(1665-AUG. 13, 1721, BARB.)

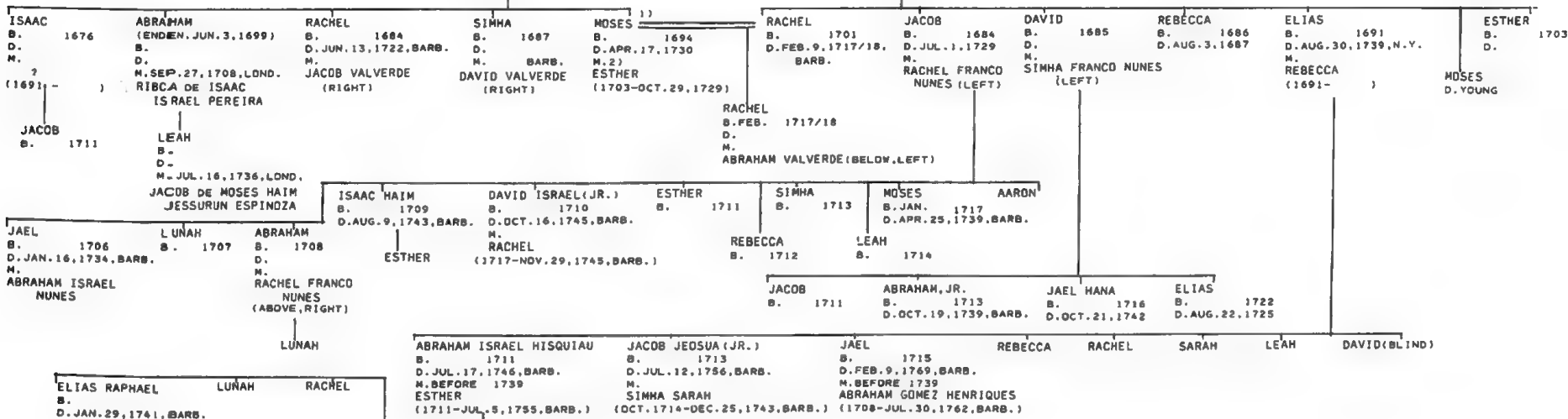

WAAG (E)

KRAUS-SANDOR COLL.
PAJHS V. 21, P. 156
PAJHS V. 31, P. 34F.
SHEARITH ISRAEL REC.
WILL OF REBECCA GOMEZ (AJHS)

ELKAN, OF BOPPARD
(IN FRANKFURT AM MAIN, 1516)

SIMON
B. D. 1531

MOSES (FLOURISHED 1529-51)

PHABUSH URI BACHARACH ZUR WAAGE (IN FRANKFURT, CA 1565)

MOSES WAAG

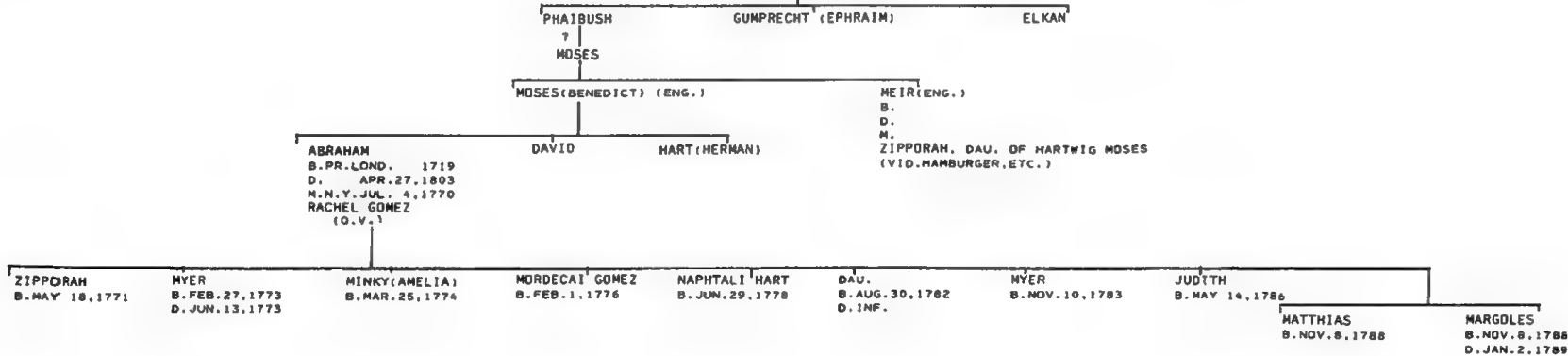

B'NAI JESHURUN REC.
EZEKIEL FAMILY REC.
SHEARITH ISRAEL REC.
M.A.BRANDT 11

LEVI VAN VEEN
B.CA. 1745, VIENNA
D.CA. 1820, AMSTERDAM
M.

ABRAHAM LEVI WATERMAN
B.
D.LONDON

YETTA
B.
D.BALTO., 1837

NOTE: LONDON SETTLERS TOOK NAME ABRAHAM

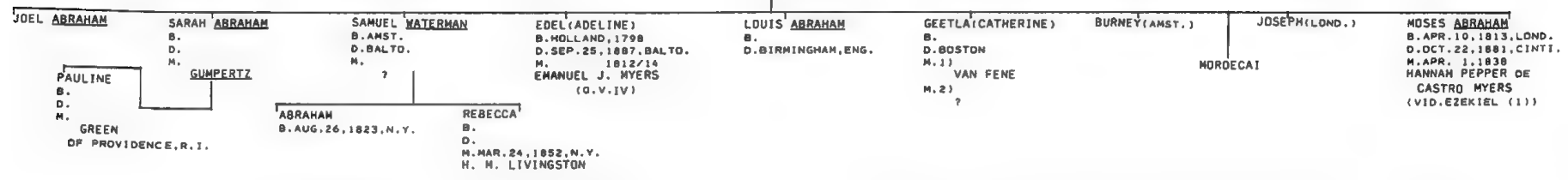

LEON L. WATTERS-PIONEER JEWS OF UTAH
JON STEDMAN
WHO'S WHO IN WORLD JEWRY. 1965, P.1019
AJYB, 1966, P.613

MICHEL WASSER
OF POMERANIA

(1) HANNAH
(2) ABRAHAM WATTERS (ARR.N.Y., JUL.6, 1835)
(2) MICHEL (TO U.S.1850)
(2) LEISER

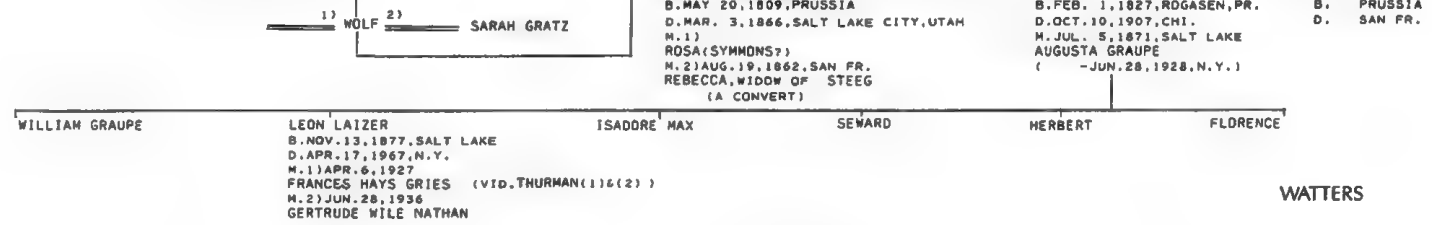

MIKVEH ISRAEL REC.
MORAIS-JEWS OF PHILA.
MEYER SOLIS-COHEN
FEDERAL ST. CEMETERY

SIMON WOLF
CATHERINE
B. 1775
D.OCT.13, 1850, PH.

WOLF I

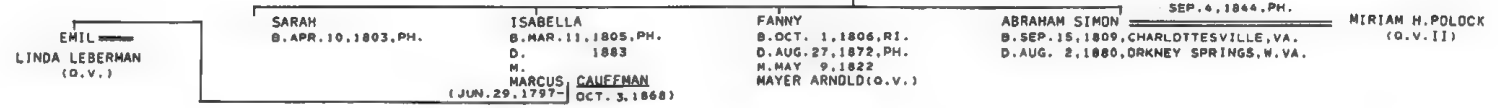

L.BAECK INSTITUTE Y.B., V.X.P.66FF.
SHEARITH ISRAEL REC.
SAWYER-N.Y.WILLS.V.3
MORAIS-JEWS OF PHILA.
N.Y.DEATHS FROM N.Y.EVENING POST
AJA.V.XIV,P.26F.
U.S.CENSUS, 1880

SISTER
FEUCHTWANGER
WILLIAM LEO-WOLF, M.D. (TO PH., 1829)
B.CA.MOV.15.1780, ALTSTRE LITZ, MECKLENBURG
D. APR.26, 1850, HAMBURG, GER.

WOLF II

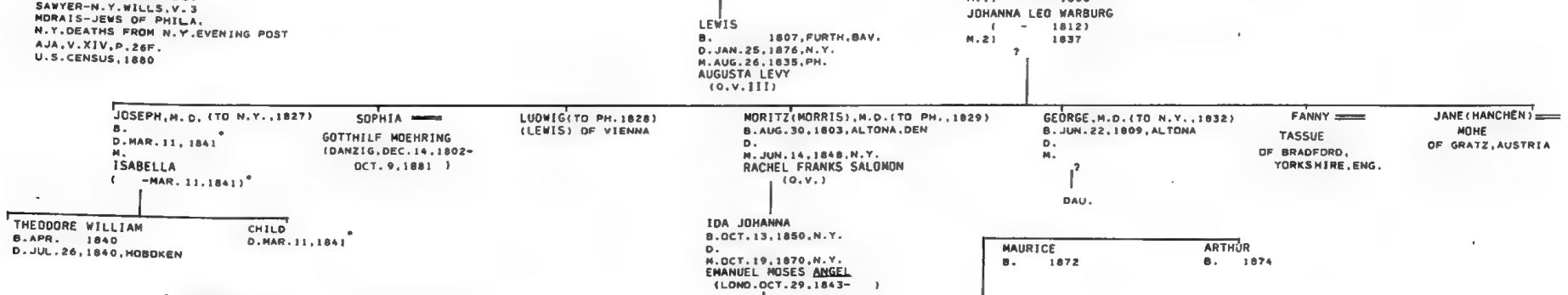

*PERISHED IN SINKING OF "S.S.PRESIDENT"

WOLFE I

THE OLD MERCHANTS, V. 3, PP. 152-159
 EZEKIEL-LICHTENSTEIN
 HENRY V. HOAGLAND
 RICHMOND PERSONAL PROPERTY RECS.
 PAJMS, V. 27, P. 112
 JOHN I. CODDINGTON, F.A.S.G.

(IN RI. BY 1787) BENJAMIN WOLFE
 B. 1767
 D. JAN. 2, 1817, RI.
 SOPHIA
 B. 1821
 D. 1821

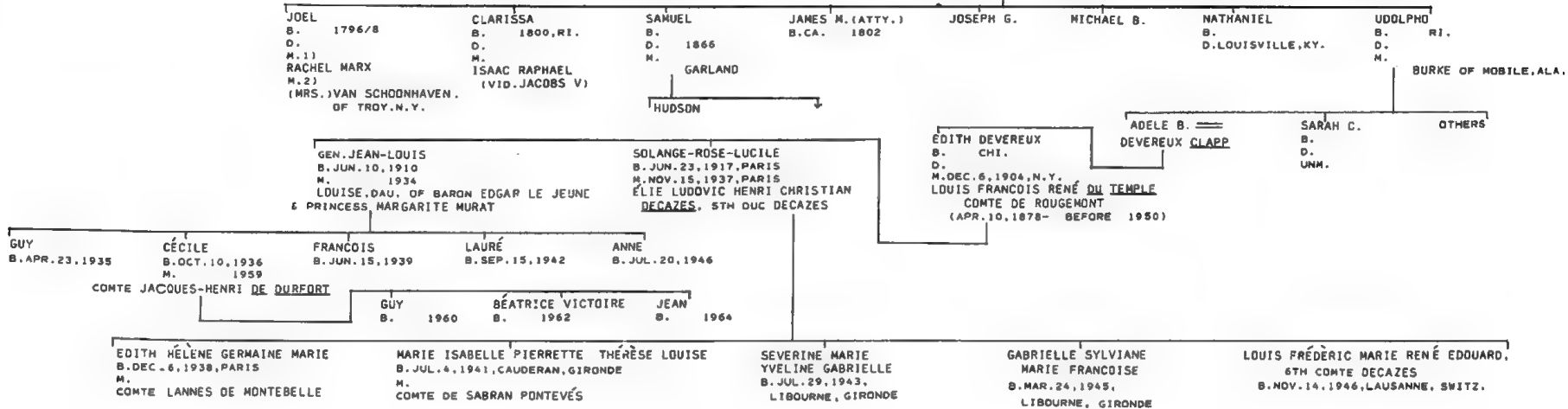

WOLFE II

CHARLES WHITEHEAD
 KRAUS-SANDOR COLL.
 DAR LINEAGE BOOKS
 ELZAS-JEW. CEMETERY AT COLUMBIA, S.C.
 JEW. CEMETERY AT ORANGEBURG, S.C.
 M. N.
 M. COIT-MR. BARUCH
 FLO. ABR.

ISAAC SALING WOLFE
 B. 1787, PRUSSIA
 D. SEP. 23, 1856, NEUMARK, PR.
 HENRIETTA
 B. 1787, NEUMARK, PR.
 D. JUN. 6, 1864, CHESTER, S.C.

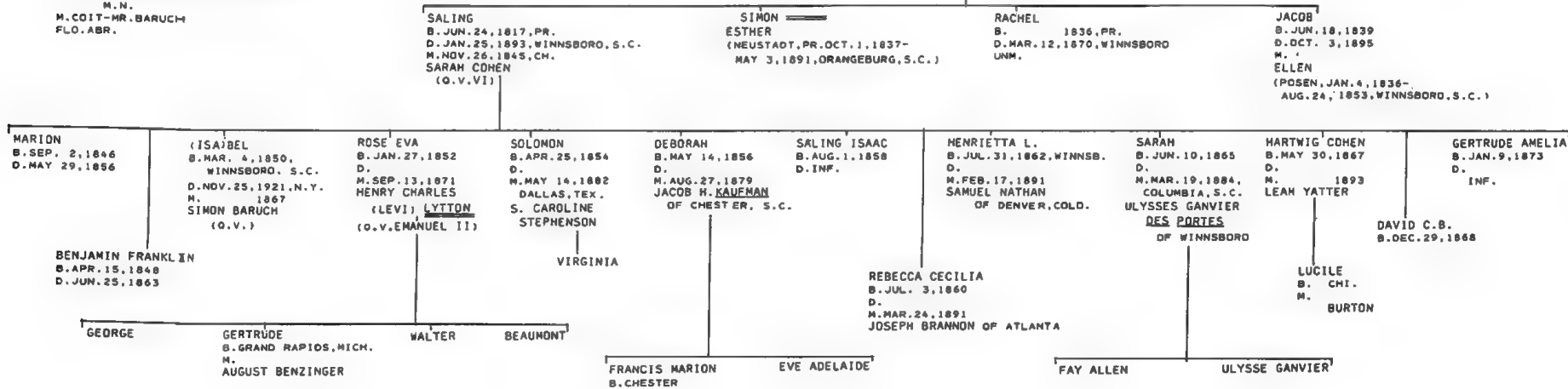

JACOB HISQUIAD ROBLES (HAZAN IN ST.EUSTATIA)
 B. 1751
 D. DEC. 28, 1791, ST. E.
 M. CATHARINA LEVY
 SEP. 21, 1794, ST. E.

REBECCA ISRAELS 1)
 (SIMON AARON CAPPE) 2) MAY 22, 1791, ST. E.
 B. 1755, KUTTENBERG (?) BOHEMIA
 D. FEB. 1834, BOHEMIA

LEVY 1) REBECCA TORRES 2) DAVID JUDAH HART
 MIRIAM B. 1767, N. Y.

REBECCA 1) MOZES WOLFF 2)
 B. 1774, ST. E. B. 1756, BERST OF GER.
 D. 1815, ST. THOS.

SIMON 1) CHARLOTTE 2)
 B. 1829 B. FEB. 1792, ST. THOS.
 D. JAN. 22, 1879, N. Y.

JUDAH B. APR. 9, 1799, ST. E.
 D. NOV. 4, 1878, ST. THOS.
 M. SARAH DE SAMUEL HOHEB
 (DEC. 1795-APR. 1, 1863, ST. THOS.)

RACHEL B. 1822 JACOB BENJAMIN D. 1822
 HANNAH B. 1850 D. 1815 M. 1815 COL. R. LINDSLAY (BRITISH ARMY)
 EL'KAH B. 1804 D. DEC. 25, 1881, ST. THOS. BENJAMIN MENDES DA COSTA (LOND. 1801-MAR. 27, 1856, ST. THOS.)
 RALPH B. 1850 D. 1834 M. 1834 JUDITH PUCTO
 MIRIAM B. 1808 D. 1839 M. 1839 PETER VAN VLIERDEN
 LEAH B. 1866 D. 1866 ELIAS CHARLES MENDES DA COSTA
 AARON B. AUG. 6, 1795, ST. KITTS D. JUN. 12, 1872, LOND.
 RACHEL B. FEB. 1792, ST. THOS. D. JAN. 22, 1879, N. Y.
 SAMUEL RACHEL M. JAN. 17, 1849, ST. THOS. SLOMON BENJAMIN (O. V. I)
 REBECCA B. JUN. 1844 D. NOV. 10, 1859, ST. THOS.

JACOB BENJAMIN B. 1815 D. DEC. 27, 1850, ST. THOS. SOLOMON B. 1816 D. APR. 29, 1826, ST. THOS.
 CHARLOTTE B. 1817 D. INF. MOSES B. 1818, ST. E. D. FEB. 5, 1855 M. JUL. 15, 1838. PUERTO CABELLO, VEN. REBECCA LEVY (ST. CROIX, 1841-AUG. 28, 1889, N. Y.)
 MIRIAM B. 1821 D. M. NOV. 8, 1843, ST. THOS. ELIAS B. DEC. 25, 1822, ST. THOS. D. JUN. 23, 1869. SANTO DOMINGO M. FEB. 20, 1855, N. Y. JOSEPHINE LUNA HENRIQUES (O. V. I (2))
 RUTH B. 1825 D. INF. ALEXANDER R. B. 1826 D. 1868 M. ANNA DONES (O. V.) ANNA B. 1827 D. INF. JOSEPH B. 1830 D. INF. DANIEL N. B. JAN. 6, 1820, ST. THOS. D. JAN. 13, 1899, N. Y. MIRIAM B. MAY 18, 1823, ST. THOS. D. JUL. 7, 1887, N. Y.
 REUBEN JULIUS B. FEB. 2, 1837, ST. THOS. D. SEP. 15, 1911, YONKERS M. OCT. 4, 1854, ST. THOS. RACHEL MIRIAM LEVY (1836-)

REBECCA B. FEB. 20, 1823, ST. THOS. D. DEC. 18, 1916, N. Y. M. OCT. 20, 1847, ST. THOS. JOSEPH LEVY (GER. 1823-APR. 9, 1903, N. Y.)
 MOSES B. NOV. 30, 1849, ST. THOS. D. APR. 6, 1885, N. Y. MILLIE MARTIN NATHAN FANNY B. NOV. 4, 1852, HAMBURG, GER. D. OCT. 3, 1922, N. Y. M. NOV. 5, 1878, N. Y. CHARLES G. WOLFF (BELOW)
 MIRIAM OLGA B. JUN. 28, 1894, N. Y. ALEXANDER B. 1853, ST. THOS. D. NOV. 13, 1919, N. Y. LILLIAN GANS HAROLD ALEXANDER B. 1894 D. JUN. 25, 1919, N. Y. M. ROSE CRYSTAL
 MOSES B. JUL. 30, 1855, ST. THOS. D. JAN. 13, 1923, N. Y. ISAAC B. SEP. 18, 1857, ST. THOS. D. MAY 25, 1934, N. Y. RACHEL B. SEP. 22, 1856, ST. THOS. D. JUN. 15, 1857, ST. THOS. INF. PERLA B. 1858 ST. THOS. GRACE B. 1862, LA. D. DEC. 20, 1934, N. Y. UNM. DANIEL B. 1866 ST. THOS. ESTHER B. 1865, ST. THOS. AARON B. DEC. 1860, LA. D. AUG. 5, 1918, N. Y. M. CAROLINE

DAVID RACHEL HENRY A. TOBIAS (O. V. I) AARON B. JUN. 18, 1843, ST. THOS. D. JAN. 4, 1920, N. Y. M. APR. 10, 1867, N. Y. AGNES HENDRICKS (O. V. I) AUGUSTA CHARLES GELLER B. MAY 3, 1848, LA. GUAIRA, VEN. D. APR. 23, 1898, N. Y. M. NOV. 5, 1873, N. Y. FANNY LEVY (ABOVE) JULIUS RUBEN B. MAY 7, 1849, LA. GUAIRA, VEN. D. APR. 25, 1886, N. Y. M. FEB. 14, 1877, N. Y. FRANCES LOUISA NATHAN (O. V. I (1)) EMITA B. JUN. 7, 1851, LA. GUAIRA, VEN. BENJAMIN B. 1852 D. FEB. 6, 1855 RACHEL B. 1890, N. Y. M. JUL. 4, 1919, N. Y. GEORGE VICTOR SIMON
 LILLIAN HENDRICKS B. JUL. 31, 1866 D. M. MAR. 30, 1892, MONTREAL LOUIS NAPOLEON LEVY (O. V. II) AGNES HENDRICKS B. JUN. 29, 1870 D. 1901, N. Y. ALMA B. SEP. 14, 1874 D. APR. 3, 1878, N. Y. MOSIES PERCY B. JAN. 21, 1875, N. Y. D. LOTTIE FOX FRANK JOSEPH B. MAR. 5, 1876, N. Y. D. MAR. 24, 1878, N. Y. EDWARD B. D. M. FOX E. FOX M. 2) BEE GAY EMITA VERA WENDY JOHN B. III JOHN B. IV JEAN S. JOHN B. JR. RALPH M. 1) LUCY M. 2) MARGARET SCHEUER PEARL ARTHUR MOSES B. 1881 D. M. 1930 GWENDOLYN MACLEOD FRANCES NATHAN B. NOV. 5, 1883, N. Y. D. M. MAR. 28, 1906, N. Y. JOSEPH FREDERICK CULLMAN, JR. (VID. STIX (1)) JOHN BENJAMIN M. 1) MARY FULLER HOI LISTER M. 2) FLORENCE FULLER JOHN B. JR. RALPH M. 1) LUCY M. 2) MARGARET SCHEUER PEARL MARY RALPH, JR. ROBIN E. WILSON

ELZAS MS. M. N. NEW CEMETERY AT CH. JENS OF S. C. (JACOB?) WOOLF SARAH B. 1735 D. JUN. 29, 1831, CH. RACHEL B. 1768 D. JAN. 22, 1843 M. REV. ISAAC CHHEN D'AZEVEDO (O. V.) ISAAC B. 1782 D. MAR. 5, 1870, CH. M. MAY 31, 1809, CH. SARAH MOSES (O. V. VII)

LEVI B. MAR. 3, 1810 D. SEP. 25, 1810 INF. MIRIAM R. B. D. APR. 5, 1857, DAYTON, O. M. DEC. 1, 1841, CH. JOHN M. HIRSCH (STOCKHOLM, SWE. DEC. 8, 1801-JUL. 29, 1874, CH.) ELIZA T. B. OCT. 22, 1815 D. OCT. 31, 1867 M. DEC. 1, 1841, CH. MORITZ LEVIN (O. V. II) RALPH B. D. M. MAR. 29, 1837, CH. CORDELIA HARRIS (O. V. II) CHARLOTTE A. B. NOV. 17, 1817 D. FEB. 1, 1883, CH. M. JAN. 21, 1844, CH. L. T. LEVIN (O. V. II) ENMA C. CAROLINE A. B. 1824 D. MAR. 9, 1904, ORANGE CO. M. DEC. 1, 1841, CH. EMANUEL N. CARVALHO (O. V.) THEODOSIA B. 1820 D. OCT. 4, 1824, CH. SOLOMON JACKSON B. FEB. 1829 D. DEC. 21, 1830 INF. CLARENCE REUBEN B. MAR. 26, 1838 D. JUN. 15, 1867

WORKUM (1)

DAVID L. ACH
 IRVING I. KATZ
 B'NAI JESHURUM REC.
 WORKUM GEN. (AJA)
 EZEKIEL FAMILY RECS. (E. PINCUS & AJA)
 SHEARITH ISRAEL
 U.J.E.
 PAJHS, V.19, P.202F.
 AJYB V.29, P.161
 SENIOR GEN.
 FECHMEIMER GEN.

JUDAH
 (TO N.O., 1818) JACOB L. WORKUM SEP. 19, 1821, N.Y.
 B. 1792, WORKUM, HOLLAND
 D. MAR. 16, 1870, CINTI.
 DAVID LEVY
 SARAH (TO U.S. 1819)
 B. DEC. 25, 1798, HOLLAND
 D. AUG. 15, 1883

LEVI JACOB GERTRUDE CLARA RACHEL DAVID DUFFIE
 B. JUN. 27, 1822, N.Y. B. OCT. 11, 1826, N.Y. B. SEP. 11, 1831, CINTI.
 D. JUL. 23, 1883. D. MAY 10, 1885, CINTI. B. SEP. 11, 1833, CINTI.
 WHITE SULPHUR SPR., W. VA. M. SEP. 28, 1864, N.O. D. MAY 1903, CINTI.
 M. DEC. 7, 1858, RI. ELIZABETH HART M. FEB. 13, 1856, CINTI.
 HANNAH EZEKIEL (O.V. (1)) (O.V. X(1)) JULIUS FREIBERG

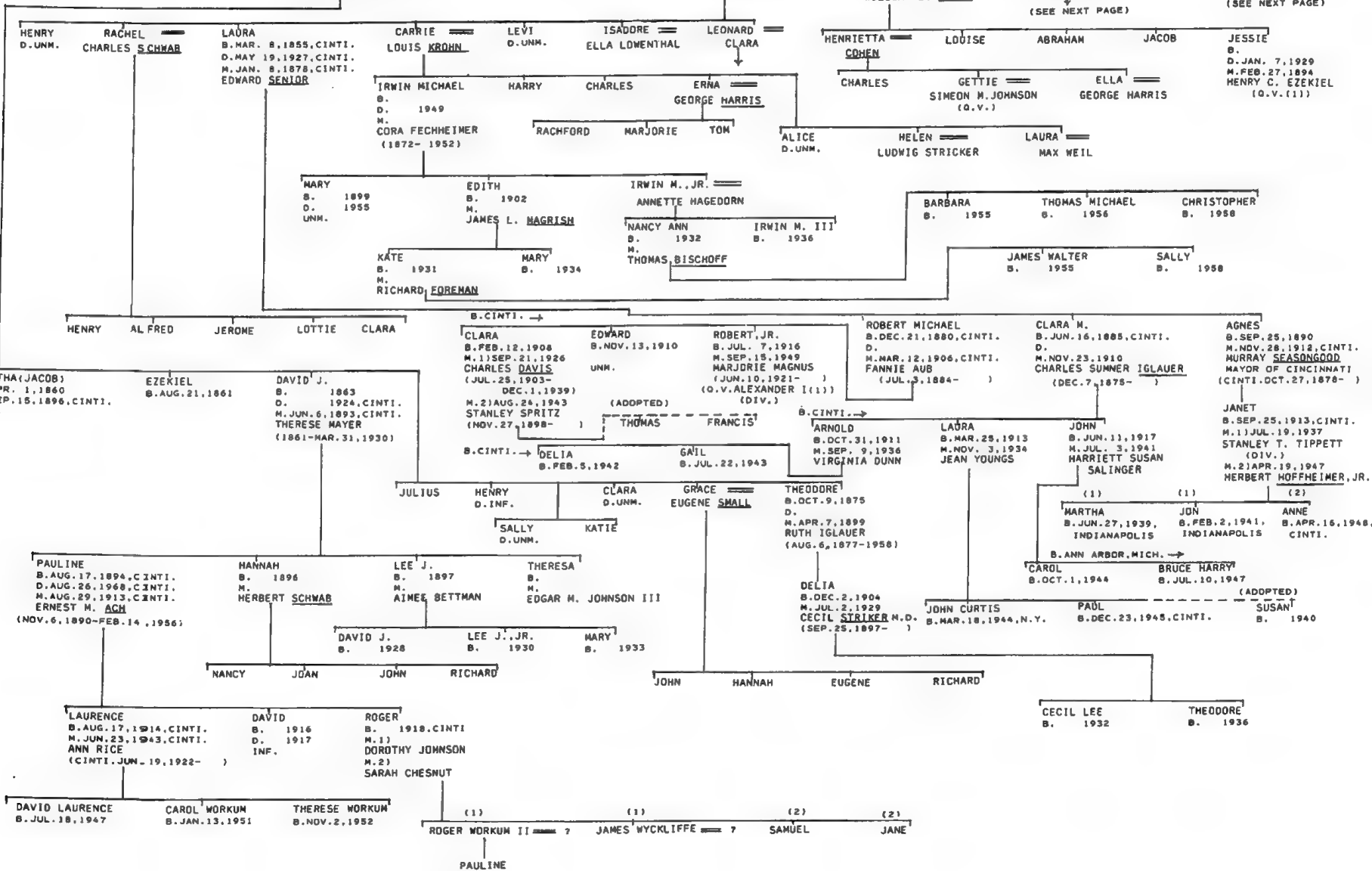

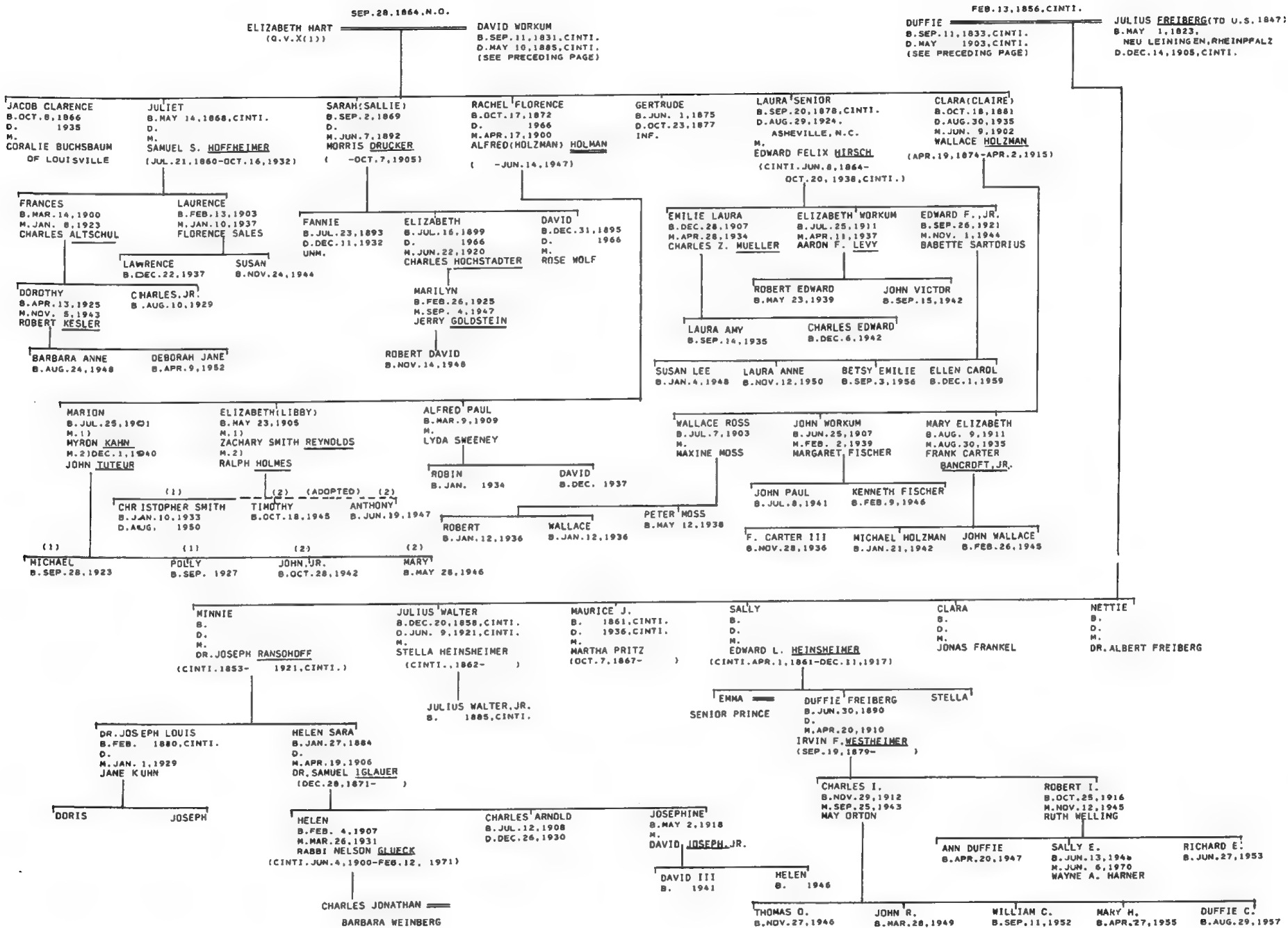

YATES

THOMAS J. TOBIAS
ELZAS, O.J.C.
KRAUS-SANDOR COLL.
SAMUEL-HIST. GEN. OF SAMUEL-YATES
SAMUEL-YATES GEN. (AJA)
SHEARITH ISRAEL REC.
F.L.D. ABR.

ELIAKIM GOETZ OF STRELITZ

MOSES ABRAHAMS
OF POOLE, ENG.

MARTHA HAYNES
(CONVERT TO JUDAISM)

FANNY LEVY

REV. BENJAMIN YATES
(HEAD OF LIVERPOOL
JEWISH COMMUNITY)
B.
D. 1798

SAMUEL YATES
B. SEP. 7, 1757, STRELITZ
D. OCT. 2, 1825, LIVERPOOL

POOLE, APR. 25, 1781

MARTHA
B. FEB. 22, 1757, SHAFESBURY, ENG.
D. JUL. 7, 1840

FLORA
B. NOV. 20, 1781
D. NOV. 4, 1851
M. DEC. 31, 1800
HENRY HART SAMUEL
(O.V. I)

KATY (CATHERINE)
B. JUN. 17, 1785, LIV.
D. DEC. 24, 1858, LIV.
M. APR. 11, 1804, LIV.
LEWIS JUDAH SAMUEL
(O.V. I)

JOCHABED
B. NOV. 26, 1787
D. FEB. 17, 1870
M. NOV. 16, 1808
SOLOMON SAMUEL
(O.V. I)

RACHEL
B. NOV. 22, 1790
D. JUL. 8, 1853
M. FEB. 25, 1818, LIV.
PHINEAS NATHAN

SARAH
B. MAR. 11, 1791 ?
D. JUN. 23, 1855
M. FEB. 25, 1818
JOSEPH HESS

PHOEBE
B. MAR. 25, 1794, LIV.
D. APR. 24, 1870, BALTO.
M. OCT. 20, 1835, LIV.
JOSHUA LAZARUS
(O.V. II)

FANNY
B. AUG. 24, 1797, LIV.
D. OCT. 21, 1817, LIV.
JACOB CLARISSE LEVY
(O.V. XI)

BENJAMIN (ELIJAH)
B. JUN. 25, 1800
D. INF.

HANAH
D. UNK.

KATE
MAY 29, 1833
B. APR. 15, 1803
D. APR. 23, 1880
(VID. SAMUEL I)

ELLIS (SAMUEL) YATES
B. FEB. 25, 1805, LIV.
D. JUN. 6, 1849
(VID. SAMUEL I)

FANNY BLUME
B. APR. 3, 1820
D. NOV. 17, 1884

RAPHAEL DE CORDOVA
(O.V.)
FEB. 22, 1848 (I)

FLORA
B. JAN. 18, 1826
D. MAR. 29, 1906

SAMUEL
EVA JOSHUA

CHARLES
NUGENT

HARRIET
M. MAR. 22, 1842
ISAAC SANGUINETTA

LOUISA

EMMA
B. SEP. 26, 1824
D. M. AUG. 9, 1854
HENRY HESS

GEORGE SAMUEL
B. MAR. 7, 1834
D. JUN. 20, 1887, BIRKDALE
M. DEC. 7, 1864
HANNAH KEYSER
(DEC. 11, 1840-)

RICHARD
B. DEC. 18, 1835
D. JAN. 15, 1840

CLARA
B. JAN. 1, 1837
D. NOV. 1, 1920
M. OCT. 24, 1855
EDWIN SAMUEL
(SEP. 19, 1825-MAR. 28, 1877)

EDWARD WILSON
B. MAY 11, 1839
D. JAN. 15, 1904
M. OCT. 22, 1873
ADA FRIEDLANDER,
OF BIRMINGHAM
(JUL. 10, 1851-)

DANIEL
B. JUL. 9, 1848
D. UNK.

EDITH
B. AUG. 5, 1874

MABEL
B. JAN. 10, 1877

AMY
B. NOV. 1, 1865
D. UNK.
EMIL KANN
(-FEB. 1918)

GEORGE EMIL
JOSEPHINE

ELLIS KEYSER
B. JUN. 30, 1867
M. JAN. 8, 1905
JULIA MOSELEY
(NOV. 3, 1875-)

LUCY
B. JAN. 4, 1869

WALTER GEORGE
B. NOV. 17, 1870

MARION ISABEL
B. AUG. 29, 1873

KATIE
B. JUN. 30, 1875
D. JUN. 1, 1960
UNK.

DORA ESTHER
B. NOV. 26, 1879

MONTAGUE SOLOMON
B. DEC. 2, 1880

PHINEAS
B.
D.
M. 7

DAU.
B.
D.
M.

FLORA
B.
D.
M.

SAUL
B.
D.
M.

LEWIS

POLLY

CATHERINE
B.
D.
M.

HANNAH
B.
D.
M.

EDWIN
B. OCT. 21, 1827, LIVERPOOL
D. JUL. 24, 1868, CH.

FRANCES

RALPH ISAAC

SOPHIE AARON
1839

SYLVESTER (COHEN) COLEMAN

ISAAC

ALEXANDER

NATHAN

MOSES CHAPMAN

SOLOMON ALEXANDER

AMELIA HART

JOHN RAPHAEL

SARAH AMELIA
B. 1813
D. 1900

GEORGINA EUGENIA
D.S.P.

MAURICE JOHN

JAMES
UNK.

FRED WILLIAM
DIANA PYKE

LEON
HONEY

ALICE FLORA
B. 1893
D. 1870
M. 1870
ALFRED, PYKE

SYLVESTER

SIMON
B. 1851
D. 1881

ADOLPHUS BENJAMIN

JULIA (TO NEW ZEALAND)
M. NOV. 8, 1848, LIVERPOOL
CHARLES DAVIS
OF AUCKLAND, N.Z.

SAMUEL
(TO NEW ZEALAND, 1853)
B. 1829, LONDON
D. SEP. 19, 1900
M.
(A MAORI PRINCESS)

PERCY LEWIS
B. 1845

NELLIE ELIZABETH
B. 1886

ROSE AMELIA
B. 1889

JOHN ROBERT
B. 1891

KAUFMAN

ETHEL
SON

CONSTANCE
SON

WALTER MARKS
SON

RAFAELLE
B. 1840
D. UNK.
ELLEN MOSES OF BIRMINGHAM
D.S.P.

ESTHER FLORA
D. 1908
UNK.

THERESA SOPHIA
M. 1867
JOSEPH H. EHRENBACHER OF LIVERPOOL
(- 1907)
D.S.P.

BLANCHE ELIZABETH
D. 1893
UNK.

EDITH ROSE
M. 1867
LEOPOLD FARMER
(- 1927)

BENJAMIN RICHARD
EFFIE ROBSON, OF EDINBURGH

CECIL
UNK.

MABEL
HERBERT

HAROLD

FREDERICK
GLADYS
MARJORIE

ZUNTZ

PODL-PORTRAITS...
SHEARITH ISRAEL REC.
PAJHS V. 27, PP. 32, 78
N.Y. DEATHS (DAR)
BARBER-N.Y. MARR.
N.Y. WEEKLY MUSEUM

JUDAH ZUNTZ
B.
D.
M. 7

ELLEN
B. JUN. 3, 1781, N.Y.
D. NOV. 29, 1866, N.Y.
UNK.

JUDAH
B. 1783
D. MAR. 4, 1829
UNK.

ABRAHAM S.
B. 1785
D. NOV. 22, 1813
UNK.

URIAH (CRIPPLE)
B.
D. UNK.

GRACE AUGUSTA
B.
D. UNK.
M. JAN. 22, 1817, N.Y.
MARCUS JACOB OF LONDON

GERTRUDE
B.
D. UNK.
M. DEC. 22, 1824, N.Y.
JACOB SOLOMON

ALEXANDER (IN N.Y. BY 1779)
B. MAY 15, 1742, WESTPHALIA
D. OCT. 15, 1819, KIPS BAY.
M. MAY 4, 1779, N.Y.
RACHEL ABRAHAMS
(O.V. I)

MOSES
B. GA. 1791
D. JUL. 22, 1810, AT SEA
UNK.

ADDENDA ET CORRIGENDA

THIS SECTION CONTAINS DATA WHICH ARRIVED TOO LATE FOR INCLUSION ON THE CHARTS, AS WELL AS CORRECTIONS TO THE CHARTS. ALL ADDITIONS AND CORRECTIONS, WHETHER THEY CONSIST OF A SINGLE LETTER OR ARE MORE EXTENSIVE, ARE UNDELINEED. ITEMS NOT UNDELINEED APPEAR UNCHANGED FROM THE CHARTS AND INCORPORATED HERE TO PROVIDE EASY REFERENCE TO THE CHARTS. THE USER IS URGED TO COMPARE THE DATA IN THIS SECTION WITH THE INDICATED CHARTS.

MISCELLANEOUS ADDITIONS OR CORRECTIONS TO AN INDIVIDUAL CHART ARE SEPARATED BY A BROKEN LINE.

SEVERAL GENERATIONS OF ONE FAMILY ARE INDICATED BY INDENTING FOUR SPACES FOR EACH SUCCEEDING GENERATION. ALL INDIVIDUALS OF THE SAME GENERATION SHARE A COMMON MARGIN OF INDENTATION, AS THE FOLLOWING SCHEME DEMONSTRATES:

PARENTS
 CHILD A
 CHILDREN OF A
 GRANDCHILDREN OF A
 CHILD B
 CHILD 1 OF B
 CHILDREN OF CHILD 1 OF B
 CHILD 2 OF B
 ETC.

SOURCES FROM WHICH THESE DATA ARE DERIVED ARE LISTED IN PARENTHESES AFTER EACH GROUP OF DATA.

PAGE AND FAMILY

5. ABRAHAMS I
 DAVID B. (FALK), DELETE II; M. JUL. 14, 1945. (ARLA FEY. (B.H.LEVY))
6. ABRAHAMS IV
 AUGUSTIA (LYON) D. JUN. 1910. (JON STEDMAN)
 VID. UNDER ISAAC S. SOLOMON, SIMON B. SOLOMON, AND SOLOMON B. SOLOMON SHOULD READ (VID. HART X(2))
6. ABRAHAMS V
 ISAAC ABRAHAMS, DELETE M.D.; B. 1727 (ROSENWAIKE - BALTIMORE)
11. ANCKER (2)
 RACHEL M. ADOLPH BITTERMAN OF EVANSVILLE, IND., AND HAD:
 JULIA M. HARRY LOWENTHAL AND HAD:
 EDWIN
 ARTHUR
 JACK
 PHILIP
 JACK M. HATTIE SCHOLEM, AND HAD:
 LEONORE, D. 1979; M. 1) ROBERT WOLLENBERG OF CHICAGO; M. 2) MALCOLM PFAELZER OF CHICAGO; M. 3) MERRITT DE JONG OF EVANSVILLE
 ALFRED
 FLORENCE, D. 1915; M. 1905; FERD. A. GUMBERTS (1871-1960) AND HAD:
 HELEN FLORENCE, M. APR. 22, 1939, MARON J. SIMON OF NASHVILLE, TENN., E.N.Y. S.P.
 RICHARD A.
 WILLIAM A.
 ARTHUR, M. JANICE JAMES AND HAD:
 JANICE M. EARL LEMOND
 DELIA, M. CLARENCE B. KAHN AND HAD:
 MARGEBY
 THEODORE, M. CORINNE KAHN AND HAD:
 JEAN, M. ALVIN LEVY
 ROSEBUD, M. HERMAN COHN OF LITTLE ROCK, ARK. (MRS. MARON J. SIMON)
18. BENJAMIN I
 PHILIP, M. REBECCA, DAU. OF SOLOMON AND EVA (LEVY) DE MENDES AND HAD:
 JACOB LEVY, B. MAR. 20, 1818, FAYETTEVILLE, N.C. (R. DOUTHAT MEADE- JUDAH P.B.)
22. BINSWANGER (2)
 STANLEY RALPH (JACOBS), M. 2) MAY 7, 1972 (STANLEY RALPH JACOBS)
 JULIUS OPPENHEIMER (HANAU, GER. 1871-SEP. 20, 1937, N.Y.) AND HAD:
 J. ROBERT, D. FEB. 18, 1967, PRINCETON, N.J. (JON STEDMAN)
23. BINSWANGER (3)
 GEORGE LOEB, M. DORIS JANE GRAM AND HAD:
 HENRY GRAM, M. NOV. 9, 1974, DEBORAH CLAXTON
 ALAN DAVID
 JACK FERDINAND, M. FRANCES TURNER AND HAD:
 VIRGINIA DOROTHY, M. WALTER WINKLER (GEORGE L. BINSWANGER)
27. BRAUER
 HARRY PINCUS (NFK, AUG. 10, 1893-JUL. 1, 1974) (ESTHER D. PINCUS)
29. CARDOZO (CARDOZA)
 ERNEST ABRAHAM, M. 2) MARY E. KAYTON AND HAD:
 MICHAEL H. IV (NOT III), M. ALICE CORNEILLE AND HAD:
 MICHAEL V
 ALICE REBECCA (NOT REBECCA ALICE)
 PETER STERLING M. 1) BARBARA HERRON; M. 2) SUSAN STRONG, BY 1) HE HAD:
 PAMELA (DELETE WENDY)
 DANFORTH, JR., M. 1) SUZANNE SOLOMON; M. 2) PATRICIA FITZSIMMONS; M. 3) PATRICIA LYNCH
 ISAAC N. M. MAHALA BAUGH AND HAD:
 MARY ELIZA, M. WILLIAM G. WILKINSON (1805-1869) AND HAD:
 CLAUDE S.
 EDWARD BERRY
 JAMES HARRIS, B. 1862; D. 1936; M. NELLIE MC CUDRY SMITH AND HAD ISSUE

- WILLIAM A. M. LOUISE JANE BURWELL AND HAD:
 LEWIS BURWELL
 RANDOLPH BURWELL, M. CONSTANCE GOODING AND HAD:
 MOSBY GOODING, M. CAROL ALICE WILCOX AND HAD:
 LEWIS BURWELL
 RUSSELL WILCOX
 ALICE CAROL
 RANDOLPH BURWELL, M. MARY WINGFIELD SCOTT AND HAD:
 RANDOLPH B., B. 1956; D. OCT. 25, 1976
 JAMES SCOTT
 CONSTANCE G.
 LEWIS BURWELL
 THOMAS CLOW G. (MICHAEL H. CARDOZO IV)
34. COHEN VI (S.C.)
 FRANCES (FANNY), D. JUN. 22, 1920 (KENNETH H. CHASE)
35. COHEN VIII(1)
 SALVADORA, M. PORTERFIELD (SAUL RUBIN)
38. COHEN IX (S.C.)
 AARON N., JR., M. FANNY COHEN (O.V. VI) AND HAD:
 HENRY, B. 1844, GA.; D. JAN. 4, 1932, N.Y.; M. EDITH EUGENIA TICE (MAY 5-1867 - NOV. 21, 1941, NEW ROCHELLE, N.Y.) AND HAD:
 LIONEL M., B. 1888; D. JAN. 1, 1934, LEOLA, PA.; M. CATHERINE A. SULLIVAN (-JUNE 28, 1940, BOSTON, N.J.); D. S.P.
 GLADYS LORBAINE DODGE, B. APR. 4, 1893; M. 1) MAY 26, 1917, N.Y.; JULIAN HUNTINGTON SEAMAN (BROOKLYN, DEC. 8, 1889-MAR. 10, 1942, NEW ROCHELLE, N.Y.) 2) 1948, ROY MARVIN PRESTON (JUN. 30, 1887-SEP. 9, 1970, GREENWICH, CT.) BY 1 SHE HAD:
 DAU. D. INF.
 BEVERLY HUNTINGTON, B. APR. 7, 1919, N.Y.; M. SEP. 8, 1942, MONTGOMERY, ALA.; HOLLIS M. CHASE (N.Y. MAY 9, 1916-), THEY HAD:
 KENNETH HUNTINGTON, B. JUL. 17, 1944, N.Y.; M. FEB. 16, 1971, JEANNE-NICOLE LEDOUX (JAN. 24, 1946-) (KENNETH H. CHASE)
- 39A. COHEN XIII
 LIEPMAN COHEN, B. GER. M., AND HAD:
 PHILIP, B. GER. D. 1786, CH. UNM. (TO S.C. 1772)
 MOSES, B. GER. 1747; D. JUN. 29, 1790, SAV. M. FEB. 1779, JUDITH DE LYON (O.V.) AND HAD:
 REINAH (RINAH, RHINA), B. SEP. 5, 1783, CH. D. JUL. 21, 1853; M. DEC. 29, 1802, DAVID MORDECAI (O.V. III)
 BELLA, B. AUG. 24, 1795, SAV. D. NOV. 1863, CH. UNM.
 ELIAS, B. GER. M., AND HAD ISSUE
 JANE
 MARY, D. LOND. M. LOND. MORDECAI LEVY AND HAD:
 JANE
 FLORA, B. ENG. D. CH. M. LOND. MICHAEL EMANUEL (O.V. III)
 MIRIAM, B. 1752; D. FEB. 7, 1815; M. ISRAEL JOSEPH (O.V. IV)
 HANNAH, B. ENG. 1761; D. JUN. 26, 1859; M. 1) MYMON HART (O.V. VI(1)) M. 2) 1792, SAV. ISRAEL DELIEBEN (BOHEMIA, 1748-JAN. 29, 1807, CH. M. 3) MAR. 1813, MOSES DAVIS (GOBLENTZ, 1759-DEC. 31, 1843, CH.) EMANUEL, B. ENG. M., AND HAD:
 ELIZABETH
 MORDECAI M. (VID. LEVY XIII)
 FLORA (VID. LEVY XIII)
 ROSINA (VID. LEVY XIII)
 CATHERINE, D. INF.
 SISTER OF LIEPMAN COHEN M. JACOB AND HAD: (OFFSPRING CALLED JACOBS)
 PHILIP (TO N.Y. 1772), B. GER. D. N.Y. OCT. 6, 1818; M. ELIZABETH AND HAD:
 DAU. B. JAN. 23, 1819, N.Y.; D. APR. 5, 1821, N.Y.
 SIMON (TO ENG. 1765), B. GER. D. 1807, LOND. M., AND HAD:
 JACOB (TO N.Y. 1808); D. CANADA; UNM.
 ABRAHAM (ENG.) (NOEL C. STEVENSON)
 SISTER, B. GER. (SUPREME COURT, JAN. TERM, 1832, P. 102FF; ELZAS OJC; SH.)
49. DAVIS I(2)
 SOLOMON MOSES LEVIN (O.V. III) (FLO. ABR.)
54. DE LA MOTTA
 LEONORA, B. APR. 1800
 RACHEL, B. ST. CROIX, MAY 4, 1768; D. CH. MAY 11, 1786; D. S.P.
 EMANUEL M. JUDITH CANTER AND HAD:
 SARAH, D. SEP. 1, 1864, SAV.
 CHARLOTTE, B. CH. 1809
 RACHEL, B. CH. 1815
 REBECCA, B. OCT. 1793; D. FEB. 8, 1856; M. EMANUEL CANTER (O.V.)
 CLARA, B. CH. 1795; D. SAV. 1864; M. SOLOMON SHEFTALL (O.V. (1) & (3)) (JOHN SHEFTALL; LAZARUS GEN.; DE LA MOTTA MS. (AJMS))
56. DE LEON II
 MOSES, D. SEP. 10, 1828
 ELEAZER (CALLED LEON; VID COHEN IV) (OLIVER STREETON)
57. DE LYON
 MOSES SON OF LIEPMAN COHEN (O.V. XIII) (NOEL C. STEVENSON)
 ABRAHAM I., M. SARAH SHEFTALL (O.V. (1)) AND HAD:
 SARAH, B. CH. JUL. 2, 1787
 MORDECAI S., B. 1809; D. FEB. 26, 1856; M. N.Y. EVELINE (-DEC. 1836, SAV.) AND HAD:
 MARGARET, B. 1831, N.Y.; D. MAR. 1837, SAV. (JOHN SHEFTALL)
62. DYER
 ROSANNA, M. BALTO., FEB. 23, 1825 (IRA ROSENWAIKE)

65. EMANUEL I I
 CHARLES LEVI, B. 1806, ENG.; M. ANN, DAU. OF JOSEPH AND ESTHER LEVY, B. 1815/18, ENG. THEY HAD:
 JOSEPH, D. N.Y., JAN. 15, 1925; M. DINAH JULIA, D. 1924
 ISAAC, B. 1841
 REBECCA, B. 1843
 JACK (JACOB), B. 1845
 HENRY C. (WYTON), B. 1846
 ARTHUR, B. 1848 (JON STEDMAN)

66. EMANUEL III
 MICHAEL EMANUEL, M. 1874, LEVY (VID. COHEN XIII) AND HAD: (ALL E. ENG.)
 SIMON
 JESSEL
 MICHAEL (U.S. SUPREME COURT, JAN. 1832 TERM, P. 102F.)

70. EZEKIEL (2)
 MORDECAI J. B., B. 1860, PI.; D. 1874, WASH., D.C.; M. LUCILLE FINSTERWALD AND HAD:
 MARGARET DE CHEVY CHASE, MD.; UNM.
 DAVID OF CLARKSVILLE, TENN.
 JONATHAN OF SEATTLE, WASH. (OBIT. WASHINGTON STAR-NEWS)

92. HACKENBURG
 REBECCA ALLEN, M. 1853 (WILMINGTON, N.C. NEWSPAPERS, D.A.R. MS.)
 WILLIAM BOWER, M. SEP. 16, 1864 (RUTH E. LEMBECK)

95. HART I
 STANLEY DAVID, B. APR. 2, 1905 (EVELYN MILLER)

97. HART II (N.Y.)
 MADELINE M. MANUEL J. SUAREZ AND HAD:
 SWADD
 JOSEPHINE M. ALFRED BECK AND HAD:
 ALFRED, JR.
 REBECCA SEIXAS M. VICTOR B. WOLF AND HAD:
 GEORGE
 MILTON
 MAUDE M. OTTO MENKERT AND HAD:
 ALINE, M. WILLIAM CLIFF
 ALINE, M. WILLIAM HENRY DOWN; M. 2 STEPHEN TILLEY, BY 1 SHE HAD:
 WILLIAM
 NORMA ALINE, M. MELVIN E. L. WOLFF AND HAD:
 ALINE, M. EUSTON E. BENJAMIN AND HAD:
 JANE
 ANN, M. ROBERT D. CLAFLIN (MICHAEL H. CARDOZO IV)

98. HART VI (1)
 MORDECAI LEVY AND DESCENDANTS APPEAR ABOVE ON COHEN XIII

103. HART XIV (EASTON)
 LOUISA ELIZABETH, D. NOV. 10, 1890; M. CA. 1834 (GORDON GRAY)

111. HENDRICKS (2)
 MARY JANE (RIESENFELD), M. VINCENT F. MC CAPTNY
 RUTH (FRANKENTHALER), M. RICHARD LEWISCHN; M. RICHARD A. FELDON, BY 1 SHE HAD:
 RICHARD III, M. SANDRA V. SAINE AND HAD:
 HEATHER HALEY
 BRANDON KERMIT
 AILEEN HENDRICKS, M. PETER A. GODSICK AND HAD:
 VICTORIA
 ANTHONY (MICHAEL H. CARDOZO IV)

114. HENRIQUES II
 A. ALEXANDER FLORIAN, B. JAN. 31, 1818, KINGSTON, JAM.; D. APR. 20, 1889, N.Y.; M. (1) M. 2) REBECCA
 JOSEPHINE HENRIQUES (BELOV), BY 2 HE HAD:
 ALEXANDER FLORIAN, JR., B. MAY 15, 1841, N.Y.; D. FEB. 3, 1929; M. 1890, ELIZABETH HARDING BIRTH AND HAD:
 CHARLES RANSON, B. 1891, N.Y.; D. 1931, LEDMINSTER, MASS.; M. 1918, MARJORIE BERA AND HAD:
 PRESCTT, D. 1876, LEDMINSTER, MASS.
 ELIZABETH, M. DONALD PAUL
 ALEXANDER FLORIAN III, B. FEB. 28, 1885, N.Y.; D. QUOCUE, N.Y.; M. ANITA O'BRIEN
 DOROTHY REBECCA, B. DEC. 23, 1899, M.; D. JUN. 1922, CARL DYCH, M. 2) MAY 1946, PHILIP VAN
 DEVENTER, BY 1 SHE HAD:
 CARL DYCH, JR., B. MAR. 21, 1923, N.Y.; M. 1952, E. RANDY CUNNINGHAM
 ELIZABETH, B. MAY 7, 1925, M., EDWARD GRATH, JR.
 CHARLES, B. 1866, N.Y.; D. FEB. 11, 1911, N.Y.; M. ANNA
 HARRY PERCY, B. SEP. 21, 1868, N.Y.; D. FEB. 8, 1930, MOUNTAIN LAKES, N.J.; M. OCT. 22, 1902, PLAINFIELD,
 N.J.; ALICE BARLOW AND HAD:
 HARRY PERCY, JR., B. MAR. 10, 1894, N.Y.; M. JUN. 1915, N.Y.; M. NORMA EDWILLE AND HAD:
 HARRY PERCY III, B. MAY 7, 1927, MORRISTOWN, N.J.; M. DEC. 29, 1957, LAFAYETTE, LA.; EMILY
 WATSON AND HAD:
 BARBARA, B. MAY 17, 1922, N.Y.; M. 1) BR. HAM, N.Y.; EUGENE CARVER, M. 2) SAN JOSE, CAL.
 KENNETH RISNER
 LAURENCE BARLOW, B. MAY 1, 1906, N.Y.; M. FEB. 11, 1930, MOUNTAIN LAKES, N.J.; CARLOTTA EMERSON AND
 HAD:
 NOEL, B. DEC. 17, 1932, MORRISTOWN, N.J.; M. DEC. 27, 1952, LARCHMONT, N.Y.; BRUCE BRACKENHOFF
 CAROLTA, B. OCT. 25, 1935, NEW ROCHELLE, N.Y.; M. JUN. 27, 1956, LARCHMONT, N.Y.; ALAN WHITE
 LAURENCE E. JR., B. NOV. 18, 1944, NEW ROCHELLE, N.Y.; M. JUN. 7, 1969, ROANOKE, VA.; DIANA
 JEFFREY BARLOW, B. JUL. 27, 1908, PLAINFIELD, N.J.; M. MAY 21, 1950, CLORIA ROS AND HAD:
 JEFFREY BARLOW, JR., B. JUL. 14, 1934, N.Y.; M. BRONXVILLE, N.Y.; KATHERINE LOFFER
 PETER ROS, B. AUG. 6, 1927, N.Y.; M. EAST HARTFORD, CT.; MARLENE UTZ
 (TWINS) LORIE, B. MAR. 13, 1940, N.Y.; M. BELHAV, N.Y.; JOHN J. PATTERSON
 JUDITH, B. MAR. 13, 1940, N.Y.; M. BELHAV, N.Y.; PAUL DUJARDIN (DIV.)

GEORGE M., M. ABIGAIL HENRIQUES (O.V. 112) AND HAD:
 REBECCA JOSEPHINE, B. APR. 17, 1839, N.Y.; D. AUG. 16, 1891, N.Y.; M. CA. 1860, ALEXANDER FLORIAN
 HENRIQUES (O.V. ABOVE)
 GEORGE WASHINGTON, D. JUN. 25, 1890
 FRANCIS, B. OCT. 18, 1826, N.Y.; D. DEC. 8, 1889, S. ORANGE, N.J.; M. AND HAD:
 ANNIE, M. OCT. 20, 1875, ST. THOS., GEORGE W. CEAL
 MARIE LOUISE, M. 1) FEB. 6, 1882, HAROLD COP; AND DE WOLFF; M. 2) OCT. 25, 1890, THEODORE STEARNS
 WILLIAM, B. OCT. 25, 1821, N.Y.; D. OCT. 9, 1914, N.Y.; M. 1) A (HARRY P. HENRIQUES III)

116. HERZOG
 KATHERINE, M. 2) 1852, JACOB NEWMAN AND HAD:
 ABRAHAM, B. APP. 27, 1852; M. CARRIE GOLDSTONE (VID. HILLER (GOLDSTONE))

116. HILLER (GOLDSTONE)
 CARRIE, M. ABRAHAM NEWMAN (VID. HERZOG)
 JEAN S. D. 1870
 SOPHIA WERTHEIM, D. OCT. 10, 1970, U.S.A.
 LAFAYETTE A., B. JUN. 22, 1856; M. ALINE MAY LEWIS (O.V. 1) AND HAD:
 JOHN (TOOK SURNAME LEWIS), M. JEANETTE KILHAM AND HAD:
 JANE, M. RALPH W. FFAVER AND HAD:
 GEORGE W. (HARMON H. GOLDSTONE)

118. HUNT
 ABRAHAM S., B. JUN. 21, 1835, RI. (DR. IRA REZAK)

123. HYNEMAN II
 LEVY LEON, M. APP. 2, 1868, PH. (FLO. ABR.)

129. JACKSON I
 JACOB, M. AND HAD:
 DANIEL (GEDALYA) (SURNAMED JACKSON); M. MARY (BELOW)
 AARON PHILLIPS, B. 1734, M. AND HAD:
 MARY, B. 1780, ENG.; D. OCT. 20, 1847, N.Y.; M. DANIEL (GEDALYA) JACKSON (ABOVE)
 (JON STEDMAN)

137. JOSEPH I
 THEODORE HAROLD; M. SYLVIA FLORANCE (O.V. 1) (DIV. 1931); M. 2) 1931, RUTH GRAFF DENZER, BY 1 HE HAD:
 DOROTHY, B. MAR. 17, 1902; M. UNM.
 MARJORIE, B. AUG. 10, 1902; M. MAY 27, 1931, THORKIL ASCHEHOUG AND HAD:
 FREDERIKKE MARJORIE, B. APR. 24, 1934; M. JAN. 2, 1954, JOHN ARVID KLEIN AND HAD:
 EDWARD THORKIL, B. AUG. 21, 1955
 (TWINS) WAYNE EDIC, B. NOV. 6, 1957
 KATHERINE LAURA, B. NOV. 6, 1957
 (FREDERIKKE MARJORIE) M. 2) NOV. 7, 1966, RICHARD FRANK BAKER AND HAD:
 RICHARD FRANK BAKER, JR., B. NOV. 1, 1967
 BARBARA, B. SEP. 26, 1913; M. AND DIV. AND HAD:
 MALLORY
 LINDA
 RUPERT LAURENS, B. SEP. 29, 1880; D. UNM. (THORKIL ASCHEHOUG)

143. KAYTON
 BERT, B. 1874; D. 1967; M. DAVID J. ROSENHEIM (O.V. 1) AND HAD (CHILDREN SURNAMED KAYTON):
 ALLAN D., B. 1908
 ROBERT, B. 1904; M. ELIZABETH KANN (1905-) AND HAD:
 JEAN A., B. 1929; M. EDWARD SONDER (1928-) AND HAD:
 KAREN A., B. 1956
 LESLIE, B. 1958
 DONALD J., B. 1931; M. MARJORIE KLEMPNER (1925-) AND HAD:
 DESORAH, B. 1959
 ANDREW, B. 1961
 MAPY, B. 1967
 BARBARA L., B. 1935; M. ROBERT TANOFSKY (1930-) AND HAD:
 JOAN, B. 1963
 MARIAN, B. 1965
 SUSAN, B. 1966
 JOHN H., B. 1906; M. SUZANNE JACOBS (1909-) AND HAD:
 JAMES B., B. 1946
 HERBERT, B. 1877; D. 1945; M. TESS R. ROSENHEIM (O.V. 1) AND HAD:
 RUTH, B. 1904; D. 1971; M. ALLAN KAUFMANN (1893-1971) AND HAD:
 JOHN, B. 1931; M. JANE SHAPIRO (1941-) AND HAD:
 KAREN, B. 1966
 ANNE R., B. 1971
 ELIZABETH, B. 1973
 MARGARET, B. 1909; M. KURT APPEL (1909-1973) AND HAD:
 JUDITH, B. 1944; M. EUGENE KELLY (1944-) AND HAD:
 DONNA, B. 1964
 DAVID, B. 1969 (ROSENHEIM GEN.)

147. KURSHEEDT
 ALBERT EDWARD, D. MAR. 24, 1973; AND HAD:
 MAE, M. EDWARD JAMES VON KALSBERG AND HAD:
 WILLIAM, B. 1958
 JAMES, B. 1967
 JUSTIN, B. 1959
 JESSICA, B. 1962
 NANCY, B. 1965
 LIONEL JUDAH, M. BESSIE KURTZ SCHELLENBERG
 MOSES MONTEFIORE, B. APR. 16, 1842; M. JENNIE SCHELLENBERG
 ROLAND SIMON (NCL SIMON ROLAND)
 EDMUND BAER, D. 1952 (ABIGAIL K. HOFFMAN)

148. LABATT
 SARAH (SIMON), M. EMILE JACOB) AND HAD:

LESTER
SANFORD
SON, M. AND HAD:
ALICE, M. ARNOLD SCHLOSSBERG
SADIE
EDYTH (ALICE J. SCHLOSSBERG)

150. LAZARUS I
MARGARET (MARKS), M. DR. H. RAWLE GEVELIN AND HAD:
HENRY
PATRICIA
PETER (MICHAEL H. CARDOZO IV)

151. LAZARUS II
AARON, D. (DELETED SEP. 20) AND HAD:
GERSHON (ADOPTED SURNAME) LARENDON, B. WILMINGTON, N.C.; D. ATLANTA; M. CH.
BENJAMIN, B. JUL. 30, 1905, WILM.; D. APR. 19, 1996, WILM., INE.
PHILA, B. WILM.; D. SEP. 29, 1888; M. FEB. 26, 1939, WILM.
RACHEL, B. WILM.
WASHINGTON, B. OCT. 20, 1908, WILM.
ANGELINA GREEN, B. SMITHVILLE, N.C.; D. SEP. 22, 1887
ALMIRA EMMA, B. HILLSBOROUGH, N.C.; M. DEC. 10, 1951
MARK EDGEWORTH, M. OCT. 1853, MARY LAURU
MARY CATHERINE, D. MOBILE; M. OCT. 2, 1842
(CHILDREN OF GERSHON LARENDON SHOULD READ:)
JOSHUA, B. AUG. 21, 1838, CH.; M. AND HAD:
EDWIN
GEORGE
FLORENCE
(TWINS) MICHAEL WASHINGTON, B. JUL. 13, 1944, CH.; M. OCT. 19, 1970
GUSTAVUS, B. JUL. 13, 1944, CH.
AARON, B. FEB. 14, 1840, WILM.
LEILA, B. AUG. 13, 1948, CH.; M. MAY 15, 1967, ATL. AND HAD:
CHARLES
AMOS
GARRIE
WALTER, B. FEB. 7, 1853, CH.
GERSHON, M. JUN. 22, 1892, HOUSTON, TEX.; ANAISE PASDELOUP
(AARON LAZARUS FAMILY BIBLE, O.A.R. RECORDS, WILM., N.C.)

(153) LEMAN
EMANUEL LEMAN, B. 1746, AMST.; M. AND HAD:
LIONE, B. 1776, AMST.; M. AND HAD:
MICHAEL L., B. 1807, AMST.; D. 1889, N.Y.; M. FRANCES CASPAR OF CHATHAM, ENG. (TO U.S. 1830) AND HAD:
MOSES HENRY, B. SEP. 17, 1834, N.Y.; D. 1913, M. DEC. 4, 1859, N.Y.; MATHIDA HEINSTEIN (FRITZ-
FELD, PRUSSIA, NOV. 16, 1841 -), HE SERVED IN CIV. W. THEY HAD:
FRANCIS FREDERICK, B. OCT. 17, 1860, N.Y.; D. 1933, N.Y.; M. MAR. 3, 1885, HENRIETTE BEGARE
AND HAD:
VIOLET FRANCES, B. ST. LOUIS, MO.; M. JUN. 18, 1912, CLARENCE H. HERNE AND HAD:
MARJORIE HENRIETTE, B. N.Y.; M. JUN. 12, 1936, BERNARD CRYSTAL AND HAD:
THOMAS HERNE, B. JAN. 21, 1938, N.Y.
(ABRAM VOSSEN GOODMAN)

154. LEVY I
MOSES (RAPHAEL), M. 1) 1695, N.Y.; RICHA (RYCHA) ASHER; M. 2) 1717, N.Y. AND HAD:
BILHAH ABIGAIL, B. N.Y.; D. N.Y.
NATHAN, B. N.Y.

159. LEVY II
JANE CAROL (ROOBY), B. 1943; M. SEP. 1965, ANTHONY GEORGE WAHL II (APR. 20, 1943 -) AND HAD:
HEATHER, B. APR. 20, 1966
MEGAN, B. JAN. 5, 1968
ANTHONY G. III, B. APR. 12, 1971
ABIGAIL, B. FEB. 12, 1973 (FLO. ABR.)

162. LEVY IV (RICHMOND)
LEWIS/LOUIS (YEHUDA), B. AUG. 16, 1798, AMST.; D. JAN. 29, 1861, HOUSTON, TEX.; M. CA. 1817, MARY A.
(MAIDEN NAME UNKNOWN) (ENG. JAN. 17, 1800 - MAY 6, 1888, BRENHAM, TEX.) AND HAD:
ABRAM GUSTAVUS, M.D., B. MAY 5, 1818, BOSTON, MASS.; D. MAY 2, 1927, N.Y.; M. (1) ? (M. 2) ANNA LANDAUER
(HUBBEN, BAV. JUN. 30, 1835 - FEB. 23, 1898, N.Y.), BY 1 HE HAD:
MOSES A. (CHANGED NAME TO EDWARD A. RUSSELL)
BY 2 HE HAD:
CLARA, B. SEP. 14, 1859, N.Y.; D. DEC. 11, 1939, PADUCAH, KY.; M. SEP. 11, 1878, HENRY DRYFUSS (DREYFUSS)
AND HAD:
BARNEY JOACHIM, M.D., B. AUG. 8, 1879, PADUCAH; D. OCT. 14, 1950, N.Y.; M. (1) OCT. 3, 1906, CLAIRE
AGNES BURKE (VINCENNES, IND. OCT. 25, 1878 - NOV. 1, 1921, N.Y.); M. 2) SEP. 4, 1922, CELE MC NULTY
PETERMAN (EMMETSBURG, IOWA - APR. 1923, N.Y.); M. 3) SEP. 2, 1928, ISABEL SINGER (N.Y. NOV. 24,
1892 -), BY 1 HE HAD:
JOHN AUGUSTUS, B. SEP. 26, 1907, N.Y.; M. NOV. 25, 1937, FRIEDA MARY TELLER (CLIFTON, N.J.)
SEP. 7, 1910 -) AND HAD:
JOHN A. JR., B. JUN. 5, 1940, N.Y.; M. JUL. 15, 1967, N.Y., MARGARET E. FLOOD (HEMPSTEAD,
N.Y., AUG. 21, 1942 -) AND HAD:
CHRISTOPHER JOHN, B. APR. 27, 1972, SAN DIEGO, CAL.
CLAIRE DIANE, B. OCT. 3, 1942, N.Y.; M. AUG. 22, 1964, WILLIAM E. EATON, JR. (JUN. 11,
1942 -) AND HAD:
JENNIFER DIANE, B. DEC. 13, 1967, VERO BEACH, FLA.
BY 3 HE HAD:
ROSANNE CLAIRE, B. SEP. 12, 1929, N.Y.; M. DEC. 25, 1959, DANIEL NATHAN LEESON (PATRICKSON, N.J.)
JUL. 13, 1932 -) AND HAD:
BARNEY, B. OCT. 26, 1961, N.Y.
MARTHA STELLA, B. SEP. 23, 1965, N.Y.
MAYME, B. JAN. 16, 1982, PADUCAH; D. AUG. 26, 1962, PADUCAH; M. JUN. 22, 1909, JAMES JACOB GRUENE-
BAUM (FRANKFORT, GER. FEB. 23, 1873 - FEB. 18, 1963, PADUCAH), D.S.P.
CARRIE, B. DEC. 4, 1861 (1); N.Y.; D. CA. 1911, N.Y.; M. JOE STEEN, D.S.P.

REGINA, B. MAR. 11, 1872, N.Y.; D. JAN. 12, 1917, N.Y.; M. APR. 7, 1889, MAX SPRINGER (BAOEN-BADY,
SEP. AUG. 1894 - JUN. 23, 1929, N.Y.) AND HAD:
FLORENCE, B. MAY 21, 1897, MT. VERNON, N.Y.; D. FEB. 19, 1965; M. JUN. 21, 1916, EDGAR NUSSBAUM
LEUCYBUS, D. JUL. 14, 1894 (1); - 1957, N.Y.; D. S.P.
ARTHUR, B. 1892; D. 1896
GLADYS, B. 1898; D. 1898, INF.
ANNA, B. FEB. 19, 1900, MT. VERNON, N.Y.; M. (1) DEC. 17, 1919, PERCY A. MOSES (GEORGETOWN, S.C.)
AUG. 27, 1926 - FEB. 9, 1964, N.Y.; M. (2) JUN. 29, 1967, MORRIS H. WERNER (N.Y., FEB. 21, 1900 -) S.P.
BERNARD A.
JACOB, B. 1831, ILL.
CECILIA C., B. CA. 1938, N.C.; M. (1) A. WERNER; M. 2) CA. 1866, HENRY GILBERT, BY 1 SHE HAD:
PAULINE, B. 1858
WILLIAM, B. 1861
DELIA, B. 1863
JACOB, B. 1865
BY 2 SHE HAD:
BERTHA (PATSY), B. SEP. 27, 1867, HOUSTON, TEX.; D. AUG. 20, 1937, HOUSTON, TEX.; M. LOUIS LECHNER
(KINAKY, KIEV, RUS. 1842 - HOUSTON) AND HAD:
RICHARD, B. M. ROSA KATZ, S.P.
GILBERT C., B. JUL. 18, 1897; D. NOV. 1951; M. JUN. 30, 1917, SARAH MAR HIRSCH (MAY 3, 1891 - DEC. 4,
1975) AND HAD:
LOUIS, B. DEC. 10, 1927, HOUSTON; M. (1) JUL. 26, 1945, MARY CAROLINE HANNA (JUL. 19, 1924 - SEP.
26, 1964 (DROWNED)) M. 2) OCT. 20, 1973, BARBARA WEINER (N.Y. OCT. 17, 1925 -) BY 1 HE HAD:
LAURA, B. MAY 3, 1949, HOUSTON
PATRICIA, B. JUL. 13, 1951, HOUSTON
PAULINE, B. MAY 7, 1914; M. OCT. 17, 1927, GERARD JOSEPH MORGENTHAU (DEC. 6, 1908 - MAY 29,
1969) AND HAD:
MARGERY, B. JUL. 28, 1940, HOUSTON; M. ROGER KROEGER (AUG. 17, 1939 -) AND HAD:
CYNTHIA, B. NOV. 12, 1965
SHARON, B. NOV. 12, 1969
CAROL, B. SEP. 9, 1923, HOUSTON; M. BARRY SILVERMAN (APR. 11, 1942 -) AND HAD:
SCOTT GERARD, B. NOV. 15, 1963
STACEY, B. AUG. 4, 1972
JOAN ELLEN, B. DEC. 1, 1945, HOUSTON, UNM.
PATSY LYNN, B. DEC. 2, 1947, HOUSTON; M. JAN. 1, 1976, GEORGE ROBERT NICHOLS (OCT. 23, 1949)
LOUIS, B. HOUSTON; D. CA. 1937, N.Y.; M. BECKY ? AND HAD ISSUE
JULIA ROSALIE, B. AUG. 2, 1927, HOUSTON; D. FEB. 25, 1931, BRENHAM, TEX.; M. FEB. 7, 1955, ALEXANDER SIMON
KONIN, POL. DEC. 11, 1828 - OCT. 1, 1922, BRENHAM, TEX.) AND HAD:
LOUIS M., B. 1856, TEX.; D. 1912, FEB. 21, 1897, HENRIETTA STIEF (1855 - 1920) AND HAD:
EDGAR JULIUS, B. MAR. 6, 1854, HOUSTON; D. APR. 13, 1972, DALLAS; M. DEC. 3, 1912, URA MAR
AMMERMAN HUBERSON (MAY 27, 1871 - OCT. 10, 1968) D.S.P.
CARROLL, B. MAR. 30, 1858; D. JUN. 8, 1968, DALLAS; M. DEC. 21, 1911/12, ADRIENNE MITTENTHAL
(GROESBECK, TEX. JUL. 24, 1892 - OCT. 24, 1972, DALLAS) D.S.P.
M. DEGARRE, B. MAR. 12, 1892; D. MAY, 1967, N. HOLLYWOOD, CAL.; M. ABE HART AND HAD:
HENRY S.
JAMES HENRY, B. MAR. 8, 1858, TEX.; D. AUG. 1, 1925, BRENHAM, UNM.
MARY (MOLLIE), B. OCT. 4, 1853, M. FRANK MADOLETON
ROSA, B. NOV. 15, 1861, DALLAS; D. APR. 1, 1953, BRENHAM; M. APR. 3, 1898, SAM RUBENSTEIN (LIVERPOOL,
ENG. - OCT. 6, 1937, BRENHAM) AND HAD:
HAROLD SAMUEL, B. MAR. 26, 1893, AUSTIN, TEX.; D. APR. 21, 1968, BRENHAM; M. (1) EDEL MATHEWS
(- 1942, BRENHAM); M. 2) SEP. 1953, ANNE BEATRICE ELLIOTT (CAPESVILLE, TEX., DEC. 27, 1913 -)
BY 1 HE HAD:
MATHEW S., B. MAY 29, 1915, N.O.; M. ADELLA ROWE (DEC. 24, 1925 -) AND HAD:
CHERYL JEAN, B. FEB. 13, 1947, N.O.; M. WILLIAM MC KENZIE JENKINS III (APR. 14, 1947 -)
AND HAD:
WILLIAM MC KENZIE IV, B. JAN. 1, 1971, LAKE CHARLES, LA.
KELLI DEE ANN, B. JUL. 17, 1975, N.O.
DAVID, B. DEC. 28, 1950, N.O.
SAM S., B. 1927, N.C.; M. (1) FRANCES ? (M. 2) GEGELIA KAMER (1926 -), BY 1 HE HAD:
DAN
BY 2 HE HAD:
HAROLD, B. JUN. 7, 1957, N.O.
SERLITA, B. MAY 23, 1958, N.O.
SAMUEL, B. NOV. 11, 1940, N.O.
STEPHEN, B. JUL. 14, 1964, N.O.
ALICE FRANCES, B. MAR. 7, 1843, BRENHAM; D. JUL. 7, 1873, BRENHAM
ALEX JACOB, B. NOV. 19, 1866, BRENHAM; D. OCT. 25, 1917, BRENHAM; UNM.
LEAH C., B. FEB. 15, 1867; M. MARTIN ?
HANNAH, B. MAR. 11, 1869, BRENHAM; D. MAR. 25, 1945, BRENHAM; M. JAN. 20, 1897, THEODORE EDLZ (CHI.
NOV. 27, 1861 - JAN. 15, 1939, BRENHAM) AND HAD:
CLARA BELLE ESTHER, B. FEB. 24, 1897, SAN ANTONIO, TEX.; M. SOL LEVY (NASHVILLE, TENN., 1894 -
SEP. 1945, BRENHAM) D.S.P.
GAIN W., B. DEC. 16, 1870
JOSEPH CECIL, B. FEB. 19, 1877, BRENHAM; D. APR. 2, 1874, INF.
ABRAHAM ISAAC, B. MAR. 23, 1875, BRENHAM; D. APR. 12, 1874, INF.
HARRY EDWARD, B. FEB. 19, 1877, BRENHAM; D. MAR. 28, 1877, INF.
CLARA JULIA, B. JUL. 21, 1873, BRENHAM; D. APR. 1, 1899, BRENHAM
ISAAC H., B. 1833, HOUSTON; M. CA. 1862, MARY ? (TEX. 1849 -) AND HAD:
HENRY, B. 1862, HOUSTON
13 OTHER CHILDREN (ROSANNE AND DANIEL LEESON)

164. LEVY VI (2)
ELEANOR MARJORIE, M. RICHARD WOODHOUSE JOHNSON, JR. AND HAD:
RICHARD CARDOZO (MAJ. USAF), M. NANCY ANN THRELKELD (OF CHARITON, IOWA)
ELEANOR LEIGHTON, M. JAMES JACOB DONNELLY (OF FOWLETON, TEX.)
(MAJ. RICHARD CARDOZO JOHNSON)

168. LEVY X (PHILLIPS & MENDES-SEIXAS)
JOHN (PHILLIPS), M. 1) APR. 6, 1922, SUSAN SOMMERS AND HAD:
EDWARD FINLEY, B. 1912; M. GERTRUDE OLIVIA JENNINGS (PH. 1913 -) AND HAD:
AUGUSTUS K., B. 1822, PH.
JOHN K., B. 1849, PH.
GERTRUDE S., B. 1849, PH.
GEORGE J., B. 1852, PH.
WILLIAM D., B. 1853, PH.

EDWARD FINLEY, B.1849;D. DEC. 16, 1913, JACKSON, LA.;M.2)MAR. 14, 1899, MARYE DAVID (SALLIE KENT PHILLIPS)

169. LEVY XIII
EMANUEL LEVY (NOT MENACHEM LEVY) IS PROGENITOR (CF. COHEN XIII, ABOVE)

170. LEVY XV
SAUL J., B. APR. 9, 1818; M. HANNAH J. HART (O.V.X(2)) AND HAD:
ESTHER H., M. JULIUS SANDS AND HAD:
ROSE A. M. ? ROBERTS
HANNAH (ANNE), M. CHARLES LEVI (VID. EMANUEL I) (JON STEDMAN)

171. LEWIS I
-- MINNIE, B. MAR. 10, 1852; D. FEB. 17, 1932; M. SOLOMON L. WAITZFELDER (OCT. 31, 1844 - JAN. 22, 1914)
HARLEY ALMA, M. RICHARD JAMES (COHN) (ADOPTED SURNAME LEWIS) AND HAD:
JAMES HENDRICKS, M. FEB. 1, 1976, JANICE LYNN BERNSTEIN
SON
-- SON
SAMUEL ALEXANDER, M. SOPHIA PHILLIPS (O.V.VI) AND HAD:
JOHN DANIEL, B. JUN. 15, 1858; D. JUL. 2, 1882
CHARLES, B. NOV. 1856; D. FEB. 14, 1886
MILDRED, D. APR. 13, 1880, INF. (HARMON H. GOLDSTONE; N.Y. TIMES 2/2/1976)

(174) LIPMAN
REV. JACOB LIPMAN (TO US 1819; HAZAN OF RODEPH SHALOM, PH.), B. JUN. 1781, LOND.; M. ESTHER (CA. 1781 - SEP. 10, 1832, PH.) AND HAD:
HENRY, B. SEP. 29, 1804, LOND.
MATILDA, B. AUG. 17, 1805, LOND.
HELTREY, B. JUL. 14, 1806, LOND.
RAPHAEL (RALPH), B. OCT. 27, 1808, LOND.; M. ? AND HAD:
DAV., B. CA. 1826
HART, B. DEC. 22, 1810, LOND.
SOLOMON, B. JUL. 15, 1812, LOND.
MOSES, B. DEC. 4, 1813, LOND.
SAMUEL, B. DEC. 2, 1814, LOND.
CATHERINE, B. SEP. 7, 1816, LOND.
REBECCA, B. NOV. 6, 1814, LOND.
RACHAEL, B. APR. 17, 1820, PH.
LEWIS, B. JAN. 14, 1823, PH. (F. JAMES DALLETT; ELZAS MSS.)

175. LOPEZ I(1)-RIVERA
-- AARON (RIVERA), B. CA. 1793; D. JUN. 15, 1838, WILMINGTON, N.C.
MIRIAM (MARIA) (LOPEZ), M. STAMFORD, CT., 1805, JACOB LEVY (SPD. OF EVA LEVY MENDES, VID. BENJAMIN I) (DAR MS., WILMINGTON, N.C.; PAJMS, V. 27, P. 74)

181. LYON II
ELVIRA, M. PERCY C. SCHEUER AND HAD:
MARGARET L., M. J. G. CARLETON PEARL, M. 2) RALPH F. WOLFF (O.V.). BY 1 SHE HAD:
MARY C. M. CHARLES A. PILLSBURY
AUGUSTA L. M. WILLIAM PATTERSON NIX
ELIZABETH EMILY, M. CHARLES B. MAXWELL, AND HAD:
ELIZABETH LYNN, M. WILLIAM LEE AND HAD:
MATHEW
EDMOND
JOHN (MICHAEL H. CARDOZ IV)

189. MAYER II - FRANK
ELEANOR LOUISA (ELLA), B. APR. 1860
JOSEPH EGGLESTON JOHNSON, B. OCT. 22, 1862 (FLO. ABR.)

201. MORDECAI I(3)
WASHINGTON (CALLED HIMSELF MORDECAI), B. MAR. 27, 1820; M. POLINA ? AND HAD:
JAMES, B. DEC. 30, 1841, BOONE CO., MO.; D. APR. 10, 1889, OPOLIS, CHEROKEE CO., KAN.; M. DEC. 2, 1865,
GARNETT, ANDERSON CO., KAN., MARY STONE (JUL. 2, 1850 - AUG. 4, 1928, GIRARD, CRAWFORD CO., KAN.)
AND HAD DESCENDANTS (MRS. JAMES L. MORDECAI)

202. MORDECAI II (S.C.)
EVA, B. SEP. 14, 1890, N.Y.; D. JAN. 1, 1976, HANOVER, N.H. (N.Y. TIMES, 1/4/1976)

207. MOSES I(4)
ISAAC HARRY, M. 2) ISABEL W. SOLOMONS (1821 - JAN. 2, 1975, SCARSDALE, N.Y.) AND HAD:
WILLIAM, M. AND HAD:
STEPHEN
ANN, M. ? CUNNINGHAM AND HAD:
WILLIAM
THOMAS
DOUGLAS
ESTHER, M. 1) ? ELSBREE, M. 2) ? WILKINS, M. 3) ? COOK, BY 1 SHE HAD:
DAVID
JOHN
BY 2 SHE HAD:
SUSAN (N.Y. TIMES, 1/4/75)

209. MOSES II
SIMON GRATZ (OF BORDENTOWN, N.J.), M. 1) FEB. 1838, N.C., MARY PORTER ASHE, DAU. OF COL. SAMUEL ASHE (EVELYN MILLER)

222. MYERS X
DELETE JOSEPH, BAV. 1812
DELETE SELIGMAN, BAV. 1821
JOSEPH MYERS, M. CAROLINE WATERMAN AND HAD:

BERTHA
LE ROY
MAX
CLARA
-- STELLA, M. FRANK LOEB AND HAD:
HOWARD, M. RUTH ? AND HAD:
DON
SUE
ROBERT, M. KITTY ?
-- FREDERICK, M. STELLA ?
FANNIE (EDEL), M. LEON FALK (1870-OCT. 21, 1928) AND HAD:
MARJORIE, M. ? LEVY
-- LEON, JR., M. 1) KATHERINE SONNEBORN (D.V.); M. 2) JOSEPHINE SONNEBORN (SIS. OF KATHERINE)
JANE ELLEN (ROTHSCHILD), M. JOSEPH FERGUSON (D.V.), AND HAD:
JASON FREDERICK
JOHN STEPHAN, M. JUN. 12, 1976, ELLEN JEAN WILLIAMS (FLO. ABR.; GEORGE ROTHSCHILD)

227. NATHAN I(2)
ROBERT GRUNTAL, M. 5) AUG. 10, 1951, CLARA BLUM; M. 6) DEC. 14, 1955, HELEN KNEELAND; M. 7) ?
BY 1 HE HAD:
JOAN FREDERICK, M. MELVIN B. BERGSTROM (FLO. ABR.; WHO'S WHO IN WORLD JEWRY)

NATHAN III
LYON NATHAN (IN READING, PA. BY 1758)
BENJAMIN (IN READING, PA. BY 1758) (WOLF-WHITEMAN, P. 396)

228. NATHAN II
CHARLES (OF RIO DE JANEIRO), M. EMMA GOODMAN (VID. HARRIS I) AND HAD:
GOODMAN MC DOWELL
VIRGINIE, UNM.
ALICE, M. HENRY WATT AND HAD:
HAROLD
CHARLES, UNM.
EDWARD, M. ? AND HAD:
ALICE
KENDRICK
JOSEPH
MARGARET, D. INF.
PERCY (SAUL VIENER)

229. NATHANS I(1)
SAMUEL G., B. OCT. 13, 1840; D. PH.; M. DEC. 1, 1858, SAV., EUGENIA MURTELLA HART (VID. SHEFTALL I) (JOHN SHEFTALL)

233. NONES
ALFRED BENJAMIN, M. DEC. 24, 1862, ESTHER PEREIRA BRANDON (FLO. ABR.)

241. PEIXOTTO I(2)
JESSICA BLANCHE, D. OCT. 1941, BERKELEY
ERNEST CLIFFORD, D. DEC. 6, 1942, N.Y.; M. N.D., MARY GLASCOCK HUTCHINSON (-1956) (STEVEN SIEGEL)

247. PHILLIPS III (ALA.)
FANNY YATES, B. CA. 1885; D. JUN. 27, 1976. (SAUL RUBIN)

254. ROWLAND
SARAH JANE, M. HENRI JOHN HART AND HAD:
ISABELLA, M. HUGO FRIEDLANDER AND HAD:
ARTHUR JONAS, M. OLIVE (WIDOW OF) HOGG AND HAD:
PATRICIA M. ARCHIE LLEWELIN
KENNETH, M. AGNETA ?
ADA R., M. LIONEL NATHAN BENJAMIN OF DUNEDIN, N.Z. AND HAD:
MURRAY
JEFFREY
NONA
ABIGAIL SARAH, M. HEINRICH KOHN (-1911) AND HAD:
SARAH (SADIE) MASCHESK, D. JUN. 12, 1861, M. MONTAGUE A. PHILLIPS AND HAD:
PETER (FLO. ABR.)

256. RUSSELL
PHILIP MOSES (NOT MILTON), M. 1) ELIZABETH C. FERRE. BY 1 HE HAD:
BENJAMIN S., D. INF.
ELIZABETH ELVIRA, B. NOV. 22, 1837, SAV.; D. FEB. 21, 1902, SAV.; M. FEB. 15, 1855, SAV., CHARLES JOSEPH
WHITE (RALTO, JUL. 27, 1825 - JAN. 1, 1906) AND HAD ISSUE
SARAH L., B. APR. 1, 1840, SAV.; D. MAR. 3, 1882, SAV.; M. OCT. 16, 1855, SAV., ANDREW J. AYLESWORTH
(PROVIDENCE, R.I., AUG. 11, 1827 - JUL. 24, 1889, SAV.) AND HAD:
DAV.
PHILIP M., JR., B. JAN. 28, 1842, SAV.; D. MAR. 25, 1890, SAV.; UNM.
ISAAC ABRAHAM, B. SEP. 28, 1844, SAV.; D. DEC. 23, 1884, SAV.; M. JUL. 3, 1878, SAV., VIRGINIA EPSTEIN
(AUG. 4, 1862 - JUN. 15, 1922) AND HAD:
ROBERT TOMBS, B. 1860, SAV.; D. 1939, SAV.; M. NOV. 28, 1905, SAV., THERESA AGNES ? AND HAD:
ROBERT T., JR., B. FEB. 4, 1909; D. JUL. 14, 1959; M. SEP. 6, 1929, LOUISE HODGES AND HAD:
ROBERT EUGENE, B. JUN. 19, 1942; M. OCT. 30, 1949, KITTY CROWDER AND HAD:
ROBERT T., III, B. JUN. 24, 1968
VINCENT EUGENE, B. AUG. 24, 1967
HOLLY, B. MAY 24, 1976
JOSEPH MATTHEW, B. 1907; D. 1956; UNM.
RICHARD WAYNE, B. SEP. 15, 1847, SAV.; D. AUG. 25, 1888; M. EMMA AZALEA SPEIR AND HAD:
ELIZABETH C., B. SEP. 9, 1871, SAV.; D. FEB. 5, 1945, SAV.; M. MAY 1, 1899, SAV., CHARLES W. MOCK AND
HAD ISSUE
PHILIP MOSES, B. NOV. 21, 1876, SAV.; D. AUG. 10, 1955, SAV.; M. 1) OCT. 31, 1899, SAV., CECELIA W.
FALLOIN, M. 2) JUL. 31, 1917, SAV., LENA R. HUCHS, BY 1 HE HAD:
PHILIP M., JR., B. MAY 14, 1902; D. JUN. 2, 1964; M. JUL. 7, 1927, SARAH AVERY AND HAD:

CECILIA MARIE, B. JAN. 30, 1929; M. 1) SEP. 16, 1946, LEONARD JULIAN MEYER (-JUN. 3, 1949); M. 2) MAR. 4, 1951, GORDON EDWARD TYO AND HAD ISSUE
 ANGE LA ELIZABETH, B. OCT. 4, 1930; M. JAN. 18, 1953, JOSEPH GOLDBERG AND HAD ISSUE
 PHILIP M. III, B. AUG. 21, 1932; M. JAN. 1958, FRANCIS CAROLYN WOODS USHER AND HAD:
 PHYLLIS CAROLYN, B. JUL. 5, 1962
 VIVIAN COLLEEN, B. MAR. 6, 1966
 BY 2 HE HAD:
 VERNON L., B. DEC. 19, 1921; D. FEB. 21, 1950; UNM.
 WARING, B. DEC. 3, 1923; D. JUN. 26, 1933
 MARIE, B. APR. 17, 1918; M. OCT. 20, 1951, THOMAS LAWLESS AND HAD ISSUE
 JUANITA, B. JAN. 6, 1920; M. SEP. 2, 1950, WILLIAM E. BURKE, S.P.
 JULIAN M. TON, B. JAN. 11, 1878; SAV. 1) OCT. 26, 1883; SAV.
 ELLEN S., B. OCT. 11, 1879; SAV. 1) FEB. 12, 1969; M. MAR. 11, 1897; SAV., CLIFFORD W. BARBEE (AUG. 31, 1873-SEP. 9, 1919) AND HAD ISSUE
 RICHARD WAYNE, B. NOV. 30, 1888; D. DEC. 17, 1953; M. NOV. 14, 1906; SAV., CORRIE ANDERSON AND HAD:
 RICHARD WAYNE, JR., B. APR. 1, 1909; D. MAY 14, 1955; M. DOREEN MORGAN AND HAD:
 JACQUELYN JUANITA, B. NOV. 5, 1926; D. DEC. 27, 1938
 CHARLES R., B. JUL. 5, 1928; D. JUL. 6, 1928; INF.
 CAROLINE, B. AUG. 11, 1911; M. 1925, GEORGE A. REEVES AND HAD ISSUE
 MARY SELINA, B. JAN. 31, 1850; SAV. 1) MAR. 21, 1933; SAV. M. SEP. 13, 1894; SAV., JOHN HENRY TUBBERSING D.S.P.
 MARGARET S., B. OCT. 7, 1852; SAV. 1) JUL. 5, 1853; SAV. INF.
 WARING, B. DEC. 2, 1854; SAV. 1) JAN. 3, 1927; SAV. M. FEB. 23, 1875; SAV., GEORGIA ANN MENDEL (JUL. 16, 1857-DEC. 18, 1919; SAV. 1) AND HAD:
 ISAAC, B. 1) D. SEP. 1875
 THOMAS SHEFTALL, B. MAY 11, 1877; SAV. 1) DEC. 26, 1952; M. DEC. 16, 1903, BERNICE JACOBS (MAY 8, 1891-MAR. 29, 1936) AND HAD:
 THOMAS S., JR., B. MAR. 29, 1905; UNM.
 GEORGIA, B. APR. 16, 1914; M. MAR. 29, 1939, ABRAM EISENMAN AND HAD ISSUE
 FRANCES M., B. APR. 4, 1879; D. MAY 14, 1923; M. 1) JUL. 23, 1894; SAV., FREDERICK F. RVHL; M. 2) APR. 23, 1899; SAV., THOMAS J. HARPER, BY 1 SHE HAD ISSUE
 GEORGIA C., B. NOV. 20, 1882; D. SEP. 5, 1913; M. BENJAMIN E. SMITH AND HAD ISSUE
 WARING, B. 1895; D. 1887; INF.
 PERLA SHEFTALL, B. MAY 24, 1897; SAV. 1) MAY 19, 1955; M. 1) 7 MENDEL; M. 2) JAN. 28, 1889, JAMES SAWYER; M. 3) JUN. 3, 1917; SAV., HANSE ANDREW HANSON; D.S.P.
 THOMAS E. LLOYD, B. MAR. 14, 1861; D. JUL. 12, 1883
 JANIE RUSSELL (GUSTIN), D. JUN. 6, 1937; SAV. M. 2) CHARLES M. STRONG (-MAR. 31, 1935) (JOHN SHEFTALL)

262. SAMUEL II (2)
 SNOWDEN, D. 1939; M. OCT. 15, 1919 (FLO. ABR.)

263. SEIXAS (1)
 (REV.) GERSHOM MENDES, B. JAN. 14, 1746
 BENJAMIN MENDES (ESTABLISHED REVOLUTIONARY ANCESTRY), B. JAN. 17, 1742
 GRACE, B. NOV. 26, 1752
 BELLA (SILVAH LEVY)
 NETTY (ESTHER), B. MAY 2, 1789 (SEIXAS FAMILY BIBLE (AJHS))

(266) SEMON
 EMANUEL SEMON, B. AMST. 1798; D. JUL. 9, 1871; PH. M. PH., MARY BAILEY (QUAKERESS) AND HAD: (ALL B. VA.)
 RACHEL C. B. CA. 1830, CHARLOTTEVILLE, VA; D. 1899; PH. M. 1864, LEHMAN LOVIE (2)
 SARAH TABITHA, B. 1835, CHARLOTTEVILLE; D. MAY 1, 1913; PH. M. NOV. 16, 1952, JACOB BACHRACH (GER. 1826-OCT. 1, 1897; PH.) AND HAD:
 MARY, B. JAN. 17, 1854; M. MAY 12, 1875, AUGUST HANFF AND HAD:
 GERTRUDE, B. APR. 2, 1874; M. EVANUEL S. CAHN AND HAD:
 EDITH, M. WALTER HARRIS AND HAD ISSUE
 HELENE M. RICHARD STRASBURGER AND HAD ISSUE
 MARION, M. BERT NEVINS AND HAD ISSUE
 SADIE, B. MAY 15, 1878; D. JUL. 17, 1878; INF.
 JOSEPH ARTHUR, B. DEC. 25, 1882; M. SOPHIE WOLF AND HAD:
 JOSEPH, JR., M. RUTH GILBERT AND HAD:
 SUSAN
 LINDA
 JANE
 PEGGY JO
 DOROTHY, M. JAMES ZABIN AND HAD:
 ANN
 BARBARA
 MINNIE, B. OCT. 17, 1879; M. RAYMOND AYERS AND HAD:
 MARY
 ROBERT
 SON
 SIMON, B. SEP. 10, 1855
 RACHEL, B. JUL. 30, 1857; M. SEP. 2, 1877, LEO N. LEVI (VICTORIA, TEX. 1856-1904; N.Y.) AND HAD:
 MINNIE, B. JUN. 5, 1879
 FLORENCE, B. APR. 1, 1881
 BERTHA, B. DEC. 22, 1891
 EMANUEL, B. MAR. 21, 1852
 CALLIE (CAROLINE), B. MAR. 19, 1860; D. 1920; M. MAR. 19, 1881, ELIAS HANFF (1853-1939) AND HAD:
 ELIAS, JR., B. JAN. 12, 1891; M. ALMA YERGER
 ARTHUR JOSEPH, B. DEC. 25, 1882; D. FEB. 20, 1949; M. MIRIAM LEVY (-FEB. 22, 1959) AND HAD:
 ARTHUR J. JR., M. ALICE CONNELLY AND HAD:
 CAROL MARJORIE, B. AUG. 27, 1941; D. MAY 29, 1951
 SHARON CONNELLY, B. APR. 20, 1947; M. JAMES WILRICH AND HAD:
 JAMES, JR.
 SCOTT
 TREV
 STILLBORN SON
 EDWARD ALBERT, M. JANE GRAVES AND HAD:
 SALLY, B. 1945
 WENDY, B. 1947
 JEFFREY, B. 1951
 EVA, B. JUN. 9, 1944; D. INF.

CECILE, B. JUL. 10, 1899; M. HENRY SAMUELS (1872-1952) AND HAD:
 CAROLINE, M. BYRON KAYSER AND HAD:
 ROY
 REBECCA, B. JAN. 22, 1862; M. OCT. 2, 1884, HARRY D. GOHLMAN AND HAD:
 RAYMOND
 HARRY, JR.
 SAMUEL, B. JAN. 13, 1864; M. ADDIE NATTINS AND HAD:
 DOROTHY, B. MAR. 1899; M. ? SCHATZKIN AND HAD:
 HARVEY
 DAUL
 ARTHUR
 EMMA, B. APR. 23, 1866; M. ISAAC LEVY AND HAD:
 IRVING LESTER, B. MAY 16, 1896
 REBECCA, M. ? BOWMAN, D.S.P.
 EMMA, M. LOUIS LIPPMAN AND HAD:
 LOUIS, JR.
 MIRIAM
 ZERUBABEL, M. ? (XIAN) AND HAD:
 HARRY (MOTION PICTURE ACTOR), M. HAZEL DAWN
 JUDAH, D. YOUNG
 ANNA, M. ISADORE HYMAN, D.S.P.
 ROSA BELLE, D. UNM.
 WILLIAM, D. YOUNG
 JACOB, M. XIAN; D.S.P.
 HENRIETTA, B. 1831; D. MAR. 3, 1887; M. LEVI HEXTER (TREYSA, GER., 1833-OCT. 27, 1909) AND HAD:
 MARY, D. UNM.
 ROSE, D. UNM.
 BENJAMIN, B. 1848; D. NOV. 17, 1955
 JOSEPH, B. NOV. 6, 1826; D. MAY 22, 1880
 3 OTHER CHILDREN (FLO. ABR.; HELENE HANFF; EZEKIEL-LICHTENSTEIN)

267. SHEFTALL (1)
 WOLF, OF FRANKFURT AM ODER; M. AND HAD:
 SCHEFFEL, M. GITTEL AND HAD:
 BENJAMIN SHEFTALL, B. FRANKFURT AM ODER (JOHN SHEFTALL)

271. SIMON
 MARY, M. HAY; M. LEVY OF OXFORD, ENG. (O.V. XVII)
 JOSEPH SIMON, M. ROSE BUNN AND HAD:
 MOSES, B. 1751
 REYNA (RACHEL), B. 1764
 LEAH, B. 1763 (DAVID BRENER)

282. STERN II (1)
 RICHARD MORTON (SIMON), M. FREDDA JEAN OSBORNE AND HAD:
 MATHW AARON, B. MAR. 14, 1874, NEWTON, MASS.
 NAN (SCHLEZINGER), M. RONALD J. SMOLOW AND HAD:
 LAUREN MEREDITH, B. JAN. 19, 1976, PH.
 NANCY JC (DE LEE), M. LEE HART FRANK AND HAD:
 DANIEL JACOB, B. DEC. 17, 1976, HIGHLAND PARK, ILL.
 CAROL DENE GOLDSMITH, M. 1) KENNETH KAGEN, BY 2 SHE HAD:
 ANNE, M. 2) 1976, LONG BEACH, CAL., JAMES PROFITT

283. STERN II (2)
 ALAN (SELIG) M. NANCY SEIDENBACH AND HAD:
 JEANNE
 THOMAS
 CATHY
 ANDREW
 JONATHAN (FLO. ABR.)

284. STERN III
 JULIUS (TO U.S. SEP. 1834), M. 1) ? LORCH (OIV. 1) M. 2) HENRIETTA ADLER (BERTRAM W. KORN)

286. STIX (2)
 ERNA SARAH (RICE), M. WILLIAM EISENDRATH AND HAD:
 ELLEN, M. 1) THEODORE STEINERT; M. 2) ? BY 1 SHE HAD:
 WILLIAM C.
 SYLVIA C.
 ERIC
 ANN, M. JOHN B. CHAFFEE AND HAD:
 ELLEN
 JOHN B., JR.
 CAROLYN
 CHARLES R., M. JULIA A. CARDOZO AND HAD:
 BENJAMIN C.
 MARK W.
 JONATHAN CHARLES, M. 1) KATHLEEN FEIBELMAN; M. 2) ? GALLWAY, BY 1 HE HAD:
 THOMAS JEFFERSON
 KATHLEEN
 MAY (MICHAEL H. CARDOZO IV)

STIX (3)
 ALICE STIX (EISEMAN) M. MILTON HELLMAN AND HAD:
 MAX B., B. FEB. 8, 1923 (FLO. ABR.)

291. SULZBERGER (2)
 BEATRICE, M. DR. LEONARD TRILLING AND HAD:
 RICHARD J., M. FAY GOLDBERGER AND HAD:
 BETH
 MICHAEL L.
 JOHN L.

-- SUSAN WARMS, M. DOUGLAS H. MAZONOWICZ
 -- CATHY JEAN, M. JOSEPH G. PERPICH
 ELLEN LOUISE, M. R. PETER STRAUS AND HAD:
 DIANE E., M. CARL TUCKER
 KATHERINE
 JEANNE
 ERIC
 ANN, M. LEONARD SAND AND HAD:
 DAVID
 ROBERT
 PEGGY (MICHAEL H. CARDUZO IV)

297. TOBIAS I (N.Y.)
 HENRY ASSHUR, M. RACHEL WOLFF (O.V.) AND HAD:
 AUGUSTA, M. DR. CHARLES RALPH KEYSER AND HAD:
 JOHN, B. JAN. 29, 1907
 FLORENCE, B. JAN. 22, 1873, N.Y., D. MAY 27, 1960, SYDNEY, AUSTRALIA, M. FEB. 17, 1904, LOND., HORATIO
 MONTEFIORE (SCHLOSS) CASTLE AND HAD: (ALL B. LOND.)
 NANCY, B. DEC. 20, 1904
 DEREK, B. JUN. 27, 1906
 NORMAN, B. APR. 14, 1912
 DOREEN, B. DEC. 29, 1917
 ETHEL, D. CA. 1954
 HENRY, D. IRE.

-- FRANCES (FANNY), B. FEB. 5, 1809, ENG.
 LISAACI ALFRED, M. HERMOINE HENDRICKS (O.V. (1)) AND HAD:
 HENRY HARMON, M. MINNIE DOUBLEDAY (OCT. 15, 1867 - JAN. 17, 1953)
 FRANCIS HENDRICKS, N. JOSEPHINE LUNA LEWIS AND HAD:
 WILLIAM ELDRIDGE, D. MAY 30, 1942; M. SARAH APPEGATE AND HAD:
 CATHERINE A. I., D. FEB. 10, 1962; M. EDWARD BRASCH AND HAD:
 NANCY ANN, M. RICHARD A. STOUT
 MARGARET ELLIN, M. ROBERT H. BALDWIN
 ELISE, D. MAY 29, 1962; M. BENJAMIN LOWENTHAL AND HAD:
 JOAN (N.Y.), M. AARON WOLF
 FLORIAN, D. UNK. (FLO. ABR.)

299. TOBIAS II (2)
 JUDITH, M. RABBI MARTIN SIEGEL AND HAD:
 TOBY SUSAN, B. JAN. 17, 1973, COLUMBIA, MD.

305. WOLFF
 LILLIAN HENDRICKS, D. JAN. 18, 1953, N.Y. (FLO. ABR.)