



SS UNIFORMS, INSIGNIA & ACCOUTREMENTS

A STUDY IN PHOTOGRAPHS
COMPILED BY A. HAYES



CHAPTER 1

UNIFORMS & INSIGNIA

The black service uniform of an SS-Obersturmführer assigned to the 3rd SS Totenkopf-Standarte "Thuringen."



OPPOSITE: Front view. ABOVE: Detail of lapels showing placement of collar insignia.

CHAPTER 1: UNIFORMS & INSIGNIA



Tailor's label in back of collar.



Tailor's label inside coat pocket with owner's name and 1938 date.



This label is inside the breeches.



Tailor's label in collar of shirt.

SS UNIFORMS, INSIGNIA & ACCOUTREMENTS

The black service uniform of an SS-Oberscharführer assigned to the SS-Standarte "Germania."



SS UNIFORMS, INSIGNIA & ACCOUTREMENTS



Collar insignia SS-Oberscharführer.



Left sleeve with brassard and "Germania" sleeveband.



Markings on leather belt.

SS UNIFORMS, INSIGNIA & ACCOUTREMENTS



Detail of sleeve diamond, which indicated a specialty in administrative services.



Tag affixed to the reverse of sleeve brassard.



Alter-Kampfer chevron.



Detail of sleeve brassard.



Shoulder cord detail.

CHAPTER 1: UNIFORMS & INSIGNIA

Black service uniform coat worn by an SS-Oberführer of SS Sub-District XXX.

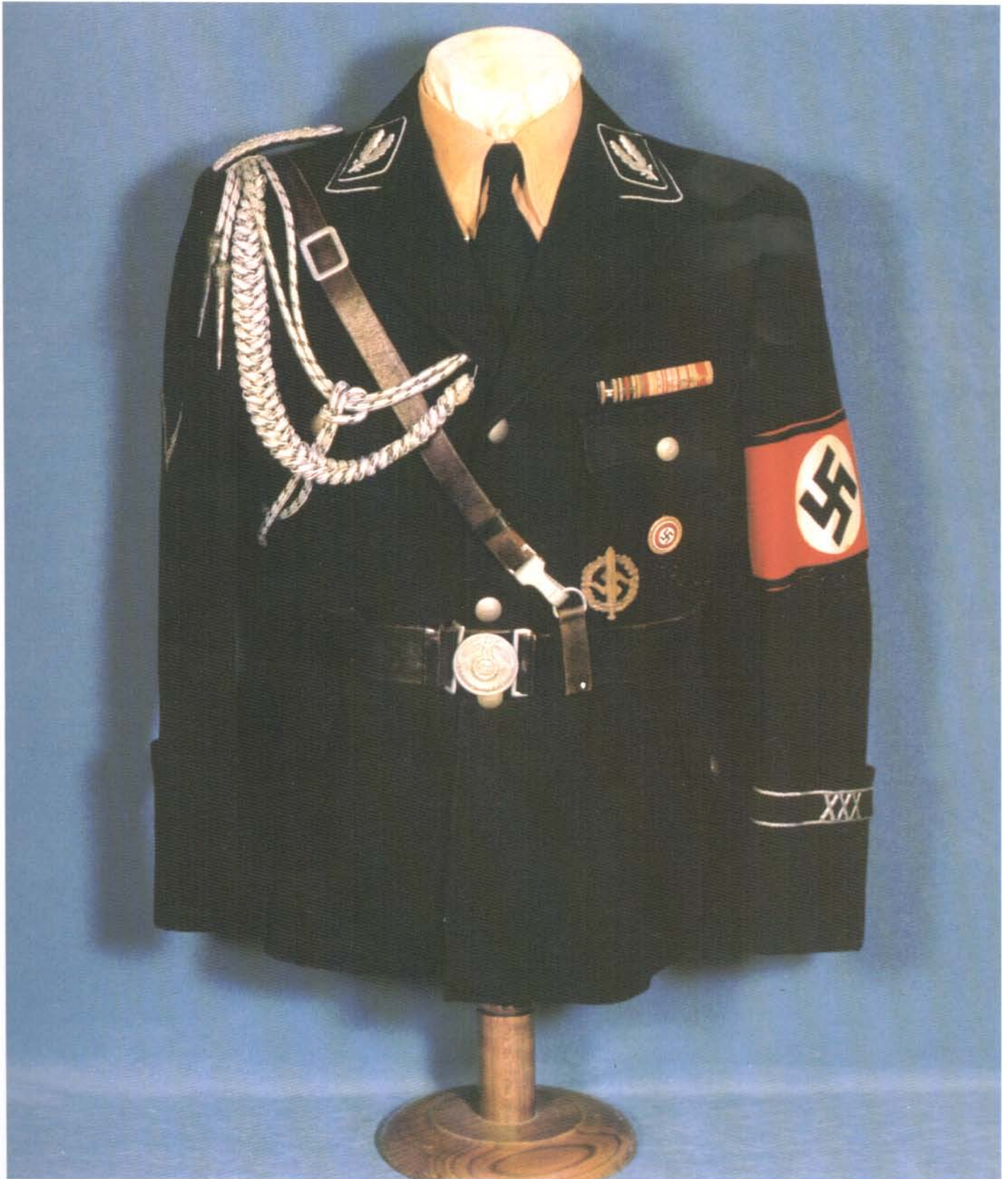

Front view.

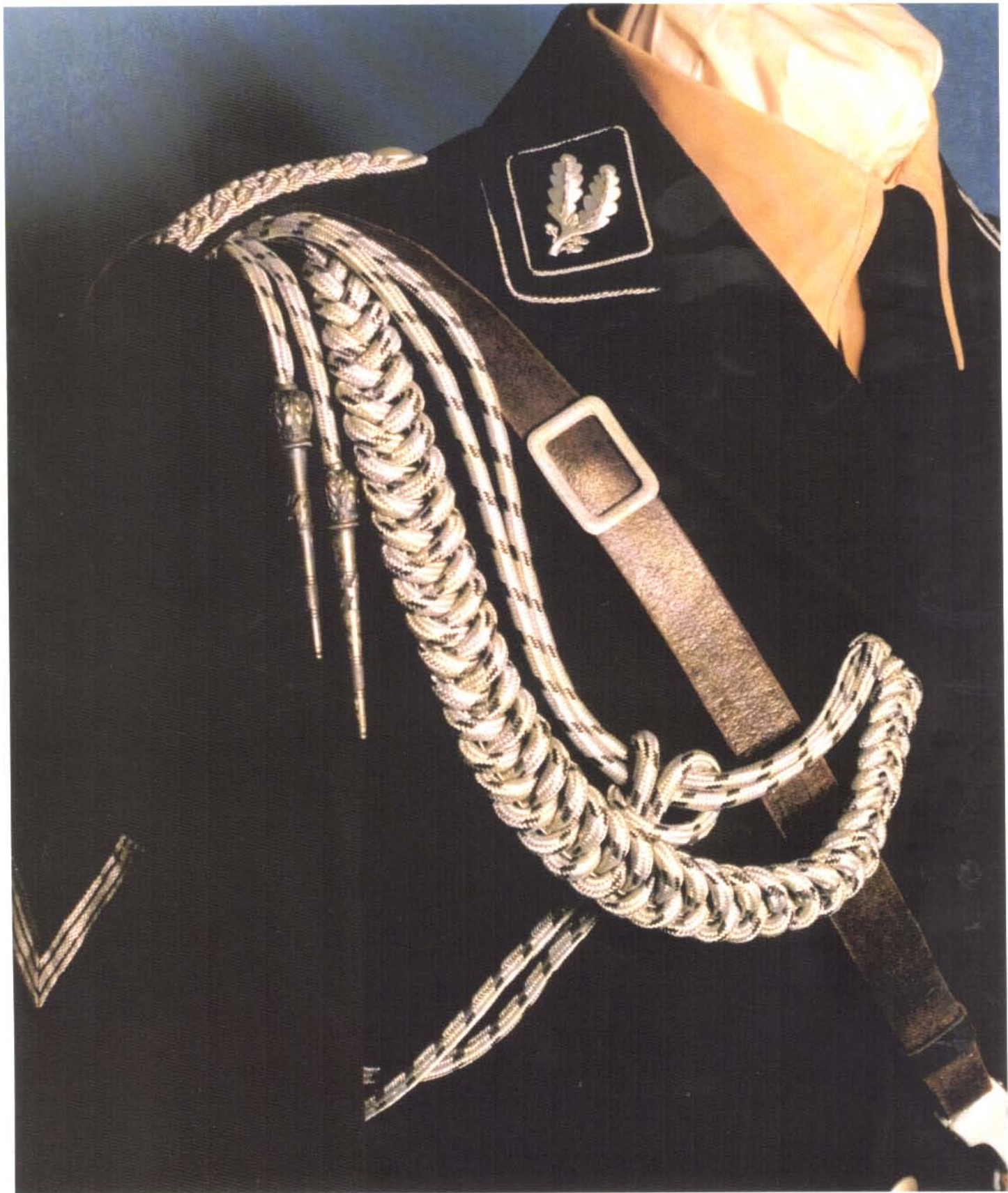

The SS Adjutant Aiguillette.

CHAPTER 1: UNIFORMS & INSIGNIA

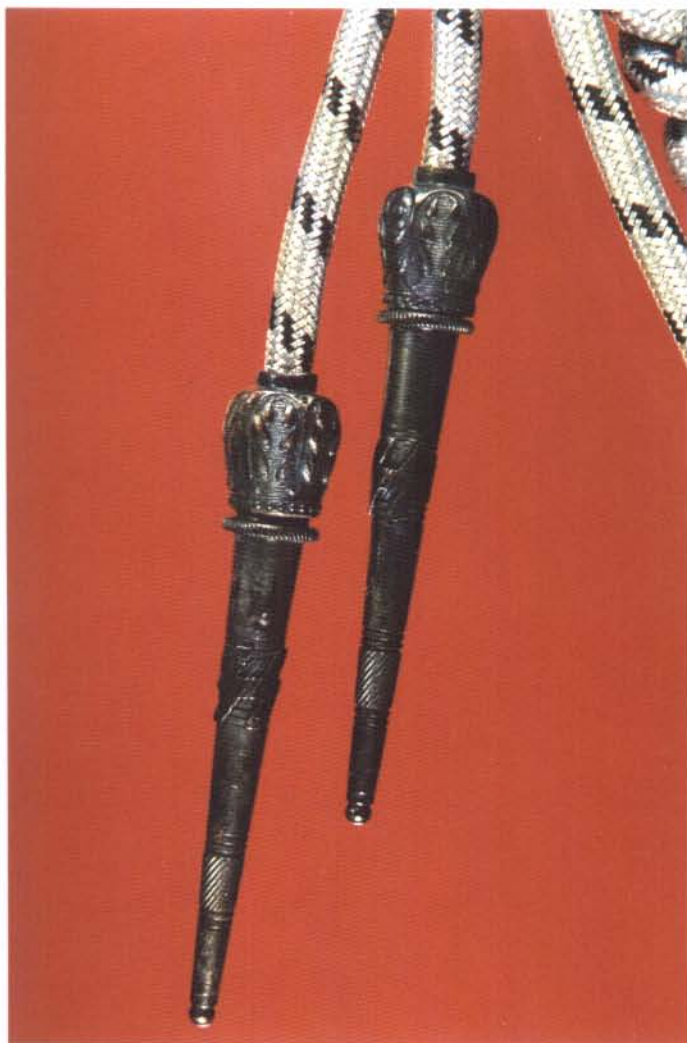

Detail of the aiguillette hanging tips. Note SS Runes.



Detail of button attachment point where the aiguillette was affixed to the shoulder under the shoulder cord.

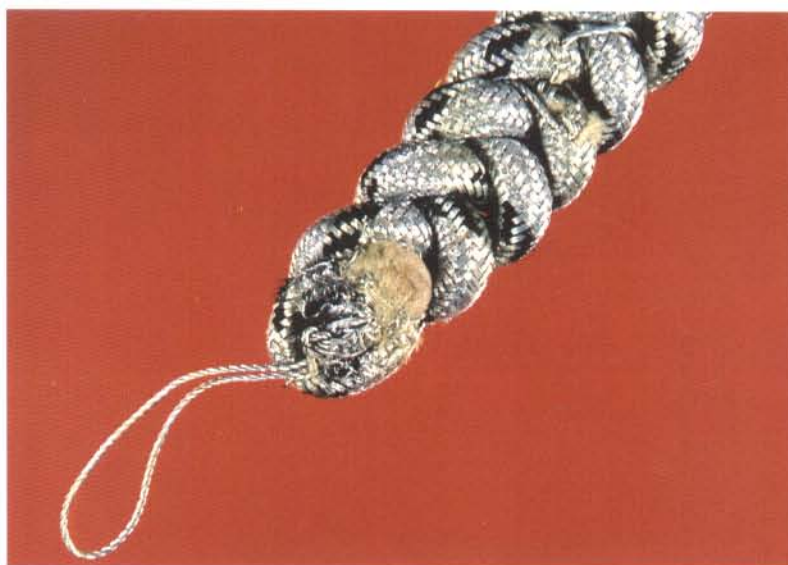

Detail of loop, which went around the top button of the uniform coat.

SS UNIFORMS, INSIGNIA & ACCOUTREMENTS

The white service uniform coat of an SS-Untersturmführer.



CHAPTER 1: UNIFORMS & INSIGNIA

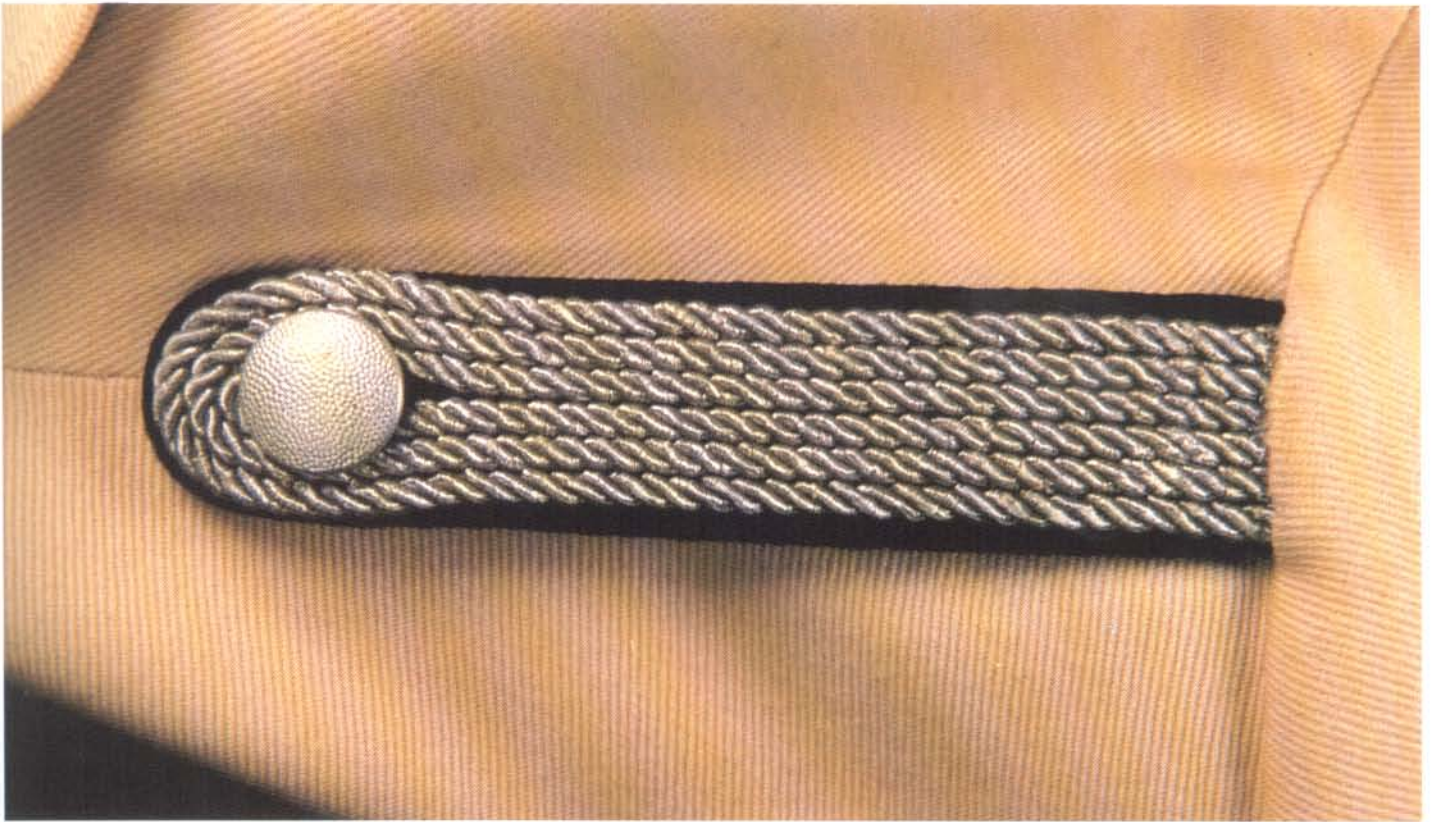

Shoulder cord.

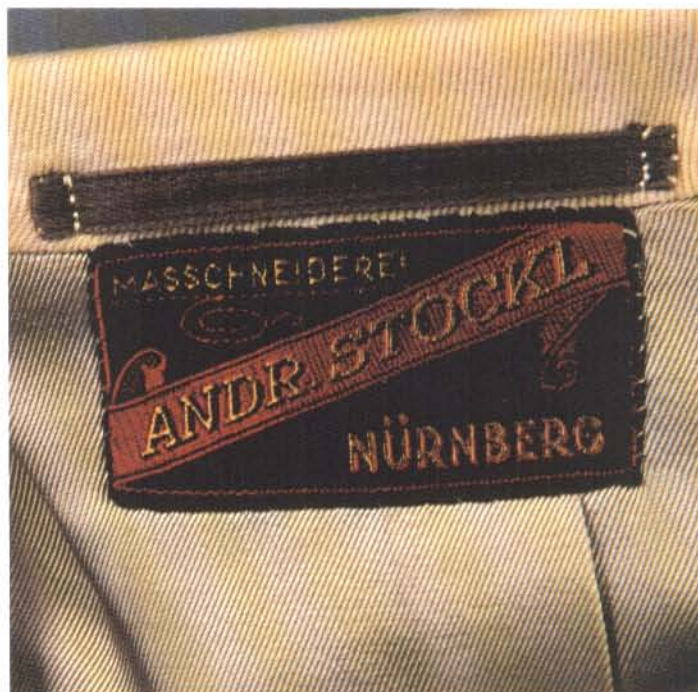

Tailor's label sewn in back of collar.

SS UNIFORMS, INSIGNIA & ACCOUTREMENTS

Field gray uniform coat worn by a Waffen SS-Hauptsturmführer of the regiment "Nordland."





OPPOSITE: Front view. The red piping on the Army style shoulder boards (original to this uniform) indicate this man was an artillery officer. ABOVE: Left side view with "Nordland" sleeveband and sleeve eagle visible.

SS UNIFORMS, INSIGNIA & ACCOUTREMENTS



Detail of "Nordland" sleeveband.



Tailor's label in collar.



Tailor's label inside pocket with owner's name and date of 4/8/43.



Dagger hanger inside coat.

SS UNIFORMS, INSIGNIA & ACCOUTREMENTS

Field gray uniform coat worn by an SS-Obersturmführer of the "SS-Standarte Kurt Eggers", which was a regiment of SS-War Correspondents. SS War Correspondents wore standard SS uniforms. Early on they wore white piping and later, lemon-yellow, as seen in this example.



Front view. (Heuvelen)

CHAPTER 1: UNIFORMS & INSIGNIA



Left side with sleeve eagle and sleeveband visible. (Heuvelen) Back of "Kurt Eggers" coat. (Heuvelen)



Collar insignia detail. (Heuvelen)

CHAPTER 1: UNIFORMS & INSIGNIA

The dress uniform of a full member of the SS serving in the German Police.



Front view.



Rear view.



Detail of cartouche and cross strap.



Police insignia on left sleeve.

SS UNIFORMS, INSIGNIA & ACCOUTREMENTS



Detail of left chest area. SS runes under the chest pocket indicates the man was a full member of the SS.

SS UNIFORMS, INSIGNIA & ACCOUTREMENTS



Detail of dress belt and buckle. Note SS runes woven into the belt itself.

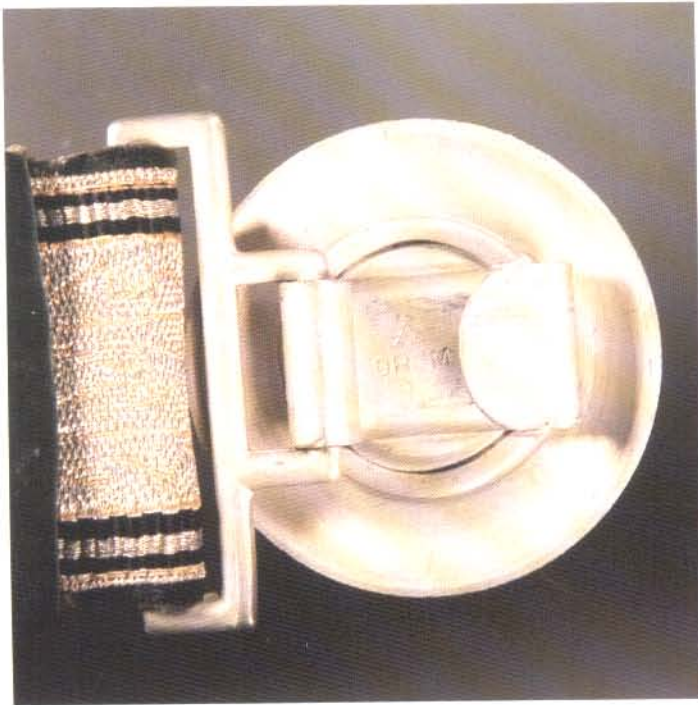

Reverse of dress belt buckle.



RIGHT: Police officers in Parade Dress.

SS UNIFORMS, INSIGNIA & ACCOUTREMENTS

Overcoat of an SS-Oberführer of SS Sub-District XXX.



Overcoat of an SS-Untersturmführer of the SD.



ABOVE: Overall front view. BELOW: Detail of lapel.



ABOVE and BELOW: Front view and left sleeve views.



CHAPTER 1: UNIFORMS & INSIGNIA

An unissued overcoat for non-commissioned officers.



Front and back.



Maker's information label still attached to left sleeve.



SS label tied to button on the back side.

SS UNIFORMS, INSIGNIA & ACCOUTREMENTS

Black leather officer's overcoat.



ABOVE: Front view. BELOW: Shoulder detail – note loop for attaching shoulder boards.



RIGHT: These men are wearing the black overcoat.



SS UNIFORMS, INSIGNIA & ACCOUTREMENTS

Overcoat of an SS-Sturmbannführer of SS-District (SS-Oberabschnitte) "Fulda-Werra."



Front view.



This officer is wearing a similar styled overcoat to the example at left.

CHAPTER 1: UNIFORMS & INSIGNIA

Green leather Waffen-SS officer's overcoat.



LEFT and ABOVE: Front and back views.

BELOW: Detail of shoulder with button and strap for attaching shoulder boards.



CHAPTER 1: UNIFORMS & INSIGNIA

Waist length dress cape for an SS officer. It was first thought this was a full length cape which had been cut down, but it appears this garment was custom made at this length.



Front view.



ABOVE and BELOW: Cape hook devices-right and left.



This photo shows how the cape hook devices are attached from the back side.



CHAPTER 1: UNIFORMS & INSIGNIA

The SS Neck Tie.

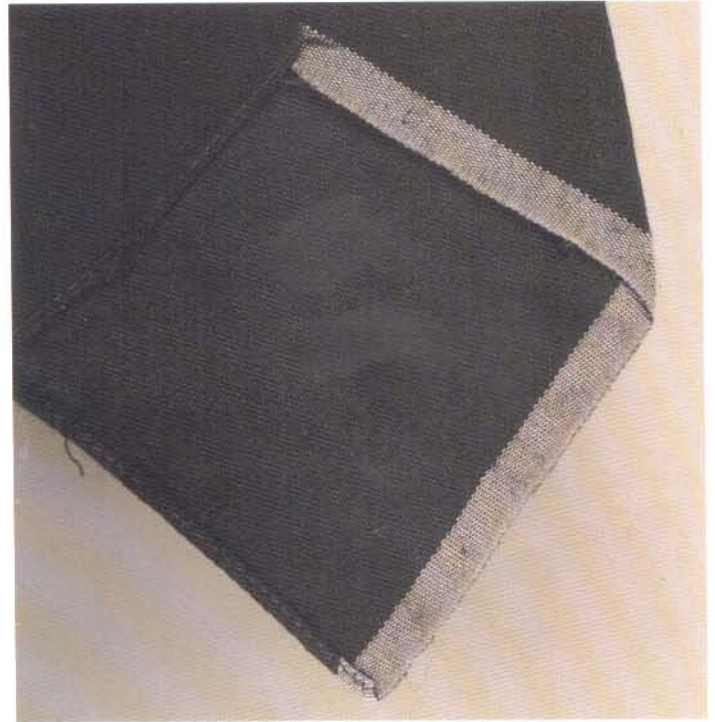
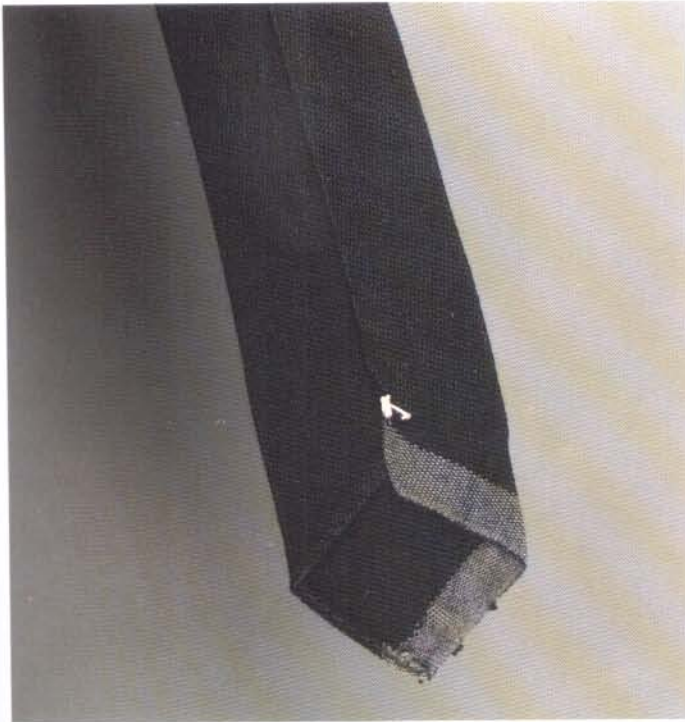

The official tie worn by men of the SS features this woven gray band at both ends.

SS Sleevebands or "Cuff Titles."

All ranks of the SS wore sleevebands which identified the unit in which they served. Sleevebands are a subject in themselves, as there are numerous types, and many

variations of each type. I have provided several original period pieces for your examination.



Sleeveband for Leibstandarte SS "Adolf Hitler" (second version).

CHAPTER 1: UNIFORMS & INSIGNIA



Another variation of Leibstandarte "Adolf Hitler."



Detail of "Adolf" in this variation.



RZM tag affixed.

SS UNIFORMS, INSIGNIA & ACCOUTREMENTS



Hand embroidered sleeveband from SS-Standarte "Deutschland" – front and back. Note paper RZM tag.

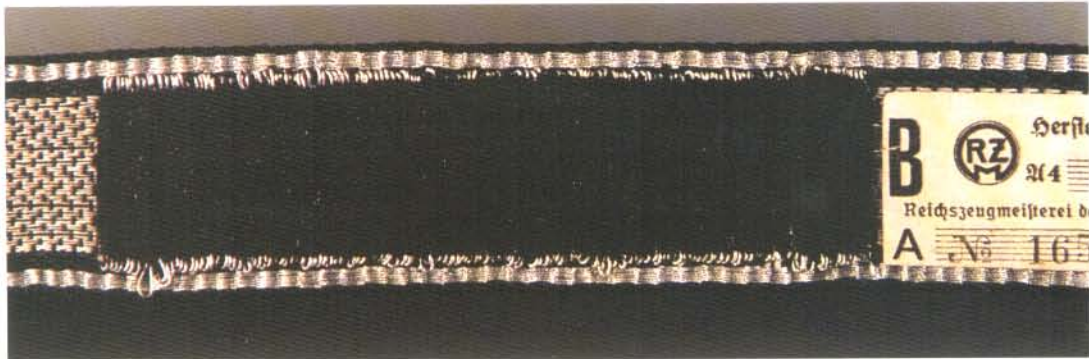

Sleeveband of an enlisted man of the 1st SS Foot Regiment (SS-Foot Standarte 1 Munchen) "Julius Schreck" – front and back.



SS UNIFORMS, INSIGNIA & ACCOUTREMENTS



SS-Totenkopf-Rekruten-Standarte "Oberbayern" machine embroidered sleeveband, front and back.



RZM tag on reverse.

CHAPTER 1: UNIFORMS & INSIGNIA



RZM tag for 12th SS-Foot Standarte Hannover sleeveband.



Sleeveband – 1st pattern "SS-Schule Tolz" (Officer Candidate School).

Collar Insignia

As was the case for sleevebands, collar insignia, commonly referred to as "tabs" or "patches", are a massive

study. This section simply provides the reader with some period examples.



Front and back – NCO SS-Runes for wear on the right collar.

SS UNIFORMS, INSIGNIA & ACCOUTREMENTS



A second variation of the SS-Runes, NCO collar tab.

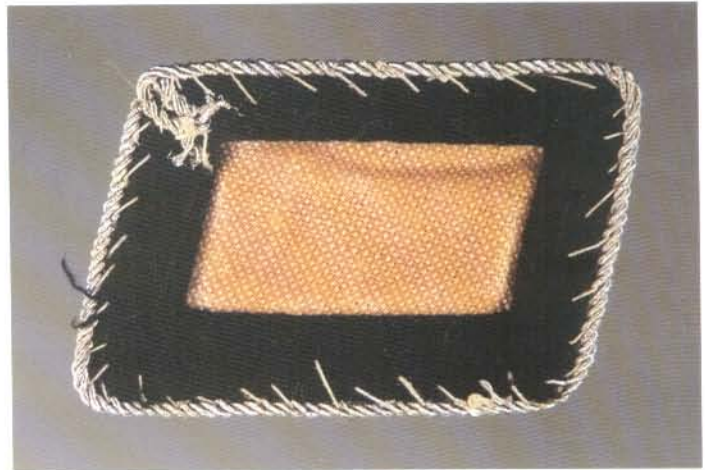
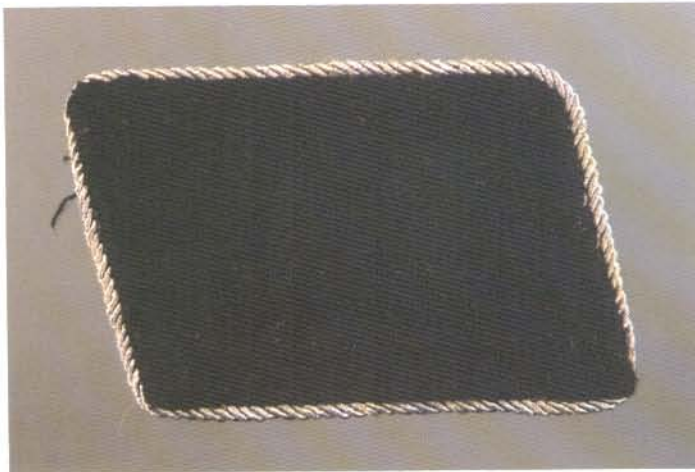

Officers of the Sicherheitsdienst (SD) wore a blank collar patch on the right collar (front and back).



Left collar patch of an SS-Sturmbannführer.

CHAPTER 1: UNIFORMS & INSIGNIA

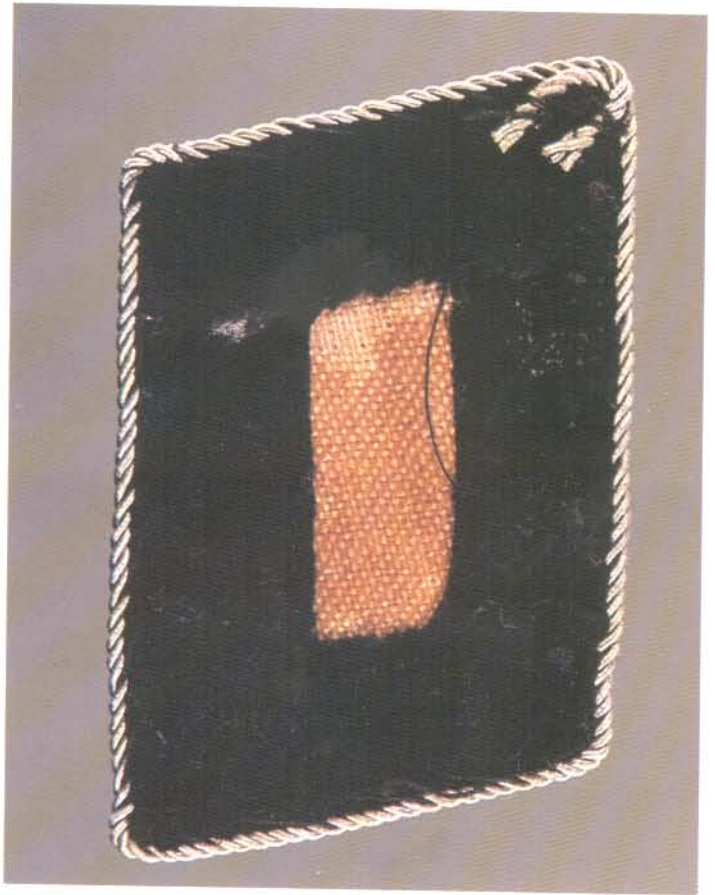

Front and back – collar patch of an SS-Obergruppenführer.



Front and back – a second example of an SS-Obergruppenführer's collar patch.

SS UNIFORMS, INSIGNIA & ACCOUTREMENTS

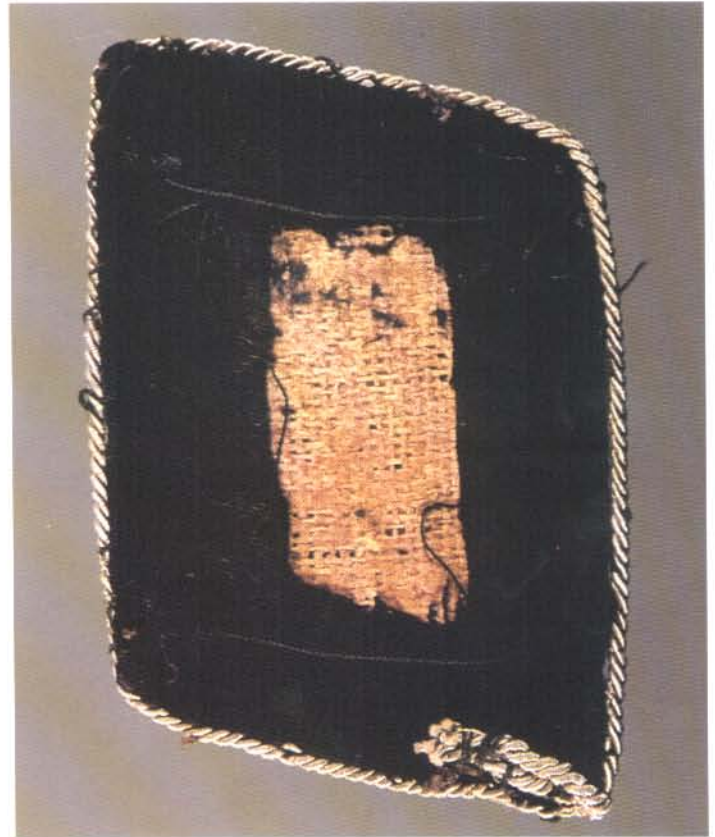

Front and back – left collar patch of an SS-Standartenführer.



Front and back – right collar patch of an SS-Standartenführer.

CHAPTER 1: UNIFORMS & INSIGNIA

The National Emblem for the sleeve – “SS Sleeve Eagles.”



Hand-embroidered first pattern SS officer's sleeve eagle.

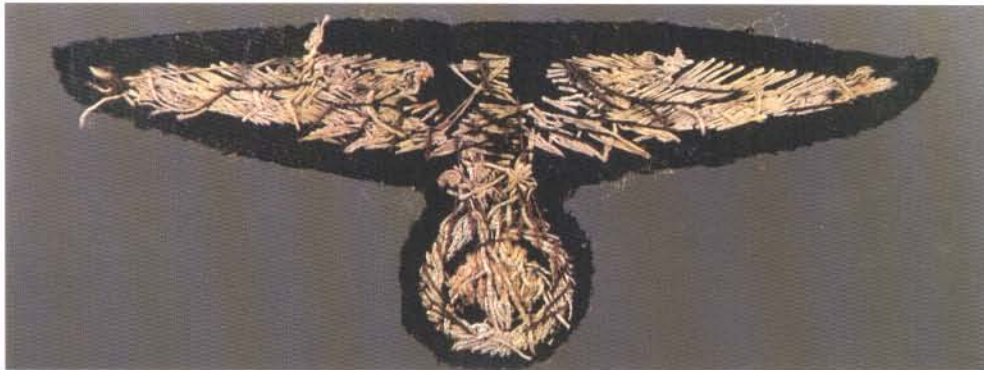

Front and back, of the standard SS officer's sleeve eagle, hand-embroidered of aluminum thread. Note how the Swastikas fill the circle.

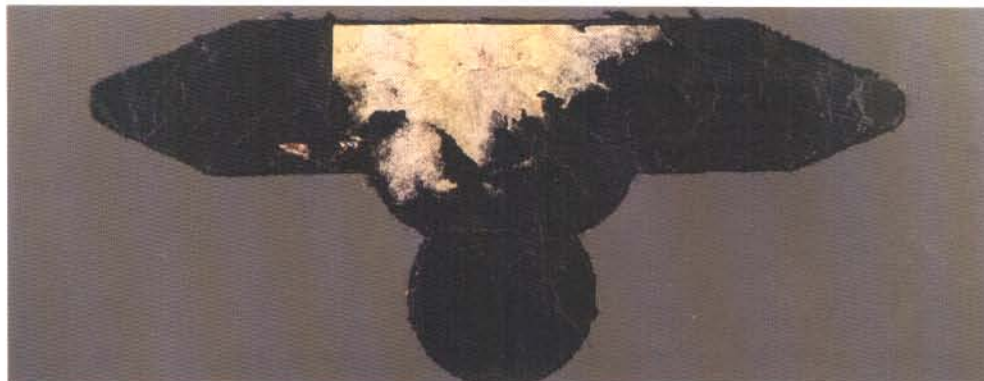

SS UNIFORMS, INSIGNIA & ACCOUTREMENTS

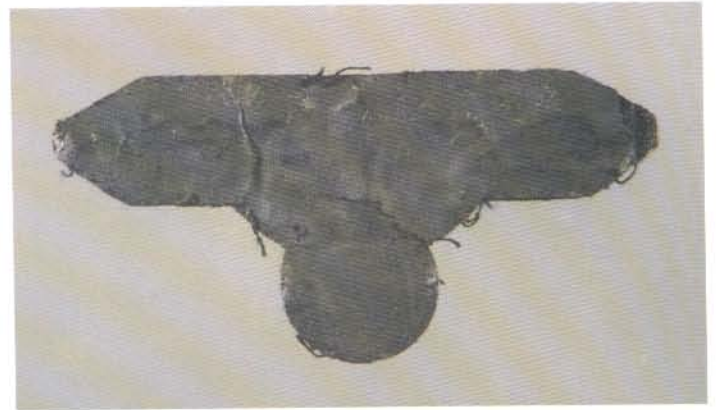

Another example of the standard SS officer's sleeve eagle, hand-embroidered of aluminum thread.



This beautifully detailed, high quality eagle was for wear on the dress cape.

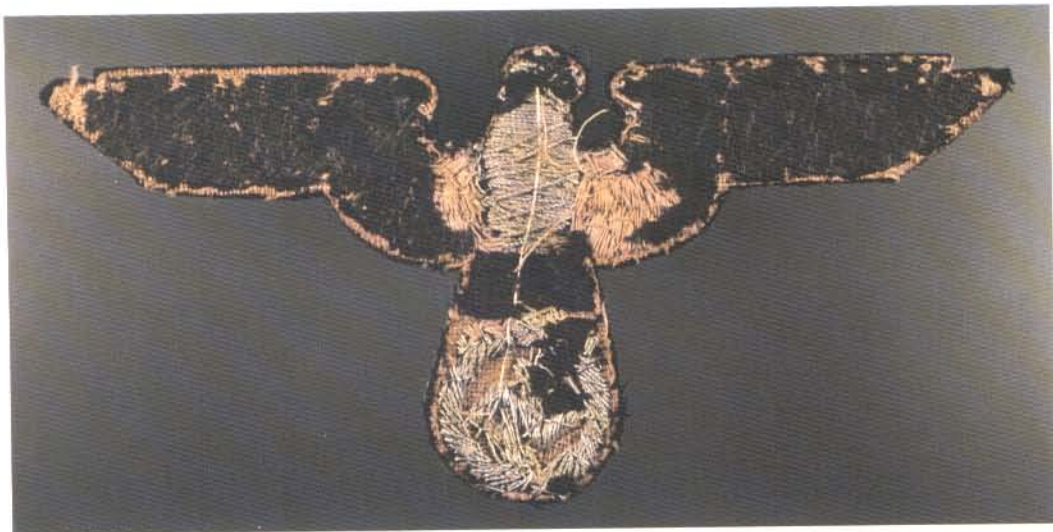

CHAPTER 1: UNIFORMS & INSIGNIA



Machine embroidered SS sleeve eagle in tan for wear on camouflage and tropical uniforms.



Machine woven sleeve eagle for enlisted men.



CHAPTER 1: UNIFORMS & INSIGNIA



OPPOSITE and ABOVE: Sleeve eagles are clearly visible on the upper left sleeves of SS men in these photographs.

Miscellaneous Cloth Insignia



Front and back – this cloth tag indicated an item was approved by the RF-SS. Note circles around both of the runes and RZM. Also note “feet” on the “A.”

CHAPTER 1: UNIFORMS & INSIGNIA



Front and back – shoulder board of an artillery SS–Sturmbannführer of “Leibstandarte SS Adolf Hitler.”

Prewar shoulder strap of an SS-Oberscharführer “LAH.”

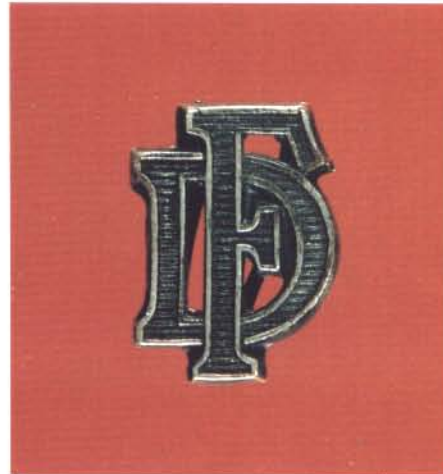

Detail of metal monogram “LAH” for wear on officer’s shoulder boards.

Front and back – white metal monogram for NCO shoulder boards of “Der Führer.”

SS UNIFORMS, INSIGNIA & ACCOUTREMENTS

SS-Armbadges were introduced to denote specialties and functions. They were usually on a black diamond shaped cloth patch and embroidered in silver bullion for officers

and gray thread for enlisted men. Many types of these arm badges exist. Several are provided as original examples.



ABOVE and BELOW: Arm badge for Staff of the SD.



ABOVE and BELOW: Arm badge for SS-Verwaltungsführer or Administrative Leader.



ABOVE and BELOW: Arm badge for an officer assigned to Staff of the SS-Main Race and Rehabilitation Office.

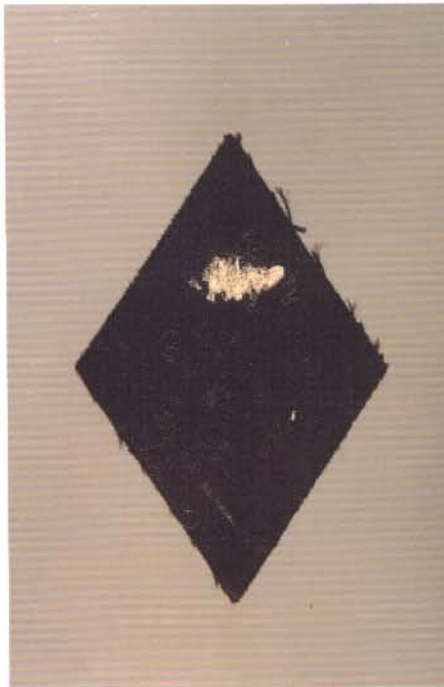

CHAPTER 1: UNIFORMS & INSIGNIA

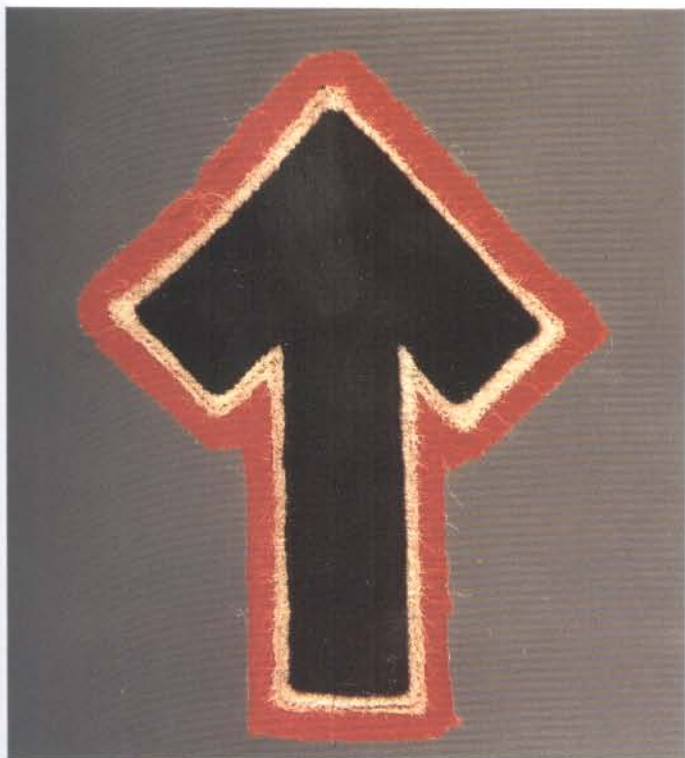

This arm badge, worn on the upper left arm, was for graduates of the Leadership School (Reichsführerschulen).

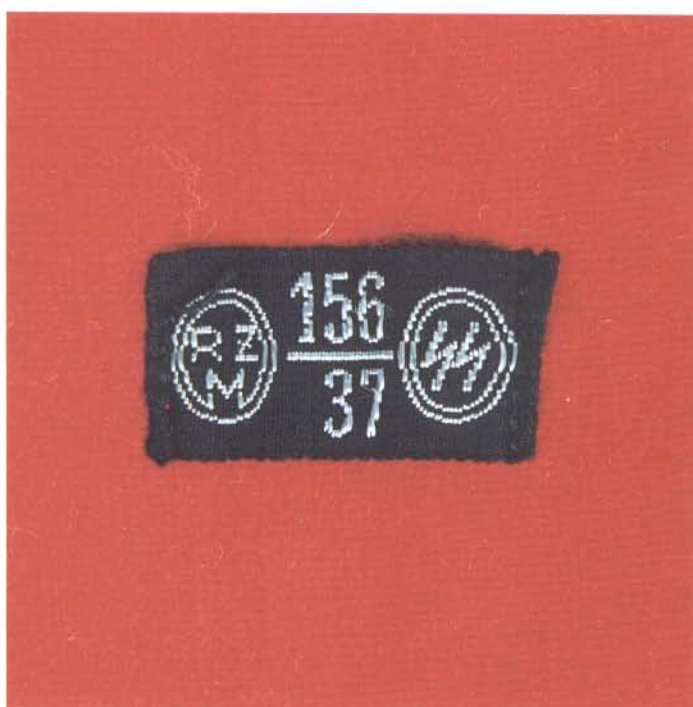

The SS-Kampfbinde (brassard) was worn on the upper left sleeve of the Allgemeine service uniform. These are commonly called "armbands." The SS armband was the same pattern as the N.S.D.A.P. armband with the addition of black bands at the top and bottom. Note the oval shape of the white disc, typical of SS-Brassards. Brassards on overcoats were normally wider by 1/2 inch than those on uniform tunics. RIGHT: RZM tag on reverse of SS-Brassard.

SS UNIFORMS, INSIGNIA & ACCOUTREMENTS

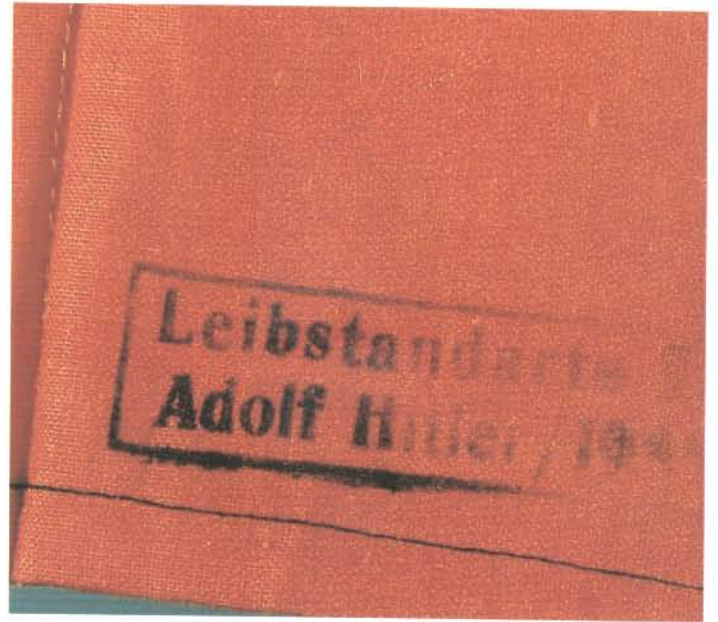
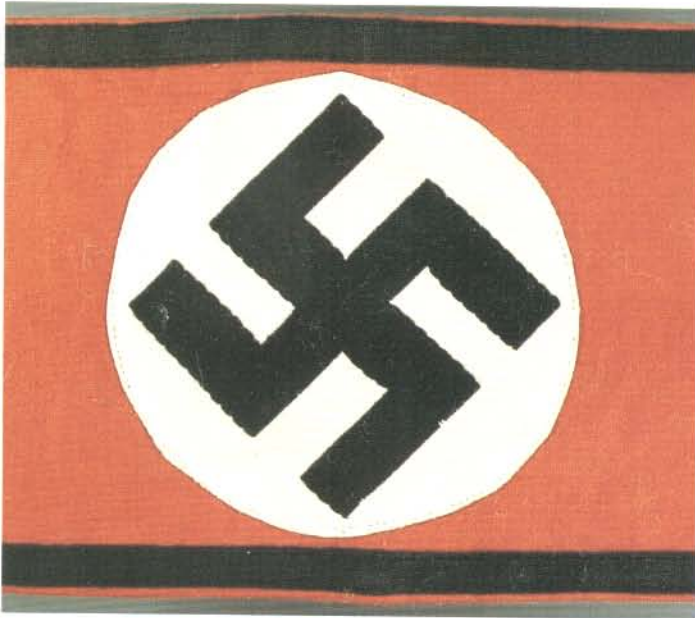

Front and back – a second example of an SS-Brassard with markings of "Leibstandarte Adolf Hitler." This is an early example dating from the 1933 to 1935 period.

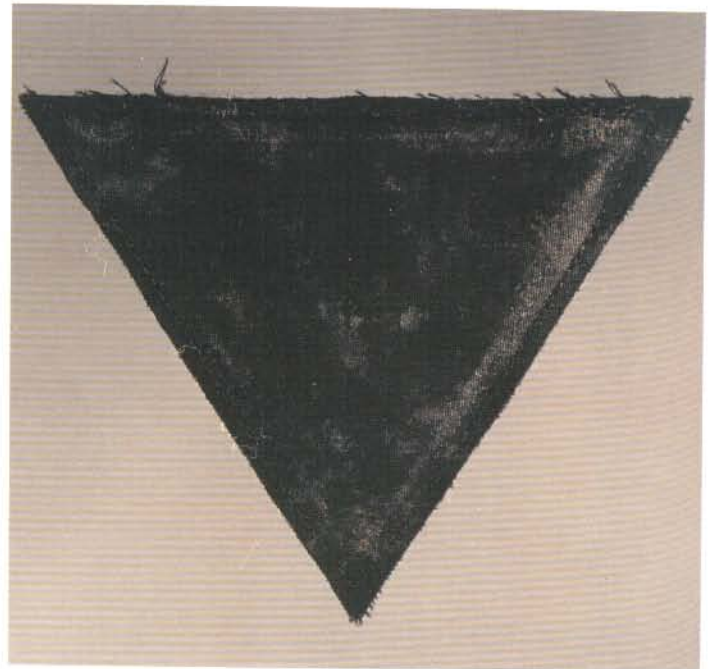

Honor Chevron for ex-members of the Police and Armed Forces.

CHAPTER 1: UNIFORMS & INSIGNIA

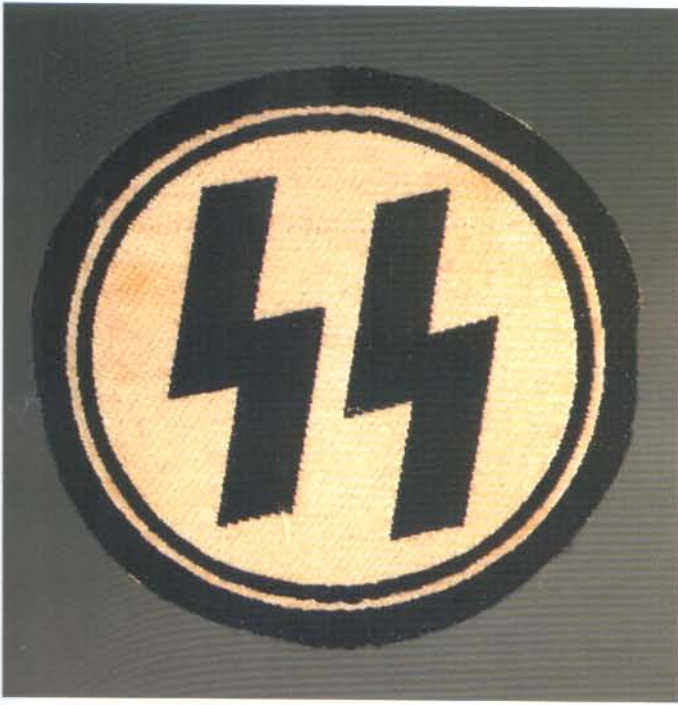

The cloth Sports insignia was worn on numerous athletic garments. This example (black runes on white disc) is the second pattern. The first pattern had the colors reversed.



Five men in this photograph are wearing the 1st pattern Sports insignia. The man center, first row, wears the second pattern.

SS UNIFORMS, INSIGNIA & ACCOUTREMENTS

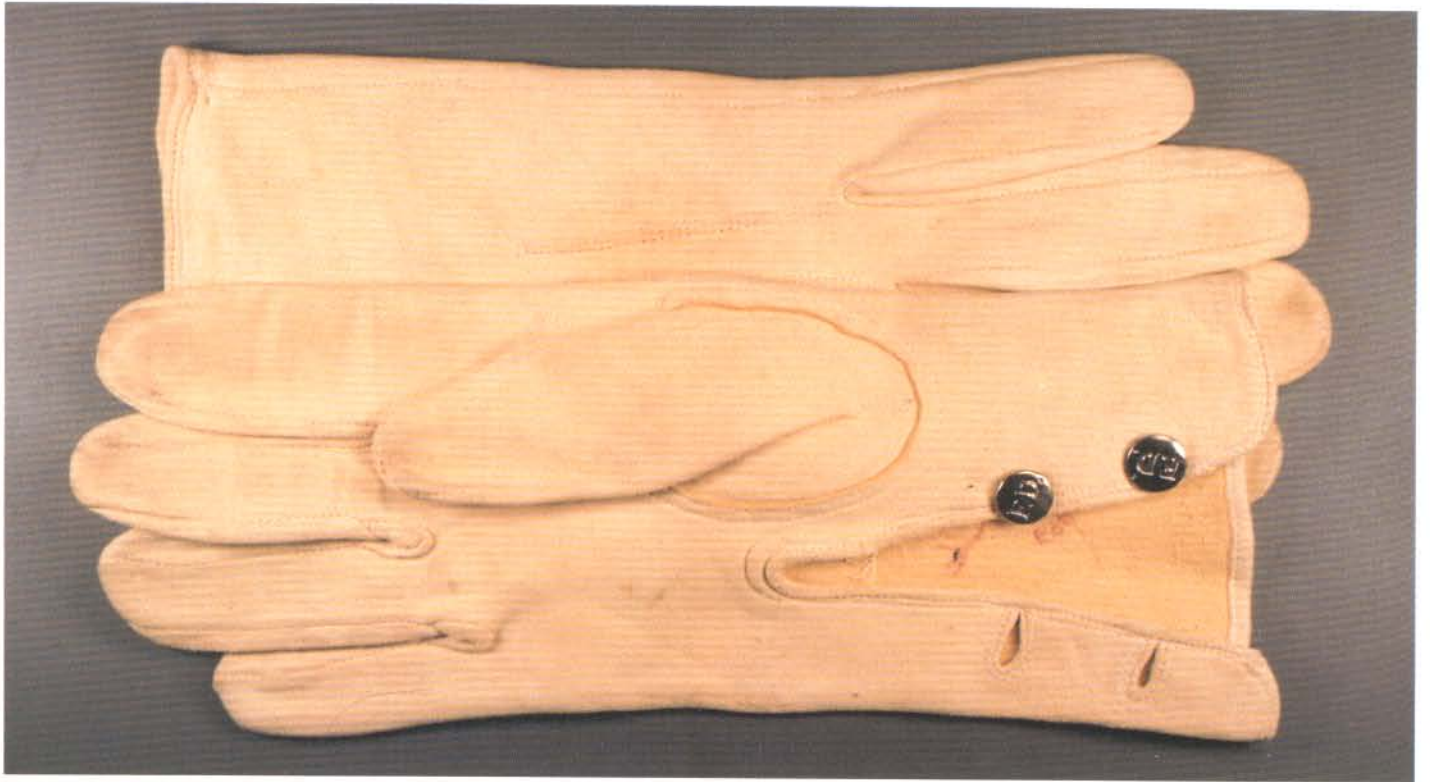

Dress Gloves



CHAPTER 1: UNIFORMS & INSIGNIA

Boots



SS Officer's Boots.



Spur in position on SS officer's boot.



RIGHT: Small SS runes can be seen stamped in the leather inside.

SS UNIFORMS, INSIGNIA & ACCOUTREMENTS



The four officers around the car are wearing boots similar to those on page 81.



SS dress boots.



Sole of SS dress boot.



SS markings stamped inside boots.

CHAPTER 1: UNIFORMS & INSIGNIA



SS field boots. This pair has reflectors strapped around the ankles.

Cloth tag sewn inside field boots.



These men are wearing similar pattern field boots.

SS UNIFORMS, INSIGNIA & ACCOUTREMENTS

Belts and Buckles



The SS enlisted belt and buckle.



Detail of catch on enlisted belt.



The enlisted belt and buckle in white.



Markings on white enlisted belt.

CHAPTER 1: UNIFORMS & INSIGNIA

The following are three examples, front and back, of SS enlisted belt buckles. Note the different markings visible on the backs.



SS UNIFORMS, INSIGNIA & ACCOUTREMENTS



CHAPTER 1: UNIFORMS & INSIGNIA

The officer's dress belt for wear with the black uniform.



ABOVE: Detail of belt. Note SS runes woven into the design.

Reverse of officer's buckle.

SS UNIFORMS, INSIGNIA & ACCOUTREMENTS

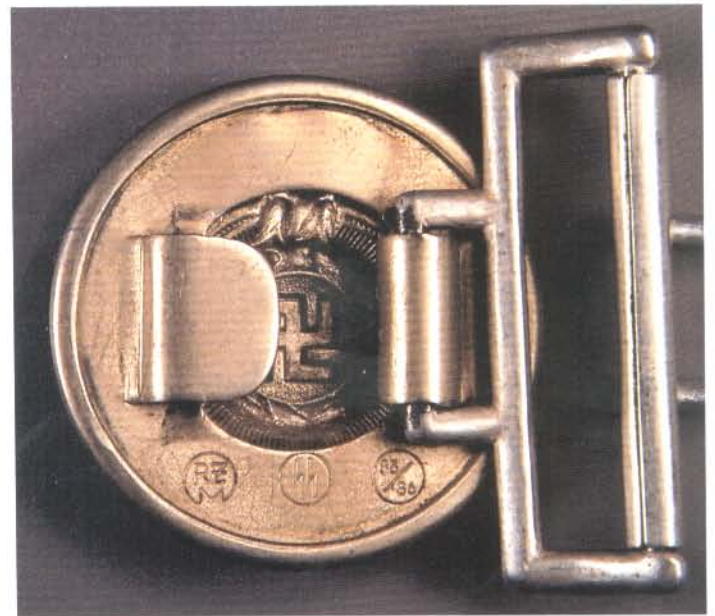

This dress belt, bordered in field grey, was for wear with the field grey uniform. RIGHT: Reverse of officer's buckle.



Detail of belt.

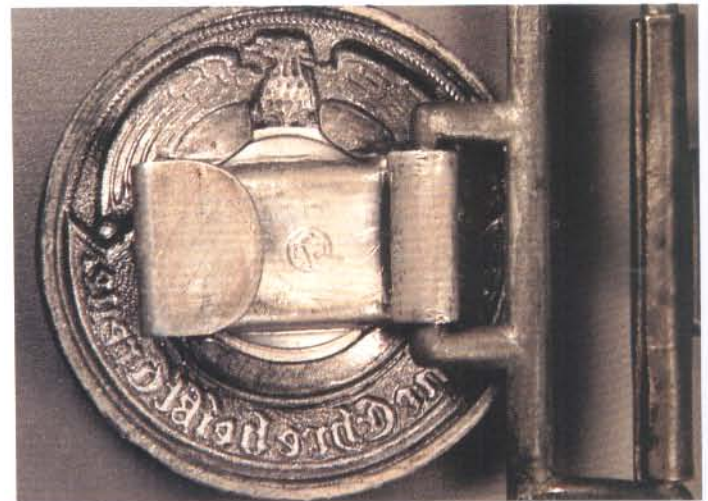

Front and back – another example of the officer's belt buckle.

CHAPTER 2

HEADGEAR

Early Allgemeine SS enlisted man's visor hat.



Interior view with maker's markings.

CHAPTER 2: HEADGEAR

A second variation of an early Allgemeine SS enlisted visor hat.



Interior view with SS markings and owner's name.



Front and back of 1st pattern hat eagle.

SS UNIFORMS, INSIGNIA & ACCOUTREMENTS



Another variation of the first pattern hat eagle-front and back.



Front and back of first pattern hat skull device.



Allgemeine SS troops wearing the early style enlisted visor hat.

CHAPTER 2: HEADGEAR

Later version of the Allgemeine SS enlisted visor hat.



ABOVE: Interior detail with SS markings and owner's name.



ABOVE: RZM SS markings on visor.

RIGHT: RZM SS markings are barely visible on the reverse of this chin strap.

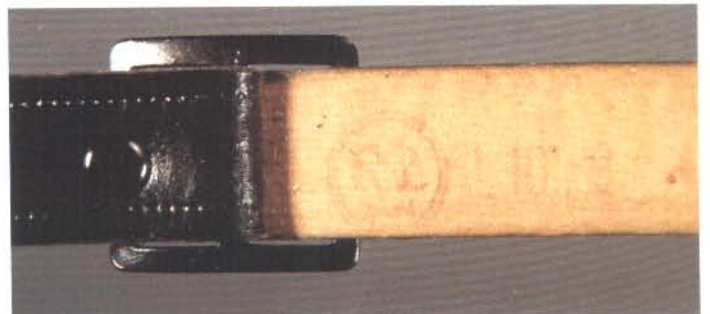

SS UNIFORMS, INSIGNIA & ACCOUTREMENTS

Allgemeine SS officer's visor hat.



Interior view of the hat at left.



This officer (right) wears the black visor hat with early style eagle.



ABOVE, BELOW and OPPOSITE PAGE: Another variation of the Allge-meine SS officer's visor hat. This example is unissued.



SS UNIFORMS, INSIGNIA & ACCOUTREMENTS

The visor hat of a General officer of the Allgemeine SS.



Detail of reverse of side button.

CHAPTER 2: HEADGEAR
WAFFEN-SS OFFICER'S VISOR HATS



SS UNIFORMS, INSIGNIA & ACCOUTREMENTS



This example shows a lot of wear, but is a fine, honest example.



CHAPTER 2: HEADGEAR



Yet another example of the Waffen SS officer's visor, is this piece marked "Extra" on the sweatband.

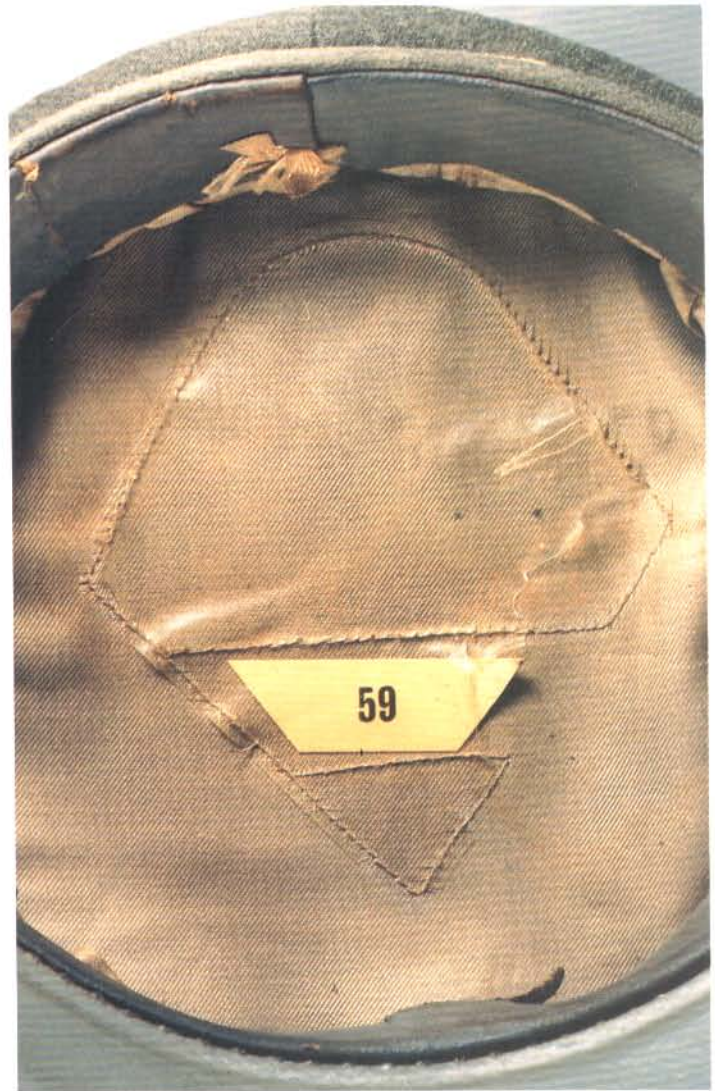

SS UNIFORMS, INSIGNIA & ACCOUTREMENTS

THE SS-FELDMUTZEN (Field Cap)

This first pattern SS field cap originated in the Imperial German Army. It was worn early on by the SS and original examples are very rare today.



Early SS-Feldmutzen.

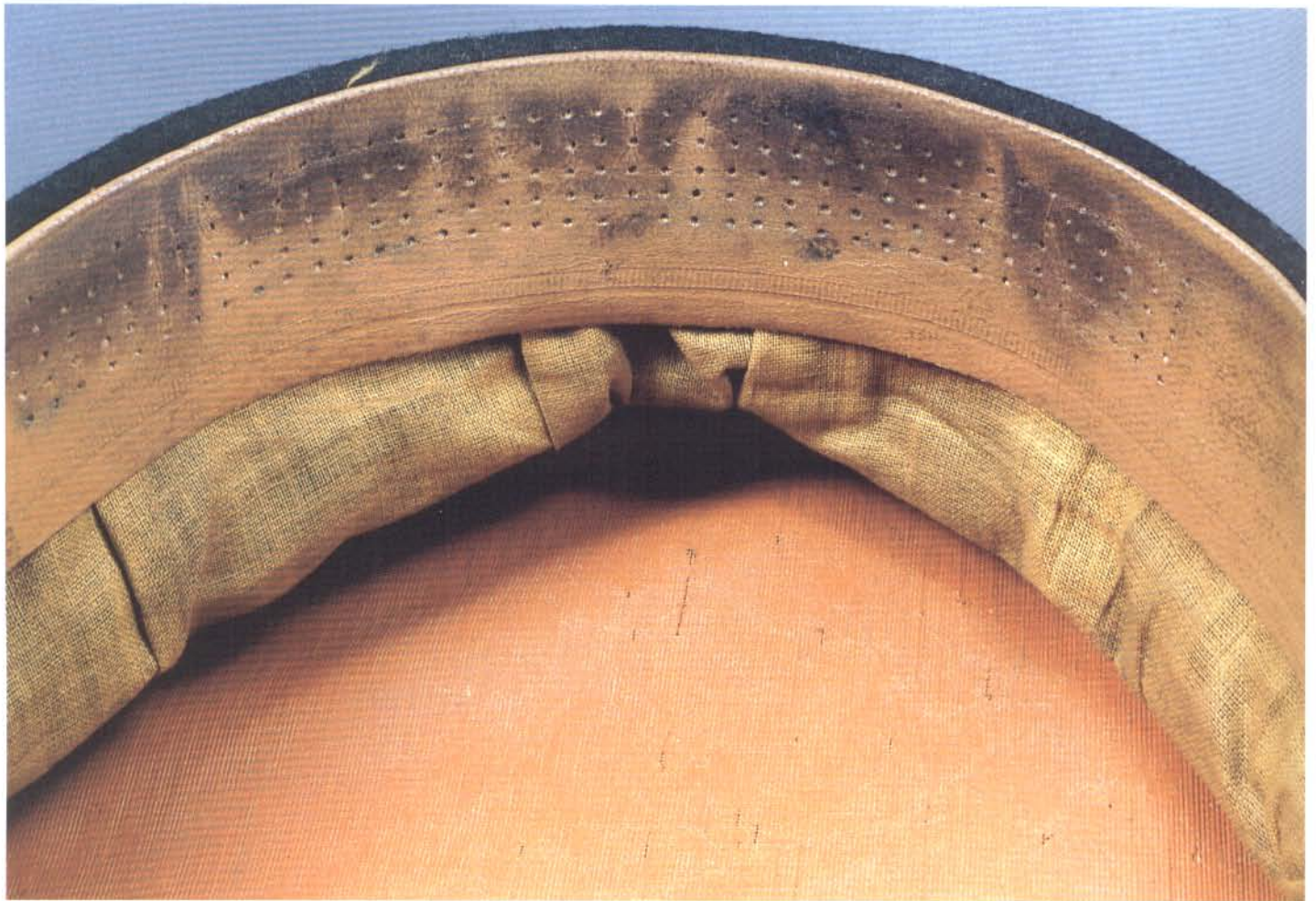

Detail of sweat band and interior lining fabric.

CHAPTER 2: HEADGEAR



Detail of insignia.

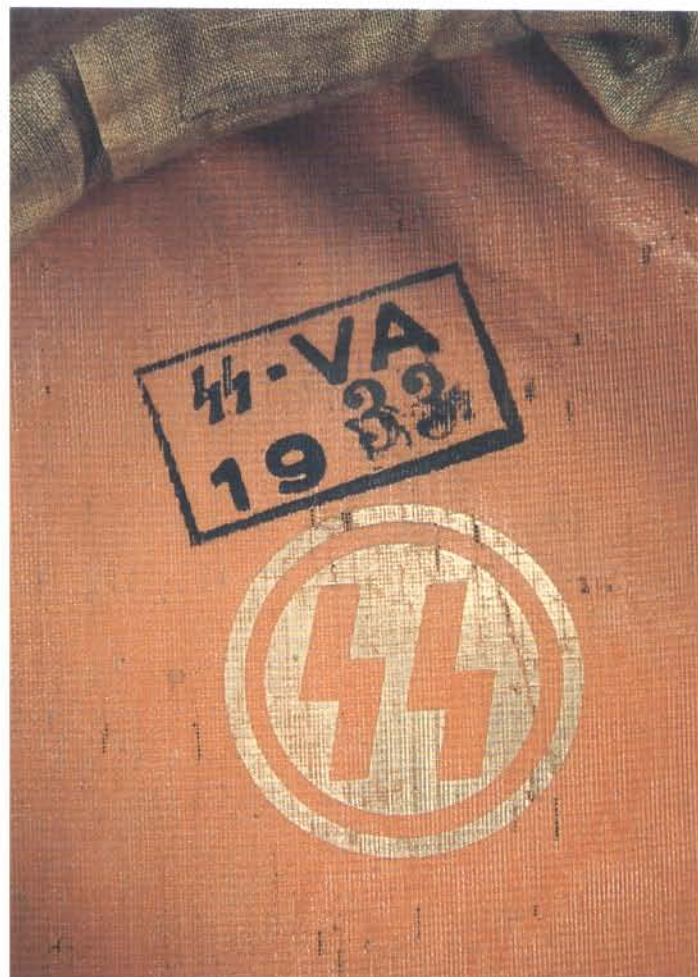

Detail of interior markings. Note 1933 date.



ABOVE and NEXT PAGE: Examples of the early Feldmutzen being worn.

CHAPTER 2: HEADGEAR



ABOVE: Later version of the SS-Feldmütze.

RIGHT: Feldmütze insignia.

BELOW: Feldmütze label.



Feldmütze for armored personnel.

RIGHT: Insignia detail.



This man wears the Waffen-SS Feldmütze in field grey.

SS UNIFORMS, INSIGNIA & ACCOUTREMENTS



The model 1938 Waffen-SS field cap. The white inverted chevron (soutache) indicates infantry.



Detail of SS eagle.



The soutache was threaded through a small slit in the cloth and stitched in place at the base on each side. This photograph shows the back side.

CHAPTER 2: HEADGEAR

The Waffen-SS 1943 general issue field cap or Einheitsfeldmütze (commonly called the M-43).



SS UNIFORMS, INSIGNIA & ACCOUTREMENTS



Insignia details Waffen-SS 1943 general issue field cap.



Several variations of SS headgear are visible in this photograph.

CHAPTER 2: HEADGEAR

The RZM model SS steel helmet was worn prior to 1931 without decals. It was very similar in appearance to the model 1916 German helmet. It is interesting to note that these helmets are actually dark blue not black.



The RZM model SS steel helmet.



ABOVE: Interior view.



RIGHT: Chin strap detail.

SS UNIFORMS, INSIGNIA & ACCOUTREMENTS



Markings inside RZM model SS helmet shown on page 113.



LEFT: The RZM model SS steel helmet worn by this standard bearer. Also of interest is the standard bearer's gorget around his neck. RIGHT: These men are holding the RZM model helmet.

CHAPTER 2: HEADGEAR
ALLGEMEINE SS M35 STEEL HELMET



SS UNIFORMS, INSIGNIA & ACCOUTREMENTS



Left side decal on the Allgemeine SS M35 helmet.



Right side decal on the Allgemeine SS M35 helmet.



Interior markings on the Allgemeine SS M35 helmet.

CHAPTER 2: HEADGEAR
WAFFEN SS M35 STEEL HELMET



Interior view.



Original owner's name inked in liner.



Interior markings.

SS UNIFORMS, INSIGNIA & ACCOUTREMENTS



Right side decal on the Waffen-SS M35 helmet.



Left side decal on the Waffen-SS M35 helmet.



ABOVE and OPPOSITE: Waffen SS troops wearing the M35 helmet.



SS UNIFORMS, INSIGNIA & ACCOUTREMENTS

WAFFEN SS M42 STEEL HELMET



Decal detail.



RIGHT: Interior markings.

CHAPTER 2: HEADGEAR

PARATROOPER HELMET WITH WAFFEN SS SNIPER (VEIL)

This helmet was "liberated" by an American soldier at the Battle of the Bulge. The camouflage, wire, and veil were in place as seen here.



SS UNIFORMS, INSIGNIA & ACCOUTREMENTS

SS FELT PITH HELMET



Right side metal insignia.



Left side metal insignia.

CHAPTER 3

FIELD GEAR & EQUIPMENT

THE SS BACKPACK



Backpack as viewed from the rear with mess tin and folded ground sheet in place.



Backpack with shoulder straps visible. BELOW: SS and RZM markings stamped into leather.



CHAPTER 3: FIELD GEAR & EQUIPMENT

SS BREAD BAG AND CANTEEN (BEFORE 1936)



ABOVE: Tag found inside bag. BELOW: SS markings on bag.



SS markings on neck of canteen.



SS markings on cap of canteen.

SS UNIFORMS, INSIGNIA & ACCOUTREMENTS

SS LEATHER MAP CASE



Front and back of map case.



Markings stamped into leather map case.



RIGHT: This SS officer is carrying a map case similar to the example pictured.

CHAPTER 3: FIELD GEAR & EQUIPMENT
SS REFLECTORS FOR WEAR AT NIGHT ON TRAFFIC DUTY

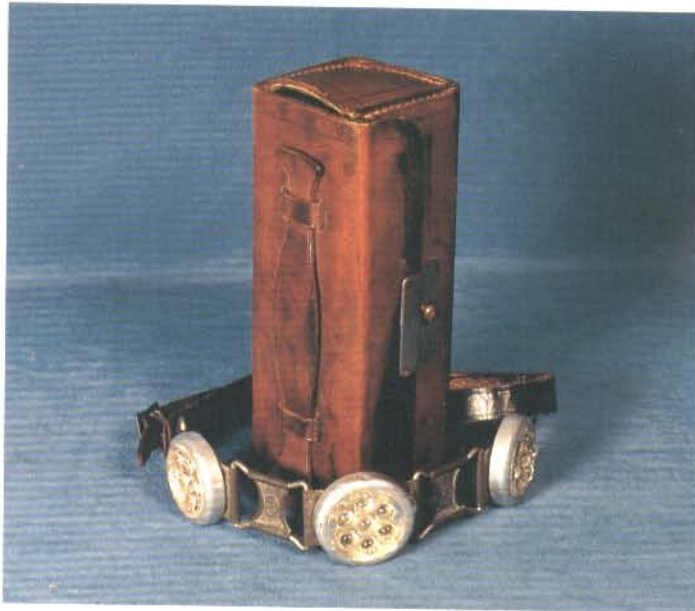

ABOVE: Reflectors and case. BELOW LEFT: Detail of back of link with SS runes stamped in. RIGHT: Reflectors and chain detail.



CHAPTER 4

FIREARMS

Luger "Black Widow", 41 dated byf (Mauser).



SS UNIFORMS, INSIGNIA & ACCOUTREMENTS

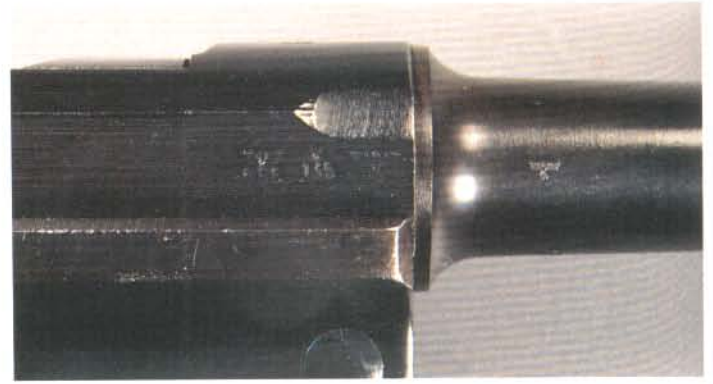
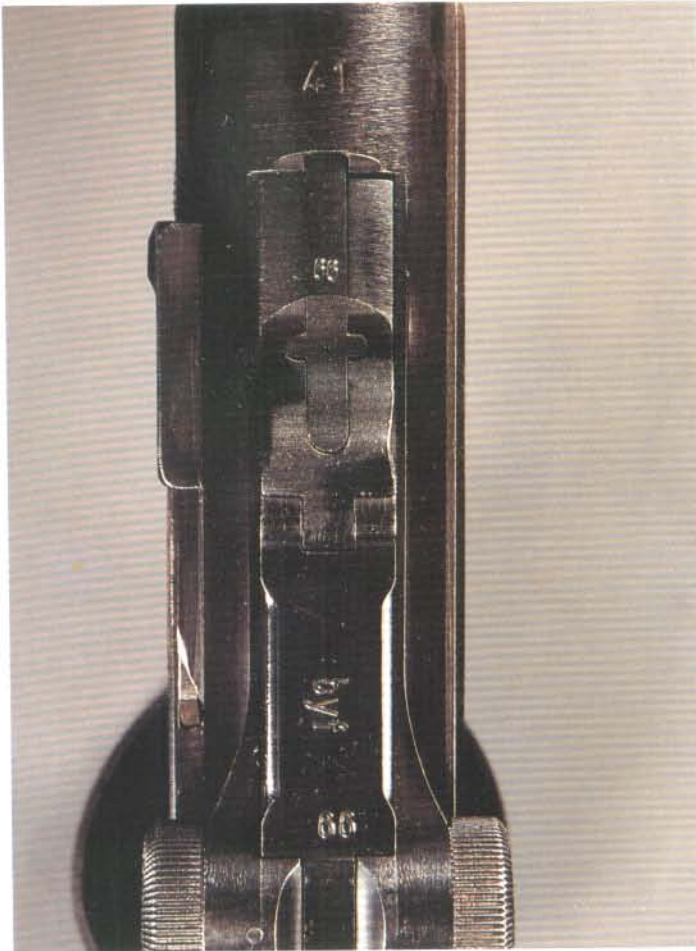

SS motto "Meine Ehre Heisst Treue" inscribed above grip. This gun was likely given as a token of friendship or as an award.

Luger, 1940-42 code "Totenkopf" (Death's Head)

Examples of lugers marked with the Totenkopf insignia are very rare. This gun was probably assigned to a concentration camp guard.



CHAPTER 4: FIREARMS



Note runes and Totenkopf stamped above grip.

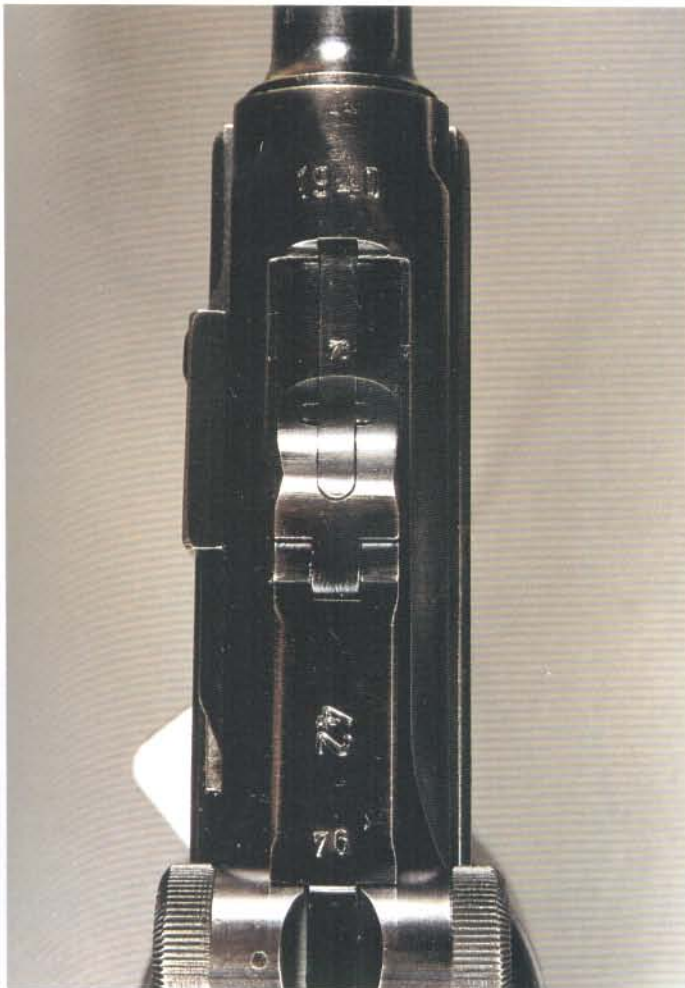

Runes and Totenkopf can be seen above 1940 date.

SS UNIFORMS, INSIGNIA & ACCOUTREMENTS

Luger, 41/42 code Mauser with double strike SS runes.

This pistol is a very unusual example which was acquired from a U.S. Army veteran of the 2nd Armored Division. It has been speculated that the double strike SS runes were put on the gun by an SS technician at the time of a rework or repair. All numbers match including the clip.



Top view of SS marked Luger.



Partial rune stamp is visible in front of the three eagle markings.



The rune stamps are again visible in front of the 9683 number.



Detail of markings.

CHAPTER 4: FIREARMS



SS men on the pistol range practicing with the Luger.

AC41 Code P.38 "Totenkopf" (Death's Head).

Very few examples of Totenkopf marked P.38 pistols are known to exist. These guns were likely issued to concentration camp guards.



SS UNIFORMS, INSIGNIA & ACCOUTREMENTS



Note matching number on clip.



"Death's Head" stamp detail.

Unusual pigskin P.38 holster attributed to an SS Oberscharführer Wittman.

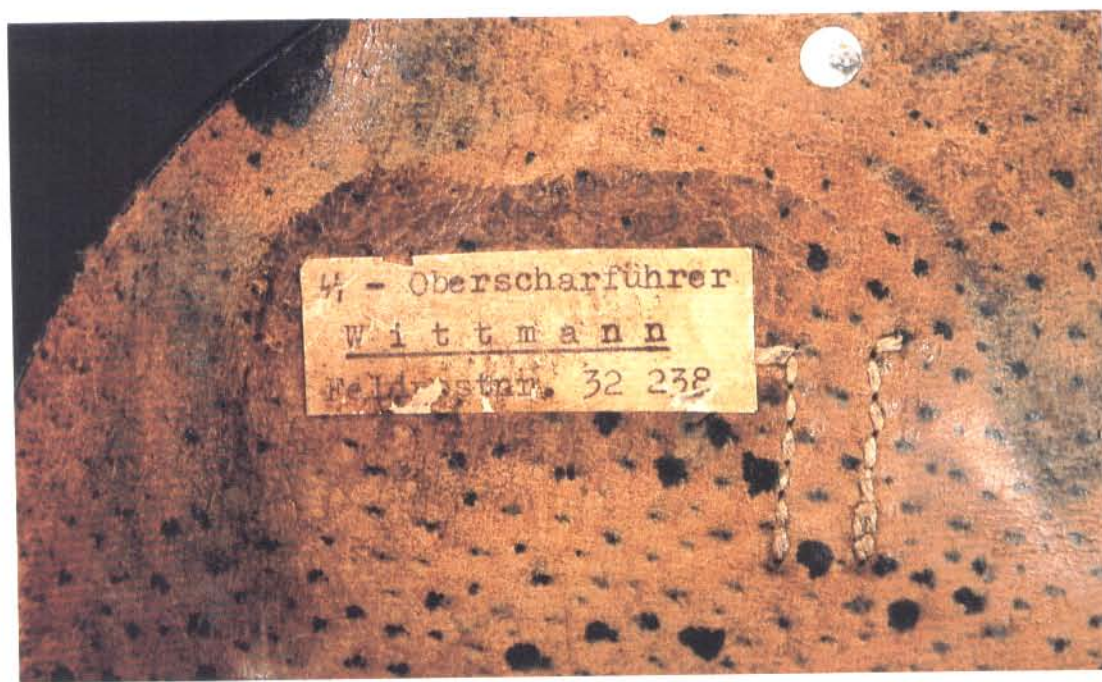

Detail of nametag inside holster flap.

CHAPTER 4: FIREARMS



Model 35 Polish Radom automatic pistol issued to a Waffen SS soldier.



SS UNIFORMS, INSIGNIA & ACCOUTREMENTS



ABOVE: SS markings inside Radom holster.

LEFT: Model 35 Radom holster.

Sauer .32 pistol and holster as preferred by many SS officers. The Sauer .32 was the only pistol designed, produced, and used during the period of the Third Reich.



CHAPTER 4: FIREARMS

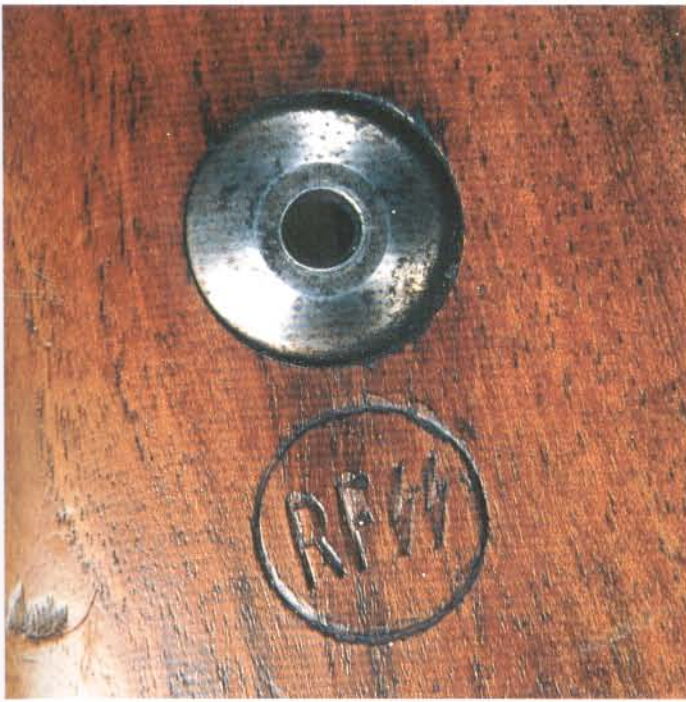

SS markings on stock of training rifle.



ABOVE: Leather holster for the Sauer .32

BELOW: .22 Mauser training rifle with SS markings.



CHAPTER 5

EDGED WEAPONS

The 1933 SS service dagger made by Robert Klaas with vertical leather hanger.



CHAPTER 5: EDGED WEAPONS



SS UNIFORMS, INSIGNIA & ACCOUTREMENTS

The 1933 SS service dagger by Gottlieb Hammesfahr.

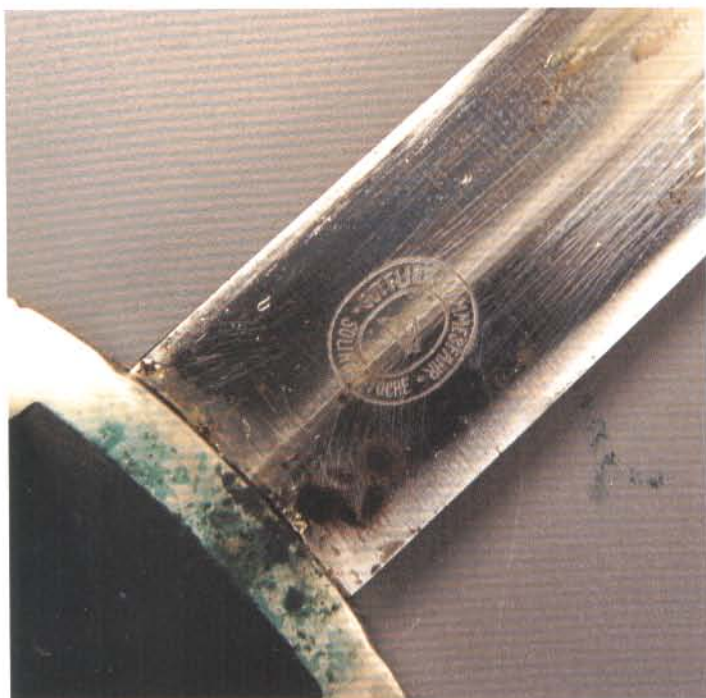

Gottlieb Hammesfahr maker's mark.



Grip detail.

CHAPTER 5: EDGED WEAPONS



SS number stamped into crossguard.

Hanger detail.



Blade inscription.

SS UNIFORMS, INSIGNIA & ACCOUTREMENTS

The 1933 SS service dagger by Boker.



CHAPTER 5: EDGED WEAPONS



The 1933 SS service dagger - later "RZM" variation.



SS UNIFORMS, INSIGNIA & ACCOUTREMENTS



The SS Rohm Honor Dagger with ground inscription.

In 1934, 9,900 SS members were awarded the "Rohm Honor Dagger." The blade was inscribed "In herzlicher freundschaft Ernst Rohm" (In heartfelt friendship Ernst Rohm). When Rohm was murdered, the inscription was ordered removed. A "Rohm Honor Dagger" with inscription intact is probably the most difficult SS dagger to find today.



ABOVE: Inscription on front side of blade. BELOW: Reverse of blade with ground inscription. On careful examination, portions of the inscription are visible. "Ground Rohm" daggers are seldom found today.



CHAPTER 5: EDGED WEAPONS



Carl Eickhorn maker's mark.

SS UNIFORMS, INSIGNIA & ACCOUTREMENTS



The blade of a Rohm Honor Dagger with inscription still present, made by Gottlieb Hammesfahr. (Henger)



Detail of inscription. (Henger)



Detail of Rohm signature. (Henger)

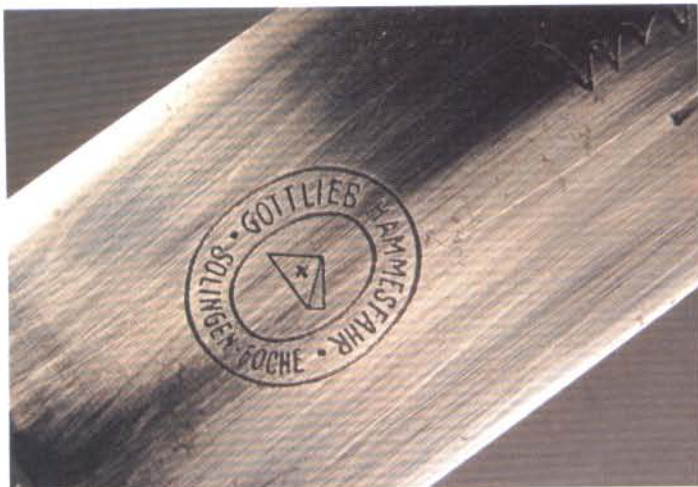

Maker's mark. (Henger)

RIGHT: Detail of grip. (Henger)



CHAPTER 5: EDGED WEAPONS



A second un-ground Rohm example is this blade by Eickhorn. *(Henger)*



Detail of Rohm signature. *(Henger)*



Detail of Eickhorn maker's mark. Note SS man's number stamped into crossguard. *(Henger)*

SS UNIFORMS, INSIGNIA & ACCOUTREMENTS

SS Himmler Honor Dagger

This is one of the most rare and sought after SS daggers today. Heinrich Himmler presented these pieces to members of the squads who carried out the assassinations of Rohm and other SA leaders. The inscription on the blade reads "In herzlicher freundschaft, H. Himmler" ("In heartfelt friendship, H. Himmler"). These daggers were all made by Eickhorn.



Detail of "H. Himmler" signature inscription.

CHAPTER 5: EDGED WEAPONS



Reverse of blade with inscription.



SS UNIFORMS, INSIGNIA & ACCOUTREMENTS

The 1936 model SS dagger or "Chained SS."



CHAPTER 5: EDGED WEAPONS

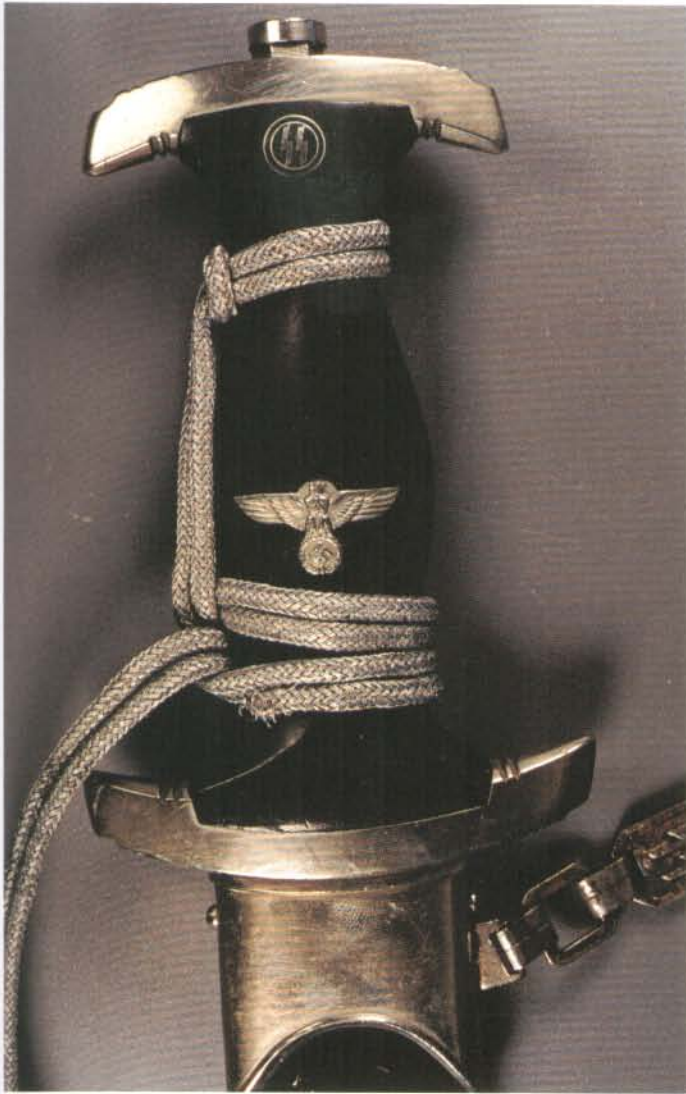

Detail of Type II chain and hanger attachment. Note the beveled connectors where the chain hooks to the cloverleaf.



CHAPTER 5: EDGED WEAPONS

1936 model SS dagger as worn with uniform coat.



Front and back of SS/RZM tag from a dagger.

SS UNIFORMS, INSIGNIA & ACCOUTREMENTS



Dress bayonet and SS troddle (knot).

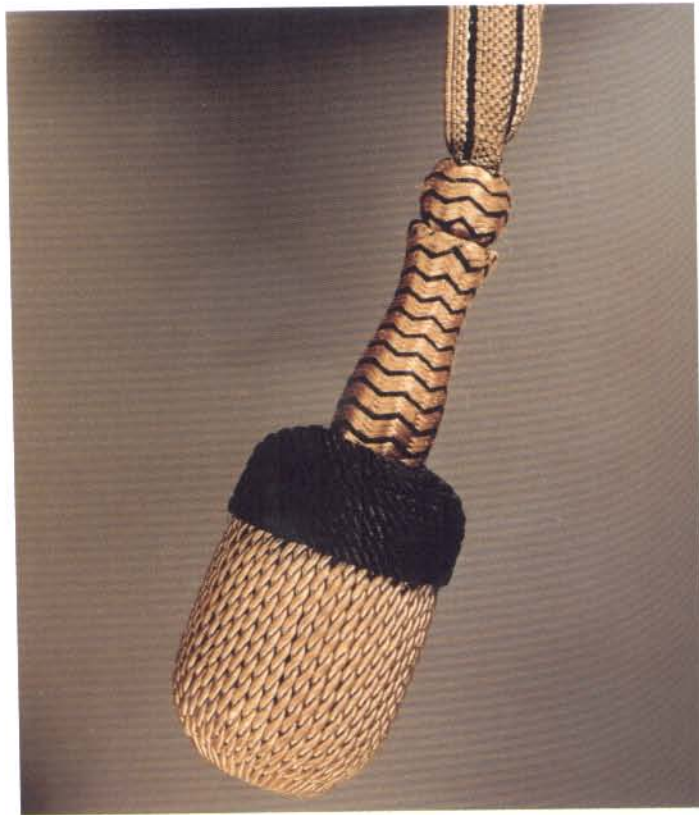

Detail of troddle.



Dress bayonet with rare white leather frog.



Markings and 1938 date stamped into leather.

CHAPTER 5: EDGED WEAPONS

SS Swords (Degens)



A mounted SS officer in the field with sword drawn.



The SS officer's sword with portepee.

SS UNIFORMS, INSIGNIA & ACCOUTREMENTS

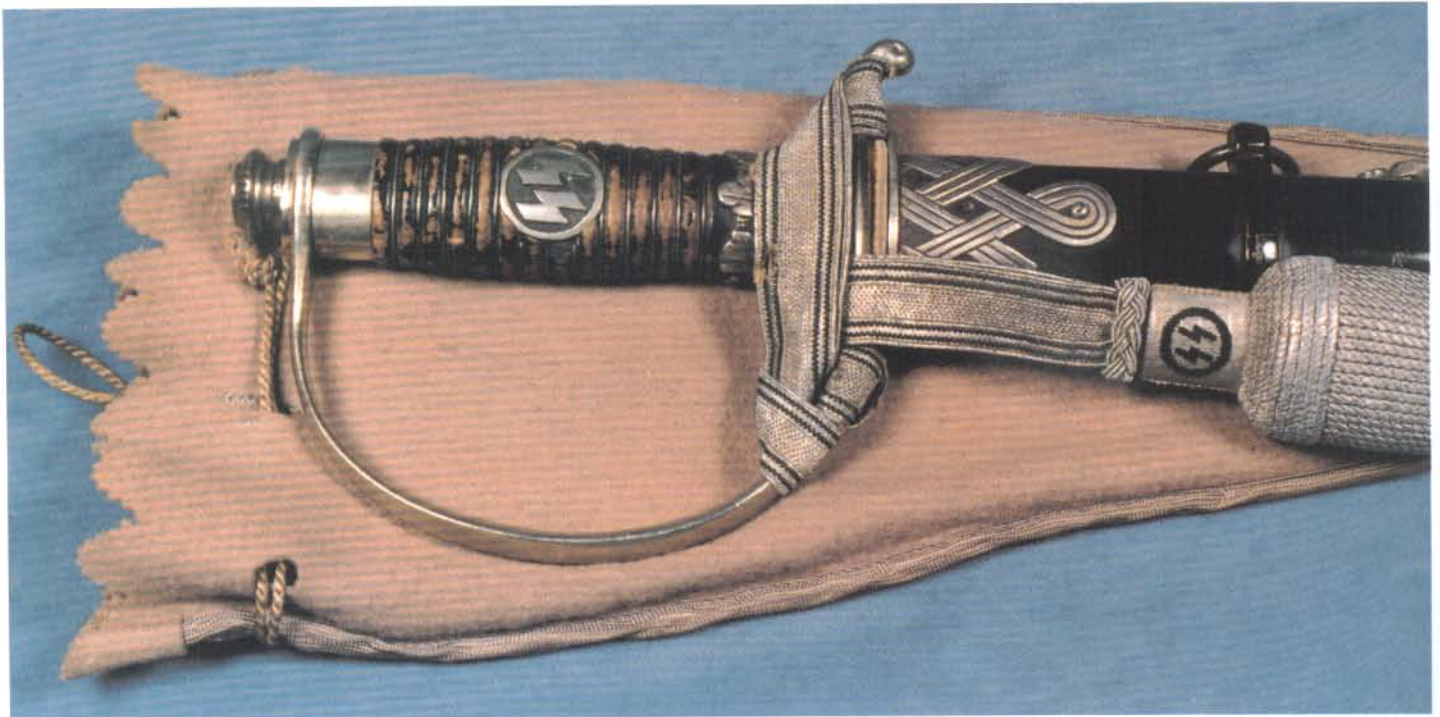

Detail of SS officer's sword and portopée laying on top of cloth storage bag.



Detail of runes in well worn grip.



Reverse of grip.

CHAPTER 5: EDGED WEAPONS



Detail of white leather washer and SS proofs in crossguard.



Pommel of officer's sword.

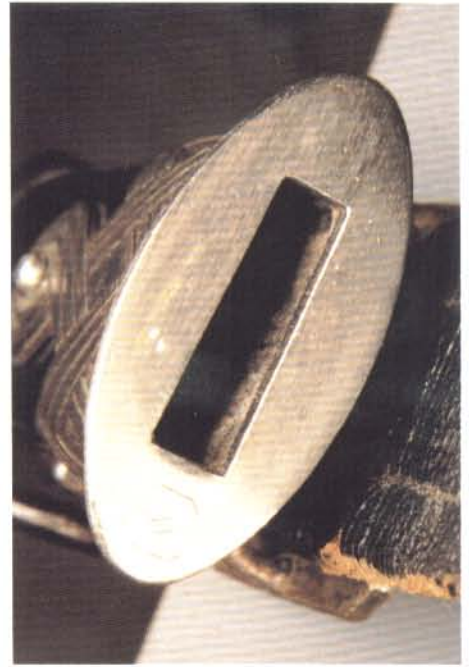

Throat of scabbard with SS proof marks.



Detail of officer's portepe.



Cloth RZM/SS issue tag on portepe.

CHAPTER 5: EDGED WEAPONS

The SS Officer Candidate Leader pattern sword and portpee.

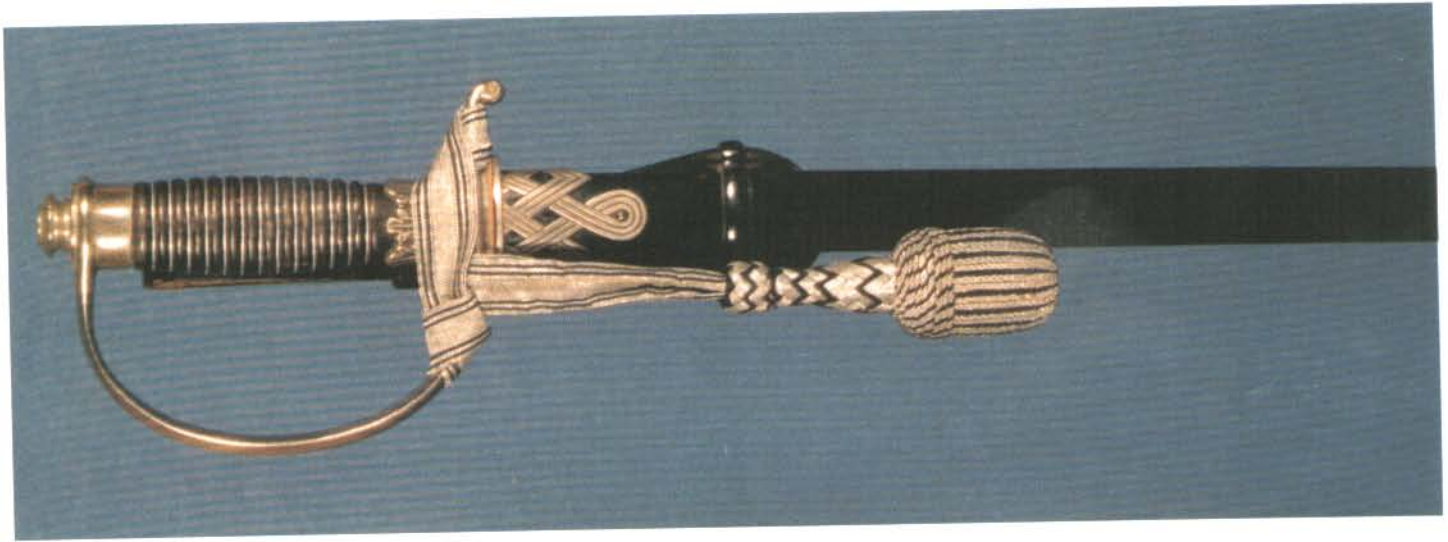

Note leather washer.



WKC maker's markings.

SS UNIFORMS, INSIGNIA & ACCOUTREMENTS

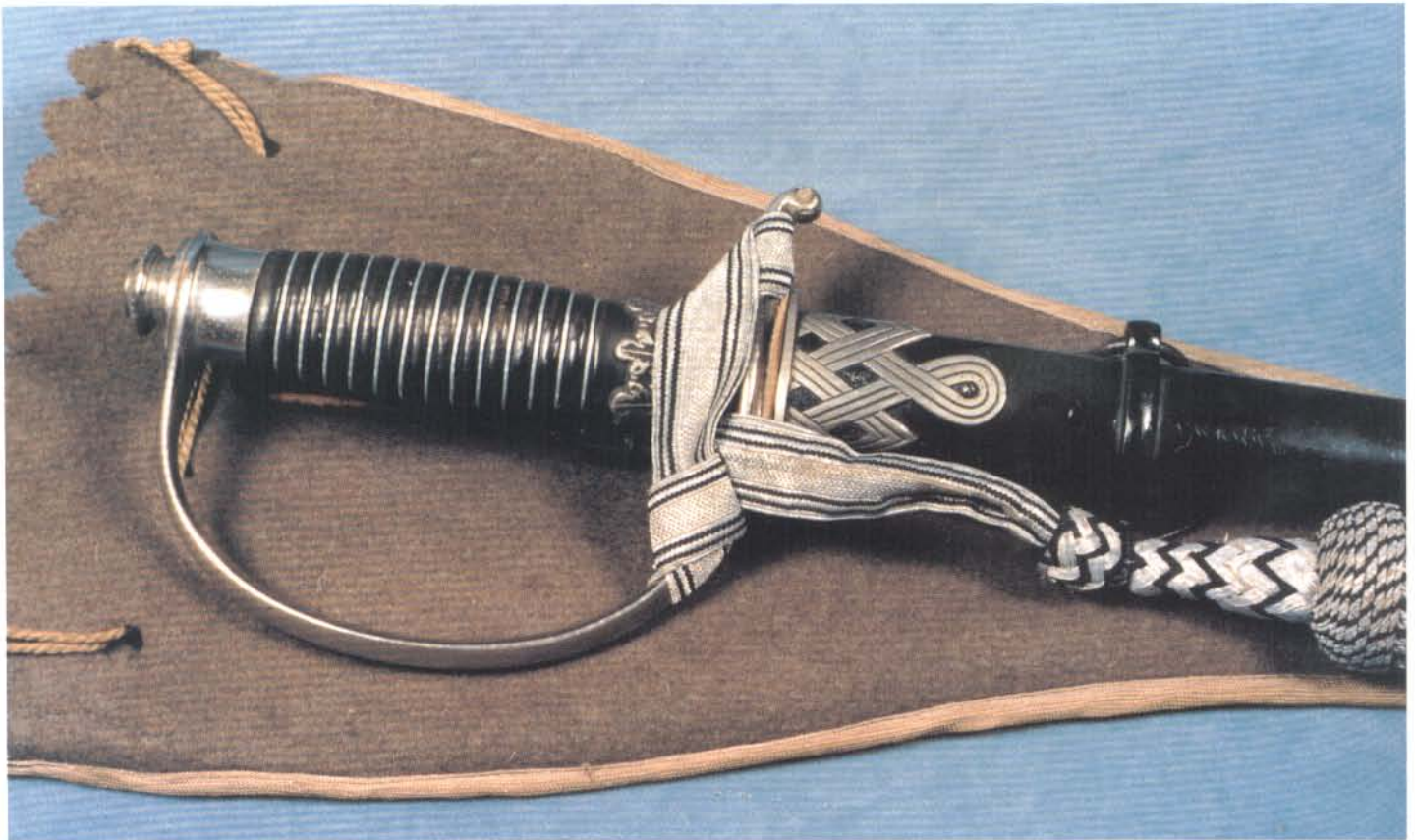

Detail of Officer Candidate Leader pattern sword laying on cloth storage bag.



Pommel.

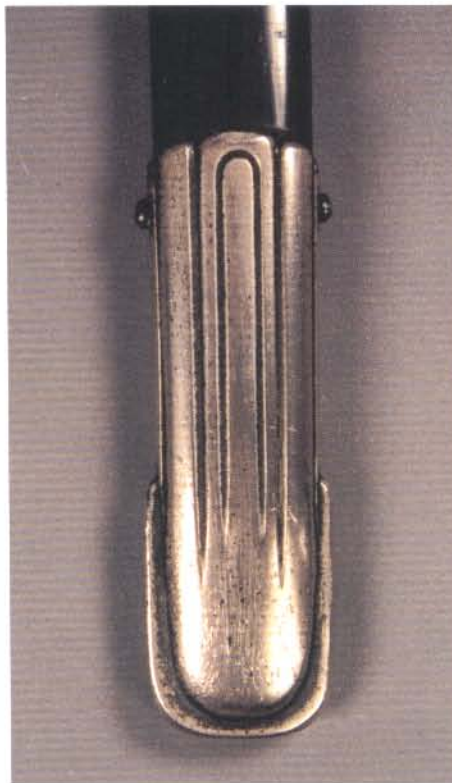

Detail of drag.



Detail of portepee.

CHAPTER 5: EDGED WEAPONS

The SS NCO sword and portepee.

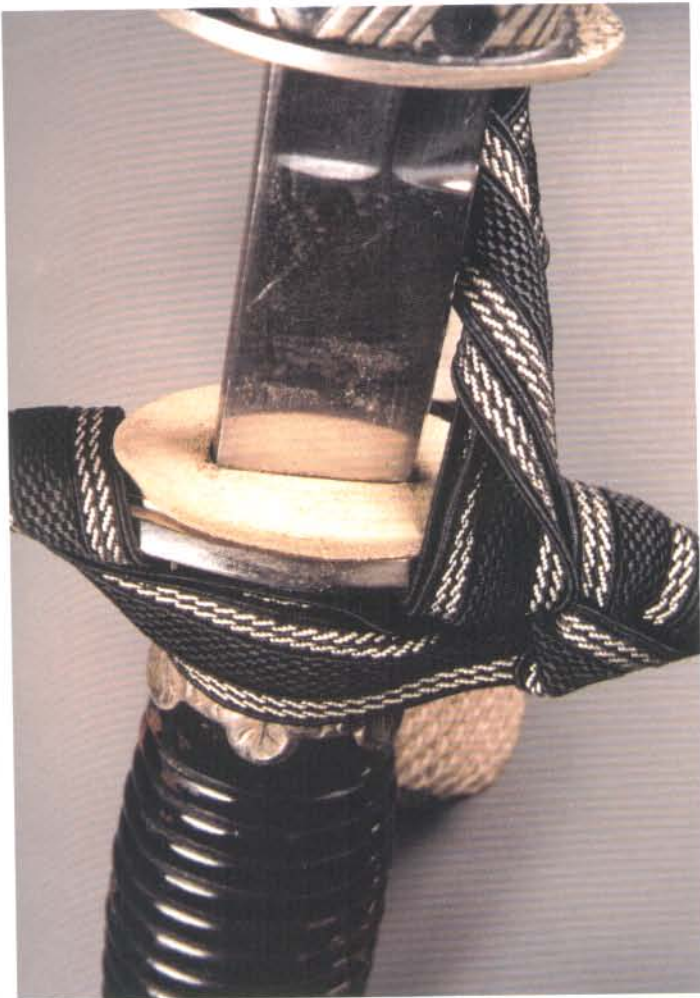
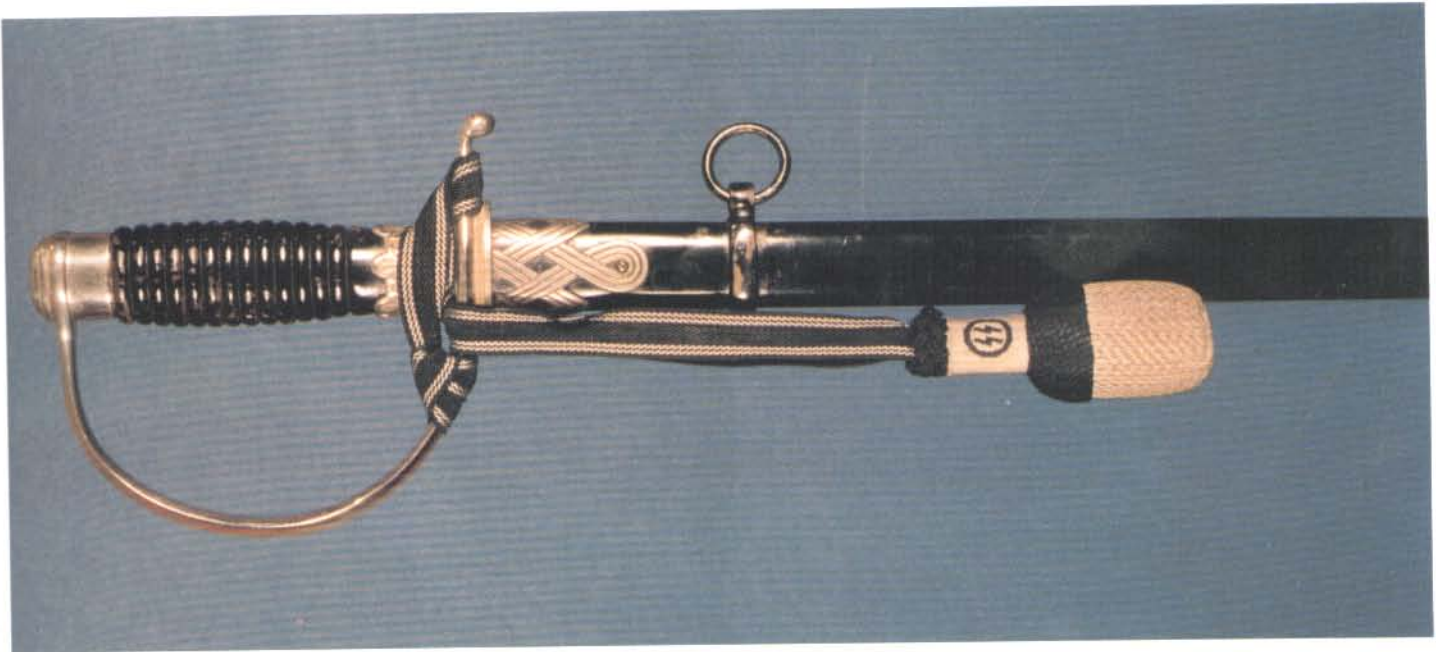

Note leather washer.



Maker's markings of F.W. Holler.

CHAPTER 5: EDGED WEAPONS

The SS Police Officer's sword and portepee.



Front and back of SS Police Officer's sword with portepee and hanger in place.

SS UNIFORMS, INSIGNIA & ACCOUTREMENTS



Detail of grip.



Back side of grip.



Pommel.

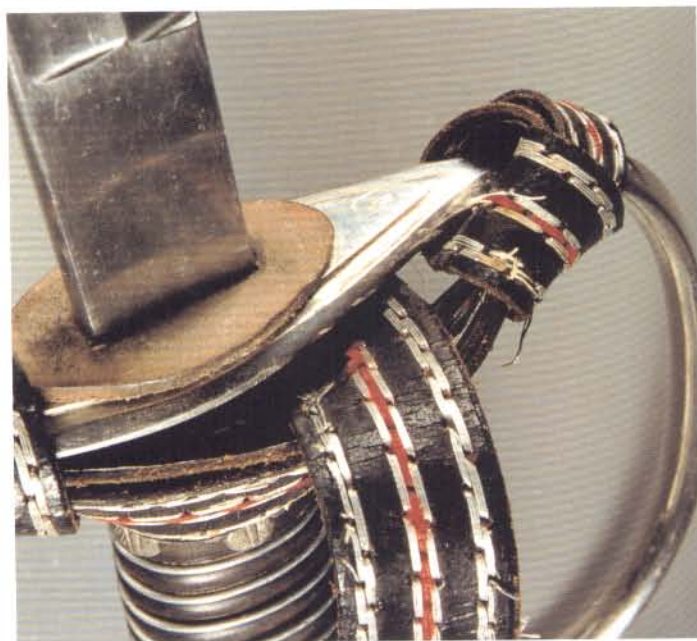

Note SS marking on crossguard.

CHAPTER 5: EDGED WEAPONS



Eickhorn maker's markings.



Scabbard throat with SS proofs.



Detail of drag.



Portepee details.

CHAPTER 6

MEDALS AND BADGES

The medals and badges awarded to the Waffen SS were, for the most part, the same ones awarded to the Army. Many political awards were also common to the SA. An in-depth study of medals and badges of the SS is much too broad a topic for the scope of this work, but I wanted the reader to have access to a photographic overview of the subject.

The Golden Party Decoration and Badge

On the 30th of January, annually, most Golden Party badges were given as the highest decoration of the party. Each was dated and marked with initials A.H.

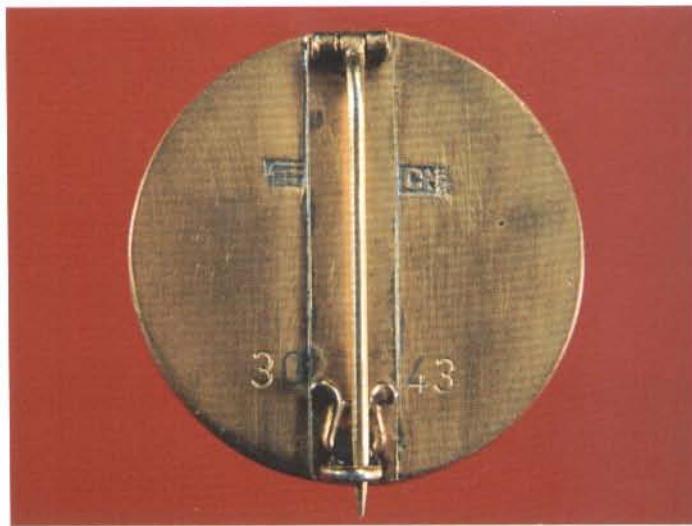

Front and back – the Golden Party Decoration. This example, dated 30, January 1943, has a war time replacement pin, which covers the A.H. markings. Note, also, lettering on face of badge is gilt.



Front and back – standard issue Golden Party Badge.

The Golden Party Badge was also given to members of the N.S.D.A.P. with solid service records and membership numbers less than 100,000.

CHAPTER 6: MEDALS AND BADGES



Front and back – this example is a period facsimile for shop window display.



Front and back – N.S.D.A.P. party pin.

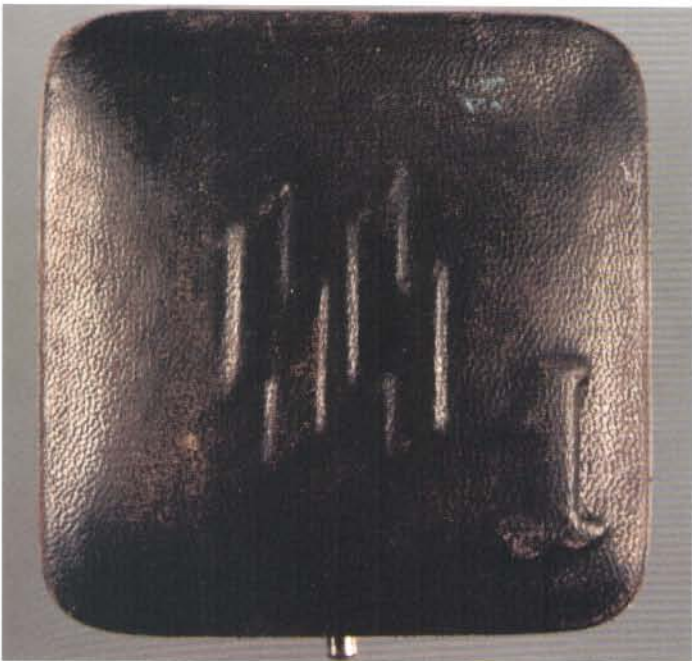

Cased set – Party Badge and Eagle stick pin. Case back is dated 1936, embossed with runes and the numeral one for SS-Standarte "Deutschland."

SS UNIFORMS, INSIGNIA & ACCOUTREMENTS



Front and back – S.A. Rally at Brunswick 1931 Badge of Honor.



Nuremberg Badge of Honor 1929 made into a watch fob.

CHAPTER 6: MEDALS AND BADGES

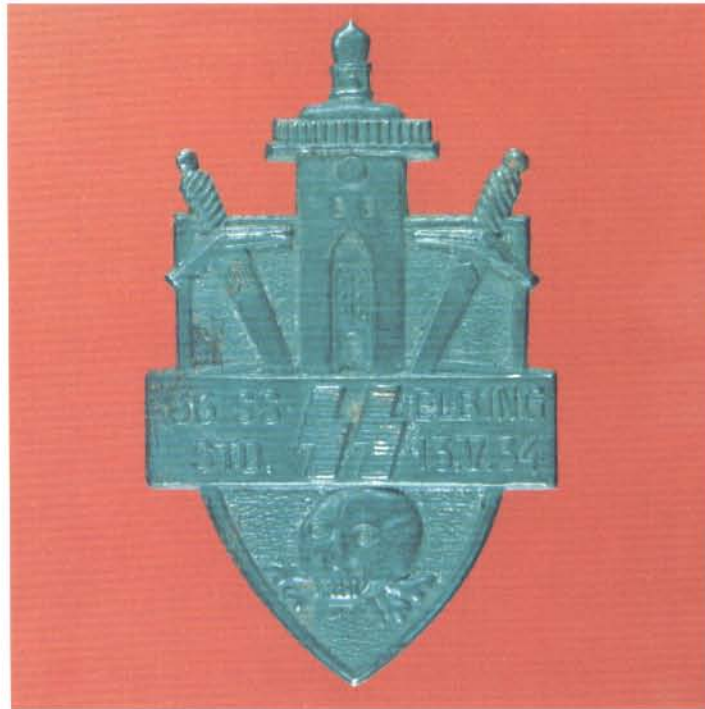

Tinnie: SS Elbing 13.V.34. Building depicted is believed to be rendition of gates to A.H. Division barracks. (Stairrett)

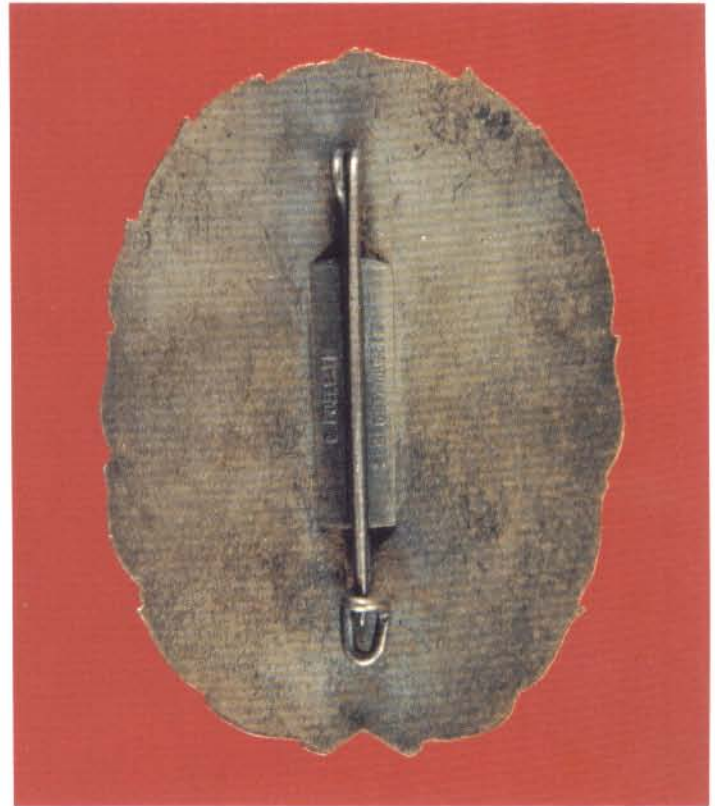

Front and back – 1934 SA-SS Ski Badge.

SS UNIFORMS, INSIGNIA & ACCOUTREMENTS



The Germanic Proficiency Runes Badge. This badge was presented in bronze and silver.



CHAPTER 6: MEDALS AND BADGES

The S.A. Military Sports Badge.

This badge was awarded in three classes – bronze, silver, and gold.



ABOVE: Front and back of the S.A. Military Sports Badge in bronze.



ABOVE: Front and back of the S.A. Military Sports Badge in silver.

SS UNIFORMS, INSIGNIA & ACCOUTREMENTS

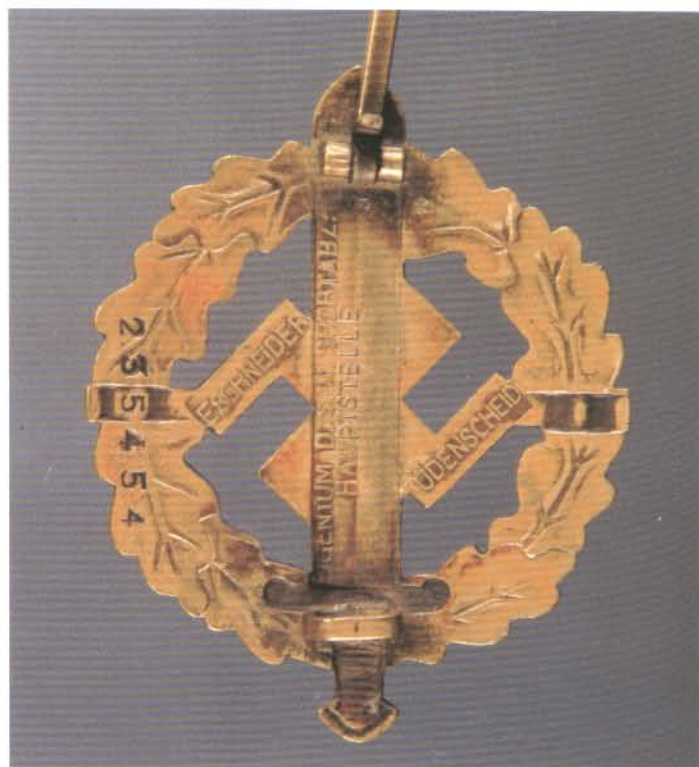

ABOVE: Front and back of the S.A. Military Sports Badge in gold.



The S.A. Military Sports Badge for war wounded.

CHAPTER 6: MEDALS AND BADGES

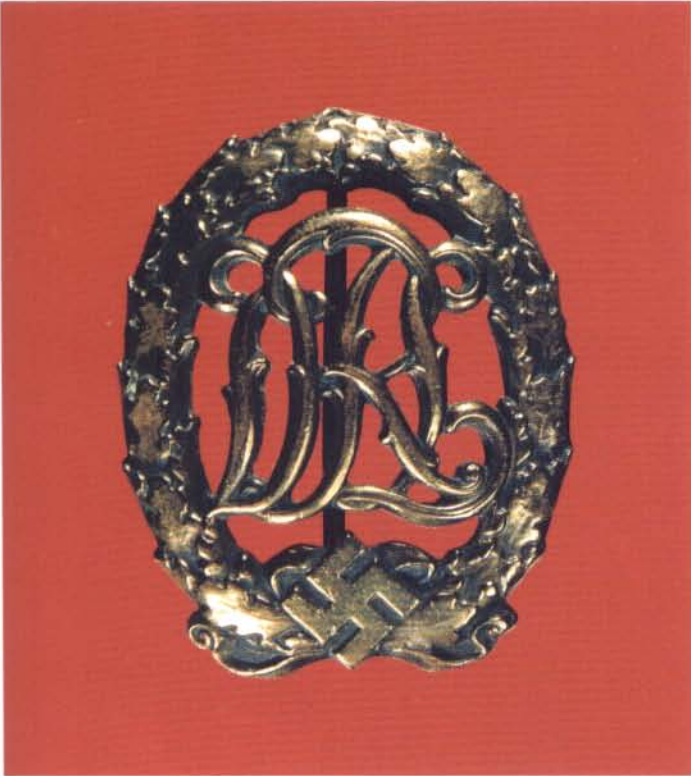

The German National Badge for Physical Training (last version with swastika). This badge was awarded in bronze, silver and gold.

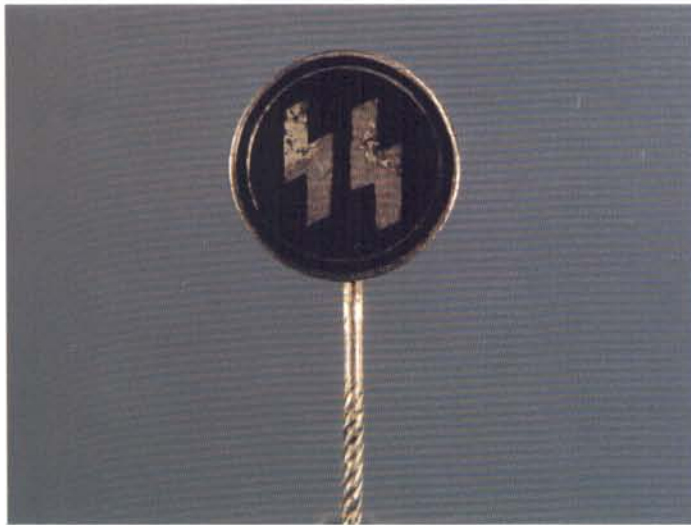

The SS Civil Badge (SS-Zivilabzeichen) – to be worn on civilian clothes to demonstrate membership in the SS. Note outer ring is thicker than inner ring.

CHAPTER 6: MEDALS AND BADGES



SS-Supporting Member's Badge.



**Silberne FM =
Ehrennadeln**

Verloren:
Nr. 2305 FM Andreas Payerl, München, Rosenheimer Straße 29
Nr. 17118 FM Erich Kleßke, Guben (Oberschl.)
Nr. 54380 FM Walter Janz, Bremerhaven, Kaiserstr. 1
Nr. 3578 FM Josefina Eicher, Villach (Kärnten)

Gefunden:
Nr. 44190 in Köln

This period document features the SS Supporting Member's Commemorative Badge.



SS Standard (Danzig) stick pin – note the death's head in the center of the swastika.

OPPOSITE: This period publication (1939) displays the SS Supporting Member's Badge on the cover.

SS UNIFORMS, INSIGNIA & ACCOUTREMENTS

Military Awards

The Iron Cross

The Iron Cross is the best known of all German medals. It was first instituted in 1813 by Friedrich-Wilhelm III. By the end of World War II, there were eight classes of the Iron Cross. The classes were: 2nd Class, 1st Class, Knight's Cross, Knight's Cross with Oak Leaves (Eichenlaub), Knight's Cross with Oak Leaves and Swords (Schwerten), Knight's Cross with Oak Leaves, Swords

and Diamonds (Brillanten), Knight's Cross with Golden Oak Leaves, Swords and Diamonds and Grand Cross of the Iron Cross. The only Grand Cross awarded in World War II was to Göring for the Battle of France.

Two examples of the Knight's Cross are shown. The first was manufactured by Steinhauer & Luck, Ludenscheid.



Knight's Cross in issue case by Steinhauer & Luck, Ludenscheid.

CHAPTER 6: MEDALS AND BADGES



Front and back of Knight's Cross by Steinhauer & Luck, Ludensheid.



Detail of medal with "935 4" marking visible.

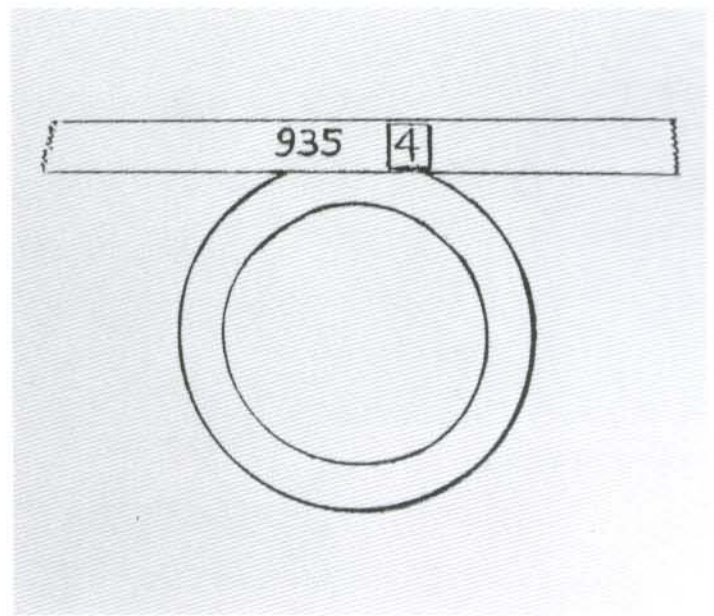

Although not to scale, this drawing illustrates the position of markings in the photo at left.

SS UNIFORMS, INSIGNIA & ACCOUTREMENTS



935 marking is also on the suspension ring.

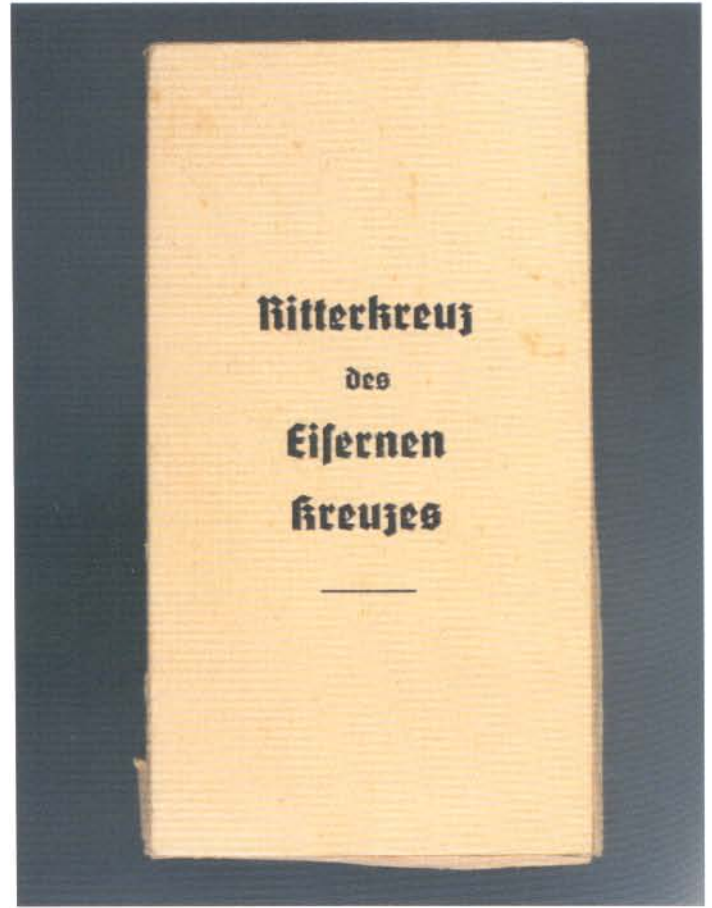

ABOVE and BELOW: Knight's Cross issue box with Steinhauer & Luck, Ludenscheid markings on the end.



Detail of the top edge.

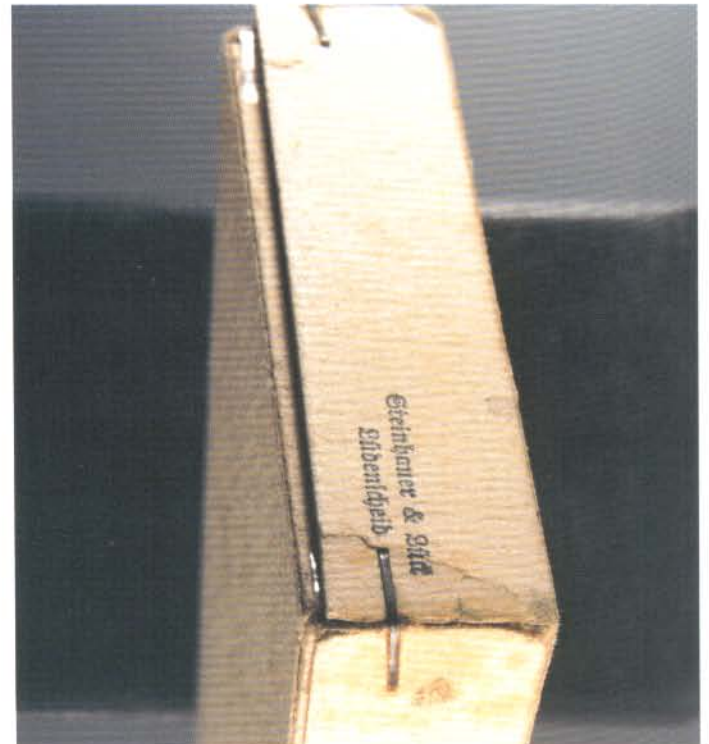

CHAPTER 6: MEDALS AND BADGES

The second Knight's Cross example is marked "800." It could have been made by C.E. Juncker-Berlin, Deschler & Sohn-Munich, or Steinhauer & Luck-Ludenscheid.



Note "800" under ring.

SS UNIFORMS, INSIGNIA & ACCOUTREMENTS

The Oak Leaves

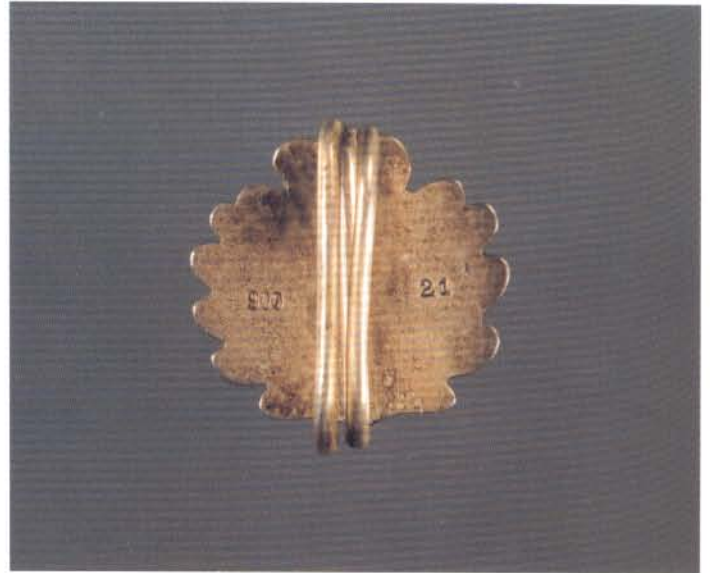

The Oak Leaves and Swords

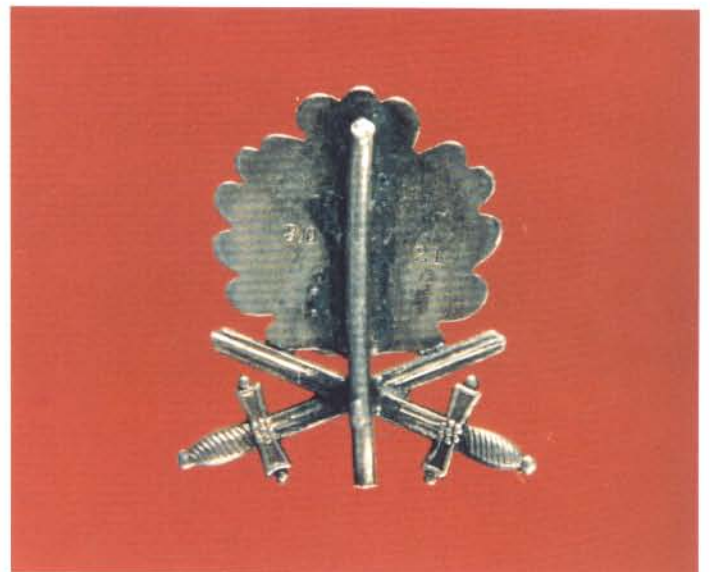

The ring has been clipped off of this example.

CHAPTER 6: MEDALS AND BADGES

The Iron Cross First Class

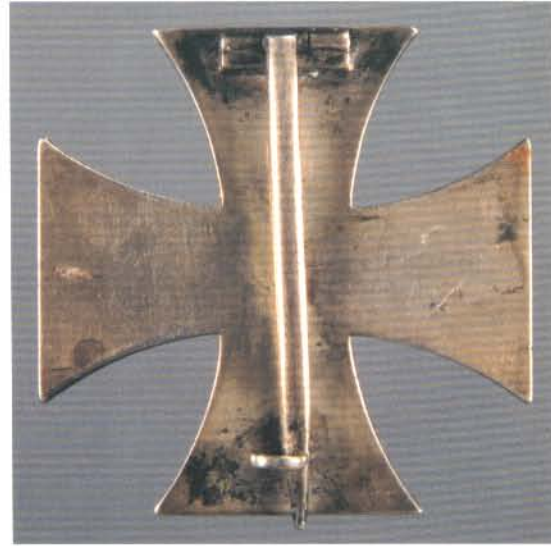

Front and back – this example is a First World War Iron Cross First Class. Many World War I veterans wore this medal on their SS uniforms in the pre-World War II years. The World War II issue medal was identical in appearance except it had a swastika in the center and "1939" at the bottom. The Imperial Crown was also removed.

The Iron Cross Second Class



World War II example as issued.



World War I example with 25 year cluster.

SS UNIFORMS, INSIGNIA & ACCOUTREMENTS

The German Cross

The German Cross was instituted September 28, 1941 to bridge the gap between the Iron Cross First Class and the Knight's Cross. It was awarded in gold to combatants and in silver to recognize distinction in military leadership – not in the face of the enemy.

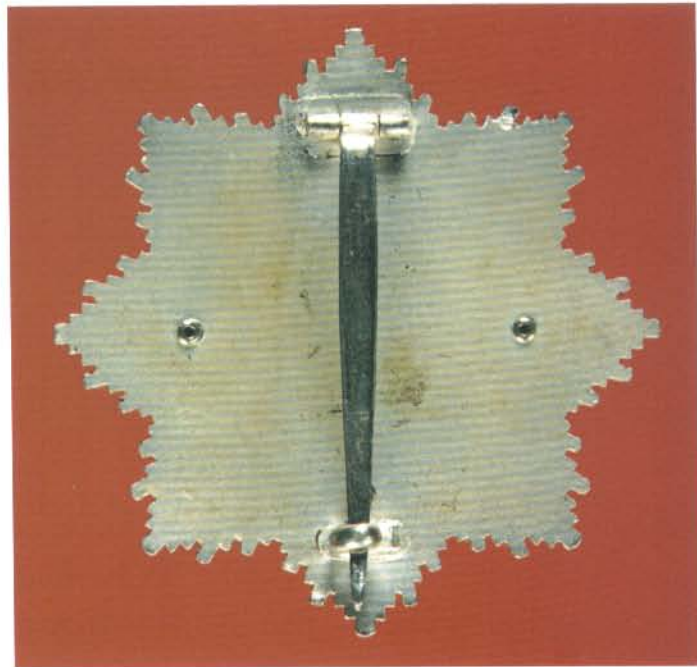

Front and back – The German Cross in gold.



Front and back – stick pin of the German Cross in gold.

CHAPTER 6: MEDALS AND BADGES

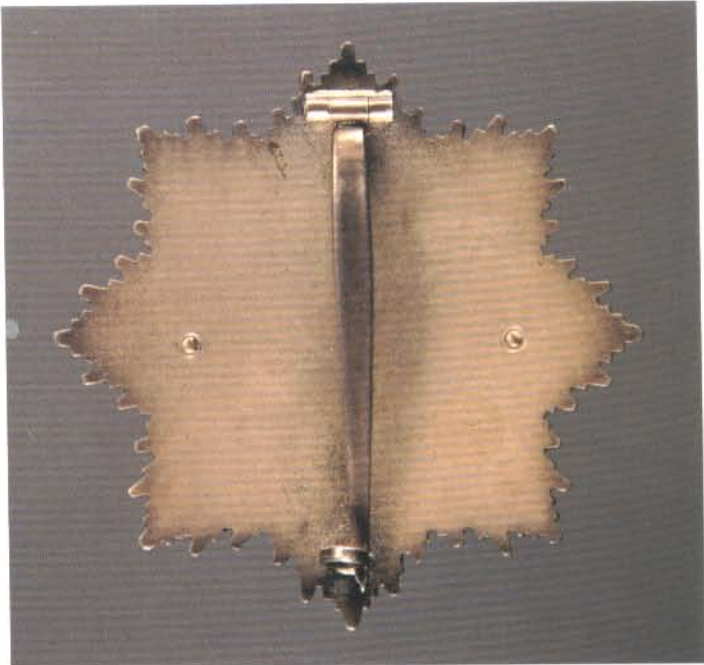

Front and back – the German Cross in silver.



Front and back – stick pin of the German Cross in silver.

SS UNIFORMS, INSIGNIA & ACCOUTREMENTS

1939 Bar to 1914 Iron Cross (Spange)

This bar was awarded to recipients of the Iron Cross in the First World War who were awarded the same grade again in World War II. The Bar or Spange was awarded in 1st and 2nd class.



The 2nd Class Bar in issue box – front and back.

The War Merit Cross

The War Merit Cross was instituted to recognize war effort contributions other than in battle. It was awarded in five grades: Bronze War Merit Medal, Second Class Bronze Cross, First Class Silver Cross, Silver Knight's Cross and Gold Knight's Cross. Each grade was awarded with swords (for military contributions) or without swords (for contributions such as propaganda, administration, etc.). Only two classes of this decoration are shown.



Knight's Cross in silver with swords.

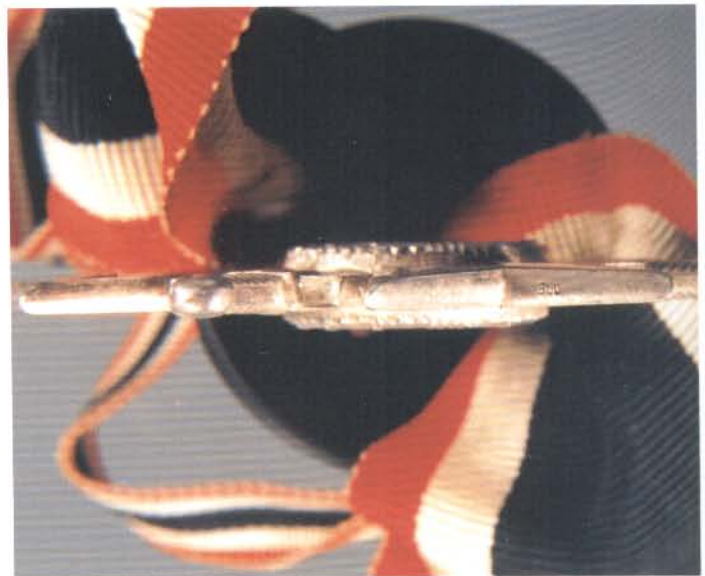

Note "900" mark on edge.

CHAPTER 6: MEDALS AND BADGES



Front and back detail.

The Knight's Cross in silver without swords.



SS UNIFORMS, INSIGNIA & ACCOUTREMENTS

The Wounded Badge

The Wounded Badge was awarded in three classes: Black (for one or two wounds), silver (for three or four wounds) and in gold (for Five or more wounds). The silver could be awarded for loss of an eye, foot, hand or deafness. The gold could be awarded for disablement or blindness.



The Wounded Badge in silver. The black and gold badges differed in frontal appearance in color only.

Infantry Assault Badge



Infantry Assault Badge in silver for infantry and mountain infantry. Motorized Infantry Assault Badges were awarded in bronze.

General Assault Badge

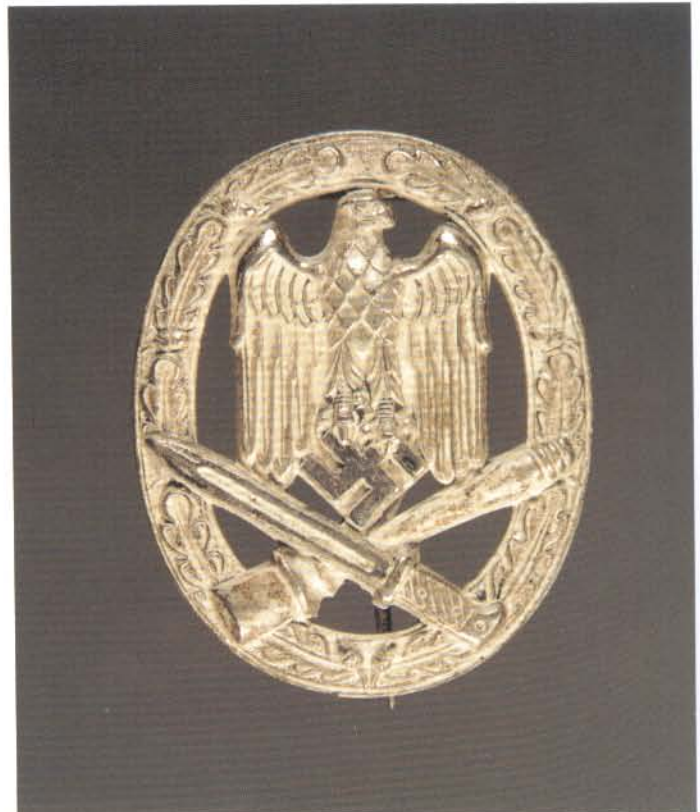

CHAPTER 6: MEDALS AND BADGES

Tank Battle Badge

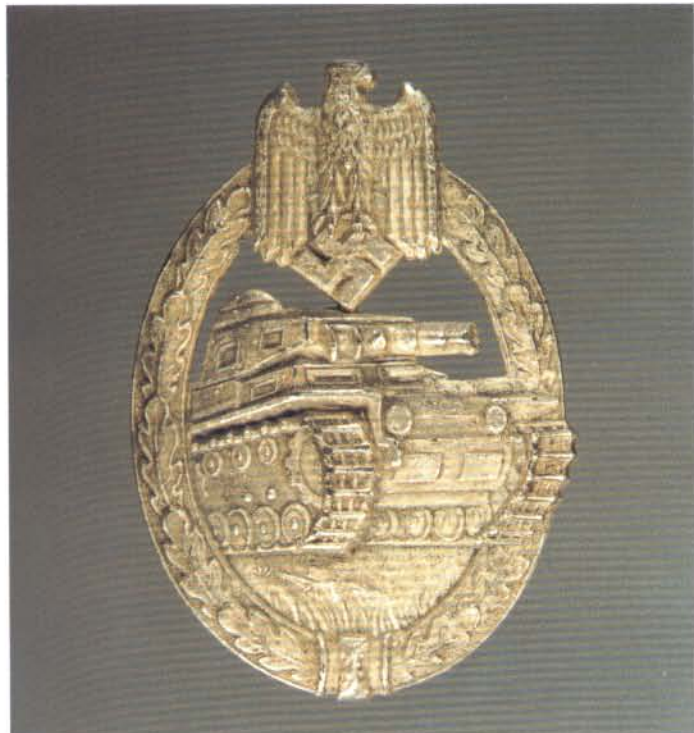

Tank Battle Badge in silver for tank crews.



Tank Battle Badge in bronze for "Panzer-Grenadier" and other armored fighting vehicle personnel.

Close Combat Clasp

The Close Combat Clasp was awarded in three grades: bronze, silver and gold for 15, 30 and 50 days, respectively, engaged in close combat.



Front and back – Close Combat Clasp in bronze.

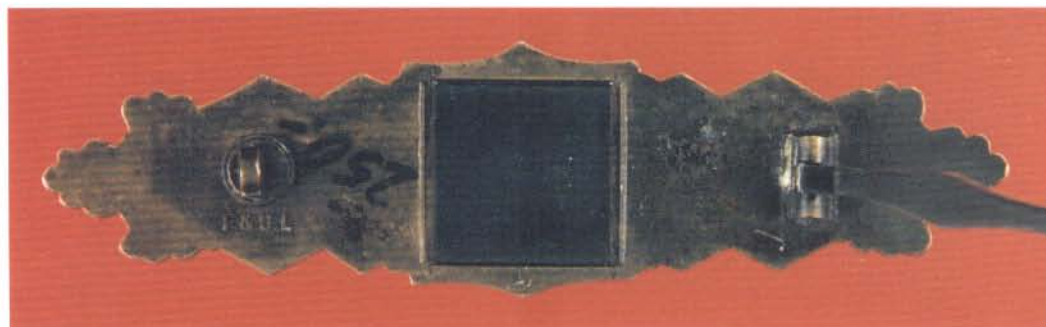

SS UNIFORMS, INSIGNIA & ACCOUTREMENTS



Front and back – Close Combat Clasp in silver.



Front and back – Close Combat Clasp in gold.

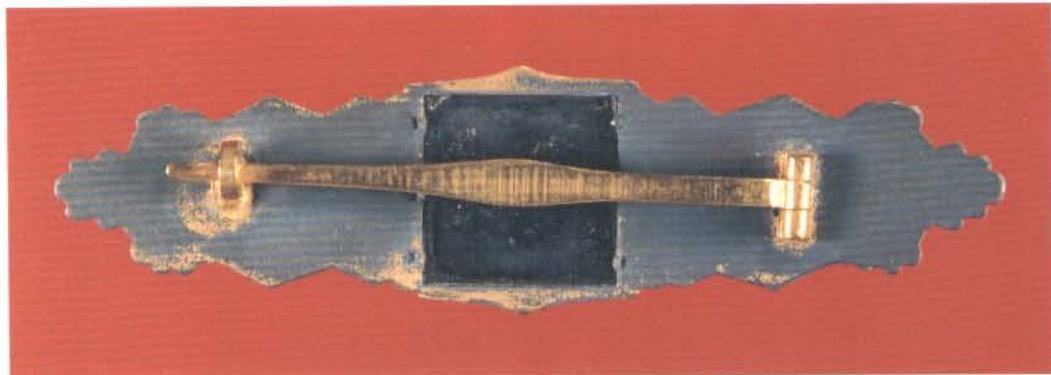

CHAPTER 6: MEDALS AND BADGES

Shield Badges

Shield Badges were awarded to members of the Armed Forces who took part in a number of battles. They were worn on the upper left sleeve of the uniform. Shield Badges awarded include: Narvik, Cholm, Crimea, Demjansk, Kuban, Warsaw, Lorient and Lapland. Warsaw and Lorient were not produced in any quantities.

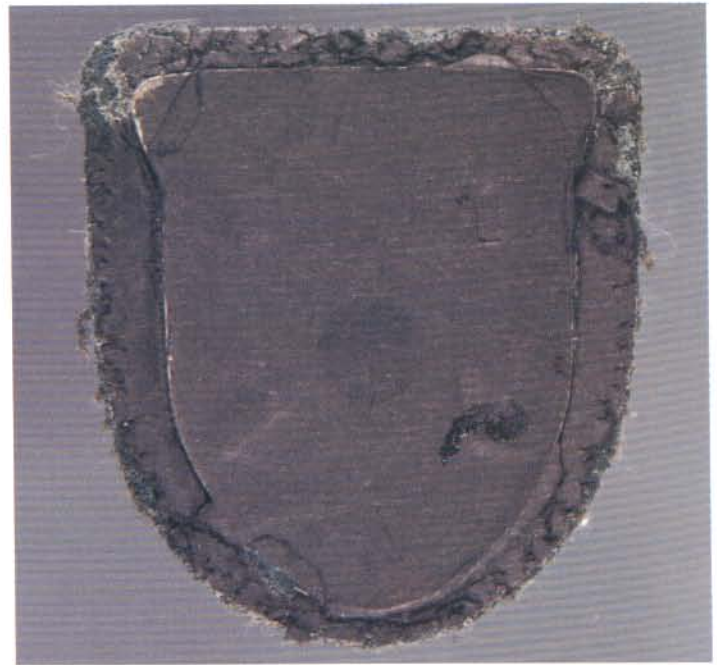

Crimea (Krim) Shield – front and back.



Commemorative Medal of 1 October 1938 "Entry into Sudetenland", with Prague Castle Bar.

SS UNIFORMS, INSIGNIA & ACCOUTREMENTS



Medal for the Winter Campaign in Russia 1941-1942. LEFT: Front and back as issued. RIGHT: Issue envelope.



The Italo-German Campaign Medal in Africa 1941

SS UNIFORMS, INSIGNIA & ACCOUTREMENTS

Identification Documents



CHAPTER 7: DOCUMENTS AND PAPER ITEMS



Standard Cover –
SS Soldbuch

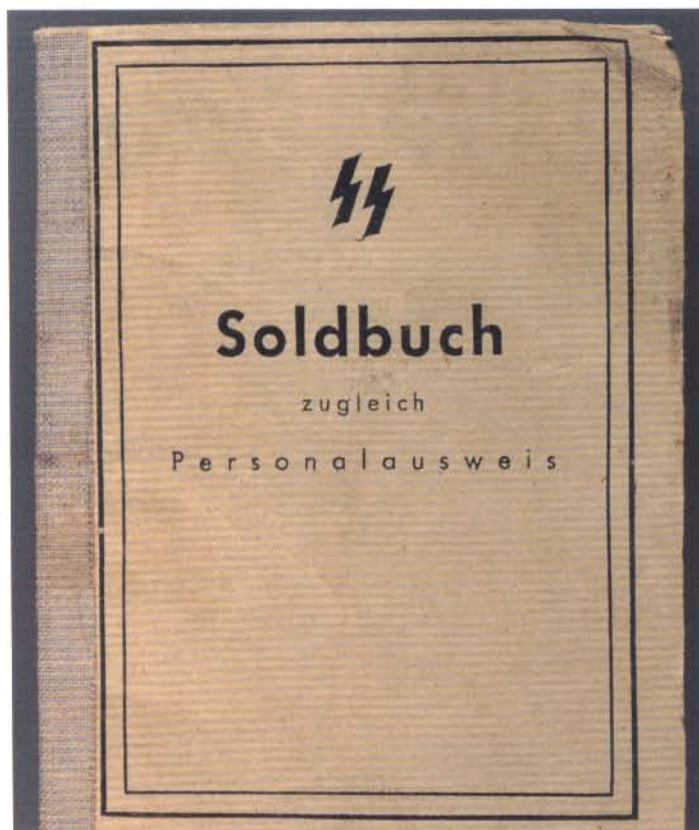

SS UNIFORMS, INSIGNIA & ACCOUTREMENTS



ABOVE: An SS newspaper of the times.



RIGHT and BELOW: An SS Police post card.

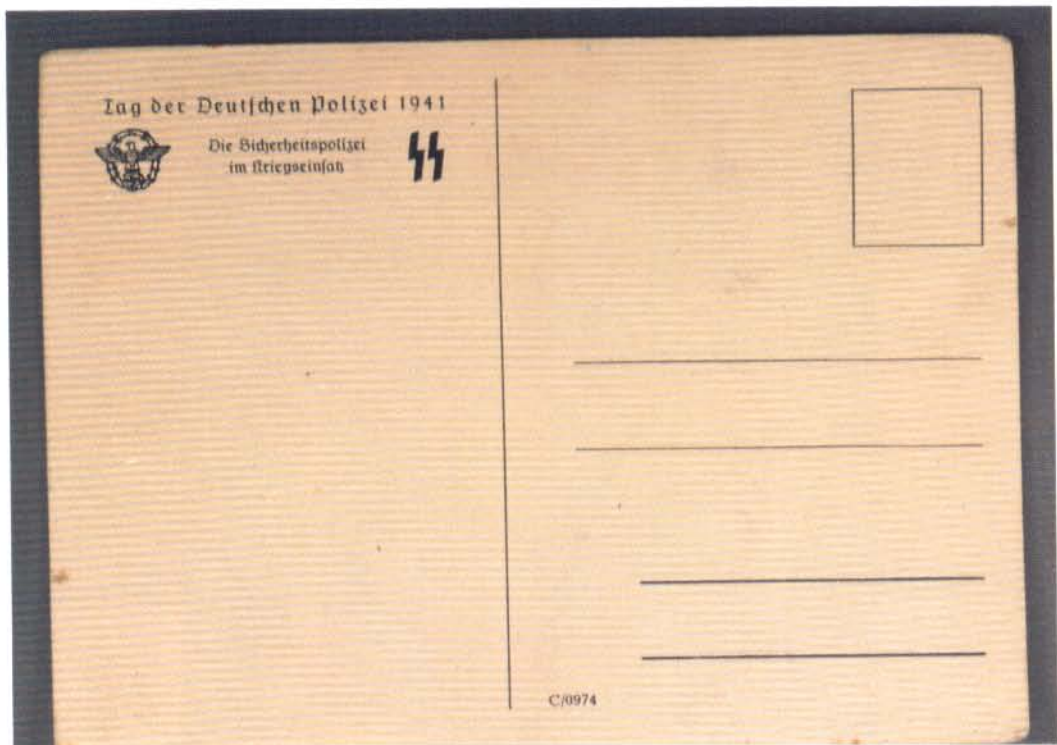

CHAPTER 7: DOCUMENTS AND PAPER ITEMS

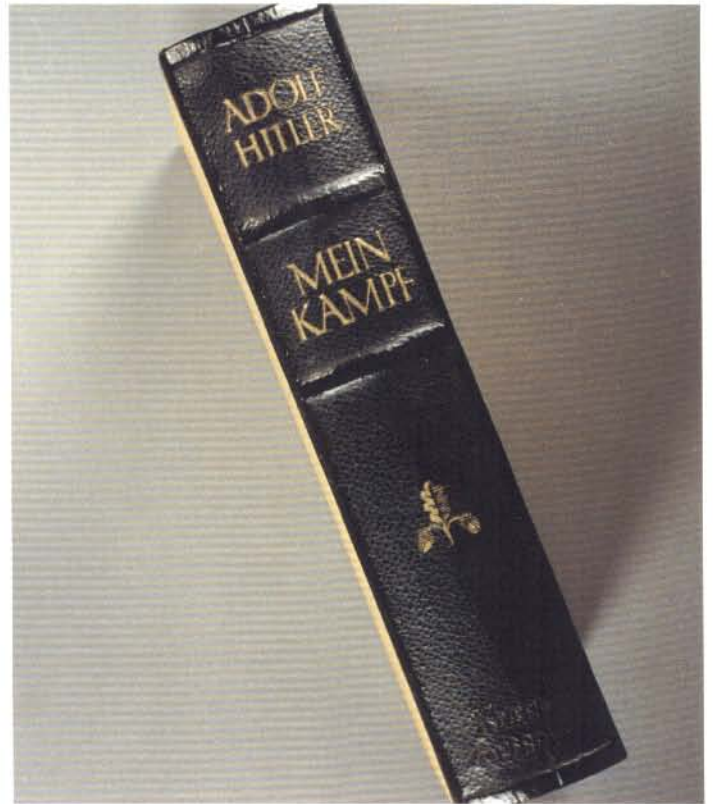
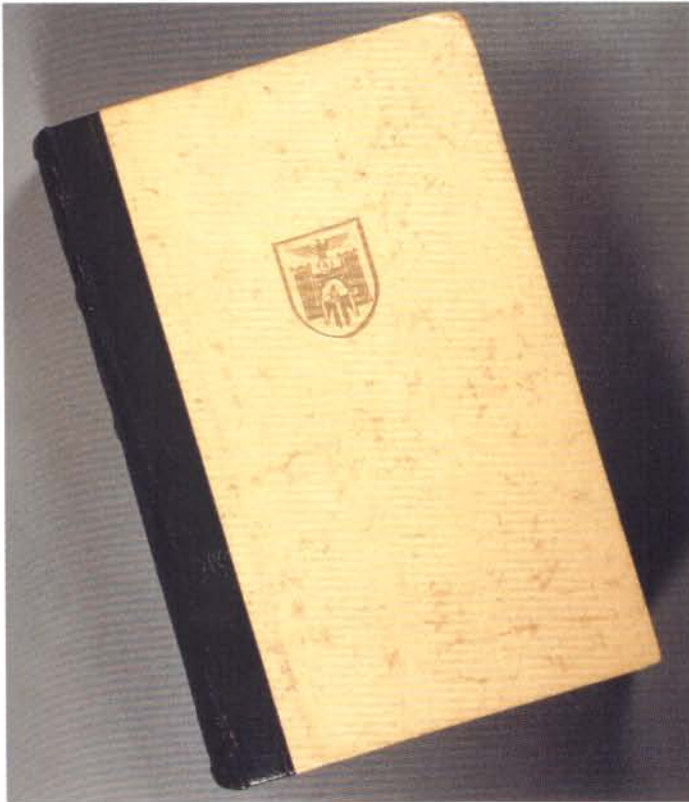

A period edition of "Mein Kampf " by Adolf Hitler.

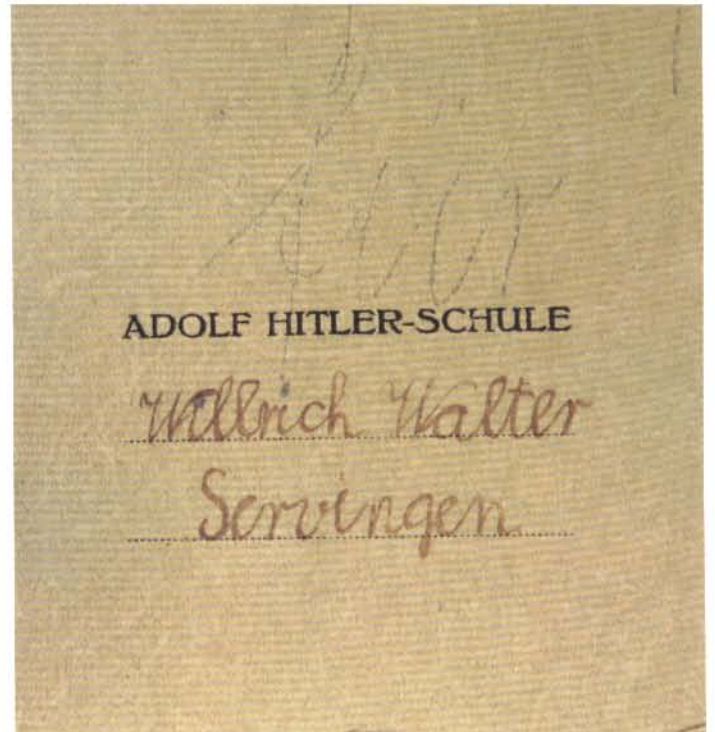
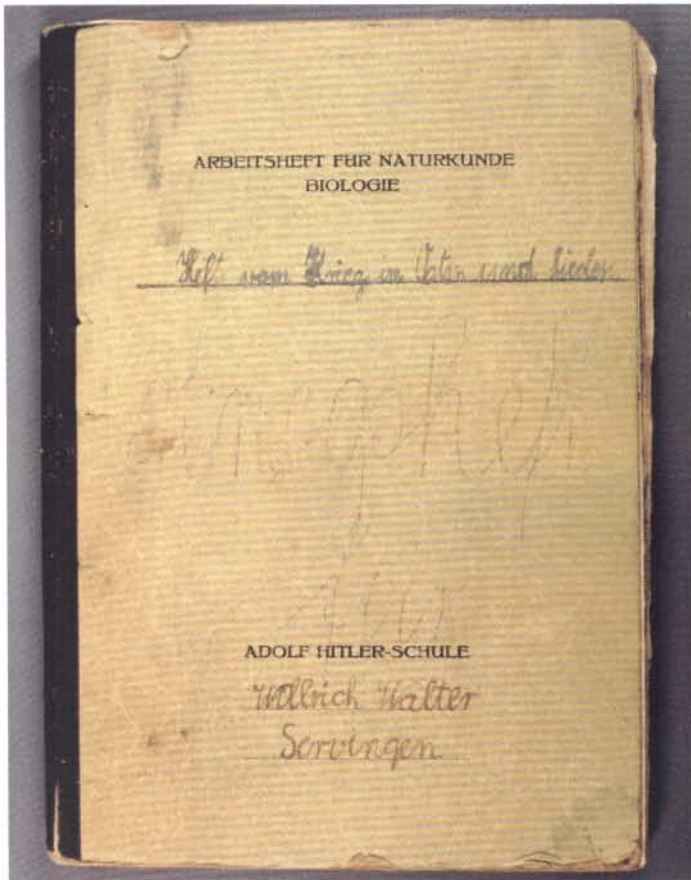

LEFT and ABOVE: A school-age child's biology workbook from Adolf Hitler School.

SS UNIFORMS, INSIGNIA & ACCOUTREMENTS



An example of letterhead.

The next five photos show examples of envelopes with SS markings.

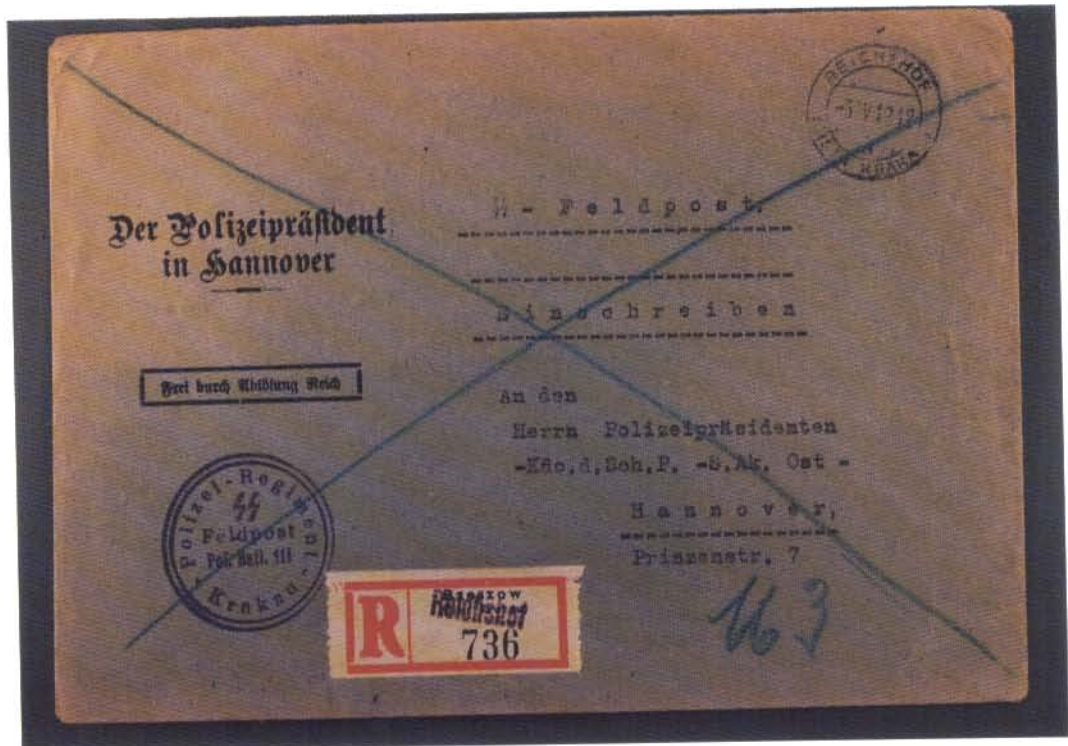

CHAPTER 8

MISCELLANEOUS REGALIA

The SS Totenkopf Honor Ring

The firm of Gahr, Marianenstrasse 3, Munich was the only authorized maker of the SS Totenkopf Honor Ring. There are no accurate records of the exact number awarded, but it is estimated that between 14,700 and 20,000 SS Totenkopf Honor Rings were awarded between 1936 and 1945.

The rings were of high silver content and the Totenkopf was separately attached. The inside of the rings were engraved with "Slb." ("SeinerLeibe" translated to "with respect and honor"), the recipient's name, date and H. Himmler. The

only markings on the original rings were the presentation inscriptions. There were no maker's or silver content markings.

The Honor Ring was awarded for personal achievement, loyalty and duty to Der Führer's ideologies.

Two examples of the Honor Ring are presented here. The first example was presented 21.12.43. The following series of photographs illustrates the Honor Ring from five angles so the reader can see the various Nordic ritual symbols in the ring.



SS UNIFORMS, INSIGNIA & ACCOUTREMENTS



The ring beside it's issue box.

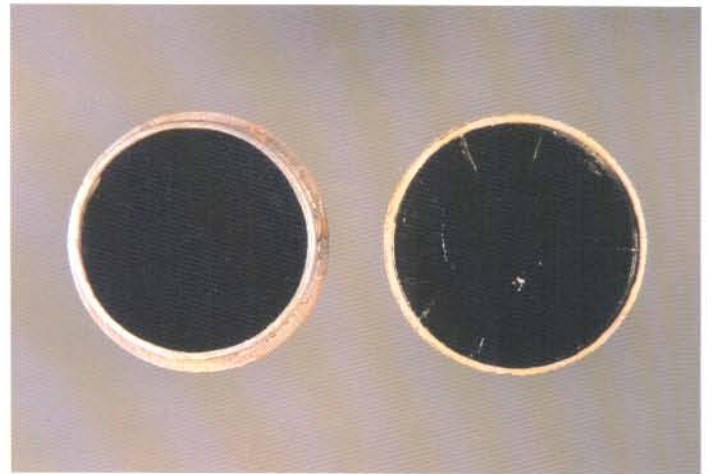

The interior of the issue box.



Note the seam where the skull is separately applied.



The date 21.12.43 is visible inside the ring.



"H. Himmler" signature engraving is visible inside the ring.



Recipient's name engraved inside.

CHAPTER 8: MISCELLANEOUS REGALIA

The second example is well worn and was issued to Officer Hardieck on 20.4.40 (Hardieck's Allgemeine uniform is pictured in Chapter I).



The well worn Honor Ring of Officer Hardieck.



Although heavily worn, it is still obvious that the skull is separately applied.



The engraving is still clear inside Hardieck's ring



SS UNIFORMS, INSIGNIA & ACCOUTREMENTS

Late war SS Honor Ring presentation document.

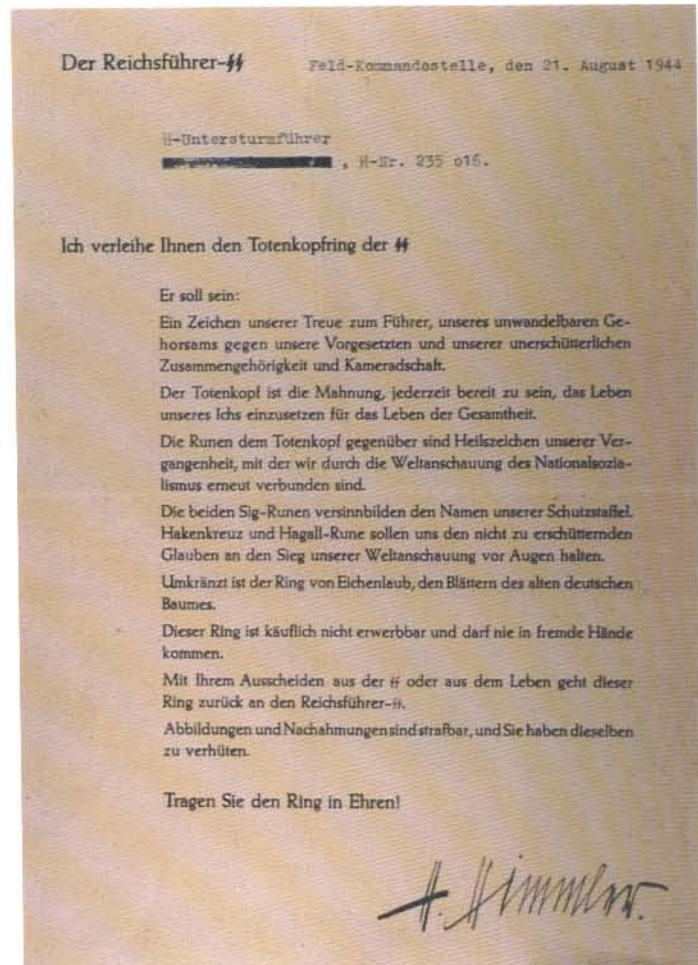

TWO BELOW: Details of presentation document.

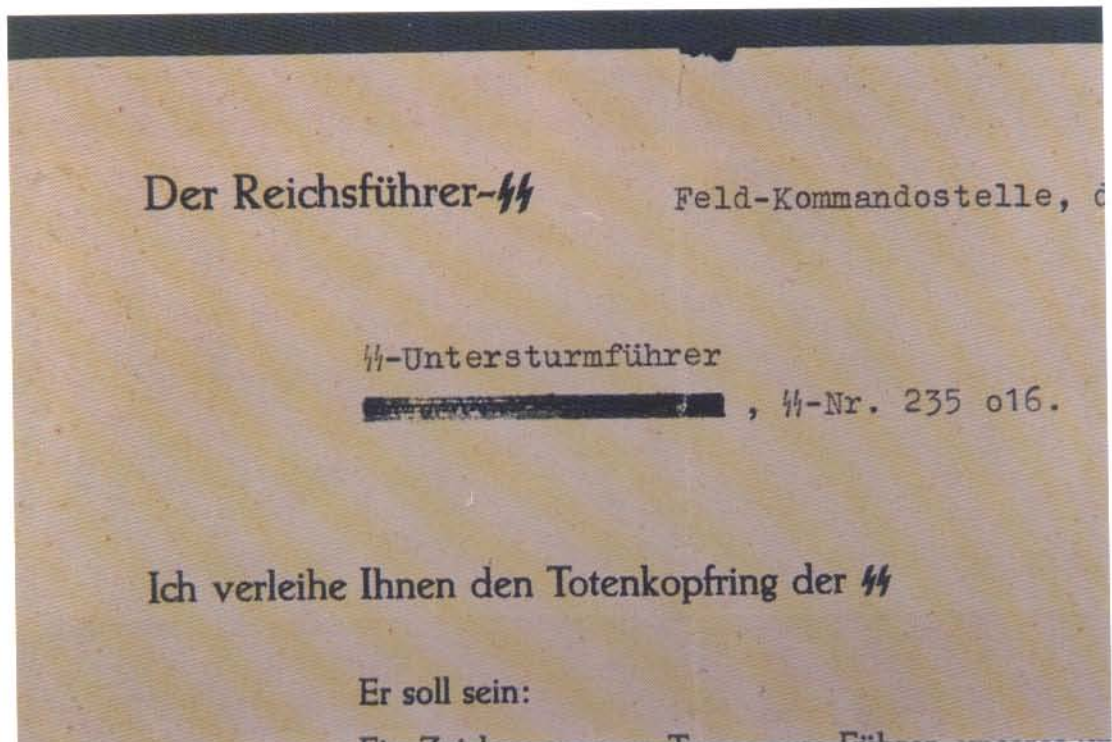
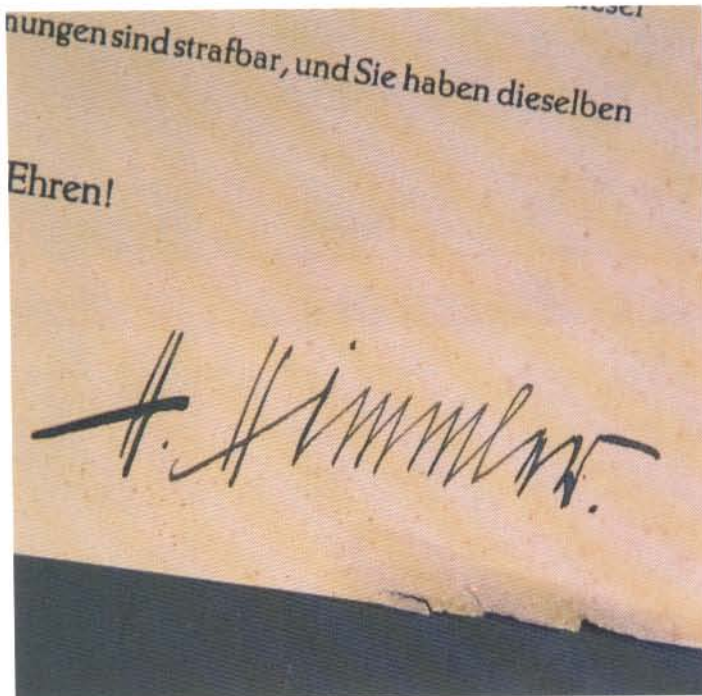

CHAPTER 8: MISCELLANEOUS REGALIA

SS Female Auxiliaries



Field cap of an SS Female Auxiliary attached to SS-Mountain Troops (identified by the Edelweiss).



Detail of eagle.

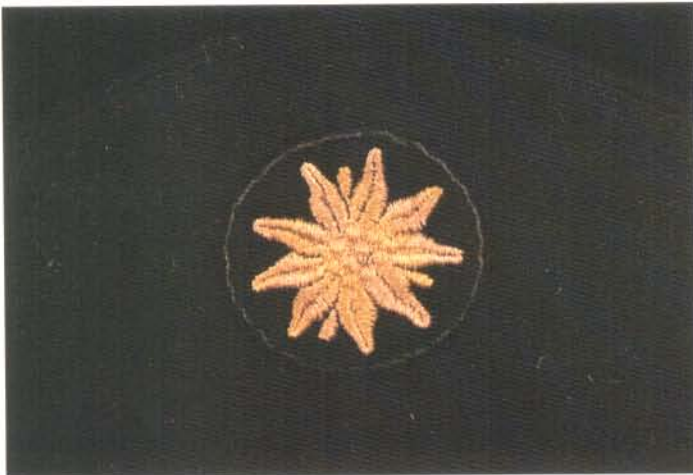

Detail of Edelweiss.

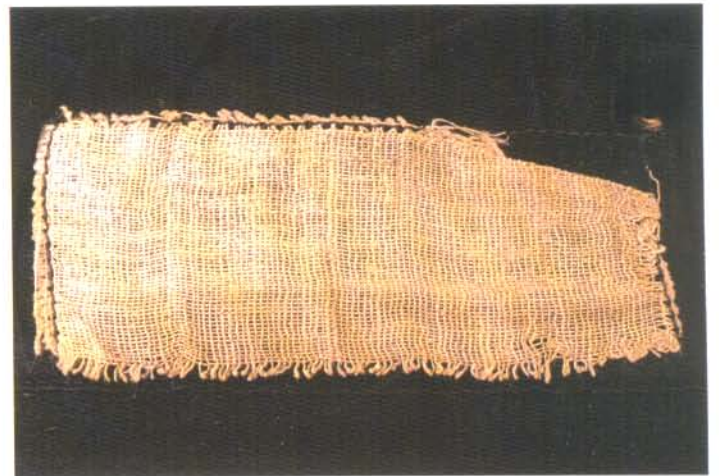

Well worn label inside female field cap.

SS UNIFORMS, INSIGNIA & ACCOUTREMENTS



Front and back – SS runes patch worn on the left breast by members of the SS Female Auxiliary.



SS Female Auxiliary signal operator's sleeve band.



Front and back – SS pin.

CHAPTER 8: MISCELLANEOUS REGALIA

SS Musicians



LEFT and ABOVE: Front and back – SS belt in white leather for drummer. Note the drum hanger on the wearer's right front, below the waist belt.

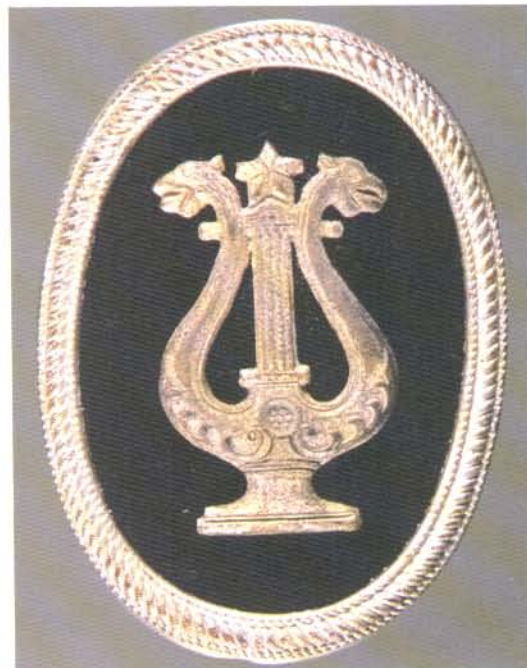

RIGHT: Front and back – SS Bandsmen sleeve band.



SS UNIFORMS, INSIGNIA & ACCOUTREMENTS



SS markings on white leather drummer's belt.



Front and back – details of SS drum hanger.

CHAPTER 8: MISCELLANEOUS REGALIA

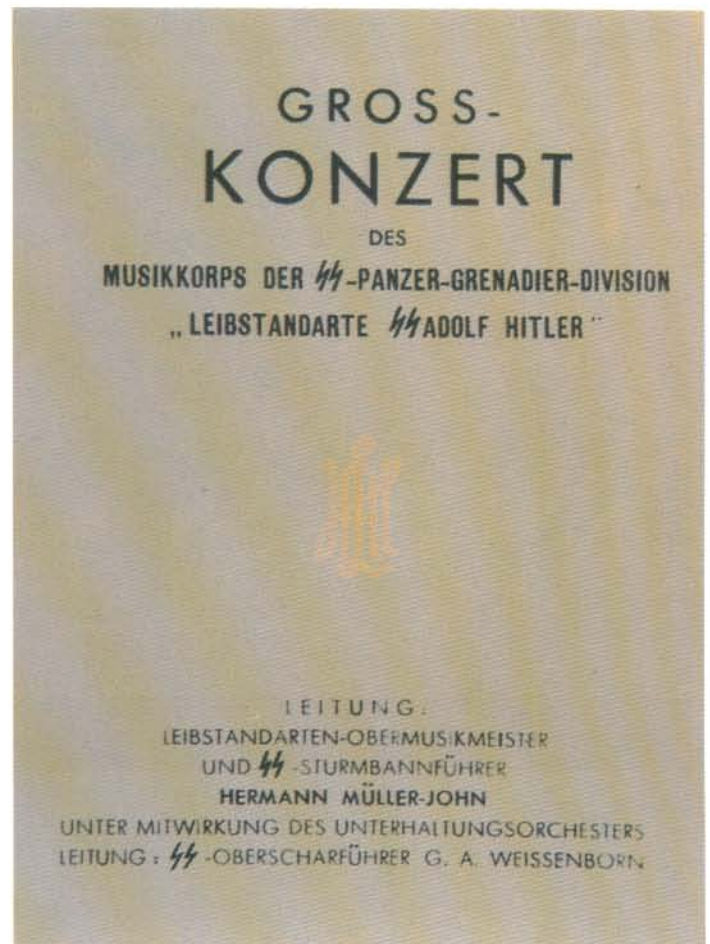

Front cover of a music program of the SS-Panzer Grenadier Division Liebstandarte SS Adolf Hitler. Detail of title page.



Inside cover of music program.

SS UNIFORMS, INSIGNIA & ACCOUTREMENTS

SS Standard Bearer's Regalia

The SS Standard Bearer's Gorget.



Front and rear.



CHAPTER 8: MISCELLANEOUS REGALIA



Standard bearers sling and gorget in place on a uniform.



SS markings on the over the shoulder flag carrier.



SS gauntlets.

SS UNIFORMS, INSIGNIA & ACCOUTREMENTS

The Standard

Some components of a political standard are presented here for reference. Although not an SS Standard, most of the components and construction details are the same.



Top piece, box, tassels, and flag components of a political standard. The top piece, tassels, and cloth flag components are identical to the SS Standard.

SS UNIFORMS, INSIGNIA & ACCOUTREMENTS



"Otto Gahr" appears at the base of the wreath on the back side.



The base of the wreath is dated "1923" on the front side.



An early (1933) handmade SS Banner.

CHAPTER 8: MISCELLANEOUS REGALIA



SS Vehicle Pennant.



SS ceremonial candle holder.



SS markings on the bottom of a piece of tableware designed to hold salt and pepper shakers.

SS UNIFORMS, INSIGNIA & ACCOUTREMENTS

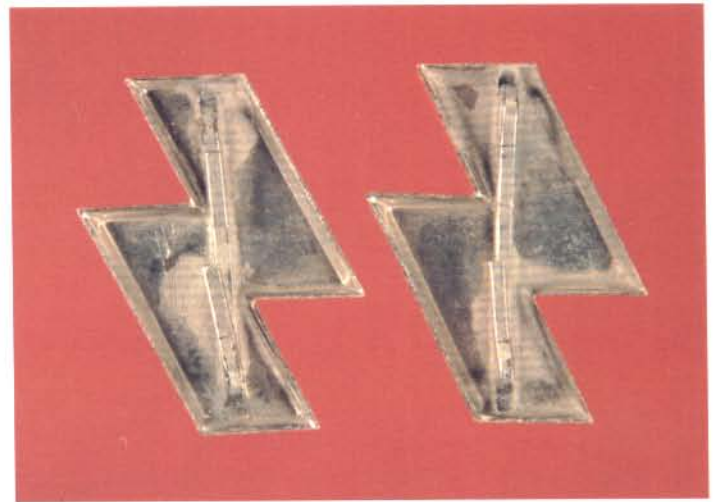
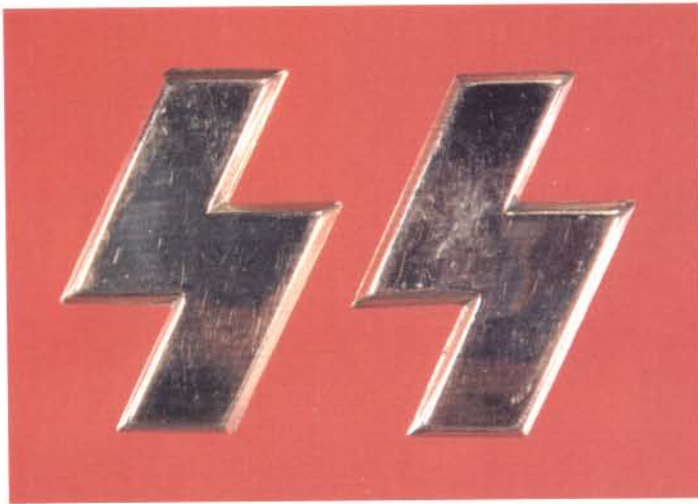

These metal runes are for the cover of a booklet or photo album.



A privately purchased officer's baton with ivory tips. Note the inlay details.

CHAPTER 8: MISCELLANEOUS REGALIA



This engraved watch was presented to a Waffen SS sharpshooter. It was brought back from the war by an American G.I.



An SS whistle.

CHAPTER 8: MISCELLANEOUS REGALIA

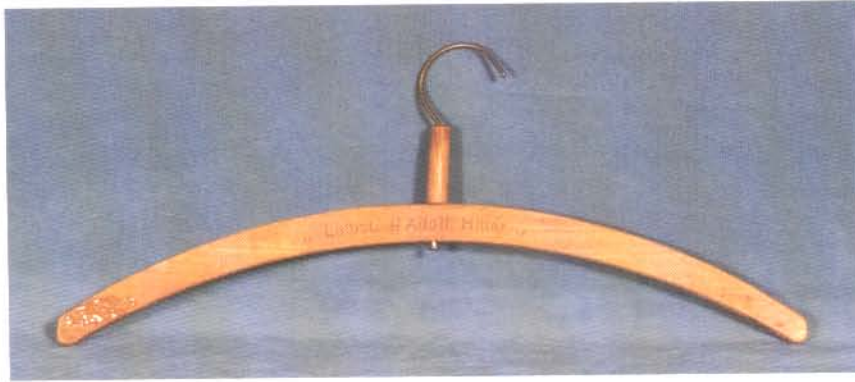

A coat hanger marked to "Leibstandarte SS Adolf Hitler." BELOW: Detail of Markings.

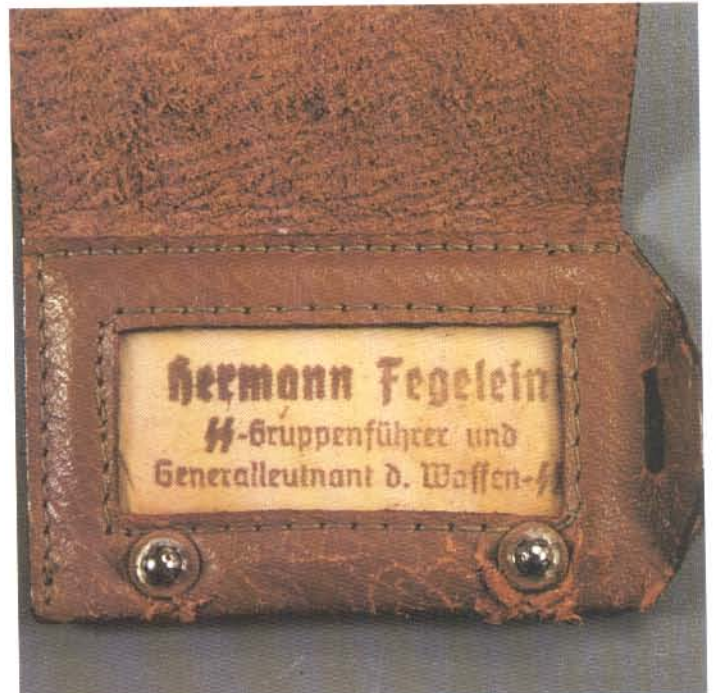
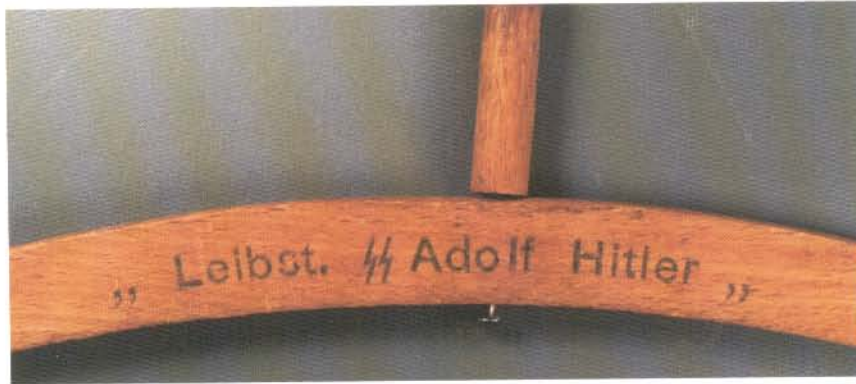

This brown briefcase is significant because it was carried by SS-Gruppenführer Und Generalleutnant der Waffen-SS Hermann Fegelein. RIGHT: Name tag from Fegelein's briefcase.