

Rockwool -The Book

How to Grow Cannabis in Rockwool

Table of Contents

Foreword

Glossary

Part I: Introduction

1. The history of cannabis

1.1. Preface

1.2. The journey

1.3. Marijuana in the Netherlands

2. Physiology of plants

2.1. Preface

2.2. Principles of growth

2.3. Osmotic processes

2.4. Intake and circulation of materials

2.5. Factors influencing the growth of plants

Part II: Necessities and climate control

3. Necessities and basic installations

3.1. Preface

3.2. The growing space

3.3. Shopping list

3.4. Growing space layout

4. Light

4.1. Preface

4.2. Choice of lamps

4.3. Using high-pressure gas lamps

4.4. Proper lighting for cannabis

5. Air

5.1. Preface

5.2. Influencing air quality

5.3. Relative humidity

5.4. Temperature

6. Water

6.1. Preface

6.2. Water quality

6.3. The irrigation system

Part III: Growing cannabis

7. Plant growth

7.1. Preface

7.2. Cloning hemp

7.3. The vegetative phase

7.4. The generative phase

7.5. Harvesting and drying

7.6. Skuff

7.7. Setting up the garden again

8. Diseases and insects

8.1. Preface

8.2. Diseases

8.3. Pests

8.4. Summary

Foreword

The number of people who grow cannabis for themselves keeps increasing. Some of them raise it in a small, modest garden for their own use; others for commercial reasons. A great deal of experimentation has been done with cannabis in The Netherlands, and through the years, further improvement took place.

Dutch weed can measure up to the best foreign varieties. After growing only in soil for years in The Netherlands, other growing methods can expect new interest. Some people grow on hydro-culture (granules), but also, growing on rockwool substrate occurs more and more. It is a clean, efficient way to raise cannabis. Relatively little has been written about growing on rockwool. Surprising, on the face of it, because in professional horticulture rockwool is being used since long. Growing cannabis on rockwool appears to go very well.

Who would have expected anything else from this indestructible weed? For this book, we have drawn from the experience of growers of the produce we ordinarily buy from the green grocers. The specific expertise of professional weed-growers is also used. Their advice is appreciated; - without mentioning any names. This book is meant for everyone who wants to grow cannabis at home. The emphasis is on growing on rockwool substrate, and on (semi-professional) climate control in the grow space. The first section takes a look at to the wanderings of cannabis throughout the world, and to how plants, in general, are cultivated. The second part is principally concerned with what is needed for growing cannabis indoors, and about the details of climate control. The third section deals with growth itself, with attention paid to plant diseases and insect pests.

We wish the reader enjoyable reading, lots of success at growing, and again, much pleasure with use

Middelburg, August, 1994

Luuk ter Aarde

Glossary

Acidity - Defines the measure for the uptake of nutrient salts by the plant. Acidity is indicated by the pH value.

A pH value of 5.8 is ideal for the cultivation of cannabis.

B - Abbreviation for boron, a material necessary in very small quantities for the growth of cannabis.

Blue light - Light given out by mercury-iodide lamps which is necessary for the formation of chlorophyll in plants.

Blue light has a wavelength of approximately 445 nanometers

Ca - Abbreviation for calcium; necessary for osmotic processes in the plant

Chlorophyll - The official name for 'leaf-green'. Chlorophyll gives the plant its green color, and is important in the conversion of CO₂ and H₂O into glucose.

Clones - Weed-growers' jargon for cuttings.

CO₂ - The chemical formula for carbondioxide; next to water, the most important basic material for the growth of plants.

C₆H₁₂O₆ - Chemical formula for glucose, the basic material used by plants for growth and flowering.

Dark Part of photosynthesis. During response, the dark reaction, the actual formation of glucose from water and carbondioxide takes place.

Deficiency Plant disease brought on by the disease-application of too little of a certain fertilizing material.

EC - Electrical conductivity. The electrical conductivity standard of water, which can be measured with an EC meter, tells whether or not the composition of the fertilizer is correct

Fe - Abbreviation for iron; an element in the nutrient solution.

Generative phase - The flowering phase of plants. When cannabis is cultivated indoors, this phase begins, at maximum, one week to ten days after a clone with roots is planted, and continues, depending on the variety, two to three months.

GH - Abbreviation for 'German hardness', a scale for the hardness of water (namely the quantity of calcium) indicated in degrees.

High- Cultivation under artificial light pressure makes use of high-pressure gaslamps. They give out the desired quantity of light with the desired wavelength. (High-pressure sodium lamps - red light for growth, mercury-iodide lamps -blue light for the formation of chlorophyll.)

H₂O - Chemical formula for water, consisting of two parts hydrogen(H), and one part oxygen (O).

Hygrometer - A meter with which the relative humidity can be established<P>

Hygrostat - An apparatus which maintains correct relative humidity. A good hygrostat keeps the relative humidity constant in a room.

Internode - The distance between the leaves and the tops of a plant. When light only from the red spectrum is applied during the generative phase, the internodes become longer.

K - Abbreviation for potassium, which is, next to nitrogen and phosphate, one of the primary nutrients for plants.

Light Part of photosynthesis in which response photolysis takes place. Photosynthesis also includes the dark response, in which the actual formation of glucose occurs.

Lumen - The international measure for luminosity from a light source.

Ma - Abbreviation for manganese, an element used in very small quantities by plants.

Membrane- Membrane allowing small molecules to pass through but not the larger ones.

Mg - Abbreviation for magnesium, an element plants need for the build-up of chlorophyll, and for osmotic processes.

Micro-element - Nutrients the plant only barely needs; for example, copper and zinc.

Millisiemens- The international measure for electrical conductivity.

Nanometer - Measure of length used to express the wavelength of light. Red light travels at a wavelength of approximately 650 nanometers(nm), blue light at

approximately 450 nm.

A nanometer is one thousand millionth of a meter(10⁻⁸m).

NPK - Abbreviation for nitrogen (N),phosphate (P), and potassium(K), the three primary nutrients for plants.

Osmosis - The phenomenon in which water containing a dissolved substance of a low concentration is absorbed via a membrane into water which contains substances of higher concentrations (for example in plants).

Osmosis is very important to plants for sturdiness, and for the transport of water and nutrient materials.

Pressure is built up by osmosis, making the plant sturdy. If this pressure falls, the plant loses its sturdiness.

P - Abbreviation for phosphate, one of the three primary nutrients.

pH - The pH is a measure of the acidity of a solution (for example, water with nutrients). The pHscale goes from 0 to 14.

The lower the pH value, the more acidic the solution

Photolysis - Part of photosynthesis, in which water (H₂O) is split up into hydrogen (H), and oxygen (O).

This occurs during the light response.

Photosynthesis - The chemical process in plants, in which carbondioxide and water are converted into glucose by the influence of light energy

Phototropism- The inclination, which plants have, to grow towards light<P>

Physiology - The science of growth. (Plantphysiology is the science concerned with the growth and flowering of plants)

ppm - 'Parts per million'.

The amount of material in the air, of CO₂, for example, is expressed not only in percent, but also in ppm. 0.03% CO₂ in the air is equivalent to 300 ppm.

Predator - A predator is an insect that protects plants against other insects such as spider mites, white flies, and thrips.

Red light - Light needed by plants in order to grow. Red light has a wavelength of approximately 650 nanometers.

RH - Abbreviation for relative humidity. The relative humidity is expressed in %, and measured with a hygrometer.

S - Abbreviation for sulphur, a nutrient which plants need only in small quantities.

Salts - Nutrients, such as NPK, but also other materials (Ca, Mg, etc.) which are dissolved in water so they can be fed to the plant. We call the solution of such materials salts.

Semi-permeable walls/membranes permeable - Play a role in osmotic processes in plants by which the transport of water and nutrients takes place, and the plant gets its strength.

Skuff - Sifted tops, from which you get as-pure-as-possible THC.

Stoma - An organ in the leaves of plants. The stomata allow the plant to breathe. Oxygen and excess water are released through the stomata.

Substrate - The 'soil'. Thus rockwool substrate means 'soil of rockwool'; the growth medium.

T-44, T-77 - Measures for sieves with which you can sift out THC resin.

THC - tetra-hydro-cannabinol.

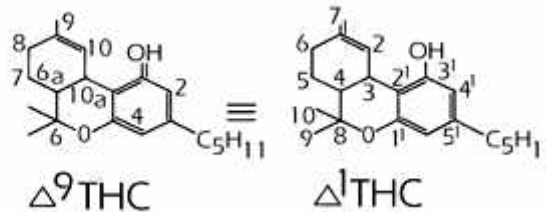

Trace-element - Another name for micro-element, nutrients the plant needs in only minute quantities, such as boron and manganese.

Vegetative- The growth phase of plants.
This lasts phase - only a short while in the cultivation of cannabis;
from one week to ten days maximum.

Zn - Abbreviation for zinc, a nutrient which plants need in small quantities.



PART I: Introduction

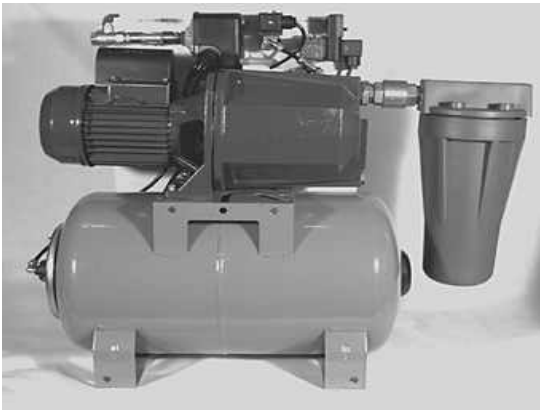

Osmosefilter

Chapter 1: A Short History of Hemp in the Netherlands

1.1. Preface

This book is not about the enjoyment of smoking or eating marijuana and hash. We can conclude that the home grower knows how to estimate the value of his or her own product, can't we? We'll just leave those stories about the nice feeling for what they are. We spend no time on the effects of cannabis products. Everyone knows what a good 'high' feels like; what you have to do, and what you sometimes have to allow to happen. This first chapter deals with the history of cannabis in the Netherlands. This way, you get a little insight into how the plant has come about in the Netherlands, and what purposes the cultivation of cannabis has served in the last centuries.

1.2. The journey

China is known principally for its tea and opium, the great number of its people, and the huge amount of Chinese restaurants. also hemp originates from China. The Chinese were already cultivating cannabis 4500 years BC. They were able to spin yarn for clothing, and make fishing nets and rope with it. The first medicinal applications were

described two thousand years later. It was used for rheumatism, gout, malaria, and a number of other disorders.



overfertilized plant

From China, hemp travelled to Arabia, and appeared in the writings of the Greek philosopher Herodote. He describes ritual use of burning hemp by the Syrian Skytes. Hemp grows everywhere. It came to Europe via India and the Roman Empire. In the Middle Ages, hemp's intoxicating effect was described by Boccaccio and Rabelais, among others. Later, it was used by Victor Hugo, Honoré de Balzac, and Alexandre Dumas in the Latin Quarter in Paris.

Scholars do not agree as to whether the Spaniards were the original importers of cannabis to America. It is certainly true that Columbus' ships were outfitted with hemp rope, and sails made from hemp cloth. The plant spread quickly in America, and at the beginning of the seventeenth century, large-scale hemp plantations proceeded in order to supply the needs of the ship- and clothing industries.

1.3. Marijuana in the Netherlands.

It wasn't any different in the Netherlands. It's not exaggerated to suggest that a considerable portion of the wealth of the Golden Age came from the cultivation of hemp. Some 11,000 ships sailed at that time, rigged with rope and sails made of hemp. Hemp was the leading agricultural product in the Netherlands; the stalk was primarily valued. The stalk, only from the male plant, was processed into hemp fiber. The female plants were used for other purposes. These were harvested later, and then threshed. The seed was used as bird feed, or was processed into oil, green soap, and raw material for paint. For the latter application, a thick pulp remained which served as animal food. After the Golden Age, less and less hemp was cultivated in the Netherlands. Competition arose from cheaper Russian hemp, along with other fibrous materials such as coconut and sisal. The steam engine made its entry, so less rope and sails were needed in the shipping industry.

Just as in other countries, the medicinal effects of the plant did not go unnoticed by its growers. Rumours had it that witches used hemp in their witches' salves. The effects of hemp had already been described in "The Herb Book" by Rembert Dodoens in the sixteenth century.

Using cannabis products for pleasure really didn't come about in the Netherlands until after the Second World War. After jazz, and later the hippie influences, marijuana smoking blew over from America. In 1962, Simon Vinkenoog a Dutch liberated poet,

wrote: 'In ten years, this will be as common as drinking whiskey or beer, or just as normal as an ordinary cigarette. And it doesn't give you lung cancer'. In the first decades, you better smoked imported hash than 'Nederweed'. Still, growing at home was so energetically pursued, that, thirty years later, Dutch weed ranks as the best in the world. There has been improvement, cross breeding, and cloning; fighting the currents, at first. Until the mid-Seventies, growing, possessing, and use of soft drugs was still punishable. Not until after the mid-Seventies tolerated points of sale originated - the coffeshops.

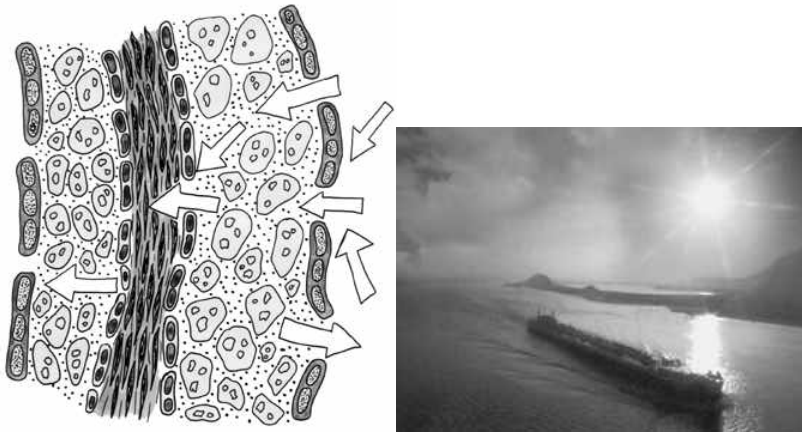

CO2 intake in the leafs Light, air and water, the bare necessities

And now it seems there's no stopping it. more and more of people use soft drugs, and more and more people try to hold down the costs of soft drug use by going to work for themselves. Sometimes, purely for their own use, sometimes to earn a few cents, sometimes to get rich.

This book has been written for the growing group of people who want to apply themselves to home cultivation. Now, this is the place to give a few warnings. In the first place, it may be generally presumed that smoking is not considered the best thing for your health. In the second place, even though the Dutch government has become more open-hearted in its tolerance of the growth, possession, and use of cannabis, the substance still stands on List 2 of the law on narcotics.

That doesn't pose a problem anymore, if it's for your own use, but for large-scale growing, possession, and dealing - it still does. Grow-gardens, green-houses, and plantations are still searched out and destroyed, and a considerable fine usually follows. Ultimately, every home grower has to gain knowledge and experience before there can be talk of a good yield. So, don't get discouraged too quickly if it doesn't go perfectly in the beginning



Chapter 2: Physiology of Plants

2.1. Preface

To achieve good results, a home grower must know about plant physiology. Plant physiology is the part of biology which is concerned with the way plants grow and flower. In this chapter, the principles of plant physiology are discussed. With the growth and flowering of plants, it involves a select combination of light, air, and water. For light, it's about sunlight for outside growing, a combination of sunlight and artificial light for greenhouses, and just artificial light for inside growing. For air, the amount of carbon dioxide (CO₂) is of principal importance. Water performs various functions. Plants need water (H₂O) for the growth process, but also to transport other important materials.

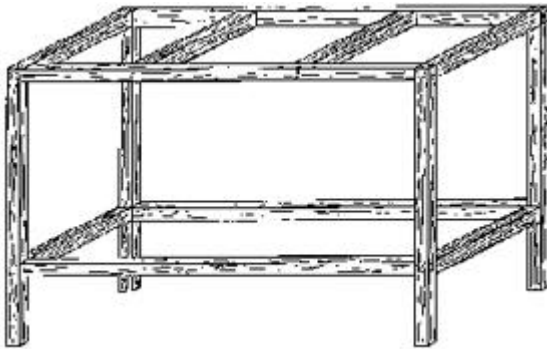

wooden frame

2.2. Principles of growth

Plants change CO₂ and H₂O into glucose under the influence of light. Glucose is the chemical building block for the structure and sturdiness of the plant. From glucose, the plant makes cellulose, the material which gives plants their fibrous structure. (Glucose is, in fact, stored light energy). The chemical process in which carbon dioxide and water are converted into glucose is called photosynthesis (from the Greek 'photos' = light, and 'synthesis' = to compose). Chlorophyll, which also gives plants their green color, is indispensable for this process. If all the conditions are right, the following chemical reaction occurs:

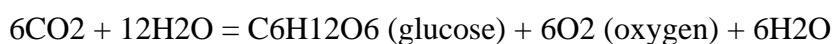

We can deduce a number of things from this formula. To get one part glucose, we need

six parts CO₂ and 12 parts H₂O. It would seem that less water is necessary. When we look at the chemical formula, six parts water are also produced next to the 6 parts oxygen, and 1 part glucose. However, research has shown that in the chemical process, 12 parts water are needed. The 'excess' water is used in the intermediate steps. The water does not re-appear until the end of the process. CO₂ is a gas in the atmosphere. There must always be sufficient carbon dioxide available, otherwise, plant growth will reduce. Everyone knows that plants need water. From CO₂ and H₂O, not only glucose, but also oxygen is made under the influence of light, by the plants with the help of chlorophyll. For plants, Oxygen is a by-product of growth. For people and most animals, it's the primary condition of life. This is a good combination. In fact, in their metabolism, animals do the converse of what plants do. They convert glucose and oxygen into carbon dioxide and water to be able to move, and to allow the heart and lungs to work, etc. CO₂, a gas which is exhaled by people, can again be used by plants for photosynthesis. It can be thought of as a cycle. The glucose made by plants is an energy source for the plant. Some processes, such as the intake of water, require energy. Next to that, glucose forms the building material for all kinds of other processes with which the plant lets all its specific properties show. It would go to far beyond the pupose of this book to look into all those chemical processes. For the reader of this book, it's about getting good results growing cannabis at home. A plant cannot grow without light, air (which contains CO₂), water, and various nutrients. The chemical process in which CO₂ and H₂O are converted into glucose and oxygen under the influence of light is called photosynthesis. When we look at this process a little closer, it actually involves two different chemical reactions. The first is called photolysis. In photolysis, water is broken down into oxygen (O), and hydrogen (H). Both light and chlorophyll are necessary for photolysis. This is called the light response. The second chemical reaction is called the dark response. As the term suggests, no light is necessary for the dark response. With dark response, carbon dioxide is converted into glucose, with the help of the hydrogen produced during the light response. The distinction between the light- and dark reaction is of interest to the cannabis home grower in order to gain insight into the manner in which the plants must be illuminated (and sometimes kept in darkness). The plants grow optimally only when a good balance is found between the light and dark reactions.

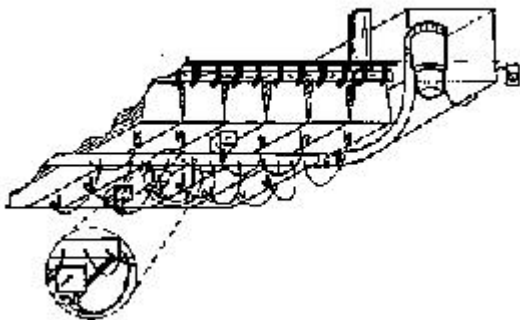

droppersystem

2.3. Osmotic processes

With osmosis, we mean the processes in which water and nutrients are absorbed by plants. Osmosis is based on the principle that the plant's walls permit some materials to

pass through, and others not. Cell walls are semi-permeable. An example: when we place a bladder with a sugar solution in a tank of water, the bladder swells. The sugar solution attracts the water. The more sugar in the solution in the bladder, the more water will be absorbed, and the pressure in the bladder will rise, but don't try this at home! Among other things, osmosis provides for the sturdiness in plants' cells. So much water is taken in that the plant cells become saturated, and the stalk and the leaves stand upright. If too little water is in supply, the plant cells give off the water; slowly, but surely. The strength is lost, and the plant wilts. Another way for a plant to lose its sturdiness is for osmosis to work in the reverse direction. If there is too high a concentration of materials in the water fed to the plant, the plant will not absorb water. It will release water, and become less sturdy. An example is the addition of too high a dosage of fertilizer to plants. With over-fertilization, plants dry out and burn . . . A second important function of osmosis is the 'hitch-hiking' of salts (nutrients) together with the water that, through osmosis, ends up in the plant cells. Nutrients are necessary to allow certain growth processes to take place. The salts also cause various kinds of plants to develop various properties. That brings flowers, fruit, and fragrances to mind. In general, plants need the following materials in a water solution: - nitrogen, phosphorus, and sulphur for the construction of cells; - magnesium to manufacture chlorophyll; - potassium, calcium, and magnesium for osmotic processes; - water for growth, for the transport of nutrients, and for sturdiness; - iron, boron, copper, manganese, and zinc as building materials. Most of the nutrients for plants are sufficiently present in our ordinary tap water. But not all. The law of minimums plays a great role in the feeding of plants. Material that is present in too small a quantity is a limiting factor on the plant's health. So-called 'deficiency disease' appears when a plant does not receive one or more nutrients. For example, a shortage of iron causes rather white leaves, while a shortage of nitrogen causes reduced growth and yellowed leaves. 'deficiency disease' involves not only the direct effect (an unhealthy plant doesn't grow well), but also impaired resistance. If needed materials are lacking, the chance for infection by moulds and vermin increases. We will discuss plant diseases more extensively in a later chapter. In order to raise healthy plants, we need further amplification of the materials which, by nature, appear in our water. This involves primarily nitrogen (N), phosphate (P), and potassium (K). A formulated combination of these materials is available in shops, and is called 'NPK solution'. We differentiate the different nutrients in order of importance. We call the most important the primary nutrients; - the NPK combination just mentioned. The secondary nutrients follow; namely magnesium (Mg), and calcium (Ca). Finally, there is a group of micro-nutrients, also called trace elements. Sulphur (S), iron (Fe), manganese (Ma), boron (B), zinc (Zn), and copper (Cu) belong to this group, among others.



overfertilized plant

2.4. Intake and transport of materials

Water, and the nutrients dissolved in it (salts), is absorbed through the root hairs of the plant. The condition of the soil plays an important role. Hard dirt allows little space for water to reach the root hairs, a looser soil has much more space, while rockwool substrate can guarantee a good water supply. Root hairs are very important. When they don't work well, the plant receives too little water and food. Growth is retarded. Root hairs are very sensitive; they can easily be damaged by exposure to air and light. Moreover, you can ruin them by careless transplanting, or just by exposure. The intake of water and nutrients requires energy from the plant, so oxygen and glucose are necessary. Ultimately, temperature is a limiting factor. Even if you take care to provide sufficient water and nutrients, the growth of the plant will be impeded if the ground temperature is too low. This is one of the reasons why most plants outside grow very slowly during the winter. The transport of water and nutrients insures that these materials end up in the leaves. Two forces are responsible for this: the suction power of the leaves, (they lose moisture by evaporation, causing suction to occur), and so-called root pressure. Root pressure can be observed when we cut off a branch of a tree in the spring. Moisture comes from the 'wound', and we call this the plant's sap. The suction force of the leaves depends on the evaporation of water through the leaves. Stomata are responsible for this evaporation process. The stomata can open and close. Next to the evaporation of water, they provide principally for the intake of carbon dioxide (CO₂) from the air. They also issue the oxygen which is produced. In the previous paragraph, we have seen that plants lose their sturdiness if they lose too much water. The stomata dispose of a mechanism to prevent that: they can close. Generally, a stoma will be open if there is light, (thus providing for CO₂ intake, and for optimal suction power of the leaves), and closed if it's dark (when no CO₂-intake, or evaporation is necessary). If the air is extremely dry (dry, hot, mid-summer days!), the stomata can also close during the day. For stomata to work properly, a clean surroundings is necessary, since a stoma can become blocked with dirt particles. Sufficient potassium (nutrients!) are also needed.

2.5. Factors influencing the growth of plants

We conclude this chapter with a summ-up of the principal concerns for the optimal growth and flowering of plants. The following factors are the most important ones: - the correct temperature; - the correct CO2 content in the air; - the correct light intensity, with the correct wavelength of the light; -the correct amount of water and nutrients - the right soil; - (for cannabis growers) the right seeds or cuttings/clones; - 'green fingers' In the second part of this book, we discuss which materials you need for growing at home. We take a deeper look into the different factors which influence growth and flowering. Summing up this comes down to an optimal control of climate.

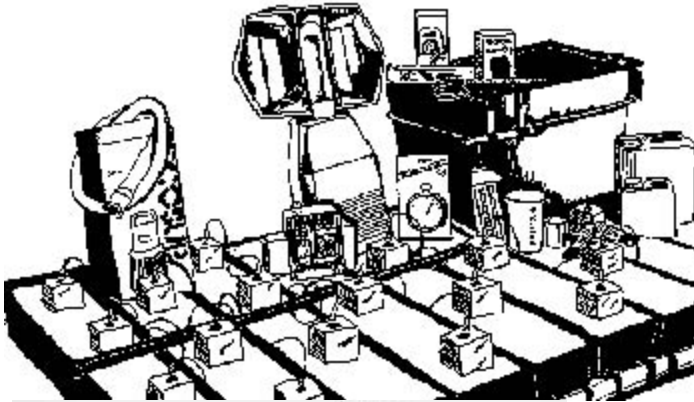

complete 2m2set



PART II: Necessities and Climate Control



Chapter 3: Necessities and Basic Installations

3.1. Preface

In this chapter, everything necessary for home-growing is discussed. After describing the conditions required for your grow room, we pay some attention to the materials you need to get started. Two things are always important: proper climate control, and complete safety. Growing plants indoors roughly involves three things: light, air, and water. After listing the necessary materials and equipment, we reveal the most important aspects about how you can achieve the best results.

3.2. The grow room

The first requirement for a grow room is that it must enable you to know how best to control the temperature, air circulation, and humidity. In any case, for good climate control, it is necessary prevent draught. For this reasons, a garage or a shed are often less suitable. If you see possibilities to make a garage or shed free of draught, then, of course, there is no objection. The grow room must be completely screened off. Make sure that everything not directly involved with growing is removed. That way, you prevent the chance for moulds and insects as much as possible. In fact, the grow room should be just as sterile as the operating room in a hospital You can only expect optimum climate control if the room is totally sealed. In practice, that means taping up windows and don't forget aal the gaps and narrow openings around doors and windows . In some cases, it is advisable to place a wall as a screen between the other activities in a room. When growing under artificial light, it is important that the walls of the grow room absorb as little light as possible. Experiments have proved that flat-white paint has the best light-reflecting properties. So, cover the walls of the grow room with matt white paint. This will maximize the light-yield per lamp. The space must also be arranged in such way that everything is within reach. That means you have to have room to walk around the tanks or tables where you're growing. It also means leaving enough space to take care of your lamps, and be able to water all the plants. A garden measuring 3x3 meters needs 200 liters of water per week, or more. All that water is not absorbed by the plants' roots, thus a drainage system is needed. The floor must be a smooth material; concrete is ideal. With other kinds of floor surfaces, it is advisable to use (white) vinyl or linoleum. Also consider an upright brim, so that water cannot leak to lower stories of the building.

Finally, it's handy to have a place to store the tools you're using. A small cupboard (painted matt white!) in the grow room is best. There's another reason to work in a well-sealed grow room: your activities should not be seen. Also, make sure that the bright lights you'll be using aren't visible from outside . . .

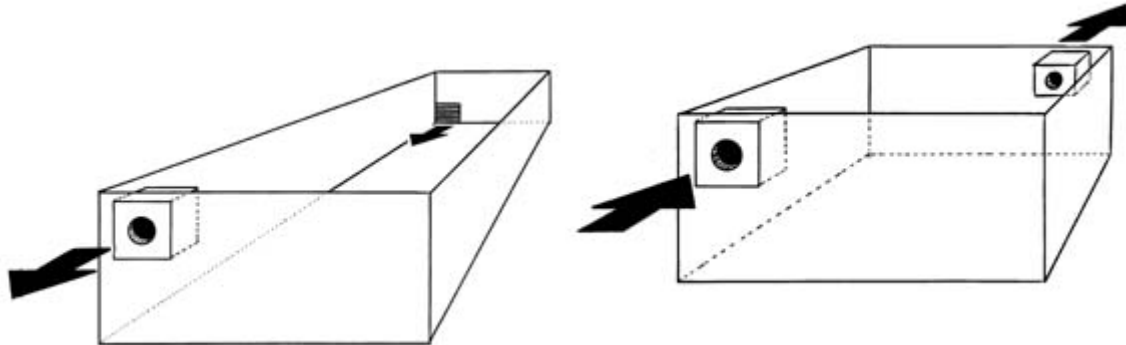

in-/outletbox
inletbox/outletlattice

3.3. The shopping list

You don't need a lot of equipment to grow cannabis on a (very) small scale. A grow tank, soil, nutrients, enough light, and an agreeable temperature make growing hemp indoors quite possible. A good alternative for growing in soil is to fill planting pots with lava stone granules, or with rockwool flakes. In order to achieve a smooth growth- and floweringprocess you must pay a lot of attention to ventilation, regular watering, proper lighting, etc. Without appliances, you have to care for the plants every day. Therefore, you have to choose between growing in soil or in rockwool. Working on rockwool is advantageous because you don't have to drag bags of soil around. Still, some weed growers swear by soil, because they think the quality of weed isn't as good if you grow on rockwool. Others see no difference. They would rather grow on rockwool, because they can achieve a greater yield. There are, however, many factors which affect the healthy growth and flowering of cannabis. 'Green fingers' are certainly not the least important. We've made a shopping list for (semi-) professional growing on rockwool substrate. Cheaper alternatives can be devised for many of the articles. We'll return to the three aspects light, air, and water later in greater detail. The materials listed below will cost between 2250, and 3000 guilders for a grow space slightly larger than two square meters:

- 3 armatures for high-pressure gas lamps;
- relay box for the lamps;
- 12 libra trays with water drainage;
- 12 rockwool slabs;
- 36 rockwool blocks 7.5 x 7.5 x 6.5 cm;
- irrigation system with an immersible pump, electric timer clock, water reservoir, air pump, heating element
- ventilator for the intake and outlet of fresh air and the discharge of humidity;
- measuring cups (100 and 500 ml);
- hygrometer;
- pH meter;
- EC meter;
- thermometer with indications for minimum- and maximum temperatures;
- fertilizers;

- saltpeter/phosphoric acid.

Unfortunately, you're still not ready, even with the materials listed above. Optimum climate control is needed for growing indoors. A ventilation system can (and in some cases, must) be added; varying from a simple bathroom ventilator to a more expensive carbon dioxide box ventilator with a humidifying system. You can go for a larger-scale approach by providing a system to keep the CO₂ content optimal, by installing air-conditioning, or your own water purification regulated by osmotic filters, or by using a computer to regulate feeding. You can easily spend more than 20,000 guilders for a complete home-grow system if you want .



CO2 computer



flow-unit

3.4. Grow room layout

First, the lamps are installed. It's important to ensure enough power capacity. The three lamps together require 1200 watts of power, while the pump and the ventilator also draw current. The safest manner is to allow a separate circuit in your tool cabinet. With a 16-ampere circuit, you have 2800 watts at your disposal. The circuit does provide more power than that, but you cannot use it all. When the lamps are turned on, they use more power than the 400 to 600 watts they give off. Too high a current drain will blow the fuse. The lamps must be distributed so that the entire growing surface will be evenly illuminated.

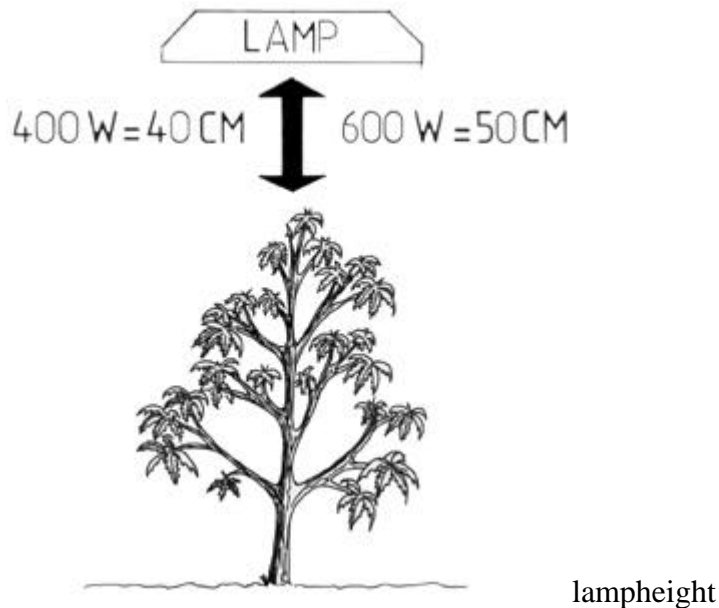

It's a good idea to build a wooden frame to hang the lamps, and to hold the libra-trays. Other devices can be fastened to the frame later. Second, the libra trays are arranged. libra trays are well-suited for growing indoors, because they provide drainage for water run-off. We can also use so-called drainsets. These should be assembled first. When they're assembled, they can be snapped onto the trays. If you don't have access to a drain, it's wise to build a drainage tank. As an alternative to libra trays, you can, of course, use ordinary pots. If you don't want to use drain sets, you can drain water via gutters. The growing trays are filled with rockwool slabs. Holes are cut into the slabs for the rockwool blocks. The blocks are fastened to the slabs with pins. The rockwool blocks are saturated with water and fertilizer. After laying out the irrigation system, the rockwool slabs are then cut on the underside in order to allow excess water to drain. We'll set up the irrigation system. First, make an electrical outlet (earth ground!). The outlet should be conveniently located, right next to the fertilizer tank. We'll put the fertilizer tank just next to, or even underneath, our grow-table(s). The immersible pump is placed in the fertilizer tank to pump the fertilizer to the plants. The pump is turned on and off by a timer switch. This way, we make sure the plants get their water and nutrients on time. A tube is attached to the pump. This tube is connected to a flexible polyethylene hose. This polyethylene hose is suspended over the middle of the libra trays. The end of the hose is sealed with a cap. Punch holes for the sprinklers. The next step is the installation of an air pump with an aerator. The aerator is placed in the nutrient tank so algae won't grow so rapidly. The air bubbles generated by the pump and the aerator take care of that. This way, you also insure that sufficient oxygen gets in the water, and that the fertilizer components remains in motion. Next, put a heating element in the nutrient tank. The element has to maintain the water temperature. To be able to check the temperature, we place a thermometer in the tank. Watering can now begin; the nutrient tank may be filled with water and the proper amount of fertilizer. Pay attention when you mix the fertilizer. Follow the directions on the package accurately. They describe the correct amounts of fertilizer to apply.



Ph and Ecmeter

With too little feeding, the law of minimums comes into play; delayed growth and flowering; unhealthy plants. With over-feeding, the plants will burn. When you apply various kinds of fertilizer (also called A- and B-nutrients), make sure the materials don't make contact with each other. If that happens, then a chemical reaction occurs between the phosphate in the one, and the calcium in the other. Calcium phosphate forms, and the fertilizer loses potency. To find out whether or not the fertilizer you're using has the right concentration, we use an EC meter (see the chapter about water). With too low an EC measurement, you should mix in more fertilizer. With too high a reading, you should dilute the solution with more water. In addition, the acidity of the water - the pH value - is important. We measure this with a pH meter (see the chapter on water). When the pH value is too high, we can lower it with saltpetre/phosphoric acid. When the pH value is too low, we can raise it with a solution of calcium carbonate. You must be very careful with concentrated saltpetre/phosphoric acid. It will burn holes in your clothes, and it will seriously burn your skin, too. The irrigation system is now ready to be tested. Always make sure the water pump is never turned on in the absence of water. This can burn up the pump's motor. Place a sprinkler in one of the measuring cups and determine how much time it takes to pump approximately 50 cc of water and nutrient into the measuring cup. Program this time into your timer. It's intended that each plant gets around 300 cc water and fertilizer, divided over at least 6 feeding times. If you have a timer which can be switched on and off more often, then you can spread the 300 cc over more feeding times. As an example, we'll consider 6 times. The first 50 cc feeding is given at the moment the lights are turned on, and the last, two hours before the lights are turned off. The other four feedings are neatly divided, via the timer clock, among the periods in between. Plants take in water and nutrients only under the influence of light. This is the reason for giving water and nutrients when the light is on. The last feeding is given approximately two hours before turning the lights off; in order to give the plants the chance to absorb the water before the dark period. The quantities we refer to in this book are average values. The starting point of every grower must ultimately be raising healthy plants. So you also have to have green fingers as you do the watering and feeding.



Chapter 4: Light

4.1. Preface

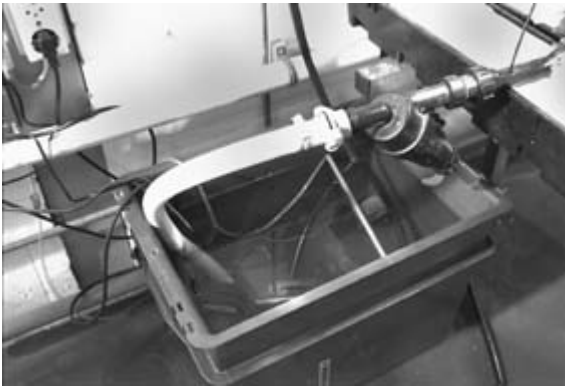

watertank with the needed accesories

Plant growth involves the conversion of light energy into plant-building materials (photosynthesis, see chapter 2). Two factors are important for optimal growth. In the first place, the light intensity. Light intensity is expressed in 'lumens'. At least 50,000 lumens are needed for growing indoors. It's not sufficient to add up the number of lumens listed by the manufacturer for each lamp. The total number of lumens given off is depends strongly upon good reflection, and proper connecting fixtures and starter ballasts for the lamps. The quality of the reflector used, and the connecting fixtures and ballasts determine the light yield for the greatest extent. For those reasons, self-built sets and home-designed illumination often deliver a lot less light yield than lamps being used in professional horticulture. We can improve the light yield in our grow room by applying reflective material. We haven't painted the walls of the room matt white, and used reflector caps for the lamps for nothing! The second important factor is the wavelength of the light. For the production of chlorophyll, and an optimum photosynthetic reaction, light from the blue spectrum (445 nanometers), and light from the red spectrum (650 nanometers) is necessary. Blue light ensures optimal phototropism. Phototropism is the phenomenon which causes plants to grow towards the light, and to spread their leaves in such a way to receive the most light.

4.2. Choices for lamps

In this book, we prefer high-pressure sodium lamps, and mercury-iodide lamps for illumination. Ordinary light bulbs are not suited for cannabis-growing due to their considerably short life span, and principally due to their low light yield. Halogen lamps are not advisable for the same reasons. Fluorescent lamps are not appropriate for home

growing. They do serve well, however, to stimulate seedlings and cuttings to set root. For actual growing, we stick to gas discharge lamps in the form of high-pressure- sodium, and mercury-iodide lamps. There are lamps being sold which emit both the wavelengths needed (blue and red) but we prefer installing separate lamps in a 1:3 proportion (1 lamp for blue light with 3 for red light). The combination lamps give off a lower amount of lumens, since they have to emit different wavelengths. This counts for growing: the more lumens, the greater the yield. This doesn't mean we can install an unlimited number of lamps. Other factors must be considered. Using many lamps means a higher temperature (the heat must be discharged of), a greater need for fresh air (containing CO₂), and a greater need for water and feeding. Always remember the law of minimums Depending on the size of the garden, we use 400 Watt lamps or 600 Watt lamps. This choice is made in such a way that all the plants in the garden area can be illuminated as evenly as possible. By using 400 W lamps, you can put up one-and-a-half times as many lamps for the same electricity use as when using 600 watt lamps. Also 1000 watt lamps are being sold but proper reflectors for these types of lamps are not available. The result is a disproportionately large loss of yield. Moreover, 1000 Watt lamps give off more heat. Therefore they must be hung high above the plants, and this means more loss of light yield plays in the question. 1000 Watt lamps, with respect to 400 and 600 Watt lamps, mostly cause pain in your wallet, because the electricity bill gets higher.

In practice, it is possible to reach a light yield of 70-90% of the lumens which are emitted. For that, (it can't be stressed enough), good reflection is necessary. Below is a chart with data for several reflective materials: Reflectivity in % - Reflective plastic sheet 90-95 - matt white paint 85-90 - semi-matt white paint 75-80 - matt yellow paint 70-80 - Aluminium foil 70-75 - Black paint less than 10 Using proper reflective material, proper connecting fixtures ballast equipment, proper reflector caps with the lamps, and a distance from the lamps to the plants of 40 to 60 centimeters, 400 Watt lamps deliver, on average, between 35,000 and 47,500 lumens, and 600 Watt lamps between 60,000 and 80,000 lumens (at a distance of 50-70 centimeters). The distance between the plants and the lamps differs because 600 W lamps give off more heat. If the plants are too close to the lamps, they will dry out and burn 600 Watt lamps are preferred, because you get the highest light yield for the lowest electricity cost. Though they do require more careful climate control The life span of a high-pressure gas lamp is approximately 2 years when it's used 18 hours a day. The lamps are, however, subject to decay, which lessens the light yield.

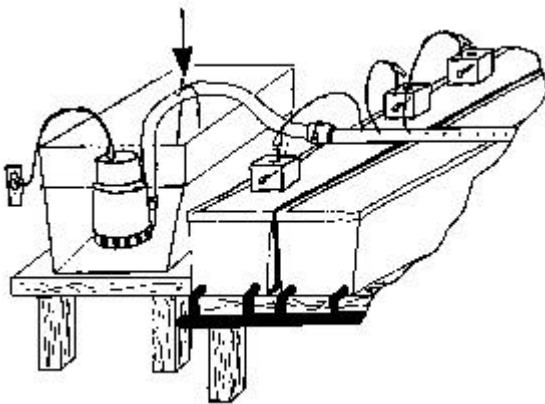

communicating vessels

In practice, it appears that high-pressure gas lamps give optimal results for 4 to 5

harvests. After those, it's advisable to replace them. It seems that the installation of one 600 Watt sodium lamp per square meter is enough to achieve the best results. Principally one can say 'the more light, the better', but with more illumination, the control of other factors (namely, temperature control) becomes a problem. Indoor growers work with their light source close to the plants. Considering the light yield of the sun, (hundreds of thousands of lumens, but a little further away), fewer lumens are needed for growing indoors. A simple formula shows that you can also use three 400 W lamps for two square meters. The sodium lamps provide light from the red spectrum. This light is used principally during growth. A mercury-iodide lamp fills in the blue spectrum. For reflection, growers use wide-angle reflectors with sodium lamps, and super-wide-angle reflectors with mercury-iodide lamps. Super-wide-angle reflectors spread the light over a greater surface area. We use the proportions of 3 red lights to 1 blue. So, the light from the blue lamp must be spread over a larger surface area.



PE filters

4.3. Using high-pressure gas lamps

High-pressure gas lamps may only be used in the fitting meant for that particular lamp type. High-pressure gas lamps all have their own start-up conditions, voltages, characteristics, and shapes. Using lamps with improper sockets can cause electrical shorts! Therefore, it's recommended that you buy all the parts of a pressurized gas lamp from the same distributor. The sockets, ballasts, and connectors must always be protected from humidity; otherwise, electrical shorts occur. As stated earlier, high-pressure gas lamps have a long life span. You must be careful when replacing these lamps. They are, as the name implies, under pressure, and they explode when you destroy them. When you do that yourself, you must always wear gloves and safety glasses. In addition, you have to protect yourself against the poisonous materials found in these kinds of lamps. The heat given off by high-pressure gas lamps, and their accompanying starter ballasts, must be completely ventilated. This means that the lamps shouldn't hang too close to the plants (hence drying and burning occurs), but also not too close to (flammable) ceilings and walls. Place a piece of non-flammable material (not asbestos!) between the lamp and ceiling or wall. Furthermore it's necessary to discharge of excess heat by using a ventilator. Finally, it's important to keep high-pressure gas lamps clean. Dirty lamps provide much less light yield than clean ones. The lamps should be polished now and then with some glass-cleaning agent. That should be done only when the lamps

are turned off, and well-cooled.



the use of gloves to protect the lightbulb cloning accessories

Be especially careful with water. Lamps which are still hot, or even warm, can explode when touched, and that's not funny. Also, take care never to touch these types of lamps with your fingers. Just like halogen lamps, bodily acids can burn through, causing the lamp to fly to pieces.

4.4. Proper lighting for cannabis

The advantage of growing cannabis indoors is the fact that you can give the plants the feeling that it's their flowering season all year round. You're not dependent on the weather or the season. We distinguish two separate phases in plant cultivation: the growth- or vegetative phase, and the flowering- or generative phase. We've already made sure the lamps are installed in such a way that all the plants can be optimally illuminated. A light period of 18 hours and a dark period of 6 hours is ideal for the vegetative phase. We're assuming that you already have cuttings with roots. With proper care, a healthy cannabis plant can grow up to 5 centimeters per day. It's very easy to cause the plant to flower. We only have to give the plants the idea that the days are getting shorter ('autumn'; for cannabis, the sign to flower). We do that by making the light and the dark periods the same length; - 12 hours. In principle, cannabis is an annual plant. The entire life cycle, from seed to death, takes place in one year in nature. When growing cannabis under artificial light, it is possible to force flowering earlier than in nature. After 4 or 5 days vegetative phase, flowering can be 'provoked'. We do that the moment the clones have visibly started to grow. Two or three weeks after the light period is reduced to 12 hours, the plants begin to flower. It's very important not to interrupt the dark period. If the plants receive light during the 12-hour dark period, they 'get confused'; they want to continue growing, and the blooming phase is postponed. The generative phase lasts 60 days or longer, depending on the variety you're growing. When working with cuttings, it's possible to harvest four to five times a year.

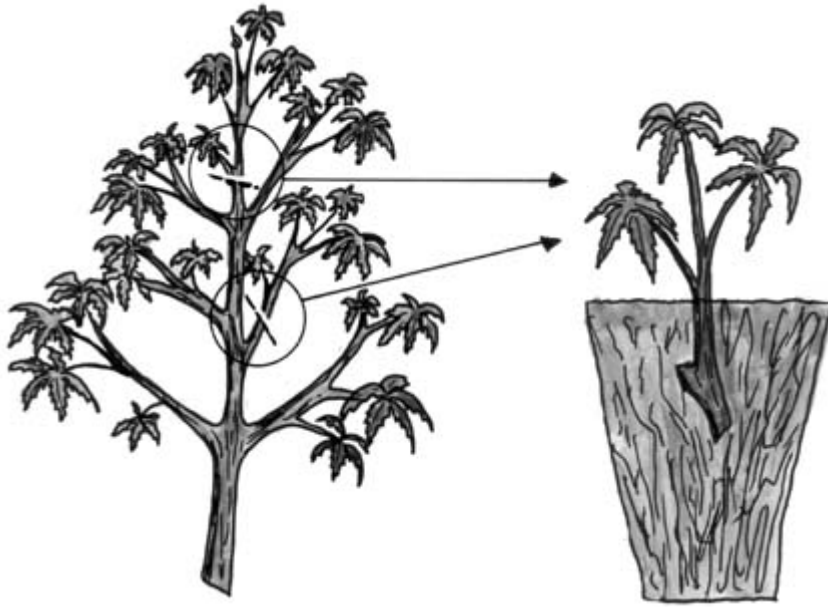

the cutting or clipping of a clone and the motherplant and its clone on a rockwool plug





Chapter 5: Other Considerations

5.1. Preface

Almost all living beings are dependent on light of satisfactory quality. For humans, that means that sufficient oxygen must be present in the air, and that the air is not too polluted. For plants, and thus also for cannabis, it means good air quality, enough carbon dioxide (CO₂), and not too much pollution. Relative humidity (RH), and temperature also play a large role in the growth of plants.

5.2. Influencing air quality

The amount of CO₂ in the open air is approximately 0.03 to 0.04%. The amount of carbon dioxide is also expressed in parts per million; ppm. 0.03% is equal to 300 ppm. There are differences in the CO₂ needs among plants. By raising the CO₂ content, growth can be accelerated. The law of diminished returns still holds true, however. Raising the CO₂ level has limits, but at approximately 1400 ppm (0.14%), good results (a faster growth) are generally achieved. Above 1400 ppm, the effect of a higher percentage of CO₂ decreases. A high concentration of CO₂ is poisonous even for plants. A CO₂ concentration of 1800 ppm or more is deadly for most plants. A simple method for guaranteeing the supply of carbon dioxide is to ventilate the room. Sufficient ventilation must be provided, so the plants keep getting enough fresh CO₂. A second and just as important reason for ventilation, is to dispose of excess heat. If the temperature gets too high, (see Section 5.4), growth is stunted. This counts not only for the temperature in the grow room, but also for the temperature in the plant itself. When the plant's temperature is too high (humans get a fever), there is less sap flow, causing growth disturbances. There is no standard solution for refreshing the air. The need for fresh air is, for a large part, dependent on the size of the grow room in cubic meters. In principal, the total air content of the room must be exchanged every 2-3 minutes. Using for example a grow room 3 meters long, 2 meters wide, and 2 meters high (12m³), this means that the ventilator capacity must amount to $30 \times 12 = 360$ m³ per hour. A standard bathroom ventilator can only handle up to 100 m³ per hour. Many growers ventilate their rooms with table fans. The point is the control of the temperature as well as the circulation of the air with sufficient carbon dioxide. Table fans are primarily intended to keep people comfortable on a hot summer day. They are much less suited to run continually for heat removal, and

for CO₂-content maintenance. Table fans have a tendency to melt with intensive use. You can imagine the consequences: not only the danger of fire, but also massive plant death . . . There are, of course, plenty of fans on the market which will take care of proper ventilation. These have been specifically designed to be able to run continually. The CO₂ content in the grow room can also be heightened by adding CO₂ from a tank. If the system is set with a timer clock, the desired amount of CO₂ can be regularly released. Work with care, because you don't know how much CO₂ is in the room at any given moment. An overdose can easily occur To prevent this, it's sensible to ventilate the area well before each CO₂ 'injection'. The most professional option is to use a CO₂ controller. This apparatus continually measures the CO₂ content in the room. When the programmed minimum value is reached, CO₂ is automatically added. If the programmed maximum is exceeded, the controller turns on the ventilating system. If CO₂ is added to the room via a tank, or a controller, cultivation can take place at a higher temperature. (More about this aspect in Section 5.4.) Ultimately, attention must be given to the relationship between ventilation, and the relative air humidity. The humidity of the air is dependent, among other things, on the amount of air moved through the room. Changing the air draws more moisture out of the plants, because the stomata release more moisture. If the relative humidity of the air drops too low, the stomata close, delaying the growth process.

5.3. Relative humidity (RH)

The relative humidity of the air influences the functioning of the stomata, among other things. Cannabis flourishes the best with an RH of 60-70%. At higher RH percentages, the stomata have problems getting rid of excess water. At a lower RH, the stoma keep releasing water until the plant dries out. At that moment, the stomata close. Then, the intake of CO₂ stagnates, and plant growth is impaired. The relative air humidity is also influenced by the temperature in the growing space. In the chart below, you can see the number of grams of water which can be absorbed in a 25 m³ room (for example: 3 x 3 meters, and 2.5 meters high). Absorption in grams of water (degrees C)

0 degrees	120
10 degrees	240
20 degrees	460
25 degrees	630
30 degrees	840
35 degrees	1120
40 degrees	1460

It may be concluded from this chart, that with every rise of 10 degrees in temperature, the air humidity doubles. Ventilation influences the relative humidity. Ventilating a space makes the RH fall. In some cases it's necessary to install a humidifier in the grow room. The best results can be achieved by using a discharge fan with a variable speed control. This way, you can easily regulate the quantity of air to be removed. When the plants are in the dark, the temperature is lower (the lamps don't give off any heat). So, you would expect the relative humidity to fall (less moisture can be absorbed by the air). But this is not the case; RH increases in the dark. The plants breathe out water in darkness. Therefore, sufficient ventilation must be provided. Too high a humidity level provides considerable risks for the health of the plants. Generally, pests and diseases (see Chapter 8) have a better chance with a high humidity level. Too low an RH is also risky; the plants can easily dry out. Prevention is better than cure . . . Finally, it should be stated that young seedlings and clones generally perform better at a humidity level of 65-70%. Their root systems are not yet developed well enough to take in water

fast enough. A higher humidity insures that the young plants will be protected from drying out.

5.4. Temperature

The high-pressure gas lamps we use for cultivation cause a considerable amount of heat in our closed-off grow space. This heat can be damaging to the plants. In the first place, we have to make sure the plants are not too close to the lamps. A distance of approximately 40 centimeters (for 400 Watt lamps), or 50 centimeters (for 600 Watt lamps) is good. The lamps also warm the air in the room. This heat must be discharged via the ventilation system. Cannabis seems to grow best at a temperature of 25 to 26 degrees Celsius. This temperature must not be allowed to rise any higher in grow rooms where no CO₂ enrichment takes place. When working with bottled CO₂, or even a CO₂ controller, the temperature can be a little higher; 27 to 29 degrees. When working at higher temperatures, the RH must be closely monitored. Every 10 degree rise in temperature means that the absorption capacity of the air nearly doubles (see Section 5.3). In the dark period, the temperature may drop a little, but not too much. If the temperature is too low during the dark period, moulds have a better chance. A temperature of approximately 20 degrees Celsius is ideal for darkness. In order to maintain an optimal temperature, you need a discharge ventilator. The discharge ventilator has a double function: refreshing the air, and drawing off the heat. As described earlier, the capacity has to be great enough to replenish the air content of the grow room at least thirty times every hour. Accordingly, when working at higher temperatures (by adding CO₂), the plant needs more water and more feeding. Remember the law of minimums. We can raise the CO₂ supply, but if we don't give extra water and extra fertilizer, plant growth adapts itself to the aspect of poor care.





Chapter 6: Water

6.1. Preface

With the short description of plant physiology, we already looked into the function of water in plants. Water has three functions: it is a building material (together with CO₂ and light energy, glucose is produced), it makes the plant sturdy (the plant cells fill themselves with water, giving the plant a firm structure), and it transports nutrients throughout the plant. Water is indispensable for the existence of plants. Remember that the law of minimums plays a crucial role here also: too little water, but sufficient light, CO₂, and nutrients, produces unfit plants. Too much water, with respect to the other criteria, produces just as poor results. Therefore it's important to find an optimal balance, so the plants will flourish.

6.2. Water quality

It probably goes without saying, but the water you use must be as clean as possible. For plants, however, 'clean' is a relative concept. Nutrients such as nitrogen, phosphate, potassium, etc. are always dissolved in water used for plant food. In any case, the concentrations the plants need of these materials make the water undrinkable for humans. In contrast to 100% distilled water, 'pollutants' are found in ordinary tap water. You can request a chart with data about the quality from the company that produces your drinking water. The hardness in degrees - the GH (German Hardness) - is also given. This is a measure for the amount of calcium in the water. Below, you have an example of this kind of water chart. Some of the 'pollutants' aren't 'pollutants' to plants, but actually fertilizing materials. To determine the water quality (and the plant foods you add), you need two types of meters. The first is an EC meter. 'EC' is the abbreviation for 'Electrical Conductivity'. Pure water, also called demineralized water, does not conduct electricity. When we add fertilizer to the water, or the water is 'polluted' in some other way, the water will indeed conduct electricity. Fortunately, home growers can make use of this property of water. With the EC meter, we can determine whether or not the concentration of nutrients in the water will provide for optimum plant growth. A high EC value means a high concentration of fertilizing materials, and a low EC value, a low concentration. Too high a concentration shows that you're over-fertilizing. As a result, your plants will dry

out and burn. (By osmotic processes, water is drawn out of the plant; the leaves curl upwards or downwards.) The fertilizer concentration must be lowered by further diluting with water. Too low an EC value means a shortage of fertilizer. This decreases the growth on rockwool substrate. The EC value is given in millisiemens. 1.8 millisiemens is the optimal value for growing cannabis. The second type of meter is the pH meter. With a pH meter, you can determine the acidity of water. Most of us have measured the acidity of a solution at one time or another in high school. We did it with a litmus test. But the litmus test is not suitable for measuring acidity when growing hemp at home. The accuracy of this test leaves something to be desired. Actually, we can only estimate the pH value, to the accuracy of one pH point. We need greater accuracy for cultivating cannabis. The average pH meter used by aquarium owners is relatively cheap, and meets the requirements well. Generally, they're up to 0.02 pH points accurate. The ability to absorb nutrients depends on the acidity of the water. If the pH is too high or too low, the plants can't absorb some nutrients properly. Then deficiency disease occurs. The pH scale goes from 1 to 14. A solution with a pH between 1 and 7 is called 'acid', a pH of 7 is called neutral, and between 7 and 14, 'basic'. The lower the pH, the more acidic the solution (in our case: water). On the next page, you have a chart showing which nutrients plants can absorb best at each pH. You can read from the chart that cannabis plants like it if they receive water which is slightly acidic. The home grower must make sure that the pH of the water being used is approximately 5.8. The EC meter, as well as the pH meter, must be adjusted now and then. Special calibrating fluids are available for this operation. The temperature is also an important factor when calibrating an EC meter. The correct temperature is listed on the package of calibrating fluid. A pH meter has two set screws, and it must be adjusted to two values. The probe of the pH meter is first dipped into a calibrating fluid with a pH value of 7.0. Then, this value is set using one of the set screws. After that, the probe must be cleaned well; otherwise, deviations will occur with the second calibration. Next, the probe is dipped in a calibrating fluid with a pH value of 4.0, and this value is set using the other set screw. It's important that the pH meter probe is kept moist. Depending on the type of pH meter, it may be stored in ordinary tap water, or in a special fluid supplied by the manufacturer. In the story about the EC meter, we've already indicated that the temperature of the nutrient solution influences plant growth. Cannabis grows best with a water temperature of 25 degrees Celsius. Below this temperature, the roots of the plant have more trouble taking up water and nutrients. Too high a temperature is not good either. That will kill the plants. Tap water must be warmed up to 25 degrees C. Use a water thermometer to keep an eye on the water temperature. Warming the water is easy with the installation of a heating element in the nutrient tank. This equipment also comes from the aquarium world. Quality heating elements with thermostats are available for aquariums. For a 100 liter nutrient tank, you need a 100 Watt heating element; with a 200 liter tank, we recommend a 250 Watt element. Make sure the heating element is always kept under water; otherwise it will be destroyed. This means that you must never pump all the water out of the nutrient tank to the plants. When you want to take the heating element out of the water, always disconnect it first. Then, let it cool off for at least 15 minutes. Only then can you carefully take it out of the water. Any other way, you run the risk the element will crack. To prevent algae growth in the nutrient tank, it's important to add air to the water. We do that by means of an aquarium pump with an aerator attached. The aerator is connected to the pump, and placed at the

bottom of the nutrient tank. The water in the tank becomes rich in oxygen by aeration, and is also kept in motion. This way, algae have much less chance to proliferate.

6.3. The irrigation system

We do everything we can to promote plant growth. We provide optimal lighting and sufficient CO₂. As a third component, regular irrigation is an essential link. This way the plants receive their water and nutrients in time. The easiest way is to water by hand several times a day. But, in the first place, that involves carrying a lot of watering cans around, in which you've dissolved the correct amount of fertilizer every time. In the second place, watering by hand requires enormous discipline. Giving water regularly on time will quickly 'water' YOU down. You can't skip a few days here and there, and leave your plants to themselves. Finding a babysitter for cannabis plants is often more difficult than finding a babysitter for your kids . . . So, we prefer to give water regularly with an irrigation system controlled by a timer clock. This way, we can rest assured the plants get their wet and dry periods on time. In Chapter 3, we've given a lot of attention to the installation of an irrigation system. Now, we'll go a little deeper. In its simplest form, an irrigation system consists of an immersible pump, controlled by a timer clock, which has hoses with sprinklers attached to it. The sump pump is placed in a nutrient tank with a capacity large enough to make refilling necessary only two times per week. We're talking about a tank with a contents of at least 25 liters per square meter of garden space. 5 to 7 liters of water with nutrients are used every day for each square meter. So, refilling the tank every 3 or 4 days is enough. Remember, there must always be enough water in the tank to cover the heating element and the pump. Both instruments will be ruined if they are left without water. Preferably, the nutrient tank should sit on the floor. There are two important reasons for this. In the first place, it saves space. The tank can also be underneath the tables. In the second place, it prevents the natural working regarding water levels between communicating vessels. If the nutrient tank is placed too high, the water will flow through the hose without the aid of a pump. This goes on until the water level in the tank reaches the same level as the lowest point of the connected irrigation hose. Solutions can be devised for the problem of 'communicating' vessels; - coupling an electric faucet between the nutrient tank and the irrigation hose, for example. This solution is unnecessarily expensive. The problem of communicating vessels can be prevented by placing a sprinkler outlet on the top of the hose. The sump pump must be powerful enough to send water to all the sprinklers that will be installed. For a garden 2 to 10 m² in size an immersible pump with performance capability of 7 meters is enough, if used with a 1-inch irrigation hose. Also, the pressure of the pump should not be too high, otherwise the sprinklers (also called capillaries) won't drip, but spray. Most sprinklers function at a pressure from 0.5 bar on up. To the immersible pump, we connect an irrigation hose (polyethylene or PE- hose). The irrigation hose goes through the middle of the grow trays. Then we make holes in the polyethylene hose and insert the sprinklers. We install one sprinkler for every plant. We have to prevent dirt and other materials from clogging up the narrow openings of the sprinklers. We take two measures: first, we keep a lid on the nutrient tank so nothing undesirable falls in the water. Second, we place a filter between the pump and the irrigation hose. In an ideal situation, plants

should get water and nutrients spread evenly throughout the day. We can arrange for this by connecting a timer clock to the irrigation system. A suitable timer clock must also have a minute setting, and must be able to switch on and off at least 6 times a day. Modern timer clocks are digital. These clocks have a memory to store the desired times. If the electricity goes off, batteries usually supply current to preserve the memory. The disadvantage is that batteries run down. If the battery is dead, and the electricity goes off, the memory is erased. The steady watering stops, and the garden is damaged. The recommended choice is a timer clock with a good car battery for backup. Now, our irrigation system ensures that the plants get the correct amount of water and fertilizer on time. The sprinklers evenly distribute the nutrient solution. We prefer growing in 'libra trays'; - so-called 'growing trays' which have been especially designed for growing on rockwool slabs. There are other methods, of course. You can also lay rockwool slabs on corrugated roofing sheets, for example. This does give problems with drainage water. It's more hygienic, and more practical to work with growing trays. They're not expensive, and it's simple to connect a drainage system to them. Easier still is snapping drainage spouts onto the growing trays. Then the water can be drained into a gutter. We divide the irrigation of the plants into 6 periods during the 18-hour light cycle. The first feeding takes place when the lights are switched on. A feeding session follows every 3 hours, until 3 hours before the lights go off again (the plants can take in nutrients only during the light period!). In the beginning, we don't let the irrigations periods last more than one minute, because otherwise, problems with root development can occur. We stick to short feeding periods. Throughout the entire vegetative phase. During the generative phase (12-hour light cycle), we also divide the 6 feeding sessions so the plants will get water every two hours. Since the plants have grown a little by then, and they need more water, we let the irrigation periods last for two minutes. When irrigating the plants, you must make sure the nutrient solutions soaks through thoroughly. Thorough watering means that about one-third of the water applied drains off. Thorough watering is important to prevent the accumulation of the nutrient salts in the rockwool slabs. If watering is not sufficiently thorough, it's sensible to raise the number of irrigation sessions. Finally, another word about safety. Everyone knows that water and electricity are equally related as water and fire. The sump pump, as well as the thermostatic heating element, work with use electric currency and under water. Use only equipment of which you are sure it is well-insulated. Moreover, it's sensible to disconnect the plugs before you put your hands in the nutrient tank. This can save you from a possibly shocking experience

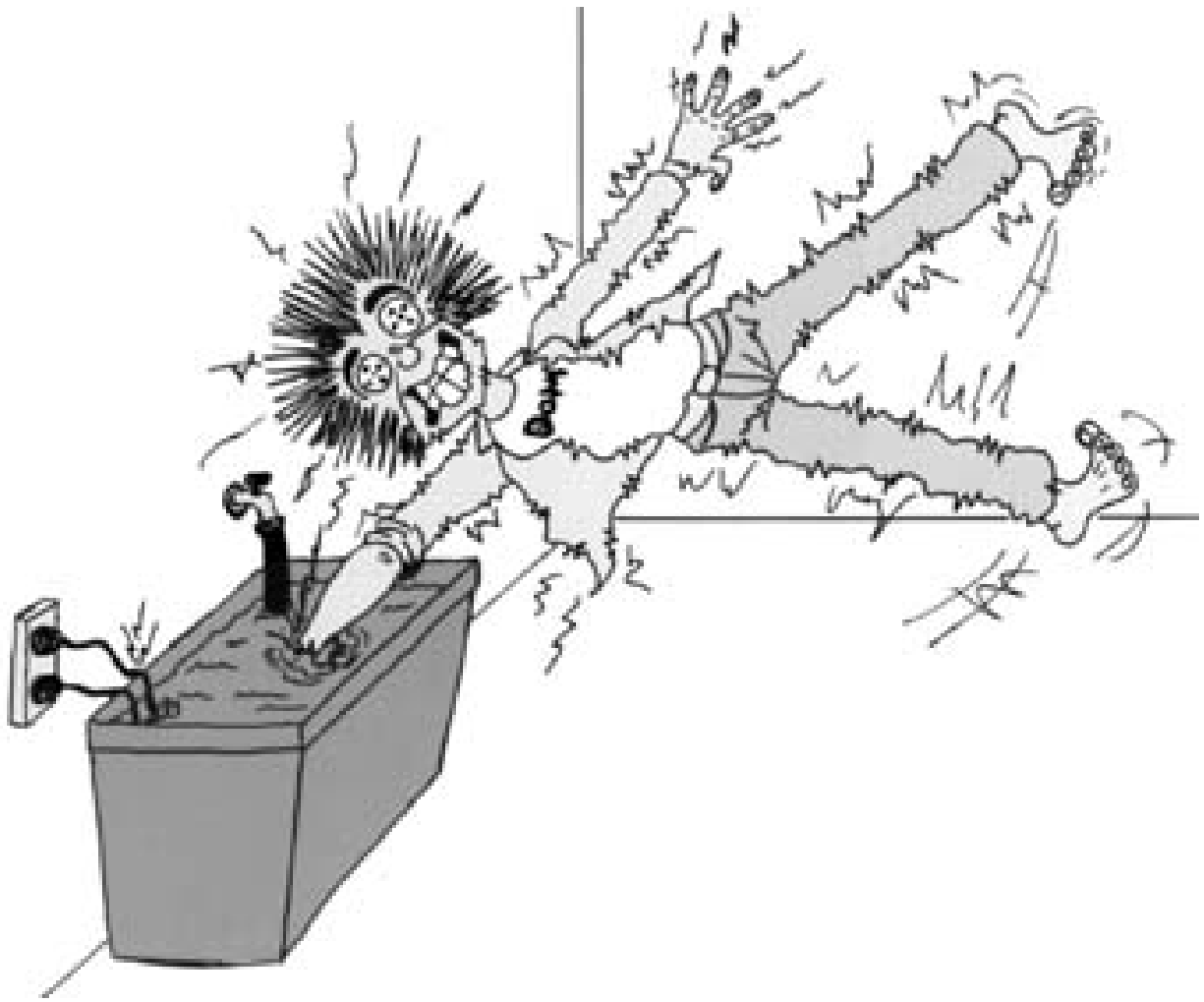



PART III: Growing Cannabis

Chapter 7: Clones and Cuttings

7.1. Preface

In the previous chapter, we've told you what equipment you need to grow hemp. Furthermore you've been initiated into the secrets of good climate control to reach an optimal result. Up until now, we haven't said a word about the living material you can use to 'rise high(!)' . . . In this chapter, we'll look at the actual cultivation. We'll leave sprouting cannabis from seed for what it is. We'll talk about starting with clones. It's not completely clear why the word 'clones' has been adopted by the weed grower; we're talking, in fact, about 'cuttings'.

7.2. Cloning hemp

Cloning hemp is a cheap, quick way to get plants. The average gardener has taken cuttings from his/her house plants at one time or another. It's not much different with hemp. We only have to make sure the carefully removed cuttings from the mother plant are brought to root. A healthy mother plant can pass on her THC-producing properties from generation to generation by means of cuttings. Each cutting has the same properties as the mother plant. A cutting can be taken from a cutting. And from that cutting, yet another. There are growers who have raised 20 generations from a mother plant this way, without diminishing the growing power of the plants. The yield from the 20th generation is just as good as the yield from the first one! By then, the original mother plant is long past use. Taking cuttings causes trauma to a plant. The plant reacts by taking on a deviant form, and by starting male branches. A third problem is regressive mutation. The mother plant has been developed by cross breeding. With regressive mutation, the carefully bred properties (to a degree) are lost. The quality of the plant (and, of course, the quality of the harvest!) decreases. For this reason, we replace the original plant with one of her fresh, healthy daughters after 12 weeks at maximum. The ease with which hemp can be cloned makes planting cannabis seed less attractive. In the first place, sowing seed takes a lot more time than growing from clones. An advantage not to be underestimated is the fact that you can harvest much more often if you raise clones rather than grow from seed. On

top of that, you get males as well as female plants from seed. The chance that a seed produces a male plant is just as great as the chance a female will appear: 50% . . . To make hemp cuttings/clones we need: - a high-quality mother plant; - sharp scissors, or a sharp knife; - any commercial hormone mixture to promote root growth; - something to start the cuttings in (a cutting tray with rockwool plugs, a small grow-tank with washed, rough sand, fine vermiculite, a soil-free mixture, or potting soil); - phosphoric acid - a 'cool white 33' fluorescent tubelight with the proper armature; - ventilation; - clean working methods, and clean surroundings; - 'green fingers' In contrast to raising cannabis plants, for which we use 400 Watt or 600 Watt high-pressure gas lamps, clones develop their roots best under fluorescent light. Fluorescent tubes emit light primarily in the blue spectrum. Controlling the temperature when using fluorescent lights is also less complicated, because fluorescent tubes give off little heat. The fluorescent tube armature is mounted approximately 25 cm above the tops of the clones. We're going to illuminate the cuttings 18 or 24 hours per day. We keep the light on 24 hours a day during the cold months. The illumination times suggested here are a guide. What it actually involves is allowing the climatological conditions to vary as little as possible. You get the best results with an even climate. It requires some experience to create the optimum conditions . . . The hemp cuttings form their roots best at a temperature of 25 to 26 degrees Celsius, and a relative air humidity of 70-75%. Just as is the case with actual growing, climate control is very important for cuttings. Moulds and pests insects must never get a chance. Above all, mould spores can cause problems if the climatic conditions aren't optimal. In principle, every part of a hemp plant is suitable to use as a cutting. But a single leaf with a few roots is of no use of course In any case, a good cutting has a growth-point. The size of the cutting doesn't matter so much; a 2 cm cutting can grow to be a top-quality plant, just like a 10 cm cutting. Before you put the cutting in the growth medium, you have to make preparations. We're talking about raising cuttings in rockwool substrate. First, the growing tray should be soaked in a nutrient solution. The pH value must be 5.8, the EC value 0.8 to 1.0. To reach a pH value of 5.8, you best use phosphoric acid. The advantage of phosphoric acid is that it helps the cuttings develop roots. We fill the tray for the cuttings with the nutrient solution and drain it off again. We do this several hours before taking cuttings from the mother plant. The cuttings are clipped, or cut with a sharp knife or scissors. Take care not to leave the ends frayed. A clean cutting loses less sap than a cutting with a frayed end. Moreover, there's the risk that ravelled parts of the plant will rot. Directly after clipping or cutting, we dip the clone first in water, and then in rooting hormones. Then we stick the cutting into the rockwool plug. The growing tray for the cuttings must then be saturated for 3 or 4 days with nutrient solution. Good hygiene is very important when getting cannabis cuttings to root. Work as clean as possible. Always clean your scissors, knife and growing trays with a medical disinfectant (i.e. Dettol) after you've used them. Check the clones daily for possible rotting parts. Rotting leaves or stems must always be removed, so that moulds won't get a chance. It's also important not to put the clone tray in a bed of water. That makes rooting more troublesome, and the roots will be of less quality. Also, a too wet clone tray causes root rots such as pythium fungus on the roots. Just like all plants, hemp cuttings also need fresh air containing CO₂. We have to ventilate the clone room, too. Sometimes, ventilation is necessary to keep the temperature stable. When using a ventilator, you must try to create an optimal climate without exposing the plants to gale force 9. The cuttings

can dry out as a consequence of too much air movement. When you have all the climatic conditions under control, you can start waiting for roots to develop. It takes about 10 days before you see the first results with healthy plants. After a fortnight, healthy cuttings will have enough roots to be transplanted. In principal, approximately 80% of the cuttings will root, if you control the climate well. Allow the cuttings which have no roots after a fortnight one more week. These cuttings can produce a plant of lesser quality. If no roots have grown after 3 weeks, you can throw those cuttings away. Don't count on all the cuttings taking root; plant about 20% more than you ultimately intend to keep. Planting rooted clones is a tedious job. The root systems of the young plants are very tender, and can easily be damaged. The extremely small root hairs are very important for a healthy plant. Many splendid cuttings have been ruined by rough transplanting. The roots of plants don't like light (they grow in the dark), and air (they dry out quickly). The young plants will now go to the spot where they will spend the rest of their lives. For plants, transplanting more than once is just as traumatic as making people move house twice a month . . . Now, the plants must become accustomed to their new surroundings. They must get sufficient water, but not yet the full amount of light. After a few days, the real irrigation schedule can begin, and the plants go under the full light of the high-pressure gas lamps. The vegetative, or growth phase begins . . .

7.3. The vegetative phase

In this phase, the plants are illuminated 18 hours per day, and kept in darkness 6 hours per day. If all aspects are in order, (sufficient light, proper ventilation, good temperature, enough water and nutrients, in short: complete climate control), the plants will grow quickly; up to 5 cm per day. The duration of the vegetative stage is strongly dependent on the control of climate. The better the climatic conditions, the earlier the cutting takes root. The vegetative phase lasts from 3 to 10 days at maximum. We'll discuss growing 15 plants per square meter. If we want to use the surface area to the maximum, then we must prune the plants; - break off the uppermost part. pruning is possible only with plants that have rooted and begun to grow. If this is not the case, breaking or clipping the tops off should be postponed for a couple of days. By pruning the plants, we ensure that they not only grow tall, but wide, as well. After cutting off the tops, we leave the plant in the vegetative stage (18-hour cycle) for a few more days. When the off-shoots have grown 3-4 cm, we start the generative phase. If all goes well, three or four large tops will then form on each plant. Then we're ready to get around 50 tops per square meter. To get a wider plant, you can now break off the top-most part of the plant. Further pruning is not necessary. Pruning makes the plant grow fuller. That's not to say you get a bigger plant, because you've also taken something away . Since the vegetative phase lasts only a short time, the plant must quickly make up for the damage. After pruning the top, two new branches will appear from the budding sight just under the spot where the top was. Be very careful with pruning; it's a more painful experience for a plant than trimming your own nails. After pruning, it's not unlikely for growth to be delayed for a few days. It needs no further explanation that a clean, razor-sharp knife or garden scissors should be used. Actually, we can only think of one good reason for pruning. When branches don't grow

well, or are sickly or too thin, in short; unhealthy, you can, of course, carefully remove them. With pruning, it always involves the removal of the whole branch. Take care to touch the leaves as little as possible. That can easily disturb the workings of the stomata in the leaves. Some people swear by removing leaves in order to allow more light to reach other leaves. This is necessary; moreover, part of the growth capacity is lost. It's also unnecessary to remove dying leaves. You only have to clear these away after they've fallen off the plant. Picking them off earlier might again cause damage to the plant . . .

7.4. The generative phase

After one week at maximum, we will shorten the illumination time, and adapt the irrigation schedule accordingly. We keep giving water 6 times per light cycle. Give water and fertilizer during the period that the light is on, and not during the dark period. In the flowering, or generative phase, the plants are in the light for 12 hours, and in darkness for 12 hours. We imitate a shortening of the day in autumn; a sign for the plant to start flowering and forming seeds during its last phase of life. In the generative phase, the plant's emphasis is less on growth. Less chlorophyll is produced and in the flowering phase, we often see fewer fingers forming on the cannabis leaf. The plant needs less blue light during the flowering phase (that was important for chlorophyll production in the leaves), and it needs more red light. The autumn sun produces more red light, because the autumn sun is lower in the sky. That doesn't mean that you must now use only the sodium lamps. With only red light, the plants lose their vegetative leaves (they turn yellow and fall off easily), while the stem of the plant is lengthened. The distance between the branches (also called the 'internode') increases. When we just let the mercury-iodide lamps supply the plants with blue light, this effect won't occur so easily. The supply of water and nutrients continues. The time between irrigations is shortened, so that the plants are still irrigated during each light cycle. Not in order to push the plants to grow as fast as possible, but to keep the metabolism at level, and to produce resins. The female plants will show their first flowers after a week or two. The following period lasts at least 60 days, depending on the variety. With some of the plants, the blooming period lasts up to 90 days. It's worth the trouble to be patient for the full flowering period before you start harvesting. Harvesting during that time stresses the plants, which can ultimately cause a decreased yield.

7.5. Harvesting and drying

In this book, we assume you've raised female cannabis plants from clones. When you've sprouted male as well as female plants, there will be some work sorting them out. The males flower earlier than the females. If you leave the males with the females, the females will be fertilized. The females then form seed, causing the tops to be smaller. The yield is lower (why did we start growing in the first place?). If you've sprouted males, you have to be sure to harvest them before the pollen reaches the female plants. When

you grow only females, you don't have this trouble. There are various methods to harvest cannabis. Some people cut the whole plant down, then hang it up to dry. Others break the largest leaves off several days before harvest, so there will be less waste. Hanging the plants, or the tops, upside down has no effect on the THC content in the tops. The resin doesn't flow. What's important with cannabis is the even drying of the THC-containing parts of the plant. What's also important is patience. Generally, drying goes quicker if you remove the stems which contain the most moisture. Using a microwave, or an ordinary oven, a hair dryer, or a fan does make drying faster, but usually also causes a (much) sharper taste. Even drying in air prevents as much as possible the loss of THC, and produces evenly dried buds with a soft taste. Controlling the climate also remains important after the harvest. Many harvests have been lost due to spider mites and mould. For the THC glands so important to us, light, heat, and friction are the most important things to avoid. Once dried, marijuana can best be kept air-tight in a reasonably cool, dark place. Air-tight glass jars are ideal.

7.6. Skuff

We'll talk about 'skuff'. This is the sifting of dried tops. When you sift your dried harvest first through a rough, then through a fine sieve, you remove all the remaining plant remnants, and get balls of resin (thus; THC) left on the sieve. It's a fairly simple, but time-consuming job. Sift the dried harvest first through a size T-44 sieve. The THC falls through (with a little extra material). We have a T-77 size sieve under the T-44. You must carefully rub your harvest through the T-77 sieve. Then you have THC in it's pure form without chemical processing



skuffsieve

7.7. Setting up the garden again

After the harvest, you must make sure you can literally start the following growth with a clean slate. First remove all the leftover plant parts. These go in the trash or in the organic waste, unless you have a compost heap. Then remove all the rockwool material. The rockwool still contains a lot of water.

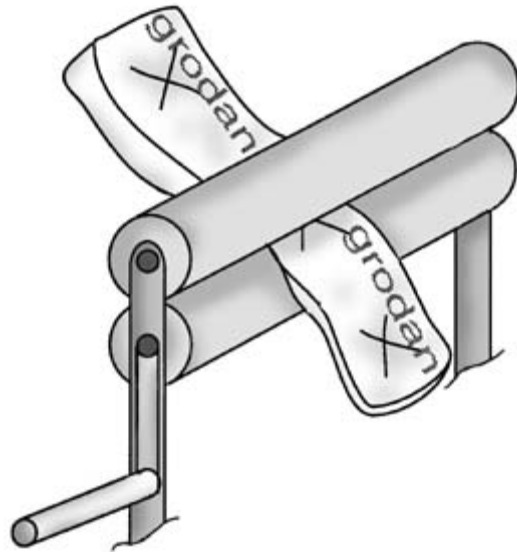

old rockwool slab in the wringer

Tip: see if you can use an old wringer, or a centrifuge. That will decrease the volume of the disposed rockwool by half. The following step is to disinfect the equipment. Any commercial disinfectant will do. Read the label to see how much to dilute it. Clean your irrigation system with disinfectant, and always thoroughly rinse afterwards. Possible calcium build-up on your humidifier should be removed. Cleaning lamps and reflective material is the next step. The lamp should be off, and completely cooled. Don't touch the lamp with your hands, because bodily acids can easily burn them. Result: shorter lamp life. Everything is now ready for the next growth. Lay out new rockwool material and wet it. It's time for new planting, so the timer clock goes back to 18 hours, and the irrigation to once every three hours.





Chapter 8: Diseases Pests and Plagues

8.1. Preface

Plants are living material. They'll stay healthy if we make sure all the climatological conditions are right. We've already stated earlier that this involves light, air, water, clean surroundings, and green fingers. Controlling the climate, in all its aspects, is the best way to prevent diseases and insects. That doesn't mean that the careful weed grower, who has everything well in order, will never be bothered by plant diseases and pests. We do want to say that good climate control considerably reduces the risks of disease.

8.2. Diseases

An easily preventable form of disease is deficiency- or deprivation illness. The plants lack some necessary ingredient in their feeding. A shortage of iron produces yellowed (and falling) leaves. The pH value plays an important role in the prevention of deficiency disease. Keep the pH value around 5.8. If this value is too low, the plants can't absorb calcium as well. Consequence: the osmotic processes are impeded. Too low a pH number causes less iron in-take, with the well-known results. A second form of deficiency disease is caused by a shortage of the primary nutrients (NPK). It often involves a lack of nitrogen (N). A nitrogen shortage delays growth, and makes the lower-most leaves turn yellow and drop off. Less often, we see a shortage of phosphate (P). With a phosphate shortage, the leaves turn deep green, and they remain small. Yellowing and dying lower leaves happen here, also. Potassium shortage (potassium is 'K') is another seldom-occurring problem. The noticeable feature is first the yellowing of the point of the leaf, after which the whole leaf turns yellow and brown, and dies off. A lack of potassium is more often caused by an acidic soil than by an actual potassium shortage. So, make sure to maintain an optimal pH! The remedy advised for these kinds of deprivation sicknesses: use NPK fertilizer. We don't encounter deficiency disease as a consequence of a shortage of the secondary nutrients very often. This usually involves a lack of magnesium and/or calcium. It can usually be remedied by using an NPK mixture containing trace elements. The same counts for the micro-elements. We must make an exception for iron, since there is rarely too little iron. In that case, the pH value is usually too high. Moulds can completely destroy a garden in a short time. If the climate in the grow room is well-controlled, moulds, in general, have little chance. Moulds and fungi thrive very well

under humid conditions, preferably without much air circulation. Under these circumstances, mould spores, which are always present in the air, search for a spot to grow into mould cultures. If you don't succeed in preventing mould growth, then you must do something about it as quickly as possible. With light mould growth, immediately remove the affected plant parts, and then create a climate in which cannabis does well, and moulds don't (good ventilation, control of humidity and temperature, and putting your plants on a medium which is not too wet). If there's already too much mould present, you don't have much choice but to spray with poison (fungicide). Repeat the treatment after a few days, even if you think the first application has definitely helped. Still,; improve climate control and growth conditions. Fungicide treatment should always be a last resort. It's not healthy for young plants or people, so here, it's also: 'prevention is better than cure' An often-occurring mould affecting cannabis is pythium. This mould causes root-rot, and rot in the lowest part of the stem. It appears most in young plants, and in cuttings. Larger, healthy plants are less sensitive to pythium. Plants get 'falling-over disease' with a serious pythium attack. We don't have to explain what that means Pythium is recognizable by the bark at the base of the stem turning brown. In the beginning, the 'brown attack' is easily removable. Later, the rotting process eats deeper into the base of the plant. Pythium is a fungus which flourishes best in wet and humid environments. Pythium spores spread only through water. Two kinds of spores are formed; Swarming ones and stable ones. The swarming spores germinate best at a temperature of approximately 15 degrees Celsius, while the stable spores germinate if it's relatively warm; around 28 degrees C. To prevent a pythium attack, a constant temperature of the soil or rockwool is needed. Large fluctuations in temperature should be avoided. Pythium can only be fought in a limited manner with chemicals. A proper relative humidity must also be maintained (not too high). Leaf moulds, such as mildew, and thread moulds occur less frequently than pythium. Mildew can cause tops to rot, among other things. Also here counts: ensure optimal climate control. Contrary to other moulds, mildew flourishes well at a low relative humidity. Mildew can be more easily fought with chemicals, and fortunately, is not often found with cannabis. Rotting tops occurs the mainly at the end of the flowering phase. The more compact the plant, the bigger the chance for tops to rot. You can identify toprot by the sudden yellowing of the top-most leaves. These yellow leaves are fairly loose on the plant, and can be easily removed. To prevent the whole plant from being affected, you must, unfortunately, remove the whole top. The appearance of toprot can be prevented in some cases, by lowering the relative humidity during the dark period.

8.3. Plagues and Pests

The most frequently occurring plague in cannabis cultivation is spider mite. A spider mite isn't an insect, as many people think, but actually a tiny spider. A spider mite is small, and difficult to discover for the inexperienced eye. But the damage caused is certainly visible. The mite feeds on the sap of the plant, mostly underneath leaves. White specks appear on the upper side of the leaf. After that, you can find spider mites on the undersides of the leaves, and on the stem of the plant. Spider mites make small webs, which you can detect by spraying with water. If there aren't too many spider mites, you

can try to get rid of them by removing them by hand. A tedious job



spidermites



predator mite

Treating with insecticide generally gives a better result. In any case, repeat the application after a few days, otherwise, you risk the chance that the whole garden will be eaten. Spider mites can also be controlled with their natural enemy *Phytoseiulus persimilis*; a predator mite which feeds on spider mites. White flies are also a formidable opponent of the weed grower. It can't be repeated enough: control the climate, and take care of healthy plants. Then, insects will have the least chance to propagate.



white



fly

assassinator wasp

White flies behave just like spider mites. The insect hides underneath the leaf, and sucks its dinner from it. Result: white spots on the top side of the leaf. White flies are easily spotted with the naked eye. If you shake the plant a little, they'll fly around. They look like little white moths, around 2 millimeters in size. A sizeable infestation can be combatted with insecticide. If you're not so anxious to use such strong methods, you can purchase a certain type of 'assassinator' wasp: the ichneumon fly (the Latin name is *Encarsia formosa*). This natural enemy doesn't sting people, but works well at eliminating white flies. Since it's only a small wasp (smaller than the white fly itself), it takes a while before all the white flies have disappeared. Additionally, you have to put new assassinator wasps out approximately every two weeks.



lice

thrips

Another common herbivore is thrips. They are small, fast-moving insects with wings. They rasp, or grate the leaves open, and then suck the sap out. Thrips prefer bloom tops, and fresh, young leaves. Affected leaves have shiny, silvery spots. This is caused by the thrips, which suck the chlorophyll out of the leaves. In spite of the fact that they're small,

you can see thrips marching in columns on an infested plant. Thrips can be fought with insecticide. It's more environmentally friendly however to unleash the thrips' natural enemy: the predator *Amblyseius cucumeris*. Lice are found inside as well as outside. During the summer, when lice do the best outside, they also do as well inside. Lice are the most interested in plants with questionable health. There are two methods to kill lice: spraying with insecticide, and setting out assassinator wasps. The problem with most flying pest- destroyers is that they're attracted by the high-pressure gas lamps, which draw them to a fiery death.

8.4. Summary

The starting point for cultivating cannabis is successful climate control. This goes two ways: the plants do well and produce the greatest possible yield, and diseases and pests get the least possible chance. So, create a good climate, and don't forget hygiene. If you're bothered by diseases and/or insects, preferably use natural methods of control rather than chemical remedies. You can fight your pests by releasing their natural enemies, or by spraying with organic solutions for diseases and/or pests. Use chemical pesticides only if nothing else works. Always stop using pesticides a few weeks before harvest, otherwise, you'll be smoking some of the poison later. Ultimately, fighting diseases and pests works best only if you know how to optimally control the climate at the same time. Along with climate control, the prevention (and if necessary, curing) of deficiency disease demands an optimal mixture of fertilizers, and the control of the pH.

