

SEA  ORG



**WELCOME**  
TO THE  
**SEA ORG**  
COURSE

SEA ORGANIZATION PRODUCT ZERO

**SEA**  **ORG**

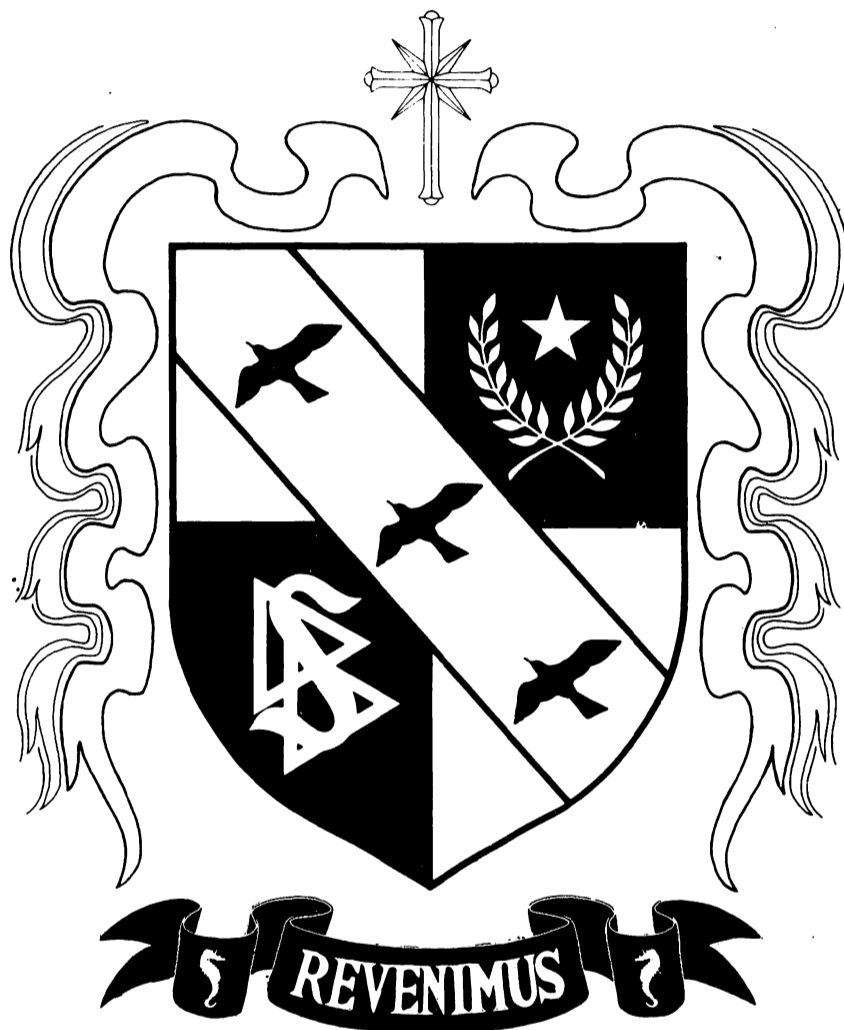

**WELCOME**  
TO THE  
**SEA ORG**  
C O U R S E

---

**SEA ORGANIZATION PRODUCT ZERO**

*Published by*  
**Church of Scientology International**

Copyright © 1990 L. Ron Hubbard Library.  
All Rights Reserved.

*No part of this course pack may be reproduced or utilized in any form or by any means electronic or mechanical, including photocopying, recording or by any information storage and retrieval system, without the permission of the copyright owner.*

DIANETICS, SCIENTOLOGY, SCIENTOLOGIST, E-METER, FLAG, HUBBARD, HCO, the Sea Org symbol and the Sea Org coat of arms are trademarks and service marks owned by Religious Technology Center and are used with its permission. SCIENTOLOGIST is a collective membership mark designating members of the affiliated churches and missions of Scientology.

Printed in the United States of America.

## **TO THE STUDENT**

This course pack contains all of the written issues of the Welcome to the Sea Org Course. Your new course pack includes such features as:

- \* A complete table of contents by page number,
- \* Full transcripts for each of the Welcome to the Sea Org lectures,
- \* Each issue and transcript professionally printed in clear, easy-to-read type, and
- \* A comprehensive glossary to the lectures.

This pack has been produced with the aim of making your study as rapid and free from distraction as possible.

Good luck in your training!

**The Editors**

# Contents

## KEEPING SCIENTOLOGY WORKING

HCO PL	7 Feb. 1965	<b>Keeping Scientology Working</b> <i>KSW Series 1</i>	1
HCO PL	17 June 1970RB 1	<b>Technical Degrades</b> <i>KSW Series 5R</i>	7

## WELCOME TO THE SEA ORG TAPES

Tape Transcript: 6910C15	<b>"The Quality of the Sea Org and What Is a Seaman"</b>	9
Tape Transcript: 6910C16	<b>"Welcome to the Sea Org"</b>	18
Tape Transcript: 6910C17	<b>"Why the Sea Org Is Successful"</b>	30
Tape Transcript: 6910C20	<b>"Third Dynamic Activity and Making Things Go Right"</b>	41
Tape Transcript: 6910C21	<b>"It's a PRO World"</b>	50
	<b>Welcome to the Sea Org Lectures Glossary</b>	63
	<b>Alphabetical List of Titles</b>	93
	<b>Chronological List of Titles</b>	93



HUBBARD COMMUNICATIONS OFFICE  
Saint Hill Manor, East Grinstead, Sussex

HCO POLICY LETTER OF 7 FEBRUARY 1965

Remimeo  
Sthil Students  
Assoc/Org Sec  
Hat  
HCO Sec Hat  
Case Sup Hat  
Ds of P Hat  
Ds of T Hat  
Staff Member  
Hat  
Franchise

***Keeping Scientology Working Series 1***

*Note:* Neglect of this PL has caused great hardship on staffs, has cost countless millions and made it necessary in 1970 to engage in an all-out, international effort to restore basic Scientology over the world. Within 5 years after the issue of this PL, with me off the lines, violation had almost destroyed orgs. "Quickie grades" entered in and denied gain to tens of thousands of cases. Therefore actions which neglect or violate this policy letter are HIGH CRIMES resulting in Comm Evs on ADMINISTRATORS and EXECUTIVES. It is not "entirely a tech matter," as its neglect destroys orgs and caused a 2-year slump. IT IS THE BUSINESS OF EVERY STAFF MEMBER to enforce it.

**SPECIAL MESSAGE**

THE FOLLOWING POLICY LETTER MEANS WHAT IT SAYS.

IT WAS TRUE IN 1965 WHEN I WROTE IT. IT WAS TRUE IN 1970 WHEN I HAD IT REISSUED. I AM REISSUING IT NOW, IN 1980, TO AVOID AGAIN SLIPPING BACK INTO A PERIOD OF OMITTED AND QUICKIED FUNDAMENTAL GRADE CHART ACTIONS ON CASES, THEREBY DENYING GAINS AND THREATENING THE VIABILITY OF SCIENTOLOGY AND OF ORGS. SCIENTOLOGY WILL KEEP WORKING ONLY AS LONG AS YOU DO YOUR PART TO KEEP IT WORKING BY APPLYING THIS POLICY LETTER.

WHAT I SAY IN THESE PAGES HAS ALWAYS BEEN TRUE, IT HOLDS TRUE TODAY, IT WILL STILL HOLD TRUE IN THE YEAR 2000 AND IT WILL CONTINUE TO HOLD TRUE FROM THERE ON OUT.

NO MATTER WHERE YOU ARE IN SCIENTOLOGY, ON STAFF OR NOT, THIS POLICY LETTER HAS SOMETHING TO DO WITH YOU.

**ALL LEVELS**

**KEEPING SCIENTOLOGY WORKING**

HCO Sec or Communicator hat check  
on all personnel and all new personnel  
as taken on.

We have some time since passed the point of achieving uniformly workable technology.

The only thing now is getting the technology applied.

If you can't get the technology applied, then you can't deliver what's promised. It's as simple as that. If you can get the technology applied, you *can* deliver what's promised.

The only thing you can be upbraided for by students or pcs is "no results." Trouble spots occur only where there are "no results." Attacks from governments or monopolies occur only where there are "no results" or "bad results."

Therefore the road before Scientology is clear and its ultimate success is assured *if* the technology is applied.

So it is the task of the Assoc or Org Sec, the HCO Sec, the Case Supervisor, the D of P, the D of T and all staff members to get the correct technology applied.

Getting the correct technology applied consists of:

**One:** Having the correct technology.

**Two:** Knowing the technology.

**Three:** Knowing it is correct.

**Four:** Teaching correctly the correct technology.

**Five:** Applying the technology.

**Six:** Seeing that the technology is correctly applied.

**Seven:** Hammering out of existence incorrect technology.

**Eight:** Knocking out incorrect applications.

**Nine:** Closing the door on any possibility of incorrect technology.

**Ten:** Closing the door on incorrect application.

One above has been done.

Two has been achieved by many.

Three is achieved by the individual applying the correct technology in a proper manner and observing that it works that way.

Four is being done daily successfully in most parts of the world.

Five is consistently accomplished daily.

Six is achieved by Instructors and Supervisors consistently.

Seven is done by a few but is a weak point.

Eight is not worked on hard enough.

Nine is impeded by the "reasonable" attitude of the not-quite-bright.

Ten is seldom done with enough ferocity.

Seven, Eight, Nine and Ten are the only places Scientology can bog down in any area.

The reasons for this are not hard to find. (a) A weak certainty that it works in Three above can lead to weakness in Seven, Eight, Nine and Ten. (b) Further, the not-too-bright have a bad point on the button Self-Importance. (c) The lower the IQ, the more the individual is shut off from the fruits of observation. (d) The service fads of people make them defend themselves against anything they confront, good or bad, and seek to make it wrong. (e) The bank seeks to knock out the good and perpetuate the bad.

Thus, we as Scientologists and as an organization must be very alert to Seven, Eight, Nine and Ten.

In all the years I have been engaged in research I have kept my comm lines wide open for research data. I once had the idea that a group could evolve truth. A third of a century has thoroughly disabused me of that idea. Willing as I was to accept suggestions and data, only a handful of suggestions

(less than twenty) had long-run value and *none* were major or basic; and when I did accept major or basic suggestions and used them, we went astray and I repented and eventually had to "eat crow."

On the other hand there have been thousands and thousands of suggestions and writings which, if accepted and acted upon, would have resulted in the complete destruction of all our work as well as the sanity of pcs. So I know what a group of people will do and how insane they will go in accepting unworkable "technology." By actual record the percentages are about twenty to 100,000 that a group of human beings will dream up bad technology to destroy good technology. As we could have gotten along without suggestions, then, we had better steel ourselves to continue to do so now that we have made it. This point will, of course, be attacked as "unpopular," "egotistical" and "undemocratic." It very well may be. But it is also a survival point. And I don't see that popular measures, self-abnegation and democracy have done anything for man but push him further into the mud. Currently, popularity endorses degraded novels, self-abnegation has filled the Southeast Asian jungles with stone idols and corpses, and democracy has given us inflation and income tax.

Our technology has not been discovered by a group. True, if the group had not supported me in many ways, I could not have discovered it either. But it remains that if in its formative stages it was not discovered by a group, then group efforts, one can safely assume, will not add to it or successfully alter it in the future. I can only say this now that it is done. There remains, of course, group tabulation or coordination of what has been done, which will be valuable—only so long as it does not seek to alter basic principles and successful applications.

The contributions that were worthwhile in this period of forming the technology were help in the form of friendship, of defense, of organization, of dissemination, of application, of advices on results and of finance. These were great contributions and were, and are, appreciated. Many thousands contributed in this way and made us what we are. Discovery contribution was not however part of the broad picture.

We will not speculate here on why this was so or how I came to rise above the bank. We are dealing only in facts and the above is a fact—the group left to its own devices would not have evolved Scientology but with wild dramatizations of the bank called "new ideas" would have wiped it out. Supporting this is the fact that man has never before evolved workable mental technology and emphasizing it is the vicious technology he *did* evolve—psychiatry, psychology, surgery, shock treatment, whips, duress, punishment, etc., ad infinitum.

So realize that we have climbed out of the mud by whatever good luck and good sense, and *refuse* to sink back into it again. See that Seven, Eight, Nine and Ten above are ruthlessly followed and we will never be stopped. Relax them, get reasonable about it and we will perish.

So far, while keeping myself in complete communication with all suggestions, I have not failed on Seven, Eight, Nine and Ten in areas I could supervise closely. But it's not good enough for just myself and a few others to work at this.

Whenever this control as per Seven, Eight, Nine and Ten has been relaxed, the whole organizational area has failed. Witness Elizabeth, NJ; Wichita; the early organizations and groups. They crashed only because I no longer did Seven, Eight, Nine and Ten. Then, when they were all messed up, you saw the obvious "reasons" for failure. But ahead of that they ceased to deliver and *that* involved them in other reasons.

The common denominator of a group is the reactive bank. Thetans without banks have different responses. They only have their banks in common. They agree then only on bank principles. Person to person the bank is identical. So constructive ideas are *individual* and seldom get broad agreement in a human group. An individual must rise *above* an avid craving for agreement from a humanoid group to get anything decent done. The bank-agreement has

been what has made Earth a Hell—and if you were looking for Hell and found Earth, it would certainly serve. War, famine, agony and disease has been the lot of man. Right now the great governments of Earth have developed the means of frying every man, woman and child on the planet. That is bank. That is the result of Collective-thought Agreement. The decent, pleasant things on this planet come from *individual* actions and ideas that have somehow gotten by the Group Idea. For that matter, look how we ourselves are attacked by “public opinion” media. Yet there is no more ethical group on this planet than ourselves.

Thus each one of us can rise above the domination of the bank and then, as a group of freed beings, achieve freedom and reason. It is only the aberrated group, the mob, that is destructive.

When you don't do Seven, Eight, Nine and Ten actively, you are working for the bank-dominated mob. For it will surely, surely (a) introduce incorrect technology and swear by it, (b) apply technology as incorrectly as possible, (c) open the door to any destructive idea, and (d) encourage incorrect application.

It's the bank that says the group is all and the individual nothing. It's the bank that says we must fail.

So just don't play that game. Do Seven, Eight, Nine and Ten and you will knock out of your road all the future thorns.

Here's an actual example in which a senior executive had to interfere because of a pc spin: A Case Supervisor told Instructor A to have Auditor B run Process X on Preclear C. Auditor B afterwards told Instructor A that “It didn't work.” Instructor A was weak on Three above and didn't really believe in Seven, Eight, Nine and Ten. So Instructor A told the Case Supervisor, “Process X didn't work on Preclear C.” Now *this* strikes directly at each of One to Six above in Preclear C, Auditor B, Instructor A *and* the Case Supervisor. It opens the door to the introduction of “new technology” and to failure.

What happened here? Instructor A didn't jump down Auditor B's throat, that's all that happened. This is what he *should* have done: Grabbed the Auditor's Report and looked it over. When a higher executive on this case did so, she found what the Case Supervisor and the rest missed: that Process X *increased* Preclear C's TA to 25 TA divisions for the session but that near session end Auditor B Q-and-Aed with a cognition and abandoned Process X while it still gave high TA and went off running one of Auditor B's own manufacture, which nearly spun Preclear C. Auditor B's IQ on examination turned out to be about 75. Instructor A was found to have huge ideas of how you must never invalidate anyone, even a lunatic. The Case Supervisor was found to be “too busy with admin to have any time for actual cases.”

All right, there's an all-too-typical example. The *Instructor* should have done Seven, Eight, Nine and Ten. This would have begun this way. Auditor B: “That Process X didn't work.” Instructor A: “What exactly did *you* do wrong?” Instant attack. “Where's your Auditor's Report for the session? Good. Look here, you were getting a lot of TA when you stopped Process X. What did you do?” Then the pc wouldn't have come close to a spin and all four of these would have retained their certainty.

In a year, I had four instances in *one* small group where the correct process recommended was reported not to have worked. But on review found that each one had (a) increased the TA, (b) had been abandoned, and (c) had been falsely reported as unworkable. Also, despite this abuse, in each of these four cases the recommended, correct process cracked the case. Yet they were reported as *not having worked!*

Similar examples exist in instruction and these are all the more deadly as every time instruction in correct technology is flubbed, then the resulting error, uncorrected in the auditor, is perpetuated on every pc that auditor audits thereafter. So Seven, Eight, Nine and Ten are even more important in a course than in supervision of cases.

*Paul Anderson*

HUBBARD COMMUNICATIONS OFFICE  
Saint Hill Manor, East Grinstead, Sussex

HCO POLICY LETTER OF 17 JUNE 1970RB

Issue I

REVISED 25 OCTOBER 1983

Remimeo  
Applies to all  
SHs and  
Academies  
HGCs  
Franchises

**URGENT AND IMPORTANT**

***Keeping Scientology Working Series 5R***

**TECHNICAL DEGRADES**

(This PL and HCO PL 7 Feb. 65 must be made part of every study pack as the first items and must be listed on checksheets.)

Any checksheet in use or in stock which carries on it any degrading statement must be destroyed and issued without qualifying statements.

Example: Level 0 to IV checksheets SH carry "A. Background Material.— This section is included as an historical background but has much interest and value to the student. Most of the processes are no longer used, having been replaced by more modern technology. The student is only required to read this material and ensure he leaves no misunderstood." This heading covers such vital things as TRs, Op Pro by Dup! The statement is a falsehood.

These checksheets were not approved by myself; all the material of the Academy and SH courses IS in use.

Such actions as this gave us "quickie grades," ARC broke the field and downgraded the Academy and SH courses.

A condition of TREASON or cancellation of certificates or dismissal and a full investigation of the background of any person found guilty will be activated in the case of anyone committing the following HIGH CRIMES:

1. Abbreviating an official course in Dianetics and Scientology so as to lose the full theory, processes and effectiveness of the subjects.
2. Adding comments to checksheets or instructions labeling any material "background" or "not used now" or "old" or any similar action which will result in the student not knowing, using and applying the data in which he is being trained.
3. Employing after 1 Sept. 70 any checksheet for any course not authorized by myself or the Authority, Verification and Correction Unit International (AVC Int).

(Hat checksheets may be authorized locally per HCO PL 30 Sept. 70, CHECKSHEET FORMAT.)

4. Failing to strike from any checksheet remaining in use meanwhile any such comments as "historical," "background," "not used," "old," etc., or VERBALLY STATING IT TO STUDENTS.
5. Permitting a pc to attest to more than one grade at a time on the pc's own determinism without hint or evaluation.
6. Running only one process for a lower grade between 0 to IV, where the grade EP has not been attained.
7. Failing to use all processes for a level where the EP has not been attained.
8. Boasting as to speed of delivery in a session, such as "I put in Grade Zero in 3 minutes." Etc.



9. Shortening time of application of auditing for financial or labor-saving considerations.
10. Acting in any way calculated to lose the technology of Dianetics and Scientology to use or impede its use or shorten its materials or its application.

**REASON:** The effort to get students through courses and get pcs processed in orgs was considered best handled by reducing materials or deleting processes from grades. The pressure exerted to speed up student completions and auditing completions was mistakenly answered by just not delivering.

The correct way to speed up a student's progress is by using two-way comm and applying the study materials to students.

The best way to really handle pcs is to ensure they make each level fully before going on to the next and repairing them when they do not.

The puzzle of the decline of the entire Scientology network in the late 60s is entirely answered by the actions taken to shorten time in study and in processing by deleting materials and actions.

Reinstituting full use and delivery of Dianetics and Scientology is the answer to any recovery.

The product of an org is well-taught students and thoroughly audited pcs. When the product vanishes, so does the org. The orgs must survive for the sake of this planet.

**L. RON HUBBARD**  
Founder

Adopted as official  
Church policy by  
**CHURCH OF SCIENTOLOGY**  
**INTERNATIONAL**

LRH:CSI:iw.gm

# THE QUALITY OF THE SEA ORG AND WHAT IS A SEAMAN



*A lecture given on  
15 October 1969*

Thank you.

Well, tonight we're going to talk about something important. We're going to talk about the crew. All the other stuff I've been talking about so far is not as important as the crew.

15th of October '69.

The first thing you have to have if you have a ship is a crew and if you don't have one you don't have a ship very long.

Now, the difference between sailors and landlubbers is as follows: the landlubber doesn't have to put the land there. And so he very often comes to sea without an awareness that the platform on which he is standing has to be put there and continued to be there, and he is there to move this platform around and keep it in place and keep it afloat.

Now, when the landlubber goes to sea and doesn't know this very important fact, that he now has an additional action which is "putting the land there," you get the damnedest things you ever saw in your life. It is the most remarkable mess.

If you look around very carefully in any yacht harbor, you will see some examples of it. Somebody has bought himself a boat and he is now going to put out for a cruise. Well, it is a very, very remarkable fact that the anchor goes down, won't come up, won't go down, the sails won't go up, won't go down and the net result of it all is "Yacht in Trouble" becomes a standard news story.

There was some fellow who shoved off, for instance, from England and he was going to go to America. And I think he got something on the order of fifteen or twenty miles out into the Channel on some bucket of bolts, which very possibly, which very, very possibly might have gone to America had it had a crew. And he managed to get that thing rolling in such a way—I think it rolled all the fuel out of its supply tanks and it couldn't go any further. And at that moment, why, the coastguard and other agencies promptly came out and towed him in the twelve miles into Torquay or something like that.

I was rather astonished afterwards at the amount of damage which had occurred—fantastic amounts of damage. And on top of all of the bills for damage he had for this yacht, he also had a six-thousand-pound bill from the—England believes in saving lives at sea, you see, but got to be paid for it—a six-thousand-pound bill for towing him into the harbor.

Now I myself have seen ships in a remarkable state. I've seen lots of ships in very remarkable states. The yachts of the United States were once turned over to the United States Navy at the beginning of World War II. For some reason or other a foreign power—or that is to say, a national power, considers a yacht, to some degree, a war vessel. That's the category in which a yacht fits. And so at the beginning of any given self-respecting war the United States and England instantly appropriates all the yachts. And at that moment you see all the yachts of the country of any size at all being collected by the navies.

CREW  
SEAMAN  
VS  
LANDLUBBER

Now, the reason for this as near as I could figure out, in 1942 up in Boston Harbor, was so that cousins and other people who were related to admirals and politicians wouldn't get sacrificed in this war, because all they did was put them aboard the yachts, at which moment all the yachts broke down. And there were hundreds of yachts, some of them very good sized yachts, all equipped as patrol vessels, and they'd driven big nails through the decks and that sort of thing, to put guns on them and so on. They were terrific, terrific display. And the very, very best caps from Brooks Brothers in New York could be seen aboard them.

And we would come in from the sea, covered with salt and very, very overworked to say the least, because I think there were only a half a dozen patrol boats in the entire North Atlantic who ever had any idea of doing anything about submarines. And we were all six of them. Hardly any exaggeration. Actually they didn't need, at that particular time, any transports to go through to Germany. All they had to do was form up the troops four abreast and march them to Germany from America on the backs of the German submarines. That was as near as . . . That was sort of the way it looked to me, you know.

I'd come into the harbor and instantly there'd be a white-belted messenger down there saying "A submarine is shelling a freighter twelve miles off Cape Cod. Uh . . . you boys uh . . . at once, Sir, should go out immediately" and so forth. And you say "What . . . what the hell? What—what—what—what are you talking about?" See? "The fuel tanks are empty. The guns—we got no ammunition. There's no food aboard. Da . . . wha . . . wha . . . What's the matter? What's the matter with all these *ships* you've got in here? These *hundreds* of them?" Forests of masts with all the best caps from Brooks Brothers. They were good yachts too. And I'm sure the guns they put on them shot. Of course, we were several times their size. So we would turn around and go out and do something about the freighter that was being shelled.

So it did begin to look to us as though there were only six vessels in the entirety of the North Atlantic and we were all six of them.

But I got to looking at these yachts and I got very interested in this. And as time went on I kept an eye on this sort of thing because in a lot of harbors these yachts still sat there. They did nothing but sit there, you know, because their purpose was to perpetrate the future aristocracy of America and I got very interested in them. And if you ever saw vessels in bad condition, they were it. They actually couldn't have moved fifty feet even though they had spent months in the yard. Even if they'd taken them into the yard and rebuilt them complete, they wouldn't have then moved fifty feet. It was the damnedest thing you ever saw. They didn't have any crews. They didn't have any crews.

What they were was a bunch of landlubbers with self-survival as their nearest action, and they put them aboard those ships and they didn't have any ships.

Well, I was very surprised . . . I was very surprised at the actual length of time that it took to get something done, because four or five years later they still hadn't gotten them into operation and all they did at that particular time was give them back to their owners or sell them at public auction. And boy, were they wrecks by that time.

I remember one yacht called the *Blue Water*. She was about 112 feet or something of that size. And she had beautiful paneling in her main salon and the guys they had put on board her couldn't keep warm where she was lying alongside of a dock up in the Chesapeake so they had laid some bricks down in the middle of the main dining hall and had kept a fire going on them. Yep, it was quite remarkable.

Now, forgive me reminiscence; World War II is several wars ago. I could talk to you about the War of American Independence or some of those wars for variety.



So the main point I'm trying to make to you however is undoubtedly the United States government had brought into its possession probably upwards of a billion dollars worth of yachts. They didn't have any crews so they didn't have one. That's interesting, isn't it? So it isn't enough to have a ship. You got to put the ship there.

After you watch something like this it becomes a vast lesson. You got to keep putting the ship there. It's a floating platform, and you haven't any idea, until you have seen him face to face, what Old Man Sea can get up to.

We had an idea given us here the other day. Somebody in England writing me, asking for—he's got all kinds of backing on this and that sort of thing—but he's going to put in a floating city. And it's all going to be afloat and he's going to anchor the thing, I think, halfway between England and Denmark or something. And undoubtedly this engineering feat could be done. But I looked at this and I wondered if he had ever been out there looking at Old Man Sea in one of his nastier moods.

The amount of ferocity which can be developed by waves and wind can't really be believed until you have seen them. So you actually operate with a ship—I don't want to scare anybody to death because there's nothing to it. It's a piece of cake. So you operate on an agreement with Old Man Sea that you do your job and keep things working right and he will leave you safe. And that is the agreement, actually, on which you operate. If you keep everything working right, and it's all shipshape, and there's nothing going to go to hell in the middle of something or other, there isn't something so weak that it's going to fall apart in the middle of sudden stress, why, then you have come to an amicable agreement with Old Man Sea—providing your watch officers also don't run you aground or get you on a lee shore during such a tempest, and you're . . . But that, again, would be just a piece of carelessness.

/ The only time you really have trouble with the sea is when you have violated the idea of putting the ship there. That's the only time you ever have trouble with him. You go out of the harbor and the engine is going "Kaff! Uhm-uhm-uhm. Kaff! Uhm-uhm-uhm." Well, there's going to be more randomness before there is less. Because if the ship runs that way in calm water, how the hell is it going to run when it gets a few waves? And what would happen if the sea really started kicking up?

So your basis of operation is far above what a land basis of operation is. The engine quits on a car, you pull it over to the side of the road and you get out.

Anyway, the . . . I have had, myself, some remarkable experiences along this line. I once took the delivery on a yacht. She was a nice little yacht but she had been lying still for a very long time. And I went over and took delivery on her and was just going to take her on a short delivery run—just going to take her across the harbor. It was a big harbor, but I was just going to take her across the harbor. It didn't seem to be much. And I had some guy and his girl who were more interested in getting drunk than taking the thing across the harbor, and the only other one I had aboard knew nothing about it either. But it didn't look like much.

We went a short distance and the generator quit. The generator quit, which of course ran the battery down promptly and that was the end of its engine. There wasn't anything you could do about that. No service stations are run by dolphins. But she had nice sails so I hoisted her sails up and she started scooting along the way she did, and then all of a sudden—crunch! Down came the mainsail. Crash! Slap! Down came the jib. And slither, thud! came the mizzen.

So I said, "Well, what's the matter?" So I looked at it, and I found out their halyards were rotten. She had been sitting still for so long that the outside of the rope looked okay, but you have to learn to take a piece of rope and give it a twist and look at the inside of the rope. And the inside of the rope was just powder. So there went the halyards.



So I scrounged around down in the bosun's locker and all I could find down there was some clothesline. So I managed to put together some clothesline and I substituted that for the main halyard and persuaded this guy to shin up the mainmast and we managed to get the mainsail going and the ship was going forward again.

In the meanwhile darkness had fallen, and the wind had freshened. There were no ships, not even any ferries about to amount to anything. The wind was off the shore and blowing us out to sea. And being pretty tired by this time I went below to try to get a cup of coffee out of the picnic kit because there wasn't even anything aboard her, you see, to do anything with except a couple of sandwiches and a bottle of coffee. And this guy, with his girlfriend—they were steering back there. And I heard a horrible crash and I looked out, and he had been wrapped up, spooning with his girlfriend to such a degree that he hadn't watched what he was doing with steering, and he had let her jibe, and that last small piece of clothesline had parted, never to be repaired again.

So there we were, drifting at night with a *storm* now coming on. I finally did, however, manage to signal down a fish boat and get a tow. And he left us alongside of a dock. I left it alongside of the dock because there was nothing I could do about it. But the dock had a lot of waves beating at it. So this boat got its whole gunwale crushed in.

I went over there the next day, rescued her to that degree and got her over to a shipyard. The shipyard took out its engine, painted it and put it back into the ship—for which they charged me the most remarkable price you ever heard of. So once more—but this time I had cordage—once more I actually set to sea and I did bring her home that time.

Taking out a new boat or one with which you're not familiar is usually your most catastrophic experience. After a while, after you've had a few brushes with Old Man Sea, you find out you haven't signed your contract with him that you'll keep things under good control and know your business and keep things running that are running, and he will pretty well leave you alone.

Now, let's take another end of this. I have been through, with a sound ship—and one I have trained the crew of and so forth—I have been through a 180-mile-an-hour hurricane in Alaska. And the only thing that happened was that we ran out of rum—which was a great oversight on our part.

So you see, there's two ends of the spectrum—a mild breeze and a complete wreck, and a 180-mile hurricane and total safety.

Now, what in essence do you have to do that is slightly different between running around on the beach and running around at sea? You notice that the land doesn't move. You can stamp on it, and so forth—nothing happens. It just goes on sitting there.

But when the weather starts kicking up, a ship starts to move. And the more the weather kicks up, the more the ship moves. And this has an interesting aspect to it. When the weather has kicked up to a point where the ship is really moving around, you will find most of the things which have been weakly secured or which are not properly bolted down or haven't been noticed, the pumps which were not quite in total repair and these other things all of a sudden have a tendency to go on a one-two-three-four-five-six breakdown.

Now, you're having to fix these things on a platform which is doing nip-ups, very often with the bilge water sloshing around with most remarkable ferocity—everything wet, nothing running, and you can't stop this. There isn't this thing of "Well, to hell with it. We'll go next door and have a cup of coffee." This is going to go on until you've got it under control.

And that makes a considerable difference of mental attitude. The mental attitude there is that it should be right, it should be very right, it should not risk coming to pieces, and that's what's known as "shipshape." And if it gets

KEEP THINGS RUNNING

SOUND SHIP  
2 ENDS OF SPECTRUM

DIFFERENCE BETWEEN LAND & SEA

SHIP SHAPE



into trouble and if we get into trouble, let's not have the trouble compounded by a bunch of faults laid into it accidentally by its crew.

You might not see anything innocent with a stack of Coke bottles stacked up against a bulkhead. There they are, all your Cokes—not just the bottles; Cokes and all—and they're stacked up in a big stack. And somebody comes along with a piece of twine and he ties it diagonally and he says, "That's secure. That's fine. That's great." And then, for some reason or another, you hit a bit of a wave—you're not even in a storm maybe but you sometimes can hit some interesting waves. And it doesn't even take much of a wave. There is a horrible crash and you go down and you have got Coke—Coke is sticky, broken glass and so on, and it's liable to be a very interesting mess.

Now, if a thing like that happened in a storm it'd be a total catastrophe because you couldn't clean it up at all and you might not be able to even walk down that passageway now. You get the idea?

So you make sure it's right and that no departures from the vertical and horizontal will deplace it, and that the pumps will keep pumping and not get full of rags. For instance, it stands your hair on end to look in a bilge and see somebody has thrown some rags in it. You know what's going to happen now. The rag, the second there's any ship motion is going to get washed down to the bilge mudboxes and there it is going to plug your whole bilge line. And if at that moment there was anything open and there were any water coming into the ship—couldn't get it out. Do you see?

So it requires, in actual fact, an extended think to go to sea. It requires a "What is the consequences of . . . ?" Actually, you don't live in that operating attitude. It's just something you sort of acquire, and you look it over, and you're passing by and you see some rags in the bilge and you say "Well, ha, shouldn't be," and you get the rags fished out of the bilge.

Now, the crew that walks by the rag in the bilge and the crew that picks it up is the difference between seamen and landlubbers. It isn't that they can tie fancy knots. It's they can do a think. And also, another difference—they have found out that they are interdependent, one upon another, on their various skills, observations and alertness.

So a nervous crew is one that doesn't really trust each other. And a competent crew is one that does. And a competent crew member is one who can be trusted.

Basically, you're dealing with the raw materials of survival. And you are trusting another crew member with your survival, and the actual fact is—the going word is "If we're going to survive, nobody must let the team down." It's not that we will just lose the game or that State will get three more points. Old Man Sea is the *hungriest* fellow you ever saw. He will eat anything.

It is very funny sometimes, when you're out in deep water—any water beyond diving depth and even in that. If you've ever had a sheath knife drop out of your hand and hit the surface of the sea and disappear, you get very impressed with the appetite of Old Man Sea because you're never going to get it back. That's for sure. On land you reach over and pick it up.

And the number of dead men in Davy Jones's locker probably could not be counted. Now, that's very, very gruesome, isn't it? Yet the sea, as far as I'm concerned, is probably a safer place than the land.

/ So therefore we get down to, basically, What is a crew? What is a ship's crew? What makes it different? And those are the things, really, that make it different.

Now, we have found out—we have just had a very interesting experience. Very, very interesting experience. We are the Sea Org and of all of the units that were up in Denmark, it was the *Athena* which was the stable datum, doing its job. Now, there's an oddity. There is an oddity. You would say, "Well, they're distracted by a ship and a ship's just an idea," and all that sort of thing. But this has held constant, ever since there's been a Sea Org, that

Sea Org members uniformly and continuously have proven to be far more competent than their org comparable members. If you look over some of the things which the Sea Org has done and some of the things for which they're responsible in the last couple of years, it is absolutely amazing.

Now a lot of fellows have done things in standard orgs—yes, that's true. They accomplish a lot of things. Why is it the Sea Org is always straightening them out? It's obviously not that we're critical, but that as we are and functioning as we are, we obviously develop a different frame of mind. And that frame of mind—probably it's an easier idea of an outness, an easier idea of what is out. What outness is an outness? It might be a lot of things. And it's also the thing that we're operating as crews. And we do develop some idea of interdependency and we do develop a higher level of competence. That's true.

But isn't it funny that if . . . Our competence concentrated on has been mainly the competence on ships, not orgs. So it just goes on the basis that if you raise any competence, you raise competence.

Now, you get some guy sitting around staring at pieces of paper and concepts and thoughts—they have never learned to confront MEST. Well, in the Sea Org we confront MEST. A ship is a fairly large object to go throwing around. And yet we throw them around. And it has a great deal to do with it. Obviously a Sea Org member is up in confront.

Now there is something to it, then, and we have been, to some degree by the political composition of the world and various factors, forced to do what any group that is a very competent and governing group does in space. The headquarters of the great space societies are practically undiscoverable. If you don't believe it, look at your own track. They're practically undiscoverable. There'll be a capital city, but is the government there? No. In OT type governments there is a considerable tendency to hit them. There is the jealousy, the fear—these various things rise up. I can tell you that governments—it wouldn't matter how nice you were about it or how pleasant you were about it. Every time I have written a government here in the last few years, the government has done something as though it was in terror.

I wrote a bit about it in *Freedom*. I traced it back. Every time I addressed a government they reacted. And I finally—"What emotion are these guys reacting on?" They were reacting on the emotion of fear or the emotion of terror.

Now, it obviously says that there must be something slightly elusive and it must be rather difficult to hit a central-control group in any line of country such as we are operating on. We have a certain elusiveness. And we count on the wog inability to make everything go through 100 percent to remain secure in that. We had experiments along this line and when we were land based, we were hit.

Now because the control organization of Scientology organizations is not that easy to hit (crossing my fingers), they know it wouldn't do any good to knock out one of the other organizations. We have posed them a problem which they can't really solve, within the framework of their own mores, and so forth. You see, if they can't hit us, why then it wouldn't do too much good to hit an org. That we're elusive makes the org safe. Do you follow? If we were in a fixed position we would be getting our brains blown out.

So when you do not have all of the artillery necessary to gun down all of the opposing forces, there is something else you can do, which is you can fade. And oddly enough our tactic, if we're hit and we fade . . . Most armies and so forth which try that—and we're not a military unit but most armies which try to be fabian (after the Roman word), they get weak. They lose—that is the army that's trying to fade away—they can't get their supplies, they can't get their troops, they can't get reinforcements, their economics are all upset. See?

Oddly enough, in a period of fading away we have become stronger.

Right now we're on a bit of a downstat streak as I talk right at this moment. But we're building that right back up again. We're mobile. And the idea of mobility itself is a protection. None of these cats can say—as they go to sleep every night, they cannot say “Thank God, those fellows are over in . . .”—because they can't be sure.

Now, you wouldn't think there was this much protest toward helping man, but there is a considerable protest toward helping man if people are being paid fantastically for keeping him very sick and in trouble. And you'll find out that the biggest appropriations on the planet are to bump people off. Governments spend more money to bump people off than they do at any other single thing. War, various things, military establishments, armed services and so on.

So, if they're of that frame of mind, we're almost their oppterm. I don't think they have any idea or any illusions about themselves. And I think they know they're bad hats because they say all man . . . all men are bad. Well, they should know.

So as a result we actually have been running a tactical situation here for many years. And it has been a successful one. We have had the combined forces of several nations being directed by their very best chief bad hats and we've not only stayed alive, we've kept orgs running and we've also expanded, which is fantastic. While being fabian we have gotten stronger.

So that is basically the real Why of the Sea Org. It gives an elusive body which might be anyplace, and which is now getting to be everyplace, if you look at our stationships and that sort of thing. But there they sit in harbor. Why attack them? All they would do is sail, see? It's upsetting. The whole thing is very upsetting.

So if we're not permitted to assume, as Scientologists, our proper action and role, if we do not get the appropriations which we should be getting in order to straighten out people and handle these various lines, why, we can go ahead and do our job anyway, and there are many ways in which we do accomplish that job.

But the idea of the Sea Org was born out of very practical experience. Not because I am particularly enamored with the sea. It is an area I know well, but I'm a good cavalry general too. But it is one which, by trial and error, served our purposes best.

In a ship we can keep our organizational papers, patterns, personnel, functioning actions going, right? So we don't have to be knocking down an org and putting it back together again. If you have ever tried that, you will know what I am talking about. To move an org from A to B—oh, my God! Three moves is as good as a fire.

Now, when we started this action stats were pretty bad and they were very, very low. And the existence of the Sea Org in the beginning of its actions, and so on, built them up steadily, steadily, steadily, steadily. And I don't know a factor of how many times we have built up international statistics in the Sea Org in the last two years. I don't know how many times we've multiplied it. But it's considerable. So they're on a little bit of a sag now—well, that's nothing. We'll have it going right back up again.

So therefore, as we look this thing over, we say, “Well, why a ship?” It's not that they're comfortable, not that they're this, not that they're that. They actually can be kind of fun.

You find a fellow being around the Sea Org after a while, after he has been ashore for a while, he says, “Oh, the hell with it. I'd like to go to sea.” Or I remember what's-his-name that wrote Moby Dick—wrote another book, and it starts out on the vein of “Every now and then when it gets too much for me on the beach, you know, I get myself together and go to sea.” And you'll see . . . you'll see, after you've been lying alongside of a dock for a while, why, you begin to look at the other boats around and you just kind of sneer and look at the dust and that sort of thing and smell the smells and

you say, "To hell with it," and you kind of start looking out for the open sea. And it's great.

And of course, that can pall too, but I have heard far less complaints about being at sea than I have of being on the beach.

So that, in essence, is what this is all about. It is the fact that a ship is not as safe as a delivery van by a long way. One of its greatest menaces are the safety conventions for the sea. And it is not something which sits there in one plane in one place, but it is liable to bounce about. And it has many complex actions. The fire hydrants don't turn on and one day there is a fire—woo, wow! wow! wow!

Old Man Sea is actually just sitting there waiting—"Well, they'll slip up, you know? They'll slip up"—not a very comfortable operating atmosphere, unless you yourself has adjusted your own competence to it. And if you've adjusted your own competence to it, it is a very, very comfortable operating atmosphere.

I've cruised in some of the worst waters of the world, bar none. One is the Tasman Sea with its seventy-foot waves from trough to crest, and the other is the Arctic Seas. And in both places I never turned a hair. Not because I was particularly brave, but because the outfit I was with was able to handle things. In other words, there was confidence.

So your best bet is to extend your prediction. Rag in the bilge predicts a *glug-glug-glug*, you see? They don't have rags in the bilge.

Fire hydrants that don't turn on—well, now that immediately predicts a fire you can't handle. Do you see? So your think gets somewhat along in these lines. When your think goes along in these lines and when you yourself are competent on your post and that post is coordinated with your other crew members, I think the sea is probably the safest place you could possibly be.

Now, at this particular moment with Communist China saying they are going to bomb Russia and the United States, and Russia and the United States sitting there worrying about getting bombed by each other, and a bunch of other sensible, sane people who are not only outside an institution, but actually have positions in the state—when these guys want to play ping-pong with a hundred megatron something-or-others, we also have another responsibility, which is the perpetuity of the technology.

If, as we sit right now, they started throwing stuff at each other, we'd be as safe as a bug in a rug. So what would you get out of it? You'd get a little bit of fallout; you might get a tidal wave or two. The best way to handle a tidal wave is to be at sea. You don't really handle tidal waves well alongside docks. Ships actually have tendencies to move over and sit down on the dock.

But at sea, it's very funny. A tidal wave at sea is a very funny thing. You sometimes will see a line on the radar screen that looks a bit above your horizon, and it seems to be approaching. And there you are. And the first thing you know why your ship lists or raises its nose a bit and you go up, up, up, up, up, up—okay. And then down, down, down, down, down, down, down. You say, "What the hell was that?" and then you hear on your radio the next day that fourteen cities have been wiped out on the coast by this vast tidal wave. So they are not very awe inspiring.

Well, although I haven't told you anything you didn't know, I was just trying to give you a little bit of background music to "Why the Sea Org," and also the slight difference of attitude which undoubtedly accounts in some part for the fact that when we run missions and we put orgs together and so forth, we get it *done*.

And we are actually a far more successful organization, and in terms of actual cash earnings are being well worthwhile. We earn more money for other people than could easily be counted. And we ourselves get less of it. We actually are terribly underpaid as an organization. Although these organizations are expanding, they expanded into the teeth of opposition—we have never, in actual fact expanded them up to a point where we had then a solid plateau

of expenditures we could afford on ourselves.

And right now, at this moment, why, we're back into the reserves again. Well, we've got to move it up so that we don't go into that.

Do you see what happens?

Actually, not only do the governments become unaware of us to a large degree but organizations become unaware of us; so that a Sea Org mission suddenly shows up at WW the other day, and one of the high executives wasn't going to have anything to do with them at all and was going to kick them out on their ear, using as an excuse that they weren't directly from Flag.

But he didn't stand up to it very long. And then they went ahead and executed their mission. And let me tell you, it was a damn good thing doing it too. They were sitting there, pretending to have some sixty, seventy thousand, eighty thousand pounds' worth of reserve. Their reserves were only sixty-eight hundred. The seventy-nine thousand pounds they had in a bank, and so forth, apparently does not belong to them but apparently belongs to me. It was actually money paid over to me for some real estate. This was their reserves. Nice work if you can get it.

So there was a Sea Org mission. It was sent out by the *Diana*, our littlest—not quite our littlest ship; we've got two or three smaller than the *Diana*. But it's our smallest stationship. And there it was, and it sent one out. And as far as I'm concerned, it probably saved WW from being wiped out, all in one fell swoop. And we saved their income; we saved the organization, as far as that's concerned.

And yet we don't expect very much of a pat on the back about that. We expect this sort of thing to happen. And we keep it running as best we can. They themselves are hit. They're having hard troubles of one kind or another, their income goes up and down. And if we can keep them straight and help them out, why, we're glad to do so. But many times in the last two years it was a doggoned good thing that there was a Sea Org.

We have actually inherited the job of running . . . beefing up orgs and developing programs. And we are very successful at that. And we . . . by reinforcing what you do well and dropping out what you don't do well, you eventually arrive at a good operating formula. And we have arrived at the fact that we are really an administrative, not a military group.

TEAM  
But our success is almost entirely due to the fact that we as a crew become a team, and an interdependency and a trust of one to another permits us to go ahead and get our job done far better than would be done if we were operating from a base on the beach. That's actually what we're really all about. And we're really not about much more.

SAILOR  
But to learn to be a sailor is simply to learn to predict what trouble you're not going to get into. And if you can carry that facility well, you know your job well.

Okay? Thank you.

Audience: Yes Sir. Thank you.



# WELCOME TO THE SEA ORG

---

*A lecture given on  
16 October 1969*

Thank you.

Thank you.

And this is the 16th of October AD 19. Correct me if I'm wrong.

Well, there are a lot of things I could talk to you about. There are a lot of things going on. But what I want to talk to you about is drills, because that's recently one of the things I've seen goes out, and goes out very, very easily. And the basic way drills go out is people don't really know their purpose.

And about the most horrible thing I saw in the subject of drills—ghastly—I saw some people being conducted on a tour of a ship. And I said, "What are you doing?" And they said, "We're running drills." And so I said, "Well, maybe—all right." And the next day I saw this same tour and the same people and I said once more, "What are you doing?" And they said, "We're running drills."

Well, apparently "drill" had been downscaled to an idea that you took some people around and showed them the ship so that they would know where things were. And whereas that's commendable, that is your first familiarization thing on the AB Checksheet. And it didn't look to me like they were ready for drills.

Drills are just exactly this:

A disaster is something which has not been predicted or prepared for. And that is a disaster. A disaster is something that has not been predicted or prepared for, right?

Now, in line of the gruesome and horrible things I was telling you in the last talk about the fact that you have to learn . . . get the capability of predicting the result of not just the rag in the bilge but the generator run without water, and so forth—not only that, you have to be able to say with confidence that on this ship, if we had a fire . . . Remember, there's this platform. You don't walk out the front door and call the fire department, do you understand? You're right there and you have had it.

I think one of the last big fires that made history was some Greek vessel—down off the coast of Portugal, I think it was, or something like that; some Christmas holiday—and they had some god-awful death toll. The earliest one that I ran into—had anything much, at a vast distance, to do with—was the *Morro Castle*, which was a very famous disaster. Anyway, these ships burned right straight to the waterline and killed almost everybody aboard. This Greek vessel off of the coast not only didn't know their fire drill but apparently the idea was all the stewards got in the boats and rowed away.

I remember the *Andrea Doria*, I think, when ships came to her rescue while she was sinking, her boats were full of only cooks and stewards and there were no passengers in those boats, and the British seamen who were in the ships, and so on, which were standing by to help her wouldn't let them aboard. They turned them around and made them go back for passengers. Because by tradition of the sea, a cook or steward is a sailor and he is responsible for it as anything else.

Now, navalwise, there are various ways of going to sea. The two chief categories of them are going to sea foolishly and going to sea sensibly. And I'm, of course, talking mostly in the vein of going to sea sensibly. Naval vessels are normally sent to sea to be sunk or to sink. They're supposed to sink somebody else or be sunk or something like that. And they take relatively few precautions on these things with regard to the ship sinking. For instance, they don't have enough life rafts to take care of anybody, and when battleships turn over you see most of the crew has run down the hull and is on the inverted hull, when they're normally picked up, those that have been saved and so on. But they've just written it off as it isn't possible to provide lifeboats or life rafts for a thousand crew members. So, well, that's not possible to do that so to hell with it.

And then there's the commercial attitude of going to sea which is the passengers and so on, and that gets up to a fantastic point of the SOLAS Convention. And the SOLAS Convention is amongst the world's greatest idiocies. It's run at the UN by the British for the British shipyards. And Mary Sue figured out one time how this came about. New ships being built by any large fleet can, of course, put into them safety precautions which aren't normal to ships. And then they influence the SOLAS Convention to make those new regulations which puts all their competitors out of business. Their ships aren't built that way.

Well, we've actually found it to be the case that—I think a thirty-five pound beam down here one time with about ten pounds worth of welding that we were going to put in to strengthen a hatch . . . The shipyard estimate of that was three thousand pounds and it was being insisted upon by an inspector. All of which was very fascinating because the same inspector was insisting that we weld up our water doors on the main deck so no sea could get out of them if it ever came aboard.

So these guys get very unreal. But most commercial vessels simply drill on one basis, and that is "Abandon ship, abandon ship." And you'll get a commercial sailor and boy, he really knows how to abandon ship. He's got his lifeboat ticket and he just knows it right down to the ground, you know? And he can lower those boats, particularly in still, calm water—he'd never lower them in real water.

It's a lot of difference between putting a boat down in a harbor and putting a boat down running just a little six-foot swell. You'd be interested to know that if you don't let go those falls in exactly the right order when you're dumping up and down in one of these six-foot swells, somebody's going to get killed by that afterblock. The afterblock is run off just a split second before the forward block is, but they've both got to go and at that moment your crew with the oars in that boat have got to have those oars flat-bladed, right straight against the side of the ship and the moment those falls go, they shove. That gets the blocks out of the way and gets the ship out of the way, do you see? Otherwise those great big heavy steel blocks—your boat is rising and falling and going this way and that way and those great heavy steel blocks can crack somebody's skull so quick that you wouldn't think of it. It's a bit different putting them down in calm water and putting them down when a sea is running. Do you see?

So drills in the merchant service normally have to do with abandoning ship. Well, if you've got to abandon ship you already stink because you couldn't keep it afloat. So all the drills must be missing up to abandon ship. Now, this is no reason why you shouldn't know how to abandon ship. But the abandonment of a vessel is a confession that all other drills have failed. So if all other drills have failed then how do you expect the abandon ship drill to go off? That's not going to come off well, either.

The navy, on the other hand, because it can't abandon ship, has a tendency to specialize in the other drills and tends to ignore abandon ship because they haven't got any boats to abandon ship with anyhow. And they get . . . of course are subjected to, in actual service, a lot of damage. So they

tend to go out very strongly along the lines of damage control.

But the long and the short of it is that the only disasters they will have are those disasters which have not been predicted and billed and drilled. That's the only disasters they'll have. You can look over a ship and actually predict what disaster it'll have simply by finding out what nobody is drilled on, and sooner or later one or another of these disasters that nobody is drilled on—it'll happen and it'll be a disaster.

But a disaster or a mishap that simply happens will only become an emergency if it's billed and drilled for. And that's the difference between going to sea safely and going to sea at risk. If your ship knows its business, the crew knows its business on billing and drilling, you are really in very safe hands. And if the crew doesn't know its business, if somebody all of a sudden said, "We had a fire a while ago in the engine room. We put it out," and they think that's all right; brother, that is not all right. Yes, they have an estimation that they can put out that fire down there. Yes, the first thing you do is the guy who is on this ground does everything possible to put out that fire as instantly as he possibly can because fires, to the length of time they burn, become more ferocious. So it has to be put out early and quick.

All they did in that instance, however, was put out the fire in front of them. They did not do all of the other things necessary to make that safe. What if the guy had missed?

I was on a yacht one time—pretty good-sized one—down in Miami Bay and out in the middle of the bay the engine caught fire. And there was a rather brassy engineer—he was a good guy—and he was down there. What happened was a flash-back occurred. And this—again, this boat was just being moved from one place to another, and it wasn't in regular service. And this flash-back occurred in the carburetor and it was a petrol, or gasoline, engine and up went a tower of flame around the engine. And the engineer stayed there trying to cope with it, but the gas tank of this thing sat aft of the engine in a rather large engine room and the fire was running right along and was underneath the gas tank.

Well, the second I got an inkling of this . . . There weren't all that number of people aboard. There was then him and me and there were a couple of supernumeraries that didn't count—they didn't have anything to do with the ship—and I picked up one of these five-gallon fire extinguishers promptly, the first one in sight, turned it upside down, held it at the fire: nothing happened. It was empty. I rushed up along the deck, got another one, got it down, inverted it to put out the fire: it was empty. I went forward and got the third one, brought it down, upset it: bang! There was no cartridge in it.

This fire in the meanwhile was starting to devour the whole engine room. So I told this engineer, I said, "It isn't worth it. It is not worth it." I said, "Let her go." And he said, "No, I can do something about it." By that time the gas tank was practically glowing. And he actually, with a couple of sacks—I couldn't even get in there—he was in a small area that wasn't yet on fire and with a couple of sacks he actually beat it out. Suddenly it run out of oil or it ran out of something and he actually beat it out. I stood there ready to yank him out of there.

But I expected at any moment that we were going to decorate the entirety of Miami Harbor with fragments of that big yacht.

When you see a few things like this—the one I told you about the last time I talked to you, of course, was the first time I had ever laid hands on a yacht this life and I got . . . that educated me into inspecting rope and that sort of thing. And this next one educated me into the ferocity and speed with which fire can spread and that you don't keep around fire extinguishers which are empty.

If you have fire extinguishers around, make sure they are not only in correct quantity, but also are filled. And every now and then take all the fire extinguishers on the ship, make sure that you've got spare cartridges for all of them, and go around on a dock or out in a boat or get someplace on a well

deck where it won't make too much mess and just let the whole crew have a ball emptying every fire extinguisher on the vessel. At which moment you, of course, promptly fill them up because fate will usually time the fire after you've emptied them and till you fill them. And then you fill them all up again. It doesn't matter these tags they have on them.

So anyway, life cannot necessarily be interesting, it can be terribly uncomfortable when you run into things of this character.

But that, of course, was not predicted. That was a disaster, that big yacht was not a predicted disaster. In the first place, she was only going about a mile and a half to the shipyard to be refitted. And she got three-quarters of the mile of that distance and decided to burn up.

So you see, it is ships which are more or less out of commission which give you more trouble. Now, you'll probably—just prediction—you'll probably have more trouble with this ship after this refit than we had with it in any of the three months before the refit, because people will have changed things and so on.

Now, already, because they're not in regular service, just today they ran a generator without turning the water . . . the cooling water on and the generator started to go red hot and was fortunately caught and stopped and probably has not been badly damaged.

But look, we're sort of not operating, you get this, right now, we're sitting here in the middle of refit. Now, when we go back to sea, somebody will have moved this piece of rope and somebody will have moved that life ring, and this or that won't quite be where it was, don't you see? And you're not set up, really, operationally. It takes a little while to set up a ship where people know where things are and know what the score is.

Now, I'm not trying to give you a long and lugubrious story about how horrible it all is. If you really want to get down morale on how horrible it is, I invite you to read the Lloyd's insurance brochures. Now, they're in the business, they think, of selling insurance. They're probably not in that business at all, because they certainly don't follow the basic rule of insurance which is get an awful lot of ships, the more ships the better, and insure them all. And they try to get as few ships as possible by contributing to the SOLAS Convention. So they're actually going broke. Lloyd's is, by the way, going broke. And the reason they are going broke is because they're trying to cut their losses by making people handle ships safely, instead of just handle a lot of ships.

If you have a lot of ships you've already figured out what your losses are going to be anyhow and if they get lost, well, you pay up. That's the way an insurance company ought to operate. You don't go around and have all the governments pass regulations so you don't have any losses in your insurance and can put it in your pocket. That's not the way it's done. Yet that's the way they're trying to do it.

But you read their fire brochures and that sort of thing and you can get more discouraged than anything you ever saw. Because in the first place they really—and these things don't give you any information, really, about handling fires. They just tell you how everybody burns up, hah! It all burns up, ha-ha-ha! And the proper way to keep it from burning up is get insured by Lloyd's.

I can just see a captain rushing out into the wing of the bridge and shaking in the direction of the engine room or the forecandle or wherever the fire is burning, a Lloyd's insurance policy. But I suppose it's owners who buy insurance and owners don't go to sea so they don't bother to tell anybody how to put fires out.

Now, there are two types of crews. There are two types of crews—getting on with drills—two types. One is a specialized trained crew and the other is a generally trained crew. You have a specialist trained crew before you have a general trained crew. Therefore, you can very rapidly make a ship safe with specialist trained crews. In other words, each person is trained to do

Two  
Types  
of  
CREW

cut  
billed  
his exact duty or his exact part of the drill. And each person being trained to do that one little piece, that can be trained in no time at all—providing they are actually billed and drilled.

By “billed,” I mean you put up the guy’s name and his duties and what the drill is. And then, drilling it, you go out and get him to do it.

So, your bill-and-drill action comes off on a specialized basis. Some guy, he just gets to be an absolute whiz at connecting fire hoses. He gets so he knows where all the fire hoses are on the ship. But the guy right alongside of him who is supposed to sound the alarm—he doesn’t even know where the fire hoses are but he sure knows where the alarms are, have you got it? This is specialist training.

And one tends, after he has a ship specialist trained, to skip it, because it looks good. But then the Recognitions Chief and the Third Mate get busy and they start transferring people. And then Operations, and so forth, sends off four or five people to an AO, see in our case. The next thing you know, you haven’t got any bill. And you haven’t got any drill. The new people have all got to be trained on their new posts.

And just because somebody’s been transferred from this post to that post and somebody else from this post to that post and somebody else from this post to that post, you still think you have it drilled. No, they’re specialist trained, their duties have been changed. If you don’t drill it you will get into trouble.

You see why? Now, the thing wrong with an engine room fire or somebody there and putting it out—he did fine, he fought it out with his coat or his fire extinguisher or something of the sort before it could get going. Yes, he’s supposed to do that. But where was the guy who turned in the alarm?

Well, now the last time I asked that question somebody said to me, “Oh, we didn’t want to alarm everybody.” I don’t care if he’s got the fire half out, man! That alarm goes on! Those loud speakers go on, fire is sounded throughout that ship! Why? Because he might miss. You understand? A trail of that fire might all of a sudden go *fttttt!* someplace else. It might be an electrical short which isn’t where it’s supposed to be, and something catches fire someplace else. Maybe this fire is getting serious. It’s also of interest to get the drill called as quickly as possible. You always put a fire out as fast as you can, but you also call the drill as quickly as possible.

So the first guy who spots the fire, of course, shouldn’t go off . . . tearing off when he’s got a chance of putting out the fire. But he ought to scream at the top of his voice until he gets somebody else. And the first thing he should tell them is “Sound the alarm!” And then alarm for fire should be known in the ship. And people report to their stations.

So it’s good news if they’re all told “Hell, the fire’s been out for the last ten minutes.” They’re nevertheless there. What if the fire wasn’t out for the last ten minutes? You’re going to leave those guys all in their cabins, in their bunks, waiting to be burned up? That’s idiocy.

No, what you want to do is get an enthusiasm for disturbing people along this line. Just get a complete enthusiasm for it and say, “Heeheehee! I dropped a match on the foredeck—fire drill! Fire!” Two-thirty A.M.

Now, somebody falls overboard. It’s a very, very funny thing that the guy who falls overboard is falling overboard to people who have no practice in salvaging people who have fallen overboard. Because it doesn’t happen very often. And yet, actually, you will see ships time and time again lose people at sea that they never should have lost. And there are certain points in an overboard drill that aren’t followed. A guy goes overboard, one of the first things somebody thinks of is maybe throw him a life ring and the first thing they do is throw it directly at him. That hits him in the head, knocks him unconscious and he now *is* gone. It’s these little points that you know.

For instance, if a man were to go overboard and the bridge was on the ball, the bridge would get the stern and screws, if you were underway, out of his road. It would throw the stern and screws on the other side. So also, you



don't just say "Man overboard!" You say "Man overboard port side!" "Man overboard starboard side!" Man overboard port side? That is immediately a hard left rudder.

Now if a Con and Wheelsman aren't educated into this, if somebody went overboard he's liable to go into the screws. It's very difficult to get anything as fast as, a guy falls overboard, you can get the screws out of the road, see?

The next thing that ought to happen is somebody ought to stop those screws, because you don't want this vessel going any vast distance from him, for one thing. Another thing is, the easiest thing you ever saw in your life is to lose sight of a man at sea. At night you get a searchlight on him or a floodlight on him, you get something on him—flashlights—and you keep the flashlight on him. And somebody has the job of keeping the flashlight on him. And in daylight somebody has the job of keeping on pointing at him, because if he takes his eye away and looks back, they won't find him. That's how they lose men at sea on Man Overboard.

So each of these drills have their own little peculiarities and what you're really working for is not a specialist trained crew but a generally trained crew.

Now, I'm going to read you, rat-a-tat-tat here the requirements of some of these drills. There's a lot of good stuff in these FOs. I've put down from time to time what people didn't know about drills and what they didn't know about ships and things and tried to give them some information because there's very little information actually available on this.

This is 23rd August, Flag Order number 41, "The Four Unprofitable Courses." Happens to contain in it towards the end, with other information—it contains in it emergency drills. The first thing it says is "Any drill is better than no drill. A good drill well practiced is best to meet an emergency."

But look, *any* drill is better than no drill, see? What's really fatal is not to predict the disaster at all. Any drill, even if badly done, badly planned—that's still much better than no drill at all.

Now, your next point up the line is that a good drill well practiced is best to meet an emergency, and not only that, it'll handle your disasters. You don't have disasters on a well-drilled ship—nah! They don't happen. The crew is sufficiently alert to this, that and the other thing and they fire it off and they start doing it right and somehow or another it comes out okay.

Now, these are the important actions in sequence of importance of the leading emergency drills. They're readapted from naval and merchant drills according to experience—my own experience with these things. Now, one of the reasons you don't have, even emergencies—there's a point before this. If you're totally predicting, your crew is totally aware of what's going on and they keep the outnesses corrected you don't even ever really get up to a point where you need the drill. They already handled it. Somebody walking by an engine saw an open oil can there that is liable to tip over in such a way as to start a fire, you know, and he moved it. On another ship they would have left it there, in a seaway it would have tipped over, it would have gotten into the electrical contacts and ignited maybe.

So, when an emergency occurs—this is another point you have to remember, that your drills are very often done when everything is calm and quiet and there's good daylight and the ship is all level, and the emergencies normally occur when you're rolling twenty degrees at least, pitching twenty more, everything is blowing wrong side out and you've already got your hands full and that was why you had the emergency in the first place. Things are being shaken up, people's attention is distracted. So your actual performance of the drill is normally carried out under very rough conditions.

Now, the way you substitute for this is you get the guys on the drills to know the drills so well that the additional randomness doesn't bother them. In other words, they know what they're supposed to do. And they go ahead and

Drills  
Reference  
FO 41

do it. And the additional motion and the chaos and the confusion and maybe a fire going on at the same time you've got a damage control drill going on, something like that. Oh well, they can take care of that. It's confidence.

You can also get a crew so confident that they aren't careful at all—of anything. One of the funniest things: There was a fire school invented, oh, sometime during World War II and the fog nozzle—which they seem now to have forgotten about—a fog nozzle was adapted to hoses and it permitted a fellow to walk through fire. All you did was hold this fire hose in front of you with what is called a fog nozzle, and the fog going out actually made a zone and area that you could walk through with flames all over the place. And they used to take a replica of a ship and they'd fill it full of oil and—it had compartments and so forth—they'd fill it full of oil and they'd set it on fire, and they'd get crews of vessels that they had there and they'd set this thing on fire and they'd give them these fog nozzles. They wouldn't give them hot papa suits or anything, you know. No asbestos suits or anything, and send them to walk through that fire and to get certain things out of those compartments and they'd give them these fog nozzles, to put the fire out.

The first time I ever sent a crew to one of these places they all came back and they were a bit singed in spots—but were they cocky. They had actually learned they could conquer fire. And after that you had to watch them all the time. They'd throw cigarettes down in oil cans.

But it's quite spectacular doing one of these things. And it's a funny thing, but they're actually not now much in use, but they send out a fog of water in front of one and as one just keeps walking, why, of course the flames don't do a thing.

Now, the first one—the first drill here is fire drill. And the alarm is a strident ringing of the ship's bell—to which you can add yelling "Fire!" and if you can get to it and it's on, PA. But the first alarm that you can get to, you get to and your first, most immediate alarm is, of course, yelling "Fire!" and you say where. Just saying "Fire!" is no good. It's a generality. It's suppressive. You could get an Ethics Order on you for being suppressive. You've got to say where this fire is, and then people are supposed to go in that direction and handle the fire.

But the traditional sound, the traditional signal that signals fire, is a strident ringing of the ship's bell. And the spotter of the fire yells alarm and tries to put the fire out. And anyone hearing, shouts the alarm. And the rest of the drill is they man the extinguishers. And you head boat to put the fire to leeward, and you rig the deck fire pumps and you form rescue teams with smoke masks and jackets. You get the bilge pumps going. You distribute life preservers, and you ready up the first-aid kit, and you ready up distress signals and turn on radio transmitter to distress and you be ready to sound damage control or abandon ship.

And regardless, if it was just a match, all those things get done, see. They all get done. If there was a fire, they all get done. It isn't somebody in the engine room all of a sudden, or back in the forecastle, sees a fire and puts it out or stands there putting it out and a couple of other guys wander up and they help him put it out and they eventually put it out so they don't bother anybody. Boy, every one of those guys, although they're doing fine putting the fire out, they're cutting your throat.

One guy's putting the fire out, he should be yelling like hell where the fire is and somebody to spread the alarm. And somebody ought to spread that alarm on the decks and get it onto the ship's bell and get it over the ship's PA system and everybody else assigned in that watch ought to go through his *entire* evolution, because they have unreasonably predicted at the scene of the fire that they will be able to stop it. And very often *that's* the fire that really gets you—when they don't but no alarm has been sounded. Do you see?

People appear to be modest and they don't like to make a fuss, and the whole civilization is getting educated that a *good* person is one who *doesn't*

make any trouble. That's for the birds. If they want the civilization to go up in smoke that's the kind of a civilization to have. Nobody ever causes any trouble.

Somebody gives you an illegal order and you don't cause any trouble about it, now you're liable to *be* in trouble. Because you've worsened the entire ship's performance—you accepted an illegal order. Right there she starts caving in.

It isn't the person who causes no trouble who is a valuable person. If you think that is the case, you could man a ship straight from the morgue.

So our actions are to drill it up—to drill it up. And that, in this old Flag Order, gives you the minimum stations. Those are the minimum stations and actions of a fire drill.

Now damage control. "The alarm is a steady blast on siren, whistle or horn. The name of the drill shouted." That's just one long, continuous blast. And you sound it on anything you can get sounded. For a long time we haven't even had a whistle, but we've got one now, by which to sound such a thing.

Now, "The spotter yells the alarm and does what he can. Anyone near the alarm sounds it. Damage control party to area with rudimentary tools, bars, blankets and so forth. Rig and start bilge pumps. Ready a deck pump. Get gear to mend damage. Stand by, distress signals and radio turned on and tuned to distress." Minimum—minimum actions.

"You ready a first-aid station and rescue party. Damage may be structural failure or accident on deck, in quarters, in hull or engine room." It's just any damage—to the hull, to a person, to anything. Damage.

Now, when you sound the alarm you say what the damage is and you go ahead and carry it out as a full drill.

"Collision is intermittent blasts on a siren." You can also make intermittent blasts on the ship's whistle. But that is collision.

"On imminence of collision, a fender party to point of possible contact with fenders and boat hooks. And if collision too much or occurring, fender party retreats." In other words, they don't stand there like the boy on the burning deck and get eaten up, because another ship coming into you can penetrate many feet. So they try to fend off what they can, and if it can't, why, they retreat.

"Collision mats or mattresses, to plug any holes, to scene. You hold ship in contact, if possible." You run into somebody you do not instantly reverse your engines. You can slow them, but you just keep that hole plugged. Because when you take your bow out, he'll sink.

"You turn on the bilge pumps, ready and man deck pumps to pump ship or fight fire or cool steel." In all collisions, and so on, steel goes red hot, sparks fly up fifteen, twenty feet in the air. I've seen iron plates of ships actually melt and curl under the heat of impact of a collision. And "You stand by distress flares and turn on and tune in radio on distress frequency and you man the first-aid station rescue team and you note the number and name of the other vessel. You be ready to sound Man Overboard or Damage Control or Abandon Ship." And those are again, minimal. Those are the minimal actions which have to be done.

"Man Overboard is shouting and long blast on whistle or horn." Of course, you can repeat this long blast. "The spotter throws a life ring toward but not at the man in the water. If spotter is steersman, signal engines to stop or if bridge control, throw engines out of gear and throw life ring in that order." In other words, the first action, actually, is to get the stern out of the road, get the engines stopped and get a life ring over. But the trouble is these things very often happen, there's only one guy around. So he's somehow or another got to impart this information. He's got to get the man overboard but he's also got to get the drill going. He does everything he can do, but he gets the drill going.

And the one fatal thing he can do is to take his pointing finger off, as we

will get to here in a moment. "You sound the alarm on whistle or horn. You turn on searchlights if at night. The spotter continues to point to man, do not take eyes off of him. If spotter is steersman, don't return to the wheel. Send man aft to keep the man in sight and get the captain at con and prepare to lower boat or raft. Prepare throwing lines. Turn ship to reverse reciprocal course exactly at reduced speed." That is, you go on a sort of a oval course. But "Shut off the engines"—or, if you're sailing, reduce sails—"before coming close to man so as not to catch him in the screw or strike him."

There was a big rescue pulled off, off of a coast of England. And three people were being picked up out of the water, they'd gone into the water from a small yacht or something like that and the guy picking them up killed all of them with his screws. It was very unseamanlike.

And then you "Rescue the fellow as seems best." Now, one of the things you don't do is send another guy over the side. In other words, the thing to do is not to just shuck off your shoes and jump in the water to get this other guy, because now you've got *two guys* in the water. You've now got two guys in the water. It might seem like a good idea later on, and that's why we say "rescue as seems best," but by that time you would be lying in the water dead alongside of the guy one way or the other and you couldn't get him over, and somebody dives in with a line on him and takes him over and gets the guy pulled back. Something like this can happen. But just seeing a man go overboard and then diving right in after him—you've now got two men overboard. That's not smart. You could then have another man see these two men and he dives overboard, and the next thing you know the whole crew is in the water.

Now, the next drill is Abandon Ship. And it's always by orders only. Nobody ever sounds any alarm or anything to abandon ship. And it's by orders. And that would normally be from the captain or in his absence or disability, the con. And you "Send up distress rockets and give the Mayday on the radio. You distribute life preservers. You prepare and launch all boats but do not let them be entered by crew and keep them on leeward side on lines. Secure ship's papers, money, valuables and pets. Get crew to grab protective clothing as time allows. Get majority crew into boats and all but Bosun, Radioman and Captain well away with one boat held for them. Get additional food, water into last boat as time allows. Throw life rings and debris and orange stain into the water as time allows. Throw out buoy to mark wreck if in shoals. Bosun, radioman and captain into boat, pull off beyond the possible limits of sinking whirlpool." Because when a ship goes down it makes a tremendous whirlpool and pulls anybody swimming around in the water right along with it.

"Pull off beyond the possible limits of a sinking whirlpool or go away from the dangerous part of the reef. Stand by ship and stay together as ship may not go down and boats must not separate. One of the worst, wildest things that have happened—repeatedly, repeatedly happened—is the crew abandons the ship, the ship is later found still afloat and the crew is never heard of again. It's happened time after time. The crew rows away—gotten in the boats and rows away—and days, weeks, months later there's the ship. She's floating, she hasn't got anybody aboard her at all, all her boats are gone, the crew is gone, nobody ever hears from them again.

It's an amazing thing how often the sinking ship doesn't sink, or how often the water suddenly reaches the fire and it goes out, do you see?

"You send up occasional distress flare as supply allows and assist rescuers by staying near debris and making lights. And you re-enter the ship if it doesn't sink or break up. And a severe accident drill, where someone is badly injured, is done by the Damage Control bill."

Now there, just to read that off at you one way or the other, but to give you its meaning and its purpose. And the meaning . . . basic meaning and

purpose of all of these drills is familiarity with the routine things that can happen.

And if a crew—if that scares you to death, what unscares you is to know that you're in a well-drilled crew. Don't just leave me being scared to death. It's better to acquaint you with the facts of life than just one or two of your officers wandering around, worrying about things.

Now, when the life of a ship is a good life is when people are doing their jobs. And when it is a safe life is when it is well billed and drilled. And there's really nothing much to this.

Now, running off a drill is not done on a walk-about fashion. What you do normally, the exact procedure of getting a drill in, is first bill it. And make sure that all these points—Flag Order 41—are certainly covered. You bill it, you assign the people, and then you take that bill and put it in someplace in the vicinity of where you're holding your drills. And you let people look up what their post is and then let them walk to their post and locate where they're going to be or what what is, and familiarize themselves with it, and walk back. Now they know where they're supposed to be and what they're supposed to do. Good? That's the last walking that is ever done in a drill. All drills are accomplished at a dead run with the maximum number of noise and thunder. And they're done in minimum speed. And if a ship is very, very well drilled, it has the whole drill done in under a minute. Bang! Done. It's all there. It's quite magical.

Now, you can extend drilling out to a considerable distance. Drilling, of course, to an army means squads right, squads left and that sort of thing. It doesn't mean that to a ship. It's not an orderly proceeding at all. It looks very disorderly and that is one of the things that a sailor has over people on the land. He's supposed to be good in an awful lot of things, and he's supposed to be able to handle a lot of things, and he's supposed to be able to operate in a total confusion. When everything is going to hell, he should be able to operate.

And that is why the Sea Org probably is successful on running missions, because it seldom goes into areas that aren't in a confusion.

So the net result of it is that a ship is drilled to a point where its crew is not only specialized but generally familiar with the entirety of the drill and can do it in a minimum amount of time so that when the ship is faced with a disaster it copes with the disaster and it only becomes an emergency.

And then the next thing you have to know about all of this is the confidence of the vessel will be in proportion to its ability at drills. A vessel which is not well drilled, a vessel which isn't fast on its drills, you will find the crew doesn't have very much confidence in.

Now, in a large ship such as this, the crew has some tendency to "hotelize." The rooms, they look like building-type rooms. You could get the illusion that you were ashore. And that is the only liability this big ship has. You can get the illusion that you're ashore. You're not. You're at sea.

People have a tendency to sort of fall out of communication with one another. People who live back aft seldom meet anybody up forward. Days can go on, you don't know somebody is even aboard.

Therefore a medium-sized ship is very easy to get drilled up, but a large ship isn't because it all looks so solid. It doesn't look bouncy about, it doesn't look like you'll ever have to do anything about it.

Let me tell you this: The larger the ship is, the more urgent it is that you have perfect drills, because of this very factor—this very factor. It looks all so stable. When you get a ship this size blowing down on a coast without its engines, wow, wow, wow! How are you going to handle this? Do you see? It's a big ship, but it becomes a very big catastrophe unless it's only handled as an emergency.

Now, I hope, in giving you these talks, why, I am not stirring up your fears and tremors, but you must realize that some crews when they just come

aboard a ship get trained up to the point where they know who the Captain is, and they then think they're doing pretty well: They know who the Captain is. Then when they get further educated they know maybe who the Chief Officer is. Then they gradually find out who the Purser is. But the truth of the matter is some crews, unless they're trained and drilled and so on, never do find out that they're at sea.

And Old Man Sea is the most amenable old fellow you ever met in your life. He hasn't got a kind bone in his body, but he does respect a ship which is well drilled. But that doesn't say he doesn't just hang around a ship every once in a while and look around and "I wonder where those guys are weak, huh? Shall we test them out?"

And the trick is not to be weak anywhere.

There's a lot of fun going to sea, there's a lot of fun that has to do with sailing around and . . . The scenery at sea, somebody might think it's monotonous, but I've never really seen two days at sea that were alike. The scenery is very changeable, conditions change, things happen and so on.

And if you want a nice, calm time at sea, why, you have a very well drilled ship. I don't know how well drilled we are right at the present moment, but at any time I could say that we could be better drilled than we are. Anybody could say that at any time and it would be true. You can always be better drilled. You've always got a recruit who hasn't been through the drills yet.

But one thing I must warn you against is letting drills become boring, walk-through, take old-timers and make them go through slow, explanatory drills, and you'll eventually wind up killing the whole subject of drilling. Guys who know their drills—you don't put them through a drill instruction period of telling them what the drills are all about. You get your new people and you take those people and you drill them for a little while on their posts and what it is all about completely separate from the rest of the ship because they won't get in the road. And then your drill period simply calls for calling off your various drills. You give some semblance of the signal and you call the drill off—bango!

Now, if you're ever going to drill around in a harbor, you put up international code for "We are conducting drills." And you go right ahead and conduct them all the way through. The idea of conducting drills without any signals, without any officers ever blowing their whistles or—all of this is balderdash.

Somebody is assigned to the radio, so you say, "You're assigned to the radio." "Yeah, all right." "Good. Well, that's a drill." No, a drill must be made as actual as possible. You light a fire someplace for your fire drills. And even if somebody puts the fire out, you go through the whole cycle of the drill. Everybody gets everything he's supposed to have.

The drill is over when the officer in charge of the drill says it is over, not when the fire is out.

Now, the net gain of all of this is a well trained, smart ship. On this particular vessel we have not done anywhere near the drilling that we should do, and one of the reasons for that is, is drilling occasionally has been made so boring that people would rather be doing something else. This walk through the drill—because you have two new recruits, you spend the whole drill period explaining to them that this is the winch. But everybody else there knows it's the winch. What the hell are you doing explaining the winch to all these other guys that know it's a winch. Why don't you have a special drill period for the new people, show them all these things, show them what they're supposed to do and so forth. And then the drill period is short and brief. And if you have a drill every day, why, you're running at about minimum drilling.

To have the drill scheduled at a particular time during the day can be a mistake, because emergencies don't schedule themselves.



But nevertheless, if you have just a brief period in which you give a drill and the drill is there and the people come up and they run like hell and they get their equipment and they've got it all straightened out and the whole drill comes off in a total evolution, somebody's standing there from the moment the drill is called with a stopwatch. The whole evolution comes off, finishes up, he stops the stopwatch; not when the fire's out, when everybody has reported and up. You'll find out that everybody has reported and the whole thing gone through and so forth will at first occupy up to twenty-five minutes, half an hour, chasing people up, trying to find out this. But you chase them up and you don't stop that stopwatch—everybody hasn't done it. Everybody hasn't manned his station, so on. So you have to dig them up.

Gradually, you do that with that drill and you do it with the next drill and you do it with the next drill, the next drill and gradually you'll start getting this time down. It comes down to fifteen minutes, it comes down to ten minutes, down to five minutes, down to four minutes, three minutes—it comes down to thirty-six seconds. Now you're there. That's good, see?

Strident ringing of the ship's bell—"Fire on the poopdeck!"—stop. "Good. Thirty-six seconds. They're getting pretty good now." You get the idea?

Drills are done against time. It is not how bored you can make people, it's how confident you can make them.

All due respect to it, when you're out there do you know that you have about two miles of water under you in very many parts of the ocean? Two miles of water. And you know you can't walk down to it. They're the safe places to be, though. A lot of places where we anchor, why, there is only a third of the length of the ship worth of water under us. It isn't how much water that's under you, it's who you've got aboard and what they can do.

Thank you very much.

# WHY THE SEA ORG IS SUCCESSFUL

---

*A lecture given on  
17 October 1969*

55 min

Thank you.

Well, this is the 17th of October, 1969, in the year of refit.

Well, there are a lot of things I could talk to you about in relationship to the Sea Org. Actually, a tremendous amount of technology has been written up and they're in Base Orders and Flag Orders and so on. And very often people don't look into these and very often you find one of them screamingly out.

For instance, I'll give you an example: There's an awning support now stretched across the after well deck which has to be taken down because it's not demountable and you'd never get a boat out of there. And there is your Division Two, Planning, do you see, over into Operations without a liaison between the two. So there couldn't have been a liaison from Four, the Deck Division, to Two saying, "Hey, you know, we keep boats on the after well deck," for the plan in the first place. Do you see? And then there's, Two didn't catch it on an observation action so that it went in.

Now, all of this says that nearly every operation in which you're engaged is a cooperative endeavor. And the basic way that an organization breaks down is guys commit little overts that they don't really much say anything about, even the overt of ignorance, and then they consider themselves very bad and tend to individuate.

And this is the way the world sort of goes. Guys commit little overts and then they individuate and then they super-super-specialize on their post. And their post ceases to be a cooperative post with the remainder of the organization, and the organization becomes not an organization at all but a whole bunch of little islands, each one trying to float around independently, trying not to commit too many overts.

And then somebody at the top, to get anything going, has to somehow or another bust through this, not understanding what he is busting through, really, and get something done somehow. And then you hear officers start to shout, and you hear snarls and barks of various kinds.

Now, the ordinary defense of an organization against snarling and barking is to tell each other that people shouldn't snarl and bark. And I can assure you that that is no defense of any kind whatsoever. Because that anybody is snarling and barking means only one of two things: (1) he can't find out or doesn't understand what is going on but he doesn't like it, and (2) the guys around there haven't taken care of it already, which they should have.

Now, you could even put it down: Why do Sea Org officers shout? The way to keep a Sea Org officer from shouting is not to put it about that he's very bad because he shouts and sort of look reproving and ARC broken or even to get desperate and prevent shouting from occurring, but to observe and do the job in the first place.

Now, the cycle of breakdown—I'll give it to you again: The guy commits

little overts, he sort of feels a bit degraded, he doesn't feel like he's quite there, he's not quite important enough, he's not quite able enough, he's not quite educated enough to do the job and by omission or commission—and omission is about twice as serious an offense as commission; leaving something undone—and as a result the fellow says, "Well now, if I just pull in all of my flippers, here, into my shell and do my little job . . . They talk about hold your post—well, I'll just move this up to a totality, you see, and I will do my post very carefully and maybe I will stay out of trouble."

I don't know why the hell you're so worried about staying out of trouble. I'm several quadrillion years old by now and I've never been in anything else. There's one thing you can say about this universe, is that anybody in it is in trouble. So I don't know why you should object to it as though it is something new, novel and strange.

The way to really get into trouble is to concentrate on staying out of trouble. Now you've got yourself vis-a-vis with a total fixation and nothing will happen and you'll sure be in trouble.

- But sometimes somebody coming in new to the Sea Org, some kind of an evolution or a situation occurring, and they will hear a voice raised to high heaven, shaking the timbers, and they will say, "They have bad tempers." No, no. They've got some people who goof. That is the analysis of that situation.

(Now, the way to ungoof is to do it right in the first place and the best way to do it right in the first place is to hell with whether I'm in trouble or not. The real way to get into trouble is not do anything.)

You'll notice that the characters who have really gone downscale are artists at doing nothing. They're artists at doing nothing and they're in trouble the whole way. There is no exception to this rule. They get in trouble all over the place.

And then, of course, it becomes incomprehensible because they're not doing anything. Probably the only reason that we ever got into trouble in Dianetics and Scientology is we didn't put our big claws on the whole, cotton-picking planet in the first place and very broadly apply technology. Because obviously, the society is in a no-auditing condition.

You can go along just so far in a community without furnishing any service as an auditor, and if you know how to do things and if you know how to cure things and you won't do them and you won't cure them, the next thing you know the society gets mad at you. That's true. That's true.

It's actually not pushing it hard enough and making it available enough to a sufficient enough distance that got us into trouble.

Now, occasionally we fight with the powers that be, and they snarl and sniff and do various things, and we find out however . . . The odd part of it is, we have to do a considerable amount to defend ourselves, but the funny part of it is that those characters are in far more trouble than we are. This is very interesting, but they're *really* in trouble. They're not doing their job at all. All they're doing is interfering with somebody who is trying to do his job. So it's an interesting picture as you look at it.

If we were totally dedicated in Scientology to staying out of trouble, do you know what would happen? We wouldn't do any auditing, processing or training of any kind whatsoever, we wouldn't organize any place, and then next life and the next life and the next life we would just be in more and more and more trouble, because things would be more and more and more confused. Do you see?

So that's sort of what happens when a crew member starts individuating. They individuate, they pull their flippers into their sea-turtle shell and they say, "Now, if I just exactly hew the line . . . And I know that there's a hole in the hull but that's not my department." You start getting destruction by specialization.

Now, an organization that is so composed of a bunch of superindividuals

will eventually cause all of them a great deal of trouble. They will have trouble. They're generating their own trouble. That is because they do not cooperate. Their liaison lines and communication lines, just as beings, are out. And as a result they don't cooperate well.

A team has a tendency to know what the other team members are doing and thinking and coordinate thereby and therewith. And that is the definition of a team: It is people who cooperate one with another to push forward a common purpose. And they normally get along great. Now, the trick is to be an individual and be a member of the team at the same time. The only way one solves that is just come uptone until he can do it. Nobody is trying to make a pattern individual with processing or anything else—training or anything. Nobody is really trying to make a pattern individual. This information is available, these technologies and so on are applicable, they are sound and they're usable. But if that starts wiping out the individual, why, then you have lost to that degree, because it is individual initiative working in the midst of a team and making things go right that eventually brings the whole thing off.

Now, one of the reasons the Sea Org is successful, where perhaps a land organization might not be, is because of the challenge of the environment. Now, man in the last few thousand years has risen up from being a food animal—which is about all he was when he was decorating the trees; a food animal for saber-tooth tigers—he has graduated himself up the line to a point where, having wiped out most of the animal kingdom and having conquered physically a great many of the diseases and bugs and natural catastrophes, or at least defended himself against them, he has achieved an environment in which he falsely feels safe. He falsely feels safe in this environment, and he feels there is not much challenge in the environment.

You take a welfare state—a welfare state is all very well unless it is run by something like a welfare agency. The welfare agency inevitably and invariably will spread out into a totalitarianism which will crush the individual absolutely, so that every portion of a person's life is superregulated, and you eventually get a totalitarianism. These are horrible. Nobody wants anything to do with them.

There is a point, however, where the individual who has individuated ceases to become or be an effective member of the state. So a state is composed of individuals who can work cooperatively. That takes pretty good individuals.

So as you improve individuals you eventually work uphill to a point where you have a cooperative action, which was the ambition in the first place of the totalitarian state. But it was included . . . included in that ambition was the crushing of the individual. So it's a nice trick.

So the organizational target in the Sea Org, in actual fact, is the improvement of the individual where while remaining as an individual he can work in full cooperation with the organization. Because we have technology in this line we have some chance of actually attaining this goal.

But from the viewpoint of somebody trying to make a unit or a ship going, it very often looks very backward to him indeed because the challenge of the environment on land is entirely different than that on the sea. Sometimes the space of a minute and a half in the handling of ships can mean the difference between total disaster for any and all around and complete safety. The action not taken in that minute and a half can spell the doom of all aboard.

So cooperation is enforced, and effectiveness and efficiency is enforced. It's enforced by the environment because on ships and at sea you are not dealing with an environment which is without challenge. It is a challenging environment.

By this you predict what's going to happen, you can predict this or that, you can complain about how this or that is, and at the same time try to move it up and improve it.

Conditions of life in actual fact are not apparently as easy as sitting some place on land. So you do have a challenging environment that does tend to enforce, itself, cooperation. And every once in a while some situation will occur where the lookout has not seen the “blank” and the Conning Officer, having noticed that “blank” has already been deprived of the two or three or four minutes necessary to take the safe action and now has to take an action in total desperation to save the situation, and does. Well, don’t expect him at the same time to take it pleasantly.

Now, one of the things that happens is that people who do not actually appreciate what is going on or see the situation or understand the operating environment too well, do not understand why immediate action is vitally necessary at that particular moment. And very often, in the wog world, the people do not understand why it is necessary to take an action at this particular time, they do not take the action, and the next thing you know it is glug, glug, glug or six feet of earth or not even the dignity of a burial.

A long time since, many of the governments on the planet should have taken action—a long time ago. And they didn’t take them and they now find themselves in various political troubles. Now they don’t even have anybody around who’s trying to solve them in desperation. And if you don’t think civilizations die, you should have been with us looking at all kinds of ruins during 1968. We were around looking at all manner of ruins. They’re the most ruined ruins you ever saw in your life. Not only ruined by politics, incompetence and time, but then ruined again by the archaeologists digging them back up.

When you have seen the number of civilizations around, or have any idea of the number of civilizations around, which have risen and fallen, or the number of countries which have risen and fallen, you get some sort of an idea that the situation isn’t often well cared for. Things happen and they are not taken care of by the team.

The team that was there—well, they had their individuation and too many fish to fry and not enough technology to operate with, and all kinds of various oddities entered into the situation. They were special interest groups and they were trying to get *theirs* out of the treasury, and they were mad at somebody who was an official in the government so they wouldn’t cooperate. And we were around looking at some of these places and they certainly . . . Well, looking at ruins is one thing, you know, but how about just a bare plain that was once a thriving civilization.

Well, people in the current civilization are actually so far from taking action necessary to resolve any situation (it’s not that I’m being critical on the matter. I mean, the record is right there) that the next thing you know, they’re going to be in the soup.

World War II should never have happened. World War I should never have happened. What did they solve? World War I was to make the world safe for democracy and after that time we got dictators. We got US totalitarianism beginning to raise its ugly head. Democracy be damned.

World War II was somehow or other to make the world safe from fascism, and the US turned something like 750 million human beings under the totalitarian Russian yoke in World War II. These are political failures of great magnitude. Do you see?

Well, a situation can deteriorate, and in the wog world they don’t even seem to notice that it’s deteriorating. They don’t do anything about it. They don’t lay out any program of advance on the matter. You don’t hear any wise statement made or somebody say . . . Even the revolutionary is usually talking balderdash. It’s just how *bad* the fellow in charge is or how *bad* the system is or how *bad* the establishment is. He doesn’t even offer a better establishment. At least he ought to do that.

So they actually don’t have any idea of keeping the machine going. They don’t have any idea of keeping it running, and they are too stupid to recognize that this unchallenging environment they’re looking—it has very long

fangs that are about to snap their heads straight off. Do you see what the situation is?

So you can actually be in a very challenging environment without recognizing there is anything challenging about it. The best frame of mind to enter this thing in is the frame of mind of perception and observation to see if you can figure it out.

Now, I have told you, in talking to you, some very, very horrible, disastrous warnings, gruesome . . . I didn't tell you that if you really want to become depressed, read some coast pilots. And you can see . . . two or three watch officers, they get together you know, and they're up there on the bridge, and they're going to go through this strait. So they open up the coast pilot, you see, and they read in the coast pilot about going through this strait. They're all happy about going through this strait; there's water in there, you know, and everything. They read in the coast pilot—"And there's an offshore lying reef one and three quarters miles with the least water of six feet over it. And there's this and that. And very often the williwaws and storms come down from the peaks and blow at a rate of blaugh which beaches vessels in all *dir-blah-brum!*" And you say, "Gee, that's a bad one. Let's find another strait." And you open it up and you read that one, and it is much, much worse. Now there are reefs in the middle of the fairway. It is the most discouraging activity you ever got into.

One time up in Alaska on an expedition, myself and a chap that was serving as a crew member, opened it up to find out how in the name of God we were going to get south. We had already overstayed our time to a point where the ship . . . It was very bitterly cold and the sun was not now rising above the horizon and we had stayed north too long.

As a matter of fact, in going south, we were just a matter of hours ahead of the forming sea ice. We really ran. But in planning this cruise, we opened up the Alaskan Pilot, and we opened this up to find out how you got south without staying in near the coast. And it seems like you go five hundred miles out to sea except for the tremendous gales which occur out there in the middle of the fog which is impenetrable. You can never see the sky so you don't know your position. And in getting out there, there are innumerable shoals, rocks and islands into which you're going to collide. But the compass is seldom correct because of the magnetic anomaly.

And we read about all these storms and the methods of getting south and it just got worse, and it got worse, and it got worse. And finally it got much too bad for either of us to support anymore, and we broke out into just roars of laughter. We absolutely were sick with hysterics. We must have laughed for two or three hours. We'd read another sentence, "And then large waves very often drive ships . . ." and we'd break out again. It was just too much.

And finally we put it down and we said to hell with it, drew a line on a course on a coast which didn't even have its coastline marked in on the chart, and went south anyway lickety-split, just ahead of the forming skim ice and we got out of there.

I remember the most pleasant part of that cruise—totally irrelevant. Conning was a matter of trying to stay unsolidified. And so what we did was pass hot rums up from the galley to the guys who were steering and conning, and we just kept a bucket line of hot rums up to whoever was on watch. And this kept them thawed out. It was Hudson's Bay Rum, 135 proof.

The cold, in actual fact, was so intense that the rum had no effect at all except to sort of warm you up a little bit. Wild experience. Then when the guys couldn't stand up on the bridge anymore, we'd send them below and send another watch up.

Anyway . . . But I remember the sun. We eventually got south far enough to rise the sun. And the sun one noon came up above the horizon as the coldest, palest ball—sort of white—and it came up above the horizon and for



ten minutes was above the horizon and then sank out of sight again. But we were awfully glad to see that sun.

Anyway, that is a little bit more of a challenging environment than most people count on. But you can get into these.

But the main point which I'm making—the fact that the environment is challenging at sea is obvious. And one gets to a position where he starts coping with what he finds.

He starts coping with his environment. And if you can get somebody to start coping with their environment, they can confront MEST, they can confront the general surroundings, where they are, they get a level of estimation, and they're not just walking down streets hoping somehow it'll be all right. But they actually move up to cause over their environment. And at sea, you are either at cause over your environment or you are dead. Do you see, there's a slight difference here.

These are some of the factors which were not thought of particularly or designed. We kind of got into the Sea Org activity sort of gradually and accidentally, and we moved further ahead not actually on a planned idea. We just knew it was going all right in this direction and we kept going further in this direction. And the further we went in this direction, the more we developed in this direction, why, the better things were getting, and as a result it sort of evolved into what we are now. It wasn't some sudden idea that Ron likes the sea so we will all go out into some boats.

As a matter of fact the basic history of the Sea Org is that we had a crew training program at St. Hill and then we got the *Diana* and it came south under vast duress. And then we got the *Athena* and it came south and got repaired under very vast duress. But meanwhile the—then called the *Enchanter* carried out quite a few very vital and quite successful missions and the *Athena* carried out some very, very successful missions. These were ship missions. And then this ship came along to be used as an AO. And when it could no longer be used as an AO, we suddenly realized that it was a better operating ship, just as itself, than the others and so retained it and continued to operate with it.

It was after . . . someplace during that line that we suddenly found out—I think it was really about September of 1967 when we actually began to realize that there was some result that we had not achieved before on the basis of missionairing, of handling organizations with missions, with trying to patch things up and put them together from a central operating area and we evolved it from about there.

As we've gone along, what we have learned of seafaring and what has been put together along that has normally been written up in FOs, AB checksheets and so on. What we've known of missionairing and so on now appears in the Mission School checksheets. And there isn't any particular reason to it. We really can run missions. If the missionary is a well-trained missionary, boy, can he run missions.

And what we've actually done is evolved into a very high level—you might say—management unit (be one of the best ways to describe it). But we really are sort of a management unit. We actually, probably, are Division Five, Earth—Qual Earth. That's probably what we are. And we feel our way forward and we make progress.

Now, the people of the Sea Org are very valuable people and it takes quite a little while, actually, to make a fully trained Sea Org member. Let's take a look at these various skills.

Now we expect them to know their tech, which is at least HDG. We're expecting them to know their OEC. But these are relatively new expectancies. Originally we expected them to be able to do their AB checksheet, to be able to do their ship duties and to be missionaries, and those are still expected.

Now, when you add to that HDG or Class VIII and OEC org expertness

SEA A CHALLENGE THE ENVIRONMENT

AT CAUSE OR DEAD

RON LIKES THE SEA ?

SKILLS OF A S.O. MEMBER

on top of that, you get what you might call a very super-able troubleshooter. They can put things together because they are running things right now. They're running orgs. We got into running orgs. But we generally can put together situations which are apparently almost beyond recovery.

The evolution, when the British government suddenly snarled and snapped and Callaghan—who I think is some kind of a foreigner in England—barred out all the Scientologists . . . Yes, I think he's a Celt from Eire, or someplace. He's some foreigner of some kind or another—Russian or something.

And anyway, when he suddenly chopped down on our students to save the situation, why, we not only had to loft AO UK as a whole operating organization, we also had to loft a complete St. Hill. And we did so and the evolution came off with a smoothness that would have surprised almost anybody. It was amazing. It was absolutely amazing.

But, as I say, it stretched us a little bit thin and when we were stretched that thin, why, we haven't quite been as able to put out as many corrective missions as we had. So now we're evolving a new pattern where, with even a very few numbers, we can do our job better than we were doing our job before. In other words, we're coping with our environment.

Therefore, there is a lot to this Sea Org. There is a lot to it. And it has tremendous disadvantages—tremendous disadvantages. I wouldn't at any moment begin to say that it was all cream. But the disadvantages which it has are normally the disadvantages of lack of know-how. Trouble is caused by any mission that fails—greater or lesser degree, trouble will occur if a mission has failed even though it's a minor mission.

Well, that's know-how on the management line. But let's move back onto the ship. If a ship can't operate and if it can't keep its schedules and it can't be here and it can't sail when it's got to sail and so on, then the whole operating pattern is shoved out of gear. Well, the reason why ships have to be refitted is they're not kept up. Any refit actually is a criticism of maintenance. Anything which is not properly maintained will have to be repaired. You can write that in letters of fire. If something isn't oiled, it'll eventually have to be repaired. If something isn't painted, it will eventually have to be thoroughly chipped and painted, you see. If a rail isn't given a coat of varnish when it should have it, it will now have to be *totally* scraped down to bare wood and given its coat of varnish, just because somebody didn't give it a lick-and-a-promise coat of varnish when it should have had it. Do you understand?

It's when maintenance fails, when upkeep fails, you get into the field of repair. And repair can slow the living daylight out of any operational situation.

Now, maintenance is basically alertness. Alertness to what's going on. Now, we have systems which assist that alertness, such as checksheets. And you've got a checksheet of all the electrical equipment on the ship or all the motors on the ship and so forth. Well, there's a checksheet that they've all got to be turned on once a week, one after the other. But I don't know right now if there is a checksheet which says each one of them has to be oiled or greased at periodic intervals. I don't know if there is such a checksheet.

Wherever that checksheet had a missing hole, maintenance isn't occurring and an electric motor is going to break down, and, and, and. And one night it's very hot weather and you're lying in your cabin and you can't breathe because it's too hot because the blowers are off. Well, it's one thing to snarl at the engineers but actually it is all our failure because it's a cooperative action. Actually, Division Two probably should have gotten out the checksheet for the oiling of all the electrical motors and then . . . and you wouldn't have had this motor, uninspected, running forever to a point of where it simply chewed itself up and all of a sudden wouldn't operate at all. You get the idea.

Now, as far as crew members are concerned, this is a very tough life. I

REFIT =  
NOT  
KEEP UP  
IN THE  
PLACE

wouldn't say it had any advantage at all; I don't know why you're here at all. It's a tough life—awful, actually. It must be—must be. Every once in a while I hear somebody saying that they have to go out into the wog world and they want to resign so that they can get their study in. I look at their study record on the ship and find out we've been study . . . they've been studying all the time on the ship, but they haven't been down to study on the ship. They never went near study, but they have to go outside to do it. These guys that really considered it a tough life actually never got into it to find out how tough it was. I'm joking when I say it is that rigorous. But Sea Org members actually work very hard. They work very well. But like all activities and organizations, why, many are called and few are chosen.

But truthfully, the people who are here have elected themselves here. Nobody's forcing them to stay here. Those people who go have normally committed overts, considered themselves too ignorant, considered themselves somehow or another, even down deep, a liability to the group, so they blow themselves off.

It's not true that somebody gets in trouble or gets a bad reputation. If you look over the bad reputations and ethics records and so forth back on the past history of most Sea Org members, it reads like the inhabitants of Leavenworth. Comm Ev, Treason—you know, this sort of thing.

Now, a lot of being a management activity or in control of things is the ability to put in ethics, and I suppose if you get enough motivators you get familiar with it. I'd say somebody who hadn't had a Comm Ev or two wouldn't be able to function at all.

The truth is, people seldom pay any attention to this sort of thing. Over a long period of time, they every once in a while we'll find out somebody hasn't ever run a successful mission or hasn't ever done a this or hasn't done a that, and they'll start riding them a little bit. The guy knows very well he hasn't. It's merely brought home to him that he is goofing. And instead of ungoofing it and figuring out what's right and getting it audited and a few other things and so on, why, he blows off in a panic. Now, that's actually how you normally will lose a recruit. He's more scared than he should be.

But the actual fact of the case is, as we move up the line, Sea Org members are more and more effective, more and more efficient. They can take care of things the like of which nobody ever heard of. And because they are all together and in the same environment, one with another, they never notice really their changes in effectiveness. It's never brought home to them. They're getting more and more effective. They're actually in a challenging environment. They're learning, recognizing and handling better and better and better those things which they are confronted with from day to day, and they're putting it right. And they get so they make these things run righter and righter. But they're all doing it as a group.

I suppose somebody brand new coming into the Sea Org would think that he was sort of out of pace for a while, but he would gradually get into a point where he was swinging with the rest of them, and he would also lose perspective on how he himself was improving. It is expected that a Sea Org member would be able to handle a situation and make things go right. Do you see?

So his improvement isn't noticed because it's expected of him.

Now, suddenly this character is transplanted out, even into a Scientology org, and he looks at what *his* standard would be and what around there is generally looked at as a recognized standard and he is instantly assaulted. His reality is assaulted, see? "These guys stink! What the hell is the matter with these—look what they're tolerating around—*wrrrh, ruoth-wrr!*" He'd chew into it and start straightening it out almost at a desperation level because it looks that bad, you see? And he goes ahead and he straightens it out.

What he really doesn't look at is that that Scientology organization is

S.O.  
MEMBER  
IN WOG  
WORLD

already running—for what it is doing and how it is doing it—is already running at a far, far higher level of competence than the area around it.

I don't think you realize that TWA and airline companies and other people in businesses and so forth only operate because they practically have somebody with a gun at their back ready to pull the trigger to go on functioning. The internal police actions of these big companies would startle you half to death. All it takes to get fired and shot from guns and deprived of all livelihood and be blacklisted forevermore as an airline hostess, you see, is forget to smile at a VIP.

"Well, Gracie didn't smile at a VIP. Here's . . ." Then to the Personnel Chief. "Gracie didn't smile at this VIP who came aboard—as a matter of fact, looked a little cross because he kept hitting her in the face," and so forth. And that's the end of Gracie. And then she goes over to United Airlines to try to get a job. And "What's your former experience?" "TWA." "Well, hmm, hmm. Bad employment record." That's it. She's finished, see? That's the duress level at which they hold in all that efficiency. They hold it in with an ax and a club.

Furthermore, they've got the whole society to drag from. And, in addition to that, they are actually served by outside training units. The training which is done outside those corporations serve those corporations. Let me exemplify what I mean.

The training which is done in business school on the subject of accounting serves TWA's Accounting Department because it answers all the income-tax queries. It doesn't get their accounts straight, but it certainly takes care of the government. You think I'm joking. That's all they run those accounting departments for anymore. And so the people who are brought in, actually . . . The cooks—well, they've been trained over in some cooking school in something.

Now, they have to do some of their own training but they are served by the society around them because they are performing skills and activities which are quite common and ordinary.

In Scientology, we are not served at all by the society around us. It is very good for a person to be very well trained in some line or another, and we're very happy when people are trained in this line. But the truth of the matter is that we ourselves are engaged in a highly technical, specialized activity not only on ships but also in orgs. Our actions as missionaries and management activities and planning and that sort of thing, don't at all compare with the commercial vessel tub-of-bolts, where the captain does all the work anyhow. It doesn't compare with commercial, it certainly doesn't compare with naval. We're not really much served in these directions. We're always glad to see some ex-naval individual show up, but he very often has some kind of an idea about officers, that they ought to be shoved overboard or something. Or he has other liabilities that perhaps he has to unlearn a bit and then eventually he learns these things and gets along all right.

But we're not, in actual fact, much served by exterior training. And that is because we are dealing, basically, with new technology and because we are very few and because we have a tremendously big job to do.

Now, the job that we do do out over the world is unbelievable. It's big. What we're shoving into line and holding straight and so on is not only very important but it is highly influential in the various currents of affairs.

If we were just in the business to fly an airplane from A to B and then turn the airplane around and fly it from B to A and make sure that some passengers were collected and put on board it and got the money and wrote it down in a book so that they could be flown from A to B and B to A, and that some freight was collected and put on board and flown from A to B and B to A, then all we'd have to do is make sure that we hired some mechanics who were trained someplace and they repaired the thing, and we get some pilots that have been trained by the US Army or Air Forces or somebody and

they'd fly the thing and you see, it's all served and it's all usual and there are all kinds of guys who know all about how to do this, so it all—very ordinary. See? Easy, because it fits.

Now, they're trying to make service a little bit better so they serve things on pink plastic instead of white plastic. Their idea . . . They say, "On Tuesdays and Thursdays you can fly free with your wife." That is to say, your wife can fly free on these days when they have low traffic days. This is *big* promotion, do you see?

These guys had to work it up for years and years and years and years. These guys had to work it up in order to get aviation itself promoted to a point where it would run as a usual action.

We actually are not up to a point where the world even has an idea that anybody could do anything about it or straighten it out in any way, see? We're actually three feet behind the world's head. And we're handling technology which is far, far, beyond the ordinary level of technology which man has. We're actually operating in advance of his scientific technology, we're operating in advance of his business technology, and a guy comes in from those fields, like an accountant—my God, if I ever get another trained accountant. He has to be untaught and straightened out because he hasn't got 135 people in his accounting department to mess up the books. Do you see? At that level of push and development and the amount of accounting which has to be done, you couldn't do it.

So the net result of that is that our actions are understandably very advanced technical actions and we have to fit ourselves to them. So we've got another challenge in our environment in that we're moving forward as pioneers in a new frontier, and we're having to keep this frontier expanding and handling at every side. And then the old guys, the Indians—or the aborigines; I wouldn't disgrace the Indians—the aborigines that are already trying to hold the territory around, with smoking their stone pipes and going "Ugh" . . . "Everybody ought to be killed," you see, is about the level of their technology.

We're actually operating in an area where it is an inverted line. They don't have the idea of curing anybody; the insane ought to be butchered. Wow, I mean, the disparity . . . The public is with us, but the field that we are in is actually operated by a bunch of guys who are operating it over their own dead bodies, practically. In other words, it's a rough area of action.

And because human minds are handling the problem of the human mind, it is infinitely rougher. If all you had to do was fit gaskets on a carburetor or something like that, that's one thing. But areas where you're handling the randomness of aberration become themselves rather random. So it takes a lot to hold together.

When you add all this up, the Sea Org has evolved itself into a very successful activity, and it is a very vital and necessary activity. And it, for instance, just disappeared out of the running for about six weeks and was not along the line, was not apparent on the comm lines of the world, and during that period of time stats went down very steeply and very badly, even though we ourselves had done something to beef them up before we stepped off those lines. So when we stepped off the lines the stats all went down.

And it has happened that way before. So we are a very necessary, very vital activity.

Now, sooner or later, we will break it through to a point where we are above the make-break point—the make-break point being that point where we are enough of us, activities are sufficiently large where they run at enough surplus of cash money and reserve, and so on, so that our services become more paid for. Right now we're in a level where although we're performing very necessary services all over the world, the income lines and that sort of thing are not really so arranged that they're on a point above this make-break point. We're worth far more than we get, that's for sure.

If you just go right down to the bottom of the line, a psychoanalysis, leading to nothing in five years, costs nine thousand pounds. Twenty-five hours of auditing in London is probably still fifty pounds. In twenty-five hours of auditing, you can take a guy all the way up through Dianetic Triples and Scientology Triples. Wow. A little difference. Yet the characters that are charging nine thousand pounds, why, try to complain about our prices. Do you see? We have trouble.

But sooner or later, we'll get up above this make-break point and there'll be enough money in and enough power on the line, recognizably, so that we don't have to watch every penny as it comes along. Right now we do. And there's where we're pushing forward toward and we are being successful and we are making it and we're moving right on up the line.

You look at our advancing international stat over the period of the last couple of years that we have been an organization, it is a continual advance and it is very high indeed. When we step off the line, it goes down; so we must be very valuable people. Sooner or later, we could even get up to a point of where we're paid for. But right now, why, we try to keep things going and the situation in which we operate seems to be novel, but it works and people seem to get better at it, and the truth of the matter is we're a howling success.

Very few Sea Org members ever really realize how much they're appreciated or what stature they have until they show up someplace in a Scientology org. And they show up in an org and if they're a Sea Org member about to carry out this, that or the other thing, they get one of two things: Either people go absolutely white, or they get snap, pop and courtesy compared to which VIPs wouldn't get. So, when you look at the actual effect, you recognize the amount of power there. And, of course, you retain the power to the amount that it is not abused.

Now, when you look over the entirety of the Sea Org you find out, then, that for Qual Five, Division Five, Planet Earth to be only composed at this time of about three hundred guys and gals is absolutely fantastic, when you figure out we're already handling one, two, three, four, five—five organizations, six or seven ships and the management activity of Flag. And this is done by about three hundred guys and gals? Oh, wait a minute, that's impossible. Every government knows absolutely that to organize and to handle that much and so on, it would easily take four or five hundred thousand people.

And in the degree and what we really accomplish for our numbers is fantastic. The one guy who never seems to find out about this, really, however, is the Sea Org member. He just goes on doing his job.

Thank you very much.



# THIRD DYNAMIC ACTIVITY AND MAKING THINGS GO RIGHT

---

*A lecture given on  
20 October 1969*

48 min

Thank you.

Well, this is the 20th of October, 1969. This is actually the fourth lecture in a series.

The dynamic on which the Sea Org seems to operate is the third. It seems to operate on the third toward the fourth. And nothing is more plainly evident in that than the traditional willingness of the members of this organization to work on post, often under very trying circumstances and to get the job done. It's amazing, actually.

And if you want to upset things in the Sea Org, why, you try to move it over onto the first dynamic. Now, this is very peculiar. It doesn't work this way in industry or according to the social sciences. In other words, it doesn't go by the psychology textbooks and it doesn't go by capitalism because if you try to enforce an award in the Sea Org, you get into trouble. That's the truth of the matter. It's fantastic. You try to enforce on a Sea Org member such a thing as study and even, sometimes, auditing, and if you do this on too broad a scale, you actually practically shatter morale.

This is a very hard thing to understand. It doesn't go according to the textbook at all. For instance, the study breakdowns normally occur because of scheduling. And the scheduling on post and to get the job done—the theoretical scheduling, actually, doesn't really permit enough time to get the job done. And then when the scheduling includes study, or something of that sort, and then an enforcement is attempted to keep the scheduling in, you're liable to be looking at a mutiny. I mean, definitely, this is the result of survey, not my say-so, because it defies logic.

Every now and then in the past we have had somebody—they weren't doing very well on the job. They weren't doing very well, they'd never done very well, and they have gone off someplace in order to be able to do full-time study. I actually think, however, that this was basically the result that they were given the compulsion to study but didn't have time to.

And in all of the time of the Sea Org, I don't really know of any instances of people complaining about—from the first dynamic aspect, of long hours on post or quantity of work to be accomplished on board or organizationally, or something like this—I don't have any complaints in that direction.

I have complaints in the direction that they're distracted from their post by trying to do something to them. It even goes up to the third dynamic sometimes, which is quite amusing. Very funny. I have had a suggestion by somebody who was going around saying that we all ought to have a party of some kind or another, and all I have heard from officers and crew members is "We don't have time for it" and snapping and snarling about the whole thing, all of which sort of works backwards.

So, anyhow, you get from that that it's a very hard organization to understand. There are certain certainties and stable data about the Sea Org which you can fairly well count on, and that is that people one way or the

other will try to get the job done. You can count on that. It may be sometimes disorganized and knuckleheaded, and sometimes maybe the job isn't worth doing, but they will try to get the job done. And you can count on a willingness to find out what the right way to run it or do it was. You get that willingness.

Peculiarly absent in the Sea Org, in spite of ethics conditions, innumerable Comm Evs—I think we probably average one Comm Ev per person per year in the Sea Org, and probably a low condition per person per month, something like the averages on the thing. And if you stood outside all of this parade of ethics conditions and looked at it, you could say, "Boy, those guys are a lot of bad hats, boy. Boy, they . . . they really . . . they're really a lot of tough eggs."

The truth of the matter is, I know of no instance in the Sea Org since its inception, of anybody willingly or maliciously doing anything to injure anything or sabotage anything in the Sea Org. Isn't that interesting? I know of no instance. And remember, we're the experts on that sort of thing. We put people on E-Meters and find out what the score is.

We have had the factor of somebody who felt he was doing the group in or was tripping over things or goofing up and he would say this, or infer it one way or the other, that he was a danger to the organization and he would blow off. We have had that happen, which is quite the reverse.

I am in a very good position to know this because I have C/Sed, really, the majority of cases that have been audited in the Sea Org. And after this, that or the other thing has happened, why, generally the person will show up in Review and you will get the C/S having to do with an assessment or ARC breaks or something of that sort. And when you get all this down and you find out what the answers are, the strange and rather pathetic fact is that even on the worst goofs, why, the causation behind it is rather pitiful, really. I mean, the guy is really in bad shape because he feels bad for having done this. So I can say with truth that this is why people have left the Sea Org. They have said they wanted full-time study, they have said this, they have said that, they have said other things. But if you look in their case folders or get their final Review data and so on, it's because they feel they are not really worthy of the group or are liable to louse things up. All of which is quite remarkable.

The things people will put up with in the Sea Org are fantastic. And . . . Well, I can be counted on to try to make things go right and other officers usually can be counted on to make things go right, and other people can be, and in spite of this, there are certain areas where they seem to go wrong, and one of those areas is food. This is very remarkable. It's up to the group, actually, to generate the operating climate in which the group operates. And you can issue all sorts of orders if you want to, and unless they agree to some degree with the group's mores or purposes, they won't get executed. And one of the most difficult things to get executed in the Sea Org is just plain chow. Sounds weird.

People look on it as a first dynamic thing, if you want to analyze it. And they don't make, actually . . . There are complaints around but as many times as there have been complaints or upsets about food, and I or someone else have put those things right, it tends to go out again. Well, if there was real pressure there, I can assure you that that area would clean up, and it wouldn't have to be cleaned up all the time by me.

There's an old gag that I pull every once in a while, which is single-handing a ship. Well, I really . . . it doesn't worry me at all to single-hand a ship. Now, that means run it all by yourself. That doesn't mean run it administratively by yourself, that means steer it and turn the engines over and navigate it and you know, all that. That's single-handing a ship. You got an idea of that with Francis Chichester, when he was pushing that bucket of bolts around the world where it should never have gone. That's single-handing.

SWAG - [unclear] / [unclear]



And when you have an almost totally untrained crew, why, the man who is in charge is, of course, left with the task of single-handing because they don't really know what to do, no matter how willing they are, and they don't know what to look for for a while. And there is always a period there where a new ship, new crew, and so on, has to be single-handed. Somebody's single-handing it. If they don't, why, some catastrophe or another will occur. And single-handing is also done by every watch officer. And the con or Conning Officer who has control of the bridge actually has to do a small amount of single-handing every time he gets a green watch member. Even if he has just one green watch member, there is going to be some section there that he himself is going to have to be alert for.

So, single-handing—if he had a totally green watch, the Conning Officer would be single-handing the vessel. And somebody's got to keep it running and then gradually, why, the watch or the ship will learn the ropes and begin to back you up and take the ship off your plate and it'll begin to go.

This inevitably occurs. It's sometimes a long and arduous process in which it is occurring, but whoever is in control of a unit or section of the Sea Org actually does operate on the principle of himself somehow getting the job done while he gets people or gets people trained up to a point of helping him get the job done. And that is normally the process by which one keeps things running.

This is not a strange process nor a new one, particularly, but it is one which recurs continuously in the Sea Org.

Now, we go on the relatively outrageous principle that if a person is on post, he knows how to do everything on that post, regardless of whether he does or not. See, it's the unreasonable expectancy. Actually, oddly enough, people live up to that expectancy very well. You'll see the general situation in ship handling improve, improve, improve, improve, improve. Well, that is to the degree that the ship is not now being single-handed but is being handed by more and more people.

In other words, every time we have an individual action occurring, it builds rapidly up into a third dynamic action. In other words, we build a first dynamic action out of existence. Do you follow me? The first dynamic action is not tolerated. I mean, it's not just let go on, you know. People don't just let it go on being a first dynamic action.

Now, the only exception to that is the galley, of course, and apparently the Sea Org is perfectly willing to let a cook go on single-handing the galley while being served lousy chow. I mean, this is one of those puzzles that gets built into organizations.

And there used to be an old gag on the *Athena*. I had it worked out how I could go out on deck, throw off the lines, go down and open up the oil feed on the boilers, open up the throttle, go through the galley—when you go from the engine room up to the bridge you can easily go through the galley—go through the galley, stir the cook's dinner (or stir the crew's dinner), and then go up on the bridge and then turn the wheel and so on, to get it going in the right direction. People looked on that as simply a joke. But the truth of the matter is it came true. I find myself repeatedly having to stir the cook's soup for him and feed the crew, because they don't seem to do that well.

I'm always writing orders: "The crew will be fed."

Now, I worried about the *Apollo* for quite a while because actually I couldn't figure any way to single-hand her. And I couldn't figure any way to do all these jobs on a ship which was 3200 tons and about 320 feet in length, twin-screw, diesel. And I finally, not too long ago, managed to figure out how you did it. You opened up the cattle doors on either side, and you went up on deck and got the lines thrown off and got them aboard. And then you went down and with those cattle doors open, you could run in and open or close the twin screw throttles, don't you see, to get her backed out from the dock, by going out and peeking through the cattle doors and rushing back into the

EVANGELINE

1st - 3rd

3rd - 4th

SINCE  
ON  
engine room. And then, eventually, when you got her clear of the dock, why, you could set them ahead at some speed or another and get up on the bridge in time to steer it.

Now, that was all very well, but I couldn't figure any way . . . Actually, it's not quite complete. I couldn't figure any way to get through the galley and stir the crew's soup.

But people thought I was joking when I was talking about single-handing the ship away from a dock all by myself. But the truth of the matter, I wasn't. And it frankly could be done.

Now, we have had instances where I've single-handed a vessel but wasn't permitted to do so very long. People start coming up and taking the ship away from me. You know, they take pieces of it, one right after the other, you know? And I almost drove a crew frantic one time by insisting on single-handing something on the *Enchanter* and that was a very upset crew.

They were supposed to have gone down and dived the night before and untangled the anchors. They had two anchors out, and they were tangled. They were supposed to have gone down and undone those the night before and that order was neglected. That was a neglected order; they didn't do that. They were supposed to get out and operate at 1:00 o'clock, 1300 the next day, they were supposed to have sailed.

Well, at 1300 the next day, the anchors were still tangled and they were not about to leave harbor. And the Captain of her at that time actually had started the crew training on the ship's org book at that time. And this was unfortunate.

So at 1300, seeing no activity on the decks, why, I went up and started bringing in the anchors. I think I checked out the engine to see whether or not it'd run and then went up and started bringing in the anchors.

Well, they were crossed, and very difficult, because one anchor was trying to raise the other anchor and they were all wadded up. And trying to get those two anchors up off of the harbor bottom was quite difficult. I managed to get a boat hook and pull them apart a little bit and then I managed to haul them up high enough to get them off the floor of the harbor.

Well, the truth of the matter is, Mary Sue, who was aboard, immediately started pitching in, and she went down below and closed all the portholes and did all the things necessary to get the ship to sea. I had one anchor holding the other anchor up off the bottom, went back aft, got her engine going well and got her out into deep water, and then dropped both anchors, and dropped them way out on their chain. And because they could hang way down now, they disentangled and I managed to get them back up again.

It was a very pathetic action, because various members of the crew kept coming forward while I was doing all this, saying, "Can't I help?" They looked very abashed. They were quite upset, actually. And by the time I got both anchors into the hawsepipe and got her sailing and going along all right, why, one after the other had actually taken over this piece and that piece of the operation of the ship, and she was fully operating. And by the time we anchored again, why, her crew was her crew.

It was an interesting experience from a viewpoint of morale. I have never seen people quite so worried or quite so upset as when their help wasn't used and they were excluded out as far as the group was concerned.

Well, it was an amusing instance, but the truth of the matter is that it is almost impossible to do anything by yourself. You sooner or later will pull in assistance, and people will begin to handle the situation, unless interfered with or expressly forbidden, and even then, will form up into a third dynamic activity, which is interesting.

Now, where we fall down, then, whenever we do fall down, is to try to maintain something as a single activity or not to back up posts which are overloaded. And there's where we do badly. And that is basically because we are overexpanded to a marked degree, we have too many things to do, we are holding things and keeping them going in too many parts of the world to do

it comfortably. So we go on and do it, but we do it rather uncomfortably.

And lacking enough hands to do this and lacking enough trained personnel, lacking enough people to get the show on the road and get it done, we very often tend to short up certain functions, and this then tends to overload them.

So, what one has to keep in mind is the following cycle: The . . . A green crew, by the way, always knows the Captain's name. This is about all they know of organization; they know the Captain's name. You can always tell when they are starting to groove in, because they go and see somebody else about something beside the Captain.

And a green crew will evolve into a competent crew. But the actual cycle of organization is you have a ship there, or a base, and then you put a crew there, and then the crew runs the ship, or the base, and the product of that crew is an operating org.

Now, when you start in at the beginning, there are so many things exterior to that activity that need to be handled right now. "That telex just came in, and so on and so on and so on. And do you know that New York . . . raa-aya-daaa! . . . And WW and so on. And we've got to get somebody out right now. And Franco just had fits and is . . . you know. Got to get it done!"

So we go on doing that and we get to operating on some kind of an external third dynamic activity while we are still trying to keep things running. Well, sooner or later, we have to take the actual step of putting a crew there to have the product of an operating organization.

See, the product of that crew is an org. And when we've got that org functioning, then we can put in other orgs and handle other actions and other lines.

But because we have to do it all at once, in spite of it all, why, very often this point of putting a crew there as your first initial action gets neglected. And even after it's done, the emergencies and so on which are going on externally and which have to be handled at thousands of miles away or hundreds of miles away, that have to be handled—these conditions tend to strip the crew back down again. So it's actually a cycle of putting a crew there; it's stripped back down by emergency operation here; and then putting a crew there; and it's stripped down by emergency actions and mission actions; and putting a crew there. And eventually, if you keep that up, you'll eventually make it so that they can then put an org there which can handle these wild things that are going on and which have to be handled by the Sea Org. Do you see?

Now, in the period of time before a crew is really there, you have all kinds of wild things going on. You have ships being single-handed; you have Conning Officers up there who are doing everything, including steer; you have an engine room that the Chief on some watches actually has to run them from his bunk; you have these weird things going on where single-handing is occurring because simply nobody has put a crew there. So, that is your first action.

But of course, the purposes of the Sea Org in handling and controlling things are actually senior to producing or putting orgs there. So, it happens that we really get torn to pieces by the urgencies of actions which have to be undertaken by us regardless of it all, and our internal organization suffers badly, and we have to remember, we have to keep it in mind, that even though we are handling these things and so on, we must keep an eye out to the fact that we have to have a basic internal organization there, a crew there, so it can have a product of putting an org there which has the product of putting orgs there. Do you follow?

And where we neglect that original step is where the Sea Org member gets overworked, rather harassed, rather knocked around. I haven't heard people complain. But that's what's, maybe, the pride of the Sea Org, see. They don't, they go on and get the work done. But if they're too hard pressed and you start distracting them by insisting they study or insisting that or

something of the sort . . . If they're too hard pressed, they tend to almost do their nut because it's too much distraction off of trying to get the job done. They're already short-handed in doing it. Do you follow? That's really what happens.

Now, if you have the three main divisions of the ship, particularly a large vessel, well covered, you won't have too much trouble. And the three actions which have to be covered, really have to be covered . . . And we've shorted these up time and time again, and every time we have done it we have built up fantastic amounts of work for the next lot that comes on. And that is the engine room. The engine room has to be fully manned and it's a very liberally manned engine room and it has to be a well-manned engine room. Otherwise little bits and pieces start breaking down, the next thing you know nobody could run it no matter how many people you put in there. There has to be a good stewards . . . cooks-and-stewards setup. That has to be handled and functioning and not shorted up and a good deck force.

Now, all else on a ship's crew can be skeletally handled. But those can't be. You've got to have your engine room, your cooks and stewards and your deck force. And those things have got to be handled. If those are not fully manned, or adequately manned, then the crew will be unable to put an org there and the org to that degree will suffer because it will not be able to have a product of controlling and handling other orgs and situations.

So, what happens is that in the anxiety to handle this or that emergency, we forget to put the crew there, and then the crew shorted up, gets very badly mauled around and nobody could do that amount of work. And then we have to remember to put that crew there. And if we do that, why, it will all come out smoothly. Do you see?

So that is the only cycle, actually, which I can tell you by long experience that tends to be neglected. What happens? We have three engineers, or we have two engineers, and they happen to be very good auditors and they know their tech. Do you follow? So some screaming tech emergency occurs someplace or another and we take one of those engineers and send him off to Keokuk. We don't put somebody back even for the period when he's gone. See? We don't put somebody back there. We don't fill in that slot. When this thing starts happening, the funny part of it is that the urgency of some operation may take the other engineer too. And then you suddenly ring up on the bells to—*reductio ad absurdum*—you ring up on the engine room telegraphs to go full speed astern and there is no reply.

And, similarly, people underestimate the amount of personnel which is vital, necessary and required in the third division, the Purser's area. They underestimate this personnel and all kinds of wild things happen. They're supposed to take care of their expenses and economics, you see, and supposed to do all their books. All right, that's full part-time. And then they're supposed to buy all the food and issue it. Now, those are two rather full-time jobs all by themselves. And then they're supposed to have three meals a day, and then they're supposed to wash all the dishes and serve those meals too. And then clean out all of the berthings and keep those all neat and straight somehow, or the internal compartments of the ship. So we put one person in the third division.

Well, I'll give them credit. Over the past time, I've actually seen them try to do it all. It's very remarkable. I've actually seen them try.

And then they get into tons of trouble, because, of course, their accounts aren't up. They don't know where the money went. It wasn't run on financial planning. They can't find their receipts. And what happened to the last hundred pounds of cabbages, nobody knows. Do you see what happens?

So we can normally be credited with being highly inefficient. And that inefficiency . . . in such areas. We could be credited with terrible inefficiency in that area, whereas the truth of the matter is we probably are producing more work in that area than anybody has ever produced at any time in history. And that there aren't enough there to produce it efficiently, and so on,



is what gives the appearance of inefficiency.

The problem, once you have dealt with it, looks different from inside than outside. It looks quite different. If you took a look at this ship from an external viewpoint, you might find quite a few things to find fault with. But all of that viewpoint would be in total ignorance of what was being done by this ship.

Most of the actions of the Sea Org are invisible to the immediate environment. They're completely invisible. Trying to pull people up the line, casewise, studywise, keeping the ship going—all of those things are actually secondary to the fact that we have our fingers on communication lines and remote communication relay points thousands of miles away. And the number of things which can go wrong at the other end of that line, nobody could imagine. It's not a problem of imagination. It's a problem of unreality and disbelief when you see how many things can go wrong.

All of a sudden, we took our finger off our number a few months ago and somebody cancelled out the Foundations of two major orgs which had, at that time, been making money very well. And immediately that the Foundations were cancelled out, the two major organizations proceeded to collapse. And it just never occurred to anybody, apparently, out at that end of the line, that there was anything wrong with suddenly knocking out their Foundations.

Well, of course, we had to do something about it. We didn't do too much along that line. We got them in, in a hurry. We got them functioning again and I haven't checked up on it recently, but that's the kind of thing that can go wrong. All of a sudden, Washington hasn't got any income and so on, and we look at this and they have given away their CF. They have taken any part of their CF that belonged in any other district—they just bundled it all up and shipped it off to them. And the guys in the other districts didn't use it, you know. And there's Washington with its . . . The things that can go wrong, boy.

So, we watch those things and we do our job on a management line and enforcement capacity, and we get those jobs done. And we do very well at handling these things, but it's at internal expense, almost always. It's like, "Who are we going to send to New York? Well, we've got to send two people to New York, and they've got to be leaving by tomorrow afternoon." And all of sudden, why, there's no Cook and no Chief Officer on the ship. Because these outer lines, of course, tend to take priority. Well, they have priority of importance in getting them done, but when that is always being done at the expense of unmocking the ship's crew and the ship, why, that, do you see, pays off wrong way to.

But somehow or other we keep it going. Since . . . for the last year, we have been fighting an interesting war—and we have been fighting a war; there is no doubt about that. Organizations were given a bad jolt. And through my analysis of the lines and so on, we were able to actually isolate the enemy who had been shooting at Scientology for about eighteen years, undetected. And he's just been sitting there shooting everything to ribbons. And we thought it was other people, and somebody else. In other words, a real covert third-party action.

We've started to clean this up now and things have eased up. But we've just gone through a year of very hectic operation. It is a great tribute to the Sea Org itself that it was able to keep in action and operation, orgs throughout the world.

Now, the Sea Org has this virtue: it has authority. And because somebody at WW or some Executive Secretary of some organization tells people to do such-and-so and so-and-such is no reason at all it's going to get done. Or even, on a long distance communication line, that I write somebody and tell them to do something is no reason it's going to get done. Ordering a thing to be handled and getting it handled happen to be two different things entirely.

There is such a thing as the communication of what you want and the

supervision of getting it done. But also there is another ingredient there which is the authority from which you operate, and that is not in the Key Ingredients. The authority with which you operate.

The Sea Org has a nasty enough, a kind enough, a powerful enough, better-stay-friends-with-them enough type of reputation that it can get things done and handle them. It isn't that somebody else hasn't seen this outness. It's that he didn't have the ethics presence or authority enough to get anything done about it.

It's a very interesting thing. You may find that the whole organization knew that the finance department didn't exist and wasn't banking the money. And yet, strangely enough, nothing happens locally about this. But we note this, and because we are the Sea Org, we call it to somebody's attention—it very often is enough to start some action just by calling it to their attention. And when you follow it up along the lines with proper communication and supervision, you really get things happening at the other end of the line.

Now, it's all right to get things to happen at the other end of the line as long as your planning is accurate enough that the orders you are trying to effect are themselves real and that the things you are trying to correct as outnesses did exist as outnesses. All of these things, don't you see, are contributory to the reality and efficiency of the organization.

So when we send people out to look at things, or when we get information and when we handle things, why, something happens. We have ethics presence. Our reputation is very bad amongst the people who don't like Dianetics and Scientology. I'm sure our reputation is terrible.

The reputation which we enjoy, however, in other quarters, and in Scientology organizations, among Scientologists where we are known at all, is very high. Where somebody has tried to fend us off and not wanted us around, time has demonstrated that they had good reasons for this. We've just had an instance in New York. Somebody has been fending us off, or trying to box us off there for a long time and has caused a lot of trouble over various times. And he blew off, and then the other two guys there who were trying to do this, they blew off, and all of a sudden, the Sea Org was being cooperated with 100 percent and managed to straighten out their tech.

In any event, the operation which we conduct is trying to put together a fourth dynamic, and we're making inroads in that direction and we are doing it from the third dynamic. And we are rather successful at it, being undermanned—actually undermanned, underfinanced, any other “unders” you can think of, except ambitious. We're not underambitious. The amount of action which we will bite off to accomplish is horrifying.

And being, as I say, undermanned and many “under” other things, we still manage to bring it off one way or the other.

Now, in view of the fact that the enemy we have had trouble with has been actually positively known to us for less—at this time I am speaking, for a year, and that he is suffering, very badly and that he has lost his eight top most important people during that time . . . We didn't kill them. We didn't do anything with them. Fate just caught up with them suddenly. These people are very unlucky.

Anybody that would fight anything . . . anybody that would fight anything like Dianetics and Scientology would also be making other enemies in various directions.

So, in any event, we're able to carry on better, and because we have a very concise idea of where we're going and what we are doing, and because we do bring our programs off to execution and so on, why, we will go ahead and make a breakthrough on this. We will go ahead and get up past the make-break point and push it on through.

Undermanning is rather chronic because we tend to be very . . . try to be very particular about recruitment, but it is better to be particular, we have learned, about recruitment than it is to have to handle somebody who is

mostly a case and then he's around underfoot and then he isn't around. It's a little bit better to keep strict lines on that than to lose all the additional motion.

But our targets are made, somehow or another, and they're made definitely on a third dynamic action. The ways we operate, and so on, is a highly coordinated drill, and we make those targets and we are successful with them. And when we're not successful with them the first time, why, we will go ahead and get successful with them the next time. There's constant pressure along these lines to get things accomplished.

And the only thing we really forget is to put a basic crew there that can have the product of an org which then can go on and do its job. And I really don't think there will ever be a time arrive when some engineer or somebody isn't being wakened in the middle of the night and told to get up and go down and get briefed because he is leaving for Keokuk. I don't think that time will probably ever arrive.

But, theoretically, it could arrive if one had enough people. But on a backward look, the income and managerial actions and the things that the Sea Org have made go right over the last two years, if added up, would become a completely incredible record. Nobody could possibly believe that this few people have been able to accomplish that much across as wide a perimeter of the world as we have into the teeth of that much opposition. And the opposition is quite real. And that it's fading down doesn't mean that we can't find another set of birds one of these days to suddenly say, "My God. Those Scientologists had better be done away with before they make everything nice." You know?

Like the undertakers. The undertakers get into cahoots with the government and have vast objections to us because their income is falling.

But the Sea Org quite obviously is a third dynamic activity and the amount of action which is accomplished by the individual Sea Org member probably surpasses anybody's belief.

Oddly enough, this amount of action really isn't directly demanded of the individual. It is his offering, his contribution. And like all elite organizations, they work like hell for very little pay and are highly respected, and out there make up for it to a very marked degree in terms of altitude. And that's the way elite organizations seem to go. The bulk of organizations which have held considerable power on the planet have actually operated, more or less, along those lines. We're fitting into a pattern which is really a very old pattern, in terms of elite organizations.

That doesn't mean it has to be that way, or that it will always be that way. The only thing I hope is that it always will be an elite organization.

Thank you very much.

# IT'S A PRO WORLD

---

*A lecture given on  
21 October 1969*

60 min

Thank you.

Well, this is the 21st of October, and the fifth and last in this short series. Want to talk to you a bit about PRO. P-R-O. It is a PRO world.

If you read very carefully in the newspapers—if you want to get your hands dirty . . . Did you ever notice when you read the newspaper you get your hands all dirty? The filth even *rubs* off!

But it's a PRO world. The president of the United States does not make any utterance or take any action that is not PRO. He doesn't take any statesmanlike actions, he doesn't take any executive or administrative actions, he just takes PRO actions, see? And actually the White House only has two types of individuals, three types of individuals, actually. And one is the Secret Service who makes laughing attempts to keep presidents from being assassinated. And they belong to the Treasury Department who also control the drug traffic in the United States. You can see how effective they are. Anyhow . . .

And the next type are the communist agents who have been sent over by Russia and most of the secret documents are handled exclusively by them because they're the only ones that are . . . the only ones that are trustworthy! And all of the rest of the inhabitants at the executive level are PRO.

Now, you think that there are perhaps secretaries in the United States or ministers in England or Australia, or . . . Well, I shouldn't include Australia in the same group. I'd better start including them in with Communist China because they will shortly be part of it.

But you think those fellows are politicians or statesmen, or are . . . have something to do with other functions, but they aren't. They are all PRO. That is the modern trend.

That has been going on increasingly. And, actually, since 1948 and the beginnings of the real cold war it has been an intelligence world. Intelligence has built up to a—meaning espionage—has built up to a level which is absolutely asinine. Nine-tenths of the national budget, or something like that, of Russia is spent on the KGB. I mean their external budget.

Penkovsky, in his papers said, "How can you get into diplomatic relations with Russia when they do not have any diplomats?" KGB and GRU is actually what all of the Russian embassies really consist of. Now, these fellows are a piece of this PRO picture.

But PRO—the president says, "We must do something about the *wuff-wuff-wuffles!*" see, and that's all PRO. Don't think they're going to do anything about them, they aren't. That is to placate the head of Time-Life, do you see, who needs a story that week or has been critical lately.

"We must now withdraw 145 thousand troops from our recent war so that we can replace them with 145 thousand troops. . . ." PRO. Do you follow?

You're not reading any statesmanship, management, anything. Finance, what the hell. The way money has been inflating currently, zoom! It hasn't

anything to do with finance; it has to do with PRO.

"Let's see how we can get on the good side of the voters or the citizens or the revolutionaries or somebody or other. Well, let's put out more welfare. And, particularly, only members of the revolutionary council can get welfare payments"—you know, something like that—anything that is PRO or will show up in the newspapers or which will sound good on television. You think I'm joking! PRO. Public Relations Officer is king.

A bunch of crummy newspaper reporters that you wouldn't bother to wipe your feet on in any other age, now, by some inferous statement in some diplomatic circles of the state can say, "What are you going to do about the natives of Bugga-wugga-wuggastan?" And instantly the president goes out of the conference . . . See, this guy's just a creep, you know. He was probably high on LSD when he said it. And he goes out . . . the president goes out of the conference and he calls in the secretary of state and he calls in the secretary of the treasury, "What are we doing about the natives of Bmfg-mwfstan?" And they work and work hours into the night and finally get out a press release. They aren't going to *do* anything, you understand, but they're going to get out a press release.

You'll find out that more and more of the logic which is employed in matters of state, more and more and more of this logic, so-called, is simply what will be a middle-course, bland policy or what will be sufficiently challenging to get a PRO reaction from the other side. And that is the world in which we live—unfortunately.

There are some real factors in this world but they are getting less and less and less attention. You think offhand that this great welfarism that goes on in the West actually results in some people that aren't starving to death. A guy goes in for relief in Washington, DC. "Well, what revolutionary group do you belong to?"

"Well, I belong to the Pink Panthers," or something, you see?

"Good, you've passed that; now, you are a pressure group. You can make trouble in the press, yes, so we'll pay attention to it. Now, you say you're broke and your family is starving to death. Yes, well, of course, that's tough. Now, let's see. Now, let's see, do you have a TV set? Do you have a watch? Do you have a car? What kind of a car is it? Oh, a 1914 Model-T Ford, I see. Well I'm sorry you're not eligible for relief. No, you can't have any welfare payments."

"Yeah, but wait a minute!"

"Well, you'll have to sell your watch and your TV set and your car."

"Well, I can't sell the car. I can't even give people money to drag it away from the parking lot."

"Yeah, but you got a car so you've had it. But you are a member of the Pink Panthers, now. Now, if you can show me that it's necessary to pay you off, why, we will. But otherwise to hell with it."

You think I'm kidding.

Guy pays in—he's a publisher or something—he pays in fabulous . . . Not a publisher; he manufactures Theetie-Weeties or something, and he pays in to Social Security all of his life. He's been paying in 1750 dollars a month to Social Security out of his pay check. He gets to be retirement age, whatever that is by law now. And he drops them a note and he says, "How about my Social Security now?"

And they say, "Well, do you own a home? Oh, you do. Well, you've had it."

The guy says, "What do you mean I've had it?"

"Well, obviously propertied. Do you have any stocks and bonds?"

"Yes, well, I've got International Tel and Tel, five shares."

"Yeah, well, you've had it. No Social Security." But it sure sounds good on the PRO line, see.

If they did pay him any money it'd be something like \$2.20 a month. See? It sounds terrific, you know? Because it's all PRO. There's no fact back

of it. Guys could starve to death in windrows but unless the Pink Panthers manage to make enough fuss in the press, why, nothing would happen. They wouldn't be paid any money. You get the idea. All I'm saying to you is the actuality—to hell with it. The PRO, that's everything. "We are a welfare state. We support every citizen. Every citizen . . . Well, we wanna vote for John Jones, because every citizen in the country, if he doesn't have two chickens in the pot, the government will put a turkey in." See? PRO, PRO.

Now, part of this stupid PRO picture that we've gotten into is almost every—and I would say you wouldn't probably exaggerate if you said every—British newspaper reporter is a member of MI6, which is foreign intelligence. There aren't any British newspaper reporters that go out of the country that aren't a member of the intelligence service.

The United States—these blokes in the United States I don't think they all are members of the CIA because there are a *lot* of intelligence services in the United States they could be members of.

So it wouldn't be true to say they're all CIA. They probably belong to other branches of the government that are intelligence. These cats, then, put you over the jumps because there isn't anybody amongst that whole lot that isn't for sale.

That's a funny statement but a head of a European intelligence activity made a statement which was quite interesting, many years ago. After a lifetime spent in the field of intelligence he had yet to find a government official or person he could not buy. The prices varied but the fact remained the same.

He had one unhappy instance where a colonel who was in charge of all the secret plans of the country—where this colonel decided to have his cake and eat it too. And the colonel was going to meet him down on the east coast of Italy someplace and he was going to show him that he had the plans, get the payment and then shoot the intelligence guy who was buying the plans dead, take the plans back and leave.

So he met him on this deserted coast in a little house that the intelligence officer used for the relay of messages, and he said, "Yeah, there's all the secret documents of all the battleships. Where is the ten thousand kaputniks?" or whatever the cash payment was. And at that moment that it was produced, why, the colonel started to drag out his revolver and kill the intelligence agent so that he could take these back and put them in the archives and pocket the ten thousand kaputniks and so forth. And, of course, the intelligence agent's agent, who was watching all this through a small hole in the wall at the back of the room shot the colonel in the back and killed him dead. That was about the only exception he'd ever had in his entire career.

In other words, this is a very venal area. So PRO is largely utilized also for political purposes, and anybody who wants to eliminate anybody, ruin anybody's reputation, something like that, can enter in on this intelligence line. Special interest groups back of these governments and so on can place reports inside these governments that then go along these lines.

An agent who shows up who is asking for information is asking for it only in part for his paper, do you see. He wants other information, and then that will go in to his government. Then that, entering on intelligence lines, is forwarded around over the place. And you actually have four major intelligence agencies operating in addition to all the minor intelligence agencies internationally. And one of the large trades in which they engage is placing false information with the other intelligence agencies.

Take a look at that. It's one of the legitimate functions of intelligence to place false information with the enemy. Actually, this is covered in *The Art of War*, some unpronounceable Chinese name wrote way back and that Mao has been using very nicely. They call this guy the dead agent. I don't know why he called him the dead agent because as far as I can see they're very much alive. They place false information and then the enemy, when they find

out it's false, shoot them. Well, the enemy never finds out it's false, really, these days.

So here is this tremendous flood of information. The KGB is putting information into the CIA, you see, to color the PRO complexion of things. And the CIA is putting information in through to the KGB to stay false information in their files. And then the Deuxieme Bureau in France, and MI5 Internal and MI6 External in England are probably the busiest guys at this that anybody ever had anything to do with. They enter in any kind of false information that will make a point, so that then this can be carried forward by a PRO newspaper action or . . . You get the idea. You talk about a bunch of nuts!

Most of these governments are actually operating almost exclusively on false information—almost exclusively. There used to be a considerable run-down to make sure that the information was accurate. And we have learned, executivewise, in recent times that we must not act upon an isolated report. Let us say a crew member or something like that—we get a report that he's wuffle-duffling, you see. To act on that without investigation or confirmation and so forth will do more wrongs than you can possibly shake a stick at. It's absolutely ruinous to act on isolated reports.

A smart executive actually never acts on an isolated report. He verifies and confirms. He hears that CF isn't *blog-blog-yig-yog*. He gets a report to this effect. Now, if he issued an order that CF should be shot down in flames because they *woff-woff-dogglogged*, do you see, without confirming this, he would actually spread a lot of chaos and disaster.

We are learning this the hard way. Every executive in Scientology really learns this the hard way. He can know it intellectually, but after it's happened a couple of times or he's noticed it happen a couple of times, he gets careful about this sort of thing.

Well, what does this add up to? This adds up to the fact that a false report, acted upon, brings about chaos and injustice.

So all an intelligence agent would have to do is feed enough false information into a government which hasn't learned the lesson the Scientology executive has learned and have that government start acting on all these false reports to absolutely destroy the whole cause of the government and the whole country. There'd be nothing to it. You could destroy a country by getting it to accept false reports.

Then whenever the political operating climate is very bad in an area . . . An area can lie dormant. Nobody's very ambitious. Nothing's happening in this area. And then all of a sudden the Russians and the CIA or the British or somebody like that starts stirring it up. You know, they want to make a couple of quick bucks for the World Bank or something like this. And they start revolutionizing it or hopping it up. Then these guys, all this time, have had these fantastic numbers of dossiers sitting around. The British Intelligence is always issuing little information sheets—"Do-do-do-do, do, de-de, do-do." And some intelligence officer down there—he's been filing them and filing them. This country of Pumjum, see—and he's been filing these things and he can hardly read, you know—"Ugh-bug," and files them and files them.

All of a sudden one day somebody starts running guns. A couple of junior ministers suddenly are found to have been in the employ of the enemy. Oh, well, they didn't look further. They'd find 90 percent of their people are getting money from somebody else somewhere. But they get nervous now. They get nervous. It wasn't that the information wasn't there; the information was there. But now that they're nervous, they *act* on it!

They break out the files and here's some file the Shell Oil Company has managed to file against Standard Oil Company in this country, don't you see. Coolly false report that the manager of the local branch actually is accepting pay from the Russians and has fifteen wives scattered over the



world and is actually wanted for murder in South Africa. You know, a whole bunch of lies. And you see Standard has put this in about the Shell agent or Shell has put it against the Standard. So, of course, all of a sudden, when the political climate suddenly hots up—all by PRO, see . . . The Russians have figured out a new angle to publish in the American press, and the Americans have figured out a new angle, and the British have figured out a new angle, and somebody wants something out of this country of Pumjum, see, so it's hotted up.

Right away their army, their president, their minister of defense, the rest of these characters, turn around to the intelligence agents and say, "Where's all the hot dope?" And, of course, this little guy who can hardly read you know, he starts bringing out the files he's been filing. And, my Christ, they find out that the head of the Shell Oil Company has been *wogh-wogh* and the manager of Standard has been *wuff-wuff* and that the international diamond syndicate and so on has been knocking somebody's head off because he owns some of their shares of stock, and they tried to depress his business so he'd sell out so one of their pals could buy them, you see. So a lot of false reports in about him.

So they look at all this stuff and they say, "My God! We're in a den of thieves!" And they just start shooting everybody, *boom-boom-boom-boom-boom, boom-boom-boom*.

The hysteria that's going on right this minute in Libya is a wonderful case in point. This guy actually was able to get enough false information assembled and brought to the right people that he was actually able to kick out the king and then kick out the king's brother, or something of the sort—or the crown prince, rather—and he was able to knock out all the old lines and so forth. Just all this false information suddenly bit. Now he's saying, "No foreign businesses of any kind whatsoever must come into Libya." Sounds like he's scared to death; he's totally hysterical. Of course, the whole country will absolutely collapse. Thud! He'll put himself off the lines, nobody will ever have anything to do with him. The Russians have promised him a great deal of help, but that was just PRO!

And all of a sudden he's driving down the road and he notices nobody has anything to eat, and all the markets are empty, and most of the cars are stopped and stalled, and there's no ships coming into the harbor. And he says, "What happens. What happened here?" And the natives said, "You led us astray," so they shoot him. And that is the next step that is going to happen in Libya. "Mysterious 27-year-old takeover found dead yesterday in his bedroom." Because it'll all collapse. Do you see? Because they do not verify their information before they act. Do you follow?

Now, you in the Sea Org are operating in this weird PRO world. And it is a weird world to operate in. The psychiatrists actually shaking down governments, working for other foreign powers, were actually able to get enough false intelligence information into enough files about Scientology and about us that where a country becomes very active they start looking up all this information—which is all false—the situation heats up, and then they all of a sudden put the heat on. And then they become very curious about us and about what we're doing and so on and *yap-yap-yap-yap*.

And, of course, the psychiatrist is protecting a multibillion dollar empire. He has the greatest racket in the world. Governments all over the world appropriate him money. They appropriate him millions just off-the-cuff. "Oh, you want a little money for research. Oh, good. We'll give you a little money for research. How about a hundred million, huh? Huh? Good. All right."]

Well, if they've got to have this money for research what do they want them around for? They haven't solved the problem because they've got to research it. Obvious. And the psychiatrists—they finance study groups with this sort of thing. And that study group becomes very interesting. They have

a lot of people in from Pumjum and Yipyap, and they all sit around and discuss it. And their latest materials are actually prefaced by the fact that scientific thinking is no part of their activity. The physical scientist—he talks in terms of results and proof and that has nothing to do with what they're doing. That's all a very crude approach. They're very artistic and they have an entirely different approach.

We've driven them into this absolute psychosis. It's the most marvelous preface. They put this preface now in each one of their published books. It's the same preface. "We are not scientific, and scientific people shouldn't . . .," you know, and "Who should expect results of us" and, you know, all that sort of thing.

And aside from financing a few of these study groups and running very tiny offices, they actually just farm out this dough to all their pals and they stick it in their pockets, ha-ha! What a racket, boy! They probably get another take from private individuals who want certain people grabbed and knocked off, and probably there are certain enemies of the government and so on that they can grab and knock off. In other words, they're a political graft activity, but they operate 100 percent along with PRO.

So they infiltrate the government lines. They enter all kinds of wild things into the PRO lines. When a country heats up that sort of stuff is brought down to view. And these governments, having no goddamn sense at all, are liable to act on it. Do you follow? That's our operating climate. Sure is a lousy operating climate.

Now, it isn't that our universe is more dangerous than anybody else's universe. Their universe is about a hundred times as dangerous, only they don't know it. They're too stupid to find it out.

We actually, before we developed good port PRO actions and good local area PRO actions, were very often in trouble. We were in trouble in the most remarkable ways. But it wasn't really Scientologists that got us into trouble. The biggest amount of trouble that happened in Spain was a commercial licensed engineer who turned homo and was that way with hired Spanish hands who then went to the police and complained about this English engineer. And he was dismissed and the whole thing was handled. But it still sits in the Office of Information in Spain. See? Not as a handled situation but that there's something, you know?

And they're having a lot of trouble lately with hippies. They aren't counting the communists that they've got in their midst—minister of defense, minister of shipping, Franco's first adjutant, second aide, chamberlain—they aren't counting these guys, they've got to get these hippies. You see, it has no political sense at all. If you knocked off every hippie in Spain, you would not have strengthened its political position a minute.

But the English newspapers recently have found out that hippies are copy and by forcing hippies into this or that position, why, they can write newspaper stories, which is quite fine, you see. Now, probably they have infiltrated the lines about something or other about hippies. So then it finally gets down to Spain, so then anybody, or anybody that they're afraid might be hippies and so on, why, this becomes a very difficult problem. Gives you some kind of a level of the unreality of operating actions of such governments.

Now, Spain is supposed to be violently at odds with England over Gibraltar. The minister of shipping's first appointment after somebody from our organization was seeing him the other day was going up to London—I suppose, to get his cut. Do you see?

So, over the years we learned how to handle this. And we're pretty savage, actually. The head of the anarchists the other day, to a visitor, said, "If you think we're bad on the subject of psychiatry, you ought to listen to the Scientologists. They're really vicious." And, yeah, they're getting sorry they started this thing. They've been sorry for the last year or two that they ever heard of us or did anything about it, see? We weren't even in their line of

country. They're going to lose their whole stinking empire before they get through because they attacked us. See, it's that rough.

But where you're concerned in the Sea Org is in your direct operating environment. Now, before we learned how to handle this and before we learned the drills in connection with this and so on, we were very often in trouble. Little sniggly things, see, in the port. Little actions here; a newspaper reporter—somebody talks to him.

We accept an insecure crew member, do you see, like this non-Scientologist Linda Smith. She was just wished off on us. And then, of course, she runs off and says how horrible we are, and her family electric shocks her into confessing how bad it is, see? But she was a plant. So these people who really aren't Scientologists and so forth are dynamite just from this particular angle. We have learned this. They are dynamite.

We get into various troubles because we take our finger off our number. We let insecure personnel come around, and we don't do our regular PRO steps.

Now, when we do our PRO, if we do our PRO superbly well, just on our drilled lines—the Ship's Rep, the Public Relations Officer, the various liaisons which are carried on . . . That is to say, the presents to the harbor master, being friendly, being cooperative; they tell you to move the ship, why, you move the ship, and it's all very fine and it runs off very easily—we take care of all of these angles, see—some kind of a handout that explains what we are and that answers all the questions of the situation. All of these various actions, you see, and we never slip on these things. And as long as this occurs, why, a new thing sets in. After we've been in a port, somebody trying to spread bad information about us in a port becomes a bad hat.

Now, when this was only partially built up, such as in Greece, we still changed the government of Greece, that's for sure. We had . . . a lot of changes and actions went on in that area. And the people of Corfu heard a rumor that we were out in the channel one day and the whole damn town went crowding down against the fence to see the *Apollo*. In other words, our local PRO was good. It was being continuously poisoned by a CIA agent who was in the town and by the British consul who went around telling people continuously that we poisoned the wells and put curses on their cattle, and so on.

Now, if that would happen now, why, we would have a different approach. We wouldn't let this go. Do you see? We wouldn't let this go even that far. Our PRO would have been better in the first place. Now, our PRO was all right in the area, but what it did was built up to the fact they now felt those guys were psychotic. And that the government would do something about this became absolutely incomprehensible. And therefore, the government was no good at all.

In other words, we built it up pretty high. After all we'd spend a lot of money in a port, we're very good people, we're very easy to get along with. If people just looked at the truth of the situation everybody could relax, don't you see.

But what we do is build up the level of loss, that if they got rid of us they would lose one hell of a lot, see? We build up their potential loss very high. We keep our ship presence, our PRO, up and this acts as an effective buffer so that the intelligence officers or agents that suddenly pick this up in these dossiers say, "Heh-heh! English. *Buulh!*"—throw it out, see.

Now, you could build this up sufficiently high that somebody who talked about us in a port, like a consul or a newspaper reporter, could be made non-persona grata in a country and booted out. Because it's obvious they are lying. So if our level of truth and reality has been built up very high, of course they look and sound like liars.

And our PRO is totally built on ARC. We build up a high level of affinity by using a high level of communication. We take all the questions out of the situation that they would handily ask and we build up a high level of R. So we build up high affinity, high communications and a reasonable R. Your

ARC goes up through the roof. And the definition of A . . . You see, ARC also bases on understanding. So they've got to understand why you're there or understand what you are doing. The more of those questions that get stumbled up, why, the lower your understanding or your ARC will drop.

So, affinity is the ability to occupy the same space—ability or willingness to occupy the same space. A high affinity—two people with high affinity are willing to occupy the same space. So if you want to occupy a space of a port you have to have a high level of affinity. And that is built up by the C and the R. That's really all there is to it. But it takes a lot of work, it takes a lot of leg work, it takes a lot of seeing people, it takes a lot of answering questions, and it takes a lot of cooperation on the part of the ship's company. It takes a lot of cooperation on the part of an AO or a base company. It takes a lot of cooperation on the part of a stationship.

But every stationship and every AO should work on this very hard. They should have very, very good PRO. They should build it up to a point where attacks on the local organization are rebuffed. They're rebuffed; people don't believe them.

Now, we've obviously done it as far as the police of Los Angeles are concerned. Why, they . . . people try to attack the org down there, they say, "Aw, go get lost." That's interesting isn't it? Now, I'm sure the police of Los Angeles have been fed information by the American Medical Association, the Better Business Bureau, the Health, Education and Welfare, which means, actually, "Disease, Ignorance and Starvation." As near as I can figure out that's the way they operate. They've been fed all sorts . . . Because that's the FDA. We've had Internal Revenue, who is directly run, as far as we can establish, by the World Federation of Mental Health. Internal Revenue Services do anything they ask them to do. Those birds operating in an area and so on could upset the operating climate of the area.

Operating climate is something you have to work for: It is not a passive thing which simply exists. That you show up has nothing guaranteed about it at all, that you are there. There are only two crimes in the universe: one is to be there and the other is to communicate. Those are two crimes. So you have to add the R and the A, and then you can be there and you can communicate and it goes on up the line. Do you follow?

Without the R, the reality of the situation, and without the affinity built up, why, your C becomes totally inhibited. So you eventually can't even speak out for yourself. So you build your ARC up very high.

Now, there are various ways by which to do this. And it isn't just the duty of Division Six and Division Seven. Actually, crew members also assist in this very, very greatly. They are already offering in Mediterranean area . . . Mediterranean areas they keep all the women dressed as ugly as possible, sitting as far back in the house as possible, because they know they'd be finished if they ever let them loose. So that is one thing you have to overcome: freedom of women. It's much more general in the United States and in England, and in Russia today, than it is in the Mediterranean areas, do you see?

So there are various little things that we have that we're not going to change but we're sure going to explain them. Do you see? We're going to get a better explanation on these things before they think of a better explanation. We normally have got to think of the explanation before they do and publicize it before anybody else can.

So we have the fact that it is an oddity to have a ship that does something else besides carry potatoes from A to B, you see. And it is an oddity to be doing anything in the world but punching a time clock and listening to PRO. I think the whole world's population is not supposed to produce these days; it's just supposed to listen to this goddamn stuff, see. "What are we going to do about the Middle East?"

Every new appointee that was appointed earlier this year in every country had the same statement to say because he knew the press would print it:

"How are we going to handle this problem in the Middle East?" See? Joseph Ergflatz or something, appointed to the United Nations—"Well, we've got to do something about this problem in the Middle East." Somebody appointed in France—"Wee must do somm-theeng about the Meedle East!" Somebody is appointed to the new Foreign Ministry and "Well, I rather think we'd bet-tah do something, you know, about the Middle East, ho-ho, right." Everybody, you know. "Das Middle East! Vee got to do somm-ting!" Do you see any change in the Middle East in the last six months? Not a damn bit! One hundred percent PRO.

So these cats go riding in along their hobby horses, and somehow or another somebody's got to listen to all of this. That people are going broke and getting shot, and that money is inflating out through the roof and a few other real problems that are happening in the world right now—such as how in the hell do you do business in this kind of an operating climate? How do you even sell potatoes in this operating climate, I wouldn't know. "Ah, potatoss, uh-uh. Cutt each vun of dose potatoss open—secret messages."

Now we sit with the total monopoly, actually, on psychotherapy, planet Earth. Fantastic! We've got a total monopoly. Actually, high level administrative skills—we've got a total monopoly. Everybody's trying to educate people. We know why people can't be educated and we normally can fix them up if we put our minds to it. See? We've got high level tech. One of the troubles is it's too high. It's what's known as a cultural lag.

Now, you're going to run into that on administrative education in Africa. I've already done some education of Africans, and coloreds and whites in Africa on administration. I've already done some of this. And I produced very, very enthusiastic administrators. They were really quivering and so forth. I wasn't teaching them anything very sophisticated. "When the mail comes in you write it down in a log. And when you mail it, you write it down in a log, and you put the stamp on it." "You do? Oh, boy!" Terrific, you know. "When you type a letter, when you type a letter, somebody at the other end is going to read it and the words have to be written so they can be read." Overwhelming cognition! "You put the stenographer's initials down at the end of it, and then everything in the place is filed in central file cabinets by alphabet."

The guys I was teaching this sort of thing to were clerical level people, and they were absolutely in awe. They were absolutely convinced the government was now going to get up off the ground. Of course, they had some kind of an insight that I wasn't quite just teaching administration. They also had the idea I might be able to do something for the country at large. And they were beating the drum for this very heavily, all on their own private line. But there was the level of reality of administration in Africa.

Every time I'd get a new girl in that was supposed to be a typist—she'd usually been turned out by a typing school or somebody—and, Jesus, she could no more spell, type or anything else. I used to open the book and every moment that girl wasn't stamping envelopes or doing something else, every spare moment she had, she wasn't supposed to be out there chewing the fat with the other girls, she was supposed to be sitting at a typewriter sight-copying and touch-typing the text of a story. And when I'd walk around through the office I would pick up the story and pick up their written text. They'd put what they had typed into the book. See? And they were getting better. They would eventually get the idea that you could type and it could be read and it could be done fairly rapidly. And their confidence would just go up through the stars. They didn't know why they'd learned to type in the first place.

There's your level of administrative action. For an executive, he's doing his nut because nobody can find his letters, nobody can mail his mail, the messenger is never available. It's all going up in smoke as far as he's concerned. The little clerical actions and lines and communication lines, and how you answer a telephone and all of this sort of thing—those things are

wildly out. Now, if he was backed up with any kind of a sophisticated administrative pattern of what he was trying to do, backed up by efficient clerical actions which matched it up, why, he would take off like a rocket.

Truth of the matter is, one is rather filled with awe at the amount of progress which has been made in some of the African countries at this time. You look over some of their brochures—which of course are putting their best foot forward—and that they have made any progress is quite remarkable. And the cost that it is costing them, they haven't added up yet. By the time they have borrowed twenty-eight million dollars from the World Bank to build a five million dollar housing project, and what this will eventually do to their economics—you get a sort of a robot society where you have a . . . a top strata of this society is actually operating each member of the society as though he is a cog in the machine. No members of that society are furnishing any impulse to its forward progress. In other words, it's a run, sort of an oddball, funny society. Nobody actually is consulting the happiness of these people, whether or not they like this brand-new thing or not.

And they have, actually, a lot of troubles coming up somewhere in the future because they are not administering economically. They're being took.

But that's beside the point that I was making. Their PRO, of course, is forward progress, freedom—this, that and the other thing—and you have to figure out, in an area, what they're beating the drum for. And this is known as ethnics.

You're at risk, always, operating in an area where you do not know the ethnic values. Now, they don't even have a word for this in English which means exactly that. It's the mores and customs. It's what do the people believe. It's what is right and what is wrong. It is the solution of good conduct—What is right? What is wrong?

Actually, some of this work was done for American troops before World War II, and they weren't supposed to do this and weren't supposed to do that, et cetera, to better their relationships with the native population. But these were simply based on careless, factual or nonfactual surveys. And a space opera approach to this situation is quite different than an Earth approach—quite different.

If you are going to control or govern or have influence upon an area, you have to make ethnic surveys. You have to find out what is most liked and what is next most liked and what is considered bad and what is considered totally evil. When you've got the lists of those things, now you know the control buttons of the society. Those are the buttons of control, boy. They aren't just "Study, ha-ha."

I get so goddamn tired of reading these psychiatrists on "We're studying the [*mumble*] now and we're going to have . . . had a conference the other day. And Professor Blotz advanced his new principle that uh . . . if people were daffy they were quite crazy. And uh . . . we discussed this for some hours and 'Are newborn babies happy?'" And they don't even get a midwife in to ask her. See, it's this total level of *nnthaaa*.

That isn't how you do ethnic surveys. You do an ethnic survey by going out and asking questions and by looking into books and backgrounds of religions and that sort of thing. You have to ask questions. And it takes a little while to get ethnic surveys. You're at risk if you're operating in an area in which you do not know the ethnics of that area.

Now, what is good conduct? Honest to Pete, if you look over today who the heroes of stories are that are being written in the United States and England and so on, you would be absolutely flabbergasted, because they obviously are representing the level of good conduct. What is good conduct? What is being good? And you think you can answer this, don't you? See? That's your first mistake. What is good conduct today has very little to do with good conduct yesterday.

But an ethnic survey will resolve it, whereby you go out on a broad-scale basis, you sample enough of the population, you'll find out what the new ethnic



is or what their basic ethnics are, really. And then after you've put together a code of performance for action, or the mock-up, you want to get *this* critically looked at. And then you've just got it taped. That's putting in your R.

And if you wanted to be very careful about this and if we were going at this on a broad scale in the whole African area, you'd put in the R *hard*, see? You'd do an ethnic survey, then you'd base a program mock-up on the ethnic survey, and then you would get that evaluated and so forth as a new survey, and then you would put it into operation. It doesn't necessarily take forever.

You probably think there's a lot of opinion in South Africa. We've just done an ethnic survey in South Africa. You probably think there's a lot of various things. You could probably give me—and even South Africans would probably give you various things that were liked and disliked in South Africa. But you're only interested in the majority. You're studying the human beings in the mass, not their personal prejudices. You start listening . . . Little samplings like this damn PRO thing, see—you listen to *one* newspaper reporter and you take *one* prejudiced politician and you add those two up. And these guys are charging in with this as a PRO action, they're going to get their throats cut sooner or later, and they do. See, it's a sampling. It's too small a sampling.

Ethnic samplings have got to be very broadly done. Something on the order of 49 percent—no other such gross figure shows up—but something on the order of 49 percent of the people of South Africa are *not* all worried about the things you would think they were interested in. The most popular characteristic in South Africa is friendliness. You look for something dramatic, you know.

Here's a scene, the PRO lets you see "And from the outside it's *rowr-rowr* and from the inside *rowr-rowr*." And yet what is most liked in South Africa is friendliness. And what is least liked in South Africa is narrow-mindedness. That is detested. And those are the high, sweeping majorities. There are no other majorities. There are little things like 11 percent, 2 percent, 1 percent—they're nothing. Forget them.

So it's friendliness versus narrow-mindedness. It doesn't even make a dichotomy. So all you've got to do is say, "Those who are against us in South Africa are narrow-minded! Because we are the friendliest people in the country!" Immediately the South Africans are for you. Got it? And that's what's meant by an ethnic survey.

Now, these are your real PRO factors. But now we're talking from space opera. This is how it is done in space opera.

We, for instance, are walking up on a new PRO triumph. Germany, apparently, medical profession is going absolutely overboard for Dianetics. Good. It won't let them down. But all of their modern technology—the psychiatrists and the psychologists—got all of their modern technology from Germany. It's gone the whole cycle.

Now, you see, some time in the near future—"Like all great psychotherapies Dianetics is being exported from Germany!"

But these are the functions and actions of PRO. Now, you'd think normally in asking . . . talking to a crew or the Sea Org about PRO I'd be saying, "Don't go ashore and get into fights, et cetera, and don't fraternize with the natives and et cetera and so on." That's what a military unit would do and they normally wind up as terribly unpopular. Because they're not the right ethnic actions. See?

Now, I couldn't at this instant tell you what in this port is exactly the best ethnic actions. You would say immediately "Well, you'd have to be pro-Mohammedanism" or something like that. Not necessarily. Nearly all of the newcomers and the younger generation are anti. You see?

So when you preconceive these ethnic values or base them upon what you read in *their* press, you make mistakes. Because they don't know how to conduct an ethnic survey in the first place.



So actually, to do excellent PRO, you follow the drill: You listen to what the Ship's Rep tells you. Don't go off lines. Don't go streaming up to agents. That's one of the things we found out: only one guy goes and sees the agent. Your PRO guy, he takes care of everything, and everything else is referred to this PRO guy. The crew keeps its nose clean, behaves itself and is friendly to people.

Beyond that you'd have to do an ethnic survey for every particular area and tie it up. Now, we do well. We do well since we ourselves got in our drill. And since we had only Scientologists aboard. I don't know *what* other ships and areas do. Full of wogs? If they're as critical of other ships as they're critical of us, and knowing sea crews as I know them, I could say that the government—ha! government—of Spain would probably have to wind up by debarring every steamship company and every line from all of their ports, do you see, if they're critical of us.

Now, they're not critical of us, they're critical of some PRO action or line infiltration action that has been done. So a part of it is do a confrontation and get that cleaned up. We've learned that: Don't let these things sit around. Do a confrontation. Punch them through. Punch them through. *Bug* these people. They've done some bad action toward you or you've caught up with them and so on—start bugging them! Don't ever let them off. Just don't ever let them off. Start tackling it. You know, because it's a pack of lies anyhow. It'll eventually collapse. So you don't let bad PRO stay around if you possibly can help it. As soon as you can do something about it, you do something about it but from the top.

But meanwhile, locally, you make all bad PRO look like a bunch of schnooks! See? You put yourself in so strong locally—with all of the powers that be and all of the factors locally, you put yourself in so strong that when they try to do something to you exteriorly it just causes one god-awful stink! And it makes the local people think the national people, or somebody at the other end of the line, are nuts! You follow? Because you're putting truth in up against a bunch of lies, and in the final analysis truth always wins.

You've got to know this drill. It's in FOs. Our PROs and Ship's Reps and people of that character—they've got to know this drill; they've got to follow this drill. It's a very precise one. They do it very well. Currently it's very well in. It must never be let drop out. And it is not in, I am sure, around certain stationships or areas to the degree that it could be, and I'm sure that it's not in around AOs and SHes to the degree that it should be. But it applies to them too.

Now what you do—if you back that up all the way up the line, if you back that up 100 percent with good, sound ethnic surveys, and then got your program, your mock-up, your actions and so forth reanalyzed after you'd gotten them planned and then went out along that line and did follow them, you'd take the world. You understand?

That's what PRO consists of. What it consists of to the governments, the outside world, the wogs—they just use it upside down and backwards to kick people's heads in. There's another way to use it, and that's to pick people up and entrench yourself solidly anywhere you want to be.

There's two sides of this PRO. It can be done right and it can be done wrong. We ourselves in the past have occasionally done it wrong and, boy, have we suffered for it.

So I would say the bad PRO that's being scattered around on a national basis is the third party action of the centuries. And I would not be a bit surprised if it didn't result in the downfall of most of the existing nations on the planet to this day—the abuses that they're making along the lines of PRO and intelligence.

The atom bomb isn't the trouble in this world today, it is bad PRO and using PRO to corrupt and enturbulate. Now, if we use PRO to straighten it all out, we'll come out on top. This is one of the most important things a Sea Org member should know. I'm not talking about it as a subject lightly

because it is the subject that has gotten us into the most trouble, and the subject which if done well can get us out of most anything.

Thank you very much.

# WELCOME TO THE SEA ORG LECTURES GLOSSARY

---

To assist in the understanding of these lectures, words most likely to be misunderstood have been defined in this glossary. The definitions used in this glossary only give the meaning that the word has as it is used in the lecture. This glossary is not meant as a substitute for a dictionary.

**AB:** short for *Able-Bodied Seaman*: a qualified sailor. An AB rating requires the completion of a checksheet and demonstration of competence in seamanship.

**aboard:** in or on a ship.

**aborigines:** the original or earliest known inhabitants of a country or region.

**adjutant:** (*military*) a staff officer who assists the commanding officer in issuing orders.

**admirals:** any naval officers of any one of the four highest ranks. In the US Navy there are the following ranks of admirals: fleet admiral (most senior), admiral, vice admiral, rear admiral.

**aft:** in, near or toward the stern (rear) of a vessel.

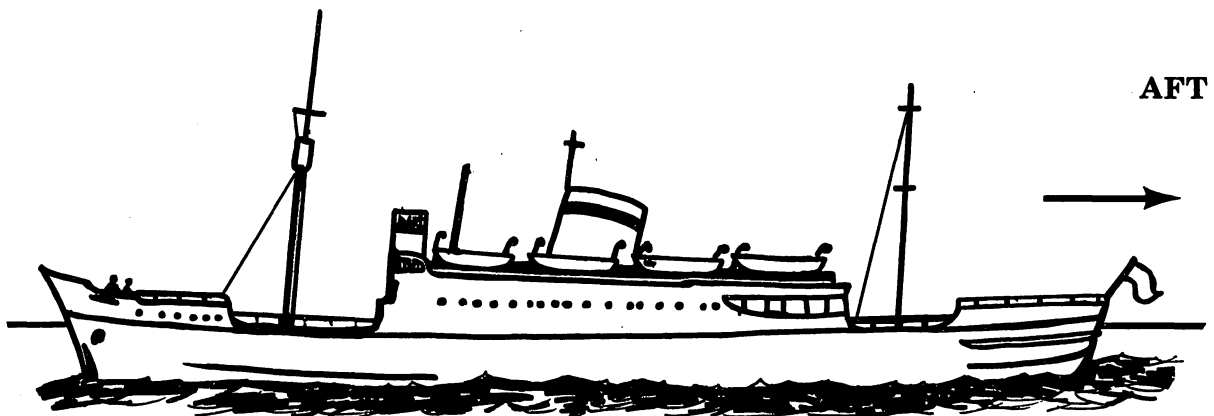

**after:** nearer the rear of a ship.

**after block:** a wooden or metal case with a pulley mounted inside. It is located at the rear end of the lifeboat and in combination with the forward block, is used to lower or raise a lifeboat. *See also forward block* in this glossary.

BLOCK



AFTER BLOCK

FORWARD BLOCK

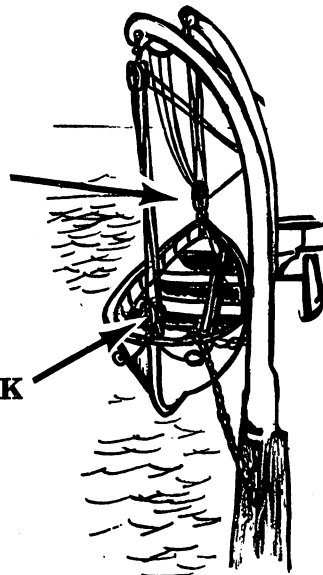

**after well deck:** the sunken deck in the rear section of the ship. See also **well deck** in this glossary.

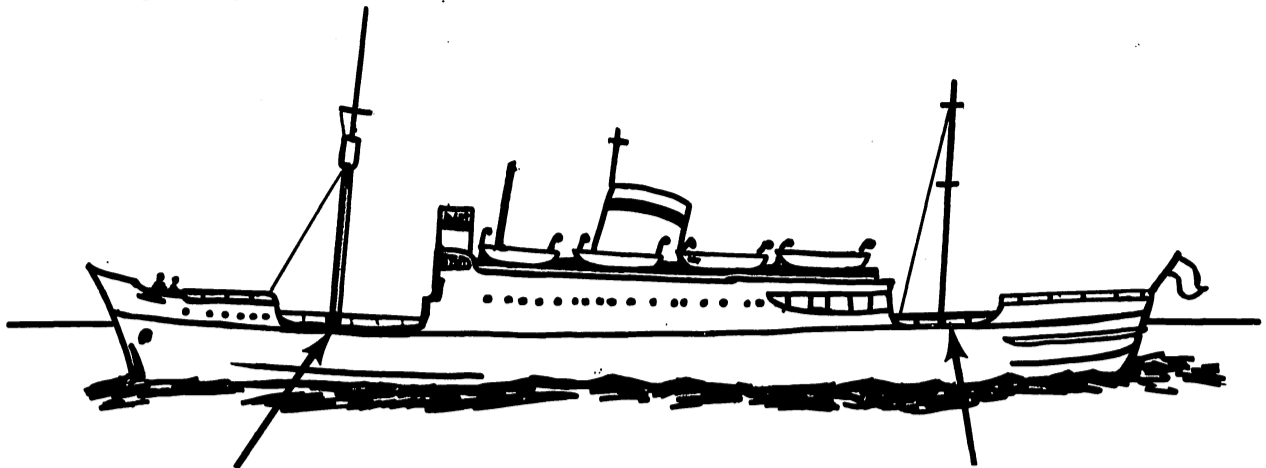

**FORWARD WELL DECK**

**AFTER WELL DECK**

**aground:** on or onto the shore, the bottom, a reef, etc.

**Alaskan Pilot:** the coast pilot for the Alaskan coastline. See **coast pilot** in this glossary.

**amenable:** ready or willing to answer, act, agree or yield; agreeable.

**American Medical Association:** a professional physicians' organization, established in 1847, with the stated purpose to promote public health, protect the welfare of doctors and support medical science. Its attacks on Scientology were based on misguided attempts to protect its private healing monopoly and huge medical-psychiatric income.

**amicable:** peaceable; friendly.

**anarchists:** individuals who support anarchism, the political theory that all systems of government and law are harmful. Believers in anarchism think that all such systems prevent individuals from reaching their greatest development.

**anchor:** a heavy object of iron or steel attached to a vessel by a chain and cast into the water to keep the vessel in place either by its weight or by its blades which dig into and grip the ocean floor.

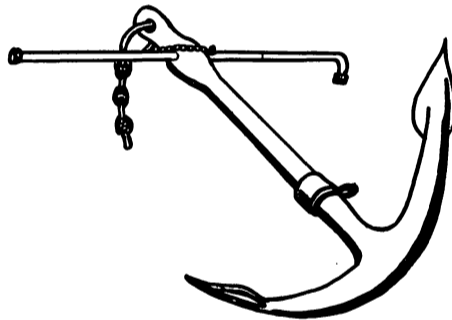

**ANCHOR**

**Andrea Doria:** an Italian ocean liner which sank in a collision with a Swedish liner *Stockholm* in July 1956, 45 miles off of the coast of Nantucket Island, Massachusetts, USA.

**AO:** Advanced Organization, an OT (Operating Thetan) organization. An AO delivers the Clearing Course and pre-OT levels from New OT I through New OT V, plus training services, including the Class VIII Course.

**AO UK:** Advanced Organization United Kingdom: originally established in Edinburgh, Scotland and later moved to Saint Hill. It is now part of AOSH UK (Advanced Organization Saint Hill United Kingdom) located near East Grinstead, Sussex, England. See also **AO** in this glossary.

**Apollo:** originally called the *Royal Scotsman*. It was acquired in September 1967. From late 1968, the *Apollo* became the Flagship of the Sea Org and the safe base for Ron, International Management, worldwide Scientology communications and the mecca for advanced technical and administrative training.

**APOLLO**

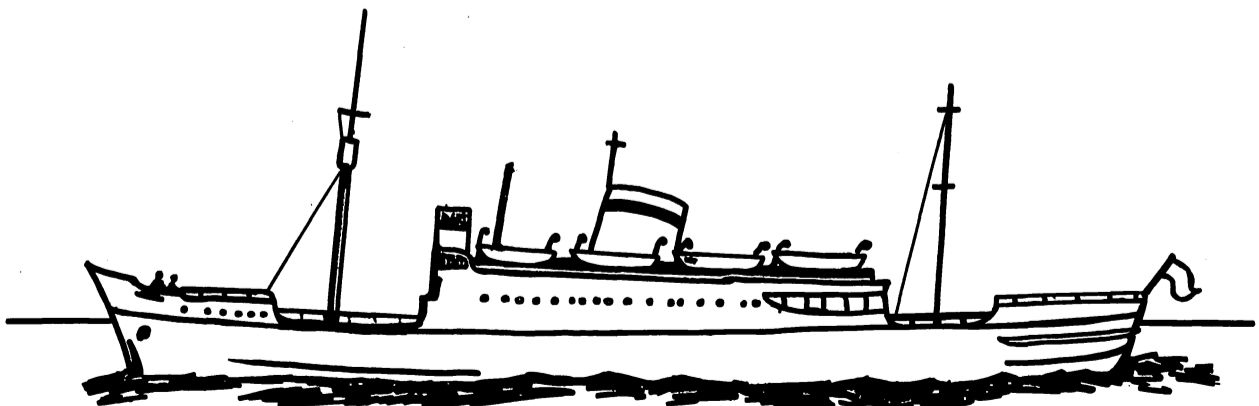

**ARC broken:** manifesting an ARC break. An ARC break is a sudden drop or cutting of one's affinity, reality or communication with someone or something. Upsets with people or things come about because of a lessening or sundering (breaking apart) of affinity, reality or communication, or understanding. It's called an ARC break instead of an upset, because, if one discovers which of the three points of understanding have been cut, one can bring about a rapid recovery in the person's state of mind.

**aristocracy:** any class that is considered superior because of birth, intelligence, culture or wealth; upper class.

**Art of War, The:** a book on warfare written in approximately 500 B.C. by Sun Tzu of China. It is the first known attempt to formulate a rational basis for the planning and conduct of military operations.

**assessment:** the action of an auditor calling off questions or items to a preclear from a prepared list and noting down any E-Meter reactions to the questions or items called.

**astern:** in a backward direction. As an order given to the engine room of a ship for the movement of her engines, it indicates that they must be made to revolve in the reverse direction.

**Athena:** a Sea Org vessel at the time of the lecture, formerly known as the *Avon River*. The *Athena* became the first Sea Organization Flagship in 1967. Earlier on, LRH took residence aboard and furthered his technical researches and continued the expansion and development of the Sea Org. It was phased over from a training vessel to a cramming vessel on 19 January 1972, where the *Athena* cramming line began. The basic plan was to have a place where a rapid (one week) cramming action could take place for Sea Organization and European org staff members to get them in on their posts and scene and other short-cycle matters and expertise they vitally needed in their orgs. At the time LRH gave this lecture he was aboard the *Apollo*, having left the *Athena* several years earlier.

## ATHENA

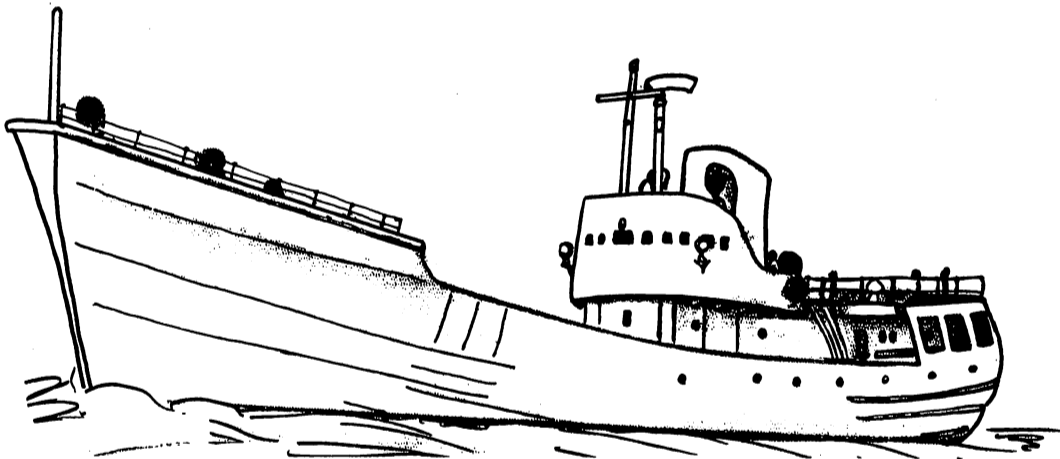

**awning:** a canvas canopy spread over a deck for protection from the sun.

**balderdash:** senseless talk or writing; nonsense.

**Base Order:** Sea Org issue type which originally began coming out in 1967 from the Base Organization which was the controlling organization of the Sea Project (now known as the Sea Organization). Base Orders have been used interchangeably with Flag Orders. *See also FO* in this glossary.

**beaches:** runs (a boat or ship) ashore.

**beating the drum:** (*informal*) giving vigorous support; promoting or advocating (something).

**bells:** *see engine room telegraphs* in this glossary.

**below:** anywhere on board a ship, below the level of the upper deck. To "go below" means go below the deck, downstairs.

**berthings:** the places where people sleep on board a ship.

**Better Business Bureau:** any of a nationwide system of local organizations, supported by business, whose stated function is to receive and investigate customer complaints of dishonest business practices.

**bilge:** the lowest part of the interior of a vessel's hull; the part either side of the keel which is most nearly horizontal. It is consequently the area where any internal water collects. The areas on either side of the keel are known together as the bilges. See also **keel** in this glossary.

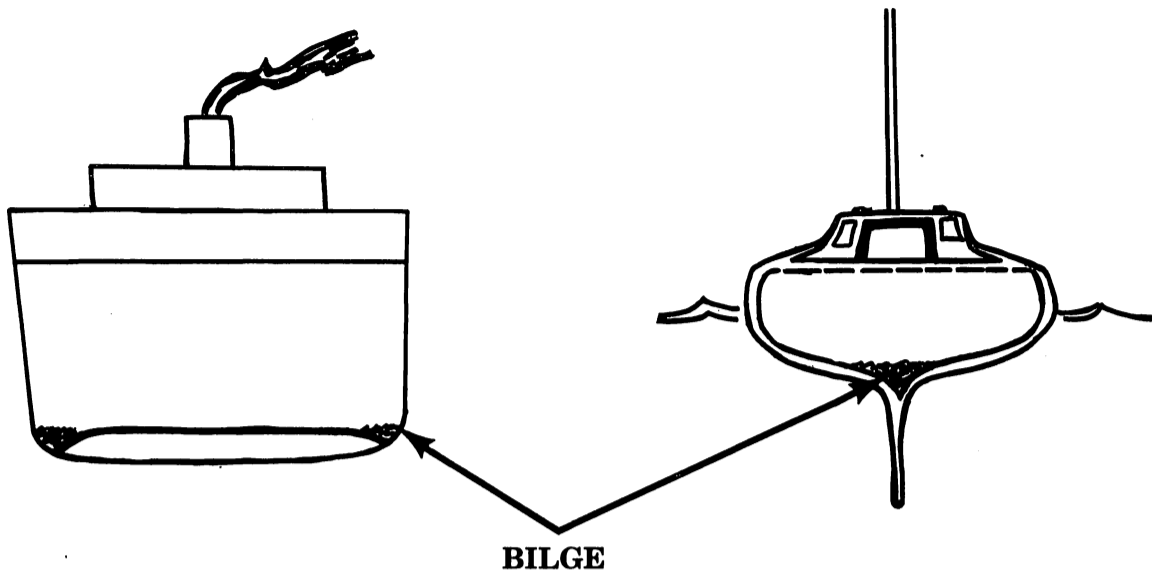

**bilge pumps:** pumps located in the bilges to drain the water that collects there. See also **bilge** in this glossary.

**bilge water:** water accumulated in the bilges of a ship. This has to be routinely pumped out or it would begin to flood the bottom of the ship. See also **bilge** in this glossary.

**birds:** (*slang*) persons, especially ones having some peculiarity.

**blacklisted:** put on a blacklist, a list privately exchanged among employers, containing the names of persons to be barred from employment because of untrustworthiness or for holding opinions considered undesirable.

**blokes:** (*British slang*) men; fellows.

**blowers:** machines or fans for forcing air into a building, furnace, mine, etc. In this case, the large fans on the *Apollo* which supplied air for the ship's engine room and ventilation system.

**boat hook:** a long pole with a hook at the end, commonly carried on vessels and used for fending off other boats and picking up mooring lines.

### BOAT HOOK

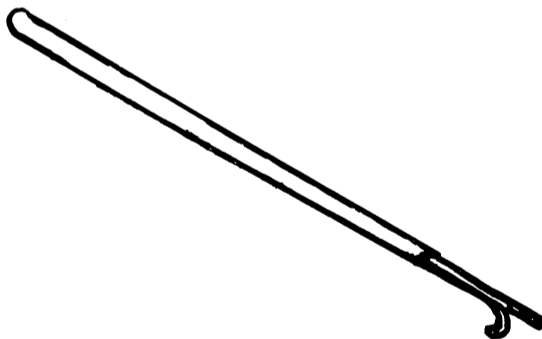

**boilers:** tanks for making steam to drive the engine of a ship.

**boom:** a long pole or beam used to extend the bottom of a sail.

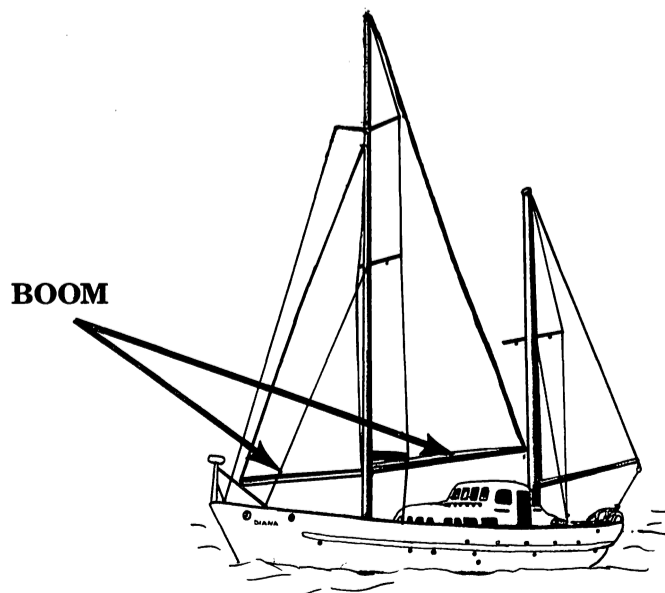

**Boston Harbor:** a sea harbor located at Boston, Massachusetts in the eastern United States.

**Bosun:** the officer on a ship who has charge of all the sails, rigging, anchors and other gear.

**Bosun's locker:** a chest or compartment in which a Bosun stows things such as ropes and blocks (a wood or metal case with a pulley mounted inside), etc. *See also* **Bosun** in this glossary.

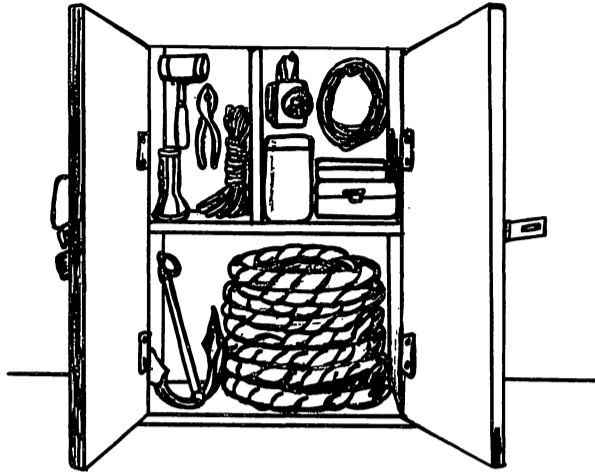

**BOSUN'S LOCKER**

**bow:** the front end of a ship as opposed to the stern which is the rear end of a ship.

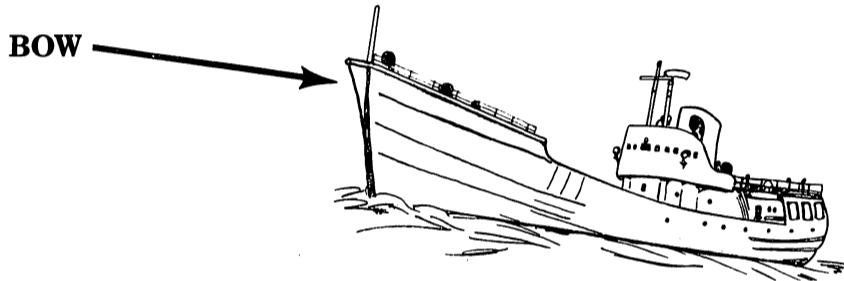

**box off:** block so as to keep from passing or achieving better position.

**bridge:** an elevated platform built crosswise above the upper deck of a ship, with a clear view all around, from which a ship is normally navigated and from where all activities of the ship are controlled by the Captain or Officer of the Watch. The bridge of a modern ship is normally totally enclosed by glass screens or windows to give protection from the weather. The main compasses are normally situated on the bridge, together with the steering wheel, a chart table for chart work and the ship's radar. The term may also refer to those who control the vessel from the bridge. *See also* **chart** in this glossary.

**BRIDGE**

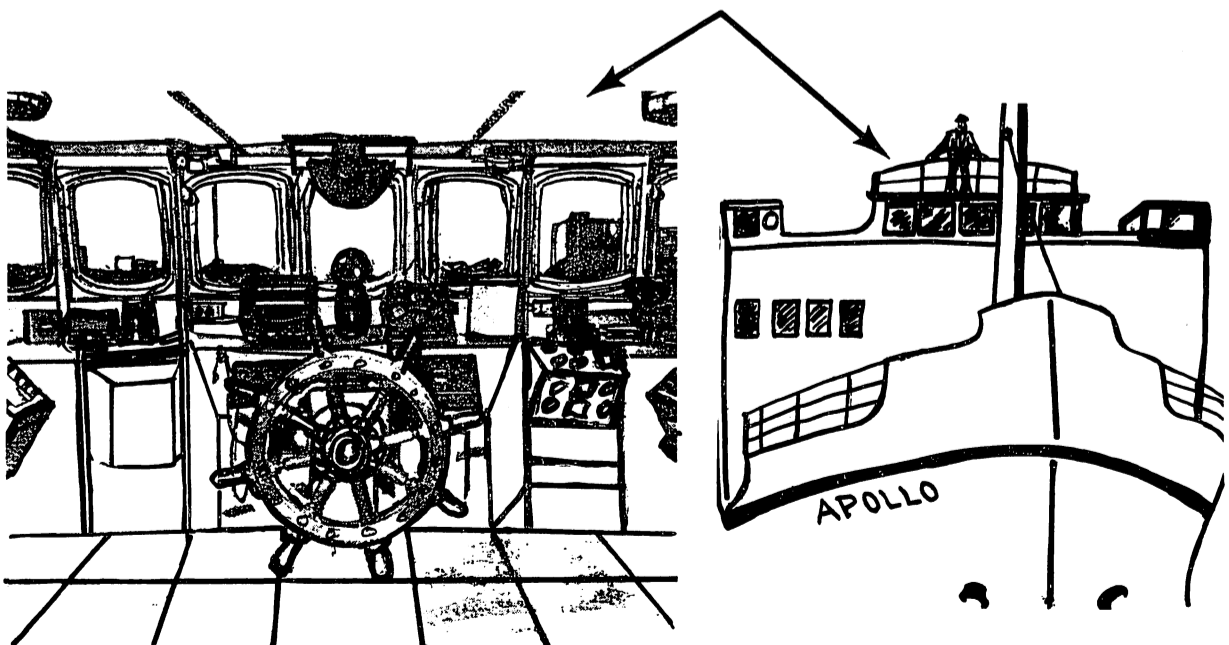



**Brooks Brothers:** a very exclusive, expensive men's store in New York City.

**brushes:** close approaches, especially to something undesirable or harmful.

**bulkhead:** a watertight partition built across a ship from one side to the other. A ship can have more than one bulkhead. For example, a collision bulkhead is one built in the front of a ship, designed to prevent flooding and the consequent sinking of a ship which has had a hole smashed into the front of it. Where there are bulkheads running across other parts of a ship, then there are watertight doors fitted where access through the bulkhead is required.

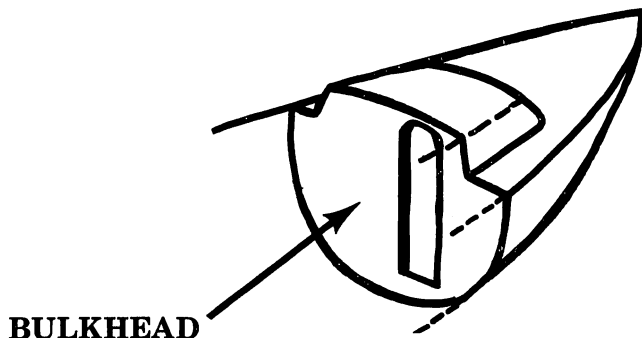

**bump off:** (*slang*) kill, especially murder.

**buoy:** an object which, anchored securely to the bottom of the ocean, floats on the surface to act as a marker.

BUOY

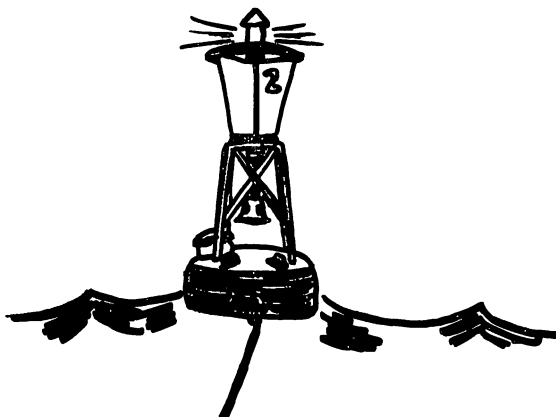

**cahoots with, into:** into secret agreement or partnership with (someone); working together secretly with, especially for harm.

**Callaghan:** James Callaghan, the head of the Home Office (British government department responsible for domestic affairs, naturalization and control of the police) around the time of the lecture. He was involved in an attack on Scientology in Great Britain.

**Cape Cod:** a sandy peninsula in southeast Massachusetts in the northeastern United States, on the Atlantic Ocean. Noted for its many resort towns.

**capitalism:** the economic system in which all or most of the means of production and distribution, as land, factories, railroads, etc., are privately owned and operated for profit, originally under fully competitive conditions.

**carburetor:** a device for sending air through or over a liquid fuel, so as to produce an explosive mixture, as in a gasoline engine.

**cartridge:** a container holding the chemical in a fire extinguisher. When a cartridge is used up the extinguisher should be loaded with a fresh one.

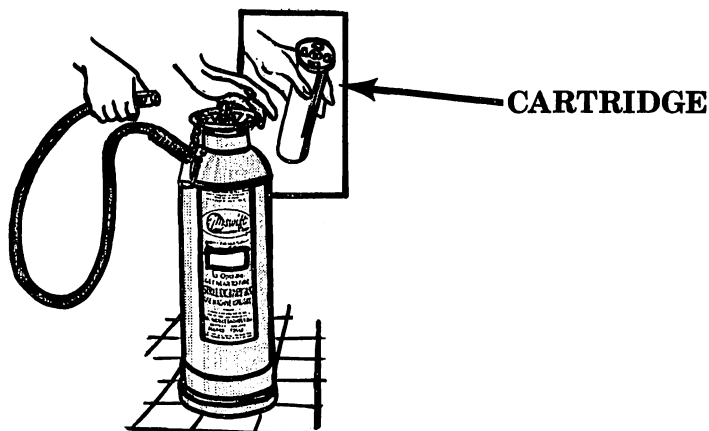

**cats:** (*slang*) people, especially men.

**cattle doors:** the wide, double doors at either side of the *Apollo*, just above the water line. Called cattle doors as they were originally used, long before the vessel became a Sea Org ship, for loading and unloading cattle.

**cavalry:** combat troops mounted originally on horses but now often riding in motorized armored vehicles.

**Celt:** a member of a people to which the Irish, Scottish Highlanders, Welsh and Bretons belong. The Celts were originally a group of tribes who dominated central Europe in the sixth and fifth century B.C. They came originally from southwest Germany and spread to the British Isles, France, Spain, Italy and parts of Asia.

**CF:** Central Files (Division 2, Department 6), a section which is responsible for collecting and holding all names, addresses, pertinent data about and correspondence to or from anyone who has ever bought anything from the organization.

**chamberlain:** an officer in charge of the household of a ruler or lord; steward.

**Channel, the:** the English Channel, an arm of the Atlantic Ocean between England and France, 21 to 150 miles wide by about 350 miles long.

**chap:** fellow; man or boy.

**chart:** a chart is the name for a map of the sea. These charts show things such as the depth of water, the kind of bottom, the location of wrecks, submerged rocks, the tides and currents and where applicable, the coastline and its features. Charts are kept in a chart room which is usually located close to or on the bridge. *See also* **bridge** in this glossary.

**Chesapeake:** Chesapeake Bay, a large bay (200 miles long by 4 to 40 miles wide) on the middle east coast of the United States.

**chewing the fat:** (*slang*) talking together in an idle, friendly fashion; chatting.

**Chichester, Francis:** Sir Francis Chichester (1901-72), a British deep sea yachtsman who sailed single-handed in his yacht the *Gypsy Moth IV* from Plymouth, England to Sydney, Australia and back again in record time. He was knighted by the Queen of England in 1966.

**Chief:** short for Chief Engineer, the officer in command of the engine room under the Captain.

**Chief Officer:** the officer who is second in command to the Captain. In Sea Org organizations and ships the Chief Officer is over Divisions 3, 4, 5 and 6.

**chow:** (*informal*) food.

**CIA:** *Central Intelligence Agency:* the US federal agency that coordinates governmental intelligence activities outside the United States.

**coastguard:** the British Coastguard, whose duties are connected with the sea. The British Coastguard was formed in 1817. Its first duty was to suppress smuggling and watch for vessels in distress. It is now the Royal National Lifeboat Institution which is charged with sea rescue in Britain.

**coast pilot:** a manual published by a government for mariners, containing descriptions of coastal waters, harbor facilities, etc., for a specific area.

**Cold War:** a state of political tension and military rivalry between nations, stopping short of actual full-scale war. The *Cold War* was the state of such rivalry existing after World War II between the Soviet Union and its satellite nations and the democratic countries of the Western world, under the leadership of the United States.

**collision mat:** a greased cloth or canvas mat which is pressed against the outside of a vessel to block up a hole and prevent the vessel from sinking. It is lowered over the side by ropes, and the pressure of the sea itself keeps the mat in place. The boat or ship can then be pumped out and the leak repaired from inside.

**commercial sailor:** a seaman who works on a ship engaged in commerce.

**Comm Ev:** *Committee of Evidence:* part of the ethics and justice system of a Scientology organization. It is a fact-finding group appointed and empowered to impartially investigate and recommend upon Scientology matters of a fairly severe ethical nature.

**commies:** (*informal*) communists.

**Con:** short for *Conning Officer*, the one who, in the absence of the Captain, controls the course and speed of the vessel and as the senior watch officer, is responsible for its safety. *Con* stands for and is short for *control*. Whoever is directing the steering of the ship, whether the Captain or the Conning Officer on duty, is said to be "at the con."

**Conning Officer:** *see* **Con** in this glossary.

**consul:** an official appointed by the government of one country to look after its commercial interests and the welfare of its citizens in another country.

**copy:** anything that can provide subject matter for a journalist, novelist, etc.

**cordage:** all the ropes and lines in a ship, no matter what they may be made of.

**Corfu:** an island off the northwest coast of Greece.

**cotton-picking:** (*slang*) damned; confounded.

**crew:** in the Sea Org when we say crew we normally mean all members of the ship's company below officer rank. It also means the people who sail or operate a ship or boat.

**Davy Jones's locker:** in sailors' mythology, Davy Jones is the name given to the devil who lives at the bottom of the sea. He is thought by some to have been a Welshman who became the devilish guardian of the deep who regards the bottom of the ocean as his storeroom. Hence anyone who falls overboard and drowns is said to have gone to Davy Jones's locker.

**debarring:** shutting out or excluding from a place or condition.

**Deck Division:** Division 4, the division at the time of the lecture which was responsible for the operational condition and safety of the vessel.

**deck force:** at the time of the lecture, the portion of the crew directly under the Bosun responsible for upkeep of the decks and hull, including maintenance and handling of lines, boats, anchors, etc.

**deck pump:** a portable pump (hand or motor driven) for fighting fire or pumping water from the ship.

**DECK PUMP  
(hand)**

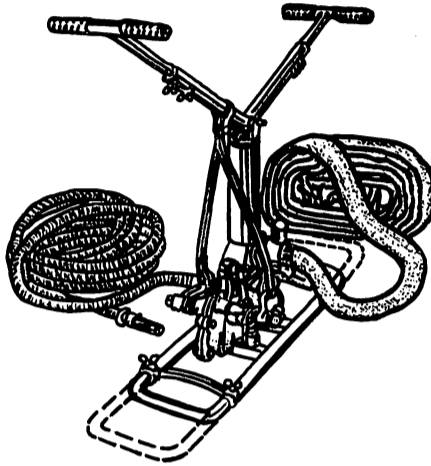

**decks:** platforms that extend horizontally from one side of the ship to the other (the floors of the ship).

**Deuxieme Bureau:** French intelligence organization, literally the *Second Bureau*.

**Diana:** earlier called *Enchanter* and was the first of the Sea Org vessels. It was a fifty-foot ketch acquired in late 1966 and used by LRH when he completed the researches which resulted in the release of OT III.

**DIANA**

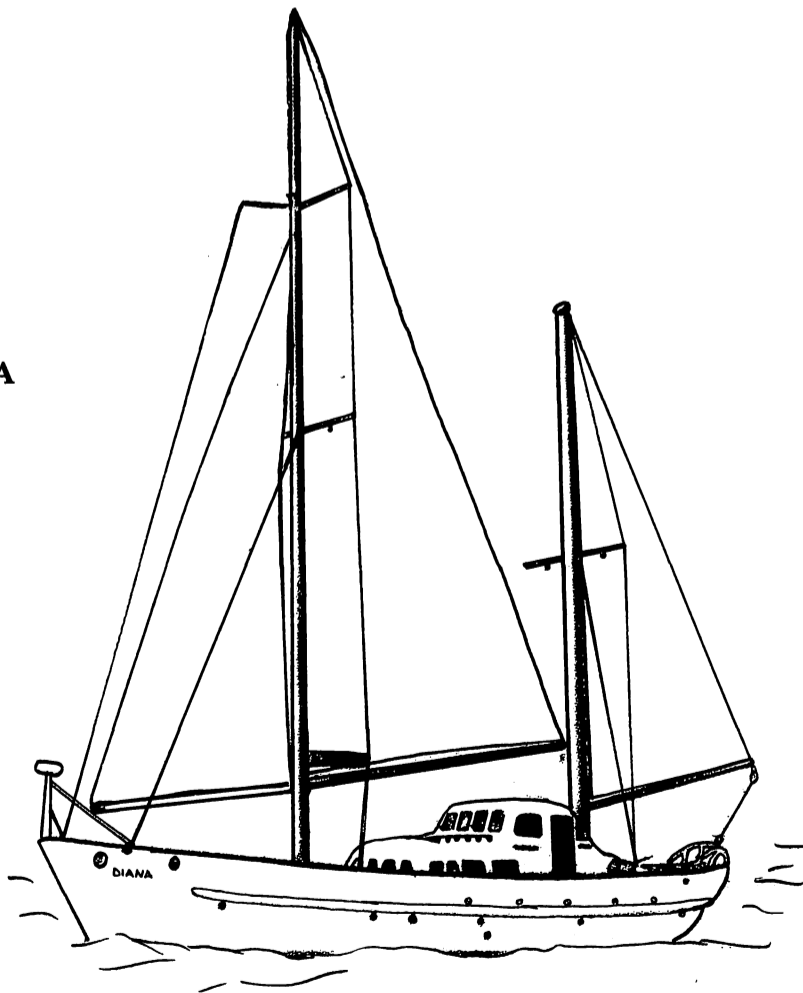

**Dianetic Triples:** the action of running Dianetics items on three flows. By "flow" is meant a directional thought, energy or action. The three flows are: inward to oneself, outward to another or others, and crossways, others to others. *Examples:* Flow 1, to self, being injured. Flow 2, self to another or others, pc injuring another person. Flow 3, others to others, people injuring other people.

**diesel:** having a diesel engine, a certain kind of engine invented by Rudolf Diesel (German inventor) in 1900, which uses a heavy mineral oil, called diesel oil.

**diplomat:** a person who is tactful and skilled in managing delicate situations, handling people, etc., especially one appointed by a national government to maintain political, economic and social relations with another country or countries.

**distress rockets:** rockets fired into the air creating an intensely bright, red light; a type of distress signal.

**distress signals:** signs, gestures, mechanical devices or other indicators serving to bring to attention that one is in need of immediate assistance.

**Division 2, Planning:** at the time of these lectures on a Sea Org ship, the action of planning was done in Division 2, wherein plans were drawn up and issued for remunerative activities for the entire ship or flotilla which coordinated activities of the organization.

**Division 4:** See **Deck Division** in this glossary.

**Division 6:** the Flag Promotion Division on the Flagship at the time of the lecture. This contained all promotion, public address and general public relations functions addressed to various publics of Flag. This was primarily planning, design, mail, flyers and other written or published material.

**Division 7:** the Flag Contact Division on the Flagship at the time of these lectures. This contained all public service and personal contact functions of Flag relations in the ports and in other zones. It contained the Office of the Chaplain. Parties, entertainments, VIPs (Very Important Persons), guests, student and pc welcoming and any other personal contact (as different than written or published) required. The safety of the vessel in ports and PRO area control in ports was a primary service of this division.

**dock:** in the USA the term refers to a structure built on the shore of a harbor extending into deep water so that vessels may lie alongside close together, and is used for the loading or unloading of cargo and passengers.

**doggoned:** damned, confounded. (Derivation: American, perhaps from *dog on it!* euphemistic alteration of *God damned.*)

**dossiers:** collections or files of documents on the same subject, especially complete files containing detailed information about a person or topic.

**dough:** (*slang*) money.

**dynamics:** there could be said to be eight urges (drives, impulses) in life, which we call *dynamics*. They are motives or motivations. We call them the eight dynamics. These are urges for survival as or through (1) self, (2) sex and family, (3) groups, (4) all mankind, (5) living things (plants and animals), (6) the material universe, (7) spirits, and (8) infinity or the Supreme Being.

**Eire:** an Irish name of the Republic of Ireland.

**electrical short:** also known as a short circuit, which is a side circuit of electricity that is formed when insulation wears off a wire or wires that touch each other or some connecting conductor, so that the main circuit is bypassed. The current flowing through the new path can overheat the wires, possibly causing fire.

**enamored:** very much in love; very fond; charmed.

**Enchanter:** See **Diana** in this glossary.

**engineer:** on a ship, the person that is in charge of the machines and engines.

**engine room:** a compartment in the lower platforms of a ship where the engine is located. The term also refers to the staff of the engine room whose basic services include maintenance and upkeep of the engines as well as providing economically produced electricity, clean hot and cold water and clean and working drains. Electronic and other equipment such as winches (see **winch** in this glossary) and pumps and service equipment in good repair are an important part of their product.

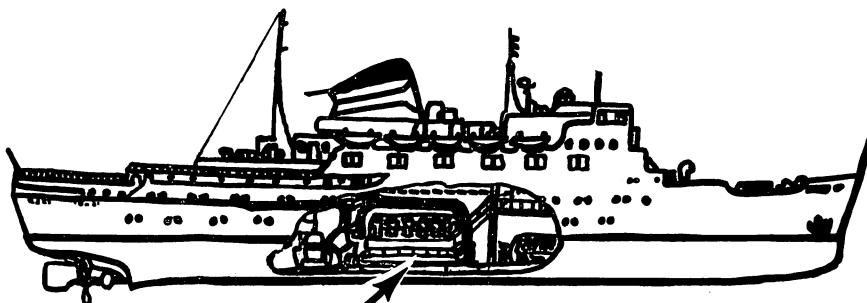

**ENGINE ROOM**

**engine room telegraphs:** mechanical devices, each with a dial and two indicators (one having a handle attached), located on the bridge and in the engine room. If the ship has two engines, there is a separate telegraph for each. The dial shows by subdivisions the various speeds which are sent below according to how the indicator is set. The engineer hearing an automatic bell notes by indicator the desired speed of the engines. As a check against error he similarly returns his signal to the bridge where it is recorded by the second indicator. Also referred to as *bells* and *engine bells*.

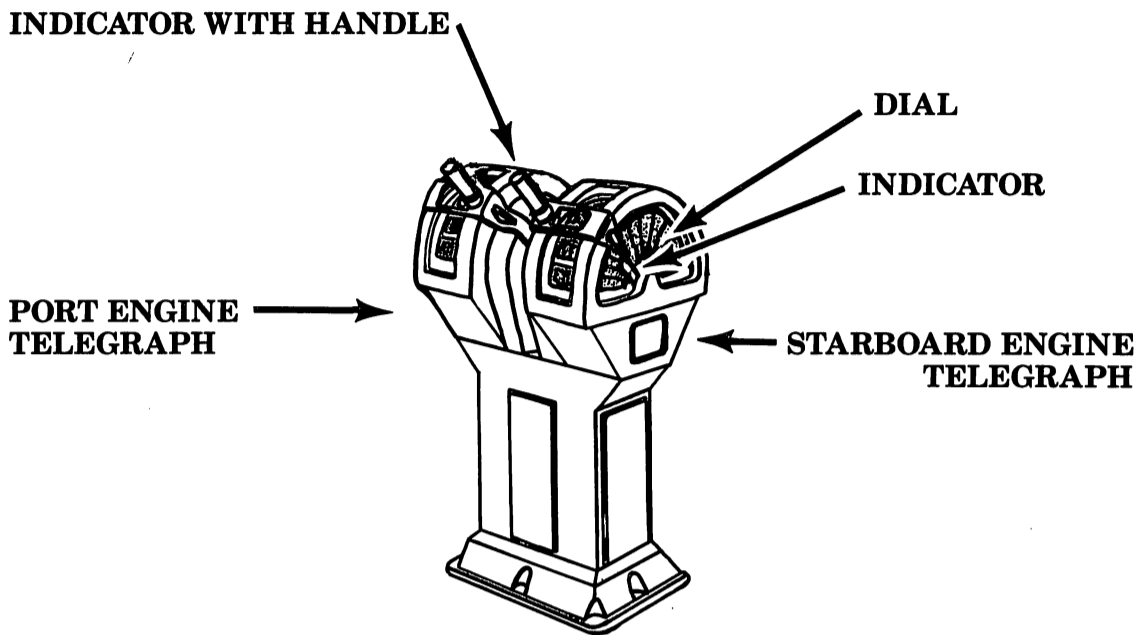

**entrench:** to place in a position of strength; establish firmly or solidly.

**Ergflatz, Joseph:** a made-up name, used satirically.

**ethics presence:** an X quality made up partly of symbology, partly of force, some "now we're supposed to's" and endurance. Because of the Sea Org we appear to have unlimited reach and in some mysterious way, unlimited resources. The ability to appear and disappear mysteriously is a part of ethics presence.

**ethnics:** beliefs, mores, customs, patterns of thought or racial or religious stable data.

**Executive Secretary:** any one of three Executive Secretaries in a Scientology Organization. There is the HCO Executive Secretary who is over the first three Divisions; Executive Division, Hubbard Communications Office (HCO), and Dissemination Division. The Organization Executive Secretary is over the next three Divisions; Treasury Division, Technical Division and Qualifications Division. The Public Executive Secretary is over the three Public Divisions.

**fabian:** remaining elusive, hard to hit, refusing direct engagement with an enemy. From the name of a Roman general, Quintus Fabius Maximus (died 203 B.C.) who successfully employed such tactics.

**fairway:** the navigable portion of a river, harbor or other partly enclosed body of water.

**fall:** that end of a rope which being threaded through various blocks is actually hauled upon. The other end, attached to the object being moved, is known as the standing part. *See also forward block and after block* in this glossary.

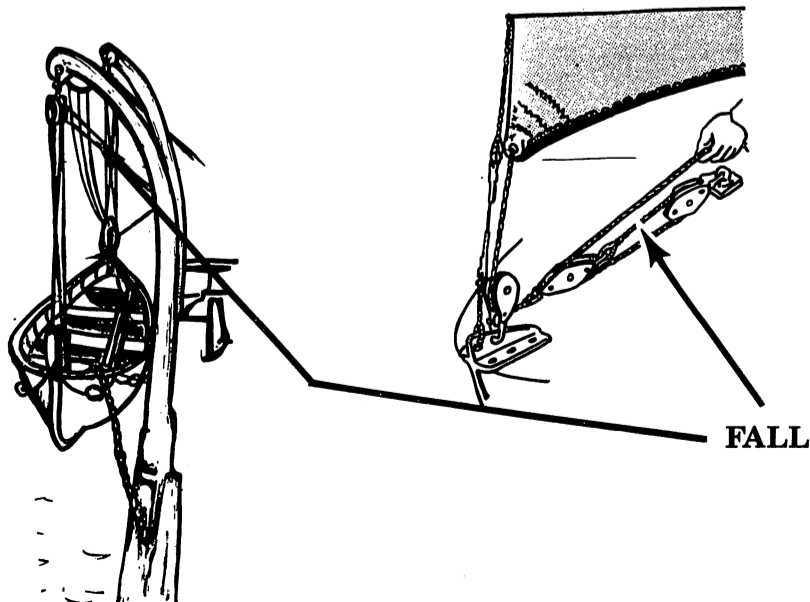

**farm out:** give out.

**FDA:** (*US government*) Food and Drug Administration, a division of the Department of Health and Human Services whose stated purpose is to protect the public against impure and unsafe foods, drugs and cosmetics.

**fender:** a buffer let down between the side of a vessel and an approached dock or other hard object such as another ship. They are traditionally made from granulated cork stuffed into canvas bags. They may take varied shapes and forms, such as plastic bumpers and old car tires.

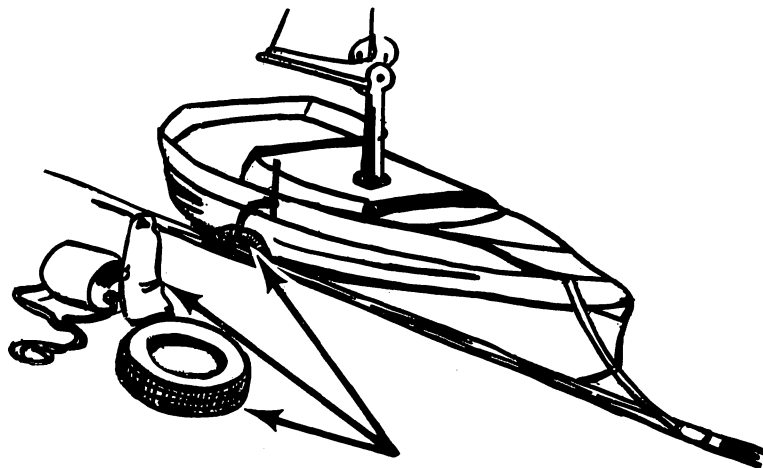

**FENDER**

**fender party:** a group of seamen who handle the fenders to prevent contact or collision of the ship with another object or ship. *See also fender* in this glossary.

**ferries:** vessels designed for the transport of persons and goods from one place to another on a regular schedule of sailings. They can vary from small boats used as ferries across rivers to large specially built ships with roll-on, roll-off facilities for cars, buses and trains.

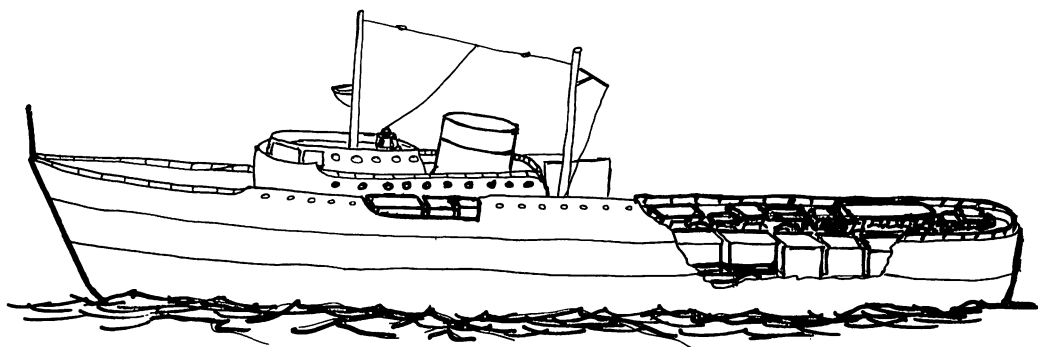

**FERRY**

**fire hose:** a special heavy-duty hose for use in fighting destructive fires.

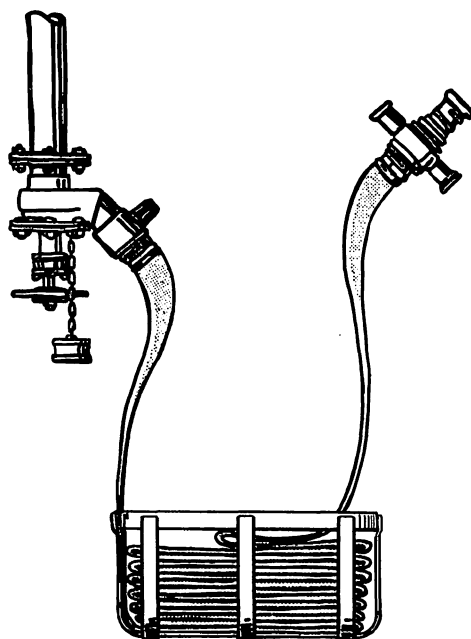

**FIRE HOSE**

**first dynamic:** see **dynamics** in this glossary.

**fish to fry:** things to do that a person falsely considers are more important or profitable.

**flabbergasted:** overwhelmed with astonishment.

**flash-back:** (of a flame consuming combustible gas) to move back through the current of gas and burn at a point nearer the source than is desired.

**floodlight:** a lamp that gives a broad beam of light.

**FO:** *Flag Order*, the equivalent to a policy letter in the Sea Org. A Flag Order contains policy and sea technical material. It is printed on white paper with black ink and is numbered and dated. HCO Policy Letters and Flag Orders are both in effect on Sea Org ships, offices, bases and orgs.

**fog nozzle:** a projecting spout on a fire hose through which the water comes out at a high velocity in a fog.

FOG NOZZLE

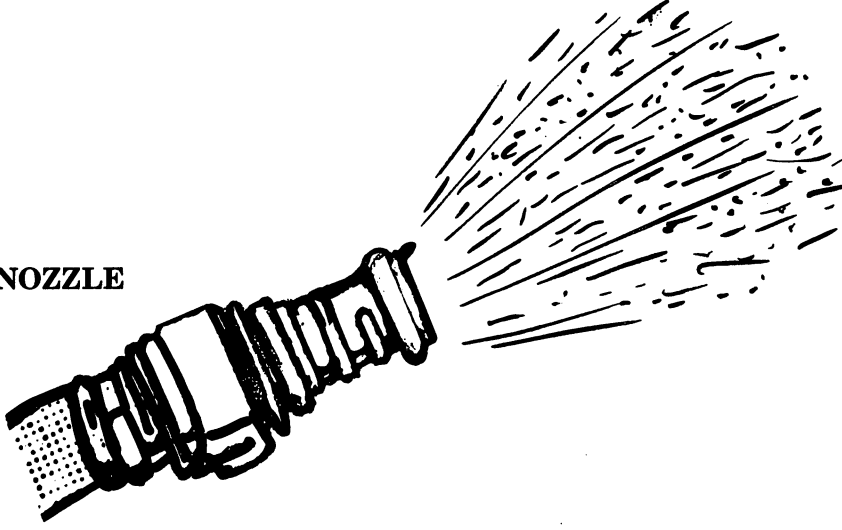

**forecastle:** the space located at the front of a ship below the short front deck. This space is sometimes used to store food, clothing, or as quarters for sailors. It derives its name from the fact that in old sailing warships there used to be a castle built at this spot from which archers fought.

FORECASTLE

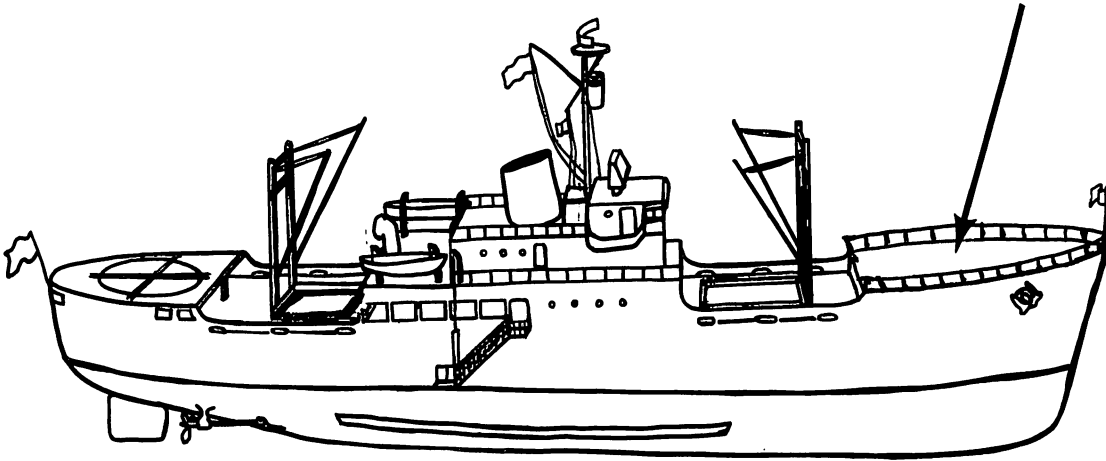

**foredeck:** the name given to a short deck at the very front of a vessel.

**Foreign Ministry:** (in countries other than the US) the office of a *Foreign Minister*, a person who is in charge of the activities of his nation in its relationships with other nations and corresponding to the Secretary of State in the United States.



**forward block:** a wooden or metal case with a pulley mounted inside. It is located at the forward end of the lifeboat and in combination with the after block, is used to lower or raise a lifeboat. *See also after block* in this glossary.

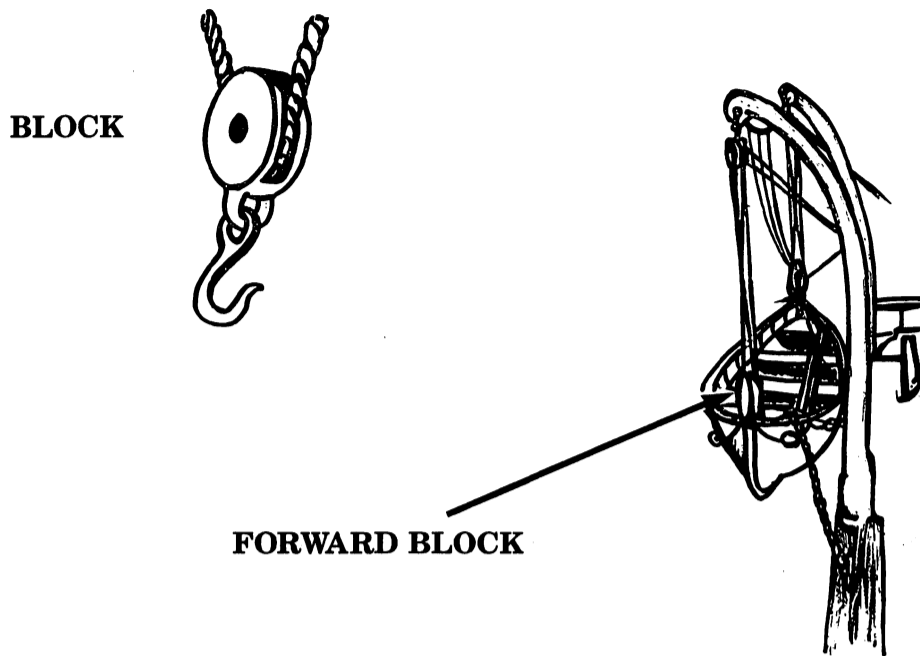

**Foundations:** the evening or weekend organizations of the Church of Scientology. The purpose of the evening organizations is to operate as a bridge from the public to the daytime orgs and to make money in their own right.

**fourth:** the fourth dynamic. *See dynamics* in this glossary.

**Franco:** (1892–1975) Spanish general; dictator of Spain (1939–75). After eight years of dictatorship, Franco published legislation in 1947 reestablishing a monarchy (a government or state headed by a hereditary sovereign, as a king, queen or emperor). The future king, Juan Carlos, arrived in Spain in 1955 to be educated and groomed up for the throne.

**fraternize:** associate on intimate terms.

**Freedom:** a journal of Scientology which champions human rights and is well known for its investigative reporting. It has a wide international readership.

**freighter:** a vessel used mainly for carrying cargo.

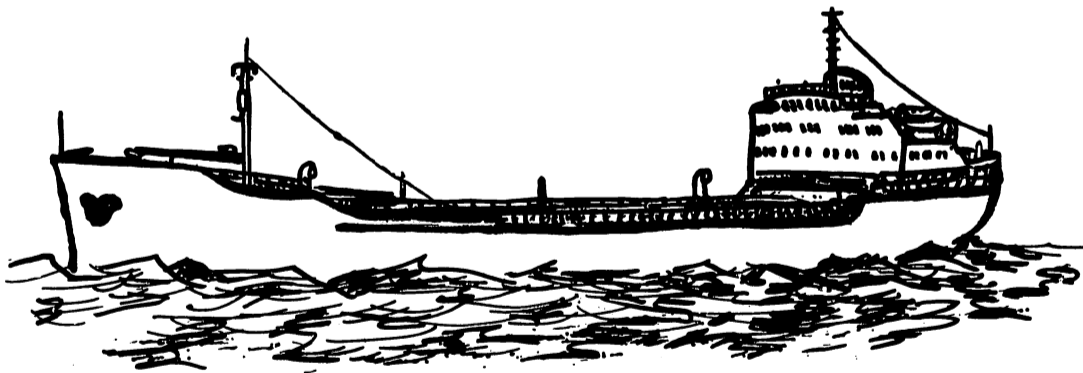

## FREIGHTER

**freshened:** increased in strength; said of the wind.

**gag:** an amusing trick.

**gales:** very strong winds with a velocity of 32 to 63 miles per hour.

**galley:** a ship's kitchen.

**gaskets:** the seals on a carburetor that keep it airtight and prevent gasoline leaks.

**generator:** the electric generator, a machine that makes electrical power from mechanical power. On a ship, generators are used to provide power to move the vessel, electricity for lights and other machines, etc.

**Gibraltar:** British territory on a small peninsula at the southern tip of Spain, including a port and naval base. It consists mostly of a rocky hill (*Rock of Gibraltar*).

**glug, glug, glug:** the sound of flowing liquid. Used as an allusion to a ship sinking, in this lecture.

**graft:** the acquisition of money, gain or advantage by dishonest, unfair or illegal means especially through the abuse of one's position or influence in politics, business, etc.

**green:** untrained; inexperienced.

**GRU:** the Chief Intelligence Directorate of the Soviet General Staff, a military intelligence organization founded in 1920 and functioning as a complement to the KGB. *GRU* are the initial letters of the three Russian words for this organization. See also **KGB** in this glossary.

**gunwale:** the upper edge of the side of a boat or ship. This area, formerly called the wale, was used to support the guns on the old wooden warships, so it became known as the *gunwale*.

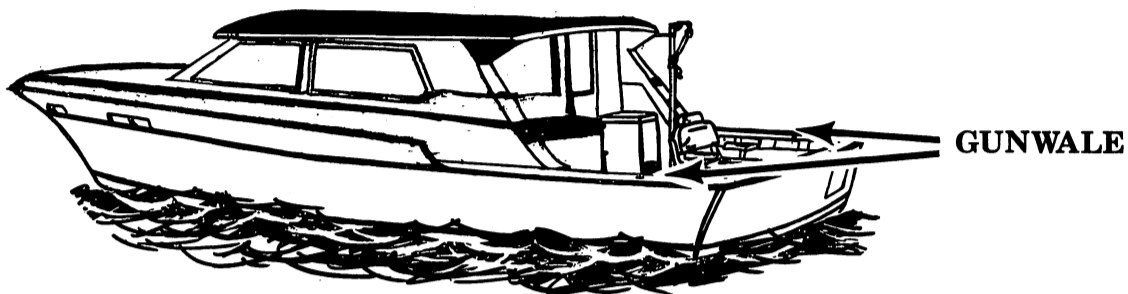

**halyards:** ropes or lines used to raise or lower sails.

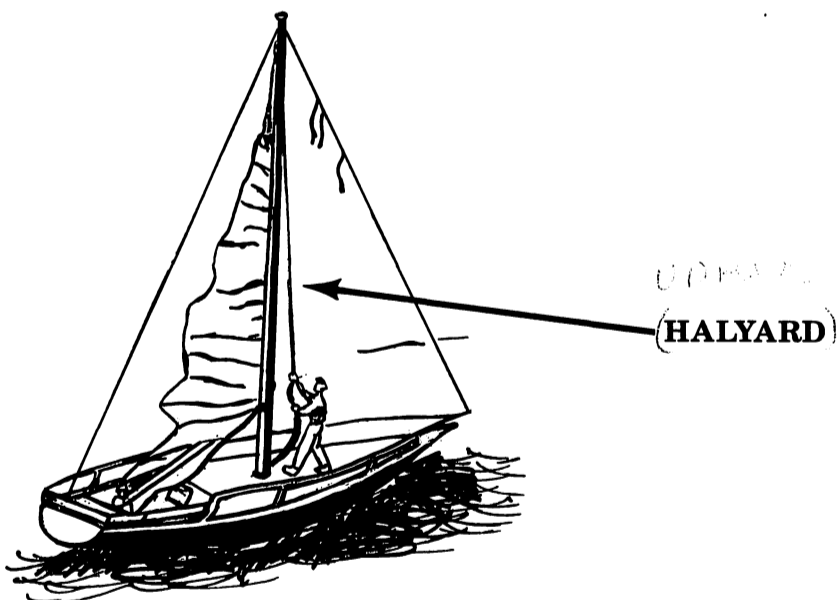

**harbor:** a sheltered part of a body of water deep enough to provide anchorage or docking facilities for ships.

**harbor master:** an official who supervises operations in a harbor area and administers its rules.

**hard left rudder:** a command and maneuver executed by turning the wheel as far to the left as it will go which, in turn, causes the rudder to move to the extreme left. This causes the stern of the vessel to move to the right (starboard side) and the bow to move to the left (port side).

**hatch:** the cover over a hatchway which is an opening in the deck leading to the interior of a ship, for loading or unloading things into or from a ship.

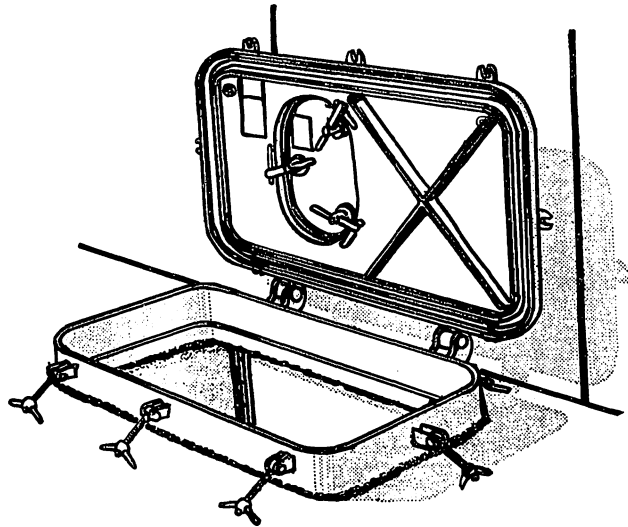

HATCH

HATCH

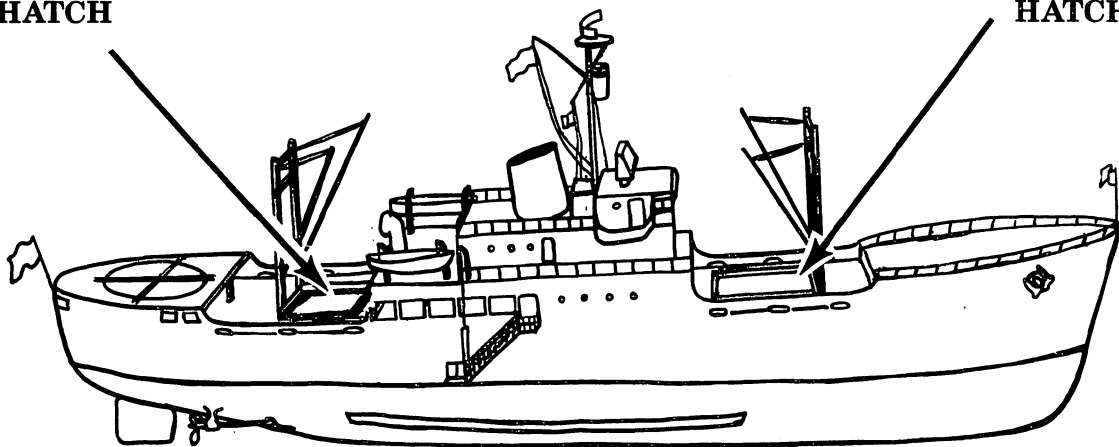

**have his cake and eat it too:** have both when one must choose one of two things.

**hawsepipe:** an iron or steel pipe in the bow of a vessel through which an anchor cable passes.

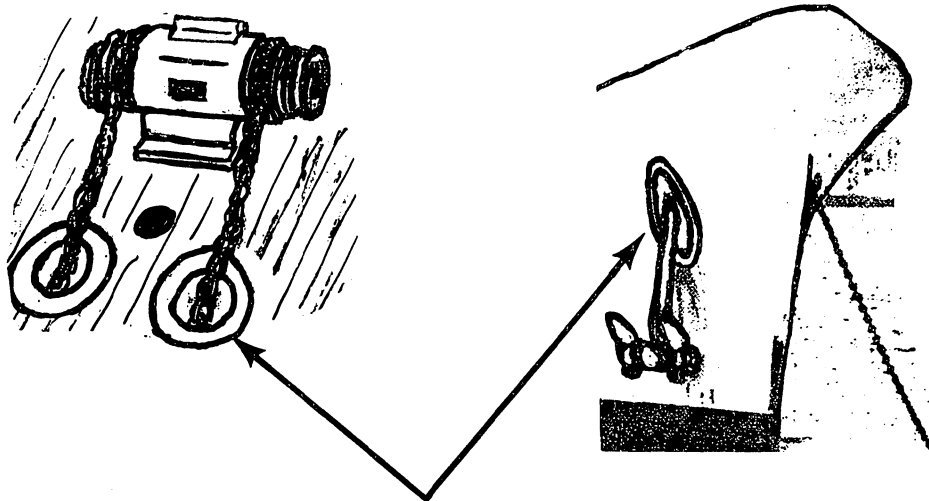

HAWSEPIPE

**HDG:** Hubbard Dianetic Graduate. In 1969, a Dianetics auditor (a graduate of the Hubbard Standard Dianetics Course) who was also trained to supervise the Hubbard Standard Dianetics Course.

**Health, Education and Welfare:** a former department of the US government (1953–79) that administered federal programs dealing with health, education, welfare and income security.

**hippies:** persons especially of the late 1960s who rejected established institutions and values and sought spontaneity, direct personal relations expressing love and expanded consciousness, often expressed externally in the wearing of casual folksy clothing and of beads, headbands, used garments, etc.

**hobby horses:** pet ideas or projects.

**homo:** (*slang*) homosexual.

**hopping it up:** creating excitement.

**hot dope:** (*slang*) extremely exciting, interesting, sensational or scandalous information, data or news.

**hot papa suit:** a suit made of asbestos or other fireproof material, which protects the wearer from fire.



**Hudson's Bay:** having to do with the Hudson Bay area, a large inland sea in northern Canada.

**hull:** the hollow, lowermost portion of a ship, floating partially submerged and supporting the remainder of the ship. Included are the deck, the sides and the bottom of the vessel. Excluded are all masts and rigging.

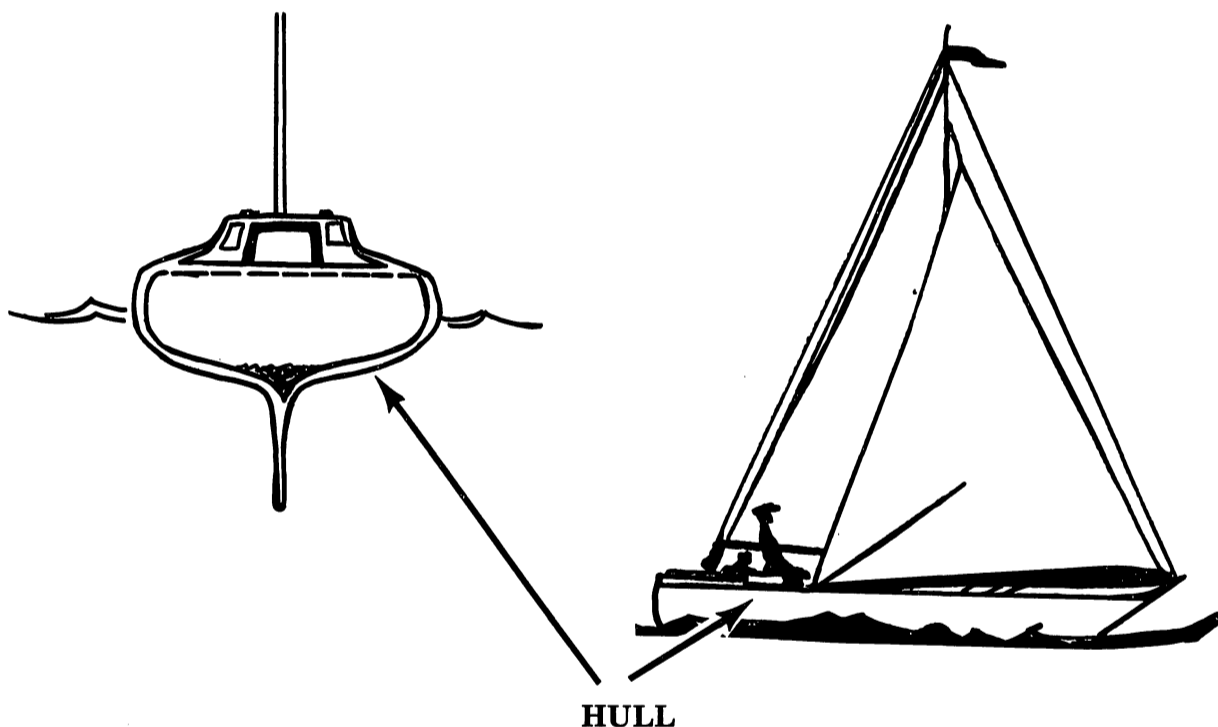

**individuate:** become withdrawn from groups and into only self.

**inferous:** an adjective coined from the word *infer*, to describe something as hinting, implying or suggestive.

**inroads, making:** beginning to have an effect upon something.

**Internal Revenue:** division of the US Department of the Treasury, established in 1862. It is responsible for the assessment and collection of federal taxes other than those on alcohol, tobacco, firearms and explosives. It collects most of its revenues through the individual and corporate income tax.

**international code:** a system of communicating at sea using differently colored flags and pendants. The code was first used in 1817 and was based on Captain F. Marryat's fifteen-flag system. It has been revised and augmented numerous times since, but has now largely given way to radio communication.

**International Tel and Tel:** International Telephone and Telegraph (ITT), a huge international company headquartered in the US which deals with communications services.

**iron plate:** the heavy sheets or plates of iron which make up the side of a ship.

**jib:** a small, triangular sail located in the forward part of a sailboat ahead of the mainsail. See also **mainsail** in this glossary.

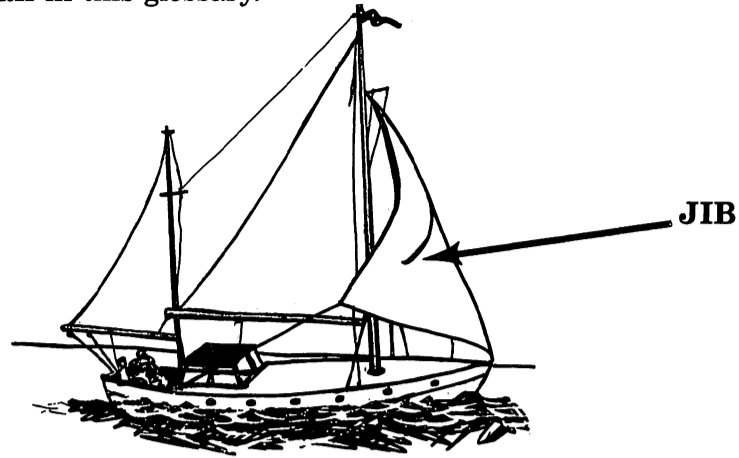

**jibe:** to change the sail from one side of the boat to the other when changing course with the wind coming from behind the sailboat. When this is done under control it is a routine and safe maneuver. However, due to careless steering or inattention to wind shifts a sail can accidentally jibe and swing the sail over with such force that the mast may snap off or the vessel be capsized.

**JIBE**



**jumps, over the:** through various tests of endurance and ability. An allusion to steeplechase, the racing of horses over a course set with fences, walls, brooks, hedges and other obstacles that a horseman might encounter riding cross-country. The sport of steeplechase gets its name from the days when such races were actually run cross-country toward a distinctive landmark, usually a church steeple.

**kaputniks:** made-up name for a currency.

**keel:** a strong piece or beam of wood or metal center of the bottom of a ship or boat. The keel is the main support of a ship and the whole frame or hull is attached to it. Also, a fin or flat-shaped piece that is attached lengthwise to the bottom of a sailboat and hangs down into the water. The keel keeps the sailboat upright so it will not tip over and prevents it from being blown sideways by the wind.

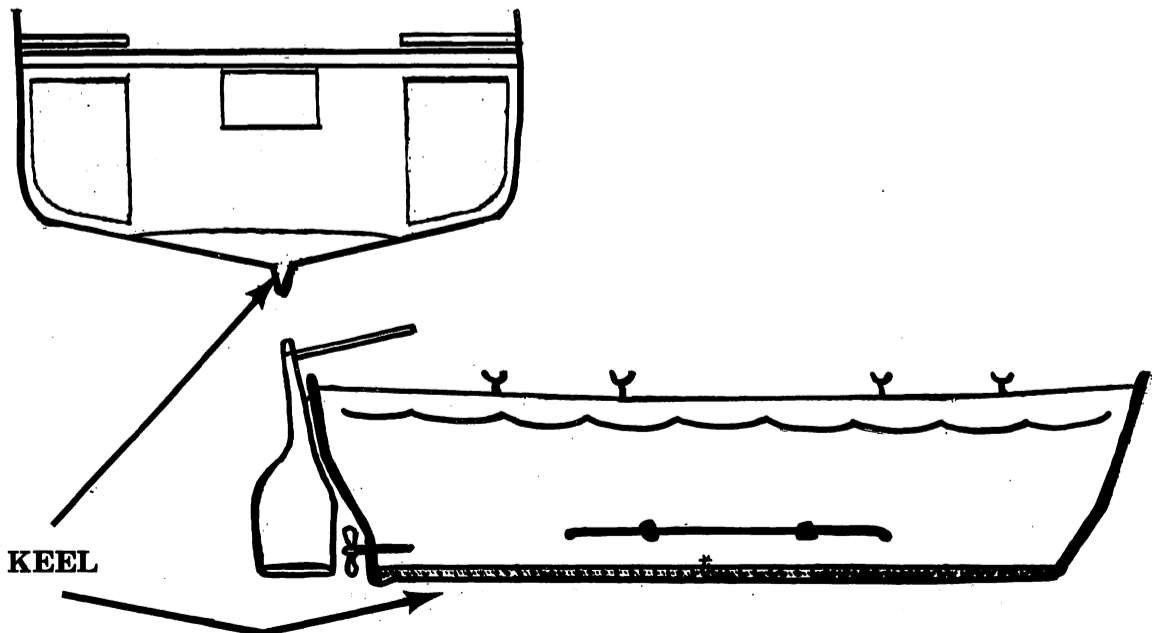

**Keokuk:** a city located on the Mississippi River, in southeast Iowa, in the midwestern United States. It has a population of about 13,000 people. Used in the lecture to mean a small out-of-the-way town.

**Key Ingredients:** *The Key Ingredients* is the title of a policy letter by L. Ron Hubbard, dated 14 September 1969. It includes the key ingredients or most basic steps that comprise administration.

**KGB:** the intelligence and internal-security agency of the Soviet Union, organized in 1954 and responsible for enforcement of security regulations, protection of political leaders, the guarding of borders and secret or underhanded operations abroad.

**knocked off:** murdered.

**knuckleheaded:** stupid.

**landlubbers:** originally confined to use as a name given to stupid and inefficient sailors by other sailors. It is now a contemptuous term by which sailors refer to non-sailors. The word lubber originally meant a big, clumsy fellow.

**Leavenworth:** a federal and military prison located in Leavenworth, a city in northeast Kansas, a midwestern state in the US.

**lee shore:** the shore onto which the wind is blowing. The inference is that the wind will tend to blow the ship onto the shore.

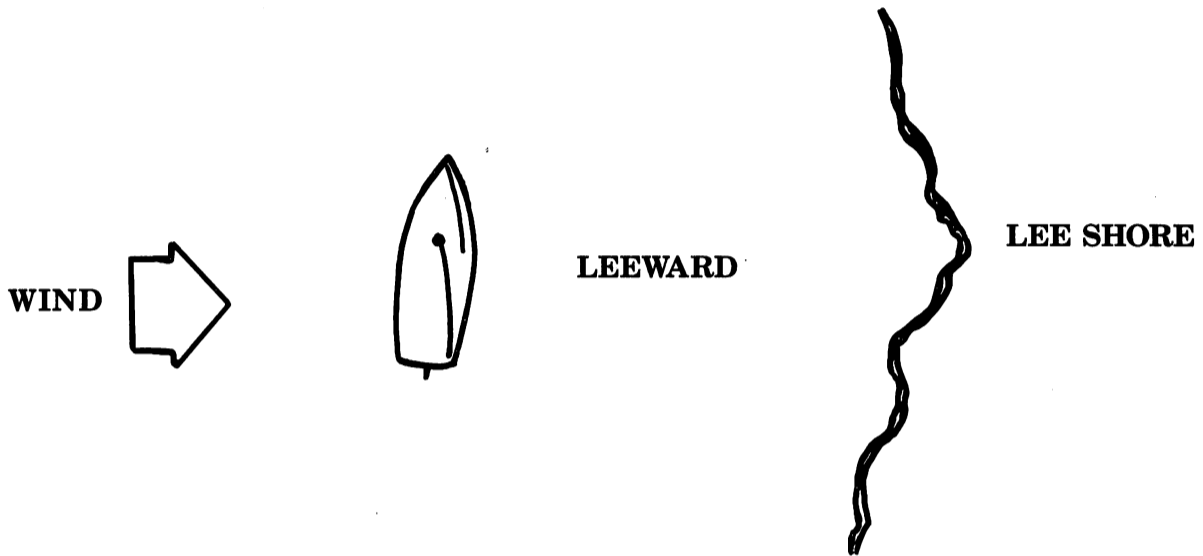

**leeward:** on the side away from the wind.

**Libya:** a country in North Africa, on the Mediterranean.

**lickety-split:** at great speed; rapidly.

**life boat:** a strongly built boat which is carried by a ship for saving life at sea, in the event the ship has to be abandoned.

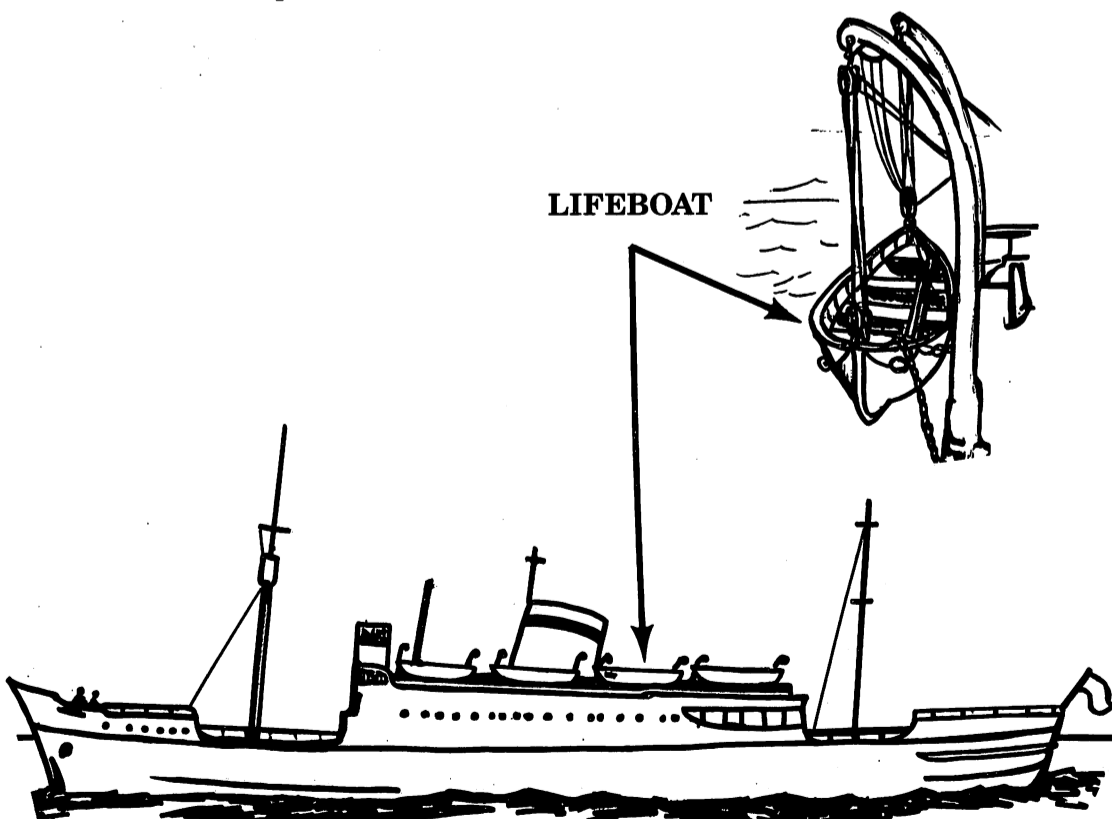

**life ring:** a ring-shaped life preserver made of cork or other lightweight material that floats.

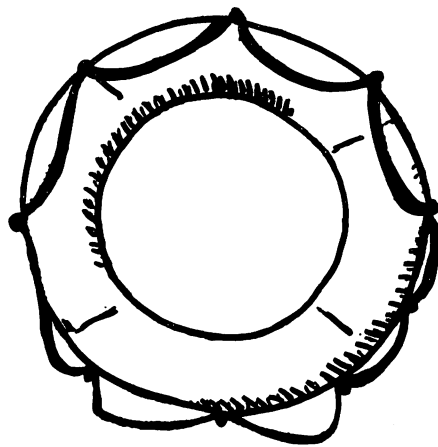

**LIFE RING**

**lines:** nautical term for rope used aboard a ship.

**list:** to lean over to one side.

**Lloyd's:** a huge insurance corporation based in London, England. Incorporated in 1871, it deals in insurance of almost every kind, but is most noted for its insurance of oceangoing vessels.

**loft:** to hit (a ball) into the air or strike it so as to lift it over an obstacle. Used figuratively in the lecture.

**long and the short of:** all that need be said; the essence or whole sum of the matter in brief.

**lookout:** person who watches outside the ship for other ships, objects in the water, hazards, menaces to navigation, cloud changes, sea changes, etc., and reports them. A lookout is the eyes of the Conning Officer. *See also Con* in this glossary.

**low condition:** liability, doubt, enemy, treason and confusion.

**lugubrious:** very sad or mournful, especially in a way that seems exaggerated or ridiculous.

**magnetic anomaly:** the magnetic compass points to the magnetic north of the planet but in certain areas regional magnetic conditions can affect the accuracy of the compass. While under the influence of those areas the compass cannot be relied upon to indicate north accurately. This phenomenon is called a magnetic anomaly. An anomaly is a departure from the regular arrangement; abnormality.

**main deck:** the principal deck of a ship. In two-decked ships it is the upper deck. In ships with more than two decks it is the second one from the top. *See also decks* in this glossary.

**MAIN DECK**

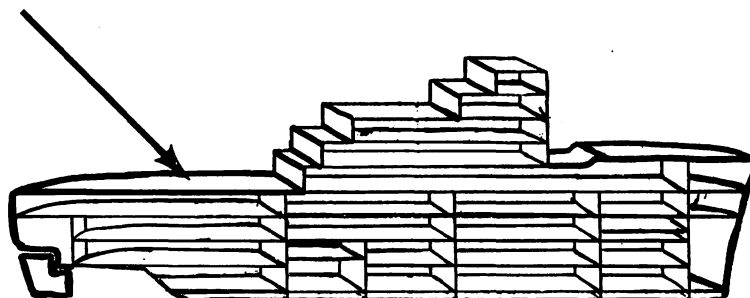



**main halyard:** the rope used to raise the mainsail. *See also mainsail* in this glossary.

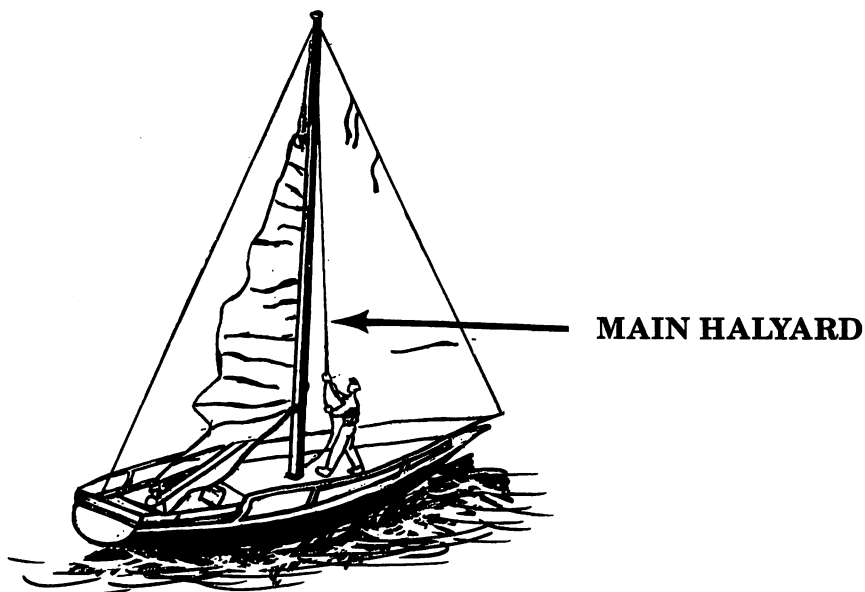

**mainmast:** the principal vertical pole of a sailing vessel for supporting the mainsail. It is the tallest mast. *See also mainsail* in this glossary.

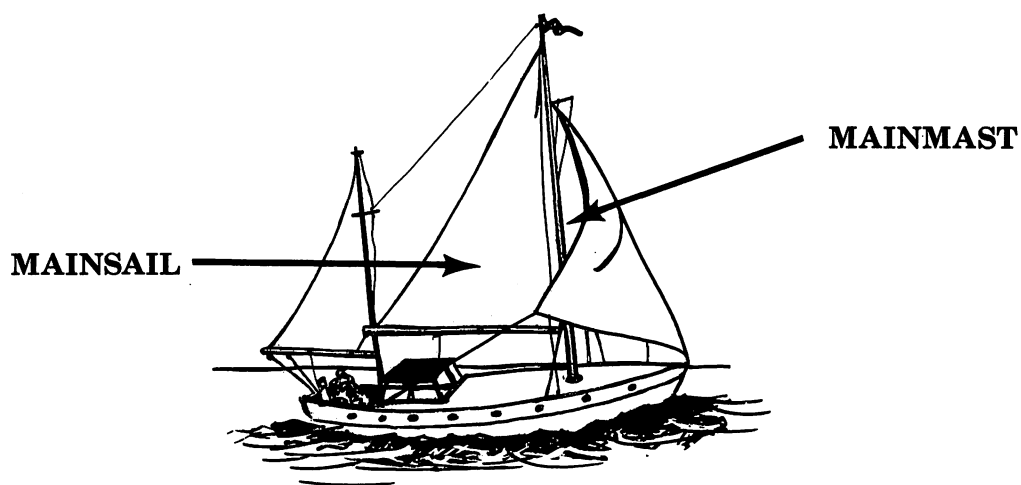

**mainsail:** the principal and usually largest sail of a sailing vessel.  
**Mao:** Mao Tse-tung (1893–1976), a communist revolutionary leader in China who ruled the country from 1949 until his death in 1976.  
**mast:** long vertical pole to which sails are attached.

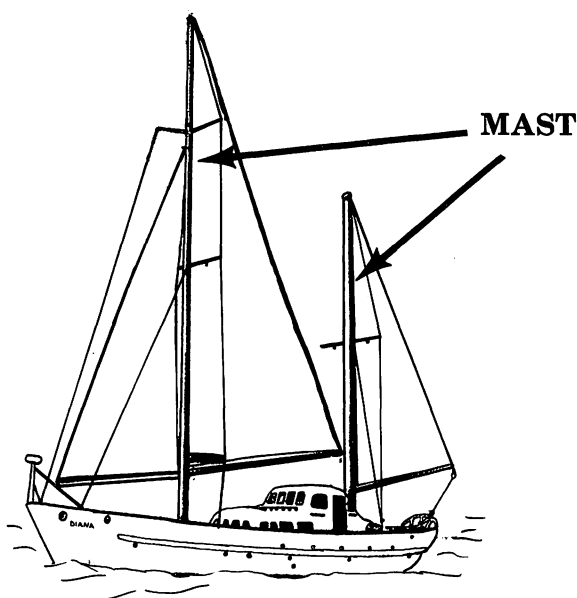

- Mayday:** the international call for help by a ship in distress, given over the ship's radio. The radio operator would broadcast on the emergency frequency, "Mayday, Mayday, Mayday," then give the name and location of his vessel, and specify the assistance needed. Any ships or coast guard installations within range would then be required to render immediate aid. (*Mayday* is from the French *m'aidez* meaning "help me!")
- megatron:** a humorously made up word for *megaton*, which is an explosive force equal to that of one million tons of TNT (a high explosive used for blasting, in artillery shells, etc.), as that of atomic or hydrogen bombs.
- merchant service:** the vessels, officers and crew of a nation that are engaged in commerce.
- MI5:** the division of British *Military Intelligence* concerned with counterespionage and security in Great Britain.
- MI6:** the British government's secret intelligence service; *Military Intelligence*, Section 6.
- Miami Bay:** a bay located on the southeast coast of Florida at Miami.
- midwife:** a person trained to assist women in childbirth.
- minister:** a person appointed by the head of a government to take charge of some department.
- mission:** a formally authorized Sea Org individual or group sent by a Sea Org management org to perform a specific task or duty. A mission is fired on specific mission orders to get done.
- missionaire:** a Sea Org member who has been fired on a mission. *See mission* in this glossary.
- mizzen:** mizzen sail, the last and often smallest sail of a sailing vessel.

**MIZZEN**

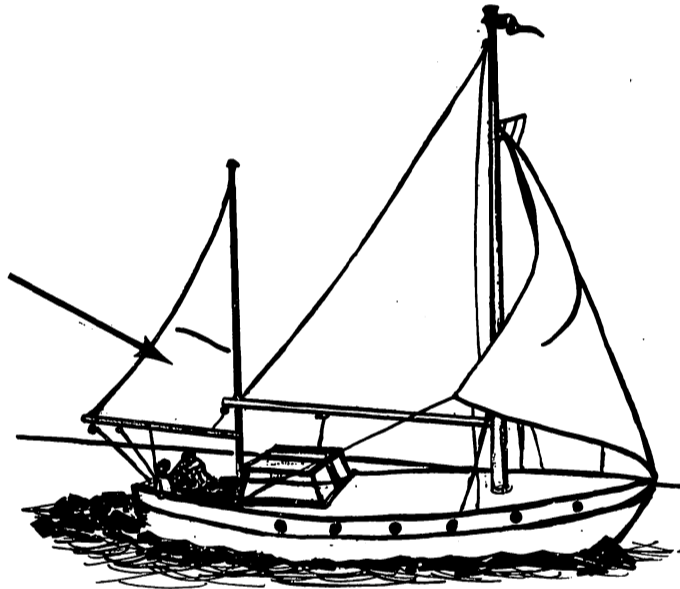

- Moby Dick:** a sea tale about a whaling ship captain obsessed with the pursuit of a huge albino whale, called Moby Dick. It was written in 1851 by Herman Melville, an American novelist (1819–91). The book is now accepted as a classic.
- Model T Ford:** an old car produced in the USA which initially appeared in 1908. It was produced by the Ford Motor Company and was their first car made with left-hand steering. It sold for 260 dollars at the time and is now a collector's item.
- Mohammedanism:** of the Mohammedan religion; Islam, which was founded by Mohammed. The followers believe in one god, Allah.
- mores:** the customs or customary practices, rules, etc., regarded as essential to or characteristic of a group.
- mudbox:** the area in the bilge which collects the mud out of the bilge water. *See also bilge* in this glossary.
- navigate:** to plan, record and control the course and position of a ship. To steer or direct a ship from one place to another by water in an expedient manner.
- nip-ups:** any sudden motions; jumping jerks.
- non persona grata:** not welcomed by the people or accepted by the government.
- number, take our finger off our:** stop watching something closely, resulting in a blunder.
- nut, doing one's:** becoming angry; losing one's head; getting worked up about something; going crazy.
- nuts:** odd or crazy persons.

- Officer of the Watch:** the ship's officer responsible for keeping the ship running inside and outside. He sees that the course is followed and reliefs occur of the wheel, etc.
- oil feed:** a valve which regulates the flow of fuel oil to the boilers. The water in a boiler is heated by burning fuel oil, creating the steam to power a steam engine.
- one fell swoop, in:** all at once or all together, as if by one blow.
- 135 proof:** the strength of liquor based upon the ratio of its alcohol content to water. The US standard is 100 proof, which equals a mixture usually containing 50 percent alcohol. Thus, 135 proof rum would be 67½ percent alcohol.
- Operations:** that part of a Sea Org management org that briefs, sends out and runs missions. *See also mission* in this glossary.
- oppterm:** short for *opposition terminal*. In auditing, an oppterm is an item or identity the pc has actually opposed (fought, been an enemy of) sometime in the past (or present). Used figuratively in the lecture.
- orange stain:** a distress signal; a bright orange, chemical dye used to discolor the water so as to attract attention from ships or airplanes.
- PA:** public address system, a system of loudspeakers on which announcements can be heard throughout the ship.
- pall:** to become distasteful or very tiresome because there has been too much of it.
- patrol vessel:** naval vessel used in wartime as protecting escorts for other ships, to hunt down submarines and to serve as general warning craft.
- Penkovsky, Oleg Vladimirovich:** (1919–63) Russian colonel in the GRU and deputy chief of the foreign section of the State Committee for the Coordination of Scientific Research (1960–62), who was convicted of spying for the UK and the US. Between 1961 and 1962 he passed more than 5,000 photographs of classified military, political and economic documents to British and US intelligence forces. He was arrested in October 1962 and executed for high treason soon after his trial. In 1965 his journal, *The Penkovsky Papers*, was published in the US. *See also GRU* in this glossary.
- perpetrate:** (*informal*) to do or make (something implied to be bad or atrocious.)
- piece of cake:** something easily done.
- Pink Panthers:** a play on words for the *Black Panthers*, members of a militant black American organization (Black Panther party) active especially in the late 1960s and early 1970s, formed for the advancement of the rights of blacks, often by radical means.
- pitching:** the up and down motion of a vessel that occurs when it is sailing at right angles to the waves of a heavy sea.

#### PITCHING



- plant:** a person placed secretly in a group or organization, to obtain internal or secret information, stir up discontent, etc.
- poopdeck:** short, raised deck at the very stern of a vessel. *See also stern* in this glossary.

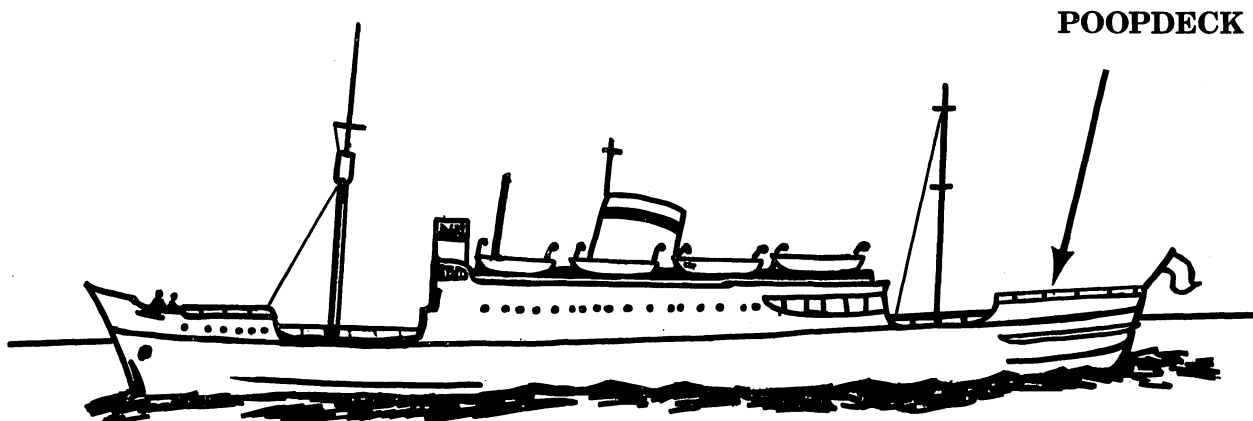

**port:** the left-hand side of a vessel when facing towards the bow. *See also bow* in this glossary.

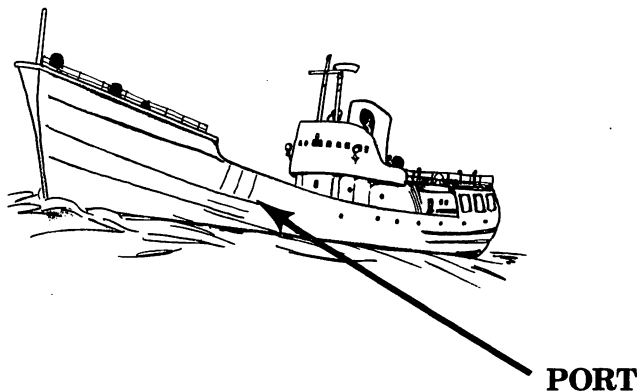

**portholes:** round, window-like openings which each have a hinged, watertight, glass cover in the side of a vessel for admitting air and light.

### PORTHOLE

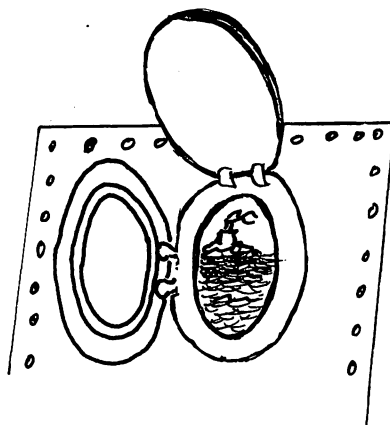

**pound:** monetary unit of the United Kingdom.

**PRO:** Public Relations Officer; also the activity or product of a Public Relations Officer, i.e., public relations. The PRO formulates, guides and utilizes public opinion to the end of enhancing the repute and expansion of his organization or client. He changes opinions or molds opinions or gets things well thought of.

**Professor Blotz:** a satirical, made-up name for a psychiatrist.

**Pumjum:** a made-up name of a country.

**Purser:** head of the third Division which handles the money and materials of the ship and provides its meals, accommodations and services. It handles the inventories and is responsible for all money and all stores of whatever kind, including balance sheets.

**put out:** (*nautical*) to leave, as a port; depart.

**quitclaim:** a document from a person, giving up a claim or right of action.

**R:** abbreviation for reality, the agreed-upon apparency of existence. A reality is any data that agrees with the person's perceptions, computations and education. Reality is one of the components of understanding.

**radar screen:** the screen like a television or computer screen, on which the reflected images of the radar are seen. It works by sending out super-high frequency radio waves which then bounce off objects, such as other ships or land masses, etc., within the range of the radar. These reflections are then reproduced as tiny electronic images. In this way other ships and objects can be observed and avoided. It is also used for navigation. The term is derived from *ra*(dio) *d*(irection) *a*(nd) *r*(ange).

**radioman:** a person who operates a radio. *See also radio transmitter* in this glossary.

**radio transmitter:** a radio set that can send messages, i.e., a radiotelephone. There is a certain radio frequency (channel) which can only be used for emergencies and not for any other purpose. The radioman would turn on the transmitter to the distress frequency in preparation for sending an emergency message.

**rail:** narrow wooden piece at the top of a ship's bulwarks (the extension of the ship's side above the deck).

## RAIL

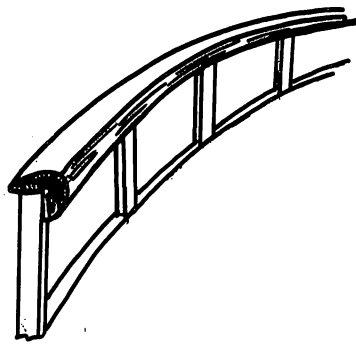

**randomity:** the amount of predicted and unpredicted motion a person has, in ratio.

**rebuffed:** checked; repelled; refused; driven away.

**Recognitions Chief:** on the Sea Org org board at the time of the lecture this was the head of Department One, responsible for recruitment of personnel, routing, post assignments, watch assignments, boards, transfers, hats and appearances. The head of Department One is now called the Director of Routing and Personnel.

**reductio ad absurdum:** (*Latin*) proof of the falsity of a principle by demonstrating that its logical consequence involves an absurdity. Literally, "reduction to absurdity." It is used loosely of taking an argument or principle to impractical lengths. *Example:* "The more sleep one has the longer one lives. To sleep all the time ensures the longest possible life."

**refit:** (*noun*) an act or instance of refitting, which is to make or be made ready or fit for use again, as by repairing, reequipping or resupplying.

**reproving:** expressing disapproval of (something done or said).

**Review:** the department in the Qualifications Division at the time of the lecture which did repair and correction of auditing and training difficulties. This is now called the Department of Correction.

**ring up on the bells:** the action of operating a telegraph. *See engine room telegraphs* in this glossary.

**rolling:** the action of a vessel moving from side to side.

## ROLLING

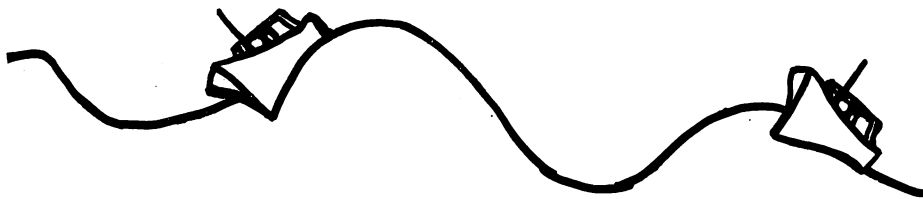

**rudder:** a vertical blade at the stern of a vessel that can be turned horizontally to change the vessel's direction when in motion.

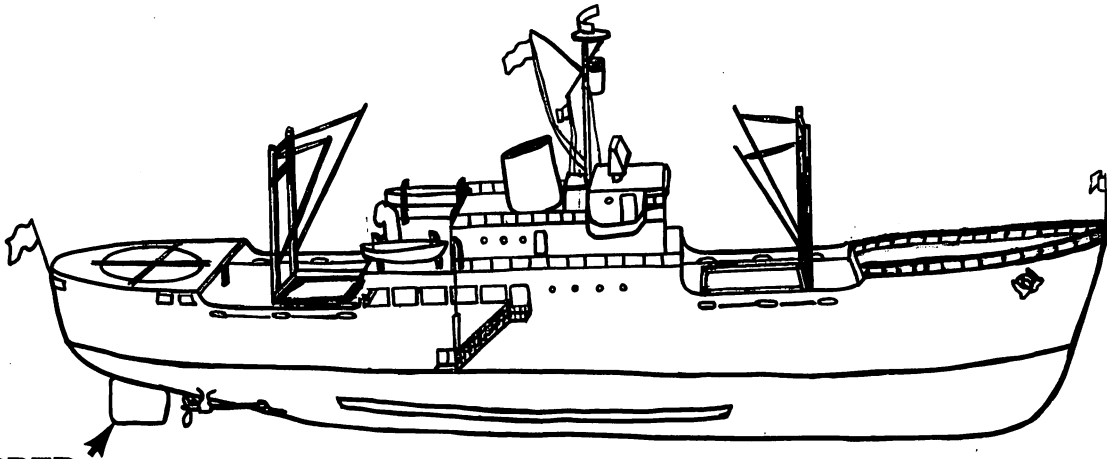

**RUDDER**

**running (running guns):** smuggling.

**Saint Hill:** the name of the original Class VI (Saint Hill) organization, located in East Grinstead, Sussex, England. It was here that L. Ron Hubbard taught the original Saint Hill Special Briefing Course.

**salon:** a large reception hall or social room, as in a hotel or on a ship.

**schnooks:** unimportant or stupid persons.

**Scientology Triples:** running Scientology processes on three flows. A flow is a directional thought, energy or action. The three flows are: inward to oneself, outward to another or others, and crossways, others to others. Examples: Flow 1, to self, drinking. Flow 2, self to another or others, pc giving them drinks. Flow 3, others to others, people giving other people drinks.

**screws:** propellers which turn through the water and move the ship forward or backward. These are positioned below the stern.

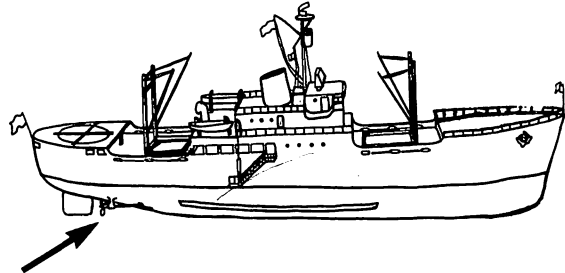
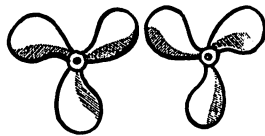

**SHIP SCREW**

**seafaring:** the act or fact of traveling by sea.

**seaway:** rough sea.

**secretary:** an official who administers a department of the government.

**secretary of state:** (United States) the head of the State Department and principal adviser to the president on foreign affairs.

**secretary of the treasury:** (United States) the head of the Treasury Department which has charge of the income and expenses of the country.

**Secret Service:** the branch of the US Department of the Treasury which is held responsible for the discovery and arrest of counterfeiters and with providing protection for the president and the president's immediate family.

**shaking down:** (*slang*) getting money from dishonestly; extorting.

**sheath knife:** a knife with a fixed blade which is carried in a sheath (case or covering for the blade of a sword, dagger or the like).

**SHEATH KNIFE**

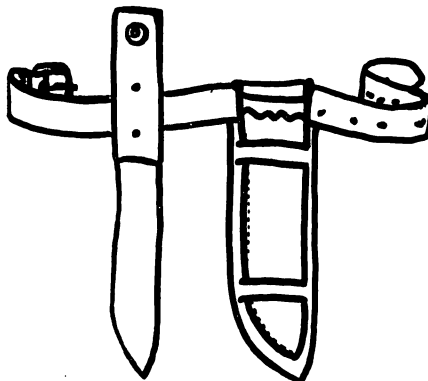

**Shell Oil Company:** a major American oil company.

**SHes:** abbreviation for Saint Hills. *See Saint Hill* in this glossary.

**ship's bell:** a hollow metal cup that makes a musical sound when struck by a clapper or hammer. On a ship this bell is traditionally made of brass with the ship's name engraved on it.

**SHIP'S BELL**



**shipshape:** in good order; well arranged; trim or tidy.

**Ship's Org Book:** a collection of writings by LRH on the organization of a ship and the technology of seamanship.

**ship's papers:** necessary papers presented at all legal inspections of a ship and containing the owner's name, description of cargo, destination, etc.

**Ship's Rep:** ship's representative, a crew member who is responsible for the ship's contacts and dealings with port officials and shore businesses and is in charge of the ship's papers, crew passports, and so on.

**shoals:** patches of water in the sea with a depth that is less than that of the surrounding water and usually not deep enough for a vessel to pass over. They are the result of banks of sand, mud or rock on the seabed. The word *shoal* derives from an Old English word meaning shallow.

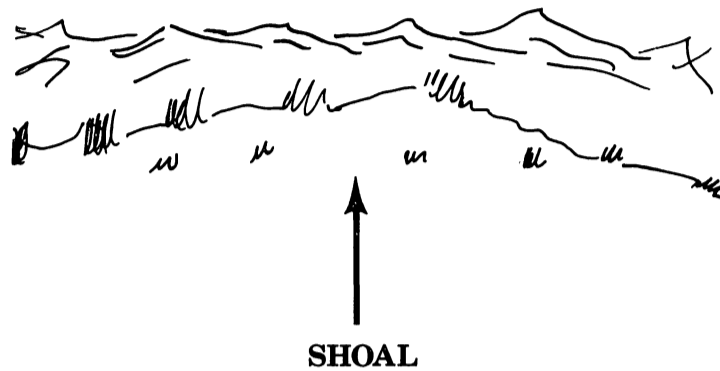

**shuck off:** take off; remove.

**siren:** a kind of whistle that makes a loud, piercing sound. It consists of a disk pierced with holes and rotating over a stream of compressed air, steam or the like. It is used as a warning device.

**six feet of earth:** dead and buried under six feet of earth.

**skeletally:** like a skeleton, in a way that is reduced to the essential or minimal parts or numbers.

**skim ice:** a thin layer or coating of ice.

**slow the living daylight out of:** to completely slow something down.

**smoke, going up in:** failing or being unsuccessful.

**sniggly:** stealthy or sly.

**social sciences:** any of several studies, as economics or political science, dealing with society and the activity of its members.

**Social Security:** a program of old-age, unemployment, health, disability and survivors insurance maintained by the US federal government through compulsory payments by specific employer and employee groups.

**S.O.L.A.S. Convention:** (International Convention for the Safety Of Life At Sea), the official body, composed of government representatives of all maritime nations, which, among other responsibilities, draws up the International Regulations for Preventing Collisions at Sea.

**space-opera:** having to do with time periods on the whole track millions of years ago which concerned activities in this and other galaxies. Space opera has space travel, spaceships, spacemen, intergalactic travel, wars, conflicts, other beings, civilizations and societies, and other planets and galaxies. It is not fiction and concerns actual incidents and things that occurred on the track.

**spooning:** kissing, hugging.

**Standard Oil:** an oil company incorporated by John D. Rockefeller in 1870 which grew very rapidly, becoming one of the largest oil companies in the United States at the time.

**starboard:** the right-hand side of a ship when facing towards the bow.

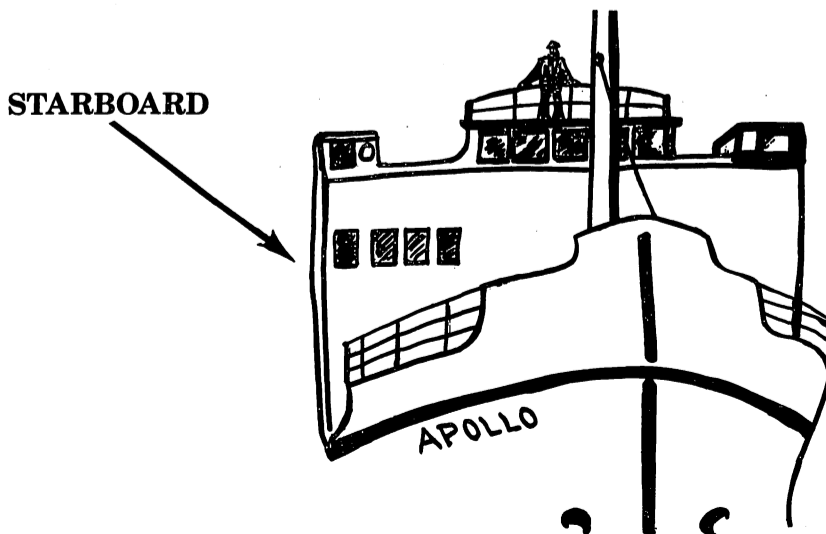



**State:** refers to a state university in the US. There are universities in the US which are supported by their state. Example: California State University, Florida State University.

**statesmanlike:** having the qualities of a statesman, a man skilled in the management of public or national affairs.

**stations:** positions as per watch duties for an emergency. These are duties with specific locations on a ship, in addition to one's own org board post.

**stationship:** a Sea Org vessel which was stationed in an area and responsible to see that Flag planning was carried out and Scientology orgs expanded within its zone of authority.

**steersman:** a sailor who steers the ship.

**stenographer:** person skilled in stenography, the writing down of dictation in shorthand and later copying it out in full, as on a typewriter. Shorthand is a system of special symbols for letters, words and phrases for taking notes and dictation rapidly.

**stern:** the rear end of a ship as opposed to the bow, which is the front end of a ship.

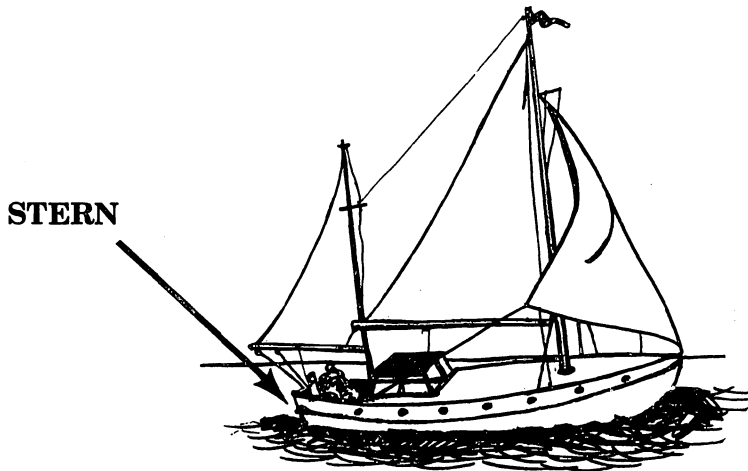

**stewards:** crew members who look after the needs of the ship's company with respect to serving food, laying and clearing tables, berthing, linen, laundry and the cleaning of the common domestic areas of the ship.

**strait:** a narrow passage of water connecting two large bodies of water.

**strident:** harsh-sounding; shrill; grating.

**supernumeraries:** extra persons.

**swells:** waves caused by the heaving of the sea due to the wind, which may last for a considerable time after the wind has died down.

**tags:** tags on chemical fire extinguishers which state when they were last filled.

**taped:** for certain; under control.

**Tasman Sea:** a part of the Pacific Ocean between southeast Australia and New Zealand. It is named after Abel Janszoon Tasman, a Dutch navigator who traveled to this area in the seventeenth century.

**teeth, into the . . . (teeth) of:** working against.

**tempest:** a violent windstorm, especially one with rain, hail or snow.

**Theetie-Weeties:** a made-up name for a product. It's taken from the term theetie-weetie, meaning someone who is all sweetness and light and not facing reality at all.

**third:** third dynamic. *See dynamics* in this glossary.

**Third Mate:** on a Sea Org ship is the equivalent of the HCO Area Sec and is in charge of Division One (personnel, communications and ethics).

**third party:** one who by false reports creates trouble between two people, a person and a group or a group and another group.

**throttles:** valves regulating the flow of steam, gasoline vapor, etc., to an engine. By closing the throttle, the speed is lessened and by opening it, the speed is increased.

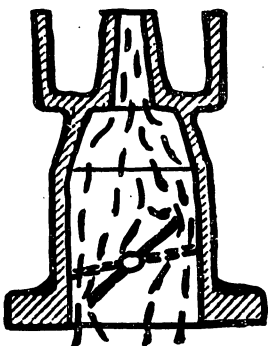

**THROTTLE VALVE**

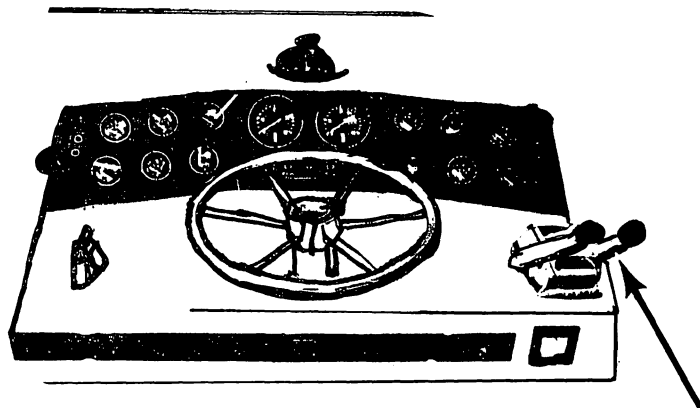

**THROTTLE CONTROLS**

**throwing lines:** ropes used to throw from a vessel to a person who has fallen overboard. The person grabs onto the line and is pulled in towards the vessel to be rescued.

**ticket:** (lifeboat ticket), a certificate of competency which is issued by the government. A person must successfully complete an examination to receive the certificate.

**tidal wave:** a large, destructive ocean wave, produced by a seaquake (an earthquake on the ocean floor), hurricane or strong wind.

**Time-Life:** publishing company that publishes *Time* and *Life* magazines in the US. These magazines cover current news and events around the world.

**Torquay:** a city in Devonshire, England, a resort in the south of England on the English Channel.

**totalitarianism:** absolute control by the state, with a centralized government that does not tolerate parties of differing opinion and that exercises dictatorial control over many aspects of life.

**trough to crest:** from the bottom or trough of a wave to the top or crest of the wave.

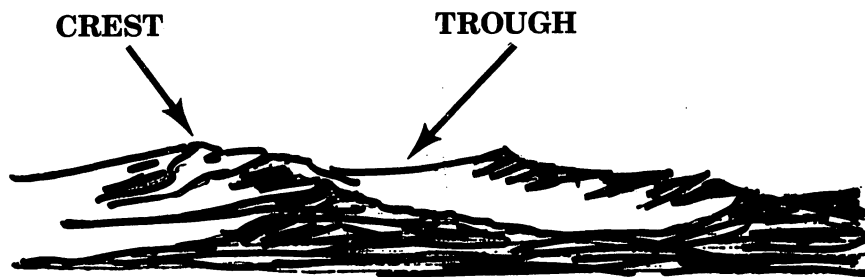

**turn the engines over:** start the engines or keep them running.

**TWA:** Trans World Airlines, a major passenger-airline company.

**twine:** a strong thread or string composed of two or more strands twisted together.

**twin-screw:** having two propellers, which usually revolve in opposite directions.

#### TWIN-SCREW

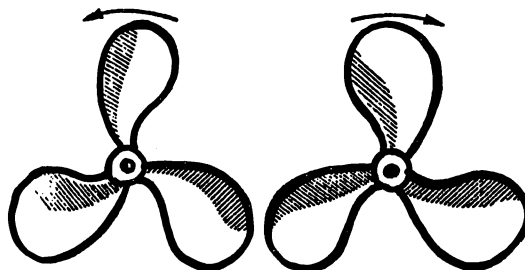

**United Airlines:** a major American airline.

**United Nations:** an international organization with headquarters in New York City, formed to promote international peace, security and cooperation under the terms of the charter signed by fifty-one founding countries in San Francisco in 1945.

**venal:** characterized by bribery or corruption.

**VIP:** very important person.

**vis-a-vis:** face to face.

**War of American Independence:** the American Revolution which was the war between Great Britain and its American colonies, 1775–83, by which the colonies won their independence.

**Washington:** abbreviated term for Founding Church of Scientology of Washington, DC.

**Washington, DC:** Washington is the capital of the United States and is located in the District of Columbia. The District of Columbia is a federal territory of the US.

**watch:** a portion of time during which a part of a ship's company is on duty. Also the part of a ship's company required to be on duty during a specific period. Every member of a ship's company has two general types of activities, one of these is as a member of watches, wherein he handles his duties of steering, lookout, engines, etc., including emergency drills.

**watch officers:** the officers in charge of the watch, namely the Officer of the Watch and the Conning Officer. *See also* **Officer of the Watch** and **Con** in this glossary.

**water doors:** water-tight doors which are fitted between the lower compartments of the ship to allow each compartment to be isolated in the event of damage to the hull and water leaking in.

**WATER DOOR**

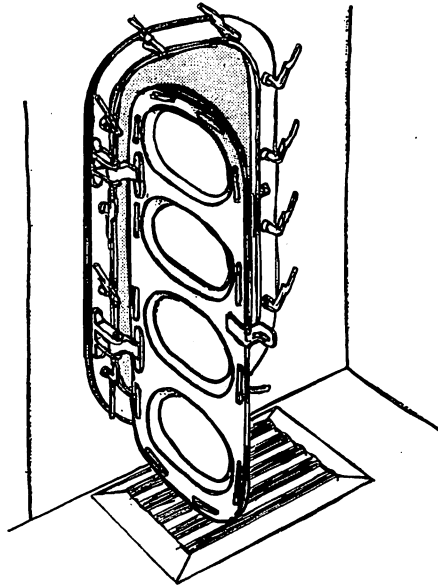

**well deck:** either of two sunken decks found between the forward and the middle and the middle and after structures.

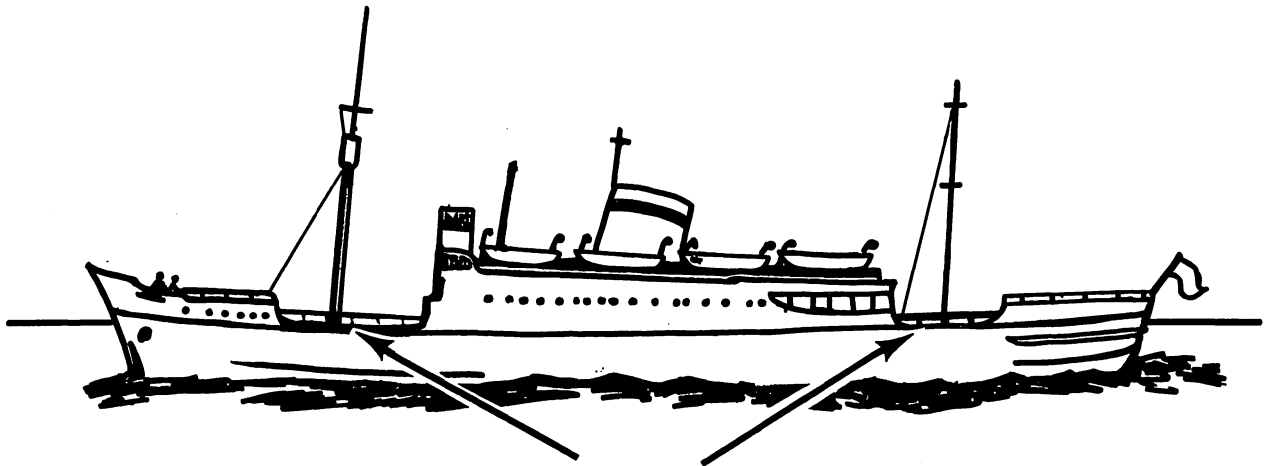

**WELL DECK**

**wheelsman:** the sailor who steers the ship.

**White House, the:** the executive branch of the US federal government.

**white-belted messenger:** a person in the shore patrol, the military police patrol of the US Navy. A wide, white belt is worn as a part of the uniform.

**williwaws:** sudden, violent, cold winds blowing down from the mountain passes toward the coast in far northern or southern regions. *Williwaw* is an Australian term for whirlwind.

**winch:** a small vertical drum around which a rope or line is passed in order to make it easier to pull that rope.

**WINCH**

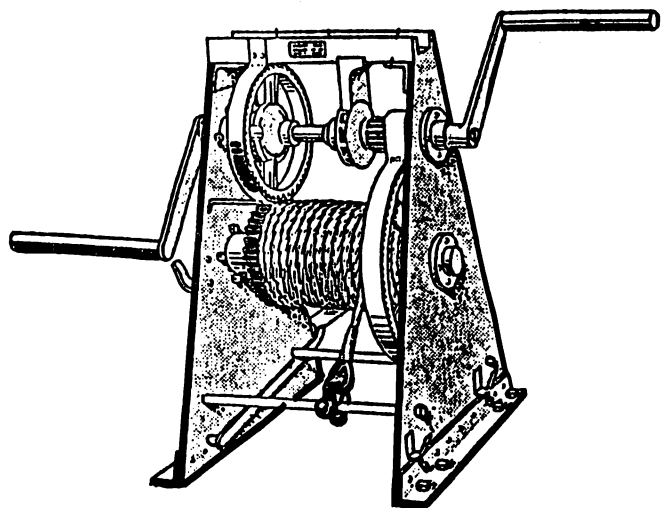

**windrows:** heaps.

**wing of the bridge:** an observation area on either side of the bridge which permits an unobstructed view to the side and behind the ship. *See also* **bridge** in this glossary.

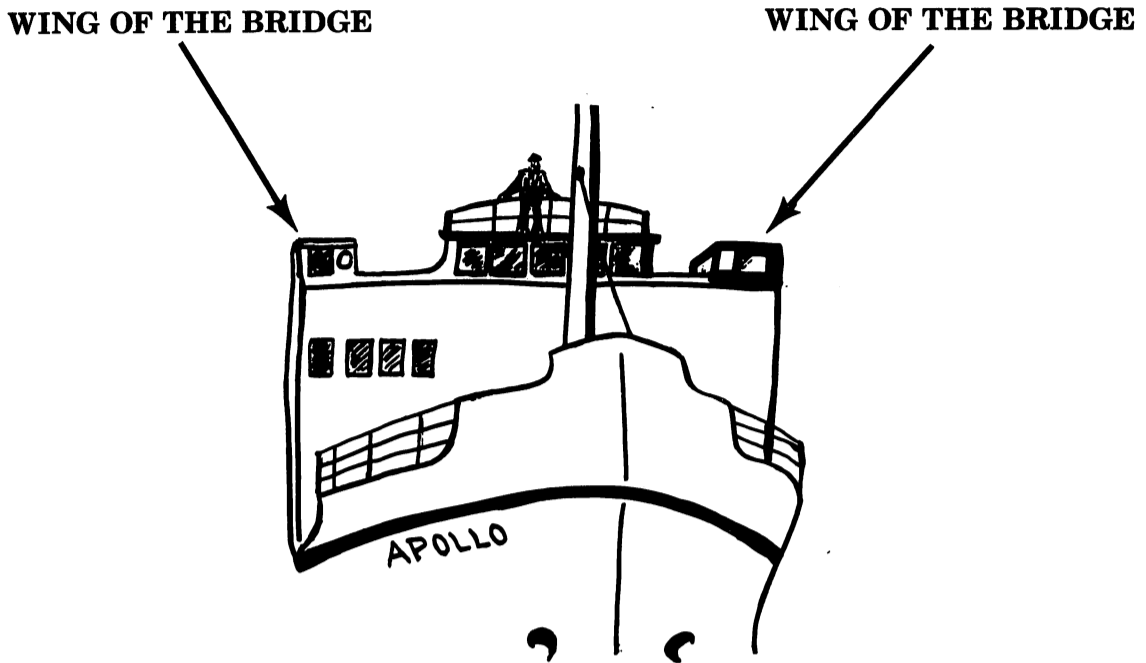

**World Bank:** the International Bank for Reconstruction and Development, an organization founded in 1944 with the stated aim of providing loans and other banking services to member nations, especially to help them build up or develop their economies.

**World Federation of Mental Health:** an international organization of psychiatrists. Its members include the National Associations of Mental Health, the American Psychiatric Association and the American Psychological Association. A member of the World Federation of Mental Health sits on every major "Advisory Council" of the US government, to name one government.

**WW:** Worldwide at the time of the lecture, was the Scientology Worldwide Management Control Center. It was established at Saint Hill Manor, East Grinstead, Sussex in 1959.

**yacht:** a sailboat for pleasure trips or racing.

**yard:** abbreviation for dockyard, the place for building and repairing ships.

**Yipyap:** a made-up name for a country.

# Alphabetical List of Titles

<b>"It's a PRO World"</b>	50	<b>"Third Dynamic Activity and Making Things Go Right"</b>	41
<b>Keeping Scientology Working</b>	1	<b>"Welcome to the Sea Org"</b>	18
<b>Technical Degrades</b>	7	<b>"Why the Sea Org Is Successful"</b>	30
<b>"The Quality of the Sea Org and What Is a Seaman"</b>	9		

# Chronological List of Titles

	<b>1965</b>				
7 Feb.	<b>Keeping Scientology Working</b> <i>KSW Series 1</i> Reiss. 15 June 70 Reiss. 28 Jan. 73 Reiss. 27 Aug. 80 Reiss. 12 Oct. 85	1	17 Oct.	<b>"Why the Sea Org Is Successful"</b>	30
			20 Oct.	<b>"Third Dynamic Activity and Making Things Go Right"</b>	41
			21 Oct.	<b>"It's a PRO World"</b>	50
	<b>1969</b>			<b>1970</b>	
15 Oct.	<b>"The Quality of the Sea Org and What Is a Seaman"</b>	9	17 June RB	<b>Technical Degrades</b> <i>KSW Series 5R</i> Rev. 9 Apr. 77 Reiss. 30 Aug. 80 Rev. 25 Oct. 83	7
16 Oct.	<b>"Welcome to the Sea Org"</b>	18			

30 Ref. to DM's - ASSAULTS

59

61 WOGS

81 MAGNETIC ANOMALY