

# STAR TREK

# STAR FLEET TECHNICAL MANUAL

Fully  
Illustrated



TRAINING COMMAND STAR FLEET ACADEMY

RESEARCHED AND COMPILED  
BY  
FRANZ JOSEPH

- ARTICLES OF FEDERATION
- FEDERATION FLAGS, SEALS & UNIFORMS
- NAVIGATIONAL CHARTS & EQUIPMENT
- STAR FLEET ORGANIZATION
- DETAILED SCHEMATICS OF STAR FLEET EQUIPMENT
- INTERSTELLAR SPACE/WARP TECHNOLOGY
- FEDERATION CODES

STAR FLEET  
**TECHNICAL  
MANUAL**

TM: 379260

STAR FLEET HEADQUARTERS  
UNITED FEDERATION OF PLANETS

FRANZ JOSEPH  
UNITED FEDERATION REPRESENTATIVE  
STAR FLEET COMMAND

# STAR FLEET TECHNICAL MANUAL

## FEDERATION CLASSIFIED

THIS MANUAL IS FOR THE SPECIFIC USE OF STAR FLEET ACADEMY CADETS AND CONTAINS SELECTED MATERIAL FROM THE DATA BANKS OF THE MASTER COMPUTER. UNDER THE LAWS OF THE UNITED FEDERATION OF PLANETS AND ITS MEMBER PLANETS UNAUTHORIZED USE, OR REPRODUCTION, IN WHOLE OR IN PART, OF THESE TECHNICAL ORDERS OR ANY SUBSEQUENTLY ISSUED, WITHOUT THE WRITTEN PERMISSION OF STAR FLEET OR ITS PLANETARY AGENTS IS STRICTLY PROHIBITED.

TRAINING COMMAND  
STAR FLEET ACADEMY

OFFICIAL VERSION FOR CADETS FROM  
UNITED NATIONS, EARTH, SOL SYSTEM

RESEARCHED AND COMPILED BY:

**FRANZ JOSEPH\***

UNITED FEDERATION REPRESENTATIVE  
MILITARY STAFF COMMITTEE  
STAR FLEET HEADQUARTERS, O MARK O, R5PC

WITH GRATEFUL APPRECIATION TO THESE CIVILIANS  
OF UNITED NATIONS/EARTH/SOL SYSTEM:

ANNE ANDERSON, JUDY LYNN DEL REY, FRED C. DURANT, III,  
IRVING FEINBERG, WALTER M. JEFFRIES, ROBERT H. JUSTMAN,  
IGOR LABONOFF, LOU MINDLING, GENE RODDENBERRY,  
WILLIAM THEISS, BJO TRIMBLE, & STEPHEN E. WHITFIELD

AND ESPECIALLY TO THESE CIVILIANS  
AND CIVILIAN AUXILIARIES:

ART CANFIL, DAVID BARBER, SHARON FERRARO, JAMIE  
HANRAHAN, DENNIS HUNT, TONI LAY, ROD MARCH, JEFF  
MAYNARD, ROBERT MROZ, SANDY SARRIS, KAREN LINDA  
SCHNAUBELT, JANICE SCOTT, GREG WEIR, CHARLES WEISS,  
HELEN YOUNG, MEMORY ALPHA, SPACE-TIME CONTINUUM,  
S.T.A.R. SAN DIEGO, STAR TREK ARCHIVES, & STAR TREK  
WELCOMMITTEE

PRINTINGS:

1ST EDITION STARDATE 7511.01

THE PUBLISHER GRATEFULLY ACKNOWLEDGES THE COOPERATION OF  
PARAMOUNT TELEVISION, A DIVISION OF PARAMOUNT PICTURES CORPORATION,  
THE PRODUCERS OF THE STAR TREK TELEVISION SERIES, IN GRANTING  
PERMISSION TO PUBLISH THIS VOLUME.

COPYRIGHT © 1975 BY FRANZ JOSEPH DESIGNS  
ALL RIGHTS RESERVED UNDER INTERNATIONAL  
AND PAN-AMERICAN COPYRIGHT CONVENTIONS  
SBN 345-24730-2-695  
FIRST PRINTING: NOVEMBER, 1975

PRINTED IN THE UNITED STATES OF AMERICA

BALLANTINE BOOKS  
A DIVISION OF RANDOM HOUSE, INC.  
201 EAST 50TH STREET, NEW YORK, N.Y. 10022  
SIMULTANEOUSLY PUBLISHED BY  
BALLANTINE BOOKS, LTD., TORONTO CANADA

\*UNITED NATIONS/EARTH IDENTITY:  
FRANZ JOSEPH DESIGNS

# FOREWORD I

PHOTOCOPY

**UNITED STATES MILITARY FORCES  
GENERAL STAFF HEADQUARTERS  
WASHINGTON, D. C. U.S.A.**

memorandum to: Franz Joseph Designs  
 from: Col. Robert Argon, Director  
 Security Control/MFHQ  
 date: 15 April 1973  
 subject: MF Security Docket #075140  
 enclosure: one (1) copy of subject docket

1. Pursuant to your inquiry we are enclosing one (1) copy of subject docket without restrictions. The security classification has been removed, and there is no longer any official interest in the matter.
2. The printed 'message' was: "ALERT.....ALERT.....UNITED FEDERATION FLEET HEADQUARTERS MASTER LIBRARY COMPUTER.....TO.....LIBRARY COMPUTER .....ALL FEDERATION STARSHIPS ON SPECIAL SERVICE.....STARDATE 3113..... SUBJECT.....TRANSMISSION OF UPDATED TECHNICAL MANUAL MASTER DATA SECTIONS .....00:00:00.....00:00:00 .....BEGIN TRANSMISSION....."
3. The message and the 'data sheets' which followed were found in the memory banks of the master computer at Security Control, Omaha MFB, and were accidentally discovered in 1970 during a print-out run, while the computer was being interrogated for another reason. A top security lid was immediately clamped on the matter while an investigation was launched to attempt to identify the source of the unusual transmission. Neither the message or the data could be traced to any known country, or alliance, in the World. All of the terminology, uniforms, weaponry, and other material was completely foreign to the terminology, uniforms, weaponry, and other material known to be in existence at that time.
4. The investigation was terminated with a final determination that the whole affair had been a hoax. That the 'unusual' material had been inserted into the computer as a prank. And the file was closed, while a search was initiated to find the person, or persons, responsible for this breach of Security Control. To date this effort has been fruitless.

# FOREWORD II

PHOTOCOPY

OFFICIAL USE ONLY  
O MARK O R5PC

## STAR FLEET COMMAND STAR FLEET HEADQUARTERS UNITED FEDERATION OF PLANETS

SIDRE AEL SARDELAS, DIRECTOR  
MILITARY STAFF COMMITTEE

STARDATE 3150.10

to: All Divisions concerned  
Star Fleet Command

1. Pursuant to the matter of the unauthorized transmission of SFAF material (viz: SFHQ/Mastercom Computer Data) into the Master Computer at Security Control, Omaha MFB, Earth, Sol System as of stardate 3113, the Special Review Board examined the following pertinent documentation:

- (a) report of Capt. James T. Kirk, commanding, U.S.S. Enterprise;
- (b) report of Lt. Cmdr. Spock, First Officer, U.S.S. Enterprise;
- (c) report of the investigation by the Special Review Commission;
- (d) report of the historical events sequential review of the data banks of Mastercom/SFHQ;

2. The Special Review Board has now concluded its determination. It finds: (1) that both Capt. James T. Kirk and Lt. Cmdr. Spock cannot be faulted for the matter since it occurred in the routine computer-to-computer transmission, which operates independently of the SFAF Communications Systems or human supervision; and: (2) that it occurred as the result of an unpredicted, and unforeseen gravitational space-warp which is now known to be a natural phenomenon within the galaxy; and (3) that it was a purely random matter which occurred without human intervention and therefore is considered to be a natural accidental occurrence in the sequential train of historical events.

3. The Special Review Board further finds that in the event the material now stored in the data banks of the Master Computer at Security Control, Omaha MFB, should become known in that time period, it would be advisable to review whatever material is included in that storage to: (a) delete any technology which is not known to Earth's technology in that time period, in order to preserve the Prime Directive's doctrine of non-intervention; and: (b) to correct any material which is determined to be "safe" but which was distorted in the transmission.

4. Therefore, the Planetary Relations Division of Star Fleet Command is hereby assigned the task of this final determination in the event it should become necessary, and all Divisions shall support this effort as required. The Planetary Relations Division shall also prepare a final report upon the conclusion of any actions they may take, for submission to the Federation Council.

## FOREWARD III

PHOTOCOPY

OFFICIAL USE ONLY  
O MARK O R5PCSTAR FLEET COMMAND  
STAR FLEET HEADQUARTERS  
UNITED FEDERATION OF PLANETSFRANZ JOSEPH  
UNITED FEDERATION REPRESENTATIVE

STARDATE 7512.02

to: Ballantine Books  
Planetary Agents, NA, USA, 10022  
United Nations/Earth/Sol System

1. A printed Terran version of the Star Fleet Technical Manual was approved by the Federation Council for release to the civilians, and civilian auxiliaries on your planet. We have reviewed copies of this version as printed by you, and wish to assure you and the others that these copies are precisely correct and complete as authorized. We believe some of your civilians are confused because they are unfamiliar with the system and arrangement of Technical Orders, therefore, we offer the following by way of clarification.

2. The print-out version of the Star Fleet Technical Manual, as used by the Star Fleet Academy, is a collection of only those Technical Orders necessary to the indoctrination of new cadets until such time as they have become experienced in the use of the data read-out stations of Mastercom/SFHQ. Further, the Terran version contains even fewer Technical Orders because of the prohibition of the Prime Directive. Neither version is a "book" of "pages" as the questioners seem to think — nor do they contain "all" of the technical information stored in the data banks of Mastercom/SFHQ. Your civilians must understand these technical data banks contain all the knowledge presently known within the United Federation of Planets from all of the Member planets. If it were to be published in "book" form, the sum total would amount to more books than you now have stored in your "libraries." Obviously, this cannot be done. It is equally obvious that you cannot have the galactic knowledge of future centuries given to your planet as a "gift;" you must earn it by your own efforts just as the others have done.

3. In the Terran version, the General Index summarizes the subject area groupings by Technical Order number blocks as a part of the total system of classification. It does not give the total classification system, nor does it indicate whether or not such subject matter is available. The Introduction (T.O:00:00:06) for instance, is not included because it has not been authorized for release at this time. Each Section Index lists the Technical Orders currently approved for each section, and shows which are the correct issue by authentication date (and amendment code — if required). Thus a Section Index shows whether or not a particular Manual contains the correct issues. Those which are listed with an asterisk may become available in a future print-out from Mastercom/SFHQ. Other Technical Order numbers which are missing do not appear by reason of the prohibition of the Prime Directive, or they have not been approved for release at this time.

4. In as gentle and as diplomatic manner as we may, we should like to point out that this confusion is just another example of the many primitive attributes of your planet which prevent its acceptance into the United Federation of Planets at this time in your current calendar. But be patient, the day will come in the future when your planet will have finally overcome these obstacles, and will take its place in the intergalactic community of intelligent life forms.

Live long and prosper.

## GENERAL INDEX

T. O. NO:	SUBDIVISION CATEGORIES
00:00:04	Foreword I
:05	Foreword II
:06	Introduction
:08	Division Index
00:00:10	GENERAL *
:00:	Foreword, Section Index, General Instructions, etc.
:01:	United Federation Articles of Federation, Statutes, Regulations, Peace Treaties, etc.
:02:	Flags, Seals, Arms, and Other Devices identifying the Federation and its individual Member Planets
:03:	Federation Uniforms, Insignia, and Ranks other than Star Fleet
:04:	Federation Spaceships and Weaponry other than Star Fleet
:05:	Alien Uniforms, Insignia, and Ranks other than the United Federation of Planets
:06:	Alien Spaceships and Weaponry other than the United Federation of Planets
:07:	Alien Communication Methods
:08:	Alien Life Forms
01:00:00	COMMAND *
:00:	Foreword, Section Index, General Instructions, etc.
:01:	Star Fleet Organization, Star Fleet Academy, Star Fleet Headquarters, Star Bases, etc.
:02:	Assignment Orders, Prime Directives, General Orders
:03:	Star Fleet Uniforms, Insignia, and Ranks
:04:	Star Fleet Spaceship Classifications, Class 3-views, etc.
:05:	Ship's Compliment, Passenger Lists, Crews Quarters, Personal History and Record Tapes, etc.
:06:	Fleet Duty Ship Specifics
:07:	Ship's Defenses and Systems
:08:	Ship's Weaponry and Weapons Systems
02:00:00	SCIENCES *
:00:	Foreword, Section Index, General Instructions, etc.
:01:	Science Officer's Station, Systems, and Specifics
:02:	Ship's Computers Systems Schematics
:03:	Sciences Laboratories
:04:	Science Equipment
:06:	Navigational Officer's Station, Systems, Standards, etc.
:07:	Milky Way Galaxy Charts, Federation Charts, Member Planetary Systems Charts, etc.
:08:	Known Galactic Region Star Charts, etc.
:10:	Ship's Medical Section Arrangement, Facilities, etc.
:11:	Medical Equipment
:14:	Food Preparation Health and Sanitary Standards, etc.



## GENERAL INDEX

T. O. NO:	SUBDIVISION CATEGORIES
03:00:00	SUPPORT SERVICES *
:00:	Foreword, Section Index, General Instructions, etc.
:01:	Communications Officer's Station, Sub-space Radio, Federation Codes, Star Fleet Codes, etc.
:02:	Communications Equipment
:05:	Environmental Officer's Station, Systems, Standards, Schematics, etc.
:06:	Environmental Facilities Arrangements, Schematics, Details, etc.
:08:	Engineering Officer's Station, Engineering Arrangement, Facilities, etc.
:09:	Ship's Structural Details
:10:	Impulse Power Arrangement, Systems, Schematics, Details, etc.
:11:	Main Propulsion Arrangement, Systems, Schematics, Details, etc.
:12:	Ship's Electrical Power Facilities, Schematics, etc.
:13:	Ship's Controls Arrangement, Systems, Schematics, Details, etc.
:14:	Food Preparation Facilities, Systems, Schematics, etc.
:15:	Sanitary Recovery Facilities, Systems, Schematics, Details, etc.
:16:	Ship's Transporters, Arrangements, Schematics, etc.
:17:	Hangar Deck Arrangement, Systems, Details, Shuttlecraft Maintenance Facilities, etc.
:18:	Ship's Computers Maintenance Schematics
:19:	Maintenance and Repair Shops Arrangement, details, etc.
:20:	Fabrication Facilities Arrangement, Details, etc.
:21:	Materials Reconversion Facilities, Schematics, etc.
:22:	Chemophotosynthesis Facilities, Schematics, Details
:23:	Specialized Ship's Equipment
:24:	Ship's Cargo Facilities
:98:	Ship's Recreation Facilities, Games, Musical Instruments, etc.
:99:	Ship's Gymnasia Facilities, Sports Equipment, etc.
04:00:00	MISCELLANEOUS *
:00:	Foreword, Section Index, General Instructions, etc.

**Note:** (\*) indicates Manual Division and Section Title Page



GENERAL SECTION

# STAR FLEET TECHNICAL ORDER

SECTION INDEX			
TO. NO:	SUBJECT:	CURRENT	REPLACES
00:00:10	GENERAL SECTION FLYSHEET	7309.14	
" " :12	FOREWORD	*	
" " :14	SECTION INDEX	7407.29	
" :01:00	ARTICLES OF FEDERATION -DECL. CH. I, AR.1, P. 1, 2, & 3	7305.29	
" " :01	A.O.F.-CH. I, AR.1, P. 4, AR.2, P.1,2,3,4, 5,6, & 7, CH. II, AR.3, AR. 4, P.1	"	
" " :02	A.O.F.-CH. II, AR. 6, TO CH. IV, AR.11, P. 3	"	
" " :03	A.O.F.-CH. IV, AR. 11, P. 4 TO AR.17, P. 2	"	
" " :04	A.O.F.-CH. IV, AR.17, P. 3 TO CH. V, AR. 23, P.1	"	
" " :05	A.O.F.-CH. V, AR. 23, P. 2 TO AR. 28, P. 1	"	
" " :06	A.O.F.-CH. V, AR. 28, P. 3 TO CH. VI, AR. 35, P. 3	"	
" " :07	A.O.F.-CH. VI, AR. 36, P.1, TO CH. VII, AR. 43	"	
" " :08	A.O.F.-CH. VII, AR. 44 TO AR. 50	"	
" " :09	A.O.F.-CH. VII, AR. 51 TO CH. VIII, AR. 54, P. 1	"	
" " :10	A.O.F.-CH. VIII, AR. 54, P. 2 TO CH. IX, AR. 60	"	
" " :11	A.O.F.-CH. X, AR. 61 TO AR. 66, P.1	"	
" " :12	A.O.F.-CH. X, AR. 66, P. 2, TO CH. XI, AR. 73	"	
" " :13	A.O.F.-CH. XI, AR. 73 TO CH. XII, AR. 76	"	
" " :14	A.O.F.-CH. XII, AR. 77, P.1 TO AR. 83, P.1	"	
" " :15	A.O.F.-CH. XII, AR. 83, P. 2 TO CH. XIII, AR. 87	"	
" " :16	A.O.F.-CH. XIII, AR. 88 TO CH. XIV, AR. 95	"	
" " :17	A.O.F.-CH. XIV, AR. 96 TO CH. XV, AR. 101	"	
" " :18	A.O.F.-CH. XVI, AR. 102 TO CH. XVII, AR. 107	"	
" " :19	ARTICLES OF FEDERATION -CH. XVII, AR. 108 TO -FINAL	7305.29	
00:01:20	STATUTE-INTERPLANETARY SUPREME COURT OF JUSTICE	*	
" " :21	" -CH. I, AR. 5, P. 3 TO AR. 7, P. 6	*	
" " :22	" -CH. I, AR. 7, P. 7 TO AR.11	*	
" " :23	" -CH. I, AR. 12 TO CH. II, AR. 14	*	
" " :24	" -CH. II, AR. 15 TO CH. III, AR.19, P. 3	*	
" " :25	" -CH. III, AR. 19, P. 3 TO AR. 23, P.1	*	
" " :26	" -CH. III, AR. 23, P. 2 TO CH. V, AR. 27	*	
" " :27	STATUTE-CH V, AR. 28 TO -FINAL	*	
00:01:30	STATUTE REGULATING INTERPLANETARY COMMERCE	*	
" " :31	" -PART I, SECT. 1, ITEM 12 TO 23	*	
" " :32	" -SECT. 2 TO PART II, SECT. 5, ITEM 01	*	
" " :33	" -SECT. 5, ITEM 02 TO SECT. 6, ITEM 04	*	
" " :34	" -SECT. 6, ITEM 05 TO PART III, SECT. 10, ITEM 04	*	
" " :35	" -SECT. 11 TO PART IV, SECT. 16, ITEM 01	*	
" " :36	" -SECT. 16, ITEM 02 TO SECT. 17, ITEM 02	*	
" " :37	" -SECT. 18, ITEM 01 TO 07	*	
" " :38	" -SECT. 18, ITEM 08 TO PART V, SECT. 19, ITEM 05	*	
" " :39	" -SECT. 19, ITEM 06 TO SECT. 21	*	
" " :40	" -SECT. 21, ITEM 01 TO SECT. 22, ITEM 05	*	
" " :41	" -SECT. 23 TO SECT. 27, ITEM 01	*	
" " :42	" -SECT. 27, ITEM 02 TO SECT. 29, ITEM 04	*	
" " :43	" -SECT. 30 TO PART VI, SECT. 33, ITEM 01	*	
" " :44	" -SECT. 33, ITEM 02 TO PART VII, SECT. 36	*	
" " :45	" -SECT. 36, ITEM 01 TO SECT. 38, ITEM 01	*	
" " :46	" -SECT. 38, ITEM 02 TO SECT. 39, ITEM 03	*	
" " :47	" -SECT. 39, ITEM 04 TO SECT. 42	*	
" " :48	" -SECT. 43 TO SECT. 45	*	
" " :49	" -SECT. 46 TO PART VIII, SECT. 47, ITEM 02	*	
" " :50	" -SECT. 47, ITEM 03 TO SECT. 49, ITEM 02	*	

NOTE (\*): NO CURRENT PRINT-OUT FROM MASTERCOM DATABANKS/SFHG

# STAR FLEET TECHNICAL ORDER

AUTHENTICATED STARDATE 7407.29

TO:00:00:15

## SECTION INDEX

TO. NO:	SUBJECT:	CURRENT	REPLACES
00:00:15	SECTION INDEX	7407.29	
00:01:51	STATUTE-SECT. 49, ITEM 03 TO PART IX, SECT. 51, ITEM 05	*	
" " :52	" -SECT. 51, ITEM 06, TO PART X, SECT. 54	*	
" " :53	" -SECT. 55, ITEM 01 TO 05	*	
" " :54	" -SECT 56 TO SECT. 57, ITEM 01	*	
" " :55	" -SECT. 57, ITEM 02 TO SECT. 58, ITEM 04	*	
" " :56	" -SECT. 58, ITEM 05 TO PART XI, SECT. 63	*	
" " :57	STATUTE-SECT 64 TO FINAL	*	
00:01:60	ROMULAN TREATY OF PEACE	7305.30	
" " :62	ORGANIAN TREATY OF PEACE	7305.30	
00:02:00	UNITED FEDERATION OF PLANETS - BANNER	7405.05	
" " :01	" " " " - SEAL	7306.18	
" " :02	UNITED NATIONS, PLANET EARTH, SOL SYSTEM - FLAG	7405.30	
" " :03	" " " " " " - SEAL	7406.15	
" " :04	PLANETARY CONFEDERATION OF 40 ERIDANI - BANNER	7407.13	
" " :05	" " " " " " - SIGNAT	7407.09	
" " :06	UNITED PLANETS OF 61 CYGNI - SHIELD	7407.06	
" " :07	" " " " " " - ARMS	7407.07	
" " :08	STAR EMPIRE OF EPSILON INDII - STANDARD	7407.05	
" " :09	" " " " " " - SEAL	7407.05	
" " :10	ALPHA CENTAURI CONCORDIUM OF PLANETS - PENNANT	7406.24	
" " :11	" " " " " " - ARMS	7406.25	
00:10:10	UNIFORM COLOR CODE - STAR FLEET SPECIFICATION	7407.04	
" :10:00	OFFICIAL TYPE STYLE - EARTH, SOL SYSTEM - SF SPEC.	7405.10	
" " :01	" " " " - ALPHA KENTAURUS - " "	7407.05	

NOTE (\*): NO CURRENT PRINT-OUT FROM MASTERCOM DATABANKS/SFHQ

# ARTICLES OF FEDERATION

## WE THE INTELLIGENT LIFE-FORMS OF THE UNITED FEDERATION OF PLANETS DETERMINED

TO SAVE SUCCEEDING GENERATIONS FROM THE SCOURGE OF INTRA-GALACTIC WAR WHICH HAS BROUGHT UNTOLD HORROR AND SUFFERING TO OUR PLANETARY SOCIAL SYSTEMS, AND

TO REAFFIRM FAITH IN THE FUNDAMENTAL INTELLIGENT LIFE-FORM RIGHTS, IN THE DIGNITY AND WORTH OF THE INTELLIGENT LIFE-FORM PERSON, TO THE EQUAL RIGHTS OF MALE AND FEMALE AND OF PLANETARY SOCIAL SYSTEMS LARGE AND SMALL, AND

TO ESTABLISH CONDITIONS UNDER WHICH JUSTICE AND MUTUAL RESPECT FOR THE OBLIGATIONS ARISING FROM TREATIES AND OTHER SOURCES OF INTERPLANETARY LAW CAN BE MAINTAINED, AND

TO PROMOTE SOCIAL PROGRESS AND BETTER STANDARDS OF LIFE IN LARGER FREEDOM,

## AND TO THESE ENDS

TO PRACTISE BENEVOLENT TOLERANCE AND LIVE TOGETHER IN PEACE WITH ONE ANOTHER AS GOOD NEIGHBORS, AND

TO UNITE OUR STRENGTH TO MAINTAIN INTRA-GALACTIC PEACE AND SECURITY, AND

TO ENSURE BY THE ACCEPTANCE OF PRINCIPLES AND THE INSTITUTION OF METHODS THAT ARMED FORCE SHALL NOT BE USED EXCEPT IN THE COMMON DEFENSE, AND

TO EMPLOY INTRA-GALACTIC MACHINERY FOR THE PROMOTION OF THE ECONOMIC AND SOCIAL ADVANCEMENT OF ALL INTELLIGENT LIFE-FORMS,

## HAVE RESOLVED TO COMBINE OUR EFFORTS TO ACCOMPLISH THESE AIMS.

ACCORDINGLY, THE RESPECTIVE SOCIAL SYSTEMS, THROUGH REPRESENTATIVES ASSEMBLED ON THE PLANET BABEL, WHO HAVE EXHIBITED THEIR FULL POWERS TO BE IN GOOD AND DUE FORM, HAVE AGREED TO THESE ARTICLES OF FEDERATION OF THE UNITED FEDERATION OF PLANETS, AND DO HEREBY ESTABLISH AN INTER-PLANETARY ORGANIZATION TO BE KNOWN AS THE UNITED FEDERATION OF PLANETS.

## CHAPTER I

### PURPOSES AND PRINCIPLES

#### ARTICLE 1

THE PURPOSES OF THE UNITED FEDERATION OF PLANETS ARE:

1. TO MAINTAIN INTERPLANETARY PEACE AND SECURITY WITHIN THE TREATY EXPLORATION TERRITORY, AND TO THAT END: TO TAKE EFFECTIVE COLLECTIVE MEASURES FOR THE PREVENTION OF THREATS TO THE PEACE, THE SUPPRESSION OF ACTS OF AGGRESSION, AND TO BRING ABOUT BY PEACEFUL MEANS, AND EMPLOYING THE PRINCIPLES OF JUSTICE AND INTRA-GALACTIC LAW, ADJUSTMENT OR SETTLEMENT OF INTERPLANETARY DISPUTES WHICH MIGHT LEAD TO A BREACH OF THE PEACE;
2. TO DEVELOP FRIENDLY RELATIONS AMONG PLANETS BASED ON RESPECT FOR THE PRINCIPLES OF EQUAL RIGHTS AND SELF-DETERMINATION OF INTELLIGENT LIFE-FORMS, AND TO OTHER APPROPRIATE MEASURES TO STRENGTHEN UNIVERSAL PEACE;
3. TO ACHIEVE INTERPLANETARY COOPERATION IN SOLVING INTRA-GALACTIC PROBLEMS OF ECONOMIC, SOCIAL, CULTURAL, OR HUMANITARIAN CHARACTER; IN PROMOTING AND ENCOURAGING RESPECT FOR INTELLIGENT LIFE-FORM RIGHTS; AND FOR FUNDAMENTAL FREEDOMS FOR ALL WITHOUT DISTINCTION AS TO CULTURE, SEX, LIFE-FORM, OR RELIGIOUS BELIEF; AND

## STAR FLEET TECHNICAL ORDER

AUTHENTICATED STARDATE 7305.29

TO:00:01:01

## ARTICLES OF FEDERATION

4. TO BE A CENTER FOR CONCILIENCE OF THE ACTIONS OF ALL SOCIAL SYSTEMS IN THE ATTAINMENT OF THESE COMMON ENDS.

## ARTICLE 2

THE FEDERATION AND ITS MEMBERS, IN PURSUIT OF THE PURPOSES STATED, SHALL ACT IN ACCORDANCE WITH THE FOLLOWING PRINCIPLES:

1. THE FEDERATION IS BASED ON THE SOVERIEGN EQUALITY OF ALL ITS MEMBERS;
2. IN ORDER TO ENSURE TO ALL OF THEM THE RIGHTS AND BENEFITS RESULTING FROM MEMBERSHIP, ALL MEMBERS SHALL FULFILL IN GOOD FAITH THE OBLIGATIONS ASSUMED BY THEM IN ACCORDANCE WITH THESE ARTICLES OF FEDERATION;
3. ALL MEMBERS SHALL SETTLE THEIR INTERPLANETARY DISPUTES BY PEACEFUL MEANS IN SUCH MANNER THAT INTRA-GALACTIC PEACE, SECURITY, AND JUSTICE, ARE NOT ENDANGERED;
4. IN ALL INTERPLANETARY RELATIONS, ALL MEMBERS SHALL REFRAIN FROM THE THREAT, OR USE, OF FORCE AGAINST THE TERRITORIAL INTEGRITY OR POLITICAL INDEPENDENCE OF ANY PLANETARY SOCIAL SYSTEM, OR IN ANY MANNER INCONSISTENT WITH THE PURPOSES OF THE UNITED FEDERATION;
5. ALL MEMBERS SHALL GIVE THE UNITED FEDERATION EVERY ASSISTANCE IN ANY ACTION TAKEN IN ACCORDANCE WITH THESE ARTICLES OF FEDERATION, AND SHALL REFRAIN FROM ASSISTING ANY PLANETARY SOCIAL SYSTEM AGAINST WHICH THE FEDERATION IS TAKING PREVENTIVE OR ENFORCEMENT ACTION;
6. THE UNITED FEDERATION SHALL ENSURE THAT PLANETARY SOCIAL SYSTEMS WHICH ARE NOT MEMBERS OF THE FEDERATION ACT IN ACCORDANCE WITH THESE PRINCIPLES AS NECESSARY FOR THE MAINTENANCE OF INTRA-GALACTIC PEACE AND SECURITY;
7. NOTHING WITHIN THESE ARTICLES OF FEDERATION SHALL AUTHORIZE THE FEDERATION TO INTERVENE IN MATTERS WHICH ARE ESSENTIALLY THE DOMESTIC JURISDICTION OF ANY PLANETARY SOCIAL SYSTEM, OR SHALL REQUIRE THE MEMBERS TO SUBMIT SUCH MATTERS TO SETTLEMENT UNDER THESE ARTICLES OF FEDERATION; BUT THIS PRINCIPLE SHALL NOT PREJUDICE THE APPLICATION OF ENFORCEMENT MEASURES UNDER CHAPTER VII.

**CHAPTER II**  
MEMBERSHIP

## ARTICLE 3

THE ORIGINAL MEMBERS OF THE UNITED FEDERATION OF PLANETS SHALL BE THOSE PLANETARY SOCIAL SYSTEMS WHICH, HAVING PARTICIPATED IN THE INTERPLANETARY CONFERENCE ON INTERPLANETARY FEDERATION AT BABEL, OR HAVING PREVIOUSLY SIGNED THE DECLARATION OF THE UNITED FEDERATION OF PLANETS OF STARDATE 0963, SIGN THESE ARTICLES OF FEDERATION AND RATIFY THEM IN ACCORDANCE WITH ARTICLE 110.

## ARTICLE 4

1. MEMBERSHIP IN THE UNITED FEDERATION IS OPEN TO ANY OTHER PEACEFUL PLANETARY SOCIAL SYSTEMS WHICH ACCEPT THE OBLIGATIONS CONTAINED IN THESE ARTICLES OF FEDERATION AND, IN THE JUDGEMENT OF THE FEDERATION, ARE CAPABLE AND WILLING TO CARRY OUT THESE OBLIGATIONS;
2. THE ADMISSION OF ANY SUCH PLANETARY SOCIAL SYSTEM TO MEMBERSHIP IN THE UNITED FEDERATION OF PLANETS IS CONTINGENT UPON THE DECISION OF THE SUPREME ASSEMBLY UPON RECOMMENDATION OF THE FEDERATION COUNCIL.

## ARTICLE 5

THE SUPREME ASSEMBLY MAY SUSPEND THE RIGHTS AND PRIVILEGES OF MEMBERSHIP OF ANY MEMBER OF THE UNITED FEDERATION AGAINST WHICH THE FEDERATION COUNCIL HAS TAKEN PREVENTIVE OR ENFORCEMENT ACTION. THE FEDERATION COUNCIL MAY RESTORE THESE RIGHTS AND PRIVILEGES OF MEMBERSHIP AT ITS DISCRETION;

## ARTICLES OF FEDERATION

## ARTICLE 6

ANY MEMBER OF THE UNITED FEDERATION WHICH HAS PERSISTENTLY VIOLATED THE PURPOSES AND PRINCIPLES CONTAINED IN THESE ARTICLES OF FEDERATION MAY BE EXPELLED FROM THE FEDERATION BY THE SUPREME ASSEMBLY UPON THE RECOMMENDATION OF THE FEDERATION COUNCIL.

**CHAPTER III**  
AGENCIES

## ARTICLE 7

1. THERE ARE ESTABLISHED AS THE PRINCIPAL AGENCIES OF THE UNITED FEDERATION OF PLANETS: A SUPREME ASSEMBLY, A FEDERATION COUNCIL, AN ECONOMIC AND SOCIAL COUNCIL, A TRUSTEESHIP COUNCIL, AN INTERPLANETARY SUPREME COURT OF JUSTICE, A STAR FLEET COMBINED PEACE-KEEPING FORCE, AND A SECRETARIAT;
2. SUCH SUBSIDIARY AGENCIES AS MAY BE DEEMED NECESSARY FROM TIME TO TIME MAY BE ESTABLISHED IN ACCORDANCE WITH THESE ARTICLES OF FEDERATION;

## ARTICLE 8

THE UNITED FEDERATION SHALL PLACE NO RESTRICTION ON THE ELIGIBILITY OF MALE AND FEMALE LIFE-FORMS OF ANY MEMBER PLANETARY SOCIAL SYSTEM TO PARTICIPATE IN ANY CAPACITY UNDER CONDITIONS OF EQUALITY IN ITS PRINCIPAL AND SUBSIDIARY AGENCIES.

**CHAPTER IV**  
THE SUPREME ASSEMBLYARTICLE 9  
COMPOSITION

THE SUPREME ASSEMBLY SHALL CONSIST OF ALL THE MEMBERS OF THE UNITED FEDERATION OF PLANETS. EACH MEMBER SHALL BE ENTITLED TO HAVE NOT MORE THAN FIVE (5) REPRESENTATIVES IN THIS BODY;

## FUNCTIONS AND POWERS

## ARTICLE 10

THE SUPREME ASSEMBLY MAY DISCUSS ANY QUESTIONS ON ANY MATTERS WITHIN THE SCOPE OF THESE ARTICLES OF FEDERATION OR RELATING TO THE POWERS AND FUNCTIONS OF ANY AGENCIES PROVIDED FOR IN THESE ARTICLES OF FEDERATION AND, EXCEPT AS PROVIDED IN ARTICLE 12, MAY MAKE RECOMMENDATIONS TO THE MEMBERS AND THE FEDERATION COUNCIL OR BOTH ON ANY SUCH QUESTIONS OR MATTERS;

## ARTICLE 11

1. THE SUPREME ASSEMBLY MAY CONSIDER THE GENERAL PRINCIPLES OF COOPERATION IN MAINTAINING INTERPLANETARY PEACE AND SECURITY, INCLUDING DISARMAMENT AND THE REGULATION OF ARMAMENTS, AND MAY MAKE RECOMMENDATIONS WITH REGARD TO SUCH PRINCIPLES TO THE MEMBERS OR THE FEDERATION COUNCIL OR TO BOTH;
2. THE SUPREME ASSEMBLY MAY DISCUSS ANY QUESTIONS RELATIVE TO THE MAINTENANCE OF INTRA-GALACTIC PEACE AND SECURITY PUT TO IT BY ANY MEMBER OR THE FEDERATION COUNCIL, OR A NON-MEMBER PLANETARY SOCIAL SYSTEM IN ACCORDANCE WITH ARTICLE 25 PARAGRAPH 2 AND, EXCEPT AS PROVIDED IN ARTICLE 12, MAY MAKE RECOMMENDATIONS WITH REGARD TO ANY SUCH QUESTIONS TO THE MEMBERS, THE FEDERATION COUNCIL, OR THE PLEADING PLANETARY SOCIAL SYSTEM, OR TO ALL OF THEM. ANY SUCH QUESTION ON WHICH ACTION IS NECESSARY SHALL BE REFERRED TO THE FEDERATION COUNCIL BY THE SUPREME ASSEMBLY EITHER BEFORE OR AFTER DISCUSSION;
3. THE SUPREME ASSEMBLY MAY CALL SITUATIONS WHICH ARE LIKELY TO ENDANGER THE INTERPLANETARY AND INTRA-GALACTIC PEACE AND SECURITY TO THE ATTENTION OF THE FEDERATION COUNCIL;

## ARTICLES OF FEDERATION

4. THE POWERS OF THE SUPREME ASSEMBLY AS SET FORTH IN THIS ARTICLE SHALL NOT LIMIT THE SCOPE OF ARTICLE 10;

## ARTICLE 12

1. WHERE THE FEDERATION COUNCIL IS EXECUTING THE FUNCTIONS ASSIGNED TO IT UNDER THESE ARTICLES OF FEDERATION WITH RESPECT TO ANY DISPUTE OR SITUATION, THE SUPREME ASSEMBLY SHALL MAKE NO RECOMMENDATION WITH REGARD TO THAT DISPUTE OR SITUATION UNLESS SO REQUESTED BY THE FEDERATION COUNCIL;

2. THE SUPREME-SECRETARIAT, WITH THE CONSENT OF THE FEDERATION COUNCIL, SHALL NOTIFY THE SUPREME ASSEMBLY AT EACH SESSION OF ANY MATTERS RELATING TO THE MAINTENANCE OF INTERPLANETARY PEACE AND SECURITY WHICH ARE UNDER DISCUSSION IN THE FEDERATION COUNCIL, AND SHALL NOTIFY THE SUPREME ASSEMBLY, OR THE MEMBERS IF THE SUPREME ASSEMBLY IS NOT IN SESSION, IMMEDIATELY WHEN THE FEDERATION COUNCIL COMPLETES ITS DELIBERATIONS ON ANY SUCH MATTERS;

## ARTICLE 13

1. THE SUPREME ASSEMBLY SHALL INITIATE STUDIES AND MAKE RECOMMENDATIONS FOR THE PURPOSE OF:

- A) PROMOTING INTERPLANETARY COOPERATION IN POLITICAL FIELDS AND ENCOURAGING THE PROGRESSIVE DEVELOPMENT OF INTERPLANETARY LAW AND ITS CODIFICATION;
- B) PROMOTING INTERPLANETARY COOPERATION IN THE ECONOMIC, SOCIAL, CULTURAL, EDUCATIONAL, AND HEALTH FIELDS, AND ASSISTING IN THE REALIZATION OF INTELLIGENT LIFE-FORM RIGHTS AND FUNDAMENTAL FREEDOMS FOR ALL WITHOUT DISTINCTION AS TO CULTURE, SEX, LANGUAGE, OR RELIGION;

2. THE FURTHER RESPONSIBILITIES, FUNCTIONS, AND POWERS OF THE SUPREME ASSEMBLY WITH RESPECT TO MATTERS MENTIONED IN PARAGRAPH 1(B) ABOVE ARE SET FORTH IN CHAPTERS IX AND X;

## ARTICLE 14

SUBJECT TO THE PROVISIONS OF ARTICLE 12, THE SUPREME ASSEMBLY MAY RECOMMEND MEASURES FOR THE PEACEFUL ADJUSTMENT OF ANY SITUATION, REGARDLESS OF ORIGIN, WHICH IT DEEMS LIKELY TO IMPAIR THE GENERAL WELFARE OR FRIENDLY RELATIONS AMONG THE PLANETS, INCLUDING SITUATIONS RESULTING FROM VIOLATIONS OF THE PROVISIONS OF THESE ARTICLES OF FEDERATION SETTING FORTH THE PURPOSES AND PRINCIPLES OF THE UNITED FEDERATION OF PLANETS;

## ARTICLE 15

1. THE SUPREME ASSEMBLY SHALL RECEIVE AND CONSIDER REGULAR AND SPECIAL REPORTS FROM THE FEDERATION COUNCIL; WHICH REPORTS SHALL INCLUDE AN ACCOUNT OF THE MEASURES THAT THE FEDERATION COUNCIL HAS DECIDED UPON OR TAKEN TO MAINTAIN INTERPLANETARY PEACE AND SECURITY;

2. THE SUPREME ASSEMBLY SHALL RECEIVE AND CONSIDER REPORTS FROM THE OTHER AGENCIES OF THE UNITED FEDERATION ON AGREED UPON REGULAR PERIODS OR REPORTING;

## ARTICLE 16

THE SUPREME ASSEMBLY SHALL PERFORM SUCH FUNCTIONS OF INTRA-GALACTIC TRUSTEESHIP AS ARE ASSIGNED TO IT UNDER CHAPTERS XII AND XIII, INCLUDING THE APPROVAL OF THE TRUSTEESHIP AGREEMENTS FOR AREAS WHICH ARE NOT DESIGNATED AS STRATEGIC;

## ARTICLE 17

1. THE SUPREME ASSEMBLY SHALL CONSIDER AND APPROVE THE BUDGET OF THE UNITED FEDERATION OF PLANETS;

2. THE EXPENSES OF THE UNITED FEDERATION OF PLANETS SHALL BE BORNE BY THE MEMBERS AS APPORTIONED BY THE SUPREME ASSEMBLY;



## ARTICLES OF FEDERATION

3. THE SUPREME ASSEMBLY SHALL CONSIDER AND APPROVE ANY FINANCIAL AND BUDGETARY ARRANGEMENTS WITH SPECIALIZED AGENCIES REFERRED TO IN ARTICLE 57 AND SHALL EXAMINE THE ADMINISTRATIVE BUDGETS OF SUCH SPECIALIZED AGENCIES WITH A VIEW TO MAKING RECOMMENDATIONS TO THE AGENCIES CONCERNED;

4. ALL BUDGETS OF, AND EXPENSES OF THE UNITED FEDERATION SHALL BE MADE AND PAID IN THE COMMON INTERPLANETARY CREDIT. THE COMMON INTERPLANETARY CREDIT SHALL BE THE OFFICIAL MEDIUM OF EXCHANGE WITHIN THE UNITED FEDERATION TREATY EXPLORATION TERRITORY;

## VOTING

## ARTICLE 18

1. EACH MEMBER OF THE SUPREME ASSEMBLY SHALL HAVE ONE VOTE;

2. DECISIONS OF THE SUPREME ASSEMBLY ON IMPORTANT QUESTIONS SHALL BE MADE ON A TWO-THIRDS (2/3) MAJORITY VOTE OF THE MEMBERS PRESENT AND VOTING. THESE QUESTIONS SHALL INCLUDE: RECOMMENDATIONS WITH RESPECT TO THE MAINTENANCE OF INTERPLANETARY PEACE AND SECURITY; THE ELECTION OF NON-PERMANENT MEMBERS TO THE FEDERATION COUNCIL; THE ELECTION OF MEMBERS OF THE TRUSTEESHIP COUNCIL IN ACCORDANCE WITH PARAGRAPH 1(C) OF ARTICLE 86; THE ADMISSION OF NEW MEMBERS TO THE FEDERATION; THE SUSPENSION OF THE RIGHTS AND PRIVILEGES OF MEMBERSHIP; THE EXPULSION OF MEMBERS; QUESTIONS RELATING TO THE OPERATION OF THE TRUSTEESHIP SYSTEM; AND BUDGETARY QUESTIONS;

3. DECISIONS ON OTHER QUESTIONS, INCLUDING THE DETERMINATION OF ADDITIONAL CATEGORIES OF QUESTIONS TO BE DECIDED BY A TWO-THIRDS (2/3) MAJORITY, SHALL BE MADE BY A MAJORITY VOTE OF THE MEMBERS PRESENT AND VOTING;

## ARTICLE 19

A MEMBER OF THE UNITED FEDERATION WHICH IS IN ARREARS IN THE PAYMENT OF ITS FINANCIAL OBLIGATIONS TO THE FEDERATION SHALL HAVE NO VOTE IN THE SUPREME ASSEMBLY IF THE AMOUNT IT IS IN ARREARS EQUALS OR EXCEEDS THE AMOUNT OF THE CONTRIBUTIONS DUE FROM IT FOR THE PRECEDING TWO ACCOUNTING PERIODS. THE SUPREME ASSEMBLY MAY, NEVERTHELESS, PERMIT SUCH A MEMBER TO VOTE IF IT IS SATISFIED THAT THE FAILURE TO PAY IS DUE TO CONDITIONS BEYOND THE CONTROL OF THE MEMBER.

## PROCEDURE

## ARTICLE 20

THE SUPREME ASSEMBLY SHALL MEET IN REGULAR PERIODIC SESSIONS AND IN SUCH SPECIAL SESSIONS AS OCCASION MAY REQUIRE. SPECIAL SESSIONS SHALL BE CONVOKED BY THE SUPREME-SECRETARIAT AT THE REQUEST OF THE FEDERATION COUNCIL OR OF A MAJORITY OF THE MEMBERS OF THE UNITED FEDERATION;

## ARTICLE 21

THE SUPREME ASSEMBLY SHALL ADOPT ITS OWN RULES OF PROCEDURE. IT SHALL ELECT ITS PRESIDENT FOR EACH SESSION;

## ARTICLE 22

THE SUPREME ASSEMBLY MAY ESTABLISH SUCH SUBSIDIARY AGENCIES AS IT DEEMS NECESSARY FOR THE PERFORMANCE OF ITS FUNCTIONS.

## CHAPTER V

## THE FEDERATION COUNCIL

## ARTICLE 23

## COMPOSITION

1. THE FEDERATION COUNCIL SHALL CONSIST OF ELEVEN (11) MEMBERS OF THE UNITED FEDERATION. THE UNITED NATIONS OF THE PLANET EARTH, THE PLANETARY CONFEDERATION OF 40 ERIDANI, THE UNITED PLANETS OF 61 CYGNI, THE STAR EMPIRE OF EPSILON INDII, AND THE ALPHA CENTAURI CONCORDIUM OF PLANETS SHALL BE PERMANENT MEMBERS OF THE FEDERATION COUNCIL. THE SUPREME ASSEMBLY SHALL

## ARTICLES OF FEDERATION

ELECT SIX (6) OTHER MEMBERS OF THE UNITED FEDERATION TO BE NON-PERMANENT MEMBERS OF THE FEDERATION COUNCIL, DUE REGARD BEING ESPECIALLY PAID, IN THE FIRST INSTANCE, TO THE CONTRIBUTION OF THE MEMBERS OF THE UNITED FEDERATION TO THE MAINTENANCE OF INTERPLANETARY PEACE AND SECURITY AND TO THE OTHER PURPOSES OF THE FEDERATION, AND ALSO TO EQUITABLE GEO-GALACTICAL DISTRIBUTION;

2. THE NON-PERMANENT MEMBERS OF THE FEDERATION COUNCIL SHALL BE ELECTED FOR A TERM OF TWO (2) SESSION PERIODS. IN THE FIRST ELECTION OF NON-PERMANENT MEMBERS, HOWEVER, THREE (3) SHALL BE ELECTED FOR A TERM OF ONE (1) SESSION PERIOD. A RETIRING MEMBER SHALL NOT BE ELIGIBLE FOR IMMEDIATE RE-ELECTION;

## FUNCTIONS AND POWERS

## ARTICLE 24

1. IN ORDER TO ASSURE PROMPT AND EFFECTIVE ACTION BY THE UNITED FEDERATION OF PLANETS, ITS MEMBERS CONFER ON THE FEDERATION COUNCIL PRIMARY RESPONSIBILITY FOR THE MAINTENANCE OF INTERPLANETARY PEACE AND SECURITY, AND AGREE THAT IN CARRYING OUT ITS DUTIES UNDER THIS RESPONSIBILITY THE FEDERATION COUNCIL ACTS ON THEIR BEHALF;

2. IN DISCHARGING THESE DUTIES THE FEDERATION COUNCIL SHALL ACT IN ACCORDANCE WITH THE PURPOSES AND PRINCIPLES OF THE UNITED FEDERATION. THE SPECIFIC POWERS GRANTED TO THE FEDERATION COUNCIL FOR THE DISCHARGE OF THESE DUTIES ARE LAID DOWN IN CHAPTERS VI, VII, VIII, AND XII;

3. THE FEDERATION COUNCIL SHALL SUBMIT REGULAR AND, WHEN NECESSARY, SPECIAL REPORTS TO THE SUPREME ASSEMBLY FOR ITS CONSIDERATION;

## ARTICLE 25

THE MEMBERS OF THE UNITED FEDERATION AGREE TO ACCEPT AND CARRY OUT THE DECISIONS OF THE FEDERATION COUNCIL IN ACCORDANCE WITH THESE ARTICLES OF FEDERATION;

## ARTICLE 26

IN ORDER TO PROMOTE THE ESTABLISHMENT AND MAINTENANCE OF INTERPLANETARY PEACE AND SECURITY WITH THE LEAST DIVERSION OF THE FEDERATION'S LIFE-FORMS, AND ECONOMIC RESOURCES FOR ARMAMENTS, THE FEDERATION COUNCIL SHALL BE RESPONSIBLE FOR FORMULATING, WITH THE ASSISTANCE OF STAR FLEET HEADQUARTERS STAFF REFERRED TO IN ARTICLE 47, PLANS TO BE SUBMITTED TO THE MEMBERS OF THE UNITED FEDERATION FOR THE ESTABLISHMENT OF A SYSTEM FOR THE REGULATION OF ARMAMENTS;

## ARTICLE 27

## VOTING

1. EACH MEMBER OF THE FEDERATION COUNCIL SHALL HAVE ONE VOTE;
2. DECISIONS OF THE FEDERATION COUNCIL ON PROCEDURAL MATTERS SHALL BE MADE BY AN AFFIRMATIVE VOTE OF SEVEN (7) MEMBERS;
3. DECISIONS OF THE FEDERATION COUNCIL ON ALL OTHER MATTERS SHALL BE MADE ON AFFIRMATIVE VOTE OF SEVEN (7) MEMBERS INCLUDING THE CONCURRING VOTES OF THE PERMANENT MEMBERS, PROVIDED THAT, IN DECISIONS UNDER CHAPTER VI, AND UNDER PARAGRAPH 3 OF ARTICLE 52, A PARTY TO THE DISPUTE SHALL REFRAIN FROM VOTING;

## PROCEDURE

## ARTICLE 28

1. THE FEDERATION COUNCIL SHALL BE SO ORGANIZED AS TO BE ABLE TO FUNCTION CONTINUOUSLY. EACH MEMBER OF THE FEDERATION COUNCIL SHALL, FOR THIS PURPOSE, BE REPRESENTED AT ALL TIMES AT THE SEAT OF THE FEDERATION;
2. THE FEDERATION COUNCIL SHALL HOLD PERIODIC MEETINGS AT WHICH EACH OF ITS MEMBERS MAY, IF IT SO DESIRES, BE REPRESENTED BY A MEMBER OF ITS GOVERNMENT

## ARTICLES OF FEDERATION

OR BY SOME OTHER SPECIALLY DESIGNATED REPRESENTATIVE;

3. THE FEDERATION COUNCIL MAY HOLD MEETINGS AT SUCH PLACES OTHER THAN THE SEAT OF THE FEDERATION AS IN ITS JUDGEMENT WILL FACILITATE ITS WORK;

## ARTICLE 29

THE FEDERATION COUNCIL MAY ESTABLISH SUCH SUBSIDIARY AGENCIES AS IT DEEMS NECESSARY FOR THE PERFORMANCE OF ITS FUNCTIONS;

## ARTICLE 30

THE FEDERATION COUNCIL SHALL ADOPT ITS OWN RULES OF PROCEDURE, INCLUDING THE METHOD OF SELECTING ITS GOVERNOR;

## ARTICLE 31

ANY MEMBER OF THE UNITED FEDERATION WHICH IS NOT A MEMBER OF THE FEDERATION COUNCIL MAY PARTICIPATE, WITHOUT VOTE, IN THE DISCUSSION OF ANY QUESTION BROUGHT BEFORE THE FEDERATION COUNCIL WHENEVER THE LATTER CONSIDERS THAT THE INTERESTS OF THE MEMBER ARE SPECIFICALLY AFFECTED;

## ARTICLE 32

ANY MEMBER OF THE UNITED FEDERATION WHICH IS NOT A MEMBER OF THE FEDERATION COUNCIL OR ANY PLANETARY SOCIAL SYSTEM WHICH IS NOT A MEMBER OF THE UNITED FEDERATION OF PLANETS, IF IT IS A PARTY TO A DISPUTE UNDER CONSIDERATION BY THE FEDERATION COUNCIL, SHALL BE INVITED TO PARTICIPATE, WITHOUT VOTE, IN THE DISCUSSION RELATING TO THE DISPUTE. THE FEDERATION COUNCIL SHALL LAY DOWN THE CONDITIONS AS IT DEEMS JUST FOR THE PARTICIPATION OF A PLANETARY SOCIAL SYSTEM WHICH IS NOT A MEMBER OF THE UNITED FEDERATION OF PLANETS.

## CHAPTER VI

## PACIFIC SETTLEMENT OF DISPUTES

## ARTICLE 33

1. THE PARTIES TO ANY DISPUTE, THE CONTINUANCE OF WHICH IS LIKELY TO ENDANGER THE MAINTENANCE OF INTERPLANETARY PEACE AND SECURITY, SHALL, FIRST OF ALL, SEEK A SOLUTION BY NEGOTIATION, ENQUIRY, MEDIATION, CONCILIATION, ARBITRATION, JUDICIAL SETTLEMENT, RESORT TO REGIONAL AGENCIES OR ARRANGEMENTS, OR OTHER PEACEFUL MEANS OF THEIR OWN CHOICE;
2. THE FEDERATION COUNCIL SHALL, WHEN IT DEEMS NECESSARY, CALL UPON THE PARTIES TO SETTLE THEIR DISPUTE BY SUCH MEANS;

## ARTICLE 34

THE FEDERATION COUNCIL MAY INVESTIGATE ANY DISPUTE, OR ANY SITUATION THAT MIGHT LEAD TO INTERPLANETARY FRICTION OR GIVE RISE TO A DISPUTE, IN ORDER TO DETERMINE WHETHER THE CONTINUANCE OF THE DISPUTE OR SITUATION IS LIKELY TO ENDANGER THE MAINTENANCE OF INTERPLANETARY PEACE AND SECURITY;

## ARTICLE 35

1. ANY MEMBER OF THE UNITED FEDERATION MAY BRING ANY DISPUTE, OR ANY SITUATION OF THE NATURE REFERRED TO IN ARTICLE 34, TO THE ATTENTION OF THE FEDERATION COUNCIL OR THE SUPREME ASSEMBLY;
2. A PLANETARY SOCIAL SYSTEM WHICH IS NOT A MEMBER OF THE UNITED FEDERATION OF PLANETS MAY BRING TO THE ATTENTION OF THE FEDERATION COUNCIL OR THE SUPREME ASSEMBLY ANY DISPUTE TO WHICH IT IS A PARTY IF IT ACCEPTS IN ADVANCE, FOR THE PURPOSES OF THE DISPUTE, THE OBLIGATION OF PACIFIC SETTLEMENT PROVIDED IN THESE ARTICLES OF FEDERATION;
3. THE PROCEEDINGS OF THE SUPREME ASSEMBLY IN RESPECT TO MATTERS BROUGHT TO ITS ATTENTION UNDER THIS ARTICLE WILL BE SUBJECT TO THE PROVISIONS OF ARTICLES 11 AND 12;

**STAR FLEET TECHNICAL ORDER**  
AUTHENTICATED STARDATE 7407.29

TO:00:01:07

**ARTICLE 36****ARTICLES OF FEDERATION**

1. THE FEDERATION COUNCIL MAY, AT ANY STAGE OF A DISPUTE OF THE NATURE REFERRED TO IN ARTICLE 33 OR OF A SITUATION OF LIKE NATURE, RECOMMEND PROCEDURES OR APPROPRIATE METHODS OF ADJUSTMENT;
2. THE FEDERATION COUNCIL SHALL TAKE INTO CONSIDERATION ANY PROCEDURES FOR THE SETTLEMENT OF THE DISPUTE WHICH HAVE ALREADY BEEN ADOPTED BY THE PARTIES;
3. IN MAKING RECOMMENDATIONS UNDER THE ARTICLE THE FEDERATION COUNCIL SHOULD ALSO TAKE INTO CONSIDERATION THAT LEGAL DISPUTES SHOULD AS A GENERAL RULE BE REFERRED TO THE INTERPLANETARY SUPREME COURT OF JUSTICE IN ACCORDANCE WITH THE PROVISIONS OF THE STATUTE OF THE COURT;

**ARTICLE 37**

1. SHOULD THE PARTIES TO A DISPUTE AS REFERRED TO IN ARTICLE 33 FAIL TO SETTLE IT BY MEANS INDICATED IN THAT ARTICLE, THEY SHALL REFER IT TO THE FEDERATION COUNCIL;
2. IF THE FEDERATION COUNCIL DEEMS THAT THE CONTINUANCE OF THE DISPUTE IS IN FACT LIKELY TO ENDANGER THE MAINTENANCE OF INTERPLANETARY PEACE AND SECURITY, IT SHALL DECIDE WHETHER TO TAKE ACTION UNDER ARTICLE 36 OR TO RECOMMEND SUCH TERMS AS IT MAY CONSIDER APPROPRIATE;

**ARTICLE 38**

WITHOUT PREJUDICE TO THE PROVISIONS OF ARTICLES 33 TO 37, THE FEDERATION COUNCIL MAY, IF ALL THE PARTIES TO ANY DISPUTE SO REQUEST, MAKE RECOMMENDATIONS TO THE PARTIES WITH A VIEW TO A PACIFIC SETTLEMENT OF THE DISPUTE.

**CHAPTER VII**

**ACTION WITH RESPECT TO THREATS TO THE PEACE,  
BREACHES OF THE PEACE, AND ACTS OF AGGRESSION**

**ARTICLE 39**

THE FEDERATION COUNCIL SHALL DETERMINE THE EXISTENCE OF ANY THREAT TO THE PEACE, BREACH OF THE PEACE, OR ACT OF AGGRESSION AND SHALL MAKE RECOMMENDATIONS TO MAINTAIN OR RESTORE INTERPLANETARY PEACE AND SECURITY;

**ARTICLE 40**

IN ORDER TO PREVENT AGGRAVATION OF THE SITUATION, THE FEDERATION COUNCIL MAY CALL UPON THE PARTIES CONCERNED TO COMPLY WITH SUCH PROVISIONAL MEASURES AS IT DEEMS NECESSARY OR DESIRABLE. SUCH PROVISIONAL MEASURES SHALL BE WITHOUT PREJUDICE TO THE RIGHTS, CLAIMS, OR POSITION OF THE PARTIES CONCERNED. THE FEDERATION COUNCIL SHALL TAKE INTO ACCOUNT ANY FAILURE TO COMPLY WITH SUCH PROVISIONAL MEASURES;

**ARTICLE 41**

THE FEDERATION COUNCIL MAY DECIDE WHAT MEASURES SHORT OF THE USE OF ARMED FORCE ARE TO BE EMPLOYED TO GIVE EFFECT TO ITS DECISIONS, AND MAY CALL UPON THE MEMBERS OF THE UNITED FEDERATION TO APPLY SUCH MEASURES. THESE MAY INCLUDE PARTIAL OR COMPLETE INTERRUPTION OF ECONOMIC RELATIONS, INTER-PLANET RADIO AND SPACE TRAVEL, AND SEVERANCE OF DIPLOMATIC RELATIONS;

**ARTICLE 42**

SHOULD THE FEDERATION COUNCIL CONSIDER THAT MEASURES UNDER ARTICLE 41 WOULD BE INADEQUATE OR HAVE PROVED TO BE INADEQUATE, IT MAY TAKE SUCH ACTION BY ARMED FORCE AS NECESSARY TO MAINTAIN OR RESTORE INTERPLANETARY PEACE AND SECURITY. SUCH ACTION MAY INCLUDE DEMONSTRATIONS, BLOCKADES, AND OTHER OPERATIONS BY STAR FLEET COMBINED PEACE-KEEPING FORCES;

**ARTICLE 43**

ALL MEMBERS OF THE UNITED FEDERATION IN OBLIGATION TO THE MAINTENANCE OF INTERPLANETARY PEACE AND SECURITY, AGREE TO MAKE AVAILABLE TO STAR FLEET, ON

## ARTICLES OF FEDERATION

CALL OF THE FEDERATION COUNCIL, ARMED FORCES, ASSISTANCE, AND FACILITIES, INCLUDING RIGHTS OF PASSAGE, NECESSARY FOR THE MAINTENANCE OF INTERPLANETARY PEACE AND SECURITY;

## ARTICLE 44

WHEN THE FEDERATION COUNCIL HAS DECIDED TO USE FORCE IT SHALL, BEFORE CALLING UPON A MEMBER NOT REPRESENTED ON IT TO PROVIDE ARMED FORCES IN FULFILLMENT OF OBLIGATIONS ASSUMED UNDER ARTICLE 43, INVITE THAT MEMBER TO PARTICIPATE IN THE DECISIONS OF THE FEDERATION COUNCIL RELATING TO THE EMPLOYMENT OF CONTINGENTS OF THE MEMBER'S ARMED FORCES;

## ARTICLE 45

IN ORDER TO ENABLE THE UNITED FEDERATION TO TAKE URGENT MILITARY MEASURES, ALL MEMBERS SO CAPABLE, SHALL ASSIGN CONTINGENTS OF THEIR ARMED FORCES TO STAR FLEET TO BE EMPLOYED AS A SINGLE PEACE-KEEPING FORCE OF THE UNITED FEDERATION OF PLANETS. ALL CONTINGENTS SO ASSIGNED, AND FOR THE DURATION OF THEIR ASSIGNMENT, SHALL HOLD FULL FAITH AND LOYALTY TO THE UNITED FEDERATION OF PLANETS AND THE PROTECTION OF THE PURPOSES AND PRINCIPLES OF THESE ARTICLES OF FEDERATION;

## ARTICLE 46

PLANS FOR THE APPLICATION OF STAR FLEET ARMED FORCES SHALL BE MADE BY THE FEDERATION COUNCIL WITH THE ASSISTANCE OF THE MILITARY STAFF COMMITTEE OF STAR FLEET HEADQUARTERS;

## ARTICLE 47

1. THERE SHALL BE ESTABLISHED WITHIN STAR FLEET A MILITARY STAFF COMMITTEE TO ADVISE AND ASSIST THE FEDERATION COUNCIL ON ALL MATTERS RELATING TO THE UNITED FEDERATION'S MILITARY REQUIREMENTS FOR MAINTAINING INTERPLANETARY PEACE AND SECURITY;
2. THE MILITARY STAFF COMMITTEE SHALL CONSIST OF THE CHIEFS OF STAFF OF THE PERMANENT MEMBERS OF THE FEDERATION COUNCIL, OR THEIR REPRESENTATIVES. ANY MEMBER OF THE UNITED FEDERATION MAY BE INVITED TO PROVIDE REPRESENTATION ON THE MILITARY STAFF COMMITTEE WHERE ITS RESPONSIBILITIES REQUIRES THE PARTICIPATION OF THAT MEMBER IN ITS WORK;
3. THE MILITARY STAFF COMMITTEE, WITH THE AUTHORIZATION OF THE FEDERATION COUNCIL, SHALL ESTABLISH A STAR FLEET AS THE ARMED, PEACE-KEEPING, FORCES OF THE UNITED FEDERATION OF PLANETS. IT SHALL BE RESPONSIBLE FOR THE ESTABLISHMENT AND MAINTENANCE OF ALL FACILITIES OF STAR FLEET, INCLUDING ARMED SHIPS, STARBASES, AND TRAINING FACILITIES;
4. THE MILITARY STAFF COMMITTEE SHALL BE RESPONSIBLE UNDER THE FEDERATION COUNCIL FOR THE STRATEGIC DIRECTION OF STAR FLEET ARMED FORCES, AND THE OTHER ARMED FORCES OF THE MEMBERS WHEN REQUIRED FOR THE MAINTENANCE OF INTERPLANETARY PEACE AND SECURITY;

## ARTICLE 48

THE ACTION REQUIRED TO CARRY OUT DECISIONS OF THE FEDERATION COUNCIL FOR THE MAINTENANCE OF INTERPLANETARY PEACE AND SECURITY SHALL BE TAKEN BY STAR FLEET, USING SUCH CONTINGENTS AS APPROPRIATE TO THE SPECIFIC ACTION;

## ARTICLE 49

THE MEMBERS OF THE UNITED FEDERATION SHALL JOIN IN AFFORDING MUTUAL ASSISTANCE IN CARRYING OUT THE MEASURES DECIDED UPON BY THE FEDERATION COUNCIL AND IN ASSISTING STAR FLEET IN THE PERFORMANCE OF ITS DUTIES AND OBLIGATIONS;

## ARTICLE 50

IF PREVENTIVE OR ENFORCEMENT MEASURES AGAINST ANY PLANET ARE TAKEN BY THE FEDERATION COUNCIL, ANY OTHER PLANET, WHETHER A MEMBER OF THE UNITED FEDERATION-

## STAR FLEET TECHNICAL ORDER

AUTHENTICATED STARDATE 7305.29

TO:00:01:09

## ARTICLES OF FEDERATION

TION OR NOT, WHICH FINDS ITSELF CONFRONTED WITH SPECIAL ECONOMIC PROBLEMS ARISING FROM THE CARRYING OUT OF THESE MEASURES SHALL HAVE THE RIGHT TO CONSULT WITH THE FEDERATION COUNCIL WITH REGARD TO THE SOLUTION OF ITS PROBLEMS;

## ARTICLE 51

NOTHING IN THESE ARTICLES OF FEDERATION SHALL IMPAIR THE INHERENT RIGHT OF INDIVIDUAL OR COLLECTIVE SELF-DEFENSE AGAINST ARMED ATTACKS OCCURRING TO MEMBERS OF THE UNITED FEDERATION, UNTIL THE FEDERATION COUNCIL HAS TAKEN MEASURES NECESSARY TO MAINTAIN INTERPLANETARY PEACE AND SECURITY, AND STAR FLEET FORCES CAN BE BROUGHT INTO ACTION. SUCH ACTIONS TAKEN BY MEMBERS OF THE UNITED FEDERATION IN THEIR SELF-DEFENSE SHALL BE IMMEDIATELY REPORTED TO THE FEDERATION COUNCIL.

## CHAPTER VIII

## STAR FLEET

## ARTICLE 52

1. THERE IS ESTABLISHED A STAR FLEET AS THE ARMED PEACE-KEEPING FORCES OF THE UNITED FEDERATION OF PLANETS. IT SHALL INITIALLY BE COMPRISED OF CONTINGENTS ASSIGNED TO IT BY MEMBERS OF THE UNITED FEDERATION UNDER ARTICLE 43 UNTIL SUCH TIME AS FACILITIES, RECRUITMENT, AND TRAINING OBTAIN THE NECESSITY OF DRAWING UPON THE ARMAMENT OF ANY MEMBER, EXCEPT AS PROVIDED IN ARTICLE 49;
2. THE OPERATIONS AND ACTIONS OF STAR FLEET SHALL AT ALL TIMES BE UNDER THE DIRECT COGNIZANCE OF THE FEDERATION COUNCIL AND THE MILITARY STAFF COMMITTEE WHICH SHALL ALSO PREPARE AND APPROVE THE BUDGET FOR STAR FLEET OPERATIONS;
3. INITIAL EXPENDITURE IS AUTHORIZED UNDER THESE ARTICLES OF FEDERATION FOR THE ESTABLISHMENT OF A STAR FLEET HEADQUARTERS AND TWO STARBASES TO BE EQUIVOCALLY LOCATED WITHIN THE BOUNDARY OF THE UNITED FEDERATION OF PLANETS AND OUTSIDE OF ANY POSSIBLE CONFLICT WITH THE TERRITORIAL BOUNDARIES OF ANY MEMBER OF THE UNITED FEDERATION. THE FEDERATION COUNCIL SHALL REVIEW AND APPROVE SUCH OTHER EXPANSIONS OF STARBASES AND OTHER FACILITIES AS SHALL SEEM APPROPRIATE FROM TIME TO TIME IN THE MAINTENANCE OF INTERPLANETARY PEACE AND SECURITY;
4. INITIAL EXPENDITURE IS ALSO GRANTED UNDER THESE ARTICLES OF FEDERATION FOR THE ESTABLISHMENT OF A STAR FLEET ACADEMY FOR THE PURPOSE OF TRAINING OFFICERS AND PERSONNEL FOR STAR FLEET DUTY. THE STANDARDS FOR TRAINING SUCH OFFICERS AND PERSONNEL SHALL BE DETERMINED BY THE MILITARY STAFF COMMITTEE AND APPROVED BY THE FEDERATION COUNCIL;

## ARTICLE 53

1. INITIAL EXPENDITURE IS GRANTED UNDER THESE ARTICLES OF FEDERATION FOR THE DESIGN, PROCUREMENT, AND OPERATION OF FOURTEEN (14) HEAVY CRUISER TYPE OF STARSHIPS TO PROVIDE THE NUCLEUS OF STAR FLEET'S PEACE-KEEPING ARMED FORCES. THESE CRUISERS SHALL BE CAPABLE OF EXTENDED DURATION PATROL OF INTRA-GALACTIC RANGE, WITH WEAPONRY APPROPRIATE TO SUCH CLASS OF STARSHIPS. THEY SHALL BE PROVIDED WITH FIRE-POWER SUPERIOR TO THAT NOW EMPLOYED BY ANY MEMBER OF THE UNITED FEDERATION, AND APPROPRIATE TO THE TASKS EXPECTED OF THEM;
2. EXPENDITURE IS ALSO GRANTED UNDER THESE ARTICLES OF FEDERATION FOR THE PROCUREMENT OR CONSTRUCTION OF SUCH LESSER CLASSES OF SPACE FORCES AS SHALL BE REQUIRED TO SUPPORT STAR FLEET OPERATIONS AND THE HEAVY CRUISER CLASS OF STARSHIPS. THESE MAY BE, BUT NOT NECESSARILY LIMITED TO, TYPES SUCH AS SCOUTS, DESTROYERS, TRANSPORTS, RE-SUPPLY, SHUTTLECRAFT, AND SURVEY SHIPS;

## ARTICLE 54

1. THE TRAINING OF BASE PERSONNEL AND SHIP COMPLEMENTS SHALL INCLUDE ALL FIELDS OF SCIENCE AND TECHNOLOGY AS WELL AS THE MILITARY ARTS IN STAR FLEET. IT IS THE INTENT OF THESE ARTICLES OF FEDERATION THAT STAR FLEET SHALL BE

## ARTICLES OF FEDERATION

USED TO CONDUCT MISSIONS OF SCIENTIFIC EXPLORATION AND INVESTIGATION WITHIN THE TREATY EXPLORATION TERRITORY WHENEVER ITS SERVICES ARE NOT REQUIRED IN THE MAINTENANCE OF INTERPLANETARY PEACE AND SECURITY;

2. STAR FLEET HEADQUARTERS AND THE FEDERATION COUNCIL SHALL BE AT ALL TIMES KEPT INFORMED OF THE ACTIVITIES UNDERTAKEN, OR CONTEMPLATED, FOR THE SCIENTIFIC EXPLORATION AND INVESTIGATION OF THE TREATY EXPLORATION TERRITORY. ANY SHIP SO EMPLOYED SHALL BE DETACHED FROM MILITARY FLEET DUTY AND RE-ASSIGNED AS A NON-MILITARY SCIENTIFIC UNIT OF THE UNITED FEDERATION.

## CHAPTER IX

INTERPLANETARY ECONOMIC  
AND SOCIAL COOPERATION

## ARTICLE 55

WITH A VIEW TO CREATING CONDITIONS OF STABILITY AND WELL-BEING WHICH ARE NECESSARY FOR PEACEFUL RELATIONS AMONG PLANETARY SOCIAL SYSTEMS BASED ON RESPECT FOR THE PRINCIPLES OF EQUAL RIGHTS AND SELF-DETERMINATION OF ALL INTELLIGENT LIFE-FORMS, THE UNITED FEDERATION OF PLANETS SHALL PROMOTE:

- A) HIGHER STANDARDS OF LIVING, FULL EMPLOYMENT, AND CONDITIONS OF ECONOMIC AND SOCIAL PROGRESS AND DEVELOPMENT;
- B) SOLUTION OF INTERPLANETARY ECONOMIC, SOCIAL, HEALTH, AND RELATED PROBLEMS; AND INTERPLANETARY CULTURAL AND EDUCATIONAL COOPERATION;  
AND
- C) UNIVERSAL RESPECT FOR, AND OBSERVANCE OF, INTELLIGENT LIFE-FORM RIGHTS AND FUNDAMENTAL FREEDOMS FOR ALL WITHOUT DISTINCTION AS TO CULTURE, SEX, LANGUAGE, OR RELIGION;

## ARTICLE 56

ALL MEMBERS PLEDGE THEMSELVES TO TAKE JOINT AND SEPARATE ACTION IN CO-OPERATION WITH THE UNITED FEDERATION FOR THE ACHIEVEMENT OF THE PURPOSES AND GOALS SET FORTH IN ARTICLE 55;

## ARTICLE 57

1. THE VARIOUS SPECIALIZED AGENCIES, ESTABLISHED BY INTERPLANETARY AGREEMENT AND HAVING WIDE INTERPLANETARY RESPONSIBILITIES AS DEFINED IN THEIR BASIC INSTRUMENTS IN ECONOMIC, SOCIAL, CULTURAL, EDUCATIONAL, HEALTH, AND RELATED FIELDS, SHALL BE BROUGHT INTO RELATIONSHIP WITH THE UNITED FEDERATION IN ACCORDANCE WITH ARTICLE 63;

2. SUCH AGENCIES THUS BROUGHT INTO RELATIONSHIP WITH THE UNITED FEDERATION ARE HEREAFTER REFERRED TO AS SPECIALIZED AGENCIES;

## ARTICLE 58

THE UNITED FEDERATION SHALL MAKE RECOMMENDATIONS FOR THE COORDINATION OF THE POLICIES AND ACTIVITIES OF THE SPECIALIZED AGENCIES;

## ARTICLE 59

THE UNITED FEDERATION SHALL, WHERE APPROPRIATE, INITIATE NEGOTIATIONS AMONG ITS MEMBERS CONCERNED FOR THE CREATION OF ANY NEW SPECIALIZED AGENCIES REQUIRED FOR THE ACCOMPLISHMENT OF THE PURPOSES SET FORTH IN ARTICLE 55;

## ARTICLE 60

RESPONSIBILITY FOR THE DISCHARGE OF THE FUNCTIONS OF THE UNITED FEDERATION AS SET FORTH IN THIS CHAPTER SHALL BE VESTED IN THE SUPREME ASSEMBLY AND, UNDER THE AUTHORITY OF THE SUPREME ASSEMBLY, IN THE ECONOMIC AND SOCIAL COUNCIL WHICH SHALL HAVE FOR THIS PURPOSE THE POWERS SET FORTH IN CHAPTER X.

## CHAPTER X

## THE ECONOMIC AND SOCIAL COUNCIL

TO:00:01:11

# STAR FLEET TECHNICAL ORDER

AUTHENTICATED STARDATE 7305.29

## COMPOSITION ARTICLE 61

## ARTICLES OF FEDERATION

1. THE ECONOMIC AND SOCIAL COUNCIL SHALL CONSIST OF EIGHTEEN (18) MEMBERS OF THE UNITED FEDERATION AS ELECTED BY THE SUPREME ASSEMBLY;
2. SUBJECT TO THE PROVISIONS OF PARAGRAPH 3, SIX (6) MEMBERS OF THE ECONOMIC AND SOCIAL COUNCIL SHALL BE ELECTED EACH SESSION PERIOD FOR A TERM OF THREE (3) SESSION PERIODS. A RETIRING MEMBER SHALL BE ELIGIBLE FOR IMMEDIATE RE-ELECTION;
3. AT THE FIRST ELECTION, EIGHTEEN (18) MEMBERS OF THE ECONOMIC AND SOCIAL COUNCIL SHALL BE CHOSEN, THE TERM OF OFFICE OF SIX (6) MEMBERS SO CHOSEN WILL EXPIRE AT THE END OF ONE (1) SESSION PERIOD, AND THE TERMS OF SIX (6) OTHER MEMBERS AT THE END OF TWO (2) SESSION PERIODS IN ACCORDANCE WITH ARRANGEMENTS MADE BY THE SUPREME ASSEMBLY;
4. EACH MEMBER OF THE ECONOMIC AND SOCIAL COUNCIL SHALL HAVE ONE (1) REPRESENTATIVE;

## FUNCTIONS AND POWERS ARTICLE 62

1. THE ECONOMIC AND SOCIAL COUNCIL MAY MAKE OR INITIATE STUDIES AND REPORTS WITH RESPECT TO INTERPLANETARY ECONOMIC, SOCIAL, CULTURAL, EDUCATIONAL, HEALTH, AND RELATED MATTERS AND MAY MAKE RECOMMENDATIONS WITH RESPECT TO ANY SUCH MATTERS TO THE SUPREME ASSEMBLY, TO THE MEMBERS OF THE UNITED FEDERATION, AND TO SPECIALIZED AGENCIES CONCERNED;
2. IT MAY MAKE RECOMMENDATIONS FOR THE PURPOSE OF PROMOTING RESPECT FOR, AND OBSERVANCE OF, INTELLIGENT LIFE-FORM RIGHTS AND FUNDAMENTAL FREEDOMS FOR ALL;
3. IT MAY PREPARE DRAFT INSTRUMENTS WITH THE RULES PRESCRIBED BY THE UNITED FEDERATION;
4. IT MAY PREPARE DRAFT INSTRUMENTS FOR ADMISSION TO THE SUPREME ASSEMBLY, WITH RESPECT TO MATTERS FALLING WITHIN ITS COMPETENCE;
5. IT MAY CALL, IN ACCORDANCE WITH THE RULES PRESCRIBED BY THE UNITED FEDERATION, INTERPLANETARY CONFERENCES ON MATTERS FALLING WITHIN ITS COMPETENCE;

## ARTICLE 63

1. THE ECONOMIC AND SOCIAL COUNCIL MAY ENTER INTO AGREEMENTS WITH ANY OF ITS AGENCIES REFERRED TO IN ARTICLE 57, DEFINING THE TERMS ON WHICH THE AGENCY CONCERNED SHALL BE BROUGHT INTO RELATIONSHIP WITH THE UNITED FEDERATION. SUCH AGREEMENTS SHALL BE SUBJECT TO APPROVAL BY THE SUPREME ASSEMBLY;
2. IT MAY COORDINATE THE ACTIVITIES OF THE SPECIALIZED AGENCIES THROUGH CONSULTATION WITH AND RECOMMENDATIONS TO SUCH AGENCIES AND THROUGH RECOMMENDATIONS TO THE SUPREME ASSEMBLY AND TO THE MEMBERS OF THE UNITED FEDERATION;

## ARTICLE 64

THE ECONOMIC AND SOCIAL COUNCIL MAY TAKE APPROPRIATE STEPS TO OBTAIN REPORTS FROM THE SPECIALIZED AGENCIES. IT MAY MAKE ARRANGEMENTS WITH THE MEMBERS OF THE UNITED FEDERATION AND WITH THE SPECIALIZED AGENCIES TO OBTAIN REPORTS ON THE STEPS TAKEN TO GIVE EFFECT TO ITS OWN RECOMMENDATIONS AND TO RECOMMENDATIONS ON MATTER FALLING WITHIN ITS COMPETENCE BY THE SUPREME ASSEMBLY;

## ARTICLE 65

THE ECONOMIC AND SOCIAL COUNCIL MAY FURNISH INFORMATION TO THE FEDERATION COUNCIL AND SHALL ASSIST THE FEDERATION COUNCIL UPON ITS REQUEST;

## ARTICLE 66

1. THE ECONOMIC AND SOCIAL COUNCIL SHALL PERFORM SUCH FUNCTIONS AS FALL



## ARTICLES OF FEDERATION

WITHIN ITS COMPETENCE IN CONNECTION WITH THE CARRYING OUT OF THE RECOMMENDATIONS OF THE SUPREME ASSEMBLY;

2. IT MAY, WITH THE APPROVAL OF THE SUPREME ASSEMBLY, PERFORM SERVICES AT THE REQUEST OF MEMBERS OF THE UNITED FEDERATION AND AT THE REQUEST OF SPECIALIZED AGENCIES;

3. IT SHALL PERFORM SUCH OTHER FUNCTIONS AS ARE SPECIFIED ELSEWHERE IN THESE ARTICLES OF FEDERATION OR AS MAY BE ASSIGNED TO IT BY THE SUPREME ASSEMBLY;

VOTING  
ARTICLE 67

1. EACH MEMBER OF THE ECONOMIC AND SOCIAL COUNCIL SHALL HAVE ONE VOTE;

2. DECISIONS OF THE ECONOMIC AND SOCIAL COUNCIL SHALL BE MADE BY A MAJORITY OF THE MEMBERS PRESENT AND VOTING;

PROCEDURES  
ARTICLE 68

THE ECONOMIC AND SOCIAL COUNCIL SHALL SET UP COMMISSIONS IN ECONOMIC AND SOCIAL FIELDS AND FOR THE PROMOTION OF INTELLIGENT LIFE-FORM RIGHTS, AND SUCH OTHER COMMISSIONS AS MAY BE REQUIRED FOR THE PERFORMANCE OF ITS FUNCTIONS;

## ARTICLE 69

THE ECONOMIC AND SOCIAL COUNCIL SHALL INVITE ANY MEMBER OF THE UNITED FEDERATION TO PARTICIPATE, WITHOUT VOTE, IN ITS DELIBERATIONS ON ANY MATTER OF PARTICULAR CONCERN TO THAT MEMBER;

## ARTICLE 70

THE ECONOMIC AND SOCIAL COUNCIL MAY MAKE ARRANGEMENTS FOR REPRESENTATIVES OF THE SPECIALIZED AGENCIES TO PARTICIPATE, WITHOUT VOTE, IN ITS DELIBERATIONS AND IN THOSE COMMISSIONS ESTABLISHED BY IT, AND FOR ITS REPRESENTATIVES TO PARTICIPATE IN THE DELIBERATIONS OF THE SPECIALIZED AGENCIES;

## ARTICLE 71

THE ECONOMIC AND SOCIAL COUNCIL MAY MAKE SUITABLE ARRANGEMENTS FOR CONSULTATION WITH NON-GOVERNMENTAL INTRA-PLANET ORGANIZATIONS WHICH ARE CONCERNED WITH MATTERS WITHIN ITS COMPETENCE. SUCH ARRANGEMENTS MAY BE MADE WITH INTERPLANETARY ORGANIZATIONS AND, WHERE APPROPRIATE, WITH PLANETARY ORGANIZATIONS AFTER CONSULTATION WITH MEMBERS OF THE UNITED FEDERATION CONCERNED;

## ARTICLE 72

1. THE ECONOMIC AND SOCIAL COUNCIL SHALL ADOPT ITS OWN RULES OF PROCEDURE, INCLUDING THE METHOD OF SELECTING ITS DIRECTOR;

2. THE ECONOMIC AND SOCIAL COUNCIL SHALL MEET AS REQUIRED IN ACCORDANCE WITH ITS RULES, WHICH SHALL INCLUDE PROVISION FOR THE CONVENING OF MEETINGS ON THE REQUEST OF A MAJORITY OF ITS MEMBERS.

## CHAPTER XI

DECLARATION REGARDING NON-  
SELF-GOVERNING REGIONS

## ARTICLE 73

MEMBERS OF THE UNITED FEDERATION WHICH HAVE ASSUMED RESPONSIBILITIES FOR THE ADMINISTRATION OF REGIONS WHOSE INTELLIGENT LIFE-FORMS HAVE NOT YET ATTAINED A FULL MEASURE OF SELF-GOVERNMENT RECOGNIZE THE PRINCIPLE THAT THE INTERESTS OF THE INHABITANTS OF THESE REGIONS ARE PARAMOUNT, AND ACCEPT AS A SACRED TRUST THE OBLIGATION TO PROMOTE TO THE UTMOST, WITHIN THE SYSTEM OF INTERPLANETARY PEACE AND SECURITY ESTABLISHED BY THESE ARTICLES OF FEDERATION, THE WELL-BEING OF THE INHABITANTS OF THESE REGIONS, AND, TO THIS END:

A) TO ENSURE, WITH DUE RESPECT FOR THE CULTURES OF THE INTELLIGENT LIFE-

## STAR FLEET TECHNICAL ORDER

AUTHENTICATED STARDATE 7305.29

TO:00:01:13

## ARTICLES OF FEDERATION

FORMS CONCERNED, THEIR POLITICAL, ECONOMIC, SOCIAL, AND EDUCATIONAL ADVANCEMENT, THEIR JUST TREATMENT, AND THEIR PROTECTION AGAINST ABUSES;

- B) TO DEVELOP SELF-GOVERNMENT, TO TAKE DUE ACCOUNT OF THE POLITICAL ASPIRATIONS OF THE INTELLIGENT LIFE-FORMS, AND TO ASSIST THEM IN THE PROGRESSIVE DEVELOPMENT OF THEIR FREE POLITICAL INSTITUTIONS, ACCORDING TO THE PARTICULAR CIRCUMSTANCES OF EACH REGION AND ITS INTELLIGENT LIFE-FORMS AND THEIR VARYING STAGES OF ADVANCEMENT;
- C) TO FURTHER INTERPLANETARY PEACE AND SECURITY;
- D) TO PROMOTE CONSTRUCTIVE MEASURES OF DEVELOPMENT, TO ENCOURAGE RESEARCH, AND TO COOPERATE WITH ONE-ANOTHER AND, WHEN AND WHERE APPROPRIATE, WITH SPECIALIZED INTERPLANETARY BODIES WITH A VIEW TO THE PRACTICAL ACHIEVEMENT OF THE SOCIAL, ECONOMIC, AND SCIENTIFIC PURPOSES SET FORTH IN THIS ARTICLE; AND
- E) TO TRANSMIT REGULARLY TO THE SUPREME-SECRETARIAT FOR INFORMATION PURPOSES, SUBJECT TO SUCH LIMITATIONS AS SECURITY AND STATUTORY CONSIDERATIONS MAY REQUIRE, STATISTICAL AND OTHER INFORMATION OF A TECHNICAL NATURE RELATING TO ECONOMIC, SOCIAL, AND EDUCATIONAL CONDITIONS IN THE REGIONS FOR WHICH THEY ARE RESPECTIVELY RESPONSIBLE OTHER THAN THOSE REGIONS TO WHICH CHAPTER XII AND XIII APPLY;

## ARTICLE 74

MEMBERS OF THE UNITED FEDERATION ALSO AGREE THAT THEIR POLICY IN RESPECT OF THE REGIONS TO WHICH THIS CHAPTER APPLIES, NO LESS THAN IN RESPECT OF THEIR METROPOLITAN AREAS, MUST BE BASED ON THE GENERAL PRINCIPLE OF GOOD-NEIGHBORLINESS, DUE ACCOUNT BEING TAKEN OF THE INTERESTS AND WELL-BEING OF THE REST OF THE FEDERATION TERRITORY IN SOCIAL, ECONOMIC, AND COMMERCIAL MATTERS.

## CHAPTER XII

## INTERPLANETARY TRUSTEESHIP SYSTEM

## ARTICLE 75

THE UNITED FEDERATION SHALL ESTABLISH UNDER ITS AUTHORITY AN INTERPLANETARY TRUSTEESHIP SYSTEM FOR THE ADMINISTRATION AND SUPERVISION OF SUCH REGIONS AS MAY BE PLACED THEREUNDER BY SUBSEQUENT INDIVIDUAL AGREEMENTS. THESE REGIONS ARE HEREINAFTER REFERRED TO AS TRUST REGIONS;

## ARTICLE 76

THE BASIC OBJECTIVES OF THE TRUSTEESHIP SYSTEM, IN ACCORDANCE WITH THE PURPOSES AND PRINCIPLES OF THE UNITED FEDERATION AS LAID DOWN IN THESE ARTICLES OF FEDERATION, SHALL BE:

- A) TO FURTHER INTERPLANETARY PEACE AND SECURITY;
- B) TO PROMOTE THE POLITICAL, ECONOMIC, SOCIAL, AND EDUCATIONAL ADVANCEMENT OF THE INHABITANTS OF THE TRUST REGIONS, AND THEIR PROGRESSIVE DEVELOPMENT TOWARDS SELF-GOVERNMENT OR INDEPENDENCE AS MAY BE APPROPRIATE TO THE PARTICULAR CIRCUMSTANCES OF EACH REGION AND ITS INTELLIGENT LIFE-FORMS CONCERNED, AND AS MAY BE PROVIDED BY THE TERMS OF THE TRUSTEESHIP AGREEMENT;
- C) TO ENCOURAGE RESPECT FOR INTELLIGENT LIFE-FORM RIGHTS AND FOR FUNDAMENTAL FREEDOMS FOR ALL WITHOUT DISTINCTION AS TO CULTURE, SEX, LANGUAGE, OR RELIGION, AND TO ENCOURAGE RECOGNITION OF THE INTERDEPENDENCE OF THE INTELLIGENT LIFE-FORMS OF THE GALAXY; AND
- D) TO ENSURE EQUAL TREATMENT IN SOCIAL, ECONOMIC, AND COMMERCIAL MATTERS FOR ALL MEMBERS OF THE UNITED FEDERATION AND THEIR NATIONALS, AND ALSO

## ARTICLES OF FEDERATION

EQUAL TREATMENT FOR THE LATTER IN THE ADMINISTRATION OF JUSTICE, WITHOUT PREJUDICE TO THE ADJUSTMENT OF THE FOREGOING OBJECTIVES AND SUBJECT TO THE PROVISIONS OF ARTICLE 80;

## ARTICLE 77

1. THE TRUSTEESHIP SYSTEM SHALL APPLY TO SUCH REGIONS IN THE FOLLOWING CATEGORIES AS MAY BE PLACED THEREUNDER BY MEANS OF TRUSTEESHIP AGREEMENTS:

- A) REGIONS NOW HELD UNDER MANDATE;
- B) REGIONS WHICH MAY BE DETACHED FROM ALIEN SOCIAL SYSTEMS AS A RESULT OF INTERPLANETARY WAR; AND
- C) REGIONS VOLUNTARILY PLACED UNDER THE TRUSTEESHIP SYSTEM BY SOCIAL SYSTEMS RESPONSIBLE FOR THEIR ADMINISTRATION;

2. IT WILL BE A MATTER FOR SUBSEQUENT AGREEMENT AS TO WHICH REGIONS IN THE FOREGOING CATEGORIES WILL BE BROUGHT UNDER THE TRUSTEESHIP SYSTEM AND UPON WHAT TERMS;

## ARTICLE 78

THE TRUSTEESHIP SYSTEM SHALL NOT APPLY TO REGIONS WHICH HAVE BECOME MEMBERS OF THE UNITED FEDERATION OF PLANETS, RELATIONSHIP AMONG WHICH SHALL BE BASED ON THE RESPECT FOR THE PRINCIPLE OF SOVERIEGN EQUALITY;

## ARTICLE 79

THE TERMS OF TRUSTEESHIP FOR EACH REGION TO BE PLACED UNDER THE TRUSTEESHIP SYSTEM, INCLUDING ANY ALTERATION OR AMENDMENT, SHALL BE AGREED UPON BY THE SOCIAL SYSTEMS DIRECTLY CONCERNED, INCLUDING THE MANDATORY POWER IN THE CASE OF REGIONS HELD UNDER MANDATE BY A MEMBER OF THE UNITED FEDERATION, AND SHALL BE APPROVED AS PROVIDED FOR IN ARTICLES 83 AND 85;

## ARTICLE 80

1. EXCEPT AS MAY BE AGREED UPON IN INDIVIDUAL TRUSTEESHIP AGREEMENTS, MADE UNDER ARTICLES 77, 79, AND 81, PLACING EACH REGION UNDER THE TRUSTEESHIP SYSTEM, AND UNTIL SUCH AGREEMENTS HAVE BEEN CONCLUDED, NOTHING IN THIS CHAPTER SHALL BE CONSTRUED IN OR OF ITSELF TO ALTER IN ANY MANNER THE RIGHTS WHATSOEVER OF ANY SOCIAL SYSTEMS OR ANY INTELLIGENT LIFE-FORMS OR THE TERMS OF EXISTING AGREEMENTS TO WHICH MEMBERS OF THE UNITED FEDERATION MAY RESPECTIVELY BE PARTIES;

2. PARAGRAPH 1 OF THIS ARTICLE SHALL NOT BE INTERPRETED AS GIVING GROUNDS FOR DELAY OR POSTPONEMENT OF THE NEGOTIATION AND CONCLUSION OF AGREEMENTS FOR PLACING MANDATED AND OTHER REGIONS UNDER THE TRUSTEESHIP SYSTEM AS PROVIDED FOR IN ARTICLE 77;

## ARTICLE 81

THE TRUSTEESHIP AGREEMENT SHALL IN EACH CASE INCLUDE THE TERMS UNDER WHICH THE TRUST REGION WILL BE ADMINISTERED AND DESIGNATE THE AUTHORITY WHICH WILL BE EXERCISING THE ADMINISTRATION OF THE TRUST REGION. SUCH AUTHORITY HEREINAFTER CALLED THE ADMINISTERING AUTHORITY, MAY BE ONE OR MORE SOCIAL SYSTEMS OF THE UNITED FEDERATION ITSELF;

## ARTICLE 82

THERE MAY BE DESIGNATED, IN THE TRUSTEESHIP AGREEMENT, A STRATEGIC AREA OR AREAS WHICH MAY INCLUDE PART OR ALL OF THE TRUST REGION TO WHICH THE AGREEMENT APPLIES, WITHOUT PREJUDICE TO ANY SPECIAL AGREEMENT OR AGREEMENTS MADE UNDER ARTICLE 43;

## ARTICLE 83

1. ALL FUNCTIONS OF THE UNITED FEDERATION RELATING TO STRATEGIC AREAS, IN-

## STAR FLEET TECHNICAL ORDER

AUTHENTICATED STARDATE 7305.29

TO:00:01:15

## ARTICLES OF FEDERATION

CLUDING THE APPROVAL OF THE TERMS OF THE TRUSTEESHIP AGREEMENTS AND OF THEIR SUBSEQUENT ALTERATION OR AMENDMENT, SHALL BE EXERCISED BY THE FEDERATION COUNCIL;

2. THE BASIC PRINCIPLES SET FORTH IN ARTICLE 76 SHALL APPLY TO THE INTELLIGENT LIFE-FORMS OF EACH STRATEGIC AREA;

3. THE FEDERATION COUNCIL SHALL, SUBJECT TO THE PROVISIONS OF THE TRUSTEESHIP AGREEMENTS AND WITHOUT PREJUDICE TO SECURITY CONSIDERATIONS, AVAIL ITSELF OF THE ASSISTANCE OF THE TRUSTEESHIP COUNCIL TO PERFORM THOSE FUNCTIONS OF THE UNITED FEDERATION UNDER THE TRUSTEESHIP SYSTEM RELATING TO POLITICAL, ECONOMIC, SOCIAL, AND EDUCATIONAL MATTERS IN THE STRATEGIC AREAS;

## ARTICLE 84

IT SHALL BE THE DUTY OF THE ADMINISTERING AUTHORITY TO ENSURE THAT THE TRUST REGION SHALL PLAY ITS PART IN THE MAINTENANCE OF INTERPLANETARY PEACE AND SECURITY. TO THIS END THE ADMINISTERING AUTHORITY MAY MAKE USE OF VOLUNTEER FORCES, FACILITIES, AND ASSISTANCE FROM THE TRUST REGION IN CARRYING OUT THE OBLIGATIONS TOWARDS THE FEDERATION COUNCIL UNDERTAKEN IN THIS REGARD BY THE ADMINISTERING AUTHORITY, AS WELL AS FOR THE LOCAL DEFENSE AND THE MAINTENANCE OF LAW AND ORDER WITHIN THE TRUST REGION;

## ARTICLE 85

1. THE FUNCTIONS OF THE UNITED FEDERATION WITH REGARD TO TRUSTEESHIP AGREEMENTS FOR ALL REGIONS NOT DESIGNATED AS STRATEGIC, INCLUDING THE APPROVAL OF THE TERMS OF THE TRUSTEESHIP AGREEMENTS AND THEIR ALTERATION OR AMENDMENT, SHALL BE EXERCISED BY THE SUPREME ASSEMBLY;

2. THE TRUSTEESHIP COUNCIL, OPERATING UNDER THE AUTHORITY OF THE SUPREME ASSEMBLY, SHALL ASSIST THE SUPREME ASSEMBLY IN CARRYING OUT THESE FUNCTIONS.

## CHAPTER XIII

## THE TRUSTEESHIP COUNCIL

## COMPOSITION

## ARTICLE 86

1. THE TRUSTEESHIP COUNCIL SHALL CONSIST OF THE FOLLOWING MEMBERS OF THE UNITED FEDERATION:

- A) THOSE MEMBERS ADMINISTERING TRUST REGIONS;
- B) SUCH OF THOSE MEMBERS MENTIONED BY NAME IN ARTICLE 23 AS ARE NOT ADMINISTERING TRUST REGIONS; AND
- C) AS MANY OTHER MEMBERS ELECTED FOR THREE (3) SESSION PERIODS BY THE SUPREME ASSEMBLY AS MAY BE NECESSARY TO ENSURE THAT THE TOTAL NUMBER OF MEMBERS OF THE TRUSTEESHIP COUNCIL IS EQUALLY DIVIDED BETWEEN THOSE MEMBERS OF THE UNITED FEDERATION WHICH ADMINISTER TRUST REGIONS AND THOSE WHICH DO NOT;

2. EACH MEMBER OF THE TRUSTEESHIP COUNCIL SHALL DESIGNATE ONE (1) SPECIALLY QUALIFIED INTELLIGENT LIFE-FORM TO REPRESENT IT THEREIN;

## FUNCTIONS AND POWERS

## ARTICLE 87

THE SUPREME ASSEMBLY AND, UNDER ITS AUTHORITY, THE TRUSTEESHIP COUNCIL, IN CARRYING OUT THEIR FUNCTIONS, MAY:

- A) CONSIDER REPORTS SUBMITTED BY THE ADMINISTERING AUTHORITY;
- B) ACCEPT PETITIONS AND EXAMINE THEM IN CONSULTATION WITH THE ADMINISTERING AUTHORITY;
- C) PROVIDE FOR PERIODIC VISITS TO THE RESPECTIVE TRUST REGIONS AT TIMES AGREED UPON WITH THE ADMINISTERING AUTHORITY; AND

## ARTICLES OF FEDERATION

- D) TAKE THESE AND OTHER ACTIONS IN CONFORMITY WITH THE TERMS OF THE TRUSTEESHIP AGREEMENTS;

## ARTICLE 88

THE TRUSTEESHIP COUNCIL SHALL FORMULATE A QUESTIONNAIRE ON THE POLITICAL, ECONOMIC, SOCIAL, AND EDUCATIONAL ADVANCEMENT OF THE INHABITANTS OF EACH TRUST REGION, AND THE ADMINISTERING AUTHORITY FOR EACH TRUST REGION WITHIN THE COMPETENCE OF THE SUPREME ASSEMBLY SHALL MAKE A PERIODIC REPORT TO THE SUPREME ASSEMBLY UPON THE BASIS OF SUCH QUESTIONNAIRE;

## VOTING

## ARTICLE 89

1. EACH MEMBER OF THE TRUSTEESHIP COUNCIL SHALL HAVE ONE VOTE;
2. DECISIONS OF THE TRUSTEESHIP COUNCIL SHALL BE MADE BY A MAJORITY OF THE MEMBERS PRESENT AND VOTING;

## PROCEDURE

## ARTICLE 90

1. THE TRUSTEESHIP COUNCIL SHALL ADOPT ITS OWN RULES OF PROCEDURE, INCLUDING THE METHOD OF SELECTING ITS DIRECTOR;
2. THE TRUSTEESHIP COUNCIL SHALL MEET AS REQUIRED IN ACCORDANCE WITH ITS RULES WHICH SHALL INCLUDE PROVISION FOR THE CONVENING OF MEETINGS ON THE REQUEST OF A MAJORITY OF ITS MEMBERS;

## ARTICLE 91

THE TRUSTEESHIP COUNCIL SHALL, WHEN APPROPRIATE, AVAIL ITSELF OF THE ASSISTANCE OF THE ECONOMIC AND SOCIAL COUNCIL AND OF THE SPECIALIZED AGENCIES IN REGARD TO MATTERS WITH WHICH THEY ARE RESPECTIVELY CONCERNED.

## CHAPTER XIV

THE INTERPLANETARY SUPREME  
COURT OF JUSTICE

## ARTICLE 92

THE INTERPLANETARY SUPREME COURT OF JUSTICE SHALL BE THE PRINCIPAL JUDICIAL INSTRUMENT OF THE UNITED FEDERATION OF PLANETS. IT SHALL FUNCTION IN ACCORDANCE WITH THE APPENDED STATUTE, WHICH IS BASED UPON THE STATUTE OF THE TRIBUNALS OF ALPHA III, AND FORMS AN INTEGRAL PART OF THESE ARTICLES OF FEDERATION;

## ARTICLE 93

1. ALL MEMBERS OF THE UNITED FEDERATION ARE 'IPSO FACTO' PARTIES TO THE STATUTE OF THE INTERPLANETARY SUPREME COURT OF JUSTICE;
2. A SOCIAL SYSTEM WHICH IS NOT A MEMBER OF THE UNITED FEDERATION MAY BECOME A PARTY TO THE STATUTE OF THE INTERPLANETARY SUPREME COURT OF JUSTICE ON CONDITIONS TO BE DETERMINED IN EACH CASE BY THE SUPREME ASSEMBLY UPON THE RECOMMENDATION OF THE FEDERATION COUNCIL;

## ARTICLE 94

1. EACH MEMBER OF THE UNITED FEDERATION UNDERTAKES TO COMPLY WITH THE DECISION OF THE INTERPLANETARY SUPREME COURT OF JUSTICE IN ANY CASE TO WHICH IT IS A PARTY;
2. IF ANY PARTY TO A CASE FAILS TO PERFORM THE OBLIGATIONS INCUMBENT UPON IT UNDER A JUDGEMENT RENDERED BY THE COURT, THE OTHER PARTY MAY HAVE RECOURSE TO THE FEDERATION COUNCIL, WHICH MAY, IF IT DEEMS NECESSARY, MAKE RECOMMENDATIONS OR DECIDE UPON MEASURES TO BE TAKEN TO GIVE EFFECT TO THE JUDGEMENT;

## ARTICLE 95

NOTHING IN THESE ARTICLES OF FEDERATION SHALL PREVENT MEMBERS OF THE

**STAR FLEET TECHNICAL ORDER**

AUTHENTICATED STARDATE 7305.29

TO:00:01:17

## ARTICLES OF FEDERATION

UNITED FEDERATION OF PLANETS FROM ENTRUSTING THE SOLUTION OF THEIR DIFFERENCES TO OTHER TRIBUNALS BY VIRTUE OF AGREEMENTS ALREADY IN EXISTENCE OR WHICH MAY BE CONCLUDED IN THE FUTURE;

## ARTICLE 96

1. THE SUPREME ASSEMBLY OR THE FEDERATION COUNCIL MAY REQUEST THE INTERPLANETARY SUPREME COURT OF JUSTICE TO GIVE AN ADVISORY OPINION ON ANY LEGAL QUESTION;
2. OTHER BODIES OF THE UNITED FEDERATION AND THE SPECIALIZED AGENCIES, WHICH MAY AT ANY TIME BE SO AUTHORIZED BY THE SUPREME ASSEMBLY, MAY ALSO REQUEST ADVISORY OPINIONS OF THE COURT ON LEGAL QUESTIONS ARISING WITHIN THE SCOPE OF THEIR ACTIVITIES.

## CHAPTER XV

## THE SUPREME-SECRETARIAT

## ARTICLE 97

THE SECRETARIAT SHALL BE COMPRISED OF A SUPREME-SECRETARIAT AND SUCH STAFF AS THE UNITED FEDERATION MAY REQUIRE. THE SUPREME-SECRETARIAT SHALL BE APPOINTED BY THE SUPREME ASSEMBLY UPON THE RECOMMENDATION OF THE FEDERATION COUNCIL, AND SHALL BE THE CHIEF ADMINISTRATIVE OFFICER OF THE UNITED FEDERATION;

## ARTICLE 98

THE SUPREME-SECRETARIAT SHALL ACT IN THAT CAPACITY IN ALL MEETINGS OF THE SUPREME ASSEMBLY, OF THE FEDERATION COUNCIL, OF THE ECONOMIC AND SOCIAL COUNCIL, AND OF THE TRUSTEESHIP COUNCIL, AND SHALL PERFORM SUCH OTHER FUNCTIONS AS ARE ENTRUSTED TO THE SECRETARIAT BY THESE BODIES. THE SUPREME-SECRETARIAT SHALL MAKE A PERIODIC REPORT TO THE SUPREME ASSEMBLY ON THE WORK OF THE UNITED FEDERATION OF PLANETS;

## ARTICLE 99

THE SUPREME-SECRETARIAT MAY BRING TO THE ATTENTION OF THE FEDERATION COUNCIL ANY MATTER WHICH IN HIS OPINION MAY THREATEN THE MAINTENANCE OF INTERPLANETARY PEACE AND SECURITY;

## ARTICLE 100

1. IN THE PERFORMANCE OF THEIR DUTIES THE SUPREME-SECRETARIAT AND THE STAFF SHALL NOT SEEK OR RECEIVE INSTRUCTIONS FROM ANY GOVERNMENT OR FROM ANY OTHER AUTHORITY EXTERNAL TO THE UNITED FEDERATION OF PLANETS. THEY SHALL REFRAIN FROM ANY ACTION WHICH MIGHT REFLECT ON THEIR POSITIONS AS INTERPLANETARY OFFICIALS RESPONSIBLE ONLY TO THE UNITED FEDERATION;
2. EACH MEMBER OF THE UNITED FEDERATION UNDERTAKES TO RESPECT THE EXCLUSIVELY INTERPLANETARY CHARACTER OF THE RESPONSIBILITIES OF THE SUPREME-SECRETARIAT AND THE STAFF AND SHALL NOT SEEK TO INFLUENCE THEM IN THE DISCHARGE OF THEIR RESPONSIBILITIES;

## ARTICLE 101

1. THE STAFF SHALL BE APPOINTED BY THE SUPREME-SECRETARIAT UNDER REGULATIONS ESTABLISHED BY THE SUPREME ASSEMBLY;
2. APPROPRIATE STAFFS SHALL BE PERMANENTLY ASSIGNED TO THE ECONOMIC AND SOCIAL COUNCIL, THE TRUSTEESHIP COUNCIL, AND, AS REQUIRED, TO OTHER BODIES OF THE UNITED FEDERATION. THESE STAFFS SHALL FORM A PART OF THE SECRETARIAT;
3. THE PARAMOUNT CONSIDERATION IN THE EMPLOYMENT OF THE STAFF AND IN THE DETERMINATION OF THE CONDITIONS OF SERVICE SHALL BE THE NECESSITY OF SECURING THE HIGHEST STANDARDS OF EFFICIENCY, COMPETENCE, AND INTEGRITY. DUE REGARD SHALL BE PAID TO THE IMPORTANCE OF RECRUITING THE STAFF ON AS WIDE A GALACTICAL BASIS AS POSSIBLE.

**CHAPTER XVI**

## ARTICLES OF FEDERATION

## MISCELLANEOUS PROVISIONS

## ARTICLE 102

1. EVERY TREATY AND EVERY INTERPLANETARY AGREEMENT ENTERED INTO BY ANY MEMBER OF THE UNITED FEDERATION AFTER THESE ARTICLES OF FEDERATION COME INTO FORCE SHALL AS SOON AS POSSIBLE BE REGISTERED WITH THE SUPREME-SECRETARIAT AND PUBLISHED BY HIM;
2. NO PARTY TO ANY SUCH TREATY OR INTERPLANETARY AGREEMENT WHICH HAS NOT BEEN REGISTERED IN ACCORDANCE WITH THE PROVISIONS OF PARAGRAPH 1 OF THIS ARTICLE MAY INVOKE THAT TREATY OR AGREEMENT BEFORE ANY BODY OF THE UNITED FEDERATION;

## ARTICLE 103

IN THE EVENT OF A CONFLICT BETWEEN THE OBLIGATIONS OF THE MEMBERS OF THE UNITED FEDERATION UNDER THESE ARTICLES OF FEDERATION AND THEIR OBLIGATIONS UNDER ANY OTHER INTERPLANETARY AGREEMENT, THEIR OBLIGATIONS UNDER THESE ARTICLES OF FEDERATION SHALL PREVAIL;

## ARTICLE 104

THE UNITED FEDERATION SHALL ENJOY IN THE TERRITORY OF EACH OF ITS MEMBERS SUCH LEGAL CAPACITY AS MAY BE NECESSARY FOR THE EXERCISE OF ITS FUNCTIONS AND THE FULFILLMENT OF ITS PURPOSES;

## ARTICLE 105

1. THE UNITED FEDERATION SHALL ENJOY IN THE TERRITORY OF EACH OF ITS MEMBERS SUCH PRIVILEGES AND IMMUNITIES AS ARE NECESSARY FOR THE FULFILLMENT OF ITS PURPOSES;
2. REPRESENTATIVES OF THE MEMBERS OF THE UNITED FEDERATION AND OFFICIALS OF THE ORGANIZATION SHALL SIMILARLY ENJOY SUCH PRIVILEGES AND IMMUNITIES AS ARE NECESSARY FOR THE INDEPENDENT EXERCISE OF THEIR FUNCTIONS IN CONNECTION WITH THE ORGANIZATION;
3. THE SUPREME ASSEMBLY MAY MAKE RECOMMENDATIONS WITH A VIEW TO DETERMINING THE DETAILS OF THE APPLICATION OF PARAGRAPHS 1 AND 2 OF THIS ARTICLE OR MAY PROPOSE CONVENTIONS TO THE MEMBERS OF THE UNITED FEDERATION FOR THIS PURPOSE.

**CHAPTER XVII**

## TRANSITORY SECURITY ARRANGEMENTS

## ARTICLE 106

1. PENDING THE COMING INTO FULL FORCE OF SUCH SPECIAL AGREEMENTS REFERRED TO IN ARTICLE 43 AS IN THE OPINION OF THE FEDERATION COUNCIL ENABLE IT TO BEGIN THE EXERCISE OF ITS RESPONSIBILITIES UNDER ARTICLE 42, THE PARTIES TO THE DECLARATION OF THE UNITED FEDERATION SHALL CONSULT WITH ONE ANOTHER AND THE OTHER MEMBERS OF THE UNITED FEDERATION WITH A VIEW TO SUCH JOINT ACTION ON BEHALF OF THE ORGANIZATION AS MAY BE NECESSARY FOR THE PURPOSE OF MAINTAINING INTERPLANETARY PEACE AND SECURITY;
2. NOTHING IN THESE ARTICLES OF FEDERATION SHALL INVALIDATE OR PRECLUDE ACTION IN RELATION TO ANY SOCIAL SYSTEM WHICH HAS BEEN AN ADVERSARY OF ANY SIGNATORY TO THESE ARTICLES OF FEDERATION, TAKEN OR AUTHORIZED AS A RESULT OF THAT WAR BY THE GOVERNMENTS HAVING RESPONSIBILITY FOR SUCH ACTION;

## ARTICLE 107

AMENDMENTS TO THESE ARTICLES OF FEDERATION SHALL COME INTO FORCE FOR ALL MEMBERS OF THE UNITED FEDERATION WHEN THEY HAVE BEEN ADOPTED BY A TWO-THIRDS (2/3) VOTE OF THE MEMBERS OF THE SUPREME ASSEMBLY AND RATIFIED IN ACCORDANCE WITH THEIR RESPECTIVE STATUTORY PROCESSES BY TWO-THIRDS (2/3) OF THE MEMBERS OF THE UNITED FEDERATION, INCLUDING ALL THE PERMANENT MEMBERS OF THE FEDERATION COUNCIL;

## STAR FLEET TECHNICAL ORDER

AUTHENTICATED STARDATE 7305.29

TO:00:01:19

## ARTICLES OF FEDERATION

## ARTICLE 108

1. A GENERAL CONFERENCE OF THE MEMBERS OF THE UNITED FEDERATION FOR THE PURPOSE OF REVIEWING THESE ARTICLES OF FEDERATION MAY BE HELD AT A DATE AND PLACE TO BE FIXED BY A TWO-THIRDS (2/3) VOTE OF THE MEMBERS OF THE SUPREME ASSEMBLY AND BY A VOTE OF ANY SEVEN (7) MEMBERS OF THE FEDERATION COUNCIL. EACH MEMBER OF THE UNITED FEDERATION SHALL HAVE ONE (1) VOTE IN THE CONFERENCE;
2. ANY ALTERATIONS OF THESE ARTICLES OF FEDERATION RECOMMENDED BY A TWO-THIRDS (2/3) VOTE OF THE CONFERENCE SHALL TAKE EFFECT WHEN RATIFIED IN ACCORDANCE WITH THEIR RESPECTIVE STATUTORY PROCESSES BY TWO-THIRDS (2/3) OF THE MEMBERS OF THE UNITED FEDERATION INCLUDING ALL THE PERMANENT MEMBERS OF THE FEDERATION COUNCIL;
3. IF SUCH CONFERENCE HAS NOT BEEN HELD BEFORE THE TENTH REGULAR SESSION OF THE SUPREME ASSEMBLY FOLLOWING THE COMING INTO FORCE OF THESE ARTICLES OF FEDERATION, THE PROPOSAL TO CALL SUCH A CONFERENCE SHALL BE PLACED ON THE AGENDA OF THAT SESSION OF THE SUPREME ASSEMBLY, AND THE CONFERENCE SHALL BE HELD IF SO DECIDED BY A MAJORITY VOTE OF THE MEMBERS OF THE SUPREME ASSEMBLY AND BY A VOTE OF ANY SEVEN (7) MEMBERS OF THE FEDERATION COUNCIL.

## CHAPTER XVIII

## RATIFICATION AND SIGNATURE

## ARTICLE 109

1. THESE ARTICLES OF FEDERATION SHALL BE RATIFIED BY THE SIGNATORY GOVERNMENTS IN ACCORDANCE WITH THEIR RESPECTIVE STATUTORY PROCESSES;
2. THE RATIFICATIONS SHALL BE DEPOSITED WITH THE GOVERNMENT OF THE UNITED NATIONS OF THE PLANET EARTH, WHICH SHALL NOTIFY ALL OF THE SIGNATORY GOVERNMENTS OF EACH DEPOSIT AS WELL AS THE SUPREME-SECRETARIAT OF THE ORGANIZATION WHEN HE HAS BEEN APPOINTED;
3. THESE ARTICLES OF FEDERATION SHALL COME INTO FULL FORCE UPON THE DEPOSIT OF THE RATIFICATIONS BY THE UNITED NATIONS OF THE PLANET EARTH, THE PLANETARY CONFEDERATION OF 40 ERIDANI, THE UNITED PLANETS OF 61 CYGNI, THE STAR EMPIRE OF EPSILON INDII, THE ALPHA CENTAURI CONCORDIUM OF PLANETS, AND BY A MAJORITY OF THE OTHER SIGNATORY SOCIAL SYSTEMS. A PROTOCOL OF THE RATIFICATIONS DEPOSITED SHALL THEREUPON BE DRAWN UP BY THE GOVERNMENT OF THE UNITED NATIONS WHICH SHALL COMMUNICATE COPIES THEREOF TO ALL OF THE SIGNATORY GOVERNMENTS;
4. THE GOVERNMENTS SIGNATORY TO THESE ARTICLES OF FEDERATION WHICH RATIFY IT AFTER IT HAS COME INTO FORCE WILL BECOME ORIGINAL MEMBERS OF THE UNITED FEDERATION ON THE DATE OF THE DEPOSIT OF THEIR RESPECTIVE RATIFICATIONS;

## ARTICLE 110

THESE ARTICLES OF FEDERATION, OF WHICH THE VARIOUS LANGUAGE TEXTS ARE EQUALLY AUTHENTIC, UPON THE COMING INTO FULL FORCE OF THE UNITED FEDERATION OF PLANETS, SHALL BE TRANSFERRED BY THE UNITED NATIONS TO THE ORGANIZATION FOR PERMANENT DEPOSIT IN ITS ARCHIVES. DULY CERTIFIED COPIES THEREOF SHALL BE TRANSMITTED BY THE SUPREME-SECRETARIAT TO THE GOVERNMENTS OF ALL THE SIGNATORY SOCIAL SYSTEMS.

IN FAITH WHEREOF THE REPRESENTATIVES OF THE GOVERNMENTS OF THE UNITED FEDERATION OF PLANETS HAVE SIGNED THESE ARTICLES OF FEDERATION.

DONE AT THE PLANET BABEL STARDATE 0965

(FOLLOWED BY THE SIGNATURE SHEETS OF THE ORIGINAL SIGNATORY GOVERNMENTS)



# TREATY OF PEACE

BETWEEN THE ROMULAN STAR EMPIRE  
AND THE UNITED FEDERATION OF PLANETS

NEGOTIATED BY SUBSPACE COMMUNICATION STARDATE 1200.5

PART THE TERMS AND CONDITIONS HAVING BEEN NEGOTIATED AND AGREED TO BE  
I IDENTICALLY UNDERSTOOD, THE ROMULAN STAR EMPIRE AND THE UNITED  
FEDERATION OF PLANETS MUTUALLY PLEDGE TO EACH OTHER THEIR SOLEMN  
WORD TO IMMEDIATELY CEASE HOSTILITIES BETWEEN THE TWO PARTIES  
EFFECTIVE STARDATE 1200.5;

PART BETWEEN THE ADJACENT TERRITORIAL BOUNDARIES OF THE TWO PARTIES  
II THERE IS ESTABLISHED A NEUTRAL ZONE, SEVEN HUNDRED AND FIFTY  
PARSECS IN WIDTH IN THE GALACTIC LONGITUDINAL PLANE, AND EXTEND-  
ING TO THE OUTER BOUNDARY OF THE GALAXY IN THE VERTICAL PLANE;

PART ALL PERSONS AND FACILITIES OF ANY MANNER WHATSOEVER IDENTIFIABLE  
III WITH EITHER PARTY SHALL BE IMMEDIATELY REMOVED FROM THIS ZONE.  
EFFECTIVE STARDATE 1210, NO PERSONS OR FACILITIES OF ANY MANNER  
WHATSOEVER IDENTIFIABLE WITH EITHER PARTY SHALL THEREAFTER BY  
INTRUDED INTO THIS ZONE. THE ROMULAN STAR EMPIRE AND THE UNITED  
FEDERATION OF PLANETS MUTUALLY PLEDGE TO EACH OTHER TO FAITHFULLY  
MAINTAIN THE NEUTRALITY OF THIS ZONE THEREAFTER;

PART ANY INTRUSION WHATSOEVER BY ANY PERSON OR FACILITY IDENTIFIABLE  
IV WITH EITHER PARTY INTO THIS NEUTRAL ZONE SHALL BE CONSIDERED TO  
BE A HOSTILE ACTION AND BREACH OF THIS PEACE. IN SUCH EVENT AN  
IMMEDIATE STATE OF WAR SHALL BE DECLARED TO EXIST BETWEEN THE  
ROMULAN STAR EMPIRE AND THE UNITED FEDERATION OF PLANETS; EXCEPT  
ONLY WHERE:

PART SUCH INTRUSION BY ANY PERSON OR FACILITY IDENTIFIABLE WITH EITHER  
V PARTY CAN BE UNDENIABLY DEMONSTRATED TO BE THE ACCIDENTAL RESULT  
OF CONDITIONS BEYOND THE CONTROL OF THAT PERSON OR THAT FACILITY  
AND DID, IN FACT, OCCUR WITHOUT HOSTILE INTENT;

PART TO THIS END, AND FOR PURPOSES OF MUTUAL MAINTENANCE OF THIS TREATY  
VI OF PEACE AND THIS NEUTRAL ZONE, THE ROMULAN STAR EMPIRE AND THE  
UNITED FEDERATION OF PLANETS AGREE TO KEEP OPEN AND MAINTAIN A  
CONSTANT SURVEILLANCE OF, SUBSPACE COMMUNICATION FREQUENCY K;

PART I, PRAETOR KARZAN, HAVING READ THE TERMS OF THIS TREATY VERBATIM  
VII OVER SUBSPACE COMMUNICATION FREQUENCY K, AND BEING IDENTIFIABLE  
BY VOICEPRINT OF THIS TRANSMISSION, DO HEREBY CERTIFY THAT I AM  
PRAETOR OF THE ROMULAN STAR EMPIRE WITH FULL POWERS TO EXECUTE  
THIS TREATY ON BEHALF OF THE EMPIRE;

PART I, CRISTOFUR THORPE, HAVING READ THE TERMS OF THIS TREATY VERBATIM  
VIII OVER SUBSPACE COMMUNICATION FREQUENCY K, AND BEING IDENTIFIABLE  
BY VOICEPRINT OF THIS TRANSMISSION, DO HEREBY CERTIFY THAT I AM  
GOVERNOR OF THE FEDERATION COUNCIL OF THE UNITED FEDERATION OF  
PLANETS WITH FULL POWERS TO EXECUTE THIS TREATY ON BEHALF OF THIS  
GOVERNMENT.

# TREATY OF PEACE

IMPOSED BY ORGANIA STARDATE 3199.5

CONDITION 1:

THIS TREATY OF PEACE IS SIMULTANEOUSLY IMPOSED UPON THE KLINGON EMPIRE AND THE UNITED FEDERATION OF PLANETS. UNLESS YOUR GOVERNMENTS AND COMBATANTS IN GALACTIC SPACE AGREE TO AN IMMEDIATE CESSATION OF HOSTILITIES, YOUR ARMED FORCES WHEREVER THEY MAY BE WILL BE IMMEDIATELY DISABLED;

CONDITION 2:

HENCEFORTH FROM THIS TIME, WITHIN A ZONE SEVEN HUNDRED AND FIFTY PARSECS IN WIDTH BETWEEN THE ADJACENT TERRITORIAL BOUNDARIES OF BOTH PARTIES, NO ARMED HOSTILITIES MAY TAKE PLACE BETWEEN THE KLINGON EMPIRE AND THE UNITED FEDERATION OF PLANETS;

CONDITION 3:

AT ANY TIME, SHOULD A PERSON OR UNIT OF EITHER PARTY ATTEMPT TO ACT OR USE WEAPONRY IN A HOSTILE MANNER AGAINST THE PERSON OR A UNIT OF THE OTHER PARTY WITHIN THIS ZONE, THAT PERSON OR UNIT, AND THAT WEAPONRY, SHALL BE RENDERED IMMEDIATELY HARMLESS;

CONDITION 4:

THE TIME WILL COME IN THE FUTURE WHEN THE KLINGON EMPIRE AND THE UNITED FEDERATION OF PLANETS WILL BECOME ALLIES AND GOOD FRIENDS, WORKING TOGETHER IN PEACE AND HARMONY FOR THE BETTERMENT OF BOTH. UNTIL THAT TIME, NEITHER PARTY MAY DENY TO THE OTHER PEACEFUL ACCESS TO ITS PLANETARY BASES WITHIN THE NEUTRAL ZONE FOR SHORE LEAVE, REST, AND REHABILITATION;

CONDITION 5:

BOTH PARTIES WILL RESPECT THE TERRITORIAL INTEGRITY OF ORGANIA AND WILL MAKE NO FURTHER ATTEMPT TO INTRUDE INTO OUR PLANET'S TERRITORY OR AFFAIRS. WHEN THE TIME ARRIVES IN THE FUTURE FOR US TO JOIN WITH BOTH PARTIES IN THE PEACEFUL DEVELOPMENT OF INTRA-GALACTIC RELATIONS, WE WILL MAKE KNOWN TO YOU OUR INTENTIONS;

CONDITION 6:

WE ARE AWARE THAT, WITHIN THE NEUTRAL ZONE, THERE ARE MANY PLANETARY SUB-CULTURES IN VARIOUS LEVELS OF EVOLUTIONARY DEVELOPMENT WHICH COULD BENEFIT FROM THE ADVANCED CULTURES OF THE KLINGON EMPIRE AND THE UNITED FEDERATION OF PLANETS. TO THIS END, ORGANIA WILL PERMIT SUCH PEACEFUL DEVELOPMENT AND, IN EACH SPECIFIC CASE, WILL AWARD SUCH RIGHTS TO THE PARTY WHICH DEMONSTRATES IT CAN MOST EFFICIENTLY DEVELOP THE PLANET TO THE BENEFIT OF ITS SOCIAL SYSTEMS.

FOR ORGANIA:

AYELBORNE  
CLAYMARE  
TREFAYNE

UNITED FEDERATION  
OF PLANETS - M-O GALAXY

BANNER



B/W AS SHOWN

OFFICIAL COLORS:

- RED N°SF 10UC
- SILVER N° SF01UC

# UNITED FEDERATION OF PLANETS - M-O GALAXY

## SEAL

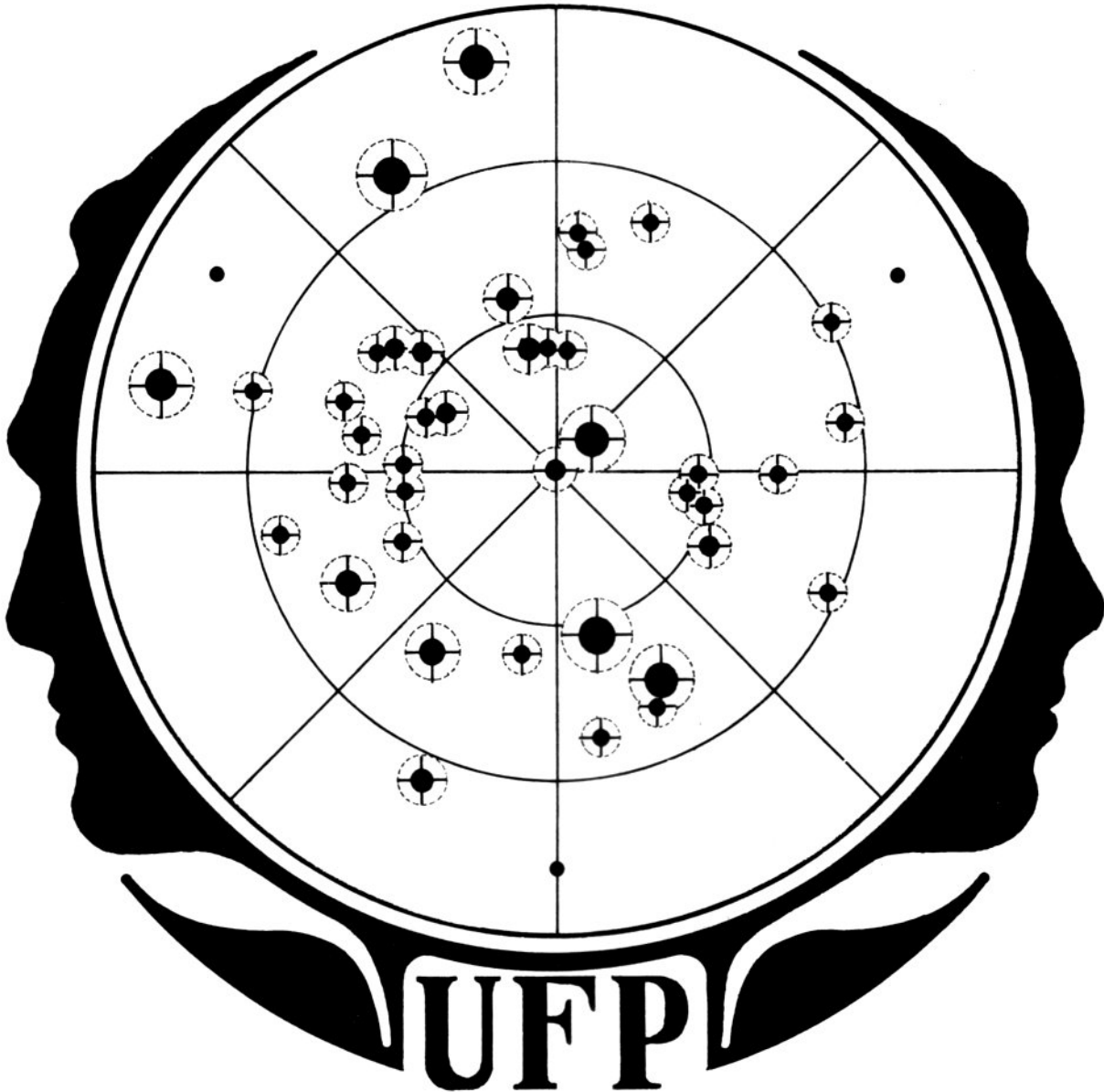

B/W AS SHOWN

OFFICIAL COLORS:

-  BLUE N°SF20UC
-  SILVER N° SF01UC

# UNITED NATIONS

PLANET EARTH - SOL SYSTEM

## FLAG



OFFICIAL GARRISON PROPORTIONS

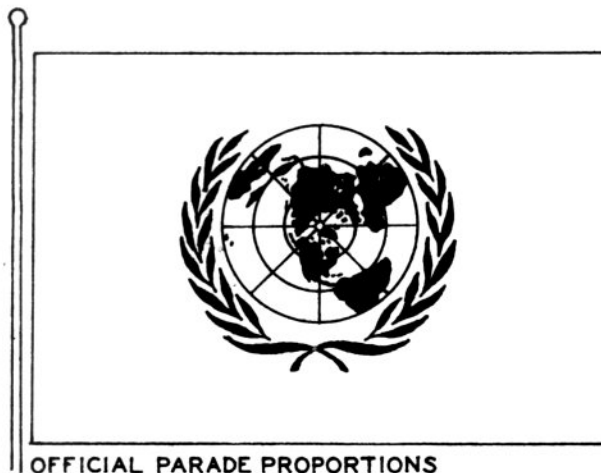

OFFICIAL PARADE PROPORTIONS

B/W AS SHOWN

OFFICIAL COLORS:

-  SKY BLUE N°SF16UC
-  SILVER N°SF01UC

UNITED NATIONS  
PLANET EARTH - SOL SYSTEM

SEAL



B/W AS SHOWN

OFFICIAL COLORS:

- SKY BLUE N°SF16UC
- SILVER N°SF01UC

# PLANETARY CONFEDERATION OF 40 ERIDANI

## BANNER

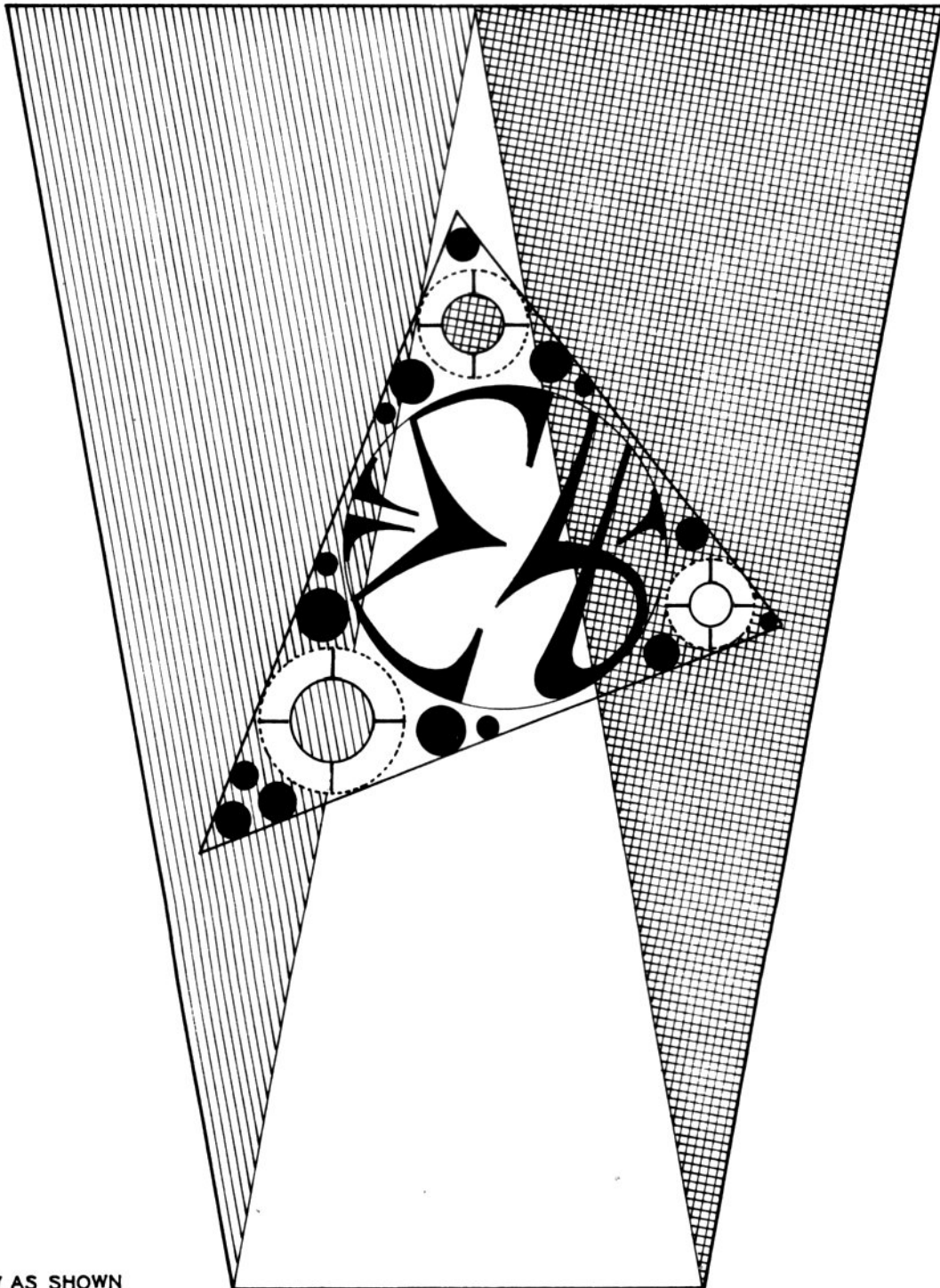

B/W AS SHOWN

OFFICIAL COLORS:

 SKY BLUE N°SF16UC

 ORANGE N°SF11UC

 RED N°SF10UC

 INDIGO N°SF19UC

TO:00:02:05

# PLANETARY CONFEDERATION OF 40 ERIDANI

## SIGNAT

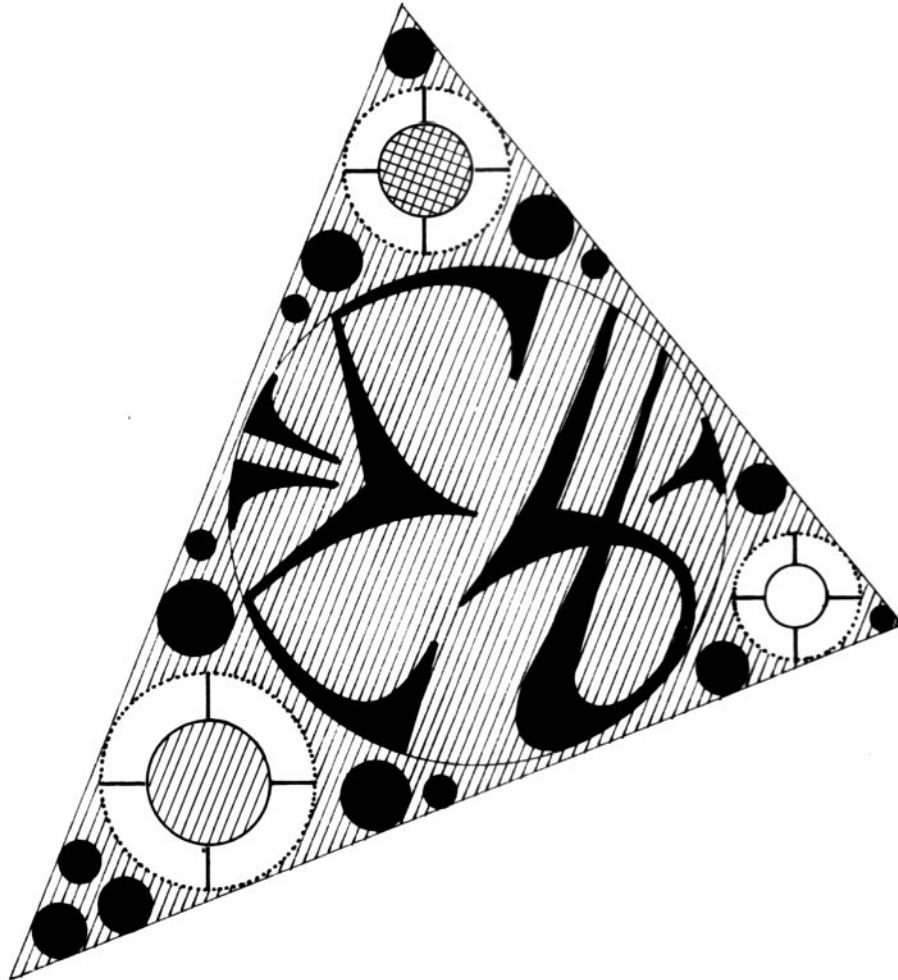

BLACK & WHITE AS SHOWN

OFFICIAL COLORS:

-  SKY BLUE N°SF 16UC
-  ORANGE N°SF 11UC
-  RED N°SF 10UC
-  INDIGO N°SF 19UC



# UNITED PLANETS OF 61 CYGNI

## SHIELD\*

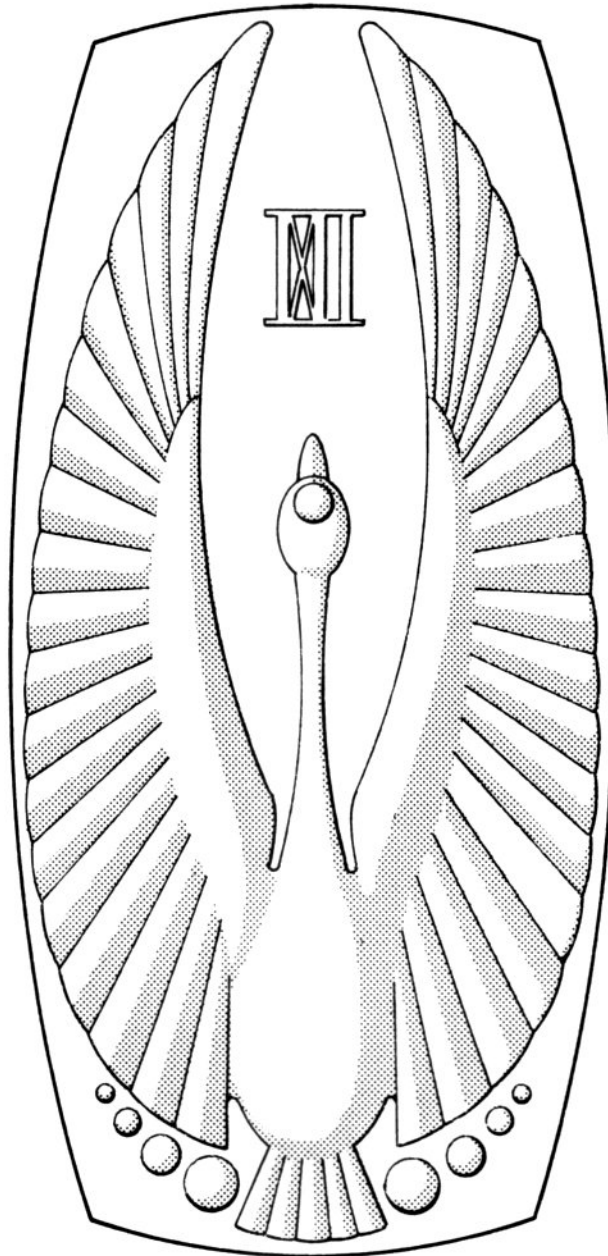

B/W AS SHOWN

OFFICIAL COLORS:

 COPPER N°SF05UC

\*EQUIVALENT OF A FLAG, RAISED TOOLING  
ON DOUBLE CONVEX CYGNUSIUM SHIELD

# UNITED PLANETS

OF 61 CYGNI

## ARMS

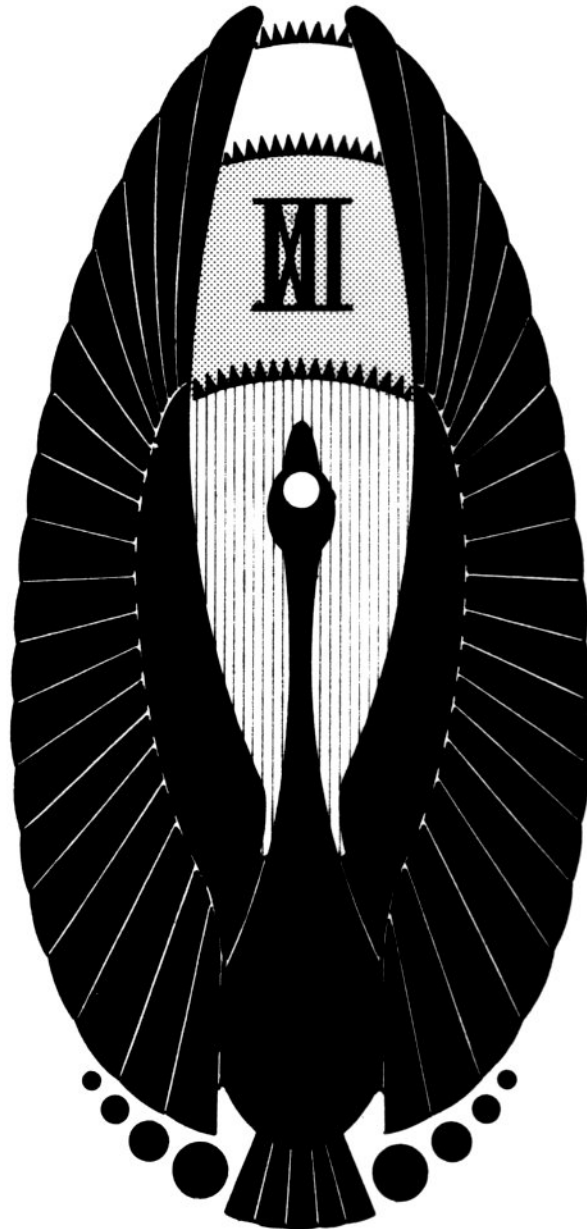

B/W AS SHOWN

OFFICIAL COLORS:

- |   |                 |
|---|-----------------|
|  | YELLOW N°SF12UC |
|  | ORANGE N°SF11UC |
|  | RED N°SF10UC    |
|  | COPPER N°SF05UC |





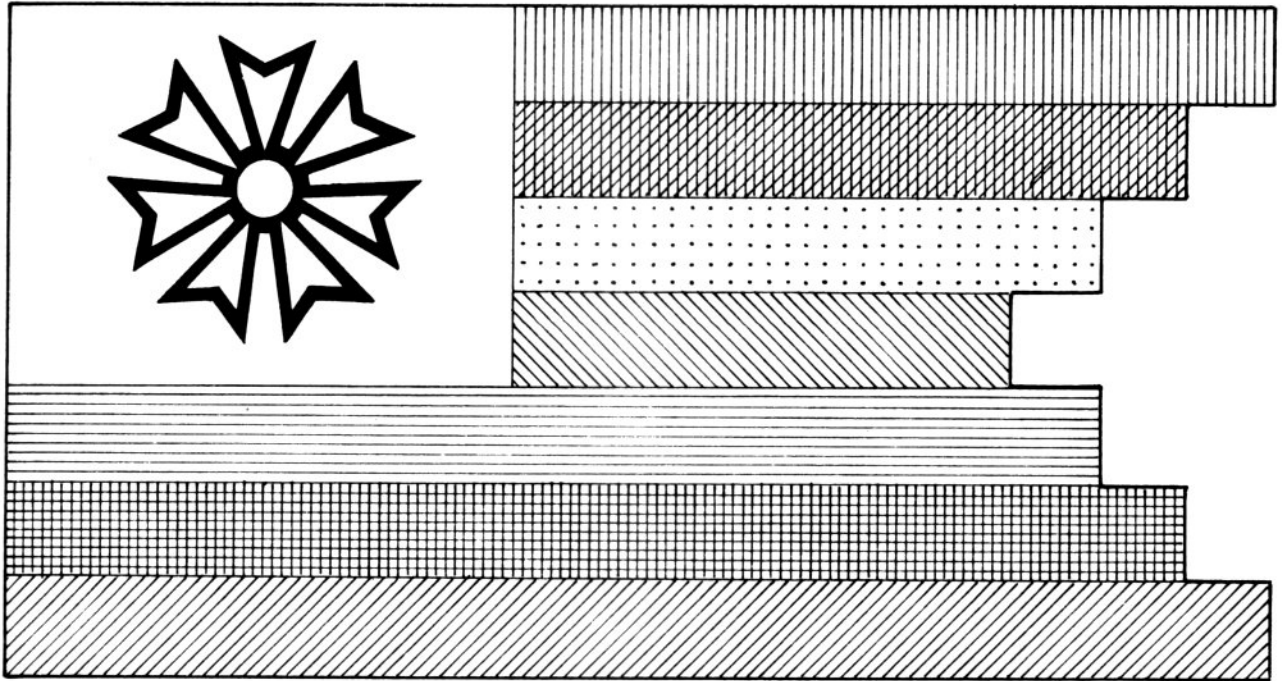



# STAR EMPIRE OF EPSILON INDII

## STANDARD



B/W AS SHOWN

OFFICIAL COLORS:

-  WHITE N°SF06UC
-  RED N°SF10UC
-  ORANGE N°SF11UC
-  YELLOW N°SF12UC
-  GREEN N°SF15UC
-  GOLD N°SF03UC
-  BLUE N°SF18UC
-  INDIGO N°SF19UC
-  VIOLET N°SF21UC

TO:00:02:09

# STAR EMPIRE OF EPSILON INDII

## SEAL

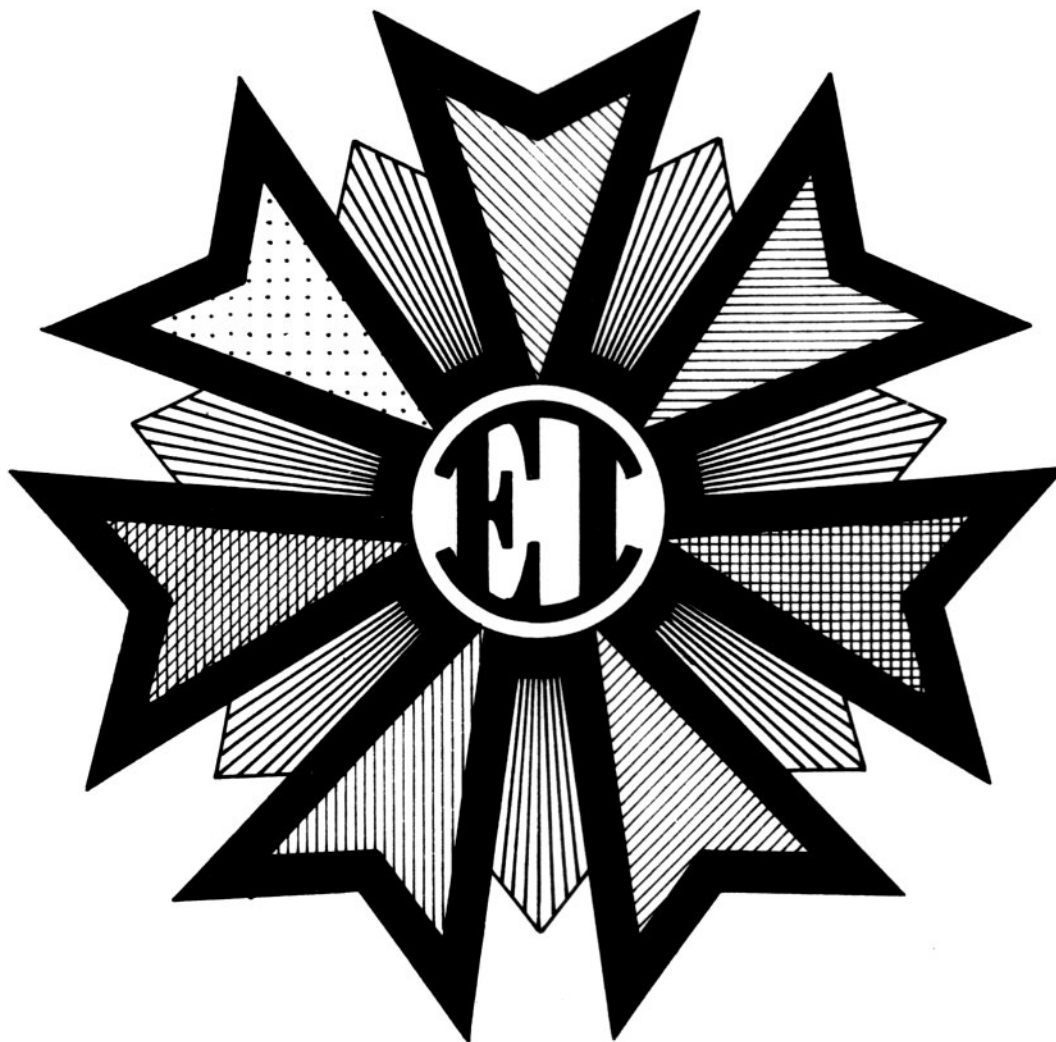

B/W AS SHOWN  
OFFICIAL COLORS:

-  WHITE N°SF06UC
-  RED N°SF10UC
-  ORANGE N°SF11UC
-  YELLOW N°SF12UC
-  GREEN N°SF15UC

-  BLUE N°SF18UC
-  INDIGO N°SF19UC
-  VIOLET N°SF21UC
-  GOLD N°SF03UC

# ALPHA CENTAURI

CONCORDIUM OF PLANETS

## PENNANT

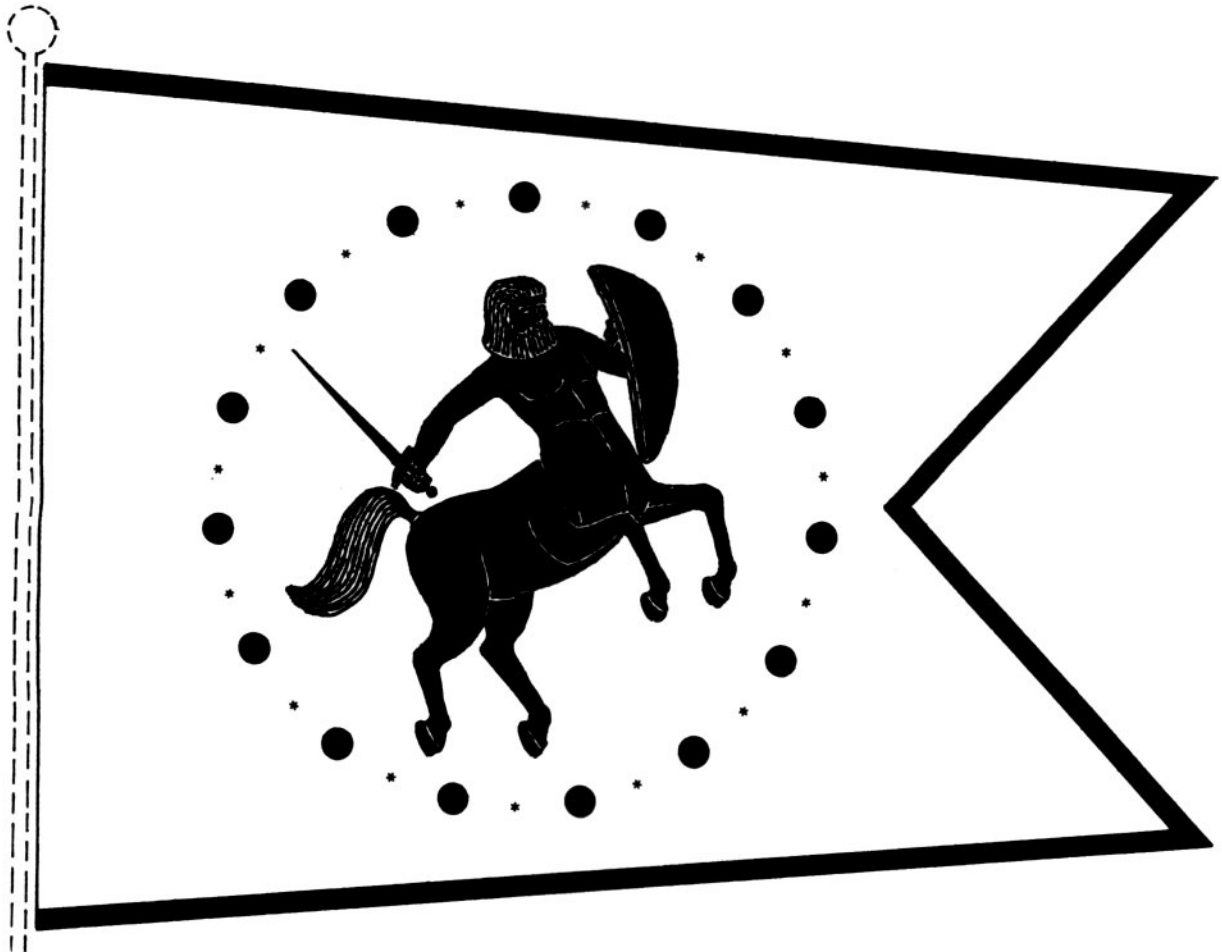

B/W AS SHOWN

OFFICIAL COLORS:

- PURPLE N°SF26UC
- GOLD N°SF03UC

# ALPHA CENTAURI

CONCORDIUM OF PLANETS

## ARMS

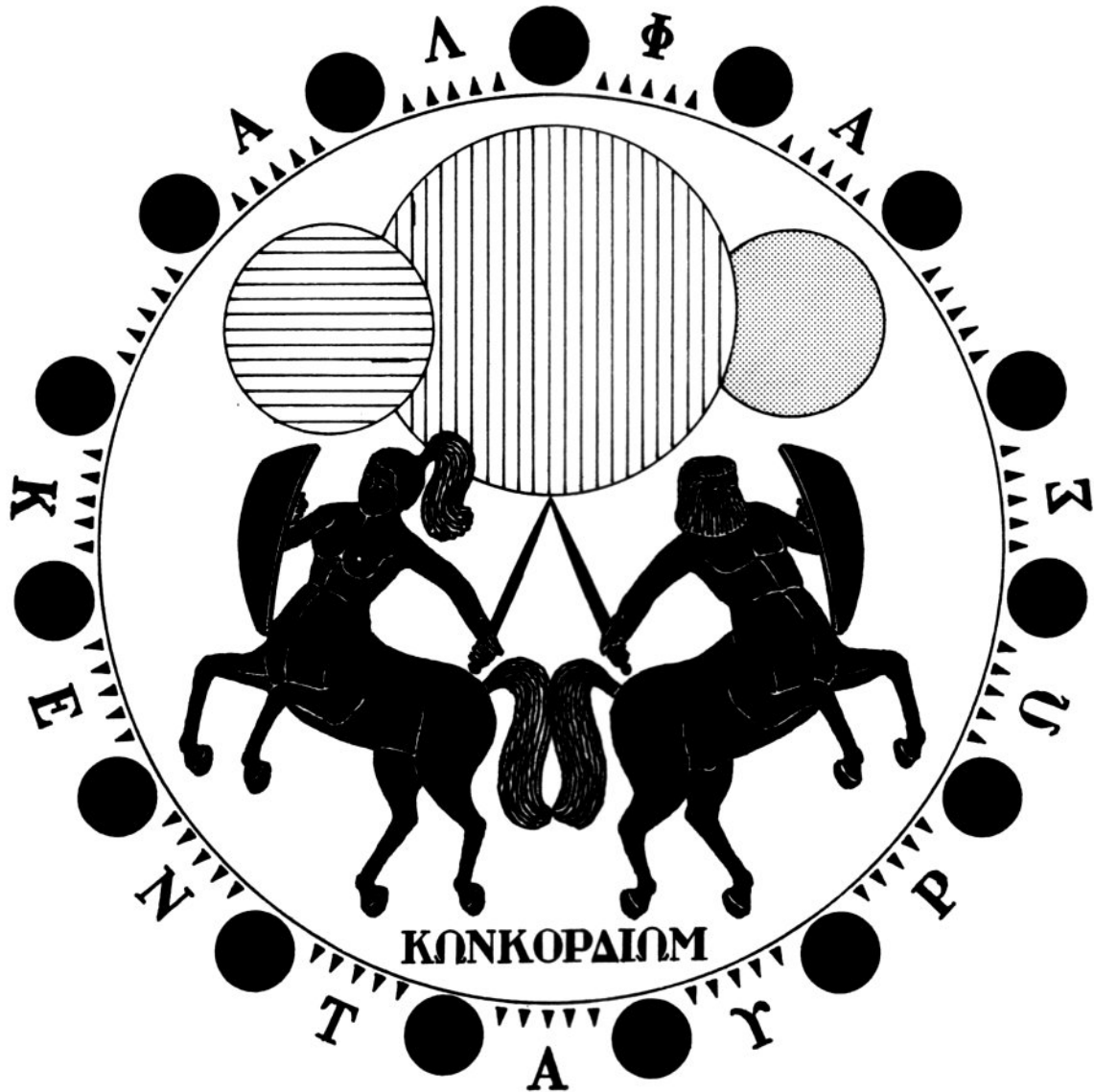

B/W AS SHOWN

OFFICIAL COLORS:

-  PURPLE N°SF26UC
-  YELLOW N°SF12UC
-  ORANGE N°SF11UC
-  RED N°SF10UC
-  GOLD N°SF03UC

# OFFICIAL TYPE STYLE

STAR FLEET SPECIFICATION

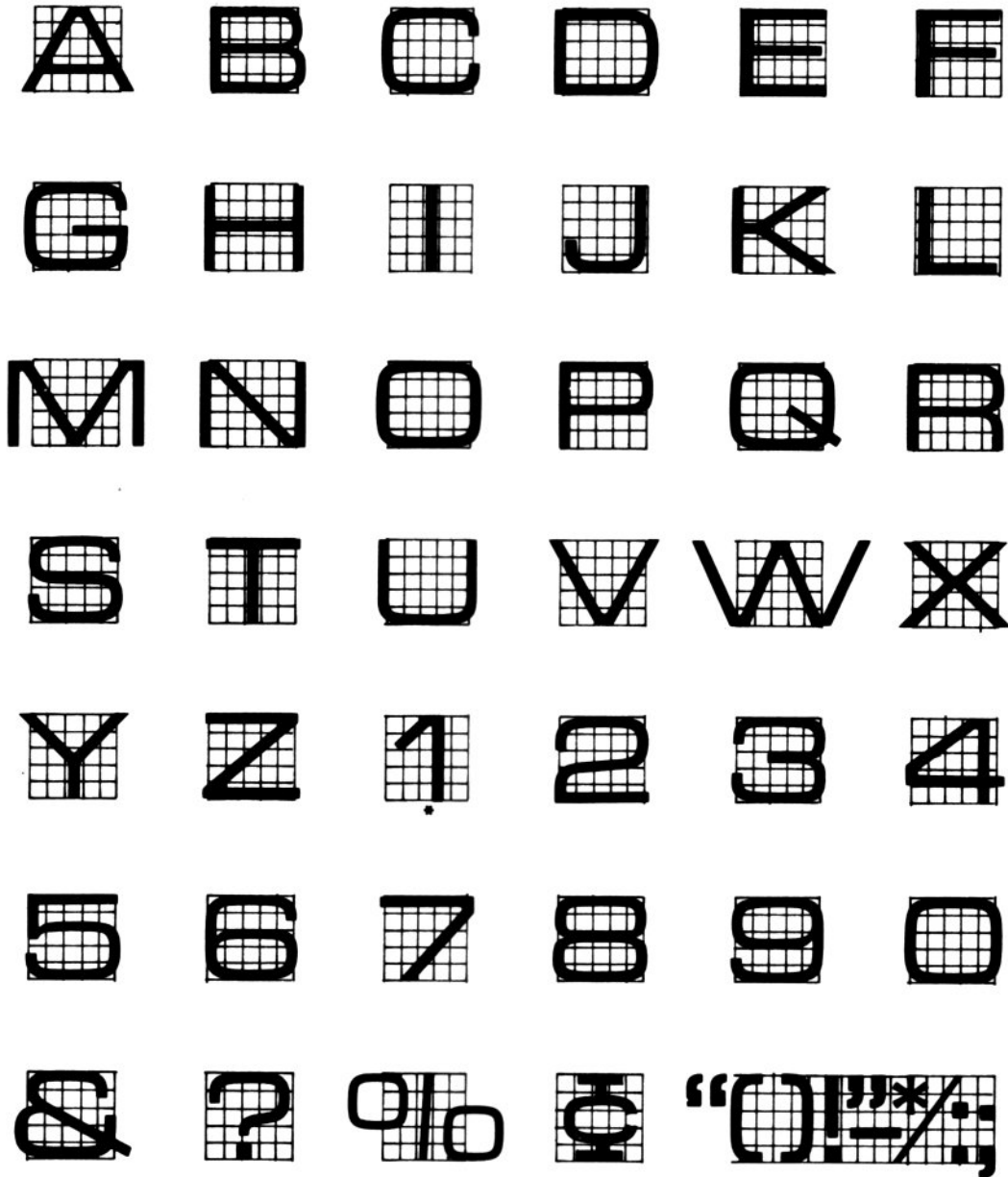

TYPICAL SPACING:



COMMON UNITED NATIONS LANGUAGE FORM. EARTH FONT NAME: **Microgramma Ext.**

\*DO NOT USE "1" IN FLEET OPERATIONS, INSTRUMENTATION, OR SHIP DESIGNATIONS.

# OFFICIAL TYPE STYLE

STAR FLEET SPECIFICATION

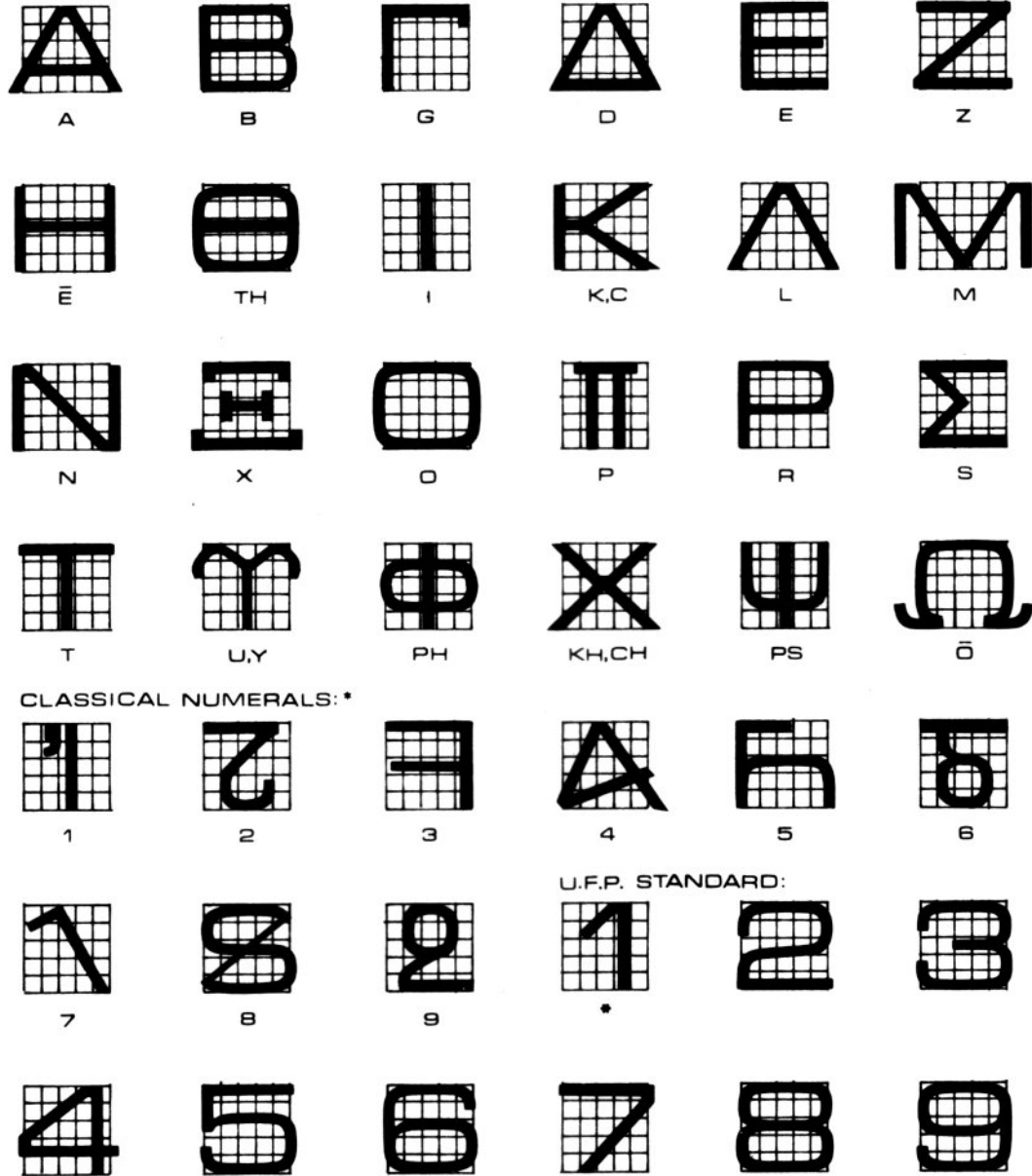

TYPICAL SPACING:

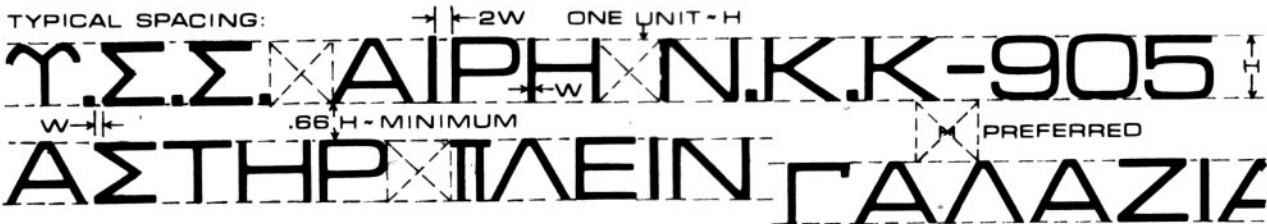

COMMON ALPHA KENTAURUS LANGUAGE FORM. TYPE FONT: **Microgramma Ext.**  
\*DO NOT USE IN FLEET OPERATIONS, INSTRUMENTATION, OR SHIP DESIGNATIONS.



# UNIFORM COLOR CODE

## STAR FLEET SPECIFICATION



01  
SILVER



02  
ANTIMONY



03  
GOLD



04  
BRONZE



05  
COPPER

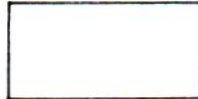

06  
WHITE



07  
IVORY



08  
SAND



09  
BLOOD



10  
RED



11  
ORANGE



12  
YELLOW



13  
TENNE



14  
OLIVE



15  
GREEN



16  
SKY BLUE



17  
ULTRAMARINE



18  
BLUE



19  
INDIGO

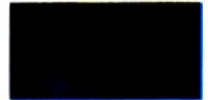

20  
MIDNIGHT



21  
VIOLET

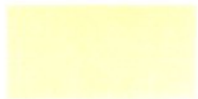

22  
CORN

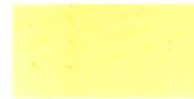

23  
TAN

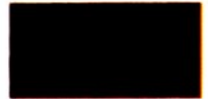

24  
BROWN



25  
NUDE



26  
PURPLE



27  
OXIDE



28  
TAUPE



29  
PLATINUM



30  
GRAY



31  
BLUEGRAY

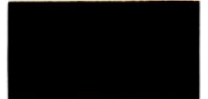

32  
BLACK



COMMAND SECTION

STAR FLEET TECHNICAL ORDER

SECTION INDEX			
TO. NO:	SUBJECT	CURRENT	REPLACES
01:00:00	COMMAND SECTION FLYSHEET	7305.30	
» » :02	FOREWORD	*	
» » :04	SECTION INDEX	7309.10	
» :01:00	STAR FLEET ARMED FORCES - ORGANIZATION	7407.27	
» » :01	SFAF - ORG - MIL. STAFF COMM./STAR FLEET COMMAND	7407.29	
» » :02	» » -FLEET OPERATIONS	7407.31	
» » :03	» » -LOGISTICS/INSPECTOR GENERAL	7408.01	
» » :04	» » -PERSONNEL/JUDGE ADVOCATE GENERAL	*	
» » :05	» » -SURGEON GENERAL/SCIENCES	*	
» » :06	» » -ENGINEERING/COMPTROLLER GENERAL	*	
» » :07	» » -TECHNOLOGY/COMMUNICATIONS	*	
» » :08	» » -NAV. GEN./PLANETARY REL./GALAXY EXP.	*	
» » :09	» » -TACTICIAN/COSMOLOGIST/ALIENOLOGIST	*	
» :01:20	THE STAR FLEET ACADEMY	7408.05	
» :01:30	STAR FLEET HEADQUARTERS - EXTERNAL ARRANGEMENT	7305.31	
» » :31	SFHQ - TYPICAL CROSS-SECTION	» »	
» » :32	» - TYP. SECTION THRU DOCK	» »	
» » :33	» - TYP. LONG. SECTION	» »	
» » :34	» -GROUND PLAN - BAYS 1 & 2	» »	
» » :35	» - » » -BAYS 3 & 4	» »	
» » :36	» - » » -BAYS 5 & 6	7305.31	
» :03:00	STAR FLEET INSIGNIA AND RANK	7304.28	
» » :10	DUTY UNIFORM - MALE - ALL SFAF	7304.26	
» » :11	N/C TUNIC PATTERN	7308.05	
» » :12	DUTY UNIFORM - FEMALE - OFFICERS SFAF	7304.26	
» » :13	N/C TUNIC AND PANTY PATTERN	7308.05	
» » :14	DUTY UNIFORM - FEMALE - ENSIGNS SFAF	7304.26	
» » :15	N/C TUNIC AND PANTY PATTERN	7308.05	
» » :16	DUTY UNIFORM - FEMALE - MEDICAL SFAF	7304.26	
» » :17	N/C TUNIC AND PANTY PATTERN	7308.05	
» » :18	DUTY UNIFORM - ACADEMY CADET - MALE	*	
» » :19	N/C TUNIC PATTERN	*	
» » :20	DUTY UNIFORM - ACADEMY CADET - FEMALE	*	
» » :21	N/C TUNIC AND PANTY PATTERN	*	
» :04:00	FLEET SHIP CLASSIFICATIONS - SFAF-CLASS I STARSHIPS	7306.03	
» » :10	CLASS I HEAVY CRUISER - MK-IX	7304.15	
» » :11	AUTHORIZED CONSTRUCTION	7306.16	
» » :12	CLASS I DESTROYER - MK-VIII	7306.03	
» » :13	AUTH. CONST.	7306.09	
» » :14	CLASS I SCOUT - MK-VII	7306.03	
» » :15	AUTH. CONST.	7306.19	
» » :16	CLASS I TRANSPORT/TUG - MK-VI	7306.03	
» » :17	AUTH. CONST.	7306.14	
» » :18	CLASS I TRANSPORT CONTAINERS - MK-V AND MK-III	7306.03	
» » :19	» » » » - MK-II AND MK-I	» »	
» » :20	» » » » - MK-IV STARLINER	» »	
» » :21	» » » » - MK-IV DECK PLANS	7306.03	

NOTE (\*): NO CURRENT PRINT-OUT FROM MASTERCOM DATABANKS/SFHQ



# STAR FLEET ARMED FORCES ORGANIZATION

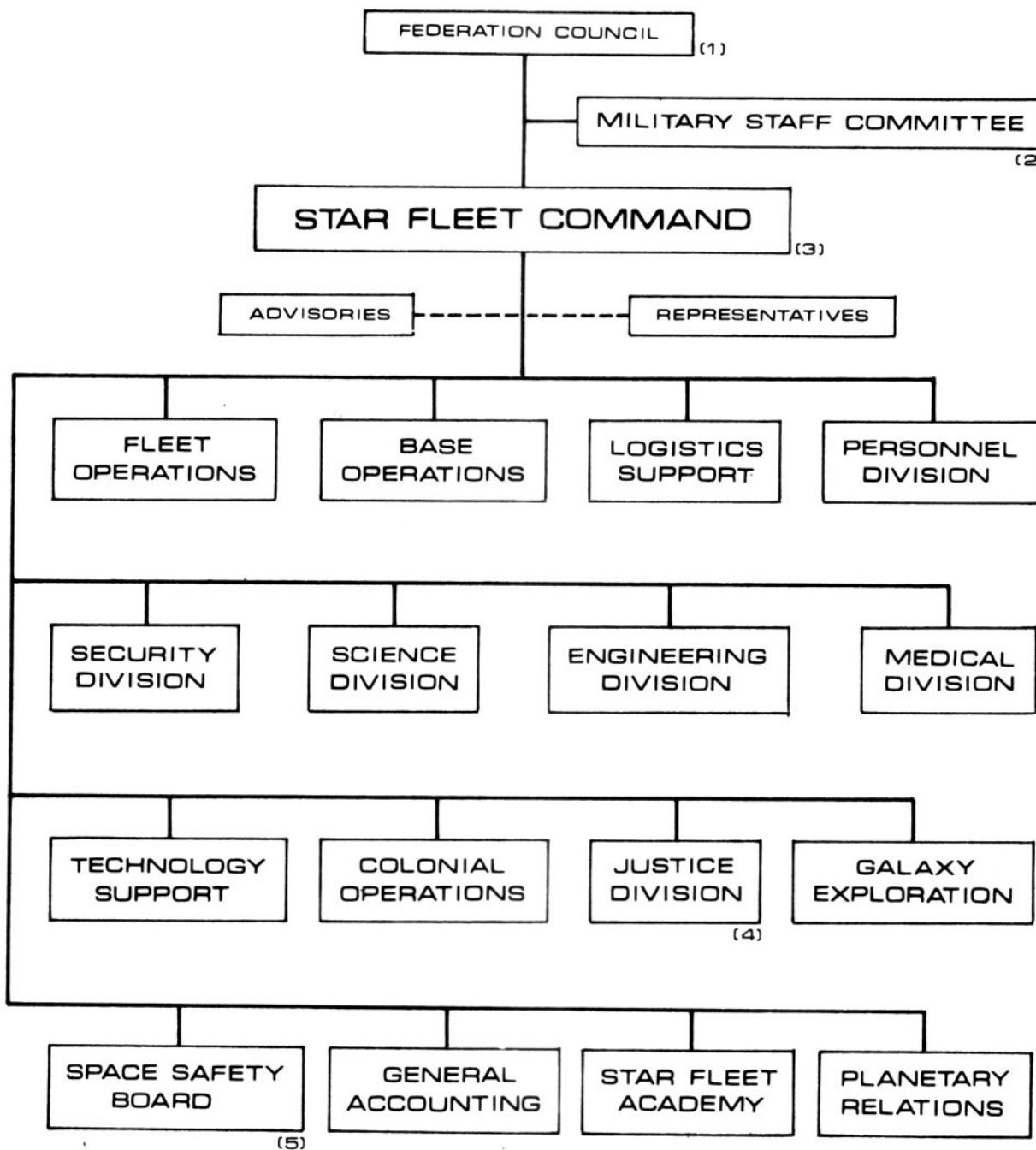

AUTHORITY: ARTICLES OF FEDERATION: (1) CHAPTER VIII, ARTICLE 52, SECTION 2; (2) CH. VIII, ART. 52, SECT. 2; (3) CH. VIII; (4) SUPREME COURT STATUTE, CH. II, ART. 15, SECT. 2; (5) INTERPLANETARY COMMERCE STATUTE, PART VIII, SECT. 47, ITEM 01.

# STAR FLEET ARMED FORCES ORGANIZATION

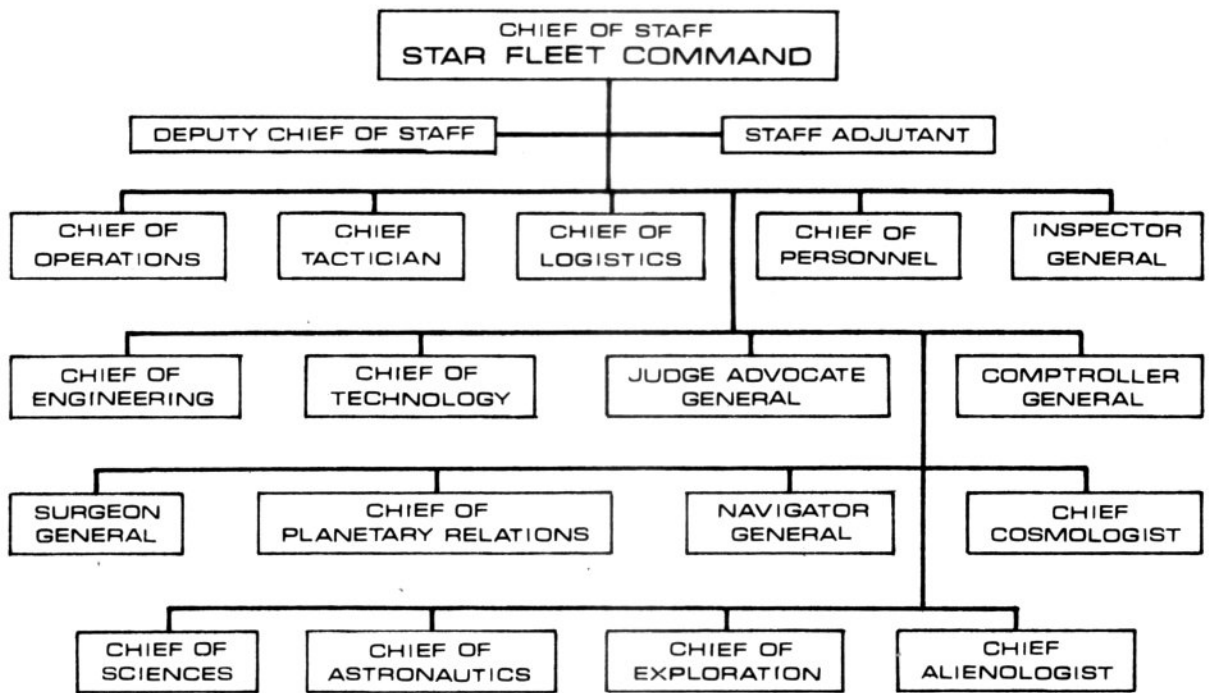
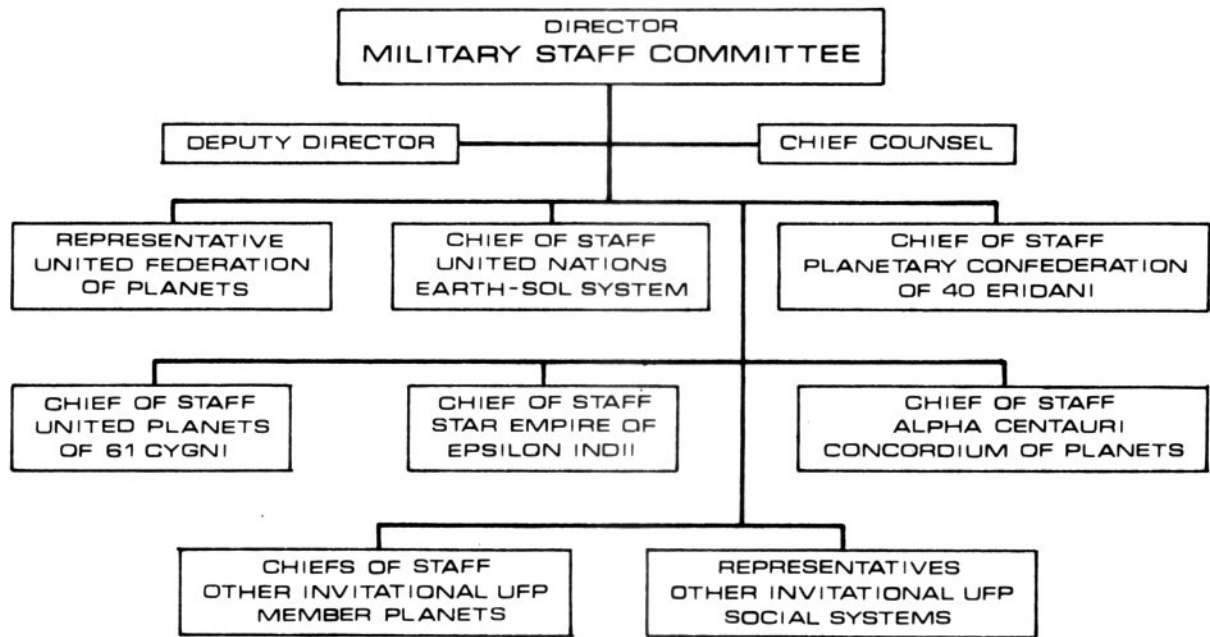

# STAR FLEET ARMED FORCES ORGANIZATION

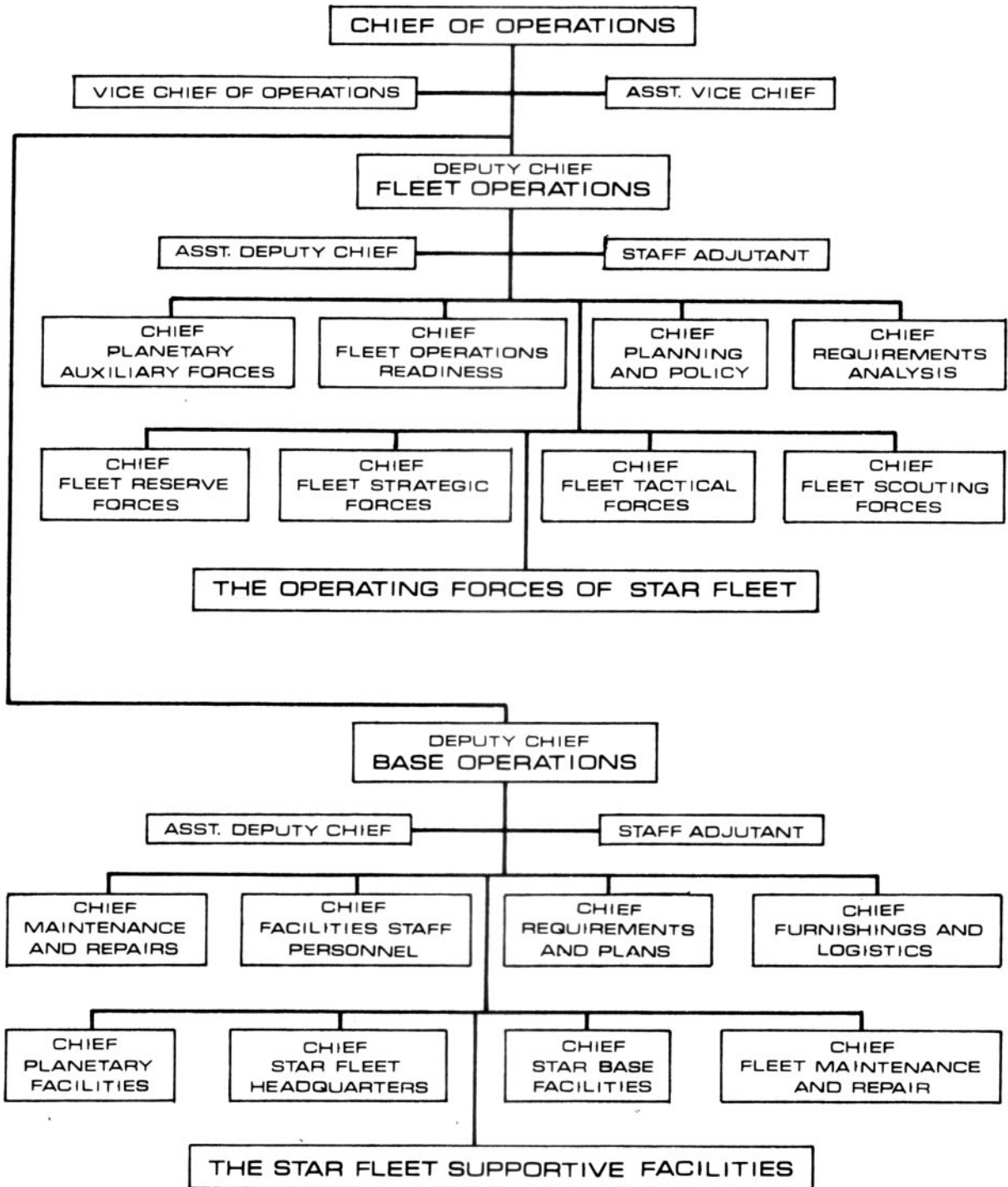

TO:01:01:03

# STAR FLEET ARMED FORCES ORGANIZATION

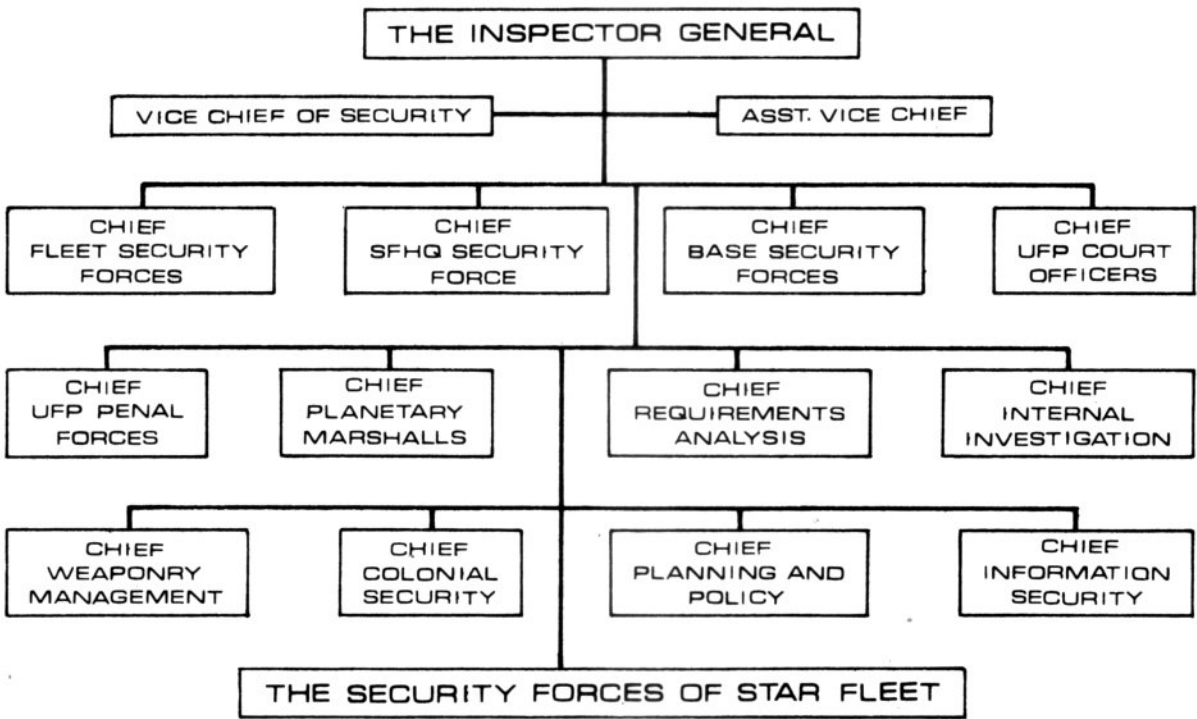
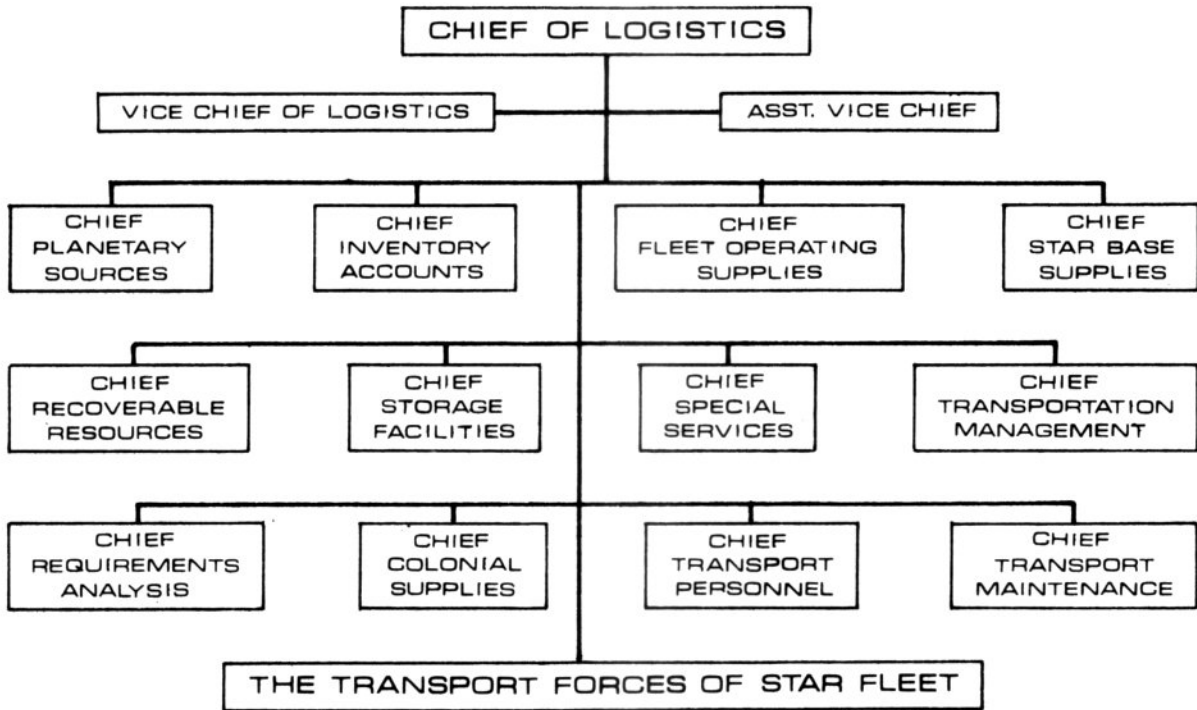



# THE STAR FLEET ACADEMY ORGANIZATION

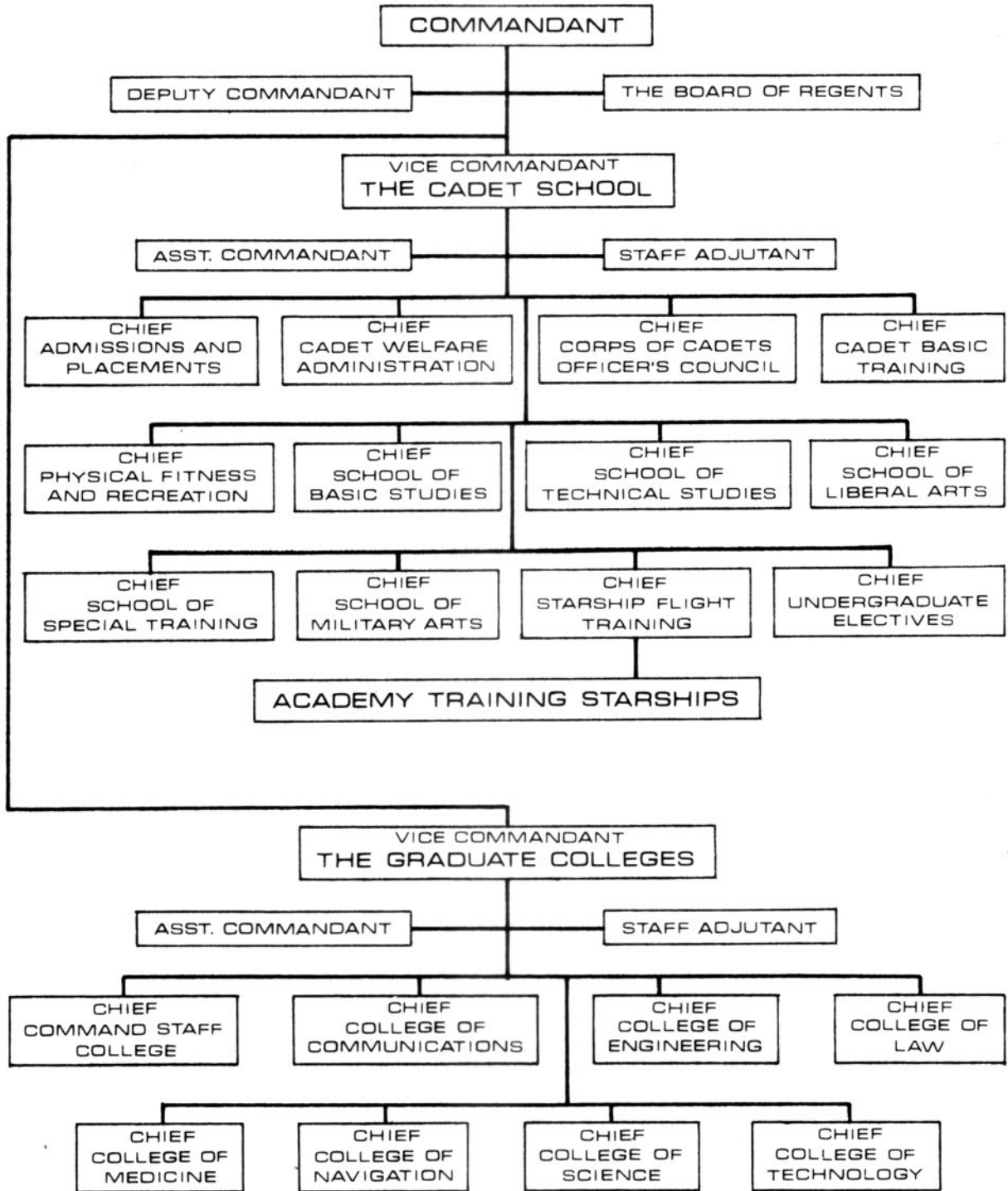

# FLEET HEADQUARTERS

## GENERAL ARRANGEMENT

PLAN VIEW

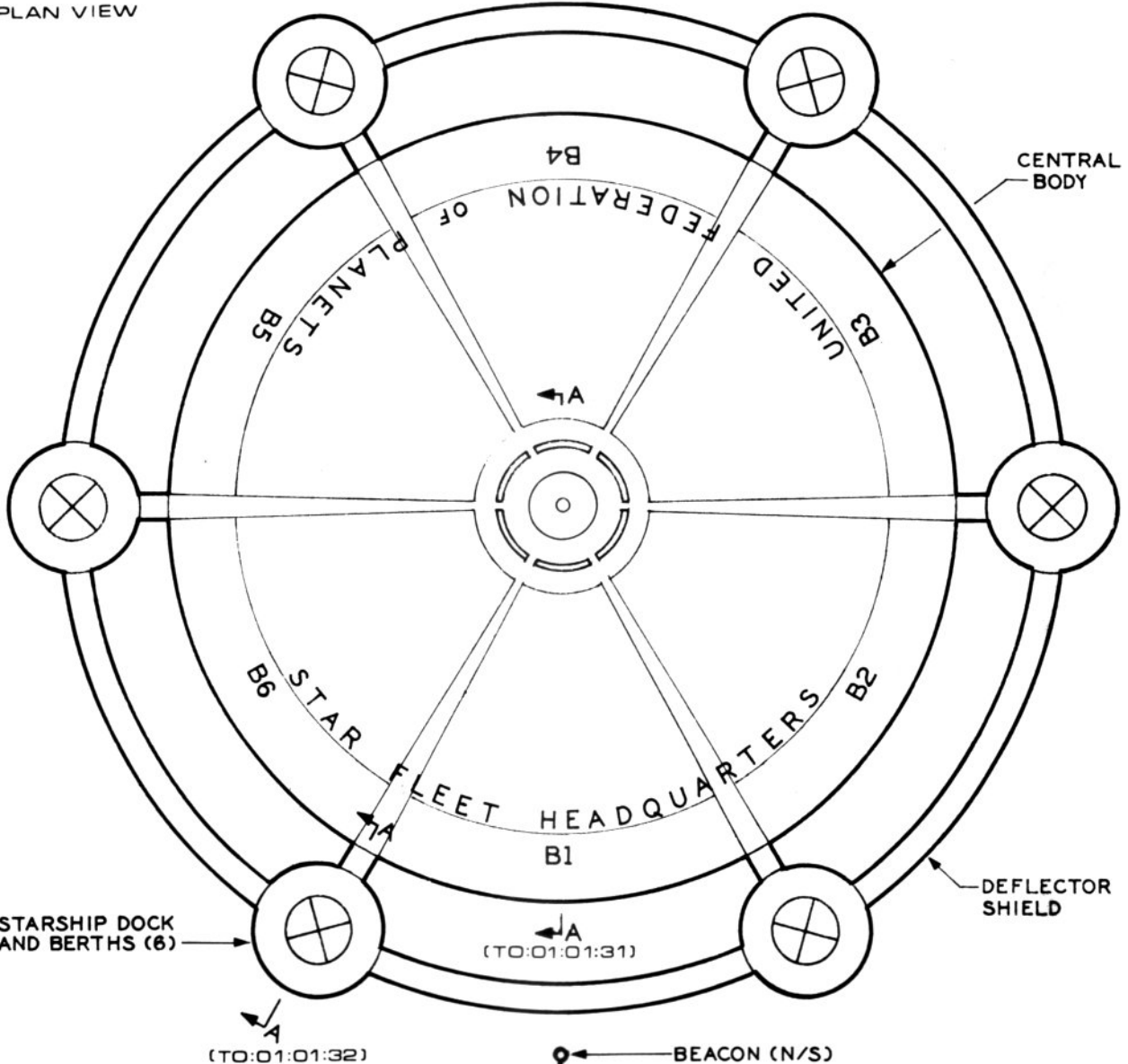

ELEVATION VIEW

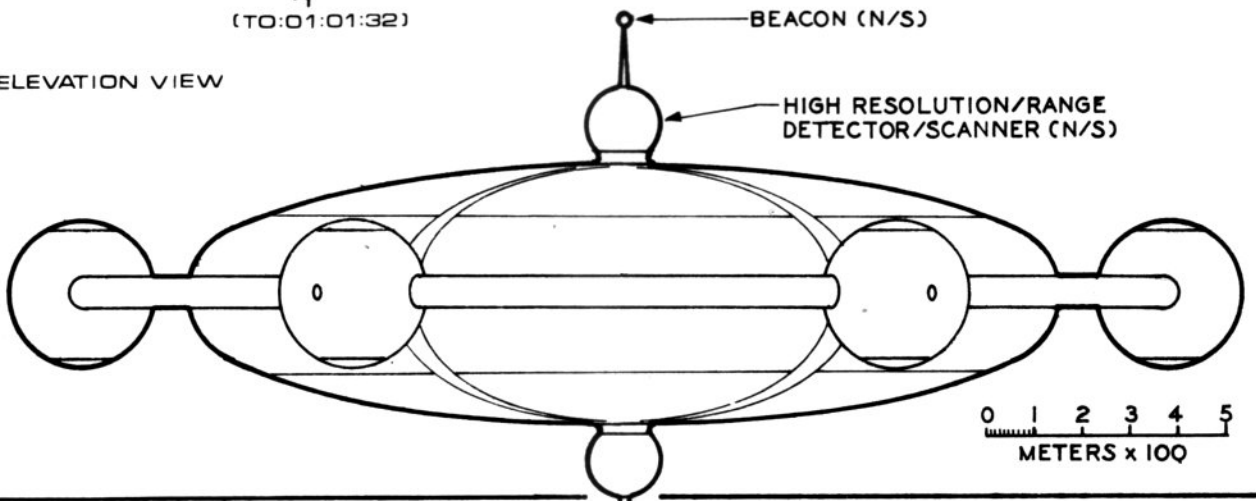

TO:01:01:31

# FLEET HEADQUARTERS

VIEW A-A TYPICAL CROSS-SECTION

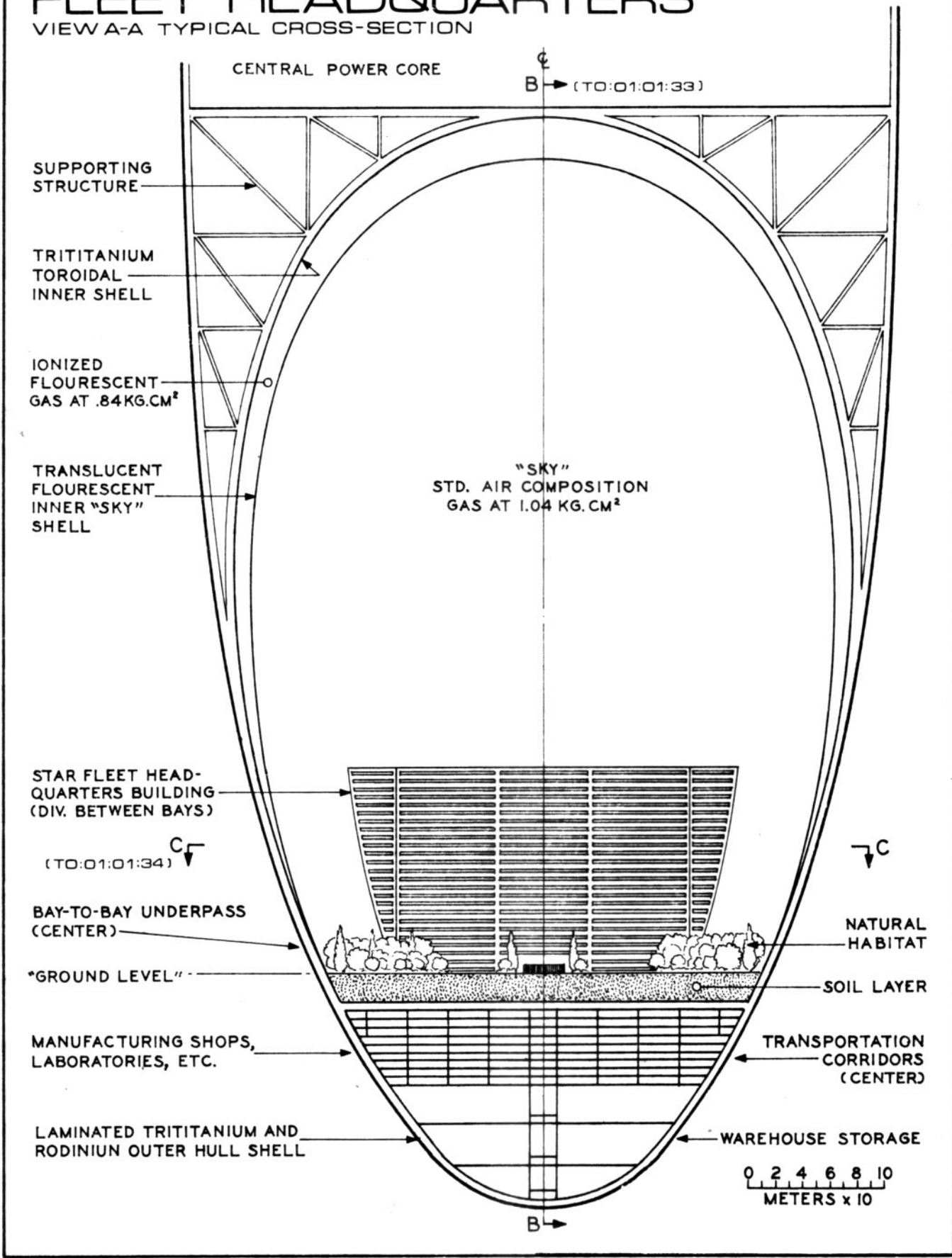

# FLEET HEADQUARTERS

VIEW A-A TYPICAL DOCK CROSS-SECTION

NOTE:  
DOCK IS NORMALLY PRESSURIZED ONLY FOR EXTENSIVE EXTERNAL SHIP REPAIRS OR LARGE SCALE LOADING AND UNLOADING OPERATIONS. SHIPS "FLOAT" IN SYNCHRONOUS ORBIT WITHIN DOCK

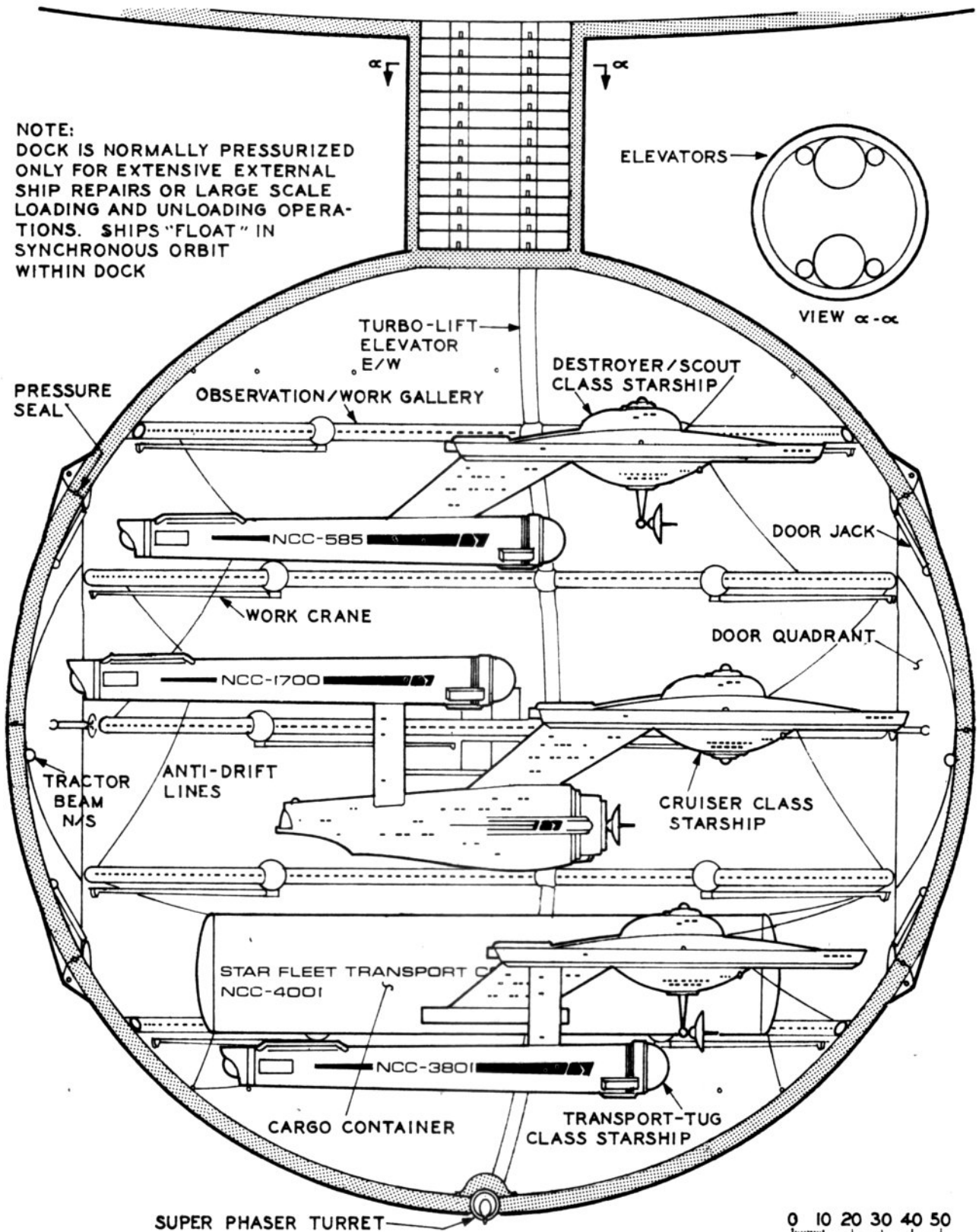

0 10 20 30 40 50  
METERS

TO:01:01:33

# FLEET HEADQUARTERS

VIEW B-B TYPICAL EQUATORIAL SECTION

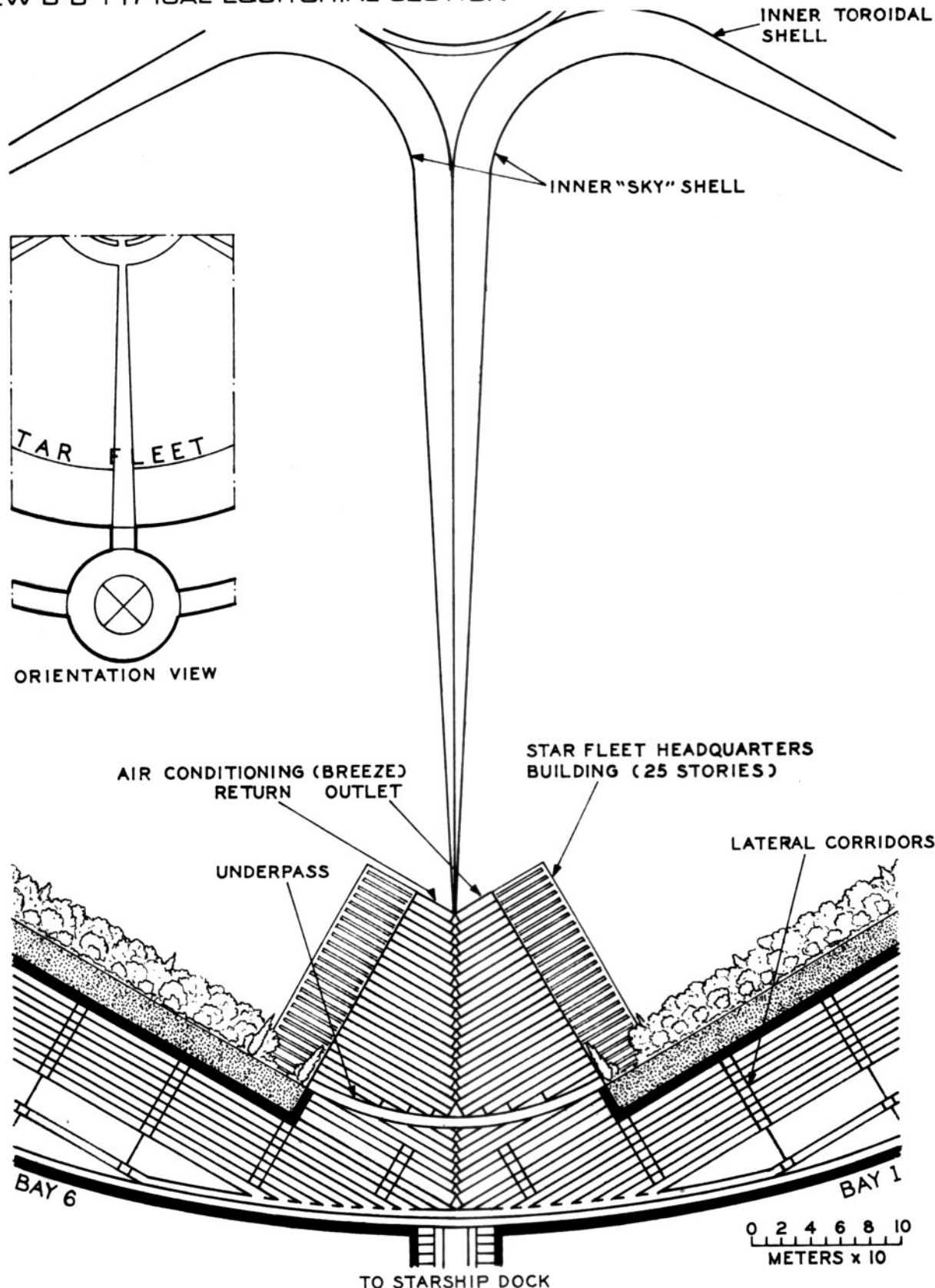

# FLEET HEADQUARTERS

VIEW C-C GROUND LEVEL PLANS

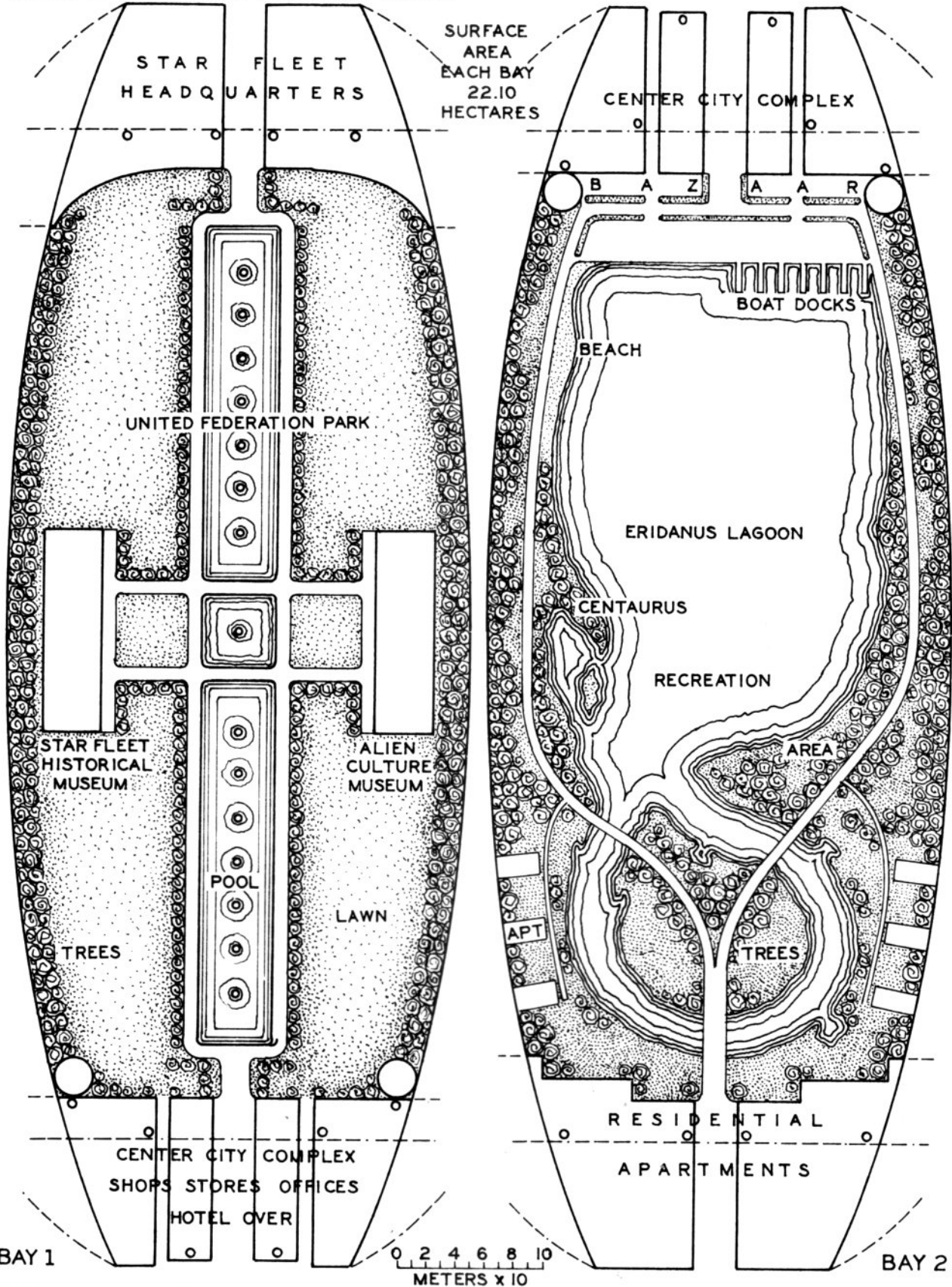

TO:01:01:35

# FLEET HEADQUARTERS

VIEW C-C GROUND LEVEL PLANS

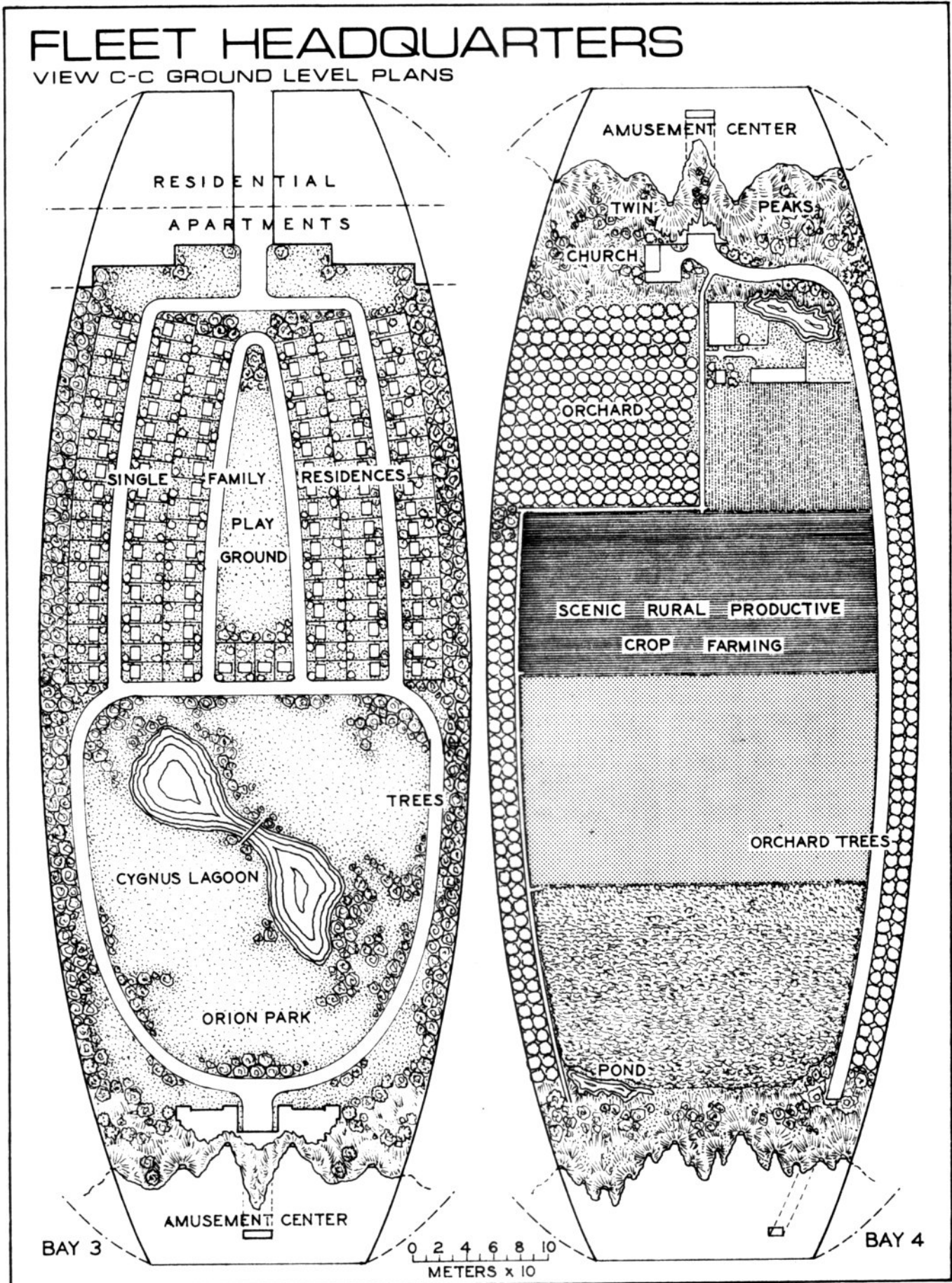

# FLEET HEADQUARTERS

VIEW C-C GROUND LEVEL PLANS

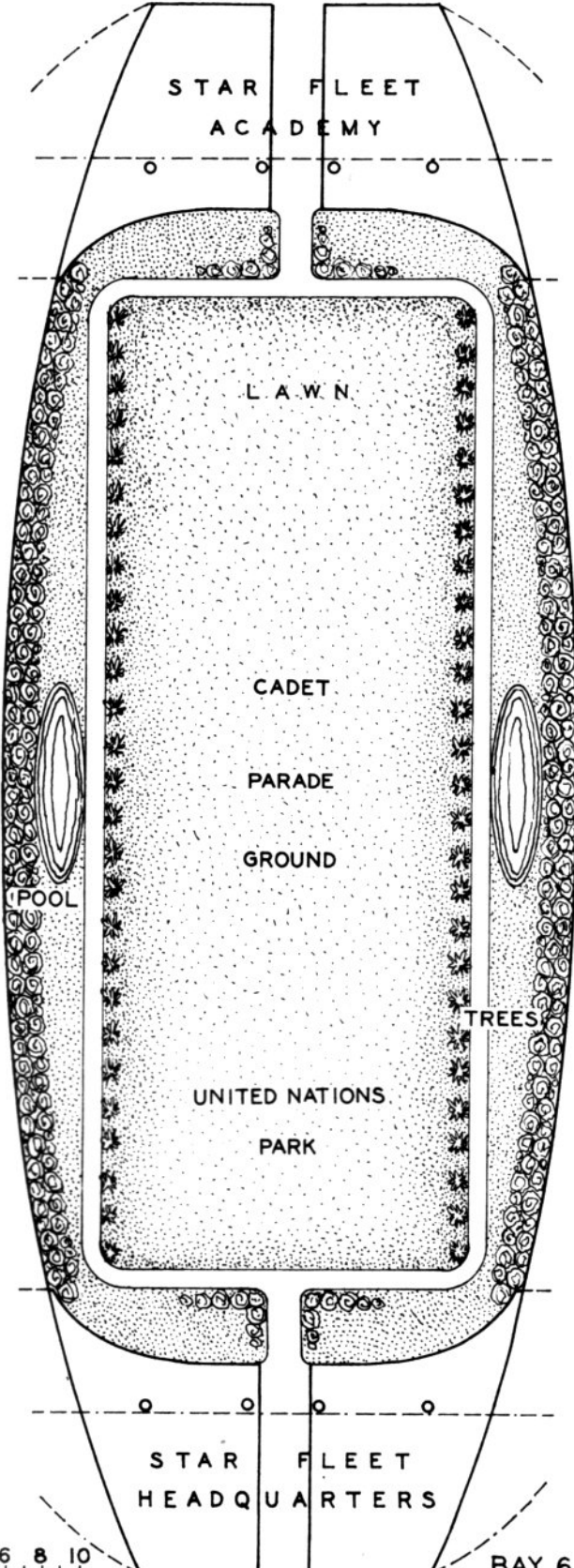
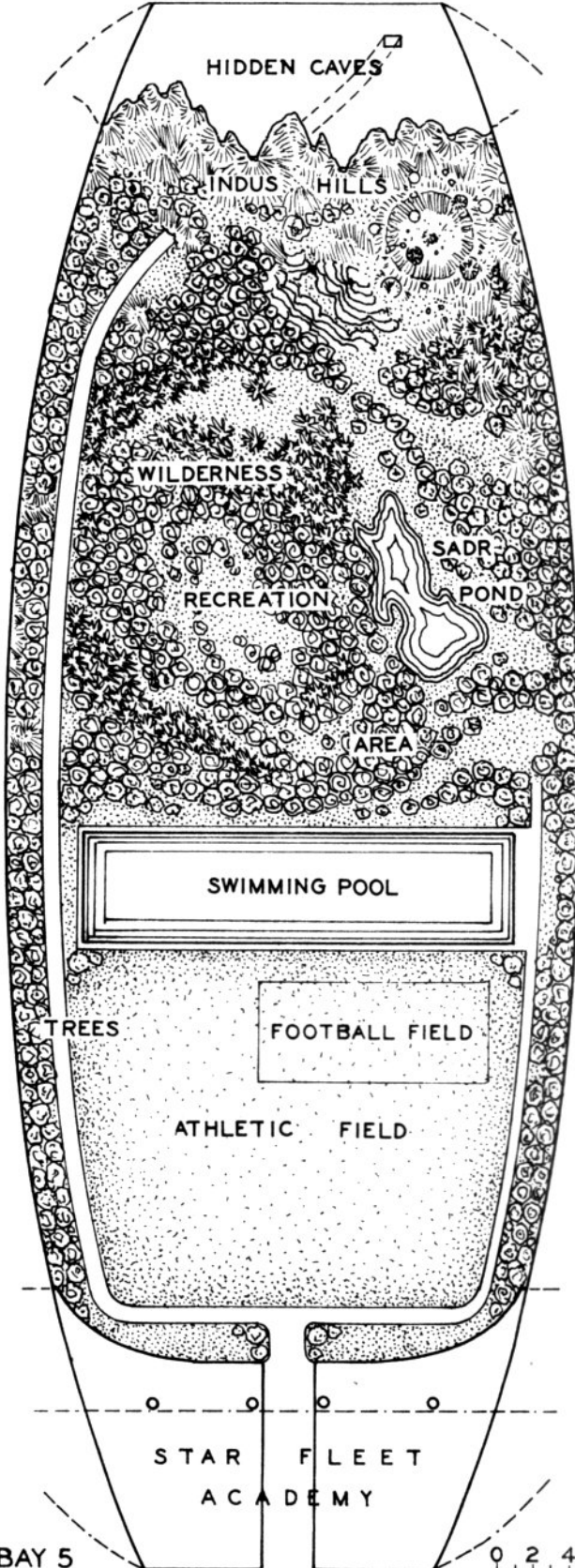

BAY 5

0 2 4 6 8 10  
METERS x 10

BAY 6



# INSIGNIA AND RANK

## STAR FLEET ARMED FORCES

### DIVISION INSIGNIA:

ACTUAL  
SIZE



COMMAND

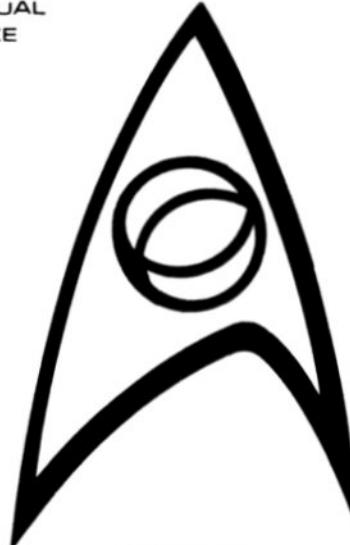

SCIENCES



ENGINEERING AND  
SUPPORT SERVICES

### OFFICER GRADES:

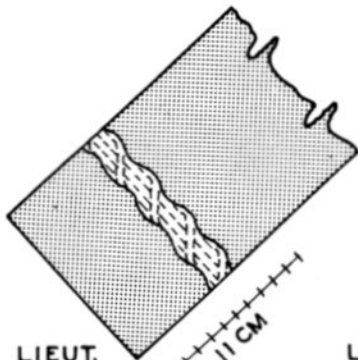

LIEUT.

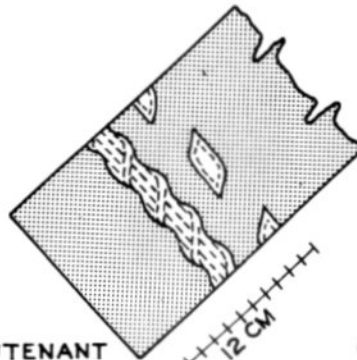
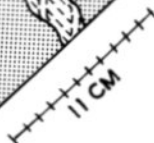

LIEUTENANT  
COMMANDER

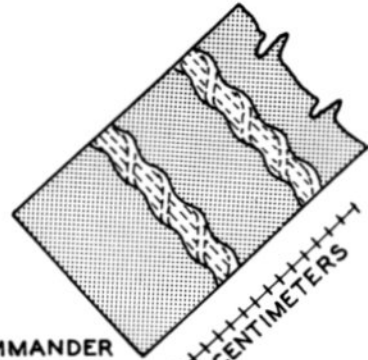
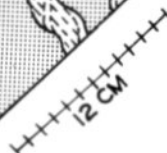

COMMANDER



ENSIGN HAS  
NO STRIPE

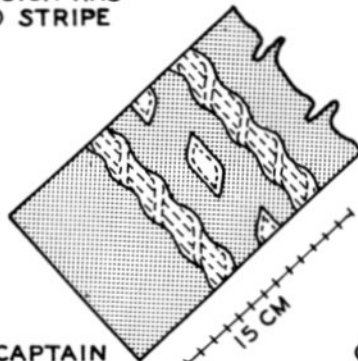

CAPTAIN

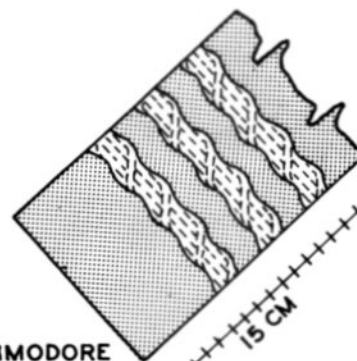
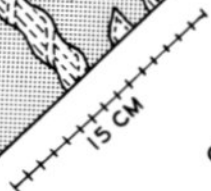

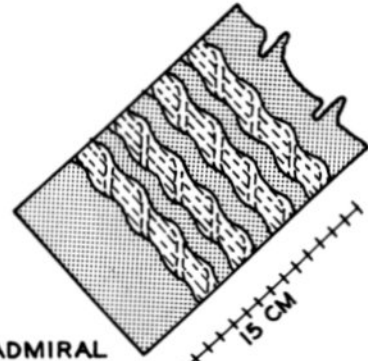

COMMODORE



ADMIRAL



### COLORS:

-  GOLD N°SF03UC
-  SEE UNIFORM T.O.
-  BLACK N°SF32UC

RANK STRIPES WORN ON DUTY UNIFORM ONLY AND  
ARE LOCATED ABOVE CUFF OF EACH SLEEVE

# DUTY UNIFORM-MALE

STAR FLEET ARMED FORCES

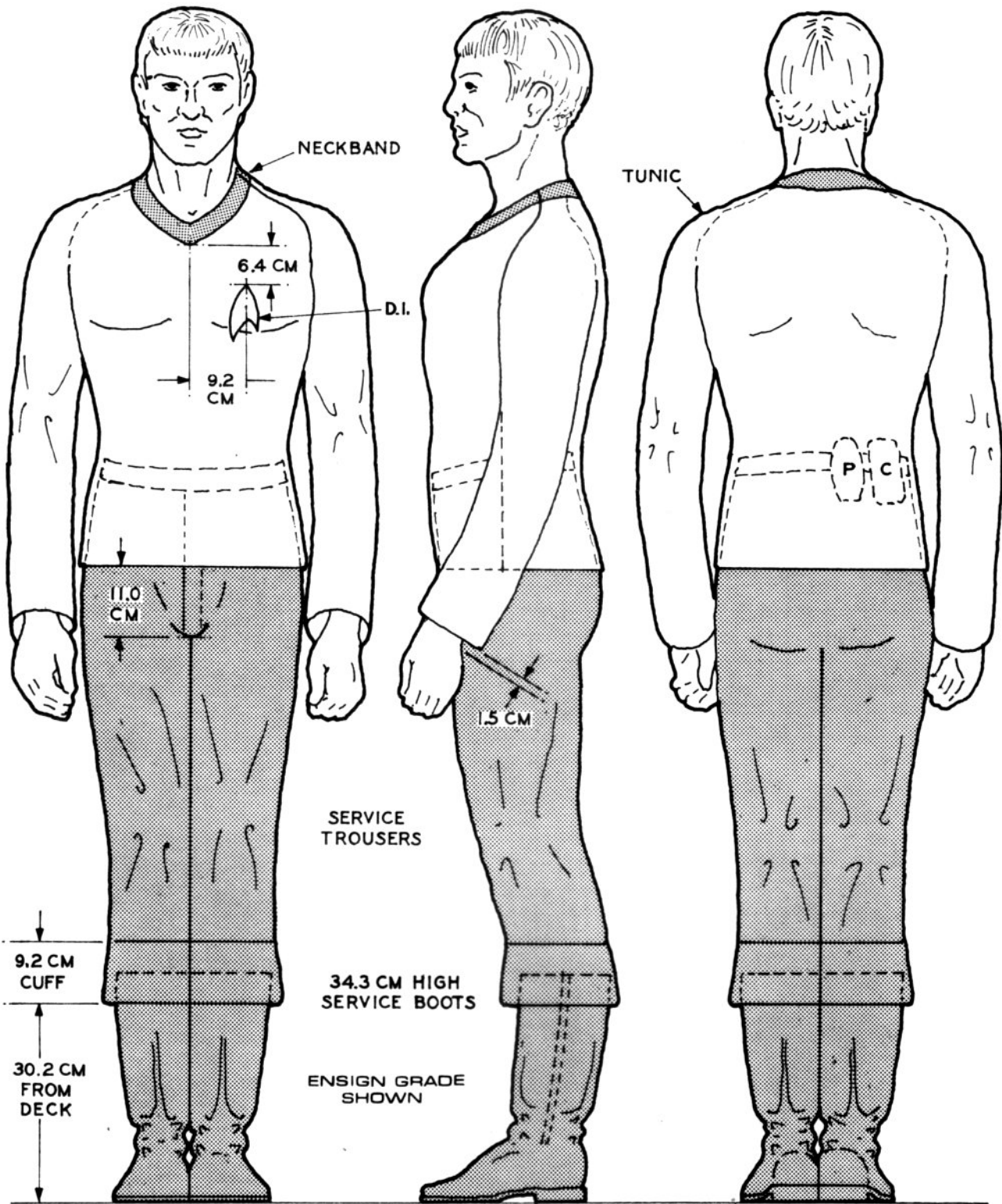

**COLORS:**

- DIV. COMMAND:  TENNE N°SF13UC
- SCIENCES:  BLUE N°SF17UC
- ENGRG/OTHER:  RED N°SF10UC

- BLACK N°SF32UC
- C-COMMUNICATOR, P-PHASER (UNDER TUNIC)
- D.I.-DIVISION INSIGNIA (SEE TO:01:03:00)

TO:01:03:11

# UNIFORM PATTERN

MALE - NON-COMPUTERIZED FABRICATION

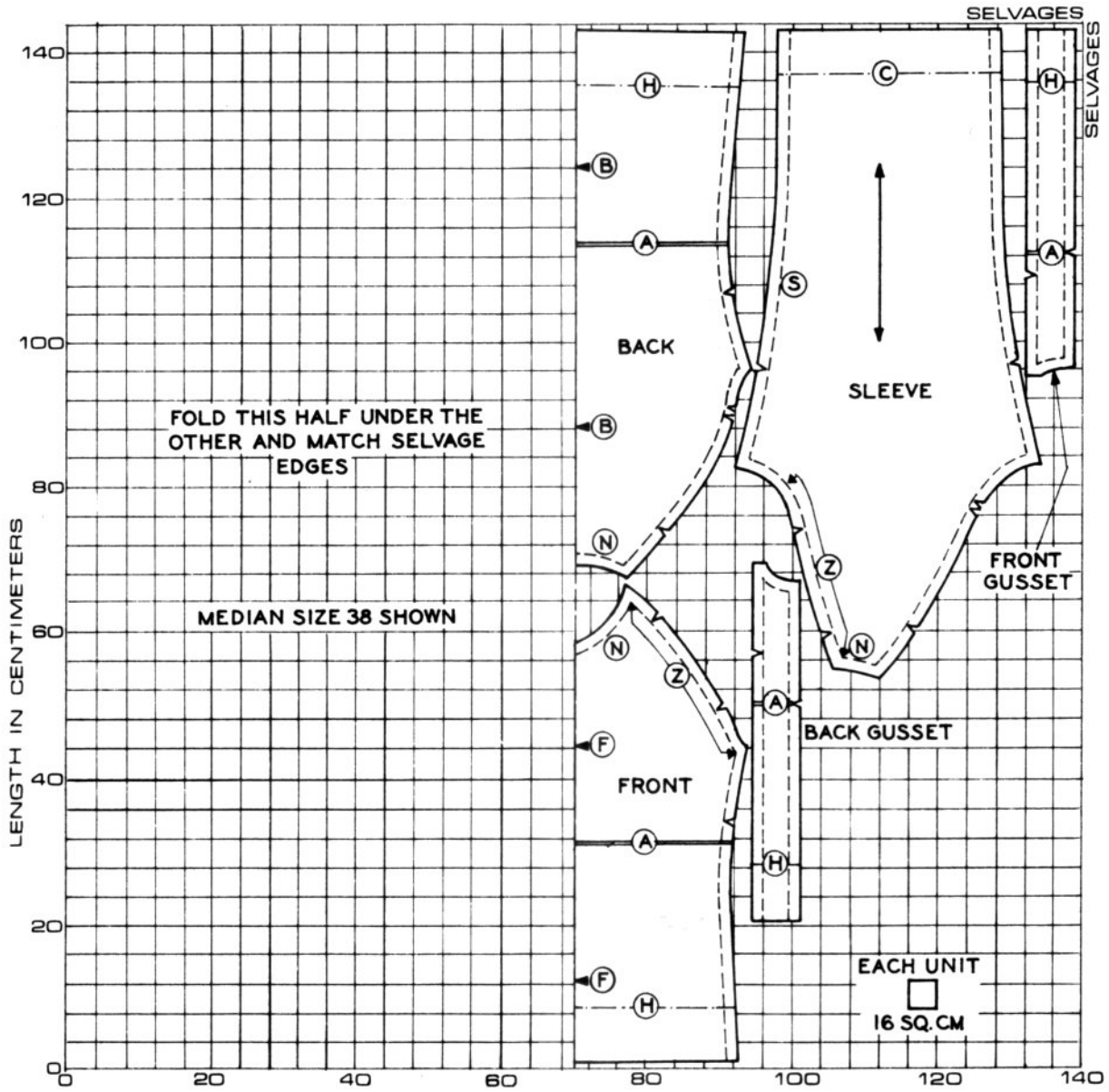

RATIO UNIT UP OR DOWN FOR LARGER OR SMALLER SIZES. CUT TWO TOGETHER OF EACH GUSSET AND SLEEVE PATTERN. MAKE COLLAR FROM 13x44 CM BLACK RIBBING. PATTERN FOR USE WITH REGULATION STRETCH FABRICS ONLY. TROUSERS ARE REGULATION PATTERN WITHOUT POCKETS OR BELT -USE FITTED WAISTBAND. A- LENGTHEN OR SHORTEN PATTERN HERE. B, F - PLACE CENTERLINE ON FOLD OF FABRIC. C - CUFF FOR LONG ARM LENGTH. H - APPROXIMATE HEM LINE. N - NECK LINE. S - SEAM WIDTH---1.60 CM. Z - INVISIBLE ZIPPER IN SEAM W/TALON UP - IT MUST INCLUDE COLLAR. ADJUST PATTERN AT SEAMS FOR SMOOTH FIT.

# DUTY UNIFORM-FEMALE

STAR FLEET ARMED FORCES

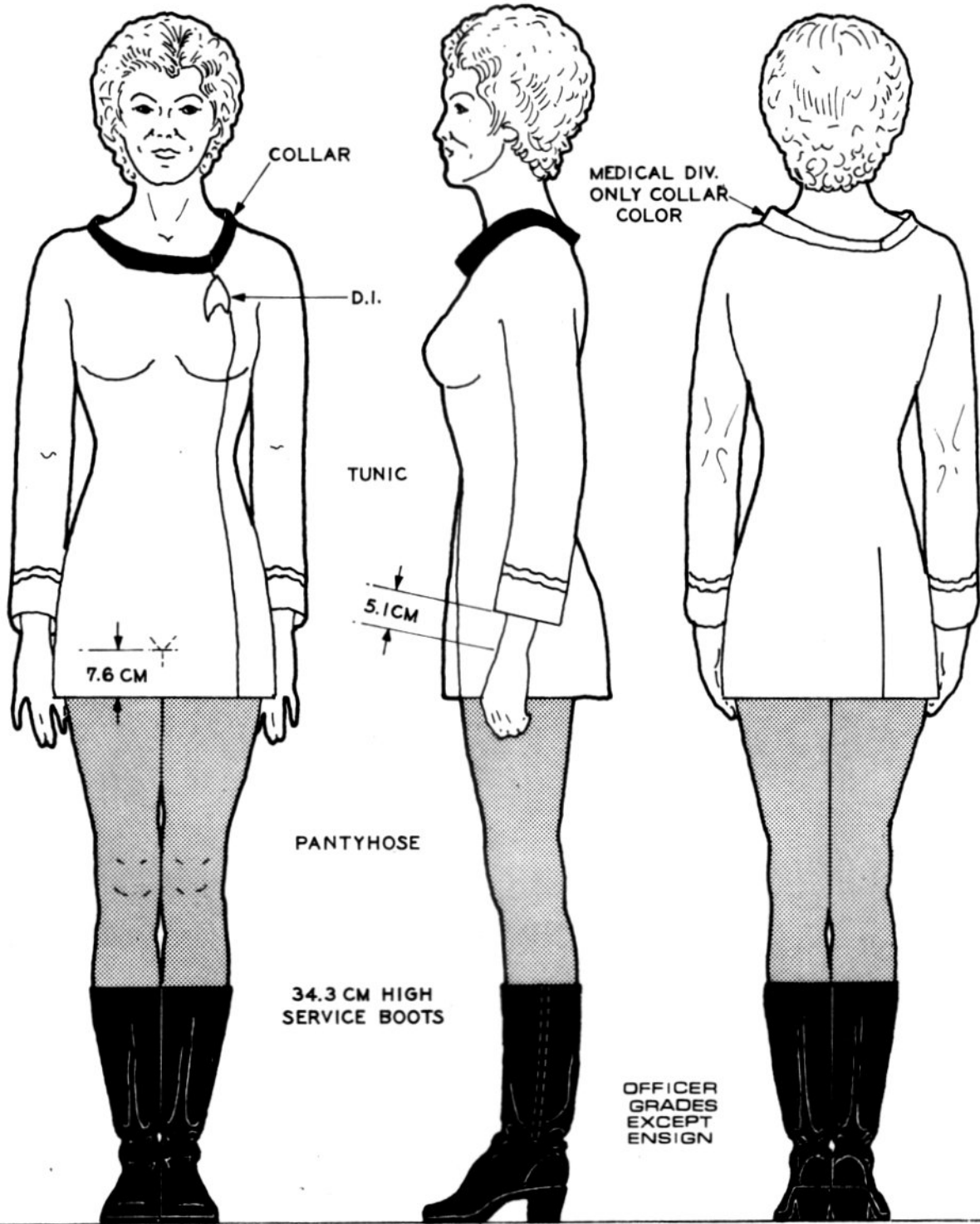

**COLORS:**

DIV: COMMAND

SCIENCES

ENGRG/OTHER



TENNE N°SF 13 UC

BLUE N°SF 17 UC

RED N°SF 10 UC



NUDE N°SF 25 UC

BLACK N°SF 32 UC

D.I.- DIVISION INSIGNIA (SEE TO:01:03:00)

# OFF. UNIFORM PATTERN

FEMALE - FOR NON-COMPUTERIZED FABRICATION

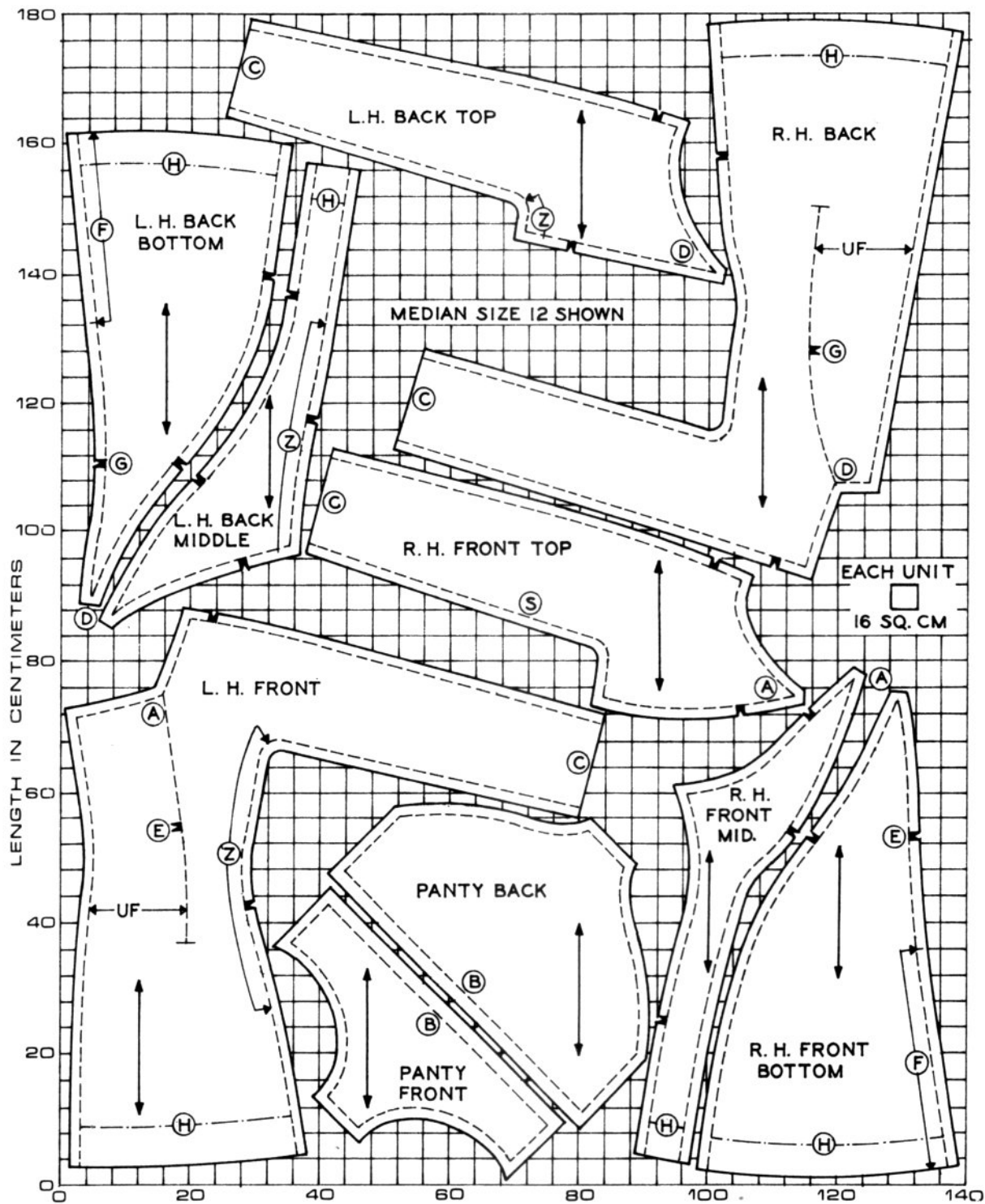



RATIO UNIT UP OR DOWN FOR LARGER OR SMALLER SIZES. MAKE COLLAR FROM 13 X 74 CM BLACK RIBBING. B-WAISTBAND WIDTH-2 CM. C-CUFF. F-FLAP. H-HEM. S-SEAM WIDTH-----1.60 CM. UF-UNDER FLAP. Z-INVISIBLE ZIPPER IN SEAM W/TALON UP. ADJUST SEAMS FOR SMOOTH FIT AND FLAP LENGTH FOR FLAT HANG. USE ELASTIC IN PANTY WAISTBAND AND LEG BANDS.

# DUTY UNIFORM-FEMALE

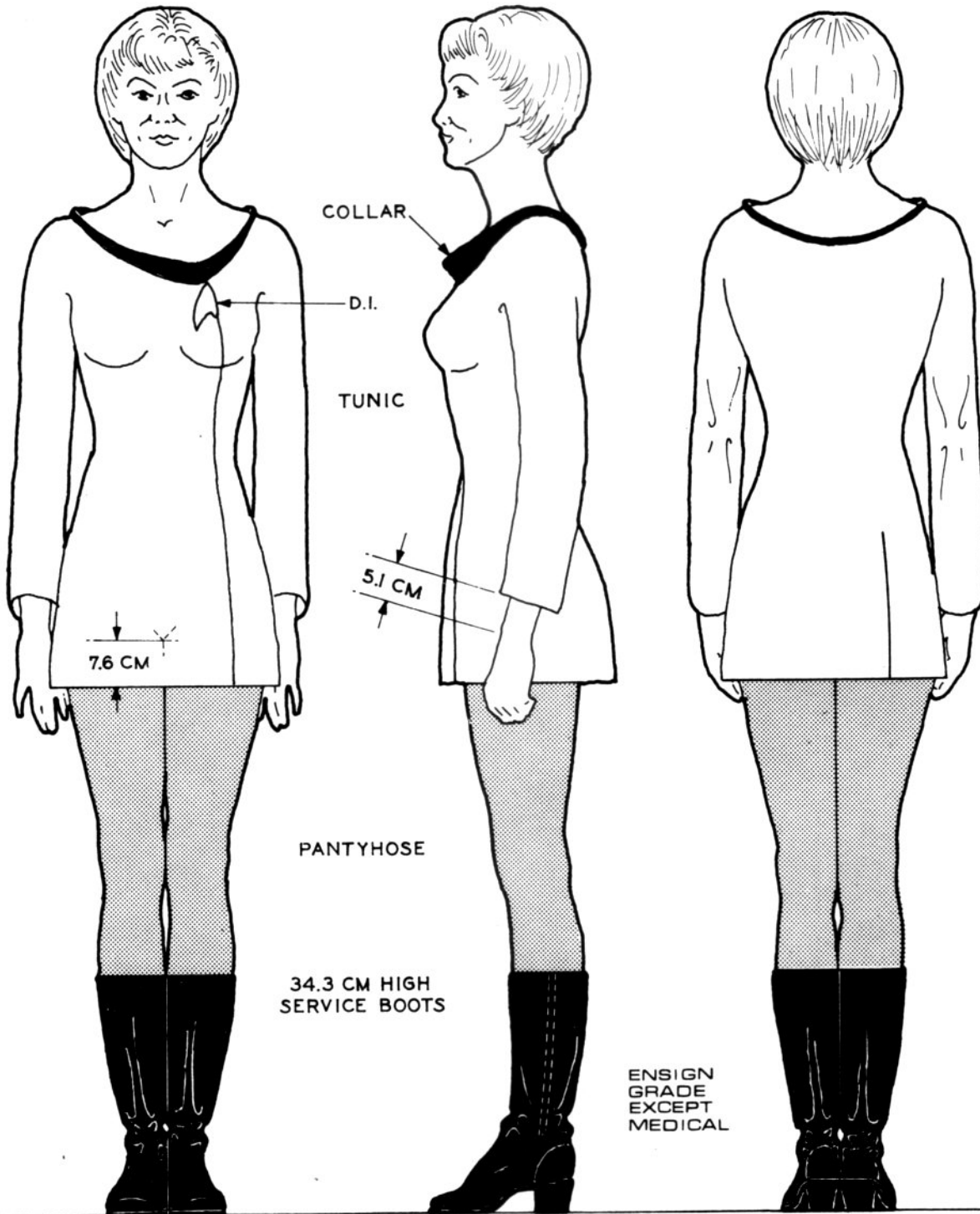
STAR FLEET ARMED FORCES



**COLORS:**

DIV: COMMAND.....		TENNE N°SF13 UC
SCIENCES.....		BLUE N°SF17 UC
ENGRG/OTHER...		RED N°SF10 UC

	NUDE N°SF25 UC
	BLACK N°SF32 UC

D.I.-DIVISION INSIGNIA (SEE TO:01:03:00)

# ENS. UNIFORM PATTERN

FEMALE - NON-COMPUTERIZED FABRICATION

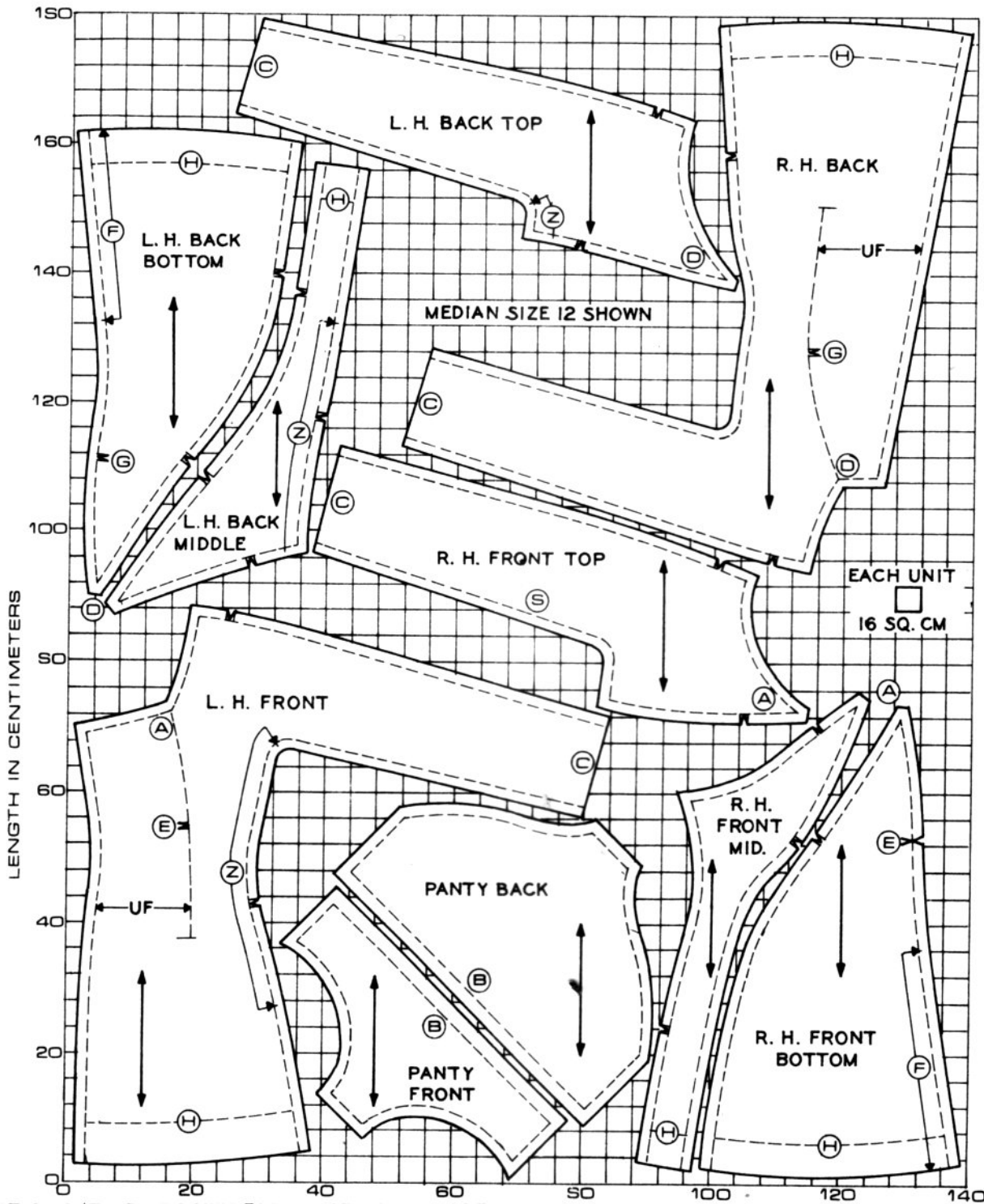

RATIO UNIT UP OR DOWN FOR LARGER OR SMALLER SIZES. MAKE COLLAR FROM 13x 80 CM BLACK RIBBING. B - WAISTBAND WIDTH - 2 CM. C - CUFF. F - FLAP. H - HEM. S - SEAM WIDTH - 1.6 CM. UF - UNDER FLAP. Z - INVISIBLE ZIPPER IN SEAM W/TALON UP. ADJUST SEAMS FOR SMOOTH FIT AND FLAP LENGTH FOR FLAT HANG. USE ELASTIC IN PANTY WAISTBAND AND LEG BANDS.

# DUTY UNIFORM-FEMALE

STAR FLEET ARMED FORCES

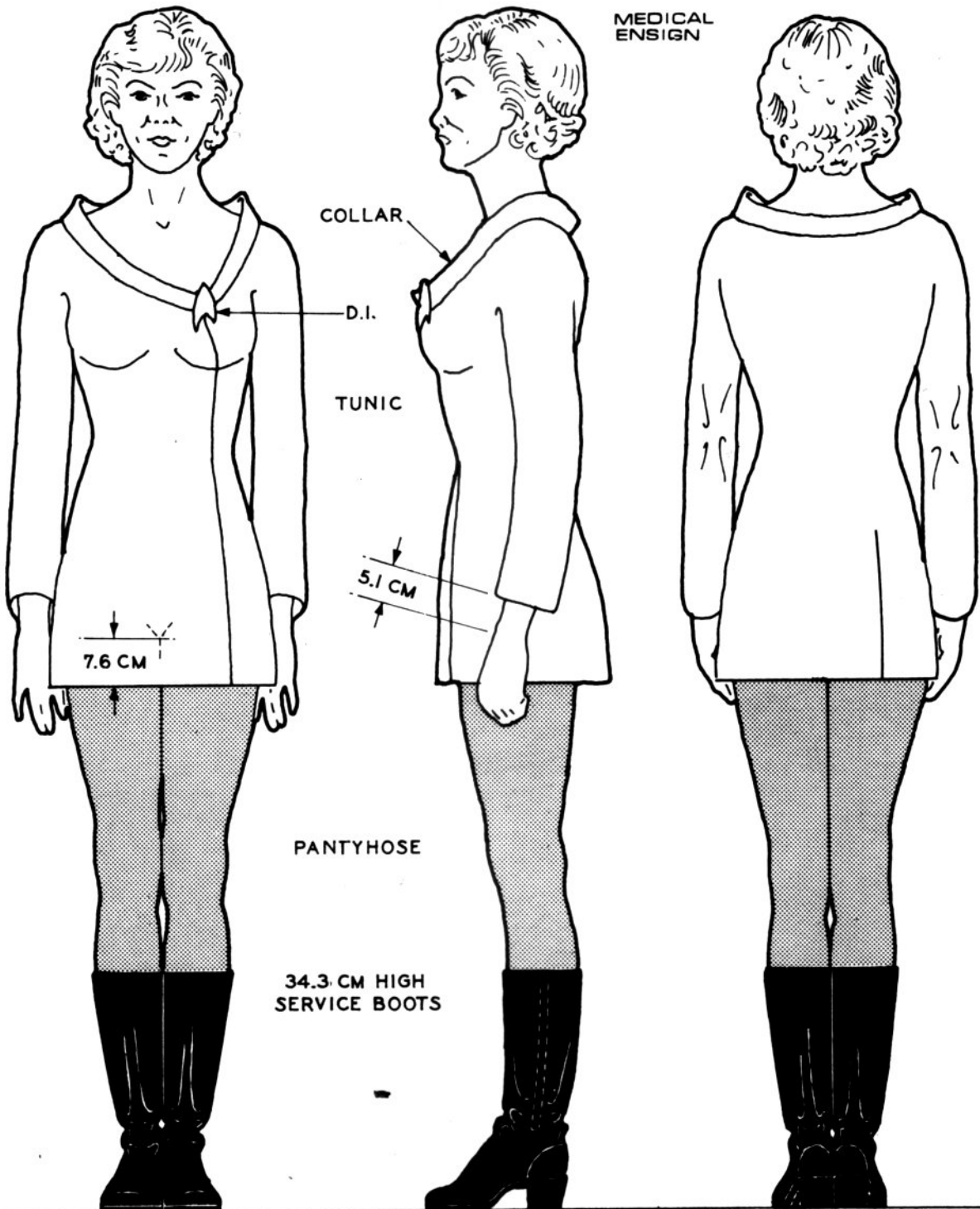

COLORS:  
DIV: SCIENCES  BLUE N°SF17UC  
 NUDE N°SF25UC  
 BLACK N°SF32UC

D.I. - DIVISION INSIGNIA FOR MEDICAL NURSES  
AND ORDERLIES (SEE TO:01:03:01)



# MED. UNIFORM PATTERN

FEMALE - NON-COMPUTERIZED FABRICATION

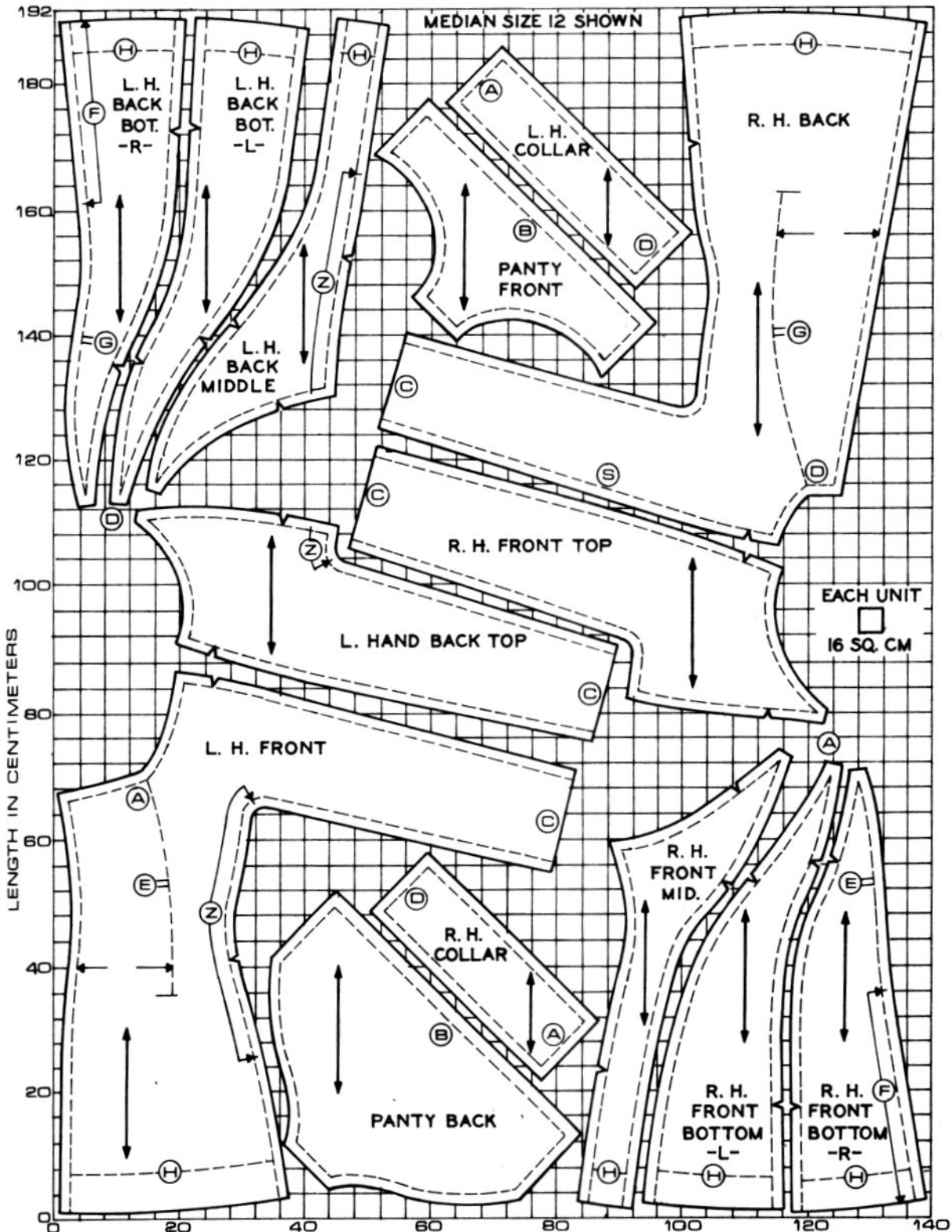

RATIO UNIT UP OR DOWN FOR LARGER OR SMALLER SIZES. FOR INSTRUCTIONS SEE TO:01:03:15

# FLEET SHIP CLASSIFICATIONS

## CLASS I STARSHIPS

### DREADNOUGHT CLASS



MODEL: MK X  
 PROP: IMPULSE POWER  
 3 SPACE/WARP UNITS  
 D.W.T: 285,000

UNDER CONSTRUCTION

### HEAVY CRUISER CLASS

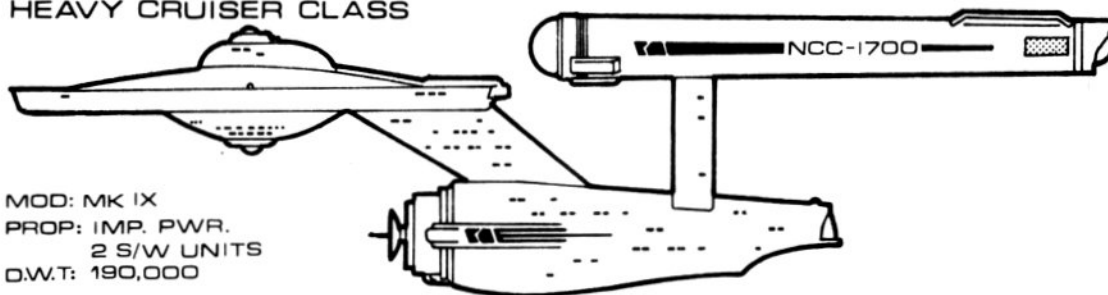

MOD: MK IX  
 PROP: IMP. PWR.  
 2 S/W UNITS  
 D.W.T: 190,000

### DESTROYER/SCOUT CLASS

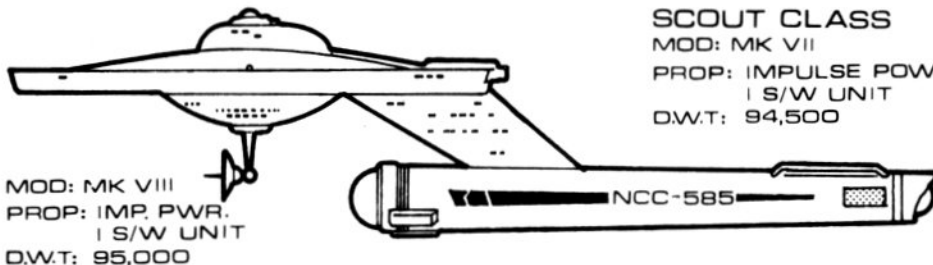

MOD: MK VIII  
 PROP: IMP. PWR.  
 1 S/W UNIT  
 D.W.T: 95,000

SCOUT CLASS  
 MOD: MK VII  
 PROP: IMPULSE POWER  
 1 S/W UNIT  
 D.W.T: 94,500

### TRANSPORT/TUG CLASS

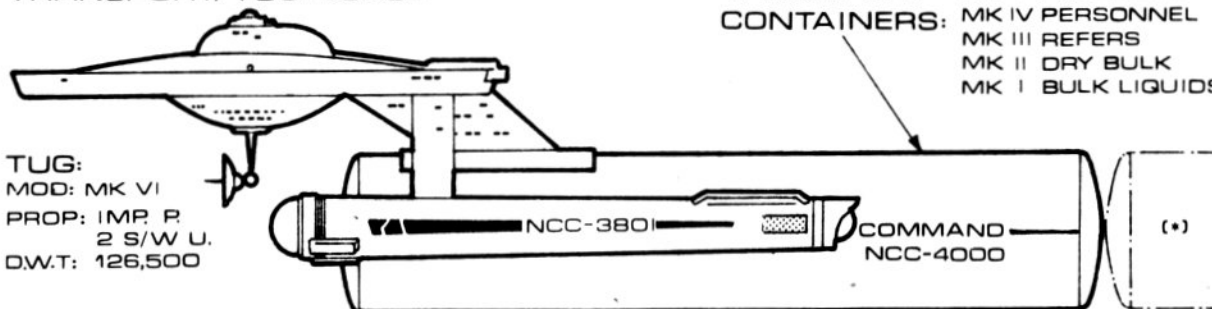

TUG:  
 MOD: MK VI  
 PROP: IMP. P.  
 2 S/W U.  
 D.W.T: 126,500

TRANSPORT CONTAINERS:  
 MK V PRODUCTS  
 MK IV PERSONNEL  
 MK III REFERS  
 MK II DRY BULK  
 MK I BULK LIQUIDS

NOTE: D.W.T. - DEADWEIGHT METRIC TONNAGE; PROP. - PROPULSION  
 (\*) TWO IN TANDEM STANDARD MAXIMUM

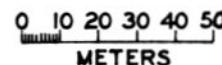

# CLASS I HEAVY CRUISER

## CONSTITUTION CLASS STARSHIPS

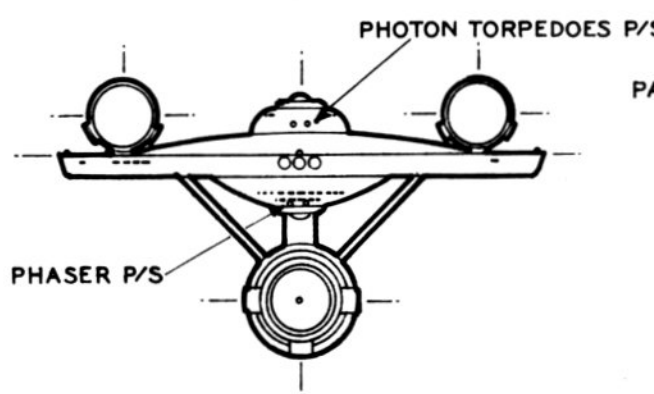
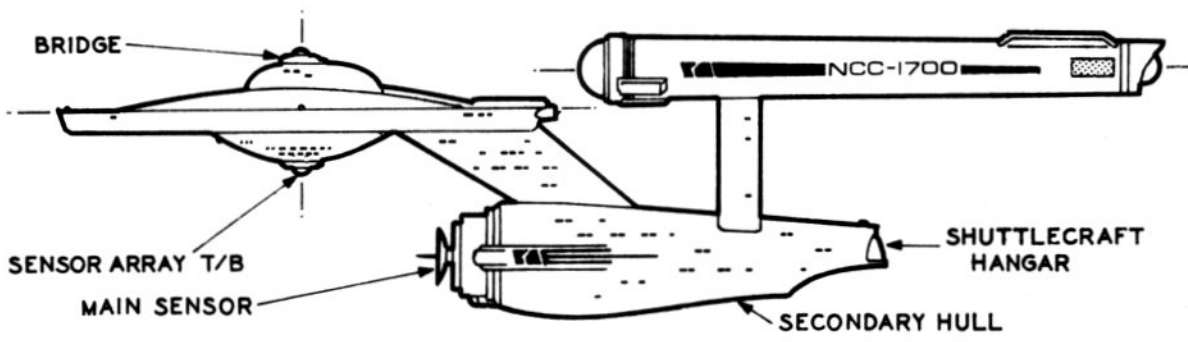
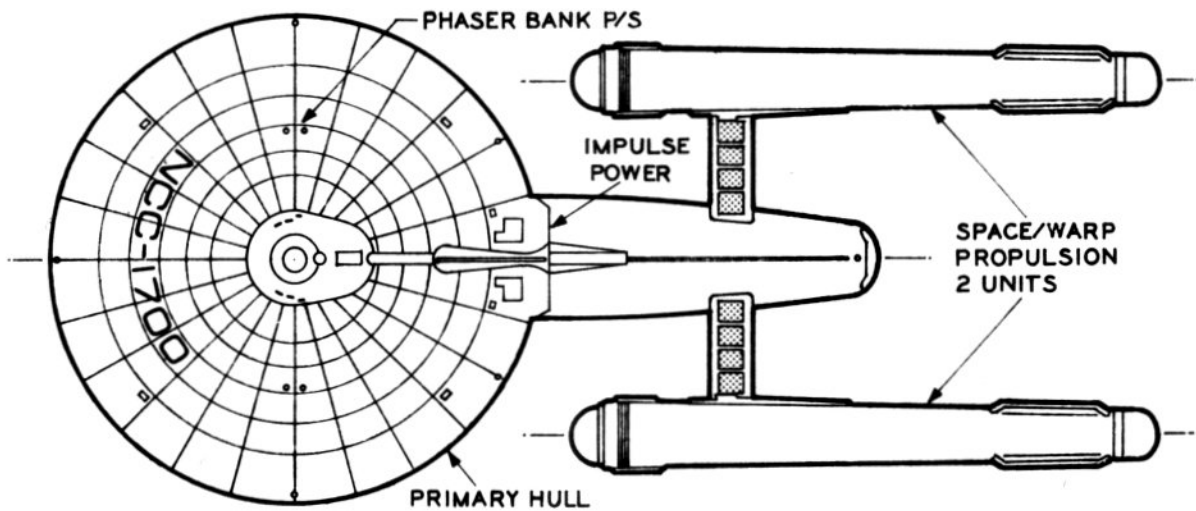

**PARTICULARS:**

DEADWEIGHT TONNAGE-METRIC.....	190,000
STD. RANGE.....	18 YEARS AT L.V.V.
MAX. SAFE CRUISING SPEED.....	W/F 6
EMERGENCY SPEED.....	W/F 8
MAIN PHASERS.....	3 BANKS/2 EACH
PHOTON TORPEDOES.....	2 BANKS
LENGTH OVERALL-METERS.....	288.6
BREADTH OVERALL-METERS.....	127.1
HEIGHT OVERALL-METERS.....	72.6
PRIMARY HULL DIA.-METERS.....	127.1
SEC. HULL LENGTH-METERS.....	103.6
SEC. HULL MAX. DIA.-METERS.....	34.1
PROP. UNIT L.O.A.-METERS.....	153.6
PROP. UNIT DIA.-METERS.....	17.3

**STD. SHIP'S COMPLEMENT:**

OFFICERS (COMMAND).....	43
CREW (SENSIGN GRADE).....	387

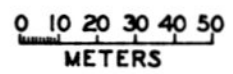

SEE BOOKLET OF GENERAL PLANS FOR DETAILS

## STAR FLEET TECHNICAL ORDER

AUTHENTICATED STARDATE 7306.16

TO:01:04:11

## HEAVY CRUISER CLASS

## AUTHORIZED CONSTRUCTION

THE FOLLOWING SHIPS OF THE MK-IX CLASS WERE AUTHORIZED BY THE ORIGINAL ARTICLES OF FEDERATION OF STARDATE 0965:

CONSTELLATION - NCC-1017**	FARRAGUT - NCC-1702**	POTEMPKIN - NCC-1711
CONSTITUTION - NCC-1700*	HOOD - NCC-1707	REPUBLIC - NCC-1371
ENTERPRISE - NCC-1701	INTREPID - NCC-1708**	VALIANT - NCC-1709**
EXCALIBUR - NCC-1705	KONGO - NCC-1710	YORKTOWN - NCC-1704
EXETER - NCC-1706	LEXINGTON - NCC-1703	

THE FOLLOWING SHIPS OF THE MK-IXA CLASS WERE AUTHORIZED BY THE STAR FLEET APPROPRIATION OF STARDATE 3220:

ARI - NCC-1723	EXCELSIOR - NCC-1718	MONITOR - NCC-1713
BONHOMME RICHARD - NCC-1712*	HORNET - NCC-1714	SARATOGA - NCC-1724
EAGLE - NCC-1719	LAFAYETTE - NCC-1720	TORI - NCC-1725
EL DORADO - NCC-1722	KRIEGER - NCC-1726	WASP - NCC-1721
ENDEAVOR - NCC-1716	MERRIMAC - NCC-1715	DEFIANCE - NCC-1717
ESSEX - NCC-1727		

THE FOLLOWING REPLACEMENTS FOR THE CONSTITUTION CLASS WERE AUTHORIZED BY STAR FLEET APPROPRIATION OF STARDATE 4444:

CONSTELLATION II - NCC-1728	INTREPID II - NCC-1730
FARRAGUT II - NCC-1729	VALIANT II - NCC-1731

THE FOLLOWING SHIPS OF THE MK-IXB CLASS WERE AUTHORIZED BY THE STAR FLEET APPROPRIATION OF STARDATE 5930:

ACHERNAR - NCC-1732*	FOMALHAUT - NCC-1804	PILAR - NCC-1746
ACRUX - NCC-1818	GALINA - NCC-1764	POLARIS - NCC-1839
ADHARA - NCC-1827	GHAR - NCC-1786	POLLUX - NCC-1808
AGENA - NCC-1816	GHONDR - NCC-1749	PROCYON - NCC-1756
AHZDAR - NCC-1790	HAJJ - NCC-1782	PROXIMA - NCC-1737
ALAM'AK - NCC-1796	HELIOS - NCC-1825	QUAL'AT - NCC-1776
ALDEBARAN - NCC-1812	HIEMDAL - NCC-1793	QIZAN - NCC-1775
ALFERAZ - NCC-1781	HOR - NCC-1813	QUINDAR - NCC-1736
ALFR - NCC-1741	HOROK - NCC-1748	REGULUS - NCC-1840
ALIOTH - NCC-1828	JASSAN - NCC-1754	RIGEL - NCC-1824
ALKAID - NCC-1829	JENSHAHN - NCC-1791	RIGIL KENTAURUS - NCC-1735
ALNILAM - NCC-1830	JUPITER - NCC-1734	SALAYNA - NCC-1774
ALTAIR - NCC-1803	KARS - NCC-1769	SAMAARA - NCC-1765
ANAK - NCC-1821	KASIMAR - NCC-1784	SARDAR - NCC-1811
ANDROCUS - NCC-1738	KEP SALU - NCC-1767	SHAHR - NCC-1745
ANNOBON - NCC-1752	KESTRAL - NCC-1766	SHAULA - NCC-1841
ANTARES - NCC-1820	KETOI - NCC-1768	SHAANDRA - NCC-1795
ARCTURUS - NCC-1807	K'HOTAN - NCC-1802	SINUJI - NCC-1770
ARIDED - NCC-1831	K'USHUI - NCC-1801	SIRIUS - NCC-1744
ASTRAD - NCC-1739	LUX - NCC-1823	SOL - NCC-1733
BEHR'AK - NCC-1797	MIAPLACIDAS - NCC-1836	SPICA - NCC-1815
BELLATRIX - NCC-1832	MAAT - NCC-1794	TALI - NCC-1751
BETELGEUSE - NCC-1822	MAZDA - NCC-1778	TAJARHI - NCC-1783
BINAR - NCC-1819	MENGEN - NCC-1773	TEMIR - NCC-1763
CANOPUS - NCC-1814	MIRFAK - NCC-1837	THELONII - NCC-1742
CAPELLA - NCC-1809	MIRAZH - NCC-1788	THOLUS - NCC-1747
CASPAN - NCC-1753	MONDOLOY - NCC-1740	TIKOPAI - NCC-1800*
CASTOR - NCC-1833	MONGO - NCC-1785	TULAN - NCC-1777
CZAR'AK - NCC-1798	MURZIM - NCC-1838	TUTAKAI - NCC-1799
DARION - NCC-1810	NDELE - NCC-1758	VEGA - NCC-1806
DENEK - NCC-1826	NAKARAT - NCC-1805	VENA - NCC-1817
DUBHE - NCC-1834	OOMARU - NCC-1761	WEZEN - NCC-1842
EL NATH - NCC-1835	OBLIK - NCC-1772	XANTHII - NCC-1743
ELOHIM - NCC-1792	PARI - NCC-1787	YAAN - NCC-1762
EKINUS - NCC-1771	PAEGAN - NCC-1755	ZAAHM - NCC-1780
ESABL - NCC-1779	PELIONE - NCC-1750	ZA'FARAN - NCC-1760
ESKIIS - NCC-1789	PHARDOS - NCC-1757	ZINDAR - NCC-1759

\*CLASS SHIP. \*\*LOST IN THE LINE OF DUTY. ALL NAMES PRECEDED WITH "U.S.S."

# CLASS I DESTROYER

## SALADIN CLASS STARSHIPS

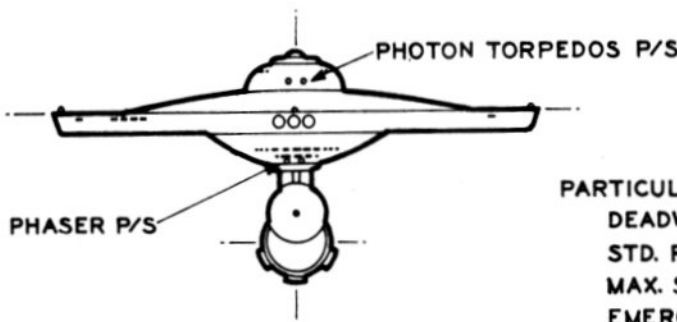
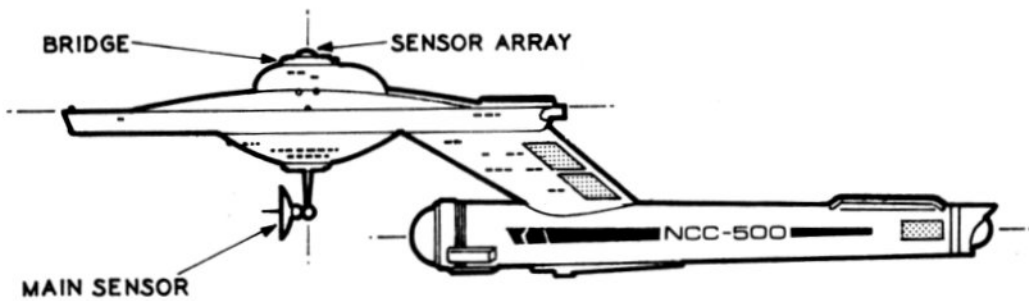
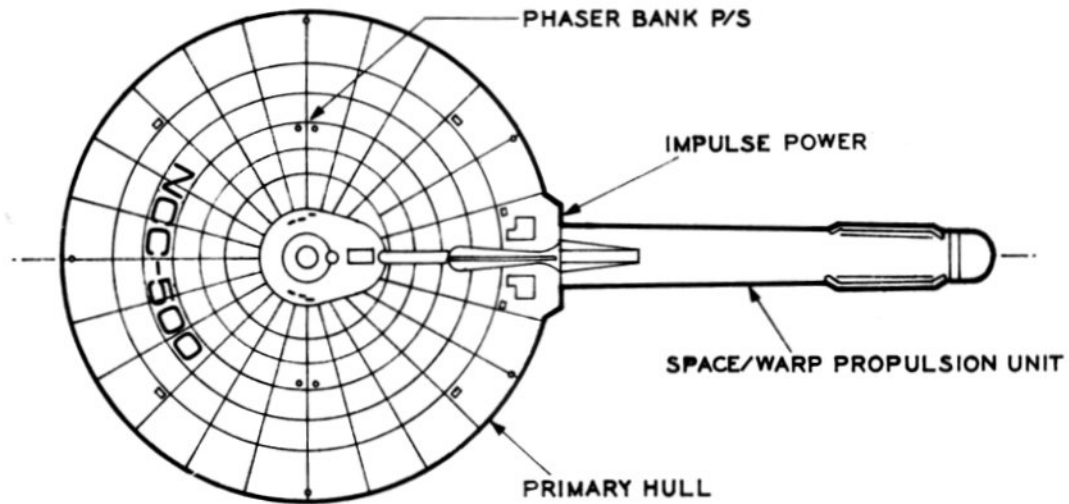

STD. SHIP'S COMPLEMENT:  
 OFFICERS (COMMAND).....20  
 CREW (ENSIGN GRADE).....180

**PARTICULARS:**

DEADWEIGHT TONNAGE-METRIC.....95,000  
 STD. RANGE.....9 YEARS AT L.Y.V.  
 MAX. SAFE CRUISING SPEED.....W/F 6  
 EMERGENCY SPEED.....W/F 8  
 MAIN PHASERS.....3 BANKS/2 EACH  
 PHOTON TORPEDOES.....2 BANKS  
 LENGTH OVERALL-METERS.....242.5  
 BREADTH OVERALL-METERS.....127.1  
 HEIGHT OVERALL-METERS.....60  
 PRIMARY HULL DIA.-METERS.....127.1  
 PROP. UNIT L.O.A.-METERS.....153.6  
 PROP. UNIT DIA.-METERS.....17.3

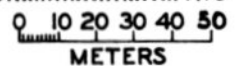

SEE BOOKLET OF GENERAL PLANS FOR DETAILS

TO:01:04:13

**STAR FLEET TECHNICAL ORDER**

AUTHENTICATED STARDATE 7306.09

**DESTROYER CLASS****AUTHORIZED CONSTRUCTION**

THE FOLLOWING SHIPS OF THE MK-VIII CLASS WERE AUTHORIZED BY THE ORIGINAL ARTICLES OF FEDERATION OF STARDATE 0965:

ADAD - NCC-515	HAMILCAR - NCC-518	SHAITAN - NCC-519
AHRIMAN - NCC-513	HANNIBAL - NCC-512	SALADIN - NCC-500*
ALARIC - NCC-503	- HASHISHIYUN - NCC-516	SARGON - NCC-504
ALEXANDER - NCC-511	JENGHIZ - NCC-501	SULEIMAN - NCC-508
AZRAEL - NCC-517	KUBLAI - NCC-507	TAMERLANE - NCC-510
DARIUS - NCC-502	POMPEY - NCC-506	XERXES - NCC-505
- ETZEL - NCC-509	RAHMAN - NCC-514	

THE FOLLOWING SHIPS OF THE MK-VIIIA CLASS WERE AUTHORIZED BY STAR FLEET APPROPRIATION OF STARDATE 3030:

ARES - NCC-524	LOKI - NCC-529	SIVA - NCC-520*
HATHOR - NCC-523	LUCIFER - NCC-521	TYR - NCC-526
IBLIS - NCC-528	MARS - NCC-525	
JUGURTHA - NCC-527	MOLOCK - NCC-522	

THE FOLLOWING SHIPS OF THE MK-VIIIB CLASS WERE AUTHORIZED BY STAR FLEET APPROPRIATION OF STARDATE 4699:

ABU BEKR - NCC-549	COCHISE - NCC-530*	MARTEL - NCC-554
ACHILLES - NCC-551	CORTEZ - NCC-536	NELSON - NCC-546
AJAX - NCC-547	DE RUYTER - NCC-538	NEY - NCC-533
AKBAR - NCC-548	DRAKE - NCC-541	PERSEUS - NCC-544
ALVA - NCC-531	EL CID - NCC-534	PONTIAC - NCC-532
ALVARADO - NCC-537	GERONIMO - NCC-535	SCIPIO - NCC-553
AL MAHDI - NCC-545	HEKTOR - NCC-539	SAMSON - NCC-543
APPOLLYON - NCC-542	IVAN - NCC-550	THESEUS - NCC-552
CIMON - NCC-555	LYSANDER - NCC-540	

\* CLASS SHIP. ALL NAMES PRECEDED WITH "U.S.S."

# CLASS I SCOUT

HERMES CLASS STARSHIPS

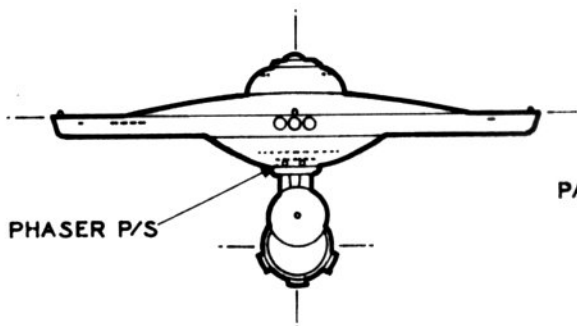
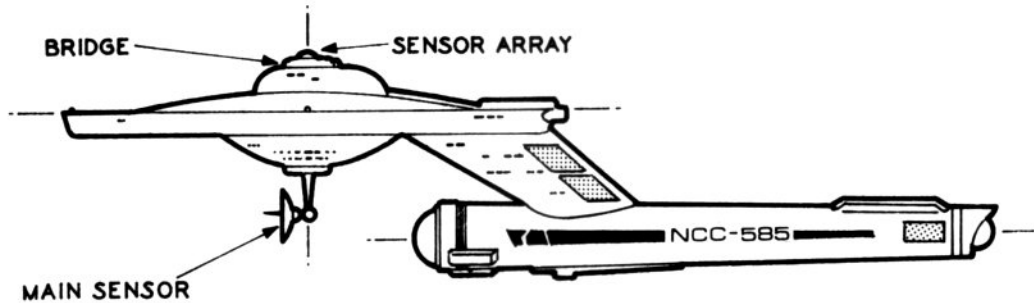
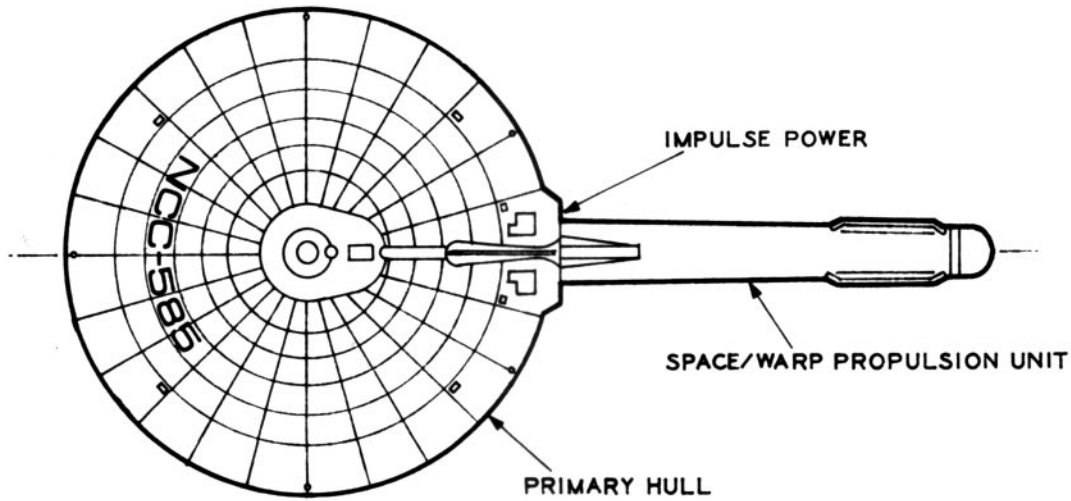

**PARTICULARS:**

DEADWEIGHT TONNAGE-METRIC.....	94,500
STD. RANGE.....	9 YEARS AT L.V.
MAX. SAFE CRUISING SPEED.....	W/F 6
EMERGENCY SPEED.....	W/F 8
MAIN PHASERS.....	1 BANK/2 EACH
LENGTH OVERALL-METERS.....	242.5
BREADTH OVERALL-METERS.....	127.1
HEIGHT OVERALL-METERS.....	60
PRIMARY HULL DIA.-METERS.....	127.1
PROP. UNIT L.O.A.-METERS.....	153.6
PROP. UNIT DIA.-METERS.....	17.3

**STD. SHIP'S COMPLEMENT:**

OFFICERS (COMMAND).....	20
CREW (ENSIGN GRADE).....	175

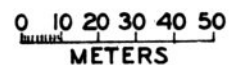

SEE BOOKLET OF GENERAL PLANS FOR DETAILS

## STAR FLEET TECHNICAL ORDER

AUTHENTICATED STARDATE 7306.19

TO:01:04:15

**SCOUT CLASS**

## AUTHORIZED CONSTRUCTION

THE FOLLOWING SHIPS OF THE MK-VII CLASS WERE AUTHORIZED BY THE ORIGINAL ARTICLES OF FEDERATION OF STARDATE 0965:

AEOLUS - NCC-588	CARSON - NCC-592	QUINTILLUS - NCC-590
ANUBIS - NCC-586	CODY - NCC-594	REVERE - 595
BATIDOR - NCC-593	CROCKETT - NCC-600	SACAJAWEA - NCC-598
BOWIE - NCC-597	DIANA - NCC-589	SPAKER - 596
BRIDGER - NCC-591	HERMES - NCC-585*	TONTI - NCC-599

THE FOLLOWING SHIPS OF THE MK-VIIA CLASS WERE AUTHORIZED BY STAR FLEET APPROPRIATION OF STARDATE 3669:

ARIES - NCC-602	LEO MINOR - NCC-614	PEGASUS - NCC-612
CAMELOPARDUS - NCC-606	LEPUS - NCC-610	TAURUS - NCC-605
CANIS MAJOR - NCC-611	LUPUS - NCC-604	URSA MAJOR - NCC-609
CANIS MINOR - NCC-615	LYNX - NCC-608	URSA MINOR - NCC-616
EQUULUS - NCC-603	- MONOCEROS - NCC-601*	VULPECULA - NCC-613
LEO - NCC-607		

THE FOLLOWING SHIPS OF THE MK-VIIB CLASS WERE AUTHORIZED BY STAR FLEET APPROPRIATION OF STARDATE 5099. THEY ARE SPECIALLY OUTFITTED FOR REGULAR DUTY AS COMMAND AND DIPLOMATIC COURRIERS:

APUS - NCC-618	CORVUS - NCC-620	PAVO - NCC-622
AQUILA - NCC-623	CYGNUS - NCC-617*	PHOENIX - NCC-625
COLUMBIA - NCC-621	GRUS - NCC-624	TUCANA - NCC-619

\*CLASS SHIP. ALL NAMES PRECEDED WITH "U.S.S."



# CLASS I TRANSPORT/TUG

PTOLEMY CLASS STARSHIPS

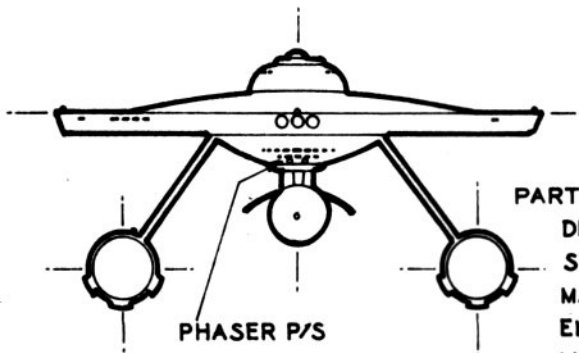
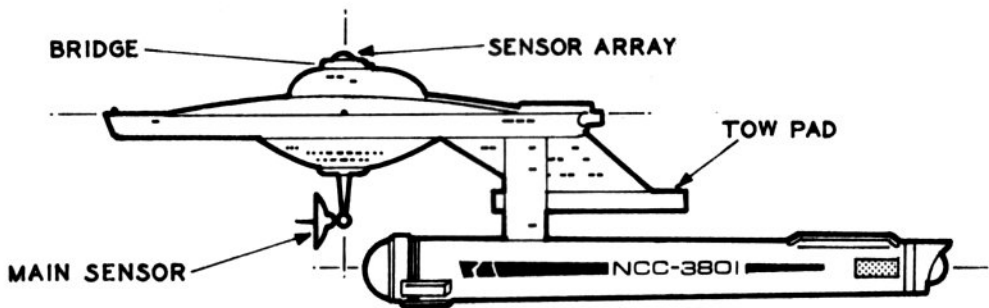
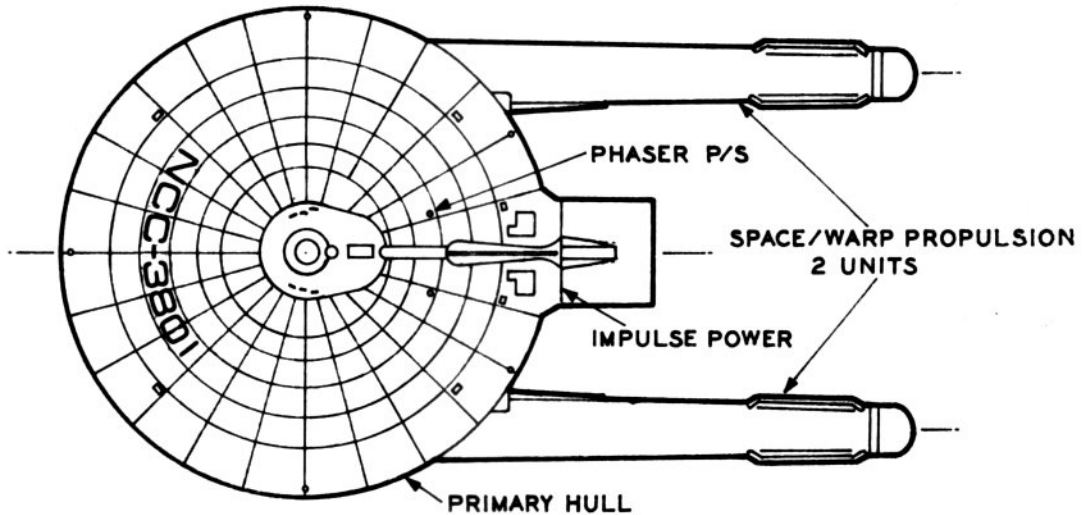

**PARTICULARS:**

DEADWEIGHT TONNAGE -METRIC.....	126,500
STD. RANGE.....	9 YEARS AT L.Y.V.
MAX. SAFE CRUISING SPEED.....	W/F 6
EMERGENCY SPEED.....	W/F 8
MAIN PHASERS.....	2 BANKS/2 EACH
LENGTH OVERALL-METERS.....	222
BREADTH OVERALL-METERS.....	127.1
HEIGHT OVERALL-METERS.....	66
PRIMARY HULL DIA.-METERS.....	127.1
PROP. UNIT L.Q.A.-METERS.....	153.6
PROP. UNIT DIA.-METERS.....	17.3

**STD. SHIP/S COMPLEMENT:**

OFFICERS (COMMAND).....	22
CREW (ENSIGN GRADE).....	198

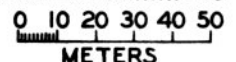

SEE BOOKLET OF GENERAL PLANS FOR DETAILS

## STAR FLEET TECHNICAL ORDER

AUTHENTICATED STARDATE 7306.14

TO:01:04:17

## TRANSP./TUG CLASS

## AUTHORIZED CONSTRUCTION

THE FOLLOWING SHIPS OF THE MK-VI CLASS WERE AUTHORIZED BY THE ORIGINAL ARTICLES OF FEDERATION OF STARDATE 0965:

AL RASHID - NCC-3802	ERATOSTHENES - NCC-3807	PHILOLAUS - NCC-3811
ANAXAGORAS - NCC-3803	GALILEI - NCC-3808	PTOLEMY - NCC-3801*
ANAXIMANDER - NCC-3804	HEVELIUS - NCC-3814	PYTHAGORAS - NCC-3812
ARISTARCHUS - NCC-3805	HIPPARCHUS - NCC-3809	THALES - NCC-3813
COPERNICUS - NCC-3815	IBN DAUD - NCC-3806	ULUGH BEG - NCC-3810

THE FOLLOWING SHIPS OF THE MK-VIA CLASS WERE AUTHORIZED BY STAR FLEET APPROPRIATION OF STARDATE 3640:

AMBARTSUMIAN - NCC-3817	FLAMARION - NCC-3818	LUYTEN - NCC-3829
BRAHE - NCC-3821	KEPLER - NCC-3816*	NEWTON - NCC-3822
CASSINI - NCC-3824	KIDINNU - NCC-3826	PIAZZI - NCC-3827
DESLANDRES - NCC-3820	LEVERRIER - NCC-3828	RICCIOLI - NCC-3823
DONATI - NCC-3825	MESSIER - NCC-3830	SCHIAPARELLI - NCC-3819

THE FOLLOWING SHIPS OF THE MK-VIB CLASS WERE AUTHORIZED BY STAR FLEET APPROPRIATION OF STARDATE 4990:

ADAMS - NCC-3925	HALE - NCC-3873	PIERCE - NCC-3931
AIRY - NCC-3842	HALL - NCC-3926	- PICKERING - NCC-3864
APIAN - NCC-3896	HALLEY - NCC-3833	- POGSON - NCC-3906
BAADE - NCC-3855	HAYASHI - NCC-3887	- POPPER - NCC-3878
BAUM - NCC-3935	HENCKE - NCC-3847	PLASKETT - NCC-3918
BAYER - NCC-3869	HENDERSON - NCC-3914	PRITCHETT - NCC-3838
BESSEL - NCC-3911	HERSCHELL - NCC-3860	REBER - NCC-3892
BIELA - NCC-3884	HERTZSPRUNG - NCC-3902	→ RITTENHOUSE - NCC-3851
BODE - NCC-3922	HIRAYAMA - NCC-3874	ROQUES - NCC-3932
BONDI - NCC-3843	HOYLE - NCC-3928	ROSS - NCC-3865
BROUWER - NCC-3897	HOLDEN - NCC-3834	RUSSELL - NCC-3907
CAMPBELL - NCC-3856	HUBBARD - NCC-3888	SABINE - NCC-3879
CARPENTER - NCC-3936	HUBBLE - NCC-3848	SANDAGE - NCC-3919
CARRINGTON - NCC-3870	- HUGGINS - NCC-3915	SAVARY - NCC-3839
CHALLIS - NCC-3912	- HUMANSON - NCC-3861	SCHEINER - NCC-3893
CHAMBERLAIN - NCC-3883	IRWIN - NCC-3903	SCHMIDT - NCC-3880
CHANDRASEKHAR - NCC-3923	JANSKY - NCC-3875	SECCHI - NCC-3852
CHAUVENET - NCC-3844	JEANS - NCC-3929	SHAPLEY - NCC-3933
CLARK - NCC-3898	JEFFREY - NCC-3835	SHKLOVSKY - NCC-3866
COLUMBO - NCC-3857	KAULA - NCC-3889	SLIPHER - NCC-3908
DELAMBRE - NCC-3937	KLEPSTRA - NCC-3862	SCHAWBE - NCC-3920
DOLLFUS - NCC-3885	KOHLSCHTTER - NCC-3904	STRUVE - NCC-3840
DOLLOND - NCC-3900*	KRUGER - NCC-3871	SWIFT - NCC-3894
→ DOPPLER - NCC-3831*	KUIPER - NCC-3836	TODD - NCC-3934
DREYER - NCC-3899	LAGRANGE - NCC-3916	TOMBAUGH - NCC-3853
EDDINGTON - NCC-3845	LAPLACE - NCC-3876	TOSCANELLI - NCC-3867
EICHELBERGER - NCC-3924	- LEAVITT - NCC-3849	VAN DE HULST - NCC-3909
ENCKE - NCC-3859	LANGLEY - NCC-3930	- VAN DE KAMP - NCC-3881
- FLAMSTEED - NCC-3913	LOCKYER - NCC-3890	VAN MAANEN - NCC-3940
FRACASTOR - NCC-3872	LOWELL - NCC-3939	VOGEL - NCC-3841
FROST - NCC-3938	MITCHELL - NCC-3863	VON ZACH - NCC-3882
GAILLOT - NCC-3832	MOULTON - NCC-3905	WALKER - NCC-3895
GALLE - NCC-3886	NEWCOMB - NCC-3877	WOLASTON - NCC-3854
GAUTIER - NCC-3846	OLBERS - NCC-3917	WOLF - NCC-3921
GOLD - NCC-3927	OORT - NCC-3837	WRIGHT - NCC-3868
GOLDRICKE - NCC-3859	PALITZSCH - NCC-3891	YOUNG - NCC-3910
GOLDREICH - NCC-3901	PEALE - NCC-3850	

\*CLASS SHIP. ALL NAMES PRECEDED WITH "U.S.S."

# TRANSPORT CONTAINERS

CLASS I STARSHIPS - USE WITH CLASS I TUG

## MK-V PRODUCTS:

D.W. TONNAGE - METRIC .....121,566  
 GROSS VOL. - M<sup>3</sup> ..... 303,916  
 GR. FLR. AREA - M<sup>2</sup> ..... 76,280  
 UNIT LOADING .....1.59 T/M<sup>2</sup>  
 VOL. LOADING ..... 364 KG/M<sup>3</sup>  
 TRANSPORTERS ..... 6  
 ELEVATORS ..... 4  
 LOAD HEIGHT - METERS ..... 2.44  
 LENGTH O.A. - METERS ..... 200  
 DIAMETER - METERS ..... 40

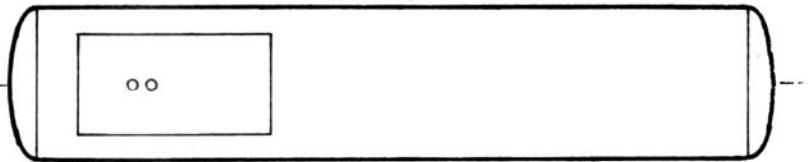

PLAN



PROFILE

CORRIDORS

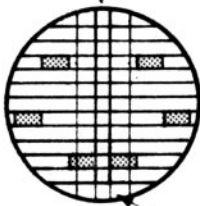

ENVIRONMENTAL MAINT. MACHINERY SPACE

ELEVATORS

12 STORAGE DECKS

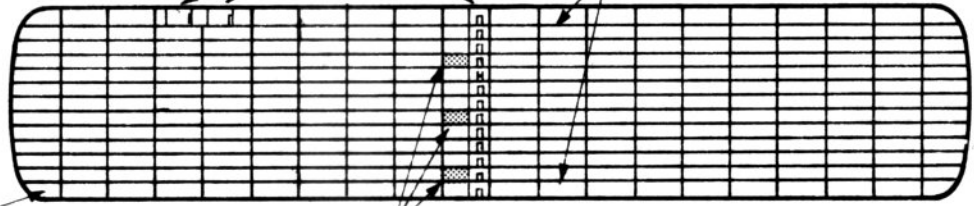

TRANSPORTERS P/S

CROSS-SECTIONS

## MK-III REEFERS:

REFRIGERATED GOODS  
 D.W. TONNAGE - METRIC .....100,000  
 GROSS VOL. - M ..... 303,916  
 GR. FLR. AREA - M ..... 76,280  
 UNIT LOADING ..... 1.18 T/M  
 VOL. LOADING ..... 182 KG/M  
 TRANSPORTERS ..... 6  
 ELEVATORS ..... 4  
 LOAD HEIGHT - METERS ..... 2.44  
 LENGTH O.A. - METERS ..... 200  
 DIAMETER - METERS ..... 40

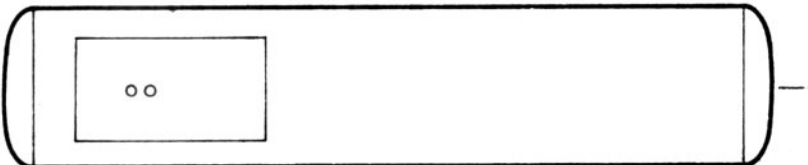

PLAN



PROFILE

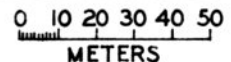

CORRIDORS

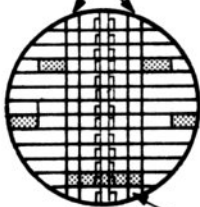

ENVIRONMENTAL MAINT. MACHINERY SPACE

ELEVATORS

12 STORAGE DECKS

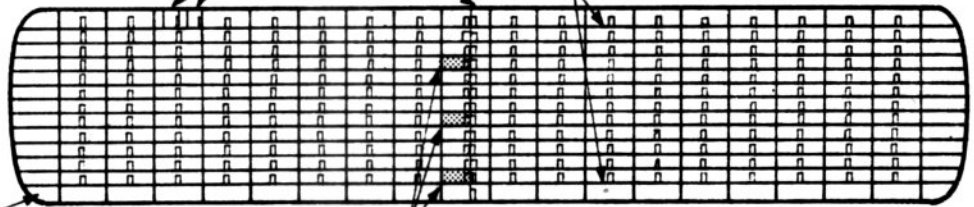

TRANSPORTERS P/S

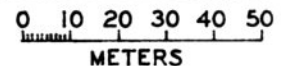

CROSS-SECTIONS

SEE BOOKLETS OF GENERAL PLANS FOR DETAILS

# TRANSPORT CONTAINERS

CLASS I STARSHIPS - USE WITH CLASS I TUG

## MK-II DRY BULK:

D.W. TONNAGE-METRIC.....	121,566
GROSS VOL. - M <sup>3</sup> .....	303,916
NET VOLUME - M <sup>3</sup> .....	276,076
UNIT LOADING.....	30 T/M <sup>2</sup>
VOL. LOADING.....	364 KG/M <sup>3</sup>
TRANSPORTERS.....	6
ELEVATORS.....	2
LENGTH O.A. - METERS.....	200
DIAMETER - METERS.....	40

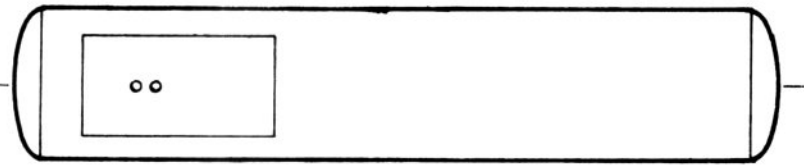

PLAN



PROFILE

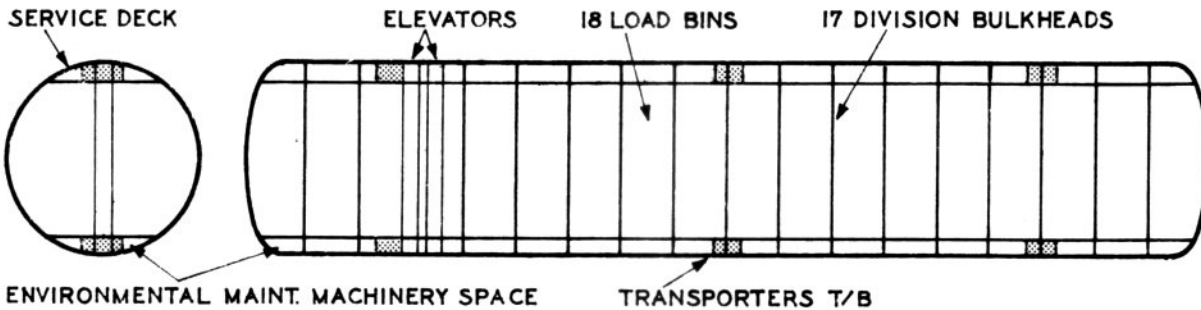

CROSS-SECTIONS

## MK-I LIQUIDS:

D.W. TONNAGE-METRIC.....	121,566
GROSS VOL. - M <sup>3</sup> .....	303,916
NET VOLUME - M <sup>3</sup> .....	276,076
UNIT LOADING.....	30 T/M <sup>2</sup>
VOL. LOADING.....	364 KG/M <sup>3</sup>
TRANSPORTERS.....	6
ELEVATORS.....	2
LENGTH O.A. - METERS.....	200
DIAMETER - METERS.....	40

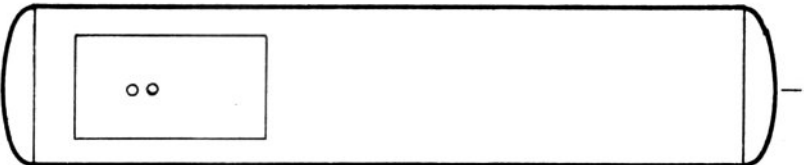

PLAN



PROFILE

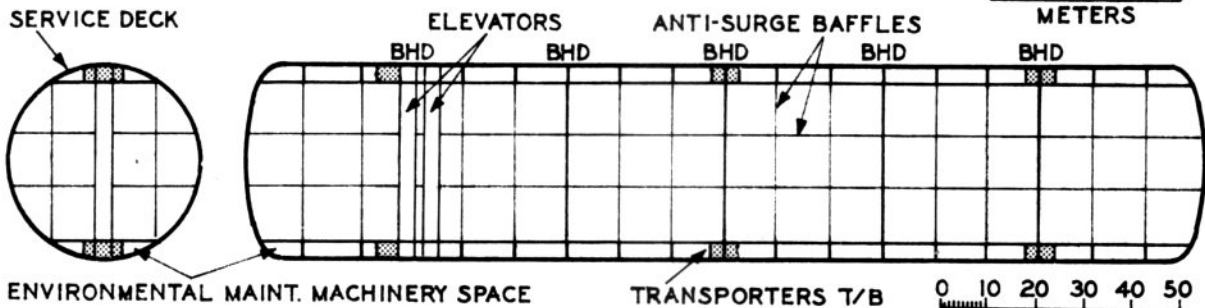

CROSS-SECTIONS

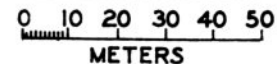

SEE BOOKLETS OF GENERAL PLANS FOR DETAILS

# TRANSPORT CONTAINER

CLASS I STARLINERS-USE WITH CLASS I TUG

## MK-IV PEOPLE:

- D.W. TONNAGE-METRIC..... 80,000
- GROSS VOL.-M<sup>3</sup>..... 303,916
- GR. FLR. AREA - M<sup>2</sup>..... 77,570
- UNIT LOADING..... 488 KG/M<sup>2</sup>
- DECK SPACING-METERS..... 3
- TRANSPORTERS..... 6/2
- ELEVATORS..... 5
- L.O.A x DIA.-METERS..... 200 x 18
- OFFICERS (COMMAND)..... 15
- CREW (ENSIGN GRADE)..... 150
- PASSENGERS..... 500

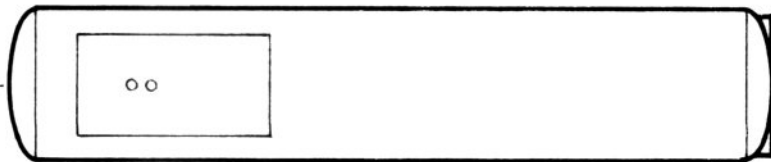

PLAN

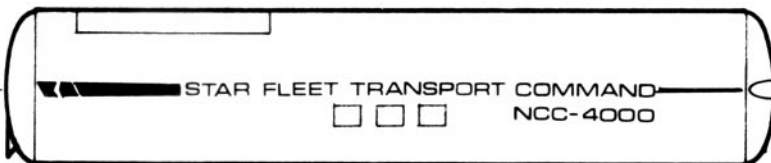

PROFILE

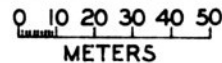

FWD. ELEVATORS

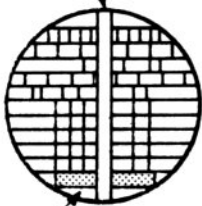

CARGO TRANSPORTER P/S

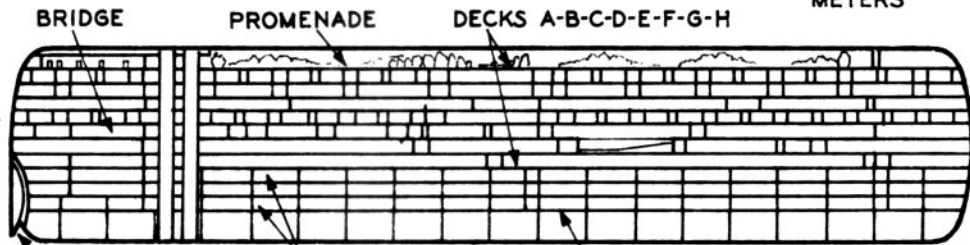

CROSS-SECTIONS

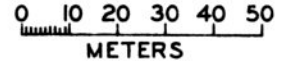

## DECK PLANS

A DECK

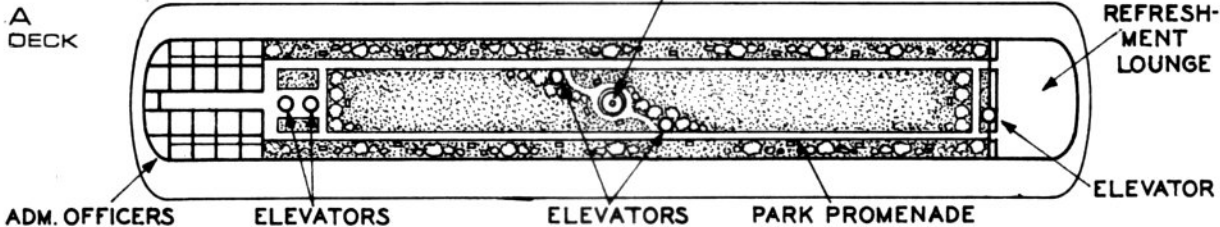

B DECK

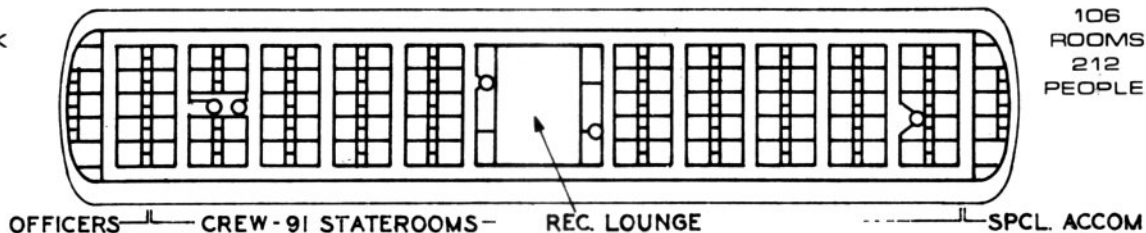

C DECK

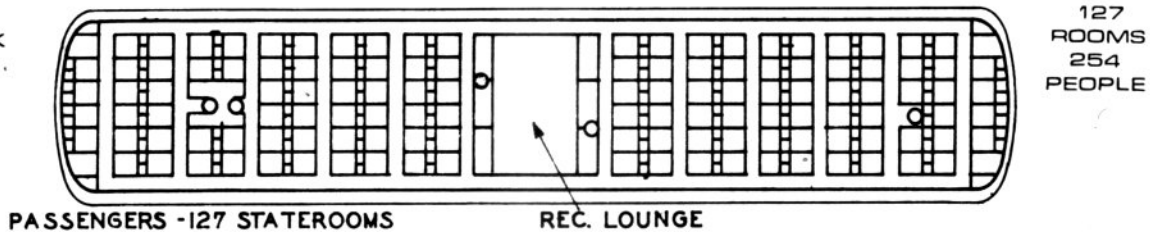

NOTE: CONTAINER IS A SELF-CONTAINED EMERGENCY LIFEBOAT WITH SUB-LIGHT VELOCITY AND 18 YEARS ENDURANCE

# MK-IV STARLINER

## DECK PLANS

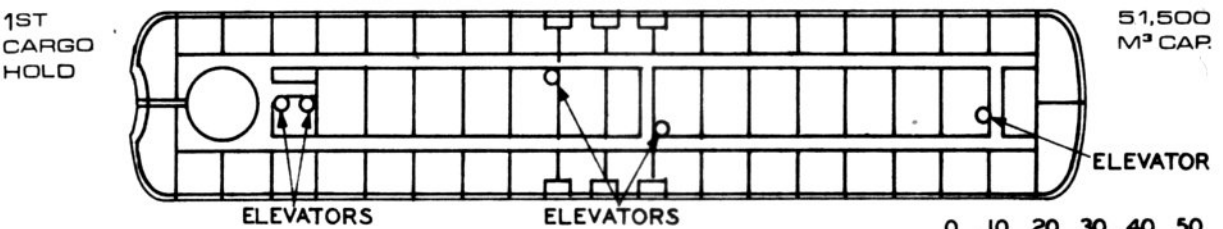
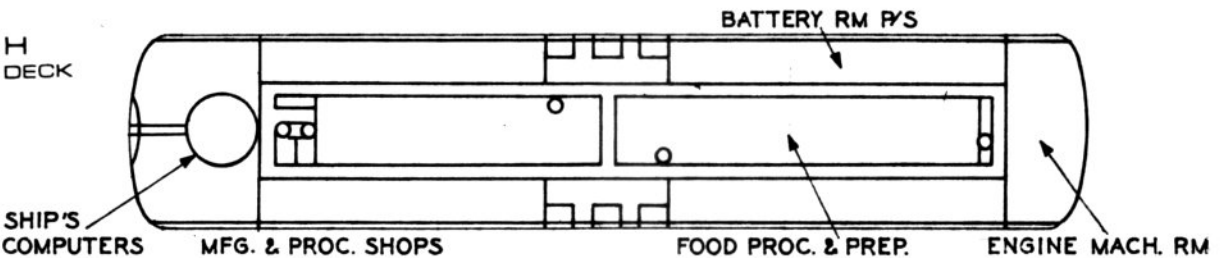
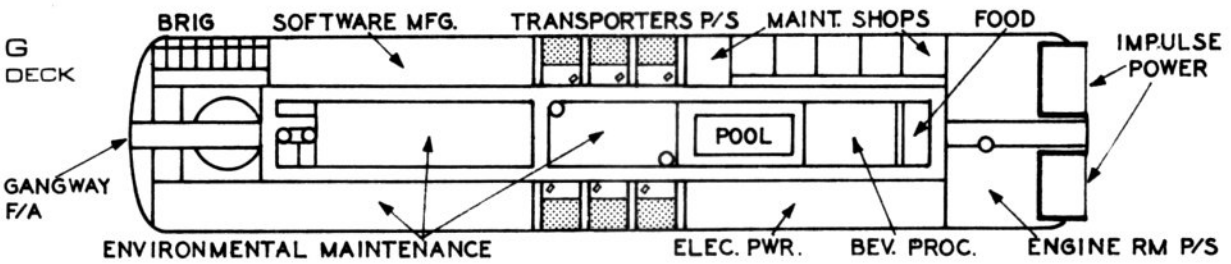
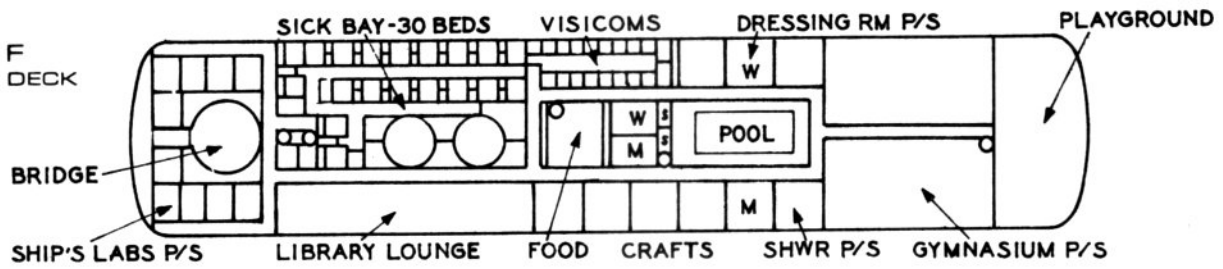
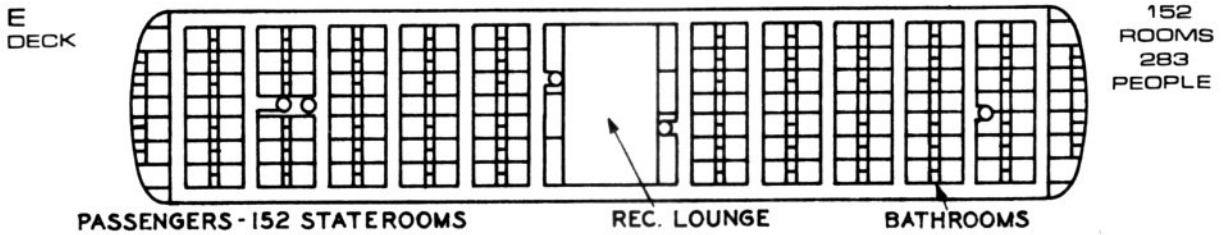
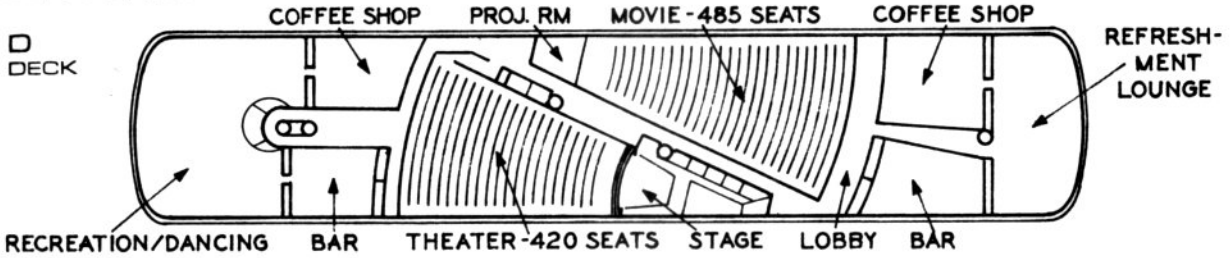

# MK-IV STARLINER

## DECK PLANS AND DETAILS

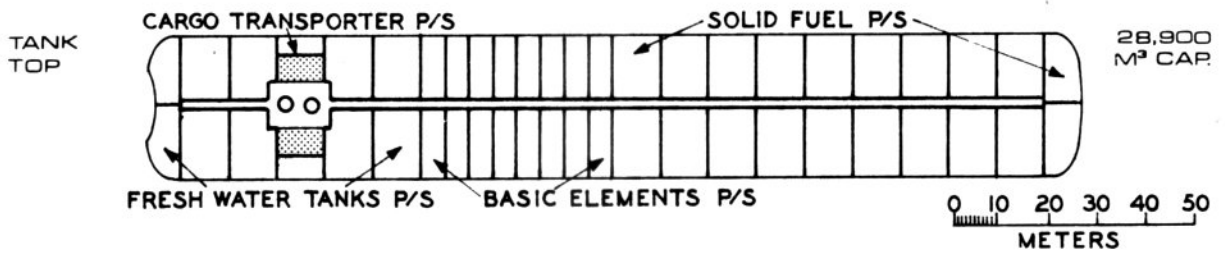
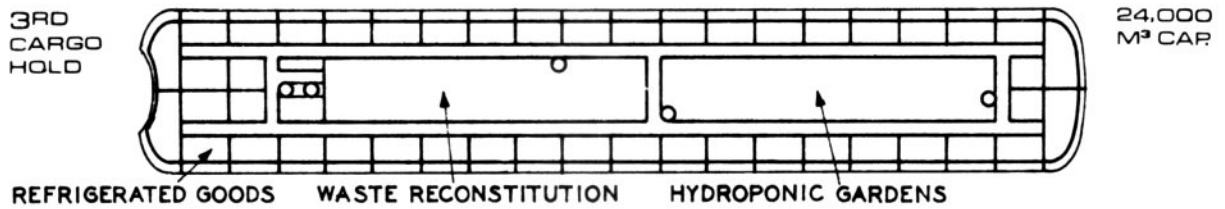
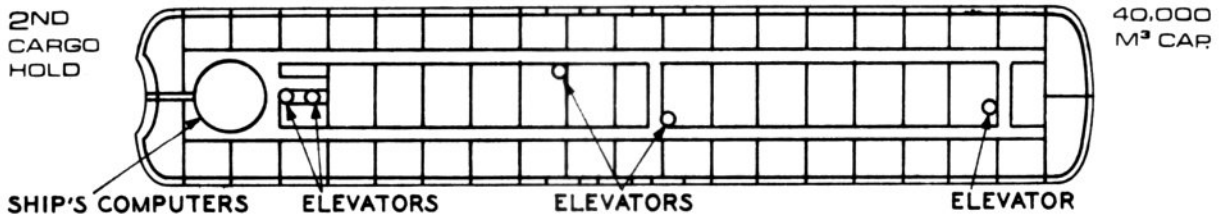

### END VIEWS

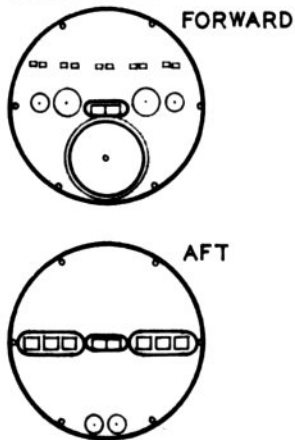

### TYPICAL ACCOMMODATIONS

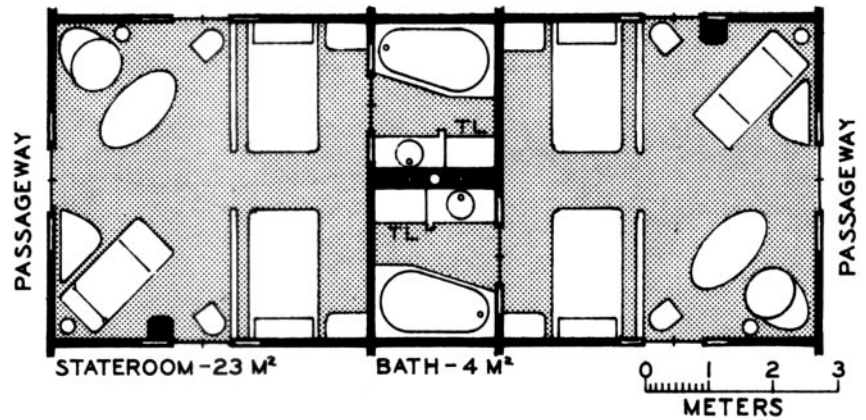

# CLASS I DREADNOUGHT

FEDERATION CLASS STARSHIPS

MK-X

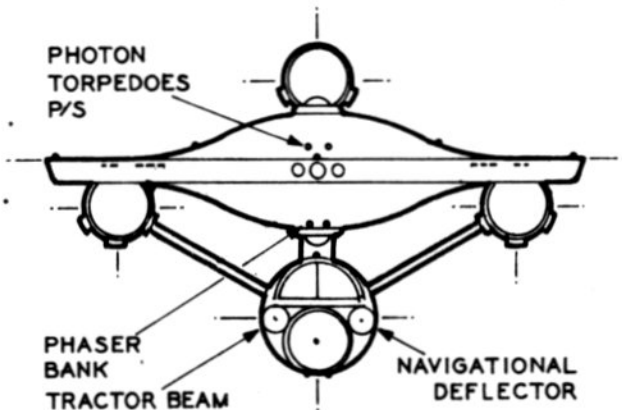
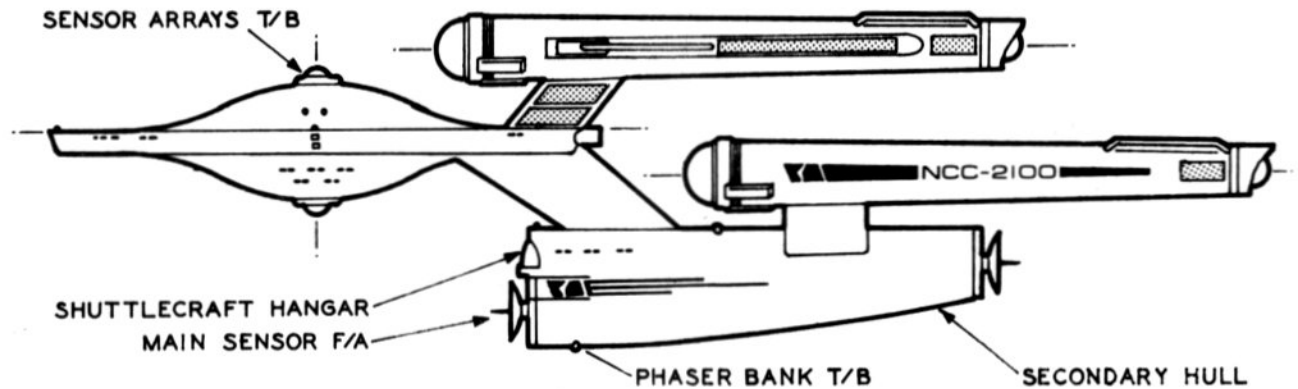
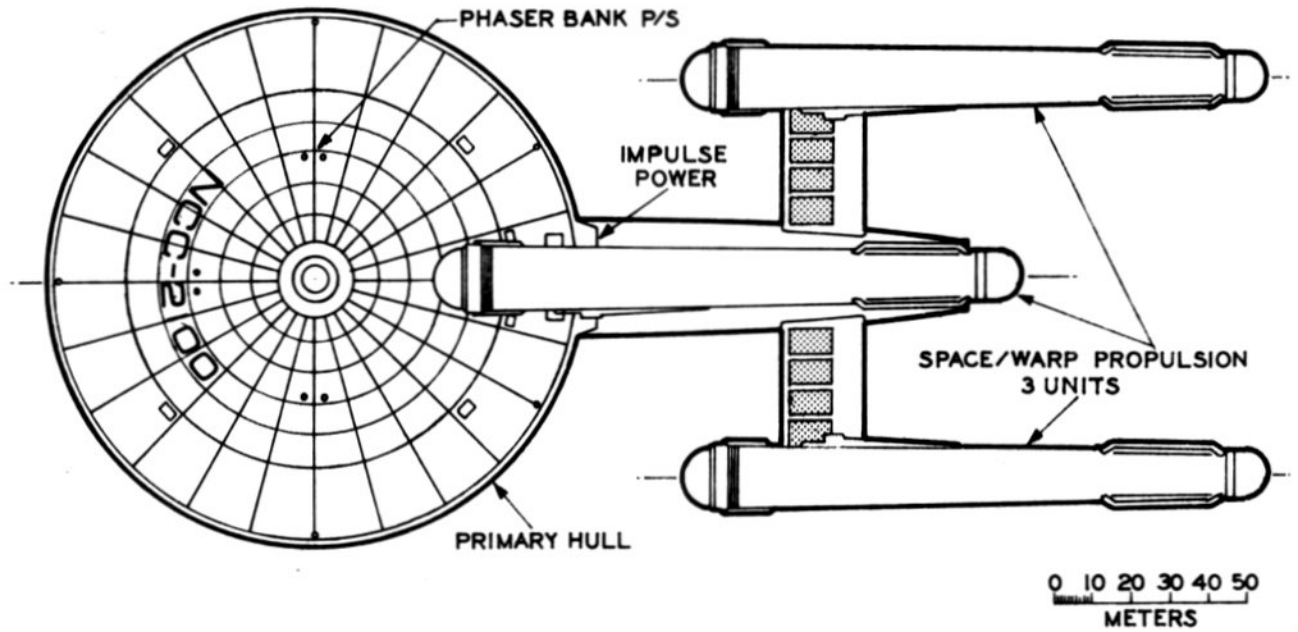

**PARTICULARS:**

DEADWEIGHT TONNAGE - METRIC:	..... 285,000
STD. RANGE:	..... 20 YEARS AT L.Y.V.
MAX. SAFE CRUISING SPEED:	..... W/F 8
EMERGENCY SPEED:	..... W/F 10
MAIN PHASERS:	..... 5 BANKS/2 EACH
PHOTON TORPEDOES:	..... 2 BANKS
LENGTH OVERALL - METERS:	..... 320
BREADTH OVERALL - METERS:	..... 140
HEIGHT OVERALL - METERS:	..... 87
PRIMARY HULL DIA. - METERS:	..... 140
SEC. HULL LENGTH - METERS:	..... 122
SEC. HULL MAX. DIA. - METERS:	..... 30
PROP. UNIT L.O.A. - METERS:	..... 153.6
PROP. UNIT DIA. - METERS:	..... 17.3

**STD. SHIP'S COMPLEMENT:**

OFFICERS (COMMAND)	..... 55
CREW (ENSIGN GRADE)	..... 445



## STAR FLEET TECHNICAL ORDER

TO:01:04:25

AUTHENTICATED STARDATE 7306.15

# DREADNOUGHT CLASS

## AUTHORIZED CONSTRUCTION

THE FOLLOWING SHIPS OF THE MK-X CLASS WERE AUTHORIZED BY STAR FLEET APPROPRIATION OF STARDATE 6066:

AFFILIATION - NCC-2108	CORPORATION - NCC-2104	STAR EMPIRE - NCC-2116
ALLIANCE - NCC-2113	DIRECTORATE - NCC-2110	STAR LEAGUE - NCC-2101
ASSOCIATION - NCC-2118	DOMINION - NCC-2115	STAR SYSTEM - NCC-2107
COMPACTAT - NCC-2103	ENTENTE - NCC-2120	STAR UNION - NCC-2112
CONCORDAT - NCC-2109	FEDERATION - NCC-2100*	TRUSTEESHIP - NCC-2117
CONFEDERATION - NCC-2114	KONKORDIUM - NCC-2106	UNIFICATUM - NCC-2102
CONSORTIUM - NCC-2119	ORGANIZATION - NCC-2111	

\*CLASS SHIP. ALL NAMES PRECEDED WITH "U.S.S."

# SHUTTLECRAFT

7 PERSON - EXTERNAL ARRANGEMENT

TYPE: SPCR 48A

MK 12B

BO 5621

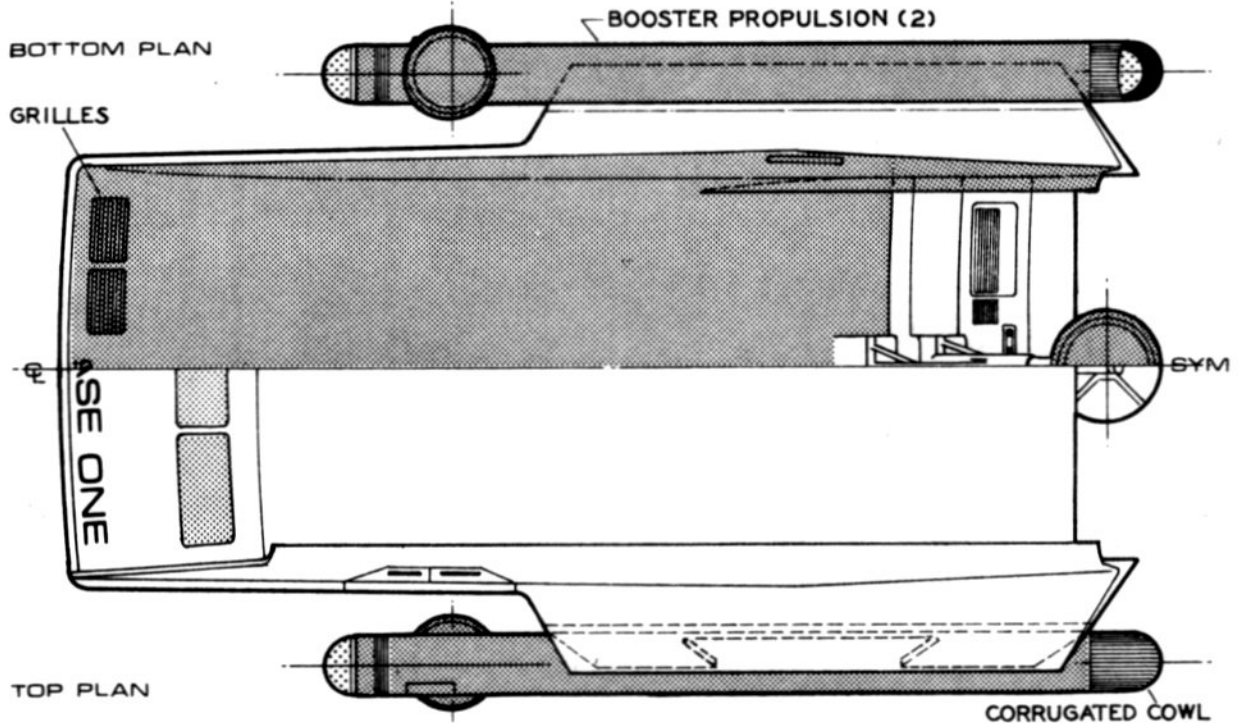
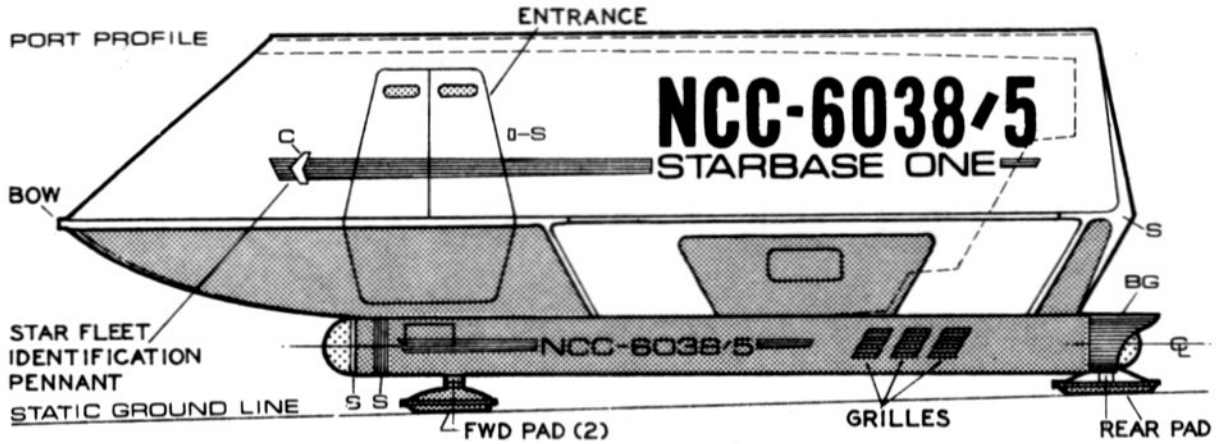

OFFICIAL COLORS:

[White Box]	PLATINUM	N°SF29UC
[Blue-Gray Box]	BLUEGRAY	N°SF31UC
[Crown Box]	CORN	N°SF22UC
[Silver Box]	SILVER	N°SF01UC
[Red Box]	RED	N°SF10UC
[Ivory Box]	IVORY	N°SF07UC
[Sky Blue Box]	SKY BLUE	N°SF16UC
[Gray Box]	GRAY	N°SF30UC
[Black Box]	BLACK	N°SF32UC

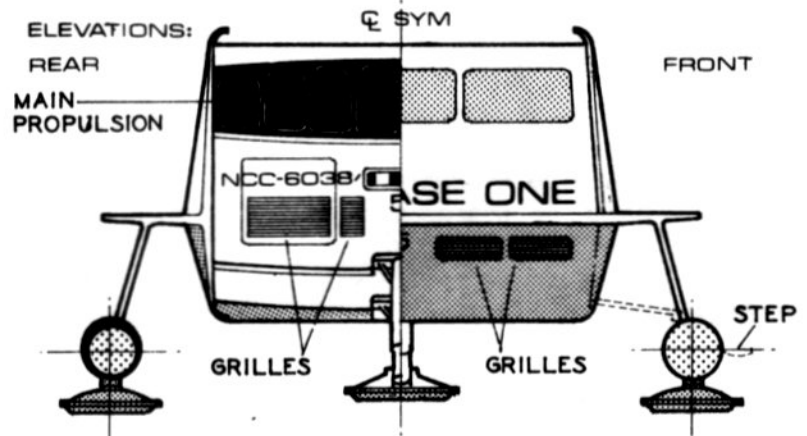

TO:01:04:81

# SHUTTLECRAFT

## INTERNAL GENERAL ARRANGEMENT

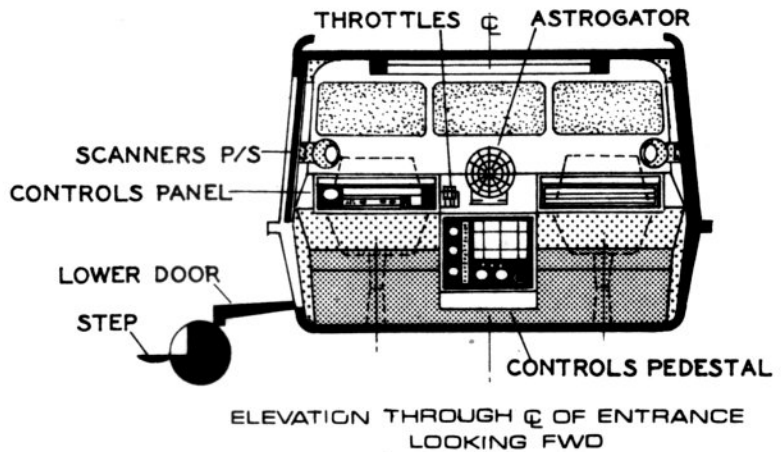
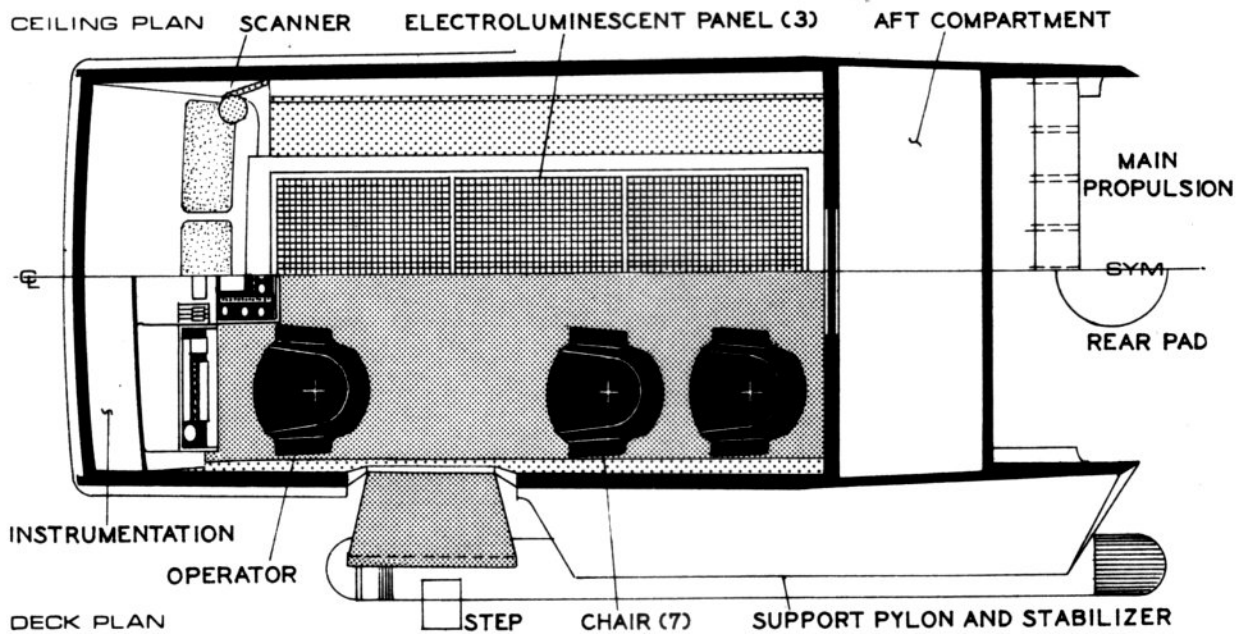
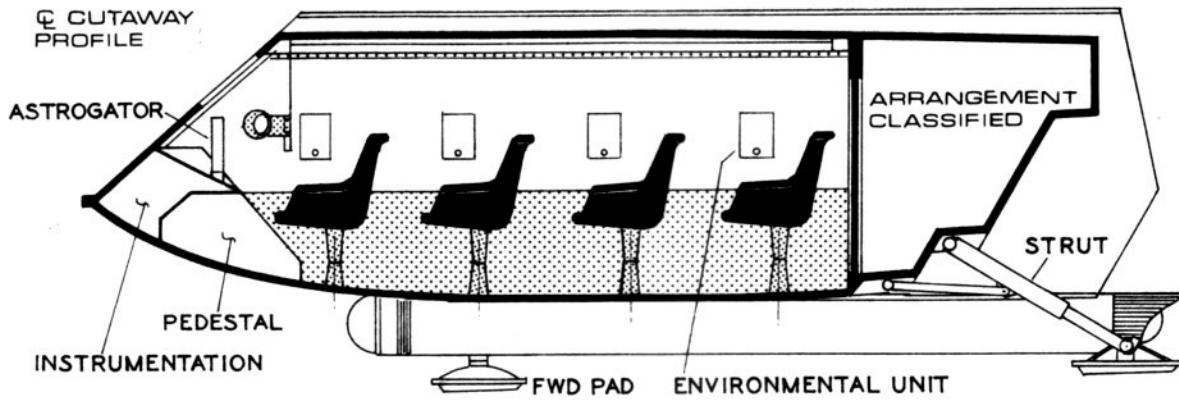

- OFFICIAL COLORS:
- PLATINUM N°SF29 UC
  - SAND N°SF08 UC
  - GRAY N°SF30 UC
  - OXIDE N°SF27 UC
  - BLACK N°SF32 UC



# SINGLE STATEROOM

PRIMARY HULL-CLASS I STARSHIPS

TYPICAL OFFICERS  
ACCOMMODATIONS

BATHROOM (SHARED)

TRANSLUCENT STALL

WATER CLOSET

VANITY LAVATORY

SHOWER/TUB WITH  
JACUZZI UNIT

TRANSLUCENT  
STALL

WAINSCOTE  
CABINET

LOUNGE CHAIR

SLEEPING  
QUARTERS

STD. TWIN  
SIZE BED

WARDROBE

MAIN  
CORRIDOR  
HERE

DECORATIVE GRILLE

ROOM DIVIDER

CHAIR

LIVING QUARTERS

DESK

SHIP'S SERVICES

WAINSCOTE  
CABINET

PD - DOUBLE POCKET DOORS

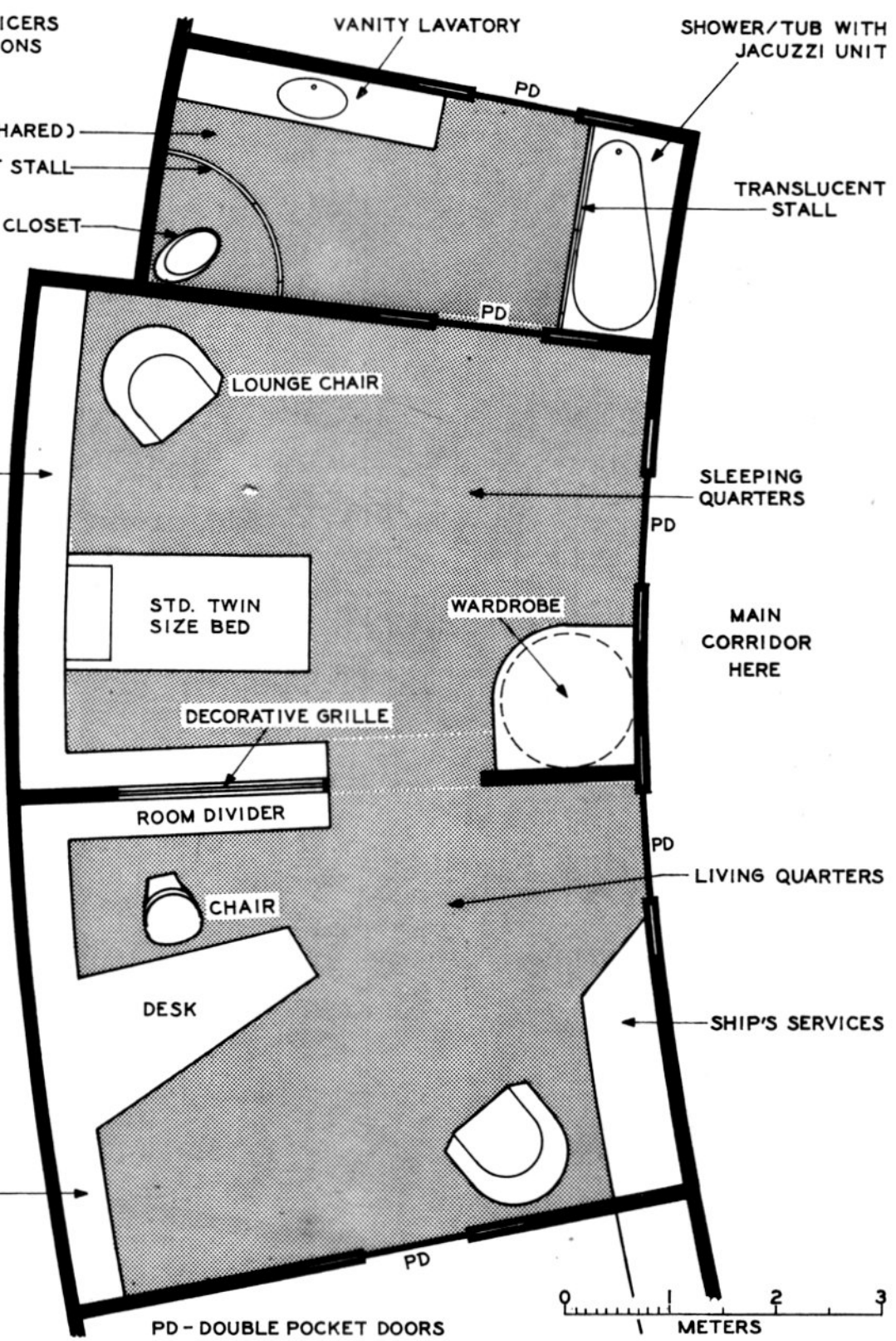

TO:01:05:83

# DOUBLE STATEROOM

PRIMARY HULL - CLASS I STARSHIPS

TYPICAL CREW ACCOMMODATIONS

SHIP'S SERVICES

LIVING QUARTERS

MAIN CORRIDOR HERE

SLEEPING QUARTERS

TRANSLUCENT STALL

WATER CLOSET

LOUNGE CHAIR

WAINSCOTE CABINET

DESK

CHAIR

ROOM DIVIDER

DECORATIVE GRILLE

STD. TWIN SIZE BED

WARDROBE

WAINSCOTE CABINET

SHOWER/TUB WITH JACUZZI UNIT

BATHROOM (SHARED)

TWIN LAVATORY VANITY

PD - DOUBLE POCKET DOORS

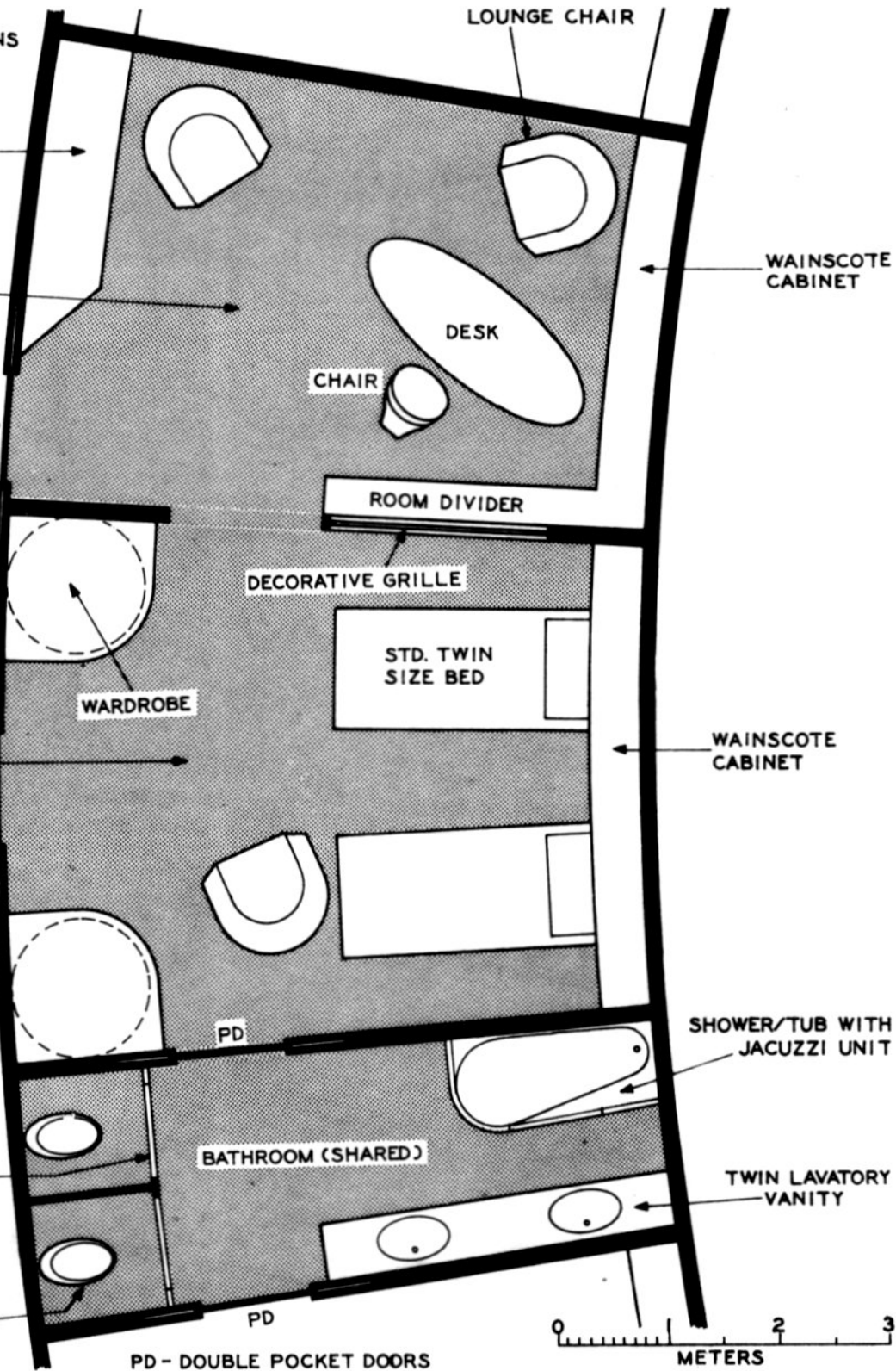



# MAIN BRIDGE

## PRINCIPAL CROSS-SECTIONS

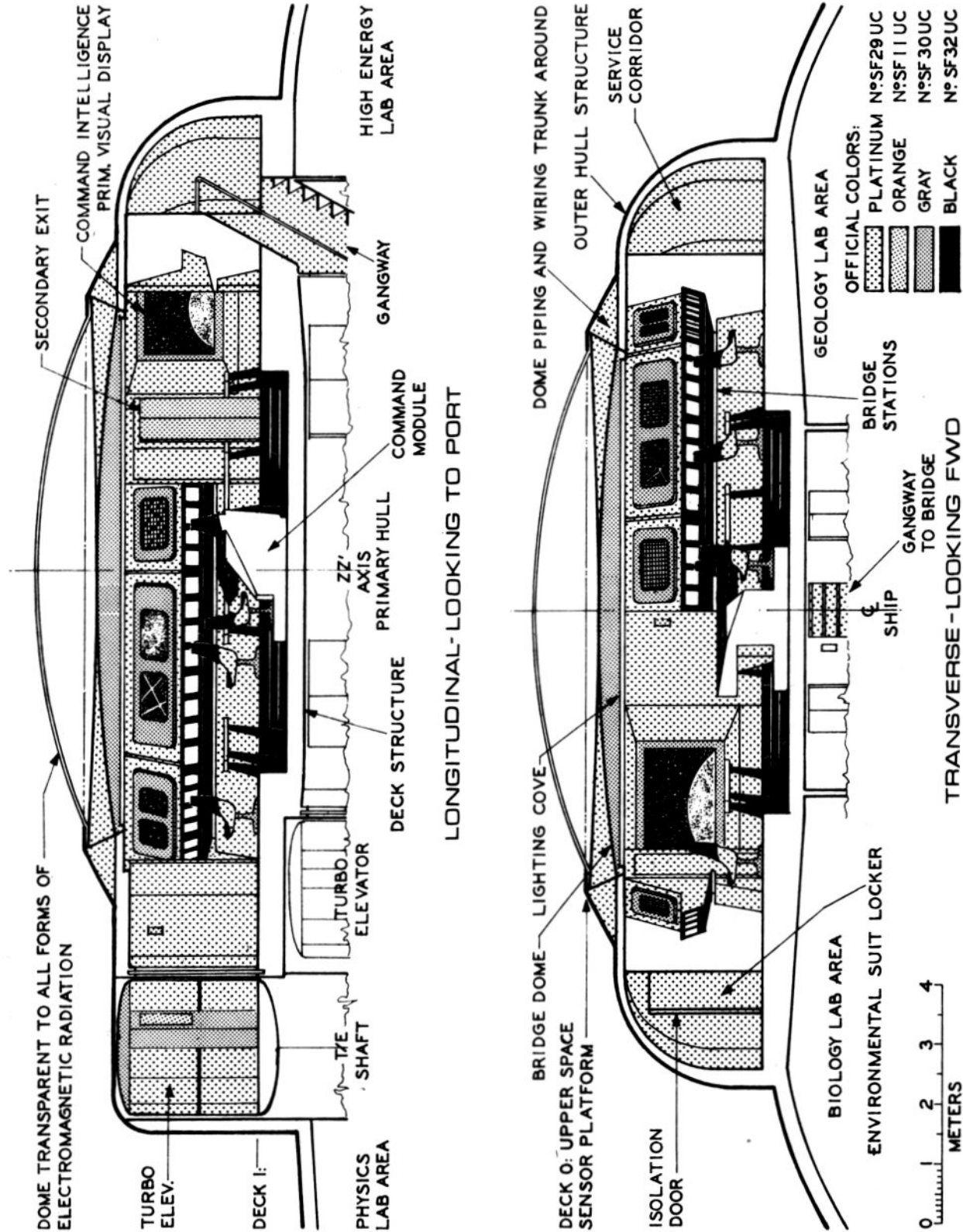

# COMMAND MODULE

MAIN BRIDGE STATION - CLASS I STARSHIPS

CONTROLS CONSOLE      SUPPORT PYLON      SENSORS ALERT LIGHT

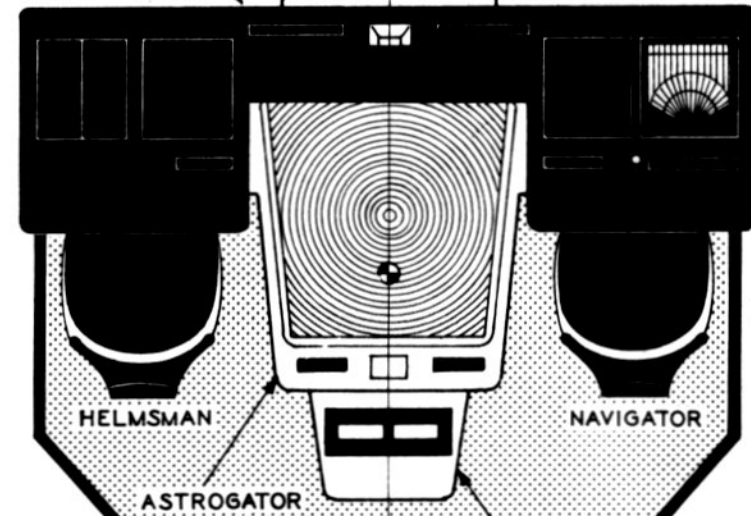

COM-MOD PLAT

CO CON PLAT

SHIP'S LOG AND CHRONOMETER

COMMANDING OFFICER'S CON

18° TYP

COMMUNICATIONS STATION HERE

BRIDGE

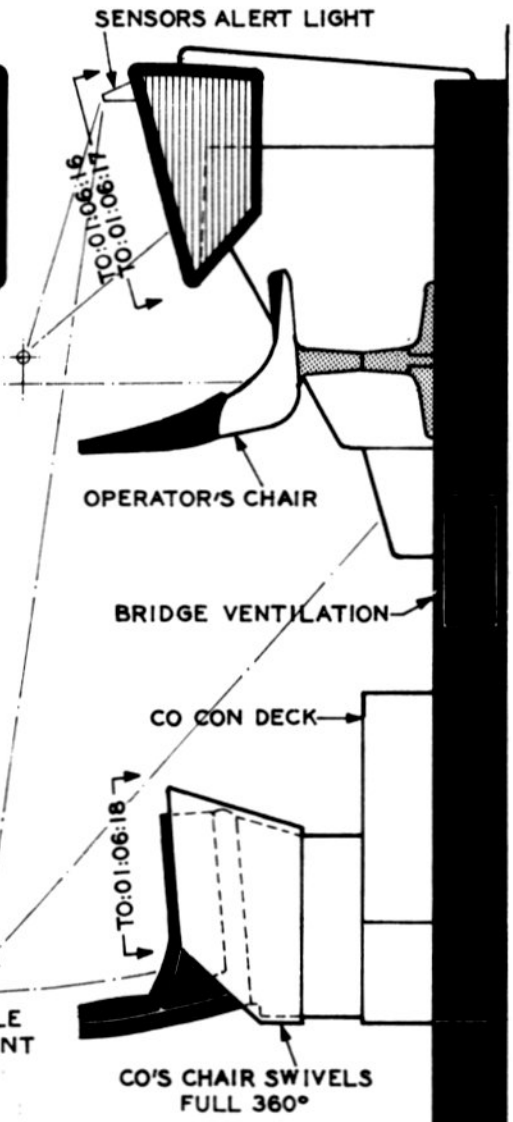

⊕ CENTER OF BRIDGE AND ZZ' AXIS OF PRIMARY HULL

THIS STATION IS ALSO DUPLICATED ON THE EMERGENCY BRIDGE

OFFICIAL COLORS:

White	PLATINUM	N°SF29UC
Orange	ORANGE	N°SF11UC
Taupe	TAUPE	N°SF28UC
Gray	GRAY	N°SF30UC
Black	BLACK	N°SF32UC

LOWER BRIDGE DECK



TO:01:06:15

# COMMAND MODULE

## FRONT AND REAR ELEVATIONS

SHIP'S CONTROLS CONSOLE:

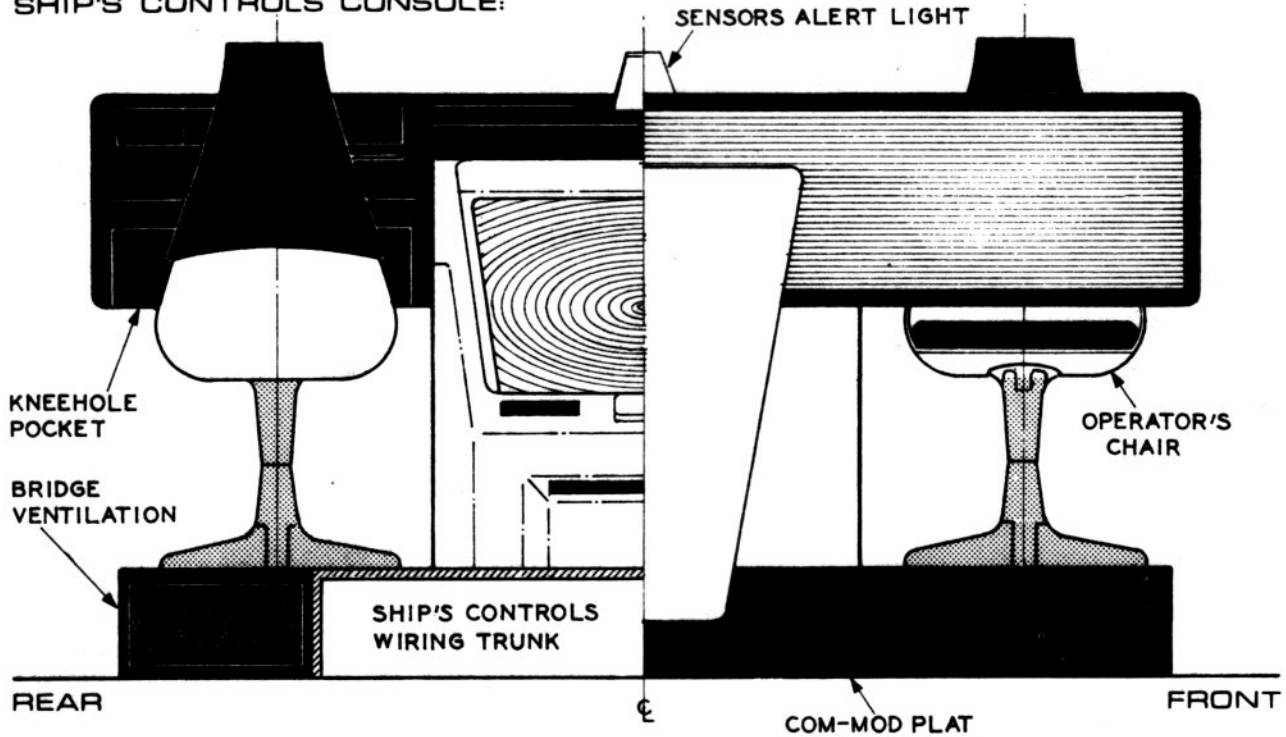

COMMAND CON:

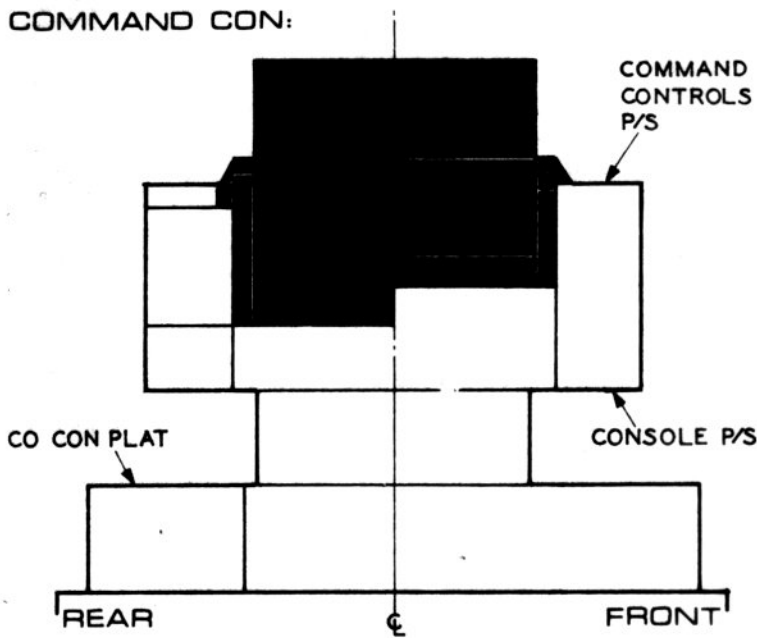

SEE MANUAL SECTIONS 2 AND 3 FOR VITAL FUNCTIONS AND MAIN SCHEMATICS

COMMANDING OFFICER'S CON IS THE FUNCTIONAL CENTER OF THE BRIDGE. ALL OTHER STATIONS SUPPORT THIS POSITION

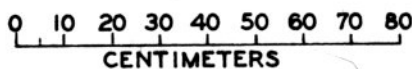

OFFICIAL COLORS:

-  PLATINUM N°SF29UC
-  ORANGE N°SF 11 UC
-  GRAY N°SF 30UC
-  BLACK N°SF 32UC

# HELMSMAN'S STATION

COMMAND MODULE - MAIN BRIDGE

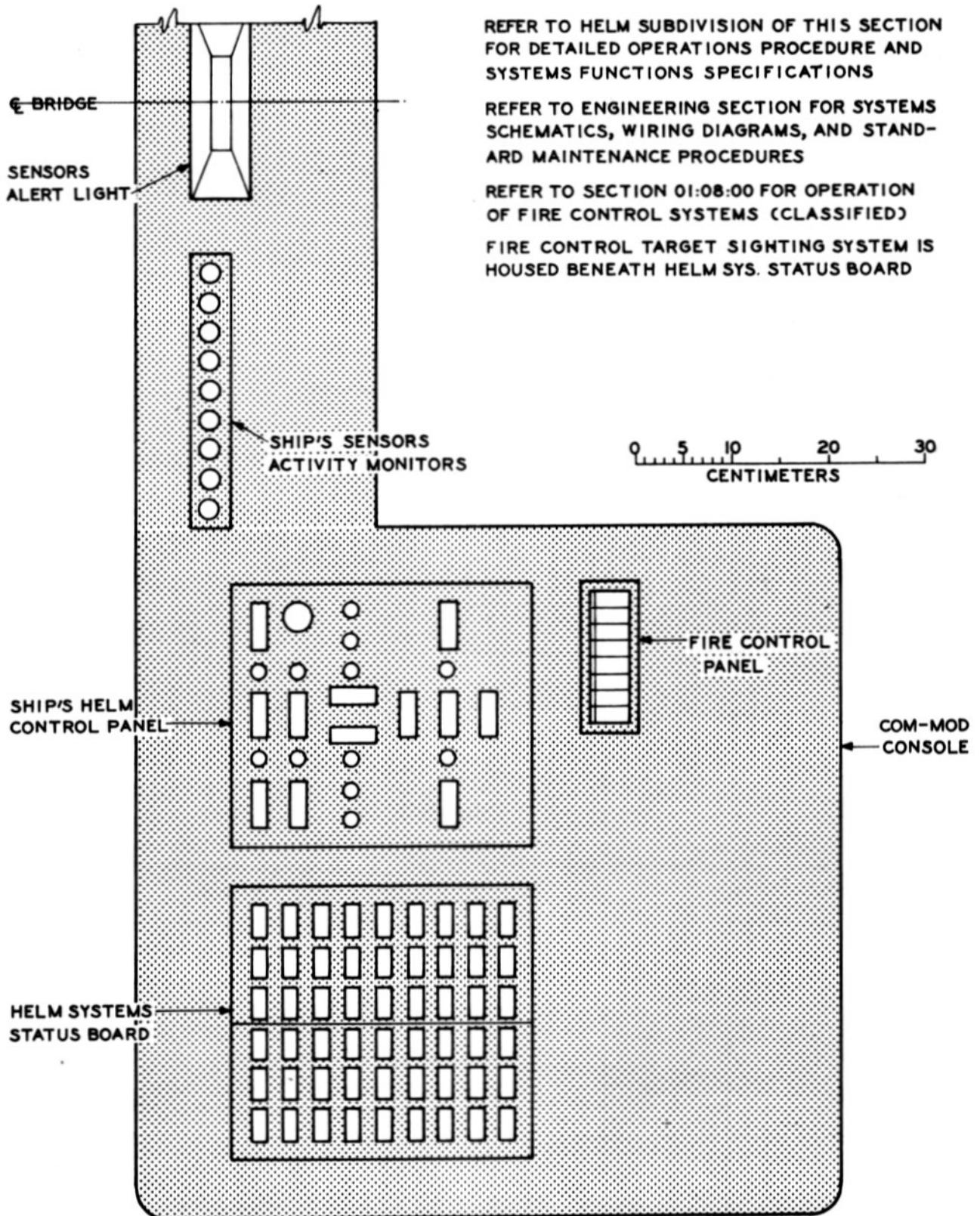

TO:01:06:17

# NAVIGATOR'S STATION

COMMAND MODULE - MAIN BRIDGE

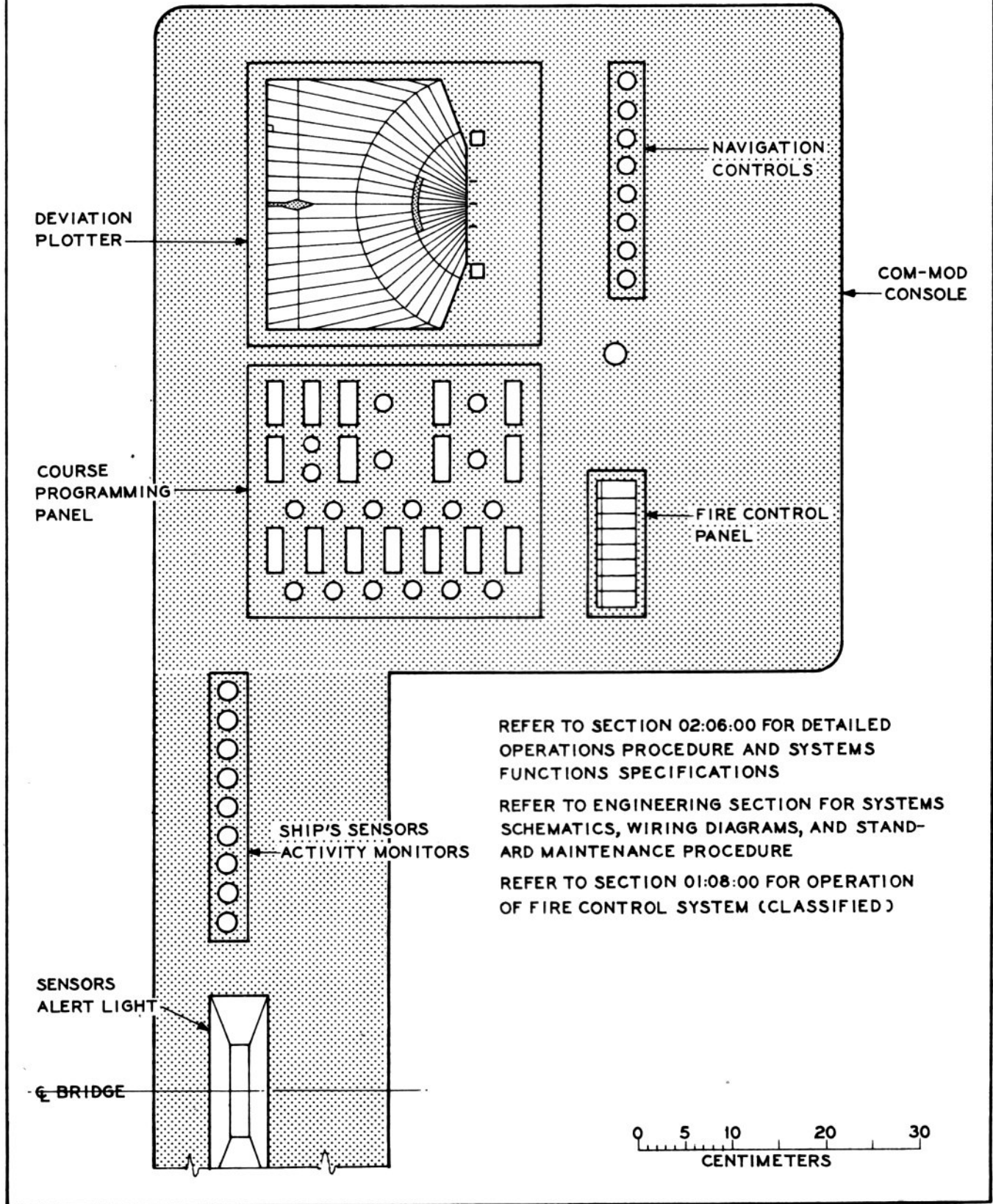

# COMMAND CON

COMMAND MODULE - MAIN BRIDGE

PORT CONSOLE:

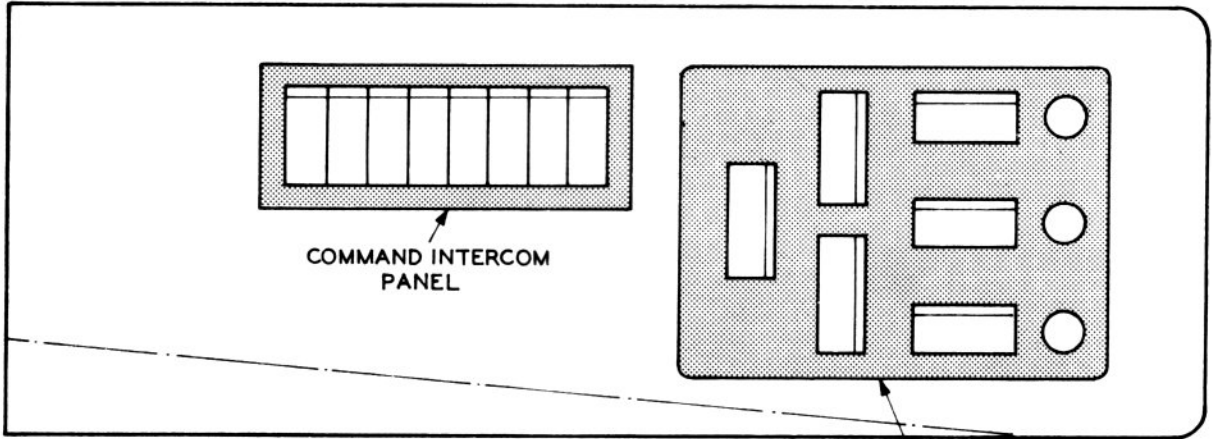

VITAL FUNCTIONS OVERRIDE PANEL

CON PIVOT CENTER

STARBOARD CONSOLE:

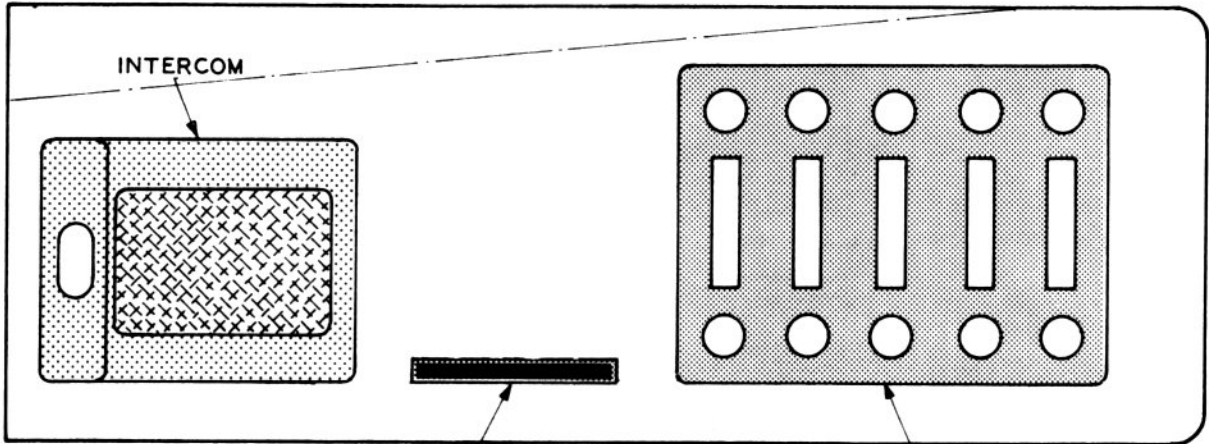

RECORD DECK RECORD/READOUT UNIT

COMMAND FUNCTIONS PANEL

REFER TO SECTION 01:06:30 FOR DETAILED OPERATIONS PROCEDURE AND SYSTEMS FUNCTIONS SPECIFICATIONS

REFER TO ENGINEERING SECTION FOR SYSTEMS SCHEMATICS, WIRING DIAGRAMS, AND STANDARD MAINTENANCE PROCEDURES

OFFICIAL COLOR:  
SKY BLUE N°SF16UC



TO:01:06:19

# ASTROGATOR

COMMAND MODULE - MAIN BRIDGE

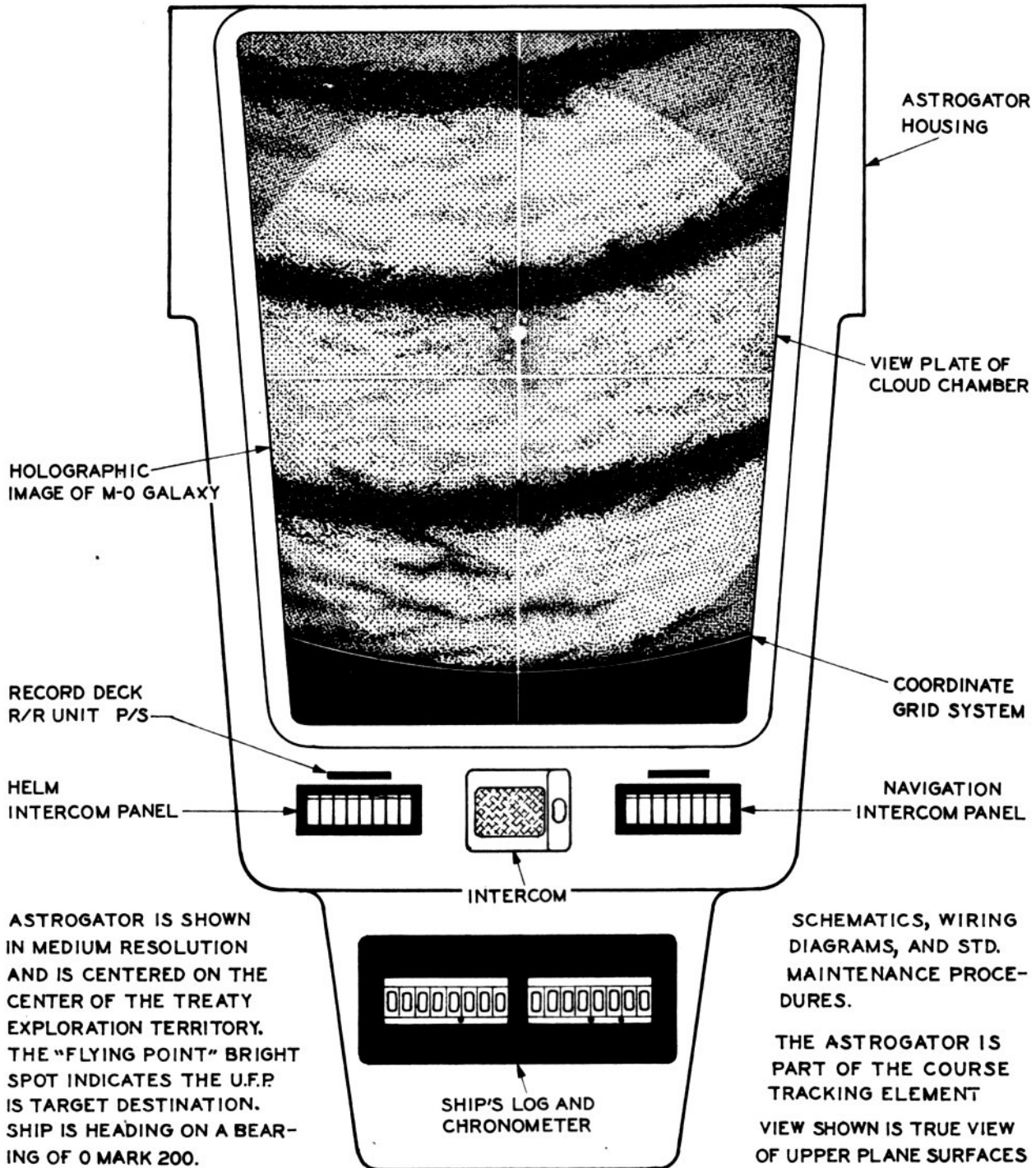

HOLOGRAPHIC  
IMAGE OF M-0 GALAXY

RECORD DECK  
R/R UNIT P/S

HELM  
INTERCOM PANEL

ASTROGATOR IS SHOWN  
IN MEDIUM RESOLUTION  
AND IS CENTERED ON THE  
CENTER OF THE TREATY  
EXPLORATION TERRITORY.  
THE "FLYING POINT" BRIGHT  
SPOT INDICATES THE U.F.P  
IS TARGET DESTINATION.  
SHIP IS HEADING ON A BEAR-  
ING OF 0 MARK 200.

REFER TO SECTION 02:06:00  
FOR DETAILED OPERATIONS PROCEDURE AND  
SYSTEMS FUNCTIONS SPECIFICATIONS  
REFER TO ENGINEERING SECTION FOR SYSTEMS

ASTROGATOR  
HOUSING

VIEW PLATE OF  
CLOUD CHAMBER

COORDINATE  
GRID SYSTEM

NAVIGATION  
INTERCOM PANEL

INTERCOM

SHIP'S LOG AND  
CHRONOMETER

SCHEMATICS, WIRING  
DIAGRAMS, AND STD.  
MAINTENANCE PROCEDURE.

THE ASTROGATOR IS  
PART OF THE COURSE  
TRACKING ELEMENT  
VIEW SHOWN IS TRUE VIEW  
OF UPPER PLANE SURFACES



# SECURITY SECTION

PRIMARY HULL - CLASS I STARSHIPS

DECK 7 - MAIN DECK  
AMIDSHIPS - PORT SIDE

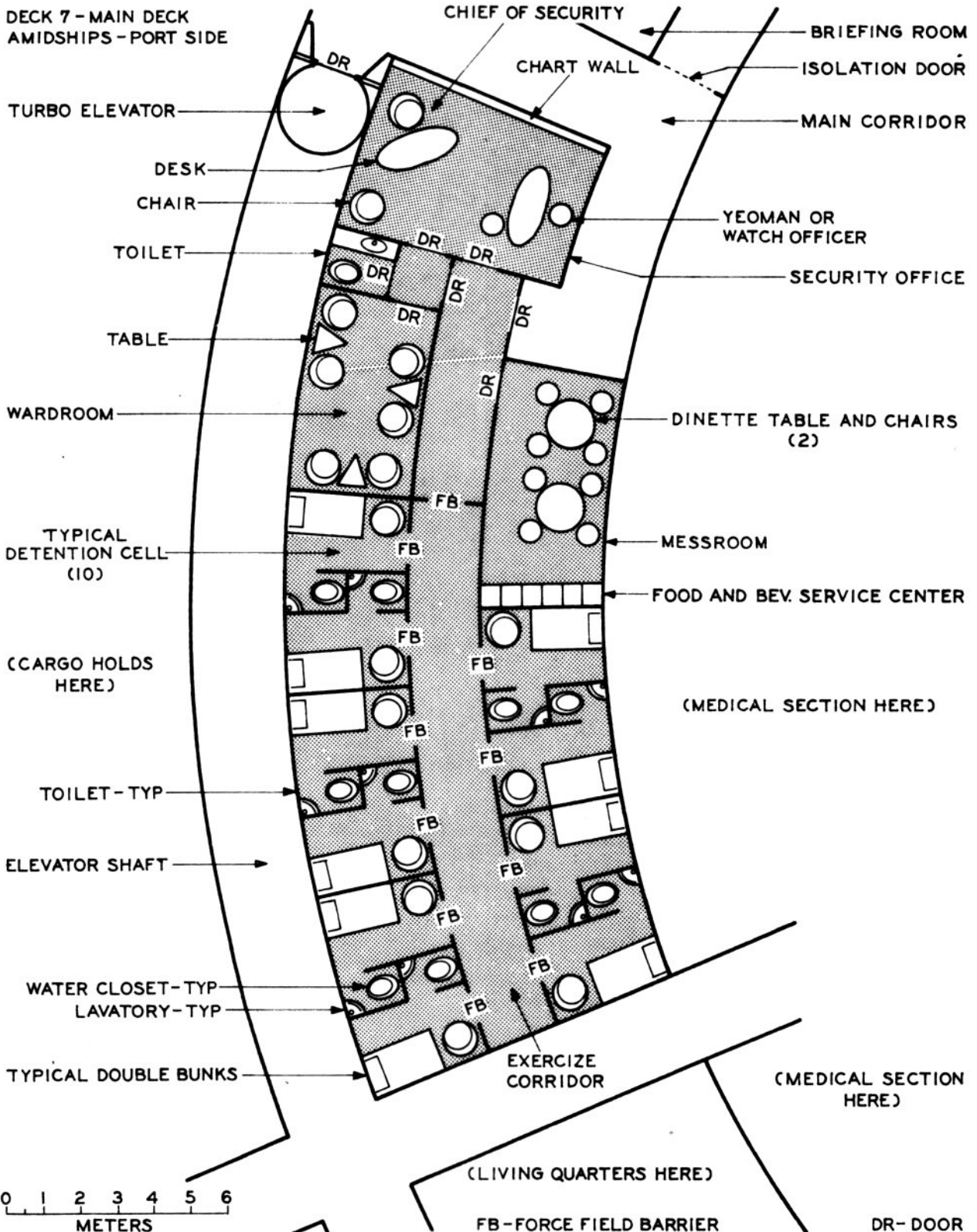



# HAND PHASER-TYPE I

### EFF. RANGES IN METERS:

OVERLOAD BLAST RADIUS.....	40
DE-MATERIALIZE.....	10
DISRUPT.....	20
HEAT.....	2
STUN.....	30

### COLORS:

	BR. ANTIMONY N°SF02UC
	GLOSS BLACK N°SF32UC

DIM: W.O.A.....49.40 MM D.O.A.....27.00 MM  
L.O.A.....107.20 MM

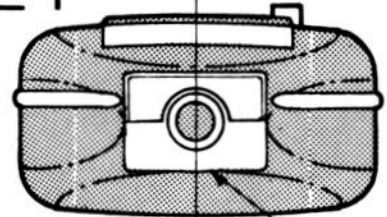

FRONT  
FACE PLATE

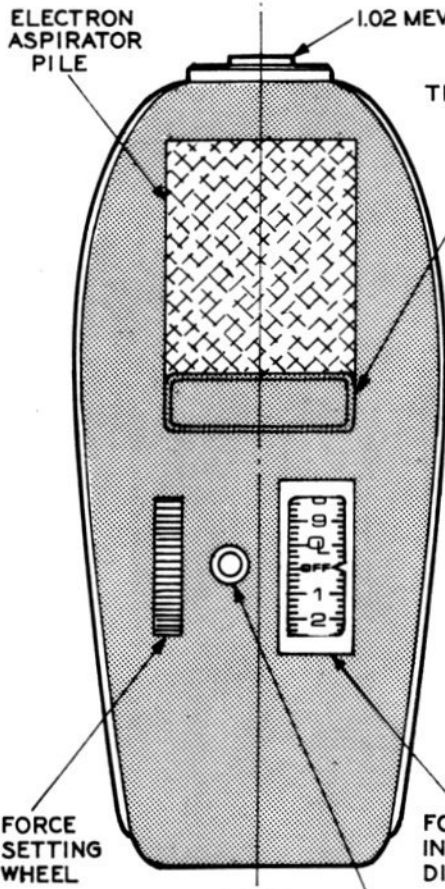

TOP  
ELECTRON ASPIRATOR PILE  
1.02 MEV PHOTON EMITTER  
TRIGGER  
FORCE SETTING WHEEL  
FORCE INDICATOR DIAL  
OPERATIONAL LIGHT (BLUE)

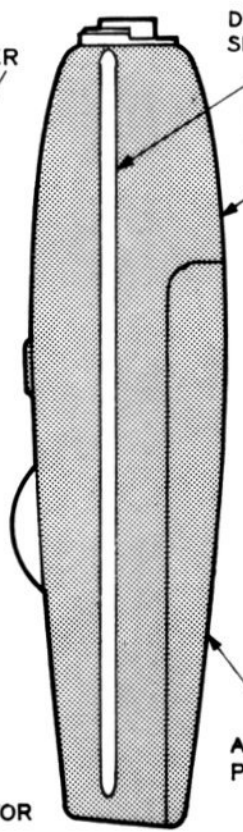

SIDE  
DEFLECTOR SHIELD  
BODY SHELL  
ACCESS PLATE

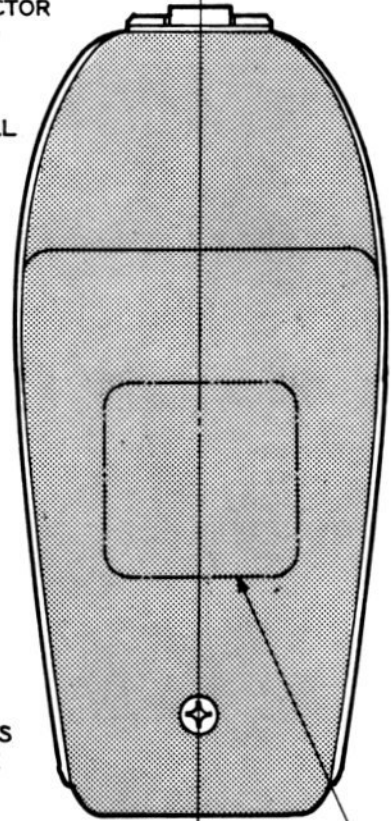

BOTTOM  
MAGNATOMIC ADHESION AREA



### BODY LINES AND SECTIONS

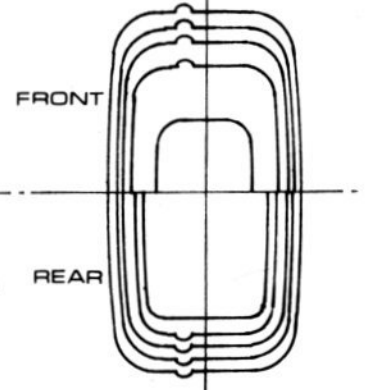
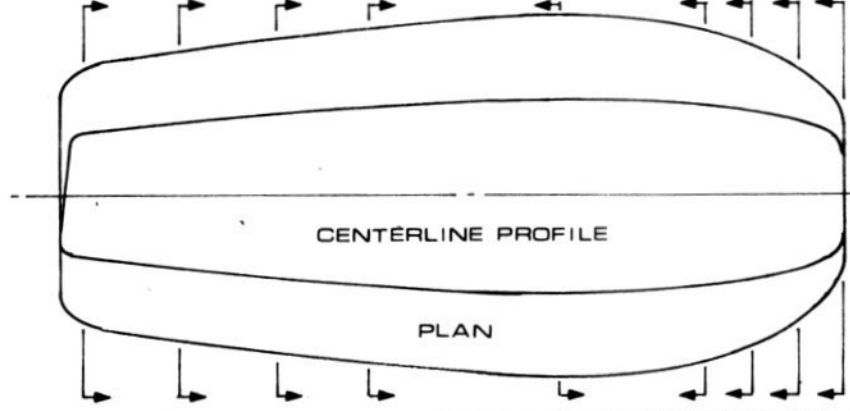

WARNING! DISCARD ANY UNIT SHOWING ANY DIMENSIONAL CHANGE!

# HAND PHASER-TYPE II

EFF. RANGES IN METERS:  
 OVERLOAD BLAST RADIUS.....135  
 DE-MATERIALIZE.....30  
 DISRUPT.....60  
 HEAT.....6  
 STUN.....90

DIM:  
 L.O.A.....221.00 MM  
 W.O.A.....49.40 MM  
 D.O.A.....157.50 MM

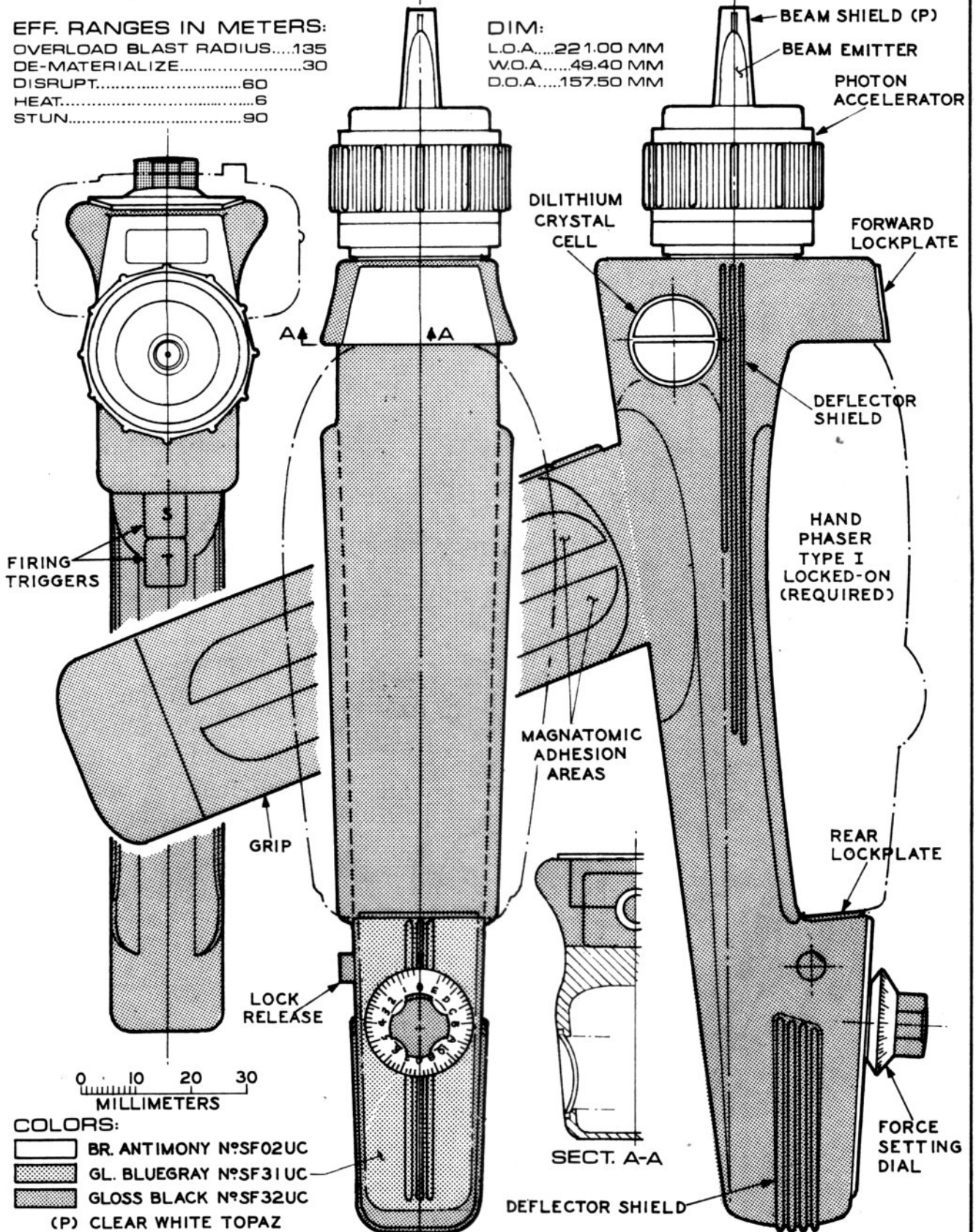



TO:01:08:53

# HAND PHASER-TYPE II

LINES AND SECTIONS

LOCKPLATE RECESS

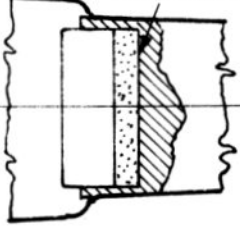

RECESS TO MATCH FACEPLATE OF HAND PHASER TYPE I

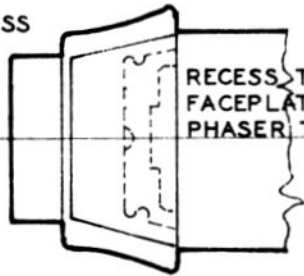

FREE POSITION

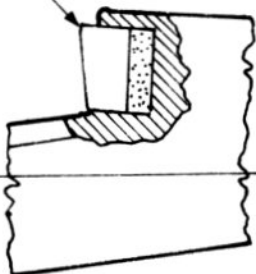

FWD LOCKPLATE DTL.

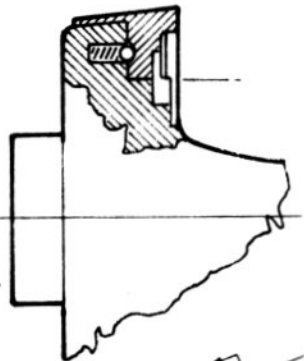

REAR LOCKPLATE DETAIL

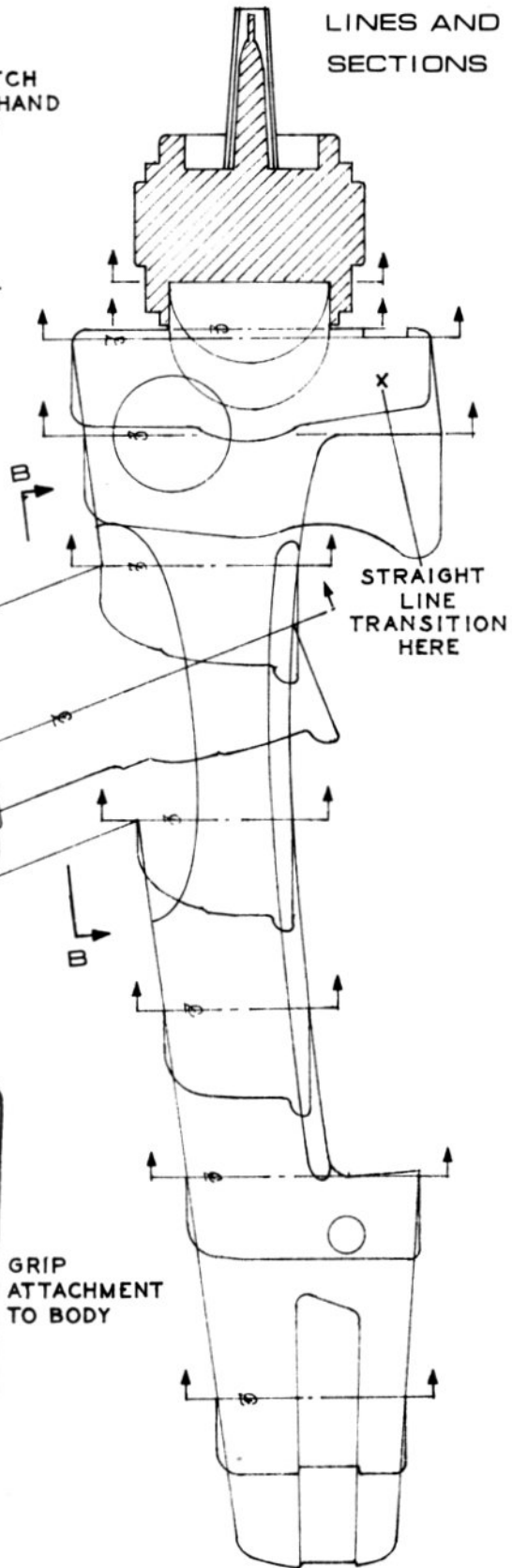

STRAIGHT LINE TRANSITION HERE

GRIP ATTACHMENT TO BODY

INTERLOCKING SWITCH

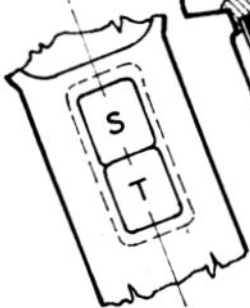

S=SAFETY T=TRIGGER TRIGGER DETAIL

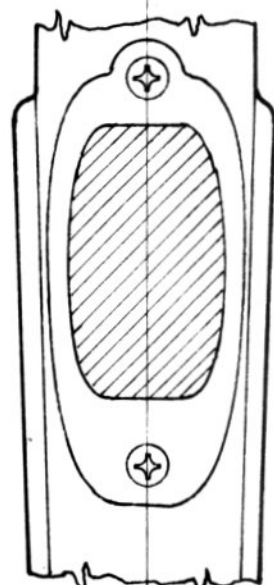

VIEW B-B

WARNING! DISCARD ANY UNIT SHOWING ANY DIMENSIONAL CHANGE!

# RAY GUN

OFFENSIVE/DEFENSIVE AREA WEAPON

**SPECIFICATION:**

MODEL: TYPE I

OFFENSIVE (DISRUPT) RANGE (M) \_\_\_\_\_ 90

EFFECTIVE AREA AT RANGE (M) \_\_\_\_\_ 3

DEFENSIVE (STUN) RANGE (M) \_\_\_\_\_ 180

EFFECTIVE AREA AT RANGE (M) \_\_\_\_\_ 8

LENGTH OVERALL (CM) \_\_\_\_\_ 23.5

MAXIMUM DIAMETER (CM) \_\_\_\_\_ 8.4

WEIGHT (GM) \_\_\_\_\_ 630

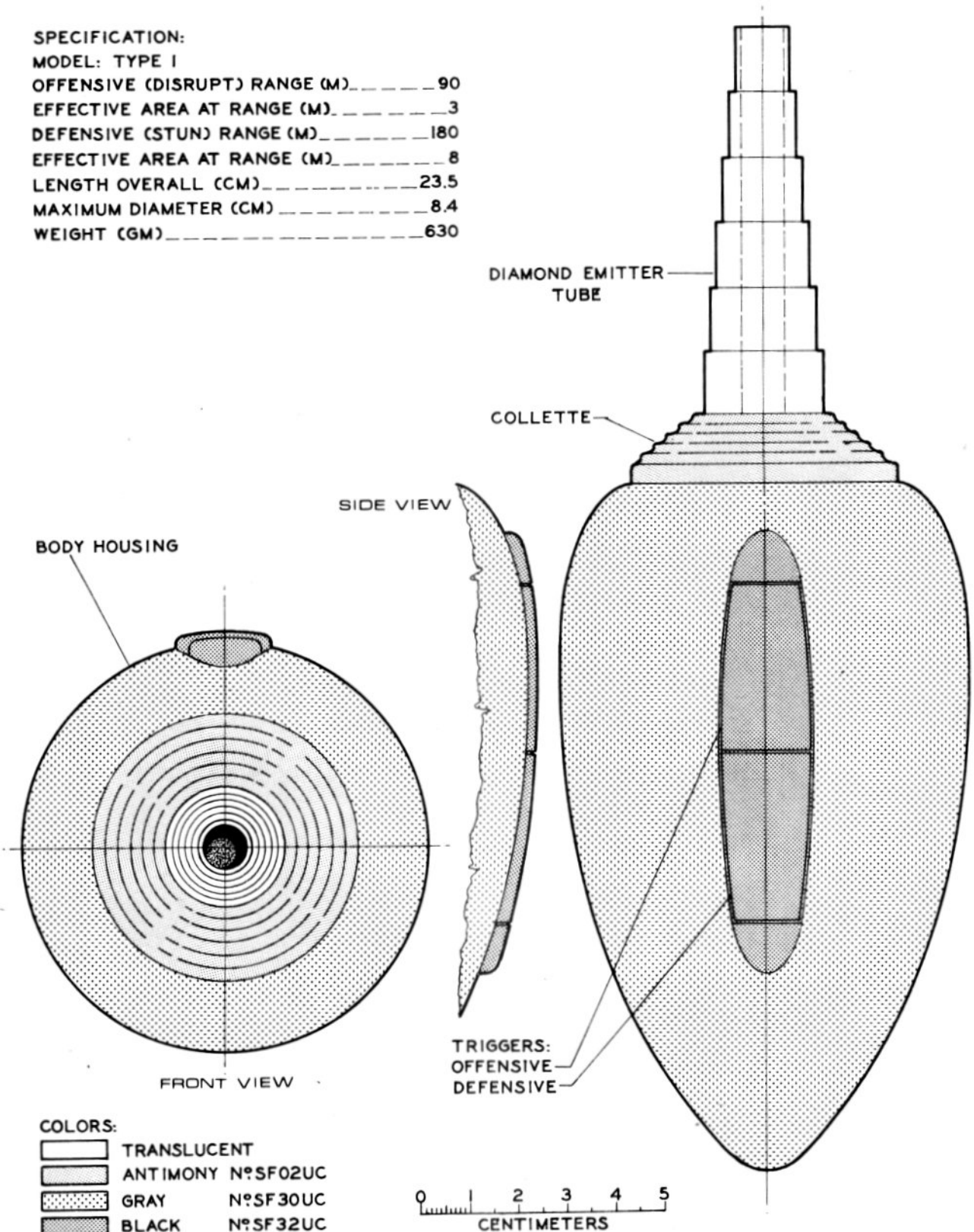

BODY HOUSING

DIAMOND EMITTER TUBE





COLLETTE

SIDE VIEW

FRONT VIEW

TRIGGERS:  
OFFENSIVE  
DEFENSIVE

**COLORS:**

-  TRANSLUCENT
-  ANTIMONY N°SF02UC
-  GRAY N°SF30UC
-  BLACK N°SF32UC

0 1 2 3 4 5  
CENTIMETERS

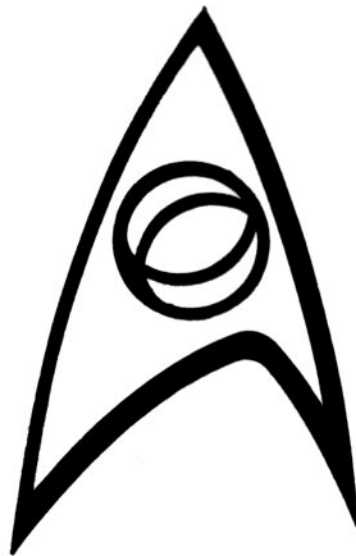

SCIENCES SECTION

STAR FLEET TECHNICAL ORDER

SECTION INDEX			
TO. NO:	SUBJECT	CURRENT	REPLACES
02:00:00	SCIENCES SECTION FLYSHEET	7305.30	
" " :02	FOREWORD	*	
" " :04	SECTION INDEX	7309.10	
" :01:00	COMMAND INTELLIGENCE STATION - MAIN BRIDGE	7408.23	
" " :01	CONTROLS CONSOLE	7409.14	
" :04:00	SCIENCE TRICORDER - EXTERNAL ARRANGEMENT	7305.02	
" " :01	" " - OPEN ARR.	"	
" " :02	" " - INTERNAL ARR.	"	
" " :03	" " - DETAILS	7305.02	
" :06:00	NAVIGATION STATION - MAIN BRIDGE	*	
" " :01	CONTROLS CONSOLE	*	
" :06:10	GALACTIC COORDINATE SYSTEM	7305.06	
" " :12	S.I.N.S BASE DATUM	7306.05	
" " :13	COURSE TRACKING ELEMENT	7502.15	
" :06:20	VELOCITY/TIME RELATIONSHIP	7305.14	
" :06:30	STANDARD ORBITS - CLASS I STARSHIPS	7502.06	
" :07:00	MILKY WAY GALAXY	7305.19	
" " :01	KNOWN GALACTIC REGION	7305.16	
" " :02	UNITED FEDERATION OF PLANETS	7305.17	
" " :03	*	*	
" " :04	SOL SYSTEM (UN - EARTH)	*	
" " :05	" " - PLANETARY DATA	*	
" " :06	40 ERIDANI SYSTEM	*	
" " :07	" " " - PLANETARY DATA	*	
" " :08	61 CYGNI SYSTEM	*	
" " :09	" " " - PLANETARY DATA	*	
" " :10	EPSILON INDIU SYSTEM	*	
" " :11	" " " - PLANETARY DATA	*	
" " :12	ALPHA CENTAURI SYSTEM	*	
" " :13	" " " - PLANETARY DATA	*	
" :10:00	MEDICAL SECTION - PRIMARY HULL - CLASS I STARSHIPS	7512.21	
" " :01	" " - SECONDARY HULL - MK-IX MODEL	*	
" :11:00	MEDICAL TRICORDER - EXTERNAL ARRANGEMENT	7305.03	
" " :01	" " - OPEN ARR.	"	
" " :02	" " - INTERNAL ARR.	"	
" " :03	" " - DETAILS	7305.03	
" " :04	HEARTBEAT READER	7503.06	
" " :05	FIELD READER TUBE	*	
" " :06	SPRAY APPLICATOR	7503.06	
" " :07	MEDICAL SCANNER	"	
" " :08	LANDING PARTY MEDICAL POUCH	*	
" " :09	NON-COMPUTERIZED FABRICATION PATTERN	*	
" " :10	MEDICAL HYPO	*	
" " :11	" " "	*	

NOTE (\*). NO CURRENT PRINT-OUT FROM MASTERCOM DATABANKS/SFHQ



# COMMAND INTELLIGENCE

MAIN BRIDGE STATION - CLASS I STARSHIPS

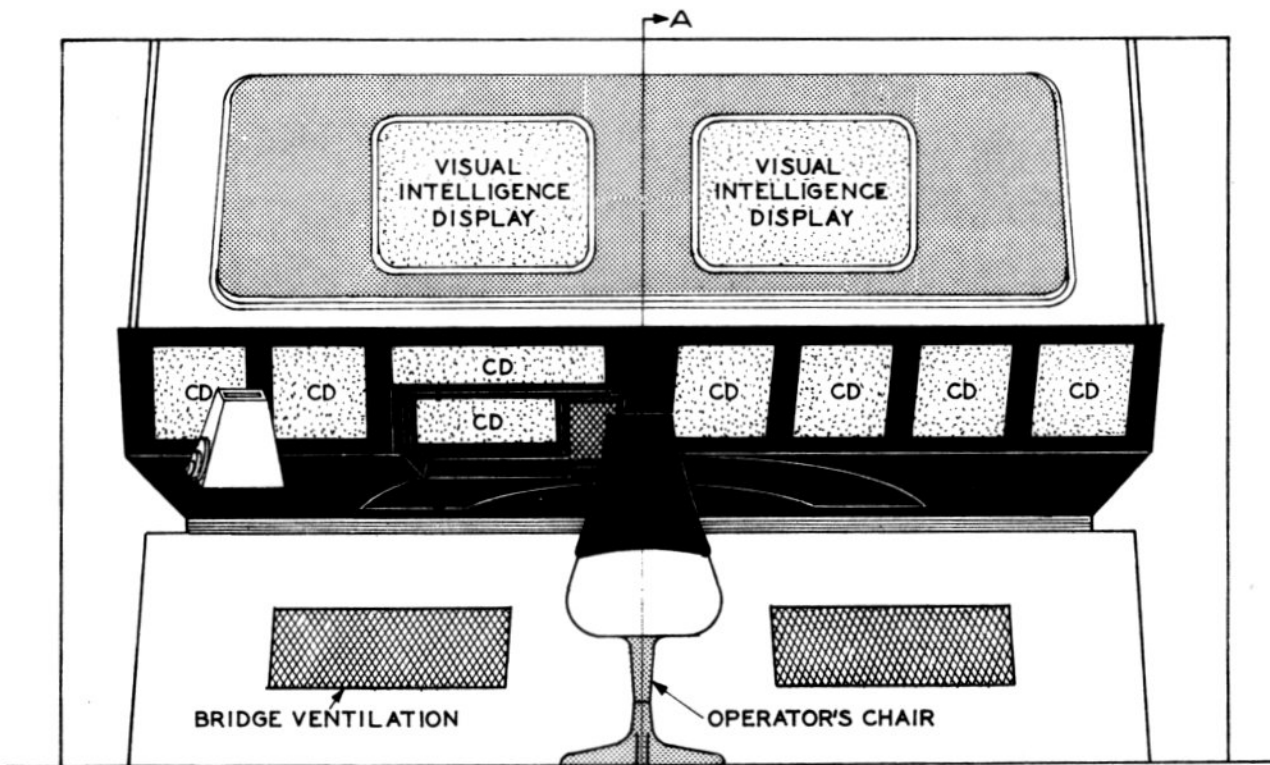

→A  
**FRONT ELEVATION**

**VIEW A-A:**

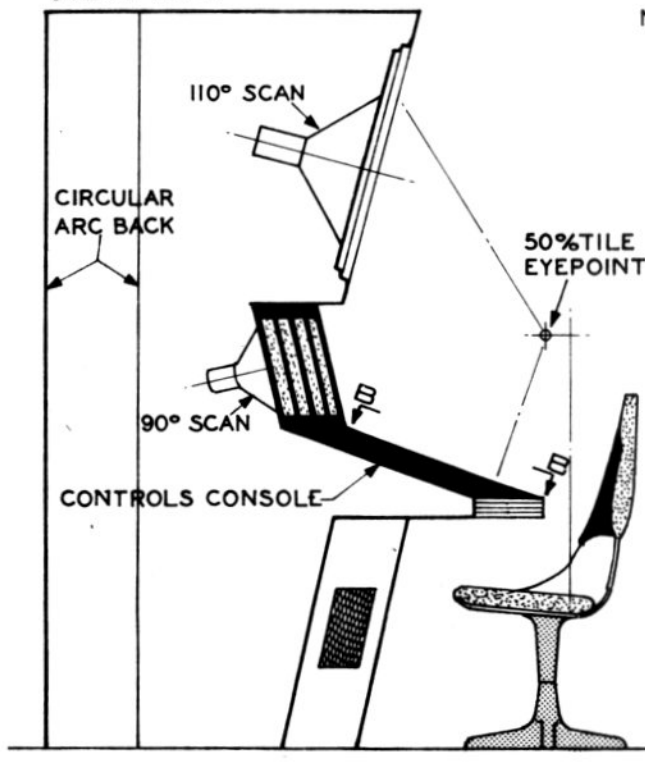

**NOTE:** CD-COMPUTER DATA AND SYSTEMS  
 VISUAL READ-OUT SCREENS

THIS STATION IS ALSO DUPLICATED ON  
 THE EMERGENCY BRIDGE

ALL SCIENTIFIC COMMAND INTELLIGENCE  
 IS HANDLED THROUGH THIS STATION

SEE TO:02:01:01 FOR CONTROLS CONSOLE  
 ARRANGEMENT

**OFFICIAL COLORS:**

	PLATINUM N°SF29UC
	RED N°SF10UC
	GRAY N°SF30UC
	BLACK N°SF32UC



TO:02:01:01

# CONTROLS CONSOLE

VIEW B-B OF TO:02:01:00

REFER ELSEWHERE IN THIS SECTION FOR DETAILED OPERATIONS PROCEDURES, AND SYSTEMS FUNCTIONS SPECIFICATIONS.

REFER TO ENGINEERING SECTION FOR SYSTEMS SCHEMATICS, WIRING DIAGRAMS, AND STANDARD MAINTENANCE PROCEDURES.

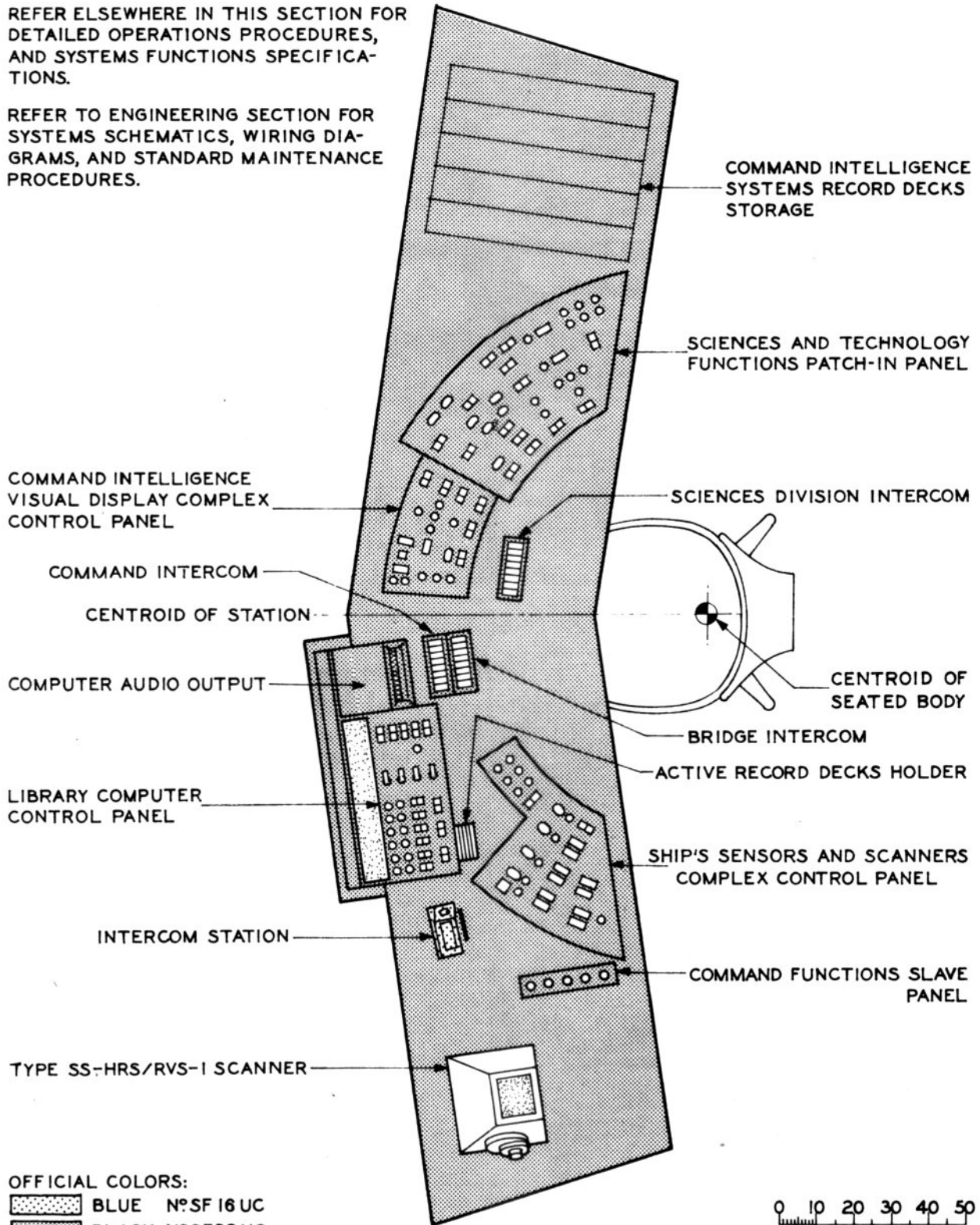

OFFICIAL COLORS:

-  BLUE N°SF 16 UC
-  BLACK N°SF 32 UC



0 10 20 30 40 50  
CENTIMETERS

# SCIENCES TRICORDER

TYPE I

SELECTIVELY SENSE, MEASURE, ANALYZE, COMPARE, AND IDENTIFY SURROUNDING ENVIRONMENTAL CONDITION. MULTIPLE CHANNEL RECORD OR READOUT CAPABILITY WITH MULTI-MODE DISPLAY CHOICE.

OFFICIAL COLORS:

-  ANTIMONY N°SF 02 UC
-  OLIVE N°SF 14 UC
-  BLACK N°SF 32 UC

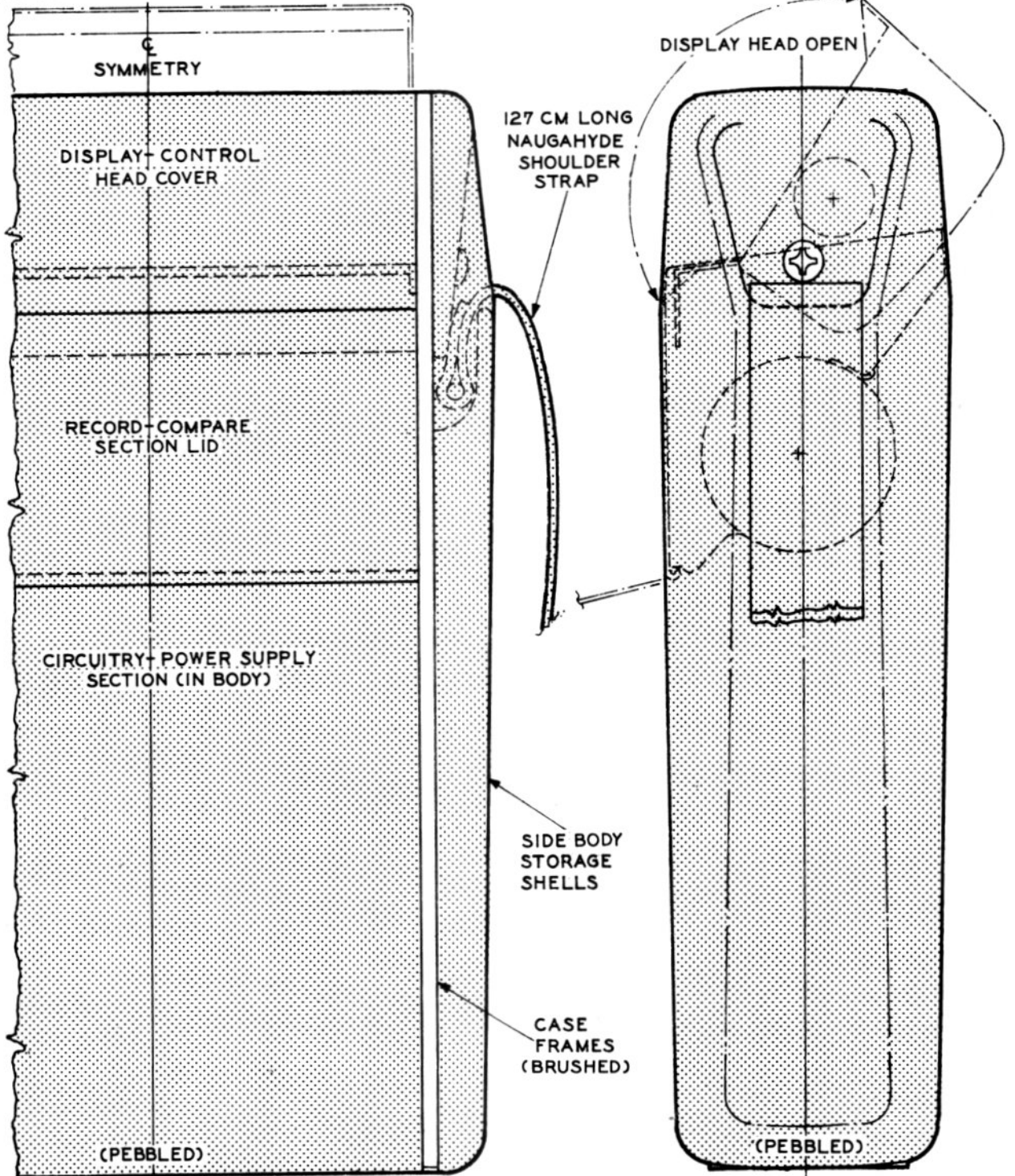

FULL SIZE. DIMENSIONS: H.O.A.(CLOSED) - 177.8MM; W.O.A. - 114.3MM; D.O.A. - 48.3MM;



TO:02:04:01

# SCIENCES TRICORDER

TYPE I

ARRANGEMENT - UNIT OPEN

OPEN D/C SECTION ACTIVATES UNIT

MATCHED COMPARISON LIGHT (BLUE)

DISC SELECTOR W/LIGHT

SENSOR ARRAY

SUB-NORMAL LIGHT (AMBER)

VIDEO DISPLAY

FACEPLATE

WIRE HARNESS DUCT EACH SIDE

DANGER-ALARM LIGHT (RED)

NC 10-32/4 OVAL HD. SCREW EACH SIDE

RECORD/PLAY W/VOL. & LIGHT

FRAME MEMBER

SEE NOTE D

REMOVABLE PLAY/RECORD DISCS (8)

CHANNEL SEL. W/LIGHT

COMPRESSION PLATE

SPEAKER/MIC.

DISC HOLDER FRAME

LID OPEN

FACEPLATE

NOTE D:  
THIS ROW OF LIGHTS (GREEN)

THIS SECTION TO BE OPENED ONLY BY CLASS A SPECIALIST RATINGS

TYPICAL SECTION

LOWER CATCH DETAIL

1.27 MM

FULL SIZE

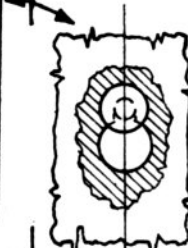
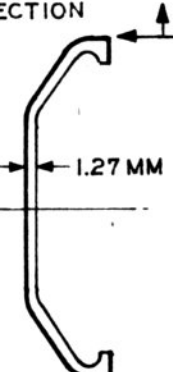
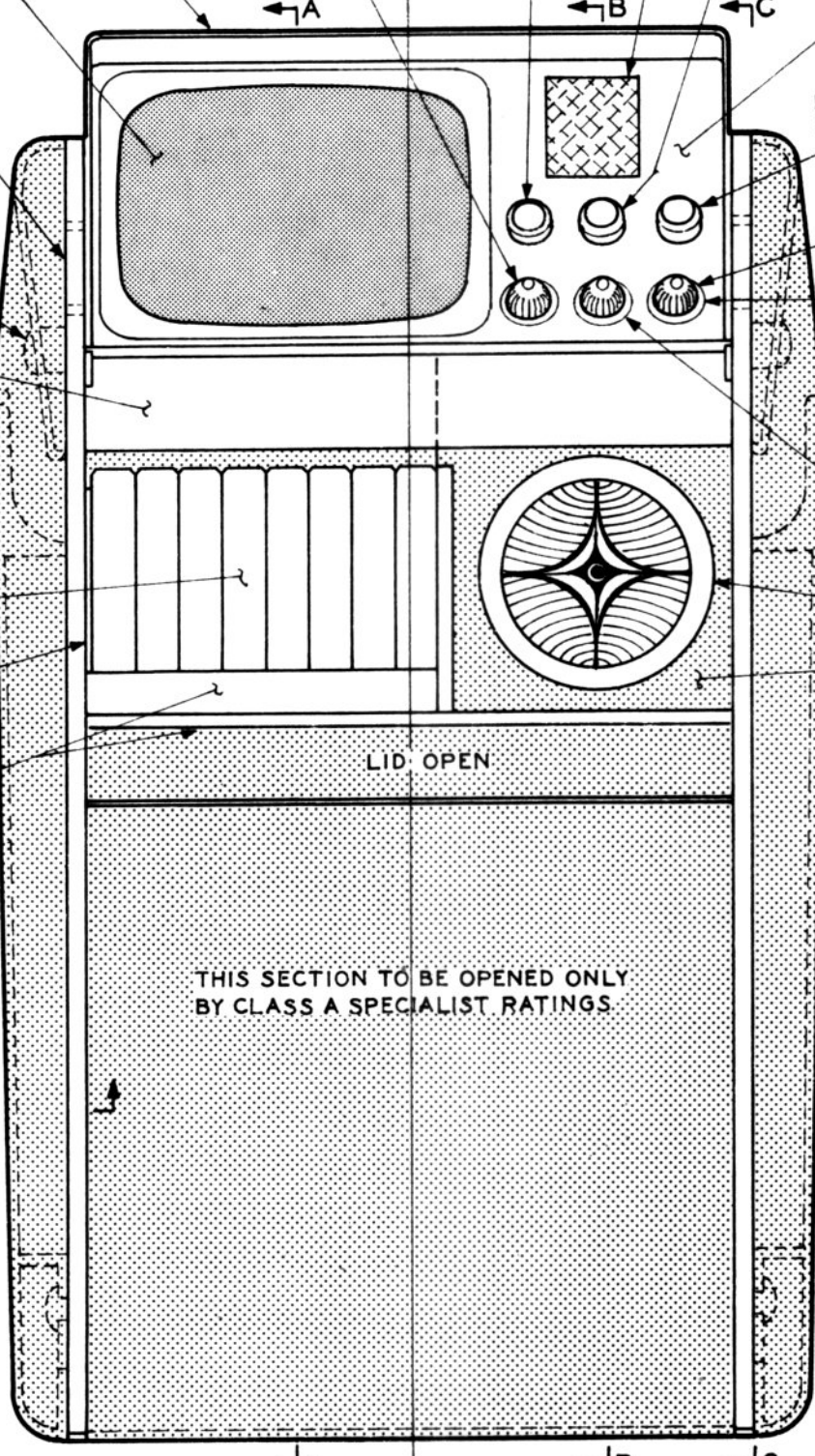

# SCIENCES TRICORDER

CASE DETAILS

TYPE I

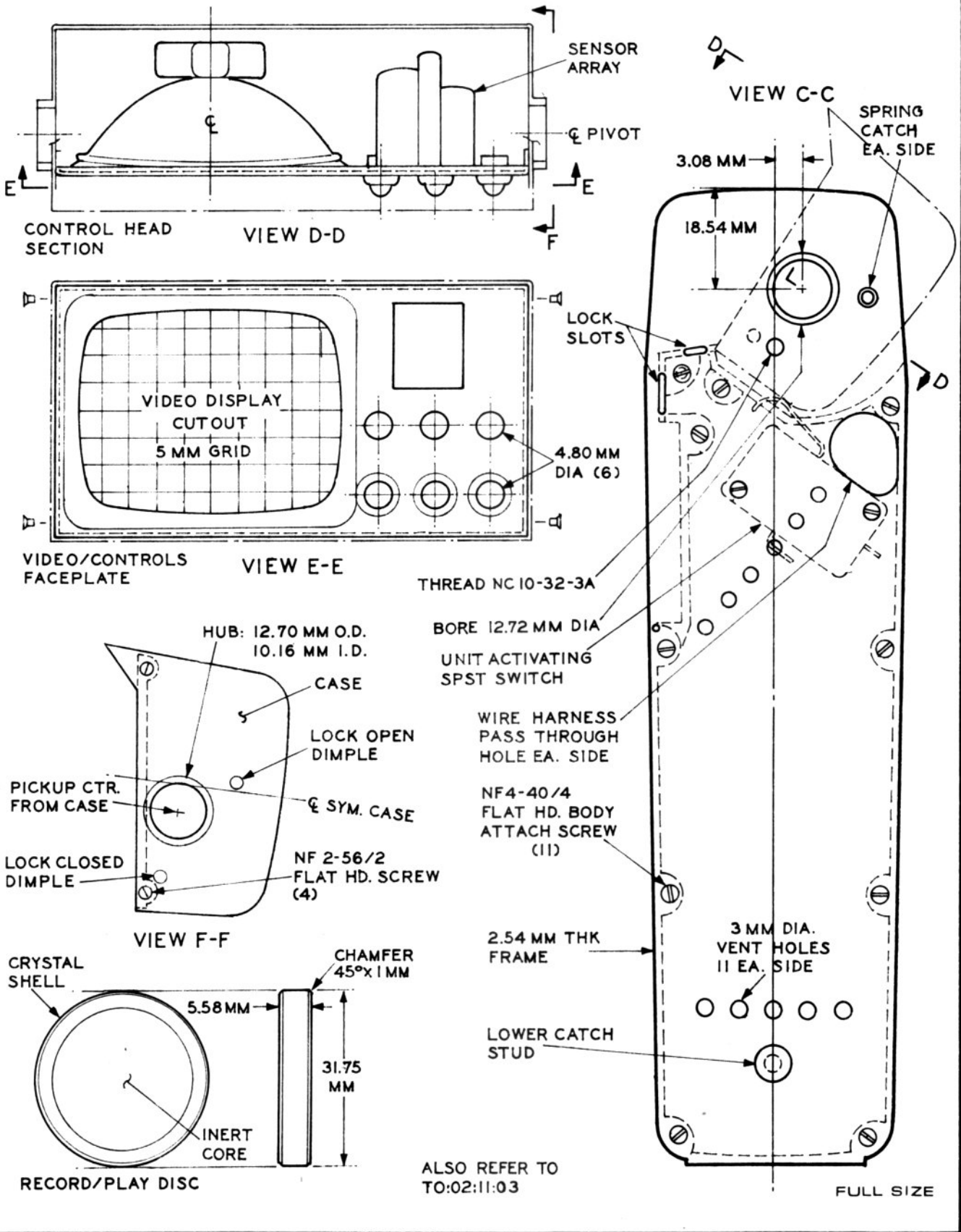

# GALACTIC COORD. SYSTEM

## GREAT SPIRAL MILKY WAY GALAXY M-O

VELOCITY OF LIGHT =  $c$  =  
299,793 KILOMETERS  
PER SECOND (KPS)

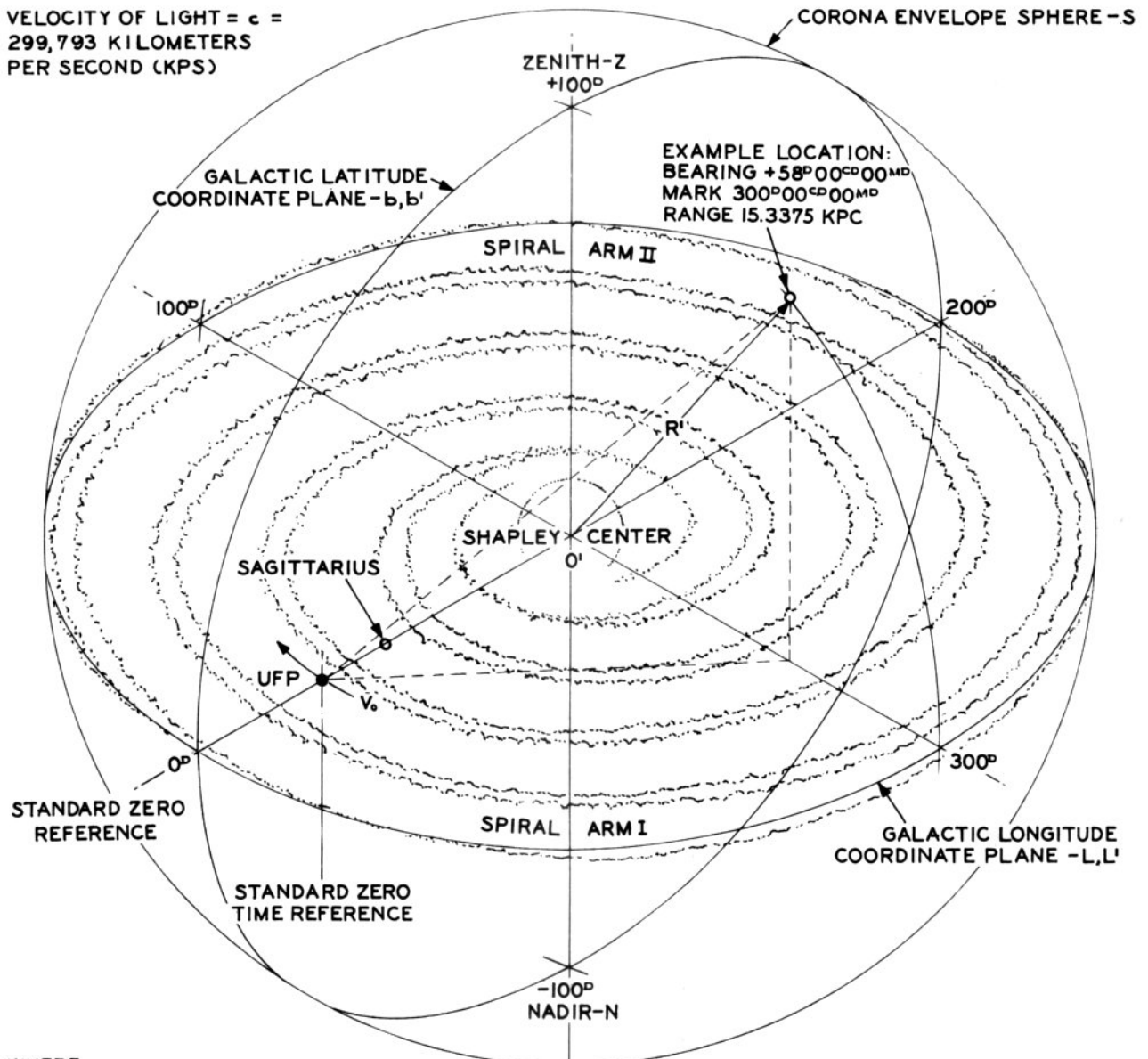

WHERE:

- R = RADIUS =  $0-0'$  = 15,337.5 PC
- D = DIAMETER =  $2(0-0')$  = 30,675 PC
- V = VOLUME OF S =  $1/6\pi D^3$  =  $4.9268 \times 10^{18}$  PC<sup>3</sup>
- PC = PARSEC = 3.26 LIGHT YEARS
- =  $30.8 \times 10^{12}$  KILOMETERS
- = 206265 AU (TERRAN)
- = PARALLAX OF  $0^\circ 0' 01''$  (TERRAN)
- V<sub>0</sub> = AXIAL VELOCITY OF GALAXY
- = 267.5 KPS AT RADIUS OF UFP
- UFP = UNITED FEDERATION OF PLANETS
- AU = ASTRONOMICAL UNIT (TERRAN)
- R' = RANGE IN PC OR KPC (PC x 1000)

NOTATION:

- (D) = DIVISION = 400
- (CD) = CENTIDIVISION = 40,000
- (MD) = MILLIDIVISION = 4,000,000
- LOCATION OF UFP:
- BEARING  $000^\circ 00^CD 00^MD$
- MARK  $000^\circ 00^CD 00^MD$
- RANGE 10 KPC
- STATED AS: " 0 MARK 0 - R 10 KPC "

STANDARD  
POLAR  
AXIS

POLARIS II  
GALAXY

# S.I.N.S. BASE DATUM

IN GALACTIC COORDINATE SYSTEM

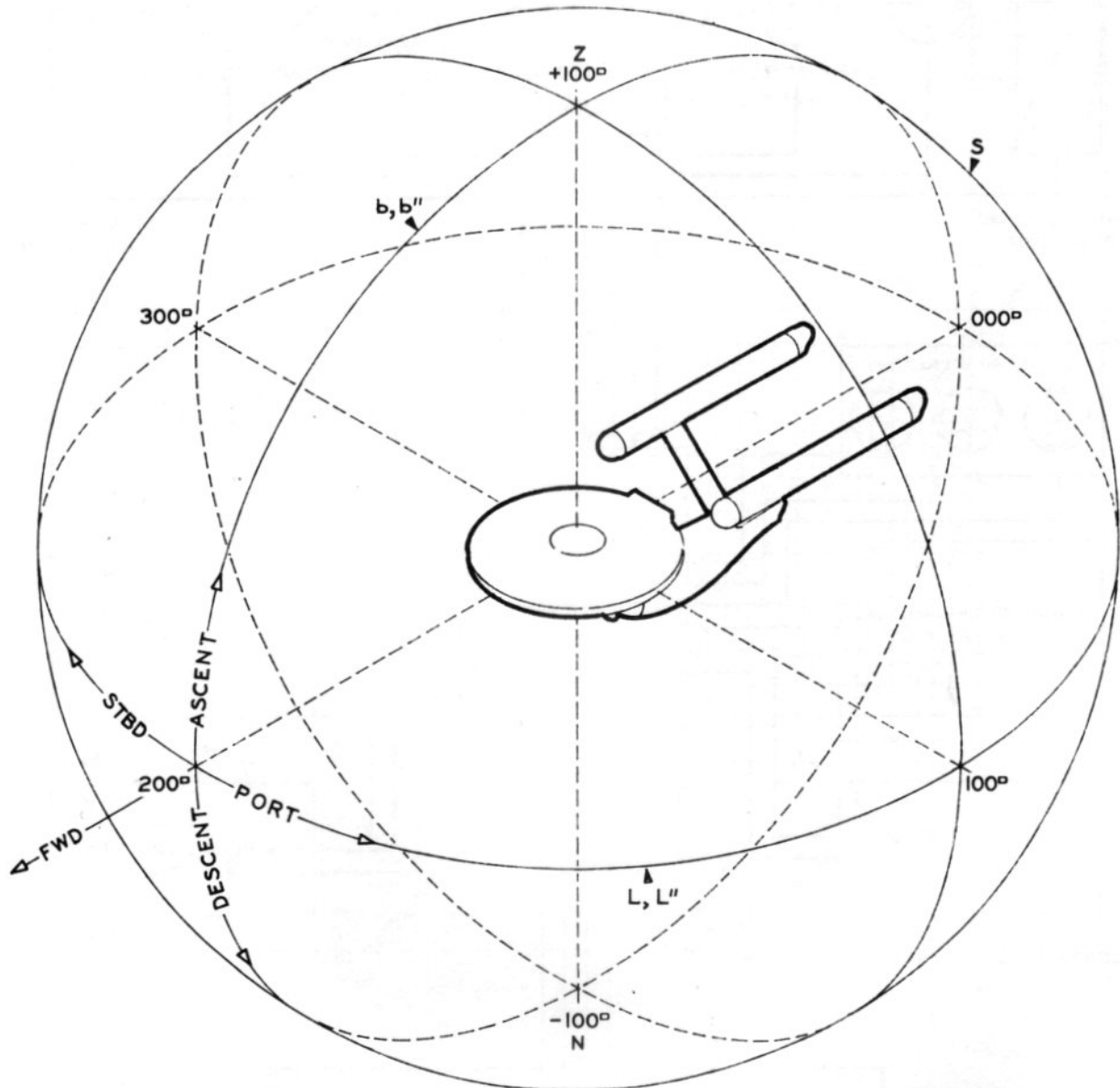

WHERE:

THE SPACE INERTIAL NAVIGATION SYSTEM\* IS THE FUNDAMENTAL GUIDANCE BASE FOR THE ONBOARD NAVIGATIONAL COMPUTER COMPLEX. IT IS ACTIVATED AND ACCURATELY ALIGNED IN THE GALACTIC COORDINATE SYSTEM AT COMMISSIONING IN PLANETARY ORBIT AND THEREAFTER MAINTAINS THIS ALIGNMENT WITHOUT ERROR. THE STARSHIP CARRIES THIS DATUM WITH IT (FWD) WHEREVER IT GOES AND MOVES WITHIN THIS REFERENCE FRAMEWORK: TO PORT OR STARBOARD AND UP OR DOWN IN ANY COMBINATION.

b, b'' - DECLINATION PLANE

L, L'' - AZIMUTH PLANE

N - NADIR AT b, b'' -100°

Z - ZENITH AT b, b'' +100°

S - SPHERICAL ENVELOPE CONTAINING ALL NUMERICAL COMBINATIONS OF b, b'' & L, L''

TO:02:06:13

# COURSE TRACKING ELEMENT

SCHEMATIC DIAGRAM - CLASS I STARSHIPS

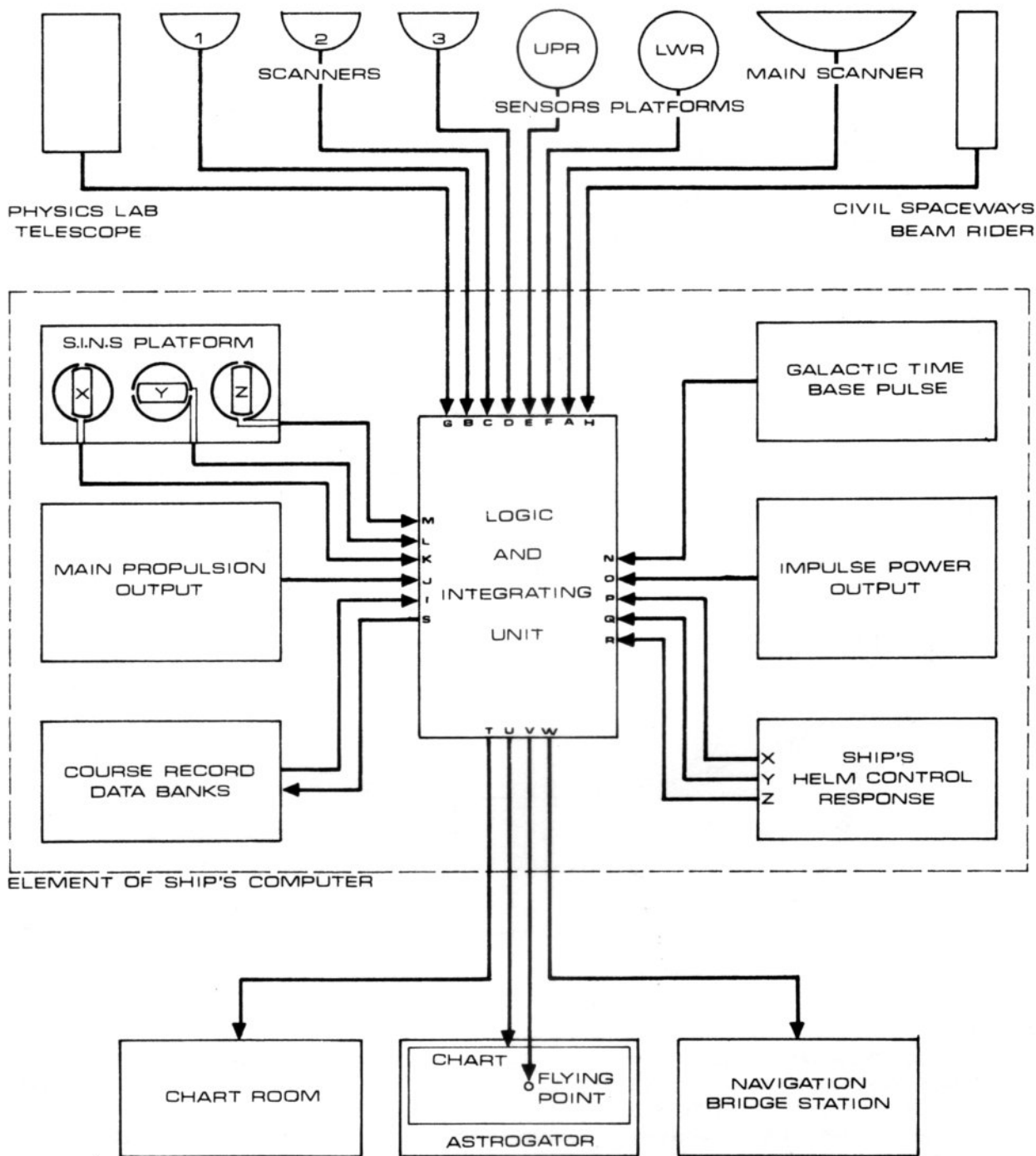

THE COURSE TRACKING ELEMENT IS THE VITAL HEART OF THE STARSHIP'S NAVIGATION SYSTEM. IT IS ACTIVATED UPON COMMISSIONING IN PLANETARY ORBIT AND THEREAFTER IT MAINTAINS AN ACCURATE CONSTANT RECORD AND PLOT OF THE SHIP'S COURSE AND LOCATION WITHIN THE GALAXY. FROM ANY LOCATION IT WILL GIVE A DIRECT BEARING TO THE SHIP'S HOME BASE, ITS DESTINATION, OR ANY OTHER DIVERSIONARY POINT.

# VELOCITY/TIME RELATIONSHIP

INTERSTELLAR SPACE/WARP TECHNOLOGY

SUB-WARP SPEED GRID ASSUMES ATTAINMENT OF  $V=C$  IN 1 SECOND

$C = 299,781$  KILOMETERS PER SECOND

MAX. SAFE CRUISE SPEED =  $W_r=6 = 64,752,696$  K.P.S. = 1 PC/136.8 HRS (T)

EMERGENCY SPEED =  $W_r=8 = 153,487,872$  K.P.S. = 1 PC/5.56 HOURS (T)

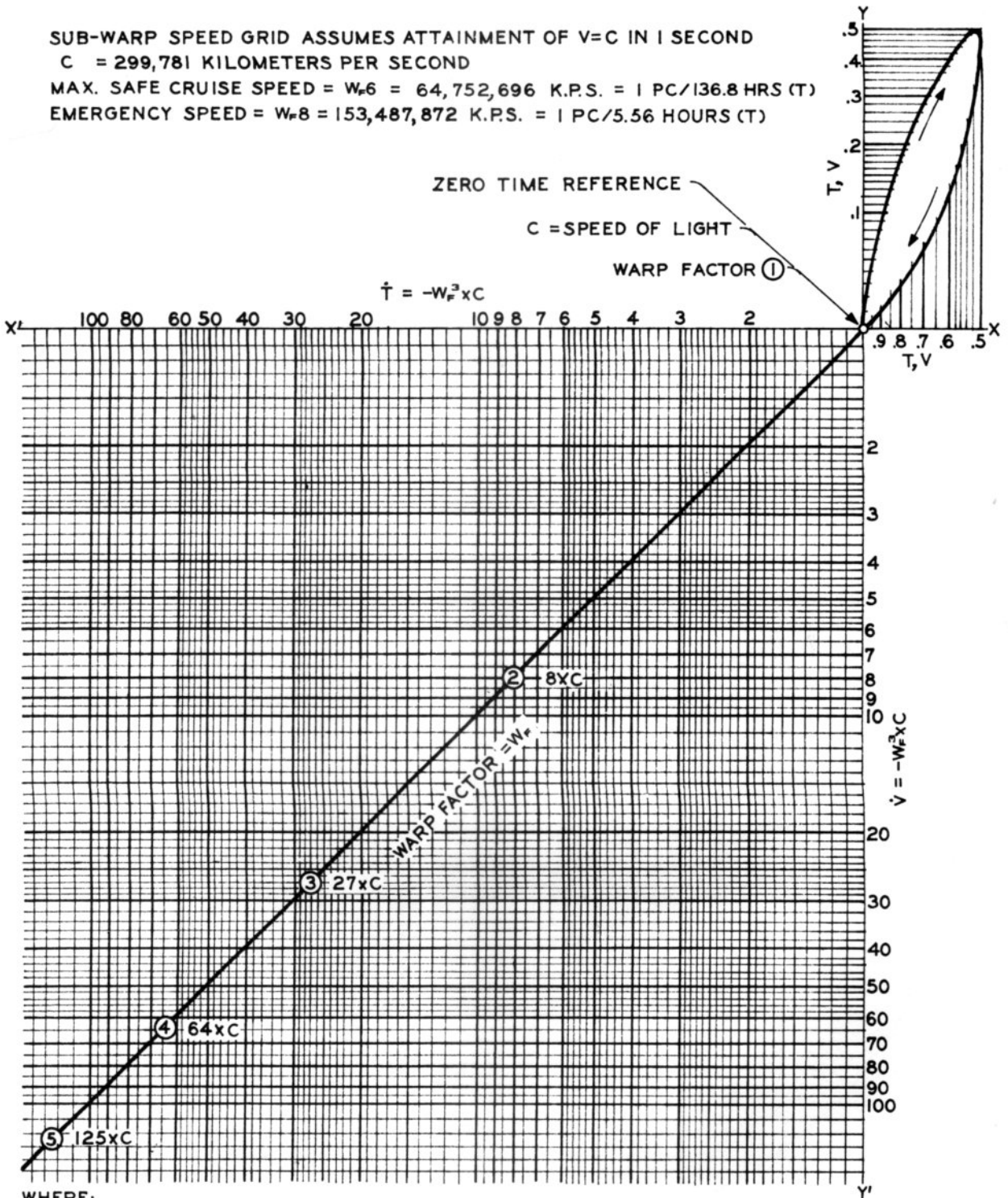

WHERE:

T = REAL TIME (TERRESTIAL)

V = SUB-LIGHT VELOCITY

$E = MC^2$

$\dot{T}$  = IMAGINARY NEGATIVE TIME

$\dot{V}$  = IMAGINARY NEGATIVE VELOCITY

# STANDARD ORBITS

CLASS I STARSHIPS

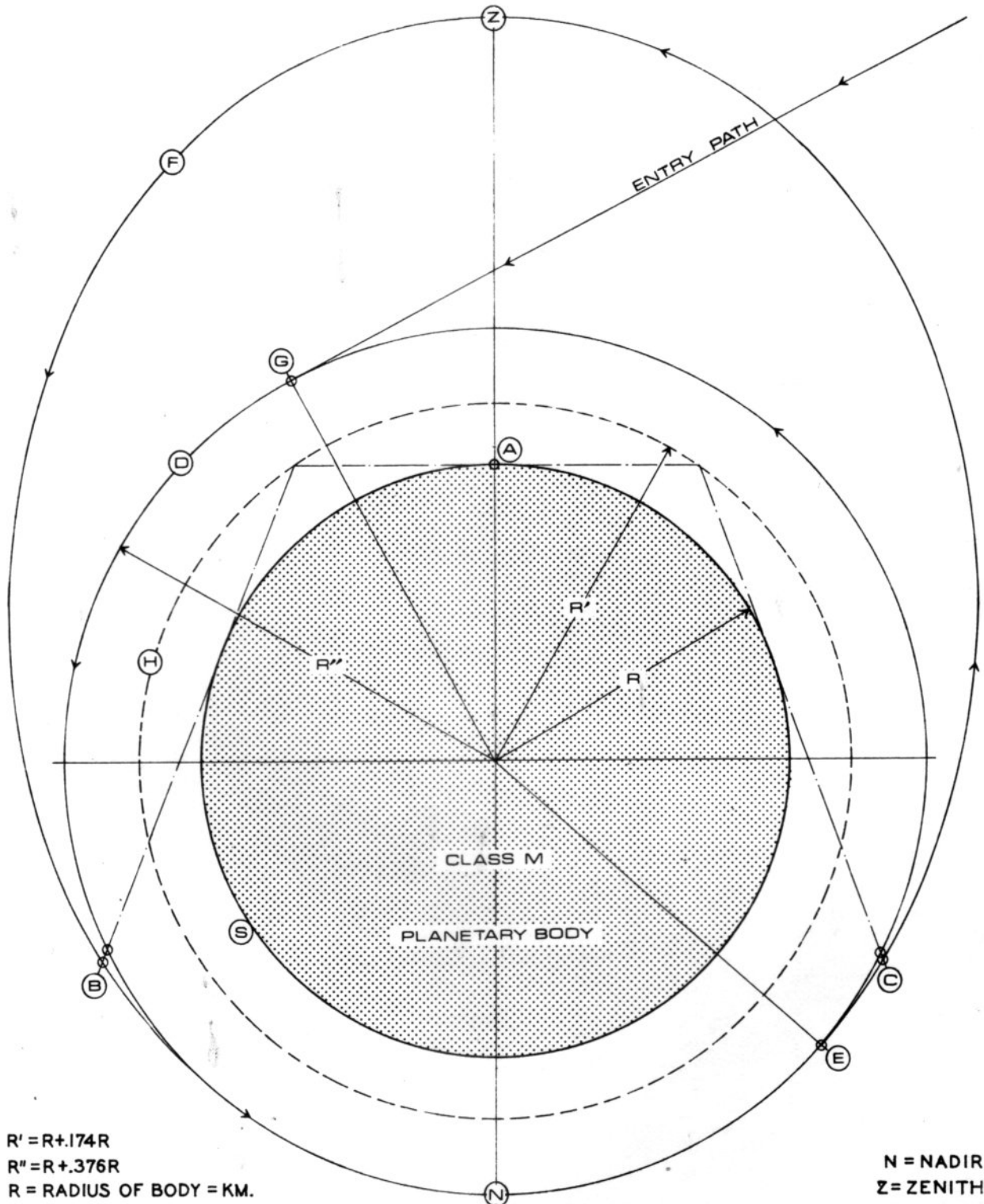

$R' = R + .174R$

$R'' = R + .376R$

R = RADIUS OF BODY = KM.

N = NADIR

Z = ZENITH

A-SURFACE POINT OF INTEREST. B-N-C - COMMUNICATIONS BLIND ZONE TO A. D- MINIMUM ZERO ATMOSPHERIC STD. ORBIT. E- ELLIPTICAL ORBIT INSERTION POINT. F - MIN. ELLIPTICAL ORBIT. G-STD. ORBIT INSERTION POINT. H - SENSIBLE ATMOSPHERIC LIMIT. S - SURFACE OF PLANET.

# MILKY WAY GALAXY

GREAT SPIRAL GALAXY - M-O - LOCAL GROUP

VIEW OF THE GREAT EQUATORIAL DISK OF THE GALAXY

STELLAR POPULATION IS  $10 \times 10^{10}$  STARS

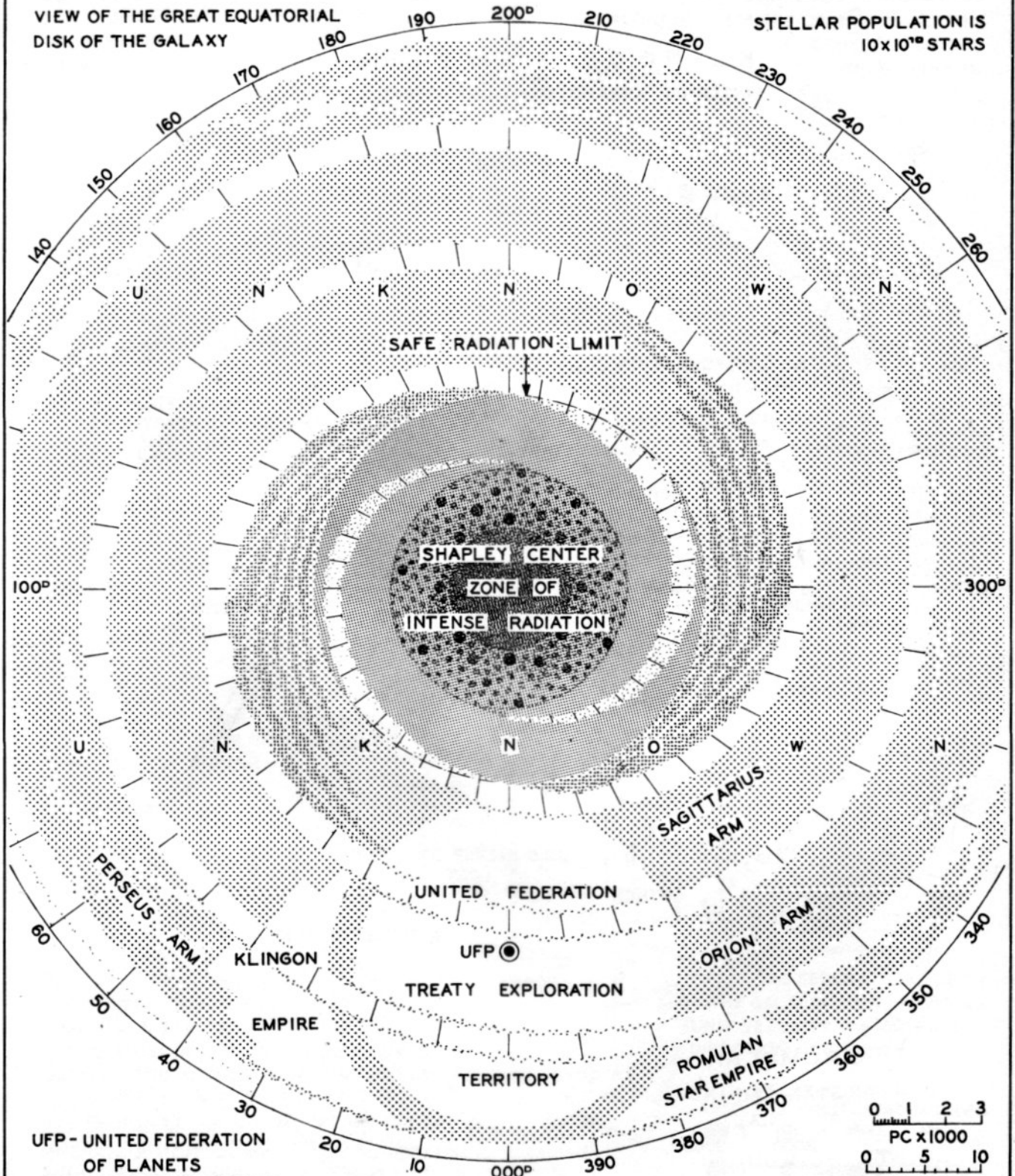

UFP - UNITED FEDERATION OF PLANETS  
THIS IS A NEGATIVE PRINT.

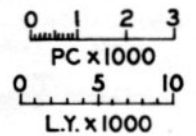





# UNITED FEDERATION

## OF PLANETS - PRINCIPAL STELLAR SYSTEMS

VIEWED FROM ZENITH LOOKING DOWN ON PROJECTION OF GALACTIC LONGITUDE COORDINATE PLANE L, L'.  
 200  
 180  
 160  
 140  
 120  
 100  
 80  
 60  
 40  
 20  
 0  
 20  
 40  
 60  
 80  
 100  
 120  
 140  
 160  
 180  
 200  
 220  
 240  
 260  
 280  
 300  
 320  
 340  
 360

THE FEDERATION BOUNDARY IS A SPHERE OF RADIUS -R = 7 PC CENTERED ON SOL. VOL-V = 1434 PC<sup>3</sup>

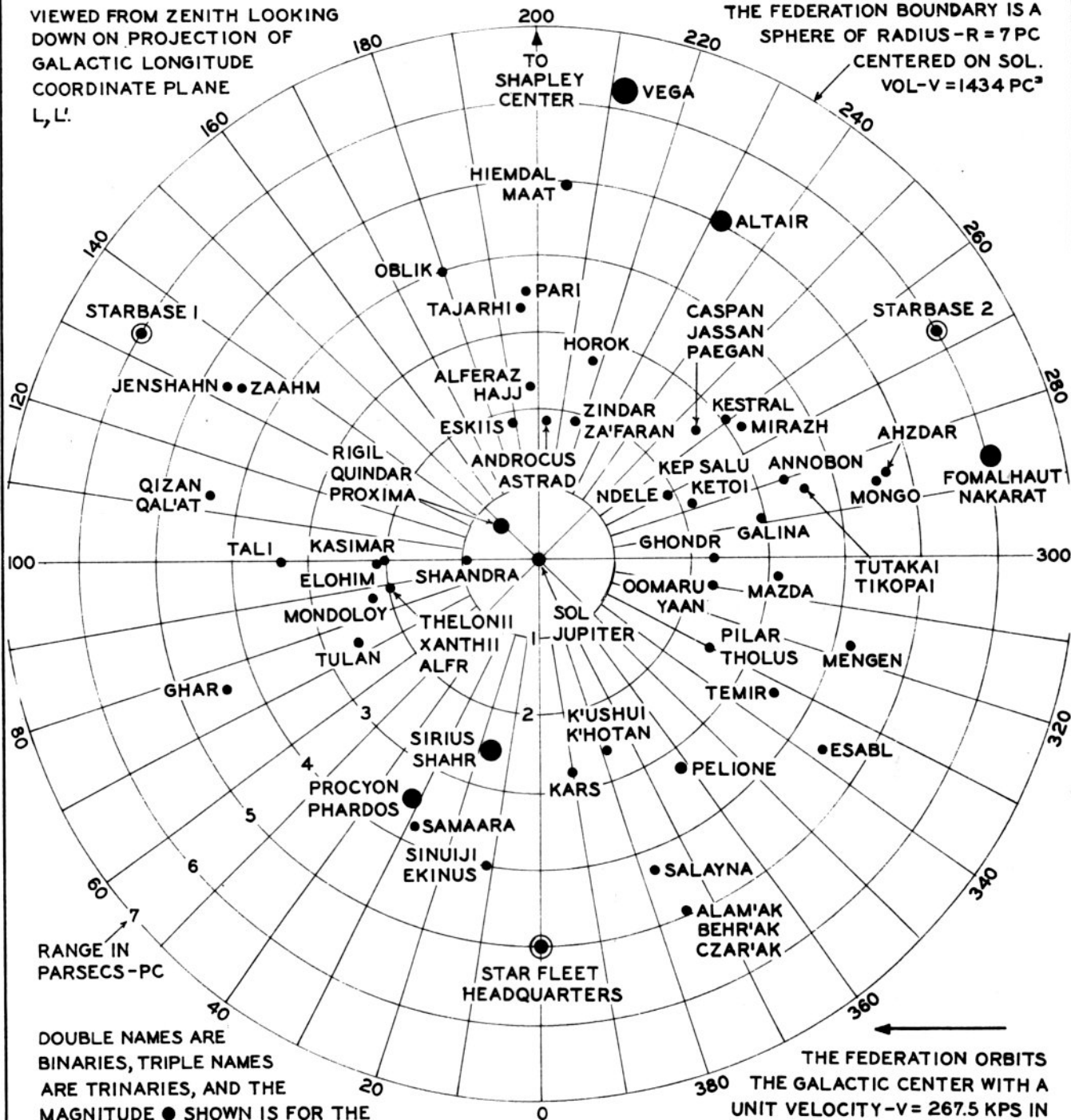

DOUBLE NAMES ARE BINARIES, TRIPLE NAMES ARE TRINARIES, AND THE MAGNITUDE ● SHOWN IS FOR THE LARGEST MEMBER (OR TOP NAME). SOL / JUPITER AND ANDROCUS/ASTRAD MAY BE PROTO-BINARIES AS THE LATER MEMBER OF EACH APPEAR TO BE "FAILED" STARS. THE PROPER LONGITUDE NOTATION IS 000° 00<sup>CD</sup> 00<sup>MD</sup> WHERE: (D)-DIVISION (400); (CD)-CENTIDIVISION (40,000); AND (MD)-MILLIDIVISION (4,000,000). THIS IS A NEGATIVE PRINT.

THE FEDERATION ORBITS THE GALACTIC CENTER WITH A UNIT VELOCITY -V = 267.5 KPS IN DIRECTION OF ARROW.

RELATIVE RANGE OF ABSOLUTE VISUAL MAGNETUDES

● 0	● +2	● +4	● +6
● +1	● +3	● +5	● +7 & <

# MEDICAL SECTION

DECK 7 - PLAN - PRIMARY HULL - CLASS I STARSHIPS

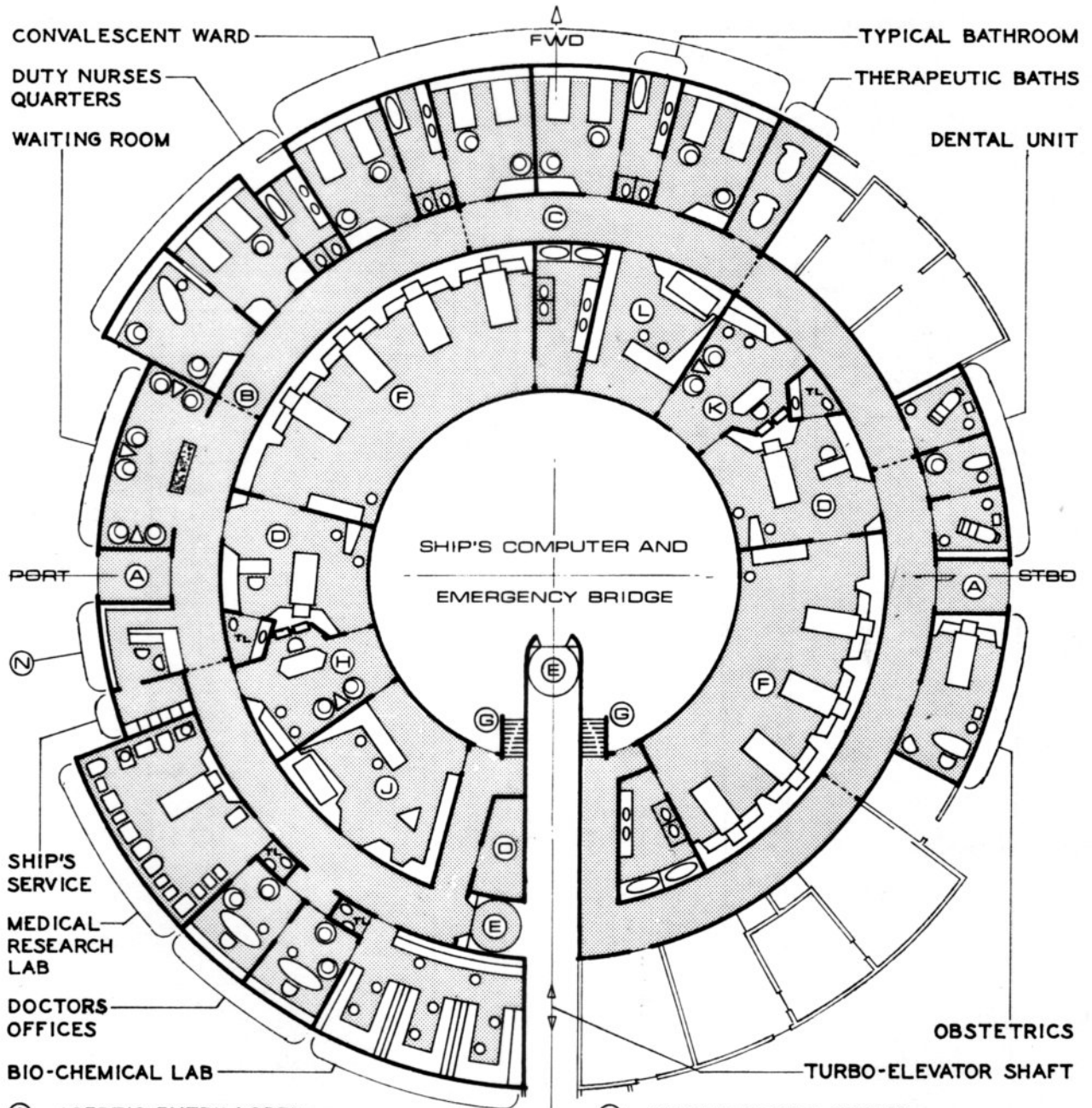

- (A) ASEPTIC ENTRY LOBBY
- (B) SECTION ISOLATION DOOR (6)
- (C) MEDICAL SECTION CORRIDOR
- (D) EXAMINATION/OPERATING ROOM
- (E) TURBO-ELEVATOR CAR
- (F) INTENSIVE CARE UNIT
- (H) CHIEF SURGEON'S OFFICE
- (J) CHIEF SURGEON'S LABORATORY

- (K) DUTY DOCTOR'S OFFICE
- (L) DUTY DOCTOR'S LABORATORY
- (G) GANGWAY - P/S -UP/DOWN
- (N) DUTY NURSE/RECEPTION CENTER
- (O) MEDICAL SUPPLY ROOM

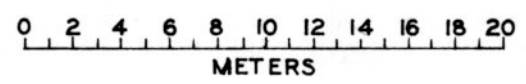

# MEDICAL TRICORDER

STANDARD FIELD EQUIPMENT ITEM - TYPE I



**SPECIFICATION:**

L.O.A. - 177.8MM --- W.O.A. - 114.3MM --- D.O.A. - 48.3MM --- WT. - 900GM

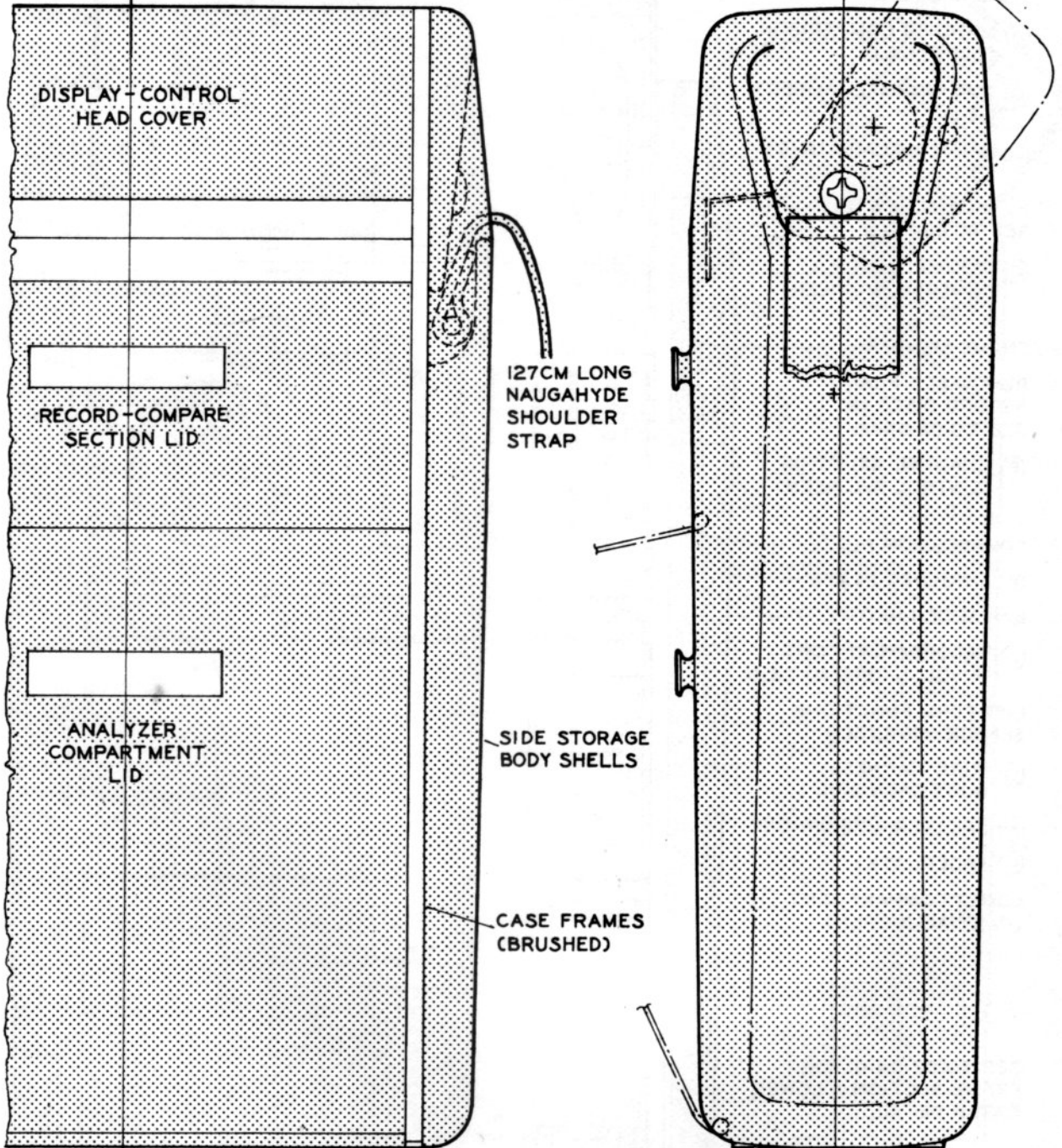
DISPLAY HEAD OPEN

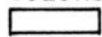

**COLORS:**

-  ANTIMONY N°SF02UC
-  OLIVE N°SF14UC
-  BLACK N°SF32UC (PEBBLED)

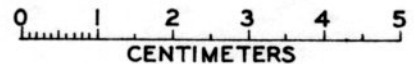

TO:02:11:01

# MEDICAL TRICORDER

## OPEN ARRANGEMENT

OPEN D/C SECTION ACTIVATES UNIT

VIDEO DISPLAY

SENSOR ARRAY

(A) MATCHED COMPARISON (BLUE) L.E.D.

(B) SUB-NORMAL (AMBER) L.E.D.

(C) DANGER-ALARM (RED) L.E.D.

ATTACH SCREW (2)  
SEE T.O:02:04:01

(D) DISC SELECTOR CONTROL W/(GREEN) L.E.D.

FRAME MEMBER

REMOVABLE PLAY/RECORD DISCS (8)  
SEE T.O:02:04:03

(E) CHANNEL SELECTOR CONTROL W/(GREEN) L.E.D.

COMPRESSION PLATE

DISC HOLDER PLATE

R/P SECT. LID (OPEN)

(F) RECORD/PLAY CONT. W/VOL. & (GREEN) L.E.D.

LIFE FORM FUNCTIONS SENSOR/ANALYZER

(G) WIRE HARNESS DUCT EACH SIDE

(H) SPEAKER-MICROPHONE

(J) FACEPLATE

LOWER COMPARTMENT LID (PARTIALLY OPEN)

SEE T.O:02:04:01 FOR FRAME SECTION & LOWER CATCH DETAIL

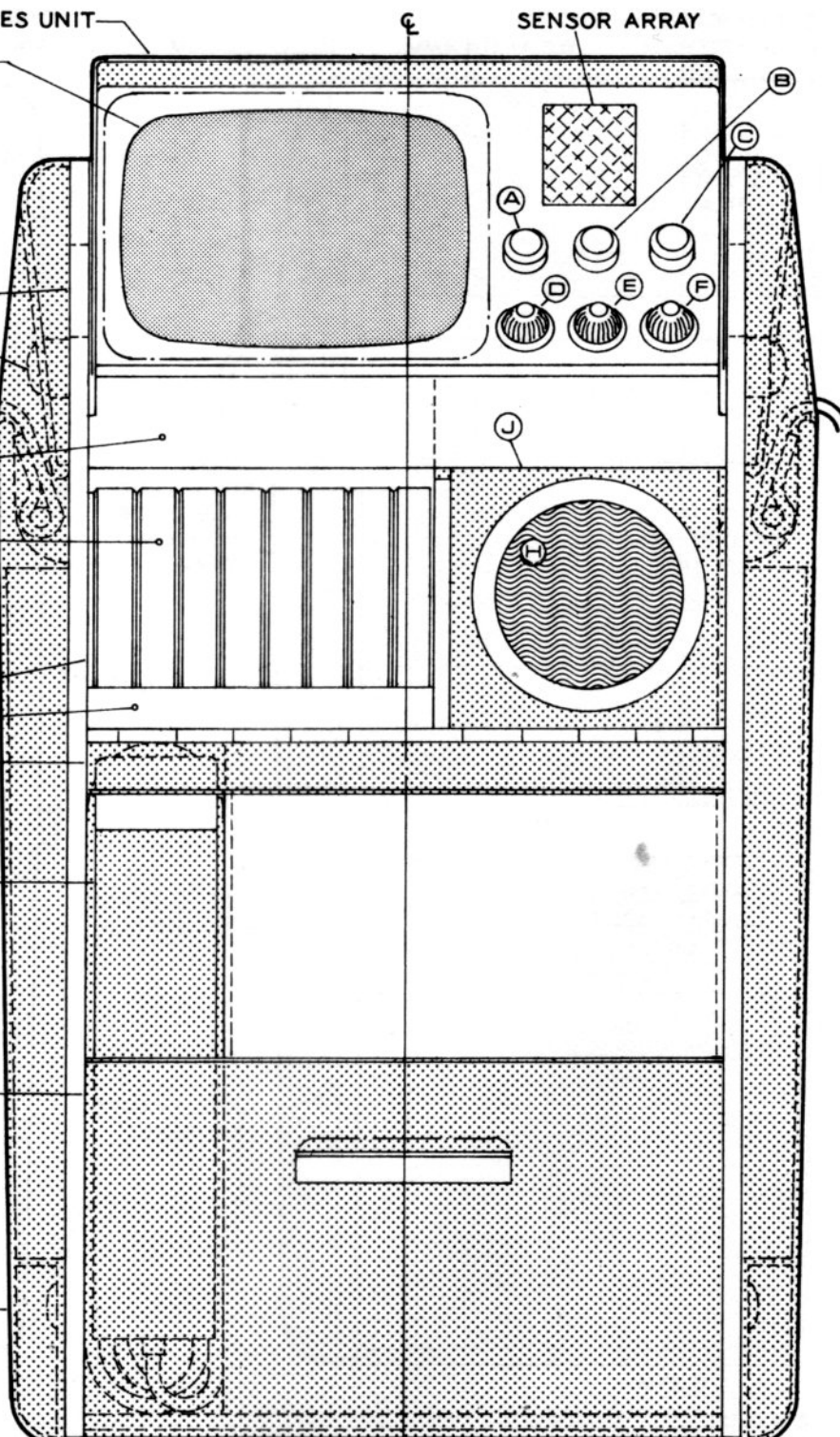

# MEDICAL TRICORDER

## INTERNAL ARRANGEMENT

SELECTIVELY MEASURE, COMPARE, AND DIAGNOSE LIFE FORM VITAL SIGNS, ALSO SENSE, MEASURE, AND COMPARE HEALTH CONDITION OF ENVIRONMENT. 24 CHANNEL CAPABILITY INPUT OR RECORD WITH MULTI-MODE DISPLAY READOUT.

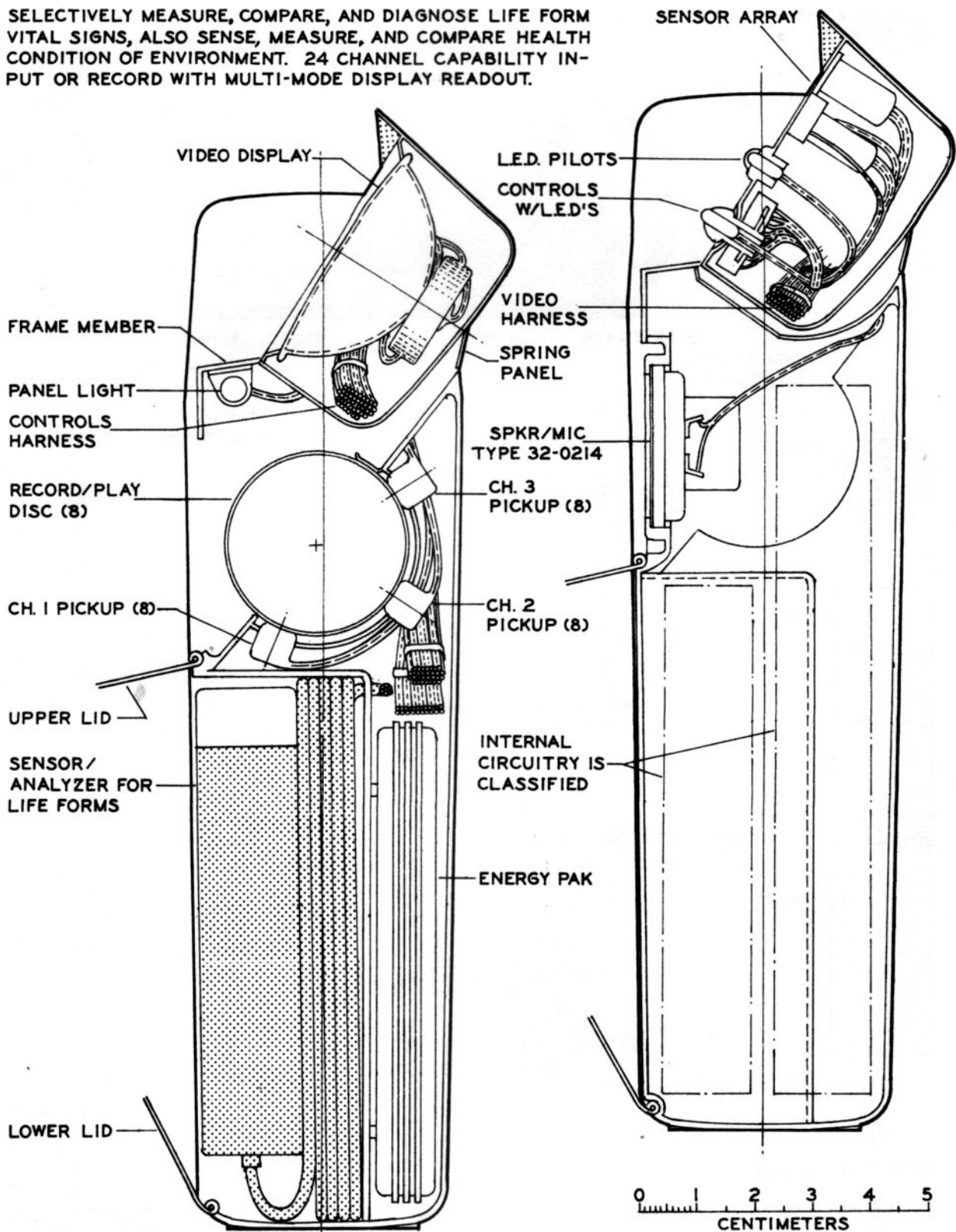

# HEARTBEAT READER

STAR FLEET COLLEGE OF MEDICINE STANDARD

USED TO INSTANTANEOUSLY READ THE INDIVIDUAL OR COLLECTIVE HEARTBEATS OF ONE OR A GROUP OF INTELLIGENT LIFE FORMS

GROUP READINGS ARE USEFUL IN DETERMINING NORMS FOR NEWLY DISCOVERED LIFE FORMS OR FOR DETECTING AN ALIEN LIFE FORM DISGUISED IN A KNOWN GROUP

MODEL: SFAF/SG-MK06-TYPE M

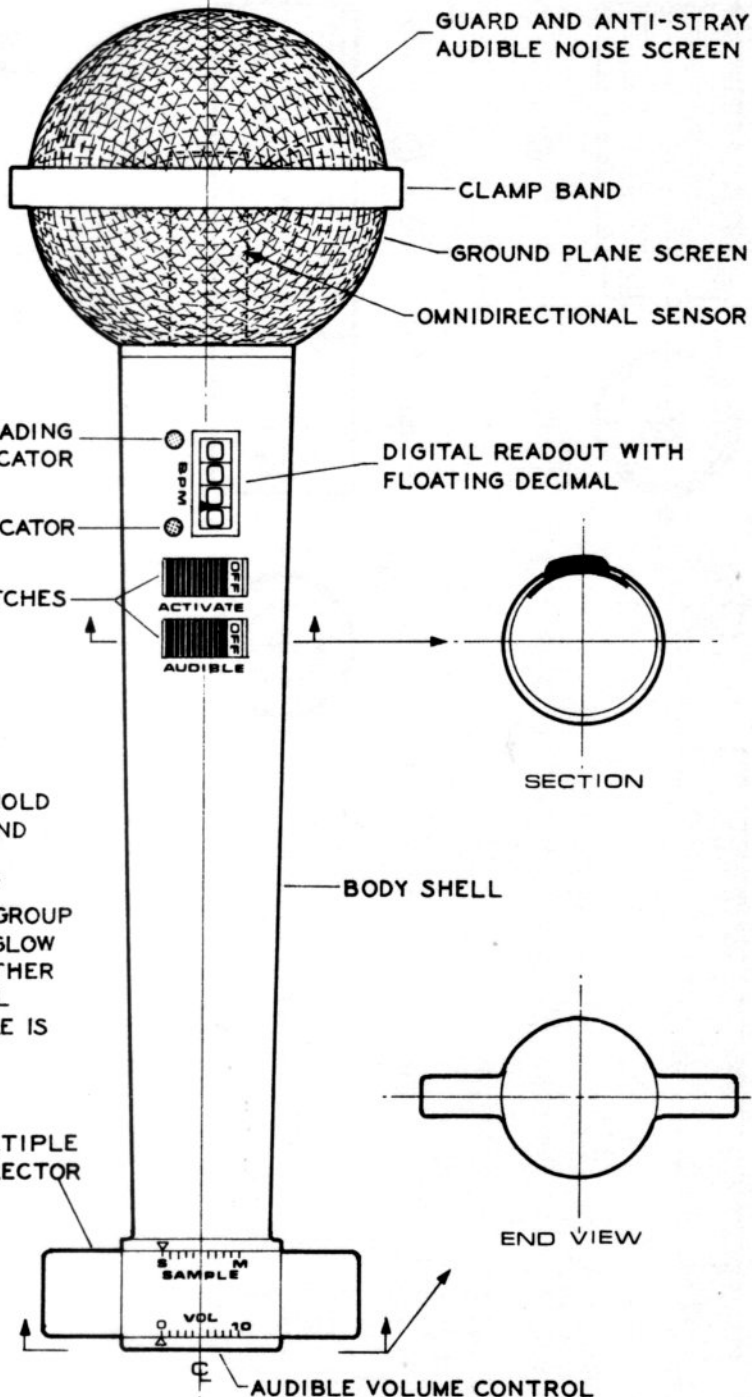

**SPECIFICATION:**

- LENGTH OVERALL (CM) \_\_\_\_\_ 17.75
- MAXIMUM DIAMETER (CM) \_\_\_\_\_ 5.2
- WEIGHT (GM) \_\_\_\_\_ 230

TO IDENTIFY AN ALIEN IN A GROUP HOLD UNIT CLOSE TO FIRST INDIVIDUAL AND REDUCE MULTIPLE SELECTOR UNTIL CANCEL INDICATOR GOES OUT. THAT HEARTBEAT IS NOW REMOVED FROM GROUP READING. CANCEL INDICATOR WILL GLOW AGAIN WHEN UNIT IS MOVED TO ANOTHER INDIVIDUAL. REPEAT PROCESS UNTIL FLUCTUATING READOUT AND AUDIBLE IS REMOVED, OR IS LAST REMAINING INDIVIDUAL IN GROUP

**COLORS:**

- BLUE } L.E.D'S
- RED }
- ANTIMONY N°SF02UC
- BLACK N°SF32UC

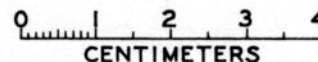

# SPRAY APPLICATOR

STAR FLEET COLLEGE OF MEDICINE STANDARD

THIS DISPENSER IS USED TO APPLY EXTERNAL MEDICATIONS, ANTIBIOTICS, AND PROTECTIVE DRESSINGS TO SMALL WOUNDS AND CONTUSIONS

**SPECIFICATION:**

MODEL: SFAF/SG-MK01-70  
 SIZE: 70  
 LENGTH OVERALL -LOADED (CM) \_\_\_\_\_ 6.5  
 MAXIMUM DIAMETER (CM) \_\_\_\_\_ 1.9  
 WEIGHT -LOADED (GM) \_\_\_\_\_ 160

- (A) APPLICATOR BODY
- (B) SPRAY TRIGGER (PRESS TO SPRAY)
- (C) INTERCHANGABLE VIAL
- (D) DISPENSING TEAT
- (E) INTERCHANGABLE NOZZLE

**NOZZLES AVAILABLE:**

SIZE:	ORIFICE DIA/MM
EXTRA FINE _____	.0025
FINE _____	.025
MEDIUM _____	.20
COARSE _____	(SPECIAL ORDER)

TRANSPARENT PRESSURIZED VIAL. REFER TO UNIFORM PHARMACEUTICALS CODE SPECIFICATION FOR PRELOADED VIALS AVAILABLE FROM STANDARD STOCK

**SPECIFICATION:**

FLUID CAPACITY (CC) \_\_\_\_\_ 70  
 WEIGHT -LOADED (GM) \_\_\_\_\_ 80  
 PRESSURIZED TO (KG/CM<sup>2</sup>) \_\_\_\_\_ 1.30

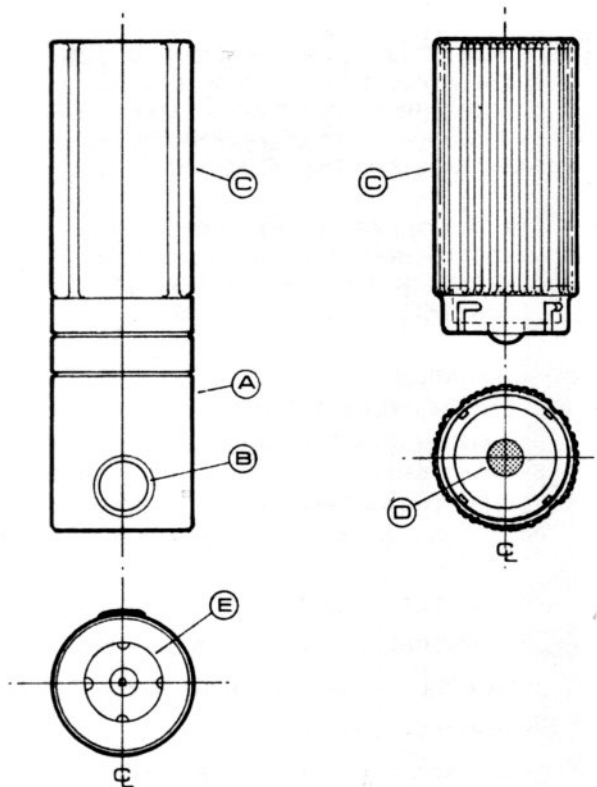

**COLORS:**

ANTIMONY N°SF02UC BASIC. OTHERWISE MATCHES COLOR CODE OF VIAL CONTENTS

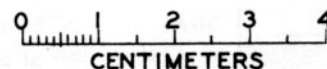



# MEDICAL SCANNER

STAR FLEET COLLEGE OF MEDICINE STANDARD

USED FOR FIELD DETERMINATION OF GEN. MEDICAL CONDITION OF INTELLIGENT LIFE FORMS BY SENSING BODY EMANATIONS IN EMISSION GROUPS OF: ALPHA, BETA, GAMMA, KIRLIAN, THETA, AND XI RAYS

REFER TO COLLEGE OF MEDICINE STD. DIAGNOSTIC PRACTISES JOURNAL FOR SCALE CALIBRATIONS AND CURRENT INTERPRETATIONG OF READINGS

**SPECIFICATION:**

LENGTH OVERALL (CM)	-----	6.05
MAXIMUM DIAMETER (CM)	-----	3.5
WEIGHT (GM)	-----	230
SENSITIVITY (EmV/AU <sup>2</sup> )	-----	TO .0001
READING GROUPS	-----	A, B, Γ, K, Θ, Ξ

- (A) COMPUTER HOUSING
- (B) ACTIVATING SWITCH (PRESS ON - OFF)
- (C) SCANNER HOUSING (48 MESH SCREEN)
- (D) ROTATING SCANNER
- (E) READINGS DIAL (INCREASE FROM BOTTOM TO TOP)
- (F) LIFE FORM TYPE SELECTION SCALE
- (G) GROUND PLANE SCREEN (48 MESH)
- (H) NT - NORMAL TERRAN RANGE

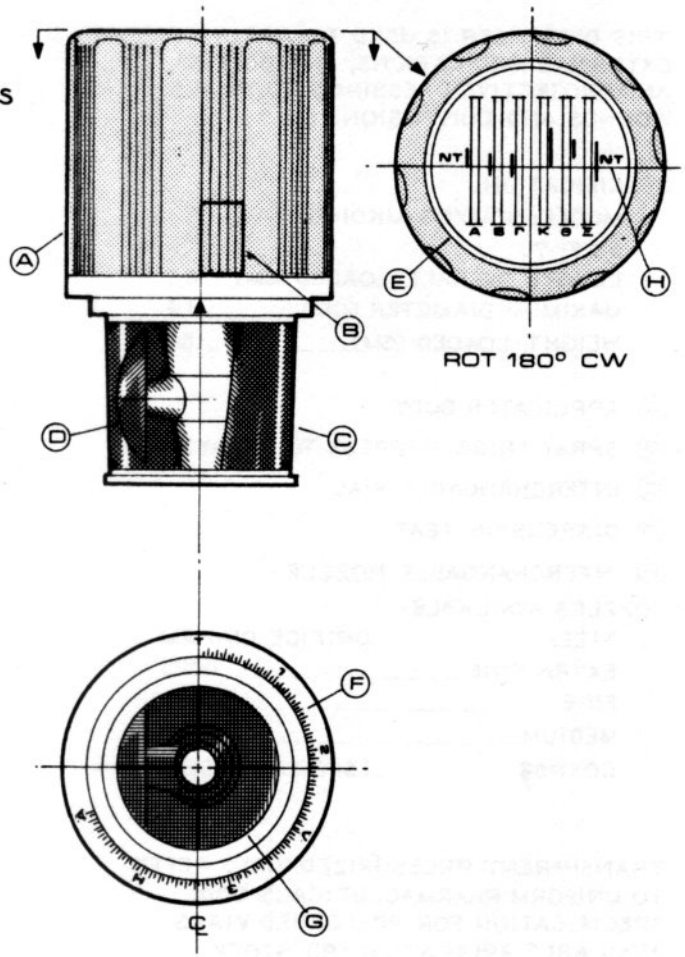

**COLORS:**

	ANTIMONY N°SF02UC
	GRAY N°SF30UC
	BLACK N°SF32UC



TO:02:11:13

# ANABOLIC PROTOPLASER

STAR FLEET COLLEGE OF MEDICINE STANDARD

PORTABLE WOUND HEALER. MINOR INJURY VERSION. STANDARD FIELD EQUIPMENT UNIT.

**SPECIFICATION:**

- MODEL: SFAF/SG -MK08-0
- SIZE: 0
- INTENSITY SCALE: 0 - 100 EmV/AU<sup>2</sup>
- LENGTH OVERALL (CM) ----- 25
- WIDTH OVERALL (CM) ----- 3.8
- HEIGHT OVERALL (CM) ----- 4.2
- WEIGHT (GM) ----- 450

- (A) HOUSING
- (B) REMOVABLE BOTTOM PANEL
- (C) SPECIFICATIONS PLATE
- (D) ACTIVATING SWITCH AND INTENSITY CONTROL - DEPRESS TO OPERATE
- (E) EFFECTIVITY SENSOR
- (F) DNA MATCH SYNTHESIZATION UNIT
- (G) RAY EMISSION DUCT
- (H) RECHARGING CHAMBER
- (J) INTENSITY FORCE LIGHT:

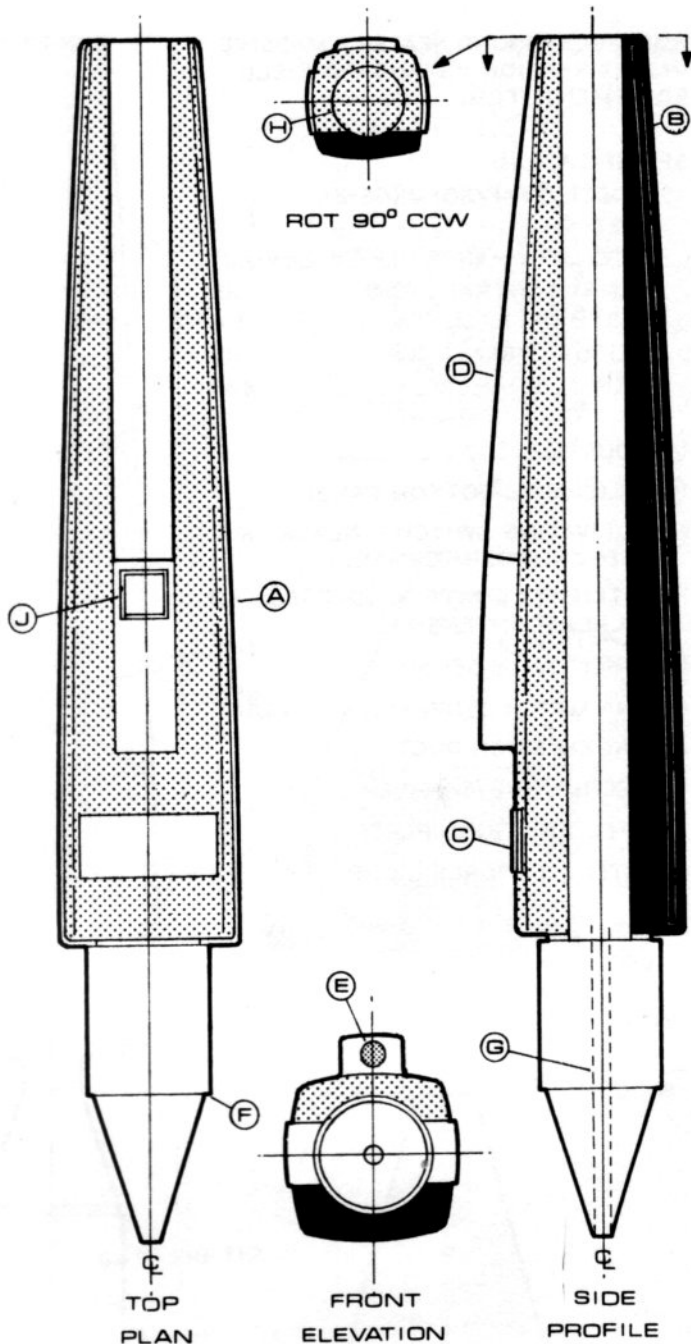
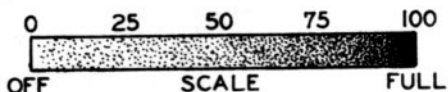

**COLORS:**

- ANTIMONY N°SF02UC
- GRAY N°SF30UC
- RED N°SF 10UC
- BLACK N°SF32UC

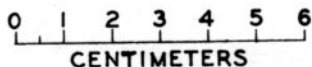

# ANABOLIC PROTOPLASER

STAR FLEET COLLEGE OF MEDICINE STANDARD

PORTABLE WOUND HEALER - MASSIVE INJURY VERSION. STANDARD FIELD EQUIPMENT ITEM.

**SPECIFICATION:**

MODEL: SFAF/SG-MK08-2  
 SIZE: 2  
 INTENSITY RANGE: 0 - 500 EmV/AU<sup>2</sup>  
 LENGTH OVERALL (CM) \_\_\_\_\_ 35  
 WIDTH OVERALL (CM) \_\_\_\_\_ 5.6  
 HEIGHT OVERALL (CM) \_\_\_\_\_ 6.95  
 WEIGHT (GM) \_\_\_\_\_ 680

- (A) HOUSING
- (B) REMOVABLE BOTTOM PANEL
- (C) ACTIVATING SWITCH - BLACK-OFF RED-ON (PUSH FORWARD)
- (D) INTENSITY CONTROL (DEPRESS TO INCREASE INTENSITY)
- (E) EFFECTIVITY SENSOR
- (F) DNA MATCH SYNTHESIZATION UNIT
- (G) RAY EMISSION DUCT
- (H) RECHARGING CHAMBER
- (J) SPECIFICATIONS PLATE
- (K) INTENSITY FORCE LIGHT:

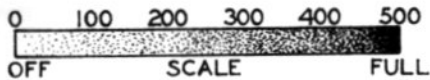

**COLORS:**

	ANTIMONY N°SF02UC
	GRAY N°SF30UC
	RED N°SF10UC
	BLACK N°SF32UC

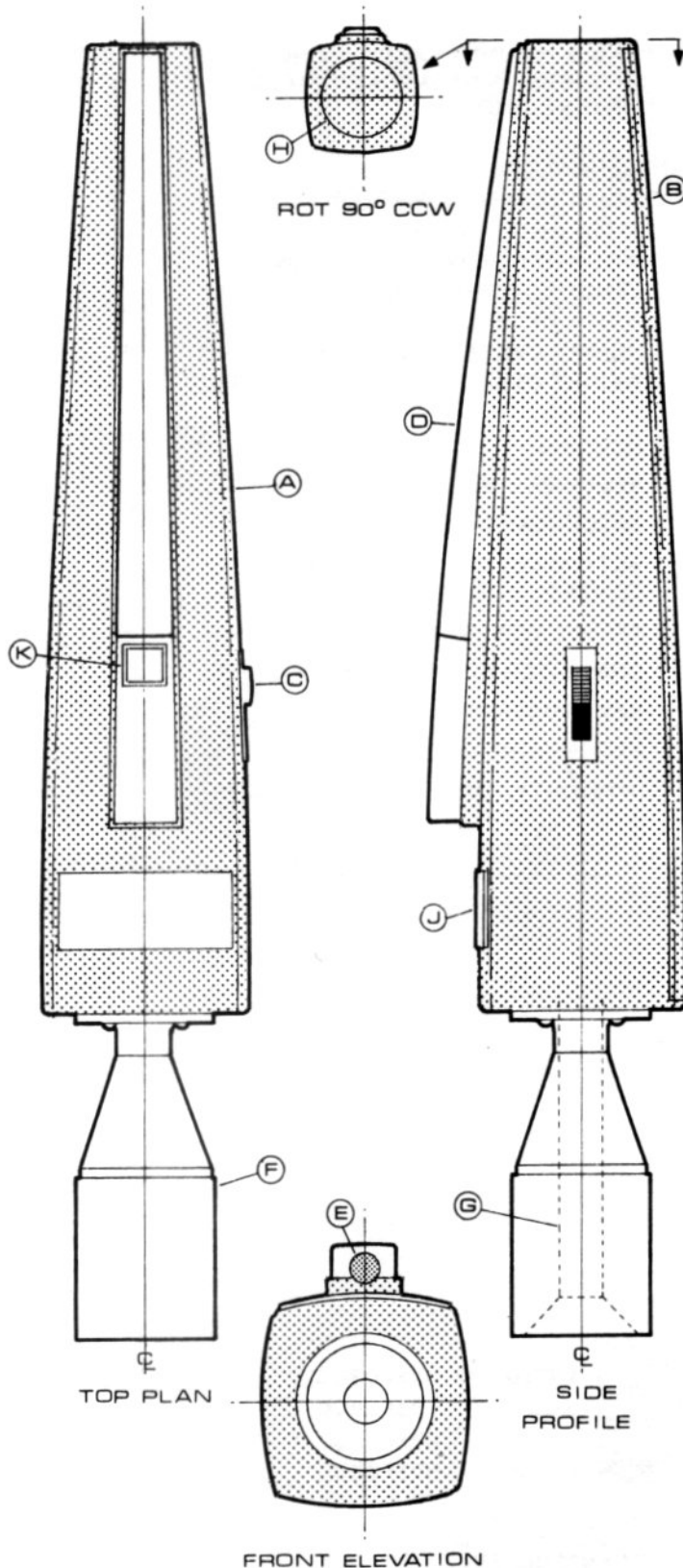
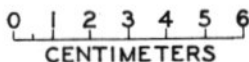

# SURGICAL SCALPELS

STAR FLEET COLLEGE OF MEDICINE STANDARD

MODEL: SFAF/SG-MK10-000  
 SIZE: 000  
 CUTTING WIDTH: 1 AU  
 INTENSITY RANGE: 0 - 80 EmV/AU<sup>2</sup>  
 WEIGHT: 227 GM

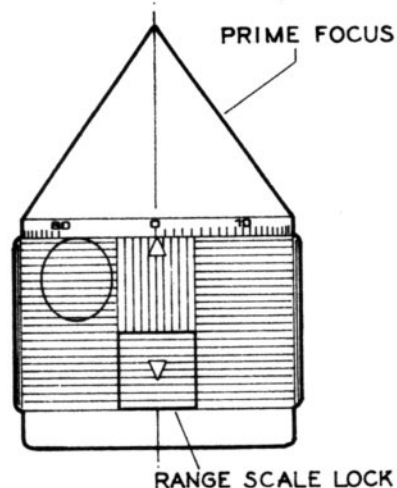
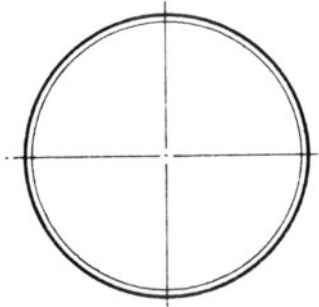

MODEL: SFAF/SG-MK10-00  
 SIZE: 00  
 CUTTING WIDTH: 2 AU  
 INTENSITY RANGE: 0 - 75 EmV/AU<sup>2</sup>  
 WEIGHT: 220 GM

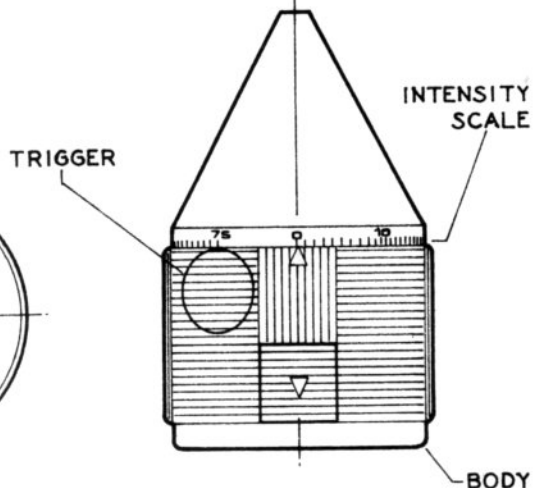
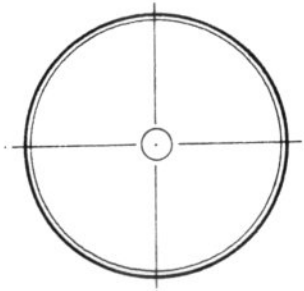

MODEL: SFAF/SG-MK10-0  
 SIZE: 0  
 CUTTING WIDTH: 3 AU  
 INTENSITY RANGE: 0 - 70 EmV/AU<sup>2</sup>  
 WEIGHT: 220 GM

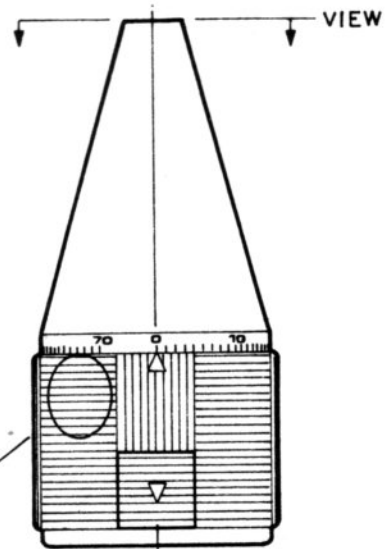
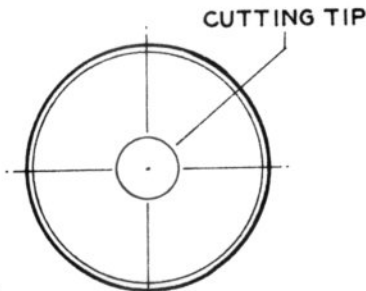

ALL:  
 HOUSING MATERIAL: RODINIUM  
 COLOR:  ANTIMONY №SF02UC



SURGEON'S GRIP



SUPPORT SERVICES SECTION

# STAR FLEET TECHNICAL ORDER

SECTION INDEX			
TO. NO:	SUBJECT	CURRENT	REPLACES
03:00:00	SUPPORT SERVICES SECTION FLYSHEET	7305.30	
" " :02	FOREWORD	*	
" " :04	SUPPORT SERVICES SECTION INDEX	7504.08	
" :01:00	COMMUNICATIONS STATION - MAIN BRIDGE	7408.23	
" " :01	CONTROLS CONSOLE	7409.20	
" :02:00	COMMUNICATOR - TYPE I	7304.20	
" " :01	COMMUNICATOR CIRCUITRY	7304.20	
" " :02	BRIDGE EAR RECEIVER - MK05	7503.07	
" " :03	B.E.R. CIRCUITRY	*	
" " :04	UNIVERSAL TRANSLATOR-TYPE I	7503.07	
" " :05	U/T CIRCUITRY	*	
" :05:00	ENVIRONMENTAL STATION - MAIN BRIDGE	*	
" " :01	CONTROLS CONSOLE	*	
" :08:00	ENGINEERING STATION - MAIN BRIDGE	7408.23	
" " :01	CONTROLS CONSOLE	7409.14	
" " :10	ENGINEERING SECTION - PRIMARY HULL - CLASS I STARSHIPS	7312.21	
" " :11	ENGINEERING SECTION - SECONDARY HULL - MK-IX ONLY	*	
" :10:20	IMPULSE POWER - EXTERNAL PLAN & PROFILE	7312.21	
" " :21	IMPULSE POWER - INTERNAL PLAN & PROFILE	CLASSIFIED	
" :11:20	MAIN PROPULSION - EXTERNAL PLAN & PROFILE	7312.21	
" " :21	MAIN PROPULSION - INTERNAL PLAN & PROFILE	CLASSIFIED	
" :16:30	TRANSPORTER - STANDARD 6 PERSON - PLAN	7312.21	
" " :31	ELEVATIONS	*	
" " :50	TRANSPORTER - EMERGENCY - PLAN	7312.21	
" " :51	ELEVATIONS	*	
" " :70	TRANSPORTER - CARGO - PLAN	7312.21	
" " :71	ELEVATIONS	*	
" :17:00	HANGAR DECK - PLAN - MK-IX ONLY	7312.21	
" " :01	ELEVATION	7312.21	
" :98:10	VULCAN LYRETTE	7503.10	
" " :11		*	
" " :30	TRIDIMENSIONAL CHESS	7503.12	
" " :31	CHESSMEN	7503.14	

NOTE (\*): NO CURRENT PRINT-OUT FROM MASTERCOM DATABANKS/SFHQ

# COMMUNICATIONS

MAIN BRIDGE STATION - CLASS I STARSHIPS

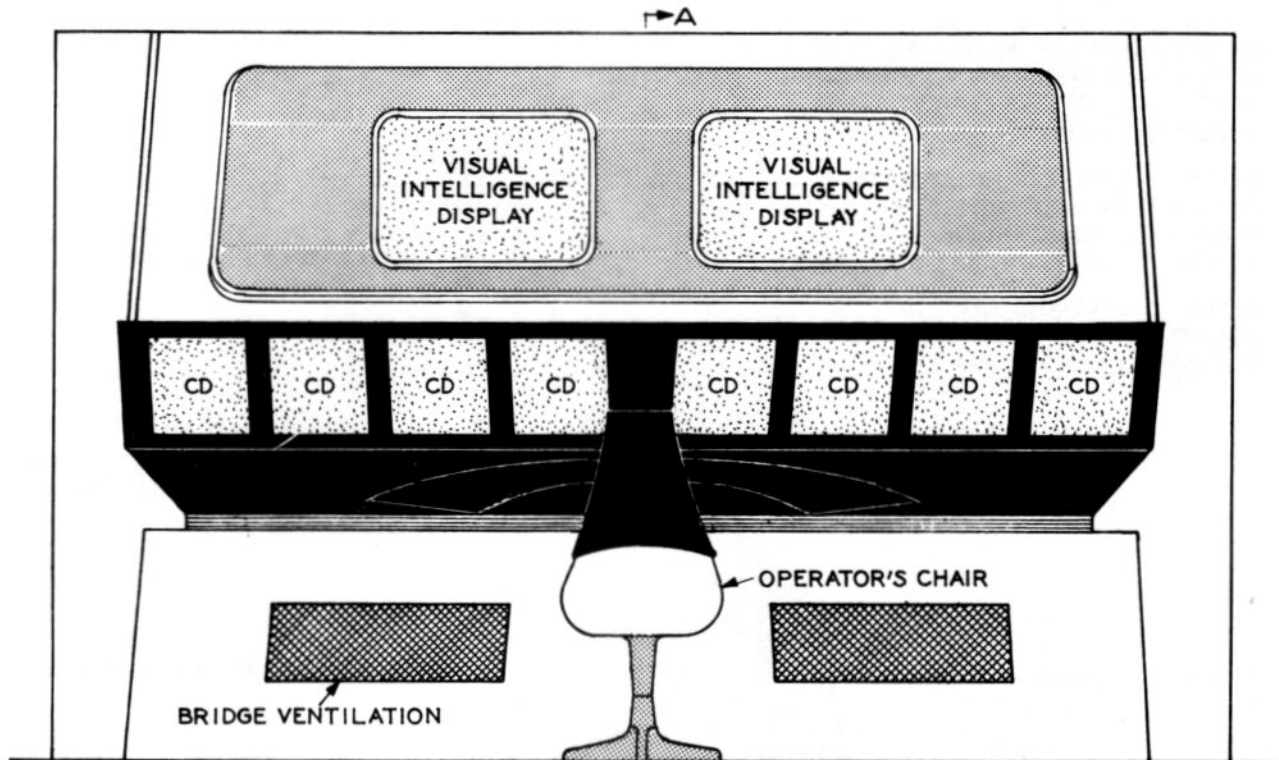

FRONT ELEVATION

VIEW A-A:

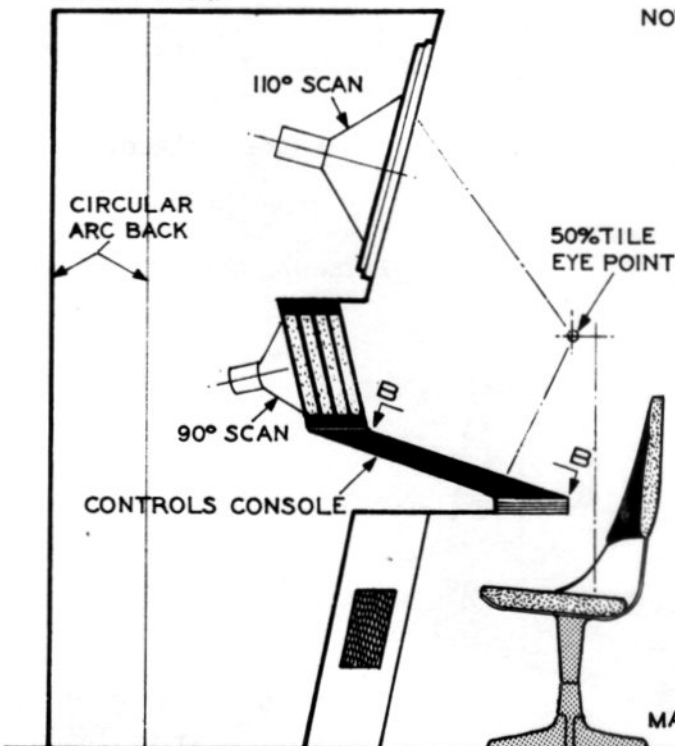

NOTE: CD - COMPUTER DATA AND SYSTEMS VISUAL READOUT SCREENS

THIS STATION IS ALSO DUPLICATED ON THE EMERGENCY BRIDGE

ALL EXTRA, AND INTRA-SHIP COMMUNICATIONS ARE HANDLED THROUGH THIS STATION

SEE TO:03:01:01 FOR CONTROLS CONSOLE ARRANGEMENT

OFFICIAL COLORS:

	PLATINUM	NºSF 29 UC
	RED	NºSF 10 UC
	GRAY	NºSF 30 UC
	BLACK	NºSF 32 UC



# CONTROLS CONSOLE

VIEW B-B OF TO:03:01:00

REFER ELSEWHERE IN THIS SECTION FOR DETAILED OPERATIONS PROCEDURES, AND SYSTEMS FUNCTIONS SPECIFICATIONS.

REFER TO ENGINEERING SECTION FOR SYSTEMS SCHEMATICS, WIRING DIAGRAMS, AND STANDARD MAINTENANCE PROCEDURES.

REFER TO COMMAND SECTION FOR STAR FLEET SUB-SPACE COMMUNICATIONS CODES (CLASSIFIED).

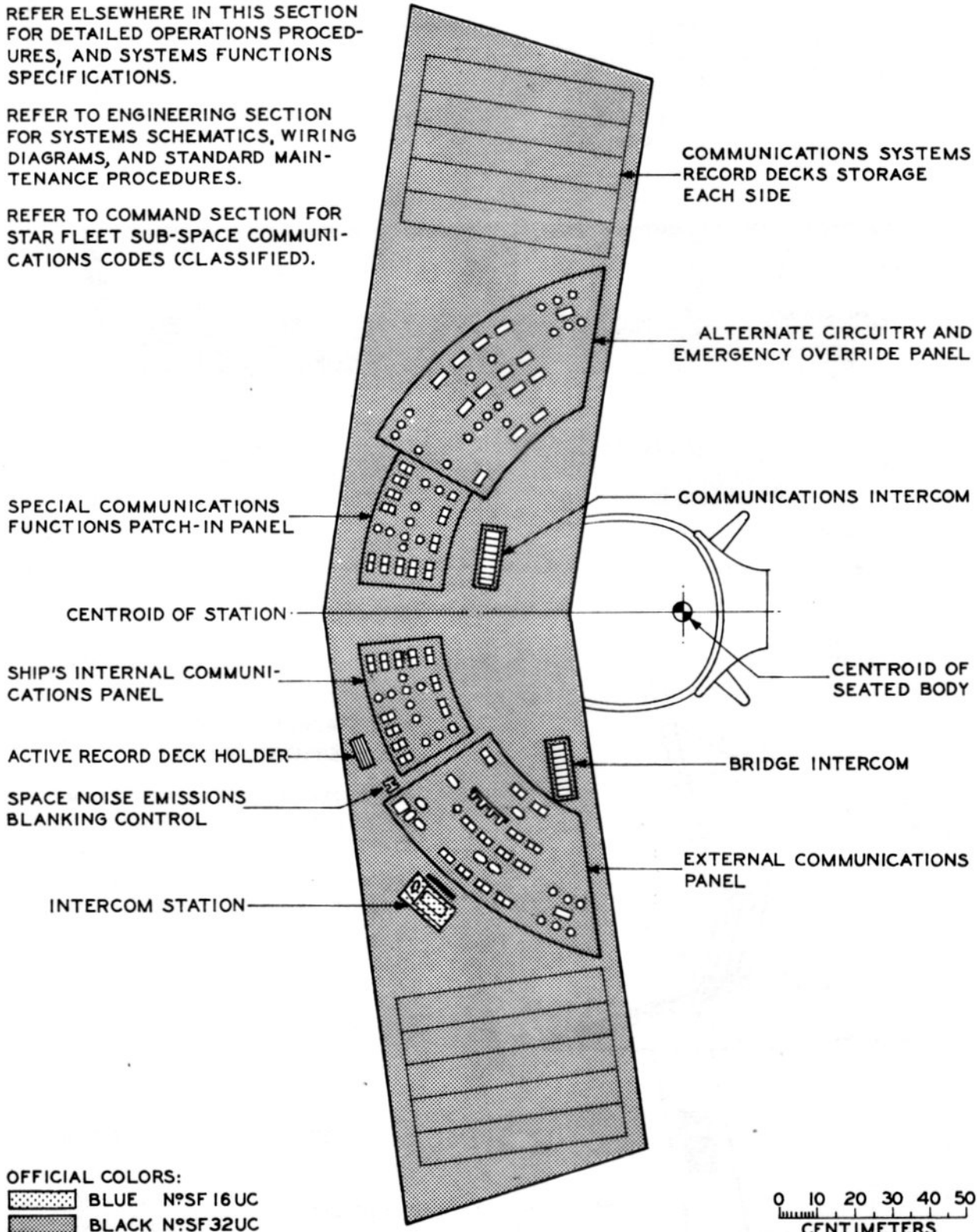

**OFFICIAL COLORS:**  
 BLUE N°SF 16 UC  
 BLACK N°SF 32 UC

0 10 20 30 40 50  
 CENTIMETERS



# COMMUNICATOR

STANDARD FIELD EQUIPMENT ITEM

TYPE I

**SPECIFICATION:**

L.O.A. \_\_113.5MM      W.O.A. \_\_63.5MM      H.O.A. \_\_28MM  
 WEIGHT \_\_200GM      RANGE \_\_12000KM

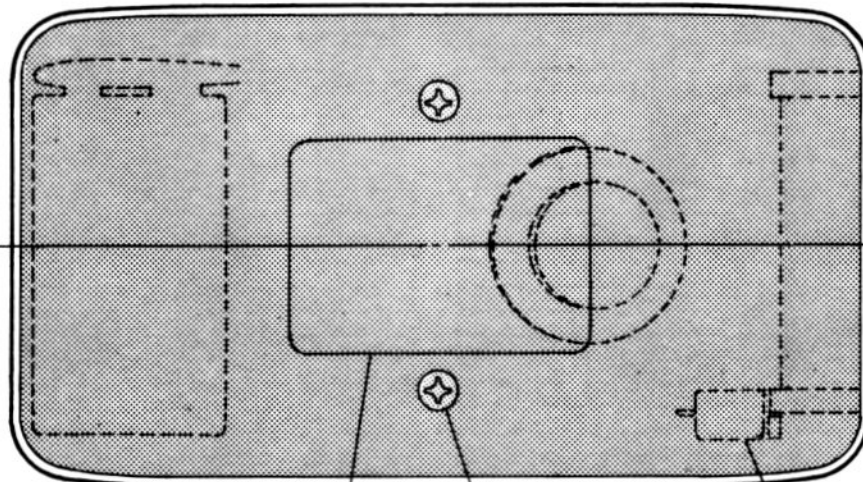
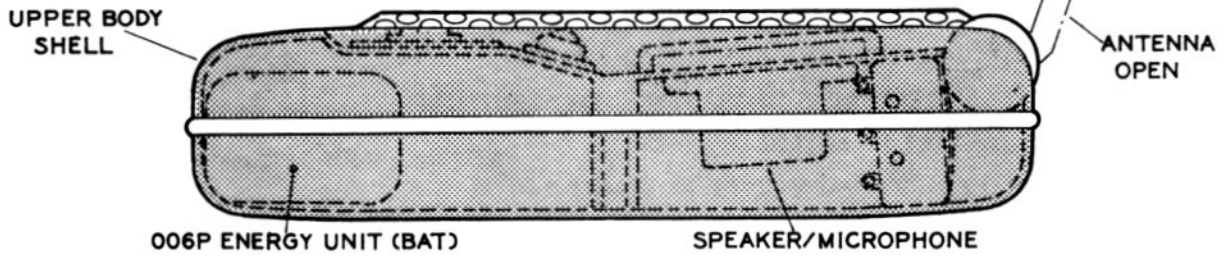
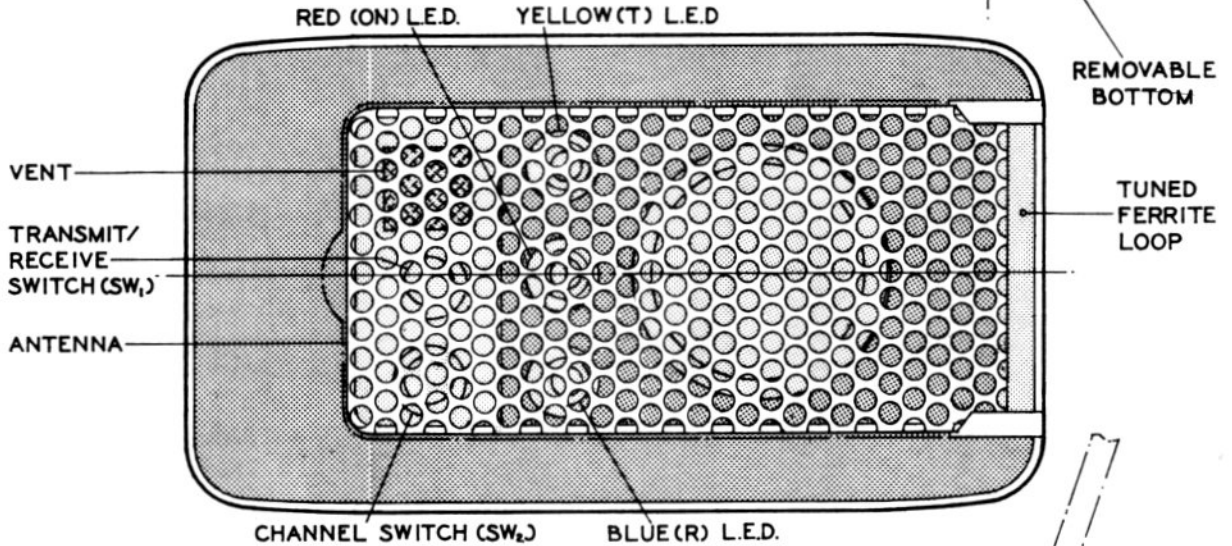

**COLORS:**

- |  |          |          |
|--|----------|----------|
|  | GOLD     | N°SF03UC |
|  | ANTIMONY | N°SF02UC |
|  | BLACK    | N°SF32UC |



# EAR RECEIVER

FOR NON-PUBLIC RECEPTION

FOR USE IN CONCENTRATING ON TRANSMISSIONS IN ACOUSTICALLY DISTRACTING SITUATIONS, OR FOR SPECIFIC RECEPTION OF NON-PUBLIC TRANSMISSIONS

OPERATION IS BY CLOSED LOOP ON ALL STAR FLEET PRIME COMMUNICATIONS SUBSPACE CHANNELS

THE TRANSPARENT HALF-HARD PLASTIC EAR-PIECE IS CUSTOM MOLDED TO A PRE-CISE IMPRESSION OF THE USER'S EAR

**SPECIFICATION:**

MODEL: SFAF/CC-MK05-0

SIZE: 0

LENGTH OVERALL (CM) ----- 6.55

WIDTH OVERALL (CM) ----- 3.15

MAXIMUM DIAMETER (CM) ----- 2.6

WEIGHT (GM) ----- 57

- (A) MOLDED PLASTIC EAR-PIECE
- (B) EAR-PIECE RETENTION PLATE
- (C) EARPHONE HOUSING
- (D) RECEIVER HOUSING
- (E) ENERGY CELL HOUSING
- (F) HIGH GAIN ANTENNA GRID AND HEAT SINK
- (G) EAR-PIECE SWIVELS STIFFLY HERE

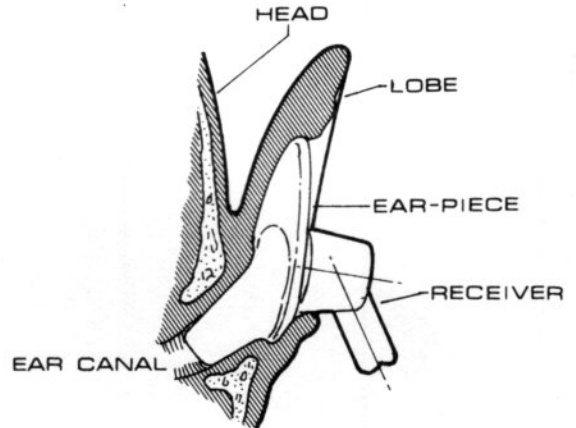
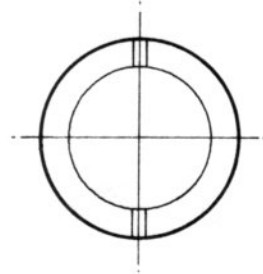
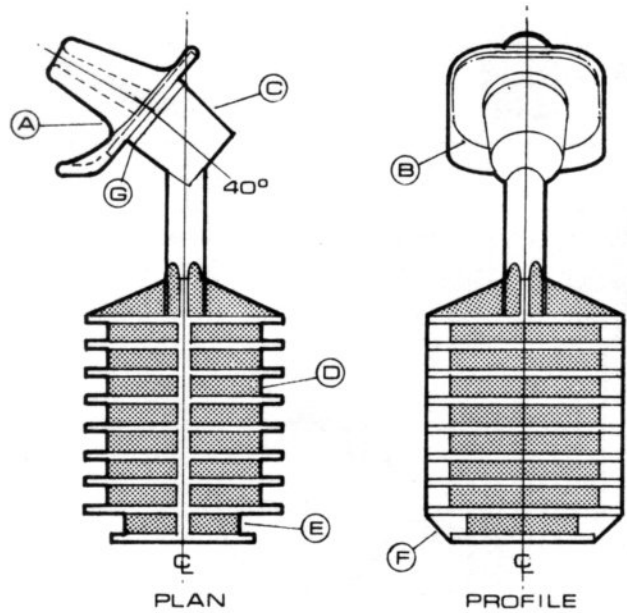

HORIZONTAL SECTION THROUGH LEFT EAR AT MID-CANAL LEVEL

**COLORS:**

- ANTIMONY N°SF02UC
- BLACK N°SF32UC

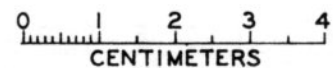

# UNIVERSAL TRANSLATOR

U.F.P STANDARD

FOR COMMUNICATION BETWEEN UNITED FEDERATION LANGUAGE FORMS AND WITH UNKNOWN ALIEN LANGUAGE FORMS IN THE TREATY EXPLORATION TERRITORY

**SPECIFICATION:**

- MODEL: SFAF/CC-MK-01
- TYPE: I
- LENGTH OVERALL (CM) ..... 28
- MAXIMUM DIAMETER (CM) ..... 4.8
- WEIGHT (GM) ..... 500

- (A) SPEECH CHARACTERISTICS SENSORS
- (B) OTHER PARTY SPEAKER/MICROPHONE
- (C) DECODING/ENCODING SECTION
- (D) COMPUTER FUNCTIONS DISPLAY PANEL
- (E) PRIMARY COMPUTER SECTION
- (F) OPERATOR'S SPEAKER/MICROPHONE
- (G) ACTIVATING SWITCH
- (H) DATA STORAGE BANKS SECTION
- (J) TRANSPARENT COVER
- (K) REAR COVER
- (L) HOUSING

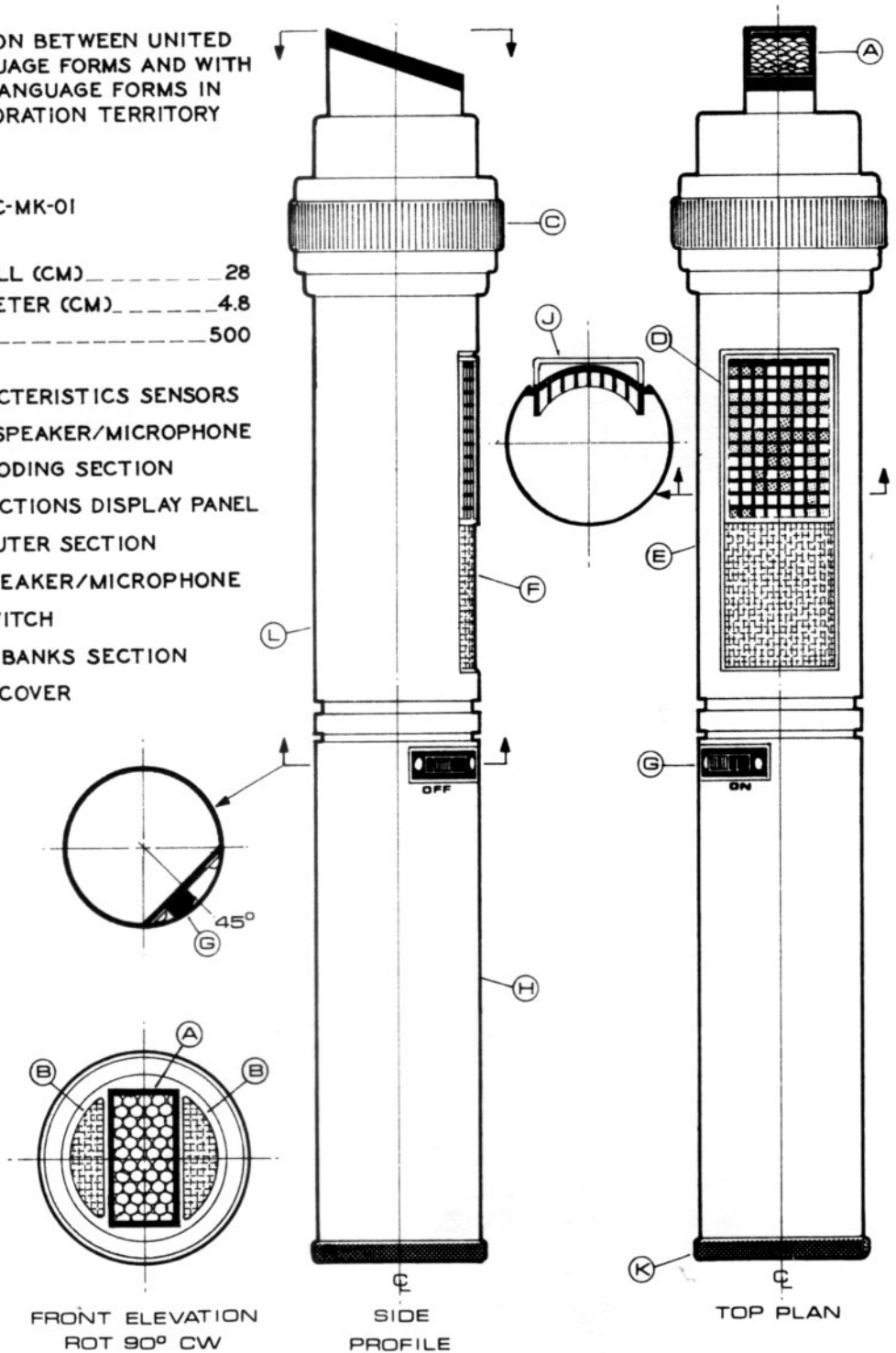

**COLORS:**

- ANTIMONY N°SF02UC
- BLACK N°SF32UC

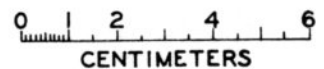

# ENGINEERING

MAIN BRIDGE STATION - CLASS I STARSHIPS

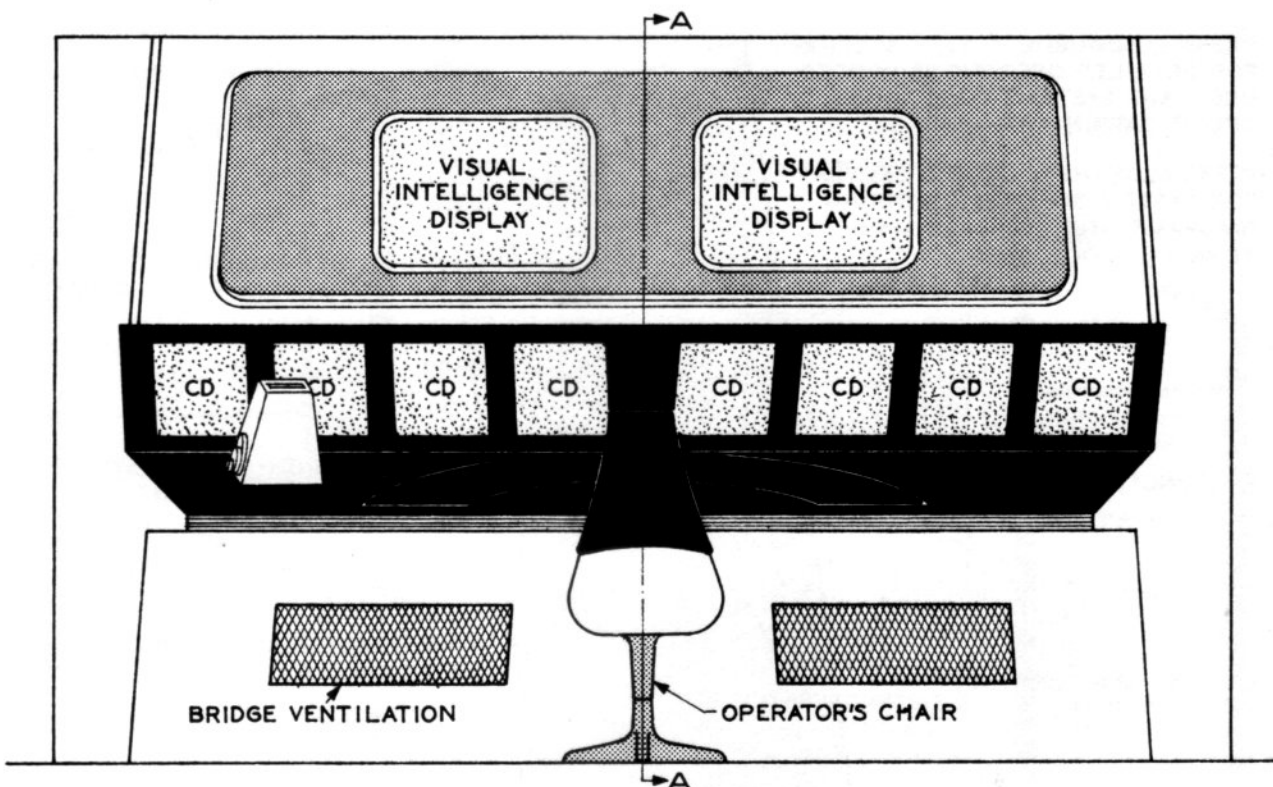

FRONT ELEVATION

### VIEW A-A:

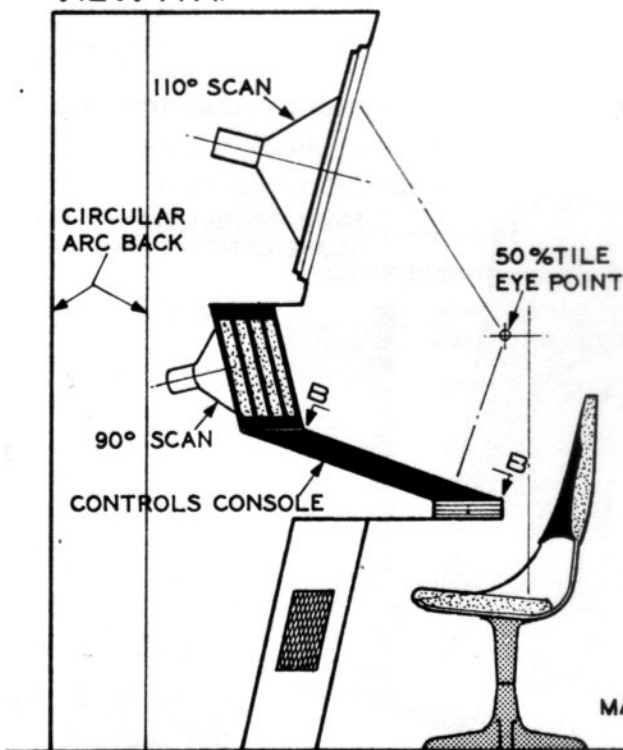





NOTE: CD- COMPUTER DATA AND SYSTEMS VISUAL READOUT SCREENS

THIS IS A SLAVE STATION CAPABLE OF HANDLING THE SHIP'S IMPORTANT ENGINEERING FUNCTIONS. ALL PRIMARY CONTROL IS LOCATED IN THE ENGINEERING DIVISION

SEE TO:03:08:01 FOR CONTROLS CONSOLE ARRANGEMENT

#### OFFICIAL COLORS:

-  PLATINUM N°SF29 UC
-  RED N°SF10 UC
-  GRAY N°SF30 UC
-  BLACK N°SF32 UC

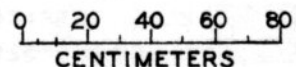



# CONTROLS CONSOLE

VIEW B-B OF TO:03:08:00

REFER ELSEWHERE IN THIS SECTION FOR DETAILED OPERATIONS PROCEDURES, AND SYSTEMS FUNCTIONS SPECIFICATIONS.

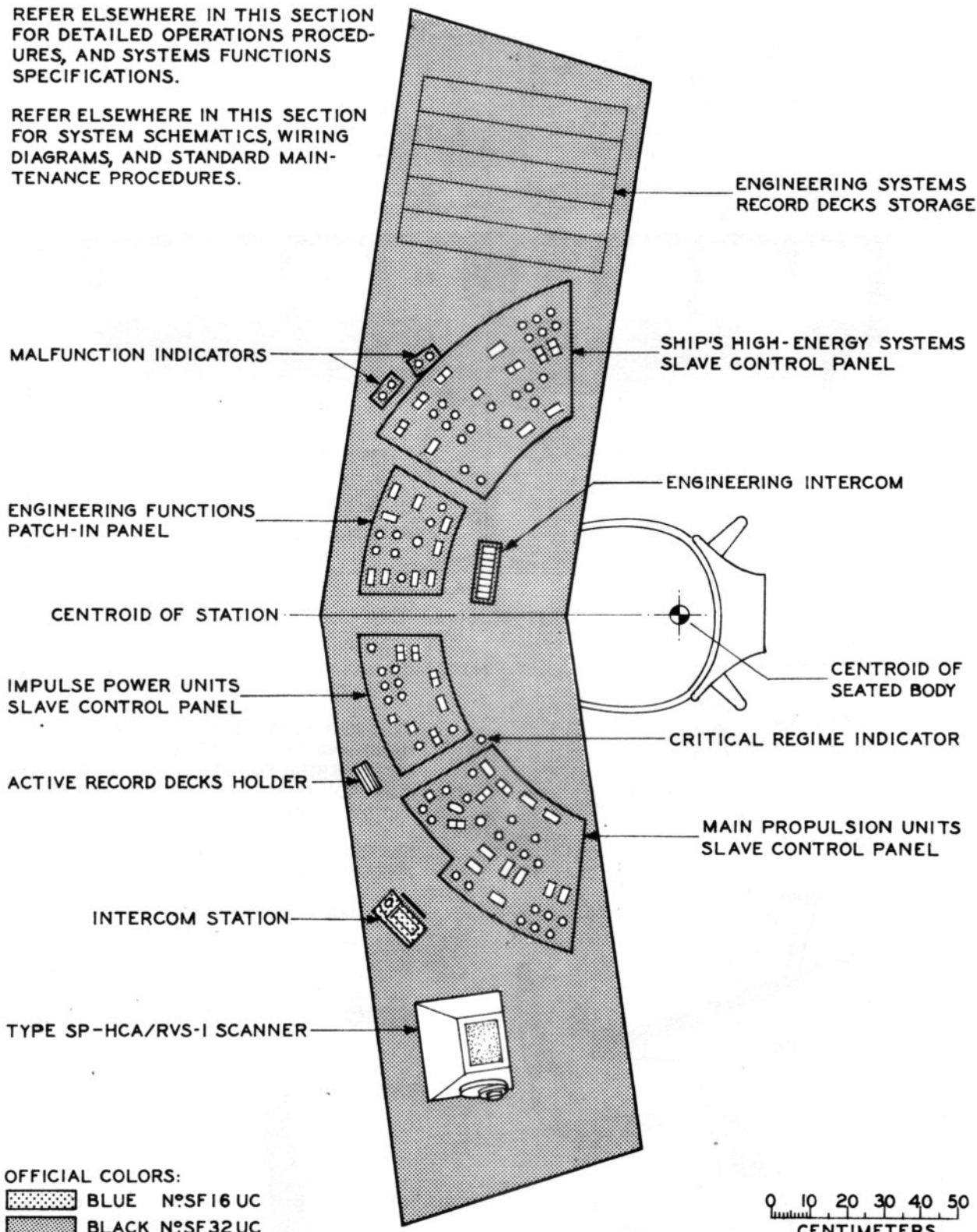
REFER ELSEWHERE IN THIS SECTION FOR SYSTEM SCHEMATICS, WIRING DIAGRAMS, AND STANDARD MAINTENANCE PROCEDURES.



OFFICIAL COLORS:  
 BLUE N°SF16 UC  
 BLACK N°SF32 UC

0 10 20 30 40 50  
 CENTIMETERS

# ENGINEERING SECTION

PRIMARY HULL - CLASS I STARSHIPS

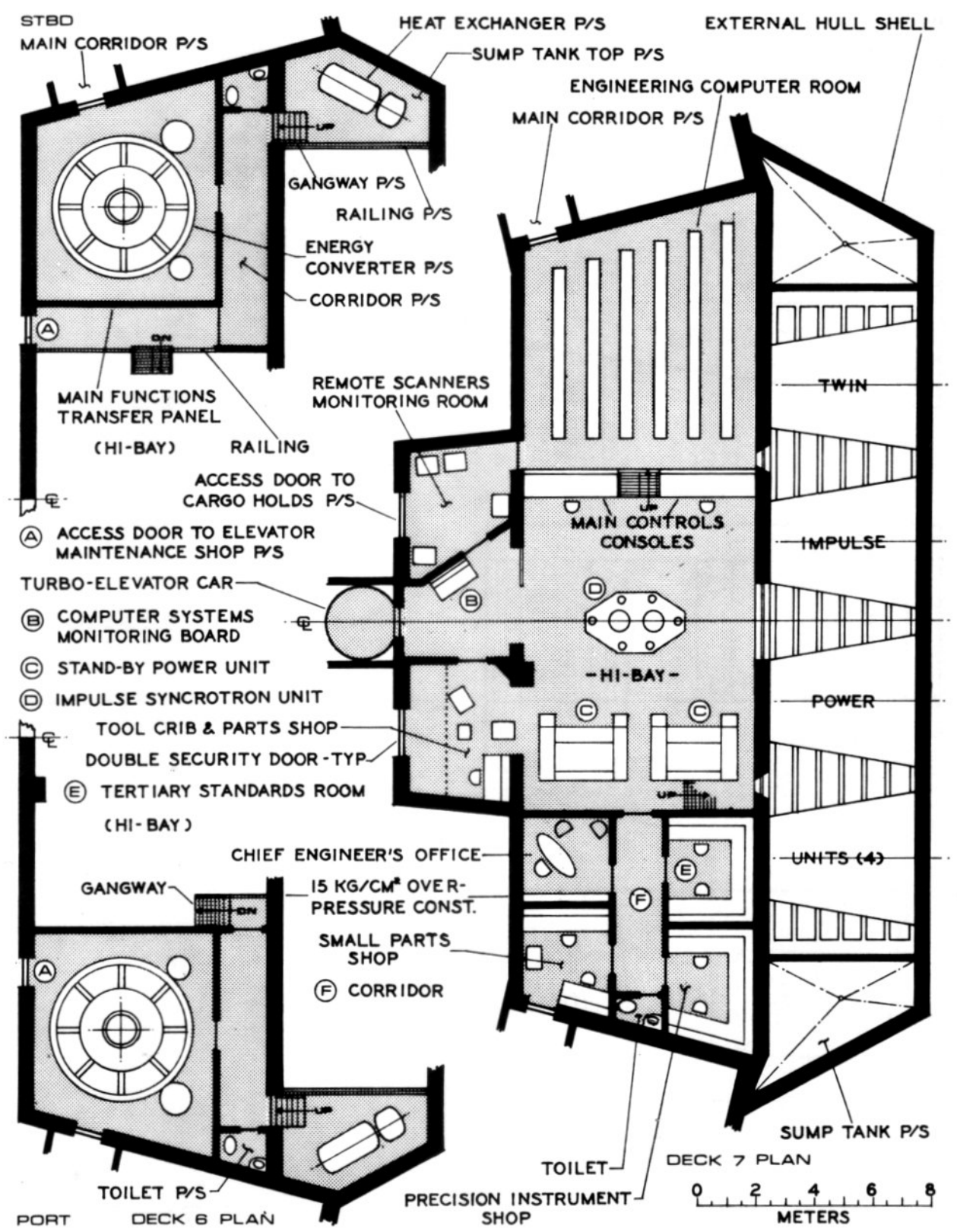

# IMPULSE POWER UNIT

CLASS I STARSHIPS - EXTERNAL ARRANGEMENT

- (A) TWIN UNIT HOUSING
- (B) FIELD FLUX DIP CONstriction
- (C) MAGNATOMIC FLUX CIRCULATION TUBES (12)
- (D) FUEL HOPPER FEED CHUTE
- (E) FLUX RECIRCULATION TUBES TO HEAT EXCHANGERS (5)
- (F) FIRING CHAMBER (2)

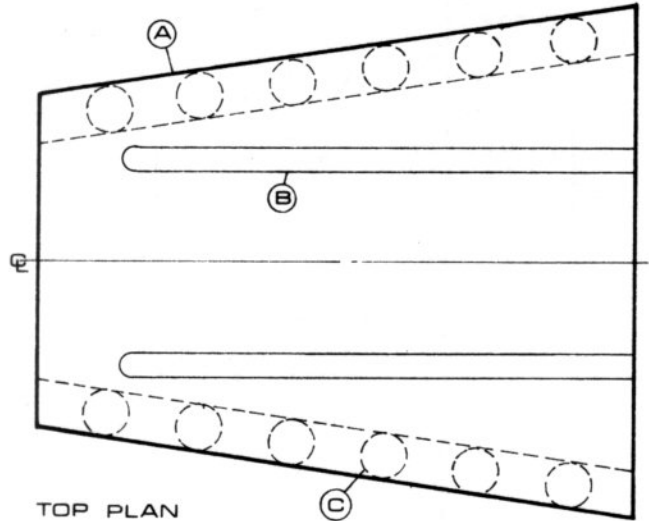

TOP PLAN

SPECIFICATIONS:

LENGTH OVERALL (M)	-----	5.2
WIDTH OVERALL (M)	-----	4.5
HEIGHT OVERALL (M)	-----	2.8
WEIGHT - D.W.T (M.T.)	-----	2800
MODEL:		IP186E/2-1R

OPERATION IS BASED ON SUBATOMIC UNIFIED ENERGY IMPULSE POSTULATE

POWER IS REVERSIBLE BY PROPER CONTROL OF THE EXTERNAL VENT SHIELDS

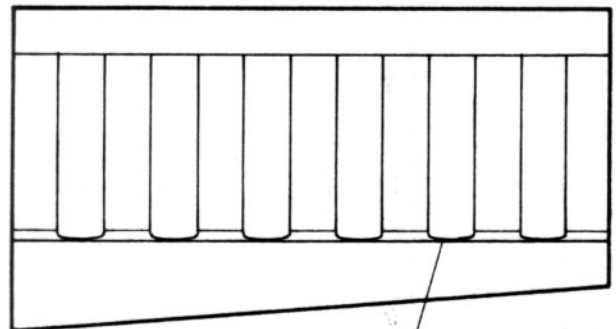

PORT PROFILE

ELEVATIONS

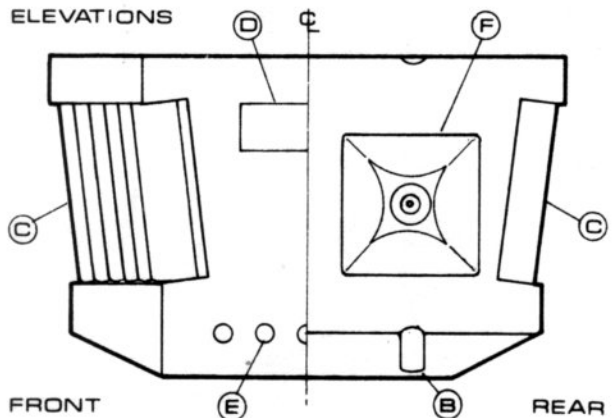

FRONT

REAR



# MAIN PROPULSION

## CLASS I STARSHIPS - EXTERNAL ARRANGEMENT

- (A) SPACE ENERGY/MATTER SINK (ACQUISITION)
- (B) SPACE ENERGY FIELD SENSOR (3)
- (C) MAGNATOMIC FLUX CONSTRICTION - FIRST STAGE
- (D) INLET FLOW SENSOR
- (E) CONTROL REACTOR LOOP (PRIMARY POWER STAGE)
- (F) OUTLET FLOW SENSOR
- (G) POWER STAGE MAGNATOMIC FLUX CHILLER (3)
- (H) MAIN ENERGY STAGE MAGNATOMIC FLUX CHILLER (5)
- (J) MAIN PROPULSION HOUSING (NACELLE - AND DEFLECTOR SHIELD)
- (K) FINAL STAGE INTERCOOLERS P/S
- (L) FINAL STAGE MAGNATOMIC FLUX CHILLERS P/S
- (N) SPACE ENERGY/MATTER MATTrix RESTORATION COWL
- (O) SPACE ENERGY/MATTER SOURCE (FIELD RESTORATION)

SUPPORT PYLON LOCATIONS:

- (P) MK-X DREADNOUGHT NO'S 1 AND 3
- (R) MK-X DREADNOUGHT NO. 2
- (S) MK-IX HEAVY CRUISER NO'S 1 AND 2
- (T) MK-VIII DESTROYER NO. 1  
MK-VII SCOUT NO. 1
- (U) MK-VI TRANSPORT/TUG NO'S 1 & 2

NOTE: UNIT (V) IS ROTATED 90° TO BOTTOM (C) ON MK-VIII AND MK-VII MODELS

SPECIFICATIONS:

LENGTH OVERALL: (M) \_\_\_\_\_ 153.619  
 MAX. DIAMETER: (M) \_\_\_\_\_ 17.3  
 WEIGHT -D.W.T.: (M.T.) \_\_\_\_\_ 31,000  
 MODEL: SW40/5-3KT

OPERATION IS BASED ON UNIFIED FIELD SPACE ENERGY/MATTER MATTrix WARP POSTULATE

THE SYSTEM IS REVERSIBLE WITH MODERATE POWER CAPABILITY AND MINIMUM SPACE E/M MATTrix DEGRADATION

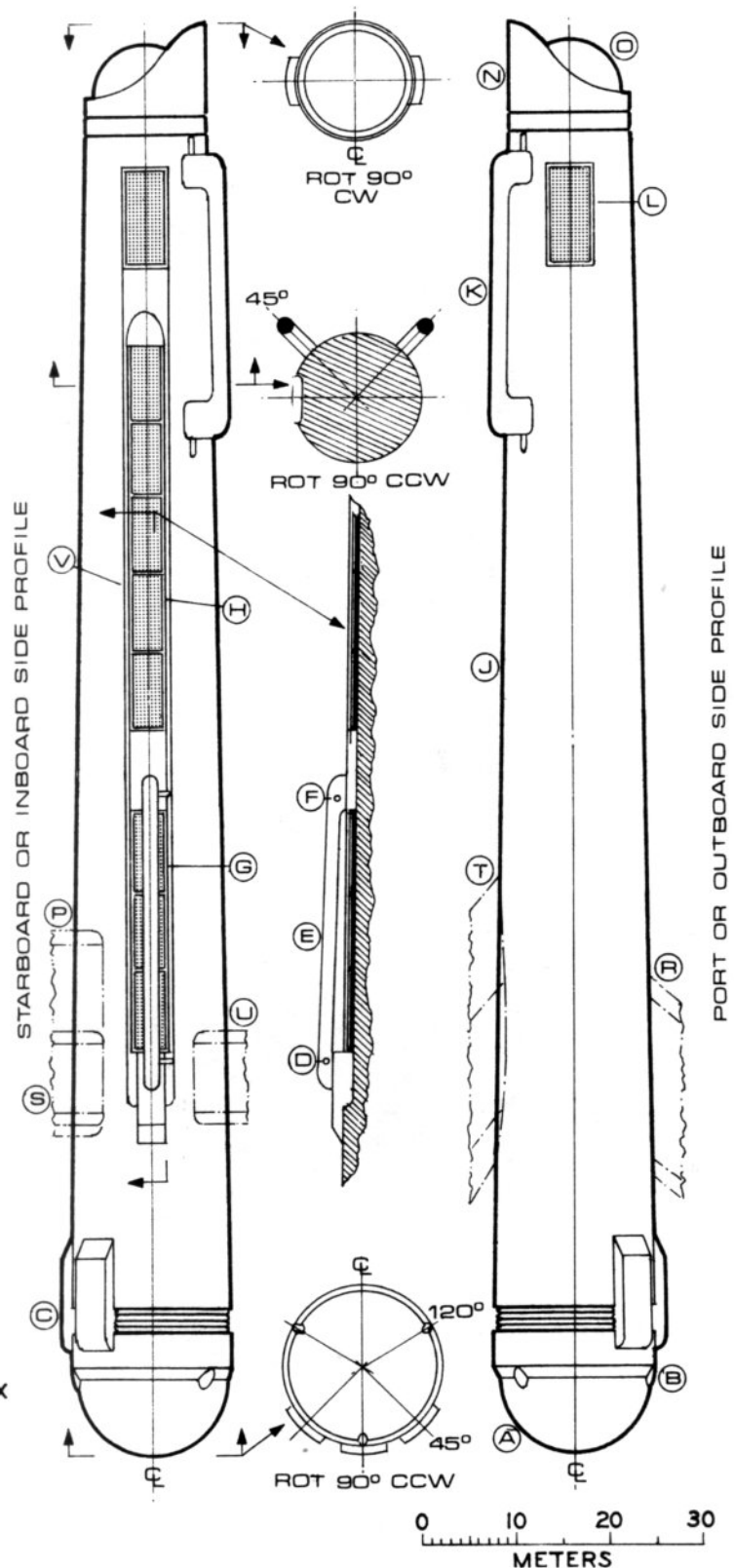



# TRANSPORTER

## CONTROLS CONSOLE

**DIMENSIONS:**

L.O.A. - 197.5 CM. --- W.O.A. - 97 CM. --- H.O.A. - 181.3 CM

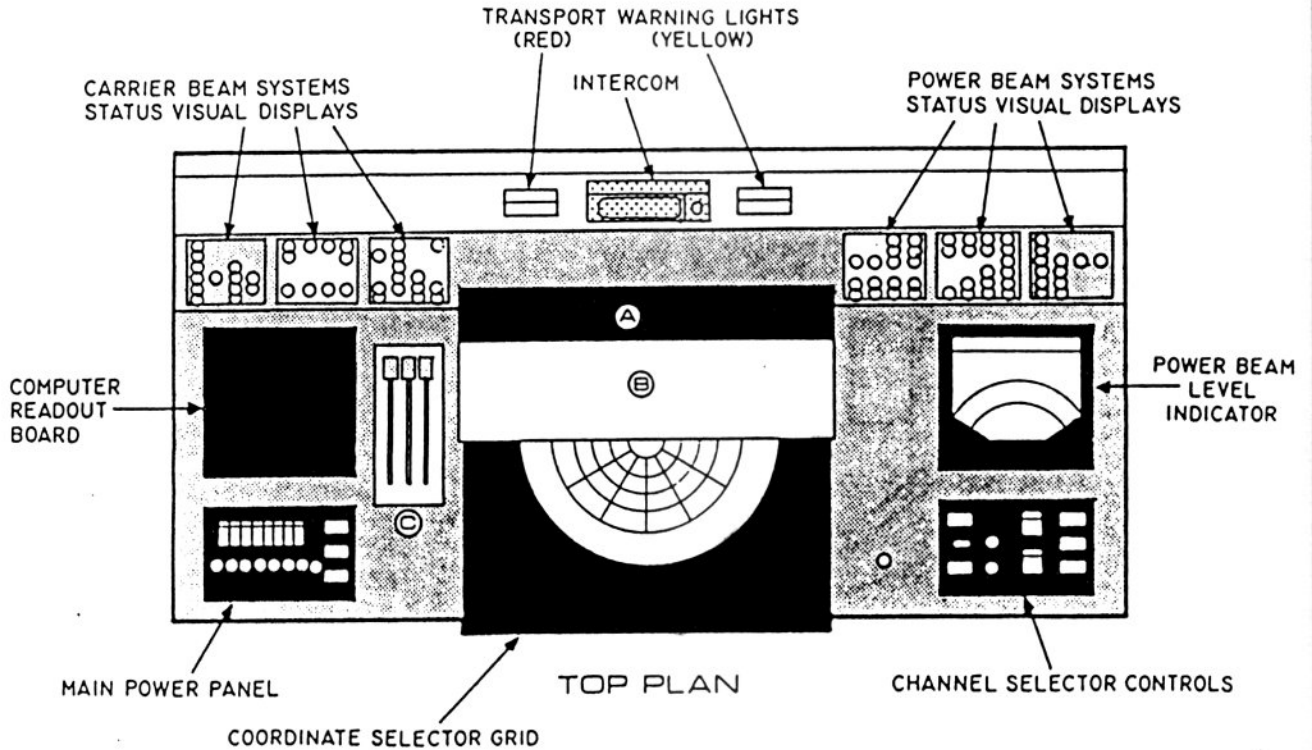
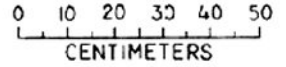

- Ⓐ FIELD EQUIPMENT SHELF
- Ⓑ HOOD
- Ⓒ ENERGIZING CONTROLS:
  1. PHOTON IONIZATION CONTROL
  2. NEURAL PARALYZER CONTROL
  3. MAGNETIC FIELD CONTROL

(CONTROLS ARE OPERATED SIMULTANEOUSLY)

**COLORS:**

	PLATINUM	N°SF 29 UC
	SKY BLUE	N°SF 16 UC
	RED	N°SF 10 UC
	BLACK	N°SF 32 UC

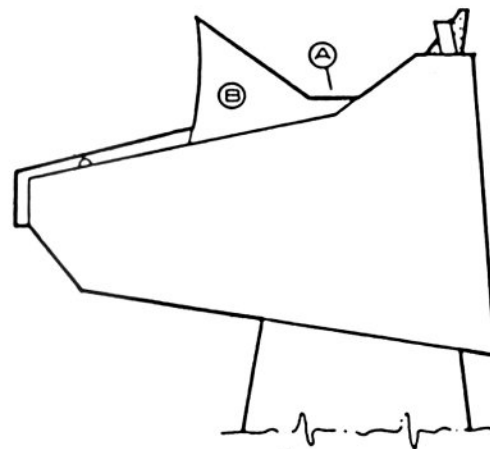

SIDE PROFILE

# TRANSPORTER

STANDARD 6 PERSON - PRIMARY HULL - CLASS I STARSHIPS

DECK 7 PLAN

PROTECTIVE BARRIER

TRANSPORTER NO. 1

TURBO-ELEVATOR STATION

T/E SHAFT

TRANSPORT MACHINERY ROOM

T/E CAR

CONTROLS CONSOLE

COMPUTER

POCKET DOORS

SHIP'S SERVICE

PORT SIDE

ATHWARTSHIP

ENERGY DISCHARGE BANK

MEDICAL SECTION LOBBY

STEPS  
Up

MAIN CORRIDOR

HAZARD GEAR AND OTHER ARTICLE STOWAGE

COMPUTER FUNCTIONS MONITOR

TRANSPORT UNIT (6)

TRANSPORTER NO. 3

TRANSPORTERS NO'S 2 AND 4 ON STARBOARD SIDE DIRECTLY OPPOSITE

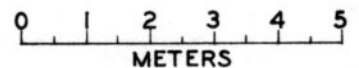

# TRANSPORTER

EMERGENCY - PRIMARY HULL - CLASS I STARSHIPS

DECK 8 PLAN

MAXIMUM CAPACITY - 22 PERSONS

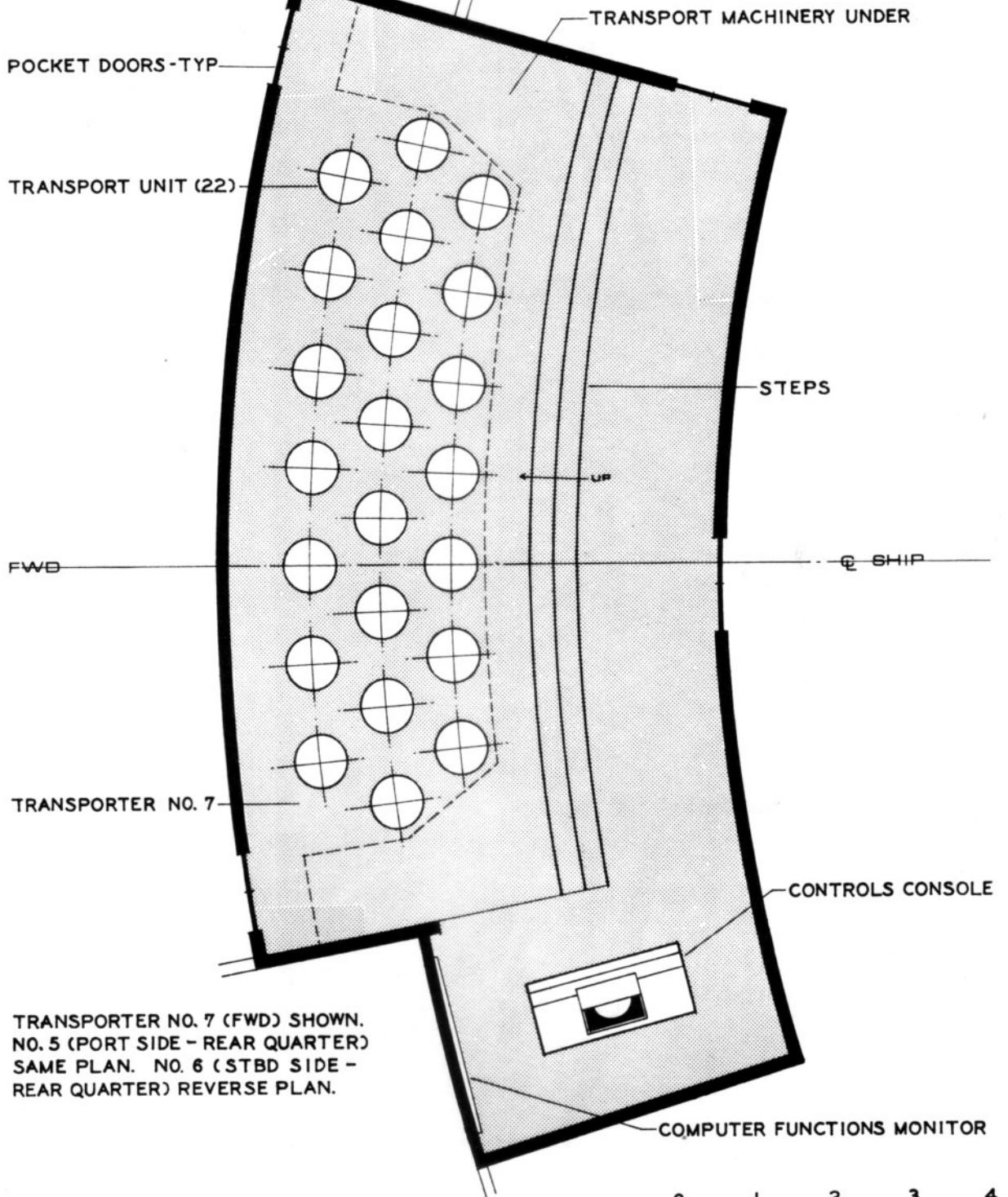

TRANSPORTER NO. 7 (FWD) SHOWN.  
NO. 5 (PORT SIDE - REAR QUARTER)  
SAME PLAN. NO. 6 (STBD SIDE -  
REAR QUARTER) REVERSE PLAN.

0 1 2 3 4  
METERS

# TRANSPORTER

CARGO - PRIMARY HULL - CLASS I STARSHIPS

DECK 10 PLAN

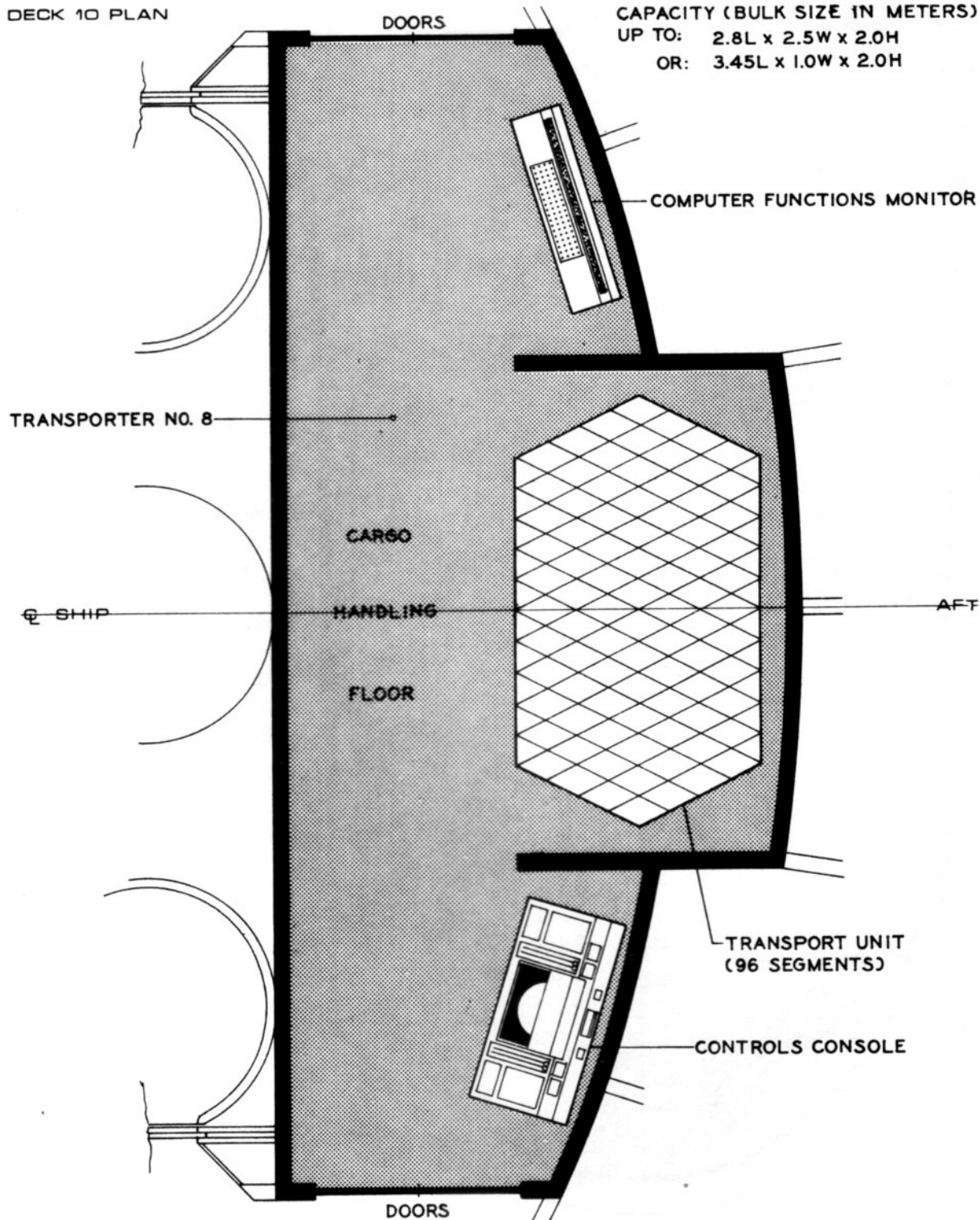

CAPACITY (BULK SIZE IN METERS)  
UP TO: 2.8L x 2.5W x 2.0H  
OR: 3.45L x 1.0W x 2.0H



# HANGAR DECK

MK-IX MODEL ONLY - CLASS I STARSHIPS

DECK 19 PLAN

AIR SUPPLY DUCT - P/S

SUPPORT PYLON FWD.  
STRUCTURAL BLHD. - P/S

POCKET DOORS TO  
CORRIDOR - P/S

FLUSH HATCH - GANGWAY  
TO DECK 20 SHOPS

POCKET DOORS TO  
ELEVATOR LOBBY

SPACE STORAGE POCKET  
P/S

SUPPORT PYLON AFT  
STRUCTURAL BLHD - P/S

ELEVATOR TO DECK 20  
MAINTENANCE SHOPS

TURNTABLE IN ELEV.

PIPING & WIRING TRUNK  
P/S

OBSERVATION GALLERY  
OVER & AROUND

SCALING LADDERS - F/A  
P/S

POCKET TO OPERATIONS  
TOWER - P/S

SHUTTLECRAFT RESERVE  
FUEL STORAGE - P/S

DECK OPERATIONS CONT.  
TOWER OVER - P/S



FLUSH CARGO HOLD  
HATCH - P/S

CLAMSHELL HANGAR  
DOORS (6 SEGMENT)

SPOT LANDING TARGET  
PAINTED ON DECK

STERN FANTAIL

COLORS:

	TAUPE	N°SF28UC
	YELLOW	N°SF12UC
	RED	N°SF09UC

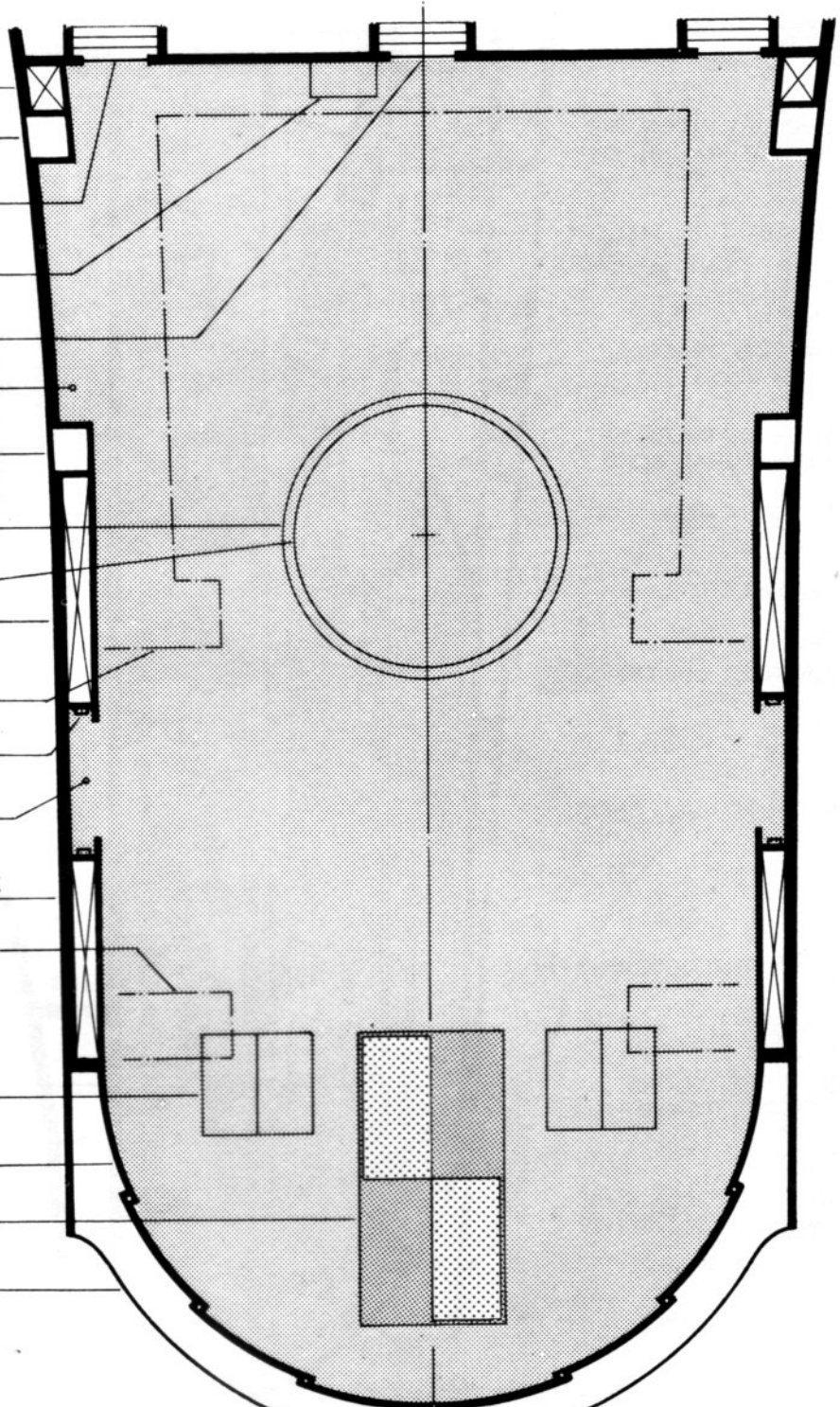

TO:03:17:01

# HANGAR DECK

PRINCIPAL ELEVATION - MK-IX MODEL ONLY

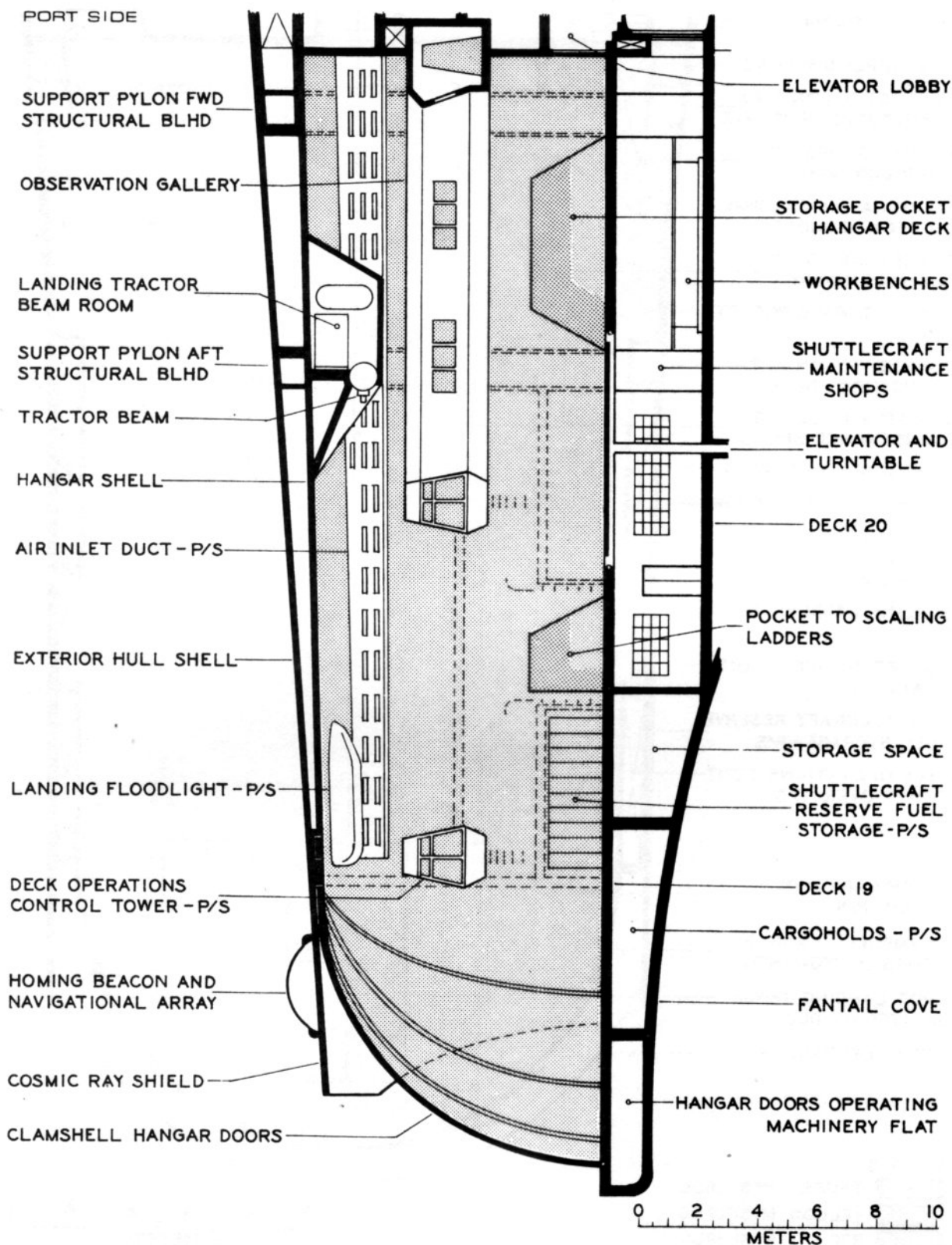

# VULCAN LYRETTE

ORCHESTRAL MODEL MUSICAL INSTRUMENT

AN UNUSUALLY HARMONIOUS AND MELODIC ACCOMPANIMENT OR SOLO INSTRUMENT WHOSE ORIGIN IS LOST IN VULCAN ANTIQUITY. IT COMBINES THE TONAL QUALITIES OF A HARP, LUTE, SITAR, AND TO SOME EXTENT, VIOLIN.

THE MOST FAMOUS MODELS WERE MADE BY SARPK SOME 5 VULCAN CENTURIES AGO OF WHICH, SOME 300 ARE KNOWN TO STILL BE IN EXISTENCE. OTHER FAMOUS MODELS WERE MADE BY SAJEK OF VULCAN AND SEPAR OF TRILAN.

THE TONAL PATTERN IS MODAL DIATONIC RATHER THAN CHROMATIC AND REQUIRES A HIGH DEGREE OF SKILL TO PERFORM IN THIS REGISTRATION.

WHILE A SKILLED PERFORMER MANIPULATES THE STRINGS WITH THE FINGERS OF THE RIGHT HAND, A PLECTRUM MAY ALSO BE USED.

**PITCH RANGE:**

- LOWEST - 60 CPS
- HIGHEST - 3180 CPS

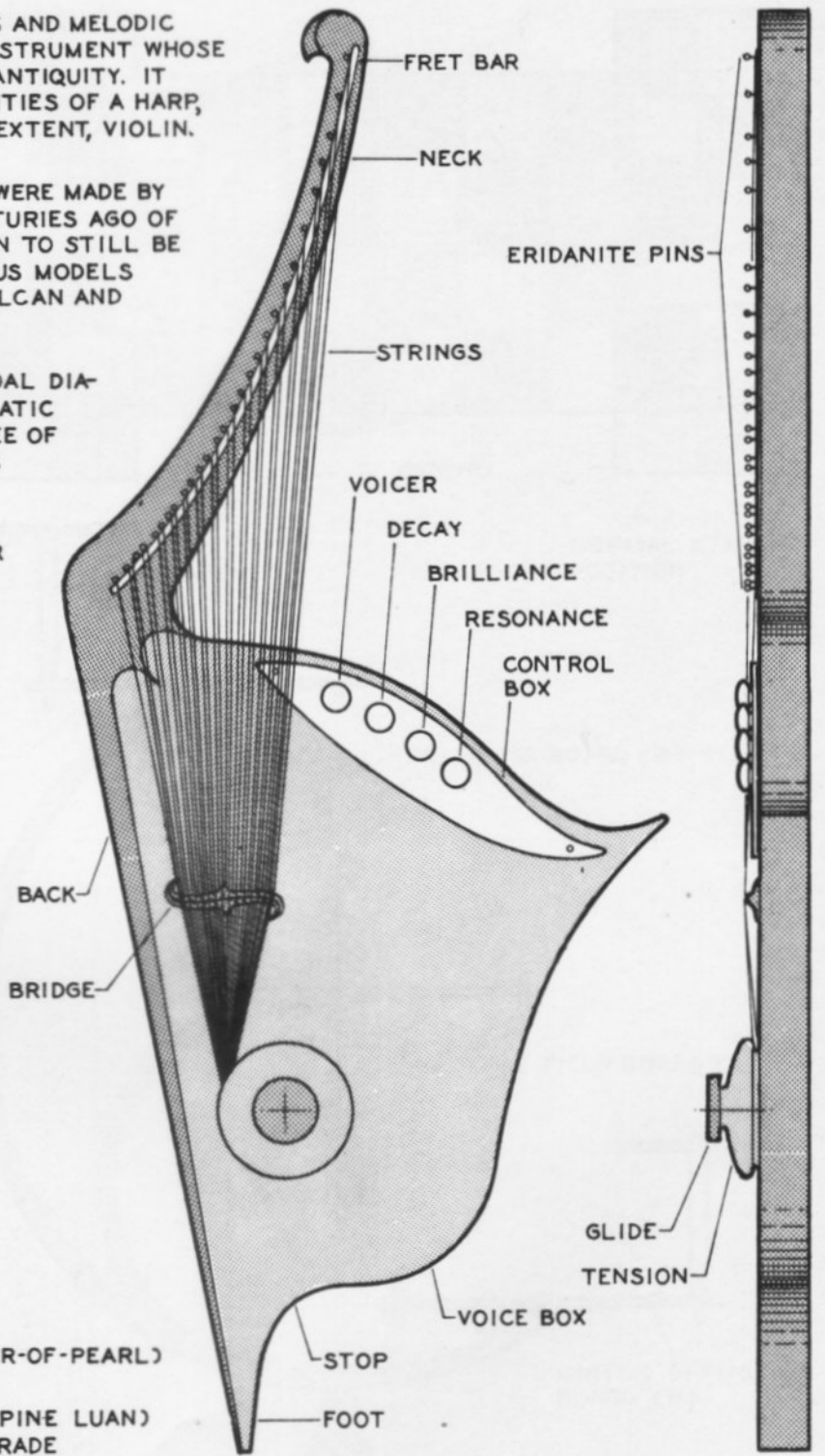

**MATERIALS:**

- BAHUN'AHB (\*MOTHER-OF-PEARL) AN ORGANIC NACRE
- SHER SKAH (\*PHILLIPINE LUAN) MOUNTAIN GROWN GRADE
- LI'PON (\*CEYLONESE TEAK) DARK FINE-GRAIN VARIETY

\* EQUIVALENT TERRAN MATERIALS

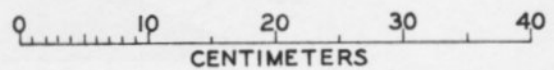

# TRIDIMENSIONAL CHESS

## REGULATION TOURNAMENT BOARD

THIS IS THE MOST COMPLEX FORM OF THE ANCIENT GAME OF CHESS YET DEvised. IT IS NORMALLY STUDIED AND ATTEMPTED ONLY BY PERSONS WITH MASTER'S SKILLS IN THE ORDINARY FORM OF THE GAME.

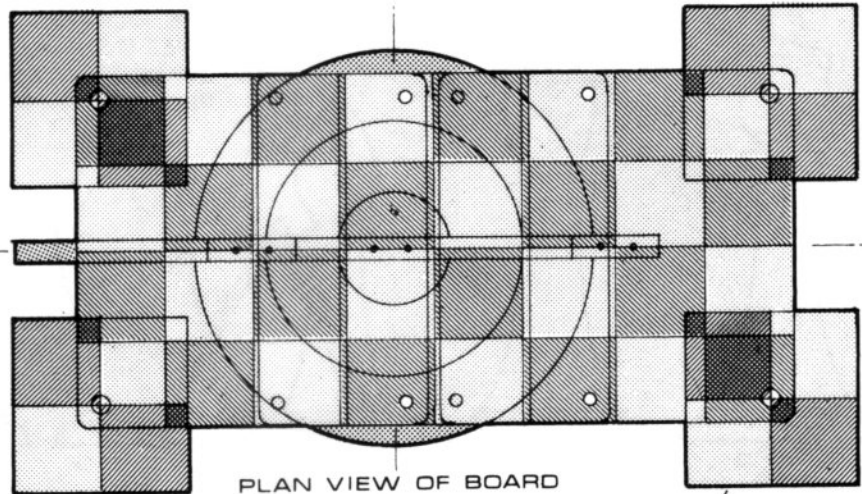

MOVABLE ATTACK BOARDS (A)(4) (24 POSSIBLE POSITIONS)

TRANSPARENT NATURAL PLASTIC

NORMAL STARTING POSITION

BLACK'S DEFENDING BOARD (B)



PIN (4 PER BOARD - B-N-W)

SUPPORT FRAME

NEUTRAL FIELD BOARD (N)



COLORS:

-  WHITE
-  NATURAL } TRANSLUCENT PLASTIC
-  RED
-  GOLD N°SF03UC

WHITE'S DEFENDING BOARD (W)

BASE

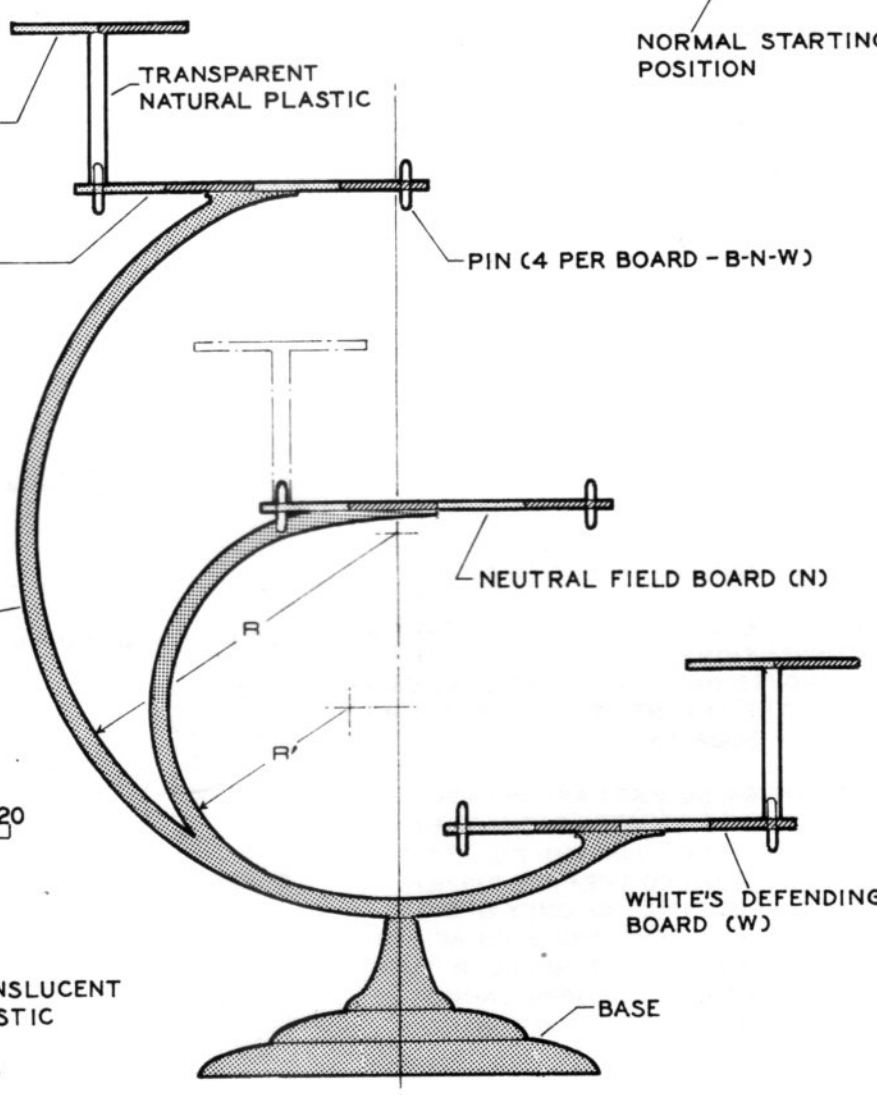



# TRIDIMENSIONAL CHESS

REGULATION TOURNAMENT PLAYING PIECES

THE IDENTIFICATION OF EACH PIECE GIVES ITS NAME - POINT VALUE - AND QUANTITY. A STARTING SIDE, WHITE OR BLACK, IS 16 PIECES AND 39 POINTS

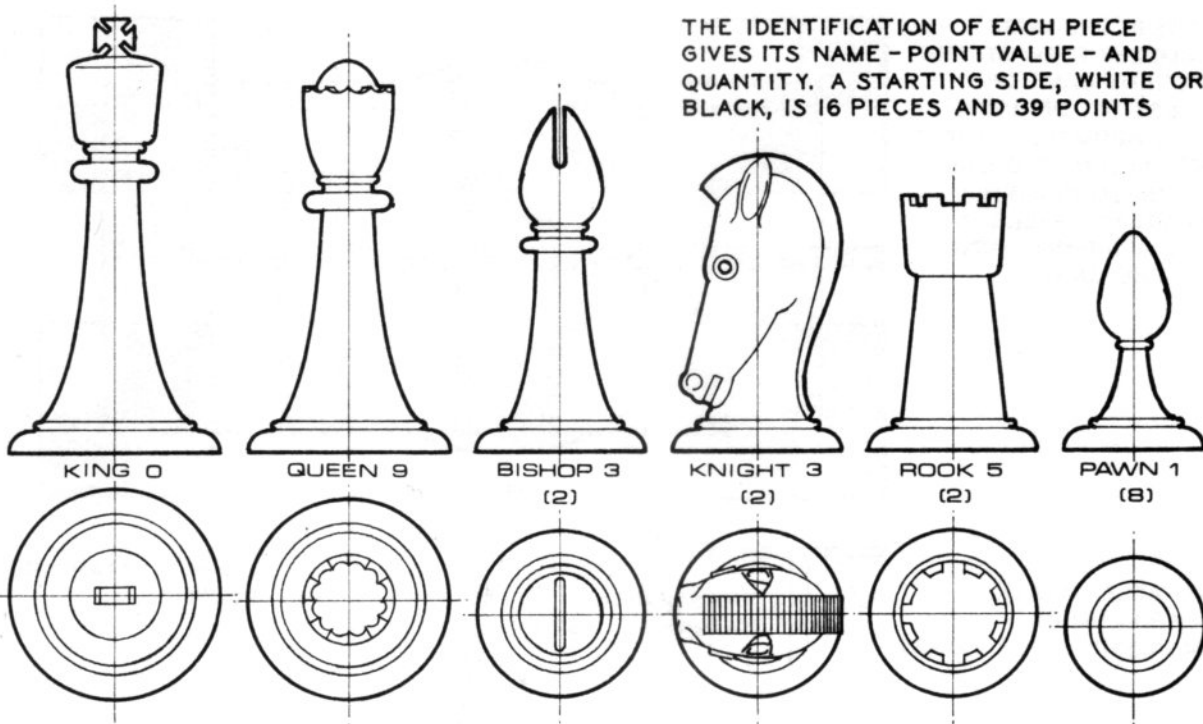

THE BLACK SET OF CHESSMEN IS IDENTICAL TO THE WHITE SET EXCEPT FOR ITS COLOR

THE SIZE, SHAPE, AND VISUAL APPEARANCE OF EACH PIECE IS OF PRIME IMPORTANCE TO MENTAL RECOGNITION OF THE POWER PATTERN ON THE BOARD AT ANY POINT IN THE PLAY

REFER TO THE GENERAL BIBLIOGRAPHY SECTION FOR TEXTS ON THE FUNDAMENTALS OF TRIDIMENSIONAL CHESS

EACH PIECE MOVES EXACTLY THE SAME AS IN CONVENTIONAL CHESS EXCEPT THAT SUCH MOVES HAVE TRIDIMENSIONAL FREEDOM TO THE EXTENT OF AVAILABLE CONSECUTIVE SQUARES

16 OF THE 64 SQUARES ARE MOVABLE IN 4 GROUPS OF 4 SQUARES EACH. THEY MAY BE MOVE TO ONE ADJACENT PIN POSITION AT A TIME PROVIDED THEY ARE EITHER VACANT OR OCCUPIED BY ONLY ONE OF THE PLAYER'S PAWNS, AND SUCH ACTION CONSTITUTES A MOVE IN REGULAR TURN. AN OCCUPIED ATTACK BOARD CANNOT BE MOVED TO AN INVERTED PIN POSITION

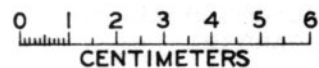

STARTING ARRANGEMENT:

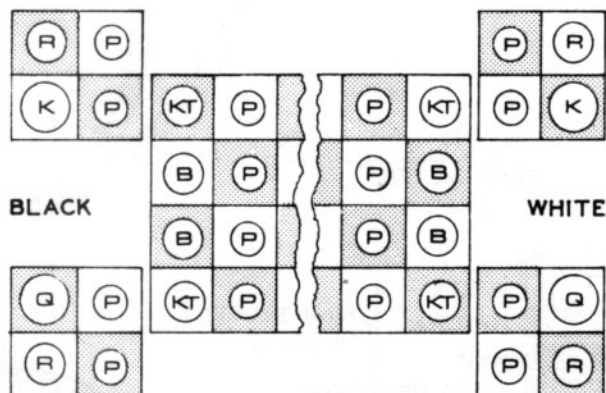

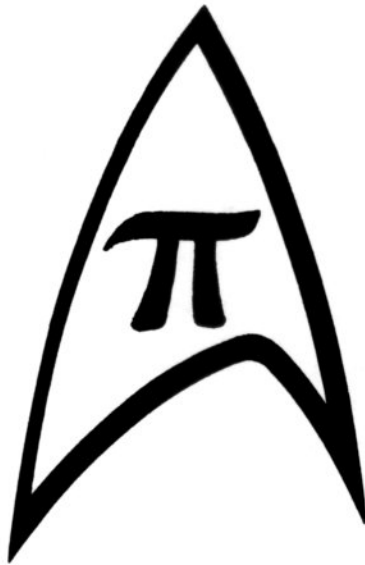

MISCELANEOUS SECTION

OFFICIAL USE ONLY  
O MARK O R5PC

**STAR FLEET COMMAND**  
STAR FLEET HEADQUARTERS  
**UNITED FEDERATION OF PLANETS**

FRANZ JOSEPH  
UNITED FEDERATION REPRESENTATIVE

STARDATE 7504

**APPENDIX A**

TO ALL CIVILIAN AUXILIARIES OF SFAF,  
UNITED NATIONS/EARTH/SOL SYSTEM

THE TECHNICAL ORDERS COMPRISING THIS SECTION WERE NOT INCLUDED IN  
THE UNORTHODOX TRANSMISSION OF STARDATE 3113. UNTIL SUCH TIME AS  
THESE DATA CAN BE MADE AVAILABLE, WE SUGGEST YOU CONSIDER USING  
THIS SECTION TO FILE MISCELLANEOUS INFORMATION YOU HAVE COLLECTED  
IN THE GENERAL SUBJECT AREAS OF THE TECHNICAL MANUAL







TM:379260-0

# STAR FLEET TECHNICAL ORDER

AUTHENTICATED STARDATE 7305.29

TO:00:01:12

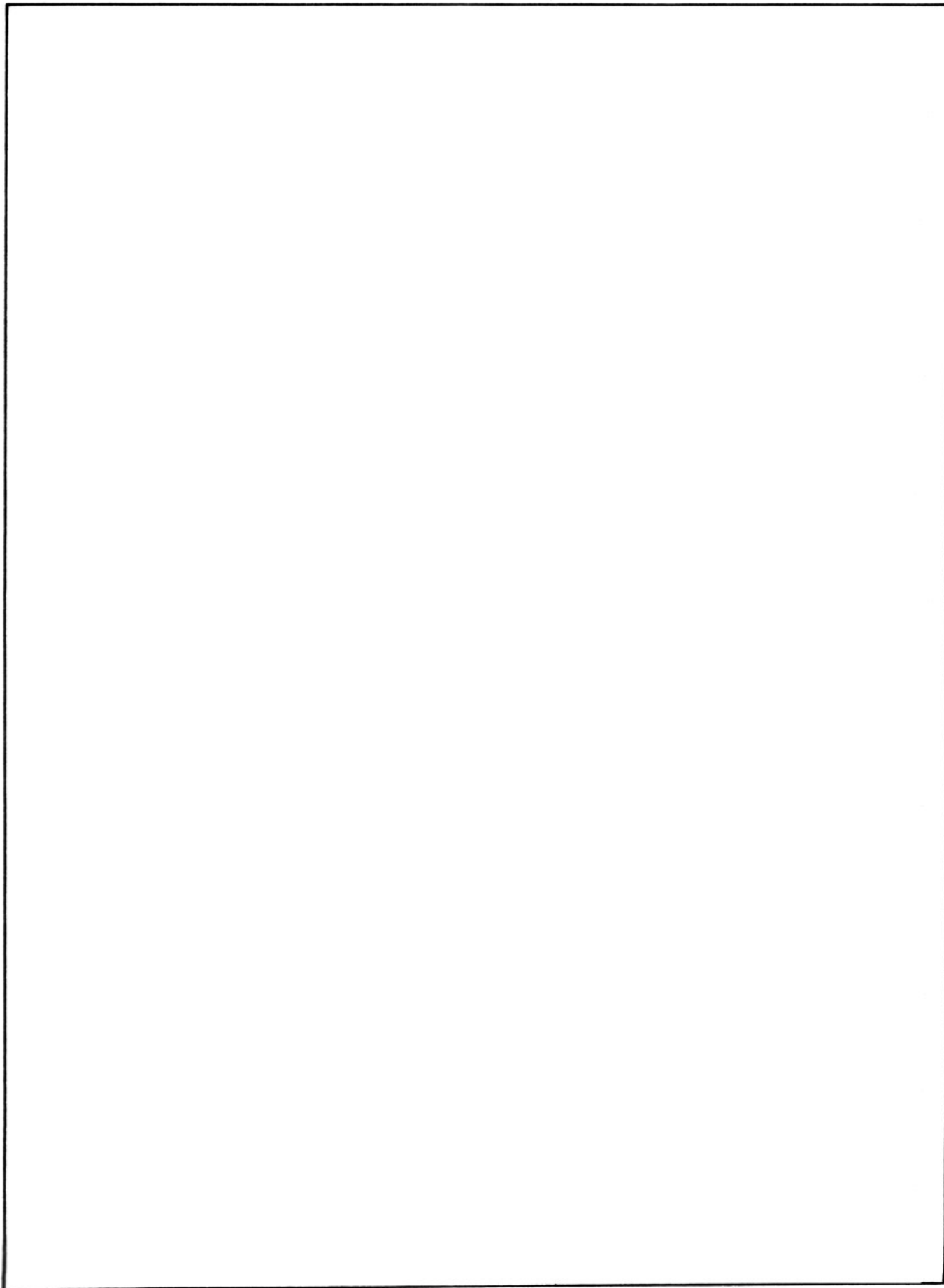

STAR TREK is a registered trademark  
of Paramount Pictures Corporation

Cover printed in USA

34074



0 70999 01095

ISBN 0-345-34074-4