

\$8.95

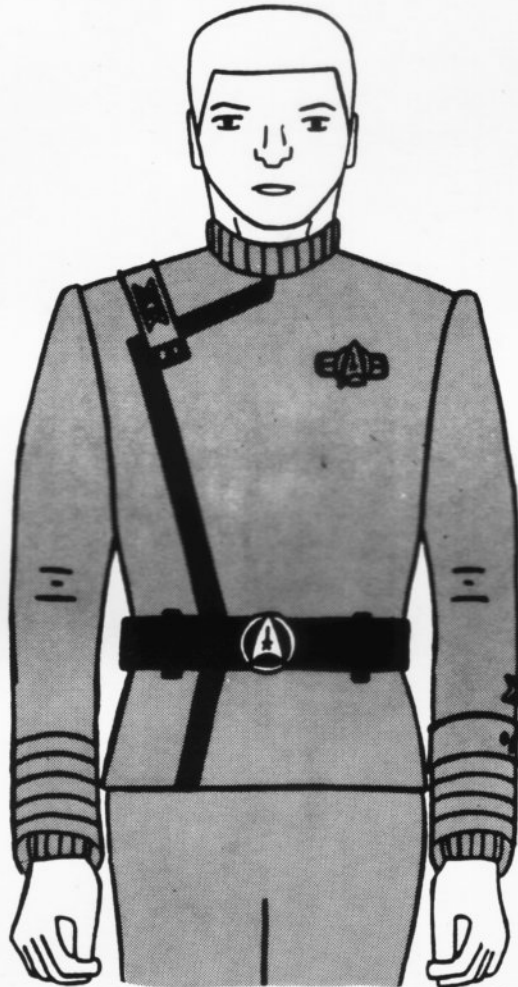

STARFLEET



OFFICER
REQUIREMENTS



STARFLEET OFFICER REQUIREMENTS

Authenticated: Stardate 8504.15

Project Head: Commander David J. Schmidt, U.S.S. Kestral

Collaborator: Captain Robert E. Day, Starfleet Research
and Development

With Thanks to: The Officers and Crew of the U.S.S. Kestral
& U.S.S. Saratoga

Authorized: Admiral Elizabeth A. Rose, Starfleet

Copyright © 1985 by David J. Schmidt, Jr., Vancouver, Washington.
All rights reserved. No part of this book may be reproduced in any
form without permission in writing from the author.



STARFLEET OFFICER REQUIREMENTS

TABLE OF CONTENTS

<u>Subject</u>	<u>Page</u>
Particulars	1
Heavy Cruiser - MK-IX-B - Enterprise Class	2
Destroyer - MK-VIII-B - Saladin Class	3
Heavy Frigate - MK-XI-B - Avenger Class	4
Scout - MK-VII - Hermes Class	5
Battleship - MK-XXV - Excelsior Class	6
Dreadnought Versus Battleship	7
Command Console	8
Command Console	9
Command Console	10
Command Console - Perpendicular Panel Chart	11
Photon Torpedo (Pho-Torp) - MK-VI	12
Destruct Sequence	13
Commissioned Officers and Ranks - Staff Officers	14
Commissioned Officers and Ranks - Ensign	15
Starfleet Academy	16
Star Bases	17
United Federation of Planets	18
Your Appearance in Uniform	19
Uniform Details and Variations	20
Dress Jacket	21
Duty Jacket	22
Jumpsuit	23
Survival Jacket	24
Radiation Suit	25
Starfleet Insignia	26
Dress Belt Buckle	27
Rank Insignia for Flag Officers	28
Rank Insignia for Officers	29
Departmental Stripe	30
Rating Insignia	31
Ratings	32
Tricorder - Type I C	33
Tricorder - Type I C	34
Communicator - Type II	35
Hand Phaser - Type I C	36
Hand Phaser - Type II C	37



STARFLEET OFFICER REQUIREMENTS

1

PARTICULARS

This text is intended as a two-fold instructional aid:

- 1) An Academy Textbook for Cadets undergoing studies in the Command Division of Starfleet, as a supplement to the Starfleet Technical Manual
- 2) A hands-on aid for officers wishing to become familiar with recent changes in several aspects of Starfleet, and to assist them in becoming fully rated.

Receipt and possession of this text automatically carries with it the responsibility of safe-guarding its materials from eyes of civilians and enemies of the Federation. Destruction of this text is indicated upon pending capture.



STARFLEET OFFICER REQUIREMENTS

HEAVY CRUISER - MK-IX-B - ENTERPRISE CLASS

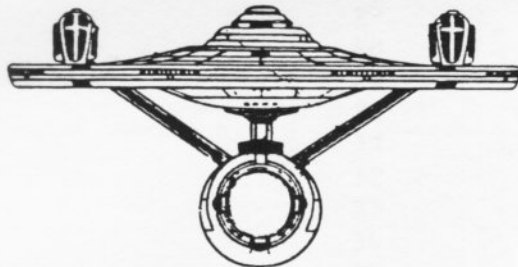
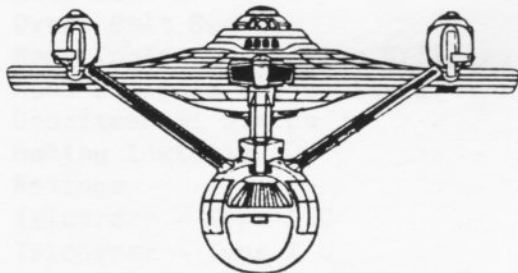
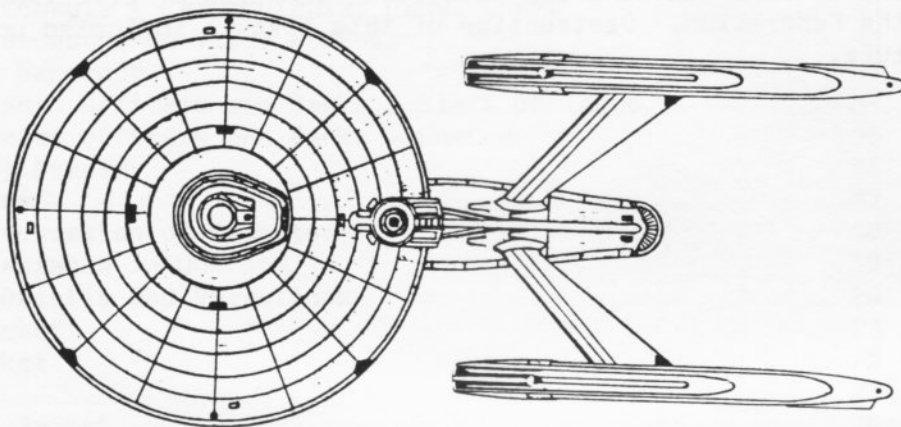
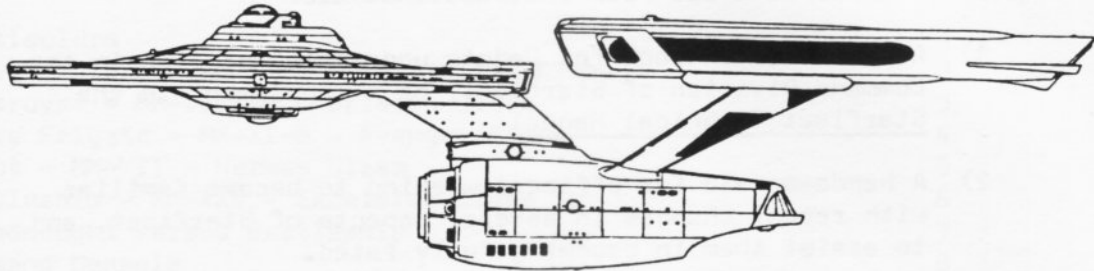

Complement

Deadweight Tonnage

Standard Range

Maximum Velocity

Overall Length

Overall Draft

Overall Beam

Ordnance

Officers -- 72

Enlisted -- 428

200,000 metric tonnes

20 years at C

Warp 12

304.8 meters

71.3 meters

141.7 meters

Phasers -- 18 (12 banks)

Photons -- 2 tubes (20 Torpedoes)



STARFLEET OFFICER REQUIREMENTS

3

DESTROYER - MK-VIII-B - SALADIN CLASS

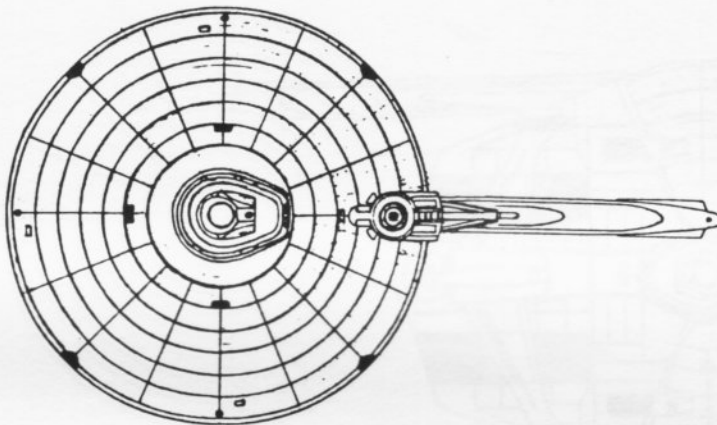
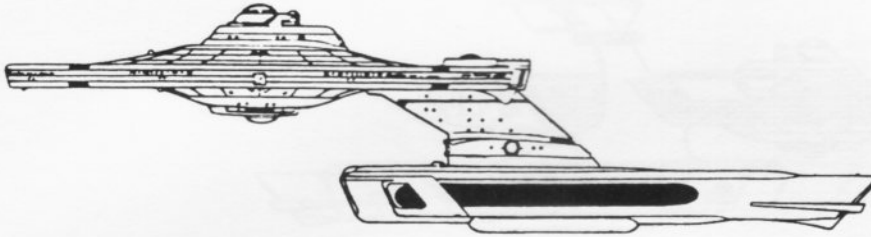

Complement

Officers -- 35

Deadweight Tonnage

Enlisted -- 265

Standard Range

100,000 metric tonnes

Maximum Velocity

10 years at C

Overall Length

Warp 12

Overall Draft

200 meters

Overall Beam

60.9 meters

Ordnance

141.7 meters

Phasers -- 12 (6 banks)

Photons -- 2 Tubes (20 Torpedoes)



STARFLEET OFFICER REQUIREMENTS

HEAVY FRIGATE - MK-XI-B - AVENGER CLASS

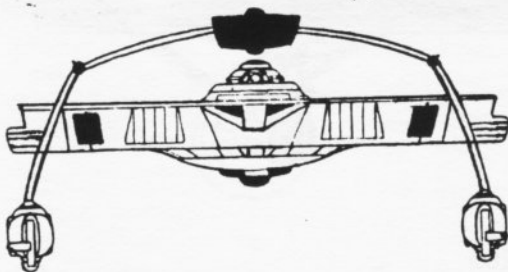
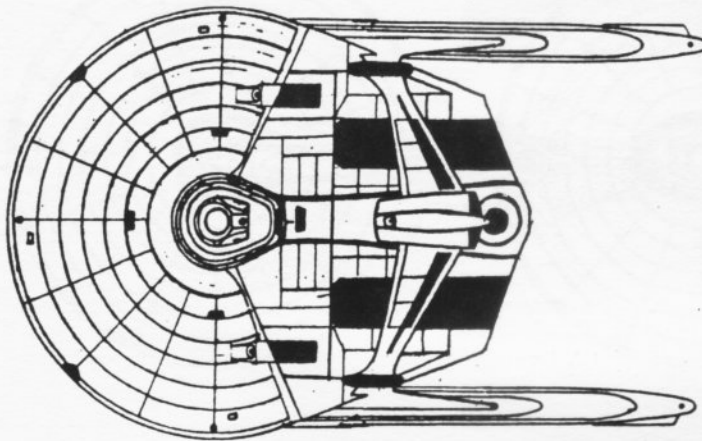
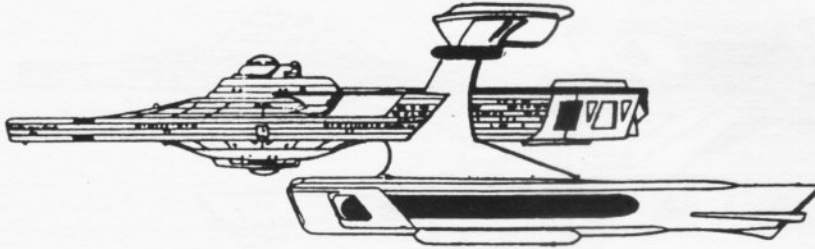

Complement

Deadweight Tonnage

Standard Range

Maximum Velocity

Overall Length

Overall Draft

Overall Beam

Ordnance

Officers -- 91

Enlisted -- 269

165,000 metric tonnes

15 years at C

Warp 11

179.1 meters

32.9 meters

141.7 meters

Phasers -- 12 (6 banks) 2 Phaser Cannon

Photons -- 4 Tubes (40 Torpedoes)



STARFLEET OFFICER REQUIREMENTS

5

SCOUT - MK-VII - HERMES CLASS

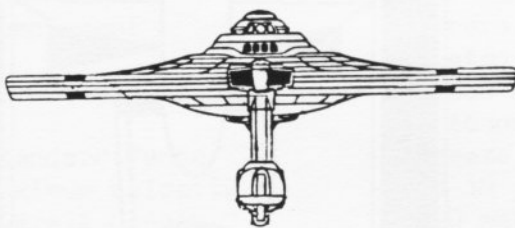
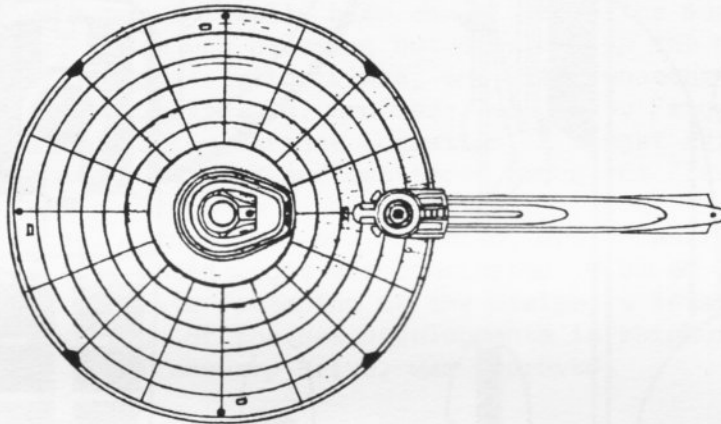
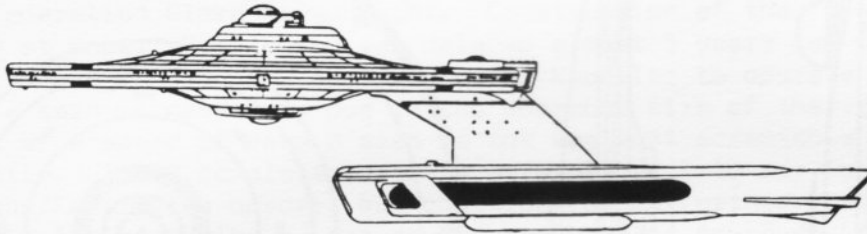

Complement

Deadweight Tonnage

Standard Range

Maximum Velocity

Overall Length

Overall Draft

Overall Beam

Ordnance

Officers -- 30

Enlisted -- 250

99,500 metric tonnes

10 years at C

Warp 12

200 meters

60.9 meters

141.7 meters

Phasers -- 2 (1 bank)



STARFLEET OFFICER REQUIREMENTS

BATTLESHIP - MK-XXV - EXCELSIOR CLASS

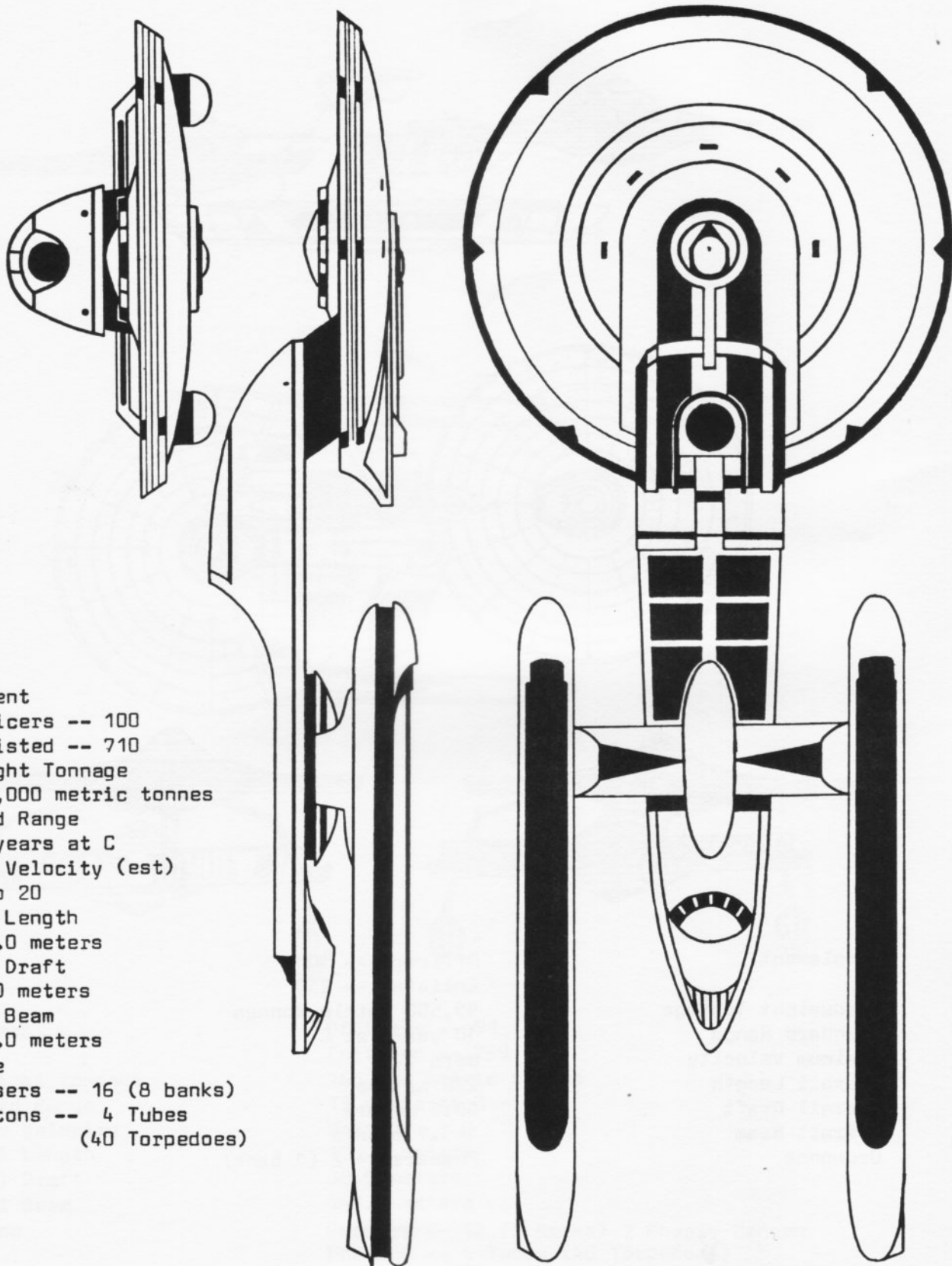

Complement

Officers -- 100

Enlisted -- 710

Deadweight Tonnage

250,000 metric tonnes

Standard Range

25 years at C

Maximum Velocity (est)

Warp 20

Overall Length

467.0 meters

Overall Draft

78.0 meters

Overall Beam

186.0 meters

Ordnance

Phasers -- 16 (8 banks)

Photons -- 4 Tubes

(40 Torpedoes)



STARFLEET OFFICER REQUIREMENTS

7

DREADNOUGHT VERSUS BATTLESHIP

On stardate 6066, the Federation Defense Council approved the plans for the Federation Class Dreadnought. Construction of the first 9 was to begin at once. Completion was delayed almost 5 years due to unforeseen problems in fine-tuning the Warp Drive Nacelles to operate as a triune unit - seen as necessary due to the enormous size of the vessel and in light of a speed of Warp 8 seen as the smallest acceptable cruising velocity. The 9 completed vessels were placed into service along the Klingon/Federation border, but construction on further vessels was delayed and finally cancelled by the development of the Advanced 4th Generation Warp Drive, and the subsequent Transwarp Drive & 5th Generation Warp Drive.

The Dreadnought had initially been conceived as the successor to the Heavy Cruiser, which was becoming outmoded. With the upgrading of the Heavy Cruiser to Constitution Class, and with subsequent upgradings of Frigates, Scouts, Destroyers, Cruisers, and Heavy Frigates, the void perceived in Federation Defense Logistics no longer existed. The 9 Dreadnoughts were upgraded and scattered among the fleet.

Ten years later, when a new void surfaced, due to enormous Klingon R & D expenditures, the Dreadnought was considered to be an obsolete approach. Rather than a complete revamping of the design, a totally new design, which took advantage of the new developments in shipbuilding, ordnance, and of course the Transwarp Drive, was approved.

	Dreadnought	Battleship
Complement	Officers --- 55 Enlisted -- 445	Officers -- 80 Enlisted -- 730
Deadweight Tonnage	285,000 metric tonnes	220,000 metric tonnes
Standard Range	20 years at C	20 years at C
Maximum Velocity	Warp 10	Warp 14
Overall Length	320.0 meters	467.0 meters
Overall Draft	87.0 meters	78.0 meters
Overall Beam	140.0 meters	186.0 meters
Ordnance		
Phasers --	10 (5 banks)	16 (8 banks)
Photons --	2 Tubes (20 Torps)	4 Tubes (40 Torps)



STARFLEET OFFICER REQUIREMENTS

COMMAND CONSOLE

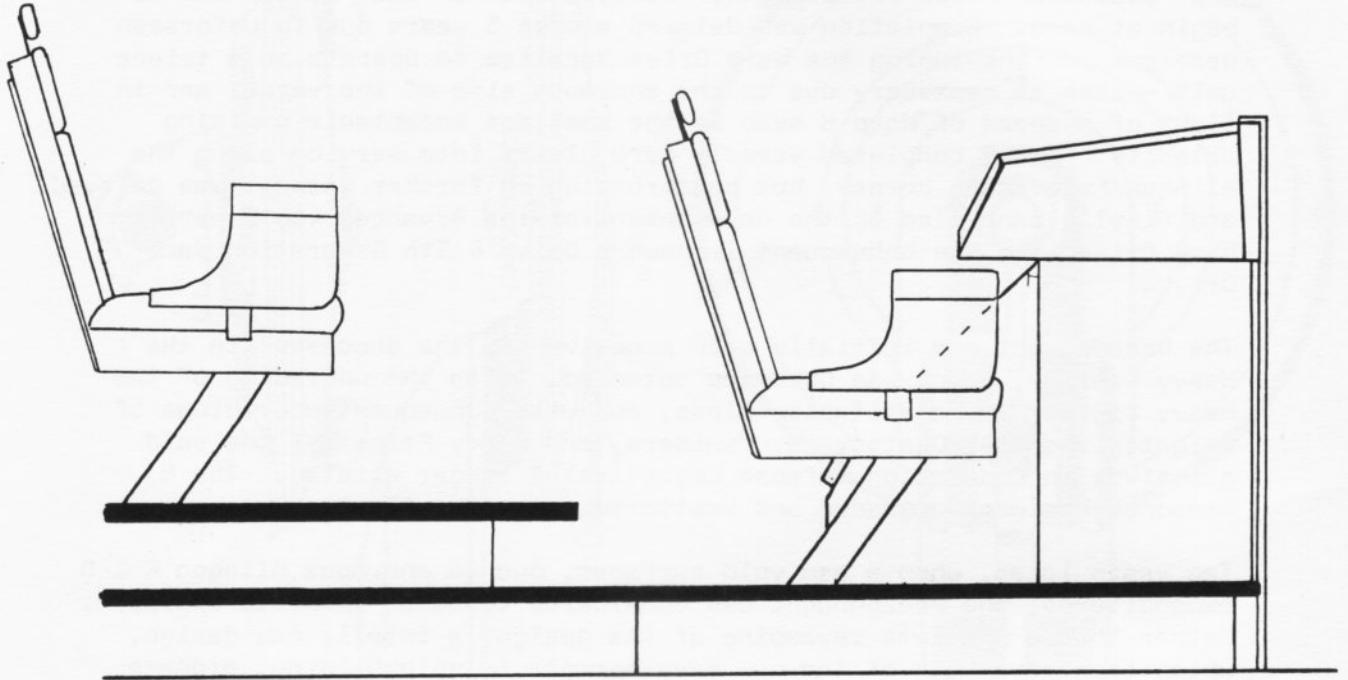

The Model 2KCC Command Console is the latest upgrading in Helm/Navigation Control Systems, and is now standard for all Class I Starships as part of the refurbishing program. Instead of 13, there are now 20 separate control panels incorporated in the console. Each is a functionally independent subsystem with its own microprocessor, memory bank, and power leads. Each panel's face is a single Chromatic Liquid Crystal display. Key intelligence panels have both touch-button and voice activated systems running parallel for ease of access to their computers. The Navigation Computer Interface is in actuality 4 independent terminal banks, normally utilized for different programming needs, but each fully capable of performing all necessary functions.

The console includes a verifying "Command prefix code" along with any order it sends to any part of the ship, to ensure Command integrity.

The console was designed and manufactured by Daystrom Duotronics.



STARFLEET OFFICER REQUIREMENTS

COMMAND CONSOLE

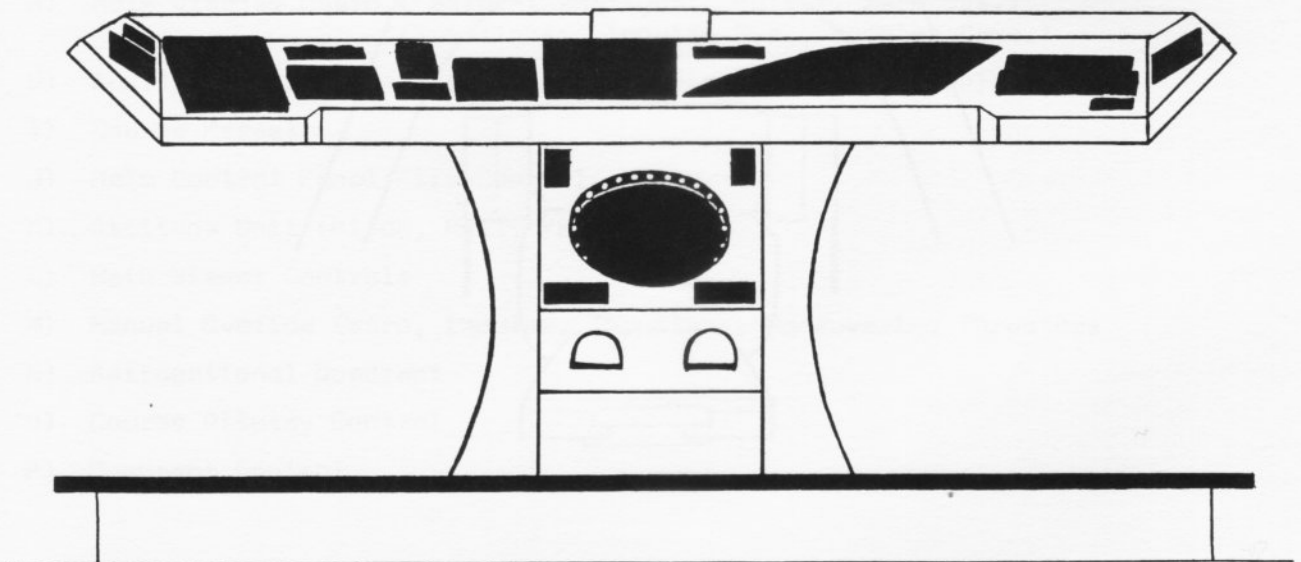
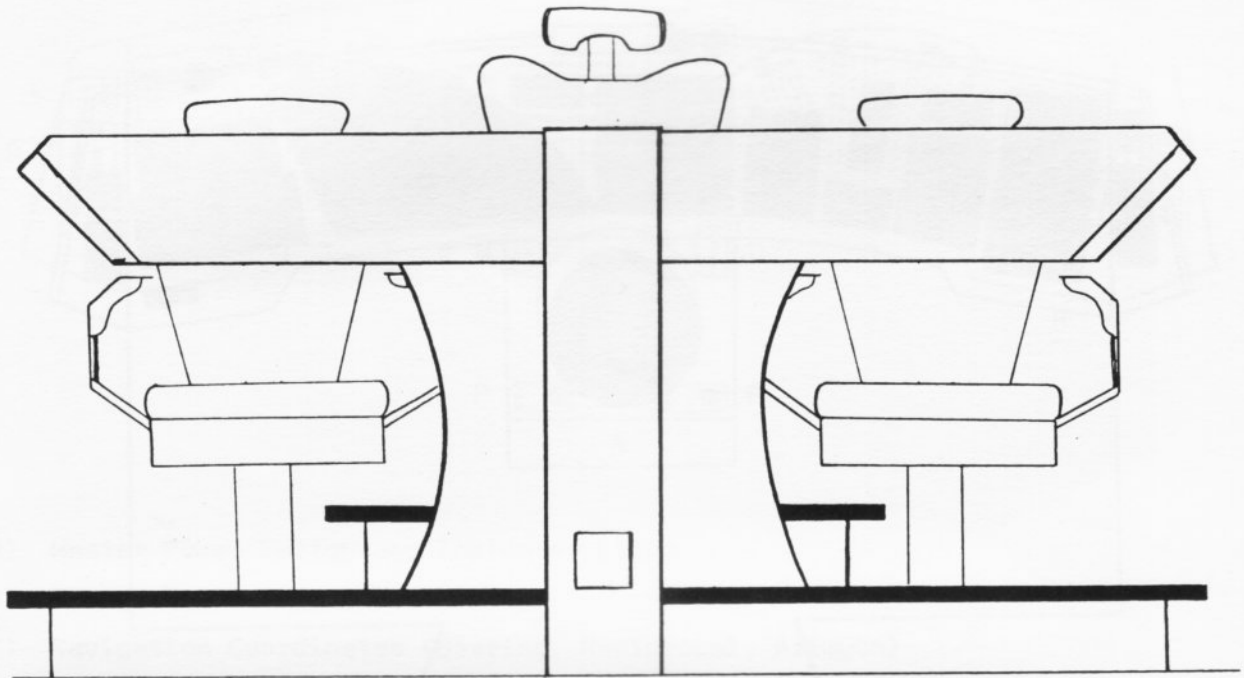



STARFLEET OFFICER REQUIREMENTS

COMMAND CONSOLE

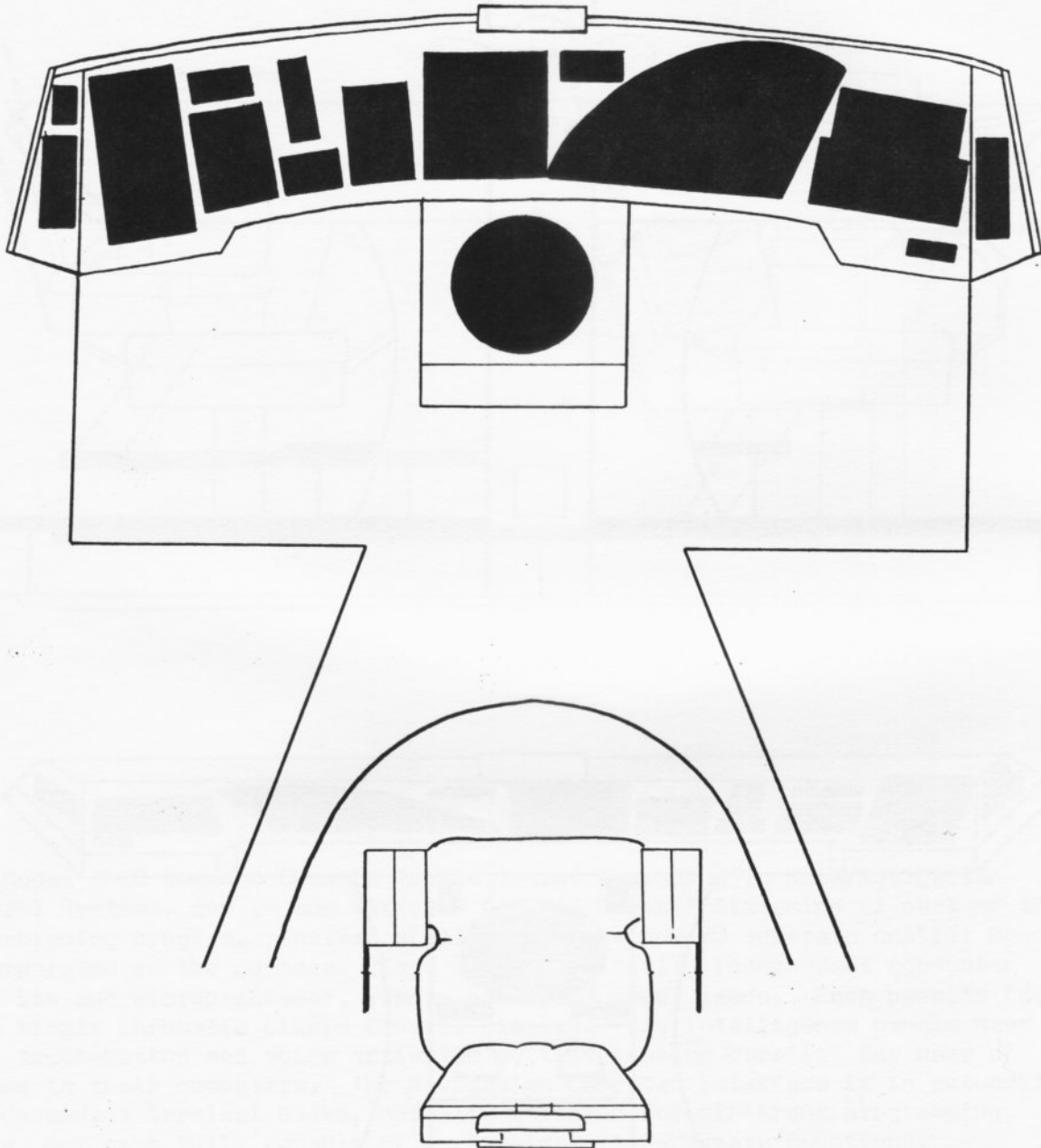



STARFLEET OFFICER REQUIREMENTS

11

COMMAND CONSOLE - PERPENDICULAR PANEL CHART

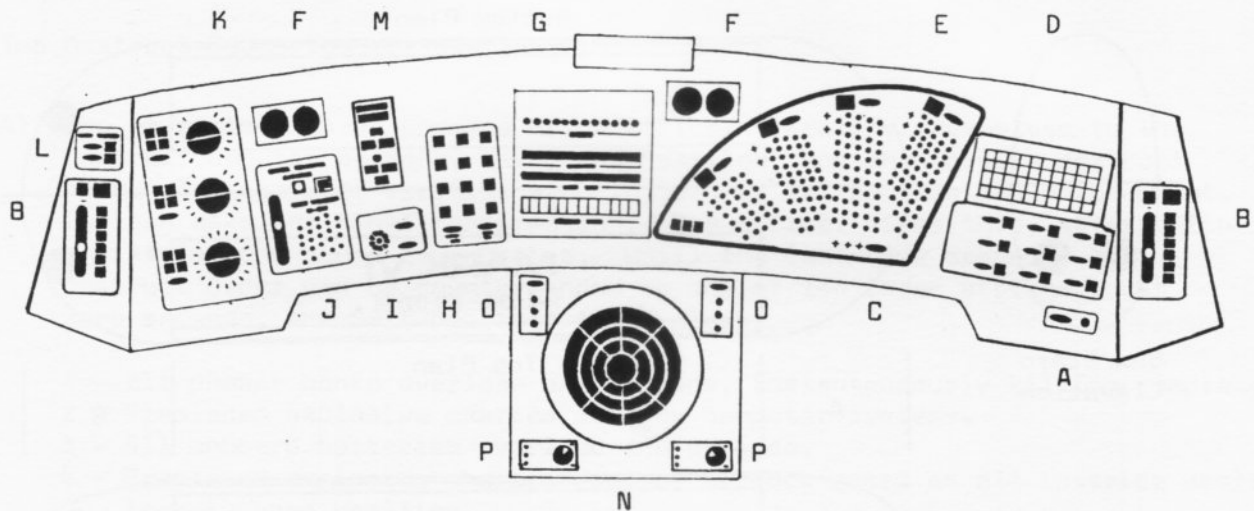

- A) Master Power Switch and Indicator Light
- B) Emergency Alarm/Intercom
- C) Navigation Coordinates (Bearing, Reciprocal, Azimuth)
- D) Course Deviation Plotter (X, Y, Z, Velocity)
- E) Navigational Computer (Mode I, Mode II, Mode III, Mode IV)
- F) Sensors Alert Lights
- G) Helm Display Board (Faster-than-light: Pulsar, Warp Sys.)
(Sub-light: Impulse Sys., Doppler Comp.)
- H) Auxiliary Steering Data (Course Steering, Course Change)
- I) Course Preset
- J) Helm Control Panel/Fire Control
- K) Attitude Unit (Pitch, Roll, Yaw)
- L) Main Viewer Controls
- M) Manual Override (Warp, Impulse, Thrusters, Maneuvering Thrusters)
- N) Astrogational Quadrant
- O) Course Display Control
- P) Quadrant Control



STARFLEET OFFICER REQUIREMENTS

PHOTON TORPEDO (PHO-TORP) - MK-VI

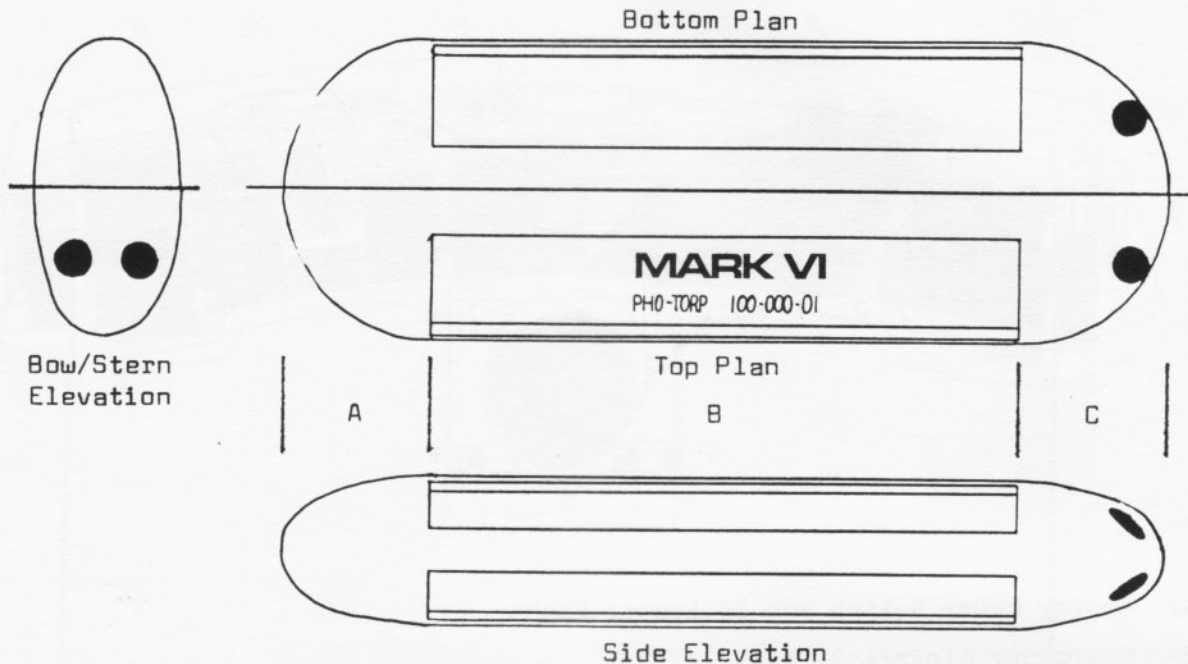

- A) Guidance/Telemetry
- B) Payload Volume
- C) Power/Propulsion

Weight (loaded)	2.0 metric tonnes
Range (powered)	1,000,000 kilometers
Maximum Velocity	0.9 C above launching vessel
Shell Composition	Terminium
Guidance System	Duotronic
Telemetry	Subspace Beacon
Fusing	Proximity/Durational/Remote Control/Impact
Payload (Warhead)	Antimatter/Force Field Generator Package
Yield (Variable)	50 megatons
Powerplant	Dilithium Storage Cells
Propulsion	Particle Beam Thrusters (4)
Length	3.0 meters
Draft	0.5 meters
Beam	1.0 meters

Depending on programming and payload, the PHO-TORP may be deployed in a wide variety of ways: as a torpedo, a mine, a space-to-ground missile, it can deliver its warhead payload to target. Replacement of the warhead package with another payload transforms the PHO-TORP INTO: a courier drone, a target-practice drone, a coordinate marker beacon/buoy, a casket for burial-at-space.



STARFLEET OFFICER REQUIREMENTS

13

DESTRUCT SEQUENCE

Two Destruct Scenarios are available:

A) One at a time, three Command Grade Officers identify themselves to the Central Computer by Rank, Name, and Position, and then give a destruct code. The computer verifies each in turn by retina scan and voice-print. It then asks for final confirmation. One officer gives this, after which a sixty second count-down begins. Until the last five seconds, the Destruct Order can be countermanded by one of the three officers. At zero seconds, the Self-Destruct takes place:

- 1 - All phaser banks overload and explode, instantaneously killing complement.
- 2 - Preplaced explosive charges destroy computer systems.
- 3 - All onboard batteries overload and explode.
- 4 - Preplaced explosive charges destroy airlock doors as all interior doors lock in open position.

Following this procedure the vessel is a lifeless inanimate hulk, useless to any enemy and yet doing no harm to the immediate vicinity.

Destruct Code:

- First - "Destruct Sequence One, Code One, One-A."
- Second - "Destruct Sequence Two, Code One, One-A, Two-B."
- Third - "Destruct Sequence Number Three, Code One-B, Two-B, Three."
- Computer - "Destruct Sequence Completed and Engaged; Awaiting Final Code for Sixty Second Count-Down."
- Final - "Code Zero, Zero, Zero, Destruct, Zero."
- Computer - "Sixty Seconds, Fifty-Nine,..."
- Countermand - "Code One-Two-Three, Continuity. Abort Destruct."

B) In the event that the Commanding Officer wishes to destroy an enemy vessel in the vicinity with his own Self-Destruct, he requests the Chief Engineer to carry out Starfleet Directive 2005. The Chief Engineer then activates a sequence on the Main Engineering Control Panel so that, in the event of a Destruct Code being ordered by the Bridge, the Computer will instead cancel out the Antimatter Storage Pods' Force-Field Envelope Generators. At the end of the sixty second count-down, the ship will detonate in a Gigaton sized explosion, taking out any vessel within 900 kilometers.



STARFLEET OFFICER REQUIREMENTS

COMMISSIONED OFFICERS AND RANKS - STAFF OFFICERS

All Starfleet personnel aboard a starship are either commissioned officers or enlisted men. Commissioned officers hold their positions of command by the authority of commissions granted them by the President of the United Federation of Planets, and by the Starfleet Chief of Staff.

A rank is a grade or level to which commissioned officers are appointed. An officer of a given rank is subject to all officers of higher ranks, and is superior in rank to any officer of lower rank. When officers have the same rank, then the officer first commissioned in that rank takes precedence. Commissioned ranks run from the Admiralty down to Ensign, followed by the Non-Commissioned Officers.

Staff Officers and the Line of Command:

Staff Officers form a specialized group. Civilians with valuable, highly developed skills in certain areas can be commissioned directly from civilian life. They are then given a rank and rating corresponding to these skills.

Example: Medical

- 1) A skilled M.D. and surgeon might be given the rank of Lieutenant Commander or Commander, and posted to the rating of Chief Medical Officer, in charge of the entire Medical Department.
- 2) A medical specialist (e.g. a Xenohematologist) might be given the rank of Lieutenant, and placed in charge of the Hematology Lab within the ship's sickbay.
- 3) A surgeon whose skill approaches that of the Chief Medical Officer might be given the rank of Lieutenant and posted to the rating of Assistant Medical Officer.

Example: Science

- 1) An accredited scientist, with encyclopedic knowledge of all fields of science as well as his or her own specialty might be given the rank of Lieutenant Commander or Commander, and posted to the rating of Chief Science Officer and placed in charge of the entire Science Department.
- 2) A scientist well versed in his or her own specialty might be given the rank of Lieutenant and placed in charge of the corresponding Science Division

Generally, Staff Officers only command those personnel within their particular department. As such, they are not included in the line of Command. The reason is that usually these staff officer, in being commissioned directly from civilian life, have little or no command training. The courses they were required to take at Starfleet Academy were for the most part aimed at familiarizing them with Starfleet duties and practices. Should they also have taken proper command training at the Academy, a Staff Officer could be posted to a rating within the line of command. As an example of this, we examine the career of Fleet Captain Spock, of Vulcan.

Already a recognized expert in the area of computer science, Spock enrolled in the Academy and took full command training. He was posted aboard the U.S.S. Enterprise as First Lieutenant (command), later Chief Science Officer (non-command), and finally held the dual position of Executive Officer/Science Officer (a command position).



STARFLEET OFFICER REQUIREMENTS

15

COMMISSIONED OFFICERS AND RANKS - ENSIGN

The rank of Ensign within Starfleet is unique due to its brevet (temporary) nature. It is the lowest commissioned rank, and can only be achieved through Academy graduation. What makes it special is that it can be lost without incurring a negative mark on the record of the officer, due to its brevet nature.

Every graduate of Starfleet Academy is commissioned as an Ensign. From this point in time, the clock starts ticking; the test has begun. The rank of Ensign must last no longer than two standard years in duration. During this time, the Ensign's performance in his or her duties is under constant scrutiny. The commanding officer observes this junior officer to see if the traits, aptitudes, and values judged as befitting an officer are exhibited. The Ensign is placed in positions where these qualities are strained to the limits.

At the end of the two year term (or sooner, at the Captain's discretion), the senior officers gather in the briefing room to evaluate this Ensign, as well as any others approaching term. Although the final decision is made by the Captain, information brought forward by the Medical Officer, Executive Officer, and the Ensign's immediate superior officer are invaluable in the final evaluation. If the Captain decides that the Ensign is ready (as is the normal case), the officer is promoted to the rank of Second Lieutenant.

If the Ensign does not meet the Captain's expectations and requirements, there are several options available. The Ensign may choose to reapply to Starfleet Academy in hopes of strengthening any weak areas of expertise. Contrawise, he or she may choose to be decommissioned, and serve as an Enlisted Crewman, probably a Warrant Officer. In this case, the loss of Commission is not seen as a disgrace, but rather as a goal which failed to materialize through the fault of no one. Finally, the Ensign may choose (although no one would suggest this) to resign from Starfleet.

An Ensign may be placed in charge of a shipboard department (such as Navigation). He may not be placed in command of a vessel or shuttlecraft, as he has not yet completed command training, and so is not qualified to run a separate command without supervision. Nevertheless, he may hold the position of Duty Officer. This designates an officer who is head of a watch. It is not considered a separate command, as the other officers on watch may request confirmation by the Captain upon receiving any order they believe is questionable. The Captain (or a senior officer) must be aboard ship in this case.



STARFLEET OFFICER REQUIREMENTS

STARFLEET ACADEMY

Starfleet Academy is located on two campuses: San Francisco, Earth (Sol III), and Starbase One. It offers a wide variety of course programs, each tailored and chosen to suit the aptitudes of the particular enrollee, training to maximize potential in the chosen field, so that upon graduation, the cadet is prepared for a role in Starfleet as a commissioned officer.

The Command Program is the longest and most comprehensive. It can take three to five years to complete, depending upon the electives chosen and the aptitudes and abilities shown by the student as well as any credits transferred from an accredited school in the appropriate areas of study. Depending upon the grades achieved, a graduate will be placed aboard a vessel as an Ensign, a Junior Lieutenant, or a Lieutenant, and posted to a position of authority in a Command area.

The Staff Officer Program is shorter (two to three years) and again can be abridged by appropriate pre-Academy training credits. While they include some Command orientation, the courses are aimed mainly at giving the trainee an overall education in his or her Department, outside the area of specialization.

Terms:

- CADET:** Any student of the Academy, of any rank, whether on campus or in space.
- MIDSHIPMAN:** A Cadet assigned to a vessel for instructional purposes, not assigned any rank.
- TRAINEE:** A Cadet aboard a vessel, with regard to his or her area or designated department of instruction and specialization. For example, all Engineering Cadets are the Chief Engineer's Trainees, all Science Cadets are the Chief Science Officer's Trainees, etc.

Before graduation, a Cadet may be granted a commission. The reasons are as follows:

1. Excellent grades.
2. The Cadet is undergoing command training, and a superior officer wishes to place the Cadet within the line of command, for observation in action. If the Cadet's performance is satisfactory, the "brevet" commission may be retained. Otherwise the Cadet will return to non-commissioned status.
3. Pre-Academy experience within the Cadet's field of endeavor.
4. Pre-Academy space experience.
5. Field commission while a Cadet.
6. The Commodore of the Academy wishes the Cadet also to be an instructor within the Cadet's field of endeavor. An instructor must be an officer. This temporary commission may become permanent upon graduation.



STARFLEET OFFICER REQUIREMENTS

17

STAR BASES

A Star Base is a large, stationary command usually planet situated, which includes orbital drydock facilities, storage and warehouse facilities, starship refueling and fuel depot facilities, communication facilities, etc. There are twenty - eight Star Bases within the 480 parsec diameter spherical volume of space which comprises the United Federation of Planets Treaty Zone. They are exclusively military posts. In setting up these bases, a symmetrical spherical volume network was chosen to more or less represent and cover all of the Treaty Zone. Generally, the stellar system with a Class M planet closest to the coordinates designated was chosen as a site for a base. If no suitable system was within a parsec of the desired coordinates, either a non-Class M world was terra-formed with domes, or an asteroid was towed into place and terra-formed, or else a large space station was constructed on the spot.

Star Bases are usually commanded by a Flag Officer, typically a Commodore.

In addition to these Star Bases, Starfleet maintains a variety of stationary commands throughout the Federation. These are generally single purpose in design and function. They include the Epsilon Monitoring Station Series (along the Federation/Klingon Border), the Romulan Border Asteroids, an assortment of space laboratories, the San Francisco Orbital Drydock facilities, plus many supply posts on various Federation worlds. Commanding Officers of these stations may range from Admiral through Lieutenant Commander.

Several off-planet facilities in Federation Space are civilian, including private learning facilities, the Vulcan Academy of Knowledge, the orbital construction facilities of space craft manufacturers, and research laboratories. These do not have a Starfleet contingency or commander. Rather they are all responsibilities of Starfleet Operations. Starfleet Operations keeps track of ongoing work, position, and maintenance scheduling, enforcing any lapses in Regulations it may find.

Some off-planet facilities are military, but have a resident civilian industry and population as well. These have an on-board Starfleet command and contingency exactly as ordinary military bases. The civilian element is responsible to obey such Regulations as are issued. Such bi-nature facilities include the K Series space stations, and of course, Space Dock.



STARFLEET OFFICER REQUIREMENTS

UNITED FEDERATION OF PLANETS

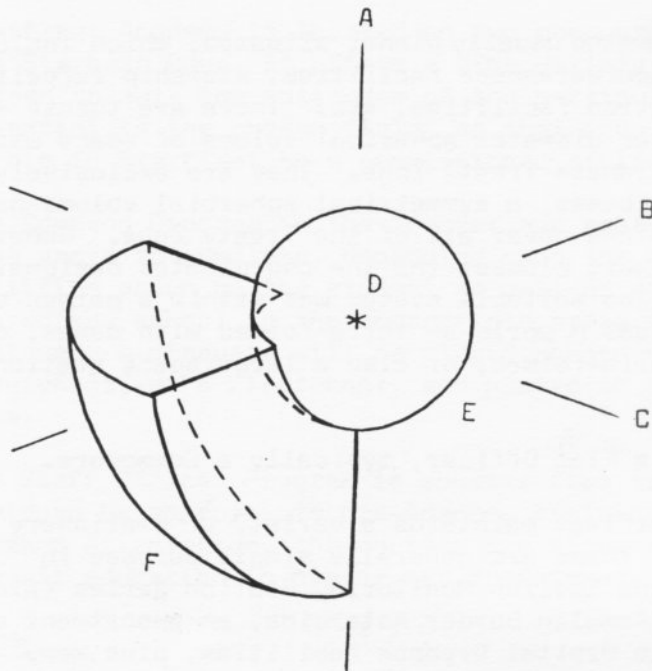

The U.F.P. is a spherical volume of space, with indentations upon its outer surface where it contacts the Klingon and Romulan Empires. It is divided into 9 Quadrants; 1 central sphere and 8 surrounding wedges. The U.F.P. is bisected along the equator by the galactic plane, on which is the X - Y coordinate plane. The Z axis is aligned with galactic north.

From galactic north, Quadrant 1 North is above Quadrant 1 South and so on. The coordinate system is based on a 3 dimensional grid with a single volume equalling 1 cubic parsec.

U.F.P. Diameter	480 parsecs
U.F.P. Volume	57,905,836 cubic parsecs
Stellar Population	5,629,000 (estimated)
Quadrant 0 Diameter	180 parsecs
Quadrant 0 Volume	3,053,628 cubic parsecs
Quadrant 1N Volume	6,856,526 cubic parsecs
Sectors per Quadrant	1,500
Typical Sector Volume	4,571 cubic parsecs

- A) Galactic North
- B) To Galactic Center
- C) Direction of Galactic Spin
- D) U.F.P. Center
- E) Quadrant 0
- F) Quadrant 2 South
- G) Klingon Empire
- H) Romulan Empire

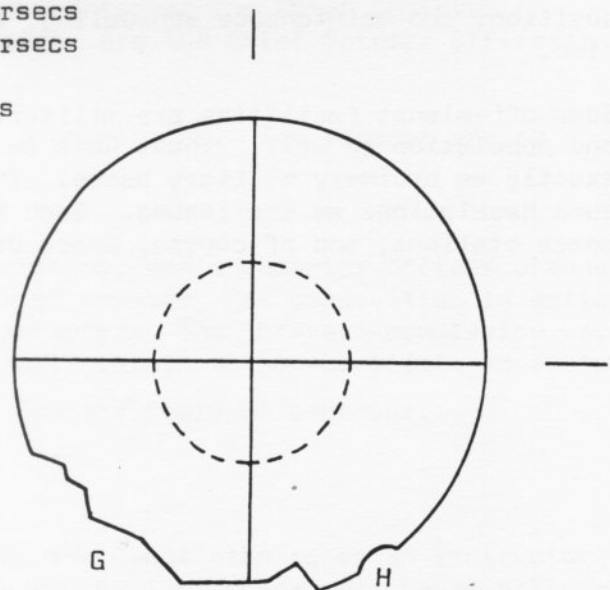



STARFLEET OFFICER REQUIREMENTS

19

YOUR APPEARANCE IN UNIFORM

Your dress and conduct should always reflect credit upon yourself, Starfleet, and the United Federation of Planets. Your uniform should be of high quality. It should be clean and worn properly.

Uniforms provided by Starfleet Quartermasters are regulation. If you buy or have a uniform made elsewhere, you must ensure it is regulation in pattern, appearance, and quality.

You must provide yourself with an adequate supply of correct uniforms. It is up to you to ensure that your uniform is processed by the ship's laundry fabricators. At all times (except when authorized to wear civilian clothes) you must wear the complete uniform prescribed for you.

Starfleet uniform regulations require that men keep faces shaven, except that a short, neat moustache/beard is permitted. No unusual beards or moustaches are permitted. Men must keep their hair neatly and closely trimmed, length not to exceed seven centimeters. Women must keep their hair neatly arranged, with back hair touching but not falling below the collar. Side hair must be trimmed to show a close contour. Cosmetics must be conservative and in good taste.

No articles such as pens, jewellery, combs, or similar items may be worn or carried exposed upon the uniform. Chronometers, identification bracelets, inconspicuous rings, and conservative earrings are permitted. However, no oddities of dress are permitted.

The dress uniform has several options available. For women, one such variation is a skirt. This is a simple, tailored-cut, wrap-around black skirt, available in three lengths: mini, knee-length, and mid-calf. The skirt is worn with black stockings and standard issue boots.

For ceremonial occasions, Pipers may wear full Highland Kit (kilt, sporran, bag pipes, stockings, and shoes) with the Dress Jacket. This is only to be worn when appropriate, and at the Commanding Officer's discretion. When worn thus the kit is part of the uniform, and as such must be maintained and worn with suitable care and decorum.



STARFLEET OFFICER REQUIREMENTS

UNIFORM DETAILS AND VARIATIONS

Dress Jacket

- | | |
|----------------------------------|-------------------------------|
| A) Starfleet Insignia | D) Rank Insignia |
| B) Departmental Stripe and Clasp | E) Sleeve Departmental Stripe |
| C) U.F.P. Symbol | F) Rating Insignia |

Colors: Jacket -- Blood Piping -- Black Pants -- Black

Note: Tunic and Shoulder/Sleeve Stripe vary in color with Department.
Flag Officers have gold-edging on front flap and a Flag
Assignment Stripe on sleeve above Rank.

Duty Jacket

- | | |
|------------------------|-------------------------------|
| A) Starfleet Insignia | D) Rank Insignia |
| B) Departmental Stripe | E) Sleeve Departmental Stripe |
| C) U.F.P. Symbol | F) Rating Insignia |

Colors: Jacket -- Blood Pants -- Black

Note: Gold-edged collar. Gold belt buckle with U.F.P. Symbol.

Jumpsuit

- | |
|------------------------|
| A) Starfleet Insignia |
| B) Departmental Stripe |
| C) Departmental Tabs |

Colors: Jumper -- Blood Upper Body -- Beige

Note: Tunic and Stripe/Tabs vary in color with Department.
Worn by Cadets and Enlisted personnel.

Survival Jacket

- | | |
|----------------------------------|-----------------------|
| A) Starfleet Insignia/Thermostat | D) Rank Insignia |
| B) Departmental Stripe | E) Solar System Patch |
| C) U.F.P. Symbol | F) Rating Insignia |

Colors: Jacket -- Blood Trim -- White

Note: All ranks identical.

Radiation Suit

- | | |
|-------------------------|------------------------------|
| A) Starfleet Insignia | D) Rating Insignia |
| B) Departmental Stripes | E) Control Monitoring Panels |
| C) Rank Insignia | F) Force Field Guide |

Colors: Engineering -- White Damage Control -- Orange

Note: Officers have black collar, Enlisted and Cadets have red.



STARFLEET OFFICER REQUIREMENTS

DRESS JACKET

See: UNIFORM DETAILS AND VARIATIONS

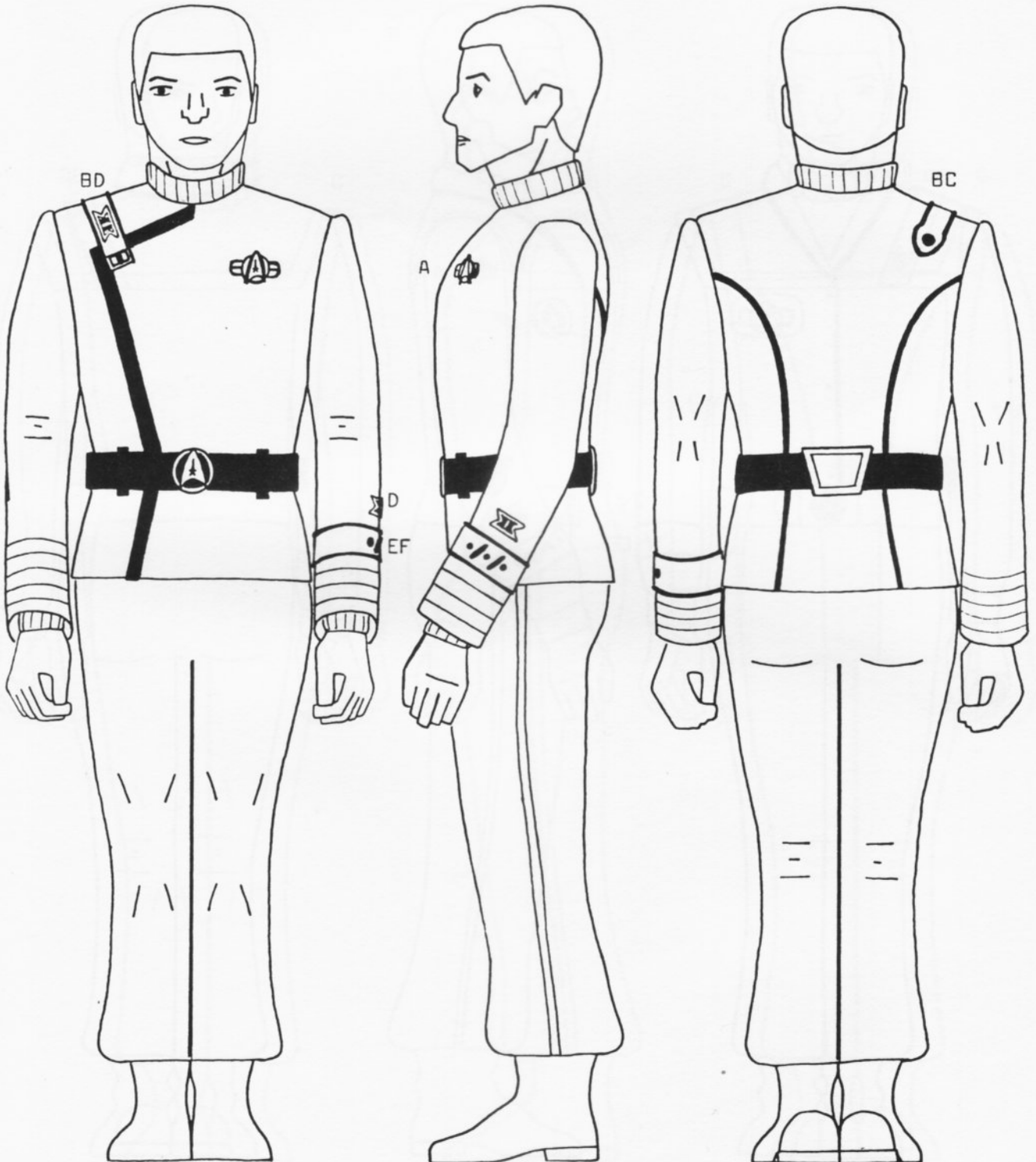



STARFLEET OFFICER REQUIREMENTS

DUTY JACKET

See: UNIFORM DETAILS AND VARIATIONS

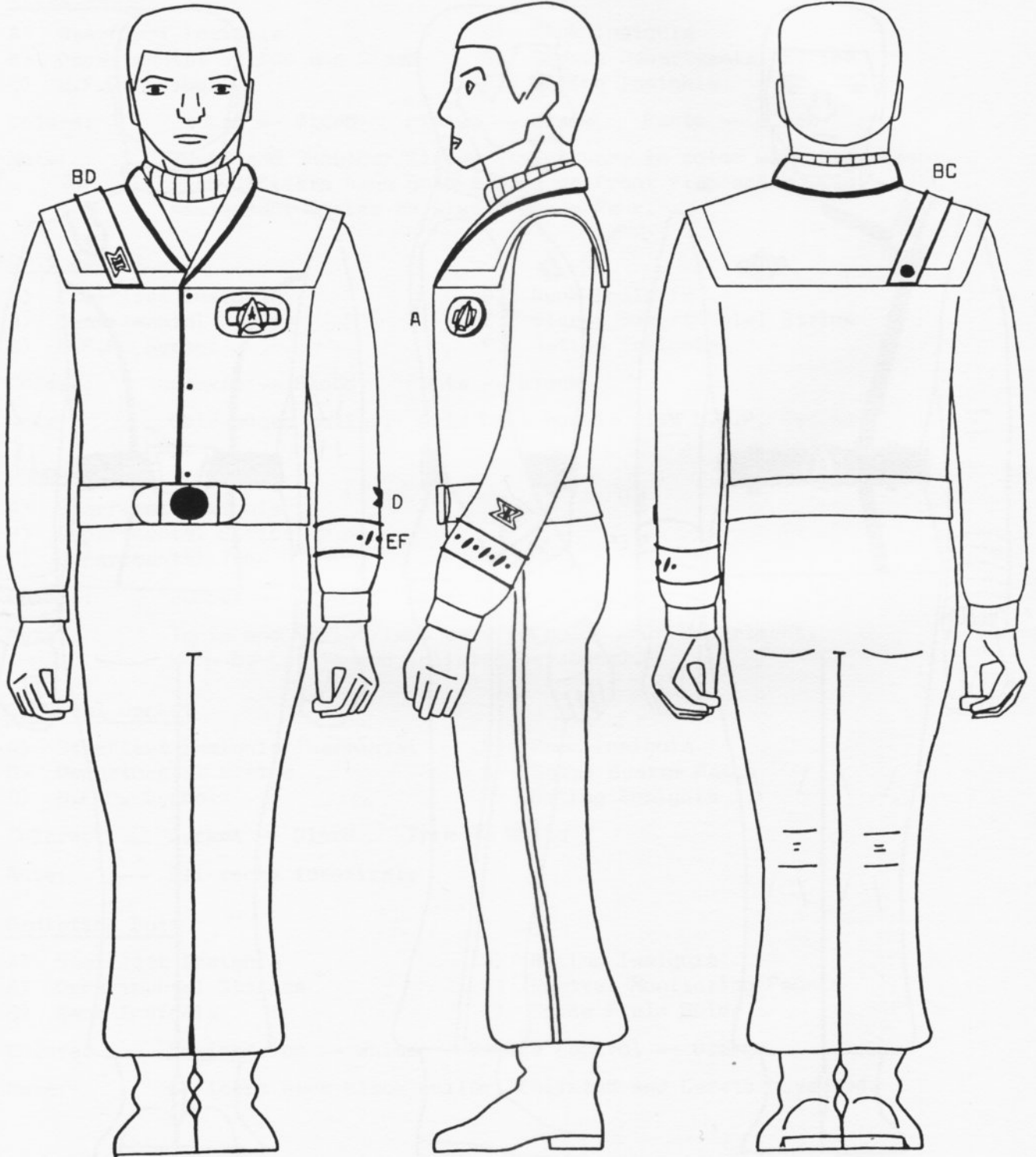



STARFLEET OFFICER REQUIREMENTS

23

JUMPSUIT

See: UNIFORM DETAILS AND VARIATIONS

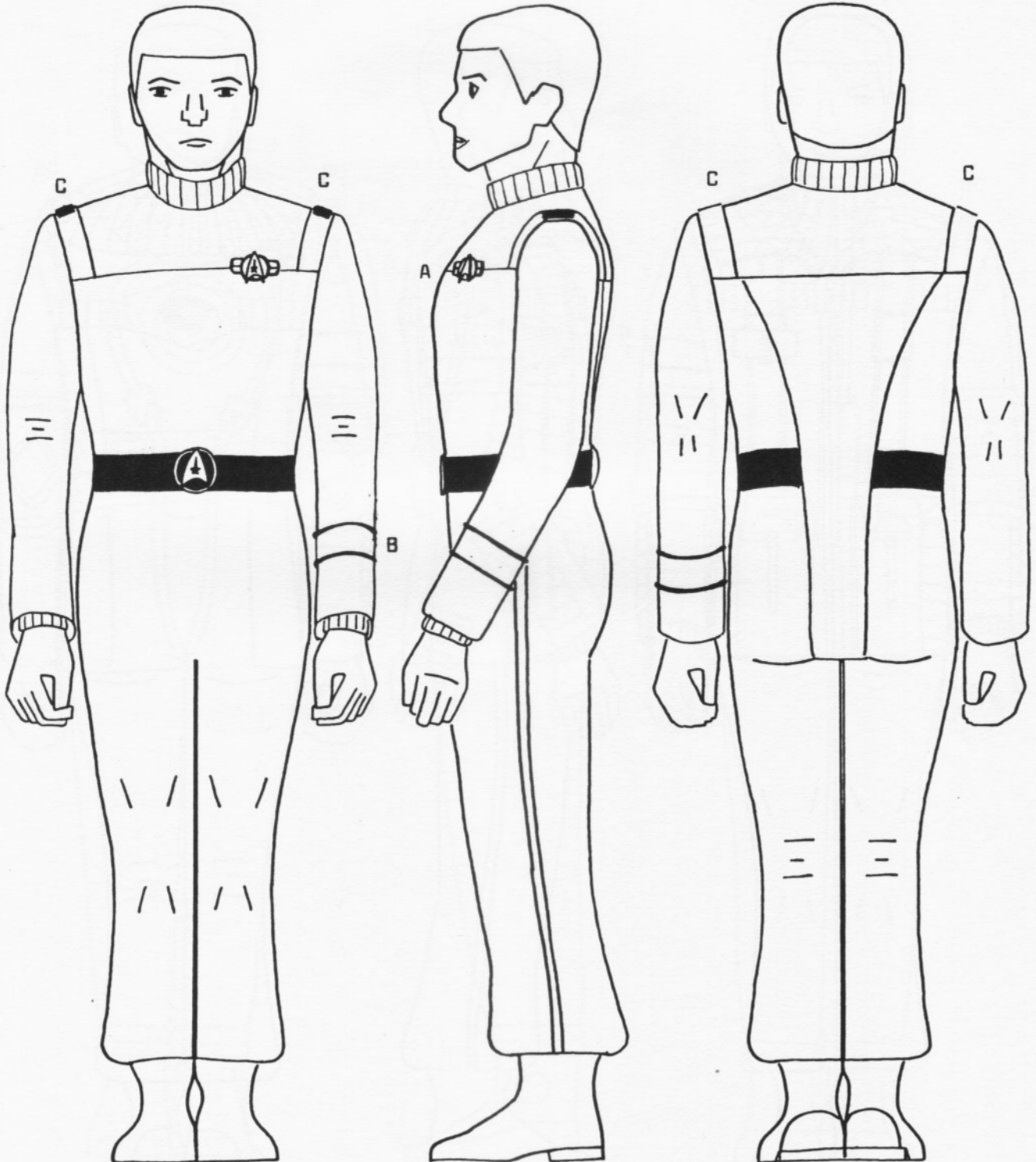



STARFLEET OFFICER REQUIREMENTS

24

SURVIVAL JACKET

See: UNIFORM DETAILS AND VARIATIONS

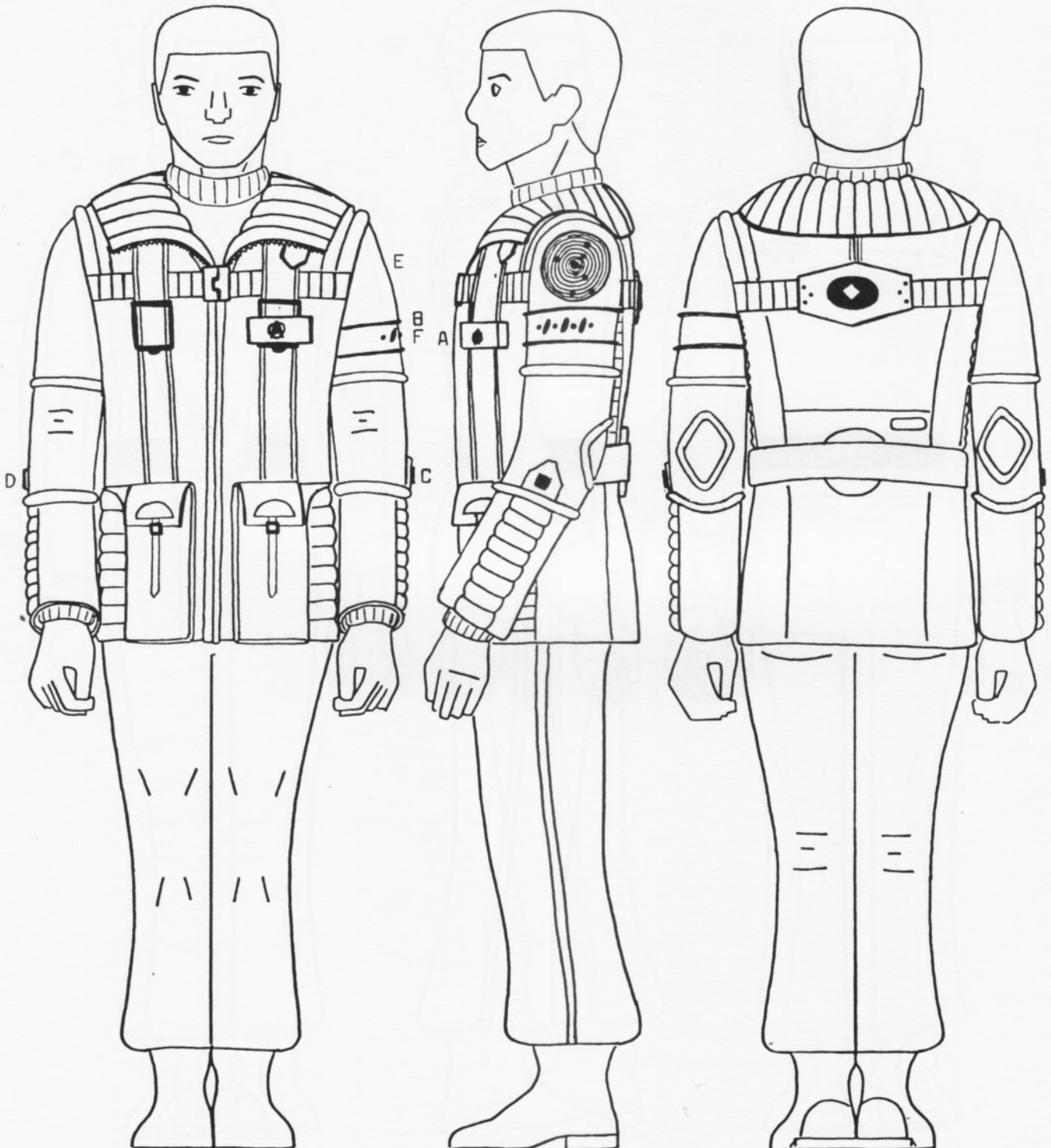



STARFLEET OFFICER REQUIREMENTS

RADIATION SUIT

See: UNIFORM DETAILS AND VARIATIONS

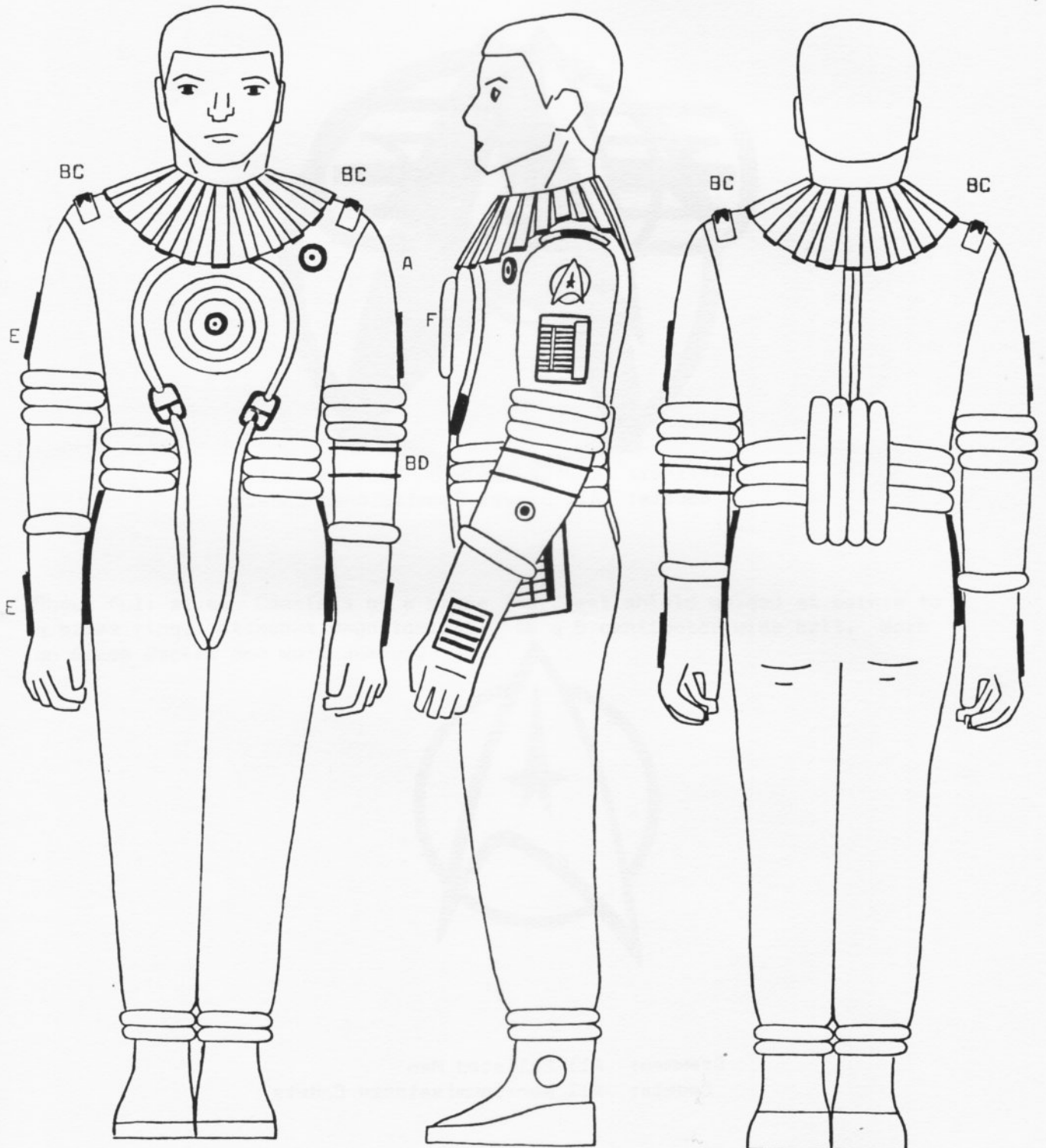



STARFLEET OFFICER REQUIREMENTS

STARFLEET INSIGNIA



Officer: Ensign through Fleet Admiral
Cadets: All Brevet-Commissioned Cadets



Crewmen: All Enlisted Men
Cadets: All Non-Commissioned Cadets



STARFLEET OFFICER REQUIREMENTS

27

DRESS BELT BUCKLE

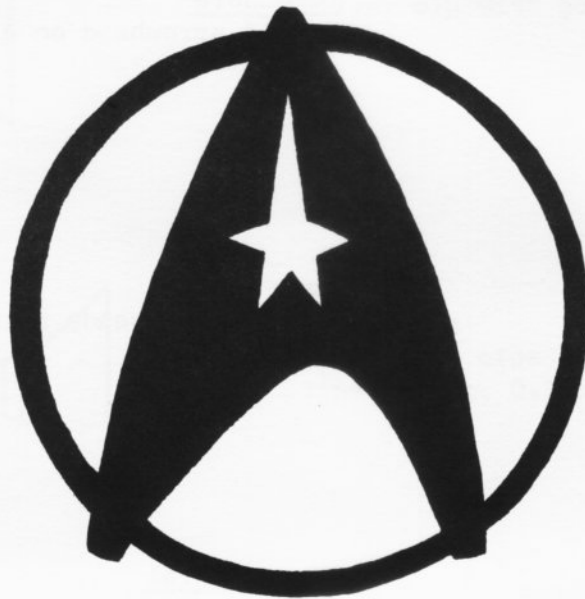

Shown full size. Consists of a brass Starfleet shield welded at points to a brass ring. Attaches magnetically to a 5 centimeter wide belt. Worn on Dress Jacket and Work Jumper.



STARFLEET OFFICER REQUIREMENTS

RANK INSIGNIA FOR FLAG OFFICERS

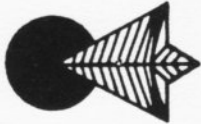

Commodore
1 gold arrowhead on a bronze circle



Rear Admiral
2 gold arrowheads on a bronze rectangle

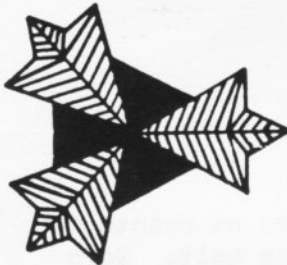

Vice Admiral
3 gold arrowheads on a bronze triangle



Admiral
4 gold arrowheads on a bronze square

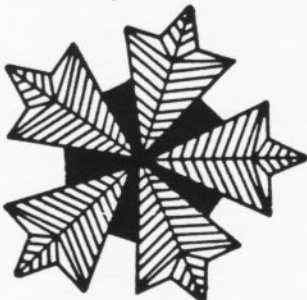

Fleet Admiral
5 gold arrowheads on a gold pentagon



STARFLEET OFFICER REQUIREMENTS

RANK INSIGNIA FOR OFFICERS



Lieutenant Junior Grade
Silver pip with gold tip

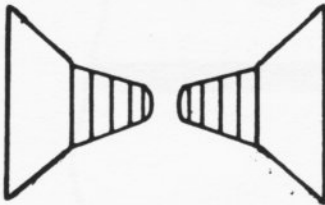

Lieutenant
Two silver pips with gold tip
Tips facing, 0.5 centimeters apart

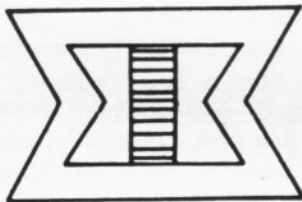

Lieutenant Commander
1 gold bar in silver cage

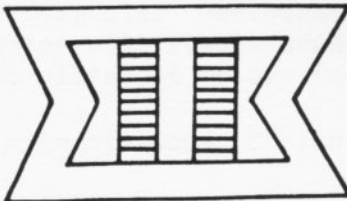

Commander
2 gold bars in silver cage

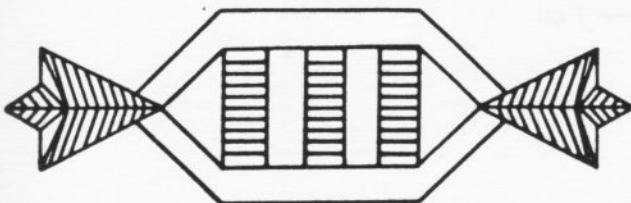

Captain, Fleet Captain
3 gold bars in silver cage
2 gold arrowheads on ends



STARFLEET OFFICER REQUIREMENTS

DEPARTMENTAL STRIPE

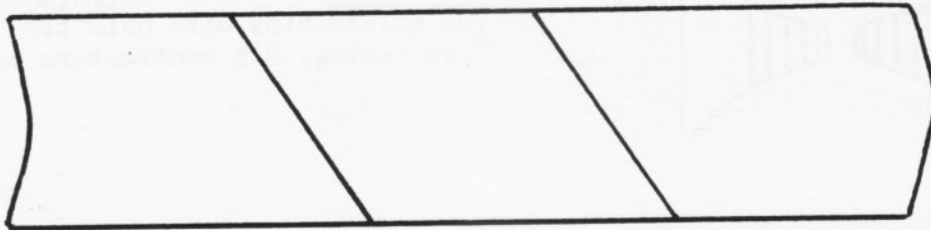
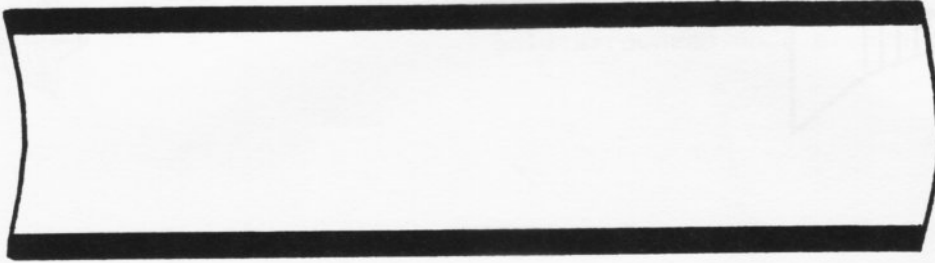

The departmental stripe (along with the uniform shirt) is colored in accordance with an Officer or Enlisted mans' department. Except in the case of Cadets, all stripes are bordered in gold braid. Officers and Cadets have stripes at right shoulder (clasp on front, U.F.P. symbol on back), as well as one on left sleeve - 8 centimeters from cuff. Enlisted men have a stripe only on the shoulder. Cadet sleeve stripes also have a diagonal slash of color on the outboard side, said color representing the department they are training for.

Departmental Colors:	Admiralty/Command	-- White
	Medical	-- Green
	Engineering	-- Gold
	Operations	-- Gold
	Communications	-- Gray
	Sciences	-- Gray
	Special Services	-- Blue
	Security	-- Black
	Trainees/Cadets	-- Red



STARFLEET OFFICER REQUIREMENTS

31

RATING INSIGNIA

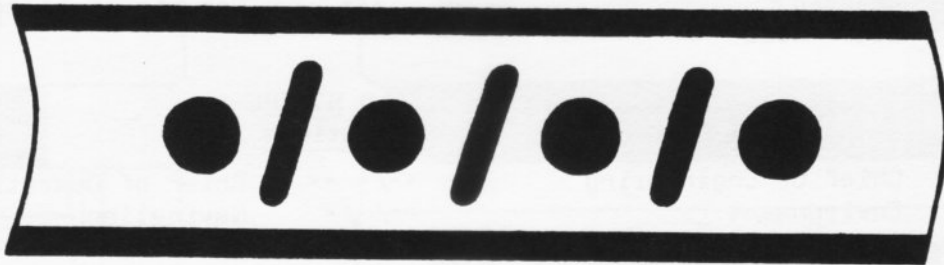

The term rating is defined as an officer's area of specialization within Starfleet. To the educated eye, the rating insignia tells where exactly within a departmental hierarchy an officer is located. Each department has three rating grades, all based on that department's unique pattern. The most complex grade is reserved for the chief of that department. The intermediate grade is reserved for the assistant chief of the department. The simplest grade refers to the division head within the department.

The rating insignia is worn as shown above, on the outboard side of the sleeve departmental stripe. The above is the rating of the Ship's Commander and so it is worn on a white stripe. Occasionally, similarities in rating insignia may arise (example: Assistant Chief Medical Officer and Chief Navigator). No confusion will result because the departmental stripes of these two ratings are of two different colors (green versus gold).

Only a Commissioned Officer may head a division, and thus wear a rating.



STARFLEET OFFICER REQUIREMENTS

RATINGS

WHITE STRIPE

Admiralty

/.//.//.//.//.//.//.//
 .//.//.//.//.//.//.//
 /.//.//.//
 .//.//.
 /.//
 Head of Armed Forces
 Commander Chiefs of Staff
 Chief of Staff
 Adjutant General
 Staff Aide

WHITE STRIPE

Command

.//.//.//.
 /.//.
 .//.
 .//.
 Ship's Commander
 Executive Officer
 Coxswain (Shuttlecraft)
 Boswain (Enlisted Men)

GOLD STRIPE

Engineering

..//.
 .//.
 //
 //
 //
 //
 //
 //
 Chief of Engineering
 Environment
 Drive Technology
 Damage Control & Airlock
 Shipfitting
 Transporter
 Power Technology

GOLD STRIPE

Operations

..//.
 .//.
 /.//.
 /.//.
 /.//.
 Chief of Operations
 Navigation
 Helm
 Finance
 Legal
 Yeoman

GRAY STRIPE

Sciences

..//.
 .//.
 ///
 ///
 ///
 ///
 ///
 ///
 Chief of Sciences
 Computer
 Anthropology & Archeology
 Biology
 Botany
 Chemistry
 Geology
 Physics

GRAY STRIPE

Communications

.//.
 .//.
 ..
 ..
 ..
 Chief of Communications
 Cryptography
 Computers
 Electronics
 Electrical

BLACK STRIPE

Security

/.../
 ...
 .
 Chief of Security
 Tactics
 Armorer

BLACK STRIPE

Special Services

.//.
 .//.
 .//.
 .//.
 Quartermaster
 Commisary
 Maintenance & Janitorial
 Miscellaneous

GREEN STRIPE

Medical

/.//.//.
 ..//.
 .//.
 .//.
 .//.
 .//.
 .//.
 .//.
 Chief Physician & Surgeon
 Xenomedicine
 Psychiatry
 Dental
 Pharmacy
 Nursing
 Pathology

It should be noted that the Assistant Department Chiefs are also Division Heads.



STARFLEET OFFICER REQUIREMENTS

TRICORDER - TYPE I C

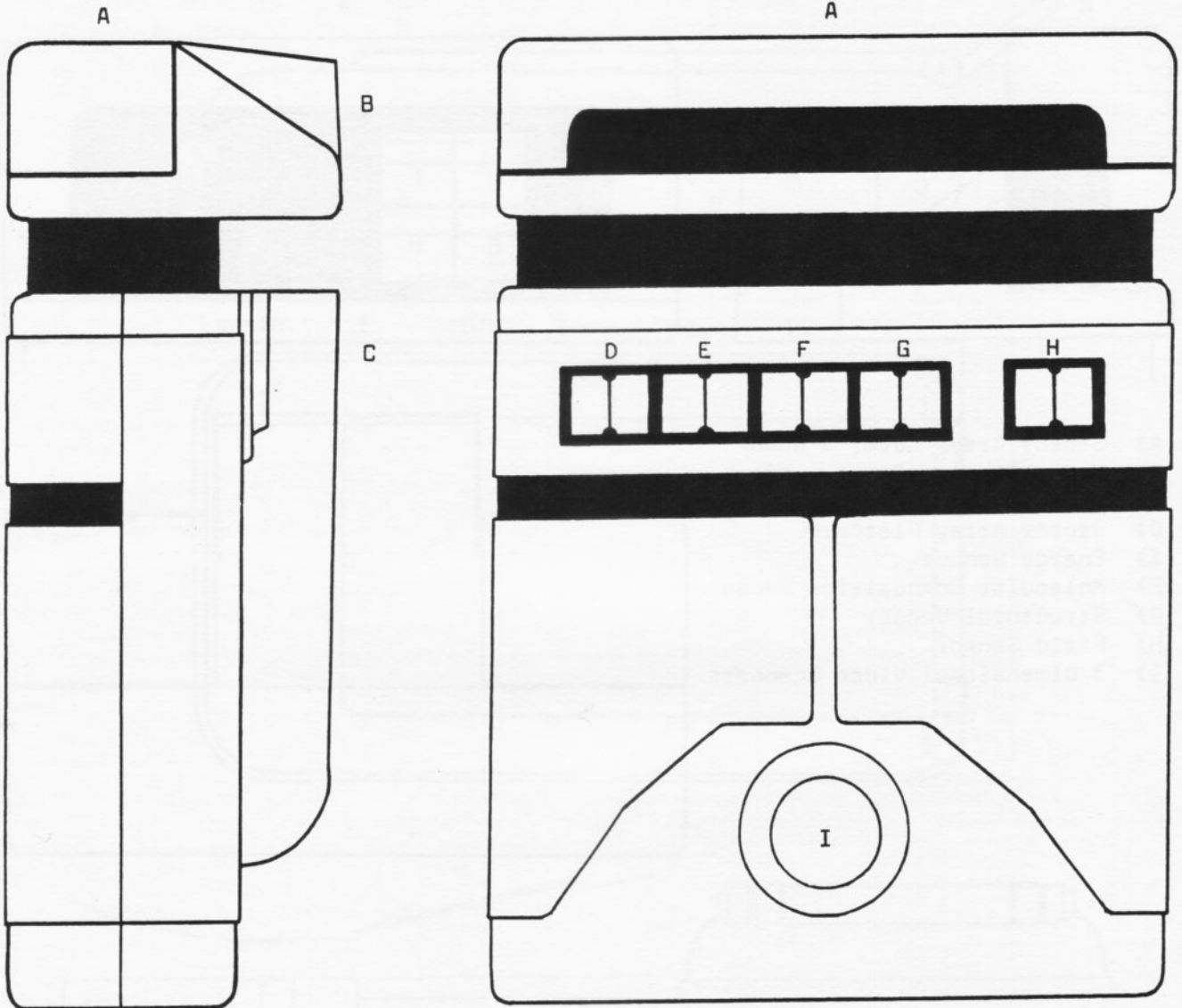

Dimensions in millimeters:

Height	(open)	161
	(closed)	142
Width		100
Depth	(open)	65
	(closed)	50

- A) Sensor Array Cover - closed
- B) Video Display Cover - closed
- C) Disc Storage
- D) Sensor Selector
- E) Channel Selector
- F) Disc Selector
- G) Record/Play Selector
- H) On/Off
- I) Speaker



STARFLEET OFFICER REQUIREMENTS

TRICORDER - TYPE I C

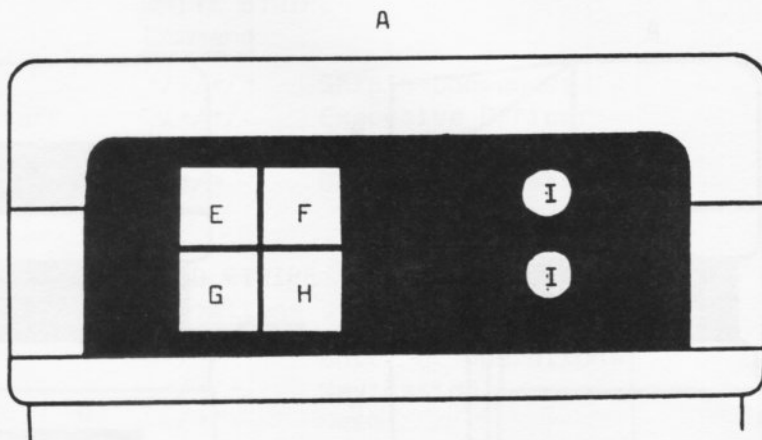
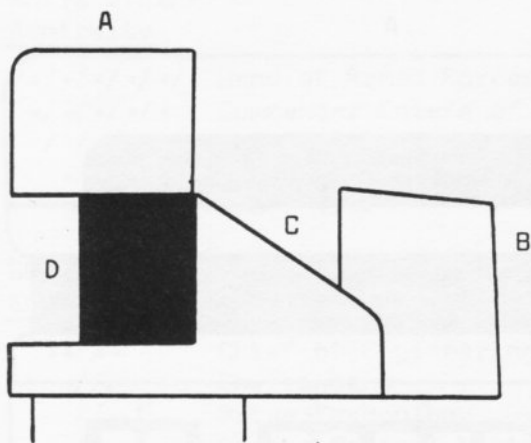

- A) Sensor Array Cover - open
- B) Video Display Cover - open
- C) Video Display Plate
- D) Sensor Array Platform
- E) Energy Sensor
- F) Molecular Composition Sensor
- G) Structural Sensor
- H) Field Sensor
- I) 3 Dimensional Video Scanners

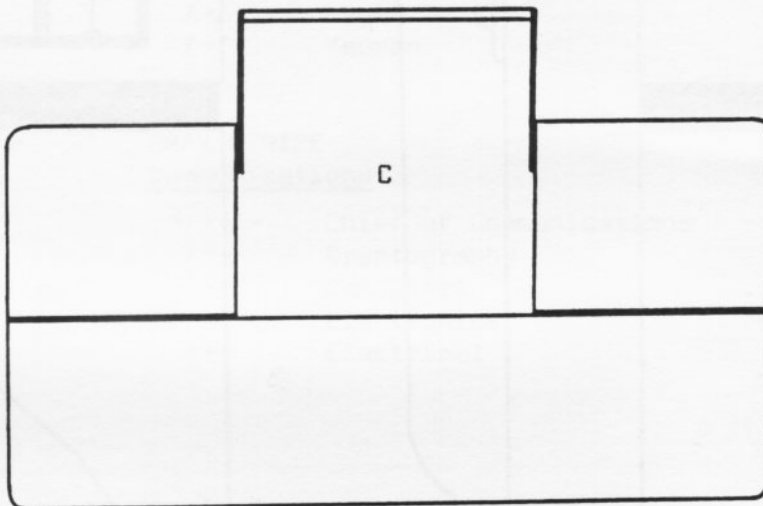

The improved Tricorder is at once smaller and more sensitive than the Type I A. Activation opens the Sensor Array and Video Display Covers. A medical version of the Tricorder is available.



STARFLEET OFFICER REQUIREMENTS

35

COMMUNICATOR - TYPE II

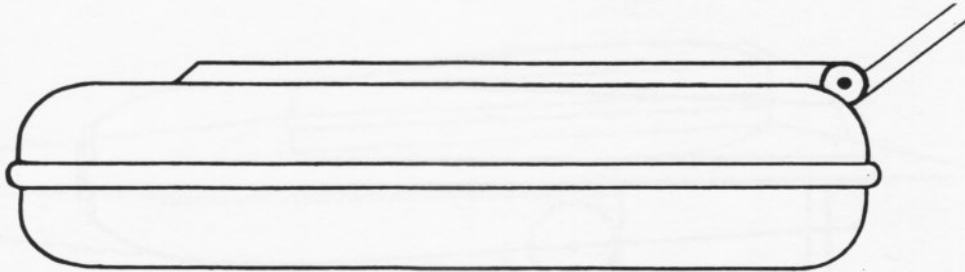

Dimensions in millimeters:

Length 115 Width 65 Height 27

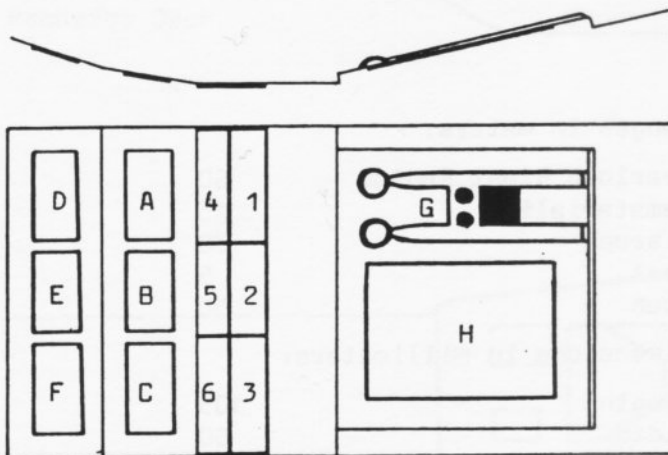
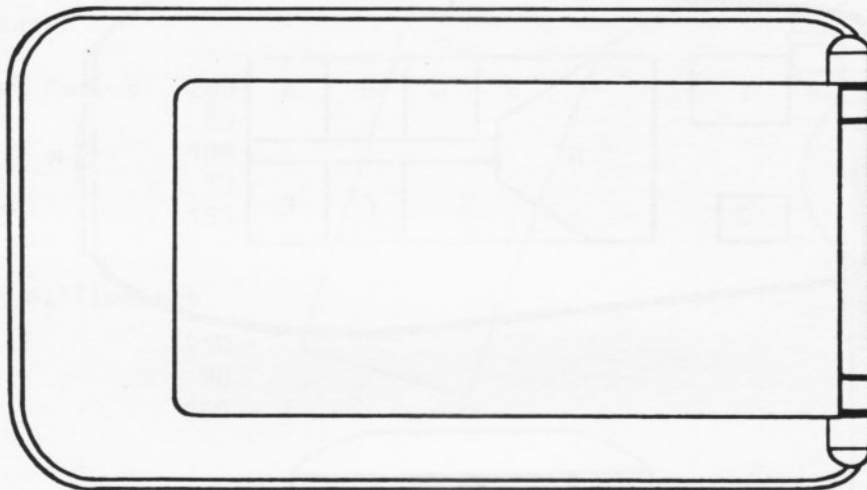

Internal

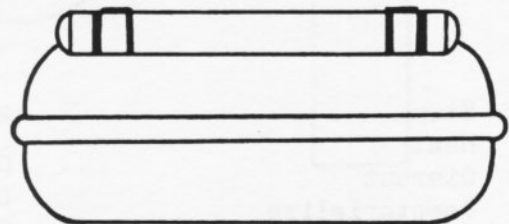

- 1-6) Channels and Status
- A) Gain - Transmit
- B) Gain - Receive
- C) Alert Signal
- D) Scramble
- E) Beacon
- F) Channel Select
- G) Microphone Assembly
- H) Speaker



STARFLEET OFFICER REQUIREMENTS

36

HAND PHASER - TYPE I C

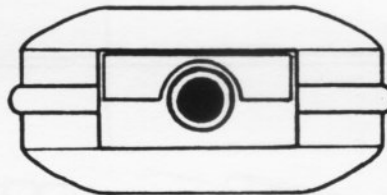
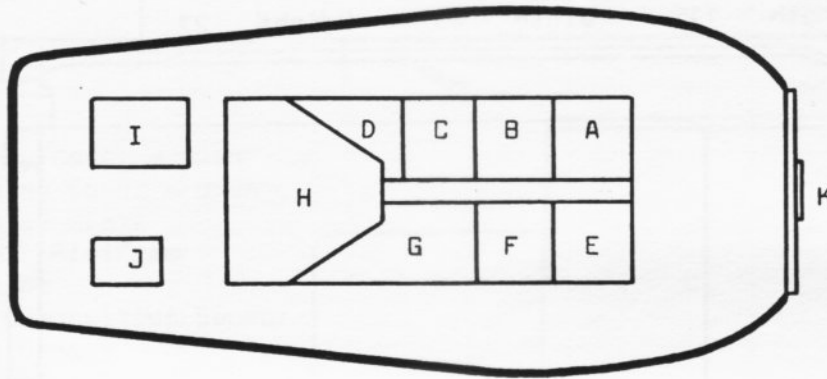
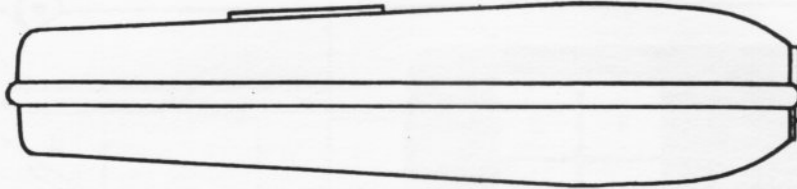

- A) Stun
- B) Heat
- C) Disrupt
- D) Dematerialize
- E) Narrow Beam
- F) Wide Beam
- G) Power Level
- H) Trigger
- I) Arm
- J) Lock Release
- K) Nozzle

Ranges in meters:

Overload Blast Radius	60
Dematerialize	15
Disrupt	30
Heat	5
Stun	50

Dimensions in millimeters:

Length	105
Width	50
Height	25



STARFLEET OFFICER REQUIREMENTS

37

HAND PHASER - TYPE II C

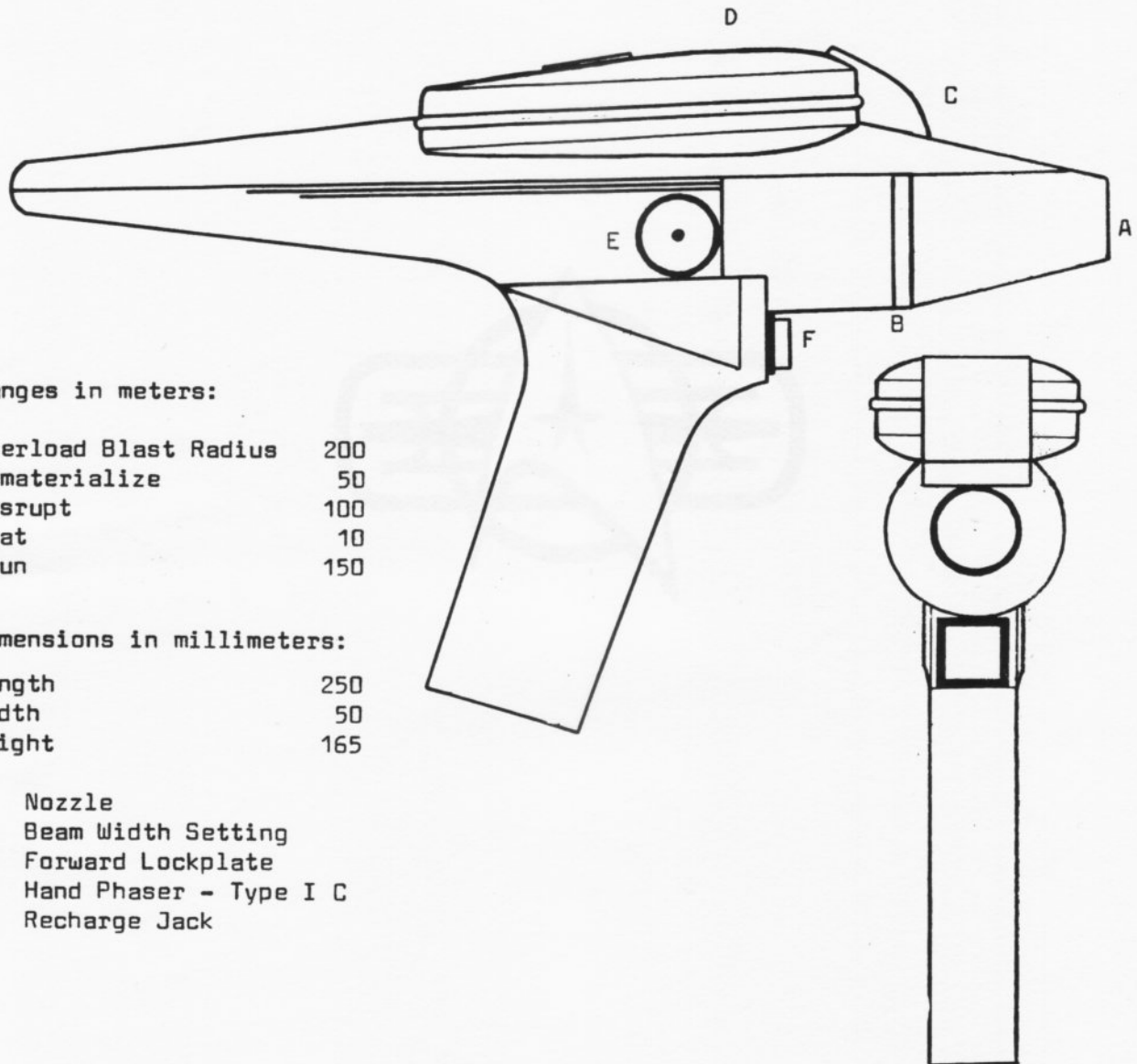

Ranges in meters:

Overload Blast Radius	200
Dematerialize	50
Disrupt	100
Heat	10
Stun	150

Dimensions in millimeters:

Length	250
Width	50
Height	165

- A) Nozzle
- B) Beam Width Setting
- C) Forward Lockplate
- D) Hand Phaser - Type I C
- E) Recharge Jack

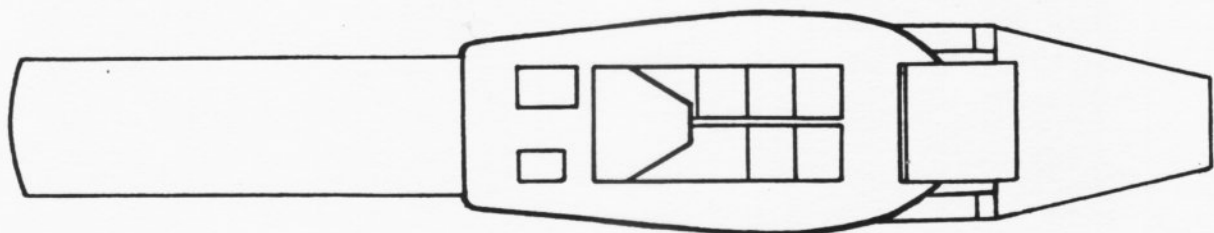

All control surfaces except Beam Width on Type I C



\$9.95



STARFLEET

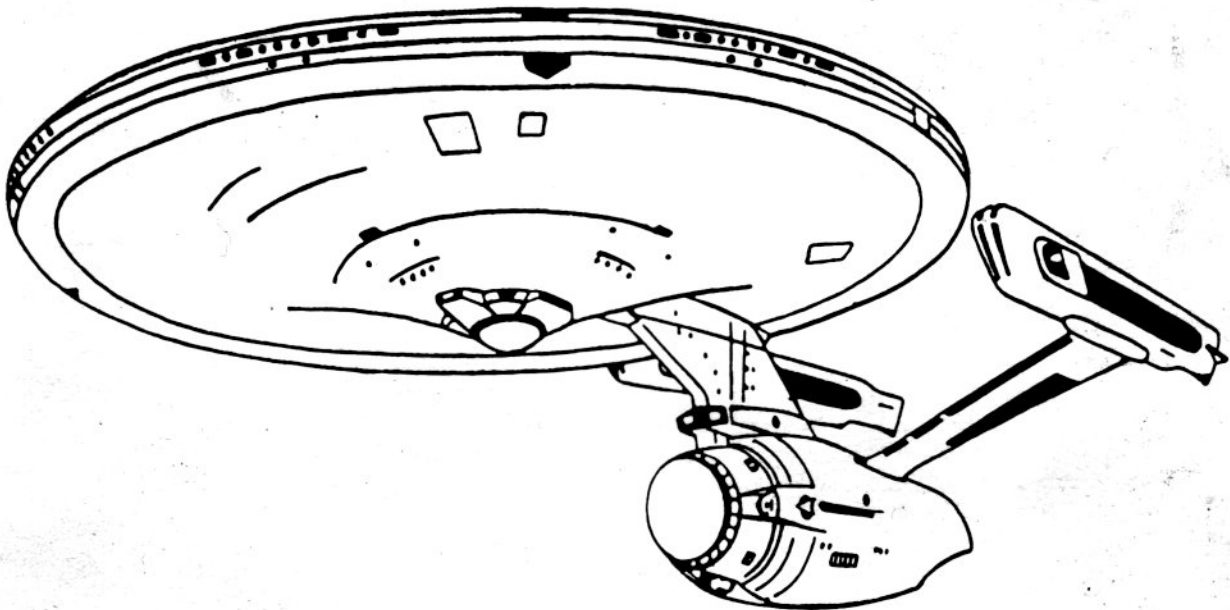

UNIFORM DETAILS AND VARIATIONS
SECURITY DEPARTMENT ORGANIZATION & DEPLOYMENT
PATROL DUTY
SENTRY DUTY
CLASSIFIED INFORMATION & MATERIALS
RESTRICTED, CONTROLLED & SEALED AREAS
AIMS & RESPONSIBILITIES OF STARFLEET
DREADNOUGHT-MK-XXI-B-ASCENSION CLASS
CRUISER-MK-XX-B-BELKNAP CLASS
FRIGATE-MK-XXII-B-KNOX CLASS
HEAVY DESTROYER-MK-XVIII-B-WARLORD CLASS
PHASER AND MEGAPHASER BANKS

OFFICER REQUIREMENTS VOL. 2



STARFLEET OFFICER REQUIREMENTS

Authenticated: Stardate 8601.01

Project Head: Commander David J. Schmidt - U.S.S. Kestral

Collaborator: Captain Robert E. Day - Starfleet R & D

Assistant: Chief Petty Officer Janet P. Reeves

Authorized: Admiral Elizabeth A. Rose - Starfleet Command

With Thanks To: The Officers and Crew of the U.S.S. Kestral

U.S.S. Saratoga

U.S.S. Belknap

This text is intended as a three-fold instructional aid:

- 1) As a textbook for Starfleet Academy for cadets undergoing studies in the Command Department of Starfleet, as a supplement to the Starfleet Technical Manual.
- 2) As a hands-on aid for officers wishing to become familiarized with the changes both technical and in uniform which have occurred in the last nine standard years.
- 3) As a guide to junior officers wishing to become further instructed in other Departments and Divisions in Starfleet.

Receipt and possession of this text automatically carries with it the responsibility of safe-guarding its contents from eyes and scanners of civilians and enemies of the Federation. Destruction of this text is indicated upon threat of impending capture.

Copyright © 1986 by David John Schmidt. All rights reserved. No part of this book may be reproduced in any form without the expressed permission in writing from the author.



STARFLEET OFFICER REQUIREMENTS

TABLE OF CONTENTS

<u>Subject</u>	<u>Page</u>
Flag of the United Federation of Planets	1
The Aims & Responsibilities of Starfleet	3
Dreadnought - MK-XXI-B - Ascension Class	5
Cruiser - MK-XX-B - Belknap Class	6
Frigate - MK-MK-XII-B - Knox Class	7
Heavy Destroyer - MK-XVIII-B - Warlord Class	8
Auxillary Craft & Characteristics	9
Phaser and Megaphaser Banks	11
Defense Fields	12
Sensors	13
Military Decorum	16
Discipline	17
Uniform Details and Variations	19
Security Armor	20
Security Duty Uniform	21
Abandoning Ship	23
Abandoning Ship - Scenarios 1 & 2	24
Life Boat Station Location	26
Life Boat	27
Life Boat Survival Package	28
Electronic Clipboard - Data Coordinating Unit	31
Electronic Clipboard	32
Intercom	33
Communicator - Type III	34
Security Department Organization & Deployment	35
Condition Status	36
Duty Classification	37
Patrol Duty	39
Sentry Duty	40
Communication	41
Classified Information & Materials	42
Restricted, Controlled, & Sealed Areas	43
Marksmanship Training	47
Firing Position	49
Security Special & Standing Orders	50

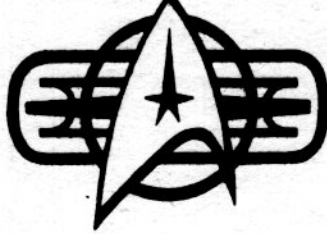

STARFLEET OFFICER REQUIREMENTS

FLAG OF THE UNITED FEDERATION OF PLANETS

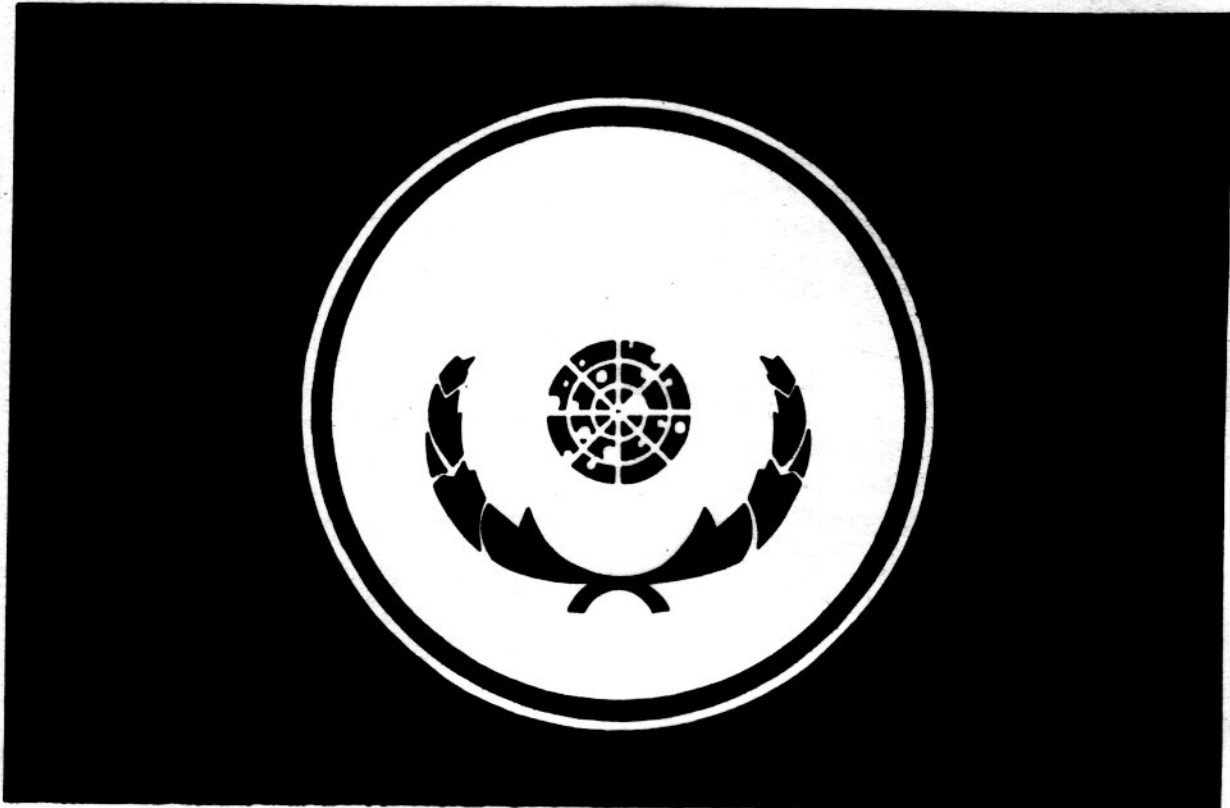

The Flag of the United Federation of Planets has changed several times during the 150 year history of the Federation. The present design was agreed upon in 2277 by a special committee of the Federation Council. Similarities between it and the Flag of the United Nations of Earth are intentional, since humans comprise 47% of the intelligent life-forms within Federation boundaries.

The flag consists of a flat representation of the Federation Treaty Zone, surrounded by a white circular field, superimposed upon a blue field. The laurel wreath represents the peaceful goals of the Federation. The white circular field represents its lofty ideals, unchanged since its founding in 2127. The enveloping blue field represents the infinite vastness of the universe.

Dimensions:	Starfleet Standard - Width	1.5 meters
	Height	1.0 meters
	Diplomatic Standard - Width	2.0 meters
		1.0 meters

Colors: White Sky-Blue

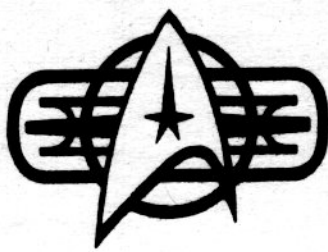

STARFLEET OFFICER REQUIREMENTS

3

THE AIMS & RESPONSIBILITIES OF STARFLEET

Upon the creation of Starfleet in 2183, it was charged with several duties and responsibilities. These act as guidelines for the entire Service, and for individual ships on extended patrol missions. Every Officer aboard a Starfleet vessel has a duty to know these responsibilities, to understand them fully, and to be ready to enforce them.

1) To protect the Peace of the Federation.

Starfleet is charged with protecting the peace of the Federation against enemies both domestic and foreign. In order to most effectively carry out this duty, Starfleet maintains a large fleet of armed vessels, and has established patrols along the territorial boundaries of enemies. Patrols within the spherical volume of the United Federation of Planets Treaty Zone insure internal peace.

2) To Provide Aid and Assistance to Members of the Federation

Such aid and assistance may entail the delivery of a diplomatic mission to a distant star system, or it may consist of acting as a courier for an immensely important cargo. Such requests are made by the Federation Council, or by a Planetary Government, to the Starfleet Commander.

3) To Serve as a Gatherer of Knowledge

Starfleet vessels - especially the Class I-B Starships - are equipped with an extensive array of sensing equipment and scientific laboratory facilities. When not actively involved in a military mission, a starship on patrol is always expanding the frontiers of knowledge for the United Federation of Planets. This information, unless deemed to be of a nature vital to Federation security, is handed over to the scientific community on a regular basis.

4) To Regulate Shipping Within the Federation Treaty Zone

Any interstellar commercial or private vessel falls under the responsibility of Starfleet. Each of these vessels must be documented - must have registers, enrollments, and licenses. These documents state and authorize the vessel holding them to engage in specific forms of commerce or activity (interstellar trade, passenger liner, prospecting ship, pleasure yacht) and within a certain prescribed routing zone. Yachts are solely for pleasure and may not engage in trade. One of the documents is a manifest - which states the amount and precise nature of all cargo aboard. Some goods and materials are proscribed and forbidden within the Federation Treaty Zone. Any materials not listed on the manifest are considered Contraband - goods being smuggled. Starfleet vessels have the right to scan any vessel they encounter and to demand a transmitted copy of the ship's manifest. If the two do not match, or if the starship Captain is suspicious, he may demand that the vessel in question come to a stop and prepare to be boarded for a physical search. As well, starships enforce the Rules of Space Navigation among all interstellar vessels. Any ship found to be breaking these Regulations will be seized by the starship Captain. He will place the vessel's master under arrest and either tow the offending vessel to the nearest port, or else assign an Officer from the starship to take charge of the vessel and bring it to the nearest port under its own power.



STARFLEET OFFICER REQUIREMENTS

5

DREADNOUGHT - MK-XXI-B - ASCENSION CLASS

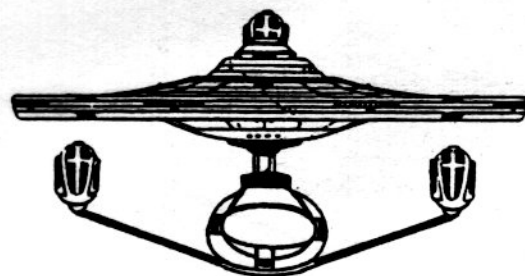
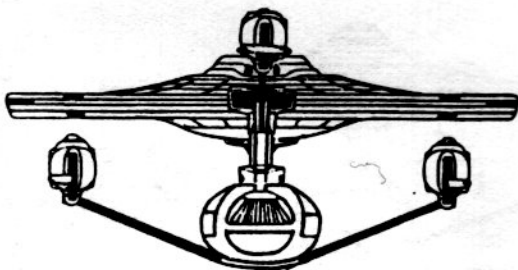
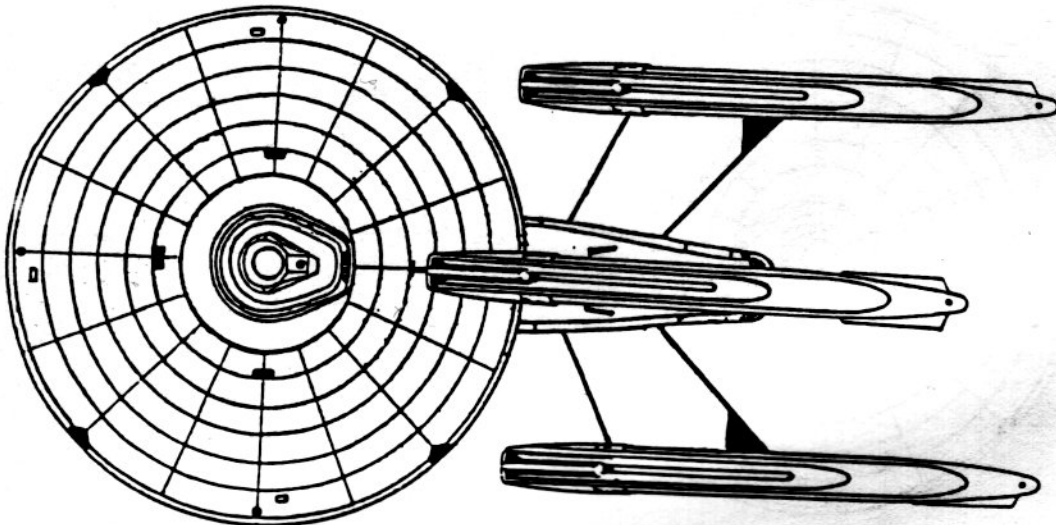
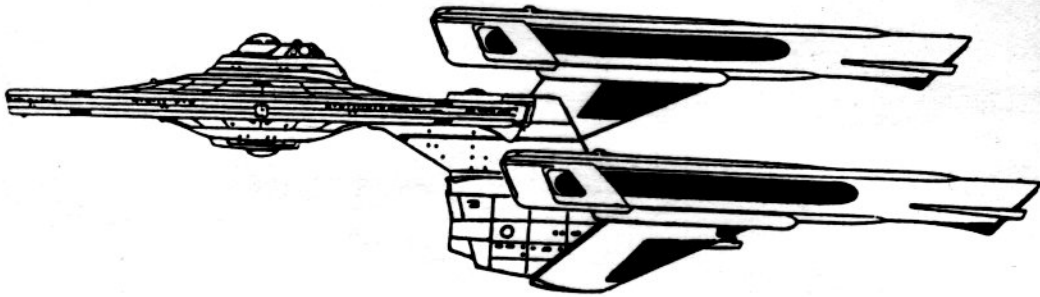

Complement

Deadweight Tonnage
Standard Range
Maximum Velocity
Overall Length
Overall Draft
Overall Beam
Ordnance

Officers -- 80
Enlisted -- 450
245,000 metric tonnes
15 years at C
Warp 13
298.8 meters
77.8 meters
141.7 meters
Phasers -- 14 (7 banks)
Photons -- 2 tubes (30 torpedoes)

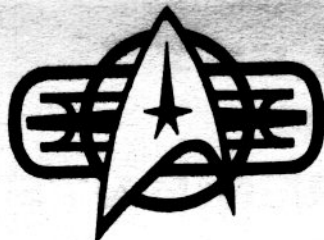

STARFLEET OFFICER REQUIREMENTS

CRUISER - MK-XX-B - BELKNAP CLASS

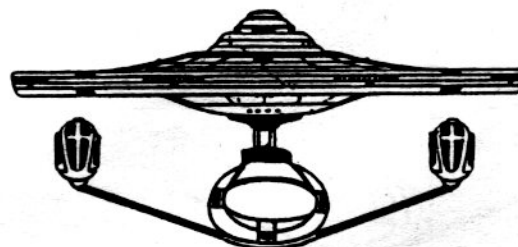
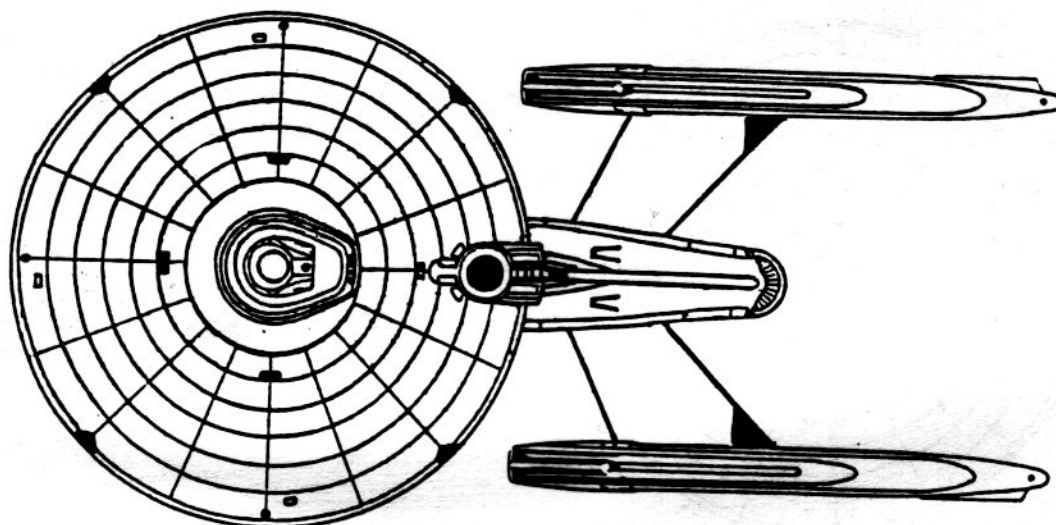
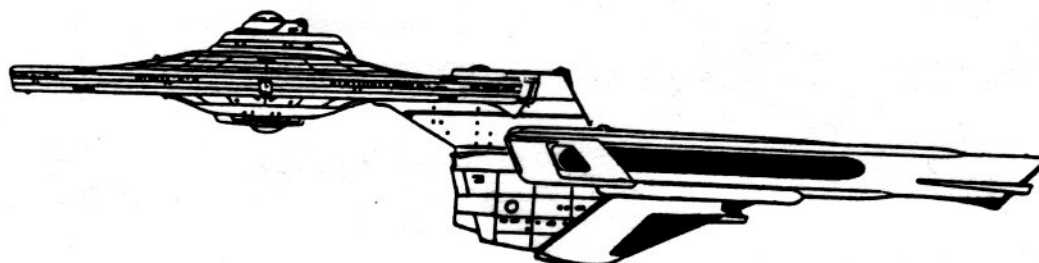

Complement

Deadweight Tonnage
Standard Range
Maximum Velocity
Overall Length
Overall Draft
Overall Beam
Ordnance

Officers -- 68
Enlisted -- 400
187,000 metric tonnes
18 years at C
Warp 12
290 meters
67.5 meters
141.7 meters
Phasers -- 15 (8 banks)
Photons -- 2 tubes (20 torpedoes)



STARFLEET OFFICER REQUIREMENTS

7

FRIGATE - MK-XII-B - KNOX CLASS

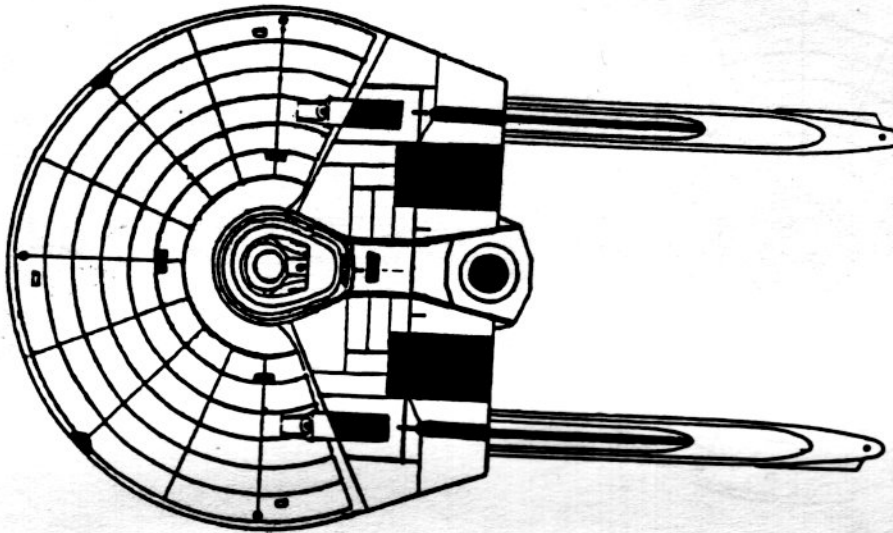
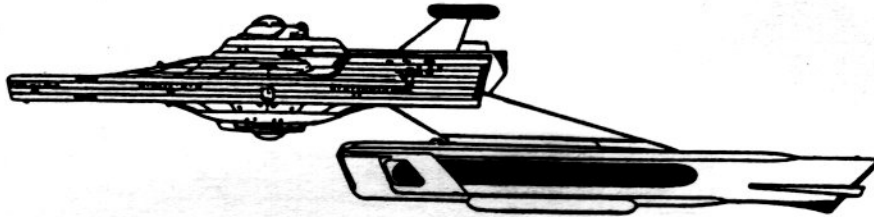

Complement

Deadweight Tonnage
Standard Range
Maximum Velocity
Overall Length
Overall Draft
Overall Beam
Ordnance

Officers -- 53
Enlisted -- 317
140,000 metric tonnes
15 years at C
Warp 12
243.3 meters
52.8 meters
141.7 meters
Phasers -- 12 (6 banks) 2 megaphasers

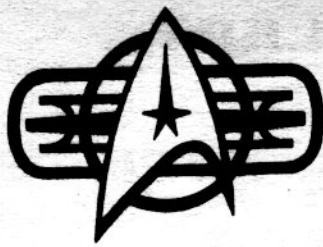

STARFLEET OFFICER REQUIREMENTS

HEAVY DESTROYER - MK-XVIII-B - WARLORD CLASS

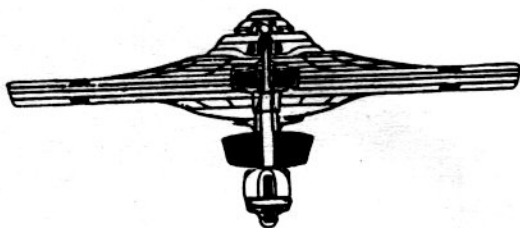
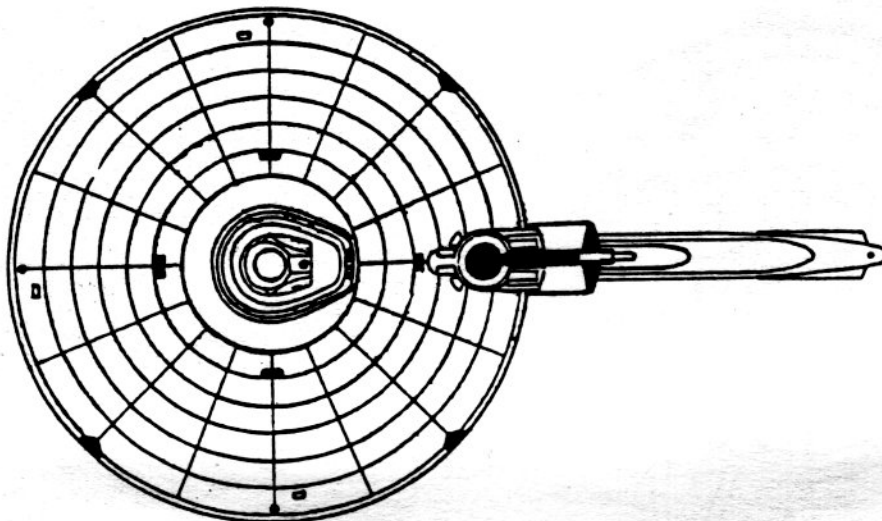
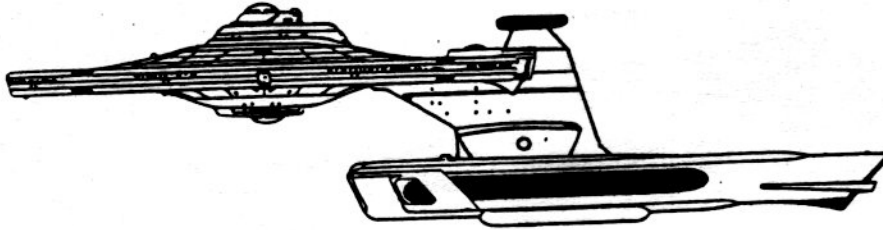

Complement

Deadweight Tonnage
Standard Range
Maximum Velocity
Overall Length
Overall Draft
Overall Beam
Ordnance

Officers -- 40
Enlisted -- 285
110,000 metric tonnes
9 years at C.
Warp 11
200 meters
60.9 meters
141.7 meters
Phasers -- 12 (6 banks) 2 megaphasers
Photons -- 4 tubes (40 torpedoes)

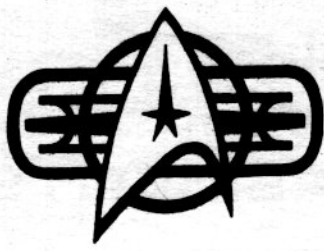

STARFLEET OFFICER REQUIREMENTS

9

AUXILLARY CRAFT & CHARACTERISTICS

Class I Starships utilize three basic types of auxillary craft. The number of each depends on the size of the vessel and its hanger facilities. These auxillary craft consist of Shuttlecraft, Travel Pods, and Workbees. Each is a highly specialized machine, intended for a particular function. All have some features in common, and some features in exclusive to themselves. All auxillary craft are landing capable on Class M planets, and such complement the vessel's transporters. All auxillary craft - and the Hanger Bay - are the responsibility of the Shuttlecraft Officer. He is responsible as well for their upkeep, and the proper training, coordinating, and deployment of their pilots. All auxillary pilots are Petty Officers. As well, the senior Suttlecraft pilot is a Chief Petty Officer.

Shuttlecraft - SW-7

The Shuttlecraft carried on Class I Starships with hanger facilities is the largest of auxillary craft, dwarfing the Class F Standard Shuttlecraft of twenty years ago. It is used principlly for planetary landings and has an interplanetary travel capability due to its onboard Micro-Impulse Drive. Unlike its predecessor, it features an optional-detachable Warp Sled - giving it F.T.L. capabilities of up to Warp 2. This Warp Sled is only carried aboard the MK-XI-B and MK-XII-B, as only their enormous Hanger Bays can accomodate it.

Crew	1 - 2
Complement	8
Tonnage	800 metric tonnes
Length	13 meters
Draft	4 meters
Beam	11 meters
Ordnance	Phasers -- 2
Propulsion	Primary -- Micro-Impulse Drive Secondary -- Particle Beam Thrusters

Travel Pod - S-10

The Travel Pod is carried on all Class I Starships. Not possessing an onboard Impulse Drive, it is used primarily as a shuttle between nearby ships, or to an orbital facility. The range is small, but outstrips that of a transporter - allowing diplomatic missions to be landed without risking the ship by bringing it into close orbit around a hostile planet.

Crew	1
Complement	4 - 5
Tonnage	4 metric tonnes
Length	4 meters
Draft	3 meters
Beam	3 meters
Propulsion	Primary -- Particle Beam Thrusters

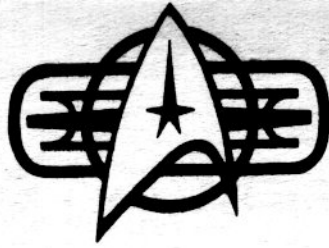

STARFLEET OFFICER REQUIREMENTS

Workbee - S-2

The Workbee is by far the most versatile of auxiliary craft. Basically a stripped down, one-man spaceship, it has an extremely limited range. Its protean versatility is derived from the large variety of adapters and sub-units which can be linked to it, transforming it into many specialized ships. These include: Cargo Train (carrying 8 cargo pods), Construction Drone (equipped with external waldoes), Killer-Bee (equipped with a Micro-Impulse and phaser weapon sled), and of paramount importance, Life Boat Tender (towing a Life Boat). When attached to the upper pole of an E.L.S.E.-4 Life Boat, the oversized thrusters are capable of lowering sixty personnel from orbit to a safe landing on a Class M world, gaining the additional power required by tapping into the Life Boat's Powerplant.

Crew	1
Tonnage	2 metric tonnes
Length	2.7 meters
Draft	1.2 meters
Beam	1.3 meters
Propulsion	Primary -- Particle Beam Thrusters

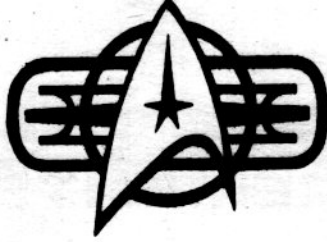

STARFLEET OFFICER REQUIREMENTS

11

PHASER AND MEGAPHASER BANKS

Phasers

Phasers are the primary offensive ordnance on all Starfleet vessels. Class I Starships feature the TT990X Phaser Bank Weapons System. Each Phaser Bank consists of two Phaser Units, each composed of an Energy Chamber and Emission Nozzle. These Nozzles are mounted on power-driven universal bearing swivels, half-exposed outside the hull, and each capable of swiveling through a 120° field-of-aim. The two units are slaved and synchronized together, and the swivel drive motors are remotely controlled by the Fire-Control Computer, which inputs aiming and tracking telemetry from the ship's sensors and Weapon's Console.

Megaphasers

Megaphasers are considered to be the penultimate refinement of phaser technology. Power yield is so great that it rivals that of Photon Torpedoes with regards to range and target damage. The TU555X has been mounted in pairs on the MK-XI-B and MK-XII-B, and singly on the MK-XVIII-B. It is significant to note that, due to the enormous fire-power inherent in the Megaphaser, Starfleet felt it unnecessary to equip the MK-XII-B with Photon Torpedo Tubes.

The Megaphaser consists of a spherical Energy Chamber linked to four Emission Nozzles - any of which can be selected by the Fire-Control Computer. This allows a 180° field-of-aim. The power demands of a Megaphaser Bank are so great that an Energy Conduit (See: MAIN ENGINE COMPONENTS & SUBSYSTEMS) equal in size and capacity to those feeding the Warp Drive Nacelles feeds each Megaphaser Bank directly from the Intermix Shaft. Because of the immense energies involved, the potential for destruction in the case of an Energy Chamber overload is enormous. For this reason, the Megaphaser is always mounted at the end of a pylon, and is attached by explosive bolts, for ease of emergency jettison.

	Phaser	Megaphaser
Range	250,000 kilometers	1,000,000 kilometers
Yield (Maximum)	7×10^{10} Joules	1.6×10^{10} Joules
Settings	STUN: Low Power Neural Frequency Bombardment HEAT: Microwave Frequency Heat Inducement KILL: High Power Neural Frequency Bombardment DISRUPT: Elimination of Inter-molecular Bonds	

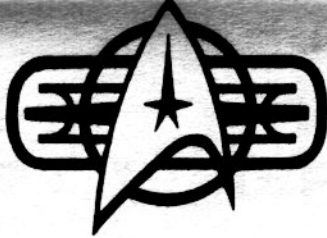

STARFLEET OFFICER REQUIREMENTS

DEFENSE FIELDS

The defensive ordnance on a Class I-8 Starship consists of a three-fold series. These are comprised of the Force-fields, the Deflector Screens, and the Cloaking Device.

Force-fields (Shields)

The function of the Force-fields is to prevent attacking matter (heavy atomic particle radiation, explosive shock-waves) and energy (phaser beams, disruptor beams, solar flux and radiation) from contact with the ship's hull. The Defensive Force-fields envelop the entire external surface of the ship's hull, at a distance from the hull of 5 - 7 Angstroms. Because it is so close to the hull, it is also referred to as the "Skin-field". The Force-field is a magneto-gravitronic effect, and has a very steep (almost vertical) gravitational "slope" - the outer periphery of the effect extends only .5 centimeters from the hull. Due to this steepness, the Force-field is a DOD (Do-Or-Die) System. If the Force-field is attacked by so much energy/matter that it cannot successfully reflect the attack, the feedback backlash will damage and destroy the generator - buckling and then dropping the Shield. For this reason each section of the ship is protected by a separate generator, so that the buckling of one Shield will not drop all of the ship's Shields.

Deflector Screens

The Deflector Screens act as a first line of defense for the Force-fields. The Deflector Screens envelop the external surface of the ship's hull, starting at 5 meters and extending to 15 meters from the hull. Another magneto-gravitronic effect, the Screens have a very shallow gravitational "slope". The Force-fields act as a wall, trying to "reflect" attacking energy - and breaking if it does not. The Deflector Screens act as a cushion, trying to dampen attacking energy/matter, so that its subsequent attack on the Force-fields is lessened in degree. Because of this, the Deflector Screens are not DOD. Anything exceeding their capacity "threshold" goes on to be stopped by the Force-fields without crashing the Deflector Screen generators.

Cloaking Device

The Starfleet Cloaking Device is based on intelligence gathered from the Romulan Empire. The Device functions as an optional, additional effect of the Deflector Screens. When activated, the Device causes the Screens to "shunt" any electromagnetic and tachyonic energy around the ship, and then allows it to proceed at the other side of the ship in its original direction. The result is that a Cloaked vessel does not occlude energy, but rather allows the energies it would otherwise block to move around it. Thus a Cloaked ship is rendered "invisible" insofar as visual sensors are concerned.

The Device itself is mounted near the center of the ship. Being extremely demanding in energy usage, it is fed by a special Energy Conduit leading from the Linear Intermix Shaft. Developments in Sensor technology can frequently detect the energy surge created by an operating Cloaking Device. This limits its tactical effectiveness in combat. However, the Device is of great use in the secret surveillance of technological societies protected by the Prime Directive.



STARFLEET OFFICER REQUIREMENTS

13

SENSORS

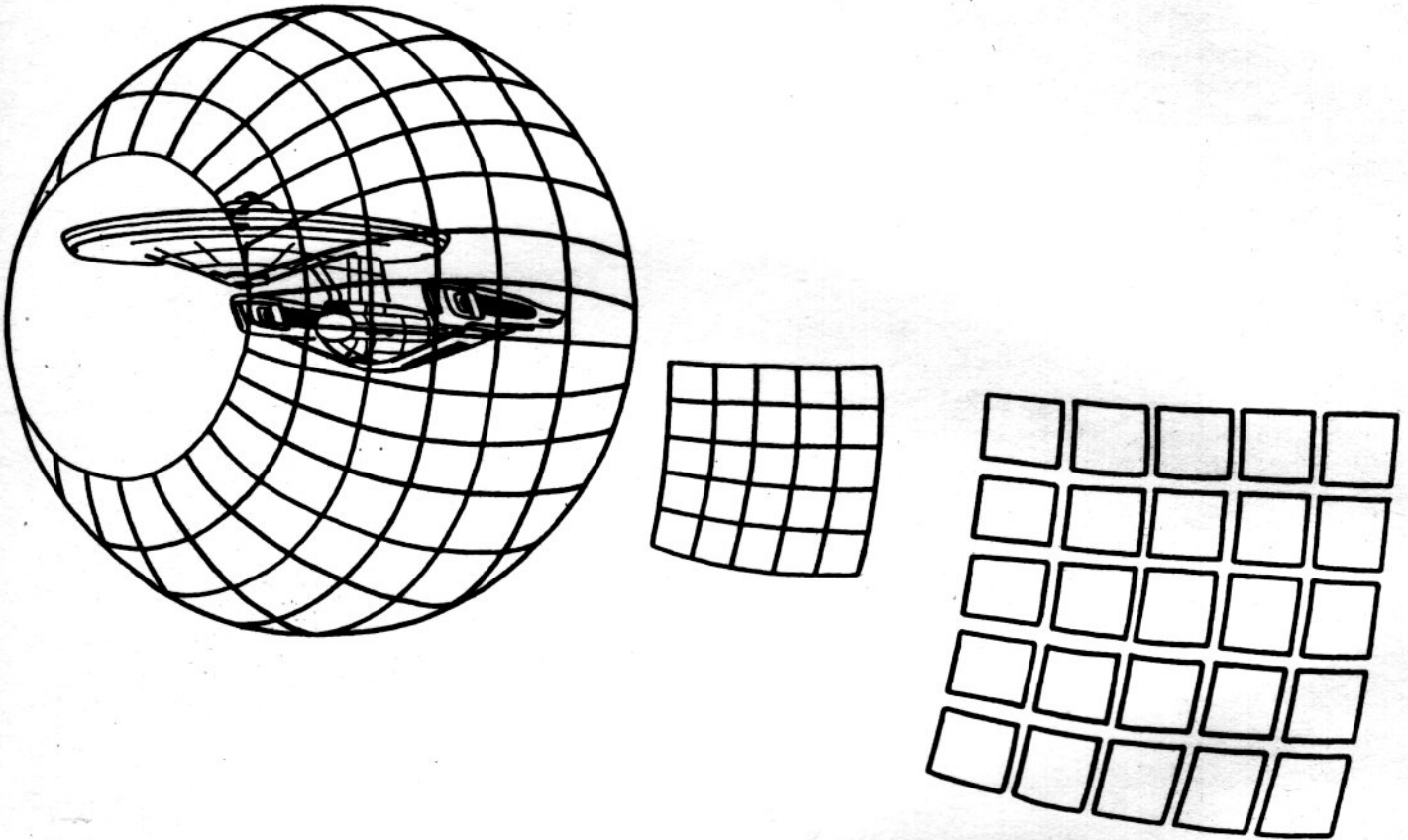

The term Sensor denotes any device which collects data. Operating on the frontiers of the Federation, it is imperative that Class I Starships have the best and latest of Sensors, with which to accurately analyse their surroundings.

Sensors are usually mounted in banks, with the Sensors for a particular function together. There are three types of Sensor banks on a Class I Starship; Engineering, Navigation, and Science.

Engineering Sensors are of two types. The Space/Energy Sensors are generally mounted on the Main or Secondary Hull (the MK-IX-B, MK-XX-B, and MK-XXI-B have three Space/Energy Sensors each, mounted on the Secondary Hull, To port, starboard, and below the Navigational Deflector Dish). The Inlet Flow Sensors are built into the front of the Warp Drive Nacelle.

Navigational Sensor banks are located in two domes, located at the upper and lower poles of the Primary Hull. It should be noted that each dome actually holds two banks, one set for slower-than-light speeds, and one set for faster-than light operations.



STARFLEET OFFICER REQUIREMENTS

15

The Science Sensors are located in a bank located at the lower pole of the Primary Hull, just above the Navigational Sensor Dome. This bank is divided into four bays, and includes launch facilities for Sensor Probes. Unlike the Engineering and Navigational Sensors, the Science Sensors are quite flexible in usage and optimum range. Short-Range Sensors denote those operating in the electromagnetic range, which propagate at lightspeed. Long-Range Sensors denote those operating in the tachyonic range, which propagate at speeds ranging from lightspeed to infinite.

Sensors: Engineering - Forward Direction
- Space/Energy Sensors
- Inlet Flow Sensors

Navigation - Omnidirectional
(Short Range)

- Wide Spectrum Visual
- Photic Sonar (Radar)

(Long Range)

- Tachyonic Visual
- Tachyonic Echo (F.T.L. Radar)
- Space/Energy Matrix Distortion
- Gravitational Strain Sensor

Science - Mono/Omnidirectional
(Short Range)

- Visual Telescope
- Neutrino Emission Detector
- Magnetic Resonance
- Laser Spectroscopy
- Photic Sonar
- Geiger Counter (Cascade)
- Dyno Scanner (Chemical Reaction Detector)
- Full Spectrum Field Sensor
(Magnetic, Gravitic, Kirlian)

(Long Range)

- Space/Energy Matrix Distortion
- Tachyonic Echo
- Gravitic Penetration Echo
- Tachyonic Visual

Note: Many of the Short Range Science Sensors are paralleled in the Type I C Tricorder.

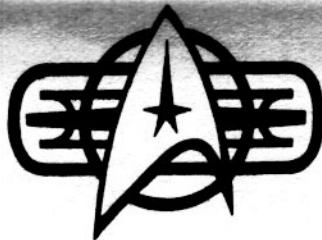

STARFLEET OFFICER REQUIREMENTS

MILITARY DECORUM

As an officer in Starfleet, you will serve among other officers and over enlisted men. Some officers will be your superiors, some your equals, and some your subordinates. Likewise, all enlisted men aboard ship will be your subordinates. There are different forms and ways of interacting with these, depending on your relative seniority. However, something in common with interacting with all of them is courtesy. Treating your fellow Starfleet crewmen with the proper respect and appropriate obedience is as essential and necessary a part of being an officer as is the giving and receiving of orders.

Addressing Officers

As an officer, you are an equal among other officers. However, some formalities pertain. When addressing or greeting a superior officer, address him either by rank or by rank and last name (eg: "Captain" or "Captain Smith"). When addressing a fellow officer of equal rank, you may address them by rank, rank and last name, or if you have his permission, by his first name (eg: "Lieutenant", "Lieutenant Jones", or "Phil"). When addressing a subordinate officer, you may address him by rank, rank and last name, the title "mister", the title "mister" plus last name, or if you have his permission, by his last name (eg: "Ensign", "Ensign Roberts", "Mister", "Mister Roberts", or "Bob"). Regardless of whether or not you use the last name (except in the friendly address) you must include some form of title, such as rank or "mister" in order to signify your equality as officers.

Addressing Enlisted Men

As an officer, you may use the following forms of address when speaking to an enlisted man. For a non-rated enlisted man, refer to him by last name (eg: "Williams"). If addressing a Petty Officer, you may refer to him by his rating and last name (eg: "Engineer Wright"). When addressing a Chief Petty Officer, you may refer to him by the title "chief", or the title "chief" plus last name (eg: "Chief", or "Chief Brown").

Answering Officers

If a superior officer gives you an order, the correct response is "Aye, aye, sir". A superior may reply "Very well", or "Very good". but not you. Saying "Aye, aye, sir" means three things:

- I heard the order.
- I understood the order.
- I will carry it out to the best of my ability.

To a question requiring a more verbose response, you will make a respectful answer, and follow it with "sir". Similarly, an enlisted man will reply "Aye, aye, sir" to you. If he is given an order from his Chief Petty Officer, he will reply "Aye, aye, Chief".

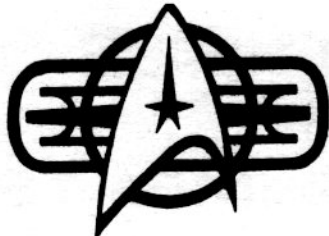

STARFLEET OFFICER REQUIREMENTS

17

DISCIPLINE

The term "Discipline" is often used to mean punishment. But the real meaning of discipline can best be described by the words "proper attitude". A well disciplined crew have the right attitudes. They are willing to follow orders because they believe in what they are doing, they respect their leaders, and feel they are being treated fairly in return. They behave in a military manner, and take pride in Starfleet, their ship, their department, and their uniform. They are ready to fight bravely to protect their world, and the United Federation of Planets.

When discipline fails - that is, when some personnel do not have the proper attitude - then punishment may be deemed necessary for those who fail to observe the rules and regulations.

Discipline is more than simply obeying the Starfleet Code of Military Justice. It refers to virtually any act of an officer or crewman while on duty or in uniform. It especially refers to the interaction of personnel of all grades in the day-to-day functioning of ship's routine. Like all military posts everywhere and anywhen, discipline is a living extension of Starfleet traditions into daily life. Respect for your fellow shipmates, for your fellow officers, for the enlisted personnel below you, and especially respect for your Commanding Officer are the essentials for a well-disciplined officer in Starfleet. Violations of these traditions, rules, and regulations will lead to one or more of the following disciplinary actions

Captain's Mast

When enlisted man or officer breaks a rule, or is negligent or unmilitary in conduct, he may be placed on report by a superior officer. This means that the person placed on report must appear before the Captain at a specified time for disciplinary actions. That is, the person must appear at Captain's Mast. The Commanding Officer of a Starship is authorized to assign certain punishments for minor offences. These punishments include:

- Withholding of privileges for up to two weeks.
- Restriction to certain specified limits for up to two weeks.
- Extra duties of two hours per day for up to two weeks.
- Reduction to next inferior grade or rank.
- Confinement to quarters for up to one week.
- Confinement to quarters when off-duty for up to two weeks.

Note: Not all Captain's Masts are for disciplinary purposes. A Commendary Mast is held by the Captain to give awards or commendations to persons who have earned them.

Summary Court-Martial

For enlisted personnel whose offenses warrant more severe treatment, a Summary Court Martial may be called. It may be composed of any officer above Lieutenant Junior Grade - preferably the officer heading the department or division of the accused. This officer is appointed to the task by the Captain. The punishments are more severe than a Captain's Mast, and must be reviewed

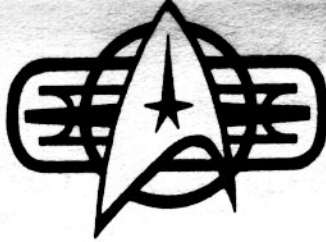

STARFLEET OFFICER REQUIREMENTS

by the Captain before taking effect. These punishments include:

- Confinement to quarters for up to one month.
- Restricted to certain specified limits for up to two months.
- Reduction to an inferior grade or rank.
- Forfeiture of one-half month's pay.

Note: An enlisted man may object to a Summary Court-Martial. If you are the designated judging officer and the accused objects, see the Captain. The enlisted man is then entitled to a Special or General Court-Martial.

Special Court-Martial

A Captain may convene a Special Court-Martial. It is composed of three officers if the accused is an officer, or two officers and one enlisted man if the accused is an enlisted man. If the accused is an officer, one of the designated judges must be of the same rank, and one must be higher. A Special Court-Martial has the authority to try any member of Starfleet for any offense. Prosecution and defense councils will be appointed by the Captain, in concert with the ship's Legal Officer. Punishment given by a Special Court-Martial can be as light as a Captain's Mast, or as severe as:

- Confinement to quarters for up to six months.
- Bad Conduct Discharge.
- Forfeiture of four month's pay.

General Court-Martial

A General Court-Martial consists of the ship's Legal Officer and between five and ten other members. If the accused is an enlisted man, one-third of the designated judges must be enlisted. If the accused is an officer, all of the designated judges must be officers, one must be of the same rank, and one must be of superior rank. A General Court-Martial has the authority to try any member Starfleet for any offense punishable under the Starfleet Code of Military Justice. General Court-Martials may also try any person - including civilians - who break the Private Shipping Regulations, or who by the laws of war is subject to trial by Military Tribunal. Severity of punishment includes:

- Dishonorable Discharge.
- Years of hard labor in a penal colony.
- Death.



STARFLEET OFFICER REQUIREMENTS

19

UNIFORM DETAILS AND VARIATIONS

Security Armor

- | | |
|--------------|---------------------------------------|
| A) Helmet | D) Tritanium Chest Shield |
| B) Headphone | E) Torso Yoke |
| C) Perscan | F) Variable Magnatomic Adhesion Boots |

Colors: Shield -- White Armor -- Brown Suit -- Maroon

Note: All ranks and grades identical.

Security Duty Uniform - Enlisted

- | | |
|------------------------|-----------------------|
| A) Starfleet Insignia | D) Binders |
| B) Departmental Stripe | E) Reinforced Cap |
| C) Holster | F) Solar System Patch |

Colors: Suit -- Gray Piping -- Black Belt -- White

Note: Worn by Starfleet Security personnel assigned to Starfleet or Federation planetary installations. Suit is a moderate to heavy yield impact armor.

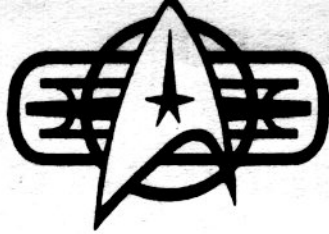

STARFLEET OFFICER REQUIREMENTS

SECURITY ARMOR

See: UNIFORM DETAILS AND VARIATIONS

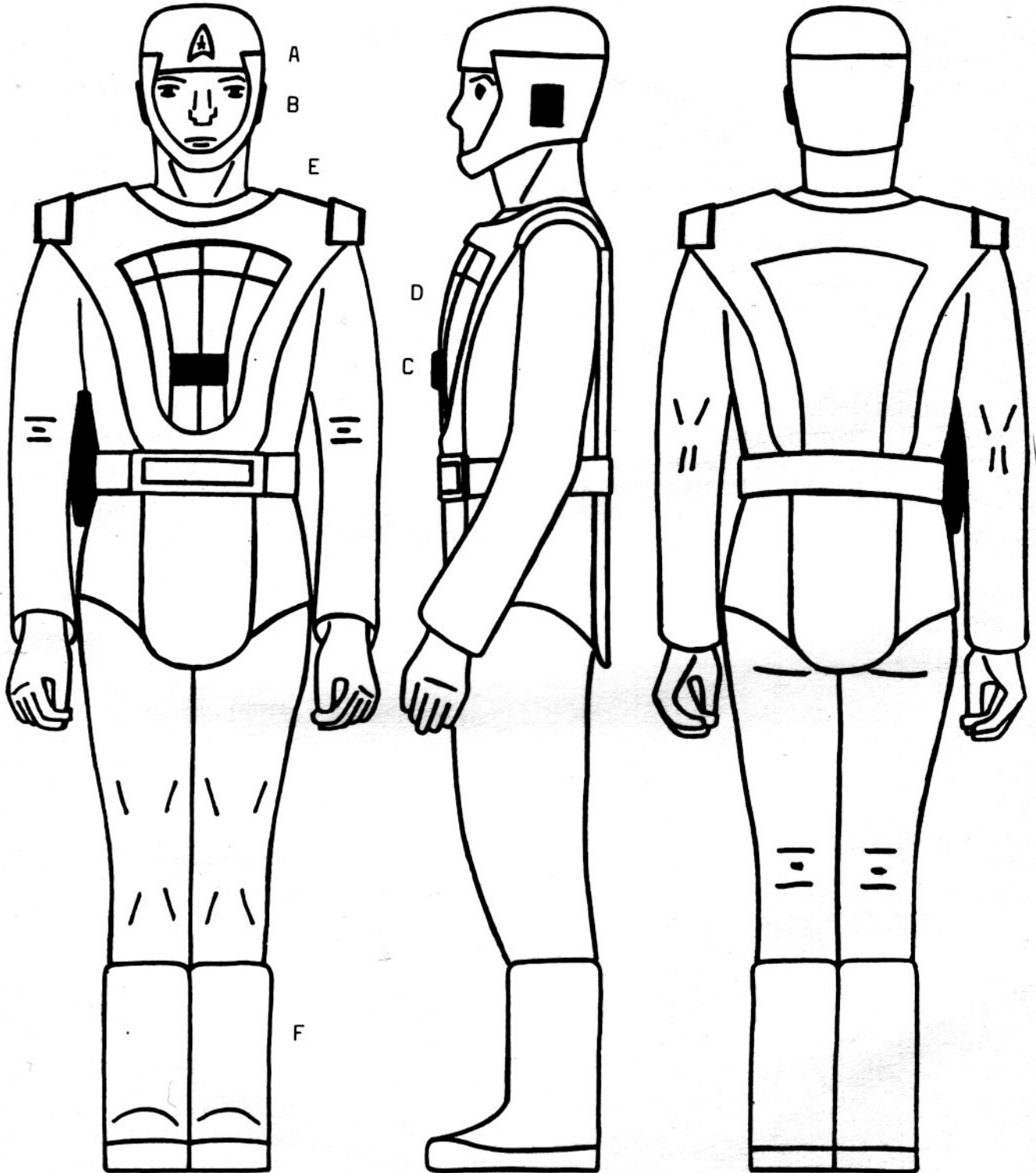

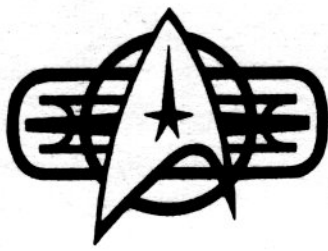

STARFLEET OFFICER REQUIREMENTS

SECURITY DUTY UNIFORM - ENLISTED

See: UNIFORM DETAILS AND VARIATIONS

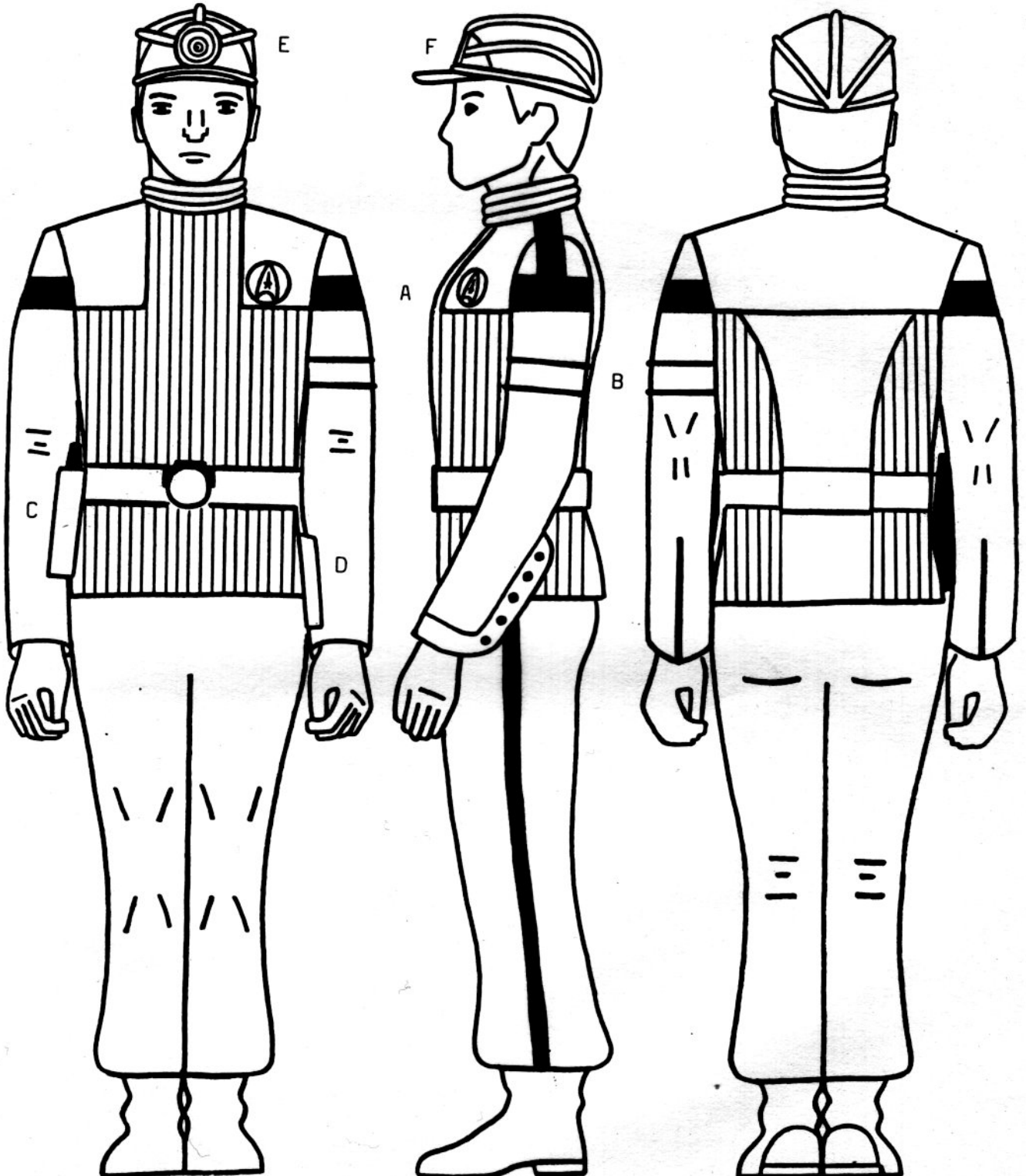

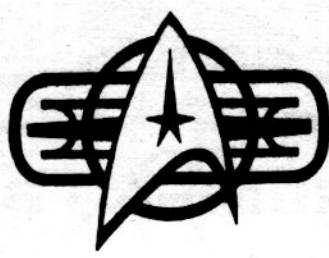

STARFLEET OFFICER REQUIREMENTS

23

ABANDONING SHIP

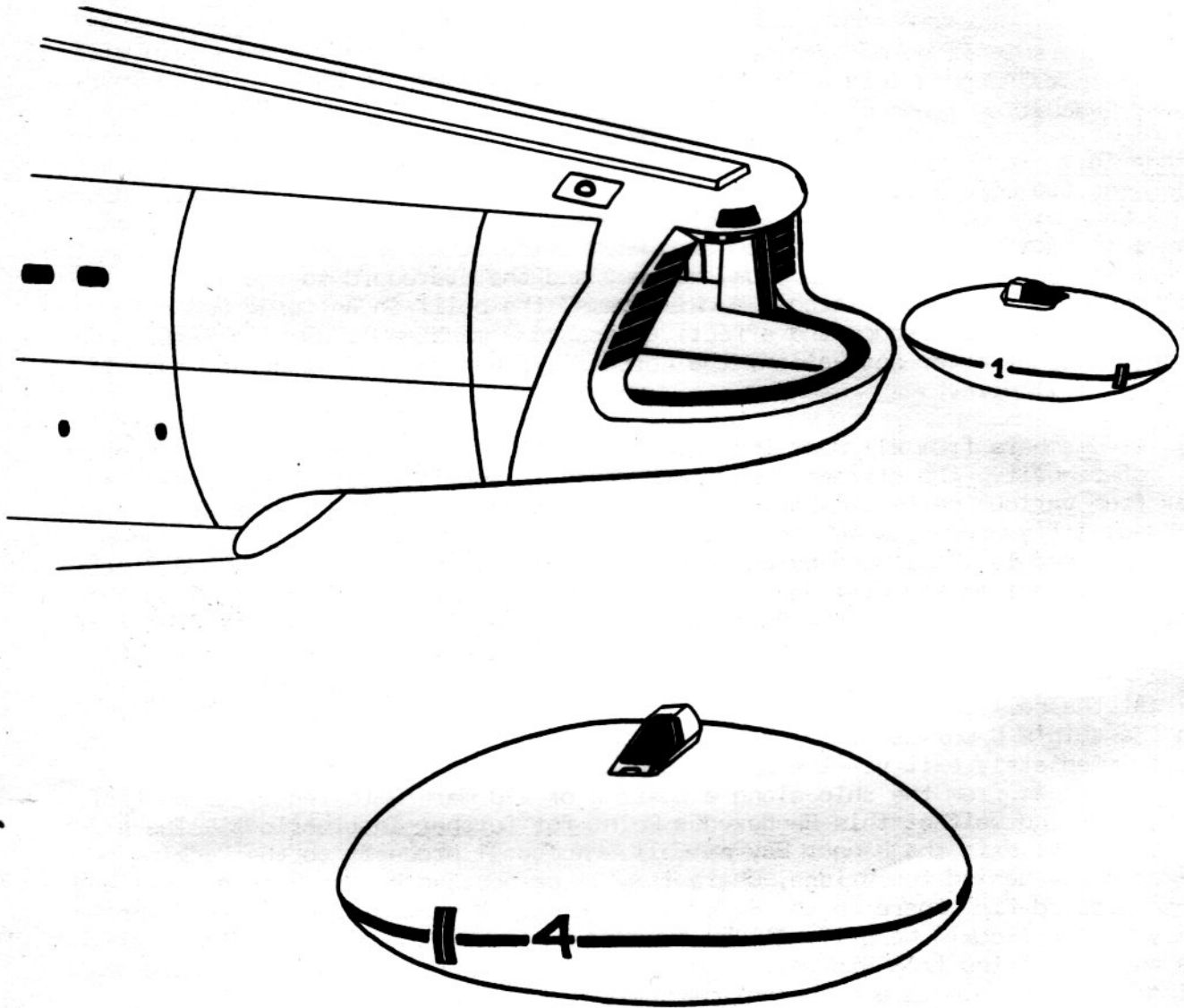

The above illustration shows a series of Life Boats being towed from the Hanger Bay of an Enterprise Class Heavy Cruiser into space. Once clear of the Hanger Bay Doors, the Workbees will tow the Life Boats to a rendezvous point , where they will be joined by the Shuttlecraft and Travel Pods.

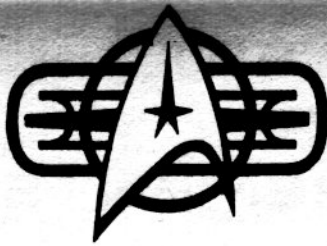

STARFLEET OFFICER REQUIREMENTS

ABANDONING SHIP - SCENARIOS 1 & 2

When a Starship is so badly damaged that it must be evacuated, the Captain will call either "Abandon Ship - To the Life Boats", or "Abandon Ship - To the Emergency Evacuation Transporters".

Scenario 1

- 1) The two Life Boat Station Operators will unlock the Life Boat Station doors. Each will pull one collapsed E.L.S.E.-4 from the locker, activate it, and heave it from the catwalk to the Cargo Deck below (the Portside Life Boat Station Operator will throw it towards the bow, and the Starboard to the stern). Although the E.L.S.E.-4 weighs 200 kilograms, the built-in Antigrav Generator will automatically reduce the effective mass to a manageable 20 kilograms. Twenty seconds after activation, the Force-field Generator will expand the Life Boat to full size.
- 2) Crewmembers from all over the ship - with the exception of the First Section of Security, the Bridge-crew, Medical Staff, and 14 pilots - will make their way from various parts of the ship to the Cargo Deck. As the Life Boats are expanded, fifty-nine crewmembers will immediately board them (no pre-arranged order or schedule), followed by one pre-arranged Security Officer from the First Section to act as the Life Boat Officer. This Life Boat will then seal up the Entry Slit, and activate the Antigrav to full power (neutralizing the effect of the Cargo Deck's synthetic gravity upon the Life Boat).
- 3) At the call to Abandon Ship, a previously assigned crew of pilots will warm-up the ship's 8 Workbees, 2 Travel Pods, and 4 Shuttlecraft. The 2 Travel Pods will immediately exit via the open Hanger Doors, They will proceed to a point 10 kilometers from the ship along a bearing of 270 Mark 0 (directly to port of the ship) and wait at this Rendezvous Point for further instructions. The 4 Shuttlecraft exit the Hanger Bay as well. Number 1 proceeds to the Docking-port immediately behind the Bridge, where it will be boarded by the Bridge-crew, and then proceed from there to the Rendezvous Point. Number 2 docks at the Main Primary Hull Airlock, where it will be boarded by the on-duty Medical Staff, as well as any casualties from Sickbay. The Number 3 and 4 Shuttlecraft will hold position near the ship to await developments.
- 4) As each Life Boat is sealed up, a Workbee will fly over it, attach to the upper pole, and tow it through the Pressure Curtain from the Cargo Bay to the Hanger Bay, and thence through the open Hanger Doors to the Rendezvous Point. As each Life Boat is removed, the Life Boat Station Operators will activate another and heave it into place. When the six Life Boats have been towed outside, and the last two are expanded, the Life Boat Station Operators will board them.
- 5) At the call to Abandon ship, Security will deploy as follows. Both off-duty Sections (2 and 3) will proceed to the Cargo Deck and join the evacuation. The remaining thirty men will divide into five squads. Squads 1,2 and 3 will do a rapid and thorough sweep search of the ship. They will give any aid and assistance necessary to any personnel requiring it, escorting same to the Cargo Deck. Regardless of whether or not they find anyone, these three Squads must be on the Cargo Deck within fifteen minutes - so that they may board one of the last two Life Boats. Squad 4 will proceed to the Brig and Sickbay. They will assist the Medical personnel in evacuating any prisoners and casualties to Shuttlecraft 2.

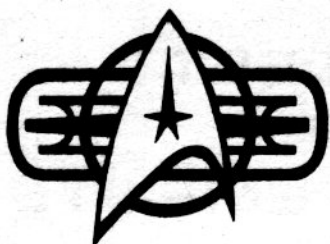

STARFLEET OFFICER REQUIREMENTS

From there, Squad 4 will proceed to the Cargo Deck and join the queue with other personnel. Squad 1 will go directly to the Cargo Deck when Abandon Ship is called. One of these six men will board each of the first six Life Boats to be launched, and become Life Boat Officer. When the last two of eight Life Boats are loading, the Life Boat Station Operators will descend to the Cargo Deck from their Stations on the catwalk and become the seventh and eighth Life Boat Officers.

6) As each Life Boat seals, its Life Boat Officer will begin listing the enclosed personnel. They will then transmit this muster to the Captain in Shuttlecraft 1 - the Command Shuttlecraft. The Workbee/Life Boats, Travel Pods, and the other three Shuttlecraft will do likewise. When the Captain has examined this list, he will decide if the number of unaccounted-for personnel warrants further risk inherent in another search mission.

7) Once all Workbee/Life Boats, Shuttlecraft, and Travel Pods have reached the Rendezvous Point, the Captain will decide which option to pursue:

- Transmit a distress call from the Shuttlecraft and await retrieval by another Starfleet or Commercial Federation vessel.
- Negotiate with non-Federation vessels for retrieval. This includes most hostile forces. With the notable exception of the Klingons, most enemy ships which destroy a vessel will rescue a Life Boat flotilla.
- If a Class M planet is within range of the Workbee/Life Boat Thrusters, the entire flotilla will make planet-fall. Utilizing 100% power, a Workbee is capable of lowering a Life Boat safely under any gravitational field below 1.4 Standard.

• Evacuation Fleet - Class I-B Starships

	MK-VII	MK-VIII	MK-IX	MK-XI	MK-XII	MK-XVIII	MK-XX	MK-XXI
Shuttlecraft	1	1	4	2	2	1	4	4
Travel Pods	0	0	2	1	1	0	2	2
Workbee/Life Boats	5	5	8	6	5	5	8	8

Note: The MK-VII-B, MK-VIII-B, and MK-XVIII-B do not have separate Hanger Bays. Instead, one Shuttlecraft and five each of Workbees and Life Boats are stored and launched from a special Bay in the Primary Hull, on the underside directly opposite the Main Airlock.

Scenario 2

Built into the Primary Hull of every Class 1 Starship are a series of Emergency-Evacuation Transporters. Each of these is capable of transporting twenty-two persons at a time. If the Captain calls Abandon Ship - to the Emergency Transporter Rooms, each crewman will make his way to his assigned Emergency Transporter. Naturally, this Scenario can only take effect if the stricken ship is within 25,000 kilometers of a Class M planet. There are three on H Deck of every Class I Starship.

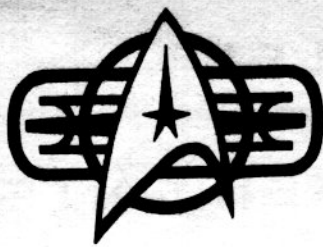

STARFLEET OFFICER REQUIREMENTS

LIFE BOAT STATION LOCATION

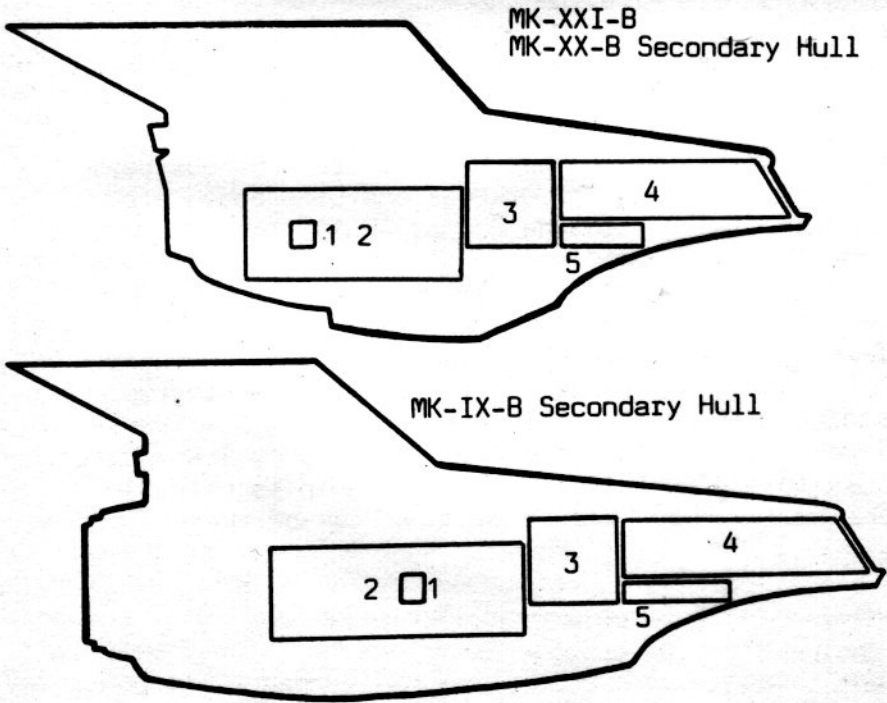
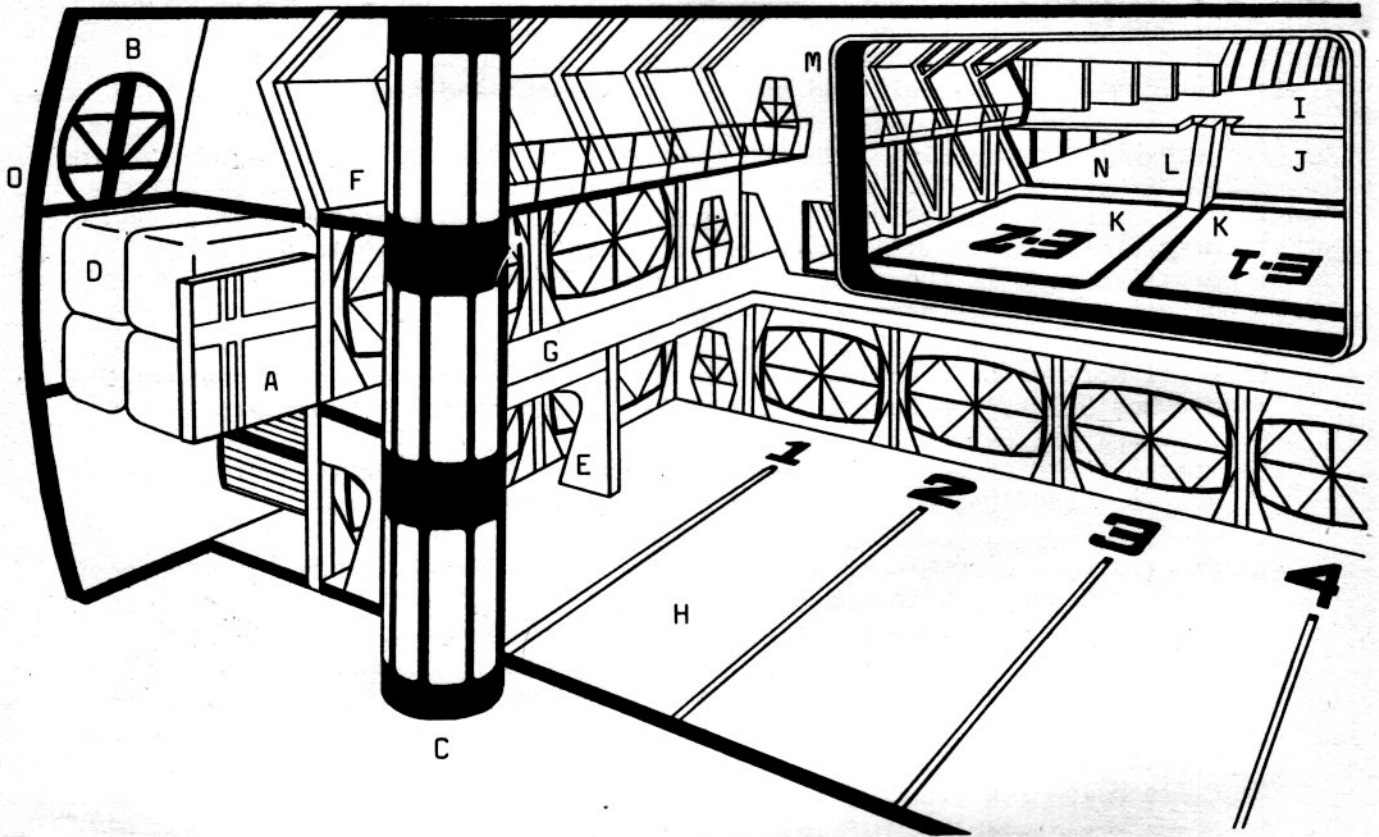

- A) Starboard Life Boat Station
- B) Starboard Docking Port
- C) Starboard Turboshaft
- D) E.L.S.E. Life Boat (4)
- E) Catwalk Support
- F) Catwalk (N Deck Level)
- G) Catwalk (O Deck Level)
- H) Cargo Deck (P Deck)
- I) Hanger Deck
- J) Shuttlecraft Parking Bay
- K) Shuttlecraft Elevators (2)
- L) Shuttlecraft Elevator Post
- M) Cargo/Elevator Bay Curtain Pressure Curtain
- N) Elevator/Parking Bay Pressure Curtain
- O) Secondary Hull Outer Skin
- 1) Life Boat Lockers (P/S)
- 2) Cargo Bay
- 3) Shuttlecraft Elevator Bay
- 4) Hanger Bay
- 5) Shuttlecraft Parking Bay



STARFLEET OFFICER REQUIREMENTS

27

LIFE BOAT

Emergency Life-Support
Environment - Mark 4

- A) Equator
- B) Upper Pole
- C) Lower Pole
- D) Workbee Attachment
Target & Umbilical
- E) Entry Slit
- F) Life Boat Ident

Colors:
Envelope -- Orange
Markings -- Yellow

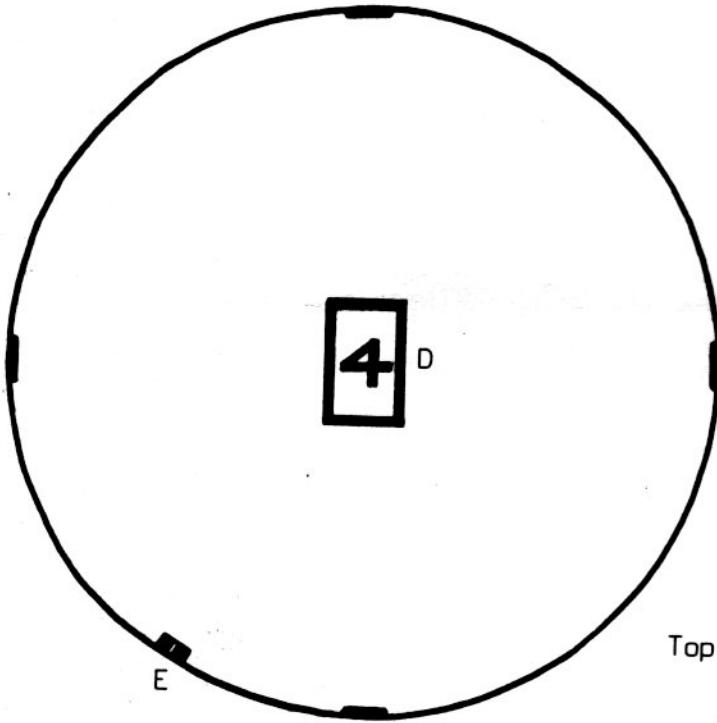

Top View

Expanded

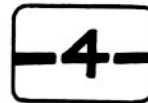

Contracted

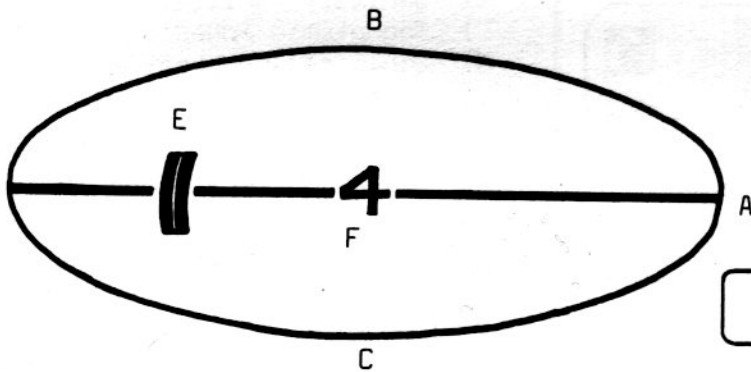

Side View

Weight	200 kilograms	
Length	(Collapsed) 3 meters	
Height	(Collapsed) 2 meters	(Expanded) 6.0 meters
Width	(Collapsed) 1.5 meters	
Diameter		(Expanded) 15.0 meters
Volume		(Expanded) 600.0 cubic meters
Powerplant	(See: LIFE BOAT SURVIVAL PACKAGE)	
Capacity	60 persons for 30 days	
Composition	Superconductor Mesh/Plastic Sandwich	

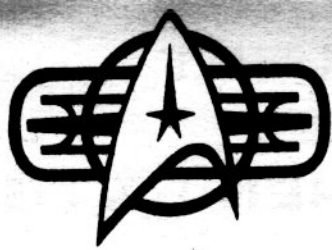

STARFLEET OFFICER REQUIREMENTS

LIFE BOAT SURVIVAL PACKAGE

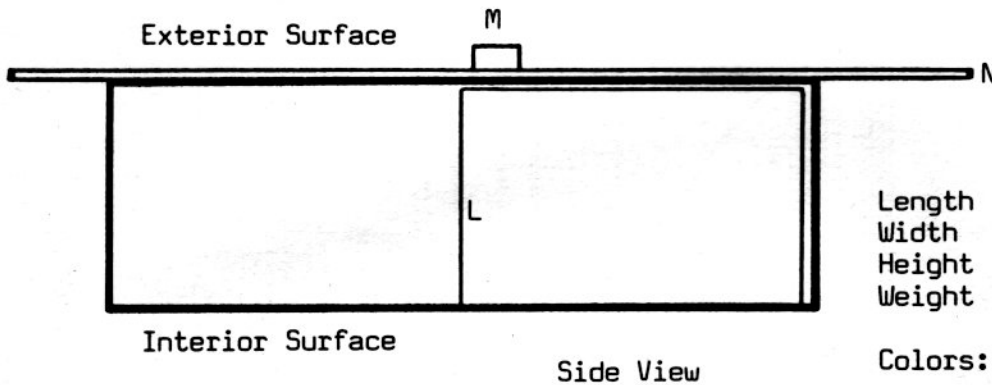

Length	1.5 meters
Width	1.5 meters
Height	0.5 meters
Weight	150 kilograms

Colors: Package -- Yellow
Markings -- Red

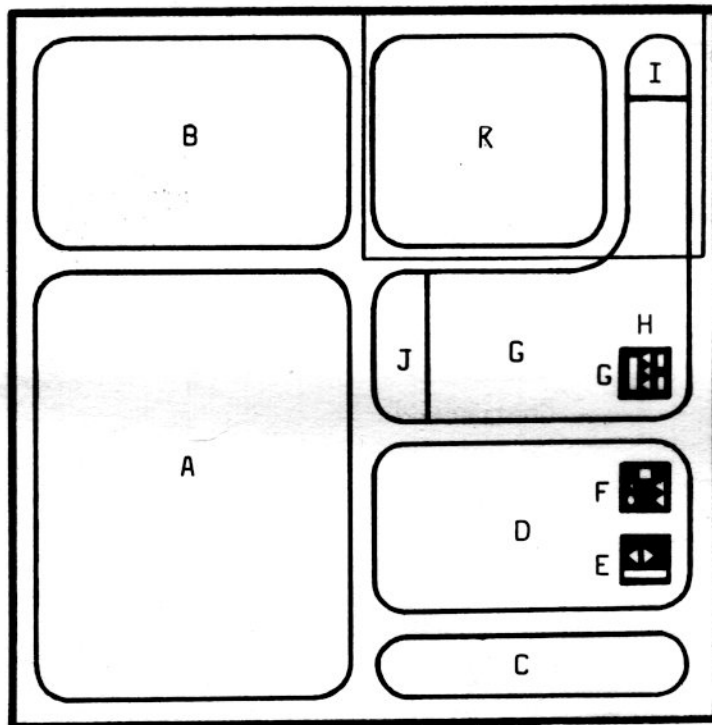

- A) Rations Compartment
- B) Water Reservoir
- C) Equipment Locker
- D) Power Unit & Powerpack
 - 3 Dilithium Crystals
 - 1 Antigrav Generator
 - 1 Force-field Generator
- E) Antigrav Controls
- F) Powerpack Controls
- G) Environmental Unit
- H) Environmental Controls
- I) Air Inlet Surface
- J) Air Outlet Surface
- K) Sanitary Facilities
- L) Magnatomic Adhesion Strip
- M) Umbilical Connection
- N) Life Boat Fabric

Interior Surface View

This package is part of the E.L.S.E.-4 Life Boat. It is mounted as an integral piece to the fabric in such a way that when the Life Boat is expanded, the package is directly inside and below of the upper pole. The package is designed to sustain sixty persons in a volume of six-hundred cubic meters for one month. It is made up of six sub-units, each with a locking cover. A magnatomic strip surrounds the Sanitary Facilities. A privacy enclosure bag (stored in the Equipment Locker) seals along here, so that the facility, user, and Air Inlet are separated from the Life Boat interior. Liquids are scavenged both from the Sanitary Unit and the Air Inlet, purified, and returned to the reservoir. Solid waste residues are reduced to a monatomic ash via a built-in phaser chamber. The Powerpack holds

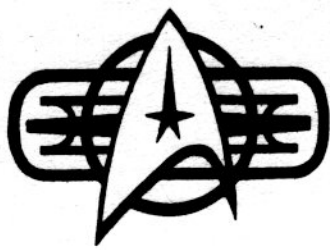

STARFLEET OFFICER REQUIREMENTS

29

three 5-megawatt capacity dilithium crystals. These can be tapped by the towing Workbee via the Umbilical Connection, for use by the thrusters, as one crystal is ample for the needs of the Life Boat for the one month rated life-time. The Equipment Locker includes two Type II C Phasers, 10 Communicators, a Type I C Tricorder, a Field Med-kit, various entertainment tapes and players, and a hardcopy of the Starfleet Medical Reference. The Rations Compartment holds two-thousand FS9-2 Food Supplement Bars - each supplying all the nourishment requirements for one humanoid for twenty-four hours in a zero-gee environment, plus assorted additional supplemental substances to tailor these FS9-2 to more esoteric alien chemistries.



STARFLEET OFFICER REQUIREMENTS

31

ELECTRONIC CLIPBOARD - DATA COORDINATING UNIT

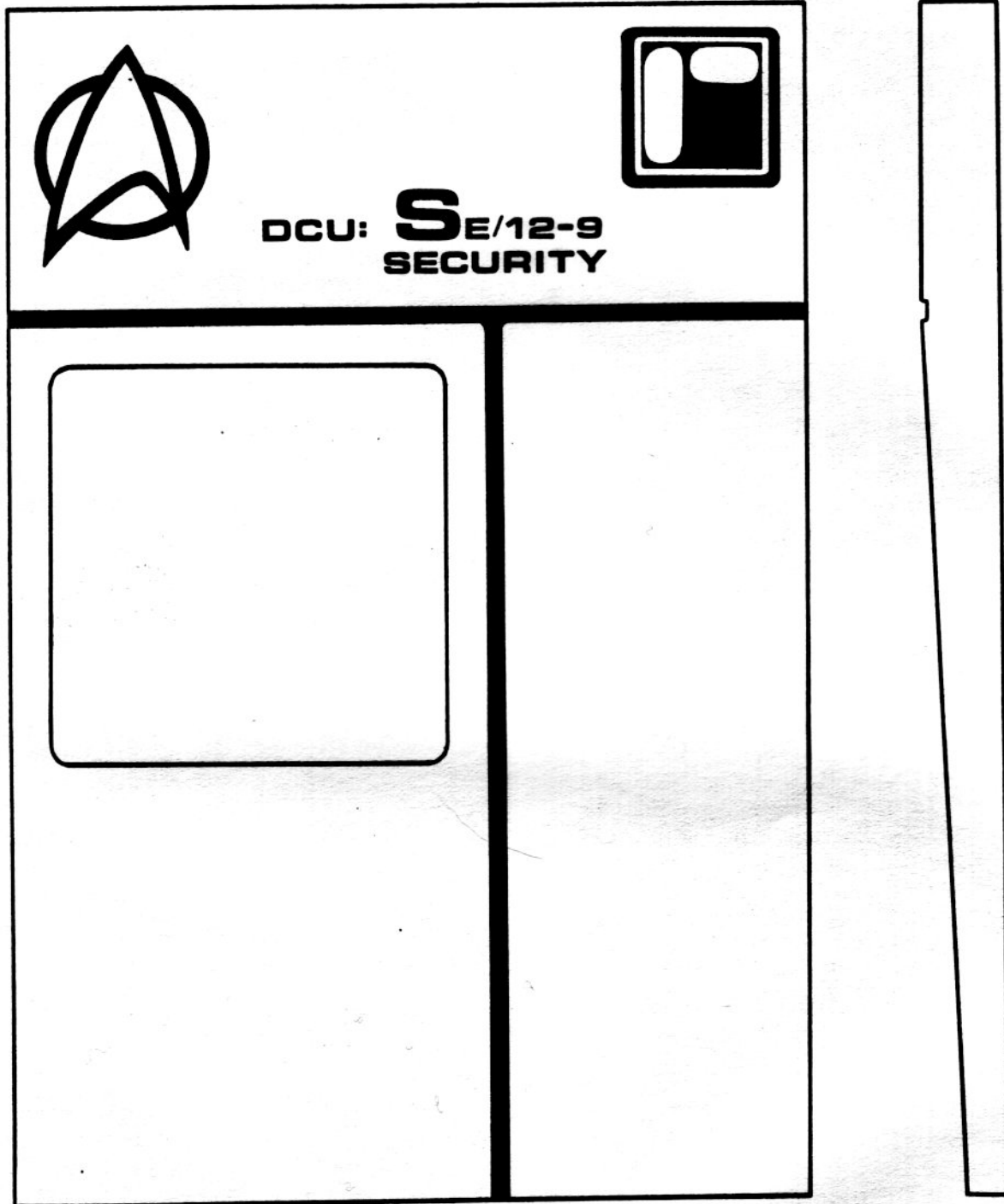

Colors: Casing -- Grey

Emblems -- Black, Red

Length

30.0 centimeters

Width

20.0 centimeters

Depth

1.5 centimeters

Weight

100 grams



STARFLEET OFFICER REQUIREMENTS

ELECTRONIC CLIPBOARD

Every Department and Division aboard ship utilizes the Electronic Clipboard - otherwise known as the Data Coordinating Unit, and henceforth referred to as the D.C.U. Basically the D.C.U. is a portable computer terminal. It is linked to the particular Departmental Computer Lobe via a low power transceiver. The extreme mobility of the D.C.U. affords the user a never before seen degree of freedom and flexibility in the performance of his duties. A user can be simultaneously carrying out an inspection and instantly accessible to anyone who might need to talk to him, or he can call up information needed on his inspection without having to walk back to the nearest fixed console. He remains in complete contact with his computer station.

The D.C.U. has a built-in data screen and speaker/mike - linked to a built-in short term memory. Thus a user may make spoken notations and observations, without transmitting them to his computer station until he is ready.

The D.C.U. is of particular value in the role of a check-list. It can be programmed to verbally list off a series of checks in sequence, pausing after each for a positive or negative response, or can be told to hold a check or skip it and return to it later.

There are twenty-one varieties of D.C.U. utilized aboard ship, from Command to Maintenance. The one illustrated is a Security S12/9. The following list shows the variety of models available aboard ship for various duties.

- | | |
|---------------------------------------|-----------------------------------|
| 093/1 - Commanding Officer's | E01/14 - Warp Drive Checklist |
| 042/2 - Executive Officer | E09/15 - Impulse Drive Checklist |
| 063/3 - Auxillary Craft Checklist | E13/16 - Main Reactor Checklist |
| 011/4 - Personnel Duty Roster | E77/17 - Environmental Checklist |
| C32/5 - Cryptography Notepad | E99/18 - Damage Control Checklist |
| C21/6 - Electronics Checklist | E68/19 - Transporter Checklist |
| Q54/7 - Maintenance Checklist | E05/20 - Shipfitting Inspection |
| Q55/8 - Quartermater's Inventory | E15/21 - Chief of Engineering |
| S12/9 - Security Officer of the Watch | |
| M66/10 - Medical Record & Chart | |
| A79/11 - Navigational Almanac | |
| A81/12 - Ordnance Checklist | |
| A83/13 - Yeoman's Log | |

As with the wall intercom, the D.C.U. utilizes a sealed, encoded transceiver, eliminating any need for hook-up via wire or fiber-optic cable. The transceiver linking D.C.U.'s with their respective computer stations all use the same frequency as intercoms. Each D.C.U. and intercom first digitalize information to be transmitted, and then encodes it in a code unique to that particular unit - and no other. Thus the computer can distinguish between them. In a similar fashion, information to be transmitted to the particular unit is first encoded in that particular code - whereupon it will be received only by that unit.

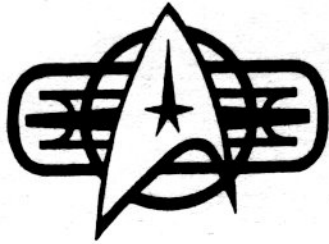

STARFLEET OFFICER REQUIREMENTS

INTERCOM

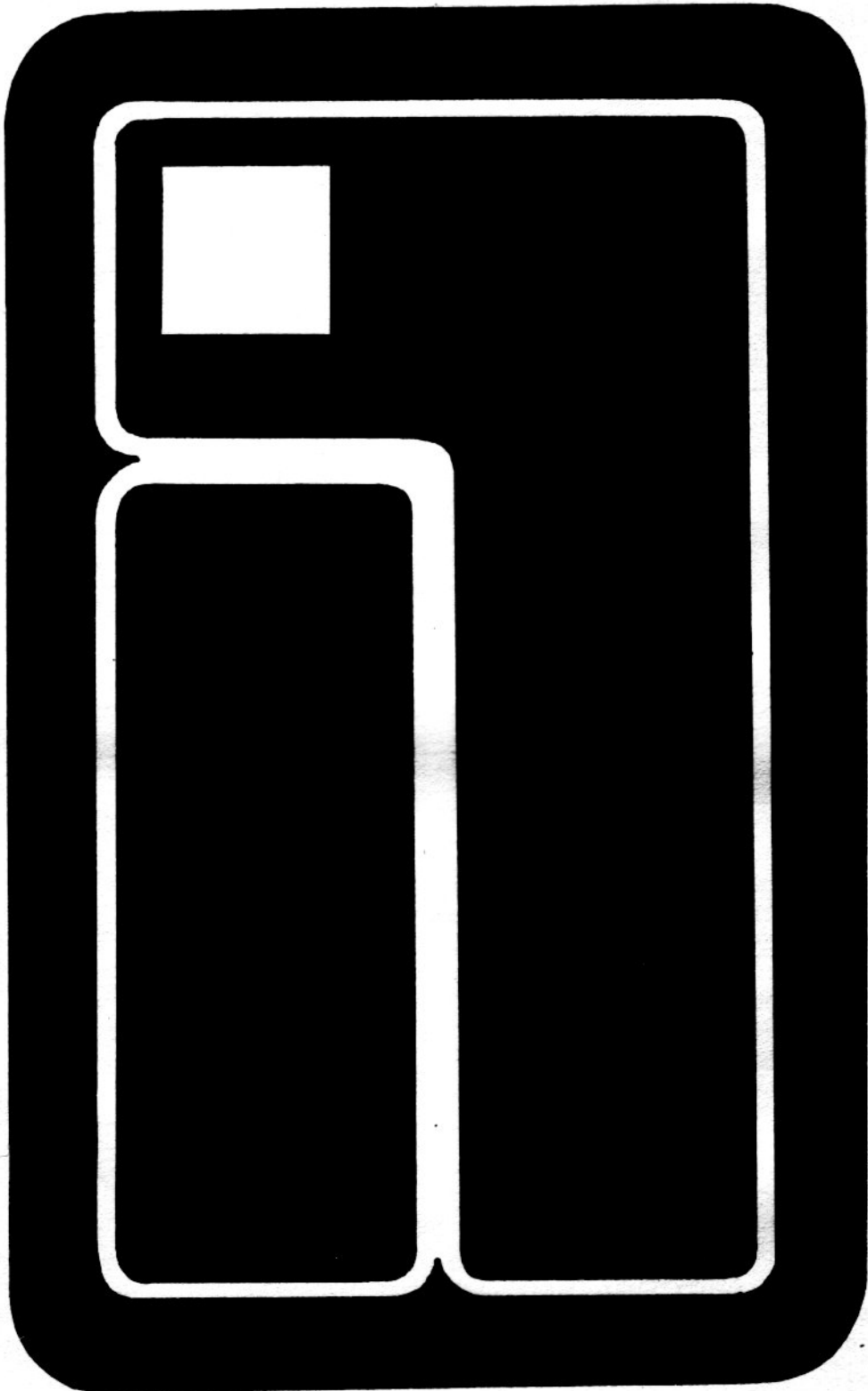

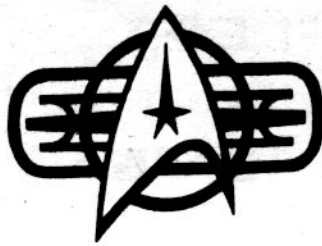

STARFLEET OFFICER REQUIREMENTS

COMMUNICATOR - TYPE III

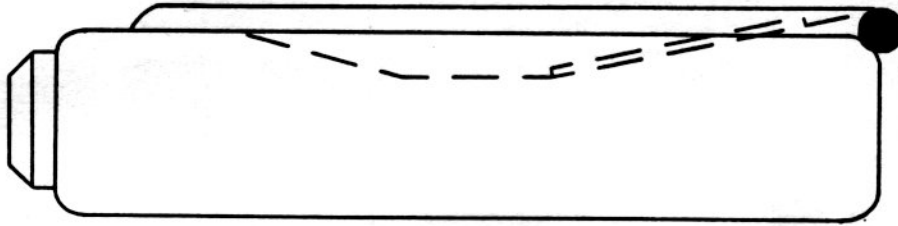

Dimensions in millimeters:

Length 120 Width 65 Height 27

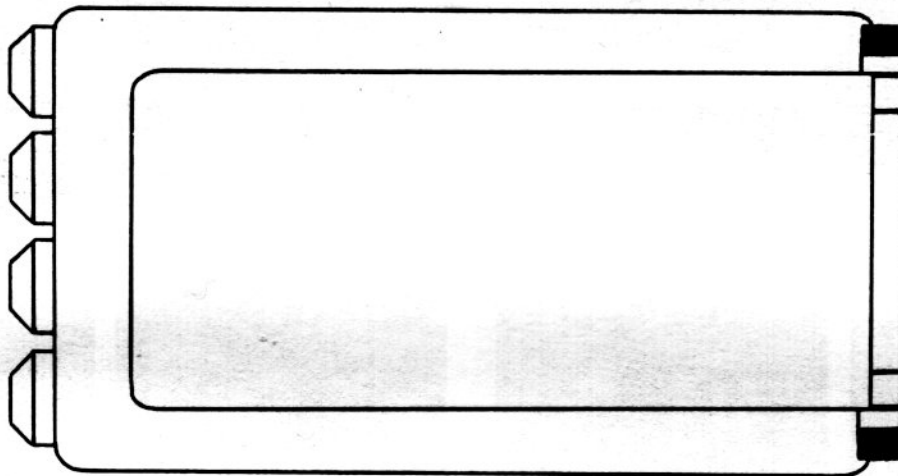

Internal Arrangement
Identical to Type II

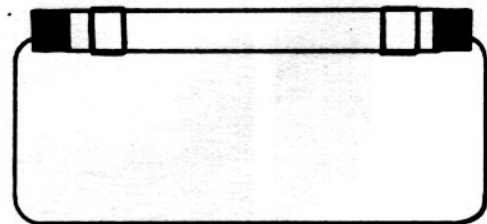

The Type III Communicator is a combat version of the Type II. Noteworthy differences are a tritanium outer shell and flip-up antennae guard, and the addition of four heavy-duty dilithium power crystals - extruding from the short side - which give it a much greater operational life-time and range (twelve hours continual use over 1,000,000 kilometers versus four hours over 500,000 kilometers). The internal display and controls are identical to the Type II, as is the circuitry - with the exception of a signal booster.



STARFLEET OFFICER REQUIREMENTS

35

SECURITY DEPARTMENT ORGANIZATION & DEPLOYMENT

The Security Department aboard a MK-IX-B, MK-XX-B, and MK-XXI-B Class Starship consists of 90 men - 6 officers and 84 enlisted men. This is equally divided into 3 Sections, each of which is further divided into 5 Squads. During Alert Condition 1, One Section will be on-duty, and two off-duty each shift, with each Section taking its shift in rotation. For duties aboard ship, Squad organization is rarely used, as most patrols and sentry posts utilize one man or a team of two.

The usual officer division is one Lieutenant Commander and five Lieutenants. The senior officer is the Chief of Security and as such is responsible to the Captain for his department. He is usually in charge of the first - nominal "day" - shift, with one Lieutenant working under him. As such, they coordinate the activities of their Security Section, assigning patrol and sentry duties. The two officers assigned to each of the Second and Third Sections and shifts.

Thus, during Condition 1, each shift has two officers and twenty-eight Security Specialists on-duty. One of the officers will be designated as the Security Officer of the Watch. He is responsible for coordinating the duties and functions of his Section and shift smoothly and efficiently. Normally he remains on the Bridge, seated at the Internal Security Console. From here he has access to all special intelligence and remote controls. Also, he can interact and be given orders from the captain or acting Ship's Commander. The other officer on-duty is usually stationed in the Security Office Complex, where he is ready to assist anyone who comes in with a problem, and can monitor the Armory. As Assistant Officer of the Watch, he is also Armorer of the Watch, signing out and receiving all weapons at the start and end of his shift. (See: DUTY CLASSIFICATION.)

When acting as either an Escort or Task Force on a planet, or as an Honor Guard aboard ship, Security Specialists are deployed in Squads. A Squad is composed of six men, one of whom is the Squad Leader. The Squad Leader is a petty officer, referred to and addressed as "Chief". Most landing parties are composed of three Security Specialists (one-half Squad) and three officers of other departments. In the case of a Task Force, standard procedure calls for a full Squad. If enough Squads are needed, and all Security personnel are deployed, The Chief of Security and five Lieutenants all act as Squad leaders themselves, thus allowing for a full-strength turn-out of three Sections, comprised of ninety men divided into fifteen Squads.



STARFLEET OFFICER REQUIREMENTS

CONDITION STATUS

Just as other officers and crewmen are controlled by the Alert Status, the Security Department is controlled by the Condition Status. This is entirely independent of the Alert Status, and any Condition may co-exist with almost any Alert Status.

- Condition One:** First Section on-duty. Second and Third Sections off-duty.
-Normal- Second Section reports to the Security Office Complex one-half hour before going on-duty for briefing. Members of First Section patrol or stand sentry as ordered - singly.
- Condition Two:** Second Section joins First on-duty. All patrols and sentry posts entail two man teams. Third Section reports to the Security Office Complex one hour before going on-duty.
- Condition Three:** Third Section dons Armor. First and Second Sections -in two man teams- are directed by the Chief of Security to the sensitive sentry posts. Phasers are drawn and set for "STUN". Third Section begins extensive sweep patrol of entire vessel, checking in at each sentry post.
- Condition Four:** Chief of Security activates the Isolation Force-field Doors, effectively cutting the ship into twenty to thirty isolated compartments - depending on the class of ship. The Third Section, which is patrolling the ship in armored teams of two, has a force-field neutralizer built into their armor. This allows them to pass through the Isolation Force-field Doors freely. All other personnel must request permission from the sentries. These sentries will pass this request to the bridge, where the Chief of Security has the only controls for the Isolation Force-field Doors. Phasers will be drawn and set on "KILL". Any order given to a sentry by any superior officer must be relayed to the bridge for confirmation by the captain.



STARFLEET OFFICER REQUIREMENTS

37

DUTY CLASSIFICATION

The types of duty listed below may be divided into three classifications:

- 1) General
- 2) Special
- 3) Ceremonial

Classifications 1 and 2 may take place regardless of the Condition Status - the only difference being the amount of Sections placed on duty. Classification 3 may only take place during Condition 1.

1) General

- Patrol:** Each Security Specialist or team of two randomly walks all corridors of the ship, keeping in occasional contact with the Security Station in the bridge to report status and progress.
- Armory:** The Assistant Security Chief of each Section is Armorer of the Watch. He is responsible for issuing and receiving weapons from the Armory, noting and tagging those in need of repair. If a visitor or passenger boards armed, the Armorer of the Watch will place said weapon in the Armory vault and issue a receipt-except as exempted by the captain. The Assistant Chief of Security is also the ship's Weapons Officer. During his duty period he is responsible for repairing any weapons which have been damaged in the previous two watches.
- ### 2) Special
- Landing Party:** A security team usually accompanies any scientific parties into unknown territory.
- Scouting Party:** An entire Section is usually deployed to scout dangerous or hazardous territory.
- Boarding Party:** An entire Section is usually the first to beam aboard a captured or incommunicative vessel. Upon establishing that there is no danger or that the situation is under control, they signal the all clear to the ship, so that the senior officers may follow.
- Brig/Prisoner:** If a prisoner is to be interned, the Chief of Security will assign a guard. This may be in the Brig, in Sickbay, or in the prisoner's own cabin. The guard will remain with the prisoner until relieved by his replacement, the Chief of Security, or the captain.
- Locking:** On the orders of the Chief of Security a security team will

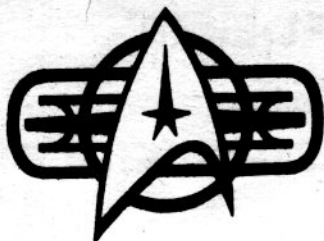

STARFLEET OFFICER REQUIREMENTS

be dispatched to a given compartment to apply Security Seals to all doors. Seals may be obtained from the Armory.

- Arrest:** On the orders of the Chief of Security, a Security team will be dispatched to a given location to physically arrest an individual and conduct him to the Brig, Sickbay, or his quarters as deemed by the Chief as Security.
- Sentry:** On the orders of the Chief of Security, a Security team will be posted to a particular station or doorway and there advised of further duties.
- Search:** There are two types of search:
 Missing Personnel - Full deck-by-deck search of ship by Security. Security personnel in EVA suits will examine exterior of ship and surrounding space. Sickbay will stand-by to receive injured person.
 Intruder Alert - Full deck-by-deck search of ship by Security. Isolation Force-field Doors activated.
- Abandon Ship:** On the order of the commanding officer, all Security personnel will assume their pre-arranged Evacuation duties.
- 3) Ceremonial
- Bodyguard:** A Security specialist may be assigned to act as guide for a V.I.P. while the latter is visiting aboard ship. The Security specialist will escort the V.I.P. wherever he wishes to go, except for restricted or controlled areas. When the V.I.P. returns to his quarters, the Security specialist will report same to the bridge station and request to be relieved.
- Escort:** A Security specialist may be assigned to act as guide for a visiting Flag Officer aboard ship, or as escort to one of his own ship's officers on another ship, or on a planet. Number and armament depend upon the situation, or as assessed by the Chief of Security.
- Honor Guard:** When a V.I.P. comes aboard, an honor guard will be deployed to the Airlock, Transporter Room, or Shuttlecraft Bay to greet him as a measure of respect. If the V.I.P. is the representative of a planetary government, he will be accorded "Presidential Honors" and the anthem of his planet played. If the V.I.P. is a Flag Officer, he will be piped aboard.
- Security Host:** During a banquet or celebration aboard ship, with non-Starfleet persons attending, Security personnel may be assigned to attend the function. They will wear concealed Type I hand phasers.

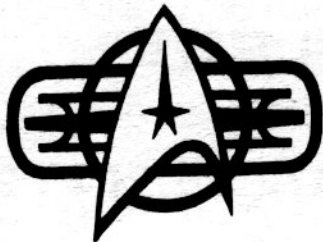

STARFLEET OFFICER REQUIREMENTS

39

PATROL DUTY

During Condition 1, one Section will be on duty at a time. Unless special sentry posts are designated (unusual for Condition 1) all but the two Lifeboat Officers will be on patrol duty. These men will patrol throughout the ship. They will receive their routes from the Assistant Officer of the Watch at the beginning of their shift, in the Security Office Complex. This route will be computer generated, striving for both random pattern and minimum redundancy. There are two basic reasons for this; it reduces the element of boredom inherent in the nature of patrolling (and thus minimizes errors caused by fatigue), and it eliminates the possibility of a spy or saboteur scheduling his activities safely according to an observed pattern.

Under Condition 1, weapons are worn, but not drawn, and are set on "STUN". A regular check-in with the Officer of the Watch is required every 15 minutes. (See: SECURITY - COMMUNICATION).

If a suspicious circumstance is observed, contact the Officer of the Watch first, before taking action. Then draw your phaser, check the setting, and approach quietly and cautiously. If there are two Security specialists, one will move in, and one will cover him. On final approach to the suspicious area, remember the unofficial rule of Security patrols: "Shoot first and apologize later". A phaser set on "STUN" cannot cause permanent injury, and it is better to be safe than sorry. It is preferable that an innocent officer or crewman take an unscheduled nap than that the safety of the entire vessel be endangered.

Of the men patrolling the ship, six of these will be in full Security Armor. These men comprise the Armor Squad. If a Security specialist on patrol reports that he needs back-up, or fails to make a scheduled regular check-in, the Armor Squad (previously patrolling like the others) will be instructed to rendezvous at his last known location and proceed along his projected route.

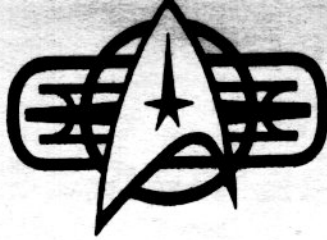

STARFLEET OFFICER REQUIREMENTS

SENTRY DUTY

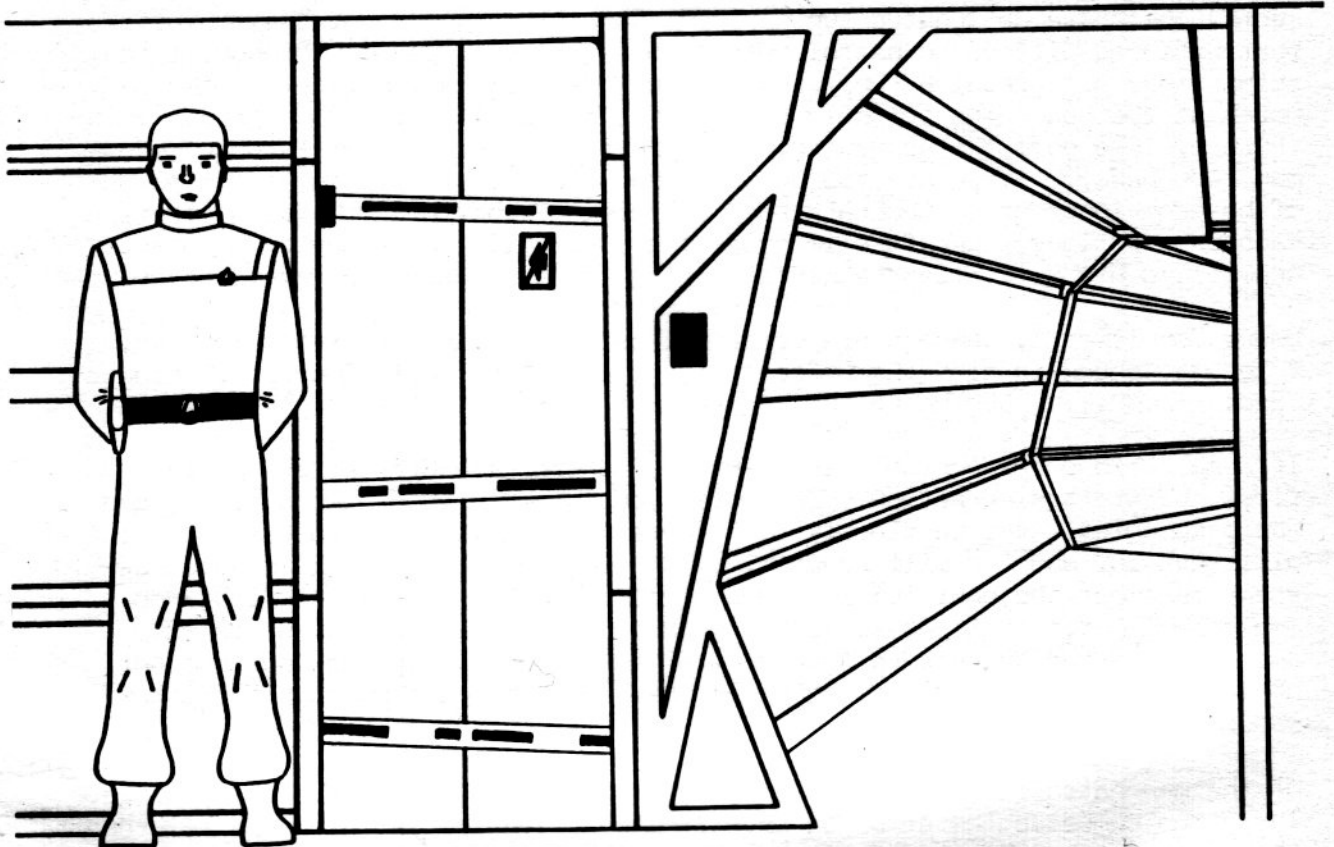

One of the duties assigned to Security Specialists is that of Sentry. A Sentry Post is any designated area of a ship wherein the Security Officer-of-the-Watch desires a Security Specialist to guard, maintain order, or observe. Under Condition 1 Status, one man will be deployed at any designated post. During other Conditions, teams of two will stand. In the diagram above, note the presence of a Restricted Access Emblem on the door, as well as a Security Seal Monitor Unit and Tape.

The following lists the Sentry Posts automatically stood during various Conditions. Additional Posts may be assigned as needed - these are mandatory.

Condition 1: - Life Boat Stations

Condition 2-4: - Life Boat Stations
 - Airlocks & Docking Ports
 - Main Computer Core
 - Emergency Bridge
 - Transporter Rooms
 - Brig
 - Hanger Bay
 - Fire-control Stations

(See: CONDITION STATUS, &
 RESTRICTED, CONTROLLED, & SEALED AREAS)

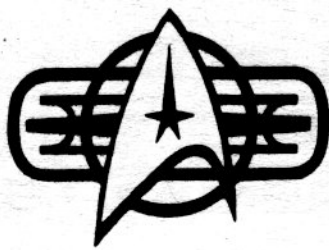

STARFLEET OFFICER REQUIREMENTS

41

COMMUNICATION

The key to any Security Operation running smoothly is communication. Communication between Teams or Squads and the Security Officer-of-the-Watch allows a Security Section to run as a well-orchestrated unit.

Your Communicator is an essential part of your equipment. While on-duty, you are required to check in with the Bridge Station once every fifteen minutes. Furthermore, you must report any change in the condition of your post or route, and report any action you are about to undertake - before you act. This ensures that help will be on the way quickly if you are captured or otherwise incapacitated.

The Bridge Security Station is capable of handling fifty calls at once. Pre-planned fifteen minute staggering is designed to reduce this to one call at a time - with twenty-eight Security Specialists each making a thirty-second report each quarter-hour.

When making a routine check-in, a Security Specialist should be short and concise - preferably under fifteen seconds (eg: "Smith, 09:45 check-in. Deck M Station 7. All quiet. Over.") If patrolling, the Specialist should give not only his present location, but also his destination (eg: "Smith, 10:00 check-in. Deck M Station 9. Proceeding to Deck N Station 1. All quiet. Over.")

In the event of trouble, the Security Specialist is urged to keep calm and rational - but not to delay reporting prior to action. A preliminary report should be made if something seems suspicious - promising a follow-up in five minutes or less, when the true situation will undoubtedly be known (eg: "Smith, 10:02 Special. Believe I just heard phaser-fire in the next corridor - Deck N Corridor 3. Will advise in two minutes. Out.") Even if it turns out that nothing was wrong, no harm will have been done. Had the Specialist charged in to investigate without checking-in first, he might have been overpowered, and the Section Chief would not have realized that anything was amiss until fifteen minutes later. If it turns out that there is no cause for alarm, the Specialist should immediately so inform the Section Chief (eg: "Smith, 10:03 Follow-up. Deck N Corridor 3. Sound was a target simulator being used by some Cadets who thought the Rec-Deck top crowded. Recommend we alter the sonic effect of the simulator for variance. Proceeding to Station 1. Out.")

If the problem actually exists, it may not be possible to call for help. This will not be a disaster, as the Section Chief will have other teams en-route after the two-minute follow-up does not arrive. If the problem does exist, the Specialist should still give his Section Chief as full a report as possible (eg: "Smith, 10:02 Follow-up. Deck N Corridor 3. Confirming phaser-fire - two Officers dead, no sign of weapon or attacker. Suggest Condition 4.")

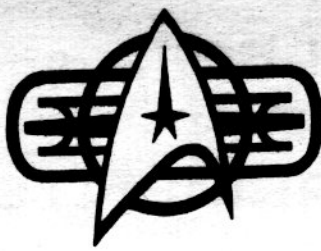

STARFLEET OFFICER REQUIREMENTS

CLASSIFIED INFORMATION & MATERIALS

Classified information is generally typed as top-secret, secret, or confidential. All classified materials carry an emblem for quick identification. Standard definitions for the various classifications follow:

- Grade 3: Of such importance to the defense of the United Federation
-Top Secret- of Planets that unauthorized disclosure would result in
 exceptionally grave damage to the Federation, its member
 planets, or its allies.
- Grade 2: Unauthorized disclosure would endanger Federation security
-Secret- or cause serious injury to the interests or prestige of the
 United Federation of Planets.
- Grade 1: Unauthorized disclosure would be prejudicial to the in-
 terests or prestige of the United Federation of Planets.

If you accidentally come across classified matter which has been left unguarded, misplaced, or not properly secured, do not read, examine, or try to decide what to do with it. It may be in the form of a booklet, a display on a console, a storage disk - you will recognize its classified status by the emblem on it. Notify the Chief of Security immediately at once, and then stand by to keep unauthorized personnel away from it until it is retrieved.

All Starfleet personnel are cleared for military information, especially those officers above the grade of Commander. However, any item of classified data carries with it a "need to know". Briefly; if your duties do not require you to be familiar with a particular item of classified data, then it is in the best interests of both Starfleet and yourself that you not examine it.





STARFLEET OFFICER REQUIREMENTS

43

RESTRICTED, CONTROLLED, & SEALED AREAS

Restricted

In every ship there are some areas to which access is restricted to authorized personnel. The reason may be the presence of classified materials, or vital equipment, so that special care must be taken to guard against espionage and sabotage. These areas will be closed off, their doors clearly marked with a special emblem. Depending on the Alert Status or Condition, sentries may be posted to prevent forced access. Regardless, computer monitored voice recognition scan is automatically carried out. Examples of Restricted Areas include:

Main Computer Core	Phaser Fire-Control
Airlocks	Pho-Torp Fire-Control
Transporter Rooms	Hanger-Bay
Security Office Complex	Emergency Bridge
Main Engineering	Sensor Platforms

Controlled

In every ship are areas to which access, while not restricted to authorized personnel, is none-the-less closely monitored. These are areas which are relatively open to the entire ship's complement, but which must be watched for the safety of the entire ship. These areas are not marked. Examples of Controlled areas include:

Bridge	Sickbay
Communications	Cargo-Bay

Sealed

On the order of the captain, any doorway in the ship may be sealed, to prevent access to a room by all personnel. Reasons may vary; a V.I.P. may not wish to be disturbed, a crime scene must remain undisturbed, etc. The doorway will be taped shut, across from doorframe to doorframe. To one of the doorframes a Seal Monitor will be attached over a tape end. This will engage the Monitor. The tape acts as a warning to personnel not to enter, as well as an antennae for the Seal Monitor. Should the door be forced open, the breaking of the tapes will alert the Monitor. The red light will flash and all intercoms in the area will sound a klaxon. The Security console in the bridge will be notified of a Seal breach immediately. While attached to the doorframe and activated, the Seal Monitor will negate the door's sensor, preventing the door mechanism from opening the door if a crewman stands before it. Depending upon the reason for sealing the doorway, a sentry may be posted. (See SENTRY DUTY for a display of a typical mounting.)

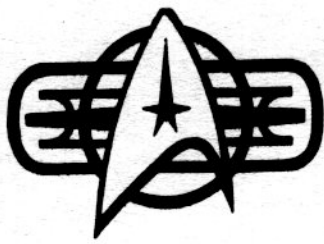

STARFLEET OFFICER REQUIREMENTS

- A) Seal Activated Light (Green)
- B) Security Breached Light (Red)
- C) Segment of Tape
- D) Magnatonic Adhesion Surface

Length	10 centimeters
Width	5 centimeters
Depth	3 centimeters
Tape Width	5 centimeters

Restricted Access Emblem

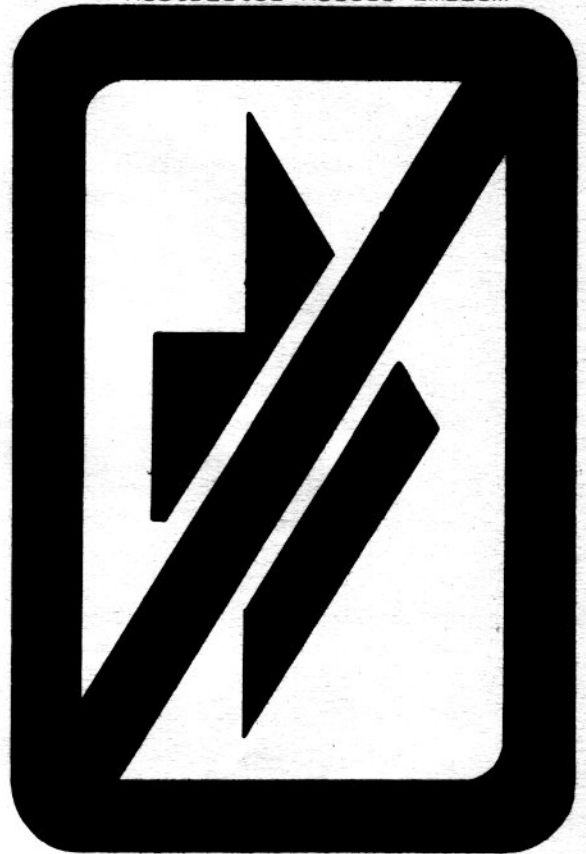

Seal Monitor Unit

Side

Front

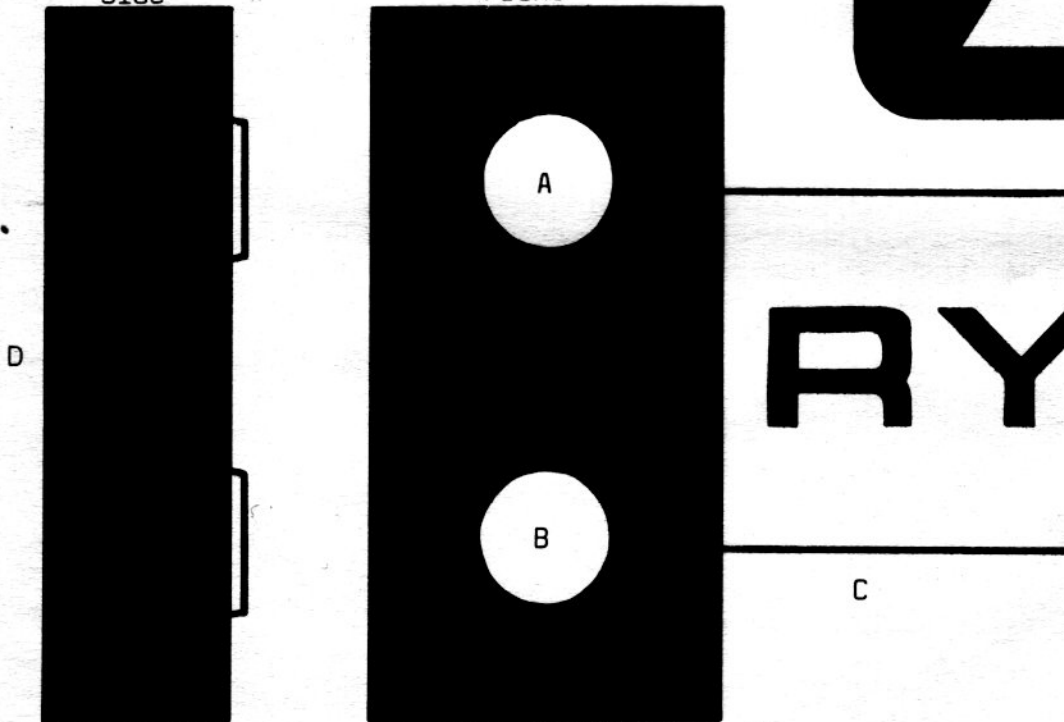

Seal Tape Segment (Reduced)

RY SECURITY  NO ENTRY SE



STARFLEET OFFICER REQUIREMENTS

47

MARKSMANSHIP TRAINING

To fire the Phaser - Type II C (henceforth referred to as the Type II C) you must press the trigger. The weapon will continue firing as long as the trigger is depressed. Depending upon the Setting utilized and the situation, long or short bursts may be desirable, in a narrow or wide spread. Good shooting is a result of training in the four elements of Marksmanship: Setting, Firing Position, Aiming, and Trigger Touch.

Setting

Except for the TRIGGER and BEAM WIDTH, all controls for the Type II C are located atop the Type I C Unit. These controls are solenoid touchpads, which light when activated. It requires a pressure of ten grams to activate most, with the exception of the ARM touchpad, which requires one-hundred grams. Also atop the Type I C are two indicator lights. The ACTIVATE indicator flashes blue when the Type I C or Type II C has almost exhausted the powerpack's crystals.

If all four Setting touchpads are depressed simultaneously (intentionally difficult) the phaser will begin a forty-five second build-up to Force Chamber Overload. This will result in an explosive blast - and enables the Type I C or Type II C to be used as a Dilithium Grenade. To prevent accidental Overload, a characteristic warbling will be heard. Pressing the TRIGGER touchpad will immediately deactivate the build-up.

Beam width is only possible in the Type II C configuration. It is accomplished by twisting the NOZZLE top to the left, from parallel to twenty degree width.

Firing Position

Due to the low mass and excellent balance characteristics of the Type II C, the weapon can be fired accurately from almost any position. However, for precise Marksmanship - essential in so powerful a weapon - a static (unmoving and balanced) position is best. You will be drilled in the two basic positions.

Kneeling: Frequently used on level ground, when there is no obstruction blocking such a low position. It allows the firer to take maximum advantage of any cover or low shelter, while providing a steady and comfortable position. It is especially comfortable when waiting needed.

Standing: Also known as the off-hand position. It is used principally when attacking, whether walking or running towards the target. The firer stops, assumes it quickly, fires, and then proceeds.

Because of the continuous firing properties of any energy weapon, it is extremely dangerous to fire when moving, as the beam will bob up and down as the phaser jiggles in the hand of the firer, unnecessarily endangering the lives of Squad members and civilians. Therefore it is strongly recommended that these positions be used.

Aiming

You will be put through sighting exercises throughout your career, first to gain expertise and then to maintain skills. You will be drilled using various target

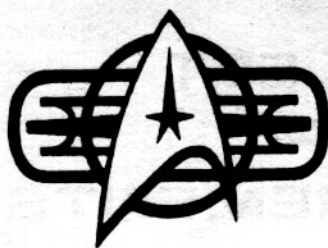

STARFLEET OFFICER REQUIREMENTS

simulations. When the weapon is armed, the Parallel Beam Indicator is activated. This is nothing more than a low-powered mono-chromatic laser diode built into the front of the Type I C and Type II C. It emits a harmless beam of red light firing parallel to the phaser beam. On the exact spot the phaser beam will hit, the holder will see a small (one centimeter diameter) bright spot. When the Type II C is set for wide beam, this dot indicates the center of aim.

Trigger Touch

Trigger Touch is the most finicky item in Marksmanship. Correctly touching the TRIGGER is not as easy as it sounds. If you jerk the slightest bit you will spoil your shot. Naturally there is no recoil from an energy weapon. The Type II C is so perfectly balanced that tapping the TRIGGER will cause the point-of-aim to swing up to five degrees. Thus you must depress your finger slowly, so that you do not know the exact instant that the pressure will be sufficient to fire.

If you are trying for a narrow beam, marksman's shot, take a breath of air, expel part of it and hold the rest. Align the Target Spot on the target and depress the TRIGGER gently, watching the Target Spot so that it does not drift. When firing is complete, release finger pressure gently.

The Type I C and Type II C uses a solenoid touchpad TRIGGER which fires at a pressure of fifty grams.



STARFLEET OFFICER REQUIREMENTS

49

FIRING POSITION



Kneeling Position

Standing Position

- For Kneeling Position:
- Head erect
 - Firm grip on handle
 - Right upper arm vertical, maximum contact with torso
 - Right fore-arm horizontal, held steady but relaxed
 - Right leg at right-angle to point-of-aim
 - Weight shifted onto right foot

- For Standing Position:
- Head erect
 - Firm grip on handle
 - Right upper arm vertical, maximum contact with torso
 - Right fore-arm horizontal, held steady but relaxed
 - Right foot at right angle to point-of-aim
 - Weight balanced equally on both feet

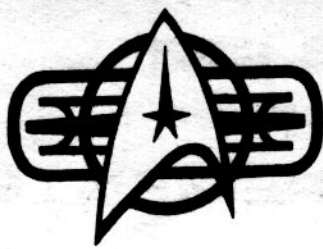

STARFLEET OFFICER REQUIREMENTS

SECURITY SPECIAL & STANDING ORDERS

There are two sets of Orders governing the duties of Security Officers and Specialists. These are essential to the smooth operation of the Security Department and of the United Federation of Planets.

Special Orders

These cover duty with regard to the specific watch in question, and must be renewed each watch to be in effect. Any Special Orders will be given to a Section by the Security Officer of the Watch prior to that Section going on-duty. Some examples of Special Orders include:

- 1) Until 0700 hours, no unprotected personnel are to enter the Main Engineering Room.
- 2) For the next four watches, the Physics Lab is a Restricted Area.

Standing Orders

These are listed below. All Security personnel are at all times responsible for carrying out Standing Orders. Standing Orders are permanent, unless cancelled by the Chief of Security.

- Aims & Directives
- 1) To preserve the integrity of the ship against intrusion and insurrection.
 - 2) To provide protection for landing parties entering unexplored or hazardous territory.
 - 3) To act in concert with Damage Control and Medical personnel in seeking out and rescuing personnel trapped in hazardous areas or missing in action.
 - 4) To ensure the safety of visiting dignitaries.
 - 5) To provide armed escort for Flag and senior officers venturing into hazardous territory.
 - 6) To serve as an honor guard as designated.
 - 7) To ensure the integrity of restricted areas of the ship against entry by unauthorized personnel.
 - 8) To provide a first-line strike force for boarding hostile vessels.
 - 9) To oversee transfer and/or confinement of persons under legal arrest or in custody.



STARFLEET OFFICER REQUIREMENTS

51

- 10) To act as bailiffs for onboard legal proceedings.
- 11) To oversee the safe and orderly proceedings of any parial evacuation of the ship, or to aid in the full abandonment of the ship.
- 12) To serve as a rescue force for any crewmember or citizen of the United Federation of Planets who is incarcerated or held hostage illegally by any hostile power and/or government.
- 13) To effectively intervene in intra-crew disputes, or in disputes between crewmembers and civilians.
- 14) To serve as a military police force on Starfleet Installations.
- 15) To expedite the transfer of Starfleet personnel charged on civil grounds to the proper civil authority (where applicable and in accordance with Federation statutes and extradition treaties).
- 16) To ensure the observance of applicable Starfleet Directives by civilian personnel on Starfleet vessels or facilities.
- 17) To ensure peaceful conduct by all parties in Starfleet and Federation supervised negotiations.
- 18) To maintain alertness at post or duties until such time as relieved by qualified personnel.
- 19) To obey all directions and orders given by the Ship's Commanding Officer, the Chief of Security, and other line officers of better than lieutenant rank, in that descending order.
- 20) To work smoothly and efficiently with assigned teammates.
- 21) To avoid the consumption of any substance of a mood-altering nature during a period of 8 hours before scheduled to go on-duty.
- 22) Weapons shall be worn at all times while on-duty.
- 23) Weapons shall be set on "STUN" unless otherwise ordered by an officer in the line of command, or unless the ship is on Condition 4, or unless special circumstances pertain making "STUN" ineffectual or undesirable.

Duties and
Responsibilities

Concerning
Weapons

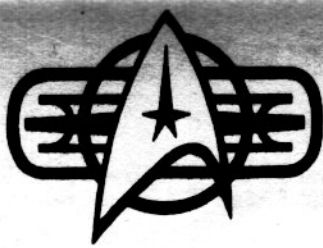

STARFLEET OFFICER REQUIREMENTS

- 23) In hazardous territory or under perilous circumstances, weapons shall be drawn at all times.
- 24) Under normal circumstances, weapons shall not be drawn unless danger to life or limb is apparent and imminent.
- 25) If a weapon is damaged or lost, the fact must be passed to the Assistant Officer of the Watch at once.
- Concerning Sentry & Patrol Duties
- 26) To take charge of the assigned post and all areas in view.
- 27) To guard the post in a military manner, keeping always on the alert and observant of everything.
- 28) To report all violations of Special or Standing Orders.
- 29) To maintain communication with the Security Officer of the Watch.
- 30) To receive, obey, and pass on to other relieving personnel any Special Orders received by the Officer of the Watch.
- 31) To talk to no one except in the line of duty.
- 32) To sound the alert in case of danger or disorder.
- 33) To call the Security Officer of the Watch in any case not covered by instructions.

